

SEPTEMBER

N.S.E.
25 CENTS

POPULAR MECHANICS

MAGAZINE

WRITTEN SO YOU CAN UNDERSTAND IT

POST. TRADE MARK, GREAT BRITAIN, NO. 30428

REG. U.S. PAT. OFF.

SEE PAGE 420



This **MAGIC DISC** Pays You up to \$30 and more Daily

What is this mysterious new invention—NO BIGGER THAN YOUR FIST

The "Magical" LUX WATER HEATER has broken all records for tremendous sales. Its breath-taking, dynamic action proves itself before your prospect's eyes. Simply plug in light socket—anywhere—and instantly you have scalding, boiling hot water for shaving, bath, laundry, washing dishes, cooking, illness or for any need. You can sell dozens in a few hours!



—that goes into action like chained lightning, and with a mighty ZOOM, boils water sizzling, steaming hot in split seconds! People gasp when LUX performs. It's truly *uncanny!* Actually 2½ times faster than any other method!

Smaller Than Your Hand. Yet A GIANT In Action!



FREE OFFER

—Also Tested, Proven Sales Plans Free



SEE LUX AND MARVEL!

UP TO \$1.95 CASH IN ADVANCE EVERY SALE

LUX sells, sells, sells—to every home, office, store, business house, doctor, dentist, nurse, traveler, garage, filling station and hundreds of others.

MISNER OF N. Y. EARNED \$30.00 IN 8 HOURS!

Swinton of Wisc. sold 18 LUX Heaters his first day. Neuman's profits \$195.00—10 days. Claude Meyers, Ohio, nets \$26.25 in only 8 hours!

Made of pure, heavy aluminum with special patented, new principle heating element. Non-corrosive, eight-foot solid rubber cord AC or DC current. Foolproof. Guaranteed.

MEN—WOMEN!!

START AT ONCE WITH LUX FULL OR SPARE TIME. YOU NEED NO INVESTMENT. WRITE TODAY . . . We'll send amazing facts and figures that prove LUX is your BIGGEST money making opportunity.

The "strange" element hidden in this curious Disc is a miniature furnace when placed in water.

Sold at a low price everyone can afford—operates hours for a fraction of a cent. There is no substitute for LUX.

DISTRIBUTORS—CREW MANAGERS

Here's the most "natural" big time seller in the entire field. Let us prove it. Write at once for special offer. DON'T DELAY.

LUX-VISEL COMPANY

97 Jackson St.

Elkhart, Ind.

RUSH THIS FOR FREE OFFER

Lux-Visel Co.,
97 Jackson St.,
Elkhart, Ind.

Please rush FREE details and special Money Making Sales Plans. Prove to me what I can do with LUX.

Name
Address
City..... State.....

Hotter than Coal and no dirt



**A New
Invention**

Do away forever with the drudgery of wood and coal. The most simple and economical invention on the market is now giving perfect satisfaction to enthusiastic users everywhere. This new invention is a new type of oil burner that takes the place of wood or coal and automatically and silently changes cheap oil into one of the quickest and hottest fires known.



Burns 96% Air and 4% Cheap Oil

The International Oil Burner fits in the fire box of your present range, stove, or furnace. It can be installed in a few minutes by anyone. No holes to be bored, no damage to your heating plant. There is nothing complicated about the International Oil Burner. It gives you all the heat you want—when you want it. Starts instantly with a match. No soot, smoke, or odor. Costs less than coal.



Costs Only a Few Dollars

International Oil Burners heat just as well as burners costing \$400 or \$500. Simply turn 1 valve and you have all the heat you want. Cleaner and better for heating or cooking. Approved by the National Underwriters' Laboratories and engineers everywhere. Over 150,000 have been sold.



30 Days' FREE TRIAL Offer

Try this wonderful automatic oil burner right in your own home at our risk. Act quickly and get our special low introductory price. Sold under absolute money-back guarantee. Write at once for free booklet on home heating and our free burner offer.



Double Blue Flame Burner for cook stoves, ranges, and parlor circulators. Burns with beautiful clean blue flame.

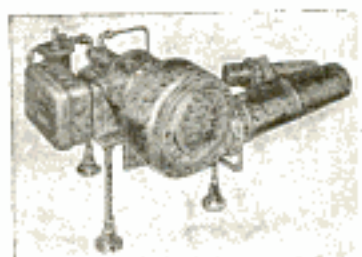

All-Electric Power Burner designed for larger houses, apartments, etc.

AGENTS—DEALERS— DISTRIBUTORS

Our free burner offer starts you in business. Big money to be made. Demand is enormous. We also want spare or full time workers immediately. If \$500 a month and more interests you, write or wire us for protected territory offer.

INTERNATIONAL OIL HEATING CO.

3800-10 Park Ave., Dept. 403-S, St. Louis, Mo.

CLIP THIS COUPON

International Oil Heating Co.,
3800-10 Park Ave., St. Louis, Mo.
Dept. 403-S

Send your free booklet and free details on home heating for stove.....furnace.....
Also free burner offer.

Do **This One**

No: 

Ad. 8AJ7-FF7-DDJ3

City and State.....

Check if interested in making money as an International representative with protected territory.

When writing to advertisers please mention Popular Mechanics



New FAUCET FILTER AMAZES EXPERTS

Removes Dirt and Filth Instantly

HERE'S the article that everyone has been looking for. Just imagine a device that filters drinking water instantly at the faucet! In half an hour it removes enough dirt and suspended materials to cover the bottom of a glass. You can actually see the difference in the water!

Makes Drinking Water Cleaner, Tastier and More Wholesome

This amazing invention shows you in a few minutes why it should be on your faucet—shows you how much dirt it collects—shows you why not to drink unfiltered water. Drink lots of water every day, medical men advise—but be sure it's clean.

You filter the oil and gasoline that goes into your car—why not use the same care in filtering the water you drink?

The Automatic Water Filter on your faucet is almost like bringing a bubbling spring into your kitchen. It uses Nature's method by filtering through millions of grains of sand. That's why it delivers sparkling water, pleasing to the taste, more wholesome.

Costs so little, everyone can afford it. Saves buying spring water. Pays for itself. You will never be without it once you have used it.

"Just Like Spring Water"

"I have one of your Filters and we sure like it and would not want to do without it again. It makes the water look sparkling clear, just like the spring water I used to drink from the mountains." JACOB FOEHL, Michigan.

"Water Tastes Better"

"The Automatic Water Filter does an excellent job. I tested it on my faucet and when I cleaned it, I found about a teaspoonful of mud, slime, decayed vegetation, rust and filth. The water filtered through the Automatic actually seems to taste better. It certainly looks clean." ROBERT LINCOLN, Massachusetts.

Filters Thru Crystal Sand

Just like Nature, the Automatic Water Filter cleans and filters through millions of grains of crystal sand. The water leaves the Filter in a sparkling stream—a straight shaft of clean filtered water without splashing. Once you drink "Automatic" Filtered Water, you will never drink the unfiltered tap water again.

Dirt & Slime Found by Chemist's Test



Here is what the chemist reports:

"It is amazing how much dirt the Automatic Water Filter takes out of city water at the faucet. After a two-hour test enough foreign material, dirty brown color, with a fishy odor, was removed to fill a teaspoon." —Sommer Chemical Laboratories.

GUARANTEE

Why continue drinking dirty, unfiltered water when it is so easy now to filter your water clean, at the faucet. It makes no difference where you live or what kind of drinking water you have, the Automatic Water Filter will remove dirt from it and deliver sparkling clear water, or the trial costs you nothing. Prove it yourself—try it on your own faucet at home at our risk.

AGENTS & SALESMEN! Make Up to \$100 a Week

We have arranged a plan that makes it possible for agents to start immediately, making big money with the Automatic Filter. Good territory still open.

Robert S. Jo sold 17 Filters in 2½ hours! A. P. Pelletier made \$52.50 in 4 hours, a profit of over \$13.00 an hour. The same opportunity is open to you.

Our plan enables those who are really interested, to obtain their sample free.

SEND FOR FREE OFFER TODAY!

AUTOMATIC WATER FILTER CO.
1256-2621 N. Third St., Milwaukee, Wis.

MAIL THIS COUPON!

AUTOMATIC WATER FILTER CO.,
1256-2621 N. Third St., Milwaukee, Wis.
Please send me full particulars of your free sample offer. Also tell me how I can make up to \$100.00 a week demonstrating.

Name _____

Address _____

City and State _____

When writing to advertisers please mention Popular Mechanics

Popular Mechanics Magazine

200 E. Ontario Street, Chicago, U. S. A.

H. H. WINDSOR, Founder

H. H. WINDSOR, Jr., Editor and Publisher

London: Messageries Hachette,
3 La Belle Sauvage, Ludgate Hill, E. C. 4

Paris: Hachette & Co.,
111 Rue Reaumur

Melbourne: Gordon & Gotch
509-513 Little Collins St.

ISSUED MONTHLY

SUBSCRIPTION:

SINGLE COPY, 25 CENTS

In United States and its possessions, Canada, Cuba, Mexico, and all }
countries in the Pan-American Postal Union, per year, postpaid } \$2.50
To all other countries in the Postal Union 3.00

All subscriptions are discontinued at expiration. Please examine the date printed on your wrapper.

Entered as Second Class Matter Sept. 15, 1901, at the Post Office at Chicago, Illinois, under Act of March 3rd, 1879.

Entered as Second Class Matter at the Post Office Department, Canada.

Published monthly by POPULAR MECHANICS CO.

Copyright, 1931, by Popular Mechanics Co.

Copyright in Australia. Copyright in France

Vol. 56

Contents for September, 1931

No. 3

into the Earland **Special Features** *Only West (Post. Realty)* 353

New Tricks of the Yawara 371

With Uncle Sam's Modern Mounties 376

Your Dream Castle in Soap! 387

Tomorrow—The Underground Railway 392

Blazing a Trail through Mexico 404

A Wild Night in the T-C-Ten 412

Burning Up the Water 420

Are You a Turtle Driver? 434

Round the World Perils of the Air Mail 440

Mystery Engine Promises Fireproof Flying 456

and Ursoche **Accidents—autos crash into trains** 446

Advertising

automobile up a tree advertises garage 381

fruit-basket display on roof attracts shoppers 385

Agriculture—U. S. loses tenth of hay crop by spon-

taneous heating 381

Airplanes

inverted spin completed by youthful flyer 399

seagoing air liner is like clipper ship 384

transport plane with twin cabins 449

"turkey plane" leaves ground at sixty-degree

angle 401

Anvil—universal, for benches saves wear on vise 370

Army, German—peace-time style of tanks carry small

guns 403

Astronomy—ghost nebulae made visible by eye of big

camera 433

Auger—giant corkscrew digs holes and pulls old posts

Automobiles—gold and silver model of a racing car 448

Automobiles, Accessories

luggage carrier on auto top 384

steel-tube auto seat adds ease to driving 465

Automobiles, Racing—tiny racing car makes speed of

ninety miles an hour 411

Aviation

gold-paved plane runway 398

"horizon in box" helps pilot learn to fly blind 400

land catapult launches big bombing plane 390

model of proposed London airdrome 452

smoke indicator for airport replaces wind sock 453

three pilots to every plane 380

Barrels—rolling is made easy with handling tool 399

Birds—crane helps to rout pigeons 445

Boats and Boating—model boat powered by dry ice

Bottles—self-adjusting bottle cork 452

Bowling—scale shows weight and balance of ball

Breakwater—floating, saves a harbor in storm 389

Building Materials—lath-marks mystery solved with

kerosene lamp 409

Buildings—workmen on capitol's dome repair light-

ning rods 369

Camera—sound and echo made visible by 454

Candles—"last of the candle-makers" hand-paints his

ware 391

Cattle—banishment of cow is seen as farm advance 438

Ceiling—sheet-metal, illuminated by hidden lights 446

Chemicals—from apple peels used for waterproofing 465

Circus—this inventor is unseen "star" of the "Big

Top" 463

Clothing—fashion requires zoo to clothe woman 462

Codes—spies and messages by machine 400

Disarmament—new discoveries are threat to 455

Diving—divers go to school in river for naval

struction 439

Dogs—dog trained to clean drains 453

Eggs—rotating scale weighs and sorts 375

Exercise—bike measures oxygen used for 397

Fish and Fishing

fish that go fishing are shown in museum 401

giant sawfish tows yacht five hours in fight 385

Fruit—suction gathers fruit shaken from trees 439

Games—ball game played with gun 455

Glider

equipped with auto-gyro vanes 380

glider kindergarten trains motorless flyers 375

Household Devices

House Plans—plan No. 5-A-78 528

Humidifier—fan washes and cools air 461

Ivory—from elephant tusk to billiard ball 398

Ladder—extension leg holds ladder straight on stairs 403

Lake—heats its own water 461

Lawnmower—file for blade sharpens accurately 445

Lighthouse—on Empire State building 370

Locomotives

ancient "iron horse" comes back to life 438

model engine and tender built by telegrapher 382

Materials—what is difference between strength and

stiffness? 465

Lightning winter on capitol dome 369

apple chemical for waterproofing

465

Copyrighted material

465

Been sorted by electric eye 4/9

Hampden wedge falls here 403

Post & Realty 353 [Continued on Page 4]

Benzol as fuel 391

Dressing Tent 389

Copyrighted material

organ - Pipeless 374
 home use
 will ordinary camera

Lamp, etc
 [4] Photographs Photo coloring 482
 501
 402
 Wraps in transparent

[Contents - Continued]

Mattress—inflated, used in water as raft	465	Cane—fitted with casters aids the blind	487
Minerals—liquid a million years old is found in crystal	416	Carving—pocketknife carving in balsa wood	499
Motorcycle—of streamline design	369	Clothesline—keeping tight	508
Music—pipeless organ turns electricity into	374	Compass—improvised from scissors	485
Navigation—mastering navigation in floating classroom	410	Doors—cable locks series of	500
Navy, German—secrets of Germany's new "pocket" battleship	450	Dowels—anchored securely	496
Ocean—continent rising from, may develop like Japan	370	Drawer—pull conceals lock	508
Paintings—of prehistoric animals	460	Fish and Fishing anchor lets boat drift slowly while casting	492
Peanuts—shelled, are heated in slot vender	454	carpenters' apron keeps bait and tackle handy	507
Photography flash bulb reflector folds into compact size	382	Footbridge—from fence wire	485
iron bars guard cameramen taking jungle pictures	449	Furniture—early American bowl table has many uses	495
Photography, Aerial—aerial view reveals beauty of the capitol	409	Gas Burner—super-burner gives intense heat	486
Plants—rubber-plant botany in your own home	433	Golf—initials burned on clubs	502
Radio—easy ways of solving your radio problems	471	Illusions—this "fast-growth" illusion scores a big hit	482
Radio, Aerial—homemade radio antenna lamp	477	Insects how to eradicate around the home	496
Radio, Apparatus crystal-controlled transmitter unit	472	smoke candle keeps away insects	502
milliammeter serves as multi-voltmeter	474	Ladder—platform eases tired feet	483
plug for lamp can be used as external load	478	Lamp Shade—woven from strips of nickelplated zinc	493
pre-amplifier improves home recording	475	Lettering—suction cup holds color container	507
primary loader is automatic	470	Logs—homemade explosive splits	482
transformers ganged for special service	478	Model Ships die for forming deadeyes and capstans	496
Radio, Broadcasting—lapel "mike" to banish radio panic	408	tool for cutting moldings	483
Radio, Construction shield for wiring on metal chassis	477	Outboard Motor—tin disk prevents oil splashing over	493
switch taps made from wood screws	478	Paints and Painting—brush rest aids in striping	494
Radio, Installation—installing phone jack for the deaf	470	Penholder—combination fine and coarse pen	486
Radio, Loud Speaker—tiny dynamic speaker used in mantel set	416	Photography—table-top Plaster—how to drill holes in without chipping	486
Radio, Receivers here is a stentube set for you	466	Pliers—insulating electrician's	497
useful parts from old sets	478	Potato—slicer from old plane	502
Radium—precious gas from, will save lives	402	Puzzles—scissors-and-twine puzzle is a teaser	493
Railroads—steepest railway in world climbs Royal Gorge	455	Searchlight—arc, throws a four-mile beam	501
Roads—rock spreader for roadbed	461	Screens—spring bolts hold screens in window frame	495
Roof—glass, on wheels covers tropic garden	448	Skiboarding—skiboarding—a thrilling sport	479
Rule—jumps out of its case when you press button	445	Snubbers—door, made from picture hook and tack	500
Scarecrow—talks and sings to frighten pests	454	Store—vender's store resembles large wardrobe trunk	502
Screwdriver—to fit key ring	446	Tent—metal stakes hold securely	483
Sculpture—sculptor makes tin figures from scraps and cans	381	Tools—names and designs applied to tools by electroplating	498
Ships and Shipping—"Old Ironsides" again rides the waves	447	Towel Rack—revolving, takes little space	492
Sidewalks—wooden frames along curb keep autos off	380	Toys—bumpers for, made of hose and cable	487
Signs—stop signs for officer's car made from floodlight	453	Trees—tree-climbing in orchard ended by barbed-wire wrapping	497
Silk—right of way is given to millions in	386	Wheelbarrow—sheet-metal tire on, for soft ground	498
Stunts—from aquaplane to a glider is thrilling transfer	416		
Swimming—machine has pedals like bicycle	391		
Tennis—court roller made from old auto	433		
Tent—dressing, hangs on auto for beach changes	389		
Tools—bolt cutter is compact and light	383		
Tower—water tower like a flower when illuminated	383		
Travel—drama of speed is shown by lights	462		
Trees age and history of told by boring in trunk	397		
hammer wedge fells trees as you wish	403		
Windows—cars for window washers help clean	411		

AMATEUR MECHANICS

Airplanes, Model—doubling power of rubber motor on	494	Agricultural Implements—vibrating hopper for liming farm soil	527
Album—files photo negatives	500	Automobiles, Repairing—removing spring-shackle bolts on Model-A Ford	527
Andirons—made from old pistons and connecting rods	487	Batteries—hook for removing and carrying	518
Automobiles—paper helps to get car out of mud hole	487	Etching—hammered-copper trays	509
Automobiles, Accessories—footrest for coach-model cars	496	Fruit Stand—sunshade for	518
Automobiles, Repairing rattling brake rods silenced with door spring	485	Furniture—rubber-tired tea cart	519
rubber hose stops rattle of hood	500	Grinding jig for grinding correct bevels	513
seven auto short-cuts worth remembering	484	rest for grinding tools to correct bevel	521
Bicycle—cardboard disk on sprocket protects trousers	496	Helmet—cape sewed to, keeps pilot warm	514
Boats and Boating holder for rowboat-anchor rope	508	Ladder—wooden plugs hold ladder from building	513
model racing yacht	503	Lathe brace makes toolholder more rigid	514
Book Ends—cigaretts stored in	507	for large-diameter work	515
Bottles cleaned with brass chain	493	locating faceplate work on, with aid of mirror	512
shelves between studs for storage of	507	wooden plugs cut on	527
Brace—extension handle increases leverage of	491	Lawnmower—getting the most out of your	525
Camera—sheet-metal wrench removes lens	501	Manhole—covers removed with this tool	511
Camping—camp bedding stowed behind rear car seat	502	Paints and Painting—wheeled cart aid in wainscoting walls	524
		Pillars—concrete-viaduct, poured in sewer-pipe forms	511
		Pipes—flat-iron handle gives leverage to turn large flanges	524
		Poultry bug trap increases profit	523
		electric feed dispenser	517
		Shafts—oiling overhead	518
		Signs—pasteboard box filled with dirt serves as	524
		Soldering durable electric iron for the shop	522
		iron is adjustable	514
		Studs—tool for driving	514
		Stumps—burning out quickly	512
		Tapping—guide for soft materials	523
		Template—for matching curves	513
		Tongs—grip goods on high shelves	516
		Tools—countersink for soft metals	522
		Wallpaper—guard holds roll of	523

Tooth brush
 ornament and dusts
 465

concrete waterproofing
 SHOP NOTES full series

Sarkisun 356
 Waterproofing from apples
 465

Plating 516



Raise the Standard of Your Products

... keep competition trailing

Build your products of Masonite Presdwood. Immediately you give to them a new and finer standard that will cause concern to competitors.

And while it's improving your products, Presdwood is cutting costs. You save on labor, on material, and eliminate loss from waste and rejection.

Presdwood harmonizes completely with mechanical operations—with the saws, planers, die cutters and drills; equally well with hand tools. It's on friendly terms with your men because it's so easy to work. Production lines never are stopped... these boards are uniform and dependable, rigidly graded and inspected.

Presdwood is versatile—a thousand kindred articles are made from it... and a ready public acceptance is evidence of finer quality. A sample sufficiently large for testing, and for showing the beauty of its rich brown surface, will be sent on request. Also the Presdwood booklet relating the story of its manufacture and listing 80 of its uses.

Masonite
PRESDWOOD
STRUCTURAL INSULATION • INSULATING LATH • QUARTZBOARD
"Made in Mississippi"

Modernize your home with Masonite Structural Insulation

Built into roof, walls and floors, this modern insulating material makes your home more desirable, continuously comfortable—and Masonite economies soon absorb the cost. Protects against heat, cold, chill and dampness. Deadens sound. Cuts fuel costs. Masonite Insulating Lath, the ideal plaster base, resists cracks. Check coupon and mail it to us today for the illustrated Masonite booklet. No cost, no obligation.

Masonite Corporation, Dept. L-9 © M. C., 1931
111 W. Washington Street, Chicago, Ill.

Please send your free illustrated booklet that describes Masonite Presdwood and its many uses.

Name.....

Street.....

City..... State.....

If interested in Masonite Insulation, check here

When writing to advertisers please mention Popular Mechanics

SUCCESS

while you are young enough
to enjoy it!

"I'm meeting Armstrong this afternoon at Ingleside—last chance for a little golf before we sail for Europe on the fifteenth . . ."

Pretty soft for Bob Carrington, you say—a lovely country home, golf on a week-day when the other boys are slaving at the office—a six weeks' trip to Europe with the family—and all this wonderful success while he is still young enough to enjoy it!

But why look with envy upon success well earned—especially when it is within your power to attain that same success?

"If young men in business only realized how immensely valuable are those early years, and how vital it is to get away to a flying start, they would make it an inflexible rule to devote several evenings every week to home-study business training."

One of America's foremost business men—an active director in a dozen big corporations—made that statement recently; and if you have the slightest doubt of its truth, you need only check it by the actual records of LaSalle-trained men, many of whom, though still in their thirties, are commanding five-figure salaries.

**TWO who achieved success early
—and one who waited***

For instance:—"I'm not going to be a \$100 a month clerk all my life," said R. P. at 20—and today he is one of the nation's outstanding accountants although not yet thirty-five years of age.

R. E. was a clerk in the purchasing department of an Illinois factory—drawing \$16 a week. Last year, his income was close to \$20,000 and he is still under 40.

*Names gladly given on request

On the other hand, C. J. F. at forty-seven was earning only \$200 a month—six years later, thanks to LaSalle training, his income was over \$10,000. Is it any wonder that he urges others to do early in life what he waited so long to do?

"TEN Years' Promotion in One"

"I'm determined to succeed," you say—and we do not deny that hard work and learning through day-to-day experience will eventually win you some measure of success. If success is sweet, however, is it not doubly sweet if it comes to you while you are still young enough to enjoy it?

And is it not a needless and tragic waste of years to continue at out-grown tasks, simply because you will not spare yourself the time to master those bigger jobs that command the real rewards?

"Ten Years' Promotion in One" is a booklet that shows you how you can save years that might otherwise be wasted. Sending for it has marked the turning point in the lives of thousands upon thousands of men—and the coupon will bring it to you FREE.

With this book we will send you, without cost or obligation, complete particulars of the training that appeals to you, together with our easy-payment plan.

Will you wait till the golden years of your life are fast slipping away—or will you set your path toward success while you are still young enough to enjoy it?

Prove that you mean what you say when you say that you want to get ahead—by what you do with this coupon NOW.



LASALLE EXTENSION UNIVERSITY

Dept. 964-R

Chicago, Ill.

Please send me, free of all cost or obligation, a copy of "Ten Years' Promotion in One," and the facts about your training in the business field I have checked below:

- | | | | |
|--|--|--|--|
| <input type="checkbox"/> Business Management | <input type="checkbox"/> Law: Degree of LL.B. | <input type="checkbox"/> Banking and Finance | <input type="checkbox"/> Business Correspondence |
| <input type="checkbox"/> Higher Accountancy | <input type="checkbox"/> Commercial Law | <input type="checkbox"/> Expert Bookkeeping | <input type="checkbox"/> Business English |
| <input type="checkbox"/> Traffic Management | <input type="checkbox"/> Industrial Management | <input type="checkbox"/> C. P. A. Coaching | <input type="checkbox"/> Effective Speaking |
| <input type="checkbox"/> Modern Salesmanship | <input type="checkbox"/> Modern Foremanship | <input type="checkbox"/> Railway Accounting | <input type="checkbox"/> Telegraphy |
| <input type="checkbox"/> Railway Station Mgt | <input type="checkbox"/> Personnel Management | <input type="checkbox"/> Commercial Spanish | |

Name.....

Address.....



When writing to advertisers please mention Popular Mechanics

I Will Show You Too

How to Start a Spare Time or Full Time

Radio Business of Your Own

Without Capital



J. E. SMITH, President
National Radio Institute

Here are a few examples
of the kind of money
I train "my boys" to make

Started with \$5. Now has Own Business



"Can't tell you the feeling of independence N. R. I. has given me. I started in Radio with \$5. purchased a few necessary tools, circulated the business cards you gave me and business picked up to the point where my spare-time earnings were my largest income. Now I am in business for myself. I have made a very profitable living in work that is play."—Howard Houston, 512 So. Sixth St., Laramie, Wyo.

Made \$700 in 5 Months Spare Time

"Although I have had little time to devote to Radio, my spare-time earnings for five months after graduation were approximately \$700 on Radio sales, service and repairs. I owe this extra money to your help and interest. Thanks for the interest shown me during the time I studied and since graduation."—Charles W. Linsay, 437 Elati St., Denver, Colo.



\$7396 Business in two and one-half Months



"I have opened an exclusive Radio sales and repair shop. My receipts for September were \$2,332.96; for October, \$2,887.11, and for the first half of November, \$2,176.32. My gross receipts for the two and one-half months I have been in business have been \$7,396.25. If I can net about 30 per cent this will mean a profit of about \$1,500 to me."—John F. Kirk, 1514 No. Main St., Spencer, Iowa.

My Free book gives you many more letters of N. R. I. men who are making good spare time or full time businesses of their own

The world-wide use of receiving sets for home entertainment and the lack of well-trained men to sell, install and service them have opened many splendid chances for spare-time and full-time businesses. Besides Radio's growth is opening hundreds of fine jobs every year. "Rich Rewards in Radio" gives detailed information on these opportunities. It's FREE.

So many opportunities many make \$10 to \$25 a week extra while learning

Many of the ten million sets now in use are only 25% to 40% efficient. The day you enroll I will show you how to do 28 jobs common in most every neighborhood for extra money in your spare time. I will show you the plans and ideas that are making as high as \$200 to \$1,000 for others while taking my course. G. W. Page, 2210 Eighth Ave., S., Nashville, Tenn., writes: "I made \$935 in my spare time while taking your course."

Many \$50, \$60, and \$75 a week jobs opening in Radio every year

Broadcasting stations use engineers, operators, station managers, and pay \$1,200 to \$5,000 a year. Radio manufacturers use testers, inspectors, foremen, engineers, service men, and buyers for jobs paying up to \$7,500 a year. Shipping companies use hundreds of operators, give them world-wide travel and pay \$85 to \$150 a month, plus free board. Radio dealers and jobbers are continually on the lookout for good service men, salesmen, buyers, managers, and pay \$30 to \$100 a week. Talking Movies pay as much as \$75 to \$200 a week to the right men with Radio training. My book tells you of opportunities in Television, Aircraft Radio and other fields.

I will train you at home in your spare time

Hold your job until you're ready for another. Give me only part of your spare time. You do not have to have a high school or college education. Hundreds have won bigger success. J. A. Vaughn jumped from \$35 to \$100 a week. E. E. Winborne seldom makes under \$100 a week now. The National Radio Institute is the Pioneer and World's Largest organization devoted exclusively to training men and young men by correspondence for good jobs in the Radio industry.

You Must Be Satisfied

I will give you an agreement to refund every penny of your money if you are not satisfied with my Lessons and Instruction Service when you complete my course. And I'll not only give you thorough training in Radio principles, practical experience in building and servicing sets, but also Advanced Training in any one of five leading branches of Radio opportunities.

64-page Book gives the Facts

Clip and mail the coupon now for "Rich Rewards in Radio." It tells of the opportunities for a spare-time or full-time Radio business of your own; also of the many fine jobs for which my course trains you.

J. E. SMITH, Pres.
Dept. 1 JP
National Radio
Institute
Washington,
D. C.

Get
my new book
It points out
what Radio
Offers You



THIS COUPON IS GOOD
FOR ONE FREE COPY OF
MY NEW BOOK

mail
it
TODAY

J. E. SMITH, President
National Radio Institute, Dept. 1 JP
Washington, D. C.

Dear Mr. Smith: Send me your book. I want to see what Radio offers. I understand this request does not obligate me and that no agent will call.

NAME.....

ADDRESS.....

CITY.....STATE.....



Rear view of 5-tube Screen Grid Tuned Radio Frequency Set—only one of the many circuits you can build with my outfits.

You will get Extensive Practical Radio Experience with my Home Experimental Outfits

My course is not all theory. You use the Eight Outfits I'll give you in working out the principles, diagrams and circuits used in modern sets and taught in my lesson books. This 50-50 method of home training makes learning easy, fascinating, interesting. You get as much practical set servicing experience in a few months as the average fellow who hasn't had this training gets in two to four years in the field.

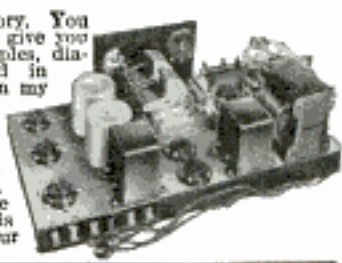

Get the facts on my Lifetime Employment Service to all Graduates

Answer This Ad!

If You Want Quick Success and Big Pay In AUTOS



Morrision Did!

When Morrision of Parkersburg, West Virginia, wrote for my auto book he was working in a steel mill for low pay. In six short months he doubled his earnings and got into business for himself—even before he finished his "Job-Way" Training. You can have the same book that started Morrision on the road to success. Clip the coupon—and mail it today.

Earn Up to \$100 a Week

Get YOUR share of the \$7,000,000,000 spent every year on auto upkeep. **Just think of it**—more than 25,000,000 autos in the U. S. No wonder there are so many big pay jobs! Get into this fascinating game, now. Don't put it off another day. Get the facts. Mail coupon for big, FREE auto book. Learn of the countless opportunities in the World's Biggest Business where real jobs and big pay come quick. See how \$50—\$75—\$100 a week is possible for you now. Learn how "Job-Way" Training has brought big money—promotion—shops of their own to scores of men. Find out about my Employment Department—how it helps you get a good job in the auto business.

3 WORKING OUTFITS
also included **FREE** of extra charge if you act quick!

Learn at Home in Spare Time

"Job-Way" Training is the short cut to Auto Success. No need to quit your present job—no need to leave home—just use your spare time to prepare for a brilliant future—a real job paying up to \$100 a week. All you need is common schooling. I don't care if you never touched an auto before, I can train you at home. You should be able to make extra money quick—a few weeks after starting. Men from all walks of life who worked

long, hard hours for low pay are becoming garage owners, foremen and superintendents. If you like autos—if you're between 15 and 55—get the facts now. "Job-Way" Training covers everything about autos—Mechanical and Electrical Work, Starting, Lighting, Ignition, Welding, Vulcanizing, etc.—Everything you need to get in line for a big money job as an Electrical and Mechanical Auto Expert. It's the trained man who gets the good jobs and "Job-Way" Training is COMPLETE, yet so simple, so easy that you get it quick.

Send Coupon for FREE Auto Book

Get my FREE Auto Book. Learn how "Job-Way" Training has brought success to hundreds. See what it can do for you. Find out how my Employment Department helps you get a good job—about the three big outfits you get. Read my money-back agreement, my aviation course offer and many other features.

B. W. Cooke, Directing Engineer
Motor Institute of America
Motor Institute Bldg. Dept. 4166
EVANSTON, ILLINOIS
(Chicago's Largest Suburb)



Do It NOW!

Don't delay another day. Clip the coupon before you turn this page. Take the first step to a big-pay auto job. Now.

B. W. Cooke, Directing Engineer,
MOTOR INSTITUTE OF AMERICA,
Motor Institute Bldg., Dept. 4166, Evanston, Ill.

Send me your free auto book. I want to succeed in the auto business. Tell me about "Job-Way" Training—about your Employment Department and your 3 testing and repair outfits offer. No obligation on my part whatever.

Name.....
Address.....
Town..... State.....
Age..... Occupation.....

DRAFTING

Learn at Home



DRAFTING is one of the best professions a young man can choose because it pays good salaries and it is the stepping stone to even better positions. Many leading architects, mechanical engineers and electrical engineers got their start at the drafting board.

There is no easier way to learn Drafting than through the International Correspondence Schools. The practical value of these courses is shown by the success of I. C. S. students and also by the fact that employers are constantly writing us for trained men. We receive more calls for I. C. S. draftsmen than for graduates of any other course.

F. E. King was "a poorly paid clerk" when he enrolled for the I. C. S. Drafting Course.

By study, industry, and perseverance he became Chief Draftsman of the U. S. Steel Furniture Company, of Syracuse. He is now earning more in a day than he used to earn in a week.

A. J. Hutchins became Chief Draftsman for the American Strawboard Company and increased his salary 300%—also as a result of I. C. S. training.

There is no doubt that Drafting offers a real opportunity to ambitious men and it will pay you to investigate it. Just mark and mail the coupon and we'll gladly send you a booklet telling all about the I. C. S. courses in Drafting or any other subject in which you are interested.

INTERNATIONAL CORRESPONDENCE SCHOOLS, Box 5560-G, Scranton, Penna.

"The Universal University"

Without cost or obligation on my part, please send me a copy of your 48-page booklet, "Who Wins and Why," and tell me how I can qualify for the position, or in the subject, before which I have marked an X:

<input type="checkbox"/> Mechanical Drawing	<input type="checkbox"/> Structural Drafting
<input type="checkbox"/> Draftsman's Course	<input type="checkbox"/> Architectural Drawing
<input type="checkbox"/> Architect	<input type="checkbox"/> Building Foreman
<input type="checkbox"/> Concrete Builder	<input type="checkbox"/> Contractor and Builder
<input type="checkbox"/> Structural Engineer	<input type="checkbox"/> Electrical Engineer
<input type="checkbox"/> Electrical Contractor	<input type="checkbox"/> Electric Wiring
<input type="checkbox"/> Electric Lighting	<input type="checkbox"/> Electric Car Running
<input type="checkbox"/> Telegraph Engineer	<input type="checkbox"/> Telephone Work
<input type="checkbox"/> Mechanical Engineer	<input type="checkbox"/> Machine Shop Practice
<input type="checkbox"/> Toolmaker	<input type="checkbox"/> Patternmaker
<input type="checkbox"/> Civil Engineer	<input type="checkbox"/> Surveying and Mapping
<input type="checkbox"/> Bridge Engineer	<input type="checkbox"/> Gas Engine Operating
<input type="checkbox"/> Automobile Work	<input type="checkbox"/> Aviation Engines
<input type="checkbox"/> Plumber and Steam Fitter	<input type="checkbox"/> Plumbing Inspector
<input type="checkbox"/> Foreman Plumber	<input type="checkbox"/> Heating and Ventilation
<input type="checkbox"/> Sheet Metal Worker	<input type="checkbox"/> Steam Engineer
<input type="checkbox"/> Marine Engineer	<input type="checkbox"/> Refrigeration Engineer
<input type="checkbox"/> R. R. Positions	<input type="checkbox"/> Highway Engineer
<input type="checkbox"/> Chemistry	<input type="checkbox"/> Pharmacy
<input type="checkbox"/> Coal Mining Engineer	<input type="checkbox"/> Navigation
<input type="checkbox"/> Assayer	<input type="checkbox"/> Iron and Steel Worker
<input type="checkbox"/> Textile Overseer or Supt.	<input type="checkbox"/> Cotton Manufacturing
<input type="checkbox"/> Woolen Manufacturing	<input type="checkbox"/> Agriculture
<input type="checkbox"/> Fruit Growing	<input type="checkbox"/> Poultry Farming
<input type="checkbox"/> Mathematics	<input type="checkbox"/> Radio
BUSINESS TRAINING COURSES	
<input type="checkbox"/> Business Management	<input type="checkbox"/> Industrial Management
<input type="checkbox"/> Personnel Management	<input type="checkbox"/> Traffic Management
<input type="checkbox"/> Accounting and C. P. A. Coaching	<input type="checkbox"/> Cost Accounting
<input type="checkbox"/> Bookkeeping	<input type="checkbox"/> Secretarial Work
<input type="checkbox"/> Spanish	<input type="checkbox"/> French
<input type="checkbox"/> Salesmanship	<input type="checkbox"/> Advertising
<input type="checkbox"/> Business Correspondence	<input type="checkbox"/> Show Card and Sign Lettering
<input type="checkbox"/> Stenography and Typing	<input type="checkbox"/> English
<input type="checkbox"/> Civil Service	<input type="checkbox"/> Railway Mail Clerk
<input type="checkbox"/> Mail Carrier	<input type="checkbox"/> Grade School Subjects
<input type="checkbox"/> High School Subjects	<input type="checkbox"/> Illustrating
<input type="checkbox"/> Cartooning	<input type="checkbox"/> Lumber Dealer

Name..... Age.....

Street Address..... City.....

State..... Occupation.....

If you reside in Canada, send this coupon to the International Correspondence Schools Canadian, Limited, Montreal, Canada

When writing to advertisers please mention Popular Mechanics



ARTISTS EARN MORE

WHILE you are dreaming of making money . . . enjoying life . . . why not train your talent for drawing? A fortune may be at your finger tips if you train them now. Many people do not realize they have artistic ability. Through art, you may find the way to a famous name and a large income.

Artists are paid more today than ever before. Since the war, rates for art work have increased tremendously. Advertisers and publishers are paying millions of dollars annually to those who are trained in Modern Art.

Think of the money paid to artists for the illustrations in this magazine alone. Many successful students of the Federal School of Illustrating are now making from \$2500 to \$6000 a year and others are making even larger incomes.

More than fifty famous artists . . . earning big money themselves . . . have contributed their drawing secrets to the Federal Course. The Federal Course teaches you their methods of Illustrating, Cartooning, Lettering, Poster Designing, Window Card Illustrating, etc. Through this course you can learn at home during your spare time.

TEST YOUR TALENT FREE

Why be content with a small income at routine work when art training offers such possibilities? Write your name, age and address on the coupon and get the Free Book, "A Road To Bigger Things" illustrated below. It gives details about how famous artists of today started their careers and shows examples of our students' drawings. With it, you will receive our Free Vocational Art Test. Clip and sign this coupon now. It may be the beginning of an art career which will enable you to clip bond coupons and sign big checks later.

FEDERAL SCHOOL OF ILLUSTRATING

9131 Federal Schools Building



Minneapolis, Minnesota



Federal School of Illustrating,
9131 Federal Schools Building,
Minneapolis, Minnesota.

Please send me free book "A Road to Bigger Things" and Standard Art Test.

Name _____

Age _____ Occupation _____

Address _____

When writing to advertisers please mention Popular Mechanics

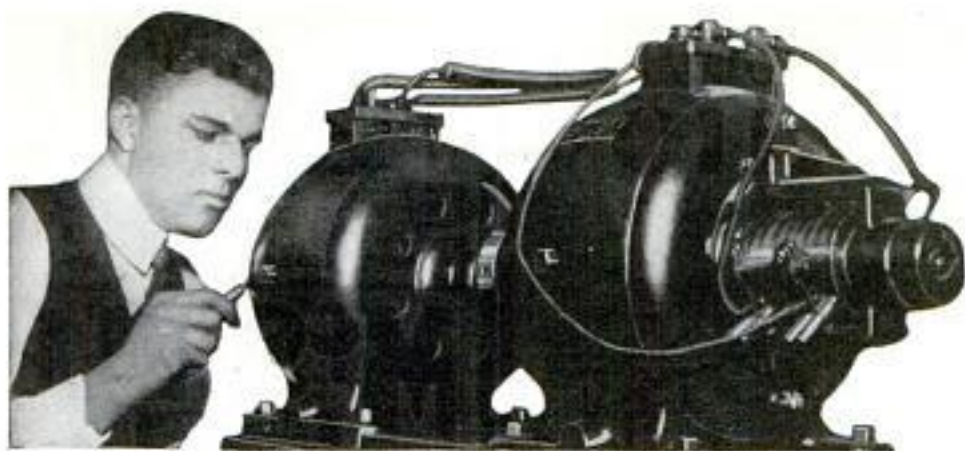

Amazingly Easy Way to get into **ELECTRICITY**

Don't spend your life waiting for \$5 raises in a dull, hopeless job. Let me show you how to prepare for a real job and how to make real money—in **ELECTRICITY**, the live, money-making field. Getting into Electricity is far easier than you imagine!

12 Weeks of Practical Shop Training

Come to Coyne in Chicago and learn Electricity the quick and practical way—by actual shop work on actual machinery and equipment. No useless theory! The average time to complete the course is only 12 weeks. You work on real dynamos, switchboards, armatures, auto and airplane engines, transmitting stations, etc.—everything from door bells to power plants—in full operation every day! No previous experience necessary.

FREE Employment Service to Students

When you graduate, we'll do all we can to help you get the job you want. We employ three men on a full time basis whose sole job is to help secure positions for our students. Also we'll help you to earn while learning. Some of our



PREPARE FOR JOBS LIKE THESE

Here are a few of the splendid positions open to Trained Electrical Men:

Power Plant Operator	\$40 to \$60 a week
Maintenance Engineer	\$250 to \$500 a month
Armature Winding	\$45 to \$75 a week
Auto Ignition	\$45 to \$65 a week
Contractor—Dealer	\$5,000 to \$10,000 a year
Motor Inspector	\$200 to \$300 a month
Electric Lighting	\$40 to \$70 a week
Signal Engineering	\$50 to \$75 a week

students pay a large part of their living expenses through part-time work we get them.

COYNE Is 32 YEARS OLD

Thirty-two years is a long time. No school or business could continue that long unless it were rendering real service and getting real results. Yet Coyne has been located right here in Chicago since 1899. Coyne Training is tested—proven by hundreds of successful graduates.

What Graduates Say About Coyne

"One week after graduating, I started my electrical job," writes Leland Hinds of Indiana. "After graduating I was home only two days when appointed Engineer in a light plant in South Dakota," writes George

Bagley, of Canada. "Two weeks after graduating I received a splendid job. The main consideration given my application was that I was a Coyne Trained man," reports Harold Soucy of Illinois. "I wish to thank your Employment Manager for securing this position for me," writes Albert Yagon, "he sent me out to this Company the first day and I was employed there immediately." And I could go on quoting from hundreds of letters of successful Coyne Trained Men. What they have done, you should be able to do!

Get The Facts

But get all the facts! You can find out everything absolutely free. JUST MAIL THE COUPON BELOW FOR A FREE COPY OF OUR BIG ELECTRICAL BOOK, telling all about jobs... salaries... opportunities. This does not obligate you. JUST MAIL THE COUPON!



NOW IN OUR NEW HOME

This is our new fireproof, modern home wherein is installed thousands of dollars' worth of Electrical equipment of all kinds. Every comfort and convenience has been arranged to make you happy and contented during your training.

COYNE ELECTRICAL SCHOOL
H. C. LEWIS, President
500 S. Paulina Street, Dept. 61-72 Chicago, Ill.

Mr. H. C. LEWIS, President

Coyne Electrical School, Dept. 61-72
500 S. Paulina Street, Chicago, Illinois

Dear Mr. Lewis:

Without obligation send me your big free catalog and all details of Free Employment Service and how I can "earn while learning."

Name.....

Address.....

City.....State.....

When writing to advertisers please mention Popular Mechanics

**Make \$60 to \$100 a Week
in AVIATION**



I'LL TRAIN YOU AT HOME

My Graduates Now Holding Down Big Jobs

My up-to-date home study Course gives you the ground work you need to get and keep a real job in this fast growing industry. Scores of my graduates, who didn't know a thing about Aviation a few months ago, are holding down fine jobs—in the air and on the ground. Over forty different types of jobs to choose from, once you have this training. Get the facts about my course and free Employment Service.

Air Craft Radio Course Included

Those who act at once will receive Hinton's complete New course in Air Craft Radio. This will come to you without a cent of extra charge in addition to my regular Commercial Aviation Course for a limited time only. With my method of training you don't need to leave home or give up your present job to prepare for a real position in Aviation. I've put my own fifteen years of experience backed by over 400,000 miles of flying—five years of instructing in the Navy—all into my thorough, quickly mastered home-study course. Send me the coupon below and I'll give you all the facts by return mail.

FREE Airplane Ride!

Right now I'm making an offer of a free airplane ride to all of my graduates. Act now—to get in on this fine offer—while it is still open!

\$75 a Week for Dobbins!

My graduate, R. N. Dobbins, got a job immediately after finishing my course. Now he's earning \$75 a week as Chief Instructor at a big Aviation School in New York.



Walter Hinton
First to fly the Atlantic; first to fly to South America; first to explore the upper regions of the Amazon by plane. Flying Instructor in Navy for five years. Now giving ambitious men practical ground work training in Aviation at home. If you are 16 or over, mail the coupon below for your copy of this big new FREE Book today.

FREE Book Brings FACTS

The big, 32 page book below, fully illustrated, will tell you all about your opportunities in Aviation today. Send in the coupon now.



MAIL NOW!

Walter Hinton, President,
Aviation Institute of U. S. A., Inc.
1115 Connecticut Avenue,
Washington, D. C.

Send me a Free copy of your book about my opportunities in Aviation, and how you train me and help me get an Aviation job.

601-D

Name.....
Address.....
City.....
Age.....
(Must be 16 or over)

When writing please mention Popular Mechanics

AUTOMECHANICS

**Easily Learned
In 8 Weeks**

**No Books—No Lessons
Not a Correspondence Course**

Learn easily now to be independent of hard times. You need not fear lay-offs or unemployment if you are a McSweeney trained man. Specialize! Learn a trade that machinery will not replace. Learn Auto Mechanics by the McSweeney Shop-Plan method of training men for Big-Pay Jobs.

Write for Big Free Book and Special Tuition Offer

McSWEENEY SCHOOLS

**ELECTRICAL
AUTOMOTIVE**

DEPT. C-4-2 CLEVELAND, OHIO

BEDFORD YMCA TRADE SCHOOL

Caterpillar Tractor Mechanic
Aviation Mechanic
Flying
Airplane Welding
Airplane Drafting
Air Navigation
Starting, Lighting, Ignition
Auto Mechanic
Machine Shop. Electric Welding
Oxy-Acetylene Welding
Radio Mechanic. Air Brush
Mechanical, Architectural Drawing
Sign Painting. Show Card Writing
Talking Pictures, Western Electric
Commercial Art. Fine Art
DAY AND EVENING SESSIONS
Write for Catalog 50
Brooklyn Engineering Institute
(Operated by Bedford Y. M. C. A.)
1125 Bedford Avenue, Brooklyn
New York City

RADIO—TELEVISION

World's TALKING PICTURES

finest home training. Prepares for best paying positions in this fast growing business. Only training endorsed by leading Radio Manufacturers, dealers and distributors. Many fine opportunities open for men with this training. Laboratory and Consulting Service included. Write for FREE "Opportunity Book."

Radio & Television Institute 2132 Lawrence Ave. Dept. 16, CHICAGO

WHY STAMMER?

Don't be a failure. Master perfect speech. Live a healthy, normal and happy life. Send for free book which tells you how. THE LEWIS INSTITUTE, 12972 Woodward Ave., Detroit, Mich.

LAW HIGH-GRADE INSTRUCTION BY CORRESPONDENCE

College, Post Grad. and Bar Ex. Rev. Courses. Law has attracted more keen, busy men than any other calling. Send today for catalog. Low cost, easy terms. Standard texts. Degrees. Chicago School of Law Dept. 801, Resper Bldg. CHICAGO, ILL.

GOV'T. POSITIONS SPLENDID SALARIES

WE HELP YOU GET ONE

Ry. Mail Clerk	Seno Typist
P. O. Laborer	Immigrant Insp.
R. F. D. Carrier	Seamstress
Special Agent	Auditor
Customs Inspector	Prohibition Agt.
City Mail Carrier	U.S. Border
Meat Inspector	Patrol
P. O. Clerk	Chauffeur
File Clerk	Watchman
General Clerk	Skilled Laborer
Matron	Postmaster
	Typist

Comments: Instruction Bureau, Dept. 111, St. Louis, Mo. Send no FREE particulars. "How to Qualify" for positions marked "X" Salaries, Locations, Opportunities, etc. ALL SENT FREE.

Name.....
Address.....

MEN - WOMEN

AGE RANGE 18 to 50

We have placed machinists, carpenters, masons, plumbers, railroad men, office clerks, farmers and even laborers in fine Drafting Jobs under this plan. Mail coupon for details of our remarkable offer.



Men Who Work With Their Hands Make the Best DRAFTSMEN



—and we'll back them with this EMPLOYMENT CONTRACT

We are looking for more ambitious young fellows with factory, building-trade or any other kind of mechanical experience to prepare for and help place in well-paid Drafting positions. Such men, we find, are unusually successful as Draftsmen, because they know how things are done, and that's a priceless asset to the man who makes the blueprint plans. Get in touch with me and I'll tell you how you can cash in on your entire past mechanical experience.

Drafting Is Logically Your Next Move!

Of course you realize the biggest handicap to mechanical work is that you're limited in earning capacity to the output of your two hands, as long as you live. Even the skilled mechanic earning \$50 to \$60 a week has reached his limit. He can never earn more and when he gets old he will earn less. So I don't blame any man for wanting to get away from this futureless outlook. For wanting to get into something where he can use his head as well as his hands—where he will be paid for what he knows, instead of only for what he does... You know enough about blueprints to understand that PLANS govern every move in factory and construction job. The Draftsman who makes them is several jumps ahead of the workman who follows them. And so I want you to know that DRAFTING is a logical, natural PROMOTION from mechanical and building work—better-paid, more interesting—just the kind of work you'd enjoy doing.

Get Our NO-RISK PLAN

The way to a fine Drafting job for you—is easier than you think. It takes no "artistic talent" or advanced education. Thousands of men no smarter than you, with no more education or ability, have learned it quickly and you can, too. With the co-operation of some of the biggest employers and engineers in the U. S., we have worked out a plan to prepare you for Drafting work in your spare time at home—then to help you get a fine position when you're only half way through the course. Mail the coupon and we'll be glad to tell you all about this lifetime chance.

THE AMERICAN SCHOOL
Dept. D-647, Drexel Ave. and 58th St., Chicago, Illinois



36-Page Drafting Book—FREE

Tells how easy Drafting is to learn—how interesting the work is—what remarkable opportunities are open for Draftsmen right now. Mail coupon for a copy—without cost or obligation.

AMERICAN SCHOOL, Dept. D-647, Drexel Ave. & 58th St., Chicago, Ill.

Please tell me, without cost or obligation, about your training and employment service in line marked X below.

DRAFTING

- Architecture Civil Engineering
 Building Auto Engineering
 Electrical Engineering
 Business Management
 Accounting
 Mechanical Engineering
 Shop Superintendent
 Foremanship
 High School in 2 years
 Structural Steel

Name _____

St. No. _____

City _____ State _____

Age _____ Occupation _____

When writing to advertisers please mention Popular Mechanics

Full Railroad Fare from Your Home to Los Angeles deducted from cost of training if you enroll soon!

MEN WANTED—
Train in California
for
Good Jobs!

Learn Autos
IN LOS ANGELES

and LEARN RIGHT!

Full Railroad Fare Allowed to Los Angeles!

It's only human for you to want to come to California. Everyone does. How much better to come and get started right—quickly qualifying for the *best pay jobs*. We are allowing full railroad fare from any point in the United States for a limited time only, to encourage more men to take advantage of California Training. Never again will you get an opportunity like this. Come West NOW!

A Few Short Weeks at National and You're Ready For A Big Pay Job!

For 26 years National has quickly helped men get ready for big pay, steady positions in the profitable Automobile fields. Don't worry about previous experience, or whether you're too old or too young. We train you by "Actual Shop" Methods on thousands of dollars worth of right-up-to-the-minute equipment. Not a Correspondence School. Start any time.

...and Don't Worry About Money! We'll Help You! Even if you're short on cash you can get National Training. We help you secure good part-time jobs to earn living expenses while learning. Unlimited Employment Service assures you real, friendly co-operation in getting started on the road to real money, steady work and a prosperous future. Employers know that National Auto Men are the best, so they don't waste their time on half-baked, untrained mechanics. 25,000 successful graduates since 1905.

National Doors Are Open to You!
Investigate at Once!

Write now—today—for the whole story. Our big free book with details sent FREE. Don't lose another minute. These offers are necessarily limited for a short time. Mail the coupon and soon you can be on the train for Los Angeles.

WRITE for FREE BOOK NOW!

National
Automotive School

Dept. 84 F, 4006 S. Figueroa Street,
Los Angeles, California

Send me, absolutely free, your big illustrated catalog of Automotive Opportunities, cost of training and Special Railroad Fare Offer.

Name _____

Address _____

Age _____

City _____

State _____



Your Future assured!
National Automotive
LOS ANGELES

Play the Hawaiian Guitar like the Hawaiians!

Only 4 Motions used in playing this fascinating instrument. Our native Hawaiian instructors teach you to master them quickly. Pictures show how. Everything explained clearly.

Play in Half Hour

After you get the four easy motions you play harmonious chords with very little practice. No previous musical knowledge needed.

Easy Lessons

Even if you don't know one note from another, the 52 printed lessons and clear pictures make it easy to learn quickly. Pay as you play.

GIVEN when you enroll
—a sweet toned

HAWAIIAN GUITAR, Carrying Case and Playing Outfit—

WRITE AT ONCE for attractive offer and easy terms. You have everything to gain. A postcard will do. **ACT!**

Value \$18 to \$20
No extra-anything included

OTHER COURSES Tenor Banjo, Violin, Tiple, Tenor Guitar, Ukulele, Banjo tiplele. Under well known instructors.

FIRST HAWAIIAN CONSERVATORY OF MUSIC, Inc.
9th Floor, Woolworth Bldg. Dept. 548 New York, N. Y.
Approved as a Correspondence School Under the Laws of the State of New York—Member National Home Study Council



Win Good Pay in Photography

Motion picture and photographic field offers worthwhile opportunities to ambitious men. You can qualify through our simplified method for: () Motion Picture Photography or Projection () Commercial and Portrait Photography or Photo-Finishing. Check branch of photography you're interested in and send for FREE book today.

NEW YORK INSTITUTE OF PHOTOGRAPHY
Dept. AK-1443 10 West 33rd St. New York City

MUSIC LESSONS IN YOUR HOME

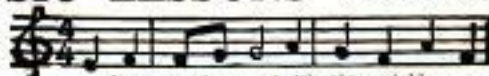

You can play music like this quickly

Write today for our **FREE BOOKLET AND DEMONSTRATION LESSON**. It tells how to learn to play Piano, Organ, Violin, Mandolin, Guitar, Banjo, etc. Beginners or advanced players. You pay as you learn. Costs you only a few cents a day. Thousands of satisfied students.
AMERICAN SCHOOL OF MUSIC, 51 Manhattan Bldg., CHICAGO

Learn Watchwork, Jewelrywork and Engraving A fine trade commanding a good salary, and your services

always in demand. Address **Horological, Dept. P, Bradley Institute, PEORIA, ILLINOIS**, for our latest catalog.



U.S.
GOVERNMENT
JOBS

\$1260 to \$3400 Year

Men—Boys—18 to 50

STEADY WORK
Paid Vacations

Common Education
Usually Sufficient

MAIL COUPON
TODAY—SURE

Franklin Institute

Dept. 6179 Rochester, N. Y.

Gentlemen: Wish to see **FREE** list of U. S. Government big pay steady positions now obtainable. Send me **FREE** 22-page book describing salaries, hours, work, vacation and how to get a position.

Name _____

Address _____

When writing to advertisers please mention Popular Mechanics

In the Air  **and on the Ground** 

LINCOLN-TRAINED MEN GET THE BEST AVIATION JOBS!



G. L. Currier



C. W. Goodman

World's Best Known Aviation School

GUARANTEE yourself a good future position as a Pilot or Airplane Mechanic now! You can do so by enrolling at the Lincoln Airplane and Flying School. For on the ground and in the air . . . Lincoln graduates get the best positions. That's because Lincoln is known throughout the aviation industry as the school that produces better-trained mechanics and pilots.

COMPLETE FACILITIES . . . SEASONED INSTRUCTORS

What Graduates Say:

"My first job paid \$300 per month. Now I earn \$400. Most essential requirement in Aviation is training such as yours."—C. L. Currier.
"I am now manager of Lindbergh Field, Lincoln, Nebr., at a substantial salary. Attribute my success largely to your school."—C. W. Goodman.

Lincoln offers facilities found in no other school. \$250,000 worth of buildings and equipment. A \$100,000 airport, with all-weather runways and lighted for night flying. A large fleet of training planes. You learn on four distinct types . . . low and high wing monoplanes, biplanes, open cockpit ships, and cabin transport planes. Government-licensed instructors. **Ground and Flying School hold highest government approval.** Operated under regular supervision of U. S. Dept. of Commerce.

Big Demand for Well-Trained Mechanics . . . Aviation needs hundreds of mechanics. Come to Lincoln for better training and get one of the better jobs! Here you get **practical** training on real airplanes, as we are connected with a large aircraft factory. You learn to build and repair wings, fuselages, rudders . . . every part of a plane under factory standards; and to overhaul all important types of aero motors. Also courses in welding and radio.

Complete Flying Courses for all government pilots' licenses. Lincoln-trained pilots get best pilot jobs!

Reasonable Tuition and an Employment Department that helps students find part time jobs to help pay board and room while training, and assists graduates in finding permanent positions . . . are other reasons you should train at Lincoln.

We also teach in Spanish

CATALOG ON REQUEST

Contains complete information about the Lincoln School, reasonable tuition, tells of big opportunities in Aviation. Gives details of our liberal part time employment offer to help students pay cost of room and board while in training. If you want to get into aviation, send for this Catalog. It tells you how. Be sure to state your age. Mail coupon today!



MECHANICS' SCHOOL CONNECTED WITH LARGE AIRCRAFT FACTORY



LINCOLN

AIRPLANE AND FLYING SCHOOL

202A Aircraft Bldg.

Lincoln, Nebr.

The Lincoln Mechanics' School Building (right). A view at our \$100,000 Airport (below).



MAIL THIS COUPON

Lincoln Airplane & Flying School
202A Aircraft Bldg., Lincoln, Nebr.

Gentlemen: Please send me your catalog "Aviation Beckons You," containing full information about the Lincoln School and reasonable tuition.

I am interested in:

- Flying Course Welding Course
 Radio Course Mechanical Course

Name.....Age.....

Address.....

City.....State.....

LEARN AVIATION AT LINCOLN...WHERE LINDBERGH LEARNED

When writing to advertisers please mention Popular Mechanics

GET INTO HIGHER ACCOUNTING and HIGHER PAY



Of course you want the bigger pay that goes with a bigger job—but if you're like most men you're wondering right now how you can get it. *Hundreds of thousands of men have found the answer!* Take the experience of any one of them—Vance Anderson, for instance.

For many years Anderson groped blindly for success. He tried farming—running a truck-line—then the study of mechanical engineering, then accounting at a resident school. Dissatisfied with that, he enrolled for LaSalle's course in Higher Accounting. From that time on his future assumed a definite form.

VICE-PRESIDENT—by the time he had completed LaSalle Training

While still studying, he became Office Manager of the Central Indiana Canneries, then joined the Olin Chevrolet Company of Indianapolis, one of the large automobile agencies of the Middle West. And before he completed the course he was made Vice-President! During that time his salary increased several times over! Is it any wonder he says, "Real study with you will pay any man."

Knowledge of Higher Accounting leads the way to so many business opportunities that the well-trained man is practically proof against unemployment. A dozen doors are open to him while the untrained man is walking the street. Advancement is swift and certain—for the very foundation of business lies in accounting control. That is why LaSalle graduates in Higher Accounting occupy some of the highest executive positions.

LaSalle has made it easy for you to master this big-pay work in spare-time study at home—no matter what your previous education or experience. This is backed by a placement, consultation and advancement service that follows throughout life.

Send for "Ten Years' Promotion in One"—the little book that has led to adding hundreds of millions of dollars to the annual salaries of 700,000 men. With it we will include full information about the big-opportunity field of Higher Accounting. Sending the coupon below may be the turning point in your life. Don't delay, but send it today—NOW!

-----Find Yourself Through LaSalle-----

LaSalle Extension University

The World's Largest Business Training Institution

Dept. 964-HR Chicago

I would welcome copy of "Accountancy, the Profession that Pays," also a copy of "Ten Years' Promotion in One," all without obligation.

Higher Accountancy

Training for positions as Auditor, Comptroller, Certified Public Accountant, Cost Accountant, etc.

Other LaSalle Opportunities

If more interested in one of the fields indicated below, check and mail now.

- | | |
|--|--|
| <input type="checkbox"/> Business Management | <input type="checkbox"/> Banking and Finance |
| <input type="checkbox"/> Modern Salesmanship | <input type="checkbox"/> Modern Business |
| <input type="checkbox"/> Traffic Management | <input type="checkbox"/> Correspondence |
| <input type="checkbox"/> Railway Station Mgmt. | <input type="checkbox"/> Railway Accounting |
| <input type="checkbox"/> Law: Degree of LL.B. | <input type="checkbox"/> Expert Bookkeeping |
| <input type="checkbox"/> Commercial Law | <input type="checkbox"/> C. P. A. Coaching |
| <input type="checkbox"/> Industrial Management | <input type="checkbox"/> Business English |
| <input type="checkbox"/> Modern Foremanship | <input type="checkbox"/> Commercial Spanish |
| <input type="checkbox"/> Personnel Management | <input type="checkbox"/> Effective Speaking |
| <input type="checkbox"/> Credit and Collection | <input type="checkbox"/> Correspondence |



Name.....

Present Position.....

Address.....

When writing please mention Popular Mechanics

ENGINEERING DEGREE IN 2 YEARS



B. S. Degree in Civil, Electrical, Mechanical, Chemical, Aeronautical Engineering in 2 years. Non-essentials eliminated. Technical training in least time and at lowest cost consistent with thorough preparation. Liberal entrance requirements. Those who lack high school training may make up work. Enter September, January, March, June. Write for catalog.

491 College Ave., Angola, Indiana

TRI-STATE COLLEGE

LEARN WATCH REPAIRING



You can learn by our modern and original system of instruction every part of the Watch Repairing Trade at home as good or better than at a shop. You can earn money while learning and secure a well paying position or start in business after completing our course of instruction. Good watch repairers are always in demand and earn from \$50 to \$75 per week. For particulars apply to the Wisconsin School of Watch Repairing 524 E. Mason St., MILWAUKEE, WIS.

1000 POULTRY SECRETS

Our famous home-study Poultry Course teaches how to get more eggs, cut feed bills, avoid losses. Methods used by successful Poultry raisers the world over. FREE Book tells all about Course. Write today for your free copy. National Poultry Institute, Dept. 411-N, Washington, D. C.



VOICE

100% Improvement Guaranteed

We build, strengthen the vocal organs—not with singing lessons—but by fundamentally sound and scientifically correct silent exercises... and absolutely guarantee to improve any singing or speaking voice at least 200%... Write for wonderful voice book—sent free. Learn why you can now have the voice you want. No literature sent to anyone under 17 years unless signed by parent.

PERFECT VOICE INSTITUTE, Studio 13-56
308 No. Michigan Ave., Chicago



Learn Shorthand

Begin Today. Write for my Free Book, "How to Become a Good Penman." It contains speediness and tells how others learned to write in spare time. Your name elegantly written on a card if you submit stamp for return. Write today. F. W. TANDLYN, 418 Ridge Bldg., Kansas City, U. S. A.

Photography



for

PLEASURE or PROFIT

A fascinating hobby or a profitable business can now be yours. Prepare quickly at home under the personal guidance of leading experts in the fine art of photography. No experience necessary. Full of spare time. Many earn while learning. Our thorough studio method also qualifies you to fill a well paying position upon graduation. Send coupon now for FREE booklet, Opportunities in Modern Photography.

AMERICAN SCHOOL OF PHOTOGRAPHY
3601 Michigan Avenue D-pt. 1356 Chicago, Ill.
Send FREE booklet, Opportunities in Modern Photography, and full information.

Name.....

Address.....

City.....State.....

The "MASTER MIND" of BUSINESS ..The Accountant!

Holds Positions Paying \$3000 to \$12000 A YEAR

In the last generation a new profession has grown up—accountancy. The accountant today is considered the most important man in the business field—he is literally the brains of business. Once he is properly trained, there is no business position too big for him to fill. Yet business experts calculate that there are less than half the number of accountants now needed to fill the big positions now open to accountancy-trained men.

“GUIDED EXPERIENCE” METHOD Trains Men Quickly at Home!

TODAY a new profession and a new method of teaching are opening the gates of opportunity wide, to men who once were seemingly doomed to mediocre jobs and limited chances for advancement. Until fifty years ago there were no accountants—only bookkeepers. Even twenty years ago, the new profession was a limited kind of work.

Yet today accountancy is one of the most vital factors in business. Accountancy is not bookkeeping. It involves the ability to use bookkeeping figures, yes. But the ordinary bookkeeper hasn't the training, or the knowledge, to interpret his own figures. The accountant has. An ordinary clerk seeing the bookkeeper's records, cannot tell what is likely to happen in the future, on the strength of the records shown. He cannot plan, from his forecast, what to do to take advantage of an opportunity, or to prevent a disaster. The accountant can—and he does, every day. The factory worker, though he knows how much time and material it takes him to make a piece of merchandise, can't tell you what it costs the firm to turn it out. The accountant does.

That is why the accountant is the brains of business. Gone are the days of slipshod record-keeping, and ignorance of what the records mean. The business man has to have facts—and the accountant is his only source of accurate information. Today, accountancy knowledge not only gives a man an advantage in seeking business promotion—to many men it has meant an opportunity to build up highly profitable practices—businesses of their own, as public accountants. To cap all this, there is more than a fifty per cent undersupply of accountants in this country!

What better opportunity could you find for a man who wants to learn a profession of dignity, that insures him a chance of real importance and success—and who, through a new teaching method, finds that he can learn it easily? That is the situation today, for literally thousands of men. Today a new method of teaching accounting, which uses college-type methods of train-



ing, has been devised to teach you right in your own home. It was designed, and is now being taught, by a group of leading accountants and accounting teachers. Certified Public Accountants who have reviewed this method, call it "The clearest and most logical method of teaching accountancy." It not only gives you mastery of the basic fundamentals of accounting—it gives complete training in the specialized branches of accountancy—Cost Accounting, Income Tax Accounting, Commercial Law. Finally, this new training gives you a complete coaching course, preparing you for Certified Public Accountancy examinations, without extra cost.

Write today for your copy of "The Modern Way To Learn Accounting," the new book which explains the present opportunities in the accountancy field. It will tell you, too, the facts about this new teaching method, and about the other services which this institution gives its members. Simply mail the coupon for it today—get it without cost or obligation and find out from it how you, too, may capitalize the increasing demand for accountancy-trained men.

AMERICAN UNIVERSITY OF COMMERCE
Dept. M-30, 17 W. Elm St., Chicago, Illinois

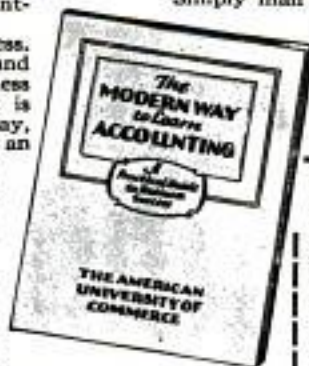

Send for Your
Copy FREE

American University of Commerce
Dept. M-30
17 W. Elm Street, Chicago, Illinois.

Without obligation or charge, please send me my copy of the new book "The Modern Way To Learn Accounting," and information concerning the American University of Commerce Training in Accountancy.

Name.....
Address.....
City..... State.....
Age..... Occupation.....

When writing to advertisers please mention Popular Mechanics

Come to sunny
CALIFORNIA



and LEARN
Electricity
RIGHT!

NATIONAL
opens its doors to you!

Right in the heart of America's most interesting place to live and learn—National—the approved trade school of the West—invites you to Los Angeles! Come West, enjoy life, learn a profitable trade in the land of prosperity, progress, sunshine and happiness.

Your Railroad Fare Allowed for a Limited Time!

Every one dreams of coming to California. National will pay your railroad fare from any point in the United States. Never again another opportunity like this! Investigate this great offer at once!

REAL Big Pay Jobs Await You!

Boulder Dam means millions for Southern California! Thousands more will soon be working on this world's greatest hydroelectrical project. Learn quickly at NATIONAL for big pay jobs in profitable Electrical Trades.

Don't Worry About Enough Money! We'll Help You!

If you are short of money, we help you secure part-time jobs to earn your living expenses while learning. We place scores of graduates on good pay jobs with real futures. Unlimited Lifetime Employment Service.

Write Today About the Greatest Offer Ever Made!

This great Million Dollar Institution, equipped with the best money can buy—the finest faculty of electrical experts in the country—a school with a Heart and personal interest in your success and personal welfare opens its doors to you. Send at once for NEW Book with full details. No age limit—no previous experience required; start any time. Send for your copy of this new book TODAY!

Send for this FREE BOOK.

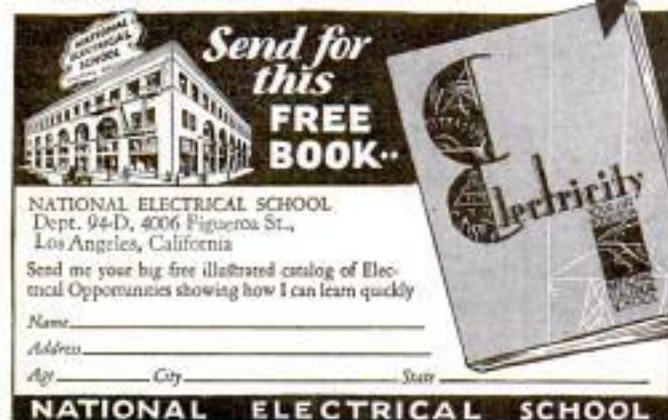

NATIONAL ELECTRICAL SCHOOL
Dept. 94-D, 4006 Figueroa St.,
Los Angeles, California

Send me your big free illustrated catalog of Electrical Opportunities showing how I can learn quickly

Name _____
Address _____
Age _____ City _____ State _____

NATIONAL ELECTRICAL SCHOOL

BE A RAILWAY TRAFFIC INSPECTOR

In Fast Growing Bus and Railway Field

For 12 years S. B. T. I. Trained Passenger Traffic Inspectors have been in demand. You report to important officials—have unusual opportunities for rapid promotion. Many graduates are now important officials in transportation work, interesting, healthful, outdoor work. Travel or remain near home.

E. G. writes: "I was placed in a position at the starting salary you told me and was raised to \$753 at the expiration of one month. I am now getting \$120 per month and like the work fine. My superiors are pleased to meet and work for. You have been a stepping stone to my future."

Complete our home-study course of perfected instruction in a few weeks. Then, we place you in a position paying from \$120 to \$150 per month (plus expense) to start or refund tuition. Free Booklet gives full details—explains opportunities. Low cost—easy terms. Write today!

Standard Business Training Institute
Div. 209 Buffalo, N. Y.

EARN MONEY AT HOME

YOU can make \$15 to \$50 weekly in spare or full time at home coloring photographs. No experience needed. No canvassing. We instruct you by our new simple Photo-Color process and supply you with work. Write for particulars and Free Book to-day.

The IRVING-VANCE COMPANY Ltd.
356 Hart Building, Toronto, Can.

STAMMERING

You can be quickly helped if you stammer or stutter

I KNOW, because I relieved myself after stammering for nearly 20 years. The story of my suffering—and relief—has interested thousands, many of whom have permitted me to help them. Full story of my successful efforts told in 279-page book. Sent anywhere for 10 cents. B. N. BOGUE, 11145 Bogue Building, 1147 North Illinois Street, Indianapolis, Ind.

SONG REQUIREMENTS OF TALKING PICTURES, RADIO and RECORDS



WRITTEN BY WALTER H. NEWCOMER

SONG WRITERS

Don't fail to read "Song Requirements of Talking Pictures, Radio and Records" an explanatory, instructive book SENT FREE on request. New writers may mail song-poems for free examination. We revise, compose and arrange music, and secure copyrights, guaranteeing approval.

P. M. Newcomer Associates, 1674 Broadway, New York



"BECOME A LIGHTNING TRICK CARTOONIST"

Send \$1.00 for Laugh Producing Program of 23 Trick Drawings with Instructions. Catalog of Chuck Talk Supplies Free. BALDA ART SERVICE, Dent, 1, Oshkosh, Wis.

Operator No. 38



FOLLOW THIS MAN

Secret Service Operator No. 38 is on the job! Running down dangerous Counterfeit Gang. Tell-tale finger prints in murdered girl's room.

Free The Confidential Report Operator No. 38 made to his chief. Write for it. \$3000 a year and up

YOU can become a Finger Print Operator at home, in your spare time, at small cost. Write for confidential full report and details. Literatures will NOT be sent to boys under 17 years of age.

INSTITUTE OF APPLIED SCIENCE
1920 Sunnyside Ave. Chicago, Ill.
Dept. 13-56

\$1000 Extra For YOU

Stoneberger makes that in SPARE Time, broadcasting from Station WJW, Washington, D. C. Hundreds of others playing for Radio, in Orchestras, etc.—BIG PAY FOR YOU!—Free Book tells you all about QUICK, EASY Way to Master popular Hawaiian Guitar. Write for it Today! HAWAIIAN STUDIO 52091, New York Academy of Music, 100 Fifth Ave., New York City

When writing please mention Popular Mechanics

Why waste time on old fashioned methods

—when you can learn to play
at home without a teacher

DON'T let the thought of long years of tiresome practice scare you away from learning to play! Don't let the thought of an expensive private teacher keep you from letting your dreams come true! For you—*anyone*—can easily *teach yourself* to play—right in your own home, in your spare time, and at only a fraction of what old, slow methods cost!

It's *so* easy! Just look at that sketch at the right. The note in the first space is *always* f. The note in the second space is *always* a. The way to know the notes that come in these four spaces is simply to remember that they spell *face*.

Now, isn't that simple? You don't have to know one note from another in order to begin. For the U. S. School way explains everything as *you go along*—both in print and picture—so that, almost before you know it, you are playing *real tunes and melodies* right from the notes.

You simply *can't go wrong*. First you are *told* what to do, then the picture *shows* you how to do it—then you do it yourself and *hear* it. No private teacher could make it any clearer.

Easy as A-B-C

No wonder over 600,000 men and women have learned to play this easy way! For this famous course is based on sound, fundamental musical principles, highly simplified. It's not a "trick" or "stunt" method. You learn to play from notes, just as the best musicians do. You learn to pick up any piece of music, read it, and understand it.

No time is wasted on theories. *You get all the musical facts.* You get the real meaning of musical notation, time, automatic finger control, harmony.

You'll find yourself studying the U. S. School way with a smile. Your own home is your studio. The lessons come

to you by mail. They consist of complete printed instructions, diagrams, all the music you need. There are no dry-as-dust exercises to struggle through. Instead, it's just like playing a game—you learn so fast!

No Talent Needed

Forget the old-fashioned idea that you need "talent." Just read the list of instruments in the panel, decide which one you want to play, and the U. S. School of Music will do the rest. And remember—no matter which instrument you choose, the cost in each case will average just the same—only a few cents a day.

Choose Your Course

Piano	Piccolo
Organ	Cello
Violin	Sight Singing
Drums	Ukulele
and Traps	Hawaiian
Guitar	Steel Guitar
Mandolin	Clarinet
Harp	Flute
Cornet	Saxophone
	Trombone
Voice and Speech Culture	
Harmony & Composition	
Automatic Finger Control	
Piano Accordion	
Italian and German Accordion	
Banjo (Plectrum, 5-String or Tenor)	
Juniors' Piano Course	



Easy as A-B-C



If you can read the alphabet you can learn to play your favorite instrument in just a few months.



You'll never regret having learned to play. For those who can entertain with music at parties—who can snap up things with peppy numbers—are always sought after, always sure of a good time! Start now and surprise your friends!

Free Book and Demonstration Lesson

"Music Lessons in Your Own Home" is an interesting little book that is yours for the asking. With this free book we will send you a typical demonstration lesson that proves better than words, how quickly and easily you can learn to play your favorite instrument by note—in less than half the time and at a fraction of the cost of old, slow methods—the U. S. School way. The booklet will also tell you all about the amazing new *Automatic Finger Control*.

If you really want to play—if new friends, good times, social popularity, and increased income appeal to you—clip and mail the coupon NOW. Instruments supplied when needed, cash or credit. U. S. SCHOOL OF MUSIC, 79 Brunswick Bldg., New York City.

U. S. SCHOOL OF MUSIC
79 Brunswick Building, New York City

Please send me your free book, "Music Lessons in Your Own Home," with introduction by Dr. Frank Crane, Free Demonstration Lesson, and particulars of your easy payment plan. I am interested in the following course—

Have you
.....instrument?.....

Name.....

Address.....

City.....State.....

When writing to advertisers please mention Popular Mechanics

A COLLEGE EDUCATION for men who think they can't afford one!



Be college trained at half the usual expense . . . and in a fraction of the usual time. The coupon tells how. Mail it, if you want outstanding value in college training.

This year, as never before, men are going to look for real value in schooling. Most men will not be able to afford the regular 4 and 5-year college education. But they will cling resolutely to their ambition to be college trained. They will go where tuition is low . . . where the cost of an education is rock-bottom, where time has been cut to a minimum.

For many . . . Chicago Tech will be the answer. Chicago Technical College is the logical school for men who are short on funds and time . . . but long on ambition. For here you can get a college course to fit your pocketbook . . . training that offers outstanding value for money and time invested.

3 Year Degree Courses—1 and 2 year Diploma Courses—also shorter courses

Amazing, but true. At Chicago Tech, you can become college trained in less time . . . and with only half the usual expense. 3-Year Degree Courses in Drafting, Engineering, Architecture and Electricity. 1 and 2-Year Diploma Courses, and 3 to 9-month courses, too. Think of it. The same courses that it would ordinarily take you 3 to 5 years to finish. Non-essentials eliminated. No necessary subjects have been sacrificed.

Earn part of your expenses . . . here in Chicago. A large city like Chicago offers many opportunities for spare-time work. We help students secure part-time positions to help defray expenses. The engineering center of the nation, Chicago offers the technical student a wide variety of building and engineering projects for observation and study.

FREE 80-Page BLUE BOOK

Gives Complete
F A C T S

Send the Coupon
for your copy

If a college education at less cost and minimum expenditure of time . . . a degree . . . the training that will bring you success, recognition and happiness means anything to you, then you will want this Free 80-Page Blue Book. It tells all about this 27-year-old technical college, its courses, instructors and what it can do for every man ambitious enough to want a college education. Fill in the coupon and send it now. You may keep the book without cost to yourself.

CHICAGO TECHNICAL COLLEGE

Dept. M-79, Chicago Tech. Bldg.

118 East 26th St.

CHICAGO, ILL.

Chicago Technical College, Dept. M-79
118 E. 26th St., Chicago

I want to know how I can get a degree or diploma and be college trained in Drafting, Engineering, Architecture and Electricity in less time and with less cost. Send me your Blue Book, free, without a cent cost to me.

Name Age

Address

City State

ELECTRICITY

Easily
Learned
in 12 Weeks

No Books—No Lessons
Not a Correspondence Course

McSweeney training makes you independent of hard times. Unemployment holds no fear for you if you are a McSweeney trained man. Specialize! Learn Electricity! McSweeney students—thousands of them—know their business because they were trained for it by practical work with real tools on real equipment.

Write for Big Free Book and Special Tuition Offer

McSWEENEY SCHOOLS

ELECTRICAL
AUTOMOTIVE

Dept. C-4-4 CLEVELAND, OHIO

FREE CATALOG OF PRACTICAL BOOKS

for Practical Men, covering the subjects of RADIO, AVIATION, ENGINEERING, AUTOMOBILE WORK, BATTERY WORK, ELECTRICITY, BUILDING, SHEET METAL WORK, PAINTING, SIGN MAKING, LETTERING, COMMERCIAL ART, will be sent to you on request.

FREDERICK J. DRAKE & CO.

181 N. Michigan Blvd.

Chicago

HOT PIANO

Ultra-modern
Piano



Jazz taught by mail. Note or ear. Easy rapid lessons for adult beginners. Also Self-instruction system for advanced pianists. Learn 358 Bass Styles, 976 Jazz Breaks, hundreds of Trick Endings, Hot Rhythms, Sock, Stomp and Dirt Effects; Symphonic and Wicked Harmony in latest Radio and Record Style. Write for Free Booklet.

WATERMAN PIANO SCHOOL, 1626 W. Adams St., Los Angeles, Calif.



Wonderful, new device, guides your hand; corrects your writing in a few days. Big improvement in three hours. No failures. Complete outline FREE. Write C. J. Osment, Dept. 34, St. Louis, Mo.



WANT A STEADY JOB?

New
Bandit Proof
Railway Mail Car

U. S. GOVERNMENT JOBS

\$1260 TO \$3400 YEAR

Men—Boys, 18 to 50

FRANKLIN INSTITUTE
Dept. G187, Rochester, N. Y.

Paid Vacations
Common Education
Usually Sufficient
Mail Coupon
—TODAY
SURE

Gentlemen: Rush to me without charge 32-page book with list of U. S. Government big paid positions. Tell me regarding salaries, hours, duties, vacations and full particulars.

Name
Address

When writing please mention Popular Mechanics

Speaking of money

WOULD YOU
RISK
2c
ON YOUR FUTURE?

If you won't take a chance, no one else will for you! Friends are fine, and it's good to "stand in" with the boss, but these advantages do not put more money in the old pay envelope.

When you look in your pay envelope, you see exactly what your work is worth! You may think you are worth more—somebody else doesn't. So there you are!

Of course you want more money. The point is, you probably *must* make more money. How are you going to do it?

All right! Risk two cents on yourself. Study this coupon—find the course of

training that appeals to you—place an X opposite it—then mail it to the International Correspondence Schools at Scranton!

"I risked two cents on myself," writes a successful business man, "and that chance is now paying me \$12,000 a year. The smartest thing I ever did was to mark and mail that I. C. S. coupon!"

It may be the wisest thing you ever did too! A two-cent stamp—that's all it costs you! The information on how you—in spare time—can acquire training that will help you earn *more* money will be forthcoming immediately.

JUST MARK AND MAIL THE COUPON—TODAY!

INTERNATIONAL CORRESPONDENCE SCHOOLS

"The Federal University," Box 5561-G, Scranton, Penna.
Without cost or obligation, please send me a copy of your booklet, "Who Wins and Why," and full particulars about the subject *before* which I have marked X:

TECHNICAL AND INDUSTRIAL COURSES

- | | | | |
|--|--|--|--|
| <input type="checkbox"/> Architect | <input type="checkbox"/> Telegraph Engineer | <input type="checkbox"/> Aviation Engines | <input type="checkbox"/> B. R. Bridge and Building Foreman |
| <input type="checkbox"/> Architectural Draftsman | <input type="checkbox"/> Telephone Work | <input type="checkbox"/> Automobile Mechanic | <input type="checkbox"/> Air Brakes <input type="checkbox"/> Train Operation |
| <input type="checkbox"/> Building Estimating | <input type="checkbox"/> Mechanical Engineer | <input type="checkbox"/> Plumbing <input type="checkbox"/> Steam Fitting | <input type="checkbox"/> Highway Engineering |
| <input type="checkbox"/> Wood Millworking | <input type="checkbox"/> Mechanical Draftsman | <input type="checkbox"/> Heating <input type="checkbox"/> Ventilation | <input type="checkbox"/> Chemistry <input type="checkbox"/> Pharmacy |
| <input type="checkbox"/> Contractor and Builder | <input type="checkbox"/> Machinist | <input type="checkbox"/> Sheet Metal Worker | <input type="checkbox"/> Coal Mining Engineer |
| <input type="checkbox"/> Structural Draftsman | <input type="checkbox"/> Toolmaker | <input type="checkbox"/> Steam Engineer | <input type="checkbox"/> Navigation <input type="checkbox"/> Boilermaker |
| <input type="checkbox"/> Structural Engineer | <input type="checkbox"/> Patternmaker | <input type="checkbox"/> Steam Electric Engineer | <input type="checkbox"/> Textile Overseer or Supt. |
| <input type="checkbox"/> Electric Wiring | <input type="checkbox"/> Pipefitter <input type="checkbox"/> Tinmith | <input type="checkbox"/> Civil Engineer | <input type="checkbox"/> Cotton Manufacturing |
| <input type="checkbox"/> Electrical Engineer | <input type="checkbox"/> Bridge Engineer | <input type="checkbox"/> Surveying and Mapping | <input type="checkbox"/> Woolen Manufacturing |
| <input type="checkbox"/> Electric Lighting | <input type="checkbox"/> Bridge and Building Foreman | <input type="checkbox"/> Refrigeration | <input type="checkbox"/> Agriculture <input type="checkbox"/> Fruit Growing |
| <input type="checkbox"/> Welding, Electric and Gas | <input type="checkbox"/> Gas Engines | <input type="checkbox"/> R. R. Locomotives | <input type="checkbox"/> Poultry Farming <input type="checkbox"/> Radio |
| <input type="checkbox"/> Reading Shop Blueprints | <input type="checkbox"/> Diesel Engines | <input type="checkbox"/> R. R. Section Foreman | <input type="checkbox"/> Marine Engineer |

BUSINESS TRAINING COURSES

- | | | | |
|--|--|--|--|
| <input type="checkbox"/> Business Management | <input type="checkbox"/> Cost Accountant | <input type="checkbox"/> Business Correspondence | <input type="checkbox"/> Grade School Subjects |
| <input type="checkbox"/> Office Management | <input type="checkbox"/> C. P. Accountant | <input type="checkbox"/> Lettering Show Cards <input type="checkbox"/> Signs | <input type="checkbox"/> High School Subjects |
| <input type="checkbox"/> Industrial Management | <input type="checkbox"/> Bookkeeping | <input type="checkbox"/> Stenography and Typing | <input type="checkbox"/> College Preparatory |
| <input type="checkbox"/> Personnel Management | <input type="checkbox"/> Secretarial Work | <input type="checkbox"/> Complete Commercial | <input type="checkbox"/> Illustrating |
| <input type="checkbox"/> Traffic Management | <input type="checkbox"/> Spanish <input type="checkbox"/> French | <input type="checkbox"/> Civil Service <input type="checkbox"/> Mail Carrier | <input type="checkbox"/> Cartooning |
| <input type="checkbox"/> Accountancy | <input type="checkbox"/> Salesmanship <input type="checkbox"/> Advertising | <input type="checkbox"/> Railway Mail Clerk | <input type="checkbox"/> Lumber Dealer |

Name.....Age.....Address.....

City.....State.....Occupation.....

If you reside in Canada, send this coupon to the International Correspondence Schools Canadian, Limited, Montreal, Canada

When writing to advertisers please mention Popular Mechanics



Learn Aviation « « Where the Leaders Learned

BEFORE you contract with any air school for instruction, satisfy yourself as to its standing and responsibility.

At the Von Hoffmann Air College you get a real thorough course in the Principles of Flight, the Theory of Flight, Principles of Construction, Materials of Construction, Engine Instruments, Flying Instruments, Maintenance and Repair of Motors, Aero Dynamics, Aerology, Aerostats—all about aviation.

Most Von Hoffmann students come to us on the recommendation of successful Von Hoffmann graduates—present air leaders in this five hundred million dollar industry.

Von Hoffmann Air College is one of the oldest and most successful in the country, with the highest possible Government rating as Transport, Limited Commercial, Private Pilot, Ground and Flying.

Located on the famous Lambert-St. Louis Airport which cost two million dollars and has the highest rating of A-1-A—used by all air mail lines operating from and through St. Louis.

We are not interested in turning out graduates. Our system calls for your consuming every bit of training. Rigorous examination standards are maintained. Thoroughness, plus unequalled aviation training facilities is the reason why Von Hoffmann graduates are air leaders today and will be tomorrow.

Von Hoffmann Air College training open only to students 17 years or older. If you are under 17, send for information on our Home Study Preparatory Course

MEMBER



Write for "What Aviation Offers You."

VON HOFFMANN AIR COLLEGE

Lambert-St. Louis Municipal Airport,
Saint Louis - - - - - Missouri



When writing please mention Popular Mechanics

FREE The Book

That has helped Thousands get Government Jobs!

Just send your name and address for my 32 page book, "HOW TO SECURE A GOVERNMENT POSITION." Tells all about CIVIL SERVICE: If you are a citizen, 18 to 50, you can get a steady government job at \$1850 to \$3300 a year. I was official examiner for 8 years. You pick the job you want; I'll help you get it. Get ready NOW for the next Railway Postal Clerk Examination! Write today for a copy of my FREE book. Address

A. R. PATTERSON, Civil Service Expert,
89 Wisner Building, Rochester, N. Y.



Learn Public Speaking

At home—in spare time—20 minutes a day. Overcome "stage-fright," gain self-confidence, increase your salary, through ability to sway others by effective speech. Write now for free booklet, *How to Work Woodrow Wilson Words*, NORTH AMERICAN INSTITUTE, Dept. 1356 3601 Michigan Avenue, Chicago, Illinois



STUDY AT HOME

Legally trained men win high positions and big success in business and public life. So independent. Greater opportunities now than ever before. Big corporations are led by men with legal training. Earn \$5,000 to \$10,000 Annually. We guide you step by step. You can train at home during spare time. Degree of LL. B. conferred. Successful graduates in every section of the United States. We furnish all text material, including fourteen-volume Law Library. Low cost, easy terms. Get our valuable freebie "Law Guide" and "Evidence" books FREE. Send for them NOW. LaSalle Extension University, Dept. 964-L, Chicago The World's Largest Business Training Institution

WELDING

ELECTRICITY RADIO AUTOMOBILES

No Finer Training Equipment Anywhere at Any Price. Pipe-Line, Sheet Steel, Structural Steel, Cast Iron, Air-Craft and Commercial Welding; Armature Winding; Power Plants; Switchboards; Transformers; Motors; Generators; Batteries; Radio, Television and Automobiles. LEARN BIG-PAY TRADES AT LOW COST

Write for Information, Mentioning Course Desired.
Coleman Electrical School, 1628 Main St., Kansas City, Mo.

Learn to Dance

You can learn all the modern dances—the latest Tango steps, the new Fox Tots, dreamy Waltzes, smart Collegiate Steps, and popular Society Steps at home, easily and quickly. New chart method makes dancing as simple as A-B-C. No music or partner required. Don't be a wallflower. Learn to dance. Complete course—248 pages, 54 illustrations, sent on 5 Days' Free Trial. Equals \$20.00 course. Send no money. Pay postman only \$1.35, plus postage upon arrival. Money back if not delighted. Catalog Free.



Franklin Pub. Co., 800 No. Clark St., Dept. 9433, Chicago

LEARN WATCHMAKING AND ENGRAVING



BY OUR PROFIT-SHARING PLAN OUR GRADUATES SUCCEED

One of our Iowa students started in a very small way—now doing over \$20,000 a year. Another in Wisconsin, over \$10,000 the first year. Day or night classes. Call or write for FREE BOOK.

Chicago School of Watchmaking, Dept. 7891, 155 N. Clark St., CHICAGO

Don't Envy The Plumber—BE ONE!

\$11.00—\$16.00 PER DAY and work EVERY day, in the Plumber's shops. LEARN IN 8 to 12 WEEKS without previous experience.

If you are making less than \$60.00 a week you owe it to yourself to investigate. Get FREE catalog that tells in pictures and words how we teach this trade. Special rates now.

UNIVERSAL PLUMBING SCHOOL, 2030 Trest Avenue, KANSAS CITY, MO.



CHARLES ATLAS
As He Is Today

FREE-

the **BOOK** that has shown **20,000** others the way to **BIG MUSCLES!**

Reveals the secrets that won me the title of "The World's Most Perfectly Developed Man." . . . Tells how YOU can win a handsome, healthy, HUSKY body—my quick Dynamic-Tension way!

—By **CHARLES ATLAS**

Holder of the Title!

"The World's Most Perfectly Developed Man"

JUST jot down your name and address on the coupon below, mail it to me—and I'll send you absolutely free of charge a copy of my big new book.

Then read the fascinating story of how I take underdeveloped, no-muscle men of all ages and give them big, powerful muscles, increased measurements, amazing strength and endurance—all in a few minutes of leisure time daily at home.

Easy My Way

No tiring apparatus my way—my natural Dynamic-Tension method does the work. No pills, "rays," fussy dieting, or other unnatural "schemes." In my free book I explain the principles of Dynamic-Tension that I discovered and used to build myself up from a 97-lb. WEAKLING to the CHAMPION of them all—"The World's Most Perfectly Developed Man."

I've helped thousands of other men, youngsters and oldsters, fat and skinny. Some were weak, run-down specimens that looked like scarecrows before I

showed them my QUICK way to add weight, get smooth, even layers of powerful muscle and the handsome, evenly-balanced proportions that you see in my own photos.

PROOF That You Can Be This NEW MAN

Now I'll give YOU the PROOF in only 7 DAYS that I can turn you, too, into an "Atlas Champion"—make a NEW MAN of you—give you a handsome, HUSKY BODY, give you big, POWERFUL MUSCLES, put on POUNDS of firm flesh, or if you are fat pare you down to FIGHTING TRIM.

And with this NEW FIGURE I'll give you NEW HEALTH—the thorough-and-through health that rids you of constipation, pimples, skin blotches and that half-alive, played-out feeling that does you out of the good times and the good things of life.

Edition Limited—Send for Free Book at Once

Why be only 50% of the man you can be? Join the regiment of Atlas Champions that stretches clear across the United States. Send NOW for a free copy of my new book containing scores of pictures of myself and the others who have used my secret methods. Then become the NEW MAN I'll prove you CAN be. Don't delay—mail the coupon NOW for YOUR free copy of my new book. Address CHARLES ATLAS, Dept. 8-J, 133 East 23rd Street, New York City.

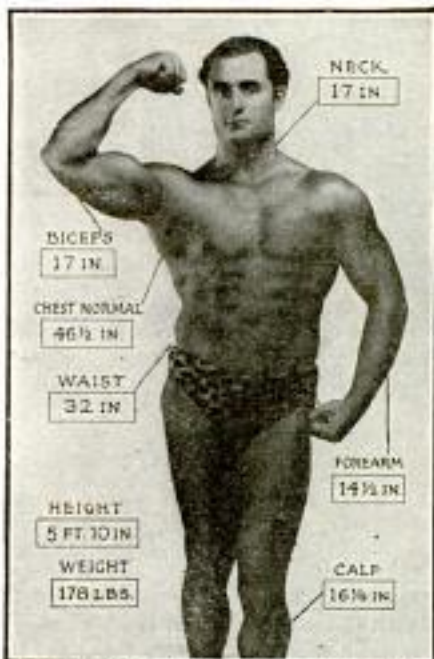

CHARLES ATLAS, Dept. 8-J
133 East 23rd Street, New York City

Send me a free copy of your book "Everlasting Health and Strength" that shows how I can win big muscles and a handsome, healthy body. Mail to:

Name.....
(Please write plainly)

Address.....

City.....State.....

TRAIN

for a big-pay job in the automobile industry

A few weeks of home study will fit you for a big-pay job selling automobiles. Thousands of men have proved the value of the Chrysler Motors course in automobile selling that is now available to you at one-third the cost you would ordinarily pay.

The automobile industry needs thousands of trained men. Men who have mastered the sound principles of successful automobile salesmanship. Men who have the foresight to prepare now for the opportunities sure to come in the months and years ahead.

Decide now to avail yourself of the Chrysler Motors training that thousands of successful men have found so helpful and profitable. Write for complete details.

Sales Educational Dept.
CHRYSLER CORPORATION
Detroit, Michigan

A-1

I am interested in your sales training course. Send further information.

Name _____

Street Address _____

City _____ State _____



High School Course in 2 Years

This simplified, complete High School Course, specially prepared for home study by leading professors, meets all requirements for entrance to college, business, and leading professions.

20 Other Courses

Over 200 noted Engineers, Business Men, and Educators helped prepare the special instruction which you need for success. No matter what your inclinations may be, you can't hope to succeed without specialized training. Let us give you the practical training you need.

without specialized training. Let us give you the practical training you need.

American School
Drexel Ave. and 58th St.
Dept. H-647, Chicago

Money Back When You Finish If Not Satisfied

American School, Dept. H-647, Drexel Ave. and 58th St., Chicago

Send me full information on the subject checked and how you will help me win success in that line.

-Architect
-Building Contractor
-Automobile Engineer
-Civil Engineer
-Structural Engineer
-Business Manager
-C. P. A. & Auditor
-Bookkeeper

-Electrical Engineer
-General Education
-Lawyer
-Mach. Shop Practice
-Mechanical Engineer
-Steam Engineer
-Draftsman & Designer
-High School Graduate

Name _____ Age _____

St. and No. _____

Town _____ State _____

Amazing! Perfected!
NEW HALF SOLES 9¢ a Pair

Pat. Appl. For

Spreads Like Butter
Wears Like Leather

Satisfaction Guaranteed. Write now for territory and Free Sample. We're sure it will make you big money.

PAYS AGENTS UP TO \$42 DAILY

Savazole—"Plastic Leather"—Spread it on shoes in a minute with old knife. Dries hard and smooth over night. Write today for Free Sample. Rebuilds worn heels, rubbers, and over 1000 other articles.

SAMPLE FREE!

Rush Name and Address for Free Sample and money making records of men and women earning up to \$42.00 daily. Everybody a prospect! Men, women, especially children. Without experience—in spare time—you can enjoy profits like Lewis of Kansas. He made \$30.10 his first morning. Now he orders in 1,000 lots. Thousands are cleaning up with this amazing specialty.

THE PERFECT MFG. CO.
CINCINNATI, OHIO
X-506 DAYLIGHT BLDG.

Avoid substitutes—only SAVAZOLE has the Double Action Process

**New Kind Of
Can
Opener**

Works Like Magic!

AGENTS
Men and Women have made up to \$6 and \$8 in an hour, full or spare time. Big, worthwhile commissions on every sale. Exclusive Territories. Send quick for FREE TEST Offer.

At last! An automatic, simple little can opening machine for the home. This revolutionary invention in only a few short months has banished old can openers from over 100,000 kitchens. And no wonder! Imagine an amazing, lifetime device that holds the can and cuts out the top leaving can rim sleek, smooth and clean. Just turn a crank, that's all. Approved by Good Housekeeping Inst., Modern Housewife, etc. Write today for special introductory advertising offer.

Central States Mfg. Co., Dept. L-705
4500 Mary Ave., St. Louis, Mo.

NERVES?

Are You Always Excited? Fatigued? Worried? Gloomy? Possessive? Constipation, indigestion, cold sweats, dizzy spells and headaches are caused by NERVE EXHAUSTION. Drugs, tonics and medicines cannot help weak, sick nerves! Learn how to regain Vigor, Calmness and Self-Confidence. Send 25c for this amazing book.

RICHARD BLACKSTONE, N-472 FLATIRON BUILDING, N. Y. C.

OIL HEAT
AT AMAZING LOW COST

LACO

Listed as Standard by Underwriters Laboratories

It's Like Magic—This Amazing Discovery of Science—the Laco Mineral Wick Oil Burner has brought the cost of heating oil within the income of all—that made oil as cheap as burning coal, it ended smoke, soot, and grease. Now will burn either oil or gas. Laco is quickly and easily installed in any type of heating system. 26 Models. Requires little service. Automatic. Safe. Economical. Now sold at startling low prices.

DEALERS WANTED QUICK

Need! Don't pass up this opportunity to cash in on the fastest growing industry in America. Enjoy the BIG Sales and BIG Income that other Laco dealers are already getting. \$3,000 to \$50,000 a year. No large investment required. Sell either oil or gas heat. Every home a prospect! Write today for our SPECIAL DEALER OFFER. Wonderful opportunity for large income.

LACO OIL BURNER CO., Dept. 147, GRISWOLD, IOWA, U. S. A.

Laco Patented Mineral Wick (with removable chamber) that changes oil into gas, also will burn manufactured or natural gas.

McSweeney's Easy Way to a New Job at Big Pay.



J. H. McSWEENEY

McSweeney Training makes you independent of hard times. There always is a demand for trained men. McSweeney teaches trades that never will be replaced by mechanical equipment. Easily and quickly you learn all about Automotive Mechanics and General Electricity. Never was opportunity greater for the man who knows how.

Eight to Twelve Weeks—Then a job that should pay from \$40 to \$100 a week, in the automotive or electrical field. Get out of the low-pay class before electricity takes your job.

No Books—No Lessons

In my shops we use tools instead of books. Students work on live equipment. Fifty thousand men can attest to the advantage of having my practical training.

Guarantee of Satisfaction

I agree to train you until you are permanently placed in a good job at good pay if you are over sixteen years of age.

ELECTRICITY | AUTOMOTIVE

Learn to control, master, and apply that magical juice which rules the universe. Be a McSweeney-Trained electrical man.

Every motor propelled vehicle—automobile, truck, tractor—requires constant service. The fewer cars sold, the more service required.

Mail This Coupon for FREE Book

J. H. McSweeney, Pres.,
Dept. C-10-9, Chester at 30th St., Cleveland, Ohio.
Without cost or obligation, send me your big FREE book and full details of your special tuition offer. (Check school interested in.) Electrical. Automotive.

Name.....

Street.....

Town..... State..... Age.....

Not a Correspondence Course—No Books—No Lessons



WANT A STEADY JOB?



MANY OTHER U. S. GOVERNMENT POSITIONS STEADY WORK

MEN—BOYS 18 TO 50

Short Hours Pleasant Work
Rapid Advancement Permanent Employment
Long Vacation with Pay

Mail Coupon Now. Act at Once.

DO IT TODAY. TOMORROW
YOU MAY FORGET.

FRANKLIN INSTITUTE, Dept. G174, Rochester, N.Y.

Book to me entirely free of charge; 32 page book, with list of U. S. Gov't Jobs obtainable and particulars, telling how to get the job here checked.

... Railway Postal Clerk	(\$1900-\$2700)
... Post Office Clerk	(\$1700-\$2300)
... City Mail Carrier	(\$1700-\$2100)
... Rural Mail Carrier	(\$2100-\$3400)
... Prohibition Agent	(\$2300-\$2800)
... Inspector of Customs	(\$2100-\$3300)
... Immigrant Inspector	(\$2100-\$3000)

Name.....

Address.....

When writing to advertisers please mention Popular Mechanics

DRAFTING

BOOKS SENT FREE!

ON APPROVAL

For Beginners

Written, so you can understand every word, by 22 famous engineers and architects. Deluxe flexible binding, nearly 2,000 pages, 1546 blue-prints, charts and diagrams; prepares you for a good drafting job in mechanical or architectural lines. Sent for 10 days' free use if you mail coupon immediately.



5 Volumes New 1931 Edition
Only 15 minutes a day with these WONDER BOOKS will prepare you for a good drafting job in less than a year. Mechanical and architectural drafting from simple straight lines to important complex plans. A step at a time! Built especially for beginners, for men with only grammar schooling. Drafting room practice. PLUS ENGINEERING, made easy and clear. Includes complete course in blue-print reading.

Big Field Big Demand Big Pay
Competent draftsmen are urgently needed right now in all building and manufacturing lines at \$50.00 to \$100.00 a week. That's just the beginning—FOR DRAFTSMEN HAVE THE BEST CHANCES FOR ADVANCEMENT. Pleasant, fascinating work, easy to learn and do. Learn quickly with these books—send coupon for a set FREE and see for yourself.

A year's consulting membership in the American Technical Society now gives free to all readers of this famous cyclopedia of drafting. Many say that it is worth more than the cost of the books.

Complete set of drawing instruments if you send for these drafting books NOW. These instruments are made of the finest of German silver, are absolutely accurate and are packed in velvet lined leatherette pocket case. Real \$10 value, but free to you with these books.

AMERICAN TECHNICAL SOCIETY
Dept. D-619, Drexel at 58th St., Chicago, Ill.

American Technical Society, Dept. D-619, Drexel at 58th St., Chicago, Ill.
Send for 10 days' free use New 5 volume set of drafting. I will pay the few cents delivery charges. If I wish, I may return books in 10 days and owe you nothing but if I decide to keep them, I will send \$2.00 after 10 days, then only \$3.00 a month, until \$19.50, the special introductory price, is paid. Send 1931 edition and include drawing instruments.

Name.....

Address.....

Employer.....

Address.....

AUTO

BOOKS SENT FREE!

on approval. Just mail the coupon and we'll send you a set of these remarkable auto books, just off the press. Whether you are a mechanic or helper, expert or apprentice, auto owner or driver, if you're interested in knowing all about automobile mechanisms, then take advantage of this Free Offer.

DON'T SEND A PENNY!

A better job—in the gigantic auto industry. BIGGER PAY—a chance to go into business for yourself and get a share of the huge profits are waiting for any man who even half tries to improve himself. Learn Auto Engineering with these wonder books a new way—without studying or memorizing. Simply use the JIFFY INDEX to look up the answer to any auto problem. Built by eleven of America's greatest automobile engineers, and written in simple language so you can understand it!

[FREE! Privilege of consulting Automobile Engineers of American Technical Society for one year without cost if you mail coupon immediately.]

AMERICAN TECHNICAL SOCIETY
Drexel Avenue & 58th Street
Dept. A-619, Chicago, Ill.

CAN YOU FIX IT?

These wonder books tell step by step HOW to take out "play" in differential—to kill the shimmy in steering—to set TIMING—how to put your finger instantly on engine trouble and then the quick expert way to FIX it. Front wheel drives fully covered. Equal to a complete trade course at less than a fourth the cost.

6 Big Volumes 1931 Edition

2500 pages, 2000 illustrations, wiring diagrams, etc., including Aviatiles Motors. Deluxe edition, gold-stamped flexible binding.

American Technical Society, Dept. A-619, Drexel Ave. & 58th St., Chicago, Ill.
I would like to see the new 6-volume, 1931 edition of your AUTO BOOKS. I will pay the few cents delivery charges only, but if I choose to, I may return them express collect. If after 10 days use I prefer to keep them, I will send you \$2 and pay the balance at the rate of only \$3 a month, until \$24.50 is paid. Please include free consulting membership as per your offer above.

Name.....

Address.....

Employer's Name.....

Employer's Address.....

Up To \$50 A DAY With Tiny 'PHONE "MIKE"



Agents are cleaning up everywhere with a phone attachment that looks like a radio mike. Absolutely controls all sounds in your phone—ends the roar that keeps you from hearing clearly; makes it easy to hear even if your phone is in the noisiest factory. Yet also assures privacy—talk unheard, with people within five feet of you!

Write and find out how agents report earnings up to \$50 a day and even more with this tiny mechanical mystery. Big quantity orders from stores, offices, etc.; amazing sales plus double calls and sales. Write for FREE introductory offer and amazing Sales Guarantee.

STANDARD APPLIANCES, INC., Dept. M-90, 21W. Elm St., Chicago, Ill.

OPPORTUNITIES IN TRAFFIC MANAGEMENT

Conditions point to an unusual demand for trained traffic men, by transportation companies and industrial organizations. Men with scientific traffic training effect big savings for their firms—command big salaries.

Three Detroit Firms Pay Their Traffic Managers Over \$20,000 a Year

Prepare at home in your spare time, under supervision of traffic experts. Low cost; easy terms. "I would not take \$50,000 for my knowledge of traffic management," writes H. E. Stiffler, Traffic Manager, Marion Steam Shovel Co., Marion, Ohio. Send now for 64-page book—

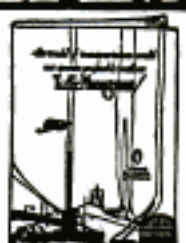

FREE!
LaSalle Extension University, Dept. 964-T, Chicago

ELECTRICAL ENGINEERING

A CONCISE, comprehensive course for men of limited time, complete in one year. Mathematics, engineering drawing, shop-work. Students construct motors, install wiring, test electrical machinery. Buildings fireproof. 33 years' successful experience. Catalog on request.



BLISS ELECTRICAL SCHOOL

119 Takoma Ave., Washington, D. C.

1000 Positions Open



Nation-wide call for trained men in hotels, clubs, restaurants, schools, colleges, hospitals and institutions. Fast experience proved unnecessary. Our Personal Coaching Plan adapts the training to your needs at home in spare time. We have put hundreds of graduates in touch with positions. Write for Free Book, "Your Big Opportunity." LEWIS HOTEL TRAINING SCHOOLS

Room DP-333 Washington, D. C.

FREE! 240-page Catalog of Technical and Business Books—1500 Titles—All Fields covered from Aviation to Welding Practice. Mention this ad and get a free copy.
McGraw-Hill Book Co. Inc., 370 Seventh Ave., New York

LEARN WATCHMAKING

and become independent. We help you secure a position. Easy to learn. Send for FREE CATALOG.
ST. LOUIS WATCHMAKING SCHOOL Dept. 5, ST. LOUIS, MO.



AN EASY WAY TO SHAPE your NOSE

Anita Nose Adjuster shapes flesh and cartilage—quickly, safely, painlessly, while you sleep or work. Lasting results. Gold Medal Winner. Doctors praise it. 87,000 users. Write today for FREE BOOKLET.

ANITA INSTITUTE, K-12 Anita Bldg., Newark, N. J.

When writing to advertisers please mention Popular Mechanics

FREE THE *Gibson* BOOK



Shows you the way to popularity, pleasure, bigger income with an easy playing Gibson banjo, guitar, mandolin or ukulele. If no teacher in your town ask about Reser's Correspondence Course.

FREE TRIAL; EASY PAYMENTS on any Gibson. Send for your book now.

Harry Reser, Chief of the Cleopatra Club Eskimos, premier banjo soloist and teacher.

Gibson Inc.
903 PARSONS STREET, KALAMAZOO, MICH.

PREVENT FATAL NIGHT CRASHES

And Get In On This **BIG PROFIT** Opportunity!



An amazing "two-beam" light invented by a famous light engineer now gives drivers complete safety at night. Road is bright as day for 1000 feet—yet secret principle absolutely prevents glare! Kinney of Chicago made \$96 in one day! Big territories—a fat share of 23 million prospects. Write today for full facts about this amazing safety Speedlight and find out about wonderful money-making sales proposition.

SPEEDLIGHT COMPANY
1731 Belmont Ave., Dept. 10-M Chicago, Ill.

67,000 BEAM CANDLE POWER
ONE FIFTH OF MILE OF LIGHT
NO GLARE

SPEEDLIGHT BEAM
LUMEN BEAM

Learn Watchwork, Jewelrywork and Engraving A fine trade commanding a good salary, and your services always in demand. Address **HOROLOGICAL**, Dept. P, Bradley Institute, PEORIA, ILLINOIS, for our latest catalog.

Who STAMMER?

I overcome my own stammering. Let me help you. My new, free book tells how. You, too, can overcome your speech defects and lead a normal, happy and successful life. Write today.

ROBT. E. CARD, 12950 Woodward Ave., Detroit, Mich.

Free Book

BE AN OIL EXPERT!

New, easy, practical way to learn at home in spare time. Geology, Drilling Methods, Pipe Line Transportation, Refining and Marketing. Write Today! **FREE Book!**

PETROLEUM ENGINEERING UNIVERSITY, Dept. 229, FORT WAYNE, IND.

Don't PEEL POTATOES

Agents!

This is brand new! Going like wild-fire! Offers a real chance for \$100 a week. Spare-time and full-time sales plans offered. Jump in on the ground floor! Write quick for big-money plans and Free Outfit offer.



An amazing new automatic invention now makes potatoes peel themselves! No more paring knives! No cut fingers! No mess, muss or waste! Here's something every woman understands and wants the instant she even hears about it! A mechanical marvel, almost incredibly small and simple, yet does more than ten pairs of hands! Peels the biggest potato in only a few seconds at the mere turn of a crank! Costs little more than a couple of good paring knives. Pays for itself many times over in saving on potatoes. Test it yourself at once. Write now. Ask quick for Introductory Offer.

GUARANTY PRODUCTS CO.
Dept. M-81, Francis Bldg.
Washington at 16th St., St. Louis, Mo.



See How Easy You Can Learn HYPNOTISM

TRY FREE 5 DAYS!

SEE for yourself how easy it is to master the great science of Hypnotism—how quickly you can learn to bend people to your will—banish fear, worry and opposition—increase your earnings—and force others to give you the recognition, power, and admiration you deserve. I'll show you how to use this great force to help you master every situation or **The Five Day Trial is FREE!**

In just a few hours I'll teach you the hidden secrets of Hypnotism—the methods used by the great operators—the amazing things you can accomplish once you understand this mighty power. You can use it to overcome obstacles, achieve your fondest ambitions and become MASTER of yourself, friends and acquaintances—either sex. Now you can quit being just one of the crowd—now you need not be unpopular, lonesome or unhappy a minute longer. Through this strange power you can learn how to stand out—dominate—to make your life what you want it to be!

In his startling NEW book, *The Science of Hypnotism*, the world famous hypnotist—Prof. L. E. Young—reveals the most carefully guarded secrets of this fascinating subject. He not only explains the methods of noted hypnotists, step by step—but tells clearly all about the nine stages of Hypnotism. The Hypnotic Mirror, Mental Telegraph, how to select your subjects, magnetic healing, methods of hypnotizing, how to wake the subject, how to make money out of hypnotism!

Try 5 Days FREE—
Send No Money

Be confident now we that Prof. Young and his great book will quickly teach you the science of Hypnotism, that we will send you a copy without one cent in advance! Simply clip and mail the coupon below. When the book arrives pay the postman the special low price of \$2.00 plus low cost postage. Then test the powers of Hypnotism 5 days! If not amazed and delighted, return the book and money will be refunded at once.

FRANKLIN PUBLISHING CO.,
Dept. L-70, 800 No. Clark Street, Chicago, Illinois

Mysteries of Hypnotism Revealed

How to Hypnotize at a Glance
Susceptible Subjects
How to Hypnotize by Telephone
How to Give an Entertainment
How to Make Others Obey You
Overcoming Bad Habits
How to Do Dozens of Hypnotic Feats
Use of Hypnotism in Operations



Franklin Publishing Co., Dept. L-70,
800 No. Clark St., Chicago, Ill.

Please send me your amazing new book—*The Science of Hypnotism*—by Prof. Young. When book arrives, I'll pay the postman only \$2.00 plus postage. If I am not satisfied after 5 days' trial, I may return the book and you are to refund my money.

Name.....
Street and No.....
Town..... State.....

If you are likely to be out when postman calls, send \$2.50 with coupon and we'll pay delivery charges. Customers outside U. S. must send cash with order.

Here it is Men!
MARVELOUS
NEW SHAVING
INVENTION

Sent on 30 Days' Trial

NOW get the Sweetest, Keenest, Happiest Shaves of your life without a pull, scratch or burn—Smooth as a feather!

Just what you have wanted for years! . . . a device that takes all the agony, grief and grouch out of shaving. Makes any blade so keen you scarcely feel it. Shaves are velvety smooth. Toughest whiskers seem to just melt away—all your shaving troubles GONE FOREVER! You'll get the thrill of your life—you'll wonder how such magic results are possible. And no more blades to buy! Mail coupon below for 30-day trial—no obligation.

\$66 IN ONE DAY!

Jesse Davis made \$66 in one day. Agents making big money everywhere. Just place device on Free Trial. Sell it—self! Check square at bottom of coupon for money-making plan.

I. L. RHODES

1418 Pendleton Ave. Dept. M-4526 St. Louis, Mo.

I. L. Rhodes,
 1418 Pendleton Ave., Dept. M-4526,
 St. Louis, Mo.

Rush full details without obligation.

Name.....

Address.....

City..... State.....

() Place X in square for money-making plan.

Write and Speak **MASTERLY ENGLISH**



Learn correct English with Sterling Cody's new invention. No rote to memorize. Like a fascinating game. Speeding study. 15 minutes each day, quickly gives you command of English. Send for free booklet "How You Can Master Good English in 15 Minutes a Day." Write today.

Sterling Cody School of English, 59 Seaside Bldg., Rochester, N. Y.

BIG Money IN ELECTRIC REFRIGERATION

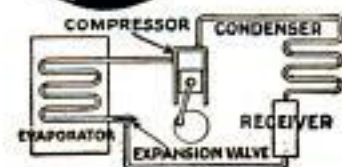

America's biggest new industry — Electric Refrigeration—needs men to fill jobs paying \$50 to \$75 a week or more. General Motors, General Electric, and others investing billions. Millions of machines being sold to homes, theaters, factories, stores, etc. Many jobs open

in production, installation, service and sales which ordinary mechanics can't fill without special training in electric refrigeration.

EASY TO LEARN AT HOME

Learning electric refrigeration is now amazingly simple thru a new easy home training praised by authorities. Endorsed by Servel, Kelvinator, and other leading refrigerator manufacturers. GET FREE BOOK. Utilities Engineering Institute, 4403 Sheridan Road, Dept. 191, Chicago.

Utilities Engineering Institute
 4403 Sheridan Road, Dept. 191, Chicago, Ill.

FREE!

Without obligation, send me valuable free book.

Name.....

Address.....

City..... State.....

30 DAYS FREE TRIAL
 Great new 10 TUBE LAFAYETTE SUPERHET \$52.50

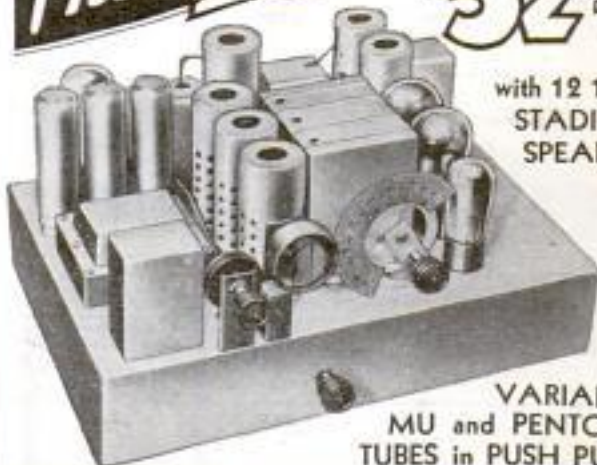

with 12 1/2" STADIUM SPEAKER

VARIABLE MU and PENTODE TUBES in PUSH PULL

FREE CATALOG

Write for new 1932 wholesale Radio Catalog. Everything new in radio at lowest wholesale prices. Guaranteed sets, tubes, speakers, replacement parts, etc.

NEW 1932 EDITION

Radio's newest and most powerful receiver. 10-Tube Lafayette Super-Heterodyne. Brand new Variable-Mu and Pentode Tubes in Push Pull. Brilliant reception and performance. Sold direct to you at lowest wholesale prices. 30 Days' Free Trial in your own home. Guaranteed by ten million dollar bonding company. Send for complete information and illustrations of beautiful cabinet models.

WHOLESALE RADIO SERVICE CO.
 38 Vesey St., Dept. J-11, New York

RADIO BLUEPRINTS

The blueprints below include the best of Popular Mechanics tested circuits. When ordering, simply quote the numbers of blueprints desired and inclose proper amount addressed to Popular Mechanics Magazine, Radio Dept., 200 E. Ontario St., Chicago, Ill. Magazines containing full descriptions of the circuits can be obtained. Send 25 cents for each magazine desired, giving date of publication.

- No. 139, Simple Television Receiver. . . Dec. 1928. . . 25c
- No. 140, Power Amplifier and B-Supply for Television. Jan. 1929. . . 25c
- No. 142, Two-Tube Screen-Grid Short-Wave Adapter. Mar. 1929. . . 25c
- No. 145, One-tube S-G Set for Beginners Nov. 1929. . . 25c
- No. 146, Adjustable B-Eliminator. . . Nov. 1929. . . 25c
- No. 148, Adding Audio Stages to S. G. Receiver. Dec. 1929. . . 25c
- No. 151, Beginners Low Power S-W Transmitter. June 1930. . . 25c
- No. 152, Portable Radio Amplifier for the Deaf. July 1930. . . 25c
- No. 153, Low Cost Code and Phone Transmitter. Sept. 1930. . . 25c
- No. 154, A. C. Screen-Grid DX Tuner Oct. 1930. . . 25c
- No. 155, Four-Tube D-X Receiver. . . Nov. 1930. . . 25c
- No. 157, Building a Light-Sensitive Relay. Dec. 1930. . . 25c
- No. 158, High-Power Supply for Amateur Transmitters. Jan. 1931. . . 25c
- No. 159, Portable S-W Transmitter. Feb. and March 1931. . . 25c
- No. 160, Building A.C. Midget Receiver. Mar. and Apr. 1931. . . 25c
- No. 161, Building Auto Receiver for 2-volt Tubes. Apr. and May 1931. . . 25c
- No. 162, Battery Eliminator for 110-volt D-C. Supply. June 1931. . . 25c
- No. 163, Two-Tube A. C. Short-Wave Receiver. June 1931. . . 25c
- No. 165, Pre-Amplifier for Home Recording. Sept. 1931. . . 25c
- No. 166, Building Stenotube Superheterodyne. Sept. 1931. . . 25c

Material Lists for any of the above instruments will be mailed free upon application.

When writing please mention Popular Mechanics

Learn to Mount Specimens like These



LEARN to mount and stuff all kinds of game, animals, birds, fish—tan furs and skins, make beautiful rugs, robes, etc. You can learn *easily and quickly* during your spare time by mail. *Great sport and lots of fun.* Lessons are easy and intensely interesting. Latest museum methods. This school is 20 years old, high class and reliable, and has 75,000 graduates. *Success guaranteed.* Don't delay, but start to learn this extremely fascinating art NOW.

FREE

Beautifully illustrated book, "How to Mount Game." Explains the secrets of taxidermy. Dozens of photos of mounted specimens. Tells how you can learn this great art, no longer a secret, right in your own home during *spare time*. Tells how to

become a taxidermy artist, how to save your own splendid trophies, how to beautify and decorate your room and home with nature's choicest art. Tells how young men and boys can make the **BIGGEST MONEY** from their spare time. Don't delay. Clip coupon now. Send **TODAY** for this Free Book.

Northwestern School of Taxidermy, 3376 Elwood Bldg., Omaha, Nebraska

Make Big Money—

Taxidermy is the most profitable OF ALL spare time work. Sell your mounted specimens. Mount trophies for your friends, hunters, trappers and fishermen. Have a side business of your own. So independent. Have plenty of spending money—for athletic goods, radio, books, traps, and for vacations. Here is your opportunity. Don't delay. Send the coupon right NOW. State your AGE.

Free Book Coupon

Northwestern School of Taxidermy
3376 Elwood Bldg., Omaha, Nebr.

Send me, absolutely free, your illustrated book, "How to Mount Game." Also tell me how I may learn to be an expert taxidermist easily and quickly by mail. No obligation.

Name _____ Age _____

Address _____



Find out how **EASY** it is to own *The New*
ENCYCLOPAEDIA BRITANNICA

Write for **FREE** Booklet

Encyclopaedia Britannica, Inc., 342 Madison Ave., New York

Wireless (Radio)

and Morse telegraphy taught thoroughly. School, oldest and largest; endorsed by Telegraph, Radio, Railway and Government officials. Unusual opportunities. Expenses low—can earn part. Course free.
DODGE INSTITUTE, Jones St., Valparaiso, Indiana.

LEARN CARTOONING

AT HOME DURING SPARE TIME

with the course that has trained **HUNDREDS** of beginners successfully. The Landon Picture Chart Method of teaching **ORIGINAL** drawing by mail makes cartooning easy to learn. This school is a Member of The National Home Study Council. Write today for sample picture chart to **TEST YOUR ABILITY** and examples of the work of successful students now earning from \$30 to \$200 and more per week. Enclose 6c in stamps and **STATE YOUR AGE.**

THE LANDON SCHOOL, 2838 National Bldg., Cleveland, Ohio



AUTO MECHANICS

Learn easily now to be independent of hard times. You need not fear lay-offs or unemployment if you are a McSweeney trained man. Specialize! Learn a trade that machinery will not replace. Learn Auto Mechanics by the McSweeney Shop-Plan method of training men for Big-Pay Jobs.

Write for Big Free Book and Special Tuition Offer

EASILY LEARNED IN 8 WEEKS
NO BOOKS—NO LESSONS
NOT A CORRESPONDENCE COURSE

McSWEENEY
SCHOOLS
Dept. C-4-1

GET INTO Aviation NOW

All indications point to a spectacular new "boom" in aviation. Men high in aviation circles are preparing for it now. Clarence M. Young, Assistant Secretary of Commerce in charge of Aeronautics, told President Hoover that "there appears smooth sailing ahead for the industry" and that it "shall be of mighty importance in restoring business stability and prosperity to our nation. The result will be added returns for aircraft builders and manufacturers of accessories used in airplanes."

**Experts Predict
New Wave of
Prosperity**

Don't Miss This Opportunity

Naturally this huge expansion program will create a shortage of man power. Inside the next few months aviation will again be crying for trained men. Will you be ready to step into a big-pay aviation job when the call comes? You will be if you prepare NOW. Just give me an hour a day and I will train you quickly for any of the 40 Ground Jobs that aviation offers. Get the facts in my big Free Book that explains my Special Tuition Offer and how I help you get a good job as soon as you are qualified. No cost or obligation. Mail coupon now.



Major R. L. Rockwell

MAIL

THIS

Major Robt. L. Rockwell,
Dayton School of Aviation,
Desk 19, Dayton, Ohio.

Dear Major: I'd sure like to be prepared when the next boom in Aviation arrives. Please rush your big Free Aviation Book and your special tuition and employment offer.

Name.....

Address.....

Oh! You Misfit Wake Up!—Be a Real Man



STRONGFORT
Man Builder

You know the truth if no one else does—you know what you lack—the vitality you need. You may hide it from others, but you can't hide it from yourself! Are you a victim of any habit that you want to get rid of? Have you a spark of ambition left to be the man you ought to be? Wake up and be a man, not a misfit!

Think of Your Future

How about it? Are you fit?—are you qualified?—do you feel it in your soul? Are others getting by you, doing more,—getting more than you are? I know what is dragging you down, what is keeping you down. I have helped thousands; physically, mentally, morally. I will help you; will make you the kind of young man that is a credit to any community. I will revitalize you so that your progress in any undertaking will be easier.

STRONGFORTISM MAKES YOU MANLY

Through my system of Strongfortism, I build your body up to the symmetrical proportions Nature intended you to possess. You will gain in vigor; your muscular power will increase in flexibility and strength; your nervous system will be fortified to renew its energy.

Just be frank and above board. Tell me your troubles.

Send for My Free Book

—Send This Coupon—

FREE CONFIDENTIAL CONSULTATION

Mr. Lionel Strongfort, Strongfort Institute, Dept. 134, Newark, N. J.—Please send me absolutely free my copy of your book, "Promotion and Conservation of Health, Strength and Mental Energy," in which I am interested.

My Address is.....

Name.....

Age.....

Street.....

City.....

State.....



FREE

Book Gives You Valuable Information!
Should be read by every man from 16 to 60.

Book is **Yours** Asking!

No cost whatsoever. No conditions. Just reply promptly. This offer is open to all who speak up now. Men trained by me in practical drafting work at home are making \$60, \$70 and even \$100 per week. Get busy. Be ready when your turn comes. Get your Drafting Tools and Drafting Table just as soon as you begin training. Write today for the New Free Book—"My Pay-Raising Plan."

ENGINEER DOBE,
1921 Lawrence Avenue, Div. 13-56, Chicago

Not a student's outfit but an imported set of professional drafting tools; you get them all when I train you.

Government Positions

Clerk Carriers, Rural Carriers, Railway Mail Clerks, Postmasters, Department Clerks, and many others. Splendid salaries, easy work, vacation with pay. Only common school education required. Examinations often. 44,817 appointed last year. Send for our Civil Service Catalog No. 6. **COLUMBIAN CORRESPONDENCE COLLEGE, Washington, D. C.**

Wrestling Book FREE



Learn wrestling at home from former world's champion Farmer Burns and Frank Gotch. Free book tells how. Secret holds, blocks, tricks revealed. Be strong, healthy. Handle big men easily. Write for free book. Haste now. Farmer Burns School 3376 Railway Bldg., Omaha, Neb.

A PRACTICAL COURSE IN MECHANICAL DRAWING

By WM. F. WILLARD

An ideal book for home study. Each exercise is clinched in the mind of the student by practical application to every day practice. 180 Pages. 157 Drawings. Cloth. Price \$1.00 Postpaid.

POPULAR MECHANICS PRESS 200 E. Ontario St. CHICAGO

START to PLAY Very First Day!

Pleasant,
Easy
Lessons
Show You
How!



Extra Money—Hosts of Friends—Loads of Fun Within Your Reach

HAPPY DAYS are in store for you if you will only act on this suggestion! Cheery evenings playing catchy music alone or with sweetheart, wife or sister; proud moments as center of interest at gatherings; nights of joy making \$5 to \$25 for work that is "play."

The Deagan Xyloimba is your opportunity! Wonderful for home, in demand at dances and entertainments, get easiest of all instruments to play. No teacher necessary—you actually play simple melodies the very first day even if you cannot read a note of music right now!

Earns \$60 a Week—Ralph Smith, Chicago, says: "Played 20 minutes at wedding. Received \$20." L. E. Hallmann, Reading, Pa., writes: "Made \$300 in 5 weeks, spare time. Had never played instrument before."

Send for Big Free Book! Our new book tells all about the delightful lessons furnished with each instrument, the five-day trial that removes risk, the wonderful Deagan easy-payment plan. No obligation—simply fill in and mail the coupon.

J. C. Deagan, Inc., Dept. 4456, 1770 Berteau Avenue, Chicago
Send me, without obligation, full details of Free Trial offer and easy-payment plan of the Deagan Xyloimba.

Name.....

Address.....

When writing please mention Popular Mechanics

NEED NEW TIRES?

Replace with our
**GOODYEAR-GOODRICH
FIRESTONE and OTHER TIRES**
at
'Chicken Feed' Prices

12 MONTHS SERVICE Guaranteed

Why Worry about Tire Trouble and Expense?

Sensational new treatment gives these reconconditioned tires new resiliency—amazing roadability. Why buy ordinary reconstructed tires when you can get these famous tires at such rock bottom prices!

SALOON TIRES

Size	Rim	Tires	Tubes
28x4-40-21**		\$2.30	\$1.10
28x4-50-20**		.40	1.10
28x4-50-21**		.45	1.10
28x4-70-19**		.90	1.10
28x4-80-21**		.90	1.10
28x5-00-19**		.95	1.10
28x5-00-20**		.95	1.10
28x5-20-19**		.95	1.10
28x5-20-20**		.95	1.10
28x5-20-21**		.95	1.10
28x5-20-22**		.95	1.10
28x5-20-23**		.95	1.10
28x5-20-24**		.95	1.10
28x5-20-25**		.95	1.10
28x5-20-26**		.95	1.10
28x5-20-27**		.95	1.10
28x5-20-28**		.95	1.10
28x5-20-29**		.95	1.10
28x5-20-30**		.95	1.10
28x5-20-31**		.95	1.10
28x5-20-32**		.95	1.10
28x5-20-33**		.95	1.10
28x5-20-34**		.95	1.10
28x5-20-35**		.95	1.10
28x5-20-36**		.95	1.10
28x5-20-37**		.95	1.10
28x5-20-38**		.95	1.10
28x5-20-39**		.95	1.10
28x5-20-40**		.95	1.10
28x5-20-41**		.95	1.10
28x5-20-42**		.95	1.10
28x5-20-43**		.95	1.10
28x5-20-44**		.95	1.10
28x5-20-45**		.95	1.10
28x5-20-46**		.95	1.10
28x5-20-47**		.95	1.10
28x5-20-48**		.95	1.10
28x5-20-49**		.95	1.10
28x5-20-50**		.95	1.10
28x5-20-51**		.95	1.10
28x5-20-52**		.95	1.10
28x5-20-53**		.95	1.10
28x5-20-54**		.95	1.10
28x5-20-55**		.95	1.10
28x5-20-56**		.95	1.10
28x5-20-57**		.95	1.10
28x5-20-58**		.95	1.10
28x5-20-59**		.95	1.10
28x5-20-60**		.95	1.10

Reg. CORD TIRES

Size	Tires	Tubes
28x5-00-20**	\$3.20	\$1.40
28x5-00-21**	3.30	1.45
28x5-20-20**	3.60	1.75
28x5-20-21**	3.90	1.90

All Tubes NEW Guaranteed First Quality

Send \$1.00 deposit with each tire ordered. Balance C.O.D. If you send cash in full deduct 5 per cent. You are guaranteed a year's service or replacement at half price. Order Today—Save Money.

MIDLAND TIRE & RUBBER COMPANY
Dept. 365 1000-10 W. Sixty-Third Street Chicago

SAVE UP TO 50% on your RADIO

Powerful NEW 11-TUBE SUPER-HETERODYNE

only \$57.50 COMPLETELY ASSEMBLED

AGAIN—America's famous Radio Manufacturers offer the Radio sensation of the year! A powerful, new, 11-tube Super-Heterodyne at the amazingly low price of \$57.50, completely assembled in a beautiful new Lowboy cabinet. This is just one of the startling radio bargains from the great selection illustrated in the FREE, 1932 Midwest catalog. Don't send a penny now. At our risk, entertain yourself for 30 full days absolutely FREE, then decide. You're not obligated to buy. Compare Midwest Radios with the costliest sets on the market. Convince yourself. We guarantee you 100% satisfaction. Midwest can make this daring offer only because of the excellent quality and proven performance of these new and longer distance radios. If you're looking for a powerful, 11-tube, Screen Grid, Super-Heterodyne, with real automatic volume control, pin-dot selectivity, and amazing new sensitivity—then mail the coupon below immediately for FREE trial offer, and beautiful new 1932 catalog.

Deal Direct with Factory Terms as low as \$5 down

The Midwest direct-to-customer policy makes the surprisingly low Midwest prices possible. Know what it means to have one of the latest and most powerful radios on the market—with all of the sensational new 1932 improvements in tone, clarity, selectivity—and at a price about half of what you would pay in retail stores.

Absolute guarantee of satisfaction protects you and eliminates all risk. And don't forget—you try any set you select for 30 full days ABSOLUTELY FREE, without obligation—before you buy. You must be delighted. Mail coupon for beautiful new catalog and complete details of FREE TRIAL, easy payment plan. You'll be amazed!

MIDWEST RADIO CORP.
Dept. 11 CINCINNATI, OHIO

30 DAYS FREE TRIAL

Mail this Coupon for Complete Details and Big FREE Catalog!

Midwest Radio Corp., Dept. 11, Cincinnati, Ohio.

Without obligation on my part send me your new 1932 catalog, and complete details of your liberal 30-day free trial offer. This is NOT an order.

Name.....
Address.....
Town..... State.....

Send me SPECIAL USER AGENTS PROPOSITION.

USER AGENTS

We pay you BIG MONEY just for showing your radio to friends and neighbors. Easy EXTRA MONEY! Check coupon for details.

Without obligation on my part send me your new 1932 catalog, and complete details of your liberal 30-day free trial offer. This is NOT an order.

Name.....
Address.....
Town..... State.....

Send me SPECIAL USER AGENTS PROPOSITION.

ENGINEERING ELECTRICAL-MECHANICAL-STRUCTURAL and ARCHITECTURE

INTENSIVE PRACTICAL TECHNICAL COURSES. Degree in 2 years. Diploma in 1 year. Special short courses 6 Weeks to 4 Months in Electricity, Radio, Power Plant, Electric Refrigeration, Automatic Welding, Wiring, Testing, Drafting, Welding, LOW TUITION. Expert instructors. Extensively equipped laboratories. Free life-time employment service for graduates. Part-time work while attending. Write for new free illustrated catalog giving all facts. 30th year.

FINLAY ENGINEERING COLLEGE
1001 A Indiana Avenue Kansas City, Missouri

TELEVISION CALLING FOR MEN

Operators, salesmen, service and repair men needed now. You must be trained to compete for big-pay jobs. Under my personal supervision you master Television in a few weeks, right here in my shops and practical laboratories. FREE. Get into real money—quick. Send name for illustrated new book, "Practical Television." It's free. Write today. "Sid" Noel, Pres.

First National Television, Inc., School Division, 808 Fairfax Airport, Kansas City, Kas.

SOMETHING DIFFERENT MYSTERY CIGAR LIGHTER

MAKE \$25 A DAY

Showing this scientific marvel to men. New principle of ignition. What makes it light! No flint or friction. All guaranteed. Sample with sales plan 25c. Sample gold, silver or chromium plated \$1.00. Agents, write for proposition.

NEW METHOD MFG. CO.
Desk P-9, New Method Bldg., Bradford, Pa.

The Science of Wrestling and the Art of Jiu Jitsu

By **EARLE LIEDERMAN**

An amazing exposition of this great art—224 pages, fully illustrated. Regular price \$4. Order now and save \$2. Sent on receipt of \$2, or C. O. D.

Address **EARLE LIEDERMAN, 305 Broadway, N. Y.**

The REFLECTO-GRAPH

COPY PICTURES - CARTOONS - DRAW FROM OBJECTS - THIS APPARATUS WILL HELP YOU DRAW SIMPLE TO MAKE - SEND \$1.00 FOR COMPLETE INSTRUCTIONS AND DIAGRAMS

REFLECTO
83 FAIRFIELD AVE - BRIDGEPORT - CT

Learn ADVERTISING at Home

Greater opportunities now in advertising. Learn easily and quickly in spare time. Practical work. No text books. Old established school. Low tuition—Easy terms. Send for free booklet of interesting information.

Page-Davis School of Advertising
Dept. 1356, 3601 Mich. Ave., Chicago

When writing to advertisers please mention Popular Mechanics

"There's a BIG JOB for the Trained Man in RADIO!"



STUDENTS WORKING ON OUR MODERN
TELEVISION TRANSMITTING EQUIPMENT



LEARN RADIO-TELEVISION TALKING PICTURES AT COYNE

Ten Weeks of Shop Training on Radio Equipment

Dissatisfied with your job? Not making enough money? Then let me show you how to prepare for a real job and how to make real money, in RADIO—one of the fastest growing, biggest money-making trades on earth.

Jobs Leading To Big Pay

Scores of jobs are open—jobs as Designer, Inspector and Tester—as Radio Salesman and in Service and Installation work—as Operator or Manager of a Broadcasting Station—as Wireless Operator on Ship or Airplane—with Talking Picture Theatres and Manufacturers of Sound Equipment—with Television Laboratories and Studios—fascinating jobs, offering unlimited opportunities to the Trained Man.

H. C. Lewis, Pres. **Radio Division** **Founded 1899**
COYNE ELECTRICAL SCHOOL
500 S. Paulina Street, Dept. 61-3 H Chicago, Illinois

PRACTICAL SHOP TRAINING

Come to Coyne in Chicago and prepare for these jobs the QUICK and PRACTICAL way—BY ACTUAL SHOP WORK ON ACTUAL RADIO EQUIPMENT. Some students finish the entire course in 8 weeks. The average time is only 10 weeks. But you can stay as long as you please, at no extra cost to you. No previous experience necessary.

BROADCASTING TELEVISION SOUND EQUIPMENT

In addition to the most modern Radio equipment, we have installed in our Shops a model Broadcasting Station, with sound proof Studio and modern Transmitter with 1,000 watt tubes—the Jenkins Television Transmitter with dozens of home-type Television receiving sets—and a complete Talking Picture installation for both "sound on film" and "sound on disk." We have spared no expense in our effort to make your training as Complete and Practical as possible.

Free Employment Service to Students

After you have finished the course, we will do all we can to help you find the job you want. We employ three men on a full time basis whose sole job is to help our students in finding positions. And should you be a little short of funds, we'll gladly help you in finding part-time work while at school. Some of our students pay a large part of their living expenses in this way.

COYNE IS 32 YEARS OLD

Coyne has been located right here in Chicago since 1899. Coyne Training is tested—proven by hundreds of successful graduates. You can get all the facts absolutely free. JUST MAIL THE COUPON FOR A FREE COPY OF OUR BIG RADIO AND TELEVISION BOOK.

H. C. LEWIS, President
Radio Division, Coyne Electrical School
500 S. Paulina St., Dept. 61-3 H, Chicago, Ill.
Send me your Big Free Radio and Television Book.
This does not obligate me in any way.

Name.....

Address.....

City..... State.....

Classified Advertisements

WORLD'S BEST WANT AD MEDIUM

Advertisements in this section, 35 cents per word, each insertion, minimum 10 words, payable in advance
To be inserted under proper classification in October issue, copy should be in our office August 18th.

ADVERTISING AGENCIES

ADVERTISE—Bargain value—24 words in 24 representative Sunday newspapers \$15; Free assistance with your ads, sales letters, literature. Helpful Ad-Guide showing best paying newspapers, magazines, rates, mailing lists, etc., free. Chicago Union Agency, Great Northern Bldg., Chicago.

GET into advertising. Learn quickly at home. Experience unnecessary. New easy plan. No text books used. Practical work. Old established school. Send name and address for interesting free booklet. Page-Davis School of Advertising, Dept. 3431, 3501 Michigan, Chicago.

BEFORE Advertising get our catalog. No charge. 25 years in business. The largest classified agency in the world. Ankrum Advertising Agency, 190 No. LaSalle St., Chicago, Ill.

FREE—New 1931 Advertisers Rate Guide, 44 pages. Includes everything. Lowest rates. E. H. Brown Advertising Agency, 140 S. Dearborn, Chicago.

ADVERTISE in rural weeklies. Lists free. Meyer Agency, 4112 Hartford, St. Louis, Mo.

ADVERTISE—28 Words in 100 different country papers \$8. Lists free. Miller, 300M City Bank, Syracuse, N. Y.

TIME Counts in applying for patents. See pages 132 and 133. Clarence A. O'Brien, Registered Patent Attorney, Washington, D. C.

FOR ADVERTISERS

ADVERTISING: 20 Words; 50 magazines 60¢; three insertions, \$1.20. Inch display, three months \$9.90; year \$24.00. Mailing Bureau, Lauderdale, Calif.

TRIAL Thousand three color stickers, \$1.00. 15 words. Harley Wolf, 6613K Quimby, Cleveland, Ohio.

ADVERTISE 50 Magazines, 3 months, \$5.00 inch. List, special offers, free. Evans King Co., Box 672P, Wilmington, Delaware.

ADVERTISE in 250 country town newspapers 28 words, \$10. Lists free. All states. Keator, Hartford Bldg., Chicago.

INCH Display (forty words) three times in Mailman, \$1.00. (10,000 international circulation. P. M. Argus, Culver City, California.

LAYOUTS For advertising is a useful handbook of 709 layout suggestions used in magazines, newspapers, booklets, folders, broadsides, letterheads and posters. Will save immense amount of time of any advertising man. Delivered to your door C. O. D. Simply pay postman \$3 and postage. Popular Mechanics Press, Room 802, 200 E. Ontario St., Chicago.

SALES PROMOTION

WRITE Any sales letter or advertisement, two dollars. Advertising specialist; national experience. Komarco, 532 Pine, Long Beach, Calif.

INFORMATION

ANY Information desired 25c coin and up. Fred Klotz, Reading, Pa.

15,000 PROFIT Making formulas. Following and many others: Accidents and emergencies, agriculture, alloys and amalgams, artist's materials, beverages, cements, glues, pastes, mucilages, bleaching, renovating, coloring metals, drying glass, heat treatment of metals, household formulas, ice cream, confectionery, chewing gum, lapidary work, exterminating vermin, lubricants, paints, varnishes, photography, condiments, canning formulas, rubber, soap, candles, soldering, toilet preparations, perfumes, waterproofing, fireproofing, writing materials. Just write for "Scientific American Encyclopedia of Formulas." When postman hands you book pay \$5.50 and postal charges. Popular Mechanics Press, Room 802, 200 E. Ontario St., Chicago, Ill.

AUTOMOBILES

TIME Counts in applying for patents. See pages 132 and 133. Clarence A. O'Brien, Registered Patent Attorney, Washington, D. C.

SHOP Notes for 1931. Get your copy now. Only a limited edition. Contains all the articles published in the Shop Notes department of Popular Mechanics Magazine during 1930. Send 50 cents. If you want the set of Shop Note books consisting of 6 volumes including the 1931 number and 6 others issued previously we will send them C. O. D. for \$3.00. Popular Mechanics Press, Room 802, 200 E. Ontario St., Chicago.

AUTO SUPPLIES

TRAILER Hitch 4 wheel—all steel, best on market. Write for price and circulars. Agents wanted. Hagstrom Model & Tool Wks., Kansas City, Mo.

BARGAINS—Excellent repossessed compressors, battery chargers, test benches, car washers. Terms. Trial. Write Ken's Automotive Service, Box M-911, Troy, O.

NEW Auto parts 25-50%. Motors, rear-ends, radiators, wheels, generators, carburetors, brakelining 50%. Used parts 50-80% off. Brightman, 2065 Main, Hartford, Conn.

STOP Brake rattle—Universal "springs of silence", all brake service stations. Universal Spring Co., Grand Rapids, Mich.

FORD Model "A" car including Model "AA" truck—just published, only book of its kind and right up-to-the-minute. For all interested in the repair and maintenance of the new Ford. 345 pages. 251 illus. Price \$2.50. Sent postpaid upon receipt of price or C.O.D. anywhere in U. S. Popular Mechanics Press, Room 802, 200 E. Ontario St., Chicago.

CHROMIUM Plating powder plates iron, steel, brass, copper and nickel, without electricity or machinery. Guaranteed not to tarnish; ½ pint can \$1.50 prepaid. Gunmetal Co., Ave. J, Decatur, Ill.

RADIO—Very latest information necessary for proper operation, maintenance and service in Modern Radio Practice including Short Wave Receivers. New 224-page radio man's guide now available at only \$1.00. Sent postpaid upon receipt of price or C.O.D. anywhere in U. S. Popular Mechanics Press, Room 802, 200 E. Ontario St., Chicago.

AUTO SERVICE EQUIPMENT

SUBSTANTIAL Savings—repossessed compressors, battery chargers, test benches, car washers. Terms. Trial. Write Ken's Automotive Service, Box M-912, Troy, Ohio.

BEST Books for \$1. All formerly sold for \$2.50 to \$5 each. Select from the following list of guaranteed bargains. All brand new books: Woodcraft by Seton, Book of Letter Writing by Crowther, Etiquette by Eichler, Creative Chemistry by Stesson, Revolt in the Desert by Lawrence, Trader Horn, White Shadows in South Seas by O'Brien, Count Luckner (The Sea Devil) and Outline of History by Wells. Delivered at your door C. O. D. Simply pay postman \$1 each and postage. Popular Mechanics Press, Room 802, 200 E. Ontario St., Chicago.

MOTORCYCLES, BICYCLES AND SUPPLIES

REBUILT Motorcycles \$25 to \$100 easy. Tires, used tires \$2.50. New Firestone \$5. Engines for motorcycle, ice sleds, airplanes, boats \$15 to \$75. Forks \$3, frames \$3, cylinder \$3, saddles \$3, chains \$1.50, handle bars \$3, belts \$5, wheels \$3, side cars \$25. Bicycles \$9.50, airplane wheel \$1.00 was formerly \$2.00. Save you dollar prices. Oldest house in U. S. Send 25c for catalogue. Price Cutter Deminger, Rochester, N. Y.

LOW Prices—Special bargains in Harley-Davidsons—14 models. Send 6c stamps for catalog. Knuth's, 2525 Fond du Lac Ave., Milwaukee, Wis.

REPAIR With good used parts, save ¼ or more. state parts needed, no lists. J. B. Dahl, 3661 Archer Ave., Chicago, Ill.

HENDERSON, Excelsior, Harley, Indian used parts, engines, conversions. Cheap. Catalogue and wings emblem pin 10c. Balaak, 100 N. 12th, St. Louis, Mo.

SEND 15c For illustrated used Motorcycle catalog. Large stock. Bargains. Indian parts. Accessories. Indian Motorcycle Sales, Kansas City, Mo.

MOTORCYCLE Bargains, lowest prices, bargain sheets for stamp, special aviation supplies, motorcycle accessories largest line in America, lowest prices. Largest motorcycle mail order house in the United States. Rochester Harley Davidson Corporation, 129 West Main St., Rochester, N. Y.

USED Motorcycles. Bargain. Two Indian racing machines. Bargain prices on radios, bicycles and parts and small lathe. Kenneth Hampton, Lancaster, Wisconsin.

GUARANTEED Reconditioned Harley-Davidsons. All models. Send for bargain list. Ruhle & Artley, 1330 N. Western Ave., Los Angeles, Calif.

USED Parts, Harley, Indian, Aero. Motors. Rebuilding. New chain, 60c foot; Corbin speedometers, \$10; Indian standard batteries \$7. Old Indian parts, cut. Same day service. Prepaid. Send stamp for circular. Boots, 622 E. Grand, Des Moines, Iowa.

A BILLION Ideas. This is the title of our remarkable catalog of books along practical lines. Arranged alphabetically by subjects for easy reference. If you have not received it, send for a copy. You will find hundreds of subjects you cannot usually locate in book stores or public libraries. Sent free upon request. Popular Mechanics Press, Room 802, 200 E. Ontario St., Chicago.

AVIATION

BE Sure that the motor you purchase for your light plane will fly it. Heath B-4 and Heath Henderson motors are guaranteed to fly and 7 years of constant performance prove it. For economy and reliability these motors cannot be equalled. Send 10c for large illustrated booklet. Heath Aircraft Corp., Dept. KP-9, Niles, Michigan.

FOR Sale: Flying boats, Standards J1; Aero Cameras, OXN; Hisso's and C6 engines. Long's Aircraft Service, Lorain, Ohio.

AMERICAN Eagle, \$500; Travelair, \$600; Hillit Jenny monoplane or biplane, \$395; small fuselage, \$25; airplane cable, 2c foot; control cable, 4c foot; caselm glue, 50c pound. Allison Airplane Co., Lawrence, Kansas.

165 H.P. 9 Cylinder Gnome Rotary Airplane motors \$65 each f.o.b. New York. Not used. Apply to D. B. Herrigan, 49 Rector Street, New York.

FOR Sale—Airplanes. Curtiss Jenny 99 H.P. 2 place \$295.00; American Eagle 3 place \$395.00. New catalog aviation and glider supplies ready. Logan Aircraft, Cleveland, Ohio.

AIR Navigation and meteorology—A practical book for every flyer. Capt. R. Duncan, the author, has presented the subject in a simple, non-technical way. 243 pages, illustrated. Delivered to your door C. O. D. Simply pay postman \$3 and postage. Popular Mechanics Press, Room 802, 200 E. Ontario St., Chicago.

TIME Counts in applying for patents. See pages 132 and 133. Clarence A. O'Brien, Registered Patent Attorney, Washington, D. C.

METAL, Tipped Henderson propellers, \$9.95; Fords, \$12.50. Hibbs, Ft. Worth, Texas.

BOYS, Girls. Learn to fly! Remarkable 10 lesson course, including membership, class pins, ratings, bulletins, wings. Send 25c for first lesson or \$2.25 complete. Details free. National Young Flyers League, Dent. H. 816 Chimes Bldg., Syracuse, N. Y.

LEARN To fly where Lindbergh learned at this flying school with highest government approval. Airplane mechanics school connected with aircraft factory. Big opportunity—write today for complete information. Lincoln Flying School, 2092 Aircraft Building, Lincoln, Nebraska.

FLYING Simplified—Just out. Here is a remarkable non-technical book for beginners, prospective or advanced students that teaches in an easily understood manner all you can need to know to master the art of flying. Will save you many dollars when you learn to fly. Pay postman only \$1 and postage when book is delivered at your door C. O. D. Popular Mechanics Press, Room 802, 200 E. Ontario St., Chicago.

SEND For descriptive list of New, Rebuilt and Used Curtiss OX5 and Hispano Sulza Airplane Engines. Heckman Machine Works, 4926 W. Lake St., Chicago, Illinois.

SEND 5c For bundle of balsa, reeds and price list on supplies. Aero Shop, 3059 Hurfbut Ave., Detroit, Mich.

"IF You want to fly" let Alexander Klemin, brilliant engineer, teach you. With great skill whole course of training has been simplified and made crystal clear. Remarkable book teaches in most practical and easily understood fashion. Recommended by skilled flyers. Sent C. O. D. anywhere in U. S. Simply pay postman \$2.50 and postage when delivered. Sent postpaid to any address upon receipt of price. Popular Mechanics Press, Room 802, 200 E. Ontario St., Chicago.

AIRCRAFT Directory 50c. Thousands surplus airplanes, motors, parts, supplies. Invaluable. Aerobuilders Service, 1345-15 So. 12th, Lincoln, Nebr.

AVIATION—Every person interested in this subject should make full use of the opportunity to learn aerodynamics with Alexander Klemin as his instructor, through his timely new book, "Simplified Aerodynamics." Heretofore this subject has been rather difficult for the thousands who need it but Klemin's method enables all to master it. Every pilot, mechanic, student needs this book. Pay postman price, \$3.50, and few cents postage when he delivers it. Order from Popular Mechanics Press, Room 802, 200 E. Ontario St., Chicago.

MODEL AIRPLANES

MODEL Aircraft—How to build and fly. Model builders and tournament contestants, get the complete official handbook of the Playground and Recreation Association, 300 pages, fully illustrated. Price \$2.25. Sent postpaid upon receipt of price or C. O. D. anywhere in U. S. Popular Mechanics Press, Room 802, 200 E. Ontario St., Chicago.

BOATS, OUTBOARD MOTORS, ETC.

THIRTY Foot double cabin cruiser. Latest design. Complete building plans August Buder, 35c. Free boatbuilding catalog. Buder, 15 Murray Street, New York.

MAKE 12' Rowboat. Blueprints, 30c. Weesho-Urn, B75, Detroit, Mich.

PROPELLERS, Pumps, stuffing boxes, bearings, etc. Wm. H. Baker, Pond St., Quincy, Mass.

MAKE 16' Rowboat. Blueprints, 30c. Weesho-Urn, B75, Detroit, Mich.

BUILD Your own boat. Save over 1/2 and have fun besides. Simplified instructions in Popular Mechanics New Boat Book, just out, are easy to follow. Every type of small boat covered, outboard, inboard, sailing and hand-propelled craft. In addition complete information on all phases of boating needed by every boating enthusiast. 269 pages. Fully illustrated. Postpaid upon receipt of price, \$3.00 or will be sent C. O. D. anywhere in U. S. Popular Mechanics Press, Room 802, 200 E. Ontario St., Chicago.

MODEL BOATS AND SUBMARINES

MODEL Boats, all hand carved. V bottom racing type. Carved any size, with motors or without. Send 15c for pictures. Anderson Model Boat Shop, 5772 Lenox Ave., Detroit, Mich.

ARCHERY

MAKE Your Bow and Arrows. We sell materials. Send 25c for working instructions and catalogue. Sidney Archery Co., Sidney, Ohio.

MANUSCRIPT SERVICE

MANUSCRIPTS Typed and revised by experienced English teacher. Terms on request. Kate L. Preusch, Slidell, Louisiana.

YOU Need a better grip on mathematics? Ask us to send you a copy of "Mathematics for the Practical Man," only \$1.50. By common sense methods it removes the mystery and difficulties to algebra and calculus are made simple. Assuming your knowledge is limited to arithmetic you quickly and easily gain a working knowledge of algebra, geometry, Trigonometry and calculus. Simply pay postman when he hands you the package. Address Popular Mechanics Press, Room 802, 200 E. Ontario St., Chicago, Ill.

BOOKS AND PERIODICALS

ALL Outdoors. An outing magazine for you and me. Fishing, hunting, camping, touring, pioneer history, feature stories and articles, 24 to 48 pages, monthly, book paper, profusely illustrated. Special offer. Three months 10c, six months 25c, yearly 50c. All Outdoors, PM534, Douglas Bldg., Los Angeles, Calif.

HISTORIAN—Something New—4000 years of history on a single page. A chart in 8 colors presenting a continuous, co-ordinated record of events and characters of history from 2000 B. C. to date. Size 13x8 1/2 inches. Price \$1.00. Should be in every school and home. Sent postpaid upon receipt of price or C. O. D. anywhere in U. S. Popular Mechanics Press, Room 802, 200 E. Ontario St., Chicago.

HYMNISM Easily learned. Lessons guaranteed. Postpaid \$1.10. Smith Pub. Co., Dept. 3, Springfield, Mass.

ROCK Gardens, how to make. A splendid book for the amateur covering every minute point in the making of a rock garden. 152 pages. Illustrated. Price \$2.00. Sent postpaid upon receipt of price or C. O. D. anywhere in U. S. Popular Mechanics Press, Room 802, 200 E. Ontario St., Chicago.

ASTROLOGY Books—25c to \$8.00; free descriptive list. Bullock, Box 1286, Providence, R. I.

LEARN Lacquer system of sign painting. Valuable new book gives complete description of methods, materials and equipment with hints and helps for sign shops. Covers latest in electric, neon tube, and daylight reflector signs, etc. Delivered to your door C. O. D. Simply pay postman \$3 and postage. Popular Mechanics Press, Room 802, 200 East Ontario St., Chicago.

GAMES, ENTERTAINMENTS AND PLAYS

PLAYS, Operettas, musical comedies and minstrels, comedy and talking songs, black-face skits, vaudeville acts, monologs, dialogues, recitations, juvenile plays and songs, musical readings, entertainments, make-up goods. Catalog free. T. S. Denison & Co., 623 So. Wabash, Dept. 11, Chicago.

CARTOONING—Let the world's most successful cartoonist tell you how to draw cartoons. Brizes in his new book gives every step in cartoon work and answers every question a beginner might ask. Elaborately illustrated. Pay postman price of book, \$3, and small amount of postage when he delivers the package C. O. D. Popular Mechanics Press, Room 802, 200 E. Ontario St., Chicago, Ill.

CHALK TALKS

LAUGH Producing program, \$1.00. Catalog free. Balda, The Cartoonist, Oshkosh, Wis.

MAGIC TRICKS, BOOKS AND JOKER NOVELTIES

SAMPLES, 10c, 20c, 30c. Meyer, Books—GPO, Box 471, New York.

"SPHINX" Magicians magazine, 25c copy. Stringers Magic Shop, 2538-N Halsted, Chicago.

MAGIC—Tricks, Books and Supplies. For amateurs as well as the great professionals. Anyone can learn through our instructions. Feature Acts in Mind-Reading, Spiritualism, Rope Ties, etc. Large illustrated professional catalog, 29c. Chicago Magic Co., 148 So. Dearborn St., Dept. B, Chicago, Ill.

FUN! 50 Puzzles only 25c. Zieten, 333 Parker Ave., Philadelphia.

ELECTRIC Fun! 200 stunts, 110 volts, \$1. Kutting Sons, Campbell, Calif.

200 TRICKS You can do—Mystify your friends; have loads of fun. This collection of tricks has been selected by Thurston for the average person. Neither unusual skill nor elaborate apparatus are required. Send for this 200-page illustrated book. Pay postman \$1 plus postage when delivered. If outside U. S. remit when ordering. Popular Mechanics Press, Room 802, 200 E. Ontario St., Chicago.

POO-POO Cushion. The belly shaking laugh producer. Fun galore. Sample 25c. Yerona Company, Box 312, Bayonne, N. J.

CHALK-TALK Your way to popularity. Audiences at your feet if you learn how to entertain with a few simple pictures. Little artistic ability needed. "How to Chalk Talk" tells what to say and what to draw. Profusely illustrated. Make money giving chalk talks. Just order on a postal. Pay postman \$1.00 and postage when delivered. Popular Mechanics Press, Room 802, 200 E. Ontario St., Chicago, Ill.

RADIO SETS AND SUPPLIES

BUILD 3-Tube radio. Send dollar for simple instructions, diagrams, pictures. A boy can build it. La Vange Laboratories, P. O. Box 45, So. Braintree, Mass.

ONE Dollar brings you How to Make Rotary Disc Variometer. Cheapest, most compact made, only thing for television. Allbaugh Radio, Mena, Arkansas.

POPULAR Mechanics Midret Steel Chassis, drilled \$1.00. Stenode parts—Radio list. Service Electric, Indianapolis.

TIME Counts in applying for patents. See pages 132 and 133. Clarence A. O'Brien, Registered Patent Attorney, Washington, D. C.

FUN—Profit. Making, selling crystal radios. Crystal with instructions, 25c; six \$1.00. Music Sales, Independence, Mo.

FAMOUS Bailey Handbook—Prepares you to pass the examination for any grade of license for stationary, marine and Diesel engineers, firemen and boiler inspectors in any state of the Union or any province of Canada. Flexible cover. Handy pocket size. Pay postman \$2.00 plus postage when he hands you the package. Popular Mechanics Press, Room 802, 200 E. Ontario St., Chicago, Ill.

STAMP COLLECTING

FREE: For many years collectors have looked for an intelligent guide book on stamps. "The Lure of Stamp Collecting," our new illustrated booklet is just that and more. It tells exactly how to derive the greatest benefits from your collection, what stamps are most profitable to collect, how to judge values of stamps and a wealth of interesting facts, information and stamp stories, etc. No book, even those selling as high as \$5.00 is more to the point, or offers as many benefits to the collector. We will send it free to approval applicants who send 5c to cover mailing expenses. Globe Stamp Co., 263 Fourth Avenue, New York City.

BIG Parade—A packet of more than twenty all different better grade stamps showing exciting scenes and records of nations at war. Includes fire-pot barrier; the storming of a city; hand-to-hand bayonet struggle; bloody battle scenes; troop transport; red cross stamp; dying soldier; victory stamps; etc. Send for this thrilling "Big Parade" packet at once—limited supply. Only 10c to approval applicants. W. A. Rowell, 58 Cornhill, Boston, Mass.

SCARCE Airmail and triangle. Beautiful Uruguay "flying horse" airmail and scarce Guatemala triangle (smallest in the world) are included in our big packet of 60 different stamps from Alouettes, Grand Liban, Venezuela, British and French Colonies, etc. All for 5c to approval applicants. Big illustrated lists free with each order. Write today! Mystic Stamp Co., (Dept. 80), Camden, New York.

100 DIFFERENT Foreign stamps from 100 different foreign countries, including Africa, Asia, Australia, Europe, West Indies, etc., for only 20c. Free with each order, our pamphlet telling "How to Make a Stamp Collection Properly," together with our price list of albums, supplies and hundreds of bargains in sets, packets, etc. Queen City Stamp Co., Room 30, 601 Race St., Cincinnati, Ohio.

ANCHER'S \$\$\$ Outfit—only 12c. Fine triangle stamp, set German stamps (pre-war) value millions dollars, perforation gauge and name scale, airmail set. Interesting stamp smallest republic, newspaper set, packet good stamps Travancore, Malay, Dutch Indies, etc., fine pocket stock book. Entire outfit 12c to approval applicants. Ancher Stamp Company, Rutherford, N. J.

LARGEST Stamp in the world! Rare China Wild Goose special delivery stamp (value 75c) for only 5c to approval applicants. Supply limited. Positively only one to a customer. Western Philatelists, 6021 Harner, M39, Chicago.

FREE—100 Stamps to approval applicants. Hoyt, Box 597, Lowell, Mass.

APPROVALS—1/2c, 1c, 1 1/2c. Paul Baringer, Defiance, Ohio.

125 DIFF. To approval applicants, 2c postage. Oak Park Stamp Co., Oak Park, Illinois.

MAMMOTH Bargain—10 different packets—10c to approval applicants. Goldwater, 1,827 Amethyst St., Bronx, New York.

PACKET Giant stamps (including world's largest stamp valued 75c). Everything 10c to approval applicants. Gem Stamp Co., 1,850 Unionport Road, New York.

25 FRENCH Colonies to approval applicants 2c. 500 different world, 25c. Norman Floyd, Norman, Ohio.

22 SIAM 40c, 23 Bolivia 65c, 16 Barbados 60c. Approval selections. Want lists solicited. Catalogue free. Moroni, 121 West 42nd Street, New York.

SOUTH-SEA Islands' stamps, 25 different—Borneo, Samoa, etc., 25c. \$1,000.00 fake stamp, 25c. Approvals 1/2c. Catalogue free. Fluck, 245 Mercer St., Trenton, N. J.

10 DIFFERENT United States commemoratives 2c to approval buyers. State size of collection and countries of interest. Leduc, Redden, Penna.

GIBRALTAR: 5 Varieties 5c to approval applicants. Allison, Angola, Ind.

WONDERFUL Approvals! Free prizes! Big discounts! Box 114, Minneapolis, Minn.

FREE! United States packet with approvals. Menjar, 1553 Knox, Cincinnati, O.

PENNY Approvals, 5,000 Sudan, Congo, Nyassa, Liberia, etc. Also 14,000 averaging 1 1/2c. Philatelic Exchange, Huntington, W. Va.

PRECANCELS, 1,000 Fine mixture \$2.00; 10,000, \$18.50. Oroc, 12 Geary, San Francisco.

PHILIPPINES, United States, 24 superb recent varieties (face \$1.58) including 6 Legislative Palace (\$2.42) only \$2; blocks, \$7.65. Catalogued high. Dozen Mexican Jumping Beans and Game, 35c; 100, \$2. Literature. Barner Stamps, Wilkinsburg, Pa.

EXCELLENT Mixture 2000 stamps. Large variety including Africa, Asia, Latin America, etc. Price only \$1.00. Longere Shop, 106 West 42 St., New York, N. Y.

BEST One cent approvals in America. P. Hand, 1117 So. 60th St., Philadelphia.

1000 MIXED U. S., old and new, 25c. Weatherby, Lakewood, Ohio.

3 ABYSSINIA 4c To approval applicants. A. Bostrom, 1618-P West 13th St., Brooklyn, N. Y.

WHOLESALE Price lists free on application. Midland Stampco, Toronto, Canada.

U. S. Mixture mostly 20th Century inclusive of Harding issue, coils, diff. perf., rotary, etc. Fine. Sample 3 or 20c. 1 lb. 75c. The Stamp Shop, Holland Bldg., St. Louis, Mo.

200 DIFFERENT Stamps including 25 U. S., 10c. Color guide 50c. Approvals. Zieton, 383 Parker Ave., Philadelphia.

SEVENTY Different stamps from seventy different countries, 6c to approval applicants. Barcus, Box 1034, Detroit, Michigan.

ABYSSINIA To Zambesia—\$4.00 catalog value. 34 scarce stamps, Abyssinia, Hejaz, Spanish Morocco, etc. Only 10c to approval applicants furnishing references. Weaver, Dept. 5, 1451 Broadway, New York.

105 FREE 2c Postage. Approvals, La Grange Stamp Co., La Grange, Illinois.

BRUNEI (Native scene), Tanganyika, Orange River Colony, Kenya, Foreign Revenue, Vatican City, Grenada, Syria, French Guinea (cataloging 25c), Nyassaland Protectorate, and scarce genuine Baden, all for 5c to introduce our famous approvals. Viking Stamp Co., Sheepshead Bay Station, Brooklyn, N. Y.

FREE—Different Luxemburg to approval applicants. E. D. Stamp Co., 3905 Forest Park Ave., Baltimore, Md.

STOP!—Look!—5 different complete sets rare old South American Envelope stamps. Just enclose 10c requesting unusual approvals. Bargain Stamp Service, 1337 South Hope Street, Los Angeles, California.

TRIANGLES: 3 Nyassa 18c. Approvals. Oppen, 337b Manhattan Ave., Brooklyn, N. Y.

UNPICKED Mission stamps from 37 countries. 5000, \$1.50; 20000, \$5.00. Gardenspot Stamps, Lancaster, Penna.

25 CANADA 10c; 10000 Pines 10c; animal packet 10c; United States packet 10c. Harvey Temple, Decatur, Indiana.

UNCHALLENGED—15 Different Venezuela 10c. Approvals. Rosswag, 329 East 86 Street, New York.

United States "Surprise" packet, two dimes. "Wonder" packet, \$1.00. Ralph Esler, Newark, Ohio.

100 DIFFERENT U. S. 30c—50 diff. 15c. Hawkeye Stamp Co., Cedar Rapids, 39. Ia.

VATICAN City 4 different 10c. Guadeloupe 10 different picture stamps 10c. 500 different stamps 25c; 25 airmail 15c. Marks Stamp Co., Toronto, Canada.

WORLD'S Loveliest stamps. Beautiful Marwar and Idar (Indian States) revenues only six cents with fine foreign revenue approvals. References required. Vanderhoof, 339 Grand Ave., Long Beach, Calif.

BOYS Wanted—Everywhere. Show our big bargain stamp assortments to friends. We trust you and pay you splendid cash commissions. Fast sellers. Earn money with our new plan. Dandy free premium if you write us at once. Leflor Stamp Co., R20 W. Jackson Blvd., Chicago, Ill.

FREE Foreign covers, 10c postage, approvals. Superior Stampco, Russell, P-1, Kansas.

COMMEMORATIVES—Pictorials on approval. References please. Free stamp togs. Dodges, Station A, Pasadena, Calif.

WANTED! Neophytes or beginners who are seriously interested in building up good collection. National Philatelic Supply Company, 4926 Southern Boulevard, New York.

WONDERFUL Stamp mixtures by weight. Free sample. Yade, Woodside, N. Y.

FREE 50 DIFF. French Colonials with approvals. 2501 No. 60 St., Omaha, Nebr.

TWENTY Liechtenstein free with approval applicants. References required. "Covered Wagon," Conshohocken, Pa.

FREE To approval applicants, 25 different domestic and foreign stamps, 2c postage. Reference. George L. Ott, Box 105, Avonmore, Pa.

STAMPS, 100 All different. Postage 2c. Lists free. P. M. Quaker Stamp Co., Toledo, Ohio.

ZANZIBAR! Packet queer freakish stamps from Zanzibar, Indore, Algeria, Malay States, Hyderabad, Gold Coast, Nigeria, British Colonials, Southerners. Don't delay! Don't wait. This whooping packet free for 5c postage. Gray Stampco, Toronto, Canada.

WORLD'S Tiniest triangle (rare Guatemala Quetzal-Bird) also scarce dead country triangle and big packet Eritrea, Vatican, Borneo, Natal, etc., 5c with lists and approvals. Semisole Company, Druid, Baltimore, Md.

WHOLESALE Catalog for dealers. Illustrated. Postage 5c. Frank Co., 5031 Queensberry Ave., Baltimore, Md.

CANADA Airmail stamp free if you ask for approvals and send 15c for 25 different airmails or 30 different Canada; both packets only 25c. We list 350 countries in our dime packets. Lists free. Special bargains, 500 different, 25c; 1,000 different, 75c; 2,000 different, \$2.50. Victoria Stamp Co., London, 4, Ontario, Canada.

FREE Outfit! 52 stamps, hinges, pocket wallet. Postage 4c. Approvals. United Philatelists, South Berkeley, Calif.

300 DIFFERENT Stamps 15c. Michael, 942 So. 23rd, Hollywood, Ill.

SELLING Quality stamps on approvals 1/2c up. Dandy free premium. Collections and job lots bought. Kelgwin Stamp Co., Vineland, N. J.

101 DIFFERENT Stamps cataloging over \$12.00 for One Dollar. Ask for free list at our dime packets. Biggest value ever offered for 10 cents. Cosmos Stamp Company, 87 Nassau St., New York City.

U. S. Stamps on approval. References. James Randall, 1621 Warren, Chicago.

UNITED States commemoratives 10 different 4c. Approval buyers. Hudson Co., Plainfield, N. J.

105 CHINA, Etc., 2c. Album (500 Illustrations) 3c. Bullard, 446 Tremont, Boston.

EUREKA Mixture 1000, \$2.50, something unique. Box 1059, Vancouver, Canada.

ILLUSTRATED Bulletin. Free to collectors. Reimers, 30 N. La Salle, Chicago.

150 GOOD Mixed foreign stamps, 2c. Stanton, East Lyme, Conn.

ILLUSTRATED United States list, price 50c, large complete United States price list, 1931, free. Stanley Gibbons, 38P Park Row, N. Y.

300 DIFFERENT Stamps 20c; 600 50c; 1,100, \$1; 2,000, \$3. Fred Osken, 630 79th St., Brooklyn, N. Y.

BEAUTIFUL Picture stamps sent free. Paul Cornish, Schenectady, N. Y.

STAMPS, Sent on approval at 50% discount. Fred Herzberg, 438 Maple Ave., Kilmhurst, Ill.

96-PAGE Illustrated Stamp Album and 100 different stamps—25c to approval applicants. Ohio Stamp Co., Box 219, Cleveland, Ohio.

FREE—Packet 52 different from Alaouites, Lebanon, Quillmane, etc.; also watermark detector and rare old Hawaiian stamp—all free to approval applicants enclosing 4c postage. Highland Stamp Co., Newton Highlands, Mass.

1,000 DIFFERENT Europe \$28.86 value, only 1 dollar. Splendid approvals! Josef Wendt, Neumarkt, Opf. Germany.

500 DIFFERENT Stamps for 25c. Big collection including Armenia, Andorra, Fiume, Spanish Morocco, Kenya, Liberia, Menel, Nigeria, Quillmane, Syria, Victoria, Vatican City and other hard-to-get countries. Catalog value over \$10.00. Price only 25c to approval applicants. Illustrated lists free. Loma Stamp Company, 4231 42nd St., San Diego, Calif.

GIANT Triangle stamp! The largest triangle stamp in the world (Spain 1930 Columbus issue) is included in our packet of 34 scarce varieties from queer, far-off lands—Bodi, Nyassa, New Guinea, North Borneo, etc. No Austria, Germany or other common stamps. Wonderful packet! Only 10c to approval applicants. Vogue Stamp Co., Dent, P., Post Chester, New York.

FREE—\$1.00 U. S. postage Lincoln memorial free, if you write for our 56 page price-list of U. S. and foreign stamps, 2,000 illustrations and fine stamps on approval. Hussman Stamp Co., 420-3 Olive St., St. Louis, Mo.

24 VARIETIES Cuban stamps, 10 cents. List of stamps free. Chambers Stamp Co., 111P, Nassau, New York City, N. Y.

ONLY 5c. 33 Different stamps including scarce Latvian triangular airmail stamps, 10 airmail, 12 United States yearly issues, commemoratives, etc.) and 10 Canada. Approvals and illustrated price list sent with each order. Curhan Stamp Company, Gloucester, Mass.

301 DIFFERENT 10c To approval applicants only. Free list of bargain packets. Kansas City Stamp Co., Lee Bldg., Kansas City, Mo.

WHOLESALE Catalog for dealers; 4c postage. Grossman, 102 W. 42nd, New York.

STAMPS Sent on approval at 70% discount. Reference required. Emory Benell, Hanover, Pa.

200 DIFFERENT 10c, 25 Japan 10c. 60% discount approvals. Covert Stamp, 29 State, Rochester, N. Y.

PENNY Approvals that satisfy. Neil Gronberg, Box 3441, Philadelphia, Pa.

FREE Stamp collection—contains Salvador, Turkey, Africa, etc., 2c postage. 10 different triangles 25c. 1000 hinges 7c. Approvals sent. Tatham Stampco, West Springfield, Mass.

TRIANGLES—Eight different triangle stamps including Guatemala (world's smallest), Latvia (air mail), Liberia, Nyassa, only 10c to approval applicants. Paul Revere Stamp Co., Box 40, Astor Station, Boston.

FREE 100 Different, postage 2c, with approvals. Noemus Stamp Co., 312 East 23rd St., New York.

"ALTHOUGH My stock of stamps is adequate to take care of business for years to come, yet results were so far beyond my expectations, that with the help I had, I was unable to take care of further new customers." Such are the reports received from advertisers using space under this classification. Your offer should do equally as well. For further information as to rates, closing dates, etc., write M. L. Rund, Manager, Classified Advertising, Popular Mechanics Magazine, 200 E. Ontario St., Chicago, Ill.

RARE COINS

OLD Money wanted—Do you know that coin collectors pay up to \$100.00 for certain U. S. Coins? And high premiums for all rare coins? We buy all kinds. Send 4¢ for large coin folder. May mean much profit to you. Numismatic Co., Dept. H, Ft. Worth, Texas.

HIGHEST Price paid for all American old coin. Buying and selling list and ancient Roman coin, 10¢. Geo. Best, Cedar Rapids, Iowa.

ARROWHEAD, 12 War notes, and 3 coins, 20¢. Paul Summers, Sagerton, Texas.

RARE United States and foreign coins, war medals and decorations. Selling catalogue, 16¢. Alexis Mengelle, Colorado Springs, Colorado.

100 DIFFERENT Foreign coins, one dollar. Fifteen large copper cents \$1. 25¢ and 50¢ notes \$1. Ten Confederate notes \$1. Large stock coins, all denominations, from half cent to fifty dollars. John Zuz, Bowie, Maryland.

20 COINS 25¢. 100 Coins \$1.00. Oddness, Box 681, Kansas City, Mo.

COIN 1500 Years old, 25¢. Rolfe Gilmore, 4243 Sheridan, Chicago.

SPECIAL Prices on United States Commemorative half dollars in unreticulated condition; Columbian 69¢; Lincoln \$1.19; Lexington \$1.17; Stone Mountain 89¢; Bennington \$1.21; old coin and bargain price list 10¢. Arvy, Box 482, Muskogee, Okla.

SILVER Coin, scarce, very old, fine; three interesting old copper and lists (monthly). Fifty cents. Southampton Exchange, 3427 Nottingham, St. Louis.

7 DIFFERENT Coins, 5 bills and catalogue, 20¢. Creamer's, 1113 Somerset, Baltimore, Maryland.

GUIDE To the value of all rare United States and early American coins, superbly illustrated. Price 50 cents. Descriptive circular free. Scott Stamp and Coin Co., 1 West 47th St., New York, N. Y.

\$5 TO \$500 Each paid for old coins. Many very valuable. Keep all old money. Get posted. Send 10 cents for illustrated coin value book, 43¢. Guaranteed prices. We buy and sell. Coin Exchange, Box 6, Le Roy, N. Y.

2 FINE Copper or nickel coin, 3 large crisp notes and catalogue, 10¢. M. Platz, Box 281, Cedar Rapids, Iowa.

SEND 10¢ For 5 different coins and catalogue or 50¢ for 25 different. Troyer Coin Co., La Fontaine, Ind.

GET Profit and pleasure in collecting old coins. Send 10¢ for large illustrated coin catalog. You'll be delighted with it. Send for it right now. B. Max Mehl, Numismatist, Mehl Bldg., Dept. P, Fort Worth, Tex. Largest Rare Coin Firm in the U. S.

CALIFORNIA Gold—Quarter size, 27¢; 1/4 size 53¢; 2¢ piece and catalogue, 10¢. Norman Shultz, Box 746, Salt Lake, Utah.

OLD Coins, large fall selling catalog of coins for sale, free to collectors only. Catalogue quoting prices paid for coins, ten cents. William Hesselton, 101A Tremont St., Boston, Mass.

UNITED States. Large cent, two-cent bronze, three-cent nickel and bargain list, 25¢. Thirteen dates large cents, \$1.00. George Coffin, Greenwood Mountain, Me.

FOR BOYS

BOYS And girls—Send 40¢ for 12 First Quality Pencils, school or any name imprinted gold, one line, sell 60¢. 30, \$1.00, sell \$1.50—109, \$3.00, sell \$5.00. Continuous. Other propositions. Pencil Market, Knoxville, Tenn.

ARCHERY Simplified. New book, just issued, is best yet written. Will enable the beginner to learn the fascinating sport quickly. Conspicuously illustrated. Price \$2.00. Sent postpaid upon receipt of price or C. O. D. anywhere in U. S. Popular Mechanics Press, Room 808, 200 E. Ontario St., Chicago.

CAMERAS AND PHOTO SUPPLIES

DETECTIVE Camera—"Expo," the greatest little camera made. About the size of a watch and shaped like one and fits the vest pocket. You can take pictures without being detected. Well made and handsomely nickel-plated. Takes twenty pictures at one loading, only \$3.95 with one roll of film. Brilliant view finder \$0.85 extra. Send \$1.00 with order and pay postman the balance plus a few cents for postage. Ask for our free bargain book listing other makes of cameras such as, Graflex, Eastman kodaks, Motion Picture, Zeiss, and other popular makes at tremendous savings. Central Camera Co., Dept. 29, 230 South Wabash Ave., Chicago, Ill.

SUPERIOR Kodak film finishing. Something different. Any 6 exposure roll finished 40¢. Tucoulats Studio, Middletown, N. Y.

FILM And twelve prints developed 25¢. Reprints 3¢. Satisfaction guaranteed. Skrudland, 4118 Overhill, Chicago.

TRIAL Offer. Developing roll 5¢, prints 3¢ each. Beautiful 10-inch enlargement 25¢. Young Photo Service, 405 Bertha, St., Albany, N. Y.

YOUR Favorite kodak picture enlarged, size 3x7, 10¢. Three for quarter, coin. Send best negative (film) today. Address Danner Photo Lab., 221 Securities Bldg., Des Moines, Iowa.

SPECIAL Trial offer: Developing any size roll 5 cents; prints 3 cents each. Beautiful 7 inch enlargement 20 cents. Send for special bargain list, Roanoke Photo Finishing Company, 209 Bell Avenue, Roanoke, Virginia.

HAVE You a camera? Write for free sample of our big magazine, showing how to make better pictures and earn money. American Photography, 116 Camera House, Boston, 17, Mass.

MAKE Money in photography. Learn quickly at home. Spare or full time. New plan. Nothing like it. Experience unnecessary. American School of Photography, Dept. 3452, 3801 Michigan Ave., Chicago.

MOTION PICTURES AND SOUND EQUIPMENT

JUST Out! Bass will mail postpaid Cine Amateur, Complete Handbook of motion picture photography for the amateur, \$1.00. Voice of the Films, a complete description of the process used in making sound motion pictures just out. Price postpaid, \$1.00. Motion Pictures With Sound by James Cameron, 400 pages crammed with information on all systems. \$5.00 postpaid. Bass Bargaining No. 207 listing red hot bargains in standard and 16mm. motion picture cameras, projectors and accessories. 4¢ stamps. Bass Camera Company, Motion Picture Headquarters, 179 West Madison St., Chicago, Illinois.

\$1.250 FOR Original photo play story. Our sales department sold unknown author's first story for above amount. We revise copyright and submit to studios stories for talking pictures. Being located in the heart of motion picture industry we know production requirements. Established 1917. Free booklet, Universal Scenario Company, 206 Meyer Bldg., Western and Sierra Vista, Hollywood, Calif.

TALKIE And movie producers are clamoring for new short story ideas, plots, etc. Perhaps you can write one that we can shape and sell for you. One writer (V.M.) received \$3,000. New York best market. Write now for free booklet, without obligation—How To Write For The Talkies! Daniel O'Malley Company Inc., Suite P, 1776 Broadway, New York.

SAVE Money. Movie cameras, \$25; projectors, \$35; Pathé camera, \$20; stereopticon, \$25; printing machine, \$75; 35m negative stock, 2 cents foot; 100 foot Eastman 16m negative, \$4.50; kodak, \$5. Typewriter, \$16. Cameras and films bought and exchanged. Ray, 266 W. 46th, New York.

ODD Reels \$1.25 plus postage. Bargain lists. Hoffman Film Service, 57 Broad, Albany, N. Y.

SPECIAL Spring camera, motor driven projector, film for camera and projector all for fifty dollars. Brand new list price \$114. Limited supply. Milton Mendelwager, 192 Ave. B, Bayonne, N. J.

WORLD'S Greatest "Passion Play" 16 MM. (new) 5 reels. Rent or purchase. Write Hemenway Film Co., 37 Church Street, Boston, Mass.

COMEDIES, Westerns \$2.50. Power's projector \$75.00. Marshall Films, Rome, Georgia.

TIME Counts in applying for patents. See pages 132 and 133. Clarence A. O'Brien, Registered Patent Attorney, Washington, D. C.

TRADE AND TECHNICAL SCHOOLS

GUSTAS School trains thoroughly in shoe rebuilding, hat renovating, clothes pressing in short time. Gustas, 7 W. Division, Chicago.

LEARN Watch repairing. Hiles School, 5330 Mission St., San Francisco.

LEARN Blue print reading. State your trade. Columbian School, Drexel Building, Philadelphia.

ELECTRICAL Trouble shooting on the motor car and airplane. Don't trust to luck or guess work. Learn to make every motion count in testing and repairing. Send for our standard 493-page book for electricians and mechanics, 300 diagrams. Hundreds of practical tests. Pay postman \$1.00 plus postage when delivered. If outside U. S. remit when ordering. Popular Mechanics Press, Room 802, 200 E. Ontario St., Chicago.

TELEGRAPHY

LEARN Wireless (Radio) and Morse Telegraphy. School, oldest, largest; endorsed by telegraph, radio and government officials. Expenses low—can earn part. Catalog free. Dodge's Institute, H Street, Valparaiso, Ind.

BUSINESS OPPORTUNITIES

DISTRIBUTOR—"I-SA-SO" powdered hand soap; takes grease and dirt off quick, without injuring skin; sanitary; repeats; big money maker; exclusive territory; sample free. Caswell, 8014 Grand, Kansas City, Mo.

ABSORBER—Chemistries latest triumph. Start your own money making business. No more ice box moisture or odors. Manufacturing cost 15¢. Formula \$1.00. Scientific Laboratories, 1256 - 32 Ave., San Francisco, Calif.

AMATEUR Cartoonists—Real chance to sell your drawings for cash. No canvassing. Draw at home, deliver by mail. Send sample drawing and 10¢ coin for working instructions. Sinclair Studios, Box 237, Cleveland, Ohio.

START Your own business buying old gold, silver and platinum jewelry. Most profitable in the world. F. Polcer, Box 81-A, Cicero, Ill.

GOLD Buying. Start business buying old gold, silver. Big profits. Beware imitators. Chicago Gold Smelting & Refining Co., 29 East Madison, Chicago.

SELL Products profitably nationally; secure \$1,200 sales promotion without cost. Details \$1. Manthey, 2159 East 24th Street, Oakland, Calif.

LEARN Marbleizing with cement; make garden furniture, artificial marble, statues, etc. Inexpensive sanitary floors. Veneer any concrete products, and wood. Enamel walls or anything. Glossy, flintlike hardness. Unlimited uses for this new industry. Dime brings samples. Caswell Institute, Grayling, Mich.

MAKE Money manufacturing building material. Marble, Granite, Fireproof Paint, Flooring, Roofing. No machinery, cheap; big profits; formulas, latest methods. Wm. Lang, 4434 Washington, Portland, Ore.

\$7.50 PUTS You in business for yourself. Make up to \$50.00 daily. Write Edde Mfg. Co., 106 E. Serboth, Milwaukee, Wis.

COOK'S Auto Gasoline Saver, Carbon and Knock Eliminator. For all cars. Thirty day trial. Money refunded if not satisfactory. Geo. Cook, 172 East 73 St., New York City.

TIME Counts in applying for patents. See pages 132 and 133. Clarence A. O'Brien, Registered Patent Attorney, Washington, D. C.

MAKE Your own products. Employ agents yourself. Toilet articles, soap, extracts. We furnish everything. Valuable book free. National Scientific Laboratories, 1950 W. Broad, Richmond, Va.

BUY Wholesale—Clothing, jewelry, radios, anything. Classified directory, 50c. Direct sales. Eureka, California.

START Home business, making artificial marble, colorful glazed tiles, novelties, tabletops, floors, garden furniture. Interesting secret methods. Surprising samples 10c. John A. Pavn, 945 Grande Vista Drive, Los Angeles, Calif.

WORKERS Wanted. You can realize \$40 per hundred pounds for old inner tubes. Send 25c for detailed instructions. Reclaimers, Berkeley, Calif.

NEED Money quick? Send 5c for our Packet of Opportunities. Tempert Company, 214-P Cambridge, Dayton, Ohio.

MAKE Illuminated signs. Patented process. No brush skill necessary. Particulars, Merritt Signs, So. Berkeley, Calif.

PAINT Users attention—save 35%. Buy finest quality paints, varnishes, caulking and roof cements, etc., direct from our large factory. Sold under a money-back guarantee. All our products comply with Government paint requirements. Lasting Products Corp., 1400 Moreland Ave., Baltimore, Md.

FIFTY Successful mail-order propositions. Address, K. Home, 3949 Metropolitan, Chicago.

\$105.00 CLEAR Profit in four days—(road signs average \$20.00 each.) Sample, including "Profit Plan"—10c. Address, Arrow Signs, Hutchinson, Minn.

EARN Large income with "chain" of peanut-chewing gum vending machines. Start small capital. Particulars free. Robbins Corp., DeKalb-Broadway, Brooklyn, N. Y.

GOLDEN Mail order business. New, original. We show you everything. A. Golden Co., 318 West 51, New York.

START Big money business at home. Liquid window wash, formula, instructions, \$1.00. Di Lemme, 928 Stebbins Ave., N. Y. C.

"SCHEMER," Alliance, Ohio, 32c monthly, prints big \$-getters. Subscriber reports \$50,000 from one tip; another \$25,000 from three schemes; another \$10,000 from one formula. Get wise! Year, only \$1.00; 3 months, 25c.

READY Market in every town for bands made of inner tubes. Start a factory of your own. Eclipse band cutting machine sold by Martin Mfg. Co., 1204 - 5th N. W., Canton, Ohio.

AMATEUR Cartoonists: Sell your work. Write Smith's Service, PW1194, Wenatchee, Wash.

INDEPENDENT Business—men earn big pay traveling by automobile carrying our portable electric block leveling machine and re-leveling butchers chopping blocks. Heath Company, 219 Lafayette St., New York.

DOLLARS In "Fixit" service, spare or full time. Small capital. Experience unnecessary. Complete copyrighted 43 lesson instruction course, \$1.00. Particulars free. Houkate's "Fixit" Service, 1395 N. El Molino, Pasadena, California.

POPCORN Machines \$15 up. Money makers. Northdale Co., 1308 Fifth, Des Moines, Iowa.

MIRRORS Resilvered at Home. Costs Near 5 cents per square foot; you charge 75 cents. Profitable business plating like new brass, worn-out autostarts, reflectors, tableware, stores, etc. Outfits furnished. Details Free. Sprinkle, Plaster, 127, Marion, Ind.

250,000 ARTICLES Wholesale. Directory 10c. W-Patterson Co., 4111 University, Des Moines, Iowa.

"TIMELY Tips" money-making ideas! Plans! Opportunities! Three samples 25c. Elite Magazines, 1821 East 101st, Cleveland, Ohio.

SUCCEED With your own products. Make-sell them yourself. Formulas, processes, trade-secrets. Expert analytical service. Catalog free. B. Thaxly Co., Washington, D. C.

WE Start you in business, furnishing everything. Men and women, earn \$40 to \$160 weekly operating our original "New System Specialty Candy Factories." Berlin home spare time. Unlimited opportunity. Valuable booklet free. W. Hilber Ragsdale, Drawer 4, East Orange, N. J.

THAXLY Formulas produce perfect products. All lines. Catalog free. B. Thaxly Co., Washington, D. C.

SELL By mail. Books, novelties, bargains! Large profits. Particulars free. B. Elfro, 325 S. Dearborn, Chicago.

WHAT To Invent—Names of manufacturers and wanted inventions sent free on request. Write W. T. Greene, 945 Barrister Building, Washington, D. C.

ARTIFICIAL Marble sanitary flooring, instructions covering wood or cement flooring 3/4 inch thick, fireproof, all colors, low cost. Ornamental casting, concrete plaster papier-mache decorations, garden furniture, statuary, flexible molds, particulars and illustrations free. Chris. Mahler, Elmont, N. Y.

LEARN The collection business. Good income, quick results. Interesting booklet, "Skillful Collecting" free. National Collectors Assn., Long St., Newark, Ohio.

FREE Book. Start your own little business anywhere, selling novelties by mail. My beginner's outfit contains everything required, novelties, circulars, instructions, etc. Descriptive book free. Hadwil, 33A-74 Cortland St., New York.

A BUSINESS Of your own making—Sparkling Glass Name and Number plates. Checkboards, signs. Big book and sample free. E. Palmer, 510, Wooster, Ohio.

OPERATE Chain of vending and amusement machines. Be independent for life. Start small, grow big. P. Go-Body, 1826 East Main Street, Rochester, N. Y.

CHEMICAL. Expert will furnish formulas and trade secrets. All lines. Lists free. W. L. Cummings, Ph. D., 228 Gordon Ave., Syracuse, N. Y.

CHARTERS: Delaware; best, cheapest; free forms. Colonial Charter Co., Wilmington, Del.

I MADE \$30 A week home. French breadmaking. 15 years' experience; free booklet talk. Ashbrook 67, Marengo, Ohio.

BIG Money at home plating auto parts, reflectors, mirrors, chandeliers; by new method; experience unnecessary. Outfits furnished. Gunmetal Co., Ave. N., Decatur, Ill.

FREE Booklet describes 67 plans for making \$20-\$100 weekly in home or office business of your own. Elite Co., 84 Elizabeth St., New York.

UNUSUAL—Uncommon specialties always sell best. Make these yourself from Miller's guaranteed formulas. Why work for others when others can be working for you? Latest eye-opening literature brings you many specialty propositions for an independent business. Miller Chemist, 705-K Chemical Bldg., Tampa, Fla.

10,000 MONEY-MAKING Formulas. Tells you how to make and sell almost everything under the sun; cosmetics, mucilage, antitreeze solutions, battery solutions, beverages, cheese, chewing gum, cleaning preparations, extracts, hair preparations, inks, bluing, leather polish, mirrors, perfumes, polishes, typewriter ribbons, carbon paper, washing powders, liquid soap and hundreds of other profitable articles. Send no money. Just write a postal for "Henes's 20th Century Book of Formulas." Pay postman postage and 24c. Popular Merchants Press, 200 E. Ontario St., Room 802, Chicago.

CHEMISTRY

HANDBOOK For chemical experimenters. 50c. Booklet of experiments, 15c. Chemical catalogue, 5c. General Chemical Co., Reading, Pa.

BECOME Trained chemist. Thousands of opportunities—fascinating career. Learn at home. Complete experimental laboratory outfit given. Write for big free book. Chemical Institute, 19 Park Place, Dept. P-921, New York.

CHEMICAL Formulas—Reliable tested formulas for every purpose. Prices reasonable. Empire State Laboratories, 553 Calvin Pkwy., Buffalo, N. Y.

ROBERT Simpson, analytical and consulting chemist, Weightman Building, Philadelphia, Pa.

YOUR Chemical problem solved and formula or process furnished for five dollars. Write me. W. Steadman Richards, Industrial Chemist, Box 2462, Boston, Mass.

CATALOG listing 2,500 illustrations chemists' supplies, 5,000 chemical, 1,000 scientific books sent for 50c. Laboratory Materials Company, 643 E. 71st St., Chicago, Ill.

FORMULAS AND TRADE SECRETS

CHEMICAL Assistance. Manufacturing profitable with small capital. Guaranteed formulas. Free consultation. Analysis. Associated Chemists, Indianapolis, Indiana.

FORMULAS, \$1 Each. Analysis and match sample \$3 to \$5. Catalogue free. David Bros., 200 North Jefferson, Chicago.

OUR Specialty selling plans, trade secrets, formulas, originators. Write Hardy Supply Company, Three Lakes, Wisconsin.

WART Cure and Fishermen's Secret, \$1.00. H. Damm, Wellington, Texas.

GUARANTEED Formulas, recipes, processes, 50c each. Catalogue free. Industrial Institute, Dept. 209, 64 West Randolph, Chicago.

LIQUID Leather; liquid wood; skin peel; Chinese beauty bleach; 28 more. 43 mail plan specialties, information. Astounding. All \$1.00. Teyrer, Box No. 1275P, Chicago.

ARTIFICIAL Ice making formula, 50c. (Machinery unnecessary.) Nell Tasker, Shamokin, Pa.

RECLAIM Used motor oil. Gallon 2c. Easy process, guaranteed. Send stamp. Ralph Brooks, Arkansas, Wisconsin.

FORMULA Encyclopedia \$1.00. List of contents free. J. Belfort, 4042 N. Keeler, Chicago.

CONSULT Research expert for best formulas, processes or information on any line. Charges moderate. No lists. Personal service only. Write H. Newman, Box 343, Madison Square Station, New York, N. Y.

FORMULAS: Beverages, syrups, extracts, flavors. Manufacturing everything. Valuable information free. The Formula Co., 5th Ave. and Broad, Seattle, Wash.

MONEY Maker formula. "Ston Alcohol Habit," 50c. Formulas, 1021 Arctic, Atlantic City, N. J.

FREE Formula catalog. Latest money makers. Western Chemical, Salem, Oregon.

SUCCEED With your own products. Make-sell them yourself. Formulas, processes, trade-secrets. Expert analytical service. Catalog free. B. Thaxly Co., Washington, D. C.

FORMULAS All kinds. Catalog free. Closer Laboratories (P), Park Ridge, Ill.

FREE Formulas—Free materials making \$22.00 worth of guaranteed highest class specialties-necessities. Thirty-third unequalled anniversary offers explains all. Miller, Chemist, 1707-G Jetton, Tampa, Fla.

500 FORMULAS And big illustrated catalog 25c. Ideal Book Shop, Park Ridge, Ill.

MAKE Your own products. Employ agents yourself. Toilet articles, soap, extracts. We furnish everything. Valuable book free. National Scientific Laboratories, 1950W, Broad, Richmond, Va.

AGENTS WANTED

BIG Pay and a great future selling world famous Public Service shirts, ties, hosiery, underwear, work shirts, etc. Cash commissions paid in advance. Also liberal cash and merchandise bonus, also promotions to district manager positions paying up to \$7,000 yearly. We furnish everything free, and supply sales help. Write immediately for complete scientific selling outfit free. Public Service Mills, Inc., Dept. 219, West New York, New Jersey. Canadian agents write: 110 Dundas St., London, Ontario, Canada.

AMAZING. New and complete line of 40 genuine neon advertising specialties. All wonderful sellers. Send 50c for beautifully illustrated catalog in colors. 50c refunded upon purchase of first sign. Neon Products, Dept. PM, Lima, Ohio.

AGENTS—New ideas for increased incomes; successful plans; inspirational suggestions, unusual money-making opportunities contained in new large "Outdoor Selling Magazine." Rush request! Outdoor Selling, 11 West 42nd, New York.

BIG Money selling shirts, ties, underwear, Sox, raincoats, lumberjacks, sweaters, leatherscoats, overalls, pants, play suits. Outfit free. Nimrod Co., Dept. 8, 4922-28 Lincoln Ave., Chicago.

AGENTS. Sell blades for Gillette type razors. Big profit. Economograph Co., 3541 Broadway, Chicago.

\$2 TO \$4 Per hour easily made. Nothing ever sold compares with the sale of Christmas Greeting Cards in box assortments. Our 1931 assortment beats all our former triumphs, contains 21 exquisite cards and folders, dainty water colors, steel engravings, embossing, glistening gold metallic effects, tipped-on illustrations, parchment and deckled-edge folders, each with tissue lined envelope. Sells for \$1. Costs you 50¢—shipping charges paid. Write for particulars and free samples. Waltham Art Publishers, 7 Water St., Dept. 98, Boston, Mass.

100% PROFIT in new mystery cigar lighter. No flint or friction. What makes it light? No wind can blow it out. Retail 50¢. Sample and sales plan 25¢. New Method Manufacturing Co., Box PM-9, Bradford, Pa.

STRANGE Ironing cord. Prevents scorching. Saves electricity. Abolishes kinks, snarls. Approved by Good Housekeeping. For telephones also. 200% profit. Samples furnished. Neverknot, Dept. 9-A, 4563 Ravenswood, Chicago.

AMAZING New electric trouser presser good for \$25 daily; puts razor edge in pants in 10 seconds, sells for \$2.50; your commission \$1.00. Sample fits pocket. Munny Mfg. Co., Dept. C-89, 817 Main St., Cincinnati, Ohio.

GUARANTEED Hosiery—Lowest mill prices, men's latest fancy hose—doz. \$1.25, \$1.50. Ladies' silk hosiery—doz. \$2.99-\$5.50. Catalogue free. Superior Knitting Company, Dept. 34, New Haven, Conn.

BIG Profits Selling Groceries, Motor Oils, Paint, Stock Minerals. Sample Case free. Lacerin & Browne, 1602-U So. State St., Chicago.

NEW, Profitable—Sell auto step mats. Quality rubber with owner's name molded white. Details free. Ebonite Products, Dent, W-19, 895 Main, Akron, Ohio.

STEP Into big money with Work Clothes. Every man needs Pants, Breeches, Coveralls. Longwear's 4 complete lines sell on sight. Cash in your pocket every day. Belt free with every 2 Complete outfit free. Dept. P9, Longwear, 489 Broome St., New York.

SO Good, it's foolish to call this selling. Men must buy Shirts, Ties, Underwear, Hosiery, other necessities. Roseriff's powerful year guarantee makes big money for you. Cash bonuses. Free shirt offer. Finest outfit free. Write today. Dept. K9, Roseriff, 1237 Broadway, New York.

AMAZING Elec. sensation brings agents up to \$15 in a day. 30 million prospects; wonderful demonstrator; \$1.50 seller. Write quick. Reardon Mfg. Dept. 9-PM, Peoria, Ill.

FREE—One new ripple cloth necktie with each shirt. Sell 4 shirts for \$5. Improved non-curling and pre-shrunk collar; also made to measure shirts; liberal commission. Menzies Shirt Co., 208 Greene St., New York.

NEW Model Genuine Gillette Blades pay you \$1.00 profit each 75¢ outfit, amazing cut-rate advertising plan. Details 10¢. Dent 116, CCP, 609 Hamilton, St. Louis.

PROFITABLE Home business. Legitimate. No canvassing. Maywood Publishers, P-223 Broadway, New York.

IMPORT Your own goods. German export magazine published in English offers numerous bargains latest novelties; opportunity for obtaining profitable agencies. Copy 60¢. Square Deal Supply, P-214, Fifth Ave., New York.

100% TO 125% Profit. Try out line of household necessities. Fast sellers. Send for Free Goods Offer. Stanley Chemical Co., 16375 Hamilton, Detroit, Mich.

EASY Money! Sell 25 card \$1. Christmas assortment, 100% profit. Also personal greetings. Experience unnecessary. Write for samples. American Cards, Dept. T-1, Lancaster, Pa.

NEW Invention makes any clock electric. Easily attached. Big Profit. Bestever Clock Co., 4319-P Irving Pk., Chicago.

300% PROFIT in new "20-in-1" kitchen necessity. Retail 25¢. Costs you \$1.00 a dozen. \$10.00 a gross. Sample 15¢ to cover cost of mailing. New Method Co., Nu-Method Bldg., Desk PMM-9, Bradford, Pa.

MONUMENT Salesmen. Wonderful opportunity. Sell famous Stone Mountain granite. World's lowest prices overcome competition. enables you secure majority business. Write today. Southeast Granite Company, Dept. G-3, Station C, Atlanta, Georgia.

BIG Pay giving away Shirts, Hosiery, Underwear. Also Lumberjackets. Smashing free offers win orders. Every man buys. No experience needed. We teach you and supply complete sample equipment Free. Write Today. Dept. 825, Albert Shirts, 869 Sixth Ave., New York.

FIVE placed 5,000 men in good paying jobs, selling Shirts, Ties, Underwear, Hosiery, Workshirts, Lumberjackets, etc. I'll give you a marvelous outfit Free. Remarkable values get orders and repeats. Big cash commissions and bonuses. Write Dept. H9, Quaker, 1107 Broadway, New York.

300% PROFIT Selling Mystery Gas Lighter. Retail 25¢. Costs you \$1.00 doz. Sample free. Square Deal Mfg., Desk PM-23, Bradford, Pa.

ELECTRIC Water heater—New. Heats water instantly. Pocket size—retails \$3.75. Two minute demonstration makes you \$1.95 profit. Lux-Visel, Dept. 97, Ekhart, Ind.

NEW Radio offer. Pentode a. c. Specialty. Agents coinize money. Free details. Radio Reporter, 20 Merchandise Mart, Chicago.

NEW Rubber goods line. 47 money makers. Rubber rugs cushions, bath mats, raincoats, rubber soles, aprons, baby goods, etc. Big profits, best values. Direct from Akron, the Rubber City. Make up to \$90 weekly. Credit given. Write for catalog and free outfit offer. Kristee Mfg. Co., 1139 Bar St., Akron, Ohio.

"POLOX" The original, trademarked "Fluid Solder," repairs radiators, gasoline lines, tanks, furniture, dishes, etc. See article page 185 August issue Popular Mechanics. Secure agency genuine article. Polox Mfg. Co., Merriam, Kansas.

BIG Profit catalog: toilet preparations, food products, remedies, household specialties, portraits, frames, medallions, Christmas cards. Credit. James Bailey Co., Station C9, Chicago.

AMAZING New electric razor! Revolutionizes shaving! New everywhere! Wild-fire seller! Enormous profits! No competition! Contract! Outfits! G. R. Co., L. I. City, N. Y.

NEW Booklet shows the way to get jobs that pay 10¢. Satisfaction guaranteed. Mopubo, 5565 Seabreeze Station, Daytona Beach, Florida.

WONDERFUL Powder shakes from can, removes anything from hands without injuring skin; everybody buys; big repeater; opportunity for hustler. Sample free. Cowell, 8016 Grand, Kansas City, Mo.

ADDRESSES—Hundreds of wholesale, agent supply houses. Particulars. J. Belfort, 4042 N. Keefer, Chicago.

AGENTS—Anywhere—Answer these questions—Can you sell my new "Charm" Wrench? Self-adjusting, best ever devised. Can you finance your virgin territory? Address Fridron, Williams Building, San Francisco.

SELFTHREADING Needles and USA needlethead. Samples, each 10¢ Agents protected. Box 485 City Hall Sta., New York.

SELL Goodyear raincoats, \$2.95 up. Goodyear Rainwear, 18 West 22nd, New York.

BIG Money easy. Simply showing New Polly Wrench, 16 wrenches in one. Guaranteed fast seller. Sample furnished. Gellman Manufacturing Co., Dept. 9-G, Rock Island, Ill.

SELL Personal Christmas cards. Names embossed in gold. Lowest prices, highest commissions. Samples free. Also box assortments. H. Dunbar Co., New Brunswick, N. J.

MAKE Up to \$15 daily introducing men's, women's, children's finest hosiery. Warranted 6 months or replaced. Amazingly low prices, 126 styles, colors. Auto and hosiery given producers. Write quick! Wilkint Hosiery Co., C-379 Midway, Greenfield, O.

MAKE Big money selling sensational instant electric water heater. Every home welcomes it. \$30 a day cash pay easy. Send \$1.00 for sample and free selling plan. Regent Electric Works, 8444 South Chicago Avenue, Chicago, Ill.

AGENTS—Sell our beautiful Christmas card assortment. Attractive Christmas dressing packages. Wonderful line. Big profits! Write today. Nickel's Greeting Card Co., Box 813, St. Louis, Missouri.

ADDING Pencil. Adds mechanically. Amazing new invention. Sells like wild-fire. Agents wanted. Get sample immediately. Add-O-Graph Co., Dept. 27, Saltville, Miss.

AUTOMATIC Cigar gas lighters. No friction. Sample 25¢. Gas Lighter Co., St. James St., Montreal, Canada.

MARVELOUS New Water Heater, heats water instantly. Pocket size. Retail \$3.75. 2 minute demonstration pays up to \$2.25 profit. Special sample offer. Solray Company, 213 East Illinois, Dept. 400, Chicago.

IF You want a wonderful opportunity to make \$15 profit a day and get a new Ford sedan besides, send me your name immediately. No experience necessary. Particulars free. Albert Mills, 9137 Menmouth, Cincinnati, Ohio.

MAKE Your own products. Employ agents yourself. Toilet articles, soap, extracts. We furnish everything. Valuable book free. National Scientific Laboratories, 1950W Broad, Richmond, Va.

POLMET Polishing Cloth Removes Tarnish from all metals without the use of liquid, paste or powder. Our agents say it sells like "hot cakes." Retail 25¢; sample free. Gale & Co., Inc., 15 Edinboro St., Boston, Mass.

AGENTS. Build a volume repeat business in your territory with nationally known Auto Beauty Kit. Fast seller, big profits. State previous selling experience. territory covered. U. S. Mfg. Corp., Dept. A, Decatur, Ill.

250,000 ARTICLES Wholesale—Directors 10¢. W-Patterson, 4111 University, Des Moines, Iowa.

SOMETHING The housewives want. A signed guarantee to save money and time in cooking. No competition, 400% profit. No license required. Station C. Box 23E, San Diego, Calif.

MIRRORS Resilvered at Home. Costs near 5 cents per square foot, you charge 75 cents. Profitable business plating autographs, reflectors, tableware, stores, refinishing metalware, etc. Outfits furnished, details free. Write. Sprinkle, Plater, 128, Marion, Ind.

SIGN Salesmen let us tell you about a New Changeable Sign that sells for \$1.50 and gives you 400% profit. National Sign System, St. Louis, Mo.

GIVE Away Ladies' Pure Thread Silk Stockings with wonderful value \$1.00 sets of Paris Toilettries, 100% profit. Paris Laboratories, 3145 Louist Blvd., St. Louis, Mo.

PHOTO Medallions. Send for latest catalogue. Hundreds of our newest designs. Photo novelties. Lowest prices. Quick service. Medallion Novelty Co., Inc., 208 Bowers, New York, N. Y.

THAXLY Formulas produce perfect products. All lines. Catalog free. B. Thaxly Co., Washington, D. C.

MAKE Your own products. Employ agents yourself. Toilet articles, soap, extracts. We furnish everything. Valuable book free. National Scientific Laboratories, 1950W Broad, Richmond, Va.

AGENTS For handiwork; original powdered hand soap. Approved Good-Housekeeping. Everybody customer. Fine opportunity for hustler. Sample free. Solar Products, J-2144 So. Troy, Chicago.

SUCCEED With your own products. Make-sell them yourself. Formulas, processes, trade-secrets. Expert analytical service. Catalog free. B. Thaxly Co., Washington, D. C.

AGENTS—Engraved name plates, signs, number plates etc., easily sold with large profits. Brett Bros., Winthrop, Mass.

NO Dull times selling food! People must eat. Federal distributors make big money; up to \$3,000 yearly or more. No capital or experience needed; unsold goods may be returned. We furnish free sample case, license and free samples for customers—sure repeat orders. Exclusive territory. Ask now. Federal Pure Food Co., A2307 Archer, Chicago.

OUR Luminous crucifix and new luminous St. Theresa statue shine brilliantly in the dark. Sell on first demonstration. Write for prices. W. G. Hannan Co., 2543 So. State, Chicago.

BIG Money applying gold initials on automobiles. Easiest thing today. No experience needed. \$1.45 profit every \$1.50 job. Free samples. "Balco," X-1043 Washington, Boston, Mass.

NEW Line Counter Displays. Aspirin, Flints, Chewing Lavative, Breath Gum, No-tartar, Silktone, etc. Steady Repeats. Over 100% Profit. Superta Co., W5, Baltimore, Md.

THIS Advertisement may make you thousands of dollars, if you write immediately for my "Eye-Opening" literature describing guaranteed formulas; valuable trade processes, money-making information how to easily make the world's best-selling specialties. All lines. Investment small. Profits immense! Start in your home, room or office. Make the good money you're entitled to. Dr. Lacombe Miller, Chemist, Tampa, Fla.

CHICAGO Expert valued \$3 stone at \$300. The diamond's only guaranteed rival. Greatest spare time, side-line article ever known! Amazing profits. \$5 pocket sample case free. Write quick. Mexican Gem Company, Dept. PM, Monterey, Calif.

FREE "Booklet of money making opportunities," new ideas, original plans, money making secrets and other valuable information. None require peddling or outfits. Elite Co., 81 Elizabeth St., New York.

SELL 3A Garage door holders, simple, automatic, quickly installed. Interests garage owners, builders, everybody. Exclusive territory proposition. Knowlson-Stevens Co., Ann Arbor, Mich.

MAKE Your own products. Employ agents yourself. Toilet articles, soap, extracts. We furnish everything. Valuable book free. National Scientific Laboratories, 1950W Broad, Richmond, Va.

FLAVORING Extracts—Bottle yourself! Labels furnished. 600% profits! Whirlwind money-makers! Repeaters! Free offer. Thomas Manufacturing Company, Indianapolis, Ind.

CALIFORNIA Perfumed beads, selling like hot cakes. Agents coinmg money. Catalog free. Mission Factory, P. 2328W Pico, Los Angeles, Calif.

\$60-200 A WEEK. Genuine gold letters for store windows. Easily applied. Free samples. Liberal offer to general agents. Metallic Letter Co., 438-B North Clark, Chicago.

WE Start you without a dollar. Soaps, extracts, perfumes, toilet goods. Experience unnecessary. Carnation Co., 641, St. Louis, Mo.

AGENTS—Make a dollar an hour. Sell Mendota, a patented patch for instantly mending leaks in all utensils. Sample package free. Collette Mfg. Co., Dept. 404, Amsterdam, N. Y.

PHOTO Medallion men and women. The largest line of photo novelties in the world. Lowest prices, quickest service. Send for catalog showing over 200 money makers. Gibson Photo Jewelry Co., Inc., 833-837 Gravesend Ave., Brooklyn, N. Y.

A BUSINESS Of your own—Making sparkling glass name and number plates, checkboard signs. Big book and sample free. E. Palmer, 512, Wooster, Ohio.

SELL Stores 5c carded breathlets, etc. Legor Products, Albany, N. Y.

AMAZING Electric water heater. Pays big profits. Heats water instantly. Pocket size. Sells fast at \$2.95. Write quick. Bestever Co., 4317P, Irving Park, Chicago.

AGENTS—Clever Invention! Inkpen makes every pen a fountain pen. Fast office seller; big profit, demand increasing everywhere. Exclusive territory offered. Sample free. H. Marul Company, Tribune Bldg., New York, N. Y.

GENUINE Gold Leaf Letters anyone can put on store windows. Guaranteed to never tarnish. Large profits. Enormous demand. Free samples. Write today. Metallic Letter Co., 438-D North Clark, Chicago.

AGENTS Everywhere making money with our line of kitchen specialties, demanded in all homes. Big earnings possible. Write today for details. P. Seed Filter Co., 353 Broadway, New York.

SELL Men's neckwear—wonderful proposition. Astor-M. 39 East 25th, N. Y.

BIG Profit putting our gold sign letters on store windows, without experience. Samples. Consolidated, 69-T West VanBuren, Chicago.

HOUSEHOLD Automatic Refrigerating Machines. Here is the first book ever published on this important subject. Refrigeration, by Meyer and Fittz. It is a thorough treatment of present-day refrigeration systems, their operation and testing for the student practicing engineer. 431 pages, 184 illustrations. Cloth. Sent C. O. D. Pay postman price \$4 and small amount of postage upon delivery. Popular Mechanics Press, Room 802, 200 E. Ontario St., Chicago, Ill.

AGENTS: Stamping names on pocket-key protectors. Sample check with your name and address, 25c. Stamping outfits, Emblem checks, check-fobs, name plates. Hart Mfg. Co., Desk 2, 363 Degraw St., Brooklyn, N. Y.

BIG MONEY and fast sales. Every owner buys gold initials for his auto. You charge \$1.50; make \$1.45. Ten orders daily easy. Write for particulars and free samples. American Monogram Co., Dept. 40, East Orange, N. J.

MAN In each town to plate auto parts, reflectors, bathroom fixtures, refresh beds, mirrors, chandeliers; by new method. No capital or experience required. Simple plan of manufacturing at home starts you in big money-making business. Outfit furnished. Free particulars and proofs. Gun Metal Co., Ave. B, Decatur, Ill.

GREATEST Opportunity; newest proposition. Build continually paying business in your own name. Household, industrial, brushes, brooms, mops, dusters, fully guaranteed. New catalog, all net prices, no discount to bother with. Make as high as 300 per cent and over. Write today. Wire Grip Sanitary Brush Corp., 41 East 11th St., New York.

HIGH-GRADE SALESMEN WANTED

EARN \$1000 Between now and Xmas. Your friends, relatives, neighbors will buy on sight. Because Process 1931 Famous Artist line of Christmas Greeting cards, imprinted with sender's name and message, costs no more than ordinary cards. Big cash commissions paid in advance, monthly cash bonuses, etc. Write for complete outfit free and confidential sales plans. Process Corp., Dept 802-C, 21st at Troy, Chicago.

WANTED Salesmen calling on mechanical lines to secure orders for small metal stampings on commission basis. Send full particulars. Otto Konigslow Mfg. Co., 3510 Perkins Ave., Cleveland, O.

\$5000 A YEAR Opportunity calling on merchants and banks. Clever "Animated Advertising Display" creates instant sales appeal. Minimum investment of \$225 required with immediate liberal profit return. Character Display Co., 3249 N. Herndon Ave., Chicago.

SALESMEN. Advertising thermometers, pencils, book matches, calendars, Christmas cards. Full sample line \$2.00. Refunded. No catalog, sell from samples. Order your kit now. Box 42, Carlstadt, N. J.

MAKE Money every day; establish agency selling men's All Wool Suits, Topcoats, Overcoats, below \$20.00. Pays you \$4.00 cash every order. Beautiful selection, easy to sell. Expensive outfit, sales help free. Write experience. All Wool Clothes, Dept. P2, 899 Broadway, New York.

SO Good, It's foolish to call this selling. Men must buy Shirts, Ties, Underwear, Hosiery, other necessities. Rosecliff's powerful year guarantee makes big money for you. Cash bonuses, Free shirt offer. Finest outfit free. Write today. Dept. L9, Rosecliff, 1237 Broadway, New York.

WORLD'S Greatest selling article, just out! Over 5 million waiting to buy now. Season starting. Big commissions. Chicago Cutting Co., 2333-A Nelson St., Chicago.

SALESMEN—New trade stimulator. Beautiful junior automobile 6 feet long furnished free to merchants. \$15, commission each \$5. sale. Drimmer, 927 Broadway, New York.

EVERY User of the mails needs an envelope sealer. The Kendall seals fifty minute. Retail \$2.50. Big profit. Good territories available. Kendall Sealer Company, Dept. 5, Berkeley, Calif.

RECORD Breaking profits selling stores amazing new business stimulator. Low cost. Unusual features. Retailers buy on sight—repeat often. Commissions in advance. Outfit free. General Premium, 66-T, East Lake, Chicago.

\$18 TO \$25 Daily; biggest selling line of men's suits. Meets present day conditions. Amazing values at \$11.95, \$14.50, \$16.95, \$18.95. Also raincoats, slickers, topcoats and boys' suits. Biggest commission paid in advance. Liberal bonus. Free outfit. State age and selling experience. "Jim" Foster, Inc., Dept. 29, 2250 South Spaulding Ave., Chicago.

\$60 WEEKLY Easy! Selling amazing value all wool 2 Pants Suits \$21.95. \$5 profit. Single Pants Suits, Topcoats, Overcoats \$18.95. Union tailored. Sample suit for producers. Outfit Free. Williams Bros., 879 Broadway, Dept. WB-32, New York.

CLOTHING Salesman—Sell wool suits, three piece, made to measure, \$12.50. Commission \$2.50 in advance. Also top coats same price and commission. Harper Mfg. Co., Rome, Ga., Dept. A-1.

\$65 WEEKLY—Easy. Selling men's made-to-order suits at \$23.50. Build a permanent and repeat business with our guaranteed clothes. New selling method. Part or full time. Liberal commission and bonus. Free suit offer to beginners. Free outfit. 28th Century Tailoring, Aurora, Illinois.

GET Something that really sells. Auto seat covers \$1.95. Write today. Colerzone Company, Des Moines, Iowa.

GOOD Steady money maker. Exclusive territory to workers. Much needed automobile signal. Pronounced best and most fool-proof by president America's largest auto association. Get particulars and make money. You Auto Signal Company, Dept. A, Post Lauderdale, Florida.

ONE \$4.75 order daily means \$100 weekly on our guaranteed money back sales promotion deals. Free kit. Sales Stimulators, Dept. 14H, 341 Madison, Chicago.

WANTED County salesman with car, to demonstrate for large Ohio manufacturer. First class job. Fyr-Fyter Co., 2185 Fyr-Fyter Building, Dayton, Ohio.

NEW And plenty different—Fast selling 5c-10c merchandise on attractive counter cards. 100% commission for you and dealers. Advertised by radio. No capital required. Catalog free. World's Products (Estab. 1921), 160 Central, Spencer, Ind.

SCREW-HOLDING Screw Drivers! Non-magnetic. Remove, insert screws inaccessible places! Factories, garages, electricians, carpenters, mechanics, auto, radio owners buy on sight! Free trial! Millen, JC-15, Winthrop Bldg., Boston.

BIG Pay giving away Shirts, Hosiery, Underwear. Also Lumberjackets. Smashing free offers win orders. Every man buys. No experience needed. We teach you and supply complete sample equipment free. Write Today, Dept. 826, Albert Shirts, 869 Sixth Ave., New York.

SELL 1000 Business cards \$1.50, card case included. Three colors. Big commissions. Complete outfit free. U. S. Business Card Co., 34-0 Varick Station, New York.

SALESMEN—One hundred percent profit selling our new patented electric water heater. New fast selling line. Jiffy Electric Company, Hazel Park Station, Detroit.

JUST Put our chewing gum outfit in your pocket. Make daily expenses. Sell to stores. Popular flavors; outfit furnished. Helmet Corp., Dept. 331, Cincinnati, O.

AGENCY Organizers for Soderite, the new and original metallic flowing solder. Needs no heat or acid. Tanks, pipes, radiators, engine heads, dishes, furniture, jewelry. See write up in June Popular Mechanics. Fluid Solder Products Co., 1446 So. Wabash, Chicago.

SALESMEN—10% Commission daily. Save merchants 50%. Sell everywhere. Outfit free. Osell, 320 Locust, Des Moines, Iowa.

EXCLUSIVE Territory, attractive commission selling low priced guaranteed line of steamers, toasters, grills, corn-cobbers, dish washers, etc., to lunch rooms, fountains, barbecues, sandwich shops, on easy terms. No investment. Write R. W. Wheeler, care Automatic Devices, Inc., Springfield, Ohio.

DISTRIBUTORS, Salesmen, agents, for new electric low priced food and drink mixer, patented, guaranteed. Samples at wholesale. Territory open. Mason Mixer Co., St. Paul, Minn.

BIG Demand for: Port, Sherry, Champagne, Claret, etc. In solid brick form; one brick makes one gallon juice; legality twice established in courts; government financing industry; every home, hospital, church, grocery, drug store prospect. 100% profit for distributors—salesmen. V. S. Co., Dept. 8-205, 335 - 7th St., San Francisco, Calif.

SALESMEN And district managers wanted for distribution of live auto accessory (necessity). Something new. No competition. Commission 33%. Identification-Registry Service, Inc., Utica, N. Y.

I'VE Placed 5,000 men in good paying jobs selling Shirts, Ties, Underwear, Hosiery, Workshirts, Lumberjackets, etc. I'll give you a marvellous outfit free. Remarkable values get orders and repeats. Big cash commissions and bonuses. Write Dept. 29, Quaker, 1197 Broadway, New York.

SALESMEN—At last! New feature sells punchboards everywhere. Dealers wild with joy—prosperity back again. Profits enormous. Samples free. Puritan Novelty, 1407 Jackson Blvd., Chicago.

WONDERFUL Opportunity. Twenty dollars per day can be earned. Experience unnecessary. Home protection at cost. Ages one to eighty. \$250 to \$1000 at death. Not insurance. You make \$5 for each member secured. Childless of Virginia, sent in 54 one day. National Aid Society, Myers Building, Springfield, Illinois.

SALESMEN—Wonderful sideline. 40% commission paid daily. Sells all merchants. Pocket outfit free. Wilcox Co., Dept. 378, 2130 Gladys Ave., Chicago.

BUSINESS Stationery. largest line. highest quality. quickest delivery. biggest commissions. Liberal bonuses, free copyrighted cuts every business, experience unnecessary. Instructions and outfit free. David Lionel Press, 312 So. Hamilton, Dept. 229, Chicago.

PENNY Golfer. new fascinating coin-controlled game. Legal. Exciting. Merchants everywhere buy. Sole distributor commission. Specialty Mfg. 617 Division, Chicago.

SELL Egg Cartons! Dandy repeat side line. Everyone who sells eggs needs cartons—grocers, poultry farms, dairies. Send for information and samples. Pick up these extra commissions. Self-Locking Carton Company, 575 E. Illinois Street, Chicago, Ill.

GREAT Sideline for any salesman! Pocket outfit free. New cash customer Building Campaigns for merchants. D&H Premium Co., Dept. 538, 116 So. Wells, Chicago.

ALL Merchants buy! So carded nuts, aspirin, etc. Steady repeats. Also low priced vending machines. Robbin Products, DeKalb and Broadway, Brooklyn, N. Y.

BAD Debt Service Salesmen. Sell service contracts. New original plan; liberal commission; extra bonus; protected territory. National Credit Service, Columbian Bldg., Washington, D. C.

MEN To sell Batteries with complete line of supplies to garages. Lowest prices. Mirkman Battery Co., St. Paul, Minn.

WE Want to hear from full and part time men who can sell complete line of business printing. One of finest in country. Thousands of live cuts. Full cooperation and progressive sales plans. Outfit free. All-Trades, 116 N. 2nd St., Rockford, Ill.

NEW Specialty—Sells every business and professional man. Four \$15 sales daily pay \$280 weekly. Foyer cleared \$4920 in three months. Write, F. E. Armstrong, President, Dept. PM, Mobile, Ala.

\$75.00 WEEKLY Job—Salesmen-Distributors! Outstanding opportunity. amazing new tire patch guaranteed 10,000 miles. Big profits, steady repeats. Protected territory as factory distributor. Write to Economy Rubber Products Co., 608 Burkhardt, Dayton, Ohio.

PUNCHBOARD Salesmen—Most gigantic line ever featured. Vending machines—all kinds. Make as high as \$28.00 on single order. Repeat commissions. Beautiful colored catalog free. Lion Mfg., Dept. 8, 308 W. Erie, Chicago.

NEW. Largest color catalogue, punchboards, vending machines, produces quicker orders, big commissions. Free outfit. Lincoln Sales, 116 So. Wells, Chicago. Dept. D. Established 20 years.

SALESMEN—Become independent. Own your business; experience unnecessary, selling our \$10,000 accidental death; \$50 accident; \$25 sick weekly benefits—\$10.00 yearly. Other amounts proportionate. Guaranteed steady income from renewals. \$250,000 deposited insurance department. Universal Policy, Dept. A, 716 Lefebvre Bldg., Newark, N. J.

SELL Nothing! \$170 weekly empty handed. \$500,000 punchboard firm announces new plan. No investment for anyone. Season starting. Hurry! K&S Sales, 4326 Ravenswood, Chicago.

BIG Profit putting our gold sign letters on store windows, without experience. Samples. Consolidated, 69-V West Van Buren, Chicago.

SALESMEN—Tremendous profits demonstrating new, patented belts. Buttons into waistband. Holds trousers up; shirt down. Slenderizes, supports abdomen, back. Adjustable support for stout gentlemen. Sample, \$2.75. Perfect elastic for slender gentlemen, \$1.75. Give actual waist measure. Nationwide demand. Write VonWald Co., LaCrosse, Wisconsin.

COMPLETE Line of Printing. New service. Illustrated cuts. Sample book free. Tracy Printing Co., 314 - 5th Ave., So. Minneapolis, Minn.

\$60 WEEKLY Easy! Selling amazing value all wool 2 Pants Suits \$21.95. \$5 profit. Single Pants Suits, Topcoats, Overcoats \$18.95. Union tailored. Sample suit for producers. Outfit Free, Williams Bros., 879 Broadway, Dept. WB-22, New York.

61 PRACTICAL Ways to Reduce Farm Labor and Expense and Increase Income. One farmer writes he would not part with this information for \$100, if he could not duplicate it. Nothing experimental. These ideas have all been put to test and proven practical. Send today for a copy of our Handbook for Farmers and get ready to put these ideas into operation for your own benefit. Pay postman only 98 cents and the postage when he hands you the package Popular Mechanics Press, Room 802, 200 E. Ontario St., Chicago, Ill.

HELP WANTED

350 MEN Wanted. Steady, profitable employment for you. If you can install an electric bell, you can make money installing Improved Fire Detectors. Underwriters' Laboratories listed automatic fire alarm device. Sale price \$3.50 each. You make over forty percent. Send \$2.00 for an Improved Fire Detector to start you at once in steady profitable employment. Complete information furnished. Improved Fire Detector Corporation, 422-A Equitable Bldg., Baltimore, Md.

GO Into business—Make big money. We start you furnishing everything. Experience unnecessary. Federal Pure Food Co., X2307 Archer, Chicago.

STOP Worrying about money! Here's a wonderful opportunity to make \$15 profit a day as my local representative. No capital or experience necessary. Write today for details. Albert Mills, 9138 Monmouth, Cincinnati, O.

AGENTS—Moss corn and callous remover will build you a steady repeat business. Send today for pocket-size trial outfit. The Moss Company, 194 Searle Bldg., Rochester, N. Y.

EDUCATIONAL AND INSTRUCTION

PHOTOPLAY Talking picture and magazine stories wanted for revision, development and copyright. Sell on commission. Established 1917. Booklet free. Universal Scenario Company, 405 Meyer Bldg., Western and Sierra Vista, Hollywood, Calif.

U. S. Government steady jobs. \$165-\$250 month. Men-women, 18 to 50. Paid summer vacation. Short hours. Common education usually sufficient. Experience usually unnecessary. 25 coached free. Full particulars and list positions free. Write today sure. Franklin Institute, Dept. G3, Rochester, N. Y.

WANTED. Men-Women, 18-50, qualify for steady Government Jobs. Salary range, \$105-\$250 month. No Government experience required. Paid vacations. Common education. Thousands appointed yearly. Write Orient Institute, 101, St. Louis, Mo., immediately.

OPPORTUNITIES Outdoors—Learn how to start building a successful industrial career, beginning in spare time and developing until full time service of yourself and others required raising small animals, birds and plants. Send for reliable instruction book. Price \$2.00. Sent postpaid upon receipt of price or C. O. D. anywhere in U. S. Popular Mechanics Press, Room 808, 200 E. Ontario St., Chicago.

LEARN Photo-Engraving at home by experience. We supply without extra cost all necessary equipment. Make money while learning. Aurora School of Photo-Engraving, Aurora, Missouri.

BEGINNERS Instructed for Florida hotel positions. Lee Institute, 141 Pearl, Somerville, Mass.

DON'T Prepare for any civil service examination without seeing our catalog. Free. Columbia Correspondence College, Washington, D. C.

U. S. GOVERNMENT Wants men. \$1,700-\$1,900 and up at start. Railway mail clerk examination coming. Let our expert (former government examiner) prepare you for this and also rural carrier, post office, customs, internal revenue, and other branches. Write today for free booklet. Dept. 8, Patterson School, Rochester, N. Y.

USE Shortcuts in Figures. Save valuable time. The quickest way of working all problems. Instructions for drilling yourself to be come rapid with figures. Complete, yet simplicity itself. Just write a postal for "Shortcuts in Figures." Pay postman \$1.25 and postage. Popular Mechanics Press, Room 802, 200 E. Ontario St., Chicago, Ill.

BECOME A landscape architect. Uncrowded profession; wonderful opportunity for money-making. Easily mastered by mail. Earn while you learn. Est. 1916. Write for details. American Landscape School, 29A Plymouth Bldg., Des Moines, Iowa.

THAT Concrete Job. Don't be afraid to tackle it. With the instructions found in the new edition of Popular Mechanics Concrete Handbook you can easily make 175 articles of utility and beauty ranging from ordinary steps to garden furniture. This book will be sent for only 98c plus postage C. O. D. Send your order today to Popular Mechanics Press, Room 802, 200 E. Ontario St., Chicago, Ill.

SHORT STORIES

SHORT Stories revised, typewritten and marketed. Details free. Hursh Service, Box P-1013, Harrisburg, Penna.

BEFORE You submit that manuscript! Los Angeles professional will edit all kinds for \$2 a thousand words. Marketing suggestions. Send cash and stamps for return. Address Editorial Aid, Box 1103, San Pedro, California.

MANUSCRIPTS. All kinds, edited by Los Angeles professional, \$2 a thousand words. Editorial Aid, Box 1103, San Pedro, California.

TYPEWRITERS AND SUPPLIES

ADD-LIFE Automatic ribbon inker. Ribbon life increased more than three times. Clear copy. Attaches any typewriter. \$1.75 prepaid. Guaranteed. Big profits. Distributors get selling plan. Cormac Products Company, 604 Mission, San Francisco, California.

BEST Typewriter ribbons, 39c. Typewriters, \$4 to \$32. Guaranteed. Catalog free. Typewriter Works, Ada, Okla.

TYPEWRITERS—All standard makes \$10 up. Catalog free. Northwestern Typewriter Exchange, 121 N. Francisco Ave., Chicago.

ADDING MACHINES

NEW \$4.75 Automatic Adding Machine. Fully guaranteed. Bassett 1458-B, Hollywood Avenue, Chicago.

PRINTING, MULTIGRAPHING AND MIMEOGRAPHING

5000 ATTRACTIVE 3½x6 Folders, \$11.50; 5000 envelope slip, \$3.00; 5000 6x9 circulars, \$7.50. Samples. Goodprint, Harrisonburg, Va.

SPECIAL—1000 Business envelopes \$1.95. Baumgartner Press, 1570 Freeman, Cincinnati.

1000 BUSINESS Cards \$1.60. Free card case. Free delivery anywhere U. S. Send \$1.60 with hand printed copy. Bradshaw Specialty Co., Dept. A, 706 North Kedzie Ave., Chicago, Ill.

RECORD Bond letterheads \$3.85 M. O. Parsons, Box P-2, Cheus, N. J.

STATIONERY Cabinets, 200 note sheets 6x7 and 100 envelopes, good white bond, neatly printed with your name and address, sent postpaid for \$1.00. Carl Edquist, Odessa, Minnesota.

NEW Depression price list—Get it! Unprecedented savings. Large plant, real service, modernized equipment, new building. Everything for mail order manufacturers, circulars, stationery, publications. Magnificent amalgamated free premium. Webb-Print Press, Gettysburg, Pa.

LETTERHEADS, Statements, Envelopes, \$3.25 thousand. Hammermill bond. Acorn Press, 40 Irving St., Montclair, N. J.

ATTRACTIVE Mimeographed letters, 500—\$2.50; 1000—\$3.50. Field, 1562 Glenmont Road, Cleveland, Ohio.

LETTERHEADS, Envelopes, 500, \$1.10; 1,000, \$2.00; \$5,000, \$8.00, plus postage. Samples, Coyle & Kimballs, Newport, N. Y.

TRIAL Thousand three color stickers, \$1.00. 13 words. Harvey Wolf, 6618F Quimby, Cleveland, Ohio.

200 SHEETS, 100 Envelopes, Ripple bond, \$1.00. Amyek, Bradenton, Florida.

1000 BUSINESS CARDS \$1.45. Marmorstein, J Vanhouten Avenue, Jersey City.

YOUR Advertisement 1000 blotters \$3.25. Sta-Sales, Box 446, Rochester, Minnesota.

150 ENVELOPES, Letterheads, cards, billheads, labels, 75 ets. each. Ware, Box 357, Ft. Madison, Ia.

1,000 LETTERHEADS Bond 6x9 $\frac{1}{2}$, \$2.00 prepaid anywhere. Cash with order. Samples, Seminele Press, Miami, Florida.

NEARGRAVUREIMBOSSED 250 Letterheads-Envelopes \$4.30 postpaid. Samples, Soliddays, Knox, Indiana.

250 BOND Letterheads, envelopes, billheads, cards, \$1.35 each. Economic Press, Leonia, N. J.

200 SHEETS, 100 Envelopes, 69c. Applebaum—P, 1258 Brook, New York.

1000 BUSINESS CARDS \$2.75 postpaid. Samples, Miller, Printer, Narberth, Pa.

WE Print stationery, booklets, catalogs, circulars. Samples, Commercial Press, Batavia, Ohio.

PRINTING OUTFITS AND SUPPLIES

PRINT Your own cards, stationery, circulars, advertising, etc. Junior Press \$5.90. Job presses \$11 up, power \$149. Print for others, big profit. Easy rules furnished. Write for free catalog and full information. Kelsey Co., R-11, Meriden, Conn.

PREUSED Printing presses and supplies. Lists 2c stamp. Popular Bargains, Richmond, Pa.

BUILD An 8x10 printing press for \$1.00. Complete instructions only 50 cents. K. Wise, 100 E. Broadway, Red Lion, Pa.

PRINTING OUTFITS—Presses, type supplies, type novelties. Send stamp for catalog. Model Press, York, Penna.

GUMMED LABELS

1,000 PRINTED: Name, business, address 50c. JBS Company, Box 93, Holyoke, Mass.

DUPLICATORS AND DEVICES

"EXCELLOGRAPH" Rotary stencil duplicator \$39.00. "Two-Faced" film duplicator \$6.00. Booklet free. Pittsburgh Typewriter Supply, Dept. 601, Pittsburgh, Pa.

RUBBER STAMPS

RUBBER Stamps: Name, address 35c coin. Newman, 2248-O, Lincoln, Neb.

NAME, Address, 2 lines 25c; 3 lines 35c. Stamp Works, Auburn, Neb.

FOR MEN

FREE Thirty day trial. Marcellus dollar abrasive device for reconditioning all makes of safety razor blades. Many weeks of luxurious daily shaving from one blade. Send for particulars. John O. Bennett, 36 Edmonds St., Rochester, N. Y.

FREE! Send your birthlar for horoscope. Mopuco, Seabreech Station, Daytona Beach, Florida.

WOOD Turning on the lathe. Both interesting and fascinating. Send for a copy of Milton & Wohlers Course in wood turning. It gives you quickly a complete mastery of this manual art. 340 pages. Cloth. 141 plates. Sent C. O. D. Per postman price \$1.50 and small amount postage upon delivery. Popular Mechanics Press, Room 802, 200 E. Ontario St., Chicago, Ill.

FOR SMOKERS

SMOKE Factory Fresh Green River Cigarettes Free. Send \$1.25 for 10 packs Green Rivers. Smoke 5 packs. If you don't find them mildest, most tasty, best flavored you ever smoked, return 5 packs. We'll return \$1.25 promptly. Green River Tobacco Co., Box 777, Owensboro, Ky.

HOME Cigarette machine! Illustrated circular, \$3.75 postpaid. Automatic Cigarette Machine Wks., 1055 Sheridan, Chicago.

FIELD GLASSES, TELESCOPES AND MICROSCOPES

\$11.50 GOVERNMENT Binoculars, six power, with carrying case, large selection field glasses, telescopes, microscopes, cameras, lenses, musical instruments, guns, rifles. Send for free bargain list. We buy, sell and exchange. Well's Curiosity Shop, 20 South Second Street, Philadelphia, Pa.

ANTIQUES, WAR RELICS AND INDIAN GOODS

GENUINE Prehistoric fossil sharks teeth, \$1, \$1.50, \$2; fossil clams, 3 for \$1; vertebrate \$1; assortments, \$10. B. Thorp, Room 5, 39 Broad, Charleston, S. C.

INDIAN Beliefs, coins, curios, beadwork. Catalog free. Vernon Lenzley, Northbrook, Kan.

MEDALS, War relics. Catalog 10c. Daro, 670 E. 42, Brooklyn, New York.

10,000 INDIAN Beliefs—Birdarrow and circular 10c. P. Heike, Pontiac, Ill.

SEND 5c For fine new list Indian relics, antique firearms. F. E. Ellis, Webster Groves, Missouri.

RAZORS AND BLADES

YOUR Dull Gillette. Probak blades resharpened, 100% keen, 1c each. Petter Wetterquist, Rockford, Ill.

MUSIC AND MUSICAL INSTRUMENTS

FORTUNES Being made from songs through talking pictures, radio, phonograph, music publishers, "Hit" writers revise, arrange, compose music to your lyrics. We submit to studios and other markets. Free reading. Send for booklet. Universal Song Service, 625 Meyer Bldg., Hollywood, Calif.

SONGWRITERS—Read "song requirements of talking pictures, radio and records" an explanatory instructive book sent free to aspiring writers of words for songs. We compose, arrange music and secure copyrights. Write today. P.C. Newcomer, Associates, 1674 Broadway, New York.

COMPOSERS—Verse or music. Brilliant opportunity. Write VanBuren, 2449 McClurg Bldg., Chicago.

SONGWRITERS, Professional plan. Edward Madden, 115 Michaels, Syracuse, N. Y.

CARLISLE Violins, world's finest tone. Artistic repairing. Carlisle, Hamlet, Ohio.

SONGWRITERS—Free booklet "How To Turn Your Songs Into Gold." Stan Tucker, 350 Wadsworth Ave., New York.

THEME-SONG Writers, free information. Hollywood Composers, Box 387, Hollywood, Calif.

SONG Poets: Investigate. MacDonald's Music Service, 42 Keenan, Watertown, Mass.

SONGS—Poems wanted, recording, broadcasting. National Composers Assn., 827-PM, Kimball Bldg., Chicago.

SONGS Composed, Arranged, Copyrighted, Printed. Brennan's Music House, Dept. P, 1658, B'way, N. Y.

CREATIVE Harmony—Improvising: pianists, instrumentalists. Sample lessons free. Sparks' Music School, Norwich, Conn.

SONG Writers! Attention! Publishing and marketing free! Box 114, Minneapolis.

EXPERT Music arranging. Mal Lee, 109, Judson, Syracuse, N. Y.

SONG Poets, write Sequoia Songwriters Service, Sherman Branch, Los Angeles, Calif.

POEMS Wanted, Work guaranteed. We publish. Great Eastern Song Bureau, Dept. 27, Thomaston, Me.

SONG Writers, Send for our "Publishing Agreement." McKinley Music Printers, 1501 E. 55th St., Chicago.

WRITE Songs, Big money and reputation. Write for information. J. Gordon Pub. Co., 201 N. Hoyne Ave., Chicago.

Duo-Flex reeds for clarinets and saxophones eliminate your reed troubles. Write for circular. Duo-Flex Reeds, 1204 1st Ave., Evansville, Ind.

"MUSIC Composed" to words. Bauer Bros. (formerly of Sousa's Band), Oshkosh, Wis.

SEND Song poems, 50-50 plan. Indiana Song Bureau. (Brookside), Salem, Ind.

CORNETISTS—Trumpeters—Saxophonists—Clarinetists. Get "Free Pointers." Name instrument. Virtuosi School, Buffalo, N. Y.

PATENT ATTORNEYS

PATENTS—Write for free information, How to Obtain a Patent and Record of Invention—or send drawing or model for examination. Miller & Miller, Patent Attorneys (former Patent Office Examiners), 1096-A Woolworth Building, New York; 259 McMill Building, Washington, D. C.

EXPENSE—Saving copyrighted plan. Let interested manufacturer pay for patenting. Write Chartered Institute American Inventors, 1136 Barrister Building, Washington, D. C.

PATENTS Procured for inventors by former member examining corps. U. S. Patent Office. Rates reasonable. A. Bostrom, Registered Patent Attorney, 1618 West 13th St., Brooklyn, N. Y.

LACEY'S Patent Sense. Valuable book free. See ad page 136.

TIME Counts in applying for patents. See pages 132 and 133. Clarence A. O'Brien, Registered Patent Attorney, Washington, D. C.

PATENTS—Write for our free book, "How to Obtain a Patent" and Record of Invention Blank. Send model or sketch of invention for inspection and instructions free. Terms reasonable. See advertisement on pages 134 and 135. Victor J. Evans & Co., 334 Ninth, Washington, D. C.

PATENTS Procured. Prompt, careful efficient service. Highest references. Moderate fees. Send sketch or model for actual search and advice. George P. Kimmel, Master of Patent Law, 34-1 Westery Bldg., Washington, D. C.

PATENTS Obtained at low cost. Free information. See page 136. Write today. Harry W. Johnson, McMill Bldg., Washington, D. C.

WHAT To Invent—Names of manufacturers and wanted inventions sent free on request. Write W. T. Greene, 946 Barrister Building, Washington, D. C.

INVENTORS: Send for booklet telling how to patent and sell your inventions at lowest cost. Ralph Burch, Patent Lawyer, 900 F St., Washington, D. C.

PATENTS. Send sketch or model for advice. Free book, "How to Obtain a Patent." Established thirty years. Highest references. Prompt service. Reasonable charges. Chandler & Chandler, 905 F Street, Washington, D. C.

INVENTORS—Write for our Guide Book, "How to Get Your Patent," and Evidence of Invention Blank. Send model or sketch of your invention for our prompt examination and instructions free. Randolph & Co., Dept. 430, Washington, D. C.

PATENTS Procured: Trade marks registered—preliminary advice furnished without charge. Booklet and form for disclosing idea free. Irving L. McCathran, 704 International Bldg., Washington, D. C.

PATENTS. Booklet free. Highest references. Best results. Promptness assured. Watson E. Coleman, Patent Lawyer, 724 Ninth St., Washington, D. C.

"INVENTOR'S Guide." valuable information, free. Frank Lederman, Registered Attorney-Engineer, 1712 Woolworth Bldg., New York.

ESTABLISHED 1864. Milo B. Stevens Company. Free booklet, Patents, Trade marks, Copyrights, Offices, Menadnock Block, Chicago; Barrister Bldg., Washington, D. C.

LANCASTER, Allwine & Bommel, 221 Ouray Bldg., Washington, D. C. "Originators of the Form Evidence of Conception." Before disclosing your invention to anyone send for blank form to be signed and witnessed. Form and patent information bulletin free.

FOR INVENTORS

INVENTIONS Small pressed metal articles. Will buy or on royalty basis. Fair treatment guaranteed. Otto Konigslow Mfg. Co., 3510 Perkins Ave., Cleveland, O.

TO Inventors: We are in the market to purchase a good patent, preferably in the automobile accessory line. Will purchase outright or on royalty basis. Purchasing Agent, 241 Front St., New York, N. Y.

INVENTORS Put your ideas across. I offer consulting, designing, and developing. Anything mechanical. Your ideas worked to meet keen competition. Write me for particulars. Paul Quinn, 76 Forman St., Bradford, Pa.

NICK-OF-TIME Wants electrical and mechanical novelties and devices. Will manufacture on royalty basis. Nick-of-Time, Tulsa, Okla.

TIME Counts in applying for patents. See pages 132 and 133. Clarence A. O'Brien, Registered Patent Attorney, Washington, D. C.

LACEY'S Patent Sense. Valuable book free. See ad page 136.

INVENTIONS—Write for free book "How to Obtain a Patent" and Record of Invention Blank. Send model or sketch of invention for inspection and instructions free. Terms reasonable. See advertisement on pages 134 and 135. Victor J. Evans & Co., 157 Ninth, Washington, D. C.

INVENTIONS In household appliances and toys bought or manufactured on royalty. Relcard Mfg. Co., Bangor, Penna.

WANTED—Inventions, toys, games. Box 22, Fond du Lac, Wis.

EXHIBIT Your invention or patent at the second International Patent Exposition, Chicago, September 14 to 27. Thousands of manufacturers will attend to inspect new inventions. You may exhibit with or without model. Write for circular to International Patent Exposition, Merchandise Mart, Chicago.

SOUND, Practical inventions, patented, unpatented, now wanted. Write Chartered Institute American Inventors, 1135 Barrister Building, Washington, D. C.

HAVE You a good patent or pending application for sale? If so, write American Patents Corporation, 1220 Barrister Building, Washington, D. C.

INVENTIONS: Patented or unpatented. Bought outright; manufactured on royalty or commercialized. Urbano Manufacturing Co., 561 Howard Street, San Francisco, California.

MANUFACTURERS Will you buy inventions. Send for important circular free. Inventions patented and marketed. Canadian patents filed \$35.00 up. J. J. O'Brien, Patent Attorney, Engineer, 136 E. 42nd New York City.

LOW Cost manufacturing. Large plant completely equipped for blanking, drawing, stamping and wire forming in any finish. Can save you money on your product. Our figures will convince. Eastern States Products, Box 721, New Haven, Conn.

NATION Wide search for best inventions. American Society of Inventors, Crosby Bldg., Buffalo.

WHAT To Invent—Names of manufacturers and wanted inventions sent free on request. Write W. T. Greene, 947 Barrister Building, Washington, D. C.

INVENTOR'S Universal Educator: contains 980 mechanical movements; 50 perpetual motions; instruction on procuring and selling patents and selecting an attorney, etc. Suggests new ideas. Price \$1.00 postpaid in U. S. A. Address Dietrich Co., 692B Ouray Bldg., Washington, D. C.

MANUFACTURERS Everywhere seek new inventions to improve their product. Names of manufacturers and wanted inventions sent free on request. Write W. T. Greene, 947 Barrister Building, Washington, D. C.

PATENTS FOR SALE

FOR Sale or royalty. Well drilling machine. J. H. Witt, Medina, O.

PATENT For sale. Office desire to save time and temper of busy man. Stamped from sheet metal and made to sell for a few cents. May 44 Eurild Ave., Albany, N. Y.

SAFETY Hasplock, no padlock required, simple, market for millions, a pressed metal chain-store article, outright or royalty. R. B. Hart, 63 So. 57th St., San Jose, Calif.

SWEATER Stretcher. Adjustable sizes. H. Cook, 1628 Catharine St., Philadelphia, Pa.

SALE Or Royalty, a new patented Grass Cutting Device. Operate at standing. Trims close to wall, smoothly, and three times faster than any shear. Full size working model to examine. Interested mfg. write or call to M. A. Kishell, Miles Ave., Olyphant, Pa.

OUTRIGHT Or royalty—Safety claw hammer. Something new, different. M. C. Belikan, 9984 Winston Ave., Chicago, Ill.

TIME Counts in applying for patents. See pages 132 and 133. Clarence A. O'Brien, Registered Patent Attorney, Washington, D. C.

JUST Issued, cheapest power for pumping and lighting. Low manufacturing cost. E. F. Wilson, Bay Lake, Florida.

FOR Sale—Half interest in new rat and mouse trap. William Stout, Neel, Missouri.

MANUFACTURERS. Get our complete list of inventions. American Society of Inventors, Crosby Bldg., Buffalo.

MANUFACTURERS Looking for new inventions should write W. T. Greene, 939 Barrister Building, Washington, D. C.

INVENTORS—Cash in on your invention now! Don't delay the sale any longer! Send for a free copy of our specially prepared booklet, "Turn Your Patent into Money," today! It contains helpful information for all inventors. M. L. Rund, Mgr. Classified Advertising, Popular Mechanics Magazine, 290 E. Ontario St., Chicago, Ill.

MODELS AND MODEL SUPPLIES

TIME Counts in applying for patents. See pages 132 and 133. Clarence A. O'Brien, Registered Patent Attorney, Washington, D. C.

INVENTORS: Send us sketch or crude model of your idea. Crescent craftsmen will develop it into a practical working model. 30 years of successful experience and thousands of satisfied clients. Confidential service guaranteed. Bank references furnished. Free illustrated book: "Making Inventions Pay." Crescent Tool Co., Dept. 8-9, Cincinnati, Ohio.

SHIPMODELER, Magazine of the ship model makers' club. Sample copy 20 cent. 55A, Mibhagh St., Brooklyn, N. Y.

MODELS, Tools, dies. General manufacturing. We carry complete stock aluminum, brass rods and sheets any shape. Modern Machine & Pattern Company, Terre Haute, Indiana.

WE Make working models for inventors and do experimental work and carry a complete stock of brass gears and model supplies. Send for catalog. The Pierce Model Works, Tinley Park, Ill.

MODEL Steam engines and boilers for miniature boats, boat and boiler fittings. Catalog 15c. Anton Bohabor, 212 Price St., Rahway, New Jersey.

SHIP And yacht model fittings. Send fifteen cents for illustrated catalog No. 7. A. J. Fisher, 1902 Etowah Ave., Royal Oak, Michigan.

PATTERNS, WOOD AND METAL

WILL Make your patterns. Castings any material. Machine work. Models, tools, dies. Modern Machine & Pattern Company, Terre Haute, Indiana.

MANUFACTURING

NICK-OF-TIME. Large factory—fully equipped for manufacture of electrical, pneumatic and mechanical devices—designing, tool and die making, stamping, assembling. Nick-of-Time, Tulsa, Oklahoma.

MANUFACTURING, Models, dies, stampings, brasswork, mechanical rubber moulds, vulcanizing. Circular free. Baum's Metal Specialties, Kansas City, Mo.

SPECIAL Machinery or parts, dies, tools, metal specialties, models, special gears, stock gears and model supplies. Send for catalog. The Pierce Model Works, Tinley Park, Ill.

LOW Cost manufacturing. Large plant completely equipped for blanking, drawing, stamping and wire forming in any finish. Can save you money on your product. Our figures will convince. Eastern States Products, Box 721, New Haven, Conn.

METAL Articles developed and manufactured. Model making. Reasonable price and first class workmanship. W. F. Meyers Company, Bedford, Indiana.

WIRE Goods made to order. Costley Mfg. Co., 3210 Carroll Ave., Chicago.

ECONOMICAL Manufacturing from sheet, bar, wire or tubing. Models, dies, special machinery. Swanberg, 5124 N. Kildare Ave., Chicago.

SPECIALIZE Complete manufacture, dies, tools, special machinery and patterns. Models made. Atlas Indicator Works, 821 W. Washington, Chicago, Ill.

CASTINGS

GRAY Iron, malleable iron, brass, bronze, aluminum, white metal castings. Will make necessary patterns. Machine work. Modern Machine & Pattern Company, Terre Haute, Indiana.

BENDING MACHINES

THE Famous Hossfeld "Wrenchless" Universal Iron Bender is the last word in bending machines. Bends metal, cold or hot, into most any conceivable shape, including Eye Bolts and Automobile Spring Eyes. Bends up to 1" bars or 1½" pipe cold. Also bends "Angle Iron." Thousands in use by all classes of trade, from the smallest shops to the largest railway systems. Write for circular and prices. Hossfeld Mfg. Co., Wilson, Minn.

BRONZE DIE CASTING MOULDS

DO Your own moulding soft metal ornaments. Send sketches or models for prices. Modern Machine & Pattern Company, Terre Haute, Indiana.

SURVEYING INSTRUMENTS

SAVE Money by buying our rebuilt transits and levels. All fully guaranteed—sold subject to field test. Cash or easy terms. Write today for list. Warren-Knight Co., (Makers of "Sterling" Surveying Instruments), 136 N. 12th St., Phila., Pa.

WELDING AND SOLDERING

LEARN All types welding. Aircraft and furniture factories; pipelines, need trained welders. National Welding School, Kansas City, Kansas.

BARGAINS—Excellent repossessed arc welders, buffers and grinders. Entirely rebuilt—guaranteed. Trial. Terms. Write Ken's Service, Box M-913, Troy, Ohio.

MACHINERY, TOOLS & SUPPLIES

13"x4" SIDNEY Lathes, practically new, complete, \$225.00; No. 3½ Fox plain milling machine, \$175.00; No. 60 Heald cylinder grinder, \$500.00; 24" Hendey shaper, \$200.00; 10" new drill press, \$21.00; air compressor, complete with tank, motor, etc., \$100.00; battery charging outfit, complete, \$125.00. Write for catalog. Terms to suit. Cincinnati Machinery & Supply Co., 27 West 2nd St., Cincinnati, Ohio.

SUBSTANTIAL Savings—used arc welders, buffers, grinders, platers, compressors, paint sprays. Entirely rebuilt, guaranteed. Trial and terms. Write Ken's Equipment, Box M-914, Troy, Ohio.

START Business of your own, small investment required, doing chromium, nickel, copper, silver plating. This work in big demand. Information free. Electro Platers Supply Co., 28 West Second St., Cincinnati, Ohio.

KELLOGG Air Compressors, excellent condition, \$6.00. Electric Refrigerator Compressors \$6.00. Taylor, 195 East 162nd Street, New York City.

CONCRETE Building block machines and molds. Easy payments. Catalog free. Concrete Machine Co., 5 North Main St., St. Louis, Mo.

ENGINES, MOTORS AND DYNAMOS

GASOLINE Engines, new ½ HP, \$10.75; bargains on electric motors, generators, one hp. 25 cycle motors \$15.00 ea. General Distributing Co., Storage Bldg., Duluth, Minn.

STEAM Engines—One h. p. \$18.00; ¼, \$12.00. James Chambliss, Bessemer, Ala.

20 NEW Air compressors with ¼ horse motors \$23.00. New ½ horse 1750 speed alternating motors \$4.50. Used \$4.50. New ½ horse 3450 speed alternating \$16.50. 1-horse same, \$25.00. Electrical Surplus Company, Dept. 12, 1885 Milwaukee Ave., Chicago.

BRAND New ¼ hp. AC motors \$6.50; ½ hp. repulsion 2450 rpm. motors \$16.50; ¾ hp. 115 v. DC \$15.00. Large stock motors, generators, rotary converters, etc., at bargain prices. Queen City Electric, 1736 Grand Avenue, Chicago.

MODEL Boilers, gas and steam engines, castings, blue prints, practical mechanical books, gears, pulleys. Inventors supplies. Send stamp for reply. Howard, 2417 N. Ashland Ave., Chicago, Ill.

TIME Counts in applying for patents. See pages 132 and 133. Clarence A. O'Brien, Registered Patent Attorney, Washington, D. C.

REFRIGERATING Machine, homemade. Inexpensive to build. Gives better service than ice. This and 328 other practical articles in our book "Home Mechanics." Just ask for this and "Handbook for Women," containing 394 valuable household helps and pay postman 98 cents and postage for the two books. Popular Mechanics Press, Room 802, 290 E. Ontario St., Chicago, Ill.

FARMS AND FARM LANDS

STROUTS New farm catalog just out! Over 1000 bargains, 800 pictures. Farms every kind, many states; equipment, crops; village homes, roadsteads, auto inns, sportsmen tracts; lowest prices. Saves you time and money. Copy free. Strout Agency, 275-P Fourth Ave., N. Y. City.

OWN A farm in Minnesota, Dakota, Montana, Idaho, Washington or Oregon. Crop payment or easy terms. Free literature; mention state. H. W. Byerly, 119 Northern Pacific Railway, St. Paul, Minn.

FREE Books on opportunities in Minnesota, North Dakota, Montana, Idaho, Washington, or Oregon. Complete information on climate, crops, location for farm or suburban tract for grain, livestock, dairying, fruit, poultry—a home, independence, plenty of food, clothing, continuous employment. No occupation offers more to industrious capable men. Write E. C. Leedy, Dept. 257, Great Northern Railway, St. Paul, Minn.

RABBIT Raising assuming large proportions. Learn how produced for food and fur. Send for reliable book by Frank G. Ashbrook, authority in U. S. Dept. of Agriculture. Price \$2.00. Sent postpaid upon receipt of price or C. O. D. anywhere in U. S. Popular Mechanics Press, Room 808, 200 E. Ontario St., Chicago.

GET Good land cheap on terms, fine neighborhood, grow certified potatoes, become independent. Mich. Arceage Co., P-601, 32 No. State St., Chicago.

SELL Your property quickly for cash, no matter where located. Don't pay big commission. Particulars free. Real Estate Salesmen Co., Desk B, Lincoln, Nebr.

MAKE Poultry Pay. Learn how to produce phenomenal layers by paying more attention to breeding of fowls. James Dryden, authority, tells how in his book, 416 pages. Over 300 illustrations. Price \$2.00. Sent postpaid upon receipt of price or C. O. D. anywhere in U. S. Popular Mechanics Press, Room 808, 200 E. Ontario St., Chicago.

TEN Dollars monthly acquires five acres pecans, tungs, figs, oranges. Guaranteed care. Big returns. Suburban Orchards, Dept. M, Biloxi, Miss.

OZARKS—20 Acres, timbered, \$100, \$5 monthly. Poultry, hogs, fruit; fishing, hunting, trapping. Hubbard, 216 Grossman Bldg., Kansas City, Kansas.

1001 GARDEN Questions Answered. Garden facts which hundreds of men have spent their lives in obtaining. Covers flowers, vegetables and fruit. 320 pages. Price \$2.00. Sent postpaid upon receipt of price or C. O. D. anywhere in U. S. Popular Mechanics Press, Room 808, 200 E. Ontario St., Chicago.

RABBITS

RABBITS \$5.00 per pair. Guaranteed to live. Brennan Rabbitry, West Berlin, N. J.

RABBIT Supplies—America's oldest Rabbit supply house. Free catalog. Desk 11, National Rabbit Supply Company, 1126 North Dearborn Street, Indianapolis, Ind.

HEALTHY Breeders and youngsters priced right. Harrison Rabbitries, Fitzgerald, Ga.

ADVICE To beginners, breeding rabbits—free. Judge Fehr, 1302 Woodlawn, Indianapolis.

GIANT Silver Fox and Chinchilla Rabbits. Hi Quality Fur Farm, Harvard, Nebr.

RABBITS And supplies. Complete literature, 5c. Albert Facey, Inc., 115-N. Valley Stream, New York.

MINK

MINK Are best money makers among fur bearers. For prices write Underwood Minkery, Eyota, Minnesota.

BIG Money made raising mink. Free information. Pennell Fur Farm, Dalhousie, Wash.

DOGS AND PETS

BEAUTIFUL Registered bull pups, \$15, Bulldogs, 501 Rockwood, Dallas, Texas.

HOUNDS, Coon, fox, rabbit, \$20. Shepherds \$8. Bull terriers \$10. Dawson, Tuckerton, New Jersey.

WHITE Mice 50c each. Toy Pomeranian puppies. Silver Kennels, Boston Place, Toledo, Ohio.

HUNDREDS Coonhounds, foxhounds, rabbit-hounds, blueticks, redbones, blacktans. Supply Catalog, Beckemels, A-51, Herkbeck, Illinois.

\$35.00 BUYS A coonhound that must please you. Kentucky Coonhound Kennel, Keril, Ky.

FITCH

HAISE Fitch—Most profitable small fur animal. I buy young raised from my vaccinated stock. Instructions free. Write Broadmont, 922 Kaufmann Ave., Roseville, Mich.

GERMAN Fitch and mink easily raised. Hercules Fur Farms, Forest Lake, Minn.

WANTED—MISCELLANEOUS

CASH For gold teeth, bridges, watches. W. Harrison, Fitzgerald, Ga.

MAIL Us your discarded jewelry, gold crowns and bridges, watches, diamonds, silver, platinum. Money promptly mailed. Goods returned if offer refused. United States Smelting Works (The Old Reliable) 39 So. State St., Dept. 71, Chicago.

BOYS! Vacation fun galore. Every Boys' Book of Handcraft, Sports and Amusements. Just the thing for ideas and suggestions for all outdoor stunts and rainy days indoors. Big 700-page book full of pictures, too. Sent postpaid upon receipt of price \$2.75 or C.O.D. anywhere in U. S. Popular Mechanics Press, Room 807, 200 E. Ontario St., Chicago.

FOR SALE—MISCELLANEOUS

MIMEOGRAPHS, Multigraphs, Kardex Cabinets, Addressographs, Dictaphones. Bought and sold. Office Machine Exchange, 1202 Office, St. Louis, Mo.

FOLEY Automatic saw filer and set. W. E. Little, Dallas Center, Iowa.

PORTO Rican Cigars, \$5.00 per 100. Sent postpaid C.O.D. R. B. Biemesderfer, Penryn Pa., Box 10.

WATCHMAKERS Lathe for sale at a bargain. R. Jaegermann, 5815 Easton Ave., St. Louis, Mo.

UNDERWOOD 5, Standard office machine \$79.95. Checkwriter, duplicator, multigraph, Dictaphones, bargain prices. Pruitt, 190 North La Salle, Chicago.

NEW Electric refrigerators, fully guaranteed. Price \$89.00. Write: Daniel Zimmerman, Craigville, Indiana.

NEW World Atlas—1926 census figures—Complete, up-to-date, just the kind you need for home, office or school. New convenient size fits in your bookcase. 288 pages. Has all maps and usual features. Price \$2.50. Sent postpaid upon receipt of price or C. O. D. anywhere in U. S. Popular Mechanics Press, Room 808, 200 E. Ontario St., Chicago.

PERSONAL

SUPPORTO Appliance. Amazing invention that restores confidence. Immediate results guaranteed. Men write for valuable information. Surgical Co., 1006 San Pablo, Oakland, Calif.

THREE Amazing health secrets. Copyrighted. Send postal. Information free. J. Shing, 1717 Ingram Ave., Richmond, Va.

"HOW To Be Well"—Gives invaluable health advice, answers hundreds of health questions. 50c postpaid. Cole, Tower Bldg., Syracuse, N. Y.

LANDSCAPING, The Complete Home Landscape, a guide to the planning, construction and planting of the garden and grounds of the average home. 178 pages. Illustrated. Price \$2.50. Sent postpaid upon receipt of price or C. O. D. anywhere in U. S. Popular Mechanics Press, Room 808, 200 E. Ontario St., Chicago.

ASTROLOGY Offers the most interesting, fascinating and accurate method of studying one's life. Analyze your friends, family and self. Lessons and readings by Collins, a teacher of astrology. Box 687, Riverside, Calif.

BUILT-IN Furniture adds convenience, comfort and beauty to your home at very low cost. Any handy man can build a great variety of this space-saving furniture from the easily-followed instructions in our remarkable book, the only one on this subject. Delivered to your door C. O. D. Simply pay postman \$2.50 and postage. Popular Mechanics Press, Room 802, 200 E. Ontario St., Chicago.

INGROWING Nails, painless correction. Satisfaction guaranteed. Folder free. Write Eugene Eaton, D106, Bandon, Oregon.

HOME Repairs. Every home owner will find this book a mine of suggestions. Its 390 pages are packed with information on how repairs of all kinds can be made and save delay and expense. Fully illustrated. Price \$2.50. Will save its cost 10 times over. Sent postpaid upon receipt of price or C. O. D. anywhere in U. S. Popular Mechanics Press, Room 808, 200 E. Ontario St., Chicago.

MISCELLANEOUS

BUILD Your own automatic electric refrigerator; use present icebox; costs only \$31.50 complete as per our prints. No special tools required; we supply special parts. Complete instructions with blue prints and text \$1.00. B. & L. Engineering Co., 706 Bergen Ave., Jersey City, N. J.

CONCENTRATED Grape Juice and Malt Syrup. David Nichols, Kingston, Georgia.

PENCILS—Your one line imprint. Nationally known makers. 1 gross \$1.00; 5 gross, \$3.75 gross; 10 gross, \$3.60 gross. Introductory 2 1/2 doz. \$1.00. Short gilt tip 10% less. Short nickel tip 20% less. Cash. Prepaid. Pencil Market, Knoxville, Tenn.

WIZZARD Easy Flow no Flux Metal Mender mends anything metal. So easy anyone can use it. Cracked water jackets, crank cases, milk cans, pans, radiators, pipes. Sample bar 35c. Large size \$1.00 postpaid. Davgar Mfg. Co., 495 Broadway, Newburgh, N. Y.

TATTOOING: Outfits, supplies. Remover, \$5.00. Miller, V431 Main, Norfolk, Va.

\$100,000.00 VALUABLE Premiums. Everybody eligible. Magic plan free. Home Supply, 30 Irving Place, New York.

HOMEOPATHIC And biochemic preparations sent postpaid to all parts of the world. Booklets free. Halsey Bros. Co., 547 Ravenswood Ave., Chicago. Established 1855.

LEARN Typewriting at home. Rational typewriting, brief course by Sorelle (a Gregg publication) enables you to become proficient at typing without the aid of an instructor. 96 pages. Illustrated (Cloth). Sent C. O. D. Pay postman price, \$1 and small amount of postage upon delivery. Popular Mechanics Press, Room 802, 200 E. Ontario St., Chicago, Ill.

PRINT Signs, pictures without press, type or machinery. Samples 10c. Straley, 13 1/2 W. Main, Springfield, Ohio.

TATTOOING Outfits, supplies. Illustrated list free. "Walters," 865 Putnam, Detroit.

INTERIOR Wall decoration is a valuable new book covering all the modern methods of artistic wall treatments. Practical working instructions for both plain and decorative finishes are given. 451 pages, illustrated. Delivered to your door C. O. D. Simply pay postman \$4 and postage. Popular Mechanics Press, Room 802, 200 E. Ontario St., Chicago.

AMATEUR Cartoonists—Earn \$25.00 week, spare time, copying cartoons for advertisers. J.M. Syndicate, Argyle, Wis.

AMATEUR Cartoonist: Sell your work. Write Smith's Service, PX1194, Wenatchee, Wash.

WOODTURNING For amateurs. Excellent new instruction book just published for the amateur and home work shop owner. Contains all the needed information and is well illustrated yet published to sell at the low price of 25 cents postpaid. Send for your copy today. Mail remittance with your order. Popular Mechanics Press, Room 802, 200 E. Ontario St., Chicago.

NECKTIES! 81K, 3, \$1.35. Circular free. Quimette's Mailorder House, 81 Holly D29, New Bedford, Mass.

OUTDOOR Sports for everyone—Enjoy them all year round with aid of great new book just published by Popular Mechanics. This veritable encyclopedia not only furnishes hundreds of ideas for new and popular sports for every season of the year, but also gives complete instruction for making the necessary equipment at very small cost. 250 pages and 450 illustrations. Send today as book is full of thrills and excitement for fall and winter sport enthusiasts. Mailed postpaid anywhere for \$2, or will be sent C. O. D. to any address in U. S. Simply pay postman when delivered. Popular Mechanics Press, Room 802, 200 East Ontario St., Chicago.



NEW YORK ELECTRICAL SCHOOL

*Opportunities
for All Men!*

Every phase of all branches of Practical Electricity taught by Actual Practice in America's Foremost Institution of Trade Learning.

Special Courses in Automobile Mechanics and Electricity.

Day and evening classes open all year.

Write for *FREE* School Booklet

New York Electrical School
44 W. 17th St., New York City

We Will Train You in a Few Months



*Day and Night Schools
in Chicago, Detroit,
Cleveland, Boston, Phila.*

No Books—No Classes
Experts Earn Up To
\$125 a Week as Me-
chanical Dentists

We teach you to make rubber plates; crowns, bridge work, metal base dentures, etc., for dentists. After graduating you are ready for a job or can open your own laboratory. We assist you.

Big Demand for Men

Thousands of dentists everywhere send work to mechanical dentists. We train you quickly in day or night school for this uncrowded field. No mechanical experience necessary.

Work your way thru school. We help you find a job to meet your expenses while taking our training.

FREE BOOK Send at once for interesting free book telling all about this thriving profession. Also details of our liberal offers. Write today!

McCARRIE SCHOOL OF MECHANICAL DENTISTRY—
1338 S. Michigan Ave., Dept. 480, Chicago.

Without cost or obligation, send me your illustrated book on Mechanical Dentistry, and complete information as to my opportunities in dental laboratory work.

Name.....

Address.....



Does Your *ENGLISH* Hold You Back?

How often do you grope for words or fail to say the right thing in the right way? Unless you have a perfect guide, you may be making mistakes in English that cause you to lose your greatest opportunities for a better position with higher pay and popularity. Now you can have an infallible guide. It is a new, quick, different method, recently developed.

SPEECHRAFT, perfected by a group of nationally-known educators after 25 years of research and teaching, will make you a master of Correct English, Effective Speech and Perfect Business and Social Letter Writing.

SEND FOR THIS FREE BOOK

SPEECHRAFT is NOT a mere set of books. It is fascinating, complete and easy. No tiresome, dull rules to learn. Just 12 minutes a day devoted to captivating study, and you can have the triple-power of business and social advancement in your possession.

FREE! Write for our new, big book, "The Way to Win With Words." It will be sent without charge to serious-minded men and women who want to get ahead and earn more money. (State age in writing.)

SPEECHRAFT, INC., Dept. 810, 25 W. Elm Street, Chicago, Ill.



AMERICAN METHOD Pays Big Profits

**\$25⁰⁰
Per Day**

Stop looking for a job. Get into business for yourself. No matter what sort of work you have been doing, you can quickly become independent through the American Method. Ask about this new and amazingly successful system. No obligation. **AMERICAN FLOOR SURFACING MACHINE CO.** 822 S. St. Clair St., Toledo, Ohio



RADIO NEEDS BETTER MEN!

Can you qualify? Men who will occupy positions of leadership in 1935 in Radio are fitting themselves NOW! By study. By training. By laboratory experience. You have time! Each week you waste 43 hours. Precious hours... that can insure you a better job... bigger pay. Write today. **RCA Institutes, Inc., Dept. MP-9, 73 Varick St., N. Y. C.** (Bring age, occupation, and branch of radio you prefer.)

UNIVERSITY of CHICAGO

HOME-STUDY COURSES

Continue your high-school, college or personal program of education. Teachers, Religious and Social Workers. Men and Women in many vocations are using the 450 courses in 45 different subjects to obtain guidance by experts for cultural and for practical purposes. The courses yield credit. Ask for free booklet.

THE UNIVERSITY OF CHICAGO
627 ELLIS HALL CHICAGO, ILL.

Handbook for Farmers

861 discoveries by practical farmers, telling how to make, repair or improve the various devices and machines used about a farm or garden. 683 illustrations. "The Most Remarkable Book Ever Published for Farmers," says one authority. **Send No Money.** When the postman delivers the book to you, hand him \$1 plus the few cents postage.

POPULAR MECHANICS PRESS
Popular Mechanics Building, Room 711, Chicago, Ill.

BLUEPRINT READING For the Building Trades



Every man who is ambitious to learn the last detail of blueprint reading will want this new book which is thorough, complete and up-to-the-minute. Written in a clear, non-technical manner. An ideal working tool for apprentices, teachers, students, carpenters, bricklayers, etc.

Over 100 pages—50 plans and illustrations.

Cloth—Price \$1.25 postpaid

Popular Mechanics Press
Room P8
200 E. Ontario St. Chicago

When writing please mention *Popular Mechanics*

Running Hot Water From Your Cold Water Faucet Instantaneously

Only \$3⁷⁵ Complete

Agents! This Mar-
velous Invention

Will Make Up to \$40⁰⁰ a Day Easy

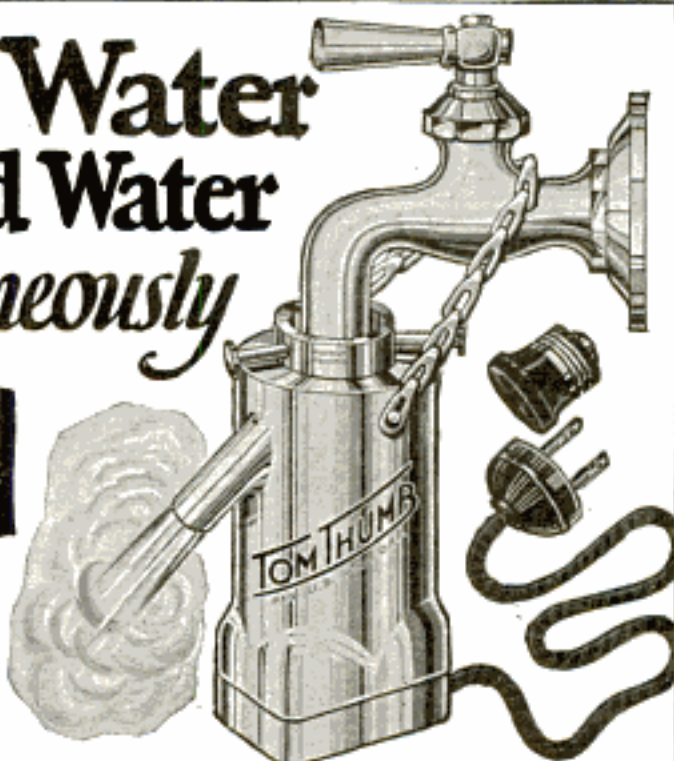

KITCHEN

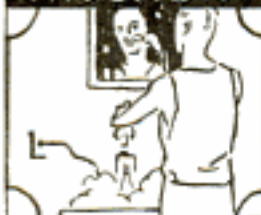

SHAVING



BATH



DOCTOR



FACTORY

Just plug in at the nearest electric outlet and presto!—you have instantaneous, continuous running hot water from your cold water faucet. This tells you in a nutshell why the invention of the Tom Thumb automatic electric hot water heater will make it easy for you to make up to \$40.00 a day.

The electric heated steaming hot water comes direct from the faucet instantaneously—yes, as quickly as you can turn on the current and the hot water runs indefinitely until you shut off the electricity. The cost is small—convenience is great. Useful wherever hot water is needed—no fuss or bother—attached to any faucet in a jiffy. Works on either AC or DC current. You and your customers will marvel and be delighted at this new discovery of electrical science. The small cost of \$3.75 for the Tom Thumb, Junior (110 volts) or \$5.75 for Tom Thumb, Senior (220 volts) does the work of any expensive hot water heating equipment costing several hundred dollars—the Tom Thumb absolutely eliminates the plumber or any other additional expense. Order direct from us! We are the originators, manufacturers, owners and patentees of the famous and original Tom Thumb electric hot water heater.

No Installation - Stick One On Faucet and Sale Is Made

Think of it! no installation, no extra expense—nothing else to do but to stick it on the faucet, turn on electricity and it is there ready for duty. Easily removed when not wanted and easily carried to any part of house where cold water is running and hot water is wanted. Has many uses—too numerous to mention here. Weighs only 1 lb., made entirely of aluminum. Cannot rust, no moving parts, nothing to get out of order.

If \$40 A Day Sounds Good To You Rush Coupon

This new scientific invention offers tremendous sales possibilities. At the low price of \$3.75 you should be able to sell at least 40 a day. You pocket \$1.00 cash commission on every sale. If you would like to know all about this proposition, sign your name and address to coupon or, better still, get started selling at once. Attach money order for \$2.75 to coupon and rush to us. We will send complete selling outfit containing 1 Tom Thumb electric hot water heater, order blanks, selling particulars and everything necessary to help you get started making up to \$40.00 a day at once.

Terminal Products Co., Inc.,
Dept. 3409, 200 Hudson St.,
New York, N. Y.

The Tom Thumb electric hot water heater looks like a big money maker to me. I am sure interested in knowing how to make up to \$40.00 a day with this proposition. I have checked below the proposition I am interested in at this moment.

Enclosed find money order for \$2.75. Please send me one Tom Thumb Junior, order blanks and selling information. It is understood upon receipt of this sample outfit I will be permitted to take orders and collect \$1.00 cash deposit for every Tom Thumb, Jr. I sell, or \$1.50 for every Tom Thumb, Sr. I sell. It is understood I will send the orders to you and you will ship direct to my customers C.O.D. for the balance.

I would like to have additional information before acting as one of your agents. Please send this by return mail free of obligation.

Name
Street
City State

Canadian please send cash with order at same price. Other foreign countries \$1.00 extra for each unit cash with order.

When writing to advertisers please mention Popular Mechanics



Go to High School at Home

You can secure a high school education right at home by studying the splendid new courses recently prepared by the International Correspondence Schools.

These courses are equivalent to the courses given in resident high schools. They have been specially arranged for men and women who wish to meet college entrance examinations, to qualify for a business position, or to make up the education they missed when forced to leave school too soon.

The College Preparatory Course, the High School Commercial Course and the High School English Course include English, algebra, ancient, medieval, modern and U. S. History, physiology, literature, geography, Latin, bookkeeping, drawing, geometry, shorthand, physics, chemistry, salesmanship, advertising, civics, trigonometry, economics, American business law, corporation finance, money and banking, business and trade economics, etc. A diploma is given at graduation.

The lessons are easy to understand and you will make rapid progress because you will be in a class by yourself and you will study under the guidance of instructors who are sincerely interested in helping you to get ahead and achieve the bigger things of life.

Just mark and mail the coupon and we will gladly send you interesting free booklets describing the High School Courses of the International Correspondence Schools or any other subject in which you are interested.

INTERNATIONAL CORRESPONDENCE SCHOOLS Box 5563-G, Scranton, Penna.

Without cost or obligation, please tell me how I can qualify for the position or in the subject before which I have marked an X:

- College Preparatory Course
 High School Commercial Course
 High School English Course
 High School Vocational Course
 High School Agricultural Course

- | | |
|--|---|
| <input type="checkbox"/> Business Management | <input type="checkbox"/> Salesmanship |
| <input type="checkbox"/> Industrial Management | <input type="checkbox"/> Advertising |
| <input type="checkbox"/> Personnel Management | <input type="checkbox"/> Business Correspondence |
| <input type="checkbox"/> Traffic Management | <input type="checkbox"/> Show Card and Sign Lettering |
| <input type="checkbox"/> Accounting and C. P. A. Coaching | <input type="checkbox"/> Stenography and Typing |
| <input type="checkbox"/> Cost Accounting | <input type="checkbox"/> English <input type="checkbox"/> Civil Service |
| <input type="checkbox"/> Bookkeeping | <input type="checkbox"/> Railway Mail Clerk |
| <input type="checkbox"/> Secretarial Work | <input type="checkbox"/> Grade School Subjects |
| <input type="checkbox"/> Spanish <input type="checkbox"/> French | <input type="checkbox"/> Illustrating <input type="checkbox"/> Cartooning |

TECHNICAL AND INDUSTRIAL COURSES

- | | |
|---|--|
| <input type="checkbox"/> Electrical Engineering | <input type="checkbox"/> Architect |
| <input type="checkbox"/> Electric Lighting | <input type="checkbox"/> Architects' Blueprints |
| <input type="checkbox"/> Mechanical Engineer | <input type="checkbox"/> Contractor and Builder |
| <input type="checkbox"/> Mechanical Draftsman | <input type="checkbox"/> Architectural Draftsman |
| <input type="checkbox"/> Machine Shop Practice | <input type="checkbox"/> Concrete Builder |
| <input type="checkbox"/> Railroad Positions | <input type="checkbox"/> Structural Engineer |
| <input type="checkbox"/> Gas Engine Operating | <input type="checkbox"/> Chemistry <input type="checkbox"/> Pharmacy |
| <input type="checkbox"/> Civil Engineer | <input type="checkbox"/> Automobile Work |
| <input type="checkbox"/> Surveying and Mapping | <input type="checkbox"/> Aviation Engines |
| <input type="checkbox"/> Plumbing and Heating | <input type="checkbox"/> Navigation |
| <input type="checkbox"/> Steam Engineering | <input type="checkbox"/> Agriculture and Poultry |
| <input type="checkbox"/> Radio <input type="checkbox"/> Coal Mining | <input type="checkbox"/> Mathematics |

Name.....
 Street.....
 Address.....
 City..... State.....

Men! Big Opportunity is here in Electric Refrigeration



This new industry is growing by leaps and bounds. Everywhere sales lead all other lines. Look around you; you'll see it's so in your town—everywhere.

Trained Men in Big Demand

Shop mechanics, installers, service men, estimators and sales engineers are needed. These jobs pay \$50 to \$200 a week and lead to rapid advancement.

Easy and Quick to Learn

You learn by doing actual work on Household, Commercial and Industrial machines.

Eight weeks is the finest and best equipped school in the country qualifies you thoroughly—then we'll help you secure a good refrigeration job. No matter what your age, education or past experience—write for FREE BOOKLET. Find out for yourself about this growing field and how we help you get into it. Write at once—NOW—to

THE NATIONAL TECH., 4300 Euclid Ave., CLEVELAND, O.

REBUILD YOUR BRAINS

for Wealth and Power. Our system "The Way to Wealth and Power" tells how "self-made men" make themselves rich and powerful, how to analyze your present chances, and how to increase them by building Prosperity habits. The author built himself from a \$3 week clerk to a \$20,000 per year executive, and gives practical instruction in plain language, \$1 post paid. Prosperity Institute, Inc., Room A, 1700 Walnut St., Phila., Pa.

EARN MECHANICAL DENTISTRY

Earn Big Money—Men Needed Everywhere. This money-making business easily learned in a few months in day or eveningsessions. Practical training. Individual instruction. Easy terms. School is highly endorsed. Write NOW for free catalog P and special tool offer. Address NEW YORK SCHOOL OF MECHANICAL DENTISTRY, 125 W. 31st St., New York



Build Muscles and Strength With This Iron Shoe

The Germans invented the Iron Shoe. They realized it enabled them to achieve physical perfection. We brought it to America and improved it. Every strong man uses one to build back muscles, tremendous chest and powerful giant-like arms. We show how to develop abdomen and legs so you will be a top-notch in 30 days. We don't just ship apparatus and let you work out your muscle building problems. We include with our

FREE SPECIAL OFFER. the IRON MAN'S FAMOUS 60-DAY ILLUSTRATED PICTURE COURSE of exercise instruction. SPECIAL STRENGTH RECORDER and STRENGTH REGISTER, thereby making this the greatest body building offer presented. Follow the choice of champions and get that grip of steel. Ring in now on our special offer for the lowest priced and greatest result getting exerciser under the sun. Write today for free information and special offer.

American Athletic Appliance Co.

239 Broadway, Dept. P.M.9.A., NEW YORK, N.Y.

When writing to advertisers please mention Popular Mechanics

Copyrighted material

Speed Course

in Drafting

—for the man who must learn in spare time and make every minute count

In drafting as in every leading profession today, it now pays to specialize. Master one of its important branches. It's the surest way to swift success. Four big fields from which to choose — mechanical — electrical — architectural — structural — each world-wide in scope — unlimited in opportunities. Specialized draftsmen have won fame and fortune as inventors, builders, architects, technicians and designers.

Our college training at home cuts time and cost to a fraction of that required to go away to school. This selective method of specialized training in draftsmanship is distinctive with Chicago Tech.



\$25 Drafting Outfit
FREE of Extra
Cost

the result of 27 years' experience in training men both in our Chicago School and at home by mail. It accounts for the swift, outstanding success of its graduates. All side-trips and non-essentials are eliminated. It offers the shortest route to the highest paid fields in drafting. The high posts and big rewards today are not won by the jack-of-all trades. Draftsmen who reach the \$5,000 and \$10,000 jobs still young enough to enjoy success are all specialists—each a master in one of its four big branches. This marvelous mechanical, electrical, building and engineering age is creating thousands of jobs annually for drafting specialists. Moreover, drafting is the greatest developer of creative and inventive ability.

Send for the Chicago Tech's Free Home-Study Catalog. Learn how anyone with a common school education can now become a college-trained, specialized draftsman—with maximum speed and surprisingly little expense. Our free employment service helps you to a good position as soon as ready. Low cost—easy terms.

Specialized
draftsmen earn

\$100
a week
and up

Chicago Technical College,

Dept. M-204, 118 E. 26th St., Chicago, Ill.

Please send me postpaid, your big Free Book on Drafting telling about opportunities and your College-Training-At-Home Plan.

Name.....

Address.....

City..... State.....

Age..... Occupation.....

Mysterious Power of Pelmanism

Let us send you a free copy of "Scientific Mind Training." An instructive book which explains an amazing system of mind training already used by more than 750,000 people. It will show you how and why Pelmanism is the only system of teaching for developing all the mental powers at the same time. Endorsed by such distinguished men as Edgar Wallace, Sir Harry Lauder, Jerome K. Jerome, Prince Charles of Sweden and hundreds of others. Write TODAY to

THE PELMAN INSTITUTE OF AMERICA

71 WEST 45th STREET DEPT. 69 NEW YORK CITY

FREE Radio Handbook

Write today for your copy of the new Radio Association handbook. Shows you easy ways to make money in Radio. Tells you how our members are clearing up \$3.00 an hour spare time. Write for Membership Plan which need not cost you a cent and FREE RADIO HANDBOOK.

RADIO TRAINING ASSOCIATION OF AMERICA
Dept. PM-9 4513 Ravenswood Ave., Chicago

CARTOON YOUR WAY TO SUCCESS!

DON'T COPY—LEARN TO ORIGINATE!

RAYE BURNS will teach you HOW to CREATE ORIGINAL CARTOONS at home that you can SELL! Course contains 26 lessons and over 600 illustrations. All for Only... **\$2.85**

Send name and address for free details.
RAYE BURNS SCHOOL, 835 Lakeview Rd., S-1, Cleveland, Ohio

CHEMISTRY



Complete, practical home-study courses prepared by some of the best-known chemists in this country, including ALLEN ROGERS, B.S., M.S., Ph.D.—Head of Department of Industrial Chemistry, Pratt Institute; L. M. TOLMAN, Ph.D.—Formerly Chief Chemist, Wilson & Co. Now Vice-president, United Chemical and Organic Products Co.; BRADLEY SROUGHTON, B.S.—Head of the Department of Metallurgy, Lehigh University, and OWEN L. SHINN, Ph.D.—Professor of Applied Chemistry, University of Pennsylvania.

Mail Coupon for Free Booklet

INTERNATIONAL SCHOOL OF CHEMISTRY
Associated with the International Correspondence Schools

Box 5564-G, Scranton, Penna.

Without cost or obligation, please send me full details of your home-study course in

- Analytical Chemistry Metallurgical Chemistry
 Chemical Engineering Short Chemistry Course
 Industrial Chemistry Pharmacy

Name.....

Address.....

ELECTRICITY

Easily Learned in 12 Weeks
No Books—No Lessons
Not a Correspondence Course

McSweeney training makes you independent of hard times. Unemployment holds no fear for you if you are a McSweeney trained man. Specialize! Learn Electricity! McSweeney students—thousands of them—know their business because they were trained for it by practical work with real tools on real equipment.

WRITE FOR BIG FREE BOOK AND SPECIAL TUITION OFFER

McSWEENEY
SCHOOLS
Dept. C-6-2 Cleveland, O.

a. 1191

'Old Iron Horse' Touched by Beauty's Hand



921 Graybar Bldg New York
pah jenn

Otto Kuhler, design engineer and the "father of streamlining," has drawn plans for a beautiful new type of railway engine that is expected to combine a thirty-eight-per-cent increase in efficiency with its esthetic appeal. By streamlining the entire locomotive-and-tender assembly, as

shown above, and using duraluminum or other aluminum alloy for a majority of the metal parts, the weight can be reduced by half. This would provide much higher speed, yet at a cost not exceeding present figures. It would decrease up-keep costs on the roadbed as well.

Popular Mechanics Magazine

REGISTERED IN U. S. PATENT OFFICE

WRITTEN SO YOU CAN UNDERSTAND IT

Vol. 56

SEPTEMBER, 1931

No. 3

01522

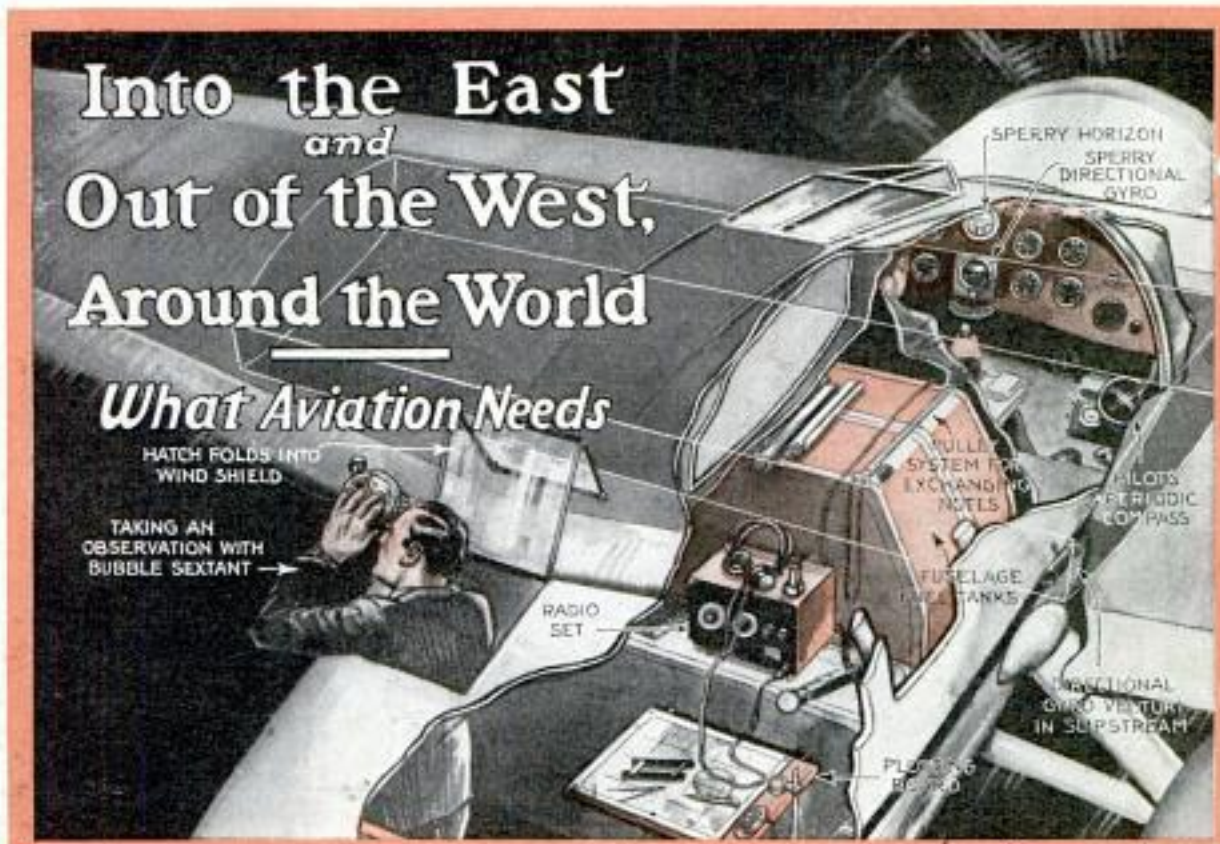

HOW about a trip around the world on your two weeks' vacation? Ask Wiley Post and Harold Gatty, who have flung a girdle around the globe in just eight days, fifteen hours and fifty-one minutes—a forecast of future air travel.

Magellan's 1,125-day world tour has shrunk to less than nine.

Wiley Post lost an eye in an oil-field accident in Oklahoma. That gave him \$2,000 compensation, and his first airplane—the start of his flying career.

Harold Gatty trained in the Australian naval academy as a navigator. He served in the merchant marine and then opened a school. Of his ability

Colonel Lindbergh remarked: "He is one of the greatest navigators in the world."

It may seem a simple thing to pilot an airplane across the ocean since steamers go with such regularity. But taking observations from a liner and "shooting the sun" from an airplane averaging 100 miles an hour are quite different jobs. The position of the plane changes so rapidly that the reckoning becomes most difficult. So, while the adventure offered a daring challenge to both men and aircraft, above all it gave a decisive test to the instruments by which men steer across seas and continents.

And what are the re-

SCIENCE AND INVENTION, a magazine long and favorably known, has been merged with Popular Mechanics. Beginning with this issue, Science and Invention subscribers will receive this magazine each month until their subscription expires. Those who have been subscribers to both will have their subscription to Popular Mechanics extended by the number of months of Science and Invention still due. We welcome our new readers with the hope that they will grow to like this magazine as well as they did the other. All contests and offers conducted by Science and Invention have been discontinued.



ature, oil pressure—in short, he had a whole staff of sleepless reporters working for him.

Only a pilot knows what a pea-soup fog means. A few hundred miles off the coast of England, and the "Winnie Mae"

sults? First, that the instruments and mathematical tables used in determining position need improvement; second, that the radio equipment was so much dead freight. But if the instruments and tables used in determining position were at fault, the bewildering array of illuminated needles, figures and dials on the dashboard acquitted themselves splendidly. Post had before him devices for measuring his distance from the earth, his velocity with reference to both the atmosphere and ground objects, motor temper-

flew blind at an altitude of 12,000 feet. It was daytime, but it might just as well have been night. Gatty watched for every crack in a cloud to get a sight. And Post held the ship true to the course of the compass.

Between Berlin and Moscow, a 925-mile land hop, they encountered the dir-

E. S. Ritchie & Sons
112 Cypress St.

POPULAR MECHANICS

Brookline, Mass

A 15 22

355

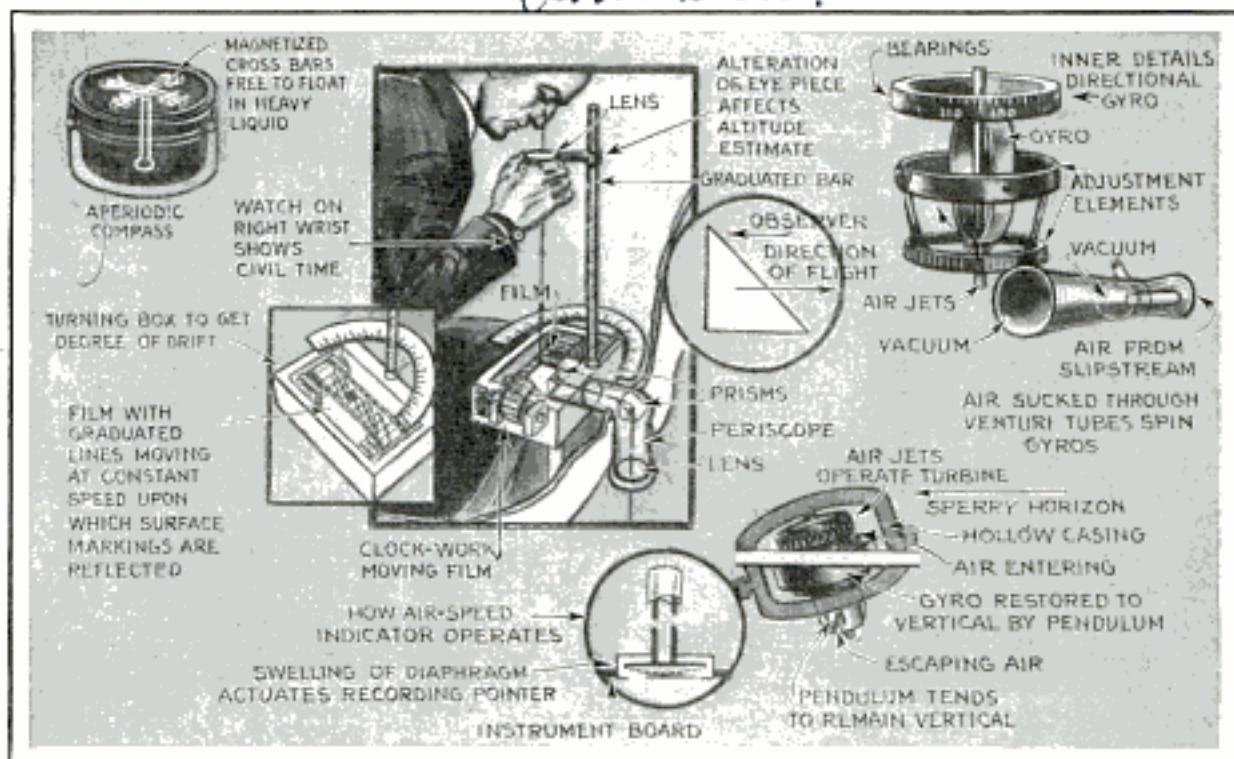

tiest flying on their entire journey. The ceiling pressed down so close that they were forced to fly just above the tree tops. Landmarks flew by so swiftly that they were unable to check their course. Here Gatty's drift indicator came to assistance. It corrected the shift in flight direction caused by cross winds. With the aid of that sense called "dead reckoning," Post struck Moscow square on the nose.

In eastern Siberia they traveled over a strange and hostile wilderness where again they almost scraped the trees, and their hearts leaped as strange apparitions loomed out of the eerie mist. Several times, they pulled the "Winnie Mae" up sharply, and here it was their Sperry horizon which saved the expedition.

They started across the Sea of Okhotsk just before darkness; and as it began to rain, the fog thickened, and for four hours no outside object could be distinguished. Every instrument on the dashboard became vital, since the avigator's tools were useless. Over the Bering sea they flew blind through more dense fog.

Among Post's most dependable instruments was the Sperry directional gyro which indicated the "Winnie Mae's" compass course. Unlike the magnetic compass, it does not oscillate in turns or in rough air. When used in connection with

the horizon, the directional gyro allows the pilot to perform all essential maneuvers without seeing outside the ship. The value of the horizon in blind flying cannot be overestimated. Its chief function is to correct the errors of our senses when judging position in space. Man relies on three special senses to determine his position in space: The eye places him with reference to the horizon line; the inner ear maintains a sense of equilibrium by means of a tiny liquid level, and the feel of his own weight sometimes tells him which is up and which down.

Experience proves that if the eyes are blindfolded, the inner ear and our sense of weight cannot define the horizontal for us. When a pilot makes a climbing turn, his notion of vertical is really a forty-five-degree line. Hence, the need for an instrument to define the horizon at all times. The Sperry horizon provides the pilot an exact picture of himself with reference to the earth's horizon. If his plane's nose is pointed above the natural horizon, he sees a tiny model of an airplane with its nose pointed that way. If he dives, this tiny plane drops below the instrument's horizon; if he banks, the tiny wings are shown tipped. The turn indicator also proved a valuable blind-flying instrument. It enables a pilot to steer a straight

A. 1522

based on one developed by
scientist at Bureau of
Standards
called *ocean*.

course when the compass cannot be relied upon. It is not affected by rolling or pitching, but indicates the least motion about a vertical axis.

Gatty, with Lieut. Commander Philip Weems, U. S. Navy, has devised new methods for determining position by celestial avigation. Their system employs an aero-chronometer and a bubble sextant. With a bubble sextant, one need not depend upon the horizon, but uses instead the sun and the stars. And the aero-chronometer, worn on the wrist, is intended to overcome the difficulty that airplane speeds place on the avigator. It is easy to remember the exact time at sea where motion is sluggish, but in flying at high speeds a great error is introduced. The aero-chronometer is a mechanical check on the exact instant of observation.

Although the "Winnie Mae's" radio proved of little help, Gatty believes that

radio can be made as useful to aircraft as it is to seacraft. He made repeated attempts to signal with his short-wave transmitter, but no one is reported to have detected his letters. And the receiver was almost as useless, since the only weather reports it picked up were in Russian, which he could not understand.

One of Gatty's chief pleasures was testing his own invention of a ground-speed and drift indicator, combined into one instrument. Across the Atlantic the "Winnie Mae" drifted as much as nineteen per cent. The instrument won his confidence.

Gatty's invention consists of an endless film cut across by fine parallel lines. This strip of film moves at a speed synchronous with that of the plane over the earth. The avigator looks through a periscope and makes his observations of the ground. He found the device quite satisfactory, but intends to refine it further.

not on market

TEN THOUSAND HOLES AN ACRE PREVENT SOIL EROSION

A. H. Davis Soil Erosion Specialist Fort Hays, Kans 7/13/30



Plow Which Prevents Soil Erosion by Leaving a Field in Alternating Hills and Hollows

also soil specialists Dept. of Agriculture

A farm implement that prevents soil erosion by leaving a field in alternating hills and holes to prevent rains from washing it away has been developed by government scientists. Alternating shovels work up and down with the forward motion of the plow, scooping out the dirt and piling it at regular intervals. The machine leaves 10,000 such holes per acre, each having a capacity of about three gallons of water. The outfit can be used for cultivating crops in rows or on fields that are lying fallow.

A. 1526

MYSTERIES OF BALL LIGHTNING STUDIED BY WEATHER MAN

Secrets of ball lightning, one of the least understood of electrical phenomena, are being sought by Dr. W. J. Humphreys, of the United States weather bureau. Observers of ball lightning are asked to answer questions prepared by Doctor Humphreys in the effort to throw new light on the phenomenon. Ball lightning is a slow, long-continuing electrical discharge that floats through the air or runs along the ground in the shape of a ball. The color varies from red through blue to dazzling white. These glowing balls often enter houses, floating around with a crackling noise, but seldom do any harm.

meteorological physicist

Science Service 538 E

Copyrighted material 7/15/31

London Express
6/28/31

41450

no further data

MIKE CALLS NURSE TO PATIENT'S BEDSIDE

21496

Patients in one London hospital only have to groan to bring a nurse to the bedside, for a microphone loud-speaker device carries that groan to the nurses' central sitting room, where one always is on duty. The instrument, which stands in a cabinet beside the bed, is so sensitive that it will record words spoken at the other side of the room. Ordinary tones from the patient are reproduced clearly in the nurses' room, while the nurse is able to carry on a conversation with the patient, finding out what is required without going to the bedside. The device also warns the nurse of the sudden collapse of a patient.

cannot locate



Riding the Surf on a Catamaran, a Raft Set on Twin Pontoons with Waist-High Oarlocks for Rowing in Standing Position

Ocean Park

FLOAT SET ON TWIN PONTOONS OPERATED WITH OARS

Shooting the surf with floats set on twin pontoons is the latest aquatic sport at California beaches. These catamarans consist of two boat-shaped pontoons which support a platform with oarlocks on waist-high rails, so the riders row standing.

RIM PULLED FROM TRUCK TIRE BY WATER PRESSURE

21460



Water pressure is used for pulling the rim from truck tires in an extractor invented to save time and labor in removal of large tires. The tool provides its own pressure by means of a small pump, incorporated in it.

Its inventor claims a saving on wedge rings, which are removed without breaking when the machine is used. Ordinarily the wedge rings are rusted to the rim, and it is hard to jar it loose even with a sledge hammer. Removal of a truck tire with the extractor requires about half the time necessary for the workman not so equipped.

AIRTIGHT LACQUER POT COVERS SPEED UP COLOR WORK

For use in home decoration, or other types of work, a lacquer pot has been developed which permits leaving the work or using the lacquer occasionally without finding the brush hardened and unusable. The pot is one-quart size, is fitted with a handle and has a cone-shaped cover, so that, after use, the cover may be put on tight enough to prevent evaporation, and still leave the brush in the lacquer. For home lacquering, six or seven pots, as many as there are colors being used, each with its own brush, speed up the work materially, inasmuch as it is unnecessary to clean the brushes.



my. Lee Hydroclear Co. Salina, Kans.

A motorcycle air-spray paint gun is being used for road marking.

Mr. Charles A. Dell,
% Adell's Fire Service
Mc Minnville, Ore

American Typefoundry Co.
519 W. Monroe
Chicago

Copyrighted material

Cont. Es. H. Eckhardt, 4528 Walnut
Phila

Q-1939
358

Fingerprinting Pistols in the War on Crime

Lighting the inside of gun barrels to help catch criminals is possible with a and several guns may be

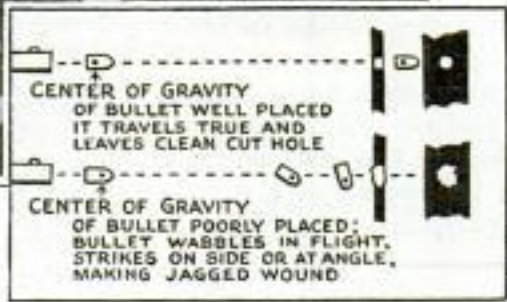
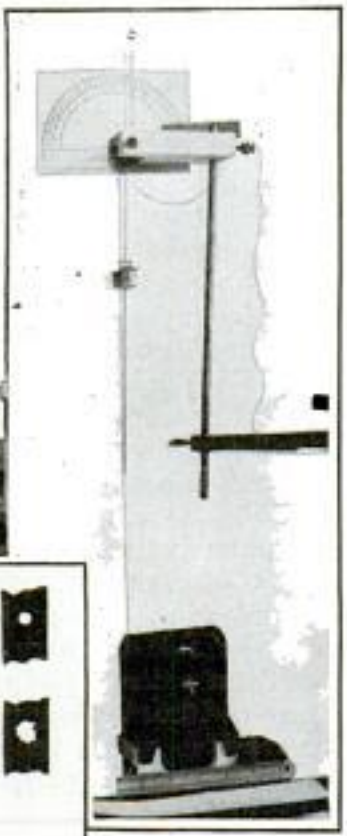
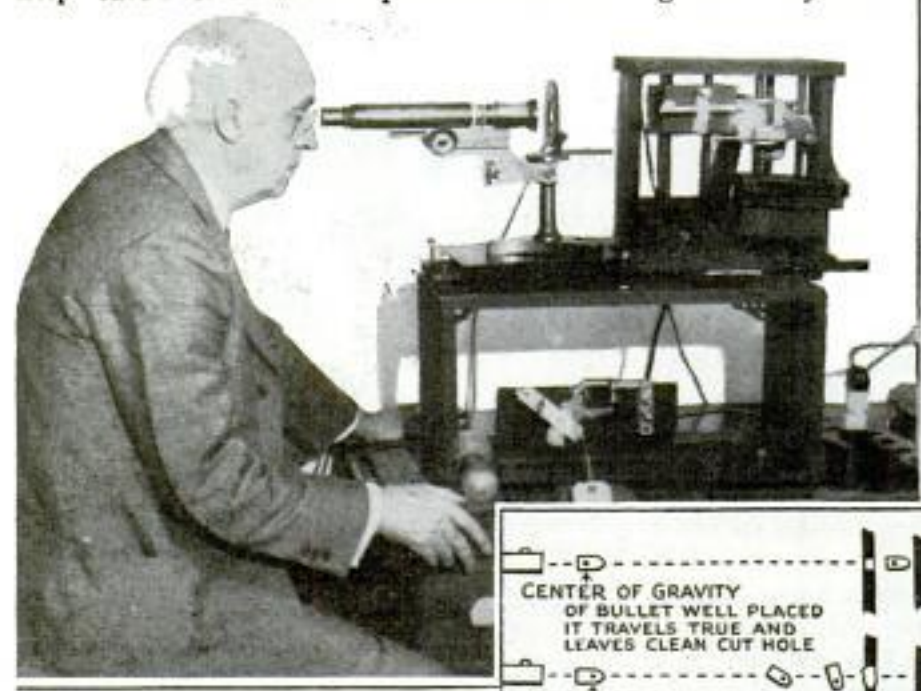

Expert Examines Pistol Barrel through Microscope on Machine in Large Picture; Gravity of Bullets Is Found with Apparatus at Right

device designed by the coroner's chief physician in Philadelphia. Full power of the microscope may be brought to bear under the full illumination of the barrel. With the same apparatus, the full length of the barrel can be studied with the microscope, which is mounted to move back and forth. Pistols to be studied are clamped in frames mounted on a rack,

studied at the same time. The apparatus is used in classifying markings on the bullet, and in detecting the condition of the barrel, the length of time since the gun was fired and the type of bullet used. Another device determines the center of gravity of bullets, showing how the bullet acts in flight and what effect it has upon striking the object.

VERTICAL AIR TUNNEL OFFERS POSSIBLE POWER SUPPLY

Possibility of harnessing the air to generate power or to create rain in mountainous tropical regions has been advanced recently. It is claimed that if a vertical tunnel were anchored to the side of a mountain, the differences in temperature, pressure and density at the various altitudes would cause to pass through the tube a current of air of sufficient force to drive turbines. If near the sea, such a tunnel would draw up great quantities of moist air that would form clouds throughout a wide radius at the top of the tube,

it is believed. Calculations have indicated that a tunnel with an aperture of forty-two and one-half feet at the top would eject a cloud mass over 75,000 acres.

ELECTRIC BULBS GAUGE WATER IN DISTANT BOILERS

Electric lamps mounted behind colored glass, green and red, are used in a new water-level indicator for boilers and tanks. The instrument may be located some distance from the boiler, since a multi-wire cable is the only connection between the two. No liquid is used in

Mr. William Weddworth

Compressed Air
July 1901

B. J. Lubas
no address

*Chicago 20
N. Wacker
Schutte & Koerting Co. 21452
2nd Thompson St. Phila 12th
James Montagnes 608 Harbor
Commission 359
S. Park Ave*

the indicator. The lights are operated through relays from a set of electrodes mounted in a water chamber attached to a steam boiler, or any other liquid vessel from which readings by level are required.

BIGGEST LINER BUILT TO CROSS OCEAN IN FOUR DAYS *a 149*

Huge turbines, generating 200,000 horsepower, will drive the Cunard line's new passenger ship across the Atlantic in only four days. The vessel, now under construction, will be able to attain speeds of thirty-two to thirty-five knots. Her builders say she will be the biggest and fastest passenger ship afloat. Important to the comfort of passengers is the \$1,000,000 gyroscopic device designed to keep the vessel from rolling and diving in rough weather, and to prevent seasickness. The top bridge will be 100 feet above the water line, with nine short decks rising like steps from a huge platformlike forecastle deck. The length of the liner is 1,018 feet, with a beam of 115 feet. Launching will take place in 1932.

NOISY MANHOLE COVERS CURED BY GRINDING *a 1436*

Grinding of covers to fit manholes is now possible through the use of a machine devised as a means of reducing city noises. The machine operates on the same principle as the garage mechanic's valve grinder, using an abrasive compound to make a perfect fit between the cover and seat.



Clock Tester Is Shown Using a Stethoscope in Listening for Defects in Electric Timepieces

HEARTBEATS OF CLOCK HEARD WITH STETHOSCOPE

Electric clocks are being tested with the aid of a stethoscope like that used by the medical profession for listening to heartbeats. Thousands of clocks on the shelves of one factory are tested in this manner to save time and eliminate the soundproof rooms usually employed in listening for defects in electrically operated timepieces. Accurate workmanship requiring adjustments to two-thousandths of an inch is needed in making these timepieces.

AIR TRAVEL FOUR TIMES SAFER THAN THREE YEARS AGO *a 1500*

Airway travel is more than four times as safe as it was three years ago, according to figures of the committee on aviation of the Actuarial Society of America. In 1930, the committee said, the chance of death among passengers in planes on scheduled flights was one in 17,000, while in 1929 it was one in 10,000 and in 1928, one in 4,000. The improvement is attributed to closer supervision, extension of radio-beacon service and weather information, and excellence of American planes and engines.



Grinder for Manhole Covers Fits the Lid to Its Seat; Noise from Auto and Truck Wheels Is Reduced

*L. W. Harold & Teiner
c/o Union Brass & Electric Co.
4th + Main, Cincinnati, O.*

*Kans. City Star.
Copy 7/8/31 material*

Used by U.S. Inf. Serv. in Canada

a 12-79

Com. Harold L. Blanchard
959-8th Ave New York

Pepping "Em up" for

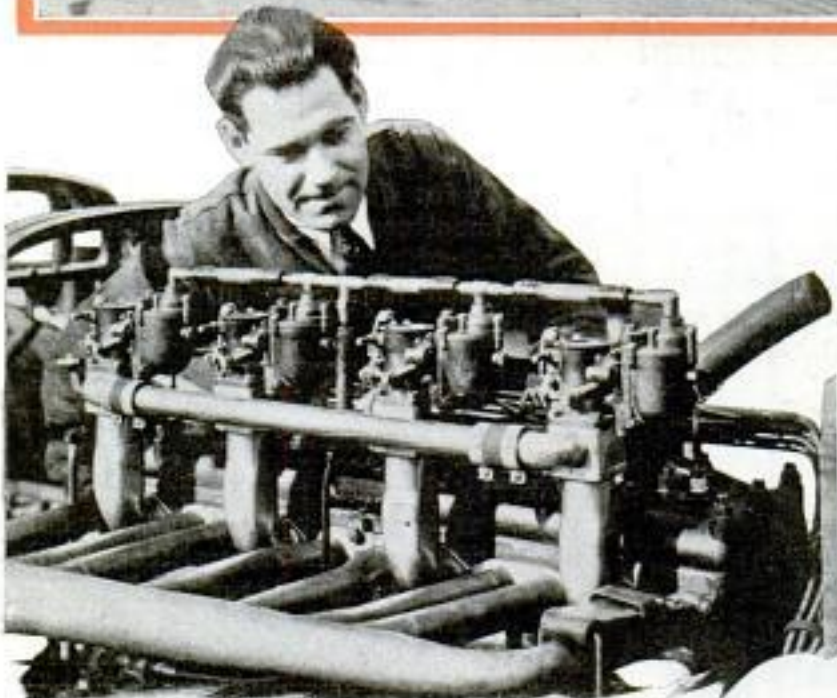
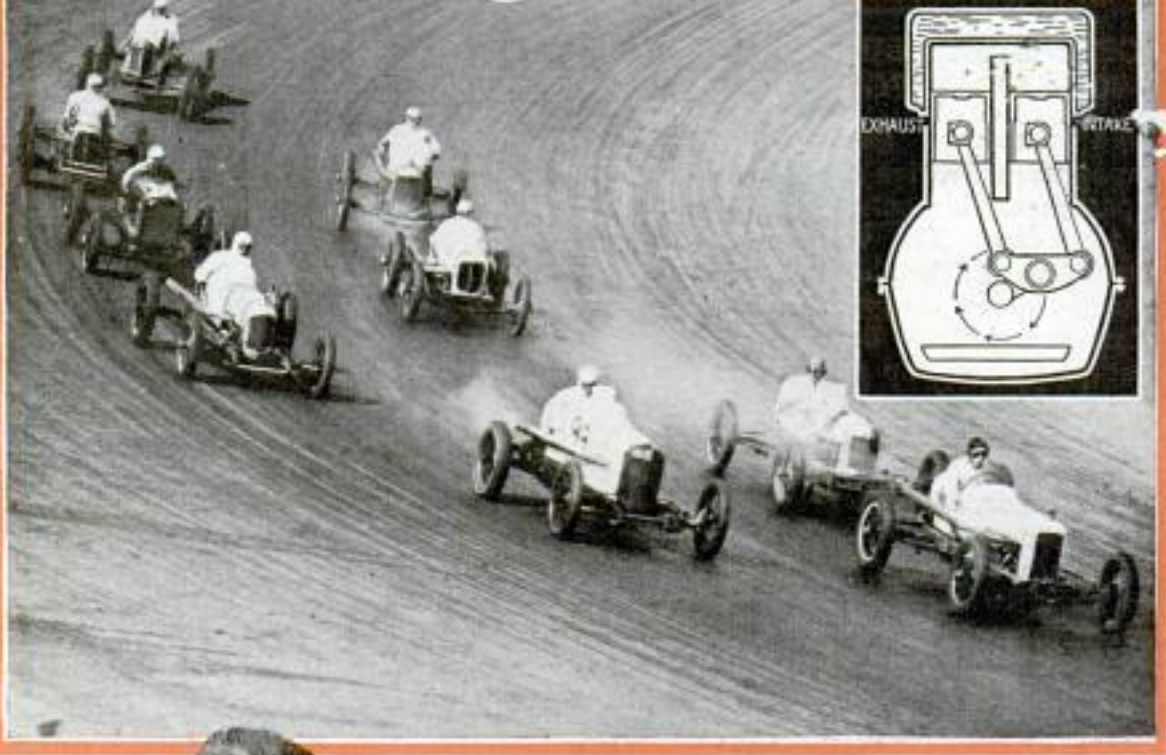

Cars Bunched on the Turn, Above, and Below, Snowberger with His Studebaker Eight; Inset, Leon Duray's Engine in Cross Section

mobile you drive. In the last few years, the racing car of one day became the passenger car of the next.

But now the tables are turned—or at least turning. The "pepped-up" passenger car now is threatening to crowd the costly racing creations off the nation's speedways. Stock cars, "stripped to fighting trim," are stealing the limelight from the custom-built "dynamite bugs."

It may seem surprising that racing cars made of the same parts used in passenger cars are able to compete successfully

FROM motor speedways have come the improvements in motor-car design, worked out under the flaming lash of speed, which, ultimately, found their way into the present perfection of the auto-

with the highly specialized race cars costing \$10,000 to \$15,000, but the explanation is simple. Generally speaking, only three major changes were made in their engines. First, the compression ratio is

the Roaring Road



Thirty-Thousand-Mile Test Run of Studebaker Cars. Above; Below, Cranking the Cummins Diesel Car with Batteries on Service Wagon

raised from, say, five to one to perhaps seven or eight to one. Second, a carburetor for every two cylinders is usually fitted, since the greater the number of carburetors the more mixture the engine is able to draw in. Third, the muffler is removed and a long exhaust pipe fitted, thus increasing power by reducing back pressure.

Some builders put in racing camshafts while others do not. Aluminum pistons are fitted in every case. Heavier valve springs are installed and, in some cases,

exhaust valves of better material are used. Oil coolers also are fitted.

Wheelbases usually are shortened to 100 inches or a little more, since a short-wheelbase car takes the turns better. Some of these cars, such as Red Shafer's Buick and Chet Miller's Hudson, both eights, use two chassis to make one car. That is, Chet Miller's

Hudson has a standard Hudson Eight engine placed in an Essex chassis with frame shortened to give a wheelbase of 107 inches. Red Shafer, likewise, used the Buick model-sixty engine, the rest of the car being a model-fifty except the frame which was specially made. All the stock cars at the last Indianapolis race had specially built bodies, and their low wind resistance, as compared with the usual passenger-car body, alone added about twenty miles to the maximum speed.

When the "Who's Who" of speed mer-



Russell Snowberger in Racer He Built around Salvaged Studebaker Engine; the Entire Car Cost Only \$1,500 to Prepare for the Track

chants and fast cars lined up for the start of the Indianapolis classic this year, nine of the starters were of stock-car origin. Further, and more significant, the car which held the coveted "pole position," emblematic of the fastest qualifying speed, was a homemade racer built and driven by Russell Snowberger—powered by a Studebaker President Eight motor picked up off a salvage pile.

Back in the track garage were half a dozen hand-built specialty jobs costing "important money," which had been crowded out of the starting list by the revamped stock cars. In one "stable,"

and construction to thousands of Studebaker passenger cars all over the country. Behind them were a score of hand-built cars, any one of which cost more than all three of those revamped passenger cars together.

To make the story complete, one of those revamped family cars really should have won the race. Indeed, it was no fault of their performance or stamina that such was not the case. It was the fickle fate that seems to rule the Indianapolis track that finally came to the rescue of the "specialty jobs." When Billy Arnold's car broke an axle, fate decreed

there were two shining speedsters which had cost their owner nearly \$70,000, but which could not match the qualifying pace set by the former passenger automobiles.

At the 300-mile mark of the Indianapolis race, three of the first five leaders were semistock cars. There were Tony Gulotta, Russell Snowberger and Lu Johnson, holding second, third and fifth place, respectively. Each was driving a car powered by a Studebaker President Eight motor—alike in all essential details of design

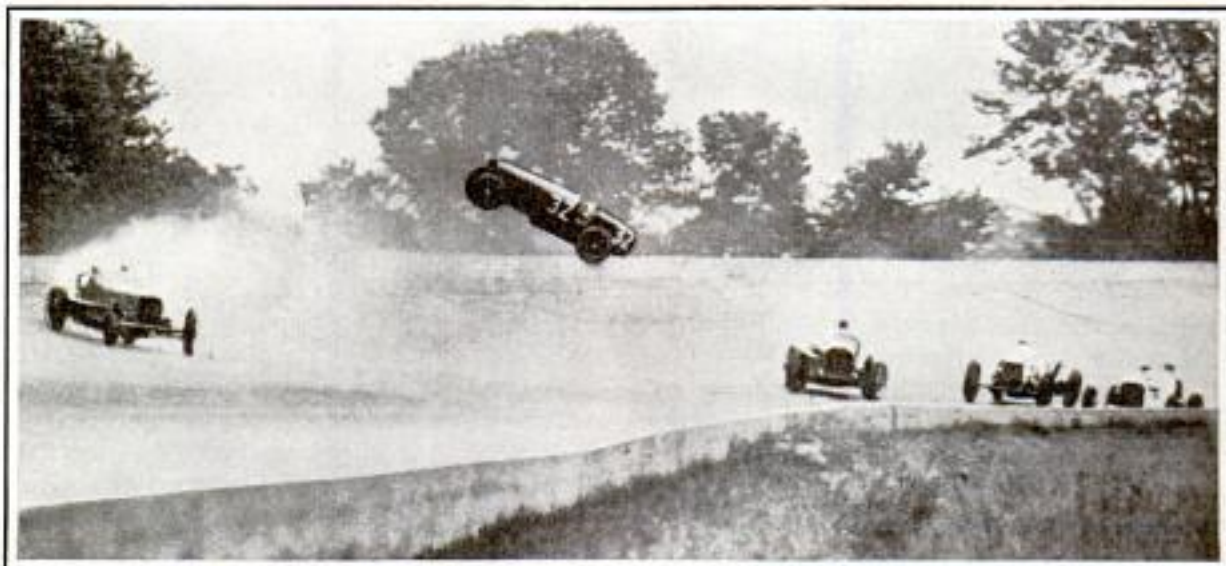

Going over the Wall at the Indianapolis 500-Mile Race; Fred Winnai Is the Driver of the Car in the Air; the Third Car from the Right Also Crashed, Injuring Both Occupants

it should go into a spin directly in front of Johnson's Studebaker, and both crashed through the wall. A few laps later, just as Gulotta was about to push his Studebaker-powered mount into the lead, grease left on the track by Arnold's wreck caused Gulotta's car to skid. With victory virtually in sight, he struck the wall. Snowberger continued on to finish in fifth place.

All of which brings up the question: How near stock is a "near-stock racer"? Consider the Hunt-Jenkins Special in which Tony Gulotta came so close to winning the nation's premier speed event.

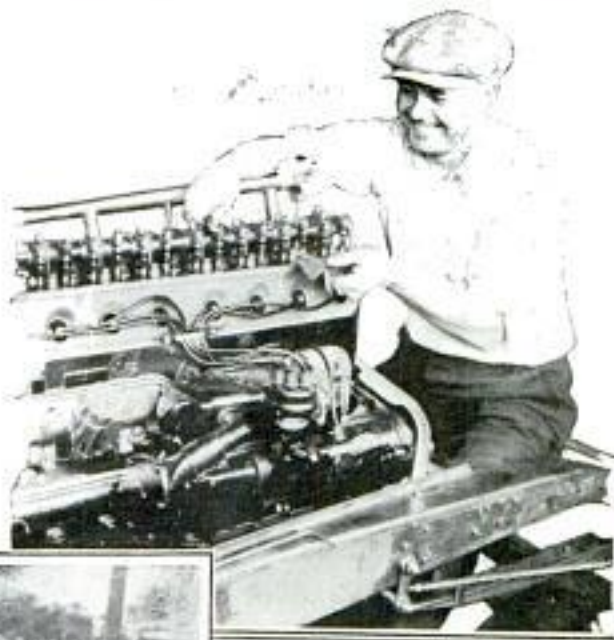

Stock Studebaker Driven by Azzari, Taking the Turn on the Santiago Circuit He Won in 1930; Top, Red Shafer and His Buick Racer

George Hunt, designer of the car, bought the motor just as you or I would buy one. He increased the compression ratio; installed four carburetors instead of the standard dual carburetor; magneto ignition, to obviate the need for carrying a storage battery, and removed the fan. Pistons, connecting rods, crankshaft, bearings, valves, lubrication system and water-circulation system remained untouched. In the chassis, front and rear axles, axle gears, free-wheeling transmission and steering system were utilized just as they came from the factory. The radiator was of standard production, cut down to decrease the frontal area. Wheels and tires were of special racing design, and the racing body naturally also was specially built.

Snowberger built up his car in 1930. When the job was ready to run, it represented a total expenditure of approximate-

ly \$1,500. Snowberger raced the car throughout the 1930 season, finishing fourth in the national championship standing, and won a total of about \$10,000 in prize money. He is authority for the statement that maintenance on this car during the entire season cost him less than the price of a new hat. During the winter the car stood in a barn. In

the spring, he replaced a few minor parts and was ready to go back to the road.

Among the specially built racing cars seen this year, Leon Duray's sixteen-cylinder two-cycle car attracted much attention. Everybody admitted it was by far the fastest car at Indianapolis, but the water jackets were so thin it couldn't be run more than a few miles before the water would boil. There were four cylinder blocks, and the crankshaft had eight crankpins. Thus each pair of bores had its two connecting rods linked to one crankpin, the pair of pistons moving up and down together. Above them was a single combustion chamber. Near the bottom of the stroke, one piston uncovers the intake port and the other piston the exhaust port, at which time the supercharger forces mixture in, driving the exhaust gas out. The supercharger was built on the gear-pump principle.

a 1509

a 1453

Harrold-Page

PLANE THAT LOOKS LIKE A BAT IS WITHOUT A TAIL

Resembling a monster bat when in flight, an airplane of most unusual design was tested recently in England. It is known as the "pterodactyl" plane and is as peculiar as its name. Besides its bat-shaped wings, the craft has landing wheels placed in tandem, and is without a tail in the ordinary sense. It was flown recently with an auto-gyro and a biplane to demonstrate the three types of aircraft.



The British Pterodactyl Plane, So Named Because of Its Resemblance to a Prehistoric Monster, the Wings of Which Form Rudder and Elevator Surfaces

Charlottesville, Va.

THREE TIMES BULLET'S SPEED REACHED BY CENTRIFUGE

Whirling so fast that its rim travels three times as rapidly as a rifle bullet, a new type of centrifuge has been devised by Dr. J. W. Beams and A. J. Weed, of the University of Virginia. The centrifuge is the device used in the cream separator to separate cream from milk. A speed of 10,000 feet a second was reached by one model of the new type, with a force equal to a million times that of gravity. The device is expected to be used in scientific laboratories where much higher centrifuge speeds are necessary for clearing fine silt out of turbid water, separating cells into their constituent parts, and for getting tiny water droplets out of oil. An

arrangement of outlet tubes provides for continuous feeding of material and for its separation without stopping the device. In this respect it resembles certain types of cream separators into which whole milk is poured, while jets discharge milk and cream.

WRENCH WITH GRIPLIKE VISE IS QUICKLY ADJUSTABLE

Two arms, which close like plier handles, are used in forcing together the jaws of a new monkey wrench so that a vise-like grip is possible. The wrench is easily adjustable, slipping loosely on or off the nut, but holds firmly when the vise attachment is applied. The head of the wrench is electrically welded to the shank.

Science Service 537. 40. 7/9/31

Woodworth Specialties Co. Binghamton, Ny

copyrighted material

N.Y. Times 7/5/31 a 1428

**SPEECH SCRAMBLER FOR RADIO
KEEPS TALKS PRIVATE**

a1482

Speech scramblers have been adopted by the operators of transatlantic radio-
phone service to prevent "listening-in"
by experimenters whose sets are capable
of reaching the correct wavelength. The
high frequencies of the human voice are
converted into corresponding low fre-
quencies while the low frequencies are
changed into high. The result is complete
unintelligibility to the listener. The words
"telephone company," for instance, come
through "play-o-fine crink-o-nope" when
spoken into the speech inverter. An elec-
tric translating brain changes all recog-
nized words and sounds so completely
that all the eavesdropper can hear is gib-
berish. At the other end of the secrecy
system, a translating brain rearranges
them back again in their proper order.

**MAGIC EYE REGULATES LIGHTS
FOR OFFICE WORKERS**

a1461

Artificial lighting of offices is limited to
the actual time it is required by a photo-
electric relay which turns the lights on
and off as it grows darker or lighter. In
order to enable the device to function in
varying degrees of light, the control
mechanism may be set to turn on or off
at any desired degree of visibility.



Photo-Electric Relay, Which Turns on Office Lights as
Darkness Approaches, Saving the Eyes of Workers

J.V. Breisky, engineer,
Westinghouse Electric Mfg. Co.
Pittsburgh, Pa.

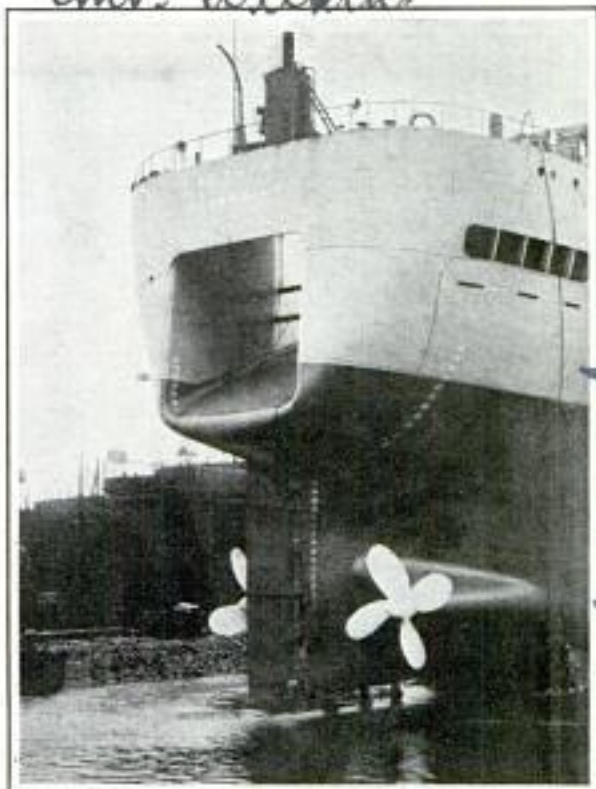

Courtesy Northern Whig and Belfast Post
Latest Type of Whaling Vessel with Door in the Stern
for Hauling Aboard Harpooned Whales

**WHALING STEAMER HAS DOOR
IN STERN TO AID WORK**

Harpooned whales are hauled aboard a
new whaling steamer through a door in
the stern. The ship with this novel fea-
ture was built in Ireland for use in the
Antarctic, to which the whale has been
driven by years of hunting.

**BRAZING SPEEDED UP BY ALLOY
WITH LOW MELTING POINT**

Speed and economy on brazing jobs
will be made possible by use of a new al-
loy, for which a patent has been request-
ed. The alloy contains a small percentage
of silver and has the unusually low mel-
ting point of 1,300 degrees Fahrenheit.
Other commercial solders containing fifty
per cent silver, or less, will not flow free-
ly at less than 1,400 to 1,600 degrees. The
new alloy, used in connecting copper
joints, stood up under a tensile test of
30,000 pounds per square inch. It can be
used also for joining brass, bronze, nickel,
nickel-silver, extruded brass and bronze,
monel metal and other metals and alloys
fusing above 1,300 degrees.

Handy & Harmon
57 William
New York

Built by Workman, Clark &
Belfast, Ireland.

\$3.00 airdrop in pound.
Thin strip small quantities
\$1.25, 100, large

a. 1464 Cont. John L County.
714 Jefferson St. N.W.
Washington. D.C.

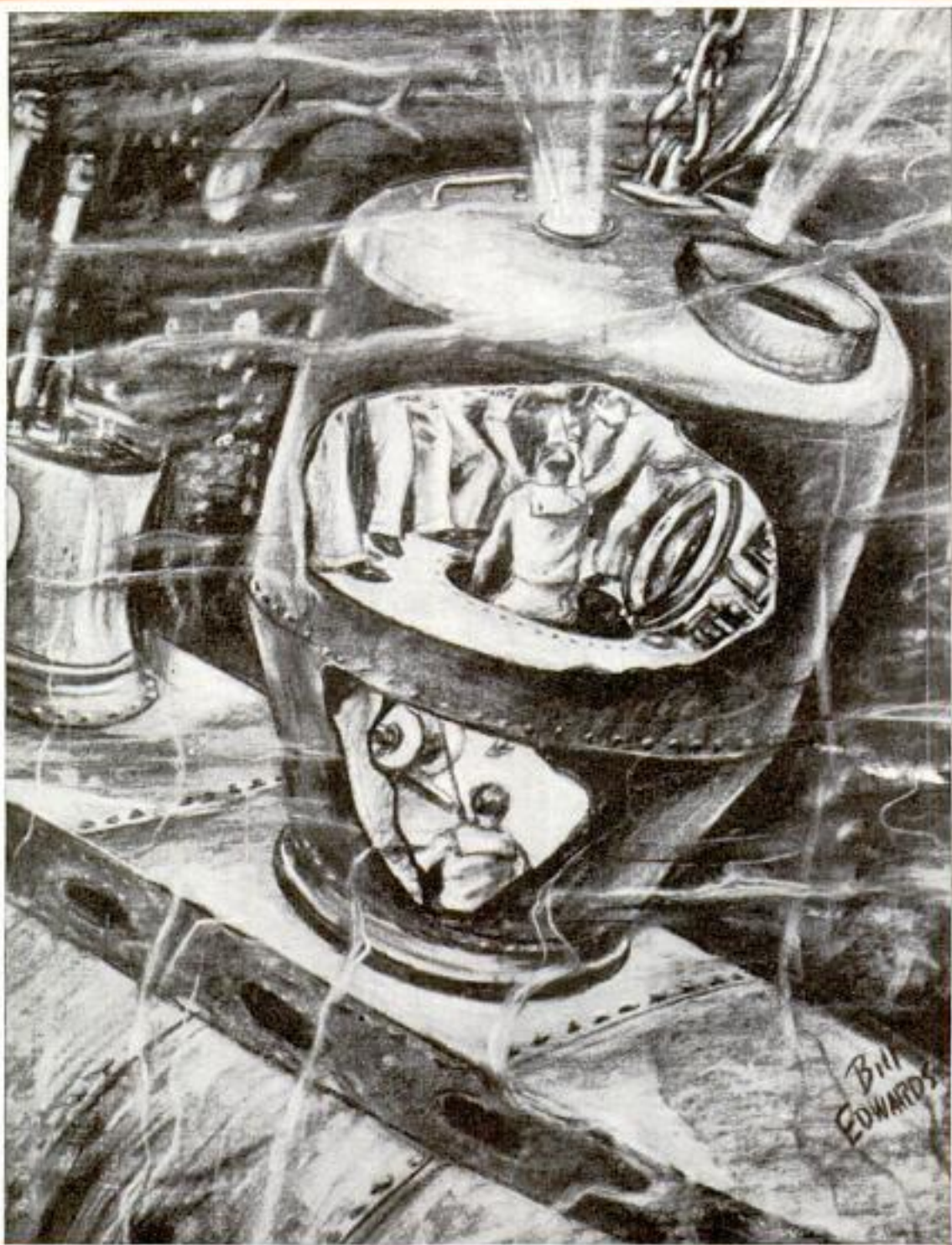

THE new submarine rescue chamber developed by the United States navy for deep-sea rescue work, depicted by the artist as it appears fastened to a stricken hull. Eighteen men can be brought up at one time and the apparatus is capable of operating at a depth of 600 feet.



Courtesy Washington Evening Star

21464

New Rescue Chamber Laughs at SEA

FOUR hundred feet below the surface of the sea forty men in a submarine sit in deathlike silence. About them are only cold steel walls. Lights flicker intermittently. One. two. five. twenty minutes pass. Watches roar on. Will they ever come? An hour drags by. one. two. three. . .

Suddenly a slight quiver runs through the submarine. The motion dies away, then comes again; steady this time, as if something were straining

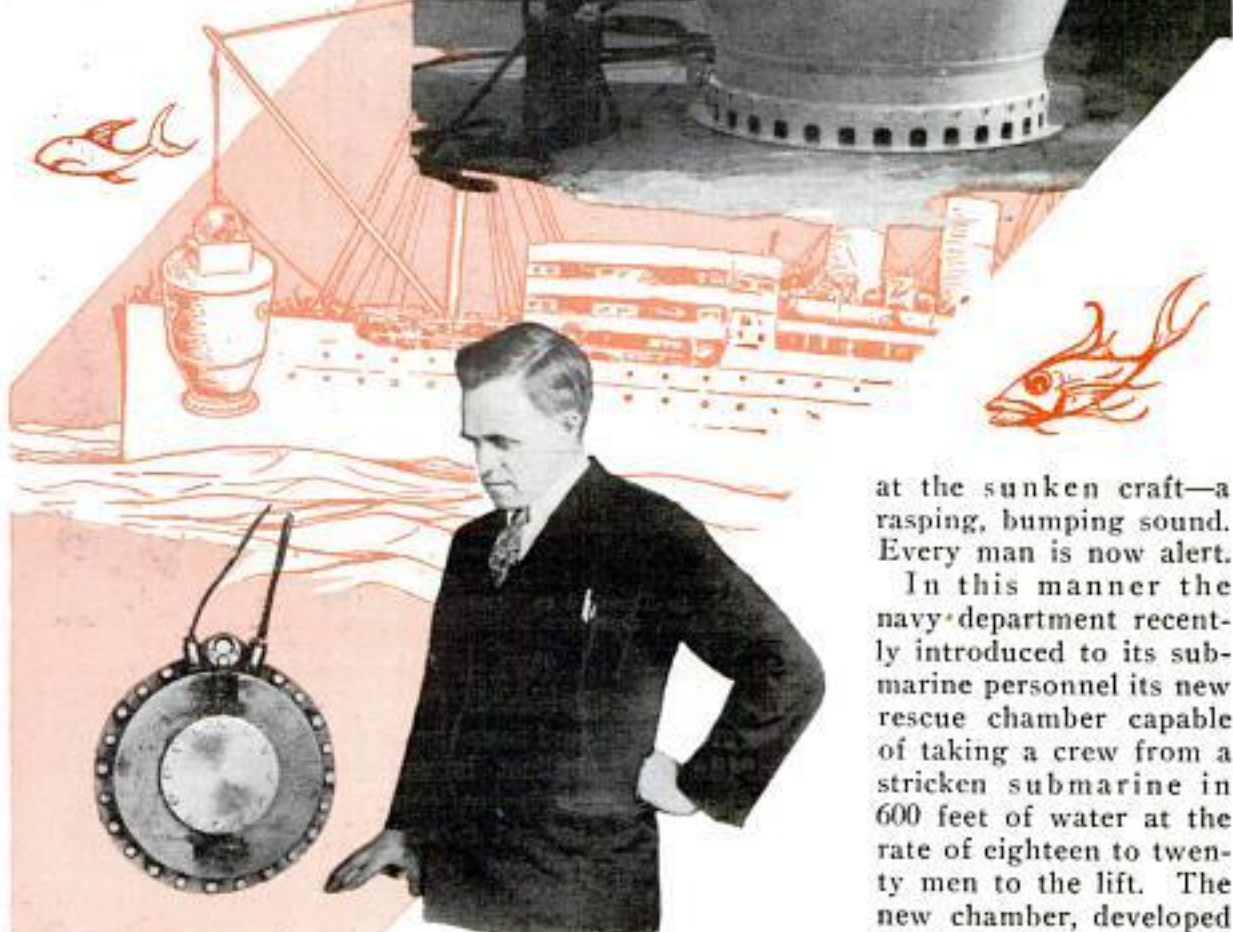

at the sunken craft—a rasping, bumping sound. Every man is now alert.

In this manner the navy department recently introduced to its submarine personnel its new rescue chamber capable of taking a crew from a stricken submarine in 600 feet of water at the rate of eighteen to twenty men to the lift. The new chamber, developed by Lieut. Com. Allen R. McCann, represents out-

The Rescue Chamber, Above; Below, Magnetic Speaker Which Can Be Attached to the Hull of the Stricken Boat for Communication

9-1464



of the chamber, and a system of counterbalancing lead weights between the outer and inner wall of the lower compartment.

"The upper compartment of the chamber is airtight and houses the chamber crew. Light, air and telephonic communication are sent them from the surface vessel through cables. A hatch leads from the upper compartment to the lower, which is open to the sea. A rubber gasket faces the mouth of the lower compartment. Water ballast tanks are housed between the walls of the chamber. The rubber mouth of the lower compartment presses tightly against a circular steel plate around the submarine hatch, making a seal. The water in the lower compartment is blown out, leaving it a vacuum cup against which the sea exerts its tons of pressure.

standing improvements in a type of diving bell experimented with by the navy during the winter of 1929-30 off Florida. Let Commander McCann explain the new bell and the principle upon which it works.

"The distinguishing feature of the new submarine rescue chamber is its self-operation. With the new rescue chamber on board, a vessel hovers over the spot where the submarine is down. A diver descends to the submarine where he hooks a heavy steel cable from the chamber to an 'eye' on the hatch of the sunken vessel. A motor and winch, operated by a crew of two men in the upper of the two compartments of the rescue chamber draw the chamber down to the hatch where it is made fast. The chamber is kept from wobbling by the guide cable fastened to the submarine hatch eye, a cable from the surface vessel to the top



Diver Ready to Descend to Connect the Rescue Chamber with the Submarine; Below, Operator Demonstrating the Subsea Two-Way Phone

"When the imprisoned men have been released, the submarine hatch is closed and then the rescue-chamber hatch. Water ballast is released into the lower compartment equal to the weight of human freight taken on, and the compartment is flooded from the sea. This causes the chamber to break its seal and rise by its own buoyancy to the surface, its speed held in check by a braking clutch."

*Ingenieur Westinghouse
Lamp Co
A 1256*

Bloomfield, N.J.

**WIRE FINER THAN HAIR
USED IN ELECTRIC
LIGHTS**

a 1398

Wire four ten-thousandths of an inch in diameter, one-fifth the thickness of human hair, provides the filament for a type of electric lamp recently developed. A diamond with a tiny hole bored in it, serves as the die through which the wire is drawn. When coiled in a filament, 1,500 turns are required to the inch, and no two turns may touch. Although the wire is made of tungsten, one of the heaviest of metals, a pound of it would stretch 144 miles. Lamps in which the fine wire is used serve to illuminate house numbers, clocks, the inside of refrigerators, cabinets and household lighting ornaments.

mayda

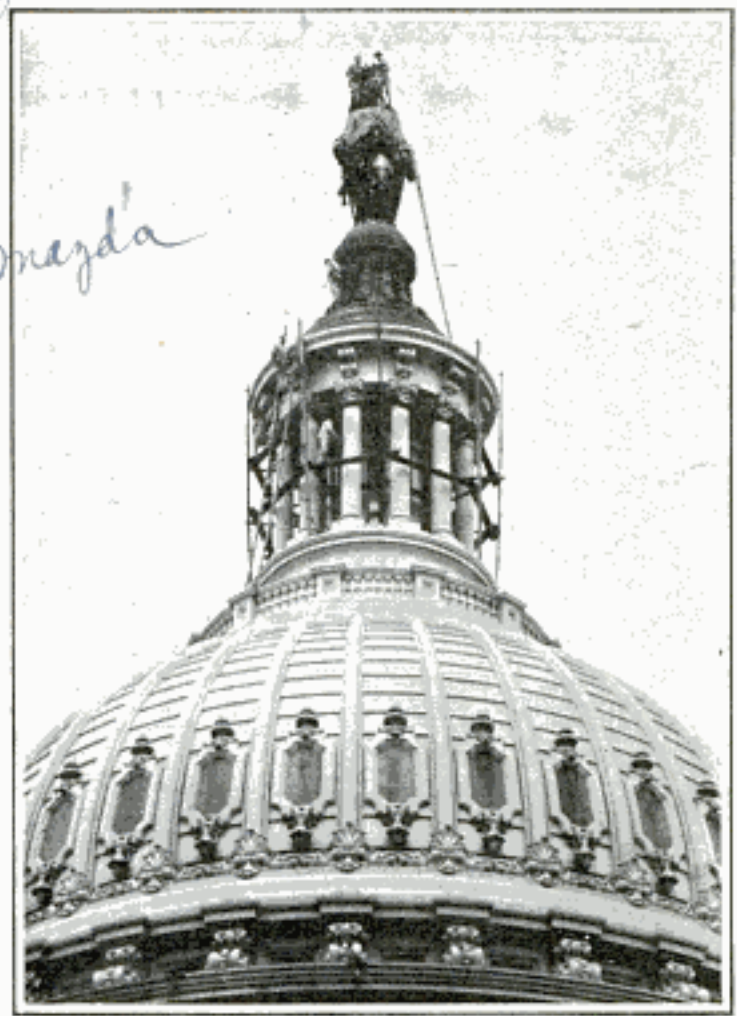

© Harris & Ewing

Steeplejacks Replacing the Platinum Tips of Lightning Arresters on Dome of the Capitol in Washington

**TWO-HUNDRED MILE BIKE
IS STREAMLINED**

a 1135

Following the example of racing automobiles and airplanes, an English motorcycle racer has had a motorcycle built and streamlined to attain a speed of 200 miles an hour. With the exception of the front wheel, the cycle is inclosed in metal, shaped to smooth the air flow around the speeder. Even the racer's helmet is streamlined in order that dragging eddies of air back of his head may be eliminated.

Arthur Simeoch

Racing Motorcycle of Streamline Design; Note the Rider's Streamlined Helmet

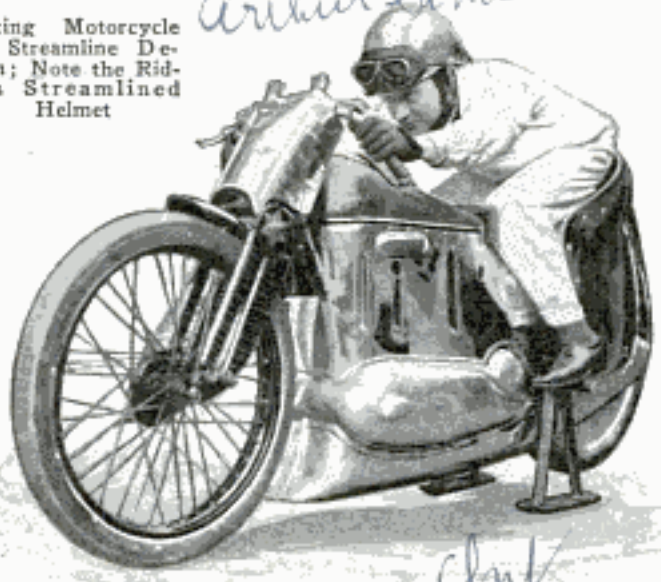

clerk

**WORKMEN ON CAPITOL'S DOME
REPAIR LIGHTNING RODS**

Steeplejacks recently made their quadrennial trip to the top of the statue of the Goddess of Freedom surmounting the dome of the capitol in Washington, to replace the platinum tips of lightning arresters that have been damaged by intercepting bolts. Every four years workmen climb to the capitol's top to repaint the dome and inspect the lightning tips.

FORECASTLES MOVED AFT

a 1353

"Sailing before the mast" will soon be obsolete in the British shipping world. Orders provide that quarters for crews must be aft of the mast, because those in the bows are unsanitary.

*Herald Examiner
6/19/31*

a 1142. Cui. Chas
 helps Astbury
 370
 1795 Broadway
 New York

N.Y. Times
 6/19/31



Lighthouse on Empire State Building Is 1,200 Feet above the Street and Can Be Seen for Fifty Miles

**LIGHTHOUSE ON A SKYSCRAPER
 VISIBLE FIFTY MILES**

Men who "go down to the sea in ships" near New York are being guided by a distinctive lighthouse, built in the heart of Manhattan's business district, and standing more than 1,200 feet above the celebrated "sidewalks." It is atop the Empire State building. Four beams of white light radiate from a chamber at the top of the 200-foot dirigible mast. They can be seen for more than fifty miles at sea

and are powerful enough to penetrate an ordinary fog. A second signal shows six beams radiating from a ball of light.

**CONTINENT RISING FROM OCEAN
 MAY DEVELOP LIKE JAPAN**

In a few hundred thousand years, a whole new archipelago like Japan may emerge from the south Atlantic ocean. This forecast has been made by the Rev. Frederick W. Sohon, Georgetown University seismologist, after recent reports of the discovery of two new islands in the region, coupled with simultaneous seismograph records showing earth tremors that might have emanated from the same territory. The islands appeared off the coast of Brazil, and at first some scientists suggested that they might mean the reappearance of the so-called "lost continent of Atlantis." Father Sohon said there is a ridge along the ocean bed equidistant between South America and Africa, but if there ever was a continent there, it had been completely destroyed. The modern development, he believes, is the result of thousands of years of erosion, sending rock from the mountains down to the continental shelf of the Americas. This, he said, might pile up so much weight that the pressure would cause a ridge in the ocean bed.

Washington, D.C.

**UNIVERSAL ANVIL FOR BENCHES
 SAVES WEAR ON VISE**

Handling hundreds of operations in the shop, garage, plant or home, a flat bench anvil has been devised that saves much time and breakage of vises on work for which they are not intended. It combines the solid base of the anvil with many of the advantages of the vise, and threaded holes are provided to permit anchoring to the bench when desirable. Any operation for which an anvil is designed can be carried out on this tool, and many additional ones are possible.



Does many jobs

Patented

Anennati Tool Co
 1900 Waverly Ave
 Cincinnati, Ohio

91222 Cmt. Andrew R. Boone
613 Spreckels Theatre Bldg
San Diego, Calif

NEW TRICKS of the YAWARA

THE officer had been cautioned not to patrol a certain darkened street without his night stick. "Some 'hood' will get you," he was warned. But he walked unconcerned along his beat until suddenly a pair of arms wrapped themselves in a headlock around his face.

Instead of trying to pull away or resist, the officer in turn surprised his assailant by crowd-



Professor Matsuyama Who Is Teaching California Police Ancient Yawara, Standing before His Family Seal; Left, the Instructor Demonstrating a Simple Trick by Which an Attacker Can Be Overcome in Less Than Three Seconds

ing quickly against him, reaching with one hand to grasp the thug's belt in the small of the back and pulling him straight up on his own hip. As he did this, he tossed the hoodlum easily to the ground, grasping his right arm as he fell. As both men struck the walk, the hoodlum lay on his back with his right arm extending horizontally at a right angle from his body. Quicker than the eye could have followed the action, the officer, also on his back, grasped the thug's arm between his knees, holding the sleeve near the elbow with his right hand and grabbing his wrist with the left. Thus in less than three seconds the would-be assaulter was

Q-1222

POPULAR MECHANICS



matched against bulk and brawn. Yawara often is confused with jujitsu and wrestling. In wrestling, one must throw one's opponent. The jujitsu expert frees himself from an opponent. The yawara man places his adversary in a position where, unless he admits his defeat, he may suffer serious injury. In yawara there is a countermove for every twist, wrench, pull, push or bend, but the yawara expert does not oppose. By a gentle twist of the wrist or slightly increased pressure on a nerve, blood vessel or bone, the smallest policeman, or police woman, can subdue

lying helpless, one arm in a powerful vise. And the officer still had his feet free to kick the thug in the stomach, ribs or face.

In this painful little trick, the officer had applied the ancient art of "yawara," a Japanese system of defense and offense older than the better known jujitsu. Not less than thirteen vicious yawara blows will bring death to the victim if properly applied. These are so deadly that not even the California police, who recently have been taught some of the secrets of yawara, know many of them.

The philosophy of the Orient is based on the theory of non-resistance. Peoples of the Far East have emphasized the practice of agreeing with their enemies, and in adopting yawara, California police agree with a criminal so quickly that the police apparently place themselves at a disadvantage. A flexible willow bends and yields before the blast of a gale, yet it remains intact. In yielding, a police officer is really tricking his adversary and opening the way to a sudden counter-attack.

In yawara, intelligence and skill are



the strongest wrestler without so much as perspiring. The tricks include such playful stunts as twisting a man's finger nearly off, wrenching a shoulder blade from its socket or breaking an instep.

Fourteen centuries ago, as Frank Matsuyama, a Japanese yawara man, tells the story, a Japanese dropped a



A Painful Handhold, Top; Officer Floors Instructor, Center, and the "Come-Along," Bottom

Q. 1222



Trainer Demonstrates How He Would Disarm a Bandit; at Right, He Is Throwing His Heavy Antagonist with a Hold So Painful He Dare Not Fight Back

cat upside down. As the cat whirled over and landed easily on its feet, the Japanese had an idea. It was then that yawara was born. And so fighting men for centuries have fought like cats, excepting that they do not bite or scratch. The Japanese character for yawara means "gentle."

If some one attempts to choke a California policeman from the rear, the officer wilts as though he were fainting. Then he rolls over on his back and suddenly throws his assailant by simultaneously kicking his right knee with one foot and pulling sharply forward against the right foot with his other. This either throws the attacker or, worse, breaks his knee. As he goes down, the officer grabs an ankle under one armpit, twists the foot so suddenly the assailant turns over on his stomach and thus takes himself out of the fight.

Should a thug try to choke an officer from the front, the officer, instead of pulling away, steps forward toward the assailant, places one arm around his back near the waist, and the other forearm against his Adam's apple. Meantime the officer grasps one of the assailant's knees between his own to prevent kicking. Then he presses in simultaneously against the back and the Adam's apple, and as the attacker falls backward, the officer plants



one or both knees on his stomach. The whole operation may last less than three seconds, but in that brief period the attacker becomes completely powerless.

If the man shows fight after the officer permits him to rise, the officer grasps the assailant's right hand with his own right hand. He then swings himself alongside his prisoner until they face in the same direction, their shoulders touching. The officer links his left arm around the prisoner's right arm at the elbow. Now the officer need only twist the prisoner's arm to the right or press his hand down sharply. The latter causes such a sharp pain at the elbow, that any fight left in the prisoner suddenly departs.

a1308
374

Cont. Andrew Halperin,
611 W. 42nd St.
POPULAR MECHANICS

Pipeless Organ Turns Electricity ^{new york} into Music

Richard Ranger, Newark N.J.
574 Baker Ave.



Top, Captain Ranger at the Keyboard of His Pipeless Organ; at Right, the Bank of Loud Speakers, and, Below, One of the Amplifying Units

Electricity is turned directly into music without the aid of pipes, reeds or blowers, in a new organ invented and demonstrated recently in New York. The instrument has 3,000 combinations of tones, employs 50,000 separate electric circuits and has a frequency range from sixteen cycles, the deep bass, to more than 8,000 cycles, capable of producing tones considerably higher than those of any pipe organ. Employing the principle that an alternating current will cause a humming or singing sound in a loud speaker, the pitch of the tone depending upon the

current frequency, the inventor developed a means of controlling the frequency with a conventional organ keyboard. Overtones and harmonics are controlled with a series of stops, so that almost any musical instrument, from a piano to a flute, can be imitated. There is a producer unit for each of the fundamental tones, and when the organ key is pressed, that tone is picked up and amplified, then reproduced in one of a series of loud speakers. Composite tones, like chords, are "mixed" internally without being heard, until they appear in the loud speaker as a blend of the characteristic sounds.

PHONE FIRE ALARMS RECORDED ON DICTAGRAPH DISK

a140

Records of every telephone fire alarm made in Portland, Ore., are being kept on a dictagraph attached to the switchboard. When an excited householder screams into the telephone, "Our house is afire," and in his haste mumbles the address so unintelligibly the firemen cannot answer the call, the disk may be "played back" slowly so that the words can be distinguished.

Cont. A. B. Nielsen
3208 42nd St.
New York

Copyrighted material

Tests made under direction of H. C. Stewart

at Pennsylvania State College

POPULAR MECHANICS

375

91258

My Herald Tribune 6/24/31

ALUMINUM FOIL IS BETTER HEAT INSULATOR a 14

Aluminum foil, no thicker than tissue paper, has been found to insulate steam pipes as thoroughly as an inch of ordinary covering. The aluminum tissue is from three-thousandths to three ten-thousandths of an inch thick and resembles burnished silver, the luster of its surface probably being the secret of its heat-insulating properties. Four experimental pipes were studied in the aluminum tests, one of bare iron, another covered with a single sheet of asbestos paper, a third covered with asbestos an inch thick, and the fourth with aluminum foil. The aluminum foil reduced heat loss twenty-five per cent, while the bare pipe suffered less heat loss than that covered with a single sheet of asbestos.



Glider Students Attending an Outdoor Class at the Flying Field Where Principles of Flight Are Learned Before They Go Aloft

GLIDER KINDERGARTEN TRAINS MOTORLESS FLYERS

Members of a primary class of glider students of one California flying school learn the fundamental principles of sustained, but motorless flight in outdoor classes on the flying field where real gliders are used for demonstration purposes. They then go aloft in a balloon to witness the actual operation of the glider before taking it up themselves. From the gondola of the balloon the flying instructor, using a megaphone, directs and corrects each student pilot.

ROTATING SCALE WEIGHS EGGS AND SORTS THEM a 1315

Eggs are weighed and sorted into uniform groups by a rotating scale that is finding use in Germany. The eggs slide down a chute onto the scale which sorts them according to weight and deposits each in a compartment set aside for that weight group. The eggs also are stamped as they pass through the machine.

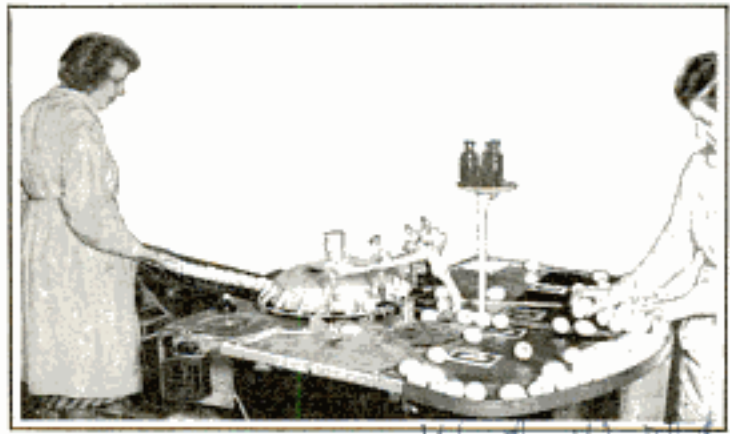

Rotating Scale Which Sorts Eggs According to Weight; a Marker in the Apparatus Also Stamps Each One

FLAME SIGNAL FOR SUBMARINE TO AVOID COLLISIONS a 1413

Japan is experimenting with a flame signal for submarines in the form of an apparatus which fires a projectile from the deck of a submerged craft, the signal bursting into flame on reaching the surface of the water. Such a signal would be used to prevent collisions with surface boats when the submarine is about to emerge, or if it were disabled under water, it could use the flame projectile to indicate its position to rescuing craft. Tests also are being made with smoke boxes placed on deck and fired automatically as the boat submerges to conceal it from the guns of enemy ships.

Stanley B. Gowles Publishing Co. Chicago, Los Angeles, Calif.

Letter rec'd 6/21/31

London Daily Express 6/25/31

Copyrighted material

a. 861

Com. Lloyd S. Abraham
131 Delaware Road
Buffalo, N.Y.

With Uncle Sam's

Letter in form file Customs Patrol Inspector
apply to District Manager, Second U.S. Civil
Houses
Dunsmuir, California
New York



Officer on Guard at International Border in Southern California with Full Field Equipment

HARD work and danger are the daily fare of the members of Uncle Sam's border patrol—jauntily uniformed, armed to the hilt and ready for any emergency along 6,000 miles of international boundaries.

On the job day and night, these men last year patrolled 7,000,000 miles, seized 20,915 smuggled aliens and 1,427 assorted criminals on charges ranging from murder and thievery to gun running and drug peddling.

All along the Mexican and Canadian lines the border patrol keeps tireless watch to prevent the smuggling of anything, from liquor to cattle, into the United States. In wooded ravines, atop mountain ranges, on the burning deserts of the southwest, they hold still watches, hidden from roving smugglers' eyes, and drive their horses and automobiles into "impossible" places seeking international criminals. Several years ago the mounted patrolmen rode horses. Today most of

them drive automobiles, although along some stretches horses carry the mounties.

The mounted border patrol is at once a new and an old organization. It first came into being several years ago when a group of border riders in Texas swore to uphold the law and keep smugglers south of the line. Since then the service has been reorganized several times and today the mounted border patrol, established in its present form two years ago, is an efficient group of man-hunters who know all tricks of the smuggler.

Not long ago two members were stationed in the brush-covered bottom of a river awaiting a "load" that had been tipped off. Each was armed with a large revolver and a searchlight capable of throwing a narrow beam over 100 yards. They also had an automatic rifle. These weapons and field glasses constituted their day-time equipment. But they also carried another important weapon for use in signaling at night—a Very pistol, for firing white, red and green lights.

At last the faint crackling of brush told the story of someone walking toward them. The mounties waited until the smuggler came within arm's length. One of them stuck a gun in his ribs. It proved to be a boy carrying two sacks of alcohol containers over his shoulders. The boy shouted a warning, and in the silence that followed brush began to crack on both sides of the officers.

"Plop." Up went a white light from the Very pistol. "Help," it called.

The officers listened. The group on the right moved around to meet the second party on the left, apparently to be picked up by a fast car.

Again the Very pistol plopped. This time a green light spread its soft glow over the landscape. It meant the fugitives were moving from the border toward the left.

Meantime other mounties from the near-by station, having seen the white light, hurried to the scene in a fast car.

Modern Mounties

As the "walking-smugglers" emerged from the bushes to be picked up in their own car, they walked into the hands of two of Uncle Sam's khaki-clad mounties who knew, by experience, where the contraband runners would hit the highway.

Along the Canadian line, when you drive over the Peace bridge into the United States at Buffalo, you will find a reception committee of at least two men waiting to greet you. Last year these officers passed 2,485,719 vehicles and a total of 7,387,997 persons, which, put another way, means an average of almost fifteen persons every minute.

People make the mistake of thinking the inspectors are working in the dark; that all cars



Above, Modern Mountie Stopping Armed Suspect; Below, Officers at the Boundary, Spying on Suspected Smugglers

and all persons look alike to them. That is not the case. The inspectors know by long experience the tricks of people bringing in liquor. They look for the unnatural in the attitude of the driver and other occupants of the car. It is next to impossible for people to act normally in a crucial moment of inspection.

One of the most puzzling cases was that of a man who came through daily,

and sometimes several times daily, driving a large car. Both he and the car were examined, but nothing was found. Cushions were examined, gas tank, top, spare tire, but everything was in order. The trips continued. Another more rigid inspection disclosed nothing amiss. But here was a V-type, eight-cylinder motor. One inspector decided to test the spark plugs. Those on one side showed normal life, while the others were dead. The cylinder head on that side was removed and disclosed several

bottles of whisky in that half of the cylinder block, which had been cut away as much as possible. The bottom was lined with copper to keep the bottles in place, and prevent oil from splashing up.

In another car, the battery was faked, the box being filled with contraband. One of the most common smuggling methods a year or so ago was to build metal containers underneath the car. Some of

9.861

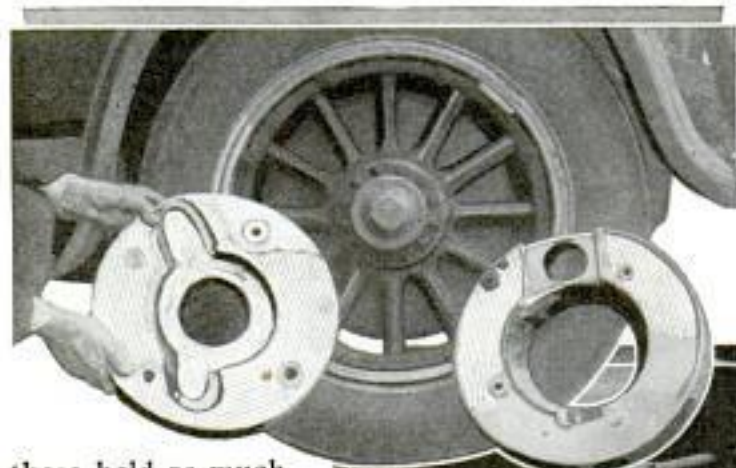

these held as much as twelve cases of whisky. It was impossible to detect them unless an inspector crawled under the car, which some of them did. But that trick has been ruined by the installation of heavy-powered, protected lights, which shine up under the car, and mirrors at the inspection side set at an angle to tell the inspectors at a glance if there is anything wrong underneath.

The most common stunt today is that of subdividing the compartments of the gas tank so that it only holds enough gasoline to make a run of ten or fifteen miles—into Canada and back—the remainder of the tank holding bottles which are reached through a concealed opening, as under a rumble seat. Sometimes, if the tank is a round one, an end unscrews. All sorts of tank compartments have been found. The smuggler usually thinks that this is a clever idea, but as a matter of fact it is one of the most easily discoverable methods of smuggling liquor. All the inspector has to do is to rap on the tank. He can tell instantly by the sound whether it contains gas only or something in addition. One smuggler thought he was unusually wise in lining his tank and fill-

ing the space between the outer and inner casing with gasoline. But it did not work. The sound was different and he was caught.

Occasionally hiding places in the body are found. A compartment within the entire top of a sedan was cleverly concealed, raised and lowered by secret springs. One of the most curious methods was found in the use of a windshield visor. One thinks of a visor as a thin projection over the windshield. To the casual observer this one was thin. But it was an illusion. It was about three inches thick at the widest part, inside the car, and was found to contain

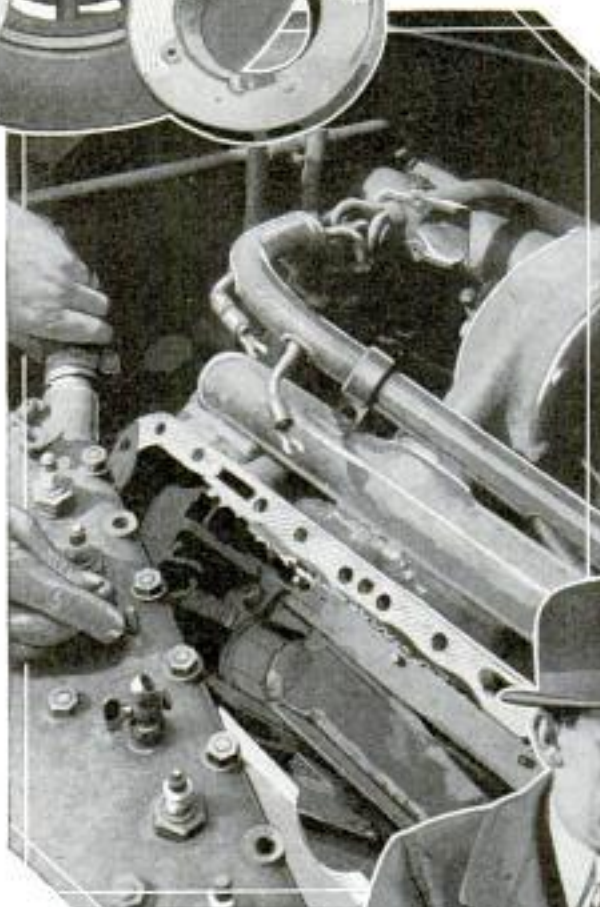

False Brake Drums, Fake Cylinders and a Dummy Battery, All Devised to Hold Smuggled Liquor

a number of flat whisky bottles.

Bottles also have been found even in spare tires. Usually a slit is cut in the inner tube. As many bottles are inserted as possible. A patch is placed over the slit. The tube is put in the casing, blown up and placed on the spare tire carrier. The tire looks and feels like any other spare tire. But there are ways of detecting this trick.



Above, Watching for Smugglers on a Lonely Trail; Left, Using "Very" Pistol for Night Signaling

American shore of the Niagara river is constantly watched. The patrol works in three shifts, and there is an average of one man to each mile and a half of river front on duty every hour of every day.

EACH TOOTH ITS OWN DENTIST IF DIET IS REGULATED Q. 1443

Carefully regulated eating promises mankind future freedom from decaying teeth, and even the healing of cavities in which decay has made considerable progress. This hope is held out as the result of recent nutritional discoveries by Dr. Sherman L. Davis and reports of cases in which teeth cavities filled themselves without mechanical assistance through dietary treatment. In treating diseased teeth by nutrition alone, an X-ray first is made of the mouth. A history of the patient's condition in the past is obtained along with various analyses to determine sugar, phosphorus and albumen requirements and disclose such conditions as anemia, infection and diabetes. With the patient's needs thus determined, a proper diet is prescribed which aids the teeth in recalcifying, or filling up, naturally.

reported to Capitol Clinic
Club, Washington
6/28/31

One of the most unusual cases of smuggling liquor in clothing was that of a man and his family. He drove up one day with his wife and two children in a flivver, for all the world like a family party out for a day's jaunt. But he gave himself away, and he and the family were ordered to climb out for inspection. In the party was a baby in arms, carefully blanketed as babies often are. Bottles of liquor were found on every person in the party including two pint bottles hidden in the baby's clothing and blankets.

Members of the border patrol co-operate closely with custom inspectors. The

a 1010
Auto-Gyro Vanes Add to Stability of Glider



Glider Equipped with Auto-Gyro Vanes; While the Four-Vaned "Windmill" Is Too Small to Increase the Lift Materially, It Is Believed to Add to the Craft's Stability

Following the principle used in the successful auto-gyro airplanes, a German aviator has adapted the horizontal windmill to a glider. While the four-vaned windmill is too small to aid materially in increasing the lift of the glider, it is believed to add considerably to its stability in flight and landing. As in the auto-gyro ships, the vanes are kept turning by the force of the wind. In recent tests at Berlin, the pilot maintained communication with the ground by radio.

THREE PILOTS TO EVERY PLANE

There are more than three pilots for every airplane in civil or commercial use in the United States, and the output of aviators has increased fifteen times as fast as the number of planes. While the "crop" of pilots being turned out by aviation schools is not as great as two or three years ago, the number of pilot licenses active is showing a more rapid increase than the number of ships in operation. A year ago there were two pilots for each plane, and today the number is 3.07 to one. The number of licensed airplanes on June 1

was 7,169 with 2,695 unlicensed. At the same time, there were 15,842 licensed pilots and 14,527 student permits active. The total increase in planes in the fiscal year 1930-1931 was three and seven-tenths per cent, while the growth in the number of pilots was fifty-seven per cent.

WOODEN FRAMES ALONG CURB KEEP AUTOS OFF WALKS



Overhanging bumpers or spare tires of parked automobiles are kept from protruding over the sidewalks in one city by the use of wooden frames along the curbing, against which the wheels of the cars rest. These frames are portable and also serve to protect the edges of curbs and sidewalks, preventing them from being cracked or broken by the autos.

Hans Richter at Tempelhof airdrome

Wide World

W. A. Barnhart & Co. Newton, Mass.

Dept of Commerce 7-1386

U.S. Marly 6/29/31

Three Rivers, P. I. Copyrighted Material

U. S. LOSES TENTH OF HAY CROP
BY SPONTANEOUS HEATING

1397
Spontaneous combustion destroys one-tenth of the harvested hay crop of the United States, Dr. C. A. Browne finds in his latest investigations for the department of agriculture. He said that while the annual loss resulting from burning of farm property as a result of spontaneous combustion has been estimated to exceed \$20,000,000 a year, the actual loss in decreased weight and nutritive value of hay during spontaneous heating will amount to many times that sum annually. To prevent fire, Doctor Browne says, a fire pocket may be found by boring into the hay with a hollow steel rod or tube with a sharp cutting edge. The rod will indicate the fire pocket's location from which all the hay must be removed.

21220
SCULPTOR MAKES TIN FIGURES
FROM SCRAPS AND CANS

Starting with a statuette of a rooster sculptured in tin, an artist, known best for his woodcuts and posters, has opened a field of demand in eastern metropolitan centers that promises to swamp him with work. He sculptured the rooster out of an alcohol can, then used up the rest of the scrap tin around his home making gifts for his friends. When his supply was exhausted, a tin manufacturer sent him a load of scrap.



Making a Group of Western Figures Out of Tin Cans and Other Scraps around the Home

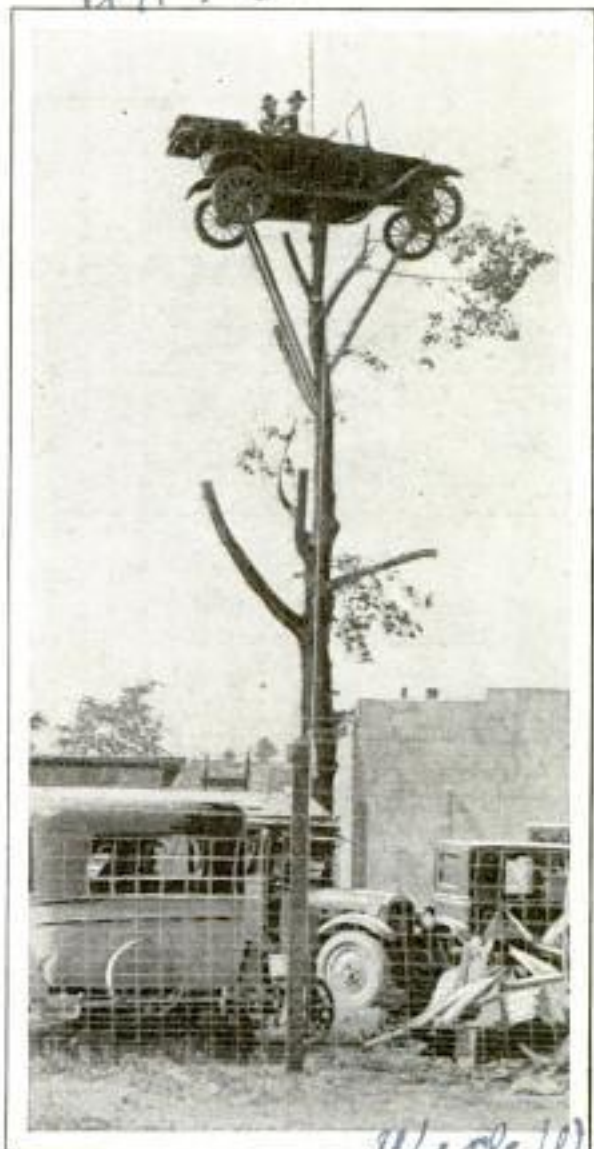

Wade W. Arla
Automobile up a Tree Advertises the Owner's Garage Business; the Figures Are Real Men

THIS AUTOMOBILE'S UP A TREE
TO ADVERTISE GARAGE

In order to attract attention to his garage and wrecking plant, a garage man in an Atlanta suburb has secured an automobile in the top of a tree near his place of business. The owner tells his customers that even should their cars climb trees in such a manner, he would be able to haul them down and fix them as good as new.

☐ The Popular Mechanics' Bureau of Information offers its free service to all readers of this magazine. Names and addresses of manufacturers and dealers in articles described, and any other details in our possession, will be promptly furnished.

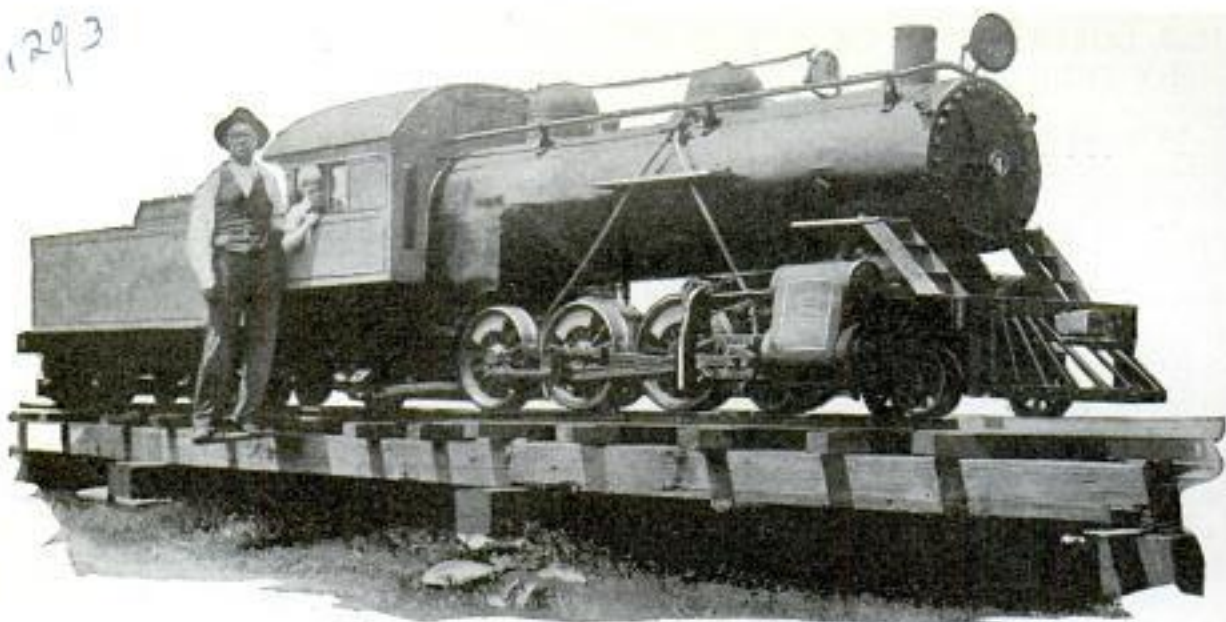

Model Locomotive and Tender That Was Built in a Blacksmith Shop; It Operates Like a Real Engine and Hauls Twenty Passengers over a Stretch of Track Built for It

MODEL LOCOMOTIVE AND ROAD BUILT BY TELEGRAPHER

After nine months of work in a country blacksmith shop, a railroad telegraph operator constructed a model locomotive and tender some six feet high, patterned after a Southern railway engine. It cost about \$1,000 to build and is operated like a regular engine on a stretch of real track, over which it hauls twenty passengers.

FLASH BULB REFLECTOR FOLDS INTO COMPACT SIZE

One of the chief problems encountered by photographers in using the electric flashlight bulbs—that of obtaining the in-

tense illumination provided by flashlight powder—has been solved by the use of a large aluminum reflector which weighs only seven ounces. The reflector is collapsible, folding up into a compact unit so it can be carried in a camera case.

NEW TYPE OF PREHISTORIC INDIANS IN TEXAS

An exciting adventure in Texas cave exploration has unearthed relics of a type of prehistoric Indian life previously unknown to archaeologists. A representative of the National Museum, following a report of the discovery of an unusual Indian cradle, explored the Big Bend region, and found a cave whose entrance had been almost blocked by huge boulders, with more threatening to fall at any minute. It was necessary to crawl twenty feet through a passage no more than two feet high, inhabited principally by rattlesnakes, scorpions and rats. Dust in the cavern was so thick that masks had to be used and lights would not burn. By the aid of flashlights, the explorer and four Mexican laborers dug out four feet of the cave's bottom. Cradles, baskets, pieces of matting and sandals were recovered, but no pottery was found.

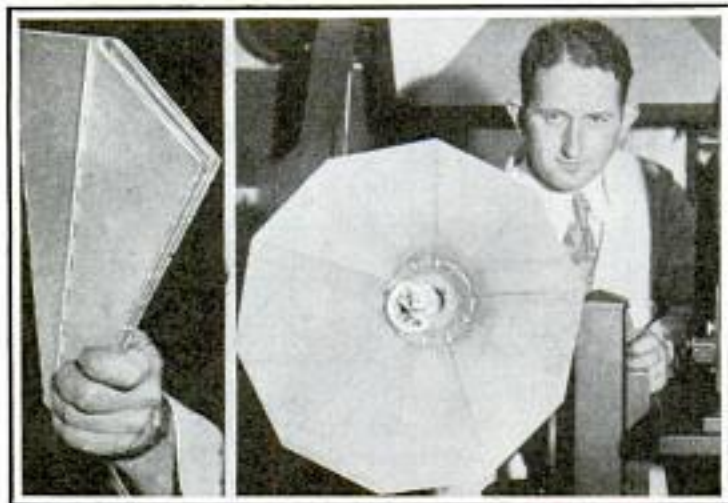

Collapsible Aluminum Reflector Used with an Electric Flashlight Bulb to Increase Intensity of Light

The Muller Co
Meriden, Conn

J. M. Saylor

W. H. Roach, Southern Railway
Loretta, Va.

a 1293

a 1307

a 139

535-a-6/22/31
Dolme. S. Bruce

a. 115 p.

**MAGNETIC TEST
OF STEEL FOR
HARDNESS**

Magnetism will detect differences in hardness of steels which to other tests seem similar, it was revealed recently in a report by Haakon Styri to the American Society for Testing Materials. Mr. Styri's method of testing the steel samples is to place them in magnetic fields as would be done in the case of testing them for fitness as electromagnet cores. The report shows that, whereas other methods of testing steel hardness depend on some mechanical method usually resulting in the destruction of the sample, the Styri method is free from this disadvantage.

a. 139 b
1315

**BOLT CUTTER IS
COMPACT AND
LIGHT**

Ordinary bolt cutters are so cumbersome that they are not used except when other means fail. To overcome this objection a lightweight cutter, resembling a pair of pliers, is being produced. It is fourteen inches long and has no complicated adjustments, as there are only three major parts. The cutting knives are of molybdenum-alloy tool steel, and the handles are hammer-forged alloy tool steel. The tool will cut wire or bolts up to five-sixteenths of an inch in diameter.

a. 125

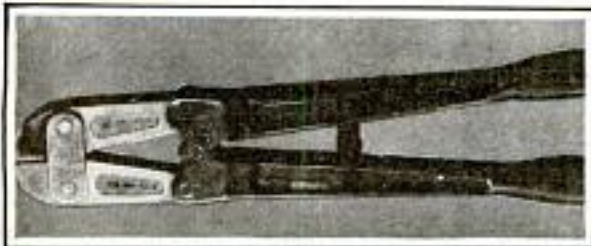

Lightweight Bolt Cutter Like Pair of Pliers

Hammer-forged Steel Products Co
Newark Pa.

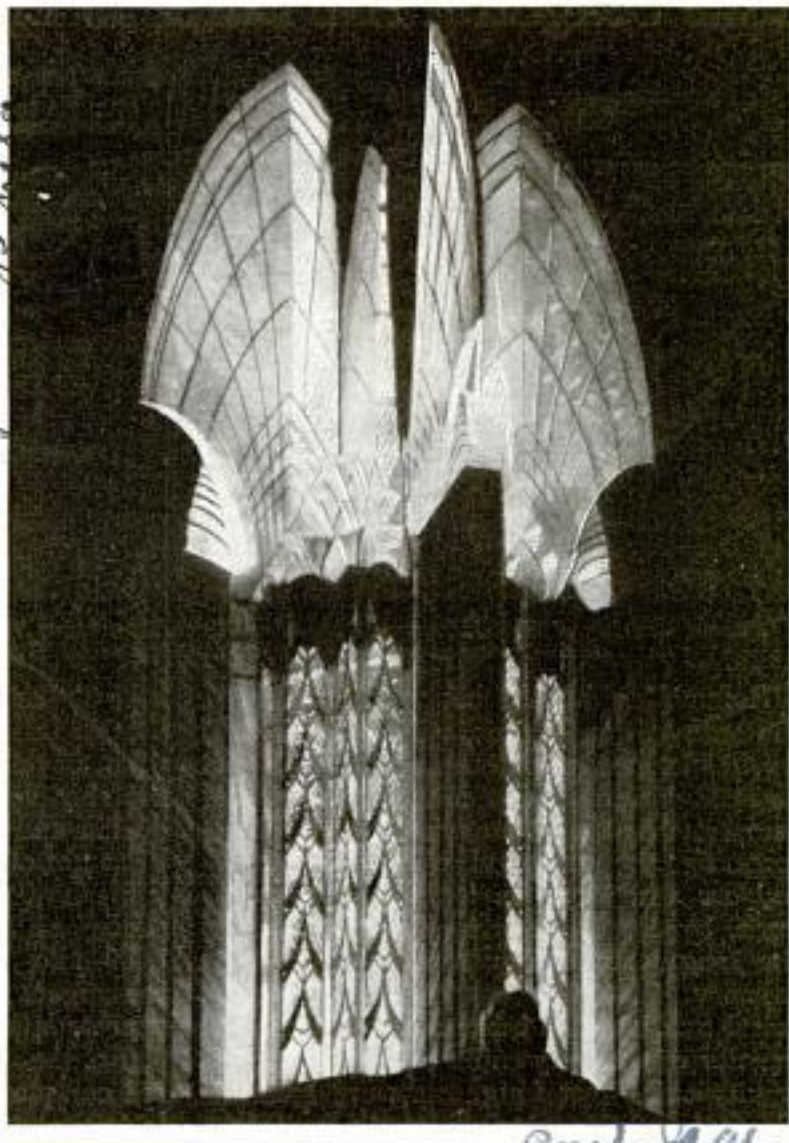

Water Tower That Blossoms into a Flower at Night; the Transformation Is Accomplished by Illuminating an Aluminum Screen

**WATER TOWER LIKE A FLOWER
WHEN ILLUMINATED**

Floodlighting and decoration have converted a necessary, if unsightly, building adjunct, the water tower, into a thing of beauty at Rochester, N. Y. Illumination experts mounted a flared aluminum screen around the tower and lighted it from the inside, so that it appears in the dark like a rare tropical flower. The lower part of the tower was formed into the shape of a carillon belfry, and the four corners were topped by gleaming fins.

Ⓞ An average of 594 gallons of gasoline was used by each motorist in the United States in 1930.

Westinghouse Electric & Mfg. Co.
East Pittsburgh, Pa.

a129

New York James 6/7/31

This Seagoing Air Liner Is Like Clipper Ship

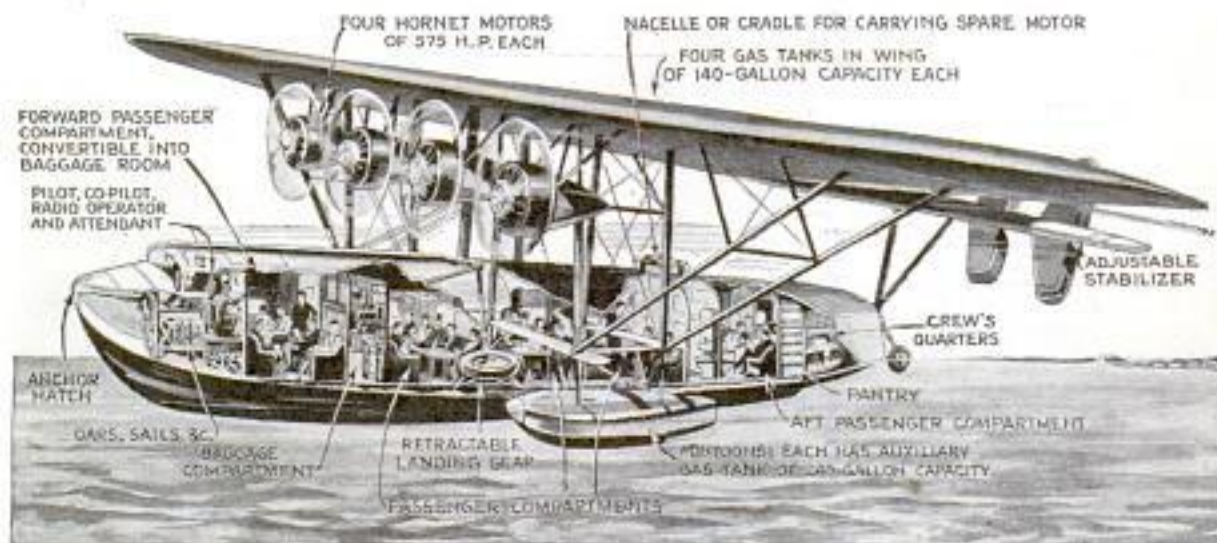

Sectional Drawing of World's Largest Amphibian Which Resembles a Water Craft as Much as an Air Liner; Note the Retractable Landing Gear and Space for Carrying a Spare Motor

Resembling a fast clipper more than the conventional type of airplane, the world's largest amphibian, and one of the largest planes of any sort, recently was completed by the Sikorsky company. This seagoing air liner will carry forty passengers and is to be used, with similar craft, by the Pan-American Airways for the long water jump from Cristobal to Jamaica. The ship has the high-prowed metal hull and the beam and comfortable interior of a roomy cabin cruiser. Its hull is fifty-eight feet long, the wing span is 114 feet and the over-all length is seven-

ty-five feet. Its four motors, cradled abreast in line beneath the big monoplane wing, develop 2,400 horsepower. Empty, the ship weighs 19,000 pounds, and fully loaded and equipped, the craft is expected to get off the water with 30,000 pounds. Wing and pontoon tanks have a fuel capacity of 1,025 gallons, sufficient for a 1,000-mile cruising radius with sixteen passengers and a crew of four, besides an express and mail load. For a 500-mile flight, the ship is intended to carry her full complement of passengers in addition to baggage and mails.

LUGGAGE CARRIER ON AUTO TOP UTILIZES WASTE SPACE

Waste space on top of automobiles can be utilized on tours by attaching a luggage carrier that fits on the roof. Installation is made without damaging the top, since there are no bolts or holes through



Luggage Carrier for Top of Automobile Rides on Vacuum Rubber Cups and Attaches to Molding

the deck. Adjustable supporting legs of the carrier are tipped with rubber vacuum cups, carrying a capacity load of 600 pounds on a cushion of air. The vacuum cups are the only parts touching the top. Webbed straps fastening to loops attached to the top inside of drip molding hold the carrier so that it cannot shift.

COKE RUNS AUTO AT LOW COST

Coke has been tested successfully in England as a fuel for automobiles, and a penny's worth has been found to run a car ten miles. The fuel is in the form of small coke which generates gas in an apparatus mounted on the running board. A truck ran eighty miles at thirty miles an hour on fuel costing less than a dime.

Belleme hfg Co
Belleme Ohio

Mr. N. Clark Jones
no index

Handy to press
London 6/14/31

*Dr. Franz
Kruichenberg*

a 1294

"RAIL ZEPPELIN" BEATS RECORD OF FASTEST TRAINS.

My James 6/22/31

a 1388
Running over a regular commercial route for the first time, the German "rail Zeppelin" established a world's record for speed by flashing from Hamburg to Berlin in one hour, thirty-seven minutes and forty-five seconds. The distance is 173 miles and the average speed was 106.31 miles per hour. At times, the propeller-driven car reached a speed of 143.75 miles. The engineer kept on schedule all the way. Gasoline consumption of three and a quarter miles per gallon was considered reasonable. The demonstration brought out that railway signals must be spaced farther apart if the land Zeppelin comes into use, so fast did the car travel. A test with pieces of paper laid on the rail showed very little draft from the propeller.

GIANT SAWFISH TOWS YACHT FIVE HOURS IN FIGHT

a 1305

Towing the sportsman's twenty-ton yacht five hours before giving up the struggle, a giant sawfish was captured recently off the coast of Panama by F. A. Mitchell-Hedges, the explorer. The fish weighed 5,700 pounds and was thirty-one feet long.



Giant Sawfish, Thirty-One Feet Long, That Towed a Twenty-Ton Yacht for Five Hours



Cut-Out Sign Depicting Basket of Fruit on Roof of Roadside Market to Attract Motorists

FRUIT-BASKET DISPLAY ON ROOF ATTRACTS SHOPPERS

One roadside fruit market in New England attracts the attention of passing motorists by means of a big sign on the roof, depicting a tempting basket of various kinds of fruit. It is of painted wood, cut out around the edges to present a more realistic effect and can be seen by approaching drivers a considerable distance.

Cont. Thos. H. Wylkorny 5133 Spruce St. Phila

FLEXIBLE WROUGHT-IRON PIPE

a 1322

Wrought-iron pipe that bends around corners has aided in simplifying plumbing problems, particularly in repiping old buildings. It can be bent to a center-to-center diameter as low as three and three-tenths times the external diameter of the pipe. Thus a one-inch pipe with an outside diameter of 1.315 inches can be bent to a circle segment having a diameter of 4.33 inches without damaging the material. The pipe can be threaded, welded or handled like ordinary piping.

Chicago Hill Warehouse

*A. M. Myers Co.
Clark Bldg.
Pittsburgh Pa*

Right of Way Is Given to Millions in Silk

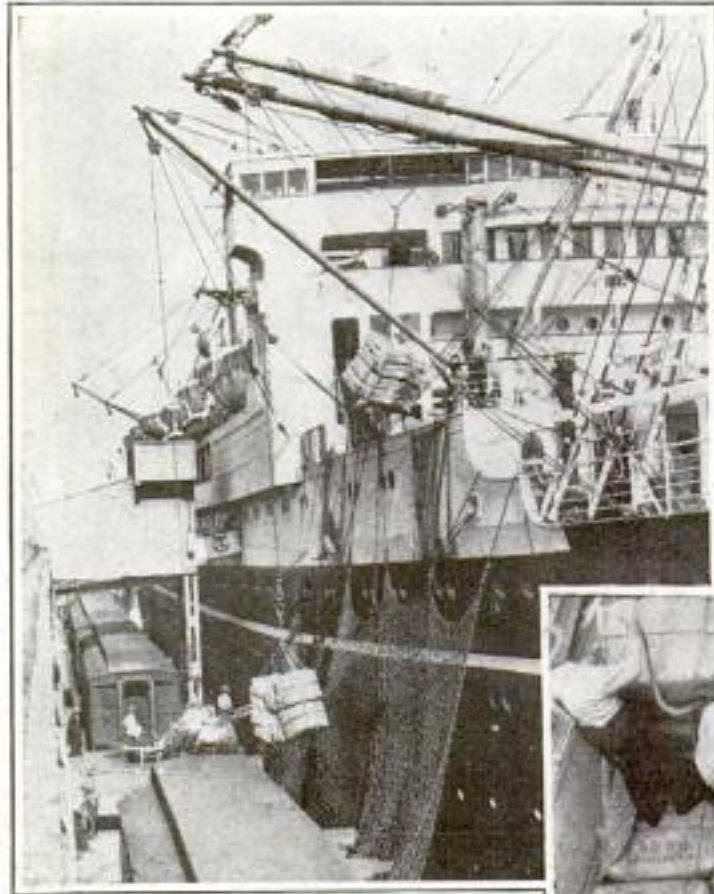

ferred in batches of ten bales each to fast overland trains for eastern markets. The silk trains are operated by the transcontinental railroads on passenger-train time schedules, much in the fashion that perishable fruit is shipped, except that the trains are heavily guarded and stops are made only for fuel and water. The trains are given clear tracks to prevent possibility of robbery, and also because of the tremendous amounts of money tied up in the cargoes, the interest on which is so great that a delay of even a day might



Above, Transferring Silk Bales from Ship to Train; Right, Looking Down into the Hold

Four million dollars worth of silk for American consumption in one shipment! Such was the staggering aggregate when 6,140 bales were landed recently at a Pacific coast port. It was by far the largest shipment to be sent across the Pacific this year. The size of the cargo was due to the release of vast stores of raw silk in Japan, which had been held up because of overproduction. The shipment was trans-

World World
spell the difference between profit and loss to the sellers and purchasers.

*91378
Columbia*

PLANETS RULE EARTH'S RAIN?

Planets, instead of sunspots, are held responsible for the wet weather cycles on earth by Halbert F. Gillette, civil engineer and former university professor. His theory is that both the sunspots and the heavy rainfall are caused by planetary conditions. He has found that the magnetic cycles of the planets line up in perfect agreement with the clay deposits in

geological formations. The thickness of the layers indicates the amount of clay deposited year by year in a given formation, and that in turn testifies to the relative amount of rainfall running over the drainage surfaces. It has also been found that the thickness of these layers corresponds to the relative thickness of rings shown in cross sections of sequoia trees, which also indicate rainfall year by year.

San Marino, Calif

*NY Herald Tribune
6/2/31*

A 1121 Cont. O. B. Is. Thachwell
4649 Beverly Blvd
Los Angeles Calif

Your Dream Castle in Soap!



A Triumph of Model Making

CARVED out of large cakes of white soap, exact miniature models of architectural and landscape projects are made by McKown and Kuehl, Beverly Hills, Calif., landscape architects and town planners. They have found that this practice is a convincing demonstration of just how a project will appear when it is completed.

Working from a preliminary plan, they recently carved out the model of a thirty-five-room house with terraced landscape, to the scale of one inch to twenty feet. For this task they required sixteen cakes of soap, nineteen tiny green rubber sponges, some small tins of paint, some shellac, a piece of wallboard, four feet by eight feet, two dozen small buttons, some pins, half a handful of tiny pebbles, ten pounds of plasteline modeling clay, a few sheets of sandpaper, a small mirror, some toothpicks, cellophane paper, nails, hot water, string and a pair of scissors.

After making the preliminary plan and a contour map of the property to show the exact topography, they were ready for the first step in the making of the



Completed Castle on Scale of One Inch to Twenty Feet; Below, Fashioning Trees from Sponge Rubber

soap home. Having agreed upon the scale, they made a wooden frame on which was nailed a sheet of wallboard to form the base of the model. Then they cut up sections of wallboard to reproduce the exact contour lines giving shape to the property. These sections were placed one over another, and when this was completed, the base represented, roughly, the shape of the landscape. This was covered

91121.



pointments out of soap and other things, and then covered the soap portions with shellac to prevent distortion from possible shrinking or expanding.

For trees, they fashioned tiny miniatures to scale by dexterous use of scissors on little green rubber sponges, which were found to be preferable to ordinary sponges for trees, as they held their shape better and looked more realistic. The trunks were made from matches or pins.

An attractive garden walk was built from two dozen small buttons which were painted. Sandpaper was used for roadways and pebbles represented rocks.

with shellac to prevent moisture from distorting it. The second step was to fill in this rude base and smooth it out by use of plasteline, a sort of modeling clay. Special instruments for this task had to be designed by the architects because it was found that those used in clay modeling would be entirely unsuitable, since they required very sharp ones to fashion exact detail in their work.

After the entire base was completed, large bars of soap were sandpapered to make them perfectly smooth, so they would fit together with exactness. Then they were held in warm water a few minutes, to make them stick together. These larger blocks were stood on end or cut in halves by use of the old trick of passing a taut string through them.

Each unit of the model was carved separately, and the sections were placed together in much the same manner as children build up structures from their play blocks.

Upon completion of the soap house, they fashioned the garden and other ap-



The Roofs Are Painted with Water Color; Toothpick Dowels Hold the Soap Blocks Together, and the Base Is Made of Wallboard

Walsh, Bugbee Co. Inc
206 E. Bascom St.
Trenton, N.J.

a1248

This Steel "Train" Saves a Harbor in Storm

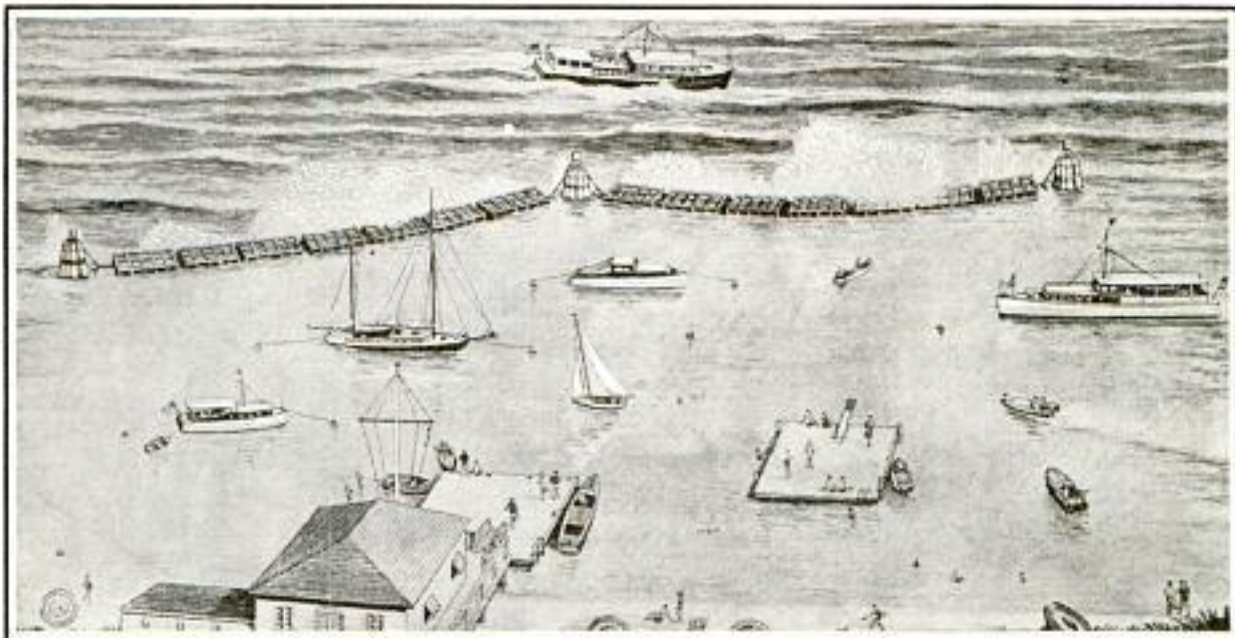

The Floating Breakwater Applied to a Shelving Beach, Making a Safe and Snug Harbor for Yachts and Smaller Craft Where the Natural Bays Are Missing

Composed of a series of thirty-foot sections, coupled together like a "train" of cars, and moored to a series of seven-pile dolphins, a floating steel breakwater has been developed for coast districts where no natural harbors are available. As many of the trains as are needed to protect any given area may be added by merely placing more dolphins. Each section of steel is kept afloat by two pontoons, between which a bulkhead extends to within a few feet from the bottom of the harbor. The completed sections have the effect of a "loggy" vessel or floating iceberg, with too little buoyancy to ride the top of the waves, yet sufficient rigidity to break the chop of the sea.

SNAP-ON PARACHUTE FOR NAVY SOUGHT AS AID TO SAFETY

Development of a snap-on or quick-connector type of parachute is under way at the bureau of aeronautics, department of the navy. This type is intended for use of passengers, machine gunners and other personnel who would be handicapped if required to wear the equipment continuously during flight. Only a harness would be worn with the type being developed, the parachute being stored in a convenient place. In emergencies, only one

motion would be required to snap the parachute to the harness, or snapping it off when landing in water.

DRESSING TENT HANGS ON AUTO FOR BEACH CHANGES

Instantly adjustable to the door of an automobile, a "bathhouse" that is collapsible and can be carried to and from the beach has been placed on the market. A simple bracket attaches a square tent to the car door. The tent is entered from the corner and is fitted with fasteners. It is floored and has pockets for clothing and towels inside, accommodating four persons. It cannot be dropped or raised while occupied, and, while bathing, may be locked in the car, clothing and all. The bracket cannot be removed while the door is locked.



Dressing Tent That Attaches to Door of the Auto, Making Portable Bathhouse for the Car

Sales office: 4 W. 56th St. New York

NS: Slority 6/23/31

Kalamazoo specialties
white material
Kalamazoo

a 1186

Land Catapult Launches Big Bombing Plane

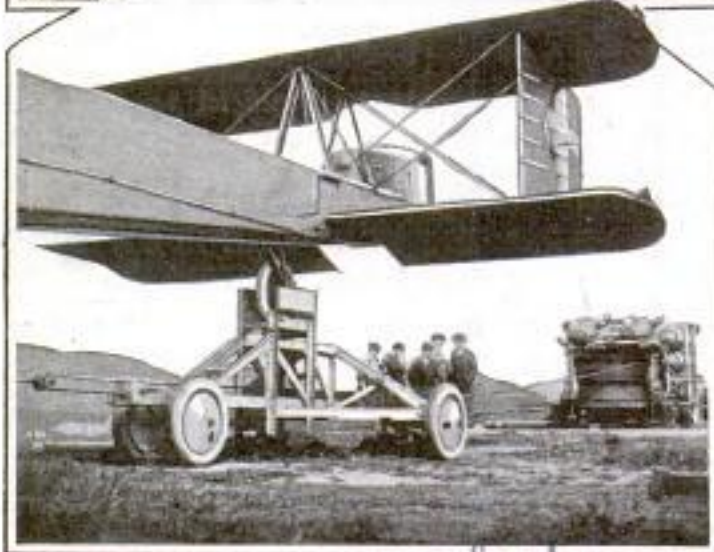
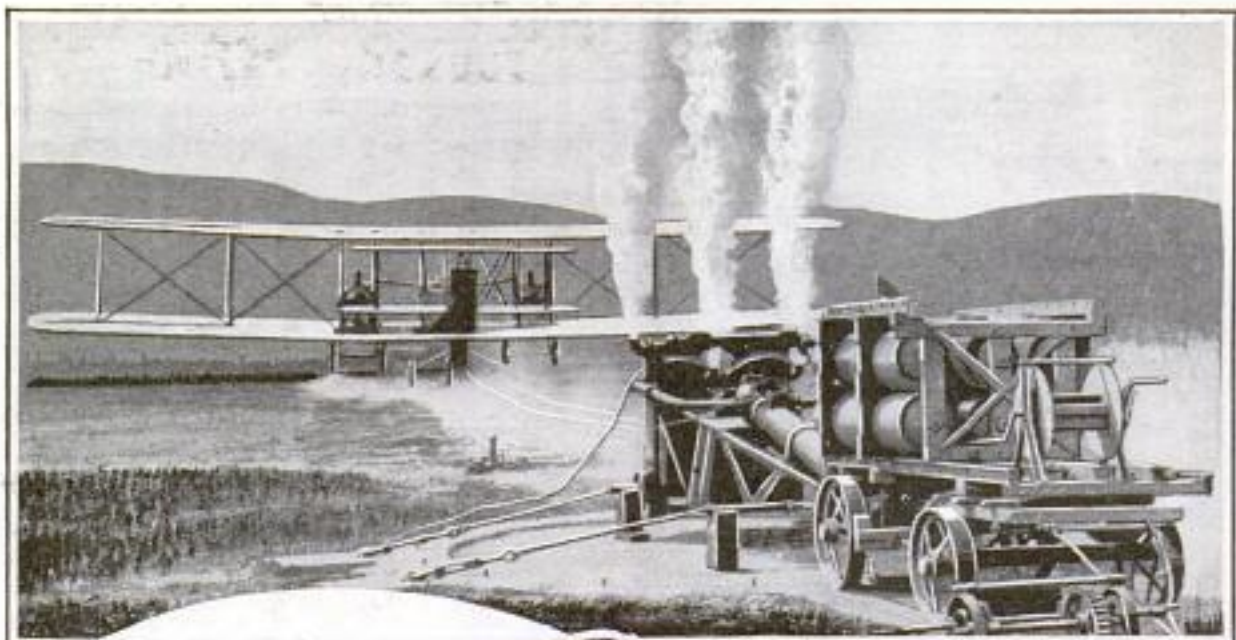

Catapult Which Launches a Seven-Ton Plane; Unlike Ship Catapults, It Pulls Plane into Air, Instead of Pushing It

is about 150 feet from the car, the drum is slowed down automatically, the momentum acquired by the ship being sufficient to throw it into the air. By such a method the take-off run is reduced about nine-tenths.

WEIGHING A SPECK OF INK

Adding "inois" to the abbreviation "Ill." in addressing an envelope to a city in that state, increases the weight of the letter.

Balances, which weigh accurately to one one-millionth gram, show the ink in "inois" weighs five ten-thousandths of a gram. Or more simply, in a matter of 56,000 letters, the total would weigh one ounce more if Illinois were spelled out.

GAS TO STOP PLANES

Fighting planes in the next war may be brought down from the skies, their motors disabled and their pilots helpless to land beyond the usual gliding distance, through use of a gas discovered in Germany. Fumes of the gas, the discoverers claim, will stop airplane motors at once.

*Prof. Karl Huffman,
Institute of Technology,
Berlin, Germany.*

launched at Royal Aircraft Establishment at Farnborough, England.

at Farnborough.

cut

a 1362

a 1333

Eckhardt

Reynolds, Gram 6/17/31

Herald Tribune 6/27/31

Mr. Edna E. Lamina 129.6

W. J. Cunningham

POPULAR MECHANICS

39
Lluvango - Jose Herrera Prof
Alberca St. Los Angeles

SECOND GUESS BETTER THAN FIRST ONE

91410

Your second guess is likely to be about twice as good as the first, and it pays students to think twice before recording their answers in college examinations. This fact has been revealed by submitting "true-false" questions to more than 1,500 students, from which it was found that the chances are about two to one that the second answer will be the correct one. It also pays to be dubious, and it is much safer to change a judgment from apparent true to false than vice versa.



This Man Is Painting Candles by Hand after Making Them by Hand-Pouring, a Method That Has Almost Vanished

"LAST OF THE CANDLE-MAKERS" HAND-PAINTS HIS WARE

Alberca St.

In the old Spanish quarter of Los Angeles is to be found the last of his type, the hand-maker of candles. Jose Herrera clings to the century-old method of hand-pouring and painting, and turns out hundreds of the crudely picturesque candles of all sizes that are to be seen almost solely in Mexican churches.

SWIMMING MACHINE HAS PEDALS LIKE BICYCLE

Even a novice can propel himself through the water faster than an experienced swimmer on a water bicycle supported on pontoons and driven by a propeller operated by pedals. The swimming machine is safe and stable, allowing the operator to rest at will, to float or to steer it without fear of sinking or overturning. The occupant lies, face down, in a natural swimming position on the bicycle which is adjustable in length. By removing one bolt, it can be dismantled for convenient carrying.

91372



used in race at Miami Fla

Swimming Machine That Rests on Pontoons; It Is Driven by a Propeller That Is Operated by Pedals

Miami Water Bike Co
Miami Fla

BENZOL VAPOR USED AS STEAM

91320

Benzol, mixed with water, will reach the condensation or steam point at the low temperature of 69 degrees centigrade instead of 100, a Hungarian experimenter has discovered. The difference in amount of heat necessary to produce steam with the mixture would mean an annual coal saving of \$625,000,000 in Germany, it is estimated. The experiments have been carried on in Hamburg, whose scientists say efficiency of the low-temperature steam is as high as that of the 100-degree product.

Herald Tribune 6/19/31

Arnold. Crunzi
at Hamburg Institute
of Energy Research

91070
Cont. H.C. McLeod, 2720

Maryland Ave
Baltimore, Md

TOMORROW - The

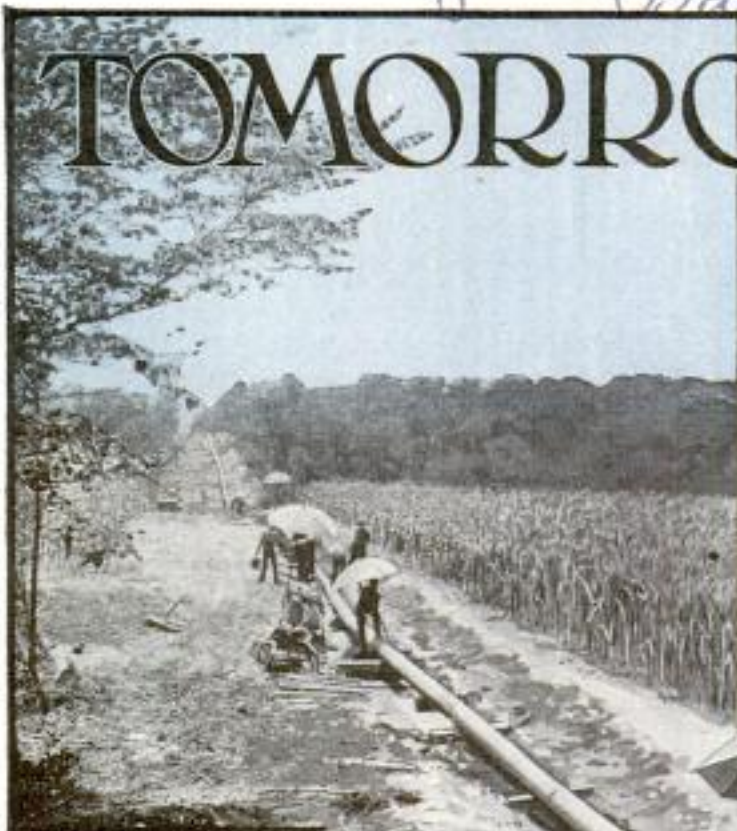

the loading and unloading of wheat, to its journey through the mill from grain to flour. Just as the transfer of mail bags from one post office to another in New York City long has demonstrated the principle of solids so transported, so has the handling of wheat at the mill proved the possibilities of conducting it through pipes.

Coal costs a dollar a ton at the mine in Illinois and \$4.50 a

NOW appears a new giant which aspires to the grueling task of carrying the weighty burdens of the world. Another creation of man steps forth, shoulders a large block of the freight of the mightiest of nations, suggests that it might take on the whole job. Sinuous steel-pipe lines, already bearing vast quantities of liquid freight, are prepared almost to make a bid for the carriage of solids.

After generations of furnishing man's favorite transportation, the railway has been assailed by one rival after another. Motor trucks have taken much short-haul business, but also contributed as a feeder to railroad business. But now appears this new competitor, which has reduced the oil carried by the roads nearly 6,000,000 tons.

Next, the coal business, which is said to have been losing ground to natural gas and oil largely because it has been less enterprising than its cousins, is considering the efficiency of powdered coal and its transportation by pipe line. And the transportation of wheat in the same manner seems equally logical.

Pipes and air pressure are applied to



Welding the Joints of a Georgia Pipe Line; a Tractor Hauls the Equipment through the Cane

ton at the factory in Chicago, St. Louis, Milwaukee or Indianapolis, 200 or 300 miles away. Similar divergencies exist between coal at the mines in West Virginia and coal at Pittsburgh, Baltimore or Cincinnati. Nearly eighty per cent of the cost of that coal is due to transportation charges. Those who are wise to pipeline possibilities hazard a guess that this coal could be delivered by that method at \$1 a ton as compared with \$3.50.

Construction of pipe lines that are able to function as conduits through which freight might be conveyed, is a recent de-

91070

Underground Railway!

velopment. It has come about through an improved means of welding steel, for freight pipe lines must be smooth, air-tight and strong. No cast iron with cemented joints for this work. But the right sort of pipe now has been developed and strings of it, twenty-four inches across and 500 miles long, already are in operation.

The old scheme of welding was based on the blacksmith's principle of bringing two pieces of steel together in a heated form and hammering them. This was all right provided the two parts



Courtesy Lincoln Electric Co.

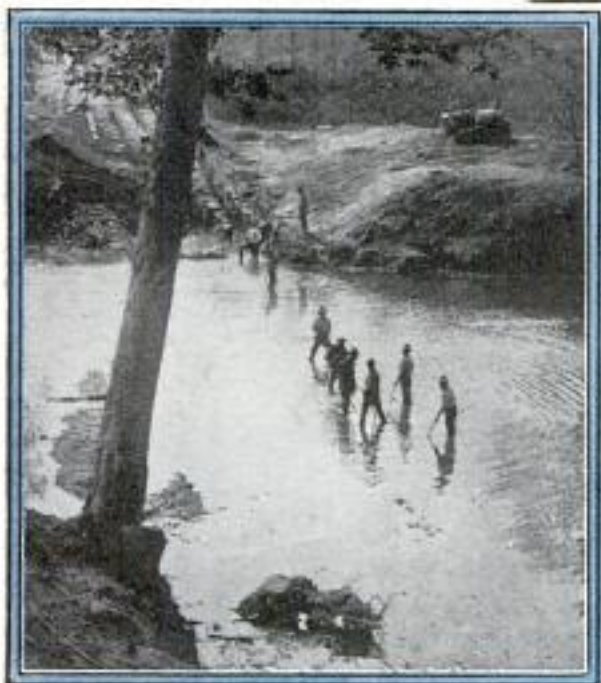

Laying the Pipe through Water and Swamp; Above, a Joint Is Welded on Twenty-Inch Line

could be sufficiently worked together. But the joint was likely to be weak and clumsy like edges of pie crust lapped over for the baking. The masterstroke came when it was found that two edges of steel brought together could be united with an electric arc, much as the housewife sews

a seam with her machine. The joint now is the strongest part of the pipe.

Having its couplings, the oil industry came back to the pipe people with a request that called for a most startling application of the possibilities of arc welding. It wanted the equivalent of one of these couplings, but it should be five feet across, thirty feet long, and its walls should be two and one-half inches thick. They would put heads on it and have a vessel that would endure higher pressure than any other in the world, and do a big business in cracking crude oil into gasoline under heat and pressure, which was what they were looking for. Yes, the steel people said, that might be accomplished—and they did it.

As a result of these advances, there are today 90,000 miles of pipe line in use. Last year more than 15,000 miles of gas

lines were added at a cost of approximately \$400,000,000.

Big business is concentrating on natural gas just now not only because of the expectation of a nationwide network of giant pipe lines, but because new and important uses for the fuel have built a \$5,000,000,000 industry around it. More and more it is becoming a rival to the oil industry, one good reason being that quicker and cheaper conveyance of gas to market is now possible.

Among the miscellaneous industries that utilize natural gas as fuel are steel and glassworks, cement plants, cotton gins and presses, chemical works, sugar refineries, salt works, bakeries and sulphur mines.

The gas has been used by steelmills, notably in the vicinity of Pittsburgh, for many years. The ease of temperature control makes it particularly adaptable for use in melting and in the heat treatment of metals. Natural gas is practically free from sulphur, and this quality is of prime importance in the manufacture of steel and glass. The even temperature obtained with gas results in fewer "seconds" and rejections. The freedom from soot makes gas an ideal fuel for use in bakeries.

Another indirect use of the gas, little

ribbons and phonograph records. But by far the most important and largest-scale use of carbon black is in the making of automobile tires. A small amount gives two or three times as much wear to tires.

Even bridges of a new type are beginning to dot the United States because of problems encountered in the building of pipe lines. In several instances, the old plan of laying pipe lines under water in crossing rivers has been discarded in favor of bridges intended for no other purpose than carrying the heavy gas mains. Some of these bridges are of the suspension type and are as impressive in appearance as railway and highway structures. From these designs, the types range to old-fashioned truss bridges and even to simple supporting trestles. In all cases, however, they are for pipe lines exclusively.

The method of laying pipe lines along the river bed had its disadvantages because of the difficulty of maintenance. To



Three Sections of Eight-Inch Gas Pipe Are Laid through Hills and Mountains near Fresno, Calif.; Wherever Possible, the Trenches Are Dug by Tractors

known to most, is in the making of carbon black, a pigment manufactured by directing the natural-gas flame onto a metal surface. This finds a market in the making of inks, carbon papers, typewriter

insure constant flow of gas and to minimize costly repairs, the pipe-line bridge was introduced. The success of the pioneer structures has caused the bridges to multiply in surprising fashion. And the

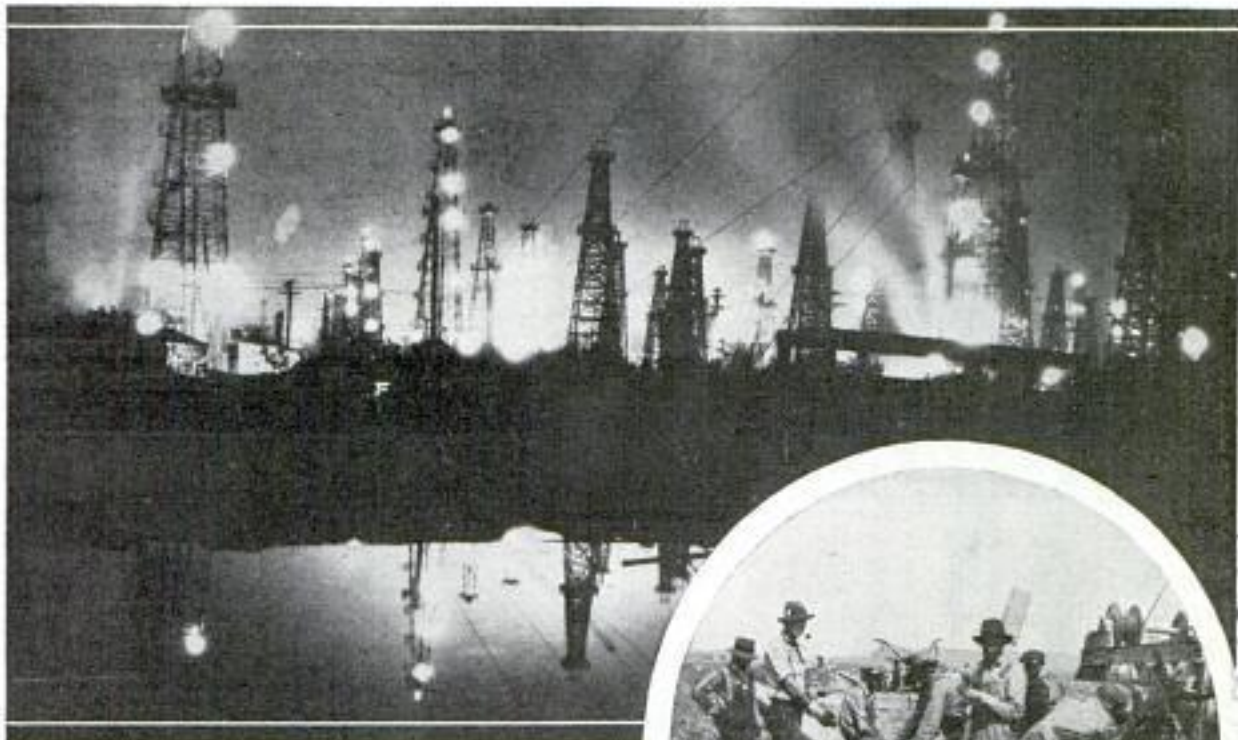

Photo by Ewing Galloway
 Oil Derricks at Night Reflected in the Sump; Right,
 Burning Tires Heat Pipe for a Bend



end is not yet. Still bigger accomplishments are in the offing. Another stupendous stride in gas transportation is about to be made. Panhandle gas is to be sent direct to Chicago through an unbroken steel tube. The distance is 1,000 miles. Two lines are to be laid at a cost of around \$3.50 a foot. Here and there along the line, booster stations will function, pushing the gas ahead and pulling that behind. This perfect, ashless fuel must be made to hurry through these steel channels if it is to supply an empire.

Poles supporting telegraph wires follow the line. There are track walkers, maintenance-of-way staffs, emergency crews in case of washouts, just as there are along railroads. There are problems, such as electrolysis, that are not to be met in railroad maintenance. Electrolysis bites into the pipe more deeply than rust and destroys it. Paint will not keep it out. It is due to stray electric currents that pass through certain soils known as "hot spots." Instruments have been devised to detect them and methods have been developed for diverting them. This sort of transmission has its own problems.

Tendencies in the laying of pipe lines at present are away from the coating of the pipe for its entire length, and toward

protection only in soils where chemical hot spots exist. In most corrosive soils the action of the chemicals on the metal pipe sets up an electric current just like that in a dry or wet battery.

In a recent government test of a dozen pipe lines, a measurable amount of electricity was found flowing through every one. It was found the current was increased in corrosive soils, or hot spots, and decreased in normal areas. The action of electrolysis, however, is most injurious where the current leaves the pipe. It was also found that the current left the pipe more rapidly in soils of low electric resistance. At these points the corrosion was particularly marked.

To simplify the location of these low-resistance areas, a simple piece of apparatus was developed that looks like two walking sticks, one with a milliammeter mounted on top and the other equipped with a small flashlight battery. Each rod is tipped with metal. By measuring the apparent resistance between the two ter-

91070
Portland Cement Association
33 W. Wacker Drive, Chicago
Can furnish details



jected to severe tension under the nightly contraction, with possible resultant breaks.

Systems of transportation are here being worked out that are on the eve of startling developments. Wherever natural gas goes, of course, the necessity of hauling coal decreases. Then there is the stupendous urge that this improved pipe is giving the transportation of oil. Long-distance gaso-

minals, the approximate resistance of the soil can be calculated.

This instrument makes possible rapid tests along a pipe line, or along the right of way of a projected one, and the results with this testing device are sufficiently accurate for all practical purposes, provided the soil is not too dry.

Concrete covering for the pipe is employed in many hot-spot areas, and an interesting new machine has been developed for this work. If the concrete is too soft, its porosity is too great after drying, so the concrete for pipe lines must be worked while in a very stiff state.

In order to apply this covering, a vibrating machine is employed, which shakes the concrete into every nook and cranny around the wire reinforcing material. Also, it has been found that, by using the vibrator, more of the crushed stone and less cement, which is more costly, can be worked into the mixture, thus effecting considerable economies in the coverings for hot areas.

A curious factor in the California climate is that of temperature changes as affecting pipes laid on the surface of the earth. To offset these conditions, it is necessary for the welding to be done in the early morning or at night when the line is contracted by the cool air. Welds made during the heat of the day are sub-



Difficulties of Pipe-Laying in the Blue Ridge, at Top; Bridge, 2,522 Feet Long, Built Only to Carry Pipe in Texas

line lines are being laid in all directions. When there are two points fifty miles apart, and gasoline must be carried from one to the other, the cost by rail is likely to be around fifty cents a barrel. The same gasoline can be carried the same distance through a three-inch pipe for four cents a barrel.

SALT WATER HELPS GOLDFISH

Salt water has been found an effective remedy for ailing goldfish. These fish sometimes float on their sides on top of the water or otherwise act unnaturally, and a white fungous growth often can be seen on their bodies. In such a case, a tablespoon of salt should be added to a quart of water and the fish placed in the solution for two or three minutes, then transferred to a bowl of fresh, cool water. The treatment is continued until the fish act naturally.

434

Chicago Daily News
6/20/31

James H. Burdett, Director
National Garden Bureau

Supermarine
Rolls Royce

POPULAR MECHANICS

Buzzard
PLANE FOR ATLANTIC SERVICE

a1343

Twenty passengers will be able to fly across the Atlantic in Britain's giant air liner, which will be launched in the spring. Power and fuel capacity for a non-stop flight of 2,300 miles have been provided. Forty passengers can be accommodated on a 1,000-mile flight. The captain and pilot will navigate the ship from a bridge constructed over the passengers' cabins, and six motors will drive the plane at a maximum speed of 145 miles per hour.

a1260
BIKE MEASURES OXYGEN USED FOR EXERCISE

Subjects of a laboratory study conducted at Yale on the influence of mild intensities of work on various types of persons, are set to work pedaling a stationary bicycle. They wear a mask connected to a bellows, which rises and falls with each complete breath. As the exercise continues, the oxygen in the bellows becomes less and less in volume, causing the bellows to inflate to a lower level at each breath, and so plot the breathing line on a drum attached to it. The subject of the test plots one curve while at rest, then another while riding the trick bicycle. The difference between the two lines shows how much oxygen is used at varying bicycle speeds.



Trick Bicycle That Shows How Much Oxygen Is Used Doing Certain Kinds of Work

Prof. W. H. Miles,
Institute of Human
Relations

a 110.2
Cont. John L. Combs
714 Jefferson St. 397
Washington

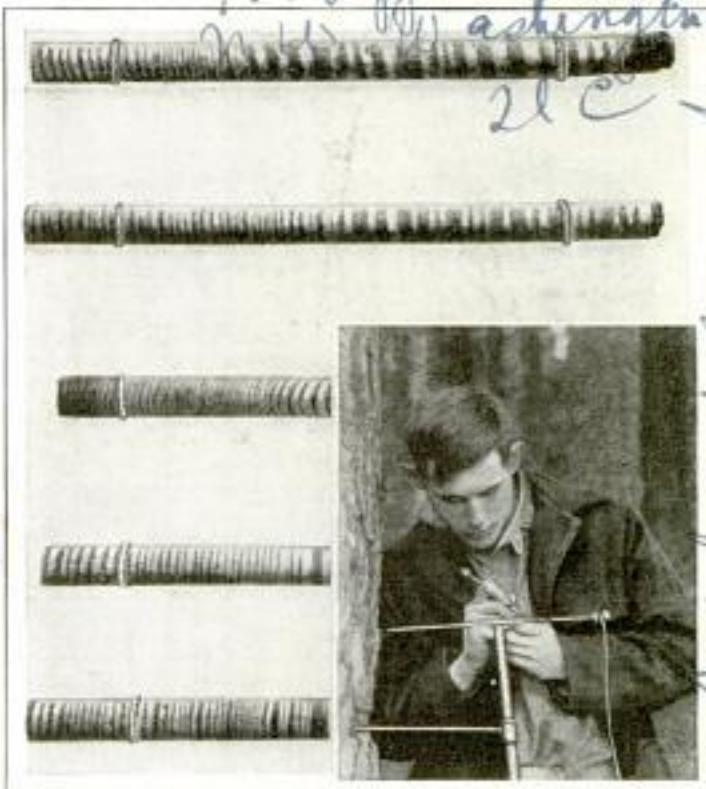

Forester Using the Increment Borer to Determine Life History of a Tree, and Samples of the Borings

AGE AND HISTORY OF TREE TOLD BY BORING IN TRUNK

Virtually the entire life history of a tree can be extracted from it by the scientific forester with an increment borer, a tool which removes a plug, or cross section, from the trunk. The boring, when removed and closely examined, shows all the vicissitudes that a tree has encountered, its age and its yearly history. The growth can be measured and progress charted in terms of annual rings in the wood. The borings even show something of soil and climatic conditions, as well as of fires and the fight between trees of different species for existence.

a 1376
ANOTHER CAVERN ELEVATOR

In operation for a considerable length of time, an elevator runs from a hotel above the Shenandoah caverns in Virginia to the floor of the caves. The elevator was built after a shaft was cut through solid limestone and is employed each year by thousands of tourists to the cavern region. This lift antedates the 750-foot elevator now being constructed at Carlsbad cavern in New Mexico.

Cont. R. S. Rader,
153 N. Main
Woodstock, Va

London Stanley
6/1/31

at New Haven Conn

Pacific Northwest Forest Experiment Station.

June 1931-963

a 1327

Ivory—from Elephant Tusk to Billiard Ball



Weighing, Sorting and Working Ivory; Modern Machines Have Replaced Hand Methods of Cutting and Carving It into Ornaments

its use in carvings and statuettes, ivory also is employed today in making piano keys, ribs for fans, billiard balls, handles for canes and umbrellas, and for book corners. Ivory has been used by man for ornamental purposes for centuries, and 5,000

Elephants' tusks still provide the world's ivory supply, but modern tools have replaced the hand methods of cutting and carving the material into ornamental forms. Antwerp is the world's largest ivory market, but is closely rivaled by London and Liverpool. The usual tusks are eight or nine feet long, and a pair may weigh all the way from twenty-five to 500 pounds. They are yellow or brown outside but pure white inside. Seen in cross section, ivory has lines of many colors, the compact cells being filled with a waxlike material that gives to worked ivory its high polish. Experienced workmen have charge of cutting the tusks into sections of the desired lengths, and special saws are required to work into form the individual pieces. Aside from

years ago ivory from Africa was sold in Egypt and built into thrones of kings.

a 1381 GOLD-PAVED PLANE RUNWAY

Airplanes are used in Mexico to carry bars of silver and gold from the mines at Tayoltita and, because of the inaccessibility of the mines, the ships are forced to land on a mountainside. The runway for the planes is 1,500 feet long and 140 feet wide, its surface representing the most expensive runway in the world, for it is made of surplus workings from the mines and has been estimated to contain gold and silver worth \$500,000.

More than 21,000 acres were planted to trees in the national forests in 1930.

Corporación Aeronáutica
 de Transportes - S.A.
 Torreón, Coahuila, México

Science Service
 534-J. 6/20/31 a1155

a1379
**SECRETS OF ANCIENT AMERICA
 HUNTED IN GRAVEL PITS**

If you find a stone arrowhead or a chipped-flint ax buried deep in a gravel bed, leave it there until scientists have had a chance to examine it. Dr. M. M. Leighton, chief of the Illinois state geological survey, advises finders to leave relics just as they are found, for the way the arrowhead or flint ax lies in its burial place may help telling who made it and how long it has been there. Gravel pits may hold evidences of prehistoric life in America, Doctor Leighton says in urging that workers be instructed to report and leave guarded all relics found in excavations until scientists from the National Research Council at Washington can examine the discovery and decide on its significance. Surface finds of Indian or other remains have little archaeological significance. But a genuine find of articles buried under obviously undisturbed gravel may be of great importance.

a1196
**BARREL ROLLING IS MADE EASY
 WITH HANDLING TOOL**

Handling of barreled materials is simplified with a tool recently developed. It is placed over the ends of barrels or steel drums, and, when pulled toward the operator, claw points are engaged and locked automatically. The handles are arranged to allow the pointed ends to revolve, so that barrel or drum may be rolled along the floor. The grip is loosened by releasing a ratchet on the handle. The tool is made of wrought iron.



Barrel Handling Is Made a Simple Matter with the Speedy New Tool Shown Here

C. Downing & Son, Inc. 1375 W. Lake Chicago
E. L. Moore, 376 7th St. N.W. Washington D.C.
 Copyrighted material

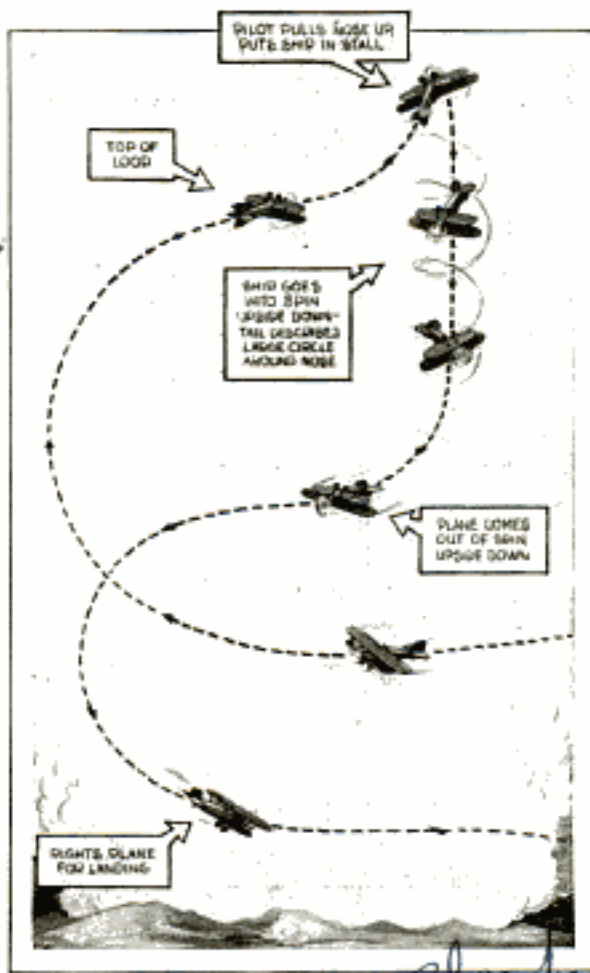

How the Inverted Spin, a Stunt That "Can't Be Done," Was Completed by Youthful Pilot

**STUNT THAT "CAN'T BE DONE"
 ACCOMPLISHED BY YOUTH**

Another of the air stunts that "can't be done" was crossed off the list by Robert Brahm, young Los Angeles flyer, who safely completed an inverted spin. He started a loop at 5,000 feet, and, while upside down, nosed the plane into a stall. After spinning downward for 3,000 feet, he pulled successfully out, flew on his back and then did a vertical half circle to return to normal flying position.

JAR BUGS FROM TREES

Adopting the methods of opossum hunters, entomologists of the department of agriculture now recommend shaking insect pests from peach trees. "Jarring sheets" are placed under the trees to collect the beetles of the plum curculio. While four men hold the sheet, another jars the tree limbs with a pole, padded on the end, and the bugs tumble down.

a1351

91032

Pilots in a "Flying Barber Chair" Learn to Navigate Blind by Watching Instruments in the Box



"HORIZON IN BOX" HELPS PILOT LEARN TO FLY BLIND

Seated in a whirling chair and looking into a box in which is an illuminated turn-and-bank indicator, airplane pilots are given blind-flying tests at the Los Angeles municipal airport, supervised by the department of commerce. It is the first step in teaching pilots, many of them old-timers who have been flying by eye and ear for years, to fly with instruments, essential knowledge in fog and at night. The chairs are whirled, dipped and put through many other evolutions, which the pilots try to follow and tell in what positions they are by reading the indicator.

BREAKING COAL WITH WATER REDUCES HAZARDS

Coal is broken from mine veins by a hydraulic machine tested in Colorado, eliminating much of the danger in mining with explosives. The machine, which is easily carried by two men, consists of a water tank and hand pump. The pump, equipped with a gauge to indicate pressure, forces water into a pipe running

through a rubber cartridge and so against the coal. Pressure of 500 to 1,000 pounds may be applied to break off the coal in large, clean lumps.

SPIES AND SECRET MESSAGES DISPLACED BY MACHINE

Secret messages now can be coded and decoded mechanically by the use of an apparatus known as a "cryptograph" which does not differ greatly in principle from an accounting machine. It mechanically ciphers and deciphers telegrams, and its operation greatly reduces telegraph tolls through the use of ten-letter combinations or "words." The coding machine is operated from a keyboard similar to that of a typewriter. A special device allows the repetition of any letter or letters, should this be necessary, and a counter controls the number of letters ciphered. The ciphering mechanism for one and the same setting of the key chambers has a period equal to 1,580,000 letters, that is, the same sequence in the substitution of letters will occur only after this number of strokes on the counter, thus enabling long messages to be transmitted without changing key members. The many combinations preclude all risk of the code being deciphered, except by persons possessing the secret.



Cryptograph Which Codes and Decodes Messages; Above, It Is Linked with Typewriter

under auspices of Professional Pilots Association

912

91349

Meyer Rotary Engine Co. Patterson Bldg, Denver, Colo.

A. St. Charles... fast in heat... Stockholm, Sweden

Emp. Harry Chapin Plymouth N.Y. 1007107

a-1373

in South Kensington

Fish That Go Angling Are Shown in Museum

Models of two deep-sea fish of the angler family, both equipped with ferocious spines on back and head and long saberlike teeth, have been placed on view at the British Museum. One of them, the female Photocorynus spiniceps has her home in the Gulf of Panama and carries her husband, who is much smaller than herself, permanently attached to her forehead. The other angler fish, Linophrynidæ, carries a luminous lure on its nose and also is the possessor of a luminous beard

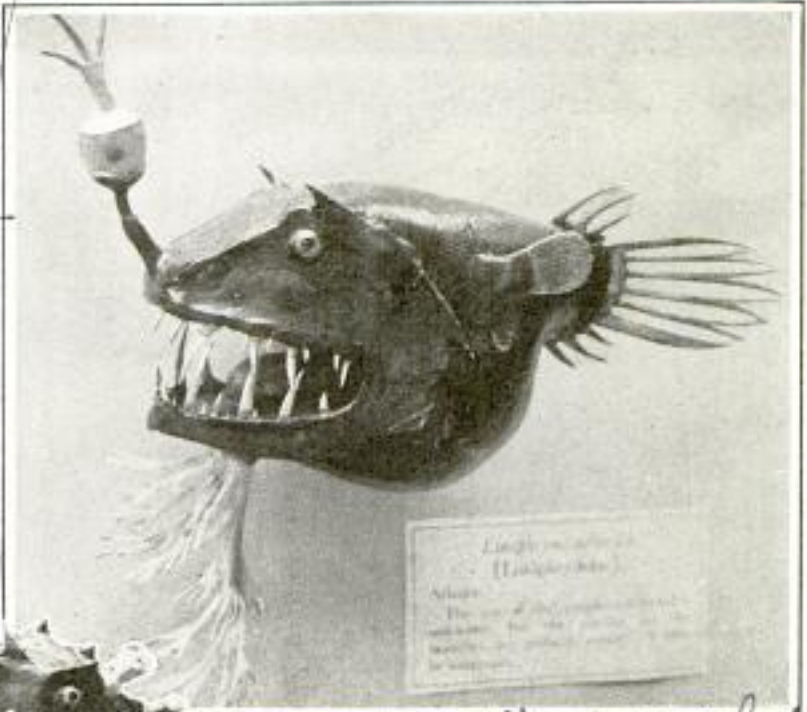

Fish That Carries Her Dwarfed Mate Permanently on Her Nose; Above, the Angler Fish Equipped with a Luminous Lure and Beard

trailing under its lower jaw. The teeth of these fish are hinged at their bases.

Science News Letter 7/4/20

MIRRORS REFLECT ARC'S RAYS TO MELT PLATINUM

Reflecting to a focus the rays from an electric arc instead of from the sun, a copper mirror has been made by two Swedish scientists which produces temperatures of more than 3,600 degrees Fahrenheit. An arc between poles of carbon, carrying up to 100 amperes of current, is fixed at one focus of an elliptical mirror seventeen inches in diameter, and the heat and light rays are concentrated at the other focus some distance away. A high temperature thus can be created at this second point. Rapid heating and freedom from admixture with foreign substances are advantages of the method, which will reduce a piece of platinum

Stockholm, Sweden

Science News 7/4/20

Prof. A. F. Benedict and Dr. J. Harsanyi, Metallurgisches Institut.

requiring 3,250 degrees centigrade to melt, to a liquid condition in less than five minutes. About twenty-five per cent of the energy put into the arc is effective in producing the hot spot. Mirrors have been used for a long time to produce heat from the sun's rays but there is a natural limit to the heating power of such a device since a mirror can pick up only a certain amount of the sun's rays.

Wide World

TURKEY PLANE LEAVES GROUND AT SIXTY-DEGREE ANGLE

Germany is experimenting with an airplane of unusual construction which is able to start and climb at a sixty-degree angle. The ship, known as the "turkey plane" because of its resemblance to that bird, also is equipped with a device which prevents it from falling in a nose dive.

a-1440



"Turkey Plane" Which Is Able to Climb at Sixty-Degree Angle and Is Equipped with Device to Prevent It Falling in Nose Dive

Designed by Herr Joseph Sparrer, Berlin, Germany

Com. Harold J. H. Carter
% Phila. Daily News
402 City West 2nd Street
a1368

Precious Gas from Radium Will Save Lives

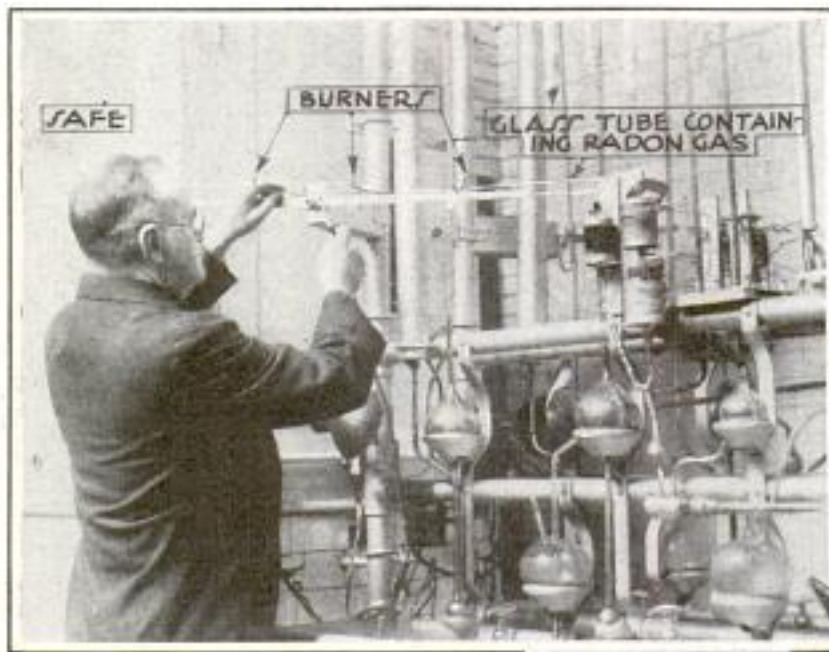

a whitish sulphate salt, in small platinum needles. But the method is slow. After months of experimentation, Doctors Failla and Duane devised a radium-emanation plant, through which radon or radium gas was drawn off the actual radium. This is sealed in glass tubes in which it keeps



Plant, Above, Extracts Radium Gas; Nurse, at Right, Uses Shield in Handling Gas

It is more precious than emeralds, rubies or diamonds and it destroys disease and saves life. Yes, you have guessed right—it has to do with radium. Two Americans, Dr. G. Failla, of the Memorial Hospital of New York, and Dr. William Duane, of Harvard, have discovered a means to produce gas from radium, which has almost equal healing qualities.

There are only about 500 grams of radium in use throughout the world. A pound of the metal is worth \$2,852,222,400. The most familiar method of using radium employs the actual metal, in the form of

its strength for nearly four days. Small "gold seeds" of radon also are made, using fine gold tubing. These are implanted into diseased tissue and left there indefinitely.

FUTURE SPEED OF PLANES SET AT FOUR HUNDRED MILES

Commercial passenger and freight airplanes in the not very distant future may travel through the stratosphere safely at speeds of 400 miles an hour. This is the prediction of Prof. Auguste Piccard following his ascent in a balloon to the rare atmosphere. The experience, he declared, has proved that traveling at a high altitude is without danger if airplanes are equipped with compressors and air-tight cabins. He also announced that, as a re-

sult of his ascent, proof had been found that cosmic rays do not originate with celestial bodies. His measurements tended to show, instead, that these rays had their origin in gaseous clouds of slight density which may be best designated as cradles of new worlds in the making, the rays appearing to emanate from this nebulous matter.

☞ The ancient Romans had indoor weather vanes, connected with a dial in the ceiling, to show in which direction the wind was blowing outdoors.

Cambridge made
2 W. 106 St. N.
a1377

NY Times 6/9/31

Reported to Dept of Commerce
and in further data

NEW COLOR MOVIES ARE TAKEN WITH ORDINARY CAMERA

Achievement of a three-color motion-picture film is claimed for a new process recently developed in England. The film base is printed with a foundation, or matrix, consisting of 500,000 minute red, green and blue violet squares to every square inch of film. Over this foundation there is coated a highly sensitive emulsion. The film which is inflammable may be exposed in an ordinary camera and shown by an ordinary projector without any special attachments.



Peace-Time Tanks in the German Army Carry Small Guns; Note the Special Headgear Worn by the Crew to Prevent Injury in Maneuvers

HAMMER WEDGE FELLS TREE AS YOU WISH

Trees being felled along a fence or near other trees may be made to drop in the correct direction by means of a wedge jack now on the market. The jack is made in the form of a hammer with a screw handle. While the woodsman is sawing through the trunk, he drops the saw about two inches and cuts a cross section about three inches deep.

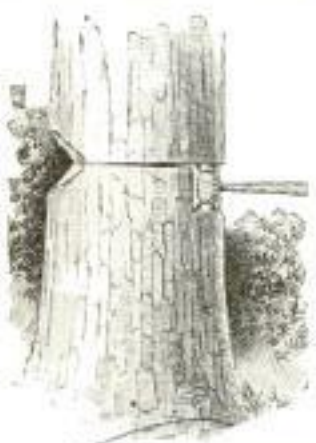

He inserts the wedge jack and as he chops out the "vee" on the side he wishes the tree to fall, he gives the wedge a turn or two at intervals until the tree tips in the right direction and will then drop into the place selected.

PEACE-TIME STYLE OF TANKS CARRY SMALL GUNS

Fleets of peace-time tanks have been built in Germany under the limitations of the Versailles treaty. The tanks are simply automobiles built on a special chassis,

armored and mounted with small-bore guns. Each car is manned by a crew of four, who wear a new type crash-helmet designed to lessen danger of injuries to their heads.

EXTENSION LEG HOLDS LADDER STRAIGHT ON STAIRS

An extension leg for ladders that saves time and effort blocking up one leg for setting up on a stairway or the side of a hill, has been developed, combining these features with safety and speed of adjustment. The leg length of any ladder can be adjusted to suit any variation merely by hooking a piece of chain by its proper link. The extension has prongs at the upper end to fit around the legs and the chain with which to raise and lower it.



\$5.00

no Chicago. send by mail

(at no. H. S. Thomas)
\$4.00 by mail, postage prep. 500 mi.

pend.
Thomas Co.
1234 W. Main
Madison, Wis.

designer

Designed and sold by
Chas. & Bonchard
and F. Kimball
Washington

a 1129

Capt. Andrew D. Borne
613 Spreckel Theatre Bldg
San Diego, Calif

BLAZING a TRAIL

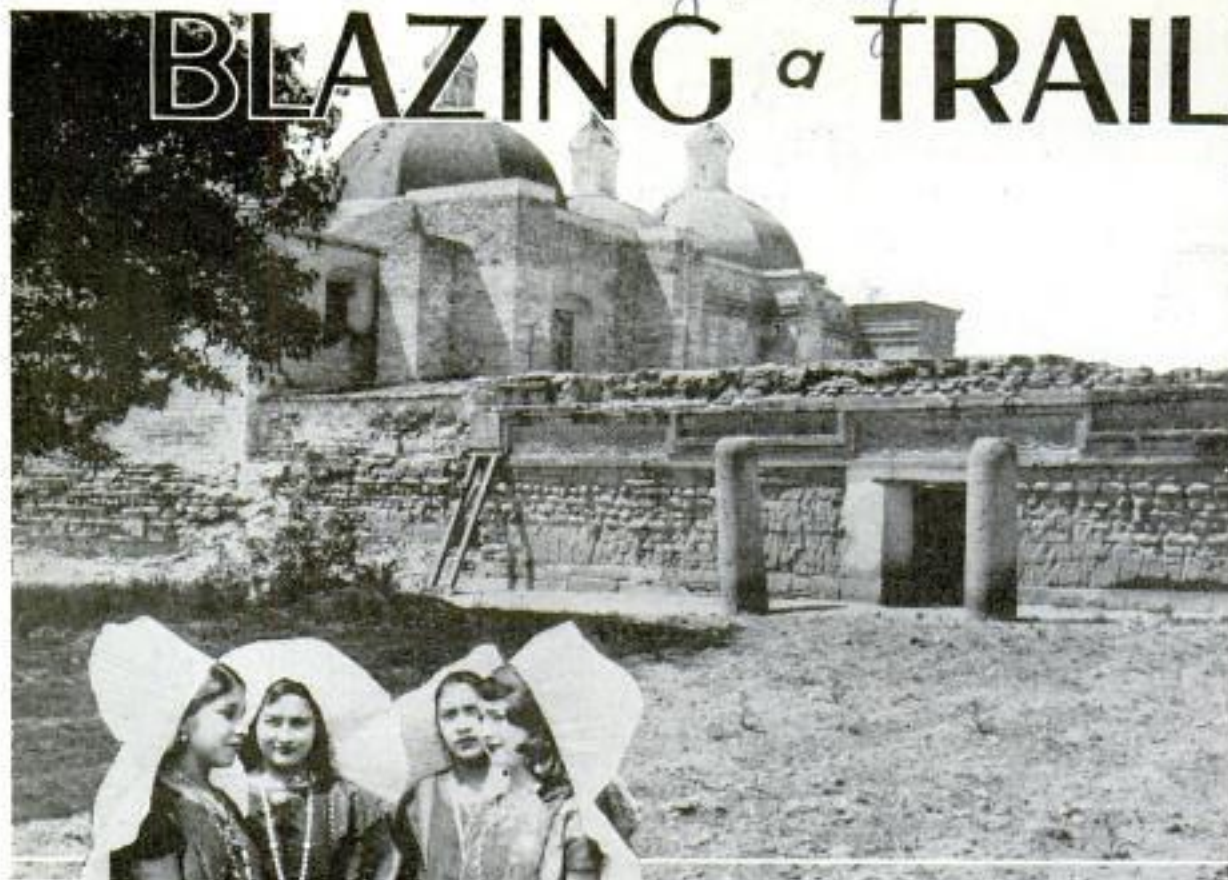

Above, Entrance to One of Temples of Mitla; Below, Senoritas of Tehuantepec Attired in Native Costume

"CQ...CQ...CQ," sang the tiny radio set. Its operator, huddled close in a large overcoat, frowned.

"IPH calling. CQ...CQ...CQ."

Five hundred miles south of Mexico City, atop a windswept mountain, the operator sat by his radio, calling. At last an amateur in Illinois heard the weak signals and answered. Then field station IPH told how three small American automobiles and their crews of six had pro-

gressed three miles during the day up steep mountainsides, en route from Nogales, 2,844 miles, to San Salvador, surveying a route for the 12,000-mile highway to connect all the nations of North and South America, from Fairbanks, Alaska, to Buenos Aires.

Across the dreaded Barrancas, the deep gorges of north Jalisco, the party had pushed its way south; down through the bad lands and treacherous canyons south of Mexico City and across high mountain ranges and through burning jungles to San Salvador, the explorers and road mappers crawled, until at last, in the late spring, they had driven

their automobiles entirely through Mexico, the one country that presents the biggest problem in the continuity of the highway.

The survey party—a chief engineer, a doctor, radio operator, interpreter and two drivers—"attacked" Mexico twice before finally being the first to traverse the country from north to south in automobiles. Last year, they drove from Los Angeles along the west coast of Mexico

a1129

through MEXICO

and on to Mexico City. Even on that journey, sometimes two yokes of oxen helped pull the cars up steep grades and occasionally blocks and tackles and racing engines assisted the oxen. The difficulties of that trip were hardly an indication of the troubles that would beset them on the journey recently completed, of the mechanical ingenuity to be developed in rounding narrow mountain burro trails with heavily loaded automobiles, of re-crossing one narrow river eighty-eight times in a seventeen and one-half mile drive.

Each car was fitted with a steel compartment to carry guns, ammunition, tools and supplies. The radio instruments were conveniently located on the sides of one truck and could go on the air without further preparation than to de-



Above, Negotiating Burro Hill in the Mountains of Oaxaca with Aid of Block and Tackle and Many Men;
Below, Radio Operator and His Portable Equipment in Same Mountains

posit a one-cylinder engine on the ground and start it. As the cars bounced down stream beds, over rough cobblestones that lined village streets, and around fallen trees, the radio set never broke loose

from its moorings, and over it the party was in daily touch with the United States through amateur stations scattered from Maine to California.

When E. E. East, chief engineer for

a 1129

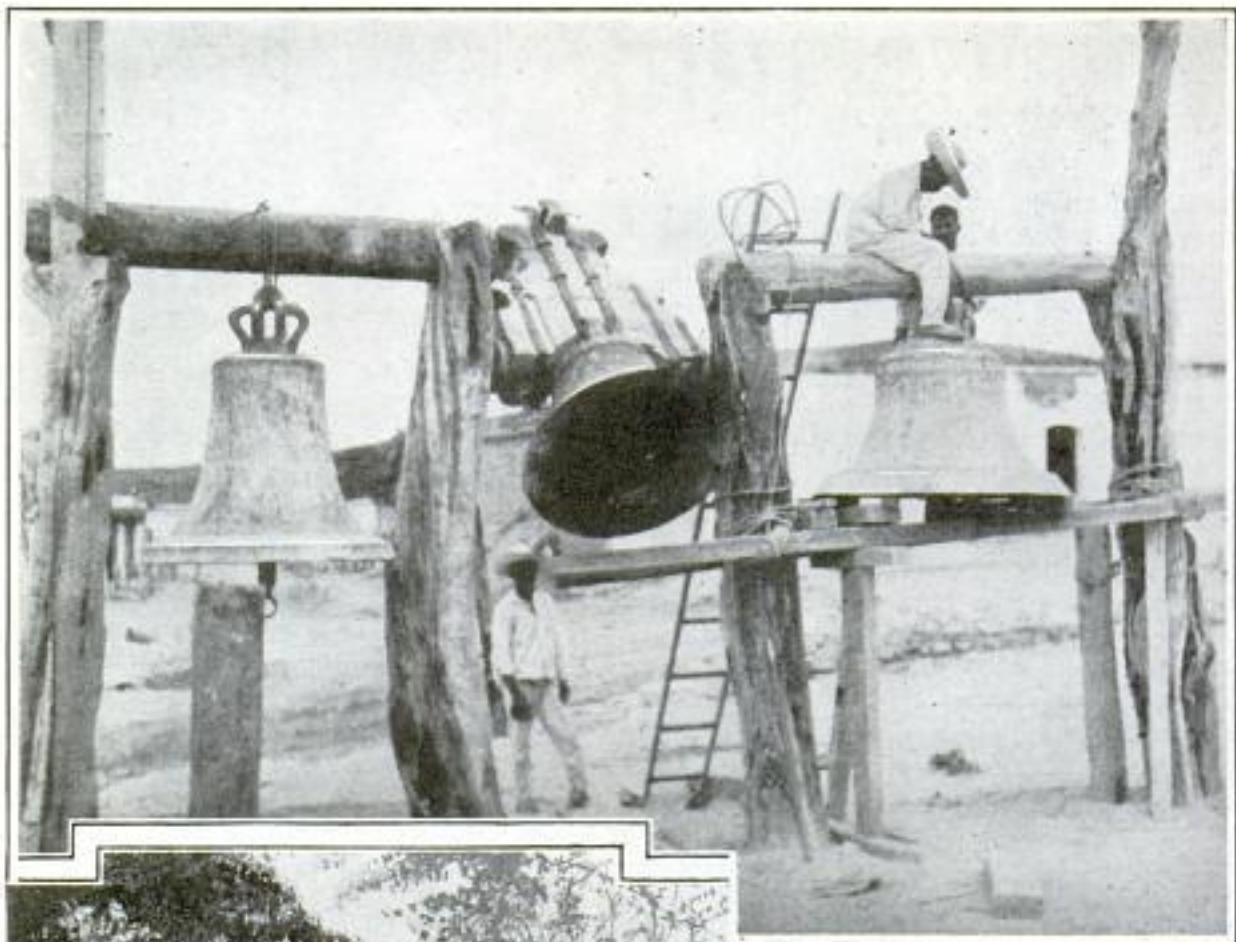

Above, Earthquakes Cause Church Bells to Be Hung on Racks;
Below, Bumps Made by Burro Pack Trains

the Auto Club of southern California, turned the lead car south from Mexico City on the journey that was to bring many hardships in a primitive land, he led the caravan along an improved road to Puebla, eighty-two miles distant. At that point, having traversed the beautiful valley of Mexico and crossed the surrounding two-mile-high rim, the party left improved highways and embarked on the ancient Spanish trail, used only by ox teams, for Suchite, a populous community on Mexico's southernmost border. Even the primitive trail soon disappeared, however, and the three drivers turned their cars into a wild country where the natives never before had seen "devil wagons," as they called the little automobiles.

"Leaving Puebla," East explained, "was much like breaking down a fence and walking

from a clearing into a primitive forest. We knew that until we should reach Guatemala we could expect no help, that we would have to blaze nearly all our own trails and create our roadways as we went.

"Once the grade pointed up at such a sharp angle that the cars would not move until twenty men assisted the racing engines by pulling on a rope tied to the front axle. Going downgrade was no easier. Engine compression, four-wheel brakes and the score of Indians holding back on the rope were all that saved the cars from pitching to the bottom.

"We were warned about the difficulties that lay ahead, but we had no alternative, even though we might have wished to retrace our steps. We never could have



forded the Rio Tehauntepec upstream. Just outside Nejapa, we climbed four mountain summits, widening a pack trail as we climbed, blasting boulders out of the path, building retaining walls and, at one sharp turn in the solid rock, constructing a bridge. Here we were, at an elevation of a mile, felling trees and lacing them together at a dizzy height over a canyon

so our cars could crawl around the bend.

"At Rio Tequisitlan, after a fifty-mile road so rough all the equipment was packed on burros, we came upon the so-called 'cerreta' roads. The cerreta is a two-wheeled oxcart. Its tread is six inches narrower than an automobile tread, so we were constantly breaking trail through the decomposed sandstone for one side of the cars. These trails became trenches which were cut sometimes to a depth of ten feet, and as we threaded our way down them, the tires would ride on side slopes and wear away as though they were turning against emery paper."

Aerial surveys of routes have been completed in British Columbia and Alas-



Top, Getting Out of Sand; Center, Mexican Toll Bridge; Below, Radio Operator at His Set

a 1129
408

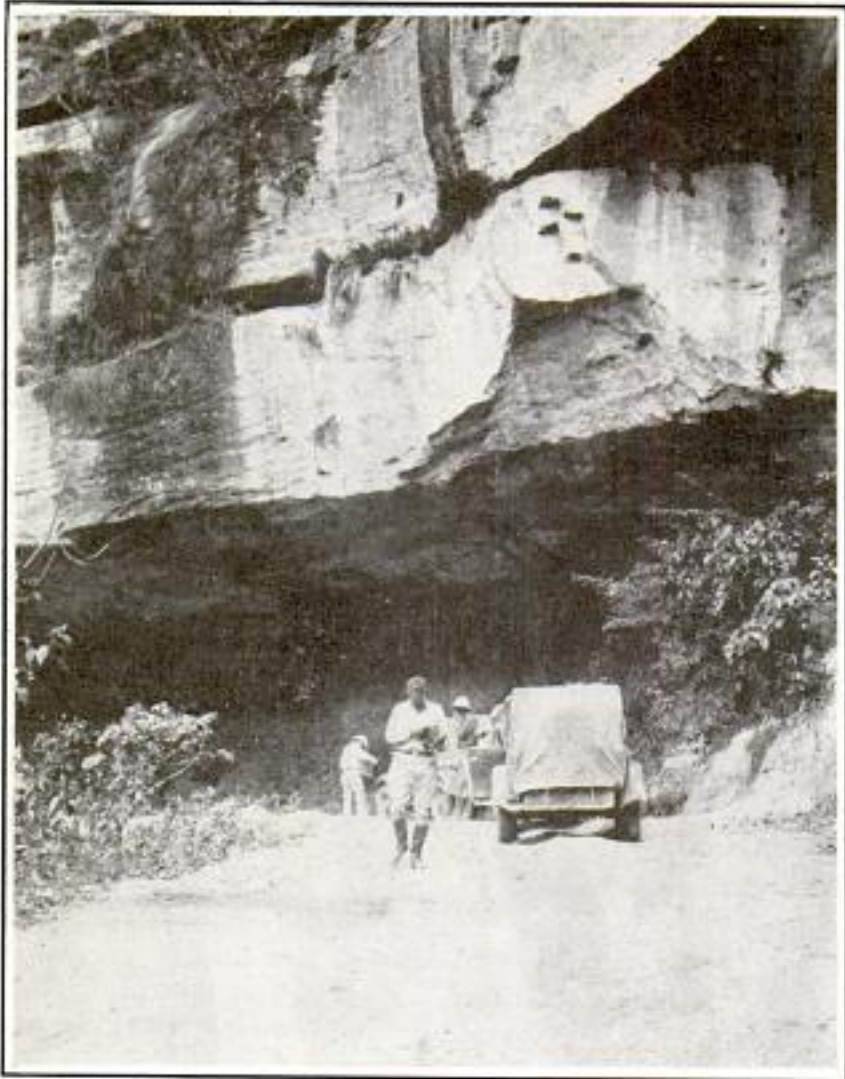

Advantage Was Taken by Mexican Road Engineers of a Natural Shelf Running under a Ledge in Routing This Mountain Highway

ministered when the lead is about to solidify from the liquid state, or when it is about to liquefy, the metal can be broken to pieces. Hence the pure lead is first melted, and while in this state is thrown in the form of spray from an injector by compressed air and reduced to fine powder. While the powder is still semiliquid, it is impacted against high-speed propellers thus pulverizing it still further. This method has been found inexpensive and produces a purer form of powder.

LAPEL "MIKE" TO BANISH RADIO PANIC

Microphone fright, the panic that grips many persons, even public speakers, when they talk over the radio or a loud-speaker system, is dispelled to a considerable extent by a tiny lapel microphone to which

ka for roads that will cost \$6,000,000. Governors of the several Mexican states met in Los Angeles several months ago to prepare plans for their sections. Even in South America the route down the Pacific coast is being mapped. Already tourist travel along one highway into Mexico has increased from two cars weekly to fourteen daily, due to the impetus of the trail blazers.

PURE METALLIC LEAD POWDER

Pure metallic lead powder is produced by a process recently patented by a Japanese inventor. The method depends on the fact that, while it is difficult to pulverize such a soft and malleable material as lead in its ordinary condition, it, like other metals, becomes brittle when in a semiliquid state. If a violent shock is ad-

thirty feet of cord is attached. The instrument is attached to the clothing and the speaker is left free to gesticulate or move about, often becoming unconscious that his voice is being broadcast. This transmitter, not as large as a silver dollar, is attached by a cord to a plug and jack carried in the pocket, and from the jack a thirty-foot cord extends

to a small cabinet hooked up with a loud-speaker installation or with a transmitting outfit. It is not adapted for broadcasting that includes instrumental music.



*Con. J. rank Early 1926
Denver, Colo. Plumeyloans 4.*

41422

*Yoshy, Takata of Contributors
J.P. Suzuki no. 4, Ichome of
Konomachibari. Uoro. nishi*

*Bell Telephone Laboratories
195 Broadway
New York*

Aerial View Reveals Beauty of the Capitol



Photo by Ewing Gallaway, *920 Lexington Ave. New York*
 Modern Photography, Aided by a Clear Day, Produced This Striking Picture of the Nation's Capitol; Note How Each Detail Stands Out; It Is One of the Best Air Views of the Capitol

Beauties of the nation's capitol are revealed in startling detail from the air. In flying over Washington on a clear day recently, a photographer took an unusual picture of the capitol and its beautiful grounds. Latest photographic methods were used to bring out the contrast between the white buildings and dark trees, shrubbery and lawns.

fect on the appearance or disappearance of the marks. Finally a draft of heated air was used instead of cold. Immediately streaks of soot were deposited. Half the section was exposed to hot and half to cold air, and in the half exposed to hot, the streaks appeared over the lath and in the half exposed to cold, the smudges formed between them. It was thus shown that lath marks indicate heat leaks.

LATH-MARKS MYSTERY SOLVED WITH KEROSENE LAMP

Lath marks on walls and ceilings *a. 202* really are due to changes in temperature of the exposed surfaces, and not to electrical phenomena, plaster porosity or dust filtration. This has definitely been established as the result of tests in which a section of wood and plaster wall was constructed, the upper surface covered with wall paper and a smudge produced by a smoking kerosene lamp. At first no lath marks appeared, then, when the laboratory window was opened, marks formed quickly. Electrical shielding had no ef-

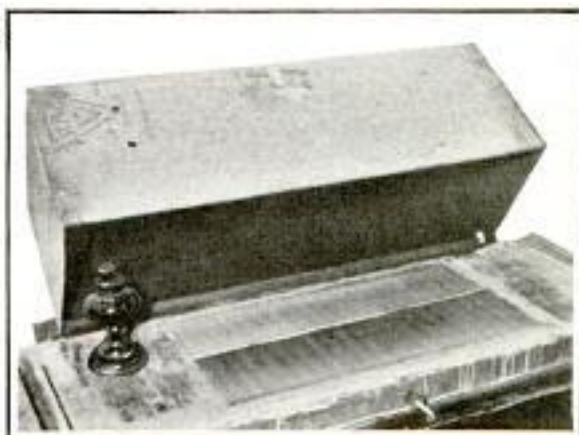

Apparatus That Showed the Causes of Lath Smudges to Be Due to Unequal Heating

*Com. Rev. J. Paul, Jr.
 1409, 537 S. Dearborn,
 Chicago*

a1357
410

Mastering Navigation in Floating Classroom

Pupils at Right Are Studying Navigation Instruments in Floating Classroom; Below, Others on the Deck of the School Ship, at Another Class Preparing Them for Their Mariner's Degree

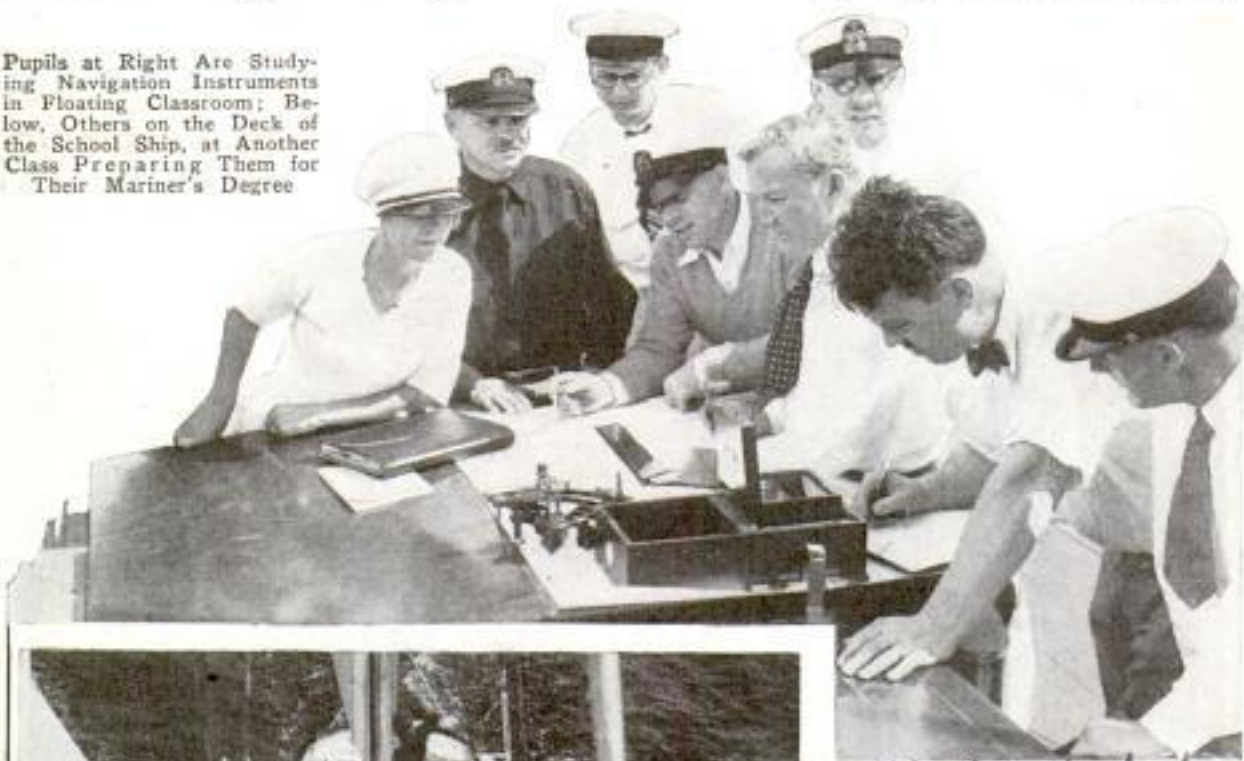

Wide World
practical tests by being taken to sea on a large yawl. The boat is equipped with sextants, charts, compasses and other necessary instruments to enable the students to prepare for their examinations as mariners.

a1414
GLACIERS MAY BE WEATHER KEY

Exploration of Greenland's glaciers may reveal two of nature's missing links, one, the source of the weather, and the other accurate information on the last ice age and a clue to the next one. These glaciers are repeating today the picture of events happening 30,000 years ago in what are now the most prosperous sections of the United States. Instead of being dead, frozen stretches, the ice areas are creative forces, in reality gigantic mills which chew and grind up the soil. In Greenland are found the same peculiar wind-erosion

Students of nautical astronomy and yacht navigating at the University of Southern California go to school in a floating classroom. In mastering the mysteries of navigation, the class is given

United States. Instead of being dead, frozen stretches, the ice areas are creative forces, in reality gigantic mills which chew and grind up the soil. In Greenland are found the same peculiar wind-erosion

under direction of Capt. Frank Jensen, University College

Los Angeles, Calif

*Kansas City Star
6/2 8/21*

a1336

markings in the stone that geologists have also found in the Mississippi valley. Greenland is one of the places where scientists hope to learn, by measurements over a period of years, whether the ice as a whole still is receding, an indication of warmer times ahead, or whether it is again preparing to make another spread of glaciation. They also desire to know the depth of the ice, estimated with some precision at 4,000 feet, although there are guesses of a maximum of 10,000 feet. This immense weight may be correlated to the sinking or rising of the land such as has left its marks in deposits elsewhere. Some meteorologists believe Greenland's chill winds may some day furnish the best key to accurate weather forecasting. Apparently these winds tend to blow outward in all directions from the ice cap, as if there were a spot where the ordinary swing of northern-hemisphere storm areas, always toward the east, did not apply. There is accumulating data to indicate that over the interior of the great cap there is comparatively little wind, a still area where the air is heavy and charged with cold.

TINY RACING CAR MAKES SPEED OF NINETY MILES AN HOUR

Not much larger than a toy model, a homemade racing car built by a California man attains a speed of ninety miles an hour, although its cylinder displacement is only seventy-five cubic centimeters. It is so light that one man can easily lift one end, but because the center of gravity is

low, the Lilliputian racer takes curves at almost open throttle. The wheels formerly were on the tail of a tri-motored airplane.



Tiny Homemade Racing Car That Makes Ninety Miles an Hour; It Has Front-Wheel Drive



Window Cleaners "Take the Trolley" around Huge Building to Wash 30,000 Panes of Glass

CARS FOR WINDOW WASHERS HELP CLEAN GLASS

Miniature trolley cars carrying tanks of hot and cold water and suspended from a rail which encircles the entire building are used by window washers who keep the 30,000 panes in the General Electric tank shop at Pittsfield, Mass., clean. The cars may be lowered or raised by chain falls. They are moved with a geared wheel and ratchet.

The Popular Mechanics' Bureau of Information offers its free service to all readers of our magazine. Names and addresses of manufacturers and dealers in articles described, and any other details in our possession, will be promptly furnished by addressing the bureau.

all 4³ Col. L. Corley McDarment
Langley Field
Hampton, Va

A Wild Night



They were over the edge of the field, about 200 feet above the hangars, but a blanket of fog hid the face of the earth. "Can't see a thing below."

"Let's turn around and make a new approach!"

The blimp was slowly swung around and the nose lifted for a little more altitude. In a few minutes, small blurred patches of light shone through the fog, but shortly the mist again swallowed everything. The airship plowed on blindly.

Crash! R-rrip! The

By *Lt.* CORLEY McDARMENT
Langley Field, Hampton, Va

AT ELEVEN o'clock on a recent night, the army blimp "T-C-Ten" under command of Lieut. William J. McCracken, nosed into a dense fog over the James river and began one of the most thrilling flights in history.

Eight men, including a stow-away, were in the airship. Sergeant Miller, a veteran of lighter-than-air service was navigating, laying a course into the dot-dash-two-dots of the Langley field radio beacon. The fog thickened, and finally the night was one black, stifling cavern into which the two propellers bored with a muffled roar.

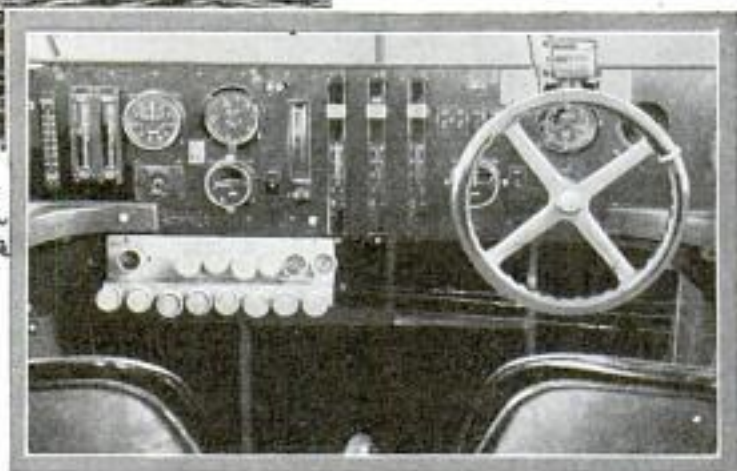

Photos Courtesy The Daily Press, Newport News, Va.

Forced Landing of an Army Semi-Rigid Aircraft; Below, the Pilot's and Navigator's Seats of the "T-C-Ten"

big bag swayed drunkenly. "Stop the motors!"

But it was too late. What the obstruction was that the blimp nosed into may never be known, but it caved in a part of the gondola, threw a motor out of posi-

all 73

in the T-C Ten



tion and, before it could be stopped, the propeller had eaten a hole through the outer fabric and punctured a forward gas cell. Ballast was quickly tossed out and the ship arose. Gas escaped from the forward cell, and the nose dropped to a perilous angle. Men clung to the rails of the gondola and fingered the hard iron rings of their parachutes. More ballast was thrown out, and the ship floated upward above the blanket of fog which was about a thousand feet thick.

In the meantime, a frantic crew—a landing party of men and officers—were burning barrels of gasoline in the middle of the field hoping the light would act as a beacon. Three times the watchers heard the dull roar of a motor in the heavy mist. But after the airship had circled the field the third time, it mysteriously headed northward and presently its motor died away. It was not until the morning that the fate of the blimp was known, and the pilot told his exciting story.

The "C-52," Better Known as the "T-C-Ten," in Flight; Lieut. William J. McCracken, Commander on the Wild Flight

When the ship arose above the fog, the question of jumping came up. Riding at the dangerous angle put a tremendous strain on the gondola, and the memory of what happened to the "Shenandoah" a few years before was still vivid in the aeronauts' minds.

While the crew was debating whether or not to go on farther up and leap, someone shouted: "Look! A light on the clouds!"

9/11/93

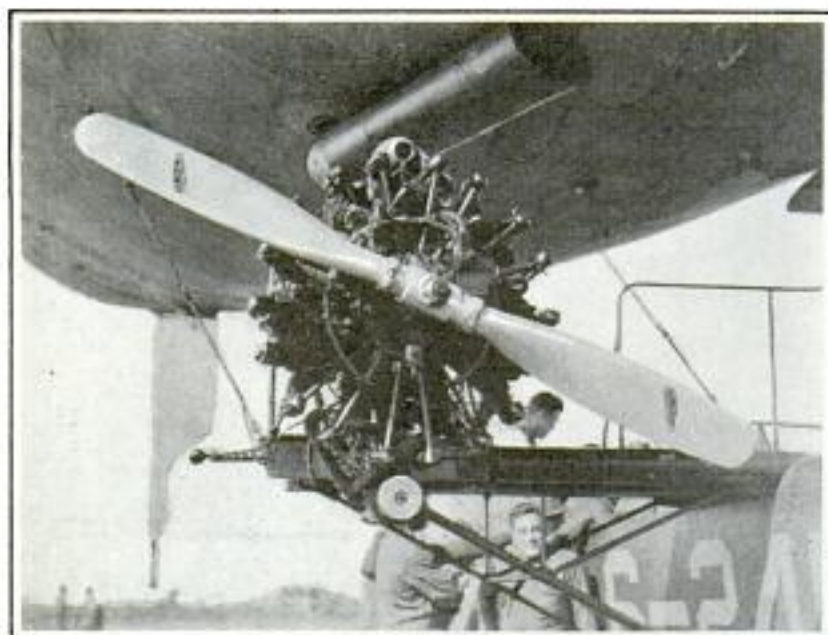

They looked down and saw a red glowing spot.

"Signal from the ground party! Let's try to make it."

The blimp was now being navigated with a mixture of free ballooning and part motor—a ticklish job when visibility is good and a most hazardous one in the dark. But with great skill the pilot and navigator managed to swing the ship around so as to come down near the red glow in the fog. But as soon as the airship descended, everything went black as a Stygian cave. Three times they rose above the fog, lined up on the red glow and tried to make it without success. The loss of gas and ballast by now was becoming serious.

The pilot and navigator knew that a large body of water lay northward of the field. There were Back river, Mobjack bay and the York river all running together. It was decided that a chance on the water would be better than the land. Life preservers were made handy, and the non-sinkable kapok coats were donned over parachute harness. It was then that the stowaway was found. But nothing

could be done about it.

Loss of valuable helium gas was not the problem now. It was the life of the crew. The pilot and navigator began free ballooning. They laid a course in a favoring wind which carried them northward. They flashed the light every few seconds upon the little statoscope in its leather case, and when the bubble broke

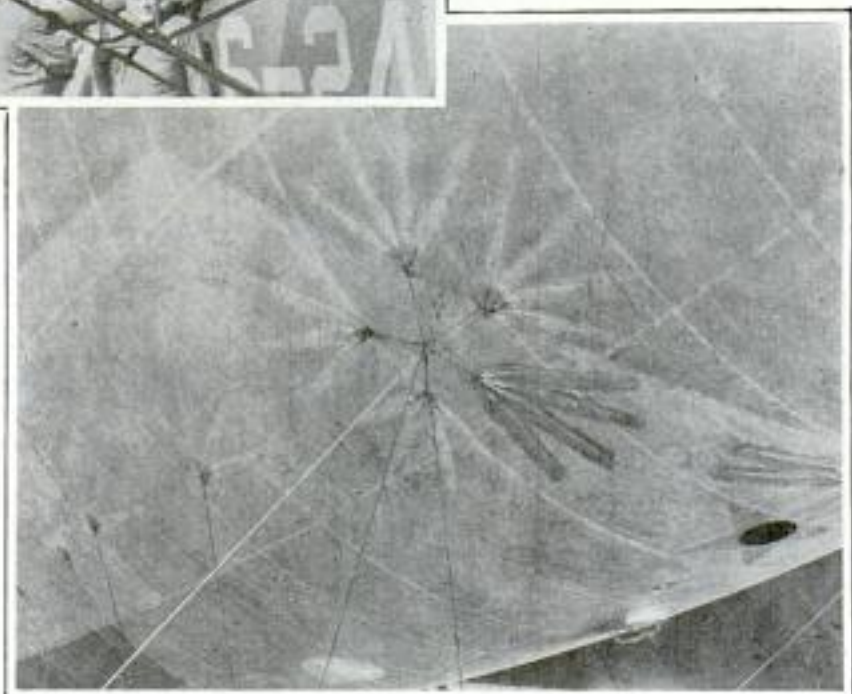

Top, Engine Mounting Which, on the "T-C-Ten," Tore Loose and Ripped the Bag; Below, How Cables Are Attached to the Envelope

too rapidly to the right or "Ascend" side, a little gas was valved out, and if the bubble broke to the left, ballast was thrown over the side. The sand ballast was dropped by trickling it slowly through the fingers and watching the effect. The crippled ship had to be brought down gently or all would be lost. Water scarcely has any "give" at all, as every one knows who ever sprawled from a diving board.

After what seemed like a very long time, the tilted car began to drag water. The only thing to do now was try to hang on until morning. The water tended to hold the flat bottom of the car to the surface and this also took up some of the



The "T-C-Ten" at Rest in the Trees at the Water's Edge, after Its Perilous Cruise All Night over a Fog-Bound Hangar, Brought Down by Ballooning Skill

weight from the remaining gas cells. The airship became like a floating nautilus and unless the wind arose, it seemed the crew might ride it out until morning.

But after floating about two hours in the blackest of nights, the sound of waves breaking upon shore or reef came from the darkness. This was cause for new alarm. If it were a rocky place or a reef, the car would be pounded to pieces. The crew were all set for the worst while the sound of breaking waves grew louder. A short time later, however, there was a scraping sound on the bottom of the car.

"There is a big cliff or a row of trees, one or the other, right ahead," somebody shouted.

The lopsided blimp strained forward. Wind could be heard rustling through tree branches close at hand. Instead of a cliff, the dark band which loomed ahead was a forest. Somebody reached overboard with the hook and found bottom in shallow water. Again the order to remain aboard was given, while a member of the crew ripped a valve on the rear gas cell and allowed the great folds of rubberized envelope to drag into the water.

Guy ropes were then taken by members of the crew who waded to the shore and fastened them to trees. Through luck, courage and skillful air work, nobody was killed or seriously injured.

91382

MODEL BOAT POWERED BY ICE PROPELLED LIKE ROCKET

Power derived from the carbon dioxide released by "dry ice" is used by a Los Angeles man to propel a small boat. The craft, about eight inches long, is made of molded tin with a screw top above the deck. Inside the boat is a small chamber in which pieces of dry ice are placed, the compartment then being filled about one-third with water and the metal cap screwed on. This causes carbon-dioxide gas to be released violently, and expelled through a tube running along the keel.



John W. Cagle,
2708 Wood St.
Los Angeles, Calif.

Malcolm Pope,
416 Winterhaven
Florida

Samuel S. Gordon
Curator of Minerals

POPULAR MECHANICS

FROM AQUAPLANE TO A GLIDER
IS THRILLING TRANSFER

the crater pressure. A second relief well was drilled on the opposite side of the crater, and later a third was bored. The pull from these wells permitted the filling of the crater-well casing with concrete.

a 1259



"Stunt Man" Thrills Spectators with a Transfer from an Aquaplane to a Glider; the Plane Was Towed by a Speed Boat and the Glider by an Outboard Craft

Sub

Using a glider instead of an airplane and an aquaplane instead of an automobile, a "stunt man" at Winter Haven, Fla., recently thrilled onlookers with an unusual transfer. The aquaplane was towed by a speed boat and the glider by an outboard motorboat. The stunt man rode the aquaplane, and when the glider came over his head, reached up and seized a trapeze—and swung off into space.

LIQUID A MILLION YEARS OLD
IS FOUND IN CRYSTAL

a 1446

Liquid, at least one million years old is contained in a sealed cavity in the center of a beautiful crystal of a mineral known as calcite, recently acquired by the Academy of Natural Sciences at Philadelphia. The cavity contains one-half gill of what is believed to be water with some minerals in solution. The crystal came from lead mines near Rossie, N. Y. Bubbles and small drops of liquid have been found in crystals previously but not in such a large quantity.

Con. Eckhardt

TINY DYNAMIC RADIO SPEAKER
USED IN MANTEL SET

a 1209

Increasing popularity of Lilliputian radio sets has resulted in the production of a tiny dynamic speaker that is incorporated in a four-tube receiver no larger than a mantel clock. This speaker is only six and one-quarter inches in outside diameter and three inches in depth.

refer to Radio



Small Dynamic Radio Speaker. Intended for a Receiver No Larger Than a Mantel Clock

WILD GAS WELL CONTROLLED
BY RELIEF HOLES

1466

By drilling relief holes near it, a wild gas well was tamed recently in Louisiana. The well was brought in at a depth of 2,475 feet with a rock pressure of 1,125 pounds to the square inch and a flow of 67,000,000 cubic feet a day. It broke the casing and formed a crater, 200 feet in diameter and from twenty to forty feet deep. To stop the flow of gas into the crater, which was becoming a menace to the gas field, another well was drilled as close to the crater as was deemed safe. When it was completed with a capacity of 64,000,000 cubic feet, the full flow was turned into a pipe line, thus decreasing

James H. W. Ellmore, Chief Engineer

natural gas Shell Corp.

Utah Radio Products Co
#1504, 360 N. Michigan
Ann Arbor, Michigan

Richard natural gas field

Copyright material

Science Service
536 20, 7/2/31 a1297

STRANGE ANIMALS TO BE SOUGHT BY EXPEDITION

Sailing for the Island of Trinidad, naturalists for the Philadelphia Academy of Natural Science, will make a special study of that strangest of all tropical fowls, the "oil bird." The young of this species are so fat that they are a regular source of food oil for the natives. The Indians each year hold an oil harvest and melt down the butter from the young birds. The product is half-liquid, transparent, has no odor and is so pure that it can be kept for more than a year without becoming rancid. The "butter bird," when grown, has a double tooth in its beak, and its small blue eyes cannot stand the sunlight. It quits its cavern only at night and hunts principally in the moonlight. In the same caves, the naturalists also will seek the curious white bat.



Teaching Parrots to Talk with the Aid of a Phonograph Which Repeats Words While the Class Listens

PHONOGRAPH TEACHES PARROTS TO TALK AND WHISTLE

Teaching parrots to talk in a Los Angeles zoo has been simplified by using a phonograph to recite the lessons. A trainer daily takes four or five birds to a quiet and secluded cage, where they are seated on a perch facing a phonograph to which a loud speaker is attached. Records for beginners carry such familiar phrases as "Pretty Polly" and "Hello, Polly." After an hour of this each day for a week, the most backward pupil usually becomes interested and begins to imitate the sound.

AUTOMATIC FIRE QUENCHER ALSO CALLS FOR HELP



Standing on guard day and night, an automatic fire extinguisher not only operates to put out a fire anywhere near it, but at the same time sounds an alarm likely to bring human aid if needed. It consists of a sealed glass container attached by a frame to a wall

and filled with a liquid gas that will smother flame. In case of a fire, the heat breaks a fusible link, releasing a hammer which smashes the glass container and at the same time sets off a blank cartridge inside the hammer to summon help. The liquid gas is drawn to the flames by the natural circulation of heat and smothers the blaze by shutting off the oxygen.

BALANCE TESTS EGGS' WEIGHT FOR COOK OR FARMER

The weight of eggs is determined by using a new testing balance designed to help the housewife in her cooking and the farmer in selecting eggs for the market, or for breeding purposes. Eggs of a standard weight contain more nourishment than small eggs, helping the cook to determine how many should be used in recipes. A dozen eggs should weigh not less than twenty-two ounces to command the best price, and the testing balance aids in classification for the market.



Colorado has fourteen national forests with a total area of 13,309,549 acres.

Fires Corp. Railway Exchange Bldg. St. Louis

Henry Troemner, 211 Arch St. Phila

Livia Park Peter Jensen

a 1419

Latest Improvements in the World of Autos

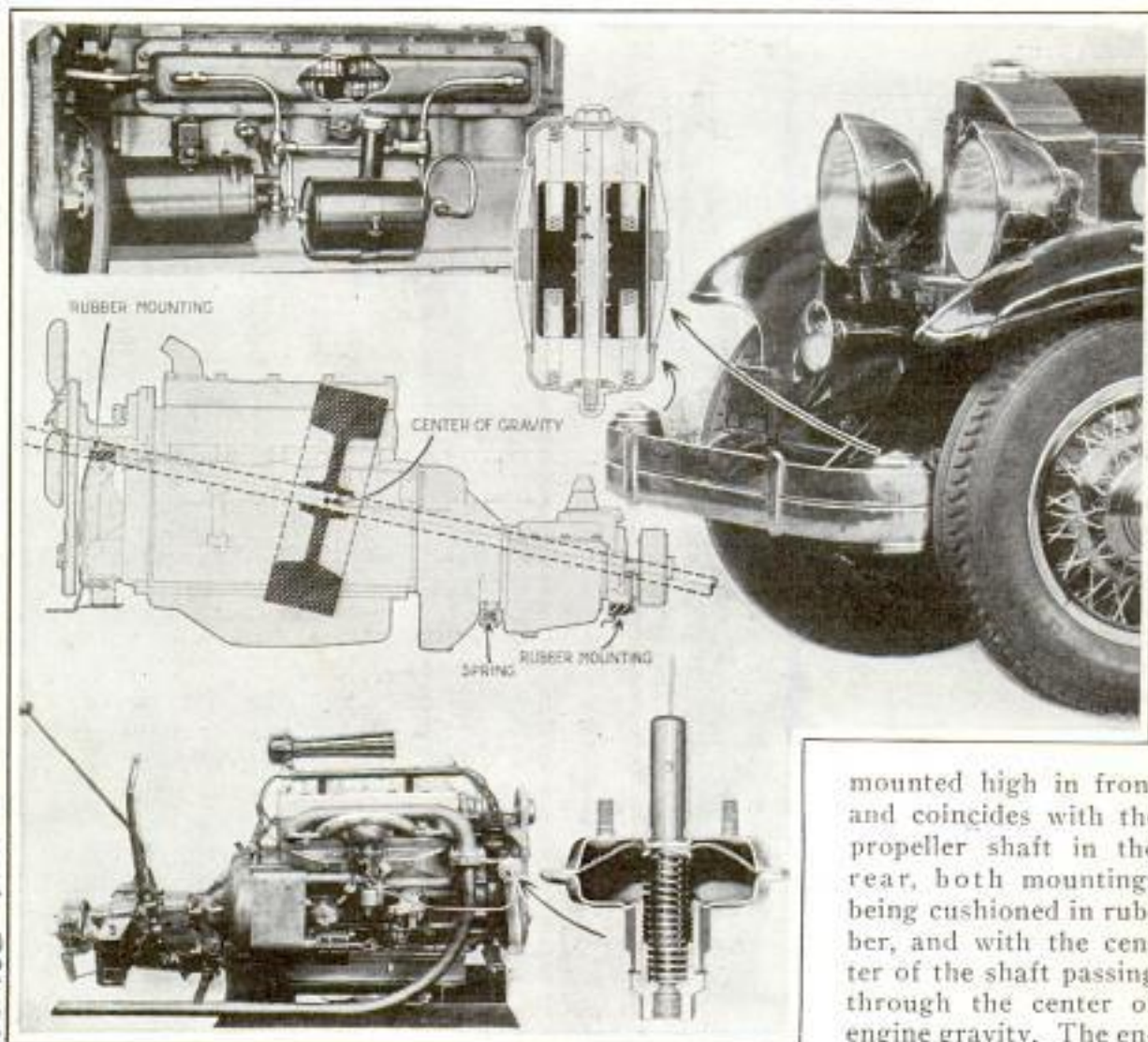

Oil Heat Control, Top, Left; Mounting of "Vibrationless Four," Center, and Pressure Spark Control, Below; Front Vibration Damper Above at Right

mounted high in front and coincides with the propeller shaft in the rear, both mountings being cushioned in rubber, and with the center of the shaft passing through the center of engine gravity. The engine is prevented from swinging too far on its mountings by a spring

Four developments that have resulted in much interest among automobile owners and prospective purchasers have been introduced in recent weeks. One of these is a front vibration damper designed to prevent wobble of radiators, lamps and fenders on rough roads. Two lead weights are placed, one in each end of the bumper. They are supported top and bottom by coil springs and housed so neatly the entire assembly looks like a bumper decoration. A leading manufacturer of four-cylinder cars recently announced a model that operates so smoothly it "feels" like an eight. The engine is placed in the frame just as if it were a huge flywheel on a shaft. The hypothetical shaft is

running from the flywheel housing to a frame member. The same car has its spark advance controlled automatically as the result of changes in pressure in the fuel system. A pipe runs from above the throttle to a diaphragm on the ignition unit. When the throttle is closed and suction increases, the diaphragm retards the spark, but as soon as the throttle is opened and the vacuum decreases, the spark is advanced. An oil-temperature regulator is a feature of a new six-cylinder model. Within an enlarged water-jacket plate are placed two corrugated tubes, through which oil is pumped, cooling it in summer and warming it in winter, thus reducing wear all year round.

torsional vibration dampers.
 Packard & Packard motor Car Co. Detroit, Mich.

Plymouth car - Chrysler Corp. Detroit, Mich.

Nash motor Co. Kenosha Wis.

Designed by Hammerley 1418 U.S.W. John F. Maschner, Worcester, Mass
 • Tincken Island
 Rapids POPULAR MECHANICS 419

ELECTRIC EYE SORTS OUT BEANS DISCARDING BAD ONES

Navy beans are being sorted by an electric eye which discards all those not meeting the required standard of whiteness. The machine inspects the beans one by one and a photo-electric cell, sensitive to changes in light, closes a relay when a discolored bean passes, causing a metal finger to deflect the bad one. The beans are picked up by suction and carried around on the edge of a drum. On their way to the electrical eye they pass a patten which puts them in position so each can be viewed. As a dark bean appears, the normal current passed by the photo-electric cell diminishes, this drop acting to energize an apparatus which operates the finger.



Automatic Elevator Rises from Kitchen to Table with Food Ordered by Dropping Card into Slot

"WEATHER" IS MADE TO ORDER IN GLASS-TUBE "WORLD"

Weather is made to order in a series of tubes assembled at the California Institute of Technology to represent the processes by which nature forms rain. At one side is a lamp and reflector in the role of the sun. The heat warms a blue liquid in a glass tube representing the ocean, and the fluid rises in the tube, or air, then condenses into "clouds" in a horizontal section at the top. Passing through the horizontal tube, the clouds cool and condense moisture, or rain, which drops into a reservoir and from there into a tiny glass bowl, then into another tube representing a river and returns to the ocean.

ELEVATOR SERVES DINER FOOD FROM KITCHEN BELOW

Guests in a "magic restaurant" select their table, mark on a card the food they want, drop the card into a slot, and the food is served quickly on four silver trays or shelves which rise on an elevator from the kitchen to above the table level. The device has been patented to eliminate tray carrying and tipping, and to increase seating capacity by doing away with lunch counters. The menu has a metal edge which forms an electrical contact with a bell when dropped into the slot.

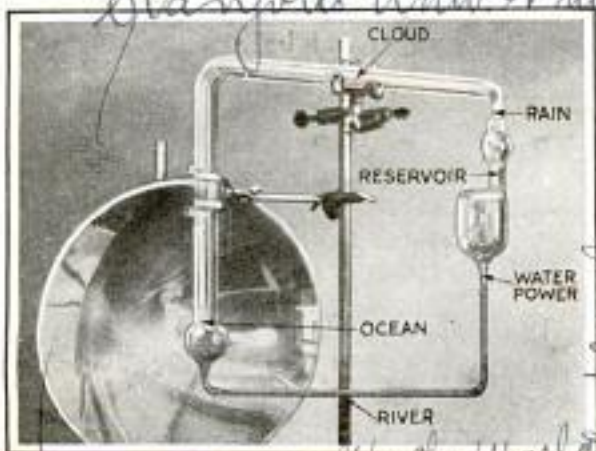

Assembly of Tubes Used with a Light to Demonstrate Process by Which Nature Makes Rain

SEA LIGHTED DEEPER IN TROPIC THAN POLAR LATITUDES

That latitude has a far-reaching effect on the distance light will penetrate sea water has been proved by scientists in recent investigations, still uncompleted. It was found at thirty-three degrees north latitude, light of a certain intensity penetrated to 800 meters, while at fifty degrees it went to 500 meters' depth, and at sixty-seven degrees the same intensity was recorded at a depth of only about 200 meters.

Stanford P.O. Calif

Dr. Austin H. Clark, Curator, Smithsonian Institution
 Washington, D.C.

Acme newspaper
#20842 na
Newport

9/22/27

Burning

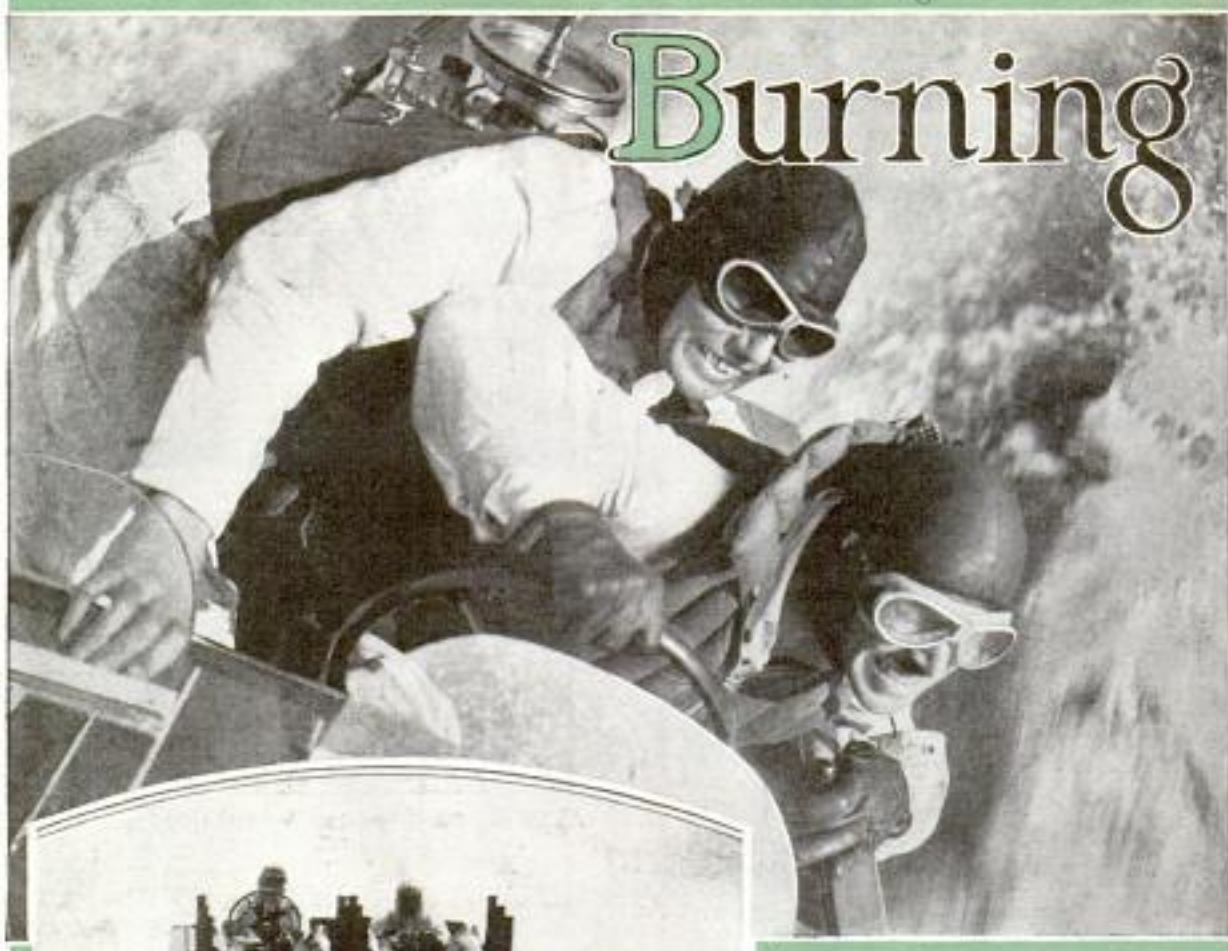

Top, Taking a Turn "in High," and, Below, Gar Wood at the Wheel of His Newest Demon of the Water

and each has broken the record set by the other in isolated time trials.

On Labor Day weekend, these two famous speed monsters will meet on the race course on the Detroit river to compete for the British International (Harmsworth) trophy, carrying with it championship in unlimited power, and held by Gar Wood since 1920.

Gar Wood's "Miss America IX" is the development of almost twenty years of experience in the building of fast racing craft.

"Miss America IX" is a single-step hydroplane, with the lines, however, are drawn to give the craft the utmost in speed for the power she carries. Wood also says the hull will respond to a lot more power than she now has.

NIP-AND-TUCK rivalry for the world's motorboat speed record between Gar Wood's "Miss America IX" and Lord Wakefield's "Miss England II," has fascinated the entire world. Both boats have now topped the 100-mile-an-hour mark

step in a straight line athwartships.

415 Connecticut Ave
Detroit, Mich

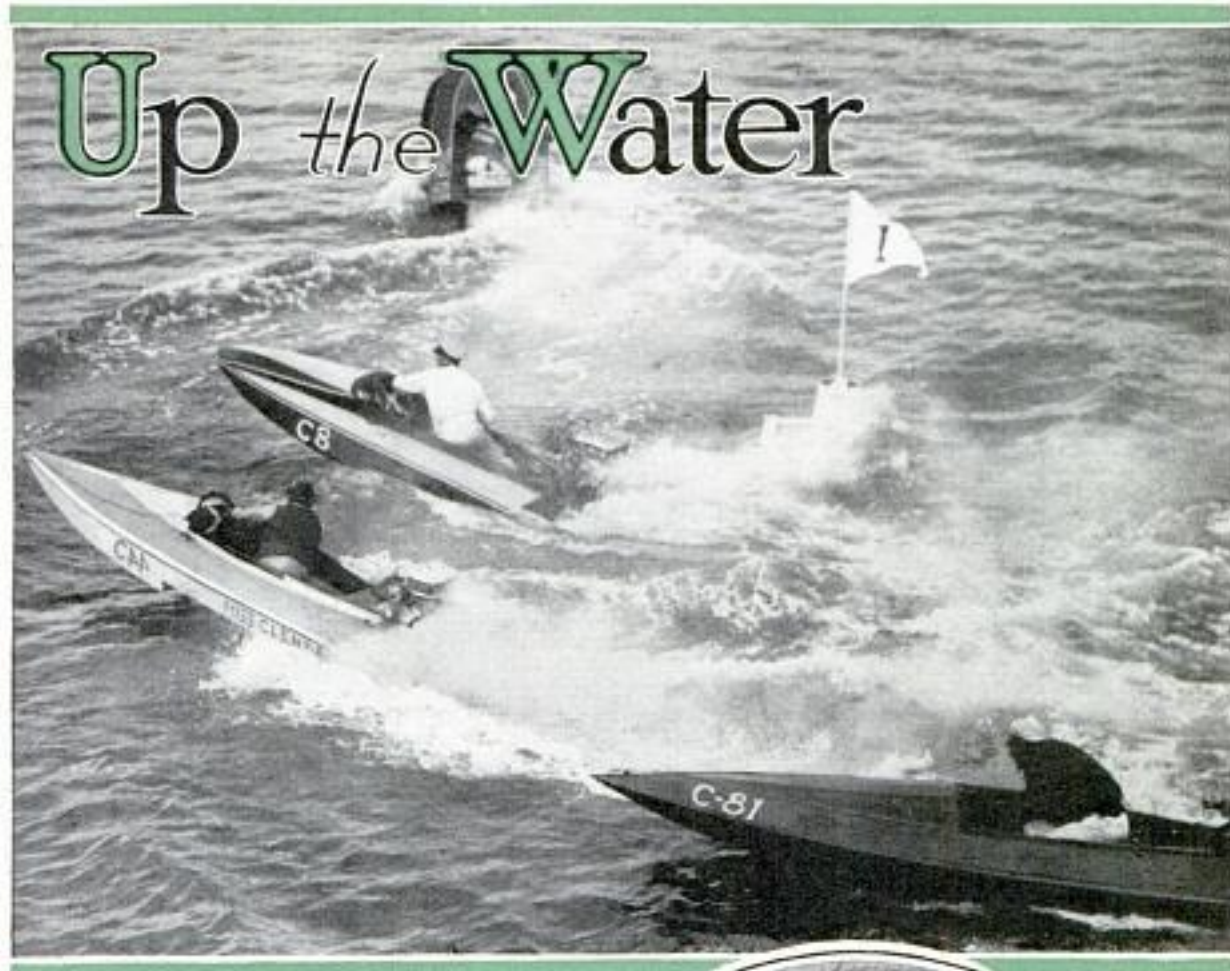

The step hydroplane rides on a "cushion of air" while in speed. The boat gets up on top of the water and runs on a wetted surface of small expanse.

"Miss America IX" is twenty-eight feet long with a beam of eight feet, seven inches. The driver and mechanic sit in the extreme stern behind the engines, and the complete outfit, without fuel or crew, weighs close to 8,000 pounds.

"Miss England II" is the result of two years' experimentation by a group of British sportsmen under the leadership of the late Maj. Sir Henry O. D. Segrave. This brilliant and fearless man succeeded in developing "Miss England I" into the fastest single-engined boat in the world, driving her to the 92.8-mile mark with only one Napier Lion twelve-cylinder engine rated at 960 horsepower.



An Exciting Turn around a Buoy, Above, and, Below, Gar Wood and His Mechanic, Orlin Johnson, in "Miss America IX"

"Miss England II" is thirty-eight and one-half feet long with a beam of ten and one-half feet. She is thus ten feet longer and almost two feet wider than "Miss

91224

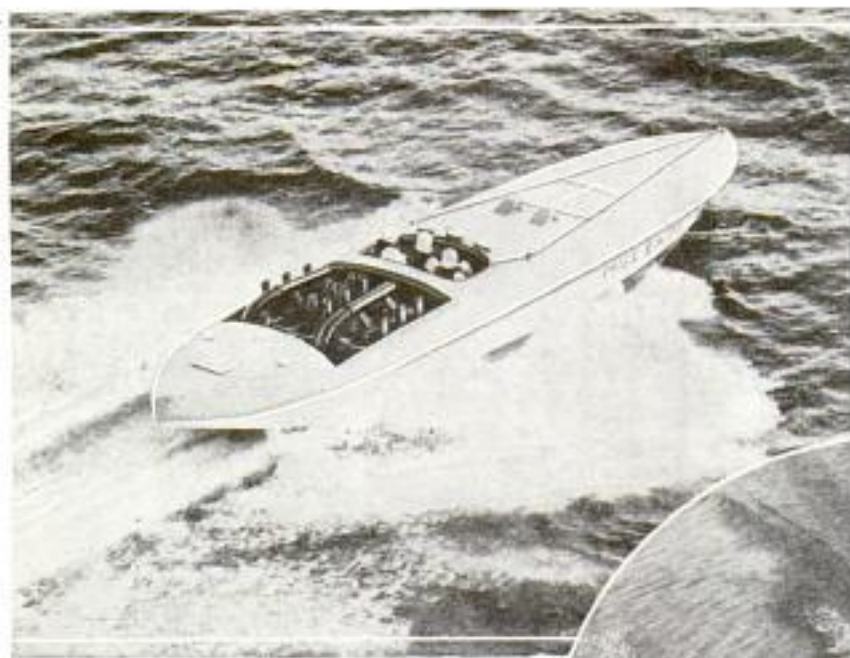

"Miss America IX" is a twin-screw craft with her propellers turning outward in opposite directions, thus balancing the boat.

The smallness of the single propeller on "Miss England II" is required to allow it to turn up at the terrific speed of 12,000 revolutions per minute



America IX." The British racer, too, is a single-step hydroplane, only her step comes to a point in a shallow V-design instead of being transverse, as with the Gar Wood boat. She weighs only 1,000 pounds more than "Miss America IX." The great beam of "Miss England II" is to offset the twist of the propeller, as she is a single-screw boat. The driver and mechanics—there are two required for her—all sit forward of the engines, an arrangement which is regarded in this country as especially hazardous in case of accident at high speed.

"Miss England II" Snapped from the Air at 103.73 Miles an Hour; Below, Boat Ride on the Grass

The engines in "Miss America IX" are Packard aviation motors, each delivering 1,060 horsepower.

The engines in "Miss England II" are secret motors developed by Rolls-Royce under supervision of the British air ministry for war purposes, and set an official boat record July 9, at Lake Garda, Italy, of 110.25 miles per hour.

The power application of the two boats is radically different. That from the twin motors in "Miss America IX" is transmitted forward to two separate gear boxes, one to each shaft.

In "Miss England II" the twin motors deliver their power to a single gear box which transmits the total power to a single propeller shaft.

and also to keep down the "twist" incident to all single-screw boats.

The steering mechanism on "Miss America IX" is most simple. It consists of a single bow rudder about the size of a post card—four by six inches.

"Miss England II" is steered by a special secret mechanism about which the late Sir Henry was most enthusiastic. There are two rudders, one forward and one aft, and in speed she appears to wobble somewhat.

Both boats have to slow down at the turns, but it is certain that Wood with his twin screws will swing them all at much faster speed than will Kaye Don, who will drive "Miss England II" in the attempt of her owner, Lord Wakefield, to lift the Harmsworth trophy.



The Merry-Go-Round, consisting of a Boat Hooked by Cable to a Swivel on a Post, Like So Many Test Devices, Has Become a Popular Sporting Medium; the Apparatus Was Originally Designed to Test a Boat in a Limited Area of Water, but Sporting Enthusiasts Have Changed Its Purpose and Added Hurdles Such as Above



Al Thompson, Above, at the Tiller of the "Black Maria III" as She Bucks the Waves at High Speed during One of the Preliminary Races in Preparation for the National Midwinter Outboard Championship Held under the Auspices of the American Powerboat Association on Lake Elsinore, Los Angeles.



Getting Ready for a Real Thrill in the Rolling Boat, Above; the Craft Originally Was Designed to Test the Inherent Stability of a Boat and the Maximum Steering Capacity of the Outboard Engine, and Was Built to Roll Completely Over in the Event of Tipping; at the Right, Is Seen the Boat in Action, Rolling Completely Over



a1069
424

J. W. C. L. Powell, Pres
Caisson Contracting Co.
POPULAR MECHANICS
51 & 42nd St New York

Giant Auger Bores Caisson Holes in Earth

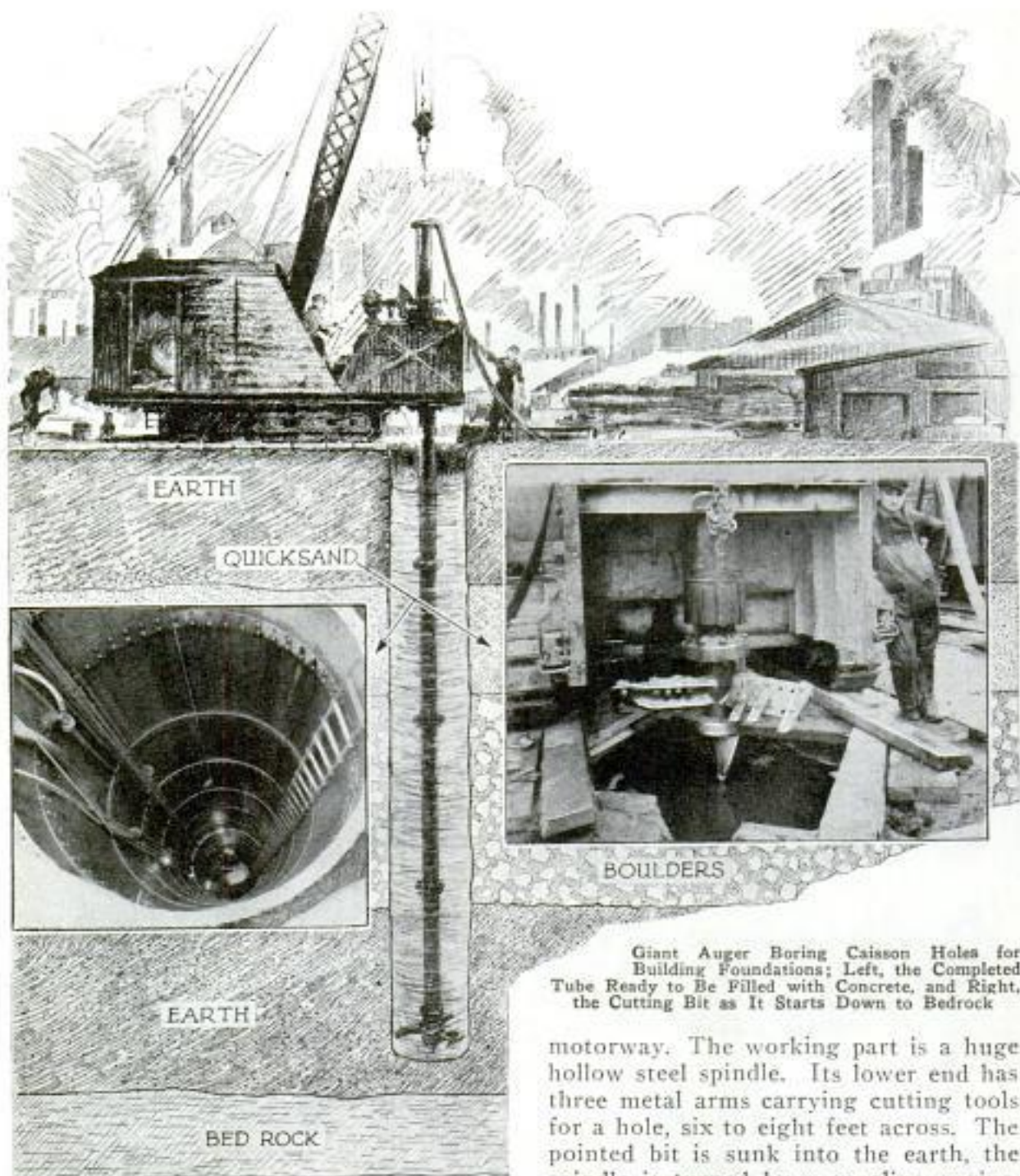

Giant Auger Boring Caisson Holes for Building Foundations; Left, the Completed Tube Ready to Be Filled with Concrete, and Right, the Cutting Bit as It Starts Down to Bedrock

A giant auger that bores holes for foundation caissons to bedrock has given sidewalk crowds something new to watch. Instead of forcing down a cylinder or a heavy box in which the diggers work in compressed air, to keep water from entering, an augerlike rotary drilling machine was employed to set the supporting piers for part of a New York elevated

motorway. The working part is a huge hollow steel spindle. Its lower end has three metal arms carrying cutting tools for a hole, six to eight feet across. The pointed bit is sunk into the earth, the spindle is turned by a gasoline engine, and water is forced down the tube to moisten the soil. The device leaves the muddy material where it is, to prevent collapse of the walls. The method of excavation can be employed even near the foundations of large buildings without endangering them. As the spindle descends, sections are joined to it to make it fifty, sixty or even ninety feet long. When bedrock is reached, the path of the

Clarence De Luca's
Research Ass't.

21334

Bureau of Fisheries POPULAR MECHANICS

425

drill is surrounded by steel casing, capped with steel beams temporarily and pounded down with a pile driver. The mixture is pumped or scooped out with orange-peel dredging buckets.

GOLDFISH VALUED AT MILLION RAISED EACH YEAR *a 1451*

Rearing goldfish for the United States market has developed into a \$1,000,000 industry. The trout and pond-fish industries increase the total value of fish farm products to above \$2,000,000 a year, according to department of commerce figures. Natural lakes in Colorado are used in trout raising, about half the water acreage of the industry being located in that state. Increasing demands for all kinds of fish have spurred efforts of fish farmers throughout the country.



Cannot locate maker

Wide World
Inflated Arm Bands Which Keep Head above Water While Beginner Is Learning to Swim

SAFETY KNIFE FOR PARACHUTE AIDS JUMPER IN ACCIDENT *a 1367*

As an aftermath of a recent mishap in which a parachute became entangled in the struts of an airplane as a jumper leaped from it, a safety knife and sheath has been designed for use of the occupant of the chute in a similar emergency. The knife fits in a pocket attached to the harness, enabling the jumper to cut himself free and rely on his emergency parachute.



Parachute Harness Equipped with Safety Knife to Enable Jumper to Free Himself in Emergency

SLEEVE-BAND LIFE PRESERVERS AID NOVICE SWIMMERS

Learning how to swim is simplified for beginners by inflated arm bands which fit on each upper arm and keep the head above water while the novice is perfecting his strokes. These side-wing life preservers are not bulky and do not interfere with arm motions in the water.

OLD ALPHABET LIKE DRAWINGS OF SPEAKING LIPS *a 1471*

Forms of the letters in a recently discovered old Phoenician alphabet show evidences of having been chosen to represent the forms of the mouth used in speaking them. This theory is advanced by Sir Richard Paget, an authority on human speech, who finds that nearly every one of the twenty-nine symbols used is suggestive of the lip formation to produce the sound symbolized. He does not suggest that the scribe who selected the mouthlike characters did so intentionally, but believes instead that the forms were chosen unconsciously. The letter "P," for instance, is represented by a sign suggestive of the closed lips used at the start of pronouncing it.

*Capt. H. Chas. H. Steyerwalt, Air Corps
Charlottesville, Va. Field Hospital*

*Submitted to War Dept
by Sgt. Nichols, Charvite
Field*

*Article on Nature
Service
7/31/31*

Science Service 5 36 20

7/2/31

a1360



Sign Reminds Passers-By of Old Whaling Days and Points Way to Shipyard

SIGN OF WHALEBOAT IN DAVITS POINTS WAY TO SHIPYARD

Days of historic whaling ships are recalled by a Massachusetts shipyard sign which shows a whaleboat, of the type in which the harpooners used to take off from the mother ship, slung to the davits. Even the ropes and tackle in the sign appear as they did in the old days. The shipyard is on the harbor opposite the famous old whaling port of New Bedford.

ALBUMEN IS MADE FROM COAL IN SYNTHETIC FOOD HUNT

Albumen has been produced from coal in the hunt for synthetic foods. Prof. Wilhelm Glud, a German scientist, who discovered the process, says it is possible to obtain all the elements of albumen from coal at a cost that will enable artificial albumen to compete easily with the natural product. The professor believes the world is on the verge of wrestling synthetic sustenance from coal from which a man could live. The albumen is taken from amino acid that is found in coal and coke.

an address by Prof. Glud in Coal Research at Bochum, Germany

WOOD FOR PENCILS SO SCARCE ALASKA MAY SUPPLY IT

Supplies of pencil wood near large factories are becoming so limited, the industry now is investigating the utilization of Alaskan red cedar, the finest-grained wood grown in the northwest. Pencil wood must be soft, light yet strong, close and straight-grained and free from defects. The older the tree, the better pencil material it makes. Wood from the heart of aged logs that have lain for years in deep forests makes the best. Another possible substitute for cedar is Pacific coast myrtle. It is light, straight-grained, well scented and of good color. Both cedar and myrtle are immune from the effects of sudden climatic changes.

RARE "JADE" CARVING OF BEADS IMITATES CHINESE WARE

Rare Chinese carvings in jade, quartz, amethyst or other extremely hard substances, usually in the form of trees and flowers, the work of generations of Orientals, and therefore extremely costly, have been cleverly imitated. Wires are wrapped with tinsel, glass leaves are made to imitate the amethyst or jade, and glass beads are strung on the wires.

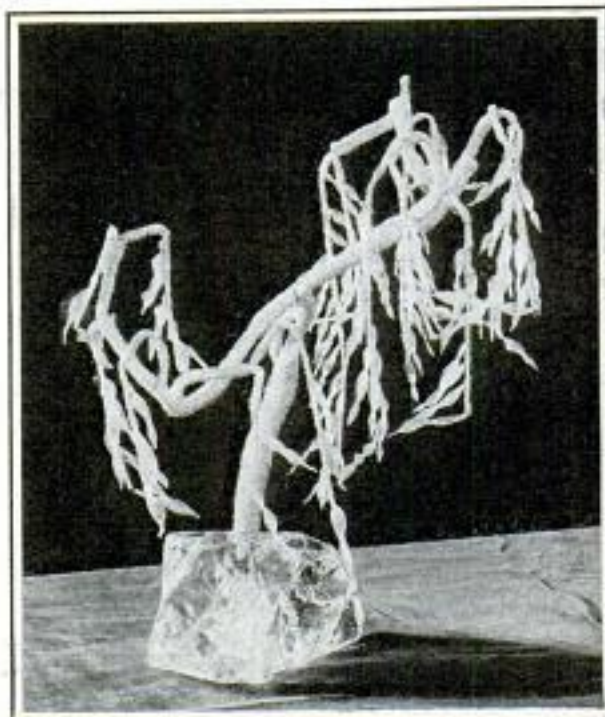

Costly Chinese Jade Ware Is Imitated in Figures Made of Glass Beads and Wire

Eckhardt

Copyrighted material

Fairbairn

W. J. Jones 6/27/31

a1349

Blackington Service

91271 Col. William Atherton 2d Pay
1869 Winwood Place, NW
Washington DC

Gold of All World's Mines Dwarfed by Oil Field



By **RAY LYMAN WILBUR**
Secretary of the Interior

A BROKEN, barren sunbaked ridge in California, five miles wide and thirty miles long, known as Kettleman Hills, has proved to be the richest oil field in the world and the greatest storehouse of wealth ever uncovered by man. There nature's oil tanks, a mile and a half underground, have been tapped by two score wells, and the flow, now restricted, may be started at any time as simply as one turns a spigot. When this is done, a forbidding strip of waste land, shunned and despised three brief years ago, will produce riches faster than it ever came from all the gold mines of the world combined.

The government, observing this possibility, and having considered the wastes incident to competitive development, has decided to use this oil field as an example in oil-field conservation so spectacular that all the world will take notice.

In an attempt to measure this oil bonanza, it may be compared to Cripple Creek, Colo., which reached the maximum of gold production in America from a

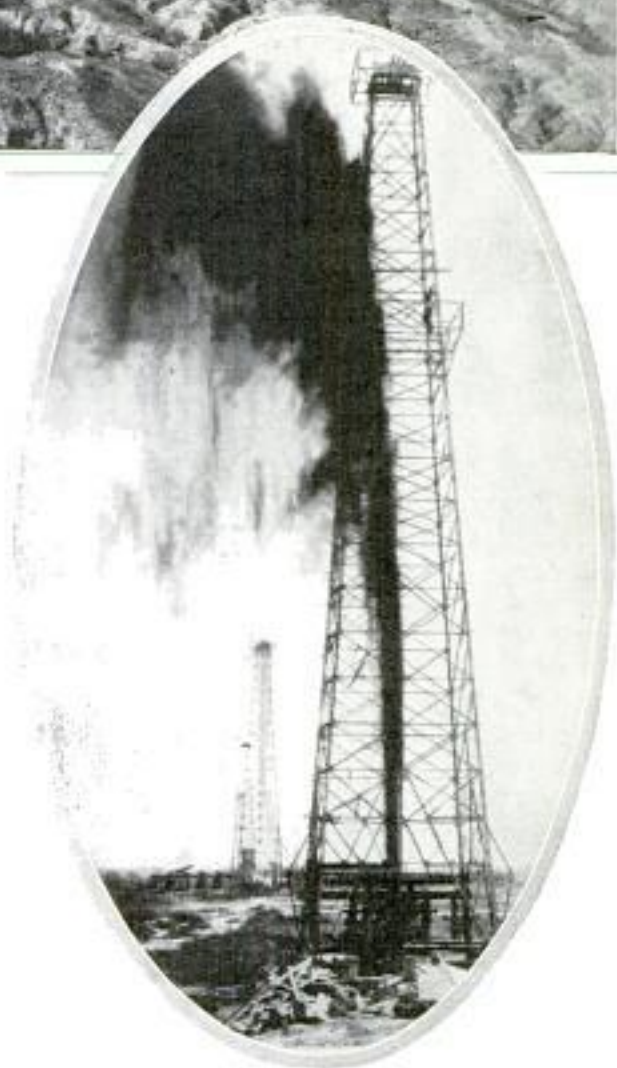

Above, Barren Land in Kettleman Hills, Selling for \$100,000 an Acre; Below, Well Out of Control

91271



single field in 1900, when it yielded \$18,000,000; or the famous Comstock lode in Nevada, which, in 1877, produced \$14,000,000 worth of the yellow metal. When three wells had been brought in at Kettleman hills, that area was producing wealth faster than either of these gold fields at its maximum.

Mother Earth, molten in the heart of her, shrinking as she cools, here and there has made continent-long cracks in her ten-mile-thick crust. In milder moods she merely wrinkles it. Just this was done in California. A group of such wrinkles rambled for a hundred miles along the east fringe of San Joaquin valley. The geologists call them "anticlines." Wherever they are found, they say, it is worth while to look for oil.

An anticline is a formation made out of the earth's stratifications that is not unlike a great bathtub turned upside down. Deep below these inverted tubs, nature brews oil and gas out of water creatures that died millions of years ago. Nearly all of the gas has dissipated itself. Only these anticlines, and kindred for-

mations, form traps that catch it. Into them it may have crowded, always increasing its pressure, liquefying, rearing to go. Puncture the bottom of one of these topsy-turvy tubs and it hisses forth just as the gas in a ginger-ale bottle if a tack is driven into its cap.

The history of drilling in Kettleman hills reveals a generation's story of the increasing depth of oil wells. In 1900, half a dozen attempts were made in this area,

ranging in depth from 600 to 1,000 feet. Later, more wells were started, some of them going down 5,000 to 6,000 feet and encountering many oil and gas showings, but nothing of value.

This deep drilling for oil is one of the mechanical marvels of the age. Conceive of the drill at the tip of a string of pipe, boring through the various rock strata of the earth, refusing to be stopped by flint-hard layers hundreds of feet thick, or diverted when glancing blows strike the sloping side of huge

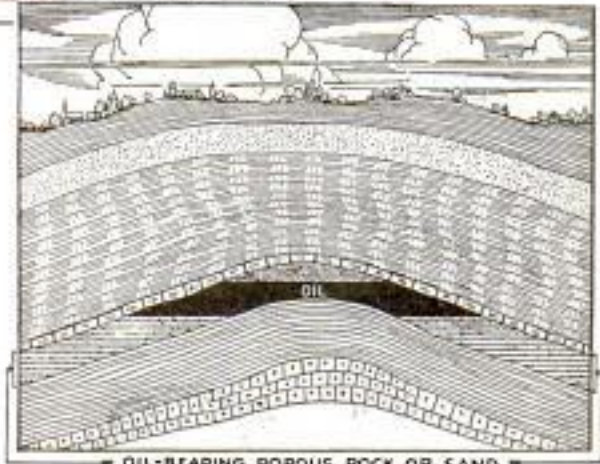

Top, Oil Map of U. S.; Center, Gusher in a Lake of Oil; Bottom, Typical Foundation for Oil Field

91271

91416

bowlders. Conceive this little tool at the end of a string of pipe, half a mile, a mile, a mile and a half long, feeling its way, meeting emergencies, leaving behind it a channel that will remain in place and carry without leakage a roaring and high-pressure torrent if the exploration turns out successfully.

So finally came Harris Hammond, son of John Hays Hammond, who decided to plunge for the fluid gold where others had failed. He drove a well 7,200 feet deep, at a cost of \$250,000, and found incomparably greater wealth than had his father in South Africa.

The government owned nearly half the Kettleman land, but had leased it for development. However, it could exert certain pressure on its lessees. So a policy of conservation was adopted. Special legislation was put through congress. A state law, prohibiting the production of oil until the gas coming up with it could be used, has gone into effect and is being fought through the California courts.

The result will be a systematic development of the field in order that its entire wealth may be conserved and ultimately used. Oil and gas will be produced only as it is needed. Gas sufficient to supply California for two generations will be saved instead of escaping into the air.

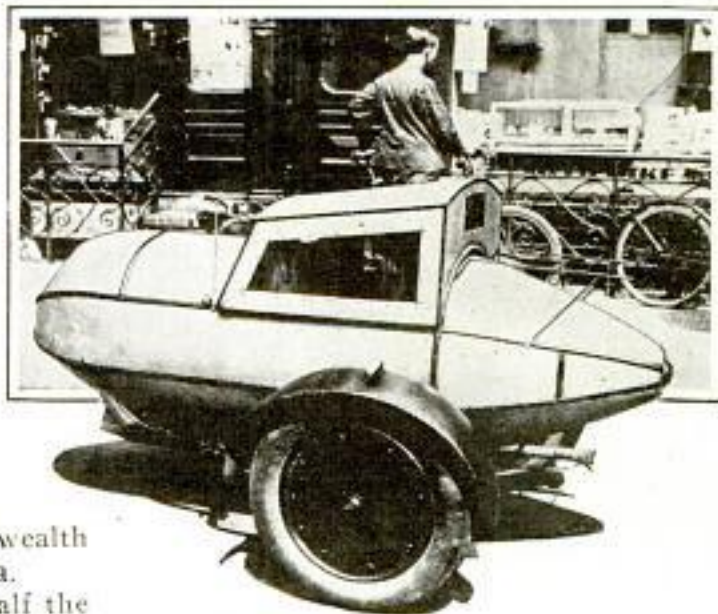

Streamlined Sidecar Reduces Wind Resistance to a Minimum; Note How the Car Follows Zeppelin Lines

Keyline
ZEP SIDECAR FOR MOTORCYCLE CUTS WIND RESISTANCE

Wind resistance has been reduced almost to a minimum by a Zeppelin-shaped sidecar for motorcycles. The car, exhibited in Germany, is a one-man limousine, with front, side and rear windows.

PUNCTURE-PROOF INNER TUBES LINED WITH PLASTIC

Puncture-proof inner tubes that repair themselves are now available to the motorist. Between two layers of cured rubber, these tubes have a lining of plastic rubber which forces its way into any opening and prevents air from escaping. The tubes are installed as easily as the ordinary kind and are built to fit in shape and size the tire with which they are to be used.



91420
Pruesary
Rubber Products Corp
3500 Michigan Ave
Chicago

WRECKERS START AT BOTTOM TO RAZE BIG BUILDINGS

There are more ways to wreck a building than by starting with the lightning rod and working down to the basement. In fact, with time at so great a premium and with contractors tearing down buildings in one or two months that took one or two years to raise, the wrecker of big buildings nowadays starts at the bottom and works up. All bulky and valuable objects in the basement now are cleared out first, and the men work up, floor by floor, to the top, gathering what material can be salvaged, and cutting holes through the floors and ceilings. Then the building starts to come down about a floor a day. Bricks, stones and other material are dropped through the holes into the basement, where steam shovels pick up the rubble, place it into trucks and it is carted off. As the steel work is exposed, it is cut away with torches and sold for remelting or used to shore up other construction, such as subways.

10/5/21
N.Y. James
Albert A. Volk & Co.
1819 Broadway
New York

Making Home Tasks

91365



Left, Automatic Electric Iron for the Home; Ironing Pad Is Vibrated by a Small Motor Which Pats Out Wrinkles Instead of Applying Pressure

91374



Right, Small Flashlight with Loop Handle Which Stands at Any Angle

91255



Left, Machine-Gun Bubble Blower That Shoots Stream of Bubbles into the Air

91216



Left, Tomato Slicer That Cuts Even Sections When Knives Are Lowered

91375



Above, Automatic Safety Attachment for Electric Wringer; If Hand Is Drawn into Wringer, Feed Belt Rises and Shuts Off Power

Below, a Playhouse for the Children Made of Sturdy Fiberboard

91328

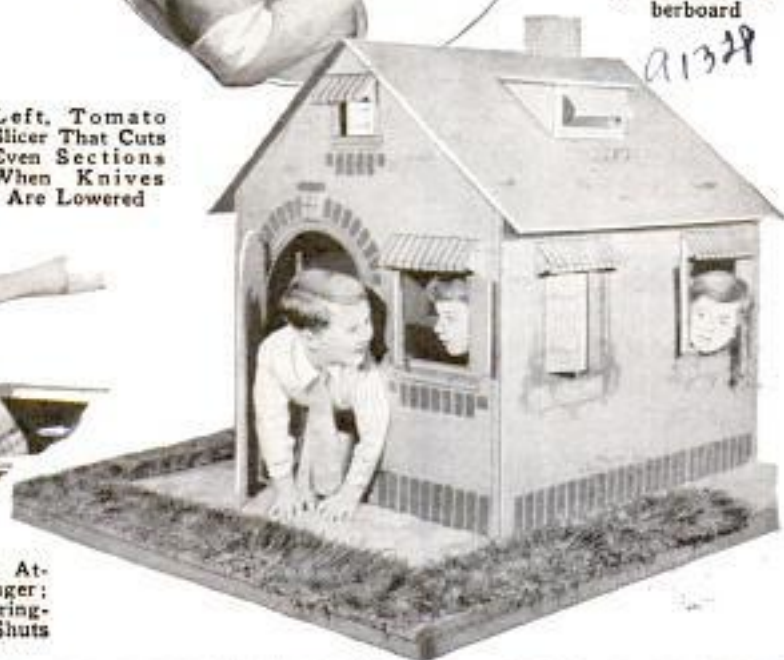

a Pleasure

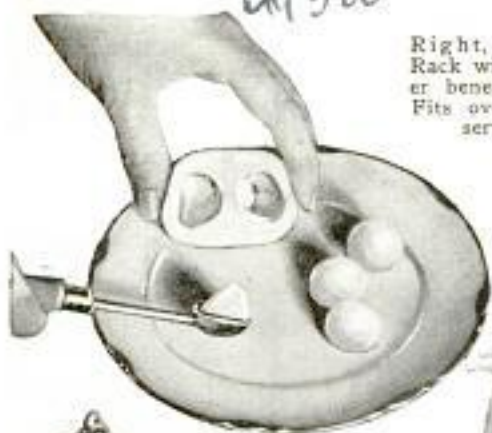

Right, Folding Clothes Rack with Electric Heater beneath It; a Cover Fits over Rack to Conserve the Heat



Above, Hemispherical Spoon for Cutting Fruit or Other Foods into Fancy Balls; Left, Air-Tight Bottle Stopper That Is Applied Easily by Hand

a1226



Left, Handy Flour Sifter That Opens When Handle Is Pressed; It Can Also Be Used as a Strainer and for Removing Eggs from Hot Water



Above, Metal Plate for Campers Divided into Three Compartments

a1375



Right, Wall Paper Covered with a Cellulose Coating Which Makes It Washable; the Coating Also Resists Dirt

a1468
432

Experimental plot handled by
Pacific Commercial &
a part of Bureau of
POPULAR MECHANICS
Plant Industry

Illustrated by
Mr. H. J.
Smiley and
Mr. L. Maughan



Photo by Ewing Galloway
Tractor at Work in a Philippine Rice Field and, beside It, a Carabao Which Formerly Did the Work Machines Now Are Doing

varied by turning a hand-wheel for any speed between a ratio limitation of three to one.

ULTRAVIOLET-RAY BATH FOR COLDS

a1465

Reduction of fifty-three per cent in the frequency of colds among a group of fourteen Cornell University women is the latest record in the battle to stamp out this common health menace. Seventy-five men taking the Cornell treatment showed a reduction of forty-two per cent. The treatment is simple, but the most important phase of it is an ultraviolet bath of from ten to fifteen minutes duration each week. In addition regular doses of some

alkali are given twice each day. Diet restrictions are imposed, ventilation recommendations are given, and eight hours' sleep each night is insisted upon.

TRACTORS INVADE RICE FIELDS TO SUPPLANT CARABAO

Antiquated methods of production are gradually giving way to modern machinery in the Philippine rice fields. For years the carabao, a kind of water buffalo, has been the one means of power that could perform successfully in the water and heavy mud of the rice paddies. Now, however, tractors are doing a large amount of this work and are supplemented by modern threshing machines and rice mills.

CARBON PAPER IS ELIMINATED BY DOUBLE RIBBONS

a1387

Duplicate copies now can be made on a typewriter without using carbon paper by means of an attachment that fits on the carriage and contains two extra spools of ribbon, synchronized with the regular ribbon. Each of the extra ribbons fits between two sheets, enabling five copies to be made simultaneously. The ribbons wind from side to side as does the original, and after a key is struck, a release movement allows the carriage to move to the left without interference. The extra ribbons drop into place between the sheets at the touch of a lever.



VARI-SPEED PULLEY ABOLISHES GEARS AND CHAINS

a1380

Several speeds are available in a motor pulley which is mounted directly on the motor shaft and forms the driving element between the motor and the driven shaft. Auxiliary equipment, such as chain drives and gears, is eliminated by this pulley. The design and construction details are unusually simple, the speed

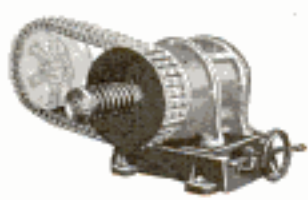

Wm. C. H. Thornblade

Chicago-39 S. Clinton

Reeves Pulley Co
Columbus, Ohio

Original Copyrighted &
Northern Copy Power
Seattle Wash.

Rubber-Plant Botany in Your Own Home



Rubber Plants in the Home Can Be Increased by the Method Shown Above, Which Involves Cutting Away a Few Leaves, Wrapping the Cut in Moss, and Watering Until Roots Sprout

Housewives who grow rubber plants as an adornment for the home can increase the number of such plants by a simple process that is being employed successfully by some botanical gardens. Three or four leaves are cut away from a branch, care being taken not to injure the eye at the base of each leaf. Moss is wrapped around the cuts and the tapped branch and moss are watered occasionally. When roots begin to sprout from the moss wrapping, the branch is cut from the plant close to the moss and placed in another pot where it is given a start in life. Two or more tapplings can be made simultaneously on one healthy plant.

GHOST NEBULÆ MADE VISIBLE BY EYE OF BIG CAMERA

Roving island universes in the vast recesses of the sky are being pictured by the giant camera at Mt. Wilson observatory as they were millions of years ago, not as they are today. These ghost pictures are being obtained, explains Dr. Edwin Hubble, because the groups are so far away that light from them, traveling 186,000 miles a second, takes from 100,000,000 to 250,000,000 years to reach the earth. Thus, when a picture is obtained, it is only a view of what they were that long ago. These nebulae average about 100,000,000 times as bright as the sun, but are seen only as faint points of light by the most powerful telescopes. The stellar

Tribune 6/18/31

system of some 30,000,000,000 stars is but one island universe, known as the Milky Way galaxy, and it spreads over an area represented in miles by the figure 960 followed by fifteen ciphers. It is beyond this that the work of the star explorers begins. It is estimated that about 30,000,000 island universes are within reach of the Mt. Wilson telescope.

ROLLER MADE FROM OLD AUTO KEEPS TENNIS COURTS FIT

Tennis courts of one club at Lincoln, Nebr., are kept in condition with a roller made from material found in an automobile junkyard. It is mounted on an auto chassis and driven by an old car motor. The implement weighs 2,500 pounds, and can do the work of five men, rolling seven courts in about fifteen minutes.



Tennis-Court Roller Made from Parts Found in Auto Junkyard; It Does Work of Five Men

Ans Joe Stanton
Lincoln, Neb

Emb Joe Wang 3102
Lincoln, Neb

a1126 Cmt. Uthaj Vincent Weber
1331 Es St. N.W.
Washington, D.C.

Are You a

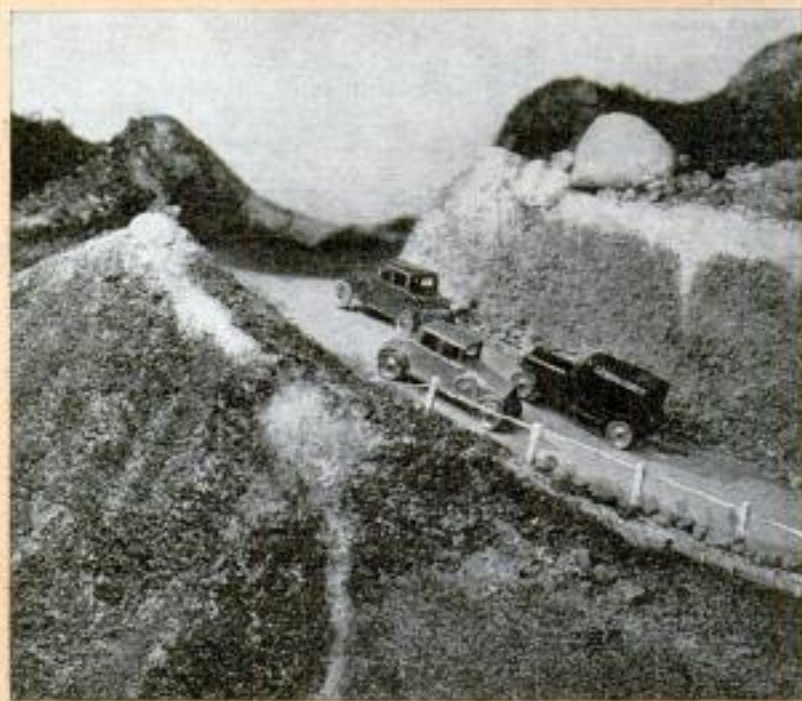
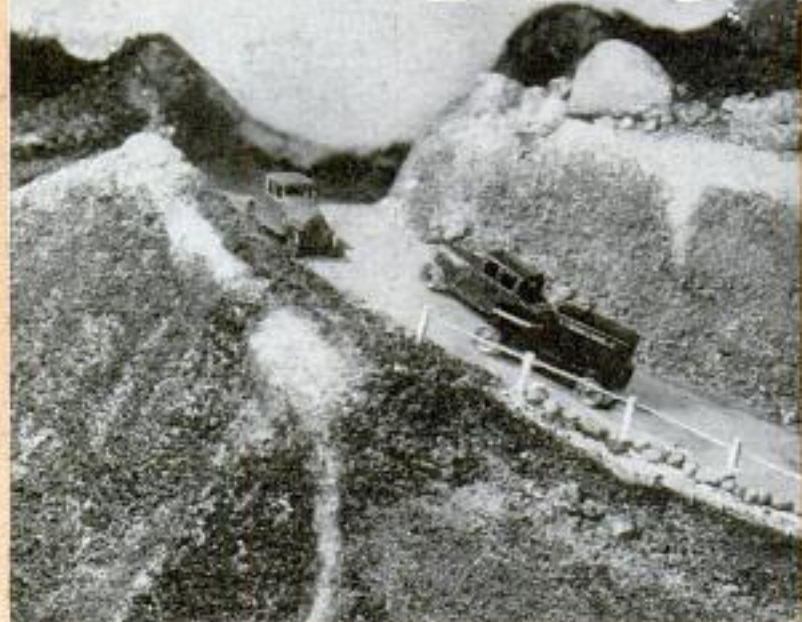

“Worse than War” Toll of Fifty Thousand Auto Deaths Is Largely Due to Disregard of Rules

refer to certain all-too-common types of automobile drivers and pedestrians who, through carelessness or indifference, cause most of the serious motor-vehicle accidents in this country. And last year there were 835,250, with 32,500 deaths.

Probably the worst offender is the turtle driver. His name fits him perfectly, Mr. Smith says, because he has the habit of sitting at the wheel with his head down like a turtle in its shell, and literally shutting his eyes to whatever is happening on the road. He's the chap who whizzes past you on your right and then bawls you out if you clip him; who makes a devious and sudden turn without trou-

The Wrong and the Right Way to Drive over a Hill: Attempting to Pass Will Cause a Collision or the Downcoming Car Will Leave the Road

DO YOU belong to the grand army of “turtle drivers”? Or do you qualify as a “street ostrich,” a “sidewalk edger,” a “green gazer” or a “red rusher”?

Let's hope you can answer no to all questions. For these queer and striking terms, just devised by Ernest N. Smith, of the American Automobile association,

bling to put out his hand; who disregards a boulevard sign, or backs out of an alley at twenty-five miles an hour.

A close second, as an ever-present menace to safety, is the street ostrich. He's the type of pedestrian who might be called the sidewalk counterpart of the turtle driver. One minute you'll note

Turtle Driver?

him aping the ostrich, shambling carelessly along a crowded intersection reading a newspaper; later on, he'll dash blindly from behind a parked car, and later still, will jay-walk in the middle of a congested street crossing.

As for the sidewalk edger, he has the annoying and perilous habit of

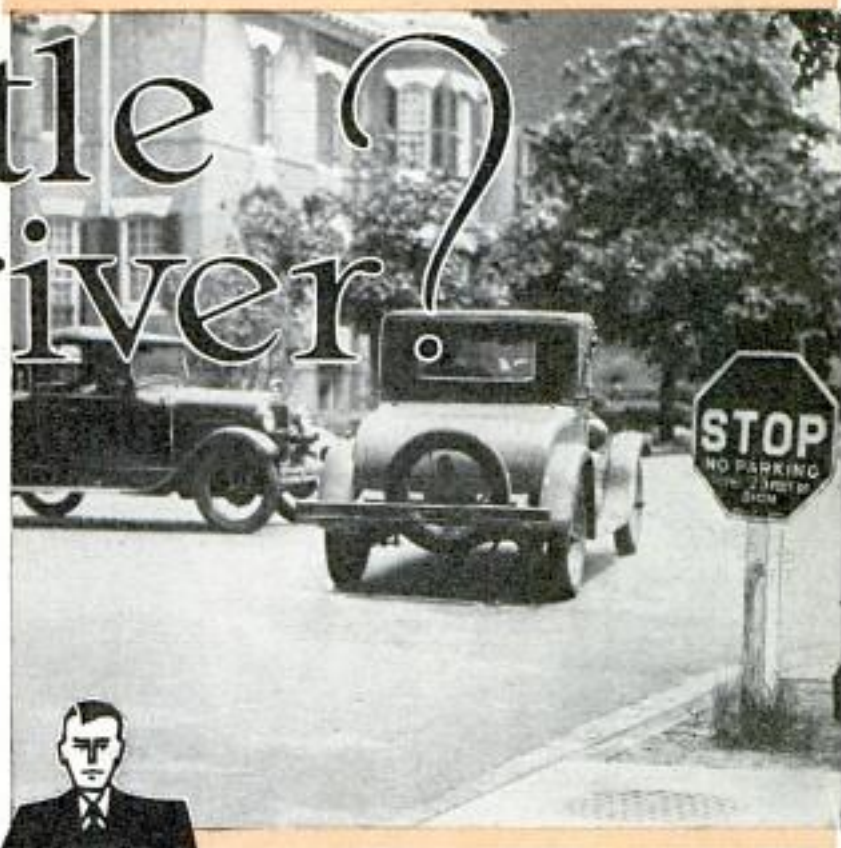

0-4 YRS. 5-14 YRS. 15-54 YRS. 55 YRS. OVER

Courtesy of Travelers Insurance Co.

The Turtle Driver in Action, Disregarding Boulevard Stops; Below, the Dangerous Ages from an Automobile-Fatality Standpoint

walking alongside the curb instead of on the sidewalk. Thus he places himself in the very path of automobiles traveling from the rear. Sooner or later he becomes the direct cause of an accident to himself or others.

Maybe the green gazer isn't as dangerous as the edger, but he's just as annoying. He's the kind of driver whose mind apparently falls fast asleep while the traffic lights are changing. Often the green light will be on fully ten seconds before he discovers the fact and steps on the gas. Meantime horns are blowing,

autoists behind him are yowling, and many people are forced to miss the light who should easily have made it.

Just the opposite type of driver is the red rusher. Instead of being slow on catching the traffic lights, he's usually a second or so ahead of them. Speeding through a crowded intersection, he's extremely likely at any moment to strike another car or a pedestrian.

Even those of us who claim to be good drivers needn't feel proud, Mr. Smith says, for if our memory is accurate, then we'll usually discover that, at times, we have given excellent imitations of most of the human menaces to safety that have been mentioned.

Nor is the experienced driver necessarily a careful one. This is proved conclusively by the fact that about ninety-one per cent of the drivers involved in fatal and non-fatal accidents in 1930 had handled a car for more than a year.

Which causes most accidents, pedes-

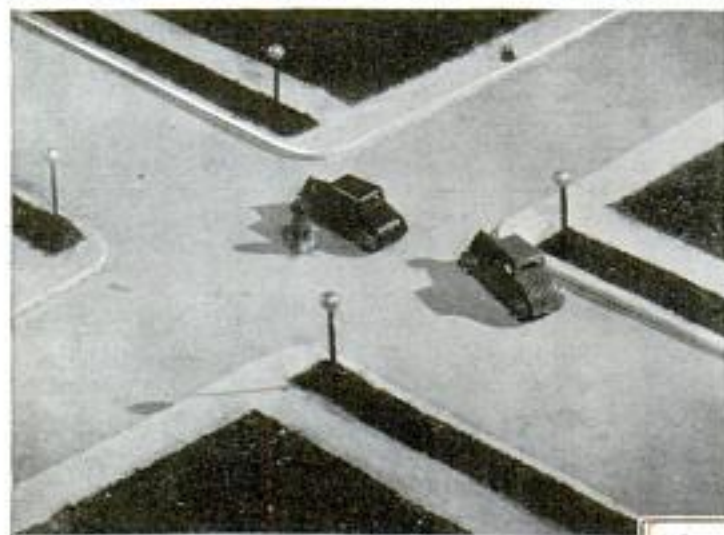
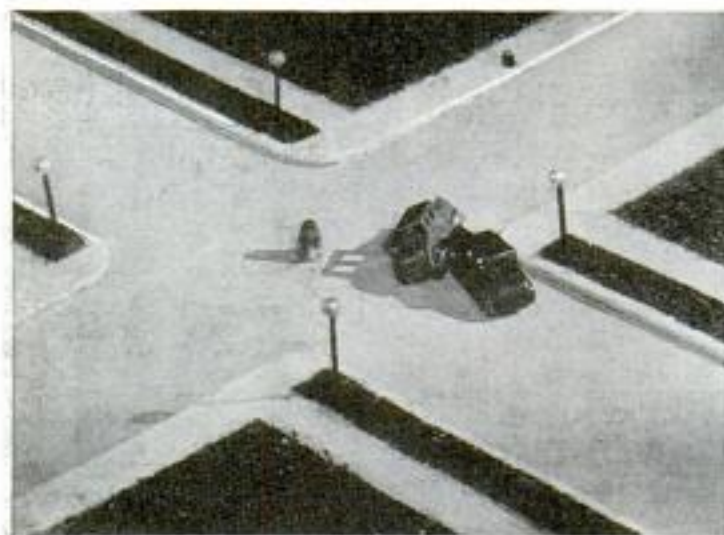

When Making a Turn, Stay on the Side to Which You Will Circle; Above, the Wrong Way

trian or driver? According to an official study made by the American Automobile association, last year drivers were responsible for more than three times as many vehicle accidents as pedestrians, more than twice the number of fatalities and around four times the number of persons injured.

But this doesn't mean that pedestrians do not cause their share of harm. More than 7,000 pedestrians met death during the year in automobile mishaps primarily through their own fault; while less than half that number were killed because of the actions of drivers. Moreover, the injuring of more than 150,000 persons was traceable to the actions of pedestrians and over 45,000 to motorists, while more than 110,000 injuries were due to the actions of both.

Nearly three-fifths of the 1930 accidents due to improper driving were traceable to three specific violations: failing to grant the right of way, exceeding the speed limit and driving on the wrong side of the road. The worst of these was the first, causing thirty-one per cent of all accidents due to improper driving. Exceeding the speed limit came a close second, being responsible for twenty-one per cent; while driving on the wrong side of the road accounted for sixteen per cent. These violations also caused around sixty-nine per cent of the total number injuries to persons as a result of actions of drivers.

Other major causes of accidents due largely to the driver's fault, are these, in the order named: failing to signal; cutting in; passing a standing street car; passing on a curve or hill, and passing on the right-hand side.

What's the most dangerous place on the road for both pedestrian and motorist? Mr. Smith answers this question by pointing out that, last year, nearly twice as many accidents occurred at in-



Proposed International Signals; No Words Will Be Used, so They Will Be Intelligible to All

tersections as between intersections. Careless pedestrians who crossed between intersections caused more than twenty-four per cent of the 1930 accidents; crossing intersections where there was no signal light accounted for about twelve per cent of the total; crossing intersections against signals caused over ten per cent of the total, and coming from behind a parked car accounted for about eleven per cent.

Certainly you might call Sunday the "jinx day" of the week for the autoist. More than a fifth of all fatalities happened on Sunday, with Saturday, Friday and Monday ranking in order in the number of deaths.

Mr. Average Motorist would do well to think over carefully these splendid little rules for road safety, recently prepared by the Auto Club of Missouri:



Photos Courtesy Bureau of Public Roads

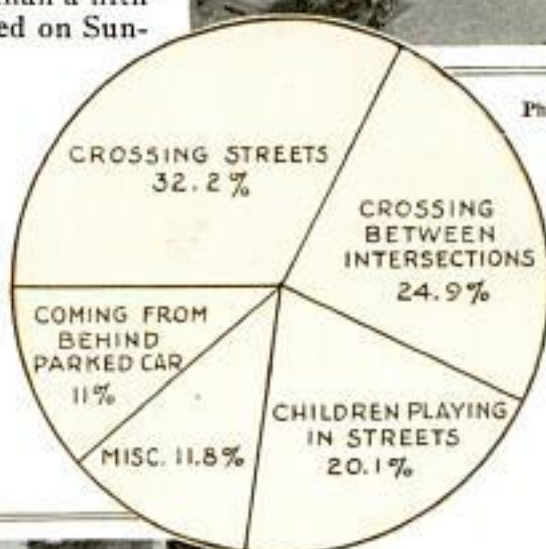

"Yield right of way to all street cars at intersections; watch out for one-way streets; be sure to pull immediately to curb and stop for fire, police or emergency vehicles; always keep to the right unless traffic lanes direct otherwise; never fail to stop before crossing

sidewalk when emerging from alley or private driveway; learn to use the brake instead of the horn and the gas."

WASPS AND FLIES IMPORTED TO FIGHT CANE BORER

Insects from Argentina and Peru have been imported by the department of agriculture to fight the sugar-cane borer in Louisiana. The borer has cost Louisiana growers \$3,500,000 a year by drilling holes in the cane, depositing larvæ, causing red rot and often killing the plant. Two natural enemies of the borer were found in a world-wide hunt, a wasp in Argentina and the Peruvian fly. The larvæ of both feed on the borer. Entomologists say the imported insects subsist on juices sucked from plants when they cannot find borers to feed on, and that the wasp and fly have established for themselves a record of not becoming crop pests.

Conf. W. D. Robinson
Pass Christian, Miss

Copyrighted material



Intersections Are Most Dangerous; How Pedestrians Caused Accidents, and the "Street Ostrich"

Ancient "Iron Horse" Comes Back to Life



Proceeding under its own power, the grandfather among locomotives of the Chicago, St. Paul, Minneapolis and Omaha railway recently participated in a gold-

Key
Fifty-Year-Old Locomotive Pulling Ancient Train in a Recent Railroad Jubilee

en-anniversary celebration at Hudson, Wis., where a stagecoach and men and women in costumes of the early eighties provided atmosphere for the old-time engine. The engine, which was exhibited with considerable pride fifty years ago as the very latest thing in railroad equipment, cost \$8,450.

1346
BANISHMENT OF THE COW IS SEEN AS FARM ADVANCE

Challenging the cow, Dr. E. A. White, of Chicago, told a farm meeting that engineers might well question her efficiency as a producer of food. "Look at all the work required," he said. "Why should the human race be compelled to feed, clean and milk cows twice daily, 365 days a year, in order to obtain fats, minerals and vitamins? The engineer is interested in a better way, and therefore will join hands with the chemist in the production and utilization of vegetable fats. There is every reason to believe

*American Society of Agricultural Engineers
Iowa State College Ames*

*American Engineering Agency, Washington, D.C.
Jackson Place, Wash DC
744*

A 1236

that, ten years hence, but-
ter will be facing much
more intense competi-
tion than is the case to-
day. Why, these chem-
ists yet may have us eat-
ing alfalfa."

A 1269

**SUCTION GATHERS
FRUIT SHAKEN
FROM TREES**

In large prune or-
chards, the ripe fruit is
shaken from the trees,
then picked up and
packed. To lessen the
cost of harvesting, a suc-
tion picker has been in-
vented, which is mount-
ed on an automobile
chassis and operated
by the car engine. A fan
sucks the prunes through
a hose which deposits
them on a conveyor belt,
so constructed that
leaves and smaller parti-
cles of dirt drop to the
ground as the fruit trav-
els along it. Larger clods
are eliminated when the
prunes drop on pins ar-
ranged in rows along a
drum. When this is at
the bottom of its revolution, a steel strip
knocks the fruit into a box and dirt and
stones are pushed aside. The machine
picks about fifty tons of prunes a day and
can be used also for other fruit.

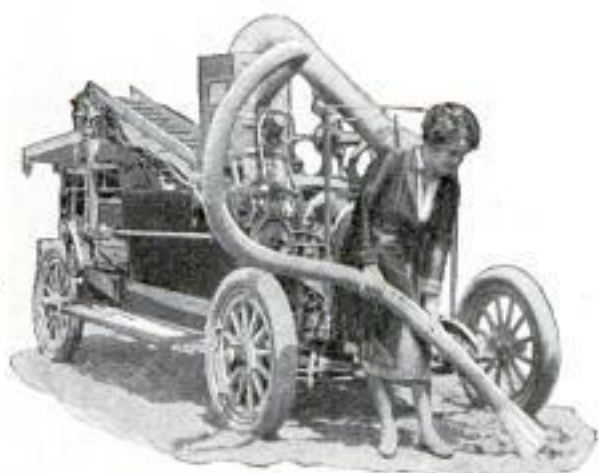

Mechanical Fruit Picker Which Employs Suction to
Gather Prunes and Other Fruit from Ground

Mr. James Hutto
13039 S. First St
San Jose, Calif

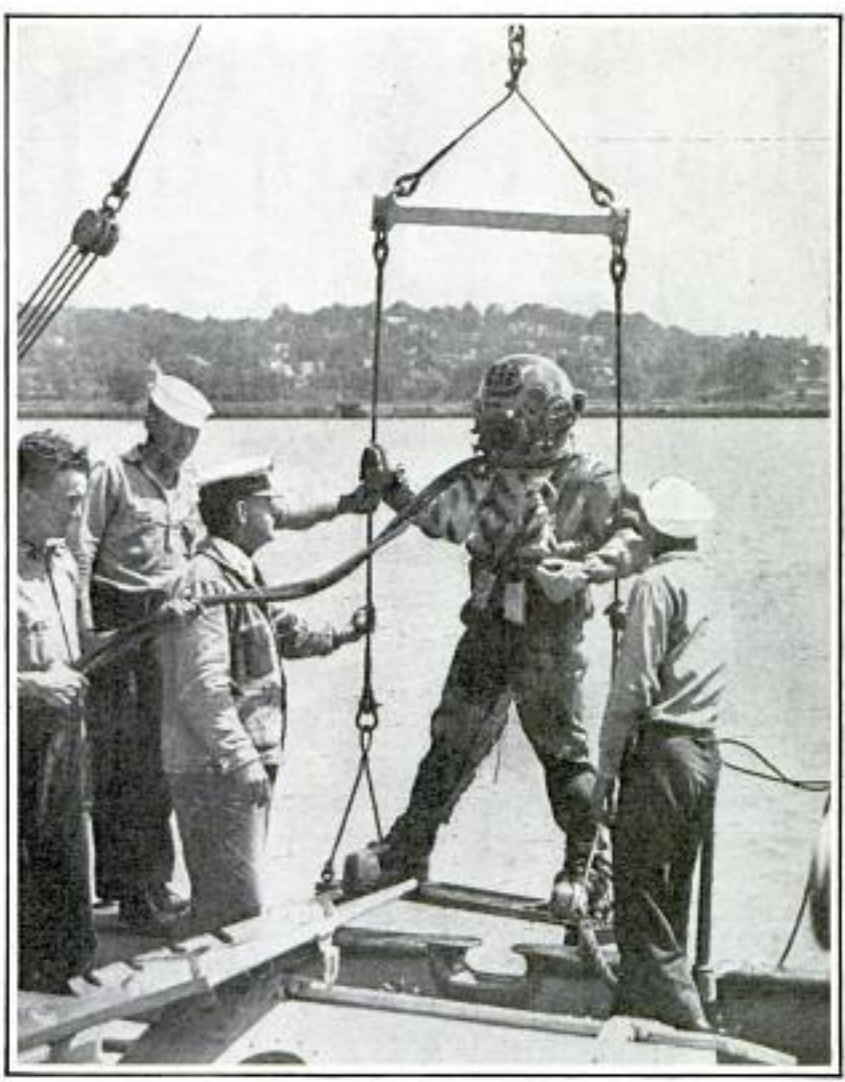

© U. & U.
Student Diver Preparing to Submerge at the Navy's Diving School at the
Washington Yard on the Potomac River

**DIVERS GO TO SCHOOL IN RIVER
FOR NAVAL INSTRUCTION**

Training of deep-sea divers, including
practical instruction in the Potomac river,
is one of the activities at the Washing-
ton navy yard. The naval scholars receive
their underwater instruction also in spe-
cial high-pressure tanks which simulate
conditions at great depths.

AIRPLANES BOW TO SNAILS

Snails infected with bilharziasis, a dis-
ease known to soldiers in the world war,
have routed a squadron of the British
royal air forces. The squadron had chos-
en a site near Bagdad for establishment
of a base, but were forced to move to
prevent infection of the men when the
site was found swarming with the dis-
eased snails.

A 1355

Kans. City Star
6/18/31

a 1014

Round *the* World Perils

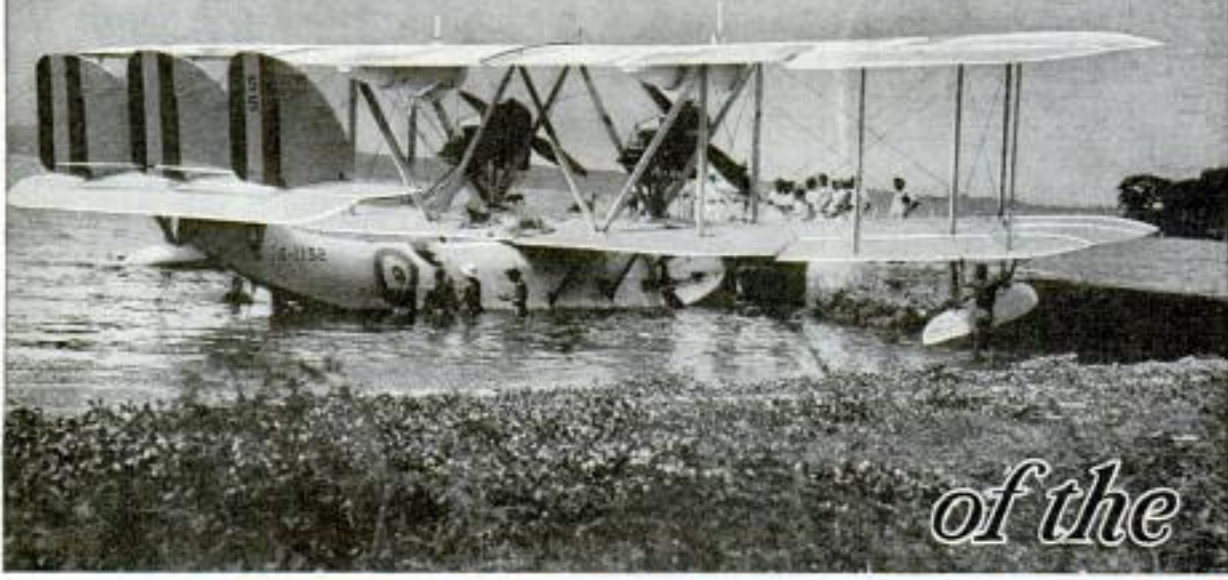

of the

Natives Scrape the Barnacles and Other Marine Growths from the Hull of a British Seaplane after a Long Flight over the Water in the Far East

Courtesy Supermarine Aviation Works

29. *Begin Road* By HAROLD T. WILKINS *Cap Colombiere*
See Key Health re London Eng

PICTURE a desolate landscape of rolling sand, scorched by hot winds blowing from far inland over the desolate wastes of the Rio de Oro to the unpeopled northwest African shores of the Atlantic. You would have to travel 4,000 miles to the West Indies before you met a civilized person, unless it were aboard some steamship plowing her way southward.

Here is one of the world's loneliest and most dangerous airways. Two airplanes are droning over the skyline from the river Wadi Draa and the distant Atlas mountains. Past Cape Juby, they hug the coast so as to avoid a forced landing on the desert floor. One of the planes seems to be in trouble. It is flying low over the dunes by the sea. Loss of oil or, perhaps, an engine defect compels it to land.

The second plane, seeing the plight of its fellow, comes lower. It is about to land to pick up the stranded mail and pilot and then take off again to fly to the west African port of Dakar, in French Senegal.

"Crash!" The undercarriage hits a boulder concealed under the sand. The plane tilts over and spills out the pilot and observer. Hidden behind the dunes inland, a cutthroat gang of sharp-sighted, sharp-shooting nomads have spotted the two planes. They creep along the sand gulleys toward them and open fire on the airmen. The pilots take refuge behind wings and fuselage. Unless a rescuing plane zooms over from the distant mountains to the north, the pilots are in for a hectic time, in which kidnapping will be the least hurtful thing that may happen to them.

Such incidents were more frequent three years ago than they are today on the "African Adventure Airways," which the French Compagnie Aeropostale runs down south from Rabat and Casablanca, in Morocco, to the Senegalese port of Dakar, which is the jumping-off place of the airline to South America, across the Atlantic to the mid-ocean islands of Fernando Noronha, and the mainland of Brazil at Port Natal.

Not long ago, three airmen of the Com-



Air Mail

pagnie Aeropostale set out to rescue the crew of a stranded steamer. The nomadic Arabs came on the scene, but were met by a fusillade of bullets and driven back. They then flew the shipwrecked men to Port Etienne and safety. Later, a pilot was caught with a broken undercarriage while his ship lay on the dunes. The Arabs kidnapped him, put him on the back of a fast-trotting camel and took him to a desert fastness, where he endured great hardships until he was ransomed. A few weeks later, two French airplane pilots, named Gourp and Erable, with a mechanic, named Pintado, and a Moorish interpreter, landed on the desert off the Rio de Oro, when a force of Arabs, headed by a renegade from a French regiment of Spahis (Algerian cavalry) arrived and

took the men prisoners. The Arabs themselves were disposed to listen to the interpreter's suggestions about a ransom, but the renegade with his own hand shot one of the pilots and the mechanic and badly wounded Gourp.

Many French and Spanish airplanes recently made a sweep over the deserts of

Courtesy The Graphic

Plane Sights Stranded Flyers in the Mountains and Drops Them a Spirit Stove, Bandages and Food and Water by Parachute



the Rio de Oro—river of gold as the Spanish territory in this wild region of northwest Africa is called. There is no river there, and nothing but sand and waste. The combined air squadrons were trying to solve the mystery of two missing airplanes. In one machine was Commandant Burguett and a Moorish chieftain, named Taleb Buya; in the other, Captain Nunez and a mechanic. While planes sped over the desert and observers scanned the wastes with binoculars, cavalry and camel troops scoured the desert below. The two planes had disappeared, swallowed up in the night of the unknown Sahara of the northwest.

"SOS, SOS, SOS. We are down on the water South Atlantic. Lat... Long... Loss of oil. Hurry rescue boats. Mer-moz." This radio, recently flashed to the port of Dakar, announced a misadventure to the French pilots who had attempted the first air-mail crossing of the south Atlantic from Natal to Dakar. The radio galvanized into activity a fleet of fast motor "breakdown-gang" boats which rushed to the rescue of the plane. With his radio, and the international code, the pilot was able to keep in constant touch with the motorboats, until, in the nick of

time, he was rescued just as a heavy storm was approaching. The mails were taken off, but the seaplane went to the bottom in the gale.

There also is the recent case of three French airmen who



Photos Courtesy Henri Bouche

Air View of Spanish Fort in the Heart of the Desert, Africa; Below, Result of a Blizzard in the Andes

set out to blaze a trail for commercial and passenger airplanes across the west African Sahara. Aboard one plane, they left Gao on the River Niger, to fly to Reggan, in Morocco, which they should have reached the same day. They did not arrive, and the French military authorities became anxious, and sent out planes and fast autos to search the desert. Days later, an Arab wandered into a military outpost and said he had seen a smashed airplane lying on the desert about 300 miles south. A physician was rushed by air, to find native troops surrounding a machine, while the pilot, M. Goulette, lay badly hurt.

Herr Ernst Udet, the German "ace," told, a few weeks back, a remarkable story of an aerial adventure he had in the African wilds, when he was making a film of animal life.

"A powerful lion suddenly sprang at the airplane, while we were flying low to

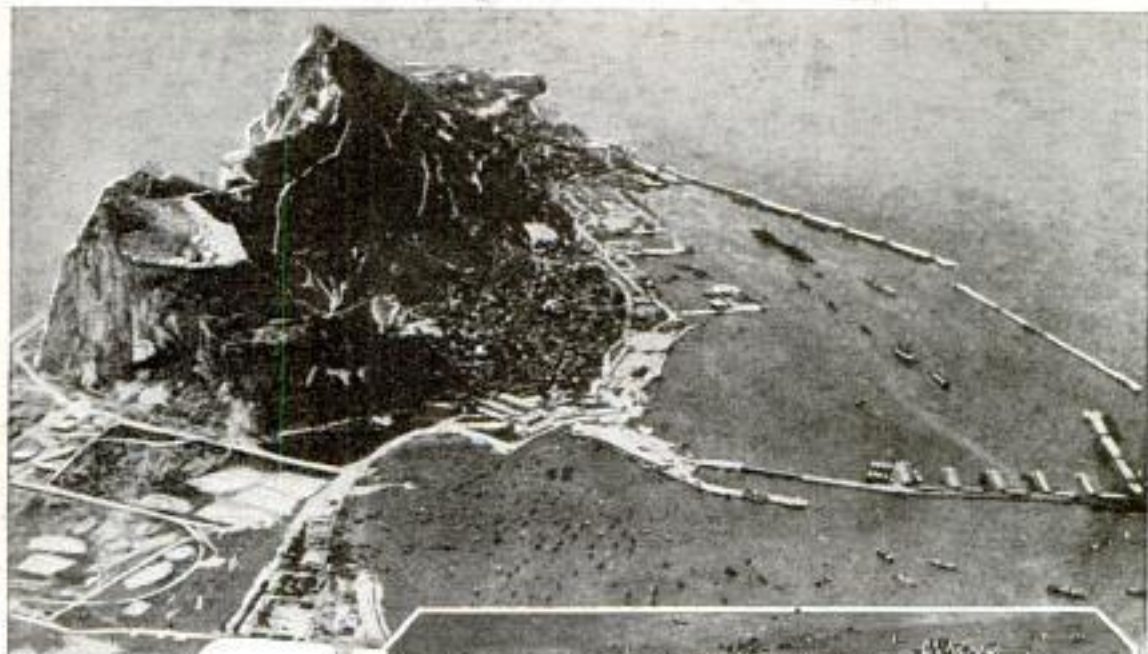

Photos Courtesy Henri Rosche

A French Aeropostale Liner Catches Sight of the Famous British Fortress of Gibraltar on the Southern Tip of Spain While Bound for Dakar, West Africa, across the Moroccan Atlas Mountains, via Rio de Oro in Northwest Africa; at the Right Is Seen an Arab Market in the Desert near One of the Lone Outposts of the Rio de Oro on the Airline from Paris to Buenos Aires; the Senegalese Port of Dakar Is the Jumping-Off Place for This Transatlantic Service



© Planet News, London
A Crew, Stranded in Arctic Wastes, Signals to Planes Passing Overhead for Aid, by Placing Tent Poles and Other Pieces of Wood on the Surface of the Snow to Form the Word "Help"; If the Planes Are Unable to Land, They Drop Food

91014



Courtesy Imperial Airways

take pictures. A wing was badly damaged, and it was only with the greatest difficulty we landed. The airplane was hardly on the ground before an angry rhinoceros attacked and injured my pilot. Our second machine was quickly on the spot, and the crew drove off the animal and rescued our men.

"Again, in March, 1931, I was stranded on the sandy wastes in the dangerous Nile-Sudd country. I had run out of gasoline and was forced to land without food, water or radio, or any means of communicating with the outside world. Hours passed. Suddenly, I looked up into the sky and saw, with indescribable relief, a plane passing overhead. It came lower. Yes, the pilot had noticed my plight! There was great risk in attempting to land on such marshy terrain, but the pilot took that risk. He was Capt. Campbell Black, flying solo from Nairobi, in East Central Africa, to England.

"I heard you were missing,' he said to me. 'They told me at Nairobi that you left for Khartum down the Nile in the Sudan. . . Well, I'll give you all I can to help you out of your fix.' He chivalrously shared his own slender rations of water and biscuits, and 'Sorry, Herr Udet,'

he said, 'I can't give you gas to enable your machine to reach the nearest depot. But I'll send help from Juba. Good-bye.' "

Mountaineering by airplane recently has added some unexpected thrills to the already exciting life of a transcontinental mail pilot. M. Guillaumet, known as "the courier or 'air-post boy' of the Andes," was flying 21,000 feet above a range in



Courtesy Henry Bouche

Above, Airdrome en Route from Cairo to Bagdad; Below, the Spanish Fort of Cape Juby Where Rescue Planes Are Kept

the Cordillera of the Andes, while carrying mails from Santiago to Mendoza, on the Argentine side, en route for the South American air-mail line from Buenos Aires to Dakar, in West Africa, and Paris, when, "suddenly," he says, "I found myself surrounded by clouds. I entirely lost my sense of direction. Then a tempestuous wind raged. My machine spun out of control. I felt I was dangerously losing altitude. I crashed in a basin on a mountain nearly three miles high. The machine turned turtle and flung me out onto the snow. The plane was badly damaged, but my fall was broken on the soft snow. Hours later, I saw an airplane pass overhead. I waved frantically, but the pilot did not notice my signals. Night was falling.

"The cold at that great height was intense. To keep myself from perishing

a1252

from cold, I decided to walk to civilization. The region is entirely deserted, and the nearest help is at an Argentine frontier post. I strapped the mail on my back, and marched across ice-packed gulleys and over snowy ranges, for seventy hours without a stop. I had to go on. To halt was to die of cold. The first day I traveled slowly. I tumbled into a ravine 150 feet deep. I escaped with bruises and a severe shaking. In one day I covered only two miles. At last, after four endless days, I staggered, with bleeding and frost-bitten feet, into the porch of a lonely ranch, where I was given food and restoratives and put into touch with the Argentine frontier guard."

On the other side of the globe, in the Swiss-Italian Alps, the experience of M. Guillaumet recently had a parallel in the adventures of five Swiss soldiers who lost their way during the maneuvers in the region of St. Gotthard. All night they wandered around in the blizzard, trying to shelter under the lee of rocks, till the intense cold drove them out again. Luckily, an airplane located them, dropped food and a map, and put the lost soldiers on the way to an outpost which they reached in safety.



Portable Crane Used to Reach Nesting Places of Pigeons That Damage London Buildings

CRANE HELPS TO ROUT PIGEONS NESTING ON BUILDINGS

Hordes of pigeons do heavy damage to buildings in some parts of London, and removing them and their nests from lofty perches has long been a difficult problem. One man now is employing a large portable crane for the purpose. The crane is elevated to a point within reach of the nesting places, and the man climbs along it to remove the birds and nests.

Handwritten: C. C. Schumacher
22 E 69 St New York

FILE FOR LAWNMOWER BLADE SHARPENS ACCURATELY

a1325



Lawnmowers are sharpened by application of a simple, light file to the moving blades by an Indiana company. The lawnmower wheels are raised from the ground, the bedplate, or part of the machine just below the blades is loosened and the sharpener applied to the blade. As the blade is revolved, the sharpener is moved back and forth with an even pressure. Approximately the same number of strokes must be used on each blade.

As the blade is revolved, the sharpener is moved back and forth with an even pressure. Approximately the same number of strokes must be used on each blade.

Handwritten: Cleve Bros. Mfg. Co.
Plymouth Ind.
W. S. Corporation
136 W. 52nd St. New York

RULE JUMPS OUT OF ITS CASE WHEN YOU PRESS BUTTON

a1249

Combining the rigidity of a measuring rod with the flexibility of tape, a steel rule which can be propelled from its case by pressing a button, or extended manually, is now available. It is made for measuring out-of-the-way places, around corners, and curved surfaces, and also is convenient for general home use.



Handwritten: \$2.50
Mayhew Steel Product
Co. Shelburne
7 Falls, Mass.

Emb. S.A. Lewis, 236 Broadway
Bldg. Los Angeles, Calif.

Cap. J. Zgnje
A. Brachy
U.S.
Berlin

446
a188

a1366



Sheet-Metal Ceiling Illuminated by Hidden Lights Which Make It Appear Like Colored Glass of a Modernistic Pattern

HIDDEN LIGHTS MAKE CEILING SHINE MYSTERIOUSLY

Sheet metal and hidden lights have been combined to convert the ceiling and upper walls of one San Francisco cafe into a semblance of colored glass. For the ceiling and parts of the walls, sections of metal were arranged in geometric patterns giving a somewhat modernistic touch. Colored lamps were placed above the metal ceiling and the light was projected against the back of the sections, being reflected through slots between them onto the under surfaces. Five colors are used, and these are connected with a system of dimmers, operated by remote control from the orchestra pit. At times, the ceiling appears to be red-hot and again it seems icy-cold.

Automotive industries
91342
11/13/31

AUTOS CRASH INTO TRAINS

Twenty-five per cent of highway grade-crossing accidents in 1930 resulted from operators of automobiles, busses, trucks and motorcycles crashing into the side of trains. Railroads report 1,276 such accidents. Of this number, 1,130 automobiles were driven into the side of trains, killing 214 persons. There was a decrease in the number of these accidents from 1929.

I.C.C. report

POWERFUL X-RAY FROM LIGHTNING IS FORESEEN

X-rays as penetrating as cosmic rays, with voltages of 18,000,000, are predicted by two German scientists who already have made a tube tested at 3,000,000 volts. Working in a narrow valley between two mountain peaks in Italy, the scientists set up a gathering system which collects energy from the skies during thunderstorms to obtain a twenty-five foot spark of 18,000,000 volts. Assured that nature would provide the high-tension discharge needed, they constructed an X-ray tube

of alternate rings of rubber and metal which took 3,000,000 volts for one-millionth of a second. These X-rays are the most powerful yet produced, and electrons are so speeded up in the tube, less than a dozen feet long, that they drill holes, an inch deep, in a brass plate. An ordinary X-ray tube would need to be half a mile long to withstand such voltages.

a1241

SCREWDRIVER TO FIT KEY RING HAS FOUR BLADE SIZES

Carried on the key ring, a pocket screwdriver has recently been introduced with four short blades, each of a different size. It is in the form of a steel disk with the blades spaced around the edge, and pierced with a hole to slip on the key ring. It is about the size of a half dollar and, made to be



gripped between the thumb and forefinger, gives a powerful leverage that will move the average screw with ease.

W.D. Products, Trinity Bldg. Boston, Mass.
Dist. Electrocraft Corp. Boston
66 Massachusetts Ave. Boston
Edm. St. W. Lubben, 168
10 Boston Mass

"Old Ironsides" Again Rides the Waves

The Famous Frigate "Constitution," Known to Every Student of American History as "Old Ironsides," Seen Below as She Has Been Rebuilt with Funds Supplied by School Children and Just before Starting on a Cruise of the Cities along the Atlantic Seaboard

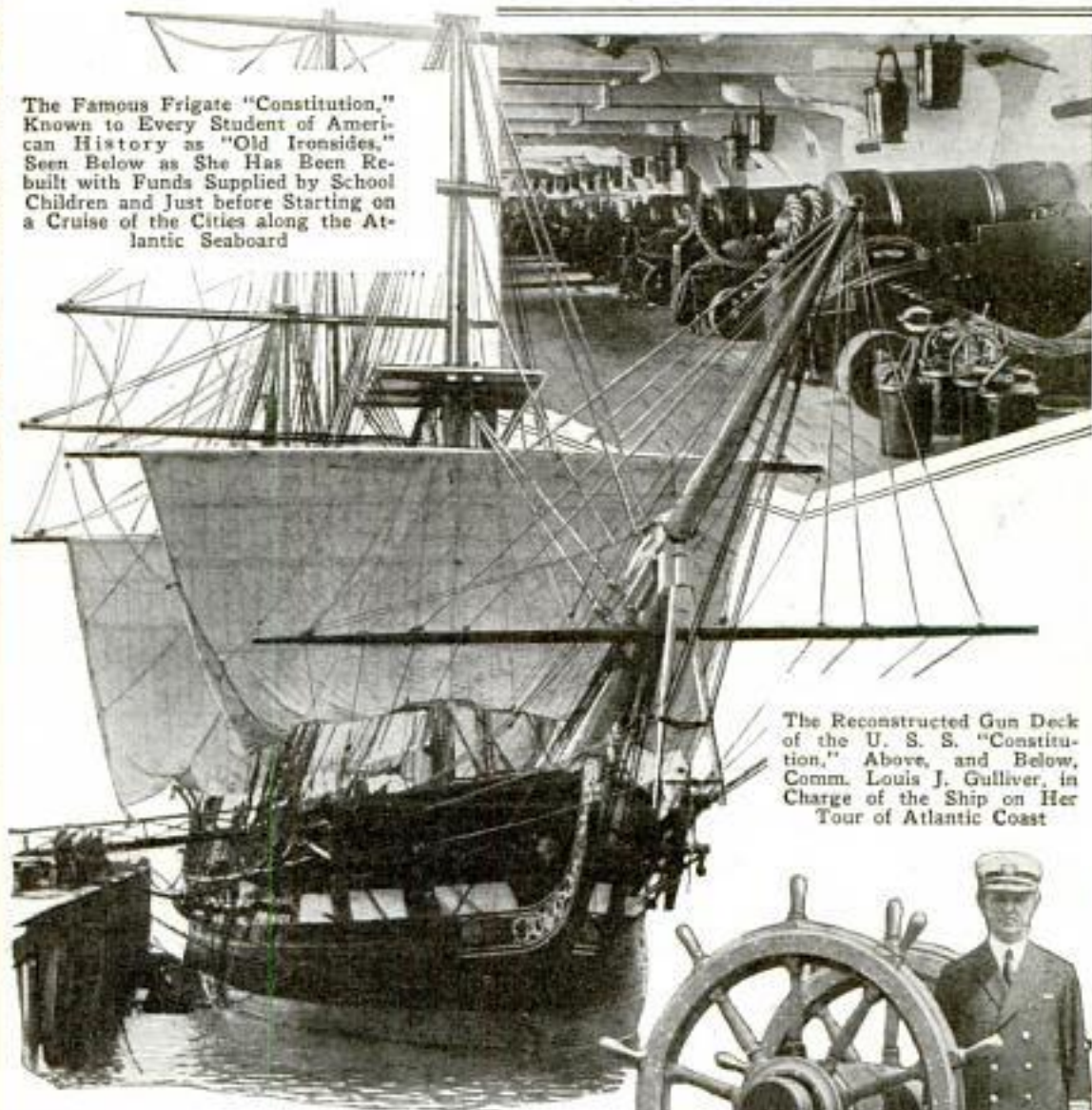

The Reconstructed Gun Deck of the U. S. S. "Constitution," Above, and Below, Comm. Louis J. Gulliver, in Charge of the Ship on Her Tour of Atlantic Coast

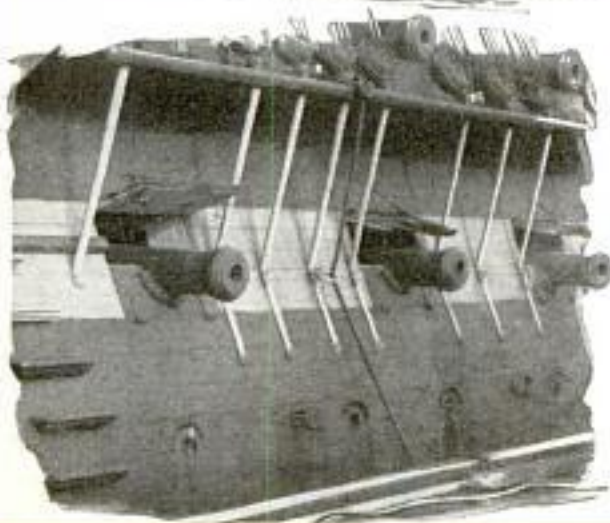

Left, Cannon of the Famous Old Frigate Which a Century Ago Tamed the Pirates of the Barbary States; So Vigorous Were These Guns, the Bey Came Aboard Bare-headed to Surrender

KSU

u 11 7 48

Cml. to H. Stacy, 4639 Montgomery Ave
Bethesda Md
POPULAR MECHANICS

Glass Roof on Wheels Covers Tropic Garden



Tropical Garden Covered by Sliding Skylight, and Inset, How the Roof Rolls on Wheels

In the form of a mammoth skylight on wheels, a huge glass roof, weighing fourteen and a half tons, is delighting thousands of visitors to the Pan-American building in Washington, D. C. More than 500,000 visit the building annually, and while intrigued by the gigantic ceiling which crowns the patio decorated with 100 varieties of tropical plants and flowers, very few have fathomed its secrets.

It was necessary to make the skylight movable, in order to take advantage of direct sunlight when the weather would allow. Roller-bearing wheels, running on a track seated in the roof, finally solved the problem of moving the heavy glass section without breakage. An electric motor, controlled by a push-button, furnishes the power to slide the movable section slowly open or shut.

TINY RACING CAR WORTH MORE THAN FULL-SIZE AUTO

Plated in gold and silver, a \$10,000 miniature model of the eight-cylinder racing car which won the Indianapolis auto race in 1930, attracted much attention at this year's motor classic. The Lilliputian racer was made by an automobile salesman who spent three and one-half years at the job. It has an eight-cylinder motor that will run, as well as a complete miniature crankshaft, piston and rods, valves and cam shafts, clutch, pinion and ring gear, differential, a four-speed transmission, universal joints, four-wheel brakes, steering gear, magneto, spark plugs, intake and exhaust manifolds and is a front-wheel-drive machine. The car is nineteen and one-half inches long, ten inches wide, five and one-half inches high and weighs fifteen and one-half pounds. The parts are of steel, brass, copper and chrome, with the engine hood silverplated and the wire wheels goldplated. Small photostatic copies of the instrument faces were placed on the dash with a convex lens over each,

giving a deceiving appearance of reality. The maker used 3,000 screws in the car and spent about \$1,000 building it, as he had to buy all the machinery used in producing the diminutive auto.

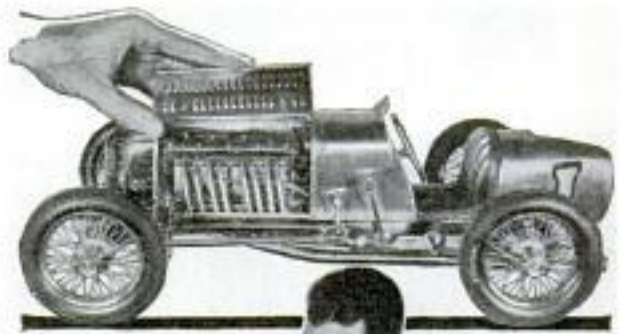

Gold and Silver Model of a Racing Car Which Contains Eight-Cylinder Motor That Runs

Made by J. Angerite (1567 David Ave
Fall Lake City
Ill.
9-11-37
John Allen

Cont. Jack Ceynar Apt. 203 20357
Meridian St.
Indianapolis Ind

Copyrighted material

91228

Alerick

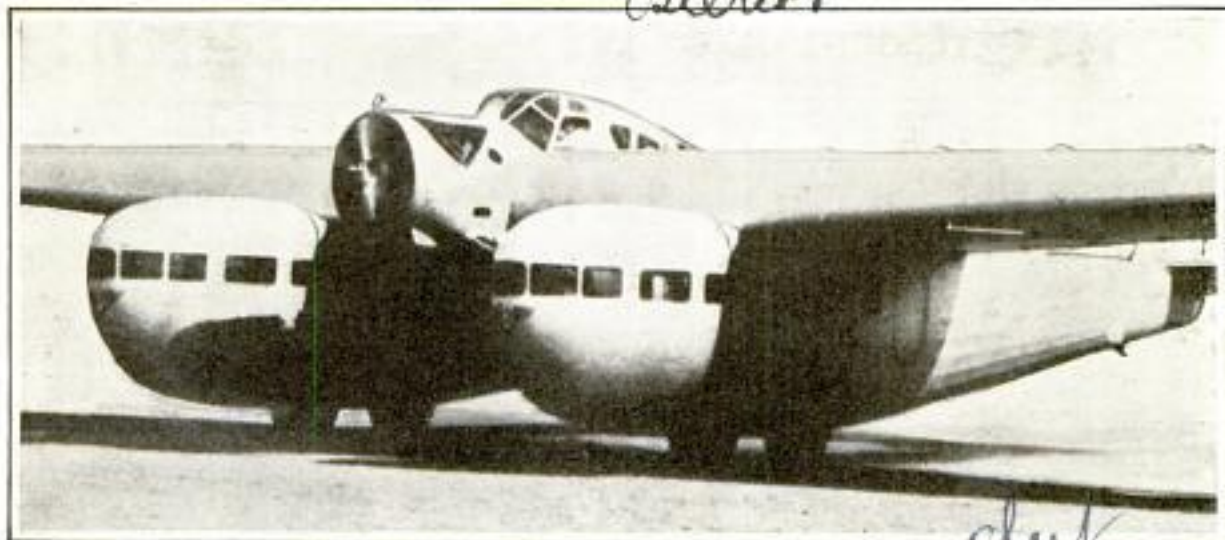

clut

Transport Plane with Twin Cabins for Passengers and a Landing Gear for Each Compartment; the Pilot's Cabin Is Placed above and between the Double Body of the Ship

AIRPLANE WITH TWIN CABINS CARRIES LARGER LOADS

Appearing like an amphibian with over-size pontoons, a large transport plane with a double body was recently exhibited in France. The craft has two separate compartments for passengers with a landing gear under each, while the pilot's cabin is placed above and between the twin bodies.

9143

IRON BARS GUARD CAMERAMEN TAKING JUNGLE PICTURES

Motorized iron cages protect six men and a woman engaged in filming sights and sounds of the South African jungles. The party is making a 1,000-mile trip. Motors drive the cages, in which the party travels, close to the fiercest animals, and the pictures are taken in comparative safety. Close-up "shots" are taken with long-range cameras from a distance of 3,000 feet. The outfits are waterproof, and about fifty copies of each sound film can be made while traveling.

BOWLING-BALL SCALE SHOWS WEIGHT AND BALANCE

91361

Bowling balls must be of standard weight and circumference and accurately balanced, and to insure true balls, a scale has been developed for testing them. It has a ring at one end into which the ball fits. The ring shows circumference, and if the ball is balanced by weights, it will

weigh the same as it is turned about in the ring, provided its balance is true. If it is heavier on one side, however, this fact will be revealed. One of the most desirable shots for bowlers is a curve, the ball turning in as it is about to strike the pins. This can be attained by a skillful twist of the wrist in throwing the ball, but a sphere that is off balance will curve even if thrown straight. The scale detects faulty and worn balls and is employed particularly in tournament play.



Testing Bowling Ball in Scale That Measures Its Balance as Well as Its Weight

expedition headed by Herr Schomburgk

Copyrighted material
Henry Troppner,
911 Arch St.
Phila

Secrets of Germany's New Pocket Battleship

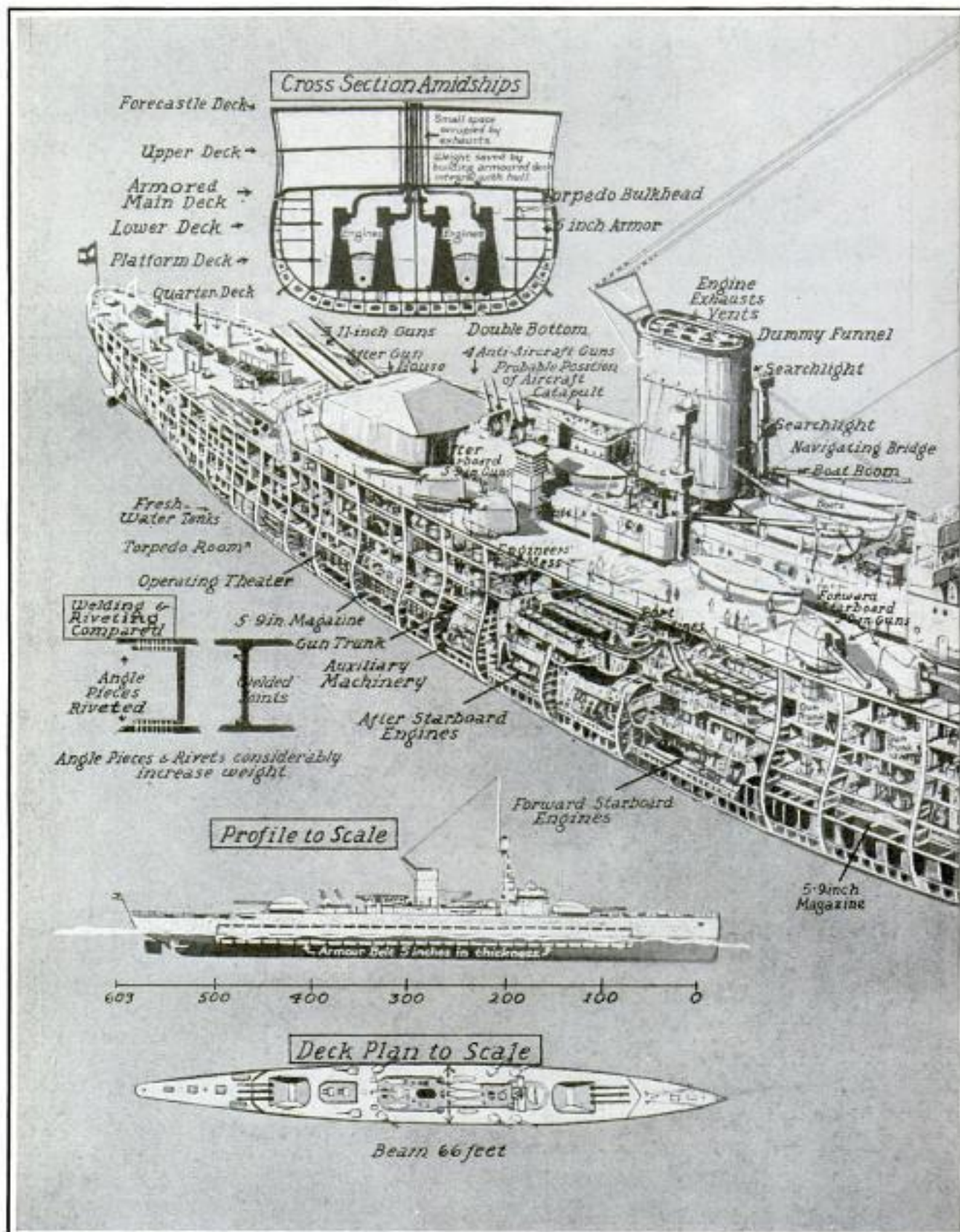

Drawings of Germany's Newest Fighting Ship, the "Deutschland," Which Combines the Gun Power of a Warship with the Speed of a Cruiser; Welding Was Used to Save Weight

"Deutschland" and Her Wonderful Engines

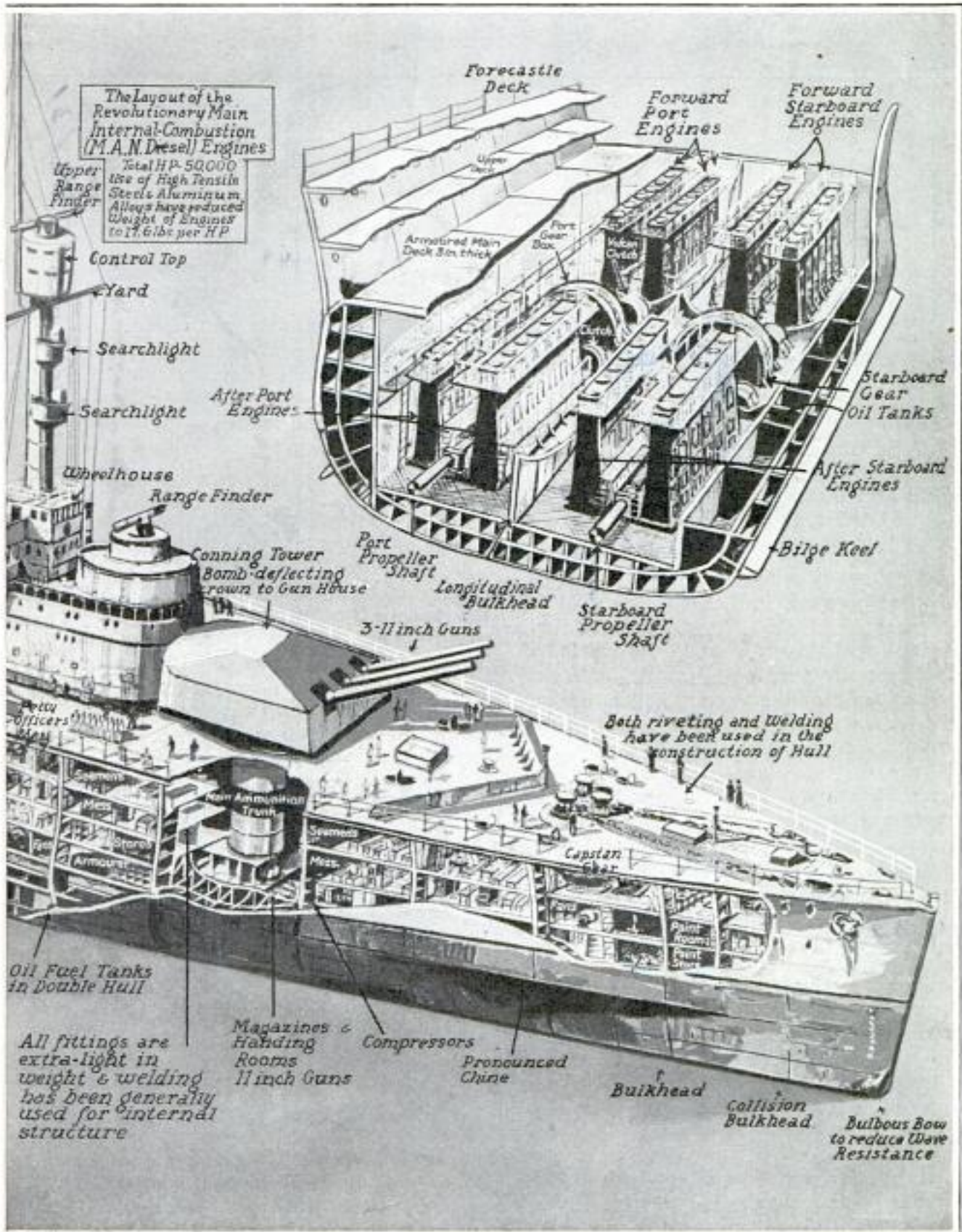

This "Pocket" Battleship Has Internal-Combustion Engines Delivering 50,000 Horsepower and a Speed of Twenty-Six Knots; She Carries Six Eleven-Inch Guns and Several Smaller Ones

*M. Chartrain
Paris, France*



Model of Proposed London Airdrome to Be Constructed over Two Railway Stations; Note the Wheel-Shaped Design Suggested by the Architect

AIRPORT OVER LONDON ROOFS SUGGESTED BY MODEL

By constructing an airdrome over the roofs of two London stations, an English architect proposes to connect two passenger carriers, the railroad train and the airplane, and to provide a landing for air passengers in the heart of London. The architect has built a model airdrome in the form of a wheel or merry-go-round, with runways extending in eight directions to the rim of the wheel. The airdrome is planned to rest on supports erected around the two stations, King's Cross and St. Pancras, and under the runways and rim.

UNIVERSE BUBBLE MAY SHRINK

a1473 **VIEW OF EINSTEIN**
Our universe is like a giant bubble steadily increasing in size at present, but likely at some time to cease expanding and enter a long period of shrinkage. This is the view of Prof. Albert Einstein as expressed recently in an address. Professor Einstein termed the modern approach to problems of matter and space "a new kind of mysticism which expresses itself in differential calculus instead of pictures." For a time the theory of the distribution of matter in space was that space was empty except for the crowded Milky Way. Later, he pointed out, sci-

ence had to admit that distant nebular wisps really were systems as big as the Milky Way. According to Newtonian astronomy, however, such a universe would be lopsided and could not maintain its equilibrium.

UNSYNKABLE LINER IS SUCCESSFUL IN TESTS

French naval engineers recently witnessed successful tests of a ship model described by the inventor as "unsinkable." The model, a diminutive ocean liner, has a hull of thin plate. It was rolled

to an angle of forty-five degrees and holes were driven below the water line, but the craft only floated a half inch lower in the water. Three men stood on the boat until it was almost submerged, but when they leaped off, it righted itself and came up pouring water from every orifice. The inventor offered to cut the model in two to demonstrate that each end would continue afloat, but the engineers expressed themselves as satisfied.

SELF-ADJUSTING BOTTLE CORK USED FOR RECAPPING



clamp over the neck and if any gases form, it automatically seals tighter.

Scientists are seeking a cheap and durable cup for gathering turpentine gum.

*Herald Examiner
6/27/31*

*Thomas Sales & Supply Co.
24 Berlin St.
Worcester, Mass*

Charles W. Jelover, London

New York Times 9/26/31

STOP SIGN FOR OFFICER'S CAR
MADE FROM FLOODLIGHT

91422

To inform motorists that they are being hailed by officers, deputy sheriffs in Michigan have made stop signals out of floodlights used in backing up, and employ them in halting cars at night. The sign is made by painting the lens a bright red and pasting on the inside the word "stop" in large letters, with the designation of the proper law-enforcing agency above and below it. The light is mounted on the right side of the officer's car. Previously exhaust whistles were used by officers to stop autos, but many drivers mistook the warning for a threat of a holdup and attempted to speed away.

Capt. A. O. James, 7496
Lewiston, Fernvale Mich



"Lion" Being Lowered in a Manhole to Draw a Brush through the Drain to the Next One

GIANT CORKSCREW DIGS HOLES
AND PULLS OLD POSTS

91314

A huge auger is in use in a California city to dig holes for electric-light posts. It is mounted on a truck, and in the assembly is included a derrick that pulls out the old posts. The giant corkscrew will dig a hole from six to nine feet deep in seven minutes, and allows a crew of two men to take out seventy old and install the same number of new posts in a day, where it formerly took eight men a day to remove and install an average of only eight posts.

our wheel drive Co

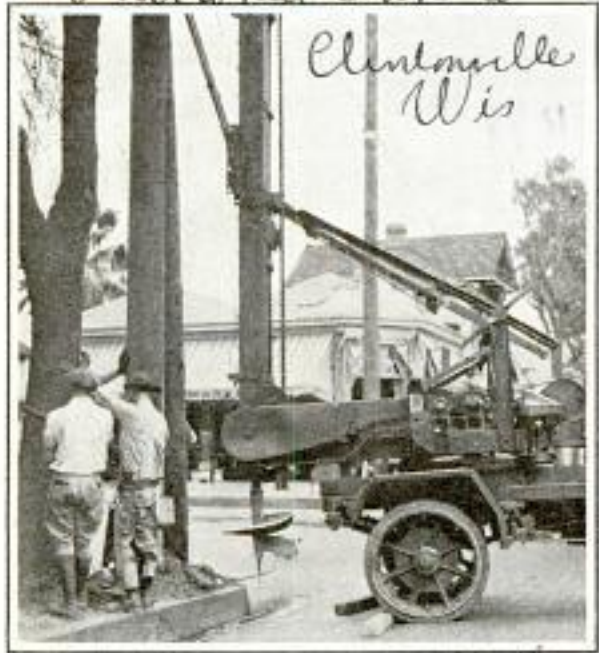

Clintonville Wis

Giant Corkscrew That Pulls Old Posts and Digs Holes for the New Ones

Used by Los Angeles
L. S. Clark
Los Angeles, Calif.

DOG TRAINED TO CLEAN DRAINS
IS GIVEN A DIPLOMA

"Lion," a French dog, so named because of his strength, is a great help to those whose job it is to clean the city's drains. A light cable is attached to the dog's collar and he is let down a manhole. He scampers through the drain and is pulled out at the next manhole. Attached to the cable is a huge brush which cleans the drain as the canine runs through. He recently was awarded a diploma for his work at the canine exposition in Nice.

Sanworth Park

SMOKE INDICATOR FOR AIRPORT
REPLACES WIND SOCK

91427

Installed on an airport near London, a wind indicator that shows direction of the currents on any part of the field has been developed. "Smoke pots" burning low-grade oil are sunk into the airport floor at central points where the planes land, instead of at one side as in the case of the wind sock. The smoke streams through a hole in the top of a concrete chamber, covered with steel flaps strong enough to bear the weight of any plane landing on the field.

Inv. Dr. Ahrens, German Scientist. Copyrighted material

a1264



A Talking Scarecrow That Has the Birds Bluffed; a Loud Speaker Is Concealed Inside the Coat and Connected to the Radio in the Home of the Farmer Who Built It

Berry farm of H. Johnson

SCARECROW TALKS AND SINGS TO FRIGHTEN PESTS

Given a voice in the affairs of its owner, a scarecrow on a farm near Portland, Ore., has succeeded in doing the thing most scarecrows are made for and seldom accomplish—scare crows. A loud speaker has been rigged inside the gentleman's coat, and connected to the radio in the farmer's home. The crows have kept far away from the berry patch since the introduction of the musical effigy.

SOUND AND ECHO MADE VISIBLE BY EXTRA-FAST CAMERA

Sound and its echo are made visible by a Japanese camera which takes pictures at the rate of 40,000 a second. On the screen the sound is like a moving shadow, behaving much like the waves that come from dropping a pebble into the water. The sound is produced in an oily liquid in a glass container. When the sound waves reach the edge of the glass, they rebound, resulting in actual pictures of

the echo. One picture shows the phenomenon of the whisper, which, when breathed at the right spot in an auditorium, can be heard at a certain place on the other side, but nowhere in between.

SHELLED PEANUTS ARE HEATED IN SLOT VENDER

"Toasted" peanuts are sold in a slot machine just placed on the market. A



red lamp fitted on top flashes intermittently to draw attention, and when a coin is placed in the slot, a quantity of peanuts is dropped into the heating chamber and delivered warm and crisp. The peanuts in the storage jar will not turn rancid.

a1454

Patented by

also 2940 Stuarte Road, Port Jervis, N.Y.

Designed by Barrio Shiba, Japanese Imperial Institute, Tokyo, Japan

Roy Stringer & Co. Ltd. 968 W. Wainwright, Chicago, Ill. and

1298

NEW DISCOVERIES ARE THREAT TO DISARMAMENT

a 1435

Fear that later scientific discoveries may make disarmament agreements invalid before they are fairly ratified has been expressed by Sir Samuel Hoare, president of the British science guild. The scientific aspects of disarmament deserve as much consideration as political and financial angles, he said, and pointed out that science might develop new types of weapons outside the scope of any disarmament agreement based on conditions at any particular time. The main problem lies in finding some method of controlling the future weapons of destruction, for scientists are bound to discover new rays, gases and explosives in the course of their ordinary work. The question to be faced, he said, is whether the world can prevent the use of invention and discovery for the purpose of destruction, for, if anything is certain, it is that any future war will be very different from the last.

BALL GAME PLAYED WITH GUN CALLS FOR FAST ACTION

a 1400

Bang ball, a court game which calls for fast and snappy action, has been introduced for use on the playground, bathing beach and home lawn. It is played indoors or out. The game requires less

Bang Ball



Two Bang-Ball Players "Shooting" the Ball through a Hoop on an Outdoor Court

space than many others, and celluloid balls are used for safety. Each player is equipped with a "gun" which is used to shoot the ball through a large hoop on top of a standard about seven feet high.

The Lubbs Mfg Co.
Canton, Ohio.



View of World's Steepest Railway, Which Is Built up the Side of the Royal Gorge

STEEPEST RAILWAY IN WORLD CLIMBS ROYAL GORGE

Standing virtually on end, like a giant ladder, the steepest railway in the world is the recently opened electrified road built up the side of the Royal Gorge of Colorado. The line extends 1,725 feet, or more than a quarter of a mile, from the base of the crest of this great wonder of nature and is built on a 100-per-cent grade at an angle of forty-five degrees. Cars are controlled by the latest safety-brake devices, and the line connects with the famous hanging bridge over the gorge, which was another remarkable feat of engineering.

¶ We want all our readers to write us freely and often whenever they wish additional information on articles published in this magazine. Address Bureau of Information, Popular Mechanics, Chicago.

a 1221

Comd. Lt. Carley McHarment
Langley Field
Hampton Va

Mystery Engine Promises



This Giant Wind Tunnel Has a Mouth Sixty Feet Wide and Thirty Feet High; a Full-Sized Airplane Is in Position to Be Blown by 100-Mile-an-Hour Wind

FOR years the most brilliant aviation brains of France, England, Germany and America have been working secretly to produce a light engine that would run on furnace oil, thus eliminating the hazard of fire from flying.

Millions have been spent, as motors roared on test benches and engineers peered into wind tunnels, testing, verifying and experimenting. At Langley field, the big Packard laboratory and the Rolls-Royce plant in England the work has gone on.

America has produced several engines and England has announced the perfection of a "mystery engine," which is said to produce more power per pound of weight than any built in the world. A model is declared to have run a full year without missing fire once.

This startling power plant, details of which are not known even in England outside the offices of the government and the research staff, is expected to eliminate all hazards of fire in the air.

It will operate on shale oil, gas oil or any other type of heavy fuel, and even on alcohol if necessary. Where it scores over

any other of its type so far produced, according to meager information that has filtered through the closely guarded factory portals, is in its flexibility of speed ranges, light weight with great power, and in a mysterious detail of design in its injection-pump system.

The engine has been named the "Condor III." While heretofore it has been a difficult matter to run a Diesel-type engine at slow speeds, the new engine will turn over comfortably at about 300 revolutions per minute. Its normal full-power speed is around 1,900 revolutions and its maximum well over 2,000.

One of the most coveted records since man has learned to fly is now held by the Packard aircraft Diesel engine, completed and flown for the first time in September, 1928. This was the first oil-burning engine ever to be used in an airplane. It holds the record for non-refueling endurance flights of eighty-four hours and thirty-three minutes. On May 13, 1929, this engine flew from Detroit to Norfolk, Va., 700 miles, at a total fuel cost of \$4.68.

Uncle Sam will test his mystery engines of the future in the world's greatest wind

Copyrighted material
Packard Motor Car Co
1580 ? Grand Blvd
Livon. Mich

Fireproof Flying

tunnel at Langley field, Va., where somebody recently pushed an electric button and a 100-mile-an-hour gale screamed through the gaping sixty-by-thirty-foot mouth of the tunnel, and struck a full-sized navy airplane hard on the nose.

Opening of the enormous wind tunnel means that at last airplane engineers have a "test block" where their flying wares may be tried out. Tests were hitherto performed on little models.

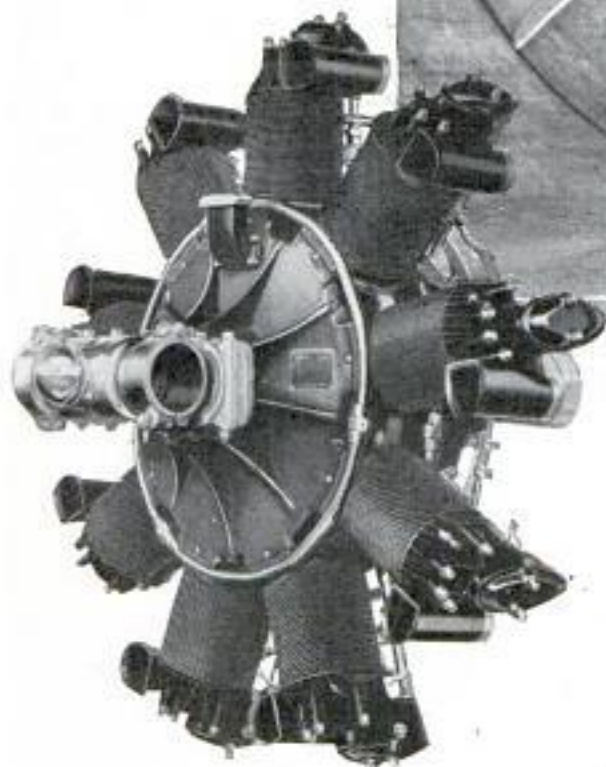

Giant Propeller That Draws Air through the World's Largest Wind Tunnel, and a Barrel-Valve Diesel Aircraft Engine

The value of working on full-sized airplanes, instead of models, is not readily appreciated. It would appear that if a principle holds good for a small object, it

should be true with one of larger size. But experience has proved otherwise. A coin and a feather will drop together in a vacuum tube, but in air the feather floats, and the smaller the feather the longer the float. So will big airplanes drop quicker than little models, depending, of course, on the shape of the wings and other peculiarities.

At the time the wind tunnel was opened, the 2,050-foot seaplane channel also was set into operation. The wind tunnel and the seaplane runway will be used in conjunction. The water runway will tell what a full-sized machine will do before it leaves the surface, and the wind tunnel what it will do in the air.

While a wind blast of 100 miles an hour is supposed to be a fair "cruising" speed for the great wind tunnel, it is predicted

91121

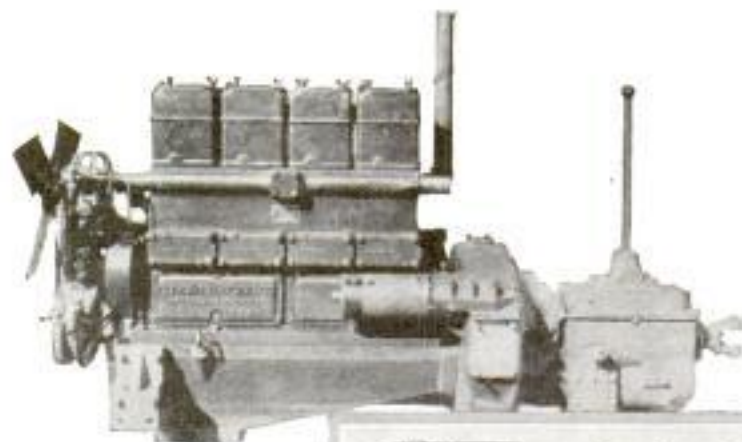

A specially built elevator has been provided to put the airplane "on the spot." The plane is pushed upon adjustable props which are strong metal tubes, set to catch the plane beneath the undercarriage and at the tail skid. A button then is pressed, and up goes the machine into position.

It is expected the blast of wind will sometimes blow off tails, ailerons and flippers.

This is exactly what the tunnel is for—to test the strength. If pieces fly away in the artificial wind, it means they need strengthening.

This big wind tunnel has cost around a cool million dollars. But nobody can begrudge it for such a test block of safety.

But safety is not the only use the tunnel will be put

the speed can be stepped up to about 150 miles an hour. Speeds such as this will give the pursuit planes a chance to show their fatal wing flutters.

These artificial speeds are produced by huge fans, turned by two 4,000-horsepower motors. And the howl of the wind as it rushes through the vast throat can be heard a mile away.

In the seaplane runway, the pontoons or hull of a full-sized craft can be towed through the water at a speed of fifty miles per hour or more. Two 1,000-horsepower motors do the dragging. An electric frame, operating on the same principle as a street car, with overhead trolley wires, is used for the purpose of pulling the hull or pontoons through the water.

When an airplane is set up for test before the tunnel mouth, it is fixed like a patient about to undergo an operation. But the airplane is chloroformed with recording instruments. Instead of taking the pulse of the airplane, it is watched for such reactions as pressures, pushes, pulls, strains, twists, turns, sags and breakages. After a full-sized airplane has been checked with the full blasts of tunnel breath, it may be taken down, torn apart and the structure of the fuselage, wings, etc., studied with microscope or even X-ray.

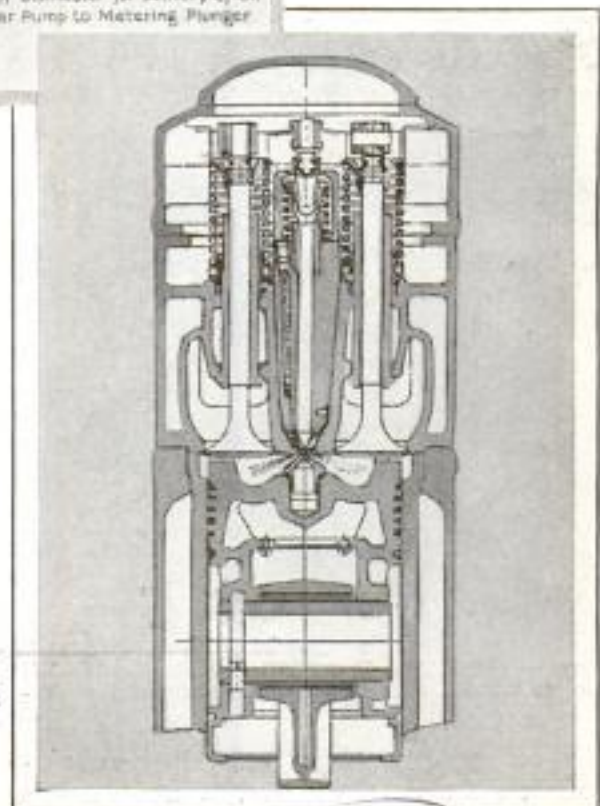
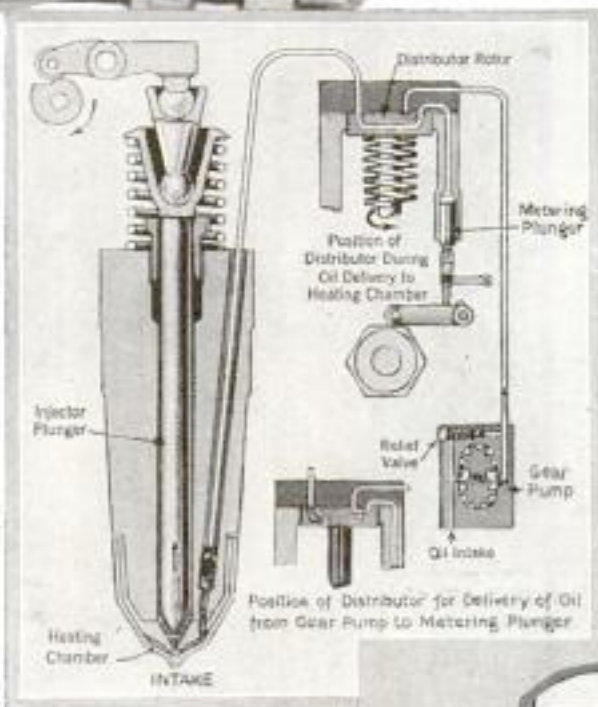

Four-Cylinder Cummins Diesel Engine for Autos, and Drawings of Its Fuel-Injection System

Cummins Engine Co.
Columbus, Ind.

to in studying aircraft. Speed may be studied through tests of different kinds of "fairing" or streamlining. The giant motor stand which holds the biggest four-bladed propeller in the world at the rear of the tunnel, is faired by having all the rough corners shaved down. This stand allows the wind blast to ride over it as the long wide blades of the propeller suck the air through the tunnel throat.

Engines have had to be tested heretofore upon the ground and in air that is comparatively still. Even engines with regular propellers attached do not

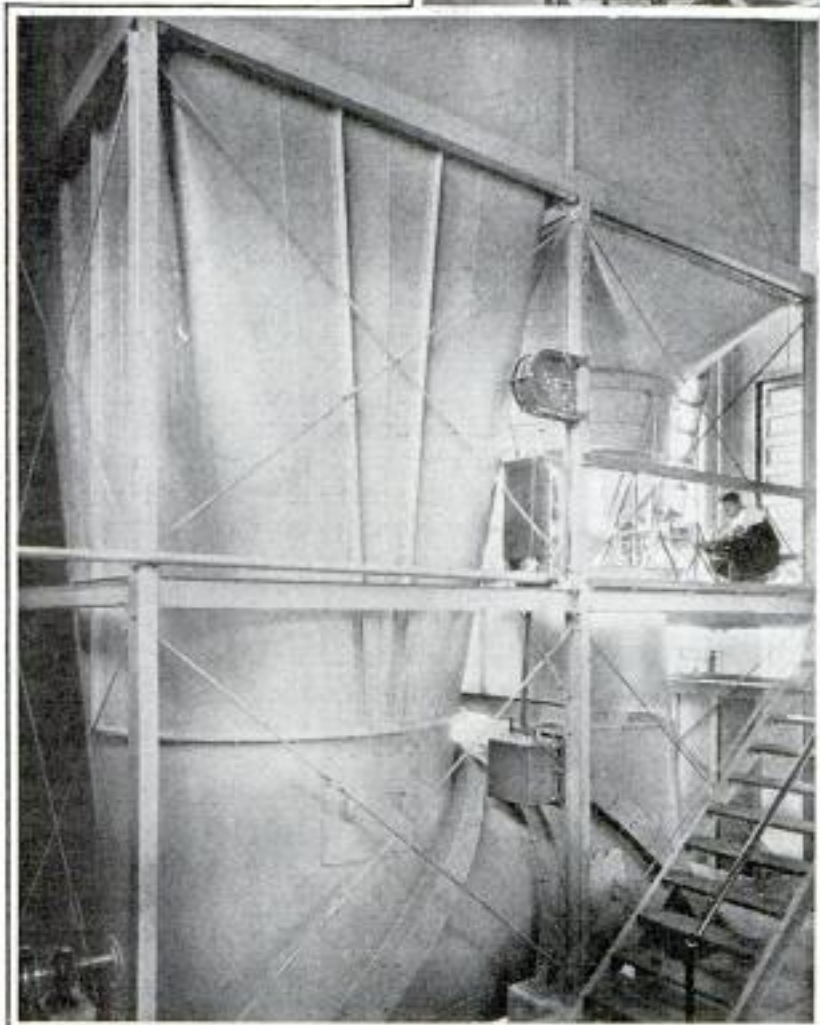
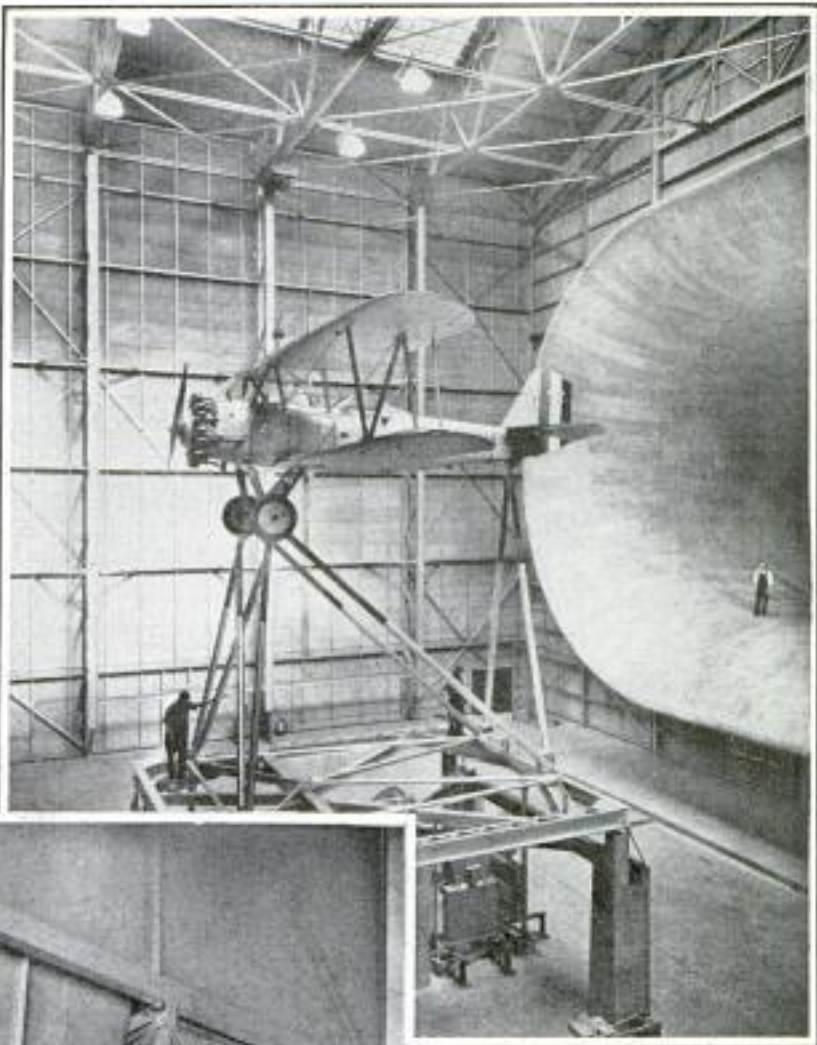

Navy Plane "on the Spot" before the Wind Tunnel; Below, the Vertical Tunnel That Tests Spins and "Falling Leaves"

get the same air stream as they do in the air. But by putting them in the mouth of the wind tunnel, regular flying conditions can be set up. The wind rushing past the air intake of carburetors makes a decided difference in performance.

Low operating costs, reduction of fire hazards to the absolute minimum; dependability, as the result of fewer working parts, and the absence of any electrical ignition apparatus that might give trouble in the air or cause radio disturbance, are factors which have brought Diesel-type engines more and more to the consideration of the public.

a1338

460

Comd. Herbert Peardsley
 Walcott Ave. Newport, R.I.

POPULAR MECHANICS

Painting the Giant Thrillers of Bygone Ages



Paintings of Prehistoric Animals Made from Models Built after a Careful Study of Fossils

of this country. To visualize a diplodocus or dinosaur, it is first necessary to make a precise study of the fossil structure, including the recording of hundreds of measurements. From such a study, a clay model is built up that is accurate to scale, the natural posture and the various details of body structure all being carefully worked out and incorporated in the small model. When this model is considered scientifically exact and correct in every detail so far as present knowledge makes possible, the artist is able to begin work on his painting or mural, using the miniature for a model and producing the scenic background to represent the earth as it appeared at the time the creature lived. Charles R. Knight, one of the foremost painters of prehistoric life, has made a study of animal anatomy in order to enable him to visualize and reproduce with scientific accuracy a picture of some extinct giants whose fossilized bones are the

Prehistoric giants of the animal kingdom that walked the earth millions of years ago are being reproduced faithfully in models and paintings from studies of fossils of these extinct creatures uncovered in Montana, Indiana and other parts

21351 Mrs. H. Burghart
New Bedford, Mass

Rob. Roe

only evidence that it ever lived. The diplodocus is one example of the creatures thus visualized. Its fossils have been found in Wyoming, and it probably was one of the largest animals that ever trod the earth, being seventy feet long and weighing about twenty tons. It appears a combination of elephant, lizard and giraffe with a small head, supported by a twenty-foot neck, and a thirty-five foot tail that it used in balancing to rear itself thirty feet in the air for browsing on trees. Mammoths and mastodons, somewhat resembling oversize elephants, have likewise been brought to life on canvas.

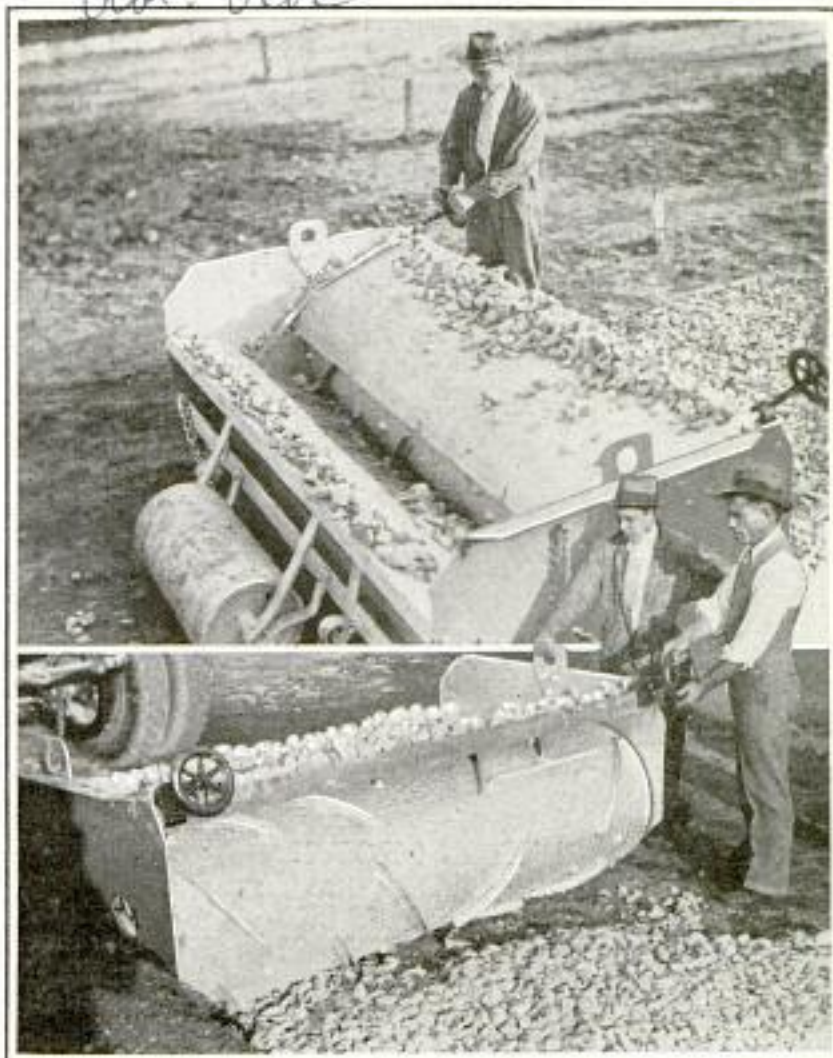

Crushed-Rock Spreader That Lays an Even Depth of Material under the Concrete-Surfaced Road, Thus Preventing "Valleys" and Bumps

Highway Service, 117 N. 6th St.
New Bedford, Mass.

21299
**FAN-HUMIDIFIER
WASHES AND
COOLS AIR**

Warm air is washed, cooled and circulated in a room by means of an electric fan which also includes a humidifier.

The air is blown through a very fine spray of water which moistens, cleans and cools it, the cooling being effected by evaporation of the water. The water is lifted from a tank by an endless spiral elevator to a central distributing drum which emits a fine spray as it revolves. A valve adjusts the spray and any excess water is caught by an outer drum and returned to the tank. A few drops of perfume in the water fills a room with a mild



Best results are obtained by placing the fan in an open window and closing openings which admit heated air.

Wheat, rye and whole-wheat bread are being produced all in one loaf.

M. Carpenter Baking Co
Milwaukee Wis

**ROCK SPREADER FOR ROADBED
MAKES HIGHWAY EVEN**

Designed to end the chief difficulties of road construction, including particularly the familiar "cup-hollows," a crushed-stone spreader now is available. It is hauled behind a truck of galvanized steel which feeds it. Spiral blades travel along the surface of a cylindrical roller, discharging the rock and flattening it into position in the same operation.

LAKE HEATS ITS OWN WATER

At a Swiss health resort is a lake which supplies the electric current to keep its waters at a constant temperature of seventy degrees. It is situated at an altitude of 4,000 feet, and the current is generated below its outfall.

Klosters

Army's Naggy & Cores, Esplanade
Old Bombay India

Keep the water in the tank
to be used for the next day's supply

21472

Allydingle
Technic
7/25/31

a1218

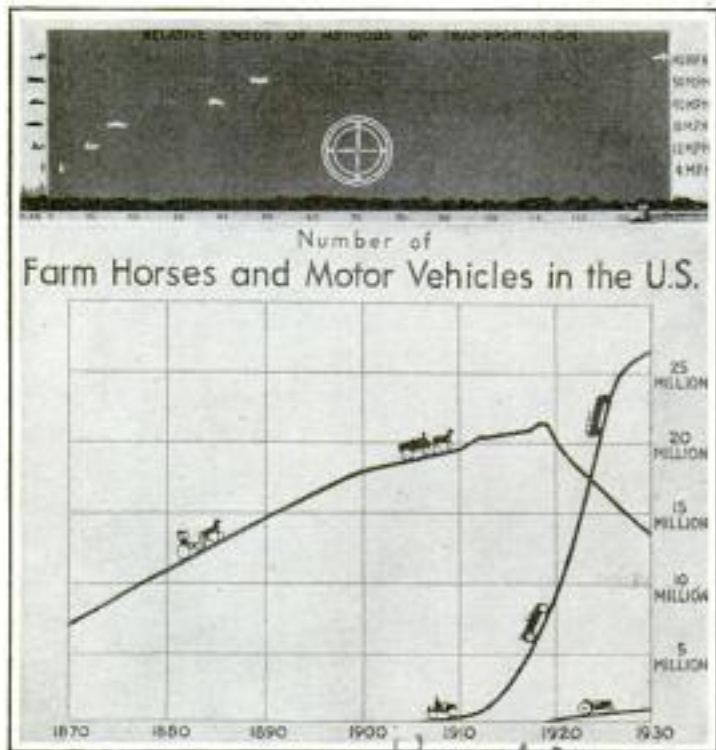

Chart Showing, Above, the Progress of Travel since Horse and Buggy Days, and, Below, How Automobiles Replaced Horses

DRAMA OF SPEED IS SHOWN BY LIGHTS

Striking illustrations of man's progress in his methods of travel are offered in the exhibit of the Museum of Science and Industry in New York, which includes models of every form of conveyance from prehistoric to modern times. One chart demonstrates by means of lights the difference in speed between the horse-and-buggy days and the present. It compares the speed of an airplane, locomotive, automobile, river steamer, horse and buggy and a pedestrian, all starting from Forty-Second street. In one hour, the chart shows the plane at Albany, the train fifty miles away, the auto almost as far, the boat eighteen miles distant, the buggy twelve miles and the man on foot four miles from his starting point. Another chart compares the decline of the horse with the phenomenal rise of the automobile, showing how the number of horses have decreased as the number of motor cars and autos grew in the last two decades.

FASHION REQUIRES ZOO TO CLOTHE WOMAN

If all the animals and reptiles that are called on to supply a part of the raiment of modern woman were gathered under one roof, the collection would represent a well-stocked menagerie. To begin with, the felt hat that Dame Fashion decrees may have had its origin in a rabbit, muskrat or beaver. The hair and fur are removed from the skins, separated by a blower and from the fur the hats are made. South America, Canada, Australia and other places supply hat fur. For the fur coat there seems no limit upon the animal range. It may be made from the pelts of lowly rabbits or from the more expensive sable, ermine, leopard or seal. Silkworms supply dress materials, oysters furnish pearls, cloth fabrics may come from the

wool of sheep or the hair of the llama, gloves may once have been the skin of the chamois, some rare deer or the pig, and for shoes the modern miss goes to the reptile house. Snakes, lizards and crocodiles help to supply footwear and the soles represent the hides of cattle that roamed the plains.



Carl Eckhardt

91280 Cap Curtis, Sells Flats
Circus

This Inventor Is an Unseen "Star" of the Tanbark and the Big Top

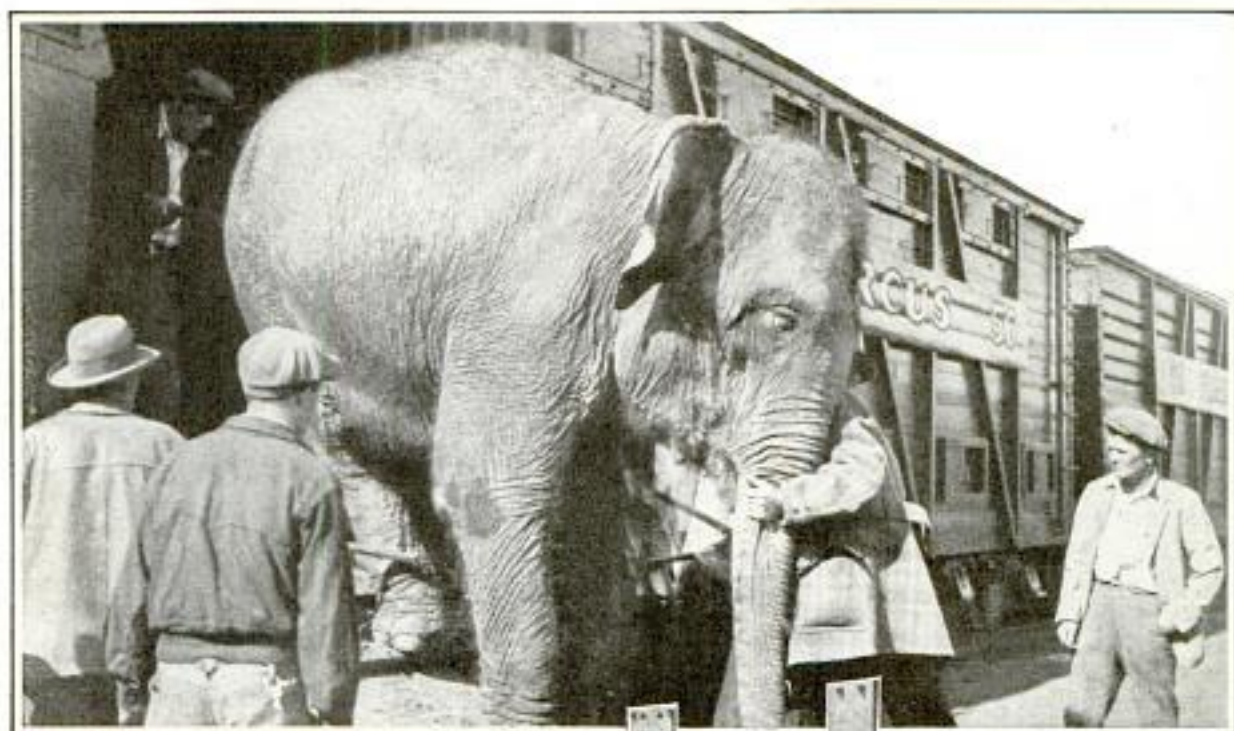

IN ITS mechanical perfection, a large circus is a world unto itself—a world in swift, ceaseless transit.

Time is money to anyone, but to a circus it is existence itself. The advance crews are kept three weeks ahead of the show, "spreading paper" to herald the coming of the "Big Top."

A man who has invented perhaps a dozen time and labor-saving mechanical contrivances is therefore as much a circus star as any billed performer. Such a man, and the only one, is William H. Curtis, known in the realm of canvas and calliope as "Cap" or "Bill." His crowning invention is the triple-stake driver, a most advantageous improvement over the single-stake driver he devised about fifteen years ago. Other inventions of his are: loader crane to hoist bulky canvas rolls into wagons; chain system of circus seats by which bleacher seats can be set

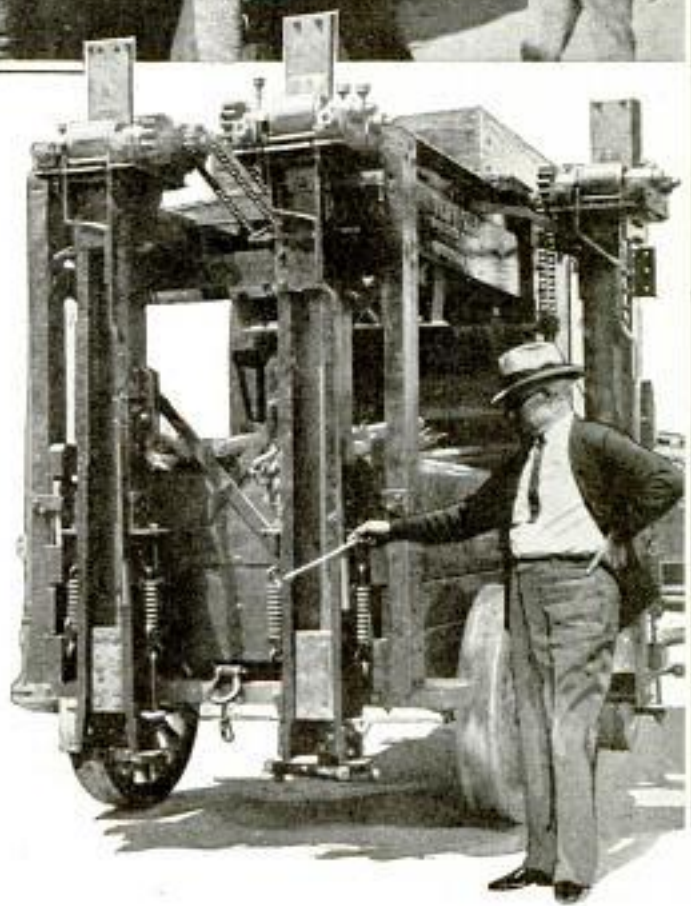

"Fanny" Objects to Loading, One of the Many Delays a Circus Train Suffers; Below, Triple-Stake Driver That Circles the Big Top in Fifty-Four Minutes

91280

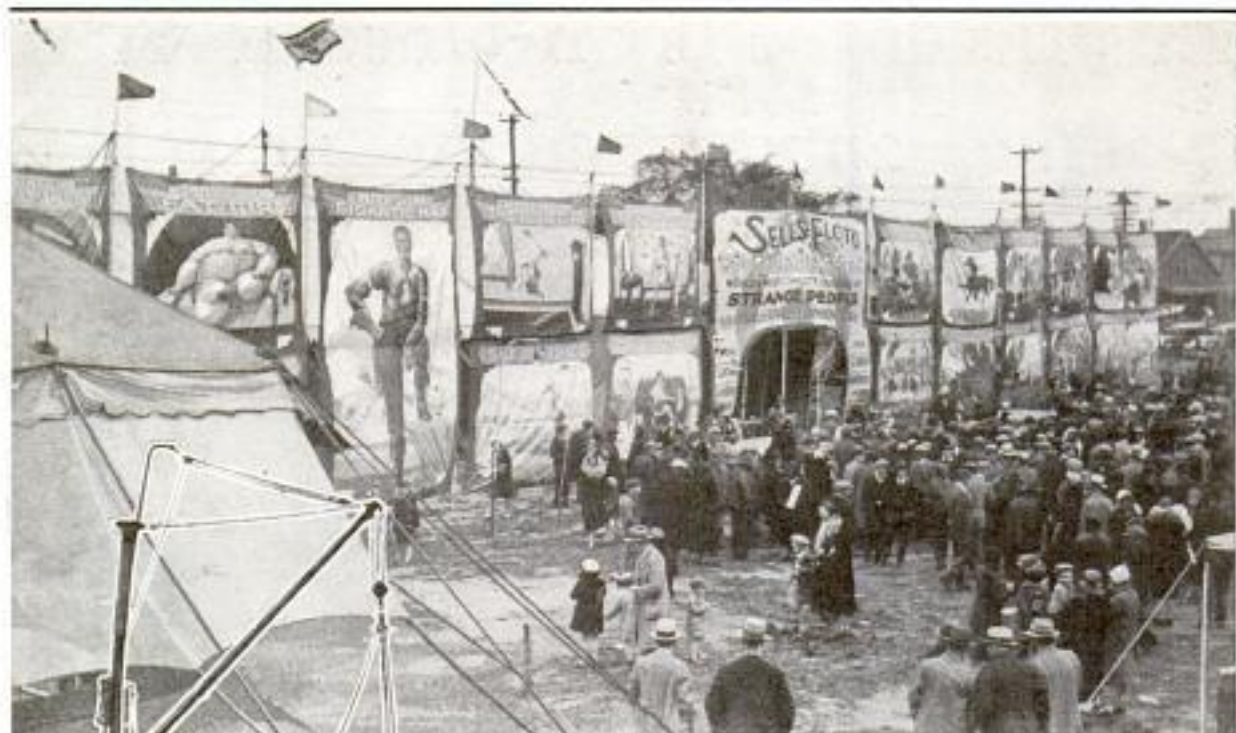

Throwing Up the Banner Line to Draw the Crowd: Below, the Canvas Loader That Speeds Up the Departure

up on pavement without use of stakes; a canvas-carrying spool to facilitate rolling and handling of canvas; a guy-rope tightener and several other smaller articles.

Cap Curtis has been a real trouper for forty-one years. As a boss canvas man, he has fought the elements—wind, flood, snow, mud and temperature extremes. The night a troop train plowed through the rear coaches of the Hagenbeck-Wallace circus train, Cap was knocked from his berth unconscious and rode on through the wreck on the pilot of the engine. The next season, he was limping about the circus lots as usual, and he is still at it.

Circuses used to travel in from three to ten railway cars, and, of course, some smaller ones do still, but the big shows have merged and remerged until they have reached dimensions P. T. Barnum never dreamed of. The biggest show in

America needs ninety cars, has about 600 horses, and even more humans. Besides the big top, there are the sideshow, menagerie, dining, dressing, horse and a dozen midway tents to set up and take down each day.

A circus closes its night performance between ten and eleven o'clock. By that time, the first section is loaded with the cook

house, ticket wagons, parts of the menagerie and the properties used in the first part of the program. It gets the "high-ball" and moves away. Perhaps three hours later, the second section begins the jump of from fifty to a hundred miles. The spectre of delay because of breakdown, wreck, flood, storm or any one of many other causes always harasses the circus manager. A recalcitrant elephant may hold up loading for hours, and the big shows have as many as twenty bulls.

Several hours later, the cook house goes up on the new lot, and breakfast is served all too early. The lot superintendent lays out the ground and turns it over to the boss canvas man. He has assistants for the menagerie and sideshow tops. There is rush, but no confusion. Then come the parade, the afternoon and evening performances, and the whirlwind is renewed.

Emb. E. L. Moore, 376 7
 Oliver St. N.W., Washington D.C.

21195

135 2

**CHEMICAL FROM APPLE PEELS
 USED FOR WATERPROOFING**

Millions of pounds of apple pomace may be reclaimed from cider and vinegar mills and converted into ursolic acid, a valuable new chemical recently extracted from apple peelings by the department of agriculture. This chemical is a yellow powder in its pure state and repels water. When added to lacquers, it increases their gloss and water resistance. It is being investigated as a possible waterproofing for fabrics and wood. The chemical is contained in the waxlike coating found on apples stored for some time.

men float

Inflated Mattress Used in Water as Raft and on Land as Auxiliary Bed



*Converse Rubber Co
 Malden Mass*

Bureau of Chemistry 9109

**STEEL-TUBE AUTO SEAT
 ADDS EASE TO DRIVING**

Adapting the steel-tube chair of modernistic furniture, German automobile manufacturers are equipping their cars with seats made with bent steel-tube frames and cloth or leather stretchers. The advantages claimed for these seats are lightness, comfort, economy, cleanliness and long life. When the front seats of a close-coupled car are of steel tubing, foot room for passengers in the back is increased. The frame is usually a single piece bent to the required shape. In some cases steel springs are added and the fabric of seat and back attached to them.

31600 retail

Auto Seat of Flexible Steel Tubing, Bent to Resemble Chair and Covered with Cloth or Leather

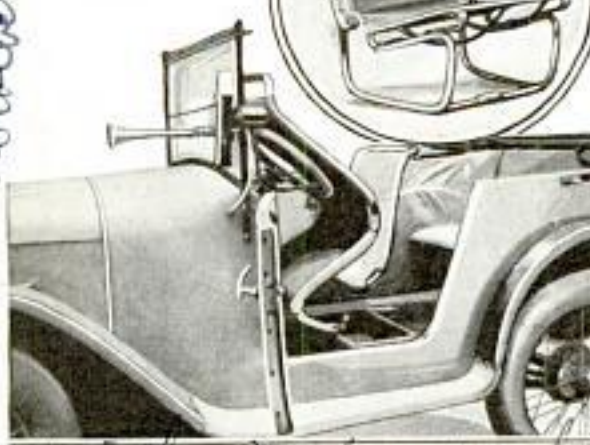

**MATTRESS FLOAT MAKES BOAT
 OUT OF AUXILIARY BED**

Automobiles, bicycles and other vehicles have been converted into watercraft, and now comes the bed that is also a boat. It is an inflated mattress that makes an air raft for surf-riding, boat-trailing and other forms of water sport. When taken from the water, it dries quickly and then can be used for an auxiliary bed, or for lounging, as it provides a full body-length cushion for chair, canoe or porch. It folds when deflated and has large eyelets for attaching handhold ropes.

91354

**WHAT IS DIFFERENCE BETWEEN
 STRENGTH AND STIFFNESS?**

Stiffness of a material often is confused with strength. Tests on steel rails, for instance, show that in the case of the new 152-pound rail adopted by an eastern railroad, the addition of twenty-two pounds in weight increased the stiffness of the rail seventy-five per cent but its breaking strength only forty per cent.

There were 248,448 motorboats registered in the United States on January 1, an increase of nearly 7,500 for the year.

*Emb. Henry Slaberg
 47 Zvezdalen
 P. R. 10*

*Mucke-Welder Works
 Znojmo-Astrava
 Czechoslovakia*

*J. J. Loree, U + N. A. P.
 Albany, N. Y.*

Here is a **STENOTUBE**

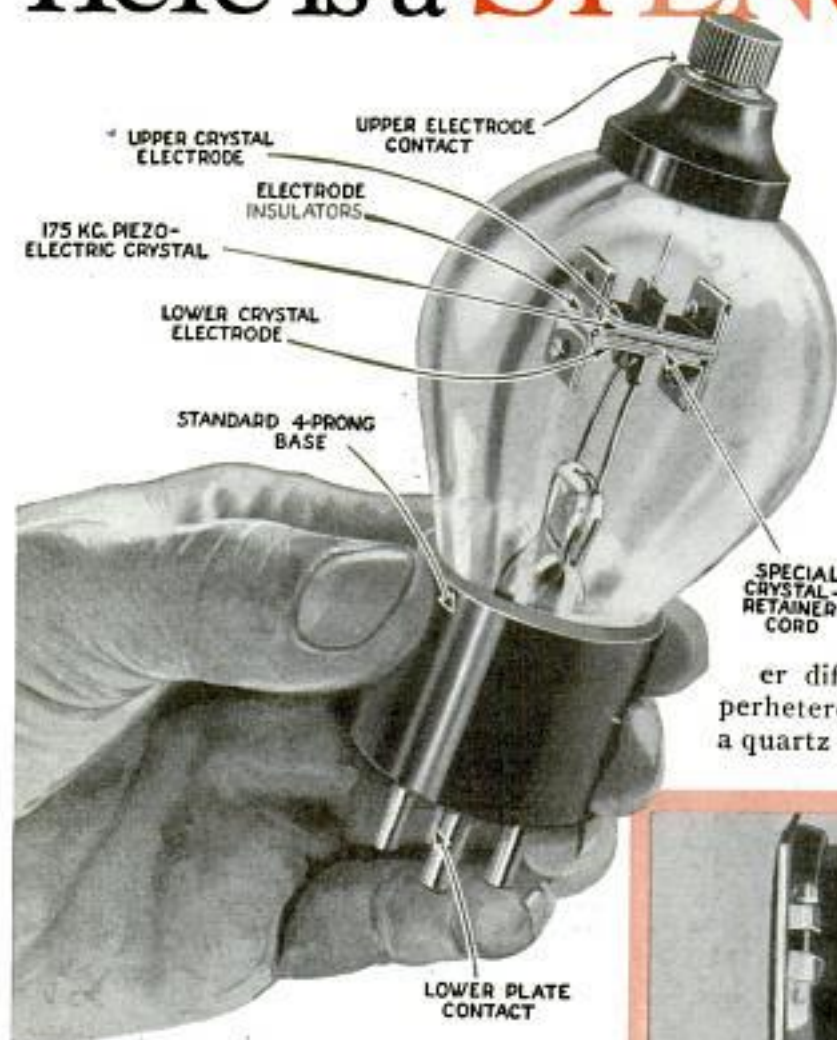

By **BERYL B. BRYANT**

A NEW order of selectivity has arrived when it is possible to tune between two high-powered stations, separated by 10 kilocycles, to a point of complete silence without retarding the volume control. Dr. James Robinson's quartz-crystal superheterodyne, recently introduced in this country by Arthur H. Lynch, not only makes this selectivity possible but has other equally remarkable features not found in modern receivers.

Using American apparatus and general circuit practices, with the addition of the "Stenotube" device, any radio experimenter can assemble this receiver and prove these claims to his own satisfaction. Anyone who has tuned a modern radio receiver to full sensitivity, to pick up distant stations, knows that

the background noise or static makes these stations hardly worth listening to. The receiver offers distant reception without background noises and may be instantly adjusted to eliminate heterodyne interference between stations.

Operating into a standard audio amplifier and dynamic speaker, this receiver will give as perfect reproduction, at both ends of the scale, as any modern receiver.

The Stenotube receiver differs from the standard superheterodyne chiefly in the use of a quartz crystal between the first de-

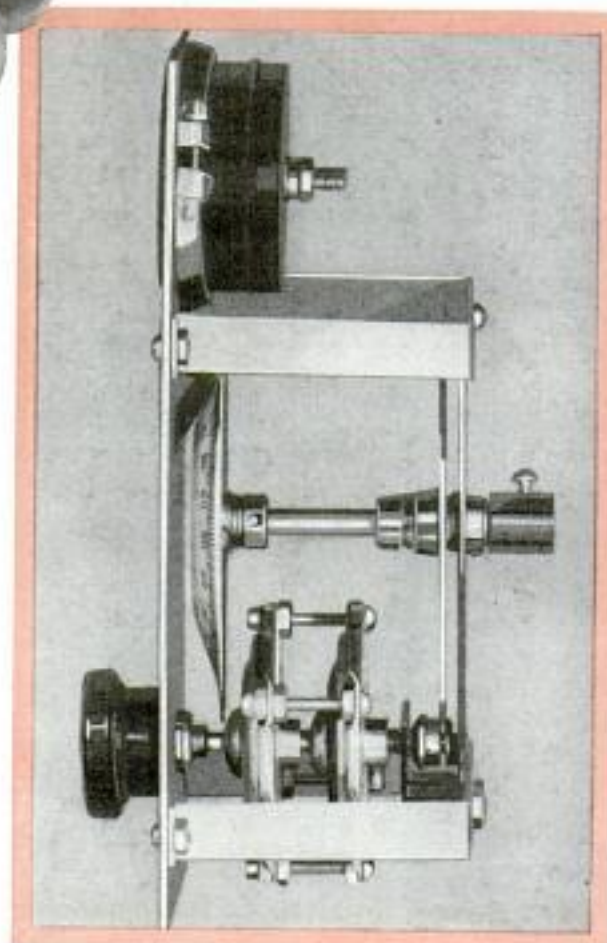

Planetary Dial for Stenotube Receiver Provides Two Speeds, Both Ratios Controlled by the Single Knob

Set for You

*Latest Radio Development
Gives Perfect Tone and
Complete Selectivity With
No Background Noises*

detector and the intermediate-frequency amplifier. The crystal vibrates between two metal plates and is housed in a tube mounted on a standard UX-base. Signal frequencies close to, or identical with, the natural frequency of the crystal pass

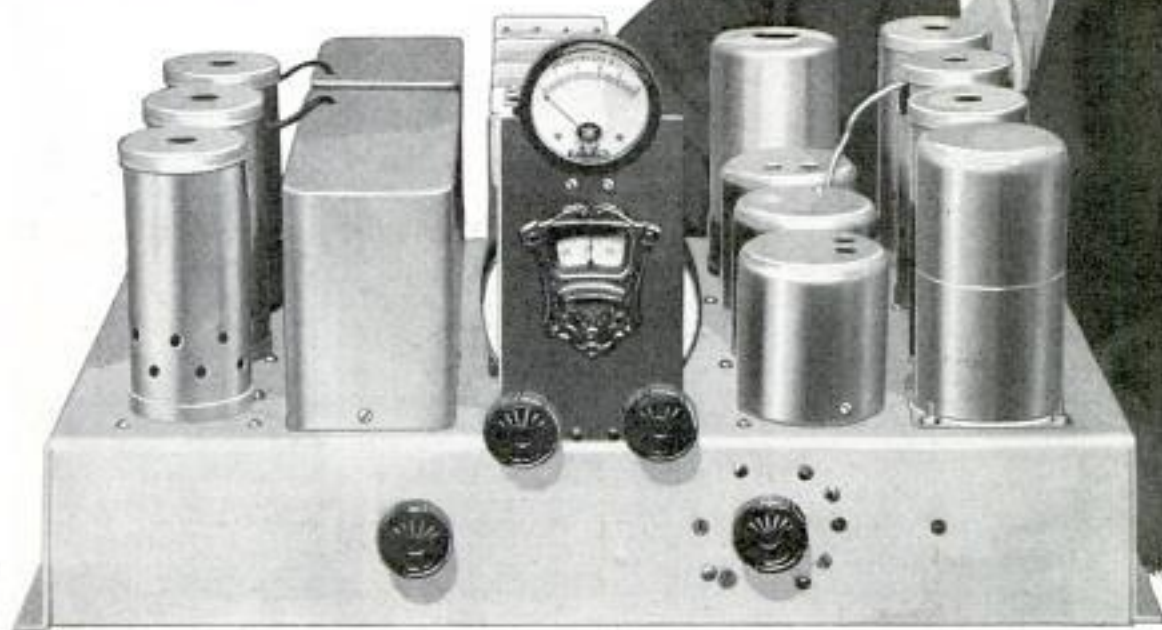

through it to the intermediate amplifier, while others are barred. The crystal is operated in a bridge circuit, as the two plates of the crystal mounting form an unwanted capacity. One arm of the bridge is a three-plate midget condenser known as a "Stenodon." When properly adjusted, this condenser prevents the undesired signals from using the capacity of the crystal holder as a path, while the station signal passes through the oscillating crystal to the intermediate amplifier without opposition.

The special tuning dial developed for this receiver is shown in the photo on page 466. A planetary form of transmis-

sion is employed to provide two speeds—one ratio of 1 to 10 for quick station location and a low ratio of 1 to 200 for the final adjustment. Both ratios may be controlled by a single knob. An 0-to-10 d.c. milliammeter is mounted above the dial and is connected in the circuit to act as a resonance or fine-tuning indicator. This greatly simplifies the fine tuning necessary for maximum results, as the receiver is tuned for the greatest swing of the needle.

The special parts required to build this receiver are all available, and the simplified diagram is made from the actual working model, demonstrated by Mr.

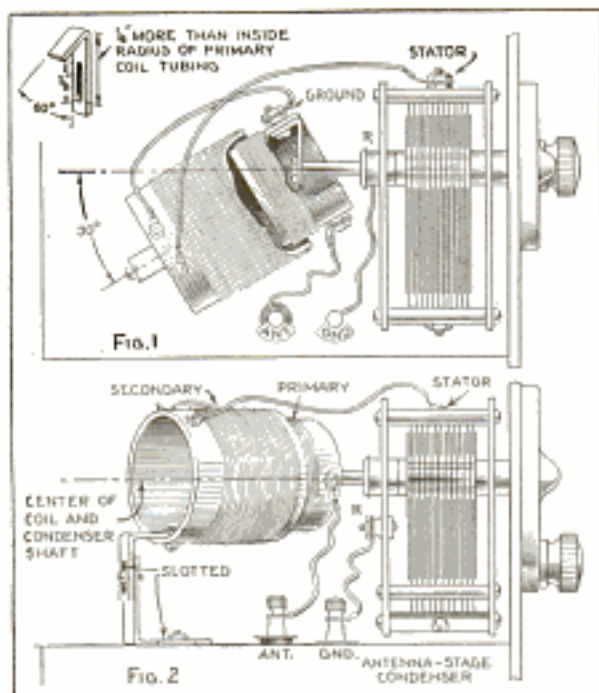

Primary Loader Is Automatic

Turning with the condenser shaft, this primary loading coil changes position in relation to the secondary so as to maintain the same signal strength at both ends of the dial. To install this device, the shaft of the antenna-stage condenser is extended about 3 in. from the condenser frame. If the condenser shaft is of the removable type, this is a simple matter; if not, a coupling may be used to attach the extra length. The tubing on which the primary is wound is $\frac{1}{16}$ in. smaller in outside diameter than the inside diameter of the secondary coil. This is necessary in order that the primary coil may swing into the secondary as shown in Fig. 1. Both primary and secondary coils should be wound about $\frac{1}{8}$ in. from the ends of the tubing, the number of turns, of course, depending on the capacity of the variable condenser used. The coil forms may be coated with shellac and the wire wound on while the shellac is still sticky. The finished coils need not be coated. An angle of 30° is correct for the secondary, to give the best entrance to the moving primary coil. With the condenser plates all in, the primary coil should be fully inside the secondary, swinging outward and upward on an angle as the plates open. Fig. 2 shows the method of mounting the secondary coil on the adjustable bracket. —Henry S. Laraby, New Haven, Conn.

Baseboards Insulated against Leakage

Wooden baseboards used for radio receivers or transmitters should be given a coating of either clear or orange shellac. Where extra precautions against leakage are advisable, some experimenters boil the baseboard in paraffin. Black lacquer and other similar finishes, likely to contain pigments that would form leakage paths for the small radio currents, should be avoided.—Ross J. Plaisted, Brecksville, Ohio.

Installing Phone Jack for the Deaf

Headphones may be plugged into any receiver, for the benefit of a deaf member of the family, without disturbing the output of the speaker. The first step, as shown in the diagram, is to find the plate leads to the tube sockets. A 1-mfd. 200-volt by-pass condenser is connected to each plate as indicated at X, and the other sides to the outside terminals of the potentiometer. The center terminal is connected to the frame of the phone jack. The parts are mounted either on a small panel, or the jack and volume control on the side of the console and the condensers inside. The operator merely plugs in the phones and turns up the volume control to the desired volume for the deaf listener without interfering in any way with the operation of the set or loud speaker. In sets using straight audio-coupled output,

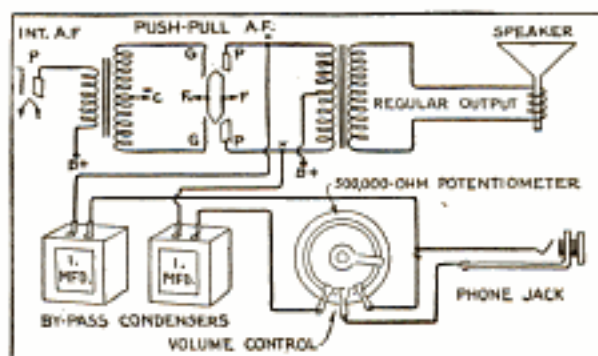

one condenser will go to the plate of the last audio tube and the other to positive-B for this tube. Tube adapters may be used without wiring into the circuit if desired.—John A. Kendall, New York City.

For further information on any radio construction article write to the radio department; this service is free.

Easy Ways of Solving Your Radio Problems

*Ward Leonard Co
South Pearl St
Mount Vernon NY
Chicago 53 W Jackson*

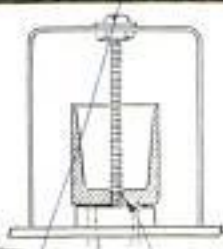
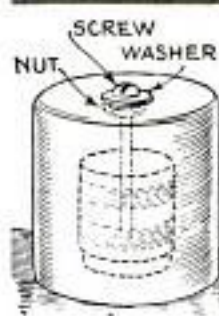

Above, Aluminum-Cup Shield Combined with Plug-In Coil; Right, Keying Relay Operates on A.C.; Below, Service Tubes Marked for Locating Filament Prongs Quickly When Changing from One Set to Another



Voltage-Divider Terminal Panel and Handle for Plug-In Coil Made from Scrap Bakelite

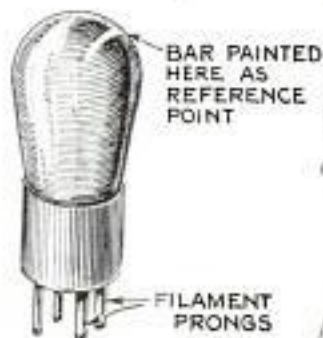

Below, Transmitter-Filament Supply Units That Operate on Either 110 or 220-Volt a.c. Lines

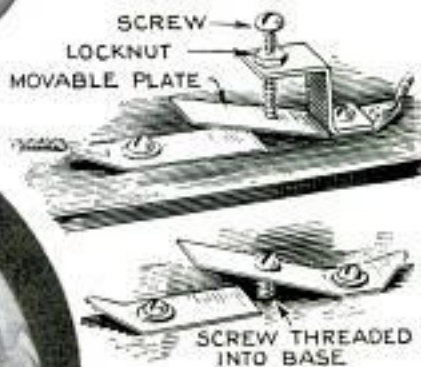

Above, Neutralizers, Trimmers, or Series Antenna Condensers for Short-Wave Sets May Be Made from 28 Gauge Sheet Brass or Phosphor Bronze, 3/4 by 1 1/2 In.; the Angle Is Made from 1-16-In. Brass Strip; Left, Auto Lamp and Socket Handy for Checking Antenna Current

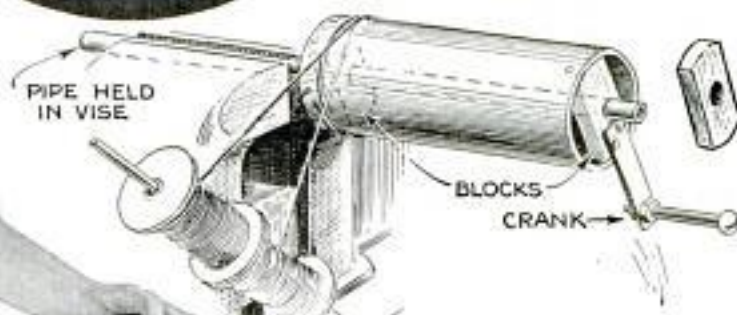

Simple Homemade Coil Winder with a Lower Spool for Spacing Turns; After Coil Is Wound, It Is Coated with Collodion and Dried, Then the Second Winding Is Removed

*Thordarson Mfg Co
500 W 1st St
Mount Vernon NY
Copyrighted material*

Crystal-Controlled

by Frank L. Brittin

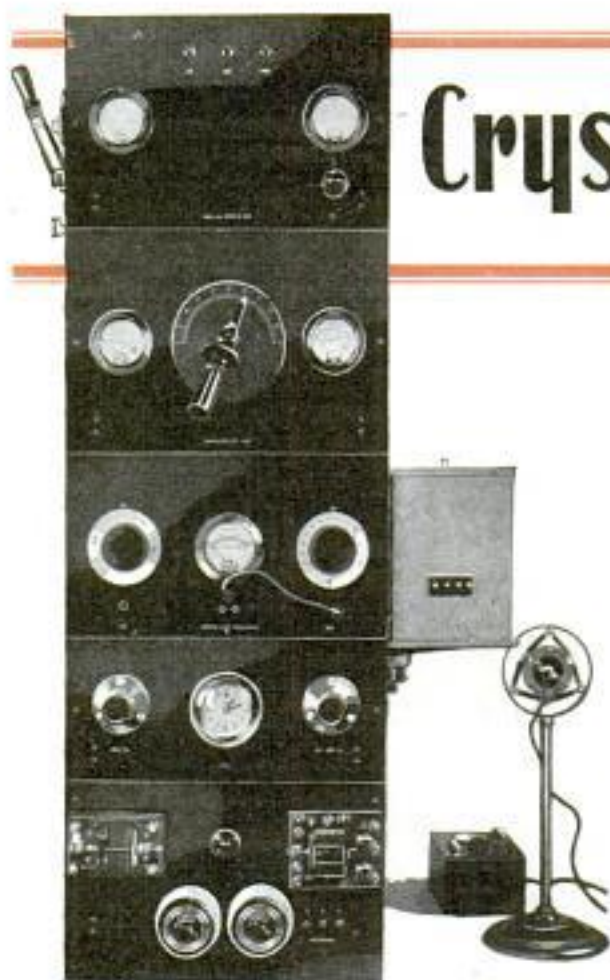

screen-grid voltage of the buffer tube employed in the foundation unit. The transmitter is placed on a heavy table and the power unit is installed on a shelf below.

The bottom unit contains a separate plate supply for the type-410 crystal-controlled oscillator and also the filament supply for this tube and the 565 buffer tube. The filament and plate-control switches, for the complete transmitter, keying relays and microphone-input jacks, are mounted on the front of this panel. In the next unit above are the additional filament-supply transformers and the necessary rheostats at either side of an electric clock. The third unit is the oscillator and buffer stage. The temperature-control oven, mounted on the shelf at the right, was described in detail in the June, 1931, issue. Directly below this shelf is a master switch in series with the 110-volt

PERHAPS the most difficult problem confronting the amateur radio operator is the arrangement of the various units that go to make up a modern key and phone transmitter.

Compactness and accessibility are easily obtained, however, by means of the unit method of assembly. This means that each stage is as complete as possible and properly shielded from preceding and following stages. The unit panel arrangement may be varied to suit individual needs, and, owing to the flexibility of this type of assembly, the builder may start with the foundation unit, described in this article, and add or change the following stages to any other type of transmitting circuit he prefers.

The five-panel assembly shown in the photo on this page is a complete 50-watt phone and CW-installation with the exception of a 1,500 to 2,000-volt power supply for the two 50-watt tubes and the

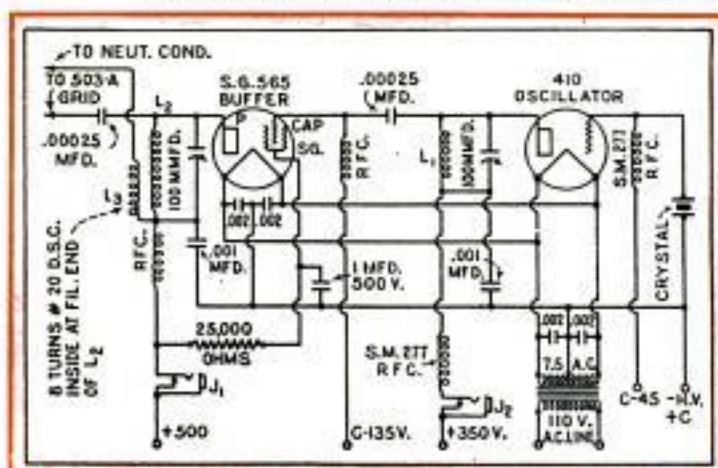

a.c. line and a small candelabra lamp mounted behind the large red jewel in the center of the bottom panel.

The panel next to the top is for the modulated 503-A r.f.-amplifier unit, and the top section contains the speech amplifier and a type-545 modulator tube. Details of the microphone-control box, shown at the left of the microphone, and construction data for the units described will appear in following articles; diagrams

Transmitter Unit

W 9 D C X

and material lists will also be available.

The frame for housing the transmitter is made of 1 by 2-in. channel iron, $17\frac{3}{8}$ in. wide, 11 in. deep and 50 in. high, and $1\frac{1}{4}$ -in. strap iron is used at the sides, back and top to hold the frame together. The shelf brackets are made of 1 by 1-in. angle iron.

Four plywood baseboards, $\frac{1}{2}$ by $10\frac{3}{4}$ by $15\frac{3}{8}$ in., are required. These should be well sanded and coated with a good grade of shellac. No baseboard is used for the oscillator and buffer foundation unit, as the copper container rests directly on a shelf made of heavy sheet brass, $\frac{1}{8}$ by $10\frac{3}{4}$ by $15\frac{3}{8}$ in.

The construction of the foundation unit, a CW-transmitter in itself, is quite simple, as shown in the upper photo on this page. The container is made of No. 17 gauge copper, $14\frac{3}{4}$ in. long, $8\frac{1}{4}$ in. deep and 9 in. high. A flanged copper partition, with a cut-out for the meter at front, divides the box into two sections. The oscillator tube is at the left and the buffer at the right. A bakelite subpanel is used, and is raised above the bottom of the can by means of four 1-in. brass or fiber posts. This enables the builder to mount most of the small fixed condensers under the subpanel. The two 100-mmf. condensers are of the new small two-bearing type. Coil L_1 consists of 18 turns of No. 14 enameled wire, wound on a bakelite tube



having an outside diameter of 3 in., and the turns are spaced the diameter of the wire. Coil L_2 is the same as L_1 , and L_3 is a neutralizing coil, consisting of 8 turns of No. 20 d.s.c. wire, wound on a bakelite form that will fit inside the filament end of coil L_2 . The lead from this coil is brought out through the side of the can and terminates in a clip for the .0001-mfd. neutralizing condenser mounted in the r.f. stage above.

The buffer output lead is also taken out to a clip for the grid terminal of the 503-A tube. The bakelite front panel is $\frac{1}{4}$ by $9\frac{1}{2}$ by $17\frac{3}{8}$ in. The two closed-circuit jacks J_1 and J_2 are mounted below the tuning condensers, and a flexible lead terminating in a plug is used to shift the d.c. 0-to-150 milliammeter from one stage to the other. Two phone-tip jacks for the crystal leads are mounted directly under this meter. The 1-mfd. 500-volt condenser is mounted on the back of the can, and all terminals are brought to soldering lugs at the rear of the subpanel, leads being taken to a strip of binding posts on the shelf behind the unit.

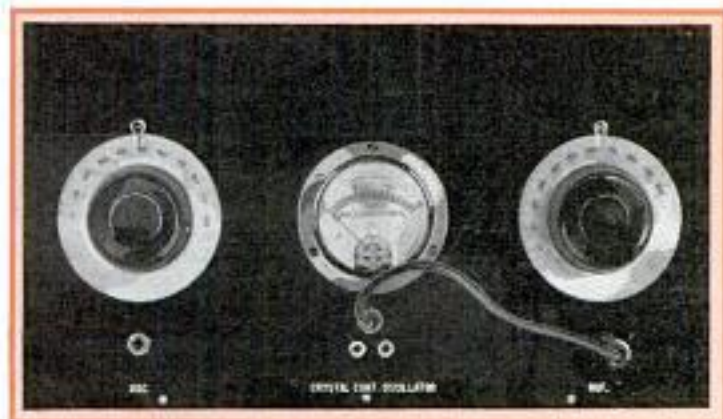

Milliammeter Serves as a Multi-Voltmeter

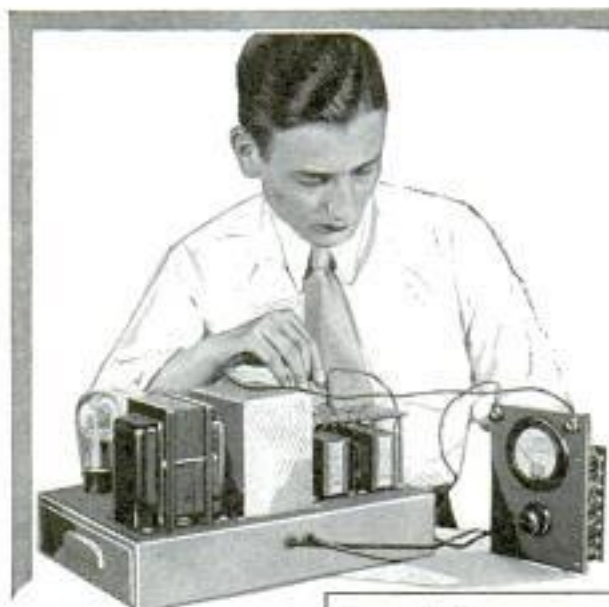

Experimenters who happen to have a good d. c. milliammeter, reading from 0 to 1, full scale, can easily make it serve as a multi-voltmeter by means of suitable multiplying resistors. The resistors, however, must be chosen with care, the new wire-wound variety being sufficiently accurate for the purpose. Individual voltmeters to cover the ranges indicated in the diagram would cost too much for the average experimenter. Therefore this simple, and comparatively inexpensive, means of obtaining a high-resistance d. c. voltmeter for 1 to 2,000 volts at 1,000 ohms per volt is well worth consideration. At 2,000 volts, the highest-value resistor should be capable of passing about 2 watts. If this type of resistor is not available, two 500,000-ohm resistors should be connected in series instead of using the single 1,000,000-ohm unit. It is, of course, understood that this meter is not to be used in the circuit continuously, as the resistors would heat and probably break down. A bakelite panel, $\frac{3}{16}$ by 7 by $5\frac{1}{2}$ in., or any size necessary to fit a box to house the instrument,

may be used. The illustrations show the arrangement of the milliammeter, multiple-point switch and binding posts on the panel. This switch is one of the common inductance types, but good contact should be provided as otherwise high resistance will be introduced and the calibration thrown off, especially at the higher voltages. The wire-wound resistors have small knurled nuts at both ends enabling the builder to use a single mounting for the entire group, as shown in the simplified wiring diagram. Two strips of bakelite, $\frac{1}{8}$ by $\frac{1}{2}$ by $5\frac{1}{2}$ in., are drilled to space the resistors about $\frac{1}{8}$ in. apart. The resistors are then installed and the entire assembly is mounted at the left side of

the meter and switch with small angle brackets. It is well to check the completed unit with a standard voltmeter of similar range, so that proper allowance can be made for any defect in the resistor values.—L. B. Weitzel, Chicago.

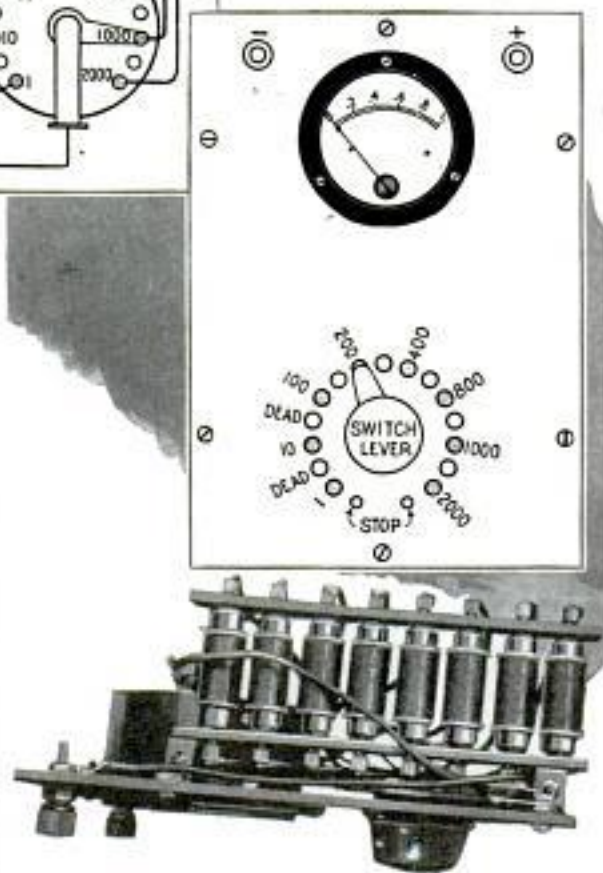
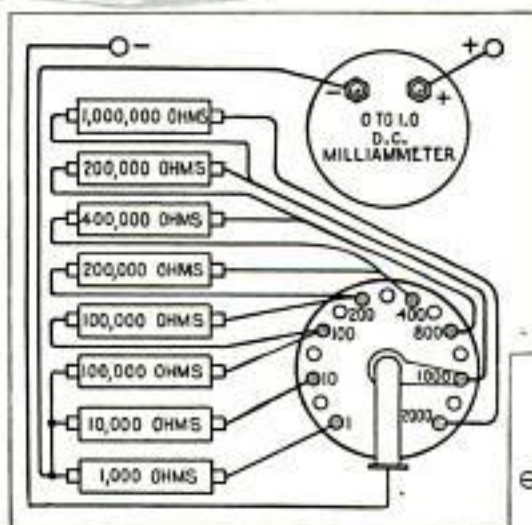

Pre-Amplifier Improves Home Recording

by R.E. Clarke

WHEN your a. c. receiver lacks sufficient audio amplification for the proper operation of a microphone, home-made records want volume and tone quality. This pre-amplifier supplies the necessary punch and may also be used to convert a radio receiver into a small public-address system.

A simple transformer-coupled circuit is used, as other forms of coupling sometimes cause "motorboating," and the tone quality is limited only by the microphone and radio receiver with which the pre-amplifier is used. It is easily connected to the audio amplifier of any a. c. receiver without any internal changes in the wiring of the set. Two adapters replace the detector, or first audio, and one of the r. f. tubes in the set, and a small clip is connected to the ground binding post, or to any grounded metal part of the set. There are only two controls. A 1,000-ohm rheostat, which must have an off position, regulates the microphone current, the correct value of which is determined by the reading of the milliammeter. A volume-control potentiometer of 500,000 ohms is also needed, because the pre-amplifier cuts out the usual volume control of the set.

No batteries, or separate power supply, are required, but a small self-contained C-battery is used to furnish the microphone current. All heater, plate and grid voltages are supplied by the receiver.

The unit has been tested with a number of standard receivers and in every case the loud-speaker response was equal in both volume and tone quality to a radio signal from a strong local station. When used on a home-recording machine, the volume was far greater and the tone quality better than with the ordinary equipment. Because of the wider needle cut, the life of the records will be longer.

In this particular model, the three leads



from the two-button microphone were brought in at the rear of the cabinet to a special plug. This may be simplified, however, by mounting three binding posts on the front panel. If a single-button microphone is used, there would be but two leads, one connected at point 2 and the other at either of points 1 and 3, as shown in the diagram.

The circuit is so simple and free from feedback effects that no special precau-

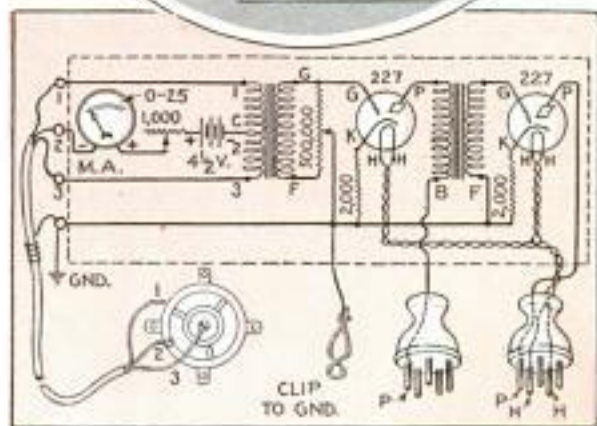



tions are necessary in building. Almost any arrangement of parts that suits the builder will do, the arrangement in the model being chosen only for compactness and symmetry. It is a good idea to mount all the parts on the base first and complete as much of the wiring as possible before mounting the front panel. The bakelite base panel is $\frac{3}{16}$ by 5 by $10\frac{3}{4}$ in. and is supported by two wood strips, $\frac{1}{4}$ by $1\frac{1}{4}$ by $4\frac{3}{4}$ in., and two pieces, $\frac{1}{4}$ by $1\frac{1}{4}$ by $10\frac{3}{4}$ in. The bakelite front panel is $\frac{1}{8}$ by $6\frac{1}{2}$ by $11\frac{1}{2}$ in. The leads to the plug-in adapters should be as short as possible. The amplifier will be freer from hum if the heater wires are heavy, and these wires should be twisted.

The layout of parts is clearly indicated in the lower photo on page 745, the microphone transformer being at the right, the audio transformer at the left, and the two type-227 tubes between them. The volume-control unit is mounted on the front panel directly ahead of the audio transformer and the rheostat at the extreme right with the Weston type-301 0-to-25 d. c. milliammeter between. The leads for the $4\frac{1}{2}$ -volt microphone battery are brought up to binding posts on the base panel, and it will be noted that most of the wiring is done under the base as shown. The only parts mounted under the base are the two 2,000-ohm 2-watt fixed resistors.

It is a good idea to use shielded cable for the microphone leads; these shielded cables are grounded. They are connected to the buttons on the front and back of

the microphone, the frame to the lead going to the center post on the panel. The adapter plug with the single lead is plugged into any r. f. socket. If type-226 tubes are used in the r. f. stages, the five-prong socket is replaced with a four-prong type.

The adapter plug with three wires is plugged into the detector socket of sets not using a type-227 tube in the first audio stage. In the contrary case, plug the adapter into the 227-socket. The unit has two stages of amplification, so only one stage is required. If two stages are used, it will be necessary to regulate the volume carefully. Howling may be avoided by keeping the



Top, Underside View and Details of Base Construction; Below, Front View of Completed Instrument

microphone as far as possible from the loud speaker. Simplified diagrams and a material list are available for those who wish them. To insure long life for the microphone, the current should be kept as low as possible with the rheostat. The outside dimensions of the cabinet are 7 in. high, 6 in. deep and $11\frac{3}{4}$ in. long.

Oil Increases Condenser Capacity

When a variable condenser of large capacity is required for the construction of a wavetrap, an ordinary .00025 or .00035-mfd. condenser may be adapted for the purpose. It is mounted in a can filled with either castor or transformer oil, which will raise the capacity several times its original value and also increase its ability to withstand high voltage.

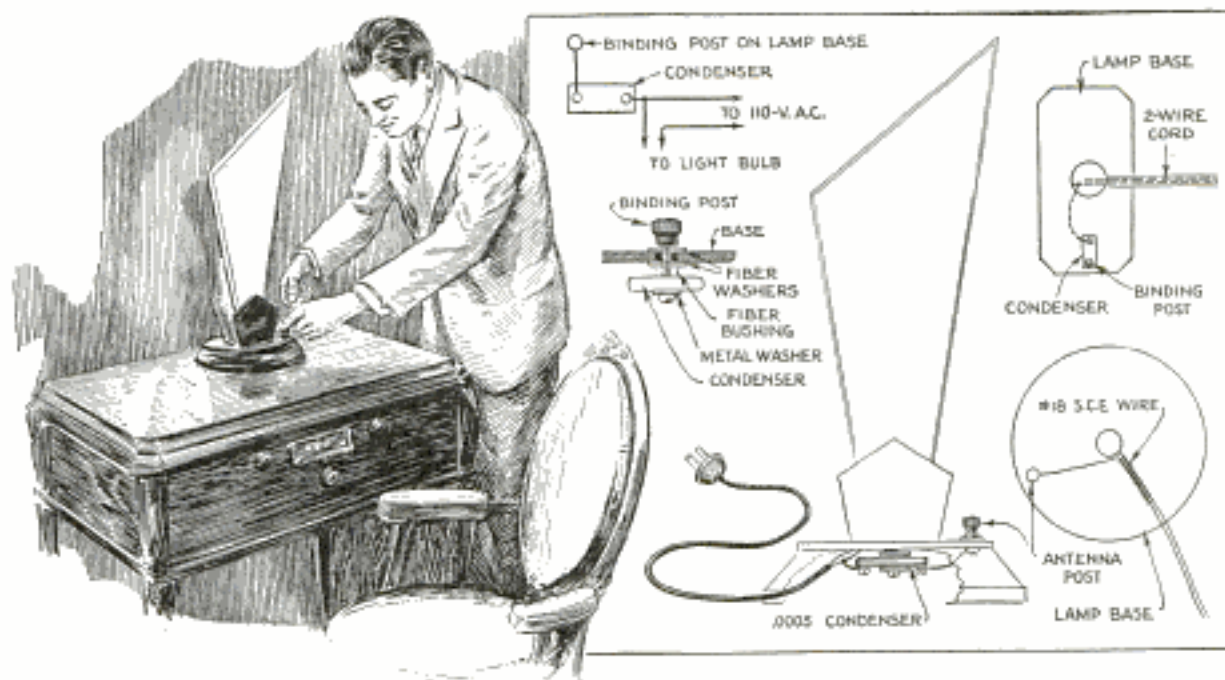

Top, Left, Diagram Showing Condenser Connected to One Side of the Supply Line; Below, Condenser and Antenna Post in Position; Right, Optional Antenna Connection

Homemade Radio Antenna Lamp

During the warm summer months many set owners will move the radio out on the front porch to furnish entertainment for lawn parties. Furnishing antenna and ground connections then sometimes is quite difficult, and the receiver is often put in a location that is more or less a disadvantage. Generally there are more convenience outlets around the average home than antenna and ground connections, so the advantage of having an antenna system within reach of the receiver at all locations would be appreciated by those who like to move the radio. Nearly every receiver has a lamp of some description adorning the top of the cabinet. Regardless of the style, it can be adapted to replace the antenna when portability is desired. A fixed condenser of .0005-mfd. capacity is mounted in the base of the lamp, as shown, and connected to a binding post on the base, but insulated from it. The condenser is connected to one side of the lamp cord. Another method consists in using a 30-in. length of No. 18 gauge s. c. e. magnet wire wrapped around the insulated cord supplying the current to the lamp. The wire is wrapped around that part of the cord between the outer edge of the lamp base and the entrance of the cord into the socket support. A layer of friction tape prevents

the winding from becoming short-circuited on the sides of the base. An optional layout, employing a two-wire cord for greater pick-up, is shown in the upper right-hand corner. If the cord of the lamp is connected in with the current-supply cord of the receiver, the set can be moved to any location, and the antenna connection will be made when the receiver supply cord is plugged into an outlet.—D. A. Brown, Marion, Ohio.

Shield for Wiring on Metal Chassis

Bakelite or fiber tubing, about $\frac{3}{4}$ in. in diameter, may be clamped under the chassis by means of a piece of sheet aluminum, bent as shown, to form an insulated conduit and shield for bunched wiring. The wires are led out of the tube at convenient points for wiring the circuit through holes drilled through the tube and metal chassis.

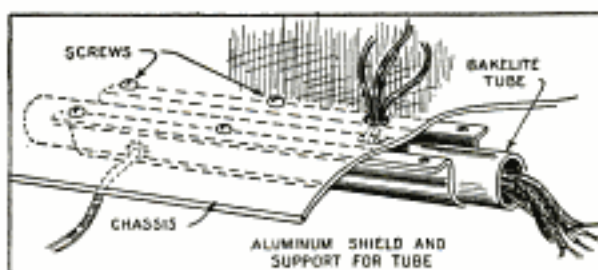

Insulating Conduit and Shield. Showing Method of Bringing Out the Connections

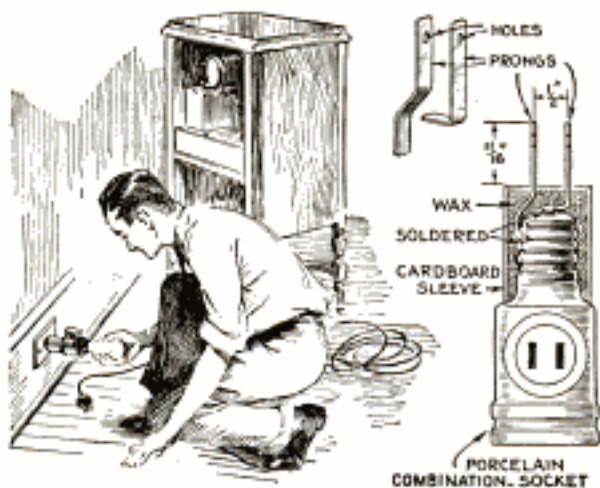

Inserting Combination Plug and Lamp Socket in Baseboard Outlet and Details for Altering Combination

Plug for Lamp Can Be Used as External Load

When testing power packs it is often necessary to insert a lamp, or other load, in series with the supply line so as to reduce the consumption of the unit under test. As the ordinary combination socket with a plug outlet on one side can be used only in a screw-socket receptacle, it must be altered to fit any standard outlet. How this can be done is shown in the sketch. Obtain a cardboard sleeve from an old candle-type socket and insert it in a short piece of thin brass tubing. The prongs are made of brass strips, shaped as shown and soldered to the end and screw-shell contacts, after which sealing wax is poured into the end to close the base.—
J. M. Wallace, Toronto, Ontario, Can.

Transformers Ganged for Special Service

Filament transformers, of the same type and make, may be connected to serve purposes for which they were not originally designed. In Fig. 1 two transformers with 110-volt primaries and secondaries delivering 2.5 amp. at 5 volts are con-

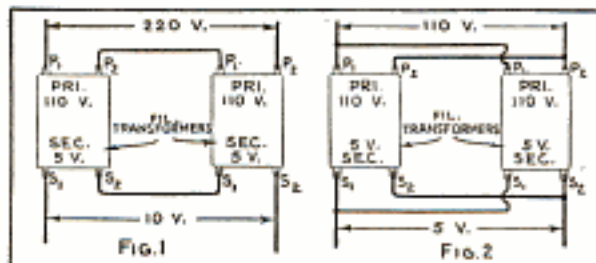

nected so that the primaries can be supplied from a 220-volt source, while the

secondaries, in series, will deliver 10 volts, at 2.5 amp. If a secondary voltage of 5 volts with 220-volt operation is desired, the secondaries should be connected in parallel. This will deliver 5 volts at 5 amp. In Fig. 2, the transformers have their primaries connected in parallel, enabling their use on a 110-volt source. The secondaries, also in parallel, will supply 5 volts at 5 amp.

Useful Parts from Old Sets

Odds and ends of old receivers may be obtained from any radio store for little or nothing. These parts may be used in their original form in many cases or refashioned for constructing experimental equipment. The panels can be cut up for insulating material and the binding posts are always useful additions to the amateur's junk box.

Switch Taps Made from Wood Screws

Inductance switches, employing the usual tap arrangement, are also handy for cutting multiplying resistors in and out of multi-range voltmeters and similar

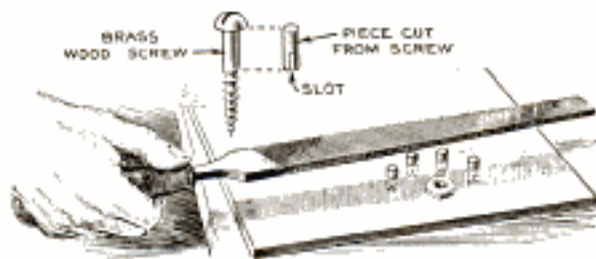

testing apparatus. Suitable switch levers may be salvaged from old rheostats or potentiometers, but the necessary taps are not always available. Such taps are easily made from the shanks of wood screws prepared as shown. A slot is cut in one end with a hacksaw to provide a good contact for the terminal wire, which is inserted and clamped with a pair of pliers before soldering. Holes are drilled in the panel to provide a force fit for the taps which are driven into place with a small hammer. The taps are then lined up with a sharp file.

Blueprints covering radio construction articles in past issues can be obtained for 25 cents each; material lists are always available without charge.



AMATEUR MECHANICS

Skiboarding—a Thrilling Sport

By R. D. POPE

UNQUESTIONABLY the skiboard is the most spectacular aquatic craft designed for sport. You can shoot the waves at high speed or get into an exciting game of water polo. Just hang onto the reins and steer by moving your body to either side.

Building a skiboard is no trick at all. A couple of days' work will see you through from start to finish. The first thing to do is to cut out a paper pattern for both sides as shown in Fig. 1. Trace the pattern on $\frac{3}{8}$ -in. pieces of spruce, cedar or cypress, and saw the curved edge carefully, using a keyhole saw if a bandsaw is not available. Then cut the two intermediate cross-pieces of the frame from the same material. The front piece is made from 2-in. stock, trimmed down to correspond to the curved line of the sides. Flat-head No. 5 brass wood screws, 2 in. long, are used in assembling, as they

will not corrode. The work at this stage can best be done on a pair of horses, as shown in Fig. 5. The sizes of the cross and stern pieces are given in Figs. 2 and 3, while Fig. 4 shows the transom attached to the rear crosspiece. Both this and the transom are made of 2-in. stock and should be assembled securely as they are to hold the motor. The unit consists of two separate pieces, drilled to receive $\frac{3}{8}$ by 11-in. carriage bolts, the heads and nuts being counter-sunk after allowance has been made for the thickness of the plywood top which is to be put on later. A 6-in. lagscrew is driven in at the center. Plane the edges flush and square to avoid humps and hollows, which would make the skiboard ride badly, and then

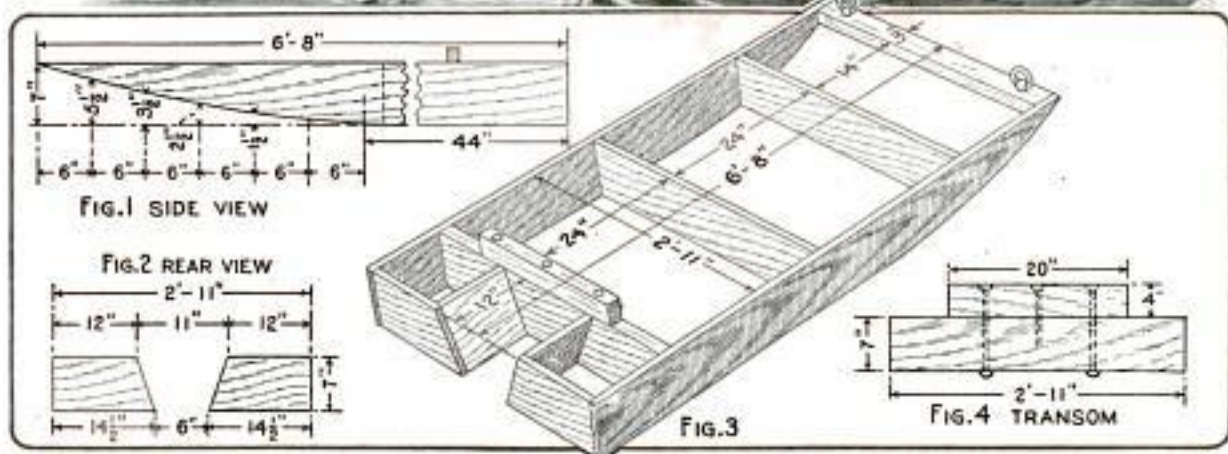

Courtesy Skiboard Corp.

479

Copyrighted material



In Water Polo a Course Is Arranged by Anchoring Barrels in Groups of Two About 300 Ft. Apart

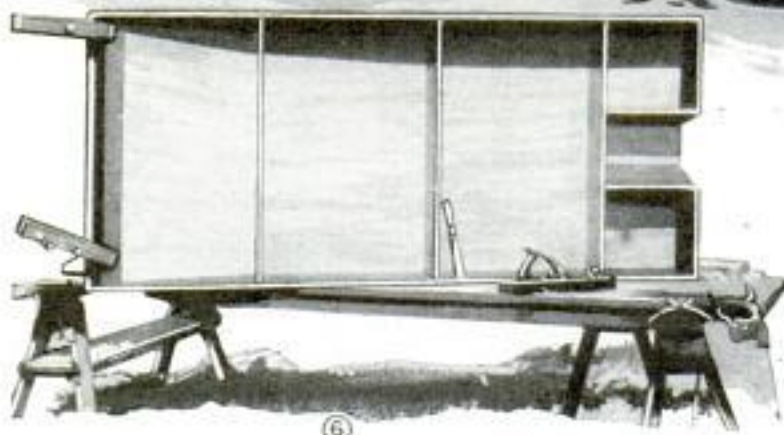

apply two pieces of three-ply veneer, each of which measures 36 by 67 in., allowance being made for trimming. Waterproof plywood, which is manufactured for airplane construction, is preferable although not necessary. Wood clamps should be used to hold the forward end of the plywood, as shown in Fig. 6, so that there will be no distortion while driving in No. 6 flat-head brass screws, 1 in. long. Dress off all sharp edges with a plane, as shown in Fig. 7, so that they will not cut the canvas covering, applied next. Paint the entire bottom, back and sides 4 in. above the lower edge, using four-hour enamel and immediately tack the edge of a piece of medium-weight canvas, 44 in. by 14 ft. in size, to the back of the frame, 4 in.

from the bottom, slitting the canvas along the center of the motor slot so that it will cover part of the three inner sides of the slot. Use copper tacks here and space them about 1 in. apart. Then pull the canvas tight from the front, tacking it temporarily at the bow, after which the rest of the canvas is stretched tight over the top and temporarily tacked at the stern.

Now proceed with tacking the edges of the canvas below to the sides and, after painting the top,



overlap and tack the edges of canvas above, as is shown at the corner of Fig. 9.

When applying the plywood and canvas to the top the upper portion of the transom must, of course, be removed, which is done by loosening the bolts and reassembling later. A rubber washer should be placed under each bolt head to prevent entrance of water. A strip of molding is screwed directly over the overlapping edges of the canvas, applying marine glue to waterproof the lap, and similar pieces of molding, to serve as runners, are screwed along the lower edges, as shown in Fig. 9. The runners prevent undue wear on the edges when pulling the skiboard over a dock. A good coat of paint is now applied over the canvas, as in Fig. 8, letting it dry in the sun. All that is now left to complete the craft, is the insertion of two eyebolts at the bow, spacing them at equal distance from the sides and coating them with marine glue

before driving home, after which a length of sash cord is tied on to serve as a "rein." The motor must be clamped on tight so that it cannot pivot from side to side as this would affect the steering. After cranking the motor, lean forward with your hands on the deck, holding the ropes so that, the moment the skiboard runs even, you can stand up.

Water polo is an exciting game with four players, each maneuvering a skiboard.

First arrange a course by setting out four barrels in groups of two, about 300 ft. from goal to goal. With four players there are two teams, one player of each team acting as a guard and staying at his opponents' goal, while the other does most of the shooting. The referee throws a 6-in. rubber ball into the middle of the "field" and the forwards, equipped with bicycle-polo or croquet mallets, run in from opposite sides, attempting to drive the ball to their own goal. Drives of 40 and 50 ft. are possible, and one of 60 ft. has been made in trial games.

It may be desirable as a safety measure to install a knife switch on the motor that will automatically short-circuit the ignition, thereby stopping the motor in an emergency. One terminal of the switch



is grounded and the other is connected to the cut-off button, the switch being arranged so that when the rider jerks or pulls a light cord tied to his wrist and the switch, the latter

will close. This is a good idea to prevent an unoccupied skiboard from racing around at large, menacing other boaters in the vicinity.

Grease Prevents Battery Corrosion

Heavy grease, such as is used in universal joints, will prevent corrosion on storage-battery terminals. Remove the cable clamps from the terminals, scrape off the corrosion and brush clean with a strong solution of washing soda. Then the clamps are replaced and a generous coating of grease applied. This will resist the battery acid and will also prevent the clamp from rusting. Do not put the grease on the parts until they have been connected and tightened.

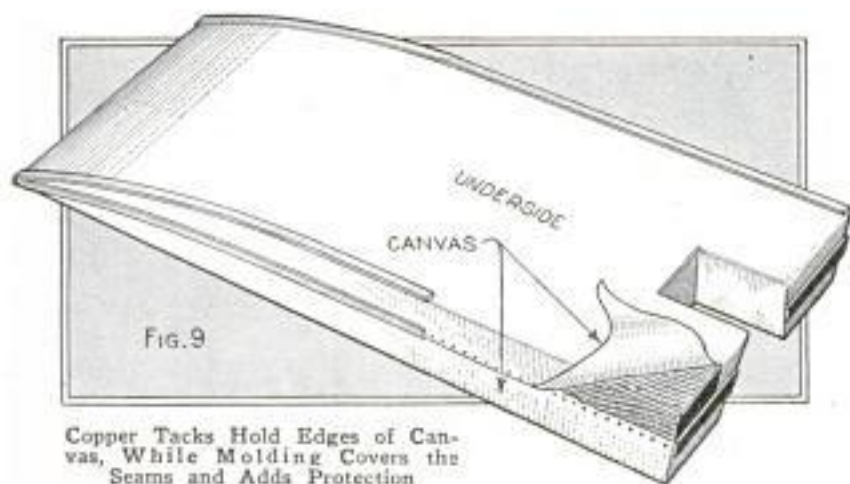

Fig. 9
Copper Tacks Hold Edges of Canvas, While Molding Covers the Seams and Adds Protection

This "Fast-Growth" Illusion Scores a Big Hit



The effect of this mysterious and laughable illusion is the apparent growth and shrinkage of a person in full view of an audience. Quickly stepping out of the room, throw a long overcoat or ulster over your head and shoulders, letting the collar come up over your head, then take a man's hat, and hold it over the top of the coat collar as shown. Pinch the two well together and drape the coat over the shoulders to the front. Crouching as low as you can by bending the knees, walk or glide into the room sideways with

your back to the audience. Now bend over slightly to the right and left, as low as possible, repeating this as you slowly raise yourself until you have reached your full height. Then, grasping the hat and coat tightly, repeat the same movements as you gradually push them up as far as you can reach on tiptoe. Then reverse the process and come down the same way. This original creation has been shown to the most critical audiences and has always scored a great hit.—B. L. Gilbert, Chicago.

Homemade Explosive Splits Logs

Heavy logs can easily be split with a cheap explosive consisting of equal parts of granulated sugar and chlorate of potash, a household remedy often used for



Large Log Split by Homemade Explosive of Sugar and Chlorate of Potash

sore throat. A log, 24 in. in diameter and 10 ft. long, was split with three tablespoonfuls of this mixture, which was poured into a 1-in. hole drilled in the center of the log about 1 ft. from the end. The explosive was set off with a length of fuse inserted in the hole, which was then tamped full of dirt. The chlorate of potash can be purchased at most drug stores for a few cents a pound, and the explosive is less dangerous to handle than other kinds.—S. E. Grover, Peru, Nebraska.

Coloring Photographic Prints

Color finishes of wide variety can easily be applied to any photo without toning powders or other chemicals. Take photographic or other transparent oil color and thin it with turpentine to such a consistency that a wad of cotton will readily ab-

sorb it. Be sure to use nothing but turpentine for the thinner. Squeeze out the surplus color and rub the cotton wad over the print, first lengthwise and then crosswise, rubbing the color into it until the surface is dry.

An Acid-Proof Cement

A cement that is acid-proof can be made as follows: A quantity of India rubber is melted over a slow fire, and tallow, equivalent to 6 or 8 per cent of the rubber by weight, is then added and thoroughly mixed. In 24 hours, slaked lime is stirred in until the mixture assumes the consistency of soft paste. About 20 per cent of red lead is then added, which causes it to harden and dry when used.

Metal Stakes Hold Tent Securely

Metal tent stakes can be made from 15-in. lengths of $\frac{1}{4}$ -in. iron rod, which are bent over a wooden form made of 1 by 4-in. hardwood stock, as shown in the upper detail. The form consists of two blocks nailed together with a hole, 2 in. deep, drilled into one piece to receive the end of the rod, after which the latter is bent over the rounded end as indicated. Metal stakes last much longer than wooden ones, and take less space when packed in the automobile.



Kerosene Kills Lice on Dogs

For killing lice on dogs, a cheap and effective remedy can be made by adding a little kerosene to soapsuds. Wait until a warm sunny day and apply the liquid gently until the dog is thoroughly wet. Do not rub the mixture into the skin as it may irritate. If the first treatment does not kill all the lice and mites, repeat it again in a few days.

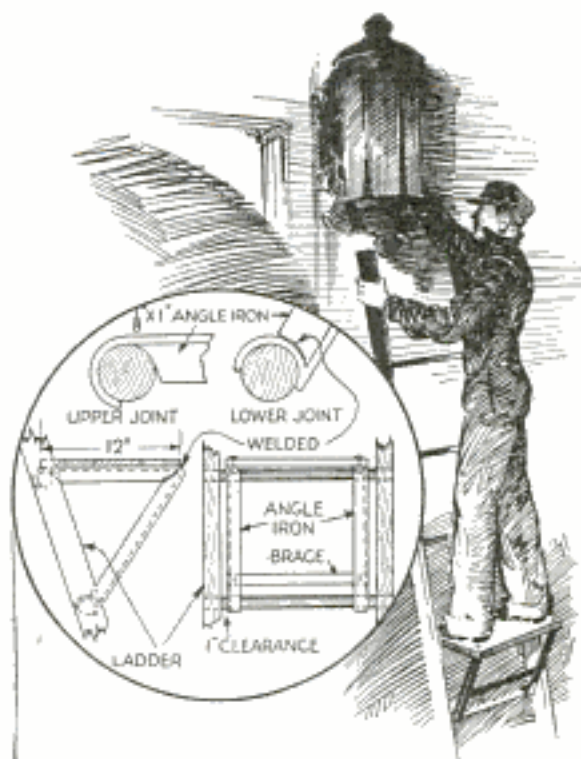

Those Who Constantly Work on Ladders Will Find This Platform More Comfortable Than the Rungs

Ladder Platform Eases Tired Feet

When it is necessary to stand on the rungs of a ladder for a considerable length of time, a footrest or platform slipped over two adjacent rungs will be found comfortable. The one shown here consists of two lengths of angle iron, cut and bent as indicated, to form brackets to which the platform is bolted. Both ends of the angle irons are bent to form hooks to fit the rungs, while the cut part at the bend is welded to strengthen it.

Tool for Cutting Moldings for Model Ships

This tool, made from a coping-saw blade and a wooden block, is useful in cutting moldings for model ships. The blade is held in a groove cut in the center of the block by means of fine wire, as shown. Small cleats are glued to the top of the block on each side of the saw as guides for the work.

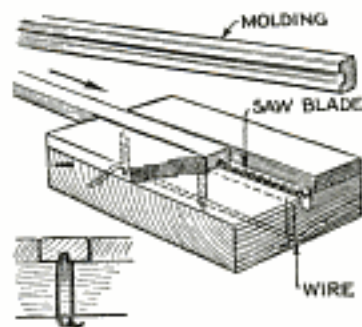

Seven Auto Short-Cuts Worth Remembering

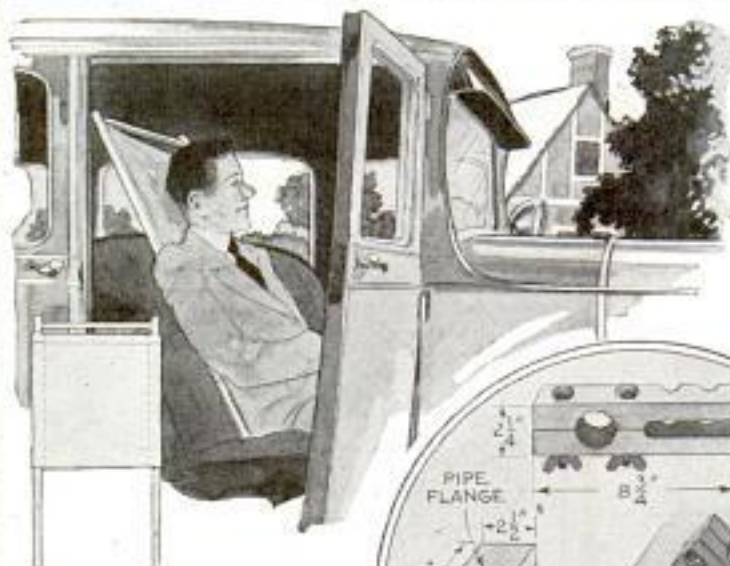

Here Is a Comfortable Headrest That Enables the User to Snatch Some Sleep on Those Long Night Drives



Coil Spring Holds the Oil-can Down, While Rifle Shell Caps the Spout

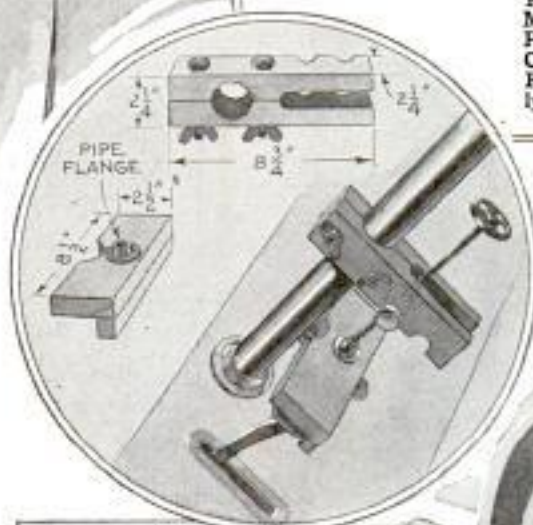

For Holding the Road Maps in a Convenient Place, Stretch a Light Coil Spring across the Front of the Car Directly above the Windshield

Clamped to the Steering Post, This Brake-Pedal Depressor Has a Hand-screw That Gives a Gradual Range of Pressure Needed for Making Adjustments Accurately

If Your Tire Pump Won't Work, Air Can Be Transferred into the Flat from Your Spare

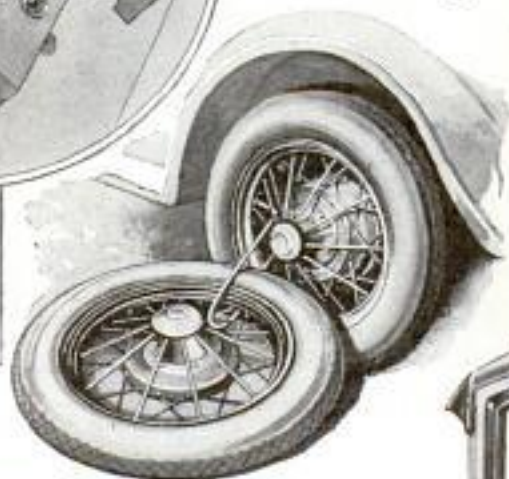

Right, by Placing Your Ear to One End of a Mailing Tube Inserted in the Crankcase Breather Pipe, It Is Comparatively Easy to Detect Compression Leaks, as the Defective Cylinders Cause Louder Hissing Than Those That Are Tight



Left, Felt Weather Stripping Attached to Auto Door Posts with Rubber Cement Will Keep Out Dust and Cold Drafts



Ventilating Your Shoes to Avoid Perspiring Feet

Those who are troubled with perspiring feet will get relief by ventilating their shoes. This can be done so that it will not be noticed by purchasing shoes that are decorated with perforated strips and punching holes through the leather directly under the perforations. Place a wooden block inside the shoe. The holes will still look the same, but will allow the air to get in and out of the shoe as the foot moves.—I. Clyde Cornog, Philadelphia.

Rattling Brake Rods Silenced with Door Spring

Brake rods that rattle can be silenced by the use of an ordinary screen-door spring. Fasten one end of the spring to the rod and the other end to the opposite side of the frame. The tension of the spring will hold the rod firmly against the guide clamps, without interfering with operation of the brake.—Albert L. Ball, Cleveland, Ohio.

Compass Improvised from Scissors

When a compass is not available, one can be quickly improvised from a pair of scissors, a small cork and a rubber band. The cork is placed between the scissor blades and is moved up or down to get the desired radius, after which the rubber band is slipped over the blades and under the cork as shown. This holds the blades firmly against the cork, and the compass at its setting.

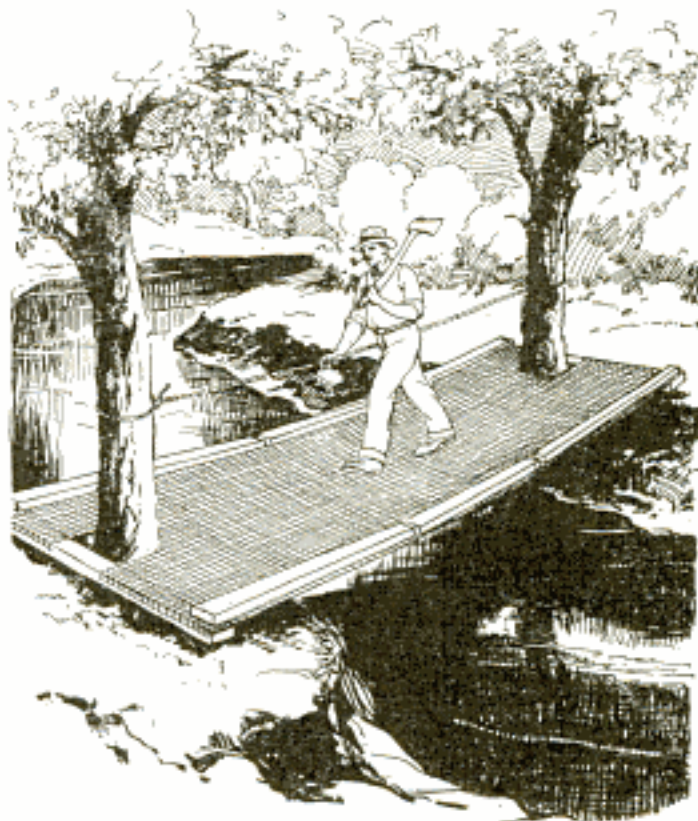
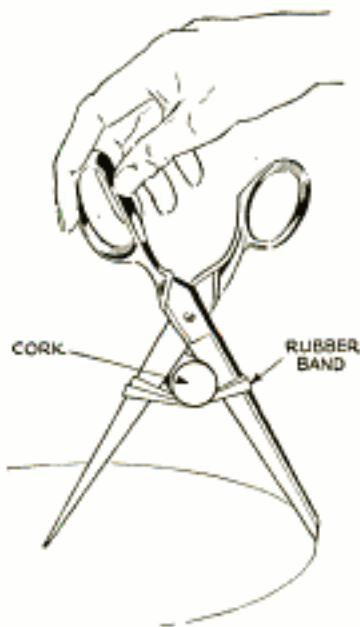

Meshed Fencing Wire, Stretched across a Small Creek between Two Trees, Serves as a Footbridge

Footbridge from Fence Wire

Ordinary meshed fence wire can be used to make footbridges across small creeks. The wire is stretched across the creek between two trees or posts driven into the banks. The ends are stapled to two lengths of 2 by 4-in. stock to hold the wire taut. Lengths of the same stock are also attached to the edges of the fencing to give extra rigidity. Boards can be laid on the wire for a walk if desired. A rope stretched between two supports, nailed to the trees about 4 ft. above the ground, will serve as a handrail.—C. C. Ames, Mayville, N. D.

Transparent Coin Wrappers

Coin wrappers can be cut from standard sheets of cellophane. As this material is transparent it is not necessary to print the denominations on the wrappers, and the coins can also be readily counted without disturbing the package.

☛ A set of two blueprints, SN-7 and SN-8, on "Aero Boat" can be obtained for 50 cents and a material list will be sent free.

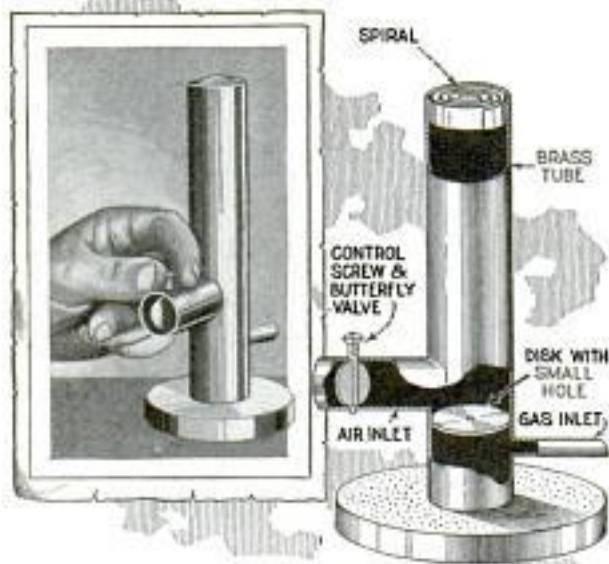

Made of Brass Tubing, This Adjustable Bunsen Burner Generates an Intense Heat

Super-Burner Gives Intense Heat

Unusually high temperatures can be obtained with this Bunsen burner, which uses city gas for fuel. It consists of a 7-in. length of brass tubing, 1¼ in. in diameter, and is fitted with gas and air inlets as shown. A brass disk, having a small hole in the center about the size of a darning needle, is soldered inside between the gas and air inlets, while a length of flat brass is bent to form a spiral, which is inserted in the top of the tube. A butterfly valve is provided in the air intake, while a tin lid, filled with plaster of paris, provides a base for the burner. In use, the valve in the air inlet is closed and a lighted match is held at the top after turning on the gas. The valve is then opened until a blue flame is obtained. This burner will quickly melt glass, and will be useful whenever an exceptionally hot flame is needed. It will be found handy around any workshop.

How to Drill Holes in Plaster without Chipping It

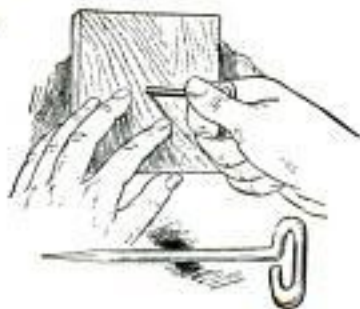

Holes can be drilled in plaster without breaking or chipping it by the use of a wooden block and a piece of iron rod bent

to form a handle and ground to a square point at the other end. A hole to receive the rod is drilled through the center of the block. In use, the block is held firmly against the plaster, and the rod is inserted and turned back and forth to make a clean-cut hole through the plaster.

Mending Cracks in Stoves

Cracks in the iron casing of a stove can be mended with a cement made by mixing iron filings with silicate of soda to a thick paste. This is forced into the crack with a putty knife, and the surface over and around it is covered with the same material. The heat hardens the cement, making it almost like iron. Another good iron cement can be made by mixing iron filings, flowers of sulphur and water to a stiff paste, applying it in the same manner. The mixture burns when heated and turns into iron sulphide, which fuses onto the iron of the stove.

Combination Fine and Coarse Pen

For those doing work that requires a fine point and a stub point, this penholder will be found useful. Cut a slot in one of the pen points and a similar one in the ferrule on the holder, as shown. Then solder the head of a small cotter key in a hole drilled in the other pen point, and fit both in the holder with the key head projecting through the slot. To change the relative position of the points, slide the key up or down.—John French, Saint John's, Quebec, Can.

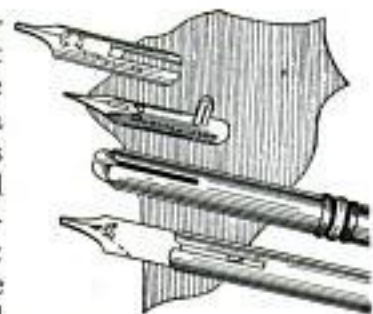

Rubbish Kept Out of Roof Gutters Prolongs Their Life

Prompt removal of leaves and other rubbish accumulating in gutters, will prevent the downspout from being clogged, which causes the water to flow over the edges of the gutters. This overflow may cause much damage if the gutters run into the cornice so that the water goes down in-

side of the walls. If it flows down on the outside, stains on the paint will result. Decayed leaves will cause the gutter to corrode and eventually leak. Cinders and cinder dust will also set up a corrosive action. When dirt of this kind is removed, the gutter should be flushed out with clean water to rid it of all traces of acid resulting from such decomposition. The life of gutters and downspouts can also be prolonged by occasionally giving them a coat of good metal paint.

Bumpers for Wheeled Toys Made of Hose and Cable

Children often scratch the furniture when riding their toys indoors. This trouble can be prevented by providing a bumper, consisting of a suitable length of cable run through a piece of rubber hose of the same length. The bumper is fastened by means of flat-head screws inserted in holes drilled through the hose and cable. For metal toys, the bumper can be attached with improvised clamps. The length of the bumper, of course, depends on the size and shape of the toy.

Andirons Made from Old Pistons and Connecting Rods

Andirons can be made from discarded pistons, connecting rods and lengths of angle iron, the latter being bolted to the top of the pistons and either welded or bolted to the connecting rod, as shown. Made in this manner, they will afford plenty of clearance for draft.—M. F. Thurmond, College Station, Tex.



Serviceable Andirons Can Be Made from Discarded Pistons, Connecting Rods and Angle Iron



Cane Fitted with a Swivel Caster Is a Great Improvement over the Type Ordinarily Used by Blind People

Cane Fitted with Caster Aids the Blind

The blind man's walking stick can be improved by fitting it with an offset swivel caster, as this eliminates the necessity of constant tapping. The illustrated cane was made from an old billiard cue. A hole was drilled in the lower end to receive the shank of the caster, and a ferrule was slipped over the end to prevent it from splitting. The user can tell by the sound when the wheel is rolling over earth, concrete, brick or asphalt.

Paper Helps to Get Car Out of Mud Hole

Crumpled newspapers fed under the rear wheel of a car sometimes will provide sufficient traction to get it out of a small mud hole. If a layer of several thicknesses is spread from the wheel to solid ground, the car can usually be run out under its own power. This is a faster and much cleaner method than putting on skid chains, and often they are not at hand when needed if an emergency such as this is to be met.

Table-Top

WHITE water cascading over a sheer cliff of huge rocks, tumbling helter-skelter on its way—this on top of your dining-room table! Colorful as many other phases of picture taking are, there are few subjects that offer so much variety and enjoyment to the amateur cameraman as table-top photography. Any small hand camera can be used, and, if the "set" has been arranged with care, one cannot tell at a casual glance whether it was taken indoors or out.

While the study pictured in Figs. 1, 2 and 3 is fairly heavy, demanding more than the ordinary number of stones and twigs, there is much simplicity in the lighthouse scene shown in Figs. 4 and 8. In this case, the whole set is mounted on a piece of cardboard, which should be

streaked with black ink or shoe polish to resemble water. The background of clouds is roughly daubed on the lid of a suit box. The sailing boat is cut from a magazine, while three small bits of sponge and a rock or two compose

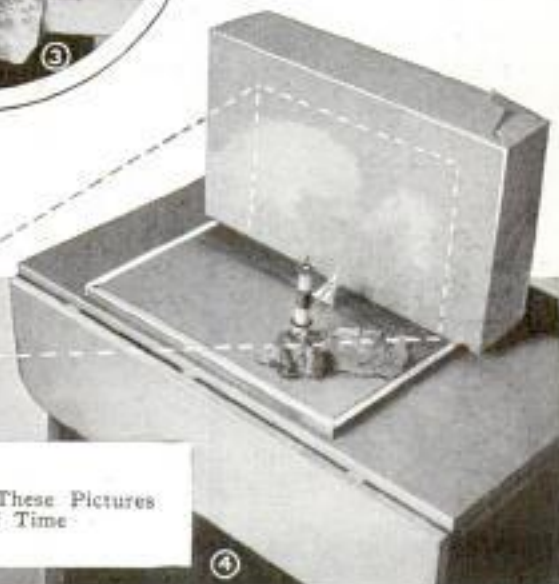
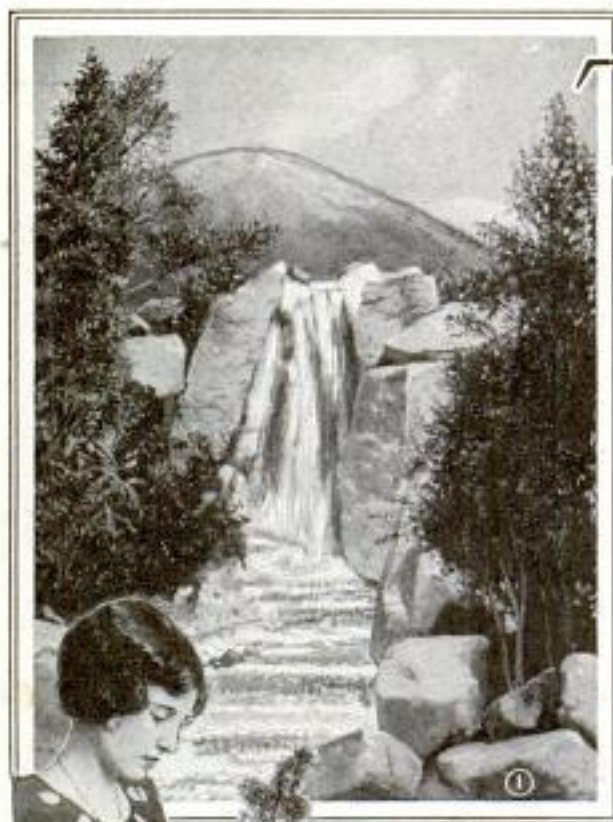

You Can Give These Pictures
Plenty of Time

Photography

the dangerous reef. Fig 4 shows the relation between the set and the camera and the position of a lamp. As no action is required in any of these pictures, time exposures may be given. With a cluster of bulbs, totaling about 250 watts and located about 4 ft. from the set, the average camera will take a good picture, with a f. 16 stop and a full minute of exposure. By doubling the light, the exposure time can be cut in half, and if a normal flash, either bulb or cartridge, is used, a full-timed negative can be obtained in one twenty-fifth of a second.

The lighthouse can be made by rolling a sheet of paper, and pasting the end down to hold the conical shape thus formed, as in Fig. 7. Each end of the tube is cut off square. The top is fashioned from a disk of cardboard, onto which a 1/2-in. length snipped from the end of a

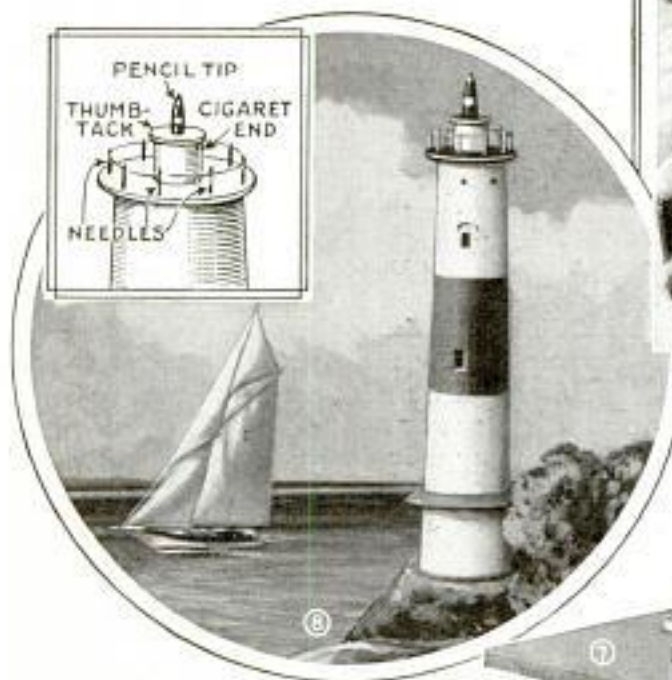

Land Scenes as Well as Seascapes Can Be Imitated with Surprising Realism

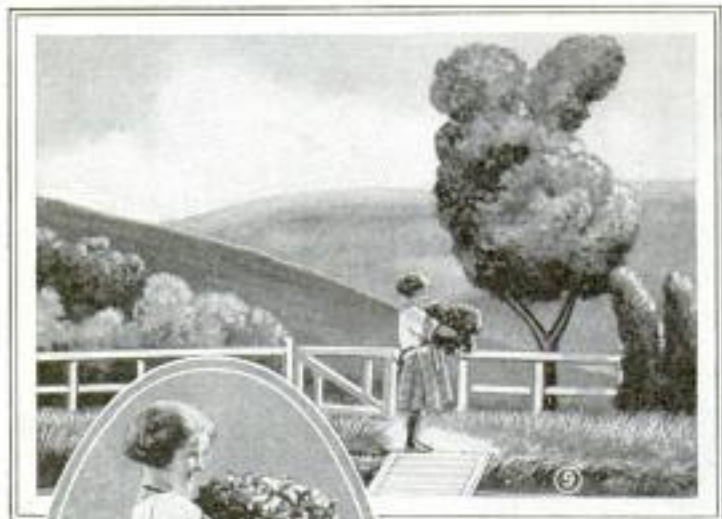

cigaret is fastened. The tip of a pencil, slightly blunted, painted black and touched up with white chalk, is held on top of the cigaret with a thumbtack. A railing can be placed around the tower by using needle ends, bringing a bit of black thread all around, as shown in the detail, Fig. 8.

Perhaps the easiest kind of picture to take in miniature is an imitation of a snow scene, as in Figs. 5 and 6. Any white material may be used for the snow, such as fine salt, powdered sugar or flour. Small hills can be made by merely heaping up the material and modeling ravines and broken slopes with a sharp pencil. A brilliant side lighting can be used to give the effect of sunrise or sunset, and clouds can be printed in from a cloud negative or obtained by means of a roughly painted background. Mountain ranges can be made by using a few sharp-angled pieces of coal or fragments of broken stone, sifting the white powder on these in a

close imitation of nature. The fencing shown in Fig. 6 was built up from small twigs, gradually diminishing the size of the posts in order to give the picture the proper perspective. The deposit of snow on the railings was faked with narrow strips of cotton batting, lightly sprinkled with powdered sugar. The foliage in the background was made from short twigs set into a slope covered with cotton batting. If it is desired to make the scene an actual snowfall, the effect can be

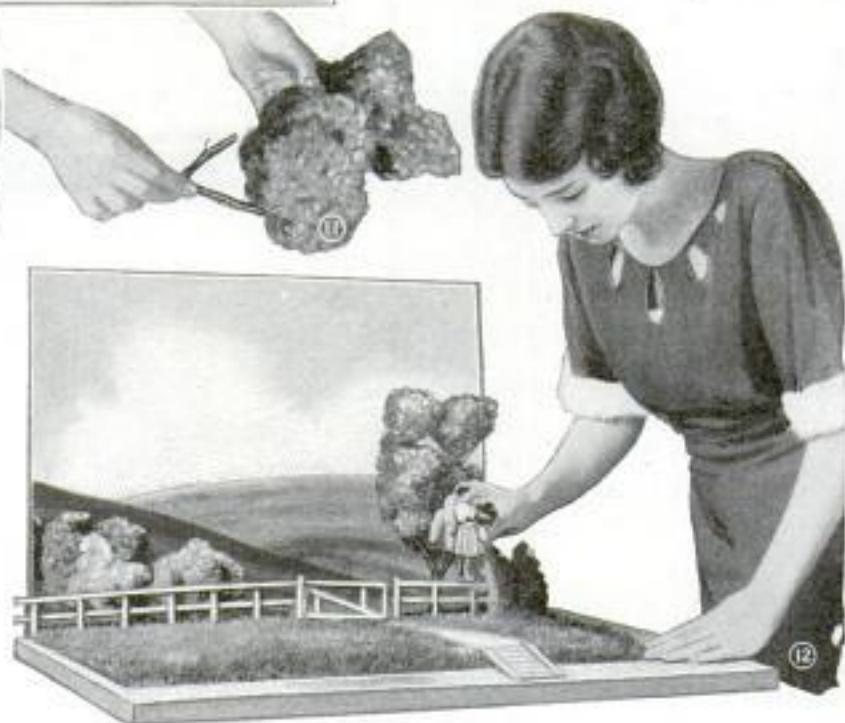

obtained by daubing the flakes on a sheet of glass and interposing this between the set and the camera. This would give a gentle diffusion to the whole picture. While none of the pictures shown in this article have been softened, better pictorial studies can be obtained if the whole picture is more or less toned down. This can be done by using a regular diffusion disk, which you can procure at any camera store, or by covering the lens with a piece of fine-mesh cloth or screen.

Table-top photography is a practical art as well as an entertaining pastime. The same principles, on a much larger scale, are used by professional and amateur movie makers in fashioning sets for difficult-to-get or unusual pictures. Great-

er care, of course, must be used in the making of miniature scenes, as any imperfection immediately brands them as artificial and spoils the whole effect. The same exactness is demanded in the construction of model homes and buildings when these are to be presented as a true picture of the finished job.

The introduction of figures widens the scope of these table-top mounts. You can easily work your own picture into any set by cutting it from an old snapshot, mounting it on cardboard and resetting it amid new scenery, as shown in Figs. 9, 19, and 11. Thus, without setting foot outside your own state, you can furnish photographic proof that you have scaled the mighty Alps, shot lions in Africa and "mushed it" in Alaska. Some attention must be given the proportions, of course, in order that you may not seem to tower above the Alps nor shoot at a lion as big as an elephant.

Tissue-Paper Pulp Stops Leaks in Radiator

An emergency repair on a honeycomb radiator can be made with moistened tissue paper. Tear the paper into small pieces and soak it in water to form a pulp of the consistency of putty. Force a small amount of this tightly into the perforation where the water leaks until it comes flush with the front and back of the radiator. If the leak is about halfway between the front and back, the pulp should be forced about $\frac{1}{2}$ in. past the leak from the back, and then filled up bit by bit until flush with the front. This method will stop the leak immediately.

Extension Handle Increases Leverage of the Brace



Leverage of Brace Increased by Using Extension Handle When Drilling in Hardwood with Large Auger

Made of pipe and fittings, this handle will be useful when drilling large holes in hardwood with an ordinary large brace and auger. It consists of a 12-in. length of $\frac{1}{2}$ -in. pipe fitted with a tee and two short nipples. In use, the drill is started and then the handle placed on the brace as shown, to obtain more leverage. Of course, care should be taken not to bend the brace.

Money for YOUR Ideas

EVERYBODY is an inventor because everybody has at some time or other thought of a time, labor or money-saving short-cut which would help others if they only knew about it.

Such ideas, trivial though they may seem to you, are interesting and helpful to others, and so we are offering three special awards each month for ideas that will help the autoist, the home craftsman and the shop worker.

All ideas used will be paid for at our regular rates and, in addition, there will be three prizes of \$25 each for the best ideas submitted.

Send your ideas to the Shop Notes editor, with a small sketch or photograph to make them clear, if necessary.

Ink for Writing on Celluloid

When it is desired to write on celluloid articles, such as draftsmen's triangles, it can be done by dipping the pen in acetic acid and using it as ink. Writing done with this acid will, when dry, have a dull appearance on the surface of the celluloid. Such ink may be colored by adding pigment.

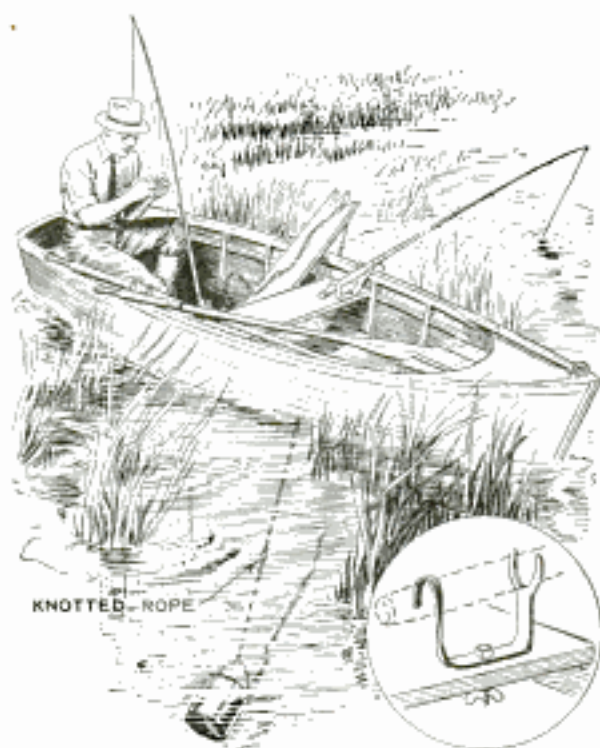

Weighted Bucket Serves as Anchor and Allows Boat to Drift Slowly While Casting

Anchor Lets Boat Drift Slowly While Casting

When fishing alone from a boat which should be kept in motion while casting, provide a dragging anchor to allow the boat to drift slowly. A bucket filled with sand or rocks will serve the purpose. It is tied to a length of rope, which should be knotted at regular intervals so that it can be held at various heights by means of a notched board projecting over the edge of the boat as shown. When still-fishing, a holder for your rod can be made by cutting and bending a length of flat iron to the shape shown in the detail and fastening it to a seat with a bolt and wingnut, leaving both hands free for another rod.—Addison Bain, Marion, Ohio.

How to Grow Healthy Trees

By carefully observing the following rules, one should not experience any difficulties in growing healthy trees, provided, of course, good nursery stock is used. The first step is to keep the exposed roots covered with a damp sack or cloth until the trees are planted. Remove at least one-third of the branches to avoid crowding, and cut off all broken roots. Cut a cleft, deep enough to pierce the bark,

along the side of the trunk, starting at a point just below the surface of the ground as it will be when the tree is planted. Dig the hole large enough to avoid crowding or bending the roots, after which rich black loam is tamped firmly, but not too tightly, around the roots. Also spread plenty of top soil around the tree so that after settling the surface will be level.—Jos. M. Creamer, Astoria, N. Y.

Rust-Proof Nails for Roofing

Nails often rust off, allowing the roofing material to become loose long before it has worn out. This trouble can be prevented by using rust-proof nails when laying the roof. Another important factor in preserving a roof is to use the correct size of nails. Five-penny nails are best for two layers of wood shingles, while three-penny nails are better for one layer. Cut shingle nails are considered to be the best for wood shingles, while large-head roofing nails are preferable for composition shingles or roll roofing, as the large heads prevent leaks around the nails.

This Revolving Towel Rack Takes Little Space

Easily attached to the bathroom or kitchen wall, this revolving towel rack has greater capacity than a rack of the usual type. It consists of a wooden bracket holding a hub to which pegs are attached, all details and sizes of the parts being given in the accompanying drawing. The bracket is drilled to receive a screw which revolves freely in the hole, but is driven into the hub to hold it in place. The hub should be of such depth

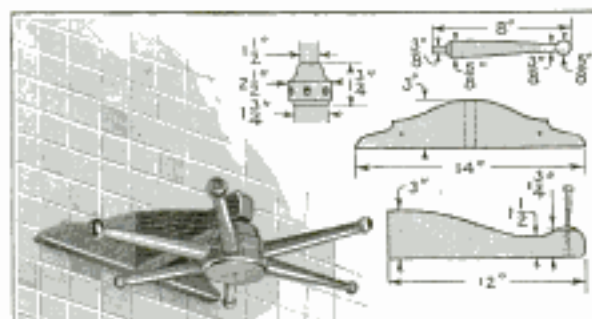

Revolving Towel Rack Suspended from Bracket Arm Occupies Little Space and Has Large Capacity

that the pegs will not hit the bracket when turned.

Boiled Water Keeps Roses Fresh

Cut flowers placed in water that has been boiled will remain fresh longer than if placed in ordinary water. This is especially true in cities where the water is purified with chlorine. At flower shows held in Cincinnati and Chicago, it was discovered that roses lasted four days at the former city, while they only lasted twenty-four hours in the latter, due to the high chlorine content in the water supply.

Bottles Cleaned with Brass Chain

Bottles can be cleaned with a 2 or 3-ft. length of small-size brass furnace chain. Half fill the bottle with warm, soapy water, drop the chain inside and shake until all the dirt has been loosened, holding your thumb over the mouth or closing it with a cork. This is better than using shot, as the chain is more easily handled.

Scissors-and-Twine Puzzle Is a Teaser

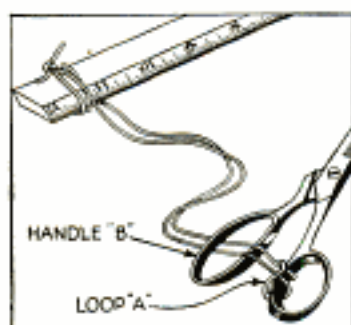

Here is a puzzle to try out on your friends. Get a pair of scissors and a 2-ft. length of twine, and tie the twine to the scissors as shown, looping it over one handle and then tying the ends to a ruler or other suitable object. The idea is to remove the scissors without cutting or breaking the twine. To do this, take the loop A and run it through the scissor handle B, bringing it up over the point of the scissors. The twine can then be pulled out of the handle.

We Beg Your Pardon

The grasshopper toy, described on page 1008 of our June issue, we find, is patented by the Hubley Manufacturing Company, Lancaster, Pa. Therefore, the making of this toy would be an infringement.

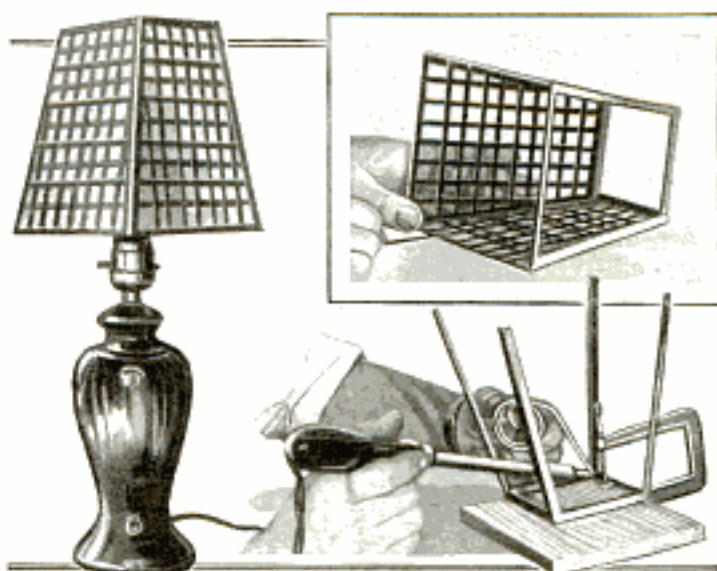

Lamp Shade Made from Strips of Nickelplated Zinc Woven Together and Backed with Pieces of Colored Silk

Lamp Shades Woven from Strips of Nickelplated Zinc

The illustrated lamp shade was made from strips of nickelplated zinc, $\frac{3}{16}$ in. wide, woven on a frame of zinc strips soldered together at right angles. The horizontal strips are evenly spaced and soldered to the frame, after which the vertical strips are woven between them and also soldered at the ends. Care should be taken in the spacing so that the effect is uniform throughout. The shade may be lined with colored silk and fitted with wire loops for clamping it over a light bulb, or a socket may be attached if it is to be used on a bridge lamp.

Tin Disk Prevents Oil Splashing over Outboard Motor

Splashing of oil through the air vent on the gas tank of an outboard motor can be prevented by placing a tin disk inside the filler cup as shown. The disk is soldered to two small strips of sheet metal, and these are in turn soldered to the bottom of the filler cup. This arrangement does not interfere in any way with the filling of the tank or the action of the air vent.

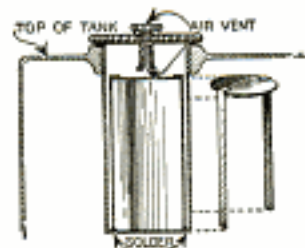

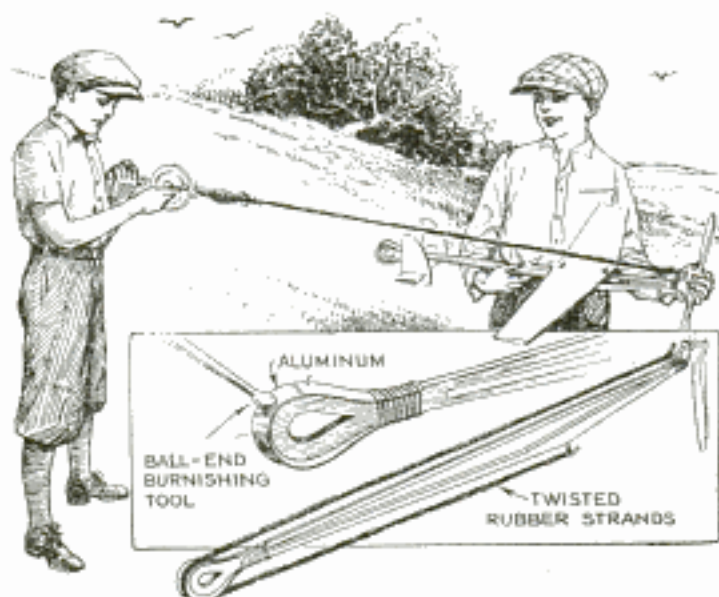

Unusually Long Rubber-Band Motor Looped over Polished Thimble Doubles Power of Model Airplane

Doubling Power of Rubber Motor on Model Airplane

The power of model airplanes can be practically doubled by using longer strands of rubber, looping them over an aluminum thimble at the tail and fastening the free end to a screw eye driven into the underside of the fuselage near the propeller. It has been found that such a motor, wound to approximately 3,000 turns with the use of a winder, will turn a 15-in. propeller for fully 5 minutes, depending, of course, upon the length of the fuselage. The thimble is merely a strip of .005-in. sheet aluminum, bent around the curved end of the fuselage and pressed into a groove, previously cut in the curved end, by means of a ball-end burnishing tool, the ends of the aluminum strip being securely tied as indicated. In forming the groove, an even pressure is necessary to prevent the formation of humps and hollows which ruin the job. Be sure that the sharp edges of the aluminum are smoothed so that no burrs are left to cut the rubber. Where the rubber comes in contact with the thimble, apply a copious amount of graphite to eliminate friction. The effect of this arrangement is the same as that of an ordinary rubber-band motor of twice the usual length. As the tension is equal on both sides of the fuselage, vertical bending is practically eliminated, which is an advantage over the conventional type. Side bending can be prevent-

ed by sawing a $\frac{1}{8}$ -in. slot through the center of the fuselage the greater part of its length, and gluing in a reinforcing crosspiece of $\frac{1}{8}$ -in. balsa the entire length of the slot. With this type of motor, the rudder cannot be attached along the center of the fuselage and therefore two rudders must be provided, as shown. It is also essential to have the thimble highly polished.

Color Filter for Your Camera

Colored cellophane will provide a filter for your camera that will work as well as the more expensive ones. This material can be purchased from any chemical-supply house. The cellophane may be held directly in front of the lens in the usual way, or a wooden or metal frame may be made for it, in which case the frame should fit snugly on the lens.

Brush Rest Aids in Striping

Striping can be done easily by anyone with the aid of a simple brush rest made from circular typewriter erasers, pinned together with a stove bolt. An ordinary pencil clip holds the brush in place, while a guide can be provided by bending a short wire at right angles and attaching it to the end of the stove bolt by means of a small collar fitted with a setscrew.

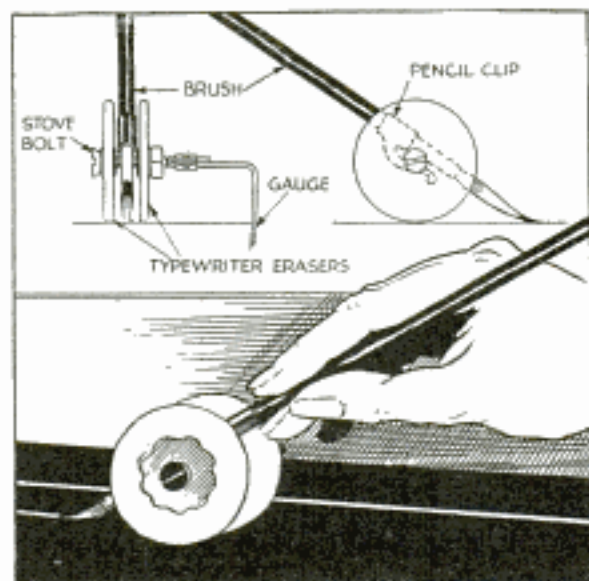

Anyone Can Do Striping Accurately with the Use of This "Rubber-Tired" Brush Rest

Early American Bowl Table Has Many Uses

Reminiscent of early America, this three-legged bowl table is useful for holding almost anything from magazines to growing plants. Its construction is both easy and inexpensive, and it can be made by anyone having access to a wood lathe. The top is a wooden mixing bowl, obtainable from any hardware or house-furnishing store for \$1 or so, depending on size. Usually these bowls are of maple, thoroughly waxed. Therefore, the legs and cross rungs should be of the same material, although birch, gum or poplar can be used without detracting appreciably from the appearance. For a 13-in. bowl,

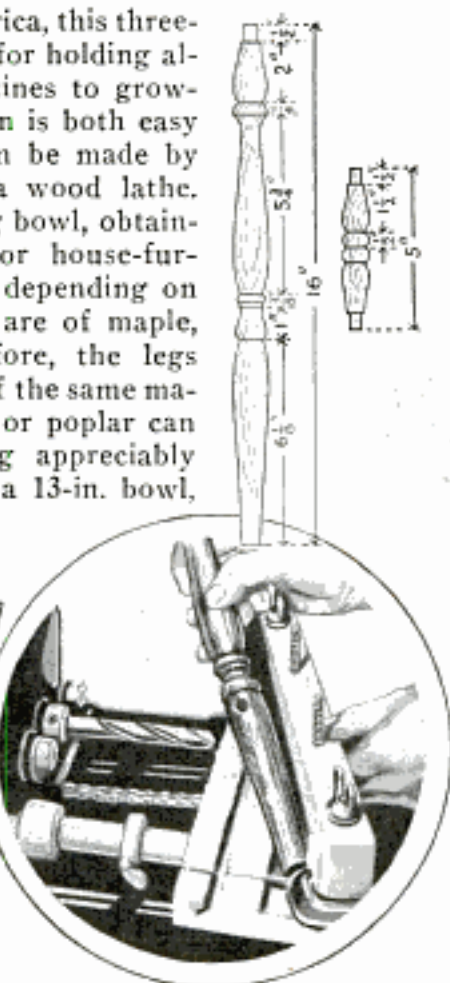

Fitting Legs to a Mixing Bowl Forms an Interesting Table and Can Be Done by Any Home Craftsman



colonial type. After each piece has been turned to shape, give it two applications of wax and polish it while still between the lathe centers, but do not wax the ends that are to be glued. The wood is left in its natural color, save for whatever slight change the wax may produce. Holes in the bowl bottom, legs and center block for the legs and cross rungs, can

be bored by any conventional means, at the proper angle. The center insert shows this being done on a home-workshop machine having a boring attachment.

enough material for the legs and other pieces is contained in a board measuring 22 by 6 by $1\frac{1}{4}$ in. After a 3 by 3-in. block has been cut from this piece, rip the remainder into strips, $1\frac{1}{4}$ in. square. Cut these about 2 in. longer than the finished legs and rungs and mark the centers so that they can be set up in a lathe for turning. The center block, into which the three rungs are fastened, is turned on a small faceplate. Of course, the size of the bowl will determine the dimensions of the legs and other parts. The board mentioned provides material for converting a 13-in. bowl into a table 18 in. high. Exact dimensions of the parts for this are given in the detail. In assembling, use glue and small brads. The design turned into the legs and rungs need not be a replica of that illustrated, but should be of

Spring Bolts Hold Screens in Window Frame

For holding screens in place, the use of window spring bolts is superior to the usual methods. A hole to receive the bolt is drilled in the center of each side of the screen frame, and corresponding holes are then drilled in the window casing. This method is especially convenient when putting up screens above the first floor, as the job can be done from the inside.

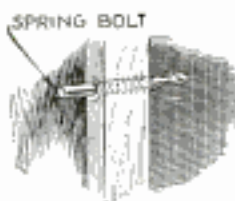

Footrest for Coach-Model Cars



Length of Pipe Forms Comfortable Footrest and Prevents Passengers from Soiling Front Seat

The annoyance of having the back of front seats in coach-model cars soiled by passengers in the rear, can be reduced by providing a footrest. It is bent to shape from a suitable length of pipe with the ends flattened and drilled for screws, by which it is fastened.—Myron L. Harmon, South Bend, Ind.

Draining Sink Water Quickly

When water drains slowly from your bathtub or sink, try whirling it. Move your hand around in the water above the drain hole. After the water starts to whirl you will find that it drains much faster than in the ordinary way.—Joseph Minarovich, Berwyn, Ill.

Dowels Anchored Securely

A dowel can be anchored securely as follows: Drill two holes through the lower end at right angles to each other, as indicated by the dotted lines in the drawing. The dowel should be an easy fit

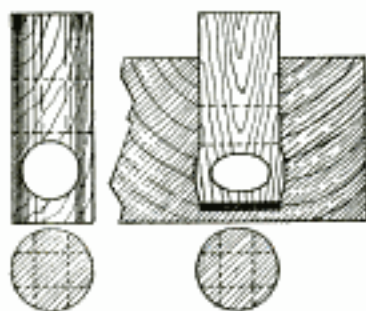

in the hole, and after it has been inserted, a few taps with a hammer will cause the walls of the drilled portion to bulge

and thus anchor the dowel securely. Glue should, of course, be applied before it is inserted.—Sherwood J. Gee, Salt Lake City, Utah.

Die for Forming Model-Ship Deadeyes and Capstans

Deadeyes and capstans can easily be made by using a die cut from brass or similar material, and stamping them out of hard rubber or old phonograph records. Heat the die and the rubber in boiling water, which softens the latter so that it can be cut more easily. The die may be conveniently used by making the parts in the form of a hinge, and applying pressure in an arbor-press or vise. This method is useful also for making other small articles of this nature.

Cardboard Disk on Bicycle Sprocket Protects Trousers

A heavy cardboard disk, slightly larger than the sprocket wheel of a bicycle, can be used as a guard for trouser cuffs. A slot is cut in the disk as shown in the detail so that it can be slipped over the pedal crank on which it should fit snugly. This is an excellent emergency measure when the regular trouser guards have been mislaid or forgotten.

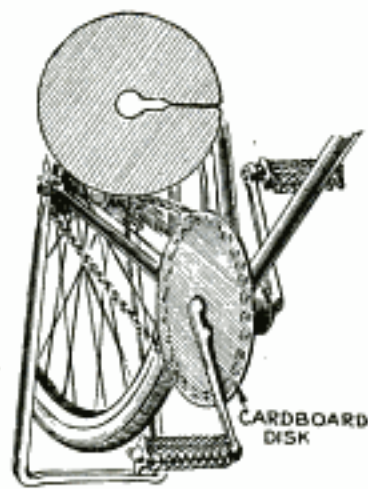

How to Eradicate Insects around the Home

Insects around the home, such as roaches, ants, croton bugs and bedbugs, can be destroyed by using a solution of alum, 2 lb., dissolved in 3 or 4 qt. of water. Heat this solution to the boiling point and apply it to the cracks and crevices with a brush, where the insects are likely to be. Moths can be kept out of woolens and furs by wrapping them in heavy paper that is free of holes, making

sure, of course, that the garments are free of moths before wrapping them. Cedar wood, gum camphor, tobacco leaves or anything that is strongly aromatic should be put in the pockets previously. Another method of keeping moths away is to wrap the garments in a piece of linen and put pieces of blotting paper inside the wrapping, which has been saturated with a solution of alcohol, $\frac{1}{2}$ pt., turpentine, $\frac{1}{2}$ pt., and camphor, 2 oz. This solution can be kept for some time if placed in a bottle, shaking well before using.

Insulating Electricians' Pliers

Electricians' pliers can be insulated and furnished with a comfortable grip by wrapping the handles with rubber and friction tape, and cord. The rubber tape is applied first, stretching it tight, and then two layers of friction tape, starting the first layer at the jaw end of the handle and doubling the second back from the other end. Then dip the handles in shellac and allow them to dry until tacky. Next lay 3 in. of medium-size fishline along the inside of the handle toward the jaws, making one turn on the metal of the handle, and continue the wrapping up to 1 in. from the end of the handles. Lay a piece of wire, with an eye bent at one end, upon the section not yet covered with line and wrap around it, as shown in the drawing. When the remaining space has been covered, loop the cord through the eye of the wire and draw up the previous turns. Then work the turns tight before cutting the line. Three or four dips, allowing the shellac to dry between dips, complete the job.

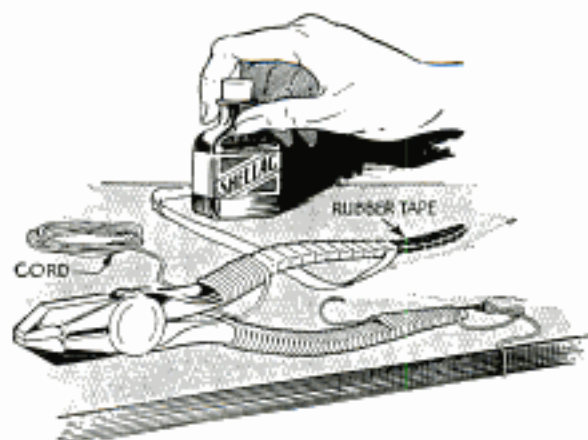

Wrapping of Tape and Fishline Insulates Electricians' Pliers and Forms Comfortable Grip

Barbed Wire, Loosely Wrapped around Fruit Trees, Stops Pilferers and Saves Your Fruit



Tree-Climbing in Orchards Ended by Barbed-Wire Wrapping

Barbed wire wrapped around the trunk of fruit trees will prevent tree climbing in your orchard. The wire should be wrapped loosely to allow for the growth and expansion of the trees. Limbs that hang near the ground can be raised out of reach and held by means of wires run through two short lengths of rubber hose, one of which straddles the trunk and the other the hanging branch.—Andrew Vena, New York City.

Paraffin Prevents Fingerprints on Piano Keys

Spread over piano keys, a thin coating of paraffin will keep them from becoming quickly soiled with fingerprints. After the keys have been cleaned and allowed to dry, melt the paraffin and apply it to the keys with a small camel's-hair brush. Care should be taken not to get the paraffin between the keys, as it may cause them to stick when playing.—Lieut. D. B. Owens, Jr., Dayton, Ohio.

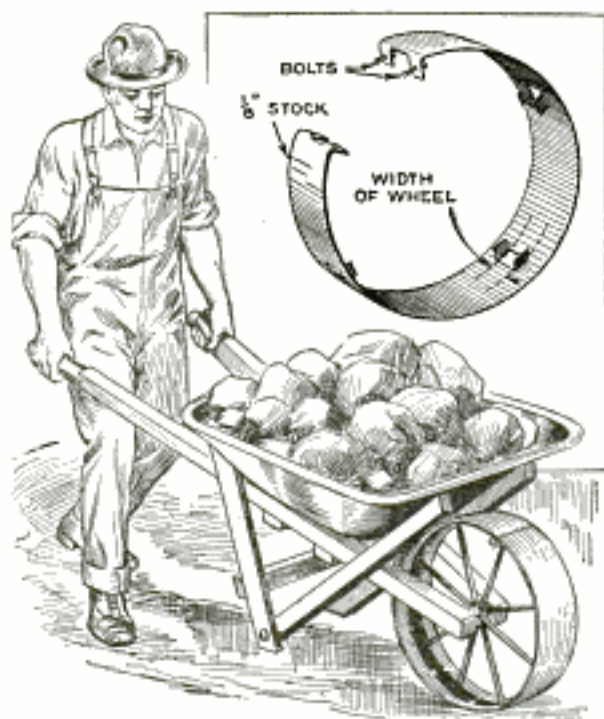

Wide Sheet-Metal Band around Barrow Wheel Aids in Wheeling over Soft Ground

Sheet-Metal Tire on Barrow for Soft Ground

Provided with this wide sheet-metal band around the wheel, a wheelbarrow can easily be pushed over soft ground. The band is held together at the ends by means of two stove bolts, while tabs, formed by cutting slits in the band at regular intervals, keep it from slipping sideways.

Flashlight Photos Can Be Made with Magnesium Ribbon

Magnesium ribbon, tightly rolled and kept in a small cylindrical container in your camera case, will be found useful for taking flashlight photos when regular equipment is not at hand. The ribbon, when ignited, will provide sufficient light, but the exposure should be longer than usual and motion must be avoided.

Chains for Model Ships Crocheted with Heavy Thread

Where it will not be subjected to strain, a good imitation chain for model ships can be made by crocheting heavy thread in a "chain" with loops of the required size. When completed, it is rubbed with beeswax and quickly passed over a flame to melt the wax into the fibers, after

which aluminum paint is brushed on rapidly. When the paint is dry, dry-brush with black japan, letting some of the aluminum show through. The effect is a very credible iron chain.

Names and Designs Applied to Tools by Electroplating

Any name or design can be put on tools or other metal surfaces by means of a simple electroplating process. Get a piece of mimeograph-stencil paper and cut the desired design on it. Then soak two pieces of heavy blotting paper, of the same size as the stencil paper, in a strong solution of copper sulphate and water. Place the blotters on the stencil paper, which is placed on the tool. A sheet of copper is put over the blotters and a wooden block on the copper. Place the bare end of the positive wire from a 6-volt storage battery between the copper plate and the wooden block to make electrical contact with the former. The block insulates the wire from the C-clamp, which is used to hold the assembly tightly on the tool. Be sure that neither the positive wire nor the C-clamp touch the tool, as this would result in a short circuit. Next fasten the negative wire from the battery to the tool with a small clamp or clip. After 5 or 10 minutes, the design will show on the tool

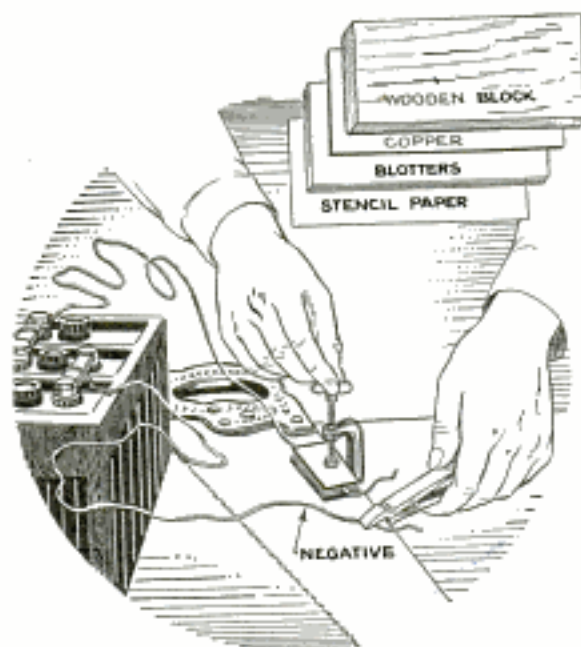

Lettering and Designs Can Be Put on Tools or Other Metal Surfaces with Copper Sulphate

in bright copper color, which cannot easily be removed.

Pocketknife Carving in Balsa Wood

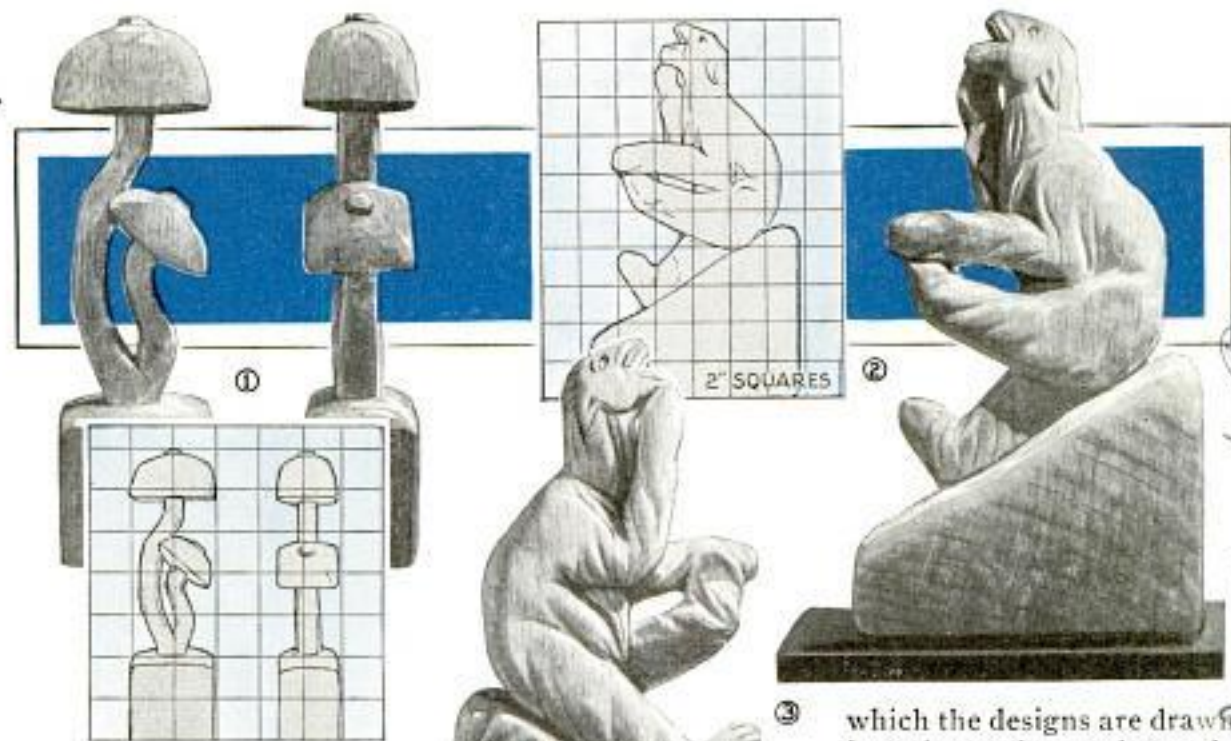

With very little practice anyone can produce beautiful carvings in balsa wood, leaving a bold, rough finish, or sanding down the harsh edges to a greater degree of fineness, as desired. The feature that especially makes this kind of carving easy is that the wood is extremely soft and can be cut with a razor or sharp pocketknife. It is advisable, however, to get a 25-cent fret-saw for removing large waste portions before the finishing cuts are made. As a preparation to actual carving in wood, it is a good idea for the beginner to experiment with cutting in soap in order to get the necessary sense of direction. The cut soap is not wasted but can be handily used. Profile pictures of anything that strikes your fancy can be obtained from magazines and newspapers, or if you have talent in sketching, it is a simple matter to produce original and distinctive designs. The three suggestions given here form excellent projects. A template is first prepared by ruling off a sheet of paper in 1 or 2-in. squares, after

which the designs are drawn in and traced onto the work. The polar bear, mounted on a huge cake of ice, is especially interesting. Figs. 2 and 3 show the two sides. From the shadows in the photos, the depth of the cuts can be determined with reasonable accuracy. The block of wood from which this specimen was cut was approximately 3 in. thick, 20 in. high and 12 in. wide, but it can be carved from a block just one-half of this size, using 1-in. squares in the template. You will note that the portion representing the ice cake, is left rough, especially at the bottom, the original saw marks being plainly visible. If desired, this part may be cut off in haphazard manner to give it a more realistic appearance. If the object is quite high, it is advisable to screw on an additional base of hardwood to give greater rigidity and to prevent it from being accidentally upset, which would probably mean breakage. Two other examples of good projects for beginners are the toadstool in Fig. 1 and the tulip in Fig. 4. Both side and front views of the former are given,

*J. H. Montebell Co
210 Lewis St
New York*

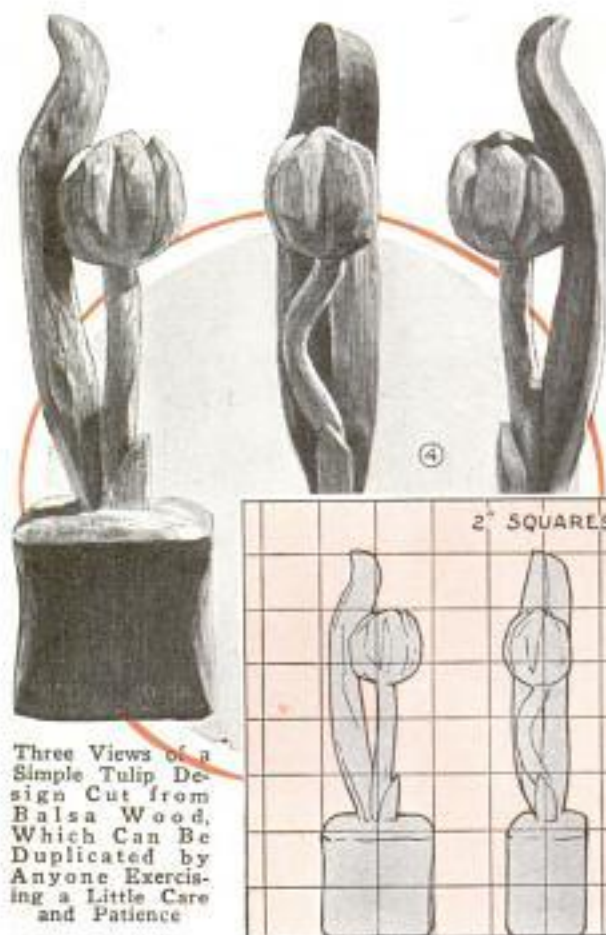

Three Views of a Simple Tulip Design Cut from Balsa Wood, Which Can Be Duplicated by Anyone Exercising a Little Care and Patience

while the appearance of the other side is the reverse, and that of the back quite obvious. In case of the tulip, three sides have been given so that you will have no difficulty in executing it. One point to remember when laying out the design on a piece of wood is to have the grain run so that there will be no narrow projections across the grain. These necessarily would be weak and likely to break off easily. However, if such a mishap occurs, the broken piece can usually be glued on so that the break is almost invisible.

Door Snubbers Made from Picture Hook and Tack

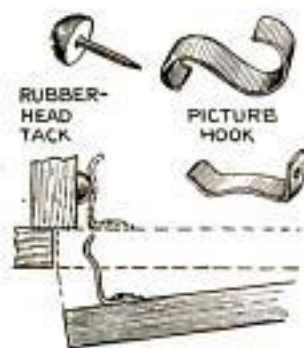

Snubbers for cabinet doors can be made from an ordinary picture hook bent to the shape shown, and a rubber-headed tack, which is used as a catch for the snubber. The material can be bought at

any 10-cent store if not on hand.—H. L. McConanghy, West Orange, N. J.

Cable Locks Series of Doors

Where lockers are arranged in rows a good way of locking the doors is to pass a length of cable through the staples on the doors or locker stiles. This method places the key to all the lockers in the hands of one individual and makes it impossible for anyone to pilfer the lockers. Another advantage is that it eliminates the often recurring trouble of lost keys, where so many different keys and locks must be handled. As a means of locking the end of the cable without altering its size so that it will pass through the staples, a simple clamp can be made from spring steel. The piece is doubled and an eye is formed at the doubled end to fit the cable, so that, when

pinched together and held in this position with a padlock, the clamp cannot be removed. Two holes drilled through both ends of the clamp allow attachment of the lock.

Album Files Photo Negatives

When putting your snapshots or photos in an album, it is a good idea to place the negative in first and put the print over it as shown. The print protects the negative from injury and you can readily find any negative by looking at the prints.



Rubber Hose Stops Rattle of Auto Hood

Most of the rattling around the front of my car came from the hood at the four points where it was clamped. By slipping a piece of hose between the hood and each fastener, the rattle was completely eliminated.—J. T. Temple, Cactus, Ariz.

Arc Searchlight Throws a Four-Mile Beam

Throwing a white beam of light for four miles, this searchlight consists of an old gas-type auto headlight fitted with carbons connected in series to a suitable resistor, and operates on 110-volt current. The lens should be removed to provide sufficient ventilation. A hole is cut in both top and bottom to take the carbons. The carbon holders are made from 4-in. lengths of $\frac{1}{8}$ -in. flat iron, 1 in. wide and bent to conform to the curvature of the lamp. A $1\frac{1}{2}$ -in. length of brass tubing, of $\frac{1}{2}$ in. inside diameter, is soldered or

brazed over a $\frac{1}{2}$ -in. hole drilled in the center of each holder, after which the latter is attached to the lamp. This is done by drilling two holes for screws through both the holder and the lamp, and through two fiber insulating strips of the same width and length as the holder. Fiber bushings are slipped through the holes in the lamp and through the strips, whereupon the holder is set in place and the entire assembly securely fastened with bolts passing through the fiber bushings. They must not touch the lamp. As the focusing of the light depends on the distance between the carbons and the reflector, the holes in the lamp should be elongated to form slots, so that the holders can be moved back and forth. Also, a hole is drilled and tapped in the brass tube of each holder, to receive a thumbscrew, which holds the carbon in position. The resistance needed in the circuit can be obtained by winding 60 ft. of No. 20 soft-iron wire on a piece of porcelain or mica and attaching this to the lamp, taking care that the wire does not come in contact with the latter and that the individual turns do not touch each other. One carbon is wired to the resistor while the other side of the resistor connects to one terminal of a plug. The second carbon connects directly to the other side of the plug. If desired, a heavy-duty switch

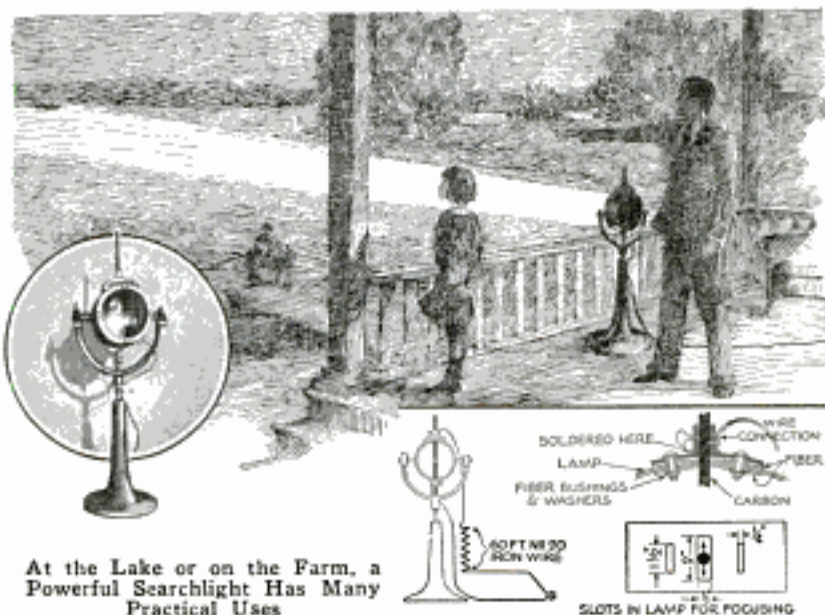

At the Lake or on the Farm, a Powerful Searchlight Has Many Practical Uses

can also be cut in the circuit to prevent burning at the plug prongs. When the current is turned on, do not touch both carbons at the same time or you will get a shock. Also avoid touching one carbon and a water pipe or other grounded conductor at the same time. To operate the light, set the carbons so that they touch each other at the center of the lamp and tighten the lower setscrew. Plug in, turn on the switch and start the arc by raising the upper carbon slowly until the flame becomes white, which takes place when the carbons are separated $\frac{1}{8}$ to $\frac{1}{2}$ in. Then tighten the top setscrew and focus the light. When correctly adjusted, it will throw a four-mile beam.—Sanford Marlor, Berkeley, Calif.

Sheet-Metal Wrench Removes Camera Lens

The flange holding a camera lens often corrodes, making it rather difficult to remove the lens without scratching or breaking it. A wrench made of sheet metal, and cut to the shape shown, is useful for this purpose.



The wrench is sufficiently flexible to be expanded and slipped over the lens.

Central Scientific Co.
460 E. Ohio, Chicago



This Portable Wayside Store for Street Venders Can Be Left on the Lot or Taken Home at Night

Vender's Store Resembles Large Wardrobe Trunk

Wayside venders will find this portable store useful, as it can be locked up and left on the lot or taken home at night. The supports are set in holes dug in the ground to prevent the store from falling over. The illustration shows how the wares are displayed in three hinged sections that can be folded and locked.

Smoke Candle Keeps Away Insects

When insects bother you around the camp, try a smoke candle, made by soaking equal parts of pulverized dry leaves and fresh pine sawdust in a strong solution of saltpeter until it is thoroughly saturated, after which it is taken out and dried. Then tamp it into a $\frac{1}{2}$ -in. paper tube. A candle of this kind will burn slowly and produce a smudge that is sure to keep all insects away.—H. Bosshard, Winterthur, Switzerland.

Potato Slicer from Old Plane

Potatoes can be sliced with an old wood plane, by holding it upside down and



pushing the potato over the blade as shown in the photo. The thickness of the slices can be regulated by adjusting the blade. This is an excellent meth-

od of preparing potato chips, as the slices can be cut unusually thin. The plane is also handy for slicing soap.

Peppermint Oil Used to Test Drain Pipes

Leaks in drain pipes can be located by using peppermint oil. To do this run enough water into the pipe to fill the traps, then add 3 oz. of peppermint oil to 6 gal. of hot water and pour this into the pipe at the uppermost

point of the system, as a sink on the second floor. When doing this keep the door closed tightly and have someone, who has not inhaled the peppermint fumes, follow the course of the pipe through the building. If there is a leak, an odor of peppermint will be detected around it.

Camp Bedding Stowed Behind Rear Car Seat

Storage space for camp bedding can be obtained by removing the upholstering from the back of the rear seat, which usually only necessitates the removal of a few screws.

The bedding is folded into a compact, flat bundle held together with a canvas cover. If the rear seat cushion, too, is removed, still more space will be available.—G. R. Rodgers, Decatur, Ill.



Initials Burned on Golf Clubs

Your initials can easily be burned on the handles of golf clubs, tennis rackets, etc., by means of a copper wire and an electric soldering iron. Twist one end of the wire to form the letter and wrap the other end around the tip of the soldering iron. Then heat the iron and press the wire initial against the handle, and the letter will be neatly burned into it.

Model Racing Yacht

28 in.
36 in.

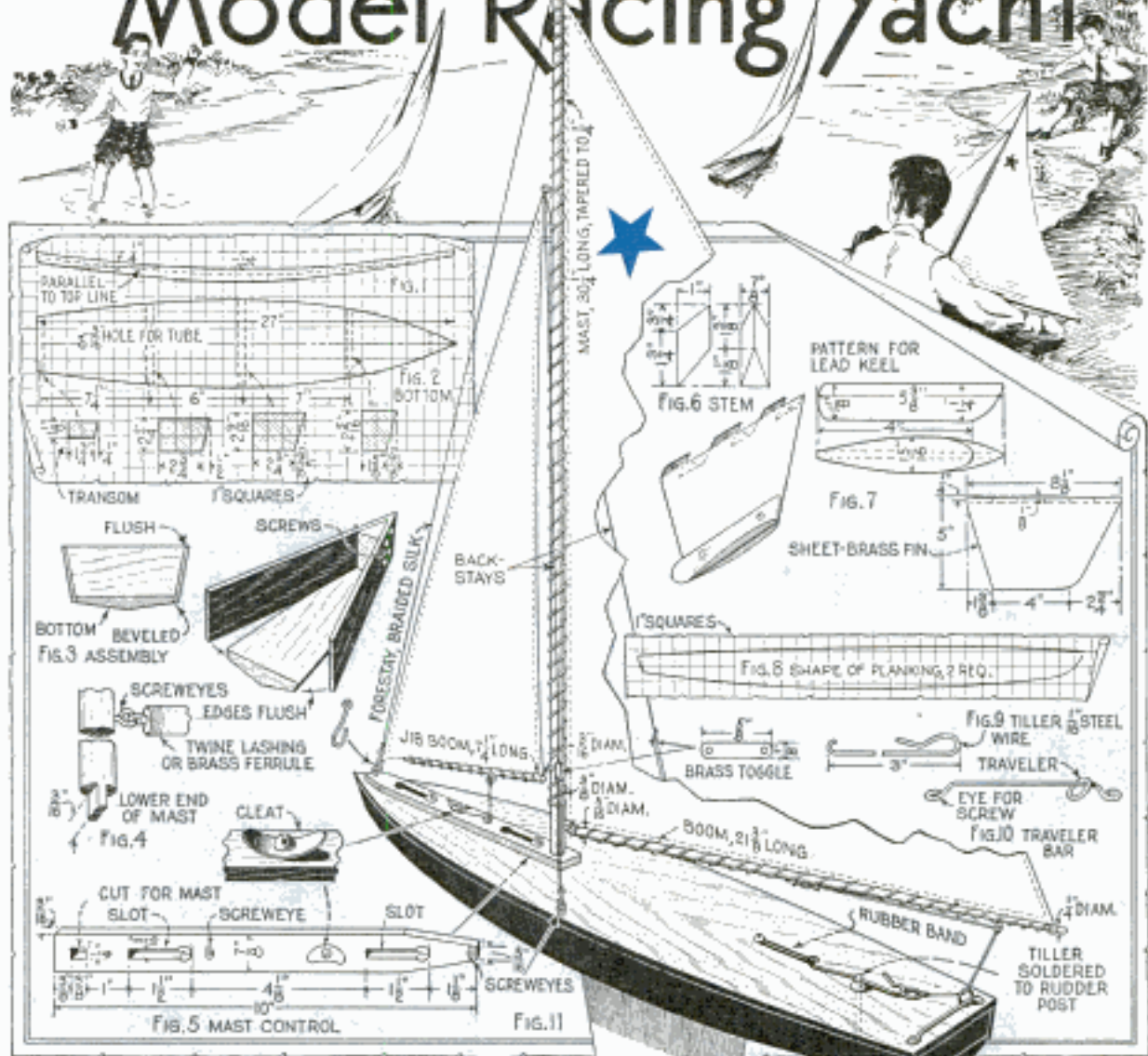

THERE'S as much real fun in building fast model racing yachts as there is sport in sailing them.

First make two full-size patterns for the bottom block, according to the drawings in Figs. 1 and 2, and paste them on adjacent sides of a 2 by 6-in. block of clear-grained white pine, 28 in. long. Cut out the work on a bandsaw if you have one, or with a keyhole saw. Draw a center line along the bottom from the sharp point at the stem to the center of the stern. Take a plane, as in Fig. 13, and working with the grain, cut away the wood on either side of the center line to the dotted line in Fig. 1, so that a cross section of the bottom will be slightly V-shaped. A $\frac{3}{16}$ -in. hole for the rudder post should be drilled at this time, exactly 3 in.

from the stern. The stem, transom and the three molds which determine the shape of the boat are made from $\frac{3}{8}$ -in. stock to the dimensions given in the details below Fig. 2 and in Fig. 6. The stem may be fitted to the bottom board now, making certain that the bottom edges are flush, and then fastening it in place with four $\frac{3}{4}$ -in. brads. The three molds and the transom should be lightly pinned at their proper places, but the nails should not be driven home. It will be necessary to bevel the bottoms of the pieces slightly so that they will stand upright.

Now for the $\frac{1}{4}$ -in. white-pine planks

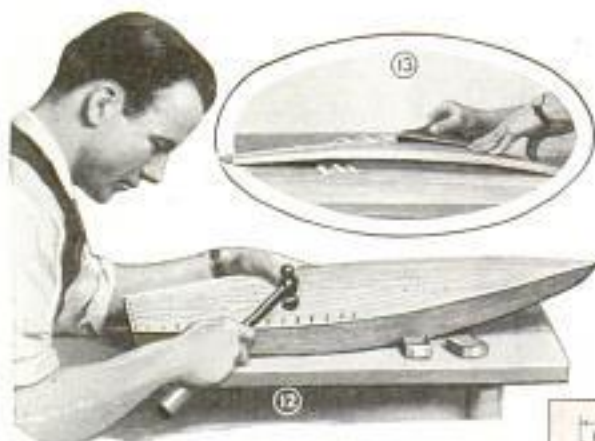

for the sides, each being shaped as shown in Fig. 8. After cutting, attach the planking roughly with a few brads and some string. At the stem, you will find it necessary to make a long bevel so that the pieces will come together, as can be seen in Fig. 3. At the stern, there will be a slight bevel to take the gradual curve of the plank, and all along the bottom block there will be a slight bevel to take care of the outward sweep of the sides. Once the beveling is finished, the planking can be put on permanently. Commence by fastening each plank to the stem with three $\frac{3}{4}$ -in. flat-head brass screws, gradually working toward the stern and fastening the planking with $\frac{5}{8}$ -in. brads at $\frac{1}{4}$ -in. intervals. Three or four nails are also driven into each mold. Then plane away the bottom edge of each plank so that it comes flush with the bottom block, as shown in Fig. 3. Then give the whole interior a coat or two of thin paint, particularly at the joints so that the hull will be watertight. While the paint is still wet, a 2-in. length of $\frac{1}{8}$ -in. (inside diameter) brass tubing is fitted in place to hold the rudder, and forced down through the hole at the stern, as shown in Fig. 15, until the bottom edge comes flush.

Putting on the $\frac{1}{8}$ -in. plywood deck is done by pressing a $7\frac{1}{2}$ by $28\frac{1}{2}$ -in. slab of wood over the hull, penciling around it to get the right shape, sawing it out and then fastening it with $\frac{1}{2}$ -in. brads all along

the sides and crosswise at the transom and at each mold, as shown in Fig. 12. A small hole is cut in the deck to allow the rudder tube to come through flush.

The rudder is fashioned from a sheet of $\frac{1}{32}$ -in. brass and a $\frac{1}{8}$ -in. brass rod, as shown in Fig. 14. The rod should be about 3 in. long so that it will just project $\frac{1}{8}$ in. above the deck when slipped up through the rudder tube. The tiller is shaped from $\frac{1}{16}$ -in. steel wire as shown in

Fig. 9, and soldered to the rod at the top of the tube. The traveler bar for the main sheet is made at this time and fastened at the stern to complete the rudder assembly, as in Figs. 10 and 11. The tiller is held at its forward end by a rubber band, slipped over a screw driven into the deck.

In the bow, a mast control is provided, shown in Fig. 5, which allows the mast to be shifted fore and aft, thus insuring the proper balance between hull and sail area. This mast control is made from a piece of $\frac{1}{4}$ -in. hardwood, to the dimensions given, and is fastened by means of two $\frac{3}{4}$ -in. round-head screws, which are driven into the deck just sufficiently to al-

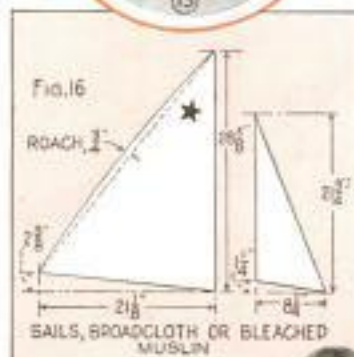

When Rigging a Model Yacht There's Advantage in Having a Sailor Granddaddy

low the control to slide beneath the heads along the two long slots. For the keel weight you will need about $3\frac{1}{2}$ lb. of lead. To get the required shape, first make a wooden form, then fashion a mold from plaster-of-paris and pour the lead into it, casting one-half of the weight at each operation. To do this get a piece of soft white pine, $5\frac{1}{2}$ by $1\frac{1}{2}$ by $1\frac{1}{2}$ in. in size, and on adjacent sides of this paste full-size patterns of the ones shown in Fig. 7. Then fashion the piece on a bandsaw,

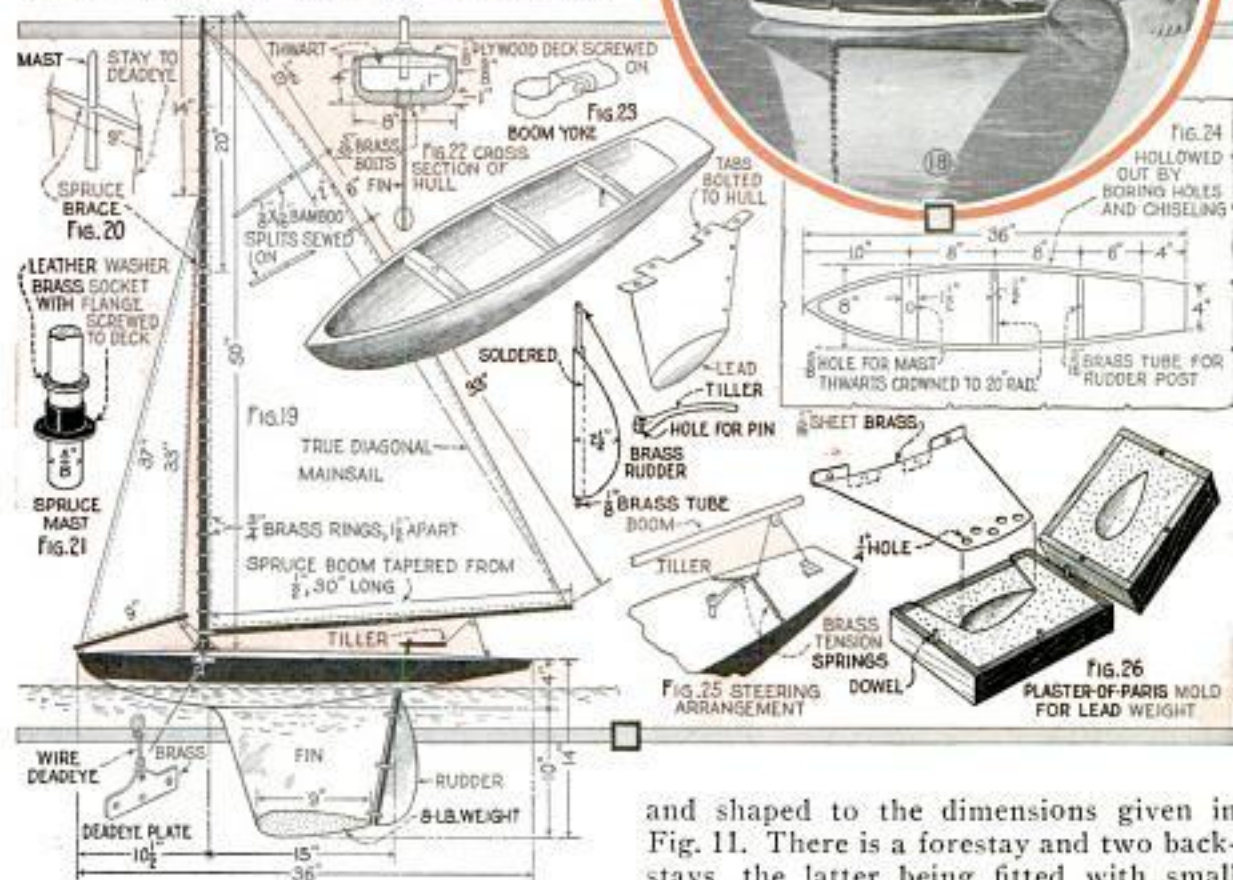

making the two cuts indicated by the patterns. After cutting, shape the pieces from top to bottom in a smooth curve, sand them and split down the center, after which a mold is made of each side. About 13 oz. of lead are required for pouring each half of the keel. The two halves, when finished, are bolted to the fin portion of the keel, dimensions of which are also given in Fig. 7. The tabs on the fin are turned over, and the complete assembly is fastened to the underside of the boat, the after edge of the fin exactly 7 in. from the stern.

Masting and rigging come next. The mast and spars are cut from dowel rod,

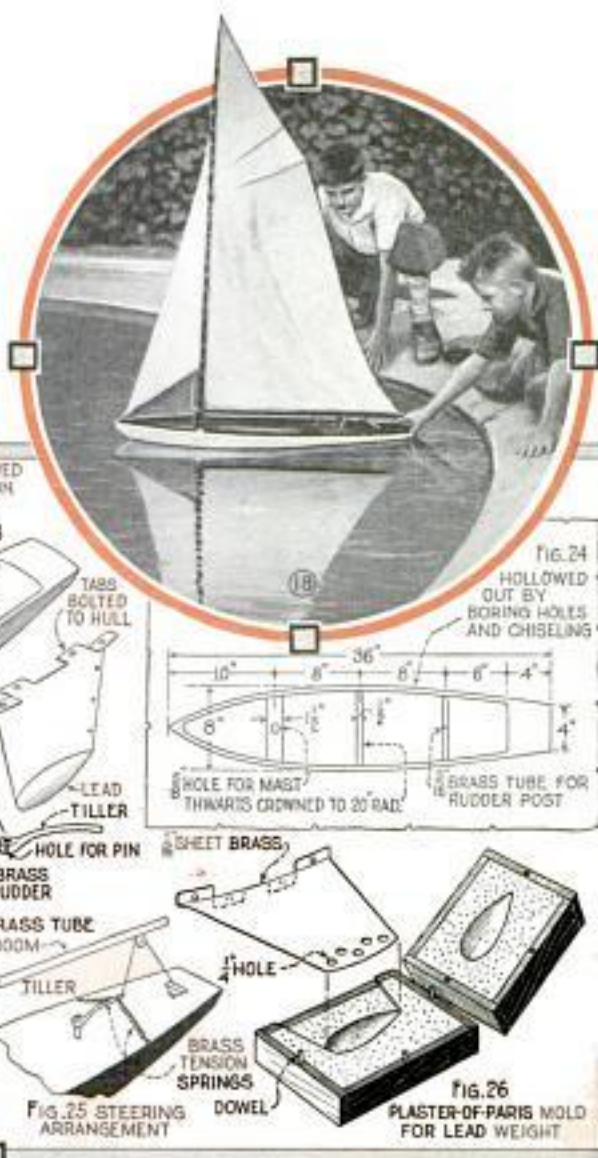

and shaped to the dimensions given in Fig. 11. There is a forestay and two backstays, the latter being fitted with small toggles so that the lines may be pulled tight or loosened. All rigging lines as well as the jib and main sheets are quite satisfactory if made from braided silk cord. Notice that the sheet line is run from a ring, which slips over the end of the tiller, then through a ring on the traveler, through a block and to a cleat on the underside of the boom.

The sails should be cut from broadcloth or bleached muslin of a good grade to the shapes shown in Fig. 16, with the selvaige along the back edge of each sail. While this makes hemming on a sewing machine rather difficult, it is quite necessary to prevent the sails from being stretched out of shape by the wind. The



You Can Just Bet That the Sea Yarns of This Sail-maker Are Thrilling

sails may be cut "raw" and finished with a light coating of shellac around the edges, or the edges may be hemmed by hand after first marking the outline and cutting down to the hem line at several places along the leech (the curved edge) so that the cloth will not wrinkle. In fitting the sails, care must be taken that they fit well and hang properly. After making them, they should be sewed in place. Use white button thread, running it around the spars and through the sails. Do not do this in a haphazard manner, but measure each stitch before you start, and then insert the needle through the markings and as close to the edge of the cloth as can be safely done without tearing the cloth, spacing the stitches $\frac{1}{2}$ in. apart on the mainsail and $\frac{3}{8}$ in. on the jib. The sails may be sewed while the rigging is in place, but a better job is done by removing the mast and spars for the sewing.

Paint the hull up to the deck line in any color, using flat paint or stain. After the color has dried, the whole hull, including the deck and spars, should be given two coats of clear spar varnish. All painting should be done before the sails are fitted.

Sailing the model is quite simple. The mast control enables you to keep the boat on a straight course. If the wind blows

hard, the control should be shifted forward, if lightly, the control moved aft. The force of the wind on the sails will automatically pull the rudder over to the proper angle. When sailing close-hauled, however, the ring may often be removed from the rudder to obtain better results.

A second racing yacht, built in the same general way, but measuring 36 in. in length, is shown in Fig. 18, while the details are shown in Figs. 19 to 26 inclusive. In this case, the hull, Fig. 24, is hollowed out by boring holes and chiseling, and three thwarts, slightly crowned, are fastened across the hull. The deck is then cut out and fitted accurately. The lead keel is poured over the end of the keel fin, making both integral as in Fig. 26, and the fin is bolted to the hull as shown in Fig. 22. In casting the lead weight, a plaster-of-paris mold is poured in a small wooden box, the two halves of which should fit together snugly by using dowels. A recess is allowed for the keel, which is drilled so that the lead will anchor in it securely. Also, the rudder is hinged directly to the keel fin. The tiller in this case is provided with two small brass tension springs, attached to the edges of the deck as shown in Fig. 25, while the tiller is controlled by a line tied to the end, slipped through a screw-eye on the boom and then fastened to a cleat on the deck behind the tiller. Instead of making the mast adjustable, it is set into a hole drilled in the center of the forward thwart, while a brass flange is screwed onto the deck directly over the hole to give additional support. Brass rings are used to hold the sail to the mast instead of thread, and a yoke keeps the boom in place on the mast instead of screw-eyes, a leather washer, slipped over the mast holding the boom yoke in place. A 9-in. spruce brace, shown in Fig. 20, straddles the mast, 20 in. from the tip, while the stays run from the tip over the ends of the brace, notches being filed for the purpose. The lower ends of the stays are anchored to the edges of the deck by means of wire deadeyes, which are in turn held by small sheet-brass deadeye plates. If you have gone over the construction of the first yacht, it will be an easy matter to build the second by merely following the drawings.

Carpenters' Apron Keeps Bait and Tackle Handy

When fishing in streams where it is sometimes necessary to walk some distance from your car or camp, a carpenters' apron is convenient for carrying fishing supplies, such as a bait can, an extra reel, a pair of pliers, etc. As it is worn at the front, it is easier to get at than coat pockets, and the contents will not drop out.—L. S. Landmichl, Riverton, Wyo.

Rubber-Covered Clothespins Protect Silk Garments

Runs in silk garments, caused by the rough edges on wooden clothespins, can be prevented by covering the prongs of the pins with thin rubber. Get a piece of $\frac{3}{8}$ -in. rubber tubing and cut it into lengths to cover the prongs and slightly project over the ends so that the rough wood will not come in contact with any garment when it is hung on the line. The tubing, being waterproof, can easily be cleaned.

Shelves between Studs for Storage of Beverage Bottles

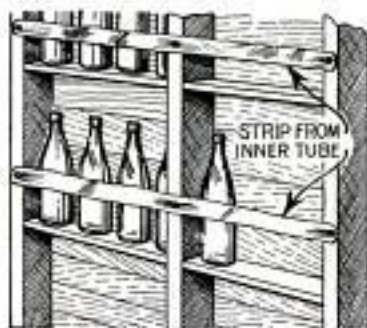

Bottles used for home-made beverages can be stored out of the way in the garage or basement by providing a number of shelves between wall studs to hold them. Rubber strips, cut from an old inner tube, are tacked across the studs. In this way the bottles are kept in a safe place and are always accessible when needed.

When running rods through the headings of curtains or drapes, a thimble placed over the end of the rod will prevent it from catching in the fabric and allow the rod to slip through much more easily.



Hollow Book Ends Provide Storage Space for Cigaretts and Matches, or May Serve as Ash Receivers

Cigaretts Stored in Hollow Book End

Constructed as shown in the illustration, a hollow book end will provide a convenient place for storing cigarettes. It can be made out of almost any kind of wood, the various pieces being cut to the shapes shown, and glued or nailed together. If desired, a small hole can be drilled in the top, which is hinged to the base, and an ash tray placed inside.

Suction Cup Holds Color Container When Lettering Windows

In putting temporary lettering on their windows, merchants will find the illustrated method of holding the color container useful, as it leaves both hands free. A suction cup, such as is used to hold ash trays on auto windshields and similar purposes, will do the job. Punch a small hole in the container and attach the cup to it by means of the bolt with which it is fitted.



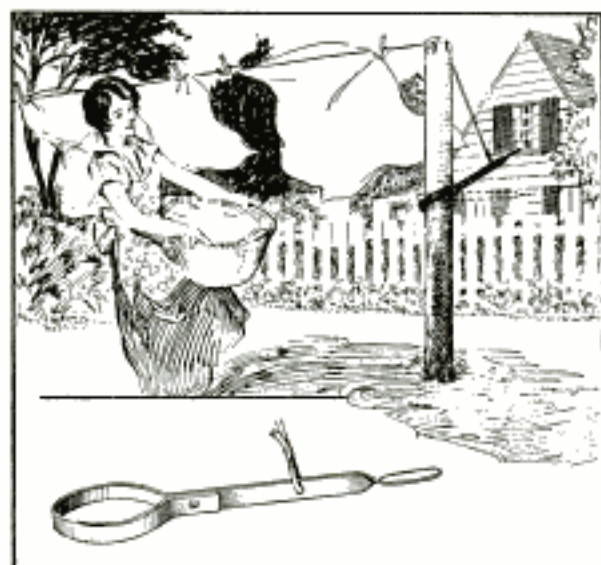

Strap-Iron Lever Can Be Slipped Up or Down to Adjust the Clothesline

Keeping the Clothesline Tight

Made from a length of heavy strap iron, this tightener will keep your clothesline taut. One end of the iron is bent to fit loosely around the post, while the other is twisted to form a handle, as shown. The clothesline is run over a small pulley at the top of the post and fastened in a hole drilled in the holder at the point indicated. In use, the line is loosened or tightened by pulling down on the handle and slipping the looped end up or down on the post.

Holder for Rowboat-Anchor Rope

An anchor on a rowboat can easily be handled by the person rowing, without getting off the seat, by using this anchor-rope lock, which grips the rope and holds it in any desired position, yet allows it to

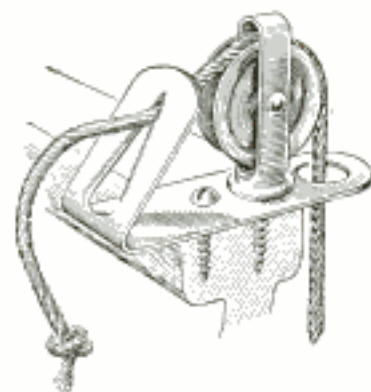

be loosened at will. It consists of a clothesline pulley and a length of flat iron, bent and attached to the bow of the boat. A tapered slot is cut in one end of the piece

of iron to receive the rope, after which this end is bent over at the angle shown. The edges of the slot are turned over to-

ward the pulley so that the rope will not be frayed. In use, the anchor rope is threaded over the pulley and through the slot, and a knot is tied at the end to avoid losing both rope and anchor. By merely giving the rope an upward jerk it is securely wedged in the slot. To loosen it, the rope is pulled down again.—George Madsen, Chicago.

Blackboard Made at Small Cost

By applying a coat of the following mixture, a good blackboard can be made of plywood, wallboard or even cardboard. To cover about 40 sq. ft. of surface, mix 4 tablespoonfuls of finely pulverized air-slaked cement or pumice in $\frac{1}{4}$ pt. of quick-drying black or dark-green enamel. This mixture must be stirred often while it is used and should be applied with a brush. If the surface is too rough after the coating has dried, it can be rubbed down with fine sandpaper.—E. J. Worley, Vancouver, B. C.

Drawer Pull Conceals Lock

An ordinary drawer pull can be made to serve as a cover for a lock by filing a small notch from the lower edge to one of the screw holes. The pull is placed over the lock and one end is screwed to the drawer loosely, so that the pull can be raised.

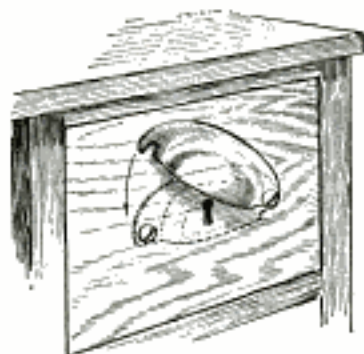

This arrangement is especially useful on small drawers where there is not enough room for both a pull and a lock.

How to Clean Camera Lens

A camera lens should be cleaned frequently, in order to keep the pictures free from a foggy appearance. A piece of absorbent cloth, such as is used for removing cold creams, will serve this purpose. The lens is wiped with a circular motion, from the center toward the edge, applying very little pressure.



Etching Hammered-Copper Trays

ETCHING is perhaps the simplest process of producing beautiful patterns in sheet metal, and if carefully done, good results are assured. The trays illustrated here can be made from copper or brass. For large trays, No. 18 gauge metal is used, while smaller ones can be made from 20 gauge stock.

One type of tray has a depressed center and is known to the metal craftsman as a simple type of "formed" tray. The other is turned up at the edges and is known as "lipped," the edge being turned up from $\frac{1}{4}$ in. to $\frac{3}{8}$ in. depending upon its size.

a circle and cut away the surplus with a pair of snips. Then clamp the piece in a vise and file the edge smooth, using wooden blocks between the jaws to avoid mar-

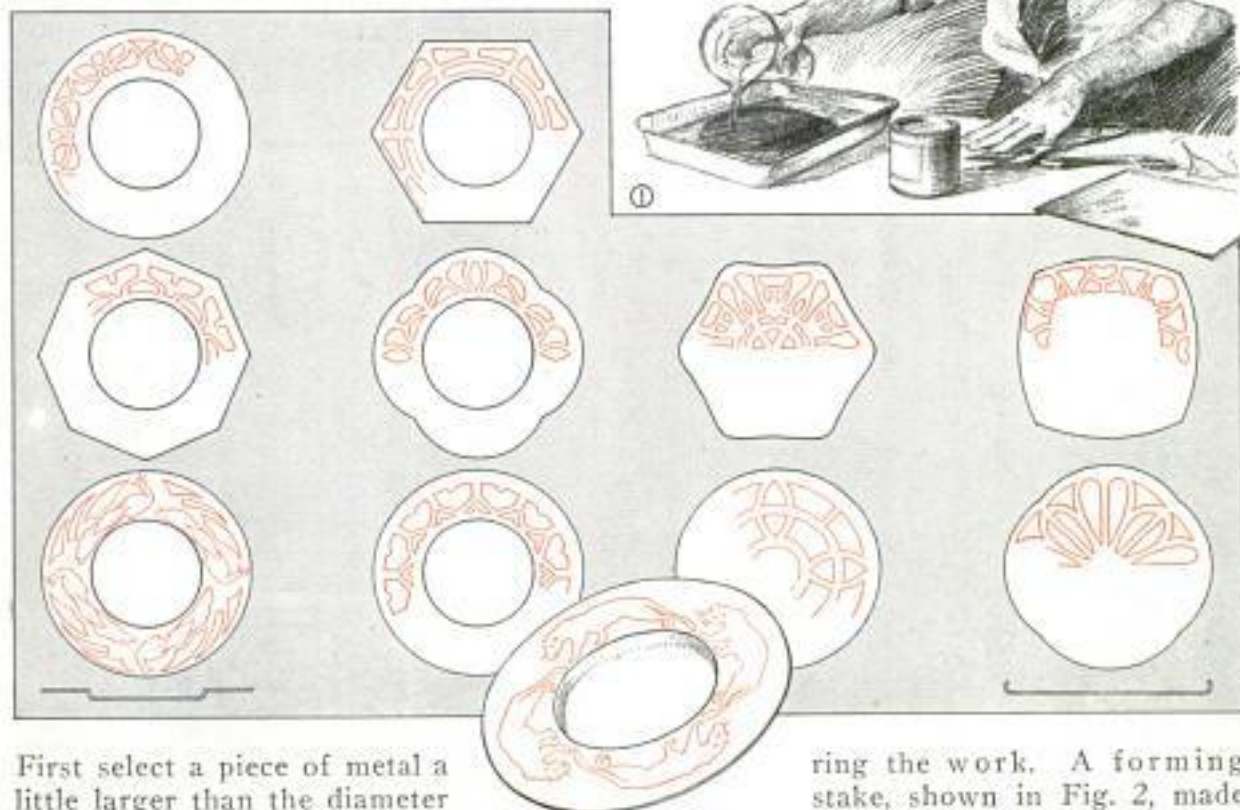

First select a piece of metal a little larger than the diameter of the tray and flatten it over a heavy bench top, iron block or anvil. To do this, strike a succession of sharp blows on the metal with a wood mallet. When the piece is smooth, lightly scribe

ring the work. A forming stake, shown in Fig. 2, made of hardwood such as maple or beech, is used to turn up the edge of the tray, the curvature of the stake approximating that of the tray, and the forming is done with a wood or rawhide mallet of

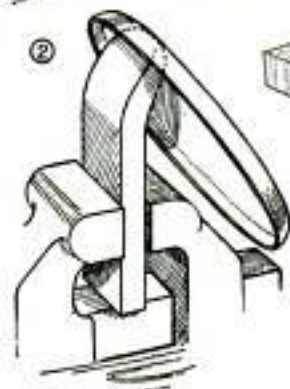

moderate weight. The blows should not be too heavy or the metal will buckle badly. The edge must be turned up gradually by continuous hammering while turning the tray around the stake. Any buckling can be hammered out over a smooth surface.

The formed type of tray, with a depressed center, is shown in Figs. 3 to 6. The depression should be from $\frac{1}{4}$ to $\frac{1}{2}$ in. deep, depending upon the diameter of the tray. A forming block is made from 2-in. hardwood, as illustrated in Fig. 3. It may be gouged out by hand if a lathe is not available. The metal disk is centered upon the block and the depression formed with a ball-pein hammer, as shown in Fig. 4. Light, quick blows are made, and, as the metal buckles, it should be smoothed out in the way already mentioned. The final step is to smooth

the curve over the edge of a metal block or anvil, as in Fig. 5.

The hammering of copper hardens it, so that it must occasionally be annealed to restore its softness. This is done by heating to a cherry-red and plunging in cold water. You are now ready to make a stencil, which is used to transfer the design to the tray. A number of examples are given in Fig. 1. First draw the design on a paper disk that fits the tray. It may be traced on the tray four, six, or eight times, as desired, and accordingly should cover 90, 60 or 45°. One-half the design is drawn on one side of the center line,

after which the paper is folded and the design cut entirely through both parts with a sharp knife. Tracing the design on the tray is then an easy matter. To repeat the pattern around the tray merely shift the stencil.

The portions of the metal not to be etched must now be covered with asphaltum varnish applied with a small camel's-hair brush, as

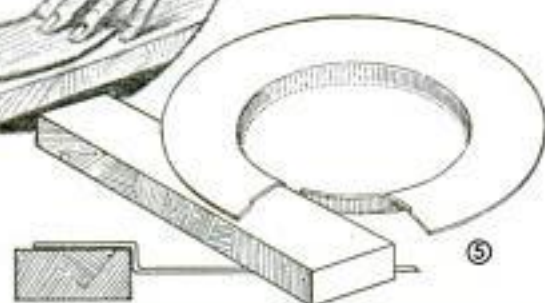

All Portions That Are Not to Be Etched Are Carefully Covered with Asphaltum Varnish, Which Should Be Dry before Etching

shown in Fig. 6, making sure that the edge and bottom of the tray are completely covered. Do not attempt to do this with a single application. It will be necessary to touch up the work wherever the metal shows through, for if the coating is too thin, the etching acid may eat through. Brush on the varnish evenly and carefully at the edges of the design to assure sharp outlines. Then lay the tray aside to dry.

The etching solution consists of one part of nitric acid and two parts of water, and must be kept in a glass or earthenware container. Be careful not to get the acid on the flesh or clothing as it may cause serious burns and will destroy fabric. It is a good idea to wear rubber gloves. Also, when mixing, pour the acid slowly into the water; not the water into the acid. Before the etching solution is applied to the tray, the latter must be thoroughly cleaned so that there is no trace of oil from the hands on the bare portions. Such cleaning is done by immersing the tray in a solution called a "pickle," which consists of 1 part of sulphuric acid and 15 parts of water, the same precautions being taken in preparing this mixture as with the etching solution. Allow the tray to remain in this solution for a few minutes and then rinse with clean water. Now place the tray in a glass dish and slowly pour on the etching solution, which will eat into the unvarnished parts. Small bubbles and fumes will arise as the acid attacks the metal. If bubbling is violent, the solution should be weakened with water. The action generates heat, and if the acid works too fast, the heat may soften the varnish. If the solution stops working, it is poured off and replaced with fresh solution. After the etching is done, the varnish is removed with turpentine or benzine, and the tray again pickled, rinsed and dried. A coat of transparent lacquer will prevent oxidation of the metal and consequent loss of luster.—L. Day Perry, Chicago.



Pickax Properly Shaped Enables One to Remove Manhole Covers Single-Handed

Manhole Covers Removed with This Tool

One man can easily remove manhole covers single-handed with this pickax, which has one end ground to fit the small hole in the covers. The other end is flattened to a chisel shape, as shown in the detail, for removing ice, tar, cement, etc., from the top of the covers.

Concrete-Viaduct Pillars Poured in Sewer-Pipe Forms

When building a viaduct on a grade elevation, one railroad used concrete sewer pipe or forms in making the pillars. The pipe is left in place on the finished job, and furnishes a good jacket.



Sections of Large-Size Concrete Sewer Pipe Can Be Quickly Set Up to Provide Durable Forms for Viaduct Pillars



Stumps Are Easily Burned Out with Two Pipes Arranged to Furnish Sufficient Draft to Keep the Fire Alive

Burning Out Stumps Quickly

Stumps can be burned out with very little work by following the method illustrated. Two lengths of sheet-metal pipe are made, one 6 in. in diameter and 6 ft. long, having large notches cut at the bottom to allow draft for the fire, and the second 8 in. in diameter and 3 ft. long, with small notches cut at the top end and crimped over to center the other piece, which is slipped inside. A large flange at the bottom of the outer pipe serves to hold it in place on the stump. In use, the assembly is arranged on the stump and kerosene is poured down the smaller pipe and lighted by dropping a piece of burning paper on it. Air coming down between the pipes will supply sufficient oxygen and cause the fire to burn out the stump. As the wood is consumed, the inside pipe will sink gradually continuing to furnish the proper draft for the fire, and this goes on until the stump has been completely hollowed out or consumed.

Old plane butts can be made into excellent scrapers for wood-finishing work.

How to Avoid Breakage of Taps

Breakage of small taps can usually be prevented by exercising a little care. Be sure to use the correct size for the hole to be tapped. Using a too small one not only makes more work for the tap to do, but also causes it to bind and break. Let the first tap cut as much as possible, but do not force it. The holes should be drilled all the way through, provided, of course, that the work is not too thick, or that it will not be weakened by the hole. A deep hole will prevent the tap from coming in contact with the bottom which often causes it to break. Therefore, if the hole cannot be drilled all the way through the work, it should be drilled a little deeper than necessary. If the hole must be tapped to the bottom, be sure to clean out all chips, or they will "mat" and not allow the tap to cut to the full depth. If a tap breaks in the hole and cannot be removed with

tools made for this purpose, it will have to be annealed and drilled out.

Locating Faceplate Work on Lathe with Aid of Mirror

In the absence of a test indicator to locate a punch mark on the work centrally on the faceplate, accurate results can be obtained by the use of a small mirror attached to a rod with pointed ends. The work is clamped on the faceplate in the usual manner and one end of the rod is

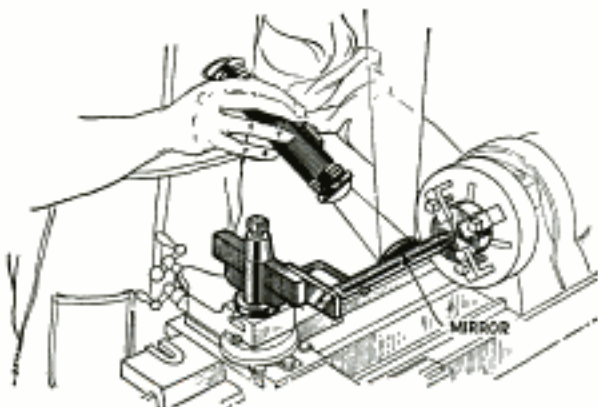

Small Mirror and Flashlight Used to Locate Center-Punch Mark on Lathe Faceplate

engaged with the center-punch mark, while the other is inserted in a small hole drilled in a piece of flat stock clamped in the tool post. An L-shaped pin, also attached to the rod, engages with the tool post to prevent it from turning. A flashlight is used to direct a beam of light against the mirror, which reflects it against the ceiling or wall. If the work is not accurately located on the faceplate, an oscillating motion will be imparted to the mirror, which will be exaggerated by the reflection on the wall.—R. H. Kasper, Philadelphia, Pa.

Jig for Grinding Correct Bevels

This jig for grinding tools, such as plane bits, chisels, etc., to the correct bevel, consists of two flat-iron uprights with one end bent over at right angles and screwed to the bench top, while the upper end is drilled to receive a rod. The length of the uprights should be equal to the distance between the bench top and the center of the wheel. A U-shaped piece, with the ends drilled to make a sliding fit on the rod, forms one side of the tool clamp, while the other consists of a piece of flat iron, both being held together by means of two screws fitted with wing-nuts. The rod is kept in

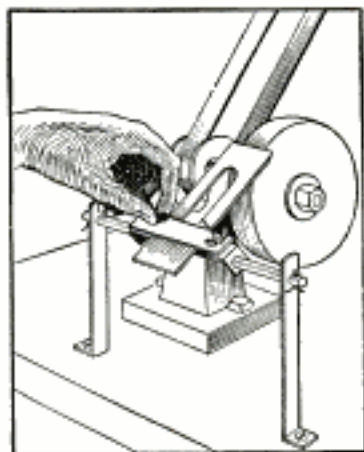

place by cotter pins fitting holes at the ends. In use, the plane bit or other tool is clamped in position and held against the grinding wheel at the correct angle, which is largely determined by the distance from the edge of the wheel to the jig.—R. H. Copeland, Tallassee, Ala.

Templates for Matching Curves

Artists and draftsmen, who experience difficulty in matching irregular curves of a symmetrical design, will find the use of a template handy. Sketch one-half or

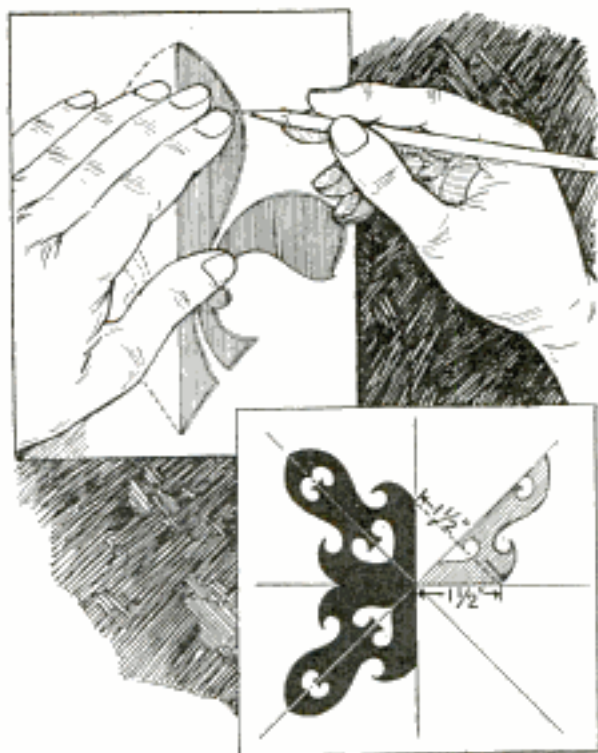

Templates Cut for Producing Symmetrical Designs Aid in Duplicating Irregular Curves

one-quarter of the design on paper, then cut it out and use it as a template. If the design is simple, it is often possible to fold the paper and cut the desired shape without sketching. Fold it once for a two-part design and twice for a four-part design. If it is to be repeated several times, thin board or stencil paper should be used instead of ordinary paper.

Wooden Plugs Hold Ladder Away from Building

When painting the upper part of a building, it is inconvenient for the worker to run down and move the ladder in order to paint around its upper end. By fitting pegs in the ladder as shown, this trouble is avoided. The pegs are made of hardwood, and driven into holes drilled in the sides about 2 in. from the ends.—Bert Moorehouse, Pasadena, California.

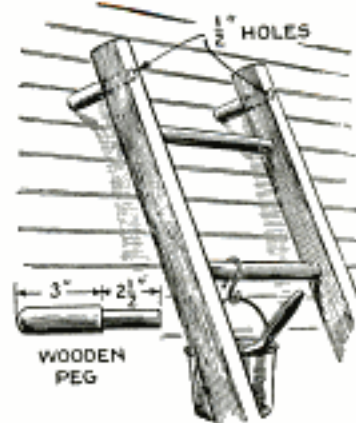

Cape Sewed to Helmet Keeps Pilot Warm



By sewing a cape to the lower edge of an airplane pilot's helmet, greater comfort will be assured, as the cape effectively keeps out the cold air. Woolen cloth is preferable, and the cape should be large enough to cover the shoulders in the manner shown. The flying suit is then

pulled on over the cape.—Chas. H. Deerwester, Rantoul, Ill.

Soldering Iron Is Adjustable

Here is a soldering iron that can be set at several different angles. Round off one end of the iron and fasten a U-shaped length of strap iron to it with a pin, which is inserted into a hole drilled for this purpose. A piece of iron rod to form a handle is threaded at one end to fit a tapped hole in the bottom of the U-shaped strap, and is fitted with a locknut. Shallow holes are drilled in the rounded end of the

soldering iron to receive the end of the handle. In use, the iron is held at the angle desired, and the handle is screwed down until the end engages one of the holes. Then the locknut is driven down to hold the handle in position.

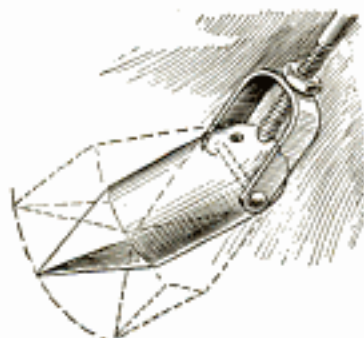

Then the locknut is driven down to hold the handle in position.

Compound for Pipe Joints

A pipe-joint compound that will not "rust-set" the couplings, or otherwise make them hard to uncouple, can be made by mixing molasses, 1 gal., air-floated graphite, 10 lb., and oil of mirbane, 1 fl. oz. If the compound is used imme-

diately after mixing, the oil of mirbane may be omitted, as it acts only as a preservative for the molasses. This compound is applied to boiler plugs, gaskets, or other fittings that are subjected to heat, and it supplies a lubricant to the threads of the couplings.—E. Perry, Oakland, Calif.

A Tool for Driving Studs

Studs can be driven with the illustrated tool without damage to the threads. The tool is made of cold-rolled steel rod to fit the stud. In one end of the rod, a hole is drilled and tapped to a depth equal to one and one-half times the diameter of the stud. A steel ball, of suitable size to keep it from falling out, is driven to the bottom of the hole to form a bearing for the end of the stud; whereupon the tool is ready for use. Two types of this tool are shown, one for hand use and one for power use.—Omar Fluharty, Columbus, Ind.

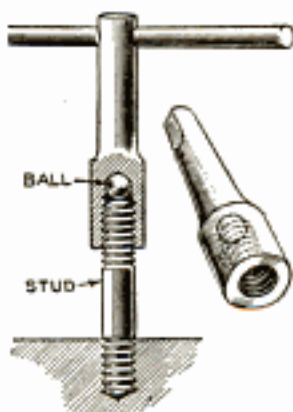

Brace Makes Lathe Toolholder More Rigid

If the lathe tool chatters when taking heavy cuts, due to lack of rigidity in the holder, the trouble can be overcome by using the brace shown here. The toolpost is slotted and drilled to receive a pin on which the brace pivots. One end of the latter is bent and notched to form teeth, while the other end is drilled for the regular toolpost screw, with which the brace is clamped against the tool securely. Braced in this manner, a toolpost will be more rigid, owing to the two-point support.

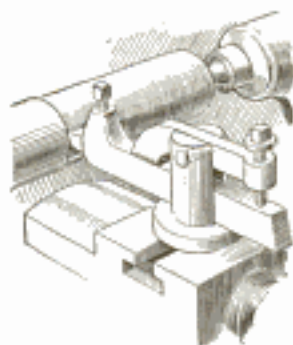

☞ A piece of cloth saturated with oil and wrapped around your extra fretsaw blades will keep them from rusting.

A Lathe for Large-Diameter Work

By W. CLYDE LAMMEY

AS a rule a 10 or 12-in. disk is about the largest that may be safely turned on the outer end of the headstock spindle of the average small wood lathe. Where the work is 20 in. or more in diameter, the spindle speed should not exceed 500 r.p.m. for the first truing cut, and even for the final finish cut, the speed should not be over 800 r.p.m. However, a lathe giving the necessary reduction in speed, to permit turning faceplate work up to 36 in. in diameter, is easily made from materials readily available. It consists simply of a headstock with a three-step cone pulley and a countershaft, also with a cone pulley, driven by a $\frac{1}{4}$ -hp. motor, the whole assembly, as shown in Fig. 4, being constructed of hardwood.

Each step of the cone pulleys consists of two disks, $\frac{7}{8}$ in. thick and glued together with the grain of the wood at right angles. Thus, twelve disks are re-

quired for the two cone pulleys. Key the steps with $\frac{1}{4}$ -in. dowel rod on both countershaft and headstock cone pulleys.

Next, center a $\frac{3}{4}$ -in. hole through both cone pulleys. If possible, this should be done on a drill press, but if you must bore the hole with a brace, be careful to get it as accurate as possible from both ends, the two holes meeting at the center. For spindles carrying the countershaft and headstock cone pulleys, cut two 11 $\frac{3}{4}$ -in. lengths from 1-in. dowel rod, mount between centers in the lathe and turn down to exactly $\frac{3}{4}$ in. in diameter throughout the length. Drive the spindle through the cone pulley, place it as indicated in Fig. 5, bore a $\frac{1}{4}$ -in. hole transversely

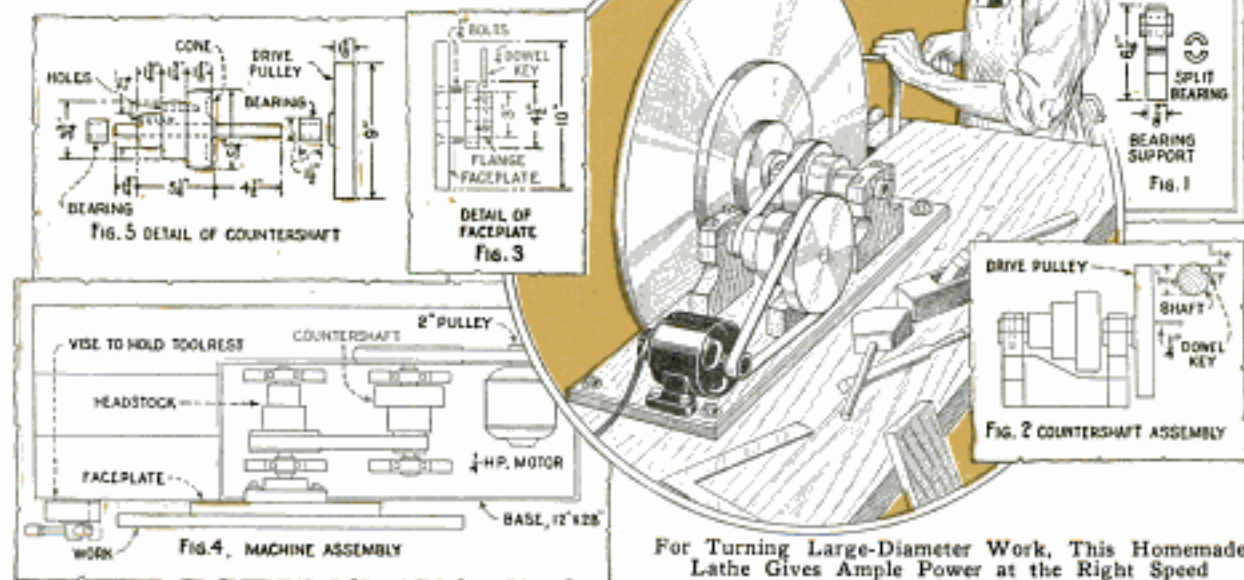

For Turning Large-Diameter Work, This Homemade Lathe Gives Ample Power at the Right Speed

quired for the two cone pulleys. Glue up the two disks forming each step separately, then glue the three steps together, taking care that they are centered so that they will turn true. Bore two $\frac{1}{4}$ -in. holes parallel to the axis and near the edge of the rim on both intermediate and smaller steps, at the points indicated by the dotted lines in Fig. 5, the holes being slightly deeper than the thickness of the single

through the center step of each pulley, and drive in a key cut from $\frac{1}{4}$ -in. dowel rod. Remount the work between lathe centers and turn the pulleys to the diameters and widths indicated, the three steps of each being turned to exactly the same diameters, so that the belt will run with equal tension on any two of the steps. The steps should be only slightly crowned. The four bearing supports are band-sawed from $\frac{3}{8}$ -in. hardwood to the

dimensions and shape indicated in Fig. 1, while the four split boxings are formed from hard-maple disks.

The countershaft drive pulley is made

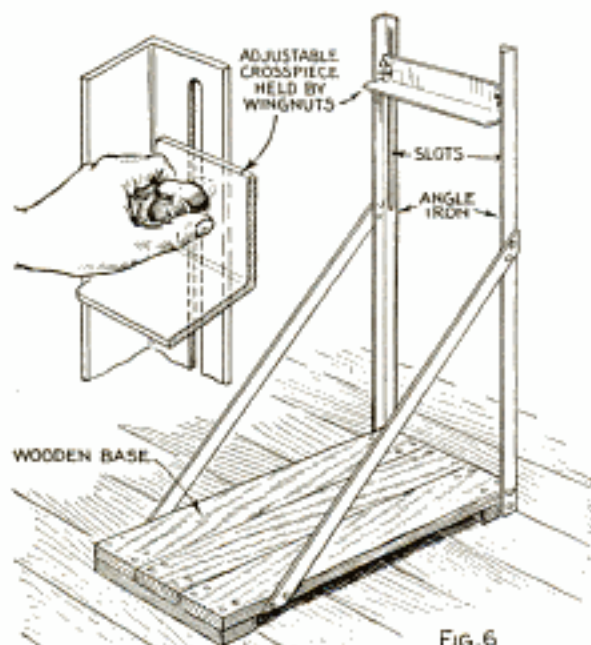

The Worker's Weight on the Base of the Tool Rest Holds It in Position While Turning

from two disks of $\frac{3}{4}$ -in. stock, $9\frac{1}{2}$ in. in diameter, glued together with the grain at right angles. The edge should be crowned slightly. Center a $\frac{3}{4}$ -in. hole clear through, drive the pulley on the end of the countershaft spindle and key as in Fig. 2, the key being cut from $\frac{1}{4}$ -in. dowel rod and driven in a $\frac{1}{4}$ -in. hole bored parallel to the spindle, half in the latter and half in the pulley.

Fig. 3 details the construction of the faceplate, the flange being formed from two hardwood disks glued together and further secured with screws, centerbored $\frac{3}{4}$ in. and keyed to the headstock spindle with a traverse key as in Fig. 3. Scribe a $3\frac{3}{8}$ -in. circle on the face of the flange rim, and bore four $\frac{1}{4}$ -in. holes, equally spaced, with the centers on the line. Then scribe, saw and turn a 10-in. disk from $\frac{3}{4}$ -in. hardwood, scribe a $3\frac{3}{8}$ -in. circle about the center and bore four equidistant holes, centering on the line and counterbored to take $\frac{1}{4}$ -in. bolts. Bolt the faceplate to the flange rim and assemble the headstock and countershaft on a base, 12 by 28 in. in size, making sure that the parts are the same distance apart, and that the pulleys are in line. Bolt a $\frac{1}{4}$ -hp. motor to the

base, the motor pulley lining up with the countershaft drive pulley. Bolt the assembly to the bench top in such a position that a tool rest may be clamped in the bench vise as shown. Another handy tool rest for use with the lathe may be made as in Fig. 6, the slotted angle-iron uprights allowing quick adjustment.

The operator stands on the wooden base, his weight holding it securely in place while turning.

Ammonia Gives Wood Finish of Fumed Oak

Ammonia can be used to give wood a fumed-oak finish. The wood is placed in an air-tight chamber as soon after planing as possible, and is there exposed to ammonia fumes until it has taken on the required depth of color. If desired, the ammonia can be applied to the surface of the wood with a cloth. If a chamber is used, care should be taken that the fumes will reach all of the surfaces to be fumed and for this reason the work should be suspended.—John E. Hyler, Peoria, Ill.

Tongs Grip Goods on High Shelves

Tongs for gripping articles on high shelves that are out of one's reach, can be made from a broomstick, three 1-ft. lengths of $\frac{1}{8}$ -in. flat iron, and some No. 9 galvanized-iron wire. Two of the flat-iron



strips, bent to form jaws, are pivoted together as indicated in the drawing, and one of them bolted to the end of the broomstick. The third strip is doubled and pivoted on the broomstick near the lower end providing a lever, which is connected to the movable jaw by the wire so that the latter will open or close the jaws.—Jerry Koan, Schoolcraft, Mich.

Electric Feeder Serves the Poultry on Time

It is not necessary to be home just to feed the poultry or to depend on your neighbor's good will in doing this chore. If you are supplied with electric-lighting current, an automatic feeder can quickly be rigged up with a small motor and an eight-day clock. Build a hopper of suitable size similar to that shown, providing it with a funnel-shaped bottom to let the grain drop out. A 12-in. wheel, made as shown in the detail, is built up from a core, two side disks and a number of cleats, spaced equidistantly between the latter. The wheel is mounted on a wooden shaft so that it comes directly under the spout of the hopper, which must be the same size as the

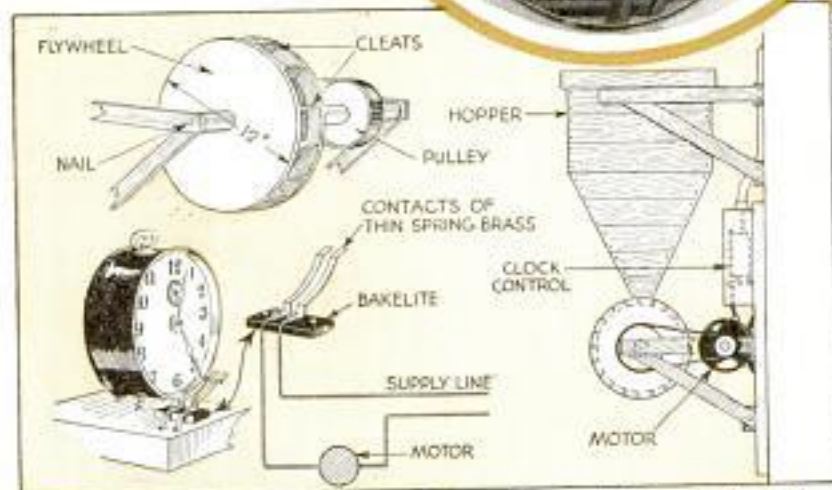

Electric Feed Dispenser Runs Twice Every Day, and Insures That Your Poultry Will Be Fed While You Are Out Visiting

width of the wheel, to avoid dropping grain when the wheel is at rest. It is obvious that the feed drops into the spaces between the cleats and is thrown a considerable distance when the wheel is revolved. The shaft is mounted on a pair of hangers or brackets, also made of wood. A pulley on the shaft is belted directly to a motor of about $\frac{1}{8}$ hp. The clock operates an improvised switch, which sets the motor in operation for a few moments twice

every 24 hours, at any predetermined time, depending on how the switch and clock are arranged. The switch consists of two light spring-brass strips, mounted parallel on a piece of bakelite and connected in the circuit as shown in the diagram. A small brush is attached to the hour hand of the clock to wipe over the spring contacts, closing the circuit.

The length of time the brush touches the contacts determines the quantity of feed scattered.

A Good Cement for Celluloid

For fastening celluloid to wood, metal and other substances, a satisfactory cement can be made up of 2 parts of shellac, 3 parts of spirits of camphor and 4 parts of alcohol.

~~Powdered Iron~~ Central
Scientific Co. 460 8
Chicago

Concrete Can Be Waterproofed with Pulverized Iron

Concrete, brick and masonry walls can be waterproofed by the use of finely pulverized iron mixed with water and applied with a brush. When the water soaks into the wall, it carries the fine iron particles into the pores of the concrete. By rusting, the particles swell to many times their original size and completely seal the pores. As rust does not deteriorate with age, concrete treated in this manner will be permanently waterproofed. The coating of rust may be covered with plaster troweled on, or by a wash coat of cement mixed with water and applied with a brush. The bonding power of the iron will insure a permanent repair on broken or cracked walls. Another use for pulverized iron is in hardening concrete floors. The iron is scattered over the surface before the concrete has set and is then troweled in. This increases the wearing qualities of the floor and makes it both oil and waterproof.

A Sunshade for Fruit Stands

This adjustable shade keeps an apple vender's stock in good condition. It consists of a wide board of lightweight wood, which is notched and held on to an umbrella staff by means of a cleat nailed



along the edge of the board and across the notch as shown in the detail. The shade can be raised, lowered or swung around to shade the fruit at all times.

Repairing Copper Tubing

A copper gasoline or oil line that is nearly worn through can be repaired by "floating" solder on the weakened spot to build it up. Unless reinforced, the pipe will eventually break at that point.

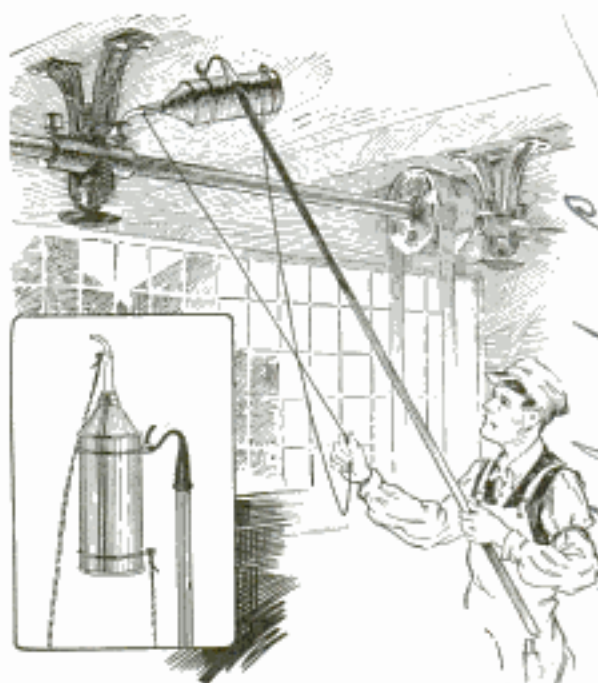

Oilcan with Long Handle and Cord Oils Overhead Shafts without Use of a Ladder

Oiling Overhead Shafts

Shafts that are out of reach with an ordinary oilcan, can easily be lubricated by using one with a long handle. A wire band is clamped around the can near the top and a loop formed to receive a hook on the end of the handle. Other wire bands are drawn up around the bottom and the spout of the can so that the ends of a long cord can be attached, enabling the worker to manipulate the can easily, so that the bearings can be reached by merely tilting the can.

Hook for Removing and Carrying Storage Batteries

With the hook shown in the illustration, storage batteries can be removed from their compartments and easily carried about. The tool consists of a length of iron rod, flattened at one end, and bent to shape as indicated. In use, it is slipped under the cell connectors.

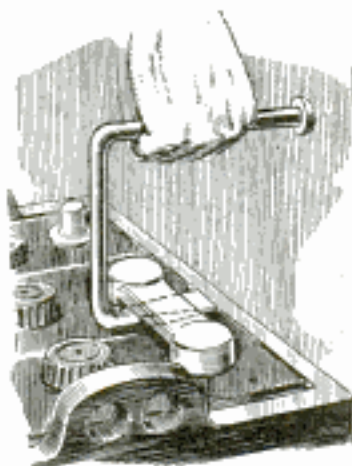

Patented to the inventor

*142 W. Adams St. Chicago
Cerret's Waterproofing Co.
512 S. Canal. Chicago*

not in file 2/10/11

A RUBBER-TIRED TEA CART

By L. DAY PERRY

ATTRACTIVELY finished in lacquer, in one or two tones or colors as you desire, a tea cart is one of the most useful pieces of furniture, and the fact that it has a distinctive touch of home craftsmanship, gives it still greater value.

You may use your own judgment about the wood to use, considering, of course, the kind of furniture in your home and its finish. Oak, walnut and mahogany are all excellent woods, particularly where a natural finish is used, although poplar is an easy wood to work with, if you intend to finish it in lacquer.

Over-all dimensions are given in Fig. 1. The construction may begin at any point, but the turned work is a good starter. Square up the four posts to the finished size in width and thickness, allowing a little excess length for cutting off after removing them from the lathe. Detailed dimensions for the posts are given in Fig. 2. Note that the cuts are simple ones, and that there is no undercutting. Care must be exercised, however, for the four legs must be alike. This requires much closer application to size than if only one is required. While turning, the handle, as shown in Fig. 3, is also completed. The turned pieces are then sanded and laid aside until needed. The two brackets for the handle, detailed in Figs. 7 and 14, are next. First make a



pattern of stiff paper in accordance with the sketch, 1-in. squares being used as guides in laying out the contour. This is then traced on wood, the surface being finished beforehand. A coping or band saw is used to make the cut-out, and the edges are then finished by filing and sandpapering. The holes for the screw and dowel pins and the mortise for the tenon on the handle are next, after which the handle and the bracket are assembled with glue and clamped in position.

The shelf rails and top aprons, shown in Figs. 4, 5, 6 and 8, should then be cut out and finished to size. The rails are plain, and the aprons have a bead along one edge. The eight pieces are cut to size; then the bead is run on each apron with a combination plane using a bead cutter of the size indicated in Fig. 5. Each apron is clamped



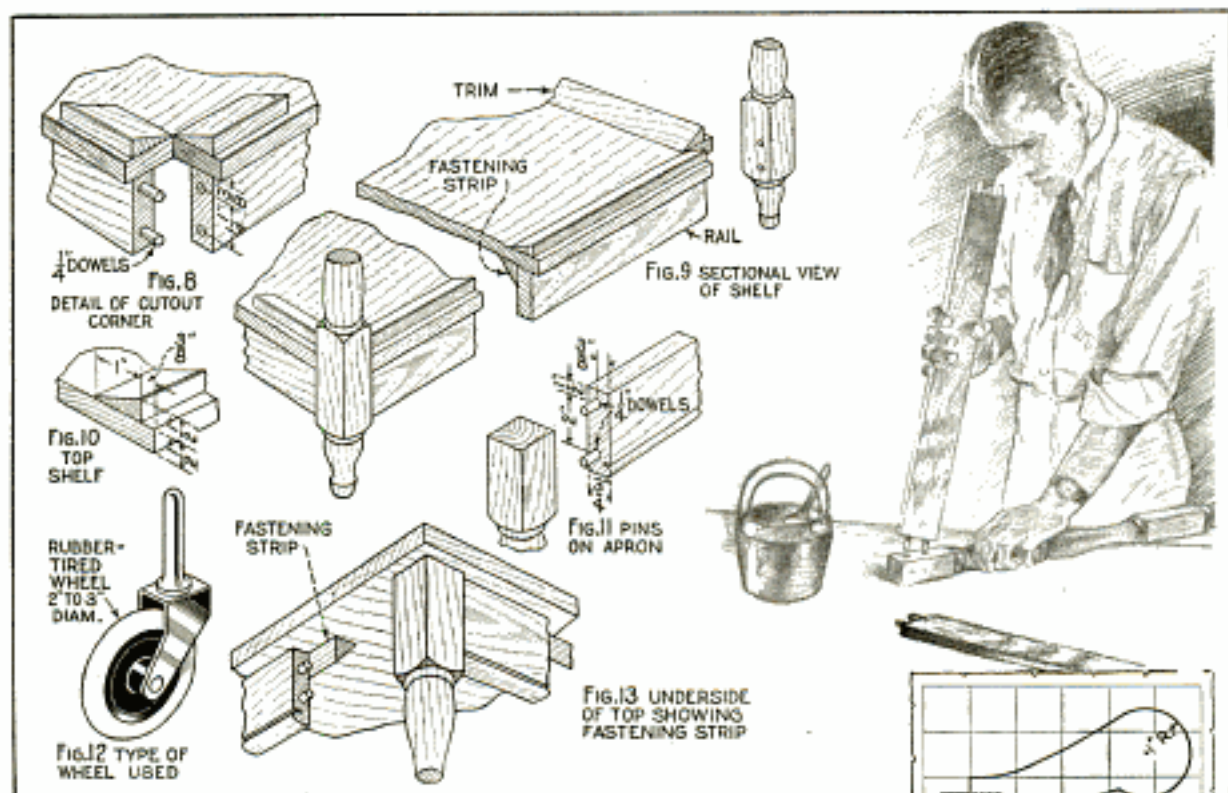

procedure is followed, and sufficient material is left for cutting the trim as well as the shelf at the corners, which should be marked off carefully, as shown in Fig. 8. The fit should be a snug one, but the shelf must not be driven into place, or the glue joints may open. Both the top and shelf are held to the framework by means of triangular fastening strips, as shown in Fig. 13, which are glued and fastened in place with screws. The entire assembly should be sanded where necessary and the nail heads covered with crack filler, which is also sanded down smooth after it has hardened. A coat of thin shellac is then applied. Rubber-tired casters, 3 in. in diameter, may be purchased from hardware dealers. Holes of the correct diameter for the shanks of the casters are drilled in the legs, taking care to get the holes straight.

Sand the coat of shellac lightly after it has dried, and apply a coat of lacquer. Allow the lacquer to dry at least one hour before applying a second coat, and at least two hours before applying a third, three coats being sufficient. The beads on the turnings and the edges of top, shelf and brackets may be given a contrasting color. Lacquer may be left dull or it may be polished with rottenstone and water

or oil. As an added ornament, a transfer or decalcomania of delicate harmonious colors may be applied in the exact center of the top. These may be purchased from paint stores, and a booklet giving full directions for their application may be had for the asking.

Rest for Grinding Tools to Correct Bevel

To hold tools at the correct angle when grinding them on an emery wheel is a difficult performance, but can be simplified by using a number of wooden blocks for a tool rest. When the proper height has been attained to get the correct angle with the tool lying flat on the blocks, you may be reasonably certain that a good job will result, provided, of course, the tool is fed against the wheel uniformly.—A. M. Parker, Edmonton, Alberta.

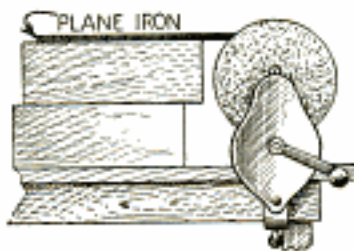

*Dr. H. J. Farman Co.
211 N. Dearborn
Chicago*

Durable Electric Soldering Iron for the Shop

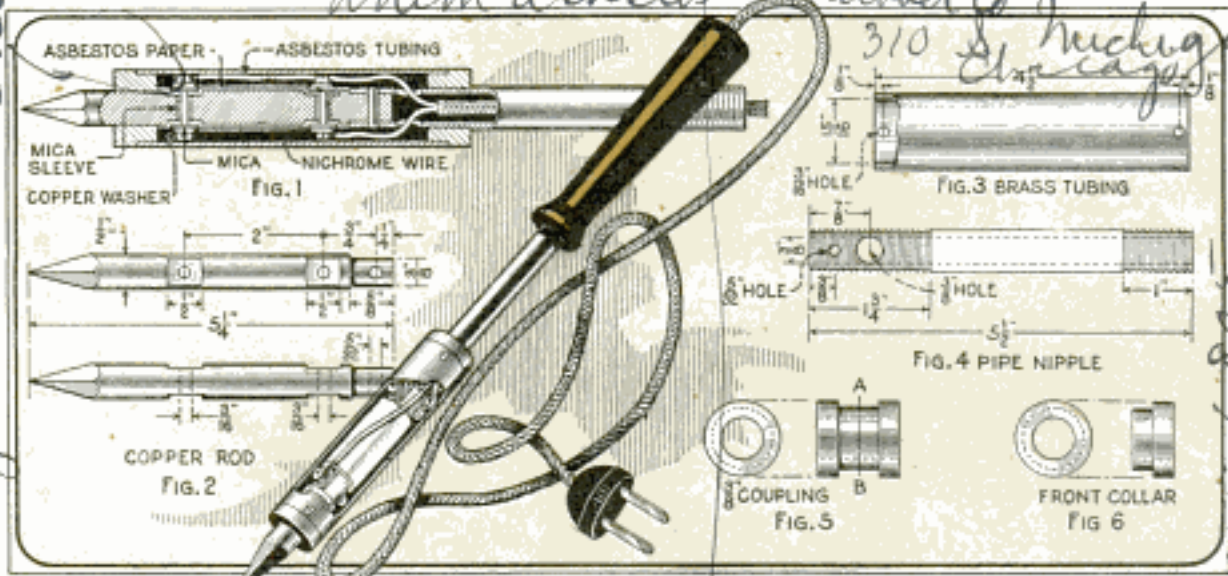

Here is a Durable Electric Soldering Iron That Can Be Made at Small Cost; It Has Many Uses around the Average Home Workshop and Will, with Proper Care, Last for Many Years

For general purposes around the home, this heavy-duty soldering iron has the advantage over smaller ones that it holds the heat. Get a $\frac{3}{8}$ -in. pipe coupling and cut it in half as shown in Fig. 5, forming two separate collars. Turn one-half of each down to $\frac{15}{16}$ in. One is screwed onto a short $\frac{3}{8}$ -in. nipple, which is cut off flush on both sides and filed out to fit a $\frac{1}{2}$ -in. rod, while the other is screwed onto a $5\frac{1}{2}$ -in. nipple, threaded $1\frac{1}{4}$ in. at this end. Drill a $\frac{3}{8}$ -in. hole through the nipple as in Fig. 4. A copper rod, $5\frac{1}{4}$ in. long, is filed to a point at one end, while the other end is turned down to $\frac{3}{8}$ -in. diameter to fit snugly inside of the nipple, after which both are drilled for a 6-32 machine screw. File four $\frac{1}{2}$ -in. flats on the rod, as shown in Fig. 2, and drill a $\frac{3}{16}$ -in. hole through each pair. Insert mica sleeves or bushings in the holes, put mica washers on the flats and smaller brass washers over them before inserting brass screws and screwing on nuts. Make sure that neither washers nor screws touch the rod. The next step is to wrap a layer of asbestos paper or mica around the rod between the flats and wind on 48 turns of No. 30 gauge nichrome wire, allowing a slight space between turns. Take care that the screws, washers and wire do not touch the rod, or a short circuit may result. Attach the ends of the wire under the heads of two screws, together with

the bared ends of a 6-ft. length of stranded asbestos-covered copper wire, drawn through the $5\frac{1}{2}$ -in. nipple and slipped through the $\frac{3}{8}$ -in. holes. If asbestos-covered wire is not available, use asbestos tubing over the ends inside of the iron. A brass sleeve, having an inside diameter of $\frac{15}{16}$ in., is slipped over the collar on the nipple, whereupon the other collar is slipped over the copper rod and into the sleeve. Small holes are drilled and tapped in each collar and in the sleeve for 6-32 screws, which hold the assembly together. Fit a suitable hardwood handle, drilled lengthwise and threaded to fit the end of the nipple, then attach a plug to the cord, and the iron is ready for use. Erwin R. Erdmann and Leonard R. Giuliano, Chicago.

Countersink for Soft Metals Does Not Burr

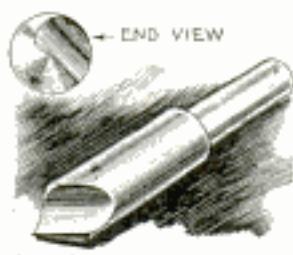

The illustrated countersink is made from a short piece of drill rod, and has proved useful for soft metals, such as aluminum. The point is ground as shown in the detail, and then hardened. Having no clearance back of the cutting edge, it does not form burrs around the hole.

Mica Insulator Co. 200 Dearborn St. Chicago

Central Scientific Co. 460 S. Alton Chicago
also Technical Service Bureau
Central Scientific Co. 460 S. Alton Chicago
Technical Service Bureau Chicago
Erwin R. Erdmann and Leonard R. Giuliano, Chicago

Causes of Overheated Lumber Saws

One of the most common causes of overheated lumber saws is that the inside of the saw collar is out of true, which can be remedied by truing the inside of the collar on a lathe. Other causes are too much play in the mandrel, poorly fitted bearings, improper lining of the saw with the carriage and track, too much or not enough lead to the saw, teeth not set enough to clear the saw properly, too fast a feed, too fast or too slow a sawing speed, saw greatly worn out of round, saw bent, kinked or dished the wrong way, and badly worn shanks in an inserted-tooth saw or improperly tensioned saw for the work being done. Once the cause of the overheating is determined, it can easily be remedied. If a saw has been badly burned by overheating, the tension is usually hard to control and the saw should, therefore, be sent to the factory to be retempered and tensioned.—W. L. Brown, Gravette, Ark.

Guide for Tapping Soft Materials

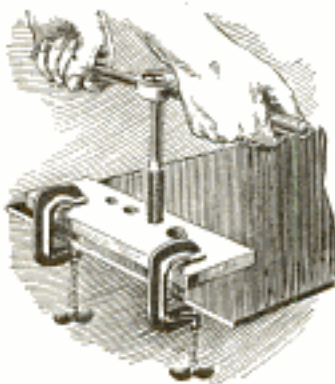

Soft materials, such as hard rubber, bakelite and hardwood, can be tapped without producing a ragged thread by the use of this guide. It consists of a metal plate having holes of

different sizes drilled and tapped through it. In use, the guide is clamped on the work so that the hole in it coincides with one of similar size in the plate, and the tap is then driven through.

Artists' Paint-Mixing Pan

Indented pasteboard separators used in egg crates make serviceable pans for mixing small quantities of paint, each cup being used for a different color. It is a good idea to give the pasteboard a coat of shellac or varnish to prevent the paint from soaking through, and also to stiffen the pan.—W. A. Allhands, Cliffside, N. C.

Yardstick Holds Wallpaper Roll at End of Paperhanger's Paste Table

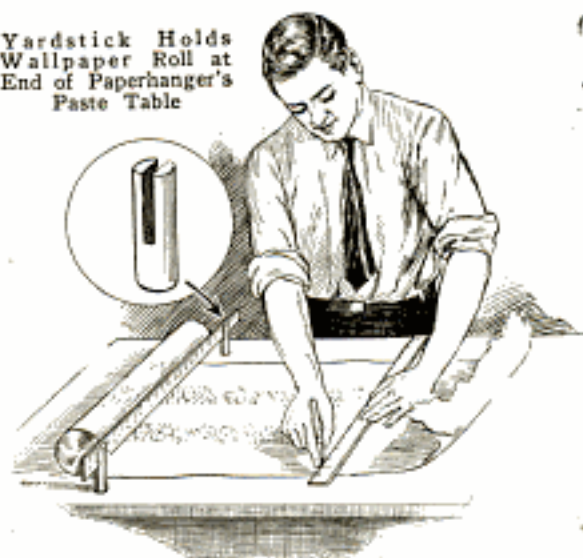

Guard Holds Roll of Wallpaper

To keep a roll of wallpaper at one end of the paste table, the illustrated guard has been found effective. It consists of two slotted dowels, 3 in. long, inserted in holes drilled near the edge of the table. A yardstick is slipped into the slots, and the paper can then be unrolled in the manner indicated by the yardstick keeping the roll in position and leaving both hands free to handle the paper. This method is better than allowing the roll to rest on the floor where it may become soiled.

Bug Trap Increases Poultry Profit

A bug trap, which provides his poultry with a good supply of food, has been found entirely practical by a western poultry raiser. It consists of a screen box with a small door at one end and an inverted screen cone in the top, through which insects enter. An electric fan of large size is mounted directly over the cone to force a strong current of air down, while an electric lamp is set over the cone. At night, the lamp attracts insects, and the strong current of air from the fan forces them through the cone and into the trap.

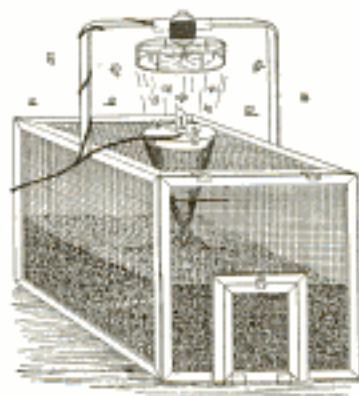



Low Platform Fitted with Casters Provides a Seat for the Painter in Wainscoting Walls

Painter Finds Wheeled Cart Aid in Wainscoting Walls

Four small casters and a board, about 20 in. square, form a cart which one painter finds of great help in wainscoting walls. An inverted pail serves as a seat leaving sufficient space for the paintpot. The cart is pushed along as the work proceeds.—F. H. Townsley, Chicago.

Flat-Iron Handle Gives Leverage to Turn Large Pipe Flanges

When a pipe flange is too large to be held by any available pipe wrench, and holding the flange in a vise seems the only alternative,



use the illustrated tool. It consists of a length of $\frac{1}{2}$ by 2-in. stock with one end bent to fit over the edge of the flange. Several holes for bolts are drilled at the points indi-

cated, and one is also drilled through both parts of the bent end to receive a pin. In use, the tool is slipped over the flange and the pin is inserted as shown. Then a bolt is passed through one of the holes in the handle and a flange hole, to provide a fulcrum. Considerable leverage can be obtained with this handle.

Brine Used for Pre-Dipping Metal Heated in Lead Bath

When heat-treating metals by the lead-bath method, a mixture of alcohol and whiting, in equal parts, is superior to a solution of water and whiting for pre-dipping the metals. If neither is available, salt-water meat-pickling brine is a good substitute. The brine will form a white film which prevents the lead from adhering to the work.

Pasteboard Box Filled with Dirt Serves as Warning Sign

An ordinary pasteboard box, filled with dirt to weight it down, serves as a good temporary sign. The sides are cut and bent over at an angle, a short piece of wood being tacked on to hold them down. The lettering is painted on the vertical side. Easily made, the signs are useful in excavation jobs.



Gout Remedy for Poultry

Although many poultry owners do not know it, chickens are subject to gout. The symptoms are lameness and weakness in the knee joints, the cause, of course, being too rich food. Separate the sick birds from the rest of the flock, and give them Epsom salts in their drinking water, at the rate of 1 lb. to 3 gal. of drinking water for every 100 birds. Also reduce the meat scraps and similar food, and give them more greens.

Getting the Most out of your Lawnmower

THERE are a few simple adjustments that will greatly improve the operation of a lawnmower. If it runs hard, the chances are that it needs a good cleaning. Thick grease and dried grass work into the teeth of the gears causing them to bind. In order to clean out the gears the drivewheels must be removed. On most mowers this can be done by means of a screwdriver and a wrench, if the nut on the inner side turns. (See Fig. 1.) After removing the wheels, flush the interior with kerosene and clean out each individual tooth of the gear. The pinion housing should be removed next. This will allow the pinion gear to be slipped off the shaft as shown in Fig. 2. Inside of the pinion, there is a hardened steel pawl of some kind, which engages the wheel on the forward motion, but allows it to turn freely when reversed. The ends of the pawl have a bevel on one side, and its exact position should be carefully noted so that no mistake will be made when replacing it. Fig. 3 shows details of the pinion and pawl. Now clean the housing, pinion and pawl with kerosene and repack with cup grease, after which the mower is reassembled and lubricated thoroughly with a medium grade of the best machine oil.

When a mower is dull or out of adjustment, it will leave ridges of uncut grass as shown in Fig. 5. If this is your trouble, the mower needs more



than cleaning and re-oiling. First examine the bearings of the spindle carrying the rotating cutters to determine if there is excessive play. These bearings can usually be taken up by means of a setscrew or similar device. Only enough play should be allowed to permit the spindle to turn freely. It will probably be necessary to adjust the stationary blade after the spindle bearings have been taken up, or perhaps the former adjustment alone is needed. On most mowers, the raising

Various Steps in Adjusting a Lawnmower

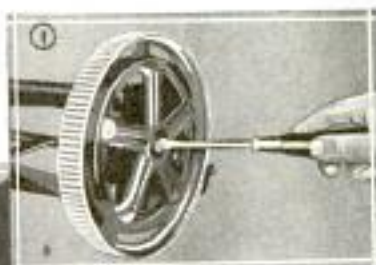

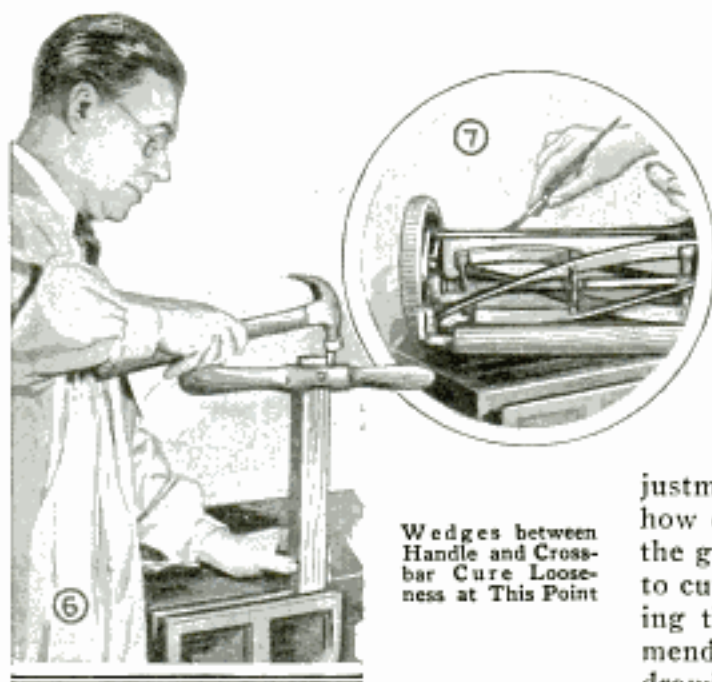

and lowering of the stationary blade is accomplished by means of two adjusting screws on each end of the mower frame. Fig. 4 shows how this is done, while the pivot and relative position of the blade are shown in Fig. 3. First lower the forward screws about a quarter turn, then drive down the back ones, those nearest the wooden roller, an equal amount to raise the blade, after which the blade is locked in position by tightening the screws first loosened. To lower the blade, the process is reversed. The clearance between the stationary and revolving cutters should be very slight.

If the cutters are dull, they can usually be sharpened by simply reversing the pawls so that the blades of the mower will run backward. Coarse valve-grinding compound is spread on the stationary cutter and the mower is pulled backward over the floor until the cutters are sharp. If your mower cannot be reversed, the knives may be touched up a bit with a file, but great care is needed to avoid filing them uneven. If the blades are badly

worn and nicked, or so hard that the file will not cut them, the sharpening job should be left to a professional, who uses a machine especially designed for the purpose.

As rust is the greatest enemy of a lawnmower, you should not neglect to provide what protection you may against it. A coat of aluminum or bronze paint applied with a small brush, as in Fig. 7, once a season will add years to the life of a mower. Adjustment of the wooden roller determines how close the grass will be cut. To have the grass quite long, lower the roller, and to cut it off short, raise the roller. Leaving the grass about 1 in. long is recommended. Handles are easy to tighten by drawing up the bolts. If the crossbar is loose, drive a hardwood wedge at one or both ends of the tenon, as shown in Fig. 6. The bolt through the tenon is then tightened. In the absence of such a bolt one can readily be provided.

Care and Uses of Handscrews

When new handscrews are received, care should be taken to see that they are in the best of working order. The threaded spindles should work freely and when they are to be used around glue, they should be dipped in linseed or thin lubricating oil, and then in hot beef tallow. This prevents the glue from adhering to them. The wooden parts, including the handles, can be better protected by an occasional coat of shellac. On some of the

later types, the threaded bars work in swiveled members, which allows the clamping also of tapered and offset work. Glue will not adhere to bars of this type. Besides the regular function of clamping material, two handscrews can be used as a vise or for holding small parts for grinding.

For Your Workshop

An attractive 16 by 23-in. table giving both the decimal and metric equivalents of the fractional parts of an inch, for use in the home workshop as well as the drafting room, machine shop, garage, etc., will be sent to anyone upon receipt of 10 cents to cover mailing costs. Address Book Dept., Popular Mechanics Magazine, 200 E. Ontario St., Chicago.

A Vibrating Hopper for Liming Farm Soil

For spreading lime on his fields, any farmer can quickly improvise this spreader, which was designed, built and tested by the department of agriculture. The box is made of 2-in. lumber and is securely bolted to the endgate of a truck. The lower edges of the sides are brought together at a sharp angle and the bottom, or slip board, is hung onto the ends with lengths of flat iron, a slot being cut in each hanger to fit a lagscrew, which holds it in place, but allows slight vertical movement to increase and decrease the separation between the sides and bottom. Hinged to the box are two extension pieces which hold a shaft on which a five-pointed wheel, 3 ft. in diameter, is mounted. A length of rope and a stout spring link the wheel to the slip board so that, when the points of the wheel strike the ground,

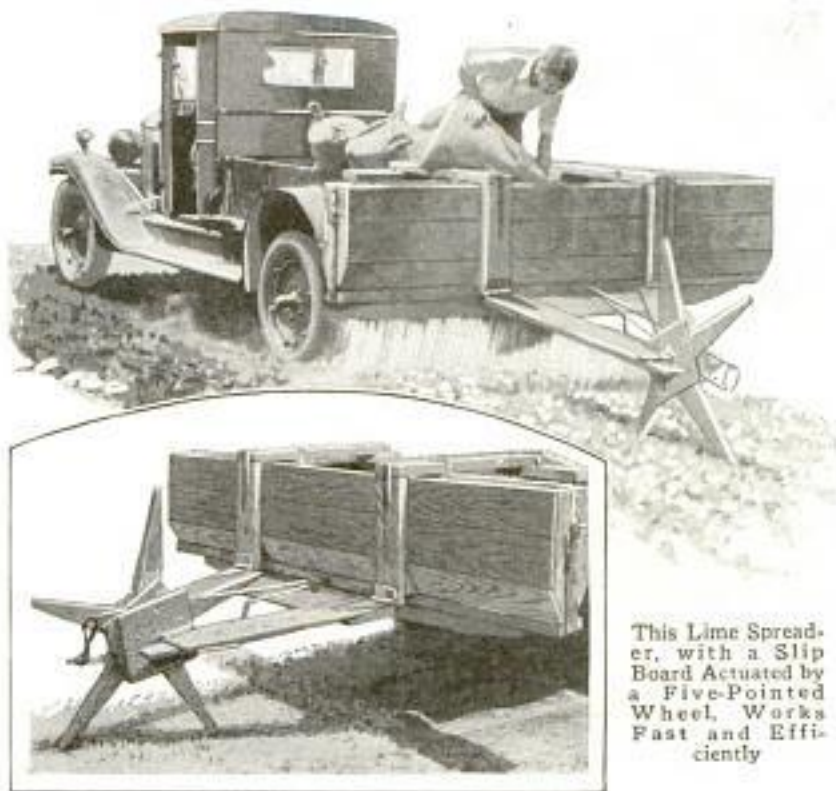

This Lime Spreader, with a Slip Board Actuated by a Five-Pointed Wheel, Works Fast and Efficiently

the jar pulls the rope and opens the slip board, allowing lime to fall out uniformly on the ground. One man drives the truck while the other empties the lime into the spreader as it is needed.

Wooden Plugs Cut on a Lathe

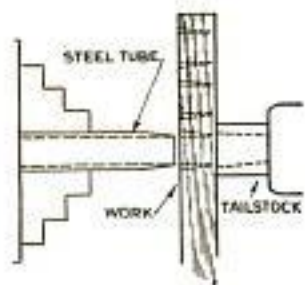

Wooden plugs with the grain running crosswise, which are often used for filling counterbores and screw holes, can be cut on a lathe with the aid of a short piece of pipe, the

inside diameter of which is slightly larger than the hole to be plugged. One end of the pipe is tapered to a sharp edge and placed in a chuck. The lathe is run at its greatest speed, and the work is pressed against the cutter by means of the tailstock. The plugs are then pried out of the board and glued into the holes. By carefully matching the grain of the plugs with that of the surface around the holes, they will be hardly noticeable. If the

plugs are to be made on a production basis, the cutter should be bored out on a lathe and hardened.

Spring-Shackle Bolts on Model-A Ford Easily Removed

The difficulty often encountered in removing and replacing the shackle bolts in a model-A Ford spring, when taking out the rear-axle assembly, can be overcome by using an old driveshaft of suitable length. It is bent to clear the differential housing and placed between the ends of the spring before the rear end of the car is raised. As soon as the weight is taken off the spring, the shaft will keep it spread in its natural position.



Pleasing Version of the Spanish Bungalow

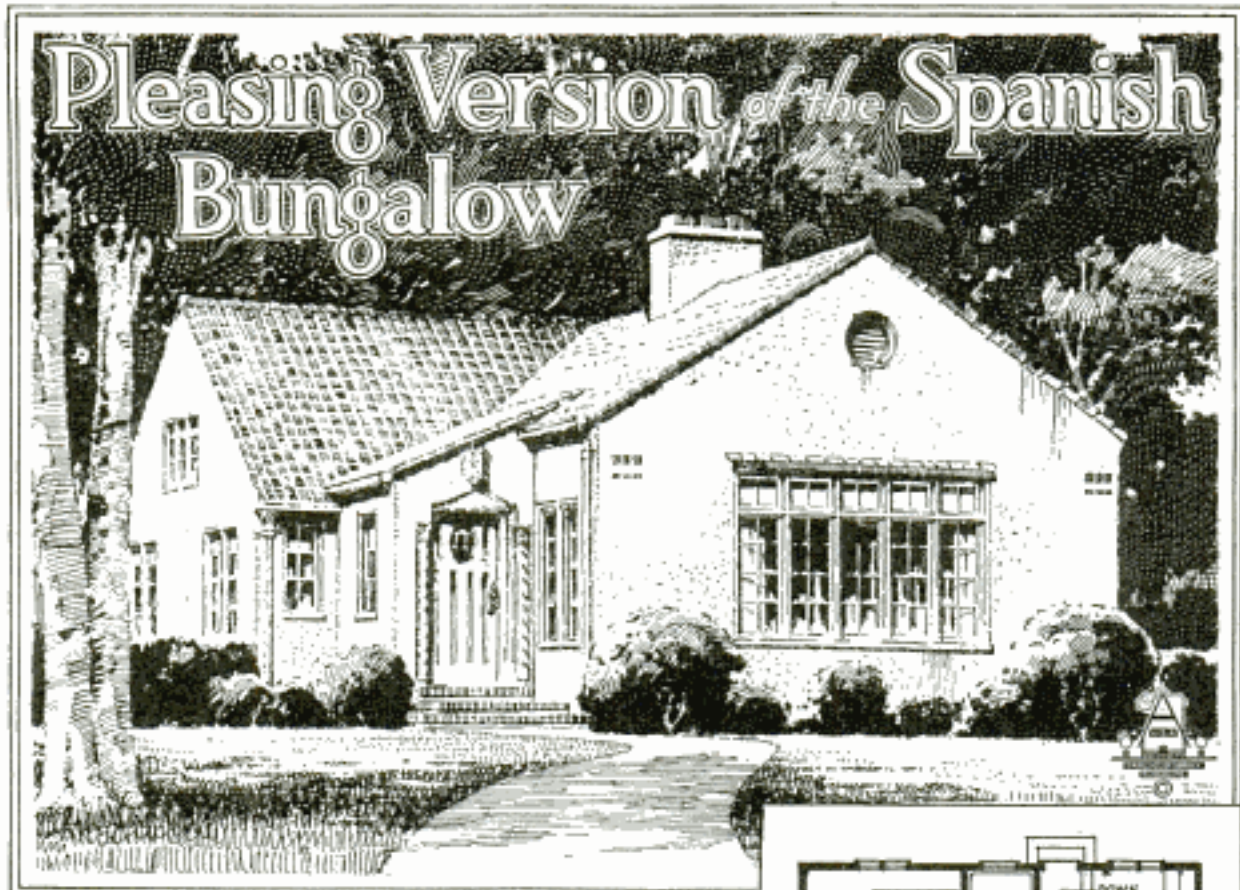

© The Architects' Small House Service Bureau

Plan 5-A-78

THE finished appearance of this bungalow is a pleasing departure from that of many of the small houses which line our streets. Such a one is not a matter of guesswork. In form and mass, in the choice of ornamental detail and treatment of the openings and in the convenience of the plan, the design shows itself the work of a skilled architect. The construction is of wood frame with an exterior finish of stucco.

Well lighted by windows so as to be flooded with light during the entire day, the rooms are all of generous size. The center hall, although somewhat long, fully justifies the space it requires, for not only does it afford convenient circulation between rooms, but also privacy to both sleeping and living quarters. The day has passed when we are content to have our bedrooms open directly into living room and dining room where the house is all one floor. Both bedrooms are double rooms, and both have commodious closets.

The living room lacks nothing in itself to make it comfortable and livable. Generous dimensions, many windows to keep it bright and sunny, and a fine hearth for a cheerful fire, make it a room attractive to the entire family.

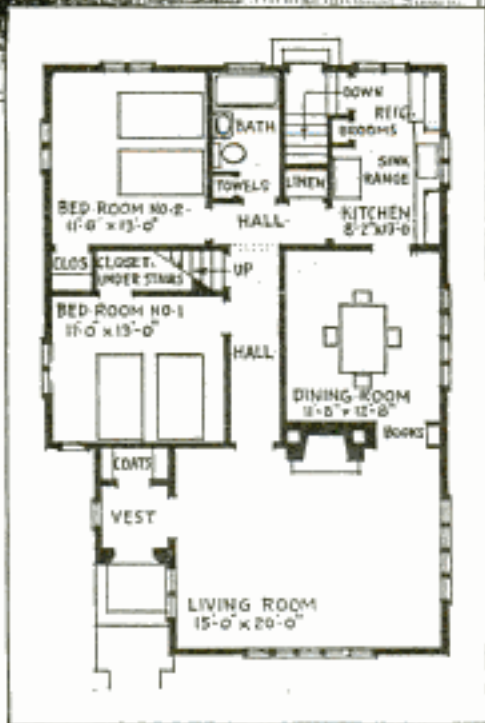

The Architects' Small House Service Bureau of the United States, Inc., was formed to furnish a complete and dependable small-house plan service at moderate cost. For information regarding the blueprints and specifications address the bureau at 1200 Second Avenue, South, in Minneapolis, Minn., from which also a booklet, containing twenty-seven selected small-house plans, may be had for the price of 10 cents. The bureau is under the control of the American Institute of Architects.

“No matter what screws...”



Spring in handle makes it the Quick-Return. Up or down is same to this tool — spring keeps bit in screw-head.

No. 130-A.—“Yankee” Quick-Return Spiral Ratchet Screw-driver. Price, with three bits, \$3.45.

No. 30-A.—“Yankee” Spiral Ratchet Screw-driver. Standard Pattern (without spring in handle). Price, with three bits, \$3.00. Also made Heavy and Light patterns.

For complete list of “Yankee” Attachments for Spiral Screw-drivers, get “Yankee” Tool Book. Use coupon below.

Three different-size bits included with tool. Attachments sold separately for drilling holes, 1/16 to 11/64, countersinking for screwheads, etc.

Chuck and eight drill-points

Countersink

YOU can get the famous “Yankee” Spiral Ratchet Screw-driver with a spring added in the handle.

Ask your tool dealer to let you see it. “Yankee” No. 130-A. Take it in your own hands and try it. The spring makes it the “Quick-Return.” Adds “life” to screw-driving; new interest to the jobs you do. Just push! Spring brings handle back for next push. Pressure of spring keeps bit in screw-slot.

Driving screws—no matter what screws . . . when, where or why, is easy and quick for the man with a “Yankee” Spiral Driver. Surprisingly easy—even one-handed, when he has this famed “Yankee” Tool with spring in handle.

And “Yankee” Spiral Screw-drivers are always like new! Now chromium plated, over nickel. No extra charge.

“Yankee” adjustments: Right and left spiral; right and left ratchet; and rigid.

“YANKEE” TOOLS

Make Better mechanics

NORTH BROS. MFG. CO., Lehigh Avenue, Philadelphia, U. S. A.

You may send “Yankee” Tool Book illustrating all styles of “Yankee” Screw-drivers, listing all Attachments for Spiral Drivers, showing Ratchet Braces, Push Drills, Two-speed (11-inch) Hand Drills, Ratchet Breast, Hand and Chain Drills, Removable-base Vises, Etc.

Name

Address(pm)

When writing to advertisers please mention *Popular Mechanics*

All-American Star Practiced at Home



A star halfback for four years in college—he gained nationwide fame by his ability to sidestep tacklers! As a boy—he practiced for hours dodging through and around newspapers placed in his back yard! Good footwork . . . learned by such training . . . made him a marvelous broken-field runner! He was All-American two years!

COLLEGE CAPTAIN TRAINED HIMSELF IN FOOTWORK

Stories of Stars who were not "Born" but "Made". No. 16

THIS great college halfback (his coach told us about him a few days ago) became a star because he was able to dodge and twist away from tacklers—because he learned—even as a boy in grammar school—the greatest secret for success in any sport—*good footwork*.

Watch a clumsy player in baseball, basketball or football—you'll see he's down because he's clumsy on his feet. Good footwork, having your feet help you, working for you, is a thing every star player learns.

Star players *train* themselves in footwork. Visit a college gym and you'll see football halfbacks, hockey stars and baseball players playing handball, skipping rope, boxing—taking a hundred different kinds of exercise to train their feet.

You'll see, too, that for this sort of training more of them wear Keds than any other kinds

of canvas rubber-soled shoes.

Keds are made to *help* your footwork. Keds' safety soles, for instance, are of specially compounded rubber. They give you a sure grip, that means fast starting and instant stopping. Keds' canvas tops are built to fit snug and comfortable around your ankles and insteps. They bring you long wear and true athletic support.

You'll find Keds carried by the best shoe dealers in your town. Ask for Keds *by name*. They are not Keds unless the name "Keds" is on the shoe.

Tune in on Gus Van, the Keds Radio Man, every Tuesday evening over N.B.C.—stations WJZ New York, WBAL Baltimore, and WCKY Cincinnati at 7:15 Daylight (6:15 E.S.T.) Stations WENR Chicago, KWK St. Louis, and WREN Kansas City at 6:15 Daylight (5:15 C.S.T.).



The Dog Contest Winners!

The names of the 542 winners in the Keds Rhyme and Keds Photo Contests will be announced on posters displayed in Keds stores between Sept. 25 and Oct. 1. Your Keds dealer will have a complete list of all winners and will tell you

whether or not you have won one of the pedigreed dogs or one of the pairs of Keds.

Do not write the Keds Contest Editor. Names of winners will be announced *only* on the posters in Keds stores. However, on or about Sept. 15, Contest Editor will send a personal letter of congratulations to every boy or girl who has won a prize.

KEDS "HOLDFAST"—A light shoe and a fast one, "Holdfast" gives you remarkable speed, sureness and comfort at a low price.



THE SHOE OF CHAMPIONS

Keds

REG. U.S. PAT. OFF.

United States  Rubber Company

Keds sell for \$1.00, \$1.25, \$1.50, \$1.75, and up to \$4.00. The more you pay, the more you get—but full value whatever you spend.

KEDS "GLADIATOR"—"Gladiators" have popular red and black soles. The snug supporting stays and rugged tops bring you more speed and surer footwork.



When writing to advertisers please mention Popular Mechanics

Sensational Offer

BRAND NEW \$250

FEDERAL

ADDING - LISTING
MACHINE

\$59.50

F.O.B.
CLEVELAND

SAVE ALMOST \$200 ON WORLD'S FASTEST ADDING AND LISTING MACHINE

Do not confuse the Federal Adding and Listing Machine with rebuilt machines or low priced machines. These are brand new Federals and carry the original guarantee. They are not toys—not special models, but full-size, highest grade machines, built to sell for \$250, richly finished in gleaming, shining, satin finish black enamel—even the working parts have a handsome damascened finish—the kind of machine you will be proud to have in your office—the kind that will serve you for years to come.

Hundreds of banks took advantage of this opportunity to buy Federal Adding Machines last month. Many re-ordered. Now we are extending the offer to the general public.

The Federal at \$59.50 is the most amazing bargain in adding machine history. It was designed by the late Charles Wales, the father of the adding machine business and genius of mechanical motion. Built by Colt's Patent Fire Arms Co., famous for precision machine work. Never before has a machine of its calibre and capacity been offered for so low a price. This unparalleled value is possible only because we bought the assets of the Federal Adding Machine Company and intend to liquidate the entire inventory quickly.

One of the Finest Adding and Listing Machines Ever Built

This \$250 Federal is the identical machine that is in use in many of the biggest business houses in the country. It has an adding and listing capacity of 9,999,999.99. This easy working Federal has every known adding machine improvement—full visibility—self-correcting keyboard—two color ribbon—13 inch carriage—fully visible dials—and every key on the keyboard is within easy reach of the shortest fingers. It multiplies, divides and subtracts, as well as adds. It prints nine columns. Each machine is carefully tested, inspected and packed so that it will reach you in A-1 condition. Why pay high prices for adding machines when you can buy the finest machine ever built for \$59.50.

9,999,999.99 adding and listing capacity

Gleaming satin black finish.

Weight, 65 lbs.

Note the richly damascened working parts.

ORDER
YOURS TODAY

Tomorrow May Be Too Late

Get one of these remarkable adding machines. You will be delighted with your purchase. You will be proud of your bargain and if you have use for additional machines you will be quick to order more Federals as others have done.

We will ship on open account to concerns rated in Dun's or Bradstreet's, otherwise send us check or money order for 20% of the price.

You can quickly ascertain our financial standing by referring to Dun's or Bradstreet's or to any bank.

Send in your order today. There isn't a mercantile institution, bank, factory, shop or office that can afford to be without an adding machine at this low price.

The M & M Company 500 Prospect Avenue,
Cleveland, Ohio

When writing to advertisers please mention Popular Mechanics

Copyrighted material



These tragic blue eyes belong to Helen Twelvetrees, now starring in RKO-Pathé pictures. She has flaming red hair, is 5 feet, 5 inches tall, and weighs about 120 pounds.

soothing to hay fever eyes!

If your annual hay fever attack is accompanied by itching, burning, watering eyes, here's welcome news for you. All you need to do to gain relief is apply a few drops of soothing *Murine* from time to time. Almost immediately the irritation will cease, and before long your eyes will stop watering.

MURINE

FOR YOUR EYES

Build a CLOCK for *Pleasure or PROFIT!*

FREE BOOK of Clock Making, Money Making ideas. Gives details, prices of movements, parts. Write NOW for copy!

Shows How YOU Can Make Fine Clocks Right at Home—*for yourself, or to sell at Big Profits.* We furnish instructions, parts. Works 2145 top; others with chains, all prices. Make case or assemble parts. Cash-in on demand for Mantel, Banjo, Grandfather's Clocks. Ask about new low-priced Electric Clock and Special Blue Print Offer. FREE Catalog.

AMERICAN CHIME CLOCK COMPANY
1670-P Ruffner St. Philadelphia, Pa.

\$500.00 REWARD

To Anyone who can prove that this plate, which is holding a 25-pound weight, is not cemented with Peerless Waterproof Cement, or that this illustration is not an actual demonstration in daily use.

Peerless Cement is 100 times stronger than glue; waterproof, heatproof, coldproof, acidproof. Free from every fault and weakness of other cements and glues.

Vastly superior in mending, patching and repairing anything.

1000 Uses
Peerless Waterproof Cement repairs dishes, furniture, radios, airplanes, auto tops, boats, tents, etc.
Use it on any material—cloth, leather, wood, china, glass, fibre, iron or any kind of metal, etc.

AGENTS WANTED
Make big money all year round selling Peerless Cement to every home, store, garage, shop, factory, etc., spare or full time—excellent side line. Repeat orders sure.

Satisfaction guaranteed or money refunded. Big profits on each sale. Write or wire today for full details and special "Get Acquainted" Offer.

SEND 25c for a full size bottle of Peerless Waterproof Cement and also ask for our liberal "Get Acquainted" Sales Offer. NO FREE SAMPLES.

PEERLESS WATERPROOF CEMENT CO.
2730 Dodier St. St. Louis, Mo.

A BOAT for YOU



Be one of the thousands who own fine boats—thanks to the Brooks method. The Brooks knock-down system puts a real boat within reach of any pocket-book, because it saves the prospective owner two-thirds of his cost. No experience is needed—even the rank amateur, if he can handle a hammer and a screw driver—can build any Brooks boat. Every part is cut exactly to size, and fits the complete plan that helps you do the work.

Send 10 cents today for the new 1931 catalog. 38 assorted models of cruisers, outboards, runabouts—any kind you want.

BROOKS BOAT CO., Inc.
Dept. 10-1 Saginaw West Side, Michigan

WRIGLEY'S THE FLAVOR
SPEARMINT
THE PERFECT GUM LASTS
MINT LEAF FLAVOR

Good and Good for You.

INCREASE YOUR BUSINESS by using the NEW \$5.85 "Two-Faced" Film Duplicator to make 100 copies, in 1 to 5 Colors each time. Or the \$37.05 "Excaligraph" Rotary Stencil Duplicator to Print Copies of Anything Typed, Penned, Drawn or Traced in numbers up to 3000 each operation, as Price Lists, Hand Bills, Special Sales Announcements, Bulletins, Menus, Quotations, or "what have you?" Write—

Easy Terms

PITTSBURGH TYPEWRITER & SUPPLY CO.
Suite 552, 339 Fifth Avenue Pittsburgh, Pa.

MOVIES In Your Home

Our marvelous, practical Movie Machines sell as low as \$5.00 postpaid. Also finest 16 mm. cameras and projectors at factory prices. A complete line of both standard and 16 mm. film available at low prices with exchange service. Write for big, FREE catalogue.

PARAMOUNT MFG. CO. Dept. C-43 Boston, Mass.

AUTO RADIO
Long Distance Receiver

Amazing Low Price!
Quality Performance

Six tube triple screen-grid, using 3-224, 2-227, and 1-245 power tube. Easy to install. Will fit any car. Single dial control. We guarantee that this set will pull in stations within a radius of 1000 miles and that it will deliver the volume and tone qualities of an electric set, or your money will be refunded. Order TODAY

PRICE OF SET ONLY \$20.00

Price complete including tubes, batteries, dynamic speaker and suppressors. \$29.50. Send \$5.00 deposit with order. Balance C. O. D. On foreign orders remittance in full required.

Successors to Aero Products, Inc.
CHAS. HOODWIN CO. 4240 Lincoln Ave., Dept. J-20, Chicago, Ill.

\$20

When writing to advertisers please mention Popular Mechanics

30 of the 1,001 Uses for PLASTIC WOOD

Repairs furniture
Repairs gouges
Repairs chipped veneers
Seals cracks
Repairs breaks
Secures loose drawer pulls
Secures loose castors
Repairs broken toys
Re-seals built-in tubs
Secures loose tiles
Repairs bathroom fixtures
Repairs towel racks
Fine for modeling
Seals drainboard cracks
Seals holes around pipes
Seals cracks in shelving
Repairs broken balusters
Repairs linoleum
Repairs baseboard cracks
Seals floor cracks
Repairs concrete floor cracks
Fills old screw holes
Seals cracks in stucco
Repairs wood rot
For sealing window frames
Strengthens rungs and joints
Fills cracks between floorboards
Repairs loose tool handles
Rectifies mistakes in carpentry
For cabinet-making

Many Industrial Uses

Tensile Strength
1500 lbs. per sq. inch
Crushing point
3000 to 4000 lbs. per sq. in.
Weight per Cubic Foot 30 lbs.
Absorption, Fresh Water 30%
Absorption, Oil . . . 33%
Hold upon small screws
(White Pine at 100) . 143%
Combustibility, inception
(charring) . 400° to 500° F.

You Get a Can of PLASTIC WOOD FREE!

—if you can
Name 5 Other
Uses for
this New Kind of Wood



This amazing new kind of wood that handles like putty and quickly hardens into wood—water-proof, weather-proof wood you can carve, paint, or turn in a lathe—has a thousand and one uses. In repairing breaks, in covering up signs of wear and tear, in modeling, it always does an expert job.

Without a doubt PLASTIC WOOD is the greatest discovery of the century.

Here you'll see 30 of the most common uses for PLASTIC WOOD. Name just 5 more. Write them down on the coupon below. Then mail us the coupon and we'll send you a regular size can of PLASTIC WOOD—absolutely free. Also we will send you a big, profusely illustrated 48-page book crammed full of interesting facts concerning this new kind of wood that comes in cans and tubes. PLASTIC WOOD is sold in 9 colors by all paint, hardware and department stores.

FILL IN AND MAIL FOR FREE CAN

The A. S. BOYLE CO., Dept. 9-PM
Cincinnati, Ohio

Here are 5 more uses for PLASTIC WOOD. Please send me—free a regular size can of this new kind of wood.

- 1.....
- 2.....
- 3.....
- 4.....
- 5.....

Name

Street & No.

City State

When writing to advertisers please mention Popular Mechanics

SCIENCE PUTS HEAT IN TUBES

STERNO
CANNED
HEAT



... NOW
MORE
CONVENIENT
THAN EVER ...

HHEAT can help you anywhere—at camp, in the shop, at home—with anything that needs heat right on the spot—soldering, hot glue, etc. How does heat help? A FREE booklet gives practical, time-saving uses. Let Sterno serve you. Full-sized tube only 10¢. Use the coupon.

STERNO CORPORATION PM-9
9 East 37th Street, New York

Send me your free booklet.
I enclose 10¢ for full-sized tube.

Name _____

Address _____

6 FUSES in ONE PLUG

**Agents & Distributors
Making Big Money** A necessity everywhere. A "turn to the right brings back the light." Safe, economical, dependable, **6-in-1 Fuse Plug**. Most useful invention in years. Many of our distributors in exclusive territory making \$500 to \$1000 a month. Easy to demonstrate. Easy to sell. Profits begin right away. Write at once for proposition. Send 25¢ for sample and working instructions.
6-in-1 Fuse Co., 801 W. Madison St., Dept. 63 Chicago

Desirable Territory Is Still Available

to experienced franchise salesmen accustomed to closing cash sales \$800 to several thousand dollars: factory connection: protected territory: hot peanut vending machine: snappy brand new deal: full of life: our formulated sales plan big success: work from leads: Give selling qualifications and reference in first letter.

Roy Stringer Co., Ltd.
968 Ft. Wayne Ave.
Indianapolis, Indiana



DIRECT-TO-YOU AT A NEW LOW PRICE

A Genuine
BROWNING
AUTOMATIC

49⁷⁵

3
Guns
In One

the favorite with sportsmen all over the world—3 or 5-shot capacity—no equal in quality, appearance, smooth action.
12 or 16-Gauge

12 or 16-Gauge

12 or 16-Gauge

12 or 16-Gauge

12 or 16-Gauge

12 or 16-Gauge

12 or 16-Gauge

12 or 16-Gauge

12 or 16-Gauge

12 or 16-Gauge

12 or 16-Gauge

12 or 16-Gauge

12 or 16-Gauge

12 or 16-Gauge

12 or 16-Gauge

12 or 16-Gauge

12 or 16-Gauge

12 or 16-Gauge

12 or 16-Gauge

12 or 16-Gauge

12 or 16-Gauge

12 or 16-Gauge

12 or 16-Gauge

12 or 16-Gauge

12 or 16-Gauge

12 or 16-Gauge

12 or 16-Gauge

12 or 16-Gauge

12 or 16-Gauge

12 or 16-Gauge

12 or 16-Gauge

12 or 16-Gauge

12 or 16-Gauge

12 or 16-Gauge

12 or 16-Gauge

12 or 16-Gauge

12 or 16-Gauge

12 or 16-Gauge

12 or 16-Gauge

12 or 16-Gauge

12 or 16-Gauge

12 or 16-Gauge

12 or 16-Gauge

12 or 16-Gauge

12 or 16-Gauge

12 or 16-Gauge

12 or 16-Gauge

12 or 16-Gauge

12 or 16-Gauge

12 or 16-Gauge

12 or 16-Gauge

12 or 16-Gauge

12 or 16-Gauge

12 or 16-Gauge

12 or 16-Gauge

12 or 16-Gauge

12 or 16-Gauge

12 or 16-Gauge

12 or 16-Gauge

12 or 16-Gauge

12 or 16-Gauge

12 or 16-Gauge

12 or 16-Gauge

12 or 16-Gauge

12 or 16-Gauge

12 or 16-Gauge

12 or 16-Gauge

12 or 16-Gauge

12 or 16-Gauge

12 or 16-Gauge

12 or 16-Gauge

12 or 16-Gauge

12 or 16-Gauge

12 or 16-Gauge

12 or 16-Gauge

12 or 16-Gauge

12 or 16-Gauge

12 or 16-Gauge

12 or 16-Gauge

12 or 16-Gauge

12 or 16-Gauge

12 or 16-Gauge

12 or 16-Gauge

12 or 16-Gauge

12 or 16-Gauge

12 or 16-Gauge

12 or 16-Gauge

12 or 16-Gauge

12 or 16-Gauge

12 or 16-Gauge

12 or 16-Gauge

12 or 16-Gauge

12 or 16-Gauge

12 or 16-Gauge

12 or 16-Gauge

12 or 16-Gauge

12 or 16-Gauge

12 or 16-Gauge

12 or 16-Gauge

12 or 16-Gauge

12 or 16-Gauge

12 or 16-Gauge

12 or 16-Gauge

12 or 16-Gauge

12 or 16-Gauge

12 or 16-Gauge

12 or 16-Gauge

12 or 16-Gauge

12 or 16-Gauge

12 or 16-Gauge

12 or 16-Gauge

12 or 16-Gauge

12 or 16-Gauge

12 or 16-Gauge

12 or 16-Gauge

12 or 16-Gauge

12 or 16-Gauge

12 or 16-Gauge

12 or 16-Gauge

12 or 16-Gauge

12 or 16-Gauge

12 or 16-Gauge

12 or 16-Gauge

12 or 16-Gauge

12 or 16-Gauge

12 or 16-Gauge

12 or 16-Gauge

12 or 16-Gauge

12 or 16-Gauge

12 or 16-Gauge

FREE 36-Page Catalog



New Invention Keeps Soft Collars Neat and Trim!

BARSTAY

24 K. Gold. Not a pin.
Bar slides into collar.

Agents are ordering up to 1000 at a time—making \$50 to \$100 a week. Every man buys. No competition. Makes soft collars lie smooth and flat. 200 to 600% profit selling direct to users and dealers. Send 25¢ for 1 sample Barstay. Credit given on first order. Send at once for sample and proposition.

CREST SPECIALTY CO.

199 Crest Building Chicago, Illinois
227 W. Van Buren St.



Only 8 Sales a Day Nets You \$116 a Week

Profits on larger size run higher. Unusual earning opportunity for ambitious man. No experience necessary; we teach. Part or full time.

FUGO World's Simplest
Fire Extinguisher

Automatic and instantaneous action. Within reach of every home, shop, store, theatre, garage, car owner, etc. Even smallest place needs two or more. Exclusive territory to producers. You get your pay every day. Write for full details.

The National Formetal Co.
6535 Metta Ave. Cleveland, O.

BABY CALCULATOR
ADD, SUBTRACT, MULTIPLY, DIVIDE. Does work of \$200 machine. Not a toy. Million dollar capacity. Simple and accurate. Guaranteed 1 year.

FREE TRIAL \$2.50
—SEND NO MONEY— Total Cost

Just name and address. We will ship Calculator immediately. On delivery, pay postman \$2.50 (plus low extra postage). If outside U. S. add 1.00 additional in Letterette Case. If not satisfied after 30 days' trial you get your money back. THOUSANDS OF SATISFIED USERS. Write for Agents' Proposition. **BABY CALCULATOR MACHINE CO.** (Mfrs.) P. O. Box 1118, Dept. 31, CHICAGO, ILLINOIS

Big 3 ft. Telescope Five Sections. Brass bound. Powerful Lenses. 10-Mile range. Special Eye Piece for looking at the Sun, included FREE. Can be used as a Microscope. Guaranteed. Big value. Postpaid. \$1.75. C. O. D. 15¢ extra. **Benner & Company, 1-48, Trenton, N.J.**

MOTORCYCLES

Pay As Low As \$2.00 per Week
Hendersons, Harley-Davidsons, Indians
Slightly used and rebuilt. Hundreds to select from. Send 10¢ for list today.

MYEROW BROS. CO., 15 Berkeley St., Boston, Mass., U. S. A.

When the camera looks . . .



Gasoline has always hidden behind iron walls for the most important act in its life. But now engineers have lifted this cloak of mystery. The difference they see between the smooth combustion of Ethyl Gasoline and uneven explosion of ordinary gasoline is astounding.

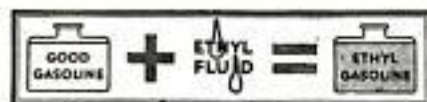

The active ingredient used in Ethyl fluid is lead



through this quartz window—

Knocking Gasoline must CONFESS!

ENGINEERS can now *watch* gasoline burn. A quartz window sealed into the top of the cylinder tells their eyes—or their camera—the full story.

A photograph of ordinary gasoline shows a smooth burning *up to a certain point*, then a quick explosion of the remaining gasoline vapor. Instead of pushing down the cylinder smoothly, much of this remaining power is wasted in the knock, causing overheating and vibration.

A photograph of Ethyl Gasoline shows all the vapor burning steadily. The power is released in one smooth downward pressure just as the piston is in position to use it. Controlled combustion gives maximum power without overheating, vibration or harmful knock.

The camera reveals these two types of gasoline combustion. One or the other of them is happening in your car every time you drive it. Get the power out of gasoline that is there—the power out of your engine that it was designed to give. Fill up with Ethyl and enjoy the sweeter, more powerful motor, the better performance of Ethyl's controlled combustion. Ethyl Gasoline Corporation, Chrysler Building, New York City.

© E. G. C. 1931

ETHYL GASOLINE

When writing to advertisers please mention *Popular Mechanics*

Saw-Filing PAYS BIG



Earn \$2 to \$3
an Hour

in
Your
Own
Cash
Business
with
the

FOLEY AUTO MATIC SAW FILER

Files all kinds of hand saws, cross-cut circular saws and band saws

W. B. Menees reports, "Am using the Foley Automatic Filer with great success. Business is increasing daily due to the satisfactory work turned out." M. S. Gray writes, "I file for the school system here, The Telephone Co., City Water Works, Oil Burner Co., Carpenters Union, lumber yards and many others. Between Aug. 4 and 28 I filed 300 saws for the schools."

No Canvassing Our Free Plan tells you how to get started. Many have started in spare time and built up a big-paying permanent cash business. You can do it, too! No experience necessary. Just follow a few simple instructions and the Foley does the rest! Sold on easy payments. Act now!

FOLEY MFG. CO.

217 Foley Bldg. 11 Main St. N. E.
Minneapolis, Minnesota

Please send FREE PLAN on how I can have my own Cash Business with the Foley Automatic Saw Filer.

Name.....

Address.....

If you would also like information on Foley Key-Making Machines, check here....

Mail
Coupon
for
FREE
PLAN

When writing please mention Popular Mechanics

**BIGGEST
SAVINGS.
IN YEARS**

NEW—FREE!
**Kalamazoo
Catalog of
FACTORY PRICES**

Write now for this new KALAMAZOO-DIRECT-TO-YOU Catalog, quoting you factory prices at sensational reductions. Make your selections direct from factory stock. 200 styles and sizes. Kalamazoo prices are lower, far lower than ever, but Kalamazoo quality, famous for 31 years, is rigidly maintained.

Ranges as low as \$37.50

Don't miss the new Coal and Wood Ranges, new Combination Gas and Coal Ranges—new colors, new improvements. Also Gas Stoves, Oil Stoves, Household Goods.

Heaters as low as \$24.15

Pages of colored pictures and descriptions of heat circulators. New low prices on furnaces (pipe or direct heat).

Furnaces as low as \$57.85

Kalamazoo gives you 30 days Free Trial. Every Kalamazoo carries a 5 year guarantee based on material and workmanship—\$100,000 bank bond guarantee of satisfaction. 24 hour shipments. Only \$5 down on any stove, range or furnace, regardless of size or price. A year to pay. 300,000 satisfied customers. Write today for this wonderful new book.

KALAMAZOO STOVE CO., Mfrs.
391 Rochester Ave., Kalamazoo, Mich.

**"A Kalamazoo
Direct to You"**



**Build
Your Own
Boat!**



**Outboard Speeders
— Cruisers —
Fast Runabouts**

It's fast, easy work with our full size paper patterns, semi-erected frames and ready-cut materials. Try it and we'll let us build one for you. Eighteen motor models. Special four passenger outboard runabout, mahogany finish, copper and brass fastenings, only \$167 net. Germanic Boats and unique system of boat construction have been popular for more than a quarter of a century. Write today for FREE Circular. Germanic Boat Co., 31-32 Lake Blvd., Saginaw, W.S. Mich.

Write
for
FREE
CIRCULAR

MOTORCYCLES



WONDERFUL BARGAINS
Can be purchased through our co-operative plan for as low as \$1.00 per week.

Indians Harley-Davidsons, Ace and Henderson

Send ten cents for Bulletin A
Motorcycles shipped to all parts of the world

WALKER-INDIAN CO., 1308 Boylston St., BOSTON, MASS.

BUILD YOUR OWN AUTOMATIC ELECTRIC REFRIGERATOR



Why pay \$200.00 and upwards? Use your present ice-box. We supply parts. Can be built for only \$34.50. Easily made. No special tools necessary. Operating cost, quality and size of machine same as well known makes. Complete blue-prints and instructions—\$1.00. Circular "B" on request.



B. & L. ENGINEERING CO., 706 Bergen Ave., Jersey City, N. J.

DO YOU WANT a new business profession of your own, with all the trade you can attend to? Then become a foot correctionist, and in a few weeks earn big income in service fees,—not medical nor chiropody—easy terms for home training, no further capital needed, no goods to buy, no agency. Established 1894. Address **Stephenson Laboratory, 1 Back Bay, Boston, Mass.**

NEW KIND of ROADLIGHT!

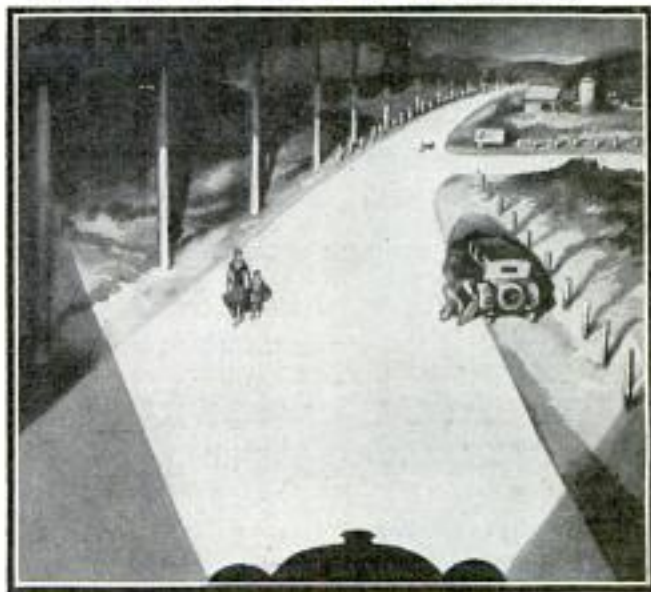
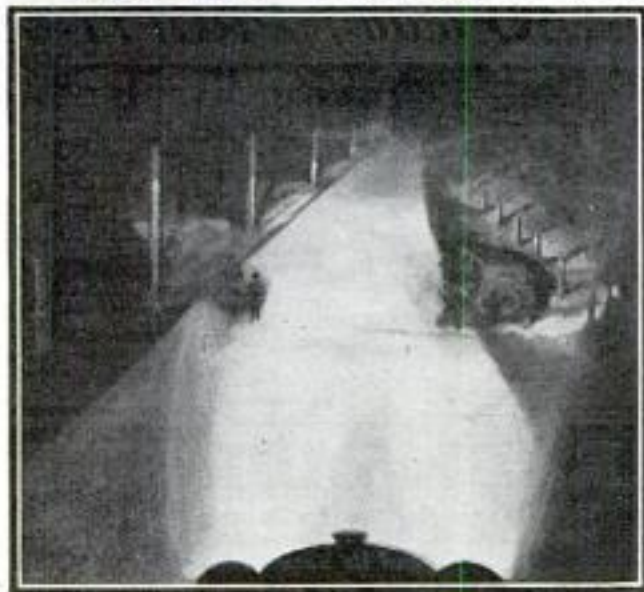

TINY INVENTION NOW TURNS HEADLIGHTS INTO SEARCHLIGHTS -INSTANTLY!

At last! An invention that makes any headlights give at least twice the road illumination! Shoots an entirely new kind of "infused" light that banishes glare! So new and uncanny that it amazes everyone. Now offered for introductory test to all who mail the 10-DAY TRIAL COUPON promptly!



PERFECT-O-LITE astonishes expert and layman alike! Science at last has conquered the grief of night driving!

DOUBLES ROADLIGHT.. BUT ENDS DIMMING!

IT is a well-known fact that motor car manufacturers have solved every big problem **except one**. As soon as the sun goes down at night, the highways of America break forth into a constant rushing stream of "dimming and damping." Speed is cut down one-third to one-half. Every Monday morning finds the highways littered with broken glass, wrecks, cars in the ditch, overturned, shattered against telephone posts. Every man who ever groped dizzily down the highway in traffic at night knows the horrible sensation of being half-blinded by cars on his left, unable to see the ditch on his right, his own lights seeming dim and shadowy and practically worthless. Now, in a twinkling, this curse of night driving is lifted completely and **inexpensively** from the shoulders of the entire motoring world!

Fits Any Headlight

This new lighting discovery is called Perfect-O-Lite. It is a little invention that replaces the ordinary "bulbs" in your automobile headlights. No extra wiring or installation. Millions of motorists have invested from \$10 to \$25 or more in so-called "Spot" Lights and "Driving" Lights which at best are only makeshifts. This new lighting method costs only a

tiny fraction as much, yet actually DOES double road illumination. Banishes need for Glare Shields. Cuts through the other fellow's light, yet absolutely cannot glare in his eyes. Makes ruts, animals, children, detour signs, etc., visible at least three times as far. Now night driving at 40 to 60 miles an hour is safe and easy.

Make Your Own Test Free

The secret of the amazing things this new light does is in the kind of "beam" or "ray" that it throws. Instead of ordinary light, this new invention pours a solid beam of double-reflected or "infused" light down the entire roadway. Shows up ditches at the side, as well as distant objects, absolutely clear. Space here limits further discussion of the facts about this discovery. Under an introductory offer you are now invited to be the judge without risking one penny. The coupon brings full details of the invention, offer of a set on FREE TEST and facts about agents' money-making opportunities. Mail it TODAY!

PERFECT-O-LITE

HACHMEISTER-LIND CO.
Dept. M-30 Pittsburgh, Pa.

When writing to advertisers please mention Popular Mechanics

AGENTS! DAVIS MAKES \$1400 IN ONE WEEK

Here actually IS that chance for \$8 to \$14 your FIRST hour. \$6,000 to \$10,000 THIS year, with no limit **WHATEVER** for Distributors! Davis, Pa., made \$1,400 in one week! Fleet owners buy quantities. Sacks, W. Va., made \$236 on one order. Wallace & Tiernan, N. J., trucks just equipped. Blue and Gray Bus Line orders for fleet. Other big orders flooding in. Start full time or spare time. Use coupon for FREE TEST OFFER and get full details of Territory, etc. Guaranteed Sales Plan. Mail Coupon QUICK!



HACHMEISTER-LIND CO.,
Dept. M-30, Pittsburgh, Pa.

Rush details of Free Test Offer, also facts about agent's money-making opportunities, without obligation.

Name.....

Address.....

City..... State.....

NEW BATTERY METER PREVENTS CAR TROUBLES



Amazing Invention Now Makes It Possible to Keep a Battery Perfectly Charged at All Times—No More Overcharging—No More Undercharging—No More Dry Batteries—Battery Life is Doubled

Automobile owners will welcome this new instrument, called "Tel-a-Charge," that instantly tells the condition of your battery—right on the dash. It tells at a glance if the battery is overcharged, undercharged, or if water is needed. These three conditions cause practically all battery troubles. When your battery is low your car may stall anywhere at any time. It is dangerous as well as annoying to have to crank an automobile to get it started. Keep your battery in perfect condition and your car starts easier, runs smoother, has more power, and expensive troubles are eliminated.

FREE SAMPLE AND BIG MONEY MAKING OFFER TO AGENTS

We need men in every locality to aid us in the distribution of "Tel-a-Charge," and are making a proposition so unusual that workers can easily make up to \$100 a week. We are furnishing those who work for us with a free sample for demonstrating purposes. Send TODAY for this big opportunity and free sample offer.

CLUM MANUFACTURING CO.
Dept. 113 601 W. National Ave. Milwaukee, Wis.

Become a Specialist at This Fine School

To earn top wages, to be the one picked for the job, learn the trade you like best at this Y M C A resident school famous for turning out good men. Modern equipment. Individual instruction. Low tuition.

MAIL FOR FREE INFORMATION

**BEDFORD
Y M C A
TRADE
SCHOOL**

1115 Bedford Ave., Dept. PM-2
Brooklyn, N. Y.

Send me without obligation complete information on (check subjects).

- Caterpillar Tractor Mechanic
- Aviation Mechanic
- Flying
- Welding
- Auto Mechanic
- Radio Mechanic
- Talking Pictures, Western Electric

Name.....
Street & No.....
Town..... State.....

Let us recommend the best books to study on any subject. Popular Mechanics Press, Chicago, Illinois.

A MONEY MAKER! \$30 a day PROFIT

**SELL
KORN
SMAX!**

This wonderfully appealing confection sells on sight... made with KINGERY POP-CORN KRISP OUTFITS... small space required... big profits all year 'round. \$ to \$50 profit on every sale. Go into business for yourself this modern, money-making way. KORN SMAX sells wherever there are crowds.

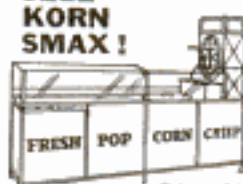

Get complete catalog of Kingery Outfits today. Investigate, lose no time, start making money now!

THE KINGERY MANUFACTURING CO., Cincinnati, Ohio

RADIO BUILDERS

We carry a complete line of radio parts for all Popular Mechanics circuits and replacement parts for all sets.

Send Us Your Order

NEWARK ELECTRIC CO.

228 W. Madison St.

CHICAGO, ILL.



Build your own outboard hydroplane motor or sail boat. Use our plans or knock-down frames and machined parts. Many models to select from. Write for new catalog. Please enclose 10c for catalog.

J. B. WELCH, Inc., Dept. B, 3211 No. 41st St., Milwaukee, Wis.

AGENTS 500% PROFIT GENUINE GOLD LEAF LETTERS

S guaranteed to never tarnish. Anyone can put them on stores and office windows. Enormous demand, large profits. Paul Clark says: Smallest day \$28.70. R. L. Reel made \$920 in two months. Write today for free sample and liberal offer to general agents.

METALLIC LETTER CO. 433-B N. Clark St., CHICAGO

WANTED: SERVICE MEN

Large manufacturer has a number of positions open in various parts of the country for middle-aged men who are capable and willing to call on Factories, Stores, Garages, Warehouses, Schools, Hotels, etc., and inspect and service their Fire Extinguishers. Opportunity to sell new equipment while doing this service work. Earnings on inspection and service range from \$40 to \$50 a week with added earnings from sale of new equipment. Address: Fyr-Fyter Co., 90-45 Fyr-Fyter Bldg., Dayton, Ohio.

Cal. 30-40 Six Shot



KRAG CARBINE

All the qualities of a high price rifle. In fine used condition, all working parts guaranteed for one year. Send today for our Free 60-page illustrated catalog of money saving values; Guns, Ammunition, Cutlery, Sports and Gov't goods.

Deposit required on all orders. Money refunded if not satisfactory.

W. Stokes Kirk, Dept. P. M.-9, 1627 N. 10th St., Phila., Pa.

Price
\$975

THOMPSON BETTER BUILT DUCK BOATS

**\$36
AND UP**

Swift, silent gliders, exceptionally steady—even in rough waters. Four models for open lake and river use and for still hunting in marshes and shallows. Two big Factories. Quick delivery from either one. Write for Free Catalog.

THOMPSON BROTHERS BOAT MFG. COMPANY
213 Ann Street, Peshtigo WISCONSIN 113 Elm Street, Cortland NEW YORK



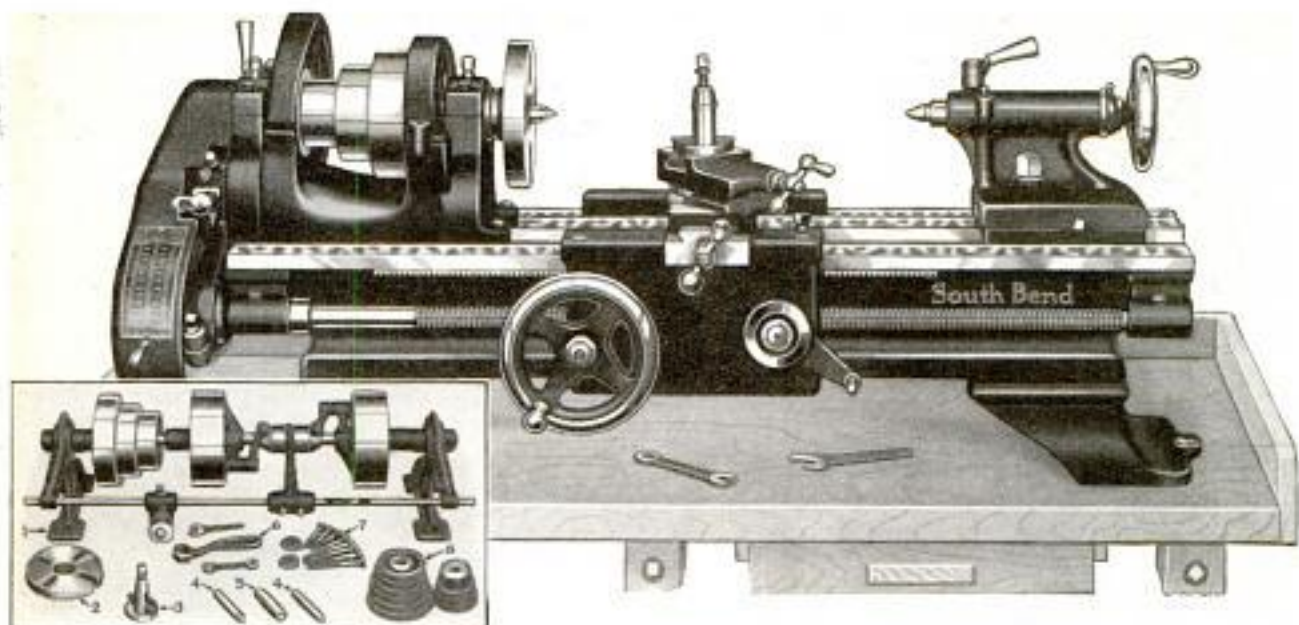

9" x 2' new model Junior Back Geared Screw Cutting Bench Lathe. Weight 325 lbs. Price \$150. Only \$30 down, \$10.50 monthly.

New Model South Bend Lathes on Easy Payments

YOU can now install any South Bend Lathe on Easy Payments of 20% down, balance in 12 monthly payments. You get the same lathe that is used by the U. S. Government, State and municipal departments, General Electric, Eastman Kodak, R.C.A., General Motors and hundreds of other leading industries.

New features include double wall aprons and hardened headstock spindles on Series "N" Lathes. Ninety-six sizes and types in both Series "O" and Series "N" are available, all of which are built and recommended for fine tool room work, production in the manufacturing plant and for general service and maintenance. Send coupon for details.

Send Now for These Books

"How to Run a Lathe"—Latest Edition of this famous work, contains 160 pages, with more than 300 illustrations. Simplest, most complete and practical book on lathe operation. Shows how to handle 400 different types of lathe jobs as practiced in the modern machine shop. Sent postpaid for only 25 cents; coin or stamps of any country accepted.

Latest Auto Shop Practice—This 48 page book shows a model auto service shop, gives up-to-date methods for servicing armatures, valves, bushings and pistons; describes complete equipment for these jobs, costing only \$265.00 complete. Sent free, postpaid.

Catalog No. 91-A—This 104 page book illustrates and describes the 96 different sizes and types of New Model South Bend Lathes. Send the coupon now for your copy, free.

SOUTH BEND LATHEWORKS

Lathe Builders for 25 Years - - Over 50,000 in Use

SOUTH BEND LATHEWORKS
639 East Madison St., South Bend, Indiana, U. S. A.

Gentlemen: Please send me books checked

How to Run a Lathe (25c)

Latest Auto Shop Practice (Free)

Catalog No. 91-A (Free)

Easy Payment Plan

Name _____

Address _____

City _____

State _____



9 inch Junior New Model Simplex Wall countershaft Lathe and Lathe equipment. Price **\$150**
Complete with motor, switch, wiring, conduit and belting \$180.75. Only \$36.15 down; \$12.65 monthly.

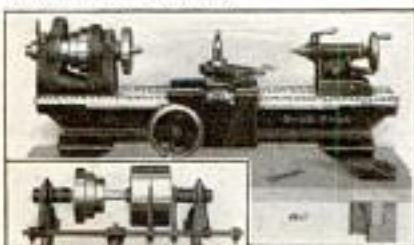

9" x 2' Back Geared Special Metal Turning Lathe. Weight 275 lbs. Price **\$100**
Only \$20 down; \$7 monthly.

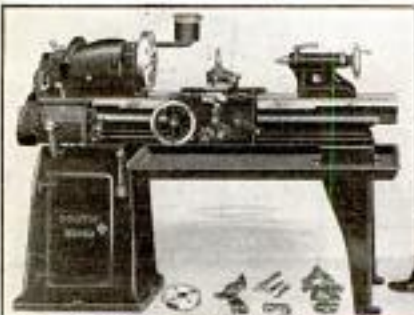

New Model Underneath Belt Motor Driven, Back Geared, Screw Cutting Lathes, available in two series, 96 sizes and types, 9" to 18" swing, priced from **\$283 to \$1356**
Can be bought on easy payments.



Chock-full!





**BUILD YOUR OWN BOAT
AT SMALL COST**

Whatever type of boat you want; whether it be a speedy outboard cruiser, a racing hydroplane, a serviceable outboard runabout, snappy inboard runabout, sailing boat, flat-bottom rowboat for outboard motor, round-bottom rowboat or canoe, the new

**POPULAR MECHANICS BOAT BOOK
SHOWS YOU EXACTLY HOW TO
CONSTRUCT IT**

The need for easily understood directions for the amateur builder of small craft has been met by actually building these boats and photographing every vital step in the construction. Thus you are shown everything just as it is done; nothing being left to guesswork. The designs used in the new Boat Book are of the very latest, up-to-the-minute craft.

**THE ONE BOOK NEEDED
BY EVERY BOATING ENTHUSIAST**

**269 PAGES
(Several in Color)**

**PROFUSELY
ILLUSTRATED**

**LARGE SIZE
7x10 INCHES**

CLOTH—PRICE \$3

Gives you in addition to boat building information, everything you need to know about the operation, equipment, care, repair and maintenance of boats. This includes navigation, pilot rules, handling sailing craft, government regulation of motor boats, knots, storm signals, useful boat kinks of various kinds, glossary of boating terms, tables, etc.

Sent postpaid upon receipt of price or by parcel post C. O. D. anywhere in the U. S. A.

POPULAR MECHANICS PRESS—ROOM P9—200 E. ONTARIO ST., CHICAGO

When writing to advertisers please mention Popular Mechanics

Copyrighted material

Fly Over the Roads

ZOOM to the crest of a hill—dive down into the valley—bank around that sharp turn in the road—and “gun” her for the straightaway!

All those thrills of flying are yours when you ride a Harley-Davidson. Yet you are on solid ground all the time, safe and sound.

No wonder red-blooded men get a kick out of motorcycling—its the greatest sport on wheels. And so inexpensive!

**New Models—Lower Prices
—a Single at \$195!**

The 1932 models are out—at lowest prices in Harley-Davidson history! See them at your nearest dealer's. A Single

—a true Harley-Davidson
—speedy and thrifty—at
only \$195 f. o. b. factory!
Ask the dealer about his
Pay-As-You-Ride Plan.

*Mail the coupon for literature showing the 1932
Twins, Single and Sidecars.*



Ride a
HARLEY-DAVIDSON

Harley-Davidson Motor Company
Dept. P., Milwaukee, Wis.

Interested in your motorcycles. Send Literature.

Name

Address

My age is 16-19 years, 20-30 years,
 31 years and up, under 16 years.
Check your age group.

When writing to advertisers please mention Popular Mechanics

WOLLENSAK

350 POWER

Only **\$18.50**



Fully
Extended



Showing base
detached
for examining
large objects.

This new microscope is precise enough for thousands of professional men, yet so simple that growing boys and girls use it with ease. Reveals thousands of nature's miracles.

NEW FEATURES

Magnifies 100 to 350 times, in steps of 50 magnifications. Concave mirror gives brilliant illumination above or below object. Rack-and-pinion adjustment aids delicate focusing. Stand tilts for use in any position. Detachable base permits examination of large specimens. Used day or night. Case, mounted object and glass slide included. American mass production assures superior value. Money-back guarantee by American maker.

[At Dealers or Direct, Postpaid, \$18.50
Similar Wollensak Microscope, 50 to 110 power.....\$10.00

Complete catalog free.

WOLLENSAK OPTICAL CO.

869 HUDSON AVE., ROCHESTER, N. Y.

Lens problems our specialty

ENGINES

Enclosed,
Self Oiling, Roller Bearing

The sensation of the year, something new. Runs smooth as an electric motor. Low operating cost. Let this engine make money for you. Big illustrated Catalog Free.



ALL LIQUID FUELS

WITTE ENGINE WORKS
4746 OAKLAND AVE. KANSAS CITY, MO.

FREE TOOL BOOK The entirely new Disston Saw, Tool and File Manual tells how to choose, use, and care for tools, file and set saws, etc. Sent free.
Henry Disston & Sons, Inc., Dept. M, Philadelphia. Canadian Factory, Toronto



MONEY! MONEY!

Let this sturdy PREMIER—the finest circular saw you ever handled—make you more profit—cash—right at home. Send for complete catalog of Parks Machines.

Dept. PM-9
1530 Knowlton St.

THE PARKS WOODWORKING MACHINE CO.
CINCINNATI OHIO

PARKS

WOODWORKING MACHINES

OTTAWA LOG SAW



only **\$39**
GREATEST OFFER
EVER MADE
Make Money! Wood is valuable. Saw 15 to 20 cords a day. Does more than 10 men. Ottawa easily operated by man or boy. Falls trees—saws limbs. Use 4-hp. engine for other work. 30 DAYS TRIAL. Write today for FREE book. Shipped from factory or nearest of 4 branch stores.
OTTAWA MFG. CO., 1741 -W Wood Street, Ottawa, Kansas

Brown & Sharpe Tools

"World's Standard of Accuracy"

Send for Catalog No. 31 describing 2300 Precision Tools.
Brown & Sharpe Mfg. Co., Providence, R. I., U. S. A.

BOYS—Build and Fly

the IDEAL

"EAGLET"

All hollowed (not cardboard) with many features of expensive models. Easy, quick construction; everything ready to put together; weighs 1 oz. complete. Flies like a big one! Get one now and have some real fun!

Send 5c for Big 48 pg. Catalog of New Models and Reduced Prices.

26 West 15th Street
IDEAL AEROPLANE & SUPPLY COMPANY, Inc.
New York City



20 in. Size
Construction Outfit
50c Pre-paid

BASHFUL?

"Shame on you!" Are you nervous, embarrassed in company of the other sex? Stop being shy of strangers. Conquer the terrible fear of your superiors. Be cheerful and confident of your future! Your faults easily overcome so you can enjoy life to the fullest. Send 25c for this amazing book.
RICHARD BLACKSTONE, B-479 Flatiron Bldg., N. Y.

New Food Idea Pays Big Profits!

Men! Women! Investigate the wonderful NEW Brown Bobby GREASELESS Doughnut. Sells like wildfire! You can easily make \$50 week spare time; \$5000 to \$8000 year full time. Investment small. No experience needed. Write today for big special offer.
Food Display Machine Corp., Dept. 3-J, 500-510 N. Dearborn St., Chicago

Now! Do Your Own Electric Nickel Plating

Introductory Offer

ONLY
\$6.50

For Plating
Nickel, Brass,
Copper, Silver,
Gold, etc.



A REAL MONEY-MAKING OPPORTUNITY

NO EXPERIENCE REQUIRED. Do YOUR OWN Electro Plating in Your Home; Garage, Office, or Place of Business. Electrically Deposit Metal—Nickel, Brass, Copper, Silver, or Gold. You can Successfully do all the plating on your Automobile, Electric Fixtures, Faucets, spoons, Forks, Chandeliers, Tools, Coffee Urns, Surgical and Dental Instruments, Utensils, large or small, Iron Stoves, Music Instruments; recondition worn plating or plate New Work; do it instantly without interrupting the Service or without removing the parts to be plated with the

ALADDIN PORTABLE ELECTRO-PLATER

Simple and Economical to operate. Not a toy, but a practical Plating Outfit with which Perfect and Durable Work can be done. Positively Guaranteed to do as we claim. BE YOUR OWN BOSS! Build up a Profitable Aladdin Electro-Plating Business of your Own. This offers wonderful ECONOMY to users and BIG MONEY-MAKING possibilities to AGENTS. Thousands in Service since 1924. Write today for FREE PARTICULARS and TESTIMONIALS.

P. J. F. BATENBURG CO. Dept. 255 RACINE, WISCONSIN

—AGENTS—
WANTED EVERYWHERE

Crescent
Tinners'
Snips No. 547
75c.

G-26
Plier
50c.

Crescent
Hack Saw
Frame
No. 1042
75c.

**FOR LESS
THAN \$1.00**

You can slip any one of these Crescent Tools into your kit

Pick the tool you need—any hardware store can supply you with it at the price above. Look over the many other Crescent popular priced quality tools—the kind experienced mechanics choose the world over.

There's a Crescent tool to fit every pocket in your kit at a price to fit your pocket-book.

For Catalogs, write
CRESCENT TOOL COMPANY
Jamestown, N. Y.

CRESCENT and Smith & Hemenway TOOLS

**BURN YOUR NAME ON TOOLS
WITH THE
ARKOGRAF**

PROTECT YOUR TOOLS FROM THEFT
Write with electricity any name or design on the hardest and finest tools and instruments, or any metal, like writing on paper with pen or pencil.
Complete Outfit \$3.50—**Free!** Anywhere interesting illustrated circular free. Write today. Agents wanted.
ARKOGRAF PEN CO., 1177 E. Stark St., Portland, Oregon



**SYSTEM and SAFETY
for Tools**

GERSTNER Chests have been the choice of Machinists and Toolmakers for many years.

The Gerstner Sons
493 Columbia St. Dayton, Ohio



Send for FREE BULLETINS

**CRESCENT
WOOD WORKING
MACHINES**

Crescent Wood Working Machines make money for you by turning out work accurately, fast and easily. Portable machines operate from any light socket. Big line of heavy machines for factories, all quality models moderately priced.

Send for Free Literature.



The Crescent Machine Co., 93 Columbia St., Leetonia, O.

New Tractors from Old Fords

Do All Farm Work! Easy to Build—We'll give you help

Make powerful tractor out of your Model "7" or "8" Ford, or Chevrolet with SHAW Tractor Equipment. Low cost! New HIGH ARCH Model with 30 inches clearance straddles 1 or 2 rows of corn and other crops. Cultivation, plow, mow, disc, etc. Rear belt machinery. Easy to attach. **SPECIAL LOW INTRODUCTORY PRICE!** Write for FREE literature!
SHAW MFG. CO., 4809 Center St., GALESBURG, KANS.

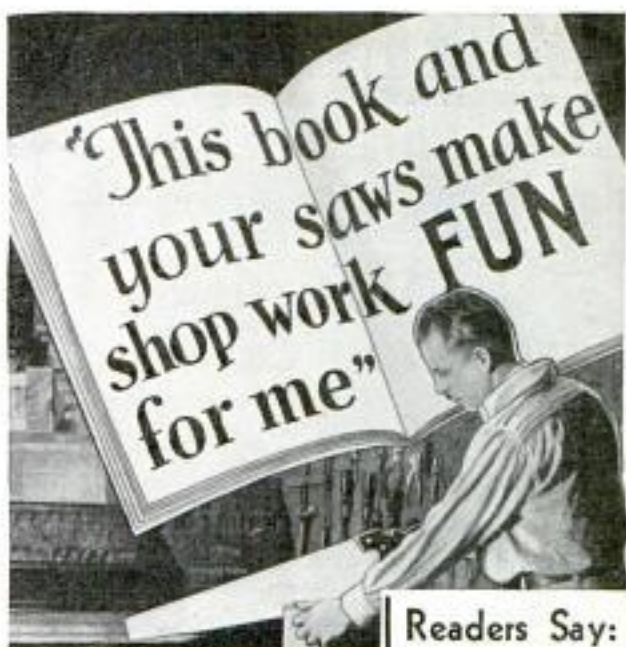
Readers Say:

"In an hour with this book, I learned more about joinery and saws, than in years of casual home-crafting."

"It's a source of real pleasure and profit in my shop, and on the job."

"A handy guide book for all who have a shop, or plan to start one."

"The section on joinery is worth several times the book price."

"The what-to-make list is a gold mine of ideas for projects."

"It tells just what the home worker wants to know."

"To me, 'How to File Saws' was worth many times the book cost."

"Has lots of real instruction on tools and joints."

HUNDREDS of home-craftsmen tell us that! You'll say so too, when you see how much practical information is packed into the 32 pages of this workshop book—and when you feel the thrill of cutting with an ATKINS "Silver Steel" Saw.

This book is brimful of facts on how to do things! How to plan, equip and enjoy a workshop . . . what saws, tools and machines to get for a small, medium or large shop . . . easy ways to make 24 types of wood joints . . . how to build a shop bench, worktable, saw horse, tool cabinet.

Next comes a reference list of over 200 things to build, and where to get job plans. And in the back you'll see 50 of the world-famous "Silver Steel" Saws, with reasons why they cut so much faster and easier, and far outlast ordinary saws.

This handy book will improve your work and help you get more fun out of your hobby. Just send the coupon.

If your hardware dealer does not have the Atkins saws you want, write us.

**E. C. ATKINS and
Company (Est. 1857)**
426 So. Illinois St.
Indianapolis, Ind.

I enclose a dime for the
ATKINS Saw Book.

Name.....
Street.....
City..... State.....
My dealer is..... (9)



When writing please mention Popular Mechanics

AMAZING



MAGIC

Saves Many Car Washes

HERE is an automobile accessory that every car owner needs. Think of it, with the Dust Puff in a few minutes time a dusty car can be made to look spick and span. No hard rubbing, no hard work. Think of the satisfaction of always having your car looking clean and shining, and of the money that can be saved in car washings alone.

A special Dust Puff is made for household use. Cleans furniture instantly and leaves a beautiful polished appearance.

Free Sample and Big Money Making Offer

Your profits as a Dust Puff agent are limited only by your own efforts. D. C. Champion of Marion, Ohio, is now selling 1000 Dust Puffs a month. There is no reason why your territory should not be equally as good. Up to \$100 a week profit is possible. Every automobile owner, every housewife is a 100% prospect. We also make it possible for you to sell to stores, garages and filling stations. Send today for our Free Sample and Big Money Making Offer.

U. S. MANUFACTURING CORP.

Dept. 112

DECATUR, ILL.

MOLES and WARTS

REMOVED PERMANENTLY



Rid your face, neck, arms and body of all unsightly moles and warts with "ANTI-MOLE." One application does it. Safe—easy to use—painless—leaves no scar. Used successfully by physicians, skin specialists and beauty experts for 28 years. Write for FREE booklet on treating all kinds of moles and warts.

Miller Co., 2445 South St., Lincoln, Nebr.

Polox Fluid Solder

Requires no heat. Super-Strong for repairing Metal, Wood, Leather, Glass, Etc. Write for FREE Circular.

POLOX MFG. CO..

MERRIAM, KANS.

The man who studies gets ahead. Popular Mechanics Press will advise you what books to read to advance in your trade. 200 East Ontario Street, Chicago, Illinois.

Our New Combination Genuine Neon and Changeable Letter

SIGNS

OFFER OPPORTUNITY TO EARN

UP TO \$30 A DAY

PROSPECTS EVERYWHERE

MILWAUKEE NEON SIGN CO., Dept. I
722 E. Lakeview Ave., Milwaukee
Please explain sales proposition.

Name
Address
City State 9: M, 9 '31

SAVE ON TIRES

LOOK! TIRES

NEW LOW PRICES

Why Pay More?

GOODRICH · GOOD YEAR · U.S. Firestone and OTHER TIRES

Lowest Prices on Earth!
Thousands of satisfied tire users all over the U.S.A. Our 10 years of business speaks for itself. This big responsible company will supply you with reconstructed standard make tires at lowest prices in history—
Guaranteed to give 12 months' service

Don't Delay—Order Today

CORD TIRES		BALLOON TIRES	
Size	Tires Tubes	Size	Tires Tubes
30x3 1/2	\$2.20 \$1.00	30x4.40	\$2.30 \$1.10
30x3 3/4	2.25 1.00	30x4.50	2.40 1.15
30x3 1/2	2.70 1.15	30x4.50	2.45 1.20
31x4	2.95 1.15	30x4.75	2.45 1.20
32x4	2.95 1.15	30x4.75	2.45 1.20
30x4	3.00 1.15	30x4.75	2.90 1.25
30x4 1/2	3.00 1.15	30x4.75	2.95 1.25
30x4 1/2	3.20 1.45	30x4.75	2.95 1.25
30x4 1/2	3.20 1.45	30x4.75	2.95 1.25
34x4 1/2	3.45 1.45	30x4.75	2.95 1.25
30x5	3.60 1.75	31x5.25	3.10 1.25
30x5	3.60 1.75	30x5.75	3.20 1.40
30x5	3.45 1.75	30x5.75	3.20 1.40
		31x5.75	3.20 1.40
		31x5.75	3.20 1.40
		32x5.00	3.20 1.40
		32x5.00	3.20 1.45
		32x5.20	3.50 1.60

12 MONTHS SERVICE GUARANTEED

DEALERS WANTED

Send only \$1.00 deposit with each tire ordered. We ship balance C.O.D. Deduct 5 percent if cash in full accompanies order. Tires failing to give 12 months service will be replaced at half price.

YORK TIRE & RUBBER CO., Dept. 309-A
3855-59 Cottage Grove Ave. Chicago, Ill.

HOT SHOT... NEW ELECTRICAL WIZARD

GOOD FOR \$15 TO \$25 A DAY!

NEW MOTOR INVENTION

HOT-SHOT saves battery—gas—oil. Makes old plugs act like new. More power—speed. Transparent—shows magnified spark. Write for FREE SAMPLE OFFER.

Dept. F-3 REARDON MFG. CO. Peoria, Ill.

A. C. Electric Plants



ONAN A. C. PLANTS furnish the same current as city service—110 volt, 60 cycle.

A. C. Operate Radios, Water Systems, Refrigerators, all Household Appliances.

Sizes 500 to 2000 Watts

Available from stock. No battery used except to start the engine. Ideal for farms, camps and lake homes.

Also a complete line of D. C. Models.

D. W. ONAN & SONS

89 Royalston Ave. Minneapolis, Minn.

MAKE \$100.00 A WEEK FOR ONLY 2 SALES DAILY



Take orders for my wonder value all-wool suits, tailored-to-measure. Finely made. New low prices. Bigger commissions than ever, paid daily. Generous bonus to producers. Style creations to please critical men. A big selling, big profit line. No experience needed. Write now for FREE outfit of large swatch samples. You are under no obligation.

W. Z. GIBSON, Inc., Dept. J-516, 500 Throop St., Chicago, Ill.

NEW SQUAB BOOK FREE



Breed PR Royal squabs and make money. Sold by millions at higher prices than chickens. Raised in one month. Send four cents stamps for postage on brand new big 64-p. illustrated free book how to breed and profit by best sales method. Thirty-first year.

Plymouth Rock Squab Co., 634 H St., Melrose, Massachusetts

Do Your PRINTING



Cards, stationery, circulars, advertising, labels etc. Save money. Print for Others, Big Profits; easy rules sent. Do Raised Printing like Engraving. Junior Press, \$5.90, Job Presses \$11 up, Power \$149. Write for free catalog or fill in and mail coupon. The Kelsey Co., C-37, Meriden, Ct.

Please send me free catalog of your printing presses and all details.

Name

Address

City or Town & State

When writing to advertisers please mention Popular Mechanics

HEATH ANNOUNCES AN IMPROVED AIRPLANE MODEL "LN" PARASOL



FRISE type balanced ailerons—push rod aileron control—enlarged tail surfaces, all of which make for perfect control at speeds below the stalling point. For 23 years Heath has been pioneering light aircraft because that is the road to safe, sane flying at the lowest possible cost. In Heath aircraft only is that 23 years' experience available to you, augmented by skilled aeronautical engineers, splendid new factory, and a volume of business making low prices possible.

HEATH STILL LEADS

Send 10c for the new booklets today. They tell about the splendid flyaway jobs,

Model V.....\$975.00 Model LN.....\$1075.00
and how to start building these ships by the famous Heath group plan.

Model V—material kit complete.....\$199.00
Model LN—material kit complete..... 269.00

First group only \$12.00

HEATH AIRCRAFT CORPORATION

Dept. P-9, Niles, Michigan



HEALTH for YOU

Suffering Relieved
Work Made Easy!

Overcomes weakness and organic ailments; develops lungs, chest; ere t, strong figure. Replaces and supports misplaced organs. Supports enlarged abdomen. Strengthens and straightens the back—corrects stooping shoulders. Relieves backache, nervousness, curvature, constipation, after effects of flu. A wonderful proved aid for rheumatism.

THE NATURAL BODY BRACE

COSTS YOU NOTHING TO TRY 30 DAYS

If Not Satisfactory At End of Trial, Write now for free illustrated booklet, "Health, Strength and Perfect Figure," and liberal trial proposition.
THE NATURAL BODY BRACE CO., Howard C. Rash, Pres.
205 Rash Bldg., SALINA, KANSAS



Send for Free Catalog

2000 illustrations—Diamonds, Watches, Jewelry. Largest Diamond and Watch Credit House in the World.

LOFTIS BROS. & CO.
Dept. D-894, 30 N. State St.
CHICAGO, ILL.

Catch Fish!

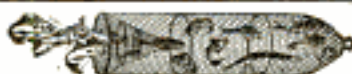

Eels, Mink, Muskrats with our new folding galvanized **STEEL WIRE TRAP**. Write for our **FREE TRAP OFFER** and Bargain Catalog. \$1 Box of our famous Fish Bait FREE to introduce our traps.
WALTON SUPPLY CO., 3502 JUNIATA AVE., ST. LOUIS, MO.



"FLYING CLOUD"

Get clean-cut parts and clear blueprints for 20" model. Readily made in spare hours as hull fully shaped and sanded. Set includes anchor, bell, capstan, dead eyes, wheel, rigging line, etc. Complete for \$11. Postage 5 lbs. White metal figurehead 50c. Send 15c (coins) for beautiful catalog of ships and coaches.

ROY HANCOCK

323 Douglas Ave. Portsmouth, Va.

Make big money from repair work



Practically every householder spends at least \$10.00 to \$50.00 each year and many spend several times that much on simple repairs that can be made *quickly, easily* and *well* with

Smooth-On No. 1

With a can of Smooth-On, you can save this money in your own home—and by doing similar repair work for others, you can make money.

No skill is required to make repairs and the amount of Smooth-On used on any one job seldom costs more than a few cents.



Leak at radiator joint stopped with Smooth-On

Typical repairs that can be made perfectly with Smooth-On:—Stopping leaks in steam,

water, gas, oil or stove pipes, mending cracks, breaks or

leaks in furnaces and boilers, radiators, tanks, sinks,

pots and pails, making loose handles tight on umbrellas, knives, hammers, brushes, drawers, etc.,

tightening loose screws, hooks, locks, door knobs, etc.

*On the Automobile:—*Making cracked water jackets and pumps good as new, stopping leaks in radiators, hose connections, gas tanks and gas, oil and exhaust lines, making a fume-proof joint between exhaust pipe and tonneau heater, tightening loose headlight posts, keeping grease cups, hub caps, and nuts from loosening and falling off, etc.

To get perfect results, write to us for and use the Smooth-On Repair Book. Free if you return the coupon.

Get Smooth-On No. 1 in 7-oz., 1-lb. or 5-lb. tins at any hardware store or if necessary direct from us



Write for
FREE BOOK



Do it with SMOOTH-ON

SMOOTH-ON MFG. CO., Dept. 37,
574 Communipaw Ave., Jersey City, N. J.
Please send the free Smooth-On Repair Book.

Name.....

Address.....

9-31.....

When writing to advertisers please mention Popular Mechanics



LUMINOUS PAINT

Make Your Watches, Clocks, Etc., Visible by Night

The very latest discovery in the scientific world, luminous paint, practically self-luminous except as an exorbitant price, we have at last succeeded in producing this remarkable LUMINOUS PAINT, which, applied to the surface of any article, emits rays of white light, rendering it perfectly visible in the dark. THE DARKER THE NIGHT, THE MORE BRILLIANT IT SHINES. Quite simple to use. Anyone you can do it. A little applied to the dial of your watch or case will enable you to tell the time by night. You can paint the plates and switch plates of your electric lights, match boxes, and innumerable other articles; make your own Luminous Candles, Luminous Nostrils, etc. Small bottle, price 25c, Larger size, 50c and \$1 postpaid. JOHNSON SMITH & CO., Dept. 818 RACINE, WIS.



CIGARETTE MAKER

Roll your own and save money. Better and quicker; save more than half. Use your favorite brand of tobacco. Next, useful, handy. Perfect new, weight in oz. Made entirely of metal, nickel plated. 25c, 3 for 75c.



GOOD LUCK RING

Very striking, quaint and unobtrusive. Silver finish; solid and crosswise design; two brilliant, flashing eyes; sparkle out of the eyes. Said to bring good luck. Only 25c p.pd.



Exploding Cigarettes

Box contains ten genuine cigarettes of excellent quality. They appear so real, but when each cigarette is about one-third smoked, the victim gets a very great surprise as it goes off with a loud BANG! A great thrill provoker yet entirely harmless. Price 25c box.

NOVELTY BADGES



Kissing Permit 10c. Garter Inspector 10c. Two very novel metal badges, nickel plated, that you can wear, giving you fun out of all proportion to their trifling cost. 10c, each badge, 3 for 25c, or 75c per doz. postpaid anywhere.

SURPRISE MATCHES

More fun than fighting with your wife. Look just like ordinary matches. As the victim tries to light one he gets quite a surprise. Price 10c per box, 3 boxes for 25c, 12 for 75 cents.



STAR TOY MAKER

Greatest boys' book written. Tells how to make a Pinball Carver, a Carver, model Railroad, a Telephone, Boomerang, Telegraph Instrument, Box Kite, Talking Machine, Microscope, Electric Motor, Electric Door Bell, Water Wheel, Paddle Kart, a pair of Skis, a Dog sled, Bird House, Rabbit Yard, etc. 64 pages, 150 illustrations. PRICE 10c.

BOY'S OWN TOYMAKER. A new book. Tells how to make chemical toys, electrical toys, airplane toys, mechanical toys, paper toys, cardboard toys, boats, traps, etc. 200 illustrations. Price 25c postpaid.

AMATEUR ELECTRICIAN. All about electricity in simple language. How to make batteries, dynamos, motors, telephones, bells, electric bells, radios, lights, etc. Price 10c postpaid.

MONEY MAKING SECRETS. Golden opportunities for everyone. 54 easy copyrighted book full of money-making ideas, recipes, formulas, wrinkles, trade secrets, etc. Business that can be started with little or no capital at home in spare time. 10c postpaid.

BOPE SPLICING. How to make different knots, hitches, splices. 22 pages, 100 illustrations. 20c postpaid.

WIZARD TRICKS. All the best and best card tricks as performed by celebrated magicians. With exposure of said tricks used by professional magicians. Price 25c postpaid.

MAGIC FOR AMATEUR MAGICIAN. Conjecturing with cards, coins, etc.; experiments in magnetism, chemistry, electricity, etc. 25c.

HELLER'S BOOK OF MAGIC. Magic and its mysteries. Numerous step-by-step tricks explained and illustrated. 100 pages. 25c.

TRICKS & SOCIAL ENTERTAINER. Contains hundreds of simple tricks, illusions & variations that anyone can do. Also contains secret of secret light. Price 25c postpaid.

63 OLD TIME SONGS. All old time favorites, sentimental, patriotic, sacred, etc., with words and full notes. Price 25c postpaid.

WONDERFUL X-RAY TUBE. A wonderful little instrument producing optical illusions both surprising and startling. With it you can see what is apparently the bones of your fingers, the lead in a lead pencil, the interior opening in a pipe stem, and many other similar things. Price 10c, 3 for 25c.

SERPENT'S EGGS. Box contains 12 eggs. When lit with a match, each one gradually hatches itself into a snake several feet long, which curls and twists about in a most life-like manner. Price per box, 10c postpaid, 3 for 25c.

MIDGET BIBLE

GREAT CURIOSITY. Smallest Bible in the world. One of a complete set of 200 pages. Bound to bring good luck to the owner. A genuine work of art. Must be seen to be appreciated. Make good money selling them to friends, church organizations, etc. PRICE: 18c each, 3 for 40c, 12 for \$1.25, 100 for \$7.50. Also obtainable in Leather Binding, with gold sides. Price \$5.00 each, 3 for \$1.25, \$4.50 per doz. Magnifying Glass for use with Midget Bible 15c.

LEARN TO DANCE without a teacher. Book gives instructions in old and new dances: Foxtrot, Tango, One Step, Quadrille, etc., explained and illustrated. 25c postpaid.

STAGE MONEY

With a bunch of these bills, it is easy for each person of limited means to appear prosperous by flashing a roll of these bills at the proper time and peeling off a genuine bill or two from the outside of the roll, the effect created will be found to be all that can be desired. Prices, postpaid: 49 Bills 20c, 120 for 50c, or \$3.50 thousand postpaid.

NOSE FLUTE. The Magic Nose Flute, or Nostril Flute, is a unique and novel musical instrument that is played with nose and mouth combined. There is just a little knack in playing it which, when once acquired after a little practice, will enable you to produce very sweet music that somewhat resembles a flute. There is no learning, and once you have mastered it you can play all kinds of music with facility and ease. When played as an accompaniment to a piano or any other musical instrument, the effect is as charming as it is surprising.

Post Paid 10c

LATEST CATALOG. JOHNSON SMITH & CO., RACINE, WIS.

BLANK CARTRIDGE PISTOL

Protection against Burglars, Thieves, & Dogs. Special Offer 1 Blank Cartridge Pistol 100 Blank Cartridges 1 500-yrage Novelty Catalog ONLY \$1.50



Combination Thrift Vault and Savings Bank

HAS REAL THREE NUMBER COMBINATION LOCK KEYLESS—CANNOT BE PICKED. Your money and valuables will be perfectly safe in this new Combination Thrift Vault and Savings Bank, because it has a real combination lock just like the regular Bode and Vandyke. The lock requires three numbers to open it. There are over 9,000 different combinations. The lock is pick-proof. It cannot be opened by "listening" for the combination because it operates silently like the lock on a safe or vault. It is keyless in every sense of the word. No key is required. Once you learn the combination it can be used in a moment or two. It takes coins of any size, currency, etc., or you can use it for storing jewelry and other valuable articles, and it keeps your private memoranda, etc., from prying eyes. Coins and currency can be placed in the bank through the slot at the top, but the larger articles will necessitate opening the bank by means of the combination. PRICE with secret instructions for opening, \$1.50 p.pd.



LOOK 35c LOOK Wonderful Instrument.

Greatest thing yet. Nine separate articles in one. Everybody delighted with it. Odd, Curious and Interesting. Lots of pleasure as well as very useful. It is a double Microscope for examining the wonders of nature. It is also an Opera Glass, a Stereoscope, a Burning Lens, a Reading Glass, a Telescope, a Compass, a pocket Mirror, and a Laryngoscope—for examining eye, ear, nose and throat. It is worth all the cost to locate even one painful cinder in the eye. Folds flat and fits the pocket. Something great—you need one. Don't miss it. Sent by mail, Only 35c or 3 for \$1.00.

PISTOL CIGARETTE CASE

It looks like a deadly weapon, but it is merely a novel Cigarette Case. This clever contrivance has proved itself better than the real thing in many an awkward encounter. Great fun "sticking up" your friends. They squirm and protest it might be loaded. Pull the trigger and the slide flies open disclosing the cigarettes. Well made, light and compact. Weight only 2 ounces. PRICE POSTPAID 25c

GYROSCOPE TOP



The Gyroscope Top is a popular scientific toy that defies the law of gravitation. The illustrations above show a very few of the ways of spinning it. It can be thrown and caught, rotating rapidly all the time. It will travel along a taut string or wire. You can suspend it from a loop of string, still rotating vigorously. It will spin on the point of a pin, and will revolve in a dozen different ways on the pedestal. An effective leak can be performed by spinning the top at a high speed and quickly placing it into the square cardboard marking box. Put on the lid and there set the top on one of its corners. The bar will spin around for quite a while, presenting a very curious appearance. It is a most instructive novelty, always interesting for the many amusing experiments which scientists find hard to explain. As a scientific instrument it is used to demonstrate the principle of rotation, attraction and repulsion of bodies in motion, the center of gravity and centrifugal force. Placed on the pedestal it illustrates the rotation of the globe better than any other mechanical device. Gyroscopes are used to steer torpedoes, steady ships, to balance naval vessels, and in aerial navigation. PRICE 35c. JOHNSON SMITH & CO., Dept. 818 RACINE, WIS.

JOHNSON SMITH & CO.

Dept. 818 RACINE, WIS. A De Luxe Edition of our new CATALOG mailed on receipt of 25c. Handsome binding. Bigger and better than ever. Only book of its kind in existence. Nearly 600 pages of all the latest tricks in magic, the newest novelties, puzzles, games, sporting goods, rubber stamps, unusual and interesting books, curiosities and plants, etc., unobtainable elsewhere. Remit by Cash, Money Order, Check or unencd. U. S. Cash and Foreign Stamps for all articles listed above. See next page.

BOYS! BOYS! BOYS! THROW YOUR VOICE



Into a trunk, under the bed, under a table, back of the door, into a desk at school, or anywhere. You get lots of fun fooling the teacher, policemen, peddlers, and surprise and fool all your friends besides.



The Ventrilo

is a little instrument that fits in the mouth out of sight. Cannot be detected. It is used in connection with the above, and with the aid of this wonderful DOUBLE THROAT, or VENTRILLO, you can imitate many kinds of birds, animals, etc. Remember you get everything for ONLY TEN CENTS—a booklet giving you full instructions how to become a ventriloquist and throw your voice, the Double Throat, or Ventrilo, and our big catalog of novelties, tricks, puzzles, masks, books, etc.

All Sent Postpaid to Any Address for Only **10c**

INVISIBLE INK | Rubber Chewing Gum

The most confidential messages can be written with this ink, for the writing makes no mark. Cannot be seen unless you know the secret. Invaluable for many reasons. Keep your pencils and other private memoranda away from prying eyes. Great fun for playing practical jokes. Only 15c a bottle; 3 for 40c.



It is just like a regular package of chewing gum and looks so real that it fools everybody. Of course no one suspects it is not genuine until they start to chew it. There's a world of fun in this rubber chewing gum—5 sticks to the package. Price, 10c. Pkg. 3 for 25c; 12 for 75c postpaid.

Rubber Tacks, Box 10c | Rubber Cigarettes, Price per Box, 2c
Rubber Cigars, Price Ea. 10c | Rubber Matches, Price per Pkg. 15c

U. S. BABY TANK



It goes with real Yankee Pep—by its own power. Most remarkable toy ever presented. By drawing the Tank backward, either with the hand or over the foot of table and then placing it down, it will crawl along, overcoming all obstacles, in the same life-like manner as the larger tank that proved so deadly in the great war. What makes it go is a screw that is a mystery, for there is no mechanism to wind up as is usually understood with mechanical toys, yet this tank will keep plodding along ten times longer than the ordinary run of toys. It will perform dozens of the most wonderful stunts; 25c. Price only 25c prepaid. Stamps accepted.

It goes with real Yankee Pep—by its own power. Most remarkable toy ever presented. By drawing the Tank backward, either with the hand or over the foot of table and then placing it down, it will crawl along, overcoming all obstacles, in the same life-like manner as the larger tank that proved so deadly in the great war. What makes it go is a screw that is a mystery, for there is no mechanism to wind up as is usually understood with mechanical toys, yet this tank will keep plodding along ten times longer than the ordinary run of toys. It will perform dozens of the most wonderful stunts; 25c. Price only 25c prepaid. Stamps accepted.

\$1.50 JOHNSON SMITH & CO.

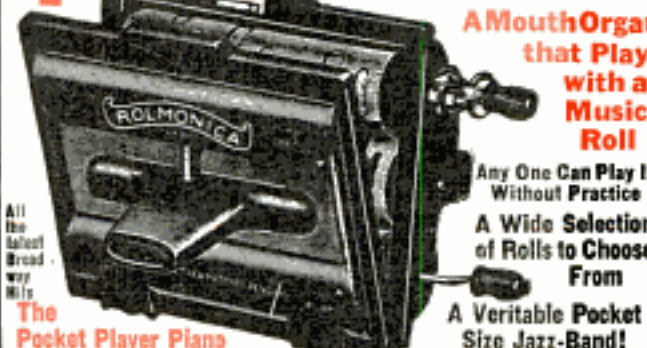

A Mouth Organ that Plays with a Music Roll
Any One Can Play It Without Practice
A Wide Selection of Rolls to Choose From
A Veritable Pocket Size Jazz-Band!

Rolmonica is an automatic harmonica, that plays a music roll just like a player piano. It is a whole brass band all in one—the biggest sensation of the musical world in the last few years. Anyone can play it, for all you have to do is to insert a roll, and turn the handle while you blow. That is all there is to it. Nothing could be simpler. Any child who can do these two simple things can play the Rolmonica. It is a veritable pocket size jazz-band, containing the entire orchestra of the harmonica and the player piano. It is an instrument of a thousand melodies, it plays the popular airs of the past, as well as the latest Broadway hits. There are hundreds of rolls to select from, such as My Blue Heaven, Home Sweet Home, America, Old Black Joe, Annie Laurie, Sidewalks of New York, Humoresque, Wild Irish Rose, Rosie O'Grady, Among My Souvenirs, Love's Old Sweet Song, Dixie, Mighty Lak 'a Rose, Aloha Oe, Havana, Juggins, Rose Marie, O'ward Christian Soldiers, Rally of My Dreams, Caroline Moon, I Fow Down & Go Back, Wooty River, Over There, Ma Cherie, Long Way to Tipperary, Mike's Beloved, Desert Song, La Polona, Sweet Adeline, I've Got a Feeling, Pagan Love Song, When My Dreams Come True, Parade of Wooden Soldiers, Land of Sleepy Song, Turkey in Straw, Hail the Gen's All Here, and hundreds of others. An untiring source of amusement. You can delight your friends for hours and play time after time simply by changing rolls. Small in size, fitting your pocket, yet mighty in its finger-tinkling, tantalizing tone power. Not a toy, but a genuine musical instrument and the life of any party. One Roll free with each Rolmonica. Extra Rolls always obtainable; complete list with each instrument. New Rolls added each month. PRICE with 1 Roll \$1.50; Extra Rolls 10c each, all postpaid.

Send remittance (Postage Stamps accepted) for all articles listed above, also in our other ad on previous page

THE DANDY PERISCOPE

Very Interesting and Amusing Novelty
SEE WITHOUT BEING SEEN



Look Over the Heads of the Tallest Men in a Crowd.
See Over a Fence, Around Corners, Etc.
LOTS OF FUN AND AMUSEMENT

Strongly Made. Equipped with Mirrors, Sight-Finder and Eye-Piece.

THIS is the same kind of instrument that the soldiers use in the trenches to watch the enemy without risk of being seen themselves, and every submarine has one to project above the surface of the sea to keep a look-out for other vessels, etc. With it you can gaze over a high wall or see around a corner without being seen yourself. If, you are in a crowd, you can look right over the heads of the tallest men and watch all the fun. Our illustrations will give you some idea as to the numerous uses to which the Periscope can be put. Every Boy Scout should have one for spying and anyone else who wants some rare amusement. The Dandy Periscope is very strongly made, will stand the roughest handling and the hardest wear, and with ordinary use should last a lifetime. It measures 17 inches long, and a little over two inches wide. The Periscope Tube is handsomely decorated with colored designs to show many of its uses, and each Periscope comes complete in box.

Price Postpaid to any Address. **\$1.00**

MAGICIAN'S BOX OF TRICKS

Apparatus and Directions for a Number of Mysterious Tricks, Enough for an Entire Evening's Entertainment. **\$1.00**

ANYONE CAN DO THEM
It is great fun mystifying your friends. Get the cleverest fellow in your district. It contains the apparatus for ten first-class tricks, including THE MAGIC BALL AND VASE TRICK (a wooden ball is placed inside and upon removing the lid the disappeared ball is found in someone else's pocket); THE HINDOO TRICK (CARD TRICK) (can be made to change completely in less than five times); DISAPPEARING COIN BOX (a coin, placed in the wooden box, vanishes entirely or changes into any other specified denomination); THE GLASS GLOBE TRICK (a coin is dropped into a glass of water and when the water is poured out the coin has vanished and is found somewhere else); THE RIBBON FACTORY FROM THE MOUTH TRICK (a seemingly endless supply of colored paper ribbons comes out of your mouth); the DISAPPEARING HANDKERCHIEF (a handkerchief held in the hand mysteriously vanishes); the WEARD'S RING COIN TRICK; the ENCHANTED BOTTLE (an one foot vessel is able to make it dry down); the GREAT HAT AND DICE TRICK (a large dice is placed on top of a hat, disappears, and is found underneath yet no one has touched the hat, and last, but not least, the GREAT PHANTOM CARD TRICK, or two from five leaves nothing. Full instructions are sent for performing each trick. In addition to the above, a number of other tests and illusions are fully explained for which you can make ready or prepare the necessary apparatus. Price complete \$1.00 postpaid. JOHNSON SMITH & CO.



up and starts to grow in few minutes. Taken out it dries up and goes to sleep until put in water again. PRICE 10c, 3 for 25c, 75c per dozen, postpaid.

RESURRECTION PLANT

Place in water, plant opens

up and starts to grow in few minutes. Taken out it dries up and goes to sleep until put in water again. PRICE 10c, 3 for 25c, 75c per dozen, postpaid.

MAGIC MADE EASY 250 MAGIC TRICKS 10c

A splendid little book gives 250 Paris tricks for tricks with cards, coins, and other objects. EASY TO LEARN, EASY TO PERFORM THEM. Profusely illustrated. Sent postpaid, by any address for only 10c, 3 copies for 25c.

Comical Motto Rings

Lots of harmless fun and amusement wearing these rings. Made in platinum finish (to resemble platinum), with wording on enamel, as illustrated. Price only 25c Postpaid.

The "Little Giant" Typewriter

A First Class Writing Machine For \$1.50

A perfect little typewriter for \$1.50. There are thousands of persons who would like to use a typewriter but whose heads and business do not want that the expense attached to the purchase and use of a fifty or seventy-five dollar machine. To such persons we confidently recommend our Little Giant. It is strongly made, but simple in construction, so that anyone can quickly learn to operate it, and write as rapidly as they would with pen and ink. The letters of the alphabet most frequently used are so grouped as to enable one to write rapidly, the numerals 1 to 10, and the punctuation marks being together. With this machine you can send your business typewritten love letters, address envelopes, make out bills, and do almost any kind of work not requiring a large, expensive machine. With each typewriter we send a tube of ink and full printed instructions for using the machine. Price complete \$1.50 by mail postpaid to any address in the world. Stamps accepted.



JOHNSON SMITH & CO. Dept. Racine, Wis. 818

PATENT

Protect Your Ideas

Take the First Step Today

If you have a useful, practical, novel idea for any new article or for an improvement on an old one, you should communicate with a competent Registered Patent Attorney AT ONCE. Every year thousands of applications for patents are filed in the U. S. Patent Office. Frequently two or more applications are made for the same or substantially the same idea (even though the inventors may live in different sections of the country and be entirely unknown to one another). In such a case, the burden of proof rests upon the last application filed. Delays of even a few days in filing the application sometimes mean the loss of a patent. So lose no time. Get in touch with me at once by mailing the coupon on the opposite page.

Prompt, Careful, Efficient Service

This large, experienced organization devotes its entire time and attention to patent and trade mark cases. Our offices are directly across the street from the U. S. Patent Office. We understand the technicalities of patent law. We know the rules and requirements of the Patent Office. We can proceed in the quickest, safest and best ways in preparing an application for a patent covering your idea. Our success has been built on the strength of careful, efficient, satisfactory service to inventors and trademark owners located in every state in the Union.

NO CHARGE for Information On How to Proceed

The booklet shown here contains valuable information relating to patent procedure that every inventor should have. And with it I will also send you my "Record of Invention" form on which you can sketch your idea and establish its date before a witness. Such evidence may later prove valuable to you. Simply mail the coupon and I will send you the booklet, and the "Record of Invention" form, together with detailed information on how to proceed and the costs involved. Do this NOW. No need to lose a minute's time. The coupon will bring you complete information entirely without charge or obligation.

My Offices
Just Across
Street From
U.S. Pat. Office



Above is a view of my drafting and specification offices where a large staff of experienced experts is in my constant employ. All drawings and specifications are prepared in my offices.

NEWS

Inventors Write for these Free Books

Strict Secrecy Preserved

All communications, sketches, drawings, etc., are held in strictest confidence in strong, steel, fireproof files, which are accessible only to authorized members of my staff. Feel free to write me fully and frankly. It is probable that I can help you. Highest references. But **FIRST**—clip the coupon and get my free book. Do **THAT** right now.

Clarence A. O'Brien

Registered Patent Attorney

Member of the Bar of: The Supreme Court of the United States, U. S. Court of Customs and Patent Appeals, U. S. Court of Claims, Court of Appeals, District of Columbia and Supreme Court of the District of Columbia.

Practice confined exclusively to Patents, Trademarks and Copyrights

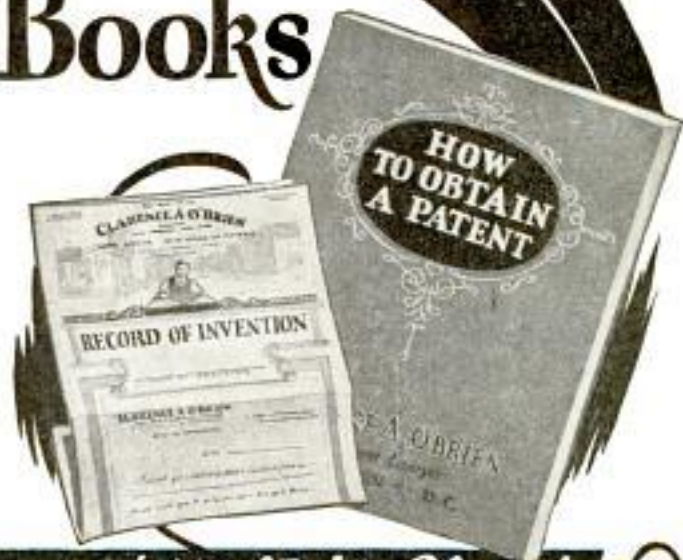

Clip this Coupon and Mail it Now!

CLARENCE A. O'BRIEN, Registered Patent Attorney
70-L Security Savings and Commercial Bank Bldg.
Washington, D. C.

(Or, Suite 1106, Dept. A-15, Woolworth Bldg., New York City)

Please send me your free book, "How to Obtain a Patent" and your "Record of Invention" form without any cost or obligation on my part.

Name.....

Address.....

(Important—Write or print name plainly and address office nearest you)

When writing to advertisers please mention Popular Mechanics

PATENTS TRADE MARKS COPYRIGHTS



Our New York Office
Suite 1007 Woolworth Bldg



Our Philadelphia Office
828 Fidelity Bldg. Trust Bldg.



VICTOR BUILDING
Our New Building Nearly Opposite U. S. Patent
Office Specially Erected by Us for Our Own Use



Have You An Idea?

Our Offer: FOR THE PROTECTION OF YOUR INVENTION

YOUR FIRST STEP—The Inventor should write for our blank form "RECORD OF INVENTION." A sketch and description should be made on this Blank, signed, witnessed, then returned to us. **We also give our opinion** as to whether the invention comes within the Patent Office definition of a patentable invention. This "Record of Invention" will serve as "proof of conception." *There is no charge or obligation for this service.*

Our Five Books Mailed Free to Inventors
Our Illustrated Guide BOOK

How to Obtain a Patent

Contains full instructions regarding U. S. Patents, Our Methods, Terms, and 100 Mechanical Movements illustrated and described.

Our Trade Mark Book

Shows value and necessity of Trade Mark Protection. Information regarding *Trade Marks and unfair competition in trade.*

Our Foreign Book

We have Direct Agencies in Foreign Countries, and secure Foreign Patents in shortest time and lowest cost.

Progress of Invention

Description of World's Most Pressing Problems by Leading Scientists and Inventors.

Payment of Fees in Installments

It is not necessary that the total cost for the preparation and prosecution of a patent be paid in one payment. Our custom is to permit our clients to pay for their applications in three installments as the preparation of the application progresses in our office. This plan makes the payments easy for the inventor.

We Regard a Satisfied Client as our best advertisement, and furnish anyone, upon request, lists of clients in any state for whom we have secured patents.

Highest References—Prompt Service
—Reasonable Terms

VICTOR J. EVANS & CO.

Patent Attorneys, Established in 1898

Main Offices: 789 9th St., N. W., Washington, D. C.

Nearly Opposite U. S. Patent Office

DELAYS ARE DANGEROUS IN PATENT MATTERS

IMPORTANT! To Avoid Delay!

YOU SHOULD HAVE YOUR CASE MADE SPECIAL IN OUR OFFICE to save correspondence, secure protection and early filing date in the Patent Office. To secure **special preparation** of your case send \$25.00 on account with model or sketch and description of invention. If the invention is not patentable we will return fee less cost of search.

We Assist our Clients to Sell their Inventions.



Our Chicago Office
Suite 1640-42 Conway Bldg.



Our Pittsburgh Office
Suite 514 Empire Building



Our San Francisco Office
Suite 1010 Hobart Building



MAIN OFFICE, VICTOR J. EVANS & CO.—VICTOR BUILDING, WASHINGTON, D. C.

Our Large, Comprehensive Organization has been established for 30 years and offers Prompt, Efficient and **Personal Service** by experienced Patent Lawyers and Draftsmen. Every case is in charge of a Specialist who has been selected for his knowledge and experience in certain lines of invention. Our Lawyers practice in all U. S. Courts and defend clients in suits involving Patents, Trademarks and Copyrights. All Communications, Sketches, Drawings, etc., preserved in fireproof Files, strictly **Secret and Confidential**. We shall be glad to have you consult us or to answer any questions in regard to Patents, Trademarks or Copyrights without charge or obligation.

**FREE
COUPON**

VICTOR J. EVANS & CO.
PATENT ATTORNEYS *Established in 1898*

NEW YORK OFFICES
1007 Woolworth Bldg.

CHICAGO OFFICES
Suite 1640-42 Conway Bldg.

PHILADELPHIA OFFICES
828 Fidelity Phila. Trust Bldg.

PITTSBURGH OFFICES
514 Empire Bldg.

SAN FRANCISCO OFFICES
1010 Hobart Bldg.

MAIN OFFICES: 789-9th Street, N. W., WASHINGTON, D. C.

Gentlemen: Please send me *Free of Charge* your books as described on preceding page.

Name

Address

PATENTS SECURED TRADE-MARKS REGISTERED

High-class professional service for Inventors and Trade-Mark Users is necessary for PROPER PROTECTION. We Offer you our facilities on Reasonable Terms. If you have an invention send us a model or sketch and description and we will give you our OPINION whether your invention comes within the provisions of the Patent Laws. Our book, "HOW TO GET YOUR PATENT" and Record of Invention Certificate sent on request. DELAYS are DANGEROUS in Patent Matters.

Terms Reasonable.

Best References.

.....WRITE TODAY.....
RANDOLPH & COMPANY, Patent Attorneys
 301 VICTOR BUILDING, WASHINGTON, D. C.

Name.....

Address.....

PATENTS

PROTECT YOUR IDEAS

Write today for FREE BOOKLET, HOW TO OBTAIN A PATENT and RECORD OF INVENTION—or send Drawing or Model of your Invention for Examination.

Promptness Assured with Best Results

MILLER & MILLER REGISTERED PATENT ATTORNEYS

Former Members Examining Corps U. S. Patent Office
 Dept. A-1006 Woolworth Bldg. New York
 255 McGill Building Washington, D. C.

PATENTS—TRADE MARKS

All cases submitted given personal attention by members of the firm. Information and booklet free. Patent Office & Federal Court Practice.

LANCASTER, ALLWINE & ROMMEL
 PATENT LAW OFFICES
 480 Ouray Bldg. Washington, D. C.

PATENTS

TO THE MAN WITH AN IDEA

Preliminary advice gladly furnished without charge. Booklet of information and form for disclosing idea free on request.

IRVING L. McCATHRAN, Patent Lawyer

Formerly with and successor to RICHARD B. OWEN
 750 International Bldg. Washington, D. C.
 41-E Park Row New York City

TRADE-MARKS

TRADE
MARKS

PATENTS

COPY-
RIGHTS

BEST RESULTS. LOWEST FEES. PARTIAL PAYMENT PLAN

Write today for free information—No obligation, sending sketches and description of invention.

HARRY W. JOHNSON

Registered Patent and Trade Mark Attorney

FORMERLY MEMBER EXAMINING CORPS U. S. PATENT OFFICE

Member of the Bars: Supreme Court of the District of Columbia, The Court of Appeals of the District of Columbia, and the U. S. Court of Customs and Patent Appeals.

219 McGill Building, Washington, D. C.

INVENTORS

who derive largest profits know and heed certain simple but vital facts before applying for Patents.

Our book *Patent-Sense* gives those facts; sent free. Write LACEY & LACEY, 635 F Street N. W., Dept. 5, Washington, D. C. Estab. 1869.



AN EASY
WAY TO

SHAPE your NOSE

Anita Nose Adjuster shapes flesh and cartilage—quickly, safely, painlessly, while you sleep or work. Lasting results. Gold Medal Winner. Doctors praise it. 87,000 users. Write today for FREE BOOKLET.

ANITA INSTITUTE, K-11 Anita Bldg., Newark, N. J.



BOW LEGS?

THIS GARTER (Pat'd)
 Makes Trousers Hang Straight
 If Legs Bend In or Out

Free Booklet—Plain Sealed Envelope
THE T. GARTER CO., Dept. B
 South Bend, Ind.



BUCHSTEIN'S FIBRE LIMB

is nothing to your stump—strong, cool, neat, light. Easy payments. Brans, for all deformities
D. BUCHSTEIN CO.
 610 3rd Ave., So.
 MINNEAPOLIS, MINN.

Send for Catalog Today

PATENTS

Booklet Free

Highest References

Promptness Assured

Best Results

Send drawing or model.

ALL BUSINESS GIVEN PROMPT AND PROPER ATTENTION

Listed Patent Lawyer in the latest editions of the Rand-McNally Directory of Bankers and Bank-Recommended Attorneys, published by Rand-McNally & Co., Chicago, Ill.; The Baggott & Ryall Directory of Guaranteed Attorneys, published by Legal Directory Corporation, Boston, Mass.; Flugel's Law List, published by Legal Directory Publishing Co., St. Louis, Mo.; American Lawyers Annual, published in Cleveland, Ohio; Bankers Service Legal Directory, published by Bankers Service Co., Boston, Mass.; Eyre's Law List, 9 Park Place, New York City; Walters Legal Directory, Omaha, Nebraska, and the National Directory of Attorneys, Baltimore, Maryland.

WATSON E. COLEMAN,
 REGISTERED PATENT LAWYER

Victor Building, 724 Ninth Street, N. W.
WASHINGTON, D. C.

An Amazing Business
Paying UP TO
\$1000
Monthly

Sell
"Hot Dogs"
This New Way



If you want a real live Business with a chance for \$1000 monthly profits, open a "hot dog" stand, and cash in on the tremendous demand for the luscious wiener. Millions of pounds sold monthly for sandwiches and everybody loves them. Will buy more readily, roasted this new way by electricity with all the delicious flavor roasted in. Profits are enormous—up to \$12.00 an hour. Machine pays for itself in a week.

Roasted By Electricity

Entirely New!—the Presto Electric Wiener Roaster. Clean, wholesome, and inviting. Attracts trade. No unsavory odors. Wieners simmer with delicious, enticing aroma. Wieners do not shrink, but actually get 20% larger. Roaster is portable. Move it anywhere. Just plug in light socket—that's all. Roasts 12 Wieners to a delicious golden brown in 3 minutes.

Start NOW Anywhere

AGENTS WANTED

Show merchants who sell foods this amazing Hot Dog device, and make up to \$150 weekly. Write for agent's offer.

Open up a "Hot Dog" Stand in front of your home on the highway or anywhere traffic is heavy. Cash in on the big demand now for "hot dogs" and the bigger demand when roasted this amazing new way. Write for details on how to get started. We show you.

PRESTO ELECTRIC ROASTER CO.
 M-45 American Bank Bldg.
 Pittsburgh, Pa.

BUILD MODEL SHIPS OF THE BETTER KIND

We can supply construction sets and all sorts of parts, such as semi-finished hulls, blocks, deadeyes, flags, anchors, steering wheels, compasses, figure heads, guns, ring masts, books, etc., for building real fine scale models of the U. S. Destroyer Preston, Flying Cloud, Constitution, Spanish Galleon, Viking, Baltimore, Clipper, Mississippi steamboat, Huzzon, Mayflower and many others. Also special construction sets for racing sail boats, power boats, model steam engines, boilers, propellers, etc., and fine tools for the model maker. New large 50-page photographically illustrated ship model booklet has just been released. This booklet contains valuable information and hints for building ship models, in addition to prices and full description of the above articles. Many people only slightly interested in models have become greatly enthused upon receiving this booklet. A copy will be sent postpaid upon receipt of 15 cts. (cash preferred).



MODEL SHIP SUPPLY COMPANY DEPT. K MINEOLA, N. Y.

Information on any book free. Write Popular Mechanics Press, Chicago, Ill.

QUIT TOBACCO

No man or woman can escape the harmful effects of tobacco. Don't try to banish unaided the hold tobacco has upon you. Join the thousands of inveterate tobacco users that have found it easy to quit with the aid of the Keeley Treatment.

KEELEY Treatment For Tobacco Habit
 Successful For Over 50 Years

Quickly banishes all craving for tobacco. Write today for Free Book telling how to quickly Free yourself from the tobacco habit and our Money Back Guarantee.

Home of the famous Keeley Treatment for Liquor and Drugs. Booklet sent on request. Correspondence Strictly Confidential.
THE KEELEY INSTITUTE, Dept. A-949, Dwight, Illinois



dollars

for REPAIRS

... or pennies

for GOOD OIL?



WHEN poor lubrication of shop equipment can cost you so many repair dollars every year, isn't it wiser to spend a few cents more for oil that really *protects*?

Three-in-One Oil does far more than merely lubricate. As it *oils*, it also *cleans* the bearings and working parts and *guards* them against harmful rust. Blending from three different oils—*animal*, *mineral* and *vegetable*—makes 3-in-One do these jobs as no plain mineral oil ever can. Regular use of 3-in-One will add years to the life of all tools and equipment in your workshop.

Sold by all good stores, in handy cans and bottles. Write today for free sample.

THREE-IN-ONE OIL CO., DEPARTMENT A-115
 170 Varick Street, New York
 260 Second Ave., Ville St. Pierre, Montreal, Que.

3-IN-ONE OIL

CLEANS - OILS - PROTECTS



Stop!

Using Tobacco

Perhaps you've tried to stop using tobacco only to find that the habit has such a hold on you that you gave up trying.

You know, better than anyone else, whether tobacco is hurting you, and if it is, that sooner or later, it will undermine your health. Heart trouble, indigestion, dyspepsia, nervousness, insomnia, poor eyesight—these and many other disorders can often be traced directly to the use of tobacco, according to good medical authority. Besides it is an expensive, utterly useless habit.

Let Us Help You To Banish The Habit

No matter how firm a grip tobacco has on you—no matter whether you've been smoking cigars, pipe or cigarettes or chewing plug or fine cut for a month or 50 years—Tobacco Redeemer will in most cases remove all craving for tobacco in any form in a very few days. It does its work so quickly that all tobacco "hunger" is gone almost before you know it. The desire for a smoke or chew usually begins to decrease after the very first dose.

Tobacco Redeemer contains no habit-forming drugs of any kind—it is in no sense a tobacco substitute. It does not cause the slightest shock to the nervous system; on the contrary, it often helps to quiet the nerves and make you feel better in every way.

SEND for PROOF

Get our free booklet. It tells you all about the deadly effects of tobacco and how easy it is now to quit. We will also send you copies of letters from confirmed users telling how this simple, home-treatment freed them absolutely from the habit. Just mail coupon—or a postal will do.



NEWELL PHARMACAL CO.

Dept. 999 St. Louis, Mo.

Send me without obligation to me in any way, proof that Tobacco Redeemer will positively free me from the Tobacco Habit or my money will be refunded.

Name

Street and No.

Town.....State.....



Burning Feet

Ended in 3 seconds

HOW cool and refreshed your tired, burning, aching feet feel the instant Coolene is applied. Every throbbing nerve is soothed. Every bit of fire and pain is drawn from the swollen, irritated nerves and tissues. Pains from corns, bunions, and callouses go like magic. Coolene is greaseless, vanishes instantly. Ends all agonizing foot pains in 3 seconds. Get a jar today.



AGENTS AND SIGN MEN

Earn up to \$100 Weekly, and over, Putting up OUR GENUINE GOLD LEAF SIGN LETTERS

R

—on store and office windows, board signs, trucks and glass signs. We also make to order script signs and business emblems singly or by the thousands. A permanent business. No capital or experience required. Big demand in every City. Samples and Literature Free.

CONSOLIDATED SIGN LETTER CO. 71-X W. Van Buren CHICAGO, ILLINOIS

DEAFNESS IS MISERY



Many people with defective hearing and Head Noises enjoy conversation, go to Theatre and Church because they use Leonard Invisible Ear Drums which resemble Tiny Megaphones fitting in the Ear entirely out of sight. No wires, batteries or head piece. They are inexpensive. Write for booklet and sworn statement of the inventor, himself deaf.



A. O. LEONARD, Inc., Suite 699, 70 5th Ave., New York



How to Obtain A Better Looking Nose

Improve your personal appearance. My free book tells you how I guarantee to improve the shape of your nose by remodeling the cartilage and fleshy parts, quickly, safely, and painlessly, or refund your money. The very fine, precise adjustments which only my new patented Model 25 Nose Shaper possesses, make results satisfactory and lasting. Worn night or day. Over 100,000 users. Send for free book to M. TRILETY, Pioneer Nose Shaping Specialist Dept. 197 BINGHAMTON, N. Y.

SCIENCE FINDS NEW DRUGLESS GLAND STIMULANT

Science has discovered a new method of applying a positive-nature force. The method is wholly different—a tremendous step forward in regaining prostate gland health. Amazing effects produced in thousands of men, many beyond sixty.

"A hundred years ahead of modern medicine," writes a New York physician. Doctors and osteopaths are using and prescribing it. No drugs, medicine, massage or violet rays. Absolutely safe.

Does what Gland Tablets can never do. Directly stimulates prostate gland, often bringing about an amazing improvement within seven days. Also frequently tones up entire system, usually routs constipation. Bladder weakness and frequent painful urination often relieved as if by magic. Either you feel ten years younger in seven days, or you pay nothing.

Scientist's FREE book, "The Destroyer of Male Health," explains these amazing facts. This book is now FREE. No obligation at all. Simply ask for FREE book. THE ELECTRO THERMAL CO., W. J. Kirk, Pres., 2145 Morris Ave., Steubenville, Ohio.

When writing please mention Popular Mechanics

STENODE! Licensed and approved parts for the new Stenotube radio

KIT \$50

Foundation kit containing: Chassis; shields; preselector, detector and oscillator coils; I-F Transistors; Stenodial; balancing condenser; Stenoformer; four-gang tracking condenser; hardware. Special approved parts at a special price!

THE ONLY MODERN RADIO

ZEH BOUCK LABORATORIES

35-39 164th St.

FLUSHING, N. Y.

- Check enclosed. Send the foundation kit—
 Send literature and complete parts list—

-TO-

Name.....
 Address.....

EASY TO MAKE MONEY



in your spare time by building these miniature models of Ships, Coaches or Spinning Wheels—We supply all parts, easy to put together with full instructions and diagrams. Ready market and steady demand from gift shops and others at a good profit—Send 2 cent stamp for illustrated catalogue.

MINIATURE SHIP MODELS, INC.
 Dept. RT PERKASIE, Pa.

Canadian office, 90 King Street W. Toronto

Deaf 20 Years



But now I hear and will tell any deaf person FREE, who writes me, how I got back my hearing, and relieved head noises by a simple, invisible, inexpensive method which I myself discovered.

Geo. H. Wilson, President
 Wilson Ear Drum Company, Inc.
 769 Todd Bldg., Louisville, Ky.

G. E. Phonograph Motor

\$12.99 Value
 ONLY \$3.95

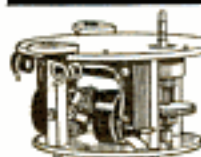

Synchronous 110 Volt, 60 Cycle, 80 R. P. M. Motor
 Can be installed in place of old fashioned hand winding spring motors. Also many other uses. These G. E. Electric motors are all brand new in original factory cartons. Fully guaranteed. \$12.00 value only \$3.95. Shipped Prepaid. Manufacturers and dealers write for Special Quantity prices.

NATIONAL JOBBING & EXPORT CO.
 Dept. A 192 N. Clark St. Chicago



Forms to cast Lead Soldiers, Indians, Trappers, Hunters, Wild and Farm Animals. 239 different forms to select from. Every Form guaranteed to cast perfect figures. Send 5c stamp for illustrated catalogue.

HENRY C. SCHIERCKE SPENCER RD. GHENT, N. Y.



Heat-proof
 Liquefied Graphite

REVOLUTIONIZES LUBRICATION

DISTRIBUTORS! Earn Up to \$100-\$150 Weekly

This amazing new lubricant astounds every user—makes motors perform almost unbelievable feats! PYROIL—for all internal combustion motors—protects every moving metal part. Seals rings, frees valves, reduces carbon, increases mileage by reducing friction-drag. Actually **doubles—triples** life of crankcase oil. Cuts repair bills, stops noise and wear.

Simply add to oil and gas. Purely a lubricant—cannot harm.

100% GUARANTEED—PATENT PROTECTED

Airplanes, automobiles, motor boats, trucks, tractors, farm machines, all develop amazing new efficiency with PYROIL.

Government tested and used. Endorsed by leading fleet owners.



TREMENDOUS DEMAND—ASSURED REPEATS

Nationwide acceptance and acclaim stamps PYROIL as the greatest lubricating development of all time.

Write at once for remarkable facts, proof, territorial offer and liberal sales plans. Don't Delay.

W. V. KIDDER, Pres.

THE PYROIL COMPANY
 591 Pyroil Bldg. La Crosse, Wisc.

Where High Quality and Low Price Meet

We are power tool specialists. Designing and manufacturing bench machinery is our sole business. For this reason BOICE-CRANE represents highest quality at lowest prices.



Guard Extra

Ball Bearing 4" Jointer

\$25

Ball bearing. Graduated fence tilts 2 ways. Long tables. Wide robot sets.

Every Machine Fully Guaranteed

This guarantee not only covers the quality, durability and performance of BOICE-CRANE equipment, but it also guarantees your personal satisfaction with our power tools. Such a sweeping guarantee can only go with tools that are designed right, made right and priced right. Get our big, complete catalog showing lathes, circular saws, band saws, jig saws, jointers, shapers, etc. Send 10c to partly pay mailing costs. Filled from cover to cover with interesting information and data.

W. B. & J. E. BOICE, PM 9G, Toledo, Ohio



19" Band Saw less \$32.50
 Guards...

Table tilts 45 degrees. Saws 4 1/2" thick. Bronze bearings. Very rigid frame. Blades for wood, metal or composition.

"If I wasn't an expert
before... I am now!"



"Since I've used Kester Radio Solder, I do a really slick repair job!"

A "half-way" or messy job of soldering radio connections is just naturally impossible when Kester is used! Perfect, professional results are absolutely assured. First because Kester has the plastic rosin flux that keeps out dust and moisture, and aids receptivity... second because it's so easy to use. The flux is inside the solder, and all you have to do is apply heat. The set-builders use Kester... so should you. Buy it from your radio store or from other dealers... or try it first at our expense. Kester Solder Company, 4201-04 Wrightwood Ave. Chicago, Illinois. Incorporated 1899.

FREE SAMPLE! Write for it NOW

KESTER RADIO SOLDER

New MYSTERY BOAT



Operates with Geyser Motor

This genuine miniature motor boat sells on sight to everyone on one minute demonstration, when they hear the motor put-out and see the boat speeding along before their eyes. Sell merchants too. Sample will be sent for \$1.50 prepaid or C. O. D. along with big money making offer and free demonstration outfit.

GOBAR PRODUCTS

Dept. P. 9, Merchandise Mart CHICAGO, ILL.

SELLS
FOR
\$1.00

NEW SHOE SOLES for 10c

New, soft pliable waterproof soles may now be yours for only 10c. Spreads on with a knife like butter and hardens over night. Agents bestirred of making up to \$25 daily write for no-cost sample offer. Universal Laboratories, Inc., Dept. 6298, Des Moines, Iowa

100 Shaves from EACH Blade

The Master-Hose puts a hair-splitting edge on the finest safety razor blade—ANY razor—in 5 seconds. Many get 100 shaves per blade. W. P. Walsh, Windsor, Ontario, used some blades daily, 8 months. Having given others thousands of smooth shaves from a single straight edge blade. Only shaving can put a NEW edge on a safety razor blade. This patented, absolutely best-of-its-kind, extra-size abrasive, makes each 10c blade give \$1 to \$2 worth of service. Also hones straight-edge blades. MONEY REFUNDED if not DELIGHTED.

YOURS FREE We will send you a Master-Hose absolutely free WITH FIRST ORDER of 12 for \$3; or send 50c for 1 or \$1 for 3, POSTPAID. Or you may send no money and pay when plus postal charges. But SEND TODAY.

WISCONSIN ABRASIVE CO.

Dept. 6096

Station A.

Milwaukee, Wis.



Agents

net up to \$20 a day. Mr. Nor sold 40 at noon hour. R. Blomson sold 1000 one week from window.

Earn Big Profits Making Keys

**Special Offer
for a limited
time only!**

One girl took in \$98.30 her first week! Be independent! Let us show you how. Write today!

BUILD A PERMANENT BUSINESS OF YOUR OWN!

Duplicate any type of key in one minute. Make new keys from lock number. New patented key cutting machine is simple, easily operated and fully guaranteed. No experience is needed. A boy or girl can cut perfect keys with it. Everyone needs keys. Be the one to fill the demand in your territory. Full information FREE, regarding machine, liberal time payment plan and special offer. Write quick.



Beisser Key Machine Co.
3921 Woodward Ave.
Detroit
Michigan

Special
Price
NOW!

BE YOUR OWN BOSS MAKE BIG PROFITS



The ELECTRIC CARPENTER

makes it easy to start a profitable business in your home workshop. Do general repair work, make screens, furniture, alterations. Not a toy. A complete planing mill, Saw table, Mortiser, Lathe, Shaper, Jointer, Bender and Fold-Over Band Saw. Ask for FREE illustrated Folder and "1001 Things to Make of Wood." AMERICAN FLOOR SURFACING MACHINE CO. 524 South St. Clair St. Toledo, Ohio

MAKE YOUR FORD INTO THIS SPORT CAR

Picture **WORTH'S STEEL REAR PATTERNS** \$3.99 De- You can easily convert your Ford into this Fast Sassy Sport-Car as thousands have with easily obtained materials. \$3.99 includes pressed metal rear. No need to lay up the car. Makes wonderful riding speed car. You'll be the talk of the town. Send dime for actual photo of sport car and new method of distinctive sport car patterns from \$1.99 up — "RKO" Steel "Dust-Lo" Underlugs \$1.99. Sport and speed accessories. ORDER RIGHT NOW for a real thrill.

KUEMPEL COMPANY, "Speed Engineers," No. 7 Kuempel Bldg., Guttenberg, Ia.

Let us recommend the best books to study on any subject. Popular Mechanics Press, Chicago, Illinois.

Get Into A Business of Your Own — EARN \$150 to \$300 Monthly



AUTOMATIC AIR SERVICE

Dependable, space saving compressors bring customers to your door. Only \$12 Monthly. 30 Days' Trial.



PAINT SPRAY PROFITS

Paint autos, houses, furniture. One man does work of 5 — highly profitable. Only \$12 Monthly, will pay its own way.



8-HOUR BATTERY CHARGING

Recommended by leading battery makers. Halves cost, doubles profits. No special set-up or license required.



20 MINUTE Car Washer

Big profits washing cars — saves 2/3 time, does better job. Savings pay for it. Only \$17 Monthly.

30 Days' Trial to prove it. Easy Terms. Check items of interest and mail to

HOBART BROTHERS
Box H-91, Troy, Ohio

WRITE TODAY » Only \$16 Monthly — 30 Days Trial to Prove it « NO OBLIGATION

Easy to Own Big Money Business

A delightful, dignified and fascinating business. Make and sell CRISPETTES. Delicious confection. Young and old like them. Come again and again for more. Easy to make. I supply all equipment. Raw material plentiful and cheap. Profits big. No town too small. Start now.

Quick Success Possible anywhere—cities, towns, villages; open a little retail store; or begin at home; wholesale to stores, grocers, bakers, druggists, parks, baseball games, picnics, wayside stands.

New Pop Corn Specialty Shops making lots of money now. Letters just received during past month tell of many successes.

We Start You in Business for little money. Supply machines, secret formulas, and raw material. Little capital starts you. No experience needed.



Write for "Book of Facts"—it's free, contains success letters from others—shows their places of business, tells how to start.

LONG-EAKINS COMPANY
928 High St.
Springfield, Ohio

LOG SAWS

MAKE MONEY—BE YOUR OWN BOSS
Turn Your Trees Into Cash
Be independent, start a wood sawing business, have money coming in all the time. Use the portable engine year 'round. Pays for itself. Low factory prices. Big FREE Catalog.

WITTE ENGINE WORKS
1746 OAKLAND AVE. KANSAS CITY, MO.

STOEGER STANDARD PAPER TARGETS
Complete line for Rifle & Revolver Target Shooters and Clubs. Fully illustrated in the most complete Arms & Ammunition catalog ever issued. Send 25c in stamps for this 144 page catalog.
A. F. STOEGER, Inc., 509 5th Avenue, N. Y.

AERO WORLD-WIDE
Only \$6.45
Short Wave Receiver
Span the World with this Set!

A new radio thrill for you! Listen in DIRECT to London, Paris, Berlin, Buenos Aires and other broadcasting stations throughout the world via short waves. Enjoy unique foreign programs from strange lands. Your ordinary receiver cannot tune in these low wave stations. **WORLD-WIDE RECEIVER** gets 14 to 550 meter stations with surprising clarity. **SEND NO MONEY!** Just write your name and address on a postcard and ask us to send you this wonderful guaranteed short wave set. Pay postman \$6.45 plus a small delivery charge. All orders west of Rockies must be accompanied by \$1.00 deposit. Foreign countries \$7.75 delivered. Write today for new catalog of radio bargains.

CHAS. HOODWIN CO., Successors to Aero Products, Inc.
4240 Lincoln Ave., Dept. J-2 CHICAGO

Buy DIRECT
on credit
at New
Low Prices
Our 1931 Cut-Price
Offers a Remarkable
Opportunity to Own
A 21 Jewel—
**Santa Fe
Special**



Send for Catalog Now!

Compare
the **Santa Fe Special**
with other Watches costing
30% to 50% more

Send No Cash In addition to our NEW LOW PRICE, I will send for your approval one of these Standard Watches, guaranteed for a lifetime of satisfactory service, not only by the Santa Fe Watch Company, but by the Great Illinois Watch Factory. So accurate, Government officials carry them; so perfect and beautiful, jewelers say they are worth 1-3 to 1-2 more than we ask for them. I will send you one to see WITH-OUT ONE PENNY DOWN—allow you to wear it 30 days FREE—then sell it to you on easy payments.

Diamond Rings— Wrist Watches

Write for our New Diamond Ring of Romance and Bulova Wrist Watch Catalog, showing marvelous new designs. Never have we been able to offer such beautiful diamond rings and artistic dependable watches at such low prices. The catalog is sent FREE. Ask for our Special Spot Cash Offer, Good for 30 days only.

Santa Fe Watch Co.

96 Thomas Bldg., KANSAS

TOPEKA

To SANTA FE WATCH CO.,

96 Thomas Bldg., Topeka, Kans.

Please send me catalog I have checked.

Railroad and dress Pocket Watches.....

Ladies' and Men's Wrist Watches.....

Ladies' and Men's Diamond Rings.....

Name.....

Address.....

A New Tool for Woodworkers

Delta Combination No. 468—Jointer, Circular Saw, with Boring, Routing and Mortising Attachment—all mounted on convenient portable stand—is being greeted enthusiastically by woodworkers everywhere. And this new unit is just one of the large line of Delta moderate-priced, practical, and efficient motor-driven tools. They all save you time, money, and labor. Find out more about them. Write today.



"Delta" Boring and Routing Attachment makes child's play out of difficult boring, routing and mortising. Easy to operate. Furnished separate if desired.

"Delta" Combination Circular Saw and Jointer—Each unit may be operated separately—furnished with or without motor.

Complete Delta 1931 line includes: Woodturning Lathes, Jointers, Circular Saws, Band Saws, Mortiser and Router, Moulding Cutters, Shaper, Scroll Saws, and Complete Hand-Shops.

10 Day Trial—Easy Terms

Send today for complete details and FREE illustrated literature fully describing the new 1931 "Delta" line of woodworking units. You will learn also how you can try any "Delta" equipment for 10 days under actual working conditions—AT OUR RISK. Choice of three convenient Easy Payment Plans. Write TODAY!

DELTA SPECIALTY COMPANY

Division of Delta Mfg. Company
1775 N. Holton St. Dept. A, 331, Milwaukee, Wis.

\$50.00 SHIP MODEL for \$4.50 COACH MODEL for \$4.98



We furnish all parts cut to fit, numbered and ready to assemble for the following models: Clipper Ship and Flying Cloud (with electric lights), Santa Maria, Mayflower, La Pinta, \$4.50—Columbus, \$4.98—SPANISH GALLEON fully equipped for electrical illumination, \$4.98—COACH MODELS: Geo. Washington, Princeton to Philadelphia, TALLY-HO, Deadwood, Overland Western. Our new Illustrated Catalog FREE. All models sent C. O. D. Foreign orders accompanied by check or money order. Illustrated Catalog free on request. C. J. BIERBOWER, Dept. PM3216 Baring St., Philadelphia. Originator of Build Your Own Ship Model.

ADJUSTABLE INK FEED AND RUBBER SPONGE

ON THIS No. 8 fountain pen, as shown, make this pen write better and sell faster than any other on the market. A trial order will convince you. MONEY BACK IF NOT PLEASED. Sells regularly for \$1.25, can be sold at special price of 75c. GUARANTEED FOR LIFE.

SAMPLE ONLY
39c

ADJUSTABLE INK FEED



FREE

over 800 fast sellers. WRITE FOR YOUR COPY NOW.

SPORS IMPT. CO., 731 Main Street, LE CENTER, MINN.

When writing to advertisers please mention Popular Mechanics

\$1500 A DAY

Easily Earned

Big cash Profits earned daily taking orders for our high-grade made-to-measure, all-wool suits. Beautifully styled. New low prices—\$21.50—\$23.50—\$29.50—\$36.50 retail, direct to wearer. Real quality all the way thru. Just show samples and you sell on the spot. Big commissions paid daily. Steady repeat business. Free Ford Sedan to hustlers. Write at once for particulars.

all Wool SUITS \$21.50

SPENCER MEAD COMPANY. Dept. J-816
Harrison and Throop Sts. Chicago, Ill.

\$BIG MONEY\$

QUICK, EASY SELLING RADIANT HEATER

"Made \$100 in a day" says Sponglar. "Cleared \$33.00 in a day" says Maloney. Yes, you, make Big Money selling Sunshine Radiant Heater! Gives clean, beautiful Gas Heat—wherever you live. Makes and burns own gas. No piping. No installation. No dirt, smoke, ashes. Easily carried anywhere. Below zero is not too cold for Sunshine. It is bringing cheery comfort to thousands of homes now. Every home, store, etc., a good prospect. New low prices make easy sales. Your profit is not cut.

15-Days Trial—Try FREE—Start-Sunshine in your own home 15 days. Know why Write Quick!

Sunshine Products Co., 331 Factory Bld. Kansas City, Mo.

You Collect Your Profits in Advance!

No stock to buy

GAS HEAT Anywhere—1 1/2¢ PER HOUR

\$20 A DAY

Sensational new invention. Increases strength of headlight 15%. No glare. Protrudes for and rubs shaft for \$1.50 a pair. Every month earns on sight. Guaranteed. Agents earn more than \$20.00 per day. Send for exclusive agents offer. Now—today. Only a few territories open.

SIKO SALES, INC.
Dept. A, 69 Union St., Newton Centro, Mass.

SIKO NON-GLARE

NO JOKE TO BE DEAF

—EVERY DEAF PERSON KNOWS THAT George P. Way made himself hear, after being deaf for 25 years, with Artificial Ear Drums



—his own invention. He wore them day and night. They stopped head noises and ringing ears. They are invisible and perfectly comfortable. No one sees them. Write for his true story, "How I Got Deaf and Made Myself Hear." Also booklet on Deafness. Address



Artificial Ear Drum

George P. Way, Inc., 605 Hofmanns Building, Detroit, Michigan

AGENTS—BIG MONEY IN NEW FLASHER SIGN

New Price \$5.00. Neon like effect. Write for Details. WILLIAMS SIGN CO. Dept. 4-9
117 W. Austin Ave. Chicago

CHROMIUM PLATING POWDER

PLATES IRON, STEEL, NICKEL, BRASS AND COPPER without electricity or machinery. Guaranteed not to tarnish; dispenses with polishing. Half pint can \$1.50, prepaid. Particulars FREE. GUNMETAL CO., Ave. T, Decatur, Illinois

**RUCKSTELL
FORD
SPEED
UNITS**

70 to 80 mi. pr. hr.

Step Ahead
of the rest

Synchro-Shift

60 mi. pr. hr. in Silent Second

with a
**RUCKSTELL
Equipped!
FORD!**

Four new Ruckstell Speed-Plus Combinations put 70 to 80 miles-per-hour top-speed within the reach of every Ford owner.

Ruckstell High-Compression Power Head of Alcoa Aluminum Alloy, Two Quiet High Synchro-Shift Transmission, and special Downdraft carburetor provide, in addition, new power, pep and vibrationless smoothness that put Ford performance and comfort ahead of anything else on the road, regardless of price.

Completely assembled—simply replace standard Ford parts with no cutting, changing or altering of any parts. Write for prices.

**RUCKSTELL DISTRIBUTING
COMPANY**
748 E. 140th ST. CLEVELAND, O.

Books on 32 Subjects

Popular Mechanics Press specializes in supplying books on any subject. Look over this list. Check the books you want, and mail this advertisement as your order blank. Catalog with lists on 2,000 subjects free.

AIRCRAFT (Modern) Complete, Up-to-date... \$5.00	INVENTIONS How to Make Pay... \$2.50
ARTIST (Commercial) Money-Making Art... \$5.00	LETTERING AND DESIGN Studio Handbook of... \$3.00
ATLAS (of World) Modern. New Boundaries... \$3.00	MAGIC World's Best Book of... \$2.00
AUTOMOBILE Painting... \$1.50	PAINTS AND COLORS Mixing of... \$2.00
BOOKKEEPING Practical Handbook... \$1.00	PICTURES (FUNNY) How to Draw... \$3.00
BRICKLAYING Plain and Fancy... \$1.50	PLASTERING Best Instruction Manual... \$1.25
CARBURETORS (All Makes) Only Book Covering... \$2.00	RADIO ENCYCLOPEDIA Very Complete... \$6.00
CHALK TALK and Crayon Presentation... \$1.25	REAL ESTATE Educator... \$2.00
DRAWING Freehand and Perspective... \$1.50	SHOW CARDS Artistic... \$3.50
DRY CLEANING (Practical) and Dyer... \$3.00	SIGN PAINTING Laquer System of... \$3.00
FLOWER RAISING 1001 Questions Answered... \$2.00	Steam Engineer's License How to Obtain... \$2.00
FLYING Simplified... \$1.00	STEEL SQUARE How to Use... \$1.00
FUR RAISING For Profit... \$4.00	TELESCOPE (Amateur's) How to Make... \$3.00
FURNITURE REPAIRING Finishing and Decoration... \$5.00	TOOLS (Using) Tinkering with Tools... \$2.00
HOME FURNISHING and Decoration... \$3.00	TRICKS (200) For the Amateur... \$1.00
	WOOD FINISHING Plain and Decorative... \$2.00
	WOODWORKING (New) Most Complete Book for Amateurs... \$2.00

-----SEND NO MONEY-----

Just check the books you want, and mail the whole advertisement. It is your order blank. When postman hands you books, pay him the price and few cents postage. If outside the U. S. remit when ordering and include 10 cents per book extra for postage.

POPULAR MECHANICS PRESS, Room P9, 200 East Ontario St., Chicago, Ill.

Only by Building the 11 Tube

STENODE

Designed by Stenode Engineers under the direction of Dr. James Robinson



STENODE selectivity curve makes 100% selectivity, so-called, look like broad tuning.



STENODE selectivity is compared above to that of ordinary receivers. All background noise is contained in outer curve. Stenode's curve, shaded, contains but 1/30 the total noise.



Made in England

STENOTUBE. Only one required in each Stenode.

This heart of the Stenode circuit consists of a quartz crystal ground to 175 KC frequency and mounted in tube form for easy handling. Standard UX socket base.

Price \$15

Now genuine without the inventor's signature.

James Robinson



9 Blue Prints
Data Book
Direction Book
ALL for \$10
ONLY

The STENODE opens up new fields for shortwave and television work, as well as broadcasting. Full details of all sorts of applications are given in the STENODE Data Book. Nine full-sized diagrams show where to place every part. How to make every connection is clearly told in STENODE Book of Directions. Your finished STENODE will put you into a new world of radio. Fill in and mail the coupon with your money order for the biggest value ever offered custom set builders.

STENODE CORP. OF AMERICA, HEMPSTEAD GARDENS, L. I. N. Y.
(Formerly American Radiostat Corp.)

STENODE CORP. OF AMERICA
Hempstead Gardens, L. I., N. Y.

Enclosed find Money Order Check, for \$..... Please forward me STENOTUBE, BLUE PRINTS, DATA BOOK and DIRECTION BOOK, for building STENODE.

Name

Street

City State

"IF IT ISN'T A STENODE IT ISN'T A MODERN RECEIVER"



Isn't she worth fighting for?

She believes in you and trusts you and she's depending on you to fight some of her battles for her.

As wife or mother, she can't go out in the world and earn the money necessary to support a family in comfort. That is your job.

Are you fair to her when you let the days drift by without making a real effort to get ahead? Is it right to ask her to scrimp and save and deny herself when with just a little grit and effort you could provide her with the comforts and luxuries she would like to have?

Think this over—then act! Decide today that you are going to get the special training that is becoming more and more necessary in every line of business.

There is an easy, fascinating way to do it. Right at home, in the spare time that now goes to waste, the International Correspondence Schools will prepare you for advancement and more money.

At least find out how by marking and mailing the same salary-raising coupon that has meant so much to so many other men in just your circumstances.

It doesn't cost you a penny or obligate you in any way to do this, but it may be the means of changing your entire life. Do it now. Do it for HER.

Mail Coupon for Free Booklet

INTERNATIONAL CORRESPONDENCE SCHOOLS

"The Universal University"

Box 5362-G, Scranton, Penna.

Without cost or obligation, please send me a copy of your booklet, "Who Wins and Why," and full particulars about the subject before which I have marked X:

TECHNICAL AND INDUSTRIAL COURSES

- | | |
|--|--|
| <input type="checkbox"/> Architect | <input type="checkbox"/> Automobile Mechanic |
| <input type="checkbox"/> Architectural Draftsman | <input type="checkbox"/> Plumbing <input type="checkbox"/> Steam Fitting |
| <input type="checkbox"/> Building Estimating | <input type="checkbox"/> Heating <input type="checkbox"/> Ventilation |
| <input type="checkbox"/> Wood Millworking | <input type="checkbox"/> Sheet Metal Worker |
| <input type="checkbox"/> Contractor and Builder | <input type="checkbox"/> Steam Engineer |
| <input type="checkbox"/> Structural Draftsman | <input type="checkbox"/> Steam Electric Engineer |
| <input type="checkbox"/> Structural Engineer | <input type="checkbox"/> Civil Engineer |
| <input type="checkbox"/> Electric Wiring | <input type="checkbox"/> Surveying and Mapping |
| <input type="checkbox"/> Electrical Engineer | <input type="checkbox"/> Refrigeration |
| <input type="checkbox"/> Electric Lighting | <input type="checkbox"/> R. R. Locomotives |
| <input type="checkbox"/> Welding, Electric and Gas | <input type="checkbox"/> R. R. Section Foreman |
| <input type="checkbox"/> Reading Shop Blueprints | <input type="checkbox"/> R. R. Bridge and Building Foreman |
| <input type="checkbox"/> Telegraph Engineer | <input type="checkbox"/> Air Brakes <input type="checkbox"/> Train Operation |
| <input type="checkbox"/> Telephone Work | <input type="checkbox"/> Highway Engineering |
| <input type="checkbox"/> Mechanical Engineer | <input type="checkbox"/> Chemistry <input type="checkbox"/> Pharmacy |
| <input type="checkbox"/> Mechanical Draftsman | <input type="checkbox"/> Coal Mining Engineer |
| <input type="checkbox"/> Machinist <input type="checkbox"/> Toolmaker | <input type="checkbox"/> Navigation <input type="checkbox"/> Boilermaker |
| <input type="checkbox"/> Patternmaker | <input type="checkbox"/> Textile Overseer or Supt. |
| <input type="checkbox"/> Pipefitter <input type="checkbox"/> Tinsmith | <input type="checkbox"/> Cotton Manufacturing |
| <input type="checkbox"/> Bridge Engineer | <input type="checkbox"/> Woolen Manufacturing |
| <input type="checkbox"/> Bridge and Building Foreman | <input type="checkbox"/> Agriculture <input type="checkbox"/> Fruit Growing |
| <input type="checkbox"/> Gas Engines <input type="checkbox"/> Diesel Engines | <input type="checkbox"/> Poultry Farming <input type="checkbox"/> Radio |
| <input type="checkbox"/> Aviation Engines | <input type="checkbox"/> Marine Engineer |

BUSINESS TRAINING COURSES

- | | |
|---|--|
| <input type="checkbox"/> Business Management | <input type="checkbox"/> Business Correspondence |
| <input type="checkbox"/> Office Management | <input type="checkbox"/> Lettering Show Cards <input type="checkbox"/> Signs |
| <input type="checkbox"/> Industrial Management | <input type="checkbox"/> Stenography and Typing |
| <input type="checkbox"/> Personnel Management | <input type="checkbox"/> Complete Commercial |
| <input type="checkbox"/> Traffic Management | <input type="checkbox"/> Civil Service <input type="checkbox"/> Mail Carrier |
| <input type="checkbox"/> Accountancy <input type="checkbox"/> Cost Accountant | <input type="checkbox"/> Railway Mail Clerk |
| <input type="checkbox"/> C. P. Accountant | <input type="checkbox"/> Grade School Subjects |
| <input type="checkbox"/> Bookkeeping | <input type="checkbox"/> High School Subjects |
| <input type="checkbox"/> Secretarial Work | <input type="checkbox"/> College Preparatory |
| <input type="checkbox"/> Spanish <input type="checkbox"/> French | <input type="checkbox"/> Illustrating <input type="checkbox"/> Cartooning |
| <input type="checkbox"/> Salesmanship <input type="checkbox"/> Advertising | <input type="checkbox"/> Lumber Dealer |

Name..... Age.....

Address.....

City..... State.....

Occupation.....

If you reside in Canada, send this coupon to the International Correspondence Schools, Canadian, Limited, Montreal, Canada

Popular!

YOU will be doubly welcome everywhere when you learn to play a Conn. Chances to join a band or orchestra, to travel, to make extra money. Conns are the choice of Sousa and the world's greatest artists. Easiest to play. Recommended to beginners for quicker progress.

FREE TRIAL, EASY PAYMENTS on any Conn. No matter which band or orchestra instrument interests you most, Conn will send you a special booklet on that instrument giving valuable facts.

C. G. CONN, Ltd., 931 Conn Bldg., Elkhart, Ind.

CONN

World's Largest Manufacturers of BAND INSTRUMENTS

Write for FREE BOOK
Mention Instrument

FREE

Get BB Magic at once. A wonderful shooter's digest—tellsho to hold, aim and handle rifles; helps you guide others in correct knowledge of guns. Gives facts that make crack shots. Gives safety and common sense instruction parents all like.

SEND NOW!

The principle of compressed air action that made the Benjamin Single Shot world famous has been applied to 25 shot automatic rapid firing. Learn all about both guns. Write!

Benjamin Air Rifle Co., 649 N. Broadway, St. Louis, Mo.

RAISE CHINCHILLA

AND NEW ZEALAND WHITE FUR RABBITS

Make Big Money We Supply Stock AND CONTRACT FOR ALL YOU RAISE

Save up to \$2.50 each. Large illustrated book catalog and contract, also copy of Fur Farming Magazine, all for 30c. STANLEY'S OUTDOOR ENTERPRISE CO., Box 141A, Holmes Park, Missouri

HOME WOODWORKING NOW EASY

Earn an extra income in spare hours with H & A equipment. Easy to learn. Profitable and pleasant work. New H & A Spindle Shaper produces finest shaper and moulding work with expert ease. Highly accurate. Reversible Rotation. Steady High Speed. Self-binding adjustment. Low priced. Portable. Electric. Write for FREE H & A catalog giving complete details, and other H & A portable electric wood-working equipment. Dealers and jobbers—special offer. Write today.

HESTON & ANDERSON, 609 Stone Street, FAIRFIELD, IOWA

ONE-MAN SAW MILL

Makes lumber, shingles, cross ties, fence posts, laths, fruit and vegetable crates and boxes, dimension blanks for furniture, etc. Splits blocks into firewood. Needed by farmers, timber owners, contractors. Pays for itself in a week, or on one job. Guaranteed. Sold direct from factory. Write today for special offer and Free Book "How To Make Lumber."

39 BRINGS IT TO YOU

BEISAW MACHINERY CO., 704-C, Migs. Ex. Bldg., Kansas City, Mo.

450 MILES in a gallon of gas

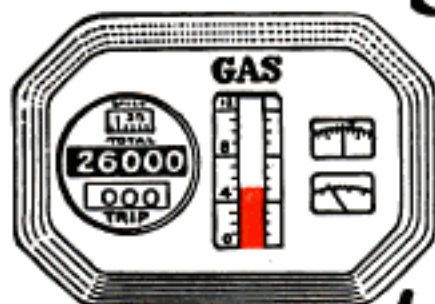

*startling
statement
of famous
Automotive Engineers*

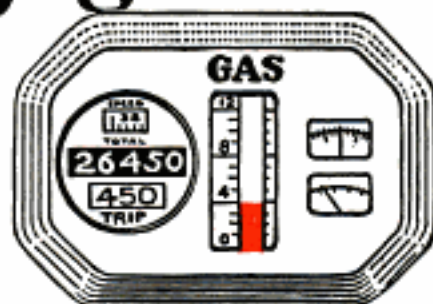

How to increase gasoline mileage has been a problem that Automotive Engineers have been trying for years to solve. Recently a world famous engineer made the statement that the energy produced by burning a gallon of gasoline would run an auto a distance of 450 miles. Other well known authorities go on record as saying that eventually it may be possible to get over four times as much out of gasoline as in the past.

Amazing Whirlwind Device Saving Millions of Gallons of Gas for Auto Owners

The Whirlwind Carbureting device embodies scientific features which conserves part of the gasoline that formerly went to waste.

Letters coming into the office tell of record mileages resulting in amazing gas savings. Low gasoline mileage is reported on practically every make of car. Greater power and smoother running motors are also noticed by users. The cost of the Whirlwind is so little that, basing its gas saving features even on the most modest reports, it would pay for itself almost immediately and then save many, many dollars for its owner by reducing gasoline consumption.

Car owners all over the world are saving money every day with the Whirlwind, besides having better operating motors. Think what this means on your own car. Figure up your savings—enough for a radio—a bank account—added pleasures. Why let the Oil Companies profit by your waste? Find out about this amazing little device that will pay for itself every few weeks in gas saving alone.

FITS ALL CARS

In just a few minutes the Whirlwind can be installed on any make of car, truck or tractor. It's actually less work than changing your oil or putting water in the battery. No drilling, tapping or changes of any kind necessary. It is guaranteed to work perfectly on any make of car, truck or tractor, large or small, new model or old model. The more you drive the more you will save.

SALESMEN and DISTRIBUTORS WANTED To Make Up To \$100.00 a Week and More

Whirlwind men are making big profits supplying this fast-selling device that car owners cannot afford to be without. Good territory is still open. Free sample offer to workers. Full particulars sent on request. Just check the coupon.

WHIRLWIND MANUFACTURING CO.
Dept. 686-A, Station C. Milwaukee, Wis.

GUARANTEE

No matter what kind of a car you have—no matter how big a gas eater it is—the Whirlwind will save you money. We absolutely guarantee that the Whirlwind will more than save its cost in gasoline alone within thirty days, or the trial will cost you nothing. We invite you to test it at our risk and expense. You are to be the sole judge.

FREE OFFER COUPON

WHIRLWIND MANUFACTURING CO.,
Dept. 686-A, Station C, Milwaukee, Wis.

Gentlemen: You may send me full particulars of your Whirlwind Carbureting device and tell me how I can get one free. This does not obligate me in any way whatever.

Name.....

Address.....

City.....State.....

() Check here if you are interested in full or part time salesman position.



To smokers who are **HARD-TO-CONVINCE**

We like nothing better than to induce a hard-to-convince smoker to switch to Camels for just one day.

For we know that after he has made a real test, it will be mighty hard to lure him away from this famous brand. It's not easy to smoke parched-dry cigarettes once you have known the delights of perfectly conditioned Camels.

After inhaling the cool, soft fragrance of the Camel blend of choice Turkish and mellow Domestic tobaccos protected by the Humidor Pack, your throat protests against the bite and sting and harsh hotness that comes from crumbly, dry tobacco.

No matter where you pick them up, in any land, in any climate, Camels are the same fresh, factory-prime cigarettes.

For the Humidor Pack of moisture-proof Cellophane air-seals all the flavor in and keeps out weather, dust and germs.

This is no mere advertising story. It is a recitation of fact that has made the whole country conscious of a new superiority in Camels.

If you are hard to convince, won't you switch to Camels for just one day? Then leave them — if you can.

- *Don't remove the moisture-proof Cellophane from your package of Camels after you open it. The Humidor Pack is protection against sweat, dust and germs. It delivers fresh Camels and keeps them right until you smoke the last one*

© 1931, R. J. Reynolds Tobacco Company, Winston-Salem, N. C.

CAMELS

NO CIGARETTY AFTER-TASTE