

AUGUST

N.S.E.
25 CENTS

POPULAR MECHANICS MAGAZINE

WRITTEN SO YOU CAN UNDERSTAND

REGD. TRADE MARK, GREAT BRITAIN, NO. 40428

REG. U.S. PAT. OFF.



SEE PAGE 191

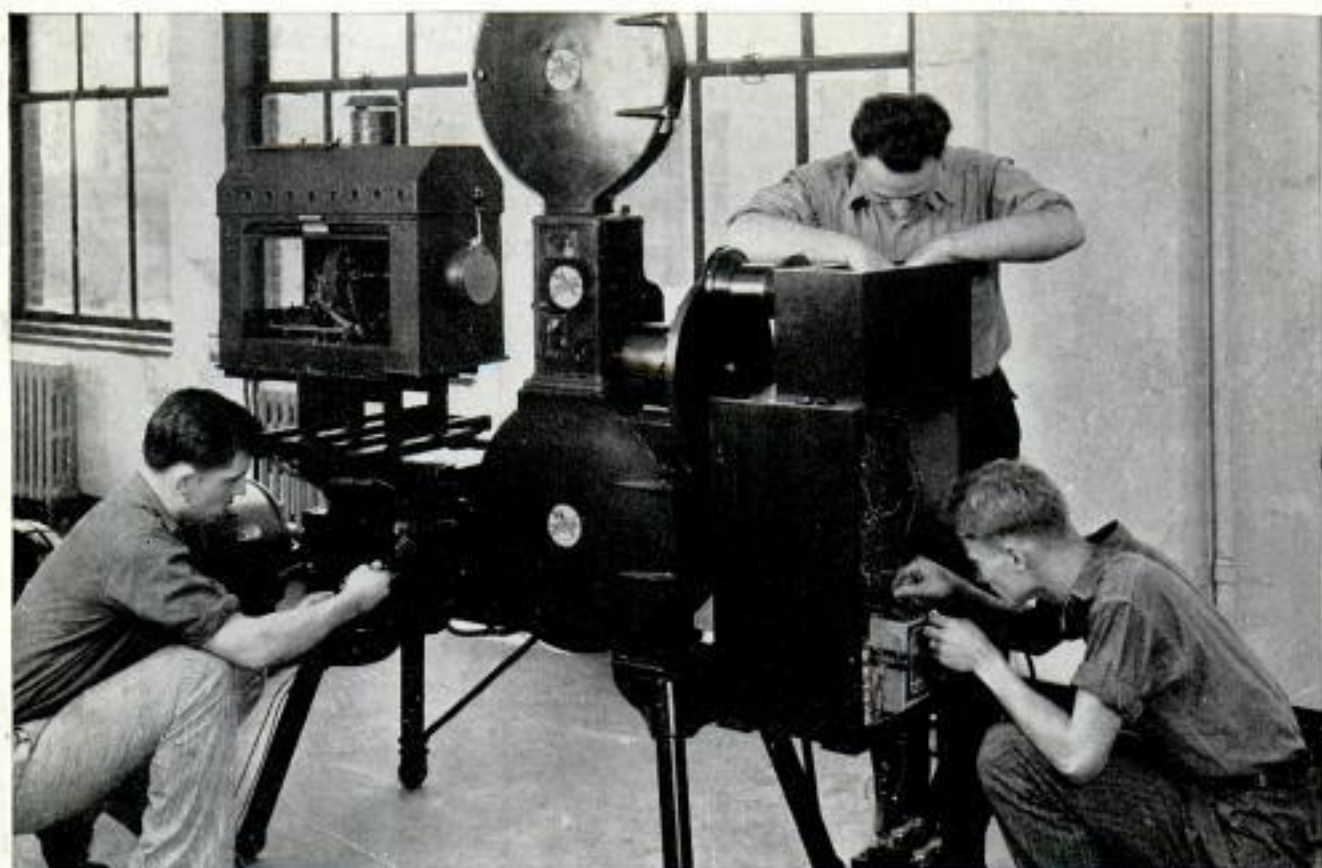

STUDENTS WORKING ON FILM SCANNING MACHINE OF OUR MODERN TELEVISION TRANSMITTER

LEARN RADIO-TELEVISION TALKING PICTURES in 10 WEEKS

By Actual Work ... In The Great Shops of Coyne

Don't spend your life slaving away in some dull, hopeless job! Don't be satisfied to work for a mere \$20 or \$30 a week. Let me show you how to make REAL MONEY IN RADIO—THE FASTEST-GROWING, BIGGEST MONEY-MAKING GAME on Earth!

**Jobs Leading to Salaries
Of \$60, \$70 a Week and Up**

Jobs as Designer, Inspector and Tester, paying \$3,000 to \$10,000 a year—as Radio Salesman and in Service and Installation Work, at \$45 to \$100 a week—as Operator or Manager of a Broadcasting Station, at \$1,000 to \$5,000 a year—as Wireless Operator on a Ship or Airplane, as a Talking Picture or Sound Expert—HUNDREDS OF OPPORTUNITIES for fascinating, BIG PAY JOBS!

**NO BOOKS—NO LESSONS
ALL PRACTICAL WORK**

Coyne is NOT a Correspondence School. We don't attempt to teach you from books or lessons. We train you on the finest outlay of Radio, Television and Sound equipment in any school—on scores of modern Radio Receivers, huge Broadcasting equipment, the very latest Television apparatus, Talking Picture and Sound Reproduction equipment, Code Practice

H. C. Lewis, Pres. **Radio Division** Founded 1899
COYNE ELECTRICAL SCHOOL
500 S. Paulina Street, Dept. Cr-3H Chicago, Illinois

equipment, etc. You don't need advanced education or previous experience. We give you—right here in the Coyne Shops—all the actual practice and experience you'll need. And because we cut out all useless theory, you graduate as a Practical Radio Man in 10 weeks' time.

**TELEVISION
IS NOW HERE!**

And TELEVISION is already here! Soon there'll be a demand for THOUSANDS of TELEVISION EXPERTS! The man who learns Television NOW can make a FORTUNE in this great new field. Get in on the ground-floor of this amazing new Radio development! Come to COYNE and learn Television on the very latest, newest Television equipment.

**Talking Pictures
A GREAT FIELD**

Talking Pictures and Public Address Systems offer thousands of golden opportunities to the Trained Radio Man. Here is a great new field of Radio work that has just started to grow! Prepare NOW for these marvelous opportunities! Learn Radio Sound work at Coyne

on actual Talking Picture and Sound Reproduction equipment.

Earn as You Learn

You Get FREE Employment Service for Life. And don't let lack of money stop you. If you need part-time work while at school to help pay living expenses, we gladly help you get it. Many of our students pay nearly all of their expenses that way. Mail the coupon below for full particulars!

Coyne is 32 Years Old

Coyne Training is tested, proven beyond all doubt. You can find out everything absolutely free. How you can get a good Radio job or how you can go into business for yourself and earn from \$3,000 to \$15,000 a year. It costs NOTHING to investigate! Just MAIL THE COUPON for YOUR COPY OF MY BIG FREE BOOK!

H. C. LEWIS, President
Radio Division, Coyne Electrical School
500 S. Paulina St., Dept. Cr-3H, Chicago, Ill.

Send me your Big Free Radio Book and all details of your Special Introductory Offer. This does not obligate me in any way.

Name.....
Address.....
City..... State.....

450 MILES in a gallon of gas

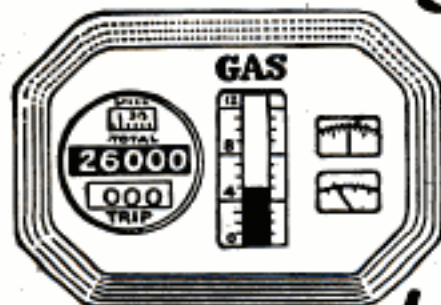

*startling
statement
of famous
Automotive Engineers*

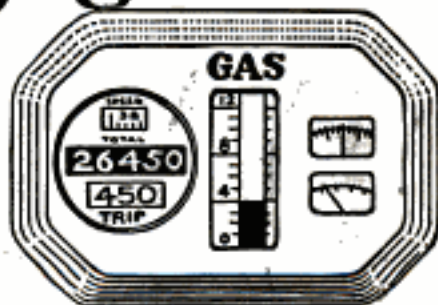

How to increase gasoline mileage has been a problem that Automotive Engineers have been trying for years to solve. Recently a world famous engineer made the statement that the energy produced by burning a gallon of gasoline would run an auto a distance of 450 miles. Other well known authorities go on record as saying that eventually it may be possible to get over four times as much out of gasoline as in the past.

Amazing Whirlwind Device Saving Millions of Gallons of Gas for Auto Owners

The Whirlwind Carbureting device embodies scientific features which conserves part of the gasoline that formerly went to waste.

Letters coming into the office tell of record mileages resulting in amazing gas savings. Low gasoline mileage is reported on practically every make of car. Greater power and smoother running motors are also noticed by users. The cost of the Whirlwind is so little that, basing its gas saving features even on the most modest reports, it would pay for itself almost immediately and then save many, many dollars for its owner by reducing gasoline consumption.

Car owners all over the world are saving money every day with the Whirlwind, besides having better operating motors. Think what this means on your own car. Figure up your savings—enough for a radio—a bank account—added pleasures. Why let the Oil Companies profit by your waste? Find out about this amazing little device that will pay for itself every few weeks in gas saving alone.

FITS ALL CARS

In just a few minutes the Whirlwind can be installed on any make of car, truck or tractor. It's actually less work than changing your oil or putting water in the battery. No drilling, tapping or changes of any kind necessary. It is guaranteed to work perfectly on any make of car, truck or tractor, large or small, new model or old model. The more you drive the more you will save.

SALESMEN and DISTRIBUTORS WANTED To Make Up To \$100.00 a Week and More

Whirlwind men are making big profits supplying this fast-selling device that car owners cannot afford to be without. Good territory is still open. Free sample offer to workers. Full particulars sent on request. Just check the coupon.

WHIRLWIND MANUFACTURING CO.
Dept. 644-A, Station C. Milwaukee, Wis.

GUARANTEE

No matter what kind of a car you have—no matter how big a gas eater it is—the Whirlwind will save you money. We absolutely guarantee that the Whirlwind will more than save its cost in gasoline alone within thirty days, or the trial will cost you nothing. We invite you to test it at our risk and expense. You are to be the sole judge.

FREE OFFER COUPON

WHIRLWIND MANUFACTURING CO.,
Dept. 644-A, Station C, Milwaukee, Wis.

Gentlemen: You may send me full particulars of your Whirlwind Carbureting device and tell me how I can get one free. This does not obligate me in any way whatever.

Name **This One** ..

Address ..

City ..

(..



HY6J-TZL-JE2P

SAVING MONEY

FOR TELEPHONE SUBSCRIBERS



DURING the past fifty-five years, the constant effort of the Bell System has been to provide efficient telephone service for all the people at the lowest possible price. There are many instances of substantial savings for subscribers.

Since the latter part of 1926 the reductions in long distance rates have been particularly noteworthy. For example, a telephone call across the country from New York to San Francisco now costs only \$16.50. Reductions have also been made for lesser distances. As a result of these rate reductions telephone users are saving the substantial amount of \$20,000,000 annually.

You, as a telephone subscriber, are constantly

receiving extra value from your telephone—because the number of subscribers is increasing and the more people you can reach by telephone the more valuable it is to you.

Today, there are few things purchased by the family or by a business that give so much useful service at such low price as the telephone.

Every time you pick up the telephone you become part of a communication system that uses eighty million miles of wire and represents an investment of more than four thousand million dollars. Yet the cost of local service that puts you in direct personal touch with thousands of hundreds of thousands of people in your town or city is only a few cents a day.

★ AMERICAN TELEPHONE AND TELEGRAPH COMPANY ★



Popular Mechanics Magazine

200 E. Ontario Street, Chicago, U. S. A.

H. H. WINDSOR, Founder

H. H. WINDSOR, Jr., Editor and Publisher

London: Messageries Hachette,
3 La Belle Sauvage, Ludgate Hill, E. C. 4

Paris: Hachette & Cie.,
111 Rue Reaumur

Melbourne: Gordon & Goetz
509-513 Little Collins St.

ISSUED MONTHLY

SUBSCRIPTION:

SINGLE COPY, 25 CENTS

In United States and its possessions, Canada, Cuba, Mexico, and all countries in the Pan-American Postal Union, per year, postpaid } \$2.50

To all other countries in the Postal Union 3.00

All subscriptions are discontinued at expiration. Please examine the date printed on your wrapper.

Entered as Second Class Matter Sept. 15, 1905, at the Post Office at Chicago, Illinois, under Act of March 3rd, 1879.

Entered as Second Class Matter at the Post Office Department, Canada.

Published monthly by POPULAR MECHANICS CO.

Copyright, 1931, by Popular Mechanics Co.

Copyright in Australia. Copyright in France

Vol. 56

Contents for August, 1931

No. 2

Special Features

<u>The White Squadron Sails Again</u>	195
<u>On the Trail of the Radio Pirates</u>	200
<u>The Truth About Our National Bird</u>	211
<u>The New Wonders of Movie Make-Up</u>	216
<u>Into the Sunset on Tireless Wings</u>	228
<u>Solving the Greatest Chemical Mystery</u>	242
<u>The Conquest of Flaming Death</u>	248
<u>By Auto to Alaska's Wonderland?</u>	259
<u>Did You Ever Hear of a Babiroussa?</u>	264
<u>Home of the Future</u>	276
<u>Gold Still Lures Prospectors</u>	291
<u>Agricultural Implements—mower runs hay in crusher & hurry curing process</u>	215
<u>Air-Mail—ship to shore air service</u>	270
<u>Airplanes—motor that uses crude oil for fuel</u>	281
<u>Animals—unusual poses of</u>	269
<u>Aquaplane—riding the surf at night</u>	285
<u>Army, U. S.</u>	
<u>latest weapons of Uncle Sam's fighters</u>	283
<u>outboard motors aid troops to cross river</u>	287
<u>Automobiles, Accessories</u>	
<u>breaking 'em up to make them better for you</u>	280
<u>electric crank turns engine in repairs</u>	262
<u>hollow knob on gear shift holds keys or papers</u>	239
<u>one-man transmission hoist</u>	198
<u>Automobiles, Design</u>	
<u>air impulse is harnessed to drive auto</u>	221
<u>how your auto is given its beauty of line</u>	257
<u>Automobiles, Lubrication—gear pump for oil prevents burned-out bearings</u>	288
<u>Automobiles, Racing—four carburetors add speed in eight-cylinder racer</u>	210
<u>Automobiles, Tires—tire changing becomes easy with "complete" tool</u>	235
<u>Aviation</u>	
<u>air-traffic control tower guides planes by radio</u>	208
<u>all thrills of flying while safe on ground</u>	205
<u>Bowling—outdoor bowling court</u>	271
<u>Bridges—Lake Union bridge at Seattle</u>	233
<u>Building Construction—ready-made arch provides base for plaster</u>	208
<u>Bullet—speed of, recorded on six-inch range</u>	304
<u>Children—"one-way screen" used in study of babies</u>	210
<u>Clocks</u>	
<u>ancient water clock helps make modern paint</u>	225
<u>human hands on clock tell the exact time</u>	194
<u>Cloth—testing wearing qualities of</u>	223
<u>Colors—color-matching test shows your character</u>	234
<u>Compass—radio, registers direction of any station</u>	223
<u>Dancing—robot dance master shows intricate steps</u>	198
<u>Expositions—Colonial Exposition at Paris</u>	236
<u>Fire Fighting—push button of fire ladder controls extension</u>	268
<u>Fish and Fishing—self-aerating minnow pail</u>	213
<u>Football—padded bags serve as dummy team</u>	221
<u>Forest, National—safe-guarding from the air</u>	285
<u>Frogs—frog-jumping contest</u>	284
<u>Furniture—air clamp puts whole frame together in one operation</u>	234
<u>Horse Racing—riderless, latest Mexican sport</u>	272
<u>Household Devices</u>	254
<u>House Plans—plan No. 4-A-14</u>	352
<u>Insects—some queer faces found in the insect world</u>	240
<u>Lantern—projects books as well as slides</u>	233
<u>Life Saving—ten-story leap into life net</u>	282
<u>Lighting—neon-tube lights for homes</u>	273
<u>Lumber—piler builds a stack thirty-eight feet high</u>	194
<u>Maps—electric map shows power needs of railroad</u>	262
<u>Metals—super-magnetic alloy cuts waste of electricity</u>	227
<u>Meteorology—pebbles from sky mystify science</u>	283
<u>Models—model bicycles carved in wood</u>	293
<u>Motorcycle—one-man garage service car</u>	222
<u>Moving Pictures—queer movie effects result of odd-shaped lenses</u>	281
<u>Navy, U. S.—"ready" room for flyers on airplane</u>	275
<u>Paintings—art of future is seen in moving paintings</u>	215
<u>Paints and Painting—paint made from potatoes</u>	268
<u>Park—stealing land from a lake to build</u>	212
<u>Plants</u>	
<u>cherry blossoms as a food are rich in vitamin B</u>	290
<u>same plant bears potatoes and tomatoes</u>	270

[Continued on Page 4]

monorail flyer
191

Iron plated with platinum? 291
Hydro cycle 256
Plating tungsten 202
Gold Lures Prospectors 291
Ice cream miracle sauce 235

Photographed records at home 299

Copyrighted material

Living faces preserved
by plaster masks

[4] Dub disappearing 321

[Contents—Continued]

207
Micro Ray 93

Power Lines
cost of buried less than overhead 272
tame thunderbolts are aid in study of 257

Power Stations—noiseless power by grid-glow tube. 235

Radio
an arctic paradise for long-distance radio 289
no man's land of radio opened by micro-ray 193
simplified answers to your radio problems 297

Radio, Apparatus
current indicator for amateur transmitter 302
old Ford coils useful in receivers and transmitters 298

Radio, Broadcasting
how many listen to, shown by gauge 227
recording your own records at home 299

Radio, Construction—wood clamps aid in working
sheet metal 302

Radio, Installation—installing radio in a coupe 302

Radio, Receivers—improving your old set 295

Radio, Television—radio talkies unite sight and sound
signals 294

Railroads
how locomotives "grow up" is shown by rails 279
railroad on stilts crosses viaduct in Rockies 209
saving millions yearly in locomotive fuel 226

Roads
road building in the clouds is hazardous task 224
truck measures shock from bumps on wheels 290

Sculpture—living faces are preserved by plaster masks 207

Searchlights—electrical fan miles high formed by 288

Ships and Shipping
Atlantic gales in tank test model liners 199
shipwrecks made to order by working model 274
turbine ship to carry cars from Detroit to sea 206
wind and waves wreck ship in twenty-four hours 263

Shoes—automatic soler for 293

Taxis—taxi-coach gives cab speed of bus 225

Telephone
"birds" on phone lines aid long-distance talks 197
lineman rides phone wires many miles a day 258

Telescope—giant tube of, is electrically welded 204

Towers
raise selves by bootstraps in building steel towers 197
steel, strength of tested with heavy sandbags 290

Trees—bark of a tree turns the wheels of progress 267

Trench Digger—whirling wheels dig ditches 213

Village—model, to house world stars 239

Vise—operated by foot instead of hand lever 258

Watches—extremes among watches seen in contrasts 270

Weather—formation of clouds predict 222

Woodworking—rare tools show progress of 261

Wandmill rotor 262

Tree 90 kinds of apple on 252

Agricultural Implements—hook uncovers small corn. 324

Aquarium—lifelike food for pets 318

Automobiles, Accessories—celluloid side wings shield
rumble-seat riders 318

Belt—elastic strip replaces 332

Bird House—stucco finish for 324

Boats and Boating
"Aero-Boat" a high-speed hydroplane 311
detachable rudder aids steering of outboard 321
preventing loss of outboard motor 332

Camping—ax and shovel held under running board. 323

Ceiling—raising sagged beams 330

Chalk Line—quick method of chalking 309

Clocks—padded hammer softens "strike" 331

Cloth—shellac cements to iron 332

Doorstop—silent 316

Electric Motor—real motor for a cent 303

Fence Posts—fitted with clips are easily wired 305

Fish and Fishing
creel closed with hookless fastener 326
fish kept fresh in cellophane 310

Flower Basket—lined with tinfoil 321

Fountain—T-fitting on pipe forms drinking fountain. 331

Furniture—washers hold furniture level 309

Games—African "Poo" is a fascinating game of chance 315

Garage
braces strengthen end of 328
midget car kept in canvas garage 306

Gardening—lawn-edging tool made from old scoop. 331

Gate—foot-operated latch opens 305

Gauge—contour gauge for duplicating design of
turned work 304

Golf—club handles wound with cord do not slip 316

Hat Rack—on closet door saves space 322

Hedge—metal shield protects from dogs 309

Hose—tool binds wire on rubber hose connections... 314

Hosiery—runs in, prevented by tape on desk legs 310

Hunting—flashlight on gun barrel for night hunting. 320

Jars—paper clips remove paraffin covers 315

Lawn—arbor and trellis will improve the 329

Magic—whispering box for the home magician 307

Mail Box—counterweighted, clears road traffic 322

Metals—how to bend heavy sheet metal at sharp angles 323

Paints and Painting—good undercoating for paint. 306

Photography—photo flashes synchronized with expo-
sure 304

Roofing—repair for small roof leaks 331

Saws and Sawing
canvas sheath protects handsaw 331
sawhorses with vertical legs for ripping boards. 323

Screen Door—foot grip opens 330

Screens
anti-rattle clip for folding screens 324
hook aids in installing 321

Smokers' Accessories
broken pipe stem removed with clothes hook 319
pipe rack in Aztec design 328

Stairs—ladder stair helps to climb grades 328

Swing
reversible, for the garden 325
suspending from hinges 327

Telephone—bell is muffled with rubber wedge 305

Tennis
court marker made from fruit jar and roller skate 316
this knot keeps net taut 310

Tool Handles—iron strip strengthens 306

Tools—hammer handle holds center punch 326

Towel Rack—animal heads hold children's 320

Toys—this galloping team keeps the baby busy 317

Treasure Box—steel ball opens secret lock on 327

Tweezers—a self-gripping pair of 306

Water Hose—holder for 329

Wood
coloring with wax crayons 319
steaming in rubber hose 332

SHOP NOTES

Agriculture—growth of weeds checked while harvest-
ing 349

Auger—pipe extension used for boring drainage holes 351

Automobiles, Repairing
checking valve tappets for noise 351
stopping rear-wheel grease leak 346

Boring Machine—improvised toolrest for turning large
work on 344

Clamps—quick and accurate clamps for miter joints. 347

Crates—collapsible crate for live stock 336

Drain—spring keeps cock closed 337

Drilling—lathe chuck holds round stock for 344

Farm—practical ideas to lighten work on 343

Flashlight—fitted with test points for trouble-shooting 342

Furniture—ball-bearing rollers used to move heavy 336

Greenhouse—seed beds watered by using siphon 342

Hardware—hand-wrought 339

Horses—tool for cleaning hoofs 341

Lantern—reflector throws light on ground 335

Lathe
holes drilled in tailstock center simplify oiling. 346
hollow-drilling shafts 337
swinging saw table for 338

Lock Washer—an improvised 349

Motor—thread-cutting oil loosens bearings 349

Paints and Painting
paste jar holds white lead 341
varnish stand for auto finishers 346

Pliers
to handle small round work 335
wire-cutting gauge for 350

Poultry—an automatic water fountain for 341

Pump—old engine used as flywheel 351

Restaurant—phones and dish carrier improve 345

Riveting—C-clamp makes easier 346

Saws and Sawing—three shortcuts for your bandsaw 333

Scaffold—scaffolding horses are adjusted for height. 338

Screws—hacksaw stop for slotting 350

Toolkit—has tray for small parts 350

Vacuum Cleaner—portable, for the shop 335

Valves—controlling overhead valves 334

Vise—clamp for holding small parts 337

Wagon—channel-iron skids for steep grades 348

Wheelbarrow—rubber-tired, fitted with a brake 344

Wrenches—smooth jaws for a pipe wrench 345

PRESDWOOD

... Now Tempered

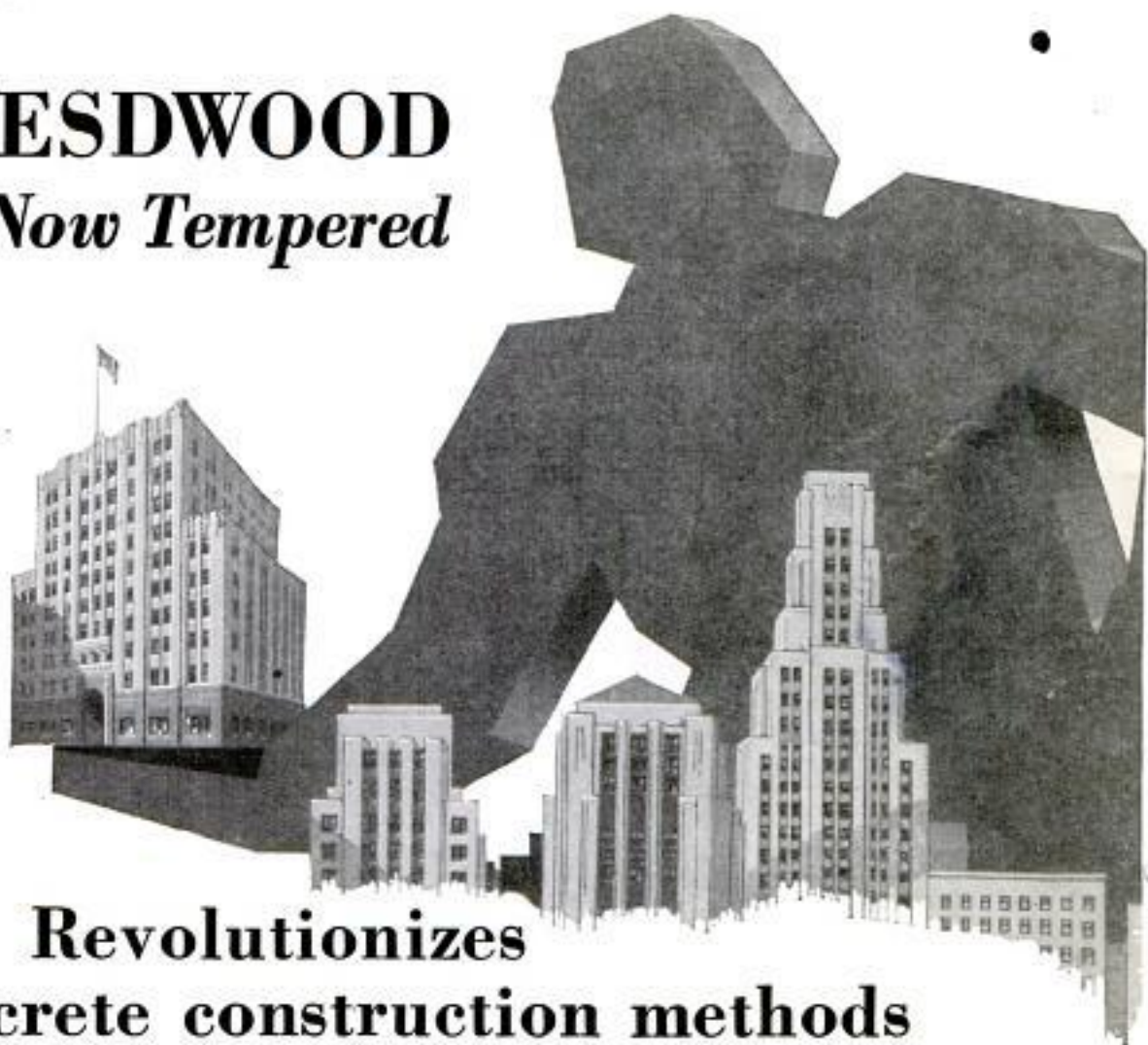

Revolutionizes concrete construction methods

SCORE another triumph for Masonite Presdwood—*now tempered!* A new Presdwood . . . subjected to treatment that does for these grainless wood boards what tempering does for steel. Marvelously increased in density, strength, and imperviousness to moisture.

Tempered Presdwood is ideal in places where it must withstand great strain, abrasion or moisture. Already it has revolutionized concrete construction methods...the entire form now is made of these new super-strong boards. No longer is Presdwood used only as a lining for forms. Tempered Presdwood

cuts forming costs to the bone. Requires less than one-third the usual backing lumber. Eliminates the need of lath and plastering. And the entire forming system can be salvaged, undamaged by use or moisture, for further service.

Many of the country's foremost builders and contractors are using Tempered Presdwood . . . and finding that it sets a new standard for economy and speed in construction. And, furthermore, that it wipes out hitherto-accepted limitations in design and application. Write for the complete story of this new Presdwood. Mail coupon today.

Masonite

PRESDWOOD

STRUCTURAL INSULATION • INSULATING LATH • QUARTERBOARD
"Made in Mississippi"

Perfect Concrete

Tempered Presdwood produces perfectly hydrated concrete—of maximum density and strength. Concrete so smooth that no rubbing is required. Tempered Presdwood is also ideal for manufacturing purposes in many industries

MASONITE CORPORATION, Dept. L-8 © M. C., 1931
111 W. Washington Street, Chicago, Ill.

Please send your free illustrated booklet that describes Masonite Presdwood and its many uses.

Name

Street

City State

If interested in Masonite Insulation, check here

Four Thicknesses

Tempered Presdwood is manufactured in boards $\frac{1}{8}$ ", $\frac{3}{16}$ ", $\frac{1}{4}$ " and $\frac{5}{16}$ " thick. They come 4 feet wide and in 12 foot length only. May be worked with same tools used on standard Presdwood and in same manner. Also takes same stains, paints, lacquers, and enamels

Are YOU afraid of losing your Job?

MANY men walk today in the company of fear—fear lest the next paycheck be the last.

But—here and there you find a man actually advancing—increasing his earnings—bettering his position—forging ahead in times when most people struggle for their bread and butter.

Their success is easy. They are not afraid of losing their jobs. There are many men walking around who are ready and eager to do it—any day.

He's a trained man—his getting ahead is a simple matter of replacing his present position with a "new" class in business.

Do you want to get into this secure class—into the well-rewarded field—out of the readily replaceable millions?

All right. Read these true records of other men—three out of thousands of similar stories about LaSalle members*—you can do the same—if you will—

Follows Lincoln's Example— Studies Law at Night

At 24—(this man's formal schooling ended with his twelfth year)—he was a laborer in a railroad shop. Wages were low and hours long.

Only four years later, he passed the bar examination and within a year he had a lucrative law practice. He has held several elective and appointive legal positions and is today an honored legal leader in his community.

In four years—studying law with LaSalle at nights and working day-

* Names on request.

times at his railroad job—his initiative and perseverance took him out of the low-paid job and gave him prestige and independence.

What are you doing with your spare time?

From Clerk to Auditor— Now He is a Preferred Man

He stopped school at 15. His first job paid \$20 a month, then \$30 a month and at the time LaSalle first knew him, he was 19 and had worked up to a tracing clerk at \$75 a month. "Wanting more pay, and a future," as he puts it, he enrolled for our Higher Accountancy training. In two months he took a job as assistant bookkeeper and at 21 he was assistant credit manager.

Today he is auditor of a large manufacturing company at a large salary, is secretary of another corporation and is taking his second LaSalle course in Business Management.

What are you doing to better yourself—besides wishing?

Seven Out of Nine Were Fired— This Man Stayed

One of our Industrial Management students in Pennsylvania worked in a group of nine men. When hard times struck, seven were discharged and only himself and one other kept.

Would you be kept if your firm cut the pay roll?

We could give you thousands of examples of LaSalle members—who have no fear of losing their jobs in hard times. This because they know that they have the trained ability which employers need.

For instance, there is our Higher Accountancy student in Delaware

EMPLOYMENT
MANAGER.



who found out
our letter to him,
telling him of
enrollment

the boss was also an enthusiastic LaSalle student and that the travel auditor to whom the boss reports regularly is a LaSalle graduate. There are the numerous companies—hundreds of them—which have standing offer to pay half the membership fee of any employe who enrolls with LaSalle and to refund the other half when that employe graduates.

Put Yourself in the Preferred Class

These few examples—and your common sense analysis of business—enough. No need to urge upon you the trained man is in demand, that is the first employe to be taken on and last to be let go. You know that already.

"Knowing" is not enough—action is necessary. The first step is to get complete information—the facts about the business field which you prefer, its demands, its opportunities, and the details of the LaSalle training program for success in that field.

Are you in earnest? Then—send the coupon. It will bring you the facts—without cost or obligation—in an interesting, vital 64-page book. Act today.

LaSalle Extension University

THE WORLD'S LARGEST BUSINESS TRAINING INSTITUTION

Find Yourself Through LaSalle!

LA SALLE EXTENSION UNIVERSITY

Dept. 864-R

CHICAGO

I would welcome an outline of the new LaSalle plan, together with a copy of "Ten Years' Promotion in One," all without obligation.

- Business Management—Managerial, Sales and Executive
- Higher Accountancy
- Expert Bookkeeping
- C. P. A. Coaching
- Modern Salesmanship
- Traffic Management
- Railway Station Mgmt.

- Railway Accounting
- Modern Business Correspondence
- Paper Salesmanship
- Law: LL. B. Degree
- Commercial Law
- Industrial Management
- Modern Foremanship
- Personnel Management

- Banking and Finance
- Credit and Collection
- Correspondence
- Business English
- Effective Speaking
- Commercial Spanish
- Telegraphy—Railway and Commercial



Name _____ Present Position _____ Address _____

I will train you at home

to fill a
BIG PAY
Radio Job!



**Here's
Proof**

If you are earning a penny less than \$50 a week, send for my book of information on the opportunities in Radio. It is free. Clip the coupon NOW. Why be satisfied with \$25, \$30 or \$40 a week for longer than the short time it takes to get ready for Radio?

Radio's growth opening hundreds of \$50, \$75, \$100 a week jobs every year

In about ten years Radio has grown from a \$2,000,000 to a \$1,000,000,000 industry. Over 300,000 jobs have been created. Hundreds more are being opened every year by its continued growth. Many men and young men with the right training—the kind of training I give you—are stepping into Radio at two and three times their former salaries.

You have many jobs to choose from

Broadcasting stations use engineers, operators, station managers and pay \$1,200 to \$5,000 a year. Manufacturers continually need testers, inspectors, foremen, engineers, service men, buyers, for jobs paying up to \$7,500 a year. Shipping companies use hundreds of Radio operators, give them world-wide travel with board and lodging free and a salary of \$80 to \$150 a month. Dealers and jobbers employ service men, salesmen, buyers, managers, and pay \$30 to \$100 a week. There are many other opportunities too.

So many opportunities many N. R. I. men make \$100 to \$1,000 while learning

The day you enroll with me I'll show you how to do 10 jobs, common in most every neighborhood, for spare time money. Throughout your course I send you information on servicing popular makes of sets; I give you the plans and ideas that are making \$200 to \$1,000 for hundreds of N. R. I. students in their spare time while studying. My course is famous as the course that pays for itself.

Talking Movies, Television, Aircraft Radio are also included

Special training in Talking Movies, Television and home Television experiments, Radio's use in Aviation, Servicing and Merchandising Sets, Broadcasting, Commercial and Ship Stations are included. I am so sure that I can train you satisfactorily that I will agree in writing to refund every penny of your tuition if you are not satisfied with my Lessons and Instruction Service upon completing.

64-page book of information FREE

Get your copy today. It tells you where Radio's good jobs are, what they pay, tells you about my course, what others who have taken it are doing and making. Find out what Radio offers you, without the slightest obligation. ACT NOW!

**J. E. SMITH, President
National Radio Institute, Dept. 1 HP,
Washington, D. C.**



I will give you my new 8 OUTFITS of RADIO PARTS for your Home Experiment

You can build over 100 circuits & outfits. You build and experiment with the circuits used by Crosley, Atwater, Eureka, Majestic, Zenith, and other sets. You learn how these sets work, why they work, how to make them work. This makes learning at home easy, fascinating, practical.

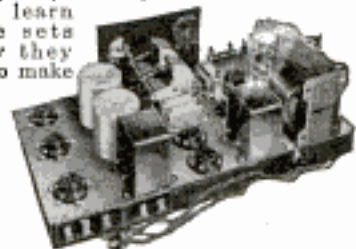

I am doubling and tripling the salaries of many in one year and less Find out about this quick way to

**BIGGER
PAY**



FILL OUT AND MAIL THIS COUPON TODAY

**J. E. Smith, President
NATIONAL RADIO INSTITUTE,
Dept. 1HP, Washington, D. C.**

Dear Mr. Smith: Send me your free book. I understand this request does not obligate me and that no salesman will call.

Name.....

Address.....

City..... State.....

Have you a friend or a pal whom you know to be interested in radio? Do him a favor. Write his name and address below. No obligation on his part and we won't mention your name unless you request it.

Name.....

Address.....

City..... State.....



\$100 a week

My earnings in Radio are many times greater than I ever expected they would be when I enrolled. They seldom fall under \$100 a week."
**E. E. WINBORNE,
1287 W. 48th St.,
Norfolk, Va.**



Jumped from \$35 to \$100 a week

"Before I entered Radio I was making \$35 a week. Last week I earned \$110 servicing and selling Radios. I owe my success to N. R. I."

**J. A. VAUGHN
4075 S. Grand Boulevard,
St. Louis, Mo.**



\$500 extra in 6 months

"I find I made \$500 from January to May in my spare time. My best week brought me \$107. I should have taken it long ago."

**HOYT MOORE
R. R. 3, Box 913,
Indianapolis, Ind.**

Lifetime Employment Service to all Graduates

BE AN AUTO EXPERT

EARN up to \$5000 A YEAR



Learn Autos
the new easy interesting
JOB-WAY



From \$30 a Week to \$90 a Week!

W. S. Yancy, Perla, Arkansas, was making only \$30 a week when he wrote for my Book. Today he's earning \$90 a week! You can get the same book FREE! Just clip the coupon — and mail it today!

Clip Coupon for Free Auto Book!

Say good-bye to low pay! Get into the Auto Business, where big pay — extra money — raises — come quick! A brilliant future awaits you in the World's Biggest Business.

LEARN AT HOME In Spare Time

If you're earning a cent less than \$50 a week, clip that coupon now. Learn how \$50—\$75—even \$100 a week is now possible for you. See how I train you, right at home, in every branch of Auto Work, quickly and easily. Find out about this Training which boosted Yancy's salary from \$30 a week to \$90 a week!

Experience, Education, Not Necessary!

All you need is common schooling—and it makes no difference if you never touched an auto before. Men from all walks of life who worked long, hard hours for low pay, are now becoming Garage Owners, Foremen and Superintendents. If you like autos, if you're between 15 and 55—get the facts now! "Job-

Way" Training covers everything about Autos — Mechanical and Electrical — everything you need to get in line for a Big Pay Job as an Auto Expert! It's the trained man who gets the good jobs and "Job-Way" is complete Training, yet so simple and so easy that you get it quick.

3 Testing and Repair Outfits also included FREE of extra cost — If You Act At Once!

Right now I am offering an Electrical Experimental Outfit, equipment for a Portable Electric Test Bench, and 381 Auto Wiring Diagram Charts to students. Send coupon now.

Auto Book FREE!

Send for this big new book. Take the first step to a Big Pay Job!



Read My Money-Back Agreement!

Learn about the 14 "Job-Way" Features shown in my big Free Auto Book. Also about my Money-Back Agreement. Be sure to get the book and see how easily you can get in line for a Job paying up to \$100 a week!

MAIL THIS COUPON!

MOTOR INSTITUTE OF AMERICA, B. W. COOKE, Dir., Engineer
Motor Institute Bldg., Dept. C 416, Evanston, Ill.

Send me your FREE Auto Book. Also proof that I can succeed in the Auto Business. Tell me about "Job-Way" Auto Training — about your Employment Department, and about your 3 Testing and Repair Outfits and Aviation Course Offer. No obligation on my part whatever.

Name.....

Address.....

Town..... State.....

Age..... Occupation.....

Get Full Particulars of AVIATION Course Offer

Find out how my Employment Department helps you get a Good Job—Raises in Pay—and Promotions. Get all the details of my offer of a complete, ground-school Aviation Course which I am making to men who enroll.

Address me **B. W. COOKE** Directing
Personally **Engineer**

MOTOR INSTITUTE OF AMERICA
Motor Institute Bldg., Dept. C 416, Evanston, Ill.

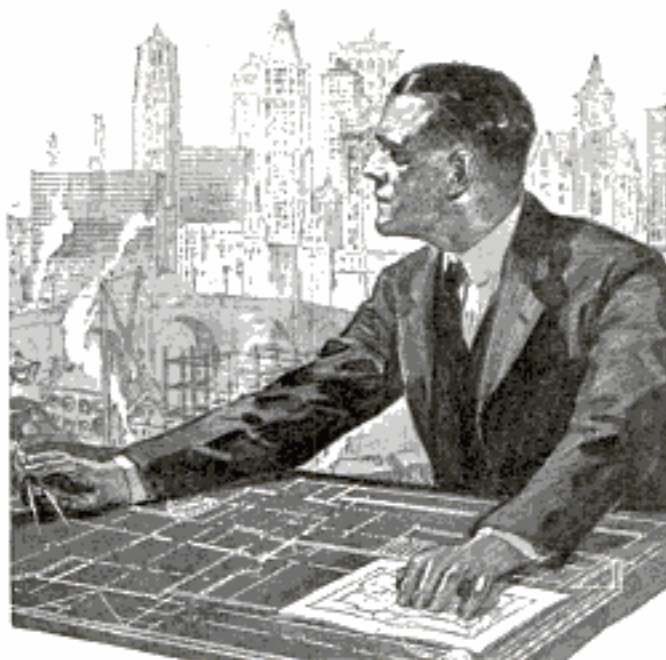

Former plasterer now earning **\$12,000** a year

"When I enrolled with the International Correspondence Schools, I was a plasterer and I didn't know a thing about blueprints. Today I have my own contracting business and I am able to figure the most difficult jobs and execute them to the satisfaction of everyone concerned. My income is between \$12,000 and \$15,000 a year. It certainly was a lucky day for me when I sent in that I. C. S. coupon."

That's a true story of what just one student of the International Correspondence Schools has done. Every mail brings letters from other ambitious men and women telling of promotions and increases in salary due directly to spare-time study.

One hour a day spent with the I. C. S., in the quiet of your own home, will prepare you for success in the work you like best. *Mail Coupon for Free Booklet.*

INTERNATIONAL CORRESPONDENCE SCHOOLS, Box 5555-G, Scranton, Penna.

"The Universal University"

Without cost or obligation on my part, please send me a copy of your 48-page booklet, "Who Wins and Why," and tell me how I can qualify for the position, or in the subject, before which I have marked an X:

BUSINESS TRAINING COURSES

- | | | | |
|---|--|---|---|
| <input type="checkbox"/> Business Management | <input type="checkbox"/> Cost Accounting | <input type="checkbox"/> Business Correspondence | <input type="checkbox"/> Railway Mail Clerk |
| <input type="checkbox"/> Industrial Management | <input type="checkbox"/> Bookkeeping | <input type="checkbox"/> Show Card and Sign Lettering | <input type="checkbox"/> Mail Carrier |
| <input type="checkbox"/> Personnel Management | <input type="checkbox"/> Secretarial Work | <input type="checkbox"/> Stenography and Typing | <input type="checkbox"/> Common School Subjects |
| <input type="checkbox"/> Traffic Management | <input type="checkbox"/> Spanish <input type="checkbox"/> French | <input type="checkbox"/> English | <input type="checkbox"/> High School Subjects |
| <input type="checkbox"/> Accounting and C. P. A. Coaching | <input type="checkbox"/> Salesmanship | <input type="checkbox"/> Civil Service | <input type="checkbox"/> Illustrating <input type="checkbox"/> Cartooning |
| | <input type="checkbox"/> Advertising | | <input type="checkbox"/> Lumber Dealer |

TECHNICAL AND INDUSTRIAL COURSES

- | | | | |
|--|--|---|--|
| <input type="checkbox"/> Architect | <input type="checkbox"/> Telegraph Engineer | <input type="checkbox"/> Airplane Engines | <input type="checkbox"/> Pharmacy |
| <input type="checkbox"/> Architectural Draftsman | <input type="checkbox"/> Telephone Work | <input type="checkbox"/> Plumber and Steam Fitter | <input type="checkbox"/> Mining Engineer |
| <input type="checkbox"/> Building Foreman | <input type="checkbox"/> Mechanical Engineer | <input type="checkbox"/> Plumbing Inspector | <input type="checkbox"/> Navigation <input type="checkbox"/> Assayer |
| <input type="checkbox"/> Concrete Builder | <input type="checkbox"/> Mechanical Draftsman | <input type="checkbox"/> Foreman Plumber | <input type="checkbox"/> Iron and Steel Worker |
| <input type="checkbox"/> Contractor and Builder | <input type="checkbox"/> Machine Shop Practice | <input type="checkbox"/> Heating and Ventilation | <input type="checkbox"/> Textile Overseer or Supt. |
| <input type="checkbox"/> Structural Draftsman | <input type="checkbox"/> Toolmaker | <input type="checkbox"/> Sheet-Metal Worker | <input type="checkbox"/> Cotton Manufacturing |
| <input type="checkbox"/> Structural Engineer | <input type="checkbox"/> Patternmaker | <input type="checkbox"/> Steam Engineer | <input type="checkbox"/> Woolen Manufacturing |
| <input type="checkbox"/> Electrical Engineer | <input type="checkbox"/> Civil Engineer | <input type="checkbox"/> Marine Engineer | <input type="checkbox"/> Agriculture |
| <input type="checkbox"/> Electrical Contractor | <input type="checkbox"/> Surveying and Mapping | <input type="checkbox"/> Refrigeration Engineer | <input type="checkbox"/> Fruit Growing |
| <input type="checkbox"/> Electric Wiring | <input type="checkbox"/> Bridge Engineer | <input type="checkbox"/> R. R. Positions | <input type="checkbox"/> Poultry Farming |
| <input type="checkbox"/> Electric Lighting | <input type="checkbox"/> Gas Engine Operating | <input type="checkbox"/> Highway Engineer | <input type="checkbox"/> Mathematics |
| <input type="checkbox"/> Electric Car Running | <input type="checkbox"/> Automobile Work | <input type="checkbox"/> Chemistry | <input type="checkbox"/> Radio |

Name..... Street Address.....

City..... State..... Occupation.....

If you reside in Canada, send this coupon to the International Correspondence Schools Canadian, Limited, Montreal, Canada

MODERN ART PAYS BIG MONEY

The amazing demand for art work of all kinds is creating hundreds of big-pay opportunities every year. Trained artists are needed. This is the Age of Color . . . of Design . . . of Art in everything. Manufacturers, decorators, publishers . . . all are seeking men and women with art training.

Through the Federal School of Illustrating many who drudged at small pay have found fascinating careers . . . larger incomes. Many Federal students are now earning from \$2500 to \$6000 a year . . . others even more.

You can learn at home . . . in your spare time . . . the Federal way. Earn while you learn . . . most of our students do. The Federal Course is for practical artists who **MUST** make good. It aims at dollars and cents profit for every student.

More than fifty famous artists . . . masters of modern art . . . contribute exclusive lessons and drawings to the Federal Course. They tell you how they create new . . . striking . . . clever . . . art work. They give you their technical tricks in illustrating, cartooning, lettering, designing, etc.

Test Your Talent Free

Send for our Free Vocational Test Chart. It's simple to fill out. Our artists judge it for you and give you a definite guide to your probable talent and earning power in art. We will also send you, without charge, "A Road To Bigger Things," giving names of the famous Federal instructors . . . showing where the big money in art is . . . what others are making. Get this Book and the Test Chart. Write now.



THE FEDERAL SCHOOL of ILLUSTRATING

8131 FEDERAL SCHOOLS BUILDING

MINNEAPOLIS, MINNESOTA

Federal School of Illustrating

8131 Federal Schools Building, Minneapolis, Minnesota

Please send me free book, "A Road To Bigger Things," and Standard Art Test.

Name _____

Age _____ Occupation _____

Address _____



A BIG PAY JOB

for YOU

in the biggest
money making
game on earth

ELECTRICITY

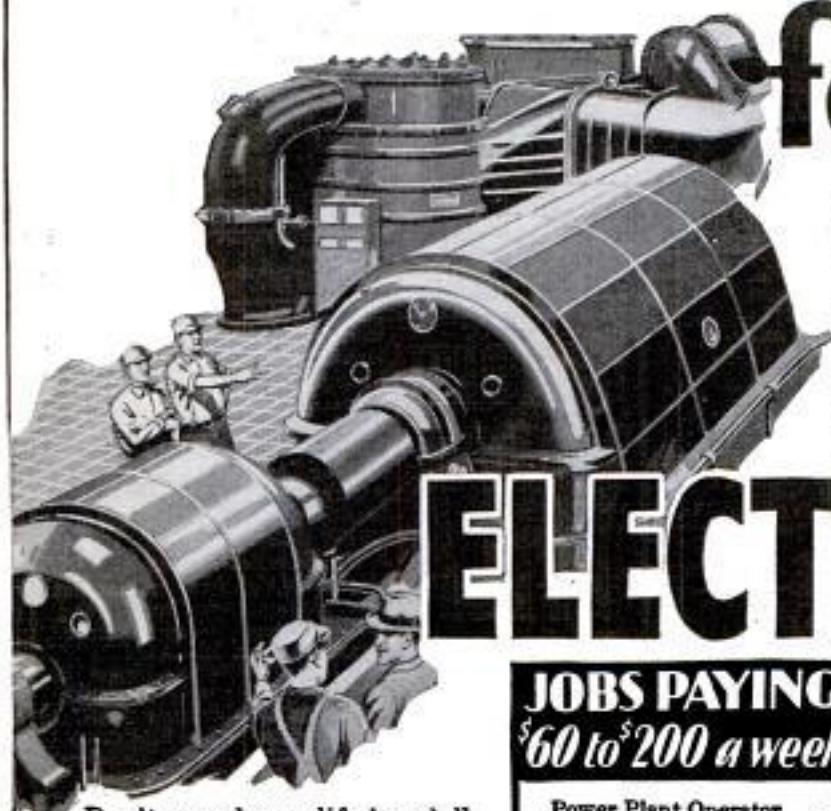

Don't spend your life in a dull, hopeless job! Don't be satisfied with \$30 or \$40 a week! MAIL COUPON BELOW FOR FREE PROOF that YOU CAN HAVE A GOOD ELECTRICAL JOB IN 90 DAYS! Electricity pays salaries of \$60, \$70 and even \$200 a week to thousands of fellows no smarter than you.

Thousands of Jobs Open

Thousands of Jobs are open, paying \$60 a week and up—in Power Plant work, Armature Winding, Auto Ignition, House Wiring, Radio Service, Refrigeration, Welding, Aviation Electricity, Illumination, etc. You can prepare for one of these Big Pay Jobs in 90 days! Mail coupon for proof!

JOBS PAYING \$60 to \$200 a week

Power Plant Operator	\$50 to \$70 a week
Maintenance Engineer	\$60 to \$100 a week
Armature Winding	\$45 to \$75 a week
Illumination Expert	\$50 to \$80 a week
Radio Service Expert	\$50 to \$100 a week
Aviation Ignition	\$60 to \$125 a week
Battery Expert	\$70 to \$200 a week
Auto Electrician	\$75 to \$200 a week
Contractor-Dealer	\$60 to \$300 a week
Signal Engineering	\$50 to \$100 a week

Free Employment Service Earn As You Learn

Don't worry about a job! My Employment Department gives you a FREE lifetime service. And if you need part-time work while at School to help pay expenses, we'll gladly help you get it. Don't let anything keep you out of this Big Pay field!

Get My Big Free Book

Get the PROOF! Mail coupon for my Big FREE book, telling all about jobs—salaries—opportunities. Find out about my FREE Radio and Automobile Electricity offers, and my special low tuition offer. This does not obligate you. JUST MAIL THE COUPON!

Learn Without Lessons in 90 days

Come to Coyne at Chicago and learn Electricity the quick and practical way—not by correspondence, but by actual electrical work—on huge motors and generators, switchboards, power plants, substations, armatures, auto and airplane engines, etc. You don't need advanced education or previous experience. Coyne has been training men for Big Pay Electrical Jobs since 1899. Let Coyne help YOU to a good electrical position!

COYNE Electrical School **H. C. LEWIS, Pres.**
500 S. Paulina St., Dept. CI-72, Chicago

H. C. LEWIS, President
COYNE ELECTRICAL SCHOOL
500 S. Paulina St., Dept. CI-72, Chicago

Gentlemen: Please send me your big Free Electrical Book with 151 illustrations. This does not obligate me.

Name

Address

City State



U.S. GOVERNMENT POSITIONS!

OVER 900 DIFFERENT KINDS of POSITIONS AVAILABLE

For Men—Women—Age 18-Up IN or OUTSIDE WORK—Local or Traveling
If you want a steady Government Position where strikes, hard times, politics, etc., will not affect you, where you draw twelve months' pay every year, get on Uncle Sam's Payroll. Stop worrying, enjoy life. Pick the position you want, it belongs to you just as much as to anyone else. Why not get it? It is all up to you! The positions described in this announcement are only a few of the many desirable ones obtainable. Fill out the coupon below, mail it today, and full particulars will be sent immediately.



SPECIAL AGENTS (Investigators)

Start \$200 Month
Government Secret Service Work is a fascinating branch of the service. These positions located throughout the country are both traveling and stationary. Salaries up to \$5,000 yearly, and all traveling expenses paid while on the road.

OUTDOOR POSITIONS

Ideal, healthy, fascinating work, where you can enjoy the forests and mountain trails. The duties vary from patrolling our Borders, furnishing information to tourists, etc., to clerical work.

RURAL AND CITY CARRIERS

\$1,400 to \$3,000 Year
Rural Mail Carrier easy, healthy work, short hours, with a large part of the day left to do as he pleases. Thousands of city positions for those who prefer inside work, delivering mail in office buildings. These positions open to both country and city people.



MEAT INSPECTORS

\$1,500 to \$1,800 Year and UP
Farmers, butchers, or anyone with a knowledge of live stock, food products, meats, etc., are in line for one of these positions. Salaries and promotions splendid. Both men and women are eligible.



RAILWAY MAIL CLERKS

\$1,850 to \$2,700 Year
These positions are both traveling and stationary. When traveling you receive an extra allowance when away from home more than ten hours; and when you grow old you are retired with a comfortable pension for the balance of your life.

CUSTOMS INSPECTORS

\$2,100 Year to Start
The duties are to check and inspect goods brought into this country, levy the duties, etc., and see that Customs regulations are not violated. This is very fascinating work with splendid salaries.



MAIL THIS COUPON TODAY

We Help You Get One

- | | |
|--|--|
| <input type="checkbox"/> Ry. Mail Clerk | <input type="checkbox"/> Steno-Typist |
| <input type="checkbox"/> P. O. Laborer | <input type="checkbox"/> Immigrant Inspector |
| <input type="checkbox"/> R. F. D. Carrier | <input type="checkbox"/> Seamstress |
| <input type="checkbox"/> Special Agent | <input type="checkbox"/> Auditor |
| <input type="checkbox"/> Customs Inspector | <input type="checkbox"/> Prohibition Agent |
| <input type="checkbox"/> City Mail Carrier | <input type="checkbox"/> U. S. Border Patrol |
| <input type="checkbox"/> Meat Inspector | <input type="checkbox"/> Chauffeur |
| <input type="checkbox"/> P. O. Clerk | <input type="checkbox"/> Watchman |
| <input type="checkbox"/> File Clerk | <input type="checkbox"/> Skilled Laborer |
| <input type="checkbox"/> General Clerk | <input type="checkbox"/> Postmaster |
| <input type="checkbox"/> Matron | <input type="checkbox"/> Typist |

OZMENT INSTRUCTION BUREAU

Dept. 176, St. Louis, Mo.
Send me immediately, FREE, full particulars about positions marked "X." Also your big list of other positions obtainable, salaries, locations, how to qualify, opportunities, etc.

NAME.....

ADDRESS.....

Play the Hawaiian Guitar like the Hawaiians!

Only 4 Motions used in playing this fascinating instrument. Our native Hawaiian instructors teach you to master them quickly. Pictures show how. Every thing explained clearly.

Play in Half Hour
After you get the four easy motions you play harmonious chords with very little practice. No previous musical knowledge needed.

Easy Lessons
Even if you don't know one note from another, the 42 printed lessons and clear pictures make it easy to learn quickly. Pay as you play.



GIVEN when you enroll
—a sweet toned

HAWAIIAN GUITAR, Carrying Case and Playing Outfit—

Value \$18 to \$20
WRITE AT ONCE for attractive offer and easy terms. You have everything to gain. A postcard will do. ACT!

Value \$18 to \$20
No extras—everything included

OTHER COURSES | Tenor Banjo, Violin, Tiple, Tenor Guitar, Ukulele, Banjo Ukulele Under well known instructors.

FIRST HAWAIIAN CONSERVATORY OF MUSIC, Inc.
9th Floor, Woolworth Bldg. Dept. 548 New York, N. Y.
Approved as a Correspondence School Under the Laws of the State of New York—Member National Home Study Council

BEDFORD YMCA TRADE SCHOOL

Caterpillar Tractor Mechanic
Aviation Mechanic
Flying
Airplane Welding
Airplane Drafting
Air Navigation
Starting, Lighting, Ignition
Auto Mechanic
Machine Shop, Electric Welding
Oxy-Acetylene Welding
Radio Mechanic, Air Brush
Mechanical, Architectural Drawing
Sign Painting, Show Card Writing
Talking Pictures, Western Electric
Commercial Art, Fine Art
DAY AND EVENING SESSIONS
Write for Catalog 50
Brooklyn Engineering Institute
(Operated by Bedford Y. M. C. A.)
1125 Bedford Avenue, Brooklyn
New York City

LAW STUDY AT HOME

Become a lawyer. Locally trained men win high positions and big success in business and public life. Be independent. Greater opportunities now than ever before. Big corporations are headed by men with legal training. Earn **\$5,000 to \$10,000 Annually**. We guide you step by step. You can train at home during spare time. Degree of LL.B. conferred. LaSalle students found among practicing attorneys of every state. We furnish all text material, including fourteen-volume Law Library, Low cost, easy terms. Get our valuable 64-page "Law Guide" and "Evidence" books FREE. Send for them NOW. LaSalle Extension University, Dept. 864-L, Chicago. The World's Largest Business Training Institution

Learn Watchwork, Jewelrywork and Engraving A fine trade commanding a good salary, and your services always in demand. Address **Horological**, Dept. P, Bradley Institute, PEORIA, ILLINOIS, for our latest catalog.



"BECOME A LIGHTNING TRICK CARTOONIST"

Send \$1.00 for Laugh Producing Program of 28 Trick Drawings with Instructions. Catalog of Chalk Talk Supplies Free. BALDA ART SERVICE, Dept. 1, Oshkosh, Wis.



WHY NOT spend Spring, Summer and Fall gathering butterflies, insects? I buy hundreds of kinds for collections. Some worth \$1 to \$7 each. Simple outdoor work with my instructive pictures, price-list. Send 10 cents (not stamps) for my illustrated Program before sending butterflies. MR. SINCLAIR, DEALER IN INSECTS, Dept. 6, Box 1424, San Diego, Calif.

Learn Advertising at HOME

Send your name and address for free booklet giving interesting information and vital facts about Advertising. Find out how we prepare you at home, in your spare time, for the opportunities open in this fascinating business. Practical work. No text books. Old established school. Successful graduates everywhere. Just the plan you have always wanted. Write today. No obligation.
PAGE-DAVIS SCHOOL OF ADVERTISING
Dept. 135C, 3601 Michigan Ave. Chicago, U. S. A.

ELECTRICITY

Your Servant



—now the World's Biggest Employer!

General Electric Company

From the report of Gerard Swope, President, we find sales in 1930 over \$376,000,000, only 9% below the biggest year in General Electric history. Net profits were \$67,000,000—ahead of all years except 1929. 78,000 people employed, salaries not reduced in 1930 from peak levels.

American Telephone and Telegraph Co.

President Gifford says "There was a net gain in 1930 in the number of telephones installed of 122,500. The total number of local phone conversations was 2% above 1929, and of long-distance calls 1% above 1929. The average investment in plant and other assets increased 14.5 per cent. Assets over 5 BILLION DOLLARS. "For the employees there has been no reduction in wage rates, and the amount paid for wages in 1930 was the largest sum in the history of the system."

Paul Garrett, financial editor of the New York Evening Post, says "In 1930 employees of the A. T. & T. saved \$70,000,000 (under company thrift plans), over 10% of their pay, where in 1929 they saved 8%."

Blazing lights—tell you about Electricity—your servant. A necessity in your home, your office, your factory. Now consider these facts about Electricity—as the world's biggest and best-paying employer!

- [1] **ELECTRICITY** is practically the only major industry that continued to prosper and forge ahead during the depression of the past two years.
- [2] **ELECTRICITY** is outstripping all other industries—employing more men, and will be the fastest growing industry during the next 25 years.
- [3] **ELECTRICITY** is not one but virtually fifty industries all combined into one huge enterprise.
- [4] **ELECTRICITY** has changed practically every mechanical line of work. Electricity has made possible — the aeroplane — the automobile — light — power — transportation — communication — electrical refrigeration—and what not. While electrical controls have electrified all mechanical processes.
- [5] **ELECTRICITY**, while it has altered the work of thousands of men, offers a logical solution of the problems of every man who finds his old trade gone or changed to such a degree that regular employment is uncertain.
- [6] **ELECTRICITY** will need thousands of additional men in the next few years.

Through the courtesy of one of America's greatest Electrical companies, we are able to offer you an illustrated booklet, "Looking into the Future of Electricity," presenting from the Employer's point of view the opportunities in Electricity. Men with personal problems, who are dissatisfied with their prospects and earnings, will find food for thought in this valuable free book. Mail the coupon.

The American School, chartered in 1897 as an educational institution, not for profit, offers a unique, combined home training and employment service, with Electrical Engineering texts prepared by 29 noted Engineers from General Electric, Commonwealth Edison, Westinghouse, Cutler-Hammer, Massachusetts Institute of Technology and other leading Corporations and Universities.

THE AMERICAN SCHOOL
Dept. EC-47—Drexel Ave. & 58th St., Chicago, Ill.



The American School
Dept. EC-47, Drexel Ave. & 58th St., Chicago.
Please send illustrated booklet "Looking into the Future of Electricity" without cost or obligation.

Name.....Age.....
St. No.....
City.....State.....
Occupation.....

Full Railroad Fare from Your Home to Los Angeles deducted from cost of training if you enroll soon!

MEN WANTED —
Train in California
for
Good Jobs!

Learn Autos
IN LOS ANGELES

and LEARN RIGHT!

Full Railroad Fare Allowed to Los Angeles!

It's only human for you to want to come to California, Everyone does. How much better to come and get started right—quickly qualifying for the *best pay jobs*. We are allowing full railroad fare from any point in the United States for a limited time only, to encourage more men to take advantage of California Training. Never again will you get an opportunity like this. Come West NOW!

A Few Short Weeks at National and You're Ready For A Big Pay Job!

For 26 years National has quickly helped men get ready for big pay, steady positions in the profitable Automobile fields. Don't worry about previous experience, or whether you're too old or too young. We train you by "Actual Shop" Methods on thousands of dollars worth of right-up-to-the-minute equipment. Not a Correspondence School. Start any time.

...and Don't Worry About Money! We'll Help You! Even if you're short on cash you can get National Training. We help you secure good part-time jobs to earn living expenses while learning. Unlimited Employment Service assures you real, friendly co-operation in getting started on the road to real money, steady work and a prosperous future. Employers know that National Auto Men are the best, so they don't waste their time on half-baked, untrained mechanics. 25,000 successful graduates since 1905.

National Doors Are Open to You!
Investigate at Once!

Write now—today—for the whole story. Our big free book with details sent FREE. Don't lose another minute. These offers are necessarily limited for a short time. Mail the coupon and soon you can be on the train for Los Angeles.

WRITE for FREE BOOK NOW!

National Automotive School

Dept. 84 F, 4006 S. Figueroa Street, Los Angeles, California

Send me, absolutely free, your big illustrated catalog of Automotive Opportunities, cost of training and Special Railroad Fare Offer.

Name _____

Address _____

Age _____ City _____ State _____

Your Future assured!

National Automotive
SCHOOL

BE A RAILWAY
TRAFFIC INSPECTOR



For Bus and Railway Service

A Career for Your Future—Pays Well to Start

AMBITIOUS, active men are in demand at all times by railway and bus lines in the fascinating, important duties of PASSENGER TRAFFIC INSPECTION. You are on your own responsibility—report to high officials—have unlimited opportunity for advancement. Travel or remain near home.

Prepare for this interesting, self-satisfying position by clear, easily-mastered correspondence course in a few weeks. After completion of training, we place you immediately at \$320 to \$485 per month, and up, plus expenses or refund your money. Expertly trained S. B. T. I. graduates make good and are promoted rapidly up to \$250 per month. Write today for complete information, Free Booklet. Don't Delay.

Standard Business Training Institute
Div. 208
BUFFALO, N. Y.

Learn to Write

I Teach by Mail

Begin Today—Write for My FREE Book. I can make a good penman of you at home during spare time. Write for my FREE BOOK, "How to Become a good Penman." It contains specimens and tells how others mastered penmanship by the Turnbull System. Your name will be elegantly written on a card if you enclose stamp to pay postage. Write today for book.

F. W. Turnbull, 418 Ridge Bldg., Kansas City, U. S. A.

HOT PIANO Ultra-modern Piano

Jazz taught by mail. Note or ear. Easy rapid lessons for adult beginners. Also Self-instruction system for advanced pianists. Learn 358 Bass Styles, 976 Jazz Breaks, hundreds of Trick Endings, Hot Rhythms, Sock, Stomp and Dirt Effects; Symphonic and Wicked Harmony in latest Radio and Record Style. Write for Free Booklet.

WATERMAN HAWK SCHOOL, 1826 W. Adams St., Los Angeles, Calif.

LEARN WATCHMAKING AND ENGRAVING

BY OUR PROFIT-SHARING PLAN OUR GRADUATES SUCCEED

One of our Iowa students started in a very small way—now doing over \$30,000 a year. Another in Wisconsin, over \$10,000 the first year. Day or night classes. Call or write for FREE BOOK.

Chicago School of Watchmaking, Dept. 7501, 155 N. Clark St., CHICAGO

LEARN MECHANICAL DENTISTRY

Earn Big Money—Men Needed Everywhere. This money-making business easily learned in a few months in day or evening sessions. Practical training, individual instruction. Easy terms. School is highly endorsed. Write now for free catalog P and special tool offer. Address NEW YORK SCHOOL OF MECHANICAL DENTISTRY, 129 W. 31st St., New York

Photography

for

PLEASURE or PROFIT

A fascinating hobby or a profitable business can now be yours. Prepare quickly at home under the personal guidance of leading experts in the fine art of photography. No experience necessary. Full or spare time. Many earn while learning. Our thorough studio method also qualifies you to fill a well paying position upon graduation. Send coupon now for FREE booklet, Opportunities in Modern Photography.

AMERICAN SCHOOL OF PHOTOGRAPHY
3601 Michigan Avenue Dept. 135-C Chicago, Ill.
Send FREE booklet, Opportunities in Modern Photography, and full information.

Name _____

Address _____

City _____ State _____

There is a **JOB** for You Here

Get Into

AVIATION

MAJOR

R.L. Rockwell

Will Train You **AT HOME**, and Until You
Get a Job Paying You
\$300 to \$400 a month

Major Rockwell, famous world war flyer, is offering to train a limited number of ambitious men who want to get into aviation and get one of the big pay jobs that aviation offers.

IN 12 SHORT WEEKS

All you have to do is devote about an hour or two a day to my Home Training Course and in 12 weeks you will be mastering the principles of Ground Training and be prepared to qualify for and accept a big pay job in this branch of Aviation. If you want to fly, my Home Training Course teaches you the principles of flight. When you have completed the ground training I will arrange for you to take

your flying instructions at any licensed airport near your home at special reduced rates. Or if you want you can come here to Dayton and get training at one of the finest and best equipped airports in America. No matter where you learn to fly you can qualify for a pilot's license and a high pay job in passenger lines, mail service, and other important branches of flying.

Advanced Education or Experience Unnecessary

You don't need a high education to master my course. My Home Training Course is thorough and complete. Everything is so clearly explained, with easy-to-understand text and pictures, that in 12 weeks you will be able to grasp every fundamental principle of Aviation ground work and get a start in Aviation qualifying for any important aviation job paying \$300 to \$400 a month. My Home Training Course will give you all the knowledge necessary to pass the U. S. Government's written examination for a license.

How I Help You Get Your Job

Because of my experience in Aviation and knowledge of the work, I am in touch with large employers of trained aviation men who are constantly seeking help. Thus I am able to help my graduates get the aviation job they want at big pay. These employers prefer Rockwell Trained Men.

Money-Back Agreement

I am so sure that you can learn Aviation with my help and step into a big aviation job that if you are not satisfied when you have finished my course, I agree to return every penny of your tuition. Read my money-back agreement. Act now while my special offer lasts. Rush this coupon to me for a copy of my famous free book.

MAJOR ROB'T L. ROCKWELL
 The Dayton School of Aviation
 Desk 18 Dayton, Ohio



AIRPORT



AIRPLANE FACTORY



AIRPLANE MECHANIC



ENGINE MECHANIC

My Book Explains All
... Sent FREE ...
MAIL COUPON

Major Rob't L. Rockwell,
 Dayton School of Aviation,
 Desk 18, Dayton, Ohio.

Dear Major: Please send me FREE and without obligation a copy of your famous book on Aviation; the details of your no-risk plan; also your special tuition offer.

Name.....

Address.....

Town.....State.....Age.....



RADIO

made easy to learn

AT HOME

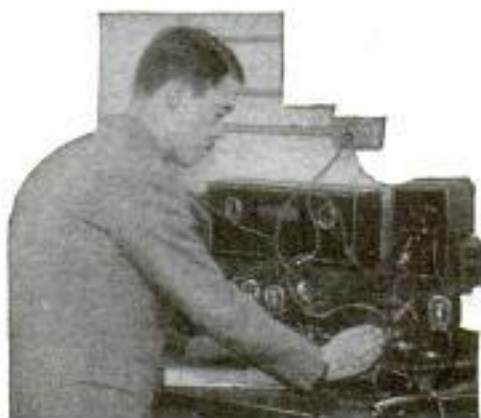

RADIO is a fascinating profession. Now you can become qualified in any one of its twenty different branches. Simply by studying in your spare time at home or at any of the four resident schools operated by RCA Institutes, Inc.

It is not hard to study radio the way it's taught by RCA Institutes. You learn radio by actual experience on the latest type of radio equipment. And you need not give up the position you now hold. You can study an hour a day or any number of hours a day, at home in your spare time.

The RCA Institutes' Home Laboratory Training Course teaches you in a most thorough manner. You learn about servicing, operating, radio telephony and telegraphy . . . also instruction in sound motion picture installation, maintenance and repairs. And you receive at no additional cost the complete RCA Institutes' home laboratory equipment, a modern outlay of apparatus furnished to every student, enabling you to easily solve radio problems.

Send for this **FREE BOOK** Today!



RCA INSTITUTES, Inc.

RCA INSTITUTES, Inc.
Dept. MP-S
75 Varick St., New York, N. Y.

Gentlemen: Please send me your **FREE** book which tells about your laboratory method of radio instruction at home.

Name.....

Address.....

Occupation.....

Men! Big Opportunity is here in Electric Refrigeration



This new industry is growing by leaps and bounds. Everywhere sales lead all other lines. Look around you; you'll see it's so in your town—everywhere.

Trained Men in Big Demand

Shop mechanics, installers, service men, estimators and sales engineers are needed. These jobs pay \$60 to \$200 a week and lead to rapid advancement.

Easy and Quick to Learn

You learn by doing actual work on household, commercial and industrial machines.

Eight weeks in the finest and best equipped school in the country qualifies you thoroughly—then we'll help you secure a good refrigeration job. No matter what your age, education or past experience is—

write for **FREE BOOKLET**. Find out for yourself about this growing field and how we help you get into it. Write at once—NOW—to

THE NATIONAL TECH., 4300 Euclid Ave., CLEVELAND, O.

FREE CATALOG OF PRACTICAL BOOKS

for Practical Men, covering the subjects of RADIO, AVIATION, ENGINEERING, AUTOMOBILE WORK, BATTERY WORK, ELECTRICITY, BUILDING, SHEET METAL WORK, PAINTING, SIGN MAKING, LETTERING, COMMERCIAL ART, will be sent to you on request.

FREDERICK J. DRAKE & CO.

181 N. Michigan Blvd.

Chicago

LAW Free Book

Write today for **FREE** 64-page book, "THE LAW-TRAINED MAN", which shows how to learn law in spare time through the Blackstone home-study course prepared by 80 prominent legal authorities, including law school deans, and U. S. Supreme Court justices. Combination text and case method of instruction used. All material necessary furnished with the course, including elaborate 25-volume law library, delivered immediately upon enrollment. Many successful attorneys among our graduates. L. L. B. degree conferred. Moderate tuition, low monthly terms. Money-Back Agreement.

Write for free book today.

BLACKSTONE INSTITUTE, 307 N. Michigan Ave., Dept. 50-C, Chicago

LEARN WATCH REPAIRING



You can learn by our modern and original system of instruction every part of the **Watch Repairing Trade** at home as good or better than at a shop. You can earn money while learning and secure a well paying position or start in business after completing our course of instruction. Good watch repairers are always in demand and earn from \$50 to \$75 per week. For particulars apply to the **Wisconsin School of Watch Repairing** 524 E. Mason St., MILWAUKEE, WIS.

AVIATION Information FREE

Send us your name and address for full information regarding the Aviation and Airplane business. Find out about the many great opportunities now open and how we prepare you at home, during spare time, to qualify. Our new book "Opportunities in the Airplane Industry" also sent free if you answer at once.

AMERICAN SCHOOL OF AVIATION

3601 Michigan Ave.

Dept. 135-C

CHICAGO

EARN MONEY AT HOME

YOU can make \$15 to \$50 weekly in spare or full time at home coloring photographs. No experience needed. No canvassing. We instruct you by our new simple Photo-Color process and supply you with work. Write for particulars and Free Book to-day.

The **IRVING-VANCE COMPANY Ltd.**
356 Hart Building, Toronto, Can.

\$1000 Extra For YOU

Stoneberger makes that in SPARE Time, broadcasting from Station WJMV, Washington, D. C. Hundreds of others playing for Radio, in Orchestras, etc.—**BIG PAY FOR YOU!**—Free Book tells you all about **QUICK, EASY** Way to Master popular Hawaiian Guitar. Write for it Today! **HAWAIIAN STUDIO 52981, New York Academy of Music, 100 Fifth Ave., New York City**

Can You Compete With A Machine?

AFTER we have gotten over our enthusiasm for the machine age—after we are done with praising modern machinery for what it does, in providing us with newer and finer standards of living, we find that there is another side to the picture.

Modern machinery has certainly helped us to have better things at lower prices. And up to a certain point, machinery helped working people by providing more and more jobs, in order to keep up with popular demands for new items.

But recently—in the last ten years or so, that is—modern machinery has taken on a new significance. It has passed the stage where it helps men to get jobs. It has begun to throw them out of their trades. Notice that—it is the trades, not the jobs alone, that are being taken away from the average worker. Not only in the shop and the factory, but in the office and the store, mechanical devices are replacing from one to twenty men at a time.

A Government report, which states that in the past seven years no fewer than two million men were thrown out of jobs by machines, will show you how serious this mechanical competition is becoming. It isn't just as though these fellows lost single jobs—they lost their chances of getting jobs in the trades where they were skilled. Instead of being able to go up, through their knowledge, to higher, better-paid positions—even though slowly—they found themselves pitchforked into the ranks of unskilled labor, practically speaking. Machine competition often forced—and is now forcing—men who have lost their trades to take lower-paid, less highly-skilled positions.

This has been the serious problem of two million men in the last seven years. It will be more serious for more millions in the years to come. A few men—comparatively speaking, that is—are going to find machine competition a real blessing. Those few thousands are the ones who realize that, if they have lost their jobs in the producing end of business, they can get better ones in the selling end. No machine can ever sell—except perhaps a penny-in-the-slot machine. And on the other hand, the increasing production of machines must be sold.

Economists and editors have clamored for ten years, saying that we are neglecting the selling end of business, in order to develop the production end. Some of them have gone so far as to say that if there had been enough trained salesmen in the world, the recent depression would have been prevented. One thing is certain—that in the next ten years we will pay as much attention to training our salesmen as we have paid, in the past, to building up our manufacturing methods. Now, when this interest in intelligent selling is beginning, is the time for foresighted men. The man who trains himself now, to make the most of the new salesmanship, will be the man who will never lose his job to a machine. On the contrary—the machine will work for him, providing him a richly-paid job for the rest of his life.

National Salesmen's Training Assn.,
Dept. K-104, N. S. T. A. Bldg.,
Chicago, Ill.

Without cost or obligation you may send me your free book,
"The Key to Master Salesmanship."

Name

Address

City State

Age Occupation



They Laughed When I Mailed This Coupon

...But It Brought Me The Book That Showed Me How to Make \$10,000 a Year!

AS I walked up to the mail box, Joe nudged Ed and winked broadly for my benefit. "Sh!" he hissed. "This is going to be the big turning point in Frank Parker's life! He's writing for a book that tells how to get into salesmanship. Pretty soon he'll be earning so much that he'll make the rest of us look like pikers!"

Ed snickered.

"Won't it be grand!" he grinned. "Now he can quit punching time-clocks and eating 40-cent lunches. Drop me a postal sometime when you get out into big business and start making \$10,000 a year, will you, Frank?"

Probably it did seem like a joke to them that a \$30 a week clerk would have the nerve to think he could ever get anywhere or make real money without some special "gift" or "pull."

But yesterday I sat down and wrote to Ed who is still at the shop, dragging along at the same old job.

"Dear Ed,"—I wrote. "You asked me to send you a card when I 'got into big business and started making \$10,000 a year.' Yesterday I was promoted to the job of assistant Sales Manager of the Western Metal Works, at a salary that goes with it. I'll loan you my copy of that book on salesmanship you used to think was such a joke."

Only a book! Just seven ounces of paper and printers' ink—but it contains one of the most vivid and inspiring messages that any ambitious man can read. It reveals the real truth about the art of selling. And not only that—it outlines a simple plan that will enable almost any man to master scientific salesmanship without losing a day or a dollar from his present position.

FREE TO EVERY MAN

See for yourself why "The Key to Master Salesmanship" has been the deciding factor in the careers of so many men. See how Mark Barichievich of San Francisco, Calif., for example, jumped from \$8 a week as dishwasher to \$150 as salesman. Find out how F. B. Englehardt of Chattanooga doubled his pay and commenced earning \$7,000. You do not risk one penny nor incur the slightest obligation. And since it may alter your entire future, it certainly is worth your time to fill out and clip the coupon at the top of this page. Why not do it now!

Where Shall We Send Your Copy... FREE?



NATIONAL SALESMEN'S TRAINING ASSOCIATION
Dept. K-104 N. S. T. A. Bldg.,
CHICAGO, ILL.

Mail Coupon Above Today!



SHOW CARD LETTERING

Learn at Home

Here is the very course you need if you want to get a good paying position as a Show Card Letterer or Sign Letterer, or have a business of your own. This course is complete and practical, arranged to meet the needs of the student who studies at home.

H. L. Wood, a clerk, made more than \$700 "on the side" before he had completed his course and also won \$125 in prizes. Harry William Lord writes that he has more than doubled his salary as a result of studying this I. C. S. course in spare time.

There is no doubt that Show Card Lettering and Sign Lettering offer a real opportunity to ambitious men and women. Just mark and mail the coupon and we'll gladly send you a booklet telling all about the I. C. S. course in Show Card Lettering, or any other subject in which you are interested.

INTERNATIONAL CORRESPONDENCE SCHOOLS

Box 5557-G, Scranton, Penna.

Without cost or obligation, please send me a copy of your booklet, "Who Wins and Why," and full particulars about the course before which I have marked X in the list below:

SHOW CARD LETTERING

ILLUSTRATING

- Business Management
- Industrial Management
- Personnel Management
- Traffic Management
- Accounting and C. P. A. Coaching
- Cost Accounting
- Bookkeeping
- Secretarial Work
- Salesmanship

CARTOONING

- Advertising
- Business Correspondence
- Stenography and Typing
- English Civil Service
- Railway Mail Clerk
- Mail Carrier
- Common School Subjects
- High School Subjects
- Lumber Dealer
- Spanish French

TECHNICAL AND INDUSTRIAL COURSES

- Architect
- Architectural Draftsman
- Building Foreman
- Concrete Builder
- Contractor and Builder
- Structural Draftsman
- Structural Engineer
- Electrical Engineer
- Electrical Contractor
- Electric Wiring
- Electric Lighting
- Electric Car Running
- Telegraph Engineer
- Telephone Work
- Mechanical Engineer
- Mechanical Draftsman
- Machine Shop Practice
- Toolmaker
- Patternmaker
- Civil Engineer
- Surveying and Mapping
- Bridge Engineer
- Gas Engine Operating

- Automobile Work
- Airplane Engines
- Plumber and Steam Fitter
- Plumbing Inspector
- Foreman Plumber
- Heating and Ventilation
- Sheet-Metal Worker
- Steam Engineer
- Marine Engineer
- Refrigeration Engineer
- R. R. Positions
- Highway Engineer
- Mining Engineer
- Pharmacy
- Chemistry
- Iron and Steel Worker
- Textile Overseer or Supt.
- Navigation Assayer
- Cotton Manufacturing
- Wooden Manufacturing
- Agriculture Fruit Growing
- Poultry Farming
- Mathematics Radio

Name.....

Address.....

City.....State.....

Occupation.....

If you reside in Canada, send this coupon to the International Correspondence Schools Canadian, Limited, Montreal, Canada

NEW YORK ELECTRICAL SCHOOL

*Opportunities
for All Men!*

Every phase of all branches of Practical Electricity taught by Actual Practice in America's Foremost Institution of Trade Learning.

Special Courses in Automobile Mechanics and Electricity.

Day and evening classes open all year.

Write for FREE School Booklet

New York Electrical School
44 W. 17th St., New York City



Learn Public Speaking

At home—in spare time—30 minutes a day. Overcome "stage-fright," gain self-confidence, increase your salary, through ability to sway others by effective speech. Write now for free booklet, *How to Work Wonders With Words*, NORTH AMERICAN INSTITUTE, Dept. 115-C, 3601 Michigan Avenue, Chicago, Illinois

STAMMERING

*You can be quickly helped if
you stammer or stutter*

I know, because I relieved myself after stammering for nearly 20 years. The story of my suffering—and relief—has interested thousands, many of whom have permitted me to help them. Full story of my successful efforts told in 279-page book. Sent anywhere for 10 cents. B. N. BOGUE, 11144 Bogue Building, 1147 North Illinois Street, Indianapolis, Ind.



Wonderful, new device, guides your hand; corrects your writing in a few days. Big improvement in three hours. No failures. Complete outline FREE. Write C. J. Ozment, Dept. 34, St. Louis, Mo.

Learn to Dance

You can learn all the modern dances—the latest Tango steps, the new Fox Trots, dreamy Waltzes, smart Collegiate Steps, and popular Society Steps at home, easily and quickly. New chart method makes dancing as simple as A-B-C. No music or partner required. Don't be a wallflower. Learn to dance. Complete course—285 pages, 64 illustrations, sent on 5 Days' Free Trial, Equals \$20.00 course. Send to us now. Pay postage only \$1.98, plus postage upon arrival. Money back if not delighted. Catalog Free.



Franklin Pub. Co., 800 No. Clark St., Dept. 9432, Chicago

Don't say
"learning music
is hard"



...until you've sent for our
FREE demonstration lesson

TIME and again you've wanted to learn to play your favorite instrument; you've longed to get your share of the popularity and personal pleasure that every good musician enjoys—to know the thrill that comes with being able to entertain musically.

Yet, so far, you've been "scared" to start.

Why? Is it because you're under the impression that learning music necessitates long years of uninteresting study—lesson after lesson crammed with dry-as-dust theory and endless practicing? Has somebody told you that you need special talent to become a musician?

Then you're in for the surprise of your life. For, now, thanks to the famous U. S. School of Music, the reading and playing of music has been made so downright simple that you don't have to know one note from another to begin.

Easy As Can Be

The lessons come to you by mail. They consist of complete printed

instructions, diagrams and all the music you need. Compulsory practice? No. You study only when you feel like it. Personal teacher? No. If you make a mistake you correct it *yourself* and continue. Monotonous scales and harsh-sounding finger exercises? Never. From the very first lesson on you are playing real tunes by note. It's as easy as A-B-C. For before you strike a note, you are told how a thing is done. Then a picture shows you how. Then you do it yourself and hear it. Little theory. Plenty of accomplishment.

A few short months pass quickly by. Almost before you realize it, you are playing selections that fit your mood—you are entertaining others with wonderful classical compositions . . . lighter airs and ballads of haunting beauty . . . dance music that thrills with the fascination of jazz. No wonder that this remarkable method has been vouched for by over 600,000 people from all parts of the world.

Bear in mind no matter which instrument

you select—the cost of learning in each case will average the same—just a few cents a day!

Get Proof Free!

Don't let a lot of false impressions and silly bugaboos delay your start toward musical good times. If you really want to learn to play—if social popularity and increased income appeal to you—then reserve your decision until we send you a Free Demonstration Lesson and a copy of our free illustrated book which describes in detail the famous U. S. School print-and-picture method. Then it's entirely up to you. You're the judge and jury. No obligation involved, of course. When writing, kindly mention your favorite instrument. Forget that old-fashioned idea that you need talent to learn music and fill in and mail the coupon now. Instruments supplied when needed, cash or credit. U. S. School of Music, 78 Brunswick Bldg., New York City.

U. S. SCHOOL OF MUSIC
78 Brunswick Building, New York City

Please send me your free book, "Music Lessons in Your Own Home," with introduction by Dr. Frank Crane. Free Demonstration Lesson and particulars of your easy payment plan. I am interested in the following course:

Have You
..... Instrument?

Name.....

Address.....

City..... State.....

PICK YOUR INSTRUMENT

Piano	Violin
Organ	Clarinet
Ukulele	Flute
Cornet	Saxophone
Trombone	Harp
Piccolo	Mandolin
Guitar	Cello
Hawaiian Steel Guitar	
Sight Singing	
Piano Accordion	
Italian and German Accordion	
Voice and Speech Culture	
Harmony & Composition	
Drums and Traps	
Automatic Finger Control	
Banjo (Plectrum, 5-String or Tenor)	
Juniors' Piano Course	

Come to sunny
CALIFORNIA



and LEARN
Electricity
RIGHT!

NATIONAL

opens its doors to you!

Right in the heart of America's most interesting place to live and learn—National—the approved trade school of the West—invites you to Los Angeles! Come West, enjoy life, learn a profitable trade in the land of prosperity, progress, sunshine and happiness.

Your Railroad Fare Allowed for a Limited Time!

Every one dreams of coming to California. National will pay your railroad fare from any point in the United States. Never again another opportunity like this! Investigate this great offer at once!

REAL Big Pay Jobs Await You!

Boulder Dam means millions for Southern California! Thousands more will soon be working on this world's greatest hydroelectrical project. Learn quickly at NATIONAL for big pay jobs in profitable Electrical Trades.

Don't Worry About Enough Money! We'll Help You!

If you are short of money, we help you secure part-time jobs to earn your living expenses while learning. We place scores of graduates on good pay jobs with real futures. Unlimited Lifetime Employment Service.

Write Today About the Greatest Offer Ever Made!

This great Million Dollar Institution, equipped with the best money can buy—the finest faculty of electrical experts in the country—a school with a Heart and personal interest in your success and personal welfare opens its doors to you. Send at once for NEW Book with full details. No age limit—no previous experience required; start any time. Send for your copy of this new book TODAY!

Send for this FREE BOOK.



NATIONAL ELECTRICAL SCHOOL
Dept. 84-D, 4006 Figueroa St.,
Los Angeles, California

Send me your big free illustrated catalog of Electrical Opportunities showing how I can learn quickly

Name _____
Address _____
Age _____ City _____ State _____

NATIONAL ELECTRICAL SCHOOL

Learn AVIATION

WHERE LINDBERGH LEARNED!

World's Best Known Aviation School

Known throughout aviation industry as school that produces the best-trained mechanics and pilots. That's why Lincoln graduates secure most responsible and best pay positions! Complete courses in mechanics, flying, welding, radio, \$250,000 worth of buildings and equipment, \$100,000 airport. **Ground and Flying School Government Approved.** Connected with large airplane factory, practical mechanical training with factory standards. You learn on 4 types training planes. Reasonable tuition. We also teach in Spanish. "Lindy" learned in Lincoln. You, too, learn here. Write today for catalog, stating your age.

LINCOLN AIRPLANE & FLYING SCHOOL
201A Aircraft Bldg. Lincoln, Nebr.

1931 Radio CATALOG

RADIO BARGAINS
WHOLESALE DISCOUNTS
LOWEST PRICES



Greatest bargains shown at **REGULAR WHOLESALE TRADE DISCOUNTS!** Nationally-advertised, guaranteed radio merchandise including the sensational **boxed LAFAYETTE ALL ELECTRIC RADIO RECEIVER**, with tone control. Write at once for **FREE 1931 Radio Bargain Catalog**, showing complete selection. Don't buy until you see this wonderful catalog!

WHOLESALE RADIO SERVICE CO.
Dept. H-11
38 Vesey St. New York

FREE!

SONG REQUIREMENTS OF TALKING PICTURES, RADIO AND RECORDS

SONG WRITERS

Don't fail to read "Song Requirements of Talking Pictures, Radio and Records" an explanatory, instructive book **SENT FREE on request.** New writers may mail song-poems for free examination. We revise, compose and arrange music, and secure copyrights, guaranteeing approval.

P. M. Newtamer Associates, 1674 Broadway, New York

30 Days' Free Trial on all MEAD Bicycles

New RANGER Models now ready for delivery direct from our factory. Astonishing new prices and terms. Do not buy until you get them.

RIDER AGENTS WANTED to ride and exhibit sample. Save big money. Many models, styles, wheels, lamps, horns, equipment at half usual prices.

Mead CYCLE COMPANY Write us today for free catalog
DEPT. Kill CHICAGO



Why STAMMER?

I overcame my own stammering. Let me help you. My new, free book tells how. You, too, can overcome your speech defects and lead a normal, happy and successful life. Write today!

ROBT. E. CARD, 12890 Woodward Ave., Detroit, Mich.

Free Book

Operator No. 38



FOLLOW THIS MAN

Secret Service Operator No. 38 is on the job! He's taking down dangerous Counterfeit Gang. Tell-tale finger prints in murdered girl's room.

Free The Confidential Report Operator No. 38 made to his chief. Write for it. **\$3000 a year and up**

YOU can become a Finger Print Operator at home, in your spare time, at small cost. Write for confidential full report and details. Literature will NOT be sent to boys under 17 years of age.

INSTITUTE OF APPLIED SCIENCE
1920 Sunnyside Ave. Chicago, Ill.
Dept. C-135

"I'll PROVE in Only 7 Days that I Can Make YOU a New Man!"

No other Physical
Instructor in the
World has ever
DARED make
such an Offer

By **CHARLES ATLAS**
Holder of the Title:

"The World's Most Perfectly Developed Man"

I HAVE proved to thousands that my system of building powerful, big-muscled men begins to show real results in only 7 days—and I can prove it to you.

You don't have to take my word for it. You don't have to take the word of my hundreds of pupils who have added inches to their chests, biceps, necks, thighs and calves in only a few days. No sir! You can prove for yourself—in just one week—by the change you see and feel in your own body—that you can actually become a husky, healthy **NEW MAN**—a real "Atlas Champion."

All I want to know is: Where do you want big, powerful muscles? How many pounds of firm flesh do you want distributed over your body to fill you out? Where do you lack vitality, pep and robust health? Where do you want to take off flabby surplus fat?

Just tell me, give me a week, and I'll show you that I can make a *New Man* of you, give you bodily power and drive, and put you in that magnificent physical condition which wins you the envy and respect of any man and the admiration of every woman.

My own system of *Dynamic-Tension* does it. That's the way I built myself from a 97-pound weakling to "The World's Most Perfectly Developed Man." And now you can

have a big, balanced muscular development like mine in the same easy way.

No "Apparatus" Needed!

You begin to FEEL and SEE the difference in your physical condition at once, without using any tricky apparatus, and pills, "rays" or unnatural dieting. My *Dynamic-Tension* is a natural method of developing you inside and out. It not only makes you an "Atlas Champion," but goes after such ailments as constipation, pimples, skin blotches, and any other weaknesses that keep you from really enjoying life and its good times—and it starts getting rid of them at once.

Let Me Tell You How

Gamble a 2c stamp today by mailing the coupon for a free copy of my new illustrated book, "*Everlasting Health and Strength*." It tells you all about my special *Dynamic-Tension* method. It shows you, from actual photos, how I have developed my pupils to the same perfectly balanced proportions of my own physique, by my own secret methods. What my system did for me, and these hundreds of others, it can do for you too. Don't keep on being only 25 or 50 per cent of the man you can be! Find out what I can do for you.



CHARLES ATLAS, As He Is Today

FREE BOOK

Where shall I send your copy of "*Everlasting Health and Strength*"? Jot your name and address down on the coupon, and mail it today. Your own new "Atlas body" is waiting for you. This book tells you how easy it is to get, my way. Send the coupon to me personally—

CHARLES ATLAS
Dept. 8H

133 E. 23rd St., New York City

CHARLES ATLAS Dept. 8H
133 East 23rd Street, New York City

I want the proof that your system of *Dynamic-Tension* will make a *New Man* of me—give me a healthy, husky body and big muscle development. Send me your free book, "*Everlasting Health and Strength*."

NAME.....
(Please print or write plainly)

ADDRESS.....

CITY.....STATE.....



"Belief in Signs" brought

300%

SALARY INCREASE

to W. F. HISEY,
Now Treasurer of One of
Nation's Large Department Stores

Ten years ago, W. F. Hisey was blue and discouraged. If you aren't satisfied with your position, salary—or even your field of work—you can understand how he felt.

Today he is Treasurer of the Palais Royal, a Washington, D. C. department store, with \$5,000,000 sales per year, employing over 600 people.

Why the amazing change? . . . Mr. Hisey saw a sign—a sign advertising the salary-value of LaSalle Training. He investigated—realized he could not attain his goal without knowledge of Higher Accounting—and, in spare time, quietly prepared himself for a position as Controller of a Department Store. His big chance came—he was made assistant Controller—a few months later, Controller. He even surpassed his ambitions—when he was appointed Treasurer, at a salary over 300% greater than when he enrolled with us!

\$5,000 Positions for Everyone
—believes Hisey

If you think such progress is beyond your ability—take heed of what Hisey says: "I will be eternally grateful to LaSalle Extension University for my advancement. I recommend your course to every ambitious young man, for a \$5,000 position is waiting for everyone who will take your training and apply himself."

You CAN SUCCEED—it is written in the records of over 730,000 LaSalle members. You CAN increase your pay—for LaSalle has a definite salary-raising plan that extends beyond a course of study—a plan that actually shapes your whole career!

We have prepared a special book on Higher Accounting—showing the rich rewards it offers to the LaSalle-trained man. If you will merely mail the coupon below, we will send you this book FREE, along with a copy of "Ten Years' Promotion in One"—that famous booklet which has put many men on the road to success.

Fill out and mail the coupon. A moment now may save a lifetime of futile efforts and regrets. Do it NOW!

-----Find Yourself Through LaSalle!-----

LaSalle Extension University
Dept. 864-HR Chicago

I should be glad to have details of your salary-increasing plan as applied to my advancement in the business field checked below. Also a copy of "Ten Years' Promotion in One," all without obligation.

O Higher Accountancy

- | | |
|------------------------------|----------------------------------|
| O Business Management | O Modern Business Correspondence |
| O Modern Salesmanship | O Modern Foremanship |
| O Traffic Management | O Expert Bookkeeping |
| O Railway Station Management | O C. P. A. Coaching |
| O Law—Degree of LL.B. | O Business English |
| O Commercial Law | O Commercial Spanish |
| O Industrial Management | O Effective Speaking |
| O Banking and Finance | O Telegraphy |
| O Personnel Management | |



Name.....

Present Position.....

Address.....

NEW INDUSTRY NEEDS MEN

Electric
Refrigeration
Calls You!

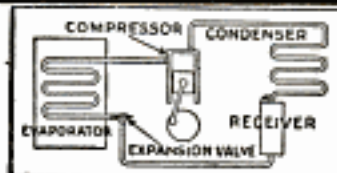

NEWEST American industry needs plain, practical men for jobs paying up to \$75 and \$100 a week in production, service, installation and sales. Fast-growing, big money field—backed by General Motors, General Electric, etc. New, easy home training fits you quickly in spare time. Endorsed by Servel, Kelvinator and other manufacturers. Free employment service. 2 weeks' actual factory training without extra cost. Low fee, easy terms. Money back agreement.

FREE new book contains full details. Sent without obligation. Write NOW! UTILITIES ENGINEERING INSTITUTE, Dept. 181, 4403 Sheridan Rd., Chicago, Ill.

Be a DENTICIAN LEARN AT HOME

To make Crowns, Plates, Bridgework, etc., for Dentists. Easy practical way to learn mechanical dentistry at home in spare time. Full equipment of tools and materials included with course FREE. Low tuition. Easy terms. Write for FREE BOOK about this money making profession and our easy-to-learn home study course and special offer.



McCarrie School of Mechanical Dentistry
1340 S. Michigan Avenue Dept. E-476 Chicago, Ill.

1000 POULTRY SECRETS

Our famous home-study Poultry Course teaches how to get more eggs, cut feed bills, avoid losses. Methods used by successful Poultry raisers the world over. FREE Book tells all about Course. Write today for your free copy. National Poultry Institute, Dept. 411-M, Washington, D. C.



Wrestling Book FREE



Learn to be an expert wrestler. Know scientific wrestling, self-defense, and hip-jitsu. Develop a sound physique, and have perfect health. Join this popular school and learn by mail. The famous world's champions—the marvelous

Frank Gotch and Farmer Burns

offer you a wonderful opportunity. Wrestling is easily and quickly learned at home by mail. Men and boys write now for splendid free book. Learn all the science and tricks. Be able to handle big men with ease. Accept this wonderful offer NOW. Send for free book today, stating your age.

Farmer Burns School of Wrestling, C337 Range Bldg., Omaha, Neb.

Employers promote men who show interest, who read upon

ELECTRICITY

AUDEL'S NEW ELECTRIC LIBRARY makes Electricity as easy as ABC for beginners; interesting as fiction. Engineers carry in pocket for spare time reading and reference. Questions, answers, diagrams, calculations, underwriter's code; design, construction, operation and maintenance of modern electrical machines and appliances FULLY COVERED. AUDEL'S BOOK-A-MONTH HOME-STUDY PLAN gives complete knowledge of Applied Electricity. Helps overcome handicaps of education. Go a day. No cash in advance. Write today for free Electric Folder. THEO. AUDEL, 65 W. 23rd Street, NEW YORK, Dept. P. M.



Now science has added low cost to the convenience of automatic oil heat. Amazing discovery of the Laco Mineral wick does 50-cents fuel waste, smoke, soot, grease. Eliminates the high cost of heating forever.

Dealers Wanted Quick! Think what an opportunity for dealers. Sells fastest because lowest priced, cleanest to operate. Liberal discounts! Exclusive territories. Openings for BIG jobs. Get full information and sensational low price offer at once! Listed as standard by Underwriters. Price as low as \$70.

LACO OIL BURNER CO., 146 Union St., Griswold, Iowa, U. S. A.

McSweeney's Easy Way to a New Job at Big Pay.



J. H. McSWEENEY

McSweeney Training makes you independent of hard times. There always is a demand for trained men. McSweeney teaches trades that never will be replaced by mechanical equipment. Easily and quickly you learn all about Automotive Mechanics and General Electricity. Never was opportunity greater for the man who knows how. **Eight to Twelve Weeks—Then** a job that should pay from \$40 to \$100 a week, in the automotive or electrical field. Get out of the low-pay class before electricity takes your job.

No Books—No Lessons

In my shops we use tools instead of books. Students work on live equipment. Fifty thousand men can attest to the advantage of having my practical training.

Guarantee of Satisfaction

I agree to train you until you are permanently placed in a good job at good pay if you are over sixteen years of age.

ELECTRICITY | AUTOMOTIVE

Learn to control, master, and apply that magical juice which rules the universe. Be a McSweeney-Trained electrical man. Every motor propelled vehicle—automobile, truck, tractor—requires constant service. The fewer cars sold, the more service required.

Mail This Coupon for FREE Book

J. H. McSweeney, Pres.,
Dept. C-10-8, Chester at 30th St., Cleveland, Ohio.

Without cost or obligation, send me your big FREE book and full details of your special tuition offer. (Check school interested in.) Electrical Automotive.

Name.....

Street.....

Town..... State..... Age.....

Not a Correspondence Course—No Books—No Lessons

McSWEENEY

**ELECTRICAL
AUTOMOTIVE
SCHOOLS**

DEPT. C-10-8 CLEVELAND, OHIO

Study
LAW
AT
HOME

Lincoln did it! Also thousands of other great lawyers, politicians and business men. YOU, too, can become a lawyer or law trained business man through home study guided by the successful practicing lawyers of our faculty. Write today for free book.

AMERICAN CORR. SCHOOL OF LAW
3601 Michigan Ave., Dept. 135-C, Chicago

Find out how EASY it is to own The New
ENCYCLOPAEDIA BRITANNICA

Write for FREE Booklet

Encyclopaedia Britannica, Inc., 342 Madison Ave., New York

IMPROVE your ENGLISH

Through Sherwin Cody's new invention you will enjoy mastering English. Few rules—no drudgery. Only 15 fascinating minutes daily gives quick command of correct speech and writing. Send TODAY for free booklet "How You Can Master Good English in 15 Minutes a Day."

SHERWIN CODY SCHOOL OF ENGLISH
58 Searle Bldg. Rochester, N. Y. **FREE BOOK**

This
**EASY
WAY**

LEARN CARTOONING

AT HOME DURING SPARE TIME

with the course that has trained HUNDREDS of beginners successfully. The Landon Picture Chart Method of teaching ORIGINAL drawing by mail makes cartooning easy to learn. This school is a Member of The National Home Study Council. Write today for sample picture chart to TEST YOUR ABILITY and examples of the work of successful students now earning from \$50 to \$200 and more per week. Enclose 6c in stamps and STATE YOUR AGE.

THE LANDON SCHOOL, 2838 National Bldg., Cleveland, Ohio



TRAVEL—for 'UNCLE SAM'

RAILWAY POSTAL CLERKS

MAIL CARRIERS—POSTOFFICE CLERKS
IMMIGRANT INSPECTORS—CUSTOMS INSPECTORS

\$1700 to \$3400 a Year for Life

No "lay-offs" because of strikes, poor business, etc.—sure pay—rapid advancement. Many other U. S. Government Jobs. City and country residents stand same chance. *Common sense education usually sufficient.*

STEADY WORK

Cut coupon and mail it before turning the page.

MEN—BOYS 18 to 45

Use Coupon Before You Lose It

COUPON

FRANKLIN INSTITUTE, Dept. F 180, Rochester, N. Y.
Rush to me, free of charge, (1) A full description of the position checked below; (2) 32-page book, with list of steady positions obtainable; (3) Tell me how to get the position checked.

Railway Postal Clerk (\$1900 to \$2700) Immigrant Inspector (\$2100 to \$3000)
 Postoffice Clerk (\$1700 to \$2300) Customs Inspector (\$2100 to \$3300)
 City Mail Carrier (\$1700 to \$2100) Rural Mail Carrier (\$2100 to \$3400)

Name.....

Address.....



Only
\$ **2** **DOWN** and **KEEP**

These SIX BIG Money-Making Books

Yes, money—big money, can be made with the help of good books—the right kind of books, books which teach you how to do things better and to make money doing it. These 6 big books on

Auto-Engineering Including Aviation Motors

are the greatest money makers that any man interested in automobile construction and repairs ever owned. Brimful of fascinating facts, designed to help anyone understand every detail of modern automobile construction. They become invaluable to you whether you own a garage, work for someone else, or are only interested in knowing how to keep your own car 100% efficient. These 6 big automobile books are published by the American Technical Society with over a million dollars of resources, enabling us to get the co-operation of the largest automobile manufacturing concerns who have supplied data sheets, specifications and the results of their own service experience. They are unquestionably the finest automobile books ever published and include over 120 pages on Aviation Motors.

New 1931 Edition

Imagine books which are so new that every page is right up to date—wiring diagrams, construction details, service problems—are all right up to the minute. Nowhere else that we know of can you get as complete information. Over a million dollars of resources have enabled us to give you the best books on the subject ever published. You will find nearly 20 pages on front wheel drives alone. Everybody interested in automobiles in any way will welcome these books, especially on our no money offer.

Free Examination

These books are sent to you without any obligation. You may keep them for full 10 days. Look them over, find out any facts you want to know, prove to your own satisfaction how valuable they can be.

OVER
2500
PAGES

Flexible Binding.
3000 Charts and Illustrations

Contains all the newest automotive developments, clearly and fully explained

SEND
NO MONEY NOW

All we want you to do before we ship the complete set is to give us your name and address. Just send the coupon and we will ship immediately. On delivery you deposit only \$2, plus the few cents delivery charges. Then keep the books for full 10 days before you decide whether or not you want them. You will immediately recognize the advantages of the Jiffy Index, which puts facts at your finger tips instantly. If you decide to keep them send \$3 in 30 days and \$3 a month until the special low price of only \$24.80 is paid. There is nothing more to pay and no other obligation of any kind.

Note: Of course, if you prefer, you may enclose \$2 with the coupon, and the books will be sent to you with the same guarantee and the same promise of an immediate refund.

Engine Principles
Four Wheel Brakes
Front Wheel Drive
Transmission
Straight Kinks
Shop Kinks

These books have been fully revised and meet every need of the automobile owner or expert.

American Technical Society, Dept. AC19,
Drexel Ave. at 58th St., Chicago.

You may send me the 6 big money-making books on automobile engineering, 1931 edition, with the understanding that I will deposit \$2 on delivery, which deposit is to be immediately returned to me if I return the books within 10 days, at your expense. If I decide to keep them, I will send you \$3 in 30 days and then \$3 a month until the special low price of only \$24.80 is paid. Note: If you are enclosing \$2.00 please check here.....

NAME.....
ADDRESS.....
CITY.....STATE.....

BIG OPPORTUNITIES in PHOTOGRAPHY



Earn \$1,500 to \$7,000 a year. Opportunities everywhere for trained motion picture, commercial or portrait photographers. Previous experience unnecessary. Train through our Simplified System. We furnish equipment.

GOOD-PAY
FASCINATING WORK
YOUR OWN BUSINESS
NATIONWIDE FIELD



Personal Service Bureau helps you start a studio or secure position. Send TODAY for FREE Book on
 Motion Picture Photography or Projection.
 Commercial and Portrait Photography or Photo-finishing.

NEW YORK INSTITUTE OF PHOTOGRAPHY, Dept. AJ-1455, 10 West 33rd St., New York City

Don't PEEL POTATOES

Agents!

This is brand new! Going like wild-fire! Offers a real chance for \$100 a week. Spare-time and full-time sales plans offered. Jump in on the ground floor! Write quick for big-money plans and Free Outfit offer.



An amazing new automatic invention now makes potatoes peel themselves! No more paring knives! No cut fingers! No mess, noise or waste! Here's something every woman understands and wants the instant she even hears about it! A mechanical marvel,

almost incredibly small and simple, yet does more than ten pairs of hands! Peels the biggest potato in only a few seconds at the mere turn of a crank! Costs little more than a couple of good paring knives. Pays for itself many times over in saving on potatoes. Test it yourself at once. Write now. Ask quick for Introductory Offer.

GUARANTY PRODUCTS CO.
Dept. L-88, Francis Bldg.
Washington at 16th St., St. Louis, Mo.



VOICE

100% Improvement Guaranteed

Send today for free Voice Book telling about amazing New SILENT Method of Voice Training. Increase your range, your tone qualities. Banish huskiness and hoarseness. Learn to sing with greater ease. 100% improvement guaranteed—or money back. Write today for free booklet—one of the greatest booklets on voice training ever written.

PERFECT VOICE INSTITUTE, Studio C-135
308 No. Michigan Ave., Chicago

Government Positions

Clerk Carriers, Rural Carriers, Railway Mail Clerks, Postmasters, Department Clerks, and many others. Splendid salaries, easy work, vacation with pay. Only common school education required. Examinations often. 44,817 appointed last year. Send for our Civil Service Catalog No. 6. **COLUMBIAN CORRESPONDENCE COLLEGE, Washington, D. C.**

QUIT TOBACCO

No man or woman can escape the harmful effects of tobacco. Don't try to banish unaided the hold tobacco has upon you. Join the thousands of inveterate tobacco users that have found it easy to quit with the aid of the Keeley Treatment.



KEELEY Treatment For Tobacco Habit Successful For Over 50 Years

Quickly banishes all craving for tobacco. Write today for Free Book telling how to quickly Free yourself from the tobacco habit and our Money Back Guarantee.

Home of the famous Keeley Treatment for Liquor and Drugs. Booklet Sent on Request. Correspondence Strictly Confidential.
THE KEELEY INSTITUTE, Dept. A-348, Dwight, Illinois

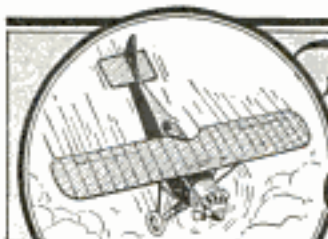

*When I Showed Them I
Graduated from VON HOFFMANN'S*

THEY GAVE "ME" THE JOB

RICHARD MCDUGALL, North Robinson, Ohio, writes: "As you will see, I have a job at the Bucyrus Aviation School. I am getting along fine. **When I showed them I had graduated from Von Hoffmann's, they gave me the job.** And I am proud of it!"

At the Von Hoffmann Air College you get a real thorough course in the Principles of Flight, the Theory of Flight, Principles of Construction, Materials of Construction, Engine Instruments, Flying Instruments, Maintenance and Repair of Motors, Aero Dynamics, Aerology, Aerostats—**all about aviation.**

Von Hoffmann Air College is one of the oldest and most successful in the country, with the highest possible Government rating as Transport, Limited Commercial, Private Pilot, Ground and Flying.

Located on the famous Lambert-St. Louis Airport which cost two million dollars and has the highest rating of A-1-A—used by all air mail lines operating from and through St. Louis.

We are not interested in turning out graduates. Our system calls for your consuming every bit of training. Rigorous examination standards are maintained. Thoroughness, plus unequalled aviation training facilities, is the reason why Von Hoffmann graduates are air leaders today and will be tomorrow.

Von Hoffmann Air College training open only to students 17 years or older. If you are under 17, send for information on our Home Study Preparatory Course

MEMBER



Write for "What Aviation Offers You."

VON HOFFMANN AIR COLLEGE

Lambert-St. Louis Municipal Airport, St. Louis, Missouri

LEARN WATCHMAKING

and become independent. We help you secure a position. Easy to learn. Send for FREE CATALOG.

ST. LOUIS WATCHMAKING SCHOOL Dept. 5, ST. LOUIS, MO.

Mysterious Power of Pelmanism

Let us send you a free copy of "Scientific Mind Training." An instructive book which explains an amazing system of mind training already used by more than 750,000 people. It will show you how and why Pelmanism is the only system of teaching for developing all the mental powers at the same time. Endorsed by such distinguished men as Edgar Wallace, Sir Harry Lauder, Jerome K. Jerome, Prince Charles of Sweden and hundreds of others. Write TODAY to

THE PELMAN INSTITUTE OF AMERICA

71 WEST 45th STREET DEPT. 68 NEW YORK CITY

AMERICAN METHOD

Pays Big Profits

\$25⁰⁰
Per Day

Stop looking for a job. Get into business for yourself. No matter what sort of work you have been doing, you can quickly become independent through the American Method. Ask about this new and amazingly successful system. No obligation. AMERICAN FLOOR SURFACING MACHINE CO. 523 S. St. Clair St. Toledo, Ohio



Wireless (Radio)

and Morse telegraphy taught thoroughly. School, oldest and largest endorsed by Telegraph, Radio, Railway and Government officials. Unusual opportunities. Expenses low—can earn part. Catalog free. DODGE INSTITUTE, Jones St., Valparaiso, Indiana.

How To Secure A Government Position

Why worry about strikes, layoffs, hard times? Get a Government job! Increased salaries, steady work, travel, good pay. I'll help you become a Custom House Clerk, Railway Postal Clerk, Post Office Clerk, City Mail Carrier, Rural Carrier—or get into any other Government job you want. I was a Secretary Examiner of Civil Service Commission for 8 years. Have helped thousands. Get ready NOW for the NEXT Railway Postal Clerk Examination! Open to citizens from 18 to 50.

Now FREE My 32-page book tells about the jobs open—and how I can help you get one. Send the coupon for your copy TODAY.

A. H. Patterson, Civil Service Expert, Rochester, N. Y. Please send me without obligation, your free book "How to Secure a Government Position."

Name.....
Address.....



BECOME A GRADUATE ENGINEER DEGREE IN 2 YEARS



SCHOOL OF ENGINEERING

Courses in Civil, Electrical, Mechanical, Chemical, Aeronautical Engineering. Essentials of engineering training included and non-essentials eliminated. B.S. Degree granted upon completion of course. Entrance requirements liberal. Those who lack high school training may make up required work. Graduates compete successfully with those of other schools. Technical training at lowest cost and in least time consistent with thorough preparation. Tuition, living expenses low. Enter September, January, March, June. Write for catalog.

481 College Ave.

Angola, Ind.

TRI-STATE COLLEGE

✓
**"I got a raise
 without asking for it"**



"WHAT do you think! The boss called me in today and said I had made more progress in the past year than any man in the organization and that, beginning this week, my pay is raised \$15!

"He said he had given my work particularly close attention since I enrolled for that International Correspondence Schools course. Said if the other fellows would take it and get as much benefit out of it as I did he would have the most efficient force in the country! You certainly had the right idea, Grace, when you persuaded me to enroll with the I. C. S."

Perhaps an I. C. S. course is just what you need to attract the attention of the boss and to get a raise without asking for it. Thousands of men have found in enrollment the beginning of successful careers. Are you willing to devote a few hours a week to pleasant study? If so, let us tell you more about the I. C. S.

Mark and mail the coupon today

INTERNATIONAL CORRESPONDENCE SCHOOLS

"The Universal University"
 Box 5559-G, Scranton, Penna.

Without cost or obligation, please send me a copy of your booklet, "Who Wins and Why," and full particulars about the subject before which I have marked X:

TECHNICAL AND INDUSTRIAL COURSES

- | | |
|--|--|
| <input type="checkbox"/> Architect | <input type="checkbox"/> Automobile Mechanic |
| <input type="checkbox"/> Architectural Draftsman | <input type="checkbox"/> Plumbing <input type="checkbox"/> Steam Fitting |
| <input type="checkbox"/> Building Estimating | <input type="checkbox"/> Heating <input type="checkbox"/> Ventilation |
| <input type="checkbox"/> Wood Millworking | <input type="checkbox"/> Sheet Metal Worker |
| <input type="checkbox"/> Contractor and Builder | <input type="checkbox"/> Steam Engineer |
| <input type="checkbox"/> Structural Draftsman | <input type="checkbox"/> Steam Electric Engineer |
| <input type="checkbox"/> Structural Engineer | <input type="checkbox"/> Civil Engineer |
| <input type="checkbox"/> Electric Wiring | <input type="checkbox"/> Surveying and Mapping |
| <input type="checkbox"/> Electrical Engineer | <input type="checkbox"/> Refrigeration |
| <input type="checkbox"/> Electric Lighting | <input type="checkbox"/> R. R. Locomotives |
| <input type="checkbox"/> Welding, Electric and Gas | <input type="checkbox"/> R. R. Section Foreman |
| <input type="checkbox"/> Reading Shop Blueprints | <input type="checkbox"/> R. R. Bridge and Building Foreman |
| <input type="checkbox"/> Telegraph Engineer | <input type="checkbox"/> Air Brakes <input type="checkbox"/> Train Operation |
| <input type="checkbox"/> Telephone Work | <input type="checkbox"/> Highway Engineering |
| <input type="checkbox"/> Mechanical Engineer | <input type="checkbox"/> Chemistry <input type="checkbox"/> Pharmacy |
| <input type="checkbox"/> Mechanical Draftsman | <input type="checkbox"/> Coal Mining Engineer |
| <input type="checkbox"/> Machinist <input type="checkbox"/> Toolmaker | <input type="checkbox"/> Navigation <input type="checkbox"/> Boilermaker |
| <input type="checkbox"/> Patternmaker | <input type="checkbox"/> Textile Overseer or Supt. |
| <input type="checkbox"/> Pipefitter <input type="checkbox"/> Tinsmith | <input type="checkbox"/> Cotton Manufacturing |
| <input type="checkbox"/> Bridge Engineer | <input type="checkbox"/> Woolen Manufacturing |
| <input type="checkbox"/> Bridge and Building Foreman | <input type="checkbox"/> Agriculture <input type="checkbox"/> Fruit Growing |
| <input type="checkbox"/> Gas Engines <input type="checkbox"/> Diesel Engines | <input type="checkbox"/> Poultry Farming <input type="checkbox"/> Radio |
| <input type="checkbox"/> Aviation Engines | <input type="checkbox"/> Marine Engineer |

BUSINESS TRAINING COURSES

- | | |
|---|--|
| <input type="checkbox"/> Business Management | <input type="checkbox"/> Business Correspondence |
| <input type="checkbox"/> Office Management | <input type="checkbox"/> Lettering Show Cards <input type="checkbox"/> Signs |
| <input type="checkbox"/> Industrial Management | <input type="checkbox"/> Stenography and Typing |
| <input type="checkbox"/> Personnel Management | <input type="checkbox"/> Complete Commercial |
| <input type="checkbox"/> Traffic Management | <input type="checkbox"/> Civil Service <input type="checkbox"/> Mail Carrier |
| <input type="checkbox"/> Accountancy <input type="checkbox"/> Cost Accountant | <input type="checkbox"/> Railway Mail Clerk |
| <input type="checkbox"/> C. P. Accountant | <input type="checkbox"/> Grade School Subjects |
| <input type="checkbox"/> Bookkeeping | <input type="checkbox"/> High School Subjects |
| <input type="checkbox"/> Secretarial Work | <input type="checkbox"/> College Preparatory |
| <input type="checkbox"/> Spanish <input type="checkbox"/> French | <input type="checkbox"/> Illustrating <input type="checkbox"/> Cartooning |
| <input type="checkbox"/> Salesmanship <input type="checkbox"/> Advertising | <input type="checkbox"/> Lumber Dealer |

Name.....Age.....

Address.....

City.....State.....

Occupation.....

If you reside in Canada, send this coupon to the International Correspondence Schools Canadian, Limited, Montreal, Canada

Big Pay Now
 and an assured future . . .
LEARN WELDING

Welding is America's fastest growing industry—60,000 new trained welders needed each year in manufacturing plants, building construction, pipe lines, gas industry, railroads, street car systems, aviation, public utilities, ship building plants, automobile factories, etc. Trained welders earn from \$50.00 to \$90.00 per week. We will train you to be an expert welder in 8 weeks. Not a correspondence course—no text books—systematic training—"Learn by doing method." Recognized as America's outstanding welding school. Lifetime employment service.

Write for big free catalog now.

AMERICAN SCHOOL OF WELDING
 3031 Locust Blvd. St. Louis, Mo.

FREE THE *Gibson* **BOOK**



Shows you the way to popularity, pleasure, bigger income with an easy playing Gibson banjo, guitar, mandolin or ukulele. If no teacher in your town ask about Reser's Correspondence Course.

FREE TRIAL; EASY PAYMENTS
 on any Gibson. Send for your book now.

Harry Reser, Chief of the Chicago Club Eskimo, premier banjo soloist and teacher.

Gibson Inc.

303 PARSONS STREET, KALAMAZOO, MICH.

Don't Envy The Plumber—BE ONE!

\$11.00—\$16.00 PER DAY and work EVERY day, is the Plumber's wage.

LEARN IN 8 to 12 WEEKS without previous experience.

If you are making less than \$50.00 a week you owe it to yourself to investigate. Get FREE catalog that tells in pictures and words how we teach this trade. Special rates now.

UNIVERSAL PLUMBING SCHOOL, 2030 Topeka Avenue, KANSAS CITY, MO.



How to Obtain A Better Looking Nose

Improve your personal appearance. My free book tells you how I guarantee to improve the shape of your nose by remodeling the cartilage and fleshy parts, quickly, safely, and painlessly, or refund your money. The very fine, precise adjustments which only my new patented Model 25 Nose Shaper possesses, make results satisfactory and lasting. Wear night or day. Over 100,000 users. Send for free book to M. TRILETY, Pioneer Nose Shaping Specialist, Dept. 197 BIRMGHAMTON, N. Y.

Deaf 20 Years



But now I hear, and will tell any deaf person who writes me, FREE of charge, how I got back my hearing by a simple, inexpensive, invisible method which I myself discovered years ago.

Geo. H. Wilson, President
 Wilson Ear Drum Company, Inc.
 731 Todd Bldg., Louisville, Ky.

MOLES and WARTS

REMOVED PERMANENTLY

Rid your face, neck, arms and body of all unsightly moles and warts with "ANTI-MOLE." One application does it. Safe—easy to use—painless—leaves no scar. Used successfully by physicians, skin specialists and beauty experts for 28 years. Write for FREE booklet on treating all kinds of moles and warts.

Miller Co., 2445 South St., Lincoln, Nebr.





FREE

Book Gives You Valuable Information!
Should be read by every man from 16 to 60.

Book is **Yours** for the Asking!

No cost whatsoever. No conditions. Just reply promptly. This offer is open to all who speak up now. Men trained by me in practical drafting work at home are making \$50, \$75 and even \$100 per week. Get busy. Be ready when your turn comes. Get your Drafting Tools and Drafting Table just as soon as you begin training. Write today for the New Free Book—"My Pay-Raising Plan."

ENGINEER DOBE,
1951 Lawrence Avenue, Div. C-135, Chicago

Not a student's outfit but an imported set of professional drafting tools; you get them all when I train you.

CARTOON YOUR WAY TO SUCCESS!



DON'T COPY—LEARN TO ORIGINATE!

RAYE BURNS will teach you HOW to CREATE ORIGINAL CARTOONS at home that you can SELL! Course contains 26 lessons and over 600 illustrations. All for Only... **\$2.85**

Send name and address for free details.

RAYE BURNS SCHOOL, 836 Lakeview Rd., Cleveland, O.

\$60 a Week in AVIATION

is what R. N. Dobbins of New York makes as Aviation instructor. WALTER HINTON, first Trans-Atlantic Pilot trained Dobbins at home, in spare time—and Hinton will train YOU too. Hinton's EMPLOYMENT DEPARTMENT got Dobbins his job and can help you CASH IN on YOUR training. Prepare for one of the thousands of big pay jobs ON THE GROUND or in the air that pay up to \$150 per week and more. Write now for FREE Book that gives all details about this training and a FREE FLIGHT. BIG SAVINGS ON FLYING INSTRUCTION, FREE AIRCRAFT RADIO COURSE—Walter Hinton, Pres., Aviation Institute of U.S.A., Inc., Suite 601-C, 1115 Connecticut Ave., N. W., Washington, D. C.

A NEW SKIN

Now You
Can
Have It!

Often
In
3
Days'
Time



"Oh,
what
joy!"

**Thousands — Both Sex — Rejoice!
READ FREE OFFER!**

WHAT would you say if you awoke some morning—looked in your mirror and saw a new, youthful, clear skin on your face, and the ugly blemishes all gone?

You would jump with joy—just like thousands of people have done who have learned how to perform this simple treatment themselves—the same that beauty doctors have charged enormous prices for.

—and, what was considered impossible before—the banishing of skin marks, surface blemishes, freckles, large pores, tan, oily skin, surface wrinkles and other defects—can now be done by the patient himself, or herself, at home, harmlessly and economically.

It is all explained in a new treatise called "BEAUTIFUL NEW SKIN IN 3 DAYS," which is being mailed absolutely free to readers of this magazine. So, worry no more over your humiliating skin and complexion. Simply send your name and address to MARVO BEAUTY LABORATORIES, Dept. 407, No. 1700 Broadway, New York, N. Y., and you will receive it by return mail without charge. If pleased, tell your friends about it. Don't delay!

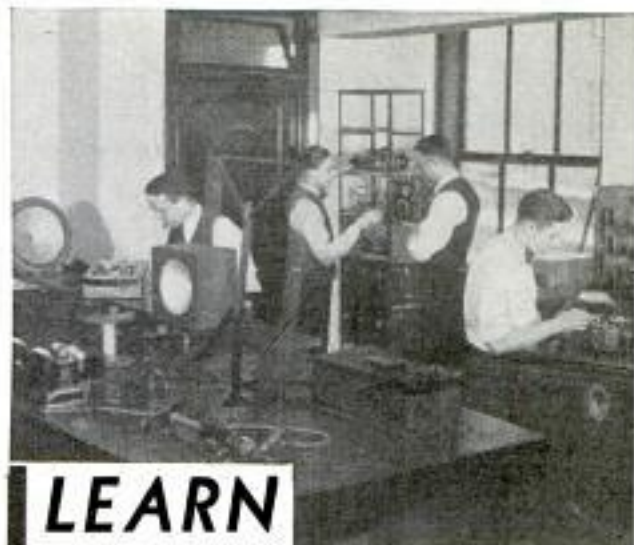

LEARN A PROFESSION Not Merely a "TRADE" in Radio and Television

You'll enjoy learning the Profession of Radio and Television at the Chicago Radio Institute, just as hundreds of other ambitious young men have done, who are now holding responsible positions paying them big salaries.

Here are a few important reasons why you should attend the Chicago Radio Institute:

You go to school in Chicago; highly specialized instructors whom you'll appreciate working with; personal contact with students and instructors for developing both *theory* and *practice*; newest type of modern equipment and private apparatus kit; reasonable living quarters arranged to suit convenience of student; personally inscribed diploma issued upon completion of course.

You cannot qualify as a "professionally trained radio man" unless you learn by specialized instruction, so thoroughly taught at the Chicago Radio Institute.

THE CHICAGO RADIO INSTITUTE
Dept. 7 DePaul University Building Chicago, Illinois



Please mail me newly designed catalog on Specialized Radio Courses taught at Chicago Radio Institute.

NAME.....

ADDRESS.....

Get This Strong Man's Library!

Molding Mighty Men

6 for \$1
25¢ Each
POST PAID

Each Book a Complete Course

Think of it! A muscle building course showing how to develop a definite part of your body for only 25c or six courses which show you how to develop the entire body for only \$1.00. That's my special offer. I will show you how to mold a mighty arm for a quarter or how to mold a mighty chest, mighty legs, a mighty back or a grip of steel, or I will teach you strong man stunts. Get all of the lessons in this Strong Man's Library for only \$1.00.

I show you how to add inches on your arm, how to put steel cables on your chest, how to get a back of might. I show you how to develop legs of a giant and a grip of steel. The strong man tricks which I reveal will amaze you and your friends. Molding mighty men is the business of George F. Jowett, The Champion of Champions.

RUSH COUPON—SPECIAL OFFER

All 6 books are profusely illustrated and will be sent to you by return mail, postpaid. Just slip a dollar bill in an envelope with the coupon below. For any single book, just send a quarter. I will include a free copy of my book titled, "The Thrill of Being Strong." Rush coupon now.

JOWETT INSTITUTE OF PHYSICAL CULTURE

422 Poplar Street, Dept. 4VA, Scranton, Penna.

Dear Mr. Jowett: Your proposition looks good to me. Send, by return prepaid mail, the lessons I am checking below and for which I am enclosing my remittance of

- \$.....
- All 6 Courses \$1.00
 - Molding a Mighty Arm 25c
 - Molding a Mighty Back 25c
 - Molding a Mighty Grip 25c
 - Molding a Mighty Chest 25c
 - Molding Mighty Legs 25c
 - Strong Man Stunts Made Easy 25c

Name.....

Address.....

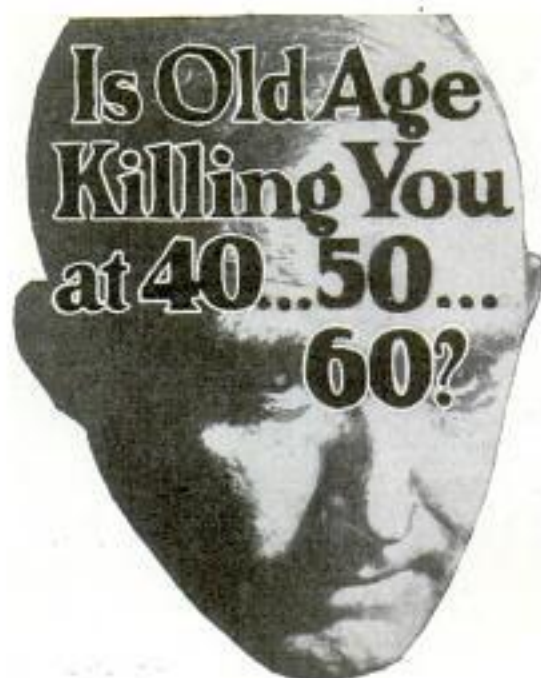

Are you aging too soon . . . getting up 5 to 10 times at night . . . is vitality ebbing steadily away . . . are you definitely on the down grade, half-living, blue, depressed, subject to chronic constipation, chronic fatigue, backache, foot and leg pains? Then look to the vital prostate gland.

New Facts About the Prostate Gland

In men past 40, do you know that these symptoms are often the direct result of prostate gland failure? Are you aware that these symptoms frequently warn of the most critical period of a man's life, and that prostate trouble unchecked usually goes from bad to worse . . . that it frequently leads to years of fruitless treatment and even surgery . . . that it even threatens life itself?

FREE to Men Past 40

No man past 40 should go on blindly blaming old age for these distressing conditions. Know the true meaning of these symptoms. Send for a new, illustrated booklet, "The Destroyer of Male Health," written by a well-known American Scientist, and see if these facts apply to you.

There is little or nothing that medicine can do for the prostate gland. Massage is annoying, expensive and not always effective. Now this scientist has perfected a totally different kind of treatment that you can use in your own home. It employs no drugs, medicine, or violet rays. It stimulates the vital prostate gland in a new natural way, and it is as harmless as brushing your hair. 100,000 men have used it with remarkable results.

Swift Natural Relief

Now physicians and surgeons in every part of the country are recommending this non-medical treatment. So directly does this new safe treatment go to the prostate gland that noticeable relief often follows overnight. So remarkable are the results that you can test it under a guarantee that unless you feel 10 years younger in 7 days you pay nothing.

Scientist's Book Free

Send now for this Scientist's free book and learn these new facts about the prostate gland and old age ailments.

Simply mail the coupon to W. J. Kirk, president, 2144 Morris Ave., Steubenville, Ohio.

If you live West of the Rockies, address The Electro Thermal Co., 303 Van Nuys Building, Dept. 21-X, Los Angeles, Calif. In Canada, address The Electro Thermal Co., Desk 21-X, 53 Yonge St., Toronto, Ont., Can.

W. J. Kirk, Pres., 2144 Morris Ave., Steubenville, Ohio.

Without obligation, kindly send me a free copy of "The Destroyer of Male Health."

Name.....

Address.....

City..... State.....

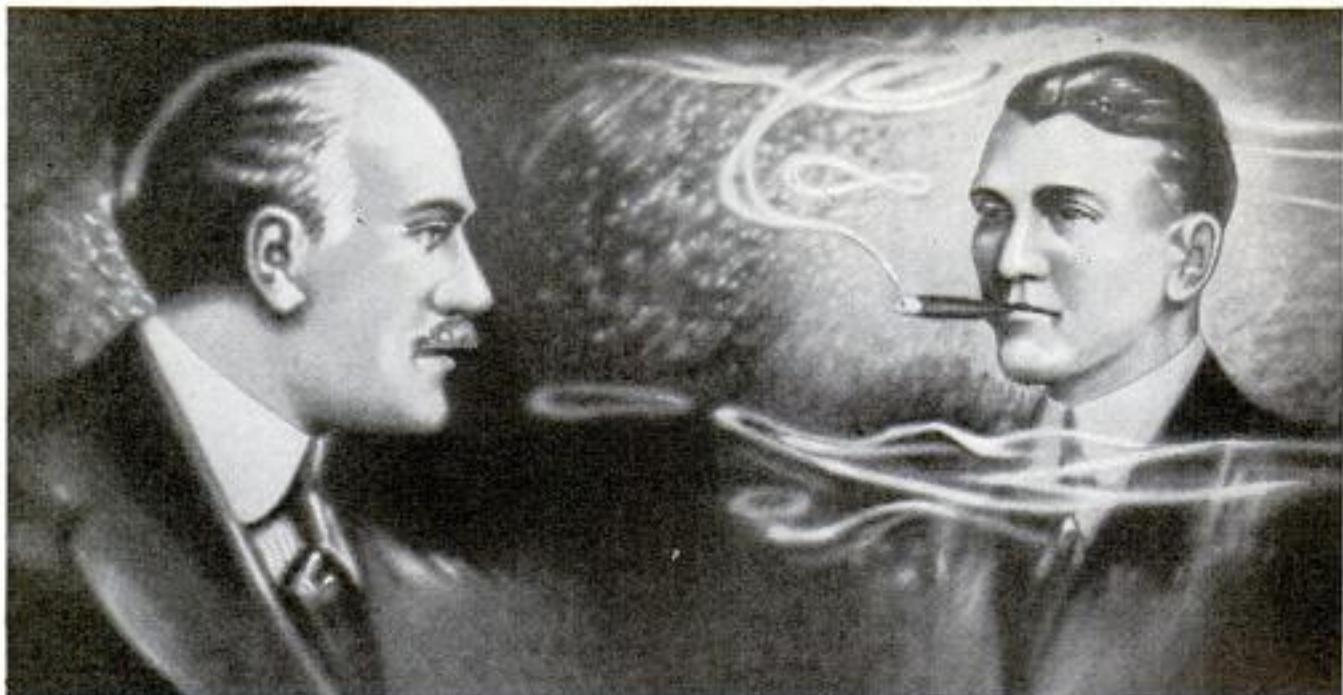

Is Tobacco Hurting You?

Look the facts square in the face, Mr. Tobacco User. You may think tobacco is not hurting you.

That is because you haven't as yet, perhaps, felt the effects of the nicotine poison in YOUR system. For you know that nicotine, as absorbed into the system through smoking and chewing tobacco, is a slow working poison. Slow, yes—but sure.

Tobacco lowers efficiency. It slows a man down. Makes it harder to concentrate the mind on work. Tobacco users seldom have the amount of "pep" and energy of those who do not use the weed. There's many a man older than you in years who is younger in energy, simply because he lets tobacco alone.

Some day, probably, you will realize to what an alarming extent tobacco does undermine the system.

When your hands begin to tremble—
and your appetite begins to fail—
and your heart seems to "skip a beat" now and then—
and slight exertion makes you short of breath—
then you have a right to suspect that
TOBACCO is getting the upper hand.

Any well-informed doctor will tell you that these are only a few of many symptoms of tobacco poisoning.

And YOU know that the use of tobacco in any form is an expensive, utterly useless habit. You know you ought to quit.

Tobacco Habit Banished In Many Cases—Let Us Help You

It doesn't make a particle of difference whether tobacco has been used for a single month or fifty years, or how much, or in what form—whether cigars, cigarettes, pipe, plug, fine cut, or snuff. In most cases, Tobacco Redeemer removes all craving for tobacco in any form in a very few days. Not the slightest shock to the nervous system. The tobacco craving will usually begin to decrease after the very first dose—there is no long waiting for results.

Tobacco Redeemer contains no habit-forming drugs of any kind and is quick, safe, pleasant and thoroughly reliable.

It is in no sense a substitute for tobacco. It helps to quiet the nerves and makes one feel better in every way.

Our Guarantee A single trial will convince you. Our legal, binding, money-back guarantee goes with each full treatment. We will refund every cent you pay for the treatment if, after taking it according to the easy-to-follow directions, it should fail to banish the tobacco habit completely.

SEND Free Proof Let us send you our free booklet on the injurious effects of tobacco, together with testimonial letters from men all over the country telling how they have been absolutely freed from the tobacco habit by this simple home treatment. You could not ask for stronger proof than the evidence we will gladly send on request. Just mail the coupon—or a postal will do.

NEWELL PHARMACAL CO.

Dept. 300 Clayton Station St. Louis, Mo.



Free Book Coupon

NEWELL PHARMACAL CO.

Dept. 300 Clayton Station St. Louis, Mo.

Please send, without obligating me in any way, your free booklet regarding the tobacco habit and proof that Tobacco Redeemer has relieved the tobacco habit in thousands of cases. If it fails my money will be refunded.

Name.....

Street and No.....

Town..... State.....

Learn **SIGN** **and** **SHOW-CARD** **WRITING**

In spare time, few hours weekly

FREE
"Book of Facts"
Write For It



Fascinating profession. Big opportunity in this fast-growing trade. Earn while you learn the sign arts. No talent or experience required. Be your own boss or obtain a good position. Learn show cards, posters, bulletins, signs, advertising layouts and allied subjects. We teach by mail or at our school. Quick results—easy to learn.

EARN \$50 TO \$200 WEEKLY

Otto C. Wiegand, Md., home-study graduate, made \$12,000 from his business in one year. Many successful graduates. Oldest and foremost school. Don't delay. Write for complete information.

DETROIT SCHOOL OF LETTERING

193 Stimson Ave. Est. 1899 DETROIT, MICH.

FREE **Radio Handbook**

Write today for your copy of the new Radio Association handbook. Shows you easy ways to make money in Radio. Tells you how our members are clearing up \$3.00 an hour spare time. Write for Membership Plan which need not cost you a cent and FILE RADIO HANDBOOK.

RADIO TRAINING ASSOCIATION OF AMERICA
Dept. PM-8 4513 Ravenswood Ave., Chicago

FREE! 240-page Catalog of Technical and Business Books—1500 Titles—All Fields covered from Aviation to Welding Practice. Mention this ad and get a free copy.

McGRAW-HILL BOOK CO. Inc., 370 Seventh Ave., New York

NO JOKE TO BE DEAF

—EVERY DEAF PERSON KNOWS THAT



George P. Way made himself hear, after being deaf for 25 years, with Artificial Ear Drums—his own invention. He wore them day and night. They stopped head noises and ringing ears. They are invisible and perfectly comfortable. No one sees them. Write for his true story, "How I Got Deaf and Made Myself Hear." Also booklet on Deafness. Address: George P. Way, Inc., 608 Hofmann Building, Detroit, Michigan



Artificial Ear Drum

SAVE **NON-TIRES**

LOOK! TIRES
NEW LOW PRICES
Why Pay More?
GOODRICH·GOOD YEAR·U.S. Firestone and OTHER TIRES

Lowest Prices on Earth!
Thousands of satisfied tire users all over the U.S.A. Our 16 years of business speaks for itself. This big responsible company will supply you with reconstructed standard make tires at lowest prices in history—Guaranteed to give 12 months' service

Don't Delay—Order Today

CORD TIRES		BALLOON TIRES	
Size	Tires Tubes	Size	Tires Tubes
30x32	\$2.20 \$1.10	29x4.40	\$2.30 \$1.10
30x34	2.25 1.00	29x4.50	.40 1.10
30x36	2.70 1.15	30x4.00	.45 1.00
30x38	2.95 1.15	30x4.25	.45 1.00
30x40	2.95 1.15	30x4.50	.45 1.00
30x42	2.95 1.15	30x4.75	.45 1.00
30x44	2.95 1.15	30x5.00	.90 1.25
30x46	3.50 1.15	30x5.25	.95 1.25
30x48	3.20 1.45	30x5.50	.95 1.25
30x50	3.20 1.45	30x5.75	.95 1.25
30x52	3.45 1.45	30x6.00	.95 1.25
30x54	3.45 1.45	30x6.25	.95 1.25
30x56	3.60 1.75	31x5.25	3.10 1.25
30x58	3.60 1.75	31x5.50	3.20 1.40
30x60	4.45 1.75	31x5.75	3.20 1.40
		31x6.00	3.20 1.40
		31x6.25	3.20 1.40
		31x6.50	3.20 1.40
		31x6.75	3.20 1.40
		31x7.00	3.50 1.65

All Other Sizes
DEALERS WANTED

Send only \$1.00 deposit with each tire ordered. We ship balance C.O.D. Deduct 5 percent if cash in full accompanies order.

Tires failing to give 12 months service will be replaced at half price.

YORK TIRE & RUBBER CO., Dept. 209-A
3855-59 Cottage Grove Ave. Chicago, Ill.

A COLLEGE EDUCATION for men who think they can't afford one!



Be college trained at half the usual expense . . . and in a fraction of the usual time. The coupon tells how. Mail it, if you want outstanding value in college training.

This year, as never before, men are going to look for real value in schooling. Most men will not be able to afford the regular 4 and 5-year college education. But they will cling resolutely to their ambition to be college trained. They will go where tuition is low . . . where the cost of an education is rock-bottom, where time has been cut to a minimum.

For many . . . Chicago Tech will be the answer Chicago Technical College is the logical school for men who are short on funds and time . . . but long on ambition. For here you can get a college course to fit your pocketbook . . . training that offers outstanding value for money and time invested.

3 Year Degree Courses—1 and 2 year Diploma Courses—also shorter courses

Amazing, but true. At Chicago Tech, you can become college trained in less time . . . and with only half the usual expense. 3-Year Degree Courses in Drafting, Engineering, Architecture and Electricity. 1 and 2-Year Diploma Courses, and 3 to 9-month courses, too. Think of it. The same courses that it would ordinarily take you 3 to 5 years to finish. Non-essentials eliminated. No necessary subjects have been sacrificed.

Earn part of your expenses . . . here in Chicago A large city like Chicago offers many opportunities for spare-time work. We help students secure part-time positions to help defray expenses. The engineering center of the nation, Chicago offers the technical student a wide variety of building and engineering projects for observation and study.

FREE 80-Page BLUE BOOK Gives Complete FACTS

Send the Coupon for your copy

If a college education at less cost and minimum expenditure of time . . . a degree . . . the training that will bring you success, recognition and happiness means anything to you, then you will want this Free 80-Page Blue Book. It tells all about this 27-year-old technical college, its courses, instructors and what it can do for every man ambitious enough to want a college education. Fill in the coupon and send it now. You may keep the book without cost to yourself.

CHICAGO TECHNICAL COLLEGE

Dept. K-79, Chicago Tech. Bldg.
118 East 26th St. CHICAGO, ILL.

Chicago Technical College, Dept. K-79
118 E. 26th St., Chicago

I want to know how I can get a degree or diploma and be college trained in Drafting, Engineering, Architecture and Electricity in less time and with less cost. Send me your Blue Book, free, without a cent cost to me.

Name.....Age.....

Address.....

City.....State.....



"There's One Man We're Going to Keep"

"Ed Wilson, there, is one of the most ambitious men in the plant. I notice that he never fools away his spare time. He studies his International Correspondence Schools course every chance he gets.

"It's been the making of him too. He hasn't been here nearly so long as Tom Downey, who was laid off yesterday, but he knows ten times as much about this business.

"I'm going to give him Tom's job at a raise in salary. He's the kind of man we want around here."

How do you stand in your shop or office? Are you an Ed Wilson or a Tom Downey? Are you going up? Or down?

No matter where you live, the International Correspondence Schools will come to you. No matter what your handicaps or how small your means, we have a plan to meet your circumstances. No matter how limited your previous education, the simply-written, wonderfully-illustrated I. C. S. textbooks make it easy to learn.

This is all we ask: Without cost, without obligating yourself in any way, put it up to us to prove how we can help you. Just mark and mail this coupon.

INTERNATIONAL CORRESPONDENCE SCHOOLS
 "The Universal University"
 5558-G, Scranton, Penna.

Without cost or obligation, please send me a copy of your booklet, "Who Wins and Why," and full particulars about the subject before which I have marked X:

TECHNICAL AND INDUSTRIAL COURSES

- | | |
|--|--|
| <input type="checkbox"/> Architect | <input type="checkbox"/> Automobile Mechanic |
| <input type="checkbox"/> Architectural Draftsman | <input type="checkbox"/> Plumbing <input type="checkbox"/> Steam Fitting |
| <input type="checkbox"/> Building Estimating | <input type="checkbox"/> Heating <input type="checkbox"/> Ventilation |
| <input type="checkbox"/> Wood Millworking | <input type="checkbox"/> Sheet Metal Worker |
| <input type="checkbox"/> Contractor and Builder | <input type="checkbox"/> Steam Engineer |
| <input type="checkbox"/> Structural Draftsman | <input type="checkbox"/> Steam Electric Engineer |
| <input type="checkbox"/> Structural Engineer | <input type="checkbox"/> Civil Engineer |
| <input type="checkbox"/> Electric Wiring | <input type="checkbox"/> Surveying and Mapping |
| <input type="checkbox"/> Electrical Engineer | <input type="checkbox"/> Refrigeration |
| <input type="checkbox"/> Electric Lighting | <input type="checkbox"/> R. R. Locomotives |
| <input type="checkbox"/> Welding, Electric and Gas | <input type="checkbox"/> R. R. Section Foreman |
| <input type="checkbox"/> Reading Shop Blueprints | <input type="checkbox"/> R. R. Bridge and Building Foreman |
| <input type="checkbox"/> Telegraph Engineer | <input type="checkbox"/> Air Brakes <input type="checkbox"/> Train Operation |
| <input type="checkbox"/> Telephone Work | <input type="checkbox"/> Highway Engineering |
| <input type="checkbox"/> Mechanical Engineer | <input type="checkbox"/> Chemistry <input type="checkbox"/> Pharmacy |
| <input type="checkbox"/> Mechanical Draftsman | <input type="checkbox"/> Coal Mining Engineer |
| <input type="checkbox"/> Machinist <input type="checkbox"/> Toolmaker | <input type="checkbox"/> Navigation <input type="checkbox"/> Boilermaker |
| <input type="checkbox"/> Patternmaker | <input type="checkbox"/> Textile Overseer or Supt. |
| <input type="checkbox"/> Pipefitter <input type="checkbox"/> Tinsmith | <input type="checkbox"/> Cotton Manufacturing |
| <input type="checkbox"/> Bridge Engineer | <input type="checkbox"/> Woolen Manufacturing |
| <input type="checkbox"/> Bridge and Building Foreman | <input type="checkbox"/> Agriculture <input type="checkbox"/> Fruit Growing |
| <input type="checkbox"/> Gas Engines <input type="checkbox"/> Diesel Engines | <input type="checkbox"/> Poultry Farming <input type="checkbox"/> Radio |
| <input type="checkbox"/> Aviation Engines | <input type="checkbox"/> Marine Engineer |

BUSINESS TRAINING COURSES

- | | |
|---|--|
| <input type="checkbox"/> Business Management | <input type="checkbox"/> Business Correspondence |
| <input type="checkbox"/> Office Management | <input type="checkbox"/> Lettering Show Cards <input type="checkbox"/> Signs |
| <input type="checkbox"/> Industrial Management | <input type="checkbox"/> Stenography and Typing |
| <input type="checkbox"/> Personnel Management | <input type="checkbox"/> Complete Commercial |
| <input type="checkbox"/> Traffic Management | <input type="checkbox"/> Civil Service <input type="checkbox"/> Mail Carrier |
| <input type="checkbox"/> Accountancy <input type="checkbox"/> Cost Accountant | <input type="checkbox"/> Railway Mail Clerk |
| <input type="checkbox"/> C. P. Accountant | <input type="checkbox"/> Grade School Subjects |
| <input type="checkbox"/> Bookkeeping | <input type="checkbox"/> High School Subjects |
| <input type="checkbox"/> Secretarial Work | <input type="checkbox"/> College Preparatory |
| <input type="checkbox"/> Spanish <input type="checkbox"/> French | <input type="checkbox"/> Illustrating <input type="checkbox"/> Cartooning |
| <input type="checkbox"/> Salesmanship <input type="checkbox"/> Advertising | <input type="checkbox"/> Lumber Dealer |

Name.....Age.....

Address.....

City.....State.....

Occupation.....

If you reside in Canada, send this coupon to the International Correspondence Schools Canadian, Limited, Montreal, Canada



Get Strong! Eight Improved Muscle Builders All for \$3.75



Easily master tests which now seem difficult. If you want physical culture for health, this equipment is what you need. **SAVE AT LEAST HALF!** We furnish ten cable chest expander adjustable to 200 lbs. resistance. Made of new live extra strength rubber to give resistance needed for sure muscle development. Pair of patented hand grips develop powerful grip and arm. Wall exercising parts develop back, arms and legs. Head grip permits exercise of neck muscles. Develop leg muscles with foot strap—given speed, endurance. Illustrated course shows how to develop any part of body.

GUARANTEE
Entire satisfaction guaranteed or money back.

SEND NO MONEY

Send name and address. We send all by return mail. Pay postage \$1.75 plus postage. (If you live outside U. S. A. price \$4.50 cash with order.)

MUSCLE POWER CO., Dept. PM-8
150 Nassau St.
NEW YORK, N. Y.

ENGINEERING ELECTRICAL-MECHANICAL-STRUCTURAL and ARCHITECTURE

INTENSIVE PRACTICAL TECHNICAL COURSES. Degree in 2 years. Licenses in 1 year. Special short courses 6 Weeks to 4 Months in Electricity, Radio, Power Plant, Electric Refrigeration, Air Conditioning, Wiring, Testing, Drafting, Welding, LOW TENSION. Expert instructors. Extensively equipped laboratories. Free lifeline employment service for graduates. Part-time work while attending. Write for new free illustrated catalog giving all facts. 30th year.



FINLAY ENGINEERING COLLEGE
1001 A Indiana Avenue
Kansas City, Missouri

WHY STAMMER?

Don't be a failure.
Master perfect speech. Live a healthy, normal and happy life. Send for free book which tells you how.
THE LEWIS INSTITUTE, 12972 Woodward Ave., Detroit, Mich.

Up To \$50 A DAY With Tiny 'PHONE "MIKE"



Agents are cleaning up everywhere with a phone attachment that looks like a radio mike. Absolutely controls all sounds in your phone—ends the roar that keeps you from hearing clearly; makes it easy to hear even if your phone is in the noisiest factory. Yet also assures privacy—talk unheard, with people within five feet of you!

Write and find out how agents report earnings up to \$50 a day and even more with this tiny mechanical mystery. Big quantity orders from stores, offices, etc.; amazing sales plus double calls and sales. Write for FREE introductory offer and amazing Sales Guarantee.

STANDARD APPLIANCES, INC., Dept. K-90, 21 W. Elm St., Chicago, Ill.

Classified Advertisements

WORLD'S BEST WANT AD MEDIUM

Advertisements in this section, 35 cents per word, each insertion, minimum 10 words, payable in advance
To be inserted under proper classification in September issue, copy should be in our office July 18th.

ADVERTISING AGENCIES

ADVERTISE—Bargain value—24 words in 24 representative Sunday newspapers \$15; Free assistance with your ads, sales letters, literature. Helpful Ad-Guide showing best paying newspapers, magazines, rates, mailing lists, etc., free. Chicago Union Agency, Great Northern Bldg., Chicago.

GET into advertising. Learn quickly at home. Experience unnecessary. New easy plan. No text books used. Practical work. Old established school. Send name and address for interesting free booklet. Page-Davis School of Advertising, Dept. 3421, 3661 Michigan, Chicago.

BEFORE Advertising get our catalog. No charge. 25 years in business. The largest classified agency in the world. Ankrum Advertising Agency, 109 No. LaSalle St., Chicago, Ill.

FREE—New 1931 Advertisers Rate Guide, 44 pages. Includes everything. Lowest rates. E. H. Brown Advertising Agency, 149 S. Dearborn, Chicago.

ADVERTISE in rural weeklies. Lists free. Meyer Agency, 4112 Hartford, St. Louis, Mo.

TIME Counts in applying for patents. See pages 124 and 125. Clarence A. O'Brien, Registered Patent Attorney, Washington, D. C.

FOR ADVERTISERS

ADVERTISE in 250 country town newspapers 28 words, \$10. Lists free. All states. Keator, Hartford Bldg., Chicago.

INCH Display (forty words) three times in Maillessman, \$1.00. (10,000 international circulation. P. M. Argus, Culver City, California.

PRINTING Cuts to order. Signature \$1.00. Adverts \$1.50; letterheads \$1.55; stock cuts 20c. Catalog 4c. Adman, 2047 North Illinois, Indianapolis, Ind.

24 WORDS—70-85 Southeast weeklies, \$3.98. S. Stout, Warm Springs, Ga.

LAYOUTS For advertising is a useful handbook of 700 layout suggestions used in magazines, newspapers, booklets, folders, broadsides, letterheads and posters. Will save immense amount of time of any advertising man. Delivered to your door C. O. D. Simply pay postman \$3 and postage. Popular Mechanics Press, Room 802, 200 E. Ontario St., Chicago.

SALES PROMOTION

POWERFUL Results assured! Cash-coaxing letters, literature, mailorder rampalms. Long, successful experience! Reasonable charges! Investigate! Finkel-Advertising, 133P Glenwood, Jersey City, N. J.

AGENCIES WANTED

TWO Able, resourceful, responsible salesmen, ask agencies Pacific coast. Edwards, 508 Miller Ave., Portland, Oregon.

MAILING SERVICE

CIRCULARS Mailed 20c 100. Photocolor Mailing Service, 1880 Elmhurst, Detroit, Michigan.

BUSINESS SERVICE

REPRESENTATION, Washington, D. C. Information, service, mail address, anything, anytime. Service, 405 District National Bank. Information reporters wanted. Details 4c.

WRITERS SERVICE

WRITERS! We pay hundreds dollars each, monthly awards, for story plots. Information free. Gazcon Co., Dept 716, 1008 West 6th, Los Angeles.

INFORMATION

CONFIDENTIAL Advice, information any subject, business or personal, 50c, coin or stamps. National Service Bureau, P. O. Box-3563, San Francisco, Calif.

HISTOMAP—Something New—4000 years of history on a single page. A chart in 3 colors presenting a continuous, re-ordained record of events and characters of history from 2000 B. C. to date. Size 13x63 inches. Price \$1.00. Should be in every school and home. Sent postpaid upon receipt of price or C. O. D. anywhere in U. S. Popular Mechanics Press, Room 802, 200 E. Ontario St., Chicago.

AUTOMOBILES

DIRT Track Racing. Now you can break into the racing game. How to build racer, contest rules, speed, "revs"—Complete illustrated treatise, postpaid \$1.00. Ray Kuns, Dept. B, Madisonville, Cincinnati, O.

FORD A owners. Speed, power, mileage 65-70-75. Genuine Ford parts. Instruction \$1.00 currency. Box 225, Fond du Lac, Wisconsin.

TIME Counts in applying for patents. See pages 124 and 125. Clarence A. O'Brien, Registered Patent Attorney, Washington, D. C.

AUTO SUPPLIES

BEAUTIFY Your car by putting on a set of our beautiful Wind Shield Wipers, with chromium plated holders. For closed cars. \$7.50 per set. Agents wanted. Maple Valley Mfg. Co., Box 203, Mapleton, Iowa.

TRAILER Hitch 4 wheel—All steel, best on market. Write for price and circulars. Hagstrom Model & Tool Works, Kansas City, Mo.

BARGAINS—Excellent reprocessed compressors, battery chargers, test benches, car washers. Terms Trial. Write Ken's Automotive Service, Box M-811, Troy, O.

NEW Auto parts 25-50%. Motors, rear-ends, radiators, wheels, generators, carburetors, brakelining 50%. Used parts 50-80% off. Brightman, 2065 Main, Hartford, Conn.

STOP Brake rattle—Universal "springs of silence", all brake service stations. Universal Spring Co., Grand Rapids, Mich.

RECHARGE Neighborhood batteries; very profitable; outfit \$7.39. Adams-Barr, Columbus, Ohio.

CHROMIUM Plating powder plates iron, steel, brass, copper and nickel, without electricity or machinery. Guaranteed not to tarnish; 1/2 pint can \$1.50 prepaid. Gunmetal Co., Ave. J, Deratur, Ill.

FORD Model "A" car including Model "AA" truck—just published, only book of its kind and right up-to-the-minute. For all interested in the repair and maintenance of the new Ford. 545 pages, 251 illus. Price \$2.50. Sent postpaid upon receipt of price or C.O.D. anywhere in U. S. Popular Mechanics Press, Room 802, 200 E. Ontario St., Chicago.

AUTO SERVICE EQUIPMENT

SUBSTANTIAL Savings—reprocessed compressors, battery chargers, test benches, car washers. Terms Trial. Write Ken's Automotive Service, Box M-812, Troy, Ohio.

FIFTEEN Capacity battery charger, direct from factory; guaranteed; 110 volts; money maker for owner \$27.31. Adams Barr Corporation, Columbus, Ohio.

MOTORCYCLES, BICYCLES AND SUPPLIES

REBUILT Motorcycles \$25 to \$100 easy. Tires, used tires \$2.50. New Firestone \$5. Engines for motorcycle ice sleds, airplanes, boats \$15 to \$75. Forks \$3, frames \$3, cylinder \$3, saddles \$3, chains \$1.50, handle bars \$3, belts \$5, wheels \$3, side cars \$25. Bicycle \$9.50, airplane wheel \$1.00 was formerly \$2.00. Save you dollar prices. Oldest house in U. S. Send 25c for catalog. Price Cutter Deninger, Rochester, N. Y.

LOW Prices—Special bargains in Harley-Davidsons—14 models. Send 6c stamps for catalog. Knuth's, 2525 Fond du Lac Ave., Milwaukee, Wis.

REPAIR With good used parts, save 25 or more, state parts needed, no lists. J. B. Dahl, 3661 Archer Ave., Chicago, Ill.

HENDERSON, Excelstor, Harley, Indian used parts, engines, conversions. Cheap. Catalogue and wings emblem pin 10c. Bialak, 108 N. 12th, St. Louis, Mo.

SEND 15c For illustrated used Motorcycle catalog. Large stock, Bargains, Indian parts, Accessories. Indian Motorcycle Sales, Kansas City, Mo.

MOTORCYCLE Bargains, lowest prices, bargain sheets for stamp, special aviators supplies, motorcycle accessories largest line in America, lowest prices. Largest motorcycle mail order house in the United States. Rochester Harley Davidson Corporation, 129 West Main St., Rochester, N. Y.

BUILD Your own boat. Save over 1/2 and have fun besides. Simplified instructions in Popular Mechanics New Boat Book, just out, are easy to follow. Every type of small boat covered, outboard, inboard, sailing and hand-propelled craft. In addition complete information on all phases of boating needed by every boating enthusiast, 269 pages. Fully illustrated. Postpaid upon receipt of price, \$3.00 or will be sent C.O.D. anywhere in U. S. Popular Mechanics Press, Room 807, 200 E. Ontario St., Chicago.

AVIATION

BE Sure that the motor you purchase for your light plane will fly it. Heath B-4 and Heath Henderson motors are guaranteed to fly and 7 years of constant performance prove it. For economy and reliability these motors cannot be equaled. Send 15c for large illustrated booklet. Heath Aircraft Corp., Dept. KP-8, Niles, Michigan.

GLIDER Motors. Lightest practical motors built. Sold ready to run or semi-finished. Singles & twins. Write, Glider Motors, P. O. Box 1585, Cincinnati, Ohio.

LIGHT Sportplane complete with motor, professional construction, bargain at \$225. Why bother build own. Ralph Brown, 326 Liberty, Penn Yan, N. Y.

NEW Turnbuckles 15c. Bargain price list, circular, etc. 4c. Russell Aircraft, Box 455, Toledo, Ohio.

AIR Navigation and meteorology—A practical book for every flyer. Capt. R. Duncan, the author, has presented the subject in a simple, non-technical way. 242 pages. Illustrated. Delivered to your door C. O. D. Simply pay postman \$3 and postage. Popular Mechanics Press, Room 802, 200 E. Ontario St., Chicago.

PROPELLERS, Plans, parts, supplies, to build Crawford powered gliders. Send two ten cent stamps for information. Crawford Power Glider, Mfr., Seal Beach, Calif.

AIRCRAFT Directory 50c. Thousands surplus airplanes, motors, parts, supplies. Invaluable. Aerobuilders Service, 1305-15 So. 12th, Lincoln, Nebr.

BARGAINS in motors, propellers, hubs and flivverplanes. Circulars 10c. Storus Aviation, Spartanburg, S. C.

\$2.00 COMBINATION-Aviation helmet, wing emblem for \$1.00. Snookler, Box 89, G. P. O., N. Y. C.

AVIATION—Every person interested in this subject should make full use of the opportunity to learn aerodynamics with Alexander Klein's as his instructor, through his timely new book, "Simplified Aerodynamics." Heretofore this subject has been rather difficult for the thousands who need it. Klein's method enables all to master it. Every pilot, mechanic, student needs this book. Pay postman price, \$3.50, and few cents postage when he delivers it. Order from Popular Mechanics Press, Room 802, 200 E. Ontario St., Chicago.

METAL Tipped Henderson propellers. 2.3.95; Ford, \$12.50. Hibbs, Ft. Worth, Texas.

SPRUCE! Plane and glider builders. Selected clear spruce (Sitka) spruce finished to size. Lowest wholesale prices. Send dimensions for quotation. Pike-Dial Lumber Co., 2257 Loomis St., Chicago.

BOYS. Girls. Learn to fly! Remarkable 10 lesson course, including membership, class pins, ratings, bulletins, wings. Send 25c for first lesson or \$2.25 complete. Details free. National Young Flyers League, Dept. H, 816 Chimes Bldg., Syracuse, N. Y.

LEARN To fly where Lindbergh learned at this flying school with highest government approval. Airplane mechanics school connected with aircraft factory. Big opportunity—write today for complete information. Lincoln Flying School, 2092 Aircraft Building, Lincoln, Nebraska.

FLYING Simplified—Just out. Here is a remarkable non-technical book for beginners, prospective or advanced students that teaches in an easily understood manner all you can need to know to master the art of flying. Will save you many dollars when you learn to fly. Pay postman only \$1 and postage when book is delivered at your door. C. O. D. Popular Mechanics Press, Room 802, 200 E. Ontario St., Chicago.

TIME Counts in applying for patents. See pages 124 and 125. Clarence A. O'Brien, Registered Patent Attorney, Washington, D. C.

SEND For descriptive list of New, Rebuilt and Used Curtiss OX5 and Hispano Suiza Airplane Engines. Heckman Machine Works, 4026 W. Lake St., Chicago, Illinois.

SEND 5c For bundle of baiza, reeds and price list on supplies. Aero Shop, 3050 Huribut Ave., Detroit, Mich.

"IF You want to fly" let Alexander Klein, brilliant engineer, teach you. With great skill whole course of training has been simplified and made crystal clear. Remarkable book teaches in most practical and easily understood fashion. Recommended by skilled flyers. Sent C. O. D. anywhere in U. S. Simply pay postman \$2.50 and postage when delivered. Sent postpaid to any address upon receipt of price. Popular Mechanics Press, Room 802, 200 E. Ontario St., Chicago.

MODEL AIRPLANES

FREE—Complete plans and instructions for B. O. G., Sessler R. O. G., and 11 Minute Indoor Tractor if you write for our new list of model airplane bargains. Madison Model Airplanes, Inc., 134 Livingston St., Brooklyn, N. Y.

FIFTEEN Paris 12" solid Balsa Glider if you pay packing, postage charges 5c coin. Azure Co., 929 Cottage Place, Union City, N. J.

FAMOUS Bailey Handbook—Prepares you to pass the examination for any grade of license for stationary, marine and Diesel engines, firemen and boiler inspector in any state of the Union or any province of Canada. Flexible cover. Handy pocket size. Pay postman \$2.00 plus postage when he hands you the package. Popular Mechanics Press, Room 802, 200 E. Ontario St., Chicago, Ill.

BOATS, OUTBOARD MOTORS, ETC.

ASSEMBLE Your own boat by the Welch System. Buy the best grade of Sear varnish, caulking cement, airplane wing dope and supplies direct from us at a saving. Write for list. Dept. S. J. B. Welch, Inc., 3211 N. 41st St., Milwaukee, Wisconsin.

PROPELLERS. Pumps, stuffing boxes, bearings, etc. Wm. H. Baker, Pond St., Quincy, Mass.

FIFTEEN Foot V-bottom racing sloop, full building plans July Rudder 25c. Free boatbuilding catalog. Rudder, 15 Murray Street, New York.

HOUSEHOLD Automatic Refrigerating Machines. Here is the first book ever published on this important subject. Refrigeration, by Moyer and Fittz. It is a thorough treatment of present-day refrigeration systems, their operation and testing for the student practicing engineer. 431 pages, 184 illustrations. Cloth. Sent C. O. D. Pay postman price \$4 and small amount of postage upon delivery. Popular Mechanics Press, Room 802, 200 E. Ontario St., Chicago, Ill.

MODEL SUBMARINES

MODEL Submarines. \$1. Will submerge and run 30 yards. Del Pincumb, Overland Park, Kansas.

FLOWERS, PLANTS AND SEEDS

WONDERFUL Japanese flowers: morning glory, chrysanthemum, lily, camellia, etc. Himalayan orchids, plants direct from India. Shipment to all countries. Catalog 5c stamp. Katayama, Box 29, Nishinomiya, Japan.

ARCHERY

MAKE Your Bow and Arrow. We sell materials. Send 25c for working instructions and catalogue. Sidney Archery Co., Sidney, Ohio.

BOOKS AND PERIODICALS

THOUSANDS Of old magazines. List 10c. O. P. Sealey, Sr., Box 734, Jennings, La.

CARBURETOR Information every auto service man needs will be found in special carburetor supplement to the famous Dyke Auto Encyclopedia. Deals with every make of carburetor. 106 pages. 246 illustrations. Price \$2. Sent C. O. D. if you prefer. Popular Mechanics Press, Room 802, 200 E. Ontario St., Chicago, Ill.

ASTROLOGY Books—25c to \$8.00; free descriptive list. Bullock, Box 1286, Providence, R. I.

861 PRACTICAL Ways to Reduce Farm Labor and Expense and Increase Income. One farmer writes he would not part with this information for \$100. If he could not duplicate it. Nothing experimental. These ideas have all been put to test and proven practical. Send today for a copy of our Handbook for Farmers and get ready to put these ideas into operation for your own benefit. Pay postman only 98 cents and the postage when he hands you the package Popular Mechanics Press, Room 802, 200 E. Ontario St., Chicago, Ill.

HYPNOTISM Easily learned. Lessons guaranteed. Postpaid \$1.10. Smith Pub. Co., Dept. 3, Springfield, Mass.

NOVELTIES, CURIOS, ETC.

WHOLESALE—Novelties, books everybody likes. Samples 10c. Photo-art, Southampton, Mass.

GAMES, ENTERTAINMENTS AND PLAYS

PLAYS, Operettas, musical comedies and minstrels, comedy and talking songs, black-face skits, vaudeville acts, monologs, dialogues, recitations, juvenile plays and songs, musical readings, entertainments, make-up goods. Catalog free. T. S. Denison & Co., 623 So. Wabash, Dept. 11, Chicago.

CARDINAL Points Foxy Game. America's new number, the 20th century check-orbed. Amusing, teasing, educational. 25c postpaid, no stamps. Sensational Toy Mfg. Co., Commerce Bldg., Linden, N. J.

200 TRICKS You can do—Mystify your friends; have loads of fun. This collection of tricks has been selected by Thurston for the average person. Neither unusual skill nor elaborate apparatus are required. Send for this 200-page illustrated book. Pay postman \$1 plus postage when delivered. If outside U. S. remit when ordering. Popular Mechanics Press, Room 802, 200 E. Ontario St., Chicago.

CHALK TALKS

LAUGH Producing program. \$1.00. Catalog free. Balda, The Cartoonist, Oshkosh, Wis.

CHALK-TALK Your way to popularity. Audiences at your feet if you learn how to entertain with a few simple pictures. Little artistic ability needed. "How to Chalk Talk" tells what to say and what to draw. Profusely illustrated. Make money giving chalk talks. Just order on a postcard. Pay postman \$1.00 and postage when delivered. Popular Mechanics Press, Room 802, 200 E. Ontario St., Chicago, Ill.

MAGIC TRICKS, BOOKS AND JOKER NOVELTIES

MAGIC Tricks, cards, books, catalog free. Geo. Fenner, Louisville, Ky.

SEVEN Optimagical delusions. Four Magic catalogues 15c. Gilmaglio, Morgan Park, Chicago.

MAGIC—Tricks, Books and Supplies. For amateurs as well as the great professionals. Anyone can learn through our instructions. Feature Acts in Mind-Reading, Spiritualism, Rope Ties, etc. Large illustrated professional catalog. 20c. Chicago Magic Co., 140 So. Dearborn St., Dept. B, Chicago, Ill.

ELECTRIC Fun! 200 stunts, 110 volts, \$1. Kutting Sons, Campbell, Calif.

MAGIC Catalog 20c. Lynn, 105 Beach, Dept. 3, Jersey City, N. J.

YOU Need a better grip on mathematics? Ask us to send you a copy of "Mathematics for the Practical Man," only \$1.50. By common sense methods it removes the mystery and difficulties so algebra and calculus are made simple. Assuming your knowledge is limited to arithmetic you quickly and easily gain a working knowledge of algebra, geometry, Trigonometry and calculus. Simply pay postman when he hands you the package. Address Popular Mechanics Press, Room 802, 200 E. Ontario St., Chicago, Ill.

RADIO SETS AND SUPPLIES

RUSSIAN, European and South American Stations come in on your regular set when used with our powerful short wave converter. Simple and inexpensive. Send 10c for Short Wave Booklet. Federal Telephone & Telegraph Co., Peasukee, Wis.

"WONDER" Crystal Set. Absolutely the Most Remarkable Value. Complete Directions. Full Price \$2.00. Postage Paid. Address, Clinton & McKnight, 259 North Fremont Avenue, Los Angeles, Calif.

NEW Chemical ground wire system gets startling results. Plans \$1.00. Satisfaction guaranteed. B. T. Sutton, Independence, Kansas.

MAKE Simple crystal radio. Crystal, with instructions, 25c. Music Sales, Independence, Mo.

MELOMITE Crystal Radio Set, \$1.00, postpaid. Music Sales, Independence, Mo.

TIME Counts in applying for patents. See pages 124 and 125. Clarence A. O'Brien, Registered Patent Attorney, Washington, D. C.

STAMP COLLECTING

BIG Parade—A packet of more than twenty all different better grade stamps showing exciting scenes and records of nations at war. Includes fire-pot hurler; the storming of a city; hand-to-hand bayonet struggle; bloody battle scenes; troop transport; red cross stamp; dying soldier; victory stamps; etc. Send for this thrilling "Big Parade" packet at once—limited supply. Only 10c to approval applicants. W. A. Howell, 58 Cornhill, Boston, Mass.

BIGGEST Bargain ever offered. On account of the midsummer season we offer this month only: The complete set of 8 values of Latvia, 2 values of the beautiful Eolus Flag stamps, 2 scarce Prussia, 1 Heligoland and 100 other stamps, total catalogue value over \$2.50 all for only 10c to approval applicants. This sensational offer will not be repeated. Globus Stamp Co., 214-3rd Ave., New York City.

SCARCE Airmail and triangle, Beautiful Uruguay "flying horse" airmail and scarce Guatemala triangle (smallest in the world) are included in our big packet of 60 different stamps from Abouities, Grand Liban, Venezuela, British and French Colonies, etc. All for 5c to approval applicants. Big illustrated lists free with each order. Write today! Mystic Stamp Co., (Dept. 80), Camden, New York.

A SNAP—300 Different foreign and 60 different U. S. stamps, including \$1 value, for only 25c. Free, with each order, our pamphlet telling "How To Make A Stamp Collection Properly," together with our price lists of albums, supplies and hundreds of bargains in sets, packet, etc. Queen City Stamp Co., Room 36, 604 Race St., Cincinnati, Ohio.

ANCHER'S \$\$\$ Outfit—only 12c. Fine triangle stamp, set German stamps (pre-war) value millions dollars, perforation gauge and memo scale, airmail set, interesting stamp smallest republic, newspaper set, packet good stamps Travancore, Malay, Dutch Indies, etc., fine pocket stock book. Entire outfit 12c to approval applicants. Ancher Stamp Company, Rutherford, N. J.

PACKET Giant stamps (including world's largest stamp, value 75c)—everything 10c to approval applicants. Gem Stamp Co., 1830 Unionport Road, New York.

BAKE Springbok, giraffe, quetzal, animal packet 5c to approval applicants. Glenn Smith, Girard, Kansas.

CANADA Airmail stamp free if you ask for approvals and send 15c for 25 different airmails or 30 different Canada; both packages only 25c. We list 350 countries in our dime packets. Lists free. Special bargains, 500 different, 25c; 1,000 different, 75c; 2,000 different, \$2.50. Victoria Stamp Co., London, 4, Ontario, Canada.

MAMMOTH Bargain—10 different packets—10c to approval applicants. Goldwater, 1,827 Amethyst St., Bronx, New York.

WORTHWHILE Penny approval, also better grade. References. Northrest, 4416 Elston, Chicago.

BOY Agents wanted for Virginia Stamp Company. Dept. PMS, Newport News, Va.

SEVENTY Different stamps from seventy different countries, 9c to approval applicants. Barcus, Box 1054, Detroit.

REMNANTS Of approval sheets and collections with few slightly damaged higher cataloging stamps, 100 different, 10c to approval applicants. A. W. Lloyd, Franklin, Ohio.

SOUTH Sea Islands stamps, 25 different. Borneo, Samoa, etc. \$100.00 fake stamp, 25c. Approvals, 5th catalog. Fleck, 245 Merrer St., Trenton, N. J.

MINIATURE Stamp collection \$1.00. Makorsky, 3903 Bridge Ave., Cleveland, O.

MISSION Stamps U. S. 40c. Foreign 40c 1/2 lb. 50 var. U. S. 25c. 35 var. Canada 25c. 40 var. Honduras \$1.00. Popular Co., 4512 North Racine, Chicago.

TWENTY Liechtenstein free with approval applicants. "Covered Wagon," Conshohocken, Pa.

BRUNEI: 3 Varieties 5c to approval applicants. Allison, Angola, Ind.

FREE Surprise packet with 500 different stamps from all the world 50c. Drexel Stamp Shop, 5720 Drexel, Chicago.

DOMINICAN Republic 25 varieties, 35c approval selection, want lists solicited. Catalogue free. Moreau, 121 W. 42 St., New York.

STAMP Cataloging \$3 for 25c to approval applicants. Bargains, Timourou, Box 277, Hoboken, N. J.

10,000 PRE-1922 U. S. \$1.00; 4000 Netherlands \$1.00. Carpenter, Wyalusing, Wis.

525 VAR. Lebanon to Victoria, cat. \$36.54 no 2c items, \$1.65. Passmore, Box 552, Glendale, Calif.

BEAUTIFUL Packet: Canada Map, Newfoundland Commemoratives, United States \$2.00, everything 10c to approval applicants applying by airmail. Special: 35 different Canada and Newfoundland 20c. Jackson, Box 864, Timmins, Ont., Canada.

ARE You a beginner and seriously interested in building up a good collection? Then Julius Goblir, 926 Southern Boulevard, New York, is the one for you.

VACATION Fun. Unsorted foreign mixtures. List free. Assorted, pound, \$3.50. Pate, Woodside, N. Y.

SURPRISE Packet—Borneo, Malay, Congo, U. S. Commemoratives, etc., with approvals 8c; 4 U. S. Airmails 10c; 4 U. S. \$1 Stamps 10c; 5 Pope Pius 10c; 3 Columbus Ships 8c; Panama Lindbergh 10c; Lists free. Moseley, 4521 Parkview, St. Louis, Mo.

FREE: 2c Norse with first selection amounting to \$1 from my approvals. F. E. Beach, Cambridge Springs, Pa.

3 PERSIAN Catalogue \$1.35. Special 17c. Williams, 230 - 15th Ave., San Francisco, California.

FREE Outfit! 52 stamps, hinges, pocket wallet. Postage 4c. Approvals. United Philatelists, South Berkeley, Calif.

100 DIFFERENT Stamps, hinges, watermark detector, millimeter, perforation gauge, free to approval applicants sending 4c postage. J. G. Ferguson, 1910 W. 41 St., Los Angeles, Calif.

FREE Present. Quality approvals 1/2c up. Pack's Stamps, 5253 Woodlawn, Chicago.

LIBERIA Triangles! Beautiful 1910 set complete, cataloging \$1.50 only 25c. Penna, Stamp Co., Greensburg, Pa.

SEND 5c For lists and free premium. Big line approvals against references. Don Berger, "Latin Americans," Manning St., Flint, Mich.

150 DIFF. Free. Approvals. Harlan Miller, 1295 Rhode Island St., Lawrence, Kansas.

MISSION Accumulation, 3000 stamps for \$1.00. Absolutely unpicked. Longacre Shoppe, 106 West 42, New York.

ANTWERP Exhibition complete for 5 cents to approval applicant. Chipewa Stamp, 42 West Chippewa, Buffalo, N. Y.

BOYS Wanted—Everywhere. Show our big bargain stamp assortments to friends. We trust you and pay you splendid cash commissions. Fast sellers. Earn money with our new plan. No references required. Dandy free premium if you write us at once. LeRoy Stamp Co., 1240 W. Jackson Blvd., Chicago, Ill.

BIG Approval bargains. Stamps 1/2c up. Josiah Babcock, St. Joseph, Michigan.

300 DIFFERENT Stamps 15c. Michael, 942 So. 23rd, Bellwood, Ill.

NEW U. S. A. \$1.00 postdue! 200 stamps! 15c. Vanvorhis, Bowlinggreen, O.

SELLING Quality stamps on approvals 1/2c up. Dandy free premium. Collections and job lots bought. Kelwin Stamp Co., Vineland, N. J.

FAMOUS Puffin Bird Stamps—5c With Approvals. Free Prizes. Box 114, Minneapolis.

101 DIFFERENT Stamps cataloging over \$12.00 for One Dollar. Ask for free list of our dime packets. Biggest value ever offered for 10 cents. Cosmos Stamp Company, 87 Nassau St., New York City.

5,000 MIXED U. S. and foreign \$1.00. Orr, 12 Geary, San Francisco.

PENNY Approvals that satisfy. Oppen, 937b Manhattan Av., Brooklyn, N. Y.

1000 MIXED U. S., old and new, 25c. Weatherly, Lakewood, Ohio.

UNITED States stamps on approval 1000 hinges, 200 different stamps, and illustrated catalogue 25c. Adam Bert, Washington, Penna.

"FIGHTING Balkans." 30 varieties 10c. Approvals. J. Novotny, Box 1115, Melrose Park, Ill.

50 DIFF.—50 Diff. countries, U. S. Commemorative, etc. Many islands and Monarchy 1 sq. mile in area. Know 1/2 10c to approval applicants. The Stamp Shop, Holland Bldg., St. Louis, Mo.

BRUNEI (Native scene), Tanganyika, Orange River Colony, Kenya, India Revenue, Vatican City, Grenada, Syria, French Guiana (cataloging 25c), Nyassaland Protectorate, and scarce genuine Baden, all for 5c to introduce our famous approvals. Viking Stamp Co., Sheephead Bay Station, Brooklyn, N. Y.

U. S. Stamps on approval. References. James Randall, 1621 Warren, Chicago.

PRE-CANCELLED: 100 Different 2-c. Approvals. Robert Briggs, Athol, Mass.

LARGEST Stamp in the world! Rare China Wild Goose special delivery stamp (value 75c) for only 5c to approval applicants. Supply limited. Positively only one to a customer. Western Philatelists, 6021 Harper, 388, Chicago.

CANADA Approvals 50%—100 varieties catalogue over \$9.00 for \$1.00. W. S. Barker Philatelist, 49 Broadfield St., Boston, Mass.

UNITED States commemoratives 10 different 4c. Approval buyers. Hudson Co., Plainfield, N. J.

10 UNITED STATES, 19th Century, 10c, 25 Newfoundland and Canada 10c. All different. Lists given. Bargain Stamp Co., 277 P West 23, New York.

FREE! Commemorative set with approvals. Aladdin, 1350 Carroll, St. Paul, Minn.

MYSTIC Box chuk full rare stamps. Guaranteed value \$3.00. Special price 25c. Rush, Dallas, Box 85, Station 8, Brooklyn, N. Y.

187 CHINA, Etc., 2c. Album (500 illustrations) 3c. Bullard, 446 Tremont, Boston.

EUREKA Mixture 1000, \$2.50, something unique, Box 1089, Vancouver, Canada.

ILLUSTRATED Bulletin. Free to collectors. Reimers, 30 N. La Salle, Chicago.

150 GOOD Mixed foreign stamps, 2c. Stanton, East Lyme, Conn.

FREE United States stamp with order for any following: 100 diff. 15c; 200 25c; 500 50c; 500 80c. No trash. Paragon approvals. Sivadah Stamp Co., Denver, Colo.

ILLUSTRATED United States list, price 50c, large complete United States price list, 1931, free. Stanley Gibbons, 38P Park Row, N. Y.

300 DIFFERENT Stamps 20c; 600 50c; 1,100 \$1; 2,000, \$3. Fred Onken, 639 79th St., Brooklyn, N. Y.

GRAND Mixture. No Europe. 1750 stamps \$1.00. Longacre Shop, 106 West 42, New York.

NEWFOUNDLAND Set of 2 Caribou 10c. Better grade approvals to applicants. DeLise, 762 Harding, San Jose, Calif.

COMPLETE Mint Sets on approval. R. E. Lee, Sheridan, Ark.

50 FRENCH Colonies, Alouites, Gabon, Caledonia, etc. with approvals 6c. Hollinbeck, 312 Marquette, Michigan.

40 DIFFERENT United States 12c. 40% approval. Seidenberg, Baroda, Mich.

BEAUTIFUL Picture stamps sent free. Paul Cornish, Schenectady, N. Y.

STAMPS, Sent on approval at 50% discount. Fred Herzberg, 433 Maple Ave., Elmhurst, Ill.

96-Page Illustrated Stamp Album and 100 different stamps—25c to approval applicants. Ohio Stamp Co., Box 249, Cleveland, Ohio.

FREE—Packet 52 different from Alouites, Lebanon, Quilmane, etc.; also watermark detector and rare old Hawaiian stamp—all free to approval applicants enclosing 4c postage. Highland Stamp Co., Newton Highlands, Mass.

TRIANGLES From Flume, Austria, Nyassa; Scarce Saxony, etc. Everything only 10c to approval applicants. Parker, 10 Charlotte Road, Marblehead, Mass.

1,000 DIFFERENT Europe \$28.80 value, only 1 dollar. Splendid approvals! Josef Wendt, Neumarkt, Opf. Germany.

FREE Premium certificate to approval applicants. Pathe Stamp Co., 301 Peck Building, Atlanta, Ga.

500 DIFFERENT Stamps for 25c. Big collection including Armenia, Andorra, Flume, Spanish Morocco, Kenya, Liberia, Meuel, Nigeria, Quilmane, Syria, Victoria, Vatican City and other hard-to-get countries. Catalog value over \$10.00. Price only 25c to approval applicants. Illustrated lists free. Loma Stamp Company, 4231 42nd St., San Diego, Calif.

GIANT Triangle stamp! The largest triangle stamp in the world (Spain 1930 Columbus issue) is included in our packet of 34 scarce varieties from queer, far-off lands—Bodi, Nyassa, New Guinea, North Borneo, etc. No Austria, Germany or other common stamps. Wonderful packet! Only 10c to approval applicants. Vogue Stamp Co., Dept. P., Post Chester, New York.

BEST One cent approvals in America. F. Hand, 1117 So. 60th St., Phila. Pa.

FREE—\$1.00 U. S. postage Lincoln memorial free. If you write for our 56 page price-list of U. S. and foreign stamps, 2,400 illustrations and fine stamps on approval. Hussman Stamp Co., 620-3 Olive St., St. Louis, Mo.

24 VARIETIES Cuban stamps, 10 cents. List of stamps free. Chambers Stamp Co., 111P, Nassau, New York City, N. Y.

ONLY 5c. 33 Different stamps including scarce Latvian triangular airmail stamps, 10 airmail, 12 United States (early issues, commemoratives, etc.) and 10 Canada. Approvals and illustrated pricelist sent with each order. Curhan Stamp Company, Gloucester, Mass.

301 DIFFERENT 10c To approval applicants only. Free list of bargain packets. Kansas City Stamp Co., Lee Bldg., Kansas City, Mo.

WHOLESALE Catalog for dealers: 4c postage. Grossman, 102 W. 42nd, New York.

25 AIRMAILS 10c; 1,000 Hinges 10c; annual packet 10c. Bargain packets, mixtures, approvals. Harvey Teeple, Decatur, Indiana.

STAMPS Sent on approval at 70% discount. Reference required. Emory Renoll, Hanover, Pa.

200 DIFFERENT 10c. 25 Japan 10c. 60% discount approvals. Covert Stamp, 29 State, Rochester, N. Y.

PENNY Approvals that satisfy. Neff Gronberg, Box 5441, Philadelphia, Pa.

FREE Stamp collection—contains Salvador, Turkey, Africa, etc., 2c postage. 10 different triangles 25c. 1000 hinges 7c. Approvals sent. Tatham Stamps, West Springfield, Mass.

TRIANGLES—Eight different triangle stamps including Guatemala (world's smallest), Latvia (air mail), Liberia, Nyassa, only 10c to approval applicants. Paul Revere Stamp Co., Box 40, Astor Station, Boston.

FREE 100 Different, postage 2c, with approvals. Noemus Stamp Co., 312 East 23rd St., New York.

ABYSSINIA To Zambesia—\$1.00 catalog value. 34 scarce stamps, Abyssinia, Helax, Spanish Guinea, etc. Only 10c to approval applicants. Weaver, Dept. 5, 1451 Broadway, New York.

CLEARANCE-Album. 1675 Illustrations, 25c; 9 Triangular Stamps, 29c; 25 Airmails, 10c; 500 Different, 25c; 2,000 Different, \$2.50; 1,000 Different, 75c; 3,000 Different, \$6.50. Foreign Stamp Service, 7657 Coles, Chicago.

"ALTHOUGH My stock of stamps is adequate to take care of business for years to come, yet results were so far beyond my expectations, that with the help I had, I was unable to take care of further new customers." Such are the reports received from advertisers using space under this classification. Your offer should be equally as well. For further information as to rates, closing dates, etc., write M. L. Rund, Manager, Classified Advertising, Popular Mechanics Magazine, 200 E. Ontario St., Chicago, Ill.

RARE COINS

WE Pay More For Indian Head Pennies. Catalogue, Monthly Bulletin, 10 Cents (Dime). National, 247 West 34th St., New York.

GUIDE To the value of all rare United States and early American coins, superbly illustrated. Price 50 cents. Descriptive circular free. Scott Stamp and Coin Co., 1 West 47th St., New York, N. Y.

WANTED: Old U. S. cents. L. Berkeimer, 717 Adams St., Piqua, Ohio.

OLD Money wanted. Will pay fifty dollars for nickel of 1913 with Liberty head, (no buffalo). We pay cash premiums for all rare coins. Send 4c for large coin folder. May mean much profit to you. Numismatic Co., Dept. H. Ft. Worth, Texas.

WORLD'S Best buys—18 large cents. \$1.00; gold half dollar, 52c; 100 foreign coins, \$1.00. Catalogue 10c. Romanocoinshop, Springfield, Mass.

10 CLASSIFIED Coins 20c. Lester White, Box 66, West Newton, Mass.

12 AUSTRIAN War notes and old silver coin 20c. Paul Summers, Sagerton, Texas.

\$5 To \$500 Each paid for old coins. Many very valuable. Keep all old money. Get posted. Send 10 cents for illustrated coin value book, 428. Guaranteed prices. We buy and sell. Coin Exchange, Box 6, Le Roy, N. Y.

SPECIAL Prices on United States Commemorative half dollars in uncirculated condition: Columbian 69c; Lincoln \$1.19; Pilgrim \$1.19; Monroe \$1.17; Lexington \$1.15; Stone Mountain 89c; California \$1.59; Oregon \$1.29; Sesqui, \$1.23; Bennington \$1.19; Old coin and bargain price list 10c. Arcy, Box 483, Muskogee, Okla.

2 FINE Copper or nickel coin, 3 large crisp notes and catalog, 10c. M. Figg, Box 283, Cedar Rapids, Iowa.

SEND 10c For 5 different coins and catalog or 50c for 25 different. Troyer Coin Co., La Fontaine, Ind.

GET Profit and pleasure in collecting old coins. Send 10c for large illustrated coin catalog. You'll be delighted with it. Send for it right now. H. Max Mehl, Numismatist, Mehl Bldg., Dept. P, Fort Worth, Tex. Largest Rare Coin Firm in the U. S.

CALIFORNIA Gold—Quarter size, 27c; \$4 size 52c; 3c piece and catalog, 10c. Norman Schultz, Box 746, Salt Lake, Utah.

OLD Coins, large fall selling catalog of coins for sale, free to collectors only. Catalog quoting prices paid for coins, ten cents. William Hestlein, 101A Tremont St., Boston, Mass.

UNITED States. Large cent, two-cent bronze, three-cent nickel and bargain list, 25c. Thirteen dates large cents, \$1.00. George Coffin, Greenwood Mountain, Me.

CAMERAS AND PHOTO SUPPLIES

DETECTIVE Camera—"Expo," the greatest little camera made. About the size of a watch and shaped like one and fits the vest pocket. You can take pictures without being detected. Well made and handsomely nickel-plated. Takes twenty pictures at one loading, only \$3.95 with one roll of film. Brilliant view finder \$0.85 extra. Send \$1.00 with order and pay postman the balance plus a few cents for postage. Ask for our free bargain book listing other makes of cameras such as, Graflex, Eastman kodaks, Motion Picture, Zeiss, and other popular makes at tremendous savings. Central Camera Co., Dept. 28-A, 230 South Wabash Ave., Chicago, Ill.

HAVE You a camera? Any kind. Build a business. Over 100% profit. No course to study. No capital needed. Free circular. Gannon-Service, Desk Pm, 8, Muskegon, Michigan.

TRIAL Offer. Developing roll 5c. prints 3c each. Beautiful 10-inch enlargement 25c. Young Photo Service, 405 Bertha, St., Albany, N. Y.

ENLARGING A specialty. Send your favorite film and have it professionally enlarged and mounted. Size 6x10, 40c. Arthur Service, 2221 Kimball Ave., Chicago, Ill.

OIL Color Photos. Spare or full time. Instructions, and complete outfit, \$3.50. Write for particulars. Ace Service, Holmington, Kans.

WE Copy any kind of picture and make 12 photo postals from same. \$1.00 with order. Original returned. Capitol Studios, 1 Trinity Place, Albany, N. Y.

AMATEUR Photographers, take perfect pictures, new easy method, details for stamp. Wolford, Massapequa, L. I.

YOUR Favorite kodak picture enlarged, size 5x7, 10c. Three for quarter. coin. Send best negative (film) today. Address Darmer Photo Lab., 221 Securities Bldg., Des Moines, Iowa.

FILM And six prints developed 15c. Reprints 2c. Satisfaction guaranteed. Skrudland, 4118 Overhill, Chicago.

SPECIAL Trial offer: Developing any size roll 5 cents; prints 3 cents each. Beautiful 7 inch enlargement 20 cents. Send for special bargain list. Roanoke Photo Finishing Company, 209 Bell Avenue, Roanoke, Virginia.

HAVE You a camera? Write for free sample of our big magazine, showing how to make better pictures and earn money. American Photography, 116 Camera House, Boston, W. Mass.

MAKE Money in photography. Learn quickly at home. Spare or full time. New plan. Nothing like it. Experience unnecessary. American School of Photography, Dept. 3432, 3601 Michigan Ave., Chicago.

MOTION PICTURES AND SOUND EQUIPMENT

JUST Out! Bass will mail postpaid Cine Amateur. Complete Handbook of motion picture photography for the amateur, \$1.00. Voice of the Films, a complete description of the process used in making sound motion pictures just out. Price postpaid, \$1.00. Motion Pictures With Sound by James Cameron. 400 pages crammed with information on all systems. \$5.00 postpaid. Bass Bargaingram No. 207 listing red hot bargains in standard and 16mm. motion picture cameras, projectors and accessories. 4c stamps. Bass Camera Company, Motion Picture Headquarters, 179 West Madison St., Chicago, Illinois.

TALKIE And movie producers are clamoring for new short story ideas, plots, etc. Perhaps you can write one that we can shape and sell for you. One writer (V.M.) received \$3,000. New York best market. Write now for free booklet, without obligation—How To Write For The Talkies! Daniel O'Malley Company Inc., Suite P, 1776 Broadway, New York.

SAVE Money. Movie cameras, \$25; projectors, \$35; Pathex camera, \$20; stereopticon, \$25; printing machine, \$75; 35mm negative stork, 2 cents foot; 100 foot Eastman 16mm negative, \$4.50; kodak, \$5. Typewriter, \$16. Cameras and films bought and exchanged. Ray, 266 W. 46th, New York.

SPECIAL Motor driven sixteen millimeter projector in case \$29.00. One hundred foot comedies, etc., \$2.50. One hundred foot panchromatic reversible negative, \$4.50. Milton Mendelwager, 192 Ave. B., Bayonne, N. J.

BARGAINS. Machines, Films, Stereopticons, Slides, National Equipment Co., Duluth, Minn.

FOR Sale:—Photostone, 200 records like new, suitable for theatre or skating rink, \$150. D. B. Dyer, Grover, Colo.

COMEDIES, Westerns \$2.50. Power's projector \$75.00. Marshall Films, Rome, Georgia.

MOVIE (16 mm. 35 mm.) Exchange club. Application 10c. No-Wat-ka, Southampton, Mass.

SACRIFICING Films, Bargain list. Francis Key, 2519 Jackson, Anderson, Ind.

AT Sacrifice—16mm film comedy and cartoon two cents foot. Thousand foot reels 35mm film \$2.00. 16mm and 35mm projectors for home use, silent or talkie. Theatre Equipment Co., Box 524, Cincinnati, O.

TIME Counts in applying for patents. See pages 124 and 125. Clarence A. O'Brien, Registered Patent Attorney, Washington, D. C.

MOVIE Films for 16mm. and standard machines. Low price exchange plan. Exclusive Film Service, 732 S. Wabash, Chicago, Ill.

WORLD'S Greatest "Passion Play" 16 MM. (new) 5 reels. Rent or purchase. Write Hemenway Film Co., 37 Church Street, Boston, Mass.

TRADE AND TECHNICAL SCHOOLS

LEARN Watch repairing. Hiles School, 5329 Mission St., San Francisco.

LEARN Blue print reading. State your trade. Columbian School, Drexel Building, Philadelphia.

TELEGRAPHY

LEARN Wireless (Radio) and Morse telegraphy. School, oldest and largest; endorsed by telegraph, radio, railway and government officials. Expenses low—can earn part. Catalog free. Dodge's Institute, H Street, Valparaiso, Ind.

BUSINESS OPPORTUNITIES

AN Unusual opportunity—Splendid opportunity to get into exceedingly profitable business on easy terms with direct factory cooperation. We want an ambitious man with \$1000 or more to own and run legitimate money making equipment in high grade business places. You handle your own money; all cash trade; no bad accounts; income starts immediately. You become associated with a big successful, progressive manufacturing concern with 41 years of established success and highest financial rating. Call or write immediately for full information. President, Room 810, 4100 Fullerton Ave., Chicago.

LEARN Marbleizing, with cement composition. You are taught how to enamel any concrete products, wood, lumber, etc. Wall-board so finished can be cut nailed perfectly. For statures, garden furniture, novelties. All have glossy face finish, flintlike hardness. All colors (see samples). Sanitary floors, marbleized, nothing better. You are taught practical marbleizing. A real opportunity, nothing like it before. We are sole owners. Send dime for samples. Corwell Institute, Grayling, Mich.

ARTIFICIAL Marble, for business, sideline or hobby. Beautifully colored glossy tile, no polishing, hardly believable. Make tabletops, novelties, floors, base, bookends, slabs, garden furniture. Cement compositions, multitudinous opportunities, enamels wood, etc. Workable, or hacksaw proof. Astonishing samples and particulars 10c. John A. Payne, 915 Grande Vista Drive, Los Angeles, Calif.

10c BRINGS You 24 Ways To Make Money and free information of 30 Self Help Opportunities. Publishers Syndicate, Box 199, Saginaw, Mich.

INCORPORATE Your business. Delaware laws. Many advantages. Cost \$46.50. Free information. Write Dept. 21, Corporation Fiscal Company, Wilmington, Del.

IF You are wasting your time, printed matter, postage and prospects trying to make a success of the Formula-selling-business with the old played-out methods, send stamp for my folder which explains all about a sure-fire Big Profit formula-selling-plan that is New and Different. W. G. Kraft, 246 Evans Avenue, Aurora, Illinois.

FANCY Dark milk, most practical and profitable business. Raise them in your back yard. Depression prices on breeders. Write Valles-Keys Ranch, Collins, Wis.

AMATEUR Cartoonists: Sell your work. Write Smith's Service, PW1194, Wenatchee, Wash.

THREE Tested spare time businesses, complete \$1.00. Details free. Gamlowski, 909 West Sixth, Topeka, Kansas.

INDEPENDENT Business—men earn big pay traveling by automobile carrying our portable electric block leveling machine and re-leveling butchers chopping blocks. Health Company, 210 Lafayette St., New York.

DOLLARS In "Fixit" service, spare or full time. Small capital. Experience unnecessary. Complete copyrighted 43 lesson instruction course, \$1.00. Particulars free. Houlgate's "Fixit" Service, 1395 N. El-Molino, Pasadena, California.

ADVANTAGEOUS Promotion; Investments quick return possibilities. New essential development. Scientific Mass Fishing, patented. Sale—leasing—partners. Biecker, Interborough Subways, Van Cortlandt Pl., New York.

25 SURE-FIRE Money-making Ideas 25c coin. If you are ambitious, write Rodrigues, Box 220, Grand Central Annex, N. Y.

LIQUID Glass Enamel. Real knock out. No melting. Hard as adamant. Samples, literature and business plan mailed you for 50 cts.—help, postage and printing. Brown Laboratories, Box 1481, Washington, D. C.

GET Into Advertising—50% profit; \$12.50 starts you. Circular. "Classified." Warm-springs, Ga.

OPPORTUNITY Is seeking men who want to make good money, whole or part time, buying old gold and silver for us. Beware of imitators. F. Polcer, Box 81-A, Chicago, Ill.

SALESMEN Who can sell \$25. therapeutic device to professional and lay prospects write for exclusive territory at once. Device new. Passed upon by American Medical Association. Big returns on small investment. Markle Products Co., 1221 Bridge St., Grand Rapids, Mich.

YOUR Own Business; No Investment. Write Leahy, Security Bldg., Minneapolis, Minn.

POPCORN Machines \$15 up. Money makers. Northside Co., 1306 Fifth, Des Moines, Iowa.

AMAZING Patented envelope sealer. Seals 50 minute. Retail \$4.50 only. Offices buy on sight! Tremendous market. Free Trial. Rede, 8023 Winthrop Bldg., Boston.

MIRRORS Resilvered at Home. Costs Near 5 cents per square foot; you charge 75 cents. Profitable business plating like new brass, worn-out auto parts, reflectors, tableware, stoves, etc. Outfits furnished. Details Free. Sprinkle, Plaster, 127, Marion, Ind.

WE Seek Novelties, Specialties, Any Kind, Importable to Italy. Write; Trading, Ruffini 9, Milan, Italy.

RETURNING To Buenos Aires, S. A. Financially responsible man wishes agency or other proposition. E. L. Beltrame, General Delivery, Los Angeles.

EARN Large income with "chain" of peanut, chewing gum vending machines. Start small capital. Particulars free. Robbins Corp., DeKalb and Broadway, Brooklyn, New York.

250,000 ARTICLES Wholesale. Directory 10c. W-Patterson Co., 4111 University, Des Moines, Iowa.

AMAZING Sales Plan! "Hand 'em out—that's all" and make 200% profit selling remarkable New 50c Blade Stripper. Gives keenest edge in 20 seconds. Makes one blade last indefinitely. Most territories available. Rush 25c for sample and quick-money plan. Daxmole, 173 Newbury, Boston.

"TIMELY Tips" money-making ideas! Plans! Opportunities! Three samples 25c. Elite Magazines, 1821 East 101st, Cleveland, Ohio.

OWN Your own business. Big money spare or full time. No canvassing. Literature free. Plans \$1.00. Veerjay Pub. Co., Box 285, Beacon, N. Y.

START Your own business. Write for details. M. Velasco, Box 143, Habana, Cuba.

RECLAIM-EM. \$10. Hundreds pounds on old auto inner tubes. I sell nothing. Workers wanted. Unusual opportunity. 2% brings details. Reclaimer, Eugene, Oreg.

CANADIAN Distributor, novelties and office specialties. Good lines wanted. Freedman, 4485 Marcell, Montreal, Canada.

AMAZING Invention. Biggest money maker today. Start your own business. Refrigerator without moving parts. Every home will buy one. Production costs about \$7.00. Send \$15.00 for blueprints and instructions. Scientific Laboratories, 1256-32nd Ave., San Francisco, Calif.

CHEMICAL Expert furnishes reliable manufacturing formulas with working directions. Charges reasonable. Dr. Vanbeeden, 817 East 46th, Chicago.

CONCRETE Building block machines and molds. Easy payments. Catalog free. Concrete Machine Co., 5 North Main St., St. Louis, Mo.

SUCCEED With your own products. Make-sell them yourself. Formulas, processes, trade-secrets. Expert analytical service. Catalog free. B. Thaxby Co., Washington, D. C.

BECAUSE Those old chairs. We show you. Steady income. Koch & Henne, Ann Arbor, Michigan.

WE Start you in business, furnishing everything. Men and women, earn \$40 to \$100 weekly operating our original "New System Specialty Candy Factories." Begin home spare time. Unlimited opportunity. Valuable booklet free. W. Hilber Baggdale, Drawer 4, East Orange, N. J.

\$10 TO \$25 Daily the year round in your locality. Why share for others. Clean, dignified work. Complete plans and samples to start you on the road to independence for \$1. Home Products, Box 1632, Boston, Mass.

THAXLY Formulas produce perfect products. All lines. Catalog free. B. Thaxby Co., Washington, D. C.

NEW Catalog money making business ideas. Coral Co., Laurel, Miss.

TIME Counts in applying for patents. See pages 124 and 125. Clarence A. O'Brien, Registered Patent Attorney, Washington, D. C.

SELL By mail. Books, novelties, bargains! Large profits. Particulars free. B. Elfo, 525 S. Dearborn, Chicago.

WHAT To Invent—Names of manufacturers and wanted inventions sent free on request. Write W. T. Greene, 945 Barrister Building, Washington, D. C.

SNAPPY New money maker. Get free particulars and judge it. Proved, tested, positive winner. Elwood Co., P-1 84 Rverson, Paterson, N. J.

ARTIFICIAL Marble sanitary flooring. Instructions covering wood or cement flooring 1/2 inch thick, fireproof, all colors, low cost. Ornamental casting, concrete plaster, paper-marble decorations, garden furniture, statuary, flexible molds, particulars and illustrations free. Chris. Mahler, Elmont, N. Y.

LEARN The collection business. Good income, quick results. Interesting booklet. "Skillful Collecting" free. National Collectors Assn., Long St., Newark, Ohio.

MAKE Illuminated signs. Patented process. Artistic ability unnecessary, one order cleared \$500. Particulars, Merritt Signs, So. Berkeley, Calif.

FREE Book. Start your own little business anywhere, selling novelties by mail. My beginner's outfit contains everything required, novelties, circulars, instructions, etc. Descriptive book free. Hadwell, 33A-74 Cortlandt St., New York.

A BUSINESS Of your own making—Sparkling Glass Name and Number plates. Checkboards, signs. Big book and sample free. E. Palmer, 549, Wooster, Ohio.

OPERATE Chain of vending and amusement machines. Be independent for life. Start small, grow big. P. Goodbody, 1826 East Main Street, Rochester, N. Y.

FIFTY Successful mail-order propositions. Address, K. Home, 3919 Metropolitan, Chicago.

CHEMICAL Expert will furnish formulas and trade secrets. All lines. Lists free. W. L. Cummings, Ph. D., 228 Gordon Ave., Syracuse, N. Y.

CHARTERS: Delaware; best, cheapest; free forms. Colonial Charter Co., Wilmington, Del.

MAKE Your own products. Employ agents yourself. Toilet articles, soap, extracts. We furnish everything. Valuable book free. National Scientific Laboratories, 1950 W. Broad, Richmond, Va.

I MADE \$30 A week home. French breadmaking. 15 years' experience; free booklet tells. Ashbrook 67, Marengo, Ohio.

BIG Money at home plating auto parts, reflectors, mirrors, chandeliers; by new method; experience unnecessary. Outfits furnished. Gunmetal Co., Ave. N, Decatur, Ill.

FREE Booklet describes 67 plans for making \$20-\$100 weekly in home or office business of your own. Elite Co., 84 Elizabeth St., New York.

UNUSUAL—Uncommon specialties always sell best. Make these yourself from Miller's guaranteed formulas. Why work for others when others can be working for you? Latest eye-opening literature brings you many specialty propositions for you an independent business. Miller Chemist, 706-K Chemical Bldg., Tampa, Fla.

CHEMISTRY

BECOME Trained chemist. Thousands of opportunities—fascinating career. Learn at home. Complete experimental laboratory outfit given. Write for big free book. Chemical Institute, 19 Park Place, Dept. P-831, New York.

CHEMICAL Formulas—Reliable tested formulas for every purpose. Prices reasonable. Empire State Laboratories, 553 Colvin Pkwy., Buffalo, N. Y.

ROBERT Simmons, analytical and consulting chemist, Weightman Building, Philadelphia, Pa.

YOUR Chemical problem solved and formula or process furnished for Five dollars. Write me. W. Stedman Richards, Industrial Chemist, Box 2462, Boston, Mass.

FORMULAS AND TRADE SECRETS

MANUFACTURE Useful specialties. Five formulas \$1.00. Mats Specialties, Reading, Pennsylvania.

NON-EXPLOSIVE Cleaning fluid, formula, 25c coin. Many others. List Red stamp. Gateway Specialties, Rapid City, S. Dak.

ANALYSIS \$5.00. Manufacturing the most profitable field. Small capital sufficient. Write for guaranteed formulas with free consultation aid. Associated Chemists, Indianapolis, Ind.

GOLD And silver plating formula for glass, \$10.00. Both make a good mirror. Good for glass signs or process work. Sample free. Nashville Mirror & Sign Co., 612-614 Commerce St., Nashville, Tenn.

BEAUTY Preparations. Ten formulas one dollar. Chemical service. Buskett, Joplin, Mo.

ORIGINAL Automobile Formulas. Have sold thousands of cans and bottles of goods made from these original formulas of my own. Red stamp brings list. Geo. E. Cook, 172 East 73rd St., N. Y. City.

GUARANTEED Formulas, recipes, processes, 50c each; analysis \$5. Catalogue free. Industrial Institute, Dept. 208, 61 West Randolph, Chicago.

FREE Formula catalog. Latest money makers. Western Chemical, Salem, Oregon.

FORMULAS, 50c. Catalog free. T. Huffman, Room 723, 1518 Wilson, Chicago.

FORMULA Encyclopedia \$1.00. Write for complete list of contents. J. Beifort, 4042 N. Keeler Ave., Chicago.

SUCCEED With your own products. Make-sell them yourself. Formulas, processes, trade-secrets. Expert analytical service. Catalog free. B. Thaxby Co., Washington, D. C.

FORMULAS All kinds. Catalog free. Clover Laboratories (P), Park Ridge, Ill.

FREE Formulas—Free materials making \$32.00 worth of guaranteed highest class specialty-necessities. Thirtieth-anniversary offer explains all. Miller, Chemist, 1707-G Jetton, Tampa, Fla.

500 FORMULAS And big illustrated catalog 27c. Ideal Book Shop, Park Ridge, Ill.

MAKE Your own products. Employ agents yourself. Toilet articles, soap, extracts. We furnish everything. Valuable book free. National Scientific Laboratories, 1950W, Broad, Richmond, Va.

10,000 MONEY-MAKING Formulas. Tells you how to make and sell almost everything under the sun; cosmetics, moulage, anti-treese solutions, battery solutions, beverages, cheese, chewing gum, cleaning preparations, extracts, hair preparations, inks, bluing, leather polish, mirrors, perfumes, polishes, typewriter ribbons, carbon paper, washing powders, liquid soap and hundreds of other profitable articles. Send no money. Just write a postal for "Honey's 20th Century Book of Formulas." Pay postman postage and \$1. Popular Mechanics Press, 200 E. Ontario St., Room 802, Chicago.

AGENTS WANTED

\$2 TO \$1 Per hour easily made. Nothing ever sold compares with the sale of Christmas Greeting Cards in box assortments. Our 1931 assortment beats all our former triumphs, contains 21 exquisite cards and folders, dainty water colors, steel engravings, embossing, glistening gold metallic effects, tipped-on illustrations, parchment and deckled-edge folders, each with tissue lined envelope. Sells for \$1. Costs you 50c—shipping charges paid. Write for particulars and free samples. Waltham Art Publishers, 7 Water St., Dept. 97, Boston, Mass.

MAKE Your own products. Employ agents yourself. Toilet articles, soap, extracts. We furnish everything. Valuable book free. National Scientific Laboratories, 1950W Broad, Richmond, Va.

BIG Money easy. Simply showing New Pully Wrench, 19 wrenches in one. Guaranteed fast seller. Sample furnished. Gellman Manufacturing Co., Dept. 3-G, Rock Island, Ill.

"OPPORTUNITY For you" booklet and copy of "Mail Order Selling" magazine, 10c. Pruett, Brookfield, Ill.

I START Men in a Grocery Business a New Easy Way. You use my money. Don't need to put up a penny of your own cash for stock. Expansion program now opens up many desirable opportunities also established trade. Hustlers make good money from the start increasing rapidly as they learn the business. Not a "chain" proposition but your own business. Buy on credit. Give credit if you wish. If honest and need more money write at once for application and details to McCann & Company, Room L-6698, Winona, Minn.

CAN Write in the dark—electric pencil. Agents make big profit. Demonstration in the evening. Guarantee sales. Earn \$100 to \$200 per week. Write for information, Tilden-Kienly Co., 345 Sutter St., Dept. 4, San Francisco, Calif.

NEW "Wonderful" No-Pin Clothes Line. Absolutely banishes clothes pins—Instant demonstration, sure sale, big commissions daily, no investment, John Dunn, Hempstead, New York.

WANTED: Aggressive man to sell new auto accessory. Exceptional opportunity. Applicant must have Model-A Ford. American Supply Co., Quincy, Illinois.

NEW Device revolutionizes model A Ford. Invented by famous speedway driver. Nothing like it. Every Ford owner a prospect. Satisfaction or money back. Whole or part-time men wanted in U. S. and Canada. Chance to build own business. 40 to 55% profit. Backed by reliable concern. Marshall Metal Co., National Distributors, Desk 212, 407 East Pico Street, Los Angeles, Calif.

NEW. Profitable—Sell auto step mats. Quality rubber with owner's name molded white. Details free. Ebonite Products, Dept. T-40, 895 Main, Akron, Ohio.

100% PROFIT Selling quality Pen-Pencil sets at \$1.00 per set. 75c brings sample set and wholesale prices. Wright Service, 290-A Madison Avenue, Paterson, N. J.

SO Good, it's foolish to call this selling. Men must buy Shirts, Ties, Underwear, Hosiery, other necessities. Rosecliff's powerful year guarantee makes big money for you. Cash bonuses. Free shirt offer. Finest outfit free. Write today. Dept. K8, Rosecliff, 1217 Broadway, New York.

AGENTS And dealers wanted everywhere to sell the Reedy Neckties. Sell 3 for \$1.00. Cost \$1.65 the doz. 3 doz to carton. Mail 25¢ with order, hal. C. O. D. Newest assorted colors. Harry B. Reedy, Inc., 828 Myrtle Ave., Brooklyn, N. Y.

POLMET Polishing Cloth Removes Tarnish from all metals without the use of liquid, paste or powder. Our agents say it sells like "hot cakes." Retail 25¢; sample free. Gale & Co., Inc., 15 Edinboro St., Boston, Mass.

BIG Profits Selling Groceries, Motor Oils, Paint, Stock Minerals. Sample Case free. Loverin & Browne, 1602-T So. State St., Chicago.

AGENTS. Build a volume repeat business in your territory with nationally known Auto Beauty Kit. Fast seller, big profits. State previous selling experience, territory covered. U. S. Mfg. Corp., Dept. A, Decatur, Ill.

BIG Pay giving away Shirts, Hosiery, Underwear. Also Lumberjackets. Smashing free offers win orders. Every man buys. No experience needed. We teach you and supply complete sample equipment free. Write Today, Dept. A25, Albert Shirts, 860 Sixth Ave., New York.

BIG Profit Catalog—Guaranteed portraits, frames, medallions, photo pillows, household specialties, toilet preparations, food products, remedies, pictures, crucifixes, religious goods. James Bailey Co., Station C-8, Chicago.

250,000 ARTICLES Wholesale—Directory 10c. W-Patterson, 4111 University, Des Moines, Iowa.

35 CHRISTMAS Cards sells for \$1.00 (worth \$1.75). No two alike. Agents and district managers wanted. 51% profit. Sample \$1.00. Talbert Novelty Company, Hager Street, Buffalo, N. Y.

I'VE placed 5,000 men in good paying jobs, selling Shirts, Ties, Underwear, Hosiery, Workshirts, Lumberjackets, etc. I'll give you a marvelous outfit free. Remarkable values get orders and repeats. Big cash commissions and bonuses. Write Dept. H8, Quaker, 1167 Broadway, New York.

JUST Out—latest thing. Monogrammed Door-Mats. Attractive patterns and colors with individual monogram. Women buy on sight. Most homes need two. Durable rubber. Outwears three ordinary doormats. Agents making clean-up. 47 other fast selling rubber specialties. Big catalog and money making information free. Kristee Mfg. Co., 1438 Bar St., Akron, Ohio.

SOMETHING The housewives want. A signed guarantee to save money and time in cooking. No competition. 400% profit. No license required. Station C, Box 25E, San Diego, Calif.

MIRRORS Resilvered at Home. Costs near 5 cents per square foot, you charge 75 cents. Profitable business plating autoproducts, reflectors, tableware, stoves, refinishing jet-ware, etc. Outfits furnished, details free. Write, Sprinkle, Plater, 128, Marion, Ind.

BRAND New Money-Maker! Good for \$2.00 an hour. Wonderful article. Sells like wildfire. Carry right with you. Particulars free. Albert Mills, 9135 Monmouth, Cincinnati, O.

STEP Into big money with Work Clothes. Every man needs Pants, Brasches, Coveralls. Lowwear's 4 complete lines sell on sight. Cash in your pocket every day. Belt free with every 3 Complete outfit free. Dept. P8, Longwear, 489 Broome St., New York.

CASH Paid for butterflies, insects. See Sinclair Display Advertisement on page 12.

300% PROFIT Selling Mystery Gas Lighter. Retail 25c. Costs you \$1.00 doz. Sample free. Square Deal Mfg., Desk PM-22, Bradford, Pa.

WANTED Reliable, energetic men to supply famous Watkins products to satisfied customers. 150 household necessities favorably known everywhere. Earnings \$35 to \$100 weekly. Write at once. J. R. Watkins Company, Dept. PM831, Winona, Minnesota.

STRANGE Ironing cord. Prevents scorching. Saves electricity. Abolishes kinks, snarls. Approved by Good Housekeeping. For telephones also. 200% profit. Samples furnished. Neverknot, Dept. 8-A, 4503 Ravenswood, Chicago.

ELECTRIC Water heater—New. Heats water instantly. Pocket size—retails \$3.75. Two minute demonstration makes you \$1.95 profit. Lux-Visel, Dept. 87, Elkhart, Ind.

ABSOLUTELY Brand new. Hand-colored popular priced panel portraits going big. Everyone wants them. Make \$10-\$25 daily. Samples furnished. Cruiser, 2402-18 Jackson, Chicago.

HOLLOW Ground blades for double edge razors; ten cent packages, easy selling. Carried. Sold everywhere. Standard Safety Razor, Pittsburgh, Pa.

START Your own Christmas Card business. Personal and box assortments. Sample books and supplies furnished. Large profits. Season just starting. Get free details. Dollar Card Manufacturers, New Brunswick, New Jersey.

100% PROFIT With Margo Bottle Moth Preventive and Deodorant. Instant seller everywhere. Send \$1.00 for four full-sized samples postpaid. Money back if not satisfied. Margo, 906 Chestnut, Philadelphia, Pa.

EARN Real money selling "Zipp-Over" wonder dust mop. Fits over any broom. Every home needs, wants, likes, and buys one or more. "Zipp-Over" Mfg. Company, St. Paul, Minn.

SIGN Salesmen let us tell you about a New Changeable Sign that sells for \$1.50 and gives you 400% profit. National Sign System, St. Louis, Mo.

BEAUTIFUL Gold window letters. 2 in., 2c each; 3 in., 2½c; 4½ in., 3c; 6 in., 6c. Sample to Midland Sign System, G28 W. Warren, Detroit, Mich.

CHANCE For \$11 daily introducing rheumatic new discovery. Write for samples, territory. Vanl Comparo, Carew Tower, Cincinnati, O.

GIVE Away Ladies' Pure Thread Silk Stockings with wonderful value \$1.00 sets of Paris Toiletries. 100% profit. Paris Laboratories, 2145 Locust Blvd., St. Louis, Mo.

BIG Profits—Sells like hot cakes. Box 261, St. Paul, Minn.

NEW Automatic Washer. Cleanses and sterilizes clothes quickly. No rubbing. No electricity. Fast seller! Price \$7.50. Automatic selling plan! Agents reap big repeat profits! Write Story Royalty Co., 2601 Enright, St. Louis, Mo.

I'VE Placed 5,000 men in good paying jobs selling Shirts, Ties, Underwear, Hosiery, Workshirts, Lumberjackets, etc. I'll give you a marvelous outfit free. Remarkable values get orders and repeats. Big cash commissions and bonuses. Write Dept. J8, Quaker, 1167 Broadway, New York.

SELL Fun! Everybody smiles, laughs, buys new joke novelties we manufacture. Real profits! Mospubco, 5654 Seabreeze Station, Daytona Beach, Fla.

100% PROFIT In new mystery cigar lighter. No flint or friction. What makes it light? No wind can blow it out. Retail 50c. Sample and sales plan 25c. New Method Manufacturing Co., Box PM-8, Bradford, Pa.

GUARANTEED Hosiery—Lowest mill prices, men's latest fancy hose—doz. \$1.50, \$1.50, Ladies' silk hosiery—doz. \$2.99-\$3.50. Catalogue free. Superior Knitting Company, Dept. 34, New Haven, Conn.

ADDRESSES—Hundreds of wholesale and agent supply houses. Particulars free. J. Belfort, 4042 No. Keeler Ave., Chicago.

WANT A good one? See Dasmico advertisement under "Business Opportunities."

FREE Formula Catalog, agents fast demonstrators. Western Chemical, Salem, Oreg.

ELECTRIFY Any clock! New, inexpensive, profitable. "Lektrex," 2945 Fullerton, Chicago.

PHOTO Medallions. Send for latest catalogue. Hundreds of our newest designs. Photo novelties. Lowest prices. Quick service. Medallion Novelty Co., Inc., 298 Bowery, New York, N. Y.

AGENTS Wanted to sell electric, battery radios and tubes. Bright Radio, 3240 Lawrence Ave., Chicago, Ill.

500% PROFIT! Gold and colored sign letters for windows, trucks, signs. Easily applied. Big demand. Neonite, Akron, O.

AUTOMATIC Gas or cigar lighter. No friction. Sample 25c. Lighter Co., 88, James St., Montreal, Canada.

NEW Fast-selling Bump Paper Fastener for stores, offices, banks, factories. Demonstration sells it. Selling supplies free. Commissions paid weekly. First replies your territory given preference. Write quick. Bump Co., Dept. P-8, La Crosse, Wis.

AMAZING New electric trouser presser good for \$25 daily; puts razor edge in pants in 10 seconds, sells for \$2.50; your commission \$1.00. Sample fits pocket. Munny Mfg. Co., Dept. C-88, 817 Main St., Cincinnati, Ohio.

SOUND Tells weather chart, 90 cents postpaid. Agents wanted. W. B. Hartung, Connell, Wash.

NEWEST Invention! Ankle Supports Sock. Circulation Unobstructed. Extreme Comfort. Pair 5¢. Dr. Benzon Wolf, 3159 Roosevelt Road, Chicago.

SEE National Campaign ad under Salesmen Wanted. CCP., St. Louis.

THE Christensen dirt removing oval double cone mop wringer. Price \$2.20. H. K. Christensen, Mfgs., Ft. Atkinson, Wis.

THAXLY Formulas produce perfect products. All lines. Catalog free. B. Thaxly Co., Washington, D. C.

CALIFORNIA Perfumed genuine beads, sell like hotcakes. Factory prices, full line. Eastern headquarters Kulier Mfg. Co., 33-22 Northern Boulevard, Long Island City, New York.

NEW Hemstitcher. It's different. Agents, demonstrators wanted everywhere. Money making wonder line. Samples 10c, retail 50¢ and dollar. K J Manufacturing, 648 N. Vermont, Los Angeles, Calif.

MAGICLOTH. World's best polishing cloth. For all metals. Quick sales; big profits. Sample free. Magicloth, 3317 Summit, Kansas City, Mo.

MAKE Your own products. Employ agents yourself. Toilet articles, soap, extracts. We furnish everything. Valuable book free. National Scientific Laboratories, 1950W Broad, Richmond, Va.

AGENTS—Something new! Make old style clocks into electric clocks. Anyone can attach. Low price. Free details. Bestever Clock Co., 4319-P Irving Park, Chicago.

AGENTS For handlek; original powdered handsoap. Approved Good-Housekeeping. Everybody customer. Fine opportunity for hustler. Sample free. Solar Products, J-2144 So. Troy, Chicago.

SUCCEED With your own products. Make-sell them yourself. Formulas, processes, trade-secrets. Expert analytical service. Catalog free. B. Thaxby Co., Washington, D. C.

SELL Perfume incense. Wonderful proposition. Particulars free. Law Laboratories, 72 East 133rd Street, New York.

SELL Stores 5c carded breathlets, etc. Lorraine Products, Albany, N. Y.

THIS Advertisement may make you thousands of dollars. If you write immediately for my "Eye-Opening" literature describing guaranteed formulas; valuable trade processes, money-making information how to easily make the world's best-selling specialties. All lines. Investment small. Profits immense! Start in your home, room or office. Make the good money you're entitled to. Dr. Liscombe Miller, Chemist, Tampa, Fla.

CHICAGO Expert valued \$3 stone at \$900. The diamond's only guaranteed rival. Greatest spare time, side-line article ever known! Amazing profits. \$5 pocket sample case free. Write quick. Mexican Gem Company, Dept. P.M. Monterey, Calif.

FREE "Booklet of money making opportunities," new ideas, original plans, money making secrets and other valuable information. None require peddling or outfits. Elite Co., 81 Elizabeth St., New York.

SELL 3A Garage door holders, simple, automatic, quickly installed. Interests garage owners, builders, everybody. Exclusive territory proposition. Knowlson-Stevenson Co., Ann Arbor, Mich.

MAKE Your own products. Employ agents yourself. Toilet articles, soap, extracts. We furnish everything. Valuable book free. National Scientific Laboratories, 1950W Broad, Richmond, Va.

FLAVORING Extracts—Bottle yourself! Labels furnished. 600% profits! Whirlwind money-makers! Repeaters! Free offer. Thomas Manufacturing Company, Indianapolis, Ind.

CALIFORNIA Perfumed beads, selling like hot cakes. Agents coming money. Catalog free. Mission Factory, P. 2328W Pico, Los Angeles, Calif.

\$68-200 A WEEK. Genuine gold letters for store windows. Easily applied. Free samples. Liberal offer to general agents. Metallic Letter Co., 438-B North Clark, Chicago.

WE Start you without a dollar. Soaps, extracts, perfumes, toilet goods. Experience unnecessary. Carnation Co., 641, St. Louis, Mo.

AGENTS—Make a dollar an hour. Sell Mendota, a patented patch for instantly mending leaks in all utensils. Sample package free. Collette Mfg. Co., Dept. 404, Amsterdam, N. Y.

PHOTO Medallion men and women, the largest line of photo novelties in the world. Lowest prices, quickest service. Send for catalog showing over 200 money makers. Gibson Photo Jewelry Co., Inc., 833-837 Gravesend Ave., Brooklyn, N. Y.

A BUSINESS Of your own—Making sparkling glass name and number plates, checkerboard signs. Big book and sample free. E. Palmer, 512, Wooster, Ohio.

AGENTS—Engraved name plates, signs, number plates etc., easily sold with large profits. Brest Bros., Wintthrop, Mass.

NO Dull times selling food! People must eat. Federal distributors make big money; up to \$3,000 yearly or more. No capital or experience needed; unsold goods may be returned. We furnish free sample case, license and free samples for customers—sure repeat orders. Exclusive territory. Ask now. Federal Pure Food Co., A2307 Archer, Chicago.

OUR Luminous crucifix and new luminous St. Therese statue shine brilliantly in the dark. Sell on first demonstration. Write for prices. W. G. Hannan Co., 2543 So. State, Chicago.

BIG Money applying gold initials on automobiles. Easiest thing today. No experience needed. \$1.45 profit every \$1.50 job. Free samples. "Balco," X-1048 Washington, Boston, Mass.

NEW Line Counter Displays. Aspirin, Filints, Chewing Laxative, Breath Gum, Nottartar, Silkstone, etc. Steady Repeats. Over 100% Profit. Superba Co., W5, Baltimore, Md.

AMAZING Electric water heater. Pays big profits. Heats water instantly. Pocket size. Sells fast at \$2.95. Write quick. Hestever Co., 4317P, Irving Park, Chicago.

AGENTS—Clever Invention! Inkspoon makes every pen a fountain pen. Fast office seller; big profit, demand increasing everywhere. Exclusive territory offered. Sample free. H. Marui Company, Tribune Bldg., New York, N. Y.

GENUINE Gold Leaf Letters anyone can put on store windows. Guaranteed to never tarnish. Large profits. Enormous demand. Free samples. Write today. Metallic Letter Co., 418-D North Clark, Chicago.

AGENTS Everywhere making money with our line of kitchen specialties, demanded in all homes. Big earnings possible. Write today for details. P. Seed Filter Co., 353 Broadway, New York.

LARGE Importer of necklaces offers exclusive agency and entirely new proposition. Enormous demand. No competition. Unlimited possibilities. La Romance, 568 Broadway, New York.

AGENTS—Mosco corn and callous remover will build you a steady repeat business. Send today for pocket-size trial outfit. The Moss Company, 101 Searle Bldg., Rochester, N. Y.

BIG Money and fast sales. Every owner buys gold initials for his auto. You charge \$1.50; make \$1.45. Ten orders daily easy. Write for particulars and free samples. American Monogram Co., Dept. 40, East Orange, N. J.

MAN in each town to plate auto parts, reflectors, bathroom fixtures, refinish beds, mirrors, chandeliers; by new method. No capital or experience required. Simple plan of manufacturing at home starts you in big money-making business. Outfit furnished. Free particulars and proofs. Gun Metal Co., Ave. H. Decatur, Ill.

GREATEST Opportunity; newest proposition. Build continually paying business in your own name. Household, industrial, brushes, brooms, mops, dusters, fully guaranteed. New catalog, all net prices, no discount to bother with. Make as high as 300 per cent and over. Write today. Wire Grip Sanitary Brush Corp., 41 East 11th St., New York.

SELL Men's neckwear—wonderful proposition. Astor-M. 39 East 28th, N. Y.

BIG Profit putting our gold sign letters on store windows, without experience. Samples. Consolidated, 69-T West VanBuren, Chicago.

AGENTS: Stamping names on pocket-key protectors. Sample check with your name and address, 25c. Stamping outfits, Emblem checks, check-fobs, name plates. Hart Mfg. Co., Desk 2, 303 Degraw St., Brooklyn, N. Y.

HIGH-GRADE SALESMEN WANTED

EARN \$1000 Between now and Xmas. Your friends, relatives, neighbors will buy on sight. Because Process 1931 Famous Artist line of Christmas Greeting cards, imprinted with sender's name and message, costs no more than ordinary cards. Big cash commissions paid in advance, monthly cash bonuses, etc. Write for complete outfit free and confidential sales plans. Process Corp., Dept. 802-B, 21st at Troy, Chicago.

SELL Egg Cartons! Dandy repeat side line. Everyone who sells eggs needs cartons—grocers, poultry farms, dairies. Send for information and samples. Pick up these extra commissions. Self-Locking Carton Company, 575 E. Illinois Street, Chicago, Ill.

BIG Pay giving away Shirts, Hosiery, Underwear. Also Lumberjackets. Smashing free offers win orders. Every man buys. No experience needed. We teach you and supply complete sample equipment free. Write Today. Dept. A26, Albert Shirts, 869 Sixth Ave., New York.

SCREW-HOLDING Screw Drivers! Non-magnetic. Remove, insert screws inaccessible places! Factories, garages, electricians, carpenters, mechanics, auto, radio owners buy on sight! Free trial! Millon, HC-20 Wintthrop Bldg., Boston.

ANY One Can Sell Our Carded Mdos. Under your own name. All stores buy. Lowest prices. \$15.00 daily. Quick Sale Products Co., Portland, Oregon.

IS Money your need? See Damsico advertisement under "Business Opportunities."

SALESMEN—Tremendous profits demonstrating new, patented belts. Buttons into waistband. Holds trousers up; shirt down. Slenderizes, supports abdomen, back. Adjustable support for stout gentlemen. Sample, \$2.75. Perfect elastic for slender gentlemen, \$1.75. Give actual waist measure. Nationwide demand. Write VonWald Co., LaCrosse, Wisconsin.

COMPLETE Line of Printing. New service. Illustrated cuts. Sample book free. Tracy Printing Co., 314 - 5th Ave., So. Minneapolis, Minn.

\$40 WEEKLY Easy! Selling amazing value all wool 2 Pants Suits \$21.95, \$5 profit. Single Pants Suits, Topcoats, Overcoats \$18.95. Union tailored. Sample suit for producers. Outfit Free. Williams Bros., 879 Broadway, Dept. WB-22, New York.

GREAT Sideline for any salesman! Pocket outfit free. New cash customer Building Campaigns for merchants. D&H Premium Co., Dept. 338, 116 So. Wells, Chicago.

MAKE Money every day; establish agency selling men's All Wool Suits, Topcoats, Overcoats, below \$20.00. Pays you \$1.00 cash every order. Beautiful selection, easy to sell. Expensive outfit, sales help free. Write experience. All West Clothes, Dept. PS, 899 Broadway, New York.

I'LL Pay You 68% Commission every week for taking just 2 orders a day for my sensational value made-to-measure suits. Fine woolsens. Superb tailoring. Amazing money-making plans pay big money even to beginners. If you speak English, rush name for details sent free. W. Z. Gibson, Inc., 500 Throop, Dept. H-517, Chicago.

SALESMEN—Four \$15.00 sales to stores net you \$18.00 daily. Savers Systems, Est. 1895, 2801-123 Sheffield, Chicago, Ill.

EVERY User of the mails needs an envelope sealer. The Kendall seals \$1/4 minute. Retail \$2.50. Big profit. Good territories available. Kendall, Dept. 4, P. O. Box 153, Berkeley, Calif.

SO Good, It's foolish to call this selling. Men must buy Shirts, Ties, Underwear, Hosiery, other necessities. Roscliff's powerful year guarantee makes big money for you. Cash bonuses. Free shirt offer. Finest outfit free. Write today. Dept. L8, Roscliff, 1237 Broadway, New York.

BUSINESS Stationery—Largest Line—Highest Quality—Quickest Delivery—Biggest Commissions—Liberal Bonuses—Free Copyrighted Cuts Every Business—Experience unnecessary—Instructions and Outfit Free. Willens Co., Dept. 375, 2130 Gladys Ave., Chicago.

SALESMEN—Wonderful Sideline. 40% Commission paid daily. Sells all merchants. Pocket outfit free. David Lionel Press, 212 So. Hamilton, Dept. 222, Chicago.

ALL Merchants buy! 5c carded nuts, aspirin, etc. Steady repeats. Also low priced vending machines. Robbin Products, DeKalb and Broadway, Brooklyn, N. Y.

BAD Debt Service Salesmen. Sell service contracts. New original plan; liberal commission; extra bonus; protected territory. National Credit Service, Columbian Bldg., Washington, D. C.

SALESMEN—At last! New feature sells punchboards everywhere. Dealers wild with joy—prosperity back again. Profits enormous. Samples free. Puritan Company, 1407 Jackson Blvd., Chicago.

\$18 TO \$25 Daily; biggest selling line of men's suits. Meets present day conditions. Amazing values at \$11.95, \$14.50, \$16.95, \$18.95. Also raincoats, slickers, topcoats and boys' suits. Biggest commission paid in advance. Liberal bonus. Free outfit. State age and selling experience. "Jim" Foster, Inc., Dept. 28, 2250 South Spaulding Ave., Chicago.

WANTED County salesman with car, to demonstrate for large Ohio manufacturer. First class job. Fyr-Fyter Co., 2181 Fyr-Fyter Building, Dayton, Ohio.

ONE \$6.75 order daily means \$100 weekly on our guaranteed money back sales promotion deals. Free kit. Sales Stimulators, Dept. 13H, 241 Madison, Chicago.

NEW And plenty different—Fast selling 5c-10c merchandise on attractive counter cards. 100% commission for you and dealers. Advertised by radio. No capital required. Catalog free. World's Products (Estab. 1921), 155 Central, Spencer, Ind.

ARE You Old at Forty? See our advertisement on page 28 of this issue. The Electro Thermal Company, 2144 Morris Ave., Steubenville, Ohio.

SUMMER Drinks—California Concentrates in brick form; each brick makes gallon juice; fruit cocktail, orange, lime ricky, grape, port, sherry, champagne. Legality twice established in federal courts. Every home, camp, picnic ground, fair church, hospital, soft drink place, drug, grocery store prospect; 100% profit for salesman with no investment. State and county rights open. V. S. Co., Dept. S-198, 393 - 4th St., San Francisco, Calif.

IF You can reach inventors having patents for sale, you can represent us selling exhibiting space at the Second International Patent Exposition at Chicago, to be attended by thousands of manufacturers and patent buyers. Liberal fees to competent men. Concessions also open for Exposition lasting two weeks. 300,000 persons to attend. B. Hamilton Edison, Manager, Merchandise Mart, Chicago.

NATIONWIDE Advertising Campaign. New model Genuine Gillette Blades pay you \$4.00 profit each 75¢ outfit by amazing cut-rate advertising plan. Details postpaid 10¢. Dept. 110, CCP., 609 Hamilton, St. Louis.

MEN To sell Batteries with complete line of supplies to garages. Lowest prices. Miekman Battery Co., St. Paul, Minn.

SALESMEN And Distributors. Patented office specialty. Positive repeats. Exclusive territory. Markwell Fastener Co., 209 Hudson Street, New York.

SALESMEN And Distributors—Open ter.; large field; extracts. Send for selling plan. Dill's, 827 Fulton, St., Brooklyn, N. Y.

SELL New patented pipe cleaner for smokers to retail tobacco stores—see ad page 118.

BIG Profits; every smoker wants one on sight. Sample offer. Wm. F. Jones, 320 East Klossa, Colo. Springs, Colo.

DISTRICT Managers make money selling mystery polishing cloth. Approved by Good Housekeeping. Write for territory. Mohler, Omaha, Minn.

WE Want to hear from full and part time men who can sell complete line of business printing. One of finest in country. Thousands of live cuts. Full cooperation and progressive sales plans. Outfit free. All-Trades, 110 N. 2nd St., Rockford, Ill.

NEW—Startling—amazing. \$10 to \$25 a day easily earned. Home protection \$250 to \$1000, at death. Ages 1 to 80. Net an insurance company but a society furnishing protection at cost. Write National Aid Society, Myers Building, Springfield, Ill.

NEW Specialty—Sells every business and professional man. Four \$15 sales daily pay \$280 weekly. Fover cleared \$4920 in three months. Write F. E. Armstrong, President, Dept. PM, Mobile, Ala.

\$75.00 WEEKLY Job—Salesmen-Distributors! Outstanding opportunity, amazing new tire patch guaranteed 10,000 miles. Big profits, steady repeats. Protected territory as factory distributor. Write to Economy Rubber Products Co., 603 Burkhardt, Dayton, Ohio.

PUNCHBOARD Salesmen—Most gigantic line ever featured. Vending machines—all kinds. Make as high as \$28.00 on single order. Repeat commissions. Beautiful colored catalog free. Lion Mfg., Dept. 8, 298 W. Erie, Chicago.

NEW, Largest color catalogue, punchboards, vending machines, produces quicker orders, big commissions. Free outfit. Lincoln Sales, 116 So. Wells, Chicago. Dept. D. Established 20 years.

\$60-\$200 A WEEK. Genuine gold letters for store windows. Easily applied. Free samples. Liberal offer to general agents. Metallic Letter Co., 438-A North Clark, Chicago.

SALESMEN—Become independent. Own your business; experience unnecessary, selling our \$10,000 accidental death; \$50 accident; \$25 sick weekly benefits—\$10.00 yearly. Other amounts proportionate. Guaranteed steady income from renewals. \$250,000 deposited insurance department. Universal Policy, Dept. A, 716 Lefcourt Bldg., Newark, N. J.

SELL Nothing! \$170 weekly empty handed. \$500,000 punchboard firm announces new plan. No investment for anyone. Season starting. Hurry! K&S Sales, 4326 Ravenswood, Chicago.

BIG Profit putting our gold sign letters on store windows, without experience. Samples. Consolidated, 69-V West Van Buren, Chicago.

GENUINE Neon—Priced to sell 40% commission. Buyers want it. Willis Austin, Miami, Okla. made four calls, sold four. Collected \$80.00, three hours work. Doubt it! Write him. Every hustler hits with Neonette—the genuine Neon border display with changeable letters and posters. Sizes for all show windows. Also mounted Neon letters. Plug in any A.C. socket. Big money for early birds. Special 30-day demonstrator trial offer. Display Products Co., 409 East 31st, Kansas City, Missouri.

HELP WANTED

IF You want to get your groceries and household supplies at wholesale, and a wonderful chance to make \$15 cash profit a day besides, send me your name immediately. No experience necessary. Albert Mills, 9136 Monmouth, Cincinnati, O.

CASH Paid for butterflies, insects. See Sinclair Display Advertisement on page 12.

EDUCATIONAL AND INSTRUCTION

MEN—Women, 18-50. \$105.00 to \$280.00 month. U. S. Government life jobs. Steady work. Paid vacations. Common education usually sufficient. Valuable book with list positions, sample roaching and full particulars—Free. Write immediately Today Sure, Franklin Institute, Dept. FJ, Rochester, N. Y.

WANTED Men-Women, 18-50, qualify for steady Government jobs. Salary range, \$105-\$250 month. No Government experience required. Paid vacations. Common education. Thousands appointed yearly. Write Ozzent Institute, 101, St. Louis, Mo., immediately.

GOVERNMENT Mail Positions, \$140-\$225 month; qualify. Booklet free. Chisholm Service, Rockwall, Texas.

RADIO—Very latest information necessary for proper operation, maintenance and service in Modern Radio Practice including Short Wave Receivers. New 224-page radio man's guide now available at only \$1.00. Sent postpaid upon receipt of price or C.O.D. anywhere in U. S. Popular Mechanics Press, Room 807, 200 E. Ontario St., Chicago.

LEARN Home Fur Craft. Profitable home work. We teach it. Furnish for material. Information free. Homesite Industries, Geneva, Ohio.

LEARN Golf Club Making. Pictures and particulars free. Ralph Conrad, Aurora, Missouri.

LEARN Photo-Engraving at home by experience. We supply without extra cost all necessary equipment. Make money while learning. Aurora School of Photo-Engraving, Aurora, Missouri.

LEARN Lacquer system of sign painting. Valuable new book gives complete description of methods, materials and equipment with hints and helps for sign shops. Covers latest in electric, neon tube, and daylight reflector signs, etc. Delivered to your door C. O. D. Simply pay postman \$3 and postage. Popular Mechanics Press, Room 807, 200 East Ontario St., Chicago.

LATEST And most scientific methods of cleaning and dyeing taught by mail. Even if now in the business this course is invaluable. We make you an expert craftsman. Good spotters alone always in demand. Enrollment with first two lessons \$5. Terms. American School of Dry Cleaning, Box 134, Lansing, Mich.

WE Want men and women of average school education, gifted with common sense, to study Secret Service and Scientific Crime Detection. If in this class and interested, write International Secret Service Institute, 77 River St., Hoboken, N. J., Dept. 101-1.

BECOME A landscape architect. Uncredentialed profession; wonderful opportunity for money-making. Easily mastered by mail. Earn while you learn. Est. 1916. Write for details. American Landscape School, 29A Plymouth Bldg., Des Moines, Iowa.

DOUBLE Entry bookkeeping 60 hours with 8 keys guaranteed. (Diploma.) International Bookkeeping Inst., 8 Springfield, Mo.

DON'T Prepare for any civil service examination without seeing our catalog. Free. Columbia Correspondence College, Washington, D. C.

U. S. GOVERNMENT Wants men, \$1,700-\$1,900 and up at start. Railway mail clerk examination coming. Let our expert (former government examiner) prepare you for this and also rural carrier, post office, customs, internal revenue, and other branches. Write today for free booklet. Dept. 8, Patterson School, Rochester, N. Y.

CARTOONING—Let the world's most successful cartoonist tell you how to draw cartoons. Brings in his new book gives every step in cartoon work and answers every question a beginner might ask. Elaborately illustrated. Pay postman price of book, \$3, and small amount of postage when he delivers the package C. O. D. Popular Mechanics Press, Room 802, 200 E. Ontario St., Chicago, Ill.

SHORT STORIES

SHORT Stories revised, typewritten and marketed. Details free. Hursh Service, Box P-1013, Harrisburg, Penna.

TYPEWRITERS AND SUPPLIES

ADD-LIFE Automatic Typewriter Ribbon Inker increases life of ribbons more than 3 times. Produces clear, uniform copy. Attaches any typewriter. Introductory \$1.75 prepaid. Guaranteed. Cormac Products Company, 604 Mission Street, San Francisco, California.

TYPEWRITERS, \$4 to \$32. Ribbons, 25¢. Guaranteed. Catalog free. Typewriter Exchange, Ada, Okla.

TYPEWRITERS — Motorcycles — Radios \$2.99. Best \$23.99. Terms. Agents, Knights, 1512 Locust, St. Louis, Mo.

TYPEWRITERS—All standard makes \$10 up. Catalog free. Northwestern Typewriter Exchange, 121 N. Francisco Ave., Chicago.

ADDING MACHINES

NEW \$4.75 Automatic Adding Machine. Fully guaranteed. Bassett 1458-A, Hollywood Avenue, Chicago.

PRINTING, MULTIGRAPHING AND MIMEOGRAPHING

1,000 LETTERHEADS Bond 6x9 1/4, \$2.00 prepaid anywhere. Cash with order. Samples. Seminole Press, Miami, Florida.

PICTURES Make printing powerful. Cut catalog 10¢. PrinterCrafters, (950), Indianapolis.

1000 BUSINESS Cards \$2.00. Underwood Press, Porter Station, Detroit, Mich.

500—8 1/2 x 11 BOND Letterheads \$1.85. Wilson, 2922 Victor, Kansas City, Mo.

QUICK!—Get new low prices on high quality printing. Now's time—save real money. Battiefield Press, Gettysburg, Penna.

GET Annualized offer—100 8 1/2 x 11 letterheads 100 6 1/2 envelopes printed, \$1.00 postpaid. Morris Printery, Cass Bldg., Saginaw, Mich.

1,000 LETTER Heads, envelopes, statements, or business cards \$2.50. Send us samples your printing, get our low prices. Halberstadt Printing, Terre Haute, Ind.

ZINC Etchings, cuts from your copy or drawings, 5 square inches for \$1.00. Samples free. Peerless Mfg. Co., Box 2081, Akron, Ohio.

NEARGRAYEMBOSSED 250 Letterheads-Envelopes \$1.50 postpaid. Samples. Spillidays, Knox, Indiana.

1000 BUSINESS Cards \$1.50. Marmorstein, 7 Vashouten Avenue, Jersey City.

PERSONAL Stationery, 200 note sheets 6x7 and 100 envelopes, good white bond, neatly printed with your name and address, sent postpaid for \$1.00. Carl Edquist, Odesa, Minnesota.

1 LETTERHEADS, 150 Envelopes \$1.00 postpaid. Cards, billheads, labels, Ware, Box 357, Ft. Madison, Iowa.

200 SHEETS, 100 Envelopes, 60¢. Applebaum—P, 1258 Brook, New York.

1000 BUSINESS Cards \$2.75 postpaid. Samples. Miller, Printer, Narberth, Pa.

250 BOND Letterheads, envelopes, billheads, cards, \$1.35 each. Economic Press, Leontia, N. J.

200 LETTERHEADS And 100 envelopes, \$1.00; 200 letterheads, 8 1/2 x 11, 150 envelopes, \$2.00; 250 cards, \$1.00. Hoosier Print Shop, Portland, Ind.

WE Print stationery, booklets, catalogs, circulars, Samples. Commercial Press, Batavia, Ohio.

THREE-Color business cards, \$2.95 thousand. Crescent, 1715½ Wood, Dallas, Texas.
250 LETTERHEADS, 250 Envelopes, raised letter printed, postpaid \$4.50. Samples free. Sunko, Mohawk, N. Y.

PRINTING OUTFITS AND SUPPLIES

COMPLETE Printing outfits, presses, type, ink, paper, supplies. Write for free catalog. Kelsey Co., B-11, Meriden, Conn.
PRINTING OUTFITS—Presses, type supplies, type novelties. Send stamp for catalog. Model Press, York, Penna.

DUPLICATORS AND DEVICES

"EXCELLOGRAPH" Rotary stencil duplicator \$39.00. **"Two-Faced"** film duplicator \$6.00. Booklet free. Pittsburgh Type-writer Supply, Dent, 601, Pittsburgh, Pa.

RUBBER STAMPS

NAME, Address, 2 lines 25c; 3 lines 35c. Stamp Works, Auburn, Nebr.

GUMMED LABELS

GET Our prices on labels: Gummed and un-gummed. Send sample of your label for prices, circulars, additips, folders, letter-heads, envelopes, blotters. Plain or in colors. Write us. Old Dominion Label Company, Bridgewater, Va.

FOR MEN

BE A handuff king, travel and make money anywhere. Guaranteed instructions 50 cts. postpaid. Fuerle, Box 1022, Los Angeles, Calif.

SIDELINE—Cartoon books. Samples 10c. 20c. Meyer G P O. Box 411, New York.

A BILLION ideas. This is the title of our remarkable catalog of books along practical lines. Arranged alphabetically by subjects for easy reference. If you have not received it, send for a copy. You will find hundreds of subjects you cannot usually locate in book stores or public libraries. Sent free upon request. Popular Mechanics Press, Room 802, 240 E. Ontario St., Chicago.

FOR SMOKERS

SMOKE Factory Fresh Green River Cigarettes Free. Send \$1.25 for 10 packs Green Rivers. Smoke 5 packs. If you don't find them mildest, most tasty, best flavored you ever smoked, return 5 packs. We'll return \$1.25 promptly. Green River Tobacco Co., Box 775, Owensboro, Ky.

DIAMONDS, WATCHES, CLOCKS AND JEWELRY

CLOCK-CONTROLLED Switch: 8-Day, 15-Ampere, Single-pole, in Cabinet, \$15 postpaid. Send \$1 deposit. Pay postman \$14. Guaranteed. Ansonia Clock Company, 12 East 41st Street, New York.

ANTIQUES, WAR RELICS AND INDIAN GOODS

ARROW Heads, 10c each. Moran Bohmette, Parcellet, S. C.

10,000 INDIAN Relics:—Birdarrow and circular 10c. P. Heike, Pontiac, Ill.

INDIAN Relics, coins, curios, beadwork. Catalogue free. Vernon Lemley, North-branch, Kansas.

SEND 5c For fine new list Indian relics, antique firearms. F. E. Ellis, Webster Groves, Missouri.

RAZORS AND BLADES

SALESMEN Write for free sample New Imported Genuine Swedish Gillette Type Blade. Keen agents wanted. Viking, 408 S. Main, Los Angeles, Calif.

YOUR Dull Gillette, Probak blades re-sharpened, 100% keen, 1c each. Peter Wetterquist, Rockford, Ill.

MUSIC AND MUSICAL INSTRUMENTS

FORTUNES Being made from songs through talking pictures, radio phonograph, music publishers. "Hit" writers revise, arrange, compose music to your lyrics. We submit to studios and other markets. Free reading. Send for booklet. Universal Song Service, 625 Meyer Bldg., Hollywood, Calif.

COMPOSERS—Verse or music. Brilliant opportunity. Write VanBuren, 2419 McClurg Bldg., Chicago.

WRITERS—Songpoems, melodies, 50-50 royalty collaboration, opportunity. Legitimate, PM 4215 North Ave., Chicago.

SONG Poets, write Sequoia Songwriters Service, Sherman Branch, Los Angeles, Calif.

SONGS Composed, arranged, copyrighted, printed. Brennan's Music House, Dept. P, 1638 Broadway, N. Y.

POEMS Wanted. Work guaranteed. We publish. Great Eastern Song Bureau, Dept. 27, Thomaston, Me.

SONGWRITERS—Read "song requirements of talking pictures, radio and records" an explanatory instructive book sent free to aspiring writers of words for songs. We compose, arrange music and secure copyrights. Write today. P.M. Newcomer Associates, 1974 Broadway, New York.

SONGWRITERS Write now for free booklet how to make money out of songs, by America's well-known composer, Stan Tucker, 330 Wadsworth Ave., New York.

SONG Writers. Send for our "Publishing Agreement." McKinley Music Printers, 1501 E. 54th St., Chicago.

CORNETISTS—Trumpetists—Saxophonists—Clarinetists. Get "Free Pointers," Name Instrument. Virtual School, Buffalo, N. Y.

WRITE Songs. Big money and reputation. Write for information. J. Gordon Pub. Co., 291 N. Huron Ave., Chicago.

SUBMIT Modern song poems. Valuable marketing assistance. Clifford Studios, 4562 Hollywood Blvd., Hollywood, Calif.

DUO-FLEX reeds for clarinets and saxophones eliminate your reed troubles. Write for circular. Duo-Flex Reeds, 1204 1st Ave., Evansville, Ind.

"MUSIC Composed" to words. Bauer Bros. (formerly of Sousa's Band), Oshkosh, Wis.

SEND Song poems, 50-50 plan. Indiana Song Bureau, (Brookside), Salem, Ind.

\$7,500 PAID For one song! More wanted! Particulars free. Greenstreet, Park Avenue, Kearney, Ill.

PATENT ATTORNEYS

PATENTS—Write for free information. How to Obtain a Patent and Record of Invention—or send drawing or model for examination. Miller & Miller, Patent Attorneys (former Patent Office Examiners), 1690-A Woodworth Building, New York; 259 McGill Building, Washington, D. C.

PATENTS Procured. Prompt, careful efficient service. Highest references. Moderate fees. Send sketch or model for actual search and advice. George P. Kimmel, Master of Patent Law, 51-H Westory Bldg., Washington, D. C.

SAVE Patenting expense. Definite protection while selling. New copyrighted plan. Write Chartered Institute American Inventors, 1136 Barrister Building, Washington, D. C.

PATENTS Obtained at low cost. Free booklet. See page 128. Write today. Harry W. Johnson, McGill Bldg., Washington, D. C.

TIME Counts in applying for patents. See pages 124 and 125. Clarence A. O'Brien, Registered Patent Attorney, Washington, D. C.

JOHN P. Nikonow, mechanical and electrical engineer, registered patent attorney. 5425 Giles Pl., New York City.

LACEY'S Patent Sense. Valuable book free. See ad page 128.

WHAT To Invent—Names of manufacturers and wanted inventions sent free on request. Write W. T. Greene, 946 Barrister Building, Washington, D. C.

INVENTORS: Send for booklet telling how to patent and sell your inventions at lowest cost. Ralph Burch, Patent Lawyer, 960 F St., Washington, D. C.

PATENTS. Send sketch or model for advice. Free book, "How to Obtain a Patent." Established thirty years. Highest references. Prompt service. Reasonable charges. Chandler & Chandler, 908 F Street, Washington, D. C.

INVENTIONS Patented and Exploited. Former patent office examiner; Master patent law. Beni Webster, Esq., No. 15 East 26 Street, New York.

PATENTS—Write for our free book, "How to Obtain a Patent" and Record of Invention Blank. Send model or sketch of invention for inspection and instructions free. Terms reasonable. See advertisement on pages 126 and 127. Victor J. Evans & Co., 654 Ninth, Washington, D. C.

INVENTORS—Write for our Guide Book, "How to Get Your Patent," and Evidence of Invention Blank. Send model or sketch of your invention for our prompt examination and instructions free. Randolph & Co., Dept. 430, Washington, D. C.

PATENTS Procured: trade marks registered—preliminary advice furnished without charge. Booklet and form for disclosing idea free. Irving L. McCathran, 704 International Bldg., Washington, D. C.

PATENTS. Booklet free. Highest references. Best results. Promptness assured. Watson E. Coleman, Patent Lawyer, 724 Ninth St., Washington, D. C.

INVENTOR'S Guide, valuable information, free. Frank Ledermann, Registered Attorney-Engineer, 1712 Woolworth Bldg., New York.

ESTABLISHED 1894. Milo H. Stevens Company. Free booklet. Patents. Trade marks. Copyrights. Offices. Monastorok Block, Chicago; Barrister Bldg., Washington, D. C.

LANCASTER. Allwine & Rommel, 221 Ouray Bldg., Washington, D. C. "Originators of the Form Evidence of Conception." Before disclosing your invention to anyone send for blank forms to be signed and witnessed. Form and patent information bulletin free.

FOR INVENTORS

INVENTORS! Fifty new ideas for useful inventions, 25c each. For particulars write, P. Stover, Box 107, Robinson, Ill.

INVENTIONS In household appliances of wood, sheet metal or wire, bought or manufactured on royalty. Reichard Mfg. Co., Bangor, Penna.

EXHIBIT Your invention or patent at the second International Patent Exposition, Chicago, September 14 to 27. Thousands of manufacturers will attend to inspect new inventions. You may exhibit with or without model. Write for circular to International Patent Exposition, Merchandise Mart, Chicago.

INVENTORS: "Don't walk into Pitfalls," save your money and invention. My book, "Success Or Failure?" containing over one hundred mistakes which you must avoid before and after you get your patent, will be a revelation to you. Postpaid \$1.50. Fred Poole, 1739 College, Springfield, Missouri.

IDEAS Or patents in baby goods line wanted, including small harmless toys. Can purchase outright or royalty. Dandee Co., 151 West 28th St., New York City.

SOUD. Practical inventions, patented, unpatented, now wanted. Write Chartered Institute American Inventors, 1135 Barrister Building, Washington, D. C.

HAVE You a good patent or pending application for sale? If so, write American Patents Corporation, 1220 Barrister Building, Washington, D. C.

INVENTIONS: Patented or unpatented. Bought outright; manufactured on royalty or commercialized. Urbano Manufacturing Co., 561 Howard Street, San Francisco, California.

TIME Counts in applying for patents. See pages 124 and 125. Clarence A. O'Brien, Registered Patent Attorney, Washington, D. C.

INVENTIONS—Write for our free book "How to Obtain a Patent" and Record of Invention Blank. Send model or sketch of invention for inspection and instructions free. Terms reasonable. See advertisement on pages 126 and 127. Victor J. Evans & Co., 654 Ninth, Washington, D. C.

LACEY'S Patent Sense. Valuable book free. See ad page 128.

LOW Cost manufacturing. Large plant completely equipped for blanking, drawing, stamping and wire forming in any finish. Can save you money on your product. Our figures will convince. Eastern States Products, Box 721, New Haven, Conn.

NATION Wide search for best inventions. American Society of Inventors, Crosby Bldg., Buffalo.

PATENTED Inventions wanted. Will buy or commercialize. Write, N. Tutty, 1103 Bell Telephone Bldg., St. Louis, Mo.

WHAT To Invent—Names of manufacturers and wanted inventions sent free on request. Write W. T. Greene, 947 Barrister Building, Washington, D. C.

INVENTIONS Patented and Exploited. Former patent office examiner; Master patent law. Beni Webster, Esq., No. 15 East 26 Street, New York.

INVENTOR'S Universal Educator: contains 900 mechanical movements; 50 perpetual motions; instruction on procuring and selling patents and selecting an attorney, etc. Suggests new ideas. Price \$1.00 postpaid in U. S. A. Address Dietrich Co., 602B O'Quay Bldg., Washington, D. C.

MANUFACTURERS Everywhere seek new inventions to improve their product. Names of manufacturers and wanted inventions sent free on request. Write W. T. Greene, 944 Barrister Building, Washington, D. C.

INVENTIONS—Have you conceived one? There is a long, winding road to travel before your vision of rewards can be realized. Send for the new book "Inventions and Patents, Their Development and Promotion" by an eminent authority. It is designed to guide the inventor on his way and help him avoid pitfalls. Will be sent C. O. D. Pay postman \$2.50 plus postage when he hands you the package. Popular Mechanics Press, Room 802, 200 E. Ontario St., Chicago.

PATENTS FOR SALE

FOR Sale—Invention: Scribe pipe any angle. A. E. Goolsby, Box 820, Prescott, Ariz.

ROYALTY Or Sale: My Patent on Measuring Instrument. A. L. Daniels, 69 East Spring St., Winooski, Vermont.

ONE-WHEELED Automobile; "rolling boat"; power-plant; gun mechanism; roller-bearing and about one hundred more inventions, unpatented; want royalty. Fred Peterson, Box 213, Bagdad, Fla.

SALE Or royalty. True hydraulic brake. No brake shoes. Developed. Charles W. Hamer, 747 Warfield Ave., Oakland, Calif.

PATENTED, 1569822 "Road Map and Case," for automobiles, trucks, airplanes, etc. Market for millions. Cash or royalty. Write K. C. McGee, Laurel Hill, N. C.

FOR Sale—Canadian and U. S. patents on Rear View Mirror Shield. Very simple and practical invention. Should prove very valuable to manufacturer. Full particulars on request. Wm. E. Hummel, 2122 Charala St., Santa Barbara, Calif.

PATENT Pending. Sanitary Doche Support. Cash or royalty. Arthur Wiggins, 217 E. Henry, Pontiac, Ill.

FOR Sale—patent on internal combustion engine having no "dead center." Address Leo S. Tolale, New Albany, Miss.

AUTOMOBILE Cylinder heater. Patented. Inexpensive, big profit, very efficient. Sell or royalty. William H. Rohr, Kent's Hill, Maine.

PATENT—Snow and rain tight weather stripping for cabriolet auto bodies. J. A. Bayer, 3312 No. 50th St., Milwaukee, Wis.

PATENTED Boring device, suitable for automobiles, self-guiding; finishes six cylinders in 90 minutes. Perfect without grinding. Vertson, 1300 Garden Street, Hoboken, New Jersey.

GARMENT Stretcher. Adjustable sizes. H. Cook, 1628 Catherine St., Phila., Pa.

TIME Counts in applying for patents. See pages 124 and 125. Clarence A. O'Brien, Registered Patent Attorney, Washington, D. C.

OUTRIGHT. Tripod for cameras, vertical, horizontal use. Great help for amateur photographers. Nothing alike; small, very practical. Make offers. Leco. 491 E. 188 St., New York.

MANUFACTURERS. Get our complete list of inventions. American Society of Inventors, Crosby Bldg., Buffalo.

MANUFACTURERS Looking for new inventions should write W. T. Greene, 929 Barrister Building, Washington, D. C.

INVENTORS—Cash in on your invention now! Don't delay the sale any longer! Send for a free copy of our specially prepared booklet, "Turn Your Patent Into Money," today! It contains helpful information for all inventors. M. L. Rund, Mgr. Classified Advertising, Popular Mechanics Magazine, 200 E. Ontario St., Chicago, Ill.

MODELS AND MODEL SUPPLIES

INVENTORS: Send us sketch or crude model of your idea. Crescent craftsmen will develop it into a practical working model. 30 years of successful experience and thousands of satisfied clients. Confidential service guaranteed. Bank references furnished. Free illustrated book: "Making Inventions Pay." Crescent Tool Co., Dept. 8-8, Cincinnati, Ohio.

MODEL Builders. Handy man supplies—gears, motors, materials, books, 3,000 price listings. Illustrated catalog No. 28, 25c coin. Amalgamated Corp., 601 Washington, Chicago.

WE Make working models for inventors and do experimental work and carry a complete stock of brass gears and model supplies. Send for catalog. The Pierce Model Works, Tinley Park, Ill.

MODEL Steam engines and boilers for miniature boats, boat and boiler fittings. Catalog 15c. Anton Bohabey, 212 Price St., Rahway, New Jersey.

THREE Ship model plans for \$1. Catalog 6 cents. Richter's, 3227-A West Walnut St., Milwaukee, Wis.

SHIP And yacht model fittings. Send fifteen cents for illustrated catalog No. 7. A. J. Fisher, 1892 Etowah Ave., Royal Oak, Michigan.

TIME Counts in applying for patents. See pages 124 and 125. Clarence A. O'Brien, Registered Patent Attorney, Washington, D. C.

MANUFACTURING

MANUFACTURING, Models, dies, stampings, brasswork, mechanical rubber moulds, vulcanizing. Circular free. Baum's Metal Specialties, Kansas City, Mo.

SPECIAL Machinery of parts, dies, tools, metal specialties, models, special gears, stock gears and model supplies. Send for catalog. The Pierce Model Works, Tinley Park, Ill.

LOW Cost manufacturing. Large plant completely equipped for blanking, drawing, stamping and wire forming in any finish. Can save you money on your product. Our figures will convince. Eastern States Products, Box 721, New Haven, Conn.

METAL Articles developed and manufactured. Model making. Reasonable price and first class workmanship. W. F. Meyers Company, Bedford, Indiana.

WIRE Goods made to order. Cooley Mfg. Co., 3210 Carroll Ave., Chicago.

ECONOMICAL Manufacturing from sheet, bar, wire or tubing. Models, dies, special machinery. Swanberg, 5124 N. Kildare Ave., Chicago.

SPECIALIZE Complete manufacture, dies, tools, special machinery and patterns. Models made. Atlas Indicator Works, 821 W. Washington, Chicago, Ill.

HOME WORK SHOPS AND SUPPLIES

STEEL Bench Legs shipped knockeddown from \$2.75 up. Kirk Hardware, Box 365, Madison Square, New York City.

WOODTURNING For amateurs. Excellent new instruction book just published for the amateur and home work shop owner. Contains all the needed information and is well illustrated yet published to sell at the low price of 25 cents postpaid. Send for your copy today. Mail remittance with your order. Popular Mechanics Press, Room 802, 200 E. Ontario St., Chicago.

WELDING AND SOLDERING

BARGAINS—Excellent repossessed arc welders, buffers and grinders. Entirely rebuilt—guaranteed. Trial. Terms. Write Ken's Service, Box M-815, Troy, Ohio.

WOOD Turning on the lathe. Both interesting and fascinating. Send for a copy of Milton & Wohlers Course in wood turning. It gives you quickly a complete mastery of this manual art. 340 pages. Cloth. 141 plates. Sent C. O. D. Pay postman price \$1.50 and small amount postage upon delivery. Popular Mechanics Press, Room 802, 200 E. Ontario St., Chicago, Ill.

FOR MECHANICS

THAT Concrete Job. Don't be afraid to tackle it. With the instructions found in the new edition of Popular Mechanics Concrete Handbook you can easily make 173 articles of utility and beauty ranging from ordinary steps to garden furniture. This book will be sent for only 98c plus postage C. O. D. Send your order today to Popular Mechanics Press, Room 802, 200 E. Ontario St., Chicago, Ill.

USE Shortcuts in Figures. Save valuable time. The quickest ways of working all problems. Instructions for drilling yourself to be come rapid with figures. Complete, yet simplicity itself. Just write a postal for "Shortcuts in Figures." Pay postman \$1.25 and postage. Popular Mechanics Press, Room 802, 200 E. Ontario St., Chicago, Ill.

BENDING MACHINES

THE Famous Hossfeld "Wrenchless" Universal Iron Bender is the last word in bending machines. Bends metal, cold or hot, into most any conceivable shape, including Eye Bolts and Automobile Spring Eyes. Bends up to 1" bars or 1½" pipe cold. Also bends "Angle Iron." Thousands in use by all classes of trade, from the smallest shops to the largest railway systems. Write for circular and prices. Hossfeld Mfg. Co., Winona, Minn.

SURVEYING INSTRUMENTS

SAVE Money by buying our rebuilt transits and levels. All fully guaranteed—sold subject to field test. Cash or easy terms. Write today for list. Warren-Knight Co., (Makers of "Sterling" Surveying Instruments), 130 N. 12th St., Phila., Pa.

MACHINERY, TOOLS & SUPPLIES

15"x1' SIDNEY Lathe, practically new, complete, \$225.00; No. 3½ Fox plain milling machine, \$175.00; No. 60 Heald cylinder grinder, \$500.00; 24" Hensley shaper, \$200.00; 10" new drill press, \$21.00; air compressor, complete with tank, motor, etc., \$100.00; battery charging outfit, complete, \$125.00. Write for catalog. Terms to suit. Cincinnati Machinery & Supply Co., 27 West 2nd St., Cincinnati, Ohio.

KELOGG Air Compressors, excellent condition, \$6.00. Taylor, 105 East 102nd Street, New York City.

REAL Bench Lathes \$7.50. Castings, etc. Irvin Depoy, Muncie, Ind.

POPULAR Mechanics Midget Steel Chassis, drilled, \$1.00. Steeado parts—Radio list. Service Electric, Indianapolis.

START Business of your own, small investment required, doing chromium, nickel, copper, silver plating. This work in big demand. Information free. Electro Platers Supply Co., 28 West Second St., Cincinnati, Ohio.

SUBSTANTIAL Savings—used arc welders, buffers, grinders, platers, compressors, paint sprays. Entirely rebuilt, guaranteed. Trial and terms. Write Ken's Equipment, Box M-814, Troy, Ohio.

CHROMIUM Polish. Generous quantity 50c. Chromico, 708 North Dayton, Ohio.

WELDING And Cutting Torches, best make, cheap. Engineering Company, Tenth and Carroll St. Louis, Mo.

ENGINES, MOTORS AND DYNAMOS

NEW ½ Horse 110 volt 3450 speed alternating motors, \$16.50. 1-12 horse 110 volt Universal \$2.75. Also new air compressors at one-half price. Electrical Surplus Co., Dept. 12, 1885 Milwaukee Ave., Chicago.

BRAND New ¼ hp. AC motors \$6.50; ½ hp. repulsion 3150 rpm. motors \$16.50; ½ hp. 110 v. DC \$15.00. Large stock motors, generators, rotary converters, etc., at bargain prices. Queen City Electric, 1736 Grand Avenue, Chicago.

AUTO Engines for stationary or portable power. We make necessary attachments. Thirty day trial. No cash down. Candee-Smith Governor Co., 215 North Los Angeles St., Los Angeles.

MOTOR And line-shaft lubricators. Send stamp for circular. Live agents wanted. Everhardt, 2036 North 34th St., Milwaukee, Wisconsin.

TIME Counts in applying for patents. See pages 124 and 125. Clarence A. O'Brien, Registered Patent Attorney, Washington, D. C.

ELECTRICAL EQUIPMENT

ELECTRIC Transformers. Acme Specialty Co., 1826 So. Morgan St., Chicago.

SHOP Notes for 1931. Get your copy now. Only a limited edition. Contains all the articles published in the Shop Notes department of Popular Mechanics Magazine during 1930. Send 50 cents. If you want the set of Shop Note books consisting of 6 volumes including the 1931 number and 6 others issued previously we will send them C. O. D. for \$1.00. Popular Mechanics Press, Room 802, 200 E. Ontario St., Chicago.

TREE KILLERS

BO-KO. Enough to kill quick over 100 trees, \$2.00. Saves time, work and dollars. Bo-Ko Co., Jonestown, Miss.

FARMS AND FARMS LANDS

FREE Minnesota farm book—Opportunities for profitable farming and dairying. Fine schools, churches, clubs in every community. Share in over \$500,000,000 annual crop. Plenty of moisture; sure crops; excellent roads. Play while you earn—10,000 lakes for health, recreation, profit. Buying opportunities greatest in years. Write H. C. Hotaling, Dept. 722, Ten Thousand Lakes—Greater Minnesota Assn., St. Paul, Minnesota.

OWN A farm in Minnesota, Dakota, Montana, Idaho, Washington or Oregon. Crop payment or easy terms. Free literature; mention state. H. W. Byerly, 119 Northern Pacific Railway, St. Paul, Minn.

FREE Books on opportunities in Minnesota, North Dakota, Montana, Idaho, Washington, or Oregon. Complete information on climate, crops, location for farm or suburban tract for grain, livestock, dairying, fruit, poultry—a home, independence, plenty of food, clothing, continuous employment. No occupation offers more to industrious capable men. Write E. C. Leedy, Dept. 257, Great Northern Railway, St. Paul, Minn.

40 ACRES Near Birmingham. Make offer. Box 338, Brewton, Ala.

\$300 SECURES Florida 80 acres, bordering lake and highway 1230 feet, only 3 miles to village. Good fishing; quail, rabbit, wild turkey and some deer right at your door. No buildings. To close \$850 with \$300 down and easy terms. C. L. Fuller, Bonded Street Agent, DeLand, Fla.

GET Good land cheap on terms, fine neighborhood, grow certified potatoes, become independent. Mich. Acreage Co., P-601, 22 No. State St., Chicago.

SELL Your property quickly for cash, no matter where located. Don't pay big commission. Particulars free. Real Estate Salesmen Co., Desk B, Lincoln, Nebr.

TEN Dollars monthly acquires five acres pecans, tungs, figs, oranges. Guaranteed care. Big returns. Suburban Orchards, Dept. M, Biloxi, Miss.

OZARKS—20 Acres, timbered, \$100. \$5 monthly. Poultry, hogs, fruit; fishing, hunting, trapping. Hubbard, 216 Grossman Bldg., Kansas City, Kansas.

1001 GARDEN Questions Answered. Garden facts which hundreds of men have spent their lives in obtaining. Covers flowers, vegetables and fruit. 320 pages. Price \$2.00. Sent postpaid upon receipt of price or C. O. D. anywhere in U. S. Popular Mechanics Press, Room 808, 200 E. Ontario St., Chicago.

* BEES AND HONEY

BEST outfit for finding bee trees. Will Grover, Bristol, Vermont.

RABBITS

RABBITS And supplies. Complete literature. Sc. Albert Facer, Inc., 115-X, Valley Stream, New York.

RAISE Rabbits. We pay \$10.00 each. Information time. Eastern Rabbitry, New Freedom, Pa.

RABBIT Raising assuming large proportions. Learn how produced for food and fur. Send for reliable book by Frank G. Ashbrook, authority in U. S. Dept. of Agriculture. Price \$2.00. Sent postpaid upon receipt of price or C. O. D. anywhere in U. S. Popular Mechanics Press, Room 808, 200 E. Ontario St., Chicago.

MINK

RAISE Mink. Make good profits. Start now. Browns Mink Ranch, Schofield, Wis.

BIG Money made raising mink. Free information. Pennell Fur Farm, Dulken, Wash.

MINK—Genuine Labrador, Eastern Quebec. \$35.00 pair. Canadian Mink Farms, Croton on Hudson, N. Y.

DOGS AND PETS

BEAUTIFUL Registered bull pups, \$15. Bulldogs, 501 Rockwood, Dallas, Texas.

HOUNDS, Coon, fox, rabbit, \$20. Shepherds \$8. Bull terriers \$10. Dawson, Tuckerton, N. Y.

FOR Sale. Minks, squirrels, racoons, foxes, ferrets, muskrats, ginseng, rabbits, skunks, wolf pups, opossums. B. Tinsman, Caledonia, Minn.

WHITE Mice, fifty cents each; wholesale prices on large orders. Also toy Pomeranian puppies. Siron Kennels, Boston Place, Toledo, Ohio.

HUNDREDS Coonhounds, foxhounds, pabithounds, blueticks, redhones, blackstans. Supply Catalog, Beckennels, A-51, Herrick, Illinois.

\$35.00 BUYS A coonhound that must please you. Kentucky Coonhound Kennel, Kevill, Ky.

I Have some fine shooting dogs well trained and shipped on trial. Write for booklet and descriptive price list. M. L. Turner, Herrick, Ill.

REGISTERED Newfoundland male pups \$30. Marion Van Gorp, Pella, Iowa.

WANTED—MISCELLANEOUS

CASH For old gold teeth—old or broken jewelry, antiques, watches, diamonds, silver, rare U. S. coins. Cash by return mail. Goods returned in 10 days if you're not satisfied. Ohio Smelting Co., 215-B, Hippodrome Bldg., Cleveland, Ohio.

CASH For gold teeth. Highest prices paid for dental gold—bridge-work, crowns. Send what you have at once first class mail. Fair and square treatment. Satisfaction guaranteed. Free information. Southwest Gold & Silver Co., Box 68LD, Fort Worth, Texas.

MAIL Us your discarded jewelry, gold crowns and bridges, watches, diamonds, silver, platinum. Money promptly mailed. Goods returned if offer refused. United States Smelting Works (The Old Reliable) 29 So. State St., Dept. 21 Chicago.

BOYS! Vacation fun palace. Every Boy's Book of Handcraft, Sports and Amusements. Just the thing for ideas and suggestions for all outdoor stunts and rainy days indoors. Big 700-page book full of pictures, too. Sent postpaid upon receipt of price \$2.75 or C. O. D. anywhere in U. S. Popular Mechanics Press, Room 808, 200 E. Ontario St., Chicago.

FOR SALE—MISCELLANEOUS

WATCHMAKERS Lathes for sale at a bargain. R. Jaegermann, 5815 Easton Ave., St. Louis, Mo.

UNDERWOOD 5. Standard office machine \$39.95. Checkwriter, duplicator, multi-graph, Dictaphones, bargain prices. Pruitt, 190 North La Salle, Chicago.

NEW Electric refrigerators, fully guaranteed. Price \$89.00. Write: Daniel Zimmerman, Craigville, Indiana.

BEST Books for \$1. All formerly sold for \$2.50 to \$5 each. Select from the following list of guaranteed bargains. All brand new books: Woodcraft by Seton, Book of Letter Writing by Croucher, Etiquette by Niebler, Creative Chemistry by Blosson, Revolt in the Desert by Lawrence, Trader Horn, White Shadows in South Seas by O'Brien, Count Luckner (The Sea Devil) and Outline of History by Wells. Delivered at your door C. O. D. Simply pay postman \$1 each and postage. Popular Mechanics Press, Room 808, 200 E. Ontario St., Chicago.

FIELD GLASSES, TELESCOPES AND MICROSCOPES

\$5.00 GOVERNMENT Used Field Glasses with case. Large selection Binoculars, Telescopes, Microscopes, Cameras, Lenses, Musical Instruments, Guns, Rifles. Send free list. Wolf's Curiosity Shop, 20 South Second Street, Philadelphia, Pa.

PERSONAL

MODERN Astrology! Love, marriage, financial success, indicated by the Zodiac signs of your birthdate. Complete interesting book, 50c postpaid. Francis Lucas, 949 Madison, Chicago, Ill.

ASTROLOGY Offers the most interesting, fascinating and accurate method of studying one's life. Analyze your friends, family and self. Lessons and readings by Collins, a teacher of astrology. Box 687, Riverside, Calif.

AT Last. Amazing discovery. Grow hair any head or money back. \$2.50 postpaid. 143 O St., Cottage Grove, Oregon.

NERVOUSNESS, Nervous fear, etc., overcome without drugs! Positive results. Investigate! John Englund, Ontonagon, Mich.

ELY Stops falling hair, prevents baldness, cleans scalp. Ask druggist or write John Paulus, Wabash, Ind.

PAINFUL Bunions quickly relieved, then gradually dissolved at home. Danish fur union. Booklet with guarantee offer free. Write Eugene Eaton, Dept. 106, Bandon, Oregon.

ASTROLOGER Can read your life. Send year and birthdate. 20c reading. 2 questions answered for 50c. G. Nieweyer, Box 228, Mays Landing, N. J.

OUTDOOR Sports for everyone—Enjoy them all year round with aid of great new book just published by Popular Mechanics. This veritable encyclopedia not only furnishes hundreds of ideas for new and popular sports for every season of the year, but also gives complete instruction for making the necessary equipment at very small cost. 350 pages and 650 illustrations. Send today as book is full of thrills and excitement for fall and winter sport enthusiasts. Mailed postpaid anywhere for \$2, or will be sent C. O. D. to any address in U. S. Simply pay postman when delivered. Popular Mechanics Press, Room 802, 200 East Ontario St., Chicago.

HYPNOTISM Learned. Zenda marvelous method. Dr. Zenda, 4259 Cottage, Chicago.

MISCELLANEOUS

ELECTRIC Tattooing Machines. Low prices. Win. Jones, 133 Ward St., Paterson, N. J.

CASH Paid for butterflies, insects. See Sinclair Display Advertisement on page 12.

SALESMEN! Be successful. Get the Montgomery sales formula, a valuable aid to selling and other helps from "What a Master Salesman Should Know," by L. L. Montgomery. Price \$2.50. Sent postpaid upon receipt of price or C. O. D. anywhere in U. S. Popular Mechanics Press, Room 808, 200 E. Ontario St., Chicago.

TATTOOING. Learn with my outfit. Send for circulars—they explain. Sergt. Benney, 307 So. Main, Providence, R. I.

HOMIOPATHIC And biochemic preparations sent postpaid to all parts of the world. Booklets free. Halsey Bros. Co., 5747 Ravenswood Ave., Chicago. Established 1855.

PRINT Signs, pictures without press, type or machinery. Samples 10c. Straley, 134 W. Main, Springfield, Ohio.

TATTOOING Outfit, supplies. Illustrated list free. "Waters," 965 Per-gram, Detroit.

LANDSCAPING. The Complete Home Landscape, a guide to the planning, construction and planting of the garden and grounds of the average home. 178 pages, illustrated. Price \$2.50. Sent postpaid upon receipt of price or C. O. D. anywhere in U. S. Popular Mechanics Press, Room 808, 200 E. Ontario St., Chicago.

AMATEUR Cartoonists—Earn \$25.00 week, spare time, copying cartoons for advertisers. E. M. Syndicate, Anzley, Wis.

MODEL Aircraft—How to build and fix. Model builders and tournament contestants, get the complete official handbook of the Playground and Recreation Association. 200 pages, fully illustrated. Price \$2.25. Sent postpaid upon receipt of price or C. O. D. anywhere in U. S. Popular Mechanics Press, Room 808, 200 E. Ontario St., Chicago.

OPPORTUNITIES Outdoors—Learn how to start building a successful industrial career, beginning in spare time and developing until full time service of yourself and others required raising small animals, birds and plants. Send for reliable instruction book. Price \$2.00. Sent postpaid upon receipt of price or C. O. D. anywhere in U. S. Popular Mechanics Press, Room 808, 200 E. Ontario St., Chicago.

ARE You old at forty? See our advertisement on page 28 of this issue. The Electro Thermal Company, 2144 Morris Ave., Steubenville, Ohio.

AMATEUR Cartoonist: Sell your work. Write Smith's Service, PX1194, Wenatchee, Wash.

SWIM Faster than professionals with more ease. Break astonishing records with new speed shoes. Particulars free. Lynn Pelcher, 5670 Newport, Ocean Beach, Calif.

NECKTIES! 80c. 3. \$1.25. Circular free. Gull-ette's Mailorder House, 81 Holly D20, New Bedford, Mass.

NEW World Atlas—1930 census figures—Complete, up-to-date, just the kind you need for home, office or school. New convenient size fits in your bookcase. 288 pages. Has all maps and usual features. Price \$2.50. Sent postpaid upon receipt of price or C. O. D. anywhere in U. S. Popular Mechanics Press, Room 808, 200 E. Ontario St., Chicago.



DRAFTING

BOOKS SENT FREE!
ON APPROVAL

5 Volumes New 1931 Edition

Only 15 minutes a day with these WONDER BOOKS will prepare you for a good drafting job in less than a year. Mechanical and architectural drafting from simple straight lines to important complex plans. A step at a time! Built especially for beginners, for men with only grammar schooling. Drafting room practice. PLUS ENGINEERING, made easy and clear. Includes complete course in blue-print reading.

Big Field Big Demand Big Pay

Competent draftsmen are greatly needed right now in all building and manufacturing lines at \$50.00 to \$100.00 a week. That's not the beginning—FOR DRAFTSMEN HAVE THE BEST CHANCES FOR ADVANCEMENT. Pleasant, fascinating work, easy to learn and do. Learn quickly with these books—send coupon for a set FREE and see for yourself.

A year's consulting membership in the American Technical Society now given free to all readers of this famous encyclopedia of drafting. Many say that it is worth more than the cost of the books.

Complete set of drawing instruments if you send for these drafting books NOW.

These instruments are made of the finest of German silver, are absolutely accurate and are packed in velvet lined leathette pocket case. Real \$10 value, but free to you with these books.

AMERICAN TECHNICAL SOCIETY
Dept. DC19, Drexel at 58th St., Chicago, Ill.

For Beginners

Written, so you can understand every word, by 22 famous engineers and architects. DeLuxe flexible binding, nearly 2,000 pages, 1546 blue-prints, charts and diagrams; prepares you for a good drafting job in mechanical or architectural lines. Sent for 10 days' free use if you mail coupon immediately.



FREE

American Technical Society, Dept. DC19, Drexel at 58th St., Chicago, Ill.

Send for 10 days' free use New 5 volume set of drafting. I will pay the few cents delivery charges. If I wish, I may return books in 10 days and owe you nothing but if I decide to keep them I will send \$2.00 after 10 days, then only \$3.00 a month, until \$10.00, the special introductory price, is paid. Send 1931 edition and include drawing instrument.

Name.....

Address.....

Employer.....

Address.....

BE AN OIL EXPERT!

New, easy, practical way to learn at home in spare time. Geology, Drilling Methods, Pipe Line Transportation, Refining and Marketing.

Write Today! FREE Book!

PETROLEUM ENGINEERING UNIVERSITY, Dept. 228, FORT WAYNE, IND.

Information on any book free. Write Popular Mechanics Press, Chicago, Ill.

START to PLAY Very First Day!

Pleasant,
Easy
Lessons
Show You
How!



Extra Money—Hosts of Friends—Loads of Fun Within Your Reach

HAPPY DAYS are in store for you if you will only act on this suggestion! Cheerful evenings playing catchy music alone or with sweetheart, wife or sister; proud moments as center of interest at gatherings; nights of joy making \$5 to \$25 for work that is "play."

The Deagan Xyloimba is your opportunity! Wonderful for home, in demand at dances and entertainments, yet easiest of all instruments to play. No teacher necessary—you actually play simple melodies the very first day even if you cannot read a note of music right now!

Earns \$60 a Week—Ralph Smith, Chicago, says: "Played 20 minutes at wedding. Received \$20." L. E. Hallmann, Reading, Pa., writes: "Made \$300 in 5 weeks, spare time. Had never played instrument before."

Send for Big Free Book! Our new book tells all about the delightful, the five-day trial that removes risk, the wonderful Deagan easy-payment plan. No obligation—simply fill in and mail the coupon.

J. C. Deagan, Inc., Dept. C-445, 1770 Berteaux Avenue, Chicago

Send me, without obligation, full details of Free Trial offer and easy-payment plan of the Deagan Xyloimba.

Name.....

Address.....

Address.....

Address.....

Address.....

Address.....



New Kind Of Can Opener

AGENTS

Men and Women have made up to \$6 and \$8 in an hour, full or spare time. Big, worthwhile commissions on every sale. Exclusive Territories. Send quick for FREE TEST Offer.

Works Like Magic!

At last! An automatic, simple little can opening machine for the home. This revolutionary invention in only a few short months has banished old can openers from over 100,000 kitchens. And no wonder! Imagine an amazing, lifetime device that holds the can and cuts out the top leaving can rim sleek, smooth and clean. Just turn a crank, that's all. Approved by Good Housekeeping Inst., Modern Practical, etc. Write today for special introductory advertising offer.

Central States Mfg. Co., Dept. L-704
4500 Mary Ave., St. Louis, Mo.

NEED A BETTER GRIP ON MATHEMATICS?



SEND for a copy of "Mathematics for the Practical Man," only \$1.50. By common sense methods it removes the mystery and difficulties so that algebra and even calculus are made simple.

Assuming your knowledge is limited to arithmetic you quickly and easily gain a working knowledge of Algebra, Geometry, Trigonometry and Calculus. Simply pay postman price of book plus the postage when he hands you the package.

Popular Mechanics Press
Room P3

200 E. Ontario Street, Chicago

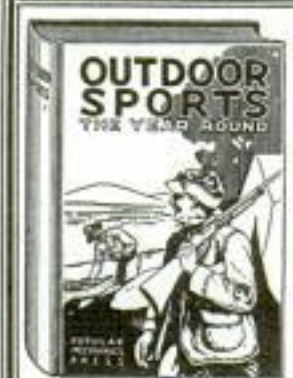

ENJOY Outdoor Sports

The Year Round
With the Aid of This Great Book

THE new, revised and enlarged edition of Outdoor Sports the Year Round, just published by Popular Mechanics Press, contains hundreds of ideas for new and popular sports and pastimes as well as the old favorites. Attractive to Young and Old Alike is the interesting variety for all seasons.

The intensive follower of a few sports will appreciate the wealth of suggestions that render the pursuit of any hobby more enjoyable. For example, for the hunter there are important details on the care and handling of guns; for the swimmer, complete instructions in fancy diving; for the camper, ideas that tend to make camping one hundred per cent comfortable and convenient; for the fisherman, many practical kinks, etc.

SPORT ENTHUSIASTS

will be amazed at the large number of devices that furnish thrills and excitement. Probably the most unique feature of the book is the fact that it contains complete instructions that enable any handy man or boy to make sport devices or equipment at very little cost.

352 Pages (large size, 7 x 10 in.) Price \$2.00
650 Illustrations. Cloth Binding

Mailed Postpaid upon receipt of price anywhere in the world. Will be sent C. O. D. anywhere in U. S. Simply pay postman price plus postage when he delivers the package.

POPULAR MECHANICS PRESS
(Room P-8) 200 East Ontario St. Chicago, Ill.

SPORTSMEN

Read This Offer!

Send the COUPON and receive a magnificent Sportsmen's Book telling you how to learn to MOUNT GAME-HEADS, BIRDS and ANIMALS. You can NOW be your own Taxidermist. Our school has over 100,000 graduates throughout the world. You can now learn AT HOME in SPARE TIME.

Mount Your Own Trophies!

Hunting and Fishing have entered a new era. All true sportsmen now kill fewer specimens, but DOUBLE their interest by mounting their trophies. The secrets of Taxidermy (mounting birds and animals) are now revealed. YOU CAN NOW LEARN TAXIDERMY FOR YOURSELF. Be a Taxidermy artist. Mount birds, animals, game-heads, fishes, tan skins and make beautiful rugs and robes. Easily and quickly learned in your own home. Adorn your home and den with nature's finest ART. If you enjoy hunting—you will enjoy Taxidermy MORE.

Big Profits

Do you want to MAKE MORE MONEY? Then give your SPARE TIME to Taxidermy. Make \$50 to \$250 a month by mounting for others or selling your mounted specimens, or go into business—open a Taxidermy shop of your own, and earn \$3,000 to \$5,000 a year.

This Book FREE

Every Sportsman should have this marvelous book. You can right now, while this edition lasts, get a copy Free and prepaid by mailing the coupon NOW. Only limited number free—Send Today. Nothing like it. Just off the press. Contains 48 large pages and cover in brilliant colors. More than 100 photos of splendid game specimens and masterpieces of the National Museum at Washington. Brim full of interest to every sportsman. And think of it, this valuable unique and artistic book can be had now, by Sportsmen for the asking.

Mail the Coupon!

If you want to preserve your trophies; if you desire to make money from your spare time, if you are a nature lover—send the coupon and receive your copy by return mail. State your AGE.

N.W. School of Taxidermy, C337 Elwood Bldg., Omaha, Neb.



N. W. School of Taxidermy

C337 Elwood Bldg., Omaha, Neb.

Send me your free illustrated book "Sportsmen and Their Trophies." Also tell me how I may learn this fascinating art easily and quickly by mail. No obligation.

Name Age

Address

Books on 32 Subjects

Popular Mechanics Press specializes in supplying books on any subject. Look over this list. Check the books you want, and mail this advertisement as your order blank. Catalog with lists on 2,000 subjects free.

AIRCRAFT (Modern) Complete. Up-to-date. \$5.00	INVENTIONS How to Make Pay. \$2.50
ARTIST (Commercial) Money-Making Art. \$5.00	LETTERING AND DESIGN Studio Handbook of. \$3.00
ATLAS (of World) Modern. New Boundaries. \$3.00	MAGIC World's Best Book of. \$2.00
AUTOMOBILE Painting. \$1.50	PAINTS AND COLORS Mixing of. \$2.00
BOOKKEEPING Practical Handbook. \$1.00	PICTURES (FUNNY) How to Draw. \$3.00
BRICKLAYING Plain and Fancy. \$1.50	PLASTERING Best Instruction Manual. \$1.25
CARBURETORS (All Makes) Only Book Covering. \$2.00	RADIO ENCYCLOPEDIA Very Complete. \$6.00
CHALK TALK and Crayon Presentation. \$1.25	REAL ESTATE Educator. \$2.00
DRAWING Freehand and Perspective. \$1.50	SHOW CARDS Artistic. \$3.50
DRY CLEANING (Practical) and Dyer. \$3.00	SIGN PAINTING Laquer System of. \$3.00
FLOWER RAISING 1001 Questions Answered. \$2.00	Steam Engineer's License How to Obtain. \$2.00
FLYING Simplified. \$1.00	STEEL SQUARE How to Use. \$1.00
FUR RAISING For Profit. \$4.00	TELESCOPE (Amateur's) How to Make. \$3.00
FURNITURE REPAIRING Finishing and Decoration. \$5.00	TOOLS (Using) Tinkering with Tools. \$2.00
HOME FURNISHING and Decoration. \$3.00	TRICKS (200) For the Amateur. \$1.00
	WOOD FINISHING Plain and Decorative. \$2.00
	WOODWORKING (New) Most Complete Book for Amateurs. \$2.00

SEND NO MONEY

Just check the books you want, and mail the whole advertisement. It is your order blank. When postman hands you books, pay him the price and few cents postage. If outside the U. S. remit when ordering and include 10 cents per book extra for postage.

POPULAR MECHANICS PRESS, Room P8, 200 East Ontario St., Chicago, Ill.

Oh! You Misfit Wake Up—Be a Man!



LIONEL STRONGFORT
Man Builder

You know the truth if no one else does—you know what you lack—what you need. You may hide it from others, but you can't hide it from yourself! Are you a victim of any habit that you want to get rid of? Have you a spark of ambition left to be a real man? Are you an easy victim to every little ailment that comes along; going around without snap or ginger? Wake up—be a man, not a misfit!

Come to me if you are a physical wreck. Join hands with me and I'll make you the vigorous fellow you want to be—and it will be done without drugs or stimulants.

STRONGFORTISM

Science of Health and Strength

Through my system of Strongfortism, I build your body up to the symmetrical proportions Nature intended you to possess. You will gain in vim and vigor; your muscular power will increase in flexibility and strength, your nervous system will be fortified to renew its energy.

Send for My Free Book

Strongfort Institute, Dept. 131, Newark, N. J.—Send free copy of your illustrated book "Promotion and Conservation of Health, Strength and Mental Energy."

My Ailment is.....
Name.....
Age.....
Street.....
City.....



39th YEAR

A Special
Technical
School



ELECTRICAL ENGINEERING

Complete Course in One Year - Theory and Practice Combined
Non - Essentials Omitted — Underlying Principles Emphasized

A concise, comprehensive course in Electrical Engineering complete in one college year, to prepare earnest, ambitious young men of limited time for the increasing opportunities and advancement offered in the electrical field.

Theory and practice closely interwoven in classroom and laboratory. Mathematics, engineering drawing and intensive shop-work. Students construct motors, install wiring and test electrical machinery. 38 years' experience assures you maximum training in minimum time. Graduates are qualified to enter the electrical field at once.

Bliss Training Prepares Men for Advancement

Bliss-trained men are in demand and hold responsible technical and executive positions. Fireproof dormitories, dining hall, laboratories and shops.

Catalog on request

BLISS ELECTRICAL SCHOOL
118 Takoma Ave. Washington, D. C.



1000 Positions Open

HOTEL and institutional field calling for trained men. Thousands of high-class positions as Manager, Assistant Manager, Steward, Room Clerk, Sports Director and many other important positions paying \$2,000 to \$7,500 a year, open annually. Nearly one billion dollars' worth of **NEW HOTELS, APARTMENT HOTELS, CLUBS AND INSTITUTIONS** being built this year. Lewis trained men start at salaries up to \$2,500 a year, with living often included. At any time there are over 1,000 positions open.

Previous Experience Proved Unnecessary

Quality for a fascinating, well-paid position—our Personal Coaching Plan adapts the training to your needs. Lewis-trained men of both young and mature age winning success. A good grade school education, plus Lewis Specialized Training, qualifies you. We train you in your spare time and put you in touch with big opportunities. All of your training under the personal supervision of Clifford Lewis, who was appointed Managing Consultant by over 300 hotels throughout the United States. Our students employed by leading hotels everywhere. Send coupon today for Free Book, "Your Big Opportunity," explaining our Money Back Agreement, and our Personal Coaching Plan.

—FREE BOOK COUPON—

Lewis Hotel Training Schools,
Room DM-385, Washington, D. C.

Send me without obligation the Free Book, "Your Big Opportunity," and details of your Personal Coaching Plan.

Name.....
Address.....
City..... State.....

ACCOUNTING

New Revised Course



Thousands of ambitious men are earning more money today because they know Accounting. Send for new booklet, "The Accountant—Who he is, What he does, How to become one," and first lesson of new revised Course. Both sent free. In reply please state age and position.

International Accountants Society, Inc.

A Division of the

ALEXANDER HAMILTON INSTITUTE

Dept. 216 3411 So. Michigan Ave., Chicago, Ill.

RADIO—TELEVISION World's finest TALKING PICTURES

home training. Prepares for best paying positions in this fast growing business. Only training endorsed by leading Radio Manufacturers, dealers and distributors. Many fine opportunities open for men with this training. Laboratory and Consulting Service included. Write for FREE "Opportunity Book."

Radio & Television Institute 2132 Lawrence Ave. Dept. 1-c, CHICAGO

Learn Watchwork, Jewelrywork and Engraving

A fine trade commanding a good salary, and your services always in demand. Address **Horological**, Dept. P, Bradley Institute PEORIA, ILLINOIS, for our latest catalog.

The Science of Wrestling and the Art of Jiu Jitsu

By **EARLE LIEDERMAN**
An amazing exposition of this great art—224 pages, fully illustrated. Regular price \$5. Order now and save \$2. Sent on receipt of \$3, or C. O. D. Address **EARLE LIEDERMAN, 305 Broadway, N. Y.**

WANT A STEADY JOB?

Railway Postal Clerks



Mail Car
Conductors

\$158 to \$225 a Month—Mail Coupon Before You Lose It

FRANKLIN INSTITUTE, Dept. F188
ROCHESTER, N. Y.

Send: Rush to me without charge—copy of 32-page book "How to Get U. S. Government Jobs," with list of positions obtainable and full particulars telling how to get them.

Name.....

Address.....



NEW KIND OF AUTO EYES

Makes Night Driving Safer Than Day!

Queer little inexpensive invention now replaces the old glass headlight bulbs in your car! Instantly doubles road light, yet absolutely ends dangerous dimming! Revolutionary new principle. Throws solid beam of double-reflected or "infused" light. Ends glare, yet cuts through any light on the road. Even pierces fog, rain and snow. Shows up rats, detour signs, animals, etc., clearly, without usual flickering shadows. Send now for details and introductory FIVE TEST OFFER.

AGENTS
Webster, Pa. made \$1,125 in 30 days. We guarantee sales. Exclusive territory. Big repeat business. Wallace & Tierman, N. J., Post, Texas newspaper, other big companies equipping fleets. Write quick!

NO MORE DIMMING

Nachmeister-Lind Co., Pittsburgh, Pa. Dept. L-30

New INVENTION

Needed by

20 MILLION SHAVERS



AGENTS MAKE UP TO \$150 A WEEK!

MEN! Here's a new, easy way to make Big Money! Astounding new invention gives velvety smooth shaves, like a feather's touch, the best of a man's life. So keen you scarcely feel the razor—no pulling, scratchy, burning sensation. Toughest whiskers seem to just melt away. And no more blades

to buy! A million already in use. No selling necessary. Just place on Free Trial. Once used, shavers can't give it up. R. VanDerhof made \$54 one day. Hundreds cleaning up. Guaranteed sales offer—no risk. Hurry while territory is open. Sent you on 30 days' trial.

I. L. RHODES, 1418 Pendleton Ave., Dept. K-4525, St. Louis, Mo.

Don't Be Afraid To Tackle That Concrete Job!

With the instructions found in the new, revised edition of Popular Mechanics Concrete Handbook you can make any of the following useful articles:



Garden Seats—Fountain and Basin—Flower Boxes and Vases—Pedestals and Bird Baths—Ornamental Pools—Sanitary Drinking Fountain—Gateposts—Auto Driveway—Sidewalks—Boat Landings and Docks—Entrance and Garden Walks—Sidewalk Flaggings—Narrow Carb Walks—Carbs and Getters—Wall Coping—Steps—Garage Floor—Basement Floor—Fence Posts—Lawn Roller—Cistern—Chimney Cap—Refrase Burner—Culvert—Benches for Greenhouses—Tile—Retaining Walls—Foundation Supports—Engine Foundations—Septic Tank—Toy Blocks—Furnace—Fireproof Safe—Ice House—Watering Troughs—Milk House—Smokehouse—Silo—Horse Stalls—Hitching Post—Rural Mail Box Post—Cyclone Cellar

Build With Ease for Permanence and Beauty

This is a book of practical plans for using concrete about the home, farm or shop. For amateurs as well as contractors. In addition to making all the articles mentioned above the making of good concrete mixtures for various classes of construction is given; mechanical mixers and homemade tools are dealt with. All necessary form and mold making are covered as well as many other valuable pointers too numerous to mention here.

Simply write and ask us to send you this book. When postman hands you the package pay him \$1.00 plus the postage. If outside U. S. remit when ordering and include 15 cents extra for mailing.

POPULAR MECHANICS PRESS
Room PB 200 E. Ontario Street CHICAGO

Speed Course in Drafting

For the man who wants to go far and must make every minute count



Learn in Spare Time

This is the day of specialists. In drafting as in every leading profession, it now pays to specialize. Master one of its important branches. It's the surest way to swift success. Four big fields from which to choose—mechanical—electrical—architectural—structural—each world-wide in scope—unlimited in opportunities. Specialized draftsmen have won fame and fortune as inventors, builders, architects, technicians and designers.

\$25 Drafting Outfit Free of Extra Cost

This high-grade outfit included. No extras to buy. A small first payment brings everything needed to start course and make rapid progress.

College Training at Home

—a new, elective plan that cuts time and cost to a fraction of that required to go away to school

This highly selective method of training in draftsmanship is distinctive with Chicago Tech. It accounts for the swift outstanding success of its graduates. All sidetraps and non-essentials are eliminated. It offers choice of specialization—the shortest route to the highest paid fields in drafting. The high posts and big rewards today are not won by the jack-of-all trades. Draftsmen who reach the \$5,000 and \$10,000 jobs still young enough to enjoy success are all specialists—each a master in one of its four big branches. This marvelous mechanical, electrical, building and engineering age is creating thousands of jobs annually for drafting specialists. Moreover, drafting is the greatest developer of creative and inventive ability.

Send for the Chicago Tech's Free Home-Study Catalog. Learn how anyone with a common school education can now become a college-trained, specialized draftsman—with maximum speed and surprisingly little expense. Our free employment service helps you to a good position as soon as ready. \$100 a week paid experts. Low cost—easy terms—complete drafting outfit included without extra charge.

CHICAGO TECHNICAL COLLEGE

Dept. K-204, 118 E. 26th St., Chicago, Ill.

Architecture—Engineering—Drafting—Electricity—Building

We also offer resident day and evening courses in above subjects. Founded 1904, our College-Training-At-Home Plan is the result of 27 years' experience in training men both in our Chicago School and at home by mail.

Chicago Technical College
Dept. K-204, 118 E. 26th St., Chicago, Ill.

Please send me postpaid, your big Free Book on Drafting telling about opportunities and your College-Training-At-Home Plan.

Name.....

Address.....

City..... State.....

Age..... Occupation.....

() Check here if you prefer coming to Chicago to take our short resident day or evening course in Drafting.

A-1286

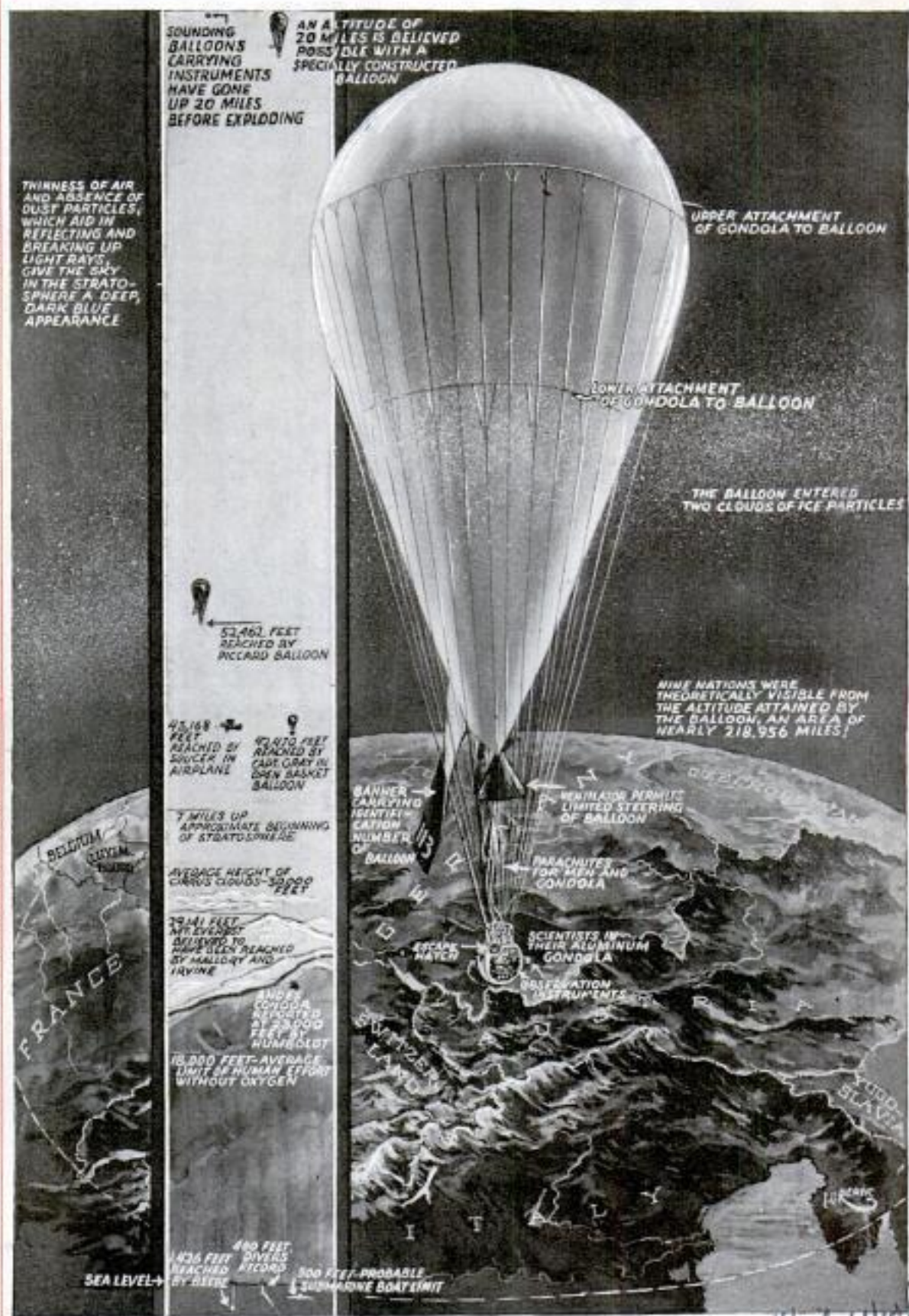

Over the Earth and under the Water—Comparative Records Achieved by Man, Charted alongside the Epochal Ascension of Prof. Auguste Piccard

Popular Mechanics Magazine

REGISTERED IN U. S. PATENT OFFICE

WRITTEN SO YOU CAN UNDERSTAND IT

Vol. 56

AUGUST, 1931

No. 2

Q. 1286

"Prisoners of the Air"



90 Brussels University, Brussels Belgium
Prof. Auguste Piccard, Who Soared Higher than Man Ever Before Attained, behind the Barred Porthole of His Aluminum Sphere, Examining One of His Instruments

TWO men hitched their chariot to a star and figuratively raised the roof off the world—an adventure, an epic, a chapter in history.

Prof. Auguste Piccard and his assistant, Charles Kipfer, have come down from their ten-mile ceiling after the most astonishing feat of roof-raising in human history.

Piccard's flight carried him to 52,462 feet. It was mainly an effort to study cosmic rays at an altitude where they would not be cut off by the earth's atmosphere. In preparation for the flight, the

"CH-113" was only partly filled with hydrogen, as it was feared that at 50,000 feet, the expansion of the gas would burst the balloon envelope. Tests revealed that human beings can survive half the ordinary atmospheric pressure comfortably if they do not move. This pressure corresponds to an altitude of about 16,000 feet. Above 7,000 to 8,000 feet, man must have artificial respiration. From 30,000 to 40,000 feet, human energy ebbs to its lowest, even with the assistance of oxygen tanks.

These considerations forced Piccard to

*see also Nov. 1932 693
Oct. 1932 528*

A-1286



hydrogen was admitted. Even so, the "CH-113" stood 150 feet above the ground, like an inverted yellow pear. The gondola hung from the base, relatively toylike in size. One hemisphere was black, the other white, for it was Piccard's theory that he could heat up the interior by turning the black side toward the sun, and cool it off by doing the opposite. The balloonists wore large straw hats lined with pillows, to protect their heads if knocked against the metal gondola.

Before dawn on May 27, the lashings were cut and the "CH-113" bounded into the pale sky like a rubber ball. Soon the red disk of the sun, far below the earth's rim, was speeding up to meet them. The altimeter needle showed an amazing rate of speed. Twenty-five minutes after the take-off they were near 50,000 feet! A blanket of mist obscured the earth. The temperature inside the gondola frequently reached 106 degrees Fahrenheit, while simultaneously the outside temperature fell as low as seventy-six degrees below zero.

Piccard found that the gases generated by cosmic rays increase their conductivity at high altitudes. After reaching the ceiling, he also discovered that the balloon valve was out of order, preventing a descent, and he wrote in his log a line

devise an airtight gondola. Hermetically sealed and supplied with tanked oxygen, such a cabin is perfectly safe; but if it leaks, at once it becomes a death chamber. The spherical cabin was built of an aluminum-tin alloy. Every seam was handwrought and welded. The balloonists moved in a spherical space seven feet in diameter. Two filters, each with a capacity of eight hours, were employed to remove exhaled carbon dioxide. That simple equipment saved their lives, for while they intended to remain aloft only six hours, they actually stayed up seventeen hours. Although the bag had a capacity of 500,000 cubic feet, not nearly that much



The Balloon That Went to the "Top of the Universe," and, Below, the End of the Journey, on a Glacier

a. 1286

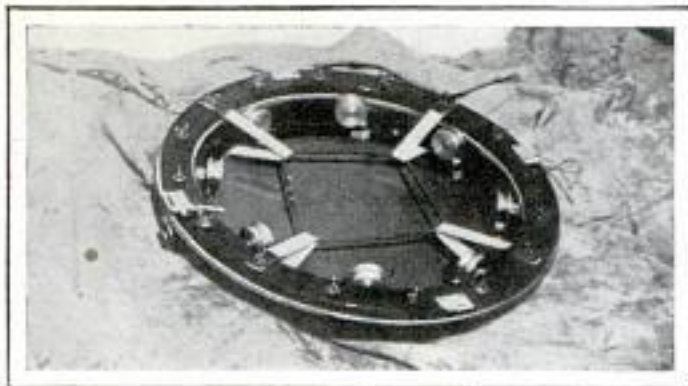

Valve of the Balloon, the Failure of Which Caused the Scientists Successfully to Rise Higher than They Intended



Basket Hat Worn to Prevent Injury in Sudden Drops; at Left, Preparing the Metal Sphere for the Trip; Below, Doctor Piccard Looks Over His Equipment in the Gondola Before the Take-Off

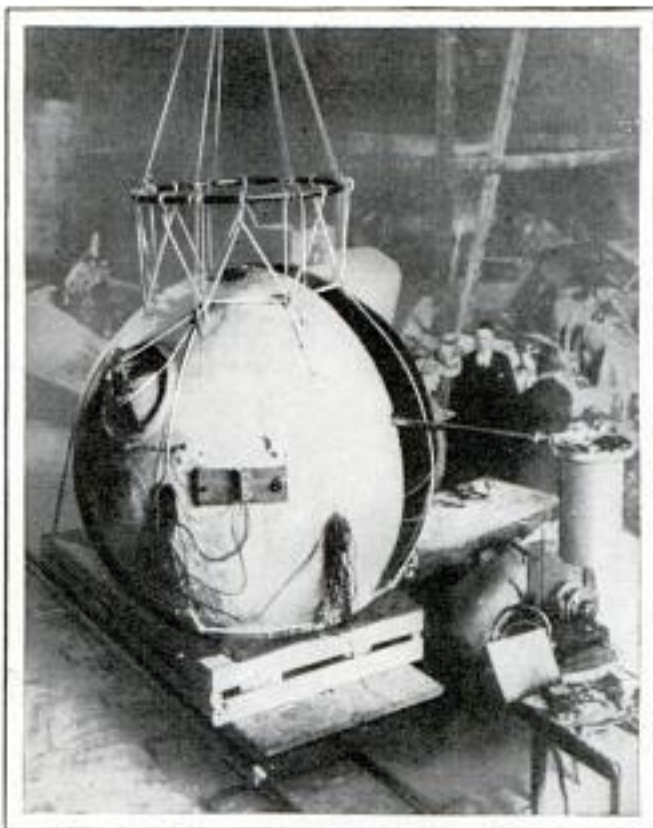

describing the situation: "Prisoners of the air!"

By the end of the afternoon, the balloon had floated over the Alps, and the voyagers eagerly anticipated the setting sun, because the condensing balloon gas would force a descent.



As the sun began to sink, the "CH-113" pursued it.

When the outside pressure equaled that inside, they opened the scuttles and pre-

A-1286

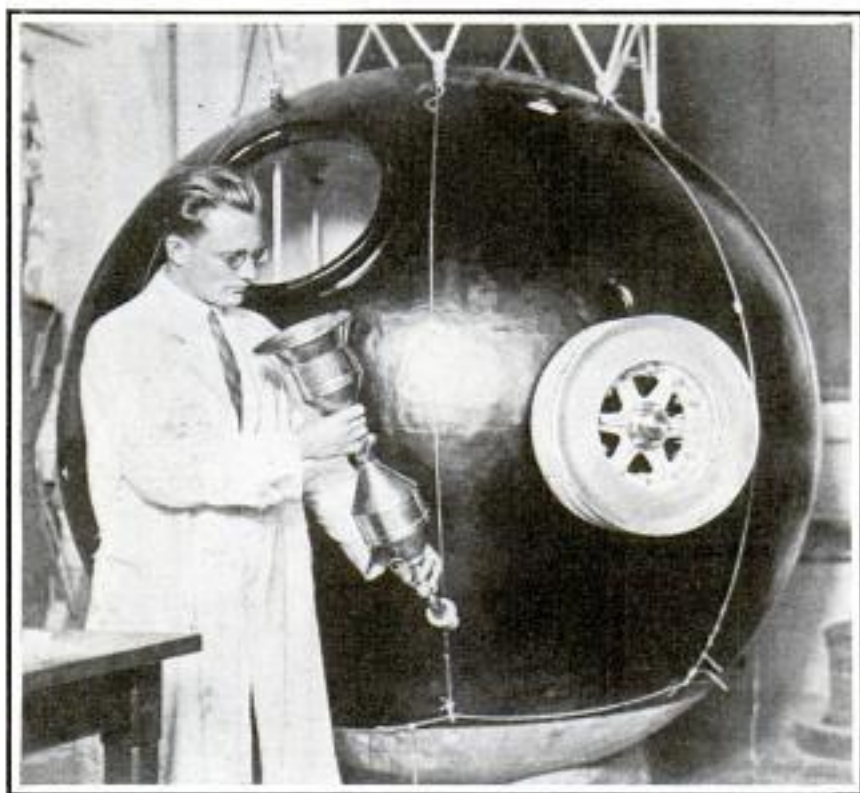

Kipfer Examines Valve Which Allowed Air to Enter and Leave the Gondola, Preventing Differences in Pressure from Causing Damage

lifting power. Small balloons carrying instruments have reached as high as 100,000 feet, and a pilot balloon is said to have gone 120,000 feet. Withal, the extent of the earth's atmosphere is still problematical."

The aurora borealis rises to 300 to 400 miles, and this may indicate that a thin atmosphere exists at that altitude.

SEEK BEST WOOD PRESERVATIVE BY TESTS

A-1209

To combat the destructive agencies that cause damage to frame buildings, the British department of scientific research is conducting hundreds of tests with

pared to land, finally coming down on a glacier.

"The trip proved," said Piccard, "that the stratosphere is navigable, and that man will be able to master this region of cold. Our flight was a series of indescribable sensations. At our ceiling the sky was a dark deep blue, but no stars were to be seen."

Piccard does not confirm the theory that the prevailing wind in the stratosphere blows contrary to the direction of the earth's rotation. "That's all bosh," he says.

Dr. W. J. Humphreys, of the U. S. weather bureau, says that the safe return of Piccard indicates that passengers could live in rocket-propelled planes traveling in the stratosphere, provided the passengers could withstand the enormous velocity at which such conveyances would travel.

"If Piccard and Kipfer reached 52,000 feet," continues Humphreys, "they were more than two-thirds as high as it is possible for a balloon to go with passengers. A balloon carrying human beings cannot possibly rise more than 75,000 feet, or about fourteen miles, because at that height the atmosphere loses their

wood preservatives in the hope that one may be found that will make the frame house of the future virtually indestructible as far as the weather is concerned. The test field looks like a cemetery, for the wood posts under test are set upright in the ground, each specimen of wood being treated differently. Careful record is kept of the life of each post.

Buckinghamshire, Eng.



Posts Treated with Different Forms of Wood Preservative in Test to Find Best Kind

*Cont. Sec. St. Paul
No. 1409 537 J. I. Harbarn
Chicago*



HANDLING A HALF MILLION WORTH OF RADIUM



Lead Shield and Carrier Employed to Safeguard Those Handling Radium, and Patient Receiving Treatment

Acme

Radium, the dangerous and precious substance used in treating cancer, also may cause the dread disease, if it is carelessly handled and the operator is burned by its rays. For this reason the Memorial Hospital in New York which possesses about \$500,000 worth of radium, is equipped with every safety device for transporting the radium "seeds" and applying the treatment to patients. These include lead shields for handlers and long rods and forceps for placing the tiny tubes in the applicators. The radioactive seeds are too powerful to carry by hand, and are placed in a carrier that resembles a lawnmower when they are to be moved. Those handling them have lead guards for both face and hands and when a radium container weighing a quarter of a ton is suspended over a patient for the "pack" treatment, the attendant stands outside a lead door.

distant spaces might not be the same as that from our nearer neighbors, that it might become "tired" on its long journey and not travel so speedily. He measured its speed, however, and found it to tally exactly with measurements conducted on earth. Thus, these aged light beams have lost none of their youthful fire, although they have speeded along at the rate of 186,000 miles a second for countless eons. The tests were made to find whether the universe is exploding.

A-1143

ODD-SHAPED FRUIT IS PEELED BY AUTOMATIC KNIFE



Many uses long have awaited a machine that will peel oranges, or similar irregular fruit, completely and evenly and ly. A New hospital has installed one, which peels both inner and outer skin from any orange regard-

less of size, thickness of skin or shape. It peels just to the inner fruit and no farther. It is entirely automatic in action and will handle more than 500 oranges an hour.

*Coms Fruit Machinery Co
441 W. 42nd St
New York*

*Science Service 533 20.
6/11/31*

LIGHT FROM DEPTHS OF SPACE JUST LIKE OUR OWN *A-1309*

Light from the depths of the heavens, its source so far away that it takes more than seventy million years for it to travel to earth, is just the same kind and travels at exactly the same rate as that shining on the earth every day from the sun, it has been found by Dr. Gustav Stromberg at the Mt. Wilson observatory. He feared that the light from these unbelievably

*James J. Cleary
Syracuse N.Y.*

a-1215



Radio Set Developed by the Signal Corps for Use by Cavalry; the Pole Held by the Rider Acts as the Aerial

HORSEBACK RADIO RECEIVER KEEPS CAVALRY IN TOUCH

Developed by the signal corps, a portable radio that operates on the back of a horse on the march has been adopted by America's cavalry forces. The apparatus is mounted behind the cavalryman's saddle, and a pole aerial is carried by the rider. The set was found satisfactory in recent mountain and desert maneuvers.

BRAKE SHIELDS STOP SCREAMS BY KEEPING OUT GRIT

To remedy screaming and grinding internal automobile tires, a rubber-manufacturing company has placed shields on



Brake Shield Protects Lining from Water and Sand, Thus Preventing Noise and Wear

a-1237

Lutherswerke

General Tire & Rubber Co
Akron, Ohio

the market, which make the brakes water and weatherproof. The shields can be installed in less than half an hour, withstand oil and grease, and prevent frozen, slipping or dragging brakes and scored drums, caused by grit entering between the shoe or lining and the drum. Longer-lasting lining also is claimed, inasmuch as grit entering one drum will chew the lining so badly that all brakes, though some of them may be only partly worn, must be relined to make them uniform.

a-1311

SPEED CHAMPIONS BUILT TO REACH STRATOSPHERE

Airplanes intended to fly at altitudes of more than six miles, where they can reach much higher speeds, are being constructed in Germany. One such ship has been built and will try to find paths in the stratosphere that can be employed as regular airplane trade routes. The mysterious guns of the German army, bombarding Paris from a distance of seventy-five miles, were the first practical application of the decidedly lower resistance of the upper atmosphere, of which aircraft now are preparing to take advantage. The stratosphere plane is not built for high speed or long flights, but it is expected that high speed can be attained at such a height, due partly to a calm atmosphere and lowered air resistance. The first craft is a Junkers metal deep-deck single-motored machine with a wing span of sixty feet, and weighs 9,000 pounds. A small compressor keeps air pressure normal inside the cabin which is double-walled and airtight. Control of the motor and steering is accomplished by levers in the cabin, working in airtight shafts, and the motor has a pump to supply sufficient air for the engine in the rare atmosphere six miles up. The necessary scientific instruments form the equipment of the craft.

Science Service 531.C 5/27/31

Built by
Junkerswerke
- Dessau Germany

"WE THREE" GETTING READY TO HOP PACIFIC



Col. and Mrs. Charles A. Lindbergh as They Prepared for "Tour" Together

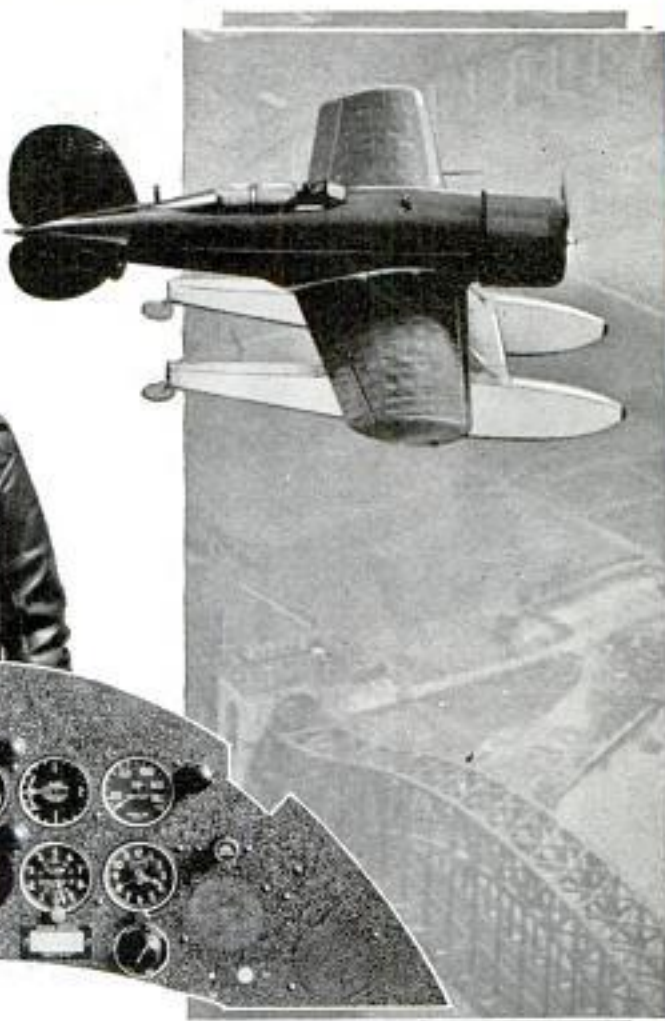

Pilot's Instrument Board for Lindy's Place in the Front Cockpit; Mrs. Lindbergh's Board Is Slightly Smaller; Above, Testing the Plane over Long Island

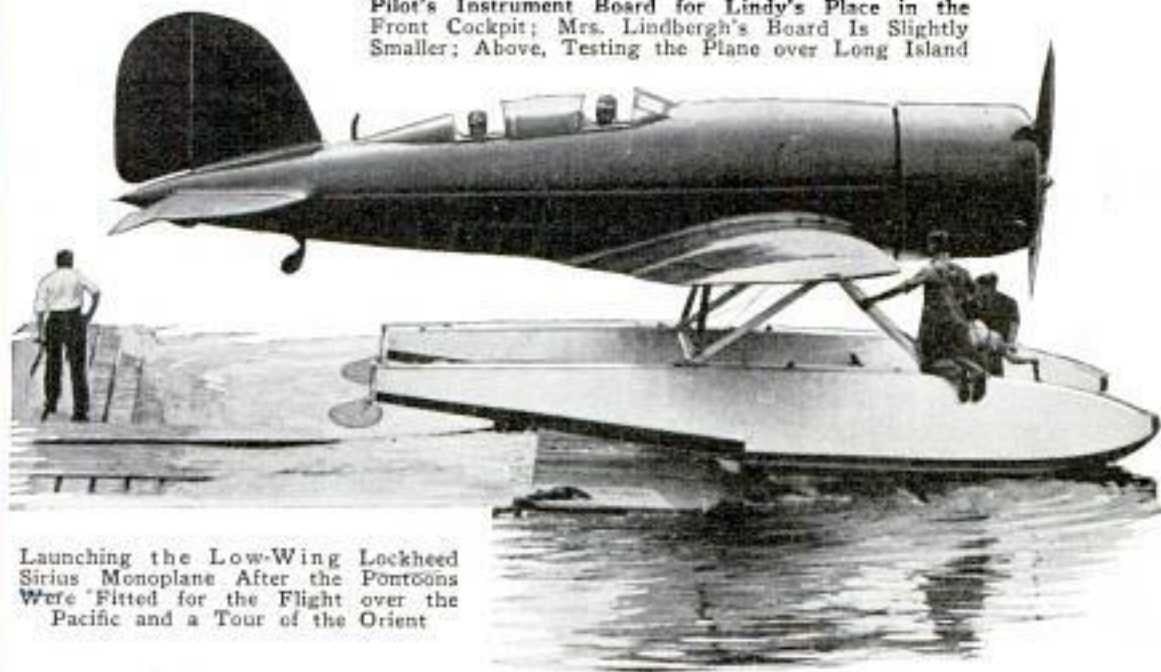

Launching the Low-Wing Lockheed Sirius Monoplane After the Pontoons Were Fitted for the Flight over the Pacific and a Tour of the Orient

u 5 u

ELECTRIC MAP PREDICTS THE COMING WEATHER



Electric Weather Map for Aviators Which Shows by Means of Colored Lights Flying Conditions to Be Encountered in Any Area

To meet the exacting requirements of modern aviation for up-to-the-minute weather data on flying conditions, the navy has made an electric weather map for its pilots which, at any minute of the day, gives the latest information as to conditions existing along any projected route where data are available. With this map, located in the pilots' room at the naval air station Anacostia, the flyer can tell at a glance not only the general character of the weather along the route, but also the nature of unfavorable conditions in specific areas through which he may pass. The map is operated from a control panel in the office of the station aerologist, where weather reports are being received constantly by radio, telephone and telegraph. Changes are indicated on the map by throwing a switch on the control board. The type of weather in any area is shown by white, green and red lights. If the white light is burning, the flying weather is excellent, good or average. Green indicates undesirable, and red means bad flying conditions. If the white light is burning over his route, the pilot has nothing to worry about, but if green or red is showing, he finds what undesirable condition prevails by referring to a zone panel at the side of the map which shows the cause of the bad weather by a

light burning on the side panel under the proper zone heading. The side panel also shows the velocity of the wind at an average flying altitude of 3,000 feet for each zone.

BABY CARRIAGE FINDS A PLACE IN MUSEUM

For the first time a baby carriage has been placed in the collection of vehicles of transport at the Smithsonian Institution. For some reason no one ever thought of including a perambulator until one of them, bought in 1863, was donated to the institution. The carriage differs from the modern four-wheel perambulator. It looks like a miniature one-horse shay, has two wheels and is pulled by a long handle.

U.S. Study 6/11/31 130
Mr. Chamberlain

SIGN PORTRAYING OPEN DOORS OFFERS WELCOME TO CITY

Tourists entering the town of Plymouth, Mass., where the Pilgrim forefathers landed, are greeted by a large, flat signboard painted to give the impression of a pair of doors. The signboard extends a welcome to the thousands of visitors who travel to Plymouth annually and is the work of a local artist.

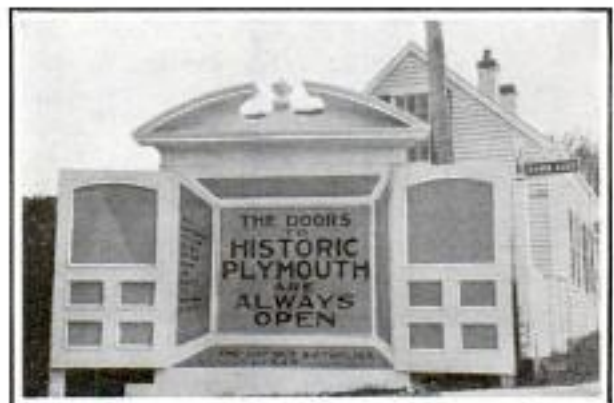

Sign, Showing a Pair of Opened Doors, Which Welcomes Visitors to Plymouth, Massachusetts

Cont. Thomas H. Withkorski
5133 S. Price
Philadelphia

Cont. J. B. Hancock, Bureau of Aeronautics, Navy Dept. Washington D.C.

Mr. Chamberlain

U.S. Study 6/11/31 130

Copyrighted material

a.1131



Build at Navy Yard Washington, D.C.

© U. & U.

Rescue Ship Built to Aid Airplanes That Fall in Open Water; Where Towing Is Impossible, the Salvaged Plane Can Be Raised to the Deck at the Stern and Brought to Land

SHIP DESIGNED FOR RESCUE OF WRECKED AIRPLANES

For the rescue of airplanes that fall or stall on open water, the war department now has a special emergency ship built to make possible the speedy arrival of a competent means of help. The vessel, welded throughout, is equipped with a winch for retrieving wrecked planes, and where towing is impossible, the salvaged ship can be anchored on a deck at the stern of the boat.

yield brought up by three companies operating the field is averaging twenty-one-hundredths of a karat, about \$5.67 worth of rough diamond for each thirty-six cubic feet of earth. The prize find in the field weighed slightly over forty karats.

SOLDER THAT FIXES "ANYTHING" SETS WITHOUT HEAT

Liquid solder that, it is claimed, "hardens like rock and holds like iron," has been placed on the market for the repair

of broken furniture, crockery, porcelain, tile, tool and implement handles, cracked cylinder blocks, leaky radiators, gasoline tanks, such as shown in the photo, automobile tops, upholstery, luggage, tents, awnings, toys, miniature



aircraft, spectacle frames, broken shoe heels, golf clubs, glass, and the like.

Polox Chgo. Dist. G. Parkway
622 W. Congress
Chicago, Ill.
9/10/26
a.125
9/10/26
Polox Mfg Co
Meridian, Kansas
Inquire from Indian...
to...
a.125
9/10/26

DIAMONDS MINED IN ARKANSAS JUST LIKE AT KIMBERLEY

Toiling away along a dry little gully in Arkansas, called "Poor House Branch," workmen with picks, shovels, plows and scrapers are bringing forth diamonds in what geologists declare is the only matrix in the United States that bears the precious stones, and the only counterpart in the world, so far as is known, of the famous South African field. During the time this seventy-three-acre tract has been mined, it is estimated 25,000 ranking diamonds have been discovered, and the matrix is far from being exhausted. The

Pike County

W. James 6/14/26

Polox Mfg Co
Meridian, Kansas
Inquire from Indian...
to...
a.132
9/10/26

North Bennington, Vt.



Toy "Steam" Shovel Which Performs Like a Big One under the Guidance of a Juvenile Engineer

TOY "STEAM" SHOVEL HELPS YOUTHFUL BUILDERS

Back-yard sand piles become scenes of major engineering projects when a toy "steam" shovel is added to the spades and pails. For with the miniature, muscle-driven steam shovel a boy of six can perform all the fascinating operations of the man who handles a big high-powered digger. The toy is so strongly built that it will not only work in dirt, sand and gravel but will stand up under the hard treatment of juvenile engineers. With a bar the operator swings his apparatus right or left, and two levers control the action of the shovel as it digs, extends and dumps its load.

"ROCKET MOTOR" FOR AIRCRAFT PERMITS HIGHER FLYING

Embracing rocket, turbine and propeller forms of power, an airplane engine of revolutionary type has been produced. The high-speed gases from the rockets are directed against blades of a turbine,

to the shaft of which is connected the airplane propeller. In extremely rarefied atmosphere, where the propeller has so little pulling power as to be practically useless, the direct blast of gas from the rockets themselves drives the plane. In altitudes that now are considered high, where in the propeller's power is diminished but not entirely exhausted, the engine allows part of the gases to blow directly into

the air for propulsion and part to turn the turbine, so that both means of power are made available.

RUBBER GLOVES IN THE MAKING OFFER UNUSUAL PICTURE

Ordinary objects often give startling effects when viewed through the eye of the camera. When a photographer invaded a rubber-glove factory and took a picture of some of these gloves on the way to the vulcanizing department, he obtained a photograph that might easily be mistaken for the skyscrapers of some future metropolis instead of a gnat's-eye view of a few rubber fingers. Forms made of wood or porcelain are dipped in the rubber solution and dried repeatedly until the right thickness is obtained; then the gloves are vulcanized.

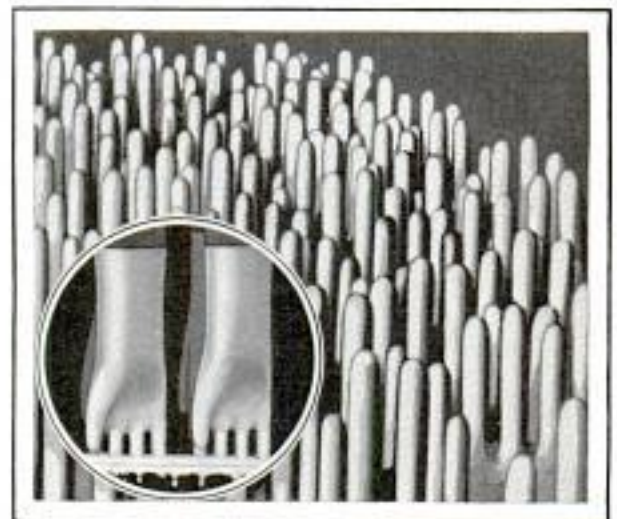

Not an Aerial View of City Skyscrapers, but Rubber Gloves on Way to Be Vulcanized

in Germany

Copyrighted material

American Toyventure Mart.
666 Lake Shore Drive.
200, 5th Ave. New York N.Y.

Prof. Robert H. Goddard,
Clark University,
Worcester Mass

Wander Worker
with only 75
cents 15.00

a-112

a-

U-1206

Com. Ben Ames, (Sheridan
Square, New York)

The World's Most Amazing Yacht Puts to Sea

ALMOST 300 years ago the "Mayflower" sailed from Plymouth to America. This summer a fleet of a dozen or more English and American yachts sailed on a long race from Newport to Plymouth.

But how different these yachts were! Limited in length between forty-five and seventy-two feet, they resembled her only in that they depended on the same winds.

One of the most interesting of these yachts is the ketch "Landfall." Secretly built in Germany, she is a marvel of design, and is fitted out with the latest and most ingenious devices known to the nautical world.

"Landfall's" oval main mast is hollow and composed of thirty-six lengths of wood, fitted and laminated to obtain lightness and strength. She carries twenty-six different sails—12,000 square feet of canvas. She has a huge spare mainsail that converts her into a cutter; jibs and staysails that overlap half the vessel; heavy storm canvas; sails for every condition of weather that might be met.

Rigging and halyards are of stainless steel, and on her deck are winches that do the work of ten men.



The World's Most Ingenious Yacht, the "Landfall"; Secretly Built, She Is Equipped with the Latest and Most Unusual of Nautical Facilities

Owner - Paul Hammond

187

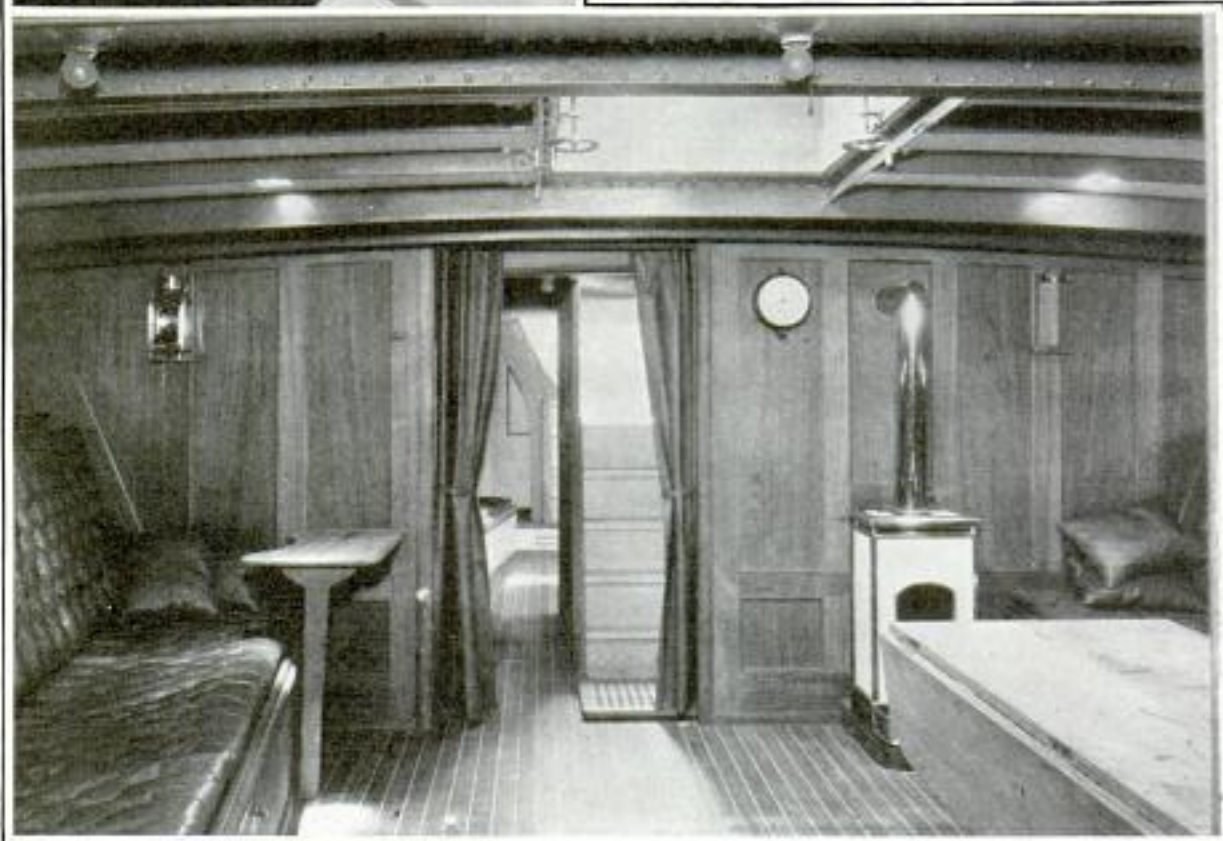

setting sheets and halyards. She has three separate steering systems for safety.

But for all her innovations on deck, it is down below that the old-fashioned sailor would be astounded. At the foot of the companionway, the navigator's room resembles the control compartment of a submarine. Dials, gauges, and gadgets are everywhere. There is a French instrument which records the speed through a sensitive, flexible blade protruding through the side of the boat. Another dial records the force of the wind. Still another records its direction. The three chronometers, ticking away in their compartment, are checked by radio.

Because, in a small vessel in rough weather, it is often necessary to batten down all hatches for long periods, the ventilating system on the "Landfall" has been carefully worked out. A new type of port keeps out the water, while fresh air can circulate in the worst weather, and electric blowers dispel the stale air.

The oversize galley range burns coal or gas, the gas being carried under pressure in large tanks. Open-faced stoves are provided, giving the effect of fireplaces.

Photo by Edwin Levick
Above, the Hull of the "Landfall"; Middle, the Radio Control Room; Below Is the Luxurious Cabin; Note the "Fireplace" Stove, of Which There Are Two

a-1278

Capt. Lieut. Chas. H. Deerwester

A. E. Chanute Field

Reservoir, Ill.

HUMAN PENDULUM YANKED FROM PLANE IN AIR



While the entire personnel at Chanute field watched spell-bound and horrified, the oldest of human dramas, risking of lives to save another's, was re-enacted in a new setting—the clouds. Private

Harold E. Osborne, a student in the parachute riggers' school at Chanute, was scheduled to make a test leap. He climbed out of the cockpit, thousands of feet in the air, and by accident released his parachute rip cord before he could jump. The chute caught in the tail assembly of the plane, yanked Osborne into the air and left him there, stranded and swaying like a pendulum in the slip stream of the plane. Although the strain of the soldier's weight was terrific, the pilot, Lieut. C. H. Deerwester, managed to maintain his altitude and control, while another plane, piloted by Lieut. H. E. Engler and car-



Courtesy, U. S. Army Air Corps

Private H. E. Osborne Who Took the "Longest Parachute Ride" When His Shroud Lines Became Entangled with the Plane's Tail

rying Lieut. A. A. Straubel as a passenger, took off to attempt a rescue. The second plane, with "Follow Me" chalked on its side, headed out over a near-by lake, followed by Deerwester and his dangling

human pendulum. When over the lake, Lieutenant Straubel lowered a knife on the end of a weighted rope, to the unfortunate soldier, the planes meanwhile being held in as near the same relative positions as possible. Osborne finally caught the knife, cut the shroud lines of his entangled chute, dropped like a plummet, and then pulled the cord of his reserve equipment and floated safely down from the "longest parachute ride in history."

☛The blood of fish and turtles contains nearly three times as much phosphorus as that of the higher mammals.

a-1061
190

FLOATING AMBULANCE ALWAYS READY TO SERVE

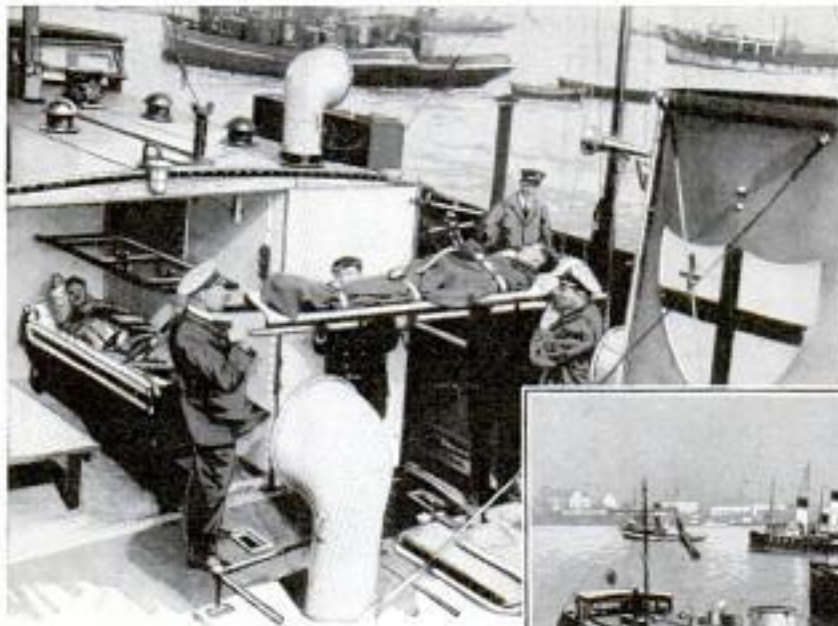

Floating Ambulance Which Meets Incoming Ships and Removes Sick Passengers

taken to a hospital for treatment before being allowed to come into contact with London's dense population. The ambulance boat is on duty twenty-four hours a day, with three shifts of specially trained men ready to meet emergencies at any time.



acme

In order to prevent the spread of ship-borne diseases, a floating ambulance has been put into service on the Thames river at London. Vessels arriving with contagious disease among passengers or crew are stopped before docking and the invalids removed to the ambulance boat. Patients are

SECRETS OF THE STRADIVARIUS REVEALED BY PHOTOS

Photographs of the sound waves from a Stradivarius have proved the reputation of violins made by this master for quality of tone to be fully justified. A striking power is revealed by pictures of the sound waves of the Stradivarius in contrast to other violins. The secret of the tone quality of the instruments made by the Italian craftsman, in the opinion of Dr. William Braid White, acoustic expert, who made the pictures, lies mostly in greater simplicity and symmetry of its fundamental vibrations. He recorded the physical properties of tones from each string of such an instrument, made in 1714 and valued at \$60,000. For the powerful "open" tone drawn from the G-string, a line was traced resembling a series of low, almost perfectly formed waves. When other strings were sound-

ed, the waves became more jagged vertically, but none the less symmetrical.

SOLDERING-IRON HEAT CONTROL KEEPS TOOL JUST RIGHT

Thermostatic heat control that keeps the soldering iron at just the right temperature, has been made available with a product that combines these faculties with a rest for the iron. The control is connected between the iron and the current source. The tip of the iron, when too



hot, closes a thermostat which reduces the voltage and cools the iron.

a 1312
W. J. Caruso 6/10/31

American Steel & Wire Co. Chicago

Supreme Electric Products Corp. 425 Clinton Av. S. Rochester N.Y.

Copyrighted material

2259.

and Miller L. Tech.

MONORAIL FLYER TO PUT THRILL IN TRAVEL

Monorail connections that will make possible speeds of 150 miles per hour between cities, and materially reduce traveling costs, will be in operation in America soon, according to plans now being formed. Engineers of the Pennsylvania railroad, the Westinghouse Electric and Manufacturing company, and the president of Queens, N. Y., have designed a monorail system, patterned after the Langen line in Germany, and the Pennsylvania has offered to turn over its right of way between College Point, L. I., and Whitestone for the first installation. In the American design the cars are suspended from rails running between T-shaped towers. The bottom of the car will be fifteen feet or more above the street level. Stations will be similar to elevated types, but the climb will be shorter for passengers. The cars will be streamlined for speed and will be driven electrically. They will be about the same size and capacity as those used in subways.



Type of Monorail Flyer Planned for the Pennsylvania Line, Providing Thrills of Air Travel with Capacity of a Passenger Train

Cond. Don Pulanymay 55 W. 86 St. N. New York

TIN SHEARS MADE LIKE PLIERS SPEED UP SMALL WORK

Made on the same principle as pliers, which they resemble, two types of sheet-metal snips have been introduced for smaller varieties of work. The cutters are of tool steel, so that even heavy, tempered



Using Curved-Nose Plier-Shears to Speed Up Small Sheet-Metal Work

stock can be handled. One of the tools is for straight-line work, while the other, with curved and pointed blades, will cut circles and other curved shapes.

ELECTRIC EYES MIX CONCRETE IN PROPER PROPORTIONS

One concrete mixer has an automatic control system operated by photo-electric cells that can be depended on to measure out the different ingredients with unflinching precision and dispatch. These cells are built into dial scales in such a way that the pointer of each scale swings between an associate cell and its exciting lamp. Each ingredient is brought to the mixing plant by conveyors that feed into weight hoppers. The charging goes on until the pointers pass through beams of light focused on the electric eyes, when sensitive relays stop the flow. With the eyes on watch, concrete of a uniform grade can be produced regardless of the number of batches made up.

4975-535-8 High

R. W. Shury Hardware & Supply Co. Akron, Ohio

Stephens-Adams Co. 210 Ridge Ave. Aurora, Ill.

Copyrighted material

Alliance Mfg Co

192

POPULAR MECHANICS
Alliance, Ohio

fuel - paraffin or heavy oil

Chicago agent. Henry
E. Klein, 4014 N. Mayor Ave



Good-Klip

\$2.50

Long-Handled Grass Clipper for Trimming along Walks; It Can Be Operated with One Hand

LONG-HANDLED GRASS CLIPPER DOES AWAY WITH STOOPING

Stooping is eliminated and grass trimming along walks and under shrubbery is speeded up with a long-handled grass shears that is operated with one hand. The clipper is supported by wheels which keep the shears at a uniform height, and the operator walks at a natural pace, doing the clipping by pressing on the grip handle which is mounted on a tubular shaft and connected to a rod that actuates the blades.

ENGINEERS' MYTH COMES TRUE IN GASOLINE TURBINE

Almost an engineering myth like perpetual motion, so difficult has been its road to completion, an internal-combustion turbine has been produced. A French engineer is the builder of the motor, and he has operated it as long as five hours continuously without overheating. The combustion chamber is essentially two cones, each grooved in a helical manner, with the grooves widening at the outer end. Air is taken in through a similar set of cones, but with the helical grooves

M. Isabriel Bertin
and his co.

spreading in the opposite direction. Gasoline is used as the starting fuel. When the motor is revolved with a crank, the air is brought into the combustion chamber, where it heats and expands. As it expands, it tends to push apart the spirals of the two cone-shaped members, causing one to revolve, and finally is exhausted at ordinary pressure, therefore without noise. The first engine weighs 150 pounds, develops fifty horsepower, operates at 2,000 degrees Fahrenheit, and is only thirty-two inches long and fourteen inches wide and high. It is a true turbine, having no pistons, crankshaft, connecting rods or valves. Overheating of the cones is prevented by placing surfaces of fused sand on the spiral grooves.

HISTORIC SHIP STANDS ON END BEFORE PLUNGE TO BOTTOM

After more than forty years at sea during which she made 576 voyages and traveled more than 4,000,000 miles, the Australian steamer "Wodonga" was sunk recently off Sydney Heads, Australia. The finish of the vessel was dramatic, for she reared on end before the final plunge, giving an opportunity for an unusual picture of the death throes of a big ship.

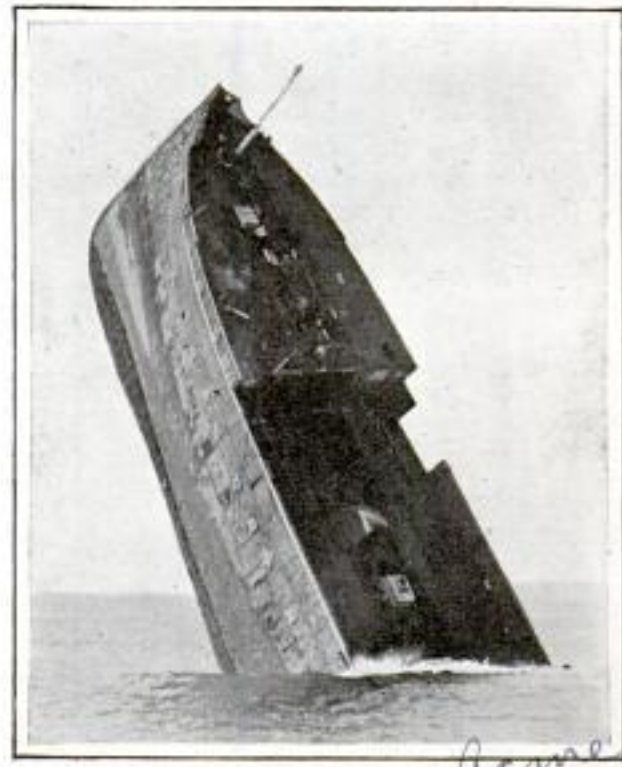

Dramatic Plunge of an Australian Steamer, Which Was Sunk After Traveling 4,000,000 Miles

Aeronautical Engineering to the Aeroplane
May 27, 1931
175 Buccardilly
1289

NO MAN'S LAND OF RADIO OPENED BY MICRO-RAY

Than's d

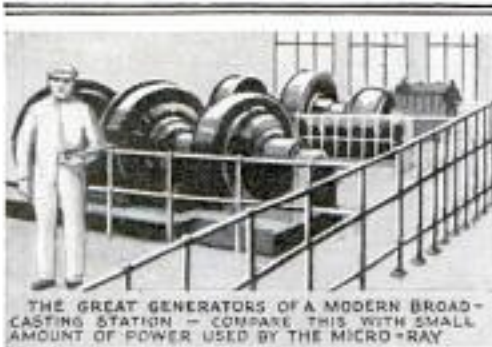

THE GREAT GENERATORS OF A MODERN BROADCASTING STATION - COMPARE THIS WITH SMALL AMOUNT OF POWER USED BY THE MICRO-RAY.



2 INCH
HERE IS ILLUSTRATED, FULL SIZE, THE MINUTE AERIAL USED IN TRANSMITTING CLEAR SPEECH ACROSS THE ENGLISH CHANNEL BY THE MICRO-RAY SYSTEM.



HERE ARE SHOWN THE LONG & LOFTY AERIALS NOW REQUIRED FOR MEDIUM-WAVE BROADCASTING.

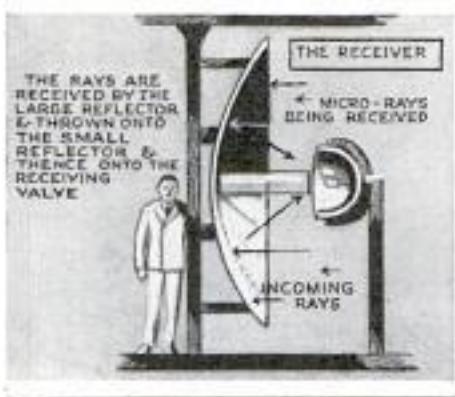

THE RAYS ARE RECEIVED BY THE LARGE REFLECTOR & THROWN ONTO THE SMALL REFLECTOR & THENCE ONTO THE RECEIVING VALVE.
THE RECEIVER
MICRO-RAYS BEING RECEIVED
INCOMING RAYS

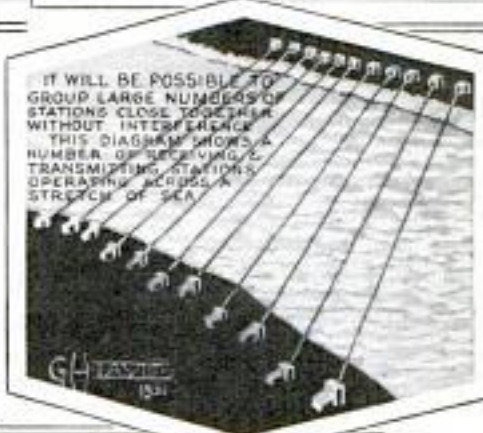

IT WILL BE POSSIBLE TO GROUP LARGE NUMBERS OF STATIONS CLOSE TOGETHER WITHOUT INTERFERENCE. THIS DIAGRAM SHOWS A NUMBER OF RECEIVING & TRANSMITTING STATIONS OPERATING ACROSS A STRETCH OF SEA.



THE POWER USED FOR OPERATING THE MICRO-RAY SYSTEM, GIVING VERY CLEAR SPEECH ACROSS THE ENGLISH CHANNEL, IS HALF A WATT, JUST SUFFICIENT TO LIGHT A FLASH-LAMP BULB.

Courtesy The Illustrated London News

Radio fans of the future may pick and choose from a quarter of a million stations if full advantage is taken of the opportunities that recent experiments indicate are offered by the micro-rays, the ultra-short radio waves ranging in length from ten to 100 centimeters. Using aerials less than an inch long and one-half watt of power—just enough to light a flashlamp bulb—a two-way radiophone conversation was conducted across the English channel on the micro-rays, and from this demonstration has come the prediction that the extremely short waves offer room for 250,000 transmitters which can operate without any interference with each other. After the long waves, great power and lofty aerials of today, such a Lilliputian system would seem almost impossible for practical purposes, but the secret lies in the receiving and transmitting arrangement. Reflectors, about ten feet in diameter, are used at each end.

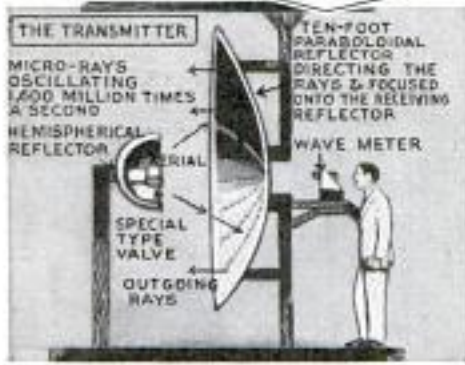

How Micro-Ray Receiver and Transmitter Operate, and Comparison of Small Power and Equipment Needed with That of Ordinary Station

In front of the transmitting reflector is another small hemispherical one with a special tube. The micro-ray, oscillating 1,600,000,000 times a second, is sent from the small to the large reflector, the latter being focused on the receiving reflector. The receiving reflector throws the waves onto a smaller one facing it, from which they travel to the receiving tube.

Instead of fighting for space in the narrow bands now available, radio stations, by utilizing the micro-rays, may be able to select their own band with no fear of ether congestion for years to come and without danger of interference from any other station. Television, which requires considerable room on the air, also may benefit from the micro-rays, since they will make available so much additional space. The rays are unaffected by climatic conditions, so that they may be useful in extending the value of lighthouses, aiding communication between ships and assisting aerial navigation.

rec. July 1931 International Telephone & Telegraph Laboratories
P. 114
Copyrighted material
New York
St. Broad
6-7

A-948
194

Mr. Karl J. Kellerman
Bureau of Plant Industry

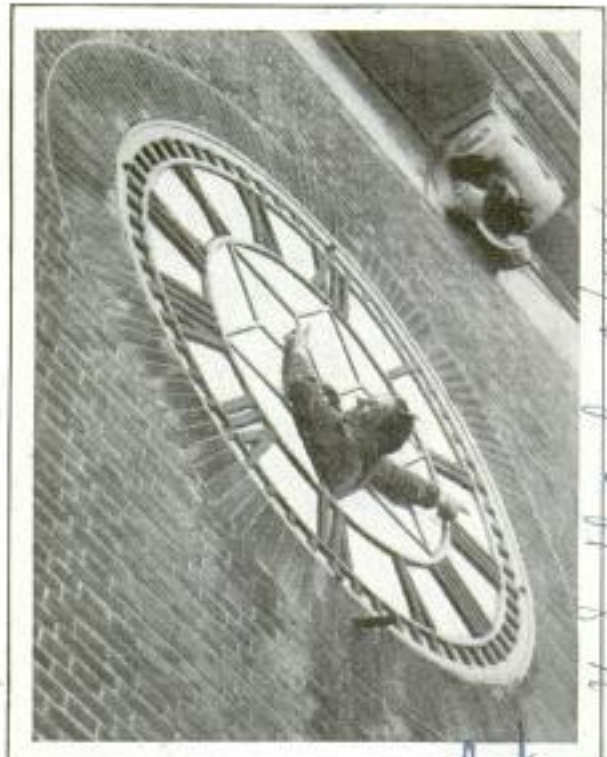

Clock with Human Hands: This Man Substituted for Regular Hands While Timepiece Was Repaired

HUMAN HANDS ON CLOCK TELL THE EXACT TIME

Human hands for a while pointed out the time recently on the face of a big town-hall clock in Colchester, England. The two regular hands were lost and a man consented to use his own two hands as a makeshift so the townspeople could tell the time while the old clock was given a spring cleaning and provided with a pair of new hands.

SHEEP GIVEN TOBACCO AS CURE FOR INTERNAL PARASITES

Tobacco, mixed with salt, has become an approved addition to the diet of sheep afflicted with internal parasites. The Canadian department of agriculture has announced that a paste made of ten parts of salt to one of crushed tobacco is palatable to sheep and has a curative effect on such troubles. In making the "tobacco lick," leaf tobacco is crushed to about the size of wheat bran and mixed with slightly moistened salt.

Mulberry trees are being planted in Mexico in the hope that a silk industry may be established there.

DECAY OF FOODSTUFFS HALTED BY SHORT RADIO WAVES

Checking of decay in food materials through treatment with ultra-short radio waves has been reported to the department of agriculture from Holland. After the short-wave machine has been operated about ten days, a field of influence is found about twenty meters in all directions from its set-up, in which no organic matter can decompose. The field permeates everything within its radius, including stone walls, lead, iron, wood, and glass, works indoors or outdoors, and in any atmosphere or temperature.

LUMBER PILER BUILDS A STACK THIRTY-EIGHT FEET HIGH

Capable of handling 10,000 feet of lumber an hour, a piling machine eliminates the need of conveying lumber long distances, saves storage space and reduces loss from stained lumber. With the piler, the lumber can be stacked twice as high as by hand methods, one such machine building a stack thirty-eight feet high.



Lumber-Piling Machine Which Is Capable of Building a Stack Thirty-Eight Feet High

The Johnson Lumber Co.
202 Ave and 1st St
Seattle, Wash.

Carl James Montague
609 Harborway
Com. Bldg
Portland, Ore.

A-1160
H. S. Stanley 5/20/31

Rec. Mar. 19 31. 712

A-1117

Copyrighted material

A-1095 Comd. John Warren Woodley
2559 29th St NW
Washington, D.C.

The White Squadron Sails again

BACK in 1907 when the American fleet went around the world, the navy had white ships. Long since, however, our fighting craft have been painted a business-like gray.

But there is in the navy today a group of white ships, and once more they have steamed out of the blue Caribbean after a season's work along the Spanish Main. They are the three survey vessels led by the veteran "Hannibal."

Attached to this white squadron and preceding it homeward this spring by a few hours were two silver-white amphibian planes. They had air-mapped Porto Rico, assisted the "Hannibal" in charting the shores of Venezuela, reconnoitered for another naval survey ship off Panama, then had returned to the United States along the jungle shores of eastern Cen-

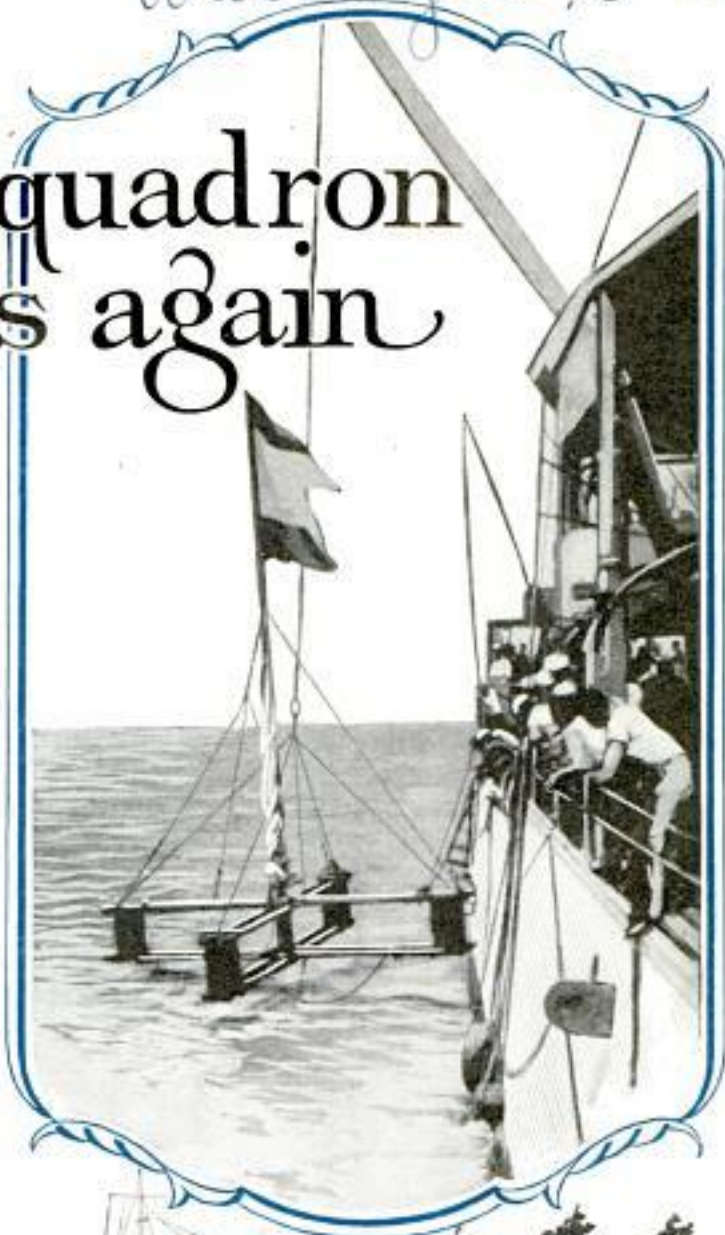

Above, Putting Overboard a Flag Marker to Be Anchored to Define Corner Boundary of Area to Be Surveyed; Below, Former Submarine Chaser Towing a Flag Marker into Position

A-1095
196



Above, Motor Launch with Special Platform for Making Soundings with Lead



Above, Running a Line; Below, One of Two Towers Used as Key Positions from Which to Run Survey Lines



Above, Air Photographs of Porto Rico Taken by Naval Planes and Pieced Together to Form a Mosaic; the Photographs Are Systematically Taken to Overlap

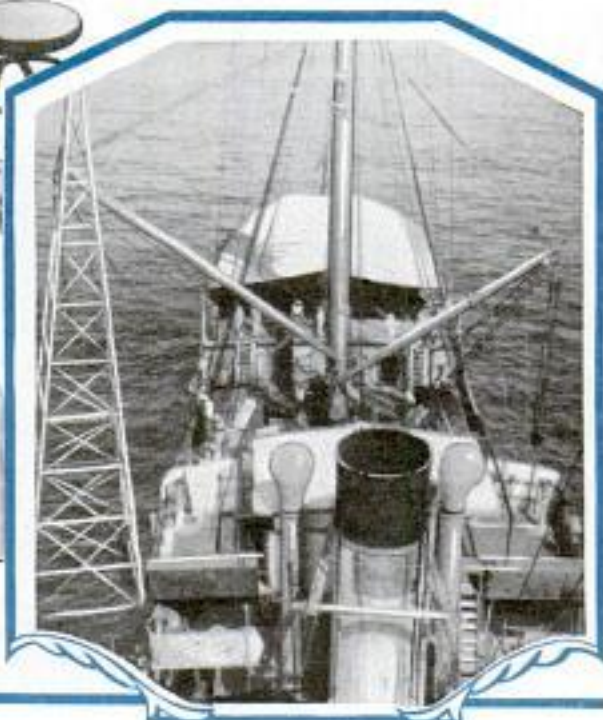

tral America. The white ships have gone to their home yards, where they will be overhauled for the tasks allotted to them next season. Commencing in the fall, this small but significant fleet, again aided by planes, will resume in the Caribbean its harbor and coastal charting.

As a part of this duty, they will drag with buoyed wires for pinnacles which have been reported extending dangerously upward from the ocean's bed; take lead and sonic soundings of sandy banks, believed shallow and therefore forcing vessels from their direct courses between

ports; continue tidal observations, and further photograph from the air regions of which geographical knowledge still is inexact.

Their season's work in the Caribbean will average, as in the past, about 1,200 miles of coastal survey, 1,000 square miles of soundings and 2,500 square miles of mosaic air-mapping. The data compiled by the white squadron will be transferred to engraved charts, coast pilots, air pilots and sailing directions, which will continue to be issued to the entire seagoing world so that this great cross-

a-1116. Carl Thackwell
4649 Beverly Blvd. 197
Los Angeles Calif.

road of the Americas may be safer for all. This fall the "Hannibal" will survey the approaches to the Nicaragua canal.

This work follows a definite plan of surveying coasts of countries which do not maintain adequate facilities to accomplish such accurate mapping and which have invited the United States to undertake the mission. In accordance with such requests, the navy has charted areas the world over since 1837: Japan, Brazil, the Arctic, Mexico, the Mediterranean, Siam, the Antarctic, the Pacific archipelago—just to mention some spots on the globe.

While on the survey, work for all hands continues from early daylight until dark. Surveying is hard, grueling labor, but it has its full share of adventure and thrill. The personnel become highly skilled in astronomically exact plotting and in the handling of small boats in strong winds and heavy seas. Because of this experience, and for the reason it often takes them into strange and interesting localities, service in the navy's white squadron is popular both with officers and men.

"BIRDS" ON PHONE LINES AID LONG-DISTANCE TALKS

a-1134

If, when out driving, you notice something that looks like birds sitting on telephone wires which do not fly when you approach, do not be alarmed, for chances are they will be the new type transposition brackets which are connected to the wires midway between the poles. Modern telephone lines used for long-distance conversation must be absolutely free from

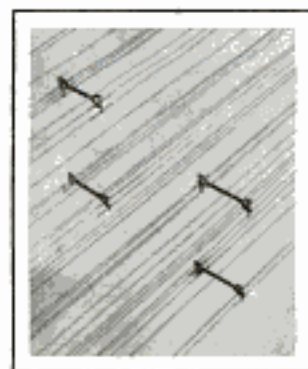

noise and this is accomplished by balancing the line perfectly. To accomplish this balance, it is necessary to reverse or transpose the wires at certain intervals. So important are the exact locations of these transpositions that they are measured to the inch and not placed at the nearest pole as was formerly the practice.

They are measured to the inch and not placed at the nearest pole as was formerly the practice.

Carl Ray Blair, Signal
Office of Mr. Hayes
Columbus, Ohio

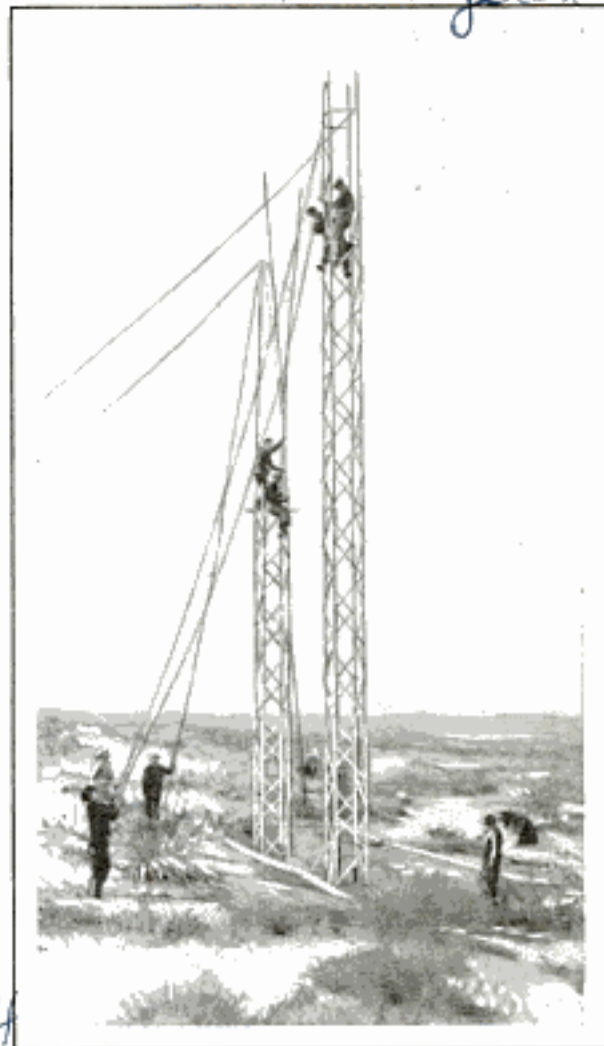

Members of Construction Crew Erecting Steel Towers for Power Line, Climbing as They Build

RAISE SELVES BY BOOTSTRAPS IN BUILDING TOWERS

Climbing as they build, members of a construction crew erecting the steel towers for a power line in California and Nevada have found one efficient way to get up in the world. These men almost pull themselves up by their bootstraps as they erect the towers, placing one section then climbing on it to start the next. The line will furnish the power for the construction of Hoover dam.

FIRST RAILWAY IN AMERICA TO RUN LAST TRAIN

a-1161

America's first steam railway line, operated between Carbondale and Honesdale Junction, Pa., a distance of twenty-three miles, will be abandoned, its owners have announced. They gave bus and truck competition as the reason.

U.S. Daily 5/20/31

Nevada, California Electric Corp

a-983

Ans. Walter
Carlos
Berlin, Germany

Process bought by The
Sandvik's Stachwark



Electric Dance Instructor Enabling Pupils to Execute Intricate Steps by Watching the Disk

ROBOT DANCE MASTER SHOWS MANY INTRICATE STEPS

Sight and sound have been combined in an electric dancing instructor by means of which the members of a class execute difficult and intricate step combinations simply by following instructions flashed on a disk. These, being accompanied by sound, give the proper tempo. The dance machine resembles a loud speaker with space for dance steps and numbers.

STOKER CHANGES BLACK GANG TO WHITE-COLLAR WORKERS

One man, by merely pressing push buttons, stokes all the coal-burning boilers of a forty-seven-story New York hotel, supplying not only the heat for its 2,500 rooms, but also the power for all the hotel's mechanical equipment, from its private lighting plant to the delicate parts in the guestroom radio speakers. The stoker, who pushes buttons instead of a shovel, can even wear a white collar, for the equipment eliminates any necessity of his touching the coal from the moment it is dumped into the building's bunkers until it is hauled away as ashes. The furnaces burn pulverized coal, and when the boiler man presses a button, the precise

Hotel New Yorker

amount required is automatically weighed out from the bunkers, after which it is pulverized and blown onto the fires. Another button starts suction apparatus which cleans the ashpits four stories below street level, and blows the ashes into closed storage compartments seventy feet above. From these compartments they frequently are removed by trucks at the street level, again by suction process. More than \$100,000 annually is saved in lighting bills by hooking up the lighting equipment with a Diesel engine for private power generation.

a-1067 Harry Johansson
IRON PLATED WITH ALUMINUM

Iron now can be plated with aluminum by a process invented by a Swedish metallurgist. The plating is done at a temperature of about 1,650 degrees Fahrenheit and the aluminum not only covers the surface of the iron but penetrates it, forming a kind of alloy which resists rust, oxidation and corrosion by gases and fluids. The process has been used with success in the manufacture of cold-drawn tubes and steel belt conveyors, and is expected to be applied also in the making of household utensils and dairy supplies.

ONE-MAN TRANSMISSION HOIST SAVES LIFTING BY HAND

Lifting the transmission assembly from an automobile is made a simple instead of a laborious operation with a one-man hoist that is portable, collapsible and adjustable. The hand-operated tool enables one man to accomplish easily a task usually requiring the services of two or more mechanics. The hoist spreads to thirty-eight inches, the ends of the curved frame being equipped with wheels which roll on the ledge where the floorboards rest. When extended to capacity, the hanger itself takes the load, and it is unnecessary to rest the wheels on a track or against anything substantial. It has a load capacity of 600 pounds and fits nearly all cars and trucks.



#13-80

Shepard Moore, Inc.
Cleveland Ohio

Ans. George A. Strader, 37-25
88th St. Jackson Heights 1101

amount required is automatically weighed out from the bunkers, after which it is pulverized and blown onto the fires. Another button starts suction apparatus which cleans the ashpits four stories below street level, and blows the ashes into closed storage compartments seventy feet above. From these compartments they frequently are removed by trucks at the street level, again by suction process. More than \$100,000 annually is saved in lighting bills by hooking up the lighting equipment with a Diesel engine for private power generation.

A 1075 Built for Cunard line
at Clydebank.

ATLANTIC GALES IN TANK TEST MODEL LINERS

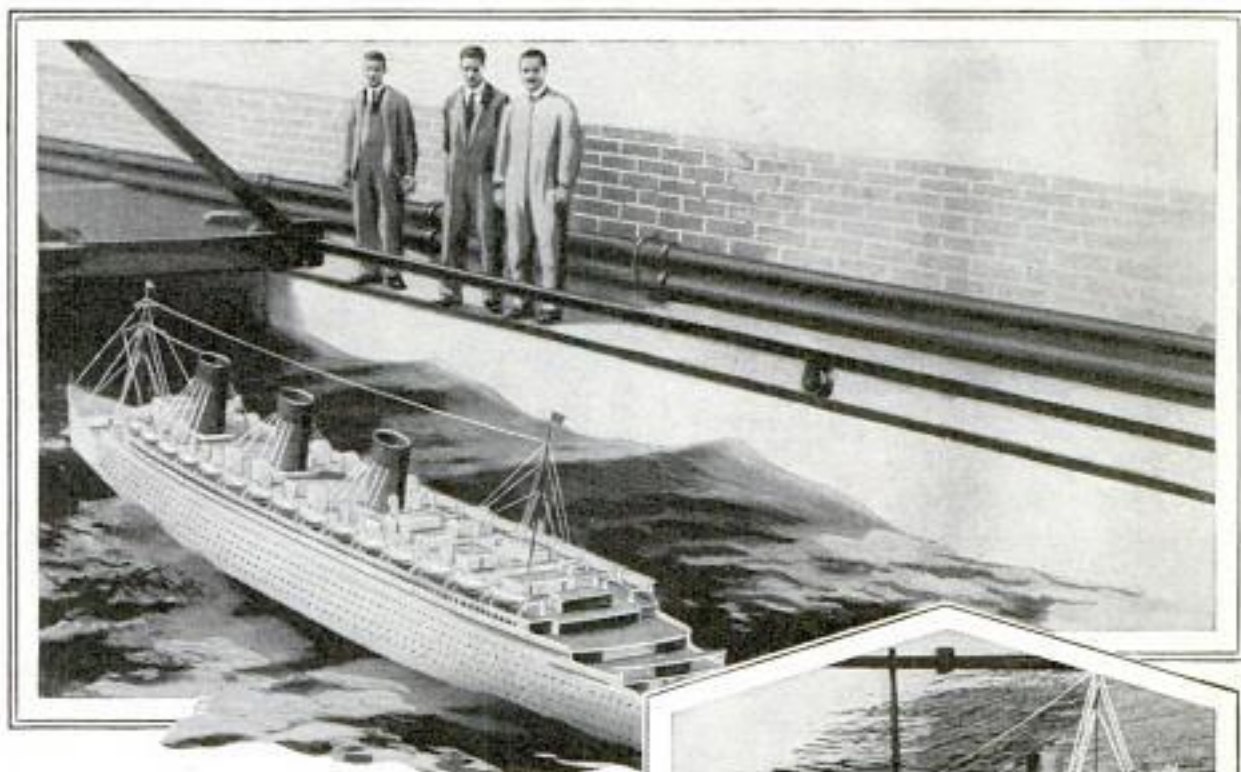

North Atlantic gales are produced in miniature in a huge tank in a Scotland shipyard where scale models, eighteen feet long, of what is to be the world's largest liner are tested. Ocean storms are simulated by an apparatus that makes waves like those a boat in a gale would encounter. The models are driven through the tank at full speed as the storm rages, and experts check the effects by electrical instruments attached to the hull.

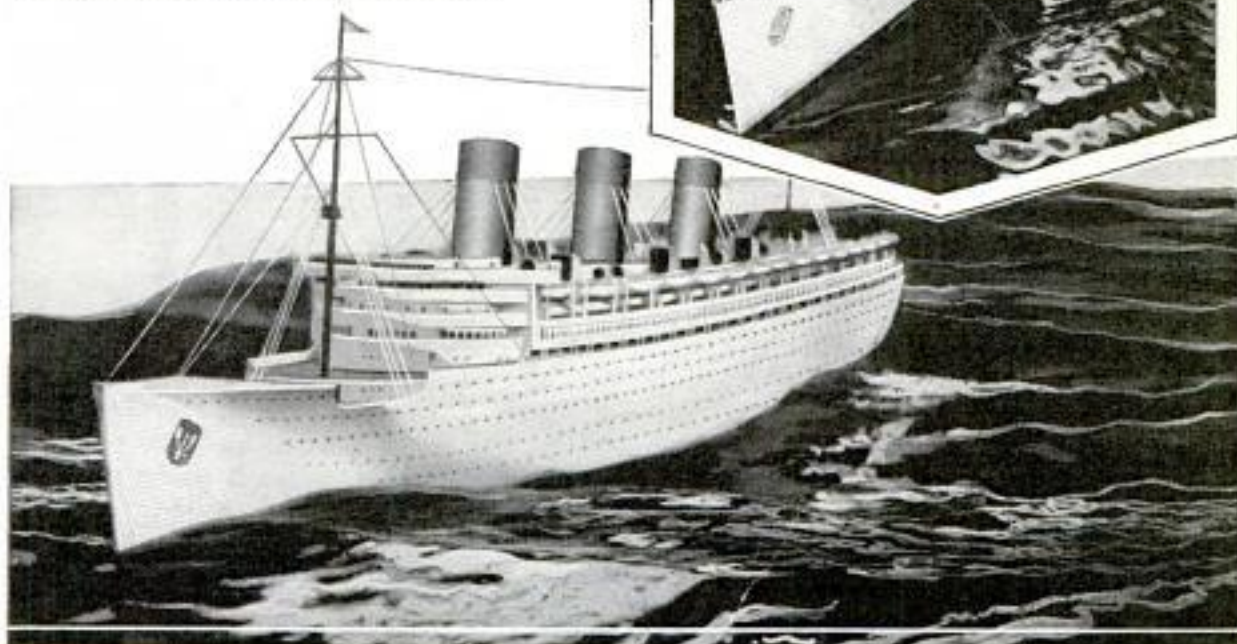
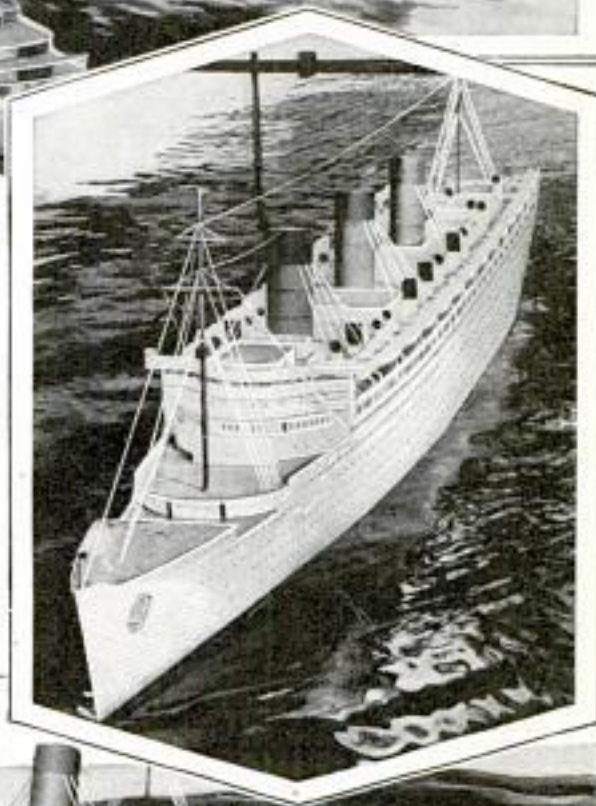

a-830

Carl. John L. Coonty, 714 Jefferson St
Washington, D.C.

On the Trail of the



TEN miles off the Jersey coast, a fast, small vessel is cutting the water swiftly and the captain watches nervously. A rum-runner is coming in, loaded with a cargo of liquor. Suddenly the course of the vessel is altered.

An hour later, a coast-guard boat is hovering around the spot where the rum-runner was last seen. But a radio code message to the captain of the "rummer," from a hidden station on shore, has turned the trick and saved the cargo for the smuggling syndicate.

However, at the same time the radio operator on the rummer was getting his warning, out in a small brick building on the lonely prairies of Nebraska, the code message was also received. As a result, the illegal radio station was ferreted out by department of justice operatives, silenced, and its owners were in the clutches of the law.

How was this done? How could a single person sitting out on the prairies of Nebraska have anything at all to do with the putting out of commission of this illegal station and throwing into the hands of the law the members of the rum-running syndicate? Let George E. Sterling, acting supervisor of a federal radio-monitoring station, of which there

are something like nine throughout the country operated by the department of commerce, tell the procedure.

"When we hear a station broadcasting that is unfamiliar to us, we listen in for the call letters at the sign-off. These are



Coast Guardsman behind One-Pounder, Ready to Enforce Command to "Heave To" After Patrol Has Intercepted Radio Message to Smuggler

then checked by our call-letter list, of which we have two, one foreign and one American, to see if it is a licensed station.

"After determination that the call letters of the station indicate that it is unlicensed, the frequency on which it operates is measured. Also, all the characteristics of the signal are carefully noted as well as the ability of the radio operator and any peculiar characteristics that he exercises in transmission, as, for instance, his failure to follow the procedure prescribed by international regulations. His failure to do so, incidentally, gives us a

Radio Pirates

further clue that his station is unlicensed.

"Our next step now is to determine with what station or stations he has established communication, which, of course, includes their call letters and the ease with which communication, if established, is carried on. And right here it might be said that easily established communication, carried on without interruption or interference between the communicating operators, indicates close proximity of the mobile station to some other mobile station or master control station on land.

"Every call letter, signal, word or group of words is now copied for the purpose of interpreting the message which, in general, is transmitted in a complicated code or cipher. A code, I might say here, is a pronounceable group of letters; a cipher is an unpronounceable group of letters or figures, or combinations of both. When the message has been copied, we decipher it ourselves if possible; if we are not able to do so, we turn it over to special agents in the department of justice.

"Now, let us suppose that we have picked up a shore-to-ship message of a rum-running syndicate, warning a ship's captain that a federal patrol has just left port to search him out. We get the message in code and the call letters of the sending station. The station, we easily determine by looking in our call-letter book, is not licensed. The code we de-

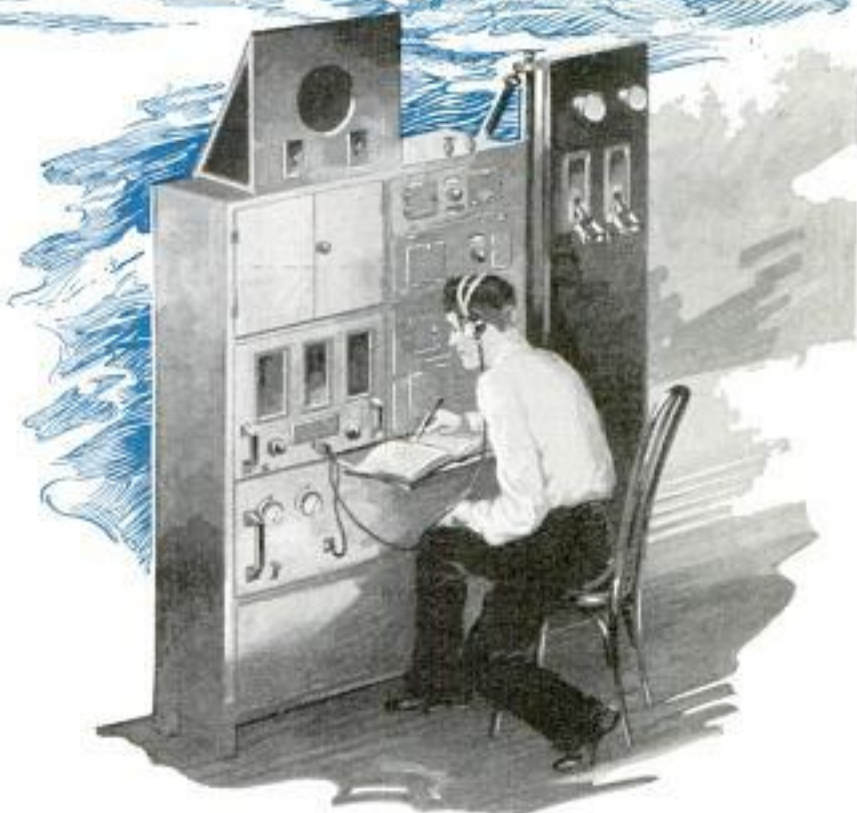

Here Is a Conventional Type of Short-Wave Transmitter and Receiver Used by Amateurs; Similar Equipment Can Be Employed Illegally

cipher. But still we are a long way from the station's location. To get this we must repeat the operation of listening in as often as possible, determining as much as we can about the station, character of the signal, peculiarities of the operator in sending, and the direction from which the message is coming. Gradually—it may take weeks and months—we work out the station's location from this and other data gathered by use of automobiles equipped for testing frequencies and power, moving them here and there until the end sought is attained.

"Once the 'bootleg station' has been located, the information regarding it is turned over to the department of justice. Here our work ends unless the station is to be raided. In this case radio experts go along with the raiding party to establish technical evidence of the use of the

G. P. B. U.
202

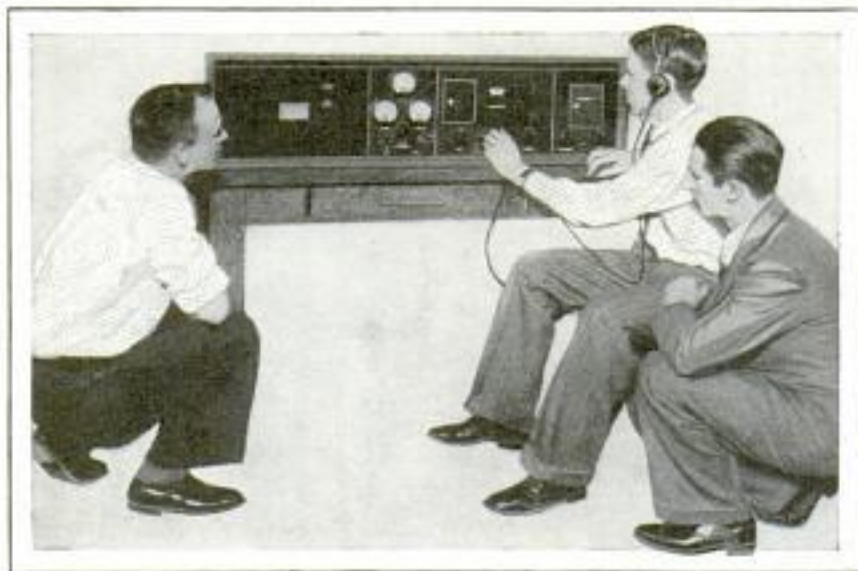

accuracy of one part in one hundred thousand. In addition, there are five receivers, two of which operate on a frequency of 30,000 to 1,500 kilocycles, two on frequencies from 1,500 kilocycles to 100 kilocycles, and one on frequencies from 100 to ten kilocycles. This enables the measurement of all us-

radio illegally. The radio men test out the apparatus and establish beyond a doubt that the transmitter is capable of carrying on the communication with which it is charged.

"Measuring the frequency of an illegally operated station, or a legally operated one for that matter, is rather an involved process. Briefly, the frequency is obtained by comparing the incoming signal from the receiver with the frequency of a meter—a specially designed measuring instrument."

In the new constant-frequency monitoring station at Grand Island, recently completed and equipped, there has been installed one standard of frequency having an accuracy of one part in a million, and one secondary standard having an



Above, Portable Set Used by Federal Radio Experts in Autos to Trace Illegal Stations; Below, Radio-Equipped "Rummer" Fleeting Coast Guard

able frequencies in the radio spectrum.

During tests of the apparatus at the time of installation, says an official of the radio division of the department of commerce, under whose administration the conduct of the monitoring stations of the government falls, over 300 broadcast stations were received, as well as a number of other services in the United States. In addition, reception of stations in Chile, Canada, Cuba, Portugal, France, England, the Philippine Islands, Hawaii, Argentina, Peru, Netherlands, Brazil, Panama, Costa Rica, Nova Scotia, Russia and many others in the world is recorded.

Monitoring of stations operating on the frequencies which can be measured at Grand Island cover the following classes of service: transoceanic; telegraph and telephone; marine, operating on high, low and intermediate frequencies; marine coastal; aircraft; aircraft ground stations; various point-to-point services; broadcasting; amateur; televi-



© Henry Miller
Federal Radio Transmitter and Receiver, Mounted in Auto and Used to Track Down Illegal Stations

a-830

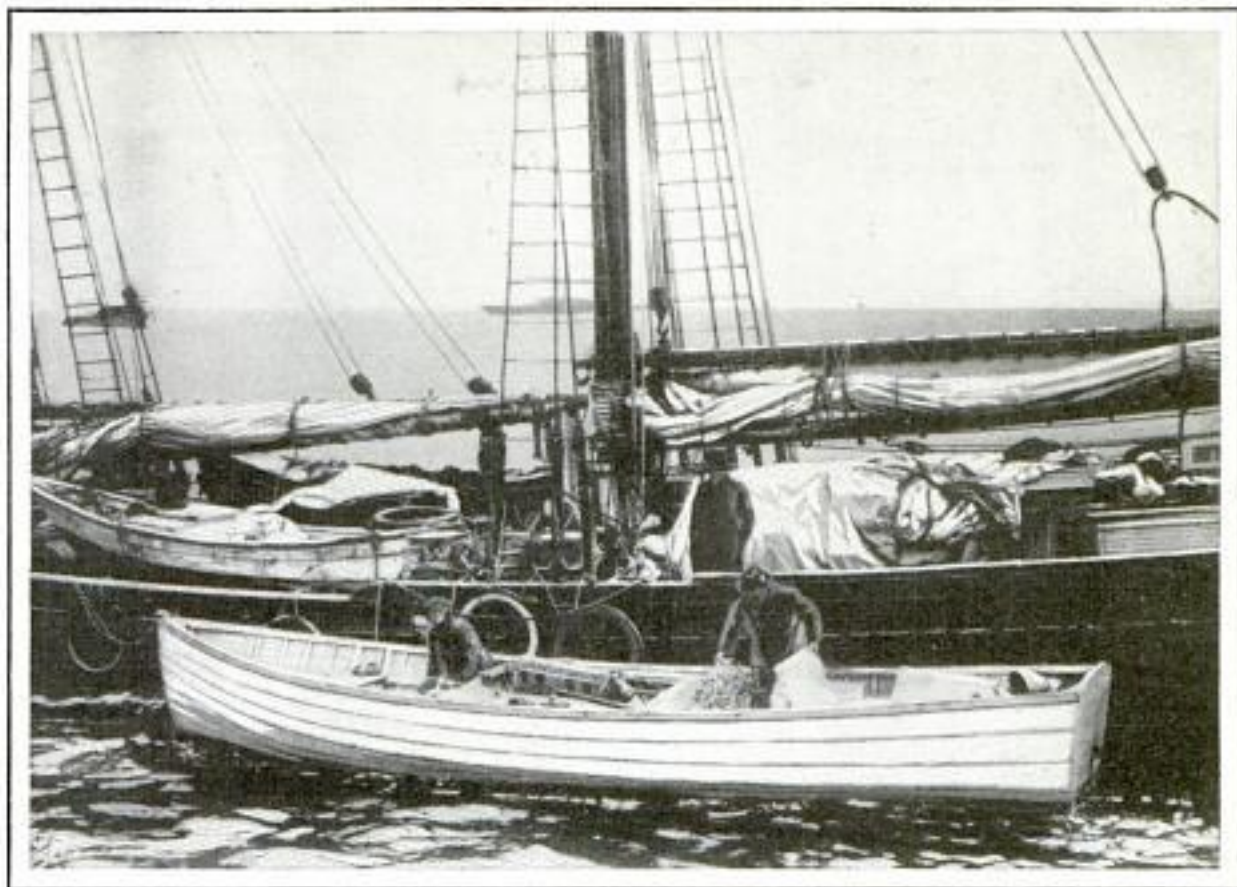

Picture Shows How Rum Is Transferred from a Vessel to a Fast Motorboat outside Twelve-Mile Limit; When Motorboat Leaves, the Vessel Radios Notice of the Fact to Headquarters on Land

sion and facsimile—to say nothing of the pirate stations among which is to be numbered the bootleg station.

The Grand Island station covers a fifty-acre site approximately seven miles west of the city. This site was chosen after a middle-west survey as being most desirable for the important work to be done in monitoring, because of little or no man-made interference at this point and because stations in foreign countries as well as continental United States were regularly received without difficulty there.

There are no telegraph, railroads, power lines or residences within three miles of the station.

Illegal stations are, as a rule, operated on short wavelengths. They are not so easily detected, and the antennæ of such a station may easily be located in a house. Such stations have an operating range of over 1,000 miles. The radio-equipped automobiles, which in the last instance run to the ground such stations, are equipped with portable sets and a number of them are assigned to each federal radio district.

FIVE-HUNDRED-MILE AIR SPEED FOUND HIGH OVER ALASKA

Fourteen miles above the weather bureau station at Fairbanks, Alaska, a small hydrogen-filled pilot balloon was observed moving at a speed of 574 miles an hour. The perfectly clear air enabled observers to keep the balloon in sight, through powerful glasses, for a distance of forty miles. According to reports, this sounding of the upper air currents establishes a new

record for altitude. As the pilot balloon ascended it found twenty-five-mile-an-hour wind currents at the seven-mile level. Two hours after its release, the balloon had reached an altitude of fourteen miles, at which time its velocity was checked by means of the special scales and equipment developed for the weather bureau.

Electricity is the only domestic item costing less now than in 1913, according to a recent survey of thirty-two cities.

*Com. J. W. Finkle, 5021
12th, N.E., Seattle
Wash*

a. 10. 11
204

Com. Arthur A. Young
Editor Chinese Christian

Student 34
made some
nylon

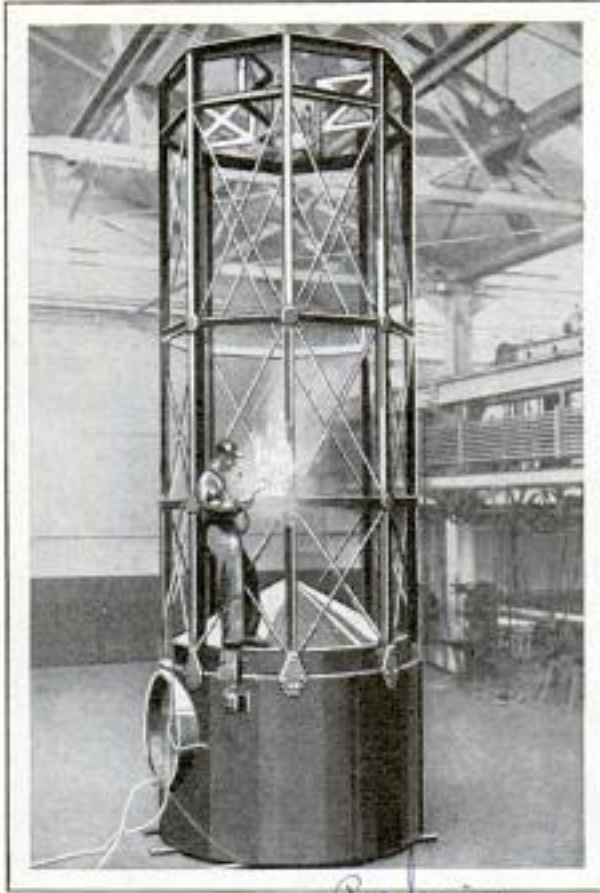

Large Telescope Tube Being Electrically Welded to Provide a Greater Degree of Rigidity

GIANT TUBE OF TELESCOPE IS ELECTRICALLY WELDED

Electrical welding of joints, replacing the use of rivets or bolts, is expected to produce greater rigidity in the telescope tube being built for the observatory at Ohio Wesleyan University. The tube, twenty-two feet long, is the first of its kind to be constructed by means of electrical welding. The rigidity obtained through welding will, astronomers believe, insure accuracy of observations. The tube will carry the first large telescope mirror to be made in the United States, a product of the bureau of standards.

CHOP SUEY ORIGINATED IN AMERICA NOT CHINA

Contrary to popular belief, chop suey was born in America and not in China, for even today it is not found anywhere in the Orient. Many stories are told of its origin but the one generally accepted attributes its invention

to Marshal Li Hung Chang. During a trip to America, he planned a feast for friends and was asked to serve something Chinese. Unable to obtain Chinese food-stuffs, according to the story, his cook did the best he could with American materials and succeeded in giving the dish an exotic tang by using a Chinese sauce made from soya beans. American guests who sampled the dish with chopsticks were quite enthusiastic and asked its name. The marshal did not want to disillusion his friends, so he glanced at the chopsticks and the sauce and replied, "chop soya." His friends repeated the name as "chop suey" and it has been that ever since. News of the banquet was quickly relayed to San Francisco where a Chinese restaurant had been opened, and chop suey soon appeared on the menu, to be followed by the spread of such eating houses and the inevitable American product with its Americanized Chinese name.

SPEED OF BULLET IS RECORDED ON SIX-INCH RANGE

Accurate measurement of the velocity of a rifle bullet is given by a simple recorder that indicates precisely the time required by the bullet to travel through a six-inch range. The recorder is electrically operated and the bullet breaks a tinfoil fragment at one end, interrupting the current. At the other end of the range, it breaks another piece of tinfoil, re-forming the circuit as it emerges from the recorder. The time between the break and connection is shown on a dial from which the speed of the pellet is computed easily.

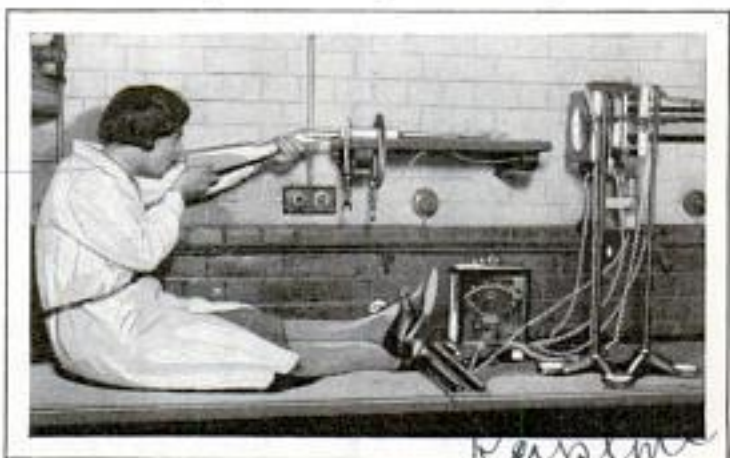

Firing Rifle into Electric Recorder Which Times Speed of Bullet as It Travels through Six-Inch Range

a. 1069

shown at Scientific Institute
Exhibition Polytechnic
Holloway Road, N. London, Eng.
Copyrighted material

ALL THRILLS OF FLYING WHILE SAFE ON GROUND

For teaching student flyers, a training plane has been mounted on an automobile trailer to give most of the sensations and experiences of flying without the at-

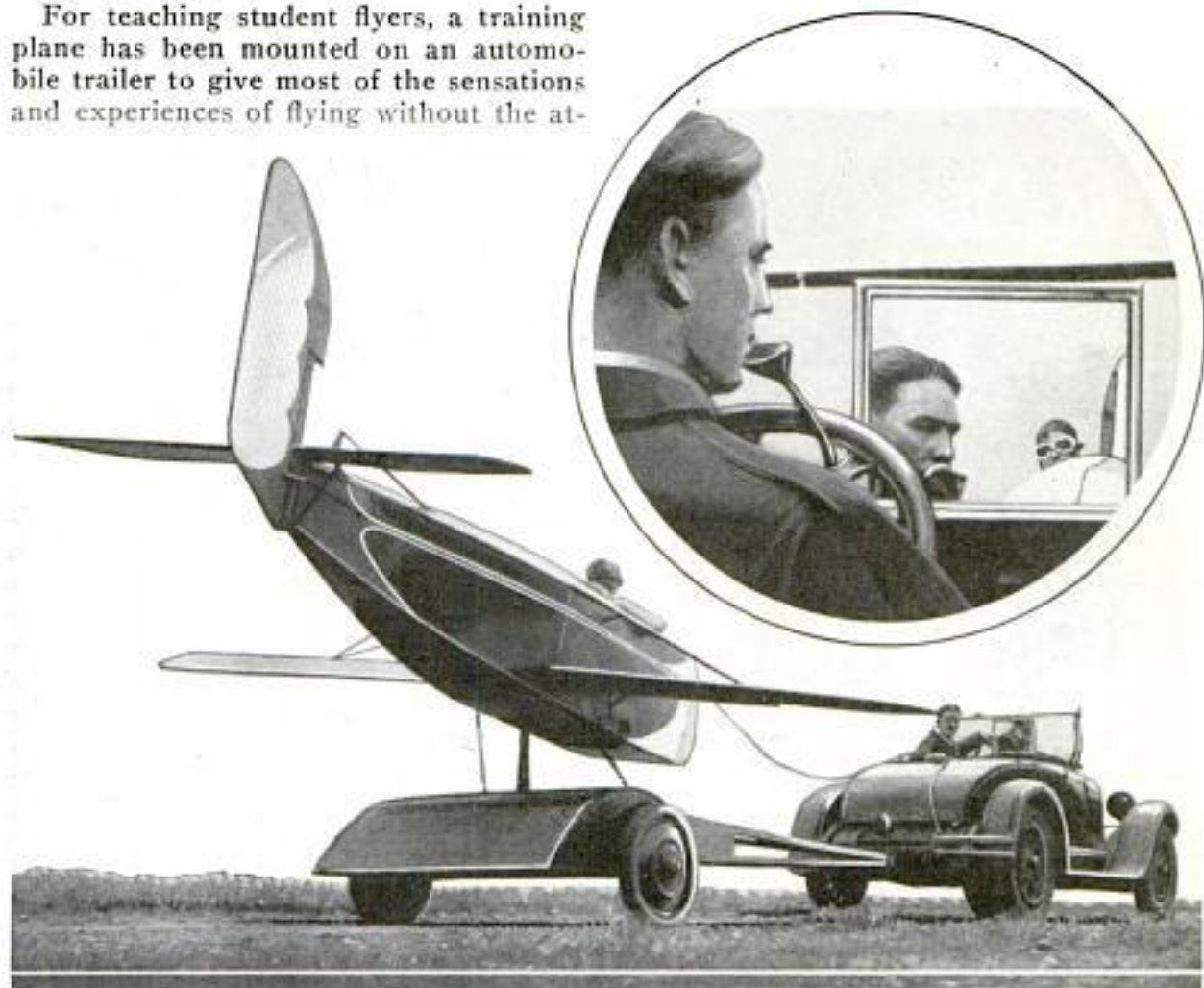

Pilot Trainer Mounted on an Auto Trailer to Give the Student Experience in Handling a Plane; Circle Shows Instructor in Auto Watching Maneuvers of Pupil in Large Rear-View Mirror

endant dangers to the novice. The trailer runs on rubber-tired wheels and contains a frame on which the training plane is set on a steel rod with a ball-and-socket connection. This arrangement allows the student to put the training plane through all the movements of a ship in free flight as the instructor tows him about the field. On the automobile windshield is a large mirror in which the instructor watches the student's maneuvers.

DOES EARTH FACE A WARM AGE AS RESULT OF INDUSTRY?

Earth, according to geologists, is getting warmer. And its recovery from the last ice age may be speeded up a little by the increasing combustion of coal in the furnaces of factories and homes. Burning coal releases carbon dioxide into the

air and it is believed that the increase or decrease of carbon dioxide has much to do with changes in the average temperature of the earth's surface. Studies in the U. S. naval research laboratory have shown that the average temperature may be raised ten degrees by doubling the amount of carbon dioxide in the air. To do this, however, would require the burning of 1,000 tons of coal for every person in the world. While the total present coal consumption is less than one ton a year for every person, it is considered that the effect of releasing even that much carbon dioxide into the air may be a slight increase in temperature. Experts believe that ice ages have resulted from a reduction of the carbon dioxide in the air, and that lowering the earth's average temperature ten degrees will suffice to bring on a glacial period.

E. O. Hulbert, Naval Research Laboratory.
 U.S. Daily 5/3/31
 Copyrighted material

a 1046



Launching a Turbine Ship Which Will Carry Automobiles from Detroit to Atlantic Seaboard; the Vessel Is 300 Feet Long

TURBINE SHIP TO CARRY CARS FROM DETROIT TO SEA

Second ship of its kind on the Great Lakes, the turbine ship "Chester" was recently launched and prepared for service as a carrier of motor cars from Detroit factories to the Atlantic seaboard. These all-metal turbine ships are 300 feet long and, in their specially designed hulls, have space for 2,000 tons of crated motor cars.

ANIMALS OF OLD WEST GIVEN MISSISSIPPI RESERVATION

If present projects of the government materialize, the game reserve created by congress in the bottom lands of the lower Mississippi will be stocked with bison, antelope, elk and other animals which used to make that country their home. Reports of early French explorers and Indian legends indicate that these bottom lands were once thick with hooved and horned animals. The coming of civilization forced them out of their native haunts and some of the animals are today almost extinct. It is believed that the engineering work planned to convert

Wid. Della

the 300-mile strip of bottom land into a chain of lakes flooding it permanently, will produce conditions under which the animals will flourish.

a 1028

SANDING-MACHINE DUST REMOVED BY SUCTION

Dust has been virtually eliminated in the operation of a portable hand belt-type of sander by equipping it with a suction attachment that operates like the ordinary vacuum cleaner. The dust-removal system has been built into the tool, a double-bladed fan creating a vacuum to draw the dust through ports directly back of the belt. The dust is deposited in a bag and is removed through a zipper opening. The bag itself is easily attached or detached by a single twist of a coupling. The dust remover not only keeps the air clean but prevents the abrasive belt from becoming clogged, thus lengthening its life. The motor is laid horizontal to the frame to give the machine better balance and place the weight over the sanding shoe.

ford

6/13/31

1065

credited to Service 529-C



Sander Equipped with Suction Attachment Like a Vacuum Cleaner to Catch Dust and Dirt

Porter, Cable, Hutchinson Corp 100 Wall Street, N.Y.

Gerrion Bailey & Co. Biological Survey.

chester Tabernum

Chicago 1607 Ogden

a 1043

Peter P. Fechner
Berlin, Gehländer
Am Negeviwikel, 58.
Germany

POPULAR MECHANICS

207

LIVING FACES ARE PRESERVED BY PLASTER MASKS



Masks of living faces can now be made by a method devised by a Berlin sculptor which preserves the human features, exactly as they are in life, in all their naturalness and detail. The face is gradually covered by a plastic material that is applied bit by bit while it is warm, the nostrils and eyes being left uncovered. The model must remain perfectly still for about an hour while the mask sets and cools. It is then carefully removed and serves as a negative from which a positive can be made in wax, ceramics, bronze or stone. The pictures on this page show the various operations in applying the plaster and removing the mask. At the bottom is a positive and an example of the finished work.



Mr. George F. Paul
No. 1409, 1537 Dearborn
Chicago

From the Works
6/2/31 R-506

a 10 35
208



Airport Traffic Tower from Which Pilots Receive Orders by Radio; the Tower Operator Also Controls the Lights for the Field

AIR-TRAFFIC CONTROL TOWER GUIDES PLANES BY RADIO

From a traffic tower at the Cleveland municipal airport, pilots are guided in taking off and landing by means of a short-range voice radio transmitter. The system is of particular benefit to flyers approaching the field, as they are informed in advance of ground conditions. In addition, the tower includes an apparatus by which the position of all airline planes leaving or approaching Cleveland is marked on a map and may be seen at a glance. All field boundary lights, obstruction lights, building lights and floodlights also are controlled from a switchboard in the tower.

TEARS POISON TO GERMS

Tears have a very practical purpose. An English biologist has discovered that tear fluid, even greatly diluted, is an exceedingly powerful destroyer of bacteria.

The bacteria poison in tears is so strong that a solution of 40,000 parts of water to one of the fluid fully retains its germicidal property. Presence of this powerful antiseptic in the tear ducts undoubtedly protects the eye from many germ-carried ills.

READY-MADE ARCH PROVIDES BASE FOR PLASTER

Ready-formed metal arches are being offered as a building accessory to provide a unit plaster base of symmetry and uniformity for all types of doors. The arch is nailed to the rough bricks over the lath, and in one operation the plastering base and the corner bead are in place. The metal bases eliminate two difficult operations, the construction of curved

wooden forms for the arches and the shaping of corner beads around curves. The beaded edge of the arch can be continued on the straight runs with regular corner beads, and perforated flanges in the metal afford excellent keying for the plaster and keep it from cracking. The arches can be obtained in several sizes.



Ready-Formed Metal Arches Which Provide a Symmetrical Plaster Base for Such Types of Doors

United States Insipsum
9, 300 W. Adams Chicago

a-1100

\$2.00 to \$3.50

Fleming

Q1047

RAILROAD ON STILTS CROSSES VIADUCT IN ROCKIES

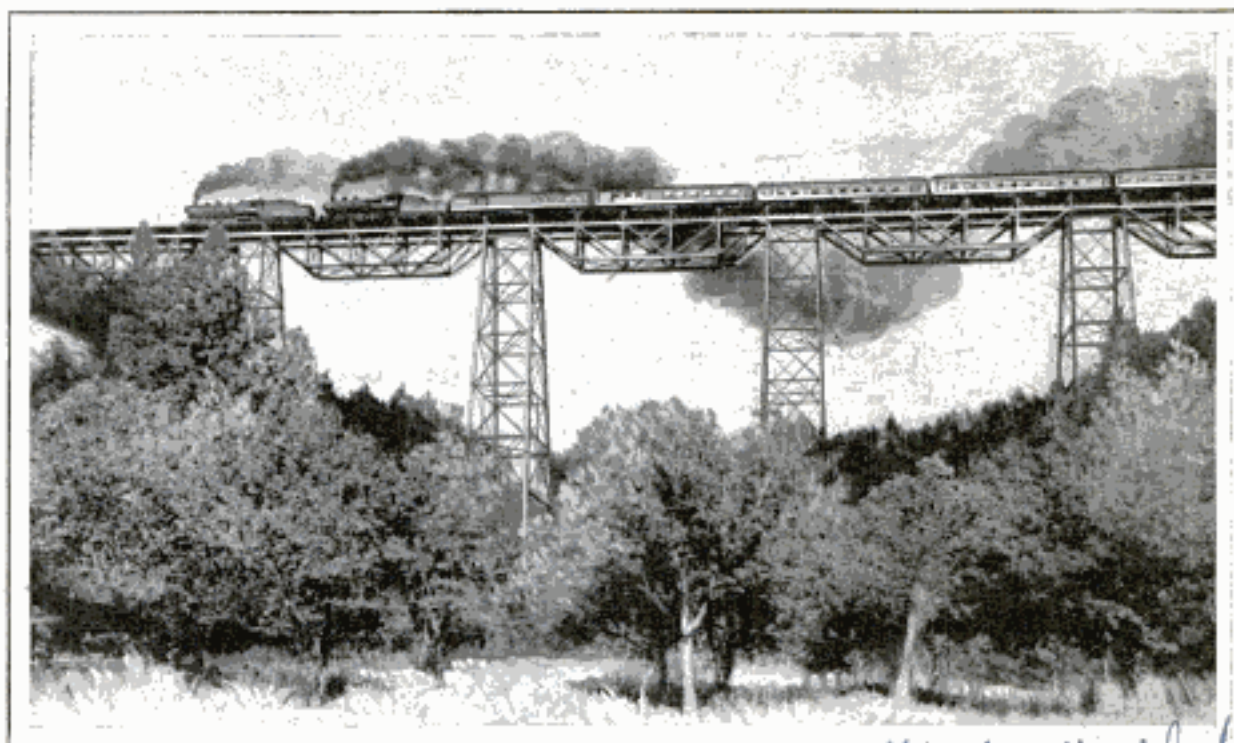

Passenger Train Traversing a Railroad on Stilts; This Viaduct, near Missoula, Mont., Is 226 Feet High and 797 Feet Long, and Represents a Remarkable Feat of Railroad Engineering

Building a railroad through the Rocky mountains entails many remarkable feats of engineering of which one of the most striking, from a scenic angle, is the Marent viaduct on the Northern Pacific system, a few miles from Missoula, Mont. This viaduct, stretching from one elevation to another, is literally a railroad on stilts. It is 797 feet long and 226 feet high, and, from below, a train crossing the span looks like a toy locomotive and coaches.

DREAM OF TUNGSTEN PLATING FINALLY COMES TRUE

Tungsten plating, long a dream of chemists, now can be made through an electric process discovered by Prof. Colin G. Fink, of Columbia University, who also was the first to plate chromium commercially. Tungsten plate appears even whiter than silver, because it does not tarnish when exposed to the air. In addition, it is one of the hardest of metals, is insoluble in acids and has a melting point of 6,150 degrees Fahrenheit. These qualities make it useful in industries depending on chemical processes where resistance to heat and acid is important. If household

utensils of tungsten plate come into general use later, the polishing labors of the housewife will be ended and, plated on aluminum, it will give an article of great lightness and durability. At present, however, it is particularly suited for electrical contacts and arcking points subject to great temperature changes. The plating process involves the passing of an electric current through a water solution of sodium tungstate. In this manner, deposits of metallic tungsten have been produced on a variety of metals, including brass, copper, zinc, iron and carbon. The plated surface is smooth, hard and coherent, having a high luster. Tungsten plate is superior to chromium because the latter melts at a lower temperature and is soluble in hydrochloric acid.

SELF-INFLATING BICYCLE TIRES

Bicycle tires are kept at a constant pressure by a small pump built into each wheel. A German inventor has demonstrated that this device, which is driven by a cam on the hub of each wheel, automatically goes into action when the tire pressure falls below normal and stops when proper inflation is reached.

J. Erdmann & Co.
Berlin, S. W. 11, Kleinburenstr.
26. Erdmanns.

Used World

a-1164

a. 100 6

*Science Service
528-5
5/31/16*

*Electrochemical Dept.
New York City*

Winfield Carburetor Co. Ltd.
 Box 698, Glendale
 Calif

a 1015

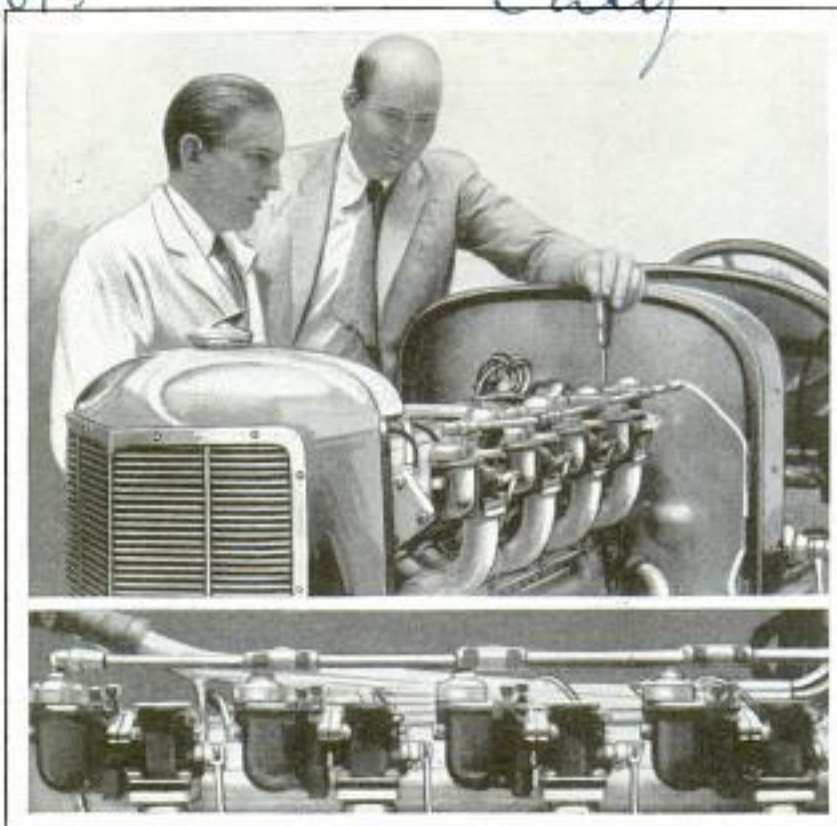

More Cylinders Have Brought More Carburetors for the Racing Auto; Here Are Shown Four Carburetors, One for Each Pair of Cylinders

FOUR CARBURETORS ADD SPEED IN EIGHT-CYLINDER RACER

One carburetor for every two cylinders is the practice in building many of the racing cars which are going after records this year. Multiple carburation eliminates the possibility of "starved" cylinders and adds punch when it is needed. Four, eight and sixteen-cylinder racers have gone over to the "one to two" principle with the result that both designers and drivers expect to hit speeds well above former best records. Double and multiple carburation in racing cars is believed to indicate that ordinary automobiles may soon be similarly equipped.

PARAFFIN WAX MADE INTO OIL FOR HIGH-GRADE MOTORS

Paraffin wax, the petroleum by-product formerly considered of least value as a lubricant, has been found to have in it the elements most desired by oil chemists in their search for the "perfect" lubricant. Millions of dollars were spent in the development of refining processes which would eliminate the paraffin wax; large

amounts are now being spent to produce the paraffin-wax motor oil on a commercial scale. The oil made from the once shunned wax is at present expensive, due to the complicated processes which are necessary, but tests have shown that it is less affected by temperature changes than any other known oil. It can be made thick or thin and has been found useful for airplane engines, auto gear shifts and shock absorbers, etc.

a-1012

"ONE-WAY SCREEN" USED IN STUDY OF BABIES

"One-way observation" has been made possible by a special screen developed for the use of students in the Yale institute of human relations. The curious dome-shaped screen completely hides those on the outside, but permits them to see clearly whatever goes on inside the dome. This equipment is particularly useful in the observation of infants and children who would otherwise be distracted by the presence of the watchers. Entirely unaware of the observers the children meet the various tests naturally and instinctively.



One-Way Screen Which Permits Observers to Watch Infants in Nursery without Being Seen

a 105

Standard Oil Co of Indiana 910 S Michigan Ave Chicago

at New Haven

Copyrighted material

Study of Child Development
 Dr. Arnold Gesell
 not in market probably
 the infant in the screen is Bond
 the infant in the screen is Bond

A. 936 Com. Walter E. Burton,
1082 Florida Ave Akron, Ohio

The TRUTH about OUR NATIONAL BIRD

HATCHING of three eagle eggs recently marked the final chapter in a long study by Dr. Francis H. Herrick, of Western Reserve University, to solve the mystery of the American, or "bald" eagle's life history. For years Doctor Herrick has been building towers near eagle nests, and watching and photographing the home activities of the birds. The tower method gave but a part of the

Cleveland Ohio



Eighty-Foot Tower and a Platform on Which a Tent Was Placed to Observe the Eyrie of an American Eagle at Vermilion, Ohio; Below, Female Preparing to Feed Hungry Youngster

whole story because of its distance limitations. Until Doctor Herrick found three eagle eggs in Canada and brought them to Cleveland hens, no one knew

how a young eagle was hatched, or how it grew up.

The coming-out process of an eaglet showed unusual mechanical abilities. On

a. 936



in length and two to three inches in diameter, are carried to the nest. An adult eagle weighs from eight to ten pounds and has a wingspread as great as seven to eight feet.

Although farmers are inclined to blame eagles for loss of numerous chickens, turkeys, and even lambs and small calves, Doctor Herrick has found that the eagle does not deserve such reputation. True, he likes chickens, but his taste is satisfied only occasionally, so that each farmer near an eyrie will lose perhaps a fowl or two in a year.

When the young Vermilion eagles were reaching full growth, they put on an interesting show for Doctor Herrick and the other observers. Using sticks for playthings, they whiled away the hours much like human children do. But their play often had a purely practical purpose. They engaged in flying exercises that gradually resulted in their acquiring full power

the upper mandible of the eaglet's bill, near the tip, is a sharp spur or "egg" tooth." With this the bird makes perforations about the circumference of the shell. Then, by exerting pressure outward on the two halves of the shell, the eaglet creates a crack and enlarges this gradually until the egg splits apart, and the eaglet begins its life cycle. As the bird grows older the egg tooth disappears.



At Vermilion, Ohio, on the shore of Lake Erie west of Cleveland, a pair of American eagles had established their home prior to 1840. Ever since, these eagles or their successors have maintained nests and reared young in the same neighborhood. The eagle, like many of its human neighbors, mates once, and, barring accidents, for the remainder of its life. An eagle in captivity in Vienna is reported to have lived 104 years.

Both mother and father eagle, it was learned, engage in the nest building. This is not a difficult task for these large birds. Swooping low over fields, they pick up bunches of hay or dead weeds in their talons. Sticks, some as much as six feet



Top, Eagle Carrying a Fish; Center, Eleven-Day-Old Eaglet; Below, Close-Up of Eagle's Nest

to conquer the winds. First flights attained an altitude of a foot or two above the nest, and first trips beyond the rim were made for very short distances.

It is only when his home is molested that the eagle becomes the warrior he so often has been pictured. Then he will attack man or any other intruder.

You probably have observed that the eagle appears in the decorative scheme of bank interiors and that sometimes the reproduction shows a bird with feathered legs. This is illustrative of one of the kinds of misinformation about our national bird. The true American eagle wears no feather leggings. Furthermore, the researches have proved that no other bird could have been selected that would have displayed greater courage, intelligence, majesty and faithfulness so desirable in a nation's hero.

FREE WHEELING FOR ANY AUTO IN ONE SIMPLE UNIT Q 1042

Any make of automobile, truck or bus now can be converted to the free-wheeling type of car by installing a simple unit that operates by vacuum to disengage the motor and allow the car to coast when the foot is lifted from the accelerator. The unit is attached to the dash under the hood and connected to the clutch pedal below the floor. It consists of a cylinder and piston connected to the intake manifold with a copper tube. The piston is operated by the vacuum caused by the idling of the motor, thus releasing the clutch. The vacuum is relieved when the accelerator is depressed. A button on the dash converts the car to the conventional gear shift, and a safety appliance automatically starts the motor, should it die while free wheeling. \$18.00

CA long-distance gliding record of 165 miles has been made in Germany.

Safety Free Wheeling Co.
540 N. Michigan Ave.
Chicago

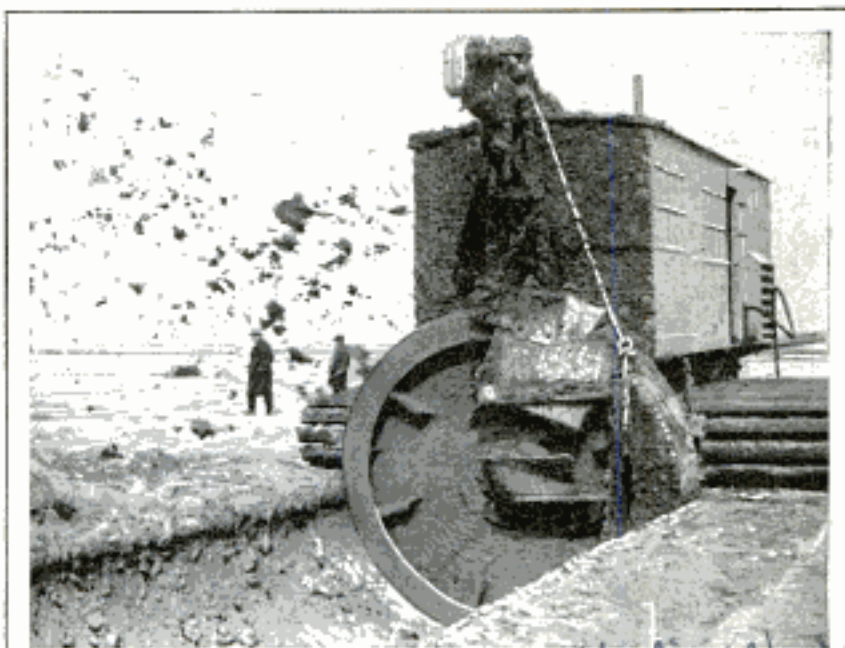

Rotary Trench Digger Operated Like Snowplow; the Revolving Blades Cut into the Soil and Send Up a Shower of Dirt

Wide World

WHIRLING WHEELS DIG DITCHES FOR WATER PIPES

Along the shores of the Zuyder Zee, Holland, a fleet of rotary trench diggers is busy excavating for a new drinking-water system. The trench machines use swiftly revolving blades which cut into the soft soil and send up a constant shower of mud and dirt. In principle, they are much like rotary snowplows. As the trench diggers move along, crews of workmen lay the pipes.

SELF-AERATING MINNOW PAIL KEEPS BAIT ALIVE Q 1001

To keep minnows alive for longer periods, the inside container of a perforated bait bucket is made of porous material that lets air reach the fish without draining the water. As lack of oxygen in the water causes minnows to die quickly, the self-aerating bucket obviates this difficulty and keeps the bait alive longer than in an ordinary container.



Shakespeare Co.
Kalamazoo, Mich.

STEALING LAND FROM A LAKE TO BUILD A PARK



solving its problem of finding more room for expansion by pushing back the lake and manufacturing its land. Much of Lincoln Park, on the north side, today stands on made land, formed by building jetties into the lake and filling in the lake front, allowing the water itself to help with the task by bringing in sand. To alleviate its growing pains the city now has under way a huge reclamation project providing for the making of 259 acres of park land out of what at present is water. It will cost \$4,000,000 and



University Ave. S.E.
Munich, Minn.

General View of a Section of Chicago's Lake Front Composed of "Made" Land, Formed by Filling in Sand along the Shore Line; Above, One of the Big Sand Boats Dumping Its Load

Chicago is growing so fast that it is spilling over into Lake Michigan and is

7,000,000 cubic yards of sand will be used to fill in and extend the shore.

Probably Physical Review 1500

MICHELSON'S LAST LIGHT TEST WILL BE SURVEYING AID

Although the originator of the experiment is dead, the world's most precise determination of the speed of light is to be completed by the associates of the late Dr. Albert A. Michelson, famous scientist. At the time of Doctor Michelson's death the experiment had reached a stage where his associates were able to fix the tentative value for the velocity of light resulting from the work as about the same as that obtained from the scientist's previous experiment on Mt. Wilson. A

few days before he died, the physicist dictated the outline for a scientific paper which eventually will announce to the world the most precise value of light's speed. The mile-long tube in which the present experiment is being performed, is located near Santa Ana, Calif., cost \$50,000 and took two years to build. Its length is accurate to one part in a million. Its welded construction made it possible to exhaust virtually all the air in it and pumps are run day and night to preserve the near vacuum of the mile-long cylinder, which is three feet in diameter. The tube gives the first oppor-

A 10 39

Science Service Bulletin 529-A. 5/11/31

tunity to measure the speed of light in a virtual vacuum. The previous measurements were made by sending a beam of light from a distant mountain peak to a revolving mirror on Mt. Wilson. This gave a figure of 186,290 miles a second, which is believed to be accurate to within about three miles per second. When the present experiments are finished, the measurement is expected to be so exact that it will be possible to use the speed of light as a yardstick in precise surveying.

91091

MOWER RUNS HAY IN CRUSHER TO HURRY CURING PROCESS

To lessen the time required for curing hay and alfalfa, a power mower is equipped with a crusher somewhat like a clothes wringer that squeezes out the moisture as the grass passes between rubber-covered steel rollers. The cut hay falls on a draper which elevates it to the rear of the mower where it passes between the rollers mounted parallel to the cutter bar. The lower roller is held rigidly, and the upper floats under a 2,000-pound tension maintained by two springs. All of the stems are crushed by the rollers, and the internal moisture is pressed out to be taken up by the sun's rays. Alfalfa, cut in the morning of a good drying day, is ready to put up late in the afternoon and the hurrying of the curing process results in less bleaching. The whole unit is mounted on a tractor. The cutting, elevating and crushing mechanism is driven through a chain from a sprocket on the pulley jackshaft of the tractor.



Power Mower That Runs Hay or Alfalfa through a Crusher, Made Like a Clothes Wringer, to Lessen Time Required for Curing

*Being developed by the
Wood Machinery Corporation
St. Louis, Mo.*

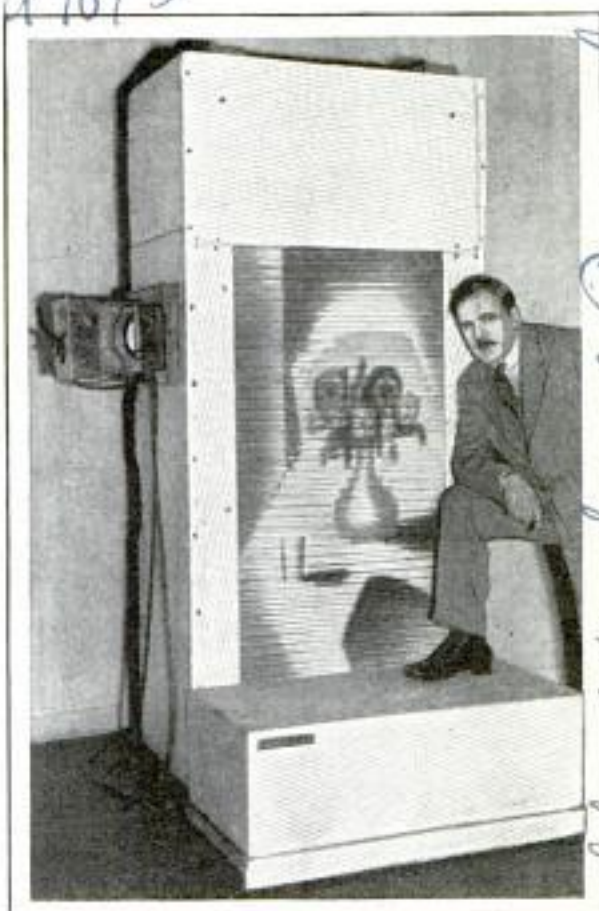

Boxlike Apparatus Which Shows Paintings in Motion, Effect Being Similar to Moving Pictures

ART OF THE FUTURE IS SEEN IN MOVING PAINTINGS

Motion has been added to art by an apparatus recently demonstrated in New York which literally shows paintings with the images moving. The effect is somewhat similar to moving pictures, since the boxlike moving painting machine reveals, on one of its two faces, many varied designs and pictures, constantly moving, and each a complete and perfect image. On the opposite face is the picture of a woman in many poses and costumes, also constantly changing as a score of belts move on a turnstile arrangement. While thirty-two assorted images are now the capacity of the device, the future range for change and movement is said to be virtually unlimited.

*at School for Social Research
66 W. 12 St., New York
I. M. Alexander
Archipenko*

a 919. Cmt. Andrew G. Boone
613 S. Preschels Theater Bldg
San Diego, Calif

The New Wonders of



AN AGED actor, the dark lines of many years shadowing a once-handsome face, breathes the fumes from a potent compound. He seeks eternal youth.

"Is it to be failure?" he asks, "or"—as he turns his face again into the fumes—"is it to be success?"

On the screen, in a test picture, the gray lines of his face gradually disappear. Youth comes to one side of his face and in a few seconds, as the camera continues to grind, spreads across his countenance.

Here you have one of the most intricate tricks of movie make-up, accomplished not so much by the camera as by the make-up artist. No abrupt change, such as would be obtained by stopping the camera and replacing the actor an hour later in the same spot, but a gradual, though rapid, counterevolution from sixty years to twenty.



Make-Up Room, Above; Below, the Artist Makes "Age" by Penciling in Lines around the Eyes

Here's the trick: The actor is made up to look like a sixty-year-old professor. His eyebrows, lips and hair are red. The

a 919

Movie Make-Up



Often Seven Make-Up Artists Will Work on One Actor; Here Are Three Hairdressers, Body Make-Up Man, Beard Trimmer, Property Man and Face Make-Up Man Preparing a Subject

winkles and lines of age are green. As the camera shoots through a red filter, his hair, lips and eyebrows appear to be white, and the green lines of age in his face stand out strikingly. Now the filters, overlapped and shaded, begin to move across the camera lens. As the red filter leaves and the green passes in front of the film, the red hair becomes black, the green age lines disappear and, lo, before your very eyes age changes to youth.

Young actors are made old for the camera by intricate and skillful application of hair and grease paint. Old actors "go young" by temporary plastic surgery. This involves use of fish skin glued in front of each ear and pulled upward to smooth out flabby flesh. Then a dark shade of brown grease paint restores youthful luster to old cheeks, for youth's skin is darker than that of age.

Gray-haired German, French and Italian women, who seldom see motion pictures, contribute materially to realism ob-

tained in filming close-ups of young actors, turned gray for character parts. The hairs from those venerable heads, hairs that are cultivated for sale, are baled and shipped in 300-pound packages to the United States. Finer hair is worked into hair-lace pieces, which also are shipped to Hollywood. Later these pieces become groundwork into which human hairs of various shades are "ventilated," as the process of fixing the hair to the lace is called.

Fully half the movie stars, when made up to appear older, or to show hair over a receding hair line, wear the hair-lace pieces. Two twin brothers, Ern and Perce Westmore, members of a famous family of movie make-up artists, developed the use of hair lace to replace the old-fashioned and cumbersome wigs.

The lace is hand-made, and a tiny piece containing possibly five square inches costs \$6. The lace itself is fabricated in Europe from white human hairs, and the

a. 919
218

Can be obtained from
Max Factor's Makeup Studio
POPULAR MECHANICS
666 N. Highland Ave



Hollywood
Cady

"We can add youth to nearly any face," explained Ern Westmore, as he gave a practical demonstration of temporary plastic surgery on Roscoe Ates to make the character actor's eyes droop and add fifty years to his appearance, "but it's not so easy with age. We first must have a face with the proper contour, but on the proper subject a good make-up artist can produce age ranging from youth to hoary antiquity."

He reached into a box for a long strip of fish skin, which, because transparent, has the same photographic value as human skin; produced from another a bot-

Fish skin! 25



Removing the Natural Beard, Above, in Favor of an Artificial One; When Possible, the Artist Works from a Photograph, as Below, in Making Up

movie trick of using them consists in applying hair and making them into a hair line that looks more natural than an actor's ordinary stand of hair. Each hair fastened to a hair lace is looped, and a knot similar to a crochet knot is tied.

Actors partly bald in a few minutes may acquire a more youthful appearance by donning a hair lace. They may portray a character, take on several decades in age, adopt almost any appearance in this manner. A few years ago, wigs of hair built into silk milling gauze, such as that used in the milling of flour, were used. But they showed abrupt hair lines, patently were false. Now the "more human" hair lace enables make-up artists to graduate the wig from luxurious growth at one point, to a very fine application that causes it to appear as though the hairs were growing out of the actor's skin. In fact, the hair lace does not register on the screen, even though a head may appear forty to sixty times larger than the original.

How and why do these changes in an actor's face make him older or younger?

of liquid adhesive, and gathered up other bottles of talcum powder, grease paint, a ball of wax and other accoutrements. The actor sat facing three mirrors, illuminated both from the sides, the top and the bottom.

"Here," Westmore explained, "we have the same light conditions the actors will have when on the set. We can cut out any of the lights for various effects of top or side lighting. By watching the lights carefully we know exactly how the actors will appear on the film."

As he spoke he covered the actor's face with the black grease.

"In doing age," he explained, "we first cover the face with black, then with white talcum powder to get a hard surface. At this point the actor must raise his forehead and wrinkle it. While the wrinkles

liquid drug store
hospital supply stores
material

GROWING OLD SPEEDILY—HOW YEARS ARE ADDED

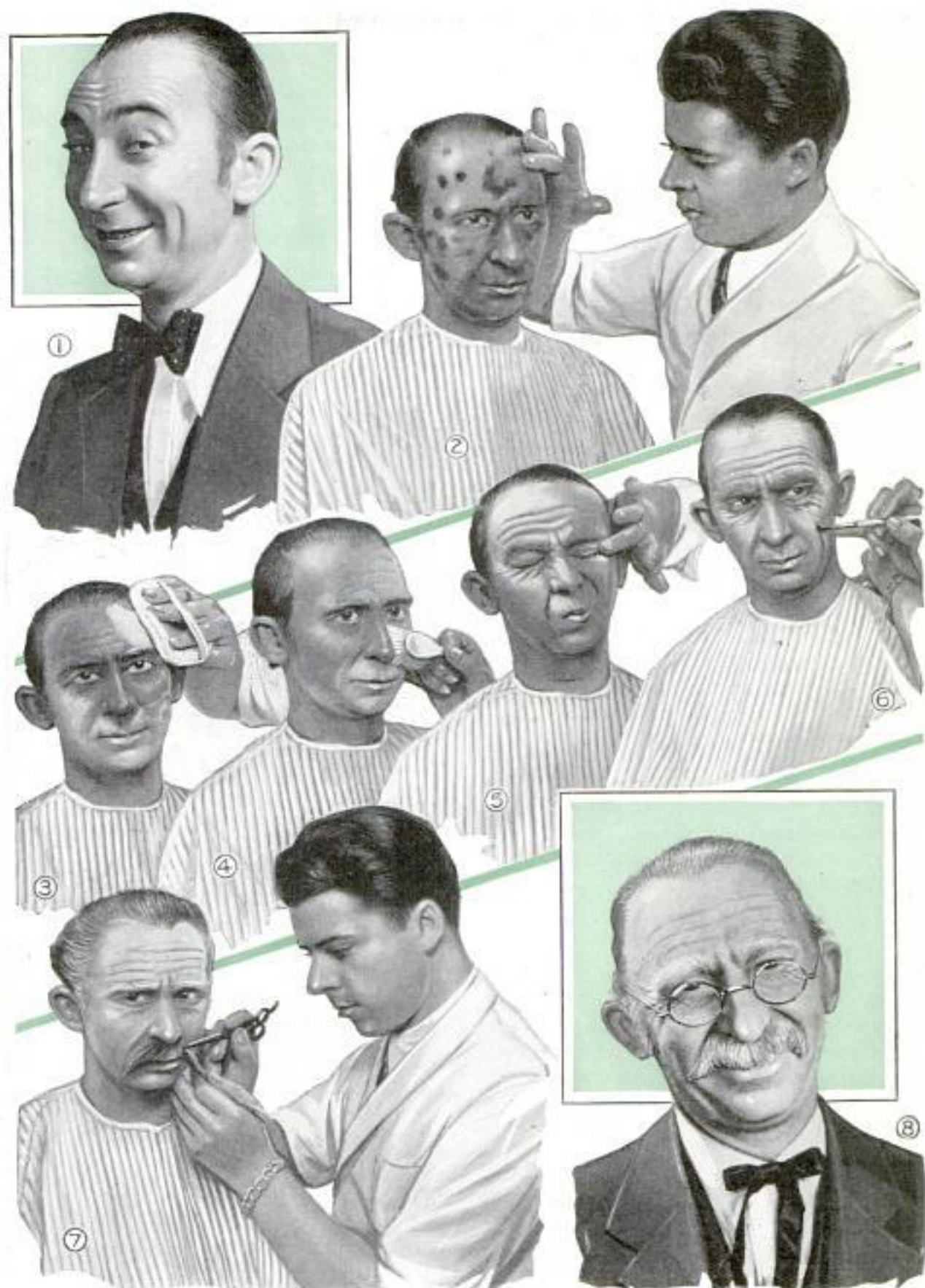

Above, Left, the Actor at Thirty; Figs. 2 to 7 Show the Progressive Stages in Adding Age, and Fig. 8 Is the Finished "Product," Forty Years "Older" in About Two Hours

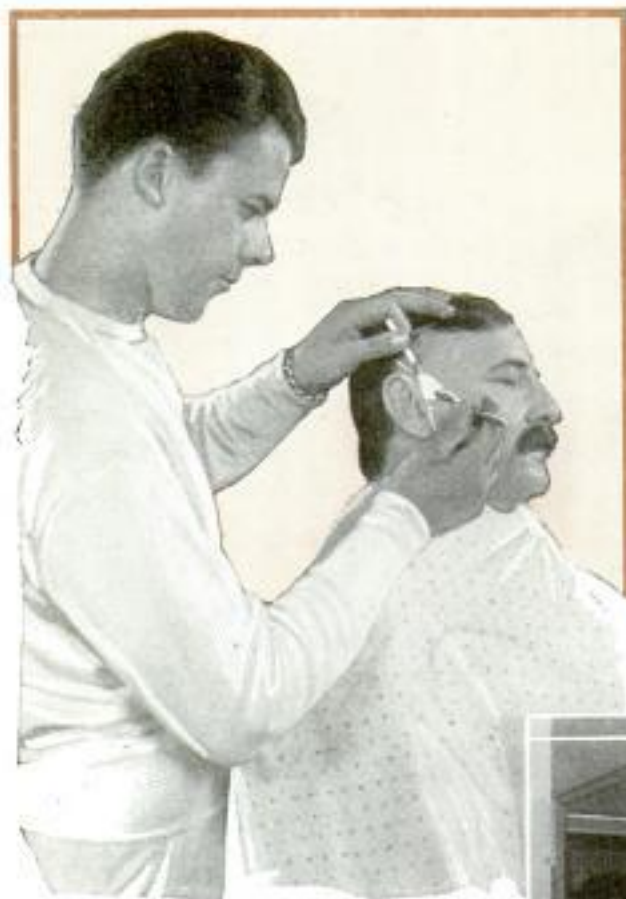

use most. Studying the high lights and shadows, we apply grease paint of various shades with a brush. The lighter shades give us the high lights, and the darker shades the shadows.

"Some of these lines, and the fish skin, will be covered by his beard.

"As you note, we apply the beard a hair at a time and sometimes in small clumps of thirty or forty hairs. Here again, the artificial looks more natural than the original. Suppose we were called upon to make up a white actor to resemble a Hindu. If he shaved his own beard, it would take on an artificial appearance with sharp edges. With an artificial beard we not only can shade the hairs to match perfectly, but we cut it down on the edges so perfectly that a hair line is not visible in the camera.

are up, we pat skin-shade grease paint on. Then, when he smooths his forehead again, the dark wrinkles stand out prominently. In addition, patting rather than rubbing the grease paint gives his skin a porous look which makes his facial appearance seem much older than the smooth skin of a young man."

Now the face was ready to make a few additional touches of age. Westmore pulled down the skin under the actor's eyes and gathered it under the upper end of a narrow strip of fish skin. From each eye, the fish skin passed down the wall of his face and overlapped underneath the chin. This added fifty years to his eyes in less than five minutes, but the make-up was not complete.

"The next important step," Westmore said, "is to cause his lower face muscles, his jowls, to drop. Always in preparing for that part of the make-up, the actor reads a few lines from the script so we can determine what expression he will



Above, Temporary Plastic Surgery Rolls Back Time for the Elderly Actor; Below, Wigs Are Baked in Ovens

"It is less difficult to make men appear very old than it is to add a half century to a woman's appearance," Westmore explained. "Yet we must be very careful with male make-up to avoid giving the actor an effeminate appearance. For instance, we never use artificial eyelashes on men."

a 1085 d w. Bernard Akers
line coach, University
221
of Nebraska.
Lincoln Nebraska

POPULAR MECHANICS

PADDED BAGS SERVE AS DUMMY FOOTBALL TEAM

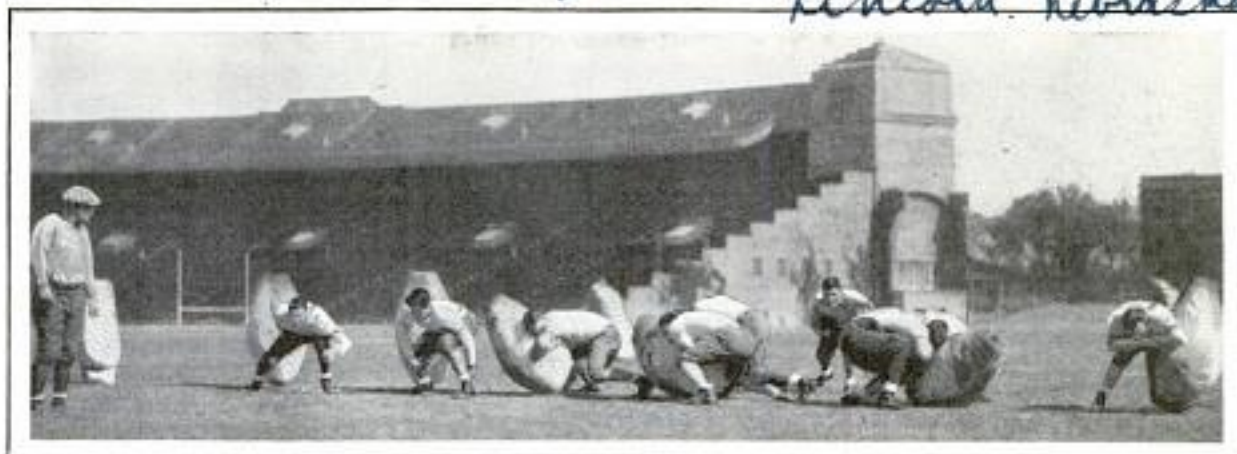

Football Players Bucking a Dummy Line Consisting of Sacks Padded around Iron Rods to Which Coil Springs Are Attached; When Struck by the Players, the Sacks Are Pushed Downward

Football players of the University of Nebraska are bucking a dummy line of padded bags that offers about as much resistance as a wall of real players might. The dummy team consists of seven canvas sacks, each padded around an iron pipe. The pipes fit in holes in the grid-iron and are on coil springs so that they bend when hit by the charging players, then spring upright again. A series of iron rods, sunk in the field and filled with plugs when not in use, enables the line coach to arrange any formation of the dummies he desires. The line machine is better than the old apparatus, which involved a framework with swinging dummies attached by ropes, since the bags do not give way before a light charge by a lineman and are never out of place. Also, the top beam of the framework often interfered with forward-pass play, and the trestles did not permit a team to run full speed through its offensive drill.

SIGNS PAINTED ON ROADS GUIDE
AIR-MAIL FLYERS a 1166

Air-mail flyers, traveling across Iowa from east to west, now are guided by huge signs painted on the surface of one of the state's main highways, which approximates the path of the mail planes across this commonwealth. These markers, in yellow letters, are seventy-five feet long and eighteen feet wide, and are plainly visible to pilots at a high altitude. The guides appear a few miles apart and were painted on the highway without disrupting traffic by closing half the road

Cond. George G. Harrison
218 Logan
Criminal Bluff, Iowa

while the lettering was done and dried, then closing the other half and completing the job.

AIR IMPULSE IS HARNESSSED
TO DRIVE AUTO a-1113

Two German inventors have made what they call an aeromobile which is an auto driven by an air propeller. The air screw is not installed vertically, however, but lies horizontally on the back part of the chassis. Above it are several parallel plane surfaces forming a sort of lattice-work arrangement, the angles of which can be altered. The air stream produced by the propeller breaks through these surfaces, providing the driving power. When the surfaces are perpendicular the car stops, when they lean back, it moves forward, and when they are pushed forward, the car moves backward.

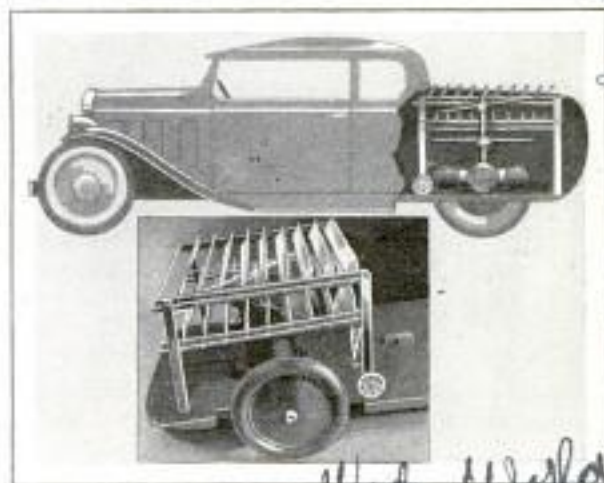

Auto Driven by Propeller at Rear, Which Sends Air Stream Upward through Movable Planes

Wade Work

Emil Bohm and
Herbert Kohner

Epico 4/25/31

99 99

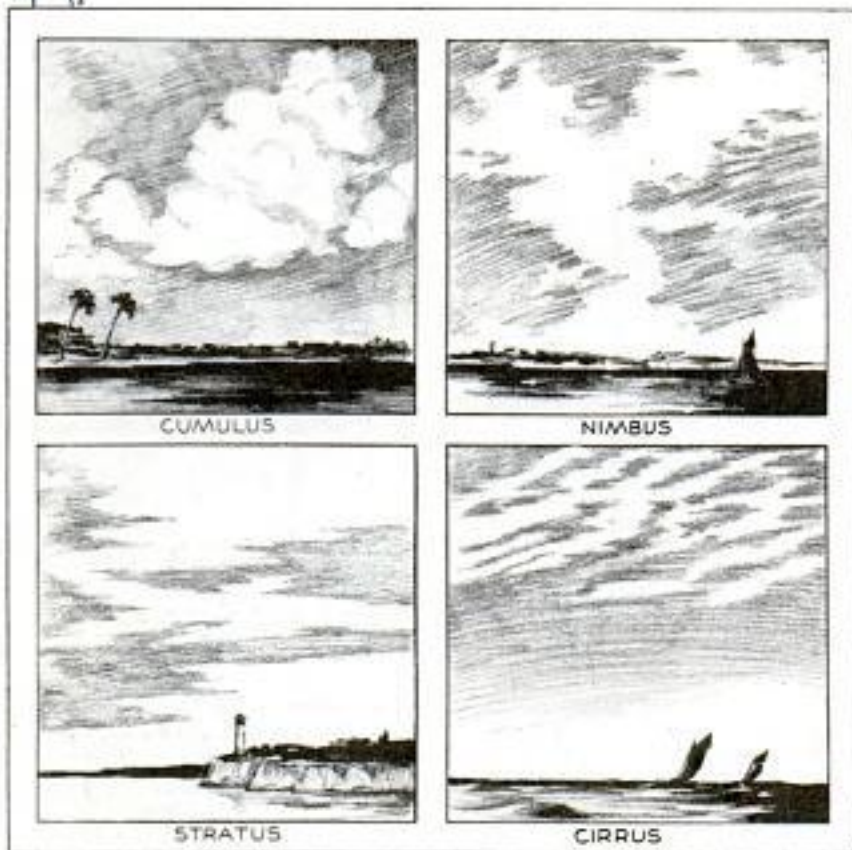

Illustrating the Four Principal Types of Cloud Formations, from Which the Weather Can Be Predicted to a Limited Extent

FORMATION OF CLOUDS SHOWS WEATHER TO BE EXPECTED

Weather can be predicted to some extent by cloud shapes and formations. There are four principal types of clouds, although frequently in the same sky may be seen combinations of the various types. Cumulus clouds are the large, white lumpy ones usually associated with calm, sunny days, while nimbus clouds are those dark ones with shiny, sunlit edges that tell of rain. Stratus clouds are the low-hanging variety that stretch entirely across the sky, and cirrus is the name applied to little feathery ones seen high in the sky on a very windy day.

ALL-BLACK OPERATING ROOMS AN AID TO SURGEONS

To offset the glare of gleaming white walls, white ceilings and equipment in hospital operating rooms, Russian hospital builders are turning to its opposite as the ideal finish for surgeries. The walls are painted a dead-black and all operating-table linen and garments worn by the surgeon and his assistants are made of

black cloth. With careful lighting, it is claimed that delicate work can be done with a minimum of eye strain. All-black operating rooms are being advocated for American hospitals by a physician who recently returned from Russia.

9105-7

ONE-MAN GARAGE SERVICE CAR

Garages that heretofore have been compelled to send two men to call for a car now can do the job with but one through the use of a motorcycle service car equipped for towing behind the automobile. The garage employe makes the trip after the car on the motorcycle, then attaches the three-wheeled vehicle to the rear bumper of the

auto by means of a padded clamp and drives back to the garage. The motorcycle has a differential and brakes on all three wheels and a box body large enough for tools, parts and batteries. If a second man is needed, he can ride on the box, or it can be used to attach a spare tire or other parts. The cycle will not upset or skid, even on sharp curves.

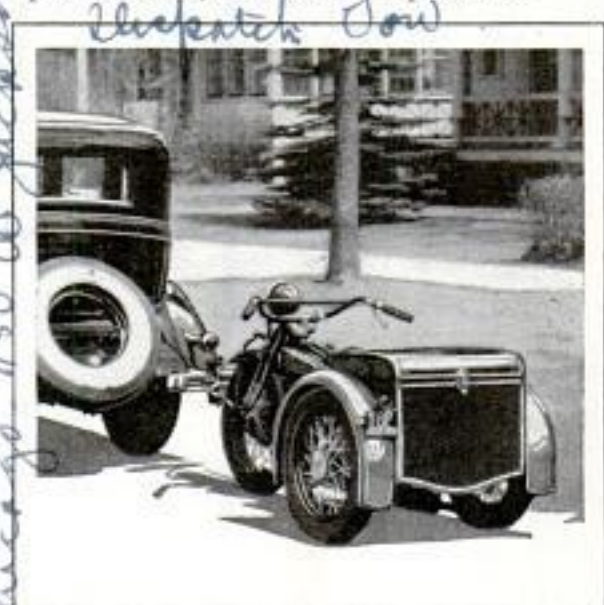

Motorcycle That Can Be Towed behind Auto, Enabling One Man to Call for or Deliver a Car

Indian Motorcycle Co., Springfield, Mass.

Herald and Examiner 5/16/31

91063

Mr. Alfonso A. Bacon before north side branch Chicago Medical Society

Vertical text on the right side of the page, possibly a page number or reference.

JUST HOW LONG WILL A SUIT OF CLOTHES WEAR?



Left, Rubbing Apparatus for Measuring the Wearing Qualities of Cloth; Right, Testing Cloth for Warmth; the Cylinder Is Heated and the Heat Escapes Only through the Cloth at Top

Mr. Simmons works for clothing manufacturers, and other cloth buyers.

Whether or not that new overcoat will keep you warm, or a summer suit will keep you cool, is no longer guesswork, but a matter of scientific testing. Textile engineers and chemists now determine the wearing qualities of cloth before the material is even bought by the manufacturer, much less made into suits. Just how long a pair of trousers, or the elbow of a coat, will last is now a matter of accurate calculation in the laboratory, which also finds what the hot summer sun will do to dyes, whether a coat is rainproof, and the effects of perspiration. For the elbow-rubbing test, a piece of cloth is fastened to a board, and another piece attached to a movable arm. A small machine is started and the effect is the same as the sleeve of a coat brushing against the side of a garment. Each rub is recorded on a counter, and the results are tabulated for each kind of material. In addition to the rubbing, in testing summer materials, an acid is added that has the same effect as perspiration on the cloth. The result of a few hours on the testing machine is the same as playing tennis daily for two months with a coat made of the material

tightly buttoned about the player. Other materials are impregnated with the acid having the effect of perspiration and then tested on an apparatus which determines the force necessary to tear the cloth. An electric arc in a few hours tells whether or not sunshine will fade colors and rain-proofing is indicated by applying a certain amount of moisture and determining the time required for the dampness to pass through. To determine warmth, a sample is placed tightly over the top of an electrically heated cylinder. The cylinder is insulated so all the heat must escape through the cloth. Ammeters determine the amount of heat in the cylinder and thermometers the amount escaping.

A 1006

IRON KEEPS TREES GREEN

Trees threatened with a disease called chlorosis, which produces a loss of green in the foliage, can be kept healthy by treatment with solutions of iron salts. The salts may be injected through an iron tube, inserted into the tree trunk and sealed up, or they may be placed in a narrow trench around the base of the tree.

*Cont. William Zukas
 4756
 221st, Mich*

α 1024

224

Arch. J. E. Murphy.

1052 Milwaukee, Denver Colo

POPULAR MECHANICS

ROAD BUILDING IN THE CLOUDS IS HAZARDOUS TASK

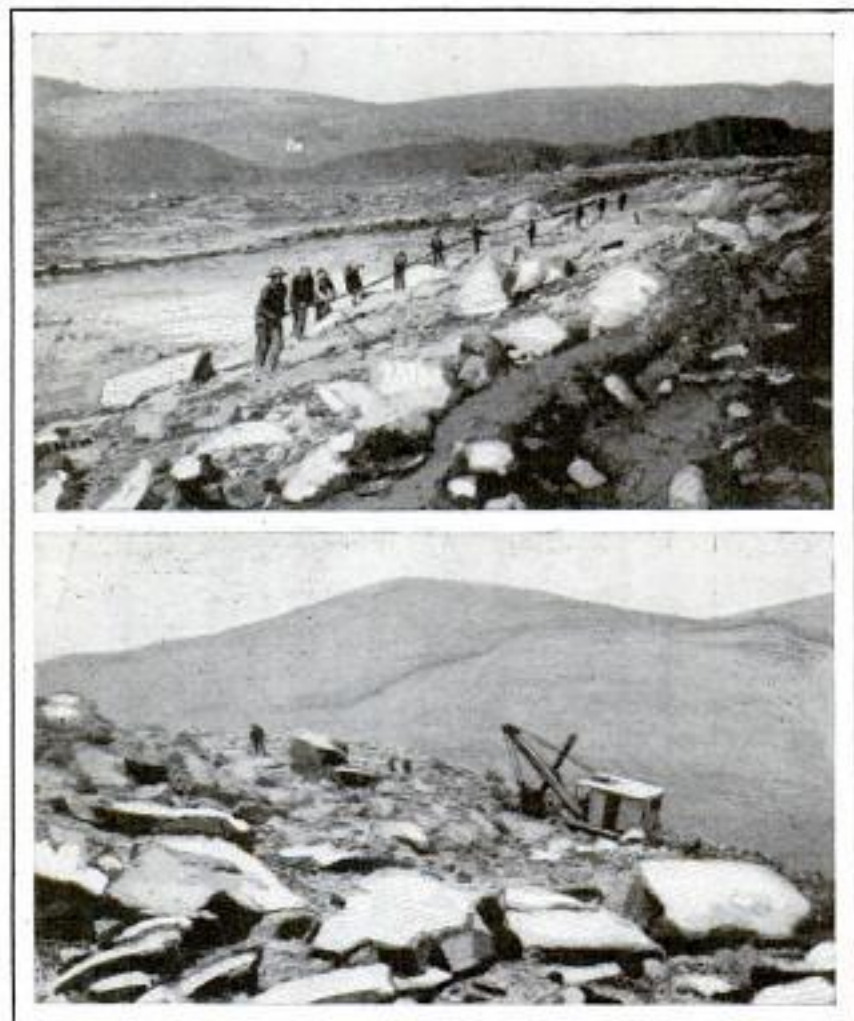

Above, Carrying 1,500-Foot Air Pipeline from One Switchback Up to Next; Below, Power Shovel Excavating Road after Dynamite Blast

In a road-construction camp near the top of Mt. Evans, Colorado, the cook reached unhesitatingly into a pan of boiling water and picked up a spoon that had been left there through oversight. There was no scalding, and little or no discomfort. In itself this was an insignificant incident, but indicates the unusual, fascinating and sometimes dangerous things met with when you live and work near the 14,000-foot level. The explanation of the incident lies in the low atmospheric pressure. At 13,700 feet, where this camp was located, the air pressure is only nine pounds to the square inch, and water boils at 189 degrees Fahrenheit. Road-building jobs are pretty much the same wherever located. But this job, building the last two miles of the automobile road connecting Denver with the summit of Mt. Evans, was unusual in the matter of

living and working conditions and in the operation of construction equipment. Of the forty men who started in June, last year, only six were able to carry on without a break to the end of the season in September, and only one was entirely immune to the effects of altitude. In general, it took three men to do the work that would ordinarily be done by one man at sea level. In the mountain country, Denver, a mile above sea level, is considered the dividing point between high and low. Real altitude begins at the timber line, which is slightly under 12,000 feet. Here also begins a different world, a weird bare land of silence inhabited only by the chipmunk and the diminutive marmot and cony. The effect of the thin air on the construction equipment was fully as pronounced. The

two gas-operated shovels and the motor trucks were adjusted to an exceedingly fine spray, but even then they worked at only half their normal capacity. A dangerous thing frequently found at high altitude is the condition of electric tension called static, and the workers on the Mt. Evans road had their full share of it. Static is a condition that comes and goes, and when it is present, it is best to keep at a safe distance from all metallic objects. In one severe spell of static, the operator was knocked from one of the shovels, and three men working in the blacksmith shop were knocked down and slightly injured. Because of the danger from static, all dynamite charges were fired by fuse and cap. In one case a charge was set off prematurely when static struck a few inches of uninsulated wire at the connection with the battery box.

William Harrigan

POPULAR MECHANICS
national Retail Day
TIRES AND CLOTHING FROM OIL
CALLED NEAR IN U. S.
225 W 34th St
a-1234

225

all 1 5

Petroleum in a relatively short time will have applications almost undreamed of, according to an engineer speaking recently before a convention in Washington. "We may well expect petroleum to become a factor in the manufacture of furniture, as upholstery and top covering for automobiles, as insulating material for electrical apparatus, as synthetic cloth for the making of clothing, and in great demand for synthetic rubber, giving the automotive industry, for the first time, tires made from petroleum," he declared.

TAXI-COACH GIVES CAB SPEED WITH CAPACITY OF BUS

Cross a taxicab with a bus and the result is the taxi-coach, a commercial vehicle with the speed of a private automobile, and one which is handled almost as easily. The vehicle has three compartments, each with an outside door, three seats facing forward and three backward. Each seat has individual cushions. The over-all width is the same as the standard automobile's. Fares are collected from each compartment by dropping the proper coin in a slot. When change is desired, the passenger places his money in a small container similar to cash-carrying tubes in a department store. The box runs to the driver, who makes change and returns it to the passenger.

a-1141



Three Timepieces—Two Water Clocks, Ancient and Medieval, and a Sundial

ANCIENT WATER CLOCK HELPS MAKE MODERN PAINT

Used by the Babylonians several centuries before Christ, the water clock has become essential in the manufacture of paint. It is declared the simplest means of testing ever invented. The old water clock was a cone with a tiny hole in the bottom, which, when inserted in a jar of water, was known to fill to a certain level within an hour. In its new field, the cone is inserted in varying grades of paints, the viscosities of which are measured by the length of time it takes each sample to fill the cone to a certain level.

Cont. Washington Electric Mfg. Co.

Chicago 105 W. Adams



The Driver of the Taxi-Coach Sits over the Engine So He Can See the Road

Twin Coach Corp
Kent Ohio

DOORKNOBS MADE OF COTTON TO HELP THE FARMER

Efforts to find new uses for cotton, emphasized in connection with aid to southern farmers, have found results in plans for doorknobs, buttons, automobile paint, combs, movie films, writing paper, shock absorbers, wire insulators and artificial leathers made from the entire cotton plant, except the roots. Revival of cotton in its textile form of dimities and gingham, has received impetus through new markets in the form of upholstery linings, auto-tire cords, and the like.

a-1248
new material in
refers to use a

Christian Science Monitor

6/3/31

copyrighted material

Urbania Ill. Prof. E. C. Schmidt, Chief of Railway Engineering

1172 Cont. Ed. H. Stacy, 4639 Montgomery Ave

226 Bethesda Md POPULAR MECHANICS

SAVING MILLIONS YEARLY IN LOCOMOTIVE FUEL

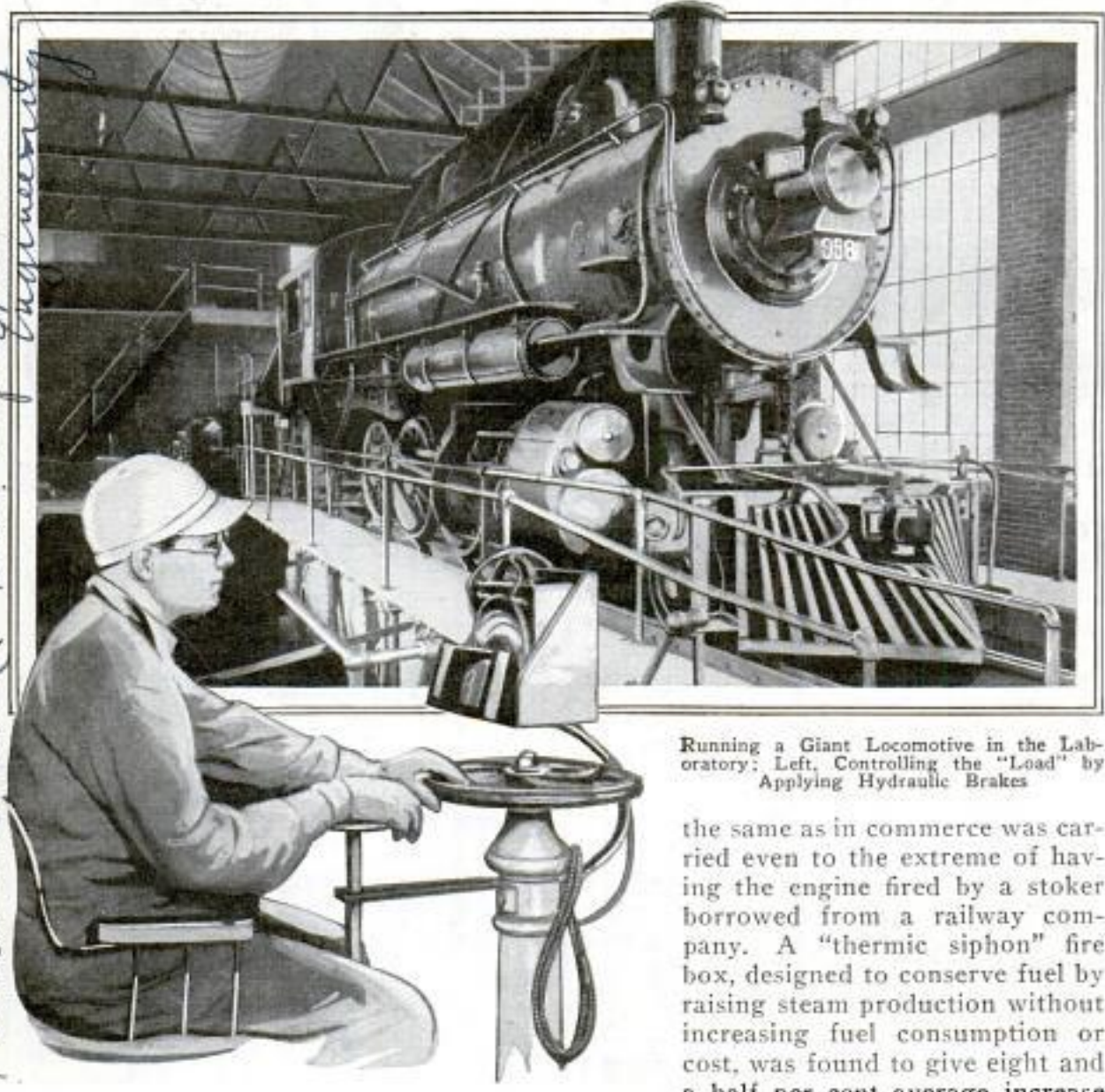

Running a Giant Locomotive in the Laboratory: Left, Controlling the "Load" by Applying Hydraulic Brakes

the same as in commerce was carried even to the extreme of having the engine fired by a stoker borrowed from a railway company. A "thermic siphon" fire box, designed to conserve fuel by raising steam production without increasing fuel consumption or cost, was found to give eight and a half per cent average increase in efficiency. In making the test, the engine was placed on special rollers. Brakes produced the load, while the pull was measured by a hydraulic cylinder. All water was weighed, the fuel weighed and analyzed, the smoke washed and weighed, and even the cinders and ashes were weighed and analyzed after each run.

Moving a huge railroad locomotive from the track to the laboratory, and operating it there under conditions exactly paralleling its service in commerce, but without it traveling a mile, is a feat of research accomplished at a state university in the middle west. Knowledge that locomotive performance can be dissected and analyzed like baseball statistics was the intriguing result. Of no less importance was the discovery that American railroads can save approximately \$25,000,000 per year in fuel, enough to swing many of them from the red to the black side of the ledger, by the adoption of certain new methods tested at the school. The desire to keep conditions absolutely

CITY OF FORTY CENTURIES AGO SHOWS LIFE OF ABRAHAM

Life in the time of Abraham has been brought to light through the excavations at Ur in Mesopotamia, carried on in behalf of the British Museum and the University of Pennsylvania. Leonard Wool-

ley, who returned recently from the scene of the digging, reports the expedition found street after street with the walls complete up to about the second floor. Abraham's contemporaries built two or three-story houses, and it was possible to see how the business of this 4,000-year-old city had been carried on by the nature of the buildings. Shops and schools were easily identified as well as private homes and public chapels. The houses were large, some of them having twenty rooms or more with private chapels attached. So well preserved are the ruins that excavators are considering compiling a city directory of the part of Ur already cleared.

HOW MANY LISTEN TO RADIO SHOWN BY GAUGE a-120

How many persons listen to any particular radio program and what type is most popular with the majority? This question, which has been a puzzle to many broadcasting stations, is being answered accurately on a system of dials and meters in one British relay station. This station supplies about 1,200 families with radio entertainment, the programs being relayed to their homes from one large receiving set. A pressure meter attached to the relay set indicates the percentage of subscribers listening in, showing when they switch their sets on and off. The reaction to the program of every subscriber is indicated on the dials.



System of Meters in One British Relay Station Which Shows Popularity of Radio Program

Dr. Sam Youles
Brighton - England



Demonstrating Permeability of New Magnetic Alloy, and, Below, Models of Atoms of This Alloy

SUPER-MAGNETIC ALLOY CUTS WASTE OF ELECTRICITY

Hailed as a product that eventually will save the electrical industry millions of dollars, a magnetic alloy of superior qualities has recently been placed on a commercial basis. It is a refined iron-nickel alloy, known as "hipernik," made by annealing the materials in an atmosphere of hydrogen at a temperature of from 1,000 to 1,300 degrees for hours to purify it. Dr. Trygve D. Yensen, of the Westinghouse Electric and Manufacturing company, who discovered hipernik, estimates that the 10,000,000 transformers that furnish power and light in the United States dissipate about 10,000,000,000 kilowatt-hours of energy as heat, and that one-half of this could be saved by the use of hipernik in the transformers.

SCHOOL TRAFFIC LIGHTS FLASH ONLY IF PUPILS ARE OUT a-1223

Traffic signals in front of one Nebraska school operate only when the children are playing or using the streets coming to and from school. The stop lights are timed by a self-winding clock inside the building and flash to protect the safety zones near the school. They are controlled by a set of disks in the clock and can be timed in any manner desired. During the school year, they skip Saturdays, Sundays and holidays.

Mr. C. A. Nichol
Beatrice, Neb.

a. 849. Amh C. B. Palmer. of Boston.
Transcript. Boston, Mass

Into the Sunset



Westward Ho!—At Left Is Shown Interior of Boeing Plane with Heated and Ventilated Cabin, Hot and Cold Water, Lights, Reclining Chairs and Soundproof Walls



opening the iron highway from coast to coast and reducing travel time from three months to three weeks.

Today you can fly safely and comfortably from ocean to ocean in a three-ton, fourteen-passenger Pullman of the air in twenty-eight hours. As you leave the ground, there is only an astonishing feeling of stability. Though ordinarily you may suffer from fear of heights, this does not

touch you now, for there are no lines of perspective drawing you earthward.

Your giant tri-motored car moves upward on a cushioning ramp of air. Streets, monuments, buildings are fractions of inches in size. Hedges, fences, plowed fields form ruglike patterns. Trains wind through hills with lazy deliberation. Your fellow passengers move freely about to

JUST a little over a hundred years ago, if a man wished to send a message from New York to the west, it had to be carried by a forest runner in fear of his life.

In 1869, two wood-burning locomotives halted by the shores of Great Salt Lake, bearded men in stovepipe hats descended, and a golden spike was driven into a tie,

on Tireless Wings

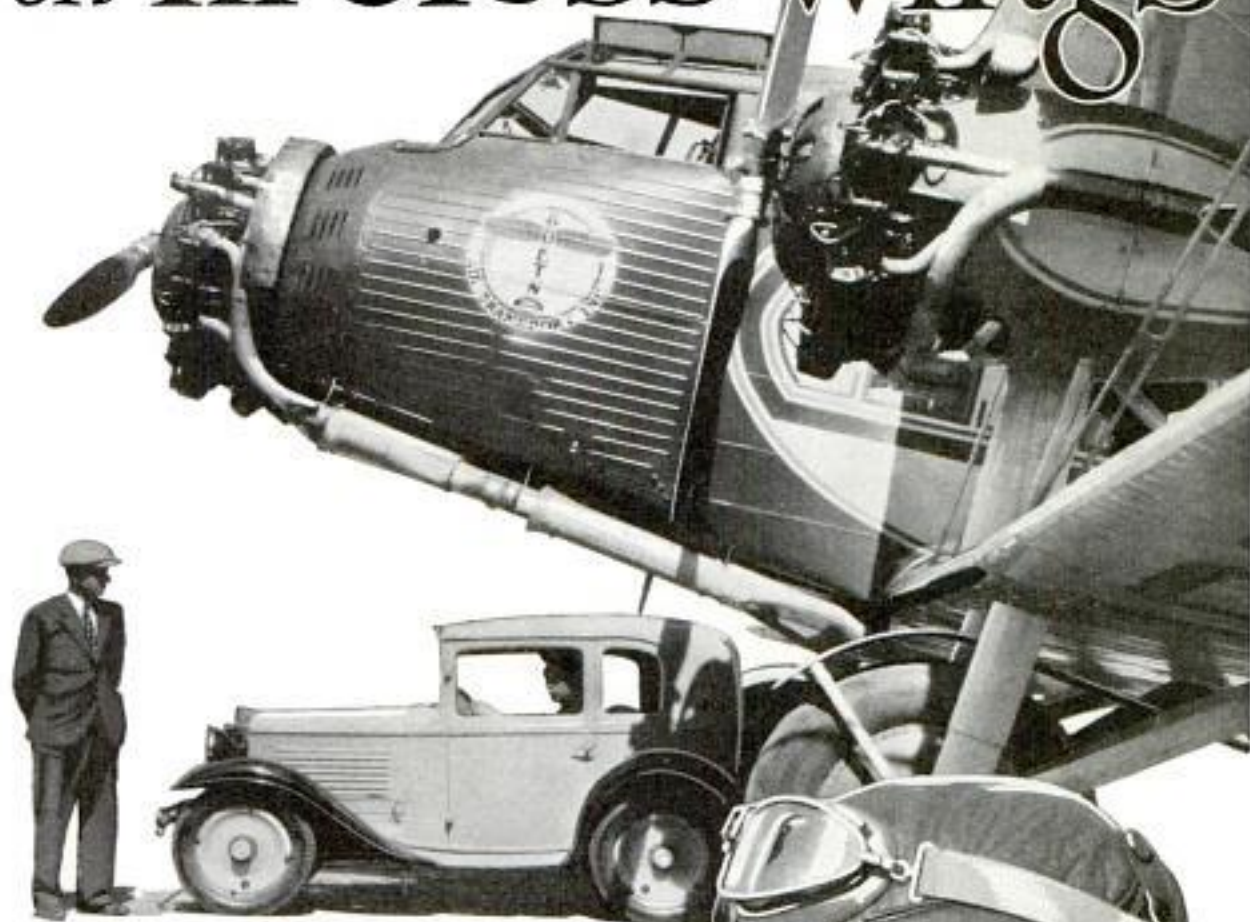

Right, Pilot Wearing Radio-Equipped Helmet and Attached Microphone; Earphones Are Built into It

play cards, to write or to make sketches. You are hardly aware of the forward motion, though moving twice as fast as an express train.

Breakfast in New York and lunch the next afternoon in San Francisco—you can now accomplish overnight what your great-grandfather spent several tiresome months in doing. Reverently one of the passengers, a silk broker, speaks of four epochs of transportation that had touched his life. After the wagon-train days there was the Pony Express that one of the younger sons in that pioneer family rode. His own father was a surveyor for the last link of a great railroad. And here he was roaring through such a night as would have drawn the old wagons into a protective circle around a fire.

It's a big thrill to be flung across the third largest continent like a flea in a football, plucked from the earth at one sea-



board, sent hurtling straight and sure at an invisible target over the horizon, caught and sent on through the clean air in a Titan's race with the sun. One gets to know a new kind of men, a new kind of ships, a new kind of country. If they are not new, they seem so, compacted into this one swift experience. You step into a shiny United Air Lines transport from a

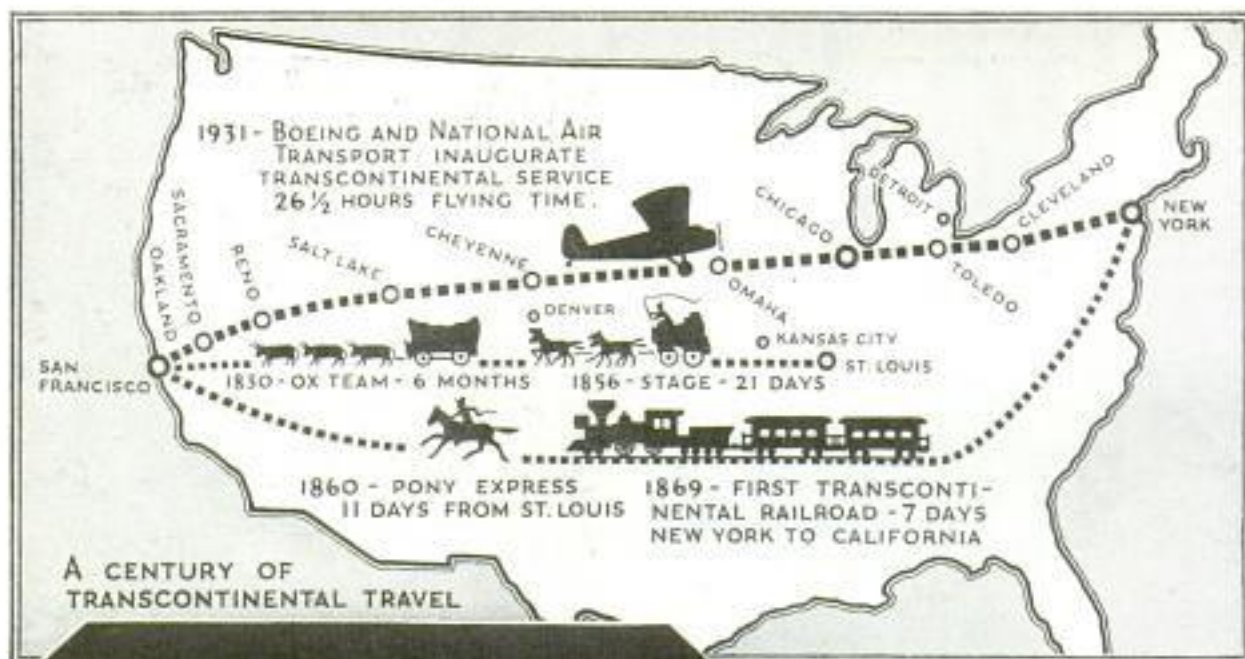

Courtesy Boeing Transport System
Boeing Trimotor Transport Photographed at Night; Part of the Schedule Is Flown over Well-Lighted Airways

covered runway at Newark airport. You have just arrived in a bus so you didn't see the mechanics working around this plane an hour or more earlier, didn't look into the dispatcher's office where weather reports have been interpreted. Flying high above the earth a few minutes later, you couldn't know that several radio stations are interested in you, flashing quick, curt messages back and forth, relaying them on. A surprising number of people know where you are, and more will know as you cross invisible boundaries.

Your pilot can, in effect, see 1,500 miles ahead and know that a tractor is working in the southeast corner of the field, that the surface of a fill is still soft and that he ought to use the runway. Later on, you're going to be surprised again, say at Cheyenne, to come down out of the starlit sky, when all the world is asleep, and find that a five-course meal is just ready, the soup hot and chops nicely broiled.

Why are you surprised at all this? Because you somehow think of flying as being still in the stunt stage. You expect that sort of service on a railroad. Well, you'd also be surprised to find out how much like a railroad this airline is.

For instance, at Chicago ten or more airlines center, just as the railroads do visibly. In the waiting room passengers talk, read magazines, get something out their bags. A young man in uniform steps in and says, "Passengers for Kansas City and Dallas, please." And they pick up their topcoats and stroll down to a plane that is as ready as any train ever was to whirl them down the Mississippi valley.

And your plane, like all the others, moves on schedule time; it is an item in a time-table as intricate as that of a great rail system. Its crew is assigned, reported, on definite shifts. The plane is checked as to movements as well as operations. It goes into its lofty steel "roundhouse" after each trip for cleaning, inspection and servicing. Someone knows the hours of each engine, the craft itself, the radio set, and the pilots. Its baggage is checked through from city to terminal. It has a shiny steel cage which holds the sacks of precious mail. It has lighting system, running water—yes, even plumbing. On it meals can be served on

A. P. 49

little tables that lock into recesses in the wall. It provides reading matter and such information as connections and facts about the country it passes over.

One place in which it outshines the railroads is in its communications. A really remarkable system has been worked out, in effect "a private line" of radio. West of Chicago alone are twenty-two ground stations and fifty plane installations on an exact wavelength. The sets are built tuned in. One switch, at the pilot's left hand, is all he needs. It is called expressively the "talk-listen" switch. On the ground or in the air, an operator knows he can talk and be heard by somebody immediately, without tuning, without calling. He speaks and his words go where he wants them to. And when he wants an answer, he knows it will come.

Pilot and copilot, up in the glittering cockpit of the plane, listen and talk interchangeably. A "muzzle mike" is fixed to the head-phones and is ready at the mouth for a message. All the apparatus is back in the tail, remote-controlled, leaving the hands free.



Naturally one wonders how seventy stations can use one wavelength. Naturally again, it is by synchronism. A big clockface in the office at Cheyenne—"central"—tells the chief operator when this plane or that airport will be reporting, and on the dot it comes in. Clocks are synchronized and each station has a few seconds—a very definite period—to say what it has to say and get off the air. It says an exact formula at an exact time, filling in the information at the proper place. And it is said at a speed and in a jargon that defies interpretation by a layman. It sounds like "Glpskom fropke five sliz num esser; go ahead!" But that means a lot to the man at the desk. There is absolutely no chaff, no "how's the weather up there?" Nothing but "go ahead" ends a message to which an answer is wanted. A terse OK is acknowledgment.

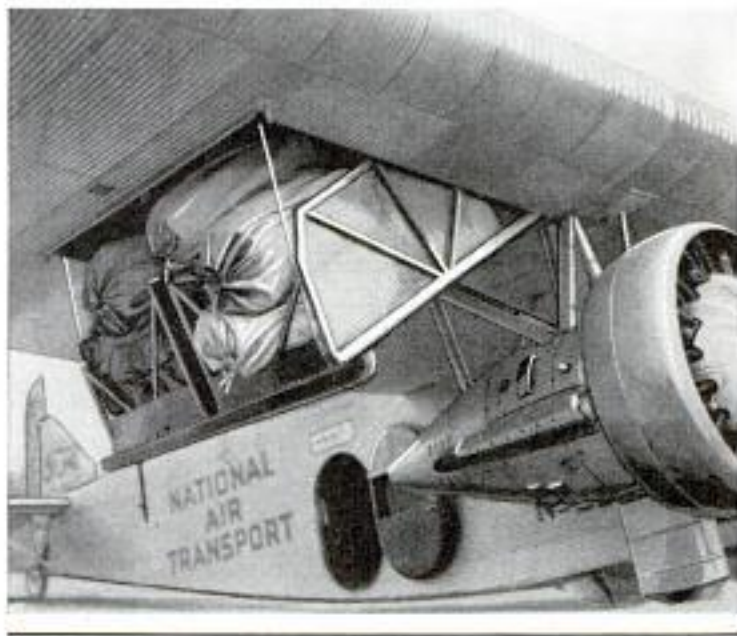

Receiving Weather Reports before Take-Off, Tuner for Radio, and Disappearing Cargo Compartment in Wing



And there is no chatter between meeting pilots either. In the air, they are cool, clear-eyed young men doing their one job at a time and doing it well. However, if there is ten minutes wait or so at some field, they can be hearty, easy-going men with marvelous, sometimes ridiculous, tales to tell. If a passenger is fortunate, there may be two pilots to get yarning with each other, telling about the time they slipped down in a black night into a field and couldn't believe it

themselves next morning, when they saw a snake fence surrounding them. Or about the student pilot who thought he didn't have fuel enough to get to Pasco and solemnly radioed, "If I run out of gas I'm gonna land!" They may be like the great, rotund, laughing fellow who consumes bottle after bottle of root beer. Or the slim fellow in white coveralls, head swathed in helmet, goggles and radio gear, who stands squinting through his cigaret smoke at the yellow strip that piles on the floor from a teletype machine. He has just brought his little mail ship



Getting the Latest Weather before Flight: Radio Brings Reports Once Pilots Are in the Air

through a prairie duststorm. In a minute or two, he clears for the west, becoming a red dot against noiseless lightning flashes.

Weather and radio are the twin gods of air travel. Crossing the continent now, one is in the hands of a great project of organization engineering. The new route links nineteen cities. Eight hundred beacons and blinkers mark the way, as well as the department of commerce directive radio beacon. The teletype brings the weather bureau service. And land telephone and telegraph aug-

ment all this. The trans-continental companies combined have a background of 23,000,000 miles of flying. The Coast-to-Coast Limited leaves New York at nine in the morning; Oakland at 12:45 p. m. Earlier and later planes cover the same routes on different schedules, but not connecting at Chicago. A complete map of affiliations and connections makes a web of lines over the whole United States, reducing travel time from point to point to something like a third of that required by any other method.

LANTERN PROJECTS BOOKS AS WELL AS SLIDES

Intended particularly for classrooms, a four-purpose lantern projects any opaque material and can be used for showing postcards, charts, drawings, pages from books and the usual glass slides, film slides and microscope slides. Should occasion demand, the several types of illustration can be used in one lecture, as it is a simple matter to change from one to the other. The lantern accommodates a book of nearly any size, projecting a six-inch square area at one time.



Up and Over; Center Span of Lake Union Bridge at Seattle, Which Is Nearing Completion, Shortening Route into City

HUGE BRIDGE LINKS SEATTLE TO PACIFIC HIGHWAY

Commuting time will be reduced materially when engineers open the new \$1,500,000 bridge across an arm of Lake Union near Seattle's business district, shortening the route over the Pacific highway into the city. The bridge has a clearance of over 150 feet to allow passage of ships.

SMOKE GAUGE INSIDE FURNACE SHOWS FAULTY FIRING

A simple form of smoke gauge now offers the fireman of a furnace a continuous picture of smoke conditions inside the furnace. The instrument consists of a projector throwing a beam of light across a smoke passage to an indicator opposite. Its center portion is a shadow screen on which the beam is thrown. Smoke particles in the beam cast shadows on this screen. Around it are illuminated sectors, graduated in a scale of smoke densities with which the shadows are compared.



Lantern Which Projects Any Opaque Material, Throwing Image of Paper Chart on a Screen

all 48

all 84

acme

Model Vac

pond. Smoke meter. a-1218

Chicago - S. S. Walsh

Eastern Mfg. Co. Chicago, A. 3620 Chrysler Bldg. New York

Spencer Lens Co. 192 Front St. Buffalo N.Y.

The Sales Corp. Richmond

Copyrighted material

Cont. Es. H. Eckhardt,
4528 Walnut St

Christian Salvia
Monitor 6/3/31

234
a 1147

POPULAR MECHANICS



Man Using One Eye to Match Colors in Test Which Helps Show His Mental Balance

COLOR-MATCHING TEST SHOWS YOUR CHARACTER

Color sense, the ability to match various tints of colors, has been found to have a definite relation to character, since it indicates mental balance. Dr. William S. Wadsworth, coroner's physician of Philadelphia, has evolved a color test to gauge a man's mental make-up and show whether or not he is capable of certain acts. From the results of such tests, he claims, it is possible to determine whether an individual is mentally well-ordered, whether he is whimsical and, aside from showing possible criminal tendencies, demonstrate also if he is fit to be put in a position of trust upon which the lives and safety of others may depend. The equipment consists of a blackboard on which are pasted ten colored slips of paper with a small box back of each slip. The person taking the test is handed a package of 100 slips of tinted paper and asked to place in the receptacle the tints most nearly matching the sample in front of each. After the test, the papers are pasted on a large chart, each near the sample with which the person associated it. Provided the individual is not color-blind, he would be classed as whimsical, unstable and unreliable if he placed orange tints near greens and blues near yellows. The combinations may reveal a hysterical streak in another individual, and from the method he uses in sorting the colors, his mode of life can be determined to some

extent. Some artists and painters taking the tests have shown a queer color sense, and one etcher who works in blacks and whites was found to be color-blind.

PEE-WEE FURNITURE FOLDS UP INTO TRICK SHAPES

a-1244

Trick furniture, much of it small to compare with the size of the modern apartment, was shown recently at a furniture exhibition at Chicago. Reclining chairs with trick arms, living-room sofas upholstered in white cloth that is removable and washable, and tables that fold into any number of shapes and sizes were among the exhibits. A three-cushioned davenport, for instance, is made into a comfortable bed by merely switching the cushions around. A long console table by day is doubled in width for the evening meal. Combinations also were shown whereby a desk can be bought today, a radio tomorrow and a bookcase a week or so later, all the same style and all fitting together to make one piece.

TWO MEN DO WORK OF SEVEN BY USING AIR CLAMP

a-1192

Invented by their own foreman, an air clamp has been adopted by manufacturers of upholstered furniture in a Los Angeles plant, enabling two men to do the work of seven. The clamp puts the whole furniture frame together in one operation, with one man gluing the pieces and the other operating the tool.



Air Clamp by Means of Which an Entire Furniture Frame May Be Put Together in One Operation

Upholstery Co., Los Angeles, Calif.

done M. C. Anderson
Foreman, Brown. Saltman
Copyrighted material

A 1053

see Feb 1931 203

aven
comb'
and

that n.
them are
Kiel Fu
Corp.,
Michig



Demonstrating the Transmission of Noiseless Power from a Model Station by Use of Grid-Glow Tubes Which Can Change Alternating Current to Direct Current or Reverse the Process

NOISELESS POWER IS OFFERED BY GRID-GLOW TUBE

Noiseless power stations without any moving parts for transmitting electric current over long distances are a possibility as the result of the development of the principles incorporated in the ordinary grid-glow radio tube. A Westinghouse research engineer recently demonstrated the transmission of noiseless power from a model station by the use of such tubes, which are capable of changing alternating current to direct current at relatively high voltages for transmission to a distance, then transforming the direct current to alternating current for local distribution. For years electrical engineers have dreamed of transmitting large

amounts of power by direct current while generating it with ordinary alternating-current equipment. In the past the difficulty has been to make satisfactory equipment for producing the necessary high-voltage direct current for the transmission line and the changing of this direct current to low voltage, either direct or alternating, for local use. It is now believed the grid-glow tubes may be employed in direct-current districts of cities to make ordinary radio sets, refrigerators and other electrical equipment directly available without using special equipment or a small power-plant set. If radio power should ever become a reality, the tubes are expected to play a large part in changing high-frequency current coming over the air to commercial frequencies.

A 1193

TIRE CHANGING BECOMES EASY WITH "COMPLETE" TOOL

Tire changing is made a quick, clean and easy job with a tool recently marketed, according to its makers. It is a combination iron and spreader, the handle of which is iron, with a thin tapered end of heat-treated steel made to stand much abuse. The curved end is a tire spreader that can be used in place of the hands to inspect the inside of



the tire and locate trouble. The tool has enough leverage to spread the tire and replace tube with very little effort.

"MIRACLE" SAUCE ON ICE CREAM RELIEVES STOMACH ILLS

Relief from certain forms of stomach ills is promised as the result of research at the Northwestern University medical school, where neutral gastric mucin, obtained from the gastric membranes of swine, has been mixed with foods, with curative results. The substance is mixed with malted milk, fruit juices, or as a sauce for ice cream and is said to have given sufferers from stomach ulcers relief in very short periods.

*Snow. Craggs Corp
1800 S. Dearborn*

Sold by Clearing & Rogers S. Cutter. not on market

Handwritten notes: # 1,488,096, Chicago Ave 7, 537, Chicago Ave 7, 537

a 10 49

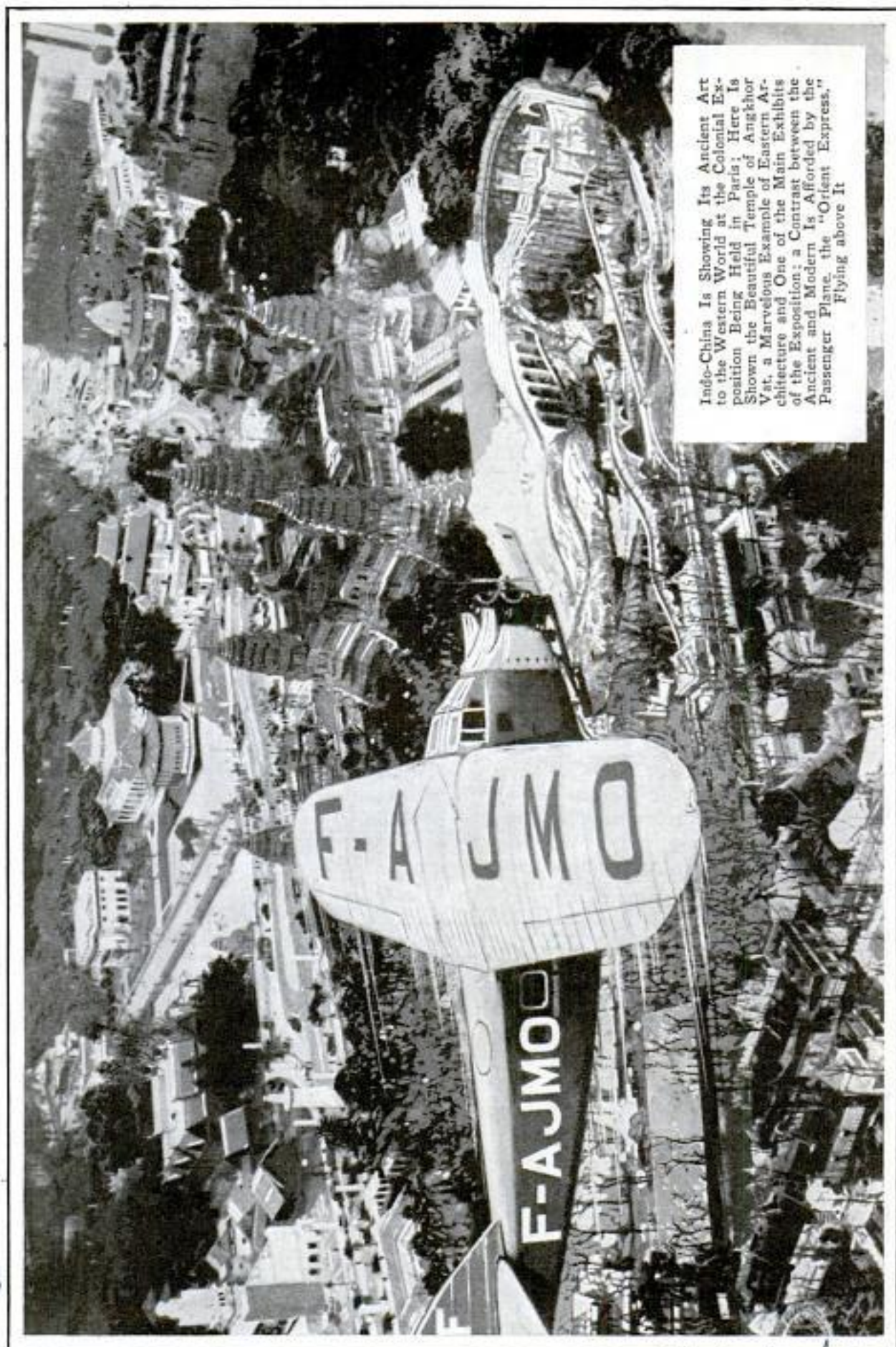

Indo-China Is Showing Its Ancient Art to the Western World at the Colonial Exposition Being Held in Paris; Here Is Shown the Beautiful Temple of Angkor Vat, a Marvelous Example of Eastern Architecture and One of the Main Exhibits of the Exposition; a Contrast between the Ancient and Modern Is Afforded by the Passenger Plane, the "Orient Express," Flying above It

A COLONIAL EMPIRE MOVED TO WALLS OF PARIS



Above, General View of Some of the More Important Buildings of the Colonial Exposition; Right, Decorative Figure from the Belgian Congo



France Is Seeing Her Colonial Empire Moved Up to the Walls of Paris in This Great Exposition; Above Is Shown a Part of the Pavilion of a Building from the Dutch Indies

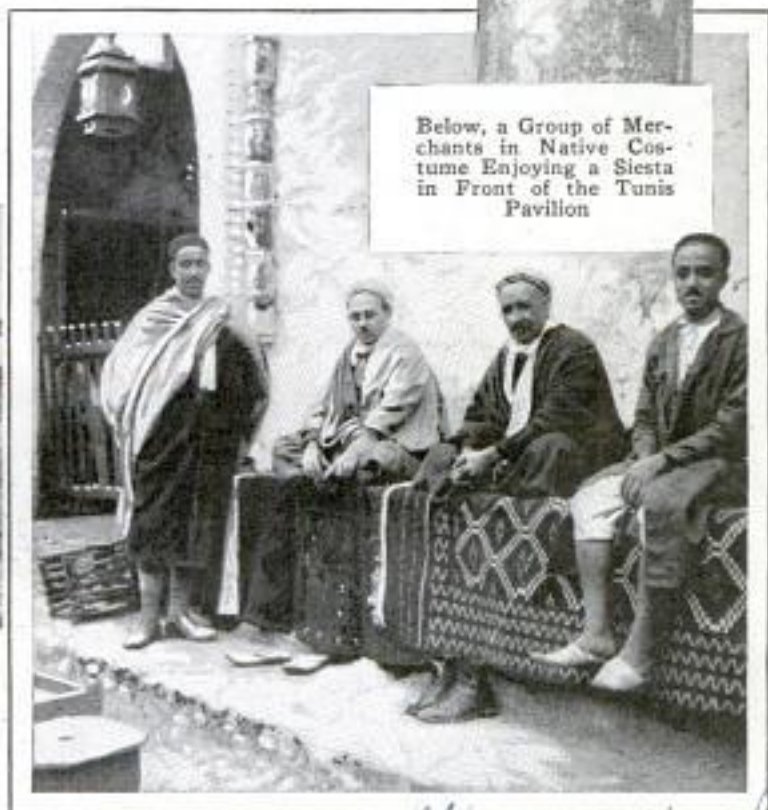

Below, a Group of Merchants in Native Costume Enjoying a Siesta in Front of the Tunis Pavillon

INDO-CHINA SHOWS ITS ART TO WESTERN WORLD

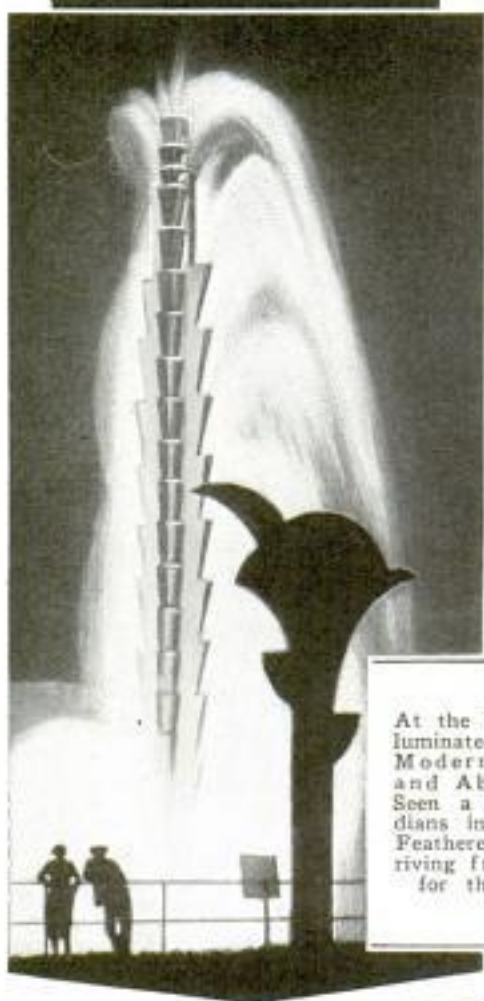

At the Left Is an Illuminated Fountain of Modernistic Design, and Above May Be Seen a Group of Indians in Blankets and Feathered Bonnets Arriving from America for the Exposition



In Circle, Group of Elephants from One of the French Colonies on Their Way to the Zoological Gardens to Be Quartered; Below, View of the Illuminated Temple of Angkor Vat

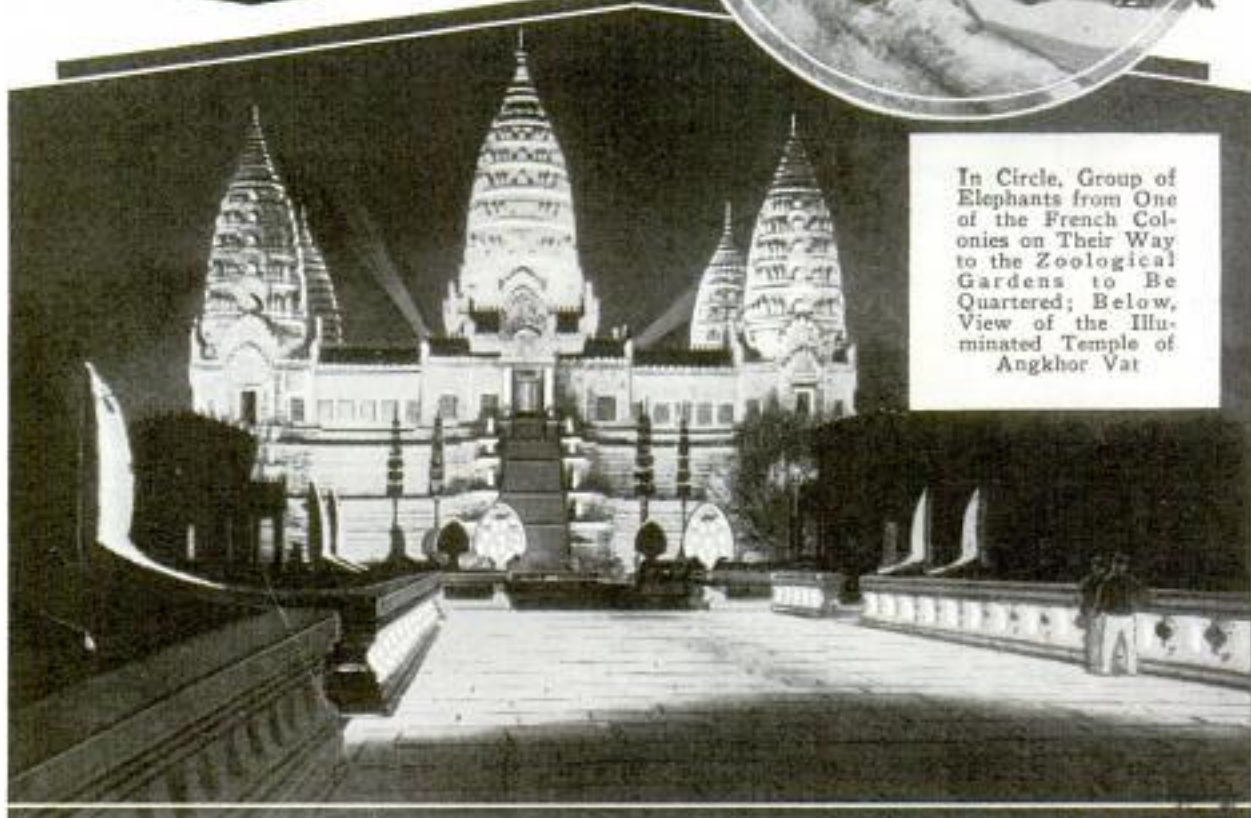

General Electric Co a 1189 Cont. S. A. Lewis
 Schenectady, N.Y. 376 Broadway Bldg
 POPULAR MECHANICS Los Angeles 239 Calif

91231
**ELECTRIC EYE AIDS
 IN FOLDING PAPER
 NAPKINS EVENLY**

One manufacturer of paper napkins has placed an electric eye, or photoelectric cell, on guard to see that the machine which folds the flimsy pieces of paper does the job right. The paper is fed from rolls to machines which emboss, fold and cut it, but heretofore it has been difficult to keep the paper in the correct position so the napkins would be folded evenly. Recently a relay, sensitive to light, was set to keep watch on the tissue as it passes through the folder. By means of signal lights, it warns operators to change the position of the paper when it is not right. An electric light shines on the paper and below the paper are two photoelectric tubes so arranged that a decrease of light actuates one and an increase actuates the other. One is placed a bit to one side of the paper, and the other is under the tissue, so that, regardless of the error in position, one light or the other signals a warning.



Section of Model Village Fronting on Stadium Track, Built for Athletic Stars Entering the Olympic Games

**SIXTY-DAY MODEL VILLAGE TO
 HOUSE WORLD STARS**

Between 600 and 800 individual dwellings, each with two rooms and a bath, are being constructed in Los Angeles to form the "Olympic Village," housing international sports stars at the 1932 Olympic games. Each house will be designed in the character of the nation its occupants will represent, with correct furniture and community dining rooms and kitchens for each division, so the athletes will receive the home atmosphere and cooking to which they are accustomed. The houses will stand only sixty days, when they will be sold for summer cottages. Each has an inside shower bath, four specially constructed six-foot beds, and attached to each wall is a washbowl with running water. Furnishings include wicker chairs, tables and rugs. The village system will be for men only, the women athletes being housed at the University of Southern California, near the stadium.

**HOLLOW KNOB ON GEAR SHIFT
 HOLDS KEYS OR PAPERS**

Room for extra keys, license and registration papers is provided in the hollow knob now being made for attachment to the gear-shift levers of standard automobiles. The knob screws into place exactly as the ordinary one and has much the same weight and "feel." Unscrewing the cap of the knob reveals a snug cavity large enough to hold several articles.



☐ The Chicago district builds more railroad cars than any other area in the world.

Kerrin A. Paulson Lem Knob

Electrocraft Corp.
 161 Massachusetts Ave. Boston, Mass.
 Copyrighted material

SOME QUEER FACES FOUND IN THE INSECT WORLD

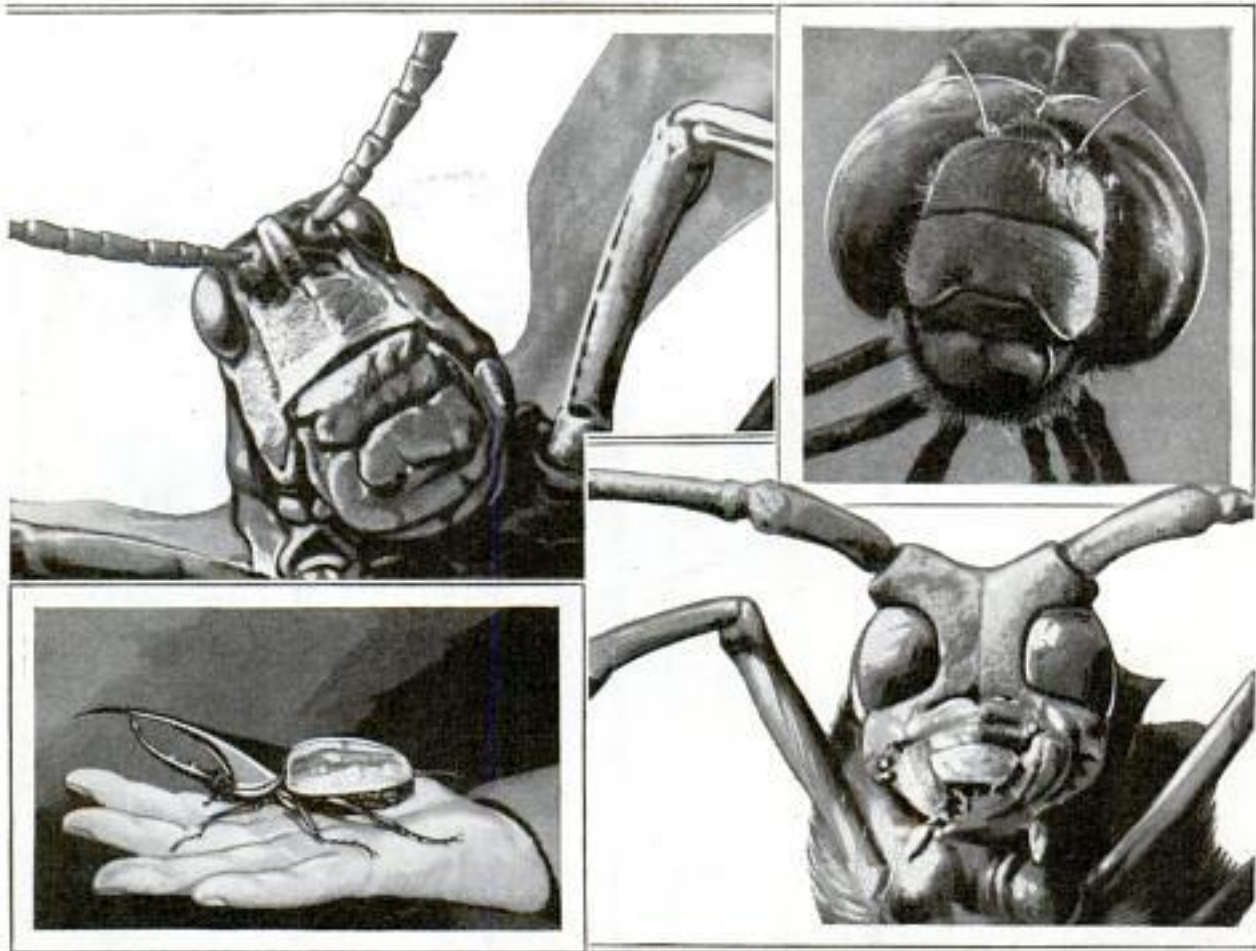

Top, Left, Grasshopper's Mouth Is Below Its Chin; Right, Head of the Cannibal Dragonfly; Lower Left, Great Horned Hercules, and Lower Right, the Studious Batocera Beetle of Japan

Ranging from a smirking amiability to an expression of gloating frightfulness, features to be seen on the countless inhabitants of the insect world are believed to have been supplied by old Mother Nature to protect her offspring. While the grasshopper, for instance, has lines in his

face which look like a mouth, actually his mouth is below the chin. He might be classed as a "highbrow" with his unusually long forehead. The common dragonfly or "darning needle" is all eyes and whiskers, and while it looks harmless, there is no greater destroyer of fellow insects.

SINGER MUST "SEE" TONE PITCH TO BE GREAT TESTS SHOW

Great singing voices are due to the singer's mental and emotional perception and not solely to bodily ability, hundreds of tests on trained and untrained voices by acoustical experts have shown. A mental "picture" of the pitch he is about to sound is vastly more important to the singer than a "cathedral throat," it is declared. Though the speaking voice may be trained into near-perfection, if the mental concept is faulty, the pupil cannot be taught to sing. Many new ideas as to breath

control and sound production have been put forward as the result of these tests, which were conducted with the aid of New York University and the Bell Telephone laboratories. For instance, it was discovered great singers never produce a "dead" tone except when singing very softly. As the intensity increases, the tone fluctuates, and at very high intensities, even the pitch varies. This produces the "vibrato," which actually is a sort of "stop and go," that is, the singer sings and stops singing, but the frequency is so great the result to the human ear is the "trill" or vibrato.

A-1230

Douglas Stanley reported to Engineering Foundation, 29 W. 39th Street, New York

A. 1273. Weather Bureau:
Washington, D.C.

Active Manufacturers
220 W. 43rd
New York
A. 1214

POPULAR MECHANICS

Kansas City Star 6/17/31

AIR SPEED GAUGED BY CLOUDS AS AN AID TO FLYERS

Clouds are being utilized by the weather bureau as wind gauges for aviators. A cloud travels with the wind and makes visible the speed of the wind at a certain altitude. The bureau has devised an apparatus by which observers can determine just how fast a cloud is moving. The cloud is sighted in a mirror mounted on a frame graduated in degrees. One factor for the computation is obtained by observing the image of the cloud as reflected by the mirror for a period of time. The second factor needed is the cloud's distance from the earth which is determined by sending aloft a standard "ceiling" balloon and timing its ascent.



Specimens of Large Stone Spheres That Have Been Formed by Nature in Utah; They Are Known Locally as "Goliath's Golf Balls"

GIANT "GOLF BALLS" OF STONE FORMED BY NATURE

Nature apparently was in a playful mood when she created some of the formations in Manti national forest, Utah. Among the most unusual specimens are scores of almost perfectly round hard-stone balls found in the soft sandstone strata, some of them two or three feet in diameter. They are known as "Goliath's golf balls," and scientists are studying them in an effort to explain their origin.

STAMP PAD LIKE TYPEWRITER INKS FROM RIBBON

A. 1122

Stamp pads with ribbon surfaces instead of felt, giving long service and assuring the user of even inking throughout the life of the pad, have been placed on the market. The ribbon is much like that used in a typewriter and is wound from end to end of the pad with finger screws, so that when the inking surface becomes dim, a few turns will give the

73.00



Stamp Pad with Renewable Ribbon That Inks Like That of a Typewriter

user a new one. The ribbon, when used up, is replaceable.

RAINBOW HUES FOR RAIL CARS

A. 1317

Coaches in color schemes to suit every mood of passengers have been introduced by an English railroad. The "Spectrum special," as officials of the line call it, has six cars, ranging in color from violet to crimson, and is operated between a suburb and the heart of London. After a year's test, the most popular color will be adopted for the whole train.

LAMP DETECTS FAULTY GLASS

A. 125

Defective glassware now can be detected before it leaves the factory by tests with a light which shows up the faults. The lamp produces polarized light which reveals the defects in the glass.

Life Long Stamp Pad
Co., 230 W. Superior St.
Chicago

Libby Owens Ford
Glass Co. 1500
Detroit, Mich

2025
Libby Owens Ford
Detroit, Mich

Ant. ds. H. Macy, 4689 Montgomery Ave Bethesda, Md.

9-12-61

Solving the Greatest



PERIODIC CHART OF THE ATOMS																		
The Atoms Grouped According to the Number of Outer Electrons																		
	I		II		III		IV		V		VI		VII		VIII		IX	
1	H														He	2		
2	Li	Be	B	C	N	O	F	Ne	10									
3	Na	Mg	Al	Si	P	S	Cl	Ar	18									
4	K	Ca	Sc	Ti	V	Cr	Mn	Fe	Co	Ni								
5	Rb	Sr	Y	Zr	Nb	Mo	Tc	Ru	Rh	Pd								
6	Cs	Ba	La	Hf	Ta	W	Re	Os	Ir	Pt								
7	Fr	Ra	Ac	Th	Pa	U												

What the Finding of Element No. 85 Means to You

1575 Michigan Chicago

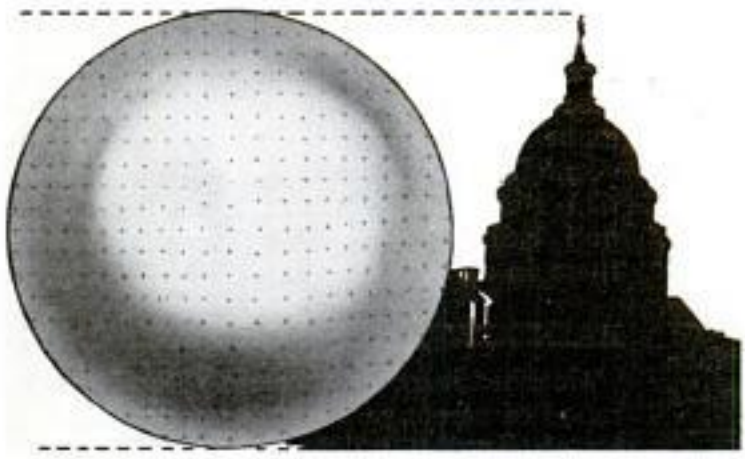

If the Atom Were as Large as the Nation's Capitol, Each Electron Would Be the Size of a Bullet

MARKING a new epoch in human achievement, the end of a 2,000-year search, comes the announcement of the success of Dr. Fred Allison, of the Alabama Polytechnic Institute, in isolating the last of the ninety-two chemical elements, the foundation stones of the universe, No. 85—eka-iodine.

And what does that mean to you—a new triumph for chemistry which, in its role in the life of man, surpasses the pow-

er of kings. Today there are more than a million workers in American plants dependent on the chemical engineer for translating the results of such research into new and profitable enterprises and products. Chemical industries now produce at least one-half the manufactured wealth of the United States.

Ten years ago, for instance, it was believed impossible to make wire cloth with meshes finer than 100 to the square inch. Today an American company, aided by

chemistry, can supply metal cloth in which there are one million microscopic openings in one and one-half inches. Although made of metal, its silky threads are as soft to the touch as the sheerest silk. Indeed, it is now possible to weave non-rusting metallic stockings—at a fabulous cost, of course—which no naked eye could distinguish as metal.

Enduring and beautiful vases from cheese, furniture from carbolic acid, cloth-

Antburn. Ala

see July 1913

Newark Wire Cloth Co Newark, N.J.

copy righted material

Chemical Mystery

ing from crude oil, and vast numbers of new products from corncobs, are some of the facts of the present generation. The variety and quality of these artificial substances is something to conjure with. Modern plastics may be compared to new metal alloys. It is now possible to produce almost every article of commerce



Dr. Fred Allison, Who with Magneto-Optic Method, Found the Last Elements 87 and 85; at Left, the Spectroscope

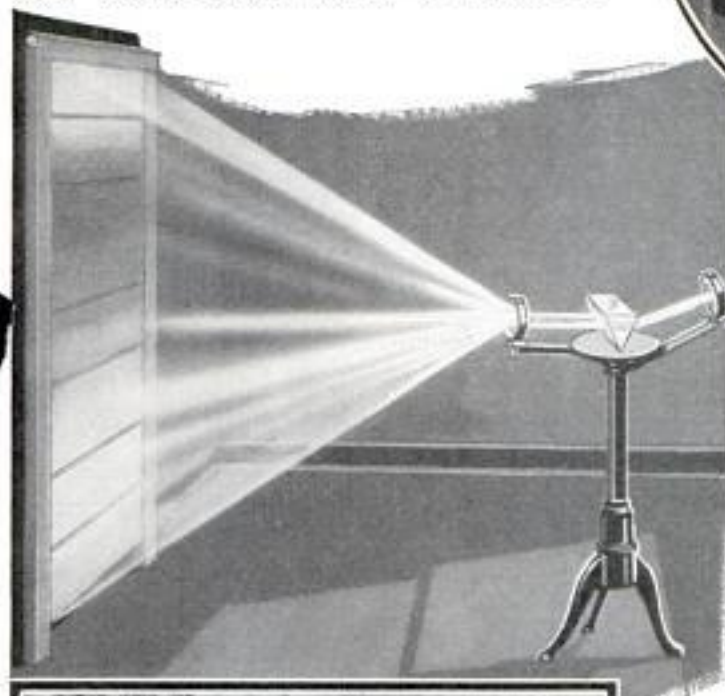

that in use will not be subjected to temperatures higher than twice the boiling point of water.

Today the manufacture of synthetic plastics is a \$250,000,000 industry. Three hundred and fifty different plastic materials are employed to make innumerable things, ranging from a toothbrush

handle to inkstands, lighting fixtures, abrasive gears, furniture and clock cases. As plastics become lower in price, they will begin to compete with such standard materials as glass, steel and iron. The essential for bringing this change about is a cheapening of raw materials. Chemists have recently shown that methanol can be made from carbon dioxide and water. In this reaction they have the key to unlock a vast quantity of materials, and it is also possible to synthesize ammonia from nitrogen and hydrogen, one derived from air and the other from water. Hence, plastics are literally made out of the sky and the sea.

When the raw materials for plastics are cheaper, a great revolution may junk many of our prevailing manufacturing methods. Chemical engineers foresee plastic automobile bodies, molded in a single piece and in a single operation, and mold-

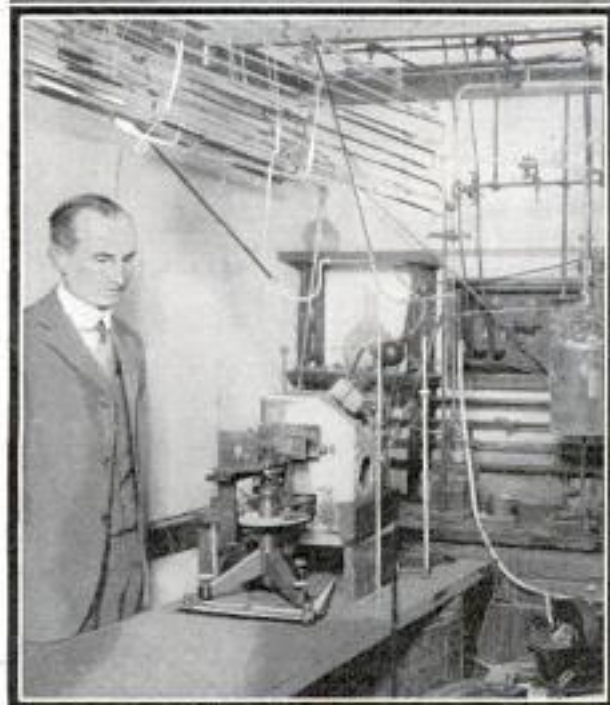

Prof. B. Smith Hopkins and Experimental Equipment with Which He Discovered Ilinium

View of Allison

*Cyanamid Co. New York
535 5th Ave.*

Q. 125-244

Dr. Lee Charles Wertz
Chemist, 101 Park
Are useful

Dr. Buckton Egloff

See Oct. 1928

7/31/3

53090
5/20
770



Fruits and Vegetables Are Ripened Artificially with Ethylene Gas While the Onlooker Watches the Process

mospheric moisture, and corrosion-resisting tantalum for laboratories where strong acids are used.

The magician called the chemical engineer is especially active in the rubber, petroleum, cosmetics and wood-pulp industries. Chemistry has ordained a revolution in the newsprint industry. The forest service has successfully manufactured white paper from the pulp of the young slash pine, the yellow pine of the south. Heretofore

ed airplanes. In the field of home and office furniture, the plastic chemist will reign supreme. Architects will specify plastics for the interior trimmings of homes and buildings.

In combination with rustless alloys and non-shatterable glass, it will be possible to construct a whole building out of materials, none of which is found as such in nature. A synthetic flexible glass that can be molded and bent without breaking is now available. It is made from sulphur, ammonia and cyanide, waste products of illuminating gas. Among other new materials are asbestos wall tile for bathrooms, kitchens and restaurants; asbestos rock cork for insulating purposes; waterproof airtight cloth bags designed for shipping chemicals attacked by at-

slash pine, loblolly pine, short-leaf pine and long-leaf pine, all growing in the south, were considered worthless for newsprint because they were thought to contain too much resin.

It would require 300 years to restore some of the wood we are using in the paper industry, but newsprint can now be made out of wood that can be cultivated almost like corn and potatoes. Another sensational revelation is the making of synthetic rubber out of petroleum.

The old dogma that oil and water do not mix also has been exploded by the chemist. By subdividing the oil into tiny droplets and enveloping them in a film of emulsifying agent, oil and water can remain in partnership indefinitely. By doing the "impossible," the chemist was

Benj. S. Brooks, Chemist
1148 32nd New York

The Foundations of the Universe

1 Hydrogen	20 Calcium	39 Yttrium	57 Lanthanum	75 Rhenium
2 Helium	21 Scandium	40 Zirconium	58 Cerium	76 Osmium
3 Lithium	22 Titanium	41 Columbium	59 Praseodymium	77 Iridium
4 Beryllium	23 Vanadium	42 Molybdenum	60 Neodymium	78 Platinum
5 Boron	24 Chromium	43 Manganese	61 Promethium	79 Gold
6 Carbon	25 Manganese	44 Ruthenium	62 Samarium	80 Mercury
7 Nitrogen	26 Iron	45 Rhodium	63 Europium	81 Thallium
8 Oxygen	27 Cobalt	46 Palladium	64 Gadolinium	82 Lead
9 Fluorine	28 Nickel	47 Silver	65 Terbium	83 Bismuth
10 Neon	29 Copper	48 Cadmium	66 Dysprosium	84 Polonium
11 Sodium	30 Zinc	49 Indium	67 Holmium	85 EKA-IODINE
12 Magnesium	31 Gallium	50 Tin	68 Erbium	86 Radium
13 Aluminum	32 Germanium	51 Antimony	69 Thulium	87 Eka-Cesium
14 Silicon	33 Arsenic	52 Tellurium	70 Ytterbium	88 Actinium
15 Phosphorus	34 Selenium	53 Iodine	71 Lutetium	89 Thorium
16 Sulphur	35 Bromine	54 Xenon	72 Hafnium	90 Protactinium
17 Chlorine	36 Krypton	55 Caesium	73 Tantalum	91 Radium
18 Argon	37 Rubidium	56 Barium	74 Tungsten	92 Uranium
19 Potassium	38 Strontium			

6/26/960

a-1261

able to produce new and better polishes, cleansers, cosmetic creams, insecticides, disinfectants, deodorants, flavors and countless other useful products to benefit mankind.

Ancient alchemists believed the earth and its gases were made up of four things—earth, fire, water and air. But the modern chemist builds with ninety-two elements. For all things he goes back to the atom—a bit of matter so small that there are billions of them in a bubble of gas no bigger than the letter "o," while an electron is a thousand times smaller than the smallest atom.

Atoms may be compared to the letters of the alphabet which can be put together in innumerable ways to form words. So the atoms are combined in equal variety to form what are called molecules. Thus the association of words into sentences is like the combination of molecules to form materials. Each atom is like a miniature solar system. There is a nucleus, or sun, and around it are the planets, or electrons.



Think of nature as a builder, making all that we see out of atoms of ninety-two different kinds, just as the builder of a house constructs it of bricks, slate and glass. The atomic table places atoms in regard to their weight, starting with the lightest, hydrogen. This table is comparable to the keyboard of a piano. Some places in it were long vacant, but have now

all been filled by Doctor Allison's discovery of element 85 in sea water, fluorite, apatite, monazite sand and in potassium bromide. Less than two years ago he discovered element 87.

The scientist employed the magneto-optic method which enabled him to detect one part of substance in 100 billions.

Until the discovery of illinium by Prof. B. S. Hopkins, of the University of Illinois, in 1926, no American investigator had ever been on the greatest honor roll of chemistry. But it is noteworthy that the last three elements needed to complete the chemical structure of the universe were discovered by Americans.

he n
lscov
he gr
as to
hrough
and sol
he li
direct
passing
"About
on the
is obse
Allison
substr
identi
in pay
35. E
until e
new me
"No s
five
ur



First Rubber from Oil, Airtight Bags for Shipping Chemicals, and Broadcasting Color

a. 1285

Developed by H. S. McQueen

are subjected to acid treatment and the residue is examined under a microscope, it has been discovered by state experts in the Missouri bureau of geology and mines. It was found that specimens taken from deep wells all looked alike, although it was believed that layers at varying depths represented different geologic ages. Deciding the limestone matrix of the rock was what made the specimens resemble each other, the limy substances were dissolved and the fossils, which are the usual dating tags in geological research, were found in the residue, untouched by the acid. The method is of value to such undertakings as mining, oil prospecting and deep drilling.



Roulette on a Large Scale and Golf on a Miniature One Are Combined in This Game, in Which a Golf Ball Replaces That of Roulette

GOLF AND ROULETTE COMBINED IN FASCINATING GAME

Roulette golf is the latest form of miniature sport to be introduced on the Pacific coast. The game consists of a giant roulette wheel and a tee from which a golf ball is driven into the bowl surrounding the wheel. The ball spins around the bowl just like the small one does in the conventional roulette outfit. Features of both games are combined in scoring.

are subjected to acid treatment and the residue is examined under a microscope, it has been discovered by state experts in the Missouri bureau of geology and mines. It was found that specimens taken from deep wells all looked alike, although it was believed that layers at varying depths represented different geologic ages. Deciding the limestone matrix of the rock was what made the specimens resemble each other, the limy substances were dissolved and the fossils, which are the usual dating tags in geological research, were found in the residue, untouched by the acid. The method is of value to such undertakings as mining, oil prospecting and deep drilling.

WONDER TROPHY OF GLASS IS MADE FOR OLYMPICS

Three weeks' steady work by R. J. Manley, a Venice, Calif., glass blower, has resulted in the completion of a glass replica of "The Discus Thrower." It has been presented to the Olympic committee. Set



R. J. Manley, of Venice, Calif., Putting the Finishing Touches on His Glass Statue

on a reflecting base, the figure is of crystal with a background of four black Grecian columns. It represents Manley's ninth effort to complete so large a figure.

FLYER ESCAPES VOLCANO

Flying for the first time over the Aniakchak volcano in Alaska, twenty-one miles in circumference, a plane, piloted by Harry Blunt and carrying a mechanic and a passenger, was sucked by the hot gases into the crater. The plane was pulled insistently toward the pit, and only by a sudden dive away from the hot mouth, did the pilot save the ship from plunging in. Sulphur fumes were noticeable forty miles from the pit and at more than 6,000 feet in the air, the flyers reported.

AGES OF ROCKS ARE DISCLOSED BY ACID TREATMENT

Rocks that, when dug out of the ground, cannot be told apart, give up their ages and other secrets when they

Carlo level course
6th and Vermont
Los Angeles Calif

Monte
Mfr.

Rev. Bernard
Hydrant
Santa Clara Calif
a. 1283

a. 1304

Science News Letter
6/13/31

Chicago

QUEEN OF WHITE FLYERS SETS NEW FUEL RECORD

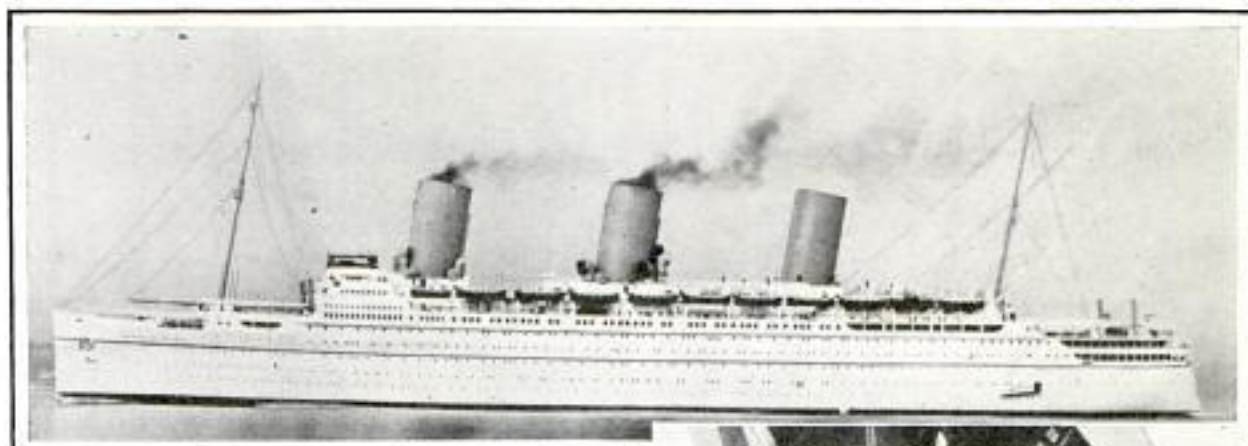

"Empress of Britain," New Queen of the Canadian Pacific's Fleet of Atlantic Liners

"She's verra savin' on fuel," say her Scotch builders proudly, and claim for the new "Empress of Britain" a record for fuel economy at sea. But oil buyers for the owners, the Canadian Pacific railway, explain it as "maximum efficiency" in the high-pressure boilers of the block-long, sixteen-story high, white flyer, that has just become the new queen of a white fleet of oil burners on two oceans. The record now held by the "Empress of Britain" was established by seven consecutive days of trials at full express speed. The previous record was made by the "Empress of Japan," which holds every speed mark for the Pacific ocean. The record is credited to the new Johnson boilers, designed by the company's superintendent engineer. These boilers generate double the amount of steam of any other type. There are nine of these boilers, driving four propellers almost twenty



feet in diameter. There are two smaller boilers, also, for domestic uses on the ship. Modern oil-burning machinery eliminates, even at thirty miles an hour, the romantic but dirt-distributing smoke plumes that used to pour from a liner's funnels. Also, the new cruiser's bow and stern "iron out" the water.

A1124

SPRING-WIND STEEL TAPELINE ALSO SERVES AS RULE

All the convenience of a pocket tape and the utility of a rule are combined in one six-foot measure in the form of a steel tapeline contained in a metal case equipped with a spring-winding attachment. This



tape gives the rigidity of a rule, but winds into a case only two inches in diameter. It can be obtained marked in inches to sixteenths, or in feet from tenths to hundredths like an engineer's measure. It has a ratchet stop and may be projected unsupported to any length or flexed to measure circular or round-cornered objects.

☐ We want all our readers to write us freely and often whenever they wish additional information on articles published in this magazine. Address Bureau of Information, Popular Mechanics, Chicago.

Lufkin Rule Co.
Saginaw, Mich

a 1096
Capt. Wilbert Edwards
1518 Earl St
Tyler, Texas

The CONQUEST OF

ONE of the most spectacular oil-well fires ever known was the blazing Sinclair No. 1 Cole well in the center of the great new east Texas field, which took a toll of nine lives and roared defiance almost 200 hours to all efforts to conquer it.

Like a bolt from the blue, the stream of liquid gold which had been gushing uncontrollably from the earth for more than thirty hours was changed into a flaming geyser. The clash of steel tools caused a flash which ignited the gas-laden stream with a terrific blast that knocked workmen from their feet and enveloped them instantaneously with death.

It happened about five o'clock in the afternoon, during change of shifts. A double crew was on the derrick floor,

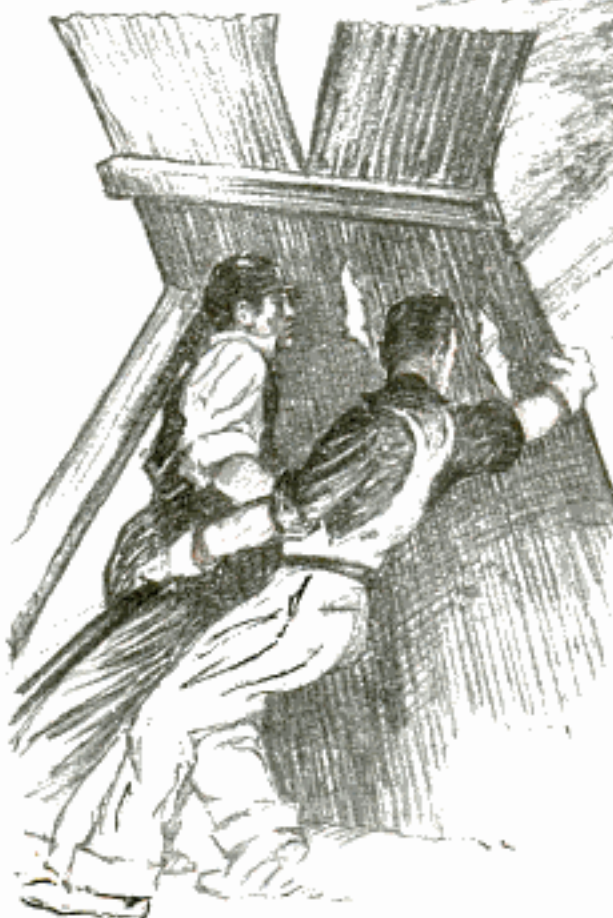

and equipment was being moved into place for completing the task of controlling the well. Only two minutes more and the job would have been done. And then...

But hear the story from the lips of an eye witness, a few days before his death from burns.

"I was standing about halfway between the edge of the derrick and the hole. Suddenly the elevators fell. The burst of flame was immediate. The falling elevator must have caused a spark that set fire to the oil and gas fumes. I started to run. I found my clothes on fire. I rolled on the ground to put out the fire, but that did no good. I had on only a shirt and trousers. I got out of my shirt, and another fellow helped me get out of my trousers."

Some of the ten or twelve who were on the derrick floor ran through the woods screaming for help. The owner of the land on which the well was located and two or three others were standing outside the reach of the flames when the explosion came and grabbed the victims as

Workmen Approaching the Fire behind Metal Shields, While Others Spray Them with Water



An Airplane Engine Mounted on a Truck Blew a Blast of Air against the Inferno, While Chains Were Carried Forward to Snake Away the Hot Machinery

they ran from the well, tearing the flaming garments from their bodies.

A water line was quickly laid a half mile to the nearest creek, and two large storage tanks near the well were filled.

M. M. and Harry Kinley, official "shooters," flew from Tulsa, Okla., to Tyler, where they found one of the most difficult jobs they ever tackled.

The Kinley brothers are not novices at the business of extinguishing oil fires. Back of them are fifteen years of experience, and they bear many marks telling of the price paid for their victories.

They finally decided an attempt should be made to shoot the well with nitroglycerine, but the white-hot metal lying around the well first must be dragged away and cooled off, for it was feared any hot metal left near by might re-ignite the stream.

Clad in asbestos suits, the Kinley brothers approached the well, and hooked cables to the hot machinery which then was "snaked" out of the danger zone by tractors.

A gooseneck joint contributed in large measure to the hazard of subduing the

wild well and did much to retard placing the nitroglycerine which finally brought victory. The fire was spread out near the surface of the ground by the gooseneck casing flange.

A couple of machine guns were brought by state rangers with the hope they might be used to shear off the hindering joint, but it was decided they could not do the work.

A cable finally was attached to the top of the joint and it was bent over to an angle, making it possible for men to walk around the well with the cable and unscrew the joint after twenty-six revolutions had been made. Then they were unable to unseat the joint.

At last, a seventy-quart charge of nitroglycerine was exploded under the joint, and it was blown up.

The charge, which it was hoped would serve the double purpose of removing the joint and extinguishing the blazing well, hardly caused the flames to flicker.

Undaunted, the fire fighters prepared a much larger dose, packing 200 pounds, or about 130 quarts, in an asbestos-covered container on a "sled" of pipe.

a 1096
250

Science Bulletin
533-12 6/11/37.



Courtesy Dallas News
Preparing a Seventy-Quart Charge of Nitroglycerine to Blow Away a Joint That Was Diffusing the Flaming Spray

have an indirect influence. Recent California quakes are believed to have had their origin in some weak part of the San Jacinto fault and it is Doctor Allen's theory that at some relatively shallow depth, there is a point unable to resist the pulling forces exerted by the moon, and the quake is "set off" there. Strong shocks, on the other hand, seem to occur mostly a few days after the moon is either new or full, in which case the sensitive spot of the crust would appear deeper and more plastic. Forces can thus deform this layer without creating a disturbance, except by the repeated action of the tidal pull from day to day. Doctor Allen believes that the moon may produce these effects either by a direct pull on the surface of the earth or by piling

A cable attached to the sled was pulled to the opposite side of the well from the nitro charge, and the sensitive bundle hauled cautiously up to the base of the flames. From only 200 feet away, the Kinleys closed an electric switch—and thousands breathed a sigh of relief. The fire was out.

up waters in the upper part of the gulf of California, although it is not yet known which actually starts a quake.

Then a steel derrick, which had been built while the flames were raging, was skidded over the hole and the spouting gusher capped with special apparatus.

AUTO WITH "STRAW HAT" BODY KEEPS PASSENGERS COOL

"Straw-hat" automobiles are the latest fad in the Madeira islands, where a motor car with body, running boards and fenders of straw was exhibited recently. The idea is to keep the passengers cool.

MOON'S INFLUENCE ON QUAKES IS STUDIED IN WEST

a 1306

In far more cases than chance would allow, earthquakes occur when the moon is in a certain part of the sky, the critical time seeming to be about five hours after it has reached its highest point and again some twelve hours later. Dr. Maxwell W. Allen, California scientist, who has studied the relation of the moon to earthquakes, says the shocks are not caused directly by the moon, although it may



Woven Straw Gives This Auto a Summer Dress the Year Round in Tropical Madeiras

Sanger, Calif.

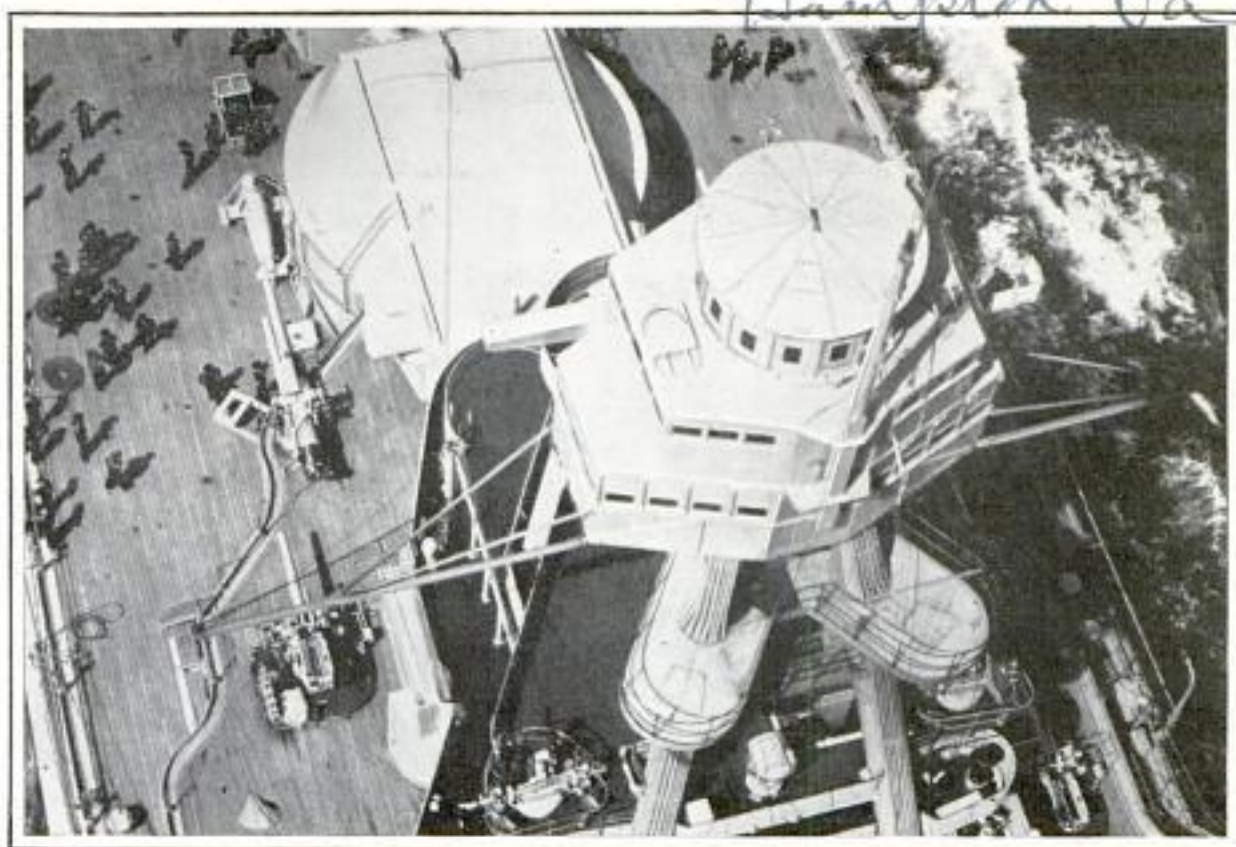

A Modern Battle Cruiser as It Might Appear to a Seagull Flying Overhead; This Unusual View of One of Uncle Sam's Fighting Ships Was Taken from an Airplane

**BIRD'S-EYE VIEW OF WARSHIP
TAKEN FROM AIRPLANE**

Some idea of how a United States battle cruiser might appear to a bird flying above it may be gained from an unusual view of such a vessel made from an airplane. Members of the crew are depicted in the photograph as mere pygmies and even the boat's guns appear like a boy's toy cannon.

a-1156

**MAGNETIC DEVICE PUTS EDGE
ON SAFETY-RAZOR BLADES**

Safety-razor blades can be kept keen-edged for many more shaves than usual by a magnetic sharpener that preserves the cutting edge automatically and without stopping or other form of hand manipulation. The sharpener consists of a small case containing a magnet of alloy steel terminating in two poles to hold the blade. Before each shave, the blade is placed in the case and the cover closed, then the lid is opened, the blade turned and the process repeated, or the wafer can be kept in the case between shaves, and turned over just before using. The magnet is not intended to put a new edge on old blades, but to keep a keen edge on fresh ones. Examination of any blade under a microscope shows not an edge but a myriad of tiny, jagged teeth, and each shave twists and bends these teeth until finally the blade becomes dull. The magnet pulls these teeth down flat against the polished surface, thus keeping the cutting surface more nearly uniform.



Chicago - 16th St. Agency

SCALES WEIGH MOVING TRAINS

Scales that record weights up to 400 tons and strong enough to withstand the shock of a locomotive passing over them, are now being employed by the railroads to weigh moving trains. The scales are constructed in seventy-five-foot sections suitable for weighing, while in motion, the longest and heaviest cars now in use.

a-1301

*Pennsylvania
New York Central*

Factory - Sanford Conn

*Monroe Specialty Co.
119 W. 23rd New York*

Reprinted by a. B. Overfield, Chief Engr. E. & J. F. Overbanks

1071
252

Com: H. J. Welkins, Esq. 29, Bean Road, Berkeley Heath, nr London
POPULAR MECHANICS Eng

LATEST OIL TANKER IS BUILT LIKE A BATTLESHIP

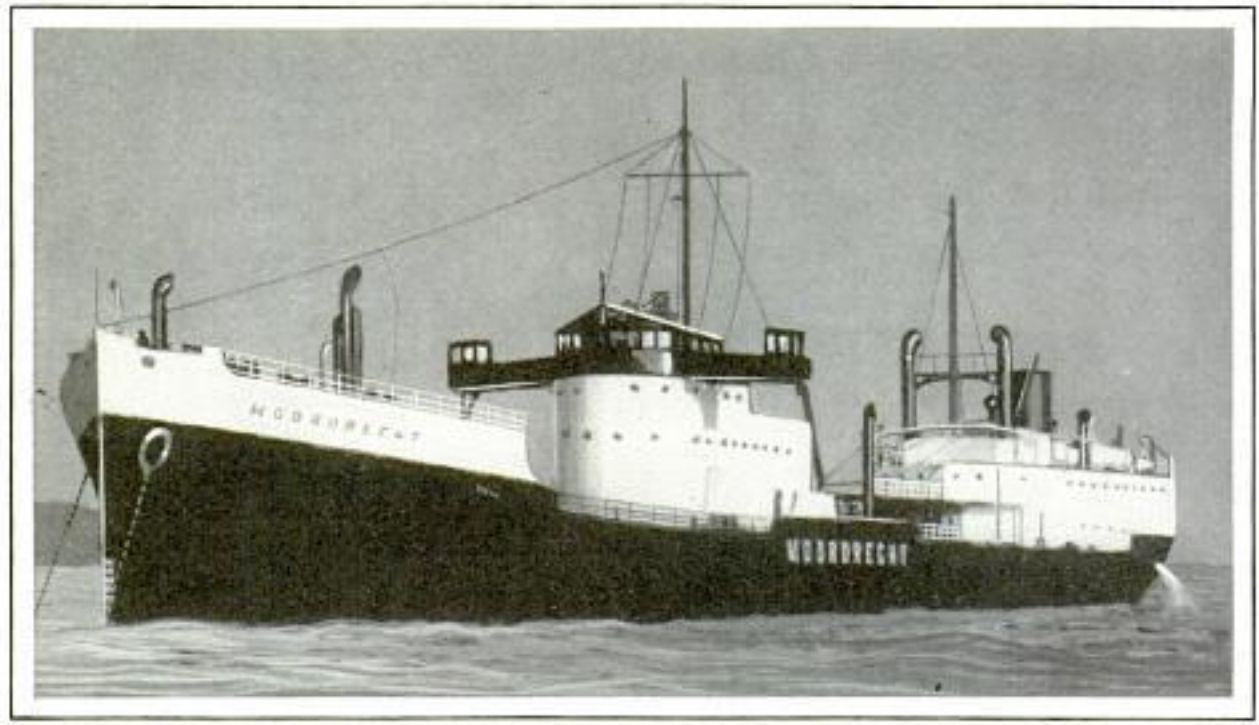

Dutch Oil Tanker Equipped with Armored Turret Like Those Used on Battleships; It Has a Wheelhouse on Its Summit and Forms a Protection for the Crew in Case of Fire or Explosion

As a protection to the crew from fire or explosions, a Dutch oil tanker is equipped with an armored turret very similar to those on battleships. This turret forms the quarters of the captain and officers and has a wheelhouse on its summit. The movements of the ship are controlled from this compact bridge which is placed in a position above danger from fire or explosions originating in the oil tanks underneath.

OVER NINETY KINDS OF APPLES GROWN ON ONE TREE

Ninety-one varieties of apples have been grafted on one apple tree by a Canadian farmer. In the autumn, the fruit shows distinct differences. The grower now hopes to graft 100 varieties on one tree next season. In another experiment in apple grafting, a mountain ash has taken several apple grafts. Efforts to graft pears on the apple tree were not successful.

TROUT GUARD DRINKING WATER

Trout are used by the Paris waterworks department as guardians against an overdose of chlorine in the drinking water supply. These fish have been found to be as sensitive to chlorine as canaries and

white mice are to impure air in mines. Before the drinking water goes into the mains, some of it is diverted to the tanks of an aquarium. If the trout are unaffected by the chlorine content, the water is considered safe.

SHELLER FOR PEAS AND BEANS LIKE CLOTHES WRINGER

Peas and beans are removed from their pods easily with a sheller that operates like a miniature clothes wringer. It is held to a table top by vacuum cups, and the pods are fed, stem first, into a spout.



As a handle is turned, they pass between two rubber rollers, the seeds being separated from the pods and falling back down the spout, while the pods pass through the rollers in the opposite direction. A pound of peas can be shelled

in about four minutes, it is claimed, with this kitchen aid.

D.A.L. Wood, Kingston, N.B. Canada

Technik für Alle
June 1931 0.119

Holmes & Co.
645 S. Olive St. Los Angeles, Calif.

MERCURY CAUGHT BY STEAM FROM HOT SPRING

Recovery of mercury by pumping hot water from wells located where there are steam and sulphur vents, is believed feasible as the result of tests conducted by the owner of land at a hot spring near the California-Nevada boundary. The test was made by suspending copper plates in the fumes, which, when left overnight, tested six to eight pounds of mercury to the ton. It is planned to drill a number of hot-water holes and treat the fluid that is forced up by the steam. A number of by-products of the process, including the manufacture of dry ice, are foreseen by experts who have assisted in the process.

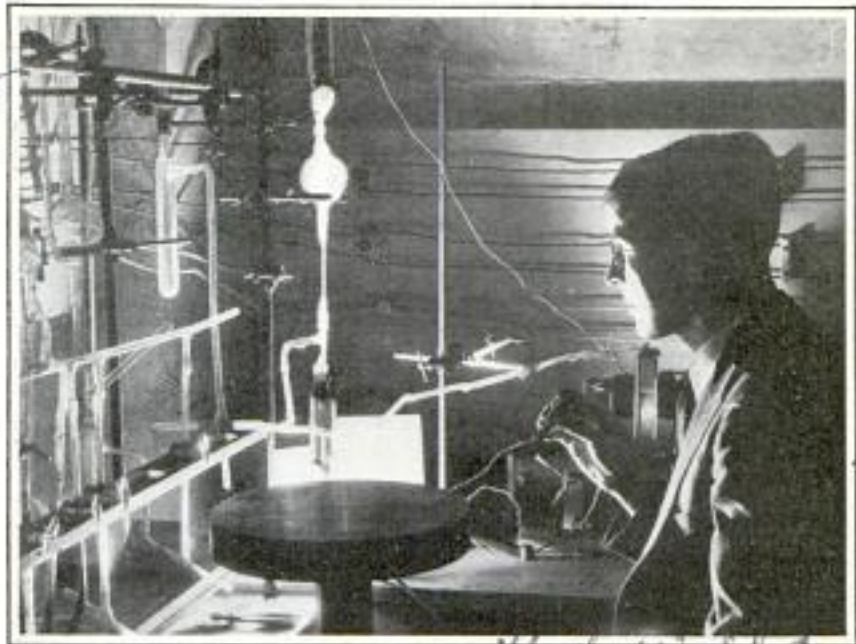

Tube and Other Apparatus Employed in Creating a Man-Made Aurora Borealis Expected to Open Way for Further Study of Nitrogen

MAN MAKES AURORA BOREALIS IN A LABORATORY TUBE

After five years of effort a scientist has succeeded in creating the aurora borealis in a laboratory discharge tube. Dr. Joseph Kaplan, of the University of California, who produced the aurora spectrum expects the feat will enable scientists to clear up any differences of opinion as to the cause of the phenomenon and also anticipates the experiment will open the way for a further study of nitrogen. Early in his work, he found he could produce a portion of the aurora in a discharge tube, but since the peculiar nature of the spectrum is due to the fact that the aurora is an electrical discharge in the upper atmosphere, the problem of re-creating it artificially became one of changing the

glass walls of the discharge tube so they would behave as if not present at all. This was accomplished by allowing an electrical discharge to pass for a long time through air maintained at one-millionth of the atmospheric pressure. This coated the tube with a film, and a more faithful reproduction of the spectrum resulted.

LUNCH ROOM LIKE LOCOMOTIVE AND PASSENGER COACH

After converting an old railway coach into a stationary lunch room, the proprietor of one such establishment decided his customers needed a further illusion of going somewhere when they entered. To add the extra atmosphere, he did some trick painting to produce a locomotive. Patrons approaching the lunch room now have the impression that an engine is attached to the diner, ready to pull out at any minute.



A Stationary Lunch Room That Looks as if It Were Ready to Travel; It Consists of an Old Railway Coach and a Painted Locomotive

Carl Thos W Whitaker, 6133 Spruce St, Philadelphia

at Narragansett Pier R.I.

Southern California, Calif. Los Angeles, Calif.

Easier Ways



Right, One-Hand Egg Beater Operated by Pressure of Thumb: Mixture Is Swirled Inward, to Prevent Splashing



Above, a Clothes Drier and Lawn Umbrella in One; It Has a Revolving Top of Rust-proof Metal, and a Canopy and Sidepieces to Convert It into a Tent



Left, Perforated Tube Filled with Tea Which Is Stirred in Hot Water



Above, Camper's Knife with Safety Blade Which Locks into Position When Thumb Is Pressed on Section to Snap It Open; Note the Fish Scraper and the Bottle Opener



Left, Mitten Mop for Washing, Dusting and Polishing Furniture or Auto; Below, Cookie-Cutter Set for the Bridge Party



of Doing It



Above, Aluminum Skillet with a Heat Meter in Its Top, to Show the Temperature of Contents



Above, Portable Steam Furniture Renovator That Operates from House Electric Current; It Can Also Be Used to Clean Hats and Clothing, and Exterminate Insects



Above, Square Fried Eggs Can Be Cooked in This Pan Which Maintains a Uniform Thickness of the White Part, Thus Preventing Burning the Edges; It Also Can Be Used for Cooking Gridle Cakes

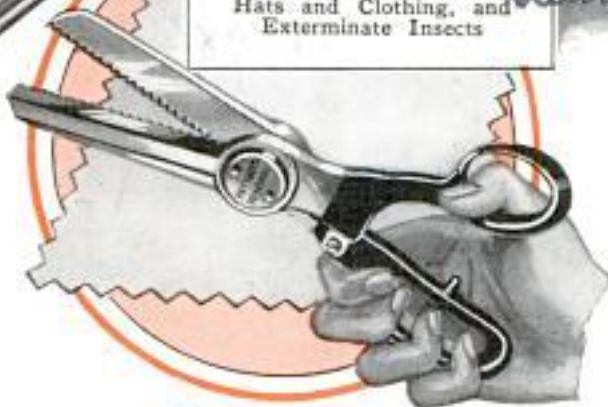

Left, Pinking Scissors Whose Ziggzag Edges Are Self-Sharpening; the Tool Cuts and Pinks Any Kind of Material Evenly in One Operation



Above, a Simple Cutter Which Makes a Dainty Fruit-Basket Design, Like That Shown at Right, Out of an Orange in Less Than One Minute; It Is Simple to Operate and Easily Cleaned



Right, Tape Measure in an Egg-Shaped Container; the Tape Is Pulled Out by Lifting the Fly, and the Measure Winds Up Automatically



For further information write Daniel Hodgman,

Herald Tribune. 6/7/31

POPULAR MECHANICS

256 American Combustion Engineers

CHIMNEY WASHES THE SMOKE AND CUTS FIRE HAZARD

Closed.

on Los Angeles Hotel

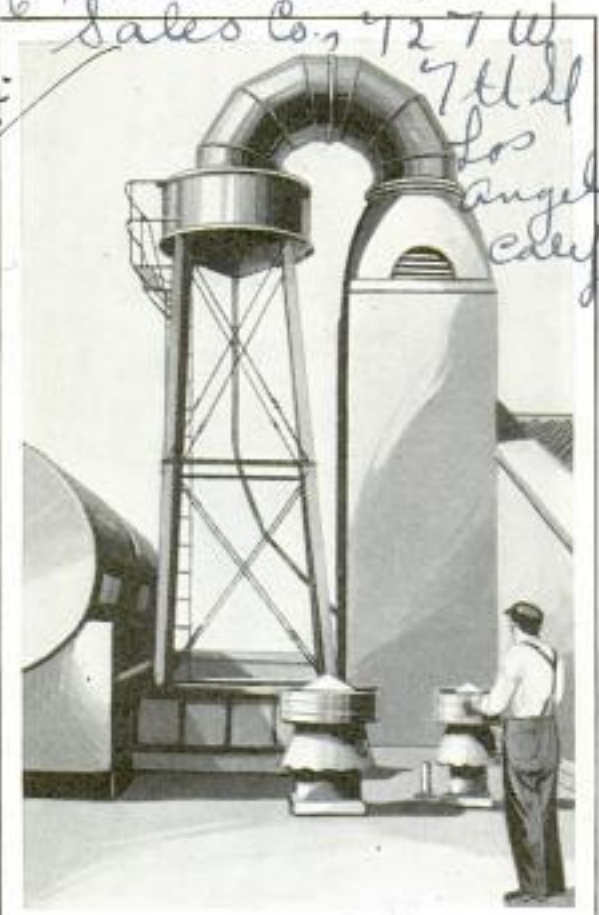

The Gooseneck Washer for Smoke Also Acts as a Water-Controlled Damper

To reduce the smoky haze surrounding cities and to obviate fire hazards, a chimney has been developed that "launders" the smoke and quenches in the water any sparks that might fly. It is built with a curved neck emptying into a metal basin filled with water. By lowering or raising the water level the draft is regulated. Designers of the stack claim better combustion and considerable fuel savings.

COLOR OF VEGETABLES SHOWS THEIR VITAMIN CONTENT

Color of vegetables is related to some extent to their food content, and the yellow plants furnish the equivalent of vitamin A. The pigments of plants have attained new significance through the discovery of unexpected potencies of some of their colored constituents in human and animal food, says Dr. Lafayette B. Mendel of Yale University, an authority on nutrition. Various yellow vegetables

Stirling professor of physiological chemistry

seem to furnish the equivalent of vitamin A, the food factor abundant in butter and cod-liver oil. Yellow corn, for instance, has been found more effective than the white varieties; the yellow sweet potato is richer than the white, and the yellow carrot abounds in something that can avert the lack of vitamin A in the diet. The latest findings indicate that the yellow plant pigment, called caratone, is the forerunner of vitamin A in the body. Apparently some green plants that have been known as comparatively rich sources of this vitamin carry the yellow pigment hidden beneath a veneer of green chlorophyll.

TWO THOUSAND PIGEONS RACE

Weary members of a coop of 2,500 pigeons, liberated in the morning near Danville, Va., began the same night to flutter into their coops on hundreds of lofts in New York and its suburbs, after flying 410 miles against heavy winds in the annual homing-pigeon concourse. The average time for the race was about twelve hours, but it was believed some of the pigeons may have arrived in ten hours.

SWIMMING MACHINE IS RUN BY SMALL PROPELLER

Supported by air pontoons shaped like torpedoes, a hydro-bicycle has been introduced in Philadelphia to aid in teaching beginners to swim. It is propelled by hand levers which operate a small propeller on the underside of the frame. It will support weights up to 500 pounds, and may also be used for water sports.

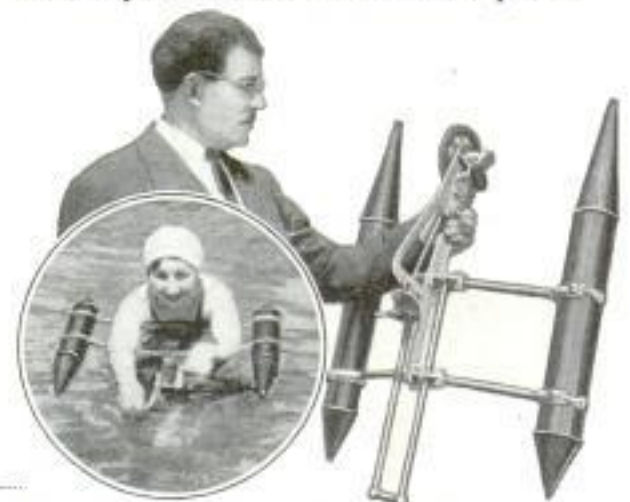

Swimming Machine That Teaches Beginners and Provides a New Toy for the Water

W. E. Storiey Stroudsburg, Pa

Murray Bell Homing Pigeon Club.

Copyrighted material

A 1050

Coventry Works
Singer Car Co

HOW YOUR AUTO IS GIVEN ITS BEAUTY OF LINE

From radiator cap to tail light, designs for automobiles to be produced by a British maker are drawn full size before they are finally approved. An artist-engineer does the work on a drawing board as big as

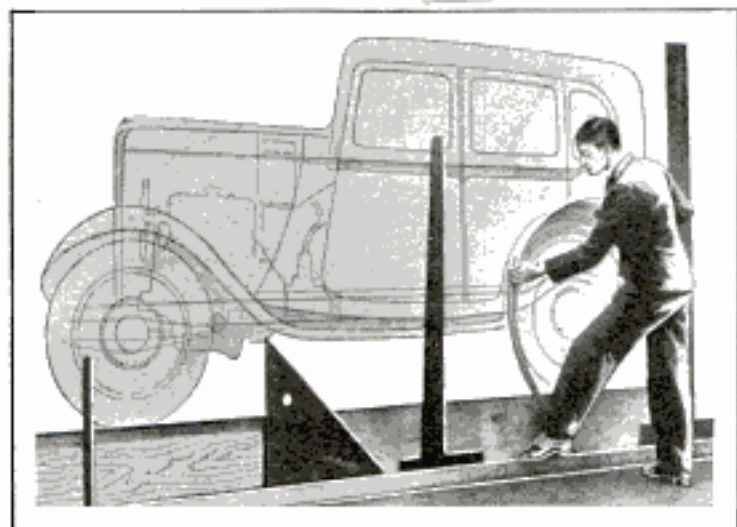
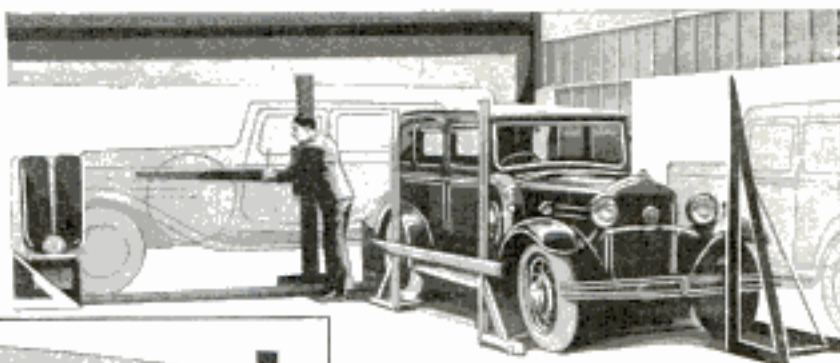

Artist-Designer Making Full-Scale Drawings of Auto Bodies, to Show Appearance of Cars When They Are Completed

the side of his workshop. By making the designs full size, he can easily discover whether or not his ideas for improvements in appearance will work out practically. A panel at the base of the big board guides the artist's seven-foot T-square. Every detail of equipment and accessories is carefully drawn and checked to determine its effect on the final appearance of the car.

TAME THUNDERBOLTS ARE AID IN POWER-LINE STUDY

Outside a laboratory at Purdue University hangs an artificial electric "cloud" and inside is caged a million-volt stroke of lightning, also man-made, so tamed that it bangs away by the hour at the cloud with no more fuss than a bright spark and a snap like a small firecracker. Between the artificial cloud and the ground pass the wires of a power line, and by storming away at this line with the thunderbolts, engineers are hoping to find ways to minimize the winking out of

lights during storms. The cloud is a group of parallel electrified wires which produce no moisture but radiate to the earth the same electrical forces which supercharge the air during a thunderstorm. Hanging a foot below the cloud, the power line is in precisely the same kind of electric field that would surround it if coming from a real cloud several thousand feet distant. The effects of the tamed stroke are equal on this small-scale storm to those of a huge thunderbolt under natural conditions. Through

the experiments, the engineers determine the effects of unexpected strain from the induced charge of electricity sent over the light wires, and the added insulation needed to prevent damage.

LIONS WORTH LESS THAN APES ON ANIMAL MARKETS

Lions are the lords of the jungle but their value on the open market is often much less than that of other animals. A good gorilla usually is worth about \$1,000, while lions have sold for even less than \$200. And a gorilla is a risky purchase because the climate of most American cities is hard on the big apes. In the zoo market, the rhinoceros brings the highest price—\$5,000 or more. Snakes are sold by the foot, some of the more interesting varieties selling at \$15 a foot. Giraffes have recently gone up in value and run the rhinos a close race in price. A pair of angelfish are snapped up at \$100. Among birds, the little blue lovebirds are worth their weight in gold.

Herald Tribune
5/24/31

Answers 5/9/31
Copyrighted material

Simplex Tool Co Station
W3 x K near Washington

258
 a-1127

POPULAR MECHANICS
Womsocket

Vise the Jaws of Which
 Are Controlled by
 Treadle, Leaving Both
 Hands Free



**EDUCATIONAL MOVIES ON AIR
 TELEVISION TESTS**

Educational moving pictures made by the department of agriculture are now on the air as well as on the screen. Recent experiments with several of the department's movies, broadcast from a station near Washington by television, brought favorable comments from points as far south as Georgia and as far north as Massachusetts. These pictures were sent in halftone, direct from the film, on a wavelength of 145 meters.

**LINEMAN RIDES PHONE WIRES
 MANY MILES A DAY**

Telephone wires carry other things besides conversation, as proved recently when a lineman literally traveled by wire from London to Brighton. He was one of the engineers engaged in installing a telephone extension between these cities and rode in a seat suspended from a strand of cable. Besides saving much time in his work he found that he was able to make good speed in his aerial conveyance, covering several miles a day.

**WISE IS OPERATED BY FOOT
 INSTEAD OF HAND LEVER**

Bench workers, faced with the necessity of handling many pieces of work in a vise, find that a foot-operated release for the vise jaws not only saves time but simplifies operations. A recently developed treadle adapter for a standard make of vise opens the vise jaws about half an inch, so that no change need be made in the vise setting for a series of work units of approximately the same size. On releasing the treadle, a spring operates a toggle action on the vise jaws, exerting a pressure sufficient to hold a piece of work firm under most bench conditions.

**FOUR-BLADED SHIP PROPELLER
 REDUCES AIR SHOCK**

Two years of pondering by a ship's officer have resulted in a four-bladed, seven-ton brass propeller, for installation on a Canadian freighter. Each of the blades has a "canal" cast in it, starting on its pressure side and ending near the hub. Air collecting against the sides of the blades is expected to escape through the apertures and thus reduce vibration and loss of speed. Less pitch of the blade also is said to be required.



Lineman Riding Telephone Wires over a Busy Highway on a Seat Suspended from a Cable

Propeller built by J. S. Gao & Co. a Deptford, London Eng

*Master Propeller Co
 R. 902, 420 LaSalle Street N.
 Montreal, Canada*

Copyrighted material.

A 1694 Cont. Lseo. St. Paul, B.C.
1409, 537 S. Dearborn Chwy.
see Travel File

By Auto to Alaska's Wonderland?

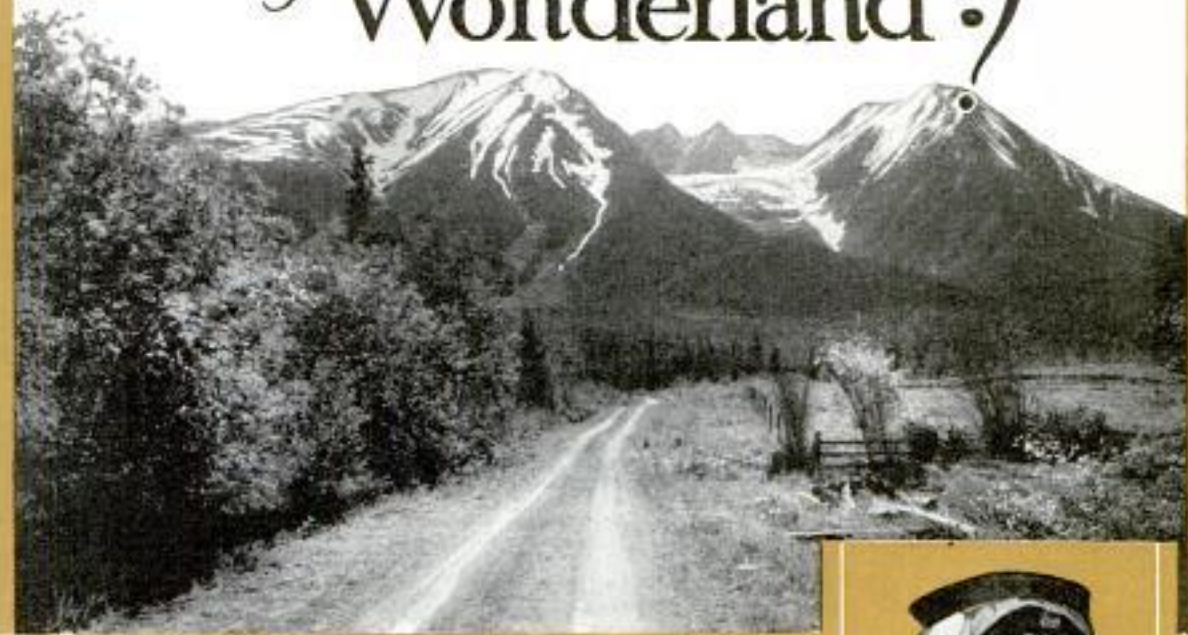

ALASKA will be pulled in hundreds of miles closer to the great cities of the northwest through the building of an international highway. The Pacific-Yukon highway is the name given to this projected road which, when completed, will connect the northwestern part of the United States with British Columbia, Yukon territory, and Alaska. At present the northern half of British Columbia, all of Yukon territory and Alaska, though physically a part of the North American continent, can be reached conveniently only by ship or airplane. Overland transportation to this great country is impracticable except by pack horse or walking.

The mighty Fraser river has always been the avenue to central British Columbia. In the early days, the boats went up this river to Yale, and from there the travelers went in quest of furs and minerals over the famous Cariboo highway, built in 1859-63. This road is now extended, and you can drive in ease and comfort from Seattle, through Vancouver,

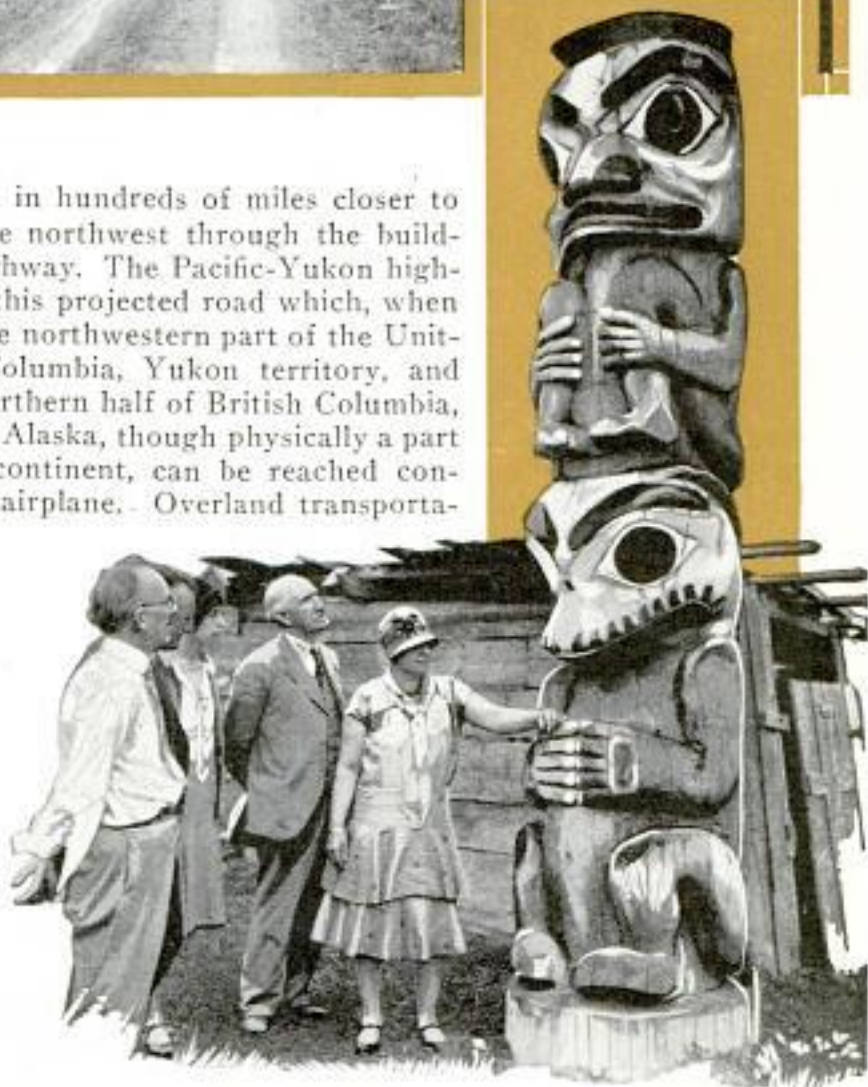

Above, Road in British Columbia with Hudson Bay Mountains in Distance;
Below, Totem Poles at Skeena Crossing, near Hazelton, B. C.

Refer inquiries to Chamber of Commerce
Seattle, Wash

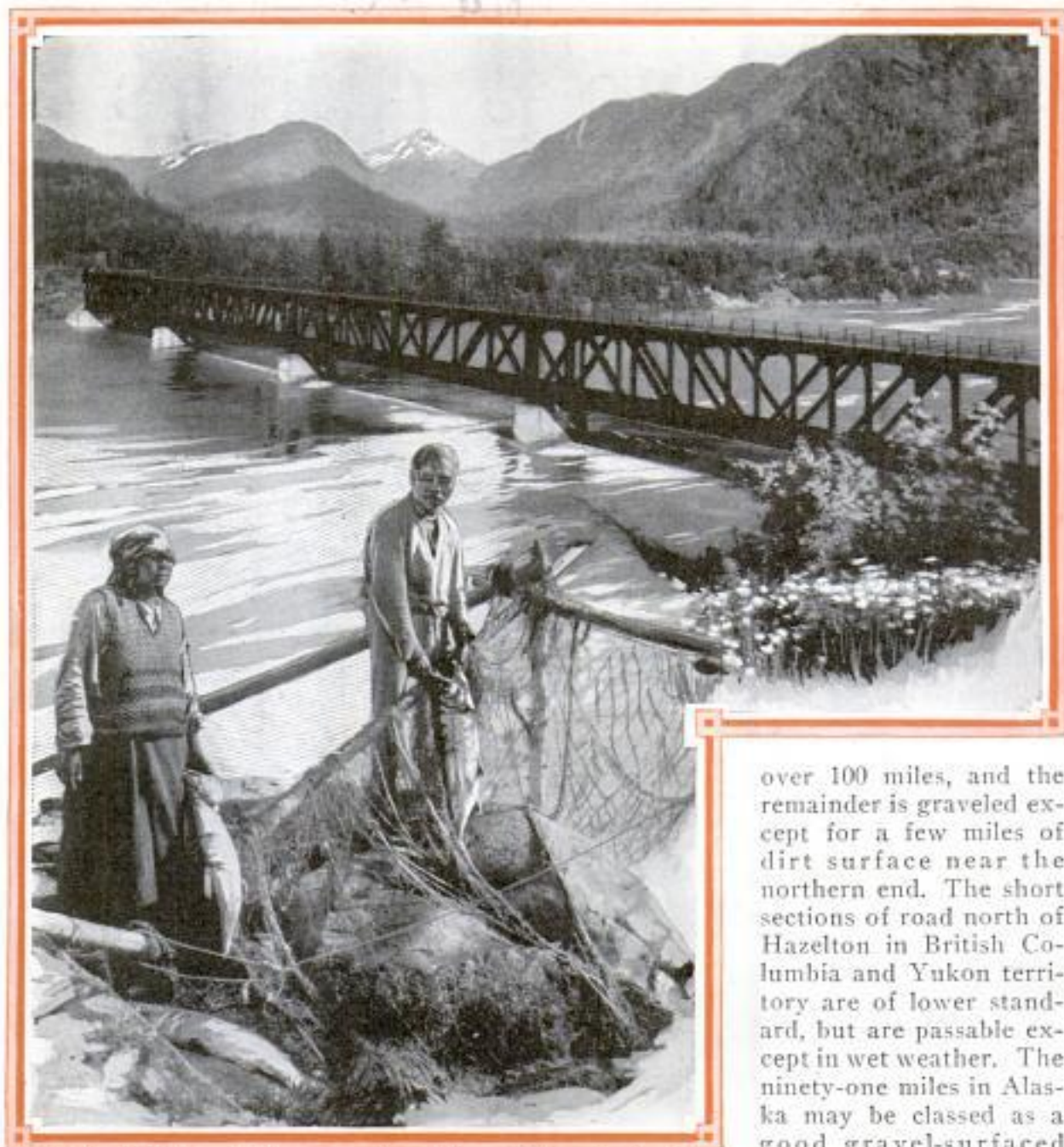

Railroad and Highway Bridge across Fraser River at Hope, B. C.; Below, Indian Chief and His Wife Fishing near Hazelton

over 100 miles, and the remainder is graveled except for a few miles of dirt surface near the northern end. The short sections of road north of Hazelton in British Columbia and Yukon territory are of lower standard, but are passable except in wet weather. The ninety-one miles in Alaska may be classed as a good gravel-surfaced road over which traffic passes without difficulty

to Hazelton—nearly 1,000 miles. North of this there are no roads except short systems radiating for a few miles from the settlements.

Out of a total distance of about 2,221 miles from Seattle, Wash., to Fairbanks, Alaska, there already are available about 1,249 miles of road, leaving 972 miles of new construction for completion of the project. Of the new work, British Columbia has 452 miles, Yukon territory 294 miles and Alaska 226 miles. The road from Seattle to Hazelton is good. At the southern end there is hard pavement for

at all times during the short open season.

In addition to the mining, industrial and agricultural development that may be expected to attend the construction of this new highway, there is also the touring value of the project. Several thousand people from all parts of the United States annually visit Alaska on the steamships. Probably even more will tour Alaska by automobile, especially when, in doing so, they can traverse a region so rich in scenic advantages and historical significance, and unexcelled in hunting and fishing opportunities.

Q 1023

Mrs Margaret H Schurcliff
66 Mt Vernon St
Boston Mass

RARE TOOLS SHOW PROGRESS OF WOODWORKING

Carpenters, both amateur and professional, and woodworkers will be interested in the hobby of a Boston woman, which is the collection of rare and nearly obsolete woodworking tools, and their use in the making of reproductions of early American furniture. She spends a great part of her time in the collection of these tools, and in making "pegleg" furniture, one of the earliest types made by the first settlers. In the collection are many items that are practically obsolete, so far as their present use is concerned, having long been superseded by machinery. Routed out of farmhouse attics, old barns, and abandoned shipyards, the collection constitutes a veritable museum by



Women Making "Peg-leg" Furniture as Hobby, and Old-Time Compass Plane and a Turning Saw

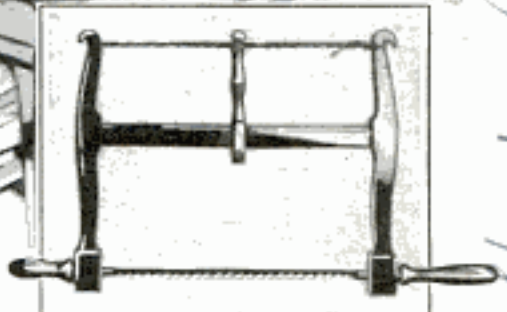

which can be traced the evolution of woodworking tools, though some prove that these have not been changed in design and construction since the days of the Romans. "Many tools termed modern," she says, "are similar in design to those used by the Assyrians, Chinese, Greeks and Egyptians thousands of years ago." In the collection is a carpenters' brace or bit-stock, handsomely ornamented and strengthened with brass, used in America during the eighteenth century, which is almost identical with that shown in a Flemish wall painting of St. Joseph at work as a carpenter, painted in 1438 and now hanging in Brussels. There are also ancient saws, toggled with homespun hemp rope; a huge paring chisel, six inches wide and three feet long, used in a shipyard; a rare compass plane, adjustable by thumbscrews to any desired curve; many old jackplanes, quaint and primitive; several pull planes, used by coopers; a toothing plane, a gutter plane, used for smoothing the concave surfaces

of rain gutters; a convex plane for use on the outer curve; several molding planes; screw boxes for threading wooden pegs; an old "Worrall-patent" box plane dating back to 1856, with a metal top; turning saws; Indian basket knives; a steel-bottomed double-bed plane; right and left planes in pairs, and many other unique tools. There is a ship drill without a center core; a shingle ripper; a screw box and threader in pairs, giant screwdrivers three feet long; peculiar mortising chisels, and many other tools never used today. The owner of this collection, the largest of its kind in the country, has spent years at woodworking, having taken a course in carpentering at school and later a woodworking course at the Massachusetts Institute of Technology.

Those wishing further information on anything described in the editorial pages can obtain it by addressing Bureau of Information, Popular Mechanics Magazine, Chicago.

Ans. J. N. Hollingsworth, 18, Huntington Ave Boston, Mass

same address

also } Mrs. Theodora B. Jones
Mrs. Charlotte L. Ware

a 10 30
262

Chicago Rapid
Transfer Co

Science Service
529-a. 5/11/31

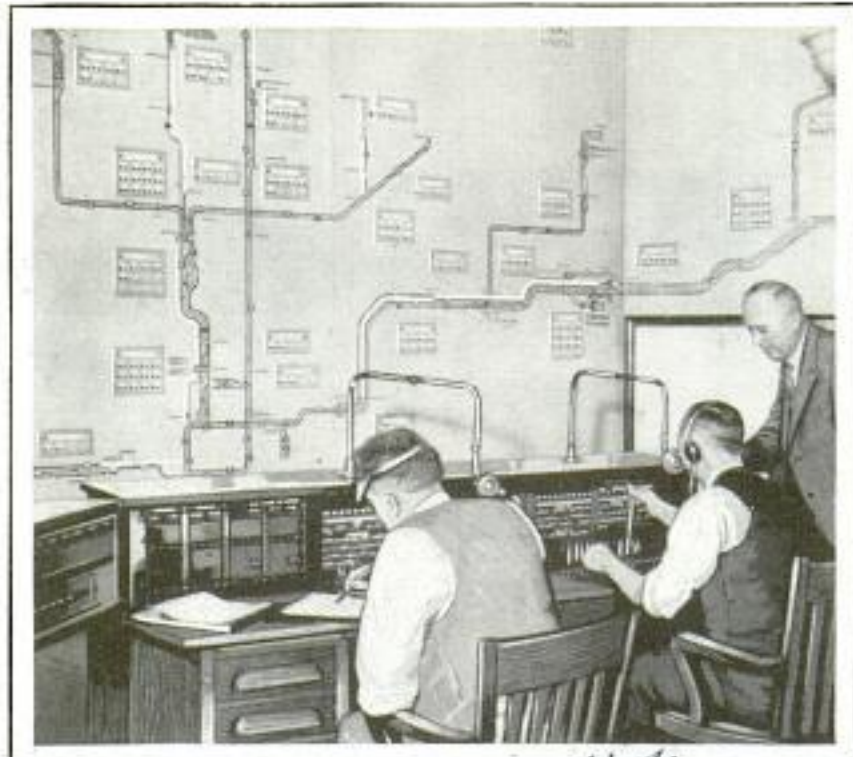

Electrified Map of Chicago's Elevated-Railway System with Colored-Light Signals to Indicate Power Requirements along Lines

ELECTRIC MAP SHOWS POWER NEEDS OF RAILROAD

Two walls of an office high in a Chicago building are covered with an electrical map which reproduces the entire 230 miles of track in the elevated-railway system of the city. Little colored electric lights flare up to indicate a power need somewhere along the track. Power supervisors, seated at a telephone switchboard below the map, relay the information and correct the difficulty.

S-SHAPED ROTOR GETS POWER FROM WIND AND WAVES

Picturesque but inefficient old-style windmills are being replaced in many parts of Europe by an S-shaped vertical rotor, the product of an inventor in Finland. The S-rotor is a development of the Flettner rotor, which was widely demonstrated a few years ago as a power source for ships. However, the Finnish invention works on a different principle, using the direct power of wind or water, whereas the Flettner rotor relies on the "skin friction" of wind against a curved surface. In making the first S-rotor, a Flettner rotor was cut in half vertically

and the halves separated along the cutting line. One advantage of the S-rotor is that it always revolves in the same direction and does not have to be turned about to face the wind or the tide. It has been found to be highly effective in ventilating systems and in creating strong suction to draw smoke through sluggish chimneys. As a windmill, it is said to cost no more than ordinary types, although its efficiency is greater.

ELECTRIC CRANK TURNS ENGINE IN REPAIRS

Controlled by a push button on an extension cord, an electric crank that fits any car takes the place of one mechanic when work is being done on bearings, connecting rods, valves, or other parts of the automobile which necessitate revolving the motor. The crank turns as slowly as desired and stops the motor at any point, giving positive control for any operation. During cold weather, the electric crank can be used to start cold motors, thus saving the work of cranking. It is attached to the front axle, can be adjusted to the height of any crank and operates from any light socket.

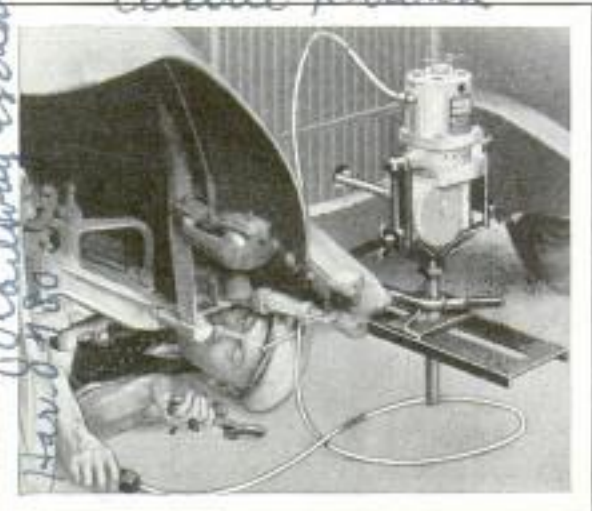

Electric Crank That Clamps to Front Axle and Turns Over Motor during Repairs to Car

Portable Power Tool Co
Warsaw, Ind

see July 1931-98

Chicago Rapid Transfer Co

91106

2160

J. Savonius
Helsingfors



Proof of the Power of Wind and Waves Is Offered in These Two Pictures, One Taken Immediately After a Vessel Had Gone Aground, and the Other Twenty-Four Hours Later

WIND AND WAVES WRECK SHIP IN TWENTY-FOUR HOURS

Pounding waves and whistling wind, if given an opportunity, are capable of converting the stanchest vessel to driftwood in a few hours. No better illustration of this is found than in two remarkable pictures of the motor ship "Malabar," one

taken nine hours after it had gone aground near Sydney, Australia, and the other twenty-four hours later. The first photograph shows the boat still in fair condition after the passengers had been taken off. The second reveals parts of the broken hull and a mass of jumbled wreckage when the wind and waves had finished with the big ship.

FLEXIBLE-STEEL RAILROAD TIE

To overcome the disadvantage of rigidity that handicaps most metal railroad ties, a German inventor has made a flexible steel tie that retains the strength and permanence of the more rigid ones. It

consists of a tube of approximately elliptical cross section, slotted along its lower side in order to allow a certain amount of "give" when a train passes. The hollow interior is filled with ballast, and sideslip on curves is prevented by stopping the open ends of the ties with steel plates.

Handwritten notes:
 a-1131
 at Long Bay.
 Dr. Herr Franz H. O. Auerbach
 bei Dresden, Germany, Scheibe & Klotzsche
 Internationale
 source
 530-222-1021/21

Q. 84
Cmt. Andrew A. Boone
613 Spreckels Theatre Bldg
San Diego Calif.

Did You Ever Hear of a



agents in eighty-five localities throughout the world, expert hunters and trappers who capture vicious black tigers, temperamental antelope, timid deer, and animals who thrive on bugs. His biggest task lies not in capturing the animals, but in readjusting their diets so they will thrive in captivity. Animals, Mr. Horne has found, enjoy captivity once they learn they have nothing more to fear from marauding enemies. They grow fat and happy.

But their food! Primarily an "animal man," Mr. Horne also has become a chemist and physicist, devising foods

Photos Courtesy I. S. Horne

This Creature with the Pessimistic Outlook on Life Is a Giant Elephant Seal, One of the Rarest Animals to Be Imported

FROM a hundred localities scattered through the world agents of many nationalities gather odd animals that later enter through several ports of the United States, destined for circuses, zoos, and for other places where strange animals are brought together.

The echidna, an egg-laying mammal and one of the lowest types of all mammals; tiny elephants, albino ring-tailed capuchin monkeys, black leopards, blood-sweating hippos, mouselike deers and all manner of animals are brought here for your entertainment.

Rare animals are not available in large quantities, as they were when Theodore Roosevelt roamed Africa with his rifle, according to I. S. Horne, who since boyhood has been importing strange animals from the darker places of foreign countries, and has witnessed the disappearance of the rarer specimens.

Mr. Horne and his organization have

to supplant their natural diets in the wide open spaces. He has, for instance, made a chemical analysis of the spugna moss, lichens and other foods of the reindeer imported from Alaska, Norway and Greenland. From those analyses he devised a formula of minerals to add to the grains of the captives' diet. For other animals, particularly those living on ants and grubs, he adds formic acid, found in the ants' bodies, to the meat and eggs fed in captivity. In this manner, the animals get their necessary vitamins. From kelp he takes iodine, which does away with rickets and strengthens bones in the young.

Some of the animals he imports, Mr. Horne has learned, possess criminal cunning; others are friendly. Among them he finds each year an assortment of temperaments and intelligence one would expect to see only among the varied population of a large city.

"Many animals," explains Mr. Horne,

General Manager, Hornes Zoological Arena Co.
505 Alhambra St. Alhambra, Calif.

Babiroussa?

"are temperamental, the antelope particularly. The antelope will lick your hand one minute and try to ram a horn through you the next. Chimpanzees are much the same, but they have an uncanny in-



telligence. The 'chimp' almost can talk. He gestures in a thousand ways."

"But what animals," he was asked, "do you prefer to handle? These intelligent, expressible creatures, or some of those more cunning?"

"Ever since I was a boy," Mr. Horne said, "I have preferred the big cats. We can control them, odd as it may seem, more easily than deer. Antelope and deer are fractious. They break their legs easily. They are constantly battering themselves



Capuchin Monkey That Shades Its Eyes in Strong Light; Left, Kodiak Bear in Playful Mood

against their crates, aboard ship and en route to zoos. Bears, also, present many difficulties. They tear with their teeth and claws. Sometimes they reach through the bars and rip the skin off some handler's arm. But the lions, tigers and leopards, contrary to popular thought, are not man-killers, and once in a cage they lie down and behave themselves. All except the black leopard are tractable. The black leopard is an off-colored or 'sport' of the spotted leopard. It gets its color from inbreeding and is not a distinct species.

"Vicious? I should say the black leopard is the most dangerous animal ever held in captivity."

"What are the rarest animals you ever brought into the United States?"

"Recently we brought across the Pacific two babiroussa from north Borneo.



These animals never were imported before. They are members of the hog family. A circular tusk grows through the upper lip and, in the adults, makes an eight-inch circle over the head and grows down alongside again. One of them died and is now in the Washington museum.

"Mouse deer also are very rare. They stand ten inches high at the shoulder when mature. These tiny creatures exist in limited numbers in Borneo, Sumatra, Java and the Malay peninsula. They eat fresh lettuce, spinach, carrots, apples, hay and grain in captivity. We keep these things on ice and serve them chilled. You see, for every animal we have a slightly different feeding problem."

Also, Mr. Horne explained, some animals are great bluffers. The alligator, found within our own shores, likes to appear vicious, yet a single thumb and finger applied at the top of his mouth can hold that yawning cavern closed. Alli-

gators are easily handled. By tying the mouth closed, six men can pick up even the largest and carry him anywhere.

Two of the rarest animals ever imported are the elephant seal from Guadaloupe island and the bear cat (binturong) from Sumatra and Java. The elephant seal eats slowly moving things and swallows them whole. He seldom lives longer than three years in captivity.

The bear cats, of which there are only three or four specimens in the United States, are the only carnivorous animals with tails like monkeys'. They have heavy fur coats and climb trees readily. Oddly, bear cats will not permit handlers

to pet them, yet they will climb up a trainer's leg as though seeking human companionship. They sleep when the sun is out and prowl about their cages in the moonlight.

One of the most popular animals is the big hippopotamus. It is supposed to sweat blood, but the substance exuding through the pores is poisons thrown off in this manner.



Top, Blood-Sweating Hippopotamus; Center, Feeding Milk to Baby Seal; Below, Monkey Cuddling Kitten

BARK OF A TREE TURNS THE WHEELS OF PROGRESS

Do you know that the center of many baseballs is the bark of a tree? And that the bark from this same tree is used as a

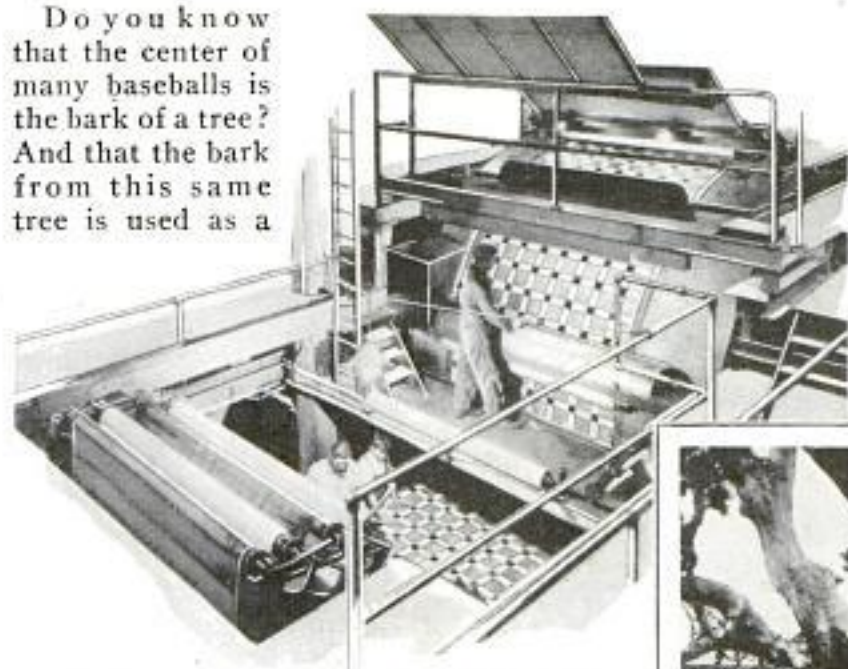

trunk is sometimes as much as four feet in diameter. One of the most interesting processes in which cork is utilized is in the manufacture of linoleum. This article contains scrap material from the making of bottle corks and other products, but cork can only

Above, Making Linoleum from Scrap Cork; Right, Species of Oak Tree from Which Cork Is Obtained

foundation layer beneath the outside wrapping on the handle of your favorite golf club? The same bark is used in life preservers to keep people afloat and is finding new applications almost daily. Cork is used in your automobile, in your shoes and in many different places about your home. When you go duck-hunting, a lifelike decoy, fashioned from natural cork, is taken along. On your fishing trips, you'll have cork bobbers, while the handles of your fishing rods likewise will be of cork. Cork table mats prevent hot dishes from marring your dining-room table. Cork is the product of two species of oak trees—*Quercus occidentalis* and *Quercus suber*. The trees grow to a height of from twenty to sixty feet, while the



be included in the linoleum after having been ground to a fine dust.

BETTER WAY TO WASH DISHES SOUGHT BY SCIENTISTS

It probably will surprise the housewife to learn that dried egg, after all, is not the hardest thing to get off a plate. Scientists of the Westinghouse laboratories have discovered that a mixture of castor oil and lampblack is more resistant than egg, but the highest standard of dirtiness in dishes is achieved by allowing tomato soup to drop on plates from a height of

six feet and then dry. This covers the dishes with interlocking fibers of about 1,500 circular tomato-soup splotches. The investigations were made in order to find how electric dishwashing machines should be constructed, and various designs are rated according to the number of tomato-soup splotches they can remove in a given time. The efficiency was found to vary from twenty to eighty-seven per cent, but one has been made which removes ninety-eight per cent of the spots.

Cont. H. A. Kyser, Minter, Ala. Copyrighted material



Automatic Extension Ladder Mounted on German Fire Truck; the Ladder Is Electrically Controlled by Means of a Push Button

PUSH BUTTON ON FIRE LADDER CONTROLS EXTENSION

Germany is modernizing her fire-fighting apparatus and among the latest equipment is a truck on which is mounted an extension ladder controlled by electrical means. The ladder is in four sections, each twenty-five feet long, and can be raised to any height by a mere push on a button. The automatic ladder is not only more efficient in fighting a fire, but adds to the safety of those on it.

RADIO-TUBE COMPASS PROVIDES ADDED SAFETY FOR FLYERS

Two German scientists have made a compass for flyers that depends for its operation upon the fact that so-called

a-1040
Mr. Mayer
Mr. Brüche

"slow" electron streams, generated by the glowing cathode of a radio tube, are deflected by the earth's magnetic field. For the purpose of the compass, the stream or ray is made to pass a vacuum of certain length and then reflected upon a fluorescent screen where it produces a luminous point. If the ray were not deflected by the earth's magnetic field, the light spot would appear in the exact center of the screen, but, being deflected, the spot falls a short distance from the center and to the east of it. Hence a line connecting the two gives a true east-to-west indication from which the remaining points are laid out on the screen. Since the ray's deflection varies according to the inclination of the airplane in reference to the magnetic field, the compass also shows if and how far the ship is out of level laterally and longitudinally, this information being

read from scales on the screen. It is claimed the compass is absolutely proof against vibrations and changes in flying performance.

PAINTE MADE FROM POTATOES

a 1030
Potatoes provide the base for a cheap and durable form of paint suitable for use particularly on farms for gates, fences or machinery exposed to the weather. One pound of potatoes are peeled and well baked. They are then mashed in three or four pounds of boiling water and passed through a sieve. To the mixture is added two pounds of powdered chalk mixed with four pounds of water. This forms a sort of glue capable of receiving any kind of color, even powdered charcoal or soot for a fine black.

Cmd. Es. H. Eckhardt
4528 Walnut
Phila

9408

"WHAT'S THE JOKE?"—SNAPPED IN ANIMAL WORLD



"Look Pleasant, Please," Requested the Photographer as He Aimed His Black Box at "Fay," a Lioness at the London Zoo; "Fay" Was Obliging and Did Her Best, and Here Is the Result; Top, Center, a Rare Specimen of Toucan Which Seems to Have Heard a Funny Story

"Laugh and the World Laughs with You" Seems to Be the Motto of the Animals and Birds on This Page, and the Pictures Would Appear to Offer Proof That They Can Not Only See the Joke, but Are Able to Chuckle over It as Well; Above Is "Tom" Attending a Tea Party and Dressed Like a Girl; Someone Has Just Called Attention to His Costume; Left, a Happy Dog in the Midst of an Uproarious Outburst



Is He Laughing or Crying? This Bull Pup May Be Either Hungry or Happy, but His Feelings Were Not Consulted When the Picture Was Made and His Expression Is Puzzling

"He Who Laughs Last Laughs Best," Says This Shoe-Billed Stork as It Indulges in What Appears to Be a Hearty Guffaw; the Bird's Opened Mouth Gives an Effect as Though It Were Laughing



a 1048
270

Perfected by Leon Hommel
Machine Works
340 Adeline St
Oakland, Calif
a 109
EXCELSIOR MADE
FROM PAPER

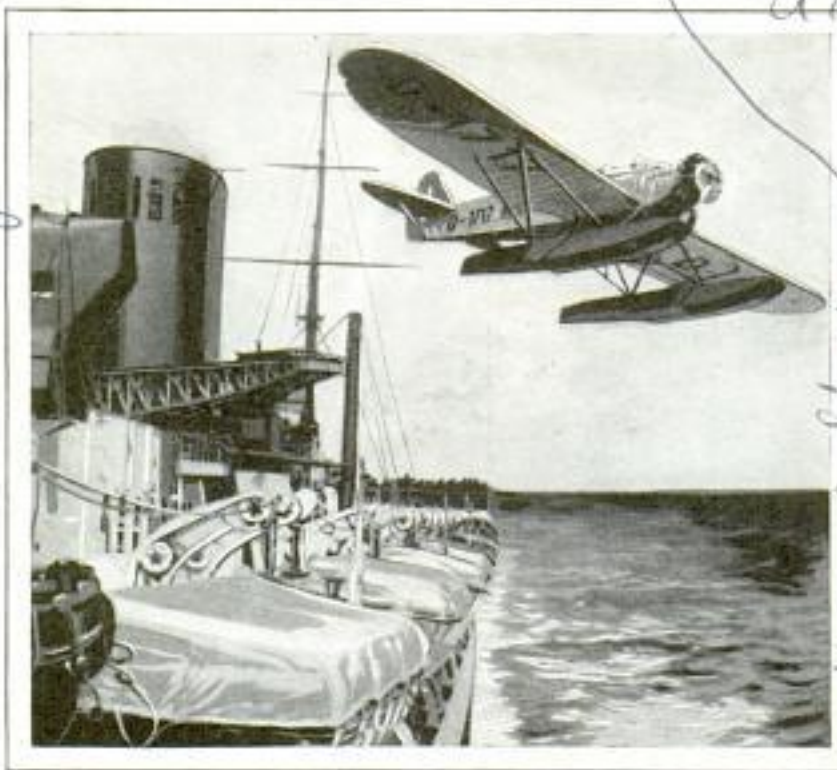

Air-Mail Plane Taking Off from Ocean Liner with Letters Which Will Reach Shore a Day or More Ahead of the Ship's Mail Cargo

SHIP-TO-SHORE AIR SERVICE AGAIN SPEEDS MAILS

Ship-to-shore air-mail service has been resumed on the Atlantic after having been tried and abandoned for further tests. Working on a definite schedule, pilots now take off from the speeding liners long before the coast is reached and land the mail for delivery a day or more ahead of the regular mail cargo. Improvements in catapults now insure a take-off at flying speed, with a minimum of shock to the plane and pilot.

SAME PLANT BEARS POTATOES AND ALSO TOMATOES

By grafting a young tomato plant on the growing roots of a potato plant, an interesting crossbreed that bears potatoes as roots and tomatoes as fruit can be developed to save space in the vegetable garden. The potato plant is cut off diagonally near the ground, and onto it is grafted a tomato plant also slit diagonally. Care must be taken that the parts of the plants immediately under the bark come in contact. The graft is wrapped with raffia, and it is not necessary even to cover it with wax, although this is desirable.

James Lambert, director,
Botanic Gardens, Univ.
Pennsylvania, Phila

Any sort of paper stock can be converted into paper excelsior for packing purposes by a shredder made particularly for cutting up this and other similar materials. It also will cut alfalfa into chicken feed, chop cardboard into parts as fine as sawdust and clip rags into fragments for use in making roof material and other compositions.

**EXTREMES AMONG WATCHES SEEN IN CON-
T**

Giant and midget among watches recently passed the time of day in

Chicago where both were on exhibition. Side by side they offered a striking contrast in timepieces, for the big watch weighs 550 pounds and the movement of the small one tips the scales at a quarter of an ounce. Both tick off the minutes



A Contrast in Watches; the Big One Weighs 550 Pounds, the Small Less Than an Ounce

accurately and both were brought from Europe to this country.

North German Lloyd Liners
Breitfurt and Europa

Hommel Shredder

a-1079

at Marshall's

a-1068

Pin Ball, 111 E 4th St.
Ann Arbor, Mich

ANCIENT GAME MADE NEW FOR OUTDOOR SPORT

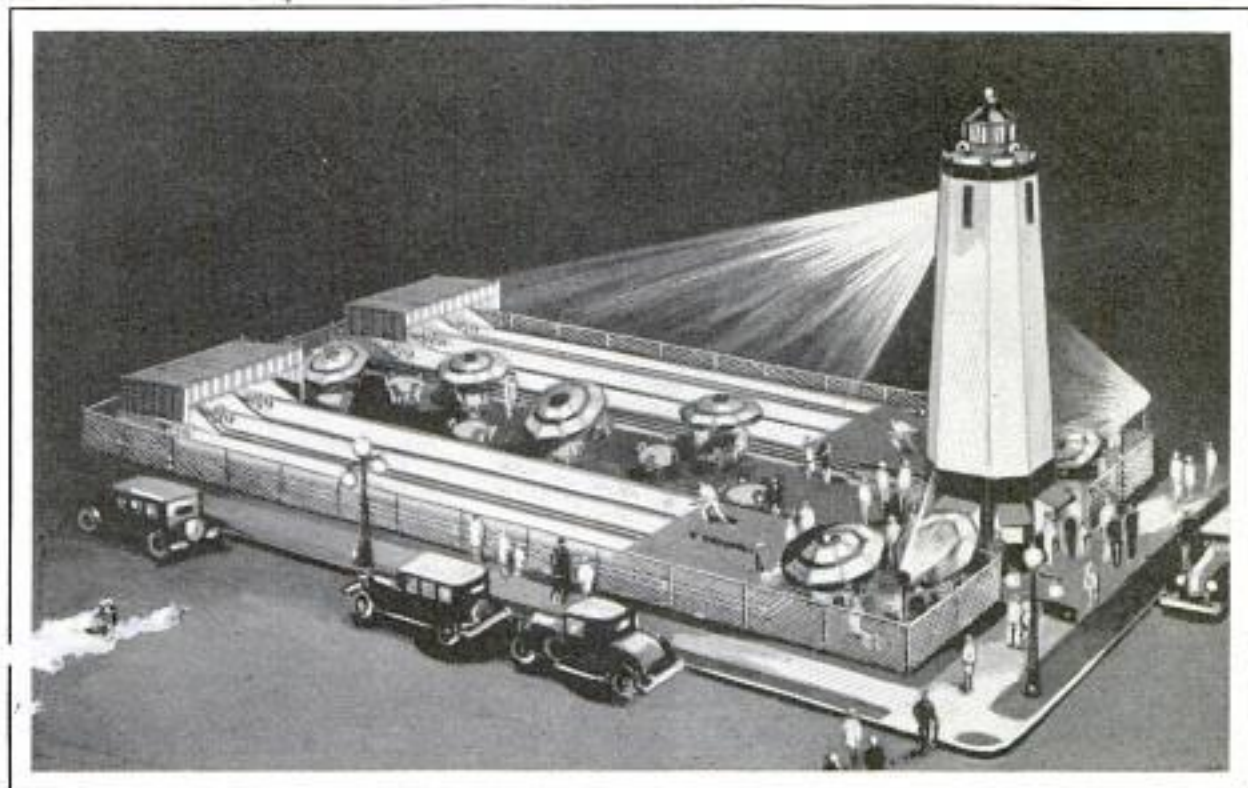

Outdoor Bowling Court with the Alleys Supported on Steel Piers; the Entire Equipment Is Weatherproof, and the Bowling Surface Is a Composition Material with the Resiliency of Wood

Bowling, which had its ancient origin on the green, again is being moved outdoors in the game of pin ball which is simply standard bowling played on a court in the open. The equipment is weatherproof since the courts are constructed of steel and the bowling surface is of a composition unaffected by rain, sun, snow or ice. The alleys come in sections and are supported by steel piers on top of which are leveling nuts to keep the surface al-

ways uniform. The composition can be highly polished but because of its dull color there is no glare from sun or from floodlights at night. Heretofore canvas canopies have been required to protect the alleys from sun glare and rain. Pin ball has no covers except at the pit for the purpose of deadening noise. The walls of the pit are steel-lined, and a swinging panel in front seals the-pit when the courts are not in use.

AUTOS INTERFERE WITH RADIO SO HORSES GET WORK

Because the ignition systems of motor cars interfere with the reception and re-routing of radiophone calls, horses have supplanted automobiles in the vicinity of a big transatlantic telephone station in New Jersey. The station has been carefully located as far as possible from regular airways to eliminate interference from airplane motors, and only official cars, with shielded ignition systems, are permitted within a zone established about the station. Annoying background noises,

often serious enough to spoil radiophone communication, were traced to automobiles in the neighborhood. So the anti-auto rule was established, and horse-drawn vehicles now serve the station.

ULTRAVIOLET PROTECTION

Dangerous and invisible rays of ultraviolet light produced by arc welding are absorbed by a special paint developed for the covering of walls in rooms where such work is done. It is an oil-type paint, gray in color, and dries in about two hours after application.

Radio Press, 35-16 4th St. N.Y.

Bell Telephone Advertising Station, Newark, N.J.

merchandise dept
General Electric Co.
Schenectady, N.Y.

a 1036

a-1114

Copyrighted material

a 1080

RIDERLESS HORSE RACING LATEST MEXICAN SPORT



Wide World

Riderless Race Horses Closely Bunched on a Mexican Track; These Animals, Trained to Race without Jockeys, Stage Contests as Hard-Fought as When Urged on by Riders

Race horses, trained to run without jockeys, are attracting attention in Mexico, where this innovation in racing was made. Jockeyless racing puts the full responsibility on the animals. Spectators say that the horses, running by themselves, put up fast, hard-fought races, just as exciting to watch as the usual kind.

IS THE UNIVERSE EXPLODING ASTRONOMERS INQUIRE

a 1126

Is the universe actually exploding like a gigantic shell, flying to pieces at rates of thousands of miles per second, and doubling in size every 1,400,000,000 years? Astronomers now are trying to solve this problem, one of the universe's greatest scientific mysteries. Sir James Jeans, British astronomer, after a visit to Mt. Wilson observatory in California, revealed that a dual attack by scientists there may answer the question in a few more years. The basis for the theory is the discovery that the great nebulae or gigantic star groups are rushing away from the earth at terrific speeds, some as high as 12,500 miles a second. Whether the immense recessional velocities are real exploding motions of the universe,

or merely apparent effects that can be explained otherwise, still remains to be seen. Sir James explained that the stars are known to be millions of years old and thus the universe, if it has been exploding continuously, must once have been extremely small and compact. Explaining the size and structure of the universe, Sir James said that, if the farthest reach of the largest telescope today, a distance that would take light 140,000,000 years to cross, were only a mile, and 300 tons of apples were scattered seventy-five feet apart, each would represent a system of stars like the Milky Way in which our sun is but one of several hundred million.

COST OF BURIED POWER LINES LESS THAN OVERHEAD

a 1066

Rural electric-power lines can be run underground cheaper than they can be strung on poles. This is shown in a recent report to the National Electric Light association and indicates that it may be possible for farming areas to enjoy underground electric distribution. The report urges underground construction of two-wire circuits that will not be changed to three-wire for some years.

Scene Service 530.B
5/19/31

Scene Service 529.C
5/13/31
Copyrighted material

Cont. K. & Chute Box 407
Route 4, Hayward Calif

Dr. J. E. Dougherty,
University of California
Berkeley Calif

A-1153

ICELESS STORAGE KEEPS EGGS WITH LITTLE SHRINKAGE

Using evaporating water instead of ice as the cooling medium, a storage bin for eggs has been invented by a California professor. It holds eight cases of eggs in stacks of four each, and is covered with burlap, treated to keep it from rotting. The burlap is kept moist by water fed from a tank on top of the cooler. The tank is connected directly to a water supply, and the level is kept constant by means of a float valve. In a test, eggs held five days in the cooler showed a shrinkage of four per cent, as compared with forty-two per cent for eggs stored outside.

NEON-TUBE LIGHTS FOR HOMES GIVE SOFT ILLUMINATION

Neon-tube lighting, which heretofore has been confined to signs and decorations, is now being developed for homes and offices because, aside from its economy of operation, it possesses a softness not found in other forms of illumination. Georges Claude, noted French engineer, has made a light for interior use that operates directly from low-voltage house current like an ordinary incandescent bulb. It consists of a coiled glass tubing containing a combination of rare gases and is about the size of the usual light bulb. It can be placed in the ceiling, on wall brackets or in table or floor lamps, and the specially prepared tubing together with the rare gases produces only the beneficial ultraviolet rays, the shorter and harmful ones being entirely eliminated.



Neon-Tube Light for the Home That Operates from House Current; the Reflector Is Unnecessary

Claude Henri Luc
Liggett Bldg. 42nd + Madison
New York

POPULAR MECHANICS

Radio Compass Which Registers Direction of Any Broadcasting Station



RADIO COMPASS IS SO LIGHT ONE MAN CAN CARRY IT

Modern yachtsmen now can guide their vessels with the radio compass, an adaptation of the radio direction finder to boats. The apparatus is so light that one man can easily carry it about, and operates by picking up and registering the direction of any broadcasting station tuned in by the man in charge.

AIR BEACON ALSO IS "SUNDIAL" TO TELL TIME AT NIGHT

Using light instead of shadow to tell time, a giant nocturnal sundial is to be installed by the city of Guayaquil, Ecuador. An electric searchlight will revolve once every twenty-four hours and indicate the time by illuminating surrounding landmarks at the same hour each night. The clock tower is to be in the center of beautiful gardens now being laid out along the waterfront. A historic clock, built in 1841, will be housed in the structure, which will be of Moorish architecture. The giant air-beacon-searchlight clock will be mounted atop the tower.

About 50,000 Canadian farmers and other land owners are in the maple-sugar business.

Copyrighted material

273

Dr. W. S. Perhard
Fischer Research
Eng. R. Radio Laboratories
Broadway, New York
A-118/120
bought from
Chubna Lidales & Co.

*design of small weather bureau apparatus
Highland Light Cape Cod*

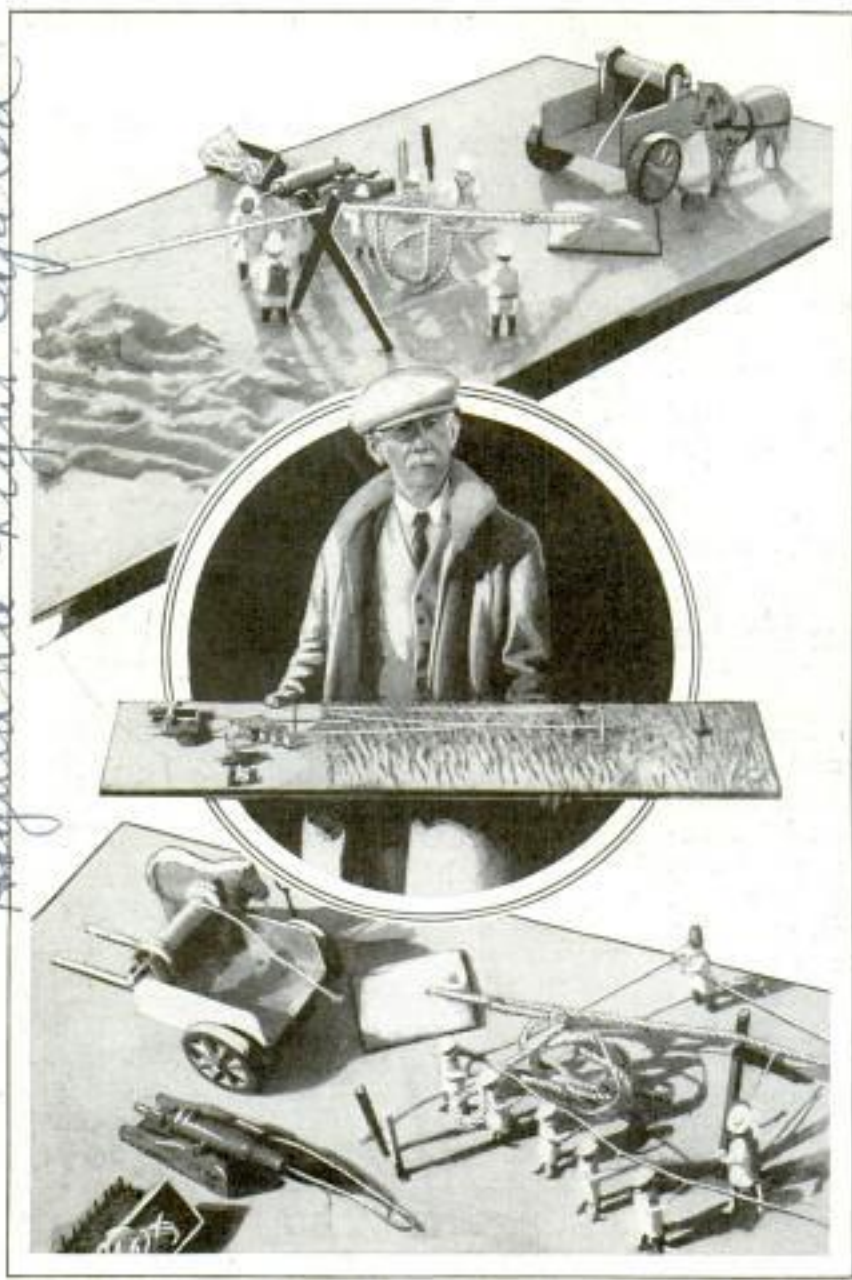

Model of a Shipwreck Built to Demonstrate the Operation of a Breeches Buoy; It Is Constructed on a Plank Five Feet Long

SHIPWRECKS MADE TO ORDER BY WORKING MODEL

A model of a shipwreck has been made for a weather recorder stationed on the tip of Cape Cod to aid him in answering the queries of curious visitors as to the operation of a breeches buoy. His model includes the wreck, the ocean, the coast-guard station and a breeches buoy that really operates. It is built on a plank, five feet long and one foot wide. A small sailing vessel is represented as having grounded on a sand bar, and is being pounded to pieces by the plaster-of-paris waves. On the shore, the coast guard is

shown in action with all equipment set up and the breeches buoy in operation. The cannon which shoots the lifeline is spiked in place, and the horse used to drag the beach wagon is tied up at one side in regulation manner. All members of the crew on ship and on shore are in their correct positions, the ropes are in order and even the tags used in giving directions in several languages are reproduced.

TELEVISION TRIED WITH WHITE LIGHT

91156

With microphones installed in the audience chamber, a speaker in a recent television test at the General Electric laboratories heard queries addressed to him, which he answered by television. The test was conducted before an audience of 700. The speakers were placed in the laboratory of Dr. E. W. Alexanderson, in another building. An additional feature of the test was the demonstration of television projected by white light, instead of the usual pinkish glow of the neon tube.

The theater projection outfit designed by Doctor Alexanderson was used, and the television image thrown on a large screen in the conventional black and white shades, giving depth and detail to the image.

The Popular Mechanics' Bureau of Information offers its free service to all readers of our magazine. Names and addresses of manufacturers and dealers in articles described, and any other details in our possession, will be promptly furnished by addressing the bureau.

Schneetady, NY

"READY" ROOM FOR FLYERS ON AIRPLANE CARRIER

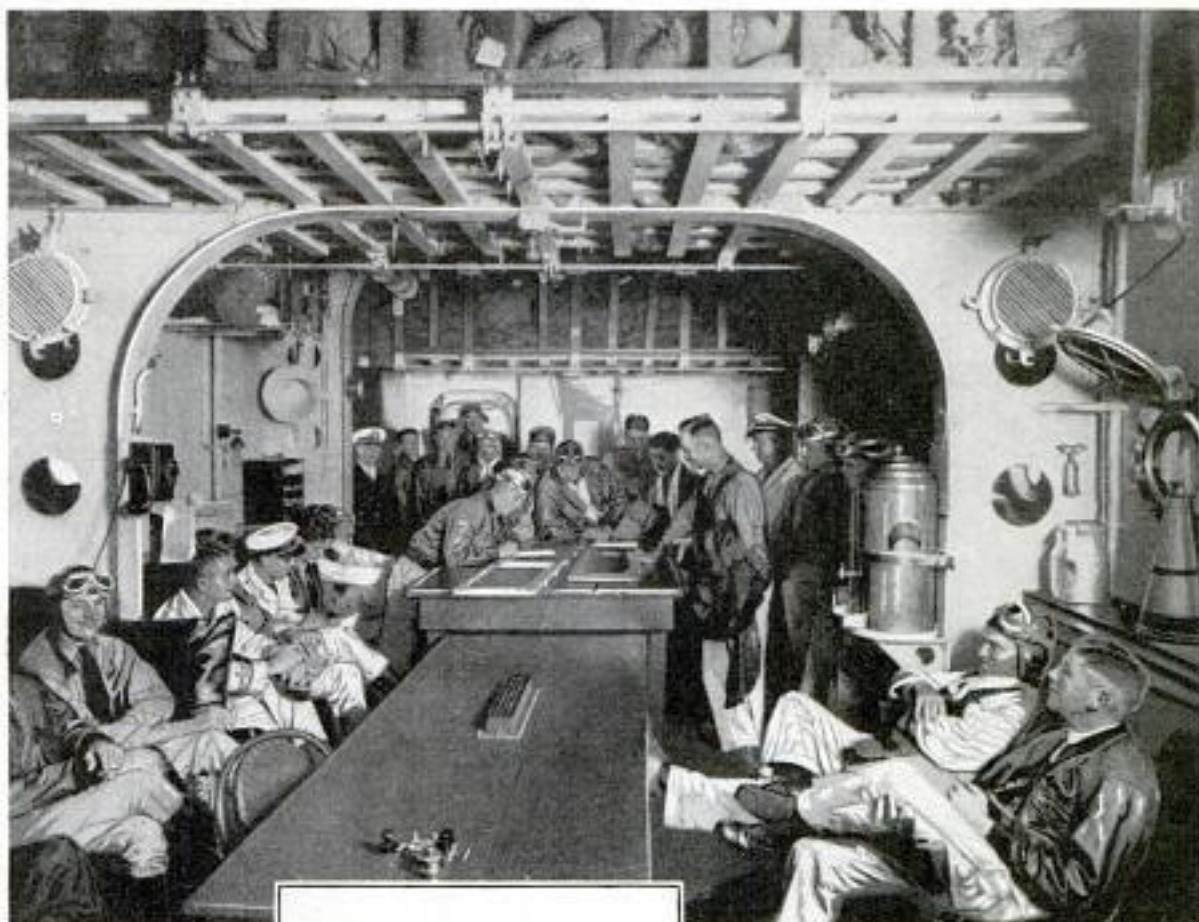

Views below Deck on Board the Navy's Airplane Carrier "Saratoga"; Above Is Shown the Aviators' "Ready" Room on the Ship Crowded with Flyers Preparing for Flights or Awaiting the Call to Duty; Below, Left, Aerographer Keeping Track of Meteorological Vagaries by Making the Daily Weather Chart for the Guidance of the Flyers; Right, a Corner of the "Saratoga's" Printing Shop Which Includes a Linotype and All Equipment of a Plant Ashore



a-908 Cont. Elm Classroom, New York
55 W. 16th St.

The HOME of

With all the recent improvements in the art of living, there is a crying need for many more. Before the days of centralized heating, houses were uncomfortably cold in winter, but today almost any home boasts an efficient heating plant.

On the other hand, inventors have done little or nothing about making those homes comfortable during the hot summers. What is sorely needed in almost every section of this country is a moderate-priced system to cool and purify the domestic atmosphere in the hot season. This is one of many improvements which mankind waits.

It is hard to conceive how our fathers endured the inartistic homes and appalling discomfort of fifty years ago. Dinner tables rolled on squeaky casters; bathtubs were curios; housewives swept with germ-breeding brooms; the shower bath was unknown; factories belched black smoke; scraggy horses dragged street cars; gas lamps lighted the home; theaters were fire traps and

unventilated; traveling other than by railroad was a great hardship; window screens were unknown; hordes of flies polluted food and pestered sleepers, and business thoroughfares were obstructed by unsightly poles weighed down by telegraph wires.

The present year long will be remembered as the time the world's first all-metal home, built to full size and completely equipped, appeared fresh from the draft-

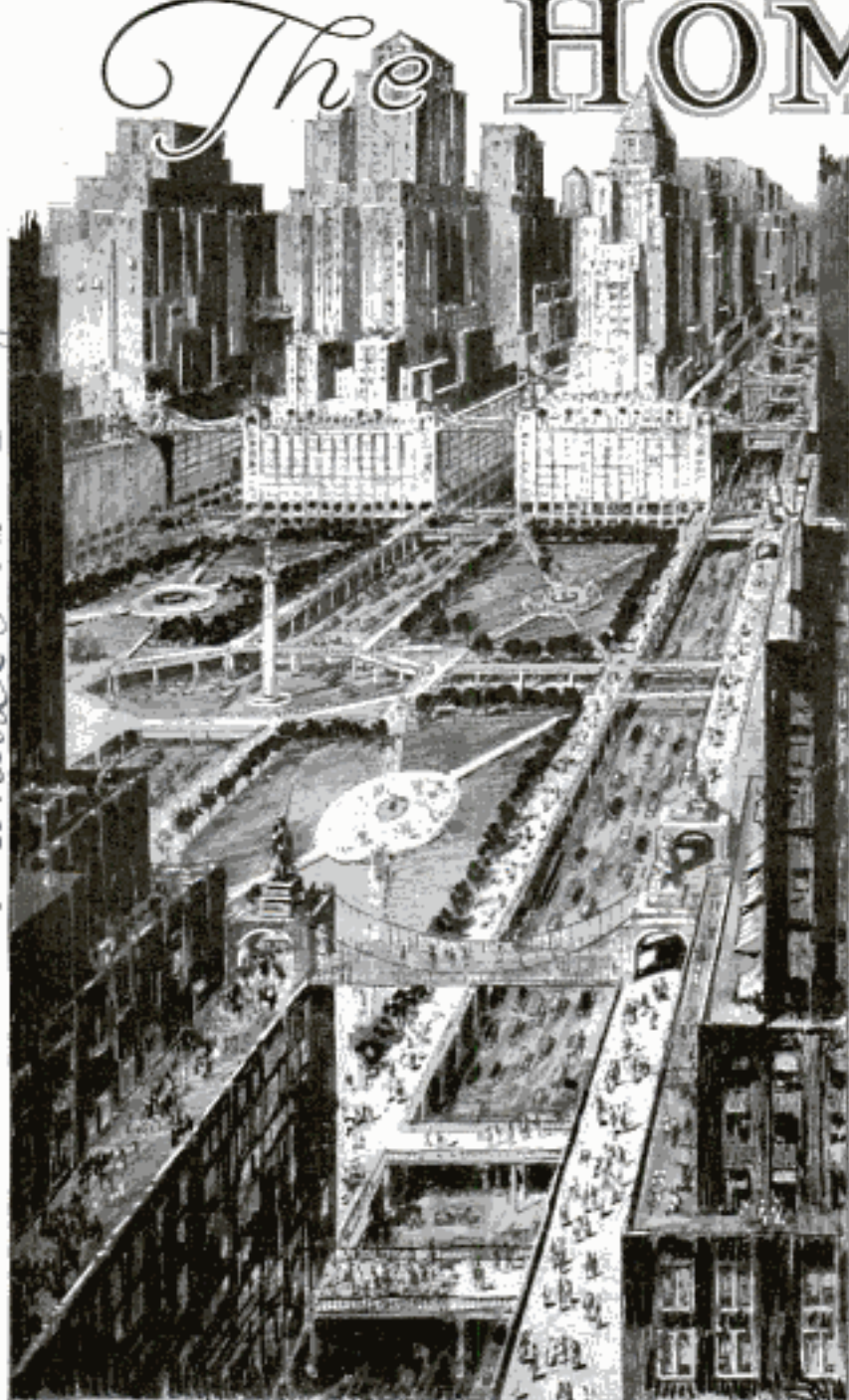

New York in 1950 as H. W. Corbett Pictures It; Ground Levels Will Accommodate Autos While Sidewalks Will Be Elevated

THAT the average American will live more comfortably and luxuriously, and at less cost, than he does today was the prediction at a recent architectural show in the east.

In 1910, the average person in this country consumed only six and a half kilowatt-hours of electricity; in 1920 he consumed nineteen and in 1930 he consumed forty-nine. Yet one can buy nine times as much electricity for one cent in 1931 as in 1890.

Architectural and Allied Arts Exposition Apr. 18-25
Grand Central Palace

Designed by W. Lawrence
Kocher and Albert
Frey, 4 Park End Place
New York
A. 908
Long Island
N.Y.

the FUTURE

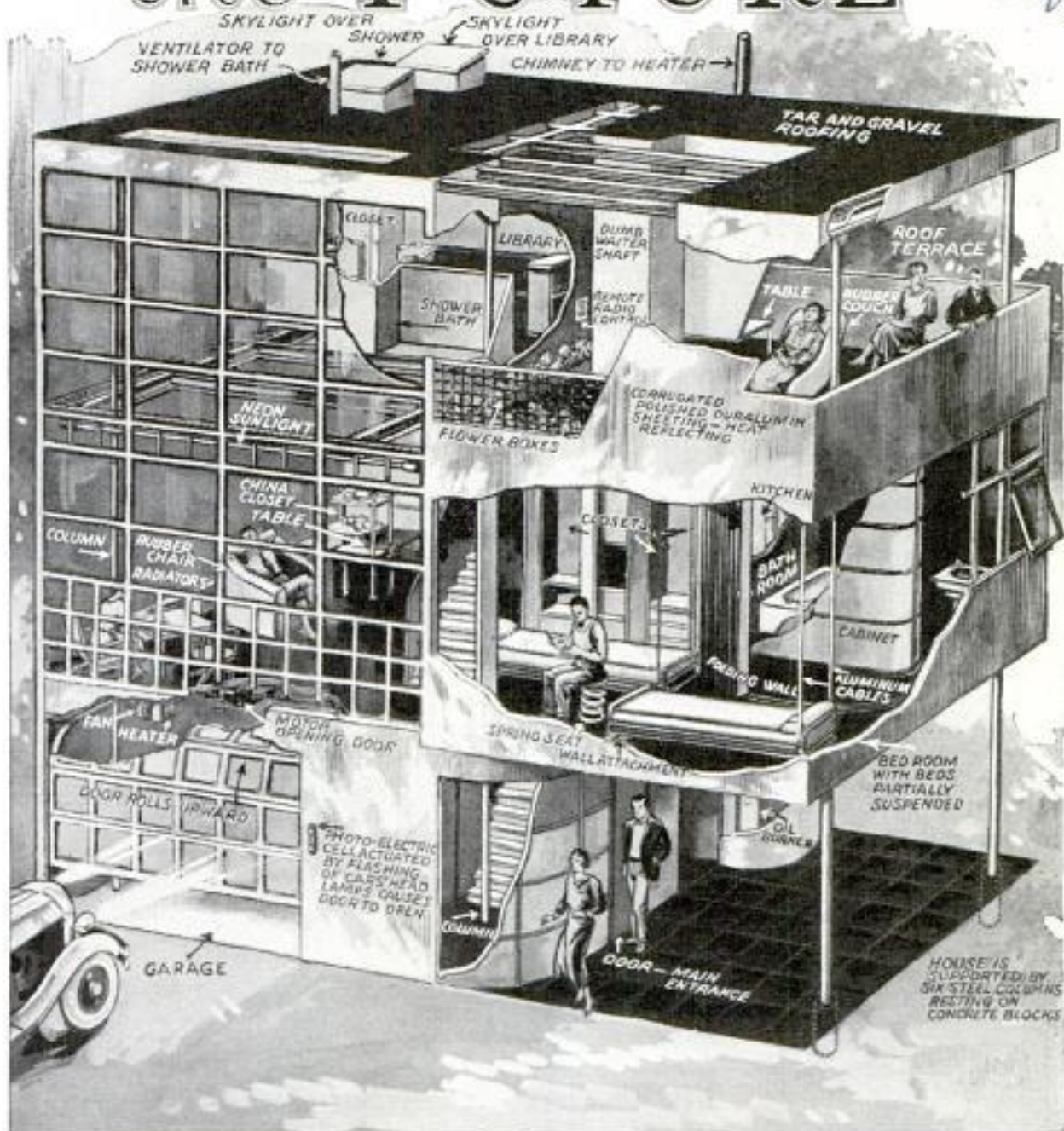

Review Sept 1932 - 353

Drawn by Logan U. Beares
Cut-Away Representation of the Home of the Future; the House Is Constructed Entirely of Metal and Glass, with the Latest Space and Labor-Saving Features

ing room, the foundry, laboratory and the brain of man.

As it stood at the exposition, this house represented the effort of centuries, although it cost only \$4,000.

The ground dimensions are twenty-two by twenty-eight feet and the height is thirty-five feet. The house has no basement, because, according to the architect, basements are hold-overs from the days

before mechanical refrigeration, when foods were kept cool underground.

As for convenience and comfort, this house embodies almost everything man has so far devised to add to his ease. It might be regarded as a sort of museum of domestic invention. The architect conceived it on the principle that moderns want luxury at moderate prices, not merely quaint, vine-clad cottages.

a-908
278

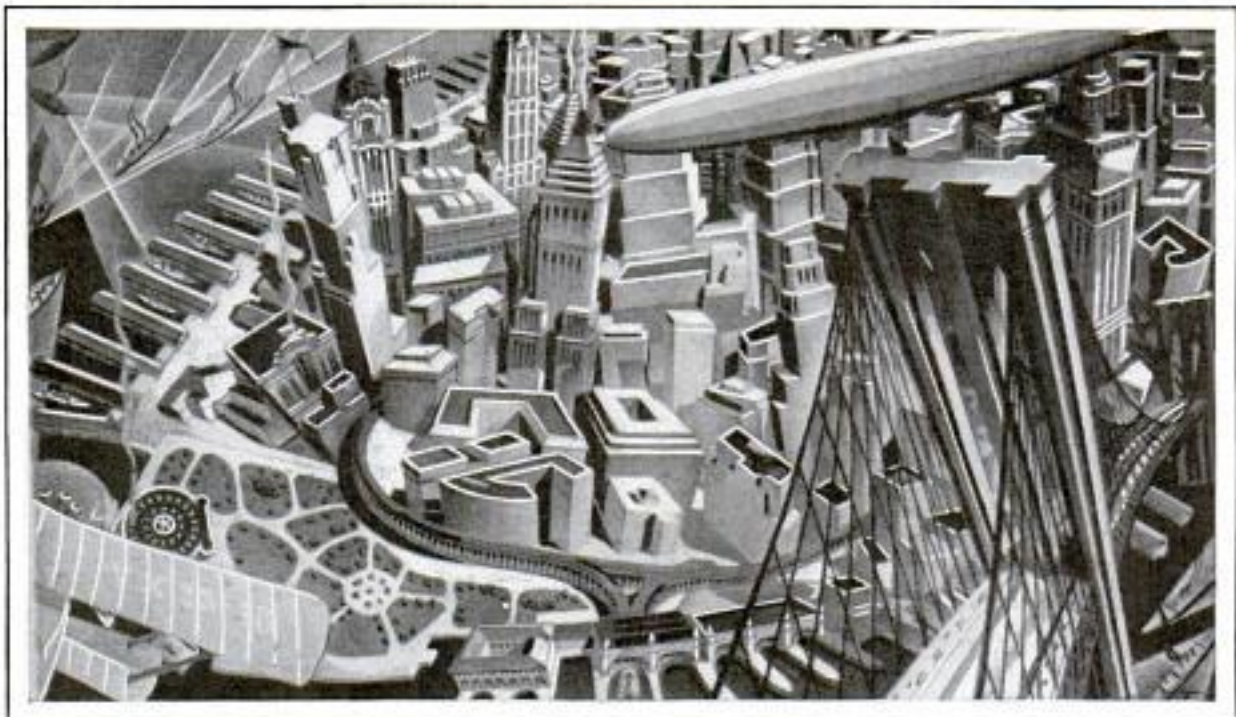

"Downtown," a Mural Depicting Three Different Districts of Manhattan; the Painting Is Modernistic in Keeping with the Architecture and the Interior Decorative Scheme

The exterior walls are sheets of corrugated aluminum, and have insulation which makes their three-inch thickness more weatherproof than the ordinary thirteen-inch masonry wall. All materials in the house are now easily obtainable, and yet the house neglects all past standards of building. It is a house such as men on some other planet might build, yet undeniably American.

In construction, it resembles our modern skyscrapers. Six slender aluminum

columns, within the house area, support cantilever beams from which the outside walls are suspended, as opposed to the ordinary house where the outside walls support the inside structure. Windows may be located wherever it pleases the owner, and inside partitions, likewise, may be shifted about to suit the individual taste.

Aluminum-alloy columns bear the main load. The steel deck floors are rigid, but the visitor does not know he is walking

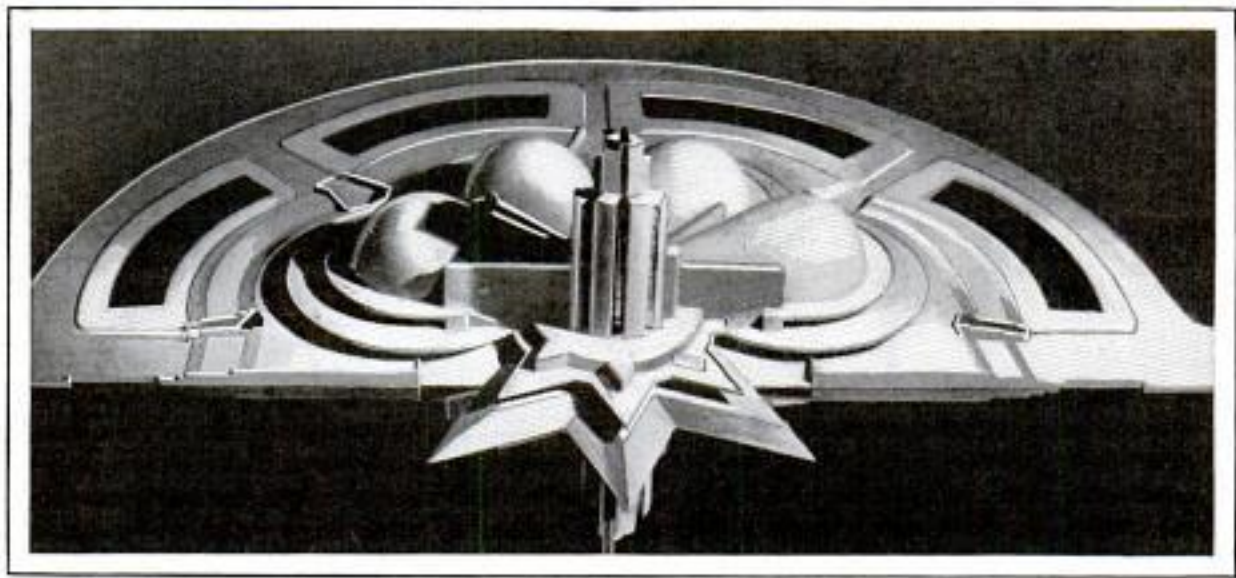

The Temple of Music, One of the Beautifully Modernistic Buildings Now in Course of Construction for the World's Fair at Chicago in 1933

© Norman Bel Geddes

on steel, for the floor covering is linoleum or a sponge-rubber composition.

Windows that pass ultraviolet light extend the full length or height of the room. Even the roof may be converted into a sky window.

The main living room is duplex and extends the width of the house. The dining table has an "elastic" top which rolls up like a window shade.

A long neon tube, hung over the window top, illuminates this room so that the light comes from the same direction at night as by day.

By turning a dial, one may have either white, ultraviolet, or a selection of colored lights. The living room also has a sun-ray lamp and radio.

On the top floor the library is illuminated by a sky window. A wall case and built-in case are made entirely of glass. From the library one passes to the roof terrace. By means of an ingenious folding partition, the whole living-room floor can be made into a single room with a twenty-two-foot window. In this way the architect provides for a spaciousness rarely found in small homes. The twin beds in the master bedroom are not side by side, but at right angles.

A single dumb-waiter serves almost every room in the house.

Interior walls are extremely light sheet steel, only two and one-quarter inches in their over-all dimension. Three types of windows are used; the monumental, the casement and the curved bay window.

An asbestos insulation board insures smooth wall surface and noise-proof chambers. The kitchen has a special perforated sound-absorbing ceiling. Bath and shower rooms are faced with opaque and polished vitreous-slab material.

☐ In telephoning from New York to San Francisco, the voice must be "boosted," or increased in volume, thirty-six different times.



Above, "Salamanca," the First Commercial Locomotive; Below, Growth of Rails to Match Power Development

HOW LOCOMOTIVES "GROW UP" IS SHOWN BY RAILS

Keeping pace with the development of larger and faster locomotives, American railroads are adopting the 152-pound rail, said to be the heaviest in the world. Most roads handling heavy and fast traffic now use the 130-pound type, but at least one company already has adopted the 152-pound stock, capable of sustaining 100,000-pound axle loads and much higher speeds. It is also said to possess seventy-five per cent greater stiffness or strength. Development of this nature was demonstrated at the opening of a permanent exhibition in New York, showing exact scale models, including one of the first locomotives to be used in regular commercial work. It was the "Salamanca," built in 1815, and for which a cog track was necessary.

Pennsylvania

200 Park Ave New York
Chas. Stanley W. Todd 200

a. 1130

Carl. Berau von Linderi Langdorne -
2205 Babstien Place Los Angeles

280

318 W. Plymouth St

POPULAR MECHANICS

Calif

BREAKING 'EM UP TO MAKE THEM BETTER FOR YOU

Angewood Calif

Some Commercial Industries equipped at factory
A.C. Air Cleaner and Carburetor Science

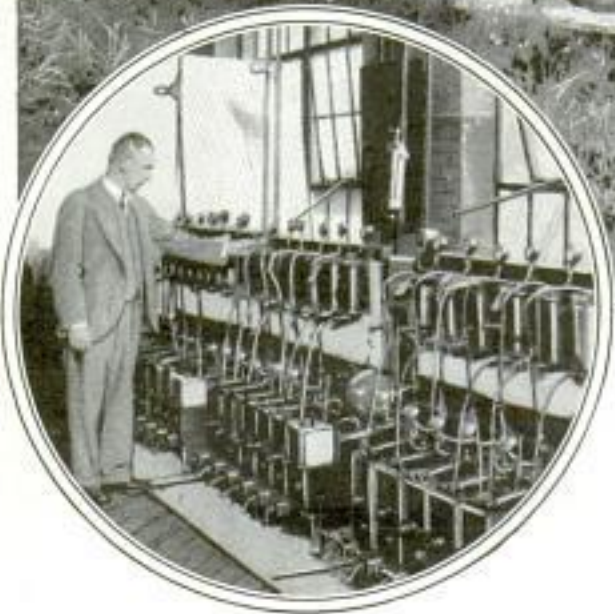
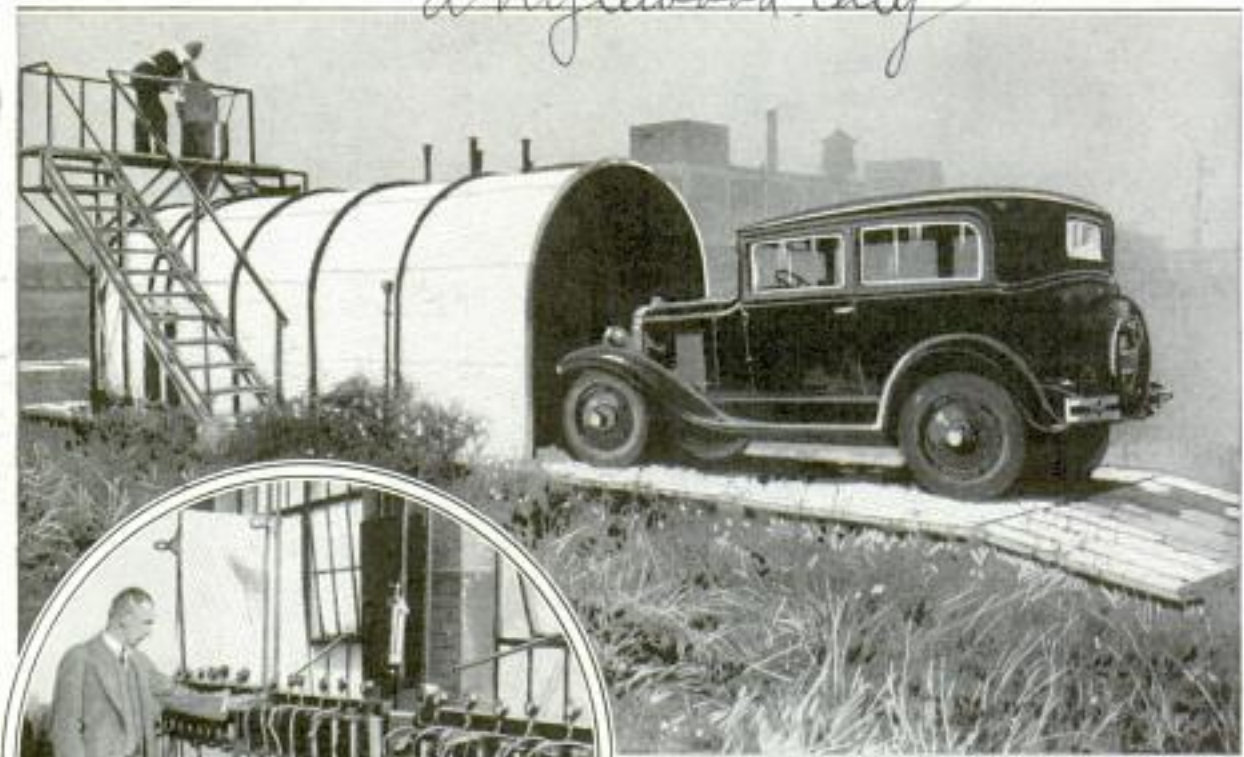

Above, Car Ready to Enter Wind Tunnel for Air-Cleaner Test; Left, Testing Oil Filters

"A million tests a year," states one manufacturer of automobile accessories; "ten thousand a month," vies another, and the purchaser is the one who profits because nothing is left to the chance of failure in operation or on the road. When you tell the salesman, "I'll try that thing out," he can well afford to smile, knowing that it already has been subjected to harder tests than it will ever receive from the ultimate user. An air cleaner which prevents grit and other foreign matter from entering the engine through the carburetor, is tested in a dust tunnel, through which, under pressure of a powerful blower, dense clouds of dust are driven against a standard automobile in greater concentrations than are likely to be encountered on any modern road under normal conditions. Oil filters, taken at random from routine production, are given thorough tests not only for efficiency, but for dur-

ability and life. One of the more interesting tests is that given fuel pumps. One manufacturer has already operated a pump through its 300,000th mile in test. Speedometers are tested on vast boards, at all the average automobile speeds and many of the higher speed ranges, up to half a million miles. The continued improvements in spark plugs, and the development of new materials, are made possible by photographically recording a portion of the spark that occurs in one-millionth of a second. Spark-plug insulators are tested and hardened simultaneously in a huge tunnel kiln, where they are fired at a temperature of more than 2,400 degrees Fahrenheit. Day and night engineers are seeking ways to break up things you use so as to make them better.

VALUE TWICE THAT OF GOLD, AMBERGRIS IS RARER

a-1176

Ambergris, the evil-smelling material found in sick whales, is becoming so scarce with the ever-lessening number of the huge sea mammals that it has recently been quoted at double the price of gold. Despite its evil odor, it is essential in the

Carl F. U. Finkle
5021-12th St
Seattle Wash

Copyrighted material

see Jan, 1928-43

A 103 4

July 1922-95
180 Park St.

*Myer-Wodge, Alcott
to the
myer*

manufacture of perfumes,
no satisfactory substitute
as yet having been found.
Another thing: amber-
gris is not amber, it's
gray or black in color,
and is found most com-
monly in the Indian and
Antarctic oceans. Often
pieces of it will break off
the whale and wash
ashore. Masses, varying
in size from an ounce to
250 pounds, have been found float-
ing on the surface, or washed on-
to the beach, and have made their
discoverers wealthy overnight.



Expert Lens Grinder and Some of the Lenses of Odd Shapes That Produce the Unusual Effects in the Movies

Herron, Los Angeles only

PLANE CRUDE-OIL MOTOR HAS DOUBLE PISTONS

Experiments recently have been conducted in Germany with an airplane motor that uses crude oil for fuel. Its employment has forced the design of a large motor of unconventional appearance, one of the unusual features being the double pistons. Each cylinder has two pistons moving in opposite directions.

A 905

© Presse Photo

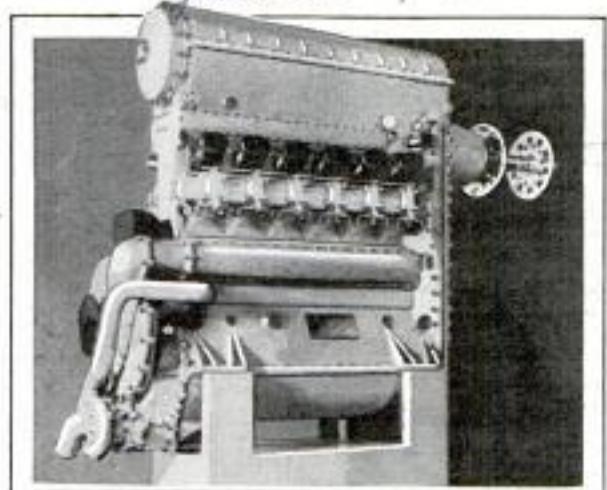

PROPELLER SHAFT

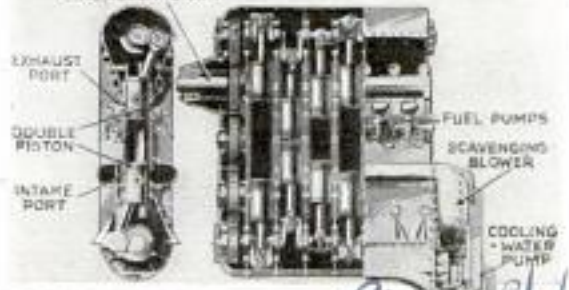

Airplane Motor That Uses Crude Oil for Fuel; Note Double Pistons for Each Cylinder

*Junkerswerke
- Dessau Germany*

QUEER MOVIE EFFECTS RESULT OF ODD-SHAPED LENSES

Many of the unusual photographic effects in moving pictures are produced by specially ground lenses and prisms. A great many of these lenses of odd shape are polished and ground by hand in the little shop of one Los Angeles artisan, who works from plans executed on paper. One of his latest achievements is a lens which makes seven separate images on a motion-picture film simultaneously.

James

APPLES SAVED BY ELECTRICITY IN COLD-STORAGE CAVE

Electrical cold storage for an apple cave has solved the problem of one Iowa orchardist in preserving his surplus crop at picking time. A cave, large enough for a team and wagon or a truck to enter, was dug in a hillside and in it was placed a small refrigerating machine. Loads are driven in on a ground-level floor, and, after sorting, the apples are lowered into the cave proper. In the winter the temperature is regulated without artificial means, but with the advent of warm weather the storage plant, operated from a near-by power line, keeps the fruit until higher prices offer a desirable market.

A 1174

*J. W. Carter
Copyrighted material
dawa*

Installed by the Forest Radio Co. Passaic, N.J.



Fireman Testing a Life Net by Leaping into It from the Top of a Ten-Story Building; He Landed without Even a Scratch

TEN-STORY LEAP INTO LIFE NET OFFERS UNUSUAL PICTURE

When the Los Angeles fire department recently received a consignment of life nets, the firemen decided to test one of them, and a volunteer offered to jump from the top of a ten-story building. The cameraman was ready when the fireman made the plunge, and the resulting picture might be termed a bird's-eye view of a thrilling fire rescue, since the jumper reported no bad effects from the leap.

HOTEL FRAME GIANT ANTENNA FOR RADIO TO ROOMS

Using the framework of the hotel itself as the antenna, and feeding radio programs to rooms by retransmitting the impulses from small broadcasting apparatus, a Washington hotel has installed di-

rected radio which makes the entire building a veritable giant radio set. The saying "Sermons from Stones" thus has turned out to be no based entirely on fancy. A master receiver is located in the building connected to a single aerial and receiving four programs at the same time. The programs are retransmitted to four small broadcasting units, which pour the waves into the steel framework of the building. Highly simplified receiving sets, requiring only an electrical power connection and a ground, are placed in each of the rooms, and guests may tune in any of the four programs.

des. Mr. J. L. Ray - Baltimore
patents owned by Ray system

NEW SAFETY FUEL IS PROOF AGAINST LIGHTED MATCH

By means of a special process of hydrogenation, a safety fuel has been produced for automobiles and airplanes, as incombustible as Diesel oil yet as powerful and as productive of engine performance as good aviation gasoline. A lighted match can be tossed into this fluid without igniting it, and hence it is expected to help prevent fires that often follow upon crashes of gasoline-engined airplanes. To use the fuel, which is not yet on the market, it is necessary to replace the conventional carburetor with an injection pump, but the explosive mixture within the engine cylinder is fired by electrical ignition rather than by compression as in the Diesel engine. With such a liquid it is possible that the problem of providing aircraft with safer fuel may be met by an adaptation of present internal-combustion engines rather than a complete change to the Diesel type. The fuel is yellow in color, contains less sulphur and does not gum as readily as ordinary gasoline.

Science Service 531-20, 5/28/31

Hotel Lincoln New York

demonstrated at national advisory committee for aeronautics

Q-119

Copyrighted material

Write to the Quartermaster General at Washington, D.C.

a 1058 Cmt. Wilbur H. Rose
3608 Lularoa St.
El Paso, Texas

THE LATEST WEAPONS OF UNCLE SAM'S FIGHTERS



Above, Army Kitchen on Wheels So Built That Cooking for 250 Men Can Be Done While It Is in Motion; Below, Electric Grooming Machine for Currying Horses



Above, Anti-Tank Gun with Well-Balanced Carriage, Which Makes It Easy to Train the Weapon on a Moving Target; Right, Semi-Automatic Rifle That Is Gas-Operated to Decrease Shock of Firing; It Weighs About Nine Pounds and the Magazine Holds Ten Shells

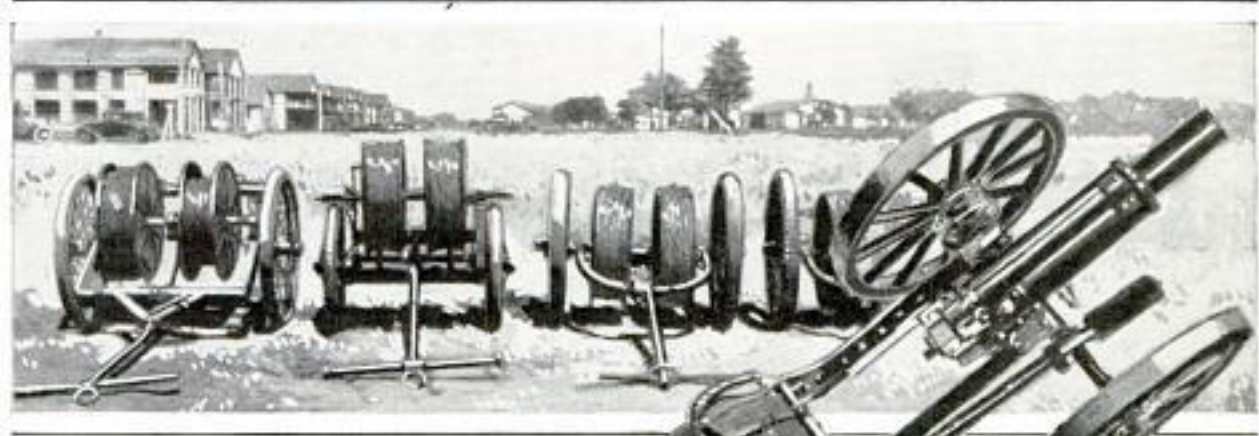

Above, Experimental Models of Reel Carts: Each Reel Carries About One Mile of Wire Which Weighs 165 Pounds; Right, Wheel-Mounted, Breech-Loading Mortar Used to Fire High Explosives, Gas, Shrapnel and Smoke Shells

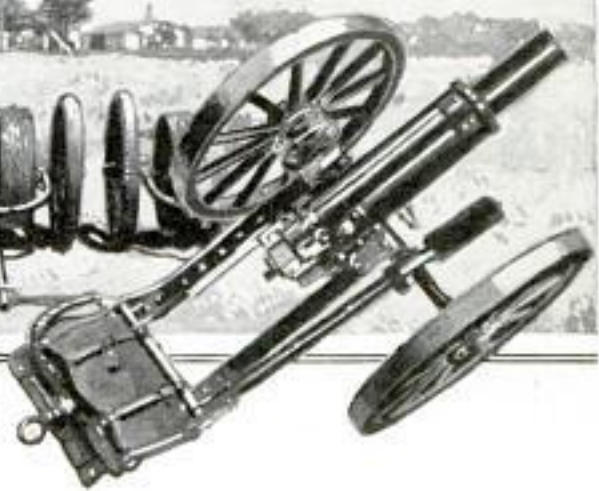

a 1137

HOW FAR CAN A FROG JUMP ANSWERED BY RACE



Wide World

Above, Crowd in Old-Time Costumes around Some of Entries in California Frog-Jumping Contest; Left, Jumper Atop His Traveling Case



HANDLE CAREFUL **JUMPING FROGS** RUSH QUICK
 ON OUR WAY TO THE
JUMPING FROG JUBILEE

Frog-jumping contests are vying in popularity with turtle racing. In the fourth annual frog-jumping jubilee staged by Calaveras county, California, the winner repeated his victory of 1928 with a leap of eleven feet and five inches. The second in a field of 150 entries from all

parts of the country was only four inches behind the champion. Crowds in old-time costumes attend the hopping contests, and entries come from all parts of the country where the frogs are groomed carefully for months by their backers.

91083

SOLUTIONS OF PUZZLES FILED IN THE PATENT OFFICE

Patents for 481 "useful puzzles" have been granted to inventors who have shown how to solve their mystifying creations. No patent can be awarded a puzzle, no matter how fascinating, unless its solution can be filed away for reference, along with the puzzle itself. In order to qualify for a patent, a puzzle must be useful. The first puzzle to be patented was of the "take apart and put together" type, for which a patent was issued in 1863. This seems to be the most popular type, as patents have been awarded for 103 of these jigsaw puzzles.

U-S Slady 5/16/21

at Angel's Camp

Chicago Daily News
5/16/31 - a 1133

TRADE IN BROKEN EGGS GROWS

Egg breaking and the powdering of yolks and whites of egg has become an American industry, with more than \$2,000,000 invested in it. About 11,000,000 pounds of egg powder are used in the United States every year in the making of noodles, ice cream and cake flours. At present most egg powder is imported from China, but American producers are organizing to foster the native industry.

a 1152

PEBBLES FROM SKY MYSTIFY SCIENCE

Scientists are mystified by the formations of a literal shower of pebbles which fell in widely separated localities in Ohio during a hailstorm. Most of the pellets were almost round, about the size of marbles, and smooth. Some appeared to be hard, opaque stone, while others were of frosted crystal and so hard that glass could be cut with them as with a diamond or the hard steel used for cutting tools scratched.



Handfuls of Pebbles Which Fell during a Hailstorm; Their Composition Has Mystified Scientists



Riding the Surf at Night by the Light of Flares; the Rider Is Holding the Towline in His Mouth and Grasps a Torch in Each Hand

EERIE RIDERS OF THE NIGHT CARRY FLARES OVER WAVES

Aquaplane riders who do not find enough excitement in being towed at high speed behind a motorboat by day when the hazards can be seen, now are riding the surf at night. One California surf rider attaches his craft to a speed boat after dark, holds the towline in his teeth and in each hand grasps a sparkling flare to light his way, presenting an eerie figure as he skims over the water.

PHOTO BETWEEN HEART BEATS TAKEN BY X-RAY CAMERA

X-ray photographs made of the chest cavity ordinarily are blurred slightly by the throbbing of the heart. To eliminate this trouble, University of Pennsylvania research specialists have developed an X-ray camera which works on the principle of the between-propeller type of airplane machine gun. Several short exposures are made between beats so as to produce a clear, composite negative.

Charles W. Moore
School of Electrical Eng.

Elmer E. Pack Venice, Calif.

Chicago Trib., 5/12/31

Copyrighted material

SAFE-GUARDING NATION'S FORESTS FROM THE AIR

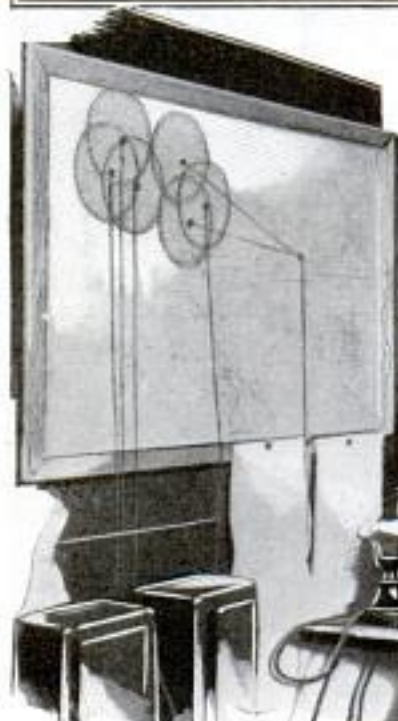
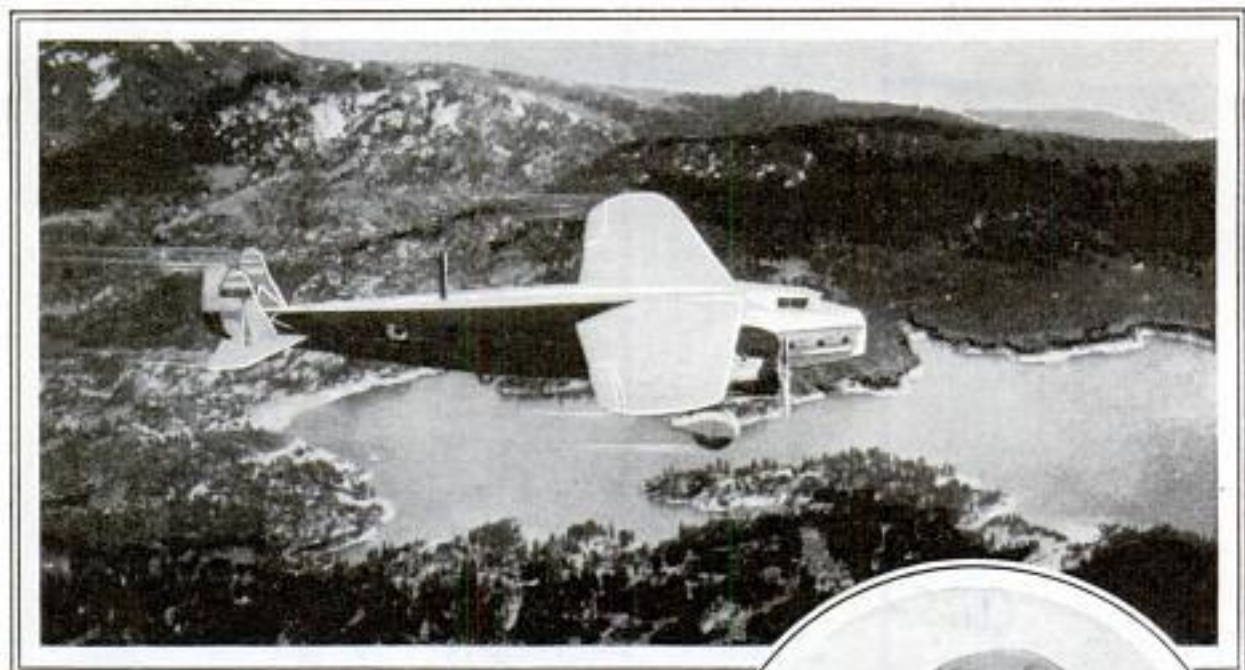

Above, Air-Express Plane Flying over San Bernardino National Forest in Southern California; Pilots of Such Ships Last Year Detected and Reported Twenty-Four Forest Fires Here



Above, Pilot of a Transport Plane Reporting a Forest Fire by Radio Telephone; Air-Route Flyers Are Helping Conserve California's Forests by Watching Constantly for Such Fires

Above, Chief Dispatcher of Angelus National Forest with Map on Which All Reports of Fires Are Checked; Right, Dispatcher at Airport Receiving Radio-Telephone Report of Forest Fire from Pilot; He in Turn Will Notify Forest-Preserve Officials



Division of music

A 1145

Capt. N. E. Miles
287
Lafayette, Ind.

POPULAR MECHANICS

CONGRESS COPIES
OLD SONGS FOR
LIBRARY

Q 1225

Photostats, photographs on non-inflammable film, phonograph records, and even the experimental telegraphone which records words and music on piano wire, are being employed by the library of congress to make a complete record of American folk songs from all sections of the country. Wherever possible, the music is recorded from the section of the country in which the song is predominant. The library executives have obtained numerous private collections, original manuscripts and unpublished songs of this type for copying.

US Daily C/2/31

SCHOOLS OF TUNA
ARE LOCATED BY
THERMOMETER

Q 1208

Discovery by means of thermometers of many new shoals along the Pacific coast, has helped to revive the albacore, or white-meat tuna, fishing industry, threatened with extinction the last three years by failure of the fish to return to their former haunts. Although the shoals are too deep to cause trouble for boats, they have been well-defined through the differences in water temperature. Sounding the depth with ordinary means is too slow to allow the fishermen to cover sufficient territory. It has been found the colder water is deflected upward by the rising ocean floor, so that when the fisherman strikes a section of cold surface water, he knows the shoals are beneath. Many new banks inhabited by the albacore thus have been discovered.

☐The trade value of a wolf skin in Montana sixty years ago was two cups of sugar, and a beaver skin was worth half a cup.



Whole Section of Horse-Drawn Artillery Is Ferried across River on Motor-Driven Pontoons; Top, Two Sections of Motorized Ordnance Land

OUTBOARD MOTORS AID TROOPS
TO CROSS RIVER

Using outboard motors to propel pontoon rafts, two whole batteries of United States artillery were taken across a river under protection of a dense smoke screen, in tests near Ft. Hoyle, Md. The rafts were equipped with aluminum pontoons, while small boats accompanying the guns laid down the smoke screen. It was found that the two batteries could be taken across the river in six trips, thus making it possible for an advance guard of light artillery to be thrown hurriedly over a body of water, while the "heavies" waited for a bridge to be constructed. The rafts were capable of handling two sections of motorized artillery or one section of horse-drawn ordnance including a gun, caisson, limbers and its complement of thirteen horses, at one load.

Capt. Thomas J. Keeney
4104, Utah St. Salt Lake City

at meeting of American Forestry Association at Asheville N.C.

ELECTRICAL FAN MILES HIGH FORMED BY SEARCHLIGHTS

a-971

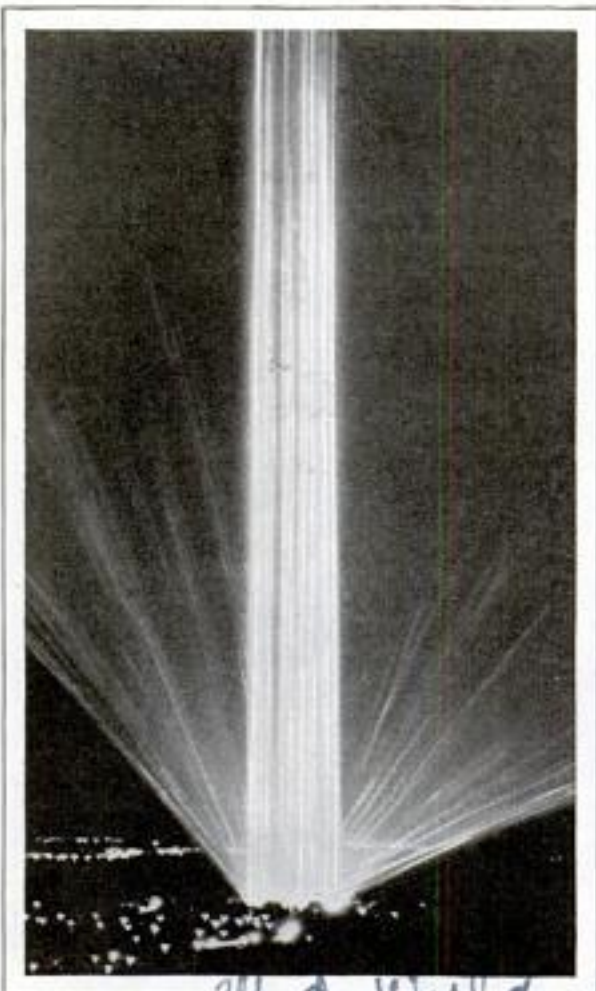

Dazzling Shaft of Brilliance Formed by Converging Beams of Twenty-Four Searchlights

Opportunity for an unusual night picture was afforded by a recent searchlight drill at Fort Shafter, Honolulu, when the beams of twenty-four powerful lights were massed together for a display of dazzling brilliance. The scene showed a white shaft of light extending far into the sky with a fan-shaped effect at each side. Action was afforded by airplanes which dodged in and out of the massed lights at an altitude of 15,000 feet.

SHEET EROSION BIGGEST CAUSE OF LAND DEPRECIATION

a-1196

Sheet erosion, the unending process which steals a part of the top soil every time there is rain enough for water to run downhill, is a major cause of land depreciation, but because it is more gradual and less noticeable than gully washing, it

is not considered so damaging. H. H. Bennett, soil scientist of the department of agriculture, estimates that excessive washing has virtually destroyed more than 17,000,000 acres of formerly tilled land, and adds that there is a vastly larger area whose surface soil is slowly but surely being washed thinner and thinner by every rain. As a result, despite the benefits of research and extension services, crop yields are not increasing but, in fact, are decreasing in many localities. Land impoverished from overcropping frequently can be made productive, but land worn out by erosion is hopeless, because the top soil contains the elements necessary for plant growth. Erosion can be halted or decreased, it has been found, by better land utilization, better protection of cultivated slopes with terraces and by other means, and the use of certain lands for forests to prevent the rapid erosion brought about largely by the fact that the land has been stripped of its stabilizing cover of trees, forest mold, grass, bushes, etc., and further weakened by excessive cultivation and the trampling of stock, both of which expose it to rain wash.

GEAR PUMP FOR OIL PREVENTS BURNED-OUT BEARINGS

Wid World a-1140

For lubricating line shafts on railroad cars or automobiles, a minister of an inventive turn of mind has made a gear pump for oil, the meshed gears bringing up the oil by suction to prevent "hot boxes" on trains and burned-out bearings on cars. The pump throws two streams of oil and, when used on railway cars, does away with the waste in journal boxes, oiling the axles through the journal. The pump is operated by the wheel, and it is estimated a quart of oil will last six months. On an auto, the pump is operated by a battery and throws two streams of oil on the bearings to keep them lubricated at all rates of speed.



U.S. Dept. of Agriculture Cross Service

Dr. J. A. Ryan, 513 ...

AN ARCTIC PARADISE FOR LONG-DISTANCE RADIO



Above, Radio Station at Kanakanak, Alaska; Upper Right, Mail Plane Stopping There; Below, the Reindeer Which Is Beast of Burden, Food and Pet

Kanakanak, Alaska, is just about as far northwest as one can travel and still be on the North American continent. It is a radio paradise where stations from many parts of the world roll in over the loud speaker. It is a queer and quaint country with weather milder than in northern Wisconsin and a land where dogs are draft horses and reindeer are both pets and cattle. On the long waves, Italy, Germany, England, Russia, Japan, Australia and the United States come in every day with little variation of signal strength day or night. The closest broadcasting station is at Anchorage, some 300 miles east of Kanakanak. The closest amateur short-wave station is in Unga, on the island of the same name, four hundred miles to the south. Flies, so small as to be almost invisible, are the worst pests. They are called "No See Ums" and bite with ferocity, leaving welts. During the winter the radio operators trap foxes and mink in off hours, ski, snowshoe and go dog driving and hunting. The long winter evenings are spent listening to radio programs. Each dog is fed one fish a day and that only at night after he is through work. They are chained outside with no shelter, and sleep in the snow.

This may seem cruel, but if they are fed more they either get sick or else dig holes and bury all but the one they eat. They will not stay in boxes for shelter, preferring to live and sleep in the open even in storms. There are only a few hours of daylight in winter. The sun rises about 9:30 a. m. in December and sets again shortly after three o'clock in the afternoon. Farther north it rises even later and sets sooner.

HOW TO WATERPROOF MATCH

Matches can be waterproofed by dipping the heads in a creamy solution made by dissolving shellac in denatured alcohol. Thus treated, they can be used by hunters, fishermen, or others engaged in outdoor work or play, in damp weather when ordinary matches absorb so much water they will not ignite. The waterproof coating dries quickly.

Carl Chas. J. Iselbert
Rev. J. L. Owen Jr. 420 E. Bay St.
Dayton, Ohio

Cml. John Winters Flaming
207 Voorhees Ave
Buffalo, NY

290

POPULAR MECHANICS

led. made by New York Paper & Light Corp.

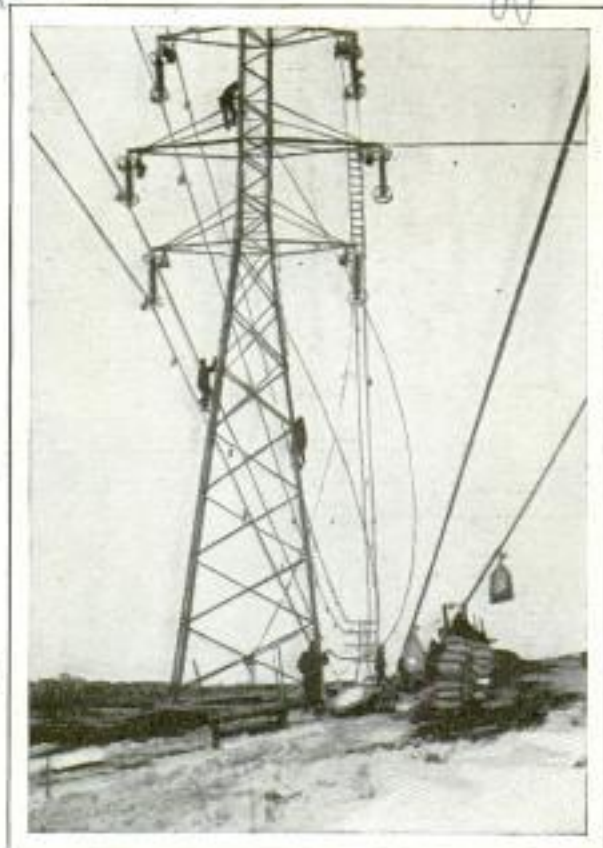

Stringing Bags of Sand on Power-Transmission Lines to Test Strength of the Steel Towers

STRENGTH OF TOWERS TESTED WITH HEAVY SANDBAGS

To test the ability of steel power-transmission towers to withstand the stress and strain of midwinter sleet and wind on the wires, one electric company strung more than 500 bags of sand, weighing twenty-five tons, along the line, then exerted a side strain of five tons. The weight of the sand was equivalent to the pressure of one-half inch of ice completely covering towers and wires, and the side pull equaled the force of a sixty-mile gale. The towers apparently were unaffected by the double strain.

CHERRY BLOSSOMS AS A FOOD ARE RICH IN VITAMIN B

Two Japanese doctors of the Osaka hygienic laboratory have determined that the blossoms of cherry trees, lotus flowers, dandelions and other plants are exceptionally rich in vitamin B. If it were practicable, these scientists contend the best way to obtain this important vitamin in concentrated form would be actually to eat flowers. In Japan, for instance,

cherry blossoms seasoned with salt, are considered a delicacy, but their dietetic value was not known heretofore. Tests have been conducted with birds which were fed leaves, flowers, twigs, roots and peelings, and from these experiments it was found the flower of a plant contained the most vitamin B, followed in order by leaves, roots and stems.

a 1022

TRUCK MEASURES ROAD SHOCK FROM BUMPS ON WHEELS

Federal engineers are taking the bumps out of the highways by means of instruments which register the shock impact when a wheel comes in contact with an obstruction, and the drop impact when it hits the pavement after the bounce. Elimination of uneven surfaces on highways is expected to increase the safe speed of automobiles, trucks and busses. The vehicle used to iron out bumps and measure their interference is a bus chassis equipped with a special body, the floor of which is divided into small compartments, each containing a 100-pound iron weight to vary the load. Various types of tires and rims are employed and the obstructions range from one and one-half inches high to rectangular plates twelve inches wide. The magnitude of impacts is measured by a multiple-element contact accelerometer, consisting of ten sensitive elements.



Truck Equipped for Measuring Shocks from Bumps; Small Compartments Hold 100-Pound Weights

Cml. Carl W. Hoag, Ashville, N.C.

a. 996
Osaka Japan

Cml. Kenkichi Katayama
47 Sanjyocho, Nishikomaya
near Osaka Japan

Bureau of Lighted material
Public Roads

A. 903 Com. Thomas E. Stinson, Jr.,
145 S. Spring St
Los Angeles, Calif

Gold Still Lures Prospectors

THREE years ago a mining engineer took a short cut through the Nevada hills. Using old trails and footpaths, he traveled 150 miles without seeing a soul. A few months ago he made the same trip. This time he found prospectors at every turn. Nearly a thousand were camped in the washes and hills, panning the gravels and chipping at outcroppings.

It is estimated that in California alone, 10,000 people are looking for gold. Some are old prospectors, but most of them are making their first trips. Everywhere the search for gold has started again.

Has all the gold in the United States been discovered? Mining men do not think so. They point out that some of the richest finds have been made in districts that have been prospected for years. The 1927 gold strike at Weepah, Nev., was made on ground that had been worked over for forty years. Deposits of other precious metals are sometimes overlooked, too. Years ago a railroad was built to the Randsburg mining district in California. One cut through a hill exposed a rich vein of tungsten ore that was more valuable than most gold ores. But it was a long time before some curious individual chipped off a specimen and had it assayed.

The fabulously rich Kelly-Rand silver mine was found only after hundreds of miners had worn a smooth path across the outcropping, walking between a boarding house and another mine. For years the ore was only a place where miners stubbed their toes.

Not only do engineers think that new gold deposits will be found, but they say valuable discoveries may be made very soon, perhaps this year. They recall that



Here is a prospector with his pan washing the gravel in his search for gold as thousands of old-timers have done

after every business depression, accompanied by a fall in the price of silver, thousands of men have gone out to comb the western hills. In the past, each of these searches has revealed bodies of ore that were previously unknown.

A complete prospecting outfit consists of several sizes of basinlike pans, an iron mortar and pestle, a magnifying glass, bottles of quicksilver and muriatic acid, a square of chamois, a pick and shovel, supplies, and perhaps a dry-washing machine. Those who carry a complete outfit usually travel in a "tin burro" or stripped-down car in which they can reach seemingly inaccessible spots. Others travel on foot, alone or with a burro, some carrying only one pan with which to prospect.

Placer gold is found in river sands and gravels, and gold ore is found in the hills. What a prospector looks for depends upon the surroundings. Placer gold is loose

Pans, hammers, picks etc
Wemyer of 716 Chamber. Denver Colo

364 p. 57 illus
pocketbook style

Prospectors Field Book and Guide 291
Isborn - Von Bernentz \$3.00

Copyrighted material



and consists of tiny specks and grains, with sometimes a larger nugget. Coming across a likely-looking stream, the prospector proceeds to pan for "colors." Gold is rarely found in the pools or at the bends of a river. The wise prospector fills his pan with gravel from a point or a bar. Some prospectors use nothing but a frying pan; others carry three pans graduated in size from eighteen to six inches wide so that as the gravel is concentrated they can shift to a smaller pan.

Half filling the pan with gravel and then filling it with water, the miner swirls it around with a circular motion, holding it at a slight tilt so that some of the water runs over the edge. This separates the materials, the heavier and finer grains moving to the bottom and to one side, while the larger and lighter grains accumulate on top and at the opposite side. These the miner throws away by working them over the side or scraping them off. He dips it constantly into the stream so that it is kept full of water. Soon nothing is left in the pan but a small quantity of heavy material, consisting mostly of black magnetic iron sand. If gold is present, the miner can often see it at once; or by rapping the bottom of the pan with a rock, causing the sand to bounce up and down, the heavy particles of gold are tossed into the air where they may be seen. A few drops of muriatic acid brighten the gold.

To completely separate the gold from the black sand would be too long a task, so the prospector drops a small amount of mercury into the pan and swirls it. The mercury picks up



Top, a Makeshift Flume to Recover Gold from River Gravel; Right, a Homemade "Dry Wash" for Concentrating Pay Dirt

any gold that is there. Then the mercury is strained through the piece of chamois, leaving the flakes of gold on the surface.

Gold in the surface gravels usually means richer pay near the bedrock. The particles of heavy gold tend to sift to the bottom of the gravel. Sometimes the natural riffles and pockets on the uneven surface of the rock beneath the river actually collect handfuls of gold.

Heavy black sand is generally taken to mean that gold is present, but it is not a sure test. Banks of clean washed sand rarely contain gold. Colors and shades of red and blue in the sands of a gravel deposit are considered by miners to be a good sign that gold is there.

As placer gold is always washed down-

Designed by Carl
 9109 4 Westminster
 1923 Colorado Ave
 293
 Santa Monica Calif

stream from a mother lode, the prospector slowly works his way up the stream until gold is no longer found in the gravel. Then he carefully combs the surrounding hills to discover the lode. Sometimes he finds "float" in the river bed—small chunks of ore containing gold. This is definite proof that somewhere upstream there exists a large body of gold ore.

Dry panning, similar to wet panning, is done when no water is available. The dirt must be crushed. Properly done, all the gold may be saved. If gold in paying quantities is found, a portable concentrating machine known as a dry washer is used. Dirt is dumped through a screen into a hopper which feeds the dirt out slowly on an incline across which baffleboards have been nailed. The incline is vibrated by turning a wheel, and the dirt slowly falls off the end. All of the heavy material, including any gold, is held by the riffles and is scooped off later.

The prospector does not confine himself to streams. "Gold in the grass roots" denotes easy riches and several mines have been discovered by pulling up tufts of grass. However, such gold is usually found on hilltops and more of it than farther down.

MODEL BIKES CARVED IN WOOD WITH JACKKNIFE Q1031

In the spare time of a few months, a fourteen-year-old California schoolboy carved two small but perfect bicycle models out of blocks of wood. His tools were only a sharp jackknife and fine sandpaper.



A Jackknife and Sandpaper Were the Only Tools Used in Carving These Bicycle Models

Erville Crum
 Redondo Calif



Automatic Shoe Soler That Fits and Attaches Soles to Uppers, Increasing Output of Workmen

AUTOMATIC SOLER FOR SHOES INCREASES OUTPUT

Tests with recently developed shoemaking equipment indicate that the present rate of shoe manufacture may be increased eighteen times. An automatic shoe soler fits and attaches soles to uppers at a speed far above that of other methods used at present.

HOW SAFETY-GLASS DISCOVERY RESULTED FROM ACCIDENT Q1089

Safety glass, the non-shattering material used in automobile windshields and the windows of bank cages and armored trucks, was discovered quite by chance in a laboratory accident. A French chemist knocked over a test tube that had not been used for months. He stooped to pick up the pieces and found that the paste substance in the tube held the shattered parts intact. He then recalled that the long unused tube had contained a mixture of trinitro-cellulose, ether, acetone and an acetate, and began a series of experiments which resulted in the production of the form of safety glass that is being used today.

L. Henry
 42 Le Roy St
 Cincinnati
 Copyright material
 L. Henry Owen Jr.
 Dayton Ohio

RADIO TALKIES UNITE SIGHT AND SOUND SIGNALS

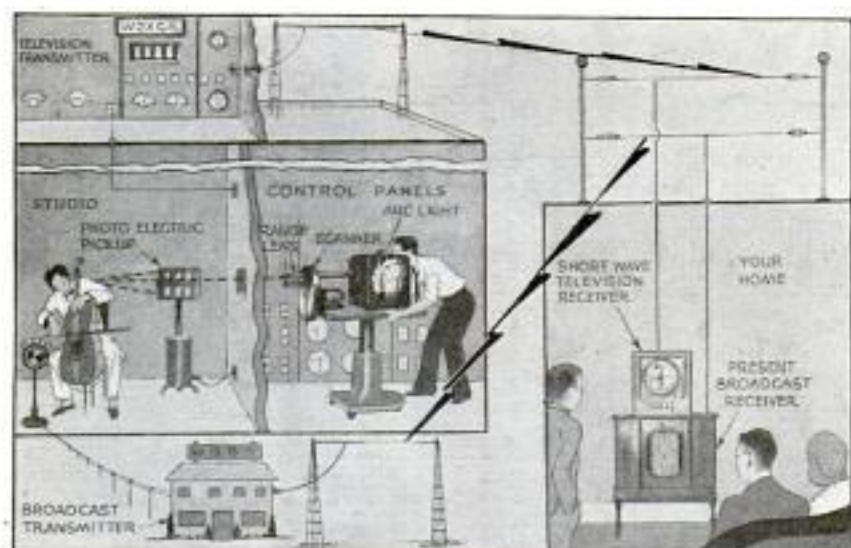

voice, music or other desired sounds while the performers face the television scanner. In addition to the direct pick-up of living subjects, the studio is equipped for the transmission of motion-picture films. The film pick-up is like the usual projector. The diagram shows the method of transmitting and receiving the united sight and sound signals. The

Jenkins television station W2XCR and WGBS serve eastern listeners. Similar sight and sound programs are transmitted by WMAQ and its television station W9XAP, also WIBO and W9XAO, both using Western Television corporation apparatus. These stations serve sight and sound fans in

Radio artists and speakers may now be seen as well as heard by the radio audience in homes provided with a television receiver in addition to the usual broadcast receiver. Radio talkies, or combined sight and sound programs, are produced in a studio similar to the usual broadcasting studio with the exception that the artist faces a sweeping beam of light which completely scans the image to be transmitted.

The Jenkins "flying spot" scanning device, shown in the center photo, is used to pick up living subjects. The reflected light from the image is picked up by the battery of photo-electric cells, shown below, which translate the varying intensity of light into corresponding electrical fluctuations. Amplified millions of times, the electrical impulses are impressed on the television transmitter which broadcasts corresponding signals. With a powerful arc light, lenses and adjustable mirrors, the operator can direct the scanning beam to pick up a close-up, a half length or a full length of the performers. The nearby microphone in the studio picks up the

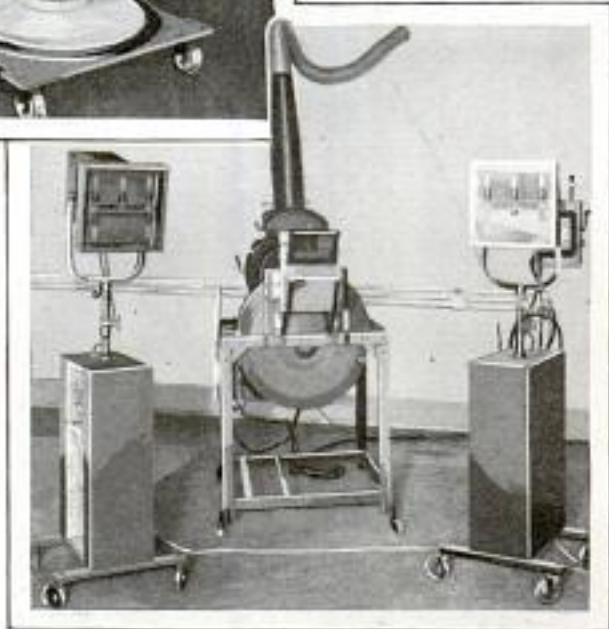
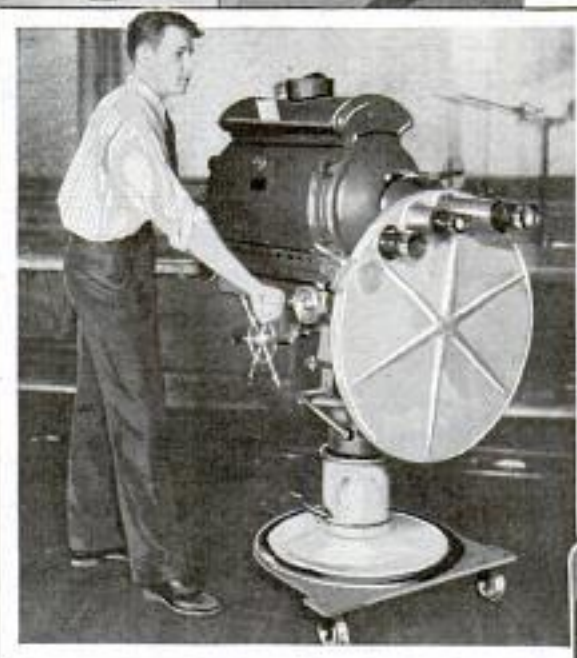

the middle west and the programs are listed in the daily newspapers.

Improving Your Old Set

by F. E. Baker Part Two



THE type-45 power-tube adapter shown on page 121 of the July issue is inexpensive and easy to build. It will enable owners of sets having low-power amplifiers to operate a louder speaker with better output quality without making any changes whatever in the set itself. The type-45 tubes may be used either singly or in push-pull, according to the design of the original amplifier in the receiver.

The core cross section, for the filament transformer, is $\frac{3}{8}$ in. square and may be obtained with a core $\frac{1}{2}$ by $\frac{3}{4}$ in., or if the laminations taken from an old audio transformer happen to be $\frac{5}{8}$ in. wide, they may be piled to a height of $\frac{5}{8}$ in. The form for winding the coil is shown in Fig. 2 in Part I. This is made of wood and the bobbin will have a cross section $\frac{1}{16}$ in. larger than that of the core to permit the insertion of the latter after the bobbin is removed. A $\frac{1}{4}$ -in. hole is drilled lengthwise through this form. The ends are of $\frac{1}{4}$ -in. wood and large enough to retain the wire. Lengths of friction tape are placed on the form, as indicated by the dotted lines, to hold the coil in shape when the bobbin is removed. A length of threaded $\frac{1}{4}$ -in. brass rod is thrust through the form and the ends clamped to the bobbin at each end by means of nuts. This holds the form rigid, and one end of the rod may be placed in a hand

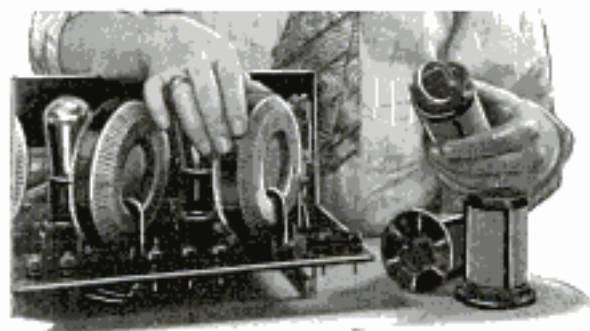

drill and clamped in a vise to act as a coil winder. A hole is drilled through

the bobbin at one end for the starting end of the primary winding, which consists of 1,320 turns of No. 30 enameled wire. Wind in layers as evenly as possible and cover each 300 turns with a layer of wrapping paper. After this coil is completed, cover it with three layers of friction tape.

The filament winding for two type-45 tubes must supply 3 amp.; therefore it will be necessary to use heavy wire. As

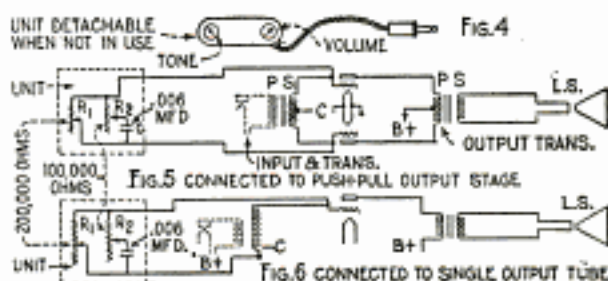

the size required is not easily obtained, the writer used two smaller wires wound in parallel, as indicated in the schematic diagram. Two 16-ft. lengths of No. 18 bell wire are used to make 30 turns over the primary. This winding is then covered with a layer of tape.

The coil is now removed from the form and the laminations inserted snugly to prevent vibration.

The container, detailed in Fig 1, of Part I, may be made of thin brass or sheet tin if this is on hand. Fig. 3 shows the assembly of the unit on the wood base. The original audio tubes, removed from the set, are replaced by the plugs. The type-45 tubes are inserted in the sockets of the adapter, and the unit is ready for testing. If but one amplifier tube is used, the only change required is in the biasing resistor A, which must be altered from 700 to 1,400 ohms. The plate and grid connections, indicated as 1, 2, 3 and 4, in Part I, are soldered to flexible rubber-covered leads and also to the plate and grid prongs of the plugs. The

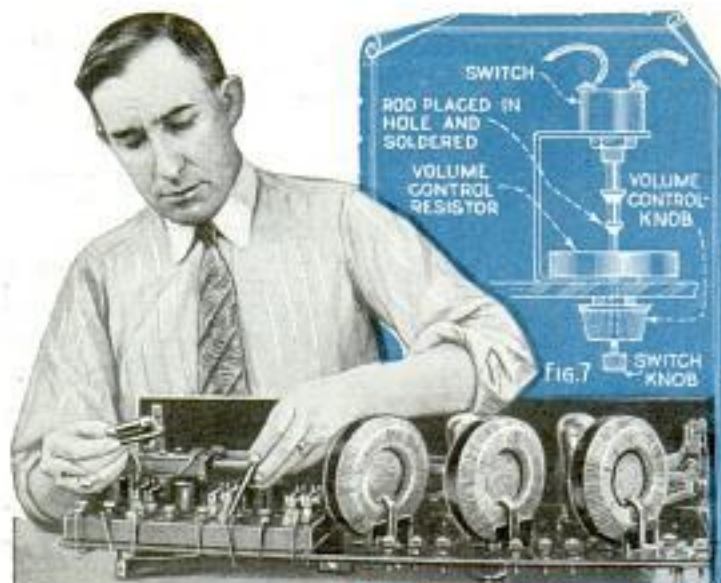

return lead from the end of the biasing resistance is connected to the negative-B on the receiver.

A handy improvement for the old set is shown in the photo at the head of this article. It consists of an extension tone-and-volume control unit that anyone can make for himself. It is merely plugged into an open-circuit jack, mounted at any convenient point on the front panel. The unit consists of the two variable resistances R_1 and R_2 , mounted in a box of suitable size, the leads being of any length desired and terminating in an ordinary phone plug, as shown in Fig. 4. The unit is indicated within the dotted lines in Figs. 5 and 6. The connections to the jack are made to the grids of the push-pull tubes and, in the case of a single output tube, to the grid of the audio tube, the other end being taken to the opposite end of the transformer or to the bias lead. In most cases it may be connected directly to the filament lead at the socket. If hum occurs with this connection, it will be necessary to connect at the bias lead as indicated in Fig. 6.

The lower photo on page 295 shows a common method of improving old tuned r. f. receivers by substituting solenoid coils of modern design for obsolete or damaged coils. Such coils should, of course, match the capacity of the variable condensers used in the set.

For receivers employing resistance-coupled amplifier units using obsolete tubes that require no filament regulation a suitable amperite or ballast may be in-

serted in the negative-A lead to such units as shown in the photo on this page. This will enable the owner to use standard tubes without making any other changes in the circuit.

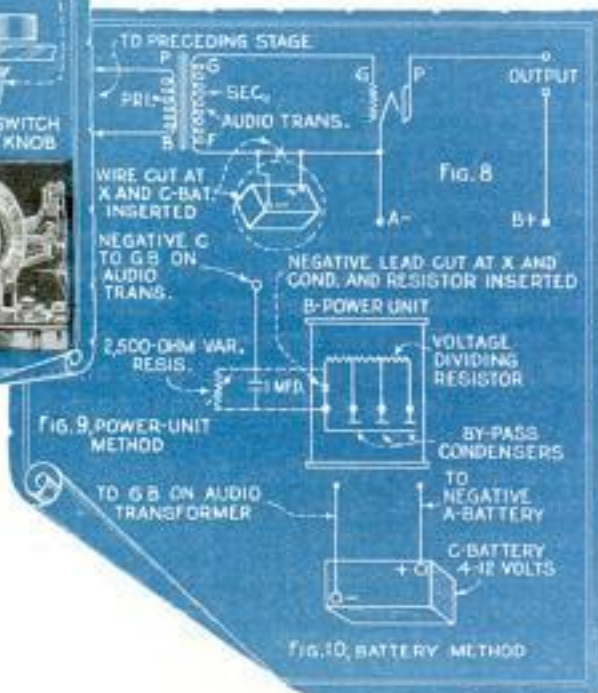

A simple method of combining a filament switch with a volume control is shown in Fig. 7, which is self-explanatory.

Many battery sets do not use C-batteries for grid bias on the a. f. transformers. Without such a bias even the best transformers would give poor results. Figs. 8, 9 and 10 show several simple methods of adapting such receivers for grid bias. The mark "GB" indicates grid bias, and these leads are taken to the negative-F post on the ordinary audio transformer.

Checking Grid Voltage

A high-resistance voltmeter is necessary for checking the grid voltage. The negative terminal of the meter is connected to the grid terminal of the tube, and the positive is then connected to the filament post or, on a. c. sets, to the chassis of the receiving set.

For further information on any radio construction article write to the radio department; this service is free.

SIMPLIFIED ANSWERS TO YOUR RADIO PROBLEMS

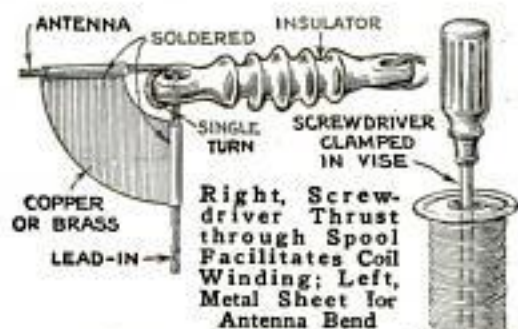

Lightweight Angle Iron Used for Assembling Small Transmitter Frames May Also Be Employed for Constructing Shielded Metal Cabinets to House Homemade Radio Receivers

Wire-Wound Resistors, Used as Multipliers for Extending the Range of Meters, May Be Inserted in Gridleak Mounts

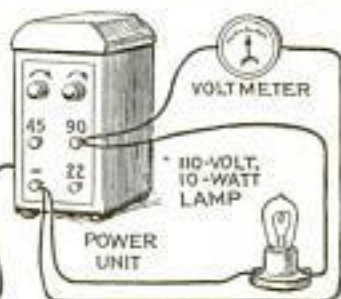

Lamp Used as an Artificial Load for Testing B-Power Units under Working Conditions; Below, Wall Plates Adapted for Switch Panel; Left, Phone-Tip Jack Arrangement

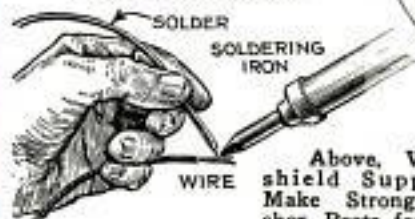

Above, Windshield Supports Make Strong Anchor Posts for Antenna Guy Wires; Left, Above, a Flexible Lead May Be Tinned as Shown; Below, Brass Strips Clamped on Resistors Relieve Strain on Wires

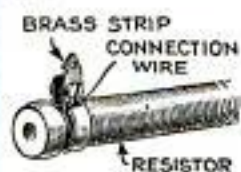

Below, Handle Pointers and Engraved Scales for Large Amateur Transmitting Condensers

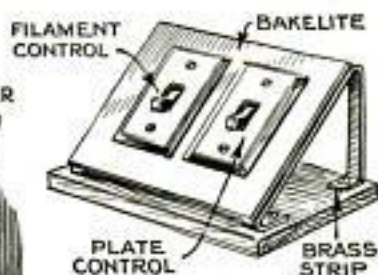

Left, a Brass Drawer Pull Makes a Handy Reflector for a Small Dial Light and Is Easily Mounted by Means of Two Small Machine Screws as Shown

Allen H. Cardwell
 Prospect St. Brooklyn 297 N.Y.

Old Ford Coils Useful in Receivers and Transmitters

Nearly every radio enthusiast's junk box contains at least a few old Ford coils; these have many uses in radio circuits, quite a different application from their original use. The various diagrams

other coil in parallel with the first, as the d. c. resistance of a single coil is pretty high. To do this, solder connection No. 2 of the second coil to No. 2 of the first, No. 3 to No. 3, and No. 4 to No. 4, and the job is completed. In Fig. 2 the coil is employed as a filter choke in a B-eliminator and C_2 is one of the filter condens-

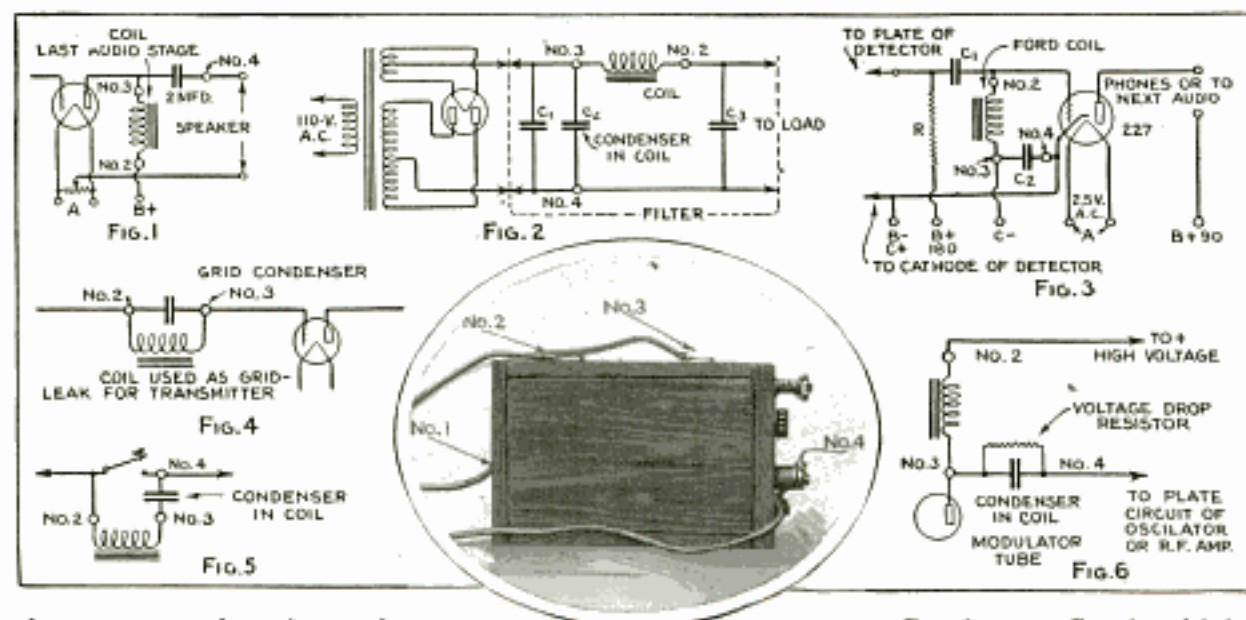

show some that have been proved practical by the writer, and which may be useful to many others. In this type of coil there is a secondary of some 30 henries and a condenser across the vibrator contacts of 2-mfd. capacity which will stand up under about 400 volts continuous direct current. The photo shows a coil of this type with four numbered connections soldered to it. These connections are similarly numbered in the various diagrams showing uses of the coils. It is not necessary to dismantle the coil; just solder on the leads as they are shown in the photo and connect as in the diagrams. There are two kinds of these coils, an old type having a metal top and one with a wooden top. Wire No. 4 is connected to the lower vibrator if the coil has a metal top, and to the upper vibrator if the coil is of the latter variety. A piece of fiber or other insulating material must be placed between the vibrator contacts, or they may be removed entirely if desired. Fig. 1 shows the coil used as a method of coupling the loud speaker to the audio amplifier. The tube may be any type such as the 171-A or 245. If you have more than one coil, it is a good idea to connect an-

ers. Condenser C_1 should be about 4 mfd. and rated to stand at least 1,000 volts, and C_3 should be of the same capacity and rating. In order to keep the voltage drop in the coil low, it is advisable to use several of the coils as chokes connected in parallel. Fig. 3 shows the coil used in an impedance-coupled stage of audio amplification employing a type-227 tube. Condenser C_1 should be .01 mfd., and R should be a resistor of 250,000 ohms. C_2 is the condenser in the coil. The writer used the hook-up in Fig. 4 to provide a grid leak for a low-power transmitter, and in Fig. 5 it is shown as an effective key thump filter in the same transmitter circuit. Fig. 6 shows the method of using the coil as a modulation choke, and in this case it is best to use several of the coils in parallel to keep the voltage drop in the coils at a low value. The coils may be used with tubes as large as type-210, providing several coils are used in parallel.—Robert I. Crowell, Dennis, Mass.

☛ The thick end boards from packing boxes, sanded and shellacked, make excellent baseboards for the construction of experimental apparatus.

Recording Your Own Records At Home

by H. McKay — Part 2



THE LAST unit to complete the tracking device described in Part I of this article in the July issue, is the threaded clamp shown in Fig. 4. It is fastened to the cutter and is made of two pieces of brass, $\frac{3}{16}$ in. thick, one piece 1 in. square and the other 1 by 2 in., which are joined at one end by means of a stout hinge. If a milling machine is available, it will be found convenient to shape the pieces as shown in Fig. 4, so that they may be pinned together, the hinge being part of the block itself. Two holes are drilled, as shown at 4A, in the legs of the longer pieces. The exact location of these holes will depend on that of the mounting holes in the phonograph pick-up which is used as a cutter. A No. 4 hole is drilled and tapped in the middle of the end of the shorter piece, as shown at B, Fig. 4. A piece of spring steel is then bent as shown at 4C and screwed to the end of the shorter arm as indicated at 4B. This spring slips between the legs of the larger piece and serves to hold the two pieces together as indicated.

A plate of brass, $\frac{1}{8}$ in. thick and shaped



Adjusting the Control Panel for Best Tone and Volume before Recording

as shown at 4D, is then made. The narrow arm is twisted as shown at 4E and bent down as indicated at 4F₁. The two holes A, shown on 4E, are drilled to correspond with the two holes A in the split nut. This nut is now screwed to the pick-up with the piece 4D clamped between these two pieces as shown at 4F₂. The 4-in. arm of the piece 4D projects forward

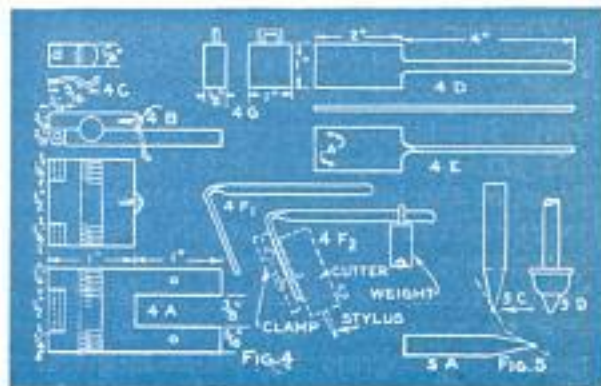

and serves to carry a weight which may be regulated as desired. The weight, shown at 4G, is used to adjust the pressure of the needle upon the record and is provided with a wire bail, set in the top as shown. The needle is prepared by grinding an ordinary loud-tone needle as shown in Fig. 5A. The ground surface will appear as a pointed oval, the rounded side of the needle doing the cutting as the record moves against it, as shown at 5C. Some phonograph stores sell sapphire needles, shaped somewhat as shown at 5D, which will prove very good cutters for this work.

This completes the tracking device which serves to guide the cutting stylus across the face of the record.

Any phonograph may be used for re-

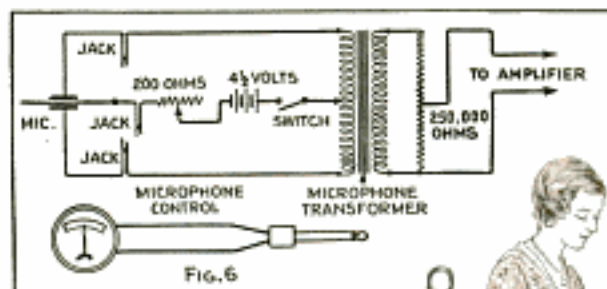

ording, provided it has the strength to pull against the friction of the cutting point. The electric motor is preferred because it is more uniform in action than the spring-driven types. A suggested improvement for the phonograph is to remove the turntable and pour about 2 lb. of melted lead in the underside. This added weight will tend to steady its motion, but the lead must be evenly distributed to preserve accurate balance.

The cutting head may be any good phonograph pick-up, but the reproduction of course depends on the quality of this device. The microphone may be one of the inexpensive popular single-button hand types or the improved two-button carbon model that sells for about \$25. Both types are shown in the central picture on this page. If the two-button type is used, it will be necessary to arrange a control panel, the diagram for which is given in Fig. 6. The control panel supplies the current for the microphone, a control meter and a volume control. The meter may be an external plug-in type, as shown.

A good amplifier for home recording is either the Loftin-White circuit or one of the conventional phonograph amplifiers using two type-45 tubes in push-pull for the output. Many receivers having excellent amplifier stages may, of course, be used for this purpose especially if a pre-amplifier is used. A pre-amplifier of this kind will be described in the September issue.

With the entire equipment connected as shown in Fig. 7, you are ready to start testing. Aluminum record blanks, about 6 in. in diameter, are available for home recording and make a suitable size for in-

closing in an envelope as a "vocal letter" to a distant friend or relative.

The layout for the switching panel is shown in Fig. 8. This convenient change-over device consists of two double-pole double-throw anti-capacity switches which are mounted on a bakelite panel and installed at any convenient location between the control panel and amplifier. The output of the control panel is connected to the binding posts marked "mike" in Fig. 8; the leads

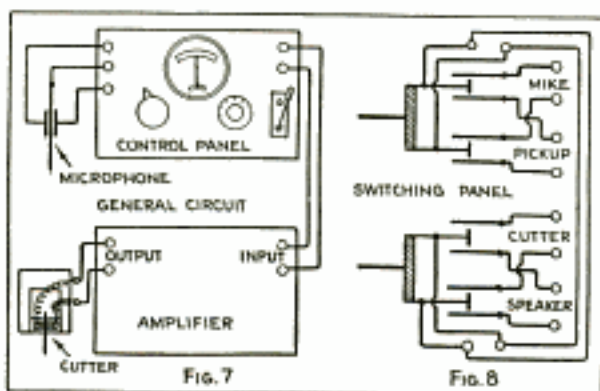
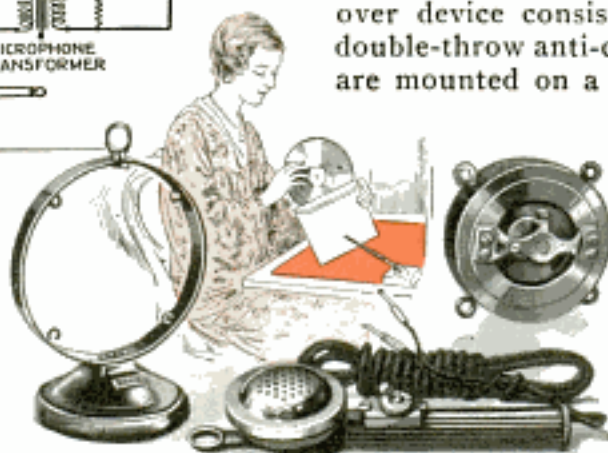

from the pick-up to the switch terminals indicated, and the leads to the cutting head and speaker to the posts indicated on the lower switch. The wiring of the switchboard is now completed by the two sets of binding posts, which are connected to the center poles of the two switches, as shown in Fig. 8.

The switchboard enables the operator to connect the electric phonograph pick-up, or radio-detector output, to the cutting head for duplicating, or to the loud speaker for playing records in the ordinary manner; to connect the microphone to the loud speaker for testing purposes, and to the cutting head for direct recording. All the instruments may be kept set up and the change-over made by merely throwing the switches.

When preparing to make a record, adjust the microphone-control unit for best tone and volume by connecting the microphone to the loud-speaker terminals and substituting a headset for the speaker, as shown in the photo on page 299. The

*Universal Microphone Co.
Glendale, Calif.*

rheostat should be adjusted to show a current of about 10 milliamp. for each button when recording. After the control unit is adjusted, replace the connections and throw the switch to the recording position. Holding the cutting needle against the finger, and speaking sharply into the microphone, the operator should feel the response of the needle to the voice.

The split nut fastened to the sound box is now opened and the sound box adjusted on the threaded shaft, so that the needle is near the outer edge of the record. The phonograph may now be started and the operator should speak distinctly and directly into the microphone. With some microphones, especially the two-button type, it is better to speak across the microphone from a distance of about 6 in. When the test record has been completed, it may be played back immediately, as shown in the photo at the head of the article. Fiber or so-called "cactus" needles should be used for this purpose. A steel needle will scratch the surface of the record and will not give satisfactory reproduction.

The microphone should work efficiently with the 250,000-ohm volume-control potentiometer about halfway between minimum and maximum. If this is the case, it will be possible to record instruments up to 6 ft. away by increasing the volume control. If an amplifier of the Loftin-White type is used, the "hum-bucker" will have to be adjusted critically on high-volume work. The 0-to-25 milliammeter should be connected to a suitable length of cord so that it may be plugged into either of the jacks in series with the buttons for frequent checks, to be sure that the current on each button does not exceed 12 milliamp. The center jack, connected in series with the 200-ohm variable resistor and the diaphragm of the microphone, is used to read the total current for both buttons, and this is the reading to be watched while recording.

After the recorder has been completed, a number of further tests will be necessary to put it into proper final adjustment. Maximum results will depend on the care with which these tests are made. The tests include the current and pressure applied to the microphone, the angle at

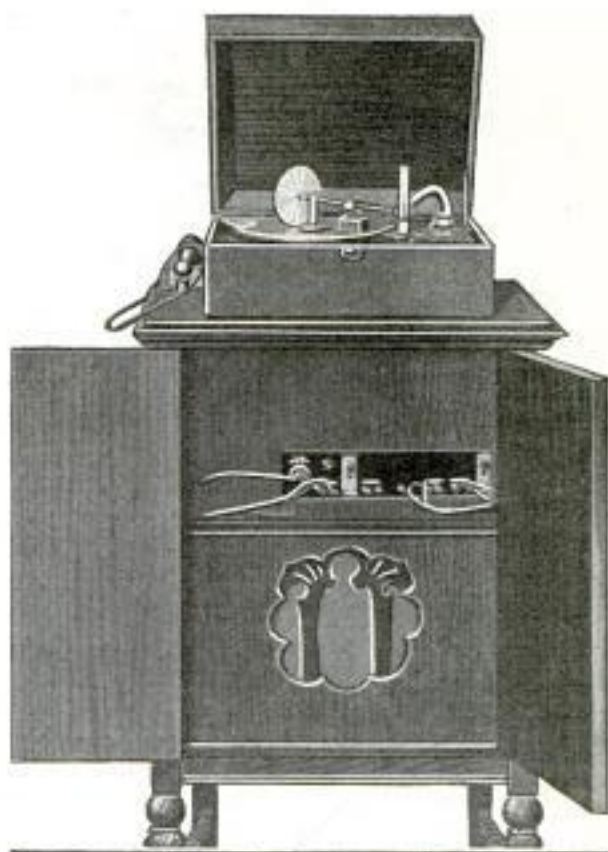

Combined Amplifier and Switch Panel Installed in Console with Loud Speaker; Above, Portable Electric Phonograph with Record Cutter

which the needle rests upon the record, the weight which is applied to the cutting needle and the preparation of the record for cutting, unless a commercial record blank is used. Homemade blanks may be made of aluminum, copper, pewter or zinc; copper is very satisfactory when the pure sheet metal can be obtained, but the ordinary commercial sheet copper is not uniform enough for the purpose. Zinc takes the recording well, but gives off considerable ground noise; pewter gives excellent results but is more expensive. Aluminum sheet, about $\frac{1}{2}$ in. thick, will give the best results at a moderate price, and should be perfectly flat and free from scratches.

Before using the blank, a few small pieces of paraffin should be melted on its surface, just enough heat being applied to melt the wax without causing the metal to warp. While the wax is still hot, turn the disk on edge to allow the surplus wax to drain off, then let it cool. This waxing is necessary, regardless of the material used, as it aids in recording and reduces the ground noise. Completed blanks should be kept in waxed-paper envelopes.

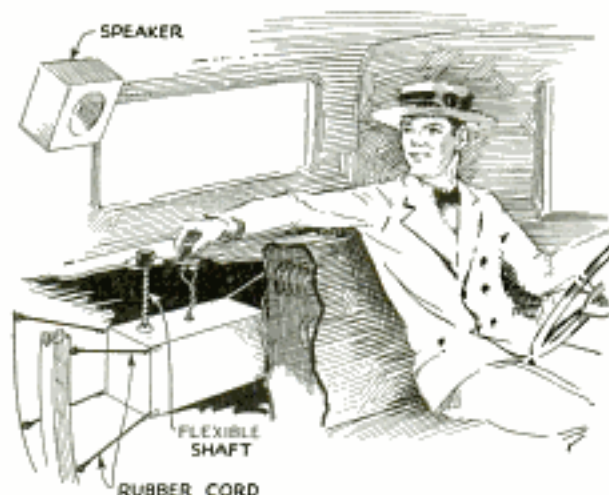

Sectional View Shows Method of Suspension and Location of Tuning and Volume Controls

Installing Radio in a Coupe

A handy place for the set is behind the seat where it is out of sight, yet instantly available for adjustment and tube renewal, by raising the rear deck. The receiver is suspended by means of airplane shock-absorber cord, and the flexible leads to the controls are run up to the deck in the manner shown. The necessary batteries may be installed under the seat or suspended below the car in a battery box. The speaker can be mounted on brackets in the position shown or behind the instrument board, as preferred.

Current Indicator for Amateur Transmitter

The relative amount of current in the antenna or tank circuits may be estimated by means of a flashlight bulb connected to two short flexible wires terminating in small battery clips. One clip is pushed along the high-frequency conductor with a wooden stick until the lamp lights. The closer the clips can be brought to each other and still light the bulb, the more current there is in the conductor.

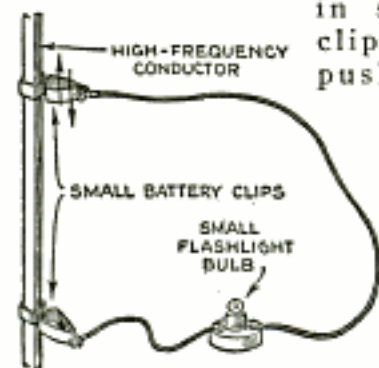

Resistance wire for a variety of uses may be had from discarded household appliances.

Quality Improved by Detuning

The band-pass system of r. f. amplification, which will not cut side bands or cause distortion, may be tried by any owner of a two or three-dial receiver. The results will only approximate those obtained with this system, but a distinct improvement will be noticed. For example, if all three circuits of a receiver are tuned to exactly the same frequency, the amplification of that frequency will be great but the side bands, or high audio frequencies, probably will be cut off. If one of these tuned circuits is left alone, the second raised a degree or two, and the third lowered the same amount, an improvement in quality will be obtained. This detuning will result in a little less amplification, but is well worth while.

Wood Clamps Aid in Working Sheet Metal

Lightweight sheet metal, such as is used in making stage shields, may be easily drilled, filed or cut if clamped between two boards as shown. By this method the sheet metal is held rigid, so that holes will be without burrs, and clean straight cuts can be made.—Ross J. Plaisted, Brecksville, Ohio.

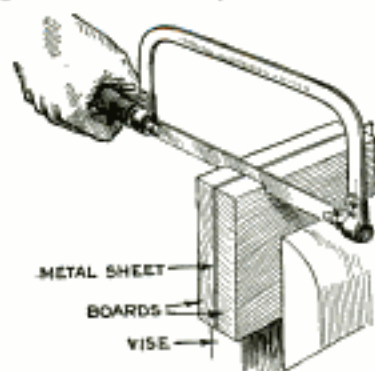

Overloading Shortens Tube Life

Overloading of transmitting tubes results in inefficient operation and greatly shortens the life of the tubes. When used as an r. f. amplifier, the plate should not be allowed to heat to a cherry-red. The cause is too high plate voltage and plate current, inefficient transfer of energy between this tube and the succeeding stage of amplification or to the antenna. If the input voltage and plate current are normal, the cause is the last-mentioned, and the condition may be corrected by retuning succeeding stages and the antenna circuit.



AMATEUR MECHANICS

A Real Electric Motor for a Cent

by DOMINICK LABINO

MADE from ordinary wire paper clips and No. 26 enameled wire, this small electric motor takes only a few minutes to construct. It is a series motor and will run either on a. c. or d. c. at a low potential, such as that provided by a single dry cell.

The framework for the field coils and the armature are first made from paper clips bent to the shape indicated, and the armature supports are then made in a similar way. Wind 50 turns of enameled wire on F_1 and F_2 , the direction of winding on these poles being opposite and both coils being connected together. The free end of one coil is connected to the battery while the end of the other coil, marked F , connects to one of the armature brushes B_1 , shown in the lower right detail. The armature is wound next, 25 turns of wire being wrapped on poles A_1 and A_2 , both coils being wound in the same direction and terminating at C_1 and C_2 , where the enamel is removed from the wire, leaving the bright copper surface which forms the commutator. The brushes B_1 and B_2 are simply lengths of enameled wire with the ends brightened

to form good electrical contact and wound in a spiral form, as indicated, to produce a spring effect which causes the ends to make good contact with the commutator. The field-coil frame, the armature supports and the brushes are then fastened to a wooden base with thumbtacks, and the armature is slipped in position. Carefully adjust the brushes so that they will touch the commutator lightly, the proper tension at this point being highly important. Now hook up B_2 to the other terminal of the battery and the motor will run if it has been correctly wired and properly adjusted.

The operation of the motor can be greatly improved by having the coils on the armature balanced as closely as possible and spaced exactly the same distance from the center. This point should also be taken into consideration when forming the armature frame. The small eyes at the end of the armature supports, which serve as bearings, should make a loose fit on the armature shaft, and light machine oil may be used here to reduce friction. Drops of solder at the ends prevent the shaft from slipping out.

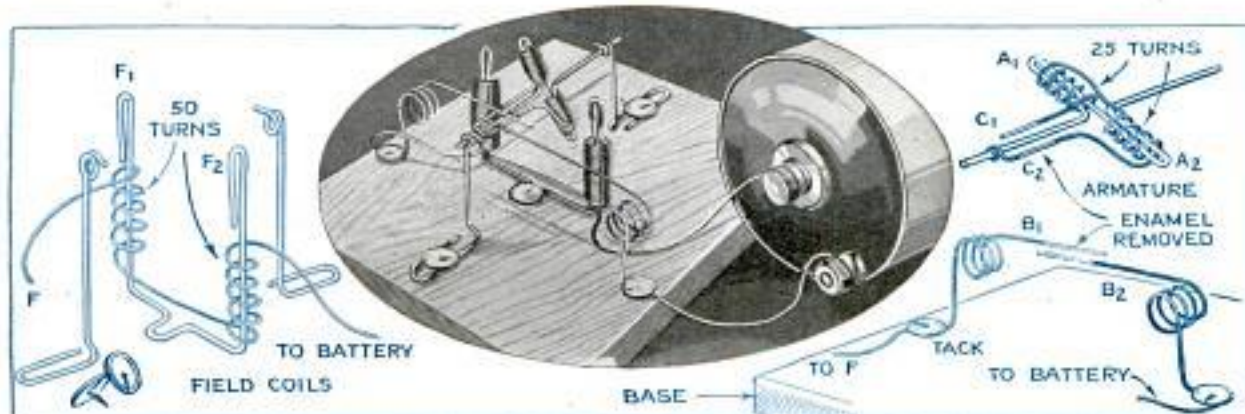

The Framework of This Small Motor Is Made from Paper Clips, While Enameled Copper Wire, Wound on the Poles of the Field Coils and Armature, Is Also Used for the Brushes and Commutator

PHOTO FLASHES SYNCHRONIZED WITH EXPOSURE

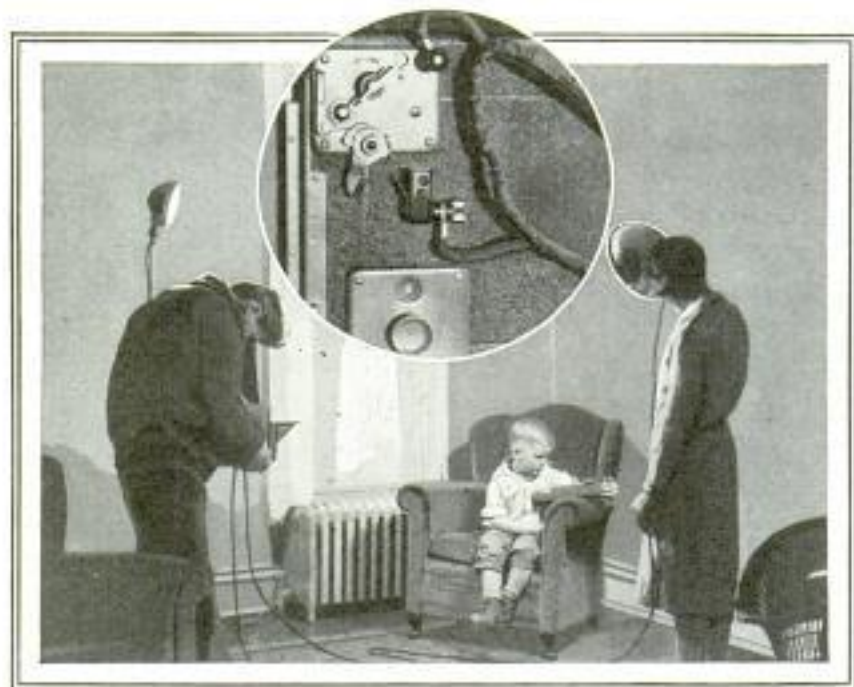

Two or More Photo Lamps Can Be Flashed at the Same Time the Graflex Shutter Is Operated with Switch near Releasing Mechanism

Synchronizing the flash of one or more photo lamps with the action of your Graflex is made comparatively easy by providing a switch on the camera to close at the same time the shutter is opened. A switch of this kind is shown in the circular insert of the illustration. After the photo lamps have been placed where

needed for correct illumination, the extension cords are brought to the source of current supply. One of them is cut, and the two ends thus formed are connected to a similar cord, long enough to reach to the camera, where the two free ends are hooked to the switch. You can readily see how the switch is arranged, one end of the cord being attached to the shutter-release plate to make a good electrical contact, while the other is attached to a small binding post carrying a spring, with which the lever on this plate makes contact, thereby closing the circuit and flashing the lamps. In use, the mirror lever is pulled down, the shutter curtain is set at zero and the tension at No. 3 or less. Pressure on the shutter release raises the mirror at exactly the same time that the current flashes the lamps, which is just before the curtain drops.

Sharp Sand Protects Young Plants from Slugs

Young plants can be protected from slugs by using sharp sand. First remove all the slugs from the ground about the plants and then spread a 1-in. layer of sharp sand around each. Finely crushed rock or powdered lime can also be used, but the latter should be replaced often.

Contour Gauge for Duplicating Design of Turned Work

Consisting of two strips of wood, clamped over a number of nails or lengths of wire, the illustrated gauge is handy for determining the contour of turned work when the design is duplicated. A number of notches cut in one side of each clamp and spaced about $\frac{3}{8}$ in. apart, serve to

hold the nails parallel to each other. Two stove bolts fitted with thumbnuts are slipped through holes at the ends of the

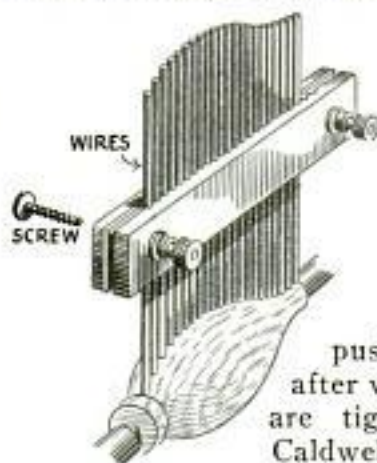

clamps to hold the assembly together. In use, the clamp is placed parallel to the center line of the work and the nails are pushed against it, after which the screws are tightened.—F. W. Caldwell, Nebo, Ill.

☛ A set of two blueprints, SN-7 and SN-8, on "Aero-Boat" can be obtained for 50 cents and a material list will be sent free.

How to Eradicate Moths

Moths in carpets can be eradicated by taking up the carpet and cleaning it. If signs of moths are discovered in the cracks of the floor under the carpet, wash it with benzine and sprinkle red pepper over it before putting the carpet down. If heavy carpets are suspected of harboring moths, fold the edges back, and wash the floor with strong soapsuds in which a tablespoonful of borax has been dissolved. After the floor has dried, tobacco leaves, laid along the edges of the carpet, will help keep moths out. Another method is to mix a tablespoonful of turpentine to each quart of water used, going over the carpet with a sponge dipped in this solution, and squeezing until nearly dry, the carpet having been thoroughly swept first. Change the water as often as it gets dirty. In this way the carpet will be well cleaned as well as disinfected, and all moths and eggs will be destroyed. A good way to brighten up a carpet is to put a half tumbler of spirits of turpentine in a basin of water, into which the broom is dipped and swept over the carpet two or three times. Spots can usually be removed by using ox gall or ammonia and water.

Fence Posts Fitted with These Clips Are Easily Wired



Galvanized-wire clips imbedded in concrete fence posts as shown need not be bent when putting on or removing barbed-wire. The ends of the clips should project

beyond the surface and are bent at right angles in opposite directions, with sufficient space between them to allow the wire to be inserted.

Detecting Counterfeit Coins

Counterfeit coins can be detected by using a solution consisting of silver nitrate, 24 gr., nitric acid, 15 drops, and distilled water, 1 fluid oz. Thoroughly mix the solution and apply to the coin with a glass rod. If any other metal is present in larger quantities than in the standard U. S. alloy, a black stain appears.



When Your Arms Are Full of Bundles a Foot-Operated Latch Is Handy

Foot-Operated Latch Opens Gate

When you have to pass through the back-yard gate with arms full of packages, a foot-operated latch will be appreciated. It consists of two pivoted members, one engaging the latch and the other attached to the lower rail of the fence, both being connected with an iron-rod link, as shown in the upper detail. The lower pivoted member has a tread nailed to the underside at one end, while the other end should project far enough from the pivot to form a counterweight which keeps the latch closed. The tread is extended so that it can be reached from both sides of the fence. To keep the gate closed, a coil spring or a counterweight can be used as shown.

Telephone Bell Is Muffled with Rubber Wedge

When it is desired to muffle the telephone bell, a small wedge-shaped piece of rubber will be found effective. Slip the wedge between the bells and the box so that it will not touch the clapper. In case of illness, or when privacy is desired for other reasons, this idea will be found especially useful.



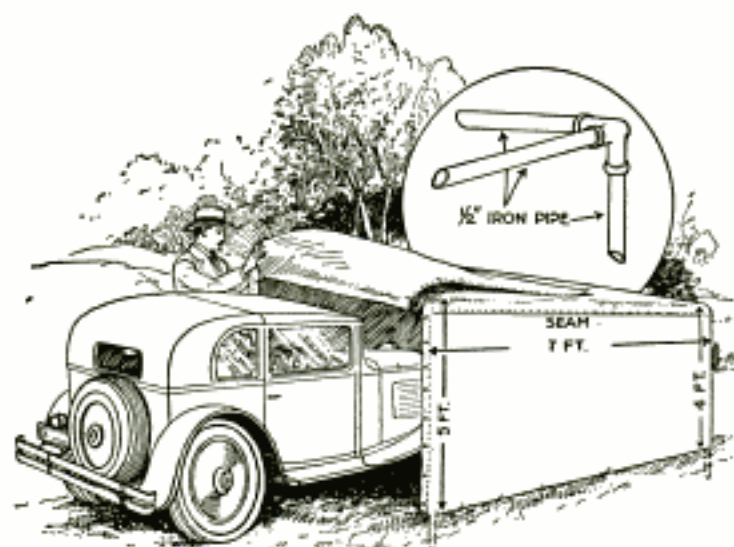

This Small Canvas Garage to House Your Midget Car Has the Advantage of Portability

Midget Car Kept in Canvas Garage

Owners of midget cars who find the average garage too spacious for their needs, will find this canvas garage, which can be rolled up and taken along from place to place, highly convenient. The framework consists of pipe and fittings as shown in the detail, the uprights being pointed at the lower end so that they can be driven into the ground to obtain the necessary rigidity. The door is merely a flap sewed to the front edge of the roof and is thrown back when the car is driven in or out. Snap buttons or hookless fasteners can be used to close it. The edges of the roof should overlap the sides so that the rain cannot leak in.

Iron Strip Strengthens Tool Handles

Tool handles that are subjected to considerable strain can be reinforced by the use of an iron strip in the following way:

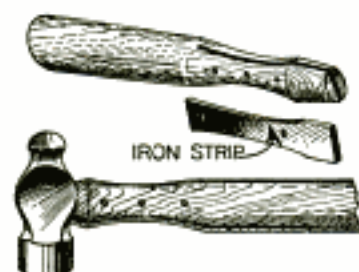

Saw a slot in the end of the handle lengthwise as shown in the illustration, after which a piece of flat iron, fitting the slot, is cut to the shape of the handle, and inserted into the slot. Three holes are drilled through both the handle and the iron core for rivets, the ends of which are smoothed down with a file.

Saw a slot in the end of the handle lengthwise as shown in the illustration, after which a piece of flat iron, fitting the slot, is

Good Undercoating for Paint

So many different kinds of wood are being used nowadays in the construction of homes that it is often rather difficult to get any degree of uniformity. The different grades vary in density, which accounts for the fact that one piece will absorb much more paint than another. This has been found to be especially true in the case of siding. It is, therefore, hard to get a good foundation or undercoating for finishing coats of paint. By using a mixture of red and white lead in equal parts, thinned down to the proper consistency with boiled

linseed oil, the trouble can be overcome. In some cases where finishing coats are not satisfactory, it will be found advantageous to remove the paint entirely with a torch or with paint remover, and then build up a new surface, using the red and white-lead mixture. When dry, any good grade of house paint can be applied.

A Self-Gripping Pair of Tweezers

For those who handle small screws and parts, these self-gripping tweezers will be found convenient. A length of

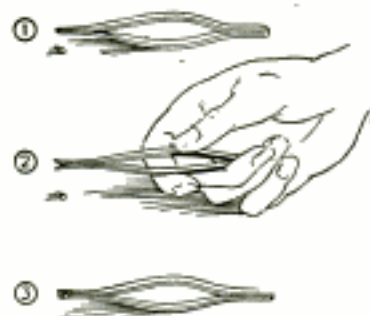

spring steel or brass is bent to the shape shown. By pressing the tweezers, the points are opened and will automatically close when the pressure is released.

Reinforcing Celluloid Toys

Hollow celluloid novelties used by children for playthings can be reinforced so they will last indefinitely. Make a small hole in the toy at an inconspicuous place and fill the inside with paraffin or plaster of paris. The former has the advantage that it can be removed by melting if desired, which should in this case be done by immersing the celluloid toy in hot water to avoid any danger from fire.

THIS WHISPERING BOX WILL MYSTIFY YOUR FRIENDS

SUPPORTED on a table or carried about the room without any wires or other connections, this whispering box, which mysteriously answers all questions, makes a hit at any party, and the time spent in making it is well repaid by the enjoyment derived from its use.

The operator, hidden in the basement, attic or some other room, where his voice will not be directly audible to the guests, hears their questions distinctly through a radio, telephone or dictaphone receiver, wired up with two dry cells and a small dictaphone transmitter concealed in the guest room. He speaks into a similar transmitter, which is connected with a battery of dry cells and to a larger coil of wire under the rug of the room where the whispering box is located. The resulting fluctuations of electric current passing through the rug coil produce a magnetic field of varying intensity, which sets up corresponding electrical impulses in a small coil inside of the whispering box, and these are passed through a receiver, also in the box, where they are transformed into audible sounds. This process of induction is illustrated in Fig. 5, while the complete wiring diagram is shown in Fig. 8.

The whispering box is octagon in shape. Cut the sides from $\frac{5}{16}$ -in. stock to the dimensions given in Fig. 2, and bevel the edges so that they will fit together snugly when assembled on the octagon-shaped ends. A portion of one side is perforated with a number of small holes, arranged in symmetrical order so that the sound produced by the receiver, which is located directly underneath, will not be muffled. The receiver is held in place by means of two rubber bands tacked on the inside, as shown in Fig. 1, and its two terminals are connected with a coil of wire shown in Fig. 3. This coil consists of 400 turns of No. 24 enameled or d.c.c. magnet wire, and its outside diameter should not

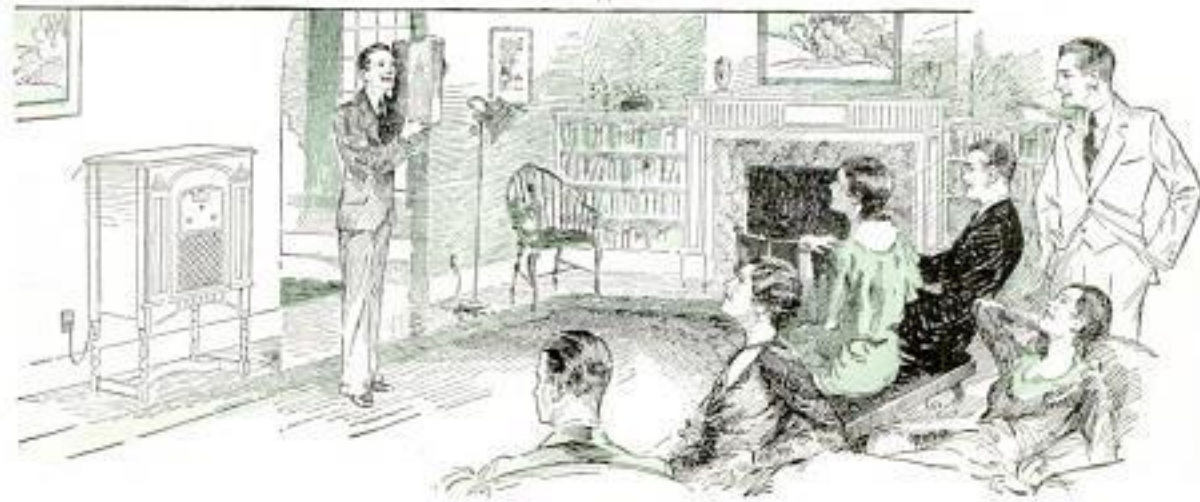
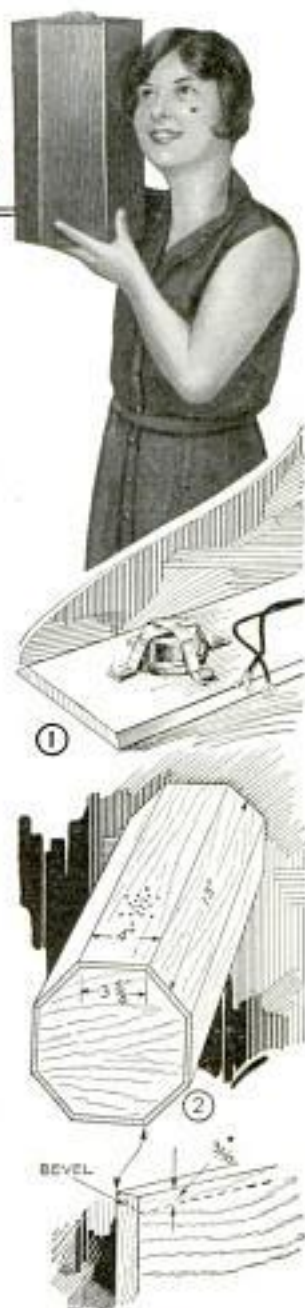

answering any questions that the guests may choose to ask. Of course, you need not confine yourself to a whispering box for such entertainment. By adhering to the basic principles involved, you can use a talking vase, a whispering Buddha, the voice of a lost mariner (in a ship model), a talking teakettle, etc. A different mode of construction along the line of an octagon or hexagon box would be to use two boxes, one within the other with the wiring between them, but the center space open for inspection to show the guests that everything is above board.

Rubber Tips for Chairs

Windsor chairs, and others generally used on tile or highly polished floors, often slip and their fragile construction may be responsible for accidents. The slipping can be prevented by fitting rubber crutch tips over the leg ends. The tips may be painted in the same colors as the chairs.

Quick Method of Chalking Line

For quickly chalking a line, a tin can having two narrow sheet-metal guides



soldered across the bottom and a row of holes punched between the guides, will be found convenient. The guides are spaced just far enough apart to allow the chalkline

to be slipped through, and the exposed edges are bent over slightly. The can is then filled with talcum powder or whiting, after which the line is slipped through.

Mousetrap Used for Bill File

A holder for bills and other papers around the home or shop, can be made from an ordinary spring mousetrap. The trigger is removed and the trap is screwed to the wall or cabinet. The bills are slipped under the spring, and if desired, the trap can be painted to match the trim.



Old Auto Hood Set Up against Hedge Closes Opening and Provides Protection for New Shrubs

Metal Shield Arrests Dogs

Often a hole in a hedge used by dogs is hard to mend unless a solid barrier is set up. An old auto hood will serve this purpose nicely. After a few unsuccessful attempts to break through, the dogs will forget all about this opening, and you may plant some new shrubs with the assurance that they will not be molested by the canines again.

Exposed Push Button Covered with Door Handle

When a push button is in a position where it is likely to be accidentally pressed by some one leaning against it, an ordinary screendoor handle can be used as a guard. The handle is screwed to the wall with the curved part directly over the button, which arrangement will not interfere with its operation.—George Tompkins, Monroe City, Mo.

Washers Hold Furniture Level

Pieces of furniture, provided with casters, can be leveled to stand solidly on the floor by means of thin washers, slotted as shown in the drawing. Remove the caster and place the washers over the tang, using as many as may be necessary for the purpose.—F. J. Wilhelm, Cincinnati, O.



Fish Kept Fresh in Cellophane



Fish that have delicate flesh and spoil quickly, will remain fresh longer if wrapped in cellophane. Clean the fish as soon as caught and wrap them individually, tightly twisting the ends of the cellophane as shown. This makes the bag practically airtight, and keeps the fish free from dirt and flies.

Runs in Silk Hosiery Prevented by Tape on Desk Legs

Wooden desk legs that are splintered or rough on the edges are very often the cause of runs in silk hose. Such damage can easily be avoided by the simple precaution of applying ordinary adhesive tape over the rough edges so that it extends from the bottom of the legs to within an inch or so of the top. Although this detracts somewhat from the appearance of the desk, it is an effective preventive against this annoyance.—Lowell R. Butcher, Des Moines, Ia.

Condenser Lens Intensifies Flash of Photo Lamp

Greater brilliancy can be obtained from a photo flashlamp by placing it in a box fitted with a condensing lens. This concentrates the light on the subject and subdues the background. Any shape of light can be obtained by cutting a shield to the desired shape and holding it in front of or behind the lens. A box, 6 by 6 by 7 in. in size, with a hinged top, is suitable for the purpose. The lamp socket should be set into the side opposite the lens, so that the base can be placed on any flat surface. The lens is held over a circular opening, just a little smaller than the lens, by means of screweyes. The box

may be painted any color desired, but should be white or aluminum on the inside to increase its reflecting power.

Playing Cards Given Coating of Lacquer

Playing cards can be given a finish resembling that of celluloid, which will make them last longer. Add two parts of lacquer thinner to one part of transparent lacquer and dip the cards in this solution with a pair of tweezers. The cards can be given further individuality by tinting the lacquer.

This Knot Keeps Tennis Net Taut

Tennis nets that have a tendency to sag, due to slippage of the knot tied in the rope at the support post, can be kept taut by tying the rope as follows: If there is an eyebolt in the support, bring the rope around the post and loop it over the projecting end of the bolt, bringing the end of the rope down between the rope and the post so that the pressure of the rope will hold the end firmly against the post and prevent it from slipping. To tighten the net, pull on it close to the post and take up the slack by pulling on the end of the rope. If the bolt does not

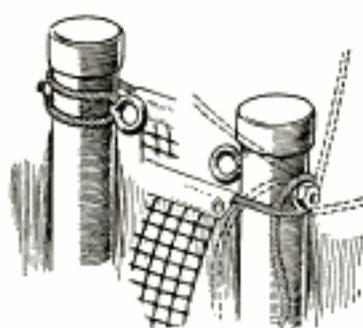

project far enough at the back, the rope can be brought around and looped over the eye of the bolt and the end fastened in a similar manner at the back, as shown in the left-hand detail.

Artichokes Smother Quack Grass

Gardens or fields that have become infested with quack grass can be cleared by planting Jerusalem artichokes on the land. These plants make a dense shade and smother out the grass. With a little cultivation, one year usually suffices to smother the grass, but in two years' time the artichokes will kill the grass without any help.

"AERO-BOAT"

A High-Speed Hydroplane

by L. J. GORENFLO



PART II

AFTER finishing the pontoons and trusses as described in the July issue, and fully covered in large blueprints, the fuselage is built. Four frames are needed, one at each truss and another in the tail, as indicated in Fig. 25.

Details of the construction of the frames are shown in Figs. 28 and 29. Note how the top is made of plywood or pressed wood fastened to filler blocks, the latter being necessary for attachment of the $\frac{1}{4}$ by $1\frac{1}{2}$ -in. battens, as screws placed in the edges of plywood would not hold. Frames No. 2 and 3 are made exactly alike and are fastened to trusses No. 2 and 3 respectively. Frame No. 1 is somewhat different, and frame No. 4 can be made later, when assembling the tail. The curved nosepiece is built up from separate strips, as indicated in the left-hand detail of Fig. 25, and is joined to frame No. 1 with two strips, nailed to a filler

The Horizontal Position of "Aero-Boat," after Taking a Sweeping Curve at Top Speed, Shows Its Unusual Stability

block for strength. After completing it, you are ready to put on the center-line batten, which should run parallel to the pontoons. It is first fastened to the mid-section of the nose and extends to the tailpiece, which is detailed in Fig. 33, the batten being nailed to the frames half-way between the top and bottom as indicated in Fig. 28, just above the legs of the A-trusses. By spacing these battens exactly alike on both sides, you will be able to get a beautifully streamlined fuselage. Note how the side battens are held together at the tail by fastening them to a piece of plywood or pressed wood, as shown in Fig. 33. The lower batten of

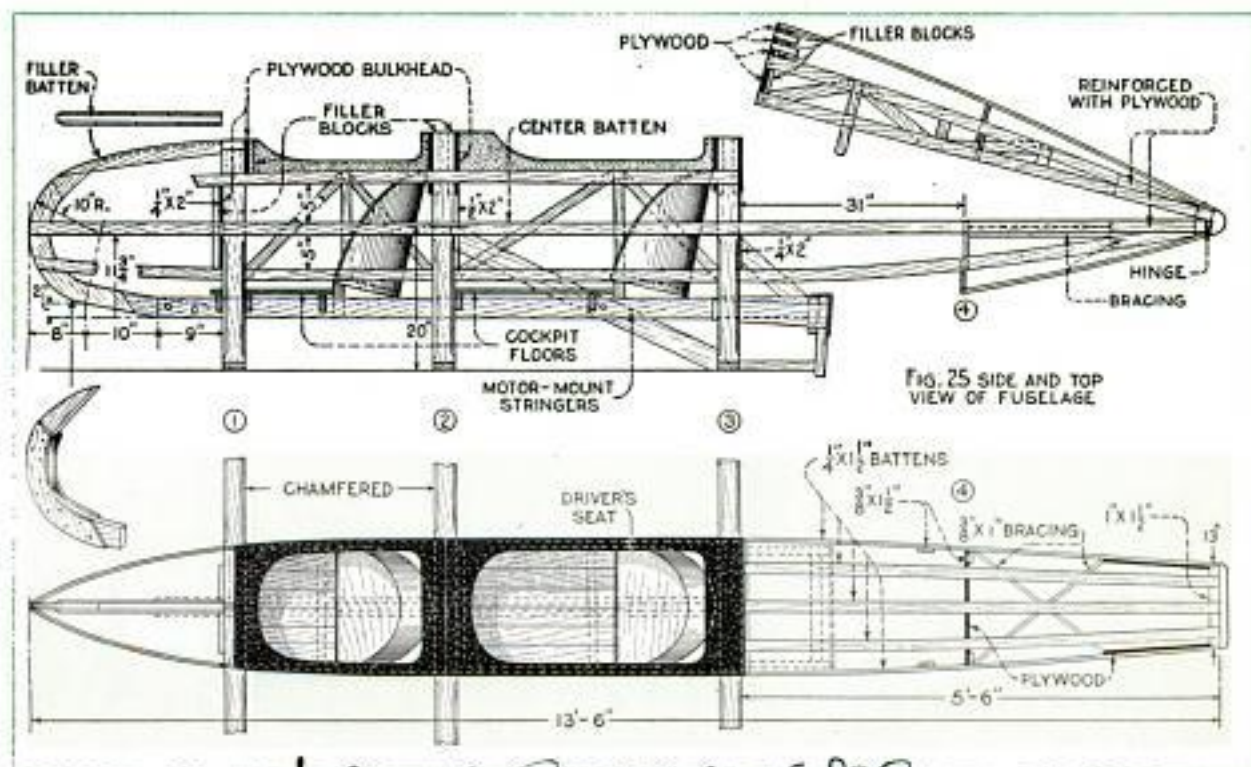

J. N. B. P. 688, 689



the hinged tail is placed on the center-line batten, from frame No. 3 to the tail-piece, and the plywood is later cut with a saw between these two battens.

Diagonal bracing for the sides is also necessary as shown in the drawings. Frame No. 3 really consists of two parts, one to hold the body fuselage and the other to hold the tail, and the adjoining edges should, of course, come flush. A vertical piece on each side of the tail holds it in position securely, while a turn-button or a hook and eye at the top serves to keep it in place at the point where it joins the body, as indicated in

Fig. 36. It is an easy matter to provide a strong butt hinge at the tail and also side-strap hinges to hold the tail up while the motor is being put in place or removed. Another point to remember is to put in the cross bracing before the top-line batten. If the latter is cut before the bracing is inserted, it will be impossible to make the curvature of the tail

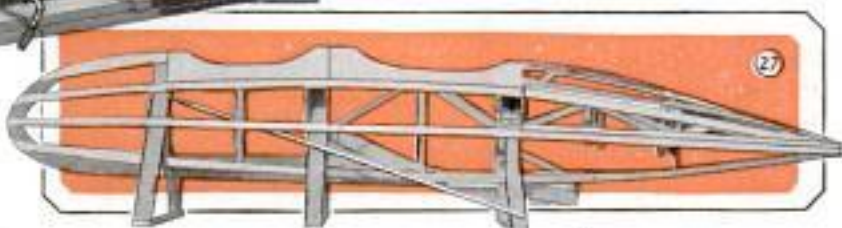

conform to that of the body. Frame No. 4 is made in one piece, as shown in Fig. 29, and is cut in half at the point indicated, after which the tail battens are fastened on. Cross bracing of $\frac{3}{8}$ by 1-in. stock in the tail is also highly essential.

The covering or capping for the cockpits is made of pressed wood, cut to the dimensions given in Fig. 31, and the position of these covers is indicated in Fig. 25. Start by screwing the capping down

at the center of the top, driving the screws into the filler blocks. Bend the stock over the curved bulkheads, spacing the screws 1 in. apart. In putting on the front-cockpit cover, you will notice that there is a slight overhang, due to the fact that frame No. 1 is only 18 in. wide, while frame No. 2 is 20 in. wide. Simply cut off this overlap with a saw

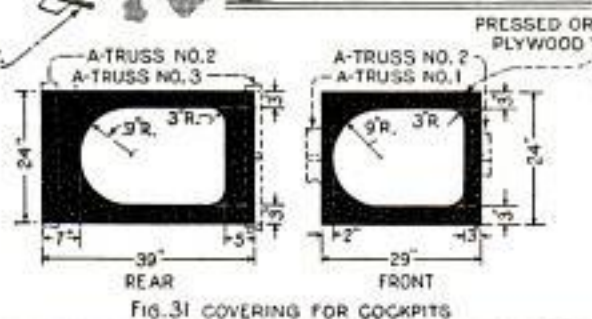
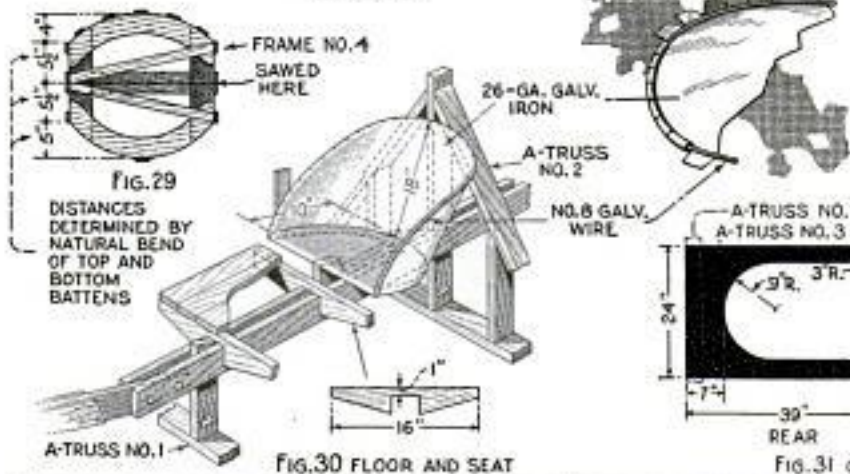
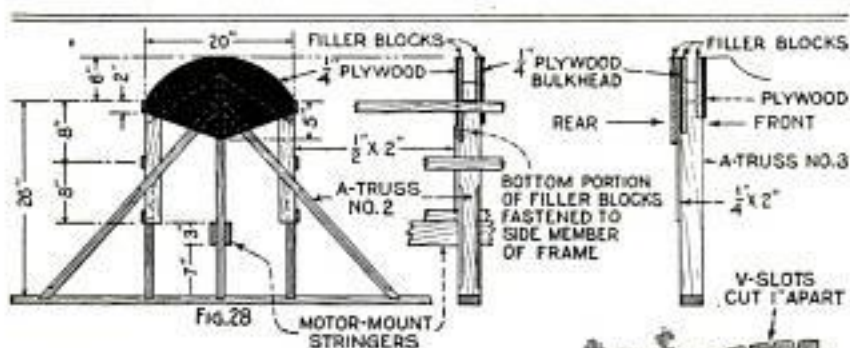

and fasten the covering along the top-line batten with straps, spaced 4 in. apart as shown in Fig. 38.

The "bucket" seats are easy to make and their construction is shown in Fig. 30. The back is a piece of No. 26 gauge galvanized sheet iron, the edges of which are notched and bent over a length of wire. The seats are set at the angle most convenient for riding, which is done by means of a small block of wood. Both the seats and the floorboard, which is also shown in Fig. 30, are supported by the two long motor-mount stringers. Crosspieces, to which the flooring is attached, are notched to fit the stringers and are nailed in place.

At this point it is necessary to install the side braces on the outside of the fuselage, as shown in Figs. 27 and 32. These braces prevent one pontoon from dragging behind the other and also serve to obtain rigidity. One is provided on each side, and they run from the top of truss No. 1 to the bottom of truss No. 3, being bolted to the trusses with $\frac{1}{4}$ by 2-in. flat-head stove bolts. Do not omit these braces for any reason, for the dragging mentioned may cause the two pontoons to tear apart at high speed.

The fuselage is now temporarily removed from the pontoons in order to apply the covering, which is ordinary muslin, waterproofed and stretched by means of airplane-wing dope, this being applied after the cloth has been tacked to the frame. First cover the upper half of the fuselage, as shown in Fig. 26, using a single piece of cloth, 44 in. wide,

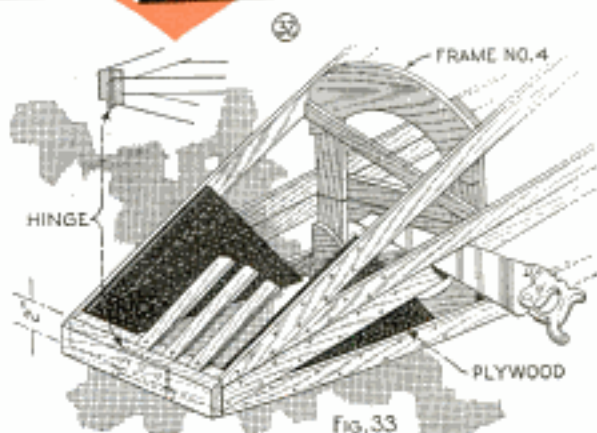

and tacking it to the center-line batten on both sides. The over-all distance from the nose to the tail is about 14 ft. Stretch the cloth tightly and tack it down at 2-in. intervals. The holes for the cockpit are not cut until the upper part of the covering has been treated with two coats of clear nitrate wing dope, allowing the first to dry before applying the second. This will cause the cloth to adhere to the cockpit capping, making a neat job, after which it can be trimmed off. The underside of the fuselage is covered with two pieces, tacking one edge of each piece along the underside of the motor-mount stringers

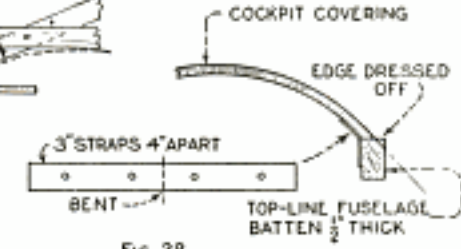
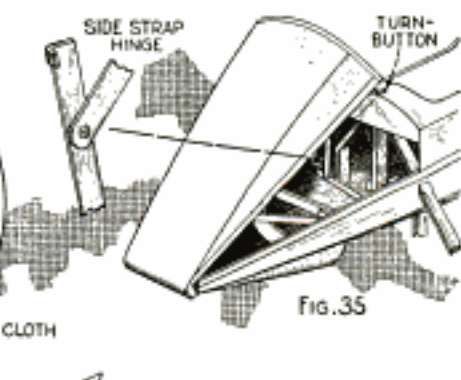
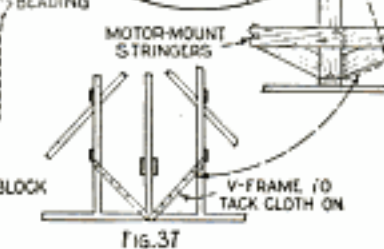
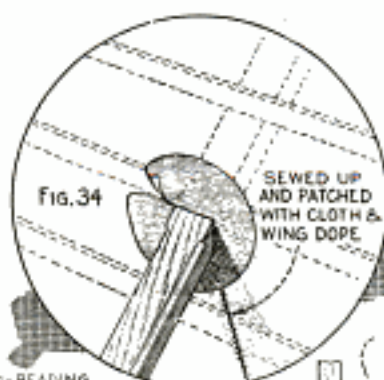
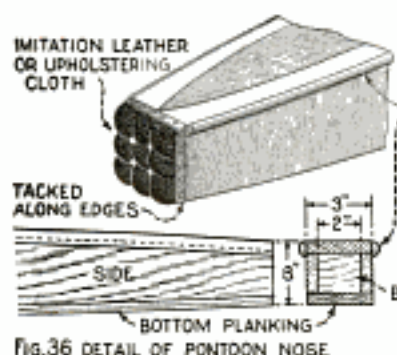

*Elto Div. Culboard
Motor Corp
Milwaukee, Wis*

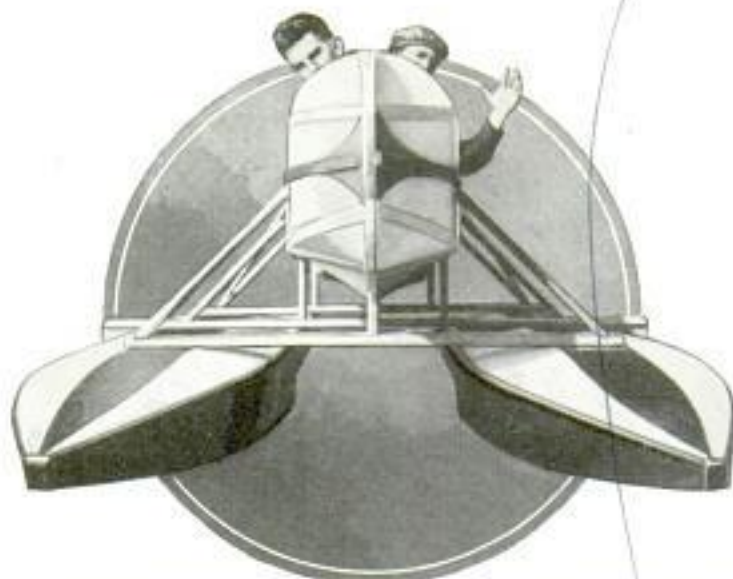

Here Is "Aero-Boat" When Finished, Showing How Both the Fuselage and Pontoons Are Beautifully Streamlined

and stretching the cloth up to the center-line batten where it is fastened on as before. Try to keep all the tacks in a straight line. Slits are cut so that the cloth can be brought up around the truss legs, the slits being sewn up later, but before the dope is applied. Circular patches of cloth, about 5 in. in diameter, are cut to fit around the truss leg where it enters the fuselage, to give the joint a finished appearance, as shown in Fig. 34. Wing dope is also put on the patch, thereby gluing it to the cloth underneath. The underside of the fuselage, between the motor support and frame No. 3, is left open for the motor. Note from Fig. 37 how a V-shaped frame is provided to car-

ry the cloth directly behind frame No. 3. This is not absolutely necessary, but is advisable, to keep the motor dry. The row of tacks on the center-line batten should then be covered with upholsterers' gimp.

While the fuselage is removed from the pontoons, the latter are also covered with canvas. The method of applying the canvas is similar to that of the cloth on the fuselage and wing dope on the canvas, and is, of course, preferable to paint. A few finishing touches of color to the craft, and it is practically finished, except for reassembling the fuselage on the pontoons and providing the

latter with a nosepiece of leather, as shown in Fig. 36. Also be sure to streamline the truss legs by chamfering the edges. Almost any smart complementary color combination can be used to make the craft attractive. The motor used should be no less than 22 hp., which will drive the boat about 35 miles per hour and over. More powerful motors will develop greater speed. The one used was a class-D four-cylinder motor, which developed a speed of approximately 40 miles an hour. No inboard motor can be used. It is possible to leave the cockpit and step out on the catwalks of the pontoons while going at full speed, without appreciably affecting the course.

Tool Binds Wire on Rubber Hose Connections

When binding hose connections with wire, this tool will speed-up the work besides making a good joint. It consists of a length of $\frac{3}{8}$ -in. bar iron, with a notch at one end to fit over the hose and a hole drilled 3 in. from the notched end for a rod, which is bent to form a crank. Small holes, to receive the ends of the binding wire, are drilled about $\frac{3}{4}$ in. apart at one end of the crank. In use, the notched end of the bar is placed against the hose over the looped end of the wire, and the free ends are threaded through the holes in the crank. It is then an easy matter to tighten the wire around the hose by turn-

ing the crank and then bending the wire over to lock it.—P. R. Moak, Monroe, La.

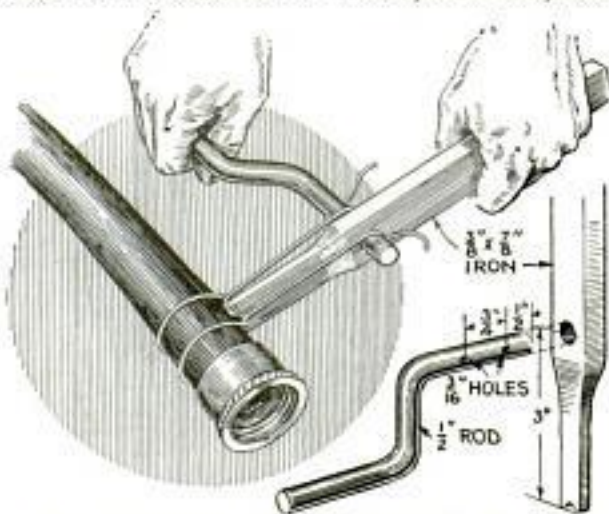

Hose Connections Easily Bound with This Tool

AFRICAN "POO" IS A FASCINATING GAME OF CHANCE

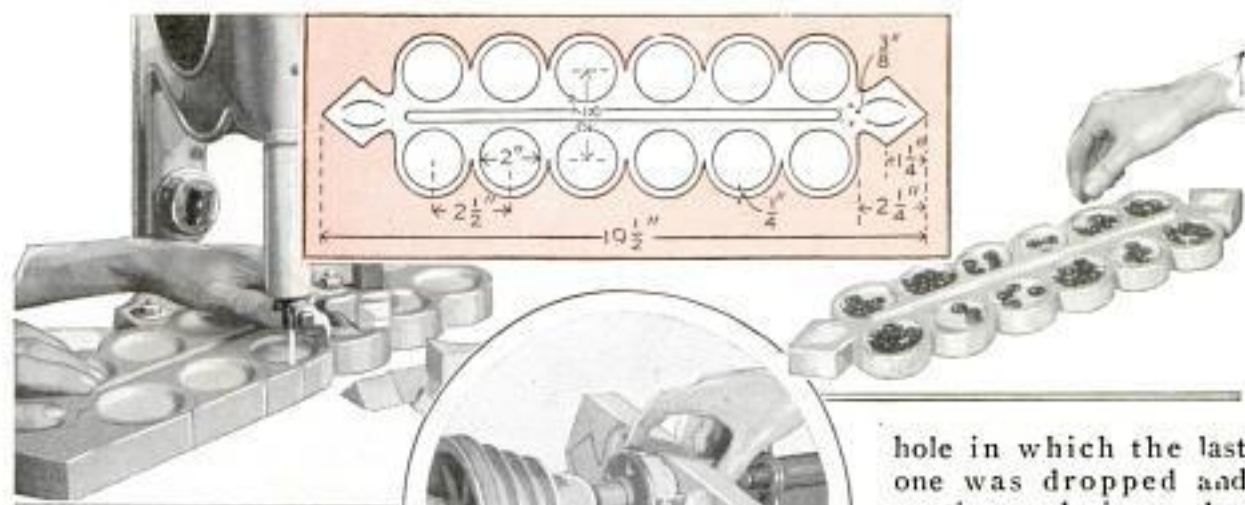

"Poo," or "Mancala" as it is sometimes called, is a game known to many an African hut and is considered the most popular time-killer in many parts of the Dark Continent. It is played on a board somewhat similar to the one shown here, although the native board is equipped with a runnerlike support and is set between two squatting contestants. Get a piece of poplar, or other easily worked wood, $19\frac{1}{2}$ by $5\frac{1}{4}$ by 1 in. in size, and mark off two rows of 2-in. circles which are bored to uniform depth, and then smooth with a circular block as indicated. Emery cloth is used instead of sandpaper, as the latter is likely to tear. After the holes have been finished, nail a $\frac{3}{8}$ -in. square strip of wood between the two rows and cut the board to the shape shown with a fretsaw or bandsaw. Now for the game. The two players seat themselves on opposite sides of the board. One of them takes 98 buttons—the natives use pebbles or cowry shells—and distributes them in the 12 holes, not less than two in each and as many more as desired. The first player starts by picking up all of the buttons in the hole at the right end of his row and drops them into the other holes, one button in each, beginning at the left end of his opponent's row and going toward the right, then working toward the left in his own row. The player continues dropping the buttons in this way until the last one has been deposited, whereupon he takes all the buttons from the

hole in which the last one was dropped and continues playing as before. Eventually he will end by depositing buttons in an empty hole. Then he stops and his opponent takes up the play. However, if the first player stops at a

hole holding either one or three buttons, he takes all the buttons of that hole plus those of the hole directly opposite, on his opponent's side. Furthermore, if the holes immediately following this one toward the right in the direction of playing contain two or four buttons, he takes them also. The winner is he who, at the conclusion of a predetermined number of rounds, has the greater number of buttons. Rules can be varied as desired.

Paper Clips Remove Paraffin Covers

Paraffin covers on preserve jars can be easily removed without breaking by imbedding ordinary paper clips in the paraffin while it is poured on. To do this, bend the clips at right angles and twist the ends to form hooks, which are hung over the edge of the glass before the paraffin is poured into the top of the jar.



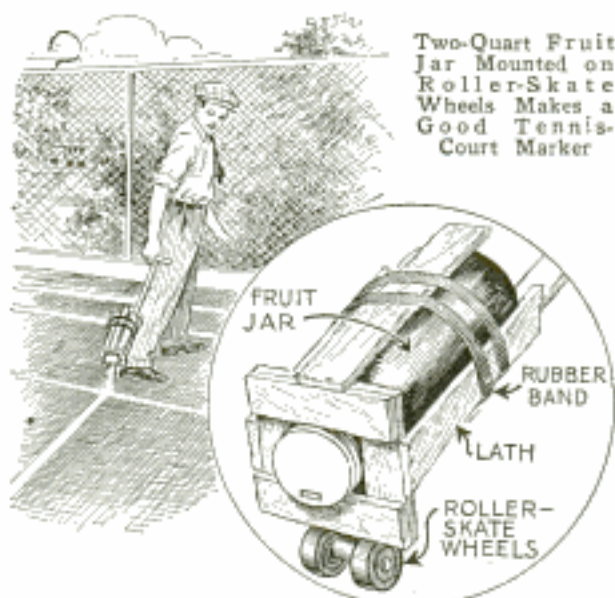

Two-Quart Fruit Jar Mounted on Roller-Skate Wheels Makes a Good Tennis-Court Marker

Tennis Marker Made from Fruit Jar and Roller Skate

Tennis courts can be marked quickly with this improvised marker, consisting of a 2-qt. fruit jar held in a framework made of lath. A pair of roller-skate wheels are attached to the frame and a handle is provided, so that the marker can be pulled along while walking over the court. A rectangular slot, measuring $\frac{1}{4}$ by $1\frac{1}{2}$ in., is cut in the cover of the jar, to allow a uniform flow of the marking fluid, which consists of a lime-and-water solution. The top of the jar projects through the end of the frame to which three short slats and the handle are tacked, the jar being held in position by a couple of rubber bands cut from an inner tube. A crosspiece on the handle provides a good grip.

A Silent Doorstop

A silent doorstop can be made from a length of sheet metal, $1\frac{1}{4}$ in. wide, and a piece of old inner tube. Punch a hole in each end of the strip of sheet metal and bend it as shown. An 18-in. length of old inner tubing is then wrapped around the bent portion of the strip, which is drilled and fastened to the door or wall at a point where the door strikes.

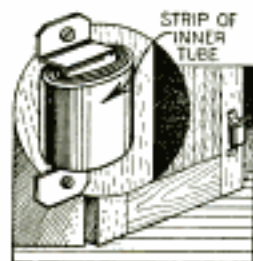

Thread Removes Tight Ring from Finger

A ring that fits too tightly to be slipped off the finger, can be removed with a length of strong thread and a needle. After threading the needle, wind the thread tightly around the finger up to the ring, starting at the finger tip. When the ring is reached, slip the head of the needle under it and draw the thread through. Now proceed to unwind the thread and you will find that the ring will slip down the compressed finger easily.—Lieut. Don. B. Owens, Jr., Dayton, Ohio.

Mirror Locates Objects Submerged in Clear Water

Submerged objects can be located by holding a mirror at the proper angle to reflect the rays from the sun into the water. If the water is covered with ripples causing poor vision, knock out the bottom of a box and hold the lower edge just below the surface. Reflect the rays into the box, where the water will be free from ripples. This is also a good method of inspecting deep wells when no flashlight is at hand.

Golf-Club Handles Wound with Cord Do Not Slip

The danger and embarrassment of having a golf club slip out of your hand can be prevented with a wrapping of cord. Both ends of the cord are fastened to the handle, and a tack is used for this purpose at the top end. This will provide a grip which is not likely to slip, and it is an easy matter to remove the cord at any time when it is not needed.

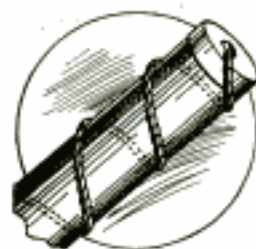

Emergency Cement Quickly Prepared

A cement that is strong and can be quickly made in case of an emergency is prepared as follows: The white of an egg and slaked lime are stirred together until the mixture assumes the consistency of paste. The paste must be used immediately as it sets very quickly.

This GALLOPING TEAM KEEPS *the* BABY BUSY

by
H. W. Magee

ALTHOUGH not new, this galloping team is one of the best animal toys to keep your baby happy for many hours. Besides merely rocking, the child soon learns to travel all about the house, and if the ends of the rockers are covered with strips of rubber, no scratches or marks will be left on the woodwork.

Poplar is the best wood to use. The rockers should be bent to shape from suitable lengths of the same material, which is a comparatively easy matter when thoroughly soaked in boiling water. It is not advisable to cut the rockers as they are likely to



the seat should run parallel to the sides, and dowel-rod supports are located under the front end of the seat and behind the upper end of the backrest; these two parts are joined together with screws.

The best method of construction at this point is to fasten a cleat to the inside lower edge of the backrest to hold the rear edge of the seat, which is then screwed to the cleat. The dowel-rod supports fit holes of corresponding size drilled through the sides and are held in place by means of wood screws and washers, which latter should be larger in diameter than the holes. The tray is screwed to the sides and a dowel rod is fitted across the front just above the tray to serve as a handhold. The footrest is attached in the most convenient position for the child's feet. If desired, a dowel rod may also be run across the rear end of the

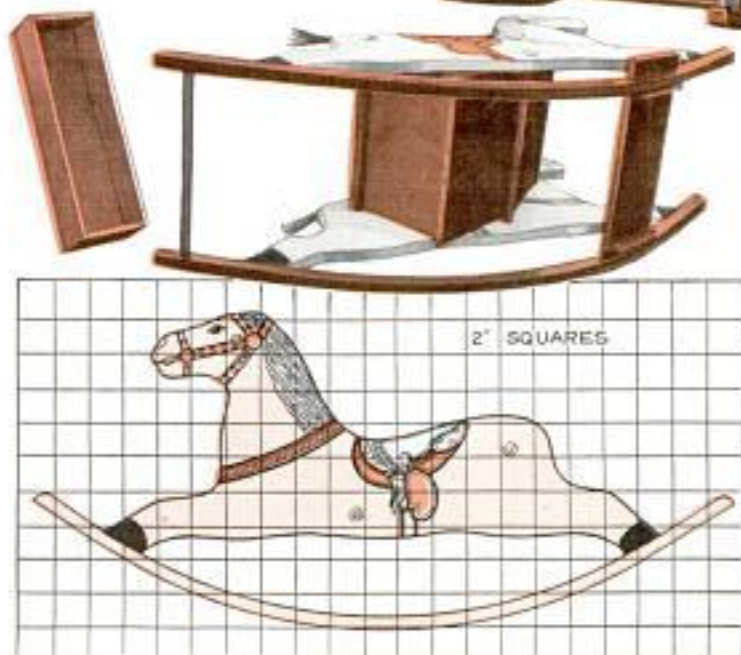

split where the grain crosses the stock at the ends. Get a large sheet of wrapping paper and rule it off in 2-in. squares; then draw the outline of the horse over these squares as closely as you can to the template given here. Variation from this design is likely to affect the balance. Stock of $\frac{3}{4}$ -in. thickness is used for the horses, while $\frac{1}{2}$ -in. material is satisfactory for the seat, tray and footrest. The grain of

rockers. As strong joints are necessary between the rockers and the horses' feet, 2-in. wood screws are used at these points. In bending the rockers to shape, be sure to get the exact curve of the template and that they are free from humps and hollows. When they are thoroughly dry after bending, take a small plane and round the lower edges slightly.

The completed rocker is given a coat of

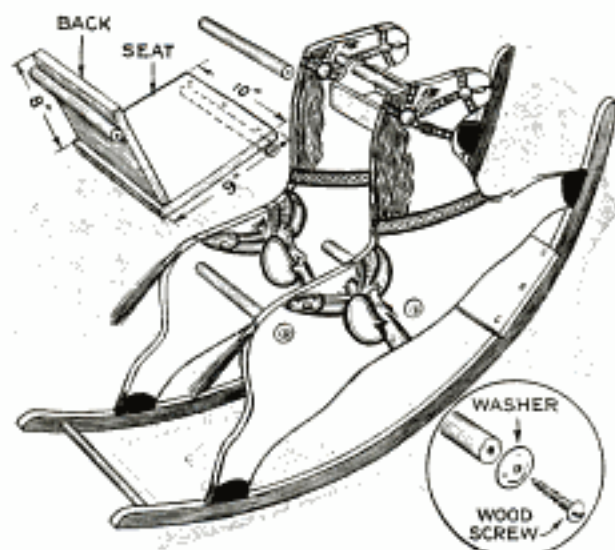

shellac and can be painted white or gray, while the saddle and bridle decorations may be of any color that suits your fancy.

Lifelike Food for Aquarium Pets

Aquarium pets such as turtles, frogs, etc., that are kept in the garden aquarium can be "fooled" into eating and kept alive for some time. Many of these creatures will only take food that is apparently alive and kicking. Cut a piece of lean, fresh beef into small pieces so that the animal can swallow it. Draw a length of thread through a piece with a needle, but do not tie a knot in the end of the thread, so that it can readily be pulled out again. Swing the bait back and forth in front of the animal. If hungry, it will immediately take the food, after which the thread can be slowly removed. Turtles, salamanders and newts will take meat in this way, and also some of the snakes. Pets fed in this manner will soon learn to come up to the edge of the aquarium when you approach and wait for the swinging bait. It is a good idea to substitute a piece of liver now and then for the beef.—C. Bernard Peterson, North Evans, N. Y.

Homemade Soap Washes Clothes without Rubbing

A soap, which will wash clothes without the usual rubbing, but only rinsing, can be made of common laundry soap cut into thin slices, 2 lb., sal soda, 2 lb., water, 10 qt. Mix the above ingredients and boil for two hours, after which the solution should be strained. Put the clothes into

a tub, adding 1 lb. of the soap to every bucket of water. Let the clothes soak in this solution overnight, after which they are thoroughly rinsed.

Improving Pictures Taken at the Beach

Pictures taken at a beach on a sunny day can be greatly improved by shading the object with an unfolded newspaper. This evens up the light so that there will be no dense shadows. As the sunlight is reflected from the sand, plenty of time will be given by setting the camera for normal exposure.

Celluloid Side Wings on Coupe Shield Rumble-Seat Riders

By attaching two side wings of celluloid to the back of your coupe, greater comfort will be enjoyed by those riding in the rumble seat. Although this type of wing was designed for use on convertible models, they can be adapted with equal success to closed models. The wings consist of a wire framework, bent as indicated. A celluloid pane is fitted in the large section and is held in place by means of a cloth binding sewed over the edge. The smaller panel should be inclosed with a piece

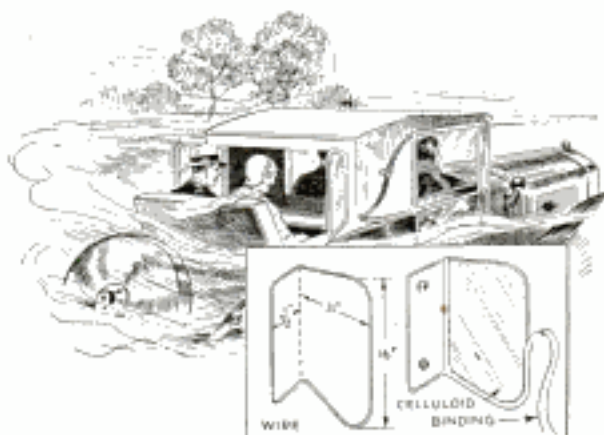

The Comfort of Rumble-Seat Riders Can Be Greatly Increased by the Addition of Celluloid Side Wings

of light sheet metal, the edges of which can be bent over the wire frame. The sheet-metal portion of the shield is attached to the back of the car with screws or bolts. In a convertible model or coupe, short bolts fitted with large washers will be found a convenient method of attachment and will not tear the fabric of the top.—Joseph A. Carrera, Dawson, N. M.

WAX CRAYONS AND GASOLINE FOR COLOR-STAINING



Wax Crayons Softened or Dissolved with Gasoline or Turpentine Can Be Used to Make Beautiful Colored Effects on Wood

Coloring wood with wax crayons is extremely simple and gives effects that cannot be obtained in any other way. The simplest method is to wash the surface of the wood with a wad of cloth soaked in gasoline. Immediately after washing, rub the surface with whatever color you desire. The gasoline softens the colored wax, allowing part of it to penetrate the wood, much like a stain. You can obtain polychrome effects by applying patches of different colors and merging them by rubbing with a cloth, or you can wash over the colors with a gasoline-saturated cloth to remove the surface wax, leaving only that which has penetrated the wood. Then apply a coat or two of floor wax, preferably liquid, which can be rubbed to a polish. For carved book ends, letter racks and other objects, beautiful two-tone effects can be obtained as follows: Go over the tooled portions with a gasoline wash consisting of $\frac{1}{2}$ teaspoonful of white oil paint and $\frac{1}{8}$ teaspoonful of warm gray oil paint mixed together in a cupful of gasoline. Apply the wash with a brush. While the wash is still damp, rub the desired color of wax crayon into the background. Another method is the following: First color the wood with crayon and then rub lightly with a rag dipped in turpentine. This softens the wax so that it penetrates into the wood and at the same time removes the surplus. As no other protective coating is applied, the crayon itself produces a surface that is easily cleaned. A crayon paint can be made by cutting the crayon into small pieces, pouring turpentine over

them and warming slightly, this being done by putting the container in a hot-water bath. Stir thoroughly until mixed and apply with a rag or brush. You can produce almost any hue by mixing colors in this way. If it is desired to remove the coloring from the wood, wash with turpentine, although small spots and lines can be scraped clean with a knife. Crayons can also be used for coloring other surfaces than wood, as for instance, plaster, pottery and wall-board. When purchasing crayons, be sure to get the kind made of wax, as other kinds are not adapted to this purpose.

Broken Pipe Stem Can Be Removed with Clothes Hook

An easy method of removing a broken piece of pipe stem from the bowl end without damage, is to drive a clothes hook into the broken piece, which can then be readily pulled out. The threaded

Ordinary Clothes Hook Can Be Used to Extract Pieces of Broken Stems from Pipe Bowls

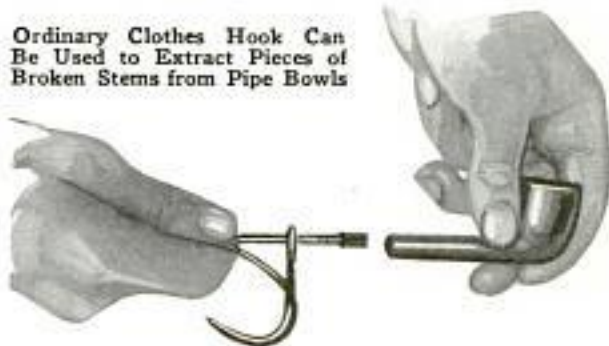

end of these hooks will make a snug fit in most pipe stems.

Animal Heads Hold Children's Towel Rack



Juvenile Towel Rack of Animal-Head Design Stimulates Tidiness in the Bathroom

Two animal heads, holding a towel rack for the children, form a pleasing and useful addition to your bathroom. The heads, which may represent any animal you choose, are cut from $\frac{1}{2}$ -in. stock. By clipping the heads from magazines and crosshatching them in small squares, it is easy to duplicate the design on a larger sheet ruled off in 1-in. squares as shown. Drill a hole to receive a rod in the approximate position of the mouth, which is then formed by cutting a narrow slot. Both heads are held on a suitable base of $\frac{1}{2}$ -in. stock, by means of screws, driven in from the rear, and the length of the base depends on the available space where the rack is to be placed.

Protecting Rustic Timbers

To prevent the bark from flaking off logs used in rustic structures, the following methods have been found effective: First, the timber should be cut late in the summer. Score it on two sides; that is, cut off two narrow strips of the bark, for the entire length. Pile the timber in the shade, in an open pile, to allow thorough circulation of air. Allow the timbers to season until the following spring or summer before using them. A second method requires that the timbers be cut and

seasoned as just described, and, in addition, the ends, stripped portions, and knots be coated with coal-tar creosote, using one coat a few days after the timbers have been cut, and another just before using them. The third method also requires the timber to be cut in late summer, and to be seasoned until the following spring or summer, but the bark is not scored. When the timbers are in place, the bark is tacked on with large-headed nails, placing one to each square foot of surface. Paint the nail heads to resemble the color of the bark. The fourth method is perhaps the simplest, in that the bark is tacked or nailed on without particular attention to the time of cutting or other treatment. The nailing method has been successfully used by one western company which maintains numerous rustic hotels, and also on a large rustic building erected for exposition purposes.

A Water Gate That Will Not Wash Away

Washing away of water gates across creeks can be prevented as follows: Set a post on each side of the creek and fasten poles to one of them with wire which will permit them to swing around. Cleats are nailed on the other post at an angle, on the downstream side, to hold the free end of the poles. When the creek rises, the poles will be forced off the cleats and will swing around to the opposite bank where they are pivoted, but will not float away.—H. F. O'Neal, Noblesville, Ind.

Flashlight Mounted on Gun Barrel for Night Hunting

As an aid in shooting rats, owls and other night-prowling animals, an ordinary flashlight, attached to the end of the



Shooting Rats, Owls and Other Animals Is Easier with a Flashlight Attached to the Gun Barrel

gun barrel, will provide light, where it is needed. Tape is used to bind the flashlight on the barrel securely.

Static Removed from Mimeograph Paper

Mimeograph operators often experience trouble in getting the paper to drop quickly and smoothly into the receiving tray. This trouble is usually caused by the sheets of paper becoming charged with electricity when passing through the machine. By placing a length of metallic tinsel across the discharging end of the machine so that it will touch the underside of the paper as it comes out and also touch the metal frame of the machine, the charge is removed. Talcum powder dusted on a sheet of paper and run through the machine will also help.

Hook Aids in Installing Screens

For putting up screens in windows above the first floor, this hook will be useful. It consists of a 12-in. length of rather heavy wire bent to a U-shape, the ends of which are formed into small hooks

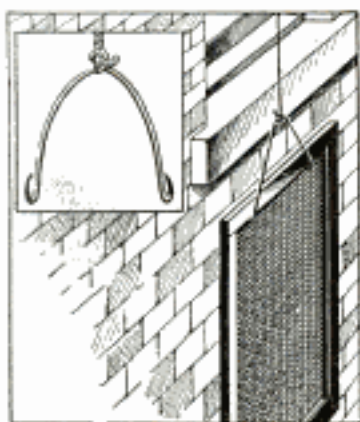

filed to a sharp point. Fasten a rope in the center so that the hook can be lowered to pick up screens set against the side of the building on the ground.
—Ray J. Marran, Kansas City, Mo.

How to Make Disappearing Ink

A writing fluid that will disappear and can be caused to reappear when desired can be made as follows: Mix linseed oil, 30 drops, ammonia, 1 fluid oz., and water, 5 fluid oz. To make the writing appear when this ink is used, dip the paper in water. As soon as the paper dries the ink will disappear again.

☛ For rolling dough to a uniform thickness, place wooden strips along two sides of the dough; then roll the ends of the rolling pin over the strips.

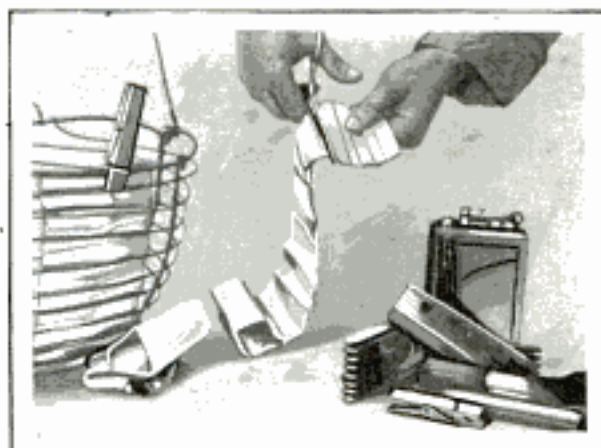

Piece of Tinfoil Placed on the Inside of a Wire Flower Basket Forms a Good Lining

Flower Basket Lined with Tinfoil

Wire flower baskets of the hanging type can be lined with ordinary tinfoil. If an old Ford coil is available, break the case and remove the condenser. Unwind it and you will find enough tinfoil and wax paper to line the basket. It is advisable to leave the wax paper on the inside of the tinfoil, as this will strengthen it.

Concrete Floors and Walls Reinforced with Old Auto Frames

Old automobile frames can often be used to advantage as reinforcement in concrete work. Garage floors, foundation walls, piers, and similar jobs, are a few instances where the frames may come in handy.—Walter Harvey, Baltimore, Md.

Detachable Rudder Aids Steering of Outboard

Steering an outboard motorboat is almost impossible when coasting up to a dock or pier with the motor shut off. A sheet-brass rudder extending behind the propeller will remedy this trouble. Small holes are drilled and tapped in the flat part of the propeller-shaft housing and the rudder is bolted on, it being cut out to clear the propeller.

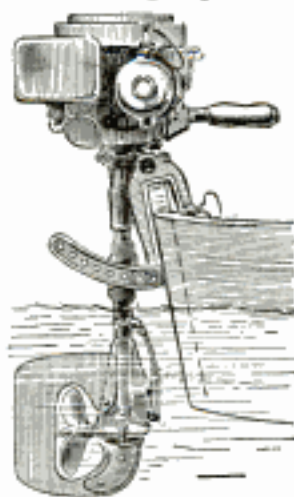

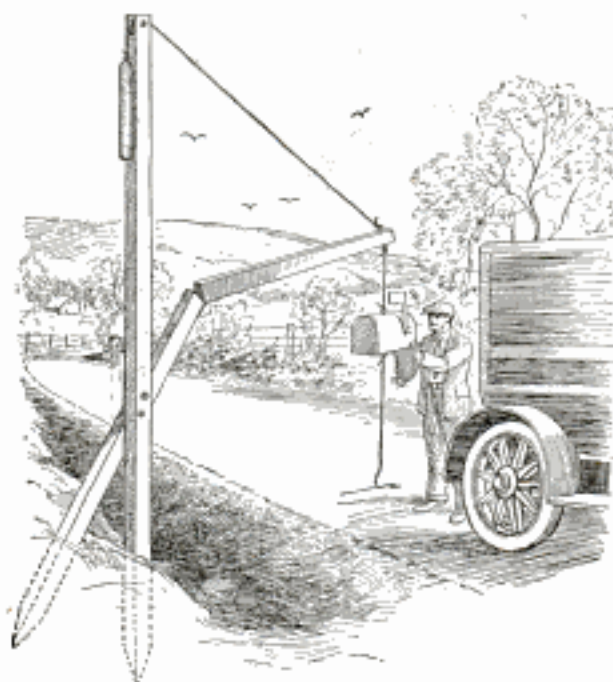

Mail-Box Support, Equipped with Counterweight, Holds Box Clear of Road Traffic

Counterweighted Mail Box Clears Road Traffic

A counterweighted mail box that will be accessible to the mailman but entirely out of the way of traffic, can easily be constructed from three lengths of 2 by 4-in. stock. Two of these are hinged together and set up at an angle so that the end carrying the mail box will be about 10 ft. above the road, while the third forms a vertical support having a pulley at its upper end. A rope running over the pulley and attached to a counterweight is tied to the mail box. In use, the box is pulled down and will return to its normal position as soon as released.—J. J. Brindos, International Falls, Minn.

Cutting Glass Straight on Newspapers

Several sheets of newspaper, cut to the desired size, will provide an accurate line to follow when cutting glass. Place the paper under the glass and follow the outline.—H. A. Insinger, St. Charles, Mo.

Window Wiper Used to Spread Wood Filler

For spreading and removing surplus wood filler after it has been applied to a floor, an ordinary window wiper will be found useful. The advantage of this over the usual method of using a piece of bur-

lap is that it forces the liquid along and fills all cracks or small nail holes that may have been overlooked. After going over the floor with the wiper there will be so little filler left that it can easily be wiped up with a cloth when fairly dry.

Fence Posts Pulled with a Tractor

Fence posts can be pulled easily with a tractor. Back the tractor wheel close to the post to be pulled and fasten a chain around the post close to the ground. Run the chain up over the wheel and fasten it to one of the lugs. By running the tractor forward slowly, it is an easy matter to pull up the post.—Harold Rose, Coleridge, Nebr.

How to Make a Good Compost

For potted plants a rich compost can be made as follows: Scoop up ordinary sod and place it in a pile with the grass side down. A layer of stable manure is then spread over it, and more sod piled on. Repeat this process until a pile of the desired size is obtained. After four to six weeks, the sod and manure are thoroughly mixed and the compost is ready for use in potting plants, or as a fertilizer for outdoor flowers.

Hat Rack on Closet Door Saves Space

Where closet space is limited, the illustrated hat rack will be found convenient. It is made from a length of stiff wire, bent to the shape shown and fastened to the inside of the closet door with staples.—Eugene Poplawski, Depew, N. Y.

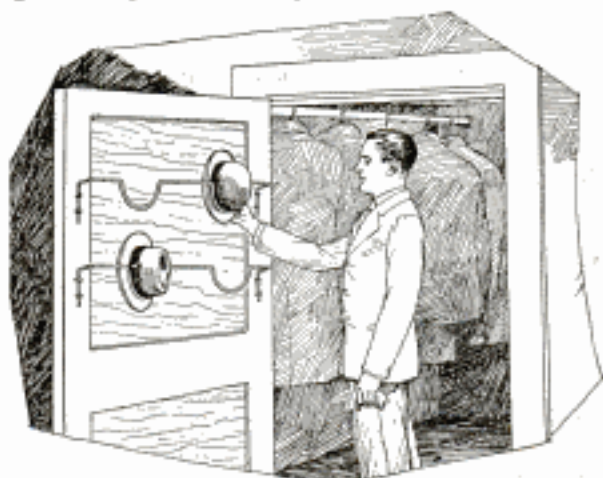

To Save Space, This Convenient Hat Rack Is Stapled to Inside of Closet Door

Mercuric-Chloride Solution Kills Parasites on Flower Seeds

Before planting flower seeds, have your druggist make a one-tenth-per-cent solution of mercuric chloride in water, and soak the seeds in it. As mercuric chloride is a poison, be sure to exercise care in using it. Most seeds can be kept in the solution for 15 minutes without injury. After removing them, rinse the seeds in clean water and plant immediately. It is advisable to throw away the poison if you have any left, instead of letting it stand around.

Hookless Fastener Improves Dust Bag on Vacuum Cleaner

Dust bags on vacuum cleaners can be made to open easier by using a hookless fastener. Starting at the top of the bag, cut a slit down the side equal to the length of the fastener and attach it in the usual way.

Camp Ax and Shovel Can Be Held under Running Board

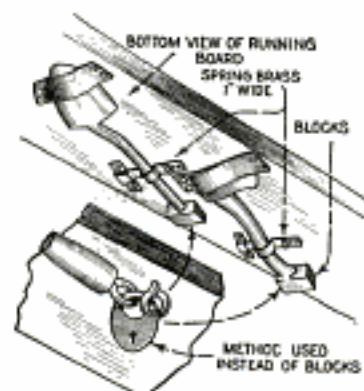

Spring brass clips and catches, fitted on the underside of the running board, will hold a camp ax and shovel securely and entirely out of the way. Wooden

blocks at the end of the handles prevent the tools from slipping out of the clips. Another method of locking them is to drive screweyes into the end of the handles and the running board to receive a padlock, as shown in the lower detail.

Solution for Waterproofing Canvas

Canvas can be waterproofed by dipping it in a solution consisting of gum tragacanth, 50 gr., dissolved in 1 gal. of water, and adding lead acetate, 2 oz. The gum should be allowed to swell in the water several days before adding the lead acetate.



Sawhorses Having Single Legs Are Convenient for Ripping Long Stock

Sawhorses with Vertical Legs for Ripping Boards

Sawhorses having a single vertical leg at each end, instead of a pair of legs set at an angle, will be found convenient for ripping long stock. The legs are nailed to the top member with a suitable brace, toenailed on to provide rigidity. Feet are cut from 1 by 4-in. stock and nailed across the bottom of the legs.

How to Bend Heavy Sheet Metal at Sharp Angles

For bending heavy sheet metal, mark the work at the point where it is to be bent, and place it in a strong vise with the top of the mark just above and parallel to the top of the jaws. A piece of 1 by 4-in. wood, 2 or 3 ft. long, is placed on the back, and a smaller piece of sheet metal is placed in front of the work, after which the assembly is securely clamped. Grasp the top of the piece of wood and pull it forward slowly, and the work will bend at a sharp angle.

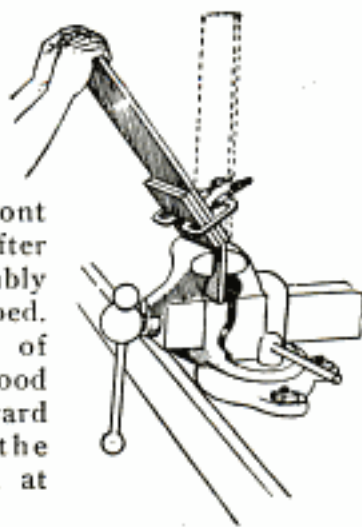



Hook on End of Broomstick Used to Free Buried Corn When Cultivating

Hook Uncovers Small Corn

When cultivating, small corn is often covered with dirt. By bending one end of an iron rod to a right angle and fastening it to a short broom handle, a hook can be formed to uncover corn quickly, and without the necessity of the operator getting off the seat.

Anti-Rattle Clip for Folding Screens

Folding screens sometimes rattle due to the frame being too small to fit snugly into the window slide. This trouble can be prevented by bending a strip of sheet metal around the edge of the screen frame

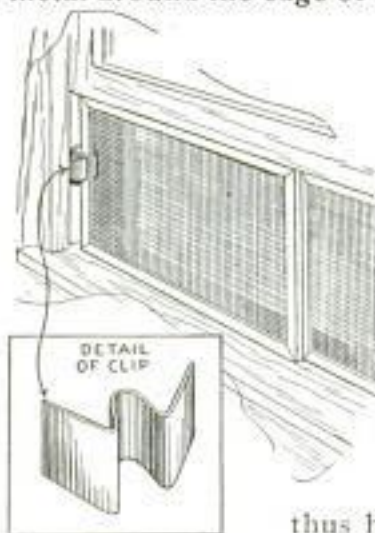

and turning the ends back in the opposite direction to form wings, as shown in the detail. In use, the clip is slipped over the frame with the wings pressing against the side of the window slide,

thus holding it firmly.

Renewing Old Paint Brushes

Paint brushes that are apparently worthless, usually due to improper cleaning, can often be renewed as follows: Place the brush on a flat surface and cut off the short paint-clotted bristles close to the ferrule, about $\frac{1}{8}$ in. deep. Then give the remaining bristles a thorough cleaning with a wire brush, to remove all traces of dried paint, and dip the cleaned brush in turpentine or benzine, after which the treatment with the wire brush is repeated until the desired result is obtained and all the bristles are cleaned thoroughly.

Road Oil Is Good Roof Preservative

Farmers around Arthur, Ill., are cutting their roofing-paint bill to almost nothing by using common road oil as a substitute. This oil costs less than 10 cents a gallon and has been found entirely satisfactory for the purpose. After being thinned by heating, it is spread on with ordinary brushes in the usual way. It gives a light-brown color to new shingles and a darker shade to old shingles and other roofing materials, which is not at all objectionable.—Oney Fleener, Chicago.

Stucco Finish for the Bird House

Bird houses can be given a very attractive stucco finish by applying a thick coat of paint and then throwing on some fine sand while the paint is still tacky. An ordinary salt shaker will do nicely and different-colored sands should be used.

For convenience in handling, the house can be temporarily fastened to a board.



☛To prevent part of the liquid from running down the sides of a bottle while pouring, warm the lip and rub it with paraffin on the top and side.

SWING FOR THE GARDEN REVERSES AT YOUR TOUCH

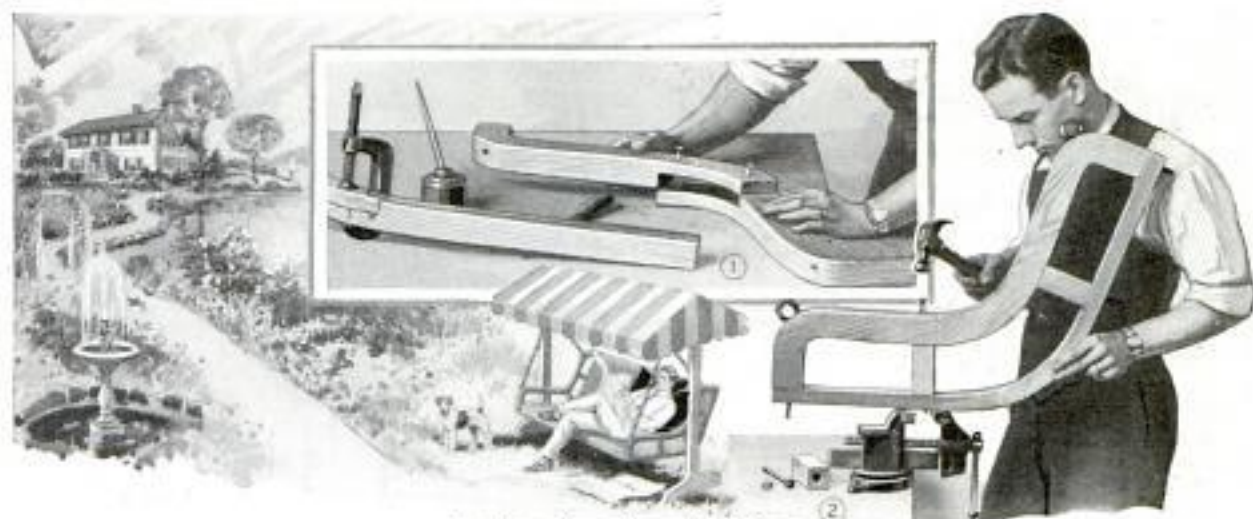

Installed in the summer cottage or used on the lawn, this reversible swing offers a two-way sitting position which may be changed any time by simply touching the back with the hand and pressing down. You will notice that the swing differs in shape from the usual type as the chains are fastened by means of two long bars or sliding links. First make the two endpieces from 2-in. stock and assemble them as shown in Fig. 3. Lay out the design on a piece of paper ruled off in 1-in. squares. The dimensions and curves, being essential, should be reproduced accurately as given here. The extreme curve does not permit the sections to be cut from one piece of stock and it is therefore necessary to use two pieces, half-lapping them together as shown in Fig. 1. Apply glue to the joining edges and countersink screws into the stock so that the holes can be plugged. Fig. 2 illustrates the method of assembling. Long eyebolts are used at the extreme ends, and not only serve to hold the wood together but also provide support for the chain. Ordinary $\frac{3}{8}$ -in. carriage bolts of sufficient length to extend through both curved portions and the $\frac{3}{4}$ by $1\frac{1}{2}$ -

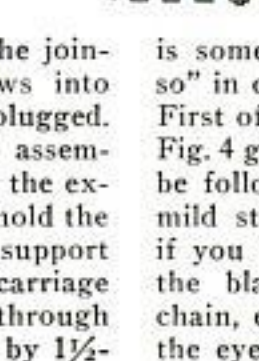
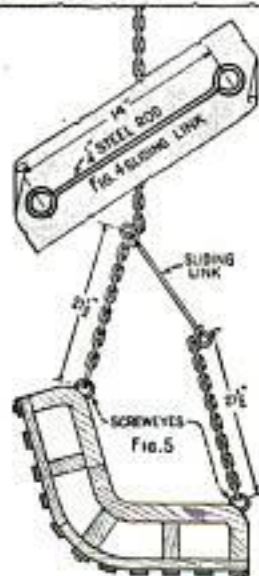
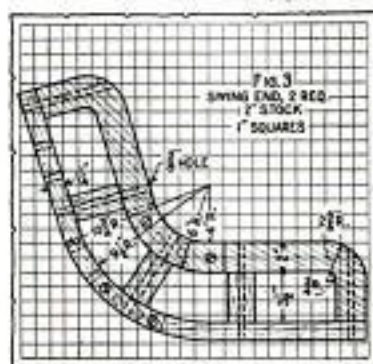

in. pine slats, which form the bottom, are inserted through two filler blocks. Between the major slats there should be two other slats, making 13 slats in all, though only 11 are shown in Fig. 5. The intermediate slats are fastened to the frame with small bolts, inserted from the top, at the points indicated by dotted lines in Fig. 3. The holes should be plugged to make a neat job. A strap-iron band may be fastened across the underside of the slats, midway between the ends, for reinforcement, if the slats show any tendency to sag under pressure, which, of course, depends on the length of the swing, and this, in turn, can be varied to suit your taste. A 5-ft. swing of this type will meet average requirements. The actual hanging of the swing is something which must be done "just so" in order to insure satisfactory results. First of all the two sliding links are made. Fig. 4 gives the dimensions and these must be followed exactly. The stock is $\frac{1}{4}$ -in. mild steel, and may be hammered cold, if you do not wish to take the piece to the blacksmith. Two short pieces of chain, each $21\frac{1}{2}$ in. long, are fastened to the eyes of each link. The free ends of



Cutting the End Frames for the Reversible Swing Takes Very Little Time on a Bandsaw

the chains are then hooked to the eye-bolts on the swing. The main chains, which support the swing, are fastened to the sliding links so that they will slip over them as shown in Fig. 5. It is then quite apparent that, as long as the swing is left alone, its position will be fixed. When the sun becomes too bright, or when the scenery on the other side of the swing is more interesting, the mere act of pushing on the back of the swing will turn it over. In making the swing, remember that the dimensions for the chains and sliding links must be followed as given, otherwise the swing will not operate satisfactorily.

Beads Strung without a Needle

When no needle is at hand, beads can be strung by moistening the end of the thread with glue. Press out the surplus glue and roll the end of the thread between the fingers to a fine point, then let it dry.—Alton Adair, Stamford, Conn.

Creel Closed with Hookless Fastener to Keep Out Flies



Attached to the lid of a fishing creel, a hookless fastener will be found effective in keeping out flies, while affording easy insertion of the fish, when the hook is pulled open. Of course, the holes in

the side of the creel for the carrying straps should also be made flyproof by wrapping adhesive tape around the straps and pushing it into the holes.

Cement for Glass and Pottery

A cement for mending glass and pottery can be made by mixing plaster of paris with the white of an egg or with white shellac. After the cement has hardened, the surplus is smoothed down with sandpaper, and the filling cement can then be colored to match the surface of the piece repaired, using ordinary water colors. To obtain a glossy finish, apply white shellac with a fine camel's-hair brush after the color has dried.—Francis W. Henry, Pottsville, Pa.

Hammer Handle Holds Center Punch

A hole drilled in the end of a hammer handle as illustrated, provides a convenient holder for a center punch. A small metal strip fastened above the hole with a wood-screw prevents the punch from falling out.

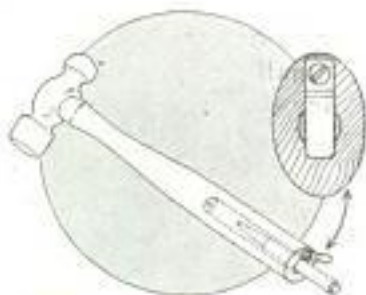

Household Paste Has Many Uses

A satisfactory household paste can be made by mixing flour and cold water, 2 cupfuls of each, and adding 2 teaspoonfuls of powdered alum while stirring. When thoroughly mixed, pour in 2 cupfuls of boiling water. Then place the mixture over a fire and boil until thick, after which 1 teaspoonful of essence of peppermint is stirred in as it cools. This paste will keep indefinitely in small jars fitted with tight covers

Filler for Chipped Bakelite

When objects made of bakelite become chipped, they can often be refinished by filling the spots with melted hard rubber, which can be obtained from old combs, etc. The cavities should be roughened before applying the melted rubber and after it has dried, the spots may be polished.

STEEL BALL OPENS SECRET LOCK ON TREASURE BOX

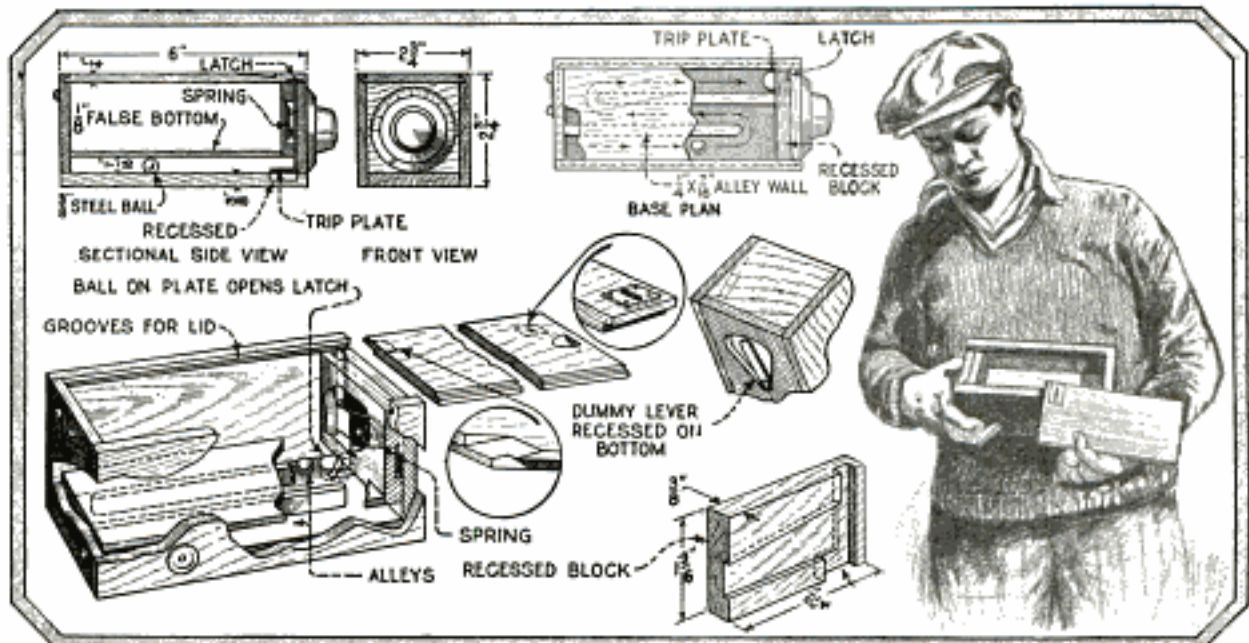

A Rolling Ball Is Used in This Treasure Chest to Open the Secret Lock, and Only by Bringing the Ball through a Maze of Alleys Can the Latch Be Sprung

This secret lock for a boy's treasure box is opened by a steel ball dropping on a small plate, which releases the latch. Alleys for the ball are arranged under a false bottom, and the box must be twisted and tilted in a certain manner before the ball reaches the trip plate. If desired, a more complicated maze of alleys than the one shown can be laid out. Use $\frac{1}{4}$ -in. wood for the sides, ends and lid, and $\frac{3}{8}$ -in. material for the bottom. Sheet metal can be used for the trip plate and latch, although duralumin was found preferable. First make the latch assembly, with a light brass spring mounted on the front end of the box. A tire-valve spring, straightened out and bent to the shape shown, can be used. Next, chisel out recesses in a block to fit over the latch piece. If neatly made, the latch will slide freely in its groove without excessive horizontal play. Now lay out the alleys and put on the sides and back, which are grooved near the top to receive the lip of the lid. The grooving can be done with a circular saw. Mortised corners make a better job, but lacking facilities for doing this, use glue and brads. Everything should fit accurately and all joints should be sanded flush and smooth. Make the lip around the lid about $\frac{1}{8}$ in. wide and $\frac{1}{8}$ in. deep, which can also be done on a circular saw. A small recess is cut in the top side to

provide a finger grip and a sheet-metal plate, preferably brass or galvanized iron, is set in on the underside of the lid, with a slot for the latch. The plate must be flush with the surface of the lid. Small brads and model-airplane cement are used to anchor it. Careful work is necessary to make the slot engage with the latch. Chisel the lip to a taper at the back end so that the lid will depress the latch when sliding into place. A number of levers, dials, etc., here and there, will help to increase the mystery of the box.

Suspending a Swing from Hinges

Hinges will make a swing safer and will eliminate the danger of the rope wearing through at the point where it is attached at the support. One half of the hinge is screwed to the crosspiece on the posts as shown, while the other half is bent to form a hook, to hold a ring to which the end of the swing rope is tied. The hinges should

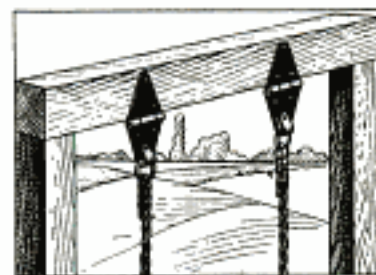

be kept well oiled.—J. T. Watkins, Astoria, N. Y.

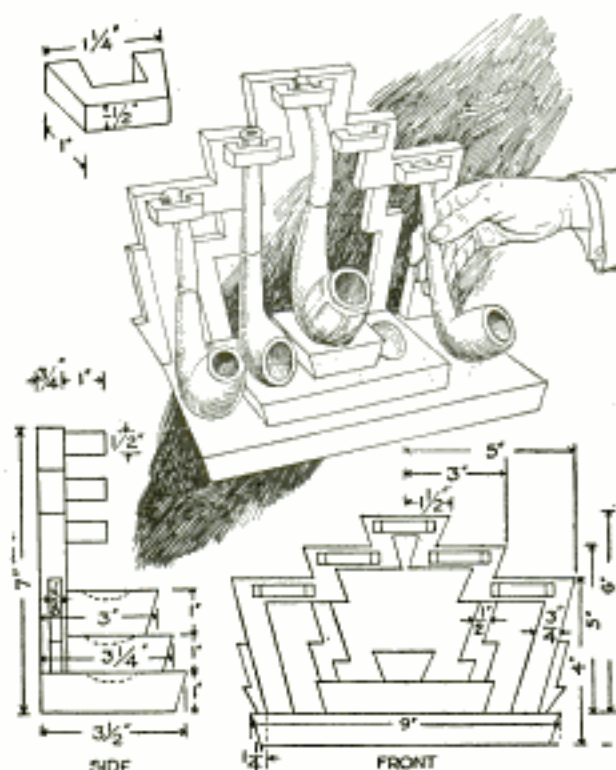

Holding Five Pipes, This Distinctive Rack Makes an Ornament for Your Smoking Table

A Pipe Rack in Aztec Design

Made from almost any kind of wood, this "five-passenger" pipe rack in modified Aztec design can be made in a few hours with a scrollsaw, plane and gouge. The base is built up of three 1-in. pieces, and the back is cut out in zigzag fashion from $\frac{3}{4}$ -in. stock. The pipe stems are held upright by small brackets screwed or nailed to the back, and hollows are gouged in the base to receive the bowls. Be sure to sandpaper all the parts smooth before assembling them and fill all nail holes before finishing, which can be done to suit your taste.

Braces Strengthen End of Garage

Where the end of a shed or garage is nearly all door, a couple of heavy flat-iron braces, bent at an angle as illustrated,



will greatly increase its strength. Sagging sides can often be prevented by this method. Long lag-screws are used to attach

the braces and should be driven into adjacent studs and rafters. Protected in this way, the building will be able to withstand heavy storms without damage.

Maps Tinted Evenly by Using Dissolved Crayons

Maps and drawings on tracing cloth or paper, blueprints or photostats, can be tinted evenly by means of a chamois stump or wad of cotton, moistened with gasoline and rubbed over a wax crayon of the desired color. The advantage of this method over water color is that the paper or cloth will not wrinkle. Besides, color applied in this way has an even density not usually obtained with water colors, and it has been found that, after the color has been well rubbed in with gasoline, it is as permanent as either ink or water color. If large sections are to be colored, and several rubbings on the crayon might cause variation in the density, dissolve part of the crayon in gasoline and dip the stump or wad into the solution.—E. A. Telfer, San Jose, Calif.

Ladder Stair Helps to Climb Grades

For climbing steep slopes this ladder stair will be found helpful. The step treads, and also the blocks supporting them, are made of 2-in. wood



nailed at an angle to a heavy plank. Three methods of attaching the steps to the plank are shown.—James Thomas, Orland, Ill.

Food-Grinder Cutters Sharpened with Grinding Compound

Knives on a food grinder can be sharpened with valve-grinding compound. Remove the knives and apply a thin coat of the compound to the edges, after which they are replaced. Turn the handle back and forth, not more than half of a revolution, and occasionally turn it around completely to bring new surfaces into contact. The operation is similar to that of valve grinding.

AN ARBOR AND TRELLIS WILL IMPROVE THE LAWN

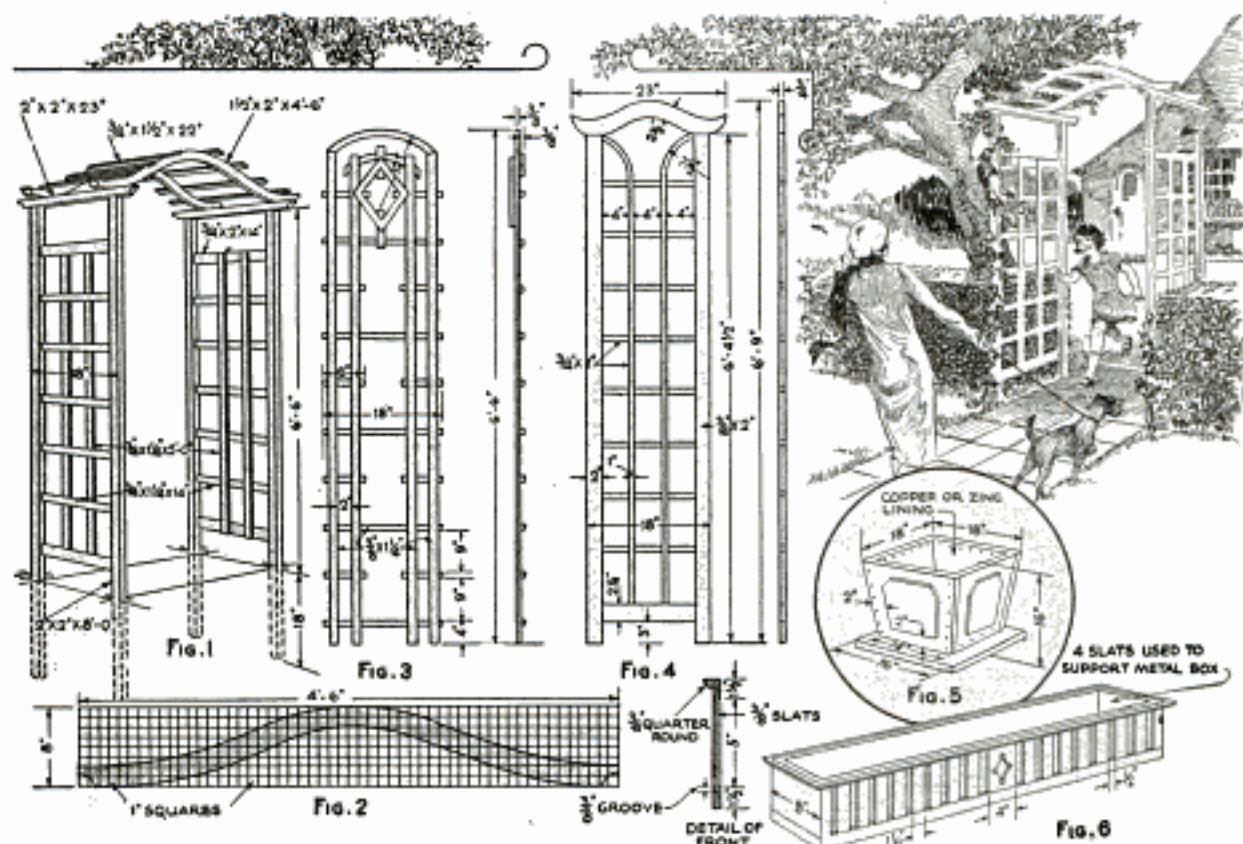

Three most widely used pieces of garden furniture are the arbor, trellis and flower box. Good designs, with dimensions and constructional details, of these are given in the drawing.

The legs of the arbor shown in Fig. 1, should be made of cypress or southern pine, which does not decay easily, and a coating of creosote or tar will also prevent deterioration, or the legs may be set in concrete to give additional rigidity. The sides and top should be built in the shop and not "on the lot," as more accurate work can be done in this way. The curved top frame, Fig. 2, may be cut out on a bandsaw, or if none is available, at the mill.

Unattractive wall spaces on the house or garage can usually be improved by adding a trellis, two designs of which are shown in Figs. 3 and 4. The joints between the outside rails and crossrails are mortised, while the crossings between vertical and horizontal pieces are half-lapped, resulting in a good-looking and durable structure.

Tree and flower boxes, shown in Figs. 5 and 6, are made of wood but should be lined with copper or zinc, as water will

seep through an unlined wooden box, even though the inside is tarred or painted. Often, especially on indoor window boxes, it is advisable to have a sheet-metal inner box. Three or four slats provide support for the sheet-metal box and allow water to drain off quickly.

A Holder for Your Water Hose

A holder that will keep your water hose in any desired position, for sprinkling the

lawn, can be made from a length of $\frac{3}{16}$ or $\frac{1}{4}$ -in. iron rod. The rod is bent in the middle to form two or three large coils, which hold the hose as shown in the lower detail. Each



end of the rod should be pointed so that it may be easily inserted in the ground.—Joe Chmelar, St. Louis, Mo.

Foot Grip Opens Screen Door

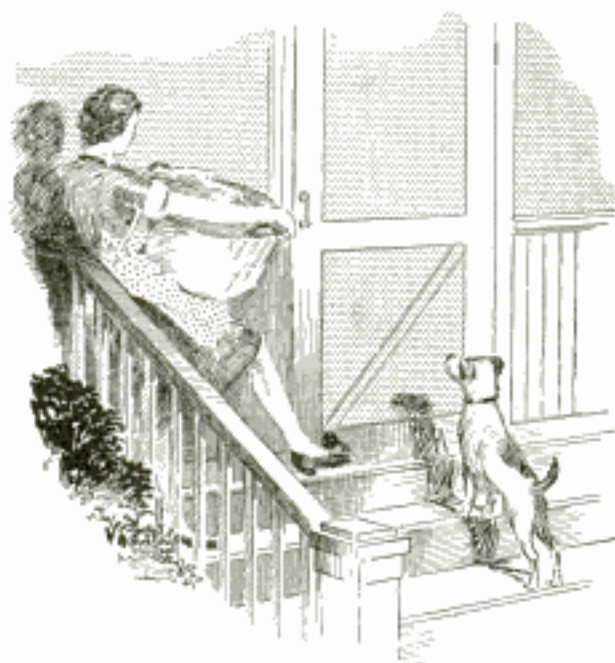

When Both Hands Are Occupied, This Foot Grip Helps to Open the Screen Door

An ordinary rubber-tipped door bumper provides a means of opening a screen door with the foot when both hands are occupied in carrying a load. Bend the end at right angles and fasten the bumper near the bottom of the door, with the bent end projecting downward. The rubber provides a grip for the foot and does not mar the shoe.—R. H. Kasper, Philadelphia, Pa.

Reducing Culls in Apple Orchards

The owner of a large number of apple trees is forced by business reasons to acquire a thorough knowledge of the orchardist's lore; he becomes a professional. The owner of a few trees usually remains an amateur and knows few, if any, of the kinks of apple culture that are commonplace to the experienced grower, but these little kinks count even when only a few trees are owned. It was so with the man who has two big, thrifty apple trees in his backyard. These trees always set fruit well, but summer hopes always gave way to harvest disappointment; the apples never colored well, and a large portion of them dropped off before the time for picking. Instead of taking these deficiencies as a matter of course, the "backyardist" consulted a professional fruit-grower. He received suggestions which, taken together, solved the problem for

him. Thinning was one of these. Picking the "runts" and culls by hand in summer cuts down the percentage of culls in fall, and vastly increases the size and quality of the remaining fruit. The professional grower suggested at least two pickings, better still, three; this would check the dropping. The apples picked the first time would be the ripest and best colored; leaving them in small piles on the ground, in the sunshine, would help them to color more. Still another suggestion was pruning; to open up the top, and before ripening time, prune out some of the small, leafy branches. The windfall problem is always accentuated by tall limbs which whip. Cutting these back tends to reduce the number of windfalls. Following these suggestions, the home orchardist converted trees which had been principally an aggravation into trees which gave real satisfaction.

Raising Sagged Beams

Sagged ceiling beams can be raised with a plank, a little longer than the distance between the beam and the floor, and a crowbar. Cut a V-shaped or square notch in one end of the plank, as shown in the lower detail, and place the plank snugly between the floor and the beam, then force it toward a vertical position with the crowbar until the beam has been suffi-

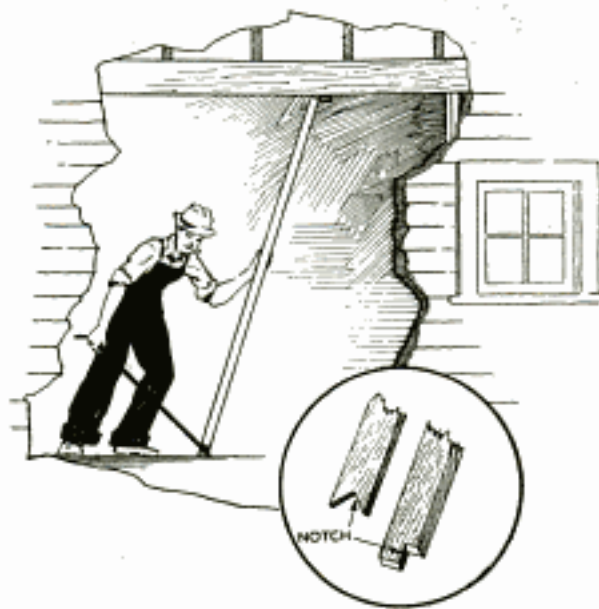

Sagged Ceiling Beams Can Easily Be Raised with a Heavy Plank and a Stout Bar

ciently straightened.—Roy Beach, Placerville, Calif.

Lime Helps to Remove Stumps

Stumps or rocks in places where blasting is dangerous can be removed with the use of lime. Make as many holes as possible to a depth of 30 in. at various points around the stump or rock and fill them with fine unslaked lime to within 6 in. of the top. Then pour 1 pt. of water into each hole over the lime and finish by filling it with sand. The gas from the slaking lime will pass through the soil and loosen it so that it can be readily dug up and the stump or rock removed.—Dick Stafford, Ft. Collins, Colo.

Repair for Small Roof Leaks

A piece of tin, cut to suitable size and placed between the shingles on the roof, will stop small leaks. Force the tin between the shingles directly over the leak. If the tin is coated with paint or roofing cement, the repair will last indefinitely.—E. A. Darmer, Hasbrouck Heights, N. J.

Padded Clock Hammer Softens "Strike"

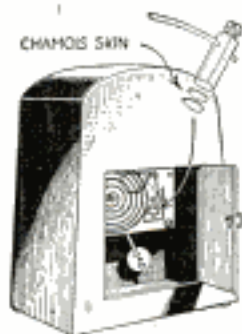

Clocks can be made to give a mellow tone by gluing chamois-skin pads to the hammer as shown. Use either glue or hot rosin and allow it to dry thoroughly before you again set the clock to running.

Lawn-Edging Tool Made from Old Scoop

A simple lawn-edging tool can be made from an old coal scoop. One side is bent to a V-shape and the front edge is sharpened. In use, the scoop is pushed along the edge of the sidewalk with the bent side over the edge.—John L. Dougheny, Toledo, Ohio.

A Good Metal Polish

A mixture of water, two tablespoonfuls of ammonia, a tablespoonful of salt and one of fine powdered limestone, makes a good metal polish. Soak a flannel cloth in the mixture, wring out and allow to dry before using.



Sanitary Drinking Fountain for the Farm Attached to Windmill Overflow Pipe

T-Fitting on Pipe Forms Sanitary Drinking Fountain

By attaching an ordinary tee in the pipe that conducts windmill water to the stock or cooling tank, a satisfactory and sanitary drinking fountain can be improvised. The open end of the tee should point upward so that, when the hand is pressed against the outlet end of the pipe the water is forced out of the tee. To avoid splashing of water on the ground, the fitting should be installed inside the edge of the tank.

Removing Seeds in Clothing

Small seeds, such as "Devils' darning needles," that cling to the clothes, can often be removed by brushing the garments with ordinary household cotton. The cotton catches the seeds and the lint that remains on the clothing can be brushed off in the usual manner.

Canvas Sheath Protects Handsaw

Handsaws can be protected against rusting by keeping them in a canvas sheath, made from one piece cut a little longer than the blade and wide enough to be doubled over and sewed at the edge as shown. This also protects the teeth when the saw is placed in the tool kit.



Steaming Wood in Rubber Hose

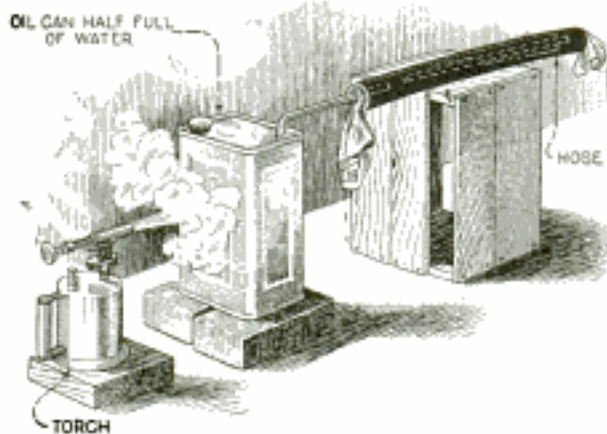

This Steamer for Bending Small Pieces of Wood Consists of Blowtorch, Oilcan and Rubber Hose

For bending small pieces of wood, a steamer can be quickly improvised from a blowtorch, a 1-gal. oilcan and some rubber hose. A length of brass or copper tubing is soldered to the top of the can and bent over at right angles, so it can be slipped into the end of the hose. The pieces to be bent are placed inside and the ends closed with wads of cloth. Water in the oilcan is heated with the torch and the steam is conducted to the hose, the filler opening of the can being closed.

Elastic Strips Replace Belt

Strips of elastic webbing or rubber, sewed on the inside of the waist band of trousers, will aid in holding them without the use of a tight belt, which is often uncomfortable.

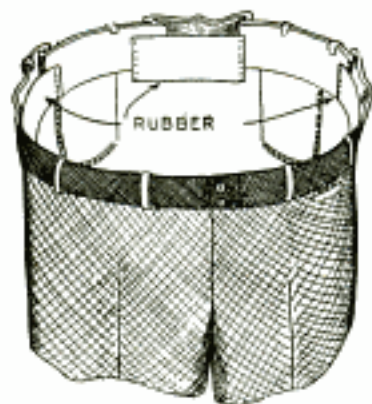

The strips should be cut into 3-in. lengths. Draw up the cloth over the elastic as shown, so that the trousers will fit snugly and then sew the strips in place.

Maps Preserved by Cloth Backing

Maps and charts that must be folded and unfolded repeatedly will last much longer if a piece of cheesecloth is pasted on the back. The paste can be made by mixing flour, one part, and water, five

parts, and cooking it over a slow fire for a few minutes. The cloth is laid over the map or chart and the paste spread on, rubbing it into the cloth lightly with the palm. When dry, the map or chart can be folded in any manner desired.—Shepherd L. Witman, Omaha, Nebr.

Shellac Cements Cloth to Iron

To cement cloth to iron, first heat the iron until it is a trifle too hot to touch with the fingers and coat it with shellac. The cloth is then pressed on the surface. The shellac dries quickly and will hold the cloth firmly.

Preventing Loss of Outboard Motor

Chances of losing your outboard motor can be reduced to a minimum by the use of a wooden wedge screwed to the boat transom.

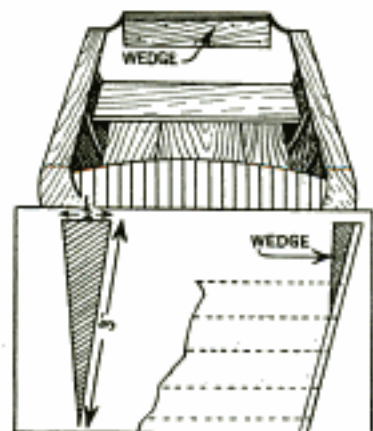

The wedge should be 3 in. wide, 1/2 in. thick at the top and long enough to reach across the transom. The motor is clamped over the wedge, which prevents it from slipping off, if the clamps become slightly loosened.—L. J. Gorenflo, Biloxi, Miss.

Paint Resembles Polished Silver

A paint that will have a finish of highly polished silver can be made by mixing No. 600 aluminum powder with clear lacquer until it takes on a silver hue. The paint should be applied with a fine brush and should be stirred frequently to prevent the powder from settling in the bottom of the can, which will cause irregularities in the finished color. If a high luster is desired, brush on a coat of clear lacquer after the paint has dried. Make up just enough of this paint for the job at hand as it soon spoils if kept.

Iron cotton dresses on the wrong side to obtain a good finish and gloss.

Handwritten notes:
 50 cents. H. L. will
 not including postage
 will fill mail orders
 Remier Kuhnert
 63 W. Grand Chicago



Three Shortcuts for Your Bandsaw

WOODEN disks of various sizes can be cut in any bandsaw by using the auxiliary table shown in Fig. 1.

It consists of a piece of birch plywood, $\frac{3}{4}$ in. thick and of such size that it will fit over the bandsaw table, to which it is securely fastened by means of two cleats attached to the lower edges of the auxiliary table. A screw driven into the side of one of these cleats is used to lock the assembly on the bandsaw table. A $\frac{1}{2}$ -in. slot is sawed through the plywood, to clear the saw blade when the table is slipped in place, and a nail driven in from the underside, about 1 in. from the end of the slot as shown in the detail, forms a pivot on which the work rotates, a pivot hole being drilled in the work. The auxiliary table is then adjusted so that the distance between the pivot and the saw blade is equal to the radius of the desired

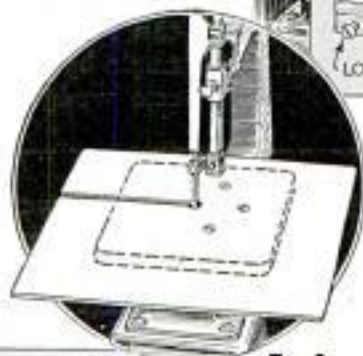

FIG. 2

disk. A cut is made from the edge of the stock to the circumference line of the disk so that the center can be placed on the pivot, after which it is an easy matter to cut a true circle.

In cutting large work on a bandsaw, the small table may not provide sufficient support. A larger one can be added by obtaining a piece of $\frac{1}{8}$ -in. steel or aluminum of dimensions suitable for the work. A slot is cut in this top so that it can be slipped over the bandsaw blade, as shown in Fig. 2. Three holes are drilled and countersunk for screws with which the top is attached to the table, corresponding holes being drilled and tapped in the latter, and flat-head machine screws are used for attachment, the heads being sunk just a trifle below the surface so that they will not interfere with the work. The edges and corners of the auxiliary table should be rounded slightly with a file.

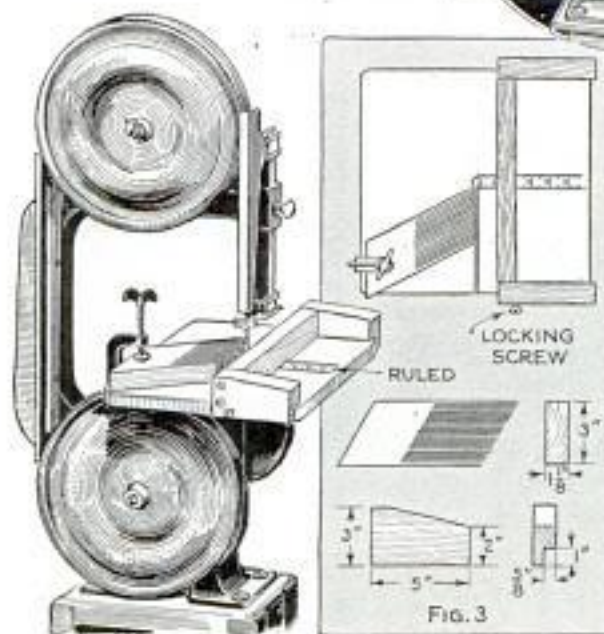
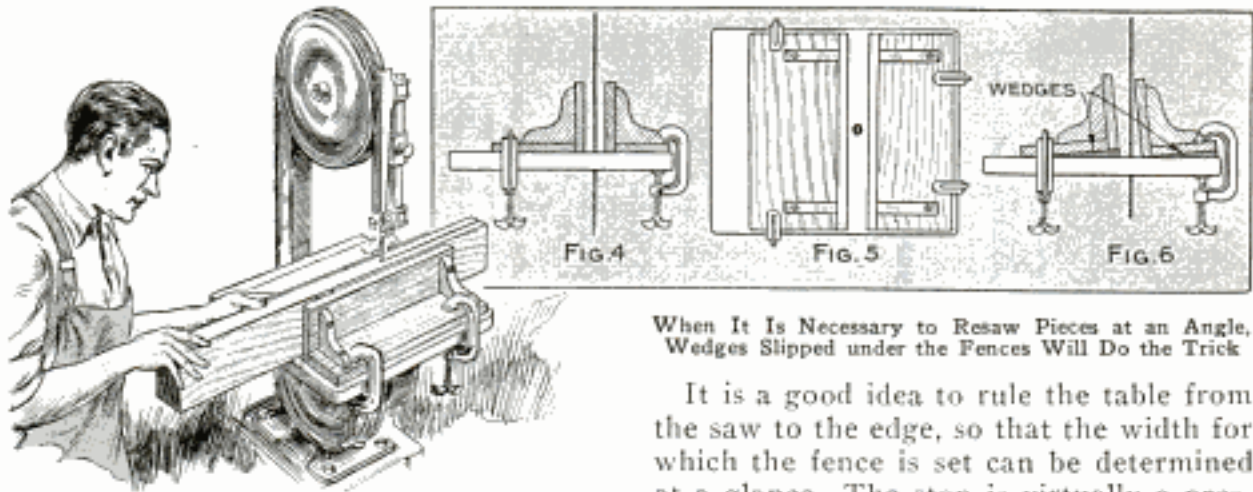

FIG. 3



When using your hand saw for cutting stock to odd widths, or resawing, which is sometimes necessary in cabinet work, the fence and guide shown in Fig. 3 will be useful. The fence is built up of three parts, which are screwed together and arranged to slide over the edges of the saw table so that the fence will guide the work straight. For this reason it is necessary to rabbet the endpieces $\frac{5}{8}$ by 1 in., so that they slide over the edges, all irregularities on the latter being removed with a file. A locking screw is also provided on this fence, in the same manner as explained in connection with the auxiliary saw table shown in Fig. 1.

When It Is Necessary to Resaw Pieces at an Angle, Wedges Slipped under the Fences Will Do the Trick

It is a good idea to rule the table from the saw to the edge, so that the width for which the fence is set can be determined at a glance. The stop is virtually a pressure spring made of a 6-in. piece of $1\frac{1}{8}$ -in. soft wood, about 3 in. wide, with the ends sawed off at an angle of 30° . One end is kerfed on a power saw, the kerfs measuring about $\frac{3}{16}$ in. apart from center to center. The guide is then attached to the hand saw table with a C-clamp, as indicated, and is set according to the width of the stock to be cut.

A second method of resawing is illustrated in Figs. 4, 5, and 6, where two fences are employed. These are held to the saw table by means of C-clamps and can be set to saw the stock at any desired angle by using wedges as shown in Fig. 6, one wedge under each fence.

Dump Truck Tows Wrecked Auto

A wrecked auto can easily be towed to the repair shop with a truck having a dump body. Tip the truck body and fasten the front of the disabled car to the rear end of the body with chains. When the truck body is returned to its normal position, the front part of the car will be raised from the ground so that it can be easily towed.

Controlling Overhead Valves

Overhead valves that are not readily accessible, but must be opened and closed rather frequently, can be controlled by means of an extension handle or with a length of rope. In the latter case, a wooden pulley is made to fit the handwheel of the valve, and a length of rope, both ends of which are wrapped around the pulley, is brought over two small grooved pulleys,

and allowed to hang down to a point where it can be reached. Pulling the rope closes or opens the valve. For making an extension handle, pipe and fitting can be used as indicated in Fig. 2, the forked end engaging with the handwheel. This method is the simpler of the two, but can only be used where the handwheel is in an inverted position.

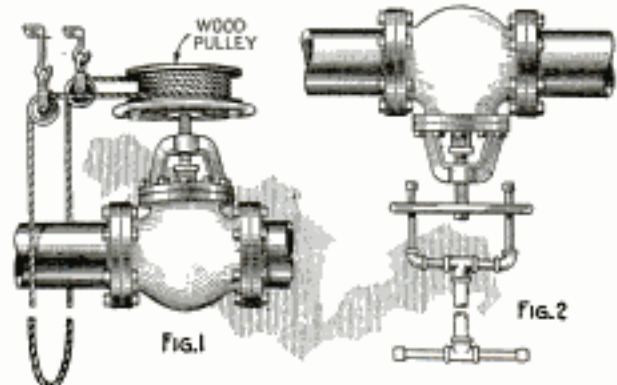

Overhead Valves Out of Reach from the Floor Can Be Controlled by These Methods

Guide for Creasing Large Sheets of Metal

When it is necessary to handle a wide piece of sheet metal at a side-creasing tool, a small pulley for supporting the work allows the operator to use both hands to guide it into the machine. The pulley is attached to the end of a length of $\frac{1}{2}$ -in. pipe, fastened to the bench so that it can be slipped back and forth to accommodate various widths of stock and locked securely at any desired point. The same idea can be applied to support work on machines of similar types.

A Cement for Glass and Brass

To cement brass and glass together, the following preparation is effective: Boil together 1 part of caustic soda, 3 parts of rosin, 3 parts of plaster of paris and 5 parts of water. Let the mixture cool and then apply. It should harden in about 20 minutes.

Lantern Reflector Throws Light on Ground



A lantern reflector that will throw the light on the ground can be made from a piece of brightly polished tin or galvanized iron. Cut and form the tin into a cone so that the hole in the center will be about 1 in. smaller than the diameter of the flange on the draft hood. The ends are bent over to form an interlocking seam. The reflector can easily be removed by unhooking the seam.

Tank Corrosion Prevented by Using Zinc Blocks

When salt water is used in coolers or tanks, a galvanic action is set up in the tank causing corrosion of the steel plates. This can be prevented by suspending blocks of zinc in the tank, being sure that a good contact is made between the tank and the blocks.



Old Vacuum Cleaner, Provided with Flexible Hose, Salt Bag and Handle, Cleans the Shop

Portable Vacuum Cleaner for Shop

Sweeping up dust and dirt on floors and benches is rather difficult with a brush, and a portable vacuum cleaner will be found more satisfactory. Only the motor and fan of an old machine are used, two 5-ft. lengths of rubber hose being attached to the intake and a small salt sack to the outlet. A light handle can be made from heavy galvanized-iron wire, so that the cleaner can be carried about or hung up when not in use. An extension cord of suitable length is, of course, also provided. When the salt sack is filled it is thrown away. The rubber hose enables one to reach places inaccessible with a brush, and to remove dirt without picking up tools and small parts.—P. C. Grose, McComb, Ohio.

Improving the Long-Nose Pliers to Handle Small Round Work

When round work is to be handled, a pair of long-nose pliers can be adapted to the purpose by heating the ends of the jaws and bending them over a piece of round stock of suitable diameter. The jaws are then hardened and tempered to a straw color.—Darwin Harris, Grand Rapids, Mich.



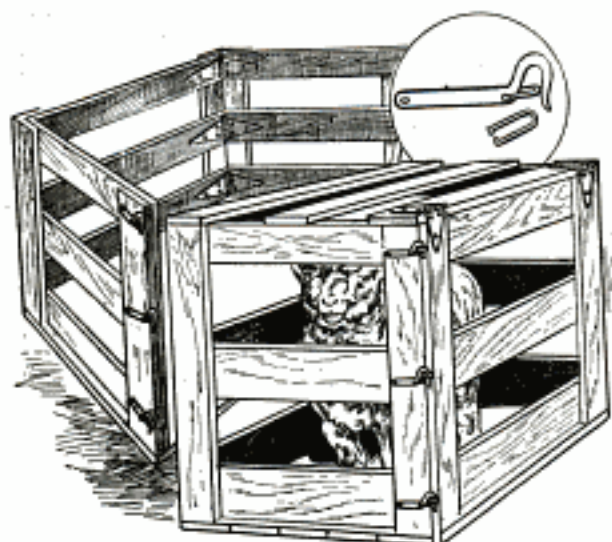

The Sides and Bottom of This Crate Are Hinged Together So That It Is Collapsible

Collapsible Crate for Live Stock

For shipping live stock, collapsible crates have been found practical. The sides are hinged together at three edges while the fourth is provided with hooks to engage with screweyes. The top and bottom of the crate are also hinged and hooked to the sides. When the crates are empty, it is an easy matter to fold them up so that they will occupy very little space and permit quick handling. A coat of white paint adds to their durability and makes them more attractive, which makes a good impression on buyers.—R. A. Meeks, Mannville, Alta., Can.

Rear Auto Wheels Easily Removed

Removal of rear auto wheels on tapered axles is an easy task if the shafts have been given the proper treatment when the wheels are put on. Both the axle and wheel hub should be thoroughly cleaned, and a coat of clean engine oil is then applied. When it is necessary to take off the wheel again, run the retaining nut out flush with the end of the axle and strike the end a sharp blow with a heavy hammer. This will loosen the wheel.

Glycerine Used for Quenching

A mixture of approximately 75 parts of glycerine and 25 parts of water will be found satisfactory for hardening tools, when an intermediate quench between water and oil is needed. Another advantage of glycerine is that it has no odor.

If the cover is kept on the glycerine container when not in use, there will be no evaporation, and it will be as economical to use as the ordinary oil quench.

Surfacing Small Emery Wheels

When no dressing tool is at hand, a small emery wheel can be surfaced with a steel table knife. The toolrest is adjusted $\frac{3}{4}$ in. from the wheel and the knife placed flat on the rest, with the end of the blade held against the wheel. The blade will vibrate and quickly dress the wheel down.—Joseph Minarovich, Berwyn, Ill.

How to Drive Nails into Hardwood without Splitting

Nails or screws will not split a small piece of hardwood if they are heated to a blue color and driven slowly into the wood. Another method is to drill a hole slightly smaller than the screw to receive it.—J. H. Beebe, Rochester, N. Y.

Ball-Bearing Rollers Used to Move Heavy Furniture

Heavy furniture, which is rather difficult to move in the usual manner, can easily be rolled on ball-bearing rollers. These are fitted on short lengths of steel rod, which are in turn slipped into the ends of lengths of pipe. In use, the assembly is placed under the object to be moved and planks are used to prevent marring the floor. Ball-bearing rollers can be obtained at almost any auto junk yard.—Rupert Anderson, Kearney, Nebr.

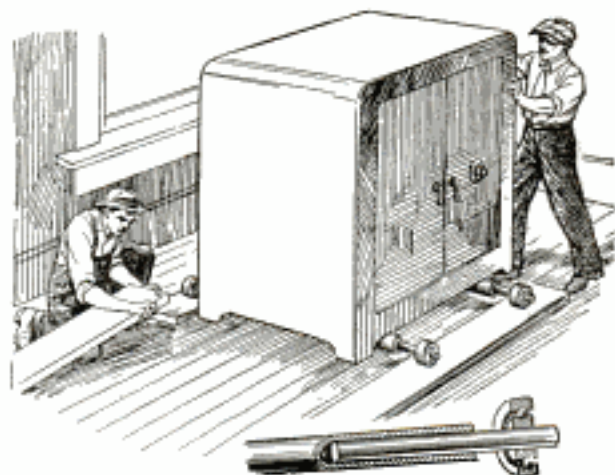

Moving Heavy Furniture Becomes Comparatively Easy with the Use of These Ball-Bearing Rollers

Protractor Scale and Concentric Useful on Lathe Chuck

Concentric circles on a lathe chuck, labeled with their respective diameters and circumferences, will be found convenient when laying out work. The circumference sizes make it easy to determine cutting speeds. A protractor scale on the chuck will also be helpful. The graduations on the chuck can be marked with a solution of copper sulphate and common salt, which is applied to grooves scribed in a layer of wax or paraffin.

Auto Radiator Quickly Cleaned

Radiators can be quickly cleaned with most of the compounds used for cleaning washbowls and sinks. Run the motor until the water is heated to the boiling point, then pour about half a can of the compound into the radiator. Allow the motor to continue running for about an hour to keep the water in constant circulation. Then drain and flush the radiator thoroughly.—A. H. Vance, Bensenville, Ill.

Spring Keeps Drain Cock Closed



A length of $\frac{3}{4}$ -in. semi-spring steel can be formed into a lock to hold a drain cock closed. One end of the spring is doubled and a hole is drilled to fit over the threaded end of the cock, while the other end is slotted to straddle the cock handle. The spring is then bent and attached as indicated.

Knurling Round Work in a Shaper

Round work can be knurled in a shaper when it is not convenient to do it in a lathe. Insert the knurling tool in the holder, and place the work in a V-block, which is strapped to the shaper table. By turning the drive pulley by hand, a good knurl can be cut.

Anti-Rust Solution for Tools

Melt a mixture of tallow, 2 oz., and rosin, 1 oz., and strain the solution while hot. A thin coat of this applied to the tools with a brush will prevent rusting.

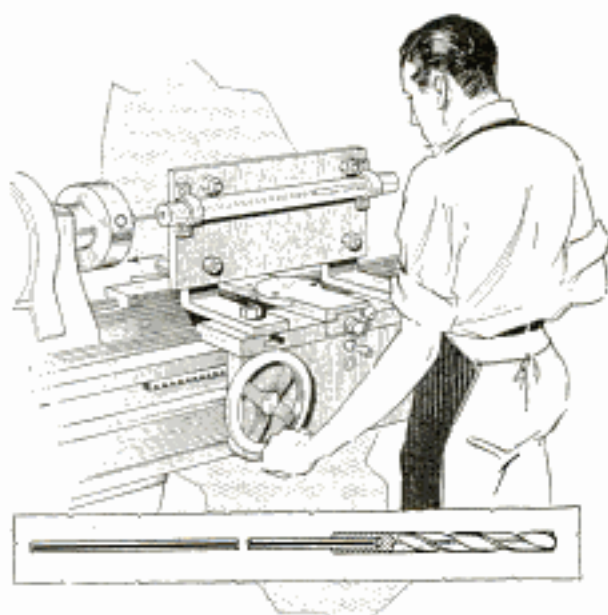

Improvised Holder on Lathe Carriage Forms Extension Drill for Hollow-Drilling Shafts

Hollow-Drilling Shafts

Long shafts can be hollow-drilled on a lathe by attaching a suitable holder to the lathe carriage. It consists of a piece of hardwood bolted to two angle brackets, which are in turn bolted to the lathe carriage, the exact method of attachment depending on the type of lathe. The work is held on the vertical plate by means of flat-iron straps. After being centered with a drill held in the chuck, run the drill into the stock. For this purpose an extension drill is needed, which consists of a rod of smaller diameter than the drill shank, sweated into a hole drilled in the latter, as shown in the lower detail.

Vise Clamp for Holding Small Parts

Small parts, such as screws and stove bolts, can be held in a vise without damaging the heads by using a clamp, consisting of a length of sheet steel bent to the shape shown. It is practically a rectangle with the butting edges filed to accommodate screws, and will be found especially useful for threading.



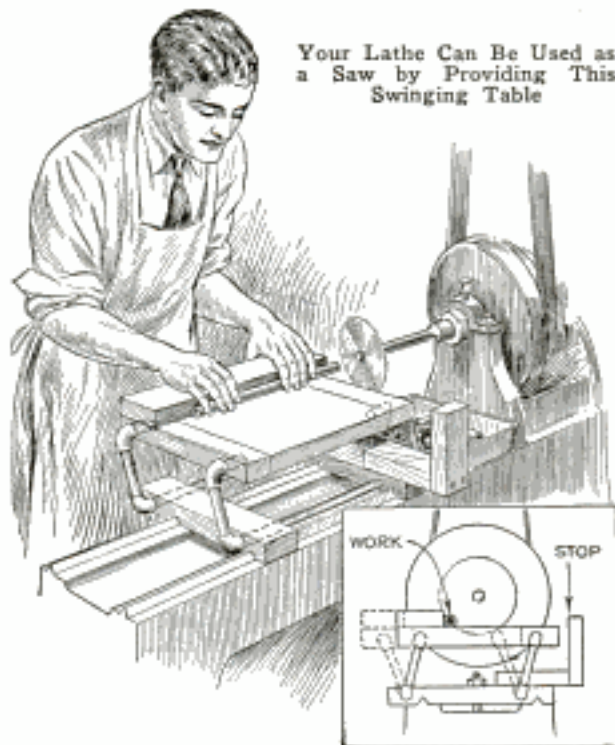

Your Lathe Can Be Used as a Saw by Providing This Swinging Table

Swinging Saw Table for the Lathe

In small garages and other shops equipped with a lathe but not with a circular saw, the lathe can be used for sawing by providing a swinging table. It is made of 2-in. wood and pipe fittings. Two 2 by 4-in. pieces, a little longer than the width of the lathe bed, are notched to fit the ways and drilled for $\frac{1}{2}$ -in. pipe, as indicated by the dotted lines in the drawing. The crosspieces are clamped to the bed by means of blocks and bolts in the same manner as the steadyrest. Two lengths of $\frac{1}{2}$ -in. pipe, of equal length, are passed through the holes in the crosspieces, after which elbows and nipples are added to form two swinging members, which fit the saw table in the same way, although short nipples may be used here instead of single lengths of pipe passed entirely through the table. A crosscut guide is screwed to the edge of the table, and a stop is attached to one of the crosspieces to limit the forward travel of the table. It is comparatively easy to fit a saw on an arbor which can be held in the chuck, or a special mandrel can be made to fit the chuck screw, in which case, of course, the chuck is removed. In use, the table is arranged so that its edge just clears the saw and a pan can be placed on the ways under the saw to catch the cut-off pieces.—Leslie G. Roller, Sioux City, Iowa.

Simple Test for Auto Coil

To test the coil on your auto-ignition system, fasten one end of an insulated wire to the frame or motor so that a good connection is made, and hold the other end within $\frac{1}{8}$ in. of the high-tension wire on the coil. Crank the motor by hand; if no spark appears between the two wires, and all connections are intact between the coil and battery, the coil is at fault.—August Jeffers, Bedford, Ind.

Grounding Static on Machines to Prevent Fires

Fire in machine shops, due to sparks caused by static electricity generated by belts and other moving apparatus, can be prevented by grounding the machines. One bared end of a length of No. 10 insulated copper wire is securely fastened to the machine, while the other end is attached to a copper plate, buried in charcoal or salt about 2 ft. under the ground.

Scaffolding Horses Are Adjustable for Height

Those who do much overhead work, such as plastering, etc., will find a pair of adjustable horses to hold the scaffolding at any desired height, of considerable utility. The top members of the horses are made of 2 by 6, or 4 by 6-in. stock, and two rectangular holes are cut for the extension uprights, which are drilled at 2-in. intervals to receive pins. A crosspiece is nailed to the top of each set of uprights to support the scaffolding.

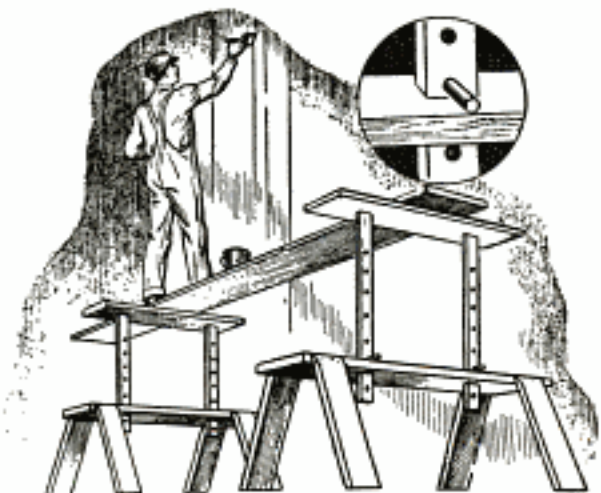

Holding the Scaffold at Various Heights. These Adjustable Horses Are Convenient for Overhead Work

Swedish wrought iron-
 Swedish American Steel Corp
 429 Kent Ave Brooklyn N.Y.

HAND-WROUGHT HARDWARE

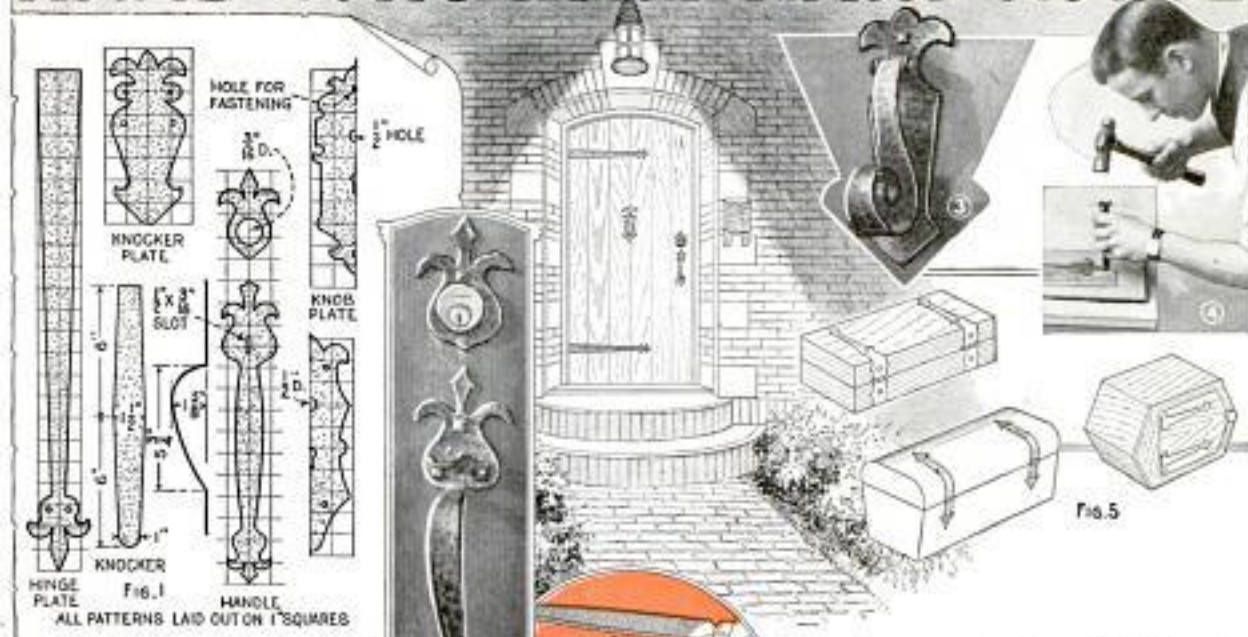

DRESSING up the oak doors with hand-wrought hardware calls for a handle, knocker and hinge plates to correspond.

One of the simplest types of hinge plates is pictured in Fig. 1, with accompanying trim to match shown in Figs. 2 and 3. The making of the hinge demands, first of all, a paper pattern ruled off in 1-in. squares on which the design is drawn. The completed pattern is transferred to the stock, which can be either $\frac{1}{8}$ -in. wrought iron, or $\frac{1}{8}$ -in. Swedish iron, which is of the same general malleability but of finer texture. Soft steel, which is considerably harder than either of the others but of fine quality and fairly practical for shaping "cold," can also be used. Brass and copper, too, produce beautiful effects. The design is first cut out with a hacksaw and cold chisel, as in Fig 4, and the edges are then smoothed with a file. Holes should be drilled through the hinge at the points indicated to take fastening nails, and as the door itself is not dependent on these fastenings, they may be held in

FIG. 6. MANNER OF MAKING DUMMY NAIL HEADS

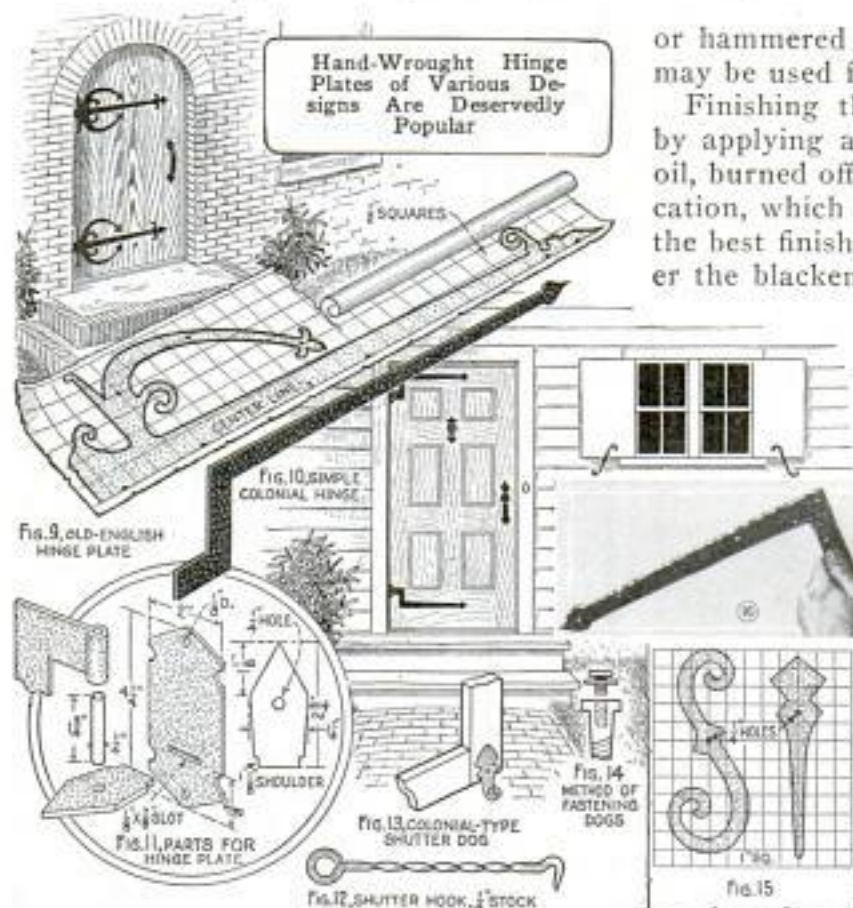

Fig. 7



place merely with hand-forged pyramid-headed nails. These can be made quite simply by filing the heads of round-headed galvanized nails to obtain the proper shape, or by making dummy heads from a $\frac{3}{8}$ -in. square piece of wrought iron, as shown in Fig. 6. The bar is first drilled lengthwise down the center, the end is filed to a pyramid shape and the filed portion then sawed off. The dummy head thus formed is held in place with a small finishing nail, after which the dummy head is lightly peened over the nail head to cover it.

The door knocker to match this set of hinge plates is made from two pieces of $\frac{1}{8}$ -in. stock and shown in Fig. 3, while its pattern is given in Fig. 1. The bending from eye to curl can be done by working the stock on a flat surface with a hammer, as shown in Fig 7. The eye is hammered first; then, by gradual rolling from the smaller curves into the larger ones, the complete curl of the knocker is fashioned. The piece can then be slipped over a section of pipe and lightly hammered to take out bumps and hollows. Fig. 8 shows the assembly of the two



pieces, the knocker portion being held to the plate with a soft-metal rivet, fitting the turned-over portions of the plate. Like the hinge plate, the fastenings are fake nails, but these should be as long as possible in order that they may have greater holding power. Round-headed wood screws may be used throughout, if the heads are hammered down later. A door handle and plate, in a matching tulip design, to fit any standard cylinder lock are also shown. The handle portion of the lock proper is bent to shape and is rounded in the front, while the concave back can then be built up with solder hardened with antimony. If the handle is of the knob type, the knob should also be hammered, as in Fig. 18.

Other designs in door trim are equally feasible. The more ornate old-English hinge with accompanying hardware, as shown in Fig. 9, is particularly adapted to some homes, while the simpler colonial type, shown in Fig. 10, is well suited for either town home or lakeside cottage. Hinge plates for chests, toolboxes, etc., are shown in Fig. 5. Plain

or hammered brass, copper or aluminum may be used for these smaller items.

Finishing the hardware is often done by applying about three coats of linseed oil, burned off with each successive application, which blackens the metal. This is the best finish for exterior hardware. After the blackening process, the high spots are brightened by rubbing with emery cloth, and spar varnish is applied. Another popular finish is obtained by rub-

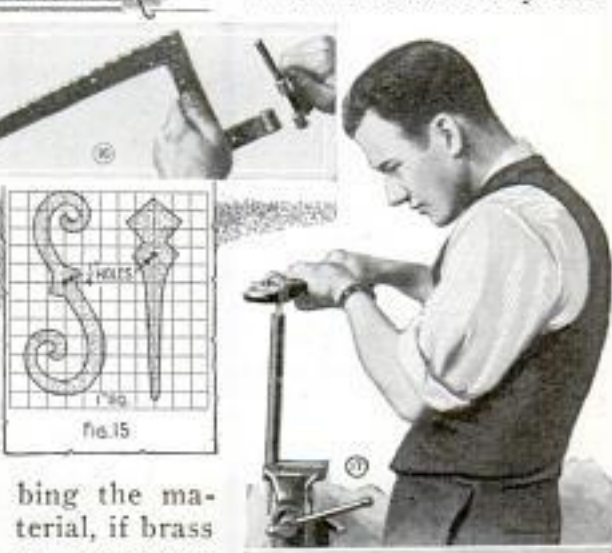

bing the material, if brass or copper, with fine powdered pumicestone, soap and water. This will leave the metal quite bright for a time, but it soon changes to a deep, rich bronze color. If desired, copper can be oxidized by dipping it into a mixture of liver of sulphur and water, brought to the boiling point. The pieces are then rinsed in clean water, after which a fine brush and pumicestone are used to slightly brighten the high spots.

It is quite practical to go a step farther and make actual working hinges, as shown in Figs. 11 and 16, for use on shutters and light doors. Attractive shutter dogs or "hold-backs," to match almost any design, are shown in Figs. 13 and 15. Both of these are cut from flat iron to the dimensions indicated, and are held in place with a $\frac{1}{4}$ -in. bolt, which is tapped into a lagscrew, as shown in Fig. 14. The shutter-dog design in Fig. 13 should be made slightly concave so that the sharper edges will not mar the shutter. Hooks are also quite neces-



sary if a semi-adjustment of the shutters is desired. These are readily fashioned from $\frac{1}{4}$ -in. square stock, as shown in Fig. 12, while the twist can be made by means of a pipe wrench, with the stock inclosed in a $\frac{3}{8}$ -in. pipe to prevent kinking, as shown in Fig. 17. The eye and hook are formed later.

Replacing the Differential-Housing Gasket on Your Car

After the gasket in a differential housing has been removed, it can easily be replaced, without taking down the rear axle assembly, in the following way: Take out four of the bolts at the bottom and loosen the bolts at the top of the housing, allowing the grease to drain out, then clean the gap in the housing with a hacksaw blade or other similar tool. Put in as much of the gasket as you can and replace the bolts. The top bolts are then removed, and the housing raised with a jack to spread it apart at the top. The rest of the gasket can now be put in place and the bolts tightened.—Jos. C. Coyle, Englewood, Calif.

Paste Jar Holds White Lead

An old paste container of the "inner-well" type, will be found handy for holding white lead for frequent use. The inner well is kept partly filled with linseed oil, while the outer one contains the white lead. The paste brush is used to apply the lead. The cover should, of course, be kept on when the jar is not needed.



Graduated Toolrest Helps Turning Faceplate Work

Graduations on the toolrest of a wood-working lathe will be found helpful in turning faceplate work. They should be cut deeply enough to be easily seen. With the rest placed parallel to the face of the work, the correct distances for making cuts can readily be determined by holding the tool at the proper graduation on the toolrest.—H. C. Roberts, Urbana, Ill.

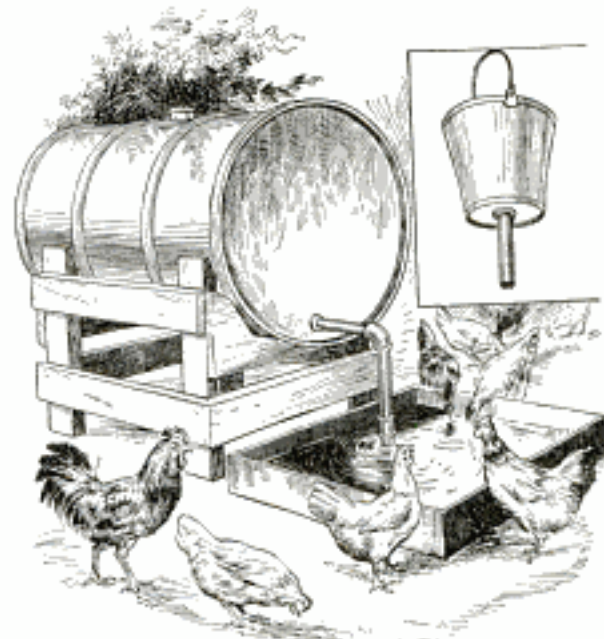

Poultry Watering Trough Consists of an Old Oil Drum Set on a Wooden Crib

An Automatic Water Fountain for Poultry

A large automatic water fountain for your poultry can be made from an old oil drum mounted on a sturdy wooden crib. Two pipe nipples and an elbow are assembled to fit the opening near the edge of one end of the drum as indicated. The outlet pipe is extended into a suitable trough and must be plugged or inverted when filling, after which the filler opening is closed with a plug and a rubber gasket to make it airtight. A bucket for filling the drum is shown in the detail.

Tool for Cleaning Horses' Hoofs

A tool that will be found handy for cleaning horses' hoofs or the lugs on tractor wheels can be made as follows: A length of iron, 11 by 1 by $\frac{3}{8}$ in. in size, is split at one end and bent to the shape shown, one end being ground to a round point and the other ends to chisel points. A $\frac{3}{8}$ -in. hole is drilled through the tool so that it can be hung up.—W. A. Whitfield, Lincoln, Nebr.

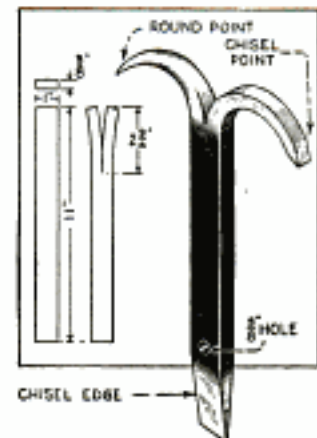



Water Siphoned from Pail through Rubber Tubing Waters Seed Beds in Greenhouse

Seed Beds Watered by Using Siphon

Where water pressure is not available, greenhouse seed beds, which are a trifle too high to be watered conveniently with a hand sprinkler, can be supplied with moisture as shown in the illustration. A pail filled with water is placed on a shelf above the beds and a length of rubber tubing, fitted with a suitable nozzle, conducts the water from the pail to the beds. The end of the tubing submerged in the water should be securely tied to the bail. An old funnel with a perforated piece of tin soldered over the wide end forms a good spray for this purpose and is especially handy as it is readily removable from the tubing.

Kerosene Dries Wet Ignition Wires

Ignition wires that are grounded by water getting on the distributor head or around the spark plugs, can be dried by spraying kerosene over them. If a spray is not available, a brush can be used. The kerosene, penetrating the dampened surfaces of the wires and other parts, forces out the water.

Heating Steel with a Torch

When using a torch to heat steel for bending or straightening, heat the thinnest portion first with the tip of a neutral flame. When it is red-hot, draw the torch away gradually and at the same time turn on both valves of the torch to the limit.

The hot steel will burn the fuel, making an intense flame against the surface of the steel. As it heats up, direct the flame toward the heavy parts. This flame is several times more intense than the neutral flame, and speeds up the work of heating the metal. In this way heavier work can be handled with one torch, keeping the torch and operator farther away from the heat.—Mart Banke, Detroit, Mich.

Flashlight Fitted with Test Points for Trouble-Shooting

For locating short and open circuits, a compact tester can be made from an ordinary flashlight fitted with flexible leads. The upper detail shows a flashlight having a fiber body and metal ends, which, when connected, light the lamp. Taking advantage of this type of construction, two U-shaped clips, fitted with pins to engage the rivets on the metal ends, are used, suitable lengths of flexible rubber-covered wire being soldered to the clips. In this way the testing leads can be removed at any time and do not interfere with the usefulness of the flashlight for other purposes. The second method is shown in the lower detail and in this case the testing leads are permanently attached. A short strip of spring brass is fastened to the metal sleeve in the lamp end with one rivet so that the front can be turned back over the body of the flashlight when not in use. A small spring-wound steel measuring tape, fitted with a test point, is attached to the other end. In use, the tape is unwound as needed.—Steffen Hundevadt, Chicago.

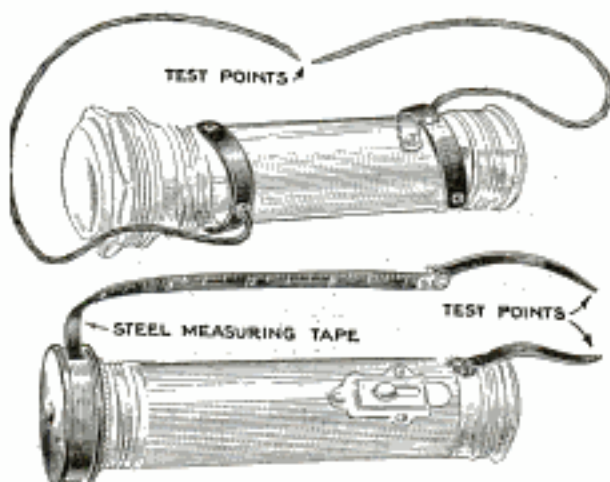

Pocket Flashlight Fitted with Test Points Forms Compact Trouble Shooter

PRACTICAL IDEAS TO LIGHTEN WORK ON THE FARM

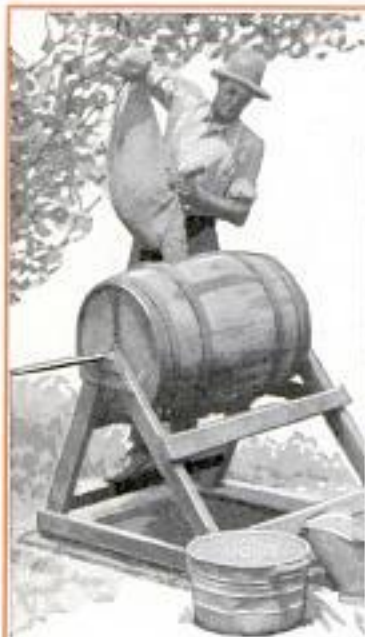

Homemade Mixer for Inoculating Soybeans on the Farm of Henry Marshall, Indiana

Below, Labor-Saving Method of Loading Feed on Wagons from an Overhead Storage Bin into Which It Is Blown



Wire Basket Fitted with Claws and Attached to a Long Pole Makes Fruit Picking Easy



Old Mower Wheels, Which Lay Around or Can Be Had for a Song, Make an Excellent Roller



Tandem Milk Cooler, Hinged to Side of Milk House, Is Operated by the Windmill



Above, Wagon Wheel Forms Flywheel on Driveshaft of Farm Hoist; Left, Bushel Basket Fitted with Funnel Avoids Spilling Seed or Fertilizer, and Extension Boxes Increase Capacity of the Planter

*similar - Hamblett - Russell Mfg Co
Worcester, Mass*

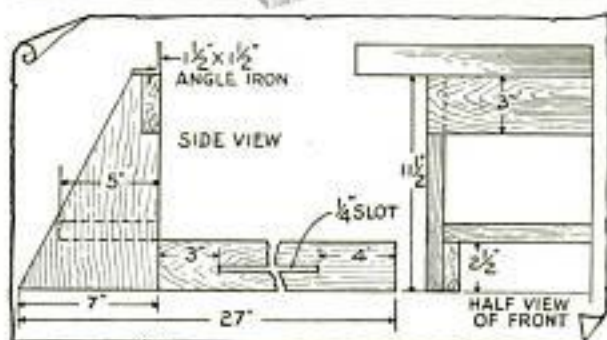
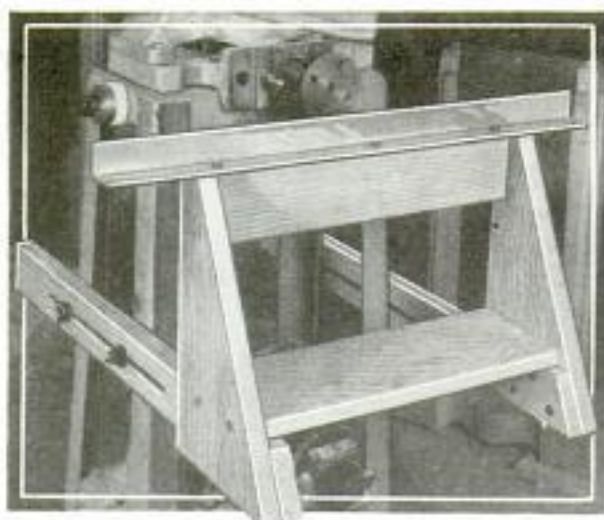

Sturdy Wooden Toolrest Bolted to Home Utility Machine Enables Turning Large Work

Improved Toolrest for Turning Large Work on Boring Machine

Utility workshop machines of the combination types, which are equipped with a boring spindle, can be used for turning large disks if a suitable toolrest is provided. An adjustable rest for this purpose is shown in the photo, and consists of a wooden framework clamped to the machine frame by means of bolts and wing-nuts, and a length of angle iron screwed to the top. The exact dimensions of the framework will, of course, vary with the size and construction of the particular machine on which it is to be used, although the dimensions given in the detail convey an idea of its approximate size. The two lower rails, with which the toolrest is fastened to the machine, are slotted to allow horizontal movement in adjusting the rest of the work. A bolt is passed through each leg of the machine to engage with the slots of the rails, and, when the bolts are tightened by means of the thumbnuts, you may be sure that the rest is attached securely. A length of angle iron screwed to the top may extend a few inches beyond the rest.

Weight of Sales Slips Indicates Day's Receipts

A New York department store has found that by weighing the sales slips at the close of each day, a fairly accurate estimate of the daily receipts can be made. A separate slip is used for each transaction, and it was found that an average in dollars per ounce is obtained, which will run practically constant day by day. The estimate obtained in this way will be fairly close to the actual figure.

Lathe Chuck Holds Round Stock for Drilling

If there is no tool at hand to hold round stock when drilling on a drill press, place it in the chuck of a small bench lathe. As the bottom of the chuck is true, it can be set on the drill table, enabling the stock to be held firmly and accurately.

Rubber-Tired Wheelbarrow Fitted with a Brake

When heavy wheelbarrow loads are handled on grades, some kind of braking equipment is advisable. A good method is to replace the barrow wheel with the rear wheel of a bicycle or motorcycle, which comes equipped with a brake. It is an easy matter to extend a control wire to the handle so that it will be within easy reach. The fitting of the larger wheel may necessitate an extension on the barrow frame to hold it. Another advantage of having a large rubber-tired wheel is



Large Rubber-Tired Wheel on Wheelbarrow Equipped with Brake to Control Loads on Grades

that it does not sink into soft earth as readily as the usual iron wheel.—Myron Albertson, Jr., Los Angeles.

Dr. B. B. Black, 6042 Roy St.
Los Angeles, Calif.

POPULAR MECHANICS
will furnish drawings for \$20.00.
PHONES AND DISH CARRIER IMPROVE RESTAURANT

345



As the average lunch room and restaurant has very little space behind the counter, which results in more or less confusion during rush hours, an automatic conveyor system and a number of counter phones with which chef and waiters can communicate, will be great improvements. A pair of large wooden rollers are provided at each end of the conveyor, these being held in a suitable framework which permits them to rotate freely. An endless fabric belt is fitted over the rollers and is supported at intervals by means of smaller rollers, while an electric motor is belted to the lower roller in the kitchen. As the two sides of the belt move in opposite directions, one is used to convey dishes from the kitchen to the waiters, while the other returns empty dishes to the kitchen, a sloping platform being provided at this end to receive the trays if no attendant is at

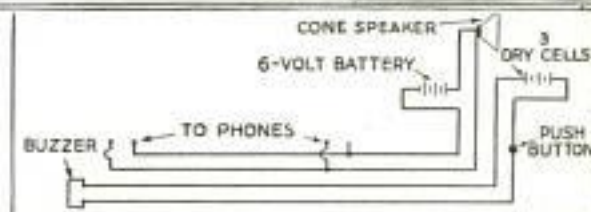

hand, thus preventing damage. A similar platform should also be fitted at the front end of the conveyor. Two hand phones on the counter are connected to a 6-volt battery and a cone speaker located in the kitchen. With this arrangement, the waiters can talk to the chef, and he, in turn, can communicate with them by talking into the loud speaker. The buzzer at the counter is connected to a push button and dry cells in the rear, permitting the chef to signal the waiters, and the trays he sets on the conveyor carry numbered cards indicating for which waiter they are intended. The diagram shows the complete hookup.

Smooth Jaws for a Pipe Wrench

When it is desired to use a pipe wrench on a square or hexagon nut, spring-steel covers over the jaws of the wrench will afford protection for the nut. After annealing the steel, two pieces are cut out and shaped to fit tightly over the jaws as shown. Bend the edges of the pieces so that they will snap into the depressions on the sides of



the jaws. After hardening, the covers are ready for use.

Steel-Polishing Powder and Oil Prevent Rust

Before storing a machine or tool, paint it with a solution of equal parts of tripoli powder and a good grade of machine oil. When the machine is to be used again, rub off the solution with a brisk motion.

☛ For speed in driving screws, cut off the blade of an ordinary screwdriver and fit it into the chuck of a breast drill.

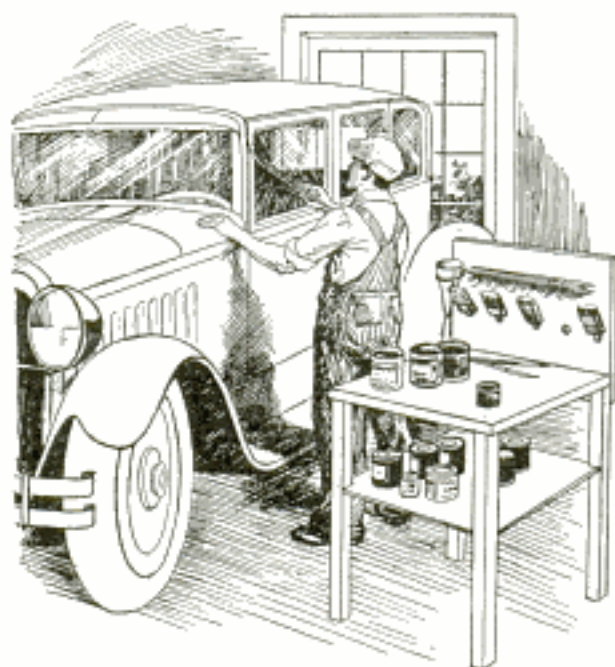

Small Table for Paints and Brushes Will Be Found Handy by Auto Finishers

Varnish Stand for Auto Finishers

Constructed of light wood, a small stand for holding paint and brushes will be found helpful to auto finishers. A board is tacked to the edge of the table to hold paintbrushes and other accessories, and one or more shelves under the top will increase the capacity. If desired, small casters may be fitted to the legs of the table so that it can easily be moved about from place to place wherever needed.—V. F. Clayton, Detroit, Mich.

C-Clamp Makes Riveting Easier

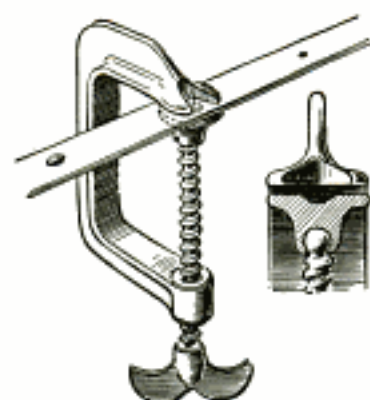

When riveting light work, a C-clamp, altered as follows, will be found helpful: Cut a V-notch in the foot of the clamp and counter-sink a small hole in the end of the screw. By placing the head of the rivet in this hole and tightening the clamp on the work, the rivet will be held firmly while being driven. It is advisable, of course, to support the clamp while hammering in order to avoid breaking it.

When riveting light work, a C-clamp, altered as follows, will be found helpful: Cut a V-notch in the foot of the clamp and counter-sink a small

Solution Prevents Peeling of Paint from Galvanized Surfaces

To counteract peeling of paint from pipes or other galvanized surfaces apply a solution of 2 oz. each of copper chloride, copper nitrate and sal ammoniac in 1 gal. of water. Prepare this in an earthenware container. Then slowly add 2 oz. of commercial muriatic acid. Let this dry for three hours before painting. The solution is harmful to the hands while wet but not after it has dried.

A Good Polish for Duralumin

Duralumin can be given a glossy finish with a solution consisting of equal parts of fine emery flour and machine oil, mixed to a heavy paste. Apply the paste with a circular rubbing motion and remove it with a soft cloth soaked in lard oil, after which the rubbed surface should be allowed to dry.

Holes Drilled in Tailstock Center Simplify Oiling

Two holes drilled in the tailstock center of a lathe will greatly simplify oiling when turning heavy work. Grind a $\frac{3}{16}$ -in. flat on the point of the center. Then anneal it so that a $\frac{1}{8}$ -in. hole can be drilled lengthwise to a depth of about 2 in. and a $\frac{1}{4}$ -in. hole in the side to meet the first. If desired, the outer hole can even be tapped for a grease cup, after which the center should again be hardened for service.



Stopping Rear-Wheel Grease Leak

When the axle housing of your car leaks at the rear wheels, replace the felt washer with one that has been thoroughly saturated with glycerine. As this substance does not emulsify, it provides a positive seal, preventing penetration of the oil.—Aaron H. Yonteff, Bronx, N. Y.

☛ A broken twist drill, ground to a blunt point, makes an excellent center punch.

Quick and Accurate Clamps for Miter Joints

IT IS comparatively easy to construct a clamp from seasoned hardwood that will successfully draw up a considerable range of sizes on plain mitered work. A simple miter clamp, which is designed to draw up all four miters of a square or rectangular framework in a single operation, is shown in Figs. 1, 2, 3, 4 and 7, while a clamp for a single plain mitered joint is shown in Figs. 5 and 6. In both cases the pressure is exerted by cam action.

To make the first, eight small cams are cut from hardwood to the form and dimensions shown in Fig. 3. Strike off a template on 1-in. squares to the exact shape indicated. For heavy work, the cams should be

frame is given under Fig. 3, and clamps of these dimensions have an adjustment range on square work of approximately 18 to 26 in., and on rectangular work from 12 by 24 to 16 by 22 in. The clamp can be made larger or smaller if desired. To make the slots at the ends, drill two $\frac{5}{16}$ -in. holes, centered on the stock, $1\frac{1}{2}$ in. from the end and $3\frac{3}{4}$ in. from center to center. Then saw out the wood between the holes with a coping saw. From the same stock, ripped to the same width, cut four pieces, each $10\frac{1}{2}$ in. long. Measure $\frac{3}{4}$ in. from one edge at the end of each and

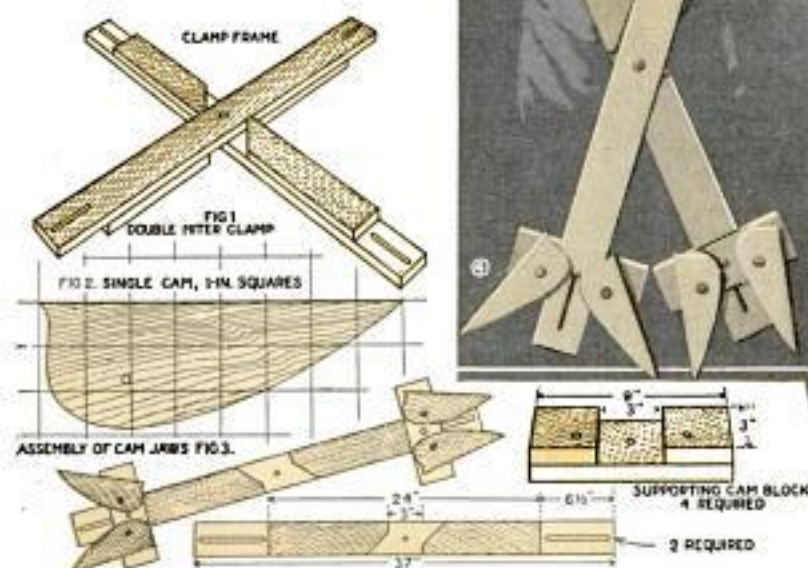

of 2 by 4-in. stock and the supporting frame of corresponding material, but for light work, 1-in. wood is sufficient. Each pair of cams must be exactly alike, and the binding edges must have a smooth even contour, besides being square with the flat faces. If the cams are made of 2-in. stock, they should be 4 in. longer than shown, in order to obtain the necessary leverage. Rivet, screw or dowel the cams through the grain of each cam, on each side of the bolt hole, to prevent splitting.

The dimensions of a single arm of the

from this point miter the corner. Screw these pieces on the longer arm as shown in Fig. 1. The ends opposite the mitered corners are cut square. Spread glue between the joining surfaces and screw together. Then drill a $\frac{1}{4}$ -in. hole at the exact center of the completed frame. Both arms are the same size in all cases and are fastened together with a $\frac{1}{4}$ -in. bolt through the center. Note that one arm is inverted over the other to provide a flat surface for the work.

The supporting block carrying the cams is shown directly under Fig. 4. Drill a

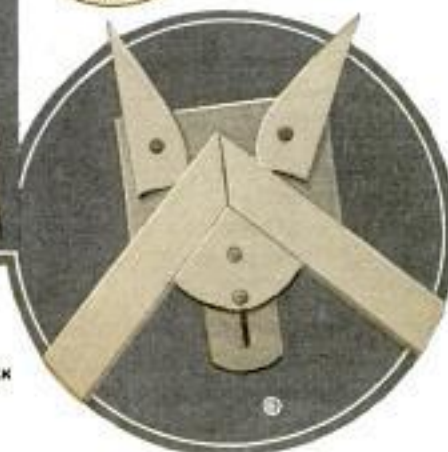

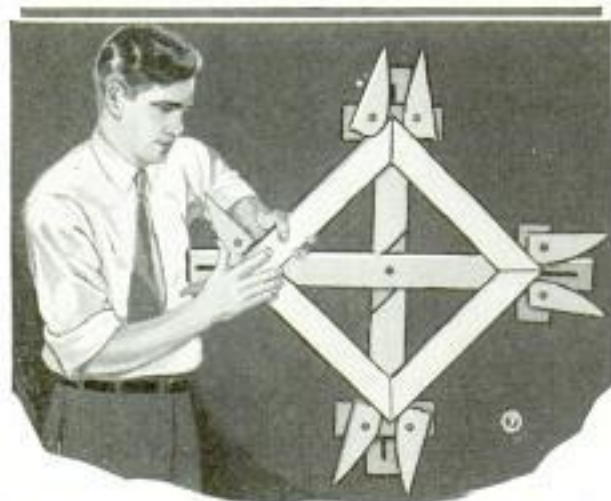

With This Double Miter Clamp, You Can Be Sure of Doing Quick and Accurate Work

$\frac{1}{4}$ -in. hole through the center of each. Set the cam blocks in place on the arms, and while holding the cams in their proper positions, mark the location of the holes in the blocks with a punch. Drill all holes with a $\frac{1}{4}$ -in. bit, and then assemble the cams on the blocks, remembering that the blocks on one frame piece must be inverted. Drive carriage bolts through from the underside and tighten the nuts on washers. When bolting the blocks to the frame, drive the bolts from the top.

To make the frame and guide block for the single miter clamp, two cams are made to exactly the same dimensions and contour as those in Fig. 1. The frame consists of pieces A and B, Fig. 5, the former being halved to the latter. Glue and screw these parts together and smooth the surface. Slot piece A, as shown, for $\frac{1}{4}$ -in. bolts. The triangular guide block is 3 by 3 in. in size with one side rounded. It must be cut square so that it will fit any miter joint perfectly. Before rounding off one side, strike a diagonal line across one face and, on this, mark two $\frac{1}{4}$ -in. holes for bolts. Locate the cams somewhat farther apart than on the double clamp. Drill two additional holes in piece B, so that the movement of the guide block, when setting for wider stock, may be compensated for by changing the position of the cams. This clamp may also be made heavier if desired. Four individual clamps made to the same dimensions form an excellent miter-clamping equipment for the individual shop where the work is almost certain to vary considerably in size.

Flashing-Metal Keys in Concrete between Pourings

When concrete is used for basement walls it is not always possible to obtain a good bond between pourings, if it is not all done the same day. The absence of a good bond permits water seepage, and this is, of course, highly objectionable. Here is a method that will overcome the difficulty: Before the concrete has been allowed to set after the first pouring, push strips of 6-in. flashing metal into the center of the wall, overlapping the strips and imbedding them about half of their width in the concrete. This will form a water-tight key if the concrete does not make a good bond.—L. H. Georger, Buffalo, N. Y.

A Wagon Skid for Steep Grades

Use of a channel-iron skid to brake his wagon on downhill grades, was found effective by a driver hauling heavy loads of dirt. The channel iron is drilled at one end to permit the attachment of a chain, which is securely fastened to the wagon by means of a hook slipped over a brace on the side. At the top of the hill, the skid is laid in front of one rear wheel, which is then run into it. This takes the wheel off the ground and pulls the chain taut. Sliding down on this skid retards the load sufficiently to make it easy for the team. Of course, the skid must be renewed occasionally due to wear on the bricks and concrete. At the bottom of

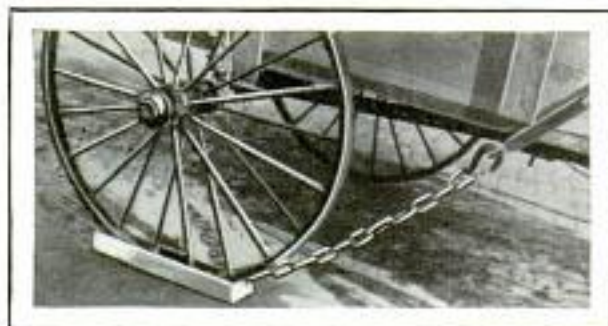

Channel-Iron Skid, Chained to Side of Wagon, Retards Heavy Loads on Steep Grades

the hill the skid is removed and thrown on the load.

☛ A small but strong chain is a good substitute for the top rung of your ladder, as it provides a good grip on trees and poles.

GROWTH OF WEEDS CHECKED WHILE HARVESTING

When cutting with a binder, ripe weed seeds are shelled by the reels and fall on the platform canvas from which they roll back to the ground through the opening between the platform and elevator canvases. Ripe seeds distributed in this way only cause a greater crop of weeds, and a good method of checking the weed growth by stopping this distribution of seed, is to provide a seed pan directly under the point where the platform and elevator canvases meet. Two lengths of angle iron are attached to the framework of the binder to hold a long sheet-iron pan, about 8 in. wide and 3 in. deep, the edges of which are slipped over the angle iron to keep the pan in place. A stop is provided at the front to prevent the pan from sliding forward, and a hook and eye at the rear will help hold it in place. Periodically the pan is emp-



Sheet-Metal Seed Pan on Farm Binder Collects Ripe Weed Seeds and Checks Further Distribution and Growth

tyed, and it is surprising how much seed will be collected in a day's cutting. The method of fastening the seed pan, of course, may be varied as desired, as long as it is placed under the edge of the platform canvas.

Thread-Cutting Oil Loosens Electric Motor Bearings

Motor bearings that have become "frozen," due to friction caused by gum forming on the bearing and shaft surfaces, can be loosened by applying thread-cutting oil. On motors that are equipped with oil rings and a reservoir, the lubricating oil is first drained out, and as the motor is started, thread-cutting oil is squirted into the slot on the top of the bearing, so that it flows into the bearing and around the shaft. The oil will quickly dissolve the gum, and will also polish the bearing and shaft surfaces. After the motor has run for a few minutes, drain off the surplus thread-cutting oil and flush the bearing with a good grade of lubricating oil. The drain plug is then put in place and the reservoir filled to the proper level. If the motor is equipped

with wicks and grease or oil cups on the bottom side of the bearing, it is necessary to turn the motor upside down, remove the cups and wicks and apply the oil to the shaft through the wick hole, after which the same procedure is followed as given above.—R. K. Beal, Marion, Ohio.

An Improved Lock Washer

If a lock washer is not at hand, one can be quickly improvised from a small sheet-metal disk with a hole drilled to fit the bolt, forming a large washer. Drive the nut down tight, bend the washer up against a flat side and make a deep punch mark in the opposite side of the washer. This will prevent the nut from turning.

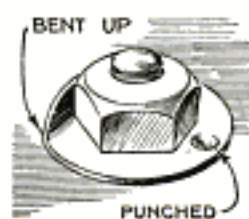



Small Brads and Tacks Are Always Ready to Hand When Kept in a Sliding Drawer of the Toolkit

Carpenters' Toolkit Has Tray for Small Parts

The usefulness of a carpenters' toolkit can be increased by fitting it with a tray for small parts as shown. Instead of using a round handle in the customary manner, a short $2\frac{1}{2}$ -in. strip of wood is screwed across the top, and cleats are nailed to the ends on the inside to support the tray, which is made by drilling large holes through a piece of 1-in. stock and nailing it to a $\frac{1}{4}$ -in. strip of the same size. A leather suitcase handle should be attached to the center of the top to carry the kit, and if desired, small hooks can be used to prevent the tray from slipping out of place when closed.

Wire-Cutting Gauge for Pliers

For cutting wire into short uniform lengths, this gauge, made from sheet metal, will be found useful. A strip of heavy sheet metal is bent to fit the plier jaws, and the other end is bent at right angles to form a stop. In use, the wire is slipped between the cutters up to the stop.—D. W. Clark, Buffalo, N. Y.

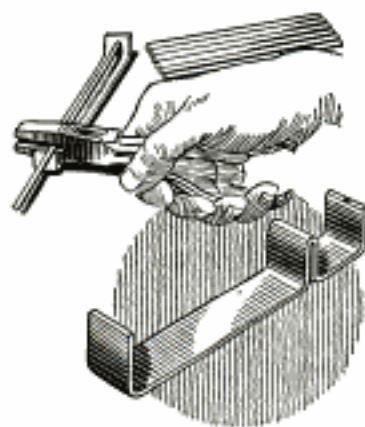

Insects Killed with Glue

A new method of exterminating insects on evergreen trees about your home is suggested by experiments at the State University of Ohio, where it was found that a solution of glue and water was an excellent insecticide. The solution is made by mixing glue, 1 lb., and water, 5 gal. It is sprayed on the trees and holds the insects in the same manner as flies on sticky paper, without injuring the trees. Besides killing the insects, it also prevents their eggs from hatching.

Auto-Radiator Hose Installed with Aid of Gasoline

When it is nearly impossible to slip a section of radiator hose over the connections, soak the hose in gasoline for half a minute, and you will find it can then be easily slipped on. The gasoline makes the hose slippery and allows it to stretch more. No damage will result to the hose from such treatment.

Hacksaw Stop for Slotting Screws

When cutting slots in screw heads, much time can be saved by using the illustrated gauge.

Place two blades in a hacksaw frame, one having the teeth and part of the blade ground off parallel to the edge, as shown in the lower detail, to serve the purpose of a stop. This prevents the other blade from cutting too deeply and makes all cuts of uniform depth.

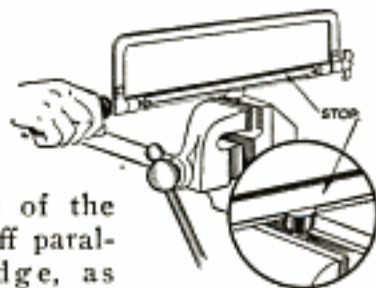

Imitating Walnut Wood

The appearance of walnut wood can be given to cheaper and more common white woods by painting or sponging them with a solution of potassium permanganate and warm water. One application of the solution will be sufficient for some of the woods, while others will need more to get the desired color. The permanganate is decomposed by the fiber of the wood,

forming peroxide of potassium on the surface. Wash off the excess potassium with clean water and allow the wood to dry, after which it can be varnished and polished in the usual way.

Checking Valve Tappets for Noise

Valve-tappet noise in a gasoline engine is so similar to other noises that may be present, that it is sometimes rather difficult to determine the exact source. The tappet clearance can easily be checked while the engine is running by cutting several narrow strips of sheet metal of the proper thickness to fit the clearance space, where they are allowed to remain while the engine is running. If the noise is still present while these shims are used, one may be reasonably certain that it is not caused by loose tappets.

Cooling Overheated Saws

It is common practice to throw water on an overheated circular saw to cool it, but this may cause the saw to either crystallize or warp. The best remedy is to remove the cause of overheating, but if the saw must be cooled, allow it to continue running and apply machine oil to the sides with an oilcan. This will cool the saw slowly and without damage.

Old Engine Used as Flywheel

It has been found that the crankshaft and flywheel of a discarded gas engine, used as an equalizer between an electric motor and a pump, make the installation run more smoothly. The drawing shows

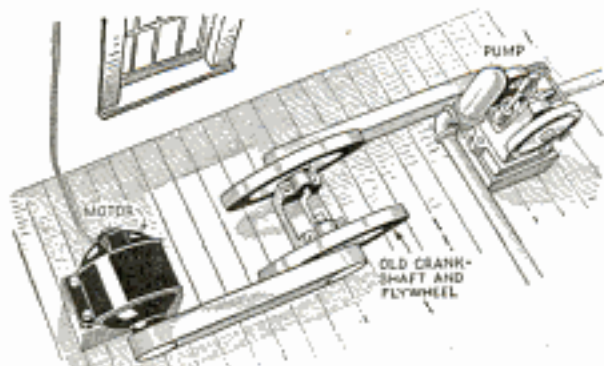

An Old Crankshaft and Flywheel Make an Efficient Equalizer for a Motor-Driven Pump

how the flywheel is belted between the motor and pump.



Pipe Extension on Post-Hole Auger for Boring Drainage Holes under Obstructions

Extension Auger Used for Boring Drainage Holes

In drainage work on the farm, when it is necessary to tunnel under obstructions, an ordinary post-hole auger fitted with an extension handle of pipe and fittings will be found useful. The pilot is welded to the nose of the auger and should extend about 6 in. As many 4-ft. lengths of 1-in. pipe as will be needed, are held together with pipe couplings, and a tee with two nipples provides a suitable handle. In use, the auger is driven into the earth until the first extension is needed, which is then added and the work continued, more extensions being used as the work progresses.—R. F. Starzl, Le Mars, Ia.

Shellac Holds Handles on Tools

Tool handles that have a tendency to come off can be kept tight by filling the hole in the handle with heavy shellac. Heating the tang of the tool before it is pressed into place will cause the shellac to dry more quickly.

☞ To restore the readability of an underexposed blueprint, apply peroxide of hydrogen with a soft brush.

Q. 562

A Lifetime of Satisfaction Here

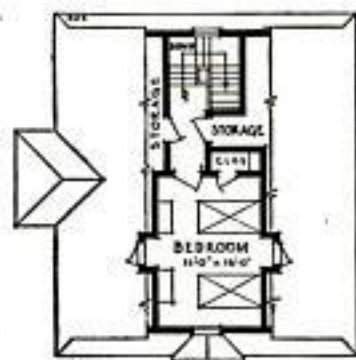

© Architects' Small House Service Bureau, Inc.

Plan 4-A-14

SOMETIMES a single detail will lift a small home out of the commonplace. It is so with this one. The fine proportions, the Germantown hood, the well-spaced windows are all important considerations. Yet it is really the pleasing entrance, the small stoop and the side seats which suggest hospitality that differentiates it from most small houses.

There are other features of interest about the exterior. The dining alcove extension, the dormers which tend to make the roof planes interesting and add qualities of hominess so desirable in the small house.

The plan is of a popular type, with bedrooms grouped on one side, where they have privacy, and the living quarters arranged on the other. In the front is a small vestibule, always desirable in severe climates, and the ever-useful coat closet.

The fireplace in the living room is so located that a fire on the hearth may be enjoyed equally from the dining alcove. This means economy, too, since one chimney serves the flues from fireplace, range and furnace. In the kitchen there is cross-light and ventilation, and the room is planned to route steps and minimize labor.

The second floor may be finished at any time to provide a fine bedroom. This room will have light and air from three sides, together with a large closet, and there is room for additional storage space on this floor.

The Architects' Small House Service Bureau of the United States, Inc., was formed to furnish a complete and dependable small-house plan service at moderate cost. For information regarding the blueprints and specifications address the bureau at 1200 Second avenue, South, in Minneapolis, Minn., from which also a booklet, containing twenty-seven selected small-house plans, may be had for the price of 10 cents. The bureau is under the control of the American Institute of Architects.

Master of all boring jobs from $\frac{1}{16}$ inch to $\frac{11}{64}$ inch



WHEN you have at hand "Yankee" Automatic Push Drill No. 41 (or No. 44) you are fixed to make holes rapidly and accurately in all eight sizes shown in diagram below ($\frac{1}{16}$ inch to $\frac{11}{64}$ inch).

Just push on handle! The drill bites in. Spring brings handle back for next push. On return movement drill-point revolves backward and clears chips. Makes it easy to drive screws, screw-eyes, and the like. You don't split the wood or break off screws.



"Yankee" Push Drills

No. 41.—World-standard Mechanics' Automatic Push Drill. Eight tested drill-points arranged in handle. Price, \$2.60.

No. 44.—Adjustable Tension regulates pressure to suit kind of wood, size of drill. Eight tested drill-points. Price, \$3.15.

Always Like New . . . Chromium Plating over nickel on "Yankee" Tools now adds beauty and durability, at no increase in price.

"YANKEE" TOOLS

TO HELP YOU MAKE THINGS

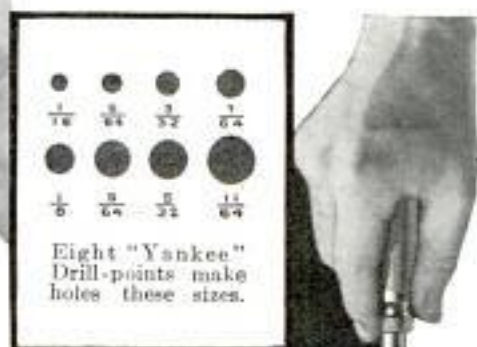

Eight "Yankee" Drill-points make holes these sizes.

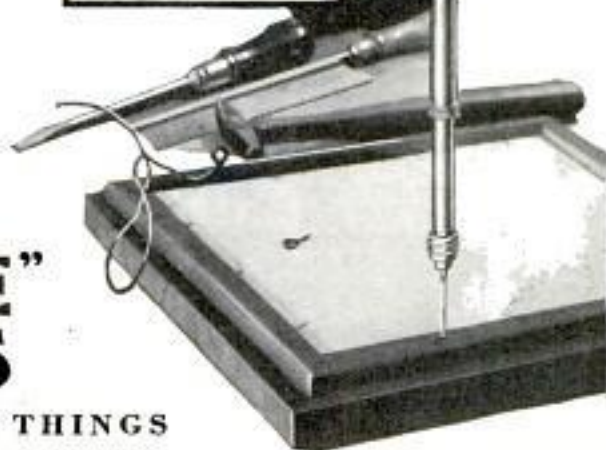

NORTH BROS. MFG. CO., Lehigh Avenue, Philadelphia, U. S. A.

You may send book showing *action pictures* of famous "Yankee" Ratchet tools: such as Ratchet Screw-drivers, Spiral Ratchet Screw-drivers, Ratchet Push Drills, Ratchet Push Braces, Ratchet Breast and Hand Drills, Ratchet Chain and Bench Drills, Ratchet Tap Wrenches, Etc.

NAME.....ADDRESS.....(pm)

A handy knife for the handy man



Electrician's Knife K4713
Price, \$2.00

Same Knife without reamer K1973—Price \$1.50



If you're the one detailed to do the odd jobs around the house you'll find one of these Remington Electrician's Knives the handiest tool you've ever owned. Use it to strip and scrape wires, to attach plugs, to drive screws... to shape and punch wood, felt, rubber or leather... and for the thousand and one other jobs you're called upon to do.

Have a heart and spare mother's good kitchen cutlery. These Remington knives cost so little, and are so much easier to use. Professional electricians prefer them because the blades are made from the highest quality of tool steel, forged, tempered, and hardened to give the longest service. You'll like the new safe way the screw-driver blade locks in position, and the way it's released by pressure on the large cutting blade.

If your dealer hasn't them in stock, send his name with the price, and you'll be promptly supplied. Address: Remington Cutlery Works, 942 Barnum Avenue, Bridgeport, Conn.

REMINGTON ARMS COMPANY, Inc.
Originators of Kleanbore Ammunition

Go to your dealer and ask him to show you The Remington Standard American Dollar Pocket Knife

Remington

Thompson BEATS the World on BOATS

BETTER BOATS at Lower Prices



The BEST that Skill and Experience can Produce TWO BIG FACTORIES

Our complete line of 22 models offers you a variety to choose from. Prompt shipment from factory to you. Catalog Free—Save Money—Order by Mail Please state kind of boat in which you are interested.

THOMPSON BROS. BOAT MFG. CO. (190)
213 Ann St., WISCONSIN (Write to either place) 113 Elm St., CORTLAND NEW YORK



Good and Good for You.

INCREASE YOUR BUSINESS by using the NEW **\$5.85 "Two-Faced"** Film Duplicator to make 100 copies, in 1 to 5 Colors each time. Or the **\$37.05 "Excallograph"** Rotary Stencil Duplicator to Print Copies of Anything Typed, Panned, Drawn or Traced in numbers up to 3000 each operation, as Price Lists, Hand Bills, Special Sales Announcements, Bulletins, Menus, Quotations, or "what have you?" Write—

Easy Terms

PITTSBURGH TYPEWRITER & SUPPLY CO.
Suite 552, 339 Fifth Avenue, Pittsburgh, Pa.

MAKE YOUR FORD INTO THIS SPORT CAR Picture (over's), STEEL REAR, \$399 De- Patterns: 399 Do-
Famous sure-fit RED-I-KUT life-size patterns and picture instructions show you how you can easily convert your Ford into this Fast, Sassy Sport-Car as thousands have with easily obtained materials. \$3.99 includes pressed metal rear. No need to lay up the car. Makes wonderful riding speed car. You'll be the talk of the town. Send dime for actual photo of sport car and also material of distinctive sport car patterns from \$1.99 up — "RKO" Steel "Spring-La" Underseats \$1.50. Spare and spare accessories. ORDER RIGHT NOW for a great thrill. KUENPEL COMPANY, "Speed Engineers," No. 6 Kuempel Bldg., Gettysburg, Pa.

MOTORCYCLES

Pay As Low As \$2.00 per Week
Hendersons, Harley-Davidsons, Indians
Slightly used and rebuilt. Hundreds to select from. Send 10c for list today.

MYEROW BROS. CO., 15 Berkeley St., Boston, Mass., U. S. A.

HOT SHOT... NEW ELECTRICAL WIZARD

GOOD FOR \$15 TO \$25 A DAY!
NEW MOTOR INVENTION

HOT-SHOT saves battery—gas—oil. Makes old plugs act like new. More power—speed. Transparent—shows magnified spark. Write for FREE SAMPLE OFFER.

Dept. F 8 REARDON MFG. CO. Peoria, Ill.



There Are a Thousand Uses for this New Kind of Wood



Many Industrial Uses

Tensile Strength	1500 lbs. per sq. in.
Crushing point	3000 to 4000 lbs. per sq. in.
Weight per Cubic Foot	30 lbs.
Absorption, Fresh Water	.30%
Absorption, Oil	.33%
Hold upon small screws (White Pine at 100)	143%
Combustibility, inception (charring)	400° to 500° F.

Science has discovered an amazing new kind of wood! It handles like soft putty and quickly hardens into wood. It is actually wood—Plastic Wood you can mould with your hands. Yet it has longer life and greater strength than natural wood. Never dries out, nor rots, nor warps after it hardens. You can plane it, turn it in a lathe, carve it and drive nails and screws into it. You can paint, lacquer or varnish its weather-proof, water-proof surface. You can work it as you would modeling clay.

It has a thousand uses. There's nothing better for repairing loose chair rungs, weak chair backs, broken drawer pulls... for hiding nicks, sealing cracks and setting shaky bathroom fixtures... for making finished models. It always

does an expert job in a jiffy. Without a doubt it is the greatest discovery of the century.

This new kind of wood comes in cans and tubes and is sold in nine colors by all paint, hardware and department stores. Just ask for Plastic Wood.

BIG 48-PAGE BOOK—FREE
Find out the endless variety of uses for Plastic Wood. Just mail this coupon and we'll send you—free—a profusely illustrated, 48-page book crammed full of interesting uses for Plastic Wood.



PLASTIC WOOD

SOLD IN CANS AND TUBES

MAIL COUPON FOR FREE BOOK

The A. S. BOYLE CO., Dept. 8-PM
Cincinnati, Ohio

Send me—free—Big Book of Uses for Plastic Wood.

Name.....

Street.....

City..... State.....



Special offer, act quick!

We have taken over the surplus stock of the WACO Aircraft Co. and can offer you an extraordinary value in the famous WACO gliders. Even at the original list price \$385, they were the standard of comparison and the best buy on the market. Because they were closed out at a sacrifice to make room for new aircraft production, we are able to price them to you at

only **\$248** F. O. B. Troy, Ohio

Troy Flying Service, Dept. B, Troy, Ohio

These gliders are licensed before delivery by resident U. S. Dept. of Commerce inspector. They are completely finished and doped, knocked-down for shipment, individually boxed in single shipping case. Send for complete description and specifications, if you wish additional information. But act fast, because the number available is extremely limited and the opportunity can never be duplicated. Terms: cash with order, or sight draft on delivery.

The WACO Glider

Fuselage welded aircraft steel tubing; landing skid faced with hickory shoe; wing spars aircraft spruce, web ribs; wing skids, with shock cord and pivot mount; formed seat with back rest, safety belt, foot rest; launching hook and tow hook with positive release. Inspected, approved and licensed by U. S. Dept. of Commerce.

NOW IN HANDY TUBES



**STERNO
CANNED HEAT**

... finds thousands of new uses

NEED a bit of heat? For that bit of soldering, hot glue, to start the fire, melt a bit of wax—anything that needs heat right on the spot—anywhere, at home, shop, camp or on the road.

Send for FREE booklet that's full of practical time- and energy-saving ways to make STERNO serve you. Full-size tube only 10¢.

STERNO Corporation P. M. 8
9 East 37th Street, New York

- Send me your free booklet.
 I enclose 10¢ for full-sized tube.

Name _____

Address _____



OH BOY!

Build This Car

Any boy can build this 35 mile gasoline roadster with 8yco parts. Send 50¢ for building plans and price list of parts. Here's a chance to build something worthwhile.

SYCO SALES CO.
1524 Fernwood Ave., Toledo, O.

FREE Get BB Magic at once. A wonderful shooter's digest—tellshow to hold, aim and handle rifles; helps you guide others in correct knowledge of guns. Gives facts that make crack shots. Gives safety and common sense instruction parents all like.

SEND NOW!

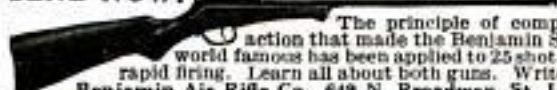

The principle of compressed air action that made the Benjamin Single Shot world famous has been applied to 25 shot automatic rapid firing. Learn all about both guns. Write! Benjamin Air Rifle Co., 649 N. Broadway, St. Louis, Mo.



"FLYING CLOUD"

Get clean-cut parts and clear blue-prints for 20' model. Readily made in spare hours as hull fully shaped and sanded. Set includes anchor, bell, capstan, dead eyes, wheel, rigging line, etc. Complete for \$11. Postage 5 lbs. White metal figurehead 50¢. Send 15¢ (coins) for beautiful catalog of ships and coaches.

ROY HANCOCK
323 Douglas Ave. Portsmouth, Va.

Sport Bodies for Fords At Factory Prices



Make Your Ford Into Classy Car

This Model in Grey Prime **\$3850**

Send 15¢ for catalog showing all models of bodies and other equipment for Ford and Chevrolet. 16-compression heads, underlating parts, 3:1 gears, headlights, fenders. Cut shows body on Model A Ford. Also made for Model T Ford.

Sport Factories, Dept. B-2, Aurora, Illinois

BUILD YOUR OWN AUTOMATIC ELECTRIC REFRIGERATOR



Why pay \$200.00 and upwards? Use your present ice-box. We supply parts. Can be built for only \$34.50. Easily made. No special tools necessary. Operating cost, quality and size of machine same as well known makes. Complete blue-prints and instructions—\$1.00. Circular "B" on request.

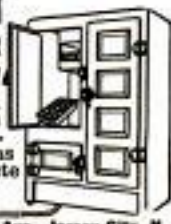

B. & L. ENGINEERING CO., 706 Bergen Ave., Jersey City, N. J.

Catch Fish!

Eels, Mink, Muskrats with our new folding galvanized **STEEL WIRE TRAP**. Write for our **FREE TRAP OFFER** and Bargain Catalog. **\$1 Box** of our famous Fish Bait **FREE** to introduce our traps. **WALTON SUPPLY CO., 3502 JUNIATA AVE., ST. LOUIS, MO.**

MOVIES In Your Home



Our marvelous, practical Movie Machines sell as low as \$5.00 postpaid. Also finest 16 mm. cameras and projectors at factory prices. A complete line of both standard and 16 mm. film available at low prices with exchange service. Write for big, **FREE** catalogue.

PARAMOUNT MFG. CO. Dept. C-42
Boston, Mass.

Only 8 Sales a Day Nets You \$116 a Week

Profits on larger size run higher. Unusual earning opportunity for ambitious men. No experience necessary; we teach. Part or full time.

FUGO World's Simplest Fire Extinguisher

Automatic and instantaneous action. Within reach of every home, shop, store, theatre, garage, car owner, etc. Even smallest place needs two or more. Exclusive territory to producers. You get your pay every day. Write for full details.

The National Formetal Co.
6535 Metta Ave. Cleveland, O.

WING AWAY! Free as the Birds

Swing out over the roads and trails where adventure lurks. Speed away from the humdrum of sweltering streets and jammed highways.

Join the good fellows who spend their play hours on Harley-Davidsons — free as skylarks, and as gay. Ride out to the lake with them — or on a week-end tour — you'll be welcome.

Vacation time is at hand—and what a wonderful one you'll have, with your Harley-Davidson!

Do you know how *easy* it is to buy a motorcycle now—and how *little* it costs to run? Ask your nearby Harley-Davidson Dealer about his Pay-As You-Ride Plan.

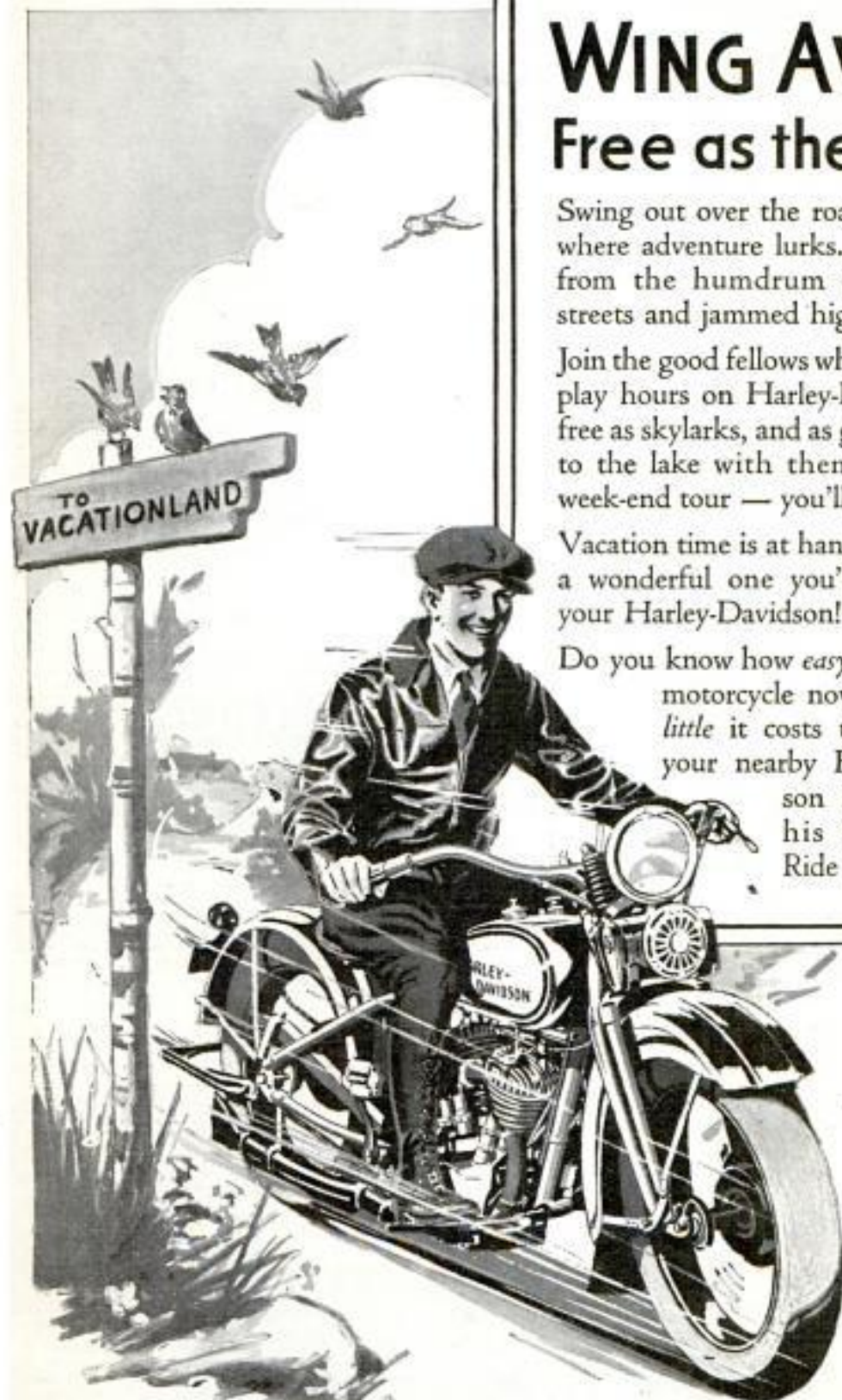

Mail this coupon for free literature showing our 1931 Twins, Single, and Sidecars.

Ride a
HARLEY-DAVIDSON

Harley-Davidson Motor Company
Dept. P., Milwaukee, Wis.
Interested in your motorcycles. Send literature.
Name.....

Address.....

My age is 16-19 years, 20-30 years,
 31 years and up, under 16 years.
Check your age group.



Gents, why worry about a little grease and grime when you know what Lava will do? In less than 60 seconds Lava will clean off the worst dirt your hands can get into - And NO harshness! It actually soothes your skin.



George,
the Lava Soap Man
takes the dirt -
protects the skin -

BOYS—Build and Fly the IDEAL “EAGLET”

All balsawood (not cardboard) with many features of expensive models. Easy, quick construction; everything ready to put together; weighs 1 oz. complete. Flies like a big one! Get one now and have some real fun!

Send 5c for Big 48 pg. Catalog of New Models and Reduced Prices.

IDEAL AEROPLANE & SUPPLY COMPANY, Inc.
26 West 19th Street New York City



20 in. Size Construction Outfit 50c Post-paid

ACTUAL LENGTH 7 1/2"

FREE TAPERED DUPLEX PIPE CLEANERS For Smokers—First improvement in 35 years. Little end easily enters bore—big end is pulled thru cleaning and drying bore perfectly. Send name and address of your tobacco dealer and get 3 full size packages free.

E. T. GILBERT MFG. CO., 228 South Avenue, ROCHESTER, N. Y.

100 Shaves from EACH Blade

The Master-Razor puts a hair-splitting edge on the dulled safety razor blade—(U.S.) each—in 5 seconds. Many get 100 shaves per blade. W. P. Walsh, Windsor, Ontario, used some blades daily, 8 months. Moving gives barbers thousands of smooth shaves from a single straight edge blade. Only shaving can put a NEW edge on a safety razor blade. This patented, universally tested razor, made of extruded aluminum, makes each 10¢ blade give \$1 to \$2 worth of service. Also hones straight edge blades. MONEY REFUNDED if not MORE than satisfied.

YOURS FREE
We will send you a Master-Razor absolutely free WITH FIRST ORDER of 12 for \$1; or send 50¢ for 1 or \$1 for 3, POSTPAID. Or you may send us money and pay postman plus postal charges. But SEND TODAY and start enjoying these quick, easy profits.

Wisconsin Abrasive Co., Dept. 609-C, Station A, Milwaukee, Wis.



Agents

net up to \$30 a day, no salesmanship needed.

AGENTS!

SELLS LIKE WILD FIRE

FILL RESEVOR WITH WATER. HOLDS ENOUGH TO CLEAN 40 WINDOWS.

WATER FEELS TERRY FINE TO WINDOW GLASS.



REMOVABLE RUBBER SQUEEGEE BRUSH. CLEANS, POLISHES WITH ONE STROKE.

RUST PROOF. SOON PROOF LASTS FOR YEARS.

REMOVES GRASS AND MUD FROM WINDOWS.

\$380 monthly selling 10 improved patented Carter Window Washers daily. Cleans, dries, polishes. Good Housekeeping approval. Restricted territory. Write today. CARTER PRODUCTS CORPORATION, 998 Front Ave., CLEVELAND, OHIO

Build a CLOCK for Pleasure or PROFIT!

FREE BOOK of Clock Making, Money Making Ideas. Gives details, prices of materials, Write NOW for copy!

Shows How YOU Can Make Fine Clocks Right at Home—for yourself, or to sell at Big Profits. We furnish instructions, parts. Works \$1.65 up; others with chains, all prices. Make case or assemble parts. Cash on demand for Mantel, Bazaar, Grandfather's Clocks. Ask about new low-priced Electric Clock and Special Blue Print Offer. FREE Catalog.

AMERICAN CHINE CLOCK COMPANY
1670-N Ruffner St. Philadelphia, Pa.

AGENTS AND SIGN MEN

Earn up to \$100 Weekly, and over, Putting up OUR GENUINE GOLD LEAF SIGN LETTERS

R—on store and office windows, board signs, trucks and glass signs. We also make to order script signs and business emblems singly or by the thousands. A permanent business. No capital or experience required. Big demand in every City. Samples and Literature Free.

CONSOLIDATED SIGN LETTER CO., 711 X W. Van Buren CHICAGO, ILLINOIS

DO YOU WANT a new business profession of your own, with all the trade you can attend to? Then become a foot correctionist, and

in a few weeks earn big income in service fees,—not medical nor chiropody—easy terms for home training, no further capital needed, no goods to buy, no agency. Established 1894. Address Stephenson Laboratory, 1 Back Bay, Boston, Mass.

Do Your PRINTING

Cards, stationery, circulars, tags, labels, advertising, etc. Save money. Print for others, big profits; easy rules sent. Will do popular Raised Printing like Engraving. Junior Press, \$5.90. Job Presses \$11 up, Power \$149. Write for free catalog. THE KELSEY, CO., Y-37, Meriden, Conn.

\$90.00 WEEKLY Easily Made

Lowest prices in years for our all wool tailored-to-measure suits. Finely made. Show our samples and make big cash profits daily plus liberal bonus. Orders come easy, quick. No experience required. Latest styles, beautiful fabrics. Big FREE sales outfit of nearly 150 swatches.

Write Today
PIONEER TAILORING COMPANY
Dept. H-1116 Congress & Throop Sts., Chicago

\$5.00 to \$11.50
PROFIT PER ORDER
Including Bonus

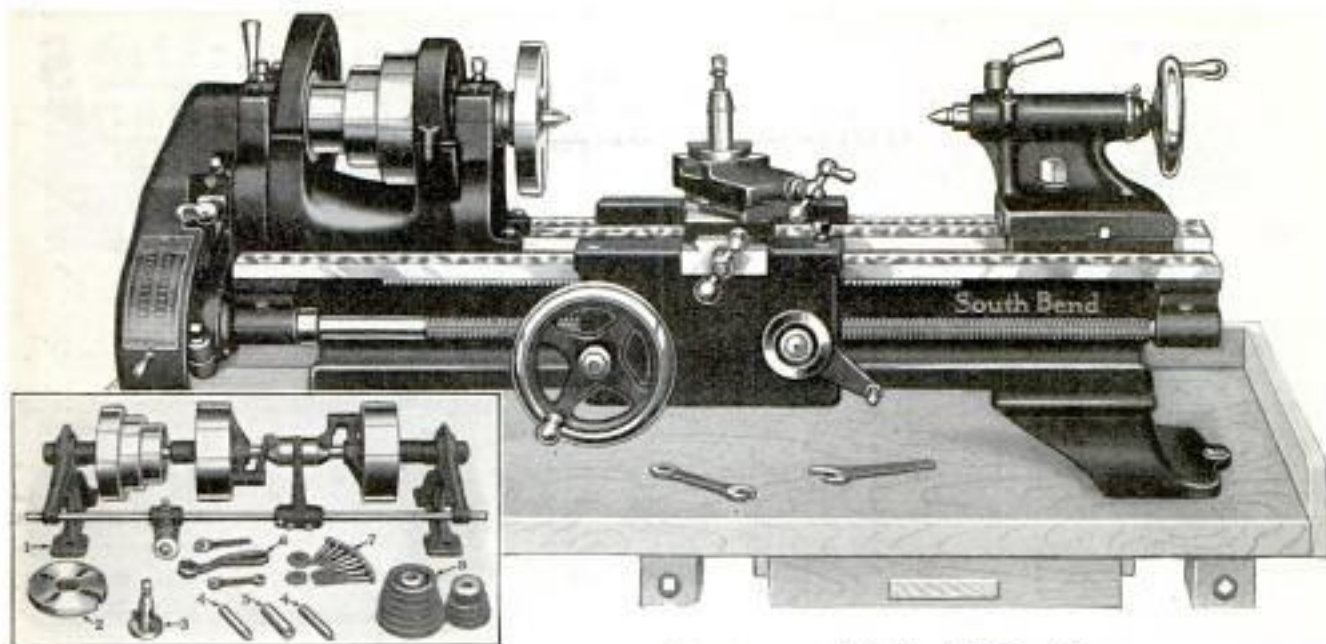

9' x 2' new model Junior Back Geared Screw Cutting Bench Lathe. Weight 325 lbs. Price \$150. Only \$30 down, \$10.50 monthly.



9 inch Junior New Model Simplex Wall countershaft Lathe and Latho equipment. Price \$150 Complete with motor, switch, wiring, conduit and belting \$180.75. Only \$36.15 down; \$12.65 monthly.

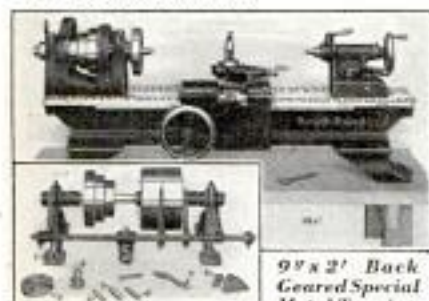

9' x 2' Back Geared Special Metal Turning Lathe. Weight 275 lbs. Price \$100 Only \$20 down; \$7 monthly.

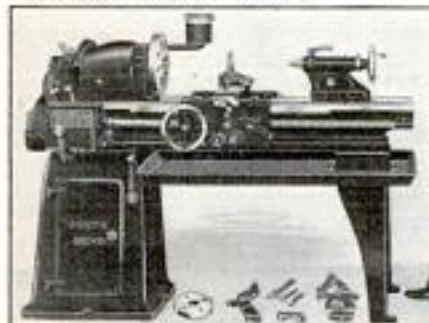

New Model Underneath Belt Motor Driven, Back Geared, Screw Cutting Lathes, available in two series, 96 sizes and types, 9' to 18' swing. priced from \$283 to \$1356 Can be bought on easy payments.

New Model South Bend Lathes on Easy Payments

YOU can now install any South Bend Lathe on Easy Payments of 20% down, balance in 12 monthly payments. You get the same lathe that is used by the U. S. Government, State and municipal departments, General Electric, Eastman Kodak, R.C.A., General Motors and hundreds of other leading industries.

New Features include double wall aprons on Series "N" lathes and hardened headstock spindles on both Series "O" and Series "N" lathes. 96 sizes and types are available in both series, all of which are built and recommended for fine tool room work, production in the manufacturing plant and for general service and maintenance. Send Coupon for Details.

Send Now for These Books

"How to Run a Lathe"—Latest Edition of this famous work, contains 160 pages, with more than 300 illustrations. Simplest, most complete and practical book on lathe operation. Shows how to handle 400 different types of lathe jobs as practiced in the modern machine shop. Sent postpaid for only 25 cents; coin or stamps of any country accepted.

Latest Auto Shop Practice—This 48 page book shows a model auto service shop, gives up-to-date methods for servicing armatures, valves, bushings and pistons; describes complete equipment for these jobs, costing only \$265.00 complete. Sent free, postpaid.

Catalog No. 91-A—This 104 page book illustrates and describes the 96 different sizes and types of New Model South Bend Lathes. Send the coupon now for your copy, free.

SOUTH BEND LATHE WORKS

Lathe Builders for 25 Years - - Over 50,000 in Use

SOUTH BEND LATHE WORKS

638 East Madison St., South Bend, Indiana, U. S. A.

Gentlemen: Please send me books checked

How to Run a Lathe (25c)

Latest Auto Shop Practice (Free)

Catalog No. 91-A (Free)

Easy Payment Plan

Name _____

Address _____

City _____

State _____



MAGIC-DISC!

BOILS WATER INSTANTLY

PAYS YOU UP TO \$30 DAILY

MEN & WOMEN!

Thousands gasp at this mysterious little disc. Its uncanny method gives you SIZZLING HOT WATER IN SPLIT SECONDS—actually 2½ times faster than any other practical water heating method!

LOW COST Sells Everywhere

Dynamic two-minute demonstration clinches fast sales. Agents! Distributors! Write at Once for New Profit Sharing Sales Plan. No Investment. Don't Delay.

LUX VISEL COMPANY

87 Jackson St., Elkhart, Ind.

Like Chained Lightning!

Strange new principle makes the LUX ELECTRIC WATER HEATER worth ten times its small cost to every store, home, office, tourist, vacationist, and hundreds of others: For dishes, laundry, shaving, bath, illness or any emergency. No larger than your fist! Simply drop LUX in water, plug in light socket and ZOOM!—Clouds of steam rise before your eyes! No chemicals, no fire, no fuss, no waiting.



Made of pure aluminum with 8 ft. waterproof cord. AC or DC Current.

GUARANTEED

FORTY DOLLARS WORTH for \$4



When you buy a kit of CRESTOLOYS at \$4.00 you are getting the equivalent of 33 double-end wrenches that cost approximately \$40.00!

Think what a savings this represents! And think of the value you are getting in return for your money.

This compact, handy kit contains three new drop-forged adjustable CRESTOLOYS wrenches. Each one... 30% thinner... 200% stronger and tougher than ever... will do the same work as eleven double-end wrenches... and with greater ease!

Why burden yourself with excess tool weight and tool cost? Go to your favorite hardware dealer today and examine the set of three CRESTOLOYS. Feel their feather weight. Test their ease of adjustment and their amazing strength. We know you'll say, "Believe you me, here's a real set of wrenches!"

CRESCENT TOOL COMPANY
JAMESTOWN, N. Y.

NO MORE BIG TIRE BILLS!

GOOD YEAR · FISK · Firestone · U.S. AND OTHER TIRE BRANDS

At ¼ Regular Prices

Tires You Know and Prefer AT NEW LOW PRICES!

You can rely upon Chicago's oldest and most reliable rubber company to deliver tire mileage at lowest cost. Actual tests on the worst roads in the country prove that our standard brand reconstructed tires deliver 60 to 80 per cent more service. A trial order will convince you.

BUY 12 MONTHS SERVICE SAVE NOW GUARANTEED MONEY

BALLOON Tires		Reg. CORD Tires		
Size	Rim	Tires Tubes	Size	Tires Tubes
28x4.40-21"		\$2.30 \$1.10	30x3	\$2.20 \$1.00
28x4.50-20"		2.40 1.10	30x3½	2.25 1.00
30x4.50-21"		2.45 1.20	32x3½	2.70 1.15
28x4.75-19"		2.45 1.20	31x4	2.95 1.15
30x4.90-21"		2.50 1.20	32x4	2.95 1.15
30x5.00-20"		2.55 1.25	32x4½	2.95 1.15
28x5.20-18"		2.95 1.35	34x4	3.50 1.15
30x5.20-20"		2.95 1.35	32x4½	3.20 1.45
31x5.25-21"		3.20 1.35	32x4½	3.20 1.45
30x5.71-20"		3.20 1.40	34x4½	3.45 1.45
31x5.90-19"		3.20 1.40	32x5	3.90 1.75
32x5.90-20"		3.20 1.40	33x5	3.60 1.75
32x5.90-21"		3.20 1.45	35x5	4.45 1.75
32x6.30-20"		3.65 1.75		

DEALERS WANTED

All Tubes New—Guaranteed First Quality

Send only \$1.00 deposit with each tire ordered, balance C. O. D. If you send cash in full deduct 5 per cent. You are guaranteed a year's service or replacement at half price.

MIDLAND TIRE & RUBBER COMPANY
Dept. 265, 1000-10 W. Sixty-Third Street Chicago



Send for Free Catalog

2000 illustrations—Diamonds, Watches, Jewelry. Largest Diamond and Watch Credit House in the World.

LOFTIS BROS. & CO.
Dept. C-894, 30 N. State St. CHICAGO, ILL.

BURN YOUR NAME ON TOOLS

WITH THE ARKOGRAF

PROTECT YOUR TOOLS FROM THEFT
Write with electricity any name or design on the hardest and finest tools and instruments, or any metal, like writing on paper with pen or pencil. Complete outfit \$3.50—Prepaid Anywhere. Interesting illustrated circular free. Write today. Agents wanted. ARKOGRAF PEN CO., 1171 E. Stark St., Portland, Oregon



CRESCENT 20" Band Saw

A high grade, moderately priced band saw for light work; affords all the accuracy, convenience and efficiency of large band saws. Self bearing. Self contained motor operates from light socket; or may be driven from line shaft. Machine finished table, with graduated scale, tilts any angle to 45 degrees. Quick locking device. Saw, with spring tension, is fully guarded. We make wide line of light machines for cabinet makers, schools, and amateurs, also heavy machines for factories.

THE CRESCENT MACHINE CO.
93 Columbia St. Leontia, Ohio



Send for FREE BULLETINS

Brown & Sharpe Tools

"World's Standard of Accuracy"



Send for Catalog No. 31 describing 2300 Precision Tools. Brown & Sharpe Mfg. Co., Providence, R. I., U. S. A.

DEAFNESS IS MISERY



Many people with defective hearing and Head Noises enjoy conversation, go to Theatre and Church because they use Leonard Invisible Ear Drums which resemble Tiny Megaphones fitting in the Ear entirely out of sight. No wires, batteries or head piece. They are inexpensive. Write for booklet and sworn statement of the inventor, himself deaf.



A. O. LEONARD, Inc., Suite 699, 70 5th Ave., New York



“I’ve shipped on a South Sea Tramp



yet you’ll find me just around the corner”

It’s a small matter where you meet up with Chesterfield. The point is — get acquainted! You’ll find the change to Chesterfield a real change . . . one which your palate will thank you for! Chesterfield uses choicer and milder tobaccos and so blends and cross-blends them that you get just what you want in a smoke . . . *greater mildness and better taste.*

Chesterfield



Chock-full!



BUILD YOUR OWN BOAT AT SMALL COST

Whatever type of boat you want; whether it be a speedy outboard cruiser, a racing hydroplane, a serviceable outboard runabout, snappy inboard runabout, sailing boat, flat-bottom rowboat for outboard motor, round-bottom rowboat or canoe, the new

POPULAR MECHANICS BOAT BOOK SHOWS YOU EXACTLY HOW TO CONSTRUCT IT

The need for easily understood directions for the amateur builder of small craft has been met by actually building these boats and photographing every vital step in the construction. Thus you are shown everything just as it is done; nothing being left to guesswork. The designs used in the new Boat Book are of the very latest, up-to-the-minute craft.

THE ONE BOOK NEEDED BY EVERY BOATING ENTHUSIAST

Gives you in addition to boat building information, everything you need to know about the operation, equipment, care, repair and maintenance of boats. This includes navigation, pilot rules, handling sailing craft, government regulation of motor boats, knots, storm signals, useful boat kinks of various kinds, glossary of boating terms, tables, etc.

Sent postpaid upon receipt of price or by parcel post C. O. D. anywhere in the U. S. A.

POPULAR MECHANICS PRESS—ROOM P8—200 E. ONTARIO ST., CHICAGO

**269 PAGES
(Several in Color)**

**PROFUSELY
ILLUSTRATED**

**LARGE SIZE
7x10 INCHES**

CLOTH—PRICE \$3

Cabinet Shop
Special

OPEN A SHOP!

Start a shop of your own and build up a profitable business. This Parks woodworker is all you need—it includes 16" band saw, 6" jointer and 8" circular rip and crosscut saw. Priced without motor at

\$247

THE PARKS WOODWORKING MACHINE CO.

Dept. PM-8, 1530 Knowlton St., Cincinnati, O.
Canadian Factory: 338 Notre Dame East, Montreal
Good woodworking machines since 1887.

PARKS

WOODWORKING MACHINES



A Real LEADER—

GERSTNER Tool Chests—
the Finest in America. Many
sizes and styles for Machinists
and Toolmakers.

Free Catalog

Gerstner & Sons

492 Columbia St. Dayton, Ohio

... IN ONE TOOL

A tool post precision grinder for bench lathes and for off-hand grinding operations... easily changed into a high speed drill... one tool with many uses. Maximum speed, 20,000 R. P. M., grinds to finest limits. Write for descriptive bulletin.

DUMORE CO., 52-16th St., Racine, Wis.



\$27.50
Complete

\$10⁰⁰ Down Brings This Lathe to You



ALL SIZES
\$17.50 to \$75.00

Don't buy until you see our catalog of lathes, bench saws, jigsaws, bandsaws, etc. We build the largest line of small lathes in America. Catalog DB8-10 etc.

SYIPHER-ARCON CO.

1524 Fernwood Avenue, TOLEDO, O.

FREE TOOL BOOK

The entirely new Disston Saw, Tool and File Manual tells how to choose, use, and care for tools, file and set saws, etc. Sent free.

Henry Disston & Sons, Inc., Dept. M, Philadelphia. Canadian Factory, Toronto

ENGINES

Enclosed,
Self Oiling, Roller Bearing

The sensation of the year, something new. Runs smooth as an electric motor. Low operating cost. Let this engine make money for you. Big illustrated Catalog Free.



ALL LIQUID FUELS

WITTE ENGINE WORKS
174C OAKLAND AVE. KANSAS CITY, MO.

OUTDOOR FUN for Father and Son!



Enjoy Making Things, with the aid of This Book and ATKINS Saws!

YOU and your boy will enjoy home-crafting OUTDOORS! Get some of your saws and tools from the workshop, and have real fun together building summer projects.

A sailing or motor boat... a surf sled... a diving board... a new dock at the lake cottage... rustic furniture for camp or garden... outdoor gym... archery set... model seaplane or yacht... a home for Bob's dog, or a house for Betty's dolls!

You'll find many other outdoor projects listed on pages 19 and 20 of the ATKINS Saw Book for Home Craftsmen—it has over 200 suggestions, and where to get job plans.

This new 32-page book tells you HOW to do things, as well as WHAT to make. HOW to build a workbench, saw-horse and tool box to use inside or out. How to fit up a workshop, cut 24 wood joints, select good tools, file a saw, and so on!

And it shows you 50 of the world-famous "Silver Steel" saws, and explains why they cut wood or metal so much faster and easier—and far outlast ordinary saws.

Send a dime for this book now, and have more FUN using saws and tools this summer.

If your hardware dealer does not have the ATKINS Saws you want, write us.

E. C. ATKINS and Company (Est. 1857)
426 So. Illinois St.
Indianapolis, Ind.

I enclose a dime for the ATKINS Saw Book.

Name.....

Street.....

City..... State.....

My dealer is..... (8)



To cut joints, use Atkins Back or a Mitre Saw.



To cut any metal faster, use Atkins Back Saw.



Atkins "Junior Mechanic" is a real saw for a boy.



THE
**ATKINS
SAW BOOK**
for Home Craftsmen

TELLS HOW TO

Start a Home Shop
Select the Correct Saw & Tool
Cut and Fit the 24 Most Used WOOD JOINTS
Build a Workbench, Saw-Horse, and Tool Box
Suggests 200 Projects to Make

10c

Send for the Making of SILVER STEEL, free

10c

10c

10c

10c

10c

10c

10c

10c

10c

10c

New Motor-Driven Woodworking Units

Save Time, Money and Labor

And produce better work, too. That's the reason they are replacing hand tools everywhere. Each "Delta" motor-driven tool is practically designed to do its work **efficiently, conveniently, and quickly.** That's why woodworkers the country over say "Delta" gives the most machine value per dollar.

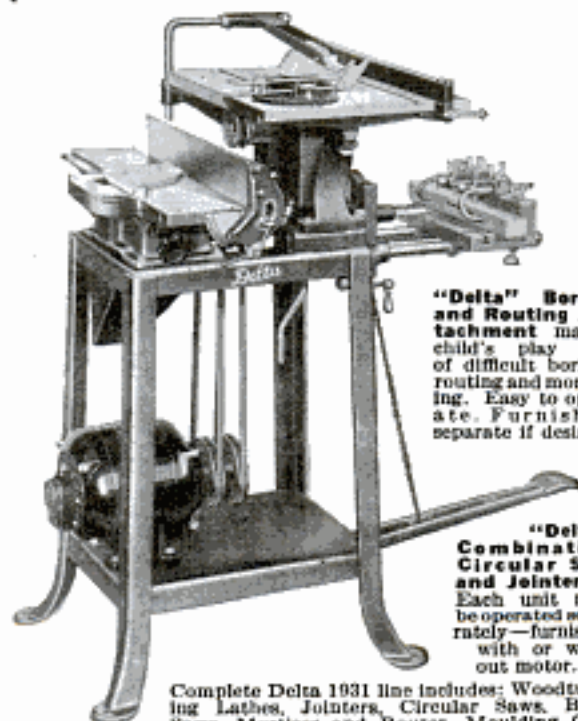

"Delta" Boring and Routing Attachment makes child's play out of difficult boring, routing and mortising. Easy to operate. Furnished separate if desired.

"Delta" Combination Circular Saw and Jointer — Each unit may be operated separately — furnished with or without motor.

Complete Delta 1931 line includes: Woodturning Lathes, Jointers, Circular Saws, Band Saws, Mortiser and Router, Moulding Cutters, Shaper, Scroll Saws, and Complete Hand-Shops.

10 Day Trial—Easy Terms

Send today for complete details and FREE illustrated literature fully describing the new 1931 "Delta" line of woodworking units. You will learn also how you can try any "Delta" equipment for 10 days under actual working conditions—AT OUR RISK. Choice of three convenient Easy Payment Plans. Write TODAY!

DELTA SPECIALTY COMPANY

Division of Delta Mfg. Company
3775 N. Holton St. Dept. A. 331, Milwaukee, Wis.

OTTAWA LOG SAW



only \$39
GREATEST OFFER EVER MADE
Make Money! Wood is valuable. Saw 15 to 20 cords a day. Does more than 10 men. Ottawa, easily operated by man or boy. Falls trees—saves limbs. Use 4-hp. engine for other work. 30 DAYS TRIAL. Write today for FREE book. Shipped from factory or nearest of 4 branch houses.
OTTAWA MFG. CO., 1741-W Wood Street, Ottawa, Kansas

AUTO RADIO

Long Distance Receiver

Amazing Low Price!
Quality Performance

Six tube triple screen-grid, using 3-224, 2-227, and 1-245 power tube. Easy to install. Will fit any car. Single dial control. We guarantee that this set will pull in stations within a radius of 1000 miles and that it will deliver the volume and tone qualities of an electric set, or your money will be refunded. Order TODAY

PRICE OF SET ONLY \$20.00

Price complete including tubes, batteries, dynamic speaker and suppressors, \$39.50. Send \$5.00 deposit with order balance C. O. D. On foreign orders remittance in full required.

CHAS. HOODWIN CO. Successors to Aero Products, Inc.
4240 Lincoln Ave., Dept. H-20, Chicago, Ill.



\$20

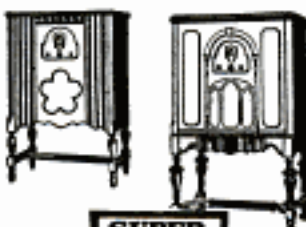

SUPER
Screen
Grid
\$49.88
Complete
less tubes

All
styles of
latest
cabinets

FREE! Send for BIG SPECIAL OFFER—No obligation.
Midwest Radio Corporation
1114 Successful Year
107-DA
Milwaukee Dept., Cincinnati, Ohio

TRY IT
30 DAYS FREE
BEFORE YOU BUY

Factory to you. Save to 50% on latest Screen Grid Electric or Battery Radio. Get 'Send No Money' Offer.

MIRACO Radio

Amazing bargains direct from big, old reliable factory. Don't buy unless 30 days' use proves entire outfit unbeatable at up to twice our price for tone, selectivity, distance, power. 1 yr. guar.

FREE! Send for BIG SPECIAL OFFER—No obligation.
Midwest Radio Corporation
1114 Successful Year
107-DA
Milwaukee Dept., Cincinnati, Ohio



BUILD MODEL SHIPS OF THE BETTER KIND

Special construction sets and all sorts of separate parts, blueprints, books, etc., for models of Flying Cloud, Constitution, U. S. Destroyer, Spanish Galleon, Baltimore Clipper and many others. Sets for \$2.25 up. Large 56-page photographically illustrated ship model booklet and catalog sent postpaid upon receipt of 15c (coin).

MODEL SHIP SUPPLY CO., Dept. J, Mineola, N. Y.

30 Days' Free Trial on all MEAD Bicycles

New RANGER Models now ready for delivery direct from our factory. Astonishing new prices and terms. Do not buy until you get them. RIDER AGENTS WANTED to ride and exhibit samples. Save big money. Many models, styles.

Tires wheels, lamps, horns, equipment at half normal prices. Easy Payments. Write for our marvelous prices and terms.

MEAD CYCLE COMPANY Write us today for free catalog
DEPT. K111 CHICAGO



RAISE CHINCHILLA AND NEW ZEALAND WHITE FUR RABBITS

Make Big Money We Supply Stock AND CONTRACT FOR ALL YOU RAISE paying up to \$0.50 each. Large illustrated book, catalog and contract, also copy of Fur Farming Magazine, all for 10c. STAHL'S OUTDOOR ENTERPRISE CO., Box 141A, Holmes Park, Missouri

POLICE DEPARTMENTS EVERYWHERE

endorse new mystifying human-like auto-alarm, making stop thief "SHOUTS" when car is touched. Crowds marvel at it. Agents cleaning up to \$25 daily. Exclusive territory. Free sample. Write ALLIED INDUSTRIES, Inc., Dept. 416, Garver Bldg., Des Moines, Ia.

Get Into A Business of Your Own—EARN \$150 to \$300 Monthly



AUTOMATIC AIR SERVICE

Dependable, space saving compressors being customers to your door. Only \$12 Monthly. 30 Days' Trial.



PAINT SPRAY PROFITS

Paint autos, houses, furniture. One man does work of 2—highly profitable. Only \$12 Monthly, will pay its own way.



8-HOUR BATTERY CHARGING

Recommended by leading battery makers. Halves cost, doubles profits. No special experience required.



20 MINUTE Car Washer

Big profits washing cars—saves 2/3 time, does better job. Save \$49.95 for \$17 Monthly.

30 Days' Trial, to prove it. Easy Terms.

Check items of interest and mail to
HOBART BROTHERS
Box M-81, Troy, Ohio

WRITE TODAY » Only \$16 Monthly — 30 Days Trial to Prove it « NO OBLIGATION



EASY TO PLAY

ANYONE who can whistle a tune can learn quickly on a Conn. Conns are the choice of Sousa and the world's greatest artists. Many exclusive features. Yet they cost no more.

FREE Trial, Easy Payments make purchase easy. Write for free book on your favorite instrument. Full of interesting facts. Illustrates latest models. Mention instrument. C. G. Conn, Ltd. 831 Conn Bldg., Elkhart, Indiana

Part Time Men Get This FREE SUIT PLAN

CASH PROFITS ALSO

To introduce our new amazing values, classy styles and perfect tailoring, we make this introductory free suit offer—something different, better, bigger, more liberal than any other offer ever made. **Prices slashed. Amazing values.** Two-piece suits, made to order at \$17.75 and up, with fit and satisfaction fully guaranteed. **\$45.00 A WEEK AND MORE.** Besides, big cash profits come easy for you. No experience needed, we show you how. Costs you nothing to get started. Our selling outfit is FREE. Write at once for our FREE SUIT OFFER and Cash Profit Plan.

PROGRESS TAILORING CO.,
Dept. H-216 Chicago, Ill.

Big free Outfit

AGENTS 500% PROFIT

GENUINE GOLD LEAF LETTERS

S guaranteed to never tarnish. Anyone can put them on stores and office windows. Enormous demand, large profits. Paul Clark says: Smallest day \$28.70. R. L. Reel made \$920 in two months. Write today for free sample and liberal offer to general agents.

METALLIC LETTER CO., 433-B N. Clark St., CHICAGO

Pick up \$5.00 a Day

SELL GUM and MINTS TO STORES

Build a steady, repeat business with candy stores, druggists, restaurants, groceries, barbecues, cigar stores, etc., on our popular flavors and novel packages. Liberal commissions; no deliveries or collections to make. Write for special starting outfit.

HELMET GUM CO., Dept. 324 CINCINNATI, OHIO

Cal. 30-40 Six Shot



KRAG CARBINE

All the qualities of a high price rifle. In fine used condition, all working parts guaranteed for one year. Send today for our free 60-page illustrated catalog of money saving values; Guns, Ammunition, Cutlery, Sports and Gov't goods.

Deposit required on all orders. Money refunded if not satisfactory.

W. Stokes Kirk, Dept. P. M.-8, 1627 N. 10th St., Phila., Pa.

Price **\$9.75**

MOTORCYCLES

WONDERFUL BARGAINS

Can be purchased through our co-operative plan for as low as \$1.00 per week.

Indians Harley-Davidsons Ace and Henderson

Send ten cents for Bulletin A. Motorcycles shipped to all parts of the world.

WALKER-INDIAN CO., 1209 Baylston St., BOSTON, MASS.

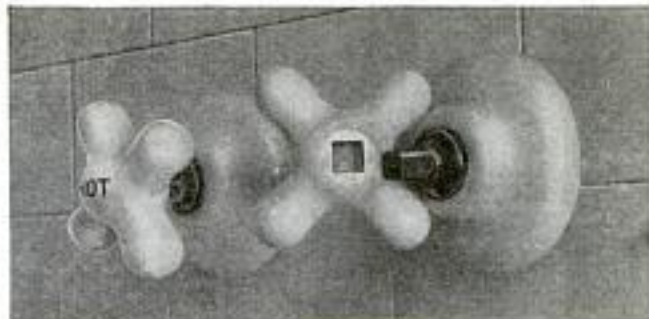
Porcelain handles will STAY tight if set with SMOOTH-ON No. 1

TO make porcelain handles tight on bath tub and wash bowl faucets, and on sink and flush tank pulls, fill the hole in the handle with a soft putty of Smooth-On No. 1, and then force the handle onto its spindle. Once the Smooth-On hardens, it becomes solid metallic iron, which will keep the handle tight for all time. You yourself can make this repair equal to a professional job and at a cost of only a few cents.

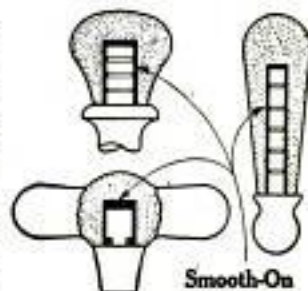

Keep Smooth-On handy and you can save much money on such repairs as: Stopping leaks in steam,

water, gas, oil or stove pipes, mending cracks, breaks or leaks in furnaces and boilers, radiators, tanks, sinks, pots and pails, making loose handles tight on umbrellas, knives, hammers, brushes, drawers, etc., tightening loose screws, hooks, locks, door knobs, etc.

Use it also on your car for making cracked water jackets and pumps good as new, stopping leaks in radiator, hose connections, gas tanks and gas, oil and exhaust lines, making a fume-proof joint between exhaust pipe and tonneau heater, tightening loose headlight posts, keeping grease cups, hub caps and nuts from loosening, etc.



Write for FREE BOOK



Get Smooth-On No. 1 in 7-oz., 1-lb. or 5-lb. tins at any hardware store or if necessary direct from us. If you want us to send a sample 7-oz. can, enclose 35 cts. in stamps when you return the coupon.

SMOOTH-ON MFG. CO.
Dept. 37, 574 Communipaw Ave.
JERSEY CITY, N. J.

Do it with SMOOTH-ON

SMOOTH-ON MFG. CO., Dept. 37,
574 Communipaw Ave., Jersey City, N. J.

Please send the free Smooth-On Repair Book.

Name.....

Address.....

8-31.....

PATENT

Protect Your Ideas

Take the First Step Today

If you have a useful, practical, novel idea for any new article or for an improvement on an old one, you should communicate with a competent Registered Patent Attorney AT ONCE. Every year thousands of applications for patents are filed in the U. S. Patent Office. Frequently two or more applications are made for the same or substantially the same idea (even though the inventors may live in different sections of the country and be entirely unknown to one another). In such a case, the burden of proof rests upon the last application filed. Delays of even a few days in filing the application sometimes mean the loss of a patent. So lose no time. Get in touch with me at once by mailing the coupon on the opposite page.

Prompt, Careful, Efficient Service

This large, experienced organization devotes its entire time and attention to patent and trade mark cases. Our offices are directly across the street from the U. S. Patent Office. We understand the technicalities of patent law. We know the rules and requirements of the Patent Office. We can proceed in the quickest, safest and best ways in preparing an application for a patent covering your idea. Our success has been built on the strength of careful, efficient, satisfactory service to inventors and trademark owners located in every state in the Union.

NO CHARGE for Information On How to Proceed

The booklet shown here contains valuable information relating to patent procedure that every inventor should have. And with it I will also send you my "Record of Invention" form on which you can sketch your idea and establish its date before a witness. Such evidence may later prove valuable to you. Simply mail the coupon and I will send you the booklet, and the "Record of Invention" form, together with detailed information on how to proceed and the costs involved. Do this NOW. No need to lose a minute's time. The coupon will bring you complete information entirely without charge or obligation.

My Offices
Just Across
Street From
U.S. Pat. Office



Above is a view of my drafting and specification offices where a large staff of experienced experts are in my constant employ. All drawings and specifications are prepared in my offices.

INVENTORS

Write for these **Free Books**

Strict Secrecy Preserved

All communications, sketches, drawings, etc., are held in strictest confidence in strong, steel, fireproof files, which are accessible only to authorized members of my staff. Feel free to write me fully and frankly. It is probable that I can help you. Highest references. But **FIRST**—clip the coupon and get my free book. Do **THAT** right now.

Clarence A. O'Brien

Registered Patent Attorney

Member of Bar of: Supreme Court of the United States; Court of Appeals, District of Columbia; Supreme Court, District of Columbia; United States Court of Claims.

Practice confined exclusively to Patents, Trademarks and Copyrights



Clip this Coupon and Mail it Now!

CLARENCE A. O'BRIEN, *Registered Patent Attorney*
70-K Security Savings and Commercial Bank Bldg.
Washington, D. C.

(Or, Suite 1106, Dept. A-14, Woolworth Bldg., New York City)

Please send me your free book, "How to Obtain a Patent," and your "Record of Invention" form without any cost or obligation on my part.

Name.....

Address.....

(Important—Write or print name plainly and address office nearest you)

PATENTS TRADE MARKS COPYRIGHTS

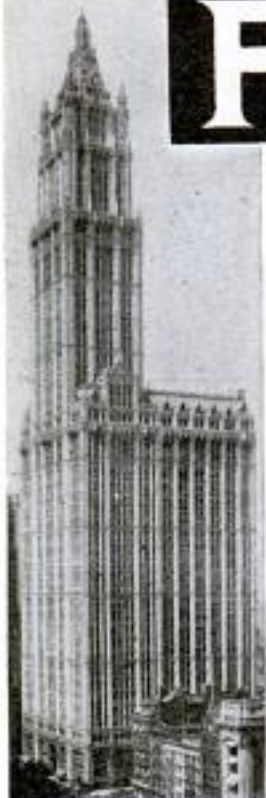

Our New York Office
Suits 1007 Woolworth Bldg.



Our Philadelphia Office
828 Fidelity Phila. Trust Bldg.



VICTOR BUILDING
Our New Building Nearly Opposite U. S. Patent
Office Specially Erected by Us for Our Own Use



Have You An Idea?

Our Offer: FOR THE PROTECTION OF YOUR INVENTION

YOUR FIRST STEP—The Inventor should write for our blank form "RECORD OF INVENTION." A sketch and description should be made on this Blank, signed, witnessed, then returned to us. **We also give our opinion** as to whether the invention comes within the Patent Office definition of a patentable invention. This "Record of Invention" will serve as "proof of conception." *There is no charge or obligation for this service.*

Our Five Books Mailed Free to Inventors
Our Illustrated Guide BOOK

How to Obtain a Patent
Contains full instructions regarding U. S. Patents. Our Methods, Terms, and 100 Mechanical Movements illustrated and described.

Our Trade Mark Book
Shows value and necessity of Trade Mark Protection. Information regarding *Trade Marks and unfair competition in trade.*

Our Foreign Book
We have Direct Agencies in Foreign Countries, and secure Foreign Patents in shortest time and lowest cost.

Progress of Invention
Description of World's Most Pressing Problems by Leading Scientists and Inventors.

Payment of Fees in Installments
It is not necessary that the total cost for the preparation and prosecution of a patent be paid in one payment. Our custom is to permit our clients to pay for their applications in three installments as the preparation of the application progresses in our office. This plan makes the payments easy for the inventor.

We Regard a Satisfied Client as our best advertisement, and furnish anyone, upon request, lists of clients in any state for whom we have secured patents.

Highest References—Prompt Service
—Reasonable Terms

VICTOR J. EVANS & CO.

Patent Attorneys, Established in 1898
Main Offices: 789 9th St., N. W., Washington, D. C.
Nearly Opposite U. S. Patent Office

DELAYS ARE DANGEROUS IN PATENT MATTERS

IMPORTANT! To Avoid Delay!

YOU SHOULD HAVE YOUR CASE MADE SPECIAL IN OUR OFFICE to save correspondence, secure protection and early filing date in the Patent Office. To secure **special preparation** of your case send \$25.00 on account with model or sketch and description of invention. If the invention is not patentable we will return fee less cost of search.

We Assist our Clients to Sell their Inventions.



Our Chicago Office
Suite 1640-42 Conway Bldg.



MAIN OFFICE, VICTOR J. EVANS & CO.—VICTOR BUILDING, WASHINGTON, D. C.

Our Large, Comprehensive Organization has been established for 30 years and offers Prompt, Efficient and **Personal Service** by experienced Patent Lawyers and Draftsmen. Every case is in charge of a Specialist who has been selected for his knowledge and experience in certain lines of invention. Our Lawyers practice in all U. S. Courts and defend clients in suits involving Patents, Trademarks and Copyrights. All Communications, Sketches, Drawings, etc., preserved in fireproof Files, strictly **Secret and Confidential**. We shall be glad to have you consult us or to answer any questions in regard to Patents, Trademarks or Copyrights without charge or obligation.



Our Pittsburgh Office
Suite 514 Empire Building



Our San Francisco Office
Suite 1010 Hobart Building

**FREE
COUPON**

VICTOR J. EVANS & CO.
PATENT ATTORNEYS *Established
in 1898*

NEW YORK OFFICES
1007 Woolworth Bldg.

CHICAGO OFFICES
Suite 1640-42 Conway Bldg.

PHILADELPHIA OFFICES
825 Fidelity Phila. Trust Bldg.

PITTSBURGH OFFICES
514 Empire Bldg.

SAN FRANCISCO OFFICES
1010 Hobart Bldg.

MAIN OFFICES: 789-9th Street, N. W., WASHINGTON, D. C.

Gentlemen: Please send me *Free of Charge* your books as described on preceding page.

Name.....

Address.....

PATENTS SECURED TRADE-MARKS REGISTERED

High-class professional service for Inventors and Trade-Mark Users is necessary for PROPER PROTECTION. We Offer you our facilities on Reasonable Terms. If you have an invention send us a model or sketch and description and we will give you our OPINION whether your invention comes within the provisions of the Patent Laws. Our book, "HOW TO GET YOUR PATENT" and Record of Invention Certificate sent on request. DELAYS are DANGEROUS in Patent Matters.

Terms Reasonable.

Best References.

..... WRITE TODAY

RANDOLPH & COMPANY, Patent Attorneys
301 VICTOR BUILDING, WASHINGTON, D. C.

Name.....

Address.....

PATENTS

PROTECT YOUR IDEAS

Write today for FREE BOOKLET, HOW TO OBTAIN A PATENT and RECORD OF INVENTION—or send Drawing or Model of your Invention for Examination.

Promptness Assured with Best Results

MILLER & MILLER REGISTERED PATENT ATTORNEYS

Former Members Examining Corps U. S. Patent Office
Dept. A-1006 Woolworth Bldg. New York
255 McGill Building Washington, D. C.

PATENTS

TO THE MAN WITH AN IDEA

Preliminary advice gladly furnished without charge. Booklet of information and form for disclosing idea free on request.

IRVING L. McCATHRAN, Patent Lawyer

Formerly with and successor to RICHARD B. OWEN
750 International Bldg. Washington, D. C.
41-E Park Row New York City

TRADE-MARKS

PATENTS—TRADE MARKS

All cases submitted given personal attention by members of the firm. Information and booklet free. Patent Office & Federal Court Practice.

LANCASTER, ALLWINE & ROMMEL
PATENT LAW OFFICES
480 Ouray Bldg. Washington, D. C.

TRADE
MARKS

PATENTS

COPY-
RIGHTS

BEST RESULTS. LOWEST FEES. PARTIAL PAYMENT PLAN

Write today for free information—No obligation, sending sketches and description of invention.

HARRY W. JOHNSON

Registered Patent and Trade Mark Attorney
FORMERLY MEMBER EXAMINING CORPS U. S. PATENT OFFICE
Member of the Bars: Supreme Court of the District of Columbia, The Court of Appeals of the District of Columbia, and the U. S. Court of Customs and Patent Appeals.

219 McGill Building, Washington, D. C.

INVENTORS

who derive largest profits know and heed certain simple but vital facts before applying for Patents.

Our book *Patent-Sense* gives those facts; sent free. Write LACEY & LACEY, 635 F Street N. W., Dept. 5, Washington, D. C. Estab. 1869.



AN EASY
WAY TO

SHAPE your NOSE

Anita Nose Adjuster shapes flesh and cartilage—quickly, safely, painlessly, while you sleep or work. Lasting results. Gold Medal Winner. Doctors praise it. 87,000 users. Write today for FREE BOOKLET.

ANITA INSTITUTE, H-12 Anita Bldg., Newark, N. J.



BOW LEGS?

THIS GARTER (Pat'd)
Makes Trousers Hang Straight
If Legs Bend In or Out

Free Booklet—Plain Sealed Envelope

THE T. GARTER CO., Dept. E
South Bend, Ind.



BUCHSTEIN'S FIBRE LIMB

is nothing to your stump—strong, cool, neat, light. Easy payments. Braces for all deformities.

Send for Catalog Today

D. BUCHSTEIN CO., 610 3rd Ave., St. MINNEAPOLIS, MINN.

PATENTS

Booklet Free

Highest References

Promptness Assured

Best Results

Send drawing or model.

ALL BUSINESS GIVEN PROMPT AND PROPER ATTENTION

Listed Patent Lawyer in the latest editions of the Rand-McNally Directory of Bankers and Bank-Recommended Attorneys, published by Rand-McNally & Co., Chicago, Ill.; The Baggott & Ryall Directory of Guaranteed Attorneys, published by Legal Directory Corporation, Boston, Mass.; Flugel's Law List, published by Legal Directory Publishing Co., St. Louis, Mo.; American Lawyers Annual, published in Cleveland, Ohio; Bankers Service Legal Directory, published by Bankers Service Co., Boston, Mass.; Eyre's Law List, 9 Park Place, New York City; Walters Legal Directory, Omaha, Nebraska, and the National Directory of Attorneys, Baltimore, Maryland.

WATSON E. COLEMAN,
REGISTERED PATENT LAWYER

Victor Building, 724 Ninth Street, N. W.
WASHINGTON, D. C.



NEW HOME OF HEATH

Greater Production—Greater Value!

May First was moving day for Heath too. Settled in its new large plant in Niles, Michigan, Heath now has greater production space which means greater values with the same fine quality, performance and reliability. Heath guarantees to continue its leadership in the light plane field—leadership based on 22 years' experience; leadership which enables you to fly Heath planes for 1c per mile with a surprisingly low first cost!

HEATH AIRCRAFT CORPORATION
Dept. P-8 NILES, MICHIGAN

EASY TO MAKE MONEY

in your spare time by building these miniature models of Ships, Coaches or Spinning Wheels—We supply all parts, easy to put together with full instructions and diagrams. Ready market and steady demand from gift shops and others at a good profit—Send 2 cent stamp for illustrated catalogue.

MINIATURE SHIP MODELS, INC.
Dept. RT PERKASIE, Pa.

Canadian office, 90 King Street W. Toronto



Build your own outboard hydroplane motor or sail boat. Use our plans or knock-down frames and machined parts. Many models to select from. Write for new catalog. Please enclose 10c for catalog.

J. B. WELCH, Inc., Dept. B, 3211 No. 41st St., Milwaukee, Wis.

YOU Can Be A MASTER CRAFTSMAN

Earn BIG MONEY now at home in spare hours, turning out beautiful, expert woodwork. Never before such a demand for small items as garden furniture, breakfast nooks, book ends, etc. Easy to make and do with H. & A. equipment. Portable. Electric. Plug in any 110 volt outlet. Durable, accurate, dependable. Preferred by builders everywhere. Machines for every home and commercial shop, lathe, band saw, rip saw, etc. Low prices. Send now for FREE catalog. Special offer to retail dealers and jobbers.



H & A WOOD LATHE

HESTON & ANDERSON, 608 Stone St., Fairfield, Iowa

New Food Idea Pays Big Profits!

Men! Women! Investigate the wonderful NEW Brown Bobby GREASELESS Doughnut. Sells like wildfire! You can easily make \$50 week spare time: \$5000 to \$8000 year full time. Investment small. No experience needed. Write today for big special offer. Food Display Machine Corp., Dept. 3-H, 600-510 N. Dearborn St., Chicago

AERO WORLD-WIDE

Only \$6.45 Short Wave Receiver

Span the World with this Set!

A new radio thrill for you! Listen in DIRECT to London, Paris, Berlin, Buenos Aires and other broadcasting stations throughout the world via short waves. Enjoy unique foreign programs from strange lands. Your ordinary receiver cannot tune in these low wave stations. WORLD-WIDE RECEIVER gets 14 to 550 meter stations with surprising clarity. **SEND NO MONEY!** Just write your name and address on a postcard and ask us to send you this wonderful guaranteed short wave set. Pay postman \$6.45 plus a small delivery charge. All orders west of Rockies must be accompanied by \$1.00 deposit. Foreign countries \$7.75 delivered. Write today for new catalog of radio bargains.

CHAS. HOODWIN CO., Successors to Aero Products, Inc.
4240 Lincoln Ave., Dept. H,2 CHICAGO

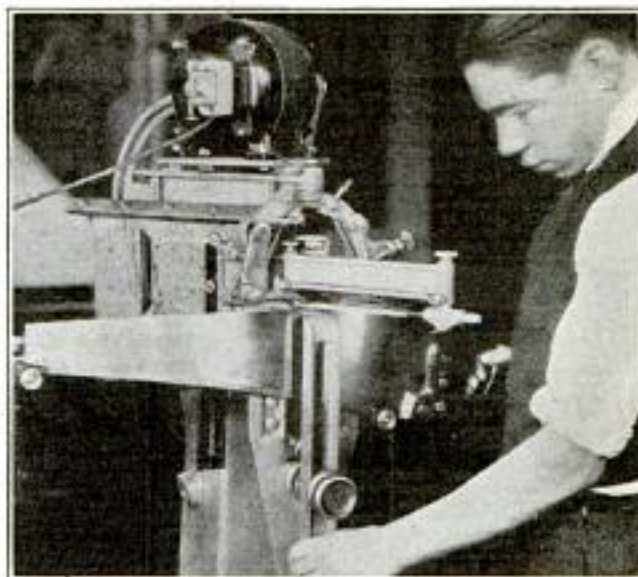

YOU can do it, too!

\$2 to \$3 an Hour can easily be made in your own cash business, in small towns and big cities . . . filing all kinds of saws perfectly on the quick, accurate Foley Automatic Saw Filer.

C. M. Howland reports, "In 1929 I filed 989 saws and in 1930 I filed 1525 saws and did my other work as school engineer. I file all kinds of saws and nearly everything on the Foley. As for filing a saw better by hand than on a Foley, I don't think it can be done. A Foley is hard to beat for all kinds of saws."

FOLEY AUTO SAW FILER

Many men have started in spare time and built up a big paying, permanent cash business. You can do it, too. No experience necessary. Just follow a few simple instructions and the Foley Automatic Saw Filer does the rest.

No Canvassing

Our Free Plan tells how to get started. There is plenty of saw filing business waiting for you . . . from carpenters, factories, meat shops, schools, print shops, etc. The Foley files all kinds of hand saws, crosscut circular saws and band saws with mechanical precision, better than expert hand filing. Sold on easy payments.

Act now get into business for yourself. Fill out and mail coupon today.

Foley Mfg. Co.

216 Foley Bldg., 11 Main St. N. E.
Minneapolis, Minnesota

Please send **FREE PLAN** on how I can have my own Cash Business with the Foley Automatic Saw Filer.

Name

Address

If you would also like information on Foley Key Machine, check here

Mail Coupon for **FREE PLAN**



LUMINOUS PAINT

Make Your Watches, Clocks, Etc., Visible by Night

The very latest discovery in the scientific world, Licharto, practically unobtainable except at an exorbitant price, we have at last succeeded in producing this remarkable LUMINOUS PAINT, which, applied to the surface of any article, emits rays of white light, rendering it perfectly visible in the dark. THE DARKER THE NIGHT, THE MORE BRILLIANT IT SHOWS. Quite simple to use. Anyone—yes, even you—can do it. A little applied to the dial of your watch or clock will enable you to tell the time by night. You can put the luminous dots or watch plates of your electric lights, match boxes, and innumerable other articles; make your own Luminous Crucifixes, Luminous Rosaries, etc. Small bottle, price 25c. Larger size, 50c and \$1 postpaid. **JOHNSON SMITH & CO., Dept. 817 RACINE, WIS.**



CIGARETTE MAKER

Roll your own and save money. Better and cheaper than any other. Use your favorite brand of tobacco. Neat, useful, handy. Pocket size, weighs 75 gm. Made entirely of metal. Nickel plated. 25c, 3 for 65c.



Exploding Cigarettes

Box contains ten genuine cigarettes of excellent quality. They appear so real, but when each cigarette is about one-third smoked, the victim gets a very great surprise as it goes off with a loud BANG! A great mirth provoker yet entirely harmless. Price 25c box.

GOOD LUCK RING

Very striking, quiet and uncommon. Silver finish; skull and crossbones design; two brilliant, flashing gems sparkle out of the eyes. Said to bring good luck. Only 25c per doz.

NOVELTY BADGES



Making Permit 10c. Garter Inspector 10c. Two very novel metal badges, nickel plated, that you can wear, giving you fun out of all proportion to their trifling cost. 10c, each badge, 3 for 25c, or 75c per doz. postpaid anywhere.

MIDGET BIBLE

GREAT CURIOSITY
Smallest Bible in the World. Size of a postage stamp. 200 Pages. Said to bring good luck to the owner. A genuine work of art. Must be seen to be appreciated. Make good money selling them to friends, church acquaintances, etc. PRICE 15c each, 3 for 40c, 12 for \$1.20, 100 for \$7.50. Also obtainable in leather binding, with gold edges. Prices 50c each, 3 for \$1.25, \$4.50 per doz. Magnifying Glass for use with Midget Bible 15c.

LEARN TO DANCE without a teacher. Book gives instructions in old and new dances: Foxtrot, Tango, One Step, Quadrille, etc., explained and illustrated. 25c postpaid.

STAGE MONEY

With a bunch of these bills, it is easy for each person of limited means to appear prosperous by flashing a roll of these bills at the proper time and peeling off a genuine bill or two from the outside of the roll, the effect created will be found to be all that can be desired. Prices, postpaid: 40 Bills 20c, 120 for 50c, or \$3.50 thousand postpaid.

NOSE FLUTE
The Magic Nose Flute, or Hornophone, is a unique and novel musical instrument that is played with nose and mouth combined. There is just a little knack in playing it which, when once acquired after a little practice, will enable you to produce very sweet music that somewhat resembles a flute. These Post Paid 10c is 20c Engraving, and once you have mastered it you can play all kinds of music with facility and ease. When played as an accompaniment to a piano or any other musical instrument, the effect is as charming as it is surprising.

STAR TOY MAKER

More fun than fighting with your wife. Look just like ordinary matches. As the victim tries to light one he gets quite a surprise. Price 10c per box, 3 boxes for 25c, 12 for 75c each.

STAR TOY MAKER

Greatest boys' book written. Tells how to make a Pinhole Camera, a Cannon, model Railroad, a Telephone, Boomerang, Telegraph Instrument, Box Kite, Talking Machine, Microscope, Electric Motor, Electric Door Bell, Water Wheel, Paddle Raft, a pair of Skis, a Dog Sled, Bird House, Rabbit Yard, etc. 64 pages, 150 illustrations. PRICE 50c.

BOY'S OWN TOYMAKER. A new book—Tells how to make chemical toys, electrical toys, galvanic toys, mechanical toys, paper toys, cardboard toys, boats, traps, etc. 200 illustrations. Price 25c postpaid.

AMATEUR ELECTRICIAN. All about electricity in simple language. How to make batteries, dynamos, motors, telephones, bells, electric bells, engines, lights, etc. Price 10c postpaid.

MONEY MAKING SECRETS. Golden opportunities for everyone. 64 pages, copyrighted book chock full of money-making ideas, recipes, formulas, tricks, trade secrets, etc. Shows you that one can be started with little or no capital at home in a spare time. 10c postpaid.

ROPE SPLICING. how to make different knots, stitches, splices. 32 pages. 100 illustrations. 20c postpaid.

125 CARD TRICKS and sleight of hand. Contains all the latest and best card tricks as performed by celebrated magicians, with exposure of card tricks used by professional gamblers. Price 25c postpaid.

MAGIC FOR AMATEUR MAGICIAN. Copying with cards, coins, etc.; experiments in magnetism, chemistry, electricity, etc. 25c.

HELLER'S BOOK OF MAGIC. Magic and its mysteries. Numerous simple parlor tricks explained and illustrated. 100 pages. 25c.

TRICKS & SOCIAL ENTERTAINER. Contains hundreds of simple tricks, illusions, diversions that anyone can do. Also explains secret of second sight. Price 25c postpaid.

83 OLD TIME SONGS. All old time favorites, sentimental, patriotic, sacred, etc., with words and full music. Price 25c postpaid.

WONDERFUL X-RAY TUBE

A wonderful little instrument producing optical illusions both surprising and startling. With it you can see what is apparently the back of your fingers, the lead in a lead pencil, the interior opening in a pipe stem, and many other similar things. Price 10c, 3 for 25c.

SERPENT'S EGGS

Box contains 12 eggs. When lit with a match, each one gradually hatches itself into a snake several feet long, which curls and twists about in a most life-like manner. Price per box. 10c postpaid, 3 for 25c.

BLANK CARTRIDGE PISTOL

Protection against Burglars, Tramps, & Dogs



Well made and effective, modified on latest type of Revolvers appearance alone is enough to scare a burglar. When loaded it may be as effective as a real revolver without danger to life. It takes standard 22 Cal. Blank Cartridge—obtainable everywhere. Special cash with order offers 1 Superior quality Blank Cartridge Pistol, 100 Blank Cartridges, and our new \$50 page De Luxe Catalog of latest novelties; all for ONLY \$1.50. Shipped by Express only. Cannot go by Special Parcel. Extra Blank Cartridges 50c per 100. Special Holster (Cowboy Type) for pistol 50c. No C. O. D. shipments.

Combination Thrift Vault and Savings Bank

HAS REAL THREE NUMBER COMBINATION LOCK KEYLESS—CANNOT BE PICKED

Your money and valuables will be perfectly safe in this new Combination Thrift Vault and Savings Bank, because it has a real combination lock just like the regular Safes and Vaults. The lock requires three numbers to open it. There are over 54,000 different combinations. The lock is lock-proof. It cannot be opened by "interfering" for the combination because it operates exactly like the lock on a safe or vault. It is keyless in every sense of the word. No key is required. Once you learn the combination it can be opened in a moment or two. It takes coins of any size, currency, etc., or you can use it for storing jewelry and other valuable articles, and it keeps your private measurements, etc., from prying eyes. Coins and currency can be placed in the bank through the slot at the top, but the larger articles will necessitate opening the bank by means of the combination. PRICE with secret instructions for opening, \$1.50 ppd.



LOOK 35c LOOK Wonderful Instrument.

Greatest thing yet. Nine separate articles in one. Everybody delighted with it. Odd, Curious and interesting. Lots of pleasure as well as very useful. It is a double Microscope for examining the wonders of nature. It is also an Opera Glass, a Stereoscope, a Burning Lens, a Reading Glass, a Telescope, a Compass, a pocket Mirror, and a Laryngoscope—for examining eye, ear, nose and throat. It is worth all the cost to locate even one painful cinder in the eye. Folds flat and fits the pocket. Something great—you need one. Don't miss it. Sent by mail. Only 35c or 3 for \$1.00.



PISTOL CIGARETTE CASE

It looks like a deadly weapon, but it is merely a novel Cigarette Case. This clever contrivance has proved itself better than the real thing in many an awkward encounter. Great fun "sticking up" your friends. They squirm and protest it might be loaded. Pull the trigger and the slide flies open disclosing the cigarettes. Well made, light and compact. Weight only 2 ounces.

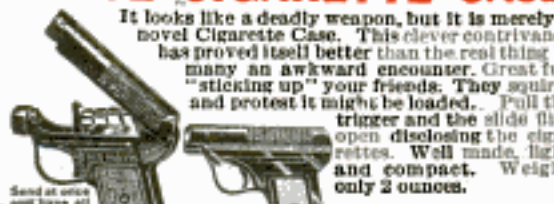

PRICE POSTPAID 25c

GYROSCOPE TOP

Spins in any position. Defies law of gravitation. The Gyroscope Top is a popular scientific toy that defies the law of gravitation. The illustrations above show a very few of the ways of spinning it. It can be thrown and caught, rotating rapidly all the time. It will travel about a taut string or wire. You can suspend it from a loop of string, still spinning vigorously. It will spin on the point of a pin, and will revolve in a dozen different ways on the pedestal. An effective feat can be performed by spinning the top at a high speed and quickly placing it into the square cardboard packing box. Put on the lid and then set the box on one of its corners. The box will spin around for quite a while, presenting a very curious appearance. It is a most satisfactory novelty, always interesting for the many amusing experiments which scientific and laymen can perform. Its scientific instruction is used to demonstrate the principle of rotation, attraction and equilibrium of bodies in motion, the center of gravity and centrifugal force. Placed on the pedestal it illustrates the relation of the globe better than any other mechanical device. Gyroscopes are used to steer torpedoes, steady ships, to stabilize monorail trains, and in aerial navigation. PRICE 35c



JOHNSON SMITH & CO., Dept. 817 RACINE, WIS.

LATEST CATALOG

Johnson Smith & Co. RACINE, WIS.

JOHNSON SMITH & CO.
Dept. 817 RACINE, WIS.
A De Luxe Edition of our new CATALOG mailed on receipt of 25c. Handsome binding. Bigger and better than ever. Only book of its kind in existence. Nearly 600 pages of all the latest tricks in magic, the newest novelties, puzzles, games, sporting goods, rubber stamps, unusual and interesting books, curiosities in seeds and plants, etc., unobtainable elsewhere. Remit by Cash, Money Order, Check or unused U. S., Canadian and Foreign Stamps for all articles listed above. See next page also.

BOYS! BOYS! BOYS!
THROW YOUR VOICE



Into a trunk, under the bed, under a table, back of the door, into a desk at school, or anywhere. You get lots of fun fooling the teacher, policemen, peddlers, and surprise and fool all your friends besides.



The Ventrilo

is a little instrument that fits in the mouth out of sight. Cannot be detected. It is used in connection with the above, and with the aid of this wonderful DOUBLE THROAT, or VENTRILLO, you can imitate many kinds of birds, animals, etc. Remember you get everything for ONLY TEN CENTS—a booklet giving you full instructions how to become a ventriloquist and throw your voice, the Double Throat, or Ventrilo, and our big catalog of novelties, tricks, puzzles, masks, books, etc.

All Sent Postpaid to Any Address for Only **10c**

INVISIBLE INK Rubber Chewing Gum

The most confidential messages can be written with this ink. For the writing makes no mark. Cannot be seen unless you know the secret. Available for many reasons. Keep your postals and other private communications away from prying eyes. Great fun for playing practical jokes. Only 15c a Roll; 3 for 45c.



It is just like a regular package of chewing gum and looks so real that it fools everybody. Of course no one suspects it is not genuine until they start to chew it. There's a world of fun in this rubber chewing gum—5 sticks to the package. Price, 10c Pkg.; 3 for 25c; 12 for the postpaid.

Rubber Tacks Box 10c
Rubber Cigars, Price Ea. 10c
Rubber Cigarettes, Price per Box, 20c
Rubber Matches. Price per Pkg. 10c

U. S. BABY TANK

It goes with real Yankee Pep—by its own power



Most remarkable toy ever patented. By drawing the tank backward, either with the hand or over the floor or table and then placing it down, it will crawl along, oversteering all obstacles, in the same life-like manner as the larva Tank that proved so deadly in the great war. What makes it go is somewhat of a mystery, for there is no mechanism to wind up as is usually understood with mechanical toys, yet this tank will keep plodding along ten times longer than the ordinary run of toys. It will perform dozens of the most wonderful stunts! 2 3/4 inches long. Price only 25c postpaid. Stamps accepted.

JOHNSON SMITH & CO.

ROLMONICA

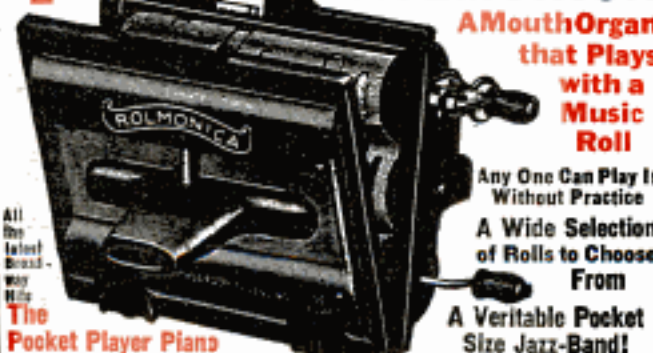

A Mouth Organ that Plays with a Music Roll

Any One Can Play It Without Practice
A Wide Selection of Rolls to Choose From
A Veritable Pocket Size Jazz-Band!

Rolmonica is an automatic harmonica, that plays a music roll just like a player piano. It is a whole brass band all in one—the biggest sensation of the musical world in the last few years. Anyone can play it, for all you have to do is to insert a roll, and turn the handle while you blow. That is all there is to it. Nothing could be simpler. Any child who can do these two simple things can play the Rolmonica. It is a veritable pocket size jazz-band, combining the principles of the harmonica and the player piano. It is an instrument of a thousand melodies, it plays the popular airs of the past, as well as the latest Broadway hits. There are hundreds of rolls to select from, such as My Blue Heaven, Home Sweet Home, American, Old Black Joe, Annie Laurie, Bideaway of New York, Homecoming, Wild Irish Rose, Boats O'Grady, Among My Souvenirs, Love's Old Sweet Song, Dixie, Mighty Lak' a Rose, Ramona, Jeannette, Rose Marie, Onward Christian Soldiers, Baby of My Dreams, Carolina Moon, I Saw Doves & Go Home, Wassy River, Over There, Ma Cherie, Long Way to Tipperary, Make Believe, Desert Song, La Paloma, Sweet Adeline, I've Got a Feeling, Fagan Love Song, When My Dreams Come True, Parade of Wooden Soldiers, Lord of Sleepy Water, Turkey in the Straw, Hail the Gang's All Here, and hundreds of others. An unending source of amusement. You can delight your friends for hours and play time after time simply by changing rolls. Small in size, fitting your pocket, yet mighty in its finger-ticking, toe-tingling tune power. Not a toy, but a genuine musical instrument and the life of any party. One Roll free with each Rolmonica. Extra Rolls always obtainable; complete list with each instrument. New Rolls added each month. PRICE with 1 Roll \$1.50; Extra Rolls 10c each, all postpaid. Send remittance (Postage Stamps accepted) for all articles listed above, also in our other ad on previous page.

THE DANDY PERISCOPE

Very Interesting and Amusing Novelty
SEE WITHOUT BEING SEEN



Look Over the Heads of the Tallest Men in a Crowd.

See Over a Fence, Around Corners, Etc.

LOTS OF FUN AND AMUSEMENT

Strongly Made. Equipped with Mirrors, Sight-Finder and Eye-Piece.

THIS is the same kind of instrument that the soldiers use in the trenches to watch the enemy without risk of being seen themselves, and every submarine has one to project above the surface of the sea to keep a lookout for other vessels, etc. With it you can gaze over a high wall or see around a corner without being seen yourself, or, if you are in a crowd, you can look right over the heads of the tallest men and watch all the fun. Our illustrations will give you some idea as to the numerous uses to which the Periscope can be put. Every Boy Scout should have one for spying and anyone else who wants some rare amusement. The Dandy Periscope is very strongly made, will stand the roughest handling and the hardest wear and with ordinary use should last a lifetime. It measures 17 inches long, and a little over two inches wide. The Periscope Tube is handsomely decorated with colored designs to show many of its uses, and each Periscope comes complete in box.

Price Postpaid to any Address. **\$1.00**

MAGICIAN'S BOX OF TRICKS

Apparatus and Directions for a Number of Mysterious Tricks, Enough for an Entire Evening's Entertainment. **\$1.00**
—ANYONE CAN DO THEM

It is great fun mystifying your friends. Get this Conjuror's Cabinet, and you will be the cleverest fellow in your district. It contains the apparatus for ten first-class tricks, including THE MAGIC BALL AND VASE TRICK (a wooden ball is placed inside, and upon replacing the lid has disappeared and is found in someone else's pocket); THE HIN DOO THICK CARDS (can be made to change completely in less than five times); DISAPPEARING COIN BOX (a coin, placed in the wooden box, vanishes entirely or changes into a coin of another denomination); THE GLASS GLOBE TRICK (a coin is dropped into a glass of water and when the water is poured out the coin has vanished and is found somewhere else); THE RIBBON FACTORY FROM THE MOUTH TRICK (a seemingly endless supply of colored paper ribbons comes out of your mouth); the DISAPPEARING HANDKERCHIEF (a handkerchief held in the hand mysteriously vanishes); the WIZARD'S RING COIN TRICK; the ENCHANTED BOTTLE (no one but yourself is able to make it lay down); the GREAT HAT AND DICE TRICK (a large die is placed on top of a hat, disappears, and is found underneath yet no one has touched the hat), and last, but not least, the GREAT PHANTOM CARD TRICK, or two from five leaves nothing. Full instructions are sent for performing each trick. In addition to the above, a number of other tests and illusions are fully explained for which you can even make up your own necessary apparatus. Price complete \$1.00 postpaid. JOHNSON SMITH & CO.

RESURRECTION PLANT

Great curiosity. Place in water, plant opens up and starts to grow in few minutes. Taken out it dries up and goes to sleep until put in water again. PRICE 10c, 3 for 25c. 75c per dozen, postpaid.



MADE EASY 250 MAGIC TRICKS 10c
An excellent little book containing 250 Party Tricks, tricks with cards, coins, handkerchiefs, paper, ribbons, glasses, etc. So simple that a child can perform them. Free postage. Best postpaid, to any address for only 10c, 3 copies for 25c.

The "Little Giant" Typewriter



A perfect little typewriter for \$1.50. There are thousands of persons who would like to use a typewriter but whose needs and business do not warrant the expense attached to the previous and use of a fifty or seventy-five dollar machine. To such persons we cordially recommend our Little Giant. It is strongly made, but simple in construction, so that anyone can quickly learn to operate it, and write as rapidly as they would with pen and ink. The letters of the alphabet most frequently used are so grouped as to enable one to write rapidly, the numerals 1 to 10, and the punctuation marks being together. With this machine you can send your best girl typewriter love letters; address envelopes, make out bills, and do almost any kind of work not requiring a large, expensive machine. With each typewriter we send a tube of ink and full printed instructions for using the machine. Price complete \$1.50 by mail postpaid to any address in the world. Stamps accepted.

JOHNSON SMITH & CO. Dept. 817 Racine, Wis.

STENODE

LICENSED APPROVED PARTS
FOR THE ONLY MODERN
RADIO RECEIVER

FOR INFORMATION WRITE

**ZEH BOUCK
LABORATORIES**

35-39 164th St. FLUSHING, N. Y.



*Wanted by a Million
Housewives*

A Cream Skimmer
that will work—surely, quickly
and easily. That is simple,
sanitary and effective.

CREME-OFF

Just drop Creme-off in a
bottle of milk and the cream flows off, it starts and stops
itself. It saves time and labor and prevents waste. Made
of sanitary aluminum, lasts a life time. 200% or more
profit to agents.

Territory going fast. Send 25c for 1 or \$1 for 6 to-day.

X-CEN-TRO PRODUCTS CO.
908—2nd Avenue So., Minneapolis, Minn.



Cools, soothes
**BURNING
FEET**
—in 3 seconds

SUFFER no longer with sore, ach-
ing, burning feet. Coolene brings
instant relief. This new ivory-white,
vanishing foot cream—with healing
oils and unguents—cools and soothes
the inflamed nerves and tissues—
relieves the congestion—brings glo-
rious foot comfort in 3 seconds. Get
Coolene today.

Save Nearly 1/2 on This New Model G-V. Rotary Compressor Type Electric Sprayer

**ONLY
\$24⁵⁰**

Regular Price \$39.50 for
This Nationally Adver-
tised Outfit

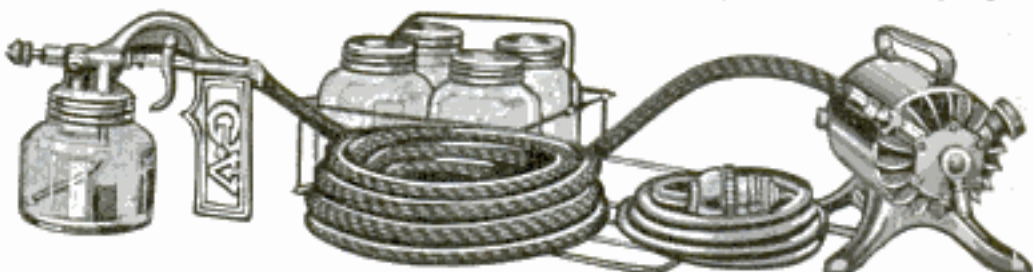

While they last we save you \$15.00 on the cost of these brand new
Nationally advertised Electric Spray Outfits. One of the best
outfits ever offered—use it for all kinds of paint, varnish and lacquer
—also for spraying insecticides and other solutions. Splendid and fast for Auto fenders,
bodies—for use in small shops, schools, factories. Paints anything, anywhere—gets
in all the corners. Six owners find it far superior to other outfits because of its speed.
G-V. units operate at highest efficiency on less than 1/3 pressure required for suction
type.

NATIONAL JOBBING & EXPORT CO.,

192 N. CLARK ST.,

DEPT. N.,

CHICAGO, ILL.

**BE YOUR OWN BOSS
MAKE BIG PROFITS**

The ELECTRIC CARPENTER
makes it easy to start a profitable business in your
home workshop. Do general repair work, make screens,
furniture, alterations. Not a boy. A complete planing
mill. Saw table. Mortiser, Lath, Shaper, Jointer,
Sander and Field-Over Band Saw. Ask for FREE Il-
lustrated Folder and "1001 Things to Make of Wood."
AMERICAN FLOOR SURFACING MACHINE CO.
524 South St. Clair St. Toledo, Ohio

**7 MACHINES
ALL IN ONE**

A. C. Electric Plants



ONAN A. C. PLANTS furnish the same
current as city service—110 volt, 60 cycle,
A. C. Operate Radios, Water Systems,
Refrigerators, all Household Appliances.

Sizes 500 to 2000 Watts
Available from stock. No battery used
except to start the engine. Ideal for farms,
camps and lake homes.

Also a complete line of D. C. Models.
D. W. ONAN & SONS
68 Royalton Ave. Minneapolis, Minn.

Big 3 ft. Telescope Five Sections. Brass bound.
Powerful Lenses. 10-Mile
range. Special Eye Piece for looking at the Sun, included FREE.
Can be used as a Microscope. Guaranteed. Big value. Postpaid.
\$1.75. C. O. D. 15c extra. **Benner & Company, 7-49, Trenton, N. J.**

NEW FOUNTAIN PEN- PENCIL WITH COMPASS

Guaranteed for life. Money Back if
not pleased. Sells for \$1.25.

Send Only
39c



Write for FREE
Wholesale catalog,
showing over 600 fast sellers.
SPORTS IMPT. CO.
631 Main St., Le Center, Minn.

ROPP'S COMMERCIAL CALCULATOR

**Mathematics Made Easy by
ROPP'S CALCULATOR
AND SHORT-CUT ARITHMETIC**

Shows the Answer as Quickly
as a Watch shows the Time to all
Problems likely to occur in the
Office, Store, Shop, Bank, Farm,
or Factory.

Over 2,000,000 Sold
Explains and simplifies every
Principle in Arithmetic, Mechanics,
and Mensuration.

PRICES POSTPAID

Desk Size, Flexible Keratol Bind-
ing.....\$2.00
Pocket Size, Art Leather Bind-
ing.....\$1.00
Pocket Size, Cloth Binding, \$0.50

POPULAR MECHANICS PRESS
Room 78 200 E. Ontario St. CHICAGO

Books on Many Practical Subjects

Popular Mechanics Press specializes in supplying the outstanding best books on many subjects. As new books of merit appear, we will revise the list accordingly.

- ARCHERY**
Simplified.....\$2.00
- ARCHITECTURAL**
Design and Lettering...\$2.00
- ARMATURE WINDING**
Excellent new book.....\$2.00
- ATLAS**
New 1930
Census Edition.....\$2.50
- AUTO ENCYCLOPEDIA**
Dyke's. (Covers New
Model A Ford).....\$6.00
- BIRD HOUSES**
How to Make.....\$1.00
- BLUE PRINT READING**
For Building Trades...\$1.25
- BOAT BUILDING**
New Edition of Popular
Mechanics book.....\$3.00
- BOY MECHANIC**
Famous 4 Vol. Library.
4000 Things to Make...\$7.00
- BUILT-IN FURNITURE**
Complete Instructions...\$2.50
- CALCULATOR**
Mathematical Ropp's...\$1.00
- CARBURETORS**
Excellent book on all
makes.....\$2.00
- CARPENTRY**
Hand book of 336 Kinks...\$1.50
- CHALK TALK**
How to.....\$1.00
- COLOR SIMPLIFIED**
Practical new Book (for
Color Users).....\$3.50
- CONCRETE**
173 Ways of Using
New Edition (Cloth)...\$1.00
- CONTRACT BRIDGE**
at Sight.....\$1.00
- DOGS**
Care and Raising.....\$2.00
- ELECTRICITY**
for Beginners.....\$1.50
- ELECTROPLATING**
Practical Results Easily
Obtained.....\$1.00
- ENGLISH**
Self-improvement in...\$1.60
- ETIQUETTE**
New 560-Page Book.
Only.....\$1.00
- FARMER'S BOOK**
of 861 Kinks and Book
for Farmers' Wives...\$1.00
- FLYING**
Simplified.....\$1.00
- FORMULAS**
10,000 Money Making...\$4.00
- FURNITURE (Mission)**
Homemade (3 vols.)...\$3.00
- GARDENS**
1001 Questions An-
swered.....\$2.00
- GLASS**
Working.....\$1.75
- GLIDING**
A B C of.....\$2.00
- HOME REPAIRS**
Practical Book of.....\$2.50
- IGNITION**
(High Speed) For
Garage Mechanics...\$3.50
- INVENTION**
Popular History of
American.....\$1.00
- JOINT WIPING**
(New Edition).....\$1.00
- KITES THAT FLY**
How to Make.....\$1.25
- LANDSCAPING**
Practical.....\$2.50
- LATHE WORK (METAL)**
and Drilling and Thread
Cutting.....\$1.00
- LETTER WRITING**
Social and Business
Only.....\$1.00
- LETTERING**
Modernistic.....\$2.00
- MACHINIST**
Complete, Practical...\$3.00
- MAGIC**
200 New Tricks for Am-
ateurs.....\$1.00
- MAKE IT YOURSELF**
900 Different Things to
Make.....\$3.00
- MARKETING BY MAIL**
Science of.....\$2.00
- MATHEMATICS**
Made Easy for the Prac-
tical Man.....\$1.50
- MECHANICAL DRAWING**
Practical Course in...\$1.00
- MODEL AIRCRAFT**
Building and Flying...\$2.25
- OUTDOOR OPPOR-
TUNITIES**
for Making a Living...\$2.00
- OUTDOOR SPORTS**
for All Year 'Round
New Edition.....\$2.00
- PAINT SHOP PRACTICE**
New, very complete...\$5.00
- PAINTING**
House (Best Methods)...\$2.00
- PLUMBING**
500 Plain Facts for
Every Homeowner...\$1.50
- POULTRY RAISING**
for Profit.....\$2.00
- PUZZLES**
Amusing Mathematical...\$1.50
- RABBITS**
For Food and Fur...\$2.00
- ROOF FRAMING**
Made Easy.....\$1.50
- SHOP NOTES**
6 Vols. of 2200 Valu-
able Kinks.....\$2.98
- SLIDE RULE**
How to use.....\$1.75
- SPEECH**
and a Story for Every
Occasion.....\$2.00
- STAMP ALBUM (Modern)**
12,000 Varieties.....\$1.50
- STEEL SQUARE**
Pocket Book, Practical...\$1.00
- STORAGE BATTERIES**
(New work) Best
on subject.....\$3.00
- TOY MAKING**
Complete Instructions...\$1.50
- WALL DECORATION**
(Interior) Newest
Methods.....\$4.00
- WHITTLING**
The Art of.....\$1.35
- WIRING**
House (New Book)...\$2.50
- WOOD TURNING (LATHE)**
Practical Course in...\$1.50
- WOODWORKING SHOP**
Modern Motor-Driven...\$1.00

Books sent C. O. D. anywhere in U.S.

Just check the books you want, write your name and address below, and mail the advertisement. It is your order blank. When post-man hands you books, pay him the price and few cents postage. If outside the U. S. remit when ordering and include 10 cents per book extra for postage. We have many other books on these and 2,000 other subjects. Catalog free.

Name.....

City..... State.....

Address.....

Mail to Popular Mechanics Press,
Room P8—200 East Ontario St., Chicago, Ill.



**Buy Direct
at New
Low Prices**

Never Before Have
Fine Watches Been
Offered at Such
Low Prices

Save 30% to 50% by
Buying NOW

In addition to our NEW LOW PRICE, I will send for your approval one of these Standard Watches, guaranteed for a lifetime of satisfactory service—WITHOUT ONE PENNY DOWN—allow you to wear it 30 days FREE—then sell it to you on easy payments. Write for catalog.

DIAMOND RINGS

Write for our new Diamond Ring and Wrist Watch Catalog, showing marvelous new designs. Think of it—beautiful diamond rings and artistic dependable watches at cut prices. Catalog is sent FREE.

Ask for our Special Spot Cash Offer. Good for 30 days only.

SANTA FE WATCH CO.
86 Thomas Bldg. Topeka, Kansas

Keds At \$1.00, \$1.25, \$1.50
\$1.75 and up to \$4.00. 
United States Rubber Company

New!

Home Beverage Dispenser

Pays Agents up to \$120 Weekly

Now any home can have delicious drinks on tap!

An amazing invention—banishes grief of washing, filling, capping bottles—more convenient, easier, far quicker, cheaper. Serves root beer, cider, fruit juices, etc., on tap. Inside coated with Food Lacquer to dispel corrosion, metallic taste. 5 gal. capacity. Nothing like it. Thousands already in use and giving perfect satisfaction. Low-priced. Guaranteed.

WRITE FOR SPECIAL TRIAL OFFER

Send quick for all details, including special low-price introductory offer and FREE trial opportunity. Agents Wanted. Make up to \$120 weekly. Write TODAY!

PEERLESS STAMPING COMPANY
Dept. 328 3540 Mitchell Avenue Detroit, Michigan

Sent for \$100
Wear while paying

10 MONTHS to PAY
Send only \$1 and this fine reliable Elgin or Waltham watch comes to you postage prepaid—no C.O.D. to pay on arrival.

10 Days Free Trial
After examination and 10 DAYS FREE TRIAL pay balance in 10 equal monthly payments.

Satisfaction Guaranteed
All transactions strictly confidential. You take no risk. Satisfaction absolutely guaranteed or money back. No interest—no extras—no red tape. Written guarantee bond with every purchase.

To ADULTS: SEND FOR CATALOGUE FREE
Send for copy of latest catalogue showing special values in genuine blue-white diamonds from \$25 to \$1,000, and standard watches from \$12.50 up.

ELGIN or WALTHAM
FE 42
Nationally advertised Waltham or Elgin; guaranteed accurate and dependable. Engraved white lifetime case. Fine engraved open link bracelet to match; with extension center opening. Only \$2.10 a month.

ESTABLISHED 1895

ROYAL DIAMOND & WATCH CO.
ADDRESS DEPT. 11-V, 170 BROADWAY, N.Y.

"RADIO CATALOG" FREE
QUALITY-VALUE SERVICE — BALTIMORE — RADIO CORPORATION — RADIO REPLACEMENT PARTS SPECIALIST

MONTHLY "FLYER"
LOWEST PRICES GREATER PROFITS

725 P BROADWAY NEW YORK N.Y.

Build Your Own Boat!

Outboard Speeders — Cruisers — Fast Runabouts

It's fast, easy work with our full size paper patterns, semi-pressed frames and ready-cut materials. Try it and see—or let us build one for you. Eighteen easy models. Special four passenger outboard. French, mahogany finish, copper and brass fastened, only \$187 net. Germanic Boat and motor systems of home construction have been popular for more than a quarter of a century. Write today for FREE Circular. Germanic Boat Co., 31-32 Lake Blvd., Saginaw, W. R., Mich.

Write for FREE CIRCULAR

PLAYING SAFE WITH THE NEW — **SUNDARK** — POSTPAID 50¢ ANYWHERE

A THOROUGHLY PRACTICAL GLARE PROTECTOR

No screws, bolts, clamps or arms. Moved over entire windshield instantly. Your money refunded if not pleased. Order and agree, write. VEERKAY PRODUCTS, Naval Station, San Pedro, California

Don't Burn Coal — use cheap oil



A New Invention
Do away forever with the drudgery of wood or coal. Save money, time and labor. Most economical and lowest priced Oil Burner on market. Simply sets in fire box of any range, heating stove or furnace. Burns 96% air, 4% cheap oil. Gives three times the heat of coal. Easy to install and operate. Absolutely safe. No noise, dirt or odor. Sold on money-back guarantee.

30 Days Free Trial Offer

Try this wonderful burner in your own home at our risk. Special low price to first user in each locality. Write at once for Free book on Home Heating. Agents write for sample offer and protected territory.

International Heating Co., St. Louis, Mo.
3808 Park Ave., Dept. 400-A



Only \$12.95 for This Spray Gun

This is the famous G-V. Full Pressure Type All Purpose Spray Gun. Nationally advertised at \$30.50. A fortunate purchase permits us to offer them for only \$12.95. G-V. guns operate at highest efficiency on less than 1/2 pressure required for station type. Works fast—fine for bit cut-off jobs or repair shops. Can be used with container or attached to large stationary compressor. Adjustable spray tip. Order now. Send \$2.00 with order, balance C.O.D. Guaranteed Satisfactory.

National Jobbing & Export Co. Dept. N
192 N. Clark St., Chicago, Ill.

AGENTS—BIG MONEY IN NEW FLASHER SIGN

New Price \$5.00. Neon like effect. Write for Details.
WILLIAMS SIGN CO. Dept. 4-B
117 W. Aust'n Ave. Chicago

BLUEPRINT READING For the Building Trades



Every man who is ambitious to learn the last detail of blueprint reading will want this new book which is thorough, complete and up-to-the-minute. Written in a clear, non-technical manner. An ideal working tool for apprentices, teachers, students, carpenters, bricklayers, etc.

Over 100 pages—50 plans and illustrations.

Cloth—Price \$1.25 postpaid

Popular Mechanics Press
Room P8
200 E. Ontario St. Chicago

Now! Do Your Own Electric Nickel Plating **Introductory Offer**

A REAL MONEY-MAKING OPPORTUNITY **ONLY \$6.50**

For Plating Nickel, Brass, Copper, Silver, Gold, etc.

ALADDIN PORTABLE ELECTRO-PLATER

Simple and Economical to operate. Not a toy, but a practical Plating Outfit with which Perfect and Durable Work can be done. Positively Guaranteed to do as we claim. **BE YOUR OWN BOSS!** Build up a Profitable Aladdin Electro-Plating Business of your Own. This offers wonderful **ECONOMY** to users and **BIG MONEY-MAKING** possibilities to **AGENTS**. Thousands in Service since 1924. Write today for **FREE BOOKLET** and Testimonials.

P. J. F. BATENBURG CO. Dept. 254 **RACINE, WISCONSIN** **—AGENTS— WANTED EVERYWHERE**

\$50.00 SHIP MODEL for \$4.50 COACH MODEL for \$4.98



We furnish all parts cut to fit, numbered and ready to assemble for the following models: Clipper Ship and Flying Cloud (with electric lights), Santa Maria, Mayflower, La Pinta, \$4.50—Constitution, \$5.95—SPANISH GALLEON fully equipped for electrical illumination, \$6.50—COACH MODELS: Geo. Washington, Princeton to Philadelphia, TALLY-HO, Deadwood, Overland Western. Our new illustrated Catalog FREE. All models sent C. O. D. Foreign orders accompanied by check or money order. Illustrated Catalog free on request, C. J. BIERBOWER, Dist. PM3216 Baring St., Phila. Originator of Build Your Own Ship Model.

New Tractors from Old Fords

Do All Farm Work!

Make powerful tractor out of your Model "A" or "A" Ford, or Chevrolet with SHAW Tractor Equipment. Low cost! New HIGH ARCH Model with 30 inch clearance straddles 1 or 2 rows of corn and other crops. Cultivates, plows, seeds, disc, etc. Rure belt machinery. Easy to attach. **SPECIAL LOW INTRODUCTORY PRICE!** Write for FREE literature!



NEW HIGH ARCH MODEL
—30-INCH CLEARANCE

SHAW MFG. CO., 4508 Center St., Galesburg, Kans.

RADIO BUILDERS

We carry a complete line of radio parts for all Popular Mechanics circuits and replacement parts for all sets.

Send Us Your Order

NEWARK ELECTRIC CO.

228 W. Madison St.

CHICAGO, ILL.

BABY CALCULATOR

FOR HOME OR OFFICE

ADD, SUBTRACT, MULTIPLY, DIVIDE. Does work of 2000 machine. Net 3 key. Million dollar capacity. Simple and accurate. Guaranteed 3 years.

FREE TRIAL

—SEND NO MONEY—

\$2.50
Total Cost

Just name and address. We will ship Calculator immediately. On delivery pay postman \$2.50 (plus few cents postage). (If outside U. S. send cash.) 10c additional in Louisiana. Cash. If not satisfied after 10 days' trial you get your money back. THOUSANDS OF SATISFIED USERS. Write for Agency Proposition. **BABY CALCULATOR MACHINE CO.** (Intrs.) P. O. Box 1118, Dept. 31, CHICAGO, ILLINOIS

861 PRACTICAL IDEAS for REDUCING FARM LABOR and INCREASING INCOME



One farmer writes: "I would not take \$100 for my copy if I could not secure another."

The Handbook for Farmers contains: 138 ideas for the farm shop, 35 on fencing, 98 on auto, truck and tractor, 61 on farm buildings, 36 on field machines, 48 on concrete work, 22 on orchard work, 23 on painting, 15 on live stock, 34 on poultry, 54 on garden work, 25 on electrical work, 22 on farm tools, 16 on hunting, fishing and trapping, 140 household helps. Pay postman 98 cents plus postage when delivered anywhere in U. S. Elsewhere remit with order and include 15 cents extra for postage.

POPULAR MECHANICS PRESS
Room 108, 200 E. Ontario St., CHICAGO

A STEADY STREAM of PROFITS for AGENTS-DISTRIBUTORS

PYROIL LIQUEFIED GRAPHITE—an amazing, newly developed lubricant for ALL internal combustion motors—performs feats absolutely unheard of before—astounds the entire motor world! Through an exclusive patent-protected process, **PYROIL** now makes possible the use in any motor of a new **LIQUEFIED GRAPHITE**—heat and friction's greatest known enemy. **IRON CLAD GUARANTEE.**

POSITIVELY CANNOT HARM THE FINEST MOTOR MECHANISM.

Used and endorsed by the country's leading motor industries. Being used in U. S. Aero and Naval Service. Under test by leading aero manufacturers. Positively stops wear and noise—cuts repair bills—saves gas up to 40 per cent—saves oil up to 50 per cent and more—unaffected by heat or cold—passes any filter—saves 10 times its small cost.



Only 1 pt. of PYROIL to 8 qts. of crankcase oil.

Every statement backed by facts and proof.

AGENTS! Earn up to \$100 and MORE WEEKLY

Write today for **FREE DETAILS and PROOF.** Special salesman-distributor plan.

Territory granted. **WRITE AT ONCE.**

W. V. KIDDER, Pres.,
The Pyroil Company, 581 Pyroil Bldg., La Crosse, Wis.

Earn \$2400 and Up in a BIG-PAY TRADE

Modern equipment worth hundreds of thousands of dollars, best instructors, individual instruction and amazingly low tuition make this school the finest in the country.

MAIL COUPON FOR FREE INFORMATION

**BEDFORD
YMCA
TRADE
SCHOOL**

1115 Bedford Ave. PM 1.
Brooklyn, N. Y.

Send me without obligation complete information on (check subjects):

- Caterpillar Tractor Mechanic
 Aviation Mechanic
 Flying
 Welding
 Auto Mechanic
 Radio Mechanic
 Talking Pictures, Western Electric

Name.....
Street & No.....
Town..... State.....

More Home Demonstrators Needed

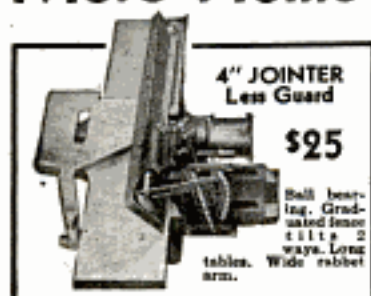

4" JOINTER
Less Guard

\$25

Ball bearing. Graduated fence 4 1/2" x 2 ways. Long tables. Wide rabbit arm.

Fall and winter season will soon open with a bang. Get your power tools on an easy basis. Be our demonstrator in your vicinity. Your territory may be open. Now is the time to prepare. Be ready to show **BOICE-CRANE** equipment to prospects in your section. No selling. No collecting. No canvassing. You show and we sell.

SEND FOR FULL DETAILS

Send 10c coin or stamps to pay part mailing cost on large 52-page catalog containing full information on our full line of power tools, and details of our Home Demonstration Plan.

W. B. & J. E. Boice, Dept. PM, 8G, Toledo, Ohio



SHAPER

Large, heavy and massive. Current design. 7000 r.p.m. Electrically reversible motor if desired.

E-2 Pay Plan

Only
\$49

COLD FACTS

ABOUT COLD CASH

THERE is no substitute for money. You already know this!

Money makes possible most of your comforts and pleasures. It provides for your family. It is the means to educate your children. Money is power!

This is why you work week after week, year after year. And of course you are always wishing for more money.

Do you ever stop to ask yourself—frankly: "When am I going to have more money?"

The answer is simple. You are going to have more money when you earn more money—and you are going to earn more money when you have more training!

It's the trained man who earns more money these days. *You can be a trained man!*

Thousands of men have been in the same fix—and they have found the beginning of the solution by marking and mailing a coupon to the International Correspondence Schools at Scranton. For 40 years our single business has been helping men like you acquire the training they need to earn more money. What we have done for them we can do for you. This coupon will bring all the information to you. Mail it today!

INTERNATIONAL CORRESPONDENCE SCHOOLS

INTERNATIONAL CORRESPONDENCE SCHOOLS

"The Universal University"
Box 5556-G, Scranton, Penna.

Without cost or obligation, please send me a copy of your booklet, "Who Wins and Why," and full particulars about the subject before which I have marked X:

TECHNICAL AND INDUSTRIAL COURSES

- | | |
|--|--|
| <input type="checkbox"/> Architect | <input type="checkbox"/> Automobile Mechanic |
| <input type="checkbox"/> Architectural Draftsman | <input type="checkbox"/> Plumbing <input type="checkbox"/> Steam Fitting |
| <input type="checkbox"/> Building Estimating | <input type="checkbox"/> Heating <input type="checkbox"/> Ventilation |
| <input type="checkbox"/> Wood Millworking | <input type="checkbox"/> Sheet Metal Worker |
| <input type="checkbox"/> Contractor and Builder | <input type="checkbox"/> Steam Engineer |
| <input type="checkbox"/> Structural Draftsman | <input type="checkbox"/> Steam Electric Engineer |
| <input type="checkbox"/> Structural Engineer | <input type="checkbox"/> Civil Engineer |
| <input type="checkbox"/> Electric Wiring | <input type="checkbox"/> Surveying and Mapping |
| <input type="checkbox"/> Electrical Engineer | <input type="checkbox"/> Refrigeration |
| <input type="checkbox"/> Electric Lighting | <input type="checkbox"/> R. R. Locomotives |
| <input type="checkbox"/> Welding, Electric and Gas | <input type="checkbox"/> R. R. Section Foreman |
| <input type="checkbox"/> Reading Shop Blueprints | <input type="checkbox"/> R. R. Bridge and Building Foreman |
| <input type="checkbox"/> Telegraph Engineer | <input type="checkbox"/> Air Brakes <input type="checkbox"/> Train Operation |
| <input type="checkbox"/> Telephone Work | <input type="checkbox"/> Highway Engineering |
| <input type="checkbox"/> Mechanical Engineer | <input type="checkbox"/> Chemistry <input type="checkbox"/> Pharmacy |
| <input type="checkbox"/> Mechanical Draftsman | <input type="checkbox"/> Coal Mining Engineer |
| <input type="checkbox"/> Machinist <input type="checkbox"/> Toolmaker | <input type="checkbox"/> Navigation <input type="checkbox"/> Boilermaker |
| <input type="checkbox"/> Patternmaker | <input type="checkbox"/> Textile Overseer or Supt. |
| <input type="checkbox"/> Pipefitter <input type="checkbox"/> Tinsmith | <input type="checkbox"/> Cotton Manufacturing |
| <input type="checkbox"/> Bridge Engineer | <input type="checkbox"/> Wooden Manufacturing |
| <input type="checkbox"/> Bridge and Building Foreman | <input type="checkbox"/> Agriculture <input type="checkbox"/> Fruit Growing |
| <input type="checkbox"/> Gas Engines <input type="checkbox"/> Diesel Engines | <input type="checkbox"/> Poultry Farming <input type="checkbox"/> Radio |
| <input type="checkbox"/> Aviation Engines | <input type="checkbox"/> Marine Engineer |

BUSINESS TRAINING COURSES

- | | |
|---|--|
| <input type="checkbox"/> Business Management | <input type="checkbox"/> Business Correspondence |
| <input type="checkbox"/> Office Management | <input type="checkbox"/> Lettering Show Cards <input type="checkbox"/> Signs |
| <input type="checkbox"/> Industrial Management | <input type="checkbox"/> Stenography and Typing |
| <input type="checkbox"/> Personnel Management | <input type="checkbox"/> Complete Commercial |
| <input type="checkbox"/> Traffic Management | <input type="checkbox"/> Civil Service <input type="checkbox"/> Mail Carrier |
| <input type="checkbox"/> Accountancy <input type="checkbox"/> Cost Accountant | <input type="checkbox"/> Railway Mail Clerk |
| <input type="checkbox"/> C. P. Accountant | <input type="checkbox"/> Grade School Subjects |
| <input type="checkbox"/> Bookkeeping | <input type="checkbox"/> High School Subjects |
| <input type="checkbox"/> Secretarial Work | <input type="checkbox"/> College Preparatory |
| <input type="checkbox"/> Spanish <input type="checkbox"/> French | <input type="checkbox"/> Illustrating <input type="checkbox"/> Cartooning |
| <input type="checkbox"/> Salesmanship <input type="checkbox"/> Advertising | <input type="checkbox"/> Lumber Dealer |

Name.....Age.....

Address.....

City.....State.....

Occupation.....

If you reside in Canada, send this coupon to the International Correspondence Schools, Canadian, Limited, Montreal, Canada

A BOAT for YOU



Be one of the thousands who own fine boats—thanks to the Brooks method. The Brooks knock-down system puts a real boat within reach of any pocket-book, because it saves the prospective owner two-thirds of his cost. No experience is needed—even the rankest amateur, if he can handle a hammer and a screw driver—can build any Brooks boat. Every part is cut exactly to size, and fits the complete plan that helps you do the work.

Send 10 cents today for the new 1931 catalog. 38 assorted models of cruisers, outboards, runabouts—any kind you want

BROOKS BOAT CO., Inc.

Dept. 10 H Saginaw West Side, Michigan

Sells on sight!

MOST MODERN
Kitchen Ventilator
The WALVENT with important new automatic start-stop feature. Easily installed in the wall of any kitchen. Chromium plated finish. Once-a-year oiling system.

Agents Wanted — Liberal Commission

NOVELAIRE CORPORATION, Sole Distributors
Incorporated, 1114 Bardstown Rd., Louisville, Ky. f.o.b. Louisville



\$35.00

LESART WHITE SIDEWALLS!

Add to the appearance of your car

a brand new preparation for whitening the sidewalls of your tires. Covers black tires with one coat—washable—lasting—harmless—easily applied. Use also for refinishing white tires. Large cans \$1.00 from your dealer or postpaid in U. S. A. from

LESART PRODUCTS CO. Dept. A Box 5230 San Francisco, Calif.

RADIO BLUEPRINTS

The blueprints below include the best of Popular Mechanics tested circuits. When ordering, simply quote the numbers of blueprints desired and inclose proper amount addressed to Popular Mechanics Magazine, Radio Dept., 200 E. Ontario St., Chicago, Ill. Magazines containing full descriptions of the circuits can be obtained. Send 25 cents for each magazine desired, giving date of publication.

- | | | |
|---|-----------------------|-----|
| No. 139, Simple Television Receiver..... | Dec. 1928.. | 25c |
| No. 140, Power Amplifier and B-Supply for Television..... | Jan. 1929.. | 25c |
| No. 142, Two-Tube Screen-Grid Short-Wave Adapter..... | Mar. 1929.. | 25c |
| No. 143, Four-Tube Screen-Grid Receiver..... | May 1929.. | 25c |
| No. 144, Three-Tube Self-Contained A.C. Receiver..... | Oct. 1929.. | 25c |
| No. 145, One-tube S-G Set for Beginners | Nov. 1929.. | 25c |
| No. 146, Adjustable B-Eliminator..... | Nov. 1929.. | 25c |
| No. 148, Adding Audio Stages to S.G. Receiver..... | Dec. 1929.. | 25c |
| No. 150, Short-Wave Receiver Without Plug-In Coils..... | Sept. 1930.. | 25c |
| No. 151, Beginners Low Power S.W. Transmitter..... | June 1930.. | 25c |
| No. 152, Portable Radio Amplifier for the Deaf..... | July 1930.. | 25c |
| No. 153, Low Cost Code and Phone Transmitter..... | Sept. 1930.. | 25c |
| No. 154, A. C. Screen-Grid DX Tuner..... | Oct. 1930.. | 25c |
| No. 155, Four-Tube D-X Receiver..... | Nov. 1930.. | 25c |
| No. 156, Switchless Test Panel..... | Nov. 1930.. | 25c |
| No. 157, Building a Light-Sensitive Relay..... | Dec. 1930.. | 25c |
| No. 158, High-Power Supply for Amateur Transmitters..... | Jan. 1931.. | 25c |
| No. 159, Portable S-W Transmitter..... | Feb. and March 1931.. | 25c |
| No. 160, Building A.C. Midget Receiver..... | Mar. and Apr. 1931.. | 25c |
| No. 161, Building Auto Receiver for 2-volt Tubes..... | Apr. and May 1931.. | 25c |

Material Lists for any of the above instruments will be mailed free upon application.

Popular faces are *shaved with* BARBASOL

"We sing the praises of Barbasol because it's the modern shave—in the quick tempo of today—softens the beard like magic and makes the hairs 'come clean' without a struggle—no pull; no scrape; no lather, brush or rub-in . . . And when you see our smile—man! It's because our faces feel so FINE when Barbasol has given our chins that spotlight look."

—GUY LOMBARDO AND HIS ROYAL CANADIANS

Barbasol testimonials are not paid for



GUY LOMBARDO AND HIS ROYAL CANADIANS, radio and recording artists extraordinary, known the world over for their unique style of rhythm and musical interpretations, now playing at the Hotel Roosevelt in New York City. (Presented through the courtesy of the Music Corporation of America)

SOME men never have that seedy look as if they needed a shave. How do they do it? Ten to one they're Barbasol Believers, because Barbasol is so easy on the face that two shaves a day won't hurt the tenderest skin, planted with the toughest whiskers.

Like magic this new, quick, modern shaving cream softens the beard while holding the hairs straight up to the blade. Crisp and easy the razor slides along; no pull; no scrape. Its wonderful ingredients protect your face. Your skin actually feels better, softer, more relaxed—after the Barbasol shave.

And Barbasol has banished forever the old shaving chore. No messing around with soap and lather; no brush; no rub-in. It's so quick and easy to use that the morning shave is a pleasure instead of a painful duty. That's why the Barbasol Believers have made it one of the fastest-selling shaving creams in America.

Follow these directions and you'll follow the crowd

1. Wet your face and leave it wet . . . 2. Spread on Barbasol. Don't rub it in—just be sure it's spread on evenly between the hairs . . . 3. Wet a good blade and —SHAVE.

That's all you have to do to get the finest shave in the world. It's simple, easy, quick. Try it today. Generous tubes at all druggists', 35¢ and 65¢, will quickly make YOU a Barbasol Believer, too.

FREE—A refillable Tefra Toothbrush, value 75¢, with your first name or initial on handle. Finest quality; cuts family toothbrush bill in half. Mail entire empty Barbasol carton (35¢ or 65¢ size, or jar) with your name and address. We will mail toothbrush absolutely free with your first name or initial engraved on handle. The Barbasol Company, Department 42, Indianapolis, Indiana.



Listen to Barbasol Ben and His Boys—Laughs—and the songs you can't forget—the happiest entertainment on the air. Tune IN, every Monday, Wednesday and Friday evening at 8:15, Eastern Daylight Saving Time, Columbia Network: Stations WABC, WMAQ, WCAU, WXYZ, KMOX, WHK, WJAS, WNAC, WCAO, WKBW, WISN, KMBC, WCCO, WKRC, WFBM, WMAL, WEAN, WSPD, KOIL, WADC, WFBL, WDRG, WPG, WOKO.

Consider your Adam's Apple!!*
**Don't Rasp Your Throat
 With Harsh Irritants**

**"Reach for a
 LUCKY instead"**

Now! Please!—Actually put your finger on your Adam's Apple. Touch it—your Adam's Apple—Do you know you are actually touching your larynx?—This is your voice box—it contains your vocal chords. When you consider your Adam's Apple you are considering your throat—your vocal chords. Don't rasp your throat with harsh irritants—Reach for a LUCKY instead—Remember, LUCKY STRIKE is the only cigarette in America that through its exclusive "TOASTING" process expels certain harsh irritants present in all raw tobaccos. These expelled irritants are sold to manufacturers of chemical compounds. They are not present in your LUCKY STRIKE. And so we say "Consider your Adam's Apple."



LUCKIES are always
 kind to your throat



Emily Boyle
 BRONXVILLE, N. Y.

"It's toasted"

Including the use of Ultra Violet Rays
 Sunshine Mellows—Heat Purifies

Your Throat Protection—against irritation—against cough

© 1961
 The A. T. Co.
 RfK.

For more
 information
 contact
 The A. T. Co.
 1200 Broadway
 New York 10036