

POPULAR MECHANICS

MAGAZINE

UNDERSTAND IT

REGD. TRADE MARK, GREAT BRITAIN, No. 40426

REG. U. S. PAT. OFF.

SEE PAGE 762



Now! Clean, sparkling water at the faucet!

Be sure it's FILTERED!



Filters Water . . . Instantly . . .

Slips onto the faucet in a moment. Once there, it stays. It'll never come off again, because it means so much to health and happiness.



Filters instantly—the very second you turn on the faucet. And, the water is always clean, pure, spring-like—free from dirt and filth. Here's actual proof! Pictured is the filth, scum and dirt collected by the Automatic Water Filter at an average faucet within 30 to 45 minutes' use. Remember, scientists say filtration prevents typhoid fever, erysipelas, pyaemia, septicaemia and other diseases. Whatever you do!—protect yourself—your family. Arrange now to put this health protector on your faucet. Act today!

Salesmen and Agents!

Here's a tested and proved opportunity to make up to \$100 a week. Act at once before someone else beats you to this lifetime opportunity. Good paying territories open. New sales plan provides FREE Demonstrator. Just mail FREE OFFER coupon today.

FREE OFFER!

We want you to see this surprising new invention with your own eyes—to try it—test it on your own faucet—know how absolutely necessary it is in your home—IN EVERY HOME! You can do this without obligation—all at our risk. Act quick—use the FREE OFFER coupon.

AUTOMATIC WATER FILTER CO.
1211-2621 N. Third St. MILWAUKEE, WIS.

Think of it! A new, amazing, invention that now helps protect your health by removing dirt, filth, scum and impurities from the water—at the faucet! Just a turn of the faucet, and the water comes thru filtered and as sparkling as though coming from one of nature's crystal springs.

Millions of homes absolutely need it. Millions of careful mothers have been waiting ever so long for this remarkable device!

Now, with one sweep, gone are the days of drinking dirty water. That's why faucets by the thousands—almost overnight—are being equipped with the Famous Automatic Water Filter—to stand guard over the health of homes.

Guards Family's Health

Nothing mysterious. Remarkably simple because it uses Nature's own method of filtering through crystal sand. So convincingly removes dirt, filth and scum you can see it with the naked eye.

There's danger in impure water—danger of illness, disease, even death. Once you see for yourself—realize how much dirt and filth is brought into your home in raw, unfiltered water, you'll wonder why a necessity like the "Automatic" has never been perfected before. You'll promise yourself never, never again to be without it—never to let your family's health unguarded.

Saves Buying Expensive Spring Water

Like Nature in her springs, the Automatic Filters thru millions of grains of sand. That's why it removes impurities—brings crystal-clear, spring-like water from the faucet. So pure, sparklingly clean, you just know it's safe and wholesome. Economical, too, because it saves buying expensive spring water.

GUARANTEE

No matter where you live, or what kind of drinking water you have, the Automatic Water Filter will remove dirt and filth from it. We guarantee it to remove impurities, protect against contamination and deliver crystal clear, sparkling water or the trial costs you nothing.

FREE Offer Coupon Mail TODAY!

AUTOMATIC WATER FILTER CO.

1211-2621 N. Third St., Milwaukee, Wis.

Without obligation, please rush me facts about the new Automatic Water Filter, with full details of Sales Plan and FREE DEMONSTRATOR OFFER.

Name

Address

City

Check here if interested in Part or Full Time Sales Position.

Mystery "TWIN-RAY" Light Makes Night Driving Safe

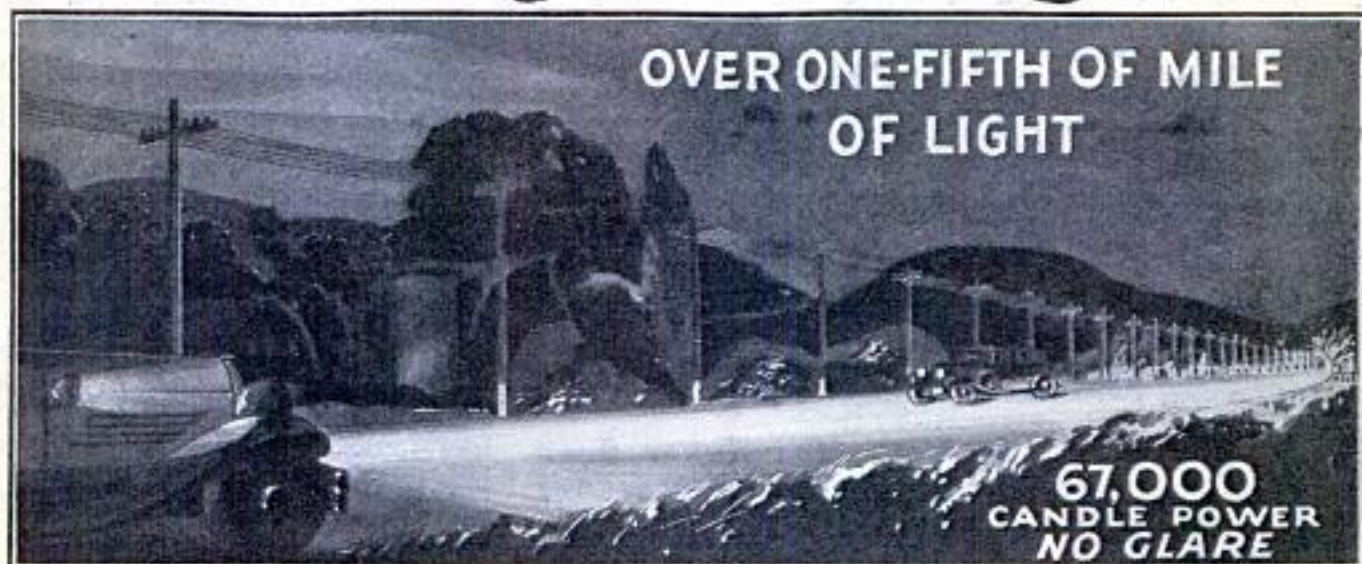

AGENTS Cleaning Huge Profits With This Instant Seller!

AGENTS and distributors all over are getting set for the biggest money of their lives with a brand-new road light that ends all the dangers of night driving. 24,000,000 motorists want this protection which guards lives against the dangers of glaring lights—yet lights up the road as clear as day. Hundreds of men have made big fortunes out of make-shift spot lights that only did half the job; hundreds more have pulled huge salaries out of lights that couldn't approach this new protection, in efficiency.

**67,000 Candle Power—
No Glare**

So judge for yourself what you can do with a light like this—a light that throws a 67,000 candle power beam for over 1,000 feet—yet which absolutely CAN'T glare in the eyes of approaching drivers! A light which costs 30 per cent less than the prices charged for some of the best sellers in the market! A light that not only can't glare itself, but which kills the glare of the other fellow's oncoming "brights!" No wonder this light was awarded the Grand Prize and two gold medals at the Paris International Exposition—and no wonder that the very earliest agents are already cleaning up big—cleaning up like Kinney, who sold 12 lights in a day—and made \$96 for just a few hours' work. No wonder new car distributors are equipping cars like Packard, Nash, Cadillac and Chevrolet with it.

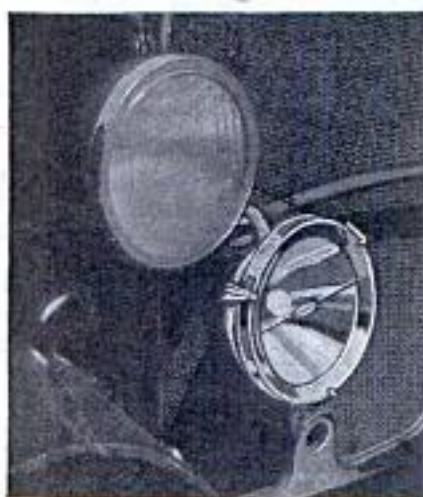

You can attach and adjust the Speedlight in fifteen minutes. Once fixed, it can't get out of alignment—it keeps a steady 1000-foot beam of glareless light between you and every danger.

There's no light like it in the world. It's not a spot. It embodies an absolutely new principle in headlighting, discovered by a famous lighting engineer.

**70 Miles
Per Hour—Safely
At Night**

With this amazing Speedlight you can drive at 50—60—even 70 miles an hour, with perfect safety, on a road as brightly lighted at midnight as at mid-day. Lights up the road in spite of driving rain and snow—defies even thick fog.

MAIL THE COUPON NOW and find out how we're putting the chance of a lifetime into your hands, with an amazing introductory offer. Find out how you can use this great device to build up a crew of your own—and double your earnings—earnings which by themselves will be bigger than you ever saw before. Do it now, before you turn this page!

**SPEED
1731 Belmo**

**SPEEDLIGHT
1731 Belmor**

Without obl.
Speedlight and

Name.....
Address.....
City..... State.....

This One



C2NC-GEA-C52F

SHATTERING EVERY RECORD



PYROIL under official test at St. Louis, Mo., airport actually saves 5 gallons of gasoline per hour on a standard transport plane in addition to other sensational accomplishments!
 PYROIL now under official test in 2 branches of U. S. Government Aeronautical Service.



Amazes the Entire Motor World

A highly concentrated lubricant embodying patent-protected liquefied graphite. ABSOLUTELY GUARANTEED to contain no ingredients which could possibly injure the finest mechanism.



Loaded Truck Runs 30 Miles Without Oil!

PYROIL equipped motor truck owned by Empire Fuel Company, St. Louis, Mo., which was run fully loaded A DISTANCE OF 30 MILES, without oil and with no harm to motor!

POSITIVELY

Stops wear—stops noise—cuts repair bills. Doubles, triples life of ordinary crankcase oil. Reduces gas consumption up to 20% to 40%. Withstands heat up to 7500° F. Cannot burn—cannot wash off bearings. Passes any filter—even chamolais skin. Gives instant starting, at 40° below zero. Enjoys patented protection. Is guaranteed 100% satisfactory.



Pyroil Helps Shatter World's Endurance Mark

At Tallahassee, Fla., O. F. Ellison and L. F. Walker smashed the world's motor endurance record by driving the Outboard Motor Boat pictured here, for 662 hours, 27 1/2 days, without stopping. PYROIL LIQUEFIED GRAPHITE—used throughout this official test—made this amazing feat possible!

Proof

The Pyroil Co. Positively Guarantees all Claims and Statements.

PYROIL endorsed by Pacific Coast Distributor of Outboard Motors Corp. as best lubricant for all internal combustion motors!

PYROIL adopted by Chicago Nash Company.

Endorsement from Mack International Motor Truck Co., Denver Branch. 100% O. K. test at Willys-Overland factory.

Leading fleet owners of Chicago, St. Louis, Milwaukee, and others adopting PYROIL.

Hundreds of other sensational accomplishments.

Inquiries by the thousands from national publicity. Orders referred to district agents and distributors, making sales easy and practically automatic.

Such As Has Never Been Enjoyed By Any Other Product



Motor truck owned by Oshkosh Motor Truck Co., Inc., recently exhibited at Wisconsin State Road School, Madison, Wis., equipped with PYROIL throughout. Rigid tests resulted in PYROIL adding 3 miles per gallon of gas used.

Iron Clad Money-Back Guarantee

Because PYROIL results are so remarkable as to be almost unbelievable by those unfamiliar with its merits, in any case where it is used as directed and the user is not completely satisfied, the PYROIL COMPANY WILL REFUND THE PURCHASE PRICE IN FULL upon return of the unused portion of the oil.

SALESMEN—DISTRIBUTORS up to \$40-\$50 Daily Profits

Men! These startling facts—only a few of hundreds of similar cases—speak for themselves. PYROIL offers you a profit opportunity so vast that neither words nor figures can here adequately describe it.

Choice Territory Now Open

Mail the attached coupon without delay for further Pyroil records and facts and the most sensational profit opportunity ever offered anywhere at any time. Don't delay.



Pyroil Stops Chronic Hot Box

"We had one pump motor bearing that ran exceedingly hot. After using PYROIL for ten days, it was one-fourth cooler!"

(Signed) R. W. Killian, Foreman (Inset above) City Pumping Plant, Wenatchee, Wash.

W. V. KIDDER, President

THE PYROIL COMPANY

551 Pyroil Building

La Crosse, Wisconsin

MAIL THIS NOW!

W. V. KIDDER, President
 THE PYROIL CO.,
 551 Pyroil Bldg., La Crosse, Wis.

Rush me full details and further facts of PYROIL and the Biggest Money Making Opportunity of today which it offers me.

Name

Address

City..... State.....

Popular Mechanics Magazine

200 E. Ontario Street, Chicago, U. S. A.

H. H. WINDSOR, Founder

H. H. WINDSOR, Jr., Editor and Publisher

London: Hachette & Co.,
3 La Belle Sauvage, Ludgate Hill, W. C. 2

Paris: Hachette & Co.,
111 Rue Reaumur

Melbourne: Gordon & Gotch
509-513 Little Collins St.

ISSUED MONTHLY

SUBSCRIPTION:

SINGLE COPY, 25 CENTS

In United States and its possessions, Canada, Cuba, Mexico, and all }
countries in the Pan-American Postal Union, per year, postpaid } \$2.50
To all other countries in the Postal Union 3.00

All subscriptions are discontinued at expiration. Please examine the date printed on your wrapper.

Entered as Second Class Matter Sept. 15, 1908, at the Post Office at Chicago, Illinois, under Act of March 3rd, 1879.

Entered as Second Class Matter at the Post Office Department, Canada.

Published monthly by POPULAR MECHANICS CO.

Copyright, 1931, by Popular Mechanics Co.

Copyright in Australia. Copyright in France

Vol. 55

Contents for May, 1931

No. 5

	Special Features	
<i>Smallest Living Things</i>		722
How Animals Talk for the Movies		722
Uncle Sam Wars on Duck Bootleggers		739
Dynamite in the Talkies		748
They're Off!		754
Is Main Street Doomed?		765
One Hundred Years of Electricity		772
Batteries to Run Train		781
Aboard a Super-Electric Dreadnaught		786
The Tricks of Life Saving		803
With the Balloon Busters		807
The Search for a Wonder Metal		819
Agricultural Implements		
combine with wire cylinder speeds harvesting	727	
revolving cutters on plow throw clods on top	791	
Airplanes		
fabric nerves test wings	734	
"iron skull" gives plane added safety	735	
telegrams sent from	817	
Airplanes, Model—tiny, flies one minute	813	
Airships		
dirigible to try mooring to skyscraper mast	812	
mooring masts in the Arctic for polar airline	745	
Aquaplane—rider makes leap to glider in flight	776	
Archaeology—skeleton of ancient reptile found on Texas farm	727	
Astronomy		
forty million miles an hour apparent speed of stars	799	
moon's surface without air its light has proved	810	
Automobiles, Accessories		
awnings for windows permit free vision	793	
hub lights for wheels add to safety	802	
lighted map holder on steering column	799	
Automobiles, Driving—time needed to apply brake measured by eye tests	784	
Automobiles, Racing—Diesel engine develops high speed	801	
Aviation—making blind flying safer without leaving ground	729	
Bakery—electric eye counts loaves of bread	813	
Bicycle—and sled combined for travel on ice	721	
Birds		
roman candles scare birds roosting on buildings	771	
that fly ocean	800	
Boats and Boating		
gauge for propellers shows proper setting	821	
inflated rubber boat becomes tent for campers at night	817	
Bowling—electric alley has no pins to set	818	
Bricks—in variety of colors	792	
Building Construction—"house" with only one wall helps sell homes	737	
Building Material—enameled-steel wall surfacing offers color variety	818	
Calendar—date is changed by rotating	777	
Cane—electric light in tip of	729	
Character—measure of head dimensions shows weak points	799	
Church—plain lines of steel show modern trend	822	
Cigarets—penny vender sells one smoke at a time	777	
Courtroom—loud speaker for witness enables jury to hear	785	
Crime		
information by radio for all of Europe	741	
secret burglar alarm for watchman	816	
Dam—mile-long earth, is impervious to water	769	
Diving—mask for deep-sea work	806	
Dogs		
as silent police used on Detroit streets	811	
rollers attached to harness for crippled	736	
Earth		
an electrical explorer for composition of weight of, compared to that of the sun	788	
Electric Time Switch—turns off automatically	738	
Elephants—on the trail of the elephant "tappers"	779	
Exploration—lost people are sought on roof of the world	822	
Fire Alarm—wired to telephone operates automatically	805	
Fireboat—smoke eaters on the water	794	
Fire Fighting		
life basket for fire victims	742	
smoke eaters on the water	794	
Fireplace—colors added to open fires by use of chemicals	790	

[Continued on Page 4]

Diesel engine racing car 801

Coal as water filter 708

Copyrighted material

*821
filter for window
out*

705

778

Railroad 753
Gloving One Piece 742
Wool. gun on sheepskin

Hotted heater 741

Wool. gun on sheepskin
amplifier for violin 780

[Contents—Continued]

AMATEUR MECHANICS

Fish and Fishing	
fish lure acts like live bug	801
indoor trout pools provide outdoor thrills	771
New York fish zoo	730
Floodlight—on top of truck for air maneuvers	798
Fountain—drinking, electric eye serves water for	802
Gold Leaf—still beaten out by hand power	816
Golf	
coin-in-slot game	809
coin-in-slot putting game	800
course fits card table	792
miniature course laid out on a billiard table	778
Homes—cost to be cheapened by standardizing	778
Household Devices	814
House Plan—plan No. 6-B-18	815
Light Fixtures—ceiling light gives ultraviolet rays	770
Mail Truck—looks like street car	743
Maps—revolving disk-map of Europe	800
Models	
miniatures of Mexican life shown in tiny	736
model of three-decker ship, historically accurate	744
Motor Bus—slot machine ticket seller for Paris bus	770
Motorcycle—ball-bearing wheel tread speeds up	783
Moving Pictures	
larger home movie views given by new lamp	827
small screen in theater lounge	794
Murals—colored strings for, make wall designs	871
Musical Instruments	
one-man stringed orchestra plays four instruments	790
radio amplifier for violin to control tone	740
violin shaped like man's ear	745
Navy, Italian—cadets climb ropes to acquire agility	742
Paints and Painting—paints for road lines tested for wearing qualities	735
Paper—mechanical eye test, to show transparency	810
Pencil—sharpener for desk looks like inkwell	805
Pipes—vent, one-piece roof flashing gives watertight fit	742
Plants—electric heater for hotbed	741
Printing—paper printed off seaweed for book bindings	751
Radio	
kite with transmitter for direction finding	802
simplified answers to your radio problems	828
Radio, Aerial—compact antenna for indoor use	830
Radio, Apparatus	
handy uses for radio headphones	830
heat control for soldering irons	824
increasing gain of r.f. coils	824
portable radio key is mounted on flatiron	824
portable speaker-amplifier	830
Radio, Broadcasting—singer hears voice as it comes over air	769
Radio, Construction	
build your own selective band-pass filter	834
power detector with one audio stage	830
Radio, Loud Speaker—volume control for remote speakers	827
Radio, Receivers—installing auto set	831
Radio, Transformer—you can build this power transformer	825
Railroads	
smoke eater devours engines' dirt	737
tie tamping outfit run by electric motor	747
Restaurant—merry-go-round lunch room has revolving counter	805
Road Roller—operated by one man	745
Rubber—first crop harvested in California	728
Ships and Shipping	
big propellers of "Majestic" look like electric fans	791
figureheads of famous ships given spring cleaning	811
the evolution of the transatlantic liner	746
Shovel—giant power, loads cars automatically	731
Signs—traffic sign posts describe attractions of city	792
Sports, Water—balloon race for swimmers	777
Steel—metal stress made visible in testing	792
Telephone	
conversations recorded for reference	801
receivers that exclude noise	738
Television—two-way television improvements are sought	785
Tractors—work recorder for shows busy time	776
Traffic—towers on wheels for congested points	743
Trees—wire web supports limbs	738
Trucking—compact motor unit pulling trailer	784
Tunnel—vehicular, planned for Boston	747
Typewriter—brush to clean has liquid in handle	752
Vegetables—glass tube over cucumber makes it grow straight	751
Welding—electric torch for	734
Wires	
joined without solder in metal tube	741
tightened or broken with a hand twister	799
X-Ray—apparatus on rockers for easy observation	780

Airplanes, Model—spray and stencil outfit for	856
Album—razor-blade cutter for slitting leaves	857
Automobiles, Tires—clip deflates tubes quickly	838
Bicycle—rubble seat for	838
Birdhouse—Zeppelin-type also serves as weathervane	842
Boats and Boating	
auto gas tanks make small boats unsinkable	846
recovering a lost outboard motor	860
Bookcase—backstop holds books in line	844
Cabinet—umbrella rib keeps doors closed	841
Camping—an elevated campfire is handy	849
Cigaret—instant extinguisher	848
Clothesline—inclosed reel keeps line clean	849
Doors—weatherstrip adjusted automatically	855
Fence—portable posts for supporting temporary	837
Fire-Alarm—cheap electric system	834
Firearms—cleaning with steam	857
Garage—doors are closed from your car	847
Glue—roller spreads quickly	857
Kites—a flying dragon kite	851
Ladder—hook prevents from slipping	843
Nails—rubber guard protects wood when driving	848
Paints and Painting	
paintbrush holder and covers made from paper	846
revolving paint stand held in vise	862
Panels—imitation paneled tile for bathroom finish	845
Photography	
opera glasses used for taking distant photos	854
the secrets of trick	839
Picture Frame—a duplex frame for photos	846
Plumb Bob—permanent, kept on portable machines	861
Potato—slicer saves time	838
Pulleys—pipe guides rope over high	850
Saws and Sawing	
hanger holds saw securely	850
picture-frame molding cut on a power saw	861
this sawbuck will not pinch	855
Signs—fastening portable signs to sidewalk	855
Stones—this stone boat is easy to dump	862
Swing—child's, is rowed like a boat	835
Towrope—tow knots that are easy to loosen	836
Toys	
boy's rubber-band machine gun	843
making a play horse	844
Twine—coconut head stores	847
Vacuum Bottle—homemade	844
Wadding—ignited on spark plug	836
Window Screens—improved method of hanging	836
Windows—shutters improve your home	858
Woodbox—rubber-tired, for the fireplace	856

2x Liner Preserving with Collodion

SHOP NOTES

Airplanes—one-man jack for lifting	865
Angle Iron—a few practical uses for, in shops	866
Automobiles, Repairing—tire-valve stem used to blow out gas feed pipe	872
Automobiles, Truck—adjustable width gauge on	874
Belts—keeping leather and rubber, in good condition	877
Drafting—hacksaw blade makes accurate section liner	874
Drip Pan—spout and handle for	865
Grease Gun—electric drill runs pump for filling	879
Jars—attached to underside of shelf solve storage	879
Lead—increasing utility of	873
Lathe—how to grind metal-cutting lathe tools	863
Photography	
hot air dries films on this overhead rack	871
reading glass helps in focusing	876
Poultry—drum mixer stirs feed quickly	864
Pulley—improvised crown on a lat	858
Pump—auto tube used to prime	876
Rods—simple jig for slotting	868
Sander—drum, for the workshop	869
Saws and Sawing—hacksaw stop limits depth of cut	877
Shaft—size increased by peening	872
Steel Rule—small bar magnet serves as rule marker	878
Stepladder—extension rod on, adds to worker's safety	872
Stereotypes—type metal used for making newspaper cuts	877
Table—a drop-leaf pivot-top	875
Toys—wiring track to stop toy train for red light	878
Tracing—electric light in desk drawer aids in	868
Warning Flag—battery clips hold	867
Wood—how to plane thin	867
Wrench	
has quick adjustment	865
pipe, monkey wrench and pliers for improvised	879

Switch. Electric Time 708

Joint Camp 765

KITCHEN CABINETS

OUTDOOR SIGNS

REFRIGERATORS

RADIO CABINETS

TRUNKS-TOYS

TRUCK BODIES

INCUBATORS

FURNITURE

Make it
out of
PRESDWOOD

*this all-purpose wood
board can serve you in
endless ways*

Seemingly, there's no end to uses for Masonite Presdwood. Manufacturers, builders, home owners, home mechanics, continually are discovering new things for Presdwood to do—and, without fail, Presdwood does them well. On this page are shown a few of its uses. The makers of these articles say this grainless, all-purpose wood board has improved their products and, besides, has reduced costs.

Presdwood works perfectly—under saw, drill or punch. Will not crack, chip, split, splinter or warp.

Write for free Presdwood booklet. Lists 80 uses. Your architect, contractor or lumber dealer also will tell you about Presdwood.

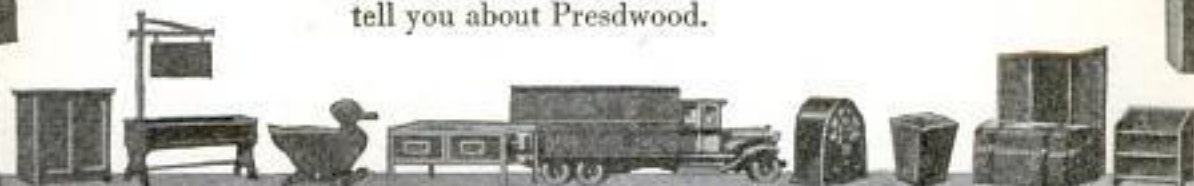

Masonite
STRUCTURAL INSULATION • INSULATING LATH
PRESDWOOD • QUAKERBOARD

"Made in Mississippi"

Masonite Corporation, Dept. L-5 © M. C., 1931
111 W. Washington St., Chicago, Ill.

Please send your free illustrated booklet that describes Masonite Presdwood and its many uses.

Name.....

Street.....

City..... State.....

If interested in Masonite Insulation, check here

How the LaSalle Problem Method Increases Your Salary



—Why in six months' time alone as many as 1,248 LaSalle members reported definite salary-increases totalling \$1,399,507, an average increase per man of 89 per cent!



No matter what you are making now, you are interested in any plan which suggests a practical way to increase your earnings—within a comparatively short time. There is such a plan—it is known as the LaSalle Problem Method—and its practical value is attested by thousands of men who have employed it to plus their native aptitude with systematic training. Read these typical experiences:

Receives Earnings More Than 500 Per Cent—"In 1920, I was employed in a local railroad office, and was earning only a living wage—I am now traffic manager of the King Company, the largest exclusive iron lamp post manufacturers in the United States, if not in the world. . . . My training in Traffic Management with LaSalle is responsible for this advancement and the increase of more than 500 per cent in my earnings."

JOHN R. MEEKS, Sheffield, Ala.

Becomes Treasurer of Big Department Store—"My salary is now 300 per cent larger than it was when I saw the sign which led me to your school—and I am now Treasurer of the Palais Royal. I will be eternally grateful to you for my advancement and I recommend your training to every ambitious young man, for a \$5,000 position is waiting for anyone who will take your training and apply himself."

W. F. HISEY, Washington, D. C.

Shop Laborer Becomes Lawyer—"When I enrolled in LaSalle Law training, I was a laborer in a shop. I worked all day in the shop and studied until late each night. I was soon promoted to the shopkeeper's office and then to accountant. In three years, I passed the Bar examination and a little later, I began the practice of law."

JOHN S. GIBSON, Douglas, Ga.

Stenographer Promoted to Comptroller—"LaSalle training in accountancy has been an important factor in my advancement from stenographer to comptroller of the Ranier National Park Company."

F. R. GRIFFITHS, Tacoma, Wash.

When thousands of men in the United States and Canada (not to mention many hundreds in England, Australia, China and other foreign countries) choose the LaSalle Problem Method to speed their progress—when over 4,000 LaSalle members belong to the LaSalle One Hundred Per Cent Club, having more than doubled their incomes—when the average increase reported by other thousands is 89 per cent—surely the LaSalle Problem Method must offer an unusually sound way of securing quickly the kind of experience that can be cashed. It does. And here are very good reasons why:



You Learn by Doing

Suppose it were your privilege every day to sit in conference with the head of your firm. Suppose every day he were to lay before you in systematic order the various problems he is compelled to solve, and were to explain to you the principles by which he solves them. Suppose that one by one you were to work those problems out—returning to him every day for counsel and assistance—

Granted that privilege, surely your advancement would be faster—by far—than that of the man who is compelled to pick up experience hit-or-miss.

Under the LaSalle Problem Method you pursue, to all intents and purposes, that identical plan. You advance by solving practical problems.

Only—instead of having at your command the counsel of a single individual—your Chief—you have back of you the organized experience of the largest business training institution in the world, the authoritative findings of scores of able specialists, the actual procedure of the most successful business houses.

Thus—instead of fumbling and blundering—you are coached in the solving of the very problems you must face in the higher positions. Step by step, you work them out for yourself—until, at the conclusion of your training, you have the kind of experience for which men are willing and glad to pay real money.

Send for Salary-Increasing Plan

The details of the LaSalle Problem Method—often spoken of as the salary-increasing plan—will be sent you for the asking. Whether you adopt the plan or not, the basic information it will place in your hands, without cost, is of very real and definite value. And—it's FREE.

Balance the two minutes that it takes to fill out the coupon against the rewards of a successful career—then clip and mail the coupon NOW.

LaSalle Extension University

THE WORLD'S LARGEST BUSINESS TRAINING INSTITUTION

Find Yourself Through LaSalle!

LaSalle Extension University, Dept. 564-R, Chicago

I would welcome an outline of the LaSalle plan, together with a copy of "Ten Years' Promotion in One," all without obligation.

- | | |
|---|--|
| <input type="checkbox"/> Business Management: Managerial, Sales and Executive positions. | <input type="checkbox"/> Law: LL.B. Degree |
| <input type="checkbox"/> Higher Accountancy: Auditor, Comptroller, Certified Public Accountant, Cost Accountant, etc. | <input type="checkbox"/> Industrial Management |
| <input type="checkbox"/> Expert Bookkeeping | <input type="checkbox"/> Modern Foremanship |
| <input type="checkbox"/> C. P. A. Coaching | <input type="checkbox"/> Personnel Management |
| <input type="checkbox"/> Paper Salesman's Training | <input type="checkbox"/> Banking and Finance |
| <input type="checkbox"/> Traffic Management—Foreign and Domestic | <input type="checkbox"/> Credit and Collection |
| <input type="checkbox"/> Railway Station Management | <input type="checkbox"/> Correspondence |
| <input type="checkbox"/> Business Correspondence | <input type="checkbox"/> Telegraphy |
| <input type="checkbox"/> Railway Accounting | <input type="checkbox"/> Business English |
| <input type="checkbox"/> Commercial Law | <input type="checkbox"/> Effective Speaking |
| <input type="checkbox"/> Commercial Spanish | |



free!
mail coupon now

Name

Present Position

Address

If you're "On the Outside Looking in"

You need this Free Book

ARE you standing on the sidelines, wishing you were in Aviation . . . envying those who are already making Aviation history while holding down good jobs with fine futures? If so, remember this:—*Wishing won't get you into Aviation—but practical training will!* Walter Hinton's free book, "Wings of Opportunity," tells you a quick, sure, inexpensive way to get the necessary practical training—in your spare time, at home.

Hinton's personalized training and his free Employment Service are putting serious-minded, red-blooded men like you in good flying and ground jobs right along, at salaries of from \$40 to \$80 a week. Martin Co., Curtiss-Wright, Curtiss Flying Service, Alexander Aircraft, T. A. T., Fokker and scores of other leaders are employing Aviation Institute graduates. In one day alone, we had calls for more than forty men!

Many other industries have reached their saturation points—and can offer only small-pay jobs with no future. But Aviation is just beginning to grow! In Aviation your future can be just as big as you want to make it. So why sit back? Why drift into something else,

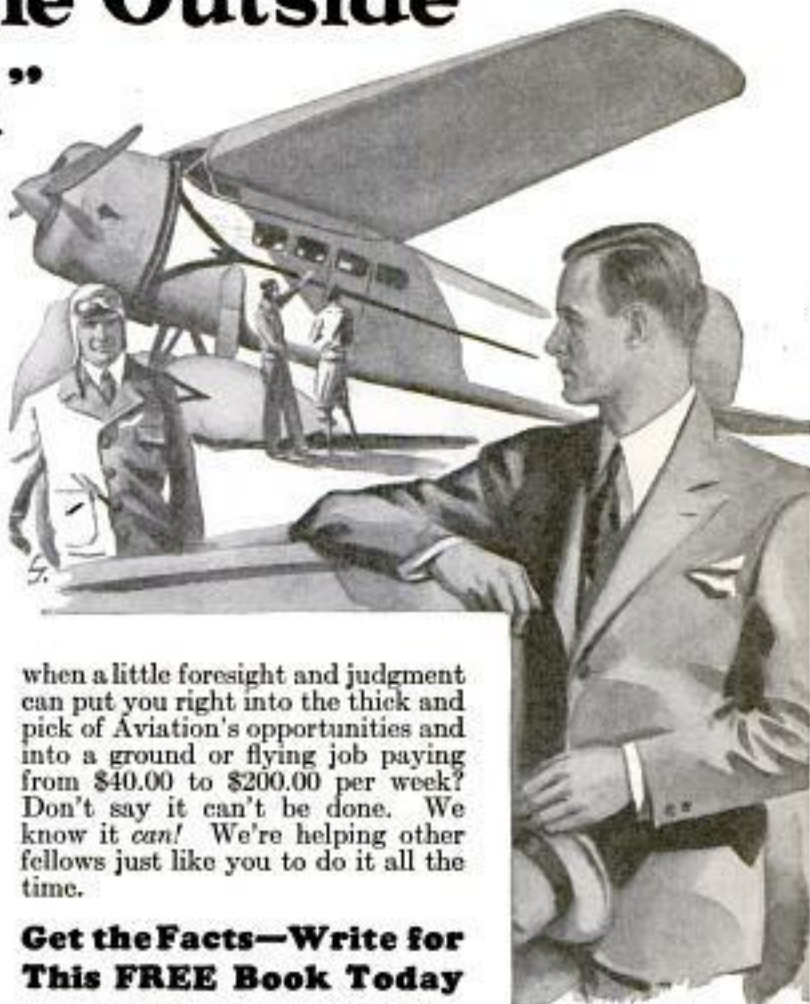

when a little foresight and judgment can put you right into the thick and pick of Aviation's opportunities and into a ground or flying job paying from \$40.00 to \$200.00 per week? Don't say it can't be done. We know it can! We're helping other fellows just like you to do it all the time.

Get the Facts—Write for This FREE Book Today

If you're 16 or over—and serious about wanting to get into Aviation, get a free copy of Walter Hinton's book. It tells how he can give you the vital facts, the necessary knowledge of plane-construction, engine-design, rigging, repairing, servicing, airport management, navigation, theory of flight, etc. If you want to learn to fly, his course can save you many times its cost in cash. It's interesting and easy to understand from the start and packed with facts that mean success for you—no matter what branch of Aviation you choose to enter. Mail the coupon today—right NOW.

Now District Traffic Agent for T. A. T.

"When I finished your course I became connected with T. A. T. and am happy to state that promotion has come very rapidly. I shall always be grateful to you for your interest and cooperation." C. E. McCullom, District Traffic Agent, T. A. T.—Maddux Air Lines.

"After completing your course I was engaged as Aeronautical Draftsman by a leading concern. I thoroughly recommend your training. It is complete in every detail!" Ira W. Bergen, Brooklyn, N. Y.

Robt. N. Dobbins, a Hinton Graduate, writes: "I cannot thank you enough for the assistance you gave me in getting my present position. Last week they promoted me to Chief Instructor at a salary increase of \$15 a week."

Aviation Institute of U. S. A., Inc.

WALTER HINTON, President

1115 Connecticut Ave. Washington, D. C.

301-Z

Aviation Institute of U. S. A., Inc.,
1115 Connecticut Avenue,
Washington, D. C.

I am serious about wanting to get into Aviation. Please send me, without obligation of any kind, a free copy of Walter Hinton's book, "Wings of Opportunity."

Name.....
(Print clearly)

Address.....Age.....
(Must be over 16)

City.....State.....



FREE BOOK

Big Pay Jobs for Trained RADIO Men

5000

Service Men Needed



ACTUAL PHOTOGRAPH OF STUDENTS WORKING IN SERVICE DEPT. OF COYNE RADIO SHOPS

LEARN RADIO ~ TELEVISION TALKING PICTURES in 10 WEEKS By Actual Work ~~~ In the Great Shops of Coyne

Don't spend your life slaving away in some dull, hopeless job! Don't be satisfied to work for a mere \$20 or \$30 a week. Let me show you how to make REAL MONEY in RADIO—the Fastest-Growing, Biggest MONEY-MAKING GAME ON EARTH.

Jobs Leading to Salaries of \$60, \$70 a Week and Up

Jobs as Designer, Inspector and Tester paying \$3,000 to \$10,000 a year—as Radio Salesman and in Service and Installation Work, at \$45 to \$100 a week—as Operator or Manager of a Broadcasting Station, at \$1,800 to \$5,000 a year—as Wireless Operator on a Ship or Airplane, as a Talking Picture or Sound Expert—HUNDREDS of OPPORTUNITIES for fascinating, Big Pay Jobs!

No Books — No Lessons All Practical Work

Coyne is NOT a Correspondence School. We don't attempt to teach you from books or lessons. We train you on the latest and finest outlay of Radio, Television and Sound Equipment—on scores of modern Radio Receivers, huge Broadcasting equipment, the very latest

Television apparatus, Talking Picture and Sound Reproduction equipment, Code Practice equipment, etc. You don't need advanced education or previous experience. We give you—right here in the Coyne Shops—all the actual practice and experience you'll need. And because we cut out all useless theory, you graduate as a Practical Radio Man in 10 weeks' time.

TELEVISION Is Now Here!

And TELEVISION is already here! Soon there'll be a demand for THOUSANDS of TELEVISION EXPERTS! The man who learns Television NOW can make a FORTUNE in this great new field. Get in on the ground-floor of this amazing new Radio development. Come to COYNE and learn Television on the very latest, newest Television equipment.

Talking Pictures A Great Field

Talking Pictures and Public Address Systems offer thousands of golden opportunities to the Trained Radio Man. Here is a great new field

of Radio work that has just started to grow! Prepare NOW for these marvelous opportunities! Learn Radio Sound work at Coyne on actual Talking Picture and Sound Reproduction equipment.

EARN AS YOU LEARN
YOU GET FREE EMPLOYMENT SERVICE FOR LIFE. And don't let lack of money stop you. If you need part-time work while at school to help pay living expenses, we will gladly help you get it. Many of our students pay nearly all of their expenses that way. Mail the coupon below for full particulars.

Coyne is 32 Years Old

Coyne Training is tested, proven beyond all doubt. You can find out everything absolutely free. How you can get a good Radio job or how you can go into business for yourself and earn from \$5,000 to \$15,000 a year. It costs NOTHING to investigate! Just Mail the Coupon for Your Copy of My Big Free Book!

H. C. Lewis, Pres. **RADIO DIVISION** Founded 1899
COYNE ELECTRICAL SCHOOL
500 S. Paulina Street Dept. 51-3H Chicago, Illinois

H. C. LEWIS, President
Radio Division, Coyne Electrical School
500 S. Paulina St., Dept. 51-3H

Send me your Big Free Radio Book and all details of your Special Introductory Offer. This does not obligate me in any way.

Name.....

Address.....

City.....State.....

BREAK

THOSE BONDS!

● ARE your hands tied? Are you bound down to a routine job because you have never learned to do any one thing well?

Don't be a slave to circumstances all your life. Break loose! All around you, you can see people with no more intelligence than yourself who have climbed out of the routine class and are making big salaries because they have had the *specialized training* that makes them valuable.

The only slavery in this free country is the slavery of inertia. If you let your ambition die—if you allow yourself to sink deeper and deeper into a rut of poorly paid drudgery—the fault is yours. Don't give up! Waiting for you at this moment is a bigger, better-

paying job. You can have it as soon as you have secured the training to handle it. And you can get that training in spare time, right in the quiet of your own home.

No matter where you live, the International Correspondence Schools will come to you. No matter what your handicaps, or how small your means, we have a plan to meet your circumstances.

To thousands of men and women like you—hands tied but eager to break free—I. C. S. training has brought success. Don't let another priceless hour of spare time go to waste. Without cost or obligation, let us prove that we can help you to get a better job and a bigger salary. Mark and mail this coupon.



INTERNATIONAL CORRESPONDENCE SCHOOLS

"The Universal University"

Box 5341-G, Scranton, Penna.

Without cost or obligation, please send me a copy of your booklet, "Who Wins and Why," and full particulars about the subject before which I have marked X:

TECHNICAL AND INDUSTRIAL COURSES

- | | |
|---|--|
| <input type="checkbox"/> Architect | <input type="checkbox"/> Bridge and Building Foreman |
| <input type="checkbox"/> Architectural Draftsman | <input type="checkbox"/> Gas Engines <input type="checkbox"/> Diesel Engines |
| <input type="checkbox"/> Building Estimating | <input type="checkbox"/> Aviation Engines |
| <input type="checkbox"/> Wood Millworking | <input type="checkbox"/> Automobile Mechanic |
| <input type="checkbox"/> Contractor and Builder | <input type="checkbox"/> Plumbing <input type="checkbox"/> Steam Fitting |
| <input type="checkbox"/> Structural Draftsman | <input type="checkbox"/> Heating <input type="checkbox"/> Ventilation |
| <input type="checkbox"/> Structural Engineer | <input type="checkbox"/> Sheet Metal Worker |
| <input type="checkbox"/> Electric Wiring | <input type="checkbox"/> Steam Engineer |
| <input type="checkbox"/> Electrical Engineer | <input type="checkbox"/> Steam Electric Engineer |
| <input type="checkbox"/> Electric Lighting | <input type="checkbox"/> Civil Engineer |
| <input type="checkbox"/> Welding, Electric and Gas | <input type="checkbox"/> Surveying and Mapping |
| <input type="checkbox"/> Reading Shop Blueprints | <input type="checkbox"/> Refrigeration |
| <input type="checkbox"/> Telegraph Engineer | <input type="checkbox"/> R. R. Locomotives |
| <input type="checkbox"/> Telephone Work | <input type="checkbox"/> R. R. Section Foreman |
| <input type="checkbox"/> Mechanical Engineer | <input type="checkbox"/> R. R. Bridge and Building Foreman |
| <input type="checkbox"/> Mechanical Draftsman | <input type="checkbox"/> Air Brakes <input type="checkbox"/> Train Operation |
| <input type="checkbox"/> Machinist <input type="checkbox"/> Toolmaker | <input type="checkbox"/> Highway Engineering |
| <input type="checkbox"/> Patternmaker | <input type="checkbox"/> Chemistry <input type="checkbox"/> Pharmacy |
| <input type="checkbox"/> Pipefitter <input type="checkbox"/> Tinsmith | <input type="checkbox"/> Coal Mining Engineer |
| <input type="checkbox"/> Bridge Engineer | <input type="checkbox"/> Navigation <input type="checkbox"/> Boltmaker |

- Textile Overseer or Supt.
- Cotton Manufacturing
- Woolen Manufacturing

- Agriculture Fruit Growing
- Poultry Farming Radio
- Marine Engineer

BUSINESS TRAINING COURSES

- | | |
|---|--|
| <input type="checkbox"/> Business Management | <input type="checkbox"/> Business Correspondence |
| <input type="checkbox"/> Office Management | <input type="checkbox"/> Lettering Show Cards <input type="checkbox"/> Signs |
| <input type="checkbox"/> Industrial Management | <input type="checkbox"/> Stenography and Typing |
| <input type="checkbox"/> Personnel Management | <input type="checkbox"/> Complete Commercial |
| <input type="checkbox"/> Traffic Management | <input type="checkbox"/> Civil Service <input type="checkbox"/> Mail Carrier |
| <input type="checkbox"/> Accountancy <input type="checkbox"/> Cost Accountant | <input type="checkbox"/> Railway Mail Clerk |
| <input type="checkbox"/> C. P. Accountant | <input type="checkbox"/> Grade School Subjects |
| <input type="checkbox"/> Bookkeeping | <input type="checkbox"/> High School Subjects |
| <input type="checkbox"/> Secretarial Work | <input type="checkbox"/> College Preparatory |
| <input type="checkbox"/> Spanish <input type="checkbox"/> French | <input type="checkbox"/> Illustrating <input type="checkbox"/> Cartooning |
| <input type="checkbox"/> Salesmanship <input type="checkbox"/> Advertising | <input type="checkbox"/> Lumber Dealer |

Name.....Age.....

Address.....

City.....State.....

Occupation.....

If you reside in Canada, send this coupon to the International Correspondence Schools Canadian, Limited, Montreal, Canada

LEARN ELECTRICITY

Without Lessons In 90 Days

BY ACTUAL WORK GREAT COYNE



Students working in our Alternating Current Dept.



Instructor explaining operation of modern airplane motor

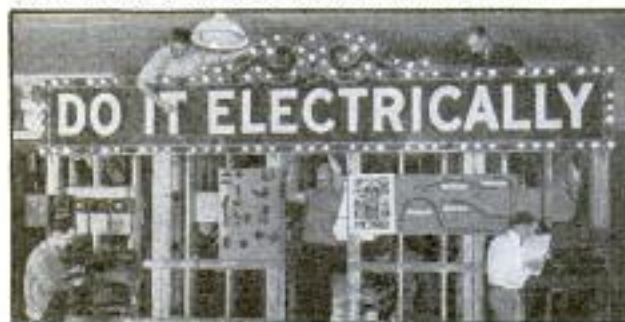

Students getting actual experience on modern electric sign

Don't spend your life in a dull, hopeless job! Don't be satisfied with a mere \$30.00 or \$40.00 a week! You don't have to. Electricity pays salaries of \$60, \$70 and even \$200 a week to thousands of fellows no smarter than you. And you can learn Electricity at Coyne in 90 days—NOT BY CORRESPONDENCE, but by actual electrical work.

Golden Opportunities

Paying \$60 a Week and Up!

In Power Plant work, Armature Winding, Auto Ignition, House Wiring, Radio Service, Refrigeration, Welding, Aviation Electricity, Illumination, etc. Thousands of Big Pay Opportunities for the Trained Man. And you can prepare for one of them in 90 days at Coyne!

No Books—No Lessons

Coyne is not a Correspondence School. We train you by actual electrical work—on huge motors and generators, switchboards, power plants, substa-

H.C. LEWIS
PRESIDENT **COYNE**
500 SOUTH PAULINA STREET,

MAIL COUPON FOR



IN THE SHOPS

tions, auto and airplane engines, armatures, etc.

You don't need advanced education or previous experience. Coyne has been placing men in Electrical Jobs since 1899. Let Coyne help you to a good electrical position!

Free Employment Service EARN AS YOU LEARN

My Employment Department gives you a FREE lifetime service. And if you need part-time work while at school to help pay expenses, we'll gladly help you get it.

GET MY BIG FREE BOOK

But get the PROOF! Mail the coupon below for my BIG FREE BOOK—telling all about jobs, salaries, opportunities. Find out about my Free Radio Service, Auto and Aviation Electricity offers. This costs you nothing and does not obligate you in any way. **Just Mail the Coupon!**

ELECTRICAL SCHOOL
FOUNDED 1899
Dept. 51-72, CHICAGO, ILLINOIS



Students working on a large synchronous Converter

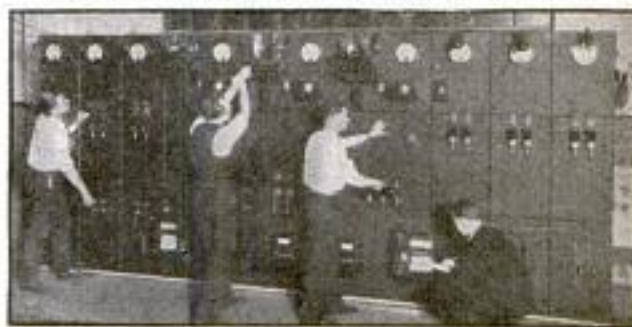

Students learning switchboard work by actual practice

H. C. LEWIS, PRESIDENT
COYNE ELECTRICAL SCHOOL, Dept. 51-72
506 S. Paulina St., Chicago, Ill.

Gentlemen: Please send me your big Free Electrical Book with 151 illustrations. This does not obligate me.

Name.....

Address.....

City..... State.....

MY FREE BOOK →

Easy home method quickly teaches HAWAIIAN GUITAR



Play all the latest hits
just as the Hawaiians do!
Have good times aplenty!

Native Hawaiian expert directs you

You get expert instruction directed by a world-famous player and teacher, Prof. Walter Kolomoku. He quickly reveals to you the secrets of this fascinating instrument.

Only 4 Motions to learn. Then you can play any music—popular songs, classical, old-time melodies, native Hawaiian airs—or real jazz. You'll never be lonesome after you learn the Hawaiian Guitar.

Complete Course 52 lessons. Nothing omitted. Pictures explain every move. You are sure to learn—what we can do for others we can do for you. Over 50,000 successful students.

Payasyouplay We make it easy for you. Start with small first payment—then pay while learning. Costs only few cents per lesson. You only pay the cost of instruction—we furnish everything.

Learn at home in spare time

Study in spare time at home. Even if you don't know a note our method is so simple, plain and easy, you begin a piece your first lesson. In half an hour you can play it!

Sweet Toned HAWAIIAN GUITAR GIVEN when you enroll

—with genuine seal grain, Fabrikoid Cover and complete playing outfit. Reliable retailers ask \$18 to \$20 for a similar instrument and outfit without the fine Fabrikoid Case, which alone is valued at \$3.50.

TENOR BANJO and other courses

The same thorough instruction on the Tenor Banjo, Violin, Tiple, Tenor Guitar, Ukulele, Banjo Ukulele—well known instructors. Write for full information.

FIRST HAWAIIAN CONSERVATORY OF MUSIC, Inc.
9th Floor, Woolworth Bldg.,
Dept. 748, New York

Approved as a Correspondence School Under
the Laws of the State of New York

Member National Home Study Council

Send This Coupon for Liberal Offer!

FIRST HAWAIIAN CONSERVATORY OF MUSIC, Inc.
9th Floor, Woolworth Bldg., Dept. 748, New York, N.Y.
Please mail full information about your 52-lesson Hawaiian
Guitar Course. I am not obliged to enroll unless I want to.

Name _____
Address _____
City _____ State _____

Win fame—
friends—fort-
tune! Play the
Hawaiian
Guitar!

✓ PRACTICAL BOOKS for PRACTICAL MEN

We publish over 200 Home Study Books, plainly written by experts so you can understand them. Some of the subjects covered are

RADIO	BUILDING
AVIATION	SHEET METAL WORK
ENGINEERING	PAINTING
AUTOMOBILE WORK	SIGN MAKING
BATTERY WORK	LETTERING
ELECTRICITY	COMMERCIAL ART

The following books are a few of the many that ambitious men are using to help toward their success—

Drake's Radio Cyclopedia, Manly.....	\$6.00
Aviation From the Ground Up, Manly.....	3.50
Practical Applied Electricity, Moreton.....	2.00
Ford Motor Car and Truck, Manly.....	1.50
Auto and Radio Battery Care and Repair, Manly.....	2.00
Furniture, Furniture Finishing, Decoration and Patching.....	5.00
The Mixing of Colors and Paints.....	2.00
How to Draw Funny Pictures—(Cartooning).....	3.00
Modernistic Lettering and Design.....	2.00
Sheet Metal Workers' Manual.....	2.00
Oxy-Acetylene Welding and Cutting.....	1.25
The Slide Rule and Logarithmic Tables.....	2.00
Marine and Stationary Engineers—Questions and Answers.....	2.00
Johnson's Manual on Heating, Ventilating and Mechanical Refrigeration.....	1.50
Johnson's Manual on Plumbing, Drainage and Sewerage.....	1.50

Any book sent postpaid on receipt of price. Write today for **FREE CATALOG** which fully describes all books we publish.

FREDERICK J. DRAKE & CO.
Room 508 - 179 No. Michigan Blvd., Chicago
Drake books are for sale at all bookstores

I Teach by Mail

Begin Today—Write for My FREE Book, I can make a good penman of you at home during spare time. Write for my **FREE BOOK**, "How to Become a Good Penman." It contains specimens and tells how others mastered penmanship by the Tumbly System. Your name will be elegantly written on a card if you enclose stamp to pay postage. Write today for book.

F. W. Tumbly, 410 Ridge Blvd., Kansas City, U. S. A.

BE AN ARTIST

WE CAN TEACH YOU DRAWING in your own home during your spare time. Twenty-five years of successful teaching proves our ability. Artists receive large salaries.

Write Today for Art Year Book

SCHOOL OF APPLIED ART
ROOM NO. 2 BATTLE CREEK MICH.

LEARN TO Mount Birds

Learn at home by mail to mount Birds, Animals, Heads, Taxidermy and Make Maps. Be a taxidermy artist. Easy, quickly learned by men, women and boys. Interesting and fascinating. Decorate home and den. **Make Big Profits from Spare Time.**

Free Book Beautiful book telling all about how to learn taxidermy sent Free if you state your AGE. Send Today for this wonderful new book. Don't delay!

N. W. School of Taxidermy, 3375 Elwood Blvd., Omaha, Neb.

Learn Watchwork, Jewelrywork and Engraving A fine trade commanding a good salary, and your services always in demand. Address **Horological**, Dept. P, Bradley Institute, PEORIA, ILLINOIS, for our latest catalog.

We have placed machinists, carpenters, masons, plumbers, railroad men, office clerks, farmers and even laborers in fine Drafting Jobs under this plan. Mail coupon for details of our remarkable offer.

Men Who Work With Their Hands Make the Best DRAFTSMEN



—and we'll back them with this EMPLOYMENT CONTRACT

We are looking for more ambitious young fellows with factory, building-trade or any other kind of mechanical experience to prepare for and help place in well-paid Drafting positions. Such men, we find, are unusually successful as Draftsmen, because they know how things are done, and that's a priceless asset to the man who makes the blueprint plans. Get in touch with me and I'll tell you how you can cash in on your entire past mechanical experience.

Drafting Is Logically Your Next Move!

Of course you realize the biggest handicap to mechanical work is that you're limited in earning capacity to the output of your two hands, as long as you live. Even the skilled mechanic earning \$50 to \$60 a week has reached his limit. He can never earn more and when he gets old he will earn less. So I don't blame any man for wanting to get away from this futureless outlook. For wanting to get into something where he can use his head as well as his hands—where he will be paid for what he knows, instead of only for what he does... You know enough about blueprints to understand that PLANS govern every move in factory and construction job. The Draftsman who makes them is several jumps ahead of the workman who follows them. And so I want you to know that DRAFTING is a logical, natural PROMOTION from mechanical and building work—better-paid, more interesting—just the kind of work you'd enjoy doing.

Get Our NO-RISK PLAN

The way to a fine Drafting job for you—is easier than you think. It takes no "artistic talent" or advanced education. Thousands of men no smarter than you, with no more education or ability, have learned it quickly and you can, too. With the co-operation of some of the biggest employers and engineers in the U. S., we have worked out a plan to prepare you for Drafting work in your spare time at home—then to help you get a fine position when you're only half way through the course. Mail the coupon and we'll be glad to tell you all about this lifetime chance.

THE AMERICAN SCHOOL
Dept. D-547, Drexel Ave. and 58th St., Chicago, Illinois



36-Page Drafting Book—FREE

Tells how easy Drafting is to learn—how interesting the work is—what remarkable opportunities are open for Draftsmen right now. Mail coupon for a copy—without cost or obligation.

AMERICAN SCHOOL, Dept. D-547, Drexel Ave. & 58th St., Chicago, Ill.

Please tell me, without cost or obligation, about your training and employment service in line marked X below.

DRAFTING

- Architecture Civil Engineering
 Building Auto Engineering
 Electrical Engineering
 Business Management
 Accounting
 Mechanical Engineering
 Shop Superintendent
 Foremanship
 High School in 2 years
 Structural Steel

Name _____

St. No. _____

City _____ State _____

Age _____ Occupation _____



"I have landed a job with the Pacific Tel. and Tel. Co. in Seattle, and I must say that I am greatly indebted to the American School for my success. You have done all that you promised in helping me obtain employment."

T. C. White
Seattle, Wash.



"I have obtained a position as a junior draftsman with the Muncie Oil Engine Co., and so far I like the work real well. I appreciate your aid in obtaining this position very much."

M. N. Hareham
Muncie, Ind.

Learn Electricity IN LOS ANGELES

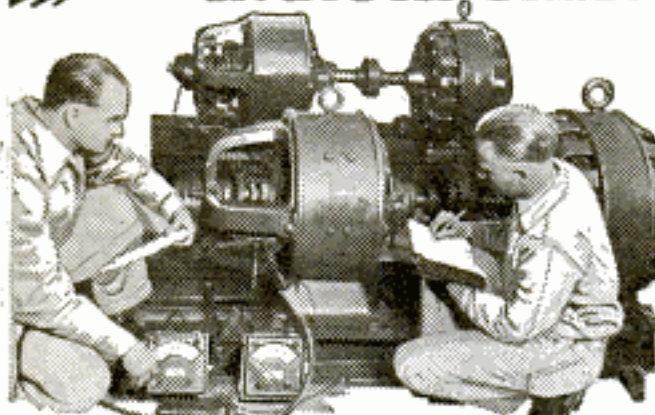

**and LEARN RIGHT!
YOU NEED GOOD TRAINING
TO EARN BIG PAY!**

National Electrical School—a million dollar institution—established in 1905—is recognized throughout the electrical industry as the foremost school of the West. National gives you practical intensive training in all electrical branches. No age limit. No previous experience necessary. Life Scholarship privileges. Unlimited training prepares you for bigger opportunities. Start any time of the year. Individual instruction under Experts.

You Can Qualify Quickly For Big Pay Jobs!

We train you *right* in the *shortest possible time*. Our condensed practical training in one of the best equipped schools in the country qualifies you as a Skilled Electrician. Don't take a chance without this training. NOT a Correspondence Course.

Don't Worry About Enough Money! We'll Help You!

If you are low on cash, we'll make it easy for you to get National Training. We help you secure part-time jobs to earn living expense while learning. Unlimited Life-Time Employment Service assures you proper co-operation in getting started in the electrical game. The Electrical Industry needs you as soon as you can get this training—that's why it's easy for us to help you.

Your Railroad Fare Allowed To Los Angeles!

We'll allow your full railroad fare from any point in the United States. Come West, get trained, enjoy life, and make more money because you are qualified. This offer is made for a limited time only, to encourage ambitious men seeking the best training.

New Descriptive Book Tells Everything! Write Today!

Fill out coupon now—and mail it today for full details of the greatest offer ever made ambitious men. You'll never equal this great offer—so send today for the complete story. Mail this coupon at once. Get names and addresses of many of our 25,000 Successful Graduates—some right near you.

WRITE for FREE BOOK NOW!

NATIONAL Electrical School

Dept. 54-F 4006 S. Figueroa Street,
Los Angeles, California

Send me your big free illustrated catalog of Electrical Opportunities showing how I can learn quickly and get a Big-Pay Electrical Job.

Name _____

Address _____

Age _____ City _____ State _____



Public Speaking - Has Its Rewards

If you are interested—



**NOW
SENT
FREE**

—to develop the ability to speak effectively in public or in everyday conversation—to forge ahead twice as fast as you are now doing, read *How to Work Wonders With Words* now sent free.

This new booklet recently published, points the road that thousands have followed to increase quickly their earning power and popularity.

It also explains how you can, by a new, easy home study method, become an outstanding speaker and conquer stage fright, timidity and fear. To read this booklet will prove an evening well spent. Simply send name and address and this valuable free booklet will be sent at once. No obligation.

NORTH AMERICAN INSTITUTE

3601 Michigan Avenue

Dept. 1355, Chicago, Illinois

Anyone CAN LEARN

No talent or experience necessary. Fascinating work. Pays big money. Complete instruction book tells about Alphabets, Colors, How to Write Points, Show Cards, Window Board and Wall Signs, Ready made letters, Gilding, Tricks of the Trade, also gives 100 Alphabets and Designs. Book bound in flexible int. leather-bound edges, and four full bearing Show Card Forms. Sent postpaid \$3.00. (C.O.D.) 10c extra.

Gleivis Pub. Co., 57 Base St., Dept. 20, N.Y. City

**EARN MONEY IMMEDIATELY—
WE FURNISH EQUIPMENT TO START!!**

MUSIC LESSONS IN YOUR HOME

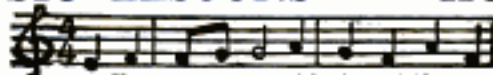

You can play music like this quickly

Write today for our FREE BOOKLET AND SAMPLE LESSON. It tells how to learn to play Piano, Organ, Violin, Mandolin, Guitar, Banjo, etc. Beginners or advanced players. You pay as you learn. Costs you only a few cents a day. Thousands of satisfied students.

AMERICAN SCHOOL of MUSIC, 51 Manhattan Bldg., CHICAGO

LEARN WATCH REPAIRING



You can learn by our modern and original system of instruction every part of the **Watch Repairing Trade** at home as good or better than at a shop. You can earn money while learning and secure a well paying position or start in business after completing our course of instruction. Good watch repairers are always in demand and earn from \$50 to \$75 per week. For particulars apply to the **Wisconsin School of Watch Repairing** 524 E. Mason St., MILWAUKEE, WIS.

"STAMMERING Its Cause and Cure"

You can be quickly cured if you stammer. Send 10 cents, coin or stamps, for 288-page cloth-bound book on Stammering and Stuttering. It tells how I cured myself after Stammering and Stuttering for 20 years. **BENJAMIN N. BOGUE** 11114 Begou Building, 1147 N. Illinois Street, Indianapolis

\$25 Extra Each Week

You can make Big Money, spare-time or full-time, playing for Dances, Parties, Orchestras, Radio! **REAL CASH** paid for melodic music of Hawaiian Guitar. YOU can make \$20 a week extra, or \$65 to \$100 a week full time. You can play for P.A.P. in 2 to 3 months!

It's Easy Now to be Popular

Be the life of every party! Bid goodbye forever to lonely evenings! Courses—Phonograph Records—full outfit—everything to insure quick social and professional success—costs only a few cents a day. Write NOW for FREE Book—**HAWAIIAN STUDIO 52051, New York** Academy of Music, 100 Fifth Ave., New York City



Pick Your Own Job!

I'll Help You to Get It

NO special experience required to get one of these attractive Government positions. All you need is to pass an examination—and it is easy if you prepare for it. And that's my business. For eight years I was a Secretary Examiner. Since then, during the past twenty years, I have helped thousands into well-paid Government positions, and I can help you get there too. I know *how to train you* to get highest rating in Civil Service Examinations, which will qualify you for first positions open. You get the job you're after within a year of passing examinations—or it *costs you nothing*.

Good Pay • Short Hours • Steady Work

Get rid of the bugaboos of hard times, strikes, layoffs, job-hunting that you must always worry about in ordinary jobs. Don't stick in the low-pay jobs that start you off in a rut and keep you there. Work for Uncle Sam in a fine position you can't lose for any religious, political or personal reasons. Here's a wonderful position you can easily get that pays you from \$1850 to \$3300 a year; where there are no strikes or lockouts, where you get vacations with pay, retirement pensions, 8-hour day, automatic yearly salary raises, unlimited opportunities for quick advancement and many other advantages you can't get anywhere else!

FREE My New Book "How to Secure a Gov't Position"

If you are a citizen, eighteen to fifty, you can get the Civil Service Position you want. Write today for my new free book that tells all about the Civil Service—the jobs open, what you must do to get the job, the pay, the vacation, and all the big advantages of Government Positions. Find out just how I can help you land a steady good-paying position in the Civil Service in Washington, travelling, or near your home. Mail the coupon or a postal today.

A. R. PATTERSON
Civil Service Expert

Patterson School
85 Wisner Bldg., Rochester, N. Y.



RAILWAY POSTAL CLERK

\$1850 to \$2700 a year

Opportunity for travel. 15 days' vacation and 10 days' sick leave with full pay. Paid all the time.

POST OFFICE CLERK

\$1700 to \$2100 a year
Special Clerks at \$2200 to \$2300

15 days' vacation and 10 days' sick leave every year with full pay. Promotions to positions paying up to \$4,700 a year.

CITY MAIL CARRIER

\$1700 to \$2100 a year

15 days' vacation and 10 days' sick leave every year with full pay. Good chance for rapid promotion to bigger pay.

R. F. D. MAIL CARRIER

\$1800 to \$2300 a year

15 days' vacation and 10 days' sick leave every year with full pay. A fine position for men in rural districts.

INTERNAL REVENUE and CUSTOMS HOUSE POSITIONS

\$1100, \$1680 to \$3000 a year

Extra Pay for Overtime

POSTMASTER

\$1200 to \$2500 a year

This is a position of great importance. In small towns a position that can be made very profitable.

DEPARTMENTAL CLERK

\$1440 to \$1620 a year and up to \$3000 a year

30 days' vacation and 30 days' sick leave with full pay. Work in Washington, or near home.

HOW TO SECURE A GOVERNMENT POSITION:



IMPORTANT

Get ready NOW for the NEXT Railway Postal Clerks' examination! Average yearly pay with allowances is \$2759.

A. R. Patterson, Civil Service Expert
PATTERSON SCHOOL
85 Wisner Building, Rochester, N. Y.

Please send me your big free book and tell me how I can secure a position with the U. S. Government paying me \$1,850 to \$3,300 a year, with excellent chance for rapid advancement. This doesn't cost me a penny.

NAME.....

ADDRESS.....

CITY..... STATE.....

men—Learn
SPRAY FINISHING



and get a
BIG PAY JOB!

**New Field Offers Golden Opportunities
—Prepare NOW!**

Almost overnight, Spray Finishing has taken its place as an important trade in hundreds of industries. Still in its infancy, this fascinating, new work offers big pay jobs to ambitious men in an uncrowded field—a field alive with thousands of opportunities for men who are properly TRAINED. Manufacturers of automobiles, radios, airplanes, furniture, machinery, etc., are calling for practical, competent Spray Finishers for these important jobs—or you may go into business for yourself in your own town. Men—here is your chance to get out of the low-pay drudgery class into a REAL JOB with good pay and promising future!

Train Quickly and Easily in Your Own Home

In only a few short weeks—right in your own home—you can quickly master spray finishing with Pioneer's easy, "Learn by Doing" method, on practical jobs, under direct supervision of Pioneer's staff of skilled spray finishing experts. *No Previous Experience Needed.* These men know the kind of training employers demand, speedily qualifying you as a Master Spray Finisher.

You Can EARN WHILE YOU LEARN

Pioneer's practical training teaches you how to get spare time jobs a few weeks after you start. Many students pay the low cost of Pioneer's course doing a few week-end jobs. *Complete Spray Finishing Outfit and all equipment furnished without extra cost.* When you graduate, Pioneer's Employment Service will assist you in getting a job without charge.

Send for Big FREE Illustrated Book!

It tells how to immediately prepare yourself for a good job in this new trade. Learn what Pioneer has done for others, and what it can do for you!

Get the facts about jobs—salaries and opportunities. Act NOW, while this fascinating field is still uncrowded—Mail the coupon TODAY!



**PIONEER SCHOOL OF
SPRAY FINISHING**

MAIL THIS COUPON FOR BIG FREE BOOK!

Pioneer School of Spray Finishing
Dept. A-531 Chamber of Commerce Bldg.
Los Angeles, Calif.

Send me, absolutely free, your big illustrated catalog of Spray Finishing opportunities.

Name.....

Address.....

City..... State.....

Earn
\$ up to
250.
per month

**WITH A FEW WEEKS
OF SPECIAL TRAINING
AT HOME**

**BE A
RAILWAY
TRAFFIC
INSPECTOR**

GRADUATES of the Standard Business Training Institute earn up to \$250 per month and expenses riding Railways or Bus Lines as Traffic Inspectors. Fascinating outdoor work—in touch with high officials.

We train active men—19 to 55—at home, in spare time, give you Certificate on completion of course and help to place you immediately to earn \$120 up per month and expenses or refund tuition. Advancement is rapid.

Write for Free Booklet and Testimonials.

**STANDARD BUSINESS TRAINING
INSTITUTE**
Div. 205, Buffalo, N. Y.



**BEDFORD
YMCA
TRADE
SCHOOL**

Caterpillar Tractor Mechanic

Aviation Mechanic

Flying

Airplane Welding

Airplane Drafting

Air Navigation

Starting, Lighting, Ignition

Auto Mechanic

Machine Shop, Electric Welding

Oxy-Acetylene Welding

Radio Mechanic, Air Brush

Mechanical, Architectural Drawing

Sign Painting, Show Card Writing

Talking Pictures, Western Electric

Commercial Art, Fine Art

DAY AND EVENING SESSIONS

Write for Catalog 50

Brooklyn Engineering Institute

(Operated by Bedford Y. M. C. A.)

1125 Bedford Avenue, Brooklyn

New York City

WELDING **ELECTRICITY**
RADIO
AUTOMOBILES

No Finer Training Equipment Anywhere at Any Price. Pipe-Line, Sheet Steel, Structural Steel, Cast Iron, Air-Craft and Commercial Welding; Armature Winding; Power Plants; Switchboards; Transformers; Motors; Generators; Batteries; Radio and Automobiles.

LEARN BIG-PAY TRADES AT LOW COST

Write for Information, Mentioning Course Desired.

Coleman Electrical School, 1628 Main St., Kansas City, Mo.



**U.S.
GOVERNMENT
JOBS**



\$1260 to \$3400 Year

Men—Boys—18 to 50

STEADY WORK

Paid Vacations

Franklin Institute
Dept. C186 Rochester, N. Y.

Common Education
Usually Sufficient

Government! Rush to me, FREE, list of U. S. Government big pay steady positions now obtainable. Send me FREE 32-page book describing salaries, hours, work, vacation and how to get a position.

**MAIL COUPON
TODAY—SURE**

Name.....
Address.....

IT ISN'T SUCH A BUM WORLD AFTER ALL!!



WHEN YOU WORK UNDER A SIMON LEGREE STRAW BOSS WITH A TIME CLOCK STARING AT YOU ALL THE TIME—



AND YOU NEVER HAVE ANYTHING IN YOUR POCKETS EXCEPT A HOLE—



AND BILLS KEEP PILING UP ON YOU TILL YOU CAN'T SEE HOW IN THE SAM HILL YOU'RE EVER GOING TO GET OUT OF DEBT—



AND THEN YOU FIND IN A LITTLE BOOK THE KEY TO SECRETS WHICH HAVE MADE THOUSANDS COMFORTABLY WELL OFF AND EVEN RICH—



AND YOU START USING THOSE SECRETS YOURSELF AND LEARN WHAT IT IS TO REALLY MAKE BIG MONEY AS A SALESMAN—



OH FELLERS IT ISN'T SUCH A BUM WORLD AFTER ALL

When Men Raise Their Pay \$3,000 to \$7,000 a Year ...After Reading This Little Free Book!

A MARVELOUS little free book is bringing vital news to thousands of men today and making momentous changes in their lives. Just sixty-four pages—about seven ounces of paper and printers' ink—but there are thousands of men holding down big-pay jobs all over the United States and Canada with earnings running up to \$10,000 a year, and even bigger, who started by reading this great book.

Take, for instance, Frank J. Walsh of Ludlow, Massachusetts. Just a few years ago Walsh was struggling along on \$1,000 a year. In just one evening, reading this little free volume, he made the change in his life that raised his pay over 600%.

About the same time that Walsh was getting his start two other men—C. V. Champion of Danville, Illinois, and R. B. Hansen of Akron, Ohio—were reading it too. Both were factory hands at the time—but today both of them are presidents of prosperous and growing companies with incomes over \$10,000 a year! Just lately a California cowboy named William Shore spent an evening reading this book, in a ranchhouse. It wasn't many months later that he told us of one week when he made \$525 clear, as a salesman.

Men from all walks of life—men who never dreamed they could master the secrets of salesmanship—regular fellows just like anybody else, without any extra advantages of money or education—that's what these men are. This little book, and the marvelous N. S. T. A. Demonstration Method, are specially planned to help just that kind of men—ambitious average fellows. The N. S. T. A. does something which people said could not be done—it makes salesmen—successful high power earners, out of average men with normal every-day brains. It has proved that

salesmen do not have to be "born." It teaches, in easy, yet thorough lessons, right in your home, the secrets which great salesmen have spent years on the road to learn.

You can't keep a good man down—not if he really is a good man and will take advantage of his opportunities to rise in life. This book, "The Key to Master Salesmanship," brings ambitious men the chance they've all been looking for—the chance to get away from dull routine time-clock jobs at low pay. It shows them the way to a free employment service which gives N. S. T. A. members the pick of over 50,000 high-pay jobs every year.

Right now this book, "The Key to Master Salesmanship," which showed these men how to get started on the road to success and independence, will be mailed as a gift to any ambitious man—absolutely free and without obligation. Why not see for yourself what amazing pay-raising secrets it contains? There is no better way to invest a two cent stamp! Simply fill out and mail the coupon to us today.



NATIONAL SALESMEN'S TRAINING ASSOCIATION

Dept. E-103, N. S. T. A. Bldg., Chicago, Illinois

National Salesmen's Training Association, Dept. E-103, N. S. T. A. Bldg., Chicago, Ill.

Please send me free and without obligation my copy of "The Key to Master Salesmanship," and full details of your Free Employment Service and other special "Earn While You Learn" features.

Name.....

Address.....

City.....State.....

Age.....Occupation.....

"LUCK DOESN'T PUT MONEY IN THE BANK!"



"A FEW YEARS AGO, when I saw other fellows putting money in the bank, I used to wonder at their 'luck' — and grumble at my own. Promotions seemed to pass me by. I never 'got the breaks.' That was my alibi.

"Then one day the boss talked to me and I woke up. He showed me how much the company needed men with a certain kind of technical training — asked if I'd ever had any. 'No,' I told him, 'but I can get it,' and I did. I studied at home, nights, with the International Correspondence Schools. Before I finished that course I had a better job — with more pay and a future. It's not luck that builds bank accounts. It's ability and training." *Another I. C. S. true story.*

Don't "wait for the breaks." Make your own, with the help of the I. C. S. Hundreds of practical home-study courses are open to you through this Universal University. Mark the coupon *now* and mail it.

INTERNATIONAL CORRESPONDENCE SCHOOLS

"The Universal University"

Box 5542-G, Scranton, Penna.

Without cost or obligation, please send me a copy of your booklet, "Who Wins and Why," and full particulars about the subject before which I have marked X:

TECHNICAL AND INDUSTRIAL COURSES

- | | |
|--|--|
| <input type="checkbox"/> Architect | <input type="checkbox"/> Automobile Mechanic |
| <input type="checkbox"/> Architectural Draftsman | <input type="checkbox"/> Plumbing <input type="checkbox"/> Steam Fitting |
| <input type="checkbox"/> Building Estimating | <input type="checkbox"/> Heating <input type="checkbox"/> Ventilation |
| <input type="checkbox"/> Wood Millworking | <input type="checkbox"/> Sheet Metal Worker |
| <input type="checkbox"/> Contractor and Builder | <input type="checkbox"/> Steam Engineer |
| <input type="checkbox"/> Structural Draftsman | <input type="checkbox"/> Steam Electric Engineer |
| <input type="checkbox"/> Structural Engineer | <input type="checkbox"/> Civil Engineer |
| <input type="checkbox"/> Electric Wiring | <input type="checkbox"/> Surveying and Mapping |
| <input type="checkbox"/> Electrical Engineer | <input type="checkbox"/> Refrigeration |
| <input type="checkbox"/> Electric Lighting | <input type="checkbox"/> R. R. Locomotives |
| <input type="checkbox"/> Welding, Electric and Gas | <input type="checkbox"/> R. R. Section Foreman |
| <input type="checkbox"/> Reading Shop Blueprints | <input type="checkbox"/> R. R. Bridge and Building Foreman |
| <input type="checkbox"/> Telegraph Engineer | <input type="checkbox"/> Air Brakes <input type="checkbox"/> Train Operation |
| <input type="checkbox"/> Telephone Work | <input type="checkbox"/> Highway Engineering |
| <input type="checkbox"/> Mechanical Engineer | <input type="checkbox"/> Chemistry <input type="checkbox"/> Pharmacy |
| <input type="checkbox"/> Mechanical Draftsman | <input type="checkbox"/> Coal Mining Engineer |
| <input type="checkbox"/> Machinist <input type="checkbox"/> Toolmaker | <input type="checkbox"/> Navigation <input type="checkbox"/> Boilermaker |
| <input type="checkbox"/> Patternmaker | <input type="checkbox"/> Textile Overseer or Supt. |
| <input type="checkbox"/> Pipefitter <input type="checkbox"/> Tinsmith | <input type="checkbox"/> Cotton Manufacturing |
| <input type="checkbox"/> Bridge Engineer | <input type="checkbox"/> Woolen Manufacturing |
| <input type="checkbox"/> Bridge and Building Foreman | <input type="checkbox"/> Agriculture <input type="checkbox"/> Fruit Growing |
| <input type="checkbox"/> Gas Engines <input type="checkbox"/> Diesel Engines | <input type="checkbox"/> Poultry Farming <input type="checkbox"/> Radio |
| <input type="checkbox"/> Aviation Engines | <input type="checkbox"/> Marine Engineer |

BUSINESS TRAINING COURSES

- | | |
|---|--|
| <input type="checkbox"/> Business Management | <input type="checkbox"/> Business Correspondence |
| <input type="checkbox"/> Office Management | <input type="checkbox"/> Lettering Show Cards <input type="checkbox"/> Signs |
| <input type="checkbox"/> Industrial Management | <input type="checkbox"/> Stenography and Typing |
| <input type="checkbox"/> Personnel Management | <input type="checkbox"/> Complete Commercial |
| <input type="checkbox"/> Traffic Management | <input type="checkbox"/> Civil Service <input type="checkbox"/> Mail Carrier |
| <input type="checkbox"/> Accountancy <input type="checkbox"/> Cost Accountant | <input type="checkbox"/> Railway Mail Clerk |
| <input type="checkbox"/> C. P. Accountant | <input type="checkbox"/> Grade School Subjects |
| <input type="checkbox"/> Bookkeeping | <input type="checkbox"/> High School Subjects |
| <input type="checkbox"/> Secretarial Work | <input type="checkbox"/> College Preparatory |
| <input type="checkbox"/> Spanish <input type="checkbox"/> French | <input type="checkbox"/> Illustrating <input type="checkbox"/> Cartooning |
| <input type="checkbox"/> Salesmanship <input type="checkbox"/> Advertising | <input type="checkbox"/> Lumber Dealer |

Name.....Age.....

Address.....

City.....State.....

Occupation.....

If you reside in Canada, send this coupon to the International Correspondence Schools, Canadian, Limited, Montreal, Canada

FREE THE *Gibson* BOOK

Shows you the way to popularity, pleasure, bigger income with an easy playing Gibson banjo, guitar, mandolin or ukulele. If no teacher in your town ask about Reser's Correspondence Course.

Harry Reser, Chief of the Chicago Club Fakino, premier banjo soloist and teacher.

FREE TRIAL; EASY PAYMENTS on any Gibson. Send for your book now.

Gibson Inc.

203 PARSONS STREET, KALAMAZOO, MICH.

ELECTRICAL ENGINEERING

Complete Course in One Year

A CONCISE, comprehensive course in Electrical Engineering to prepare ambitious young men of limited time for the opportunities in the electrical field. Mathematics, engineering drawing and intensive shop-work. Students construct meters, install wiring, test electrical machinery.

Bliss Men Make Good

Bliss graduates are in demand. 38 years' successful experience assures you maximum training in minimum time. Catalog on request.



BLISS ELECTRICAL SCHOOL

115 Takoma Ave., Washington, D. C.

COLLEGE COURSES

AT HOME

Carry on your education. Develop power to initiate and achieve. Prepare for college. Earn credit toward a Bachelor degree or Teaching Certificates by correspondence. Select from 450 courses in 45 subjects including English, Mathematics, History, Education, Psychology, Economics, the Languages, etc. Write for catalog.

The University of Chicago

827 ELLIS HALL

CHICAGO, ILL.



WHY NOT spend Spring, Summer and Fall gathering butterflies, insects? I buy hundreds of kinds for collections. Some worth \$1 to \$7 each. Simple outdoor work with my instructions, pictures, price-list. Send 10 cents (post stamps) for my illustrated Prospectus before sending butterfly. **MR. SINCLAIR, DEALER IN INSECTS** Dept. G. Box 1424. San Diego, Calif.

STAMMERERS

Learn to speak correctly, increase earning power! Our methods invariably successful. **Booklet Free**

SAMUEL A. ROBBINS, 419 Baystate St., Boston, Mass.

GOV'T. POSITIONS

SPLENDID SALARIES

WE HELP YOU GET ONE

<input type="checkbox"/> Ry. Mail Clerk	<input type="checkbox"/> Steno Typist.
<input type="checkbox"/> P. O. Laborer	<input type="checkbox"/> Immigrant Insp.
<input type="checkbox"/> R. F. D. Carrier	<input type="checkbox"/> Seamstress
<input type="checkbox"/> Special Agent	<input type="checkbox"/> Auditor
<input type="checkbox"/> Customs Inspector	<input type="checkbox"/> Prohibition Agent
<input type="checkbox"/> City Mail Carrier	<input type="checkbox"/> U. S. Border Patrol
<input type="checkbox"/> Meat Inspector	<input type="checkbox"/> Chauffeur
<input type="checkbox"/> P. O. Clerk	<input type="checkbox"/> Watchman
<input type="checkbox"/> File Clerk	<input type="checkbox"/> Skilled Laborer
<input type="checkbox"/> General Clerk	<input type="checkbox"/> Postmaster
<input type="checkbox"/> Matron	<input type="checkbox"/> Typist

Men - Women (written vertically on the left and right sides of the list)

AGE 18 and UP (written vertically on the right side)

Obtain Instruction Bureau, Dept. 111, St. Louis, Mo. Send me FREE particulars "How to Qualify" for positions marked "X". Salaries, Locations, Opportunities, etc. **ALL SENT FREE.**

Name.....

Address.....



Broadcasting studios need trained men... the jobs paying \$1,000 to \$1,500 a year.



Televisionists opening field of many great opportunities... offered by the radio.



Operators on ships see the world and get good pay plus expenses.



Aviation is needing more and more trained Radio men... Operators employed through the Civil Service Commission earn \$2,000 to \$2,500 a year.



Talking Movies—An inspection made possible only by Radio—offers many hot jobs to well trained Radio men.

You'll Get Thrills-Adventure BIG PAY in RADIO

I will Train You at Home to Fill
a Fascinating Job in Radio

*Radio's Amazing Growth is Opening
Hundreds of Big Jobs Every Year*

You like action, romance, thrills! You'll get them in Radio—plenty of them! Big pay, too. That is why I urge you to mail the coupon below for my free book of startling facts on the variety of fascinating, money-making opportunities in this great, uncrowded field. It also explains how you can quickly become a Radio expert—a Certified RADIO-TRICIAN—through my amazingly simple 50-50 method of home-study training. Thousands of men who knew absolutely nothing about Radio before taking my course are today making real money in this growing industry.

Thrilling Jobs That Pay \$50 to \$100 a Week

There are plenty of good jobs in Radio that pay \$50, \$75 and up to \$100 a week. For instance, you can see the world in grand style as a Radio operator on ship-board. There are many splendid openings in this line with good pay plus your

expenses. You'll also find thrills and real pay in Aviation Radio work. Broadcasting is another field that offers big pay and fascinating opportunities to men who know Radio. And think of the great, thrilling future for men with Radio Training in Television and Talking Movies. A Radio sales and service business of your own is another money-making opportunity I train you for.

Earn While You Learn

You stay right at home, hold your job, and learn in your spare time. (Lack of high school education or Radio experience are no drawbacks.) I teach you to begin making money shortly after you enroll. My new practical method makes this possible. I give you eight big laboratory outfits that teach you to build and service practically every type of receiving set made. Many of my students earn \$15, \$20, \$30 weekly while learning. Earle Cummings, 13 Webster St., Haverhill, Mass.,

writes: "I made \$375 in one month in my spare time, installing, servicing, selling Radio sets."

Get My Free Book

Send the coupon below for my 54-page book of opportunities in Radio and information on my home-study training. It has put hundreds of fellows on the road to bigger pay and success. I back my training with a signed agreement to refund every penny of your money if, after completion, you are not satisfied with the Lesson and Instruction Service I give you. Fill in and mail the coupon NOW!

J. E. SMITH, Pres.,
Dept. 1 E P
National Radio Institute,
Washington, D. C.

*Act
Now*



Mail Coupon Today

J. E. SMITH, President
National Radio Institute, Dept. 1 E P
Washington, D. C.

Dear Mr. Smith: Send me your book, "Rich Rewards in Radio." I understand this places me under no obligation and that no salesman will call.

NAME.....

ADDRESS.....

CITY.....STATE.....

Travelled 75,000 Miles

"Dear Mr. Smith: I have worked as Junior Operator on board S. S. Dorchester and Chief Operator of the Chester Sun. I have travelled from 75,000 to 100,000 miles, visited ports in various countries, fished and motored with millionaires, been on airplane flights, etc. I am now with Broadcasting Station WREN." (Signed) Robin D. Compton, 1213 Vermont St., Lawrence, Kansas.



\$400 a Month

"The Radio field is getting bigger and better every year. I have made more than \$400 each month and it really was your course that brought me to this." J. G. Dahlstead, 1484 So. 15th St., Salt Lake City, Utah.

Employment Service to all Graduates

GET INTO HIGHER ACCOUNTING and HIGHER PAY



Of course you want the bigger pay that goes with a bigger job—but if you're like most men you're wondering right now how you can get it. *Hundreds of thousands of men have found the answer!* Take the experience of any one of them—Vance Anderson, for instance.

For many years Anderson groped blindly for success. He tried farming—running a truck-line—then the study of mechanical engineering, then accounting at a resident school. Dissatisfied with that, he enrolled for LaSalle's course in Higher Accounting. From that time on his future assumed a definite form.

VICE-PRESIDENT—by the time he had completed LaSalle Training

While still studying, he became Office Manager of the Central Indiana Canneries, then joined the Olin Chevrolet Company of Indianapolis, one of the large automobile agencies of the Middle West. And before he completed the course he was made Vice-President! During that time his salary increased several times over! Is it any wonder he says, "Real study with you will pay any man."

Knowledge of Higher Accounting leads the way to so many business opportunities that the well-trained man is practically proof against unemployment. A dozen doors are open to him while the untrained man is walking the street. Advancement is swift and certain—for the very foundation of business lies in accounting control. That is why LaSalle graduates in Higher Accounting occupy some of the highest executive positions.

LaSalle has made it easy for you to master this big-pay work in spare-time study at home—no matter what your previous education or experience. This is backed by a placement, consultation and advancement service that follows throughout life.

Send for "Ten Years' Promotion in One"—the little book that has led to adding hundreds of millions of dollars to the annual salaries of 700,000 men. With it we will include full information about the big-opportunity field of Higher Accounting. Sending the coupon below may be the turning point in your life. Don't delay, but send it today—NOW!

-----Find Yourself Through LaSalle-----

LaSalle Extension University

The World's Largest Business Training Institution

Dept. 564-HR Chicago

I would welcome copy of "Accountancy, the Profession that Pays," also a copy of "Ten Years' Promotion in One," all without obligation.

Higher Accountancy

Training for positions as Auditor, Comptroller, Certified Public Accountant, Cost Accountant, etc.

Other LaSalle Opportunities

If more interested in one of the fields indicated below, check and mail now.

- | | |
|--|---|
| <input type="checkbox"/> Business Management | <input type="checkbox"/> Banking and Finance |
| <input type="checkbox"/> Modern Salesmanship | <input type="checkbox"/> Modern Business |
| <input type="checkbox"/> Traffic Management | <input type="checkbox"/> Correspondence |
| <input type="checkbox"/> Railway Station Mgmt. | <input type="checkbox"/> Expert Bookkeeping |
| <input type="checkbox"/> Law; Degree of LL.B. | <input type="checkbox"/> C. P. A. Coaching |
| <input type="checkbox"/> Commercial Law | <input type="checkbox"/> Business English |
| <input type="checkbox"/> Industrial Management | <input type="checkbox"/> Commercial Spanish |
| <input type="checkbox"/> Modern Foremanship | <input type="checkbox"/> Effective Speaking |
| <input type="checkbox"/> Personnel Management | <input type="checkbox"/> Credit and Collection Correspondence |

Name.....

Present Position.....

Address.....



AS A ROWING MACHINE

HEAD STRAP

10 CABLE EXERCISER

WALL EXERCISER

HAND GRIPS

SHOES

FOOT TRAP

Get Strong!

Eight Improved Muscle Builders

All for \$3.75

Easily master tests which now seem difficult. If you want physical culture for health, this equipment is what you need. **SAVE AT LEAST HALF!** We furnish ten cable chest exerciser adjustable to 200 lbs. resistance. Made of new live extra strength rubber to give resistance needed for sure muscle development. Pair of patented hand grips develop powerful grip and arm. Wall exercising posts develop back, arms and legs. Head strap permits exercise of neck muscles. Develop leg muscles with foot strap—gives speed, endurance. **Illustrated course shows how to develop any part of body.**

GUARANTEE
Entire satisfaction guaranteed or money back.

SEND NO MONEY
Send name and address! We send all by return mail. Pay postage \$3.75 plus postage. (If you live outside U. S. A. price \$4.50 cash with order.)

MUSCLE POWER CO., Dept. PM-8
150 Nassau St.
NEW YORK, N. Y.

Operator No. 38

FOLLOW THIS MAN

Secret Service Operator No. 38 is on the job! Running down dangerous Counterfeit Gang. Tell-tale finger prints in murdered girl's room.

Free The Confidential Report Operator No. 38 made to his chief. Write for it. **\$3000 a year and up**

YOU can become a Fingerprint Operator at home, in your spare time, at small cost. Write for confidential full report and details. Literature will NOT be sent to boys under 17 years of age.

INSTITUTE OF APPLIED SCIENCE

Dept. 13-55 1920 Sunnyside Ave. Chicago, Ill.

HOT PIANO

Ultra-modern Piano

Jazz taught by mail. Note or ear. Easy rapid lessons for adult beginners. Also Self-instruction system for advanced pianists. Learn 358 Bass Styles, 976 Jazz Breaks, hundreds of Trick Endings, Hot Rhythms, Sock, Stomp and Dirt Effects; Symphonic and Wicked Harmony in latest Radio and Record Style. Write for Free Booklet.

WATERMAN PIANO SCHOOL, 1626 W. Adams St., Los Angeles, Calif.

"BECOME A LIGHTNING TRICK CARTOONIST"

Send \$1.00 for Laugh Producer Program of 23 Trick Drawings with Instructions. Catalog of Chalk Talk Supplies Free. **BALDA ART SERVICE, Dept. 1, Oshkosh, Wis.**

LEARN MECHANICAL DENTISTRY

SEND FOR FREE BOOK

Earn Big Money—Steady Work

Don't waste the best years of your life. Prepare now for your future. Learn this money-making business in a few months in Day or Evening sessions. Big Demand. Schools highly endorsed. Practical training. Individual instruction. Easy terms. **Write NOW for catalog P and special tool offer.**

New York School of Mechanical Dentistry
125 West 31st Street New York

YOUR SUCCESS

There is a **JOB** for You Here

Get Into

AVIATION



MAJOR

R.L. Rockwell

Will Train You **AT HOME**, and Until You
Get a Job Paying You
\$300 to \$400 a month

Major Rockwell, famous world war flyer, is offering to train a limited number of ambitious men who want to get into aviation and get one of the big pay jobs that aviation offers.

IN A FEW SHORT MONTHS

All you have to do is devote about an hour or two a day to my Home Training Course and in a few months you will be mastering the principles of Ground Training and be prepared to qualify for and accept a big pay job in this branch of Aviation. If you want to fly, my Home Training Course teaches you the principles of flight. When you have completed the ground training I will arrange for you to take

your flying instructions at any licensed airport near your home at special reduced rates. Or if you want you can come here to Dayton and get training at one of the finest and best equipped airports in America. No matter where you learn to fly you can qualify for a pilot's license and a high pay job in passenger lines, mail service, and other important branches of flying.

Advanced Education or Experience Unnecessary

You don't need a high education to master my course. My Home Training Course is thorough and complete. Everything is so clearly explained, with easy-to-understand text and pictures, that in a few short months you will be able to grasp every fundamental principle of Aviation ground work and get a start in Aviation qualifying for any important aviation job paying \$300 to \$400 a month. My Home Training Course will give you all the knowledge necessary to pass the U. S. Government's written examination for a license.

How I Help You Get Your Job

Because of my experience in Aviation and knowledge of the work, I am in touch with large employers of trained aviation men who are constantly seeking help. Thus I am able to help my graduates get the aviation job they want at big pay. These employers prefer Rockwell Trained Men.

Money-Back Agreement

I am so sure that you can learn Aviation with my help and step into a big aviation job that if you are not satisfied when you have finished my course, I agree to return every penny of your tuition. Read my money-back agreement. Act now while my special offer lasts. Rush this coupon to me for a copy of my famous free book.

MAJOR ROBT L. ROCKWELL
The Dayton School of Aviation
Desk 1-P Dayton, Ohio



AIRPORT



AIRPLANE FACTORY



AIRPLANE MECHANIC



ENGINE MECHANIC

My Book Explains All
... Sent FREE ...
MAIL COUPON

Major Rob't L. Rockwell
The Dayton School of Aviation
Desk 1-P, Dayton, Ohio.

Dear Major: Please send me FREE and without obligation a copy of your famous book on Aviation; the details of your no-risk plan; also your special tuition offer.

Name

Address

Town..... State..... Age.....



MEN WANTED

Under 35 Years Old
for well paid positions in



ELECTRICITY

ELECTRICAL
Engineering
Drafting
Power
Telephone
Radio
Telegraphy
Railways

First Lesson FREE

See How Easy to Learn

This "machine age" means unemployment and low wages for millions of men—but it also means more jobs and higher wages for those who go into **ELECTRICITY**. Automatic machinery means Electrical power and Electrical control. Electric-

ity is expanding so rapidly—that here is one chance for the man out of a job, or worried about losing it. You can learn—in your spare time—and we will send you a lesson free to prove it.

Electricity

Always Growing—Always Prosperous

No wonder—because Electricity is the basic power of all other industries. It is Telephone, Telegraph and Radio. It is light and heat and so many more things, we'll have to send you a book to list the opportunities it offers you. No panic can stop it. And if you want a chance to make a good salary, and be secure for the rest of your life, **INVESTIGATE** Electricity.

Remarkable Offer—right now

If you act quick, we'll show you how to get a well-paid Electrical position at a big saving. This offer limited to men with at least a grammar school education, and under 35 years of age. **MAIL COUPON NOW.**

American School

Dept. E-547

Drexel Ave. and 58th Street

Chicago, Ill.

AMERICAN SCHOOL,
Dept. E-547, Drexel Ave. and 58th St., Chicago, Ill.

Please tell me, without cost or obligation, about your training and employment service in line marked X below.

ELECTRICITY

- | | |
|--|---|
| <input type="checkbox"/> Architecture | <input type="checkbox"/> Mechanical Engineering |
| <input type="checkbox"/> Building | <input type="checkbox"/> High School in 2 Years |
| <input type="checkbox"/> Drafting | <input type="checkbox"/> Structural Steel |
| <input type="checkbox"/> Business Management | <input type="checkbox"/> Civil Engineering |
| <input type="checkbox"/> Accounting | <input type="checkbox"/> Auto Engineering |

Name.....

St. No.....

City..... State.....

Age..... Occupation.....

CONFORMIST

Or Courage to Think
For Yourself?



LARRY—

Thoughts of Youth



reveals the intimate thoughts of a modern college student about girls, drinking, blind dates, sports, petting, religion, fraternities, (not written for publication).

"A most thrilling revelation of the aspirations and experiences of a remarkable personality—an inside picture of real college life."

Get this unusual book today at your booksellers or send \$1.25 to Dept. R-1

ASSOCIATION PRESS

347 Madison Ave., New York



Wonderful, new device, guides your hand; corrects your writing in a few days. Big improvement in three hours. No failures. **Complete outline FREE.** Write C. J. Osment, Dept. 34, St. Louis, Mo.

LAW Free Book

Write today for FREE 64-page book, "THE LAW-TRAINED MAN", which shows how to learn law in spare time through the Blackstone home-study course prepared by 80 prominent legal authorities, including law school deans, and U. S. Supreme Court justices. Combination text and case method of instruction used. All material necessary furnished with the course, including elaborate 25-volume law library, delivered immediately upon enrollment. Many successful attorneys among our graduates. L.J. B. degree conferred. Moderate tuition, low monthly terms. Money-Back Agreement.

Write for free book today.

BLACKSTONE INSTITUTE, 307 N. Michigan Ave., Dept. 65 Chicago

WHY STAMMER?

Don't be a failure.
Master perfect speech. Live a healthy, normal and happy life. Send for free book which tells you how.
THE LEWIS INSTITUTE, 12972 Woodward Ave., Detroit, Mich.

Learn Watchwork, Jewelrywork and Engraving

A fine trade commanding a good salary, and your services always in demand. Address **Horological**, Dept. P, Bradley Institute, PEORIA, ILLINOIS, for our latest catalog.

Learn Photography at HOME

Make money taking pictures. Prepare quickly during spare time. Also earn while you learn. No experience necessary. New easy method. Nothing else like it. Send at once for free book, **OPPORTUNITIES IN MODERN PHOTOGRAPHY**, and full particulars.

AMERICAN SCHOOL OF PHOTOGRAPHY
Dept. 1355 3601 Michigan Ave. Chicago, U. S. A.

"SHE CAN'T PLAY A NOTE"



"This'll be Funny"
 they shouted as she
 sat down to play
 — but a minute later...

"I GUESS we're stuck right here in the club for the afternoon," sighed Jane, as the rain began coming down in torrents.

"I suppose this means more bridge, and I'm tired of that," said John Thompson. "Can't we find something unusual to do?"

"Well, here comes Sally Barrow. She might offer some solution to the problem," suggested Jimmy Parsons, with a laugh.

Poor Sally! Unfortunately she was considerably overweight. Nevertheless the boys all liked Sally—she was so jolly and full of fun.

"Hello everybody," came Sally's cheery greeting. "What's new?"

"That's just it, Sally, we've just about reached the end of our rope," replied John.

"Would it surprise you if I played a tune or two for you on the piano?"

"You play, Sally? Don't be funny!" The very idea of Sally having talent in any direction struck everybody as a joke. Sally was good-natured though. She didn't mind being laughed at—as long as John Thompson didn't join in the laughter. Sally liked John—more than she cared to admit.

Sally walked nonchalantly over to the piano. Carelessly, she played a few chords. At this, everyone suddenly stopped laughing and turned to watch Sally. Then just as if she had been playing for years, Sally broke into the latest Broadway hit. Her listeners couldn't believe their ears! Sally continued to play one lively tune after another. Some danced while others gathered around the piano and sang.

Finally she finished and rose from the piano. John Thompson was at her side immediately brimming over with curiosity.

"Where did you learn? Who was your teacher?" John asked.

Sally's Secret

"You may laugh when I tell you," Sally explained. "But I learned to play at home, without a teacher. You see, I happened to see a U. S. School of Music advertisement. It offered a Free Demonstration Lesson so I wrote for it. When it came and I saw how easy it all was, I sent for the complete course. What pleased me most was that I was playing simple tunes by note right from the start. Why, it was just as simple as A-B-C to follow the clear print and picture illustrations that came with the lessons. Now I can play

many classics by note and most all the popular music."

Today, Sally is one of the most popular girls in her set. And we don't need to tell you that she and John are now engaged!

This story is typical. The amazing success of the men, women and children who take the U. S. School of Music course is largely due to a newly perfected method that really makes reading and playing music as easy as A-B-C.

Even if you don't know one note from another, you can easily grasp each clear inspiring lesson of this surprising course. First you are told how to do it, then a picture shows you how, and then you do it yourself and hear it.

Thus you teach yourself—in your spare time—right in your own home, without any long hours of tedious practice.

Free Book and Demonstration Lesson

Our wonderful illustrated Free Book and Our Free Demonstration Lesson explain all about this remarkable method. They prove just how anyone can learn to play his favorite instrument by note, in almost no time and for a fraction of what old, slow methods cost. The book will also tell you all about the amazing new *Automatic Finger Control*.

Forget the old fashioned idea that talent means everything. Read the list of instruments to the left, decide what you want to play, and the U. S. School of Music will do the rest. At an average cost of only a few cents a day! Act now. Clip and mail this coupon today. No obligation. Instruments supplied when needed, cash or credit. U. S. School of Music, 75 Brunswick Bldg., New York City.

U. S. SCHOOL OF MUSIC
 75 Brunswick Bldg., New York City

Please send me your free book "Music Lessons in Your Own Home," with introduction by Dr. Frank Crane, Free Demonstration Lesson and Particulars of your easy payment plan. I am interested in the following course:

.....
 Have you above instrument?.....
 Name.....
 Address.....
 City.....State.....

PICK YOUR INSTRUMENT

Piano	Violin
Organ	Clarinet
Ukulele	Flute
Cornet	Saxophone
Trombone	Harp
Piccolo	Mandolin
Guitar	Cello
Hawaiian Steel Guitar	
Sight Singing	
Piano Accordion	
Italian and German Accordion	
Voice and Speech Culture	
Drums and Traps	
Harmony and Composition	
Automatic Finger Control	
Banjo (Plectrum, 5-String or Tenor)	
Juniors' Piano Course	

RADIO

made easy to learn

AT HOME



RADIO is a fascinating profession. Now you can become qualified in any one of its twenty different branches. Simply by studying in your spare time at home or at any of the four resident schools operated by RCA Institutes, Inc.

It is not hard to study radio the way it's taught by RCA Institutes. You learn radio by actual experience on the latest type of radio equipment. And you need not give up the position you now hold. You can study an hour a day or any number of hours a day, at home in your spare time.

The RCA Institutes' Home Laboratory Training Course teaches you in a most thorough manner. You learn about servicing, operating, radio telephony and telegraphy . . . also instruction in sound motion picture installation, maintenance and repairs. And you receive at no additional cost the complete RCA Institutes' home laboratory equipment, a modern outlay of apparatus furnished to every student, enabling you to easily solve radio problems.

Send for this FREE BOOK Today!



RCA INSTITUTES, Inc.

RCA INSTITUTES, Inc.
Dept. MP-5
75 Varick St., New York, N. Y.

Gentlemen: Please send me your FREE book which tells about your laboratory method of radio instruction at home.

Name

Address

Occupation

YES

NEW YORK ELECTRICAL SCHOOL

Opportunities for All Men!

Every phase of all branches of Practical Electricity taught by Actual Practice in America's Foremost Institution of Trade Learning.

Special Courses in Automobile Mechanics and Electricity.

Day and evening classes open all year.

Write for FREE School Booklet

New York Electrical School
44 W. 17th St., New York City

CAN YOU remove the loose ring? It appears impossible, yet it is not, but requires clear head work. Try it. This is one of best wire puzzles made—a money-back article. Postpaid with illustrated folder of others for 10c. 3 for 25c. 75c dozen. Retail at 25c. Fine pocket piece. Secret solution with each. Dealers and agents wanted.

WESTERN PUZZLE WORKS, St. Paul, Minn.

ELCO HEALTH GENERATOR

Great New Invention for Health, Power and Beauty.

Generates High Frequency Violet Ray, Mechanical Vibration, Medical Electricity, and Ozone, For Home Treatments at less than 50 cents a year.

FREE BOOK "Health, Power, Beauty." Re-vitalizes yourself. Bring back energy. Be wholly alive. **WRITE TODAY.**

LINDSTROM & CO., 2322 Indiana Ave., Dept. 13-55, CHICAGO

WANT A STEADY JOB?



New Bandit Proof Railway Mail Car

U. S. GOVERNMENT JOBS

\$1260 TO \$3400 YEAR

Men—Boys, 18 to 50

Paid Vacations
Common Education
Usually Sufficient
Mail Coupon
TODAY
SURE

FRANKLIN INSTITUTE
Dept. C179, Rochester, N. Y.

Gentlemen: Rush to me without charge 25-cent book with list of U. S. Government big paid positions. Tell me regarding salaries, hours, duties, vacations and full particulars.

Name

Address

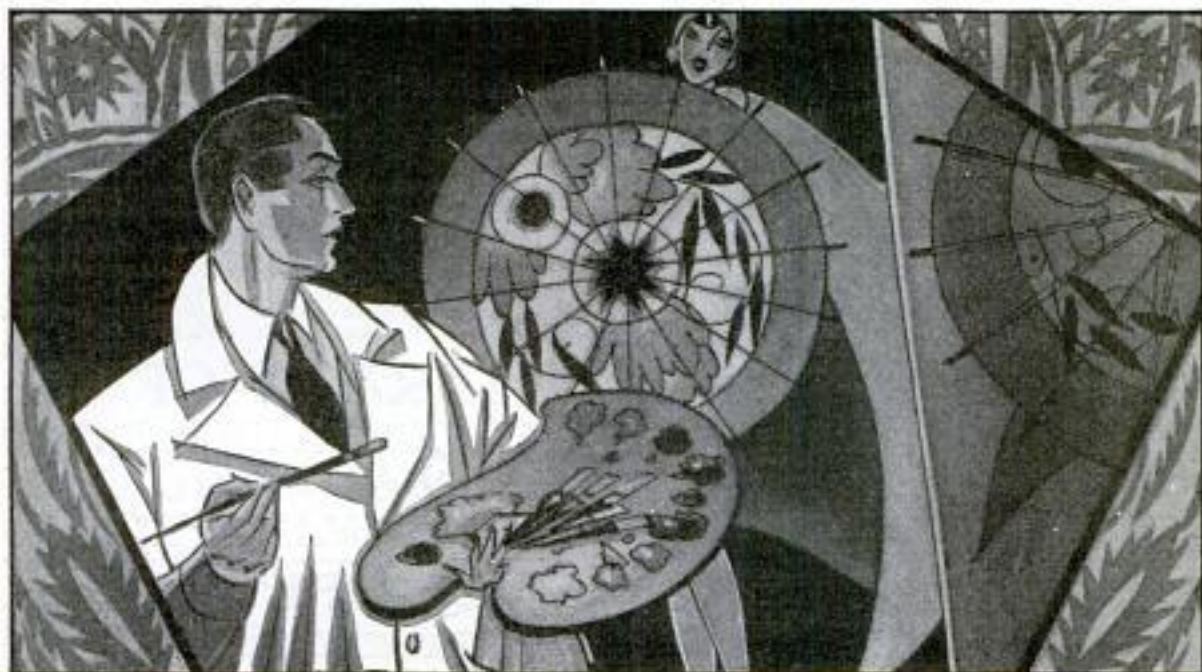

BE AN ARTIST

Earn a Big Name and a Fat Income

WHAT would you give to be this artist—earning a big income—enjoying studio life? He has learned the secret of forming simple lines into finished illustrations.

It was only a short time ago that this young artist filled out a coupon like the one below and mailed it to the Federal School of Illustrating. Now he is not only trained in modern art on which magazines are spending millions every year, but he has also had thorough instruction in all branches of illustration. Careful training by Federal Instructors has taught him to turn simple lines into dollars.

More than fifty famous artists—making big incomes themselves—have contributed to the Federal Course, giving you the benefit of their experience in illustrating, cartooning, lettering, poster designing, window card illustrating, etc.

Why drudge at routine work? Opportunities for artists have never been better. Drawing is easy to learn the Federal Home Study way. Earn while you learn, if you wish. Many students find a market for their work after a comparatively short time of study.

Test Your Drawing Talent

If you like to draw, train your talent. Open the way to success and a fine income. Write your name, age and address on the coupon and get our Free Book, "A Road to Bigger Things," illustrated below. With it, you will receive our Free Vocational Art Test to find out your ability. Hundreds of successful artists got their start by sending for these. This is your opportunity—grasp it. **MAIL THE COUPON NOW.**



FEDERAL SCHOOL of ILLUSTRATING

5131 Federal Schools Bldg.
Minneapolis, Minnesota

COUPON

FEDERAL
SCHOOL of
ILLUSTRATING

5131 Federal Schools Bldg.
Minneapolis, Minn.

Please send me free book "A ROAD TO BIGGER THINGS" and Standard Art Test.

Name _____

Age _____ Occupation _____

Address _____

Full Railroad Fare from Your Home to Los Angeles deducted from cost of training if you enroll soon!

MEN WANTED —
Train in California
for
Good Jobs!



Learn Autos
IN LOS ANGELES

and LEARN RIGHT!
Full Railroad Fare Allowed
to Los Angeles!

It's only human for you to want to come to California, Everyone does. How much better to come and get started right—quickly qualifying for the *best pay jobs*. We are allowing full railroad fare from any point in the United States for a limited time only, to encourage more men to take advantage of California Training. Never again will you get an opportunity like this. Come West NOW!

A Few Short Weeks at National and You're Ready
For A Big Pay Job!

For 26 years National has quickly helped men get ready for big pay, steady positions in the profitable Automobile fields. Don't worry about previous experience, or whether you're too old or too young. We train you by "Actual Shop" Methods on thousands of dollars worth of right-up-to-the-minute equipment. Not a Correspondence School. Start any time.

...and Don't Worry About Money! We'll Help You! Even if you're short on cash you can get National Training. We help you secure good part-time jobs to earn living expenses while learning. Unlimited Employment Service assures you real, friendly co-operation in getting started on the road to real money, steady work and a prosperous future. Employers keep us busy sending them men—they know that National Auto Men are best, so they don't waste their time on half-baked, untrained mechanics. 25,000 successful graduates since 1905.

National Doors Are Open to You!
Investigate at Once!

Write now—today—for the whole story. Our big free book with details sent FREE. Don't lose another minute. These offers are necessarily limited for a short time. Mail the coupon and soon you can be on the train for Los Angeles.

WRITE for FREE BOOK NOW!
National
Automotive School

Dept. 54-c, 4086 S. Figueroa Street,
Los Angeles, California

Send me, absolutely free, your big illustrated catalog of Automotive Opportunities, cost of training and Special Railroad Fare Offer.

Name _____

Address _____

Age _____ City _____ State _____



Increase Your Earning Power

Apply time and labor-saving kinks to your work. Your efficiency will soon be recognized and you will be in line for advancement.

If you do machine shop work of any kind, sheet-metal work, painting, carpentry, auto repairing, farming, concrete work, plumbing, electrical work, welding, building, glass work, general repairing, tool-making, poultry raising, masonry or home repair work, get this

LIBRARY OF 6000
TIME AND LABOR SAVING
IDEAS FOR SHOPMEN
AND HANDYMEN

JUST PUBLISHED
SHOP
NOTES

for
1931

192 Pages
464 Illustrations
Price 50c

See partial list
of
contents below



Including the new 1931 issue illustrated above, there are now 12 volumes in the Shop Notes Library of 6,000 easily understood short cuts to every-day jobs. Here are just a few of the subjects taken from the latest issue.

- | | | |
|--------------------------|-------------------------|-------------------------|
| Auto Drivins, Winter | Grover for Armature | Poultry Ranch for City |
| Blinds | Repair | Lot |
| Auto Trucks, Handy, | Heater for Garage or | Roofing and Fluting, |
| for Paint Shop | Workshop | Ornamental |
| Band—Lalay Strips, | Horse Plays with Broad- | Saws, Circular, Resin- |
| Making | ax Bit Squares Long | ing |
| Belt Bender Reduces | Islays, Sings | Sawder, Vertical, Made |
| Labor | Joiner in the Home | from Buffing Head |
| Bench, Portable, for Me- | Shop | Silver Solder, Use of |
| chanic, Saves Time | Kitchen Steel, Metal, | Shaper for Home Shop |
| Blower for Lowering | How to Make | Spans and Time Savers |
| Fuel Cost | Laboratory Stated | for the Shop |
| Book Ends, Hand | Makes Workshop Tool | Spiral Turnings, How to |
| Wrench, Making | Lamp, Star, for Home | Make |
| Corkscrew, Cutting | Lantern Illuminates | Stairway, Remade |
| the | House Numbers | Disappearing |
| Drawing Instruments, | Machine Chips, Vactu- | Water Heater for Sunny |
| Homemade | um Cleaner Removes | Climes |
| Flippers, Portable, How | Machine Tools, Run- | Workbench, Handy, for |
| to Build | ning Several with One | Model Airplane |
| Furniture, Drawer Pulls | Electric Motor | Building |
| for | Milling Machines Made | Table, Small Drum, |
| Garage Glass, How to | from Shaper | Making |
| Install | Pipe Repair, Emergency | Twist-Turning with |
| Grinding, Surface, on | Plating Tricks Made | Portable Reamer |
| Drill Press | Easy | |

Each volume contains approximately 500 articles and 400 illustrations and has 192 or more pages. At the regular price of 50 cents per single volume this library costs \$6.00, but for a limited period we will supply the 12 vols. when ordered at one time at the special reduced price of only \$3.75.

SPECIAL OFFER COUPON

POPULAR MECHANICS PRESS,
200 E. Ontario St., Room P5, Chicago, Ill.

Send me, as per your special offer, the following books. I will pay postman price and small amount of postage. My money will be refunded if I am not satisfied. (Check what you want.)

- 1931 Shop Notes and Lathe Handbook, both for 98c.
 Complete Shop Notes Library (12 vols.) \$3.75.

Name _____

Street and No. _____

City _____ State _____

WANT A STEADY JOB? TRAVEL FOR "UNCLE SAM"



MANY OTHER U. S. GOVERNMENT POSITIONS

Customs Inspectors
Rural Carriers

City Mail Carrier
City Postal Clerks

MEN—BOYS 18 TO 50

Short Hours
Rapid Advancement
Pleasant Work
Permanent Employment
Long Vacation with Pay

Mail Coupon Now. Act at Once.

**DO IT TODAY. TOMORROW
YOU MAY FORGET.**

FRANKLIN INSTITUTE, Dept. C174, Rochester, N.Y.

Write to me entirely free of charge; 32 page book, with list of U. S. Gov't jobs obtainable and particulars telling how to get the job here checked.

... Railway Postal Clerk	(\$1900-\$2700)
... Post Office Clerk	(\$1700-\$2300)
... City Mail Carrier	(\$1700-\$2100)
... Rural Mail Carrier	(\$2100-\$3300)
... Prohibition Agent	(\$2300-\$2800)
... Inspector of Customs	(\$2100 up)
... Immigrant Inspector	(\$2100-\$2900)

VALUABLE COUPON

Name.....

Address.....

PATENTS

Booklet Free Highest References
Promptness Assured Best Results

Send drawing or model.

ALL BUSINESS GIVEN PROMPT AND PROPER ATTENTION

Listed Patent Lawyer in the latest editions of the Rand-McNally Directory of Bankers and Bank-Recommended Attorneys, published by Rand-McNally & Co., Chicago, Ill.; The Baggott & Ryall Directory of Guaranteed Attorneys, published by Legal Directory Corporation, Boston, Mass.; Flugel's Law List, published by Legal Directory Publishing Co., St. Louis, Mo.; American Lawyers Annual, published in Cleveland, Ohio; Bankers Service Legal Directory, published by Bankers Service Co., Boston, Mass.; Eyre's Law List, 9 Park Place, New York City; Walters Legal Directory, Omaha, Nebraska, and the National Directory of Attorneys, Baltimore, Maryland.

WATSON E. COLEMAN,
REGISTERED PATENT LAWYER

Victor Building, 724 Ninth Street, N. W.
WASHINGTON, D.C.



Men! Extra Money Quick

Here's An Easy Way!
—to bring you a fine cash income! Without taking any time away from your job. Pleasant easy work at home. Decorate beautiful giftwares the Fireside way. You can do it — in spare moments. No previous training required. No special ability needed. No tedious study. No memorizing. With the Three Simple Steps sent you by Monsieur Petit the great artist — Director of Fireside Industries, it is just fun! We want men in every community. Be the first! Fireside Industries, Dept. 66-E, Adrian, Mich.

Begin Right Now!
Thousands are making Fireside decorations—making from hundreds to thousands of dollars and doing their own work besides. We supply you with everything you need. Big Generous Complete Kit WITHOUT EXTRA COST. It's a cinch! Your success is assured.

FREE!
Fill out and mail coupon at once. Without any obligation it brings you wonderful Fireside Book in colors. Explains everything. **Act Now!**



Fireside Industries, Dept. 66-E, Adrian, Mich.

Send me your wonderful Free Book in colors. This does not put me under any obligation.

Name.....
Address.....

Free →



Write for my
Job-Securing
and
Pay-Raising
Plan today—
Mailed Free.

My
drafting
students get
these drafting tools.

JOBS FOR DRAFTSMEN in Great Industries—Learn at Home

Automobiles—Electricity—Motor Buses—Aviation—Buildings Construction. Hundreds of others. Building of stores, homes, factories and office buildings is going on all the time. No structure can be erected without plans drawn by a draftsman. No machinery can be built without plans drawn by a draftsman.

I train you at home, in Drafting, spare time only. Keep the job you have now while learning drafting. Men I have trained are making from \$3,500.00 to \$9,000.00 a year. Get started now toward a better position, paying a good straight salary, the year around. Comfortable surroundings. Inside work. Through hard times—adversity—sickness—bad luck—big bills—what can equal a Job that *Lasts!* You may earn as you learn. I give you employment service. Your money back if you want it and help as long as you need it.



I'll Train You
at Home.

If You Earn Less Than
\$70.00 a Week
Write to me now for my
Pay-Raising Plan.

Engineer Dobe, Div. 13-55
1951 Lawrence Ave., Chicago



There's Quicker, Bigger MONEY for YOU—in POULTRY

Earn \$2,000 to \$5,000 a Year or
Have a Business of Your Own!



Whether you want a job at good pay or a highly profitable business of your own—the Poultry Industry offers you more than any other. There's a shortage of poultry meat and eggs — a shortage of trained poultrymen. I'll train you quickly at home—to fill a good job in Poultry—and our FREE Students' Employment Dept. will help you get one!

Spare Time or Full Time YOU Can Cash-in Big

No matter where you live—city, town or country—or what you do now, my proved methods will assure your success right from the start. I'll help you make from \$2,000 to \$5,000 a year and UP! And, if you choose to start your own business, I'll show you how to make your first investment multiply itself automatically. What I've done for thousands of others—I can do for you.

FREE Book Shows Way to Big Pay and BIG Profits

Mail coupon below TODAY—for my Big NEW FREE Book, "How to Raise Poultry for Profit." My forty years of experience are yours. The Poultry Industry needs YOU. You need my book. Get it—and get in line for the BIG Money that's waiting for you in POULTRY.

Mail NOW for FREE Book

NATIONAL POULTRY INSTITUTE, Dept. 411-J
Washington, D. C., Attn: Harry M. Lamon, Pres.

Dear Mr. Lamon: Send me your FREE Book, "How to Raise Poultry for Profit." I want to know more about my opportunity to make \$2,000 to \$5,000 a year, spare or full time.

Name

Address

1931 Radio CATALOG

RADIO BARGAINS

WHOLESALE DISCOUNTS

LOWEST PRICES

Greatest bargains shown at
REGULAR WHOLESALE TRADE DISCOUNTS!
Nationally-advertised, guaranteed radio merchandise, including the sensational Sounded LAFAYETTE ALL ELECTRIC RADIO RECEIVER, with tape control. Write at once for FREE 1931 Radio Bargain Catalog, showing complete selection. Don't buy until you see this wonder catalog!

WHOLESALE RADIO SERVICE CO.
Dept. E-11
38 Vesey St. New York

FREE!

AVIATION INFORMATION FREE!

Send us your name and address for full information regarding the Aviation and Airplane business. Find out about the many great opportunities now open and how we prepare you at home, during spare time, in quality. Our new book "Opportunities in the Airplane Industry" also sent free if you answer at once.

AMERICAN SCHOOL OF AVIATION
3601 Michigan Ave. Dept. 1355 CHICAGO

LEARN WATCHMAKING AND ENGRAVING

BY OUR PROFIT-SHARING PLAN
OUR GRADUATES SUCCEED

One of our low students started in a very small way—now doing over \$30,000 a year. Another in Wisconsin, over \$10,000 the first year. Day or night classes. Call or write for FREE BOOK

Chicago School of Watchmaking, Dept. 7201, 549 W. Randolph St., CHICAGO

Wrestling Book FREE

Learn wrestling at home from former world's champions Farmer Burns and Frank Gotch. Free book tells how. Secret holds, blocks, tricks revealed. Be strong, healthy. Handle big men easily. Write for free book. State age.

Farmer Burns School 3375 Railway Bldg., Omaha, Neb.

Study LAW AT HOME

Lincoln did it! Also thousands of other great lawyers, politicians and business men, YOU, too, can become a lawyer or law-trained business man through home study guided by the successful practicing lawyers of our faculty. Write today for free book.

AMERICAN CORR. SCHOOL OF LAW
3601 Michigan Ave., Dept. 1355, Chicago

BIG MONEY IN ELECTRIC REFRIGERATION

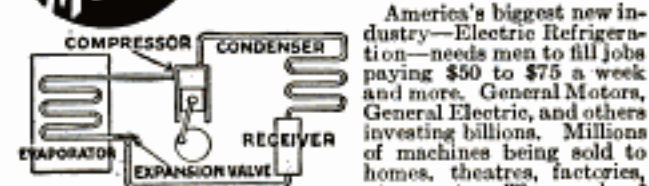

jobs open in production, installation, service and sales which ordinary mechanics can't fill without special training in electric refrigeration.

EASY TO LEARN AT HOME
Learning electric refrigeration is now amazingly simple thru a new easy home training endorsed by authorities. Endorsed by Servel, Kelvinator, and other leading refrigerator manufacturers. GET FREE BOOK. Utilities Engineering Institute, 4403 Sheridan Road, Dept. 151, Chicago.

Utilities Engineering Institute,
4403 Sheridan Road, Dept. 151, Chicago, Ill. **FREE!**

Without obligation, send me valuable free information book.

Name

Address

City

State

an OPPORTUNITY

TOO GOOD TO MISS!



The great Radio industry, because of its amazingly rapid growth, is today badly in need of hundreds of "trained" men to fill its more responsible jobs in Radio, Talking Pictures, and Television work.

To qualify for these jobs men must know Radio as they know their A B Cs.

They must know the theory as well as the practice, and be able to teach other men some of the things they know.

To such men the great Radio industry offers a wonderful opportunity for steady work at exceptionally good pay, now, and early advancement to still better jobs as a future. It is, in fact, the chance of a life-time for ambitious men.

But first these men must be trained, for no ordinary knowledge of Radio will do.

The Radio Industry, itself, has no time to train these men. It is growing so fast, and changing so fast, that its manufacturers and jobbers have all they can do to keep up with the trend of the times, by improving their methods of manufacture and distribution.

So the training of men for these jobs has become the task of the Radio and Television Institute, of Chicago.

As few men can afford to quit their work and get this Training at some University or Technical School, the Radio and Television Institute has been organized to train such men at home—no matter where they live—

in their spare time, and at a very nominal cost, for these better paying jobs in Radio, Talking Pictures and Television.

The Institute's Course of home-training was planned, written, and is actually supervised by an Advisory Board made up of prominent and highly paid engineers and executives, each of whom is actively connected with

some big Radio concern.

This means that your training will be right because these men, working with big Radio concerns, know exactly what the industry needs in the way of "trained" men, and exactly how you should be trained to meet that need. And this Advisory Board will have complete supervision over your training from the day that you become a student of this Institution.

For this reason, prominent Radio men, everywhere—and our country's largest and most important Radio Trades Associations—are unqualifiedly endorsing this home training, and recommending it to men whom they want to see make good in Radio work.

So if you are ambitious—if you are making a cent less than \$75 a week—investigate.

Find out for yourself all about this amazingly easy Course of home-training, and also all about the wonderful opportunities for "trained" men in this, the world's fastest growing industry. Everything is fully explained in the Radio and Television Institute's "Opportunity" book. Send today for your copy. It's free.

RADIO AND TELEVISION INSTITUTE, Dept. 15

2130 Lawrence Ave., Chicago

Without obligation of any kind please send me a copy of the Radio Opportunity Book. I am interested in your home-training and the opportunities, you say exist in the great field of Radio, for "trained" men.

NAME _____

ADDRESS _____

DRAFTING



Learn at Home

DRAFTING pays good salaries and is the stepping stone to even better positions. Many leading architects, mechanical engineers and electrical engineers got their start at the drafting board.

There is no easier or more practical way to learn Drafting than through the home-study courses of the International Correspondence Schools. Employers are constantly writing us for trained men. We receive more calls for I. C. S. draftsmen than for graduates of any other course.

F. E. King was "a poorly paid clerk" when he enrolled for the I. C. S. Drafting Course. By study, industry, and perseverance he became Chief Draftsman of the U. S. Steel Furniture Company, of Syracuse. He is now earning more in a day than he used to earn in a week.

A. J. Hutchins became Chief Draftsman for the American Strawboard Company and increased his salary 300 per cent—also as a result of I. C. S. Training.

Just mark and mail the coupon and we'll gladly send you a booklet telling all about the I. C. S. courses in Drafting or other subject in which you are interested.

INTERNATIONAL CORRESPONDENCE SCHOOLS

Box 5543-G, Scranton, Penna.

Without cost or obligation on my part, please send me a copy of your 48-page booklet, "Who Wins and Why," and tell me how I can qualify for the position, or in the subject, before which I have marked an X:

- | | |
|--|--|
| <input type="checkbox"/> Mechanical Drawing
<input type="checkbox"/> Draftsman's Course | <input type="checkbox"/> Structural Drafting
<input type="checkbox"/> Architectural Drawing |
| <input type="checkbox"/> Architect | <input type="checkbox"/> Aviation Engines |
| <input type="checkbox"/> Building Foreman | <input type="checkbox"/> Plumber and Steam Fitter |
| <input type="checkbox"/> Concrete Builder | <input type="checkbox"/> Plumbing Inspector |
| <input type="checkbox"/> Contractor and Builder | <input type="checkbox"/> Foreman Plumber |
| <input type="checkbox"/> Structural Engineer | <input type="checkbox"/> Heating and Ventilation |
| <input type="checkbox"/> Electrical Engineer | <input type="checkbox"/> Sheet-Metal Worker |
| <input type="checkbox"/> Electrical Contractor | <input type="checkbox"/> Steam Engineer |
| <input type="checkbox"/> Electric Wiring | <input type="checkbox"/> Marine Engineer |
| <input type="checkbox"/> Electric Lighting | <input type="checkbox"/> Refrigeration Engineer |
| <input type="checkbox"/> Electric Car Running | <input type="checkbox"/> B. R. Positions |
| <input type="checkbox"/> Telegraph Engineer | <input type="checkbox"/> Highway Engineer |
| <input type="checkbox"/> Telephone Work | <input type="checkbox"/> Chemistry <input type="checkbox"/> Pharmacy |
| <input type="checkbox"/> Mechanical Engineer | <input type="checkbox"/> Coal Mining Engineer |
| <input type="checkbox"/> Machine Shop Practice | <input type="checkbox"/> Navigation <input type="checkbox"/> Assayer |
| <input type="checkbox"/> Toolmaker | <input type="checkbox"/> Iron and Steel Worker |
| <input type="checkbox"/> Patternmaker | <input type="checkbox"/> Textile Overseer or Supt. |
| <input type="checkbox"/> Civil Engineer | <input type="checkbox"/> Cotton Manufacturing |
| <input type="checkbox"/> Surveying and Mapping | <input type="checkbox"/> Woolen Manufacturing |
| <input type="checkbox"/> Bridge Engineer | <input type="checkbox"/> Agriculture <input type="checkbox"/> Fruit Growing |
| <input type="checkbox"/> Gas Engine Operating | <input type="checkbox"/> Poultry Farming |
| <input type="checkbox"/> Automobile Work | <input type="checkbox"/> Mathematics <input type="checkbox"/> Radio |

BUSINESS TRAINING COURSES

- | | |
|--|---|
| <input type="checkbox"/> Business Management | <input type="checkbox"/> Business Correspondence |
| <input type="checkbox"/> Industrial Management | <input type="checkbox"/> Show Card and Sign Lettering |
| <input type="checkbox"/> Personnel Management | <input type="checkbox"/> Stenography and Typing |
| <input type="checkbox"/> Traffic Management | <input type="checkbox"/> English |
| <input type="checkbox"/> Accounting and C.P.A. Coaching | <input type="checkbox"/> Civil Service |
| <input type="checkbox"/> Cost Accounting | <input type="checkbox"/> Railway Mail Clerk |
| <input type="checkbox"/> Bookkeeping | <input type="checkbox"/> Mail Carrier |
| <input type="checkbox"/> Secretarial Work | <input type="checkbox"/> Grade School Subjects |
| <input type="checkbox"/> Spanish <input type="checkbox"/> French | <input type="checkbox"/> High School Subjects |
| <input type="checkbox"/> Salesmanship | <input type="checkbox"/> Illustrating <input type="checkbox"/> Cartooning |
| <input type="checkbox"/> Advertising | <input type="checkbox"/> Lumber Dealer |

Name.....
Street.....
Address.....

City..... State.....

Occupation.....

If you reside in Canada, send this coupon to the International Correspondence Schools Canadian Limited, Montreal, Canada

Books on Many Practical Subjects

Popular Mechanics Press specializes in supplying the outstanding best books on many subjects. As new books of merit appear, we will revise the list accordingly.

- | | |
|---|---|
| ARCHERY
Modern.....\$3.00 | INVENTION
Popular History of American.....\$1.00 |
| ARCHITECTURAL
Design and Lettering...\$2.00 | JOINT WIPING
(New Edition).....\$1.00 |
| ARMATURE WINDING
Excellent new book....\$2.00 | KITES THAT FLY
How to Make.....\$1.25 |
| AUTO ENCYCLOPEDIA
Dyke's. (Covers New Model A Ford).....\$6.00 | LANDSCAPING
Practical.....\$2.50 |
| AVIATION
Everybody's Guide....\$2.00 | LATHE WORK (METAL)
and Drilling and Thread Cutting.....\$1.00 |
| BACKGAMMON
How to Play.....\$1.50 | LETTER WRITING
Social and Business Only.....\$1.00 |
| BIRD HOUSES
How to Make.....\$1.00 | LETTERING
Modernistic.....\$2.00 |
| BLUE PRINT READING
For Building Trades...\$1.25 | MACHINIST
Complete, Practical...\$3.00 |
| BOAT BUILDING
35 Popular Types, Outboard Motor, Sail, Row, etc.....\$3.00 | MAGIC
200 New Tricks for Amateurs.....\$1.00 |
| BOY MECHANIC
Famous 4 Vol. Library, 4000 Things to Make. \$7.00 | MARKETING BY MAIL
Science of.....\$2.00 |
| BUILT-IN FURNITURE
Complete Instructions..\$2.50 | MATHEMATICS
Made Easy for the Practical Man.....\$1.50 |
| CALCULATOR
Mathematical Ropp's...\$1.00 | MECHANICAL DRAWING
Practical Course in...\$1.00 |
| CARBURETORS
Excellent book on all makes.....\$2.00 | MODEL AIRCRAFT
Building and Flying...\$2.25 |
| CARPENTRY
Hand book of 336 Kinks..\$1.50 | OUTDOOR OPPORTUNITIES
for Making a Living...\$2.00 |
| CHALK TALK
How to.....\$1.00 | OUTDOOR SPORTS
for All Year 'Round New Edition.....\$2.00 |
| COLOR SIMPLIFIED
Practical new Book (for Color Users).....\$3.50 | PAINTING
House (Best Methods)...\$2.00 |
| CONCRETE
178 Ways of Using New Edition (Cloth)..\$1.00 | PLUMBING
500 Plain Facts for Every Homeowner...\$1.50 |
| CONTRACT BRIDGE
at Sight.....\$1.00 | POULTRY RAISING
for Profit.....\$2.00 |
| DOGS
Care and Raising.....\$2.00 | PUZZLES
Amusing Mathematical..\$1.50 |
| ELECTRICITY
for Beginners.....\$1.50 | RABBITS
For Food and Fur....\$2.00 |
| ELECTROPLATING
Practical Results Easily Obtained.....\$1.00 | ROOF FRAMING
Made Easy.....\$2.50 |
| ENGLISH
Self-Improvement in...\$2.50 | SHOP NOTES
12 Vols. of 6000 Valuable Kinks.....\$3.75 |
| ETIQUETTE
New 560-Page Book. Only.....\$1.00 | SLIDE RULE
How to use.....\$1.75 |
| FARMER'S BOOK
of 561 Kinks and Book for Farmers' Wives...\$1.00 | STAMP ALBUM (Modern)
12,000 Varieties.....\$1.50 |
| FLYING
Simplified.....\$1.00 | STEEL SQUARE
Pocket Book, Practical..\$1.00 |
| FORMULAS
10,000 Money Making..\$4.00 | STORAGE BATTERIES
(New work) Best on subject.....\$3.00 |
| FURNITURE (Mission)
Homemade (3 vols.)...\$3.00 | TOY MAKING
Complete Instructions..\$1.50 |
| GARDENS
1001 Questions Answered.....\$2.00 | TREASURES
Hunting Hidden.....\$2.00 |
| GLASS
Working.....\$1.75 | WALL DECORATION
(Interior) Newest Methods.....\$4.00 |
| GLIDING
A B C of.....\$2.00 | WHITTLING
The Art of.....\$1.35 |
| HOME REPAIRS
Practical Book of....\$2.50 | WIRING
House (New Book)...\$2.50 |
| HOME WORKSHOP
900 Different Things to Make.....\$3.00 | WOOD TURNING (LATHE)
Practical Course in...\$1.50 |
| IGNITION
(High Speed) For Garage Mechanics...\$3.50 | WOODWORKING SHOP
Modern Motor-Driven..\$1.00 |

Books sent C. O. D. anywhere in U.S.

Just check the books you want, write your name and address below, and mail the advertisement. It is your order blank. When post-man hands you books, pay him the price and few cents postage. If outside the U. S. remit when ordering and include 10 cents per book extra for postage. We have many other books on these and 2,000 other subjects. Catalog free.

Name.....

City..... State.....

Address.....

Mail to Popular Mechanics Press,
Room P4—200 East Ontario St., Chicago, Ill.

LET ME PROVE IN 7 DAYS

that I can make
YOU
a **NEW MAN!**

By **CHARLES ATLAS**

Holder of the title:

"The World's Most Perfectly Developed Man"

All I want is *one week* to prove that I can give you a powerful body of might and muscle like mine—with my quick *Dynamic-Tension* method.

Here's all you do:

Just jot down your name and address on the coupon below, mail it to me—and I'll send you, absolutely free, a copy of my new book, "*Everlasting Health and Strength*." It reveals the secrets that turned me from a 97-pound, flat-chested weakling into a husky fellow who won the title of "The World's Most Perfectly Developed Man" against all comers! And it shows how I can build *you* into an "Atlas Champion" the same easy way.

It tells the fascinating story of how I've taken under-developed, flabby, no-muscle men of all ages and given them big powerful muscles, increased-measurements all over, amazing strength, endurance, vitality and pep—all in a few minutes of spare time daily at home.

Thousands of fellows all over the world have used my methods—and now *you can too*. Like them, you can put on firm layers of muscle where you need it most, tone up your whole system, banish constipation, poor digestion, bad breath, pimples and other ailments that rob you of the good things and good times of life, and get the "drive" that'll take you to the top of the ladder.

It's Easy My Way

I haven't any use for apparatus; I don't dose you or doctor you. *Dynamic-Tension* is all I need. It's the *natural*, tested method for developing real men inside and out. It distributes added pounds of powerful muscles over your body, gets rid of ailments and surplus fat, and gives you the vitality, strength and pep that win you the admiration of every woman and the respect of any man.

Accept My FREE BOOK

Why be only 50% of the man you can be? Send **NOW** for a free copy of my new large illustrated book loaded with pictures of myself and others who have used my secret methods. Read what I did for *them*. And find out what I can do for *YOU*. Don't put off becoming the husky, big-muscled **NEW MAN** you can be! Mail the coupon **TODAY**.

Address me personally, **CHARLES ATLAS** (Dept. 8E), 133 East 23rd Street, New York City.

CHARLES ATLAS (Dept. 8E)
133 East 23rd Street, New York City.

I want the proof that your system of *Dynamic-Tension* will give me, too, a healthy, husky body and big muscle development. Send me your free book, "*Everlasting Health and Strength*."

Name.....
(Please print or write plainly)
Address.....
City..... State.....

CHARLES ATLAS

As He Is Today

Holder of the title of "The World's Most Perfectly Developed Man," awarded in international contest, with ALL strong men willing to compete with him. His own modern method of *Dynamic-Tension* developed him from a 97-pound weakling to the physical ideal of health and strength shown in this new photo.



ARE YOU READY FOR A BETTER JOB?

Success comes to those who know HOW and WHY.

ELECTRICITY



12 Vols. Large type, fine paper, binding. Photos, diagrams, tables. 600 to 800 pages.

offers a field that will never be over-crowded. Interesting. Well-paid. Start at once to get practical working knowledge. Read a book a month.

BOOK-A-MONTH STUDY PLAN

The newest, easiest way to study. Everything simple and clear. Test questions easy to answer. Even poor students learn quickly.

AUDELS New Electric Library

makes electricity as easy as A B C for beginners; interesting as fiction; engineers can carry in pocket for spare-time reading and reference. Questions, answers, thousands of diagrams, calculations.

—Dynamo, Armature, Winding, D-C Motors, Maintenance, Tests, Batteries, Transformers, Condensers, A-C Motors, A-C Current, Motors, Power Stations, Wiring Diagrams, Electric Railways, Elevators, Auto and Aero Ignition, Radio, Telephone, Telegraph, Motion Pictures, Talkies, Refrigeration, X-Ray, Welding, Domestic and Farm Appliances.

FOR 6c A DAY we help you overcome handicaps of education. What you start the Audel way you can finish.

—SEND COUPON—NO MONEY—

THEO. AUDEL & CO., 65 W. 23rd St., New York City

Mail Vol. 1, Electric Library on 7 days' free trial. If O.K. I will remit \$1.50, otherwise I will return it. I also request you to mail one book each month on same terms. No obligation unless I am satisfied.

NAME.....

ADDRESS.....

OCCUPATION.....

EMPLOYED BY..... P.M.



High School Course in 2 Years

This simplified, complete High School Course, specially prepared for home study by leading professors, meets all requirements for entrance to college, business, and leading professions.

20 Other Courses

Over 200 noted Engineers, Business Men, and Educators helped prepare the special instruction which you need for success. No matter what your inclinations may be, you can't hope to succeed without specialized training. Let us give you the practical training you need.

American School
Drexel Ave. and 58th St.
Dept. H-547, Chicago

Money Back When You Finish If Not Satisfied

American School, Dept. H-547, Drexel Ave. and 58th St., Chicago
Send me full information on the subject checked and how you will help me win success in that line.

- ...Architect
- ...Building Contractor
- ...Automobile Engineer
- ...Civil Engineer
- ...Structural Engineer
- ...Business Manager
- ...C. P. A. & Auditor
- ...Bookkeeper

- ...Electrical Engineer
- ...General Education
- ...Lawyer
- ...Mach. Shop Practice
- ...Mechanical Engineer
- ...Steam Engineer
- ...Draftsman & Designer
- ...High School Graduate

Name..... Age.....

St. and No.....

Town..... State.....

NEW ELECTRIC ROBOT CELL

(NO LARGER THAN A GOLF BALL)

Puts AUTO Thieves



This new all metal Electric Robot Cell, called the DETEC-TO-CELL, stands constant and faithful guard over parked cars Day and Night. No thief can touch your car or anything IN or ON it without starting a Glorious Riot of Noise that will not stop until he runs away. Protects every part from spare tire and gas tank to bumper and headlight. Do not confuse with anything else you have ever seen or heard of. The DETEC-TO-CELL is entirely new, different and scientifically correct. As great and ingenious an invention as the Photo-Electric Cell. Starting and annoying in effect. Positive and accurate in operation. Contains no springs, weights or sliding contacts—cannot get out of order. Installed in ten minutes.

AGENTS

GET OUR FIVE DAY TEST OFFER

Will Outlast Any Car
STOP this man is a thief



Nothing beats the DETEC-TO-CELL as a full of spare time money maker. Amazing sales records are made daily by men who never sold anything before in their lives. Creates instant attention the moment it is shown. You can't keep the crowds away when you demonstrate. Every auto owner is a prospect. The Low Selling Price and Positive Protection feature automatically does your sales. Write today for Five Day Test Offer and liberal territory proposition.

ELECTRIC R. & S. CO., 64 E. Lake St., Dept. 822-PM, CHICAGO

LUCKY TIGER

A PROVEN GERMICIDE



For a clean, healthy scalp use Lucky Tiger. Destroys germs, and gives to thin, falling hair a new life and lustre. Delicately perfumed; world's largest seller at Druggists, Barbers, Beauty Parlors. Try it Today!



AN EASY WAY TO SHAPE your NOSE

Anita Nose Adjuster shapes flesh and cartilage—quickly, safely, painlessly, while you sleep or work. Lasting results. Gold Medal Winner. Doctors praise it. 78,000 users. Write today for FREE BOOKLET.

ANITA INSTITUTE, E-12 Anita Bldg., Newark, N. J.

BUCHSTEIN'S FIBRE LIMB



Send for Catalog Today

is soothing to your stump—strong, cool, neat, light. Easy payments. Braces for all deformities. D. BUCHSTEIN CO. 600 3rd Ave., So. MINNEAPOLIS, MINN.

NERVES?

Are You Always Excited? Fatigued? Worried? Gloomy? Pessimistic? Constipation, indigestion, cold sweats, dizzy spells and headaches are caused by NERVE EXHAUSTION. Drugs, tonics and restoratives cannot help much, such as? Learn how to regain Vigor, Calmness and Self-Confidence. Send 25c for this amazing book. RICHARD BLACKSTONE, N-475 FLATIRON BUILDING, N. Y.

MOLES and WARTS

REMOVED PERMANENTLY



Rid your face, neck, arms and body of all unsightly moles and warts with "ANTI-MOLE." One application does it. Safe—easy to use—painless—leaves no scar. Used successfully by physicians, skin specialists and beauty experts for 28 years. Write for FREE booklet on treating all kinds of moles and warts. Miller Co., 2445 South St., Lincoln, Nebr.

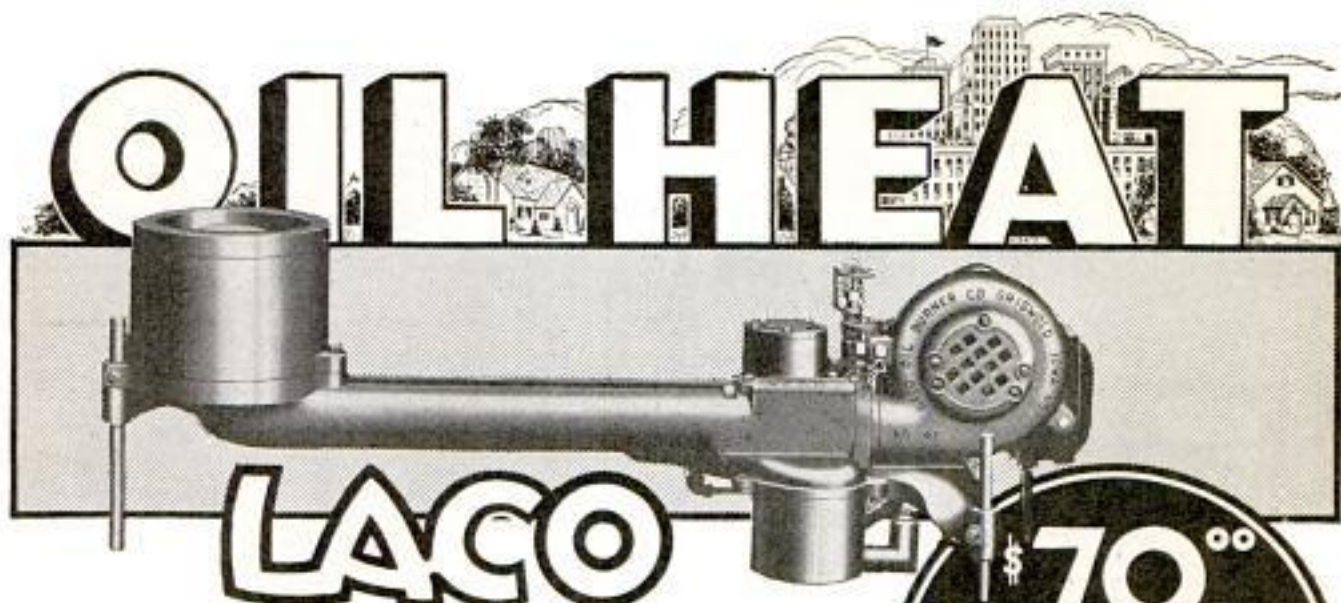

Listed as Standard by Underwriters Laboratories

Sweeping Price Reductions Due to New Features of America's Only Mineral Wick Oil Burner Bring Avalanche of Sales for Dealers. Profits Range from \$5,000 to \$50,000 Annually. Now Burns Either Gas or Oil!

THEY said it couldn't be done! But we proved that it could. First, through an amazing discovery of the LACO MINERAL WICK we eliminated fuel waste and made oil heat CHEAP AS COAL. Brought this luxury to thousands of homes. Paid our DEALERS AS MUCH AS \$50,000 annually. Now startling NEW FEATURES allowing manufacturing economies and shrewd buying of materials, again revolutionize prices! Orders simply have swamped our dealers! Millions of American home-owners and renters who believed they never could afford the luxury of automatic oil heat, now can get this King's convenience at a pauper's price!

Gas Heat Field Offers Dealers Golden Opportunity

Right in line with this announcement comes the startling news that now LACO CAN BE EQUIPPED TO BURN EITHER OIL OR GAS! Just a few extra dollars does it. We still say that wherever there's need for automatic heat, LACO PROVIDES IT CHEAPEST! CLEAN! QUIET! SAFE! CONVENIENT! No smoke, soot, grease. Quickly and easily installed. Full automatic control and safety features. 26 sizes and models. Burn either oil or gas the LACO way . . . as cheap as coal with none of the trouble and bother. Write at once for NEW LOW PRICES and easy payment plan! Tell us your present type of heating system and number of rooms you want to heat. Write today!



LACO Model "F" Radical Price Cut

World's Lowest Priced Cheapest to Operate Atomizing Power Oil Burner. Burns the heavy grades of oil, including 24 West Coast Diesel Oil. Perfect atomization. Low pressure, lazy flame catches every atom of oil and burns it without waste. Low stack temperature. Completely automatic, attractively finished. Easily and quickly installed. And now sold at NEW LOW PRICES! Send now for full information FREE!

**\$70⁰⁰
up to
\$475⁰⁰**

AMAZING NEW FEATURES

New Air and Oil Control Valves
Wider Range of Heating Capacity
New Wick Type Air Flue Orifice
Increased Heating Capacity, without extra oil consumption
New Wick Chamber burns longer with less attention
New Flame Control adjustable from wide to narrow for large type boilers
Burns either Oil or Gas

Money-Making Plan Open to Dealers

No big investment required. Just write us on your own letter-head and we'll send you the biggest offer you ever had made to you by anyone! You'll never realize the sales opportunity—the profit possibilities until you write us. Special offer if you send now! Act at once. Exclusive territories open for BIG JOBBERS!

LACO OIL BURNER CO.

ONE OF THE WORLD'S LARGEST MANUFACTURERS OF OIL BURNERS

143 UNION STREET

GRISWOLD, IOWA, U. S. A.

NOW FIX ANY MAKE OF

AUTO**SIX BIG AUTO BOOKS ALL SHIPPED FREE**

on approval; whether you want to qualify as garage owner, auto repair expert or merely wish to know how to keep your own car 100% efficient, look at these books—they are sent to you for free examination. This brand

new 1931 edition has been prepared by a large group of America's greatest automotive engineers. Anybody who can read will understand them, for this great automobile encyclopedia is a veritable gold mine of valuable facts. Take advantage of this great opportunity now; send in the coupon for FREE examination. You don't pay us a penny, you don't obligate yourself to pay anything unless you decide to keep the books. Just tell us you want to see them and the full set of 6 great volumes, just off the press, will be sent to you. Read them, look them over and prove to your own satisfaction that one fact alone, which you will find in them, may save you an expensive repair, or help you to a better job.

Aviation Motors

In addition to being a complete encyclopedia of automobile engineering, these books contain over 100 pages on Aviation Motors, and as they are just off the press they bring to you the newest and latest information obtainable. This alone makes these books invaluable to anyone.

New 1931 Edition

Imagine books which are so new that every page is right up to date—wiring diagrams, construction details, service problems—are all right up to the minute. Nowhere else that we know of can you get as complete and up to date information. Over a million dollars of resources have enabled us to give you the most up to date books on the subject ever published. You will find nearly 20 pages on front wheel drives alone. Everybody interested in automobiles in any way will welcome these books, especially on our no money offer.

**CAN YOU FIX IT?**

Can you take out "play" in differential? Can you kill the "shimmy" in steering? Can you reset TIMING? Can you put your finger on engine trouble without guessing or tinkering? Can you pull the starter off and fix it? Can you adjust and repair transmission, engine, rear axle, bearing?

These Books Tell How

and they tell you how to do any and every auto job right, the first time.

6 Big Volumes

Nearly 3,000 pages, over 2,000 illustrations, wiring diagrams, equipment charts, etc. 12c Loose edition with gold-embossed flexible binding. Sent FREE for 10 days' use. If not wanted return express collect. If kept, send only \$2.00 after 10 days, then \$3 a month until special advertising price, \$24.95, is paid.

A Year's Consulting Membership FREE!

Privilege of consulting engineers of million-dollar American Technical Society on any automotive problem for one year without charge, if you mail coupon immediately.

SEND NO MONEY

American Technical Society, Dept. A-519,
Drexel Ave. at 58th St.,
Chicago, Illinois

I would like to see the new 6-volume 1931 edition of your automobile books but without any obligation to buy. I will pay the low cost delivery charges only and will examine the books and return them at your expense in 10 days unless I like them, in which case I will send you \$2.00 (then send only \$3.00 per month until the special price of only \$24.95 is paid). You are to include free consulting membership certificate in the American Technical Society. Send brand new 1931 edition.

Name.....
Street.....
City.....State.....
Employer's Name.....
Employer's Address.....

CARTOON YOUR WAY TO SUCCESS!**CARTOONISTS ARE EARNING FROM \$50 TO \$300 A WEEK!!**

YOU, too, can now learn this profitable profession AT HOME in your SPARE TIME. Raye BURNS, noted instructor of Cartooning, has made it possible, by his method of teaching through **Illustrated Plates** and **Individual Instruction**, for you to become a **REAL CARTOONIST** in a **short time!**

This Course does **not** show you how to copy, but teaches you **HOW** to **CREATE original cartoons**. Here's a **partial** list of the lessons: **Heads, Expression, Comic Bodies, Action, Women, Children, Animals, Sport Cartoons, Comic Strips, Lettering, Getting Ideas, Selling Your Work**, etc. The complete course contains **26 lessons** and **over 600 illustrations**, thus not only **telling** you how to draw, but **showing** you.

CARTOONIST BURNS is willing to help you still further by **PERSONALLY** correcting each of the 75 drawings you are required to draw during the course. There will necessarily be a small extra charge for this service. The **simple method** used in producing such successful results that Mr. Burns **GUARANTEES**, by devoting a **few hours** each week to the lessons alone, you will be drawing **ORIGINAL CARTOONS** that are **SALABLE** before you are half through the course, enabling you to **earn** while you **learn**.

Simply send **two** of your drawings with your order. These will be criticized **FREE** of extra charge! When the lessons and your corrected drawings are delivered, pay the postman **ONLY**.

This completely pays for the course of 26 lessons and over 600 illustrations. **\$2.85**

If, after examining the entire course, you are not completely satisfied, return the lessons within 30 days and your money will positively be refunded.

THE RAYE BURNS SCHOOL

836 Lakeview Rd.

Cleveland, Ohio

WINDOW DECORATING EASY TO LEARN

Learn to decorate windows. Artistic taste only requirement. Average pay from \$40 to \$100 per week. Many earn \$3,000 to \$10,000 per year.

Write Now

One million needed windows. Your opportunities unlimited. Every retail store needs decorators. Learn in your spare time at home. Write for descriptive catalog.

MURPHY SCHOOL OF DECORATIVE ADVERTISING

107 ARLINGTON ST. - BOSTON, MASS.

Rider Agents Wanted

Select from 44 Styles, colors and sizes of Mead Bicycles. Ride and exhibit sample HANGERS and make money.

Factory to Riders: We ship on approved for 30 Days' Free Trial, direct from FACTORY. Get our marvelous offers. Easy Payments, \$5 down.

Tires keeps horns, wheels, parts, equipment, and repairs at half usual price. Established 36 years.

Mead CYCLE COMPANY

DEPT. D-111 CHICAGO



Write us today for free catalog

U.S. GOVERNMENT JOBS.

\$1260 to \$3400 YEAR
Men—Women
18 to 50

Steady Work
Paid Vacations

Common Education Usually Sufficient

Mail Coupon today—SURE

FRANKLIN INSTITUTE
Dept. C 172
ROCHESTER, N. Y.

Rush to me, entirely free of charge, 32-page book with: (1) A full description of the position checked below; (2) A list of U. S. Government Jobs Obtainable.

Railway Postal Clerk..... (\$1800 to \$2700)
Postoffice Clerk..... (\$1700 to \$2300)
City Mail Carrier..... (\$1700 to \$2100)
Inspector of Customs..... (\$2100 up)
Immigrant Inspector..... (\$2100-\$2900)

Name.....

Harmonica "AL" and his musical pal



One rainy Saturday all the crowd were in Bob's garage when Bill suggested a show. "But what will we do for music?" said Bob. Then up spoke Al, the new boy in the neighborhood, rather timidly. "I'll play my harmonica."



They all snickered when they heard what Al said, for in school Al couldn't play or sing a note. Even Mary who had been so nice to him laughed. But Al only smiled and said, "Just you wait."



The show was on. Mary's, Bill's and Bob's acts were frosts. The audience was beginning to jeer when Al appeared with his harmonica. How they clapped and cheered when he finished! Al was the hero of the day.



After the show all gathered around Al eager to know how he learned to play. Drawing a little booklet from his pocket Al said, "It's a cinch to learn with this book, and it's free, too. Why don't you send for one—and we'll all play together."

AL ALWAYS found it difficult to make friends. He was never noticed at parties because there was nothing he could do to entertain others. He was always lonesome. When he moved into a new neighborhood or went to a different school, it was weeks before he was ever invited to play with the rest of the crowd.

One day he saw an advertisement that said the Harmonica was the easiest of all instruments to play, and offered him a FREE BOOK of Instructions. Al sent away for the Book and sure enough, to his amazement, in a few days he was playing—and playing well. It was so simple—it was just like learning a game. Today, Al is the leader of the crowd, no matter where he is. He never has a lonesome moment. When he goes to parties, he's the star performer. All the boys and girls think he's wonderful.

Free Instruction Book

If you haven't the knack of making friends, if you want to be the leader of your crowd, why don't you learn to play the harmonica? Send for the FREE Harmonica Instruction Book. It's all so easy you'll be amazed at the expert way you can play in a short time.

Harmonica Bands Great Fun

Want to know what's even more fun than playing the harmonica alone? Start a harmonica band among your school-mates!

All over the country, up-to-date boys and girls are forming bands and having a great time besides winning fame playing over the radio, at entertainments, school assemblies and on the stage. If you want to start a band, ask your Teacher or Scout Master to send for the booklet that will tell all about it. Meantime be sure to send for the Free Illustrated Harmonica Instruction Book and learn to play.

A Quality Instrument

Hohner Harmonicas are the choice of professionals everywhere, and while slightly higher in price than inferior instruments, you always have the satisfaction of knowing you own the best—one that enables you to play anything from jazz to opera. You can get Hohner Harmonicas everywhere, in many different styles—at all prices. Send for Free Instruction Book—Fill out coupon now and mail it AT ONCE to M. Hohner, Inc., 114 E. 16th St., Dept. 109-E, New York City.

HOHNER Harmonicas

M. Hohner, Inc., 114 East 16th St.,
Dept. 109-E, New York

Please send me at once FREE Illustrated Instruction Book which tells me how to play the harmonica.

Name.....

Address.....

City.....State.....

Strongfort -Man Builder tells you how to be powerful

YOU—like every other man worthy of the name of "man"—have a burning desire to be strong—to be vigorous—to be capable of defense—to be an outstanding figure—admired and respected by men and women. You know the penalty of weakness. You know that the skinny fellow with hollow chest and sallow face—like the flabby fellow with too much stomach and too little wind—is a ridiculous object, laughed at or despised—undesirable in company, unsought as companions.



You don't have to be one of this kind. You can be a real 100 per cent man! You can be just such a man as any of the splendid fellows I have developed into vigorous men. The world holds no parallel for the work I have accomplished in upbuilding weak men. And what I have done for others I can do for you through **STRONGFORTISM**—my world famed Course of health and strength building.

Vibrant Life Awaits You

Many young men write me the most pathetic letters about their sorry plight and their hopeless state of mind. What I reveal to them—what I do for them, transforms their lives, makes them happy, joyous souls, with an entirely new outlook on life. My methods give to them speedily a bodily feeling so new, so different, so vigorous, that they are like men reborn—vibrant with life, bubbling with energy, eager for contact with others, full of ambition and pep! Results are truly marvelous. Thousands testify to this fact. They tell a story of rejuvenation, restoration and rebuilding of the human body that is beyond dispute.

STRONGFORTISM WILL DO WONDERS FOR YOU

You may not seek tremendous strength. You may not want to become a professional strong man, but you do want good health and strength—every man wants that!

STRONGFORT Builder of Men

You want energy and vitality. You want powerful muscles. You want a clear, unflinching eye and a steady nerve. You want courage, "sand," and pep! And you can get these by following in the paths in which I have directed thousands—you can be a real man! Above all, you can rid yourself of disheartening weaknesses and blighting ailments, such as Constipation, Indigestion, Rheumatism, Nervousness, Lassitude, Insomnia, Catarrh, Chronic Colds, etc.

GET MY FREE BOOK

It's a startling revelation of indisputable facts about the human body that will open your eyes to new vistas of life and happiness and success. It will show you how to eliminate from your system, in a very short time, any distressing disorders which may have made you feel yourself a misfit in the scheme of humanity; how to build up your body, strengthen ALL your vital organs so that you will feel the thrill of New Life coursing through your veins. It will teach you how to become FIT physically and mentally; fit for business, for society, a power among men, a pleasing personality to women. What I have done for others I can do for YOU.

I GUARANTEE IT.
SEND FOR THE BOOK NOW. IT'S FREE. Fill out the coupon. Don't delay. SEND IT TODAY.

STRONGFORT INSTITUTE

LIONEL STRONGFORT, Director

Physical and Health
Specialist for Over
30 Years

Dept. 118
NEWARK, N. J.



FREE CONSULTATION

Mr. Lionel Strongfort, Dept. 118, Newark, N. J.
Please send me absolutely free my copy of Promotion and Conservation of Health, Strength and Mental Energy. I have marked (X) before the subjects in which I am most interested.

- | | | |
|----------------|-------------------|-----------------------|
| Colds | Flat Chest | Short Wind |
| Catarrh | Constipation | Weak Heart |
| Asthma | Indigestion | Poor Circulation |
| Hay Fever | Nervousness | Round Shoulders |
| Headache | Rheumatism | Lung Troubles |
| Thinness | Dependency | Muscular |
| Rupture | Pimples | Development |
| Lumbago | Insomnia | Great Strength |

Other Ailments.....
Name.....
Age..... Occupation.....
Street.....
City..... State.....



Here's an Amazing New Business THAT PAYS UP TO \$1,000 A MONTH

A SURPRISING new profit opportunity is now offered to every ambitious man and woman! A sensational new kind of food business has been invented that can be operated by anyone in either full or spare time. Now, almost incredible as it may sound, \$400 to \$1000 a month is possible in even the smallest cities!

We supply you with equipment and plans for making and selling a delicious new greaseless doughnut that is cooked in a remarkable electrical device. Easy to digest and more toothsome than old-style doughnuts ever were. This delicious new doughnut—Brown Bobby—costs less to make and sells four times as fast. No wonder so many people without one bit of experience are literally raving up fortunes with this new money maker.

You can open a shop; rent cheap floor space in a grocery, delicatessen, lunch counter, drug store, etc. Or start at home—and make good profits your very first week!

Men and Women Start in This Business Daily

**\$3,000
in 3 Months**

"I made \$3,000 in 3 months from my greaseless doughnut business!"
Thos. Minch, Fla.

You cannot afford to delay. Details will gladly be sent without obligation of any sort. Such an amazing money maker may never be offered you again. Write at once for full plans and details.

Food Display Machine Corporation
500-510 N. Dearborn St., Dept. 3-E, Chicago

ENGINEERING ELECTRICAL · MECHANICAL · STRUCTURAL and ARCHITECTURE

INTENSIVE PRACTICAL TECHNICAL COURSES. Degree in 2 years. Diploma in 1 year. Special short courses 6 Weeks to 6 Months in Electricity, Radio, Power Plant, Electric Refrigeration, Armature Winding, Wiring, Testing, Insulation, Welding. LOW TUITION. Expert instructors. Extensively equipped laboratories. Free lifetime employment service for graduates. Part-time work while attending. Write for new free illustrated catalog giving all facts. 30th year.

FINLAY ENGINEERING COLLEGE
5001 A Indiana Avenue Kansas City, Missouri



Wireless (Radio)

and Morse telegraphy taught thoroughly. School, oldest and largest; endorsed by Telegraph, Radio, Railway and Government officials. Unusual opportunities. Expenses low—can earn part. Catalog free. DODGE INSTITUTE, Jones St., Valparaiso, Indiana.

Government Positions

Clerk Carriers, Rural Carriers, Railway Mail Clerks, Postmasters, Department Clerks, and many others. Splendid salaries, easy work, vacation with pay. Only common school education required. Examinations often. 44,817 appointed last year. Send for our Civil Service Catalog No. 6. COLUMBIAN CORRESPONDENCE COLLEGE, Washington, D. C.

BE YOUR OWN BOSS MAKE BIG PROFITS

The ELECTRIC CARPENTER

enables you to make screens, storm sash, porch enclosures, furniture, cabinets, toys, repairs. Substantial, speedy. Ideal for expert craftsmen and amateurs. Not a toy. Weight 570 lbs. Power from ordinary light socket.

Many Start In Spare Time

In the basement or garage. Easy to operate. Comes with Saw Table, Lathe, Mortiser, Stoper, Jointer, Speed Sander (for Disc sanding, polishing, etc.) and more. No job too difficult. The way to bigger savings and better living. No obligation. Write for FREE Illustrated Folder and Easy Payment Plan.

The AMERICAN FLOOR SURFACING MACHINE Co.
524 SOUTH ST. CLAIR ST. TOLEDO, OHIO

ENGINEERING DEGREE IN 2 YEARS



B. S. Degree in Civil, Electrical, Mechanical, Chemical, Aeronautical Engineering in 2 years. Non-essentials eliminated. Technical training in least time and at lowest cost consistent

with thorough preparation. Liberal entrance requirements. Those who lack high school training may make up work. Enter September, January, March, June. Write for catalog.

451 College Ave., Angola, Indiana

TRI-STATE COLLEGE

FREE-HAND DECORATIVE PAINTING

Get into this interesting big-paying field. Wall decoration and general interior decorative painting. Many now earning \$5.00 per hour and up in this work. Learn quickly through La Marr Home Study System. Simple, direct, inexpensive. Guarantee with each course. Write today for FREE booklet giving full information.

THE FERNHAVEN STUDIOS
1724 West Fifty-First Place, Los Angeles, California



Show Folks How to Resole Shoes, for Only 9¢ a Pair!

EARN UP TO \$6 AN HOUR

IT'S AMAZING! A scientific substance that completely re-soles shoes for only 9¢ a pair, and makes them look brand new. No nails or tools necessary. Just an old knife. Spreads in two minutes on pair of shoes like buttering bread. Fills all cracks and breaks. Dries hard and smooth overnight. Looks like leather. Wears like iron. Heals run down heels. Guaranteed to wear and satisfy. Agents earn up to \$60 every week. Lewis, Kansas, made \$30.10 in ONE MORNING. No experience necessary. Start spare time. Write for details and FREE SAMPLE. WE'LL PAY YOU 50¢ CASH TO TEST SAYBOL'S.

THE PERFECT MANUFACTURING CO.
Dept. R-506, Cincinnati, O.

FREE! Catalog of Technical and Business Books—1500 Titles—All Fields from Aviation to Welding Practice.

McGraw-Hill Book Co., Inc., 370 Seventh Ave., New York

**BE MY
CHEWING
GUM
AGENT**

Send No Money

Given

WRIST WATCH
Rectangle white metal case, beautifully engraved. Jewel set stem. Dainty dial with raised gold numerals. Fine jewel shock-proof movement. Guaranteed to satisfy.

DISHES Stylish decorated 21-piece dinner set. Made in the Grecian shape. Beautifully colored design finished with a gold edge.

**Sell MY GUM
and CANDY MINTS
Big Cash Profits**

Earnings besides candy presents. Just sell delicious, fresh Chewing Gum and Candy Mints at 5¢ a pack. Grape, peppermint, etc.

GIFTS GIVEN

Choice of over 60 gifts for boys, girls, men, women for selling just a few boxes. Write for 40 packs to sell, and catalog of free presents. I trust you.



**GET
THIS
FINE
FLASH
LIGHT!**

**HANDY
WELL MADE.**
Throws long, bright light. Strong, long-life battery. Powerful magnifying lens.

CHARLES DAVID STAY 1402 CINCINNATI, OHIO.

We like your drawing.



go ahead with six more

Do you like to draw? Publishing houses pay millions of dollars each year for illustrations. Trained artists are getting snug incomes from advertisers. You may have talent. Make it earn you real money. Successful Federal students are earning \$2500 to \$5000 a year—some even more.

Through the Federal Course in Commercial Designing, many famous artists will give you the benefit of their experience in drawing the human figure and animals, decorative design and lettering, poster designing, fashion drawing, color harmony, etc. Their instruction will show you how to bring your drawings to a professional standard. You don't have to give up your present job. Learn at home in your spare time.

Find out if you have drawing ability. There's no telling to what heights good art training may lead you. Fill in the coupon below and mail it. Get our Free Art Test from which our artists will judge your ability. We will send you this test and a copy of the book "Your Future," without charge.

FEDERAL SCHOOL OF COMMERCIAL DESIGNING

5A1 Federal Schools Building, Minneapolis, Minn. Please send me free book, "Your Future," also Standard Art Test.

Name

Age..... Occupation.....

Address.....





**Proof that
VON HOFFMANN
Graduates are
Readily Accepted**

On file in our office are many letters from graduates telling of their more ready acceptance for positions because they were Von Hoffmann trained.

Below are excerpts from two of them:

Mr. T. H. Worthington writes that he got a job as soon as he graduated. In writing about the incident he says—"Just as soon as I stated I graduated from Von Hoffmann Air College, I noticed they took more interest in me."

Mr. Richard McDougall, another graduate who is now an instructor in another school writes—"When I told them I graduated from Von Hoffmann they gave me the job."

**Located on the famous \$2,000,000
Lambert-St. Louis Municipal Airport**

VON HOFFMANN AIR COLLEGE
141 Lambert-St. Louis Municipal Airport
St. Louis, Missouri, MAIL TODAY

Name.....
Address.....
City..... State.....
Age..... I am interested in
() FLYING COURSE () MECHANICS COURSE
() WELDING COURSE () HOME STUDY

TRAIN WITH
VON HOFFMANN
for
YOUR PLACE

IN AVIATION

Then you can be certain of your ready acceptance into this modern industry. For the type of training you get—its thoroughness and completeness are scrutinized very closely. Aviation is looking for capable men. But positions of responsibility require men who have learned every phase of each problem they will be called upon to face.

The practical training given at Von Hoffmann has proved itself repeatedly. 97% of all of our flying students pass Government tests on first trial. That is a record you cannot overlook.

The Von Hoffmann Air College is one of the few schools in the country with the highest Government rating. This rating was awarded only after the Government made a careful study of our equipment, instructors, and system of training. It is your guarantee of the best training.

If you are over 16 years of age send in the coupon below and we shall send you full particulars.

United States Department of Commerce approved School for Transport, Limited Commercial, and Private—Ground and Flying.

VON HOFFMANN AIR COLLEGE
141 Lambert-St. Louis Municipal Airport, St. Louis, Mo.

New Way to Improve YOUR ENGLISH



A command of effective English gives you added advantages and better opportunities. Poor English handicaps you more than you now realize. You can improve your English through Sherwin Cody's 100% self-correcting invention. If you are ever embarrassed by mistakes in grammar, spelling, punctuation, or pronunciation, this new free book "How You Can Master Good English—in 15 Minutes a Day" will prove a revelation to you. Send for it now. It is free. Address
SHERWIN CODY SCHOOL OF ENGLISH
55 Searle Building Rochester, N.Y.

30 Days' Free Trial on all MEAD Bicycles

New RANGER Models now ready for delivery direct from our factory. Astonishing new prices and terms. Do not buy until you get them.

RIDER AGENTS WANTED to ride and exhibit sample. Save big money. Many models, styles, wheels, lamps, horns, equipment at half agent prices. Easy Payments.

Tires Write for our marvelous prices and terms.

Mead CYCLE COMPANY
DEPT. D111 CHICAGO

Write us today for free catalog



LEARN CARTOONING

AT HOME DURING SPARE TIME

with the course that has trained HUNDREDS of beginners successfully. The Landon Picture Chart Method of teaching ORIGINAL drawing by mail makes cartooning easy to learn. This school is a Member of The National Home Study Council. Write today for sample picture chart to TEST YOUR ABILITY and examples of the work of successful students now earning from \$50 to \$200 and more per week. Enclose 6c in stamps and STATE YOUR AGE.

THE LANDON SCHOOL, 2838 National Bldg., Cleveland, Ohio



SOMETHING NEW! POLISHED POINT AND RUBBER SPONGE

on No. 8 fountain pen as shown, make this pen write better and sell faster than any other. Guaranteed for life. Money back if not pleased. Sells for \$1.25, can be sold for special price of 75c.

AGENTS MAKING UP TO \$20 A DAY

**SAMPLE
ONLY 39¢**

ADJUSTABLE INK FEED



SPORS IMPT. CO., 331 Main St., LESUEUR CENTER, MINN.

Get Into A Business of Your Own—EARN \$150 to \$300 Monthly



AUTOMATIC AIR SERVICE

Dependable, space saving compressors bring customers to your door. Only \$12 Monthly. 30 Days' Trial.



PAINT SPRAY PROFITS

Paint autos, houses, furniture. One man does work of 3—highly profitable. Only \$12 Monthly, will pay its own way.



8-HOUR BATTERY CHARGING

Recommended by leading battery makers. Halves cost, doubles profits. No special experience required. As low as \$10 Monthly.



20 MINUTE Car Washer

Big profits washing cars—saves 2/3 the time, does better job. Services easily pay for it. Only \$17 Monthly.

30 Days' Trial, to prove it. Easy pay out of profits. Terms. Check items of interest and send this ad to

HOBART BROTHERS
Box M-51, Troy, Ohio

Train Now for New RADIO Opportunities



New inventions and improvements open up new fields for the radio-trained! By following the Association money-making plans, our members earn \$3 an hour upwards, full time or spare time. Tremendous demand now for Association-trained service men. Investigate how we train you, start you in business without capital, prepare you for big-pay positions.

NO-COST MEMBERSHIPS NOW OPEN
To a number of ambitious men, we will give No-Cost Memberships that may not sound too good to you at first. Write for details and Free Radio Handbook explaining how easily you can now cash in on Radio quick.

RADIO TRAINING ASSOCIATION OF AMERICA
4513 Ravenswood Ave. Dept. PM-5 Chicago, Ill.

SET ANALYZER
—sent to all members. Locates troubles in all types of sets. Tests circuits, measures resistance and condenser capacities, detects defective tubes.

HAENEL Super Air Pistols



The latest sensational importation. Made by the greatest gun factory in Europe; of the finest steel construction—a masterpiece of most skillful gunsmiths. Accurately rifled, most powerful air pistol made for target shooting, small game, rats, squirrels, etc. The Diabolo shaped lead pellets used in this pistol, smash at the object with terrific force. Can't you almost feel yourself blazing away at a target? Oh, man—what a thrill! Sight a Haenel and get the real joy of shooting—no noise, powder, cleaning or permit required. Length overall 10 1/2 in.; weight 2 3/4 lb. Blood steel. .177 and .22 cal. (500 lead pellets FREE)—\$11.75. Pellets per 1,000: .177 Cal.—\$1.50; .22 Cal.—\$2.50.

Write for catalog "W"—Guns, Rifles, etc.

HUDSON SPORTING GOODS CO., W-52 Warren St., N. Y. C.



Why STAMMER?
I overcome my own stammering. Let me help you. My new, free book tells how. You, too, can overcome your speech handicaps and lead a normal, happy and successful life. Write today! **ROBT. E. CARD, 12930 Woodward Ave., Detroit, Mich.**



BOW LEGS?
THIS GARTER (Pat'd) Makes Trousers Hang Straight If Legs Bend In or Out
Free Booklet—Plain Sealed Envelope
THE T. GARTER CO., Dept. E South Bend, Ind.

50 SONG HITS and MUSIC!

With Piano Accompaniment and Guitar Chords
The world's greatest collection of Mountain Ballads and old-time songs — songs that you have heard over the radio and on phonograph records.



Here is a chance for you to learn them and sing them to the simplified piano accompaniment or guitar chordal. You'll enjoy having the words and music to these 50 song hits.

HALLELUJAH I'M A BUM BIRMINGHAM JAIL, DYING COWBOY, WHEN THE WORK'S ALL DONE THIS FALL SHE'LL BE COMIN' ROUND THE MOUNTAIN, EAST BOUND TRAIN, LETTER EDGED IN BLACK HAND ME DOWN MY WALKING GAWK, GOLDEN SLIPPERS, BURY ME OUT ON THE PRAIRIE, FOUR THOUSAND YEARS AGO, THE ROVIN' GAMBLER, WE NEVER SPEAK AS WE PASS BY

And 37 Other Big Song Hits

Send 35c for a year's subscription to our monthly magazine EVERYDAY LIFE, which contains features of interest to all the family, stories, fashion department, household hints, beauty page, girl's department, etc., etc., and 35c extra or 60c in all and we will send our magazine to you for one year and this great collection, both for only 60c. A wonderful offer. Write today. You'll be pleased.

EVERYDAY LIFE, 91-S.H. 337 W. Madison Street, CHICAGO

DRAFTING

BOOKS SENT FREE!
ON APPROVAL

5 Volumes New 1931 Edition
Only 15 minutes a day with these WONDER BOOKS will prepare you for a good drafting job in less than a year. Mechanical and architectural drafting from simple straight lines to important complex plans. A step at a time! Built especially for beginners, for men with only grammar schooling. Drafting room practice, PLUS ENGINEERING, made easy and clear. Includes complete course in blue-print reading.

Big Field Big Demand Big Pay
Competent draftsmen are urgently needed right now in all building and manufacturing lines at \$50.00 to \$100.00 a week. That's just the beginning—FOR DRAFTSMEN HAVE THE BEST CHANCES FOR ADVANCEMENT. Pleasant, fascinating work, easy to learn and do. Learn quickly with these books—send coupon for a set FREE and see for yourself.

A year's consulting membership in the American Technical Society now given free to all readers of this famous encyclopedia of drafting. Many say that it is worth more than the cost of the books.

For Beginners
Written, so you can understand every word, by 22 famous engineers and architects. DeLuxe flexible binding, nearly 2,000 pages, 1546 blue-prints, charts and diagrams; prepares you for a good drafting job in mechanical or architectural lines. Sent for 10 days' free use if you mail coupon immediately.

SEND NO MONEY
Don't send a cent on this great offer. Your name and address, with that of your employer or other reference, will bring three books to you absolutely free for examination. Test them, read them, find out anything you want to know and then if you see no more than pleased send them back and you will not owe us one cent. If you decide to keep them, they pay only \$3.50 a month until the special introductory price of only \$19.50 is paid.

AMERICAN TECHNICAL SOCIETY
Dept. D-519, Drexel at 58th St., Chicago, Ill.

American Technical Society, Dept. D-519, Drexel at 58th St., Chicago, Ill.
Send for 10 days' free use New 5 volume set of drafting. I will pay the low cents delivery charges. If I wish, I may return books in 10 days and owe you nothing but if I decide to keep them I will send \$2.00 after 10 days, then only \$3.00 a month until \$19.50, the special introductory price, is paid. Send 1931 edition.

Name.....
Address.....
Employer or Reference.....
Address.....



ELECTRIC

Books Sent Free

on approval. Only 15 minutes with these wonder books will prepare you for a good electrical job in less than a year. A complete electrical course from elementary electricity through electrical subjects used by experts but written in non-technical language so that anybody can understand.

For Beginners and Experts
Written so you can understand every word. Printed on fine paper and bound in DeLuxe flexible binding. 8 Volumes, 4300 pages, 3200 illustrations.

Big Field! Big Demand! Big Pay!
Men who understand electricity are urgently needed right now in thousands of industries. Auto, airplane, machine shops—practically every industry depends on electricity and men who know this subject make big money. Pleasant, fascinating work, easy to learn and do; learn quickly with these books. Send coupon for a set for free examination and see for yourself.

A year's consulting membership in the American Technical Society now given free to all readers of this famous encyclopedia of electricity. Many say, "That's worth more than cost of books."

Free!

AMERICAN TECHNICAL SOCIETY, Dept. E-519, Drexel at 58th St., Chicago

Electricity—the biggest industry in the world—continues to grow the most rapidly and offers better jobs, bigger salaries and brighter future than other fields. Send today on this free offer. Your name and address and that of your employer or other reference is all that is necessary. No money. Examine these wonder books carefully and get, without cost, outline for organized study, quiz questions and consulting privilege with 18 experts. Also extra 120-page book, "A. C. Radio."

American Technical Society, Dept. E-519, Drexel at 58th St., Chicago.
Send for 10 days' free use, 5-volume set of Electrical Engineering. Include absolutely free, certificate of membership in the American Technical Society, entitling me to free consulting privileges for one year. I will pay the low cents delivery charges on the books. If I wish I may return them in 10 days and owe you nothing, but if I keep them, I will send \$3.00 after 10 days, then \$3.50 a month until the special sale price of only \$54.50 is paid. You are also to include extra book, "A. C. Radio."

Name.....
Address.....
City.....State.....
Employed by.....
Address.....

NEW KIND of CAN OPENER Hangs On The Wall!



**AGENTS
30 DAYS'
FREE TRIAL**

Big money? No experience needed to make \$4 and \$5 an hour. Start spare-time or full-time. Sales guaranteed. Full territory protection. We supply stock and demonstration outfit you ever saw. 30-Day introductory FREE TEST OFFER starts you. Mail coupon at once.

A HIT! New and needed everywhere! At last comes a real Can Opening Machine for the home! This amazing little patented discovery hangs on the wall. Holds the can for you. Opens it automatically at a mere twist of your wrist. No wonder it has already banished dangerous, old-style can openers from thousands of homes wherever it has been introduced!

Approved by Good Housekeeping Institute, this clever little discovery ends fuss, muss and danger. Absolutely nothing else is even remotely like it. For it cuts the top OUT, not merely off. Leaves rim as smooth and slick as a china cup. No scraping or spooning, food pours right out. All danger of infection from deadly "can opener scratches" is forever banished. Guaranteed for 5 years. Inexpensive. No wonder housewives simply go wild at mere sight of this discovery! Liberal advertising offer now gives you a chance to test it in your own home. Simply use coupon at once! Central States Mfg. Co., 4500 Mary Ave., Dept. E-704, St. Louis, Mo.

Central States Mfg. Co.,
4500 Mary Ave., Dept. E-704, St. Louis, Missouri.
Rush Details of FREE TEST OFFER. Also Agents' money-making plans.

Name.....
Address.....
Town.....State.....
 Check here if interested only in one for your home.

Books on all subjects are sold by Popular Mechanics Press, 200 East Ontario Street, Chicago, Illinois.

Don't Be Afraid To Tackle That Concrete Job!

With the instructions found in the new, revised edition of Popular Mechanics Concrete Handbook you can make any of the following useful articles:



Garden Seats—Fountain and Basin—Flower Boxes and Vases—Pedestals and Bird Baths—Ornamental Pools—Sanitary Drinking Fountain—Gateposts—Auto Driveway—Sidewalks—Boat Landings and Docks—Entrance and Garden Walks—Sidewalk Flanging—Narrow Curb Walks—Curbs and Gutters—Wall Coping—Steps—Garage Floor—Basement Floor—Fence Posts—Lawn Roller—Cistern—Chimney Cap—Refuse Burner—Culvert—Benches for Greenhouses—Tile—Retaining Walls—Foundation Supports—Engine Foundations—Septic Tank—Toy Blocks—Forge—Fireproof Safe—Ice House—Watering Troughs—Milk House—Smokehouse—Silo—Horse Stalls—Hitching Post—Rural Mail Box Post—Cyclone Cellar

Build With Ease for Permanence and Beauty

This is a book of practical plans for using concrete about the home, farm or shop. For amateurs as well as contractors. In addition to making all the articles mentioned above the making of good concrete mixtures for various classes of construction is given; mechanical mixers and homemade tools are dealt with. All necessary form and mold making are covered as well as many other valuable pointers too numerous to mention here.

Simply write and ask us to send you this book. When postman hands you the package pay him \$1.00 plus the postage. If outside U. S. remit when ordering and include 15 cents extra for mailing.

POPULAR MECHANICS PRESS
Room P5 200 E. Ontario Street CHICAGO

NEED A BETTER GRIP ON MATHEMATICS?



SEND for a copy of "Mathematics for the Practical Man," only \$1.50. By common sense methods it removes the mystery and difficulties so that algebra and even calculus are made simple.

Assuming your knowledge is limited to arithmetic you quickly and easily gain a working knowledge of Algebra, Geometry, Trigonometry and Calculus. Simply pay postman price of book plus the postage when he hands you the package.

Popular Mechanics Press
Room P5
200 E. Ontario Street, Chicago

WANTED MEN TO "MAKE GOOD" IN PHOTOGRAPHY



Opportunities everywhere for trained motion picture, commercial and portrait photographers. Recently completed survey shows increase of 533% in use of photographs by newspapers, 83% of the country's industrial concerns now using photographs. Newsreel companies, exploration expeditions and scientific laboratories, too, add to the ever-increasing opportunities for expert motion picture and "still" photographers.

Enter this fascinating field. Previous experience unnecessary. We qualify you through our Simplified Training System and furnish equipment. Earn while you learn. Hundreds of New York Institute graduates have won quick success. Life Membership FREE of extra charge in Personal Service Bureau which helps you open a studio of your own or puts you in touch with opportunities. Many successful photographers now earning \$2,000 to \$10,000 a year, started with little capital. Send coupon TODAY for FREE book.

**GOOD PAY for
"STILL"
PHOTOGRAPHERS**



New York Institute of Photography, Dept. AF-1453, 10 West 33rd St., N. Y. C.
Please send me your FREE Book and details about:

Motion Picture Photography or Projection. Commercial and Portrait Photography or Photo-finishing.

Name.....
Address.....
City.....State.....

**BE A MOTION PICTURE
CAMERAMAN!**
Fascinating Work—
Splendid Opportunities

New York Institute of Photography, Dept. AF-1453, 10 West 33rd St., New York City

BOYS WANTED

AGE 12 TO 20 YEARS

EARN \$5 TO \$15 A WEEK
SPARE TIME, MORE FULL TIME

Pleasant work. Showing and taking orders for article that sells at sight. Work to be carried on in connection with extensive National Advertising Campaign, to introduce an exceptional product. Not to be confused with ordinary agent selling. Boys wanted must be ambitious and dependable. Anxious to learn, determined to earn big money. The kind of timber that develops to great men. Boys that must make tuition money or otherwise rustle for their own during summer preferred. An ideal connection for the right boy to distinguish himself and make real cash right in his own community. Firm making this offer one of the oldest, most reliable in its field. Positions open only to limited number of boys. For full information, write H. B. SHERMAN MFG. CO., 20 Barney St., Battle Creek, Mich.

BE AN AIR MAIL PILOT

...EARN
\$550.00
a month

Learn at Lincoln Where
"Lindy" Learned!



Aviation offers world's biggest opportunity! Average monthly salary for air mail and transport pilots last year was \$550. Lincoln graduates preferred as pilots because operators know they are finished flyers.

Pilot Training on monoplanes, biplanes, open and cabin. Seasoned, government licensed instructors. \$250,000 worth of buildings and equipment; \$100,000 airport. **Ground and Flying School Government Approved.**

Mechanical Training by factory standards as we are connected with a large airplane factory. Also Radio, Welding, Home Study Aviation Courses.

We help students find part time employment to help pay room and board while training. Write for details, stating age!

Lincoln Airplane & Flying School
205 Aircraft Bldg. Lincoln, Nebr.

NEW MYSTERY INVENTION

Closes Any Door Without **SLAM**

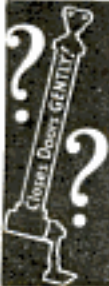

No longer need anyone tolerate the noisy nerve-racking nuisance of slamming, banging doors. Close-A-Door, an astonishing new invention, closes any door and keeps it closed. Shuts it swiftly and securely without noise or jar. Prevents damage to doors—breakage of glass—drafts which endanger health and waste fuel. Creates a furor of interest everywhere.

EASY MONEY FOR AGENTS
Veteran salesmen are introduced at the case with which Close-A-Door sells. Prospects gather everywhere! Every house, store, office can use 4 to 5-doorcases, apartments, by the dozen! \$10 to \$25 possible on a single sale! Easy big earnings the year round. Write at once for details.

THE CLOSE-A-DOOR COMPANY
Dept. E-11 1531 Washington Ave., St. Louis, Mo.

Don't PEEL POTATOES

Agents!

This is brand new! Going like wild-fire! Offers a real chance for \$100 a week. Spare-time and full-time sales plans offered. Jump in on the ground floor! Write quick for big-money plans and Free Outfit offer.



An amazing new automatic invention now makes potatoes peel themselves! No more paring knives! No cut fingers! No mess, muss or waste! Here's something every woman understands and wants the instant she even hears about it! A mechanical marvel,

almost incredibly small and simple, yet does more than ten pairs of hands! Peels the biggest potato in only a few seconds at the mere turn of a crank! Costs little more than a couple of good paring knives. Pays for itself many times over in saving on potatoes. Test it yourself at once. Write now. Ask quick for introductory offer.

GUARANTY PRODUCTS CO.
Dept. E 89, Francis Bldg.
Washington at 16th St., St. Louis, Mo.

Now—a quick, easy way to learn **Drafting**



What's ahead in your present job?—no future?—no opportunities? Then consider drafting—easily and quickly learned in spare time at home. High positions, fame, fortunes, have been won by skilled draftsmen. Business and industry could not exist today without them.

**\$25
Drafting
Outfit**

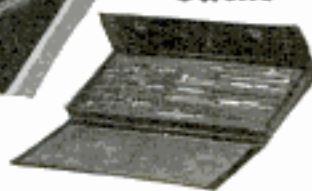

**free
of extra cost**

Enrollment includes this complete high-grade outfit—table, instruments, etc. No extras to buy. A small first payment brings at once everything needed to start course and make rapid progress.

Modern mechanics, architecture, engineering, construction, rail-roading, shipping, aviation, building, manufacturing, all offer thousands of openings. Everything built or invented must first be planned or "built" on paper. Our great builders, mechanical and inventive geniuses began as draftsmen. And any man of common school education can now learn practical drafting at home in spare time under our simplified system. Drafting is your big chance for swift development and promotion.

**\$35 to \$50 a Week to Start
\$5,000 a Year and up Paid Experts**

Nothing difficult about it . . . the simplest, shortest, step-by-step method you can imagine—the result of years of successful experience in teaching by mail and in our resident classes. Learn in spare time and evenings at home. Send for the Chicago TECH catalog of successes—engineers, architects, designers, builders, contractors, chief draftsmen, superintendents. Chicago TECH training was the ladder on which they climbed to big incomes. Low cost, easy terms. Send coupon now for Big Free Book on Drafting. Tells everything you want to know to succeed quickly in practical drafting work. This is your big chance. Grasp it today.

CHICAGO TECHNICAL COLLEGE

Dept. E-204, 118 E. 26th St., Chicago, Ill.

Architecture—Engineering—Drafting—Electricity—Building

We also offer resident day and evening courses in above subjects. Founded 1904, our College-Training-At-Home Plan is the result of 26 years' experience in training men both in our Chicago School and at home by mail.

CHICAGO TECHNICAL COLLEGE,
Dept. E-204, 118 E. 26th St., Chicago, Ill.

Please send me postpaid, your big Free Book on Drafting telling about opportunities and your College-Training-At-Home Plan.

Name.....Age.....

Address.....

City.....State.....

Check here if you prefer coming to Chicago to take our short resident day or evening course in Drafting

Be a DENTICIAN

We Will Train You in a Few Months

No Books—
No Classes—

Wonderful Future in this Uncrowded Field
Day and Night Schools in Chicago, Detroit, Cleveland, Boston, Philadelphia.



Experts Earn Up To \$125 a Week as Mechanical Dentists

We teach you to make rubber plates, crowns, bridge work, metal base dentures, etc., for dentists. After graduating you are ready for a job or can open your own laboratory.



Big Demand for Men

Dentists everywhere send work to mechanical dentists. We train you quickly for this uncrowded field. No classes—no books—no mechanical experience necessary. Work your way thru school. We help you find a job to meet your expenses while taking our training.

FREE BOOK Send at once for interesting free book telling all about this thriving profession. Also details of our liberal offers. Write today!

McCARRIE SCHOOL OF MECHANICAL DENTISTRY,
1338 S. Michigan Ave., Dept. 463, Chicago.

Without cost or obligation, send me your illustrated book on Mechanical Dentistry, and complete information as to my opportunities in dental laboratory work.

Name.....
Address.....

Information on any book free. Write Popular Mechanics Press, Chicago, Ill.



"Been on a vacation Bill?"

"No, Jim—I've stopped smoking."

Gained six pounds in a week. You know how I used to smoke—a package of cigarettes and a cigar or two a day—it sure had some

hold on me. I tried to stop many times but could only quit for a few days. But I'm through forever now—took a scientific home tobacco treatment—fixed me up in two weeks.

"Wasn't hard on me at all—noticed improvement the first day—I feel like a new man. It didn't interfere with my work—didn't leave any druggish after-effects—the money I saved in the last two weeks has paid for the treatment alone.

"Why don't you take it? It has entirely banished the tobacco habit for many thousands of men like you and me. It has been successfully used for over fifty years and comes to you with a money-back guarantee—it is a doctor's individual prescription that sure fixes you up. Write for full information NOW. No obligation. All correspondence is strictly confidential."

The Keeley Institute, Dept. A-945, Dwight, Ill.

Home of the famous "Keeley Treatment for Liquor and Drugs." Booklet sent on request. Correspondence Strictly Confidential.

Name.....
Address.....
City.....
State.....

With UKAP you can play the "UKE" in ANY KEY

UKAP, the wonder Transposer, makes it easy for any Ukulele player to play in ANY key with present knowledge. "UKE" scores on sheet music easily played without re-tuning. Professionals and teachers use and endorse UKAP. This small, chrome plated device adds to the appearance of your instrument and multiplies the pleasure of playing. Every UKAP fully guaranteed.

Big Money and Promotion for Player Agents

UKAP sells on sight at \$2; pays you \$1 profit. Big money and promotion for live Player Agents in this brand new field. Hundreds of "UKE" players in your locality need and will buy UKAP. Don't delay! Mail dollar bill today for sample and agents' proposition.

JOHNSTON BROTHERS COMPANY
1301 McPherson Avenue Fremont, Ohio



BIG MONEY FOR PLAYER AGENTS

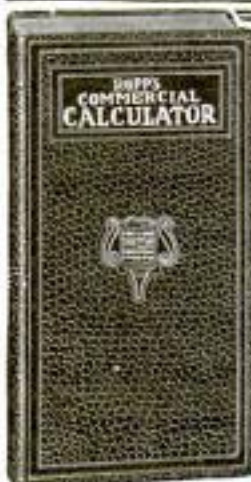

Mathematics Made Easy by ROPP'S CALCULATOR AND SHORT-CUT ARITHMETIC

Shows the Answer as Quickly as a Watch shows the Time to all Problems likely to occur in the Office, Store, Shop, Bank, Farm, or Factory.

Over 2,000,000 Sold

Explains and simplifies every principle in Arithmetic, Mechanics, and Mensuration.

PRICES POSTPAID

Desk Size, Flexible Keratol Binding, \$2.00

Pocket Size, Art Leather Binding, \$1.00

Pocket Size, Cloth Binding, \$0.50

POPULAR MECHANICS PRESS

Room 15 200 E. Ontario St. CHICAGO

The Newest RAND McNALLY WORLD ATLAS

(Readers Edition)
1930 Census Figures

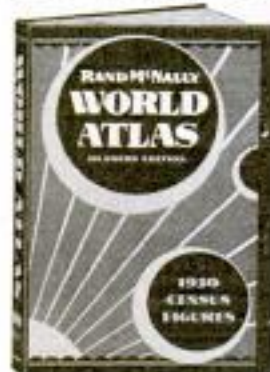

Here's a new, complete, up-to-date reference atlas of the whole world. Just the kind of atlas you need a dozen times every day at home, in the office, or at school to help you understand and appreciate current events, history, business and political developments.

This Beautiful New Atlas Contains:

160 pages of handsome 4-color maps covering the entire face of the earth, including a map of every state and every foreign country. 72 pages of indexes to U. S. cities and towns, including over 40,000 names alphabetically arranged by states, with 1930 CENSUS POPULATION FIGURES FOR EACH. 19 pages of indexes to foreign cities and towns, with latest official population of each. Includes over 10,000 names. 5-page gazetteer-index of the world containing valuable statistics on all countries of the world. 30 pages of text matter describing inhabitants, physical features, government, climate, history, etc., of every country.

NEW, CONVENIENT SIZE

This splendid 288-page atlas is a new convenient size—7 1/2" x 10 1/4"—that is easy to use, fits in your bookcase or on your desk. Bound in blue cloth and stamped in gold.

This book sent C. O. D. anywhere in the U. S. A. Simply pay the postman price, \$2.50, and the few cents postage when he delivers same. If outside U. S., send remittance with order.

POPULAR MECHANICS PRESS
Room P 5, 200 E. Ontario St., Chicago

ACCOUNTING



New Revised Course

Thousands of ambitious men are earning more money today because they know Accounting. Send for new booklet, "The Accountant—Who he is, What he does, How to become one," and first lesson of new revised Course. Both sent free. In reply please state age and position.

International Accountants Society, Inc.

A Division of the

ALEXANDER HAMILTON INSTITUTE

Dept. 203 3411 So. Michigan Ave., Chicago, Ill.

Mysterious Power of Pelmanism

Let us send you a free copy of "Scientific Mind Training." An instructive book which explains an amazing system of mind training already used by more than 750,000 people. It will show you how and why Pelmanism is the only system of teaching for developing all the mental powers at the same time. Endorsed by such distinguished men as Judge Ben B. Lindsey, Sir Harry Lauder, Jerome K. Jerome, Prince Charles of Sweden and hundreds of others. Write TODAY to

THE PELMAN INSTITUTE OF AMERICA

71 WEST 45th STREET DEPT. 65 NEW YORK CITY

Find out how EASY it is to own The New

ENCYCLOPAEDIA BRITANNICA

Write for FREE Booklet

Encyclopaedia Britannica, Inc., 342 Madison Ave., New York

BE AN OIL EXPERT!

New, easy, practical way to learn at home in spare time. Geology, Drilling Methods, Pipe Line Transportation, Refining and Marketing.

Write Today! FREE Book!

PETROLEUM ENGINEERING UNIVERSITY, Dept. 225, FORT WAYNE, IND.

AUTO REPAIRMEN EARN GREATER PROFITS

Get your share of the big money being spent on automobile upkeep.

Put improved time, labor and money-saving ideas to

work in your shop to-day. Take advantage of our special bargain offer and secure 3 valuable kink books at a reduced price.

1. 334 Valuable Discoveries made by auto mechanics in our **Automobile Repairman's Handbook**. 337 Illustrations.

2. 301 Ways to use drills, drill presses, taps and dies more effectively in our **Drilling and Thread Cutting Handbook**. 298 Illustrations.

3. 259 Kinks furnished by the most expert Lathe Operators in our **Lathe Handbook**. 212 Illustrations.

Special Offer—These 3 books (regular price 50 cents each, \$1.50 value) are offered for a limited time for only 98 cents plus postage. Pay postman C. O. D. when he delivers or if outside U.S. send 98 cents and 15 cents extra for postage.

POPULAR MECHANICS PRESS

Room P5

200 E. Ontario St.

CHICAGO

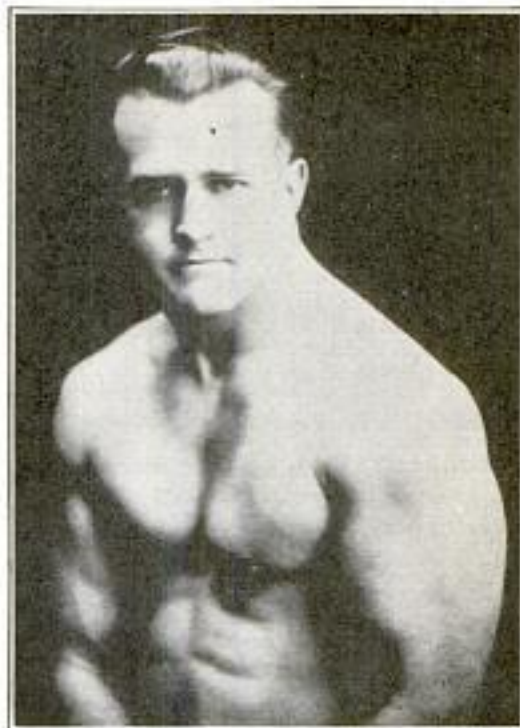

EARLE LIEDERMAN—The Muscle Builder
Author of "Muscle Building," "Science of Wrestling,"
"Secrets of Strength," "Here's Health," "Endurance," Etc.

The Man I Pity Most

POOR OLD JONES. I see him now, standing there, dejected, perishing, afraid of the world. No one had any use for him. No one respected him. He just lived on. A poor worn out imitation of a man doing his sorry best to get on in the world. If he had realized just one thing, he could have made good. He might have been a brilliant success.

There are thousands and thousands of men like Jones. They, too, could be happy, successful, respected and loved. But they can't seem to realize the one big fact—that practically everything worth while living for depends upon STRENGTH—upon live, red-blooded, he-man muscle.

Everything you do depends upon strength. No matter what your occupation, you need the health, vitality and clear thinking only big, strong virile muscles can give you. When you are fit the strength in those big muscles pulls you through. At the office, in the farm fields, or on the tennis courts, you'll find your success generally depends upon your muscular development.

Here's a Short-cut to Strength and Success

But, you say, "It takes years to build my body up to the point where it will equal those of athletic champions." It does if you go about it without any system, but there's a scientific short-cut. And that's where I come in.

30 Days Is All I Need

In just 30 days I can do things with your body you never thought possible. With just a few minutes' work every morning, I will add one full inch of real, live muscle to each of your arms, and two whole inches across your chest. Many of my pupils have gained more than that, but I GUARANTEE to do at least that much for you in one short month. Your neck will grow shapely, your shoulders begin to broaden. Your friends will wonder what has come over you. You'll look ten years younger, and you'll feel like it, too. Work will be easy.

I Strengthen Those Inner Organs, Too

But I'm not through with you. I want ninety days in all to do the job right, and then all I ask is that you stand in front of your mirror and look yourself over.

What a marvelous change! Those great squared shoulders! That pair of huge like arms! Those firm, shapely legs! Yes, sir. They are yours, and they are there to stay. You'll be just as fit inside as you are out, too, because I work on your heart, your liver—all of your inner organs strengthening and exercising them. Yes, indeed, life can give you a greater thrill than you ever dreamed. But, remember, the only sure road to health, strength and happiness always demands action. Fill out the coupon below and mail it today. Write now!

Send for My New 64-Page Book

"Muscular Development"—It Is Free

It contains forty-eight full-page photographs of myself and some of the many prize-winning pupils I have trained. Some of these came to me as pitiful weaklings, imploring me to help them. Look them over now and you will marvel at their present physiques. This book will prove an impetus and a real inspiration. Send today—right now before you turn this page.

EARLE LIEDERMAN, Dept. 2005 305 Broadway, New York City

Earle Liederman, Dept. 2005 305 Broadway, New York City

Dear Sir: Without any obligation on my part whenever please send me a copy of your latest book, "Muscular Development."

Name..... Age.....

Street.....

City..... State.....

(Please write or print plainly)

HOW'D YOU LIKE to Play This Instrument? **FREE LESSONS!**

YOU CAN PLAY THE XYLOIMBA

No reason why you shouldn't. Easy Lessons show you how. 5 days' free trial in your own home. A year to pay.

THE whole world seems different when you learn to play and now you can play the most spectacular of all instruments—the Deagan Xylorimba. No long waiting. No finger or lip exercises. No tiresome practice. Start to play the very first day even if you can't read a note of music right now. Soon you'll be the "hit" of every party. Maybe, like the Musical Hallmans (Reading, Pa.) you'll make \$65 a week spare time.

Our Big FREE Book tells all about the free trial offer, the easy lessons, the wonderful payment plan. No cost or obligation—send in coupon today.

J. C. Deagan, Inc., Dept. 4455, 1770 Berteau Ave., Chicago
Send me, without obligation, full details of Free Trial offer and easy payment plan of the Deagan Xylorimba.

Name

Address

Be a Civil Engineer!

Learn at Home!



Cyclopedia of Civil Engineering
1931 Edition

7 great volumes.
2,800 pages.
1,600 illustrations.
New edition just off the press, by twelve of America's greatest engineers. Includes: Surveying, bridges, railroads, steel structures, municipal engineering, water supply, road building, etc.

Spanish Grain Flexible Covers Gold Stamped

Loaned Free!

To prove you can learn Civil Engineering at home in your spare time. And because no description here could do it justice, to let you see for yourself the scope and simplicity, the authority and quality of this great home reading course. Cost and terms are within your reach. Send no money—just mail the coupon.

Earn \$5000

a Year—and Up!

"CIVIL ENGINEERING"—in plain English written so you can understand it, even if you have only a limited education. Prepares you for a well-paid railroad structural or public works position. Covers every branch of Civil Engineering practice. At once a reading course for the ambitious student and an authoritative reference work for the experienced engineer. Borrow a set—free. Look over the test questions which help you master each subject quickly. Mail the coupon without obligation today!

American Technical Society
Dept. C-519 Chicago

American Technical Society,
Dept. C-519, Chicago

I want to BORROW the CIVIL ENGINEERING Cyclopedia for 10 days FREE. I will gladly pay the few cents express, but I am to pay nothing for the loan of the 7 big volumes if I return them within 10 days. If I wish to keep them I will send you \$2 after the 10 days, then \$2 a month until special advertising price, \$29.50 is paid.

Name

Address

(Attach letter stating age, occupation, employer's and reference's names and addresses.)



ENJOY
Outdoor Sports
THE YEAR ROUND

With the Aid of This Great Book

The new, revised and enlarged edition of **Outdoor Sports the Year Round**, just published by Popular Mechanics Press, contains hundreds of ideas for new and popular sports and pastimes as well as the old favorites.

Attractive to Young and Old Alike is the interesting variety for all seasons.

The intensive follower of a few sports will appreciate the wealth of suggestions that render the pursuit of any hobby more enjoyable. For example, for the hunter there are important details on the care and handling of guns; for the swimmer, complete instructions in fancy diving; for the camper, ideas that tend to make camping one hundred per cent comfortable and convenient; for the fisherman, many practical kinks, etc.

Summer Sport Enthusiasts

will be amazed at the large number of devices that furnish thrills and excitement. Probably the most unique feature of the book is the fact that it contains complete instructions that enable any handy man or boy to make sport devices or equipment at very little cost.

A Few of the Subjects:

Aquaplaning	Paddle Tennis
Archery	Pole Vaulting
Boats and Boating	Rifle Sport, How to Use
Camping Out, Tricks of	Shooting Blinds, How to
Diving, Fancy	Bull
Fish Trophies, Mounting	"Shooting the Chutes"
Fishing Kinks	Shotgun, How to Use
Golf in Your Backyard	Skate-Sailing
Guns, How to Take Care of	Skins, Preparing for Mount-
Hunting	ing
Hurdle, How to Make	Skis and Ski Running
Ice Hockey	Sleds, Motor-Driven
Ice, Merry-Go-Round for	Snowshoes
Ice Sled for Sailing	Swim, Learning to
Ice Yacht	Target Shooting
Jitney Golf	Tennis-Court Backstop
Lawn-Tennis Marker	Toboggan Slide, Building
Merry-Go-Round	Trap Shooting
Model Airplane Building	Traps and Trapping
Night Croquet	Water Scooters
Outdoor Cooking	Water Skipper

352 Pages (large size, 7 x 10 in.) **Price \$2.00**
650 Illustrations. Cloth Binding

Mailed Postpaid upon receipt of price anywhere in the world. Will be sent C. O. D. anywhere in U. S. Simply pay postman price plus postage when he delivers the package.

Popular Mechanics Press (Room P-4)
200 East Ontario St. Chicago, Ill.

FREE
BOOKEvery
"FLO" Student
ReceivesMonoplane - Biplane - Cabin
and Whirlwind Training

Come to the Leonard Flo Air College in Detroit, where every student—even private pilots—receive the training that qualifies. Plenty of flying, ideal surroundings, low living expenses. Big colored catalog, profusely illustrated, gives all details and advantages of Detroit and Flo training. Sent free if you write at once.

LEONARD FLO AIR COLLEGE
Dept. 5, Dearborn (Detroit
Suburb), Mich.

WRITE
TODAYThere's
Opportunity
in **ELECTRIC
REFRIGERATION**Trained Men in
Great Demand!

Good Pay—steady work—ground floor opportunities await every man who gets into this growing industry.

Jobs Pay \$50 to \$200 a Week—Or You Can Go Into Business for Yourself

Manufacturers and distributors, ice cream and soft drink companies, steamship and railroad companies and other firms need thousands of refrigeration experts. Shop mechanics, installers, service men, estimators—many different positions are open. All you need to qualify for these big pay jobs is training and experience—and National Tech will give you that.

Learn in 8 Weeks on
Actual Machines

Eight pleasant weeks in the finest and best equipped school in the country qualifies you thoroughly. You'll work on leading machines—on household units, commercial jobs and air cooling equipment. You'll control them—repair them and repair them. When you complete this training you'll know refrigeration—you'll be experienced and capable of holding a real job.

And We'll Help You Find
Employment

Employees everywhere call on us for graduates. Write today for the whole story. Let us prove that this new field offers you a wonderful opportunity. Send at once for free details. **THE NATIONAL TECH**, 901 Utner Bldg., Cleveland, Ohio.

LAW STUDY AT HOME

Be independent. Earn \$5,000 to \$10,000 annually. We guide you step by step—furnish all text material, including fourteen-volume Law Library, Degree of LL. B. conferred. Low cost, easy terms. Get our valuable 64-page "Law Guide" and "Evidence" books free. Send for them NOW.

LaSalle Extension University, Dept. 544-1 Chicago

NEW
Revolving
AUTO
BRUSHBIG MONEY
MAKER!

Sensational new invention makes car washes work by WATER PRESSURE. No chains, soap or spray needed. Gyro sells to car owners, managers, stores, etc.

100% PROFIT FOR AGENTS: New sales plan makes success certain. Big profits easy. Write AT ONCE for particulars. Gyro Wash Co., Dept. E-14, Bloomfield, N. J.



\$150 A DAY
Easily Earned

Big cash Profits earned daily taking orders for our high-grade made-to-measure, all-wool suits. Beautifully styled. New low prices—\$21.50—\$23.50—\$29.50—\$36.50 retail, direct to wearer. Real quality all the way thru. Just show samples and you sell on the spot. Big commissions paid daily. Steady repeat business. Free Ford Sedan to hustlers. Write at once for particulars.

all Wool SUITS \$21.50

**SPENCER MEAD COMPANY, Dept. E-816
Harrison and Throop Sts. Chicago, Ill**

Boys

WIN THIS
BICYCLE
WITHOUT COST!

A Ranger Motorbike—the finest bicycle you ever saw! Made by Mead Cycle Company. Fully equipped in every way. Built for speed, easy running, and long wear. Wow! What a bike! And just think! It can be YOURS—without a cent of cost!

Write for Easy Plan

Join the Crowell Club and deliver three well-known magazines to regular customers in your spare time. No experience necessary; we show you how to win dozens of dandy prizes and earn your own spending money. This is your big opportunity. Mail the coupon NOW!



Like hundreds of other boys, you can win this speedy new bike, and many other dandy prizes—without a cent of cost to you.

Mail This Coupon Now

Don't let some other fellow get these big treats that should be yours. Act at once!

Mr. Jim Thayer, Dept. 205,
The Crowell Publishing Co.,
Springfield, Ohio.

Dear Jim: I want to earn MONEY and PRIZES. Please start me off as a salesman.

My Name.....

Address.....

City..... State.....

Swear Off Tobacco



Tobacco Tells on Nervous System



Tobacco Ruins Digestion



Tobacco Stunts Boy's Growth



Tobacco Robs Man of Virility



Tobacco Steals from You the Pleasures, Comforts, Luxuries of Life

Let Us Help You Banish the Tobacco Habit

QUICK RESULTS

Trying to quit the tobacco habit unaided is often a losing fight against heavy odds, and may mean a distressing shock to the nervous system. So don't try it! Make the tobacco habit quit you.

It doesn't make a particle of difference whether tobacco has been used for a single month or fifty years, or how much, or in what form—whether it be cigars, cigarettes, pipe, plug, fine cut, or snuff. Tobacco craving usually begins to decrease after the very first dose—there's no long waiting for results.

Tobacco Redeemer contains no habit-forming drugs of any kind and is safe, quick, pleasant, and thoroughly reliable.

Not a Substitute

Tobacco Redeemer is in no sense a substitute for tobacco, but is a radical, efficient treatment. It helps to quiet the nerves, and makes one feel better in every way. If you really want to quit the tobacco habit—get rid of it so completely that when you see others using it, it should not awaken the slightest desire in you—you should at once begin a course of Tobacco Redeemer treatment for the habit.

Our Positive Guarantee

A single trial should convince the most skeptical. Our legal, binding, money back guarantee goes with each full treatment. If Tobacco Redeemer fails to banish the tobacco habit when taken according to the plain and easy directions, money will be cheerfully refunded upon request.

Let Us Send You Convincing Proof

If you are a slave of the tobacco habit and want to find a sure quick way of quitting "for keeps," you owe it to yourself and to your family to mail the coupon today or send your name and address on a postal, and receive our free booklet on the injurious effects of tobacco on the human system and positive proof that Tobacco Redeemer does quickly relieve the habit for most users.

Newell Pharmacal Company
Dept. 300, Clayton Station, St. Louis, Mo.



Free Book Coupon

NEWELL PHARMACAL CO.

Dept. 300 Clayton Station St. Louis, Mo.

Please send, without obligating me in any way, your free booklet regarding the tobacco habit and proof that Tobacco Redeemer has relieved the tobacco habit in thousands of cases. If it fails my money will be refunded.

Name.....

Street and No.....

Town..... State.....

34 Lesson Drawing Course \$2.98

The biggest value you ever saw advertised anywhere



Haven't you often wished that you could draw cartoons; illustrate some idea, sketch some pretty face, etc.? You can do all of these things. One of America's most famous Cartoonists and Illustrators has developed a great, simple system for success in all branches of Commercial Art. This system has revolutionized the entire theory of drawing. It means that drawing can be as easy for you as writing—much simpler than learning shorthand, bookkeeping or typewriting. We are now placing this original system for learning Drawing, Art and Cartooning, consisting of 34 lessons with over 500 illustrations, within reach of every one. If you will devote a few hours each week to the Course WE ABSOLUTELY GUARANTEE that you will learn to draw and draw well before you have half finished the Course. If we fail to make this claim good, we will refund every cent paid us. By eliminating a large office force for answering correspondence, expensive catalogs, etc., we are enabled to make a price of \$2.98, the cheapest price ever known for a high-grade, home study course. Learn to draw. It is a big asset, no matter what field you are in.

Send No Money

Just order the course and on arrival \$2.98 pay postman

plus a few cents postage, payment in full for the entire Course and Drawing Outfit. If not entirely satisfied, return within five days and we will Refund Money. Address: LEDERER SCHOOL OF DRAWING, Dept. 933-0, Chattanooga, Tenn. Orders from outside the U. S. A. are payable \$3.25 cash with order.

If you order the course at once, we will include a drawing outfit, consisting of artist's pencils, pens, paper, erasers, thumb tacks, etc., enabling you to go to work without any additional cost.

Learn to Dance

You can learn all the modern dances—the latest Tango steps, the new Fox Trots, dreamy Waltzes, smart Collegiate Steps, and popular Society Steps at home, easily and quickly. New chart method makes dancing as simple as A-B-C. No music or partner required. Don't be a wallflower. Learn to dance. Complete course—255 pages, 54 illustrations, sent on 5 Days' Free Trial. Equals \$20.00 course. Send to money. Pay postman only \$1.98, plus postage upon arrival. Money back if not delighted. Catalog Free.



Franklin Pub. Co., 800 No. Clark St., Dept. 9429, Chicago

How to get the VOCABULARY you want WITHOUT using a DICTIONARY

Special Offer—\$5 Course Only \$1

A complete, amazingly simplified and practical \$5.00 Course (exactly as given in our Resident School) to increase and broaden your vocabulary. Results immediate. You'll astonish your friends. Mailed postpaid for \$1. NIAGARA SCHOOL, Inc., 210 B. L. E. Bldg., Cleveland, O.

Puncture Proof YOUR TIRES

Tires Hammered Full of Nails Leak No Air New Scientific Emulsified Compound of PURE RUBBER LATEX ends puncture troubles forever. Punctures heal instantly. Stops slow leaks. Preserves Rubber. Increases Tire Life. Clean, New, Scientifically Correct. Not a Liquid.

AGENTS Immediate Tremendous profits. NO TALKING. Just drive nails in an old tire. The low selling price and remarkable demonstration feature automatically close your sales. Write today and get the facts. ACT NOW!

ATLAS SOLVENT CO., 10 Morgan Park Sta., CHICAGO



RUBY GIVEN

To introduce our Imported Mexican Blue-Flash Gem, the only low-priced gem exactly matching genuine diamonds with same blue-white brilliancy and rainbow fire, guaranteed for life, we'll send this beautiful, flashing, fiery, red Mexican Ruby. Just clip out this ad, mail with your name, address, and 10¢ to partly cover handling cost and we'll mail with catalog of gems and special half price offer. Write today. MEXICAN GEM IMPORTING CO., Dept. 30-P, MONTEREY, CALIF.

No JOKE TO BE DEAF

—EVERY DEAF PERSON KNOWS THAT George P. Way made himself hear, after being deaf for 25 years, with Artificial Ear Drums—his own invention. He wore them day and night. They stopped head noises and ringing ears. They are invisible and perfectly comfortable. No one sees them. Write for his true story, "How I Got Deaf and Made Myself Hear." Also booklet on Deafness. Address



Artificial Ear Drum

George P. Way, Inc., 605 Hofmann Building, Detroit, Michigan

Buy DIRECT

on credit at New

Low Prices

Our 1931 Cut-Price Offers a Remarkable Opportunity to Own A 21 Jewel—

Santa Fe Special

Send for Catalog Now!



Compare the Santa Fe Special with other Watches costing 30% to 50% More

Send No Cash In addition to our NEW LOW PRICE, I will send for your approval one of these Standard Watches, guaranteed for a lifetime of satisfactory service, not only by the Santa Fe Watch Company, but by the Great Illinois Watch Factory. So accurate, Government officials carry them; so perfect and beautiful, jewelers say they are worth 1-3 to 1-2 more than we ask for them. I will send you one to see WITHOUT ONE PENNY DOWN—allow you to wear it 30 days FREE—then sell it to you on easy payments.

Diamond Rings—Wrist Watches

Write for our New Diamond Ring of Romance and Bulova Wrist Watch Catalog, showing marvelous new designs. Never have we been able to offer such beautiful diamond rings and artistic dependable watches at such low prices. The catalog is sent FREE. Ask for our Special Spot Cash Offer. Good for 30 days only.

Santa Fe Watch Co.

56 Thomas Bldg., TOPEKA, KANSAS

To SANTA FE WATCH CO., 56 Thomas Bldg., Topeka, Kans.

Please send me catalog I have checked.

Railroad and dress Pocket Watches.

Ladies' and Men's Wrist Watches.

Ladies' and Men's Diamond Rings.

Name.

Address.

BIG PAY JOBS

open

for the **Radio** Trained Man

Don't spend your life slaving away in some dull, hopeless job! Don't be satisfied to work for a mere \$20 or \$30 a week. Let me show you how to make **Real Money in Radio**—the Fastest-Growing, Biggest Money-Making Game on Earth!

JOBS LEADING TO SALARIES OF \$60 A WEEK AND UP
Jobs as Designer, Inspector and Tester, paying \$1,000 to \$10,000 a year—as Radio Salesman and in Service and Installation Work at \$45 to \$100 a week—as Operator or Manager of a Broadcasting Station, at \$1,000 to \$5,000 a year—as Wireless Operator on a Ship or Airplane as a Talking Picture or Sound Expert—HUNDREDS OF OPPORTUNITIES for fascinating, **BIG PAY JOBS!**

Learn Without Lessons in 10 Weeks

Coyne is NOT a Correspondence School. We don't teach you from books or lessons. We train you on the greatest outlay of Radio, Television and Sound equipment obtainable—on scores of modern Radio Receivers, Home Broadcasting equipment, the very latest, **newest** Television apparatus, Talking Picture and Sound Reproduction equipment, Code Practice equipment, etc. You don't need advanced education or previous experience. We give you—RIGHT HERE IN THE COYNE SHOPS—all the actual practice and experience you'll need. And because we cut out all useless theory, you graduate as a Practical Radio man IN 70 DAYS' TIME.

TELEVISION and TALKING PICTURES

And Television is already here! Soon there'll be a demand for THOUSANDS of TELEVISION EXPERTS! The man who learns Television now can make a FORTUNE in this great new field. Get in on the ground floor of this amazing new Radio development! Come to Coyne and learn Television on the very latest, **newest** Television equipment.

Talking Pictures and Public Address Systems offer thousands of golden opportunities to the Trained Radio Man. Here is a great new Radio field just beginning to grow. Prepare NOW for these wonderful opportunities! Learn Radio Sound Work at COYNE on actual TALKING PICTURE and SOUND REPRODUCTION equipment.



No Books - No Lessons All Practical Work at Coyne

No Books! No Lessons! ALL ACTUAL PRACTICAL WORK. You build radio sets, install and service them. You actually operate great Broadcasting equipment. You construct Television Receiving Sets and actually transmit your own Television programs over our **modern** Television equipment. You work on real Talking Picture machines and Sound equipment. You learn Wireless Operating on actual Code Practice apparatus. We don't waste time on useless theory. We give you just the practical training you'll need—in 10 short, pleasant weeks.

EARN AS YOU LEARN

Don't worry about a job! You get Free Employment Service for Life. And don't let lack of money stop you. If you need part-time work while at school to help pay expenses, we'll gladly help you get it. Coyne is 32 years old! Coyne Training is tested—proven beyond all doubt. You can find out everything absolutely free. Just mail coupon for my big free book!

H. C. Lewis, Pres. **Radio Division** *Founded 1899*
COYNE ELECTRICAL SCHOOL
500 S. Paulina St. Dept. 51-3 K Chicago, Ill.

H. C. LEWIS, President
Radio Division, Coyne Electrical School
500 S. Paulina St., Dept. 51-3 K, Chicago, Ill.
Send me your Big Free Radio Book and all details of your Special Introductory Offer. This does not obligate me in any way.

Name

Address

City.....State.....

Classified Advertisements

WORLD'S BEST WANT AD MEDIUM

Advertisements in this section, 35 cents per word, each insertion, minimum 10 words, payable in advance
To be inserted under proper classification in June issue, copy should be in our office April 18th

ADVERTISING AGENCIES

ADVERTISE—Bargain value—24 words in 24 representative Sunday newspapers \$15; Free assistance with your ads, sales letters, literature. Helpful Ad-Guide showing best paying newspapers, magazines, rates, mailing lists, etc., 10c. Chicago Union Agency, Great Northern Bldg., Chicago.

GET into advertising. Learn quickly at home. Experience unnecessary. New easy plan. No text books used. Practical work. Old established school. Send name and address for interesting free booklet. Page-Davis School of Advertising, Dept. 3431, 3501 Michigan, Chicago.

ADVERTISE in Southern Negro newspapers. Lists free. R. Stricklen, Jr., (Desk C), Staunton, Va.

TIME Counts in applying for patents. See pages 140 and 141. Clarence A. O'Brien, Registered Patent Attorney, Washington, D. C.

FREE—New 1931 Advertisers Rate Guide, 44 pages. Includes everything. Lowest rates. E. H. Brown Advertising Agency, 140 S. Dearborn, Chicago.

ADVERTISE—Newspapers, magazines. Lists free. Martin, 276B West 43rd, New York.

ADVERTISE. Inch display 50 magazines, three issues \$4.00. Lists free. Pennell Standard, Covington, Kentucky.

BEFORE Advertising get our catalog. No charge. 25 years in business. The largest classified agency in the world. Ankrum Advertising Agency, 190 No. LaSalle St., Chicago, Ill.

INCH Display advertisement 50 magazines year \$24. Wood's Popular Services, Atlantic City, N. J.

ADVERTISE in rural weeklies. Lists free. Meyer Agency, 4112 Hartford, St. Louis, Mo.

FOR ADVERTISERS

ADVERTISING: 20 Words, 50 magazines 60c; three insertions, \$1.20. Inch display, 3 months \$6.00; year \$24.00. Mailing Bureau, Laundale, Calif.

TRIAL Thirty words in "Mailman" three times. 25c. Argus, Culver City, Calif.

"AD Writing Made Easy". Complete. \$1.00. Walter Jantz, Grafton, Ohio.

ADVERTISE in 250 country town newspapers 28 words, \$10. Lists free. All states. Keator, Hartford Bldg., Chicago.

LAYOUTS For advertising is a useful handbook of 700 layout suggestions used in magazines, newspapers, booklets, folders, brochures, letterheads and posters. Will save immense amount of time of any advertising man. Delivered to your door C. O. D. Simply pay postman \$3 and postage. Popular Mechanics Press, Room 802, 200 E. Ontario St., Chicago.

INFORMATION

ANY information desired 25c coin and up. Fred Klotz, Reading, Pa.

INTERIOR Wall decoration is a valuable new book covering all the modern methods of artistic wall treatments. Practical working instructions for both plain and decorative finishes are given. 451 pages, illustrated. Delivered to your door C. O. D. Simply pay postman \$4 and postage. Popular Mechanics Press, Room 802, 200 E. Ontario St., Chicago.

MAILING LISTS

100 NAMES of persons who have inherited \$ to \$400,000. \$1.00. Walters, 37 Milburn Ave., Maplewood, N. J.

250 NEW England women. \$1.00. Popolek, 120 Millbury, Worcester, Mass.

AUTOMOBILES

TIME Counts in applying for patents. See pages 140 and 141. Clarence A. O'Brien, Registered Patent Attorney, Washington, D. C.

SHOP Notes for 1931. Get your copy now. Only a limited edition. Contains all the articles published in the Shop Notes department of Popular Mechanics Magazine during 1930. Send 50 cents. If you want the entire set of Shop Note books consisting of 12 volumes including the 1931 number and 11 others issued previously we will send them C. O. D. at a special reduced price of \$3.75. Popular Mechanics Press, Room 802, 200 E. Ontario St., Chicago.

AUTO SUPPLIES

COOK'S Auto gasoline saver \$2.00; pay for it after you save this amount in gas. Geo. E. Cook, 172 East 73 St., New York City.

GUARANTEED Used parts for all cars. Discounts to 80%. Schurks, 9th and Roy, Seattle, Wash.

BARGAINS—Excellent reprocessed compressors, battery chargers, test benches, car washers. Terms. Trial. Write Ken's Automotive Service, Box M-511, Troy, O.

RECHARGE Neighborhood batteries; very profitable; outfit \$7.39. Adams-Barr, Columbus, Ohio.

CHROMIUM Plating powder plates iron, steel, brass, copper and nickel, without electricity or machinery. Guaranteed not to tarnish; ½ pint can \$1.50 prepaid. Gunmetal Co., Ave. J, Decatur, Ill.

WOOD Turning on the lathe. Both interesting and fascinating. Send for a copy of Milton & Wohlers Course in wood turning. It gives you quickly a complete mastery of this manual art. 346 pages. Cloth, 141 plates. Sent C. O. D. Pay postman price \$1.50 and small amount postage upon delivery. Popular Mechanics Press, Room 802, 200 E. Ontario St., Chicago, Ill.

RADIATORS: All standard makes at wholesale. Guaranteed. Send for prices. State make, model. Independent Radiator Co., 1119 So. Wabash, Chicago.

NEW Auto parts 25-50%. Motors, rear-ends, radiators, wheels, generators, carburetors, brakelining 50%. Used parts 40-50% off. Brightman, 2065 Main St., Hartford, Conn.

CARBURETOR Information every auto service man needs will be found in special carburetor supplement to the famous Dyke Auto Encyclopedia. Deals with every make of carburetor. 106 pages. 248 illustrations. Price \$2. Sent C. O. D. if you prefer. Popular Mechanics Press, Room 802, 200 E. Ontario St., Chicago, Ill.

AUTO SERVICE EQUIPMENT

SUBSTANTIAL Savings—reprocessed compressors, battery chargers, test benches, car washers. Terms. Trial. Write Ken's Automotive Service, Box M-514, Troy, Ohio.

"FIFTEEN Capacity battery charger, direct from factory; guaranteed; 110 volts; money maker for owner \$27.34. Adams Barr Corporation, Columbus, Ohio.

FAMOUS Bailey Handbook—Prepares you to pass the examination for any grade of license for stationary, marine and Diesel engineers, firemen and boiler inspector in any state of the Union or any province of Canada. Flexible cover. Handy pocket size. Pay postman \$2.00 plus postage when he hands you the package. Popular Mechanics Press, Room 802, 200 E. Ontario St., Chicago, Ill.

MOTORCYCLES, BICYCLES AND SUPPLIES

REBUILT Motorcycles \$25 to \$100 easy. Tires, used tires \$2.50. New Firestone \$5. Engines for motorcycle ice sleds, airplanes, boats \$15 to \$75. New automobile tires \$2. Forks \$3, frames \$3, cylinder \$3, saddles \$3, chains \$1.50, handle bars \$3, belts \$5, wheels \$3, side cars \$25. Bicycles \$9.50, airplane wheel \$1.00 was formerly \$2.00. Save you dollar prices. Oldest house in U. S. Send 25c for catalogue. Price Cutter Deninger, Rochester, N. Y.

1927-8 **HENDERSONS**—Fully equipped and in good running condition, \$100 each—money back if not satisfied—hundreds of other bargains in Henderson motorcycles, parts and accessories—largest stock, lowest prices. Send for list. Wiedeman, 3517 North Avenue, Chicago.

JUST Out! Get that new 1931 catalog. Guaranteed rebuilt Harley-Davidsons. Send 4c in stamps. \$88.00 and up. 14 models. Service and satisfaction guaranteed. The Knuth Co., 2525 Fond du Lac Avenue, Milwaukee, Wis.

MOTORCYCLE Bargains, lowest prices, bargain sheets for stamp, special aviators supplies, motorcycle accessories largest line in America, lowest prices. Largest motorcycle mail order house in the United States. Rochester Harley Davidson Corporation, 129 West Main St., Rochester, N. Y.

REBUILT Motorcycles at rock bottom prices. Complete stock of used parts. Expert mechanics. Send 10c for catalog. Western Motorcycle Co., 914 E. 15th St., Kansas City, Mo.

SEND 15c For illustrated used Motorcycle catalog. Large stock. Bargains. Indian parts. Accessories. Indian Motorcycle Sales, Kansas City, Mo.

WE Specialize in tuning motorcycles for speed and power. Genuine Harley-Davidson parts, accessories and repairs. Send 25c in stamps for our parts, accessories and flat rate repair catalogs. 24 hour service on all orders. The Knuth Co., 2525 Fond du Lac Ave., Milwaukee, Wisconsin.

REPAIR With good used parts, save ¼ or more, state parts needed, no lists. J. B. Dahl, 3561 Archer Ave., Chicago, Ill.

AVIATION

HEATH PARASOL—Winner of every American light plane event for past five years. Designed for beginners to fly. Remarkably easy to construct. \$12 starts you building. Parts complete only \$199. May be shipped in 11 convenient, progressive groups as needed. Clear detailed plans and instruction sheets explain every step. 10 cents brings large illustrated booklet. Heath Aircraft Corporation—Dept. CL34P, Chicago.

AIRPLANE Photographs—Write for new complete catalog listing authorized airplane photographs. Get 5x7" photos of your favorite planes at only \$1.00 for any ten. Photo of Captain Frank Hawks in his Mystery Ship sent free with catalog. Enclose 10c for postage and mailing. Universal Airphoto Service, P. O. Box 1134, Dept. M-5, Chicago, Ill.

"SKYWARD Hol" wonder book on Aviation, sent free. Maps your road to fame and fortune—complete guide to aviation success. Fully describes and illustrates training in world's largest commercial flying school; describes Mechanic's, Limited Commercial, and Transport Pilot's Courses. Write today to Parks Air College, Section 5-PM, Parks Airport, East St. Louis, Ill.

HEATH Sea-Plane Parasol—as stable as the famous land Parasol. Lands on any small river or lake. Leaves water in 3 seconds. Sturdy pontoons withstand hardest landings. Material complete only \$228. \$12 starts you building. Pontoons alone available for your land plane. Complete, ready built \$265. Or build them yourself for \$69. Interchangeable with wheels in jiffy. 10 cents brings illustrated booklet. Heath Aircraft Corporation, Dept. CL35P, Chicago.

BUILD New Aeroford—only Glider easily converted into sporty two-place power plane by our patent conversion. \$79.00 buys Makit Kit containing all glider materials. \$10.00 starts you building. Send \$2.50 today for set biggest blueprints. Aeroford Aircraft Corp., 1990 North American Bldg., Chicago.

\$2.00 COMBINATION—Aviation helmet, wing emblem for \$1.00. Smoother, Box 89, G. P. O., N. Y. C.

NEW Heath B 4 Motor—Ideal power plant for your light plane. Absolutely free from bearing and vibration difficulties. Delivers 30 H.P. Costs only \$300 including propeller hub. Re-manufactured Heath Henderson motors also available as low as \$190. In perfect condition. Fully guaranteed. 10 cents brings illustrated booklet. Heath Aircraft Corporation, Dept. CL33P, Chicago.

AIR Navigation and meteorology—A practical book for every flyer. Capt. R. Duncan, the author, has presented the subject in a simple, non-technical way. 243 pages. Illustrated. Delivered to your door C. O. D. Simply pay postman \$3 and postage. Popular Mechanics Press, Room 802, 200 E. Ontario St., Chicago.

DECORATE Your club or den with real airplane propellers, 8 feet long, beautiful new ones highly polished \$3.00; used, \$5.00. Air Transport Equipment Inc., Garden City, N. Y.

CURTAINS Jenny airplane with overhauled motor. Make offer. L. A. Dore, Elk River, Minn.

THE American School of Aviation announces a new correspondence course in Mechanics of Aviation. A thorough training in Practical Aeronautics. American School of Aviation, Dept. 1873, 3691 Michigan Ave., Chicago, Ill.

BUILD Baby ace sportplane. Plans \$5. Folder dime. Corben Sportplane Supply, Peru, Indiana.

GET The Russell Mens. Sportplane Constructor book for building your plane. \$1.00 postpaid. Gwinner Sales Co., 2301 Chestnut St., Toledo, Ohio.

TIME Counts in applying for patents. See pages 140 and 141. Clarence A. O'Brien, Registered Patent Attorney, Washington, D. C.

"IF You want to fly" let Alexander Klein, brilliant engineer, teach you. With great skill whole course of training has been simplified and made crystal clear. Remarkable book teaches in most practical and easily understood fashion. Recommended by skilled flyers. Sent C. O. D. anywhere in U. S. Simply pay postman \$2.50 and postage when delivered. Sent postpaid to any address upon receipt of price. Popular Mechanics Press, Room 802, 200 E. Ontario St., Chicago.

SPORTPLANE Constructor book containing blueprints, plans, etc. \$1.00. Russell Aircraft, Box 455, Toledo, Ohio.

METAL Tipped propellers for Henderson and V motors \$9.95 each. Ford and Chevrolet propellers \$12.50 each. Hibbs, Ft. Worth, Texas.

BUYERS Directory 50c. Listing where to buy thousands bargains used airplanes, motors, jumping balloons, power gliders, equipment. Midwest Company, 603-5 Security Mutual, Lincoln, Neb.

STRIKING Photographs. Modern aircrafts in flight. Original prints 5x7. Six for \$1.00. Start collection of all action photographs. 10c postage will bring catalog. Court Photo, Hempstead, N. Y.

HELIOS Motors; 35 hp. and 60 hp. radials, air cooled. Real, modern aviation motors, not made-over motorcycle or auto engines. Catalog, data etc. 10c. Aviation Service, 925 Broadway, New York.

BIGGEST. Best catalog model airplanes, parts, supplies; 5c postpaid. Ideal Company, 19 West 18th Street, New York.

SEND Dime for latest aviation catalog. Karl Ort, York, Penna.

SEND 5c for bundle of balsam reeds and price list on supplies. Aero Shop, 3050 Hurbit Ave., Detroit, Mich.

MODEL AIRPLANES

MODEL Motors, airplanes, supplies, catalogue 10c. Miniature Aircraft Corp., 83 Low Terrace, New Brighton, N. Y.

STUNT Flying—A new book of flight instruction that is different. The author, Capt. Richard Duncan, has developed in this book a unique system of practicing and working out your flight maneuvers on the ground. Use it and learn as other great flyers have done. Will save you hours of costly flying practice. 185 pages, 32 illustrations, cloth. Sent C. O. D. Pay postman price \$2.50 and small amount of postage upon delivery. Popular Mechanics Press, Room 802, 200 E. Ontario St., Chicago, Ill.

MODEL Airplane supplies. Cheapest, best, for rubber and compressed air models. Catalog dime. Peru Model Aero Shop, Peru, Ind.

BOATS, OUTBOARD MOTORS, ETC.

HUBBELL Marine Coolers convert Ford engine into marine motors. Booklet free. Ford speedboat easily built, large blueprint and directions one dollar. C. C. Hubbell, Perry Ave., Norwalk, Conn.

SAVE \$ \$ \$ \$. Assemble your own Outboard runabout, stepper, rowboat. Material furnished ready-cut. Bradley-Southworth, 9828 Wyoming, Detroit, Michigan.

MAKE 16' Rowboat. Blueprint, 30c. Weesho-Uco, 31st Office, Detroit, Michigan.

MAKE 12' Rowboat. Blueprint, 30c. Weesho-Uco, 31st Office, Detroit, Michigan.

TWENTY Mile outboard racer. Complete plans 25c. Free boatbuilding catalog. The Rudder, 15 Murray Street, New York.

PROPELLERS, Pumps, stuffing boxes, bearings, etc. Wm. H. Baker, Pond St., Quincy, Mass.

BOATS—Easily made. Address Weesho-Uco, 31st Office, Detroit, Michigan.

MAKE 16' Canvas Canoe. Blueprint, 30c. Weesho-Uco, 31st Office, Detroit, Mich.

BUILD Your own boat. Complete directions make it comparatively easy and you will not only save money but have lots of fun besides. The Outboard Motor Boat book covers 35 different types of the latest outboard motor, inboard motor, rowing, sailing boats, canoes, etc., with blueprints in addition to the instructions. Pay postman price, \$3, and few cents postage when delivered. Popular Mechanics Press, Room 802, 200 E. Ontario St., Chicago.

CARTOONING

FREE Cartoon Magazine. Cartoon Publishing Co., West Springfield, Mass.

YOUR Cartoon drawn. Send clear photo and 25c to cartoonist. 119 Warner Bldg., Bridgeport, Conn.

ARCHERY

MAKE Your own bows and arrows. We furnish material with complete instructions. Write for catalogue. Sidney Archery Co., Sidney, Ohio.

BOOKS AND PERIODICALS

HYPNOTISM Easily learned. Lessons guaranteed. Postpaid \$1.10. Smith Pub. Co., Dept. 3, Springfield, Mass.

BOOK Bargains—Dime brings literature. Goldenrod Company, Dept. 403, Harrisburg, Illinois.

HYPNOTISM For beginners, 25 lessons, \$1.00. J. Tillberg, Proctor, Vermont.

MONEY in old books. Valuable information free. Thorsen, 1415 Melrose, Chicago.

ASTROLOGY Books—25c to \$8.00; free descriptive list. Bullock, Box 1286, Providence, R. I.

YOU Need a better grip on mathematics? Ask us to send you a copy of "Mathematics for the Practical Man," only \$1.50. By common sense methods it removes the mystery and difficulties so algebra and calculus are made simple. Assuming your knowledge is limited to arithmetic you quickly and easily gain a working knowledge of algebra, geometry, Trigonometry and calculus. Simply pay postman when he hands you the package. Address Popular Mechanics Press, Room 802, 200 E. Ontario St., Chicago, Ill.

PICTURES AND POST CARDS

ART Pictures—400 all different. 100 samples \$1.00. Particulars 10c. Howard Sales Co., Dept. 15, Box 529, San Francisco, Calif.

GAMES, ENTERTAINMENTS AND PLAYS

PLAYS, Operettas, musical comedies and minstrels, comedy and talking songs, black-face skits, vaudeville acts, monologs, dialogues, recitations, juvenile plays and songs, musical readings, entertainments, make-up goods. Catalog free. T. S. Denton & Co., 623 So. Wabash, Dept. 11, Chicago.

200 TRICKS You can do—Mystify your friends; have loads of fun. This collection of tricks has been selected by Thurston for the average person. Neither unusual skill nor elaborate apparatus are required. Send for this 200-page illustrated book. Pay postman \$1 plus postage when delivered. If outside U. S. remit when ordering. Popular Mechanics Press, Room 802, 200 E. Ontario St., Chicago.

CHALK TALKS

LAUGH Producing program. \$1.00. Catalog free. Balda, The Cartoonist, Oshkosh, Wis.

CHALK-TALK Your way to popularity. Audiences at your feet if you learn how to entertain with a few simple pictures. Little artistic ability needed. "How to Chalk Talk" tells what to say and what to draw. Profusely illustrated. Make money giving chalk talks. Just order on a postal. Pay postman \$1.00 and postage when delivered. Popular Mechanics Press, Room 802, 200 E. Ontario St., Chicago, Ill.

MAGIC TRICKS, BOOKS AND JOKER NOVELTIES

MAGIC—Tricks, Books and Supplies. For amateurs as well as the great professionals. Anyone can learn through our instructions. Feature Acts in Mind-Reading, Spiritualism, Rope Ties, etc. Large illustrated professional catalog, 20c. Chicago Magic Co., 140 So. Dearborn St., Dept. B, Chicago, Ill.

ELECTRIC Fun! 200 stunts, 110 volts, \$1. Kuiting Sons, Campbell, Calif.

ONLY 10c For Master System of 6 Mystifying Card Tricks. Name any card drawn, etc. Use any deck of cards. Large magic catalog sent free. Wizard Magic Co., Dept. 15-Y, Box 1055, Station C, Los Angeles, Calif.

MAGIC Tricks, cards, books. Catalog free. Geo. Fenner, Louisville, Ky.

MAGIC Catalog 20c. Lynn, 105 Beach, Dept. 3, Jersey City, N. J.

TRICK Catalogue, 10c; Fireator, 30c. Oaks Magical Co., 548, Oshkosh, Wis.

SEVEN Optimagical delusions. Four Magic catalogs 15c. Gilmaglio, Morgan Park, Chicago.

RADIO SETS AND SUPPLIES

NEW 300-Mile "pocket" radio, \$3.85. Complete with special loud receiver. No tubes or batteries required. Order direct. Spencer Laboratories, 116 Atlas, Akron, Ohio.

RADIOS—\$1.50 tubes 15c; other bargains. Write. Radio, 1214 Liberty Ave., Brooklyn, N. Y.

TIME Counts in applying for patents. See pages 140 and 141. Clarence A. O'Brien, Registered Patent Attorney, Washington, D. C.

STAMP COLLECTING

FREE: For many years collectors have looked for an intelligent guide book on stamps. "The Lure of Stamp Collecting," our new illustrated booklet is just that and more. It tells exactly how to derive the greatest benefits from your collection, what stamps are most profitable to collect, how to judge values of stamps and a wealth of interesting facts, information and stamp stories etc. No book, even those selling as high as \$5.00 is more to the point, or offers as many benefits to the collector. We will send it free to approval applicants who send 5c to cover mailing expenses. Globus Stamp Co., 214 Third Ave., New York City.

MYSTIC "Queer Country" Packet! Contains scarce stamps from the following strange lands: San Marino, Antioquia, Congo, Cyprus, Fiji Islands, Gwallor Hyderabad, Iceland, Jhind, Kenya, Uganda, Lebanon, Monaco, North Borneo, Nyassa, St. Thomas Prince, Eastern Roumelia, Siam, Sierra Leone, Tanganyika, Trinidad Tobago, Ubangi, Upper Volta, Wallis Futuna, Alasolites. Get this wonderful packet of "freak countries" and make your friends envious! Price only 10c to approval applicants! Write today. Mystic Stamp Company, (Dept. 8), Camden, N. Y.

50 DIFFERENT Stamps from 50 different countries, including Bhagal, Deccan, Gwallor, Jhind, Kenya, Bosnia, Siam, Malay, Tasmania, Travancore, Transvaal. This fine packet and 25 different Airmails, perforation gauge, 15c to approval applicants. Anchor Stamp Company, Rutherford, N. J.

SET Each of Corea, Triangles, Canada, Ceylon, Salvador, Also stamps from Sierra Leone, Mauritius, Prussia, Antioquia, Travancore, etc. Everything for 10c to approval applicants. C. M. Weaver, Dept. 5, 1451 Broadway, New York.

BEAUTIFUL Set thirteen Luxemburg, Charlotte, 50c; 300 different 20c; 50 Africa 20c. Deluxe Stamp Co., Wann, Okla.

50 FRENCH Colonies, Alasolites, Gabon, Caledonia, etc. with approvals 6c. Hollinbeck, 312 Marquette, Minneapolis.

CANADA Airmail stamp free if you ask for approvals and send 10c for 25 different airmails or 30 different Canada and Newfoundland; both packets only 25c. We list 329 countries in our dime packets. Lists free. Special bargains, 500 different, 25c; 1,000 different, 75c; 2,000 different \$2.50. Victoria Stamp Co., London, 4, Canada.

GIANT Triangle stamp! The largest triangle stamp in the world (Spain 1930 Columbus issue) is included in our packet of 34 scarce varieties from queer, far-off lands—Rodi, Nyassa, New Guinea, North Borneo, etc. No Austria, Germany or other common stamps. Wonderful packet! Only 10c to approval applicants. Vogue Stamp Co., Dept. P., Port Chester, New York.

A SNAP—300 Different foreign and 60 different U. S. stamps, including \$1 value, for only 25c. Free, with each order, our pamphlet telling "How To Make A Stamp Collection Properly," together with our price lists of albums, supplies and hundreds of bargains in sets, packets, etc. Queen City Stamp Co., Room 36, 601 Race St., Cincinnati, Ohio.

FREE Prizes! wonderful approvals! good discounts! Box 114, Minneapolis, Minn.

NEW U. S. \$1 due to approval buyers 2c. L. W. Hudson, Plainfield, N. J.

COLLECTIONS \$1; Others; approvals. A. Gregson, 195-28, 37 Ave., Flushing, N. Y.

STAMPS, 100 All different, Postage 2c. Lists free. P. M. Quaker Stamp Co., Toledo, Ohio.

25 NEWFOUNDLAND And Canada 10c. All different. Catalogue value 60c. Free lists. Bargain Stamp Co., 277 West 23 St., New York.

100 DIFFERENT For this Ad and 2c to approval applicants. Evanston Stamp Shop, 2412 Noyes, Evanston, Ill.

4 ROMANIA 1922 Coronation issue. 6c with approvals. Co-Operative Stamp Co., 738 Euclid, St. Paul, Minn.

321 DIFFERENT, From world over, 25c, with approvals. Philatelic Shop, 247 22nd, Chicago Heights, Ill.

PORTUGAL: 25 Varieties 5c to approval applicants. Allen, Angola, Ind.

24 VARIETIES Cuban stamps, 10 cents. List of stamps free. Chambers Stamp Co., 111P, Nassau, New York City, N. Y.

ONLY 5c, 33 Different stamps including scarce Latvian triangular airmail stamps, 10 airmail, 12 United States (early issues, commemoratives, etc.) and 10 Canada. Approvals and illustrated price list sent with each order. Curhan Stamp Company, Gloucester, Mass.

301 DIFFERENT 10c To approval applicants only. Free list of bargain packets. Kansas City Stamp Co., Lee Bldg., Kansas City, Mo.

COLLECTORS Outfit, album 3500 spaces, 1675 illustrations; magnifying glass, hinges, and packet of stamps \$1.00 postpaid. Approvals. Electra Co., Marbury, W. Va.

1000 MIXED U. S. etc. 10c. Wineholt, Box 307, Redlion, Penna.

LARGEST Stamp in the world! Rare China Wild Goose special delivery stamp (value 75c) for only 5c to approval applicants. Supply limited. Positively only one to a customer. Western Philatelists, 6921 Harper, M55, Chicago.

UNITED States early issues, covers, Confederates, blocks, high values, collections lists free. Nagr, 8 South 18th, Philadelphia (14) Pa.

25 Airmail 10c. 20 Cuba 10c coin. Approvals. Colonial Stamp, 8ta A, Charleston, W. Va.

1000 MIXED and genuine Zircon gem 25c. Stark, 4554 Oakwald, Chicago.

108 INCLUDING Triangle 10c to approval applicants. Reference. Clark Hollister, 3523 N. Seeley, Chicago.

5 UNITED States telegraph stamps 10c. 3 beautiful Persia Airm. and 2 Ecuador Airm 12c. Both for 25c. Finest hinges, 3000 for 25c. Air mail catalogues 50c. United States albums \$1.50. Webers Stamp Shoppe, 1377 Park Ave., Plainfield, N. J.

UNITED States 1922-1927 set, catalogues over \$1.50 for only 15c; 24 varieties 1/2c to \$2.00 complete. State size of collection and countries of interest. Ledac, Redlion, Penna.

WHOLESALE Catalog for dealers; 4c postage. Grossman, 102 W. 42nd, New York.

1000 MIXED Stamps 10c. 3000, 25c. Approvals. Wineholt, Woodbine, Penna.

U. S. PACKETS—50 varieties U. S. 20c; 100 var. U. S. 50c; 150 var. U. S. \$1; 200 var. U. S. \$2; 300 var. U. S. \$6.50; 400 var. U. S. \$25; 25 var. U. S. departments \$1.85. Headquarters for U. S. stamps and packets. Send for our price lists. Old Colony Stamp Co., 333 Washington, St., Boston, Mass.

20 BRAZIL—Showing trains, aeroplanes, blacksmith, winged mercury, harvesting, only 10c to approval applicants. Mantle Stamp Company, London, Canada.

FREE! Curious set Azerbaijan, big illustrated lists air mail, commemoratives, pictorials, 2c postage. Penna Stamp Co., Greensburg, Pa.

UNITED States dollar stamps, three different 10c to approvals. Carl Winter, Middletown, Conn.

FOREIGN Revenues wanted; especially good collections of Canadian, Mexican and South American. Send for inspection with lowest price. George Cabot, 42 King Ave., Woburn, N. J. References if desired.

FREE Scarce Vatican City set approvals. Atwood, 3831 Cliff Rd., Birmingham, Ala.

BETTER Stamps, Ten scarce stamps 10c. Quality approvals to prompt and better buyers. Payn Stamp Co., 945 Grande Vista Drive, Los Angeles, Calif.

75 VARIETIES, Unused stamps 12c. H. Martinson, Box 963M, Station Y, New York City.

RARE Airmail free with approvals. Monjar, 1533 Knox, Cincinnati, Ohio.

25 AIRMAILS 10c; 1,000 Hinges 10c; animal packet 10c. Bargain packets, mixtures, approvals. Harvey Toepke, Decatur, Indiana.

30 QUALITY Stamps cataloging \$2.25, 20c to approval applicants. Reference. Delta, 5756 Kimbark, Chicago.

47 LIECHTENSTEIN 4c To approval applicants. Hagen, Box 129, Sioux Falls, S. Dak.

NEW Editions of the Air Post and National Albums are fully described in our latest price list, also many new sets and packets, Beautifully illustrated. Free for the asking. Send for a copy. Scott Stamp and Coin Co., 1 West 47th Street, New York, N. Y.

STAMPS Sent on approval at 70% discount. Reference required. Emory Benoit, Hanover, Pa.

RARE Stamp free to approval applicants. Donald McCue, 1810 Third Avenue South, Minneapolis, Minn.

COSTA Rica free—Two beauties cat, 31c to serious applicants for our Superior approvals. Aero Stamp Co., 511 Central Ave., Jersey City, N. J.

U. S. Zepplins—Used, \$9.50; unused, \$12.50. No. 524—Superb, \$2.00. Liberia, 1c to \$5.00. Cat. #18, only \$1.75. Earl Moore, Darby, Penna.

80% DISCOUNT Off Scotts many hard to get nineteenth century stamps. References please. Hubert E. Codwise, Garland St., Lynn, Mass.

PACKET Each triangles, Fiume, Sierra Leone, Congo, etc. Everything 10c to approval applicants. Dolin, Box 85, Station S, Brooklyn, N. Y.

1000 ASSORTED United States, 25c. Auburn Stamp Co., Syracuse, N. Y.

200 DIFFERENT 10c, 25 Japan 10c. 60% discount approvals. Covert Stamp, 39 State, Rochester, N. Y.

PAPUA (Lakstol boat), Lebanon (air-mail), Zanzibar, Mesopotamia, Georgia, Congo, Morocco, Sudan, etc., in wonder packet 60 different, 5c with approvals and lists. Monumental Stampco, Arlington, Baltimore, Md.

FREE! Big mint packet to all approval applicants. Barcus, P. O. Box 1054, Detroit, Michigan.

ICELAND—10 Different, 10c to approval applicants. Frank Ewing, Box 693, Cleveland, Ohio.

"ALTHOUGH My stock of stamps is adequate to take care of business for years to come, yet results were so far beyond my expectations, that with the help I had, I was unable to take care of further new customers." Such are the reports received from advertisers using space under this classification. Your offer should do equally as well. For further information as to rates, closing dates, etc., write M. L. Rund, Manager, Classified Advertising, Popular Mechanics Magazine, 200 E. Ontario St., Chicago, Ill.

50 DIFFERENT African 20c. Michael, 942a So. 23rd, Bellwood, Ill.

300 DIFFERENT Stamps, 20c; 600, 60c; 1,100, \$1; 2,000, \$3. Fred Onken, 639 79th St., Brooklyn, N. Y.

FREE 6 Different Luxembourg to approval applicants. E. D. Stamp Co., 2905 Forest Park Ave., Baltimore, Md.

45 SCARCE Airmails, South America, and Canada stamps 5c to approval applicants. Glendale Stamp Co., 1342P Linden, Glendale, Calif.

BEAUTIFUL Picture stamps sent free. Paul Cornish, Schenectady, N. Y.

WHOLESALE Catalog for dealers. Illustrated. Postage 5c. Frank Co., 5631 Queensberry, Baltimore, Md.

STAMPS, Sent on approval at 50% discount. Fred Herzberg, 438 Maple Ave., Elmhurst, Ill.

COLLECTORS! For exchanging stamps. Illustrated postcards with 2600 collectors. Ask American booklet 162, Registre Echangelites, 51 Passage Bureau, Paris, France.

PICKED Lot 600 different including Afghanistan, North Borneo, \$2.00 postage, Triangles, Zanzibar, Hexagon Stamp, Sudan, Liberia, Congo, Ceres, Albania, prettiest stamps, etc. Everything for only \$1.00. Longacre Shop, 108 West 42nd, New York.

FREE Stamp collection—contains Salvador, Turkey, Africa, etc., 2c postage, 10 different triangles 25c. 1000 hinges 7c. Approvals sent, Tatham Stampco, West Springfield, Mass.

WORLD'S Finest triangle (rare Guatemala Quetzal-Bird), also scarce dead country triangle and big packet Eritrea, Vatican, Borneo, Natal, etc., 5c with lists and approvals. Seminole Company, Druid, Baltimore, Md.

FREE 100 Different, postage 2c, with approvals. Noemus Stamp Co., 312 East 23rd St., New York.

UNITED States, \$2 Wines, Catalog, 40c only 12c; 50 different U. S. 10c; 100 U. S. 35c; 30 Canada obsolete 12c. Robert Haynes, Point Place, Toledo, Ohio.

FREE—Ten Turkey (Beuties!) big interesting stamp mail, unbeatable penny approvals. 2c postage. Midwest Stampco, Box 6 P, Midwood Station, Brooklyn, N. Y.

ILLUSTRATED United States list, price 50 cents; large, complete United States price list, 1931 free. Stanley Gibbons, 38P Park Row, New York City.

FREE—Packet 52 different from Alascites, Lebanon, Quelimane, etc.; also watermark detector and rare old Hawaiian stamp—all free to approval applicants enclosing 4c postage. Highland Stamp Co., Newton Highlands, Mass.

TRIANGLES—Eight different triangle stamps including Guatemala (world's smallest), Latvia (air mail), Liberia, Nyassa, only 10c to approval applicants. Paul Revere Stamp Co., Box 40, Astor Station, Boston.

GENUINE Baden, Chilea, Kenya Uganda, French Guiana, cataloging 25c. Orange River Colony, Algeria, Shilling Revenue, Syria, Nyassaland, etc. in our extraordinary packet 60 different stamps. Only 5c, with excellent approvals. Viking Stamp Co., Sheepshead Bay Station, Brooklyn, N. Y.

FREE! Loose leaf postage stamp album at rate of 8 pages each month given with subscription to monthly journal. Send 2c stamp for prospectus. United Stamp Co., Marquette Bldg., Chicago, Ill.

STAMPS—100 Varieties, Africa, Brazil, Peru, Cuba, Mexico, etc., 10c; 25 different U. S. 25c; 1,000 mixed, 50c; 1,000 hinges, 15c. C. Stegman, 5941 Cote Brillante, St. Louis, Mo.

FREE—French Colonial packet (including Camerons, Monaco, Morocco, Togo-land) given approval applicants. Lincoln Stampco, Shelbyville, Illinois.

FREE—\$1.00 U. S. postage Lincoln memorial free, if you write for our 56 page price-list of U. S. and foreign stamps, 2,400 illustrations and fine stamps on approval. Hussman Stamp Co., 620-3 Olive St., St. Louis, Mo.

40 DIFFERENT United States 12c. 60% approval. Seidenberg, Baroda, Mich.

STAMP Album—The Modern Album is unsurpassed in usefulness. Spaces for 12,000 illustrations, 330 pages. Large size 9 1/2 x 11 inches. Cloth bound. Price only \$1.50. Either pay postman when delivered or if outside U. S. remit when ordering. Popular Mechanics Press, Room 802, 200 E. Ontario St., Chicago.

BIG Parade—A packet of more than twenty all different better grade stamps showing exciting scenes and records of nations at war. Includes fire-pot hurler; the storming of a city; hand-to-hand bayonet struggle; bloody battle scenes; troop transport; red cross stamp; dying soldier; victory stamps; etc. Send for this thrilling "Big Parade" packet at once—limited supply. Only 10c to approval applicants. W. A. Rowell, 58 Cornhill, Boston, Mass.

APPROVALS at 1c. (and what approvals!) Sets at all prices. Interested? You should be! Julius Goldin, 926 Southern Boulevard, New York.

96-PAGE Illustrated Stamp Album and 100 different stamps—25c to approval applicants. Ohio Stamp Co., Box 249, Cleveland, Ohio.

FREE! Triangles, airmail, Iceland and 50 others to approval applicants, including 3c postage. Hawkeye Stamp Co., Cedar Rapids, 39, Iowa.

PENNY Approvals that satisfy. Nell Gronberg, Box 5441, Philadelphia, Pa.

RARE COINS

10 **LARGE** Copper cents \$1.00. 10 attractive foreign bills 30c. 10 Confederate bills 50c. \$500 Bill, perfect new \$1.25. 10 historical medals 50c. 10 4c/10c war cents 50c. 10 Indian arrowheads 40c. 100 foreign coins \$1.00. 1/2 cents 25c. 20c pieces 60c. 50c lettered edge before 1835. 75c. 10 historical newspapers, \$1.00. Saturday Evening Post 1824-25, 50c. Civil war newspapers 35c. Catalogue free. Nagr, 8 South 18th Street, Philadelphia.

SPECIAL Prices on United States old money. Half cent 32c; large cent 9c; Eagle cent 8c; white cent 5c; 2c bronze 8c; 3c nickel 9c; 3c silver 15c; half dime 15c; bust type 3c silver 25c; bust type dime 29c; bust type quarter 50c; bust type half dollar 75c; 20c piece 60c; trade dollars \$1.15; civil war tokens 10c; hard times tokens 25c; mothers' day medals 25c; 25 different foreign coins 50c; old coin and bargain price list 10c. Arcy, Box 483, Muskogee, Okla.

ROMANO'S Collectors catalogue and 20 different foreign coins 25c. Romanocoinshop, Springfield, Massachusetts.

LARGE Priced U. S. coin encyclopaedia, valuable, useful, 25c postpaid. Maitland Milliken, University Bldg., Denver, Colo.

20 COINS 25c. 100 Coins \$1.00. Oddehon, Box 481, Kansas City, Missouri.

2 FOREIGN Coins, Confederate note, 5 foreign bills and catalogues 10c. Lester White, Box 66, West Newton, Mass.

100 FOREIGN Coins and bargain list of U. S. Large cents \$1.00. S. Drutz, Box 749, Saranac Lake, N. Y.

3 DIFFERENT Fine bronze or nickel coin, 2 large crisp bank notes and catalog, 10c. Geo. Best, Box 283, Cedar Rapids, Iowa.

CONFEDERATE State note, Foreign \$2 note, French 10c and catalog 10c. M. Figg, L. Box 283, Cedar Rapids, Iowa.

OLD Money wanted—Send 10c for illustrated book giving prices we pay. Coin Dealer, Parkways, East Orange, N. J.

SEND 10c For 5 different coins and catalog or 50c for 25 different. Troyer Coin Co., La Fontaine, Ind.

OLD Money wanted. Will pay fifty dollars for nickel of 1913 with Liberty head, (no Buffalo). We pay cash premiums for all rare coins. Send 4c for large coin folder. May mean much profit to you. Numismatic Co., Dept. H. Ft. Worth, Texas.

18 DIFFERENT Coins, 25c; 30 different, 50c; 60 different, \$1.00. Bischoff, Box 7441, No. Kansas City, Mo.

BY Return mail: Six fine, carefully selected classified, very old coins (one silver) and monthly bargain bulletins, one dollar. Southampton Coin Exchange, 5427 Nottingham, St. Louis.

BARGAINS 20 Large cents \$1.00. 100 foreign coins \$1.00. Foreign Silver dollar 6c. Hobbyshop, 853 Main, Springfield, Massachusetts.

101 DIFFERENT Foreign coins, \$3.00. Coinshop, John Marshall Place, Washington, D. C.

BARGAINS On coins. List free. Bargaindealers, 929 Main, Springfield, Mass.

\$5 TO \$500 Each paid for old coins. Many very valuable. Keep all old money. Get posted. Send 10 cents for illustrated coin value book, 4x8. Guaranteed prices. We buy and sell. Coin Exchange, Box 5, Le Roy, N. Y.

CALIFORNIA Gold—Quarter size, 27c; 3/4 size 53c; 3c piece and catalog, 10c. Norman Shultz, Box 746, Salt Lake, Utah.

OLD Coins, large full selling catalog of coins for sale, free to collectors only. Catalog quoting prices paid for coins, ten cents. William Hesslein, 101A Tremont St., Boston, Mass.

GET Profit and pleasure in collecting old coins. Send 10c for large illustrated coin catalog. You'll be delighted with it. Send for it right now. B. Max Mehl, Numismatist, Mehl Bldg., Dept. P, Fort Worth, Tex. Largest Rare Coin Firm in the U. S.

COMMEMORATIVE Half dollars for sale at low prices. Old coin and price list 10c. Towns Davis, Box 1791, Huntington, West Virginia.

RARE United States and foreign coins, war medals and decorations. Indian Cent and catalogue 10c. Alexis Mengelle, Colorado Springs, Colorado.

UNITED States. Large cent, two-cent bronze, three-cent nickel and bargain list, 25c. Thirteen dates large cents, \$1.40. George Coffin, Greenwood Mountain, Me.

CIVIL War cents 25c. American coin value booklet 25c. Frank Saco, 735-P 45th Street, Brooklyn, N. Y.

CAMERAS AND PHOTO SUPPLIES

USED Zeiss 8x30 binocular \$54.50, 2 1/2x 4 1/2 Zeiss roll film camera with Tessar f:4.5 lens and compur shutter \$29.50, 2 1/4x 3 1/4 Eastman special kodak with f:6.3 Tessar lens in Optimo shutter \$19.50. Hundreds of other bargains listed in our free bargain book. Send for your copy now. Central Camera Co., Dept. P35E, 239 South Wabash Ave., Chicago, Ill.

TRIAL Offer—Develop first film. Give 6 supergloss prints 25c (silver), one 5x7 enlargement free. Interstate Finishers, Inc., Dept. 85, Charles City, Iowa.

SPECIAL Trial offer: Developing any size roll 5 cents; prints 3 cents each. Beautiful 7 inch enlargement 20 cents. Send for special bargain list. Roanoke Photo Finishing Company, 209 Bell Avenue, Roanoke, Virginia.

ROLL Developed and 6 glossy prints 20c. Two 8x10 mounted enlargements 80c. 12 prints from negatives 40c. Young Photo Service, 465 Bertha St., Albany, N. Y.

PHOTO-Finishing at home, easy and interesting. Complete outfit, instructions, \$1.50 C. O. D. plus postage. Photocraft Company, 1087 Wayburn, Detroit, Mich.

TIME Counts in applying for patents. See pages 140 and 141. Clarence A. O'Brien, Registered Patent Attorney, Washington, D. C.

EXPO Watch Camera. Every tick a picture. Complete \$5 outfit postpaid \$3.98. G. Gennert, Inc., 24 E. 13th St., New York, N. Y.

YOUR Favorite kodak picture enlarged, size 5x7, 10c. Three for quarter, coin. Send best negative (film) today. Address Darmer Photo Lab., 221 Securities Bldg., Des Moines, Iowa.

HAVE You a camera? Write for free sample of our big magazine, showing how to make better pictures and earn money. American Photography, 116 Camera House, Boston, 17, Mass.

MAKE Money in photography. Learn quickly at home. Spare or full time. New plan. Nothing like it. Experience unnecessary. American School of Photography, Dept. 3432, 2601 Michigan Ave., Chicago.

MOTION PICTURES AND SOUND EQUIPMENT

JUST Out! Bass will mail postpaid Cine Amateur, Complete Handbook of motion picture photography for the amateur, \$1.00. Voice of the Films, a complete description of the process used in making sound motion pictures just out. Price postpaid, \$1.00. Motion Pictures With Sound by James Cameron. 400 pages crammed with information on all systems. \$5.00 postpaid. Bass Bargaingram No. 202 listing red hot bargains in standard and 16mm. motion picture cameras, projectors and accessories. 4c stamp. Bass Camera Company, Motion Picture Headquarters, 179 West Madison St., Chicago, Illinois.

1600 FT. Metal cans with wire reel 20 cents, with metal reel 15 cents. New condition. Reel Sales Company, 347 Elm Ave., Hogans, N. J.

TIME Counts in applying for patents. See pages 140 and 141. Clarence A. O'Brien, Registered Patent Attorney, Washington, D. C.

\$1,250 FOR Original photoplay story. Our sales department sold unknown author's first story for above amount. We revise copyright and submit to studios stories for talking pictures. Being located in the heart of motion picture industry we know production requirements. Established 1917. Free booklet. Universal Scenario Company, 206 Meyer Bldg., Western and Sierra Vista, Hollywood, Calif.

TALKIE And movie producers are clamoring for new short story ideas, plots, etc. Perhaps you can write one that we can shape and sell for you. One writer (V.M.) received \$3,000. New York best market. Write now for free booklet, without obligation—How To Write For the Talkies! Daniel O'Malley Company Inc., Suite P, 1776 Broadway, New York.

SPECIAL—55-Q. R. S. projector with case for \$25. One hundred feet sixteen millimeter comedies etc., three dollars. Camera \$17.50. Eastman film 16 MM for same \$4.50 per 100 ft. Milton Mendelwager, 192 Ave. B, Bayonne, N. J.

16MM Talkie \$75. 35mm reels 394 cash. No list. C. V. Film Co., 76 Laurel, St. Ridgefield Park, N. J.

EVERYTHING in motion pictures. Special, 100 feet natural color film \$1.50 pre-paid, 200 feet comedy or western \$1.50. Metropolitan, 60 Branford Pl., Newark, N. J.

BARGAINS in film and projectors. Clyde D. King, 1842 W. Fiftyeth St., Chicago, Ill. 16MM Film bargains. Big lists, souvenir strips sound cartoons for dime. Eastin Films, Galesburg, Illinois.

CAMERAS; Projectors; films; equipment. Bought, exchanged, sold. Lists free. Zehrbach, Box 2089-Q, Atlanta.

CHARLIE Chaplin—Tom Mix, 35 M. M. Toy films. Lowell Films, Allentown, Pa.

FREE Literature on remarkable new Kemo Amateur Movie Outfit. Uses Eastman film. Cuts the cost of making films one-fourth. Send for your copy and full information. Bass Camera Company, 179 West Madison St., Chicago, Illinois.

WORLD'S Greatest "Passion Play" 16 MM. (new) 5 reels. Rent or purchase. Write Hemenway Film Co., 37 Church Street, Boston, Mass.

TRADE AND TECHNICAL SCHOOLS

BE A blue print reader. Men in your trade have succeeded. Write for facts. What's your trade? Carroll Bunsar, Drexel Bldg., Philadelphia.

USE Shortcuts in Figures. Save valuable time. The quickest ways of working all problems. Instructions for drilling yourself to be come rapid with figures. Complete, yet simplicity itself. Just write a postal for "Shortcuts in Figures." Pay postman \$1.25 and postage. Popular Mechanics Press, Room 802, 206 E. Ontario St., Chicago, Ill.

TELEGRAPHY

LEARN Wireless (Radio) and Morse telegraphy. School, oldest and largest; endorsed by telegraph, radio, railway and government officials. Expenses low—can earn part. Catalog free. Dodge's Institute, H Street, Valparaiso, Ind.

BUSINESS OPPORTUNITIES

NEW "Endless Chain" selling plan guarantees amazing profits and many repeat sales with America's greatest printing line. 40%-55% profit on every order. 126-page catalog shows 1,001 printing necessities for every business. New line lithographing just added—Also line of personal stationery, pictorial parcel-post and shipping stickers, collection sticker system, advertising tags, druggist labels, etc. All statements, letterheads, billheads, envelopes, etc., now furnished in white and 5 beautiful colors—a tremendous selling advantage. Thousands of free cuts furnished. Lowest prices. Highest quality. Main or sideline. Experience unnecessary. Write quick new 1931 free outfit. Kaiser-Blair, Inc., Dept. 293, Cincinnati, Ohio.

LEARN Marbleizing, with cement composition. You are taught how to enamel any concrete products, wood, lumber etc. Wall-board so finished can be cut nailed perfectly. For statues, garden furniture, novelties. All have glossy face finish, flintlike hardness. All colors (see samples). Sanitary floors, marbleized, nothing better. You are taught practical marbleizing. A real opportunity, nothing like it before. We are sole owners. Send dime for samples. Corwell Institute, Grayling, Mich.

INDEPENDENT Business, easily carried in automobile. Your services in demand. Earnings are large. Buy our latest patented portable electric block re-leveling machine. Call on meat markets, restaurants. Anyone can operate. Complete instructions and outfit \$335.00. Universal and cuts any size or shape wood block. Heath Company, 210 Lafayette St., New York.

PUTT-SHERIDAN Business handbook directory. \$1.00 postpaid. "Circular free." Marquard Company, Venedy, Illinois.

BUILD Business of your own in spare time. Four cent stamp brings booklet describing over fifty plans. No peddling. Co-Operative, 469-A, Ansonia, Conn.

MEN Or women, be your own boss, have your own business, independent, no loss of time. For a very small sum of money, get the formula, and how to make and sell a wonderful cleaning solution, paint remover, liquid polish. Write at once for information to Malling Mfg. Co., 16148 Crutcher Ave., Detroit, Mich.

YOUR Greatest opportunity to make big money with a little time. Tested, proven, guaranteed. Big profits. Working instruction \$1. Elwood Company, P-L 84 Ryerson, Paterson, N. J.

START A business of your own. Circular free. Pickett Co., 2842 Rockwell, Chicago, Ill.

PARTNER—Advertising ability, experience, means. Promote amazing discovery; grow hair any head. Fortune right party. No triflers answered. References exchanged. 143 O St., Cottagegrove, Oregon.

SUCCEED With your own products. Make-sell them yourself. Send for free catalog of formulas, processes, trade-secrets. Read "What Our Clients Say." Expert analytical work. Foremost Formula Service, B. Thaxly Co., Washington, D. C.

NEW Business opportunity—Golf-Billiards. Write, De Press, 1036 West 90th St., Los Angeles, Calif.

SPANISH In twenty lessons, including South American information. Satisfaction guaranteed. Systema Rapido, Heintzman Hall, Toronto, Canada.

WE Start you in business, furnishing everything. Men and women, earn \$10 to \$100 weekly operating our original "New System Specialty Candy Factories." Berlin home spare time. Unlimited opportunity. Valuable booklet free. W. Hillier Bagdale, Drawer 4, East Orange, N. J.

OPPORTUNITY Course for handy men. Particulars. Houlgate's "Fixit" Service, 1305 N. Elmoline, Pasadena, Calif.

MIRRORS Restored at home. Costs near 5 cents per square foot; you charge 75 cents. Profitable business plating like new brass, worn-off autoparts, reflectors, tableware, stoves, etc. Outfits furnished. Details free. Sprinkle, Plater, 127, Marion, Ind.

"SCHEME" 32p Monthly, prints big \$-getting schemes, opportunities, ideas, formulas. Subscriber reports \$10,000 from one copy; another \$25,000 from three. Try your luck! Three copies only 25c. Lewis Patterson, Pub. Alliance, Ohio.

BIG Steady profits operating "chain" of peanut, chewing gum, candy vending machines. Start small capital. Robbins Corp., Dodworth Street, Brooklyn, N. Y.

START Absolutely competitionless business; earn \$10 daily and more; easy to produce; easy to sell. Dime brings sample, information. Riebenack, Bellrose, N. Y.

AMAZING Patented envelope sealer. Seals 50 minute. Retail \$4.50 only. Offices buy on sight! Tremendous market. Free Trial. Sealer, 8065 Spring Lane, Boston.

OWN Your own business. Our successful business plans sold at sensible prices. Shows how to build a profitable spare time business. Vern Meredith, Box 65, West Berkeley, Calif.

CAPITAL Seekers send quarter for valuable booklet explaining how to raise capital. Free analysis your proposition. If sound will consider financing. Industrial Capital Company, Chanin Bldg., New York.

ARTIFICIAL Marble sanitary flooring, instructions covering wood or cement flooring 1/2 inch thick, fireproof, all colors, low cost. Ornamental casting, concrete plaster, papier-mache decorations, garden furniture, statuary, flexible molds, particulars and illustrations free. Chris. Mahler, Elmont, N. Y.

LEARN The collection business. Good income, quick results. Interesting booklet, "Skillful Collecting" free. National Collectors Assn., Long St., Newark, Ohio.

NEW Service in great demand, needed in every home! Remarkable new machine applies wax automatically, polishes, and renews floors. Establish a profitable floor maintenance business of your own. Endorsement of satisfied customers secures new business for you. Write at once for particulars. Floorola Corporation, Salem Ave., York, Pa.

MAKE Illuminated signs, Patented process. Artistic ability unnecessary, one order cleared \$500. Particulars, Merritype Signs, So. Berkeley, Calif.

\$10-\$20 OR More daily, new industry, new discoverers, no trash, bunk or peddling. Small investment. Write National Chemical Co., 1223 N. Dearborn St., Chicago.

BUSINESS Opportunity mail for 10c. Copy my magazine included. Langdale, 2406 26th Ave., So. Minneapolis, Minn.

ANY Handy man can start furniture refinishing, painting, handyman shop on nearly nothing; mostly all profit. John Braceland, 1429 So. Ninth, Philadelphia, Pa.

MAN Able and willing to work, wants position. Will invest \$400.00. S. B. Wilbur, Sonora, Ohio, Route 2.

SCREW-HOLDING Screw drivers! Non-magnetic. Remove, insert screws inaccessible places. Factories, garages, electricians, carpenters, mechanics, auto, radio owners buy on sight. Free trial. Jiffy, 1805 Winthrop Bldg., Boston.

LARGE Quick profits making and selling the new rowing machine exerciser. Made for three dollars, sells for ten. Material obtainable anywhere. No special tools nor skill needed. Send one dollar for complete drawings and directions—Money refunded if requested. E. C. Bunnell, 924 Broad, Stratford, Conn.

WONDERFUL Opportunity for one man in each city or town. Write, Roche and Renaud, Fairhaven, Mass.

PROTECT Your business—Organize a company. Raise capital. Sell shares. Any business. Write. Free advice. Corporation Fiscal Co., Wilmington, Delaware.

BIG Money—Manufacture and sell your own extracts, beverages, soaps, perfumes, candles, etc., at home. Free booklet. Truway Laboratories, 1333-A Walton St., Chicago, Ill.

AUTO—Oil business. Start your own with little cash. Very profitable and motorists save money. Original details. Write G. Conser, 2955 West 73rd Street, Cleveland, Ohio.

ALCHEMY Equipment for range or personal use. Factory prices. Catalogue free. Teague Mfg. Co., 1027 Adams Ave., Evansville, Indiana.

TOYMAKERS—Complete blueprints of seven popular toys, 30c. Weesho-Uco, 21st Office, Detroit, Mich.

FREE Book. Start your own little business anywhere, selling novelties by mail. My beginner's outfit contains everything required, novelties, circulars, instructions, etc. Descriptive book free. Hadwell, 33A-74 Cortlandt St., New York.

A BUSINESS of your own making—Sparkling Glass Name and Number plates. Checkersboards, signs. Big book and sample free. E. Palmer, 540, Wooster, Ohio.

CAPITAL—For copy, the "Promoters' Hand Book," a leaflet on financing; an eye opener for capital seekers. Send \$1.00 to Amster Leonard, East Orange, N. J.

AMATEUR Cartoonists: Sell your work. Write Smith's Service, PW1104, Wenatchee, Wash.

TIME Counts in applying for patents. See pages 140 and 141. Clarence A. O'Brien, Registered Patent Attorney, Washington, D. C.

OPERATE Chain of vending and amusement machines. Be independent for life. Start small, grow big. P. Goodbody, 1828 East Main Street, Rochester, N. Y.

ARTIFICIAL Marble. Beautifully colored glossy tiles. Make it yourself. Hack-saw proof, or workable. Flooring, base, tabletops, inkstands, novelties. Hearty personal cooperation. Liberal astonishing samples 10c. John Pagn, 945 Grande Vista Drive, Los Angeles, Calif.

MAKE Money manufacturing building material. Marble, Granite, Fireproof Paint, Flooring, Roofing. No machinery, cheap; big profits; formulas, latest methods. Wm. Lang, 443 Washington, Portland, Ore.

START Your own business. Buying discarded old gold, silver and platinum jewelry. Most secret and profitable in the world. Write F. Polcer, Box 81-A, Cicero, Illinois

BIG Profits by mail with books and printing. Pruett, Brookfield, Ill.

WEAVE New cane seats in chairs. We show you. Koch & Henne, Ann Arbor, Mich.

AMATEUR Cartoonists—Earn \$25.00 week, spare time, copying cartoons for Advertisers. 3-Km Syndicate, Argyle, Wis.

OPPORTUNITIES Galore! Trial three month subscription to "Mallsalesman" 10c. Argus, Culver City, California.

250,000 ARTICLES Wholesale. Directory 10c. W-Publishers, 4111 University, Des Moines, Iowa.

"ODD-THINGS"—Money making ideas! plans. Opportunities. Three months 25c. Year \$1.00 with 320 page popular novel free. "Odd Things Magazine," 724 Advance Bldg., Cleveland, Ohio.

PUBLISH Your own magazine. We issue a syndicate magazine. Sample and particulars 10c. Tassan Publishing Company, P. O. Box 3594, Washington, D. C.

CHEMICAL Expert furnishes manufacturing formulas and processes with complete working directions. Reliable individual service only. No lists. Charges reasonable. Correspondence invited. Dr. Arthur Van-Heeden, 7051 Bennett, Chicago.

FIFTY Successful mail-order propositions. Address, K. Home, 3919 Metropolitan, Chicago.

POP-CORN Machines, crispette outfits. Northides Co., 1396 Fifth, Des Moines, Iowa.

A Business of your own. New book of plans, formulas, etc., \$1.00 postpaid. Circular free. Joseph H. Belfort, 4042 N. Koeler Ave., Chicago, Ill.

SELL by mail successfully! I show you how. Handsome folder free; stamp appreciated. Busler, Box 205-A, Sta. A., Canton, Ohio.

CHEMICAL Expert will furnish formulas and trade secrets. All lines. Lists free. W. L. Cummings, Ph. D., 228 Gordon Ave., Syracuse, N. Y.

CHARTERS: Delaware; best, cheapest; free forms. Colonial Charter Co., Wilmington, Del.

MAKE Your own products. Employ agents yourself. Toilet articles, soap, extracts. We furnish everything. Valuable book free. National Scientific Laboratories, 1950 W. Broad, Richmond, Va.

I MADE \$30 A week home. French breadmaking. 15 years' experience; free booklet tells. Ashbrook 67, Marengo, Ohio.

BIG Money at home plating auto parts, reflectors, mirrors, chandeliers; by new method; experience unnecessary. Outfits furnished. Gunmetal Co., Ave. N, Decatur, Ill.

FREE Booklet describes 67 plans for making \$20-\$100 weekly in home or office business of your own. Elite Co., 84 Elizabeth St., New York.

UNUSUAL—Uncommon specialties always sell best. Make these yourself from Miller's guaranteed formulas. Why work for others when others can be working for you! Latest eye-opening literature brings you many specialty propositions for you an independent business. Miller Chemist, 706-K Chemical Bldg., Tampa, Fla.

SELL by mail. Books, novelties, bargains! Large profits. Particulars free. B. Eifen, 525 S. Dearborn, Chicago.

15,000 PROFIT Making formulas. Following and many others: Accidents and emergencies, agriculture, alloys and amalgams, artist's materials, beverages, cements, glues, pastes, mucilages, bleaching, renovating, coloring metals, drying glass, heat treatment of metals, household formulas, ice cream, confectionery, chewing gum, lapidary work, exterminating vermin, lubricants, paints, varnishes, photography, condiments, canning formulas, rubber, soap, candles, soldering, toilet preparations, perfumes, waterproofing, fireproofing, writing materials. Just write for "Scientific American Encyclopedia of Formulas." When postman hands you book pay \$5.50 and postal charges. Popular Mechanics Press, Room 802, 209 E. Ontario St., Chicago, Ill.

CHEMISTRY

BECOME Trained chemist. Thousands of opportunities—fascinating career. Learn at home. Complete experimental laboratory outfit given. Write for big free book. Chemical Institute, 19 Park Place, Dept. P-531, New York.

BIG Money in manufacturing. Easily made formulas with long profits. Analysis, ideas developed. Associated Chemists, Indianapolis, Indiana.

"HANDBOOK For Chemical Experimenters." Hundreds of interesting experiments; illustrated, 50c. Booklet of experiments, 15c. Pricelist, 5c. General Chemical Company, Box 397, Reading, Pa.

YOUR Chemical problem solved and formula or process furnished for Five dollars. Write me, W. Stedman Richards, Industrial Chemist, Box 2402, Boston, Mass.

CATALOG listing 2,500 illustrations chemists' supplies, 5,000 chemical, 1,000 scientific books sent for 50c. Laboratory Materials Company, 643 E. 71st St., Chicago, Ill.

CHEMICAL Analysis, processes, technical information. Robert Henderson, Laboratory, Madison, Maine.

FORMULAS AND TRADE SECRETS

1,000,000 FORMULAS, industrial facts, tables, processes, rules, trade secrets, and calculations for all kinds of Trades and Businesses. Book—"Moore's Assistant"—1014 pages. Sent postpaid for \$2.00. Ogilvie Publishing Co., 57 Rose St., Dept. 22, New York.

RESZARICH Chemist offers valuable formulae. Formula and expert advice \$2. Dr. Graulich, 665 Holbrook, Detroit, Mich.

15 MONEY Making toilet preparations and home remedies \$1. Free famous reducing chart without drugs—free. Ektrod Co., 81 Rverson, Paterson, N. J.

GUARANTEED Formulas, recipes, processes, 50c and \$1. Analysis \$5. Catalogue free. Industrial Institute, Dept. 205, 64 West Randolph, Chicago.

CEC-O-WAX Auto polish. Formula, process, \$1.00 (currency). Gateway Specialties, Rapid City, So. Dak.

FORMULAS, Chemical analysis, catalogue free. Herstein, Chemist, 161 Goldsboro Place, Grand Rapids, Mich.

FORMULAS From experienced chemist make better and more profitable products. Information free. Buskett, Joplin, Mo.

SUCCEED With your own products. Make-sell them yourself. Send for free catalog of formulas, processes, trade-secrets. Read "What Our Clients Say." Expert analytical work. Foremost Formula Service, B. Thaxby Co., Washington, D. C.

FORMULAS All kinds. Catalog free. Closer Laboratories (P), Park Ridge, Ill.

NEWEST Formulas. Tested, guaranteed. Catalog free. Imperial Laboratories, Edwardsville, Ill.

FORMULA For making gold and silver mirrors \$10.00. Plates in 20 minutes. Nashville Mirror & Sign Co., 614 Commerce St., Nashville, Tenn.

INSTANT Automobile refinishing. Formula 50c. All formulas 50c. List free. T. Huffman, 1518 Wilson, Chicago.

FREE Formulas—Free materials making \$32.00 worth of guaranteed highest class specialty-necessities. Thirty-third unequalled anniversary offers explains all. Miller, chemist, 1707-G Jetton, Tampa, Fla.

FREE Formula catalog. Latest money makers. Western Chemical, Salem, Oregon.

MAKE Your own products. Employ agents yourself. Toilet articles, soap, extracts. We furnish everything. Valuable book free. National Scientific Laboratories, 1950W, Broad, Richmond, Va.

500 FORMULAS And big illustrated catalog 25c. Ideal Book Shop, Park Ridge, Ill.

FREE Catalog of formula and mail order books. Free list supply sources. J. Matthews Co., Van Leer, Tenn.

\$1,225.00 PROFIT From a town lot in one year. H. Cecil Sheppard tells you his disastrous and profitable experiences in raising chickens from the start until in the sixth year he took the above net profit. He would have gladly paid \$100 for this information during the first years. Send for his book. Price only 75 cents. Pay postman when delivered, or if outside U. S., remit when ordering. Popular Mechanics Press, Room 802, 209 E. Ontario St., Chicago.

AGENTS WANTED

LADIES' Full fashioned silk hosiery, \$6.25 per dozen; also seconds \$4.50 dozen. Send deposit, balance C. O. D. Betty Hosiery, 818 W. Wyoming Ave., Philadelphia, Pa.

WOULD You like the exclusive sale of a product that sold box car loads were shipped to agents last summer? Our beautiful large new package of Crescent Soft Drink Powder is the product. Makes 10 big glasses 10c. The most delicious drinks you ever tasted. Just add cold water and sugar—ready instantly. Also delicious Esherbet by adding milk and freezing. Used with cereals makes jelly. Fine for cake icing and candy. Sell stores, also retail if you wish—big profits—sure repeater. Send 25c for three packages, assorted flavors and particulars postpaid. Territory being given now—its very valuable. Don't miss this. Charles Morrissey Co., 4417-25 Madison St., Chicago, Ill.

CHANCE For \$40 daily profits showing merchants how to increase profits \$2 to \$12 daily serving Hot Dogs "Electrically Roasted." Amazing new device roasts 12 wieners in 3 minutes. Gives new delicious flavor, with all original juices retained. Wieners don't shrink. Actually get larger. No installation. Moves anywhere. Protected territory open. Presto Electric Roaster, EC-40 American Bank Bldg., Pittsburgh, Pa.

IF You have ever seen an automatic Lawn Mower Sharpener and Oilier—don't answer this! If not, send \$1.00 for sample outfit and complete details regarding exclusive territory. This amazing new, fast-selling invention sharpens and oils as it mows. Get started at once! Big profits for agents now. Miracle Manufacturing Company, Youngstown, Ohio.

CASH In \$7.50 to \$12.00 a day with fast selling 25c household specialty. No experience or talking necessary. Self-selling envelope does selling for you. Rush 10c for sample and particulars. W. Masterlite, 110 E. 23rd St., New York.

\$51.00 WEEK Clear profit with only nine easy sales daily. Sell this amazing new discovery that re-soles worn shoes for 9c pair. Details and samples free. Write Perfect Mfg. Co., Dept. RC-500, 220 E. Third, Cincinnati, O.

NEW Motor Invention "Hot-Shot" increases power, speed. Saves gas, oil. Starts motor instantly. Sparks 11,000 volts. Nationally advertised \$1.50 seller. Big profits. Free sample offer. Beardon Mfg. Co., Dept. PC3, Peoria, Illinois.

SAMPLE Free, good seller, 100% profit. Write P. Geigen, 6538 North Maplewood, Chicago, Ill.

FLAVORING Extracts—Bottle yourself! Labels furnished. 600% profits! Whirlwind money-makers! Repeaters! Free offer. Thomas Manufacturing Company, Indianapolis, Ind.

"HOW To Secure Agents," a specially prepared booklet, tells of one of the most inexpensive methods in which to secure good live producing agents. It is free; write for your copy today! M. L. Rund, Mgr., Classified Advertising, Popular Mechanics Magazine, 200 E. Ontario St., Chicago, Ill.

BECOME Our dealer without investment. Extracts, foods, medicines, toilet goods, sent on 30 day's credit. Big pay—exclusive territory. Send today for starting outfit. Midwest Drug Co., Dept. 117, Columbus, Ohio.

SELL Personal stationery, biggest commission, samples free. Harold Smith Studio, Edenville, N. Y.

MEN Wanted. Tenth successful season now starting. Thousands enjoying big incomes, full time or spare hours, selling fine shirts, ties, underwear, guaranteed full year. Shirts, ties, cash bonuses to producers. Beautiful self-selling outfit free. Write Dept. L-5, Roseliff, 1237 Broadway, New York.

MAKE Big money selling food products, prize motor and tractor oils, paints. Sure repeat orders. Write for free sample case. Lovern & Browne, 1602-M So. State, Chicago.

SALESMEN—400% profit on \$1.00 sale. Cleaner for autos, furniture, metal and glass. Your name on labels. Exclusive territory. Free sample. Write Minute-Kleen Laboratories, Dent, E. Evansville, Ind.

SOMETHING New for unemployed! Make \$10.00 a day in 1-minute photography. No experience necessary. Full particulars free. Benson Camera Company, 168 Bowery, New York.

GOLD Sign letters pay 1000%. Instructions. Johnston Co., Quincy, Ill.

SELL Metalloy!—Brand new invention brings big money to agents—marvelous chemical preparation which cleans, polishes and plates all metals; immediately upon application. Every automobile owner, garage, house, hotel, restaurant, store and industrial concern a prospect. Wonderful opportunity! Send 50c for sample; write for proposition. Chemical Utilities, Inc., 123 Fifth Ave., New York.

WHEEL-O-SCOPE. Sensational new auto safety device, prevents ditching, assists parking. Opportunity to make \$60 commission weekly. Fowler & Co., 99th Ave., Queens Village, New York.

NEW Plan brings independent cash incomes to women. Show marvelous values men's fine shirts. Give one free with every three. Removes all sales difficulty. Experience unnecessary. Complete selection beautiful pre-shrunk fabrics free. Write Dept. M-50, Albert Shirts, 860 Sixth Ave., New York.

MAKE Your own products. Employ agents yourself. Toilet articles, soap, extracts. We furnish everything. Valuable book free. National Scientific Laboratories, 1950W, Broad, Richmond, Va.

AGENTS—Million dollar company needs reliable men and women who are ambitious to earn a large, steady income. Our fast-selling household necessities are known from coast to coast. Big demand. Highest commissions. Exclusive territory. Write today. Albert Mills, 9129 Monmouth, Cincinnati, O.

JUST Out! Cement-On Rubber Soles. Cut shoe bills in half. Outdoors leather. Keep feet dry—prevent slipping. Comfortable. Also 47 other rubber specialties. Big money for agents. Outfit free. Write Kristee Mfg. Co., 1435 Bar St., Akron, O.

WRITE For free sample Dri-Cleanit. Cleans car for about 10c. Removes mud, grease, all one operation. No soap or water used. Agents wanted. American Accessories Co., Desk B 31, Cincinnati, O.

MIRRORS Resilvered at home. Costs near 5 cents per square foot; you charge 75 cents. Profitable business plating autoparts, reflectors, tableware stores, refinishing metalware, etc. Outfits furnished. Details free. Write, Sprinkle, Plaster, 128, Marion, Ind.

AGENTS—Simple demonstration sells amazing cloth. Cleans, polishes furniture without additions. Retail 25c; large profit; free sample. Williams Corp., Dept. 414, Montclair, N. J.

SELL Goodyear raincoats, \$2.95 up. Goodyear Rainwear, 18 West 22nd, New York.

SUCCEED With your own products. Make-sell them yourself. Send for free catalog of formulas, processes, trade-secrets. Read "What Our Clients Say." Expert analytical work. Foremost Formula Service, B. Thaxby Co., Washington, D. C.

CALIFORNIA Perfumed beads, selling like hot cakes. Agents coining money. Catalog free. Mission Factory, P, 2328W Pico, Los Angeles, Calif.

HERE'S the biggest money-maker in years. Just show samples, collect big cash commissions. Everone buys Longwear's sensational values, work pants, dress pants, breeches, coveralls. Big selection. Free sales outfit. Write today. Dept. P-5, Longwear Trousers Co., 489 Broome St., New York.

NEW Plan brings independent cash incomes to women. Show marvelous values men's fine shirts. Give one free with every three. Removes all sales difficulty. Experience unnecessary. Complete selection beautiful pre-shrunk fabrics free. Write Dept. P-50, Albert Shirts, 860 Sixth Ave., New York.

AGENTS—Up to \$12 daily demonstrating men's, women's, children's finest hosiery. Definite wear warranted or replaced. Amazingly low prices. 100 styles, colors. Auto and Hosiery given producers. Write quick! Wilkint Hosiery Co., Dept. C-375, Greenfield, Ohio.

ADDRESSES Of hundreds of wholesale and agent supply houses. Particulars free. J. Belfort, 4042 N. Keeler Ave., Chicago, Ill.

TIME Counts in applying for patents. See pages 140 and 141. Clarence A. O'Brien, Registered Patent Attorney, Washington, D. C.

CASH Paid for butterflies, inserts. See Sinclair Display Advertisement on page 18.

BUILD A permanent repeat order business with Roseliff's high grade shirts, ties, underwear, hosiery. Guaranteed one full year. Cash commissions, extra cash bonuses, shirts to producers. We pay postage. Prompt service. Free sales outfit. Write Dept. K-5, Roseliff, 1237 Broadway, N. Y.

NEW, Profitable—Sell auto step mats. Quality rubber with owner's name molded white. Details free. Ekhon Products, Dept. M-49, 895 Main, Akron, Ohio.

PORTRAIT Men—Big profit catalog. Guaranteed portraits, frames, medallions, photo pillows, household specialties, toilet preparations, food products, remedies, pictures, crucifixes. James Bailey Co., Station C-5, Chicago.

ABSOLUTELY Brand new. Hand-colored popular priced panel portraits going big. Everyone wants them. Make \$10-\$25 daily. Samples furnished. Cruiser, 2462-ES Jackson, Chicago.

ELECTRIC Water heater—New. Heats water instantly. Pocket size—retails \$3.75. Two minute demonstration makes you \$1.95 profit. Lux-Vial, Dept. 57, Elkhart, Ind.

100% PROFIT in new mystery cigar lighter. No flint or friction. What makes it light? No wind can blow it out. Retails 50c. Sample and sales plan 25c. New Method Manufacturing Co., Box PM-5, Bradford, Pa.

300% PROFIT Selling Mystery Gas Lighter. Retails 25c. Costs you \$1.00 doz. Sample free. Square Deal Mfg., Desk PM-19, Bradford, Pa.

STRANGE New ironing cord! Prevents scorching. Saves electricity. Cannot kink or snarl. For telephones also. Up to \$25 daily. Samples furnished. Neverknot, Dept. 5-A, 4503 Ravenswood, Chicago.

AGENTS Wanted: To sell rope making machines to make your own rope with from binder twine. Every farmer or user of rope needs and will buy one. Send one dollar for a machine. Louis O. Berg Company, Dept. PM, Madison, Minn.

HOLLOW-GROUND For new type Gillette. Ten cent packages, easiest selling blades. Carried. Sold everywhere. Standard Safety Razor, Pittsburgh, Pa.

AGENTS—Carved wood novelties, model coaches. William Smith, 73 Haverhill Street, Boston, Mass.

DISTRIBUTORS For different states to appoint agents for new automatic door seal. Investment required. Factory Distributors, 1411 Alameda, San Jose, California.

SIDELINEY Write Ellarbee, Box 35, Beverly, Mass. Samples (novelties) 25c.

JUST Out—Wonderful low priced can opener. Agents making money. Sample 25c. Allneeds Mfg. Co., Box A26, Oak Park, Ill.

PINEAPPLE And orange drinks. We supply concentrated flavors, just add sugar and water. Sell flavors soda fountains, drink stands. Greatest summer proposition. Mail \$1, both flavors, make 5 gallons each drink. Suncrest Co., 511 E. 72nd St., New York City.

SIMPLE Attachment makes old clocks electric. "Lektriklox," 2945 Fullerton, Chicago.

AMAZING New razor blade sharpener 75c. Make sure. Try one. Send 50c for sample and prices. Novelty Product Co., 1446 Argyle St., Chicago, Ill.

SELL Changeable signs to stores, six lines, costs 30c sells \$1.50. Particulars free. National Sign System, St. Louis, Mo.

300% PROFIT in new "20-in-1" kitchen necessity. Retails 25c. Costs you \$1.00 a dozen. \$10.00 a gross. Sample 15c to cover cost of mailing. New Method Co., Nu-Method Bldg., Desk PM-5, Bradford, Penna.

AGENTS, Distributors—Make \$10-\$20 daily up. New food item sells instantly to homes, restaurants, hotels, grocers. Big repeats. Ready Products, Dept. B-5, Hawthorne, N. J.

BIG Money easy, simply showing new Polby Wrench. 10 wrenches in one. Guaranteed fast seller. Sample furnished. Gellman Mfg. Co., Dept. 6-E, Rock Island, Ill.

\$60-\$200 A WEEK. Genuine gold letters for store windows. Easily applied. Free samples. Liberal offer to general agents. Metallic Letter Co., 438-B North Clark, Chicago.

WE Start you without a dollar. Soaps, extracts, perfumes, toilet goods. Experience unnecessary. Carnation Co., 641, St. Louis, Mo.

AGENTS—Make a dollar an hour. Sell Mendets, a patented patch for instantly mending leaks in all utensils. Sample package free. Collette Mfg. Co., Dept. 404, Amsterdam, N. Y.

PHOTO Medallion men and women, the largest line of photo novelties in the world. Lowest prices, quickest service. Send for catalog showing over 200 money makers. Gibson Photo Jewelry Co., Inc., 813-837 Grandend Ave., Brooklyn, N. Y.

NO Dull times selling food! People must eat. Federal distributors make big money; up to \$3,000 yearly or more. No capital or experience needed; unsold goods may be returned. We furnish free sample case, license and free samples for customers—sure repeat orders. Exclusive territory. Ask now. Federal Pure Food Co., A2307 Archer, Chicago.

A BUSINESS of your own—Making sparkling glass name and number plates, checkboard signs. Big book and sample free. E. Palmer, 512, Wooster, Ohio.

OUR Luminous crucifix and new luminous St. Therese statue shine brilliantly in the dark. Sell on first demonstration. Write for prices. W. G. Hannan Co., 2543 So. State, Chicago.

BIG Money applying gold initials on automobiles. Easiest thing today. No experience needed. \$1.45 profit every \$1.50 job. Free samples. "Balco," X-1043 Washington, Boston, Mass.

NEW Line Counter Displays, Aspirin, Plints, Chewing Laxative, Breath Gum, Nottart, Silstone, etc. Steady Repeats. Over 100% Profit. Superba Co., W5, Baltimore, Md.

BIG Money selling the big line—shirts, ties, hosiery, underwear, belts, work shirts. Something for every man! Big cash commissions—bonuses. Sales kit free. Dept. E5, Public Service Mills, West New York, N. J.

FORTUNES For live wires in hard water districts. Just patented! Water softener retailing \$7.85. Fits any faucet and flows like cataract. Competitionless. Protected territory. Sample \$4.85. Dow-Herriman, 325 Fifth, San Francisco.

GUARANTEED Hosiery—lowest mill prices, men's latest fancy hose—doz. \$1.49-\$1.75. Ladies' silk hosiery—doz. \$3.25-4. Catalogue free. Superior Knitting Company, Dept. 34, New Haven, Conn.

SELL Coin-in-the-slot devices. Transforms any electric radio into nickel-in-the-slot radio in two minutes. Easily demonstrated. Liberal commission. Big field. Radio Coin, 357 Badger Ave., Newark, N. J.

\$100 WEEKLY. Electric flasher and color-glow changeable signs. Advance, 46 W. 22nd, New York.

ENGRAVED Nameplates, signs, numbers, initial, desk, city nameplates. Big profits. Hilton Specialty, 90 Stewart, Providence, R. I.

AMAZING Profits! Permanent Chromium lustre instantly with Kwikchrome. Get paid for applying or sell jars. Details free. G. Cassidy, 569 Fifth Avenue, New York.

WANTED Representative to sell sewing machine attachment for making buttonholes. Sells for \$3.00. Alto Mfg. Co., 1648 Wolfgram St., Chicago, Ill.

AMAZING Electric water heater. Pays big profits. Heats water instantly. Pocket size. Sells fast at \$2.95. Write quick. Besterer Co., 431PE, Irving Park, Chicago.

AGENTS—Clever Invention! Inkspoon makes every pen a fountain pen. Fast office seller; big profit, demand increasing everywhere. Exclusive territory offered. Sample free. H. Marvel Company, Tribune Bldg., New York, N. Y.

CLEAN Up the year round, selling miniature Roulette Wheels. A most fascinating game. Everybody wants one. Sells on sight. 100% profit. Send \$1.00 for sample and instructions. Apex Distributing Company, 4845 Milwaukee Ave., Chicago, Ill.

FREE Circulars describing how you can make big money in Mail Order business at home. Arrah Publishers, 1217P, Avenue U., Brooklyn, N. Y.

AGENTS, House to house canvassers can earn big money selling our household necessities. Big demand, free details and circulars. Wex Sales Co., 3312 Brown St., Milwaukee, Wis.

NEW Scientific polish shines silver without rubbing. Unlimited demand. Big profit. Investigate. Naphite, 1616 Lauderdale Ave., Cleveland.

250,000 ARTICLES Wholesale—Directory 10c. W. Patterson, 4111 University, Des Moines, Iowa.

LOWER Prices! Bigger profits! Fast selling soaps, toilet articles, food products, household specialties. Premiums, free deals make sales easy. Write for big surprise offer. M. G. Roth, President, 2739 Dodier, St. Louis, Missouri.

AGENTS—New lawn mower sharpener, easily demonstrated, retails for \$1. Guaranteed. Mac-Ben, 1230 W. 8th St., Los Angeles, Calif.

SNAPPY New seller, repeats quick and often. Sell to women. Anywhere. Necessity. Your profit enormous. Get free details quick.—American Silko Co., 414 Bessemer Bldg., Pittsburgh, Pa.

NEW 25c Specialty, costs agents only 2c. Wonderful seller. Write for details. Al Schaeffer, Importer, Myersstown, Pa.

AGENTS—Dealers: Buy direct at wholesale. Save money. Write Dept. P. United Specialty Co., Smithboro, New York.

NO-TANGLE Ironing cord; cannot kink. Saves electricity. Tremendous profits. Sample free to workers. Besterer Co., 700 Irving Park Station, Chicago.

BIG Profits—Easy sales. World's best polishing cloth. Everybody buys. Sample free. MagCloth, 3317 Summit, Kansas City, Mo.

GENUINE Gold Leaf Letters anyone can put on store windows. Guaranteed to never tarnish. Large profits. Enormous demand. Free samples. Write today. Metallic Letter Co., 438-D North Clark, Chicago.

BIG Money daily selling shirts, ties, underwear, Sox, pajamas, belts, professional uniforms, raincoats, coveralls, pants, children's play suits. Outfit free. Experience unnecessary. Nimrod Co., Dept. 65, 4922-28 Lincoln Ave., Chicago.

OH Hello! Why didn't I see this before. Christy's Iron Rust and Stain Remover sells like blazes. Write for free sample. Christy, Inc., 5047 Union, Newark, New York.

AGENTS Everywhere making money with our line of kitchen specialties, demanded in all homes. Big earnings possible. Write today for details. P. Seed Filter Co., 353 Broadway, New York.

MAKE Money. Show mystery metal polishing cloth. Approved by good housekeeping. Send for free sample. Mohler, Quamia, Minn.

LARGE Importer of necklaces offers exclusive agency and entirely new proposition. Enormous demand. No competition. Unlimited possibilities. La Romance, 546 Broadway, New York.

WANT Distributing agent for handlick. Powdered Handsoap; removes anything from the hands without injury to skin; everybody a customer; great opportunity for hustler to get in business; sample free. Solar Products Co., 7-3144 So. Troy, Chicago.

FREE—Picture man Friedman's new cut price 56 page catalog, portraits and frames. Lowest in years. Friedman, 109 West Austin Ave., Chicago.

AGENTS—Mosco corn and callous remover will build you a steady repeat business. Send today for pocket-size trial outfit. The Moss Company, 104 Searle Bldg., Rochester, N. Y.

MAKE Your own products. Employ agents yourself. Toilet articles, soap, extracts. We furnish everything. Valuable book free. National Scientific Laboratories, 1950W Broad, Richmond, Va.

BIG Money and fast sales. Every owner buys gold initials for his auto. You charge \$1.50; make \$1.45. Ten orders daily easy. Write for particulars and free samples. American Monogram Co., Dept. 49, East Orange, N. J.

MAKE \$28 Daily demonstrating automatic gaslighters, sample 25c. Gross \$8; doz. \$1. Rapid Mfg. 2772 Pitkin Ave., Brooklyn, N. Y.

POLMET Polishing cloth—Removes tarnish from metal without the use of liquid, paste or powder. Agents say it sells like "hot cakes." Retails 25c. Sample free. Gale Co., Inc., 15 Edinboro St., Boston, Mass.

MAKE Your own products. Employ agents yourself. Toilet articles, soap, extracts. We furnish everything. Valuable book free. National Scientific Laboratories, 1950W Broad, Richmond, Va.

MAN in each town to plate auto parts, reflectors, bathroom fixtures, refinish beds, mirrors, chandeliers; by new method. No capital or experience required. Simple plan of manufacturing at home starts you in big money-making business. Outfit furnished. Free particulars and proofs. Gun Metal Co., Ate. H, Decatur, Ill.

THIS Advertisement may make you thousands of dollars. If you write immediately for my "Eye-Opening" literature describing guaranteed formulas; valuable trade processes, money-making information how to easily make the world's best-selling specialties. All lines. Investment small. Profits immense! Start in your home, room or office. Make the good money you're entitled to. Dr. Liscombe Miller, Chemist, Tampa, Fla.

GREATEST Opportunity; newest proposition. Build continually paying business in your own name. Household, industrial, brushes, brooms, mops, dusters, fully guaranteed. New catalog, all net prices, no discount to bother with. Make as high as 300 per cent and over. Write today. Wire Grip Sanitary Brush Corp., 41 East 114th St., New York.

SELL Men's neckwear—wonderful proposition. Astor-M, 39 East 28th, N. Y.

AGENTS: Stamping names on pocket-key protectors. Sample check with your name and address, 25c. Stamping outfits. Emblem checks, check-fobs, name plates. Hart Mfg. Co., Desk 2, 303 Degraw St., Brooklyn, N. Y.

AGENTS—Can openers, new improved hand, wall, table models. Safety Products Co., 315 American Bank, Kansas City, Mo.

NEW Automatic clothes washer. Washes quickly and thoroughly. No rubbing. No electricity. Retail \$9.75. Guaranteed. Write Storm Royalty Co., 3401 Enright, St. Louis, Mo.

SELL Housewives something they want. They are bound to be interested. A signed guarantee to reduce gas bills 25%. No competition. 400% profit. Station C, Box 25E, San Diego, Calif.

BIG Profit putting our gold sign letters on store windows, without experience. Samples. Consolidated, 69-T West VanBuren, Chicago.

MANUFACTURER Wants distributor for new "Pocket Radio," only \$3.85. "Sells itself with music." Pays 100% profit. Spencer Radio, Akron, Ohio.

AGENTS—Engraved name plates, signs, number plates etc., easily sold with large profits. Brett Bros., Wingham, Mass.

CHICAGO Expert valued \$3 stone at \$900. The diamond's only guaranteed rival. Greatest spare time, side-line article ever known! Amazing profits. \$5 pocket sample case free. Write quick. Mexican Gem Company, Dept. PM, Monterey, Calif.

FREE "Booklet of money making opportunities," new ideas, original plans, money making secrets and other valuable information. Name require peddling or outfits. Elite Co., 84 Elizabeth St., New York.

BEST Books for \$1. All formerly sold for \$2.50 to \$5 each. Select from the following list of guaranteed bargains. All brand new books: Woodcraft by Seton. Book of Letter Writing by Cressler. Etiquette by Eichler. Creative Chemistry by Shosson. Revolt in the Desert by Lawrence. Trader Horn, White Shadows in the South Seas by O'Brien. Count Luckner (The Sea Devil) and Outline of History by Wells. Delivered at your door C. O. D. Simply pay postman \$1 each and postage. Popular Mechanics Press, Room 802, 209 E. Ontario St., Chicago.

HIGH-GRADE SALESMEN WANTED

ADVERTISING Salesmen—Agencies. Here's a repeat proposition that yields big profits—placing Automatic Price Chart and Advertising cabinet at filling stations—yearly renewals—big profits first year—All velvet after that. Write for proposition. The Paramount Specialty Company, Warsaw, Illinois.

ALL Merchants buy! 5c carded nuts, aspirin, etc. Steady repeats. Also low priced vending machines. Robin Products, 21 DeLamoth Street, Brooklyn, N. Y.

ELABORATE Printing outfit free. Largest assortment specialty items and novelties at half price. Union label. 72 hours delivery. Big commissions advanced. Experience unnecessary. Northwestern 625-D Jackson, Chicago.

AMBITIOUS Salesmen wanted to sell new salted confection. Nothing like it. Taking country by storm. Tremendous field. Big profits. Virgin territory. Radio Adv. Write Korn Parishes, 705 Field Bldg., Spencer, Ind.

AMAZING Patented envelope sealer. Seals 50 minutes. Retail \$4.50 each. Offices buy on sight. Tremendous market. Free Trial. Sealer, 8004 Spring Lane, Boston.

STOP Working for small pay—start your own business on our capital; pays better than most occupations; hundreds average \$6,000 annual sales year after year; some established 30 years; many have acquired wealth, homes, farms, cars; we supply stocks, equipment, on credit; some 200 home and farm necessities; nearly 50 million sold 1930; selling experience unnecessary; wonderful opportunity to own pleasant, dignified, profitable business backed by \$17,000,000 world-wide industry; first send for complete information—then decide. Raleigh Co., Dept. E-N-PPM, Freeport, Ill.

STRAW Hats, sport and novelty models of our manufacture. Sensational sellers wherever shown. Snappy new styles and prices make every dealer a quick prospect. 25% commission. Advances made weekly. Earn \$60.00 weekly on sales of only six dozen per day. Full credit given on all orders from your territory. Line of new samples, and instructions sent prepaid immediately upon receipt of deposit of \$3.50 which is refunded when your earnings amount to only \$25.00. Southern States Hat Co., 7th and Clark Ave., St. Louis, Mo.

GENUINE Neon—Priced to sell 40% commission. Buyers want it. Willis Austin, Miami, Okla. made four calls, sold four. Collected \$80.00, three hours work. Doubt it? Write him. Every hustler hits with Neomete—the genuine Neon border display with changeable letters and posters. Sizes for all show windows. Also mounted Neon letters. Plug in any A.C. socket. Big money for early birds. Special 30-day demonstrator trial offer. Display Products Co., 409 East 31st, Kansas City, Missouri.

WANTED—Salesmen of ability to sell a high-class specialty to town and country property owners. Must furnish car. Commission proposition but terms will be arranged to suit individual cases, and different territories. Write fully regarding yourself, past experience and furnish references. Kretzer Mfg. & Supply Co., 2141 DeKalb St., St. Louis, Mo.

SELLING Like blazes. Beautiful toilet goods assortment at \$1.75 with 24 inch pearl necklace free to your customers. 100% profit. Davis Products Co., 238 North Ave., Dept. 930, Chicago.

WE Want to hear from full and part time men who can sell complete line of business printing. One of finest in country. Thousands of live cuts. Full cooperation and progressive sales plans. Outfit free. All-Trades, 110 N. 2nd St., Rockford, Ill.

NAME Your own profits. New panel portraits sell everywhere shown. No competition. Free sample offer. Steady income from repeats. Cruver, 2462F Jackson Blvd., Chicago.

SALESBOARD Men: whirlwind seller. \$15 profit every call. Repeat commissions. Best season. Hurry. Puritan Mfg. Co., 2937-F Charleston, Chicago.

GIVE Away Ladies' pure silk stockings with wonderful value \$1.00 sets of toiletries. 100% profit. Paris Laboratories, 2624 Olive, Dept. 551, St. Louis, Mo.

BUSINESS Stationery—Largest line—Highest quality. Quickest delivery. Biggest commissions. Liberal bonuses. Free copyrighted cuts every business. Experience unnecessary. Instructions and outfit free. David Lionel Press, 312 So. Hamilton, Dept. 211, Chicago.

GREATER Sales. Live ideas and suggestions in "Independent Salesman" every month will increase your earnings. It's the kind of a magazine you'll want to read. Send 10c for six months' subscription. Independent Salesman, 27 East 12th, Cincinnati.

ADVERTISING Novelty salesmen for new advertising specialty. Liberal commissions in advance. Gits Co., 5421-G Chicago Ave., Chicago.

SALESMEN—New fast selling line of 10c to 50c patented specialties, backed an attractive counter display cards. Exclusive, no competition. Every dealer a prospect; 100% profit. Big repeats. C. Masterlite, 110 E. 23rd St., N. Y. C.

SALESMEN—400% Profit on \$1.00 sale. Cleaner for autos, furniture, metal and glass. Your name on labels. Exclusive territory. Free sample. Write, Minute Klean Laboratories, Dept. E, Evansville, Ind.

NEW Punctureproof plan! We furnish everything. No investment for you or your customer. Nothing to sell or carry. 50% profit. Unsuitable merchandise returnable. Full commission on repeats. A. J. Novelty Co., 161-F Washington, Chicago.

SALESMEN Sell tires and auto accessories to garages, tire stores, filling stations, etc. Established line repeats everywhere. Liberal commission. Write for particulars. Economy Rubber Prod. Co., 606 Burkhardt, Dayton, Ohio.

NEW—Startling—amazing. \$10 to \$25 a day easily earned. Home protection \$250 to \$1000, at death. Ages 1 to 80. Not an insurance company but a society furnishing protection at cost. Write National Aid Society, Myers Building, Springfield, Ill.

EARN \$10-15 Daily. Introduce famous \$3000.00 Penny-A-Day Accident Policy. Cost only \$3.65 yearly. Covers all accidents. Everybody needs and can afford it. Men with and without experience make big money daily. Write today. Safety Underwriters, P.O. 127 N. Dearborn, Chicago.

NEW Specialty—Sells every business and professional man. Four \$15 sales daily pay \$280 weekly. Foyer cleared \$4920 in three months. Write, P. E. Armstrong, President, Dept. PM, Mobile, Ala.

WANTED—Chummy salesman with car, to demonstrate for large Ohio manufacturer. First-class job. Fry-Flyer Co., 2175 Fry-Flyer Building, Dayton, Ohio.

GRAPE Concentrate—Port, Sherry, Champagne, Claret, etc. in solid brick form; one brick makes one gallon juice; legality twice established in courts; government financing industry; every home, hospital, church, grocery, drug store prospect. 100% profit for distributors—salesmen. Vino Sano Co., Dept. 8-176, 395 9th St., San Francisco, Calif.

SALESMEN Wanted—100% pure mamilla rope 1 1/2 lb. basis. Fast selling side line. Five percent commission. State references, how long travelling present territory. United Fibre Company, 82 South St., New York City.

DISTRIBUTOR Wanted. Patented, chrome-plated safety gas tank cap. Prevents gasoline thefts and loss of cap. Recommended by auto manufacturers. Nationally advertised. Attractive proposition. Write 402 Stephenson Bldg., Detroit, Mich.

SALESMEN—Wonderful sideline. 40% commission paid daily. Sells all merchants. Pocket outfit free. Willens Co., Dept. 358, 2130 Gladys Ave., Chicago.

WONDERFUL Invention. Seals fifty envelopes minute. Sells on sight at \$2.25. Attractive trial offer. Square deal. Bank references. Kendall Sealer Co., Dept. C-30, East Jaffrey, N. H.

\$18 TO \$25 Daily; biggest selling line of men's suits. Meets present day conditions. Amazing values at \$11.95, \$14.50, \$16.95, \$18.95. Also raincoats, slickers, topcoats and boys' suits. Biggest commission paid in advance. Liberal bonus. Free outfit. State age and selling experience. "Jim" Foster, Inc., Dept. 25, 2250 South Spaulding Ave., Chicago.

ONE \$6.75 Order daily means \$100 weekly from original and repeat commissions. A lifetime job. Free kit. Sales Stimulators, Dept. 16-H, 341 Madison, Chicago.

NEW And plenty different—Fast selling 5c-10c merchandises on attractive counter cards. 100% commission for you and dealers. Advertised by radio. No capital required. Catalog free. World's Products (Estab. 1921), 140 Central, Spencer, Ind.

CHRISTMAS Cards. Real proposition for live wire district managers. Buckeye Thermographers, 1108 Adams, Toledo, Ohio.

SCREW-HOLDING Screw drivers! Non-magnetic. Remove, insert screws inaccessible places. Factories, garages, electricians, carpenters, mechanics, auto, radio owners buy on sight. Free trial. Jiffy, 1806 Winthrop Bldg., Boston.

\$40.00 DAILY Selling guaranteed collection systems used by all business men. PM1301 Washington Building, Los Angeles.

ADVERTISING Pencils sell fast to every business. New. Quick cash commission plan. Main or sideline. Free pocket outfit to real salesmen. Chicago Graphite Co., 130 So. Clinton, Chicago.

NEW. Largest color catalogue, punch-boards, vending machines, produces quicker orders, big commissions. Free outfit. Lincoln Sales, 116 So. Wells, Chicago. Dept. D. Established 20 years.

SALESMEN—Easy selling Die-U-Rat thru fobbers. 20% commission. Kills nothing but rats and mice. Rick Drug Co., Gallon, Ohio.

SALESMEN—Now calling upon exclusive men's furnishing stores, to sell outstanding line of hosiery, on straight commission basis. Send references and full details in first reply. Address Sales, 2903 N. 4th St., Milwaukee.

\$66-\$200 A WEEK. Genuine gold letters for store windows. Easily applied. Free samples. Liberal offer to general agents. Metallic Letter Co., 438-A North Clark, Chicago.

SELL Mechanics—garage help—working groups their heavy-duty work shoes. \$2.95 to \$4.95. Established line—Fast sellers. Specially for this trade. Big commissions. George Merritt Shoe Co., 65 Court, Brockton, Mass.

SALESMEN—At last! New feature sells punchboards everywhere. Dealers wild with joy—prosperity back again. Profits enormous. Samples free. Puritan Co., 1407 Jackson Blvd., Chicago.

SALESMEN—New fast selling line of counter display cards, 5c and 10c staples and novelties in tremendous demand everywhere. Quick repeats. 100% for you and retailers. Main or sideline. No capital necessary. Drexel Company, Elgin, Ill.

BIG Money daily selling shirts, ties, underwear, Sox, pajamas, belts, professional uniforms, raincoats, coveralls, pants, children's play suits. Outfit free. Experience unnecessary. Nimrod Co., Dept. 65, 4922-28 Lincoln Ave., Chicago.

SALESMEN—Become independent. Own your business; experience unnecessary. Sell our \$10,000 accidental death; \$50 accident; \$25 sick weekly benefits—\$10.00 yearly. Other amounts proportionate. Guaranteed steady income from renewals. \$250,000 deposited insurance department. Universal Policy, Dept. A, 716 Lefcourt Bldg., Newark, N. J.

SELL Nothing! \$170 weekly empty handed. \$500,000 punchboard firm announces new plan. No investment for anyone. Season starting. Hurry! K&S Sales, 4328 Ravenswood, Chicago.

SALESMEN: Our men earning \$15-\$40 daily selling to stores. Sayers Systems, Est. 1895, 2813 Sheffield, Chicago.

BIG Profit putting our gold sign letters on store windows, without experience. Samples. Consolidated, 49-V West Van Buren, Chicago.

HELP WANTED

IF You want to get your groceries and household supplies at wholesale, and a wonderful chance to make \$15 cash profit a day besides, send me your name immediately. No experience necessary. Albert Mills, 9130 Monmouth, Cincinnati, Ohio.

SPLENDID Opportunity for wide-awake man to sell nationally known Meeker-Made line calendars, signs, novelties and advertising leather specialties. Liberal commission arrangement. Protected territories. Write fully. Give experience, age, at least three reliable references first letter. The Meeker Company, Inc., Joplin, Mo.

A BILLION Ideas. This is the title of our remarkable catalog of books along practical lines. Arranged alphabetically by subjects for easy reference. If you have not received it, send for a copy. You will find hundreds of subjects you cannot usually locate in book stores or public libraries. Sent free upon request. Popular Mechanics Press, Room 802, 200 E. Ontario St., Chicago.

MEN To distribute pipe grates to merchants, on commission, write, Pipe Grate Mfg. Co., 2220 So. Keeler Ave., Chicago, Ill.

CASH Paid for butterflies, insects. See Sinclair Display advertisement on page 18.

ANOTHER Famous \$5 book now \$1. The Story of Philosophy, by Will Durant, is the latest popular book of modern times to be placed within the reach of everyone. You will want to add this to your library. The author has the knack of making the lives and opinions of great philosophers as interesting as dramas. 592 pages. Illustrated. Cloth. Sent C. O. D. Pay postman price \$1 and small amount of postage upon delivery. Popular Mechanics Press, Room 802, 200 E. Ontario St., Chicago, Ill.

EDUCATIONAL AND INSTRUCTION

PHOTOPLAY Talking picture and magazine stories wanted for revision, development and copyright. Sell on commission. Established 1917. Booklet free. Universal Scenario Company, 406 Meyer Bldg., Western and Sierra Vista, Hollywood, Calif.

U. S. GOVERNMENT steady jobs. Men-women, 18 to 50. \$105.00 to \$250.00 month. Steady work. Short hours. Paid summer vacation. Common education usually sufficient. Experience usually unnecessary. We coach you without leaving home. 32-page book with particulars and sample coaching free. Write immediately—Today. Franklin Institute, Dept. C3, Rochester, N. Y.

U. S. GOVERNMENT Wants men, \$1,700-\$1,900 and up at start. Railway mail clerk examination coming. Let our expert (former government examiner) prepare you for this and also rural carrier, post office, customs, internal revenue, and other branches. Write today for free booklet. Dept. 8, Patterson School, Rochester, N. Y.

FIREMEN, Brakemen, baggagemen; colored train or sleeping car porters. \$150-250 monthly. Experience not necessary. 810 Railway Instruction Bureau, East St. Louis, Ill.

RAPID Figuring quickly learned. For particulars, address, Frederick A. Smith, 4746 Virginia Ave., Chicago.

THE Art of Cartoon Courses for only \$2.98. Particulars free. Carl Anderson School, Madison, Wis.

LEARN Photo-Engraving at home. Signature etching and particulars free. Aurora Photo-Engraving School, Aurora, Missouri.

AVIATION—Every person interested in this subject should make full use of the opportunity to learn aerodynamics with Alexander Klemm as his instructor, through his timely new book, "Simplified Aerodynamics." Heretofore this subject has been rather difficult for the thousands who need it but Klemm's method enables all to master it. Every pilot, mechanic, student needs this book. Pay postman price, \$3.50, and few cents postage when he delivers it. Order from Popular Mechanics Press, Room 802, 200 E. Ontario St., Chicago.

DON'T Prepare for any civil service examination without seeing our catalog. Free. Columbia Correspondence College, Washington, D. C.

GET Steady government job, \$105-250 month. Men-women, 18-50. Particulars free. Write, Instruction Bureau, 101, St. Louis, Mo., Today.

REFRIGERATING Machine, homemade. Inexpensive to build. Gives better service than ice. This and 328 other practical articles in our book "Home Mechanics." Just ask for this and "Handbook for Women," containing 394 valuable household helps and pay postman 98 cents and postage for the two books. Popular Mechanics Press, Room 802, 200 E. Ontario St., Chicago, Ill.

BECOME A landscape architect. Uncredentialed profession; wonderful opportunity for money-making. Easily mastered by mail. Earn while you learn. Est. 1916. Write for details. American Landscape School, 29A Plymouth Bldg., Des Moines, Iowa.

DOUBLE Entry bookkeeping 60 hours with 8 keys guaranteed. (Diplomas.) International Bookkeeping Inst., 8 Springfield, Mo.

OUTDOOR Sports for everyone—Enjoy them all year round with aid of great new book just published by Popular Mechanics. This veritable encyclopedia not only furnishes hundreds of ideas for new and popular sports for every season of the year, but also gives complete instruction for making the necessary equipment at very small cost. 350 pages and 650 illustrations. Send today as book is full of thrills and excitement for fall and winter sport enthusiasts. Mailed postpaid anywhere for \$2, or will be sent C. O. D. to any address in U. S. Simply pay postman when delivered. Popular Mechanics Press, Room 802, 200 East Ontario St., Chicago.

SHORT STORIES

SHORT Stories revised, typewritten and marketed. Details free. Hursh Service, Box P-1013, Harrisburg, Penna.

HUMOROUS Stories illustrated. Sample, particulars free. Cartoonist Keller, 17 Maryland, Rochester, N. Y.

LEARN Typewriting at home. Rational typewriting, brief course by Sorelle (a Gregg publication) enables you to become proficient at typing without the aid of an instructor. 96 pages. Illustrated Cloth. Sent C. O. D. Pay postman price, \$1 and small amount of postage upon delivery. Popular Mechanics Press, Room 802, 200 E. Ontario St., Chicago, Ill.

TYPEWRITERS AND SUPPLIES

TYPEWRITERS—All makes, guaranteed. New lowest prices. Catalog free. Typewriter Exchange, Ada, Okla.

TYPEWRITERS—All standard makes \$10 up. Catalog free. Northwestern Typewriter Exchange, 121 N. Francisco Ave., Chicago.

ADDING MACHINES

NEW \$1.75 Automatic Adding Machine. Fully guaranteed. Bassett 1458-A, Hollywood Avenue, Chicago.

PRINTING, MULTIGRAPHING AND MIMEOGRAPHING

250 BUSINESS Cards \$1.00; 1,000, \$2.75, postpaid. Samples. D. N. Fox, Perryville, Md.

BATTERY Automatic presses ready to print for you. Distinctively different printing service. Battlefield Press, Gettysburg, Penna.

1000 CARDS \$2.85 Prepaid, other printing lowest prices, no samples or estimates unless specimen sent, postals unanswared. Lightning, 2805 Kellogg, Wichita, Kansas.

500 BUSINESS Cards \$1.75 prepaid. Automatic Press, 7543 15th Ave., Kenosha, Wis.

NEARGRAVURE—250 Each letterheads, envelopes \$3.33 postpaid. Solidays, Knox, Indiana.

5,000 ENVELOPES 6 1/2 printed, \$9.25. 200 personal stationery, 100 Envelopes Linen finish, \$1.25. Halberstadt Printing Co., Terre Haute, Ind.

NOW—Business stationery in color—for less! Write for details. Printing, 934 Bayless, St. Paul.

EXQUISITE Personal stationery! 100 folded sheets, 100 envelopes, ripple finish—bond monogram in cabinet, \$1.75. 100 cards, \$1.00. 500-\$3.00 prepaid. Dept. PM1, 2311 Listone, Houston, Tex.

HIGH Grade stationery and cards. Box 475, Starsdale, New York.

200 PRINTED Letterheads, 100 envelopes \$1.00. 1,000 Hammermill letterheads or envelopes \$3.25. 1,000 Multigraphed letters \$2.95. Everything furnished. Cash. Estimates free. Halberstadt Printing Co., Terre Haute, Ind.

PRINTED Letterheads, envelopes, cards, etc. Quality. Reasonable price. Ware, Box 357, Ft. Madison, Iowa.

500 NOTEHEADS Or half letterheads, printed, \$1.25. Kalata, Ironwood, Mich.

50 EACH—Letterheads, envelopes, note-heads, cards, \$1.00; 100 each, \$1.50, prepaid. Maywood Publishing, 921 Broadway, New York.

200 SHEETS, 100 Envelopes, 60c. Applebaum—P. 1258 Brook, New York.

WRITE, Webster's Press, Farmland, Indiana, for low estimates on printing.

1000 BUSINESS Cards \$2.75 postpaid. Samples. Miller, Printer, Narberth, Pa.

5000 TWO Color gum labels 2 1/2 x 1, \$1.25 per thousand. 5000 20 pound Hammermill Bond letterheads in neat cartons, \$3.25 per thousand. Write for other prices. Old Dominion Label Co., Bridgewater, Virginia.

RAISED Letter printing. Samples and prices on request. LaClyde Service, Westfield, Mass.

250 BOND Letterheads, envelopes, bill-heads, cards, \$1.35 each. Economic Press, Leonia, N. J.

5000 LOTS—Attractive colored envelope slips, \$5.00; 3 1/2 x 6, Tinted folders, \$13.75; 6x9 circulars, \$7.50. Samples. Goodprint, Harrisburg, Va.

LETTERHEADS, Envelopes, 500, \$1.10 1,000, \$2.00; 5,000, \$8.00, plus postage. Samples. Coyle & Kimball, Newport, N. Y.

QUALITY Printing! Reasonable prices! Send for free standardized samples and prices. Folders. Circulars. Catalogs our specialty. Earnest Fantus, 525 South Dearborn, Chicago.

500 LETTERHEADS And 100 envelopes, \$1.00; 200 letterheads, 8 1/2 x 11, 150 envelopes, \$2.00; 250 cards, \$1.00. Hoosier Print Shop, Portland, Ind.

WE Print stationery, booklets, catalogs, circulars. Samples. Commercial Press, Barta, Ohio.

PRINTING OUTFITS AND SUPPLIES

NEW Printing device—Anyone can make. Particulars free. Imperial Laboratories, Edwardsville, Illinois.

PRINT Your own cards, stationery, circulars, advertising, etc. Junior Press \$5.90, Job presses \$11 up, power \$149. Print for others, big profits. Easy rules furnished. Write for free catalog and full information. Kelsey Co., R-11, Meriden, Conn.

MIMEOGRAPHERS For sale, used and reconditioned. Write for particulars. Bond Equipment Company, 307 Cardinal, St. Louis.

PHINT Colors without plates. Simple method. W. C. Co., 29 Madison St., Wallingville, N. Y.

PREUSED Printing presses and supplies. Lists by stamp. Popular Bargains, Richmond, Pa.

PRINTING Outfits—Presses, type supplies, type novelties. Send stamp for catalog. Model Press, York, Penna.

GUMMED LABELS

TRIAL Thousand Ticolor stickers, 75c. 15 words. Harvey Wolf, 6613F Quinby, Cleveland, Ohio.

1,000 **PRINTED**: Name, business, address 50c. JBS Company, Box 93, Hahroke, Mass.

DUPLICATORS AND DEVICES

"EXCELLOGRAPH" Rotary stencil duplicator \$39.00. "Two-Faced" film duplicator \$6.00. Booklet free. Pittsburgh Typewriter Supply, Dept. 601, Pittsburgh, Pa.

STENCIL Duplicator—Anyone can make. Particulars, samples free. Imperial Laboratories, Edwardsville, Ill.

RUBBER STAMPS

SEND Dime for comic stamp and literature describing rubber stamp making. Slocum, Stamp Works, Peoria, Illinois.

ALL Kinds rubber stamps. Newman & Son, 2208 O., Lincoln, Neb.

3 INCHES Long, 1/4 inch type, 30 cents line. Additional lines 20 cents. Blomquist, New Albany, Ind.

RUBBER Stamps, name, address 35c. Stamp Works, B22M., Auburn, Neb.

FOR MEN

SIDELINE—Cartoon books. Samples 10c, 25c. Meyer G P O. Box 471, New York.

FOR THE HOME

CEDAR Chests only \$11.85—"Red-1-Kut" complete with rich copper trim—you assemble and save half—send for pictures. Kuempel Furniture Company, Guttenburg Iowa.

FOR Sale—Pure Vermont maple syrup and sugar. Bert Prescott, Essex Junction, Vermont.

THAT Concrete Job. Don't be afraid to tackle it. With the instructions found in the new edition of Popular Mechanics Concrete Handbook you can easily make 173 articles of utility and beauty ranging from ordinary steps to garden furniture. This book will be sent for only 95c plus postage C. O. D. Send your order today to Popular Mechanics Press, Room 802, 209 E. Ontario St., Chicago, Ill.

FOR SMOKERS

HOME Cigarette machine? Illustrated circular. \$3.75 postpaid. Automatic Cigarette Machine Wks., 1035 Sheridan, Chicago.

FIELD GLASSES, TELESCOPES AND MICROSCOPES

\$5.00 BOUGHT New lot government field glasses with case. Send for free list binoculars, field glasses, telescopes, aeroplane cameras, lenses, musical instruments and government radio sets and parts. Well's Curiosity Shop, 20 South Second St., Philadelphia, Pa.

FOR MECHANICS

BUILD Your own winddriven electric plant. Send \$1.00 for blueprints and building instructions. Louis Klingsiek, Optima, Okla.

WOODTURNING For amateurs. Excellent new instruction book just published for the amateur and home work shop owner. Contains all the needed information and is well illustrated yet published to sell at the low price of 25 cents postpaid. Send for your copy today. Mail remittance with your order. Popular Mechanics Press, Room 802, 209 E. Ontario St., Chicago.

RAZORS AND BLADES

YOUR Dull Gillette blades sharpened, 1c each. Pette, Wetterquist, Bookford, Ill.

GUNS, FISHING TACKLE AND SPORTING GOODS

"ALL Outdoors" for folks who enjoy fishing, hunting, trapping, camping, touring, fur-farming, game bird breeding, etc. Big swap department. 32 to 48 large pages monthly illustrated. Special offer six months 25c. One year 50c. Sample copy 10c. All outdoors, PMS34 Douglas Bldg., Los Angeles, Calif.

EARN Set of golf clubs and bag. Free information. Great American Novelty Co., 4742 No. St. Louis Ave., Chicago.

DIAMONDS, CLOCKS, WATCHES AND JEWELRY

CLOCKS Electrified; outfits as low as \$3.95. Splendid opportunity for handy men. Breilinger the Clock Maker, 1675 Ruffner St., Phila.

WATCH REPAIRING

WATCH And clock parts, repairman's tools, supplies and materials. Circulars free. Beck Brothers, Fort Wayne, Ind.

ANTIQUES, WAR RELICS AND INDIAN GOODS

INDIAN Relics, for the collector. Our bargain lists free. The Exchange House, Blackwater, Virginia.

LONGEST Steer horns for sale in Texas. Lee Bertillon, Mineola, Texas.

ENORMOUS Stock Indian relics, old arms and curios; list ten cents. N. Carter, Elkhorn, Wis.

SLOCUM Collection 20,000 various gun points, axes antiques, firearms, daggers, curios, china, glass, pewter, engravings, lists free. Antiquarian, 1536 P. Willington St., Philadelphia.

WAR Medals, Relics for collections. Illustrated catalog 10c. Dars, 670 E. 42, Brooklyn, N. Y.

200 ANTIQUE Clocks. Rare specimens. Grandfathers, Bracket, Wethored, Watchmaker, Bath, England.

SEND 5c For fine new list Indian relics, antique firearms. F. E. Ellis, Webster Groves, Missouri.

INDIAN Relics, Coins, Curios, Beadwork. Catalogue free. Vernon Lemley, Osborne, Kansas.

MUSIC AND MUSICAL INSTRUMENTS

BAHAMIAN Melodies (5) \$1.00. Catchy, amusing. R. Moore, Nassau, Bahamas.

SONGWRITERS: We guarantee to compose music satisfactory to you. National, 1475 W.F. Broadway, New York.

POPULAR Songs—35c, three \$1.00, orchestration, 50c; piano rolls, 60c. Dodge, 954 Main, Melrose, Mass.

SONGWRITERS! Invaluable services. Eddie Boyden, 731 E. 23rd, Indianapolis, Ind.

SONGWRITERS' Service, P6719 Hollywood Blvd., Hollywood, Calif. Songs revised for publication, radio, talkies. Music, words. Guarantee. Free particulars.

FREE Pamphlet for song writers. Richard Broughton, Sioux Falls, S. Dak.

SONG Writers. Send for our "Publishing Agreement." McKinley Music Printers, 1501 E. 55th St., Chicago.

SONG Poets, write Sequoia Songwriters Service, Sherman Branch, Los Angeles, Calif.

SONGWRITERS—Arranging, composing, copyrights. Information? Gladly. Tucker, 339 Wadsworth, New York.

SONGPOEM Writers—For better proposition, write Studio, 115M, Orrville, Ohio.

CORNETISTS—Trombonists—Saxophonists—Clarinetists. Get "Free Pointers." Name instrument. Virtuosi School, Buffalo, N. Y.

WRITE Songs. Big money and reputation. Write for information. J. Gordon Pub. Co., 201 N. Hoyme Ave., Chicago.

FREE! Song writers guide. Beaver, 1237 Elm, Green Bay, Wis.

\$7,500 PAID For one song! More wanted! Particulars free. Greenstreet, Park Avenue, Kewanee, Ill.

SONGWRITERS! Advance royalty payments, new talking picture song requirements, etc., fully explained in our free instructive booklet. Newcomer Associates, 1674-DD Broadway, New York.

SUBMIT Modern song poems. Valuable marketing assistance. Clifford Studios, 4592 Hollywood Blvd., Hollywood, Calif.

SONGWRITERS Free criticism. Edward Madden, 113 Michaels, Syracuse, N. Y.

DUO-Flex reeds for clarinets and saxophones eliminate your reed troubles. Write for circular. Duo-Flex Reeds, 1204 1st Ave., Evansville, Ind.

POEMS Wanted. Work guaranteed. We publish. Great Eastern Song Bureau, Dept. 27, Thomaston, Me.

"MUSIC Composed" to words. Bauer Bros. (formerly of Sousa's Band), Oshkosh, Wis.

SEND Song poems, 50-50 plan. Indiana Song Bureau, (Brookside), Salem, Ind.

PHONOGRAPHS AND RECORDS

BUILD Phonograph radio. Catalog mailed for 10c. American Phonograph, 3002 Wesley, Berwyn, Ill.

PATENT ATTORNEYS

CANADIAN Patents filed \$35; American \$55; all foreign low. J. J. O'Brien, 156 E. 42nd, New York.

TIME Counts in applying for patents. See pages 149 and 141. Clarence A. O'Brien, Registered Patent Attorney, Washington, D. C.

PATENTS—Write for our free book, "How to Obtain a Patent" and Record of Invention Blank. Send model or sketch of invention for inspection and instructions free. Terms reasonable. See advertisement on pages 142 and 143. Victor J. Evans & Co., 934 Ninth, Washington, D. C.

LACEY'S Patent Sense. Valuable book free See ad page 144.

PATENTS Procured. Prompt, careful efficient service. Highest references. Moderate fees. Send sketch or model for actual search and advice. George P. Kimmel, Master of Patent Law, 54-E, Westory Bldg., Washington, D. C.

PATENTS. Booklet free. Highest references. Best results. Promptness assured. Watson E. Coleman, Patent Lawyer, 124 Ninth St., Washington, D. C.

"INVENTOR'S Guide," valuable information, free. Frank Ledermann, Registered Attorney-Engineer, 1712 Woolworth Bldg., New York.

ESTABLISHED 1884. Milo H. Stevens Company. Free booklet. Patents. Trade marks. Copyrights. Offices. Monadnock Block, Chicago; Barrister Bldg., Washington, D. C.

LANCASTER, Allwine & Bonnell, 231 Ouray Bldg., Washington, D. C. "Originators of the Form Evidence of Conception." Before disclosing your invention to anyone send for blank form to be signed and witnessed. Form and patent information bulletin free.

PATENTS—Write for free information. How to Obtain a Patent and Record of Invention—or send drawing or model for examination. Miller & Miller, Patent Attorneys (former Patent Office Examiners), 1036-A Woolworth Building, New York; 259 McGill Building, Washington, D. C.

INVENTORS: Send for booklet telling how to patent and sell your inventions at lowest cost. Ralph Burch, Patent Lawyer, 906 F St., Washington, D. C.

PATENTS. Send sketch or model for advice. Free book, "How to Obtain a Patent." Established thirty years. Highest references. Prompt service. Reasonable charges. Chandler & Chandler, 988 F Street, Washington, D. C.

INVENTIONS Patented and Exploited. Former patent office examiner; Master patent law. Benj. Webster, Esq., No. 15 East 26 Street, New York.

INVENTORS—Write for our Guide Book, "How to Get Your Patent," and Evidence of Invention Blank. Send model or sketch of your invention for our prompt examination and instructions free. Randolph & Co., Dept. 459, Washington, D. C.

PATENTS Procured; trade marks registered—preliminary advice furnished without charge. Booklet and form for disclosing idea free. Irving L. McCathran, 704 International Bldg., Washington, D. C.

FOR INVENTORS

To Inventors: We are in the market to purchase a good patent, preferably in the automobile accessory line. Will purchase outright or on a royalty basis. Purchasing Agent, 241 Front St., New York, N. Y.

CONCERNS Willing to pay thousands of dollars for useful patents. Send \$1 for list of things to invent and start on the road to fortune. A. T. Downing, 18 Greenough Ave., Boston, Mass.

EXHIBIT Your invention or patent at the international patent exposition, Chicago, April 13 to 20. Thousands of manufacturers expected to attend to inspect new inventions. You may exhibit with or without model. Space \$7 up. Write International Patent Exposition, Merchandise Mart, Chicago.

INVENTORS, 50 Needed inventions. 25c (coin). Bauer, Box 587, Milwaukee, Wis.

PROTECT Your business—Organize a company. Raise capital. Sell shares. Any business. Write. Free advice. Corporation Fiscal Co., Wilmington, Delaware.

TIME Counts in applying for patents. See pages 140 and 141. Clarence A. O'Brien, Registered Patent Attorney, Washington, D. C.

LACEY'S Patent Sense. Valuable book free. See ad page 144.

INVENTIONS—Write for our free book "How to Obtain a Patent" and Record of Invention Blank. Send model or sketch of invention for inspection and instructions free. Terms reasonable. See advertisement on pages 142 and 143. Victor J. Evans & Co., 157 Ninth, Washington, D. C.

INVENTOR'S Universal Educator: contains 940 mechanical movements; 50 perpetual motions; instruction on procuring and selling patents and selecting an attorney, etc. Suggests new ideas. Price \$1.00 postpaid in U. S. A. Address Dietrich Co., 602B Ouray Bldg., Washington, D. C.

MANUFACTURERS now want sound, practical inventions, patented or unpatented, to meet keen competition. Information free. Chartered Institute American Inventors, Barrister Building, Washington, D. C.

MANUFACTURERS Everywhere seek new inventions to improve their product. Names of manufacturers and wanted inventions sent free on request. Write W. T. Greene, 944 Barrister Building, Washington, D. C.

OFFICIAL Patent office drawings made. Patents obtained. A. M. Jacobson, 53 West Jackson, Chicago.

INVENTIONS Patented and Exploited. Former patent office examiner; Master patent law. Benj. Webster, Esq., No. 15 East 26 Street, New York.

INVENTORS—Cash in on your invention now! Don't delay the sale any longer! Send for a free copy of our specially prepared booklet, "Turn Your Patent Into Money," today! It contains helpful information for all inventors. M. L. Rund, Mgr. Classified Advertising, Popular Mechanics Magazine, 200 E. Ontario St., Chicago, Ill.

LOW Cost manufacturing. Large plant completely equipped for blanking, drawing, stamping and wire forming in any finish. Can save you money on your product. Our figures will convince. Eastern States Products, Box 721, New Haven, Conn.

INVENTIONS—Have you conceived one? There is a long, winding road to travel before your vision of rewards can be realized. Send for the new book "Inventions and Patents, Their Development and Promotion" by an eminent authority. It is designed to guide the inventor on his way and help him avoid pitfalls. Will be sent C. O. D. Pay postman \$2.50 plus postage when he hands you the package. Popular Mechanics Press, Room 802, 200 E. Ontario St., Chicago.

PATENTS FOR SALE

IMPROVED Airship, safer faster. H. J. Ross, P. O. Box 61, Farmingdale, N. Y.

FISHING—Tackle attachment catches the large ones; inexpensive to manufacture. Address Milton Murray, Williams Wharf, Virginia.

ANTI-THIEF Device—"Eliminates hold-ups, protects lives where money is handled. No gas, no electricity to bother with. Absolutely effective. Bolvin, 28 William, Nashua, N. H.

OUTRIGHT Or royalty. Hotels, restaurants, grocery stores, etc., need this tested-patent pending No. 568,775 cheese slicer. Cuts one to six uniform slices with single operation easier than one with knife. Time and labor saver. Edward Berun, 813 N. 5th St., Toronto, Ohio.

OUTRIGHT Or royalty patented boxing toy, light metal construction, contest held between two operators providing considerable amusement and necessitating skill. H. F. Crowell, 65 Jasper St., Saugus, Mass.

NEW Marine propulsion; economical and speedier; all electric. U. S. Patent pending. O. W. Bright, 904 Elsmere Ave., Windsor, Ont., Canada.

VALENTINE-ENVELOPE! Sell patent outright. Ma-ha-la Warren, Box 231, Waukegan, Ill.

TIME Counts in applying for patents. See pages 140 and 141. Clarence A. O'Brien, Registered Patent Attorney, Washington, D. C.

SALE Or royalty. Valuable inventions, toys, games. Inventor, Box 22, Pond Du Lac, Wis.

GARMENT Stretcher. Adjustable sizes. H. Cook, 1628 Catharine St., Phila., Pa.

FOUNTAIN Brush patents 1722680, 1739872, 1760018, lawn mower patent 1770091 for sale, cash or royalty or partner. Inexpensive manufacture. Mark Sosa, 417 Main Ave., Spokane, Wash.

OUTRIGHT Or royalty, magnetized Toy marble shooting pistol. John DeCamp, 9 Quincy St., Danville, Ill.

MANUFACTURERS Looking for new inventions should write W. T. Greene, 939 Barrister Building, Washington, D. C.

INVENTORS—Cash in on your invention now! Don't delay the sale any longer! Send for a free copy of our specially prepared booklet, "Turn Your Patent Into Money," today! It contains helpful information for all inventors. M. L. Rund, Mgr. Classified Advertising, Popular Mechanics Magazine, 200 E. Ontario St., Chicago, Ill.

MODELS AND MODEL SUPPLIES

INVENTORS: Send us sketch or crude model of your idea. Crescent craftsmen will develop it into a practical working model. 39 years of successful experience and thousands of satisfied clients. Confidential service guaranteed. Bank references furnished. Free illustrated book: "Making Inventions Pay." Crescent Tool Co., Dept. 8-5, Cincinnati, Ohio.

MODEL Steam engines and boilers for miniature boats, boat and boiler fittings. Catalog 15c. Anton Bohaber, 212 Price St., Rahway, New Jersey.

TIME Counts in applying for patents. See pages 140 and 141. Clarence A. O'Brien, Registered Patent Attorney, Washington.

THREE Ship model plans for \$1. Catalog 6 cents. Richter's, 3227-A West Walnut St., Milwaukee, Wis.

SHIP And yacht model fittings. Send fifteen cents for illustrated catalog No. 7. A. J. Fisher, 1602 E. 10th Ave., Royal Oak, Michigan.

WE Make working models for inventors and do experimental work and carry a complete stock of brass gears and model supplies. Send for catalog. The Pierce Model Works, Tinley Park, Ill.

POWER Models. Steam and gasoline engines, accessories, supplies, metals for model-makers. Catalog 35c. Chas. Cole, 1355 Church St., Ventura, Calif.

MANUFACTURING

MAJESTIC'S Engineering department is devoted to improving your product without charge. Experienced craftsmen manufacture your dies, stampings, deep drawing, casting, screw machine and wire specialties very economically. Plating, enameling, assembling, boxing, warehousing. We recently doubled our space to better serve our customers. Estimates promptly submitted. Majestic Products Mfg. Company, Box 877, Chicago.

MANUFACTURING Novelties, inventions, metal moulds. Automobile cap flying Venus. Baum's Metal Specialties, Kansas City, Mo.

MACHINE To make pinless clothes lines \$35.00. Send 50c for sample line. Eberhardt, 2025 N. 34 St., Milwaukee, Wis.

WIRE Goods made to order. Cooler Mfg. Co., 3216 Carroll Ave., Chicago.

WE Develop small and medium size working models and mechanical devices to specifications. Experimental work. Tools, dies for light manufacturing. Dependable Tool and Mfg. Company, 3445 No. Racine, Chicago.

SPECIAL Machinery or parts, dies, tools, metal specialties, models, special gears, stock gears and model supplies. Send for catalog. The Pierce Model Works, Tinley Park, Ill.

LOW Cost manufacturing. Large plant completely equipped for blanking, drawing, stamping and wire forming in any finish. Can save you money on your product. Our figures will convince. Eastern States Products, Box 721, New Haven, Conn.

METAL Articles developed and manufactured. Model making. Reasonable price and first class workmanship. W. F. Meyers Company, Beiford, Indiana.

DRAWING INSTRUMENTS AND DRAFTING SUPPLIES

DRAFTSMEN: Swedish ruling pens, best in the world. "Lindholms" No. 13 sent anywhere for \$2.00. Nils Liden, Evanston, Ill.

SURVEYING INSTRUMENTS

BIG Opportunity—Rebuilt transits and levels. All makes—fully guaranteed. Sold on easy terms if desired and subject to field test. Write today for list M-55, Warren-Knight Co., Makers of "Sterling" Surveying Instruments, 126 N. 12th St., Phila., Penna.

BENDING MACHINES

THE Famous Hossfeld "Wrenchless" Universal Iron Bender is the last word in bending machines. Bends metal, cold or hot, into most any conceivable shape, including Eye Bolts and Automobile Spring Eyes. Bends up to 1" bars or 1 1/2" pipe cold. Also bends "Angle Iron." Thousands in use by all classes of trade, from the smallest shops to the largest railway systems. Write for circular and prices. Hossfeld Mfg. Co., Winoona, Minn.

ELECTRICAL

ELECTRICAL Trouble shooting on the motor car and airplane. Don't trust to luck or guess work. Learn to make every motion count in testing and repairing. Send for our standard 493-page book for electricians and mechanics. 300 diagrams. Hundreds of practical tests. Pay postman \$4.00 plus postage when delivered. If outside U. S. remit when ordering. Popular Mechanics Press, Room 802, 200 E. Ontario St., Chicago.

RADIO Trouble Shooting—Covers all electric sets and television. Greatest book ever published from the point of view of assisting the repairman as well as showing how the radio owner can do his own repairing. 328 pages. Over 300 illustrations. Flexible. Pay postman price \$3 and postage when he delivers it. Popular Mechanics Press, Room 802, 200 E. Ontario St., Chicago, Ill.

WELDING AND SOLDERING

BARGAINS—Excellent reprocessed arc welders, buffers and grinders. Entirely rebuilt—guaranteed. Trial. Terms. Write Ken's Service, Box M-512, Troy, Ohio.

SECRET Of aluminum welding taught by expert. Banke Welding Service, 15749 Littlefield Ave., Detroit, Mich.

MACHINERY, TOOLS & SUPPLIES

15" x 6" SEBASTIAN Lathe, \$150.00. No. 3 1/2 Fox Hand and Power Plain Milling Machine \$175.00. No. 60 Heald Cylinder Grinder \$500.00. 15" Steptoe Shaper \$200.00. 36" x 18" Field Lathe \$750.00. Baldwin Saw Table \$100.00. Parks Combination Woodworker \$225.00. 10" New Drill Press \$21.00. Air compressor, complete with tank, motor, fittings \$100.00. Write for catalog. Cincinnati Machinery & Supply Co., 27 W. 2nd St., Cincinnati, Ohio.

AIR Compressors, twin cylinder, worm drive, with general electric 1/2 AC motor, for tires, paint spraying etc. \$41.75 complete, also larger sizes, bench drill presses with 1/2 motors \$18.00. Electric drills 1/2 inch \$12.50. Variable speed flexible shaft units 400 to 5000 R.P.M. with motor and chuck \$18.00. All new. Electric Gas Co., Fairview N. J.

8" LATHES \$14.00. For wood turning, bronze bearings, Morse taper centers. Tunk Mfg. Co., 4065 Waveland Ave., Chicago, Ill.

SUBSTANTIAL Savings—used arc welders, buffers, grinders, platers, compressors, paint sprays. Entirely rebuilt, guaranteed. Trial and terms. Write Ken's Equipment, Box M-513, Troy, Ohio.

MOTORS, small lathes, compressors—larger equipment. Belting, gears pullers. Lowest prices. List 5c. Service Electric Company, Indianapolis.

KELLOG Air Compressors, excellent condition. \$8.00. Taylor, 105 East 102nd St., New York City.

BAND Saw blades: Direct from manufacturer 1/4" or less 29 cents per foot. 3/4" or less 25 cents per foot. Sharpened and brazed. P.P. paid. These saws are high grade steel used in our best factory saws. Oscar Goes & Sons, 565 W. Washington Blvd., Chicago, Illinois.

BEARINGS, Hangers, pulleys, gears, supplies. Kirk Hardware, Box 365, Madison Sq. Sta., New York City.

CASTINGS For lathes, Grinders, etc. Kenelpp & Son, Mt. Carmel, Ill.

CONCRETE Building block machines and molds. Easy payments. Catalog free. Concrete Machine Co., 5 North Main St., St. Louis, Mo.

START Business of your own, small investment required, doing chromium, nickel, copper, silver plating. This work in big demand. Information free. Electro Platers Supply Co., 28 West Second St., Cincinnati, Ohio.

ENGINES, MOTORS AND DYNAMOS

FOR Sale: Slightly used electric motors 1/4 H.P. \$5.00; 1/2 H.P. \$4.50. Motors not in running condition \$1.50 each. Fine for students. Also used 1/2 H.P. 2 cycle gasoline engines, with built in flywheel ignition, \$12.00. The Maytag Chicago Co., 169 E. Illinois St., Chicago, Ill.

TRANSFORMERS, Generators and rotary converters built to your requirements. Armo Specialty Co., 1326 So. Morgan St., Chicago.

STREAM Engines—One h. p. \$18.00; 1/2, \$12.00. James Chambliss, Bessemer, Ala.

BRAND New rotary converters, 32v. or 110v. DC to 110v. AC for radio \$37.00. 1/2 Hp. AC motors, \$7.00; 1/2 Hp. repulsion motors \$14.50. 1/2 Hp. 110v. DC motors \$15.00. Many other bargains. Queen City Electric, 1736 Grand Avenue, Chicago.

NEW 1/4 Horse, 110 volt alternating motor \$8.50; some used \$4.50. New 1/2 horse, 110 volt 3450 speed alternating \$16.50. 1/2 horse \$9.50. Other bargains. Electrical Surplus Company, Dept. 12, 1885 Milwaukee Avenue, Chicago.

TIME Counts in applying for patents. See pages 140 and 141. Clarence A. O'Brien, Registered Patent Attorney, Washington, D. C.

AUTO Engines for stationary or portable power. We make necessary attachments. Candes-Smith Governor Co., 215 North Los Angeles St., Los Angeles.

FARMS AND FARMS LANDS

FREE Book on opportunities in Minnesota for profitable farming and dairying. Improved and unimproved land prices lowest in years. Share in over \$500,000,000 annual crop. A farm offers independence, continuous profitable employment for industrious men. Play while you earn—10,000 lakes for health, recreation, profit. Write H. C. Hotelling, Dept. 623, Ten Thousand Lakes-Greater Minnesota Assoc., St. Paul, Minn.

15 ACRES, \$1090 Hen House, 18x60, incubator cellar; on state road now building, 4 miles city; 4 rooms prettily located, cement cellar, lovely shade. Only \$1400 with \$600 down. Picture page 31 illustrated catalog 1090 bargains. Free. Street Agency, 255-P Fourth Ave., N. Y. City.

FREE Books on opportunities in Minnesota, North Dakota, Montana, Idaho, Washington, or Oregon. Complete information on climate, crops, location for farm or suburban tract for grain, livestock, dairying, fruit, poultry—a home, independence, plenty of food, clothing, continuous employment. No occupation offers more to industrious capable men. Write E. C. Leedy, Dept. 257, Great Northern Railway, St. Paul, Minn.

MONEY Made in Michigan potatoes, \$10 down now and easy terms buys land near markets, lakes, streams. Write today. Mich-Acreage Co., P-601, 32 N. State St. Bldg., Chicago, Ill.

OZARKS—20 Acres, timbered, \$100, \$5 monthly. Poultry, hogs, fruit; fishing, hunting, trapping. Hubbard, 216 Grossman Bldg., Kansas City, Kansas.

SELL Your property quickly for cash, no matter where located. Don't pay big commission. Particulars free. Real Estate Salesmen Co., Desk B, Lincoln, Neb.

OWN A Farm in Minnesota, Dakota, Montana, Idaho, Washington or Oregon. Crop payment or easy terms. Free literature; mention state. H. W. Ryerly, 119 Northern Pacific Railway, St. Paul, Minn.

TEN Dollars monthly acquires five acres pecans, tungs, flax, oranges. Guaranteed care. Big returns. Suburban Orchards, Dept. M. Biloxi, Miss.

RABBITS

RABBIT Supplies—America's oldest Rabbit supply house. Free catalogue. Desk 11, National Rabbit Supply Company, 1129 North Dearborn Street, Indianapolis, Ind.

BEAVERLIKE Fur on rabbits. Sample, dime. Kingsmountain Farm, Gold Hill, Oregon.

PEDIGREED Chinchillas \$2.00 to \$4.00. Foullette St., Rabbitry, Oberlin, Ohio.

MAKE Good profits with Chinchilla, White New Zealand, and Silver Marten Fur Rabbits. A steady market for all you raise. Send six cents for Fur News, large illustrated Brochure, and Marketing Agreement. Conrad's Fur Ranch, 852, Englewood, Colorado.

RAISE Rabbits. Make money. Complete course of instruction by foremost authority. Free book. National Rabbit Institute, Department 3, Monrovia, California.

RABBITS And supplies. Complete literature, 10c. Albert Facey, Inc., 115-X, Valley Stream, New York.

MUSKRATS

MAKE Money with Muskrats. Start raising "Selected King" Muskrats in Dry Land Pens, or in Swamps, Ponds and Creeks. Send six cents for Fur News, Plans and Wholesale Prices. Conrad's Fur Ranch, 852, Englewood, Colorado.

TRAPPERS—"Eleven Box Traps," Complete blueprints, 30c. Weesho-Uco, 31st Office, Detroit, Mich.

MUSKRAT Farming—The greatest book on one of the greatest opportunities today. Tells of the opportunity in this business and how to do everything in connection with the raising and marketing of muskrats. Pay postman only \$2.25 and postage when delivered or, if outside U. S., remit when ordering. Popular Mechanics Press, Room 802, 209 E. Ontario St., Chicago.

MINK

IMPORTED genuine German Fitch, Golden opportunity. Free circular, Herculean Fur Farms, Forest Lake, Minnesota.

EXTRA Dark Yukon Quebec prize winners pay you more. Alaskan Mink Ranch, Earl, Wisconsin.

BIG Money made raising mink. Free information. Pennell Fur Farm, Dalkens, Wash.

DOGS AND PETS

BEAUTIFUL Registered bull pups, \$15. Bulldogs, 501 Rockwood, Dallas, Texas.

BOSTON Pups: Ideal pets, reasonable. Mrs. H. M. Hill, Lamoni, Iowa.

AQUARIUMS. Fancy fishes for pleasure and pastime. Water plants, etc. Catalog free. German Aquarium, 3823 N. Richmond, Chicago.

DOG Lovers—Every fact regarding every phase of dog training (all breeds) including psychology, obedience, guarding, swimming, rescue work, hunting, herding flocks, teaching tricks, finding lost articles, racing, war service, police dogs, sled dogs, etc., will be found in "Training the Dog," by Will Judr. Price only \$1.50. Pay postman when delivered or, if outside U. S., remit when ordering. Popular Mechanics Press, Room 802, 209 E. Ontario St., Chicago, Ill.

WANTED—MISCELLANEOUS

MAIL Us your discarded jewelry, gold crowns and bridges, watches, diamonds, silver, platinum. Money promptly mailed. Goods returned if offer refused. United States Smelting Works (The Old Reliable), Dept. 71, Chicago.

CASH For gold teeth. Highest prices. Information free. Southwest Gold & Silver Co., Box 68LD, Fort Worth, Tex.

FOR SALE—MISCELLANEOUS

NEW \$69.00 Underwood portable in carrying case \$42.50. Underwood 5, Standard office machine \$39.95. Checkwriter, Duplicator, Multigraph, Dictaphones, bargain prices. Pruitt, 190 North La Salle, Chicago.

FINE Home woodworking outfit—Utilized combination workshop—lathe, shaper, saws, motor, accessories. Cheap for quick sale. Send for details. Arcos Tool Company, Toledo, Ohio.

WATCHMAKERS Lathes for sale at a bargain. H. Jaegermann, 5815 Easton Ave., St. Louis, Mo.

WELLS' Outline of History now only \$1. The complete, illustrated, 1,200-page edition that originally sold for \$5.00. One of the most popular books ever published. Can be read with profit by young or old. Pay postman \$1.00 plus postage when delivered to your door C. O. D. Popular Mechanics Press, Room 802, 209 E. Ontario St., Chicago.

ROOTS AND HERBS

JUST Out! 64-page illustrated medicine man almanac. Contains over 500 old-fashioned herb medicine recipes and Indian secrets for home use. 10c postpaid. Worth dollars! Botanics, 145 West 112th Street, Chicago.

PERSONAL

GROW Hair any head proven discovery money back guaranteed. Mailed plain wrapper. Receipt \$2.50. Edwards, 143 O St., Cottage Grove, Oregon.

GRAPHOLOGY, Character reading from hand writing; analysis \$1.00. Neal H. Brown, Richland Springs, Texas.

ANALYSIS Dealing with every probable phase of your life, \$1.00. Advice free on three personal questions with order—give birth date. Mel-Roy, Box 575, Dept. B, Dallas, Texas.

RAIDERS—Thousands grow hair—look years younger. Why not you? Harmless formula \$1. Irwin Kolb, Wind Gap, Pa. A-77.

CUT Silk neckwear. Perfect ties, 3, \$1.55. Circular on request. Oulmette's Mailorder House, 81 Holly, Dept. 20, New Bedford, Mass.

FOOL Your friends. Letters mailed from here for 10c silver. Master Mailing Service, Box 65, Hyde Park Station, Los Angeles, California.

WANT Fun? Read 13 funny love letters, 10c. Circular free. Economy Sales Co., Dept. P., Manchester, Iowa.

YOGA, Occult books, magic incense, catalogue 10c. Hindu Publishers, Garrick Building, Chicago.

KNOW Your future. Your complete personal astrological forecast—25 large pages. Employment, love, marriage, etc. Give birthdate. Pay 75c and postage when delivered. Complete satisfaction or money back. Thurston, W-20 W. Jackson, Chicago.

TOBACCO Habit overcome or no pay. 500,000 used Superba to help stop cigarettes, cigars, chewing, pipe, snuff. Treatment sent on trial. Costs \$2.00 if successful. Superba Co., L84, Baltimore, Md.

ASTROLOGER Can read your life. Test predictions for one year 20c, dimes or stamps. Send year and birthdate. G. Niemeyer, Box 278, Mays Landing, N. J.

MISCELLANEOUS

MIRRORS Resilvered at home. Costs near 5 cents per square foot; you charge 75 cents. Profitable business plating autopaarts, reflectors, tableware, stoves, refinishing metalware, etc. Outfits furnished. Details free. Sprinkle, Plater, 288, Marion, Ind.

PERMANENT Crease, suits; instructions, dollar. Fuller, 444 Bergen Avenue, Jersey City, N. J.

TIME Counts in applying for patents. See pages 140 and 141. Clarence A. O'Brien, Registered Patent Attorney, Washington, D. C.

CASH Paid for butterflies, insects. See Sinclair display advertisement on page 18.

NICKEL Silver key check stamped with your name and address 25c. Set of five Master keys 50c. Melvin's Hardware, Halifax, Canada.

AMATEUR Cartoonists: Sell your work. Write Smith's Service, PX1194, Wenatchee, Wash.

WHOLESALE Novelties. Sample and ebrulars Ten cents. Kant Novelty, 246P Third Ave., Pittsburgh, Pa.

LEARN Tattooing. Instruction catalogue, dime. Miller, V431 Main, Norfolk, Va.

HOMEOPATHIC And biochemic preparations sent postpaid to all parts of the world. Booklets free. Halsey Bros. Co., 5547 Ravenswood Ave., Chicago. Established 1855.

PRINT Signs, pictures without press, type or machinery. Samples 10c. Straley, 13 1/2 W. Main, Springfield, Ohio.

TATTOOING Outfits, supplies. Illustrated list free. "Waters," 985 Put-nam, Detroit.

NEW "Pierce-Cap" MILK BOTTLE OPENER & COVER SELLS EVERYWHERE BIG PROFITS!

Here is a real chance for quick sales and steady repeats with this amazing new household necessity. Pierce-Cap Milk Bottle Opener and Cover is needed in every home. It eliminates squirting and spilling milk removing covers the old way. It is also a sanitary cover. Pierce-Cap is made of Bakelite in a variety of assorted colors and mottled effects. Fits any size milk and cream bottle. When you show it to housewives and mention the retail price is only 10c they buy two or three on sight. You make 100% profit selling to dealers and 220% profit selling to consumers in full or spare time.



Made of Bakelite in Assorted Colors

Arrow Lifts Cover in a Jiffy. Sanitary Cap Keeps Milk Sweet, Safe and Clean



MAKE UP TO \$20 A DAY!

We have originated an attractive, self-selling counter display card which holds 32 Pierce-Caps (16 on each side). At a glance, grocery stores, drug stores, hardware stores, soda fountains, dairy stores, 5 and 10c stores, in fact, everywhere you go you will find ready prospects. Volume sales can be built up by placing these display cards on store counters as outlined in our proven successful Dealer Plan. You can easily place 20 cards a day—60 cards in three days. Your cost in lots of 60 cards is only \$1.00 per card. You make 100% profit or \$20 a day. And just think of the tremendous repeat business you are building.

Packed 32 Pierce-Caps to each Counter Display Card. 20 Cards placed with Dealers is a Day Net you \$20 PROFIT!



Now is the time to Get Started

Don't delay. This is your opportunity to get in on the ground floor of one of the fastest selling specialties ever created. Send 25c for 3 Pierce-Caps in assorted colors or \$1.50 for a sample card of 32 packed on an attractive self-selling counter display card. You can use this card to take orders from dealers or sell out to consumers and make \$1.70 clear profit.

I Guarantee You Sales You Can't Lose

Send 25c for 3 samples or \$1.50 for a card of 32. You take no risk. I guarantee you sales on this sample order or refund your money absolutely. You will receive full details and selling plans with samples or display card. Act at once and reserve your territory.

MASTERLITE MFG. CO.
Dept. PE-14
110 E. 23rd St., New York, N. Y.

LEARN WATCHMAKING

and become independent. We help you secure a position. Easy to learn. Send for FREE CATALOG.

ST. LOUIS WATCHMAKING SCHOOL Dept. 5, ST. LOUIS, MO.

Must Men Fear 40?

65% of all men past middle age, authorities say, have prostate gland disorder. Here is the known cause of frequent nightly risings, aches in the back and legs, sciatica, weakness and lack of health. Now a new scientific, drugless hygiene usually restores this gland to normal functioning without medicine or electric rays. 100,000 men have found quick relief and grateful recovery. Send name for FREE book. Address The Electro Thermal Company, 2141 Morris Ave., Steubenville, Ohio.



How to Obtain A Better Looking Nose

Improve your personal appearance. My free book tells you how I guarantee to improve the shape of your nose by remodeling the cartilage and fleshy parts, quickly, safely, and painlessly, or refund your money. The very fine, precise adjustments which only my new patented Model 25 Nose Shaper possesses, make results satisfactory and lasting. Worn night or day. Over 100,000 users. Send for free book to **M. TRILETY, Pioneer Nose Shaping Specialist** Dept. 197 BINGHAMTON, N. Y.

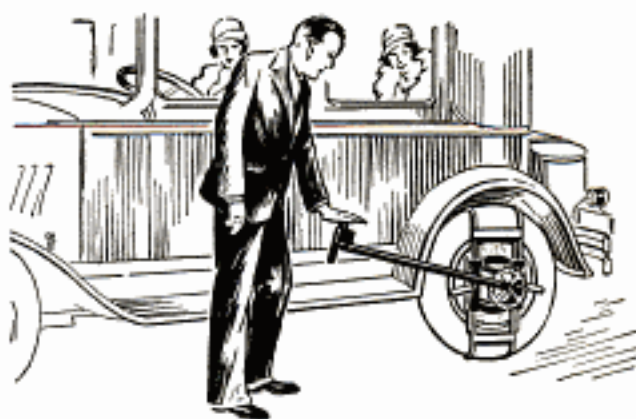

Press the Button —and make \$130 A WEEK

No experience necessary—Only a few dollars start you!

Here's a new way to make money and make it fast. Be a Brake Specialist. Get away from the over-crowded, poorly paid trades and professions that offer no future. You can simply coin money—from the first day. And profits pile up still faster as the word gets around that you're the Brake Expert in your town, that your tests are made quickly and are dependable.

Easy to Learn No wonder men make \$130 a week and more when the job is so easy to learn—and the testing so easy to do. The Badger Brake Tester is simple. Anyone with or without mechanical knowledge can learn in no time. You'll scarcely believe your eyes when you see your bank balance swelling week by week.

Brake Specialists Needed Everywhere

The day you get your Badger Brake Tester you are set up in a fast money-making profession. The demand for your services is as natural as the demand for gas and oil. Because the public wants brake tests by the Badger—it's known as the tester approved by the large car manufacturers. It's sure and dependable.

Generous Terms The cost of the Badger Brake Tester is so small—and the easy payment plan so generous—that your Badger quickly pays for itself and earns you an income in addition. Some men have paid for their Badgers in a week or ten days.

Money Back Guarantee The Badger Brake Tester can be and is fully guaranteed because it is such a wonderful mechanism and a marvelous money maker. We gladly give you this additional assurance because we know what the Badger can do. Guarantee fully explained in our literature—write NOW.

Get Going—Coupon Brings You Special Offer

Don't delay. Just write your name and address in the coupon below—tear it off and mail to us. The special offer, full particulars regarding the construction and operation of the Badger Brake Tester will go forward to you immediately. Address

BADGER BRAKE TESTER MFG. CO.

302 Baker Building Racine, Wisconsin

Badger Brake Tester Mfg. Co.,
302 Baker Building, Racine, Wisc.

Please send me complete information about Brake Testing—and why the Badger will earn \$130 a week. Also, all the facts about Easy Payments and Guarantee.

Name.....

Street and Number.....

City.....

State.....



Hotels Start You With Salaries up to \$2,500 a Year living expenses often included

HOTELS, restaurants, clubs, apartment hotels, hospitals, camps, institutions, schools, colleges, etc. calling upon Lewis National Employment Bureau for trained men. Lewis trained men start at salaries up to \$2,500 a year with living often included. Luxurious surroundings. Positions open as Manager, Assistant Manager, Chief Clerk, Auditor, Steward, Sports Director, etc., and hundreds of others paying \$2,000 to \$7,500. Almost \$1,000,000 worth of new hotels, apartment hotels, clubs and institutions to be built this year will mean even greater opportunities for trained men.

Previous Experience Unnecessary

Quality for a well-paid position. Fascinating work, quick advancement. Lewis Personal Coaching Plan adapts the training to your needs, right at home in your spare time. We put our graduates in touch with big opportunities. National Employment Service free of extra charge. Free Book, "YOUR BIG OPPORTUNITY," gives full details and explains our Money Back Agreement. Send for it NOW!

FREE BOOK COUPON

Lewis Hotel Training Schools,
Room DG-322, Washington, D. C.
Send me without obligation the Free Book, "Your Big Opportunity" and details of your Personal Coaching Plan.

Name.....
Address.....
City.....State.....

LEARN AUTOS AT HOME!

Earn Up to \$100 a Week

Stop just wishing for a good job with big pay. You'll never get it that way. Let me train you at home, my new, easy "JOB WAY"—let me prepare you for a wonderful future in AUTOS, the World's Biggest Business, where trained men—Auto Experts—get \$50, \$75 and \$100 a week.

Keep Your Job
No need to quit your job. You can learn autos better, quicker and cheaper this new, easy method. Only your spare time needed. I teach you everything you need to know and show you how to make big, extra, spare time money while training—then help you get a good job or go into business for yourself.

At Home
Clip coupon for my FREE Auto Book. Read how "Job-Way" training has lifted scores of men—many with very little education and no previous ex-

perience—out of dull, tiresome, poorly paid jobs into the big money class. "Job-Way" is easy—if you're between the ages of 18 and 35 and can understand plain, simple, everyday words, get my book and see what I can do for you.

Get My Offer

Right now, I am including 3 big outfits and also many other features, free of extra cost. Mail coupon for full details.

B. W. COOKE
Directing Engineer
Motor Institute of America
Motor Institute Bldg.
Evanston, Ill.
Dept. 4105



GET THIS FREE BOOK—MAIL COUPON

B. W. COOKE
Directing Engineer
Motor Institute of America
Motor Institute Building
Dept. 4185 Evanston, Ill.

Send me absolutely FREE your Auto Book giving proof that you can train me for a big pay job—also details of your big offer.

Name.....
Address.....
Town.....State.....
Age.....Occupation.....

Learn SIGN and SHOW-CARD WRITING

In spare time, few hours weekly

Fascinating profession. Big opportunity in this fast-growing trade. Earn while you learn the sign arts. No talent or experience required. Be your own boss or obtain a good position. Learn show cards, posters, bulletins, signs, advertising layouts and allied subjects. We teach by mail or at our school. Quick results—easy to learn.

EARN \$50 TO \$200 WEEKLY

Otto C. Wiegand, Md., home-study graduate, made \$12,000 from his business in one year. Many successful graduates. Oldest and foremost school. Don't delay. Write for complete information.

DETROIT SCHOOL OF LETTERING

193 Stimson Ave. Est. 1899 DETROIT, MICH.

Chicago TECH College

SAVE TIME WHILE LEARNING HERE IN CENTER OF INDUSTRY

Learn DRAFTING in 4 Months — at Chicago Tech.

Evening Classes. Many students earn expenses while learning. Free employment service for students and graduates. Send for 80 page "Blue Book." Mailed Free. Address the President, Charles W. Morey, B. S., M. E.

CHICAGO TECHNICAL COLLEGE
Dept. E-79, Chicago Tech. Building, 115 E. 26th Street, Chicago, Ill.

Prepare now. Increasing opportunities for Draftsmen. This 27 year old established school offers special short Drafting Course. Complete in 4 months. Also 1, 2 and 3 year diploma and B. S. Degree Courses in Engineering, Electricity and Architecture. High School subjects taught. Enter any time. Day and

Don't Envy The Plumber—BE ONE!

\$11.00—\$16.00 PER DAY and work EVERY day, is the Plumber's wage. LEARN IN 8 to 12 WEEKS without previous experience.

If you are making less than \$60.00 a week you owe it to yourself to investigate. Get FREE catalog that tells in pictures and words how we teach this trade. Special rates now.

UNIVERSAL PLUMBING SCHOOL, 2030 Troost Avenue, KANSAS CITY, MO.

Learn ADVERTISING at Home

Greater opportunities now in advertising. Learn easily and quickly in spare time. Practical work. No text books. Old established school. Low tuition—Easy terms. Send for free booklet of interesting information.

Page-Davis School of Advertising
Dept. 1255, 3601 Mich. Ave., Chicago

8 MAGICIAN'S TRICKS

1000 Hours of Pleasure. Amaze and mystify your friends with these 18 Parlor, Platform and Stage tricks, the closely guarded secrets of a professional! With Complete equipment—10 pieces of apparatus! \$10 value. Send \$1.00. Quick before supply is gone.

PROF. WEBER, 7420 GREENVIEW, CHICAGO

Let us recommend the best books to study on any subject. Popular Mechanics Press, Chicago, Illinois.

GIANT TELESCOPE \$1.75

5 SECTIONS—3 FT. LONG
See Miles Away! Distant people and objects seem close. Over 3 ft. long, brass bound. Made in Europe. Bbbs. of fun. Thousands pleased.
Send No Money! On arrival pay Postman special price, only \$1.75, plus postage. Two for \$3.25. (Or send price and we pay postage.) Satisfaction guaranteed or money back. Send today.
FREE With Order Strong leatherette Carrying Case and Solar Eye Piece to view the Sun.
Bargain House, 427 Randolph St., Dept. 14, Chicago



Choose as Your Profession Electrical Engineering

Electricity offers a brilliant future to the young man who is about to choose his career. Never before has there been such wonderful opportunity in this great field. Big paying positions in electrical work the world over are open to trained men—men who possess specialized, practical knowledge. Come to the School of Engineering of Milwaukee—one of the largest and best equipped electrical schools in America. Here you are trained in both theory and practice by a faculty of experts. You learn in large, finely equipped laboratories. If you have 14 high school credits or equivalent, you can become an Electrical Engineer with a Bachelor of Science degree in 3 years. Lacking high school credits can be made up here in a short time.

B.S. Degree In 3 Years

A Complete, Practical, Electrical Education

Learn by the thorough, approved, scientific methods which our 27 years of specializing enable us to give you. In addition to Electrical Engineering, the following complete courses are given: A. C. and D. C. Armature Winding—Wiring and Testing—Practical Electricity—Drafting—Radio Technician—Commercial Radio Engineering and Commercial Electrical Engineering.

Earn While You Learn

By our special system you may earn part of your way while learning. Our Employment Department will help you to secure a position to which you may devote a part of each day, spending the remainder at the school. This plan both solves the students' financial problems and provides experience at the same time. Low tuition fee. Board and room reasonable. Daily Broadcasting WISN. School Orchestra. Fraternities.

**New Term
Begins Now**

Write for FREE Catalog

Write today for free, illustrated catalog. Read about this wonderful institution and the great opportunities that lie before you. Find out about our specialized method of training and the details of our "Earn While You Learn" plan.



Dept. PM531, 533 E. Wells Street, Milwaukee, Wis.

SCHOOL OF ENGINEERING OF MILWAUKEE,
Dept. PM531, 533 E. Wells Street, Milwaukee, Wis.
Without obligating me in any way, please mail free illustrated book, "Choose as Your Life's Work, Electricity," and particulars regarding the course I have marked with an X.

- Electrical Engineering
- Commercial Electrical Engineering
- Commercial Radio Engineering
- Radio-Technician
- Practical Electricity
- Armature Winding
- Light, Motor Wiring and Testing
- Electrical Refrigeration
- Home Laboratory Service

Name..... Age.....
Address.....
City..... State.....
Education.....



"Mary, I Owe It All to You"

"MR. WILLIAMS called me into his office today and told me he was going to raise my salary \$50 a month.

"I am glad to give you this opportunity," he said, "for the best reason in the world. You deserve it.

"You may not know it, but I've been watching your work since the International Correspondence Schools wrote me that you had enrolled for a course of home study. Keep it up, young man, and you'll go far. I wish we had more men like you."

"And to think, Mary, I owe it all to you! I might still be drudging along in the same old job at the same old salary if you hadn't urged me to send in that I. C. S. coupon!"

How about you? Are you always going to work for a small salary? Are you going to waste your natural ability all your life? Or are you going to get ahead in a big way? It all depends on what you do with your spare time.

More than 180,000 men are getting ready for promotion right now in the I. C. S. way. Let us tell you what we are doing for them and what we can do for you.

Mail the Coupon Today

INTERNATIONAL CORRESPONDENCE SCHOOLS

"The Universal University"

Box 5544-G, Scranton, Penna.

Without cost or obligation, please send me a copy of your booklet, "Who Wins and Why," and full particulars about the subject before which I have marked X:

TECHNICAL AND INDUSTRIAL COURSES

- | | |
|--|--|
| <input type="checkbox"/> Architect | <input type="checkbox"/> Automobile Mechanic |
| <input type="checkbox"/> Architectural Draftsman | <input type="checkbox"/> Plumbing <input type="checkbox"/> Steam Fitting |
| <input type="checkbox"/> Building Estimating | <input type="checkbox"/> Heating <input type="checkbox"/> Ventilation |
| <input type="checkbox"/> Wood Millworking | <input type="checkbox"/> Sheet Metal Worker |
| <input type="checkbox"/> Contractor and Builder | <input type="checkbox"/> Steam Engineer |
| <input type="checkbox"/> Structural Draftsman | <input type="checkbox"/> Steam Electric Engineer |
| <input type="checkbox"/> Structural Engineer | <input type="checkbox"/> Civil Engineer |
| <input type="checkbox"/> Electric Wiring | <input type="checkbox"/> Surveying and Mapping |
| <input type="checkbox"/> Electrical Engineer | <input type="checkbox"/> Refrigeration |
| <input type="checkbox"/> Electric Lighting | <input type="checkbox"/> R. R. Locomotives |
| <input type="checkbox"/> Welding, Electric and Gas | <input type="checkbox"/> R. R. Section Foreman |
| <input type="checkbox"/> Reading Shop Blueprints | <input type="checkbox"/> R. R. Bridge and Building Foreman |
| <input type="checkbox"/> Telegraph Engineer | <input type="checkbox"/> Air Brakes <input type="checkbox"/> Train Operation |
| <input type="checkbox"/> Telephone Work | <input type="checkbox"/> Highway Engineering |
| <input type="checkbox"/> Mechanical Engineer | <input type="checkbox"/> Chemistry <input type="checkbox"/> Pharmacy |
| <input type="checkbox"/> Mechanical Draftsman | <input type="checkbox"/> Coal Mining Engineer |
| <input type="checkbox"/> Machinist <input type="checkbox"/> Toolmaker | <input type="checkbox"/> Navigation <input type="checkbox"/> Boilermaker |
| <input type="checkbox"/> Patternmaker | <input type="checkbox"/> Textile Overseer or Supt. |
| <input type="checkbox"/> Pipefitter <input type="checkbox"/> Tinsmith | <input type="checkbox"/> Cotton Manufacturing |
| <input type="checkbox"/> Bridge Engineer | <input type="checkbox"/> Wooden Manufacturing |
| <input type="checkbox"/> Bridge and Building Foreman | <input type="checkbox"/> Agriculture <input type="checkbox"/> Fruit Growing |
| <input type="checkbox"/> Gas Engines <input type="checkbox"/> Diesel Engines | <input type="checkbox"/> Poultry Farming <input type="checkbox"/> Radio |
| <input type="checkbox"/> Aviation Engines | <input type="checkbox"/> Marine Engineer |

BUSINESS TRAINING COURSES

- | | |
|---|--|
| <input type="checkbox"/> Business Management | <input type="checkbox"/> Business Correspondence |
| <input type="checkbox"/> Office Management | <input type="checkbox"/> Lettering Show Cards <input type="checkbox"/> Signs |
| <input type="checkbox"/> Industrial Management | <input type="checkbox"/> Stenography and Typing |
| <input type="checkbox"/> Personnel Management | <input type="checkbox"/> Complete Commercial |
| <input type="checkbox"/> Traffic Management | <input type="checkbox"/> Civil Service <input type="checkbox"/> Mail Carrier |
| <input type="checkbox"/> Accountancy <input type="checkbox"/> Cost Accountant | <input type="checkbox"/> Railway Mail Clerk |
| <input type="checkbox"/> C. P. Accountant | <input type="checkbox"/> Grade School Subjects |
| <input type="checkbox"/> Bookkeeping | <input type="checkbox"/> High School Subjects |
| <input type="checkbox"/> Secretarial Work | <input type="checkbox"/> College Preparatory |
| <input type="checkbox"/> Spanish <input type="checkbox"/> French | <input type="checkbox"/> Illustrating <input type="checkbox"/> Cartooning |
| <input type="checkbox"/> Salesmanship <input type="checkbox"/> Advertising | <input type="checkbox"/> Lumber Dealer |

Name..... Age.....
Address.....
City..... State.....
Occupation.....

If you reside in Canada, send this coupon to the International Correspondence Schools, Canadian, Limited, Montreal, Canada

a. 599

Definite Proof of the Value of Dirigibles to a Battle Fleet in Time of War Was Offered Recently When the "Los Angeles," Veteran Airship of the Navy, Participated in Fleet Maneuvers off Panama; the Dirigible Was Used Only for Scouting Purposes, and Therefore No Defense of Her Was Attempted, but in This Capacity the Lighter-Than-Air Craft Made Repeated Contacts with Theoretically Friendly Ships, and Finally Discovered the Main Body of the Enemy: the "Los Angeles," While with the Fleet, Used a Mooring Mast Aboard the U.S.S. "Patoka," as Its Base for Refueling and Servicing; as a Result of Its Performance, Naval Officials Predicted an Even Better Showing Would Be Made by the "ZRS-4," Three Times as Big as the "Los Angeles," Now Nearing Completion at Akron; the Picture Shows the "Los Angeles" Hitched to Mooring Mast of the "Patoka"



Popular Mechanics Magazine

REGISTERED IN U. S. PATENT OFFICE

WRITTEN SO YOU CAN UNDERSTAND IT

Vol. 55

MAY, 1931

No. 5

The Smallest Living Things

By JOHN E. COGGSWELL,

16, Edgemoor Road,
Belmont, Mass.

THE SMALLEST living organisms known to man are to become one of his greatest allies in the constant battle against germ diseases. In his laboratory at Yale University, Dr. F. d'Herelle has discovered these and made them do his bidding.

There is an old saying that even the

Professor Bacteriology



Test Tube Containing 40,000,000,000 Bacteriophages, Smallest Living Organisms Known, and Typhoid Bacteria in Gelatin Being Devoured by Them

bacteria—call them germs or microbes, if you wish—those minute organisms that cause milk to sour, meat to spoil and also, among many other activities, are believed to implant within our systems those ailments known as germ diseases.

smallest bugs have smaller bugs that live upon them. That seems to be the literal truth. Certainly, we have long believed that the smallest bugs in the world are

doubt about that. A hundred of them can play tag on the head of a pin. They can be seen only under the lens of the most powerful microscope. Millions of



Vacuum Filter Used to Separate Bacteriophages from Bacteria; Right, Bacteria Being Destroyed

them can find lodgment on one small spot in the human throat. They are small, but the organisms discovered by Doctor d'Herelle are a thousand times smaller. They are the parasites that infest and cause disease in bacteria, just as bacteria infest and cause disease in the human system.

Medical experts look upon the development of Doctor d'Herelle's discovery, which was given enthusiastic acclaim at the recent convention of the American Society of Bacteriologists, as a most important step toward the banishment of germ diseases. Already he has proved, under the most difficult conditions, the ability of the tiny organisms to defeat one of the most virulent epidemic diseases that the world has ever known—Asiatic cholera.

These parasites that infest bacteria are known as bacteriophages—which, literally, means bacterium eaters. They are so small that forty billion of them in half a test tube of liquid do not even cloud the solution. They are infinitesimal but they work fast. One of Doctor d'Herelle's favorite demonstrations is to dip just an inch or two of a fine wire into a solution containing bacteriophages—the name is shortened to "phage" in laboratory parlance.

Then, the same wire, with its load of phages, is dipped into a test tube holding a solution made turbid by several million typhoid-fever bacteria. Within three hours—so fast do the phages multiply when furnished with their favorite food—the solution becomes clear and the most rigid tests fail to discover a single typhoid bacterium left alive.

Of course, no one has ever seen a bacteriophage and no one will until a microscope many hundred



times as strong as any in existence is invented. Their discovery was the result of pure reasoning. Doctor d'Herelle, in common with all physicians and most laymen, knew that germ diseases are not always fatal, as they would be if the bacteria kept on multiplying indefinitely.

Such diseases progress to a certain point; then the patient either dies or begins to show improvement. Physicians long believed that the patient's body developed power to resist the onslaughts of the disease bacteria, which were then thrown off. The Yale doctor, however, came to the conclusion that some enemy organism must attack the bacteria and render them incapable of causing harm.

Doctor d'Herelle's method of finding the cause of destruction of the bacteria is illustrated by his procedure in the isolation of the cholera bacteriophage. He selected a case of cholera in which the disease had

a. 548

run its course and the patient was on his road to recovery. The doctor made an emulsion of the patient's excretions and passed this emulsion through a filter, too fine to allow passage of the smallest cholera germ. A few drops of the solution that did pass through the filter, when placed in another solution containing millions of healthy cholera bacteria, immediately spread destruction.

A first spectacular demonstration of the efficiency of the bacteriophage was recently brought to successful development. Doctor d'Herelle was asked by the British government to lend his aid in stamping out cholera in India. He journeyed to that country and centered his activities at Puri. Cholera was rampant there and in the surrounding district. The wells became contaminated and the disease spread. Doctor d'Herelle and his assistants prepared solutions of cholera bacteriophages. Throughout the city and district they dumped small quantities into wells. In a short time the death rate decreased and the number of cases fell off.

PICTURE MADE WITH BULLETS BY A PISTOL EXPERT



Indian Head "Painted" with Bullets by Detroit Policeman at Distance of Forty-Five Feet

Sergeant Max B. Woodland
pistol instructor

NEW BATTLE WAGON HAS LONG CRUISING RADIUS

a. 509

Uncle Sam's latest battle wagon is a lightweight armored car for the use of the army. It is operated by three men, has a road speed of sixty miles an hour and a cruising radius of 200 miles on one filling of gasoline. It has a turret like a heavy army tank in which are mounted two machine guns.

With a tinplate for a canvas and his pistol for a brush, an expert marksman of the Detroit police department recently "painted" an Indian head at a distance of forty-five feet. He used a thirty-eight-caliber pistol to outline the features and feathers with 125 bullets.



ELK AND DEER LEAP PARK FENCE BUT RETURN

a. 573

Deer and elk in Platt national park, Oklahoma, refuse to stay in their paddocks and also to stay out. Deer, elk and buffalo are kept in fenced-in pastures, but recently all the white-tail deer leaped the fence and fled. After several days they returned of their own accord and entered the inclosure in the same way they left.

Light Armored Car Tested for the Army; It Can Travel Sixty Miles an Hour and Has a Cruising Radius of Some 200 Miles

Acme
at Fort Curtis, Va.

Suppl William E
Branch

lighted material

Anderson, Ind

A. 503



Inflated Rubber Boat Which Resembles a Huge Doughnut and Is "Worn" by Duck Hunters and Fishermen; It Is Easily Carried When Deflated

RUBBER BOAT LIKE A DOUGHNUT HELPS FISHERMEN

Resembling a huge rubber doughnut, an inflated boat has been made for duck hunters and anglers that is worn about the waist. This light "walking" boat is inflated and placed about the waist when entering the water, and does not interfere with walking on land. When deflated it occupies but small space and is easily carried by the hunter. For greater safety, there are two bags, one inside the other, both of which are inflated. The outer boots are vulcanized to the tube, as are rings for attaching suspenders. When the angler gets beyond wading depth, he can propel the craft with a double paddle or attach collapsible propellers to the back of each leg. These collapse when the leg moves forward, but open up at the backward motion, advancing the wearer.

Alternating current sufficient to supply the average home can be generated by an electric power plant, run by a gas engine, which has been marketed recently.

W. A. ...
65, ...
...
...

COAL BETTER THAN SAND AS FILTER FOR WATER

Scientists have found recently that anthracite coal is an effective filter for water, being much better than sand and gravel. Tests have shown that certain grades of anthracite, properly prepared, filter out as much as ninety-nine per cent of bacteria in polluted waters, and in addition remove colors and odors.

A-55
A-514

...
...
...

INSECT PESTS ARE IDENTIFIED BY BIG PICTURES

Farmers are being aided in identifying various kinds of insect pests by pictures of these bugs in giant size, which are painted by artists at the direction of the department of agriculture. Enlarged to such a size that they look like prehistoric monsters, the insects are easily recognized by the farmer after he has had a close-up of the magnified bugs. The pictures thus will serve as a sort of bureau of identification in waging war on these insect criminals.

...
...



Painting Large Pictures of Insect Pests to Enable Farmers to Recognize Them More Easily

Letter Rtd. 9/18/31 W. Hook, Buesia Vista, Colo.
Cactus plant.

Carl Frank Reynolds A. 485
615 W. R.R. Ave
POPULAR MECHANICS
Earl Morgan, Colo.

NEW USES FOUND
FOR CACTUS
PLANTS A. 579

Cactus plants, heretofore considered a useless nuisance, recently have been found the basis for a new and rapidly growing industry. From them now are produced various drugs, soap, cleaners, water softeners and a boiler compound, which is the latest commercial product of the desert plant and has proved a boon to mechanics and engineers. One gallon of cactus juice placed in 10,000 gallons of water will purify an entire heating system and prevent it from being clogged by scale and corrosion. It can be used also for cleaning rust from exposed casings and removing harmful minerals in steam used in the manufacture of food preparations.

LOUD SPEAKERS ON
SHIP SHOUT
ORDERS A. 574

Forty loud speakers compose a robot boatswain's mate on a large battleship recently constructed in England. The telephone-radio equipment, located at strategic points over the vessel, shouts the commander's orders in stentorian tones heard by every member of the crew. At other times the system broadcasts music from the ship's orchestra. As a test before the apparatus was accepted, men with heavy sledge hammers beat on the iron plates to which the speakers were fixed, the amplifiers being required to operate in spite of this abuse. Carl Wilkins

Ⓢ A free-wheeling clutch unit for Ford cars now is available.

Ramsey - Martin Corp.
City Bank Bldg
Kansas City, Mo

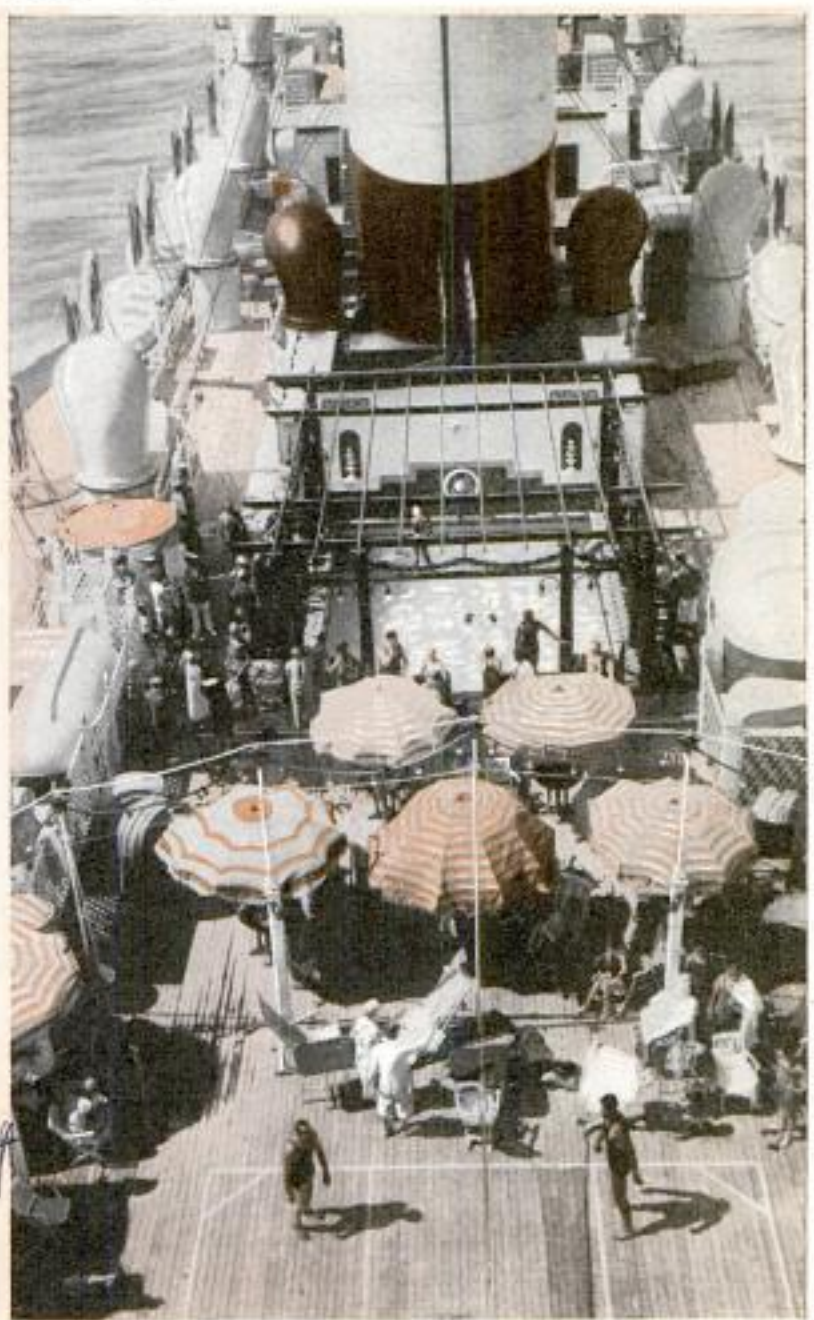

Scene on the Deck of an Italian Liner Which Has Been Transformed into a Seaside Beach, Lacking Only the Sand to Make It Realistic *Wide World*

LINER'S DECK MADE INTO BEACH
LACKING ONLY SAND

In good weather, the deck of the Italian steamer "Roma" is transformed into an ocean beach for the enjoyment of the passengers during a voyage. All the paraphernalia of a typical seaside resort, including beach tents and facilities for playing various games, are provided. About the only thing the absence of which mars the complete illusion of an actual beach, is sand.

a-495
710

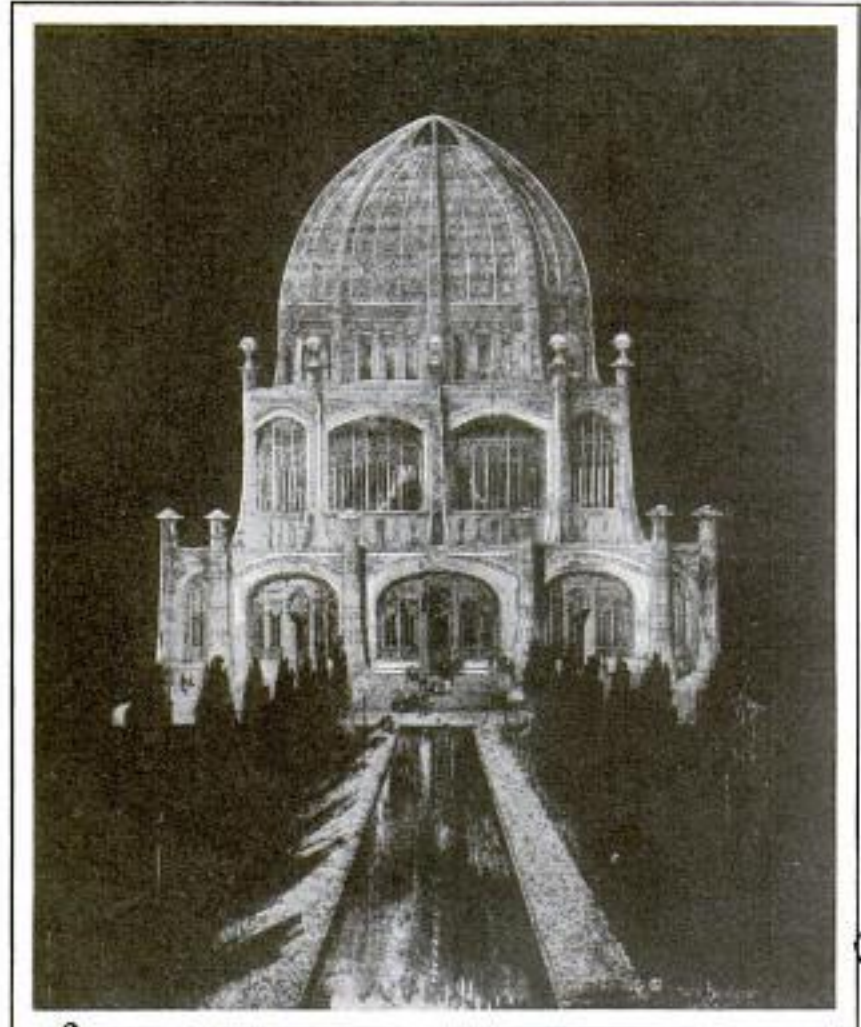

Acme

© Louis Bourgeois

Architect's Drawing of Bahai Temple, Nearing Completion; Many Believe It Will Be One of World's Most Beautiful Structures

TRIUMPH OF ARCHITECT'S ART SEEN IN MODERN TEMPLE

Bahai temple, considered by many to be one of the most beautiful specimens of architecture in the world, is nearing completion at Wilmette, Ill., near Chicago. A fire in the dome of the partly finished building, which will be the home of a religious movement, recently caused \$50,000 damage to the \$1,500,000 structure. Louis Bourgeois, the architect, died while the temple was being built.

FISH SHOOTS DROP OF WATER AT INSECTS

a-592

Little fish that shoot the insects on which they feed with liquid projectiles have been under observation in Bangkok by Dr. Hugh M. Smith, former United States fish commissioner. The fish uses

Science News Letter
3/7/31

a drop of water for a bullet and is so accurate that on two different occasions it extinguished lighted cigarets in the mouths of smokers two yards above the water. When the fish sights a likely candidate for dinner, it pokes its eyes and the tip of its snout above water, holding its body at an angle. It opens its wide mouth a trifle, and at the same instant squeezes its gill covers to propel the "bullet" which has such force that it has been known to dislodge a small lizard. The spitting fish has an effective range of from one to two yards, but can project a drop of water twice or thrice as far.

RAIL CAR IS MADE INTO SUMMER COTTAGE

a-539

Beside a Michigan lake stands an interurban car which has been converted into a summer cottage with many conveniences. It was moved to the lake on a truck and trailer. The motorman's compartment is now a kitchen, which also contains a hot-water heating plant; the smoker has been made into a dining room, and the passengers' compartment has been converted into a living room.



Old Interurban Car Taken to a Lake and Transformed into a Comfortable Summer Cottage

Shub Lake
near Albion, Mich

Owner: G. H. Haynes, 341 N. Bostwick
Charlotte, Mich

Report of Assistant Trade
Commissioner, Hong Kong

**FIRECRACKERS PLAY BIG
PART IN CHINESE
CUSTOMS**

a. 54 2

Firecrackers in China are used not only on holidays, but play an important part in weddings funerals, anniversaries and similar occasions. At the wedding of a wealthy Chinese couple often from 50,000 to 150,000 of them are fired. These are strung on long ropes, sometimes reaching from the roof of a seven-story building to the street below, and a rope requires from twenty to thirty minutes to go off. China makes its own firecrackers and also exports them throughout the world, old American newspapers often being used to wrap them.

**WETTING WITH STEAM
ELIMINATES DUST
FROM COAL**

a. 55 2

Steam, instead of water, now is being used as a more effective method of wetting down coal to lay the dust before making deliveries. Previously, a hose was turned on the coal after it was weighed, the top being soaked. Now a steam pipe with a nozzle is forced to the bottom of the load at three or four points, and the entire load is saturated in a few minutes, the dust being eliminated without any excess of water. The steam is conveyed to the pipe through a rubber hose, and leaves the boiler at a pressure of from seventy-five to ninety pounds.

*Used by Cedar Lake & Fuel Co
for wetting coal
Reported by Andy quite
it will take 100 lbs
of water to 100 lbs of coal*

**BIG BATTLESHIP FILLS
CANAL ON VISIT
TO PANAMA**

a. 50 5

When the British battleship "Nelson," one of the largest and most modern fighting craft in the world, recently paid an official visit to the United States fleet at Panama, it was found that the Panama canal was a tight squeeze for the huge flagship of the British Atlantic fleet. At one point, the boat scraped the lock walls but no damage was done. This British



Views of the Giant British Battleship "Nelson," Squeezing through Locks of Panama Canal

Wide World

fighter carries nine sixteen-inch guns, twelve six-inch guns and several anti-aircraft guns, as well as a full equipment of the latest in modern paraphernalia for naval warfare.

Q. 435

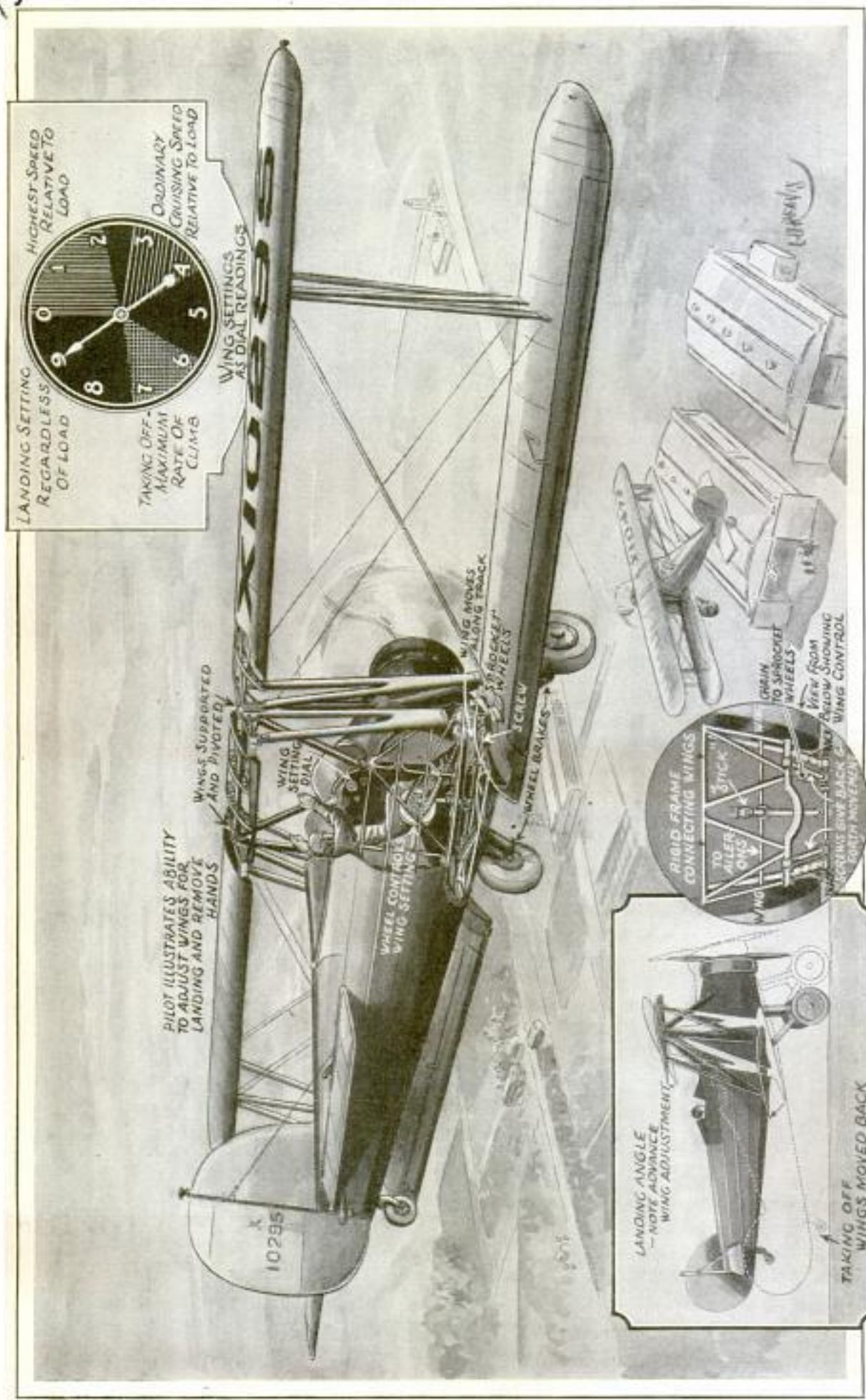

LANDING SETTING REGARDLESS OF LOAD

HIGHEST-SPEED RELATIVE TO LOAD

ORDINARY CRUISING SPEED RELATIVE TO LOAD

TAKING OFF - MAXIMUM RATE OF CLIMB

WING SETTINGS AS DIAL READINGS

PILOT ILLUSTRATES ABILITY TO ADJUST WINGS FOR LANDING AND REMOVE HANDS

LANDING ANGLE - NOTE ADVANCE WING ADJUSTMENT

TAKING OFF WINGS MOVED BACK

RIGID FRAME CONNECTING WINGS

TO ALLER

TO STICK

TO WHEELS

TO WING

WINGS MOVE BACK & FORWARD

GRAB TO SPRING WHEELS

VIEW FROM BELOW SHOWING WING CONTROL

Safety Plane with Tilting Wings Which Can Land Itself, and Mechanical Features Making the Feat Possible; the Wing Structure Is Pivoted to the Braces Connecting It to the Fuselage, and the Tilt of the Wings Is Controlled by a Wheel in the Cockpit

Merrill Aircraft Co

Q 3810, 10¢ POPULAR MECHANICS

713

Q-498

SAFETY PLANE LANDS ITSELF WITH TILTING WINGS

Ans

a-4 35

Prof. Albert Adams Merrill has announced the development of an airplane which may be as easy for the average man to learn to fly safely as it is to run an automobile safely. The following extraordinary claims are made for this plane: It can be landed safely with the pilot's hands removed from the controls. It cannot be put into a dive, stalled, and it will not go into a spin. It cannot be made to do acrobatics of any description. In a recent demonstration, a representative of Popular Mechanics Magazine saw the plane land repeatedly with the pilot's hands high above his head. Although, at first glance, the plane appears of conventional design, a closer inspection reveals two unusual features: First, the complete biplane wing structure is pivoted to the braces which connect this structure to the fuselage; second, there are no stabilizers. By operating a wheel within the pilot's cockpit, the tilt of the wings may be changed from a small angle for straight-away flying up to an angle of fourteen degrees for take-off or landing. With the wings at fourteen degrees, the pilot can throttle the engine to idling, and remove his hands from the controls while the plane automatically assumes the correct gliding angle and maintains it until it reaches the ground.



u-u

Girl Being Weighed on Huge Scales That Can Lift and Weigh 10,000-Pound Metal Ingots

SCALES THAT LIFT FIVE TONS ALSO WEIGHS PERSON

Huge scales that lift, swing and weigh metal ingots up to 10,000 pounds recently were exhibited and demonstrated at a metal congress on the Pacific coast. Despite their giant size and capacity, the scales were found delicate enough to record the correct weight of a 135-pound girl.

a-576

DO GOPHERS PREY ON SNAKES?

Many farmers of Alberta, Canada, have decided that gophers are responsible for ridding some sections of rattlesnakes. It was observed that the snakes became less numerous as soon as gophers invaded rattlesnake territory, and are not found on wheat farms where the gophers abound. It is thought they feed on the snakes while these are dormant.

Capt. Herbert E. Drain
R.R. Barons
Alberta, Canada

U. S. CAR AFTER SPEED RECORD HAS MOTOR IN EACH WHEEL

a-525

In an attempt to break the automobile-speed record of more than 245 miles an hour established a few months ago, an American car of revolutionary design is being constructed by E. J. Pennypacker, of Hollywood, Calif. It will be driven by four motors, one in each wheel.

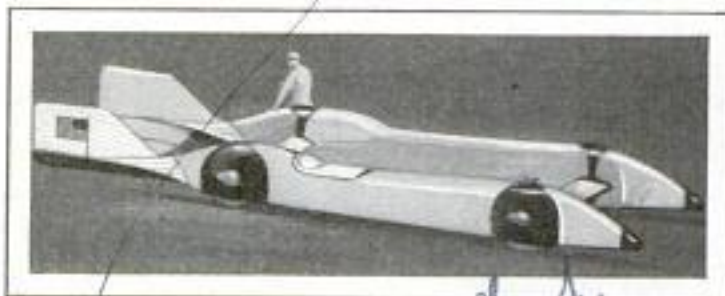

Ans

American Car That Will Try for World Speed Record

Last known address:
1716 N. Edgemont.

THOUSANDS OF LADYBUGS A DAY GROWN ON FARM

Raising bugs to eat other bugs is the sole purpose of an insect farm in California with a capacity of from 80,000 to 300,000 ladybugs a day. When mealy bugs threatened to destroy orange groves valued at \$5,000 an acre, citrus growers began searching for



kept dark until time for gathering them, when a light is thrown on a screen and they throng to the light. The ladybugs are delivered in capsules, ten insects to a capsule, and one capsule is placed in each infested tree. The ladybugs begin their war of extermination almost immediately and clear an orange grove of mealy bugs in a remarkably short

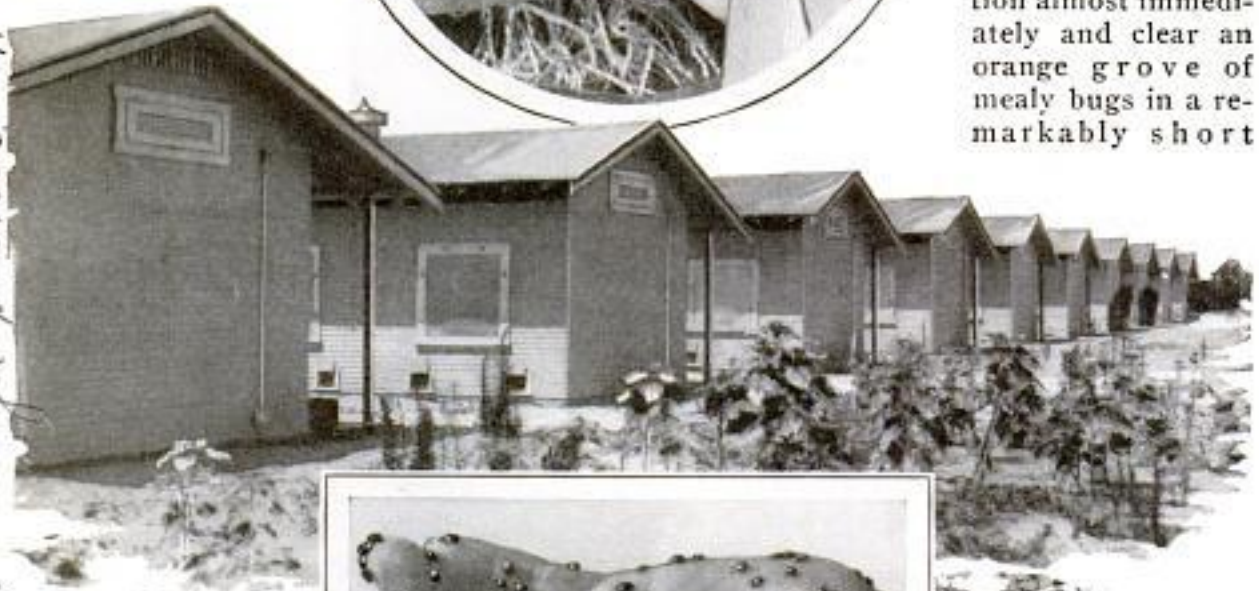

Potato Sprouts on Which Larvae of Ladybugs Are Grown; Nursery, and a Handful of Ladybugs

a means of controlling this pest and found the answer in the Australian ladybug, which is a deadly enemy of the other insect. A few thousand were imported, and a small building was constructed as a nursery for them. Today the farm includes twenty-eight buildings, each of six rooms or bug compartments. The feed bill includes over 5,000 sacks of the finest potatoes a year, and a crew of men is employed to tend the baby insects. The temperature in the bug room is kept near eighty degrees constantly and the larvae are grown on the sprouts of potatoes. The grown bugs are easy to catch, as their quarters are

time. The insectary is provided with an air-conditioning system that removes dirt and supplies proper humidity and temperature, and the plant itself is insect-proof in

order to keep the ladybugs safely in and other bugs out.

CROSSED EYES ARE CORRECTED BY STEREOSCOPE DEVICE

Crossed or squint eyes are being aided by an apparatus somewhat like the ordinary stereoscope which has been developed by an English doctor. The device does not replace former methods of correcting

Dr. Cyril E. Maddox
Bournemouth, England

Chester W. Adams, 20th & Co. St. Marysville, Calif
\$4.00 for 10,000. \$20.00 for \$50.00
125,000 1,000,000

Service Service

519. G. 2/1/31 POPULAR MECHANICS

a 534 dnd. Deputy

715

Chief Joseph O. Hauler

by glasses, prisms or operations, but merely supplements them. Suspecting that many cases of squint are due to the persistence of the infantile inability to co-ordinate the movements of the eyes, the doctor developed an apparatus to discourage the tendency of each eye to act separately. He employs the hand of the patient to educate the erring eye, thus imitating the natural process of infancy in which hand and eye mutually perfect their training by trial and error.

SUSPENSION WINGS TO ELIMINATE AILERONS

a-484

Ailerons are entirely lacking on what the inventors term a fool-proof airplane recently demonstrated on the Pacific coast. Instead of using ailerons to provide lateral balance, this task is performed by what are known as "free suspension" wings, attached at right angles to the rear surfaces of the flying wings. This arrangement, it is claimed, causes the ship to assume the proper landing position automatically at the moment the power is shut off.



Airplane with "Free Suspension" Wings, Which Cause Ship to Assume Proper Landing Position

Wich. World



Various Applications of a Fire Hose with an Extension Nozzle, Capable of Making a Powerful Stream of Water Turn Corners

WATER MADE TO TURN CORNER BY NEW FIRE NOZZLE

Capable of making a stream of water turn corners, thus enabling firemen to launch a flank attack on a blaze, an extension nozzle for a fire hose also serves in emergency as a miniature water tower. It consists of an ordinary nozzle mounted on a length of flexible brass tubing, which in turn is connected to a rigid extension of stainless steel, nine feet long. Between the hose coupling and the extension are two valves which control the direction of the nozzle and the size of the stream. When the end is bent to turn a corner, the flexible tubing is held in position by an aluminum casing. One man operates a lever which turns the nozzle in any desired direction, and another controls a valve which varies the stream. The nozzle is equipped with a removable stand so that the operator can place the nozzle in an aperture a story or more above him, thus transforming the apparatus into a small water tower. The long nozzle enables firemen to cope with smoke, flame or heat without getting in their path.

New York
Fire Dept
1938 E 15 St
Brooklyn NY

Will be put on market

Chas. George Wilbur Cornelius

Carl C. Spangenberg, Designer
Island City, Calif
Copyrighted material
Littell Ltd

a. 398

The World's First

At Tempelhof, near Berlin, is a Rocket Airdrome, a Field Equipped for Studying Rocket-Propelled Air Vehicles; from These Tests the Experimenters Hope Eventually to Develop a Practical Rocket-Propelled Airplane, and to Find Out Much about the Atmosphere Many Miles above the Earth; at Left is Shown an Explosion as a Rocket is Fired, and a Projectile Being Placed in Its Mounting



Above is an Observation Post Protected by Sand Bags from Which the Experimenters Watch the Firing of One of the Test Rockets, and, at the Right, a Man is Engaged in the Highly Hazardous Task of Filling One of the Rocket Cartridges with Liquid Oxygen; Because of the Danger Involved, He Wears an Asbestos Suit for Protection in Case of a Premature Explosion

Rocket Airdrome

Erecting the Stand on Which the Rocket is Mounted, and, at Right, a Parachute Carrying an Exhausted Rocket Back to Earth with the Apparatus Which Has Recorded Its Flight; the Parachute Is in Its Nose, and Opens When the Rocket Has Spent Its Force and Begins Falling



Below, Listening to Signals from an Automatic Radio Transmitter on a Rocket in Flight; by Turning the Loop Aerial, the Operator Follows the General Path of the Projectile as It Falls, Thus Locating It More Easily



Left, Operator Wearing Heavy Asbestos Suit Ready to Fill One of the Rocket Cartridges with Liquid Oxygen



a. 492 The Club - For mfg Co,

24 S. Canal St. Dayton Ohio

Chicago. 228 h To Sall



Gas Water Heater and Garbage Burner Combined; Burning Refuse Helps Heat Water

GAS WATER HEATER COMBINED WITH GARBAGE BURNER

For the home or apartment building, a gas water heater and an automatic garbage burner are offered in one compact unit, the same fuel that heats the water also disposing of the garbage. The double-duty appliance comes in four sizes for basement, first-floor and apartment installations, and the connections are the same as for any water heater. A thermostat maintains constant water temperature and regulates the burner. Garbage is deposited in a special hopper where it is under a constant drying temperature of 130 degrees, and is subjected to intermittent drying and slow burning until it is finally consumed. Heat generated by the burning garbage is absorbed by the water storage surrounding the hopper so that there is no waste of heat. The hopper is removable to facilitate grate repairs.

BEARS HUNTED WITH SHOVELS WHEN IN HIBERNATION

Shovels are used for bear hunting by natives in certain sections of Virginia dur-

ing the hibernating season. The small black bears frequently hibernate in shallow mounds covered only by a blanket of leaves and snow. They make distinctive mounds which the hunters investigate by digging. Dogs then hem in the slumber-dazed creatures until they are shot. Even outside the hibernating period, bears are hunted there with shotguns rather than rifles. A ball cartridge is used, a single large shot replacing the usual shotgun charge. Another method is to "ring" the shell by cutting almost through the cardboard between the wads separating shot from powder, so the charge leaves the barrel as a unit.

MINIATURE OF BRICK RESIDENCE IS CONSTRUCTED OF WOOD

Working in spare time for more than four years, a Philadelphia man has built a miniature model of a fine brick residence in that city which is complete in every exterior detail so far as appearances are concerned. The walls are of one-half-inch white-pine wood painted red, and then blocked out by hand to give the brick effect. Shingles on the roof are glued, rain spouts are made of "bean shooters" like those used by small boys, and the side veranda is made of an organ-top board. The structure is twenty-six inches high, forty-two inches long and twenty-four inches wide, with a servants' quarters adjoining in the rear, and contains forty-three windows and six doors. The build-



Miniature of Brick Residence with Walls of White Pine Painted and Blocked to Imitate Bricks

er's only tools were a jigsaw, plane, hammer and pocketknife, but the porch columns were turned in a sawmill.

a. 515

Cont. Dick Hain,
2855 Belmont Ave.
Chicago

Built by William
B. Jant 34 W.
Mt. Airy
Phila

a-513

Developed by City Engineering Dept
of Chicago and used on
POPULAR MECHANICS
Wabash Ave Bridge

719

LIFT-BRIDGE FLOOR OF NON-SKID CONCRETE SLABS

Pre-cast slabs of lightweight concrete form the flooring of the recently completed double-leaf trunnion-bascule bridge over the Chicago river at Wabash avenue in

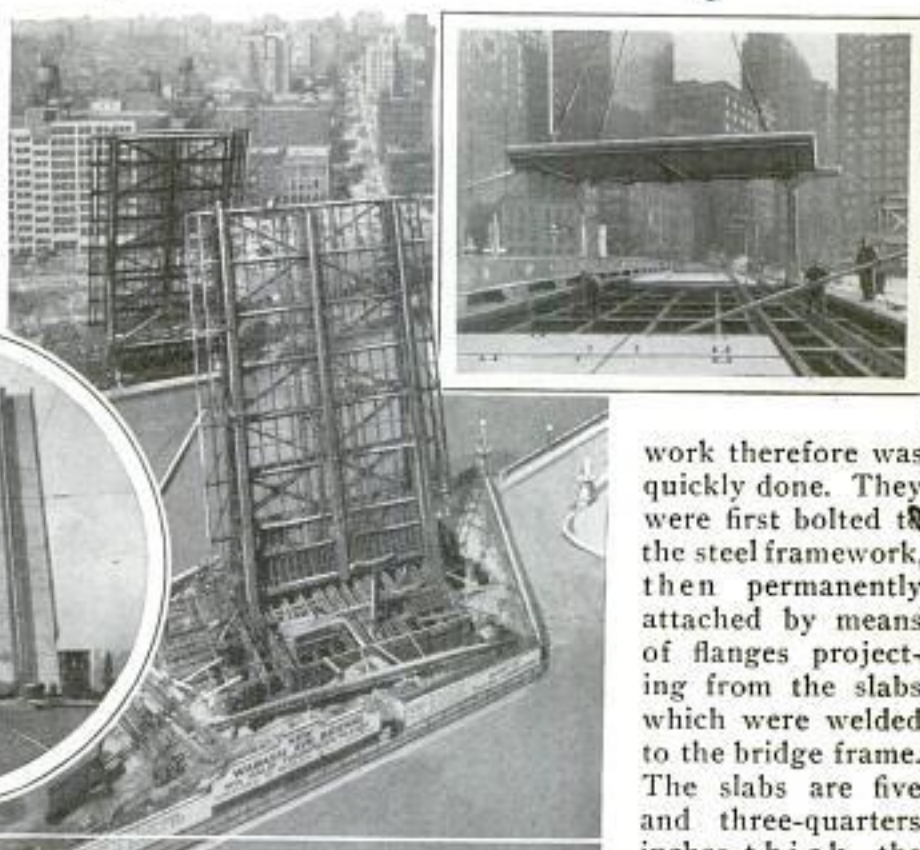

Lift-Bridge Floor of Non-Skid Concrete Slabs; Before Floor Was Laid, and Placing a Slab

Chicago. This type of flooring has been widely used in stationary structures because it prevents skidding, but it has only recently been applied to lift bridges. The flooring units have an area of 102 square feet and the

work therefore was quickly done. They were first bolted to the steel framework, then permanently attached by means of flanges projecting from the slabs which were welded to the bridge frame. The slabs are five and three-quarters inches thick, the lower four inches being made of light aggregates of burned clay and shale instead of stone, giving the concrete a weight one-fifth less than the usual kind. The top is of granite chips to give long wear.

LACQUER-COATED WALL PAPER IS EASILY CLEANED

a-562

Expensive wall paper can be kept clean easily if coated with a special wall-paper lacquer which is quick-drying and transparent. It is applied with a brush and the resulting surface is non-porous and resists both air and water. Once the lacquer is applied, the walls offer no greater problem in cleaning than a painted surface, although a cleaner ordinarily is used instead of water because streaks left by the cleaner are easily removed.

vacuum grip. The sides of the handle contain depressions which form a vacuum when the hand presses against them. It is claimed the handle prevents calluses, since it is not necessary to grip it so firmly and friction is reduced.

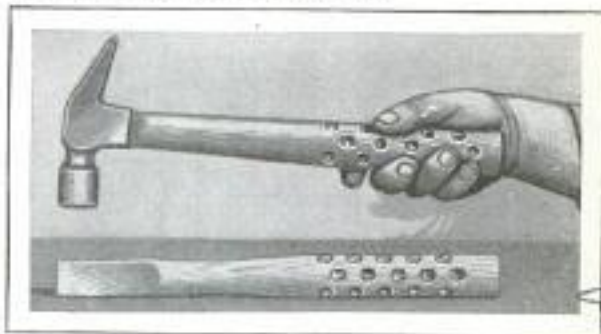

VACUUM GRIP IN TOOL HANDLE MAKES WORK EASIER

a-535

Tired hands and arm muscles from using hammers and other tools are prevented to a great extent by a tool handle with a

Tool Handle Containing Depressions in Sides Which Give a Vacuum Grip, Easy on the Hands

☛ Cotton gets its name from the Arabian word "qutn."

Chicago-2001 W. Parshing

Central Buflly. The Park
Central Bldg. 303
Cant. Carl
W. D. Layton Co. Sebastopol Calif
Box 535

Sherwin-Williams
Paint Co, 101 Prospect Ave N.W.
Cleveland, Ohio

Copyrighted material

a-512

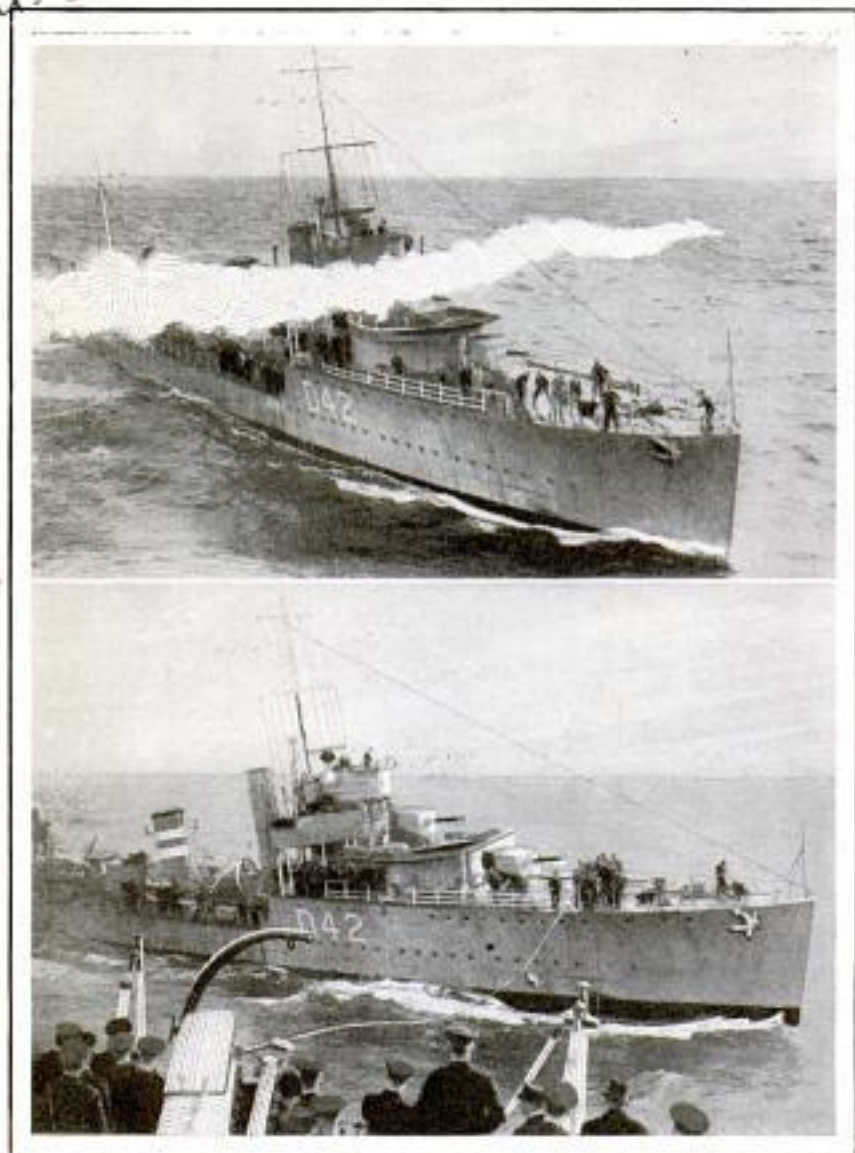

Line Being Fired from Battleship to British Destroyer; Below, Making Transfer of Mail at Sea by Means of the Line

BOATS TRANSFER MAIL AT SEA BY USING GUN AND LINE

Mail was recently transferred at sea from the British battleship "Nelson" to the destroyer "Windsor" without either boats or crews coming into direct contact. A gun aboard the battleship fired a line which fell across the bow of the destroyer. The line then was used to convey the mail pouches from ship to ship.

PHONE-CALL REGISTER TAKES RECORD OF NUMBER

Automatic, or dial, telephone systems now can be equipped with recorders which take down the number of a party calling when the subscriber is absent, enabling

the latter to call back on his return. All the party that is calling needs to do is dial his own number when he gets no response. This number then is recorded on a paper tape by the silent phone. The register consists of a specially arranged pen-register and switch to connect the device to the telephone line. This switch is thrown when the subscriber leaves the office. Ringing of the telephone energizes a magnet in the recorder which starts a spring-driven mechanism that operates the feed of paper tape. The operation of this mechanism also sends a buzzer tone back over the line to inform the party calling that the subscriber is out. He then dials his own number, which is recorded on the tape.

BURLAP PROTECTS SHADE TREES

While studying control methods for the gypsy moth, a pest of shade trees, government workers discovered that a burlap band, tied around the trunk, made an excellent trap for the caterpillars. Strips of burlap, about eight inches wide, were tied around the tree with twine, the top half being folded down over the string. Large numbers of caterpillars can be



caught in these traps and only a short time is required to crush those that take refuge under the burlap, which may be installed in the early summer, preferably any time after June fifteenth.

Automatic Electric Co.
1033 W. Van Buren
Chicago

Dept. of Agriculture

Copyrighted material

Dr. Is Failla . a. 444
and P. S. Henshaw

New York Memorial Hospital

RADIUM RAYS MORE EFFECTIVE THAN X-RAYS

a. 486

Although radium rays and X-rays cause reddening of the skin to the same extent, the radium is about three times more effective in producing deep-seated effects. This conclusion has been reached by two scientists who constructed apparatus to measure equivalent, comparable doses of the two radiations. It was found 500 Roentgen units of radium gamma rays produced the same reddening of the skin as 600 Roentgens of filtered X-rays. Other experiments were made on wheat seedlings. In both cases the effect of the radiation was shown as a stunting of the living shoots or cells, but three times as much X-ray radiation was required to produce an effect comparable to radium. For this reason, it may be desirable to use higher voltages with X-rays for medical purposes.



Giant Power Shovel Which Loads Cars in Germany; It Can Move More Than 850 Cubic Yards an Hour and Is Eighty Feet High

GIANT POWER SHOVEL LOADS CARS AUTOMATICALLY

One of the largest power shovels ever built is being used in Germany to load coal cars. The belted scoops run on rails, and the giant shovel itself is big enough to straddle a pair of railway tracks so cars can be run beneath it for filling. It is more than eighty feet high and can handle over 850 cubic yards of coal an hour. The shovel ladder has a reach up or down of some fifty feet, so that it can handle a pile of coal 100 feet high from one position.

Michal lignite coal mine near Halle, Germany

at the

BICYCLE AND SLED COMBINED FOR TRAVEL ON ICE

a. 462

One twelve-year-old New Jersey boy has taken his place with the inventors by combining his sled and bicycle into one serviceable vehicle for use on the ice or in snow. Removing the front wheel of his bicycle, he attached the forks to the rear of his sled.



Bicycle and Sled Combined into One Vehicle for Travel on Ice by Twelve-Year-Old Inventor

Billy Bataille,
12 years old at
Mohawk, N.Y.

FLIES COSTLY TO THE MOVIES FORCING RETAKES

a. 463

Common flies, the ordinary household pests, are one of the costly scourges of the moving-picture industry. One director estimates that flies cost the movies from \$4,000 to \$10,000 a day in retakes. Hundreds of feet of film may be spoiled at the last minute if a fly appears on the nose of an actress in a close-up. Flies appear to have an uncanny ability to enter the movies exactly at the climax, and light on an actor or a lens. Since the advent of the talking pictures, the fly has made an additional nuisance of itself. Two of them playing tag near a microphone record like a big naval engagement. A number of men are employed in Hollywood solely to chase flies off sets.

Chicago Evening Post
2/24/31

u-49

Amb J. J. Brown, Jr.
 805 E 182nd St
 New York

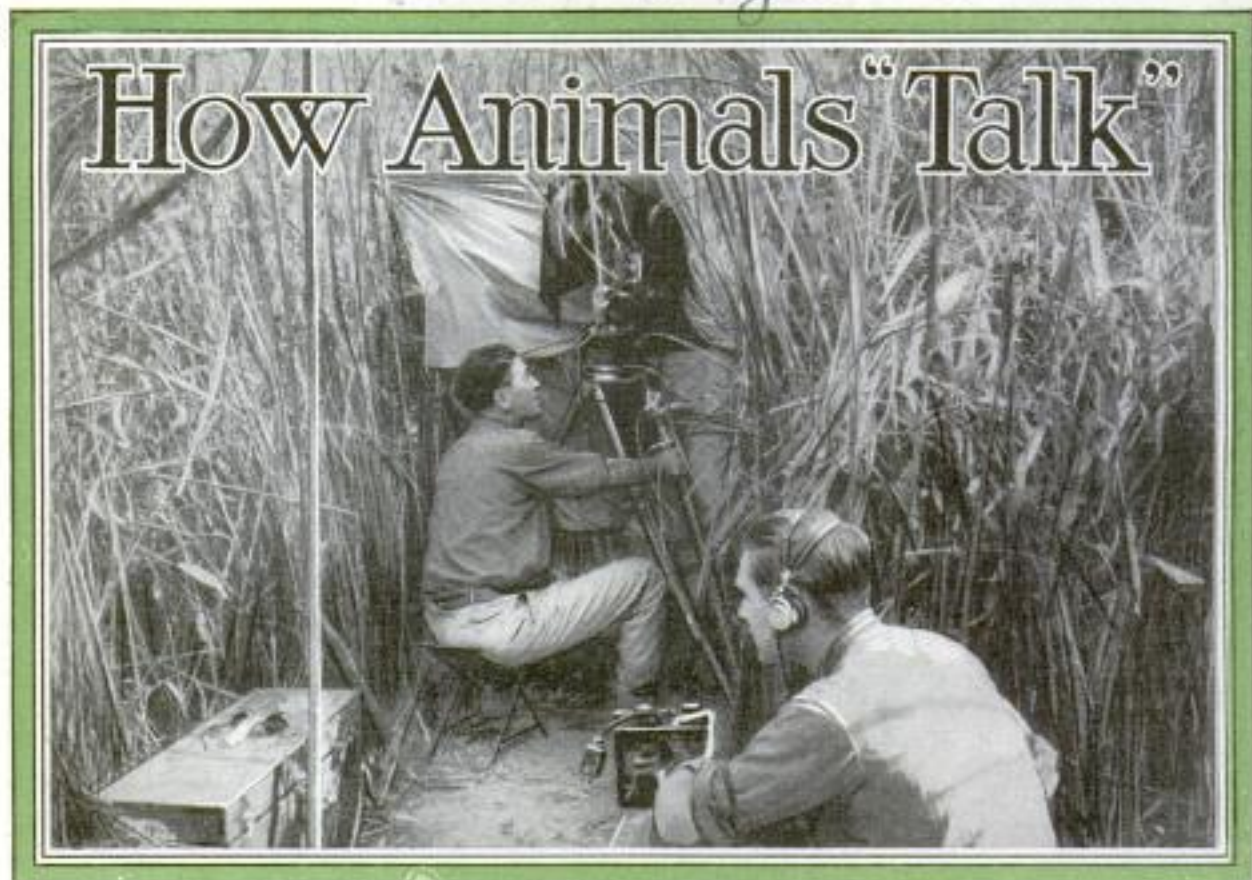

Men with Movie Camera and Sound Apparatus Screened in Ambush and Awaiting Tiger, to Make a Sound Picture of the Animal in Its Natural Habitat

SHOUTING hysterically, a perfectly sane young man cavorted on the banks of the beaver pond in the New York Zoo. Suddenly he stopped, silent and unmoving. An instant later, from the nearest beaver, there came a peculiar loud splash.

"Beat it, beavers," it signaled.

Startled by the man's frenzied activities, the sentry of the beaver colony had given the curious warning splash with its tail. In another minute every one of the industrious animals had disappeared. Behind a near-by bush, however, a motion-picture camera had been grinding away while sound apparatus had recorded the "voice" of the beaver. With the alarm slap, the beaver picture was completed. It had taken three years to make.

Dr. Raymond L. Ditmars, curator of the zoo, has just finished making an extraordinary series of talking pictures with an all-star cast of animals and reptiles. The voice of the rattlesnake, the roar of the lion, the trumpet of the elephant, the bellowings of the giant tortoise, the grunt of the hippo, the hiss of the cobra—these and other articulations of the usually

silent animal world have been secured through a variety of ingenious stratagems and despite often dangerous obstacles.

With the increasing perfection of sound and reproducing equipment, has come a growing number of attempts to record the authentic enunciations of animals—a most difficult task, in the face of their customary reluctance to vociferate. Yet, not only in zoos but in the jungles of Africa, India and South America, beasts are "talking" before hidden microphones. The Martin Johnsons, the members of the Matto-Grosso expedition and other explorers, scientists and sportsmen are now engaged in making talkies of ungentle, uncaged animals in their natural environments.

The first to make these sound pictures of jungle beasts, Comm. George M. Dyott, returned some months ago from an exploration in little-traveled regions of northern India, where he succeeded in making pictures of barking deer, screeching peacocks, growling Himalayan bears, whistling birds, wild pigs, langur monkeys and sundry jungle fowl. He concentrated, however, on carnivorous tigers,

for the Movies

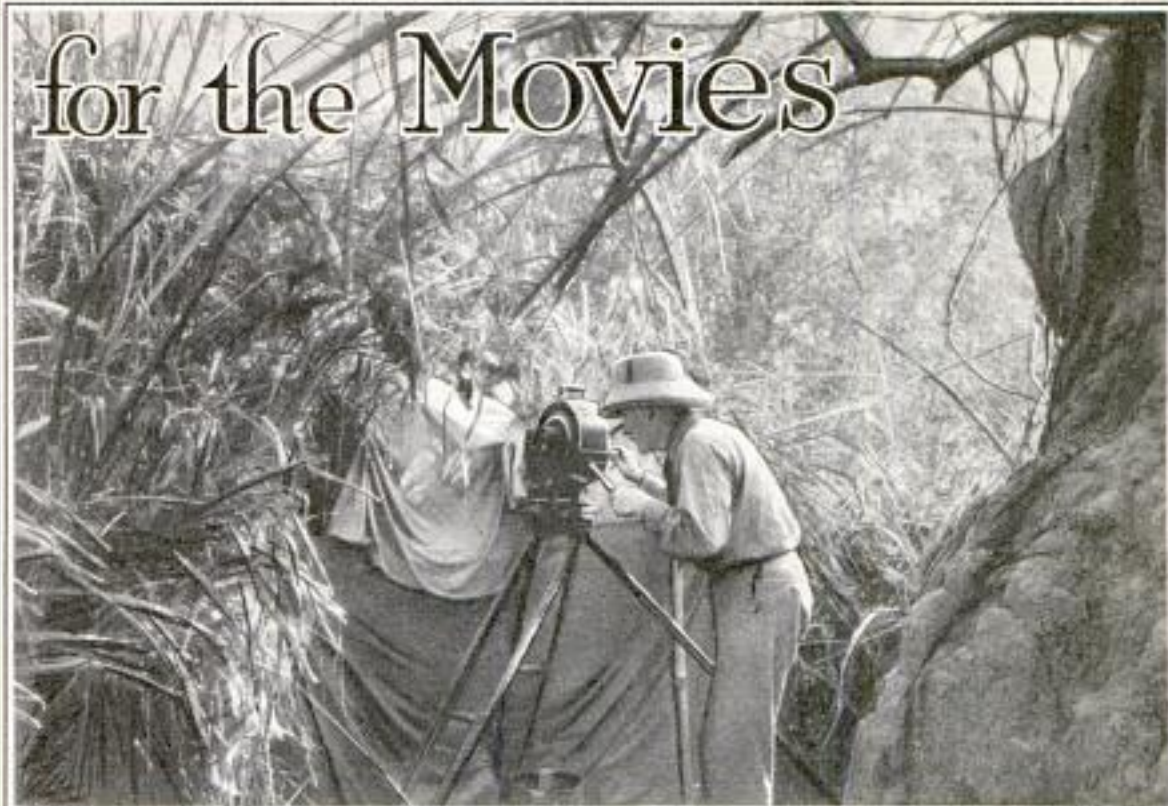

A Variation of the Tiger Set-Up; Commander G. M. Dyott, with Special Camera, Stands Where He Can Watch the Area and Direct the Hidden Movie Men

leopards and elephants. Commander Dyott's new expedition to the hazardous Xingu river country in Brazil, will have two airplanes and wireless equipment, in seeking to secure talking pictures of other jungle animals.

Getting the ferocious, untamed denizens of the jungle to pose and talk naturally before camera and mike is no simple task. The difficulties are so enormous and the process so delicate that, as Commander Dyott declares, it is only a matter of luck when a sound picture of an animal is successfully taken.

To make a tiger talk, for example, will often take weeks of preparation. You can't say "There's a tiger"; walk over to it with camera and sound apparatus, and shoot the picture. The beast must be forestalled, and awaited with all the mechanism carefully set up and cleverly screened from view. Places which the tiger is known to frequent are chosen as "locations" for pictures. A study of the animal's habits—perhaps the discovery of a scratched tree-trunk on which it is accustomed to sharpen its claws—will determine the exact scene of the drama.

Fifteen feet or more from the tigers, screened behind a grass framework made to resemble a part of the jungle, camera-man, sound man and director dare not move an eyelid. It is only because of the tiger's poor sense of smell that they can thus remain undetected and catch the tiger and its family "talking" naturally at their festive board. With the tiger's appetite aroused, the discovery of a human being in the immediate neighborhood would not be conducive to that person's health.

Because of the numerous difficulties and hazards to be overcome before an animal can be made to talk, Commander Dyott spent more than four months in getting only a thousand feet of film. Although the sound apparatus was made specially compact for him, it was not easily portable and required the greatest care in setting up. Then, of course, the beasts must somehow be persuaded to come sufficiently close to the mike to register loud enough; all this without the subject being aware of the presence of camera or humans.

Great difficulty is encountered in reproducing the low-frequency sounds of



guttural bass, noises—the tiger's roar, for instance—on the screen unless there is special amplification for this purpose. With the animal's utterances and movements completely uncontrolled, it is hard to adjust the amplifier correctly. Besides, no animal can be made to talk by artificial means. They are naturally silent in order not to attract their enemies. Birds can afford to be noisy; they are on the wing. The only sounds animals make aim to demoralize adversaries and to call their mates. It is no wonder, then, that even in the zoo, the curator found it impossible to record the voices of the wolf, the alligator and the peacock.

With animals in captivity, methods different from those used in the jungle must be employed, though it is often just as arduous a proposition to make



them vociferate. Nevertheless, before making his pictures, Doctor Ditmars succeeded in getting some of his charges to go through talking screen tests. The rattlesnake, he found, had the best speaking voice, while the lion had the poorest. Monkeys had particularly good intonation, while insects' sounds reproduced very faithfully.

In contrast with the elaborate method of inducing the tiger to talk in the jungle, Doctor Ditmars' device for forcing the tiger's or lion's roar is remarkably simple.

A large meaty bone, to which a long wire is attached, is thrown to the beast. In the midst of its enjoyment of the meal, it is suddenly yanked out of its mouth. The subsequent tremendous roar of anger is caught by the hidden microphone and synchronized with the picture.

The elephant speaks either in little squealing

Making Sound Film of Crickets, Close View of One of the Tiger Shots and Captured Elephant Making an Abundance of Sound



Coaxing Dogs to Perform for a "Barkie," and Grass Screen Used in Filming Tigers

sounds or loud trumpets when it is excited. With the captive elephant, the mike is placed in a pail, and the animal puts its trunk down into it, talking back to the keeper who addresses it. In the jungle, on the other hand, the elephant is often dangerous. If disturbed or surprised, it is always likely to attack. Its sense of smell is so keen that it can detect something a mile away. Hence, it is necessary to work to leeward of it.

The fer-de-lance, one of the deadliest of poisonous snakes in the zoo, enacted a perfect, though somewhat hazardous, performance for the audible screen. In order to get the buzz of the tropical viper, the recording instrument was placed within

two feet of its vibrating, quivering, rattling tail. The exact striking distance had to be carefully calculated and Doctor Ditmars and his assistants had several narrow escapes from the lunging snake. Similar danger was ever-present in the recording of the loud, sharp hiss of the cobra in a fight with a mongoose.

To persuade the tree toad, which has a two-inch throat, to sing for the talkies, every known artifice was tried in vain. Finally, four men started to file on pieces of brass, producing an ear-piercing racket. It proved irresistible. When the tree toad's throat began to swell, the men stopped filing, and the shrill, deafening song of the toad was successfully recorded. Purely by accident, the tree toad provided an exceedingly funny scene for the talkies. Its enormous forefeet got entangled in a piece of cord with the result that its subsequent acrobatic antics became a hilarious farce.

Monkeys are natural comedians. About fifty varieties of monkeys were photographed by Doctor Ditmars, who found the marmoset, which has a voice like a bird, the star of the lot. The curator merely lures his monkeys with food and talks to them. They jabber back, right into the mike.

The easiest voice to record is the sea lion's. It will bark whenever it is hungry, and do it unabashed close to the micro-

A-49
226



Observation Platform Rigged in Tree for Filming Sound Pictures of Animals in the Jungles of India

phone. The giant tortoise of the Galapagos islands will bellow at a certain time of the day. It is also easy to get a close-up of a hippopotamus, which makes a sound naturally about once a week—a mere grunt. Bears, normally dignified and reticent, will get noisy when a battle among them is instigated.

Most animals, however, have stage fright, and as a rule the sight of a camera, or merely the feeling that something is happening, is sufficient to make most animals refuse to talk. Many months were spent in vain in the Bronx Zoo trying to get wolves to howl while standing on the rocks. Nor have Doctor Ditmars and a number of newsreel companies been successful in getting the albino peacock to

spread its beautiful wings and articulate before camera and mike.

One of the best talking pictures made in the zoo was that of the prairie dogs. When the sentry lets loose a long, shrill cry, the entire crew rushes to its holes. A constant chattering is taken as a warning—"stand ready to beat it." A long whistling sound, and then another very prolonged sound, mean "all's well." One "eek," and they all scurry to shelter. The entire picture in sound took about a year to make.

The most successful sound picture taken was that of a chorus of katydids. These tree-top songsters, a couple of inches long, produce the greatest volume of sound in relation to their weight of any insect or animal. On a still night, its voice will carry for half a mile, yet it is so timid that it stops singing when someone approaches.

Capturing the katydids was not an easy job. The curator and his assistants had to go up to the Catskill mountains to hunt for them. On a dark night, they placed a huge umbrella beneath small scrub-oak trees, about six or seven feet high, and shook the trees. The katydids fell into the umbrella. Sometimes, when the insects stopped singing as they

saw the flashlights approach, the hunters had to wait for an hour or more until their song was resumed. In his studio, later, Doctor Ditmars was able to photograph clearly the rubbing together of the katydid's wings—that peculiar sawing which produces the sound similar to that of fiddle strings.

MANGANESE IS NOT ESSENTIAL FOR VEGETABLE LIFE

Manganese, strengthener of steels, recently believed to be equally important as a vivifier of green plants, may not be as universally necessary for vegetable life as has been assumed. Experiments at Iowa State college lend support to the

*Dr. Norman Ashwell
Clark and Claude L
De la*

Copyrighted material

a. 41
found by W. Sudwell, employe on Andy Anderson farm, 5 mi. west of Cedar Hill, head of geology dept. identified by Dr. Ellis W. Shuler.

doubters of the importance of manganese for green growths. To simplify procedure, tests were made with a floating water plant known as "Lemna." This seemed to thrive without that element.

COMBINE WITH WIRE CYLINDER SPEEDS UP HARVESTING

a-42

Harvesting and threshing of small grains has been speeded up by a combine which is equipped with a wire-brush cylinder instead of the conventional steel cylinder and concaves. The combine takes a five-foot cut and is so small that it will work anywhere a binder can be used. Its wire-brush cylinder, five feet long and eighteen inches in diameter, turns at 1,000 revolutions per minute, this motion beating the grain out of the head. Grain severed by the cutter bar is carried to the cylinder, and the kernels are whisked out as the straw passes over the brush. The straw falls to the ground and the grain is carried by an elevator to a separating device. Since eighty per cent of the straw never enters the separator at all, the combine can handle any length of straw without difficulty. It is pulled by a tractor and operated by a power take-off, one man handling both machines. A governor on the fan automatically controls the air blast, increasing the size of openings and air flow if the outfit slows down.



Skull and Neck of Prehistoric Reptile Found on Texas Farm, and Drawing of Complete Skeleton

SKELETON OF ANCIENT REPTILE FOUND ON TEXAS FARM

One of the best preserved skeletons of the prehistoric plesiosaurus ever found was discovered quite by accident recently in the mud of a pig pen on a farm near Dallas, Tex. The remains of this long-necked seagoing reptile were disclosed after the pigs had uprooted a front flipper of the gigantic specimen. Excavations soon unearthed a skull, a foot and a half long, attached to a twenty-five-foot neck. The full length of the beast was estimated to have been from forty to seventy-five feet. It lived some 20,000,000 years ago and probably weighed 50,000 pounds. The skeleton will repose in one of the buildings of Southern Methodist University.

Automobile owners pay gasoline taxes of \$500,000,000 a year, in addition to \$350,000,000 for registration and license fees.

Chicago-20 H. Wacker Street

And R. S. Fleming
Chico, Calif



Combine Equipped with Wire-Brush Cylinder, Which Beats Out the Grain as the Straw Passes over the Brush; One Man Operates It

Allis-Chalmers Mfg Co
Milwaukee, Wis

a. 352
728

FIRST RUBBER CROP HARVESTED IN CALIFORNIA

Guayule Rubber Ranch, Salinas Valley, Calif. Controlled by Intercontinental Rubber Co., 475 Broadway New York

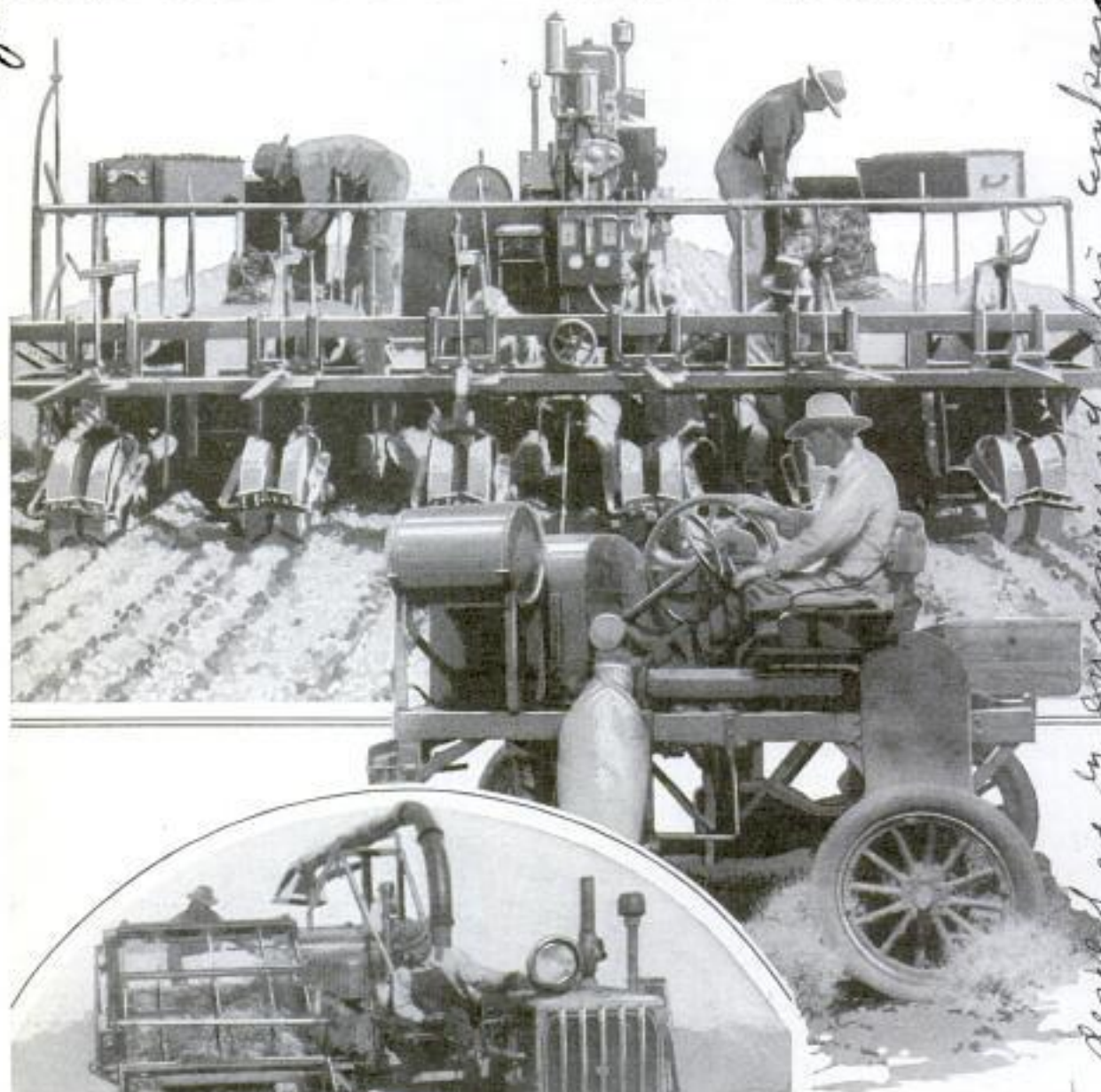

developed by engineers of this company will not be placed on market



Top, View of Six-Row Transplanting Machine Which Sets Out the Rubber-Producing Plants; Center, Pick-Up and Tractor; Left, Seed-Gathering Machine

Wide World

California this year is harvesting its first rubber crop resulting from the commercial planting and cultivation of the Guayule shrub, native of the high semi-arid plateau of central Mexico. This plant was introduced into California after seventeen years of research, and now, after

four years of growth, is yielding a crop of rubber actually grown in the United States. The plantings were started in the Salinas valley in 1926, when 200 acres were set out, and plantings to date are 6,000 acres. The care and cultivation of these shrubs have now been entirely mechanized, machines performing all the operations from transplanting to harvesting. The plants are raised from

see misc file rubber

A. 366

seeds in nurseries and, after a year's growth, are transplanted to the fields in early spring, about 7,200 plants to the acre. In the field, cultivation and weeding are required. Four years after transplanting, the shrubs are mature, being about two feet high and resembling sagebrush. The shrub is a hardy miniature tree that not only withstands frost, but requires the periods of rest or dormancy thus induced. The plant yields a rubber content of about sixteen per cent, to extract which the shrubs, including the roots, are ground in mills containing water, this operation releasing and agglomerating the rubber which is then recovered by a flotation process. Guayule rubber is not a new product as it has been produced and marketed from the wild plants since 1906. The shrubs yield from 1,000 to 1,500 pounds of rubber to the acre in four-year cycles, whereas the tropical hevea tree must be cut 180 times a year to give four pounds of rubber. A ton of rubber can be produced in the United States with an expenditure of only one-sixteenth the effort required to produce a ton of plantation rubber.

A. 352

Such arrangements of C. B. Hamilton
to Gaines of C. B. Hamilton
N.Y.



© Planet News, Ltd. *Acme*
Walking Stick with a Flashlight in Its Tip, and Another Provided with a Cigaret Holder

ELECTRIC LIGHT IN TIP OF CANE POINTS WAY IN DARK

For finding the keyhole, a house number or even lighting the way at night, walking stick is being offered with a tiny electric light in its end. Each time the cane touches the ground it makes a contact with a switch which lights a bulb. Another walking stick is provided with a cigaret holder.

ELECTRIC EYE SEES FOR BLIND BY GIVING DIRECTIONS

Electric eyes now are being used to "see" for blind persons in guiding them about their homes by giving them a sense of direction as they move about. The electric eye, or photo-electric cell, is made up like a flashlight with a small buzzer connected to its battery. Convenient electric lights are then placed about passages and hallways, particularly at turns. The blind person turns the electric eye about much as a person having his sight would direct a flashlight. When the device points to a light source, contact is made and the buzzer sounds. As long as the buzzer is sounding the blind user knows he is on the right path. In similar fashion a window through which light is streaming may be located.

MAKING BLIND FLYING SAFER WITHOUT LEAVING GROUND

Student flyers can be trained in "blind flying," or piloting an airplane by reliance on instruments alone, with an apparatus which offers the hazards of actual flying conditions without leaving the ground. It consists of an airplane fuselage and cockpit mounted on a movable base. The student, in the hooded cockpit, controls the machine by using his instruments.

A. 452

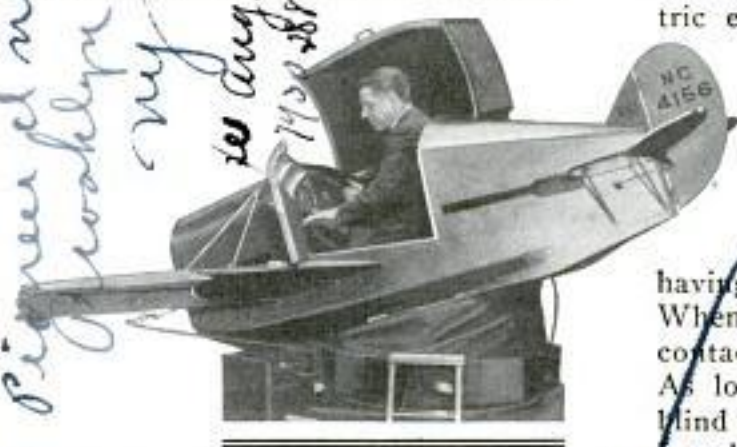

Plane for Ground Training in Which Student in Hooded Cockpit Learns "Blind Flying" before Going into Air

demanded at Laboratory
Pioneer of modern
Brooklyn
N.Y.
see Aug. 1930
1930

shown at British Industries
Fair at Cley n. s. p. makes rubber room

Brill by Clark & Instrument Co.
Travel Corp.
334 4th Ave. NYC. 119 n. 4th St Camden, N.J.

A. 282. Cont. Hon. Clarence
55 W 86th, New York

Poor



While Townsend's figures hold well for seaboard cities, the original cost and maintenance jump prodigiously for inland cities. Thus, Chicago, desiring to stock an aquarium 1,000 miles from the sea, faced peculiar problems in transporting specimens and sea water. It costs the Chicago aquarium about ten times the purchase

A CENTURY ago the government built a fort at the southern end of Manhattan, but when the fear of invasion subsided, the building was converted into an aquarium. Sixty million people have already passed through its doors and have seen the thousands of fish kept there.

Some fifty aquaria spot the globe and annually attract approximately 75,000,000 people. This is no small percentage of the world's population, and surely indicates how conscious we are of the poor fish who come out of the sea to live in tanks.

Considered one of the world's largest aquaria, the New York fish zoo has served as a model for many others. Its present population is 5,454 specimens divided among 246 species.

Charles H. Townsend, director, makes a startling comparison between zoological gardens and aquaria. "The annual cost," he said, "of keeping up the collections of this aquarium, probably the largest institution of its kind, is less than the cost of a single giraffe, rhinoceros or elephant. The cost of food is negligible compared with that expended for a zoological garden."

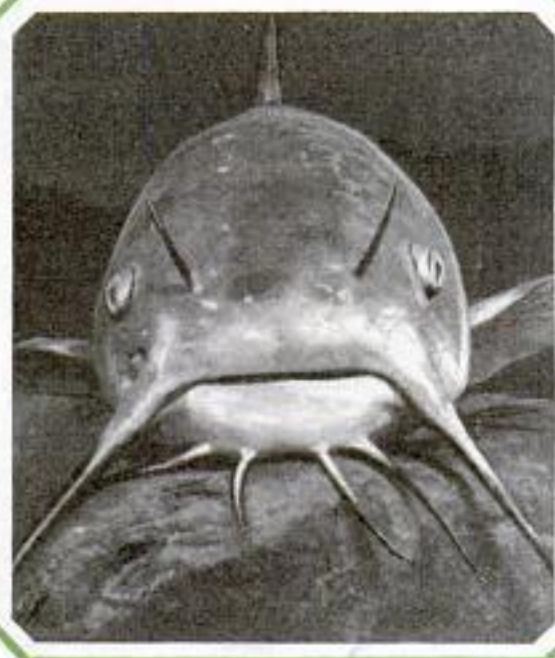

Top, a Balloon Fish Which Has the Power of Distending Itself; Below, an American Bullhead

price to place a specimen into an exhibition tank.

Even seaboard aquaria worry over the high price of bringing rare specimens from the hunting grounds. Water tanks to keep the specimens alive are enormously heavy, and since they cannot be sent by slow freight, they travel on the fastest passenger vessels under the care of trained

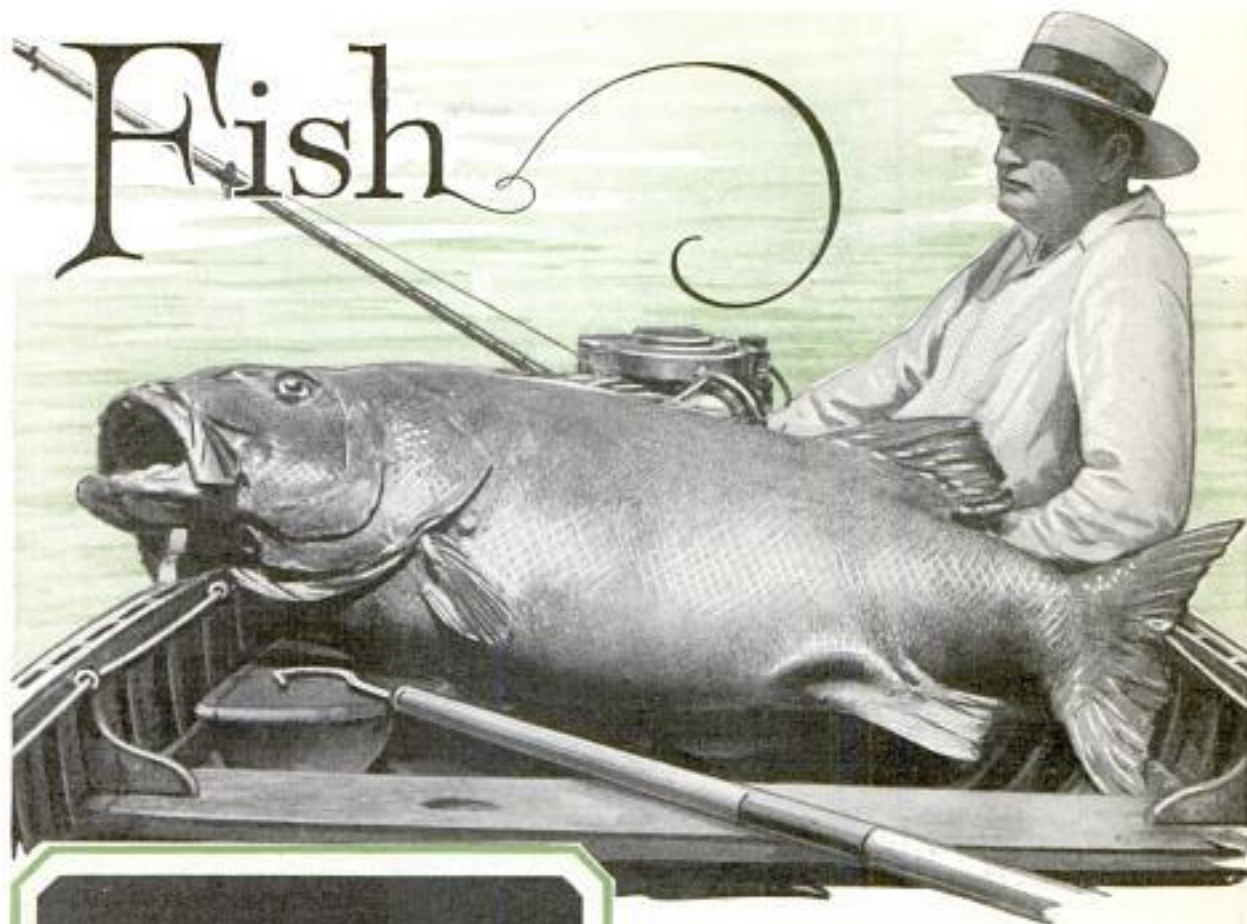

Top, a Fine Specimen of the Jewfish, Weight 184 Pounds; Below, Grotesque Dogfish Found in Brazil

attendants. While its original cost may be slight, the specimen becomes valuable by the time it goes on exhibition.

If water circulation cannot be maintained while the tanks are en route, they must be aerated artificially. It costs more to transport one big sturgeon or shark than 500 small fishes. It is cheaper and less hazardous to send a shipment of

crabs to England than to bring one good-sized sturgeon from the Delaware river.

Fish collectors frequently preserve specimens by shipping them in oxygen containers. Thus numerous small fishes and invertebrates have been sent from New York to Germany—a nine-day trip. Jars filled with water are inverted under water. Oxygen gas is allowed to displace one-third of the volume. The jars, corked and covered with tight parchment, are then ready for shipment.

Of course, fish get hungry, and the aquarist's great concern is finding the proper food for his charges. Most fishes can be kept happy if fed only once in forty-eight hours. The principal foods are meat, chopped, sliced or minced, to suit the mouths of different specimens; then clams, and various sorts of fish, both dead and alive. The principal food fishes are cod and herring. In a typical month, the 5,000-odd fishes consumed 2,160 herring, 5,200 clams, thirty-nine pounds of shrimp, twenty-five pounds of butterfish and twenty-eight pounds of beef heart, at a total cost of \$322. But other food was consumed which the aquarium does not purchase. During the summer months,



© Farrington Photo Co.

its collecting boat brings live minnows, crabs, mussels, marine worms, small soft clams and "beach fleas" from adjacent waters.

The sea horses are the most difficult specimens to feed. In addition to requiring circulating water, they demand live food. Young trout and salmon in the fish hatchery are fed minced liver and beef heart. They also like herring roe. By feeding whitefish on a menu of herring roe and mosquito larvæ, the New York aquarium succeeded in raising specimens from infancy to an age of ten years.

The sea cow or manatee likes lettuce and cabbage trimmings, but would rather munch salt-water eel grass. The manatee devours fresh bread also; one specimen consumed ninety bushels of eel grass and twenty bushels of pond weeds during five months.

Feeding is a most important consideration in aquarium management. Some virile-looking fish are really as sensitive to food and environment as are delicate flowers. The problem is to supply them



Top, Japanese Fringetail Goldfish; Below, a Thornback Skate

with the most natural foods. And they also demand a somewhat varied diet.

Just how important it is to watch the feeding habits of fish is shown by the aquarium's experience with dogfish and dog sharks. Neither was able to survive tank life more than a few months, until it was found that what they really needed was more bony material in their food. And now these fish live inside a tank for years.

The aquarium keepers are on constant guard against parasites. Worms attach themselves to the gills of the angel and butterfly fishes, causing death. By long observation it was found that certain fish, apparently, rid themselves of parasites by sucking sand through their mouths and throwing it out through the gills. At any rate, aquarists recognize the supreme wisdom of spreading loose sand over the tank bottom. Captive fishes may frequently be seen rolling in sand or taking a sand "rub-down." Some species acquire the habit of

settling into the sand and showing little more than their eyes. The flounders and skates hide this way for hours, and wait for prey.

Fresh-water turtles also seem happier when wallowing in loose sand. Turtles and other cold-blooded reptiles need direct sunlight during at least part of the day and will not feed in winter unless kept in warm water.

The mud-loving fishes present a problem. If allowed to swim in muddy water, spectators would be unable to see them. However, the keepers remove them from

the clear-water exhibition tanks occasionally and allow them to swim in real muddy water. Sudden deaths among trout have been checked by transferring specimens to muddy waters.

A group of fish in one tank usually become so accustomed to each other's company that removals or additions cause them no end of worry. When out of humor, they may fight or cease to feed. Then the aquarist realizes that he has disturbed the balance. A tank of "well-set" fish had best be left alone. This holds true for marine fishes especially. Once, when a large queen triggerfish was introduced into a tank, it was immediately attacked by the regular inmates.

Certain tropical fishes have the peculiar habit of feeding only at night, and they will not eat properly if the

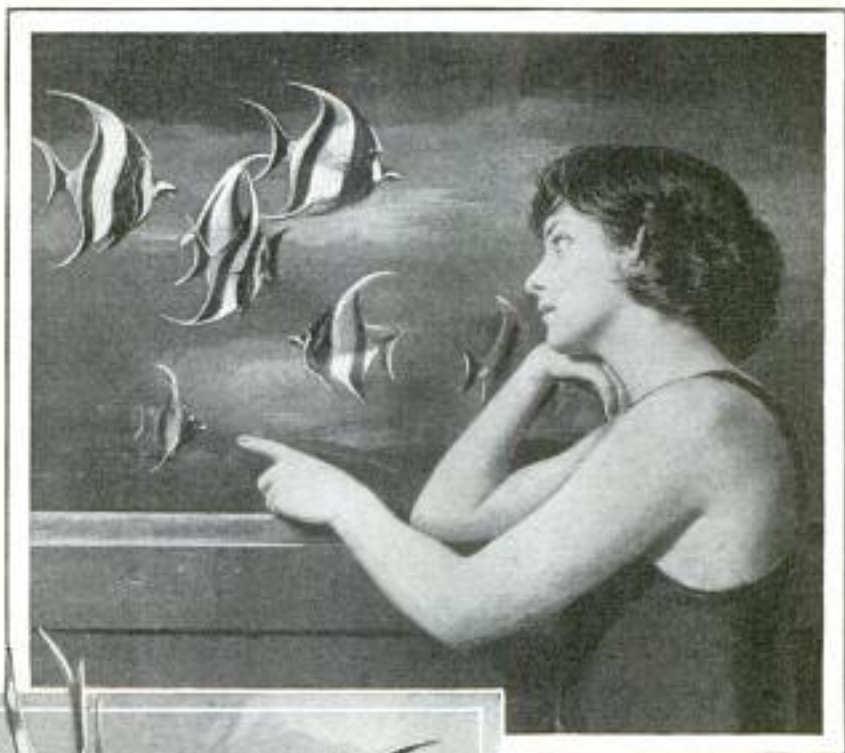

food is thrown into the tank during daylight.

How good is the treatment accorded fishes in the aquarium? It is as good as human ingenuity has thus far been able to devise. If one examines case histories in the New York aquarium, one finds records of gar, mudfish and striped bass which survived tank life for twenty-four years. On the other hand, fragile specimens have collapsed five minutes after being placed inside a tank.

Rock bass, calico bass and perch have lived in tanks for more than twelve years. The aquarium's 200-pound jewfish has been a boarder for nine years. A nurse shark also swam in a tank for nine years. Many species of groupers, hinds and grunts have survived eight years. A sea lion lived nineteen years in one of the large pools, and a giant salamander liked it for thirteen years.

The longevity of fishes is directly de-



Moorish Idol Fish; "Butterfly" Cod; Black Veil Tail

U-282
734

dr. Meritt Scott, Cornell
Univ. at meeting Optical
Society and Physical Socy

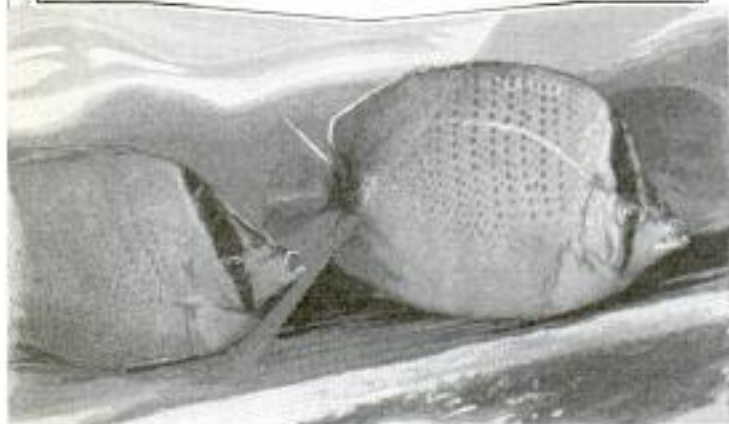
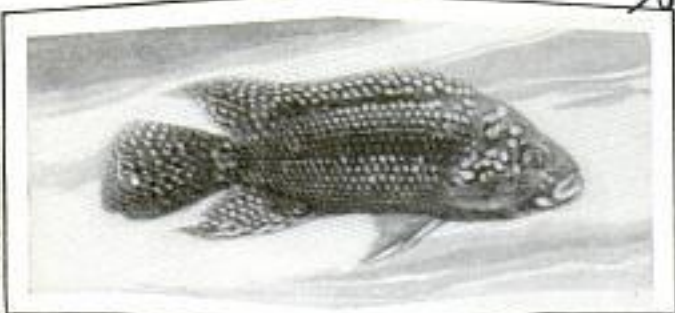

Top, the Jack Dempsey Fighting Fish; Below, Strange Species of Marine Life, Appropriately Called Puffer Fish

pendent, of course, on the environment. The ideal aquarium is undoubtedly harder to build than the ideal zoo, since fishes are so unaccustomed to land conditions.

The most important part of an exhibition tank is the glass front. This plate costs from \$75 to \$100 and is at least one inch thick. To set a plate requires great skill. If it does not fit snugly into the frame of three-inch angle iron, it develops cracks. It must be set so that there is even pressure on every square inch of the surface.

Aquarists recognize water as their fundamental problem. If water and food are right, the problem of caring for specimens is a small one. The natural waste products of fishes destroy the water's alkaline condition and it becomes acid. Waste products reduce the carbonates to bicarbonates, and finally to carbonic acid. By adding small quantities of bicarbonate of soda, the keepers restore the original alkaline condition.

The average spectator thinks of only two kinds of water in the aquarium—hot and cold. But the New York aquarium uses seven different kinds of waters. For different fishes, the water must be kept at different temperatures. In addition to varying temperatures, the water must be aerated continually and kept circulating

through the tanks and pipes. Although spectators cannot see them, the top surfaces of the tanks are open to natural daylight coming from sky windows. The amount of light streaming through these windows must be watched carefully. Some fishes are injured by excessive sunlight, and others suffer from lack of it.

FABRIC "NERVES" TEST WINGS OF PLANES

Artificial nerves in the form of fabric sensitive to heat are being used to test the air pressure on airplane wings, thus helping solve important problems in aerodynamics. These nerves consist of thin strips of a fabric selected for its rapid conductivity of heat. The strips are stretched tightly on the part of the wing surface to

be tested. The harder the wind blows, the more rapidly the fabric turns cold, and sensitive instruments register the heat change with great accuracy. Such a method makes it possible to obtain direct information about conditions of flow which at present cannot be determined by direct theoretical considerations.

ELECTRIC TORCH FOR WELDING RUN FROM LIGHT SOCKET

Weighing only thirty-three pounds complete, a portable welding outfit is being offered in the form of an electric torch that provides instant heat for brazing, welding and hard soldering. Different styles operate from 110-volt alternating current, or from 220 volts, and the power consumption may be varied from 480 to 3,400 watts, depending on the work to be done. Finger-tip control provides a simple means of temperature adjustment.

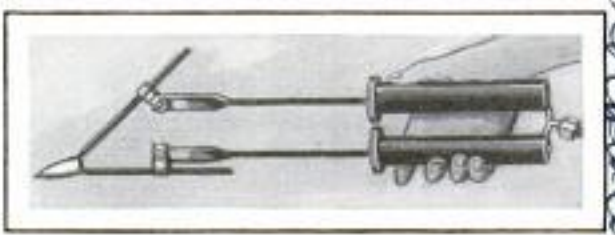

Portable Torch for Brazing, Welding and Soldering; It Operates from a Light Socket

Out of business 1921 ->

Warner Engineering Co.
950 W. 2nd
Palo Alto, Calif.

10/10/21
James
New York
me
Wash
Frank
E. Warner
Cornell
Chambers

Science Service
5/8-C
2/25/38

a. 425. dms George W. Beeson.

ATOM VIBRATIONS
PLAYED ON THE
PIANO

a. 495

Musical vibrations of alcohol, water, gasoline and other common chemical substances have been written and played on the piano by Dr. Donald H. Andrews of Johns Hopkins university. The seductive chord of alcohol, for instance, represents accurately the various vibrations occurring among the atoms of the alcohol molecule, and found in the spectrum of its light. Thus the transposed music of the atoms can now be heard directly. Of the substances so far tried, alcohol seems the favorite with listeners. With the exception of one note, the seven notes of the alcohol chord form a well-known harmonic combination, and the tones of the chord may be broken up to give a melody or theme. Gasoline atoms make a discordant combination of many unrelated notes.



"Iron Skull" Which Pilots Plane in Flight; It Operates by Magnetic-Compass or Push-Button Control

"IRON SKULL" GIVES AIRPLANE
ADDED SAFETY

Automatic control for an airplane is provided by an "iron skull" which manipulates the controls with or without the aid of a human pilot. The device, recently demonstrated by its inventor, operates from a magnetic compass or by the pressure of a finger on two tiny tube openings in a box which can be carried to any part of the craft. Such an arrangement, according to the inventor, makes possible a one-man refueling flight, the human pilot being able to attend to the fuel hose while the robot pilot takes care of the maneuvering of the plane.

PAINT FOR ROAD LINES TESTED
FOR WEARING QUALITIES

Before buying a supply of white paint for use on traffic lines and street markings, the purchasing agent of a California city tested the wearing qualities of samples furnished by several manufacturers. Each sample was given a secret number and parallel lines of each grade were painted across a heavily traveled highway, on curves, grades and at intersections.



Stripes across Road Are Samples of Paint under Test to Find the Best for Road Marking

no data

demonstrated at California
Franklin D. Roosevelt
at the University of California

Dr. George W. Beeson
inventor of
airplane, Los Angeles, Calif.

CA noiseless window-shade roller has been invented that has a slow, steady pull, and stops and locks automatically.

Dr. B. Edward Mesler, 24 State St. New York

Emb. Gray & Mervin
2225 Kansas
City, Mo.

Jesus Lacari,
Mexico City National
Theatre

Jul Bats
2/21/31

England

736

POPULAR MECHANICS



Scene Modeled in a Small Gourd by Mexican Who Specializes in Tiny Figures

MINIATURES OF MEXICAN LIFE SHOWN IN TINY MODELS

Every phase of Mexican life is presented in miniature form by the official "modelista" of the national theater in Mexico City. This man forms small clay figures representing various activities, using for tools an orange-wood stick and a toothpick. His subjects range from tiny churches to even tinier barnyard fowls, and some of his miniatures are so small that half a dozen of them stand with ease on a thumbnail. One of his unusual pieces of work is a complete rural scene done in the half of a small gourd shell.

FISH FOSSILS LEAD TO WATER FAR UNDER THE GROUND

Fish that died millions of years ago are an aid to the modern geologist searching for water far underground before sinking a deep and costly well. Water usually is found beneath certain kinds of rock, and geologists know that different fossils characterize various rock formations. A drill is sunk and the expert examines with great care the fragments it brings up. The shells and fossils of fish show clearly the rock formations through which the drill is passing and indicate to the trained eye the probable distance from water.

Jul Bats 2/21/31

SHEEP SKIN MAY GROW WOOL AFTER ANIMAL IS DEAD

Recent experiments show that a sheep may continue to produce wool long after it is dead. The tests were made by the research association of the British wool and worsted industries after it was found a tiny piece of muscle could be kept alive and healthy in the laboratory by chemical means. Now it has been discovered that, if the skin of a sheep is treated in special ways, it may continue to grow wool, apparently for an unlimited period. It is even claimed that the wool is better than that which the sheep produced when alive, because the growth can be so controlled that the proper kind is produced for any particular purpose.

Seeds
Jordan

THIS INJURED DOG SKATES

THROUGH LIFE

At least one dog is roller skating through life and apparently enjoying the experience. The animal's hind legs were paralyzed as the result of an automobile accident, and its owner made a harness to which were attached leg braces equipped with rollers. By using its front legs for traction, the dog moves on the rollers with no little speed and in apparent comfort. The owner now is trying to attach



Crippled Dog Which Goes through Life on Roller Skates Attached to a Harness

a tail-wagging brace to the harness to permit movement of this important appendage.

Cont. by J. S. Utter,
Route 6 Yakima Wash

“HOUSE” WITH ONLY ONE WALL HELPS SELL HOMES



Front and Side Views of the “House” That Is All Front; a Building Contractor Erected the Structure to Warn Home Buyers against the Practice of Purchasing for Appearance Alone

One Philadelphia building contractor has erected a single-walled “house” that is all front, to advertise his business and warn prospective home buyers against the practice of purchasing on the basis of looks only. To all appearances a direct front view shows a well constructed home with many attractive features set in pleasing surroundings. There are boulder gate posts, broken flagstone walks, a fine colonial doorway with suitable hardware, shutters and glass in the windows with curtains hanging behind them, and at night the windows are lighted to give the appearance of a comfortable and cozy home. A view from either side of the false front, however, reveals only an open space with no semblance of a home.

storax has been imported from Asia Minor. Extraction of the gum, it has been found, does not injure red-gum trees for lumber purposes.

RAILROAD-YARD SMOKE EATER DEVOURS ENGINES’ DIRT

Some railroad yards in large cities are being equipped with smoke eaters to get rid of the dirt belched forth by locomotives. When engines are standing in the yards with steam up, a hood is connected to their stacks and the smoke is carried through a section of pipe where the dirt and dust are removed, before it is finally released through a stationary chimney.

SWEET GUM LATEST PRODUCT OF LOUISIANA FORESTS

Louisiana’s forests now are producing a large quantity of storax, commonly known as sweet gum, from the red-gum or sweet-gum trees of that state. It is obtained by cutting the bark to the wood and letting the gum flow into cups attached to the trunks. The balsamlike or resinous exudation is used in pharmaceutical preparations, and for adhesives, incense, perfumes, soap, glove powders and for flavoring tobacco. Heretofore



Hood Connected to Locomotive Smokestack Which Draws Off Smoke While Engine Is Standing

State Dept of Conservation

A. 276 The Telephone Mfg Co Ltd
 Hollingsworth Works
 West Huddersfield, London E 8
 England

738



Telephone Receivers That Exclude Noise; the Transmitter Rests against Check or Throat and is Actuated by Vocal-Cord Vibrations

PHONE THAT EXCLUDES NOISE ACTUATED BY VIBRATIONS

Actuated by mechanical vibrations applied directly to it, instead of by sound vibrations borne by the air, a noise-excluding telephone is being used in Europe for carrying on conversations in workshops, on ships, in mines, on airplanes and in other places where the noise would interfere with conversation. The instrument is known as a "laryngophone," and is actually operated by the speaker's vocal cords vibrating against it. The "mouth-piece" is placed against the throat or cheek instead of before the mouth, the instrument being insensitive to all airborne noises. Picking up the mechanical vibrations of the vocal cords, the telephone transmits the voice without distortion. Hand and headsets are used, the headset resembling a radio headphone.

porch lights. The switch is turned on with a toggle which sets the dial for the time the current is to remain on. The toggle is thrown when the operator is ready to disconnect the current which is then cut off automatically when the time reading on the dial expires. A small lever disconnects the time relay so the switch can be used like any other, and the relay can be set to operate in any period from a few seconds to several hours.

WIRE WEB SUPPORTS TREES WITHOUT HURTING LIMBS

Easily and quickly adjusted, a circle-wire system has been devised for supporting the limbs of fruit and other trees to prevent breakage and insure better growth. The wire somewhat resembles a spiderweb, the various branches being held up from a central point. Protecting collars are slipped about the limbs.

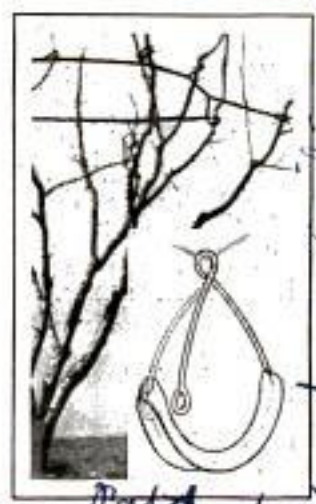

ELECTRIC TIME SWITCH TURNS OFF AUTOMATICALLY



Capable of turning off the electric current at a time previously designated, a time switch can be installed as a part of the wiring system of home or office, and is found useful in operating electric-cooking utensils, irons, lamps, store-window, parking and garage lights, as well as cellar and

HOW TO PRESERVE RED COLOR IN CANNED STRAWBERRIES

In making strawberry preserves, the loss of the rich red color of the fresh fruit is due to an oxidation process, oxygen combining with the red pigment of the berries. To prevent this to a great extent, the stemmed and washed berries are mixed with the sugar and allowed to stand overnight at room temperature before being cooked. Under these conditions, the natural respiration process of the fruit exhausts the oxygen of the tissues and materially reduces oxidation during cooking. Strawberries, both fresh and preserved, are a good source of vitamin C

No U.S. agent known
 O.K. 12/34/5.

A. 260

1414 Bell Paso Blvd.
 Sacramento, Calif.

more info. G. 1/4/14
 Tucher. Baltimore

Price varies Pat. 8/28/28

Pat'd 1, 353,850 etc.

A. 304 mark time

Mfr. Mr. H. Rhodes, Inc.
 Chamber of Commerce Bldg
 New Haven Conn.

E. J. Bohman
 W. H. Gady and
 N. Halliday

m. Canning Trade
 V. 50. P. 127

Cook to H. Slacy.

A. 386

#6 39 Montgomery Ave

Bethesda, Md

Uncle Sam Wars on Duck Bootleggers

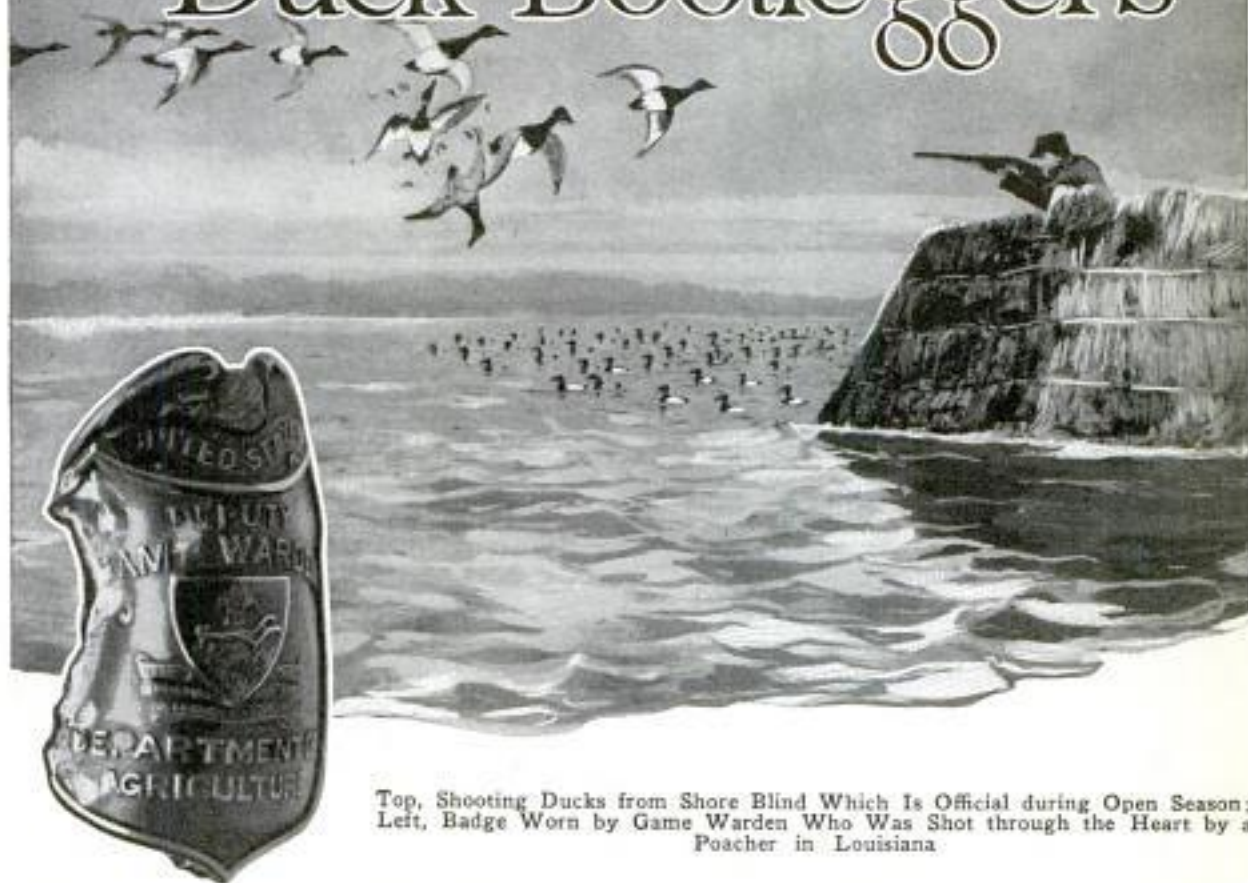

Top, Shooting Ducks from Shore Blind Which Is Official during Open Season; Left, Badge Worn by Game Warden Who Was Shot through the Heart by a Poacher in Louisiana

DUCKS by the million are being killed each year by organized poachers—the newest gangster racket—along the Illinois river, down the Mississippi, on the Gulf coast from New Orleans to Texas, on the Susquehanna flats of the Chesapeake bay country, in the latitude of Virginia's Back bay near Norfolk, at Currituck sound and along the Potomac river.

If you are "in the know," you can purchase mallards at approximately \$5 a pair almost any month in the year. These illegal waterfowl are kept in cold storage indefinitely. You can buy the finest canvasbacks almost in the shadow of the capitol at Washington. The "ante" is higher for these eastern game birds, the price frequently soaring to \$10 the pair.

These ducks are shot from brush shore blinds, from sink boxes, from motorboats and from other strategic points of waterfowl concentration. The illegitimate hunt-

ing as an organized business goes on night and day. Five-shot automatic guns are the predominating weapons used, while many guns are equipped with special extensions which screw onto the end of the automatic magazine, increasing the shots fired from one loading to nine. Under favorable conditions, a seasoned poacher will bag from twenty to fifty ducks from a single loading with one of these slaughter guns. Along the Potomac river and on the Chesapeake bay and Back bay of Virginia shooting grounds, the English punt or swivel gun, the deadliest weapon known for waterfowl bagging, is used in the poaching, which is practiced almost exclusively on moonlight nights.

The punt guns are really midget cannons, being from ten to thirteen feet long and weighing from 150 to 200 pounds. Each gun is of the muzzle-loading type and shoots one pound of powder and two



Top, Speed Boat Policing Potomac River against Duck Poachers; Left, a 200-Pound Swivel Gun Firing Two Pounds of Shot That Can Kill 100 Ducks

pounds of shot to the charge. Ready for river or bay service, one of these guns is usually mounted in a power boat with a special recoil block.

A waterfowl calamity results when one of these guns is fired at comparatively short range into a rifted flock of ducks, the bag from a single discharge usually amounting to from thirty-five to 100 ducks. As many as 125 ducks have been killed or crippled by a single shot from one of these swivel guns. The crippled ducks are left to perish, for the poachers race to another section of the river as soon as they have fired the big gun once.

If game wardens intercept a suspicious boat during their night patrol, it is only rarely they find a punt gun on board, as such a firearm is always subject to immediate confiscation. It is the traditional custom among poachers to toss the gun into the river when its capture portends. Fishlines and spools are always attached to the big weapons. The gun sinks to the bottom while the floating spools mark its submerged position. These spools and

lines are used by the poachers in retrieving the gun after the danger has passed.

Hunting the poachers is a dangerous occupation.

Not so long ago, Game Wardens K. F. Roahen and M. A. Charlton, while searching for illegal gunners in the Sangamon river bottoms, were both shot from ambush and wounded seriously. After Roahen recovered, the wild-bird bootleggers tried to kill him on various occasions, shooting at him both in the open and from ambush. Once they tried to destroy a patrol boat with the warden aboard by bombing. Poachers fired on Deputy Game Warden J. J. McHugh near Browning, Ill., wounding him dangerously in the thigh. A little later, three poachers assaulted Game Warden B. G. Merrill near Hinsdale, Ill., robbing him of his pistol and badge and threatening to drown him in the drainage canal near by unless he left that country.

Poaching is one of the two most vital causes of the rapid disappearance of mature migratory birds, being only excelled by legalized hunting during the open season in the enormity of its annual kill. Many of the poachers, particularly those in the Illinois river district, use traps of wire as reinforcements of gunfire, into which they bait wild ducks, killing the waterfowl like poultry after capture. Both wooden and living decoys are used. The government reports a fourfold increase during the last decade in the number of hunters and fishermen. A census of the poachers is impossible but they have increased greatly, particularly since the organization of duck bootlegging.

General Electric Co
Schenectady
NY

A. 239

Electromaster, Inc.

POPULAR MECHANICS

741

1803 E. Atwater St

**AUTOMATIC CONTROL OF PLANE
LEAVES THE PILOT IDLE.**

Airplanes can now be flown so accurately by instruments alone that the human pilot is virtually idle after having once set his course. The pilot of an airplane that was being steered automatically recently submitted to a radio interview, turning his ship over to the robot pilot and conversing with interviewers on the ship and others on the ground, questions and replies being heard by a radio audience. A magneto compass is responsible for the success of automatic steering. Heretofore the pilot has had to steer the ship himself, relying on his instruments or on visual observations around him. Now he simply sets his course and turns the plane over to the magneto compass. A further development is control of the steering equipment by radio beams which are already in use on airways. In combination with gyroscopic devices, the course of flight and the altitude of the plane may be controlled without the pilot's assistance. Altitude is determined by a sonic altimeter, the interval between an emitted note and its echo indicating height, the echo being received audibly or registered on a meter.

**JOIN WIRES WITHOUT SOLDER
IN METAL TUBE**

Electrical and other wires can be joined without the use of heat or solder by means of a tube device recently introduced. The tube is made of semi-hard copper. One wire is inserted in each end, and then with the aid of pliers, it is twisted in opposite directions, causing it to form a solid connection that cannot be pulled apart. After the twisting, the joint is insulated. The tube was developed especially for use in explosive plants.



Double Tube in Which Electrical Wires Can Be Twisted Together without Heat or Solder



Sliding-Frame Electric Heater Which Slips under Hotbeds and Keeps the Soil and Plants Warm

**ELECTRIC HEATER FOR HOTBED
SPEEDS SEED GROWTH**

Equipped with thermostat control, an electric heater for the hotbed automatically protects plants against sudden temperature drops. It operates on an alternating-current circuit, is easily installed and consumes comparatively little current, as the thermostat will turn the heat on or off as needed. The heater, in the form of a sliding frame, slips under the plant bed, where it warms the soil to the degree best suited for the development of the seeds and young plants.

**CRIME INFORMATION BY RADIO
FOR ALL OF EUROPE**

At a recent congress of European police officials and criminologists, a plan was adopted to create an international radio clearing house for all information pertaining to crime and the detection of criminals. A Berlin station was selected as the central broadcasting agency and the system already has been adopted by Germany, Austria, Poland, Czechoslovakia, Switzerland and Hungary. The Berlin station will broadcast regularly crimes committed, descriptions of suspects, or, if they are known, complete information about criminals with pictures, fingerprints and Bertillon measurements supplied by telephotographic apparatus.

Chicago-6161 State
Tri-Engine Lubricator Engine
Flashed Arc or Green Probs
Sperry Gyroscope Co.

Electrical Mech
Complete with thermostat \$10.00

L. S. Fairbank
Feb. 1931 P. V.

The Holtzer Cabot Electric Co
125 Quincy St Boston, Mass

Copyrighted material

A. 368

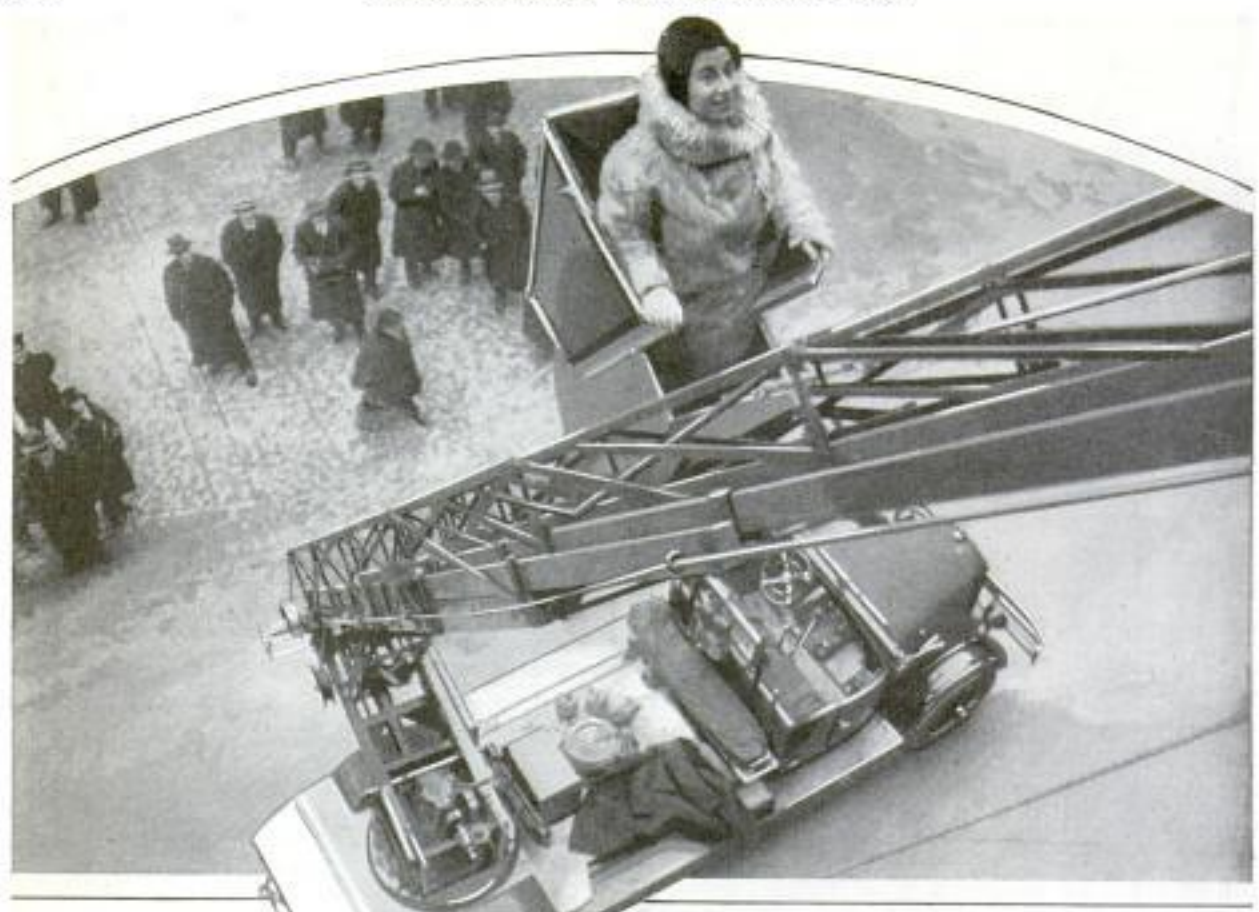

Life Basket in Which Rope Is Attached

Invalids Are Removed from Burning Buildings in Berlin; to Basket Which Is Lowered on Extension Ladder

LIFE BASKET FOR FIRE VICTIMS AIDS IN RESCUE WORK

To aid in transporting invalids from burning buildings, the Berlin fire department has been equipped with life baskets which slide down the frames of extension ladders. A patient in a burning hospital, for instance, is carried to a window, placed in the basket, and lowered to the ground, the descent down the ladder frame being governed by a rope. Such a method eliminates the necessity for carrying an invalid on a fireman's back.

SINGLE-PIECE ROOF FLASHING GIVES WATERTIGHT FIT

Eliminating the necessity for counter flashing or a hub to make watertight joint, one-piece roof flashing has been made for vent pipes. It is formed on a machine which shapes and draws the gal-



vanized iron into the form of a cone, laying the seam and, in a simultaneous operation, punching the hole to fit the size of the pipe.

WHAT CAN YOU SEE THE BEST FROM "TAIL OF EYE?"

Quite often highway signs are placed along a road so the motorist obtains but a glimpse from the "tail of the eye" as he passes by with his attention fixed on the road ahead. Recent tests indicate that the shape of the sign is important, since some shapes are more easily identified than others without turning the head, and frequently the form of the marker serves as a symbol to convey some information without reading the lettering. It was found that the triangle is recognized from the tail of the eye more often than any other shape, with the square next. On the other hand, the triangle was recognized only when it was comparatively near the point on which vision was fixed. Other shapes were recognized through a wider field of vision.

Metal Mfg. Co., 912 Howard St. Berkeley, Calif. San Francisco, Calif.

*403
L. W. Schmidt*

Jaume Service, 517 a 2/16/31

*Psychological Lab
Northwestern Univ.
R. M. Collier*

Science Service
517-H 518-a

A.344 Metropolitan
Police
at Mitcham,
Sussex Eng 743

DEPTH PRODUCED IN PICTURES
BY UNUSUAL SCREENS

Three types of screens which produce the illusion of three-dimensional depth in pictures projected on them have been tested by Dr. Herbert Ives, of the Bell Telephone laboratories. Stereoscopic pictures which stand out in solid relief can be made either by the construction of the screen itself, or by the use of goggles by members of the audience. The goggle method has been tried with moving pictures, but is awkward. The screen method cannot be applied practically to the movies as yet. The depth arises when the eyes see slightly different views of the same scene, as they do when observing a real object. The illusion of depth can be obtained, however, by taking only one photograph with a large lens or concave mirror, and projecting it from the front on a screen made of horizontally ribbed cylinders. The picture also can be thrown from the back on a celluloid screen in which cylindrical grooves are cut, or be projected from the rear on a screen consisting of transparent cylindrical rods.



© Planet News, Ltd.
Movable Traffic Tower, Mounted on Wheels, Which Can Be Placed Wherever Congestion Demands

TRAFFIC TOWER ON WHEELS
FOR CONGESTED POINTS

Portable traffic towers, mounted on rollers, are being tested in England as a means of solving the problem faced in controlling traffic in areas that are congested only at certain periods of the day. These towers, shaped like pyramids and painted with black and white diagonal lines, can be placed at any point in a street. At night they are illuminated, red and white lights flashing alternately.

TRUCK TO SPEED UP THE MAILS
LOOKS LIKE STREET CAR

Resembling a small street car, a mail truck of unusual design is being tested by the post office department as a means of speeding up the collection and distribution of the mails. The vehicle has wide doors on either side, like a dairy delivery truck, and is built close to the ground to permit ready entrance and exit.



© U. & V.
Mail Truck with Low Body and Doors on Each Side; the Unusual Vehicle Is Expected to Speed Up Collections

Juni Coach Corp.
Chrysler Bldg. New York

CANYON NATIONAL MONUMENT

One of the most noted of the dwelling sites of early man on this continent, set in a deep canyon of great scenic grandeur, has been made a national monument by act of Congress. This is the Canyon de Chelly in New Mexico at the bottom of which are the ruins of Indian pueblos of an unknown age. To protect these ruins, until the region becomes more accessible, the area was given national-monument status, which means that it has been classed as containing natural features of the first order, although, at present, it is not considered of such importance as to merit inclusion among the national parks.

Science Service
517-H 2/19/31

a 381



Ship Model Built from the Original Plans for the First Three-Decker Battleship of the Danish Navy

MODEL OF THREE-DECKER SHIP HISTORICALLY ACCURATE

One of the finest ship models extant in America, experts declare, is that of the "Christianus Quintus," originally planned as the first three-decker in the Danish navy. The model was built for the Massachusetts Institute of Technology by a Copenhagen model maker. The plans for the vessel, which was never actually built, were drawn at the close of the seventeenth century, still are in existence, and thus made possible a rare historical accuracy. It was designed when the increasing importance of guns in naval warfare forced ships to provide for from ninety to 110 cannon without any material increase in length. The three-decker proved a solution, and plans for the boat were sub-

mitted to the king for approval in 1697. Meanwhile it was rumored that Sweden was at work on an even larger vessel, and modification and enlargement of the proposed Danish ship finally resulted in the "Fredericus Quartus," so named for the successor to Christian V, who in the meantime had died. For several years it was the largest boat afloat, with a length of 190 feet and a displacement of 3,500 tons. Because they provided a fine target for the enemy, the white crosses on the gun ports later were abandoned. Inboard, the ship was painted red so blood would not be too visible in action. All carved parts were gilded, as many as 18,000 pieces of gold leaf having been used in ornamenting some of these fighting vessels.

MAN'S ENERGY IS WORTH ONE CENT AN HOUR

Man's energy, if applied to generating electricity, is worth about one cent an hour, but the cost per horsepower-hour generated by a man would be about \$4 at current wages. A dynamometer about the size of a kitchen cabinet has been made by a University of Minnesota professor to measure

the energy that man can develop and compare it with the power of motors, gasoline engines, water wheels, horses and windmills. The machine has two cranks. Turning one, a man is able to determine his physical "man-power" as indicated on a dial. The second crank is attached to a dynamo, and when it is turned sixty revolutions per minute, a voltmeter registers 110 volts. The man at the crank is then generating ninety-three and one-quarter watts, equal to one-eighth horsepower or one man-power. If the crank is turned at this speed for an hour, the man would generate electricity worth about one cent. Energy equal to a horsepower-hour from wind or waterpower would cost about one cent, from oxen or horses about fifteen cents and from steam about ten cents, it was estimated.

Prof. William Dorr
Chief of U. of Minn. material
eng. dept.

Otto Lauge
Royal Navy Yard

Q. 432 Peter Heimfort A. 378

Rosedal POPULAR MECHANICS

TORCH OPENS IRRIGATION DITCH CLOGGED BY WEEDS

Clearing irrigation ditches clogged by weeds which retard the water flow is accomplished by a California rancher through the use of a large and powerful torch. A long hose fitted with a burner nozzle is connected to a drum of low-grade distillate which has a pressure pump attachment. In operation, the apparatus burns all vegetation in the ditches down to the ground and destroys the roots. The torch was used originally to combat army worms which invaded cotton fields, and its use as a ditch cleaner was discovered quite by accident.

Agent: J.A. Perry 63, Queen Victoria St. London E.C.4 Eng.



No. 11 Bagel brand

Hedon U. Perbanich Berlin F. niederrhein. Lummern

ONE-MAN ROAD ROLLER DRIVEN BY GASOLINE MOTOR

Offering the advantages of a hand roller, which it resembles, a large road roller, with a five-foot drum weighing nearly a ton and a half, is propelled by a gasoline motor inside the drum, and is operated easily by one man at a speed greater than those requiring the services of three or four men. The one-man roller can climb steep grades, proceed forward or backward and will cover 1,200 square yards of surface in eight hours.

A. 380

Violin Built on Edge and Shaped Like a Human Ear to Improve the Tone

VIOLIN SHAPED LIKE MAN'S EAR HAS IMPROVED TONE

In an effort to improve the tone quality of the violin without detracting from resonance or volume, a German musician and inventor has made an instrument bearing a striking resemblance to a human ear, which produces sounds of great sweetness and purity. This violin has virtually been built on edge, the sounding surfaces being vertical to the bow. These surfaces, therefore, do not need to be curved to make room for the bow and this, apparently, has increased the resonance of the instrument.

Berliner - Acthe - is - cept - chaff - no - may - be - w - ing - Schwartzkopf - Berlin



Heavy Road Roller Easily Operated by One Man; It Is Driven by a Motor inside Drum

MOORING MASTS IN THE ARCTIC FOR POLAR AIRLINE

A. 428

Two parties of scientists and mechanics have been sent to the Arctic to establish the two base stations farthest north for the proposed Zeppelin polar airline, planned to run from Berlin and London over the top of the world, down to Alaska and south to San Francisco. Four stations in all are to be built in the far north, each having a mooring mast, fuel deposits, food stores and boats. An experimental flight by way of the pole is planned for this summer. Such a route by airline eliminates the present twelve days run on the Trans-Siberian railroad, followed by a steamship trip across the Pacific.

Berliner Maschinenbau Carl. Wilh. (Schwartzkopf) Gesellschaft

a-412

Cml. Logan & Reavis
55 W. 42nd St N.Y.C.

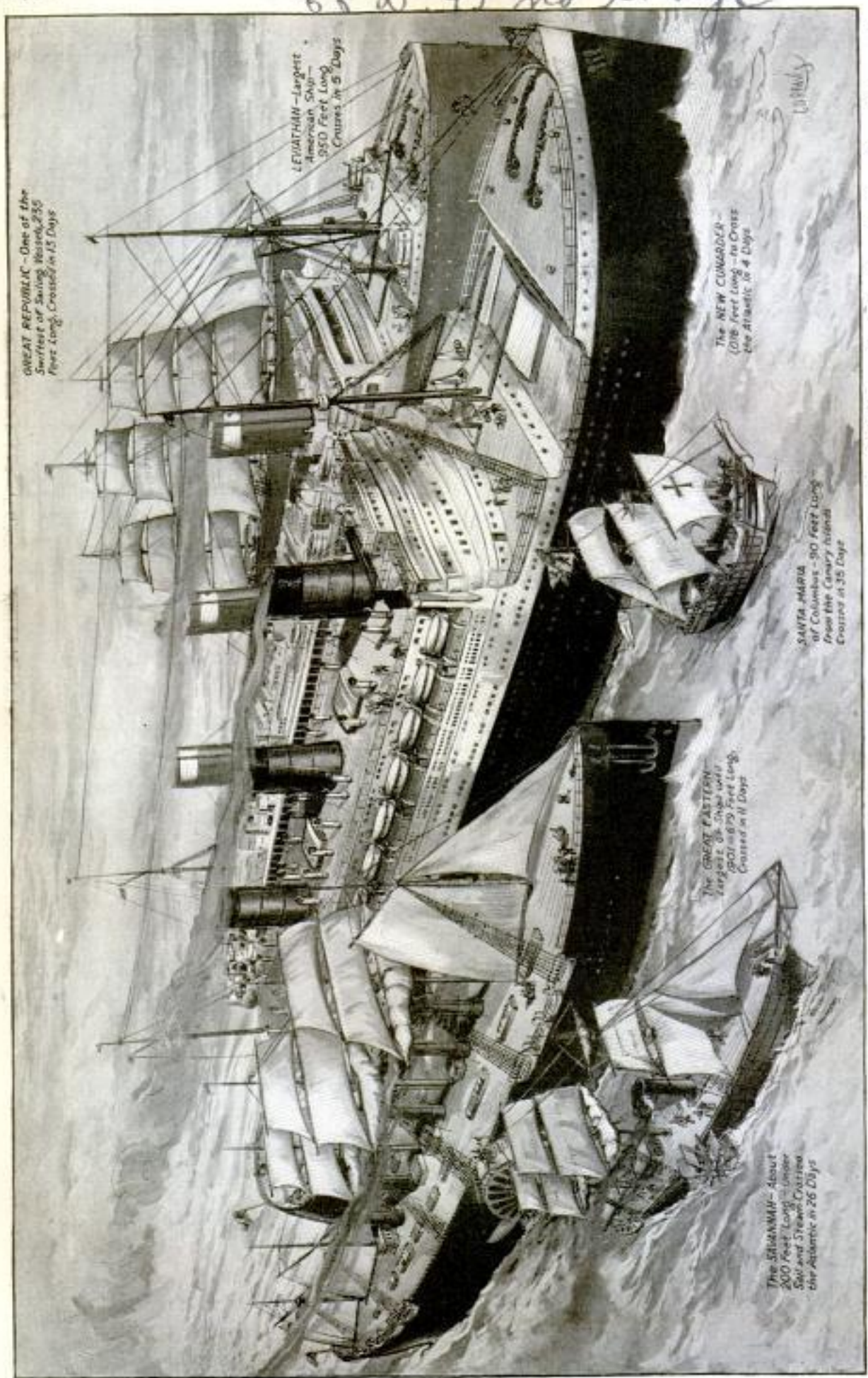

*GREAT REPUBLIC - One of the
Swiftest of Sailing Vessels, 255
Feet Long, Crossed in 15 Days*

*LEVIATHAN - Largest
American Ship -
350 Feet Long,
Crossed in 5 Days*

*THE NEW CUNARDER -
(218 Feet Long) to Cross
the Atlantic in 4 Days*

*SANTA MARIA - 90 Feet Long
of Columbus - from the Canary Islands
Crossed in 35 Days*

*THE GREAT EASTERN -
Largest of Ships with
Square Rigging, 220 Feet Long,
Crossed in 11 Days*

*THE SHIPMAN - About
200 Feet Long - Under
Sail and Steam Crossed
the Atlantic in 26 Days*

The Evolution of the Transatlantic Liner from Christopher Columbus' Tiny "Santa Maria" to the New Cunarder Which Is to Span the Ocean in Four Days, Compared with the Five Days Required by the "Leviathan"; the Larger the Boat, the Narrower the Ocean, When Computed on the Basis of Time Rather Than Distance

COAL FORMED BY PLANT DECAY ON FLOOR OF FOREST

a. 456

Coal was not formed from plant remains washed into great shallow lakes, as has been held previously, but was made by the steady fall of leaves and other plant waste on the forest floor in the vast, ill-drained swamps of the coal ages. This is the theory of Dr. David White, of the geological survey, who, in many tests, has shown the roots of the coal-age trees imbedded in the clay strata underlying the coal. He believes the laminated, or sheetlike, structure indicates a probable seasonal deposition. It is now generally recognized that coal could have been, and probably was, formed in a temperate rather than a tropical climate with recurring wet and dry periods or summer and winter weather. The occurrence of "mineral charcoal" on top of coal layers does not necessarily indicate that coal swamps were burned over at intervals, in Doctor White's opinion.

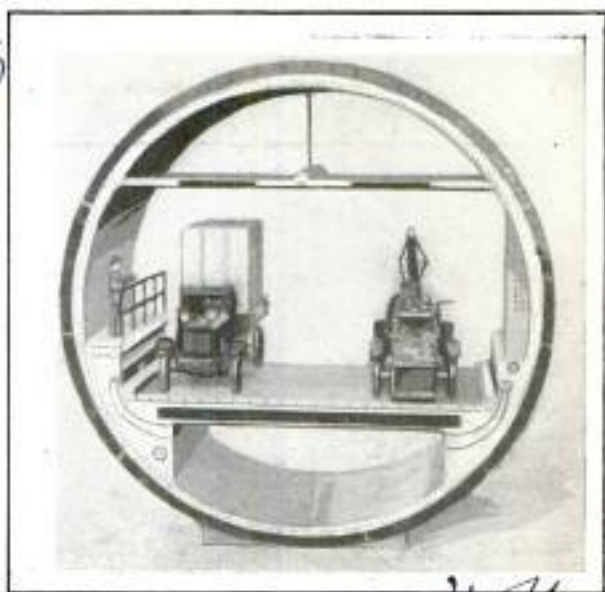

Model Section of Vehicular Tunnel Planned for Boston; Note Elevated Sidewalk for Attendants

VEHICULAR TUNNEL IN BOSTON TO COST SIXTEEN MILLION

Designed after the Holland tube in New York and the Fleetway tunnel in Detroit, a passage for vehicles planned for Boston is to cost \$16,000,000. The model section in the accompanying illustration shows the tunnel's width and height and the space at top, sides and bottoms for ventilation. An elevated sidewalk provides a passage for attendants.

RAILROAD-TIE TAMPING OUTFIT RUN BY ELECTRIC MOTOR

a. 404

Tamping railroad ties, a back-breaking job detested by every section gang, now is being done mechanically. Electric tie-tamping outfits, operated by small portable power plants, are being added to the maintenance equipment of many railroads. The tampers are simple electromagnetic hammers. A free-moving piston, reciprocated by two magnets, strikes a heavy blow on the shank of the tamping bar and the operator need only guide the tool.



Electric Tie Tamper Operated by a Portable Power Plant: Several Tampers Are Run from One Power Source

NEW VEGETABLES ARE STUDIED TO DETERMINE FOOD VALUE

a. 449

Educating the public to the food value of the host of new vegetables continually being brought from all over the world to enrich the American diet is a task of the bureau of home economics. The chemical content of each dietary newcomer is analyzed and its nutritive value accurately computed. Chinese cabbage, broccoli, dasheens and many other common vegetables of today were almost unknown in this country a few years ago. Chinese cabbage, for instance, has been found to have a fuel value of about seventy-five calories per pound. It is about ninety-five per cent water and the outer leaves are waste. The rest is made up of nitrogen, fat, ash and starch.

Science Service
517 - 7518-a

Chicago. 9 & Clinton, Chicago

Syntroon Co., 410 Lexington
Av. Pittsburgh, Pa

Charlotte Chalford
and
Adams

a. 897 Com. Isador S. Mitchell
5818 1/4 La Mirada Ave
Hollywood, Calif

Dynamite *in the*

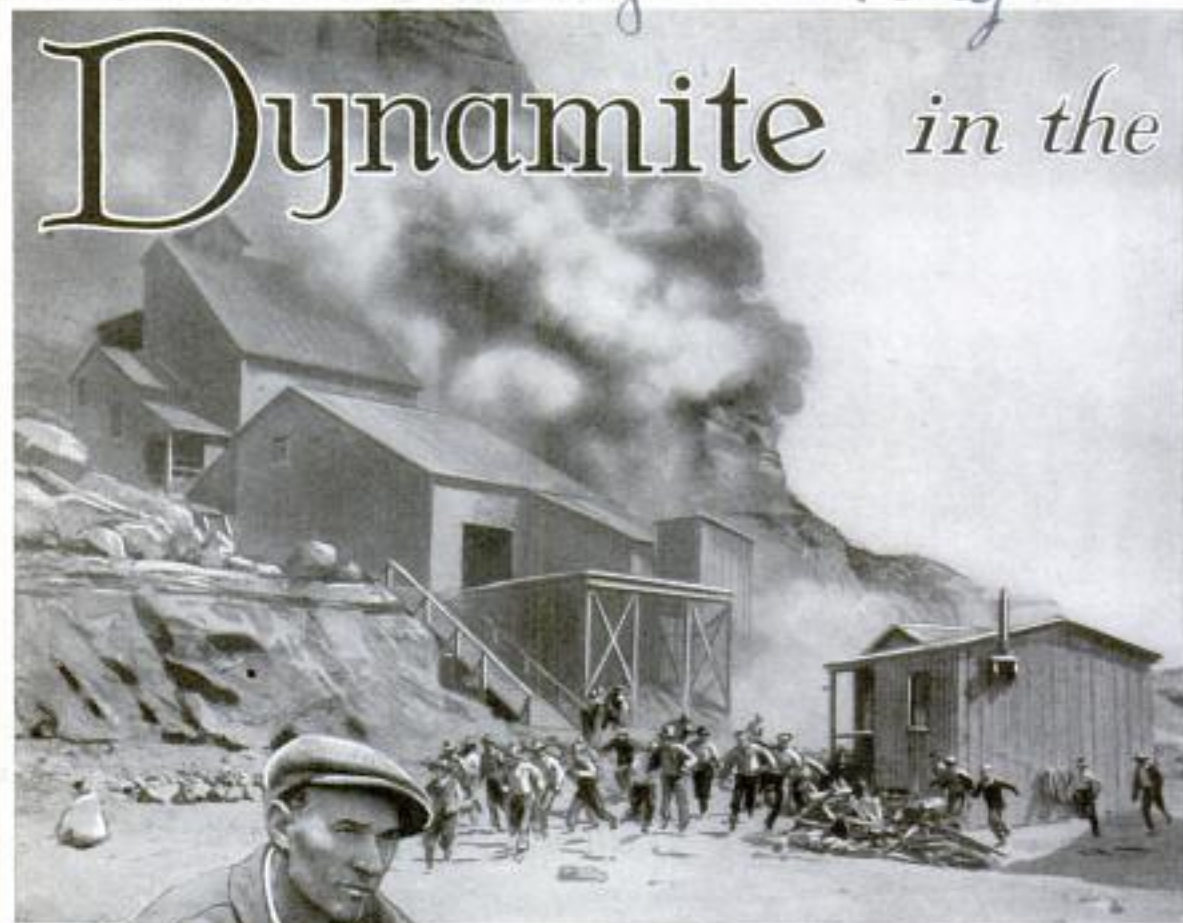

Top, Dynamiting Side of Cliff for Movies; Below, Powder Expert at His Switchboard, Ready to Set Off a Blast

THE EXPLOSIVE expert at a movie studio is a very busy man. Many keep one on salary at all times, while others call in a "blow-up" man only at such times as there is a definite need of him.

One of the most important uses of explosives is for the creation of smoke screens. Fog is invariably produced by the use of smoke pits, often in broad daylight. While many of the spectacular effects in the movies have been made in miniature, many others are made on life-size sets. Where a drifting-fog effect is desired, for a setting laid in London perhaps, three or four of the large pots are used, set directly in front of a slow-moving airplane propeller, or "wind machine." The current of air tends to drift the smoke, or fog as it will show up on the screen, before the camera lens. In miniature sets, smoke may be used to fill valleys or hollows in the terrain and add realism and distance to the setting. Yellow smoke is invariably used, inasmuch as it will photograph white.

Another important use of powder for the creation of smoke screens is for the

Talkies

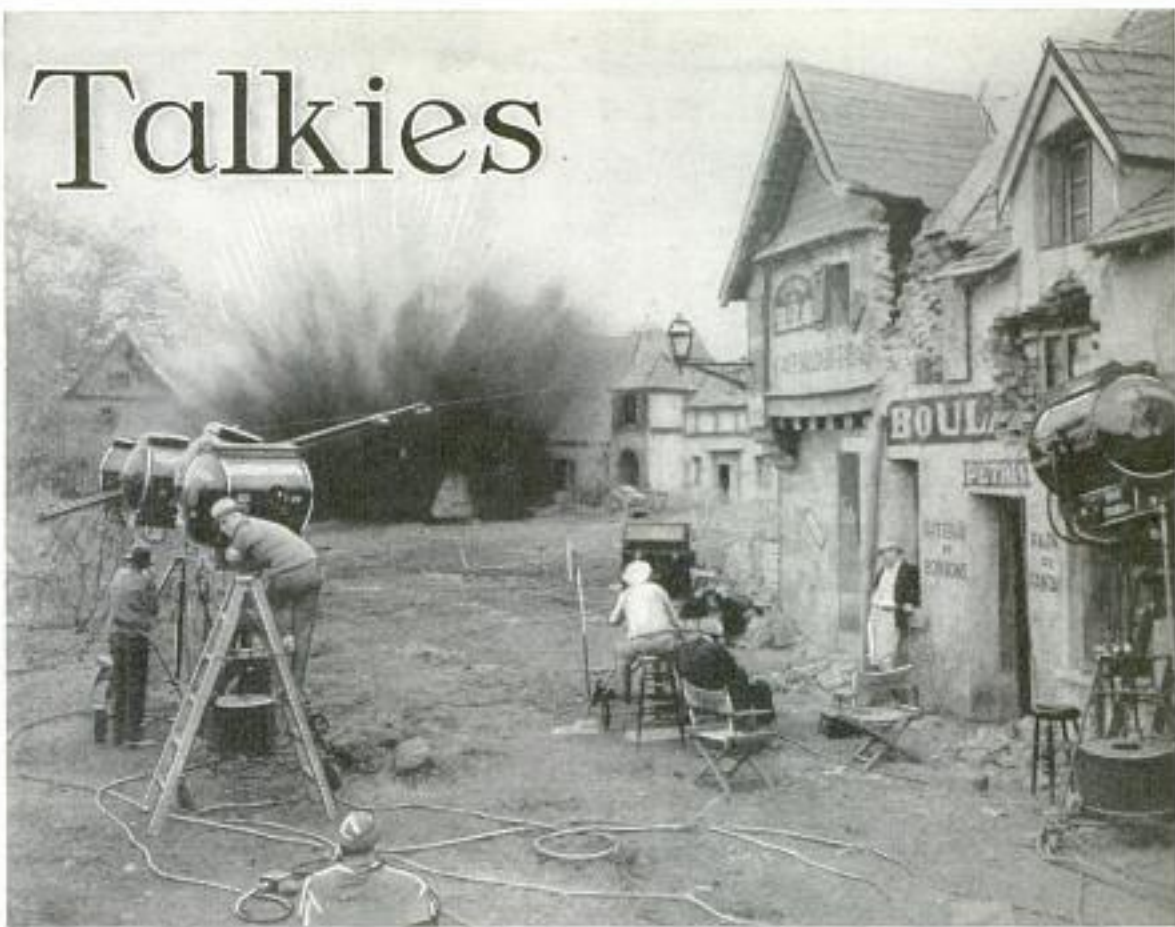

Off-Stage View with the Camera and Technical Staff in Action during a Dynamiting Scene; Note Man to Right of Camera with Coat over Head as Protection from Flying Debris

obliterating of undesirable backgrounds. Lightning effects also may be obtained in a variety of ways. Studios prosperous enough to afford one, get their lightning by the use of a torch, which resembles nothing so much as an overgrown photographers' flashpan. Powdered aluminum and magnesium, which become very inflammable if ground sufficiently fine and burn with an instantaneous and intense light, are used in it. Lightning obtained with these torches is very realistic. They have been used for lighting in rare instances where very intense illumination is desired, but for very short periods of time, on locations where it is impossible to make a set with large electric lights.

Forest fires, so lifelike that they fool even experienced rangers, have been obtained many times in the studio lots by the judicious use of smoke powder and crude oil. Trees are set up along a line, sufficiently thick so that they will show up well in the camera. A trench is dug, shallow and wide, behind the trees. This

is filled with crude oil and tar, and smoke powder is spread on top of the mixture. The trench is camouflaged, and the mixture is ignited. The oil burns with spurts of flame, which show up through the dense clouds of smoke resulting from the powder, giving a forest fire of unbelievable realism.

The use of explosives in movie battles, however, has brought the explosive expert to his present place of importance. The preparation of a battle set for occupation by the movie army requires almost as much care as the preparation for a major offensive in actual warfare. Charges of explosives are placed in designated spots, and connected electrically to a master switchboard, from which they are detonated at the desired moment. These switchboards are masterpieces of electrical design. Probably the most intricate of them all was used by the Fox studios in the filming of "What Price Glory" a year or so ago. This board contained over 6,000 separate contacts, and



Top, Filming an Explosion for a War Picture; Below, Powder Expert and Some of His Equipment

from it explosions, smoke screens, cannon fire, barrages and the movement of troops through the scenery were controlled.

In the filming of "Hell's Angels," there occurred an instance which vividly depicts the effect of accurate timing and placing of explosive shots. The scene was a partial miniature, wherein a huge Gotha

bomber, in reality a miniature of the actual plane, was to fly over the battlefield and go suddenly into a nosedive to destruction. The plane was hung on wires and controlled so that it would dive at the crucial moment into the spot upon which the camera was focused. Charges were placed in the wings of the bomber which would go off when the plane hit the ground and completely destroy the model. However, battle fire was to take place in the background. Cannons, varying in size as they were placed farther and farther from the camera, were fired during the scene. A group of soldiers also were to run through the bombardment toward the fallen plane. Lines were marked off on the ground, a good many hundred feet in front of the camera but out of sight, showing the soldiers just where to run.

The filming of Universal's "All Quiet on the Western Front" brought many problems to the fore which had to be solved before a successful picture could be made. Coming as it did as the first

A. 396 Messrs Cockerell,
at Letchworth
Derts England

pretentious war picture to be made entirely in sound, it presented many problems. Machine-gun firing, which was used so effectively in that picture, was obtained by placing thousands of detonators in the earthworks above the trenches just under the top of the ground. Connected electrically to a pianolike switchboard, they were set off in groups. Tiny puffs of dirt and smoke showed up with each explosion and gave the exact effect of machine-gun or small-arms fire.

The craters throughout No Man's Land, showing up after the "big-gun" explosion, were prepared in advance. Varying of course with the size of the crater desired, dynamite in sticks and magnesium powder were buried in the ground at the designated spots. The dynamite provided the necessary force to dig the crater, while the magnesium powder gave the required flash to the explosion. Shells bursting overhead were simulated by stringing small bombs, made of black powder and flash powder, on invisible wires and exploding them electrically at the desired moment.

The charge of troops across the battlefields, through heavy barrage, is executed in such a manner that no one is injured. Powder is placed in a pan and buried slightly under sawdust and chunks of cork, none of which is packed tightly. This mixture, exploding, throws debris far into the air and gives the impression of dirt and rock flying through the air.

ELECTRIC FOLDING BED RAISED OR LOWERED BY MOTOR

Electrically operated wall beds that are raised or lowered at the touch of a button, offer an additional convenience in homes or apartments where economy of space is important. The beds are furnished in standard sizes and are without rollers or casters. The small motor that operates the bed is plugged into a wall outlet and needs no attention. At any time during the raising or lowering, the bed can be stopped by merely turning off the motor. The mechanism, which also may be made to open the doors in the closet where the bed stands, is virtually noiseless and has an automatic cut-out that disconnects the motor when the bed touches the floor.

National Equipment Co.
Chas. C. 57 Osas & Electric
Bldg. Denver, Colo



Preparing Design from Seaweed for Printing Paper, and, Placing Paper on Design

PAPER PRINTED OFF SEAWEED FOR BOOK BINDINGS

Paper-marbling, or printing paper from seaweed, is an ancient art still practiced in its original form in making decorative designs for binding valuable books. A size is prepared from dried seaweed and inks in various colors are sprinkled on this and spread into a design with a small steel rake. The paper is placed on top, and the print transferred to it.

GLASS TUBE OVER CUCUMBER MAKES IT GROW STRAIGHT

Cucumbers can be forced to grow straight despite any tendencies toward crookedness by the use of individual glass cylinders, open at both ends. A cylinder is slipped over each cucumber when it appears on the vine, constituting an individual greenhouse for each future pickle, and at the same time guiding the growing vegetable along a straight path.

Introduced by
James Lambert,
Director Botanical
Gardens, U. S. A.

straight glass here new and chimney

Cameron
Bellevue Ind
Springfield, Ill

*E. J. Wright & Co
 Rockland, Mass
 (Shoe mfrs)*

*752
 a 367*

**COLORS IN SHOPS
 RELIEVE EYE
 STRAIN**

a-415

Eye strain and fatigue of workers in factories is being relieved by painting the machinery in gay colors. One eastern shoe factory has used delicately tinted paints not only on its machinery, but on benches, doors, walls and furniture, after extensive tests indicated that color and light in the plant had a direct effect on the health and comfort of the employes and on the amount of work they were able to turn out. The experiment started when one workman complained of eye strain and painted the machine on which he worked a bluish-green. It was found the color broke up the shadows, softened the light and relieved the eye fatigue. Acting on this experiment, the owners worked out a color scheme for the entire

Cont. F. H. Sweeney, Bull River, Mass

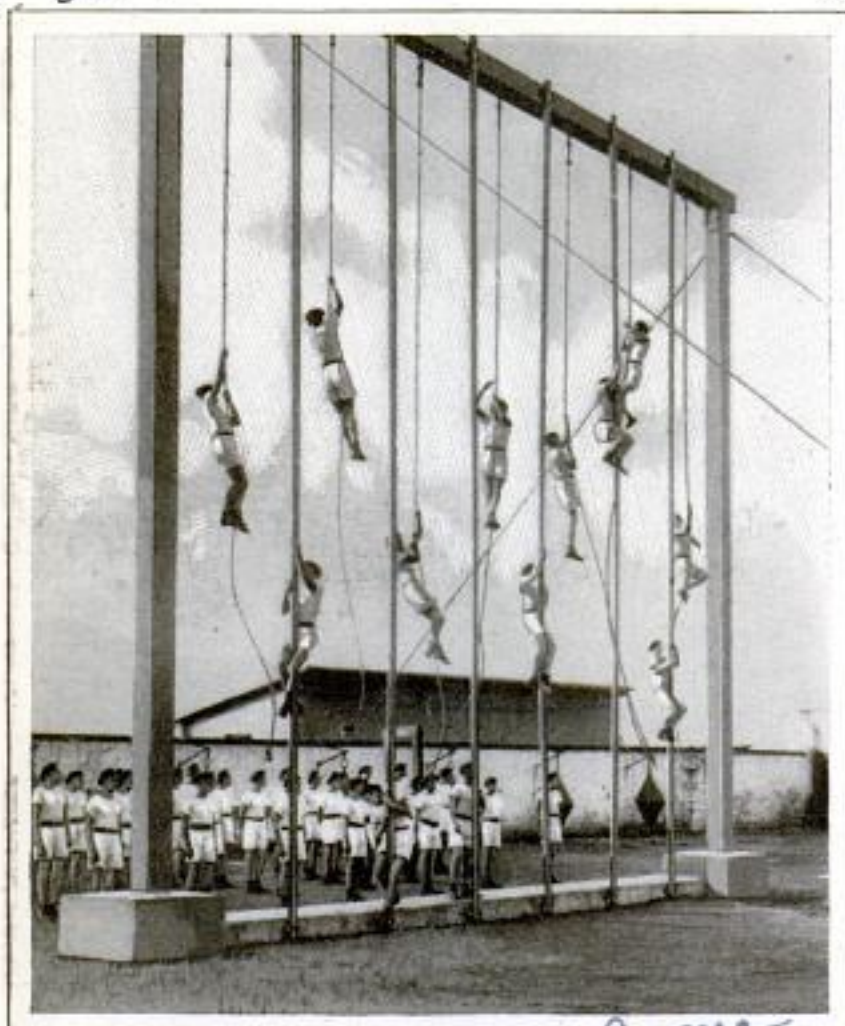

Cadets Training for the Italian Navy Climb Ropes to Increase Their Agility before Tackling the Masts of a Vessel

Acme

NAVAL STUDENTS CLIMB ROPES TO ACQUIRE AGILITY

Cadets training for entrance into the Italian navy take a complete and rigorous course in gymnastics on land before they begin climbing the masts of any vessel. As a preparatory feat for shinning up a mast, the student sailors go through a series of rope-climbing exercises in an open-air gymnasium. The ropes are attached to a lofty framework, and the students are required to make the ascent in approved manner and in a limited time.

FILLETS SKINNED BY MACHINE

Skinning filets, a tedious process even with experts, now can be done by a machine operated by a person without experience in skinning. It is of simple, inexpensive construction, and plans are available for making it at home.

*a-429
 Fisheries Experiment Station, Halifax, N. S.*

plant, some machines being tinted in orange, others in orchid-purple and still others in green. Tables, benches, steam pipes and even typewriters in the accounting department were given bright hues as the work progressed.

BRUSH TO CLEAN TYPEWRITER HAS LIQUID IN HANDLE

a-359

Soiling of hands and fingers in cleaning typewriter keys is prevented with a fountain brush containing a supply of cleaning fluid in the glass bottle which serves as a handle. The flow of this liquid is started by unscrewing the top a turn or two.



*Solvine
 Patd 8/14/25*

*Sanford Luff Co.
 Congress & Dearborn
 Chicago*

A-476 (Minton Cronkite area)
 Harmon B. Vanderhoff 753
 In Greenwuch Conn

POPULAR MECHANICS

MODEL RAIL SYSTEM TEACHES TRAIN OPERATION



Above, Electric Control Board for Model Rail System; Right, a General View of the System

Having started the work as a hobby, two Connecticut youths now are building complete miniature railroads as an occupation. They construct electrical model railroad systems with express, local accommodation, freight and mail trains in operation in the same manner as on any real railroad. The scope of their business varies. They supply parts to amateur builders, furnish model engines and cars or complete systems to be used by railroads for exhibition purposes or for instructing trainmen. The control system of the model lines is fool-proof.

SEVEN-THOUSAND-MILE PHONE FROM SHIP TO SHORE

Covering a distance of over 7,000 miles, the longest radio-telephone conversation yet recorded between ship and shore was carried on recently from the "Belgenland," located between Shanghai and Hongkong, to London. Heretofore ship to shore telephone service has been confined to the Atlantic ocean. Another long-distance telephone conversation was reported by A. J. Smith, Racine, Wis., business man,

Dept. of Commerce

who was traveling in Australia on the day trans-oceanic radio-telephone service was inaugurated between that country and the United States. He put through one of the first calls, talking with his family.

U. S. ACTS TO SAVE HALIBUT FISHERIES OF NORTHWEST

Under the recent halibut treaty, a move has been started to conserve the great halibut fisheries of the Pacific northwest, valued at about \$7,000,000 annually. An international commission is to attempt to conserve the fishing grounds without interfering seriously with commercial fishing. About sixty-five per cent of the world halibut catch comes from this region, and among remedies being considered are closure of areas inhabited by immature fishes, prohibition of destructive gear, and the lengthening of the general closure period by two weeks.

Dept. of Commerce

Copyrighted material

Crown Railway Models.
 Greenwuch, Conn

A. 322 Cont Andrew B. Boone
613 Spreckels Theatre Bldg
San Diego Calif

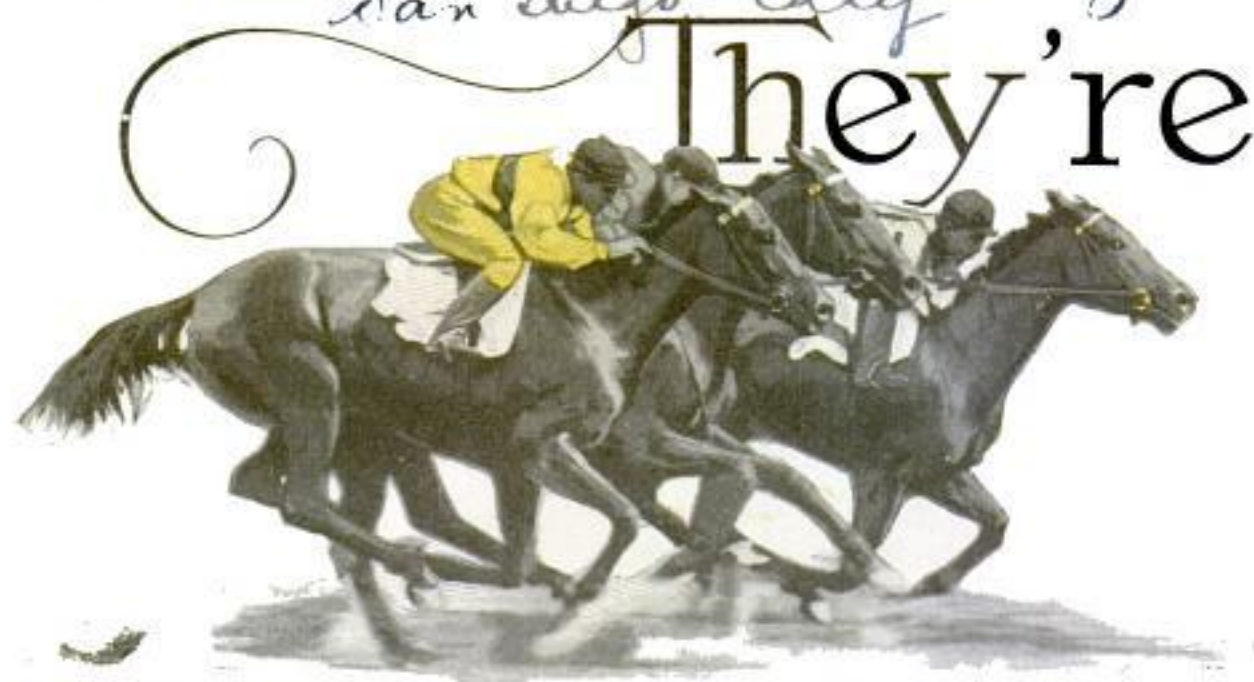

Twelve Hoofs All in the Air during a Driving Neck-and-Neck Finish to a Hard-Fought Race; Note the Positions of the Jockeys on the Necks of Their Mounts to Push Them Forward

By R. B. JAMES

TEN horses, their coats sleek in the afternoon sun, line up across the track. Marshall Cassidy, starter of 15,000 races, leans against the rail of his stand, ready to press together an electrical contact that will lift the rubber tape and ring a gong to send the field away.

Three assistant starters move rapidly from horse to horse, backing this one up, pulling another forward. All must face the tape, be fairly quiet and ready, before the barrier rises to open the way to possible fame and fortune.

Suddenly the tape rattles up the slide, the bell breaks the calm that had settled on the track, jockeys whoop and the field plunges forward. Great knots stand out as the ponies' hindlegs drive them forward, all making for the rail.

Near the grandstand, across the track from the judges' stand at the finish, a judge trains his binoculars on the racing horses. A microphone, fixed to a pair of shoulder hooks, fronts his mouth.

"They're off!" he exclaims. The crowd leaps to its feet.

Twenty-five loud speakers, scattered through the grandstand, betting ring and clubhouse at Agua Caliente, call laggards to the rail.

As the horses lunge forward from the starting stalls and emerge from the chute,

the leading horse breaks an invisible thread stretched across the track. Simultaneously, in a tiny room beneath the judges' stand, two electrical impulses are recorded on a revolving drum.

On this modern track, horses no longer win by a nose. One may appear to the public to win by a nose, but, in fact, the leading horse starts the record on the revolving cylinder when he breaks the first string with his shoulders. When he touches the tiny brown thread, it stretches; this causes a break in the line of red ink pouring on the drum, but a hundredth of a second later the string parts and another indentation is recorded. And at that moment the race officially commences. Thus, the breaking of two strings fixed to electrical circuits at start and finish enables the judges to time races to one-hundredth of a second, twenty times faster than was possible with stop watches.

It's the same old thrill, though, to jockeys and public alike, as colors flash and hoofs thunder toward the finish line.

"They're rounding the first turn," boom the loud speakers. "'Lamkin' leading, 'Rapida' second, 'Forebec' third. On the back stretch, 'Lamkin' by two lengths. On the far turn, 'Lamkin' tiring, 'Forebec' making up ground and going to the front. 'Lamkin' tiring, 'Gotham' racing

Off!

well, moving into third place. Here they come! 'Forebec' wins."

Behind the passing flash of colors, the salute of jockeys as they bring their mounts past the judges' stand after the race, one finds a gigantic organization embracing large numbers of people and the best devices mechanics and science can provide to entertain the crowd and speed the races. Seven races compose the usual card for one day at many tracks, but 3,500 men often are necessary to run a racing plant and keep the horses in condition to face the barrier.

Skilled men conduct the betting, where betting is permitted; others record results; gallop horses; assist in starting; judge races and finishes; record jockeys, prices and winning numbers on boards that disappear underneath the ground between races; school yearlings and teach them the rudiments of racing; doctors watch over horses and jockeys; valets clean colors and shine boots. It's a giant undertaking, commencing with the pony's first birthday and continuing until it runs its last races and retires to the foal or the stud.

Cassidy alone has started races with a total purse value of \$15,000,000. Many more millions were wagered on these contests of speed and stamina. And in looking down from his stand on the start of 15,000 races, he has developed a camera eye, focusing his attention on one horse and rider, yet seeing everything that takes place all along the line. Not a boy spurs

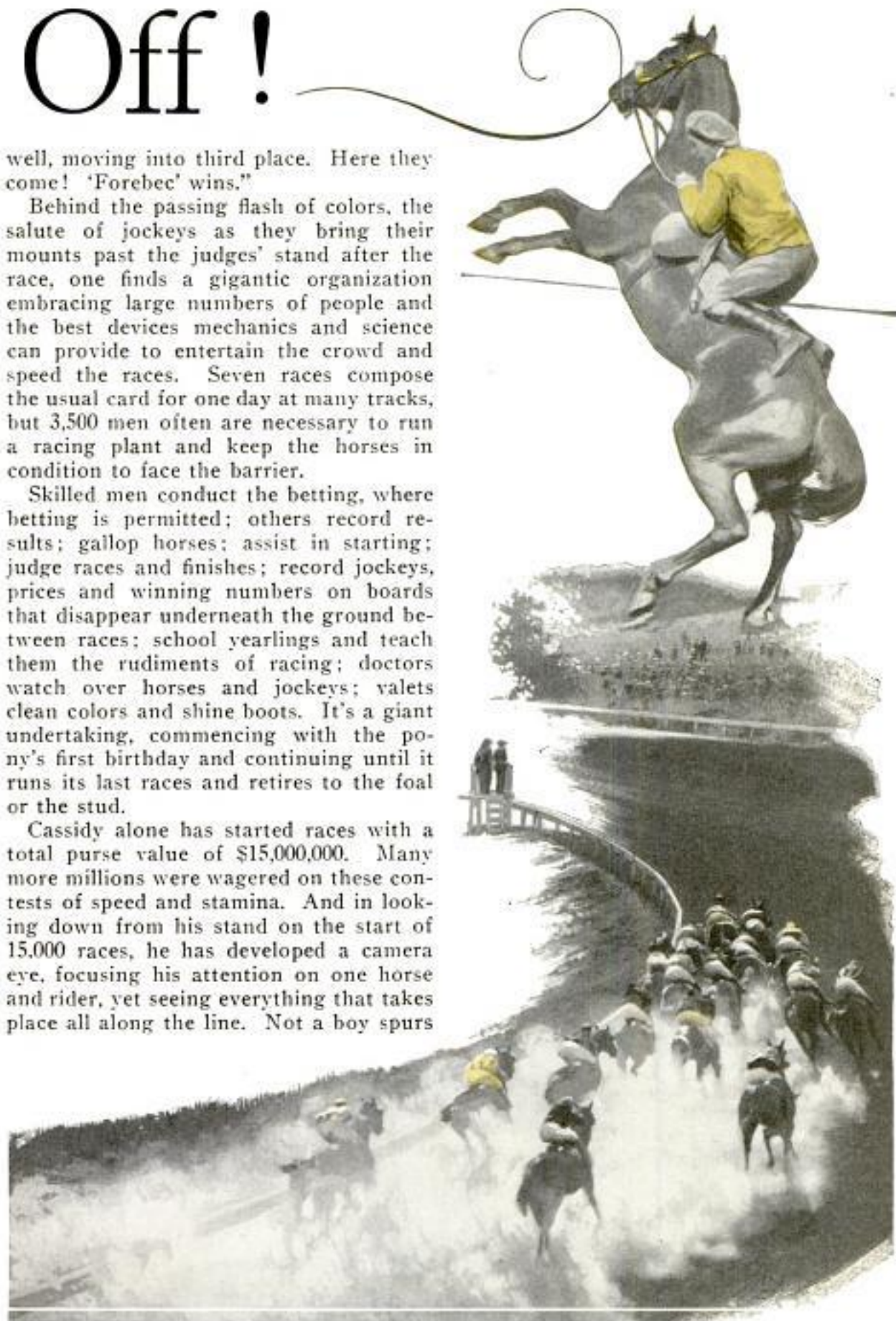

Above, a Colt Unseating Its Rider on Its First Trip to the Barrier; Below, Seventeen Closely Bunched Riders Rushing Their Horses Home during the Running of a Handicap Race



If we introduce the yearlings to the track with kindness and lead them through their primary exercises gradually as one would a child, most horses will develop into fairly dependable runners; not necessarily fast, you understand, for training cannot make a sprinter of a plug.

"Much of a horse's success depends on good riding. In schooling yearlings with the newer jockeys, I frequently take slow-motion pictures from the rear. Later I run these, then show a picture of Sande or Fator, two of the most perfect riders the world ever saw. By comparing them, youngsters can learn how they err at the start, in pulling up, riding a horse's neck or being slow in urging their mounts forward.

"Before yearlings face a barrier, however, we drill them much as a rookie soldier learns squads right and left. When the training starts they are galloped short distances to take off surplus fat. A rider breezes a yearling slowly,

a yearling nor crowds too far forward that Cassidy does not see.

"How," I asked, as I stood in the stand at the start of a seven-furlong race of three-year-olds, looking over his shoulder as a bunch of bad actors killed valuable time rearing and plunging, "do you train these temperamental beasts to maintain even a semblance of self-control under such exciting conditions?"

"The bad actors are disappearing from the American track," he replied. "They are bad generally for one of two reasons, heredity or faulty handling. Owners do not want the 'get' of those strains noted for bad acting and as a result only the fit in temperament are surviving.



Top, Starting Lock That Releases Rubber Barrier; Center, Stretching a Jockey's Boot; Below, a Colt Drinking Milk from a Bottle

first one-eighth of a mile, then one-quarter mile. After they are physically fit, the track starter takes over all the youngsters for their early education.

"When a bunch of yearlings comes to me we take all their markings, family history and other data. Up to this time the ponies have not been named. By the markings we can identify them. At the outset we start them in a series of parades, first walking singly in a circle past the starter's stand, then in twos, fours and eights. These are virtually mili-



Above, Starting a Race from Stalls; Below, Lined at the Barrier in Starting Stalls; the Tape Springs Up and Forward When Released

minute of quiet, he walks slowly toward them and along the line. After this the entire 'company front,' with jockeys in the saddle, walks ahead fifteen steps and stops. Then the jockeys and helpers back them up by voice commands and assistance on the bridles.

"Even yet the ponies have not faced a barrier. Nor are they ready. Possibly one-tenth, certainly no more, will back up without further instruction. This is accomplished simply and effectively, tapping them on the knee with short pieces of light string. Fortunately, once a pony learns to back at his rider's guidance, we never have to spend more time with this lesson.

tary maneuvers which teach them to turn in company with other ponies.

"Once they have learned to 'march,' we line up possibly forty ponies facing the starting stand, with the starter in the box. He remains very quiet and gradually raises his voice in conversation while assistants on the ground shake the ropes on the starting gate, shuffle their feet and finally shout at each other. This accustoms the yearlings to the excitement that usually accompanies a start in a race.

"Our next move calls for the ponies to line up about fifty feet from the starter. An assistant stands quietly at that distance in front of their faces. After a

"For two weeks we work daily with the yearling class, then we take them to the race track for lessons in breaking; that is, running together in a straight line on signal. We start them in groups of three or four, about one-eighth mile from the finish line, and let them breeze easily for that short distance. I stand near the



rail at the start and send them away by ringing a portable bell such as they will hear throughout their racing careers.

"During this time they are strengthening their muscles and learning to start and run in a straight line without crossing over in front of other ponies. After breaking groups of four, each group having come from a single owner, we divide the youngsters into groups of eight, no two of which have run together on a ranch or training field, and give them practice in both running and standing starts.

"Now we're ready to introduce the little fellows to the chutes. We line up a bunch at the barrier, an elastic webbing, and let them rub their noses along it, bite up, rub it behind their ears until they become thoroughly familiar with it and have no fear of it springing forward in their faces.

"Our next move depends on whether we're using starting stalls or not. At fully

nine-tenths of American tracks starting stalls are available. In schooling with stalls, the barrier is raised and the colts brought into position. After we break them two or three times with the bell, the barrier is pulled down into place. Then the yearlings are moved up until their heads are under and in front of the barrier. They hear the bell and the snap, but cannot see the line spring up; and they go away unfrightened. Now we're ready for a conventional start. If we have been careful in our work, nearly every pony will be ready to race and will shy very little at the barrier.

"The race horse is one of the finest ma-



Jockey Holding Complete Equipment for Saddling a Race Horse, and Disappearing Board on Hydraulic Ram, Where Winners' Numbers Are Posted

chines built by nature; he is his owner's only tool. But to take proper care of him, the owner must do more than oil and grease him and keep him in general repair. A race horse reacts directly as he is treated. Like a human, sudden changes upset him. From the first day a colt runs

loose in a field, every change in his method of living is brought about gradually.

"No horse is better than his feet. Trainers watch first their feet, next their diets. I have seen trainers run their horses on sandy river beds to develop strength; some trainers have found salt water of the Pacific ocean an excellent tonic and they exercise their horses on the beach and walk them in the surf. They're the finest athletes in the world and careful trainers take every precaution to keep their horses fit for racing."

ELECTRIC LOCK FOR GAS TANK FOILS AUTO THIEVES

To thwart automobile thieves, an electrically operated gasoline lock keeps the fuel from flowing through the carburetor when a secret switch is thrown by either the hand or foot, according to its location. In the event of a holdup, the motorist cuts this switch after which the car can proceed only a short distance. Control of the gas flow is governed by a steel ball and small electromagnet within the feed pipe. Turning on the switch causes the electromagnet to attract the steel ball. When the switch is cut, the ball drops and stops the gasoline flow.

GOLF COURSE FOR CARD TABLE CONTAINS NINE HOLES

Miniature golf has shrunk to card-table size. A complete nine-hole course is now laid out on a piece of heavy metal, two feet square. The fairways are of a composition material which makes them look and play like real grass, and hazards are made of wood in colors. The metal sheet is mounted in a wooden frame, and the game is played with tiny putters and balls.



Nine-Hole Golf Course on a Metal Base That Can Be Accommodated on a Card Table

The Leubbs Mfg. Co.
Canton, Ohio.



Electrically Operated Car on a Track Which Saves Climbing Steps to This California Home

HOMEMADE ELEVATOR SAVES WALKING LONG STAIRS

One Los Angeles man whose home is on a bluff tired of walking a long flight of steps from the street to the house, and constructed an electrically operated car to carry him and his family back and forth. The car, large enough to hold two persons, runs on a track made of angle iron fastened to wood timbers, and is operated by a one-third-horsepower motor to which is attached a worm gear for winding up the cable. The track is ninety feet long and rises at an angle of about forty-five degrees. The car, with ten-inch wheels, has a slanting floor with a quarter-inch cable attached to the rear end, and from this contact is made when a switch is pressed. Two dry cells under the house furnish current to start the motor and these are grounded to the rails, so that, when the switch is pressed on the car, the circuit is completed. The system operates from either end of the track by pulling a wire to reverse the motor.

Color blindness affects about four per cent of males and four-tenths of one per cent of females.

Chas. L. Davis
3855 S. Broadway
Los Angeles, Calif.

Stinson Aircraft Corp

Wayne
much

POPULAR MECHANICS

Luxianth

760
a-526



Luxurious Interior of a Club-Model Plane for the Busy Executive; Walls Are Finished in Walnut and Tapestry and Floor Is Carpeted

LUXURIOUS CLUB-MODEL PLANE BUILT FOR EXECUTIVE

One of the most modern and luxurious forms of transportation yet offered for the business man who wants to eat, sleep, work or be entertained while traveling by air is a tri-motored club-model airplane with a cabin outfitted on a scale like that of the most expensive yacht. Externally and from a mechanical standpoint, the ship resembles those used by airline operators, but the interior has been developed entirely to add luxury and comfort to air travel. Behind the pilot's compartment is a small room fitted with writing desk, chair, clothes lockers and luggage compartments. A place also is provided for a typewriter and magazine rack. Behind this is the main cabin, with side walls below the window ledge finished in stump-walnut grain and headlining materials of tapestry above. Four upholstered chairs are grouped about a removable table, and back of them is a reclining lounge chair with a drop table in front of it and a built-in cabinet near by. The floors are carpeted, and to the left of the main cabin, is an auxiliary room containing a cabinet for toilet articles, a folding mirror and washbasin, and other accessories. Behind this is a commissary room with refrigerator, sink, china cabinet and space for thermos bottles and other equipment.

Ash trays, vanity cases, glass holders and reading lights add to the conveniences and a radio receiver is available.

CELLULOID THAT IS FIREPROOF HAS MANY USES

Celluloid which is fireproof now is available and this quality has greatly extended the usefulness of this material. It is already being employed in cosmetic jar tops, lamp shades, thermometers and automobile hardware, and the extent of its non-inflammability is shown by the fact that it has been approved as a material for making night-flying lights on airplanes, and is used as a fire-retarding window in the petroleum-refining industry. Its future popularity is based on the fact that it can be machined. It can be blanked, drilled, sawed or even turned in a lathe, thus offering craftsmen an opportunity to make objects simulating semi-precious materials. It is primarily a molding material, however.

A PHONOGRAPH-RECORD MAKER ATTACHES TO RADIO

Phonograph records can be made instantly in the home or office by an attachment to any electric radio receiver, thereby forming a combination for playing the records after they are finished. The instrument can be used to make records direct from a radio broadcast, and the radio receiver then is utilized to repeat the program from the records. The device cuts and grooves its own records. Disks come in standard sizes, and are made of aluminum alloy, not easily broken or damaged. The instrument, including motor, turntable, volume control, microphone, and switches, is contained in a compact case.



Presto Corp. of America
117 N. 7th St. Phila.

Merchandise
a-553
Chicago & Dearborn
Celluloid Corp. 10 E 40th, New York

a-440

85.00, down 20% 1741.00

pat bend

Copyrighted material

BILLIONS OF FISHES PRODUCED IN GOVERNMENT HATCHERIES.

Despite some unfavorable weather conditions, the bureau of fisheries last year established an all-time record for the number of food fishes propagated and distributed. A total of 2,553,481,000 eggs, 4,766,831,000 fry and 2,553,481,000 fingerlings were produced in the federal hatcheries and distributed throughout the country. Eggs and fry of winter flounder were greatest in number, followed by cod, yellow perch, pike perch and whitefish. In addition, 161,000,000 fishes were rescued from overflow lands near the Mississippi.

COOKER ON CAR RUNNING BOARD GETS HEAT FROM EXHAUST

Motorists now can cook their meals as they travel by means of an aluminum cooker which attaches to the auto running board and utilizes the waste heat from the exhaust. About eighteen inches long and twelve inches high, the cooker rests on an asbestos pad and is connected to the exhaust by a flexible pipe. When the car is in motion, the stove is heated in less than a minute. Food in the flat pan, over which fits a tight black lid, can be fried, baked or roasted without cost of fuel, loss of time, or interference with the motor. The metal top fastens so securely that there is no rattle, while gas fumes are exhausted below and do not come in contact with



Aluminum Cooker for Auto Running Board. Which Utilizes the Waste Heat from the Exhaust

the running board stove which can be switched on or off by the motorist, or even regulated to cook faster or slower. For the tourist, it eliminates much camping equipment, and for the picnic party, it assures a hot lunch as soon as the picnic ground is reached.

Wheg. Cook
pat. app.
Chas. J. H. Whesner
680 S Vermont Ave
Los Angeles, Calif.



Sea- Onion Plant, the Bulb of Which Furnishes a Poison for Rats but Harmless to Humans

PLANT POISONS RATS AND MICE BUT NOT HUMANS

Because most rat poisons also kill other animals, and even humans through accident, the biological survey has been experimenting with a vegetable poison which is fatal to rats and mice, but is virtually harmless to other living creatures. The plant from which the poison is obtained is the "sea onion," belonging to the lily family, and also known as the red squill. It grows wild on the hills bordering the Mediterranean, the onionlike bulbs sometimes attaining a weight of ten or fifteen pounds. One grain of the powder from the dried bulb will kill a large rat. White squill is familiar in medicine, being useful as a heart tonic and emetic. Red squill has the same properties, but also contains a poisonous element not yet isolated. If swallowed in any quantity by a person or domestic animal, the red squill causes vomiting which is one reason why it does no harm, but, oddly enough, rats and mice cannot thus eject the material, and thus the poison, so deadly to them, kills them quickly. The biological survey has been growing the plants in greenhouses and drying and pulverizing the bulbs to make the poison for rodents.

G. J. Hopkins Co. 125 William St. New York
220 Broadway

A-127 x
762

Engineer George
Allert and
Hans Rottmayer
Asphalt Bituminous
Concrete
POPULAR MECHANICS

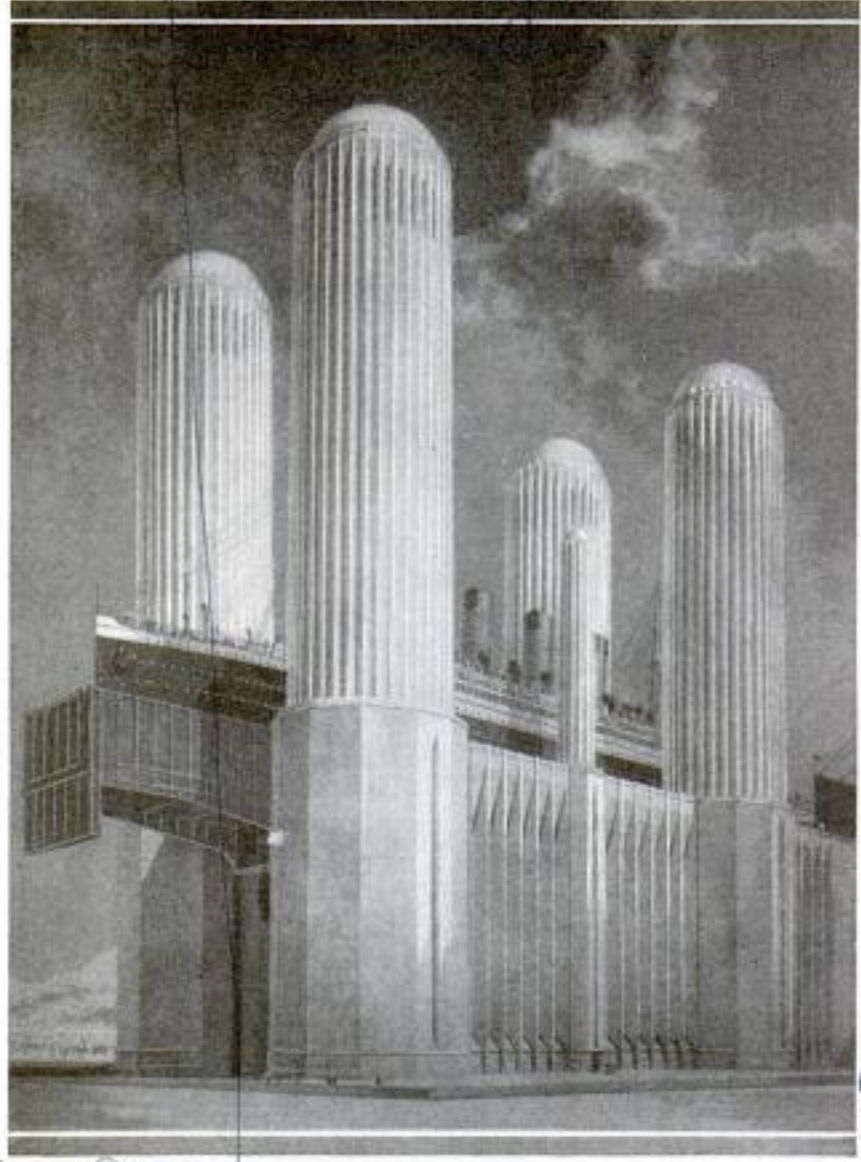

Proposed Elevator for Ships Which Would Raise the Largest Vessel 200 Feet in the Air When Repairs Are Necessary

ELEVATOR THAT RAISES SHIPS PLANNED IN GERMANY

Two German architects have drawn plans for a giant ship elevator that would raise the largest vessels to a height of 200 feet for overhauling without damage to the boat. A drawing of the proposed structure shows two massive walls surmounted by four huge towers with a slip between them into which the ship is run.

LOW-COST PAVING MATERIAL COMBINES WITH DIRT

Ordinary earth, instead of sand, gravel and stone, is used as an aggregate with a patented road-surface binder known as bituminous concrete, which, it is claimed, will produce well-constructed highways at about one-half ordinary paving costs. The material is mixed in a ratio of one to seven with any handy dirt in the path of construction, forming an asphaltic cement surface similar to the asphaltic concrete now in general use. It is handled hot, rolled in the usual way, has great tensile and compressed strength and is used with a non-skid surfacing. The material also has been tested for sea docks, gun emplacements, garage floors and for basements. The subcoat, or surface binder, sets in less than an hour, and it is also claimed that it can be laid in rain or cold weather.

tuminous concrete, which, it is claimed, will produce well-constructed highways at about one-half ordinary paving costs. The material is mixed in a ratio of one to seven with any handy dirt in the path of construction, forming an asphaltic cement surface similar to the asphaltic concrete now in general use. It is handled hot, rolled in the usual way, has great tensile and compressed strength and is used with a non-skid surfacing. The material also has been tested for sea docks, gun emplacements, garage floors and for basements. The subcoat, or surface binder, sets in less than an hour, and it is also claimed that it can be laid in rain or cold weather.

HORSELESS POLO IS PLAYED ON FOOT

Miniature polo was introduced on the Pacific coast as a sport almost as exciting as the real game, when the grooms of one polo stable challenged those from a rival outfit to a polo match without ponies. The horseless contestants play the game according to standard rules.



Polo Game without Ponies: It Is Played with Short Mallets According to Regulation Rules

The Elgin Trust Co. 651 Broadway, New York City
1206 Maple Ave. Berkeley, Calif.
1200 University Ave. Berkeley, Calif.

Test made at California Institute of Technology Pasadena Calif.

DOOR OPENS ON RIGHT OR LEFT TO SAVE STEPS

Equipped with two sets of hinges and two handles, doors for refrigerators, cabinets and many other articles can be opened from the left or from the right. The advantage of such a convenience is apparent. Working at a table or sink in the kitchen, the housewife would be saved many steps in using the refrigerator as she could open and close the door from the left or from the right side. Cabinets and other objects with the "two-way" doors could be used where the usual door arrangement would conflict with other articles of furniture, and on cupboards and similar objects overhead, the doors could be opened in such a way that they would not endanger the person working underneath. It is impossible to pull the door from its hinges, for when one side is even slightly ajar, the other is securely locked. The hinges are flush with the sides of the cabinet, so that the only extra hardware exposed for cleaning is a handle.



Apparatus Which Makes a Moving Picture of the Human Voice; on the Screen Is Shown the Image of One Voice

"MOVING TALKIE" OF THE VOICE AIDS IN LANGUAGE STUDY

It is now possible to make a "moving talkie" of the human voice or of any other sound, and exhibit it in a lighted room before a large audience with a device developed by the Westinghouse research laboratories. The picture of the voice shows curious lines wriggling from left to right, across a screen about the size of a large plate. "High" and "low" spots are indicated, making it possible for observers to distinguish the pure from the compound notes or tones which are heard by the human ear. The device enables engineers to examine the high and low levels of various sounds and thus, by dovetailing high spots with low ones, to produce or approach silence as far as hearing is concerned. This is expected to be important in combating annoying city noises. In schools and colleges, it is expected to be helpful in language study by photos of correctly pronounced foreign words.

NEW HIGH-COMPRESSION HEAD INCREASES AUTO SPEED



To increase the power and speed of Ford cars, an L-type high-compression head is being offered to replace the stock head without disturbing or changing the mechanical set-up of the engine. It can be

combined with a downdraft carburetor without adding any moving parts or changing the valves. The head is of cast iron with a special combustion chamber to handle the increased compression. The makers claim for it a substantial saving in fuel and an increase in speed up to more than eighty miles an hour. Compression ratios of seven to one or six to one are offered, the former for anti-knock fuels.

"SANDWICH" OF WOOD-ASBESTOS FIREPROOFS DOORS

In erecting a large building, the designers specified a "sandwich" door of wood and asbestos as a substitute for steel and to conform with the fire regulations. The cores were of wood with a layer of asbestos, topped by a surface veneer on each side. In event of fire, the veneer would burn but the flames would stop when they reached the asbestos layer.

Chicago-2446 Anderson Ave

Winfield Carburetor Co.
 3053 Sreadwell St
 Los Angeles, Calif.

Ymca Bldg
 Akron, Ohio
 Copyrighted material

Tested by N.B.C. officials at
Staten W. N. E.

a 369 in Washington



© U. & U.

Demonstrating a "Silent" Note Paper before the Micro-
phone; It Is Noiseless When Shuffled

"SILENT" PAPER IS DEVELOPED FOR BROADCASTING

To end the harsh crackling sounds produced by ordinary note paper in the hands of a speaker before the microphone, a special "silent" writing paper is now being used in some radio-broadcasting studios. This paper can be shuffled or crumpled without making any sound which would register on the recording apparatus.

TWO WINGS OR FOUR ON PLANE AND THE REASON WHY

If the golden plover can fly 2,000 miles across the sea and the wild duck is able to sweep down the sky at 100 miles an hour with only two wings, why has man found it necessary to equip himself with four in a "biplane" arrangement that is like no living creature the skies ever knew. Why do so many flyers prefer this "flying bird-cage" to the graceful monoplane that rides the winds like a soaring gull? The most important reason lies not in increased flying ability but in added strength. For the same structural weight, the biplane is far sturdier and more enduring than the monoplane. Its wings are braced like the beams of a bridge—held rigid by taut wires of enormous strength. The complete wing assembly on the high-powered pursuit fighters used by the army and navy will stand up under a loading twelve times the normal weight of the ship. For the

same carrying capacity, the biplane is much smaller than the monoplane. This is not only true of the span of the wings but the fuselage is shorter as well. Due also to this smaller span and shorter tail, the biplane responds more quickly to the controls. It can snap into and out of maneuvers with greater speed and requires less room in which to turn or change course. The pilot of an open-cockpit, one, two or three-place biplane has better visibility than he would have in a monoplane of the same class. The truss of the biplane takes most of the load, and the wing panels themselves can be made quite light. Therefore the biplane makes a lighter ship. This means either better performance or more pay load, whichever is most desired. So, as a general proposition, the biplane seems to be the best type for high-speed, high-performance planes, such as fighting craft, and high-powered private planes. Monoplanes have smoother lines, slightly better aerodynamical efficiency, and are steadier in the air. They are easier to design and less expensive to build.

a-516

EGG MAP SHOWS AT A GLANCE CENTERS OF PRODUCTION

Annual production of the American hen is clearly visualized on an egg map of the country constructed by the department of agriculture. A large board is cut in outline to represent a map of the nation, and the egg production of each state is represented by imitation eggs of different sizes.

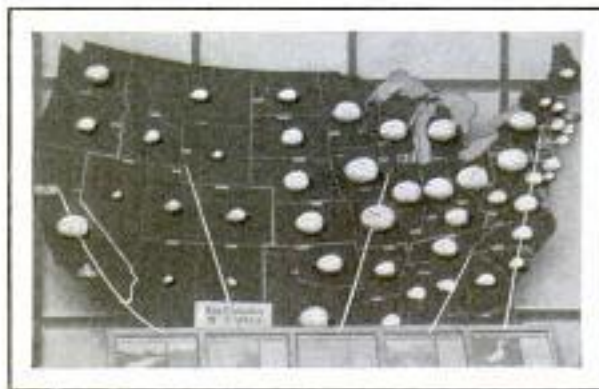

An Egg Map of the United States, Showing at a Glance
Relative Egg Production of Each State

Iowa is dignified by the largest egg of all, with Missouri, Illinois and Ohio following in order of size. The map shows at a glance the importance of the various states in terms of egg production.

National Broadcasting Corp
Merchandise Dept
New York, N.Y. 1930-765

Wanted by St. Louis
Missouri State News

a-538

Carl Norval Ballard
Boeing Master Mechanic
409 Cheney St Reno, Nev.

a. 241 Interview with Frank Lloyd Wright, Taliesin, Spring Green Wis



Is Main Street Doomed?

By CRAG DALE

LOOK at it!—the humble gasoline filling station, ready to serve any automobile with fuel.

If this filling system of distribution works with the automobile, why not extend it to staple articles of food and clothing? Already power is sold that way. Light sockets are electrical filling stations, maintained by a central-power unit.

In the opinion of Frank Lloyd Wright, an architectural pioneer of international fame, the gasoline-filling station rapidly is becoming a symbol of a trend away from Main Street—a centralization made necessary in the past by the inefficiency of individual transportation.

At every crossroads, and between them, stand gasoline-fill-

ing stations ready to serve any automobile with fuel. Since this system of distribution works so well with the automobile, suggests Mr. Wright, why not extend it to staple articles of food and clothing? And indeed in many places throughout the country Mr. Wright's idea already has been translated into action.

Government statistics show that there now are 110,000 roadside-stand owners, almost all of whom expanded from filling stations. Of that number, 45,000 are permanent year-around operators, serving not only their own communities but tourists as well.

The 16,609 retail-store operators who went into bankruptcy during the first eleven months of 1930 with liabilities of \$244,578,-

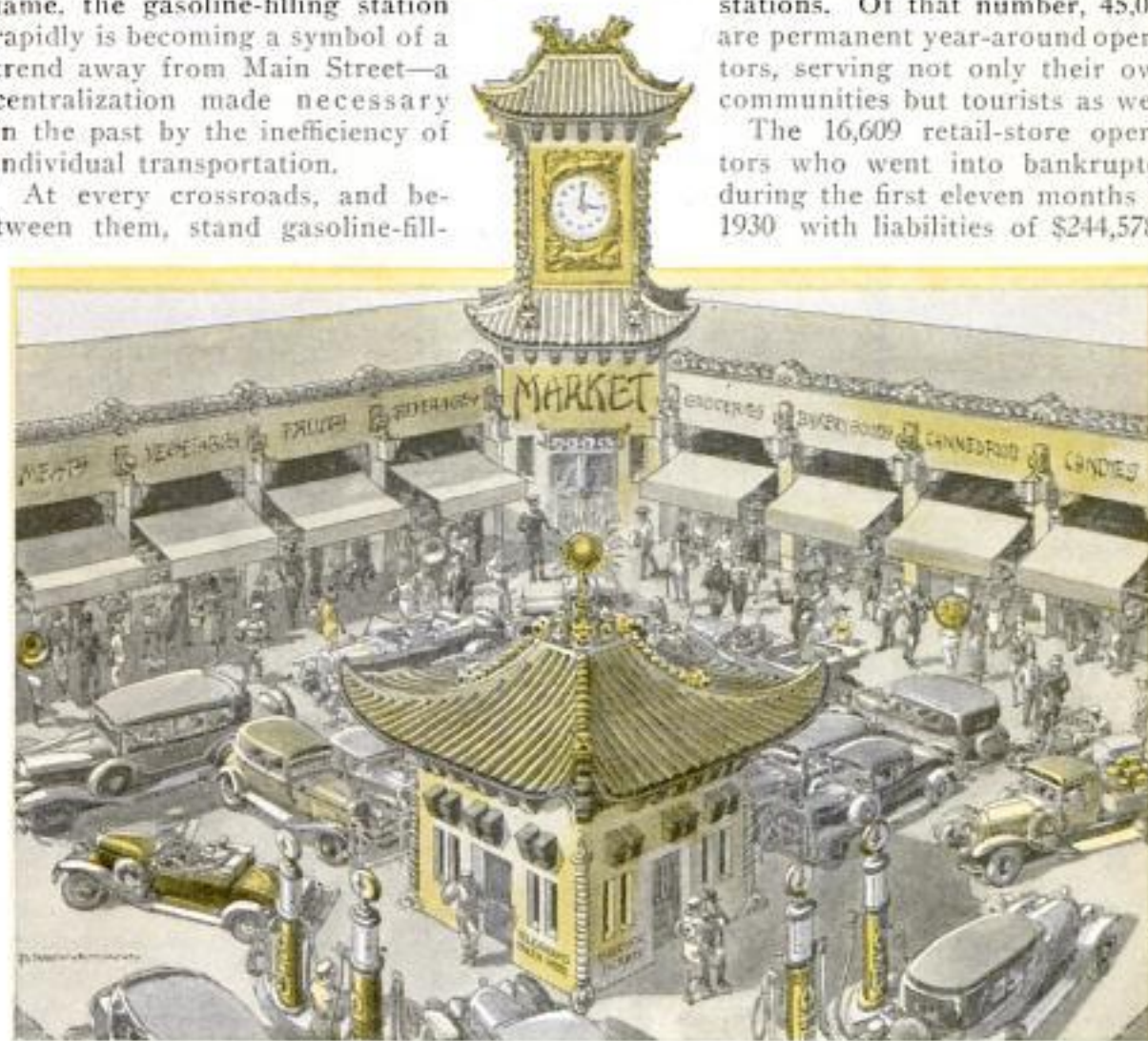

Artist's Drawing of One of California's Marketing Centers, Where Even Theater Tickets Are Sold; It Has Grown Up around the Easily Accessible Filling Station



1900 AND —



TO-DAY

This Changing World and What Has Happened to Shop Keepers Since the Man on Foot Has Taken to the Crowded Roadway with Its Ever-Present "No Parking" Signs

000, face department of commerce figures showing that roadside marketing in 1930 took from the ordinary retail business of the country \$500,000,000. In other words, it would seem that the business taken from retail stores last year by gasoline-filling stations and their accompanying roadside-marketing facilities more than doubled the total losses of the 16,609 retail bankruptcies.

A movement now is on foot, and has made great headway, to bring about a co-operative organization of filling stations engaged in selling commodities other than gas and oil. The latest census of

gasoline-filling stations shows 317,000 in operation. That figure includes 6,000 owned and operated by the larger oil-producing companies, such as the Standard Oil company, which already is engaged in distributing tires through the service stations it owns or controls. An equal number is owned by the larger oil-producing companies but operated under lease. Independently organized companies operate 8,000, while individual oil producers and private operators maintain 105,000 filling stations. The remainder are run in connection with garages or are maintained as roadside pumps.

*no information A-241
on these stands*

It is Mr. Wright's opinion, and in this he is supported by industrial leaders, that the trek to the city is about to be given the "to the rear—march" order by the very force of economic pressure, and the change which has been brought about in society by the use of the automobile. Mr. Wright holds that the automobile and the filling-station system have made possible man's accommodation to the country. The city, he thinks, served its purpose in a day when transportation and communication were undeveloped. But now, he believes, homes and industries might better establish themselves near public highways far from present congested areas. Mr. Wright's ideas are borne out by the latest estimates of the government, which show a larger population on American farms at the beginning of 1931 than at the beginning of the previous year. For the first time in ten years, according to these estimates, farm residents have increased in num-

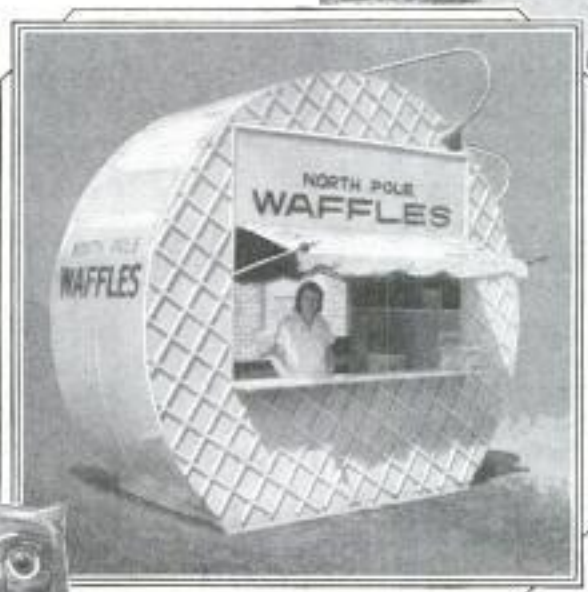

ber. More than 1,500,000 left the farms last year for the cities and 1,392,000 moved back to them. This would seem to show a small difference in favor of the cityward movement, but the normal increase by births in the farming communities makes the

net result of 208,000 more souls living on farms now than a year ago.

Added to that might be considered, in connection with the development of commodity distribution by filling stations, the fact that last year, according to the American Tourist Camp association, there were 6,000,000 campers using 2,000,000 automobiles on the highways spending an aggregate average of forty-six camping days at an expense of \$7 a day per car. The Hotel Men's association estimates that in 1930 tourists other than campers contributed \$12,000,000 to the revenues of hotel keepers in the nation.

Other statistics show that in the east and middle west the regular trade habit of farm homes is in the nearest town which averages a distance of five and a



Three Types of Quaint Roadside Stands That Attract California Motorists

*Major Chas L
Perceval, N.H. Co American*

*Townville, N.H.
52 W. 65th St. N.H.*

A. 241
768



One of California's Attractive "Drive-In" Markets, Where Everything Is Easily Available for the Motorist, Including a Free Pony Ride for Children

half miles from the farm. Observation has shown that, in many instances, the modern filling station already has supplanted the customary crossroads store as a distribution center for rural communities, and when it is taken into consideration that the average farm family consists of five persons, it may readily be understood that the revenue of a filling station which also operates as a general store is far from inconsiderable.

The newer ideas of merchandising which stress the handling of standard package goods, and the development of refrigeration, which would make it possible for any filling station or corner store to hand out meat cuts or perishable products as they would a package of breakfast food, also add materially to the possibilities that present themselves to filling-station operators. Indeed, one of the major telegraph companies has been far-sighted enough to appreciate the value of filling stations as distributing units and has recently announced that all filling stations operated by a certain oil company would henceforth be receiving branches for telegraph messages.

The annual increase in highway mileage apparently increases the potential efficiency of filling stations as distributing units, especially since government traffic studies show that there is an ever-growing ten-

dency on the part of the traveling public to avoid centralized traffic.

In some communities, notably in Texas and California, it has been proved that motorists would far rather do their shopping in the place where they have to stop to replenish fuel for the car, thus avoiding the additional stop which shopping at an ordinary retail store would entail.

TRUCK LAYS BRIDGE FLOORING A-45/AT FIFTY FEET A MINUTE

Wooden planks for bridge flooring or corduroy roads are laid automatically by motor truck recently tested in model form. The planks, joined by hooks, are unrolled from a large reel at the rear of the truck. The inventor claims a full-size machine can build a 100-foot bridge of wood planks in two minutes. It is expected to be useful particularly in fording creeks and swamps.

Mr. Benj. L. Morningstar

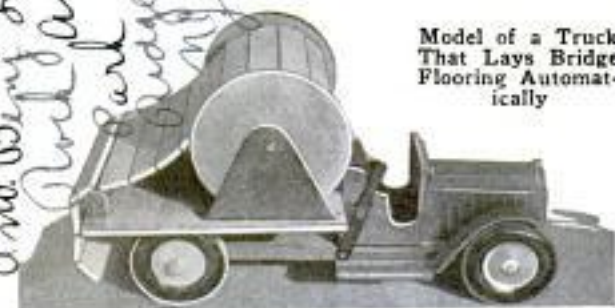

Model of a Truck That Lays Bridge Flooring Automatically

Mr. Benj. L. Morningstar, Park Ridge, N.J.

MILE-LONG EARTH DAM IS IMPERVIOUS TO WATER



One of the largest sources of hydroelectric power in the world is made possible by an earth dam nearly a mile and one-half long which is more impervious to water, according to engineers, than concrete would be. This is the recently completed Saluda dam, near Columbia, S. C. which spans the Saluda river and valley for 7,838 feet, the fill being 1,150 feet wide at the base and rising 208 feet above the river bed. It retains a lake over forty miles long and fourteen miles wide, draining an area of 2,400 square miles. The reservoir, containing 763,000,000,000 gallons of water could supply 160 cities of 50,000 population for a year, and more than 170,000 horsepower has been conjured from the river. Nearly 100,000 acres of land were purchased for the project, including 1,100 tracts occupied by 4,000 people, and schools, churches, cemeteries and homes were moved from the area. The interior of the dam was formed by the washing in of fine clay to make a water-tight core. A power station below the dam has an ultimate capacity of 200,000 kilowatts.

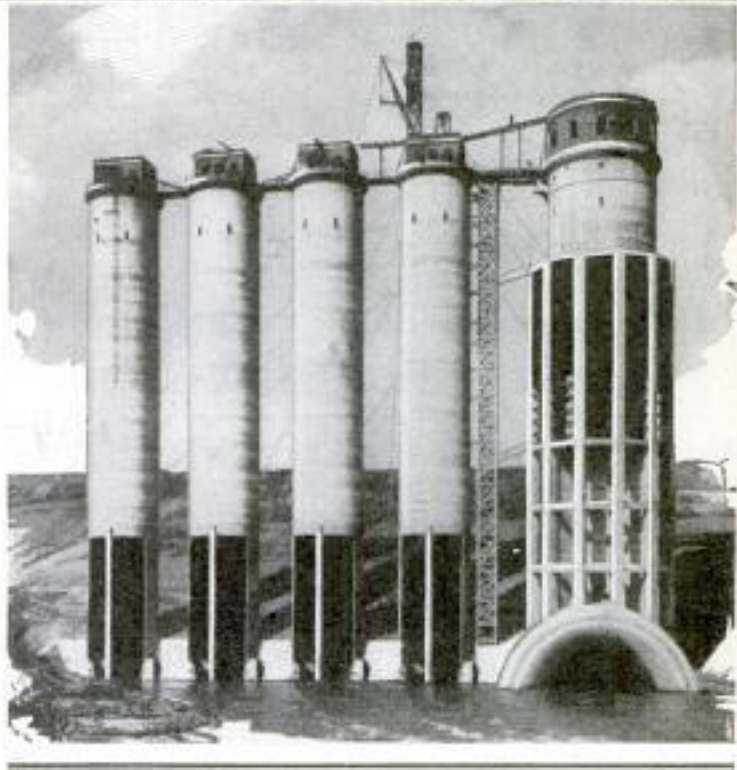

Above, Cross Section of Saluda Dam and Power Project; the Dam Is Made of Earth; Below, the Intake Towers

Generators weigh 340 tons each, and the water wheels that drive them weigh thirty tons each. Water to turn these turbines flows beneath the dam through four huge penstocks, the water entering the penstocks through four large intake towers, thirty feet in diameter and 223 feet high.

Base covers 105 acres. more than 11,000,000 cubic yards of earth fill used

SINGER FOR RADIO HEARS VOICE AS IT COMES OVER AIR *A 403*

Radio singers who entertain over WGY, the General Electric company station, now can hear themselves as others hear them. A film sound recorder has been installed as part of the studio equipment. It is placed in another room and connected by wire to the microphone, recording the singer's voice exactly as it would be heard through a loud speaker after being

picked up from the air. Experience has taught that a fine concert voice may be a failure after it has passed from transmitter to receiver and loud speaker, and the recorder enables those in charge of talent to study a new voice, and the singer to hear himself. The instrument also is used in training announcers to correct faulty speech, and in experimenting in the placing of orchestra instruments with respect to the microphone, or in the recording of feature programs during rehearsal.

Schenectady NY

INDOOR TROUT POOLS PROVIDE OUTDOOR THRILLS

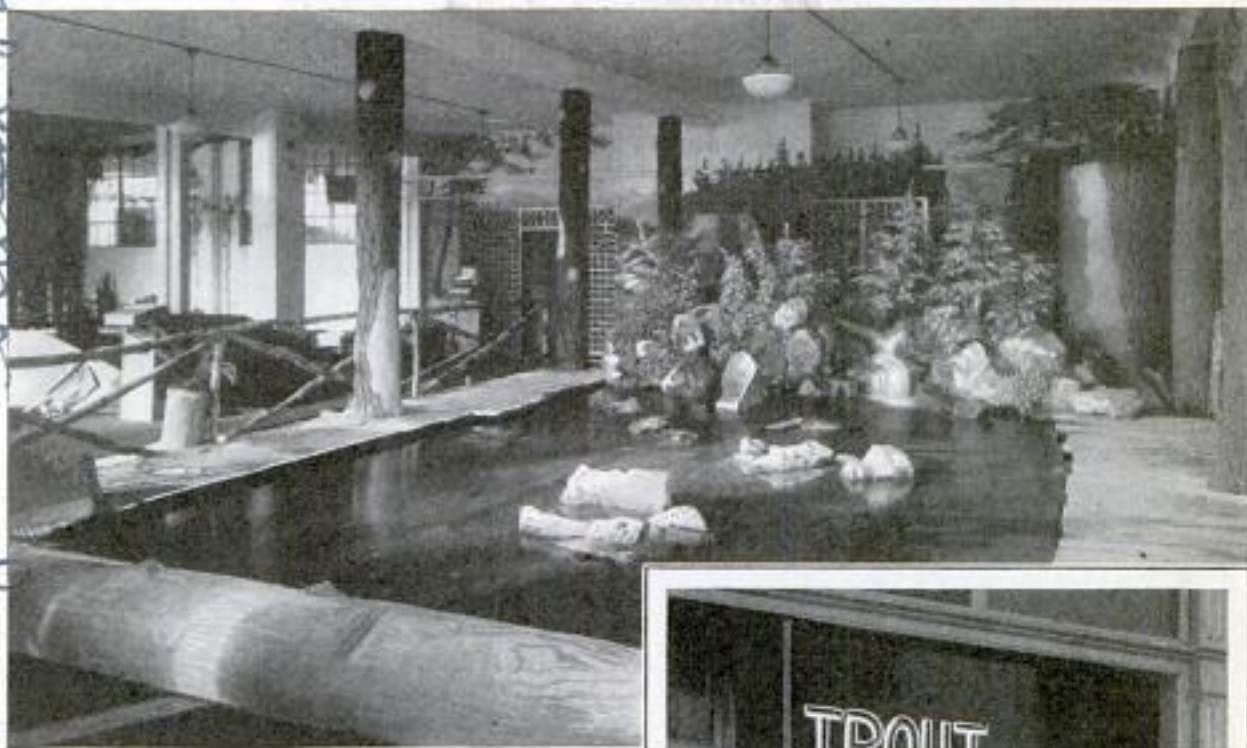

Indoor Trout Pool Where City Anglers May Enjoy Sport without Taking Time for Fishing Trip

Those who have not the time to go fishing now have the fishing brought to them. The first of a group of indoor fishing pools has been opened on the Pacific coast. The pool, located in a large building, is stocked with trout, and anglers may step in off the street and hook their dinner direct from the miniature stream. They are charged a fee for each fish caught, and have the option of taking their catch home or having it cooked for them in a kitchen on the spot. Since trout demand water that is well aerated, the pool is equipped with a pump that operates a waterfall of aerated water, recirculating the supply with a small amount of fresh water added periodically. Outdoor pools also are being planned, as are casting pools where experienced fishermen may practice this art.

ROMAN CANDLES SCARE BIRDS ROOSTING ON BUILDINGS

Roman candles are being employed successfully to rout birds which become pests to office buildings by flocking there in thousands to roost at night. Starlings



recently infested the business district of Providence, R. I., doing damage to buildings and making an annoying racket each evening as they fought for roosting places, it being estimated that 10,000 rested nightly on one structure alone. Four steeplejacks were employed on this building, and as soon as the birds had settled for the night, set off 300 Roman candles. The next night only about 1,000 birds returned and these were frightened away with more candles. After that the birds stayed away because, once scared, they do not return to the same roost.

see Feb. 1931-206

Decorative Engineering Co., Box 6, Central
Portland Ore

a 319

a. 364

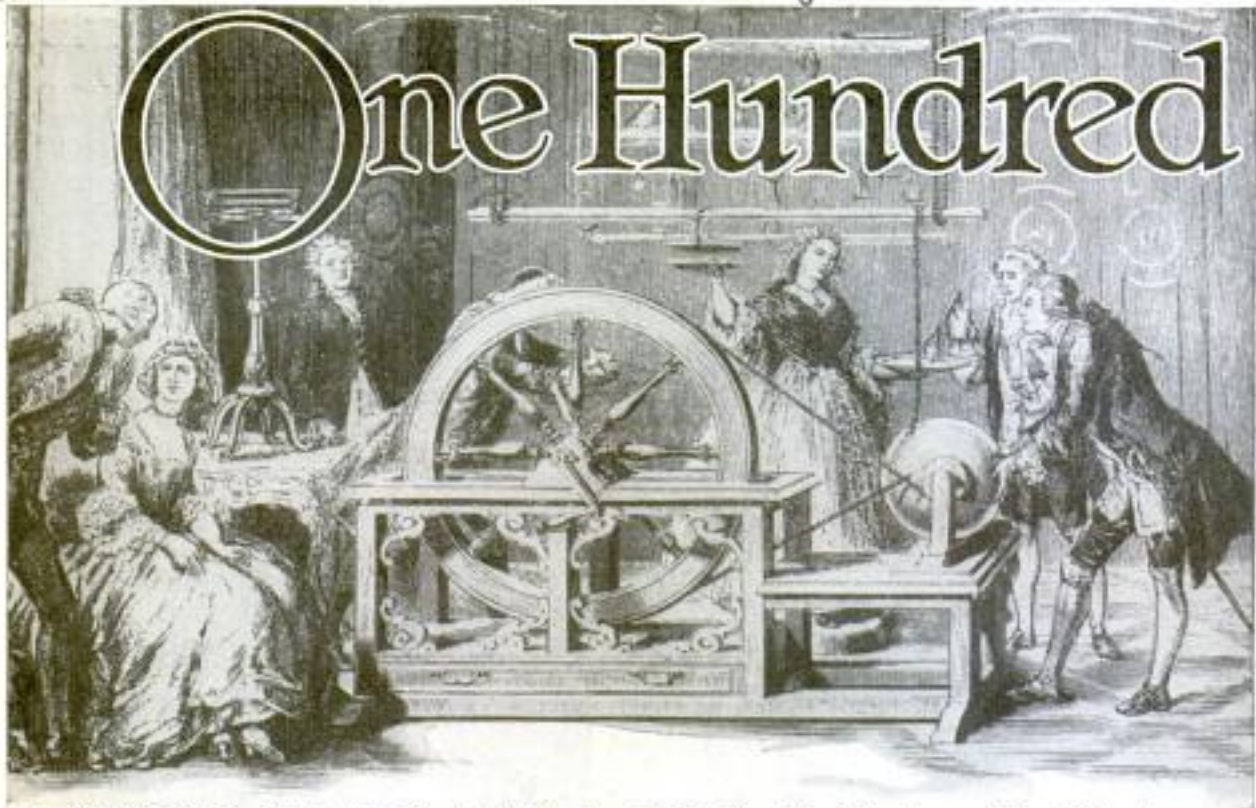
Com. Earle W. Isage,
Ashville, N.Y.

An Electric Machine Which Was One of the Wonders of 1650; Electricity Was Generated by Friction between a Rotating Sulphur Ball and the Hand of a Person Brave Enough to Touch It

JUST a century ago, on an August day in 1831, young Michael Faraday, tinkering in a British laboratory, placed two wires on a ring of soft iron, discovered the secrets of electromagnetism and blazed the way to the miracle-working electric era.

Today, thanks to the genius of Faraday, more than 500,000,000 electric slaves eliminate drudgery in the world's homes, factories and mills, while a vast horde of harnessed horses speed electric trains at 100 miles per hour, span the seven seas with fast greyhounds, encircle the earth in the fraction of a second with radio messages, as magical electric energy performs the will of man.

From a few crude pieces of metal in Faraday's hands, the electric industry has grown to gigantic proportions, more than fifty billion dollars being invested in its generation, transmission and use. On the American continent alone, more than 125,000,000,000 kilowatt-hours of electric current are generated annually, and the burden-bearing marvel is being extended at a cost of more than a billion dollars every twelve months.

Seventy out of every hundred American homes are now using electricity, while

industry is eighty-per-cent electrified. Each factory workman now has at his command four and a half horsepower of electrical energy. His producing capacity, thanks to this dependable aid, equals that of forty-five men of the pre-electric era. Mysterious electric energy is the most flexible of power sources, capable of operating a measuring stick accurately to three-millionths of an inch, or being concentrated, 100,000 horsepower at a time, for the performance of a single task.

Ever since the beginning of the race, man had trembled at the flashing lightning, had drawn sparks from amber and a crackling thunder from the fur of a cat, yet not until Faraday's epochal discovery did man really set forth upon the new highroad of freedom. For centuries mankind had amused itself with the lodestone and the compass. But until Faraday's discovery, electricity and magnetism seemed distinct, but the genius of this research worker united them into one range of phenomena, and soon there developed a hundred uses of "juice," commercial and scientific, culminating in our own electric era.

Marvelous as have been the achievements of electricity, engineers advise that

Years of Electricity

the human race has barely crossed the threshold. Slowly man is conquering the marvels and mysteries, each new day witnessing new applications. There are scientists today who declare that life itself may be found to be electricity.

Faraday reached out and plucked electricity from the air, and still other workers discovered that it existed in chemicals. The story of the simple steps which blazed the way to our own day read like pure romance. Otto Von Guericke was the first man to actually generate electric current. In 1650 he built a cumbersome machine consisting of a ball of sulphur mounted on a shaft which could be rotated.



Current was generated when the shaft was rotated and the hand lightly pressed against the ball. He also discovered that electricity generated could be conducted away from the sulphur by a metal chain from which sparks could be obtained, and thus was a pioneer in setting men forth to generate and transmit current.

In 1729, Stephen Gray demonstrated that electricity could be conducted about a thousand feet by use of a hemp thread supported by silk thread, if no metal was used. In 1733, Charles



Top, Painting of Thomas Edison and His First Electric Lamp and Dynamo; Below, Largest Automatic Electric Generating Station

a. 264

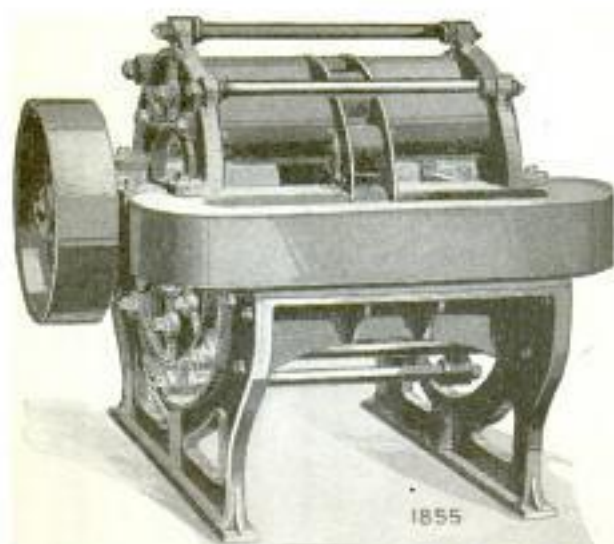

du Fay discovered that those substances which were electrified if rubbed, became insulators, and those which could not be electrified, were conductors.

In 1745, Von Kleist invented the Leyden jar, forerunner of the condenser, attempting to store electricity. In a glass bottle he placed a cork with a nail through it, touching the water stored inside. Holding the bottle in one hand and turning a frictional machine with the other, he filled the bottle with electricity. After spinning the machine for a few moments, he pulled the bottle away and touched the nail with his hand. The shock threw him down and very nearly stunned him.

Benjamin Franklin made several experiments with the Leyden jar. Connecting a battery of jars in parallel, he produced a discharge strong enough to kill a chicken. His most famous experiment was the proof that lightning is electricity. This he accomplished in 1752, by flying a kite in a thunderstorm, and drawing electricity from the clouds with which he charged jars and drew sparks from a key attached to the kite string. Modern scientists marvel that Franklin was not killed.

In 1785 Luigi Galvani, an Italian scien-

tist, held the legs of a frog with a metal clamp and, cutting the skin with a scalpel, permitted the clamp and scalpel to touch. To his utter amazement the frog's legs twitched. He repeated the experiment and proposed a theory of animal electricity. Alessandro Volta, professor of an Italian university, repeated the experiments and discovered the clamp and scalpel must be of different metals. Following up this idea, he made a "pile" of silver and zinc disks with pieces of wet cloth, saturated with salt water, between the disks. From this the voltaic pile was perfected, and in honor of its inventor, the volt, unit of electric pressure, was named after him.

In 1820, Oersted, a Danish professor, accidentally discovered that electric current flowing in a wire would deflect a compass from its true position. Andre Marie Ampere, French mathematician, followed this up and made several discoveries, among which was the idea that current flowing in a coil of wire gave it the property of a magnet, and thus effected the long-sought link between electricity and magnetism. The ampere, unit of flow of electric current, was named in his honor.

One of the most important laws of electricity was discovered in 1825 by Georg Simon Ohm,

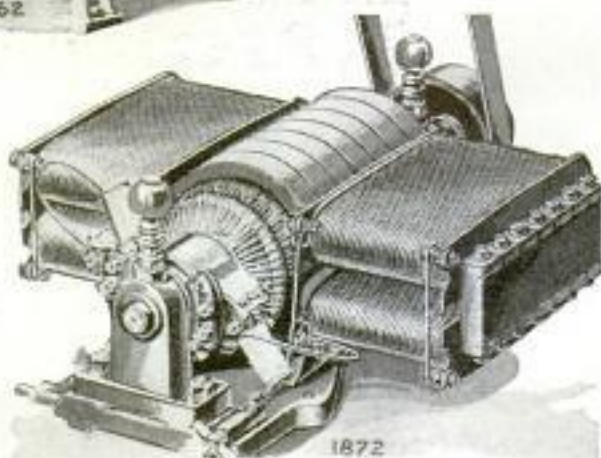
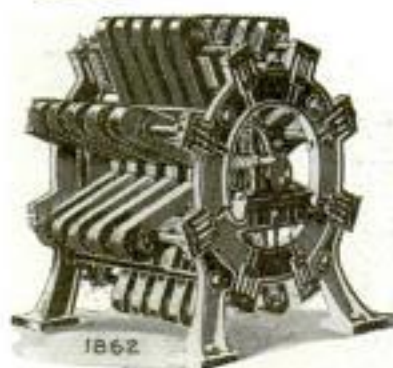

Examples of Some of Early Dynamos; the Armature of the One at the Bottom Is Drum-Wound

of Cologne. It was known that the rate of transfer of heat from one end of a metal bar to the other was in direct proportion to the difference in temperature between the ends. By analogy and experiment, Ohm discovered that the current in a wire is proportional to the difference of voltage (electric pressure) between the ends of the wire. Also, he discovered that the current in the wire is inversely proportional to the electrical resistance of the wire. These became the basis of the Ohm law that current flowing in a circuit is equal to the voltage divided by the resistance, and after this trail blazer was named the ohm, unit of electrical resistance.

Michael Faraday, son of a poor country blacksmith, born in 1791, was destined to become the miracle worker of the nineteenth century and, using the accumulated discoveries of the past, herald in the new electromagnetic induction which should make all of use in harnessing electric energy to perform miracles for humanity.

Ampere having converted



electricity into magnetism, Faraday tried to discover if the reverse were possible. After months of study he made the epochal experiment of moving a permanent magnet in and out of a coil of wire connected to a galvanometer, which generated electricity in the coil and deflected the needle of the galvanometer. Then he made a machine consisting of a copper disk mounted on a shaft so that the disk could be rotated between the poles of a permanent horseshoe magnet, a copper brush rubbing against the edge of the disk as it

rotated. Thus electromagnetic induction was discovered.

Faraday rested content upon his discovery and did not follow it out to a conclusion, and it remained for other men, adopting his methods, to build the first electric dynamo and generator. Not until 1871 was the dynamo a commercial success, when Gramme applied the ring armature. This gave man a machine which not only produced electric current, but caused it to produce power.

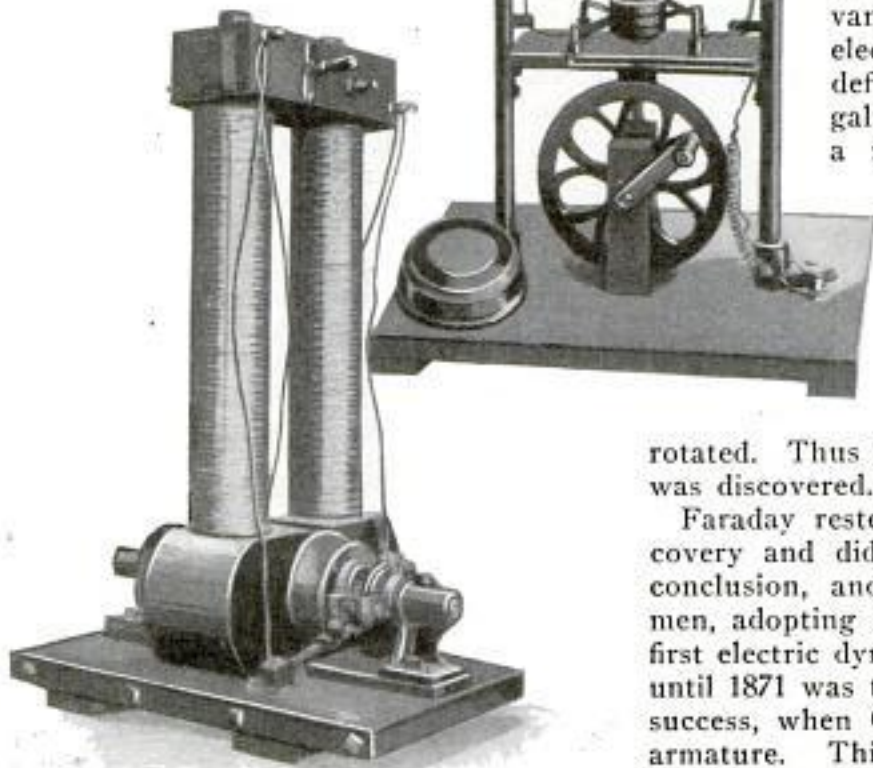

Top, Michael Faraday, Pioneer Electrical Wizard; Center, Dynamo of 1832; Below, an Edison Dynamo

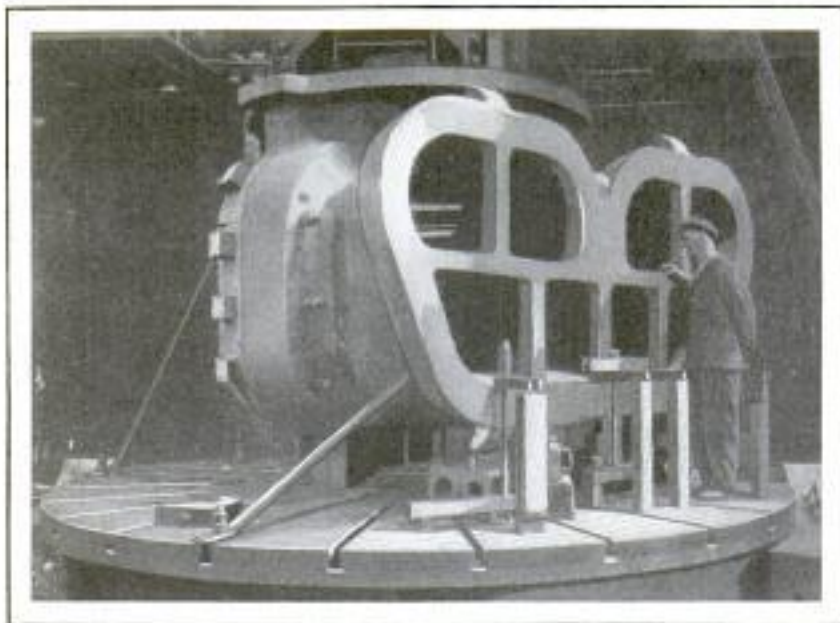

High-Pressure Casing for One of Two 160,000-Kilowatt Tandem-Compound Steam-Turbine Generators, Used by a Brooklyn Electric Company

The evolution of the devices which today generate, transmit, harness and convert electrical energy to perform the will of man, was slow and called for the combined endeavors of a host of men. Pixii, a Frenchman, at the instance of his friend, Ampere, brought out a dynamo that generated current by revolving wound electromagnets instead of a disk. He likewise perfected the first two-part commutator, and became the father of alternating current.

The real beginning of electric lighting dates from 1876, when Jablochkov illuminated a number of Paris boulevards with his "electric candle," an arc light consisting of a pair of carbon rods held together side by side, yet insulated from each other. Charles F. Brush, an American inventor, improved upon this idea, as did Thomas A. Edison, who deserted carbon for filament imprisoned within a glass bulb, inventing the incandescent electric lamp in 1879.

A mighty pioneer was he who first kindled fire. At will, he was able to enjoy light by night, warmth in winter, new feasts as he roasted roots, nuts and meat. In a later age his children caused the flame to divide copper from its ores, and make iron into spears and knives.

But the electrician is the marvel-worker of the modern age, with weapons so subtle and forceful that he far outdistances the fire users at every point. He

provides us with energy in one phase which may instantly and fully be made to pass into any other phase. A touch of the button and electricity sheds lights as vivid as sunshine; another touch and intense heat throbs in the heart of the oven or crucible, securely mantled against escape. Yet another touch, as we direct a chemical dissolution, as in separating silver from its compounds; or we may effect a union as profitable, building from air the nitrates to fertilize farm and garden. Turn a

switch and desire becomes law. Today electricity wields universal empire because it does all that fire did, easier, quicker, cheaper, better, and passes to exploits far beyond the scope of the flame.

AQUAPLANE RIDER MAKES LEAP TO GLIDER IN FLIGHT

Transfer from a speeding aquaplane to a glider in flight was made recently in a test on the Florida coast. The glider was towed by a speed boat and the rider was towed on an aquaplane by another boat. When the glider swooped low over the aquaplane, the rider grasped a dangling trapeze and pulled himself aboard the flying craft.



Aquaplane Rider after Leap to Flying Glider

Walter Meloon
Pinecastle, Fla.

DATE IS CHANGED BY ROTATING CALENDAR

Desk calendars which change dates automatically when the calendar cases are rotated are eliminating this worry from the routine of the business man. The case is supported on trunnions so it swings on a horizontal axis. Upon each side of the case is an opening so placed that no matter which side faces the front, it will always be at the bottom of the box. The case contains seventeen cards bound with metal, so arranged that as the box is turned on its axle the numbers drop into view in the window in consecutive order. Operation is by gravity, the thickness of the box being such that nine cards will just fill it when stacked one upon another when the box stands upright. In this position, the bottom contains nine cards and the top eight. As it is turned toward the operator, the end containing the eight cards becomes the bottom. While turning, these eight fall by gravity to the back of the box, and as it reaches a position approximately upright, the extra card in the opposite end, now the top, drops into the vacant space. The supporting trunnions are mounted on a heavy base, the front of which contains cards indicating the month and the number of days in each. At the end of a month, if it has less than thirty-one days, the box is rotated until "1" appears.

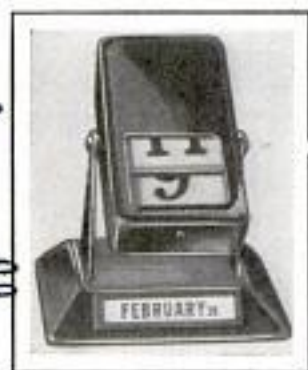

Write our Bureau of Information if you wish to know who makes or sells any article described in this magazine. Send no postage; the service is free.



Swimmers in a Balloon Race; after Swimming the Length of the Pool, They Inflate Balloons Until They Burst, Then Sprint Back

BALLOON RACE FOR SWIMMERS ADDS THRILLS TO SPORT

Aquatic balloon racing is finding favor with swimmers who are always seeking new forms of excitement to add thrills to this sport. The contestants swim the length of the pool once, clamber ashore and blow up toy balloons waiting for them to burst. As soon as a balloon bursts, the swimmer jumps into the water and splashes for the starting point.

PENNY VENDER SELLS CIGARETS ONE SMOKE AT A TIME

Vending machines now are appearing on shop counters that dispense one cigarette at a time when a penny is dropped in a slot and a lever is pressed. The supply of cigarettes is contained in a glass-inclosed case at the top of the slot machine, and no attention is required other than to replenish it.



Wilson Mfg. Co. 228 W. Chicago Ave. Chicago

suggest report Glendevanter Corp. 138 16th New York
 have similar one

Swimming Pool at Miami Beach Fla

a-394

a-427

7-28-16/34

Chicago. 3934 Kimball Ave

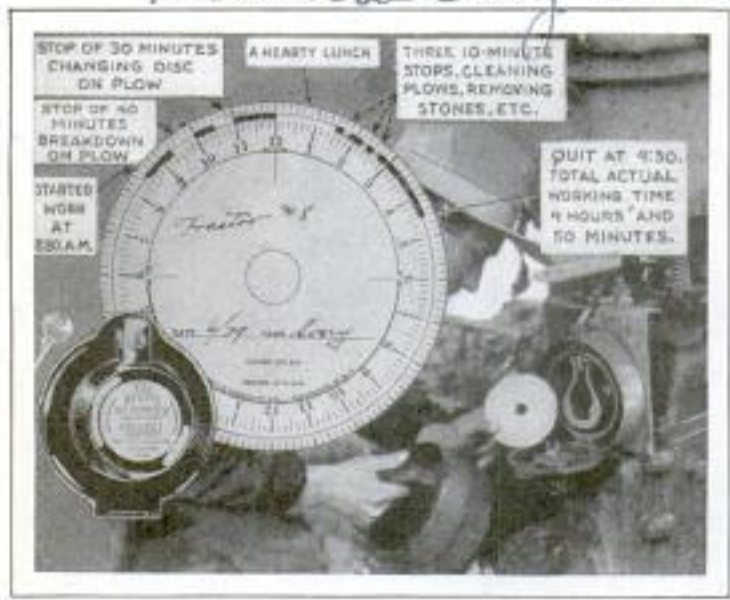

Work Recorder for Tractor Showing the Busy Time of the Machine, and One of the Waxed Service Charts

WORK RECORDER FOR TRACTOR SHOWS BUSY TIME

In operating a fleet of tractors, efficiency often demands that the owners know just how much work each is doing in order to equalize the burden. For this purpose, a clock may be attached to each tractor to keep an accurate record of busy and idle time for each minute of the day or night. The recorder consists essentially of a swinging stylus or marker and a clock movement, both inclosed in an aluminum case. The pendulum supplies motion to the stylus and any motion which will shake or move the pendulum also moves the stylus. A waxed chart is rotated at clock speed, and the stylus marks the chart during such time as the pendulum is moved by the activity of the tractor. The device can be attached anywhere on the vehicle.

COST OF HOMES TO BE CHEAPENED BY STANDARDIZING

Factory methods, if applied to the building industry, probably would cut the cost of building the simplest types of homes at least fifty per cent. This estimate is made in a report recently

Christian Science Monitor 2/4/31

submitted by the Regional Plan of New York which favors a far-reaching program of research leading to the cheap production in factories of standardized home units. The report charges the housing industry with lagging generations, or even centuries, behind other industries supplying basic commodities, and studies leading to standardization and mass production of building material are advocated as the remedy for the situation. With proper street planning, and under factory methods, homes could be built to rent for from \$5 to \$7 a room, it is estimated, the figures being based on the actual building of forty homes from standardized sections. It was found a

factory-made wall section, after being put in place, cost \$45 as compared with \$85 for brick or terra cotta of the same size. The large difference in cost was traced to the waste involved in present methods. While productivity per worker in the automobile industry has increased 172 per cent, that in the housing industry has actually decreased in some of the housing trades as much as fifty per cent.

prepared by Perrenner attorney

MIDGET GOLF AND BILLIARDS COMBINED ON ONE TABLE

By constructing a miniature golf course on a billiard table, the main features of both sports have been combined in one game that is proving popular in Australia. The difficulties of both games must be overcome by the players.



Miniature Golf Course Laid Out on a Billiard Table, Combining Features of Both Sports; the Game Is Played with Billiard Cues

at Sydney, Australia

A. 363 Cont. H. S. Wilkins, Esq.
Columberie 29 Beary Road
POPULAR MECHANICS 779
Bexley Heath nr London Eng

ON THE TRAIL WITH THE ELEPHANT "TAPPERS"

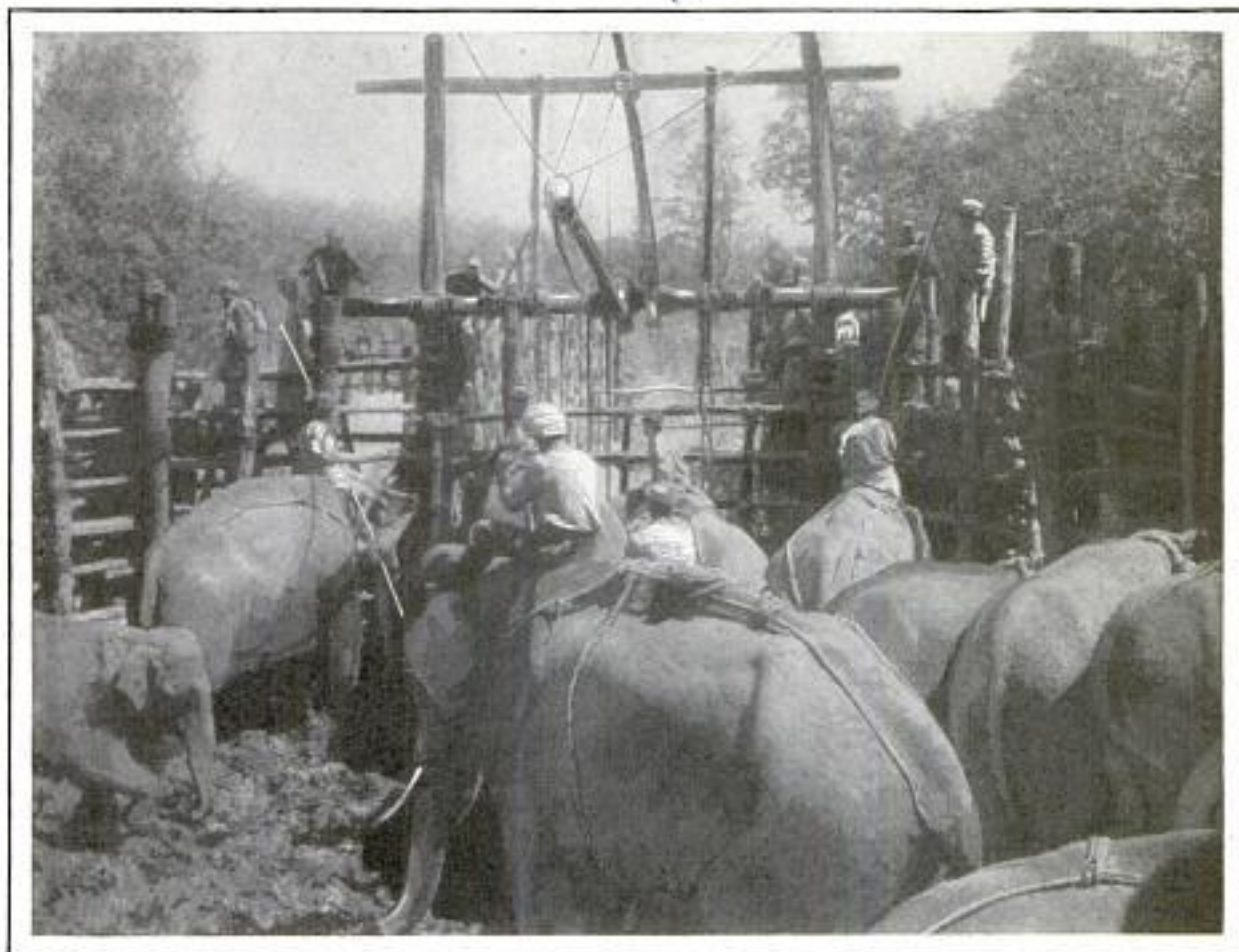

Courtesy H. A. Pelham

Stockade Such as That in Which Elephants Are Trapped in Lower Burma; Natives Tap Sticks to Confuse the Beasts, and a Gate Is Dropped When One of Them Enters the Strong Palisade

One strange species of Asiatic elephant, inhabiting the wilds of lower Burma, makes an annual pilgrimage to the seashore, and this habit is utilized by native elephant catchers in trapping the beasts for transport animals. Ordinarily, elephant trappers avoid making the least noise, but the Burmese natives trap these particular elephants by a systematic method of tapping sticks to confuse them. These elephants, in groups of five or six, make their annual trip to the sea to lick the salt from the dried-up creek beds, and follow regular trails through the forests. Native hunters conceal themselves along one of these trails, and after the animals have passed, fall in behind them and begin tapping slender sticks together. The elephants are alarmed by the strange noise, but usually keep to the trail instead of stampeding, hastening their pace until they reach a fork in the trail. Here the bull leader selects one fork, but a sharp

tap in that direction halts him, and he turns uncertainly toward the other path where a second tapping immediately is heard. The animal then usually plunges headlong down a middle path and directly into a strong palisade built to receive him. A native, high in a tree above, pulls a rattan cane, and a heavy teak or hardwood gate crashes down to block the archway. The native who releases the gate must be adept at the job because the bull is the animal wanted, and if the following cows are also allowed to enter the stockade the leader usually batters away until he makes a breach, but if he finds himself alone, he soon submits. If cows are to be caught, not more than three are allowed to enter; then the gate is released before the bull comes through the opening. These elephants are smaller than the Indian animals, and the males are frequently without tusks, standing about eight feet high at the shoulder.

780
a-330

Cont. Margaret Hume
Drum. 413 Chamberlain
are Madison Wis



X-Ray Apparatus Set in a Tilting Frame with Comfortable Space for Both the Patient and the Physician in Making Observations

X-RAY APPARATUS ON ROCKERS FOR EASY OBSERVATION

One of the most modern Roentgen institutes in the world is that at Frankfort, Germany, which is provided with the most elaborate equipment for the protection of both the patient and physician in X-ray treatment. One of the wonders of the institute is called the "look through" machine, and enables X-ray observation without danger or discomfort for either the patient or doctor. The X-ray equipment is mounted on a curved frame resembling rockers. The patient rests at full length on the frame and the doctor reclines under the subject in a seat from which he operates the apparatus.

Names and addresses of manufacturers of articles described in this magazine will be furnished free by our Bureau of Information.

FIND MANY MORE FOODS RICH IN VITAMINS

a-383

Recent tests have revealed many common foods have a rich vitamin content heretofore unsuspected. Malted milk is a good source of vitamins A, B and G, but chocolate flavored malted milk is not quite so rich in these vitamins. Water cress contains a rich supply of vitamins A, C and E, and a fair supply of vitamin B. Preserved grape fruit is nearly as rich in vitamin C as the fresh fruit.

a-350

RADIO AMPLIFIER FOR VIOLIN TO CONTROL TONE

One violin virtuoso has equipped his instrument with a radio amplifier which increases the tone volume fiftyfold. The amplifier consists of a phonograph pick-up with loud speaker mounted, by means of a bracket, on the tailpiece of the violin, its needle making contact with the top sounding board just behind the bridge. Tone volume is controlled by a potentiometer operated by an assistant who can regulate it at will from the faintest pianissimo to a fortissimo of far greater volume than any single instrument would be capable of producing, yet the tone is without distortion, and even more warmth and fullness. Hence the attachment is of special value in executing triumphal music where unusual volume is warranted. This suffices for one instrument, but in a quartet, a device is added which equalizes and blends the frequencies.



Paul Bigos

A. 361 Dr. Prof. James Joseph
Drumm, University College
Dublin
Ireland

Batteries to Run Train



© Irish Independent

Above, Railroad Car Driven by Storage Battery;
Right, the Small Battery Furnishing the Power

FOR years electricians have dreamed of a day when a simple but powerful storage battery would suffice to drive a railroad train at a high speed without needing recharging except at either end of the run.

A train hauled by a 1,000-horsepower locomotive, running at fifty miles an hour, over a stretch of 200 miles on a modern railroad, needs an engine or motor developing a tractive force greatly in excess of 1,000 horsepower.

Brilliant inventors on both sides of the Atlantic have, in the past thirty years, wrestled with this problem. Edison, years ago, invented an alkaline nickel-steel battery which threatened to put the acid lead battery out of business. But the acid battery survived and is still in use, although it cannot give the high rate of current discharge for the length of time required by modern rail transport. It becomes exhausted and requires a considerable time to recharge.

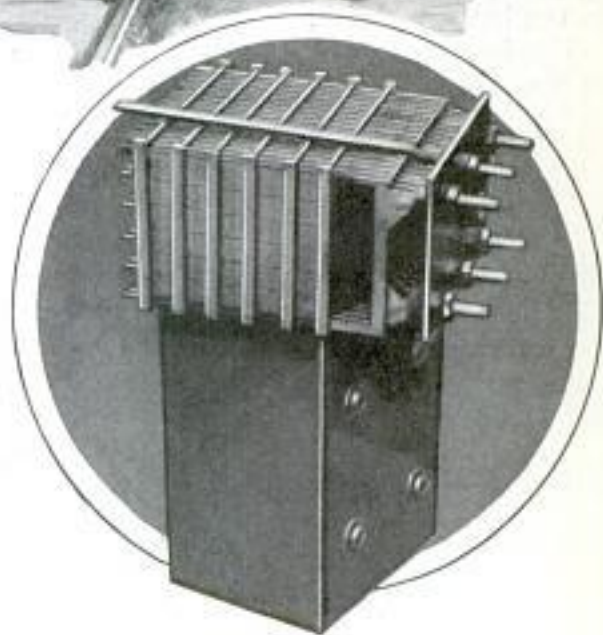

An inventor who can create a battery which can be recharged four times on a run of 200 miles—the operation of recharging taking from fifteen to twenty-five minutes each time—will have brought about a revolution in transportation.

This is the problem, the solution of which is sought by a young professor of University College of Dublin, Ireland, James Joseph Drumm. His discoveries

are embodied in the cells of a new and powerful storage battery. Patent No. 335,587, a few weeks ago recorded in the British patent office, describes it as "an alkaline storage battery wherein the positive electrode consists of a mixture of metallic silver or silver oxide and ceric oxide, and the negative electrode comprises the usual oxides of iron or cadmium or a mixture thereof—an accumulator permitting of very rapid rates of charge and discharge on account of its very low internal resistance, while the energy capacity is of high power to the unit of weight employed."

The Irish Free State government recently arranged for a test of the Drumm battery, in co-operation with the engineers and electricians of the Great Southern railroad of Ireland, when some striking results were attained. A thirty-mile stretch of road, leading from Dublin and having steep gradients, was selected for the trial. Inspection posts and examiners were stationed at every mile of the run, while a group of scientists traveled in the battery coach.

The battery was slung under the frame of the coach, a four-wheeler, thirty-five

feet long, with nothing to take up jars and vibrations, except the usual springs. Seventy cells were grouped in the crate driving electric motors attached to each axle. An express-locomotive engineer drove the Drumm-battery coach at top speed, when it developed a maximum of forty-eight to fifty miles an hour, after starting, and accelerated six miles an hour for every second of the run. As soon as the battery coach had completed a round trip, it was connected to the charging station and the battery recharged at the rate of 400 amperes in twenty minutes, although it may be charged at the rate of 600 amperes in ten minutes.

On the day of the test, the Drumm battery coach did 173 miles, and could have covered nearly half as many miles again but for interference with the regular steam service of the line. Another trial run was made in the fall, when the battery coach was driven from 9:35 a.m. till 5:30 p.m., and reached a maximum speed of fifty miles an hour, and an average speed of forty miles an hour for the day. Here are other figures of the run:

Weight of battery and crates, 5,000 pounds.

One day's output of battery, 193,000 watt-hours.

Maximum charging rates for battery, 600 amperes for ten minutes.

Temperature of cells at the end of the day, thirty degrees Centigrade.

Total weight of the loaded coach,

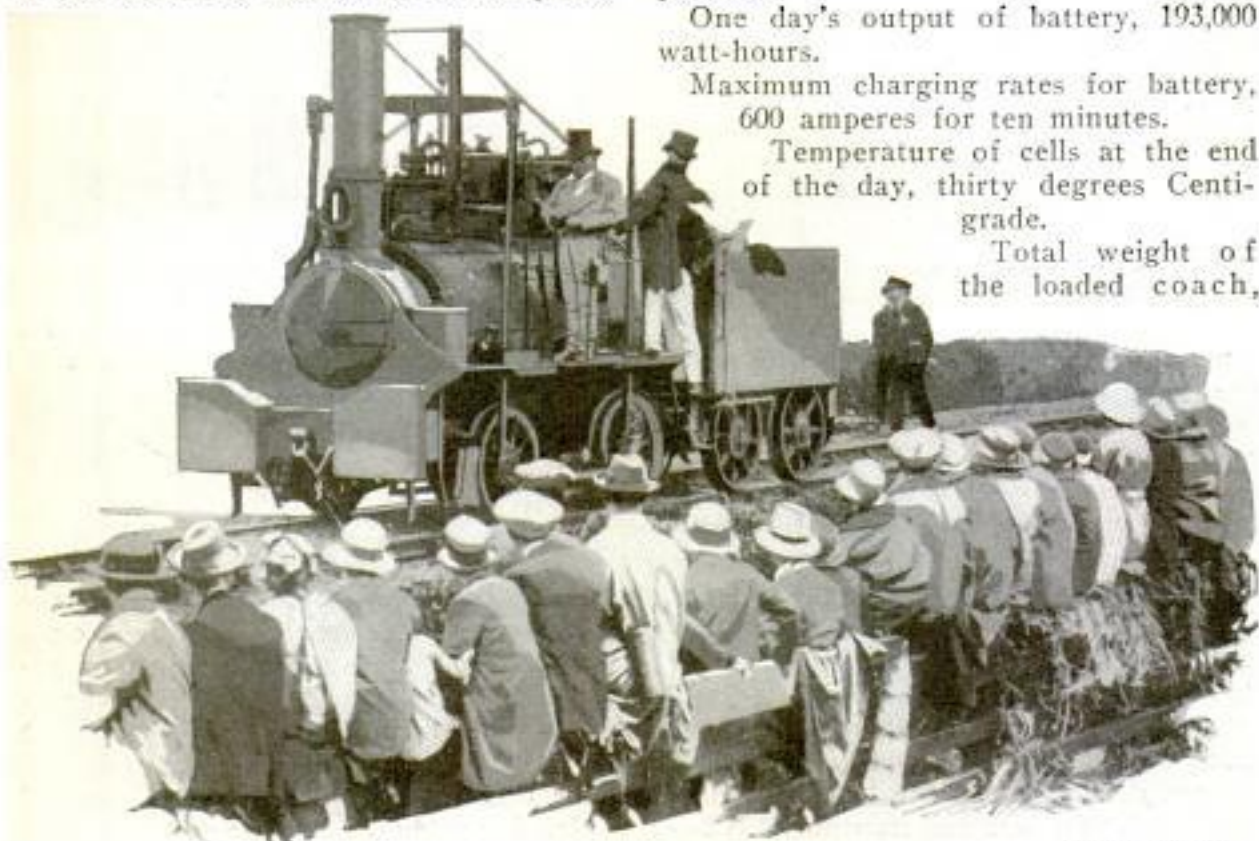

© London Times
One of the World's Earliest Locomotives, the "Hetton Colliery," Built in 1820; Over a Century Afterward, It Hauled a Train of Cars in England at a Speed of Six Miles per Hour

Top Photo, Courtesy J. L. Beddington;
Lower, Courtesy Hudson & Clarke



about thirteen tons.

Professor Nolan of the Irish National university was appointed to investigate the powers of the Drumm battery, and he and the electricians of the Great Southern railroad reported to the Irish minister for commerce and industry. It is officially claimed that the Drumm battery has a fifty-per-cent higher voltage than existing alkaline batteries and can be charged and discharged more quickly and at much higher rates. The battery is simple and inexpensive to construct and can be charged in from eight minutes to one hour as compared with five to eight hours for alkaline storage batteries. It

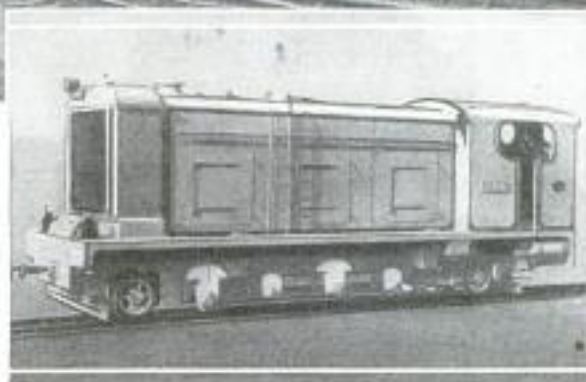

Top, Fireless Locomotive for Oil Depot Whose Boiler Is Filled Daily with High-Pressure Steam; Below, Geared Type of Oil Locomotive Designed for Mountain Climbing

does not fume or gas; has a very long life and does not overheat.

Every night between October 1930 and January 1931, the Drumm coach has been running up and down the railroad between

Dublin and Kingsbridge on the Great Southern railroad, carrying the company's employes to and from their homes.

The Free State government is satisfied with the results of the trial runs, and has induced the Irish parliament to vote \$125,000 for further tests. By the fall of this year, a Drumm electric train, now being constructed, is planned to run in regular operation carrying passengers.

BALL-BEARING WHEEL TREAD SPEEDS UP MOTORCYCLE

Ball-bearing treads are used by one English dirt-track rider on the rear wheel of his motorcycle to enable him to take turns at higher speed. The curved flange of the wheel rim is fitted with solid spheres larger than billiard balls. Since these free-rolling balls can turn at right angles to the plane of the wheel, the rider can "broadside" on a hard solid surface in making a turn, the machine sliding side-wise on the curves.

Those wishing further information on anything described in the editorial pages can obtain it by addressing Bureau of Information, Popular Mechanics Magazine, Chicago.



Ball-Bearing Tread for Motorcycle Wheel. Enabling Racer to "Broadside" on the Turns

Leo Blakborough

*d no. J. W. Bridges
1025 N. Highland
Hollywood, Calif*

*By Mr. William Arthur Mendelssohn
and Mr. Carl T. Shepard,
Chicago
Pat Graduate Eye
d. poly. int. 86374
Le. Soc. 1000*



Apparatus Which Measures Time a Motorist Requires to Apply Brake after Seeing Red Light

TIME NEEDED TO APPLY BRAKE MEASURED BY EYE TESTS

How long after seeing a red light flash does a motorist begin applying his brakes? To measure this period of time, a machine has been built which shows exactly how long it takes the driver to depress the brake pedal after he has been warned by the flash of a light. The same apparatus can be used to test reaction to an audible signal by using a bell instead of a light. It has been found that the average time between a visual warning and applying the brake is fifteen-hundredths of a second. A car driven by a motorist who reacts to a visual warning in one-tenth of a second, for instance, will travel five feet at thirty-five miles an hour before he steps on the brake, while the car of the man who reacts in one-fourth of a second will travel thirteen feet. In other cases, a mere turn of the wheel may avert an accident, and here particularly the fraction of a second is important.

THE FOGGIEST SPOT

Moose Peak, Maine, enjoys the distinction of being the foggiest spot in the United States, although it brightened up a little in 1930 and had only 1,562 hours, or a little more than sixty-five days and nights, of fog. Its yearly fog average over

*Lighthouse Service
U. S. Dept. of Commerce*

sixteen years has been 1,607 hours. Runners-up on Moose Peak's record are Libbey island and Petit Manan, also on the Maine coast. On the Pacific coast, Point Reyes light station holds the record, with an average of 1,398 hours per year for forty-five years.

FUEL WITHOUT SMOKE OR DIRT COMES IN PACKAGES

Fuel for open fireplaces that is without dirt, smoke or odor, although it gives out more heat and lasts longer than ordinary fuels used for this purpose, is being offered on the Pacific coast. It is a specially treated coke in pieces about the size of an egg and comes in a neat carton weighing seventy-five pounds. Each carton contains six packages of fuel and the kindling necessary to start it. A package is placed in the fireplace, and a match applied to a circle indicating the position of the kindling. The container makes it easy to handle the fuel, and one bundle burns from four to six hours.

Q. 286 Ready Glow

ROBOT HORSE FOR TRUCKING SPEEDS LONDON TRAFFIC

Horses may be supplanted for trucking by a motor unit introduced in London. It is more maneuverable than an ordinary motor truck, being essentially an engine on wheels to be attached to a trailer. The unit was devised especially for service at crowded docks and railroad terminals.



Compact Motor Unit Pulling Trailer; in Crowded Quarters It Is Easily Operated

TWO-WAY TELEVISION IMPROVEMENTS ARE SOUGHT

Two-way television has been much improved recently by the development of several optical features, making the received image more lifelike while the apparatus has been simplified. One noteworthy modification is the use of an incandescent lamp for scanning in place of the arc. The former eliminates flickering, causes the image to be steadier and is simpler to maintain and adjust while the filament is at lower temperature than the arc and radi-

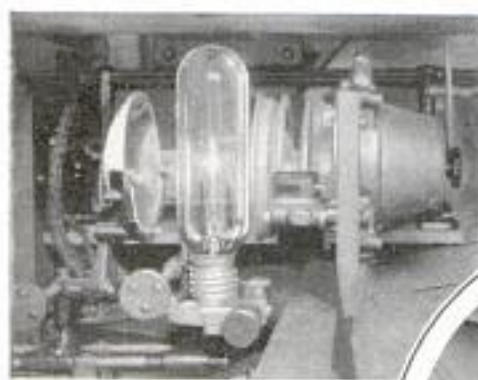

Mounting of Light Source for Two-Way Television; Cells Sensitive to Red, Mounted beside Aperture, and, Right, How Neon Lamp Is Viewed through Lenses in Scanning Disk



ates more light at the longer wavelengths. In the first two-way demonstrations, the scanning beam traversed a filter that passed only blue light and the photo-electric cells were sensitive chiefly to blue. In the two-way system, a person looks at the incoming image formed by the glow of a neon tube at the same time his own face is being scanned. The blue light made the yellows and reds in the face too dark as compared with the whites, and to obtain greater naturalness a deep-red component has been incorporated in the scanning beam, making it purple instead of blue, and two photo-electric cells, highly sensitive to red, have been added. By scanning from both ends of the spectrum, the effect is much like that which would be obtained by scanning from the middle of the visible spectrum, giving a much more faithful reproduction. The caesium-oxygen cells,



sensitive to red, are directly in front of the observer, one on each side of the aperture on which the incoming image is seen. Through filters, the system is made unresponsive to the yellow light that illuminates the booth. A lens in front of the tube and lenses on the scanning disk focus images of the glowing anode on each hole of the disk. This eliminates the necessity of the large electrode area and high currents employed in the earlier tubes.

LOUD SPEAKER FOR WITNESS ENABLES JURY TO HEAR

Shy witnesses in South African courts who refuse to talk louder at the behest of counsel or judge now fill the courtroom with their voices whether they wish or not. Courtrooms are equipped with microphones in front of witness boxes, these leading to amplifiers. Through these the lowest-voiced witness can be heard distinctly in every part of the room.

Lib Butts 2/21/31

A-140

Capt. Andrew R. Dorn,
613 Spreckels Theatre

Bldg. San Diego Cal

Aboard A Super~

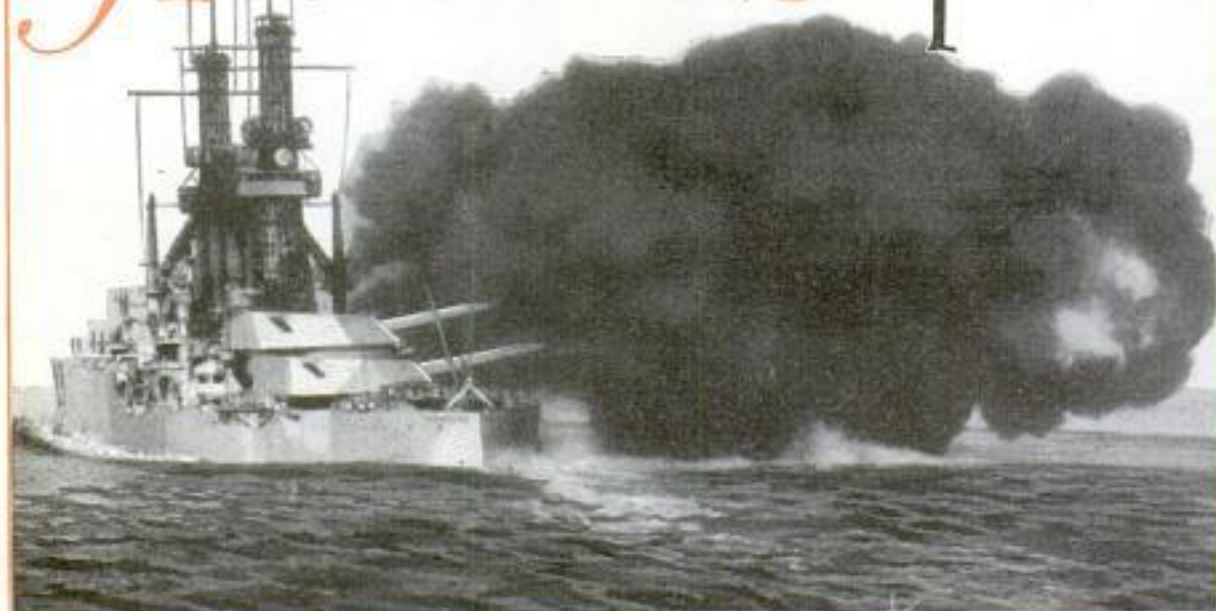

The Voice of One of Uncle Sam's Sea Fighters Speaks in a Thunderous Roar; This Is the U. S. S. "New Mexico," One of the Navy's Super-Electric Dreadnaughts, Firing a Broadside

By R. B. ANDREWS

FAR out from land on the Pacific, in the dead of night, the battle fleet steams south in preparation for a battle problem. On the bridge of one of Uncle Sam's super-electric dreadnaughts, the "West Virginia," seven enlisted men and the officer of the deck are on duty. Twenty instruments reveal the efficiency of machinery far below and carry messages to various parts of the ship. The officer of the deck scans the sea on all sides, glancing now and then at a clock.

Suddenly he gives an order. A sailor speaks into a tube: "Darken ship!" Far below in the engine room the order is repeated. Switches are pulled. Brilliantly lighted areas suddenly become pitch-dark. The battle fleet, a moment before casting its lights across limitless waters, disappears from the sea. Its ships now are only shadows on the Pacific.

Only one light pierces the curtain of darkness. On the stern of the "California," the flagship, a tiny light escapes through a hole in a three-inch cup—a star-like guide visible only to the ship next in line.

Steadily four powerful electric motors drive the "West Virginia" at twelve knots. A movement is anticipated. Now the time has arrived. The officer of the deck speaks. An enlisted man whispers into the speaking tube. A lever in the engine room is turned. The behemoth lists and slips through the water as she changes her course.

Around her, at 500-yard intervals, other darkened battleships turn in the new direction. They swing into formation just as though they had reached a street intersection. "Tricky to do with a big bucket like this," a sailor remarks. But turn they do.

The officer of the deck, responsible for the safety of his costly war machine and her crew, can see only a dark shadow ahead. Yet these ships of the line are so steady and their movements so sure that they can go several hours and continue to keep their relative places in the formation. As they turn, each slides and moves forward possibly 300 feet. Yet there is no danger of collision, for every battleship behaves in exactly the same manner,

Electric Dreadnaught

and when the lights go on, possibly an hour later, one sees them plowing ahead in their original positions.

But the story of the super-electric dreadnaughts cannot be told from the bridge. From that point they are governed much as any others. So we descend ladders and walk through dark passages until we reach the engine room. There we see no grimy sailors shoveling coal. In fact, we see no fires at all. Oil burners spread flames under the eight large boilers. All this is sheathed in metal that hides even the flames from sight. But the flames provide the steam that turns two turbines connected with two generators which drive four giant motors, each of which is connected by a long shaft to a propeller. Thirty-two thousand horses race down the propeller shafts to turn the screws.

As the big dreadnaught slides silently through the water, gun crews stand ready to toss sixteen-inch shells on enemy decks or shoot five-inch shells four miles straight up at airplanes and balloons. Yet the tremendous power that moves the big ship rests, figuratively speaking, in the hands of the two enlisted men who stand at the control panel ready to send the ship ahead faster or reverse the screws and back her away from threatening danger.

The commanding officer of an electric battleship can get quicker action than the commanding officer of an old-style battleship. Fifty thousand miles of wires carry electricity around the "West Virginia," and through them the commanding officer not only can make his commands heard, but the motors can turn the propellers from full speed ahead to full speed astern in six seconds. Of course the ship itself cannot be halted from its

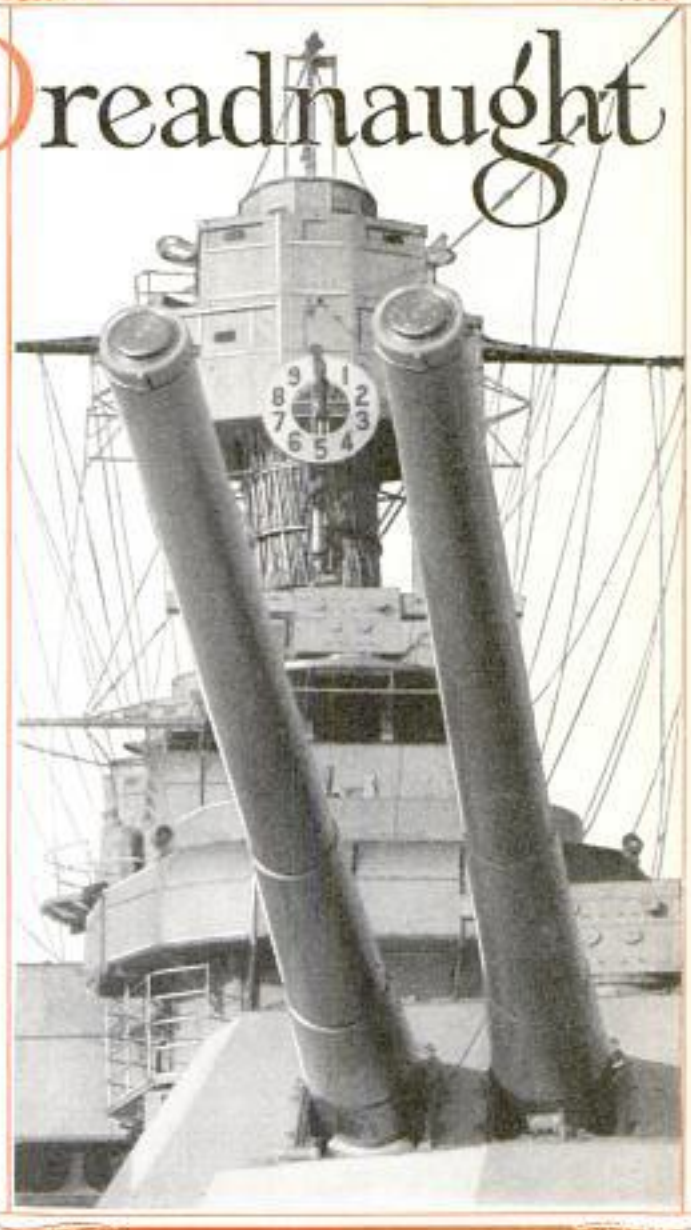

Two Sixteen-Inch Guns on the "West Virginia" Elevated for Firing at an Unseen Target beyond the Horizon

top speed and be made to back up in such a short time, but the propellers will be churning great quantities of water in the opposite direction in less time than you take to read this sentence.

As we faced the control panel, through which this tremendous energy is governed, one of the engineering officers demonstrated the ease with which he can learn of conditions anywhere in the intricate electrical apparatus. Merely by inserting a three-pronged fork into three holes he can determine whether any of the large motors are running too hot. Here wires connect electric thermometers inside the

6-140
788



Above, Hoisting a Large Launch aboard a Battleship; in Circle, Three-Pronged Fork Used to Measure the Heat of the Bearings on Any Motor; Right, Seaplane Ready to Be Hoisted aboard Ship after Flight from a Catapult; the Pilot Attaches the Hook to Four Cables Leading to Points on the Plane

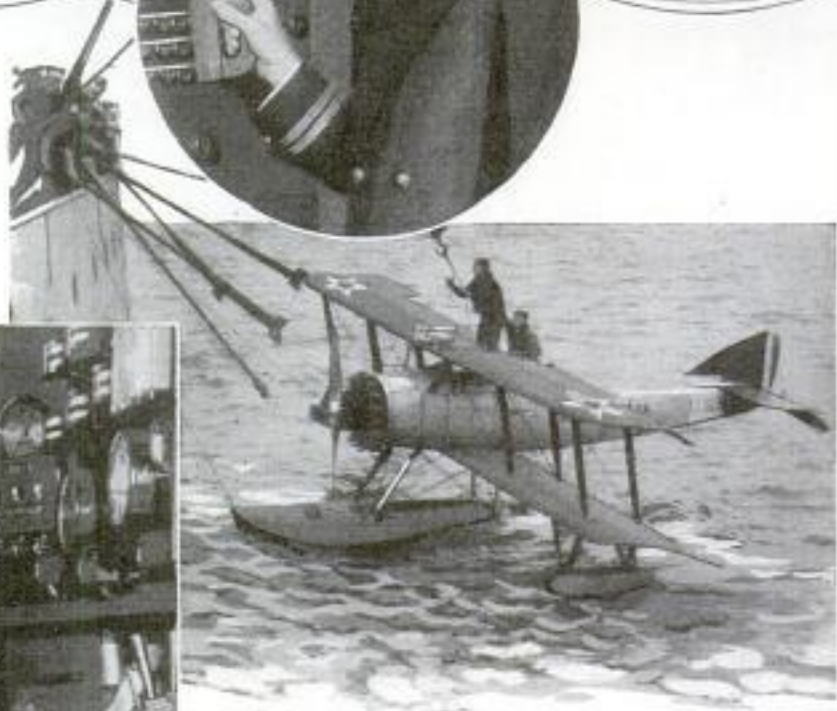

Left, View of the Control Panel on the U. S. S. "West Virginia," Where Two Sailors Are Actually Able to "Run a Battleship" Unaided

motors with his "motor heat panel."

But why electricity for Uncle Sam's fighting ships? The navy sought both a concentration of power and reliability—and has found them in electricity. If one of the steam turbines breaks down, an electric battleship does not lose half its power, as you might

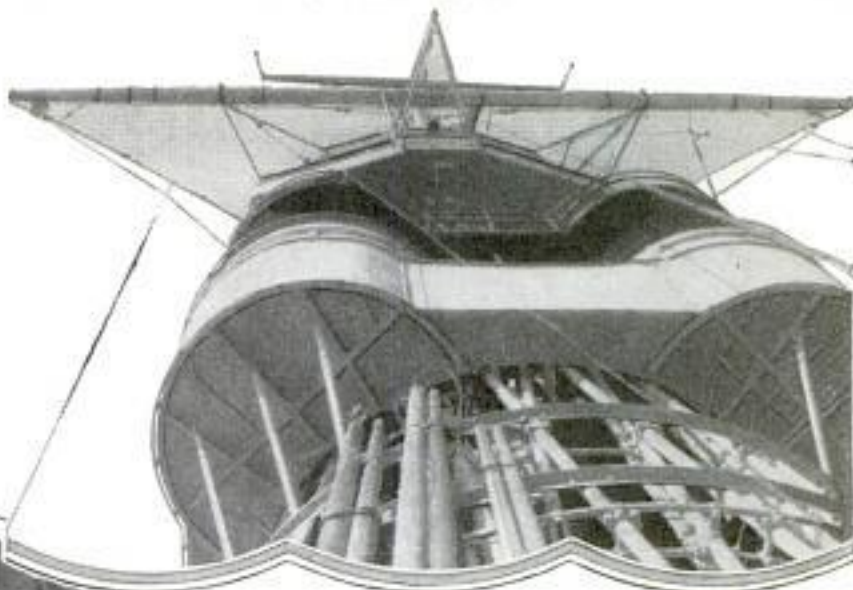

Above, Looking up the Mast of a Modern Battleship from the Main Deck; Left, on the Bridge



the steam turbines, according to naval experts. Thus smaller space may be used to house the machinery. Even the present arrangement enables builders to crowd more apparatus in much smaller space, with nearly 100 men less to operate it. Now, instead of long steam lines leading from boilers to turbines, electric wires carry the power. This permits not only savings in weight and space, but also arrangement of the main driving plants—the motors—close to the propellers.

Besides propelling these modern steel dogs of war, electricity also helps point the guns, fire them, and enables the dreadnaughts to fire over the horizon at an enemy not even the lookout in the fighting top can see. Radio, crackling through the air from observation planes catapulted from ship-deck when electricity explodes a powder charge, enables gun crews to swing the muzzles of those giant weapons and send armor-piercing shells out beyond the "bend in the ocean."

think. The electricity, in case of such a breakdown, can be spread through wires to the four motors. In fact, where, with both turbines working, the "West Virginia" has a high speed of twenty and one-half knots, it can make seventeen knots on only one turbine.

All the electric dreadnaughts in the battle fleet are of the same size. Each weighs 32,000 tons. The "West Virginia" is the latest. Her electrical sister ships are the "California," "Colorado," "Tennessee," "Maryland" and "New Mexico." They make up half the battle fleet. In addition to these, the two aircraft carriers "Lexington" and "Saratoga" are electrically propelled.

The future battleship will be electrically propelled, but Diesel engines will replace

HONEYBEES' SPEED IN FLIGHT

Traveling without a load of nectar, a honeybee makes about twenty-five miles an hour, although the ordinary speed is not more than fifteen miles, tests have shown. With a full cargo of nectar, the bee can fly almost as fast as when traveling light, although it is compelled to make frequent rests on long journeys. The average load carried is about forty milligrams, or half the weight of the bee.

Cont. David Morrison
125 Wellington Road
Upland, Pa.

A. 353

New York Times 2/27/31

Mr. Marin Wood, 143 Lyndhurst Road, Rochester, N.Y.



Composite Musical Instrument Which Gives Sounds of Piano, Mandolin, Guitar and Cello

ONE-MAN STRINGED ORCHESTRA PLAYS FOUR INSTRUMENTS

Combining four instruments in one, a music teacher, after many years of work, has made a composite instrument on which one man can present all the effects of a stringed orchestra. This one-man orchestra produces at one time the sounds of the piano, mandolin, guitar and cello. After he had finally made the instrument, the inventor was forced to spend a long period in learning to play it so that all the effects were presented simultaneously.

WEIGHT OF EARTH COMPARED TO THAT OF THE SUN

While it is impossible to place the earth on a gigantic scale and weigh it, mathematicians can closely approximate its weight by estimating the pull it exercises on the moon and other heavenly bodies. The figure arrived at is six thousand trillion tons, or six followed by twenty-one ciphers, according to English notation. This staggering figure, however, is as nothing compared with the weight of the sun. If the weight of the earth were represented by a penny, that of the sun would be approximated by 660 pounds of metal. Through the light and heat it gives off, the sun loses about 360,000,000,000 tons every day.

Ans.

Sub. Bats 2/21/31

Sir James Jean England

A-517

HUMAN EYE BEATS PHOTO CELL IN MATCHING COLORS

Contrary to general belief, many experts are of the opinion that, in spite of the wonders accomplished by the "electric eye," or photo-electric cell, it still cannot beat the human eye, particularly in matching colors. The human eye is still the most sensitive measure of color in the opinion of Irwin G. Priest, of the bureau of standards, who has applied photo-electric cells to various practical problems in industry. The human eye is the only instrument that can determine the very slight color differences in cottonseed oils, for instance, although the electric eye may do a better job in selecting colors than a human eye untrained to this work. It has been found that a trained human eye can detect with certainty differences in color of one five-thousandth of one per cent, and no instrument so far invented can compare with such a record, although far more efficient cells, of course, may be developed in the future. A fair idea of the number of colors may be obtained from a new dictionary on this subject which uses descriptive names rather than symbols, and thus reduces the almost limitless list to 7,000 shades.

COLORS ADDED TO OPEN FIRES BY USE OF CHEMICALS



Many pleasing combinations of colors may be imparted to the flames of an open fireplace or camp fire by sprinkling chemicals in crystal form on the burning wood or coal. The chemicals are contained in a metal can with a perforated top and the granules are sprinkled over the blaze frequently to continue the vivid sparkling effect.

A self-curing compound now is available for application to rubber, metal or leather surfaces.

The Hitchcock Co. Park Square Bldg Boston, Mass.

Central Railway Signal Co. Newton, Mass.

Cont. Francis Lucke
 11 Rue de la Paix
 Paris X^e V^e France
POPULAR MECHANICS
COIN-IN-THE-SLOT TYPEWRITER
FOR PUBLIC WRITING ROOM

791
 2433

Coin-in-the-slot typewriters are available for visitors to the public writing rooms of some Berlin cafes. Upon insertion of a small coin, valued at about two cents, 1,000 letters or spaces are available to the user. Should the matter to be typed exceed this length, it is only necessary to insert another coin.

**REVOLVING CUTTERS ON PLOW
 THROW CLOUDS ON TOP**

Working equally well in any kind of soil, a plow base with revolving cutters includes a number of features not associated with the conventional type of farm implement. The base, called a "turbulizer," has a turbinelike wheel instead of the ordinary moldboard, mounted to turn in a direction at an angle to that of the plow. This wheel is directly behind a short moldboard which deflects the soil as it comes from the share into the wheel. The latter revolves by friction with the ground, no auxiliary power being needed. The share is extremely hard on one side of the cutting edge and soft on the other so that it sharpens itself, and the nose is detachable and may be replaced when worn. It is claimed the turbulizer stirs the soil, prepares the seed bed from the bottom up, throws large clods to the surface and can be attached to plows now in use. It plows deep or shallow in sod, cornstalks or previously tilled land, and can be used with a tractor or on a horse-drawn plow.

Turbulizer



Plow with Revolving Cutters Which Turn by Friction with Ground and Pulverize Soil

George B. Sherman
 c/o Sherman Bros. Evanville Ind.



Small Screen in Theater Lounge on Which Is Shown Same Picture as Presented in Auditorium

**MOVIE IS SENT THROUGH TUBE
 FOR PATRONS IN LOUNGE**

On a miniature screen in the lounge of a Los Angeles theater, patrons may view and hear the identical talking picture being presented in the main auditorium. This enables those who wish, to retire to the lounging room without missing any of the continuity of the film. The picture is reflected from the film in the main projection room by means of a mirror and through a long tube to the glass screen, six feet wide, in the basement lounge.

**EIGHTY-TON METEORITE FOUND
 IN AFRICAN WILDS**

In the Tanganyika region of Africa, a land surveyor has found the largest meteorite yet discovered. It consists of a mass of iron and nickel weighing about eighty tons and is nearly fourteen feet long. The finder staked a mining claim to obtain legal title to his discovery which undoubtedly fell many years ago. Heretofore the meteorite found in southwest Africa in 1928 was the largest actually discovered.

W. H. Roth
 Surveyor

Same Service 518-8242731

792
a.454

H. E. Hold secretary
Ohio Pottery Association
Roseville Ohio

Henderson who has grown from seed rose bushes that attained a height of ten feet in less than eight months. Experiments are also being conducted with dahlias to improve the keeping qualities of the flower when cut, strengthen the stem and increase resistance to pests. In the fruit and vegetable kingdom almost as much has been done. Thus, stoneless plums are already grown, and an effort is being made to produce a stoneless peach. A crimson giant chard has been grown by crossing a sugar beet and Swiss chard.

**BRICKS IN VARIETY OF COLORS
ADD NEW HUES TO HOMES**

Bricks are now being made that will take the bright colors used in tea sets, chinaware and other ceramic products, and in addition have improved sound-deadening qualities. With this product, brick homes can be built in all the colors of the rainbow, or color schemes for an entire street can be worked out to blend into a composite picture of beauty. By generating gas through brick clay a brick is produced that looks like cork and is almost as light. It holds heat, is a good noise insulator, and is given color by applying a glaze. Lavender, yellow and orange-glazed bricks already have been produced, and the color range is almost without limit.

**TRAFFIC SIGN POSTS DESCRIBE
ATTRactions OF CITY**

One enterprising municipality has utilized the posts supporting traffic signs along a through highway to inform tourists of the places of interest in the city. Plainly lettered in black down the white sides of the posts are short descriptions of the city's attractions. Further along the route, directions are given for reaching the places to which visits are suggested.



Savannah Ga

Dr. Ding A. Radia Westinghouse
Reserve Laboratories
Fresno, Calif

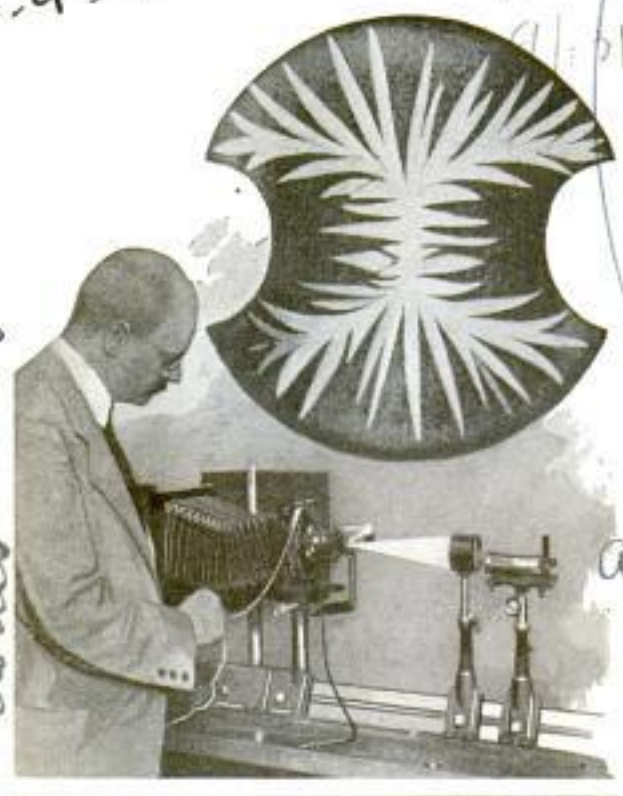

Apparatus Which Makes Visible Strains in Metals, and Picture of a Metal under Stress

**METAL STRESS MADE VISIBLE
IN TESTING STEEL**

Stresses in metals are made visible by a bench that "sees" the slightest deformation in a piece of steel under strain. When applied to model tests, reduced to size, reproducing conditions similar to those under which red-hot steel goes through the rolls, the apparatus shows in advance how various stresses are distributed. General use of the instrument, according to the inventor, gives promise of improving steel-rolling processes, thus effecting a considerable saving to the industry.

**PERFUME ADDED TO GLADIOLUS
AFTER YEARS OF EFFORT**

After five years of effort, fragrance has been added to the gladiolus which now has a perfume comparable to that of the gardenia. In addition to developing the sweet-smelling flower, William Henderson, an associate of Luther Burbank, has also produced new color varieties by crossing hundreds of thousands of plants and raising millions of seedlings. Many of Burbank's experiments to improve the rose also are being carried on by Mr.

Christian Science
Mounter 2/28/31

Finlay

a-418

L. S. Buchanan 2/14/31

COLORED MOVIES BY HIGH-SPEED CAMERA

a-50

For producing motion pictures in natural colors, an English inventor has made a camera that takes simultaneously three photographs in the three primary colors with an exposure of only one-hundredth to one-fiftieth of a second, depending on the intensity of illumination used. The actual operation is as simple as ordinary photography, although the apparatus is somewhat involved technically.

The most rapid color photography hitherto used required an exposure of two to three seconds. With the latest camera, operatic scenes in action were made recently in a Paris theater with magnesium flash powder and exposure of one-fiftieth of a second.

AWNINGS FOR AUTO WINDOWS PERMIT FREE VISION

a-293

Weatherproof awnings for the automobile windows, mounted on tubular rods, are easily adjusted. They are so constructed that they allow unobstructed vision, yet provide sun and storm protection for the occupants of the car.



Tilting Awnings for Automobile Windows Which Afford Protection without Obscuring Vision

Lucien

Mrs. E. Charinda, d. ava

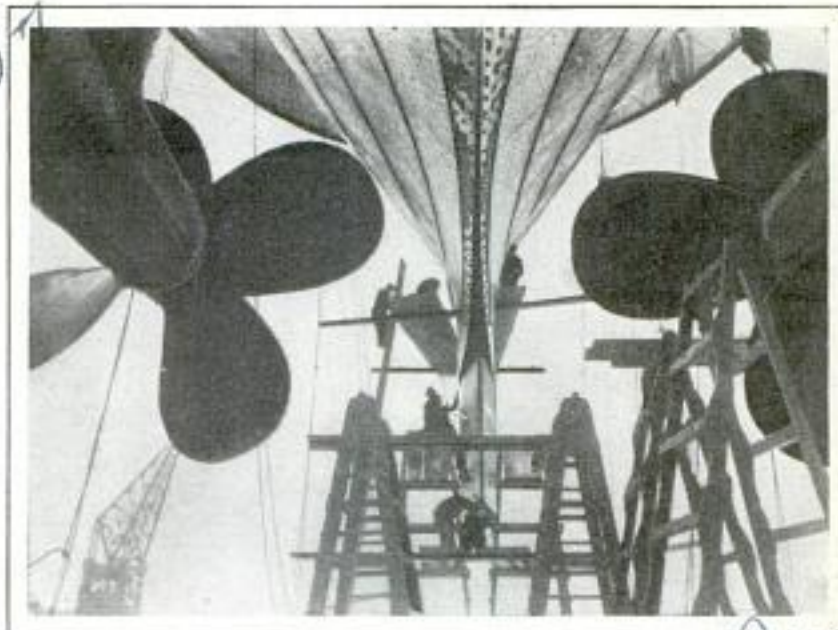

Unusual View of the Two Giant Propellers of the "Majestic"; the Picture Was Made While the Vessel Was in Drydock

Same

BIG PROPELLERS OF "MAJESTIC" LOOK LIKE ELECTRIC FANS

When the giant transatlantic liner "Majestic" was placed in floating drydock at Southampton, England, recently for overhauling, an unusual view of its huge propellers was obtained. The picture was taken from beneath the keel, and shows the propellers looming above like two mammoth electric fans, dwarfing the size of workmen near by.

GIANT ICE CRYSTALS FORMED ONLY ONCE BY NATURE

a-510

Giant ice crystals, up to eighteen inches across, are found at only one place in the world, in the famous Kangur ice caves of the Ural mountains. Russian scientists recently returned from these caverns with striking photographs of the fantastic structures taken by water in these remote grottoes. Snowflakes are seen under the microscope as delicate six-pointed crystals, and hailstones, on rare occasions, have been found to consist of crystals visible without magnification, but the huge cave crystals are more beautiful than either. They are hollow and six-angled, with a curious spiral geometry, showing the intricate effects of window-pane frost projected into three dimensions. The ice is deposited like hoarfrost by the cooling of moist air as it passes outward through the caves.

Hydrologues led by Dr. W. Aylberg. Leningrad

W. Aylberg. Leningrad

A-188 Com. Hon. Delassman
55 W. 86 St. St. New York

SMOKE EATERS

THE "Cervantes," a Spanish tramp, backed out of her slip along the East river and swung her bow downstream, outward bound on her last voyage.

A vigilante on shore, one of New York's marine firemen, heaved a sigh at the thought of strange shores lapped by tropic seas—the natural sentiment of sailors watching a vessel clear the harbor.

She crept down the bay and came abreast Owl's Head. Puff! A sooty cloud rose forward of amidships. Then the stern hatches belched smoke; also, the port holes and ventilators. The fireboats had steam up. The crews scurried aboard and shoved off just as black plumes came from the "Cervantes." She carried a cargo of case and barrel oil, and an Indian crew.

A six-mile tide drove her toward a government hospital ship anchored in the Narrows. Boom—boom! Barrel after barrel exploded and burned. Oil poured out on the water. The hospital ship lay in grave danger.

The fireboats hove to, playing streams of water on the tramp, saving members of the crew, beating back the dancing flames. With a thud and thunder the oil containers gave way. For fifty-two days and nights she burned, the most dogged and cranky blaze that ever cursed a ship.

After defying the fireboat fleet for almost two months, she lay there charred and ghostly, reeking with the stench of dead ships. Wreckers towed her away



A New York Harbor Fireboat in Action; This Is One of Many Boats Protecting a 578-Mile Waterfront Valued at Billions of Dollars

and sent her bones to the bottom. The "Cervantes" remains a haunting nightmare to all who remember the terror of her black hulk lighting the harbor for weeks, but she was, perhaps, not so ghastly as the blasts which scuttled the North German Lloyd greyhound "Muenchen" as she lay at her North river slip, just arrived from overseas.

Just before the explosion, the fireboats came alongside. They began pouring streams of water into the after hatch, where dense smoke issued from a cargo

a. 188

...on the WATER

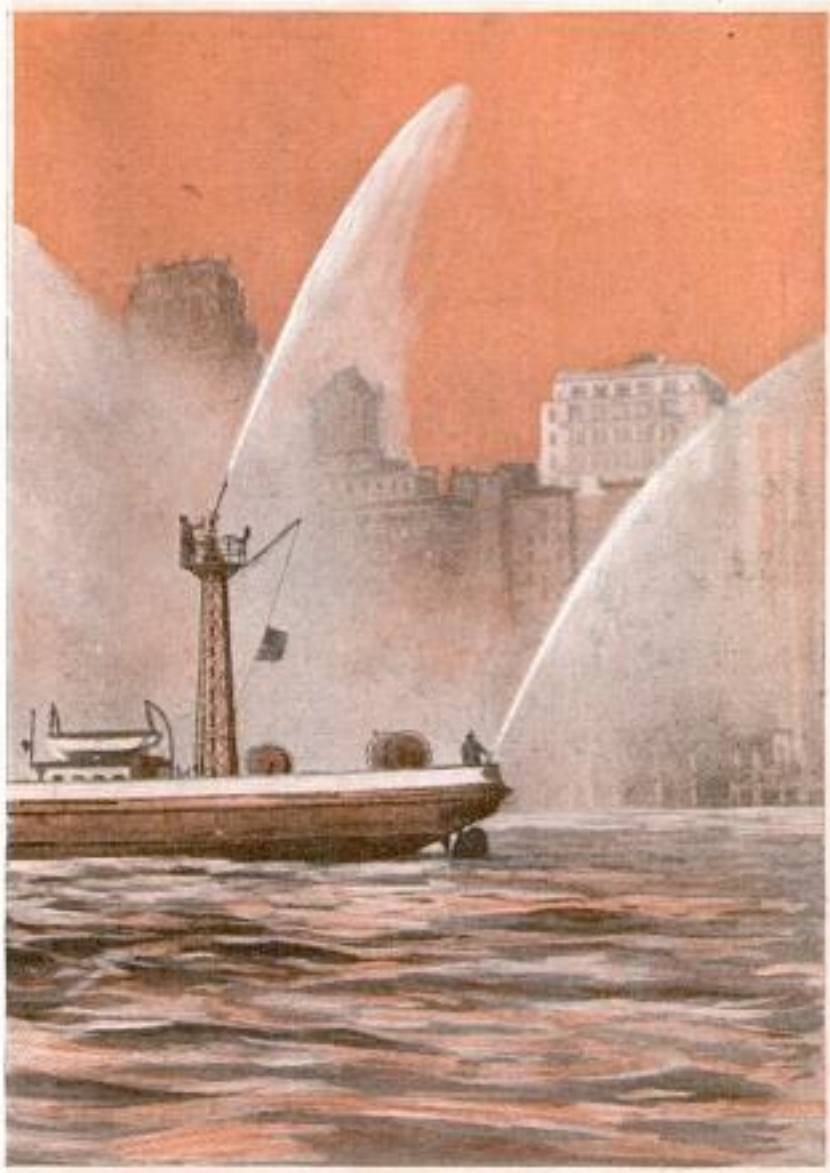

Boats Such as This Can Pump Up to 10,000 Gallons of Water a Minute; Note the Tower from Which Water Is Thrown Many Hundred Feet

of chemicals. First she was rocked by a single explosion. A series of blasts followed in five minutes, blew a jagged opening in the stern and forced such a depression in the water that the fireboat "Willett," standing hard by, was swamped under a veritable tidal wave, a wall of water six feet over the main deck sweeping men and apparatus into the river. The "Willett's" pilot was drowned, and she lost her anchor and hose reels weighing several tons each.

Duty carries the marine firemen into

such danger. The organization in New York harbor, the largest in the world, protects a 578-mile waterfront whose property value runs into billions. All structures approximately within 400 feet of the shore are under protection of the marine firemen.

The fleet of ten fireboats is manned by 300 men working on the two-platoon system. The day shift works nine hours and the night shift fifteen hours, averaging twelve hours a day for the year. The boats are strategically located in various parts of the harbor.

In addition to piers, warehouses and other waterfront properties, the fireboats must protect about 20,000 large vessels entering and clearing the port every year, besides countless small pleasure craft, houseboats and motorboats; lighters, barges and excursion boats, carrying many thousands of passengers.

About fifteen men compose the crew of each

fireboat. The members are captain, lieutenants, pilots, four engineers, four stokers and six firemen. Alarms are received in the same way as on land. Two fireboats are usually dispatched in answer to every alarm. The system has recently been augmented by a radiophone installation which enables the deputy chief at land headquarters to send instructions direct to the captain of the fireboat. In the course of a year, the fireboat fleet answers some 3,000 alarms, at an average cost of \$150 each.

9.188

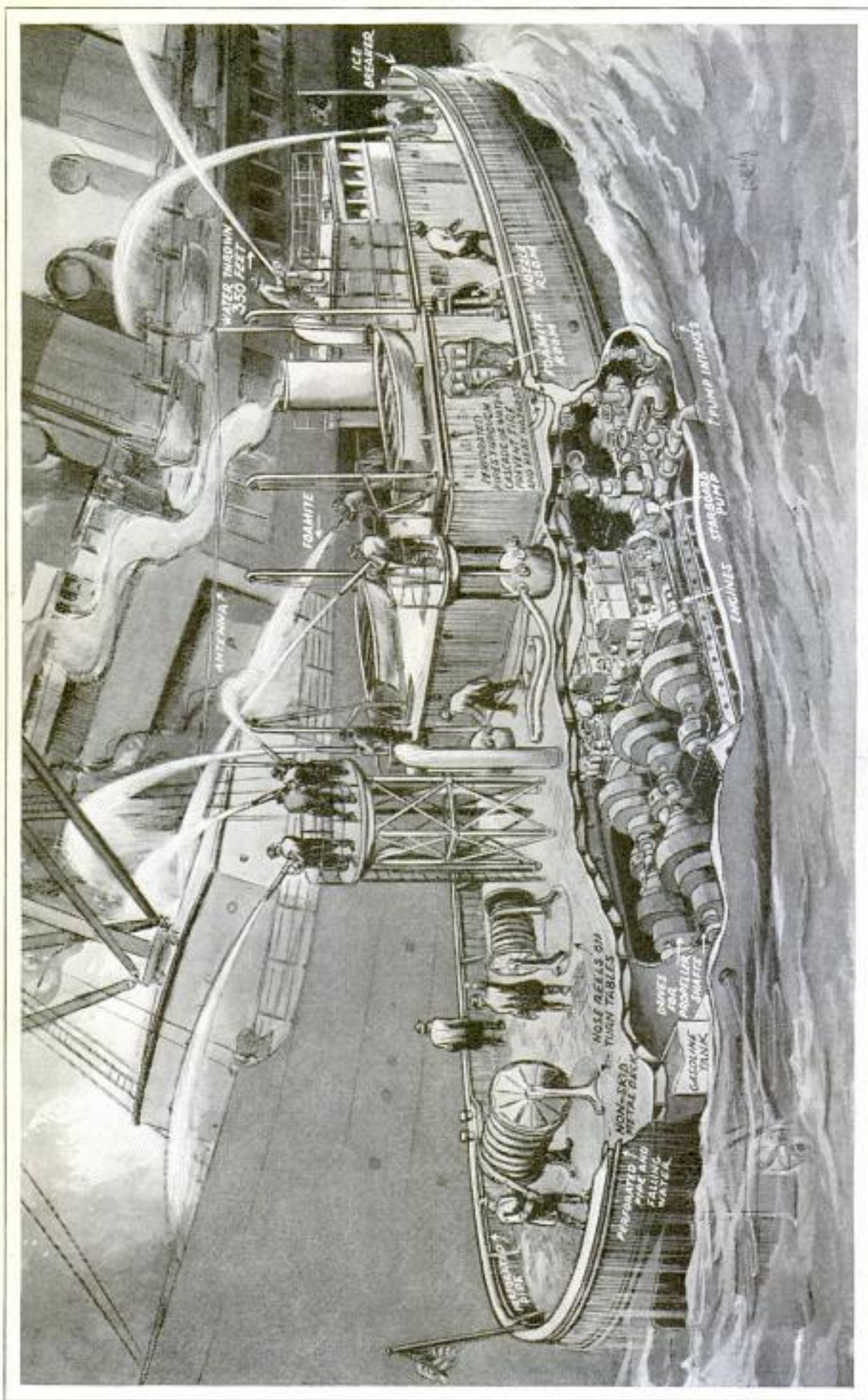

Operations Performed by a Modern Marine Fire Fighter: Note the Perforated Pipes around the Sides of the Deck, the Equipment for Throwing Chemicals on the Surface of the Water, the Ice Breaker, and the Radio Antenna over Which Alarms and Orders Are Received; Such a Boat as This Costs Over \$500,000

a-188

The modern fireboat is a steel-hulled vessel built especially for her particular work. Although she has bunks for the crew, she does not have a galley, since she rarely stays away from shore more than a day. Pumps and propelling machinery receive careful attention. The capacity of the various boats in the New York fire fleet ranges from 5,000 to 10,000 gallons a minute.

The heat-producing fuels used at present are coal and crude oil, although a fireboat now under construction will employ a new type of motive power. Concerning this gas-electric installation, Deputy Chief John J. McElligott, in command of the marine division, exclaimed: "She'll be the best thing afloat!"

From water tower to keel her construction will be metal. Her guaranteed speed will be eighteen miles an hour, and her pipes will belch 16,000 gallons per minute at 150 pounds' pressure. Fully equipped her cost will approximate \$600,000.

In her hold this new fireboat will carry two tons of "foamite," a substance which bubbles on the water's surface and serves to quench burning oil. By a system of reversible fans, foul air and smoke can be forced from all parts of the vessel, and a supply of fresh air sucked in every two minutes. An auxiliary power boat, with a pump capacity of 150 gallons a minute, is designed for fighting blazes under piers.

The hazards of marine fires are greatly increased by the fact that no two are alike. The size and construction of a vessel, and the type of cargo, determine, in a large measure, what species of fire may be expected. Successfully to fight ship blazes, fireboat officers must have intuition as well as a technical knowledge of ships. Many are recruited from the ranks of seafaring men, with experience

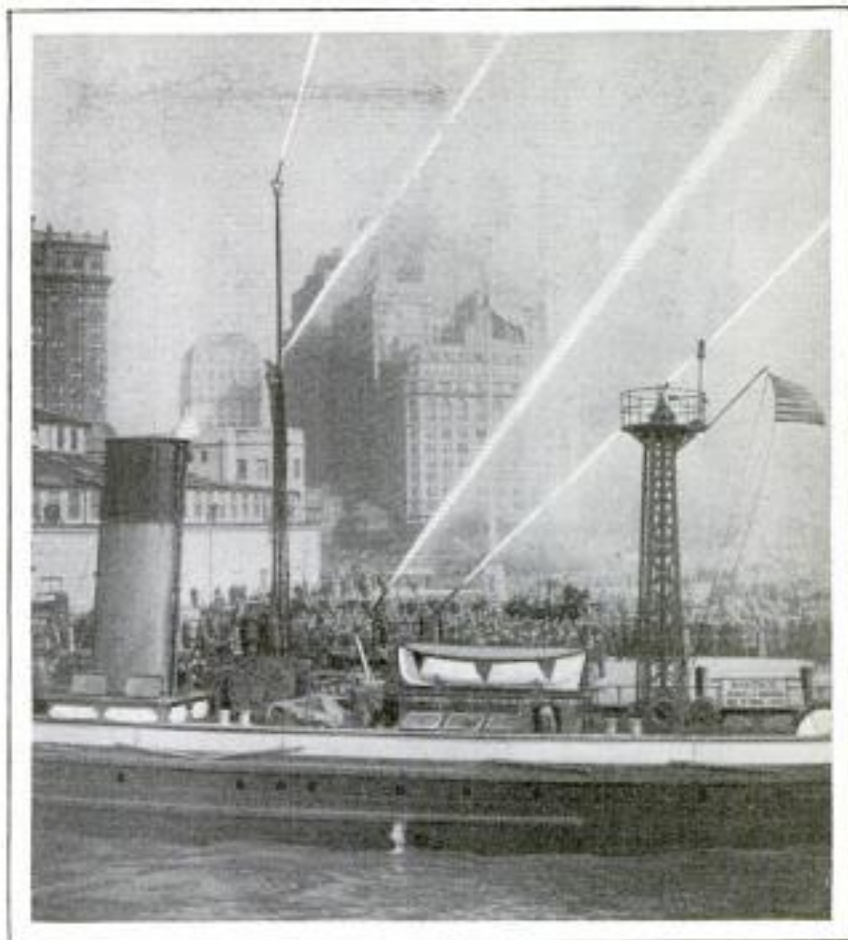

General View of a Modern Fireboat; in the Background on Shore Is a Water Tower Capable of Delivering 9,000 Gallons of Water a Minute

aboard all types of merchant-marine ships. Since the fire fleet is operated jointly under municipal and federal regulations, the crews are exposed to the strictest surveillance. All pilots and marine engineers must pass examinations before they receive licenses authorizing them to perform duties as such in the public waterways of the harbor.

The element of uncertainty enters into most ship fires. An example of what may be expected is found in this story related by Deputy Chief McElligott, who discovered a new perversity in marine blazes when the British tanker "Black Sea," carrying a cargo of bulk gas and naphtha, burned off the "oil coast" of New Jersey.

"In the midst of discharging her cargo," said McElligott, "the 'Black Sea' exploded in Kill Von Kull. That spot was dangerous to shipping, so we towed her to the flats near Robbins Reef lighthouse and turned on the pipes full blast. Having responded on the 'John Purroy Mitchel,' I ordered her nose turned into the tide

122 Greenwich described by E. S. Leonard, New York
American Institute of Mining and Metallurgical Engineers

a-188 798

POPULAR MECHANICS



Fire-Department Officials aboard a Fireboat Where Radio Apparatus Is Undergoing Tests; Alarms and Instructions Are Now Received by Radio

members of the crew who had failed to get away.

"Would you believe it? Eighty per cent of her inflammable cargo was ultimately salvaged. Why it hadn't burned or exploded is another mystery of ship fires which nobody understands."

29 W 34 St N.Y.C.
AN ELECTRICAL EXPLORER

Electrical exploration of the composition of the earth is the latest aid in tunnel making and dam building. Bedrock, for instance, can be found 100 feet or more underground by laying a few electric wires on the surface. The electric feeler current substitutes for the usual exploring drill, but instead of bringing back samples of the material it penetrates, the current sends messages telling how much resistance it encounters.

Christian Seibel mounted 2/16/37

a-324 FLOODLIGHT ON TOP OF TRUCK FOR AIR MANEUVERS

Mounted on a truck, a 30,000,000-candlepower floodlight furnished illumination for the spring maneuvers at Mitchell Field, on Long Island, in which several hundred airplanes participated. The truck carrying the powerful beacon contained a compact portable power plant, which set ablaze the entire 400-acre airport, supplying electricity for the tented city during the practice.

to keep the 'Black Sea' from drifting, if possible.

"She blazed all night, but we kept washing her down. Suddenly, the entire bay lighted up as oil began spurting out of her seams. A weird blinding flash burst out of a rivet hole on the starboard side.

"With all pipes operating, we retreated and tried to beat back the flames dancing across the water.

"It was ebb tide; the gasoline began flowing toward the Staten Island piers, where ships and warehouses are filled with valuable merchandise.

"By hard labor we managed to confine the fire near the vessel. The 'Black Sea' was colossal, fully 600 feet long, six tanks in her hull—one of the largest tankers afloat. Remembering the old 'Cervantes,' we had visions of another fifty-two-day battle. Although we kept the fire from traveling with the tide, it seemed to gain headway on the ship.

"What happened inside that vessel I don't know, but suddenly the flames became less intense and before our unbelieving eyes, they soon disappeared entirely. Eight fireboats had been playing about fifty pipes on her. Well, we wetted her down for another half hour, and then I ordered all streams shut down. We waited fifteen minutes. I boarded the 'Black Sea,' examined her fore and aft, and recovered the bodies of three mem-



Powerful Floodlight Mounted on Truck to Illuminate Army-Plane Maneuvers

Acme

Science Service 578-C 2/25/31

Announced by Dr. John E. Merriam, Pres Carnegie Institution

A-445

FORTY MILLION MILES AN HOUR APPARENT SPEED OF STARS

Eleven thousand miles a second, or nearly 40,000,000 miles an hour, is the new record "apparent" velocity detected in the reddened light from a distant universe of stars viewed through the world's largest telescope on Mount Wilson, California. The faint nebula found to be receding from the earth at this speed is so distant that light requires 120,000,000 years to reach the earth. The research result is expected to have a bearing on Professor Einstein's conception of the universe. In photographing the spectrum of the nebula with the telescope, it was observed the spectrum lines were shifted to the red in such a way that a rushing away at 11,000 miles a second would be necessary to produce the effect. This is sixty per cent greater than any apparent velocity so far observed, but astronomers do not actually believe the cluster of stars is receding at such a rate. They see the true explanation in the curvature of space, as postulated by Professor Einstein. Therefore very distant objects might give the effect of great speed, not because they are moving so fast, but because they are so far away that space is given a chance to produce its effects.

Washington
A-494
see Jan 1931 p 96



Apparatus Which Makes Minute Measurements of the Head; It Is Used to Diagnose Character

MEASURE OF HEAD DIMENSIONS SHOWS WEAK POINTS

In an endeavor to develop character, a Berlin institution is taking careful measurements of the head and various other parts of the body. The examination and measurements are said to reveal the weak and strong points of character, and the student then sets about strengthening his weak points by a course of memory and concentration exercises. These exercises, it is claimed, result in greater confidence on the part of the subject.

Dr. W. Dillingen, Berlin

WIRES TIGHTENED OR BROKEN WITH A HAND TWISTER



For tightening or breaking wires, a simple hand-operated tool gives a powerful leverage that easily twists or breaks off hoop bands or wires. The tool has three prongs, the middle one shorter than the

outer ones, and in the handle is an opening for a rod by which increased leverage can be obtained if needed. The tightener is handy for farmers and others.

More than 500 toy factories in the United States have a yearly production valued at nearly \$100,000,000.

LIGHTED MAP HOLDER FOR AUTO ON STEERING COLUMN

Accommodating maps, service charts or other information desirable in driving, a holder that attaches to the steering column of the auto is fitted with an electric light and reflector so the information can be read easily at night. It is a convenient rest for highway routings which may be folded and attached to it so directions can be seen while driving.



pat pend

#1-50

Woolworth's State St. Chicago

The Cardo Co Cresco, Iowa

Hammond Maps Co
50 Church St
New York
Article by Oliver L. Pike. 2/21/31
A-493

BIRDS THAT FLY OCEAN

There have been several known instances of birds flying across the Atlantic ocean. A lapwing ringed in England was picked up in Newfoundland, and probably crossed without resting. Many birds, however, take advantage of passing steamers, lighting on the decks for rest and showing little fear of passengers. Pigeons, owls, linnets and chaffinches are among birds seen in mid-ocean, apparently crossing the sea. Some migratory birds fly even greater distances.

A-456
COIN-IN-THE-SLOT GOLF OFFERS NINE HOLES AND HAZARDS

Nine holes of golf, each with a different hazard, are offered in a coin-in-the-slot indoor course that is only nine feet long and three feet wide. The ball is driven up an incline covered with heavy felt. The cast-aluminum hazards in various shapes are set about the edge of a circular turntable at the head of the frame, the cup being in the center. After sinking a putt, the player presses a pedal to bring the next hazard in line. When the balls fall into the cup, they roll back to the player under the runway, the nine being released for play when he inserts a coin in a mechanism. For home use, the courses can be obtained without the latter.

my Frank Pitchford & Co Ltd
London England

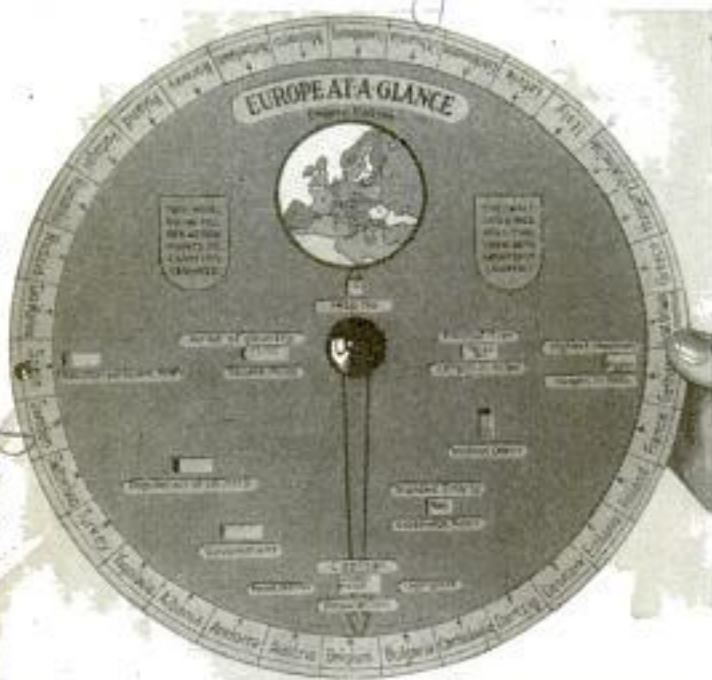

Revolving Disk Map of Europe; the Slots Reveal the Principal Facts about Country at Which Indicator Points

REVOLVING DISK MAP DISPLAYS ALL EUROPE AT A GLANCE

All the principal facts about any one of thirty-four European countries are shown at a glance on a revolving cardboard-disk map which enables the information seeker to assimilate the figures and names quickly. The map consists of a small disk containing slots superimposed on a larger one, around the edges of which are the names of the countries. Upon the upper disk is a map of Europe, with the countries indexed by numbers, and a pointer. When the pointer is set opposite the name of a country on the larger disk about which information is wanted, the openings in the upper circle display the location of the country on the indexed map, the form of government, the time in that country, when the Greenwich observatory clock registers noon, and the national colors. It also gives the name and length of the principal river, the name and height of the highest mountain, the name and population of the capital city, the population of the country, the area in square miles and the population per square mile.



Coin-in-Slot Putting Game; Nine Hazards on a Revolving Stand Offer Equivalent of Nine Holes of Golf

with coin tender \$2.75
with hand \$2.75
See We Golf Courses due
marked on bill
Copyrighted material

Developed by Electrapine Corp. Bridgeport Conn.

TALK ON PHONE RECORDED FOR REFERENCE

Both ends of telephone conversations now may be recorded for future reference with a machine known as a "telecord," which operates on principles similar to those of the apparatus on which letters are dictated, a stylus engraving the voice impression on a wax cylinder. The telephone recorder has two shafts instead of one, however, with the power supply to the two motors operated by a triple-contact mercury switch. When one cylinder is nearly full, the carriage begins to throw this switch. For a few seconds both shafts turn, so that both cylinders are recording, then the motor of the first breaks contact and the second continues. The first cylinder then can be removed and a fresh one inserted, ready to take up the task when the second is filled, so that long conversations can be recorded without interruption. The telecord does not record acoustically, but electrically. The cylinders are transcribed with a regular commercial machine for this purpose. The instrument may be connected to a switchboard, so it starts or stops as the line goes in and out of use, or it may be operated by a foot switch or manual control to record important parts of a conversation.

a. 318

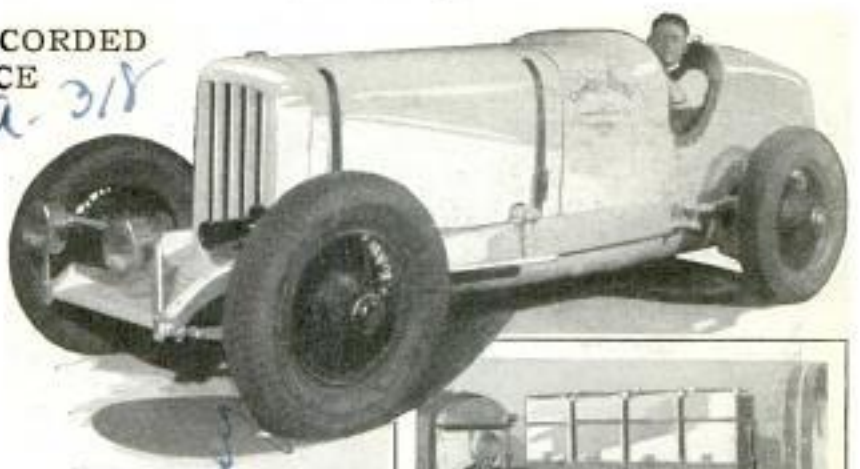

Racing Car Equipped with Diesel Engine, and Power Plant Which Burns Crude Oil

Chicago 221 & Michigan



The telecord does not record acoustically, but electrically. The cylinders are transcribed with a regular commercial machine for this purpose. The instrument may be connected to a switchboard, so it starts or stops as the line goes in and out of use, or it may be operated by a foot switch or manual control to record important parts of a conversation.

with assistance of August Lumber

car's speed as on its endurance. Its tank holds forty-seven gallons of crude oil, and the builders expect it to travel twenty-five miles to the gallon at a speed of 100 miles an hour. As a result, barring engine or tire failure, the mammoth car can make a steady non-stop run, because it will not be compelled to halt for refueling like the faster cars. The racing giant weighs about 2,800 pounds, has four cylinders and a piston displacement of about 366 cubic inches. It has no ignition system, the heat of compression being utilized to fire the fuel.

DIESEL ENGINE IN RACING CAR DEVELOPS HIGH SPEED

If the builder's plans are carried out, the world's first racing car equipped with a Diesel engine will compete this year in the Indianapolis auto races. The Diesel-powered car will stand forth like a giant among the other entries, for the snow-white machine is seventeen feet long. The designers do not depend so much on the

a. 262

FISH LURE ACTS LIKE LIVE BUG BY FLAPPING ITS WINGS

To attract the more cautious members of the finny tribe, a fish lure that imitates a live bug floundering on the surface of the water now is being offered. The lure is of metal with bright wings, the colors and the motion serving to attract immediate attention. It can be used for casting, trolling or dipping, and will not tangle or twist the line.

a. 231



1.00

Pat. pend

Designed by C. L. Cummings. H. is Allen & Co. Copyrighted material Peoria, Ill.

Cont. H. J. Dykes
K. A. K. Phoenix
Ariz.

KITE WITH RADIO TRANSMITTER FOR DIRECTION FINDING

a-281



Kite Equipped with a Radio Transmitter, Which Is Used in England in Direction-Finding Tests

Kites carrying wireless transmitters, and weighing little more than a pound, are being used at a radio-research station in England in connection with direction-finding tests. The kites are intended to reproduce the erratic conditions met at night and carry about 100 feet of aerial, eight dry cells and a tube as the transmitter units. They ascend 500 feet, and the transmitter has a range of about half a mile. This method of direction finding has proved the most accurate yet devised.

HUB LIGHTS FOR AUTO WHEELS ADD TO SAFETY

a-332



To make night driving safer, hub lights now are being provided for auto wheels. Two bulbs are mounted within each hub cap, assuring a bright red or green revolving light that can be seen

Safety Hub Lite Co.
122 S. San Fernando
Road, Glendale, Calif.

for a great distance, giving other drivers a mark for clearance in passing, and helping to prevent the danger of sideswiping.

AERIAL FIFTY MILES IN LENGTH FOR GRAND CANYON RADIO

a-362

Radio penetrates to the bottom of the mile-deep Grand canyon over an aerial fifty-two miles long. The superintendent of the Supai Indian reservation is connected by a private telephone line with the Grand canyon station fifty-two miles distant, and uses the telephone wire as his radio aerial, it being the only one that seems to work satisfactorily in the bottom of the canyon. Recently while receiving a broadcast, he telephoned a forest-service lookout station sixteen miles distant, and the lookout heard the program when the telephone transmitter was placed near the radio speaker, the same wire that served as aerial carrying the audible program back over its length to the lookout.

a-356

ELECTRIC EYE SERVES WATER FOR DRINKING FOUNTAIN

Drinking fountains now can be operated by an electric eye, or photo-electric cell, which turns on the water when a thirsty person approaches, and turns it off when he departs. The eye also operates the machinery of an electric cooler which ices the drink. An electric light is suspended in front of the cooler above a wooden platform with a hole in the center under which the eye is placed. When anyone steps on the platform, the rays of light to the cell from the bulb are interrupted, causing the cell to stimulate an amplifying tube which opens a relay switch. A magnetic valve, affected by the relay, turns on the water, and an electric refrigerator unit to cool the spray also is placed in operation. When the person steps from the platform, the process is reversed and the apparatus stops.



Sharon Farm and
Country Life Show
Madison, Wis.

Copyrighted material

A. 326 Cont. John L. County
714 Jefferson St. N.W.
Washington
D.C.

The Tricks of Life Saving

A GROUP of boys are swimming when a cry of distress terrifies the group. One lad is seized with cramps and thrashes the water desperately. He sinks—once, twice, three times—and fails to come up. Frantically two or three older boys dive for the victim. Finally somebody locates him and drags him out of the river. He is rolled over a log. After much rolling and discharge of "lung water" he is revived and taken home.

All of which makes a familiar type of rescue story during the summer



season. But it's entirely fanciful we are told, emphatically, by D. Melville Carr, nationally known life-saver with 250 rescues to his credit. For among the popular fallacies in regard to drowning persons none surpasses the two listed above—that if a person

sinks for the third time he will not come up, and that rolling a half-drowned person over a log or barrel removes the water from his lungs.

"The third time down," explains Mr. Carr, "has nothing to do with a man's chances of being saved. The truth is, a drowning man struggles until he is exhausted. He may come up three times or ten times, or not at all. The only reason he goes down in the first place is because he raises his hands high above his head instead of leisurely thrashing the water with them as he should, meantime kicking his feet in an endeavor to tread water. In fact, cases have come to my attention where men have gone



Life-Saving Tricks That a Would-Be Rescuer Should Know; Top, Breaking Front Strangle-Hold; Center, the "Head Carry"; and, Below, the "Hair Carry"

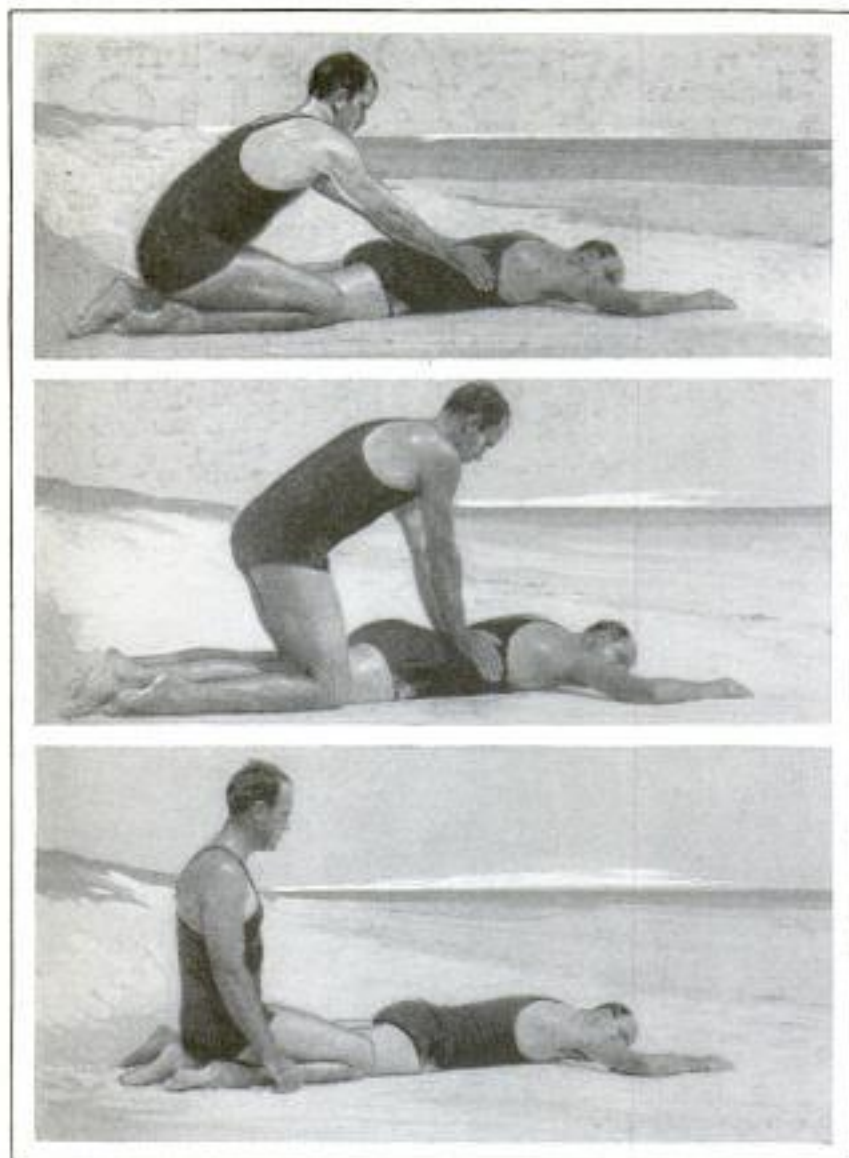

The Three Proper Positions in Inducing Artificial Respiration; Note Position of Victim, with Nose and Mouth Free for Breathing

down more than a dozen times and remained submerged fully half an hour and yet have been revived."

Mr. Carr goes on to point out that the well-known method of rolling a victim over a log or barrel is absurdly useless. In certain uninformed quarters this practice is supposed to remove water from the drowning person's lungs, whereas a great body of medical men today strongly doubt that any water whatever enters the lungs as a suffocating factor. The water commonly supposed to be lung water really comes from the stomach and would not hurt the victim if allowed to remain there, except, perhaps, to cause slight nausea. As a matter of fact, Mr. Carr says, there is no known method of getting water out of the lungs even if any were there.

Another popular fallacy about attempts to save people from drowning is that the victim ought to be hit on the jaw so as to make him helpless. Nothing could be farther from the truth, Mr. Carr says. If the drowning person is so weak that such a blow would render him unconscious then he already is too helpless to make the blow necessary. If, on the other hand, the victim is struggling so violently as to make it impossible to subdue him or grasp him with safety, the only sensible thing to do is to wait for the drowning man to exhaust himself. Breaking holds by inflicting pain is also impractical. A man fighting desperately for his life will not be affected by such methods.

But if you're endeavoring to rescue a drowning person, does he really try to grab you in a death grip? Not at all, explains Mr. Carr. The only reason he makes vicious lunges at you is

that he's trying desperately to climb on you in order to get his head out of water.

Of course, occasionally there are individuals who are so excitable that their treatment demands special measures. Granted that they have succeeded in getting a strangle-hold on their rescuer, they will try to maintain it. In such an emergency all the rescuer needs is a knowledge of the best "breaks" for the various strangle-holds plus a little common sense. A wise thing for him to do is to stop treading water. Whereupon the victim, finding he is no longer being supported, will naturally loosen any grip he may have been able to maintain.

"No matter how strong a swimmer a man happens to be, if he expects to be prepared to save a life in the water he

Blodg. F. H. + Clark,

Los Angeles, Calif

must undergo a stiff period of training," says Mr. Carr. "In a word, this involves constant practice in adapting his swimming strokes to those needed in a rescue—namely, swimming on the back without the hands, while utilizing the kick only, or swimming on one side while employing the kick and underarm only.

"The fundamentals of water safety may be listed as follows: Don't swim alone—this bad habit is the major contributing factor to drowning disasters; don't swim too far from shore—even the great champion short-distance and marathon swimmers never venture far from shore without a boat alongside; don't swim too soon after eating, and don't dive in shallow water.

"A popular misconception is that women cause their rescuers far more trouble than men due to their temperamental make-up. My own experience has been that women, if anything, are easier to save. This is because of their lighter weight and less strength and the fact that their longer hair makes the 'hair-carry' easier to accomplish.

"When a rescuer is called upon to break two persons apart who are clinging together in a front strangle-hold, he should swim to a point directly behind one of them, preferably the weaker swimmer, and place his hands on the chin. Pushing down with forearms in order to sink the victims, the rescuer should then raise one foot over the locked arms, placing the foot against the chest below the throat of the subject facing him, straighten out his leg, push down and pull up, thereby separating the two. Avoid kicking under all conditions."



Merry-Go-Round Cafeteria with an Inner Circular Counter Which Revolves, Carrying Trays of Food Constantly Past the Customers

with an inside portion of the counter which is constantly revolved at slow speed by an electric motor. Glass-enclosed cabinets of cold foods constantly pass before the patrons on this moving belt, the customer being given plenty of time to make a selection and extract a dish from a cabinet as the counter moves by.

FIRE ALARM WIRED TO PHONE OPERATES AUTOMATICALLY

A. 407

Turning in an alarm automatically when room temperature reaches a predetermined degree, a fire alarm for attachment to a telephone circuit is now available. It is intended particularly for hotel rooms, in which a blaze may be started by a carelessly tossed match as a guest is leaving. When the room temperature rises, the alarm device closes the telephone circuit, just as when the receiver is lifted from the hook, thus warning the hotel operator that something is amiss in the room before the fire gains headway. No adjustment is required after the alarm has operated, as it automatically returns to an

*new York N.Y. Heaney
100 Bedford St. N.Y.
Hembard. E. C.*



open circuit when the temperature is lowered. In homes the alarm can be attached to the door-bell circuit, causing the bell to ring continuously if the room becomes hot, and it can also be connected to annunciator systems in hotels, or sprinkler systems in factories.

MERRY-GO-ROUND LUNCH ROOM HAS REVOLVING COUNTER

A. 392

Merry-go-round lunch rooms, or trayless cafeterias, are taking a whirl for public favor on the Pacific coast. These self-service restaurants have circular counters

*The Roberts Co. Moore
Regarding Co. H. H. H.
Berene H. Hembard N.C.*

Worn by Commander
Sloan Hainshaw

806

a-343

DEEP-SEA DIVING MASK FILLED WITH SYNTHETIC AIR



Diving Mask for Deep-Sea Work Filled with Synthetic Air to Decrease Time for Decompression

Possibility of recovering sunken treasure that has lain for years at the bottom of the ocean has been increased recently by the invention of a special diving mask for deep-sea work. This mask is supplied with a synthetic atmosphere of helium and oxygen, which is said to enable divers to decrease the time required for decompression on coming to the surface by at least two-thirds. Among the treasures which divers hope eventually to recover are the \$5,000,000 in gold that went down with the "Egypt" off the coast of France, and \$1,000,000 in gold and silver that sunk with a liner off the Virginia capes.

WIDTH OF OCEAN IS MEASURED BY LONGEST TAPELINE

a-34

Stretching from Newfoundland to the Azores, a tapeline 1,264 miles long was reeled out recently from a cable steamer to obtain an accurate measure of the distance traveled, and hence an accurate estimate of the cable length. The tapeline was a fine steel piano wire which was reeled out constantly although it had no

lots and slashes
Feb. 1931 Western Union

connection with the telegraph cable which was passing over the stern sheaves at the same time. The occasion for the measurement was the laying of a new type of cable which, because of its peculiar construction, had to be laid as close as possible to the 1,341 nautical miles specified by engineers. Any greater length would have upset the calculations of these experts, and would have made operation at the desired message speed quite problematical. The length of the cable had been predetermined by the contour of the sea bottom over the route. Because the distance along the sea floor was greater than the distance traversed by the ship, sufficient slack was payed out to permit the cable to rest on the bottom. With the steel wire giving the distance traveled, and the contour of the sea floor known, it was relatively simple to figure the amount of slack required for each mile. To keep the wire taut for accurate measurements, a pull of from thirty-six to forty pounds was maintained on the wire as it was payed out by a revolving arm with a spool through which it was pulled.

PENCIL SHARPENER FOR DESK LOOKS LIKE INKWELL

a-35

Resembling an ordinary inkwell, a pencil sharpener for the desk can be operated without soiling either hands or desk with lead dust and shavings. The sharpener consists of a metal receptacle into which the circular top containing the knife fits. The blade is in the center of the cap in a vertical position, and the pencil is inserted in a hole in the upper part of the device and turned a few times, the shavings falling into the base.



Pencil Sharpener for the Office Desk with a Receptacle for Shavings and Lead Dust

Keena-Prul
Clifton Craft Works?
64 Lakeville Ave.
Clifton, N.J.
Copyrighted material

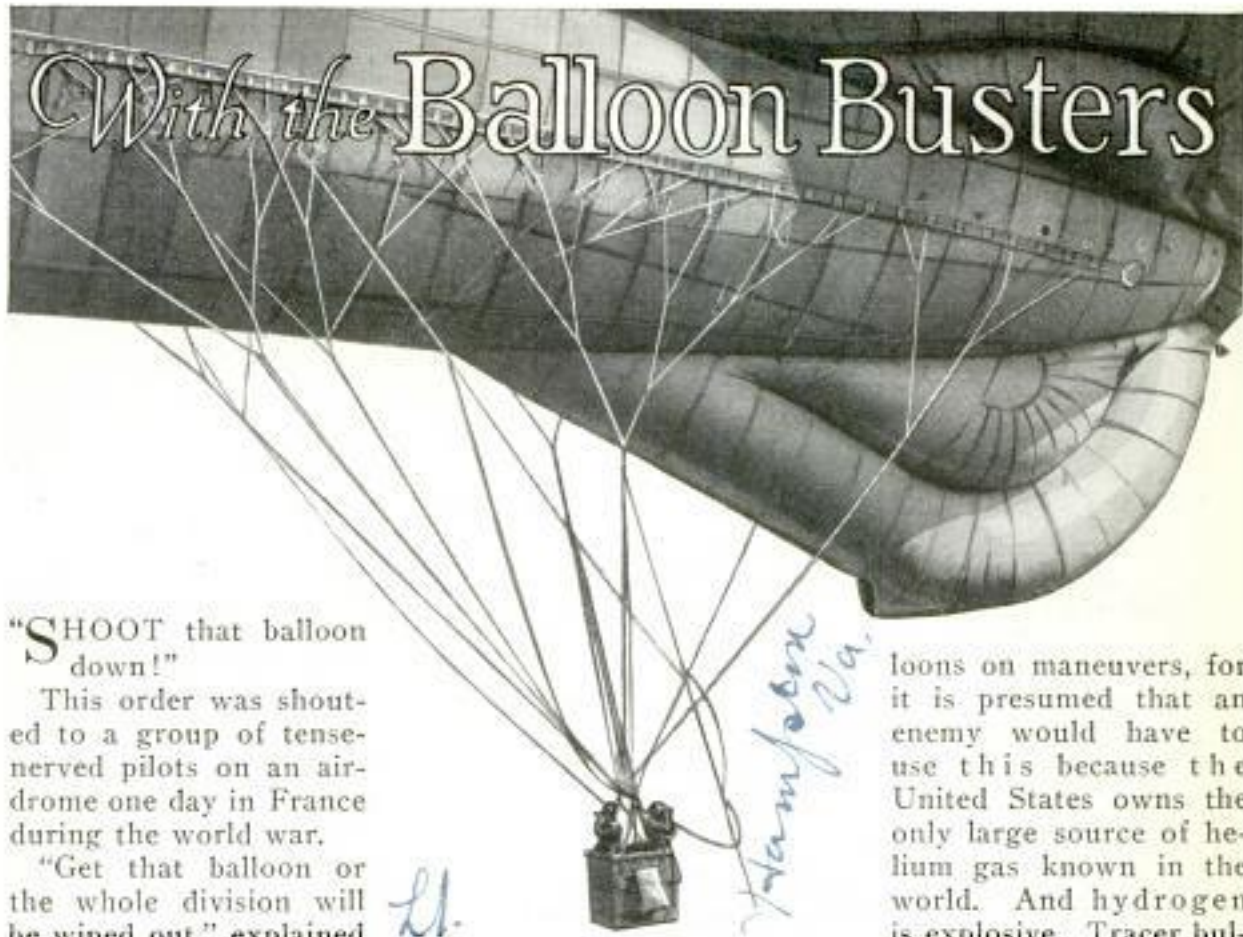

With the Balloon Busters

"SHOOT that balloon down!"

This order was shouted to a group of tense-nerved pilots on an air-drome one day in France during the world war.

"Get that balloon or the whole division will be wiped out," explained a high staff officer. "The observer in that balloon is making every enemy shell strike home. Go get him!"

The fighting airmen, many of them aces, looked knowingly at each other and, with silent hand waves of farewell, moved to obey the order. They knew that death rode the winds at a furious pace in the vicinity of observation balloons, or "sacred cows" as they were usually called. Far more dangerous than enemy airplanes were these captive balloons. Several batteries of anti-aircraft artillery filled the sky with shrieking shrapnel, and the man who could slip through this barrage of hot steel was lucky. Balloon aces were very scarce during the war, for those intrepid flyers who went in for balloon "busting" lived short and exciting lives.

Even on peace-time balloon-bursting maneuvers, death hovers in the vicinity of the big gas bags. By holding a dive too long, a pilot may fly into the bag, or he may scrape it and tangle a wing, or it may explode in his face and surround him with flaming gas.

Hydrogen is used in the captive bal-

Lt.
Langley Field
Hampden Va.

By CORLEY McDARMENT

loons on maneuvers, for it is presumed that an enemy would have to use this because the United States owns the only large source of helium gas known in the world. And hydrogen is explosive. Tracer bullets carrying a streak of fire are shot into the balloons and allowed to explode them.

The fast pursuit planes gain a great altitude above the balloon. Then the pilot sticks the nose straight down and lets the slim white marker on the air-speed indicator climb against the peg. When close to the balloon, small bombs are released or machine-gun fire is opened up, and the pilot pulls carefully out of the dive just at the right time and place. The trick is not easy to do.

Most pilots find themselves pulling out of the dive too early. It takes the most practiced judgment to tell the right moment to pull out. No censure is attached to a pilot's pulling off too quickly, but if he holds his dive too long and fouls the bag, he is usually soon beyond any worldly censure.

The very fastest airplanes are used against the balloons because in the next war these balloons will be protected by far more efficient anti-aircraft guns. The man who gets balloons in future wars must travel so fast that he can scarcely be seen.

Q-238
808

POPULAR MECHANICS

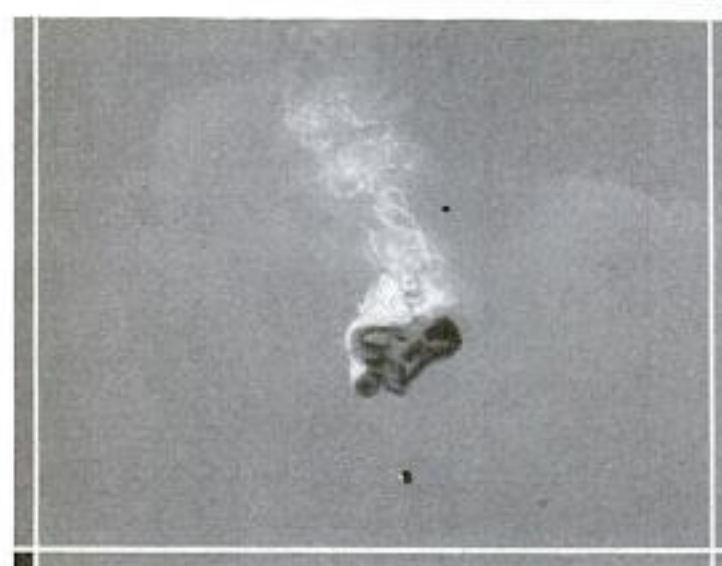
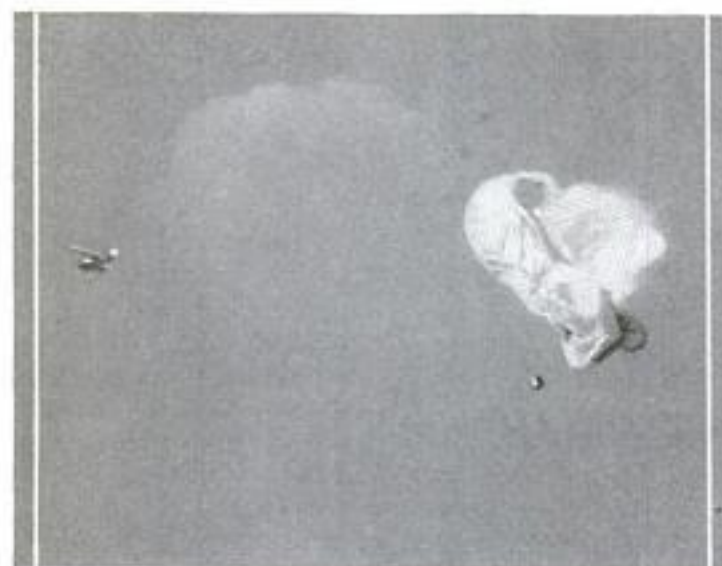
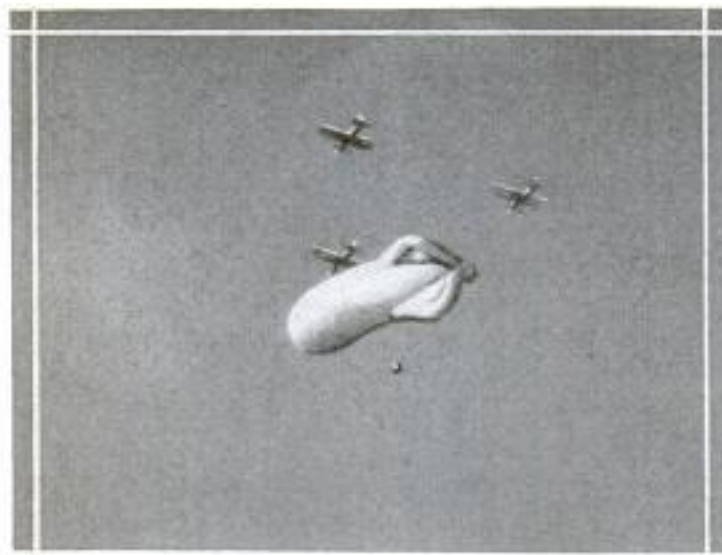

Three Planes Attacking Observation Balloon; Plane Disappearing after Bursting Balloon; Balloon Falling in Flames

big "sausages" with machine guns until it gets hit. But the machine guns do not carry far enough to be out of the anti-aircraft range, and they make too small a target with the whole sky as a background. Also, it is only the tracer bullets which will set the hydrogen on fire, and they burn out within a few hundred yards and then become as cold as ordinary shot. An aviator must get right down against a balloon and empty his tracers into it for sure effect.

Great pyrotechnic displays were made around a balloon when attacked during the war. The enemy had peculiar flaming bombs which hung in the air. There were "flaming onions" and other queer things sent up after the attacking planes. One object shot into the air was somewhat like the chain shot of Civil war days except that the links in the chain were balls of fire. These long snakelike objects were sent winding up in the vicinity of the observation balloons in the hope that they would wrap around the attacking airplane. These strange missiles used to amuse the attacking airmen rather than create fear. The thing most dreaded was machine-gun and rifle fire from the ground.

Besides the tracer-bullet method of destroying balloons, a more spectacular way has been tried several times with varied success. This is the bombing method.

Small bombs, which burst on slightest contact and start a fire, are loaded beneath the wings of the pursuit planes and at the bottom of the dive and just above the balloon, the "eggs" are "laid." If they hit, the balloon is a goner. If the bombs go on to the ground, they create plenty of confusion there with the crew at the balloon winch.

It would seem that an aviator could get off at a distance and shoot at one of these

It is hard for most aviators to get in close enough to a balloon or airship to



Close-Up of a Balloon Basket and the Old-Fashioned Parachutes in Containers; Observers from Balloons Directed Artillery Fire with Deadly Effect during the World War

open effective fire. This is because the craft looms so large that the pilot is deceived as to its distance. At 200 yards, a pilot usually feels that he is about fifty feet from a balloon or airship and he instinctively pulls away.

One new method of balloon bursting which appears to hold some promise is that in which fifty-caliber machine-gun bullets are used. These large bullets are capable of carrying big charges of incendiary material. The only difficulty with the heavy-caliber bullets is the recoil. A small speedy pursuit airplane trembles from hub to fins when the fifty-caliber guns are firing through the propeller. Pilots feel as if they had been through a whipping machine when they land after firing these big aerial "Berthas."

COIN-IN-SLOT GOLF GAME GIVES INDOOR PUTTING PRACTICE

Indoor putting practice, and some of the thrills of playing a full-size course, are offered in a coin-in-the-slot golf game recently introduced. The course consists of a fairway, some twenty feet

long, with a circular green at one end. Sections of the fairway are set at various angles, thus creating several hazards to be overcome in reaching the cup. The hazards are marked with numbers that decrease as the ball nears the cup, these numbers being used in scoring each player's shots. Balls are delivered when a coin is deposited in a slot, and are returned to the player when a foot plunger near the tee is pressed, the balls dropping into a section beneath green and fairway after being played.



Coin-In-Slot Golf Game Which Offers Indoor Putting Practice and Some of Thrills of Real Game

414
 2 millionths sold in Jeffersonville
 Copyrighted material

K & N Laboratories, Inc
411 W. Ontario

810

POPULAR MECHANICS

a. 400

MECHANICAL EYE TESTS PAPER TO SHOW TRANSPARENCY

\$350.00



Above, Testing Transparency of Paper Sample; Right, Interior View with Dividers Showing Iris and Retina

performed by a diaphragm which can be adjusted to govern the amount of light passing to the photo-electric cell just as the human iris adjusts itself when a person enters a dark room. An electric lamp serves as a light source. Between it and the diaphragm is a slot in which the sample to be tested is inserted, and beyond the iris is the photo-electric cell. The amount of energy developed by this cell is proportionate to the light striking it and a reading of the energy developed by the cell indicates the percentage of opacity or transparency of the sample. The tester is being used to grade paper stock, to determine the transparency of different

Paper, glass and textiles can be accurately tested to determine relative degrees of opacity and transparency by inserting samples in a mechanical eye that in many respects corresponds in its various parts to similar parts and functions of the human eye. The motivating unit in the instrument, known as an "opacity-transparency tester," is a photo-electric cell, or electric eye, corresponding to the retina of the human eye. The function of the human iris is

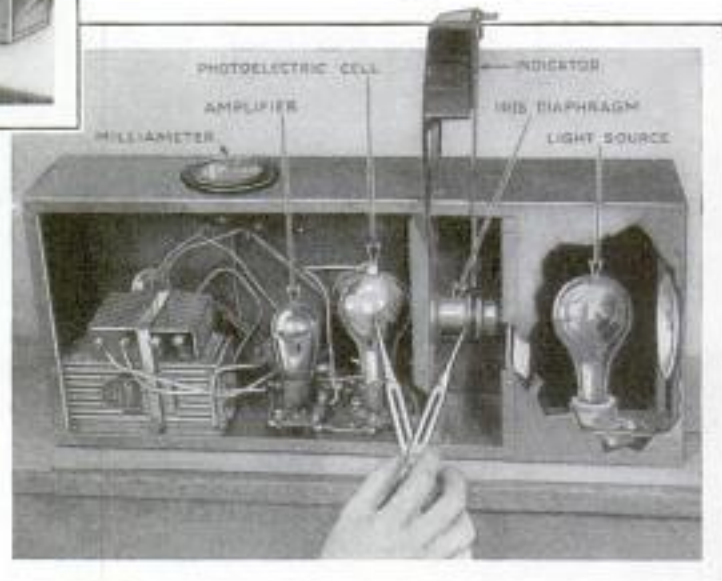

kinds of glass, and to test the sheerness of fabrics, such as stockings and dress material.

MAGNETIC SWEEPER PICKS UP PIECES OF PLATINUM WIRE

In the manufacture of the little lamps for switchboard signals, platinum is used for that part of the leading-out wires passing through the glass wall of the lamp because it has about the same heat expansion. The platinum wire is welded to a larger wire on which the filament is mounted, and some of the platinum is lost in handling, many of the particles of this costly metal dropping to the floor. Heretofore the platinum particles were salvaged from the factory floor by using a small magnet as the wire has a steel core. Recently, however, a magnetic sweeper

has been made for this purpose. It consists of a number of individual magnets placed side by side on a frame provided with wheels and a handle. The sweeper is pushed over the floor several times a day, like a vacuum cleaner.

MOON'S SURFACE WITHOUT AIR ITS LIGHT HAS PROVED

Examination of the ultraviolet rays present in full moonlight has proved conclusively that the surface atmosphere of the moon is virtually without oxygen. Dr. Brian O'Brien, of the University of Rochester, made the test by measuring the spectrum, or rainbow, of moonlight. The

a. 416
Wm. George
Sturman

Switchboard Lamps Dept
Western Electric Co

test depends on ozone, a form taken by some of the oxygen in the sun's light. It is opaque to certain kinds of ultraviolet light, and as no difference can be observed in the strength of these colors in the light reflected from the surface of the moon as compared with light direct from the sun, the absence of oxygen on the moon is shown. The presence of ozone in the earth's atmosphere did not interfere with the experiments.

DOGS AS SILENT POLICE USED ON DETROIT STREETS

Dogs play an important part in anti-crime activities. Among the most efficient members of the Detroit police department are seven German shepherd dogs which have a perfect record in stamping out crime in the lonely sections which they patrol. Every night each dog walks a beat with a policeman, and so efficient have the animals become that not a single house prowler has been reported in their district in over three years. The police dogs are first trained to strict obedience and to respect the police uniform. They are then taught to jump, so they can clear fences or hedges in trailing a suspect. The most difficult drill for the animals is to carry on in the face of gunfire, and they learn to attack under the blaze of blank cartridges.



Training Police Dog to Protect the Officer with Whom It Works in the Face of Gunfire

Palmer Park present



An Example of Mural Wall Decoration with the Figures Outlined in Strings of Various Colors

COLORED STRINGS FOR MURALS MAKE WALL DESIGNS

Murals with figures outlined in colored strings are being employed effectively for wall decorations by one American mural painter. The strings, in colors to correspond to the flowers or other figures represented, are glued to the murals to provide an artistic and colorful outline.

GROWTH OF TREE IS WATCHED UNDER THE MICROSCOPE

Days are transformed into minutes, and years into weeks by a method of studying the growth of the root tips of pine trees under the microscope. Instead of waiting years to find the effect of a fungus attacking the tree roots, the work of years of growth can now be studied in a few days. The pine seeds are sprouted in a solution made to duplicate the ideal forest soil. The solution, containing root nourishment, passes into the root chamber, and is taken off through a drain pipe. A fresh supply of nutriment constantly replaces the solution drained off, so the roots are continually gorged with food. The roots react to this ideal condition, and can actually be observed in process of growth. Various fungus growths can be studied as they act on the root tips, and remedies also can be observed in action.

Mr. Robinson, et. of Penna. and Bureau of Biological Industry, Allegheny

Edward Wheeler shown at Bureau for Mural Decoration in New York

a-442 Dept. of Agriculture U.S. Botanical Laboratories

DIRIGIBLE TO TRY MOORING TO SKYSCRAPER MAST

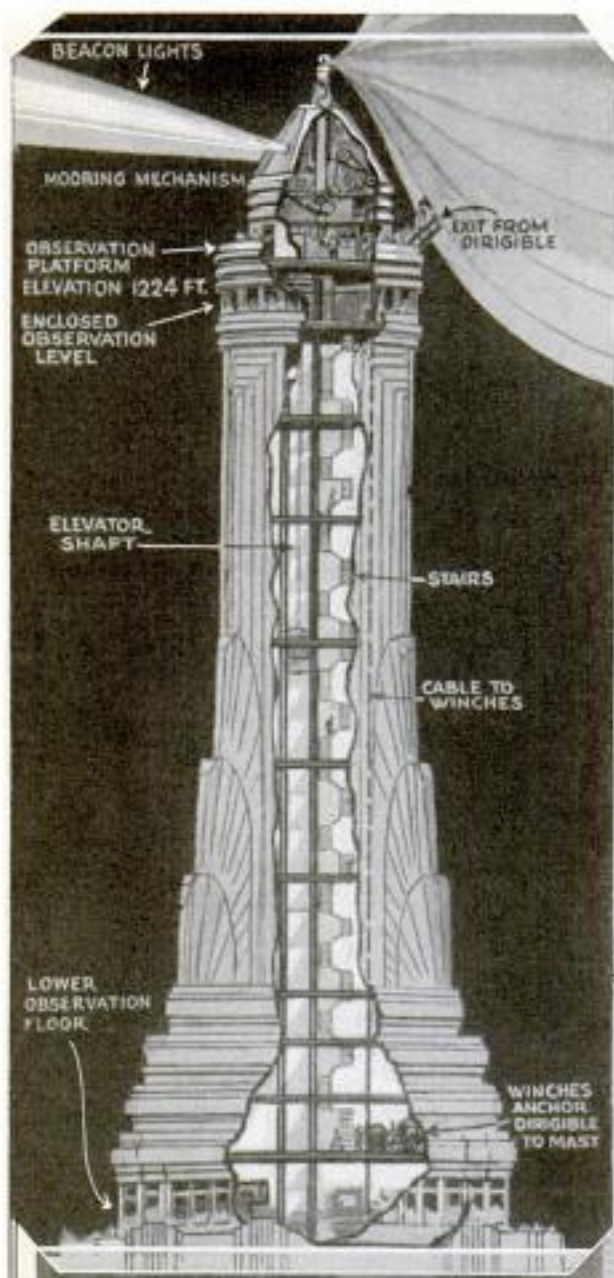

Despite the conflicting opinions of many experts, an attempt is to be made to anchor the huge dirigible "Los Angeles" to the mooring mast that has been erected atop the towering Empire State building over the heart of New York City. Ever since plans for the mast, costing \$160,000 and extending 1,248 feet above the sidewalks, were announced along with the daring scheme to moor transatlantic air liners to the tip of the world's tallest building, the subject has attracted international attention and caused widespread discussion as to the possibility of its successful operation. Now the mast itself is finished, and former Gov. Alfred E. Smith, representing the builders, has announced that Adm. William Moffett has agreed to test its practical application. Airship experts, however, continue to condemn the plan as impractical. Those favoring the project point out that the four main pillars of the Empire State building have been strengthened to withstand a fifty-ton pull by a dirigible attached to its mast. The winches for the cables to pull in the airship are



Above, Cross Section of the Mooring Mast on Empire State Building and Manner of Operation; Below, a View of New York Taken from the Top of the Mooring Mast

located on the eighty-sixth floor, nineteen stories below the actual tip of the tower. Two or three stories below the tip is a door, which turns inward, through which passengers might disembark from the air-ship, once it was made fast to the mast. Dr. Hugo Eckener, commander of the German "Graf Zeppelin," said he would never try the feat with his own ship. The air over a city, he explained, is irregular and "spotty" as the crags of the skyscrapers, particularly at the level of building tops. As a result, the ship, in his opinion, would be in constant danger of veering off and crashing into some other building, even on a quiet day. Even if the ship were tied to the mast, he declared, it would not be quite safe.



Figurehead of the Old British Battleship "Rodney," Receiving Its Annual Spring Bath and Cleaning in an English Dockyard

Wide World

TINY MODEL PLANE FLIES FOR ONE MINUTE

A. 325

Constructed of balsa wood and Japanese rice paper, a tiny model airplane, no larger than a June bug, has been made by a Philadelphia high-school boy who has dubbed his ship the "Flying Flea." The craft has a wooden propeller and a rubber-band motor and its proportions correspond to those of a full-size plane. It measures one and one-fourth inches in length, and both the ship and its hangar can rest on the maker's hand. The "Flea" stays in the air for one minute.

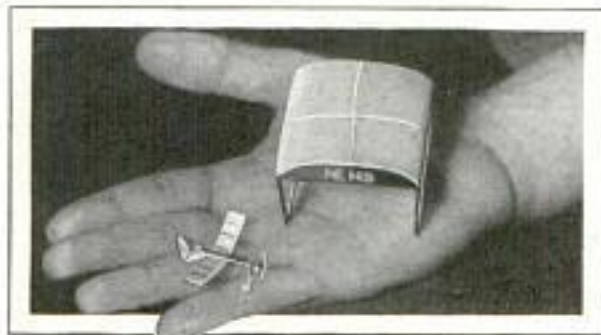

The "Flying Flea," a Tiny Model Plane That Flies, and Its Hangar Resting on Builder's Hand

Letter sent by William Howard! 1848-8. Atlantic City

FIGUREHEADS OF FAMOUS SHIPS GIVEN SPRING CLEANING

Ancient figureheads, belonging to famous old British ships dating back more than a century, are among the prized possessions of Chatham dockyard, near London. Each spring these imposing pieces are given a bath and thorough scrubbing. One of the most valued figureheads is that of the "Rodney."

ELECTRIC EYE COUNTS LOAVES OF BREAD ON CONVEYOR

A. 390

One large London bakery has applied the electric eye, or photo-electric cell, to the counting of loaves of bread as they come from the ovens on a conveyor band. The eye is mounted under the band and a light source above it. As the shadow of each loaf cuts off the light to the cell, a counting machine is set into operation.

of Analytical Tech. 2/5/21

a-230



Easier Ways

Pot Cleaner Consisting of Handle, Holder and Renewable Steel-Wool Head



Right, Perfume Diffuser Operating through Oxidation to Disseminate Liquid in Base through Wick with Platinized Heating Element at Top



a-185

Food Shredder That Will Not Cut the Fingers; a Metal Plate Protects Fingers at All Times; Right, Iron Rest That Stays on Board



a-186

a-187

Electric Radiator Fan Which Increases Radiation by Forcing a Larger Amount of Air over Radiator, Resulting in Quicker Heating

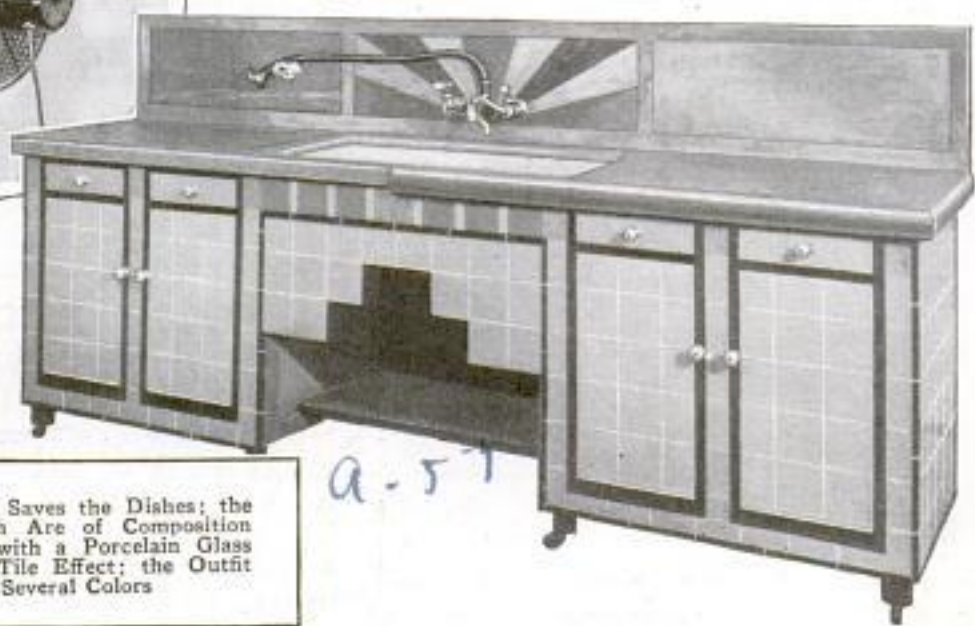

Rubber Sink That Saves the Dishes; the Cupboards Beneath Are of Composition Hardwood Fiber, with a Porcelain Glass Finish to Give a Tile Effect; the Outfit Comes in Several Colors

a-57

a. 155

a. 335

of Doing It



Hat Holder with a Spring for Use on High Shelf; a Slight Pull on the Cord Brings Hat and Holder within Easy Reach



Extension Garment Hanger for the Clothes Closet Which More Than Doubles Usable Space; the Hanger Pivots on Hinges and Swings Freely to Right or Left



Broiler with Hinged Top That Is Easily Cleaned; Meat Juices Run off Ribbed Top and into the Pan at the Bottom

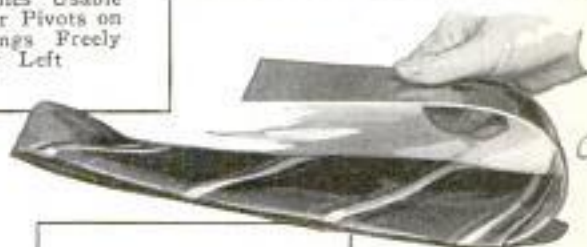

a. 347

Flexible Pressing Form for Neckties Made of Bakelite; Ties Also Can Be Dry-Cleaned on This Form

Below, Window Ventilator Screen on a Roller; the Net Screening Is Washable

a. 294



Ornamental Flashlight That Turns On When Lifted; the Contact Is in Its Base



a. 248

GOLD LEAF IS STILL BEATEN OUT BY HAND POWER

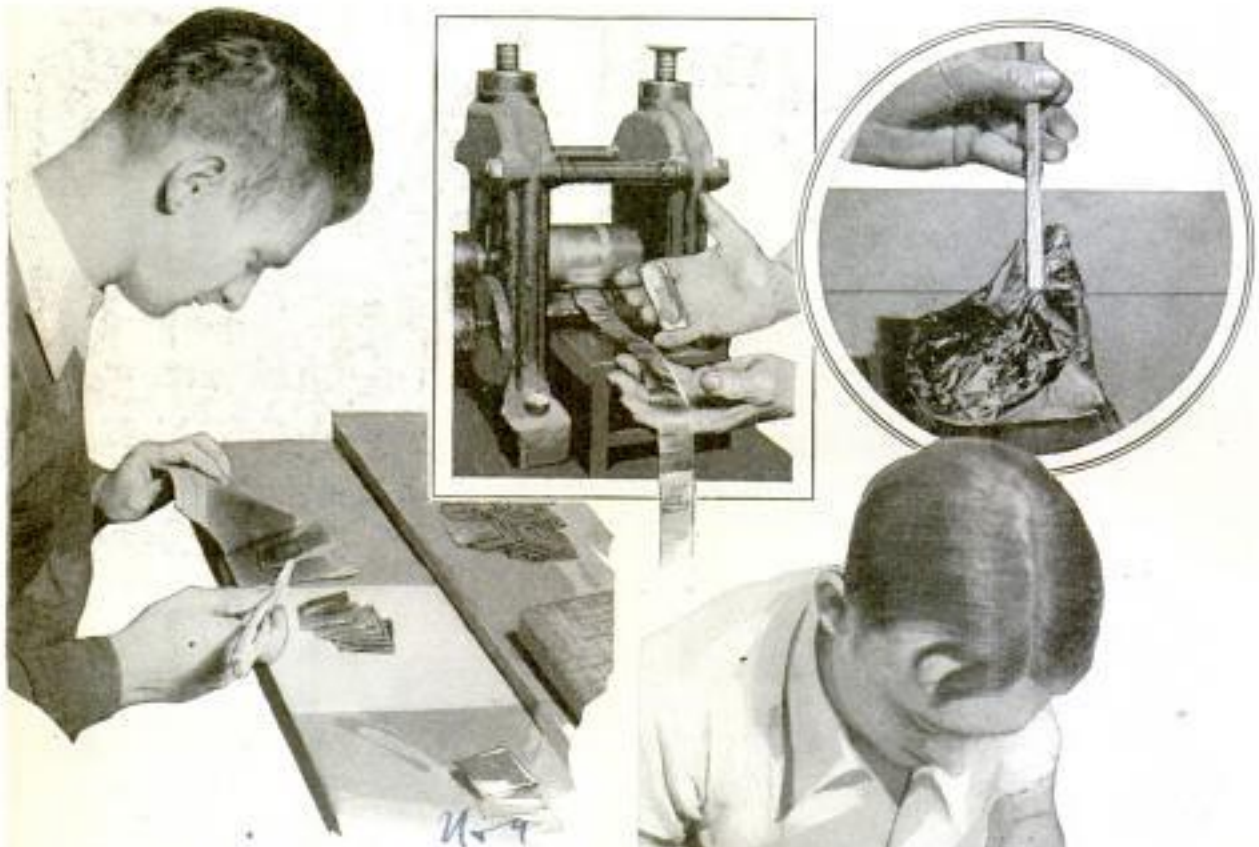

Above, Putting the Gold Squares into Containers for Beating; Top, Center, Cold-Rolling an Ingot; in Circle, the Finished Leaf Which is Nearly Transparent; Right, Cutting the Leaf after the First Hammering

At least one industry has not greatly changed in this modern machine age, for gold-leaf making remains one of the few occupations where hand power does most of the work. Gold leaf usually has its beginning in an ingot weighing about 350 pennyweights. This ingot is run through a cold roller and made into a ribbon about 150 feet long and one inch wide. The ribbon is cut into one-inch lengths and placed in containers of so-called goldbeaters' skin, each square inch being beaten by hand until it is about five inches square. This process of cutting and hammering is repeated three times, each inch length of the original ribbon yielding sixteen finished leaves, and the ingot making about 3,000 leaves.

SECRET BURGLAR ALARM RINGS IF WATCHMAN IS WAYLAID

Thieves entering a place where a night watchman is on duty usually force the watchman to make his regular rounds and "pull" his signal boxes on schedule, so the

central office to which he reports will not suspect anything wrong. To thwart this system, the latest signal box for watchmen is equipped with a special key which is operated only in one particular way. The box looks like any other signal box and the key looks no different, but unless the key is turned in one way, and unless a certain pressure is exerted, the alarm is turned in automatically despite the fact that the box appears to have been rung in the usual manner. A watchman thus is able to raise an alarm without arousing the suspicions of those accompanying him.

By lending more than 14,000,000 books annually, the Chicago public library has the world's largest circulation.

A. 312
Holtzer-Cabot Electric Co.
125 Amory St. Boston Mass

Recording device developed
 by - J. Armbryst & C. Knowles
 and W.A. Drecht
 POPULAR MECHANICS

817

a-307

Westinghouse Electric & Mfg Co

AIR BUMP IS GREATEST STRAIN ON A FLYING PLANE

a-329

Air bumps offer greater strain to a plane in flight than the shock of landing, it is revealed by tests with "electric nerve centers" placed aboard the ship to measure such stresses. The air bump showed a strain as high as 18,000 pounds on an airplane weighing only 8,500 pounds. The nerve centers are placed on a wing, fuselage and landing gear and connected by wires to a box containing six grid-glow tubes registering pressure from 14,000 to 22,000 pounds. The tubes are lighted when the electric nerve center signals an impact, the contact points being tiny weights strapped by springs into aluminum castings. The device showed high-speed landings offered less strain than slow ones. When the speed was over sixty miles an hour, no pressure was recorded, indicating it was less than 14,000 pounds. At less than fifty miles an hour, the pressure on landing was increased on both wings and landing gear. No shock was recorded at a take-off.



Sending a Telegram from a Flying Plane; the Message Is Transmitted by Radio and Then by Wire

TELEGRAMS SENT FROM PLANE BY RADIO-WIRE HOOKUP

Passengers on some European airplane routes now are able to send private telegraph messages while in flight. This is made possible through an agreement on a fixed tariff by the aerial radio service of the route and the post administration offices of Czechoslovakia and Austria. The messages are sent by radio to the airports and forwarded by telegraph to the addressees. Code messages are not accepted.

Berlin - Dresden - Prague - Vienna

INFLATED BOAT BECOMES TENT FOR CAMPERS AT NIGHT

a-331

So light and compact that it can easily be carried on the back when folded, a sporting outfit in the form of a rubber boat and tent is finding favor in Germany. The inflated rubber craft supports a large weight on the water, and when beached at night, has a cover which transforms it into a cozy tent for campers. It is prepared for the water or for carrying in a few minutes.

Inflated Rubber Boat for Campers Which Is Transformed into Tent at Night; When Deflated, the Outfit Is Carried on the Back



WHY SWISS LAKES ARE BLUE

a-347

Travelers long have marveled at the beautiful azure color of the lakes in the Tyrolean Alps, and chemical compounds in the water were generally believed to cause the color. Recent analysis, however, shows the lakes to be free from coloring matter. Scientists therefore have decided that the hue is due to reflection and refraction of the azure sky in colorless water, particularly since the azure color changes to gray as the sun declines. Other localities do not have the deep-blue water coloring because they are not favored with clear blue skies.

shown at Berlin

Refering to Photofeatures
 745 W. 4th St
 New York

Franklin Institute Phila

Del. 14 P.O. 882
8/18/31
8/18/31
wrong number

Mrs. William Turner
 1514 E 66th Place
 POPULAR MECHANICS
 Chicago

818

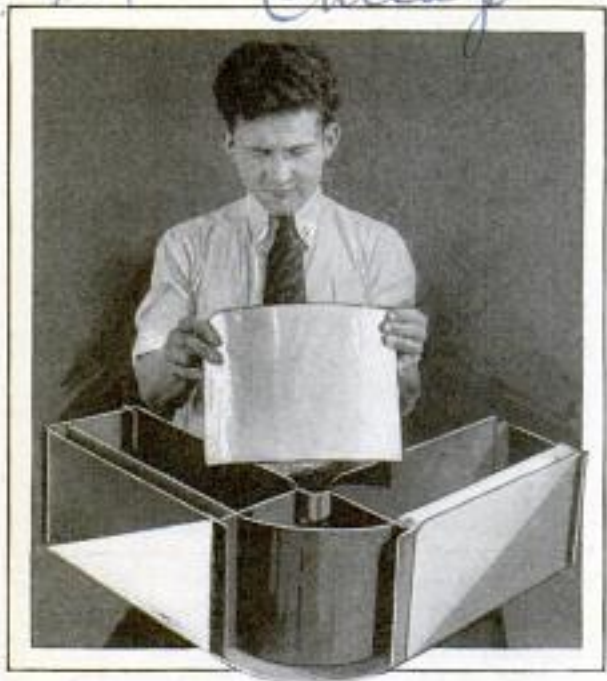

Section of Enameled-Steel Surfacing for Interior or Exterior Walls; Note Method of Assembly

BUILDING OF ENAMELED STEEL OFFERS COLOR VARIETY

Colors in endless variety are offered along with other advantages in an enameled-steel wall surfacing for buildings which can be employed for both interiors and exteriors. Such all-metal construction is intended particularly for automobile-service stations, shops, cafeterias, and other places where bright, individual colors are necessary. The wall surfacing is composed of sections of steel, eight by sixteen inches, on which porcelain enamel has been sprayed and burned in to make the metal rust-proof. The wall sections are simply slipped into place after studding, in the form of I-beams, has been bolted to the metal frame of the building, a flange at each edge of the wall section fitting over an edge of the studding. Putty is placed in the slots before the sections are slipped into place, and insulation is further aided by a layer of mineral wool between the wall surface and an inner surface, and by a

dead-air space beyond the mineral wool insulation. The edges of the enameled sections overlap to make a tight connection. In addition to being fireproof and offering any color or decorative effect, such wall surfaces are kept bright and clean easily.

ELECTRIC BOWLING ALLEY HAS NO PINS TO SET

Bowling, one of the few sports to remain virtually unchanged in an age when others are constantly altered, now is being electrified. An electric bowling alley offers several additional hazards for the pin smasher, since the pins are not stationary but are set on a vertical wheel that revolves at constant speed. This variation of bowling is known as "rolette," and the player must co-ordinate sight and skill, since he must roll the ball so it will arrive at the exact moment the pin he intends to hit is in position. The pins consist of nineteen numbered spokes on the wheel which is operated by a motor. The numbers are arranged in groups of two which add ten, except for two spokes which bear the number ten, and others with zero on them. When the numbers are struck, the spokes fall back against an arm and are set upright by pulling a wire running the length of the alley, thus eliminating pin boys. The player is expected to call the number or combination of numbers he expects to hit before throwing the ball. The alley is slightly raised above the floor, and the balls are smaller than ordinary.

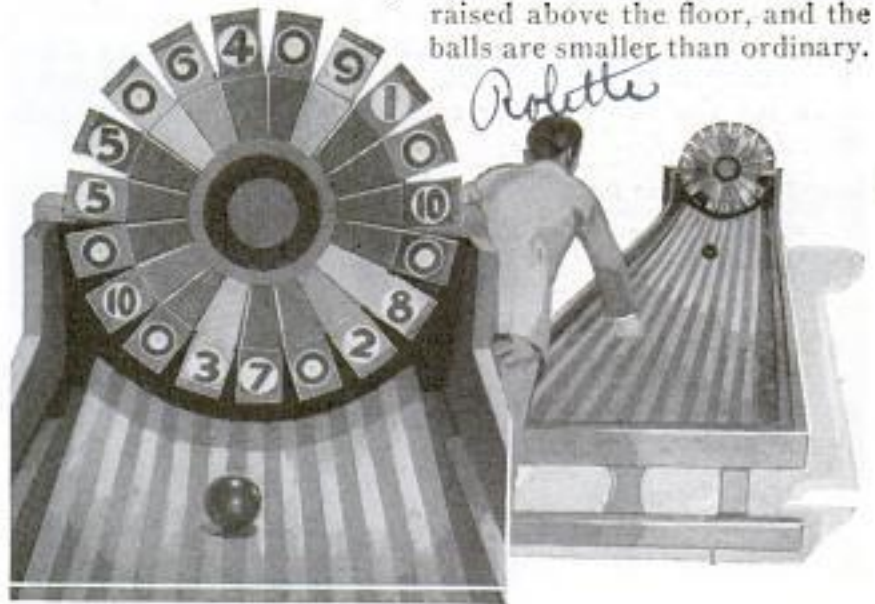

Electric Bowling Alley with the "Pins" Set on a Revolving Wheel; Considerable Skill Is Required to Strike the Number Combinations

Mrs. Fred Berkeley
 % Features, 145
 New York

a-296

Cuth C. Moran
3825-13th St N.W.
Washington, D.C.

The Search for a WONDER METAL

OUT of what cauldron of science will flow the wonder metal that will make possible bridges with an indestructible span of 5,000 feet? Airships light as thistle-down, yet dwarfing any thus far produced? Ocean liners more gigantic than the greatest of present-day leviathans?

Three hundred government scientists are working on this problem. During the past year, they have obtained and

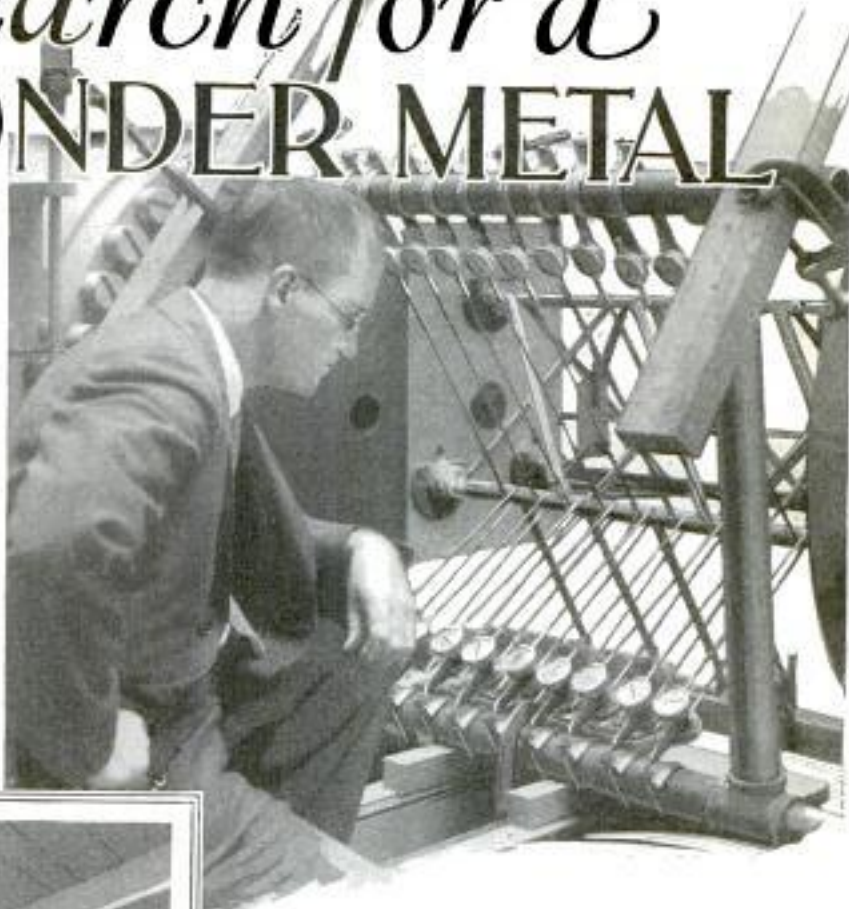

Above, Testing Duralumin Airship Girder Which Is Compressed While Eighty-Two Gauges Locate Any Weak Spots; Left, Apparatus Which Separates Liquid Metallic Substances into Their Various Elements



analyzed more than 10,000 specimens of rocks and rare metals, some of which were found 8,000 feet down in the ground. The metals are sliced into thin wafers for

study, and are then placed in electric furnaces to produce alloys that may possess the desired properties of strength, lightness and durability.

X-rays of the earth are being made to locate unknown metallic substances, and core samples of these materials are obtained by means of diamond drills. The X-ray photographs are made with seismographs which register the vibrations of natural and artificial earthquakes through different kinds of metals. These unknown metals are designated by numerals until the scientists have ascertained their elements.

The latest discovery in this field is the identification of element "No. 75." Dr. W. F. Meggers, of the bureau of standards, has named the substance "Rhenium 75," the figure "75" representing the number of electrons contained in the metal. He says that "Rhenium 75" is a thousand times more rare than gold, and constitutes

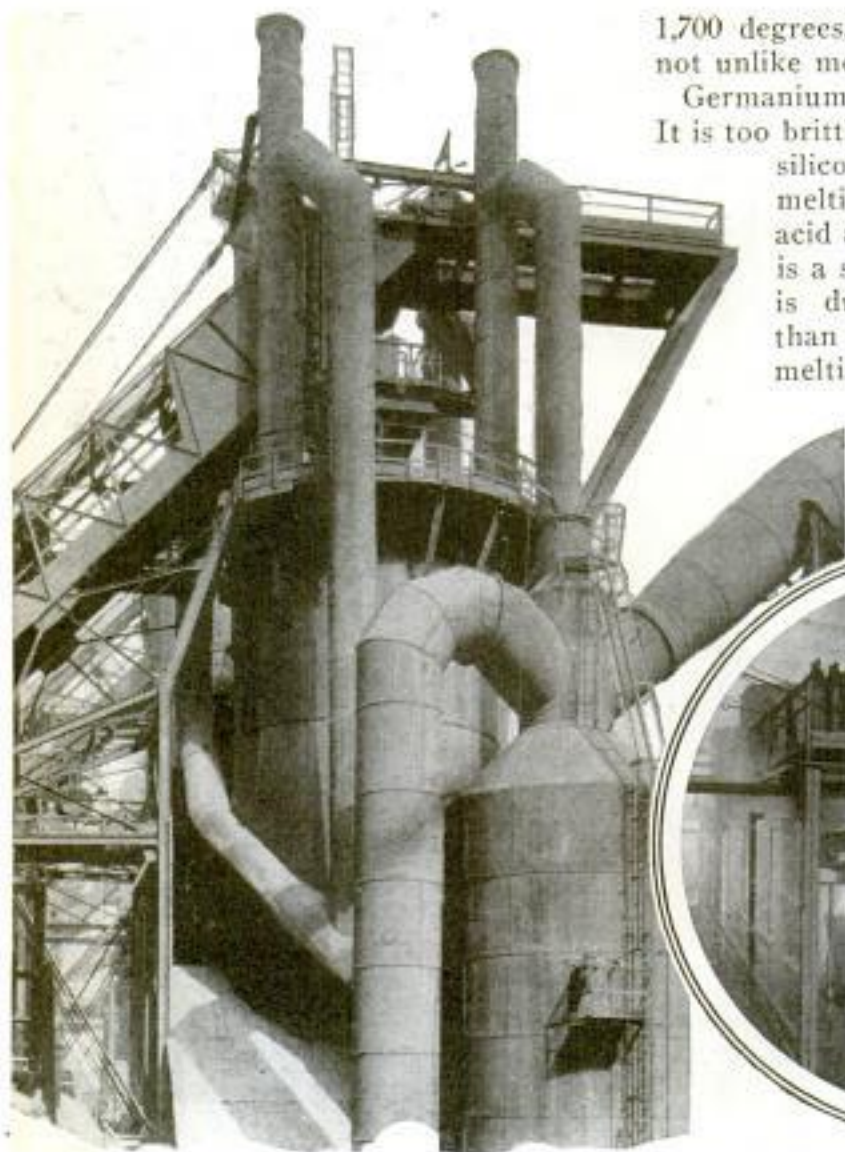

1,700 degrees. When molten, gallium is not unlike mercury in appearance.

Germanium is also a grayish-white metal. It is too brittle to be drilled. It resembles silicon in its brittleness, high melting point and resistance to acid and alkali solutions. Indium is a soft silver-white metal which is ductile and slightly heavier than zinc. Its comparatively low melting point, 155 degrees centigrade, and relatively high boiling point, 1,450 degrees, are unusual. Chemically, indium resembles

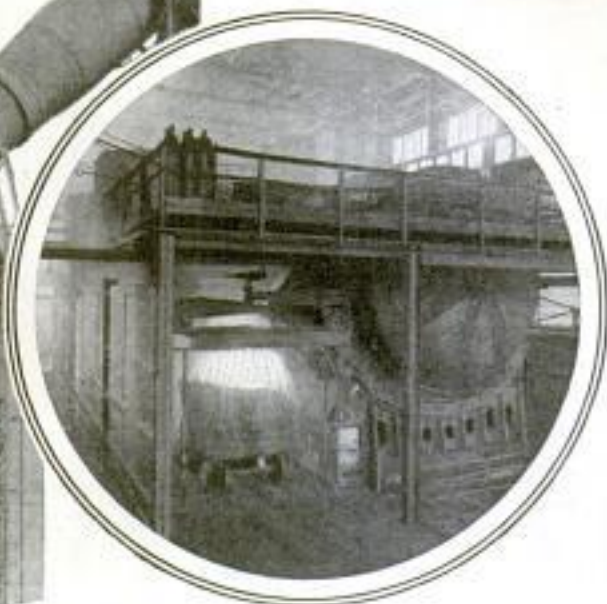

Left, Apparatus Used by Metallurgists to Reclaim the Metallic Substances from Low-Grade Ores and Waste Steel-Foundry Products; Right, Electric Furnace Where Steel Alloys Are Made

about one part in a million million of the earth's crust. Research will be made of the commercial utility of the new metal. Doctor Meggers has also begun the study of two, so far unidentified, elements, now known simply as "No. 85" and "No. 87."

In the search for new metals, hitherto unknown properties of metals already known are constantly being discovered, as in the case of gallium, germanium, indium and scandium. Gallium is a grayish-white metal which in certain lights shows a bluish-green color. The luster is brilliant and metallic but tarnishes quickly. The metal is tough, but is soft enough to be cut by a knife. Its most interesting property is the wide range of temperature through which it remains liquid. The melting point is about thirty degrees centigrade, and its boiling point is in the neighborhood of

zinc in some respects and is like aluminum and iron in others.

Aluminum alloys containing germanium have been prepared and tested. It has been found that the addition of small quantities of germanium to duralumin, "lantal" and "aludur" alloys, increases their strength and improves their rolling properties. Aluminum-magnesium alloys containing up to five per cent of germanium have been patented in Germany. Experiments are being made with the use of germanium in steel.

Two thousand samples of these and other structural materials, including cast iron, steel, alloy steels, ferro-alloys, brasses, bronzes, bearing metals, monel metal, and light aluminum alloys have been tested at the bureau of standards. Strength tests of models of the tower-column sections

A. 296

Aurgard

Complete 75.00

of the Hudson river bridge now being erected, also have been made. Two of these columns, made from ordinary steel, failed at loads of about 5,500,000 pounds, whereas two columns, made from silicon structural steel, withstood a pressure of about 8,750,000 pounds.

The investigators have learned that titanium, a metal used in the manufacture of steel, is abundant in nature but is not easily recognized. Out of 800 rocks examined, 784 revealed the presence of titanium. The element has been found in the volcanic dust of Mt. Pelee, in deep-sea dredgings, in ashes of certain coals and of different kinds of wood, in cow-peas, in cotton-seed meal, in the flesh and bones of animals, in the atmosphere of the sun and in many stars.

Titanium, resembling polished steel, is hard enough to scratch quartz. It forms alloys with most of the metals, but especially with copper, tin, iron, aluminum, chromium, cobalt, molybdenum and tungsten. It is used to alloy iron and steel, and in the making of fireworks because of the beautiful light that it produces during combustion.

Cobalt is a silvery-white metal, strongly resembling nickel in its appearance and properties, and is being used in the cobalt-chrome series of alloys known as "stellite." A new metal, called "konel," which contains cobalt, nickel and ferro-titanium, is said to be a satisfactory substitute for platinum in many of its uses. It was originally developed for use in filaments for radio tubes, but since it is harder than cold steel even when it is red-hot, it is adapted for a variety of uses, such as in the moving parts of internal-combustion engines.

u-424
ELECTRIC AIR FILTER SERVES AS WINDOW VENTILATOR

Operating from any wall outlet, an electric air filter for the home or office cleans the air which passes through it of dust and dirt, and at the same time keeps out street noises, it is claimed. The ventilator is contained in an oblong cabinet and consists of twin-blower fans operated by a small motor, an air filter to remove dirt, dust and pollen, and a sound filter to silence outside noises. The air-filter sheets



Office Equipped with Electric Window Ventilator, Which Filters the Air Passing through It

of paperlike material are replaced about once a week, when they become filled with dirt and impurities. The ventilator, by stopping pollen, proves helpful to sufferers from asthma and hay fever, and it may also be employed as a heat booster for a sluggish radiator, or fitted with a humidifier to assure proper vapor content.

u-405
GAUGE FOR BOAT PROPELLERS SHOWS PROPER SETTING

Determining the proper pitch for boat propellers often involves tedious calculation on the part of builders and operators. To make this task both easy and accurate, a gauge now shows the pitch, the fore-and-aft rake and the angles between the blades of propellers. In outboard racing, for instance, one pitch often makes a difference of 500 revolutions per minute, and in high-speed in-board craft, the taking of sharp turns may increase the pitch of the wheel propelling the boat, and in addition the blades may be bent. The gauge can be clamped



to the boat or to any handy upright support. The largest size will handle a thirty-inch wheel with shaft bore up to two and one-quarter inches in diameter.

Chicago - 20 N Wabash

\$11.25 - #13.00

Taken over by Aurgard Supply Co 609 N La Salle Chicago

American Air Filter Co. 1st and Central Ave. Chicago, Ill. 14.
Gray & Prior Machine Co. Hartford, Conn.

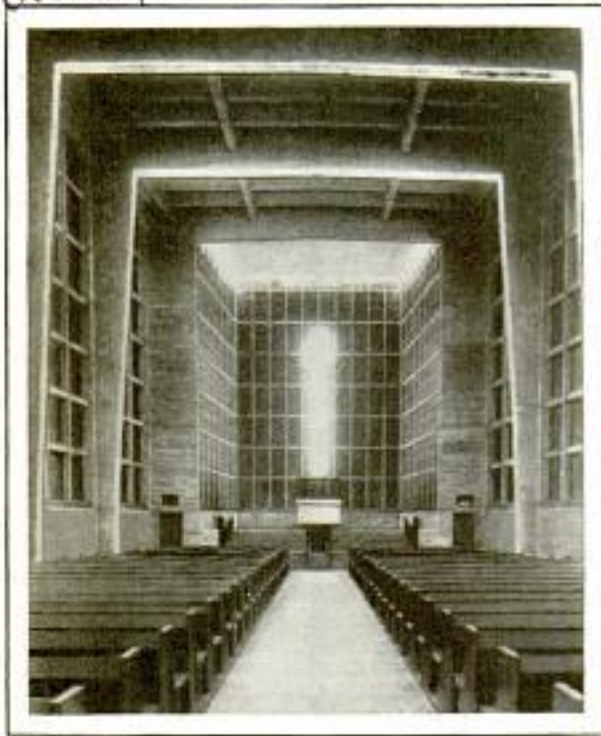

Auditorium of a Steel Church in Germany; Note Extreme Simplicity and Indirect Lighting

PLAIN LINES OF STEEL CHURCH SHOW MODERN TREND

Simplicity is being emphasized in the modern trend of architecture in Europe, and is nowhere better emphasized than in a steel church at Dortmund, Germany. A view of the auditorium reveals extreme plainness with no attempt at decoration to relieve the angles, the simple pews carrying out the same idea.

AUTOS CAUSE MORE FATALITIES THAN THE WORLD WAR

More lives were lost in the United States during the eighteen months ended Dec. 31, 1930, as a result of automobile accidents than by the American forces during a year and a half of the world war, a recent survey shows. During eighteen months of the world war, 50,510 American soldiers were killed in action or died of wounds. In the last year and a half, 50,900 persons lost their lives in automobile accidents in this country. The 1930 toll was estimated at 32,500, an increase of 1,200 over 1929, although gasoline consumption dropped more than a billion gallons in 1930. Men were behind the wheel in ninety-three of every hundred accidents in 1930. Whether the better record of women

is due to better driving, or not covering as many miles, is not indicated. In over half the fatal accidents, the drivers were between the ages of twenty-five and fifty-four. One-half of the fatalities occurred in collisions with pedestrians, one-fifth in collisions with automobiles, and about one-tenth in collisions with fixed objects. Over half the non-fatal injuries were from collisions with other cars. About nine-tenths of the killed and injured were victims of cars in good mechanical condition, and most of the automobiles involved in accidents were private passenger cars. Three specific driving violations accounted for sixty-eight per cent of the 1930 accidents. They were exceeding the speed limit, driving on the wrong side of the road, or failing to grant right of way.

LARGER HOME MOVIE VIEWS GIVEN BY NEW LAMP

Delivering a light intensity much greater than has been available previously, a seventy-five-volt 375-watt lamp has been produced for the ordinary sixteen-millimeter movie projector. This intense light for the amateur projection apparatus depends for results on a tremendous light concentration in a small area, and hence the lamps that produce more light than half a dozen sixty-watt bulbs are only about one-third as large as the ordinary bulb. Projectors using such a lamp can show black and white pictures twelve feet wide distinctly, and colors also can be shown on a larger screen than the ordinary. The light develops considerable heat, but a

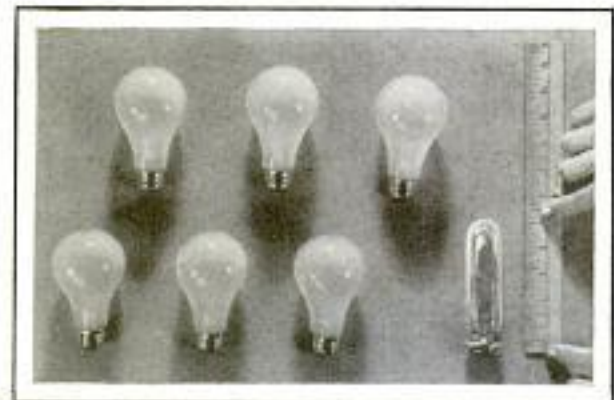

Tiny Movie Projector Lamp, Lower Right, Which Gives as Much Light as Six Bulbs Shown

projector equipped with an efficient fan-cooling system takes care of this situation.

Science Service 515-71 2/7/31

Harold C. Murray & Co. Hartford Conn

Bell + Howell Co. 1803 Larchmont, Chicago

LOST PEOPLE ARE SOUGHT ON ROOF OF THE WORLD



Courtesy Mejrabpom

Scientists Traveling among Ice "Ferns" in Pamir Mountains, Known as the "Roof of the World," in Search of a "Lost People"; Some Believe This Region the Original Home of the White Race

German and Russian explorers and scientists recently have been trying to solve the mystery of a "lost people" reported to inhabit a lonely mountain fastness on the "roof of the world," as the wild region in the Pamir mountains, back of the Hindu Kush range and the Himalayas of central Asia, is called. It is thought by many that this rugged region may have been the original home of the white races, or Aryan peoples. One theory is that these mountaineers are the remnants of an ancient civilization, perhaps allied to that which left buried cities in the Gobi desert, while others believe the people may be the descendants of the soldiers of Alexander the Great. Present day nomads tell a fantastic story of a strange people in these mountains who possess supernatural powers, but expeditions sent in the past have failed to find them, or even to penetrate the land of the Pamirs. The Russian and German cara-

van started from Turkestan and, at the approach to the Pamirs, enlisted the aid of a tribe of nomads who led them over the mountains and into the icy world on the roof of the globe where the people must live in the lowest valleys because of the rarefied air which, through a strange disease, takes a heavy toll of lives. Here the explorers traveled through great fields of ice "ferns," and after scaling a mountain peak 21,000 feet high, began their search for the lost people. Led by rumors and stories, the scientists crossed and recrossed the unknown country and uplands, invading mountainous wilds and apparently uninhabited regions, but failed to find any trace of the persons they sought. So sure are the scientists that there is some real foundation for the stories however, that another expedition already is being equipped to explore the "top of the world" even more thoroughly in the hope of actually meeting these peoples.

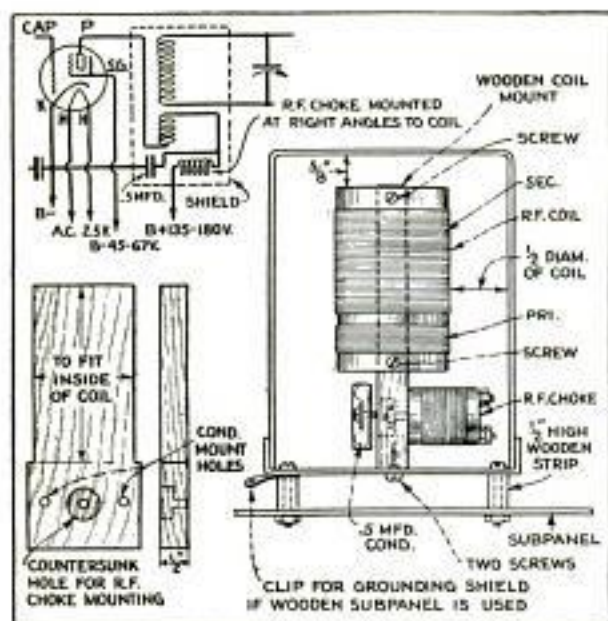

Increasing Gain of R.F. Coils

Screen-grid coils, both a.c. and d.c., must be carefully by-passed and shielded if maximum gain per stage is to be expected. The r.f. choke and by-passing condensers, shown in the diagram at the upper left, should not be omitted. Proper shielding is very simple as the coils are small and may be inclosed in aluminum drinking or measuring cups. It will be noted that the choke coil and the .5-mfd. condenser are also inclosed within the shield. The diagram for building this unit is self-explanatory and requires little comment. When a wood subpanel is used, it is a good idea to raise the shield, in the manner shown, so that the wires may be brought out of the shield base instead of running through the subpanel.

Portable Radio Key Is Mounted on Flatiron Base

A sending key, screwed to the operator's table, cannot be removed without leaving unsightly holes nor can it be moved to accommodate various postures the operator may assume when sending.



The writer made his key portable by mounting it on the base of an old electric iron. The base was painted with black enamel, and a covering of felt was glued to the underside. Care should be taken

to keep the ungrounded binding post under the key well insulated from the iron base. Mounted in this manner, it will remain in place and may be moved without scratching a polished surface.—Gilson V. Willets, San Francisco, Calif.

Raising Capacity of Variable Condensers

The radio experimenter will often find that he needs a variable condenser of higher value than those on hand. This difficulty is easily overcome by connecting a tested fixed-condenser of suitable capacity in parallel with the variable. For example, the writer had a .00025-mfd. variable on hand and needed a .0005 value in combination with it for shifting the wave bands in a small all-wave receiver. This was obtained by connecting a .00025-mfd. fixed condenser across the .00025-mfd. variable and cutting the fixed unit in and out with a knife switch mounted directly above the regular condenser dial on the front panel.

Heat Control for Soldering Irons

Soldering irons become pitted and burn out rapidly when operated on full line voltage. A control unit for one or more irons, using up to 250 watts, is now available, and the best working temperature may be had by adjusting a knob. Irons controlled in this manner may be left on the line all day without having to file the tips.



Locating Trouble in Push-Pull Amplifier

Where two type-245 tubes are used in push-pull and one shows a blue glow, that tube may be defective, or overloaded because the other tube is defective. Both tubes should be tested to determine which tube should be replaced.—Guy Newell, Bloomfield, N. J.

For further information on any radio construction article write to the radio department; this service is free.

You Can Build This Power Transformer

by S. H. Burns

AS THE power transformer is the very heart of an eliminator, it must be designed with care, and the windings should be of sufficient capacity to deliver the desired output without undue heating. The most popular power unit in use at the present time is one that will supply a set employing three r.f. tubes, detector, first a.f. amplifier and two type-245 power tubes in push-pull. The transformer described in this article will supply the necessary high voltage and required filament current for a set of this description.

Most of the new a.c. tubes use $2\frac{1}{2}$ volts, but it is necessary to separate the filament supply of some of the groups electrically, and this is easily done by providing separate windings.

Fiber is the best material for the spool ends detailed in Fig. 1, but heavy cardboard may be used instead if fiber is not available. A block of wood, $3\frac{3}{8}$ by $1\frac{1}{8}$ by $1\frac{3}{16}$ in., is required for the form. The block should be smooth so that it may be easily withdrawn from the coil when completed. A $\frac{1}{4}$ -in. hole is drilled through the block from end to end. A strip of heavy wrapping paper, $3\frac{3}{8}$ in. wide, is then wound tightly around the block until a thickness of $\frac{1}{16}$ in. is obtained. All but the first layer is now unwrapped and glue is applied to the inside of the strip, after which it is rewound, being careful not to get any of the glue on the block. The endpieces are cut and bent on the dotted lines and the flaps glued to the paper spool.

The primary of 440 turns of No. 21 enameled wire is wound first. Before starting this winding, refer to Fig. 4 and the assembly view, in which it will be noted that the terminals of the various windings are all brought out through holes drilled in the spool ends. Two small holes are required for each lead.



Thread the wire in and out of these holes and leave about 1 in. of bared wire, to which 12-in. flexible rubber-covered leads are to be soldered. These flexible leads are designated by various colors for the different windings. Wind the primary in an even layer and cover it with one layer of paper; the second layer is wound back over the first, as shown in the photo in Fig. 5. Proceed in this manner until the 440 turns are completed, counting the turns accurately, after which the coil should be wound with a layer of friction tape.

The high-voltage secondaries, for the type-280 rectifier tube, require wire of smaller diameter; this, No. 33 silk-enamel wire, need not be wound in even layers. A hand drill will be found helpful in winding this coil. Pass a threaded length of rod through the wood block and place a nut on the rod at each end to hold the block tightly. Insert one end of the rod in the drill chuck and clamp the drill in a vise so that the handle will be at the right and the coil at the left. Wind on 400 turns as evenly as possible and cover

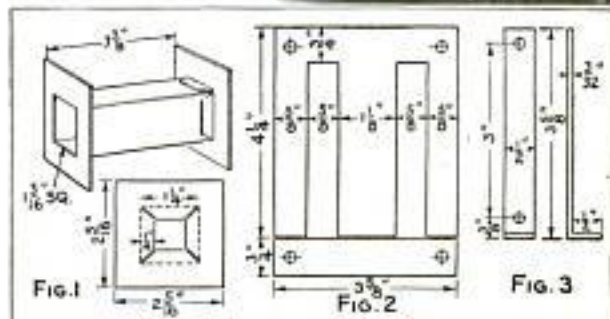

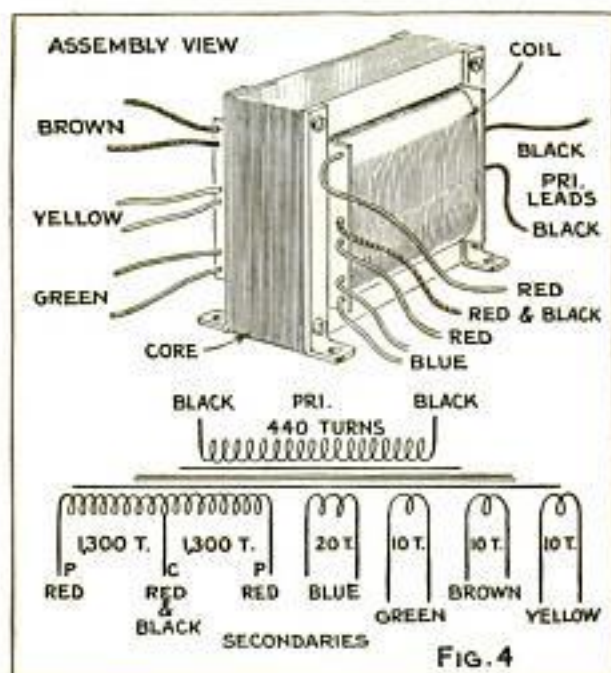

with a layer of paper; add 400 more turns and cover with paper, after which the 1,300 turns in the first half of the winding are completed. At this point, without breaking the wire, bare the insulation and solder on the red and black lead for the center tap. If color-code wire is not available, paint or ink may be used to identify the leads. Wind the second 1,300 turns in the same manner, and insulate both windings with a layer of friction tape.

For the filament-heater windings d.c.c. wire should be used. The 20-turn winding, the terminals of which are indicated with blue leads, is brought out on the same end of the spool with the high-voltage leads, as these leads supply the rectifier filament and should be kept together. This winding will take up about 1 in. of the coil; the three 10-turn windings are then wound on in the sequence indicated in the diagrams and are brought out as shown. The completed windings should now be covered with a layer of tape, after which the wood block may be removed.

The core laminations, cut as shown in Fig. 2, may be purchased in this standard stock size or they may be cut, with snips and chisel, from stock sheet as desired. Good 29-gauge transformer iron must be

used, and each piece cut to exact size, taking care to file away all burrs from the edges. The end laminations are very simple but the E-shaped ones require more care. The holes are not drilled until the core has been assembled. To fill the coil opening completely, about 80 of these laminations are required. Place the coil on its side and insert the E-laminations first in one end of the coil and then in the other, until the opening is full. At each end of the core now insert an end-piece between the E-laminations. The completed core may then be tightly clamped at each end, and the holes for the four mounting clamps drilled as detailed on Fig. 2. The mounting clamps, shown in Fig. 3, are made from four brass strips, $\frac{1}{8}$ in. long, and $\frac{3}{16}$ -in. holes, to match the holes in the laminations, are drilled to take four 8-32 machine screws, $1\frac{1}{4}$ in. long. Mount

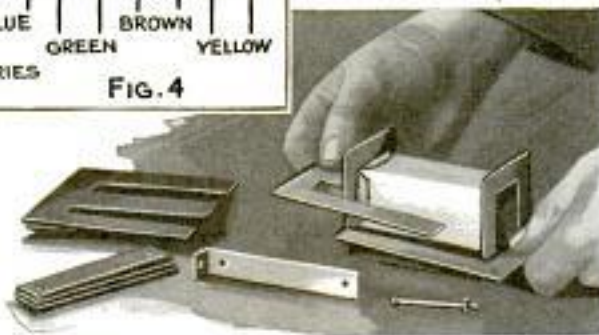

the footed brackets and draw up the nuts on the machine screws tightly, to prevent the laminations from vibrating.

To test the transformer for shorted turns, the primary is connected to the 110-volt a.c. line. Make sure that the various leads are well separated before turning on the current. The transformer is left on the line for about 30 minutes; if it has not heated to any extent at the end of this period, there are no shorts in the windings. Shorted turns will cause the transformer to heat very quickly, and the coil will smoke.

To test the secondary windings for correct output, the hookup shown in the head photo, and diagrammed in Fig. 5, is employed. When the primary is plugged into the 110-volt a.c. line, if everything is as it should be, the meter will indicate about 20 milliamp. flowing in the circuit. The transformer will deliver a total output of 300 volts at 100 milliamp., and with a current of 60 mils, the voltage will be about 150 volts. These data will enable the experimenter to determine other current and voltage combinations for his particular requirements.

stock size or sheet
Allegany Steel Co. Brackenridge Pa

The 20-turn winding supplies 5 volts for the rectifier filament, and the three 10-turn heater windings each supply $2\frac{1}{2}$ volts, which, at the rated current values, is sufficient to operate the groups of tubes specified in the diagram Fig. 5.

A suitable filter choke for use with this power transformer will be described in detail in a coming issue. This heavy-duty

choke will have an inductance of 30 henries when it is carrying 100 milliamp. Many chokes are available having an inductance of 20 to 30 henries or more, but few of them have this inductance value only when carrying comparatively little current. A power-supply unit, for a modern set, is often required to carry and filter at least 80 or 90 milliamp., and to do this,

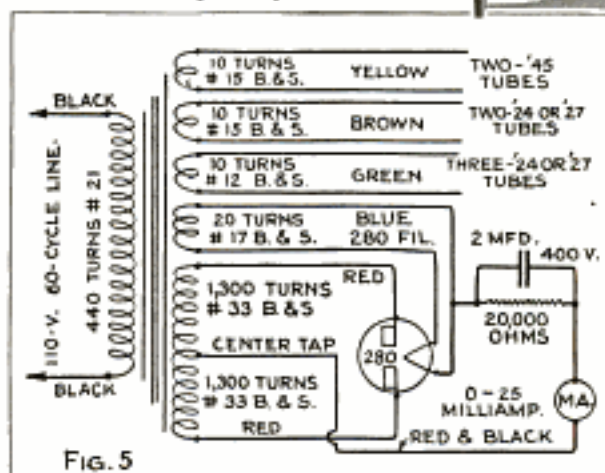
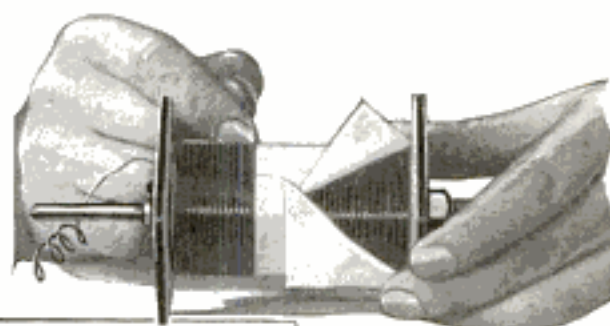

the chokes must be carefully designed.

With these simple units, which the experimenter can easily build for himself, an efficient power unit may be assembled in a very compact space. A diagram for building the complete power unit will be

included in the coming article describing the choke.

Volume Control for Remote Speakers

A 500,000-ohm variable resistor may be used to control the volume of one speaker without affecting the volume of others connected to the same amplifier line. To do this, it is necessary to cut the resistance winding at the center to provide a constant-impedance volume control. A piece of fiber is wedged and glued between the resistor halves to act as a stop for the double wiper arm. This arm replaces the original contact arm and is made from a strip of spring brass, cut and bent as

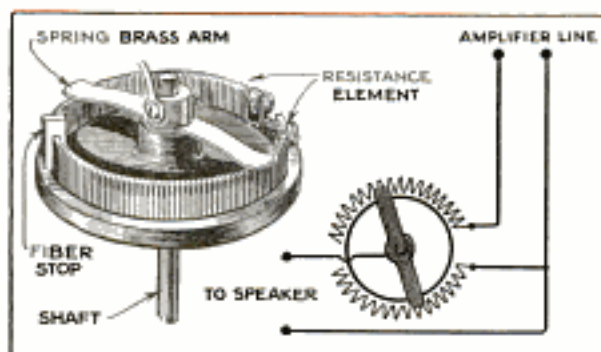

shown. A hole for the shaft is drilled at the center and the arm is held tightly

against the winding by means of the retaining bushing and setscrew. When connected in the amplifier line, both resistors may be adjusted at the same time, so that when one short-circuits the speaker to reduce its volume, the other is added to the line, maintaining it at a constant impedance.—D. A. Brown, Marion, Ohio.

Operating Tungar Battery Chargers

A friend of the writer had some difficulty with his tungar charger in which two 2-amp. bulbs were connected in parallel to give an output of approximately 4 amp. Frequently the charger would not deliver more than $\frac{1}{2}$ to 1 amp. for a long time and then would gradually regain the normal charging rate of 4 amp. Upon investigation it was found that one of the bulbs was inoperative, and a new bulb eliminated the trouble. Trouble of this sort is not limited to battery chargers alone but may also be experienced in any other circuit where two or more tubes are operated with their outputs in parallel. Proper choice of tubes is the remedy.—Ross J. Plaisted, Brecksville, O.

Simplified to your Radio

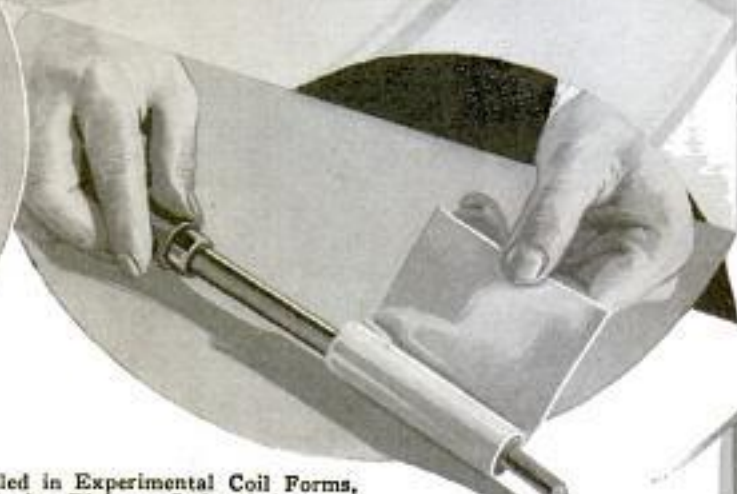

Above, Eyelets, Pressed into Holes Drilled in Experimental Coil Forms, Save Time and Provide Excellent Terminals; Right, a Strip of Asbestos Wrapped around an Electric Soldering Iron Will Bring the Iron to a Quick Heat for Emergencies, after Which It Should Be Removed

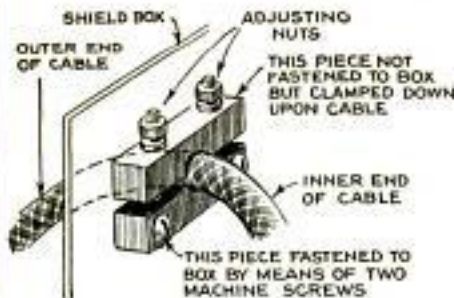

Two Pieces of Bakelite and Four Machine Screws Make a Good Cable Clamp to Prevent Strain on Small Wire Connections



Handy Test Push Button for Occasional Meter Readings, Made from an Open-Circuit Jack and a Piece of Bakelite Rod Cut and Mounted as Shown

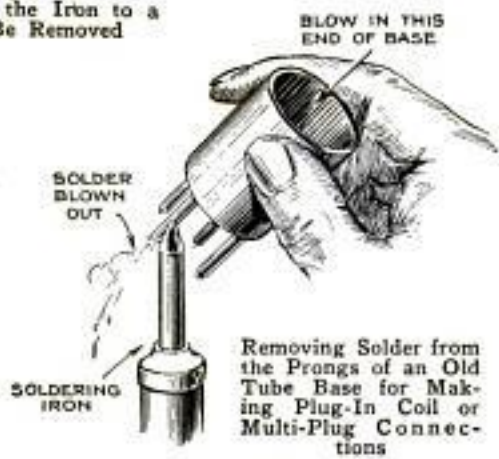

Removing Solder from the Prongs of an Old Tube Base for Making Plug-In Coil or Multi-Plug Connections

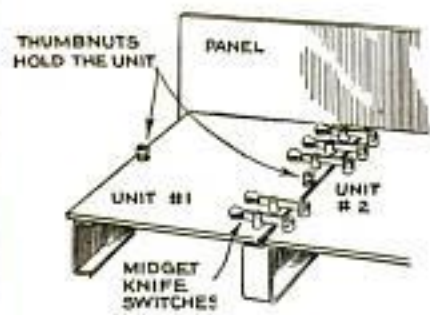

Interchangeable-Unit Idea for Experimental Circuits; Binding Posts May Be Used Instead of the Knife Switches if Desired

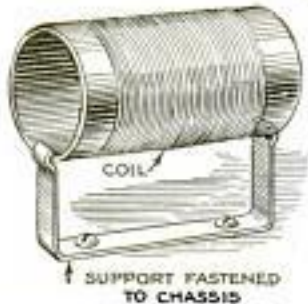
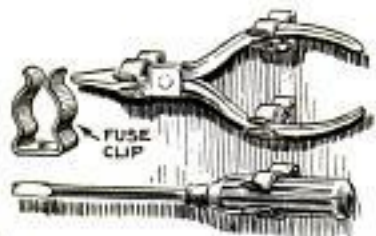

Fuse Clips Are Handy for Holding Tools on the Bench or in Portable Test Case; Left, Support for Inductance Coil Holds It Firmly, but Permits Quick Changes for Testing

Answers Problems



Tubular Resistors Make a Good Voltage Divider



Large Filter Condensers without Mounting Bases, of the Type Used in Transmitters and Public-Address Systems, May Be Mounted on Breadboard Layouts by Means of Metal Bands at Each End; Short Angle Brackets Hold the Assembly at Front and Rear

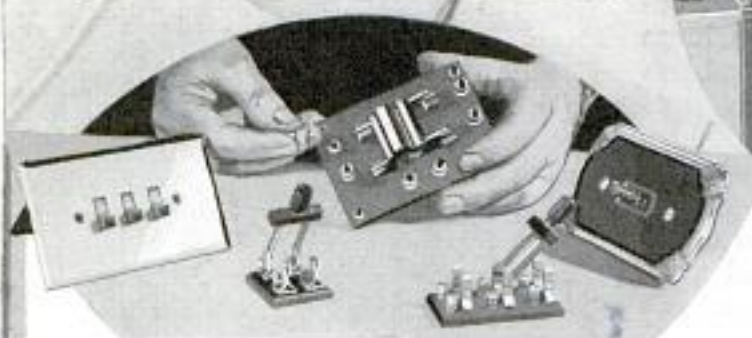

Three Handy Panel-Mounting Knife Switches Designed for the Radio Experimenter Are Shown in Center; Standard Wall-Plate Toggle Types Useful for 110-Volt Line Connections to Power Units, at Left and Right

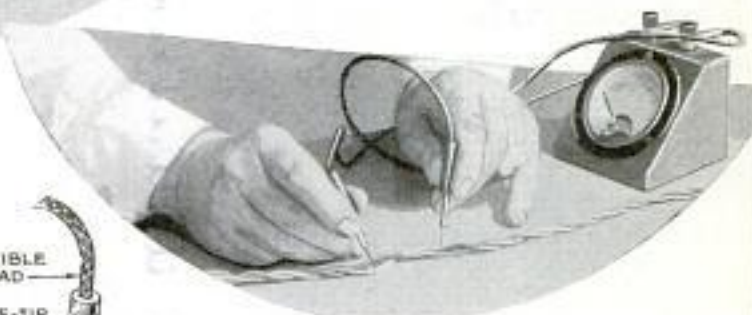

Breaks in Lampcord May Be Quickly Located with a Suitable Meter and Pointed Test Pins While Current Is On; Test-Pin Handles Should Be Well Insulated

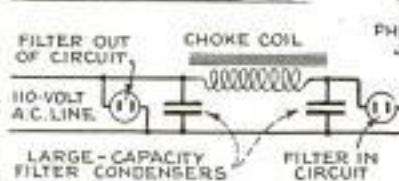
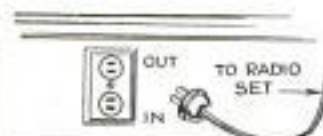

Above, a Duplex Wall Receptacle Used to Install an Interference Filter in a Concealed Position; the Filter May Be Plugged In or Out of the Line as Desired; Right, a Universal Test-Prod Arrangement; Flexible Test-Set Leads May Be Quickly Plugged In and Out of the Small Tip Jacks Mounted at the Top, Serving a Number of Useful Purposes Especially Where High Voltage Is Encountered

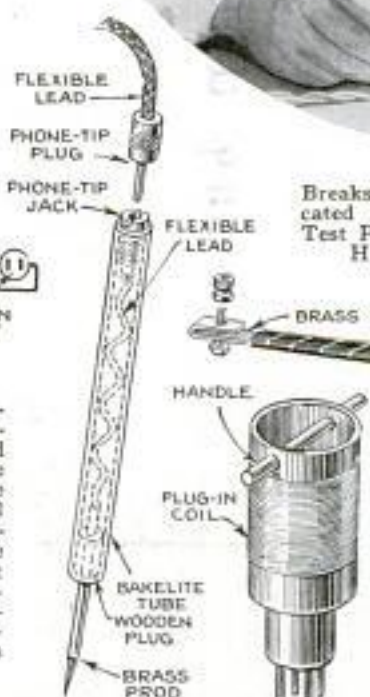

Above, a Homemade Insulated Window Strip for the Antenna Lead-In Employs a Copper Strip One Inch Wide and Twelve Inches Long; Left, Plug-In Coils Often Bind in the Sockets, and a Simple Handle Is a Good Protection against Damage to the Windings When Changing Coils for Various Wave Bands

Chicago - 9 S. Clinton

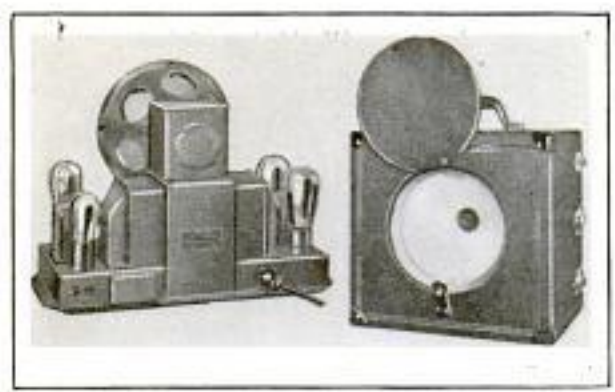

Combination Unit Showing Compact Assembly; and Cased Instrument with Speaker Cover Opened

A Portable Speaker-Amplifier

This small speaker-amplifier combination is designed for use where a large expensive installation is not warranted. In tea rooms, clubs and roadside stands it is particularly suitable because of its low cost and economical operation. It may be connected to the radio or phonograph to furnish greater volume for dancing, or used with a microphone and portable microphone-amplifier to form a low-power group-address unit.

Handy Uses for Radio Headphones

It is sometimes desirable to have both hands free while telephoning. This may be easily arranged with a pair of headphones as shown. One phone unit is removed from the headband and connected to the free end of the connector cord. The tips, where the phone unit was connected at the band, are then shorted and covered with insulating tape. When a telephone call is received, merely don the headband B and place the telephone receiver upon the face of the radio phone, as shown at A.



The insert shows two headphones in parallel to form a phone line. This works at distances up to 100 feet.

A Power Detector with One Audio Stage

A power detector to feed a single audio stage is very useful in building portable receivers where space is at a premium. A 171-A tube may be used as a detector, with 135 volts of B-battery on the plate, together with the usual gridleak and grid-condenser combination. The grid condenser should have a capacity of .0002 mfd., and the gridleak, connected across it, is a 1/4-meg. resistor. The volume obtained, with this combination, is very satisfactory and the tone quality excellent. The only disadvantage is a slight lowering of sensitivity, but not enough to cause trouble in a set of this type. Another advantage is that resistance or impedance coupling is not necessary, with this form of detector, and high-gain transformer coupling may be employed due to the low tube-plate impedance even with a high C-bias.—R. Wm. Tanner, Charlotte, Michigan.

Compact Antenna for Indoor Use

Having no connection to the house-lighting lines, this new form of indoor antenna eliminates all possibility of a.c. hum. It contains a number of feet of filtered antenna wire and condensers which are said to give it the capacity of 75 ft. of ordinary antenna.



Raising Electrolyte Level

Adding distilled water to make up for loss of liquid in a trickle charger usually results in a greatly decreased charging rate. If only a little liquid has been spilled it may be raised to the proper level by dropping glass marbles, or large glass beads into the jar. These will not interfere in any way with the operation of the charger. Purchase new electrolyte, if more than one-third is lost.

A. Moulton Corp. of America
new at 78 Cortland St.

new at 78 Cortland St.

W. Washington Ave. 549

Installing Auto Set

Part Two

by J.O. Barnes



THE COIL construction and assembly of the auto receiver described in Part 1 now completed, we are ready to finish the wiring and in-close the set in a suitable metal container for installation in the car. The simplified wiring diagram shows a view looking down on the chassis with the leads underneath indicated by dotted lines. The coil-shield cans and ganged-condenser unit are omitted. The gridleak and its condenser are shown in their relative position, but the multi-terminal plug has been shifted so that the various terminals could be indicated.

After all wiring under the chassis has been completed, the coil shields, together with the ganged condenser, gridleak unit and multi-terminal plug, are mounted on the chassis. The ganged-condenser frame is common with the rotors and, when mounted directly on the coil-shield cans, a ground to the negative side of the A-battery is obtained for all. In the actual wiring, as shown in the simplified diagram, resistor R_1 has been inserted in the positive A-battery lead for the detector and r.f. tubes instead of using it in the negative lead, as shown in the schematic diagram in Part 1. This enables the builder to use the chassis as the A-negative side, so that the resistor R_2 may be connected directly to it for the two audio tubes. The black A-negative lead, after passing through the switch, is connected to the chassis by means of a soldering lug under the mounting screw of the first r.f.-tube socket. Thus the filament supply to one group of tubes is controlled in the A-negative side, and the other in the positive, to save unnecessary wiring. All connections grounded to the chassis are indicated with the conventional symbol for ground.

Flexible insulated leads, terminating in clips for the caps on top of the r.f. tubes,

are soldered to the stators of the condensers C_1 and C_2 . The flexible lead to the cap of the detector tube is connected to one end of the

gridleak-and-condenser unit, the other end of which is connected to the stator of condenser C_3 . The trimmer condensers C_7 , C_8 and C_9 are connected directly across each of the ganged-condenser units, one

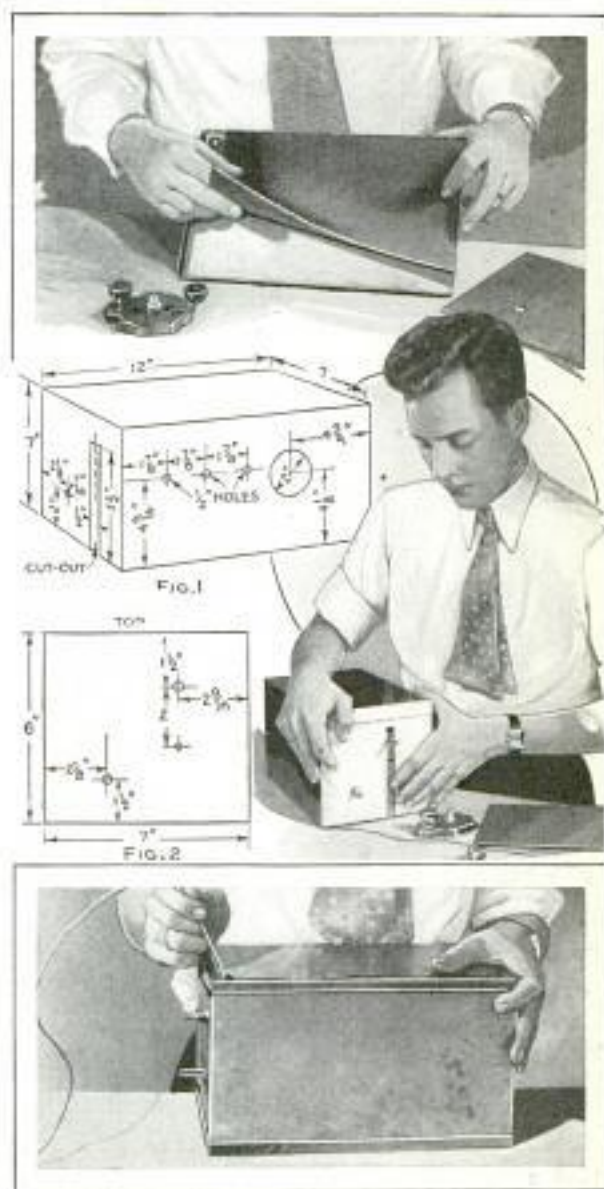

shaft and coupled to a length of $\frac{1}{4}$ -in. brass rod, so that the tuning dial may be mounted flat on the sloping instrument board. This idea is illustrated in the photo at the lower left on page 832. The set is held in position either behind the instrument board, or on the back of the front seat, by means of strap-iron brackets. This has been left to the discretion of the builder. The trimmers are easily reached through holes drilled in the side of the container, as shown in the head

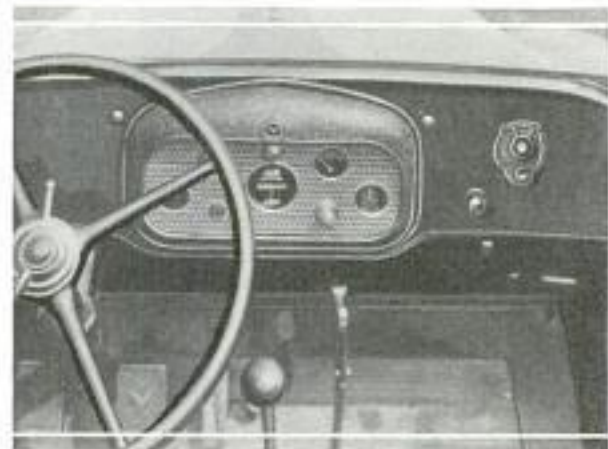
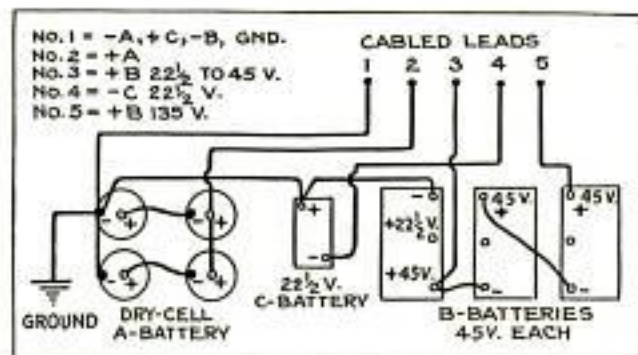

photo, for final adjustments when the set is installed in the car.

The B and C-batteries are placed in a metal box which is sunk through a hole cut in the floor in the usual manner. The dry-cell A-batteries may be placed under the seat or strapped under the cowl, as desired. Many new cars, especially sedans, are equipped with screen antenna. A good antenna device for coupes, or where the owner does not care to install one of the screen varieties, is illustrated at the lower right on this page. The closer the plate is to the ground, the greater will be the coupling capacity, but care should be taken that the plate will have sufficient clearance when the car is in motion. A good ground connection for the receiver

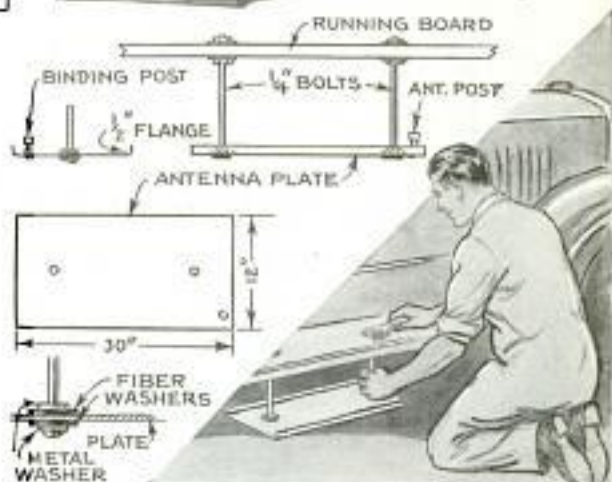

is obtained directly on the frame of the car. The speaker may be of the small magnetic type, baffled with wood or celotex as shown in the photo at upper left on page 832, or the homemade speaker described in the February, 1931, issue will give excellent results.

Shorts in Old A.C. Sets

In the older a.c. receivers the insulated leads from the power unit were often pressed tightly together under the chassis. The rubber insulation on these wires hardens and cracks with age causing short circuits. Trouble originating from this source often is attributed to shorted condensers in error.

BUILD YOUR OWN SELECTIVE BAND-PASS FILTER

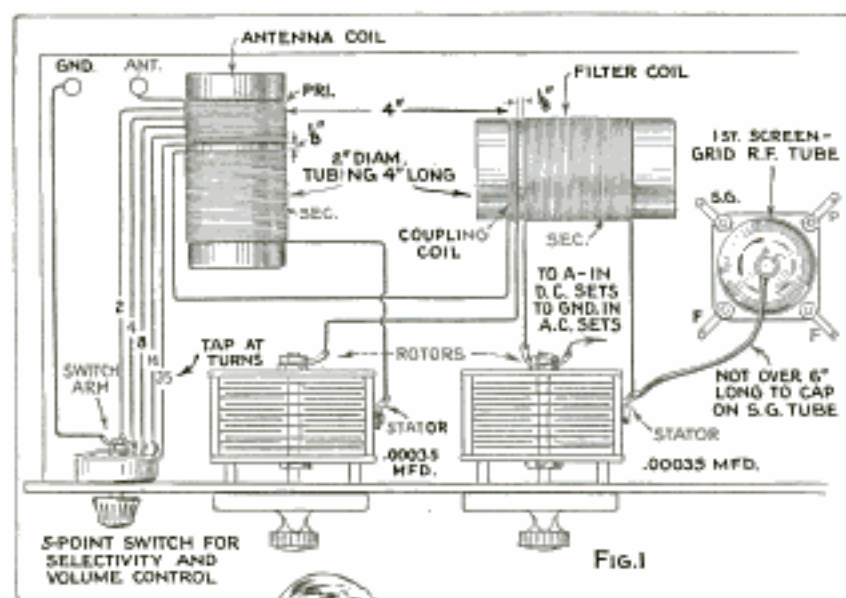

coil consists of a small coupling coil of 3 turns (see Fig. 1) and the secondary of this coil requires 80 turns. If .0005-mfd. variable condensers are used, the primary of the antenna coil is the same as before, but the secondary is reduced to 60 turns. The coupling coil will be the same but the filter secondary winding will also be reduced to 60 turns. The 5-point inductance switch helps

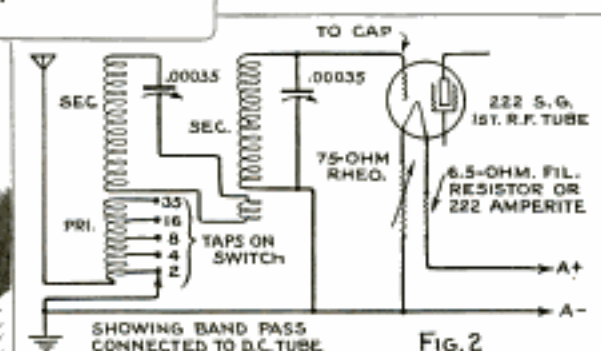

The writer has experimented with various types of band-pass filters and has finally decided on this simple arrangement. The coils are homemade and are mounted at right angles as shown in Fig. 1. They are all wound in the same direction and are spaced $\frac{1}{8}$ in. apart on each tube. The fiber tubing is 2 in. in diameter and 4 in. long; cardboard tubing may be used if it is first coated with shellac and thoroughly dried before winding the coils. No. 28 d.c.c. wire is used for all coils and a $\frac{1}{4}$ -lb. spool will be more than enough for the purpose. If .00035-mfd. variable condensers are available, the antenna coil is wound as follows: primary, 35 turns tapped at the 2d, 4th, 8th, 16th, and 35th turns. The secondary consists of 80 turns. The filter

out on the selectivity besides acting as a volume control if desired. This band-pass filter may be used with either battery-operated sets as shown in the diagram, or with a.c. sets merely by making the grid return to the chassis ground in the usual manner instead of to the negative-A as shown. The writer has received more stations with one screen-grid r.f. tube in the circuit with this device than with any other single r.f. screen-grid hookup, and thinks the idea good enough to be more widely known.

All the condensers can be ganged together, providing they all have the usual compensating condensers, but the first condenser for the antenna coil must have a small 13-plate midget condenser across it, and this midget must be controlled from the front panel. Shielding the two coils and their condensers in one shield will add greatly to the efficiency of the device. The connection to the screen-grid r.f. tube and the method of filament control are shown in Fig. 2.—Henry S. Laraby, New Haven, Conn.



Child's Swing Is Rowed Like a Boat

INSTEAD of being pushed by some one on the ground, this swing is actuated by pulling on the handle in the same manner as rowing a boat.

It consists of only five pieces of wood, cut to the dimensions given in the details. In assembling the pieces, it will be necessary first to insert the dowel pins into the uprights, 16 in. from the lower end, and into the holes provided in the seat. Then the tenons on the ends of the uprights are covered with glue and driven into the mortised holes in the hand and foot rails. Now, drill $\frac{3}{32}$ -in. holes through the rails and tenons and insert $\frac{1}{4}$ by 1 $\frac{1}{2}$ -in. carriage bolts through the holes in the hand rail, and $\frac{1}{4}$ by 2-in. bolts through the holes in the foot rail. Place a washer and nut on the end of each bolt and drive

the nut tight. Run lengths of $\frac{3}{8}$ -in. sash cord through the $\frac{1}{2}$ -in. holes in the rails and seat, tying knots in the rope on the underside of the lower rail and seat, to hold the swing securely. The ropes are to be suspended from the ceiling of the porch, attic, spare room or from a suitable frame built in the yard. Three

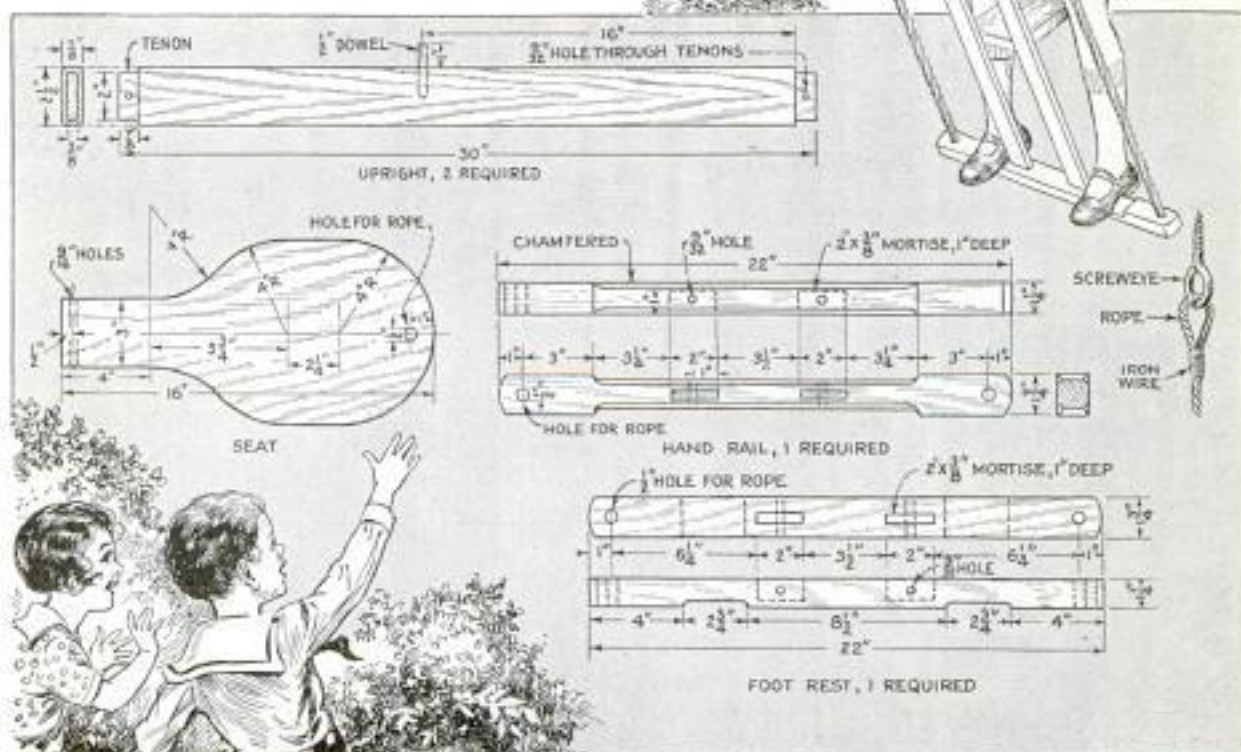

Rowing This Swing Gives Children the Thrill of Boating, and Provides Plenty of Exercise

large eyebolts are driven into the ceiling joists, and the upper ends of the ropes threaded through these, after which the

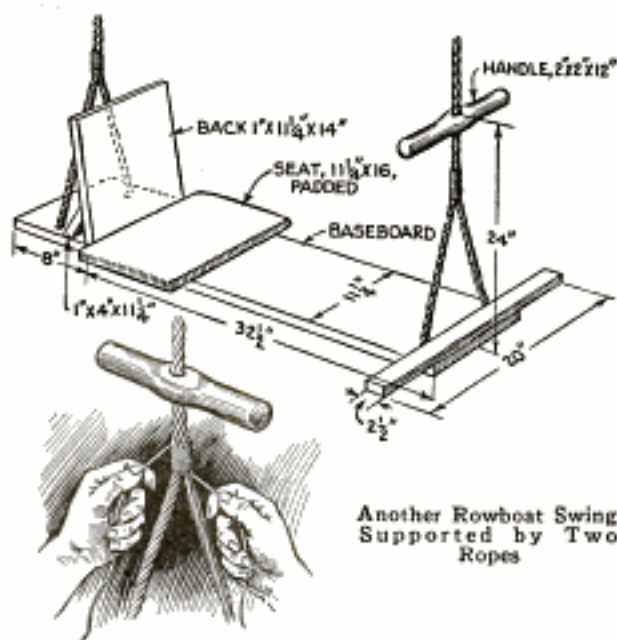

Another Rowboat Swing Supported by Two Ropes

rope is firmly spliced and bound with iron wire so that it will not come loose.

Another swing of this type, which varies a little in construction but works on the same principle, is shown in the smaller drawing. The seat should be padded for comfort, and iron wire is tightly wrapped around the rope where it is spliced. Be sure to tie a knot in the rope under each hole of the swing so that it will not slip sideways. In this case the handle is slipped over the front rope.

Wadding Ignited on Spark Plug

Being out of matches, a group of boys kindled a fire by igniting a gas-saturated wad of rags on one of the spark plugs of their car. A wire was bent at one end to form a hook to hold the wad. With the engine running, the wire was held against the motor block with the wad $\frac{1}{16}$ in. from the terminal as shown.



Making Model Rope Coils

If the surplus ends of halyards, lines and boat falls are neatly coiled on the deck of a model ship, the effect is much more realistic than if they are cut off at the point where they are fastened. A quick way to make such coils is to use transparent tissue paper, colored to match the deck and varnished. While the varnish is still wet, coil the rope upon it, using a long pin to form evenly spaced spirals. After the varnish has dried, use a pair of scissors to clip the paper off as close as possible to the outer spiral, and glue the whole in place on the ship's deck. If properly done, the paper will not show, and the coil is as perfect as though made with actual rope.—H. T. Bodkin, Chicago.

Improved Method of Hanging Window Screens

The disadvantage with the usual method of holding screens is that the small strips of molding tacked to the blind stop, over which the grooved edges of the screen are slid, warp and often break off, necessitating replacement. Remove this molding entirely and attach a strap-iron hanger in which a diagonal slot is cut as shown. Two holes are drilled through the lower end of each hanger for screwing it in place.

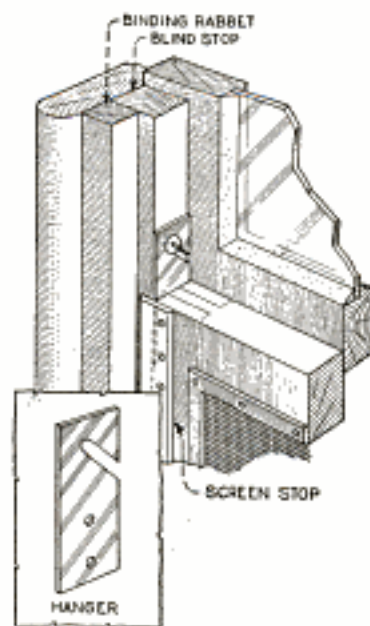

Ammonia Removes Furniture "Fog"

White marks left on tables or stands by flower vases or other objects can often be removed by wiping them with a rag wetted with ammonia and wrung out. After a thorough drying, the spot is rubbed with good furniture polish and the foggy stain usually disappears.

TWO TOWROPE KNOTS THAT ARE EASY TO LOOSEN

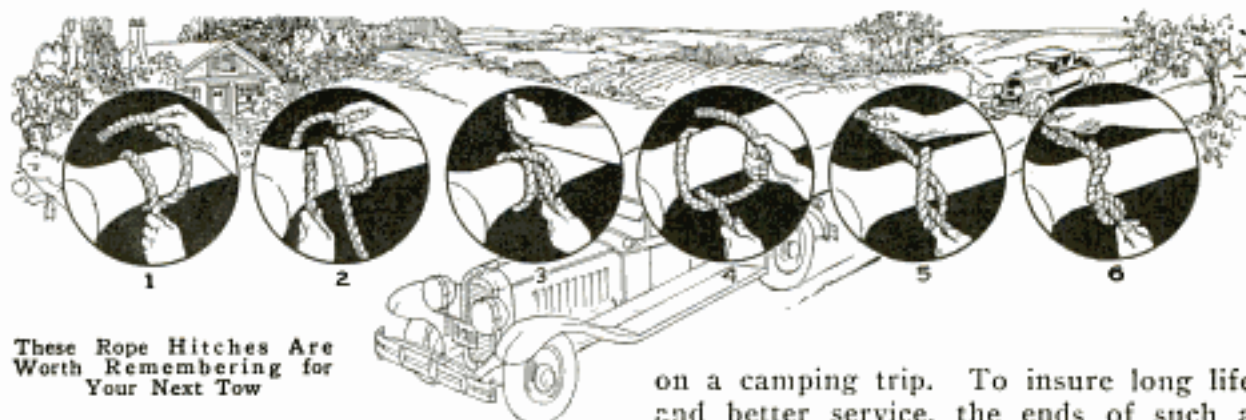

These Rope Hitches Are Worth Remembering for Your Next Tow

In fastening a rope to an axle or other part of a car, one usually wraps the free end about the main portion several times, ties three or four knots of one kind or another, and lets it go at that. Then, after the towing is over, the knots may have become so tightened that cutting the rope is the easiest way to loosen it. By learning how to tie the knots shown here, such trouble can be avoided. Details 1, 2 and 3 show how to form a simple "clove" hitch, the untying of which is a simple matter, as a jerk on the slack end of the rope loosens the knot. To appreciate this, try it on a cold day when your fingers are numb. In making a clove hitch, wrap the free end of the rope around the axle once, bringing it up on the right side. Then carry it across to the left and pass it around the axle again, running the end under the cross portion and drawing tight. The clove hitch is frequently used for tying pole scaffolding. Another kind of knot that you can use for fastening the towline, and one that sometimes works better with front axles and other parts that are not cylindrical, is the timber hitch, so called because it is widely used in hauling logs. The method of tying it is shown in details 4, 5 and 6. This knot, like the clove hitch, is easy to tie and is readily unfastened. Pass the rope beneath and upward over the axle once, bringing the end back and looping it about the main portion of the rope. Then wrap the end twice about the section, encircling the axle, and draw into place. Many motorists prefer a 16-ft. length of $5\frac{1}{8}$ -in. manila rope to the various hook-equipped cables, wire-woven ropes or chains, as a length of ordinary rope has the advantage that it can be used for other purposes, especially

on a camping trip. To insure long life and better service, the ends of such a rope should be tightly bound to prevent fraying. Waxed shoemakers' thread, fishing line or even a small-diameter wire may be used for this purpose. It is a good idea to keep the towrope in a small bag, where it will not be exposed to dirt and unnecessary wear.

Portable Posts for Supporting Temporary Fences

Where temporary fences are needed, a number of portable posts with heavy concrete bases, will be found useful. For a form, make a circular sheet-metal sleeve, about 2 ft. in diameter, 6 in. wide and slightly tapered from the bottom toward the top to facilitate its removal from the concrete. The form is laid on the ground, wide end down, and is partly filled with a rather stiff concrete mixture, after which

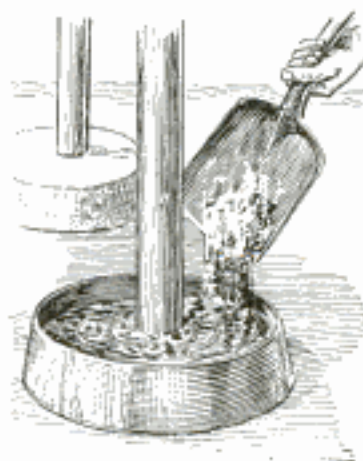

the post is set in position, and the form filled. When the concrete has been well tamped, the form can be slipped off for use again. It is advisable to reinforce the concrete with old wire laid

in circles around the post. Two high posts of this kind make good clothesline supports.

☛ Castor oil makes an ideal lubricant for the automobile transmission.

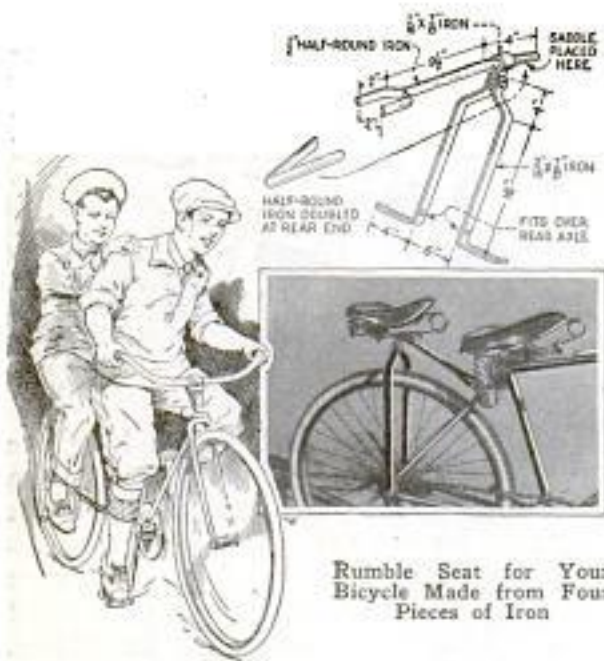

A Rumble Seat for the Bicycle

This neat bracket for carrying an extra seat on your bicycle consists of only four pieces of iron, attached with two bolts, and is as rigid as the bicycle framework itself. A little blacksmith work is necessary in bending the iron, which is best done while hot. The two uprights are made of $\frac{3}{16}$ by $\frac{7}{8}$ -in. flat iron, bent as shown and with footrests at the lower ends. A short bolt through a socket of $\frac{1}{16}$ by $\frac{7}{8}$ -in. iron at the top holds the horizontal member to which the saddle is attached. This horizontal member is made of $\frac{1}{2}$ -in. half-round iron, bent to form a fork at the front end. When completed, paint the frame to match the bicycle.

Clip Deflates Tubes Quickly

Made from a piece of spring brass, this tube deflator has been found useful and timesaving for the tire-service man. A short brass rod that will fit inside of the valve stem, is soldered to the center section of the clip to enter the end of the valve when the drilled ends are slipped over the valve stem. The ends, springing apart, lock the clip on the stem securely and the pin releases all the air.



Setting Bolts in Stone and Concrete

To fasten bolts in stone or concrete, sulphur may be used, but unless certain precautions are observed, the results may be unsatisfactory. Drill a hole for the bolt the same diameter as the bolt head. For bolts larger than $\frac{3}{8}$ in., the hole should be at least 3 in. deep. Dry out the hole thoroughly with a gasoline torch, or by dropping a hot bolt into it. The sulphur can be heated slowly in a ladle or suitable pot. If it should catch fire, smother it. Sulphur melts at about 246° F., and at this temperature is a thin liquid, but when the temperature is increased to about 320° it becomes very thick, making it hard to pour. Therefore, the sulphur should be heated until it is all melted, when it will be quite thick, and then allowed to cool until it becomes thin enough to pour into the hole. To fasten bolts in a concrete ceiling, where sulphur cannot be poured in this way, use a thick paste of litharge and glycerine, allowing this to harden thoroughly.

Potato Slicer Saves Time

Here is a simple potato slicer that will save the housewife considerable time. Take any ordinary knife and clamp the handle to the kitchen table as shown in the photo. By pushing the potatoes against the blade, while holding the end of the knife steady with one hand, a potato can be sliced in less than half the time required to do it by hand.



Water Preserves Lead in Pail

After cans of red or white lead have been opened, it is often difficult to seal them tightly again to prevent drying out. This trouble can be overcome by scraping the sides of the can inside to remove the lead that has accumulated there and covering the lead with water, which is poured off when the lead is to be used.

The Secrets of Trick Photography



Extraordinary Photo Effects, Interesting Both to Take and to Look At, Can Be Produced by Any Amateur; the Background of Fig. 2 Gives the Illusion Shown in Fig. 1

BESIDES providing interesting pictures for your photo album, the making of trick snapshots furnishes considerable amusement.

A very amusing stunt and something quite different from the usual faked picture is the big "bust-up" shown in Fig. 1. Apparently, the subject is due for a violent crack on the head, but thanks to the camera, which sometimes lies, he is perfectly comfortable. You probably know all about it from looking at the dead giveaway in Fig. 2. The camera shoots down on the subject from the top of a step-ladder. The subject rests on three pieces of wallpaper, which have been carefully placed on the floor. The ladder, a picture and a chair are so arranged as to give the observer the illusion of the wall of a room. Various other bits of "property" are appropriately placed. A small rug with a package of cigarettes, a box of matches, etc., is suspended on the real wall of the room, under the foot of the chair, which seems to rest on this false floor. Finally a piece of lumber is placed on the edge of the wallpaper to represent the base-board. After the scene has been arranged, the cameraman takes his place, the sub-

ject assumes a horrified expression, and the shot is taken. Either flash powder, natural or artificial light may be used, and the scenery can be modified to allow a considerable variety of effects.

Another unusual trick picture, which is very simple of execution, is the two-headed girl in Fig. 3. It is a freak that would delight the heart of a Barnum. But in reality, the person is quite normal. The subject takes a position for writing, with her head and shoulders bent to the right, her left arm held close to her body and the hand concealed below the table, after which a picture is taken. Then, without moving the camera, the subject bends her head and shoulders to the left. She also reverses the relative position of her hands, placing the left hand on, and the right hand, below the table. A photograph of this second position is taken on the same film. With a little care in the placing of your subject, you should get an effect like the one shown. The taking of these photos may be done either indoors or out, but it is advisable to keep the background very simple, otherwise objects on the wall or in the scenery may show through and spoil the effect. Another



Grotesque Shots Like This Two-Headed Girl Will Make Your Photo Album Attractive

form of double, which if not quite so grotesque is equally amusing, is the one pictured in Fig. 4, which shows a girl conversing with herself.

These double exposures were made with an ordinary box camera, with the aid of the two-door box shown in Fig. 5. It is made from cigar-box wood. The outside measurements of the camera are taken, and the inside of the box is made just a trifle larger, so that one end, which is left open, will fit snugly over the front end of the camera. One side of this end should be made slightly shorter than the other three sides to provide clearance for the shutter trip. The opposite end of the box is fitted with two small doors, hinged and fitted snugly. The interior is painted a dead-black, after which it is ready for use. The subject is photographed in one position with one door open. When the first shot has been taken the opened door is closed while the other one is opened, and a second exposure made on the same film. The camera should not be moved at all during the whole proceeding, and should preferably be anchored securely to prevent it from shaking. The usual exposure time is allowed, and the finished picture will appear similar in make-up to those shown. Any number of varieties of this theme, a man



about to shake hands with himself, boxing with himself, etc., can be done in a similar fashion. By holding the box so that the dividing line of the doors is horizontal instead of vertical, many other peculiar effects can be produced. You can mount the head of one person on the body of another; picture a tree growing from the waist-high figure of a man or you can photograph Barnum's original legless lady on a table. The exact method of producing likenesses of such monstrosities is merely a matter of taking two half pictures arranged to make a composite single photograph when the film is developed.

The making of black silhouettes on a white ground is a more or less familiar art to every camera enthusiast, but a variation of this effect is the white figure on a black background, as in Fig. 6. Select a good profile snapshot and cut it out neatly with a pair of scissors, as shown in Fig. 7. Take this cut-out to the dark room, where it is placed over a piece of sensitive photographic paper, as in Fig. 8, a small weight being used to hold the cut-out flat if it tends to curl. Make an exposure of about 20 seconds. Old photographs are not the only material that will serve to



make such silhouettes as practically any drawing or sketch can be attractively treated in the same manner.

An amusing little oddity in snapshots is the man with the blinking eyes. Take two portrait shots of the subject, one with his eyes open, and the other with them closed. No other part of the head should be moved in taking these two pictures, and the camera should also be kept in one position. Prints from the two negatives are thoroughly soaked and rubbed, on the back side, with a good grade machine or olive oil until they become quite transparent. Then they are pasted together at the top and bottom with a narrow strip of paper as in Fig. 9, with the "eyes-shut"

A Photo, Which Blinks at You, Consists of Two Separate, Transparent Prints

print on top. Be sure to make the faces to coincide accurately, especially the eyes. Hold the assembly in front of a bright light, with the "eyes-shut" picture facing you. By pressing the two pasted ends together a little, so that the photos become slightly separated, and then releasing them, you will see the subject open and close his eyes in a manner that is quite deceiving and realistic. In many cases extremely humorous effects can be obtained by arranging prints in this way.

Silencing Rattles in Auto Gauges

When the glass which covers the dial on dash gauges becomes loose and rattles, do not attempt to take the gauge apart in order to remedy this condition, but run some shellac between the glass and the edge of the metal retaining it. This can be done with a small brush or a toothpick. If circular in shape, the glass should be turned around in order to spread the shellac evenly, as it can be run in only at the lower edge.

Renewing Typewriter Ribbons with Stamp-Pad Ink

A typewriter ribbon that has become dim from long use can be restored by brushing stamp-pad ink over it while winding it up on one of the spools. Do not apply too much ink as it will then smear. Let the ribbon stand a while be-

fore using, so that the ink will be spread evenly over the surface.—Bennett B. Smith, Baldwin, Kans.

Umbrella Rib Keeps Cupboard Doors Closed



Cabinet doors can be made to close automatically with the aid of an old umbrella rib attached to the inside of the door and cabinet as shown. Staples are used to hold the rib. The tension on

the rib will close the door as soon as you let go of it.

THIS MODEL ZEPPELIN PROVIDES A HOME FOR BIRDS

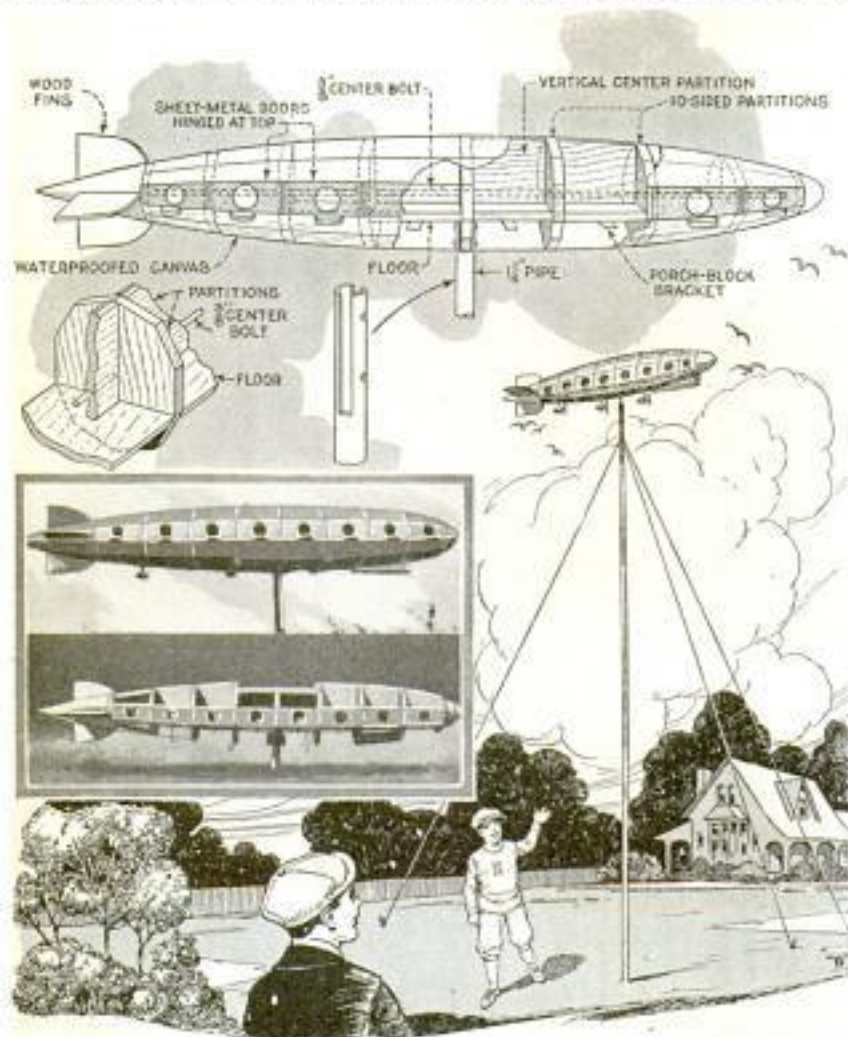

Mounted 24 Feet above the Ground, This 7-Foot Zeppelin Serves as a Weathervane Besides Being a Spacious Birdhouse

This Zeppelin-type birdhouse has a wooden framework and is covered with waterproofed canvas. To make the frame, cut nine 10-sided partitions from 1-in. stock. These vary in size from $12\frac{1}{2}$ in. for the center one, to 6 in. for the end ones. A $\frac{3}{8}$ -in. hole is drilled through the center of each, and they are then threaded on a long $\frac{3}{8}$ -in. bolt. A vertical partition and a floor are added, which divide the ship into 16 compartments. The center partition is set in a deep slot cut in the end of a length of $1\frac{1}{4}$ -in. pipe, which projects a few inches below the ship, so that it can be set on the end of a mast upon which it can turn freely in the wind to serve as a weathervane. The center bolt passes through holes drilled in the projecting lips of the pipe, while another shorter bolt holds the center partition to the pipe in the same way. Sheet-metal doors are provided for each compartment to make

it accessible, each door having a cut-out to allow the passage of birds. Small brackets are extended outward from the frame to hold porch blocks for the birds to alight on. Both the nose and tailpiece are made up of blocks of wood, cut to shape, and wooden fins are screwed to the tailpiece, after the canvas covering has been stretched over the frame. If desired, a wooden passenger cabin and five small gondolas, made of large spools and provided with aluminum propellers, can be added. The canvas covering should be waterproofed with two coats of spar varnish followed by a coat of aluminum bronze. The ship shown here was made 7 ft. long and was mounted on a well-braced pipe mast, which held it about 24 ft. above the ground. The pipe nipple

on the ship extends 2 or 3 in. over the mast, which in turn, butts up against a bolt passing through the nipple.—Roy J. Chivens, Cameron, Mo.

Auto Generator Runs Pump

On cars that have their water pumps connected directly to one end of the generator, the breaking of a fan belt is not so serious as it might be because the generator can be used to run the water pump. To do this, merely remove the cover from the generator cut-out—the little black box on the top of the generator. Inside are a pair of breaker points. Bringing the points together will run the battery current into the generator, and will make it operate like a motor. A broken match can be used as a wedge to hold the points together. The current required is only a little more than that needed to run the headlights,

and therefore this method can be used with safety for a limited period.—C. A. Packer, Chicago.

A Remedy for Mildew on Rose Bushes

For curing powdery mildew, a common disease of rose bushes, which is indicated by small ash-colored spots on the leaves, use a mixture consisting of sulphur, 1 part, and lime, 5 parts. This should be dusted on the plants twice a week in the afternoon and washed off the following morning. The treatment is also effective in combating the disease on lilacs, zinnia and other plants.

Hook Prevents Ladder from Slipping

When ladders are used on cement walks and drives, greater safety against slipping can be obtained by the use of a hook which anyone can easily make from a length of iron rod. One end is bent over at right angles and ground to a point. It should be at least 6 in. long and is driven into the ground, while the other end is bent over to form a "U", which is slipped over the lowest rung of the ladder. This holder has been found effective when used in sod or hard soil but cannot



Iron Hook Driven into the Ground Keeps Ladder from Slipping on Cement Walk

be relied upon when hooked in loose sand.—A. L. Kaser, South Bend, Ind.

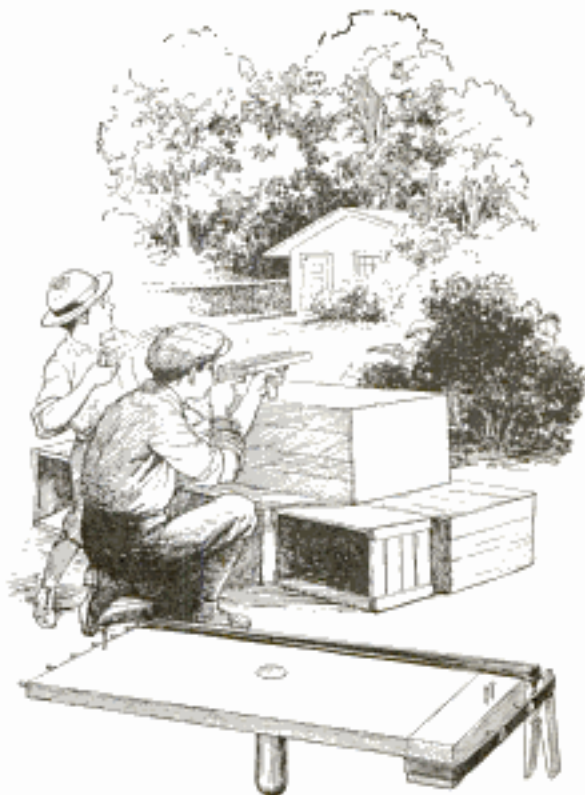

Boys Can Have Spirited but Harmless Battles with a Number of These Rubber-Band Guns

Boys' Rubber-Band Machine Gun for Backyard Warfare

Using old packing boxes as machine-gun nests, boys can have some spirited but harmless battles with a number of rubber-band machine guns made as shown in the illustration. A piece of $\frac{3}{4}$ -in. wood is cut about 6 in. wide and 12 in. long. It is provided with a handle made of broomstick, which is glued and driven into a hole drilled for it in the center. A piece of wood, 6 in. long and $1\frac{1}{2}$ in. square, is nailed to one end, and a number of spring clips are screwed to this piece so that one jaw is stationary and the other movable. A rubber band is slipped over the movable jaws of the clips and the piece to which they are attached, in order to increase the pressure, two or three nails being used to hold the band in place. The ammunition consists of rubber bands, $\frac{1}{4}$ in. wide, cut from old inner tubes. Each band is held at the muzzle end by slipping it over the end of a finishing nail, and inserting the other end between the jaws of a clip. Sights of small finishing nails are driven into the top for better aiming.

For removing fruit-jar covers, use a piece of inner tube in the hand.

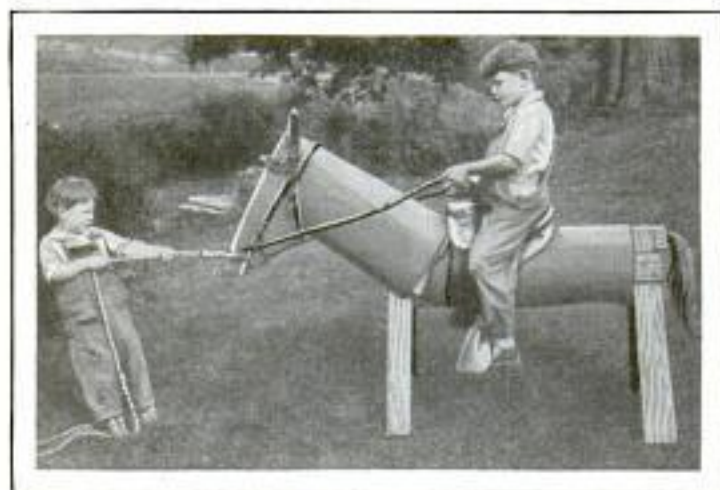

Outdoor Play Horse Can Be Made from Carpenters' Wooden Horse and Roofing Paper

Making a Play Horse

Any wooden carpenters' horse can be transformed into an attractive play horse by nailing on a wooden frame to represent the neck and head, at one end of the horse, and then cover the body, neck and head with pieces of heavy tar or roofing paper rolled over and tacked as shown in the photo. Strips of the same material are cut to form the ears, and a suitable tail is provided. A few scraps of leather harness or belting are used to make the bridle and the saddle, which may even be fitted with stirrups to please the boys still better.—Rene Bache, Washington, D. C.

Backstop Holds Books in Line in Bookcase

When your bookshelf is too deep for a set of books, and they may be pushed back too far to be easily removed, use a backstop as shown in the drawing. It consists of a piece of 1 by 4-in. wood cut to fit



across the inside of the case, directly behind the books. When these are lined up along the front edge of the shelf, the distance between the stop and the back of the case is measured, and cleats, cut to fill this

space snugly are nailed on to keep the stop in place. This will also make the shelf look orderly.

To Write on Glass

To write with ink on glass, prepare it as follows: First wash the surface with a good cleaning powder, rinse with water, then rub dry with crumpled newspapers or paper towels. Next prepare a varnish of dammar gum, 8 grams; gum mastic in sheet form, 5 grams, and alcohol, 80 grams. Dissolve the gums in the alcohol and filter, then keep in a tightly corked bottle. The varnish is brilliant, hard and transparent. To apply it, hold the glass in the left hand and pour some varnish in the center. Tilt the glass quickly in all directions to spread the varnish evenly. Drain the surplus into the bottle from one corner. Never brush the varnish on, as an even coating cannot be obtained in this way. The liquid dries quickly and forms an excellent surface for inks.—J. C. Tobias, Bethlehem, Pa.

How to Keep a Drink Hot

When necessary to keep a drink hot for several hours, try the following method:

Get a 1-lb. coffee can and a jelly glass, each having a cover. Cut an opening in the lid of the can to receive the glass snugly as shown in the drawing. Heat the liquid to be kept hot, to the boiling point, pour it into the jelly glass carefully,



taking the necessary precautions to prevent it from cracking due to too sudden application of heat, and then pour boiling water into the coffee can through the opening in the lid, which is pressed on tightly. Replace the lid of the glass and set the glass in the opening of the coffee can. You will find that the liquid will be kept hot for five or six hours.

IMITATION paneled TILE FOR BATHROOM FINISH

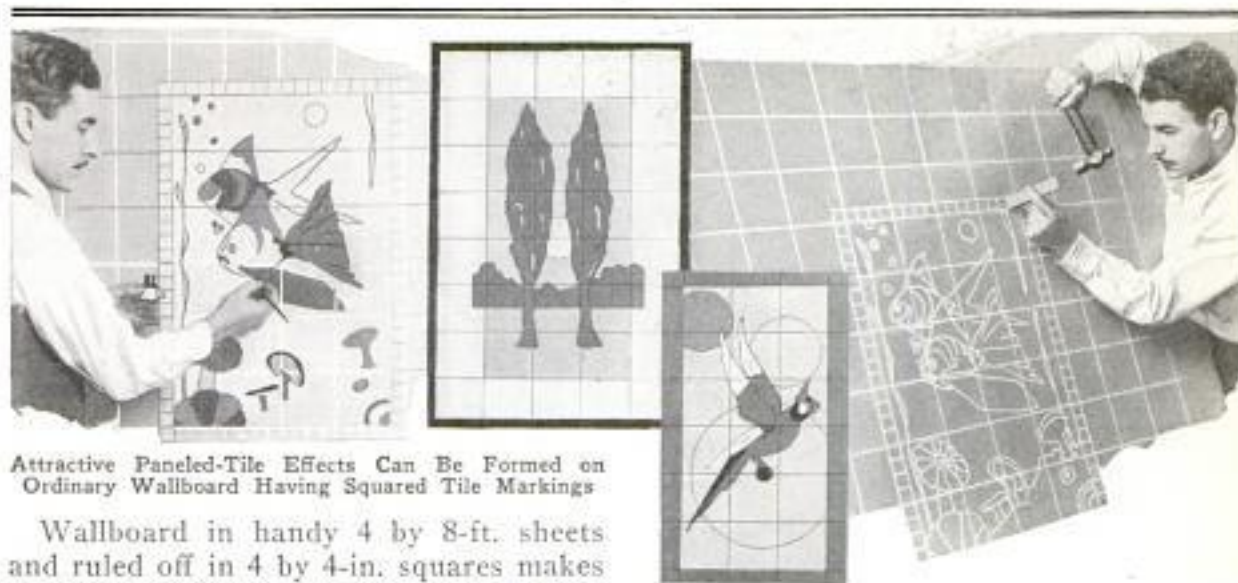

Attractive Paneled-Tile Effects Can Be Formed on Ordinary Wallboard Having Squared Tile Markings

Wallboard in handy 4 by 8-ft. sheets and ruled off in 4 by 4-in. squares makes an excellent finish for the lower half of the bathroom, kitchen, hall or, in fact, any room. It gives an imitation-tile effect which, when embellished with suitable designs, will greatly improve the appearance. The hardness of the average paper wallboard is not so great but what decorative design can easily be marked into the surface with a round-pointed hardwood stick. Select a fairly large expanse of wall where the plain tile effect of the manufactured board might prove monotonous. To relieve this, a panel may be centered in it, using some design in keeping with the nature of the room. The squared lines in the photos indicate the regular 4-in. tile markings of the wallboard, so it is easy to outline the picture. After the pencil sketch has been made, take a smooth, round-ended stick, such as a penholder, and with firm pressure, go over the lines of the picture so that the stick will leave a fairly heavy mark, as shown in the lower detail. All straight lines are followed by drawing the marking tool along a straightedge. The curved lines are then made free-hand. Any hard places in the board, which will not pack down to form a depression, may be made by tapping on a round-ended stick of the proper width, as shown in the upper right-hand detail. This method is especially useful to form short lines which are re-



peated throughout the design. The general effect, when completed, is a picture incised in tile blocks. Care must be taken, however, to keep the lines the same depth as the tile markings. The board may be nailed or cemented into place on the wall and painted an over-all color of, say, light cream, or the painting job completed before the board is fastened. At any rate, after the base coat has dried, the various colors for the panel can be painted in and, after they have dried, the various tile markings striped in black with waterproof india ink. This is best done with a ball-end pen of a size to neatly fill the tile markings. Finally a coat of spar varnish

is applied over the painted surface to provide an even glossy finish. Two simple panels, which are suitable for either kitchen or bathroom, are shown in the center details. Where a whole panel is not practical, different squares may be paneled to form a uniform effect, such as merely two diagonal lines on alternate squares.

In producing repeats of very small designs, time and effort can be saved by making a wooden form to exact size from round-edged strips of lumber. This is then used with a hammer. A stop block can be devised to make the lines all of uniform depth. Such paneled-tile effects greatly enhance the appearance of a room.

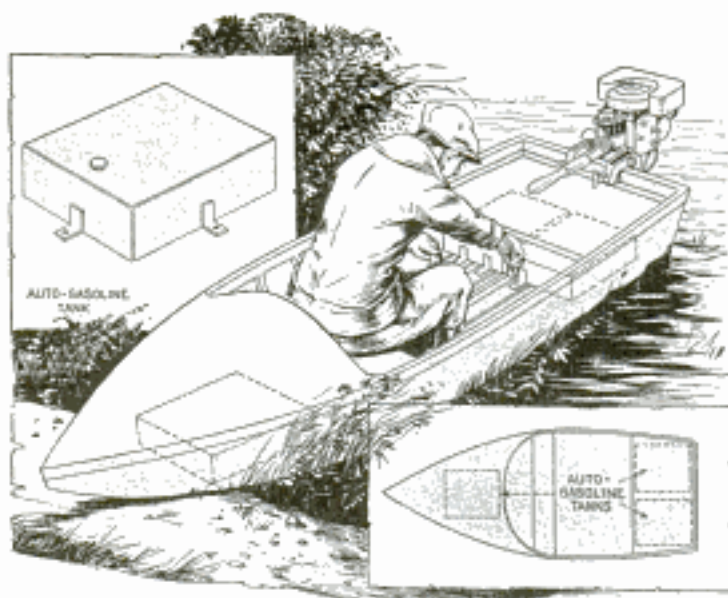

Discarded Auto Gasoline Tanks Make Excellent Air Chambers for Small Boats

Auto Gas Tanks Make Small Boats Unsinkable

To keep small boats afloat if overturned, two or three auto gasoline tanks will prove effective. Angle braces, soldered to the outside of the tanks, are screwed to the floor or sides of the boat to keep them in position. Tanks used under the front seat of model-T coupes are especially suitable for this purpose. They must be airtight and their outlets soldered shut.

A Duplex Frame for Photos

For holding a pair of small framed photos, the illustrated frame can be made by any home craftsman. It consists of a suitable base, a center upright and a cross-piece at the top. The size of the frame, of course, depends on the size of the photos it must accommodate. In the center of the top and bottom members of the photos a small hole is drilled to fit dowels projecting



from the base and upper cross-piece of the frame, so that the pictures can be turned at any desired angle.

Etching Solutions for Copper and Other Metals

For etching copper, a solution is made from perchloride-of-iron crystals dissolved in water in an earthen jar until the mixture tests 38 to 40° Beaume. The same solution testing 35° is good for etching on brass. It should be filtered through cheesecloth before using. A perchloride-of-iron solution, testing 35°, with some hydrochloric acid added, can be used for etching aluminum, the proper proportions being 2 lb. of iron in 40 oz. of water with 2 oz. of hydrochloric acid. A 40° solution of the same kind is good for steel etching. Another solution for this purpose consists of 5 parts of acetic acid and 1 part of fuming nitric acid diluted with distilled water until the etching is reasonably rapid. In making these solutions, do not neglect the precautions to add the acid, drop by drop, to water; never water to acid.

Paintbrush Holder and Covers Made from Paper

When a small can of shellac or paint is used frequently, so that the brush must be kept in the liquid, a corrugated cardboard holder for it will serve to keep dust out. It also prevents the brush from drying.



How to Preserve Leather Bindings

Leather bookbindings can be kept in good condition for many years by applying a dressing made of equal parts of neat's-foot and castor oil. The oil may be rubbed into the leather by hand or with a soft cloth. After the treatment, the books should be placed in a warm room for a day or two. The dressing should be applied when the books are new and treatments repeated about every 2 years.

THESE GARAGE DOORS ARE CLOSED FROM YOUR CAR

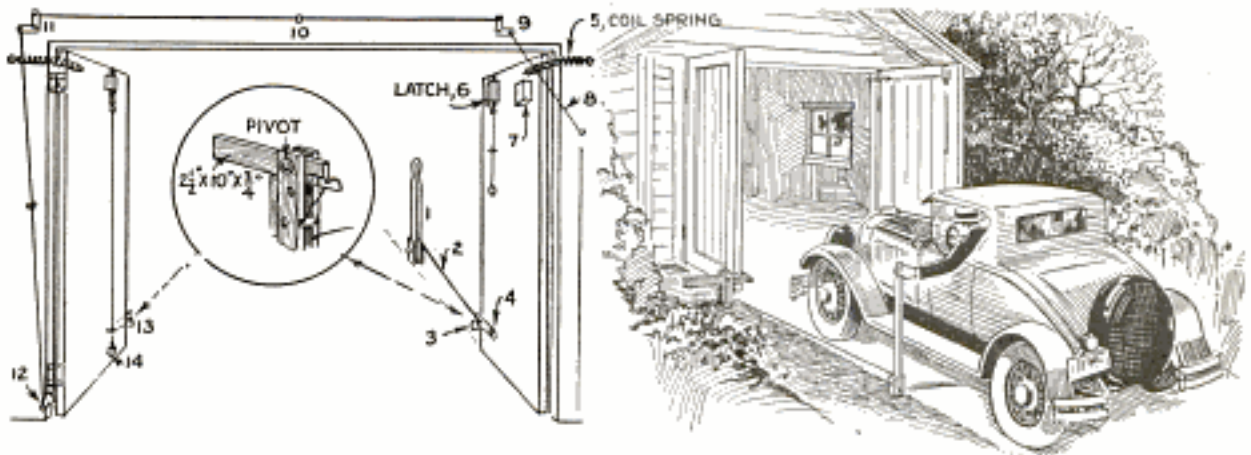

Those Who Are in a Hurry to Get Out of the Garage Will Appreciate This Practical Method of Closing the Doors Automatically without Even Getting Out of the Car

A practical device that will automatically close your garage doors, without the necessity of getting out of the car, can be made from a few pieces of flat iron, angle braces and wire. The installation shown here was designed for double doors swinging outward. Spring latches are installed at the top of both doors to lock them when closed, which is done by means of screen-door springs. Catches, shown in the circular insert, are arranged to hold the doors open while backing the car out of the garage. One of these is released by a lever (detail 1) made from a 3-ft. length of broomstick, with a hole drilled at one end and pinned to a notched post set in the ground about 1 ft. from the driveway and about 12 ft. from the garage door, where it can easily be reached by the driver when backing out. Attach a wire (2) to the lever about 3 in. above the pivot, and run the wire to the catch (3) which holds the door on that side. The catch is attached to a 1 by 3-in. length of wood which serves as the counterbalance, the whole assembly being pivoted on a second post set in the ground. The catch is notched to fit a flat-iron plate screwed to the inside of this door. A similar plate on the other door is screwed to the outside, as the second door closes last, and the plates must be so arranged that they will not interfere with each other. Drive screweyes into the door jamb at points 8 and 10, and pivot angle braces at points 9, 11 and 12, running wire such as heavy picture wire between these points as indicated, the wire being securely tied to screw-eye 8, but threaded through screw-

eye 10. A 2 by 4 by 4-in. block, nailed to the inside of the first door, presses against the wire between points 8 and 9 when the door closes. This pulls the rest of the wiring, which runs to catch 13 on the second door and releases it in the same way as the first. In operation, the first door is closed, which releases the second one and allows it to close also. The coil springs should be adjusted to the proper tension for closing the doors, so that the latches (6) will lock. A hole, drilled in the second door, directly under and in line with the latch at the top, will enable you to attach a string to the latter and release it from the outside.—R. B. Black, Los Angeles, Calif.

Coconut Head Stores Twine



A coconut, a piece of a bandana handkerchief, two brass rings and a roll of twine are used by a clever housewife to make a decorative holder for the ball of twine that so often is needed in the kitchen. The eyes and mouth are painted on and a hole is drilled through the mouth. The holder may be screwed to a suitable wooden base or hung on the wall.

A Tool for Stretching Webbing

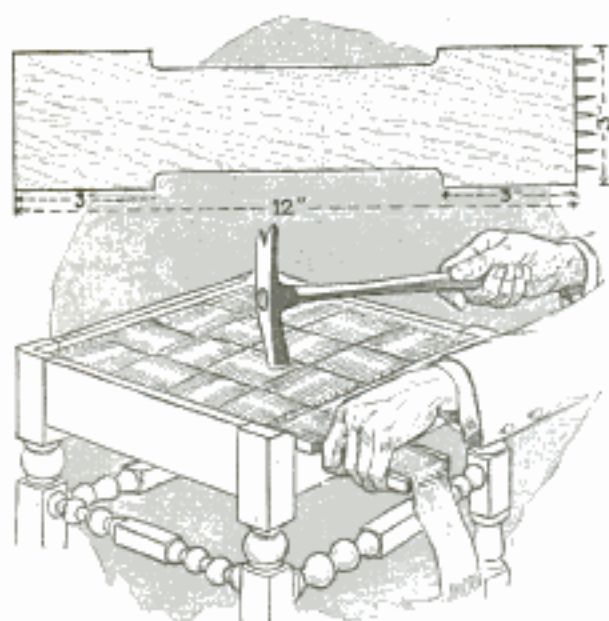

It Takes Only a Few Moments to Make This Handy Tool for Stretching Webbing

When it is necessary to stretch webbing over a footstool or other piece of furniture, the illustrated tool will be helpful. It is made from a 12-in. piece of wood, about 3 in. wide. Three or four eight-penny nails are driven in one end so that the ends project about $\frac{1}{2}$ in. The heads are cut off and the ends sharpened with a file. In use, the nails are pushed through the webbing and the other end of the tool butted against the side of the chair so that the webbing will be held tight while it is being nailed. In order to avoid marring the finish of the furniture, it is advisable to slip a rubber band over the end of the tool and tack it to the sides.

Rubber Guard Protects Wood When Driving Nails

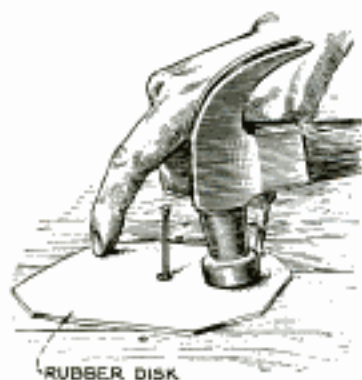

the nail has been driven well down, use a nail set in the usual manner. The rub-

To protect wood while driving nails, a piece of rubber, cut from an old inner tube, having a hole in the center and slipped over the nail, will prove effective. After

ber is so efficient a shock absorber that blows of considerable force can be struck with the hammer without marring the wood.

Dividing a Small Circle Accurately

When it is desired to lay out divisions on a small circle with accuracy, it is sometimes rather difficult to do the work with dividers. Lay out a circle as large as possible, concentric with the one to be divided. Then divide the large circle into the required number of equal parts and draw lines to the center with a straight-edge. This will divide the small circle in the same number of parts as the large one. It is easier to work on a large scale, and any errors in making the large divisions will be greatly reduced in the small circle, though, of course, the proportions will remain the same.

An Instant Cigaret Extinguisher

A cigaret can be instantly extinguished without crushing it by inserting the lighted end into one of the holes of a glass or porcelain flower holder purchased at any 5 and 10-cent store. The cigaret fits snugly into these holes, and the action cuts off the air supply to the burning tip and puts it out.



How to Make Model-Ship Rails

On most models, the forecastle and quarterdeck rails are formed by a top horizontal rail, supported by regularly spaced posts that are fastened to the deck. An equally decorative and rigid rail can be made without steaming and bending the horizontal rail and individually turning the supporting posts. To do this, extend the hull upward to the height the rail would be, then hollow out the hull block to the depth of the deck level. This leaves

a solid rail of proper thickness around the outside of the deck. With a pair of dividers, space off locations around the rail top, and drill small vertical holes through the depth of the rail and into the hull proper. Now decide how deep the horizontal rail will be, and scribe a line around the rail circumference at this point. Scribe another line the same way exactly at deck level. End both lines about amidships, leaving enough stock to form an ornamental post. Then saw just inside of both lines down to these posts, and cut away all stock between them. This leaves a top rail supported only by the two posts on the inside ends. For the other posts, use glass or wooden beads, as many as required, to fit between the top rail and the deck, and fasten in place with needles or stiff wire, driven through the holes in the top rail, through the beads and into the corresponding holes in the deck.

An Elevated Campfire Is Handy

Tired of stooping over while preparing his meals on a campfire, an Oregon woodsman uses an elevated campfire consisting of a cribbing of short logs with a floor of saplings across the top. A layer of rocks and earth on the flooring holds the fire and reduces the possibility of its spreading. A suitable cross pole is placed in crotches of two saplings set in the ground, to hold the cooking vessels.



By Building the Campfire on a Cribbing of Short Logs, Cooking Can Be Made Much Easier

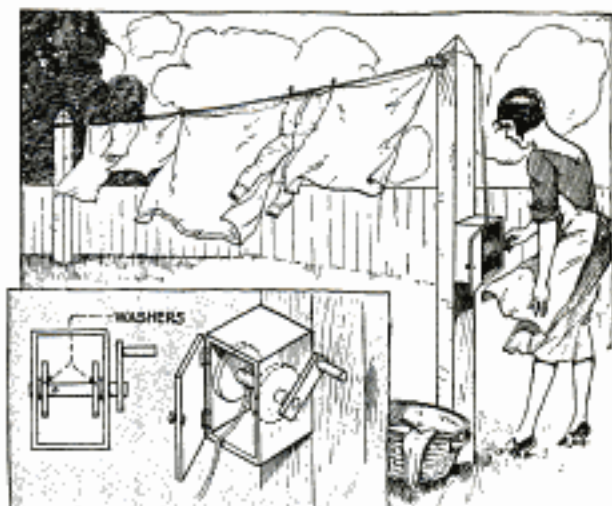

This Crank-Wound Reel, Enclosed in a Wooden Box, Will Keep Your Clothesline Clean and Handy

Inclosed Reel Keeps Line Clean

It will be found much handier to reel up your clothesline than to remove it in the usual way. Besides, by installing the reel in a wooden box permanently fastened to the post, the rope will be kept clean. A double line, suspended around the tops of two posts and laid over projecting dowels, is a convenient arrangement. The end of the line is tied to form a loop which is hooked over a dowel. The construction of the box and reel is shown in the detail. A suitable wooden crank fits holes drilled through the sides, while wooden disks form the sides of the reel, these being driven on the crank. Washers are used to keep the reel from rubbing against the inside of the box, while a cotter pin at the end of the crank prevents it from being pulled out of the box.—B. L. Filozof, Buffalo, N. Y.

How to Obtain Sharp Focus When Enlarging

When enlarging, trouble is often experienced in obtaining the sharpest focus for the projected image. The task can be simplified by ruling an overexposed or dense black negative with a sharp razor blade so that the lines cut will allow the light to pass through, enabling one to focus them sharply. If the lines are vertical and horizontal, they will also assist in truing the paper holder.

☛ Fresh flowers may be preserved almost indefinitely by dipping them in a solution of collodion, thinned with ether.

*Eimer + Amend, 3rd Ave
+ 18th, New York
about 50¢ lb.*



For Threading Pulleys in Places Hard to Reach, a Length of Pipe Will Prove Helpful

Pipe Guides Rope over High Pulley

Instead of using a long ladder, which is not always at hand, try this trick the next time you find it necessary to replace the rope over a high overhead pulley, and you will find the job comparatively easy. Farmers, for instance, will find this method highly useful for rethreading hay-rope pulleys. Get a pipe of suitable length and of a size that will let the rope slip inside. Without kinking, bend one end of the pipe so that it faces the pulley when the pipe is raised. Then slip the rope up through the pipe as shown in the drawing. After threading the pulley, keep on feeding the rope until the end can be reached from the ground.

Poor Insulation of Ignition Wires Affects Motor Performance

If your car has a peculiar jerk or lacks pep, and the cause cannot be found, a check on the ignition wiring may reveal the trouble. On a dark street or in a darkened building, watch the high-tension wiring while the engine is suddenly accelerated. Rubber insulation on ignition

wire usually deteriorates rapidly and will then allow a leakage of current. There will probably be a blue glow along the wiring under normal conditions, but if the glow is conspicuously brighter at any particular place, such as a bend near metal, or if sparks jump from the wiring, the insulation is defective. The loss of current robs the plugs of some of the electrical energy essential to smooth motor performance.

A Dropcloth for Kitchen Workshop

Using an old sheet or other large cloth to cover the floor when one has to use the kitchen as a workshop, is a practical idea borrowed from painters, who use such cloths to protect furniture and floors. The cloth will catch shavings and filings, and will save much time in cleaning up after the work is done.

Black Dirt Melts Snow Quickly

An easy way to melt snow in the spring for planting the garden, or for other purposes, is to sprinkle black dirt over it. The dirt absorbs heat from the sun instead of reflecting it like snow, and this hastens the melting. United States forest-service workers have found this method enables them to plant their nurseries earlier.

Hanger Holds Saw Securely

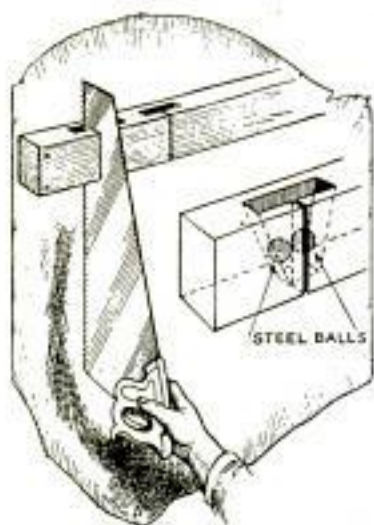

Handsaws can be conveniently held by a hanger made from a length of 2 by 4-in. stock. Mortises with two sides beveled are cut to accommodate two steel balls, and a saw cut is made through the center of

the mortise to receive the saw. The saw is pushed up in the slot between the balls. A slight downward jerk causes the balls to pinch the blade, holding it in position.

A Flying Dragon Kite

WRITHING about high in the air, this huge dragon kite will attract considerable attention, and can be seen with its 50-ft. tail for several miles. Any boy who can hold the kite, and has enough weight to hang on to it when in the air, can fly it, but he will have to get the help of two friends to launch it into the air.

The frame of this kite is the familiar X-type, comprising two main spars with a lighter cross spar all joined together a short distance above the center as shown in Fig. 1. Spruce is preferable for the spars although any other tough straight-grained wood will also serve the purpose. The main spars are $\frac{1}{4}$ in. thick and $\frac{3}{4}$ in. wide where they join, tapering to $\frac{3}{8}$ in. at the ends. A $\frac{1}{4}$ by $\frac{3}{8}$ -in. piece is used for the cross spar, and is reinforced with a 36-in. length of split bamboo bound with twine at the center, allowing flexibility without risk of breaking. The ends of each spar are slotted to receive

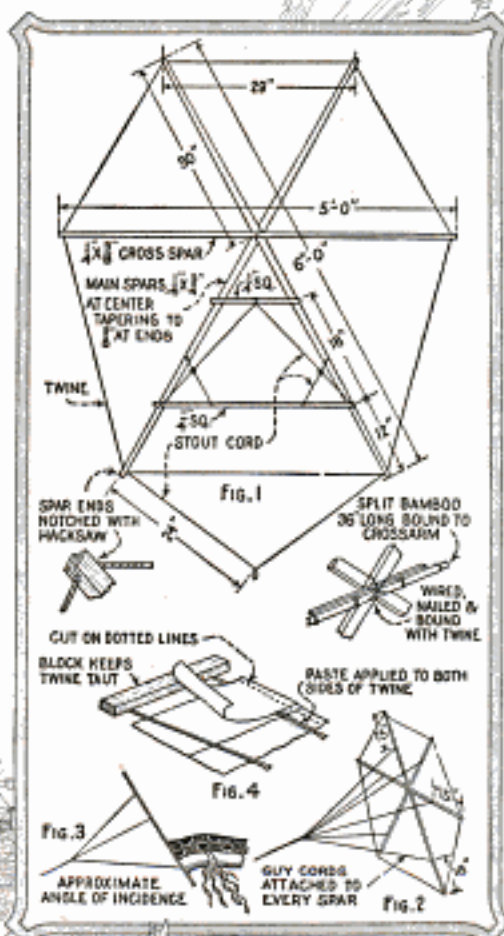

the string to which the paper is pasted. Fish-line or heavy twine is suitable for this purpose. Below the center of the frame, two cross-bars of $\frac{1}{4}$ -in. square spruce are attached to carry the body, or serpentlike tail, made of tissue paper. Where twine is used for binding, glue is also applied so that the twine will not slip. Cover the frame with tough wrapping paper, lapping the edges and pasting with glue or mucilage. The decorative effect is obtained with pieces of colored tissue paper, as shown in Fig. 7. An opening, representing the mouth, is cut to permit air to enter the body.

Select a clear, calm day for making the body in the open, as it is too long to be handled conveniently indoors. It can be made up on a sidewalk swept free of dirt, as shown in one of the photos. Paste together, edge to edge, as many 20 by 30-in. sheets of tissue paper as are necessary to make the kite the desired length. White tissue is used for the bottom, and alternating orange and green for the top, as indicated in Fig. 6. Lay



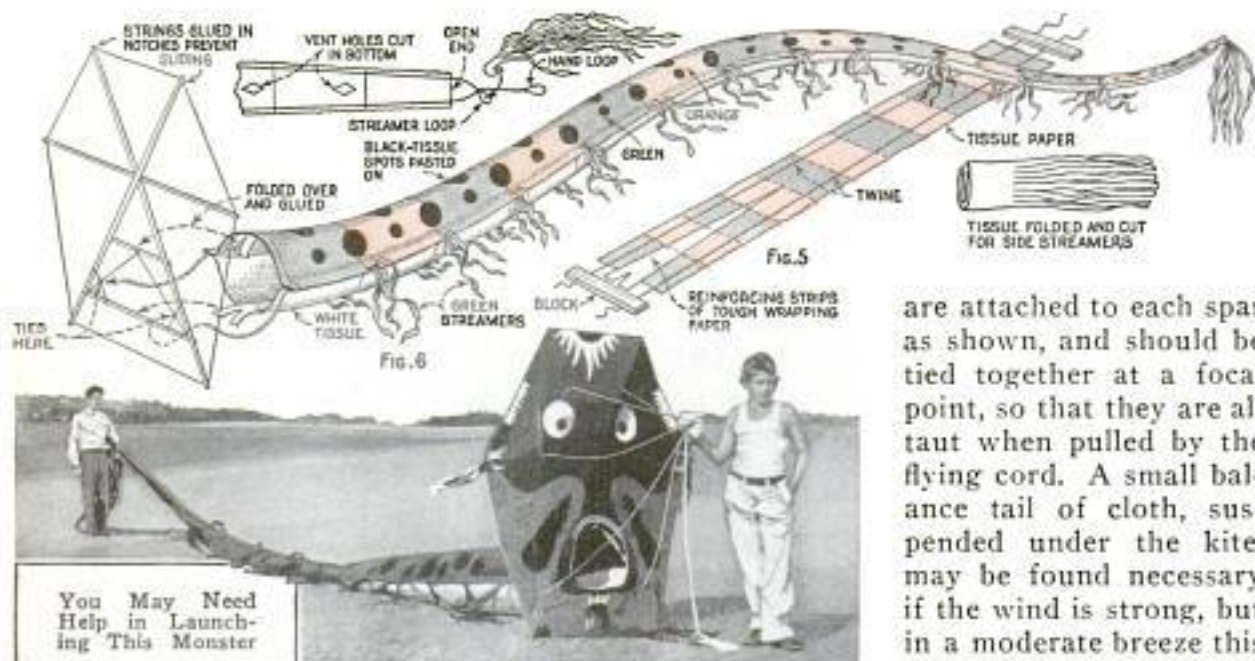

the bottom flat on the sidewalk, and draw two strings taut over them, tapering toward the tail and held in place by blocks, as in Fig. 5. Paste the top section to the bottom as you go along to get the string in the seam, Figs. 4 and 5. A long strip of tough wrapping paper, cut to a V-shape, is pasted to the front end to reinforce it. Similarly a piece of the same paper is used to reinforce the edge of the front opening. These reinforcing strips are applied before the top and bottom sections are pasted together. After the glue has dried along the edges of the body, trim away the waste about $\frac{1}{2}$ in. from the string, which completes the body except for the streamers on each side and the long tail streamer cut from the waste strips. The longer this tail is, the better, as it helps to balance the kite. Fig. 6 shows the method of fastening the body to the kite, using glue on the twine and tying it securely. Guy cords

are attached to each spar as shown, and should be tied together at a focal point, so that they are all taut when pulled by the flying cord. A small balance tail of cloth, suspended under the kite, may be found necessary if the wind is strong, but in a moderate breeze this can be dispensed with.

A crew of three are required to launch this sky monster, as shown in the detail across the bottom. Flying is really as easy as with an ordinary small kite, once it is off the ground and clear of obstructions. Select an open field for the try-out; otherwise a tree or telephone wire may wreck the kite.

Another type of serpent kite is shown in Figs. 9, 10 and 11. It is somewhat harder to fly and launch than the dragon, as it is made up of a series of kites strung together at exactly the same angle of incidence, or slant, toward the wind. First make a series of kites of the design shown, each 1 in. smaller than the next preceding one. Twelve were used for the serpent illustrated, the first having 24-in. spars and the last 12-in. spars.

Bamboo may be substituted for spruce. As the spars are necessarily of small cross section, the outline twine must be

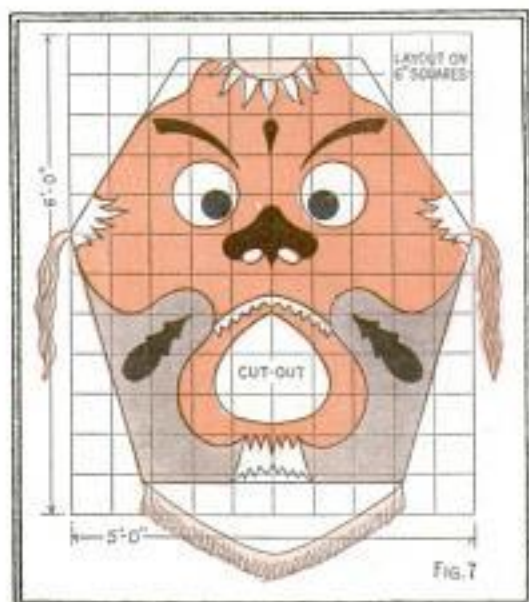

tied and glued to the ends. The kites are covered with tissue paper, and are spaced apart three times the depth of their curve, as shown in the top view, Fig. 9, or 18 in. Twine is tied to the intersections of the spars, and the entire series is strung up between two posts. The strings are then tied to the tips of the spars and waterproof glue or ambroid is used to prevent the strings from pulling off. It is important to have all three strings on each kite of exactly the same length. Loops of string are suspended under each kite to

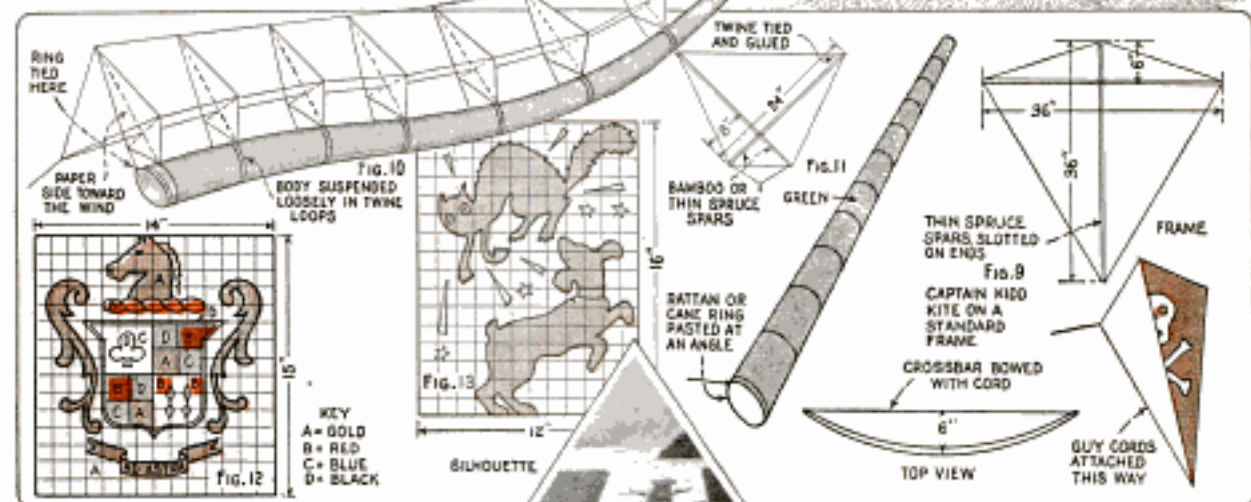
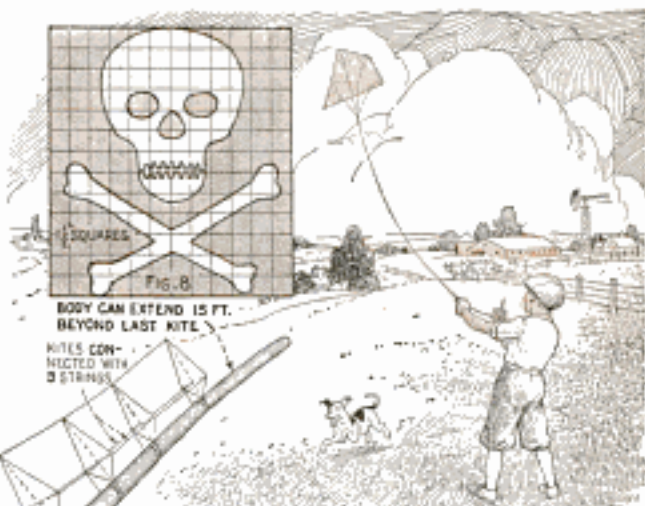

carry the serpent body loosely, so that it can equalize between the kites with variations of wind pressure. Green tissue paper is used for the body. It should be about half the girth of the dragon body, and the tail may extend about 15 ft. beyond the last kite. A ring of rattan or cane of small diameter is pasted inside the forward end at an angle, as shown in Fig. 11, and tied under the leading kite.

Fig. 9 shows a familiar type of kite and suitable designs for decorating kites are presented in Figs. 8, 12 and 13. A black silhouette against a white background stands out distinctly at a considerable height, and the skull-and-crossbones design is a favorite for this reason. Black

tissue, folded once and cut according to the squared outline shown, will make a very piratical-appearing emblem above the house-tops. The cat-and-dog silhouette is also effective at moderate altitudes. The coat-of-arms requires more work, but makes a neat design in the colors indicated, which are cut from separate pieces and pasted on.

Small novelty kites, that are excellent performers and require only a scant breeze to send them soaring, can be modeled after the larger ones of the familiar type. In making such small kites, 6-in. broom-straws have been found suitable for the cross spars, waxed sandwich paper for the covering and a fine silk thread for the control string.

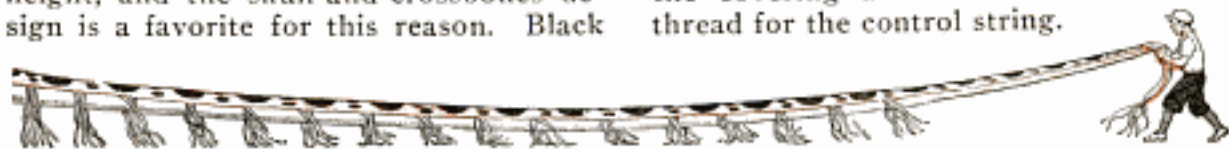

OPERA GLASSES USED FOR TAKING DISTANT PHOTOS

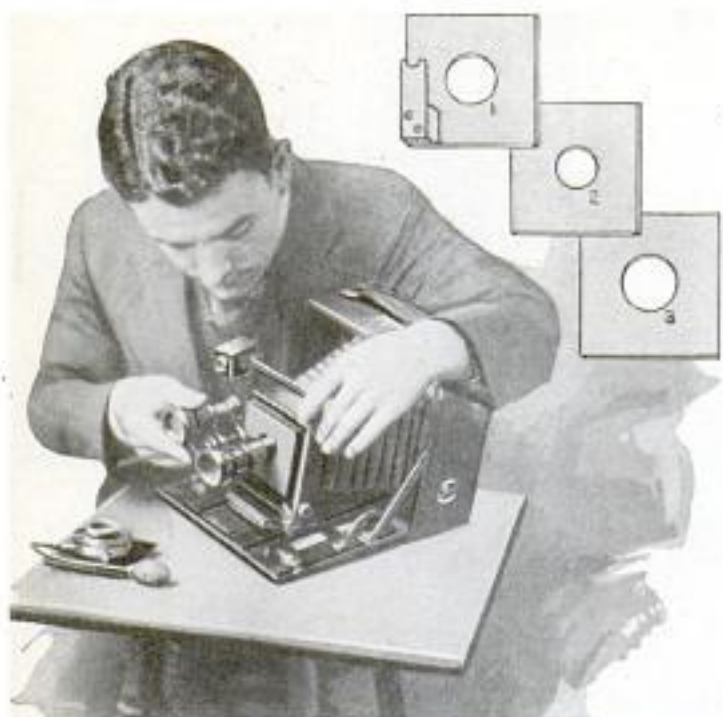

Long-Distance Photos Can Be Made to Resemble Close-Ups by Using Opera Glasses on Your Camera

Amateur photographers whose cameras are not equipped for taking long-distance photos, may use ordinary opera glasses as a substitute for a telephoto lens. The first step is to nail together three squares of cigar-box wood to form a lens board for the camera, as the regular board must

be removed. The bottom board is perforated with a hole somewhat larger than the eyepiece of the opera glass, the middle board a hole a trifle smaller than the eyepiece, and the third, a hole to accommodate the eyepiece. A suitable bracket is nailed to the lens board to form a support for the glasses. In use, the lens board is substituted for the regular unit, the glasses are fitted in place snugly and the outfit is ready for taking long-distance shots. A little experimenting will show how to obtain a sharp focus on the ground glass. In some cases, it may be necessary to focus on some object farther away than the one that is to be taken, in order to get a clear picture. As the regular camera shutter has been removed with the lens board, a substitute may be employed

in the form of a cap or piece of cloth held over the end of the glass while the plate cover is removed, and taken away for the exposure. In case film-roll cameras are used, a tight-fitting cap should be adjusted over the end of the opera glass. The outfit is not difficult to make.

Cheap Electric Fire-Alarm System Affords Adequate Protection

This electric fire-alarm system can be made in a short time by utilizing a few spring-type clothespins, a couple of dry cells, an electric bell, and celluloid strips cut from old photo films. Each clothespin is provided with two contact points consisting of short screws slipped through holes drilled in the top of the jaws. The screws are held in place with nuts, which also serve to clamp the connecting wires. The other ends of the pin are split lengthwise with a knife for about half of their length to hold strips of celluloid, which keep the jaws apart. Mount the pins on the walls throughout the house over such places where a fire might possibly originate, by driving a nail through the coil spring between the jaws. All pins are

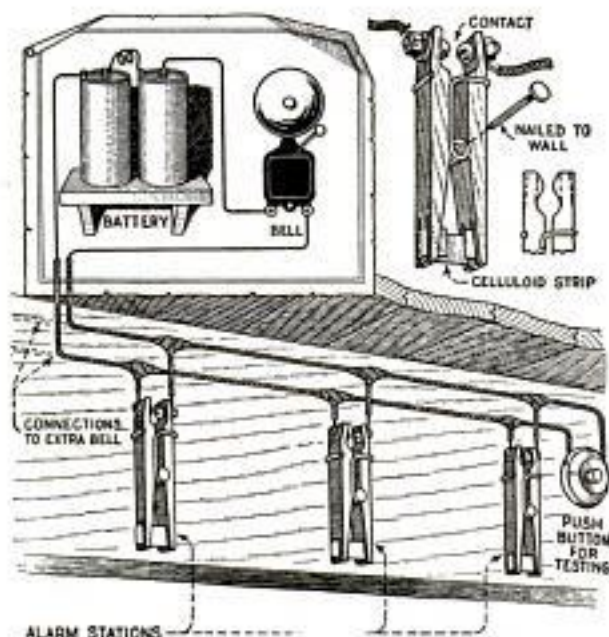

Although the Cost of This Fire-Alarm System Is Negligible, It Insures Adequate Protection

connected in parallel with each other and in series with the battery and bell, as shown in the wiring diagram. If one bell cannot be heard at all points of the house, it may be advisable to use two, both being wired in parallel. To test the system frequently, a push button should be connected across the line at the alarm station most distant from the battery. If photographic film is used for the celluloid strips, the coating must first be removed from both sides by soaking for a few minutes in warm water. This will insure quick ignition.—Eugene Emerson, Jackson Heights, N. J.

Fastening Portable Signs to Sidewalk

To prevent the wind from overturning or moving a portable sign, the arrangement shown in the drawing will prove effective. A screweye was driven into the bottom edge of the sign and an eyebolt imbedded in the sidewalk. The eyebolt should be flush with the walk so that it will not trip pedestrians when the sign is removed. A small turnbuckle connects

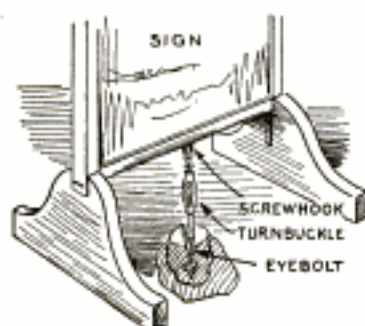

Tobacco Dust Added to Mash Kills Poultry Worms

Poultry worms can be exterminated by adding finely powdered tobacco dust to the dry mash, in the proportion of two per cent of tobacco dust, by weight, to the quantity of mash. This mixture should be fed for three or four weeks and then repeated at three-week intervals until the worms are entirely eradicated.—E. G. Moore, Washington, D. C.

☛ Garments that have been accidentally scorched should be laid out in the sunshine with the scorched portions fully exposed; light scorches will come out entirely and bad ones will be bleached.

A Slotted Trough on Sawbuck Supports Work Properly and Prevents Pinching of the Saw



This Sawbuck Will Not Pinch

Saw blades often need resetting after the teeth have been pinched between the work on a sawbuck of the usual type. The pinching can be avoided by making a sawbuck with a shallow trough, slotted halfway through its width at the center, to permit the passage of the saw as shown. The work will not pinch because it is supported for the entire length of the sawbuck.

Weatherstrip on Door Adjusted Automatically

Dropping down flat on an inclined porch floor, the illustrated weatherstrip has been found to keep out drafts effectively. It consists of a strip of 1-in. wood, pivoted at one end to the bottom edge of the door by means of a wood screw. The other end is slotted to allow vertical movement, and is held onto the door loosely with another wood screw. Both screws are provided with washers.

A small caster or roller, such as a spool, is attached as indicated in the detail, near the slotted end of the strip, so that it will ride over the porch floor without scraping.—L. T. Schiff, New York City.

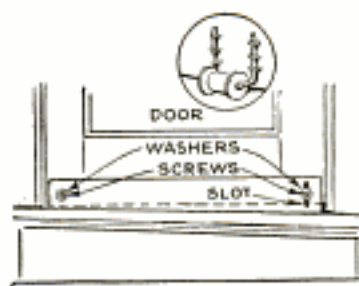

A SPRAY AND STENCIL OUTFIT FOR MODEL PLANES



This "Lung-Power" Outfit for Spraying and Stenciling Model Planes Consists of a Pencil Cap, Two Lengths of Copper Tubing and a Screw-Top Glass Jar

Unquestionably the best method of painting model planes is to use a spraying apparatus. An efficient "lung-power" sprayer can be made for almost nothing, and the only tools needed are a soldering iron and a file. Get a small screw-cap glass jar, not over 2 in. in diameter and 3 in. high. Larger jars are not so easy to handle. Perforate the top at two points for the blowpipe and paint-supply pipe. The former consists of an ordinary metal pencil cap, purchased at the 10-cent or stationery store. A short piece of $\frac{1}{4}$ -in. brass or copper tubing is filed so that it can be soldered to both the pencil cap and lid, as indicated in the drawing. A $\frac{1}{2}$ -in. hole is drilled in the tip of the cap. The paint tube is made of brass tubing, having an inside diameter of $\frac{1}{8}$ in., and a length that will allow it to be extended from the drilled end of the pencil cap to $\frac{1}{4}$ in. from the bottom of the jar. The top end is plugged with solder, a $\frac{1}{32}$ -in. hole being drilled through this and the end then filed to a taper. The extreme tip should be slightly beveled to face the air nozzle. Be sure that the two tips are properly aligned, so that the air current will strike directly against the tip of the paint nozzle. In use, it has been found that best results can be obtained with brushing lacquer, cut down about one half with thinner. Using stencils for lettering and emblems insures neat work. These can be laid out easily and accurately on squared paper sold at stationers'. Cut the stencils out with a safety-razor blade held in a slotted wooden handle with two tapered wood pegs, which can be driven out when a new blade is required. By holding the

stencil tightly against the work, a first-class job of lettering can be done without getting the paint on the fuselage or wings where it is not wanted.

A Neat Rubber-Tired Woodbox for the Fireplace

The woodbox shown here eliminates much of the labor of tending to a wood fire in the grate. Rubber-tired wheels enable it to be moved with little effort, and its good lines render it rather attractive. To make it, use 1-in. stock, preferably surfaced pine or fir, sanded on one side. After the top of the sides have been laid out with the use of a paper pattern, they can be cut with a fretsaw. Nail together with six-penny finishing nails, spaced 3 in. apart, and mount the box on two fixed

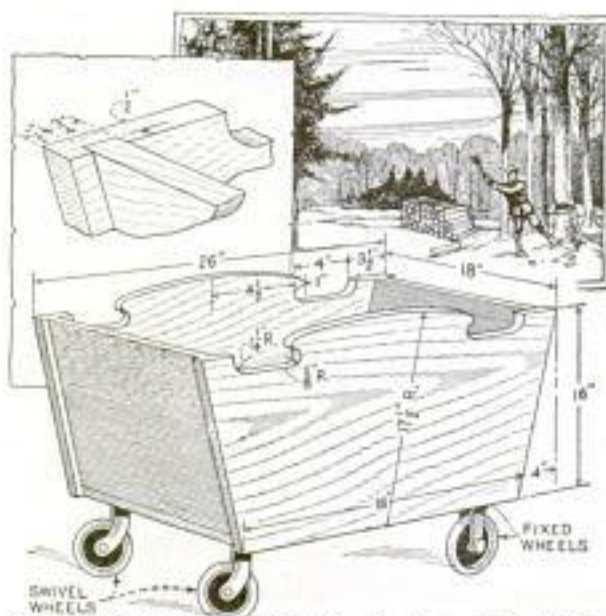

Fitted with Wheels and Finished to Suit, This Woodbox Looks Well near Any Fireplace

4-in. rubber-tired wheels at one end and two swivel wheels at the other. Coat the inside with linseed oil and then sandpaper and lacquer the outside, or finish to match other furniture in the room.

Cleaning Firearms with Steam

Firearms should be kept scrupulously clean to prevent corrosion and to prolong their life. Hot water is an excellent cleaner, but steam is better. A simple device for applying the steam can be made as follows: Solder the lid to a 2-qt. can; then punch a hole through the lid and solder a 2-in. length of brass tubing into the hole. About 5 ft. of rubber tubing is fitted over this nipple. The other end of the tubing



also is provided with a brass nipple and with a wooden grip to protect the hand against the heat. In use, water is poured into the can and set to boil until plenty of steam is produced. Then take the gun

barrel in one hand, holding it with a folded cloth, and insert the nozzle as shown. A few minutes of this treatment removes every trace of grease and burnt powder. A dry cloth is run through the barrel to remove any remaining moisture. The gun is then ready to be oiled and greased.

Stopping Auto Noise Transmitted through Oil Pipe

Motor noises are often transmitted to the inside of an automobile body through the oil line which leads to the pressure gauge on the instrument board. The sound travels along the copper tube and is sometimes amplified by the steel board, which acts as a resonator. To stop this noise, cut the oil line, separate the ends about 1 in., and slip a piece of high-pressure air hose over the ends, clamping it on securely.

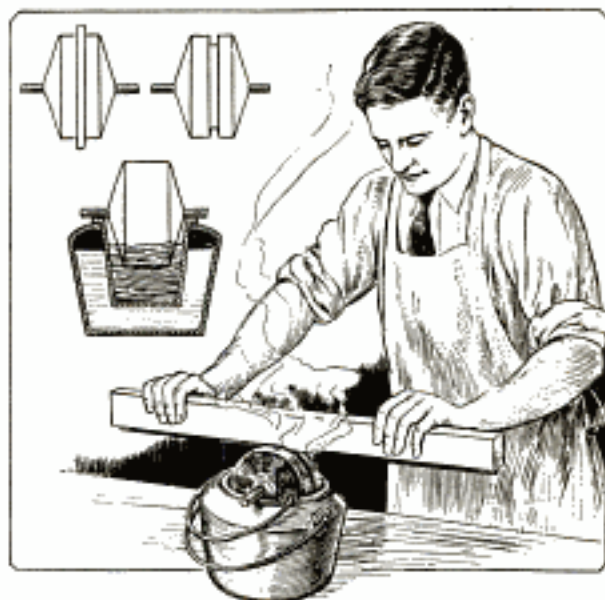

Wooden Rollers of Various Shapes Will Be Found Handy for Quickly Applying Glue to Boards

Roller Spreads Glue Quickly

For large gluing jobs, this roller-type spreader will be found a saver of time and also of glue. A large gluepot is fitted with a wooden roller driven on an iron rod, which rests in two notches cut in the top edge of the pot. In use, the stick is pressed over the roller as shown. Rollers for applying glue to the edges of tongue-and-grooved stock are shown in the detail.—Waldo Orton, Griswold, Iowa.

Razor-Blade Cutter for Slitting Album Leaves

For cutting parallel slits in album leaves to mount photos, this twin razor-blade cutter has been found extremely useful. Two small machine screws, about 1½ in. long, are slipped through one of the blades and through the flat portion of a wooden handle, which is also drilled to receive the screws. The second blade is then slipped on, and two nuts are used to hold the assembly together. In using the tool, an underlay of soft wood or smooth cardboard should be placed beneath the album leaf.



Window Shutters

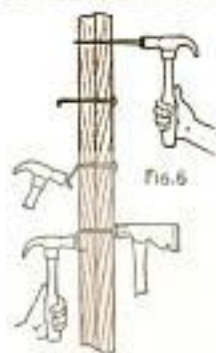
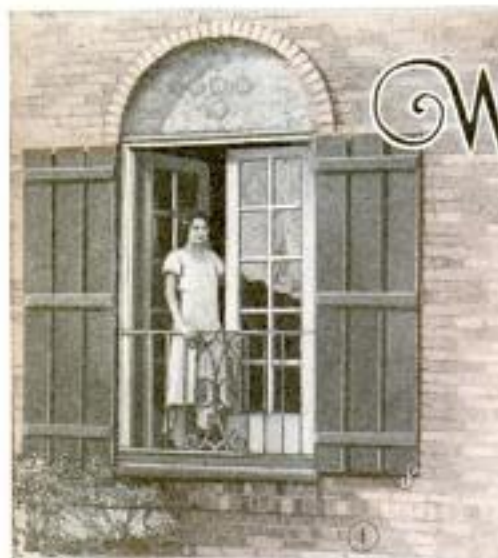

OUT of the past comes the window shutter, making plain homes attractive and attractive homes more beautiful. The simplicity of their construction offers pleasant work to the home craftsman. Before making the shutters, carefully decide what kind will look best on your home. Some types are too ornate for a simple little bungalow, while other styles may be too plain for a larger dwelling. Also, the problems of grouped windows and windows close to corners, where the siding is insufficient to back the shutter, must first be solved. Then, too, there is the question of whether or not the shutters should be hinged. If your aim in building these shutters is purely decorative, hinges are unnecessary, but if you intend to open and close them for practical purposes, hinges should be used. After these elements have been considered you can commence on the shutter construction.

Perhaps the simplest of all is the familiar grid type shown in Fig. 1; here straight uprights are banded together with two or three beveled crosspieces. Sometimes the latter are omitted, and long bolts are substituted, as

shown in Fig. 9, wooden spacers being used between the uprights. One end of each bolt is turned over to form an eye, offering an easy method of coupling to hinge pins as can be seen in the detail.

Closely allied to the grid blind is the batten shutter shown in Figs. 8, 14 and 15. In the first instance, two battens are butted close together and have diamond-shaped cut-outs in the center. The two boards are held together with cleats or with ornamental strap hinges. If the shutter is to be opened and closed, actual working hinges must be provided, but if the shutter is to be stationary, imitation hinges of wood or metal are fastened on with large-head upholsterers' tacks. The hinges should show when the shutters are open. The other side is cleated to hold the two boards together if the hinges are not strong enough for this purpose. The end of the hinge is fashioned to harmonize with the cut-outs.

Another variation of the

Improve Your Home

batten type of shutter has three or more boards, closely fitted together and with all edges beveled slightly to show a V-shaped groove between the joints. This type is cross-braced with two beveled cleats, and a diagonal strip is sometimes added as shown in Figs. 14 and 15. The true colonial method of fastening the cleats is shown in Fig. 5, round-head, square-shank nails being driven into place and clinched. While a true reproduction, this effect should not be used unless your home is of a colonial type.

Perhaps the most popular of the present-day window shutters is the paneled variety having suitable cut-out designs. An attractive cloverleaf panel design is shown in Fig. 12, the cut-out being made with a keyhole saw, Fig. 16. The outside framework is rabbeted all around to take the panels, and the crosspieces are tenoned into the uprights, after which the parts are assembled with finishing nails and glue, as shown in Fig. 7. These blinds should be hinged so that they may be opened and closed. If shutters of the panel type are your choice, and if the decorative note is your only aim, the above mortised and rabbeted construction need not be followed. A simpler panel style, offering the same effect from one side, is shown in Fig. 13. The cut-out, which is the main reason for the popularity of the panel type, may take on a score of different shapes, as shown in Figs. 2 and 11. The designs should be quite simple, as anything too ornate will weaken the wood.

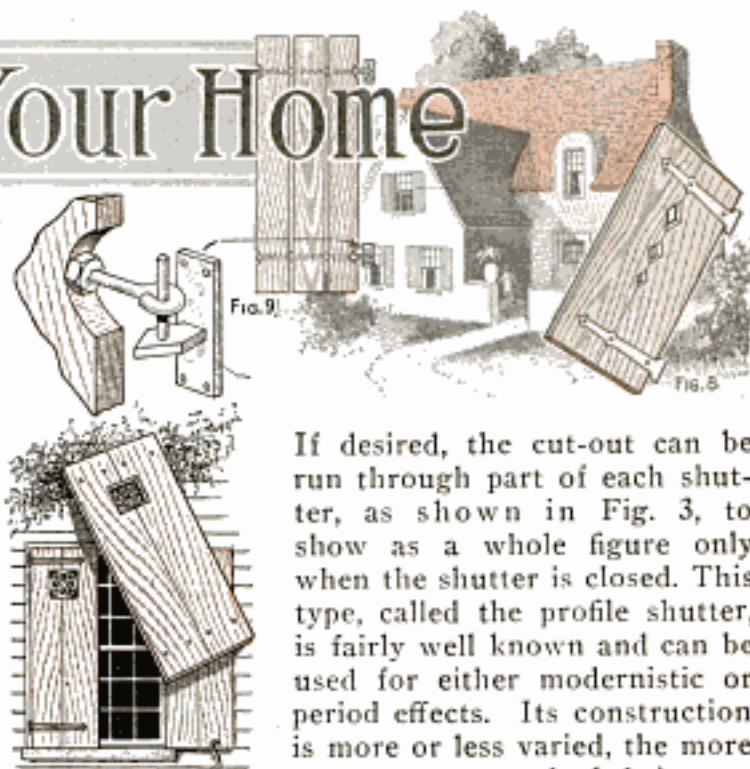

If desired, the cut-out can be run through part of each shutter, as shown in Fig. 3, to show as a whole figure only when the shutter is closed. This type, called the profile shutter, is fairly well known and can be used for either modernistic or period effects. Its construction is more or less varied, the more common method being to lap the endpieces onto the main uprights, as shown in the detail.

The Judas blind, an example of which is shown in Fig. 10, is similar to the batten type, except that the cut-out, usually square or diamond-shaped, is grilled with strap iron or flat brass to form an opening through which visitors may be scanned. The grill can be put in quite easily by merely lining the opening with channel iron or brass, and soldering the grill in place. Another method of attaching the grillwork is to drill holes through the metal and to drive round-head nails through the holes and into the wood. In this case, a pair of strap hinges, held in place with pyramid-headed rivets, may be provided on the outside to show only when the shutter is closed. Openings in Judas shutters may be fitted with cut-out silhouettes

in copper or brass, the metal being held in place with light molding.

Two-ply shutters, as shown in Fig. 4, are also attractive and are fairly simple to construct. The diagonals are made of

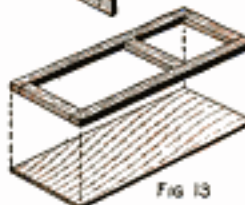

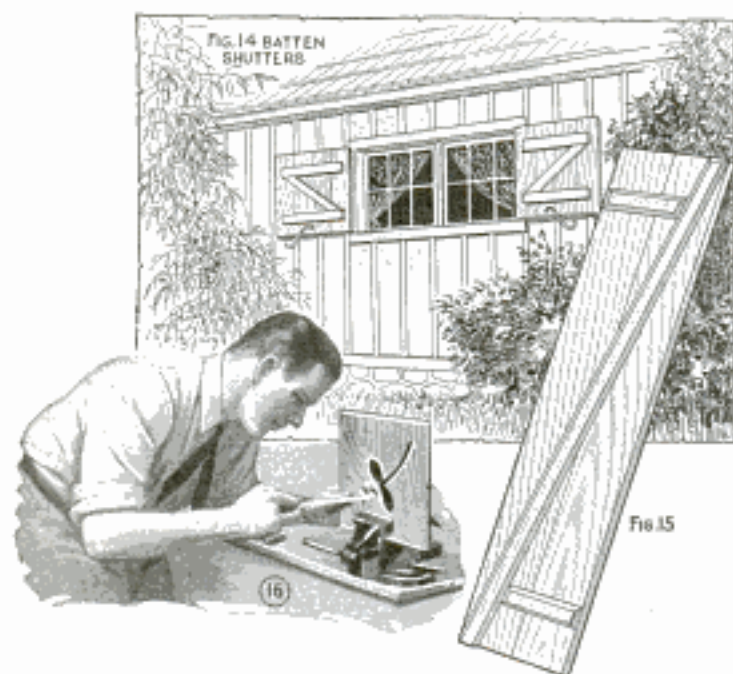

Although Panel Shutters Are Popular, the Batten Type of Blind Is Also Highly Attractive

tongue-and-groove stock, or the whole blind may be made from two pieces, with saw cuts scored diagonally across the face of each, to resemble joining widths of narrow stock.

The old-fashioned louver, with its many slats facing inward and upward, retains its well-earned popularity, but as used today is invariably a semi-louver, the top portion being paneled and carrying a cut-out design.

Naturally enough, the shape of the window largely determines the shape of the shutter. Usually a window looks best with a shutter on either side. On extremely narrow windows the shutters are often arranged to interlock, as in Fig. 5. Thus the shutter may be made a trifle wider than half of the window. Small windows are often shuttered with a single blind, especially if the window is balanced with another. Two small windows in a pair are usually shuttered with two blinds, one for each. Arched and odd-shaped windows present their own problems, usually calling for a particular shape of shutter to fit. The color scheme is also important. Nowadays, most houses are finished in one color, or in tints or shades of one color. Thus the value of contrasting shutters is at once apparent. Even though the windows are finished in the same general hue as the house, the shutters should contrast to create the most

pleasing effect. If desired, the garage can also be trimmed with blinds to match those on the house.

Blueprint Paper Made at Home

Satisfactory blueprint paper can be made at home with the following solution: In one bottle, dissolve ammonium citrate of iron, $3\frac{3}{4}$ oz., in water, 18 oz., and then dissolve red prussiate of potash, $2\frac{5}{8}$ oz., in the same quantity of water, in another bottle. Have the paper to be treated close at hand in a photographic dark room lighted only by a ruby light. Mix equal parts of the solutions and apply with a sponge. Put the liquid on in long parallel sweeps and on one side of the paper only. Hang the sheets up to dry and keep them in the dark until used. The mixtures spoil quickly, so it is advisable to throw away that which is not used.

Recovering a Lost Outboard Motor

Attached to the outboard motor, the illustrated float will often be the means

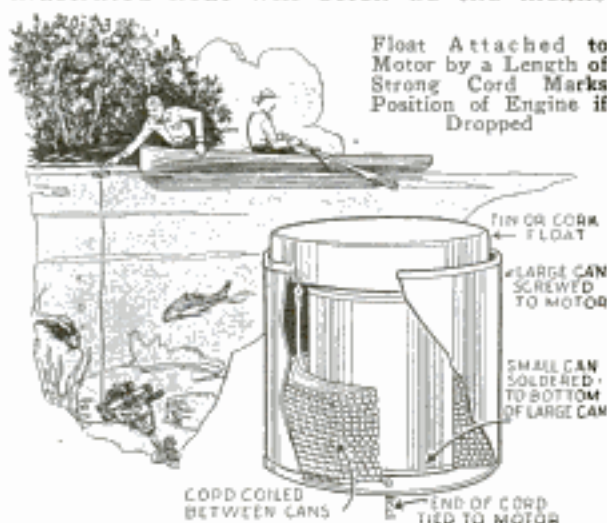

of recovering it after it has been accidentally dropped in the water. It consists of two tin cans, one containing a coil of rope and a smaller one soldered to the bottom to keep the coil from entangling. One end of the rope is tied to the motor and the other to a float, which fits inside of the larger can as shown. The float should be buoyant enough to carry the rope to the surface.

PICTURE-FRAME MOLDING CUT ON A POWER SAW

There are three or four styles of picture-frame molding that can easily be made on a circular saw. Although all operations will be ripping, a fine-tooth cut-off saw is best to use for the purpose as there will be no trace of tooth marks on the finished work if it is run through slowly and carefully. A dado may be used, but it is not necessary. To make $\frac{1}{2}$ -in. molding, set the fence $\frac{1}{2}$ in. from the saw, and run the saw table up so that it will cut through the stock, which should be $\frac{5}{8}$ in. thick. Rip the stock up into $\frac{1}{2}$ -in. strips. Lower the table until the saw will make a cut $\frac{3}{8}$ in. deep, and run the strips through again to make the bead on the $\frac{1}{2}$ -in. side as shown in Fig. 1, the fence having been adjusted so that the saw will take off just a slice equal to its width. Set the table for a $\frac{1}{2}$ -in. cut, move the fence $\frac{1}{4}$ in. from the saw, and run the strips through again, as shown in Fig. 2, after which a cut is made through the adjacent side, completing this particular type of molding. Variations

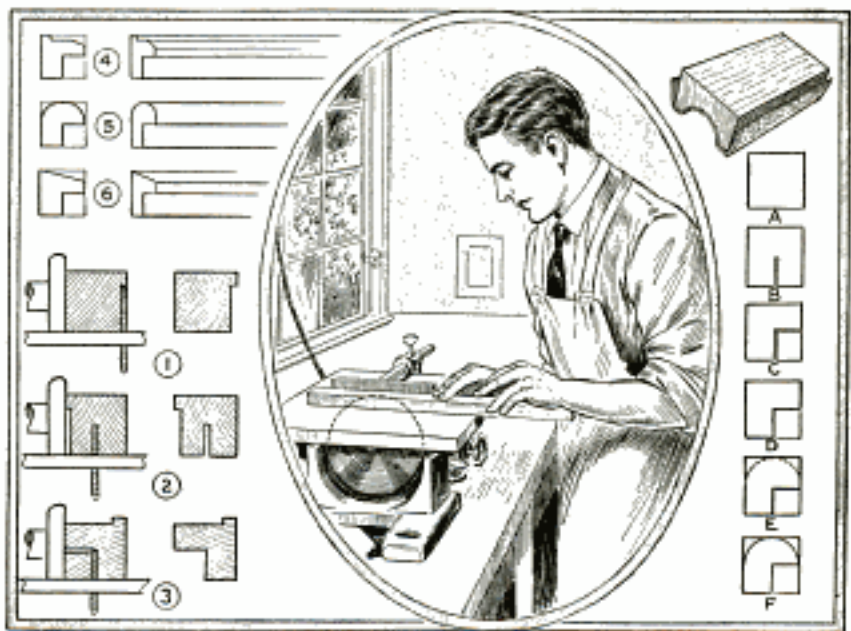

Small Power Saws Are Useful for Making Several Kinds of Picture-Frame Molding as Shown Above

from this style are shown in Figs. 4, 5 and 6. The half-round molding is run in the same manner except that there is no bead. Details A to F show the various operations. A sand block for rounding the molding is shown in the upper right corner of the illustration. First use a piece of coarse sandpaper and then finish with a fine grade. The bevel-face molding is cut in a similar way, except that the saw table should be tilted when the cutting of the face is done.

Permanent Plumb Bob Kept on Portable Machines

Leveling thrashing machines, tractors and other portable machines, which is often necessary, is simplified by applying the idea indicated in the illustration. A plumb bob is permanently suspended a few inches from a vertical part of the frame where it will not be caught by moving parts or lost in any way. A sheet-metal guard is bent to a semicircular shape and nailed or bolted to the frame around the bob, allowing sufficient space for it to swing. In case

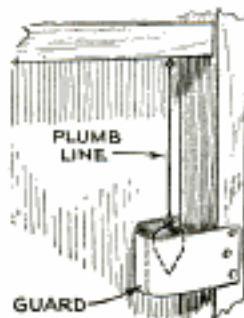

of a large machine, it is advisable to use one plumb bob at each end.

Radio Set Helps to Detect Loose Contact in Electric Cord

When the toaster won't toast or the percolator won't "perk" at the customary speed, owing to a loose connection, the source of the trouble can be located easily with the aid of your radio set. Turn on the set and then plug in the suspected electrical appliance. Push and pull gently on the cord both at the appliance and at the plug. If the radio "clicks" when you move the cord, the loose or defective part is at the point where you are handling it.

☛ Slip a small rubber band over a spool of thread to prevent its becoming unwound.

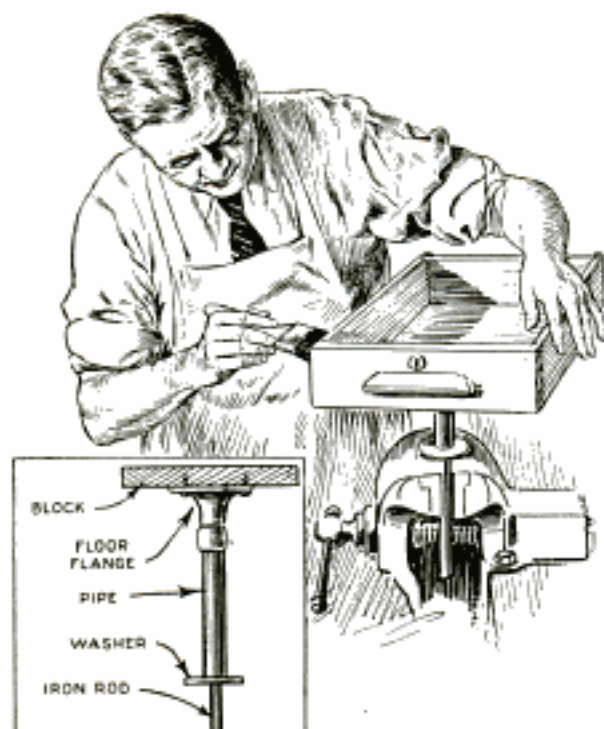

A Paint Stand Consisting of a Wooden Disk, Floor Flange, Pipe Nipple and a Rod

Revolving Paint Stand Held in Vise

When lacquering small cabinet drawers and many other jobs, a revolving stand will be found handy. A 2 by 10-in. wooden disk forms the top, which is screwed to a floor flange attached to a short piece of pipe. This is slipped over a rod held in the bench vise, allowing the stand to turn while it is held in a vertical position.

This Stone Boat Is Easy to Dump

For hauling stone on the farm, the illustrated boat was found convenient. A cylindrical container made of 2-in. wood



Dumping the Load Is No Job at All with a Stone Boat of Cylindrical Shape

is mounted on skids, with a crossbar in front to hold a chain. By turning the horses at right angles to the load and hooking the chain over one of the cleats nailed to the front, the boat is easily turned on its side. A grab hook is attached to the chain to shorten the hitch for pulling.

Correcting Sprung Auto-Door Hinge

Auto-door hinges are sometimes sprung out of position when backing into a garage with the door open. To bring them back to normal position, hold a block of wood in the hinge between the door and the frame. Then close the door sufficiently to force the hinge back into place.

Mounting Photos in Watch Covers

Nearly everyone who has ever attempted to place a photograph in the cover of a closed-face watch, has learned, usually at the expense of a broken crystal, that there is not sufficient clearance between the cover and the crystal for the thickness of the average photographic print. Such a print can be reduced in thickness by the following method: Cut out the picture to the desired diameter. Wash the hands thoroughly, and then lay the picture face down on a piece of clean blotting paper. After dipping the fingers in water, gently rub the back of the print. After a little rubbing the paper will begin to soften, and roll up. The rubbing should be carefully continued over the entire back of the print. To observe the amount of paper that is being removed, the picture should be held against a strong light. This will show up the thin places, and further removal of paper should then be confined to the thick spots. In a few minutes, the heaviest print can easily be worked down to such a thickness that it will go into the watch cover without touching the crystal.

Hardened paint and varnish can be removed from brushes with vinegar.

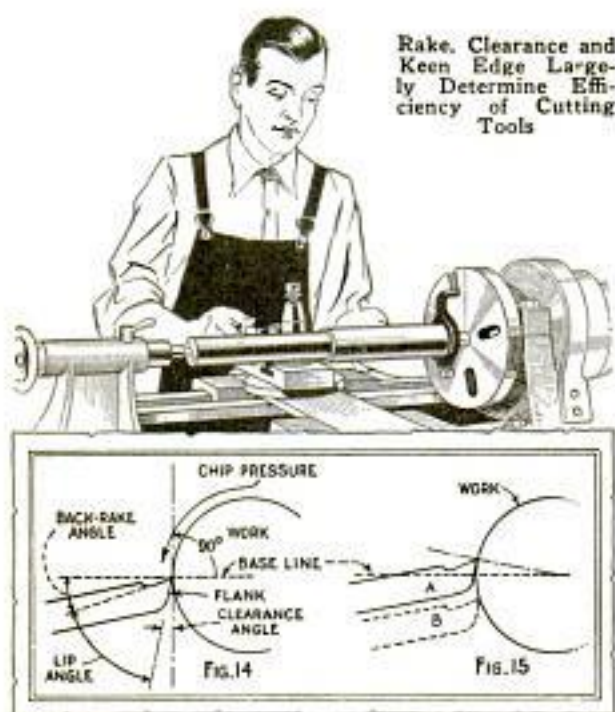

support underneath. Detail B of Fig. 15 shows this relation of the tool to the work. The angle between the lines of the front clearance and back rake should, however, correspond in such variations. This angle, known as the "lip angle," should be as large as possible in order to maintain the strength of the tool, and accordingly an angle of from 61 to 68° will be found most satisfactory.

For cutting cast iron, high carbon steel and annealed tool steel, the lip angle should be slightly greater than in the case of mild steel. Grinding the flank of the tool is done as shown in Fig. 9, while Fig. 13 illustrates the method of dressing the top. For turning brass, bronze and similar soft metals no side and back rake are ground on the tool, and the cutting edge of the latter is adjusted right on the center line, as shown in Fig. 12. Another thing to bear in mind when setting up the tool, is to keep the distances A and B, Fig. 10, as short as possible in order to give the tool the necessary rigidity to cut without chattering.

Various types of tools are needed for different operations, and a number of shapes, looking down on them from above, are shown in Fig. 8. When turning toward the left, the extreme left-hand tool is used, while the second is employed when turning toward the right. For turning on side faces, the second pair of tools

is suitable. A brass tool has a sharper end than a round-nose tool for turning steel, to eliminate the tendency of digging into the work. For making a smooth finishing cut, a tool having a broad, flat end will be found best. Thread-cutting tools can be purchased in the form shown in Fig. 4 and require only grinding on the top, or a threading tool can be ground to shape for the particular thread desired. To turn the inside of cylinders, a boring tool, as shown in Fig. 2, is used, while a parting tool, Fig. 5, serves to cut off the work. The latter is set so that the cutting edge is exactly on the center line of the work. Sufficient front and side clearance are necessary, as indicated in Fig. 7, and a chip curve is grounded on the top, providing back rake. However, no side rake is given. To get an extremely keen edge on cutting tools, treat the edges as you would a razor blade. After grinding, hone them carefully and often so that they will be sharp at all times.

This Drum Mixer Stirs Poultry Feed Quickly

This grain mixer will handle more than a bushel at a time. It is of drum shape with wooden ends, and an 18-in. width of galvanized iron is tacked to the edges of the ends. The door is a piece of the galvanized iron, bent to conform to the curvature of the drum, and is held in place by two strips of the metal raised to allow the



door to slide. The photo shows the mixer open and the door nearly pulled out. The whole arrangement is rigged between two 2 by 4-in. posts in the feed-storage room. The shaft and handle are made of 1/2-in. gas pipe and connected by a tee. The shaft is drilled for pins which lie against the ends and are stapled to the latter.

Getting More Service from Your Flashlight Battery

When your flashlight begins to get dim, it is not necessary to buy new batteries. Simply put in a lower-voltage lamp. For example, if you have a three-cell light with a 3.8-volt lamp, substitute a 2.5-volt lamp and continue to use the old batteries, which will provide enough current to give a bright light for a long time. The lamp substitution will not give as good service as a set of new batteries but it is more economical and will often serve the purpose satisfactorily. However, do not forget to replace the original lamp when new batteries are installed, as the lower-voltage lamp would burn out in a short time.

This Wrench Has Quick Adjustment

Almost any steel monkey wrench can be made quickly adjustable by removing the thumbscrew and adding a pawl. Drill



a hole in the movable jaw near the outside, as shown in the drawing, and file through to form a slot, the width of which should be less than the diameter of the hole. The pawl is ground to a dull edge at one end, to catch in the teeth. These should be filed at an angle on one side and straight on the other side so that the pawl will ride over them when the movable jaw is closed. The straight side prevents the pawl from slipping back when pressure is applied on the tool. The top end of the pawl is rounded off to fit into the slot in the movable jaw, as indicated. If desired, a hole may be drilled and tapped in the sides of the movable jaw adjacent to the hole that holds the pawl, so that the heads of short screws keep the pawl from slipping out.

⚠ To set cutting tools in a moving machine is exceedingly dangerous.



With This 12-ft. Level Jack Mounted on Casters, One Man Can Raise an Airplane

A One-Man Jack for Lifting Airplanes

In order to raise airplanes when it is necessary to change tires or wheels on the landing gear, or when making other repairs, engineers at Crissey field near San Francisco, fashioned a lever jack mounted on casters for easy moving. The lever is 12 ft. long, and one man can lift a plane with little effort, although two men generally operate the lever.—Kirk L. Truman, San Francisco, Calif.

A Spout and Handle for Drip Pans

Drip pans in machine shops will be much more easily emptied, if provided with a spout at one end as shown. This may be done by extending one corner when making the pan, or by adding a spout to those already in use. A handle, riveted to the bottom in the center, makes the pan easier to pick up, and one may be carried in each hand, if desired.



A FEW PRACTICAL USES FOR ANGLE IRON IN SHOPS

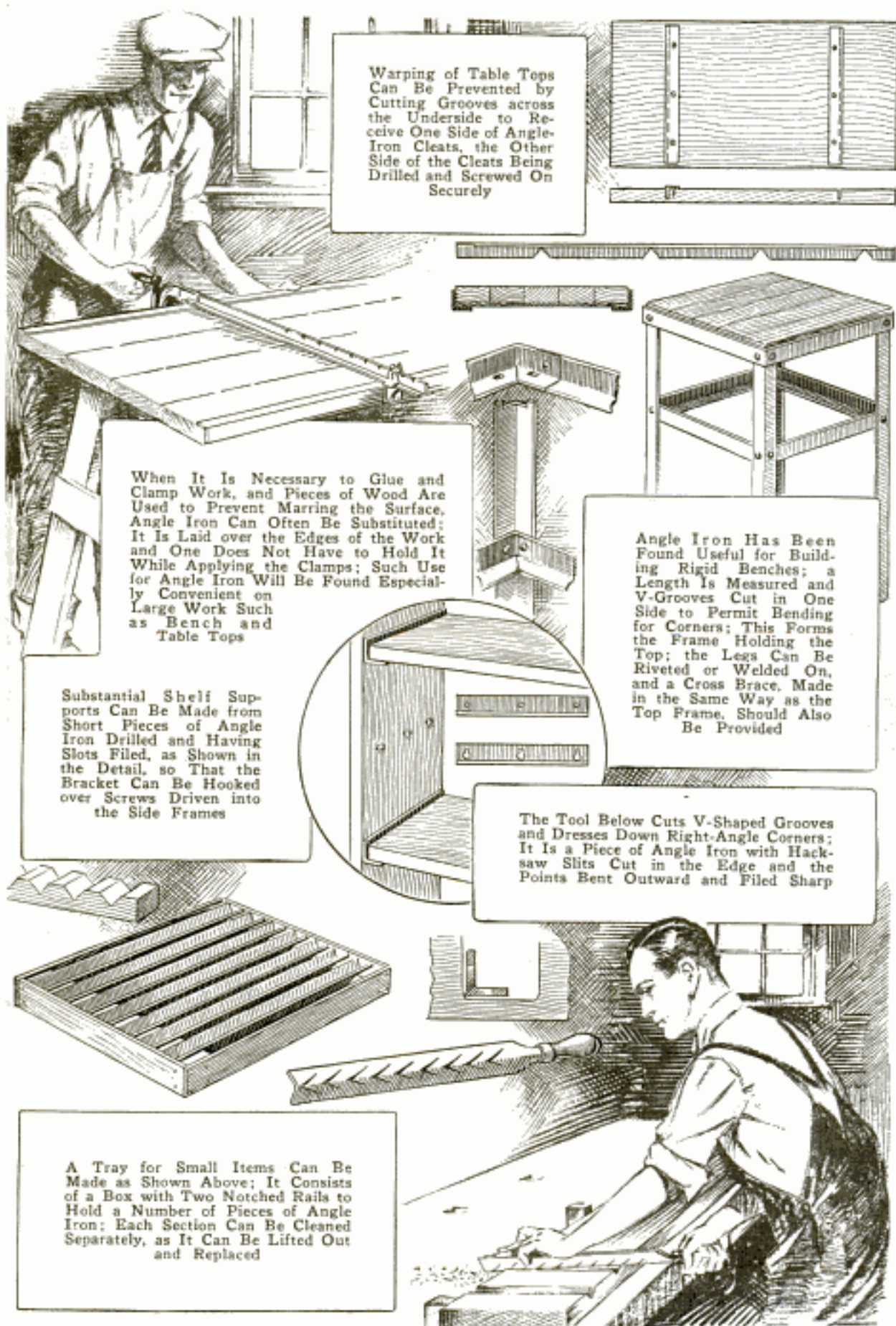

Releasing a Stuck Auto Starter

Most automobiles have starting motors fitted with a Bendix drive. If the motor does not fire on the first contact, the pinion may remain stuck in the flywheel gear. Repeated contacts of the starter switch will only make matters worse by jamming the pinion tighter. To remove the parts, so that access may be had to the offending pinion, is no small task. A quick method of releasing it, and one which has proved successful in nearly all cases, is to place the gearshift in reverse, then have another motorist give the disabled car a sudden push. This will cause the flywheel gear to revolve the pinion on its threaded axle and put it out of mesh. One should make sure, however, that the starter switch is open during this operation. Unless the teeth of the pinion or flywheel are badly battered, this procedure will save many a dirty job or the time and cost of hiring a mechanic.—J. M. Kline, Kansas City, Mo.

Battery Clips Hold Warning Flag

Spring battery clips, often used in radio installations, make excellent holders for red warning flags. A hole is drilled in the end of the clip so that it can be attached to the hem of the flag by means of a screw and nut. Suitable washers are



Spring-Type Battery Clips Make Quickly Attachable Holders for Red Warning Flags

provided under both the screw head and the nut to avoid tearing the cloth. In use, it is a simple matter to attach the clip almost anywhere.



False Bench Stop Fitted with Wooden Cleats and Pieces of Sandpaper to Hold Thin Stock

How to Plane Thin Wood

For planing thin wood without injuring it, when the ordinary bench stops are unsatisfactory for the purpose, a false bench stop with a cleat at each end on opposite sides, and some sandpaper glued to one side as shown, will be found convenient. The sandpaper holds thin work that is not as wide as the cleats. The cleats, of course, should be a trifle narrower than the material generally used. For very thin stock, a small hole can be drilled to receive match sticks, which serve as stops.

Rubber Bands Support Ironing Cord

To keep an electric cord out of the way while ironing, an effective support may be made of rubber bands. Link several of them together to form a chain, slip the cord through the band at one end and tack the other end to the wall or molding, about 3 ft. above the ironing board. The support not only keeps the cord out of the way, but also prevents excessive wear.

Thimble Forms Miniature Ladle

For handling small quantities of liquids, wax and similar materials, a serviceable dipper can be made from a large-size thimble. Wrap No. 18-gauge wire around the top rim and leave the end extend to serve as a handle. This makes a handy dipper or ladle for melting lead or wax.

☐ Oxalic acid dissolved in water is excellent for cleaning tarnished brass.



Tracing Work Can Be Simplified and Eyestrain Lessened By Installing a Lamp in Your Drawer

Electric Light in Desk Drawer Aids in Tracing

Those who frequently make small tracings at a desk will find the illustrated idea a great help in their work. An electric light is installed in the top desk drawer, using a porcelain socket which is screwed to the front of the drawer. Narrow wooden cleats are nailed along the edges of the drawer, near the top, so that a piece of glass can be held flush with the drawer top. A snap switch can be mounted near at hand, and the extension cord permanently plugged in the wall.—J. N. Stody, Kenosha, Wis.

Simple Jig for Slotting Rods

The best method of slotting small rods when the cutting cannot be done on a milling machine, is to drill a row of overlapping holes and then even it out with a small file or broach. A simple and effective jig that facilitates this job, consists of a piece of tool steel,

drilled out as shown and hardened. The first guide hole is drilled in the upper portion of the jig body; the second, in

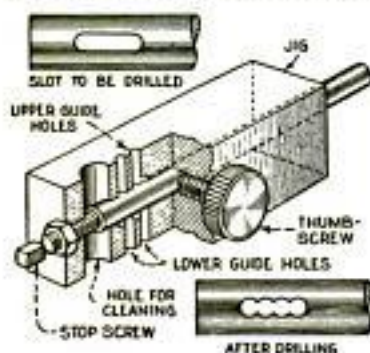

the lower portion; the third, in the upper, and so on. A cleaning hole is provided in order to allow chips to escape. If the binding screw is made of brass or bronze, it will not mar the work.

Test for Impurities in Concrete Sand

Clean sand is important in good concrete work. A simple test that reveals impurities is the following: Pour $\frac{1}{2}$ pt. of the sand into a fruit jar containing a $\frac{1}{2}$ pt. of water in which a heaping tablespoonful of lye has been dissolved. After putting the rubber and cap on the jar, shake the mixture thoroughly for a minute or two. Then set the jar aside and let the sand settle. In about 24 hours examine the water standing on the sand. If it is no darker than apple cider, the sand is suitable for concrete. If the water is of coffee color or darker, the sand is unsuitable and should be washed until the color is improved as indicated by repeating the test.

Improvised Crown on a Flat Pulley

Holes drilled between the spokes and in the center of the face of a pulley and belt lacing threaded through the holes on alternate sides of the rim, as shown in the drawing, form a false crown to keep the belt from slipping off. This improvised crown was found entirely practical.



Old Wringer Deflates Inner Tubes

A handy time and labor saver for the garage or tire-repair shop, is an inner-tube deflater made from an old clothes wringer. Lighter and weaker springs are substituted for those with which the wringer is equipped. To deflate a tube, pick it up by the valve stem allowing the tube to hang. Then grasp the tube at the bottom and, after folding it carefully, insert this part between the rollers. By turning the crank while the valve core is held open, the tube is run through as far as the valve and is then entirely free of air.

A Drum Sander *for the* Workshop

HERE is a homemade drum sander that gives excellent service and can be made for less than \$50.

One-half-horsepower induction-repulsion motors are permitted on most lighting circuits, and for intermittent use, may be connected direct to the supply line without special power wiring. Such a motor will drive a 12 by 8-in. drum with ample power for all but the heaviest work. It should be fitted with either grease-lubricated ball bearings or end shields that are separate from the base so that it may be mounted in the position shown. In purchasing it, be sure to give the characteristics of the supply line.

A drum weighing about 35 lb. was taken from a discarded floor-surfacing machine and is shown in Fig. 9. Besides serving as a flywheel, the drum has a paper lock operating with a wrench. Such drums can usually be obtained secondhand or new from manufacturers of floor-sanding machines. The shaft is generally 1 in. in diameter and one end projects to carry the drive sprocket when used on the floor sander. As a rule this is long enough to admit a babbitted bearing and pulley. A 1/2-in. fiber washer is used on the shaft between the bearing and drum on the end opposite the pulley, so that the paper lock will not strike the bearing or frame, and a thin fiber washer is used on the opposite end between the bearing and the drum to make it run quietly. Two babbitted bearings, Fig. 10, to fit the drum shaft are needed. Also get a flange collar, machined and fitted with a setscrew. The flange should be 3 or 3 1/2 in. in diameter and the hole should fit the shaft of the drum.

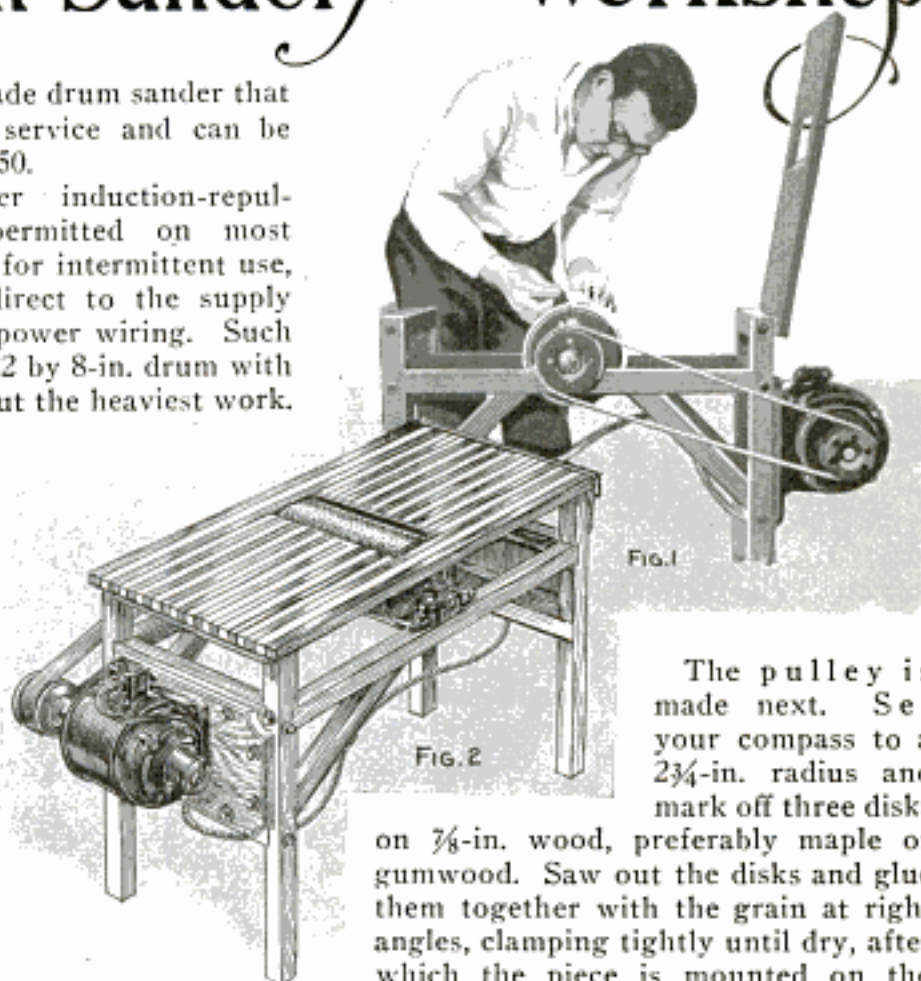

The pulley is made next. Set your compass to a 2 3/4-in. radius and mark off three disks on 3/8-in. wood, preferably maple or gumwood. Saw out the disks and glue them together with the grain at right angles, clamping tightly until dry, after which the piece is mounted on the faceplate of the lathe and turned down to correct size and shape, as shown in Fig. 8. A recess is provided to receive the flange collar. The flange rim should be a light driving fit in the recess to prevent the pulley from running out of true when placed on the shaft. Sink the recess 3/4 in. deep and do not undercut the shoulder. Use a square-nose chisel and test the diameter carefully with inside calipers just before reaching the full depth, to insure a perfect fit of the flange. After the first recess has been finished run back a second recess slightly larger than the diameter of the drum shaft, as indicated at A in Fig. 8. Drill four 1/2-in. holes through the flange rim, slip it into the recess and mark the location of holes for 1/4 by 2 1/2-in. machine bolts.

For satisfactory operation the frame of the machine must have maximum rigidity and strength without excessive weight. Use 2 by 2-in. oak.

Figs. 1 and 2 give two views of the

for floor surfacers

American Floor Surfacing Machine Co. 869
21 S. Lincoln Chicago (supplies parts)

167

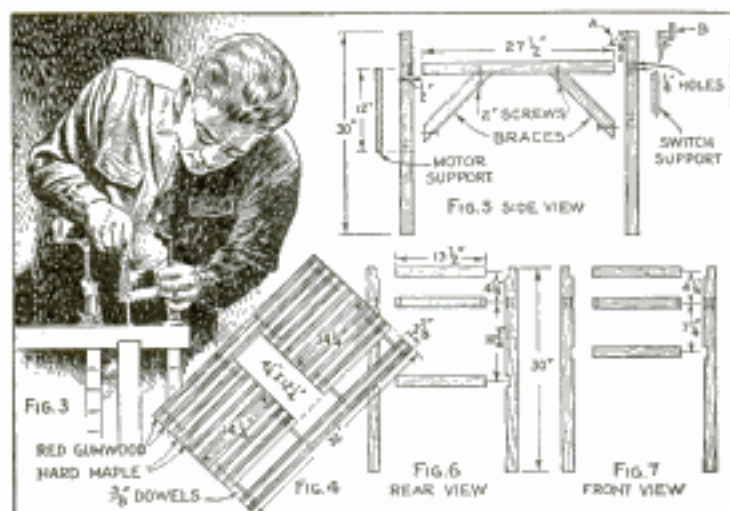

Frame Members and Table for the Drum Sander, Including All Necessary Dimensions, Except A in Fig. 5, Which Varies

completed sander. The various parts of the frame and their sizes are given in Figs. 5, 6 and 7, and the table top is shown in Figs 4 and 13. The dimension A, Fig. 5, which in this case was $4\frac{1}{8}$ in., is very important. To get this accurately, set the drum, with bearings in place, on two blocks. Lay a board on the drum, letting the end project beyond the bearing, and having it parallel to the bottom of the bearing. In this position, measure the distance from the bottom of the bearing to the underside of the board. Deduct 1 in. from this measurement, which is slightly in excess of the thickness of the table. Be sure to allow for the clearance of the drum above the table, or it will be necessary to block up the drum, which is not always satisfactory.

Cut four legs and other frame pieces, and assemble as indicated in the drawing. Lay out mortises for the center crosspieces first. Remember that the dimension corresponding to the $4\frac{1}{8}$ in. given here, determines the distance below the end of the post for the upper shoulder of the mortise. The mortises are laid out across two adjoining faces of the post, one to take the short crosspiece and the other to join the end of the lengthwise piece supporting the drum. The joints must fit tightly. Mark the waste of each mortise so that no mistake is made in cutting. The parts are held together with $\frac{1}{4}$ by 3-in. lagscrews, using a washer under the head of each. The holes for the screws are marked with the joining parts clamped together as shown in Fig. 3.

For the motor support, cut a piece of oak or gumwood 1 by 12 by $15\frac{1}{2}$ in. in size. Cut out the upper corners so that the head of the lagscrews will not interfere with the piece coming solidly against the frame. Attach it with lagscrews and glue. The support for the switch at the front is cut $\frac{1}{2}$ in. larger each way than the opening, and the edges are rabbeted to fit. It is held with glue and small screws, and adds to the rigidity of the frame. Fig. 4 shows the construction of the table, built up of laminated strips and joined with lengths of $\frac{3}{8}$ -in. dowel rod.

This design, while more complicated than the usual type, is well worth the extra work, as it results in a table free from warping and of great strength. The light-colored strips are ripped 1 in. wide from $\frac{3}{8}$ -in. maple and alternated with similar strips of red gumwood. The top is built up in four sections, the end sections measuring $12\frac{1}{4}$ by 15 in., and the side sections, $2\frac{3}{8}$ by 32 in. After each section has been assembled and glued separately, all are doweled together, and then the surface of the table is carefully sanded and shellacked.

Mount the drum on its bearings and place the table carefully in position. Hold it with hand clamps and screw on a pair of butt hinges at the rear, as indicated in Fig. 13. Get two short coil springs and hook the ends over screwhooks in the frame and bottom of the table, to hold it down firmly and enable fine adjustment with the handwheels. The construction of the handwheels is shown in Fig. 12, and their position on the table is indicated in Fig. 5. Piece B is screwed onto the hand-screw holder to protect the table edge from being racked sideways by a blow or pressure. Tack small

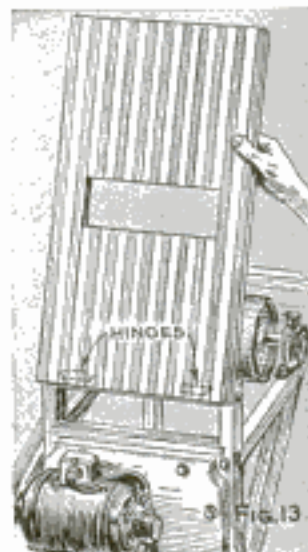

squares of tin to the underside of the table over the ends of the bolts. Bolt the motor in place, making sure that the drive pulley lines up with the one on the drum, and that the motor is square on the frame.

Complete directions for wiring to the 110-volt circuit are furnished with every new induction motor. Follow the wiring chart closely, soldering the connections where the four lead wires from the motor are connected to the line. These two connections must be very carefully insulated from each other with electricians' rubber tape and then with several turns of friction tape, after which the wrapping should be shellacked. Flexible metal conduit should be used to run from the motor to the switch of the line shown in Fig. 11, known as the "square-D type." A detachable plug is used to connect to the house-wiring circuit. The switch should never be fused higher than 15 amp. for use on

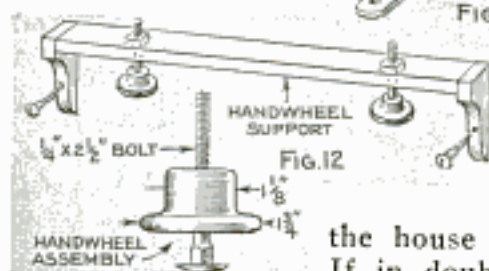

the house current. If in doubt about the wiring, consult the power company or a competent electrician. Use a 2½ by 2½-in. fiber pulley on the motor, and a belt 1½ in. wide. This size pulley will give the drum a speed of approximately 900 r.p.m. when the load speed of the motor is 1,750 r.p.m. Do not tighten the belt too much, as this will greatly increase the starting load. It is better to use a light tension and occasionally apply belt dressing to prevent slipping. The best paper for a drum of this size is the fine-grit paper for floor-sanding machines.

This drum sander has capacity for speedy sanding and will turn out the finest finish

when proper judgment is used in handling it, as is necessary with all sanders. Adjust the table so that the paper just touches the surface of the work, use only sufficient pressure to keep the work firmly on the table and, above all, keep it moving while in contact with the

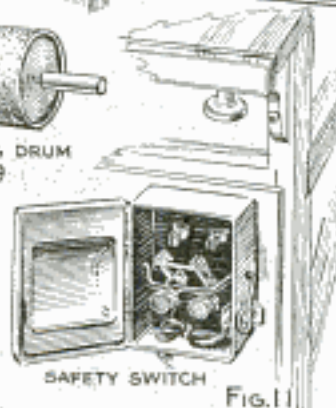
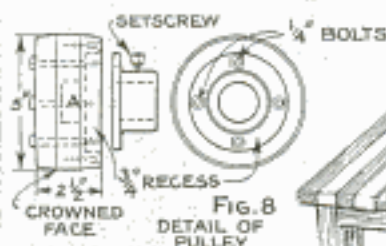

paper. Given a careful adjustment of the table and a minimum of pressure, the high speed of the drum will leave the surface of the work as smooth and clean as one could wish. To get the surface of the work perfectly

square, both handwheels raising the table should be turned exactly the same distance, which is easy, owing to the rigidity of the table.

How Wood Can Be Waterproofed

A good waterproofing solution for wood consists of 4 oz. of asphalt, 30 oz. of pure rubber and 10 oz. of mineral naphtha. It should be applied with a stiff brush in three separate coats, letting each one dry before applying the next. Care should be taken in handling this solution, as its vapor is highly inflammable.

☛ A piece of good plate glass will make a satisfactory emergency surface plate.

Extension Rod on Stepladder Adds to Worker's Safety



Danger of Falling from Stepladders Can Be Reduced by Providing This Extension Handhold

An extension rod provided on the left-hand side of a stepladder, especially a high one, is an excellent safety measure. When one has to stand on the upper step without support, such a rod will be found welcome. A couple of large screweyes are driven into one ladder sidepiece so that the rod can be slipped through both, while a small wooden block is screwed below to serve as a stop. The edge of the top step is notched to accommodate the rod. Any kind of strong metal or wood rod will serve the purpose.

Shaft Size Increased by Peening



When the inner race of a ball or roller bearing wears the shaft and the fit becomes loose, the shaft may be peened with a center punch so that the bearing can be driven tightly in place. The

use of the center punch in this manner raises small portions of the surface and the more of these raised places there are on the shaft, the better and more permanent will be the job. Wear of the outer race of a bearing in its housing may be repaired in a similar way.—A. H. Vance, Bensenville, Ill.

A Rat-Proof Brooder House

In order to keep rats from getting under the chicken brooder house, an effective barrier can be made from heavy woven-wire cloth. A trench, about 20 in. deep, is dug entirely around the house close to the edges. The wire cloth is then stapled, every 6 or 8 in., to the bottom of the brooder house and entirely around it, so that the lower edge of the cloth hangs down in the trench. Dirt is then thrown into the trench, and the result is a barrier that no rat can penetrate.—J. R. Koontz, Bremen, Ind.

Tire-Valve Stem Used to Blow Out Gas Feed Pipe

By cutting off a valve stem and beveling the cut end of the upper part, it will be found useful for blowing out gas-feed pipes with compressed air available at any garage or service station. The beveled end is held in the tubing and the other inserted in the air-hose nozzle. Air blown through the pipe dislodges any obstruction and cleans the pipe out thoroughly.

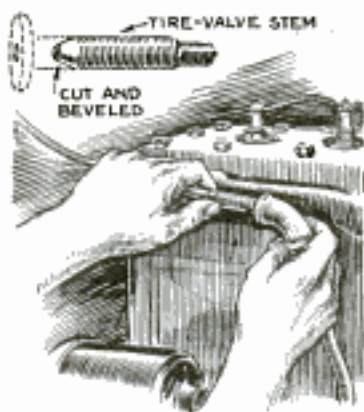

How to Save a Watch Dropped in Water

When a watch has been dropped in water, open the cover as soon as possible and immerse the watch in alcohol. Any kind of alcohol can be used for the purpose except wood alcohol. After removing the watch, shake out as much of the liquid

as possible, and drop it into a cupful of kerosene, keeping it there until it can be taken to a jeweler for cleaning and repairs. If the watch has been immersed in salt water, it will be ruined within a few hours if not quickly and properly treated, although it will suffer little damage until it has been exposed to the combined chemical action of salt water and air. If running water is available, open the cover and let the fresh water run through the works for several minutes to remove all traces of the salt water, and then follow the procedure already described.

Increasing Utility of Ladle

The illustrated ladle has been provided with several added conveniences which greatly increase its utility. An inside spout, opening at the bottom, is a most valuable feature as it prevents pouring scum which floats on the surface of babbitt. An iron rod bent to a V-shape and welded onto the underside of the handle makes a good rest, permitting a flat-bottomed ladle to be set down without any risk of spilling. A hook welded to the front edge of the cup will be found useful for lifting a crucible pot off the fire, while a similar hook on the top of the handle near the cup permits one to attach an extra handle when the load is heavy.



An Extra Rest, Spout and Two Hooks Make This Pouring Ladle Exceptionally Handy

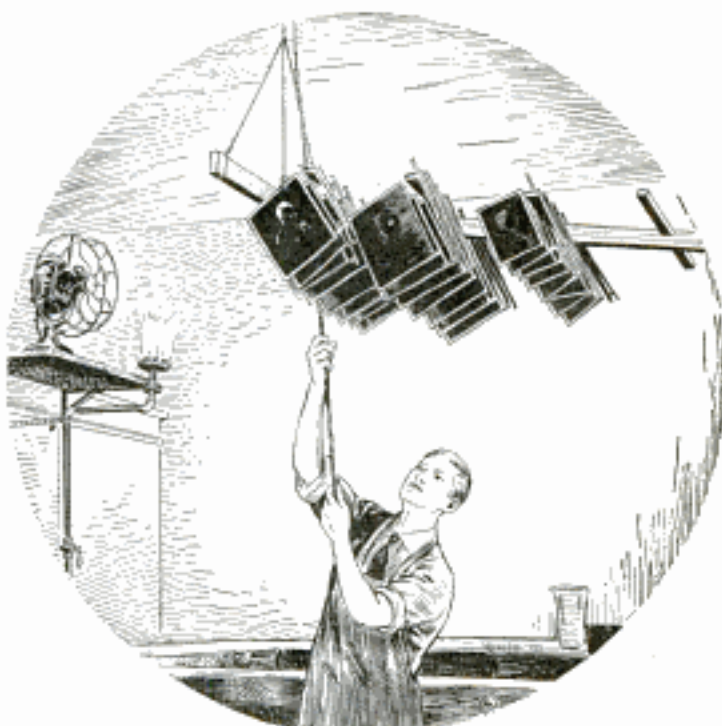

Electric Fan Placed behind Large Gas Burner Provides Warm Air for Drying Negatives on This Overhead Rack

Hot Air Dries Films on This Overhead Rack

Films and plates can be dried in a very short time on an adjustable, overhead rack that holds 3 or 4 doz. hangers at a time. It is raised and lowered by means of a sash cord run over pulleys, the same method of attachment being used at each end. The rack itself consists of 1-in. hardwood, 3 in. wide and 8 ft. long, having $\frac{1}{2}$ by 2-in. crosspieces spaced 1 ft. apart and notched to hold the hangers. A blast of warm air is directed against the negatives by an electric fan placed behind a gas burner of the kind used under large coffee percolators. By raising the rack to the ceiling the plates are entirely out of the way and also in a better position for drying as the air near the top of the room is generally warmer than that near the floor. —Fred H. English, Springfield, Mo.

Soap Used to Stick Paper to Glass

A bar of yellow laundry soap makes an excellent substitute for paste or mucilage in attaching posters to glass, store windows and soda-fountain mirrors, for instance. Simply press the corner of the cake to the poster hard enough to leave a little soap adhering to the paper.

Hacksaw Blade Makes Accurate Section Liner

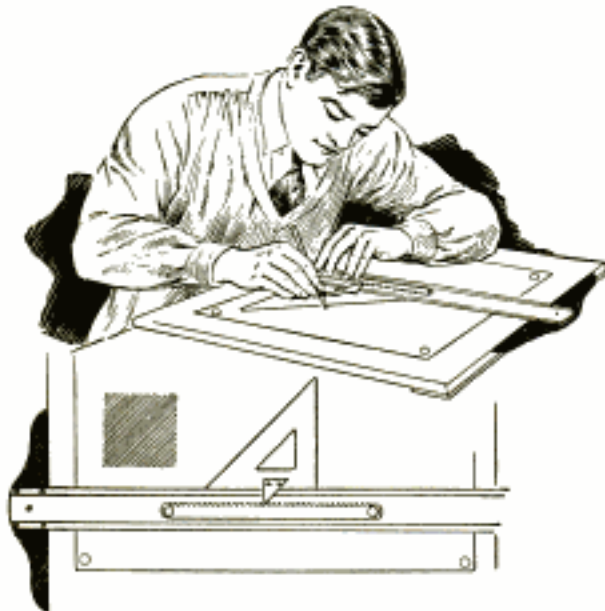

Attached to the T-Square, a Hacksaw Blade Makes a Neat and Accurate Section Liner for Draftsmen

Here is a simple section liner that costs only 10 cents. Get a hacksaw blade and attach it to the top side of the T-square, with the teeth up as indicated. A piece of sheet metal, cut to triangular shape, is attached to the lower edge of a triangle so that the point of the sheet-metal piece engages with the teeth of the hacksaw blade. As the teeth are equidistant, the spacing of the lines will be the same.

Testing Canvas for Quality

When purchasing canvas or cotton duck, there are several simple tests for determining its quality. Hold the canvas up to the light and, if you can see many pinholes or places where the material is thin, it is a poor grade and will not wear well. Canvas known as U. S. standard army duck does not show many pinholes or thin places when exposed to the light. It is made of multiple-ply yarns and is not bleached, loaded or sized. You can ascertain the ply of the yarns by untwisting and counting the number of small threads into which they separate. To determine the closeness of the weave, unravel the material and count the ends of yarn per inch. If you buy khaki-colored canvas, and wish to know whether it has been dyed with mineral or organic dyes, the following test is a positive means of identification: Burn a small piece until

no carbon remains in the ash. If the dye contains mineral matter, a considerable quantity of ash, colored from buff to dark brown, will remain, but if an organic dye has been used, only a little white to gray ash will be left.

Ammonia as a Fire Extinguisher

Ammonia pistols have been found quite effective, under certain conditions, for extinguishing small gasoline fires. As the fumes are heavier than air they quickly smother the flame, especially if it is confined. A bottle of ammonia, carried on the car, therefore makes a good fire extinguisher on tours and is also useful for cleaning glass and metal. An automatic fire extinguisher for the garage may be made by suspending bottles of ammonia from the ceiling by means of inflammable strings; which, upon burning, allow the bottles to drop and break. The ammonia fumes in the confined garage would be of considerable assistance in checking if not entirely extinguishing the blaze.

Adjustable-Width Gauge on Truck Protects the Load

Truck drivers who frequently handle loads that project beyond the sides of the truck, will find an adjustable crosspiece on the front helpful in gauging clearance. Such a gauge can be made from a pair of sliding curtain rods, arranged in front of the radiator and attached securely to the lamp brackets or fenders. Before starting with a load, the driver sets the rods to represent the width of the load so that he has a constant reminder of it before him and can readily see if he has enough space in alleys and other restricted places.

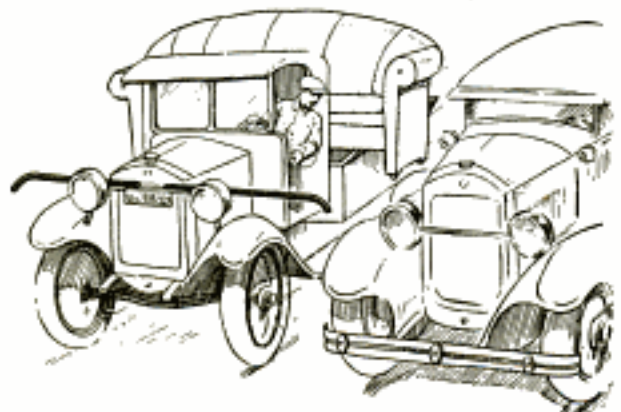

Sliding Curtain Rods on Front of Truck Form an Adjustable-Width Gauge to Protect the Load

A Drop-Leaf Pivot-Top Table

HERE is an exceptionally attractive drop-leaf table with pivoted top that can be duplicated easily by anyone. Ordinary tools found in the home workshop will suffice. The equipment of most public manual training schools is available to night as well as day classes, and offers an opportunity to turn out this job in first-class manner. Using genuine mahogany, the average cost of this table will be about \$4.

The top consists of three pieces of $\frac{3}{4}$ -in. material. For the center or pivot piece, 5-in. wide material is used, and the leaves are cut from 10-in. widths. Saw the leaves to the shape indicated in the drawing and fasten to the centerpiece with temporary battens on the underside; then fashion the edges with a molding cutter. For the legs, use $\frac{7}{8}$ -in. mahogany sawed to graceful curves as shown, the narrowest portion being about one-third the distance from the top end. There is a mortise at the top of each leg to receive a stretcher, and mortise-and-tenon joints also hold the assembly together at the bottom, as indicated. These mortises should be $\frac{3}{8}$ in. wide and $\frac{1}{2}$ in. deep. The bottom stretcher and leg should have molded edges. In the center of the top stretcher, a hole is sawed about $3\frac{1}{16}$ in. in diameter, or slightly larger than a 3-in. wood disk that is to turn in it. Before assembling the parts, mark the outlines of the duotone or imitation-inlay designs. This can be done satisfactorily with a marking gauge, and the outlines then darkened with a soft lead pencil, which also prevents the dark stain from running over into the lighter portion. Sandpaper all pieces to a smooth finish and assemble the main frame, gluing the joints and clamping together until dry. For the pivot, cut two circular disks of $\frac{3}{4}$ -in.

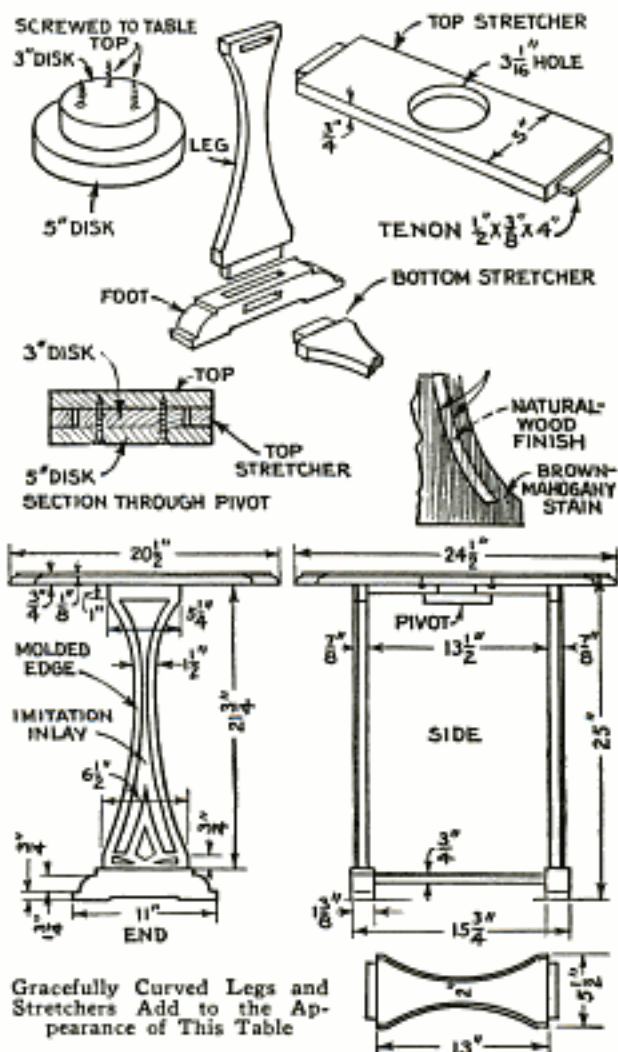

hardwood, which are to be screwed to the underside of the top centerpiece, when

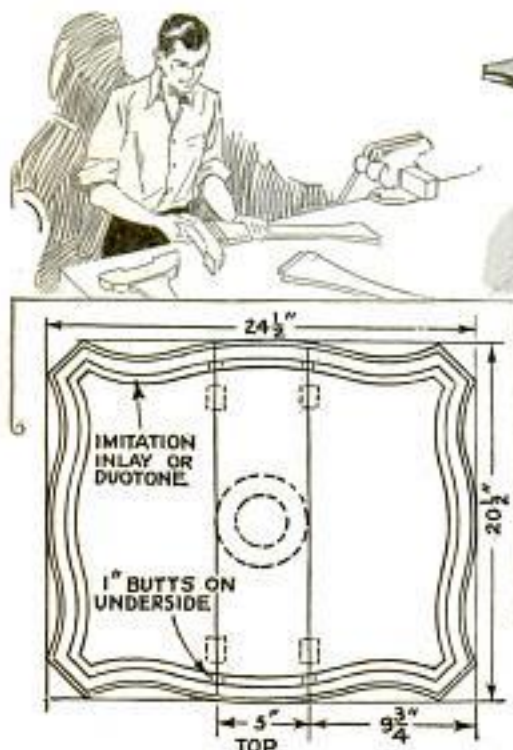

the staining and finishing have been completed. In working out the duotone effect, the lighter portions are given a thin coat of white shellac, and when dry, brown mahogany water stain is applied to the other portions, as well as filler. Finish all surfaces with a fine grade of sandpaper when dry, and apply two more thin coats of shellac. Complete the final assembly of the top, hinging the leaves to the centerpiece with 1-in. butts on the underside, about 1 1/2 in. from the edge. Insert the pivot disk in the hole in the top stretcher and screw to the centerpiece.

With carefully applied finish, this table makes a really handsome piece of furniture and will be found handy for many purposes.

Reading Glass Helps in Focusing



Photographers will find the installation of a large reading glass on the sliding bed of the camera, an aid in getting a sharp focus. It covers a large field and is always



in position when needed, even when using the sliding back to take two pictures on one plate.

Cambric for Cleaning Glass Lenses

Clean cambric, a fine thin white linen fabric, has been found especially suitable for cleaning the lenses of cameras, spectacles and other articles.

An old handkerchief of that material makes the best cleaner. Never rub the glass with anything likely to contain grit and be sure to rub lightly.

Auto Tube Used to Prime Pump

With the type of pump shown in the drawing priming can be accomplished with the aid of a piece of inner tube, one end being slipped over the spout and held tight, after which water is poured into the tube.



Where a tubful of water is handy, the water can be scooped up in the tube with one end squeezed shut.

Photo Background Tinted with Ink Can Be Folded

For several years I have used painted background curtains in making home-portrait photographs, and as the curtains had to be folded and unfolded, the paint at the folds cracked. In making up a new background, I found it much better to ink the cloth instead of painting it. This was done with the aid of a fly sprayer filled with ink of desired shade, spraying until the proper tint had been obtained. The spray was then emptied and washed with gasoline, after which ink of another color was put into it and the other side sprayed. —Duke D'Ambra, Lawrence, Kans.

Keeping Leather and Rubber Belts in Good Condition

Usually the only care the average belt gets is to have new lacings put in when the old ones wear out and a piece cut off when the belt is tightened. A little attention will increase its life and usefulness considerably. Belts should be run as slack as possible, being just tight enough to do their work. More belts are ruined by being unnecessarily tight than are worn out in actual service. If a leather belt gets dirty from an accumulation of dust and oil, take the time and trouble to clean it. The grease and dirt can be loosened with a mixture made of 3 parts of benzine, naphtha or gasoline and 1 part of turpentine. If such a mixture is prohibited in the shop because of fire hazard, use the turpentine alone. After the belt is clean and dry, apply a light coat of some good belt dressing or, in the absence of that, a little castor oil or tallow. The mixture mentioned is intended for cleaning leather belts only, and should not be used on rubber belts. These may be cleaned with a little soft soap and water. To make them more pliable and cause them to stick to the pulleys, moisten lightly on the inside with boiled linseed oil but no other kind.

Hacksaw Stop Limits Depth of Cut

For cutting with a hacksaw to a certain depth, a stop attached to the saw frame, as shown, will be found useful. It consists of a length of strap iron with the

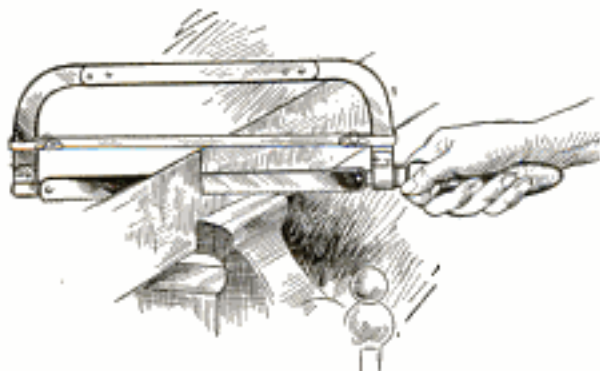

Length of Flat Steel Clamped to the Hacksaw Frame Limits Depth of Cut

ends bent to fit over the frame. Screws and wingnuts are used to clamp the bent ends onto the frame at the proper points to stop the cut at the desired depth.



Here Is a Cheap and Easy Method of Making Stereotypes with Molten Type Metal

Type Metal Used for Making Newspaper Cuts

For making cuts a small mid-western printer has found the following method successful: A steel plate or galley form is boxed to hold a $\frac{1}{16}$ -in. layer of thin paste made from chalk and water. After the water has evaporated and the chalk is thoroughly dry, the drawing is penciled on, after which it is cut through the chalk to the steel with a stylus made by grinding down the sides of a steel knitting needle. The stylus is held vertically and the lines are cut with a scratching or rubbing motion. Do not attempt to cut through the chalk in one stroke as this may chip it. After the etching has been completed and the dust blown off, type metal is poured on to a thickness of $\frac{1}{8}$ in.

Renovate Oilcloth and Linoleum with Paraffin

Dissolve $\frac{3}{4}$ lb. of melted paraffin in 1 qt. of turpentine, warmed in a pan set in hot water, and, while still warm, apply the mixture with a sponge or cloth to the oilcloth or linoleum. It can also be used on painted floors. After 24 hours, the floor should be polished, which will bring out the gloss.—Arthur T. Bowden, Ottawa, Kans.

WIRING TRACK TO STOP TOY TRAIN FOR RED LIGHT

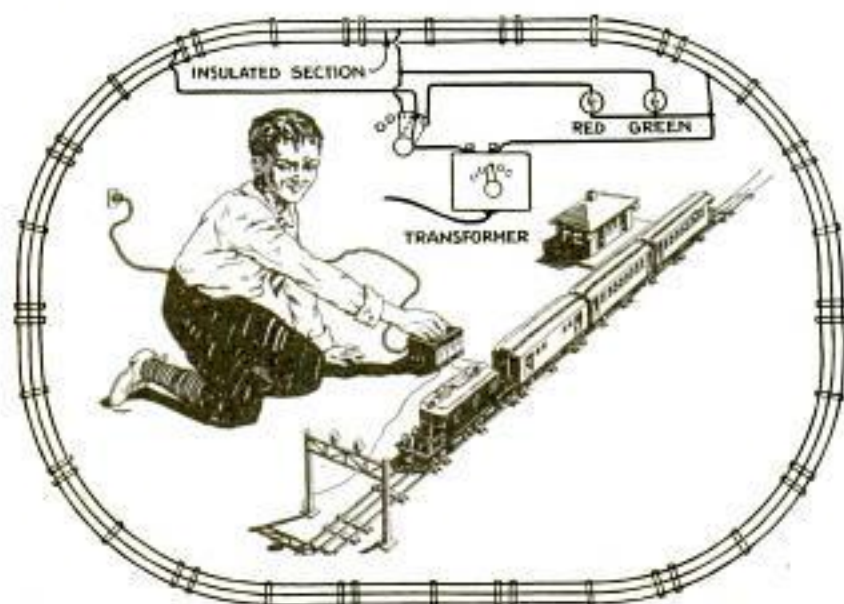

Any Boy Can Arrange This Wiring System to Stop Trains When the Semaphore Shows a Red Light

Here is a simple wiring circuit that can be applied to any toy train so that it stops automatically when the red light is turned on, but keeps on going with a green light. Get 3 flat-head switch-contact points and a switch lever from the radio store and mount them on a piece of bakelite, so that the lever touches two contacts at once. The contact at the left is connected to the green lamp and to a section of the center track, which should be carefully insulated from the rest. This por-

tion of track should be long enough to allow the train to come to a full stop before reaching the next part, which gets current from the center contact point of the switch. The right contact is connected to the red lamp, while the return from both lamps and the track goes to one terminal of the transformer supplying the current. The other terminal of the transformer is connected to the switch lever. The train continues around the track as long as the switch lever makes contact between the center and left

contact points, which also keeps the green light on. The moment the lever is turned to the right, so that contact is made between the center and right contacts, the green lamp goes off, the red one on, and the center section of the insulated portion of track receives no current supply for the train, which slows down and stops of its own accord. Both the red and the green lights may be mounted on a small semaphore, which can be made of wood and painted any suitable color.

Small Bar Magnet Serves as Rule Marker

When taking measurements with a steel rule where there is insufficient light to enable the worker to read the smaller divisions easily, it will be found a great help to place a small bar magnet on the rule at the point where the measurement is taken. Then the rule can be taken to the light and read without difficulty.



Taking Measurements with the Aid of a Small Bar Magnet Laid on a Steel Rule

Workmen who have poor eyesight will find this kink a valuable one.—Myron L. Harmon, South Bend, Ind.

How to Prevent Sandpaper from Gumming

When the atmosphere is moist, sandpaper "gums up" surprisingly fast, and as a result much of it is wasted. To avoid this trouble the following method was found successful: A cheap electric stove, and a piece of blower pipe, about 12 in. in diameter and 2½ ft. long, were obtained. The latter was slipped over the stove and three iron rods were pushed through holes punched through the sides, about 2 in. above the stove, to serve as a rest or holder for the sandpaper. A lid was placed on the upper end of the pipe to keep the heat in. The paper will not

be burnt, but will be dried out in 10 to 15 minutes. Emery cloth can be treated in the same way, although the cloth gets rather stiff. This stiffness can be removed by rubbing the back over the edge of a board.—Roger C. Dickey, Salem, N. H.

Slippery Floors Made Slip-Proof

Shop floors, especially those of wood, become very slippery around a machine, owing to lubricant being spilled there from time to time and excessive foot wear. This causes the floor to take on a polish which is dangerous to the worker. To prevent it, apply a light coat of glue, and when this becomes tacky, sprinkle sand on top. When the glue has hardened, the sand will be firmly imbedded, and the danger of slipping will be minimized.

Monkey Wrench and Pliers Form Improved Pipe Wrench

When no pipe wrench is at hand, a substitute may easily be improvised from a monkey wrench and a pair of pliers. Place one jaw of the pliers between the jaws of the wrench as shown, then tighten the wrench against the pipe in the

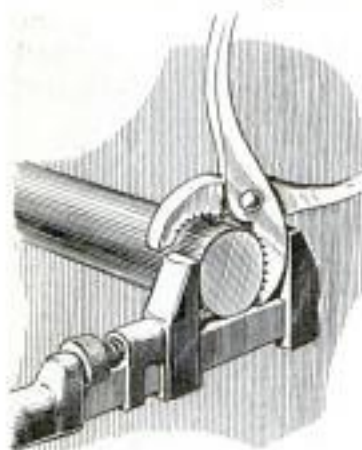

usual way, after which the pipe can be turned in one direction. By reversing the arrangement of the two tools the pipe can be turned in the opposite direction.—W. A. Milspaw, Philadelphia.

Electric Drill Runs Homemade Pump for Filling Grease Gun

Workers at the Transcontinental-Western air express terminal at Alhambra, Calif., use an electric drill to drive a homemade pump for transferring grease from barrels to grease-gun cylinders. An old centrifugal auto water pump was attached to a barrel lid on a frame of flat iron, so that the pump could be lowered to the bottom of the grease barrel. An

extension shaft attached to the pump, was passed through an improvised bearing



Auto Pump, Set in Grease Drum and Driven by Electric Drill, Fills Grease Gun Quickly

and up through the lid. Similarly a length of pipe was attached to the outlet end of the pump and projecting through the lid. Nipples and elbows were used to extend the pipe over the side of the barrel so that it could be conveniently used for filling the grease cylinder. An electric hand drill was then chucked to the upper end of the shaft.

Jars Attached to Underside of Shelf Solve Storage Problem

For keeping small articles on the stock-storage shelves, glass fruit jars were successfully used by an eastern merchant. The caps were screwed to the underside of the shelves, two $\frac{3}{16}$ -in. holes having been drilled in each cap. Held securely in this manner, the jars cannot tip over, and he can see if the supply of any one article is running low.



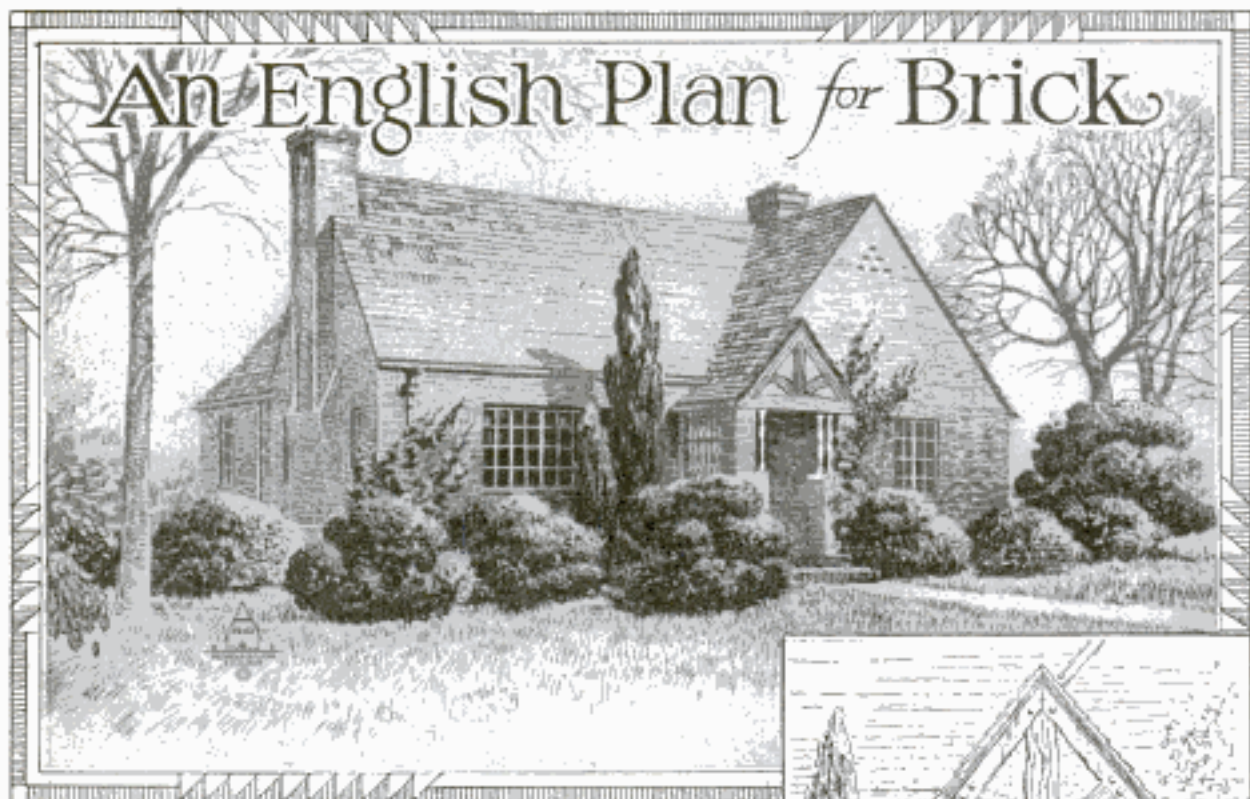

© The Architects' Small House Service Bureau, Inc. Plan No. 6-B-18

A MAN writes: "All my life I have dreamed of the house I will build. It has to be a brick house." This house design suited him perfectly.

Perhaps you, too, want one of brick. If so, it does not have to be an overexpensive wall for you, because it may be very finely executed with a good grade of well-burned common brick.

This house is just about the right size for five people—may be six. It will suit a smaller family for the time being, for the den or bedroom can be made into a play room. The closet bed shown in the plan, when lifted into place, frees floor area for any use that is wanted.

The plan is a practical one both to build and to live with. Since it has a standard arrangement—long tested by home builders—it will be easy to get financing and just as easy to attract buyers. That's a decided point to be considered by everyone, though many prominent home economists say, "build your home to keep, not to sell."

The entrance detail is as English as roast beef. The rough-timber work, combined with smoothly finished balusters, makes an interesting combination of robust and delicate woodwork.



The Architects' Small House Service Bureau of the United States, Inc., was formed to furnish a complete and dependable small-house plan service at moderate cost. For information regarding the blueprints and specifications address the bureau at 1200 Second Avenue, South, in Minneapolis, Minn., from which also a booklet, containing twenty-seven selected small-house plans, may be had for the price of 10 cents. The bureau is under the control of the American Institute of Architects.

Here is a new Bit Extension that holds bit in socket and does away with troubles you have had with the old-style extension that holds bit in chuck with jaws.

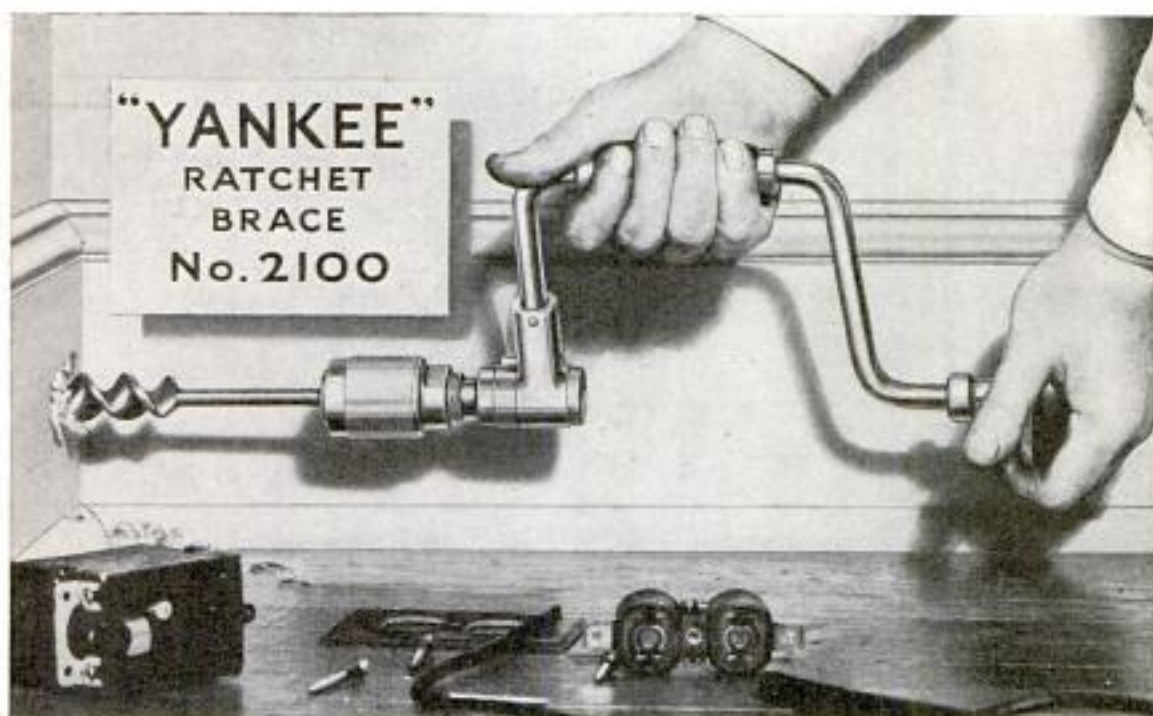

Hard boring jobs are easy with "Yankee" Brace No. 2100

The "Yankee" Brace is the speedy, easily-worked tool for all boring jobs. The smooth, silent ratchet movement brings to you ease in working on awkward jobs.

Toolmaking leadership is in "Yankee" Chuck. Holds any bit. Is ball-bearing, quick centering. Two jaws. Holds $\frac{1}{2}$ inch round; $\frac{5}{8}$ -inch square (across corners).

"Yankee" hard rubber handles won't shrink, crack or bind.

Famous "Yankee" Ratchet, unbreakable, dust-proof, moisture-proof. Quick, positive, easy-acting and visible Ratchet Shifter. Works at a finger touch.

Then a finish strictly up to "Yankee" standards.

You will prize this fine lifetime tool. See it at your hardware dealer's. Made in four sizes: 8-, 10-, 12- and 14-inch. Price, 10-inch sweep, \$3.20.

"YANKEE" Bit Extension No. 2150

No jaws. It holds bit in socket! No loosening and pulling out of bit in work. Can't jam. Fits any brace. Follows through. Stands abuse. Four lengths: 15, 18, 21, 24 inches. Prices, \$2.25 to \$2.40.

"YANKEE"
TO HELP YOU MAKE THINGS **TOOLS**



NORTH BROS. MFG. CO., Lehigh Avenue, Philadelphia, U. S. A.

Saving time is important to me. You may send book showing action pictures of famous "Yankee" Ratchet tools: such as Ratchet Screw-drivers, Spiral Ratchet Screw-drivers, Ratchet Push Drills, Ratchet Push Braces, Ratchet Breast and Hand Drills, Ratchet Chain and Bench Drills, Ratchet Tap Wrenches, etc.

NAME..... ADDRESS..... (pm)

* **Champion Hickok**

Salesmen say it's

"clean business"

to shave

with **Barbasol**

• Barbasol testimonials are not paid for



S. Rae Hickok and Champion Hickok Salesmen responsible for the success of Hickok belts, garters and suspenders

THE finest shave—for the finest of salesmen—the leaders on the Hickok sales staff! That's Barbasol. This modern shaving cream turns out better looking, better *feeling* faces. And does it in quicker time. That's why it has been chosen by these men to give each one of them the "face that gets the order."

When the day starts; when the winners are picked; in the belt business or in *your* business; the men who step into

the front ranks are generally Barbasol Believers. They've made it the fastest-selling shaving cream in America.

Here's why: It *saves time*. And delivers the smoothest, easiest, slickest shave you ever had. No brush; no lather; no rub-in. Barbasol softens the beard like magic while holding the hairs straight up to the blade. It takes the tussle out of beards—tough beards, wire-haired terrors—all beards. How crisp and easy the razor slides along! Just follow

these directions and you'll give your face a glad surprise. At that, you'll follow the *crowd*:

1. Wet your face. Leave it wet . . . 2. Spread on Barbasol so it reaches the skin . . . 3. Wet a good blade and — SHAVE.

That's all. And your skin stays soft and comfortable. No lotions needed. Blades last longer, too. Try Barbasol today. Generous tubes, 35¢ and 65¢ at all drug stores. The Barbasol Co., Department 25, Indianapolis, Ind.



Listen to *Barbasol Ben and His Boys*—Laughs—music—fast and furious fun—the happiest entertainment on the air. Tune IN, every Monday, Wednesday and Friday evening at 8:15, Eastern Standard Time, Columbia Network; Stations WABC, WMAQ, WCAU, WXYZ, KMOX, WHK, WJAS, WNAC, WCAO, WKBW, WISN, KMBC, WCCO, WKRC, WFBM, WMAL, WEAN, WSPD, KOIL, WADC, WFBL, WDRG, WPG



Do You Use A CIRCULAR SAW?

ONE of the most interesting of many chapters in the new "Disston Saw, Tool, and File Manual" tells and shows how to use circular saws. It tells also how to joint, set, and file circular saws, band saws, hand saws, etc.

This valuable manual also shows how to select the correct saws for your power outfits. It describes the most efficient circular saw for your bench machine: the Disston *Hollow Ground Combination Novelty Saw*, which rips, cross-cuts, and

mitres equally well, and makes a cut smooth enough for gluing without sanding.

Disston Circular Saws are the only circular saws made of the world-famous Disston Steel, with the Disston Temper that insures long, perfect service. See that your outfit is equipped with Disston Saws.

Order through your dealer, making your selection from the "Disston Saw, Tool, and File Manual," just out, sent free. (Mail the coupon or a post card.)

DISSTON

Makers of "THE SAW MOST CARPENTERS USE"

DISSTON
DOLLAR
SPECIALS
for the Home Workshop



New Disston No. 255 Rosewood
PLUMB and LEVEL

and the New Disston

STRONGHOLD FILE HANDLE

To introduce quickly the Disston No. 255 Rosewood Plumb and Level, a wonderfully handy, always accurate, beautiful new Disston tool, we will send you one postpaid for a dollar, and include with it, free, to introduce it to you, a Disston No. 2 Stronghold File Handle, regularly 10 cents, for all 6 to 10-inch files.

The Plumb and Level, regularly \$1, is 10 inches long and weighs 9 ounces. The rosewood is beautifully figured, highly polished. Both glasses are proved and etched.



**CABINET
SCRAPER
OUTFIT**



Scraper Burnisher - File

Disston Acme Cabinet Scrapers, made of Disston Steel, are the finest scrapers made. To prove their quality to you, Disston will send you an Acme Scraper, 2 1/2" x 5", regularly 40¢, with a Disston No. 1 Oval Burnisher, 4 1/2" blade, regularly 40¢, and a Disston 8" Mill File, regularly 30¢—all three for \$1, postpaid.

This outfit gives you not only the perfect scraper but also the best means of sharpening it. Try it, and then you will buy more from your dealer. The new "Disston Saw, Tool, and File Manual," sent with the outfit, shows how to sharpen cabinet scrapers for any kind of work. Mail the coupon and a dollar today.

HENRY DISSTON & SONS, Inc., Philadelphia
(In Canada, Henry Disston & Sons, Ltd., Toronto)
Send me, postpaid, the items checked:

- The new "Disston Saw, Tool, and File Manual," interesting, instructive, and valuable, sent free.
- The new Disston No. 255 Rosewood Plumb and Level and the new Disston Stronghold Saw File Handle, both for \$1, enclosed. (In Canada, \$1.30)
- Disston Acme Cabinet Scraper, Burnisher and File, all for \$1, enclosed. (In Canada, \$1.30).

Name and Address.....



YESSIR. Savogran Crack Filler makes it easy to tighten loose chair rungs, pulled-out screws, mend broken tiles, and do hundreds of other repair jobs. Mighty handy for building models, toys, and furniture, too. Works just like wood—you can saw, cut, smooth, nail it. And paint hides the repair perfectly. Savogran Crack Filler lets you do work an expert would be proud of. And best of all, it *will not shrink!* Savogran Crack Filler *stays put!*

Get a big one-pound can today at your paint or hardware store—only 30c. (5-lb. can, \$1.25; 35-lb. pressed-steel pail, \$7.70.) Also get a can of Painters' Savogran. It will save you hard work on painting or heavy cleaning jobs, and make hard paint brushes good as new.

VALUABLE BOOKLET FREE!

Write for your copy of the handy booklet, "How to Repair and Refinish Furniture"—24 pages packed full of helpful information. Free!

SAVOGRAN CO., DEPT. M-5, INDIA WHARF, BOSTON

SAVOGRAN CRACK FILLER

Reg. U. S. Pat. Off.

Patent 1781003

WILL NOT SHRINK!

DO YOU

WANT a new business profession of your own, with all the trade you can attend to? Then become a foot correctionist, and in a few weeks earn big income in service fees,—not medical nor chiropody—easy terms for home training, no further capital needed, no goods to buy, no agency. Established 1894. Address Stephenson Laboratory, 1 Back Bay, Boston, Mass.

NEW WOLLENSAK 350 POWER MICROSCOPE



\$18.50



With stand detached for examining bulk

The convenient size, simple manipulation and precise optical qualities of this new microscope will appeal to amateur scientists, growing boy or girl, as well as the professional man.

NEW FEATURES

Affords magnification from 100 to 350 power accurately graduated in steps of 50 power. Concave mirror... rack and pinion... tilting stand enabling microscope to be used in all positions... detachable base which simplifies the examination of any matter that cannot be conveniently placed on stage.

At your dealer or direct postpaid, \$18.50 Money back guarantee.

Wollensak 50 to 110 power microscope \$10.00

Catalogue free.

WOLLENSAK OPTICAL CO.
868 HUDSON AVE. ROCHESTER, N. Y.

Less problems our specialty

Catch Fish!

Eels, Mink, Muskrats with our new folding galvanized STEEL WIRE TRAP. Write for our FREE TRAP OFFER and Bargain Catalog. \$1 Box of our famous Fish Bait FREE to introduce our traps. WALTON SUPPLY CO., 3502 JUNIATA AVE., ST. LOUIS, MO.

INCREASE YOUR BUSINESS by using the NEW \$5.85 "Two-Faced" Film Duplicator to make 100 copies, in 1 to 5 Colors each time. Or the \$37.05 "Excollograph" Rotary Stencil Duplicator to Print Copies of Anything Typed, Penned, Drawn or Traced in numbers up to 3000 each operation, as Price Lists, Hand Bills, Special Sales Announcements, Bulletins, Menus, Quotations, or "what have you?" Write—

Easy Terms

PITTSBURGH TYPEWRITER & SUPPLY CO.
Suite 552, 339 Fifth Avenue, Pittsburgh, Pa.

Instant relief from BURNING FEET

IS WALKING torture for you because of sore, burning, aching feet? Then for quick, lasting relief, apply Coolene, the new ivory-white vanishing foot cream. With its mild penetrating, soothing oils and unguents, Coolene quickly relieves the irritated nerves and tissues—heals away pain and inflammation—and brings you new, cool, day-long foot comfort. Does not stain stockings or bed clothing. Get Coolene today at your druggist.



Taking the risk out of flying



Master Precision Level No. 199—*for leveling machines—graduated to 10 seconds inclination—\$50.00*



Easy-Grip Hackawee Frame No. 169—*perfect balance—rigid—for 8" to 12" blades—\$3.25*



Micrometer No. 230—*cut-away frame, ratchet stop and lock-nut—0 to 1" by 1000ths—\$10.00;—or 10000ths \$11.75*



Combination Set No. 9—*combination square—center gauge—protractor—hardened blade—9" size \$6.00*

Semi-Flex Hackawee Blade No. 941—*a blade for tubing, thin metal—practically unbreakable*

The crankshaft at the right will soon be turning up its rated R. P. M. behind the roaring prop of a J-6, if—IF the Starrett Indicator says those bearings are O. K. If they're out as much as a half-thousandth of an inch, that crankshaft will never leave the ground.

In airplane building and servicing, Starrett Tools are helping to eliminate mechanical failures. For *treacherous estimates*, Starrett Tools substitute *sure figures*. They drive the risks out of flight.

Are your jobs less important, to you, than this crankshaft is, to its maker? Are you willing to risk failure in your work? Isn't it *right*, then, for you to give your jobs a good break by using good tools—the kind of tools that will match your skill—Starretts?

There are over 2500 different Starrett Tools, ranging from nail sets to vernier gear tooth calipers. Send the coupon for a Starrett Catalog No. 25, which describes and prices each of these tools and explains its use. Determine *now* to own the Starrett Tools which your work really *needs*.

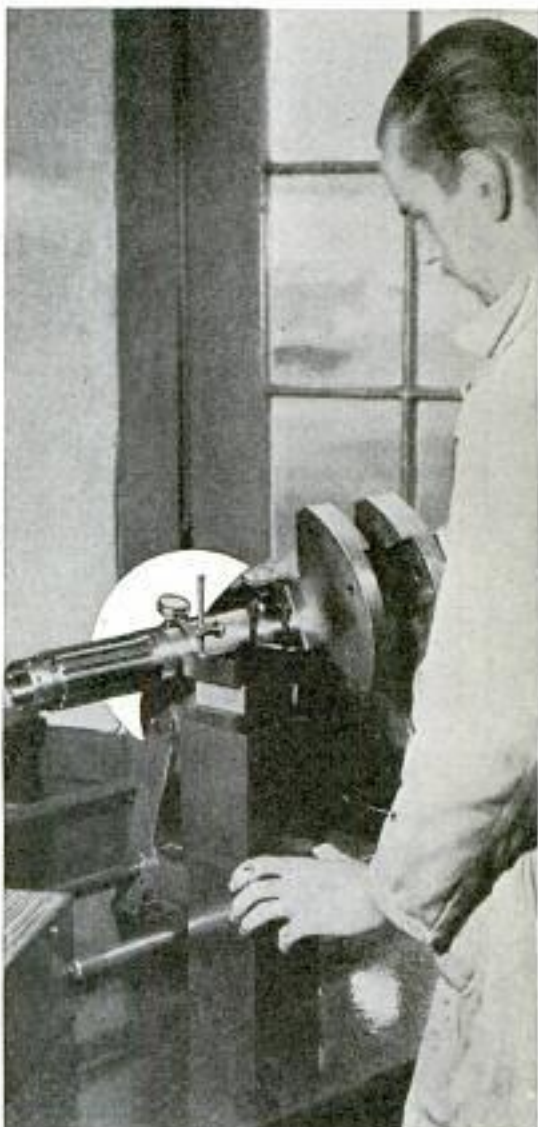

Use Sta

THE L. S. STARRETT CO., ATHOL, MASS.
Please send me my free copy of Starrett Catalog No. 25 "A P"
Name _____ Address _____ City _____ State _____

Tools

FREE

this guide to *new*
record-keeping
efficiency



HERE'S a book that will help you systematize your business—cut operating costs and increase profits now when greater record-keeping efficiency is important. Contains life-size Bookkeeping forms, completely filled in, illustrating uses. Shows simplest methods being used by 300,000 leading firms. Practical for office, factory, business or profession. Write on your business stationery and receive your FREE copy by return mail. No obligation.

JOHN C. MOORE CORP., Est. 1839
6117 Stone Street, Rochester, N. Y.

Fill in Coupon, Attach to Letterhead, and
140-page Book Will be Sent you FREE

Name _____

Business _____

City _____ State _____



Good and Good for You.

STRANGE IRONING CORD
Pays Immense Profits

PREVENTS SCORCHING—SAVES ELECTRICITY

CANNOT KINK OR SNARL



200% Profit! Hudson made \$75.00 in 15-minute sale to large Company for tele-phones. We furnish proof. Two De Luxe

and two Low Priced models give you 4 chances for sales where other salesmen have one.

New Kind of Cord Set FREE

Every Neverknot Salesman is given free the beautiful De Luxe Neverknot Cord Set (with only Unbreakable Switch Plug of its kind in the World) which automatically coils itself out of the way, prevents scorching and saves electric bills. Every woman buys this set instantly for it saves her own cost in electricity. It's brand new and it's yours free if you work for us.

Important! There is only one Neverknot. Write this Company for exclusive territory, special prices and big free offer.

NEVERKNOT CO., Dept. 5-V, 4503 Ravenswood, Chicago



New
Off'n On
Plug
Saves
Electric
Bills



Have Your
Own Business

Sharpening lawn mowers by the Foley Electrakeen System pays BIG MONEY! Easy to turn out perfect work. Does the job in 15 to 20 minutes. No previous experience necessary. Uses same system as leading lawn mower manufacturers.

FREE PLAN Helps You Start

We tell you how to build up a fine paying, permanent, repeat business that will pay you handsome profits. Thousands of lawn mower users want their mowers sharpened on the Foley—every customer is a booster for you.

Big Profits In Spare Time

This is your BIG OPPORTUNITY—take advantage of it NOW! Start at home in spare time. Very small investment necessary—practically no overhead—small operating expense. Send for FREE PLAN at once.

FOLEY MANUFACTURING CO.
1525 Foley Bldg., 11 Main St. N. E., Minneapolis, Minn.



Build your own outboard hydroplane motor or sail boat. Use our plans or knock-down frames and machined parts. Many models to select from. Write for new catalog. Please enclose 10c for catalog. J. B. WELCH, Inc., Dept. B, 3211 No. 41st St., Milwaukee, Wis.

Sport Bodies for Fords At Factory Prices



This Model in Grey Prime **\$3850**

Send 10c for catalog showing all models of bodies and other equipment for Ford and Chevrolet. Compression heads, underwing seats, 3:1 gears, headlights, fenders. Cut shows body on Model A Ford. Also made for Model T Ford.

Make Your Ford Into Classy Car

Sport Factories, Dept. B-2, Aurora, Illinois



"FLYING CLOUD"

Get clean-cut parts and clear blueprints for 20' model. Readily made in spare hours as hull fully shaped and sanded. Set includes anchor, bell, capstan and dead eye, wheel, rigging line, etc. Complete for \$11. Postage 5 lbs. White metal figurehead 50c. Send 15c (coins) for beautiful catalog of ships and coaches.

ROY HANCOCK

323 Douglas Ave., Portsmouth, Va.



MOTORCYCLES

Pay As Low As \$2.00 per Week
Hendersons, Harley-Davidsons, Indians
Slightly used and rebuilt. Hundreds to select from. Send 10c for list today.

MYEROW BROS. CO., 15 Berkeley St., Boston, Mass., U. S. A.

This **P**IN tells fortunes for **G**asoline

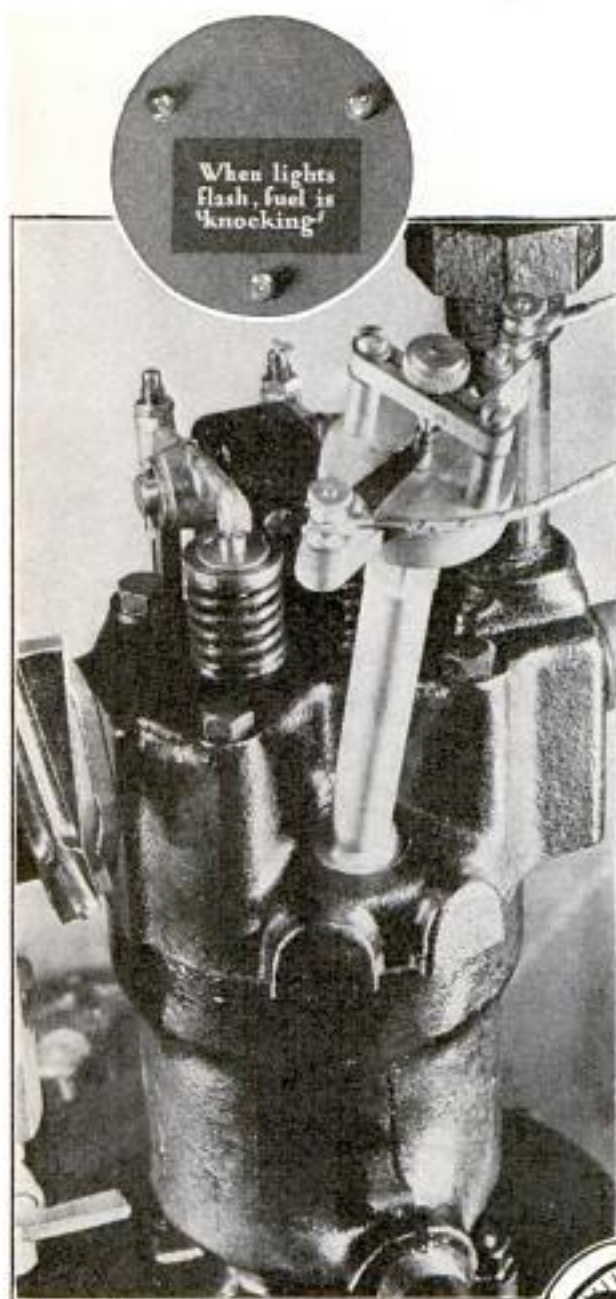

The Bouncing Pin forms an electrical contact that flashes the light above whenever gasoline is not exploding evenly. It does not flash this warning signal when the fuel is Ethyl Gasoline. Ethyl fluid prevents uneven explosions.

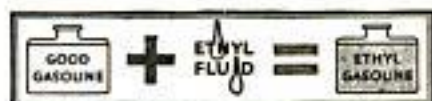

The active ingredient used in Ethyl fluid is lead.

THE Bouncing Pin it is called: because it bounces on the breaking point of gasoline efficiency.

Ordinary gasoline has a tendency to explode too quickly under the strain of cylinder pressure; causing power-waste, overheating, and causing in its worst form the banging impact of gas against cylinder walls that you call "knocking."

The Bouncing Pin detects power-wasting explosions even before they are bad enough to cause audible "knocking."

Before any gasoline is mixed with Ethyl fluid, it comes to the Bouncing Pin to have its fortune told—to find how much Ethyl fluid is needed in each gallon to prevent shattering explosions under the strain of high pressure.

At the same time the gasoline is tested in other machines for purity, quick-starting, and other desirable qualities. Then, after Ethyl fluid has been added to this good gasoline in needed quantity, it comes back to the Bouncing Pin to make sure combustion goes forward with the smoothly increasing pressure that enables Ethyl Gasoline to bring out the best performance of *any* motor.

In your car, Ethyl Gasoline will give you greater power, with less overheating, and no "knocking." It will cause less wear and tear on the motor and give you smoother, quieter performance because its combustion is controlled. Ethyl Gasoline Corporation, Chrysler Building, New York City.

© E. G. C. 1934

ETHYL GASOLINE

for only **\$27¹⁶** per month

This REGAL LATHE

built by
LeBlond

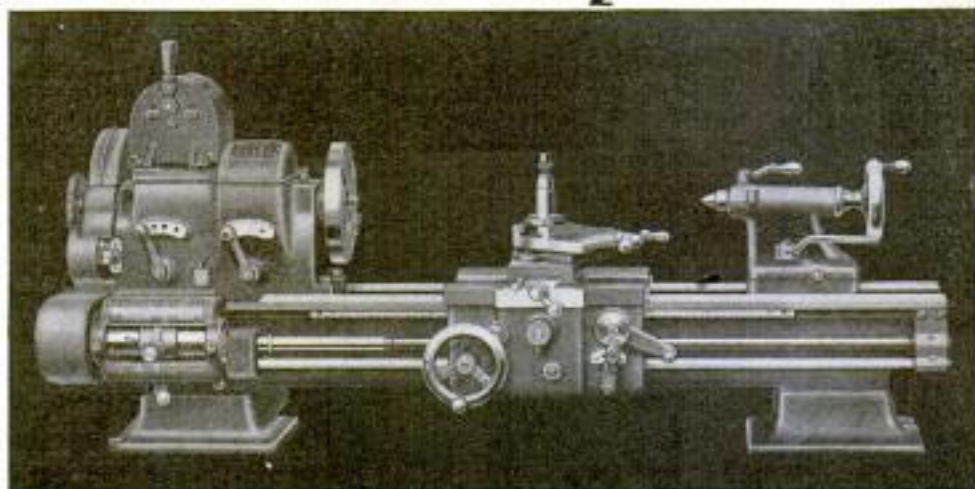

Equipped with an eight-speed selective geared headstock — quick change geared feed — positive clutch apron. All controls simple to operate.

TURN your spare hours into profits. This lathe is built for the man who wants to do things in his own workshop that will compare favorably with factory products. For repair, garage, or maintenance work, or for light manufacturing such as radio, etc., it will give you a precision and accuracy difficult to excel on any lathe, at any price.

If you are buying a lathe for the first time, check up on the popularity of LeBlond lathes in the industrial field—a Regal must measure up to the LeBlond standard.

Lathe is ruggedly built, simple and safe in operation. All dangerous overhead countershafts and belts eliminated. Equipped with helical gears. Feed rod takes the wear off the lead screw. Self-contained motor with multiple V belt drive. Lathe is sold at a conservative price consistent with value offered, and on an easy payment plan.

The Regal is built in five sizes, 10 in.-18 in. Prices range from \$388.00 to \$947.00. Lathe shown here is 10 in. (18 in. between centers). It sells for \$388.00, F. O. B. factory. Delivered to you on first payment of \$77.60. Balance in monthly payments of \$27.16. Complete with motor, ready to run, and easily installed anywhere. *Clip and mail the coupon.*

The R.K. LEBLOND Machine Tool Co. CINCINNATI, OHIO, U.S.A.



THE R. K. LEBLOND MACHINE TOOL CO.,
103 Regal Division, Cincinnati, Ohio.
Send me full details of the Regal Line of LeBlond Lathes.

Name.....
Address.....
City..... State.....

THE BLADE WITH THE "RED END"
TUNGSTEN STEEL



THE BLADE WITH THE "RED BACK"
HIGH SPEED STEEL



Now building
Industry's first
Windowless Factory

SIMONDS

"RED STREAK"
HACK SAWS

*cut fast..easy
and true!*

When you buy Hack Saw Blades look
for these brilliant RED Trade Marks:—

"RED END" for Tungsten Steel

"RED BACK" for High Speed Steel

Ask any leading hardware or supply dealer

LOOK
FOR THE
RED
END

SIMONDS SAW AND STEEL CO.

"The Hack Saw Makers"

ESTABLISHED 1892 FITCHBURG, MASSACHUSETTS
Branches throughout the United States and Canada

Announcing
CRAFTSMAN'S
Complete Workshop Service

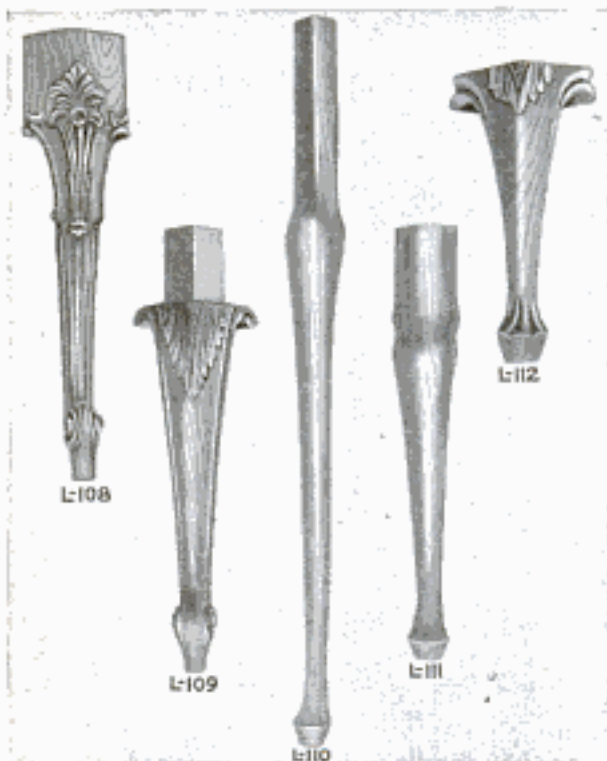

Domestic and Imported Lumber
Panels Veneers
Inlay Woods Carved and Turned Legs
Turning Squares
Inlay Bandings

Hardware Machinery Tools Supplies

Our new 44-page Catalogue just off the press—send 10 cents in coin or stamps for your copy.

CRAFTSMAN WOOD SERVICE COMPANY
7359 VINCENNES AVE. CHICAGO, ILL.

Only 8 Sales a Day Nets You \$110 a Week

Profits on larger size run higher. Unusual earning opportunity for ambitious men. No experience necessary; we teach. Part or full time.

FUGO World's Simplest Fire Extinguisher

Automatic and instantaneous action. Within reach of every home, shop, store, theatre, garage, car owner, etc. Even smallest place needs two or more. Exclusive territory to producers. You get your pay every day. Write for full details.

The National Formetal Co.
6535 Metta Ave. Cleveland, O.

VEST POCKET ADDING MACHINE

Adds, Subtracts, Multiplies, Divides. Does work of \$300 machine. Not a toy. Million dollar capacity. Simple and accurate. Guaranteed 5 years.

FREE TRIAL \$2.50 Total Cost
—SEND NO MONEY—

Just name and address. We will ship Calculator immediately. On delivery pay postman \$2.50 (plus few cents postage). (If outside U. S. send cash.) 10c additional in Leatherette Case. If not satisfied after 10 days' trial you get your money back. THOUSANDS OF SATISFIED USERS. Write for Agents' Proposition. **BABY CALCULATOR MACHINE CO.** (Mfrs.) P. O. Box 1118, Dept. 31, CHICAGO, ILLINOIS



THOMPSON
BOATS

**CATALOG
FREE!**

The Best that skill and experience can produce—at new low prices. Prompt shipment from factories to you

Outboard
Motor Boats
\$60.00
and up

A complete line of real fast, safe and sea-worthy boats for family use. Also fastest racing models.

Rowboats
\$48.00
and up

Improved models. Safe and seaworthy. Strong and durable. Easy to row and handle with oars.

Canoes
\$50.00
and up

Three models and four lengths. Including non-sinkable sponson canoes.

Motor
Boat
\$745

Mahogany Runabout. 16 and 18 ft. Speed 25 to 35 mi. per hr. Complete with 4-cycle motor installed, including electric starter and reverse gear.

CATALOG FREE—SAVE MONEY—ORDER BY MAIL
Please state the kind of boat you are interested in (44)

THOMPSON BROS. BOAT MFG. CO.
213 Ann St. (Write to) 113 Elm St.
PESHTIGO, WIS. (Either Place) CORTLAND, N.Y.

Ask for
FREE
Catalog



ITALIAN ACCORDIONS

Hand-made—Best quality at lowest prices. Guarantee of satisfaction.

FREE Accordion Lessons to buyers by Prof. Rosanova.

ITALIAN ACCORDION CO.

323 W. Polk St., Dept. PM3 CHICAGO

Big 3 ft. Telescope Five Sections. Brass bound. Powerful Lenses. 10-Mile range. Special Eye Piece for looking at the Sun, included FREE. Can be used as a Microscope. Guaranteed. Big value. Postpaid, \$1.75. C. O. D. 15c extra. **Benner & Company, 1-45, Trenton, N.J.**

MOTORCYCLES

WONDERFUL BARGAINS

Can be purchased through our co-operative plan for as low as \$1.00 per week.

Indians Harley-Davidsons Ace and Henderson

Send ten cents for Bulletin A

Motorcycles shipped to all parts of the world

WALKER-INDIAN CO., 1309 Boylston St., BOSTON, MASS.

BOYS! MAKE BIG MONEY
Build Bird Houses



The song birds are coming! Now's the time to build and sell bird houses. With my simple instructions any boy can build and erect Grandpa Bird Houses. They sell at \$2 to \$7.50 each. \$2,000 worth sold in Oak Park, Ill. in a year. Send \$1 for my big collection of work shop plans for boys who want to have fun and make money building my famous bird houses. Valuable information about song birds and tips and advice on making sales included Free

GEORGE J. BREIDERT

1043 North Elmwood Ave. Oak Park, Ill.

Are you paying 6.7¢



Startling facts developed through tests by the New York State Department of Labor show, not only the high cost, but the actual danger of using cheap tools.

for ten hammer blows?

DURING an investigation into the causes of accidents, a hammer test was made by Dean Bliss of New York University. A special machine reproduced the blows to which a hammer may be subjected.

With a cheap hammer, the head flew off after fifteen blows. The cost for ten blows was 6.7¢.

Tests of good hammers showed an average of 7,000 blows. Four hundred and sixty-six times the efficiency! Little risk from chipping faces or flying heads.

The Bulletin on "Hand Tool Accidents" issued by New York State Department of Labor further states: "This example has dealt with the poorest and the best hammer. Between these extremes are the thirty-five to seventy-five cent hammers

that some mechanics do buy. A carpenter's hammer of safe quality and assembly cannot be bought today for those prices."

Choose a Plumb Nail Hammer; with its broad face for greater accuracy; with its short neck for better balance; with sharp-bent claws for greater leverage;

—with its vise-like grip that pulls a headless brad; with that famous safety feature—the Take-Up Wedge which keeps the handle tight by a turn of the screw.

Model H F 81, 1-lb. head, Price \$1.50 at good hardware stores. Look for the Red Handle and Black Head.



**PLUMB
HATCHET**
No. 2962 \$1.60
Price

FAYETTE R. PLUMB, INC., Phila., U. S. A.



Leverage
Scientific bend of claws gives tremendous leverage.



Broad Face
For greater accuracy.

Short Neck
For better balance.

Vise-like Grip
Nipper claws grip the slimmest brad.



Safety
Take-Up Wedge tightens the handle by a turn of the screw.



Sure of foot Swift as lightning

—the mountain
lion taught Long
Lance this



The pictures on this page are taken from "The Silent Enemy," a remarkable film of Indian life, in which Chief Long Lance took a leading part.



ALWAYS hunting, the Indians, like the mountain lions they pursued, needed sure, swift feet.

Chief Long Lance, famous Indian athlete, has designed a shoe which combines the strength-building features of the moccasin with the protection of the modern shoe.

Try this remarkable shoe at your shoe store. Feel the spring and sureness of the "moccasin tread." It builds the strength and swiftness you need in sports.

The Chief Long Lance Shoe is only one of many Goodrich Sport Shoes. Wear them—and feel the joy of free, swift feet. Ask for Goodrich Sport Shoes.

The B. F. Goodrich Footwear Corp.,
Watertown, Mass.

THE CHIEF LONG LANCE SHOE, designed by the Chief himself as a result of long experience. The cut-out shank gives perfect flexibility and the "moccasin tread" which develops leg muscles.



THE RELAY—another of the many different Goodrich Sport Shoes. Comes in buff or white, with mahogany trim. Sturdy quality and comfortable fit.



Another B. F. Goodrich Product

Goodrich Sport Shoes

➔ Ask your shoe dealer about the Goodrich National Poster Contest for boys and girls—Valuable prizes! Real fun!



Write for Chief Long Lance's booklet, "How to Talk in the Indian Sign Language." Eighty illustrations.

The B. F. Goodrich Footwear Corp.,
Watertown, Mass. Dept. 3M

Enclosed please find 10¢ in coin or stamps. Please send me "How to Talk in the Indian Sign Language," by Chief Buffalo Child Long Lance.

Name _____

Address _____

City _____ State _____



"Hold On! Why Pay Money for a Job You Can Do Yourself!"

"What gave you the idea you can't do your own soldering? I do all of mine, and my jobs stack up with anything a skilled mechanic does, too. Use Kester, my boy... use Kester!"

Kester Metal Mender makes soldering as simple as sawing a board in two. The right flux for general work is contained inside the solder itself! Apply heat, and the flux flows to the job... just the right amount of it, too. It's *easy*... and what's more, you'll get perfect results right from the start!

Buy a handy can of Metal Mender today from your hardware store or other dealers. Or let us start you off with a free sample. Kester Solder Co., 4201-04 Wrightwood Avenue, Chicago, Illinois. Incorporated 1899.



Write for a Free Sample

KESTER METAL MENDER

Brown & Sharpe Tools **BS**
"World's Standard of Accuracy"

Send for Catalog No. 31 describing 2300 Precision Tools.
Brown & Sharpe Mfg. Co., Providence, R. I., U. S. A.

"FISHING WHAT TACKLE AND WHEN"

Foremost writers on fishing have helped compile this book. Invaluable to beginners. Interesting to old timers. Thousands have improved their knowledge and methods of bait and fly-casting by studying it. 1931 edition contains new ideas, new pictures, new articles on fishing. Shows variety South Bend tackle. Mailed with our compliments, *free!*

FREE
NEW 84-PAGE
BOOK ON FISHING

SOUTH BEND
Fishing Tackle of all kinds... Rods-Reels-Lines-Baits

SOUTH BEND BAIT CO.
518 High St., South Bend, Ind.

Now HOT WATER INSTANTLY Anywhere-Any Time

Spectacular—amazing—actually *breath-taking*, the new LUX ELECTRIC WATER HEATER holds spectators spellbound as it dynamically raises clouds of steam from cold water in split seconds!

Entirely New Principle. Extremely Low Cost
Every home can now afford the luxury of *boiling hot water* with this new and amazing electrical invention.

MEN—WOMEN AGENTS
Rich Profits—No Investment
Full or spare time. We'll prove you can earn up to

\$20—\$30 AND MORE DAILY
CASH IN ADVANCE EVERY SALE
You can sell dozens daily. Everyone wants LUX once they witness its convincing miracle-like performance. No danger, no trouble—*foolproof*, guaranteed. Switch LUX into action anywhere, night or day and have boiling water instantly. *Faster, easier, safer, surer than any other home appliance!*

NEVER SOLD IN STORES. NO COMPETITION
PROFIT BUILDING—PROFIT SHARING SALES PLAN
LIBERAL CO-OPERATION—TERRITORY
Write at once for full details



57 Jackson St.

Elkhart, Ind.

Build a CLOCK for Pleasure or PROFIT!

FREE BOOK of Clock Making, Money Making Ideas. Gives details, prices of movements, parts. Write NOW for copy!

Shows How YOU Can Make Fine Clocks Right at Home —for yourself, or to sell at Big Profits. We furnish instructions, parts. Works \$1.65 up; others with dials, all prices. Make case or assemble parts. Cash-in on demand for Mantel, Banjo, Grandfather's Clock. Write for Special Blue Print Offer, FREE Catalog.

AMERICAN CHIME CLOCK COMPANY
1670-N Ruffner St. Philadelphia, Pa.

PANTS MATCHED

Don't Throw Away That Coat and Vest!

Save \$15 or more! Let us match your coat and vest with new trousers tailored to your measure. Save the price of a new suit. (Average price \$8.50.) Over 100,000 patterns. Mail sample of suit, or your vest which will be returned with FREE SAMPLE for your approval.

Match Pants Co. 20 W. JACKSON BLVD., Dept. A11, CHICAGO

Boys Fly the IDEAL EAGLET

20 in. Size
Construction
Outfit
50c
Postpaid

A Perfect Model of a Commercial Plane. All balsawood (not cardboard) with many features of expensive models. Easy, quick construction; everything ready to put together; weighs 1 oz. complete. Files like a big one! Get one now and have some real fun!

Send 5c for Big 48-pg. Catalog of New Models and Reduced Prices.

Ideal Aeroplane & Supply Company, Inc. 26 West 19th Street, New York City

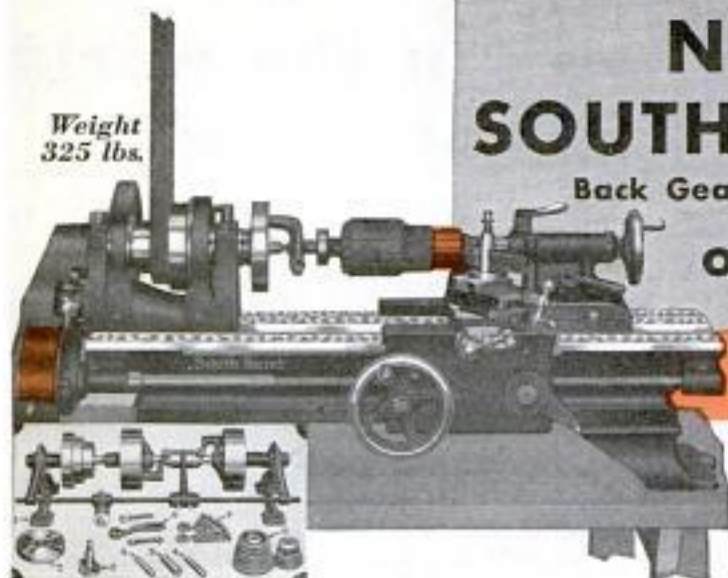

Weight
325 lbs.

New Model SOUTH BEND LATHES

Back Geared Screw Cutting Precision Lathes

on Easy Payments

Only \$30.00 Down

\$10.50 per month for 12 months for this 9" x 2' New Model Junior South Bend Back-Geared, Screw Cutting Bench Lathe with countershaft and equipment. Wt. 325 lbs.

9" x 2' New Model Junior South Bend Bench Lathe **\$150**

You can install any of the 96 sizes and types of South Bend Precision Lathes on easy terms of 20% down, balance in 12 months. The new models have improvements which make them more than ever the outstanding lathe values in the world.

Prices of Other Popular Size 9" Junior Lathes

Size of Lathe	Shipping Weight	Countershaft Drive	Down Payment	12 Monthly Payments Each
9" x 2½'	350 lbs.	\$160.00	\$32.00	\$11.20
9" x 3'	375 lbs.	\$169.00	\$33.80	\$11.83
9" x 3½'	400 lbs.	\$175.00	\$35.00	\$12.25
9" x 4'	425 lbs.	\$182.00	\$36.40	\$12.74
9" x 4½'	450 lbs.	\$190.00	\$38.00	\$13.30

Send Now for these Books

"How to Run a Lathe"
25c Postpaid

Latest Edition of this famous work, contains 160 pages, with more than 300 illustrations. Simplest, most complete and practical book on lathe operation. Shows how to handle 400 different types of lathe jobs as practiced in the modern machine shop. Sent postpaid for only 25 cents; coin or stamps of any country accepted.

Latest Shop Practice,
Free

This 48 page book shows a model auto service shop; gives up-to-date methods for servicing armatures, valves, bushings and pistons; describes complete equipment for these jobs, costing only \$265.00 Complete. Sent free, postpaid.

Catalog No. 91-A, Free

This 104 page book illustrates and describes the 96 different sizes and types of New Model South Bend Lathes. Send the coupon now for your copy, free.



9" x 2' Junior New Model South Bend Lathe with Simplex Wall Counter-shaft and Lathe Equipment **\$150**

Extra Parts for Drive

¼ H. P. Motor, 1750 R. P. M. Non-Reversing (1-Phase 60 Cycle A. C.)	\$20.25
Switch, Knife Type	2.50
Conduit and Wiring	4.00
Belting (Motor to Countershaft) 2" wide x 8¾' long	2.75
Belting (Lathe to Countershaft) 1¼" wide x 6¾' long	1.25

Total for Complete Motor Driven Lathe **\$180.75** as shown

May be bought on down payment of \$36.15 and \$12.65 for 12 months.

SOUTH BEND LATHE WORKS

635 E. Madison St., South Bend, Ind., U.S.A.

Lathe Builders for 24 Years — Over 50,000 South Bend Lathes in Use

SOUTH BEND LATHE WORKS

635 E. Madison St., South Bend, Indiana, U.S.A.

Gentlemen: Please send me books checked

- "How to Run a Lathe" (25c)
 Latest Shop Practice (Free)
 Catalog No. 91-A (Free)
 Easy Payment Plan

Name _____

Address _____

City _____ State _____

See the Metal Flow
Do Your Own
 GOLD SILVER BRASS COPPER NICKEL ETC.

ELECTRO-PLATING

This Easy, New, Scientific Way...

With an ALADDIN Portable

You actually see the metal flow—gold, silver, brass, copper, nickel, etc.

NO EXPERIENCE REQUIRED

This Miraculous New Invention enables Anyone to successfully plate Anything, Anywhere, Instantly: Auto Parts; Bathroom, Kitchen, and Electric Fixtures; Faucets, Spoons, Forks, Knives, Silver Service, Tools; Restaurant and Soda Fountain Fixtures; Surgical and Dental Instruments... No interruption of Service... No Parts to be removed. Renew Worn plating or plate New work. Add this magic touch of prosperity to your home, shop, or office.

Free

ELECTRO-PLATING
Book #1

Agents & Dealers — WANTED —

Be Your Own Boss! No Sales Experience required. Build up a Profitable ALADDIN Electro-plating Business of Your Own. Thousands in Service. A Big, Easy, Money-maker for Agents and Dealers. Take advantage of our introductory offer... \$6.50 for Master Outfit "A" to plate with Nickel. Order Today. Ask for FREE booklet and inspiring testimonials.

P. J. F. BATENBURG CO., Dept. 251, Racine, Wis.

BIG MONEY

easily made resurfacing, waxing and polishing floors by the new **American Method**. Plenty of work easy to get—No experience required. Small amount starts you—Many make \$25.00 a day. This is your big opportunity—Write quick for full particulars.

THE AMERICAN FLOOR SURFACING MACHINE COMPANY
 523 South St. Clair Street Toledo, Ohio



At Last! Aluminum CAN Be SOLDERED

Unconditionally Guaranteed To Give Perfect Results

ALUMAWELD just discovered by well known Los Angeles Consulting Engineer and Metallurgist. Easily applied by anyone. No flux required. Money Back Guaranty.

Mechanics' Kit, \$2.50

Dealers, Agents, send \$1.25 for \$2.50 Mechanics' Kit or order C. O. D. Write for ALUMAWELD Proposition.

ALLIED RESEARCH LABORATORIES
 Dept. 30, 1610 San Fernando Road
 Glendale, California

Crank Cases
 Vacuum Cleaners
 Wash. Machines
 Outboard Motors
 Cooking Utensils
 — All Aluminum
 Articles Can Be Made Like New.

USE YOUR SEARS CATALOG

why in the world should you buy anywhere else...?

Frankly, we can't think of a single reason. For prices are *always* lower at Sears. And this season they are the lowest this generation has seen. Quality is assured by definite high standards. Satisfaction is guaranteed by the World's Largest Store. If you haven't a copy of our new Spring and Summer Book, we'll gladly send one free. Write our mail order store nearest you.

SEARS, ROEBUCK AND CO.

Chicago Philadelphia Boston Kansas City
 Minneapolis Dallas Atlanta Memphis
 Los Angeles Seattle

USE YOUR SEARS CATALOG

TRY IT 30 DAYS FREE BEFORE YOU BUY

Factory to you. Save to 50% on latest Screen Grid Electric or Battery Radio. Get 'Send No Money' Offer.

MIRACO Radio

Amazing bargains direct from big, old reliable factory. Don't buy unless 30 days' use proves entire outfit unbeatable at up to twice our price for tone, selectivity, distance, power. 1 yr. guar.

FREE! Send for BIG SPECIAL OFFER—No obligation.

Midwest Radio Corporation
 1114 Successful Year
 507-D31 Miraco Dept., Cincinnati, Ohio





SUPER Screen Grid \$49.98 Complete less tubes

All styles of latest cabinets

DEAFNESS IS MISERY

Many people with defective hearing and Head Noises enjoy conversation, go to Theatre and Church because they use Leonard Invisible Ear Drums which resemble Tiny Megaphones fitting in the Ear entirely out of sight. No wires, batteries or head piece. They are inexpensive. Write for booklet and sworn statement of the inventor, himself deaf.

A. O. LEONARD, Inc., Suite 699, 70 5th Ave., New York

Do Your PRINTING

Cards, stationery, circulars, advertising, labels etc. Save money. Print for Others, Big Profits! easy rules sent. Do Raised Printing like Engraving. Junior Press, \$5.90, Job Presses \$11 up, Power \$149. Write for free catalog or fill in and mail coupon. The Kelsey Co., C-37, Meriden, Ct.

Please send me free catalog of your printing presses and all details.

Name _____
 Address _____
 City or Town & State _____

SPLIT *the* WIND!

GET the thrill that comes from speed and power under perfect control.

You can afford that thrill with a Harley-Davidson. Glorious rides through the Spring countryside—jaunts with the bunch to lake or stream—vacations that millionaires would envy! All yours with a Harley-Davidson Motorcycle that costs little to buy and next-to-nothing to run!

Let your nearest Harley-Davidson Dealer show you the 1931 Twins, Single, and Sidecars. Ask him about his easy Pay-As-You-Ride Plan.

Mail the Coupon for free Illustrated Literature.



Ride a
HARLEY-DAVIDSON

HARLEY-DAVIDSON MOTOR COMPANY
Dept. P., Milwaukee, Wis.

Interested in your motorcycles. Send literature.

Name.....

Address.....

My age is 16-19 years, 20-30 years,
 31 years and up. under 16 years.

Check your age group.

MAKE MONEY

making garden furniture

Start a business for yourself, making and selling concrete lawn benches, sun dials, bird baths, urns, flower boxes. Made easily in strong, simply operated Ideal Molds, from local materials. Sell at retail from lawn display and at wholesale to florists, department stores, building supply dealers. Each piece brings from three to four times the material cost.

Write today for booklet of designs and complete operating instructions.

CONSOLIDATED CONCRETE MACHINERY CORP.,
Adrian, Michigan



FREE CATALOG

Just off the Press

Fully Illustrated—showing footwear, clothing, and camping specialties, for fishermen and motor campers.

L. L. BEAN
263 Main St., Freeport, Maine

BURN MORE AIR

More Power

Less Gasoline

New principle—scientifically correct. Admits extra air into manifold when throttle opens. Closes for starting and idling. Study cut— $\frac{1}{2}$ actual size.

Faster pick-up guaranteed. Ends 90% carbon troubles. Fits all cars, trucks, tractors.—Installed with plug in 15 minutes. Needs no attention.

RASEY Automatic Intake Airvalve

SEND NO MONEY

Try Rasey 10 days. Compare gas mileage—note increased power. Then send us \$2.00 or return Rasey.

Or send only \$1.50 cash or N. O. with order—try Rasey 10 days—money refunded if not satisfied. Reference: East Side Bank, Milwaukee.

A. L. RASEY
1425 N. Franklin Place
Milwaukee Wis.

I made \$95

my first week

ANY MAN CAN SELL THEM

Approved by Underwriters

"I have been able to increase my earnings every year for four years with the Fyr-Fyter Company. My commissions for 3 days were \$252.71 followed by a single day of \$336.85," writes W. M. SWISHER, Arizona. C. W. BATES of Nebraska, writes, "I like this work better than any I've ever done in my 25 years of selling. It's really easy and profitable." H. J. BRINKER, Ohio, says, "Five years ago I started with the Fyr-Fyter Company as a spare time worker. I made more in spare time than my regular job paid. I have been working full time since."

Hundreds of our men are making \$60.00 to \$100.00 a week. We need more men. No experience necessary. Prospects everywhere make selling easy—garages, stores, factories, shops, farms, homes, auto and truck owners. You, too, can easily sell fire extinguishers. Don't miss this lifetime opportunity. Send now for this money-making plan; it costs you nothing.

FYR-FYTER CO., 90-41 Fyr-Fyter Bldg., Dayton, Ohio

ENGINES

Lifetime Guarantee
All Sizes and Styles

300,000 In World-Wide Use

The WITTE (Magneto Equipped) provides cheapest reliable power for farm and ranch. Does more work in less time at less cost. Put one to work—will pay for itself. Send for Big Free Catalog.

WITTE ENGINE WORKS
1745 Oakland Avenue, KANSAS CITY, MO.



Send for Free Catalog

2000 illustrations—Diamonds, Watches, Jewelry. Largest Diamond and Watch Credit House in the World.

LOFTIS BROS. & CO.
Dept. N-894, 30 N. State St.
CHICAGO, ILL.

A. C. Electric Plants



ONAN A. C. PLANTS furnish the same current as city service—110 volt, 60 cycle A. C. Operates Radio, Water Systems, Refrigerators, all Household Appliances.

Sizes 500 to 2000 Watts Available from stock. No battery used except to start the engine. Ideal for farms, camps and lake homes.

Also a complete line of D. C. Models.
D. W. ONAN & SONS
67 Royalston Ave., Minneapolis, Minn.

AGENTS 500% PROFIT

GENUINE GOLD LEAF LETTERS

guaranteed to never tarnish. Anyone can put them on stores and office windows. Enormous demand, large profits. Paul Clark says: Smallest day \$28.70. R. L. Reel made \$920 in two months. Write today for free sample and liberal offer to general agents.

METALLIC LETTER CO. 433-B N. Clark St., CHICAGO

MOVIES In Your Home

Our marvelous, practical Movie Machines sell as low as \$5.00 postpaid. Also finest 16 mm. cameras and projectors at factory prices. A complete line of both standard and 16 mm. film available at low prices with exchange service. Write for big, FREE catalogue.

PARAMOUNT MFG. CO. Dept. G-39
Boston, Mass.



Former "Dub" Elected Captain

STAR PLAYER OVERCAME AWKWARDNESS BY CONSTANT TRAINING IN FOOTWORK

Stories of Stars who were not "Born" but "Made". No. 12

HE LEARNED what every star player in every sport must learn—to *handle himself well*. Few fellows are born with this ability; anyone can acquire it. No matter what sport you're interested in, you have the same chance he had. Learn to handle yourself—to have every part of your body working together and working for you.

The secret of handling yourself well is *footwork*. Clumsy players are clumsy because of their *feet*—they trip, stumble and get tangled up in their feet whenever they have a hard play to make.

Star players like this college captain, are constantly training themselves in footwork. Go into a college gym and you'll see a halfback skipping rope, a pole vaulter playing handball, a short-stop boxing—stars in every sport taking a hundred different kinds of exercise—to train their feet. You'll see, too, more of them are

wearing Keds than any other shoe.

Keds are designed to give you fast, sure footwork. Keds' strong, tough canvas tops bring rugged support to your ankles. Keds' outsoles have the stopping power of four-wheel brakes, and they wear like iron. Throughout the hardest games, Keds' insoles keep your feet cool and comfortable.

You can get Keds at the best shoe dealers in your town. Ask for Keds by name. They are not Keds unless the name "Keds" is on the shoe.



As a freshman, laughed at for his awkwardness, he later became the captain and star second baseman of a great college team!

He and the coach practiced in the gym a whole month before the season opened! As a junior, his fielding saved three big games; his hitting won them.



YOU can own a *Pedigreed Dog!* Free, too! A wire-haired fox terrier is looking for his owner. Want him? He's one of the many dog prizes in the Second Keds Dog Contest—open to every boy and girl under 16.

Nothing to buy—nothing to sell. Simply stop in at your Keds dealer's where you see the picture of the Keds dog, or write United States Rubber Company, Dept. KM-51, 1750 Broadway, New York City, for details.



KEDS "HOLDFAST"—A light shoe and a fast one, "Holdfast" gives you remarkable speed, sureness and comfort at a low price.

THE SHOE OF CHAMPIONS

Keds

REG. U.S. PAT. OFF.



United States Rubber Company

Keds sell for \$1.00, \$1.25, \$1.50, \$1.75, and up to \$4.00. The more you pay, the more you get—but full value whatever you spend.



KEDS "GLADIATOR"—Yes, "Gladiator's" soles are red and black! And the snug supporting stays and rugged tops bring you more speed and surer footwork.

Want to Own This Profitable Business?

BIG PROFITS Can Be Earned

94c CLEAR PROFIT out of every dollar filing saws this easy way. No experience necessary—the Foley Filer turns out perfectly filed saws **automatically** and quickly, better than hand filed saws. Easy and simple to operate. Big repeat business from satisfied customers because Foley Filed saws cut better, faster, cleaner, truer and stay sharp longer.

Success!

"I now have the best saw filing business in the community and have earned \$3000 in the past year."
B. SERDINSKY

"I banked \$161.66 in one month which was accomplished in spare time."
EVERETT MYERS

"I filed 6 saws in 40 minutes at 50c each (\$3.00)."
C. FULLER

FOLEY AUTO MATIC SAW FILER

Files all kinds of saws **automatically**, making all teeth exactly uniform in size, height and spacing. Plenty of business—NO CANVASSING.

Start In Spare Time

FREE PLAN tells you how to build a fine paying, permanent business at home in spare time. Get complete details FREE. Mail coupon below NOW.

Mail Coupon for FREE PLAN

Foley Manufacturing Co.

213 Foley Bldg., 11 Main St. N. E., Minneapolis, Minn.
Send me FREE PLAN and complete details about starting my own business in spare time with the Foley Automatic Saw Filer.

Name.....

Address.....

START A SHOP! WITH A Cabinet Shop Special

Includes 16" band saw, 6" jointer, and 6" circular rip and crosscut saw.

Establish your own business and reap all the profits for yourself. This modern Parks woodworker will fit your shop and your purse. Send today for complete catalog.



\$247
without
power

Note: Descriptive circular on Parks "Product" Home Work Shop and bench woodworking machines will also be sent on request.

THE PARKS WOODWORKING MACHINE CO.
Dept. PM-5, 1530 Knowlton St., Cincinnati, Ohio

Canadian Factory: 328 Notre Dame East, Montreal

PARKS WOODWORKING MACHINES

OTTAWA LOG SAW

only \$39

GREATEST OFFER EVER MADE

Make Money! Wood is valuable. Saw 25 to 30 cords a day. Does more than 10 men. Ottawa, easily operated by man or boy. Falls trees—saws limbs. Use 4-hp. engine for other work. 30 DAYS TRIAL. Write today for FREE book. Shipped from factory or nearest of 4 branch houses.

OTTAWA MFG. CO., 1741 -W Wood Street, Ottawa, Kansas

4½ feet of lathe Here is a lathe 55' long with 10' swing and 37' between centers. Complete with bronze bearings and 4-step pulley. Biggest and heaviest ever built for the money.



Walsh Garden Tractor

and Power Mower
For Gardeners, Florists, Fruitmen, Suburbanites
Plows, Seeds, Cultivates, Mows Lawns & Hay
Single and Twin Engine-Belt Jobs Walk and Ride
SPECIAL FACTORY PRICE
New Improved Models—CATALOG FREE
WALSH TRACTOR CO. Minneapolis, Minn.
3528 Talmage Av. SE

"BOW LEGS and KNOCK-KNEES" UNSIGHTLY
Send for booklet showing photos of men with and without THE PERFECT LEG FORMS.
PERFECT SALES CO.
140 N. Mayfield Ave., Dept. S, Chicago, Ill.

Cal. 30-40 Six Shot



KRAG CARBINE
All the qualities of a high price rifle. In fine used condition, all working parts guaranteed for one year. Send today for our Free 80-page illustrated catalog of money saving values; Guns, Ammunition, Cutlery, Sports and Gov't goods.
Price **\$9.75**
Deposit required on all orders. Money refunded if not satisfactory
W. Stokes Kirk, Dept. P. M.-5, 1627 N. 10th St., Phila., Pa.

200% Stronger 30% Thinner Tougher than Ever

The New Crestoloy Wrench by Crescent

Created in Crescent Laboratories, Crestoloy, a new steel, is introduced for the first time in a remarkable line of drop-forged wrenches. Crestoloy Wrenches are nearly one-third thinner than the regular Crescent Wrench yet twice as strong. They will not tire your hand. They are better balanced, lighter weight than ordinary wrenches. Crestoloy Wrenches are made for mechanics who demand strong, tough tools, fast acting, firm gripping yet feather light. Sold individually or in compact kits containing 3 convenient sizes. Ask your dealer to show you the new Crestoloy Wrench. Try it and you'll buy it.

CRESCENT TOOL CO.
Jamestown, N. Y.



Cutting half-lap joint with Atkins Silver Steel Rip Saw No. 55.



How to Cut Better Joints

with the aid of this book and
ATKINS Silver Steel Saws!

If you're not satisfied with your skill in doing joinery, let the author of this new ATKINS Saw Book for Home Craftsmen show you the correct, easy ways to cut and fit 24 types of wood joints.

He begins with the simple lap and butt types, and then takes up rabbeted, grooved, dado, mitre, mortise and tenon, dowel, dove-tail, glue, matched and coped joints. His clear diagrams and step-by-step instructions will soon help you make perfect-fitting joints on any project you may tackle.

Joinery is only one of many subjects covered in this book. It also deals with starting a shop . . . selecting your tools . . . choosing shop machines . . . building your bench, tool box or cabinet . . . where to get 200 job plans . . . sharpening your saws . . . books for home craftsmen . . . and so on. Finally, you come to fifty pictures of the leading "Silver Steel" Saws and Saw Tools, so you can check up your shop tools, and pick any new ones you need.

This 32-page book costs only a dime, but it will double your fun in home-crafting, save your time and improve your work. Thousands of copies sold every week. Send the coupon for your book.

If your hardware dealer does not have the ATKINS Saws you want, write us and we will see you are supplied promptly.



**E. C. ATKINS
and Company**
426 So. Illinois St.
Indianapolis, Ind.

I enclose a dime for the new ATKINS Saw Book for Home Craftsmen.

Name..... (PRINT)

Street.....

City..... State.....

My dealer is.....

CRESCENT and Smith & Hemenway TOOLS



BETTER TOOL CHESTS Made by GERSTNER

The choice of Toolmakers and Machinists. The latest styles in Free Catalog.

Gerstner & Sons
409 Columbia St. Dayton, Ohio

BURN YOUR NAME ON TOOLS WITH THE ARKOGRAF

PROTECT YOUR TOOLS FROM THEFT

Write with electricity any name or design on the hardest and finest tools and instruments, or any metal, like writing on paper with pen or pencil. Complete Outfit \$3.50—Frapid Anywhere. Interesting illustrated circular free. Write today. Agents wanted. ARKOGRAF PEN CO., 1171 E. Stark St., Portland, Oregon



Fix up your Garden for Spring Make your own Garden Seat Garden Trellis

Stanley Plan No. 21b costs only 10 cents and gives simple instructions on how to make an attractive Garden Seat.

Stanley Plan No. 22b costs only 10 cents and shows you how to make Garden Trellises.

10¢ each Send for one or both today. There are 25 different Stanley Plans showing how to make 25 useful articles.

THE STANLEY RULE & LEVEL PLANT, New Britain, Conn.

STANLEY TOOLS





CHEAP OIL is poor company for good tools

You are careful to choose good tools for your workshop. Be just as careful about the oil you use. Good tools soon become poor tools in the company of cheap oil.

To keep tools and shop equipment *working* right and *looking* right, there's nothing quite so good as 3-in-One Oil. It costs a little more than plain mineral oils, but it *does* more. As it *oils*, it also *cleans* and *prevents rust*.

To do these three important jobs at one time, 3-in-One is blended by a special process from *animal*, *mineral* and *vegetable* oils. By using 3-in-One Oil regularly, you will save many a bill for repairs and replacements. Handy cans and bottles; all good stores. Write now for free sample.



THREE-IN-ONE OIL CO., DEPT. 302
170 Varick St., New York City
260 Second Ave., Ville St. Pierre, Montreal, Quebec

3-in-One Oil

CLEANS - OILS - PROTECTS

ELECTRIC PANTS PRESSER

Illinois Man Makes
\$88 in one Week

Pennsylvania agent cleared \$76 in 4 days. Texas live wire started with earnings of \$144. Profits like these easy for you with amazing new invention—just out.

Pants Pressed in 10 Seconds by ELECTRICITY

Millions waiting for this wonderful RED LION ELECTRIC Trousers Presser. Puts razor edge crease in pants by electricity. As easy to use as a clothes brush. Only presser in the world that will crease pants while being worn. Will last years. Sample fits in pocket. Take orders. 100% profits. Experience unnecessary. Write for generous sample offer, sent free.

MUNNY MFG. CO., Dept. 85, 817 Main St., CINCINNATI, O.

"WISHING" WON'T HELP YOU TO FLY—



BUT THE HEATH PARASOL WILL!

\$12 starts you building the famous Heath Parasol—first plane winner at the National Air Races for 5 consecutive years. Designed for beginners to fly, it offers you big plane safety and performance for the first time at a flying cost less than 1 cent a mile. Build the Heath Parasol now from clear easy plans for only \$199. Six plane books slightly extra. Technical training not needed. Parts may be purchased in 11 convenient progressive groups. \$12 brings first shipment. Or buy it complete, ready to fly for only \$975. Send 10 cents in stamps or coin for large illustrated booklet. Write today.

BUILD IT FOR \$199 HEATH AIRCRAFT CORPORATION
READY-TO-FLY \$975 Dept. P 531, 1721-9 Sedgwick St., Chicago, Ill.

50 POWER LOMARA MICROSCOPE \$1

SEND ONLY
For nature lovers, doctors, chemists, botanists, engineers. Finest quality. Magnifies 15-25-40 or 50 diameters at will. Fully guaranteed. Send only \$1. Pay postman \$5.75 plus postage. Additional 200 power objective, giving 200 diameter magnification \$4 extra. Stand, with stage and reflectors, \$4. Send today. Big catalog of photo and optical goods free.

CENTRAL CAMERA CO., 230 S. Wabash Ave., Dept. 25, CHICAGO

"Gas-Bug" Discovered To Save Gasoline

Uncanny discovery saves gas and does 43 other amazing things for your car. Pays agents up to \$35.00 without leaving the house. Write for offer of FREE SAMPLES to car owners.

U. S. Motor Industries, 311 North Des Plaines, Dept. 65, Chicago, Ill.

WORLD-WIDE

SHORT WAVE RECEIVER

ONLY **\$6.45**

Span the World with this Set!

A new radio thrill for you! Listen in DIRECT to London, Paris, Berlin, Buenos Aires and other broadcasting stations throughout the world via short waves. Enjoy unique foreign programs from strange lands. Your ordinary receiver cannot tune in these low wave stations. **WORLD-WIDE RECEIVER** gets 14 to 550 meter stations with surprising clarity. **SEND NO MONEY!** Just write your name and address on a postcard and ask us to send you this wonderful guaranteed short wave set. Pay postman \$6.45 plus a small delivery charge. All orders west of Rockies must be accompanied by \$1.00 deposit. Foreign countries \$7.75 delivered. Write today for new catalog of radio bargains.

CHAS. HOODWIN CO.
4240 Lincoln Ave., Dept. E-2 CHICAGO

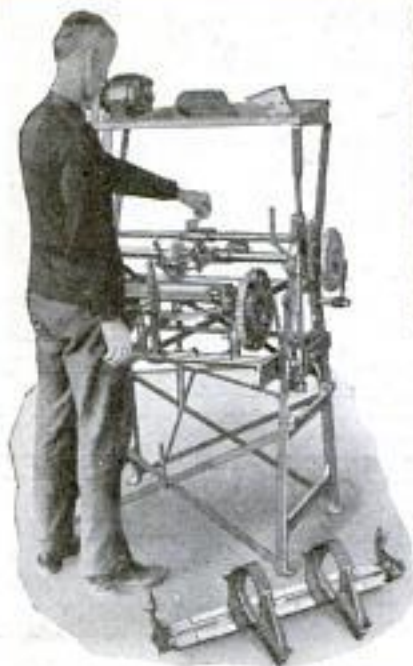

THE "IDEAL" SHARPENER

Is the ONLY machine that GRINDS as well as reconditions a mower—a Two-Methods Sharpener at practically the price of one. Just set the mower in the Ideal, make a few simple adjustments and proceed to sharpen. In 15 to 20 minutes the mower is ready for the lawn, and you have made \$1.20 to \$1.50—depending on the size and condition of the mower. No trailing necessary. Requires little space—plug into your light socket and start to sharpen. Skate Sharpener Attachment included.

You can make \$4.00 to \$6.00 an hour with the IDEAL LAWNMOWER SHARPENER

This Man Is Doing It—SO CAN YOU

You've got the chance—the same chance as W. T. Moore, Twin Falls, Idaho, who made \$1,200 net profits in 90 days—the same chance as Walter Wever, Middletown, N. Y., who made \$1,000 in 4 months—the same chance as hundreds of others who have reaped rich rewards with this amazingly efficient lawnmower sharpener.

USE YOUR SPARE TIME. If you work at a trade, put an Ideal in your basement and earn \$4 to \$6 an hour evenings and Saturday afternoons. E. W. McCormick, Saginaw, Mich., writes: "Five years ago I bought an Ideal Sharpener on which I have ground over 5,000 lawnmowers. In the last few weeks I worked at my trade, machinist, full time 9 hours a day. I also ground 97 mowers which netted me \$114.10 clear gain."

PAYS FOR ITSELF AND MAKES BIG PROFITS. C. S. Coburn, North Little Rock, Ark., writes that his "Ideal" Sharpener earned enough in 18 months to pay for itself and \$1,857.00 worth of additional machinery.

OUR FREE BOOK TELLS YOU HOW—these men and many others have made themselves independent—built substantial, permanent, BIG PAYING business with this Ideal Sharpener. Send for this book today—It's Free.



MAKE EVERY
SPARE HOUR PAY
YOU \$4.00 to \$6.00



Send for FREE BOOK Today!

THE FATE-ROOT-HEATH COMPANY,
913-944 Bell St., Plymouth, Ohio.

Send me the book that tells me how I can make my spare time worth \$4 to \$6.00 per hour.

Name

Address

City State

BUILD YOUR OWN SHIP MODEL OR COACH MODEL



We furnish all parts, cut, fitted and ready to assemble, detailed instructions and carefully numbered diagrams. Flying Cloud, \$4.00; Constitution, \$6.00; Other ship and coach models, \$4.50. Catalog FREE.

Canadian prices, duty paid, slightly more.
90 King Street, W., Toronto, Canada.

MINIATURE SHIP MODELS, Inc.
Perkasie, Pa. Dept. PM

AGENTS—BIG MONEY IN NEW FLASHER SIGN

Retails \$7.50—Looks Like \$100.00 Write for Details
WILLIAMS SIGN CO. Dept. 4-5
117 W. Aust'n Ave. Chicago

WANTED—SPECIALTIES

Desire articles which can be stamped from sheet metal and sold to Five & Ten Stores. Need not be patented. Will protect you. Over forty years in business. Reference, any bank in Cleveland.

THE OTTO KONIGSLOW MFG. CO.
3510 PERKINS AVE. CLEVELAND, O.

New Tractors from Old Fords

Do All Farm Work!

Easy to Build—
We sell you how

Makes powerful tractor out of your Model "T" or "A" Ford, or Chevrolet with MILAW Tractor Equipment. Low cost! New HIGH ARCH Model with 30 inches clearance straddles 1 or 2 rows of corn and other crops. Cultivates, plows, weeds, discs, etc. Runs both machinery. Easy to attach. SPECIAL LOW INTRODUCTORY PRICE! Write for FREE literature!



NEW HIGH ARCH MODEL
—30 INCH CLEARANCE

SHAW MFG. CO., 4505 Center St., GALESBURG, KANS.

CRESCENT

No. 87 Universal Wood Worker

Comprises 20" Band
Saw, 6" Jointer, Saw
Table, Shaper,
Borer, Hollow
Chisel Mor-
tiser and
Sander.

Send
Today for
Special
Circular



We Also Build:

Band Saws	Borers—
Saw Tables	Tenoners
Self Feed Rip	Swing Saws
Saws	Disk Grinders
Shapers—	Cut-off
Jointers	Tables
Variety	Universal
Wood-	Variety
workers	Saws
Planers and	Universal
Mortisers	Wood-
Planers	workers
Hollow Chisel	
Mortisers	

Each unit driven by its own individual motor, instantly adaptable to any of the many jobs it will perform without putting on or taking off a single attachment. Start up unit you want, shut it off and go to next one. No time wasted, no bother. Operates from lamp socket—very economical. Thoroughly practical, convenient, exceptionally substantial—well bearings throughout. This machine is a time saver. It will make money for you.

THE CRESCENT MACHINE CO. 93 Columbia St., Lestonia, Ohio



DOES THE WORK OF A HIGH PRICED IRON

The most difficult soldering jobs are easily handled with the Esico "Junior." Heats quickly and stays hot. Long tapered copper tip gets into hard-to-reach places. The ideal electrical soldering iron for the amateur mechanic; also very popular with professionals. The "little brother" of the Esico Industrial Irons used by leading electrical and radio factories and the U. S. Navy. Highest grade nickel chrome heating element; 85 watt. Heat insulated handle, dark mahogany. Weighs only 1 lb. Length 12 1/2 in. Plugs in on any current; 6 ft. cord. Complete \$2.75.

Sent direct if your dealer can't supply you.

Electric Soldering Iron Co., Inc., 137 W. 17th St., New York, N. Y.

ESICO "Junior"



The Fellowship of Men with Sporting Blood

Every Indian rider is your companion in that great informal fraternity of "men with sporting blood!" Meet them along the highways . . . join them in their "runs"—always you'll receive the glad, welcoming hand of the sportsman. And when you ride an Indian, you'll share with this happy band the joys of riding "the sportsman's steed"—you'll know the thrill of throbbing power, the flashy getaway, the easy handling that not even an airplane can match.

Go to your Indian dealer today . . . try out the new 1931 Indians . . . look them over . . . the graceful, low lines, the new colors and finish. Remember—there's 30 years of success behind every Indian Motorcycle.

Valuable dealer franchises are open . . . write for details before they are snapped up.



Indian MOTORCYCLES

INDIAN MOTORCYCLE CO., Dept. A-5, Springfield, Mass.
Please send folder on Indian Motorcycles. My age is . . . years.

Name

Address

THIS MACHINE

Makes "Hand Made"

SIGNS! A simple, rapid lettering device that makes artistic, professional-looking signs, showcards, streamers, etc., at the first trial and at negligible cost.

Showcarder

is compact, economical and efficient. Gives you just the sign you want on a moment's notice. Write for complete information and prices.

SHOWCARDER INC. 2302 University Ave. ST. PAUL, MINN.



NYOIL

SPORTSMAN'S FRIEND

KEEN SPORTSMEN PREFER IT



Nothing can equal Nyoil. Sportsmen insist on it. It cleans, lubricates, polishes, and prevents rust on all fishing tackle and firearms. It is odorless, stainless, clean, and highly refined. Per can 35c.

If your dealer cannot supply it, send to

WM. F. NYE, Inc.

Dept. T, NEW BEDFORD, MASS.



NEW H & A SHAPER

SMOOTHER WORK — EASIER TO ADJUST—MORE ACCURATE

Helps you produce the most elaborate shaper work and mouldings with expert ease. Special NEW features include ball bearing spindle, reversible rotation, and steady high speed that assures unusually smooth work. Sturdy and durable. Read now for FREE catalog, complete information, and reasonable prices.

HESTON & ANDERSON

605 Stone St. FAIRFIELD, IOWA



DIM-A-GLARE

"The World's Most Practical Glare Shield"

AGENTS Earn BIG MONEY!

New amazing invention means greater safety in automobile driving, night and day. Every car owner will want one. For all cars. . . . Sells on sight. . . . A BIG MONEY MAKER.

1000 MOVES without ONE REMOVAL! Agents, District Managers, write for territory! Going fast! Act Now! Complete details of this Big Opportunity will be sent upon request, FREE OF CHARGE. Write now. PUFFER-HUBBARD CO., DEPT. 53, MINNEAPOLIS, MINN.

FREE RADIO CATALOG

COAST TO COAST RADIO CORPORATION

HEADQUARTERS ALL RADIO REPLACEMENT PARTS

142 P LIBERTY ST., NEW YORK

SEND FOR . . . LOWEST PRICES!



RAISE CHINCHILLA

AND NEW ZEALAND WHITE

FUR RABBITS Make Big Money

We Supply Stock AND CONTRACT FOR ALL YOU RAISE

paying up to \$6.50 each. Large illustrated book, catalog and contract, also copy of Fur Farming Magazine, all for 10c. STAHL'S OUTDOOR ENTERPRISE CO., Box 141A, Holmes Park, Missouri

"Delta" Motor-Driven Woodworking Tools

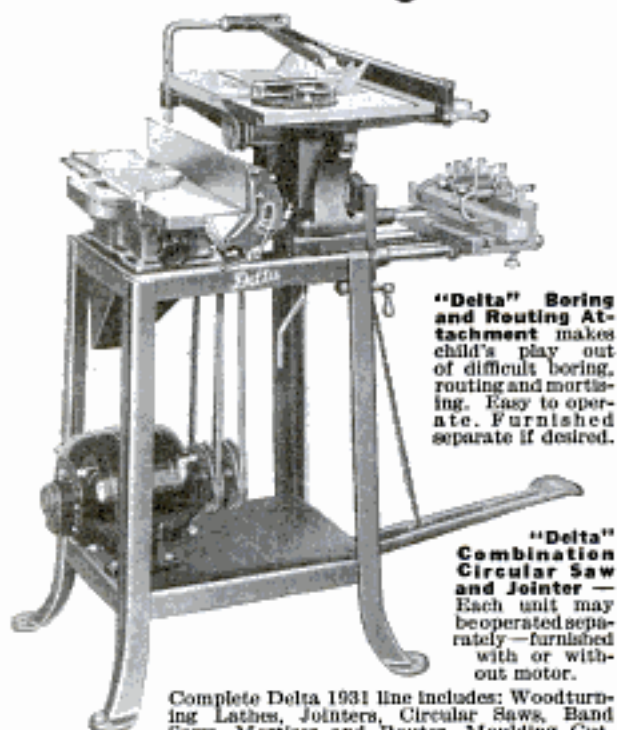

"Delta" Boring and Routing Attachment makes child's play out of difficult boring, routing and mortising. Easy to operate. Furnished separate if desired.

"Delta" Combination Circular Saw and Jointer — Each unit may be operated separately — furnished with or without motor.

Complete Delta 1931 line includes: Woodturning Lathes, Jointers, Circular Saws, Band Saws, Mortiser and Router, Moulding Cutters, Shaper, Scroll Saws, and Complete Hand-Shops.

The Modern Way of Woodworking

Motor-driven tools save time, labor, and produce better work. That's the reason they are replacing hand tools everywhere. Each "Delta" motor-driven tool is practically designed to do its work **efficiently, conveniently, and quickly.** That's why woodworkers the country over say "Delta" gives the most machine value per dollar.

10 Day Trial—Easy Terms

Send today for complete details and **FREE** illustrated literature fully describing the new 1931 "Delta" line of woodworking units. You will learn also how you can try any "Delta" equipment for 10 days under actual working conditions—**AT OUR RISK.** Choice of three convenient Easy Payment Plans. Write **TODAY!**

DELTA SPECIALTY COMPANY

Division of Delta Mfg. Company
3775 N. Holton St. Dept. A-531, Milwaukee, Wis.

KINKADE GARDEN TRACTOR and Power Lawnmower

A Practical, Proven Power cultivator for Gardeners, Suburbanites, Truckers, Florists, Nurserymen, Fruit Growers.

New Low Prices—Easy Terms
AMERICAN FARM MACHINE COMPANY
1058, 33rd Ave. SE. Minneapolis, Minn.



\$50.00 SHIP MODEL for \$4.50 COACH MODEL for \$4.98

We furnish all parts out to fit, assembled and ready to assemble for the following models: Clipper Ship and Flying Cloud (with electric light) Santa Maria, May-Bowser, La. Pata, \$4.40—Constitution, \$3.98—SPANISH GALLEON, fully equipped for electrical illumination, \$6.98—COACH MODEL: Geo. Washington, Princeton to Philadelphia, TALLY-HO, Deadwood, Overland Western. Our new illustrated Catalog **FREE.** All models sent C.O.D. Foreign orders accompanied by check or money order. Illustrated Catalog **FREE** on request.



C. J. BIERBOWER
Dept. PM 3216 Spring St., Phila.
Originator of David Taylor's Ship Model



STOP THAT LEAK WITH SMOOTH-ON No. 1

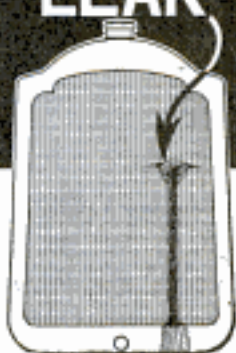

YOU can apply Smooth-On with radiator full or empty, hot or cold, without removal from the car and without putting inside anything that clogs the circulation.

Merely roll the Smooth-On into a stiff putty, press it against and into the leak with your thumb or pack it into the defect with a knife blade or screw-driver, and scrape off the excess.

The leak will stop instantly, and the repair is permanent. For a few cents and in a few minutes you will have avoided all the delays and expense of a professional repair job that couldn't be any better.

Bursting Water Jackets. Water jackets of automobile, stationary or marine gas engines which have developed long or short cracks or have even had pieces broken entirely out from freezing can be made thoroughly and lastingly serviceable by similar repair, or by applying Smooth-On under straps or a plate.

Smooth-On No. 1 can be used in a hundred ways in the household, and it often saves from \$50.00 to \$100.00 on the first job.

Keep a can of Smooth-On No. 1 with your tool kit and some day when caught with a repair job you will thank yourself for your forethought.

Get Smooth-On No. 1 in 7-oz., 1-lb. or 5-lb. tins at any hardware store or if necessary direct from us.



Write for **FREE BOOK**

FREE

This booklet tells how to stop not only water leaks in radiators, bursting water jackets, and at loose hose connections, but also how to stop gas leaks from the tank, gasoline lines and exhaust system, and oil leaks at gaskets and at cracks in crank or gear case. It also tells how to make headlight posts, nuts, hub caps and bolts and grease cups stay tight, and shows dozens of simple money saving Smooth-On repair jobs.

Send free if you return the coupon.
SMOOTH-ON MFG. CO.
Dept. 37, 574 Communipaw Ave.
JERSEY CITY, N. J.



Do it with SMOOTH-ON

SMOOTH-ON MFG. CO., Dept. 37,
574 Communipaw Ave., Jersey City, N. J.

Please send the free Smooth-On Repair Book.

Name.....
Address.....
5-31.

LUMINOUS PAINT

Make Your Watches, Clocks, Etc., Visible by Night The very latest discovery in the scientific world. Although practically unobtainable elsewhere, we have at last succeeded in producing this remarkable LUMINOUS PAINT, which, spread to the surface of any article, emits rays of white light, rendering it perfectly visible in the dark. **THE DARKER THE NIGHT, THE MORE BRILLIANT IT SHINES.** Quite simple to use. Anyone—**you** can do it. A little applied to the dial of your watch or clock will enable you to tell the time by night. You can coat the peak buttons or switch plates of your electric lights, match boxes, and innumerable other articles; make your own Luminous Crosses, Luminous Roses, etc. Small bottles, price 25c. Largest size, 50c and \$1 postpaid. **JOHNSON SMITH & CO., Dept. 814 RACINE, WIS.**



CIGARETTE MAKER

Roll your own and save money. Softer and tastier than any other brand of tobacco. Neat, useful, handy. Pocket size, weighs 1 1/2 oz. Made entirely of metal. Nickel plated. 25c, 3 for 65c.



GOOD LUCK RING

Very striking, quaint and uncommon. Never finish skull and crossbones design. Two brilliant, flashing gems sparkle out of the eyes. Best to bring good luck. Only 25c post.



Exploding Cigarettes

Box contains ten genuine cigarettes of excellent quality. They appear as real, but when each cigarette is about one-third smoked, the victim gets a very great surprise as it goes off with a loud BANG! A great mischief maker yet entirely harmless. Price 25c box.

NOVELTY BADGES



Kissing Permit 10c. Garter Inspector 20c. Two very novel metal badges, nickel plated, that you can wear, giving you fun out of all proportion to their trifling cost. 10c, each badge, 3 for 25c, or 75c per doz. postpaid anywhere.

MIDGET BIBLE



GREAT CURIOSITY Unobtainable in the World. One of a postage stamp—200 Pages. Best to bring good luck to the owner. A genuine work of art. Must be seen to be appreciated. Make good money selling them to friends, church acquaintances, etc. PRICE 15c each, 3 for 40c, 12 for \$1.35, 100 for \$7.50. Also obtainable in Leather Binding, with gold edges. Price 50c each, 3 for \$1.25, \$4.50 per doz. Magnifying Glass for use with Midget Bible 15c.

STAGE MONEY



With a bunch of these bills, it is easy for each person of limited means to appear prosperous by flashing a roll of these bills at the proper time and peeling off a genuine bill or two from the outside of the roll, the effect created will be found to be all that can be desired. Prices, postpaid: 40 Bills 20c, 120 for 50c, or \$3.50 thousand postpaid.

NOSE FLUTE



The Magic Nose Flute, or Hummerette, is a unique and novel musical instrument that is played with nose and mouth combined. There is just a little knack to playing it which, when once acquired after a little practice, will enable you to produce very sweet music that somewhat resembles a flute. There is no fingering, and once you have mastered it you can play all kinds of music with facility and ease. When played as an accompaniment to a piano or any other musical instrument, the effect is as charming as it is surprising.



JOHNSON SMITH & CO.
Dept. 814 RACINE, WIS.
A De Luxe Edition of our new CATALOG mailed on receipt of 25c. Handsome binding. Bigger and better than ever. Only book of its kind in existence. Nearly 600 pages of all the latest tricks in magic, the newest novelties, puzzles, games, sporting goods, rubber stamps, unusual and interesting books, curiosities in seeds and plants, etc., procurable elsewhere. Remit by Cash, Money Order, Check or money U. S., Canadian and Foreign Stamps for all articles listed above. See next page also.

BLANK CARTRIDGE PISTOL



Protection against Burglars, Thieves, & Dogs. Special Offer 1 Blank Cartridge Pistol 100 Blank Cartridges 1 500-page Novelty Catalog **ONLY \$1.50** The Lot Shipped by Express Cash With Order Only
Well made and effective, modeled on latest type of Revolver; appearance alone is enough to scare a burglar. When loaded it may be as effective as a real revolver without danger to life. It takes standard 38 Cal. Blank Cartridge—obtainable everywhere. Spec. 1st cash with order offer 1 Superior quality Blank Cartridge Pistol, 100 Blank Cartridges, and our new 500-page De Luxe Catalog of latest novelties; all for ONLY \$1.50. Shipped by Express only. Cannot go by parcel post. Extra Blank Cartridges 50c per 100. Special list sent (showing types) for price 25c. No U. S. D. shipments.

LOOK 35¢ LOOK Wonderful instrument.



Greatest thing yet. Nine separate articles in one. Everybody delighted with it. Odd, Curious and interesting. Lots of pleasure as well as very useful. It is a double Microscope for examining the wonders of nature. It is also an Opera Glass, a Stereoscope, a Burning Lens, a Reading Glass, a Telescope, a Compass, a pocket Mirror, and a Laryngoscope—for examining eye, ear, nose and throat. It is worth all the cost to locate even one painful cluder in the eye. Folds flat and fits the pocket. Something great—you need one. Don't miss it. Sent by mail. **Only 35c or 3 for \$1.00**

STAR TOY MAKER



Greatest boys' book written. Tells how to make a Pinhole Camera, a Camera, model Railroad, a Telephone, Boomerang, Telegraph Instrument, H. X. Kite, Talking Machine, Microscope, Electric Bell, Motor, Electric Door Bell, Water Wheel, Fiddle, Raft, a pair of Skis, a Dog sled, Bird House, Rabbit Yard, etc. 64 pages. 100 illustrations. PRICE 10c.

AMATEUR ELECTRICIAN, all about electricity in simple language. How to make batteries, dynamos, motors, telephones, bells, electric coils, engine lights, etc. Price 10c postpaid.

BOOK ON ROPE SPICING



Useful Knots, Hitches, Splices, etc. How different knots are made and what they are used for, knots that are unsafe, etc. Over 150 illustrations. All about wire rope attachments. In a few blocks, tackles, etc. PRICE 20 CENTS.

Wonderful X-Ray Tube



A wonderful little instrument producing optical illusions both surprising and startling. With it you can see what is apparently the bones of your fingers, the lead in a lead pencil, the interior opening in a pin stem, and many other similar illusions. Price 10c, 3 for 25c.

NOSE BLOWER



When some men blow their nose it sounds like a trombone. Now the **NOSE BLOWER** has come to correct it. It is a starter! It is ingeniously connected in the larynx. Pressed to blow your nose and your friends will think they heard a storm engine or something. You can blame the hideous noise to your having a very bad cold and keep up the fun as long as you like. PRICE 10c, 3 for 25c, or 75c doz. postpaid.

Serpent's Eggs



Box contains 12 eggs. When lit with a match, each one gradually hatches itself into a snake several feet long, which curls and twists about in a most life-like manner. Price per box, 10c postpaid 3 for 25c.



125 CARD TRICKS

Containing all the tricks and deceptions with cards ever invented, including the latest Tricks of the most celebrated Counters, Magicians and Prestidigitators popularly arranged, simplified and adapted for home amusement and social entertainments. The whole so explained that any one can, with a little practice, perform the most difficult feat, to his own satisfaction and to the wonder and admiration of his friends. There is also added a Complete Exposure of all the Card Tricks made use of by Professional Card Players and Gamblers. Shows how "Skin" Gamblers cheat and win money by their infernal "snake skin" and other tricks. These features make it the best work ever published on Card Tricks. PRICE 25c POSTPAID



Tricks & Social Entertainer

Cleverly performed feats of conjuring, sleight-of-hand and illusion interest everybody, and ability of the kind always makes one a welcome guest. This is a book of 96 pages, with nearly 150 illustrations. The instructions for performing are so plainly given that even a child, with a little practice, can do them, as they only require SIMPLE APPARATUS. The book gives full and clear explanations of an unusually large number of clever tricks of all kinds. In addition there is a chapter on "SECOND SIGHT" in which the limitation of five different methods which baffles the most astute investigators. The book is well worth the while even for those who merely wish to know how the tricks are done, while for the amateur magician it is a perfect treasury of golden opportunities. Price 25c postpaid.

MICROPHONE TRANSMITTER BUTTON



You can easily make a highly sensitive detector-phone by using this Transmitter Button to collect the sound waves. You can build your own outfit without buying expensive equipment. It is simple and inexpensive. You can install an outfit in your home and have conversations being held all over the house. You can connect up different rooms of a hotel. This outfit was used by secret service operatives during the war. It is being used on the stage. It is ultra-sensitive and is the greatest invention in microphone. You can mount the button almost anywhere—card board boxes, store pipes, stiff calendars, on the wall behind a picture frame, etc. Button is so light and small it cannot be detected. Persons can be overheard without suspecting it. You can listen in on conversations in another room. A dead person in the audience can hear the speaker. Connected to phonograph, piano or other musical instrument, music can be heard hundreds of feet away. Button may be used to receive telephone transmissions; often makes an old line "talk up" when nothing else will. The ideal microphone for radio use; carries heavy current and is extremely sensitive. Amplifies radio signals. Connections other than those shown will suggest themselves. Experimenters find the button useful for hundreds of experiments along the lines of telephony, amplifiers, loud speakers, etc. Many fascinating stunts may be devised, such as holding the button against the throat or chest to reproduce speech without sound waves. PRICE \$1.00, **JOHNSON SMITH & CO., Dept. 814, RACINE, WIS.**

PATENT

Protect Your Ideas

Take the First Step Today

If you have a useful, practical, novel idea for any new article or for an improvement on an old one, you should communicate with a competent Registered Patent Attorney AT ONCE. Every year thousands of applications for patents are filed in the U. S. Patent Office. Frequently two or more applications are made for the same or substantially the same idea (even though the inventors may live in different sections of the country and be entirely unknown to one another). In such a case, the burden of proof rests upon the last application filed. Delays of even a few days in filing the application sometimes mean the loss of a patent. So lose no time. Get in touch with me at once by mailing the coupon on the opposite page.

Prompt, Careful, Efficient Service

This large, experienced organization devotes its entire time and attention to patent and trade mark cases. Our offices are directly across the street from the U. S. Patent Office. We understand the technicalities of patent law. We know the rules and requirements of the Patent Office. We can proceed in the quickest, safest and best ways in preparing an application for a patent covering your idea. Our success has been built on the strength of careful, efficient, satisfactory service to inventors and trademark owners located in every state in the Union.

NO CHARGE for Information On How to Proceed

The booklet shown here contains valuable information relating to patent procedure that every inventor should have. And with it I will also send you my "Record of Invention" form on which you can sketch your idea and establish its date before a witness. Such evidence may later prove valuable to you. Simply mail the coupon and I will send you the booklet, and the "Record of Invention" form, together with detailed information on how to proceed and the costs involved. Do this NOW. No need to lose a minute's time. The coupon will bring you complete information entirely without charge or obligation.

My Offices
Just Across
Street From
U.S. Pat. Office



Above is a view of my drafting and specification offices where a large staff of experienced experts are in my constant employ. All drawings and specifications are prepared in my offices.

NEWS

Inventors Write for these Free Books

Strict Secrecy Preserved

All communications, sketches, drawings, etc., are held in strictest confidence in strong, steel, fireproof files, which are accessible only to authorized members of my staff. Feel free to write me fully and frankly. It is probable that I can help you. Highest references. But **FIRST**—clip the coupon and get my free book. Do **THAT** right now.

Clarence A. O'Brien

Registered Patent Attorney

Member of Bar of: Supreme Court of the United States; Court of Appeals, District of Columbia; Supreme Court, District of Columbia; United States Court of Claims.

Practice confined exclusively to Patents, Trademarks and Copyrights



Clip this Coupon and Mail it Now!

CLARENCE A. O'BRIEN, Registered Patent Attorney
70-G Security Savings and Commercial Bank Bldg.
Washington, D. C.

(Or, Suite 1106, Dept. A-11, Woolworth Bldg., New York City)

Please send me your free book, "How to Obtain a Patent," and your "Record of Invention" form without any cost or obligation on my part.

Name.....

Address.....

(Important—Write or print name plainly and address office nearest you)

PATENTS TRADE MARKS COPYRIGHTS

Have You An Idea ?

Our Offer: FOR THE PROTECTION OF YOUR INVENTION

YOUR FIRST STEP—The Inventor should write for our blank form "RECORD OF INVENTION." A sketch and description should be made on this Blank, signed, witnessed, then returned to us. We also give our opinion as to whether the invention comes within the Patent Office definition of a patentable invention. This "Record of Invention" will serve as "proof of conception." *There is no charge or obligation for this service.*

Our Five Books Mailed Free to Inventors
Our Illustrated Guide BOOK

How to Obtain a Patent

Contains full instructions regarding U. S. Patents, Our Methods, Terms, and 100 Mechanical Movements illustrated and described.

Our Trade Mark Book

Shows value and necessity of Trade Mark Protection. Information regarding *Trade Marks and unfair competition in trade.*

Our Foreign Book

We have Direct Agencies in Foreign Countries, and secure Foreign Patents in shortest time and lowest cost.

Progress of Invention

Description of World's Most Pressing Problems by Leading Scientists and Inventors.

Payment of Fees in Installments

It is not necessary that the total cost for the preparation and prosecution of a patent be paid in one payment. Our custom is to permit our clients to pay for their applications in three installments as the preparation of the application progresses in our office. This plan makes the payments easy for the inventor.

We Regard a Satisfied Client as our best advertisement, and furnish anyone, upon request, lists of clients in any state for whom we have secured patents.

**Highest References—Prompt Service
—Reasonable Terms**

VICTOR J. EVANS & CO.

Patent Attorneys, Established in 1898
Main Offices: 789 9th St., N. W., Washington, D. C.
Nearly Opposite U. S. Patent Office



Our New York Office
Suite 1007 Woolworth Bldg.



Our Philadelphia Office
828 Fidelity Phila. Trust Bldg.



VICTOR BUILDING
Our New Building Nearly Opposite U. S. Patent
Office Specially Erected by Us for Our Own Use



DELAYS ARE DANGEROUS IN PATENT MATTERS

IMPORTANT! To Avoid Delay!

YOU SHOULD HAVE YOUR CASE MADE SPECIAL IN OUR OFFICE to save correspondence, secure protection and early filing date in the Patent Office. To secure **special preparation** of your case send \$25.00 on account with model or sketch and description of invention. If the invention is not patentable we will return fee less cost of search.

We Assist our Clients to Sell their Inventions.



Our Chicago Office
Suite 1640-42 Conway Bldg



MAIN OFFICE, VICTOR J. EVANS & CO.—VICTOR BUILDING, WASHINGTON, D. C.



Our Pittsburgh Office
Suite 514 Empire Building



Our San Francisco Office
Suite 1010 Hobart Building

Our Large, Comprehensive Organization has been established for 30 years and offers Prompt, Efficient and **Personal Service** by experienced Patent Lawyers and Draftsmen. Every case is in charge of a Specialist who has been selected for his knowledge and experience in certain lines of invention. Our Lawyers practice in all U. S. Courts and defend clients in suits involving Patents, Trademarks and Copyrights. All Communications, Sketches, Drawings, etc., preserved in fireproof Files, strictly **Secret and Confidential**. We shall be glad to have you consult us or to answer any questions in regard to Patents, Trademarks or Copyrights without charge or obligation.

**FREE
COUPON**

VICTOR J. EVANS & CO.
PATENT ATTORNEYS *Established
in 1898*

NEW YORK OFFICES
1007 Woolworth Bldg.

CHICAGO OFFICES
Suite 1640-42 Conway Bldg.

PHILADELPHIA OFFICES
528 Fidelity Phila. Trust Bldg.

PITTSBURGH OFFICES
514 Empire Bldg.

SAN FRANCISCO OFFICES
1010 Hobart Bldg.

MAIN OFFICES: 789-9th Street, N. W., WASHINGTON, D. C.

Gentlemen: Please send me *Free of Charge* your books as described on preceding page.

Name

Address

PATENTS SECURED TRADE-MARKS REGISTERED

High-class professional service for Inventors and Trade-Mark Users is necessary for PROPER PROTECTION. We Offer you our facilities on Reasonable Terms. If you have an invention send us a model or sketch and description and we will give you our OPINION whether your invention comes within the provisions of the Patent Laws. Our book, "HOW TO GET YOUR PATENT" and Record of Invention Certificate sent on request. DELAYS are DANGEROUS in Patent Matters.

Terms Reasonable.

Best References.

WRITE TODAY

RANDOLPH & COMPANY, Patent Attorneys

301 VICTOR BUILDING, WASHINGTON, D. C.

Name.....

Address.....



PATENTS TRADE-MARKS

**Don't Lose Your Rights
To Patent Protection**

Before disclosing your invention to anyone send for blank form "EVIDENCE OF CONCEPTION" to be signed and witnessed.

LANCASTER, ALLWINE & ROMMEL
480 Ouray Bldg. WASHINGTON, D. C.
Originators of forms "Evidence of Conception."

PATENT-PROTECTION

WITHOUT cost, WITHOUT loss of time, WITHOUT disclosing to anyone, even to us. THIS FREE BOOK TELLS HOW! Write for your copy TODAY. INVENTORS — Don't expect your Patent Attorney to protect you on imaginary details of construction.

NO WONDER
THEY
FAIL!



BERNARD & HELLER
31 EAST 17th ST. NEW YORK

PATENTS

Trade Marks, Copyrights, Patent Litigation Handbook with illustrations, 100 mechanical movements. Sent free on request.

ALBERT E. DIETERICH

Successor to Fred G. Dieterich & Co.

formerly member Examining Corps, U. S. Patent Office

REGISTERED

PATENT LAWYER and SOLICITOR

621-A, Ouray Bldg.

30 Years' Experience Washington, D. C.

PATENTS

PROTECT YOUR IDEAS

Write today for FREE BOOKLET, HOW TO OBTAIN A PATENT and RECORD OF INVENTION—or send Drawing or Model of your Invention for Examination.

Promptness Assured with Best Results

MILLER & MILLER
REGISTERED PATENT ATTORNEYS

Former Members Examining Corps U. S. Patent Office

Dept. A-1006 Woolworth Bldg. New York

255 McGill Building Washington, D. C.

PATENTS

TO THE MAN WITH AN IDEA

Preliminary advice gladly furnished without charge. Booklet of information and form for disclosing idea free on request.

IRVING L. McCATHRAN, Patent Lawyer

Formerly with and successor to RICHARD S. OWEN

750 International Bldg. Washington, D. C.

41-E Park Row New York City

TRADE-MARKS

INVENTORS who derive largest profits know and heed certain simple but vital facts before applying for Patents.

Our book *Patent-Sense* gives those facts; sent free. Write LACEY & LACEY, 635 F Street N. W., Dept. 5, Washington, D. C. Estab. 1853.

PATENTS

Booklet Free Highest References
Promptness Assured Best Results

Send drawing or model.

ALL BUSINESS GIVEN PROMPT AND PROPER ATTENTION

Listed Patent Lawyer in the latest editions of the Rand-McNally Directory of Bankers and Bank-Recommended Attorneys, published by Rand-McNally & Co., Chicago, Ill.; The Baggott & Ryall Directory of Guaranteed Attorneys, published by Legal Directory Corporation, Boston, Mass.; Flugel's Law List, published by Legal Directory Publishing Co., St. Louis, Mo.; American Lawyers Annual, published in Cleveland, Ohio; Bankers Service Legal Directory, published by Bankers Service Co., Boston, Mass.; Eyre's Law List, 9 Park Place, New York City; Walters Legal Directory, Omaha, Nebraska, and the National Directory of Attorneys, Baltimore, Maryland.

WATSON E. COLEMAN,
REGISTERED PATENT LAWYER

Victor Building, 724 Ninth Street, N. W.
WASHINGTON, D. C.

You \$20 \$25 \$30 a Week Men-Listen!



J. E. Smith, Pres., Nat'l. Radio Institute, the man who has directed the Home Study training of more men for the Radio industry than any other man in America.

Im Doubling and Tripling the Salaries of Many Fellows Every Year by Fitting Them for RADIO--the Field with a Future!

SEND for FREE BOOK of FACTS and PROOF

There's nothing I'd rather do than show a \$20, \$25, \$30 a week man how to double or triple his earnings. Raising men's pay has been my business for 15 years. That I am succeeding is proven by the many letters from graduates in my work. Every year my training equips hundreds to earn two and three times the money they earned before. How do I do it? I give them the RIGHT TRAINING in the RIGHT FIELD--RADIO!

Send for my free book, "Rich Rewards in Radio." It tells about the many opportunities in this fast-grow-

\$800 in Spare Time

"Dear Mr. Smith: I did not know a single thing about Radio before I enrolled, but I have made \$800 in my spare time."—Milton L. Leiby, Jr., Topton, Penna.



ing field—and how quickly I can train you at home, in your spare time, for a good job.

Many of My Men Make \$50 to \$100 a Week

Many fellows, who had very little schooling and no Radio experience before taking my amazingly simple course, are now earning \$50, \$60, \$75 to \$100 a week in responsible Radio jobs. I train you for such jobs as operating on board Ships, in Broadcasting Stations, Talking Pictures, Television, manufacturing, selling and servicing sets for dealers and running a spare-time or full-time business of your own.

Spare Time Earnings Begin Almost at Once

I teach you to begin making money on the side almost at once. My new 50-50 training method makes learning at home easy, practical, fascinating.

Get My FREE Book

Don't wait—send the coupon at once. Get the facts on the opportunities in Radio, how little it costs to train for them, how my Employment Department helps you get a job, and how I back my course with a money-back agreement.

Jumps from \$35 to \$100 a Week

"Dear Mr. Smith: Last week I had the pleasure of earning \$100, servicing and selling Radios. Before I entered Radio I was making \$35 a week. I owe my success to N. R. I."—J. A. Vaughn, 4075 South Grand Boulevard, St. Louis, Mo.



MAIL COUPON NOW!

J. E. SMITH, President
National Radio Institute
Dept. 1 EQ, Washington, D. C.

Send me your free book. This does not obligate me and no salesman will call.

NAME.....

ADDRESS.....

CITY.....STATE.....

30 Days' Free Trial on all MEAD Bicycles

New RANGER Models now ready for delivery direct from our factory. Astonishing new prices and terms. Do not buy until you get them.

RIDER AGENTS WANTED to ride and exhibit sample. Save big money. Many models, styles,

wheels, lamps, horns, equipment at half usual prices. Easy Payments. Write for our marvelous prices and terms.

Mead CYCLE COMPANY Write us today for free catalog
DEPT. E-111 CHICAGO



COACH BUILDING MADE EASY



You can build a beautiful coach model in a few hours. We supply all the parts, set to fit and ready to put together, of the George Washington coach, the Tally-Ho, or the Deane-Wood coach (famous Western stage) for \$4.95. Full instructions for building included with each kit. Build coaches for pleasure or profit. Models sent C.O.D., plus a few cents postage. Foreign orders must be accompanied by U. S. check or money order.

HISTORICAL COACH MODELS, INC.
Dept. P. M. 11, 2206 Fairmount Ave., Philadelphia, Pa.

AMAZING NEW GUN

Men all over the country are turning to this full size automatic high power rifle using round steel shot. Light. Speedy. Sporting arm balance and precision.

TRY THE BENJAMIN 25 SHOT AUTOMATIC "THE MYSTERY RIFLE"

OUTSHOTS ALL OTHERS

Companion to the world famous Benjamin Single Shot. Same effective compressed air action with 25 shot automatic feed. 10 to 12 rapid fire shots on one pumping. Price \$10.00. Benjamin Single Shot Air Rifle \$5.00. Ask your dealer for demonstration or write for details and "BB MAGIC" FREE.

BENJAMIN AIR RIFLE CO., 605 North Broadway, St. Louis, Mo.



Less Guard \$25

Everything in Bench Power Tools—

Just a few shown. Also 7", 8" and 11" Lathes; 12" and 14" Band Saws; 17" Shaper. We have what you want in quality, low price and easy terms. Don't buy until you have seen the full line—

Universal Handisaw \$30

Wonderful value. Really 10 machines in one—will saw, rip, grind, dado, bore, mitre, rabbet, joint, sand and mortise. Graduated cross-cut guide. Table tilts 45 degrees, also raises and lowers.



Get Big Catalog

Largest and finest ever published on woodworking bench power tools. 52 pages 8 1/2 x 11". 113 illustrations. Contains vital information, interesting pictures of shops, projects, etc. Mailed upon receipt of 10c, stamps or coin, which only partly covers mailing cost.

Buy Now Pay Later



BIG Jig Saw

Large, massive and heavy. 20" capacity. Glutton for work. 15" dia. tilting table. Has improved hold-down shoe with blower. Blades swing to any angle. Weighs 70 pounds. Also 10" model priced at \$12.00.

Shaper. Big value for only.....\$49

W. B. & J. E. BOICE, Dept. P.M.-5G, Toledo, O.



New 4" Jointer

Long tables, wide rabbet arm. Graduated fence tilts two ways.

Get book "How to Build Screens" with Handisaw, 5c.

FORDS

55 mi. per hr. in Second!

Enjoy New Driving Thrills

Give your Ford the same silent, two-quiet-high, synchro-mesh performance as the most modern high-priced cars!

Enjoy two silent driving speeds; feel the thrill of a noiseless *clash-proof* second gear as quiet as 55 as standard Ford high. Sail along in the overdrive, vibrationless high, with the free-wheeling sensation of coasting, at 60 miles per hour with the motor only doing 45!

Ruckstell Two-Quiet-High Transmission replaces standard transmission with no cutting or changing. Write for full information and name of nearest distributor.



RUCKSTELL
TWO QUIET HIGH
TRANSMISSION

Synchro-mesh shift
Overdrive High
25% less engine wear

**More Speed—
—More Power!**



RUCKSTELL
POWER HEAD

RUCKSTELL DISTRIBUTING CO.

742 E. 140th Street

Cleveland, Ohio

Ruckstell High Compression Cylinder Head increases top speed of the Model A Ford 10 to 15%. Special heat-treated alloy developed by the Aluminum Company of America makes possible 25% more power, greater top-speed and faster pick-up without "ping" or motor knock. Simply replaces standard head. Write for prices.

Makes FORDS "Jump!"

Famous Inventor's Newest Creation gives lightning-like pick-up and get-away . . . a new smoothness . . . the utmost from your gas and oil

Again, P. B. Wolverton, inventor of "Free Wheeling," has set the motor world agog. Now he has perfected a tiny device . . . a power generating valve . . . that gives Fords tremendously increased power. Illustrated on Page 625 April POPULAR MECHANICS.

This revolutionary invention . . . the WOLVERTON POWER BOOSTER . . . captures heretofore wasted energy and puts it to work in your engine. Gives you instant pick-up . . . unexpected power . . . more speed. A smoothness and quietness you thought possible only in a "Six" or "Eight." Works automatically. Easily installed in few minutes with screw driver and pair of pliers.

PERFECT CARBURETION

By maintaining the proper mixture of gas and air, the WOLVERTON POWER BOOSTER gives you more perfect combustion. This means greatly reduced carbon deposit, giving longer life to your motor, and continued smooth and efficient operation. And you get all the power from your gas and life from your oil.

Let us send you full information.

Opportunity for Distributors, Dealers, Salesmen. Experience not necessary. The WOLVERTON POWER BOOSTER is a natural self-demonstrator.

WOLVERTON, INC., 43 E. Ohio Street . . . CHICAGO, ILL.

200% to 600% PROFIT



24 Karat Gold Plated

Every man buys. Biggest money-maker in years. Big opportunity to earn \$50 to \$100 a Week

The Crest Collar Layrite

Invisible device keeps soft collars flat and free of wrinkles. On in a jiffy. Eliminates starching. Lasts forever. Men buy several at one time. Sells for only 25 cents. Don't complain of hard times. Here's sure-fire money-maker. No competition. Send 25 cents for sample and complete details.

CREST SPECIALTY CO.

25 Crest Bldg., 227 W. Van Buren St., Chicago, Ill.

THEY LOVE IT PUT YOURSELF OVER . . . in a BIG WAY



LEARN to play a Buescher, for social popularity; big pay; success. Live on the cream of life. Any Buescher quickly, easily mastered. Lessons given free, on request, with instrument. Join a band or orchestra in 90 days. Ask your local Buescher Dealer for any Buescher Instrument on six days' free trial. Take it home. See what you can do. Or write direct for beautiful catalog. Mention favorite instrument. Send postal today.

BUESCHER BAND INSTRUMENT CO.

510 BUESCHER BLOCK

1888

ELKHART, INDIANA

AGENTS! SELLS LIKE WILD FIRE



\$380 monthly selling 10 new improved window washers daily. Cleans, dries, polishes. Eliminates all muck. Approved by Good Housekeeping. Restricted territory. Write today. CARTER PRODUCTS CORPORATION, 998 Front Ave., Cleveland, O.

The man who studies gets ahead. Popular Mechanics Press will advise you what books to read to advance in your trade. 200 East Ontario Street, Chicago, Illinois.

EASY MONEY HOME MANUFACTURING



Make Colorcrete Ornamental Products. New. Easy. Fascinating. No experience necessary. Sell on sight. Big growing market. Kauble of Iowa made \$2,000 with 3 designs. Martin of R. I. cleared \$3,600, and going strong, etc. Start this fast-growing business now and get exclusive franchise for your territory without charge. We furnish complete equipment. Molds as low as \$30. Send for new 32-page book giving complete data. Write today.

COLORCRETE INDUSTRIES
570 Ottawa Ave., Holland, Mich.

FREE BOOK IN COLORS

COLOR BOOK



The eyes of Lupe Velez, famous Universal Pictures' star. This brown-eyed actress, who wears 14 year size clothes, is now appearing in a film called "Resurrection".

refreshes eyes after motoring

Motoring causes eyes to tire and burn; often makes them bloodshot. Relieve these annoying after-effects by applying a few drops of harmless *Murine*. In a jiffy your eyes will feel fresh and rested; soon the bloodshot condition will disappear. Also use *Murine* after golf and other outdoor sports to offset eye irritation. 60c everywhere.

MURINE

FOR YOUR EYES

Only \$12 for this Toy Movie Projector

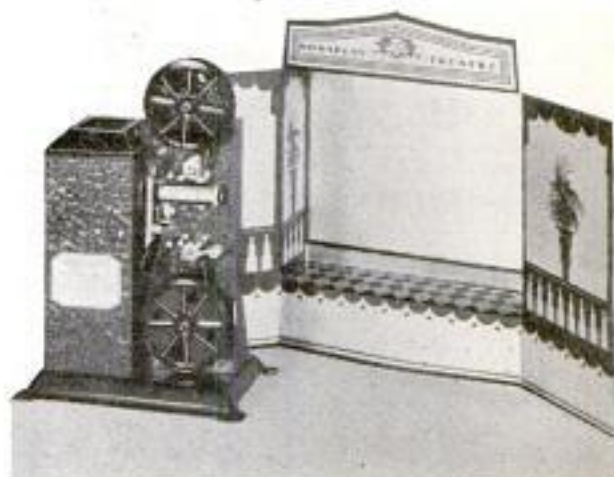

Eastman-made... Has features usually found only on more expensive machines...

KODATOY

THIS practical, safe projector uses 16 mm. Kodak Safety Film. Inexpensive, but sturdy and efficient. It has the famed Eastman quality throughout.

Kodatoy shows clear, brilliant, flickerless movies. Has sprocket threading; powerful condensing and projection lenses; claw pull-down; three-blade shutter. Costs, complete, only \$12. Motor-driven model, \$18.50. Motor sold separately, \$6.50. Outfit includes two empty 100-foot metal reels and miniature theatre with "silvered" screen surface.

Kodatoy owners can choose from hundreds of fascinating movie films. Short subjects called Kodaplays cost 30, 60 and 90 cents a reel. Longer subjects also available.

See Kodatoy in action at any leading Kodak dealer's, toy or department store.

EASTMAN KODAK COMPANY, Rochester, N. Y.

Please send me FREE the folder describing KODATOY.

Name _____

Street _____

City and State _____

PM5

RADIO BLUEPRINTS

The blueprints below include the best of Popular Mechanics tested circuits. When ordering, simply quote the numbers of blueprints desired and inclose proper amount addressed to Popular Mechanics Magazine, Radio Dept., 200 E. Ontario St., Chicago, Ill. Magazines containing full descriptions of the circuits can be obtained. Send 25 cents for each magazine desired, giving date of publication.

- No. 139, Simple Television Receiver... Dec. 1928.. 25c
- No. 140, Power Amplifier and B-Supply for Television..... Jan. 1929.. 25c
- No. 142, Two-Tube Screen-Grid Short-Wave Adapter..... Mar. 1929.. 25c
- No. 143, Four-Tube Screen-Grid Receiver..... May 1929.. 25c
- No. 144, Three-Tube Self-Contained A.C. Receiver..... Oct. 1929.. 25c
- No. 145, One-tube S-G Set for Beginners Nov. 1929.. 25c
- No. 146, Adjustable B-Eliminator... Nov. 1929.. 25c
- No. 148, Adding Audio Stages to S. G. Receiver..... Dec. 1929.. 25c
- No. 150, Short-Wave Receiver Without Plug-In Coils..... Sept. 1930.. 25c
- No. 151, Beginners Low Power S. W. Transmitter..... June 1930.. 25c
- No. 152, Portable Radio Amplifier for the Deaf..... July 1930.. 25c
- No. 153, Low Cost Code and Phone Transmitter..... Sept. 1930.. 25c
- No. 154, A. C. Screen-Grid DX Tuner..... Oct. 1930.. 25c
- No. 155, Four-Tube D-X Receiver... Nov. 1930.. 25c
- No. 156, Switchless Test Panel..... Nov. 1930.. 25c
- No. 157, Building a Light-Sensitive Relay..... Dec. 1930.. 25c
- No. 158, High-Power Supply for Amateur Transmitters..... Jan. 1931.. 25c
- No. 159, Portable S-W Transmitter..... Feb. and March 1931.. 25c
- No. 160, Building A.C. Midget Receiver..... Mar. and Apr. 1931.. 25c
- No. 161, Building Auto Receiver for 2-volt Tubes.... Apr. and May 1931.. 25c

Material Lists for any of the above instruments will be mailed free upon application.



Assure the Success You See Ahead

Would you win success? You can. Let the crowd wish for it. You plan for it. Choose your own goal. Then follow a plan that cannot fail.

Does not success mean to you more than hand-to-mouth living? It should mean respect and confidence of business associates . . . good financial standing . . . quitting work at 55—60—65 with life income . . . money in a place safer than banks, businesses or stocks, available in case of sickness or unemployment . . . provision for the family should anything happen to you.

All these, and more, are easily within your reach through a modernized form of life insurance.

This Plan Cannot Fail

A Postal Life Contract, backed by a 20-million-dollar Corporation, makes sure you will reach your goal. Not sickness, accident or even death itself can upset it. Come what may, you are bound to win.

Postal Life contracts are sold by mail only. We employ no expensive salesmen. Our patrons benefit from and share in these big savings, year after year.

Let this financially solid 25-year-old Corporation safeguard your future. Write today for suggested contract that will meet your needs. No obligation. No agent will call. Fill in and mail the coupon. Arthur Jordan, President, Postal Life Insurance Company, 511 Fifth Avenue, New York City.

Suggested Plan sent free. Only by mail can you get it. Send coupon now.

Postal Life Insurance Company
511 Fifth Avenue, New York City (PM 531)

Without obligating me now or later, please suggest a life contract for my age.

Name.....

Address.....

Occupation.....

Exact date of birth.....

Beat This If You Can!



Belt and Buckle Outfit including up to 10 letters and one emblem retails for ONLY \$3.50. BIG COMMISSION. Beautiful sample outfit free. No competition. Thousands of eager buyers. Write quick.

Stalder Mfg. Co., 330 Venice Blvd., Dept. B, Los Angeles, Calif.

Sent for \$100

Wear while paying

10 MONTHS to PAY
Send only \$1 and this fine reliable Elgin or Waltham watch comes to you postage prepaid—no C.O.D. to pay on arrival.

10 Days Free Trial
After examination and 10 DAYS FREE TRIAL pay balance in 10 equal monthly payments.

Satisfaction Guaranteed
All transactions strictly confidential. You take no risk. Satisfaction absolutely guaranteed or money back. No interest—no extras—no red tape. Written guarantee bond with every purchase.

To ADULTS: SEND FREE FOR CATALOGUE
Send for copy of latest catalog showing special values in genuine blue-white diamonds from \$25. to \$1,000 and standard watches from \$12.50 up.

\$22
ELGIN or WALTHAM
FE 42
Nationally advertised Waltham or Elgin; Guaranteed accurate and dependable. Engraved white lifetime case. Fine engraved open link bracelet to match; with extension center opening. Only \$2.10 a month.

ESTABLISHED 1895

ROYAL DIAMOND & WATCH CO.
ADDRESS DEPT. 11-5 170 BROADWAY, N.Y.

AUTO RADIO

A RADIO SET FOR YOUR AUTOMOBILE AT AN AMAZINGLY LOW PRICE

Six tube triple screen-grid, using 3-224, 2-227, and 1-245 power tube. Easy to install. Will fit any car. Single dial control. We guarantee that this set will pull in stations within a radius of 500 miles and that it will deliver the volume and tone qualities of an electric set, or your money refunded.

PRICE OF SET ONLY \$20.00

PRICE COMPLETE including tubes, batteries, dynamic speaker and suppressors, **all ready to install and use, \$39.50.**

Send \$5.00 deposit with order, balance C. O. D. On foreign orders remittance in full required. **ORDER TODAY.**

CHAS. HOODWIN CO.

4240 Lincoln Ave., Dept. E.20, Chicago, Ill.

EXPO WATCH CAMERA

NO BIGGER THAN A WATCH

Makes marvelous, sharp pictures $3\frac{1}{2} \times 4\frac{1}{4}$ ", that can be enlarged up to $3\frac{1}{2} \times 4\frac{1}{4}$ ". No focusing. Press the button and the picture is yours. "Time" and "Instantaneous" shutter. Loads in daylight. 20 exposure film costs only 30 cents. Send \$1 for Camera and film. Pay postman \$4 plus postage. Money back guarantee. Send today. Big catalog free.

SEND ONLY \$1

CENTRAL CAMERA CO. 230 S. Wabash Ave., Dept. 25A, CHICAGO

NEW COMPLETE "WONDER" WORK SHOP

\$18.30 Without Motor

BUY DIRECT

SAVE 35% to 60%

Arranged for Plain and Hot Drive

12-in. Hand Saw.....	\$24.75	\$21.25
11-in. Lathe.....	21.00	20.25
4 to 20-in. Scroll Saw.....	4.50	12.44
6-in. S. R. Joister.....	44.00	24.00

3-Plan Workshop
Three-speed Lathe, 7-in. Saw Table, 6-in. Scroll Saw.....\$34.00

All Without Motors

Write for Circulars

S. & B. MFG. COMPANY, 4611-A W. 20th St., Chicago, Ill.

THE JIF TIRE GAUGE SAVES TIME AND TIRES

New and different. Just press against tire wall and you get the tire pressure. No removing valve caps. No pliers—no skinned knuckles. You can now gauge all your tires in a jiffy. As handy as your self starter. Thousands being sold.



Manufacturer's introductory price

\$1.00

for limited time. Send your \$1.00 today.

AUTO EQUIPMENT MFG. CO.
10 S. La Salle St. Dept. H CHICAGO, ILL.
DEALERS—WRITE FOR QUANTITY PRICES



Now
in cans
and tubes
this new
WOOD

MENDS A Thousand Things

NOW—if there's anything around the house that needs an expert job of repairing—a loose chair rung, weak chair back... a broken toy or loose caster... a drawer pull that comes out... cracks in the floor... shaky bathroom fixtures... a screw hole that won't hold a screw—save yourself a lot of money and fix it in a jiffy with Plastic Wood.

Though it handles like soft putty it quickly hardens into wood. It looks like wood. It is actually wood—Plastic Wood you can mould with your hands. Has a longer life and greater strength than natural wood.

It seals cracks, hides nicks and repairs damaged furniture as skilfully as a high-priced cabinet-maker or carpenter.

Never dries out. Never warps or rots. You can plane it, carve it, turn it in a lathe and drive nails and screws into it. You can paint, varnish or lacquer its weather-proof, water-proof surface. Sold in 9 colors by all paint, hardware and department stores.

BIG 48-PAGE BOOK—FREE

This coupon will bring you by return mail a big, profusely illustrated book crammed full of interesting uses for Plastic Wood. Send for your copy today.

The A. S. BOYLE COMPANY, Dept. 5-PM-23
Cincinnati, Ohio

Send me—free—big, illustrated book of uses for PLASTIC WOOD.

Name.....

Street.....

City..... State.....

Auto Seat Covers \$2.95

Special Price Offer

AGENTS Make \$20 a Day

Write orders fast for this excellent Quality line Auto Seat Covers. Amazing value—quick sale. Cash daily. We deliver. Write for handbook: Five Leatherette Samples. Outstanding Quality Sales, 1834-36 North Ave., Dept. 516, Chicago

MODEL SHIPS

We can supply construction sets and all sorts of parts such as semi-finished hulls, blocks, deadeyes, special flags, masts, steering wheels, compasses, Eternite, line traps, blocks, etc., for building real life scale models of the Destroyer Preston, Baltimore Clipper, Flying Cloud, Constitution, Spanish Galleon, Mississippi River Steamboat, Sovereign of the Sea, Bluenose, Mayflower and many others. Also special construction sets for racing sail boats, power boats, model steam engines, propellers, etc., and line tools for the model maker. Our large 56-page photographically illustrated booklet contains valuable information and hints for building ship models in addition to prices and full description of the above articles. Many people only slightly interested in model kits become greatly enthused upon receiving this booklet. A copy will be sent postpaid upon receipt of 15 cts. (cash preferred).

Model Ship Supply Co., Dept. F, Mineola, N. Y.

NEW SHOE SOLES for 10c

New, soft, pliable waterproof soles may now be yours for only 10c. Spreads on with a knife like butter and hardens overnight. Agents desirous of making up to \$25 daily write for no-cost sample offer.

Universal Laboratories, Inc., Dept. 6295, Des Moines, Iowa

\$12.50 "Universal" Photo Cell \$12.50

500 TIMES

More Powerful More Sensitive More Rugged

This powerful cell is designed and priced to open the photo-electric use to experimenters. Uses 4 1/2 v. C battery only to operate relay direct without amplification. Send for free Bulletin A explaining simplified hookup for all experiments in talking pictures, talking light, visible sound, traffic poster, photo-graph record reproducing, electric eye, burglar alarm, clock level indicator. Bulletin B gives prices and applications on cells for industrial uses. "Universal" Photo Cell Lab., Venice, Cal.

Information on any book free. Write Popular Mechanics Press, Chicago, Ill.

JOY TO FORD OWNERS

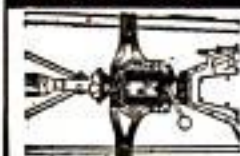

Attachments to install a Chevrolet gearshift in Model T Cars and Trucks priced extremely low.

Write for Catalog Dept. 4

HOLLINGSWORTH MFG. CO., Marshalltown, Iowa

An Amazing New Development IN NEON SIGNS

A NEW INVENTION



This Amazing New Neon Sign Brought Mr. Moon \$48.00 Profits the First Day.

Dazzling Advertising Display

Simply sets in window. Costs few cents a day to operate. Does work of \$400.00 and \$500.00 Neon Signs.

Increases Business Instantly

Makes business pick up immediately. One merchant doubles his sales the first week. Brings astounding results.

Ideal for Every Business

Dignified and appealing. Used by Doctors, Restaurants, Confectioneries, Shoe Stores, Large Advertisers, etc.

Costs Only a Few Dollars

Costs merchants only a fraction of big Neon Signs.

Biggest Seller on the Market Today

AGENTS, DISTRIBUTORS AND DISTRICT MANAGERS are wanted at once to introduce these new signs quickly. Sweeping the entire country like wildfire. Big profits and real proposition for wide-awake men who start NOW. Wire or write for proposition on selling and free sample case TODAY.

SPECIAL OFFER COUPON

PRESTON MFG. CO., Dept. S-854,
3800-08 Park Ave., St. Louis, Mo.

Without cost or obligation you may send me your selling proposition and free sample case offer on your new invention in Neon Signs.

Name

Address

New Electric NEON SIGN. Brilliant Neon lights in red, green or blue makes show windows dazzling bright. Automatic flasher and special flood lighted background.

Stage effect for displaying merchandise and illuminated name plate.

Announcing



the CHALLENGER

a highly efficient utility glider built around the famous Rhon Ranger. Complete CHALLENGER CONSTRUCTION KIT only \$131.00. (Also sold in 8 progressive groups averaging \$17.00 each.) If you already own a Rhon Ranger, you can easily convert it to the CHALLENGER for \$44.00. There is no guesswork about MEAD gliders; their high performance has been ably demonstrated in thousands of flights all over the world. Their sturdy structure meets government requirements. Send 10c today for our latest catalogs covering the famous MEAD line of gliders and supplies.

MEAD GLIDERS

Dept. B-10

12 S. Market St.

Chicago, Ill.

New Way to Sharpen Razor Blades!



Instead of merely stropping your razor blades, you can now actually re-sharpen them—with a Keenex Edge-Grinding Razor Sharpener. Nothing like it ever before on the market! A real sharpener—not just a strop! Actually grinds and polishes the edge of the blade. Makes a dull blade so sharp it will split a hair. All done in 20 seconds! Use it once a week and you'll always be sure of an easy shave. Pays for itself several times over in cost of blades. Lasts a lifetime. Sold by Dealers or direct. Write today for Trial Offer for a limited time.

THE KEENEX RAZOR SHARPENER CO.
3285 Monroe St. Toledo, Ohio

WRITE
for
TRIAL
OFFER

PORTABLE ELECTRIC SPRAYER

Sprays Paint, Varnish, Deco, Enamel, Lacquer, etc., by Electricity

Reg. Price \$68.50
our Price
\$29.50

Complete with 1-4 H.P. Gen. El. Motor and Spray Gun. Attach to light socket. Turn on switch and paint the Power way. Does work of 5 men.

SEND FOR CATALOG
Nat'l Jobbing & Export Co.
192 N. Clark St., Chicago 4



\$7.00
A Month

for this 9" x 2' Back-Geared Special Metal Turning SOUTH BEND PRECISION BENCH LATHE

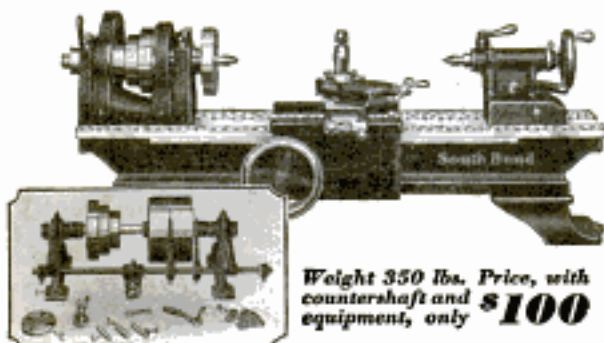

Weight 350 lbs. Price, with countershaft and equipment, only **\$100**

9 1/4" swing ... Precision type ... 3/4" hole thru spindle ... Phosphor bronze bearings ... Back-geared headstock ... Set over tail-stock ... Graduated compound rest ... Cone pulley steps 1" wide ... Bed lengths 2' to 4 1/2' with between center distances, 5" to 36".

The No. 20 9" Special is our regular Quick Change Gear Lathe stripped of all extras not needed in the small shop. Used for manufacturing, machine shop, repairing, automobile servicing, etc. Suitable for all turning jobs in cast iron, steel, brass, aluminum, bronze, wood, fibre, etc. WRITE NOW for descriptive circular—also catalog of other sizes up to 24" swing at \$2,000.

SOUTH BEND LATHE WORKS

804 East Madison Street

South Bend, Indiana, U. S. A.

LATHE BUILDERS FOR 25 YEARS—OVER 50,000 SOUTH BEND LATHES IN USE

Stewart FENCES

Opportunity Is Calling

America's greatest fence manufacturer is now enlarging staff of personal representatives. Business has survived this country's ups and downs for half century. Nationally advertised each month in Arts and Decoration, House Beautiful, American Home and other high-class magazines.

NO INVESTMENT REQUIRED

A real opportunity—highly profitable business—taking orders from Home Owners, Park and School Boards, Playground supervisors and Factory owners for Wrought Iron and Chain Link Wire Fence. You won't have to buy any stock. We will train you—furnish complete instructions, catalogs, and whole-hearted co-operation.

ACT! WRITE TODAY! DON'T WAIT!

Write to D. P. Halenkamp, agency executive, and tell him about your selling experience, age, references, and lines you now are handling. Previous Fence experience not necessary.

THE STEWART IRON WORKS CO., Inc.

Established 1886

741 Stewart Block

Cincinnati, Ohio

BUILD YOUR OWN

AUTOMATIC ELECTRIC REFRIGERATOR

Why pay \$200.00 and upwards? You can use your present ice-box—We supply special parts—Costs only \$34.50 complete—Easily made—No special tools required—Operating cost, quality and size of machine same as well known makes—Complete blue-prints and thorough instructions—\$1.00.

B. & L. ENGINEERING Co. 62 Greenville Ave. Jersey City, N. J.



Let us recommend the best books to study on any subject. Popular Mechanics Press, Chicago, Illinois



Makes old plugs act like NEW—starts car instantly without choke

New motor invention "HOT SHOT" increases power—speed. SAVES UP TO 30% GAS—60% OIL. Delivers miniature streak of lightning 11,000 volts. Transparent—shows BLUE spark if ignition O. K.—RED if faulty. Pays for self immediately. \$1.50 value. Fits any car, truck, tractor or gas engine. Installed without tools. Gold mine for agents. "325 a day, easy," says Akeman. "Rush 100 HOT SHOTS," wired Klint. "Tried my engine," writes Belke. "HOT SHOT a wonder," says Abbott. "Rush 100 HOT SHOTS at once," says Gansoway. "Last order for 64 should arrive tomorrow and I've already sold them." Car owners amazed. Agents closing up; part time, full time.

HOT SHOT is NEW—STARTLING. Nothing else like it. BIG REPEAT Sales everywhere. HOT SHOT on your old car will amaze by its performance. Act quick. Write for Free Sample Offer.

REARDON MFG. CO. Dept. F-5, PEORIA, ILLINOIS

\$32.50

COMPLETE

With Six Tubes

REGULAR \$69.50

Buy Direct and

SAVE \$37.00



Buy wholesale. In no other way could this high-powered little giant be bought at such a phenomenal price. People who have bought them at \$69.50 claim they got a \$100 value. Read the specifications and you'll KNOW they did!

The kind of bargain you'll brag about—fine workmanship, beautiful design, walnut piano finish cabinet—6 tubes, 4 screen grid, dynamic speaker—volume, smoothness and tone control of any console model—at a remarkable price. And not one cent more to spend for anything. This price is complete.

MASCOT MIDGET RADIO

Backed by a Million Dollar Guarantee!

A corporation that does \$22,000,000 worth of business a year is back of this radio and guarantees your complete satisfaction.

Nothing to worry about! You take no chance with a small unknown radio concern—you deal with the biggest sellers of radio in the world! You can place absolute confidence in every word they claim. They would not dare to risk their reputation on a misstatement.

Send for it today. Set it up. Play it for a week—daytime and night. Get your favorite stations—your favorite programs—and if you don't think it's the biggest value in a radio buy you ever saw, pack it up on the seventh day and send it back to us parcel post and we will mail you a check for every cent of the money you paid.

SEND ONLY \$3

with your order. Then when the postman brings you the actual radio itself, pay him the remaining \$29.50 plus whatever slight parcel post charge there may be. And if your whole family isn't enthusiastic about it, send it back by the end of one week and we'll cheerfully refund all the money you paid. And think what you save! A \$69.50 radio for \$32.50! \$37 to the good! More than 100%. That's what you get for being your own dealer! An opportunity you can't afford to pass up. Send in the coupon right this minute while the page is still before you.

READ THESE SPECIFICATIONS

- 1 Six R C A licensed tubes, 4 screen grids No. 224, 1 power tube No. 268, 1 rectifying tube No. 286.
- 2 Three stages tuned R. F. 1 stage tuned detector necessitating the use of interstage shielded 4 gang variable condenser.
- 3 Linear power detector.
- 4 Resistance coupled audio.
- 5 Shielded R. F. coils of tuned plate and grid, giving greater tuning range and sensitivity.
- 6 Power pack, consists of high voltage power transformer of rugged construction with a large core, so as to prevent easy saturation. One thousand working voltage filter paper type condenser, whose capacity totals 145 MFD. (No wet condensers are used.)
- 7 A photograph pick up jack, giving sufficient amplification to equal the output of any audition type power amplifier.
- 8 A tone control. Superior in quality to any, giving a full range of the musical scale.
- 9 A combination of volume control and switch allows for simplification of tuning.
- 10 Speaker of the electro dynamic type designed to take the full load of the receiver and which properly matches its impedance.
- 11 A positive drive, easy visioned dial with pilot light detachable.
- 12 The grid scraper brush of the chassis and shields, harmonizes with the artistic walnut piano finish of the cabinet.
- 13 Complete aerial equipment included.
- 14 Weight packed 23 lbs. Important—for 110-115 Volt 60-Cycle alternating current only.

WHILE THEY LAST

Mail It

Now →

SAVE

\$37

CITY RADIO CO.,

219 Varick Street, New York City

Enclosed is \$3 and I will pay the postman \$29.50 and his small parcel post fee when he delivers the beautiful MASCOT MIDGET RADIO. This will pay you in full. If I don't like it I will return it within a week and you will refund my entire payment.

Name.....

Address.....

450 MILES in a gallon of gas

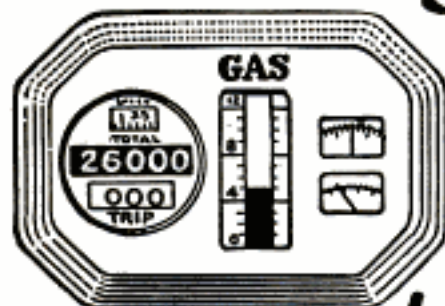

*startling
statement
of famous
Automotive Engineers*

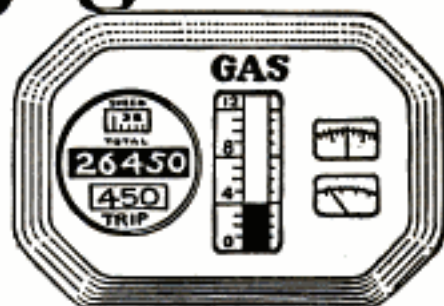

How to increase gasoline mileage has been a problem that Automotive Engineers have been trying for years to solve. Recently a world famous engineer made the statement that the energy produced by burning a gallon of gasoline would run an auto a distance of 450 miles. Other well known authorities go on record as saying that eventually it may be possible to get over four times as much out of gasoline as in the past.

Amazing Whirlwind Device Saving Millions of Gallons of Gas for Auto Owners

The Whirlwind Carbureting device embodies scientific features which conserves part of the gasoline that formerly went to waste.

Letters coming into the office tell of record mileages resulting in amazing gas savings. Low gasoline mileage is reported on practically every make of car. Greater power and smoother running motors are also noticed by users. The cost of the Whirlwind is so little that, basing its gas saving features even on the most modest reports, it would pay for itself almost immediately and then save many, many dollars for its owner by reducing gasoline consumption.

Car owners all over the world are saving money every day with the Whirlwind, besides having better operating motors. Think what this means on your own car. Figure up your savings—enough for a radio—a bank account—added pleasures. Why let the Oil Companies profit by your waste? Find out about this amazing little device that will pay for itself every few weeks in gas saving alone.

FITS ALL CARS

In just a few minutes the Whirlwind can be installed on any make of car, truck or tractor. It's actually less work than changing your oil or putting water in the battery. No drilling, tapping or changes of any kind necessary. It is guaranteed to work perfectly on any make of car, truck or tractor, large or small, new model or old model. The more you drive the more you will save.

SALESMEN and DISTRIBUTORS WANTED To Make Up To \$100.00 a Week and More

Whirlwind men are making big profits supplying this fast-selling device that car owners cannot afford to be without. Good territory is still open. Free sample offer to workers. Full particulars sent on request. Just check the coupon.

WHIRLWIND MANUFACTURING CO.
Dept. 549-A, Station C. Milwaukee, Wis.

GUARANTEE

No matter what kind of a car you have—no matter how big a gas eater it is—the Whirlwind will save you money. We absolutely guarantee that the Whirlwind will more than save its cost in gasoline alone within thirty days, or the trial will cost you nothing. We invite you to test it at our risk and expense. You are to be the sole judge.]

FREE OFFER COUPON

WHIRLWIND MANUFACTURING CO.,
Dept. 549-A, Station C, Milwaukee, Wis.

Gentlemen: You may send me full particulars of your Whirlwind Carbureting device and tell me how I can get one free. This does not obligate me in any way whatever.

Name.....

Address.....

City.....State.....

() Check here if you are interested in full or part time salesman position.

Think of it! Genuine UNDERWOOD

**Yours for
10 Days
TRIAL**

Regular \$100 Model **Now Only 39.90**

Yes—this world-famous Underwood is yours for full 10 days. See for yourself the *real bargain* it is. See how beautiful and new it looks—compare its neat, perfect work—without obligation.



Now Only



on Easy Terms

Buy Direct at Below 1/2 Mfg's Original Price



My unchallenged direct sale price and easy terms on this genuine Underwood refinished No. 4 is the lowest ever offered. While they last—less than half (1/2) the manufacturer's original price—and easy terms besides. Do not confuse this genuine late model Underwood with inferior or frail machines worth only one-half as much. This is the full sized standard Underwood with 4-row keyboard and late improvements, manufactured to sell originally for \$100. **Fully Guaranteed** in writing.

Easy Terms — Only 10c a Day

Think of it—a genuine late model Underwood reduced to \$39.90 (Cash). A saving of over \$60 by acting now. Send only \$1 deposit for a 10-day Trial. Then only 10c a day on my easy year-to-pay plan. And you use and enjoy your typewriter all the time. This Underwood all refinished like new is without question the greatest value ever offered at this rock-bottom price. (See column to right for its many outstanding features and improvements.)



Limited Quantity—Send at Once!

This exceptional bargain offer is for a very limited time only. Remember, every typewriter is sent on 10-days' Trial and Fully Guaranteed.

International Typewriter Exchange,
231 West Monroe St., Chicago, Ill., Dept. 501.

I am enclosing \$1.00 deposit. Please send the Underwood No. 4 F.O.B. Chicago at the special reduced price for 10-day Trial, with the understanding that if I am not perfectly satisfied I can return it Express Collect and get my deposit back. If I keep it I will pay \$1 a month until I have paid \$44.90 (term price) in full.

Name.....Age.....
Address.....
Town.....State.....

FREE Complete
9-Piece
Office Supply Set and
Typewriting Course

We teach you speed typewriting Free. Complete Home Study Course of the Famous Van Sant Speed Typewriting System, fully illustrated, easily learned. We also give complete office supply set free during this sensational sale.

**12 REASONS
WHY
this is the
Greatest Value
Ever Offered**

1. **Genuine Underwood**
2. **Standard 4-row Keyboard**
3. **2-color Ribbon**
4. **Back Spacer**
5. **Ribbon Reverse**
6. **Tabulator**
7. **Automatic Release**
8. **Shift Lock**
9. **Lowest Price**
10. **Easiest Terms**
11. **10-Day Trial**
12. **Fully Guaranteed**



CAMEL-LIGHTING TIME

SOFT LIGHTS and friendly shadows, intimate, alluring — and the mellow contentment of a Camel!

The pleasure of *any* moment is heightened by Camel's fresh, cool fragrance, tingling with the delicate aromas of the world's choicest tobaccos — sun-ripened — naturally mild.

CAMELS

Made to be enjoyed



© 1931, R. J. Reynolds Tobacco Company, Winston-Salem, N. C.

Copyrighted material