

JANUARY

25 CENTS

POPULAR MECHANICS

MAGAZINE

WRITTEN SO YOU CAN UNDERSTAND IT

REG. TRADE MARK GREAT BRITAIN NO. 42432

REG. U.S. PAT. OFF.



SEE PAGE 82

Copyrighted material



Opening America's Airways to Thousands Who Never Could Fly

That's what the world's champion Heath Parasol is doing! For it is easier to build, safer to fly—and more economical than any other plane. Start building NOW for only \$12.00.

No longer need anyone say "I can't afford to fly." For the Heath Parasol—America's most popular sport plane—has ushered in a new day in aviation—bringing you, for the first time, a light plane with more safety features than even the largest planes. And at a cost lower than ever before! Consider its great safety features. The Heath Parasol is totally without equal for ease and dependability of handling. Experienced pilots find it so inherently stable that they actually land the Parasol with hands off the controls! Consider that the Heath Parasol's flying cost including gas, oil, storage, etc., is actually *less than 1 cent a mile!* Then you'll understand why

ATTENTION

Don't be misled by the extravagant claims of Heath imitators. Only the original Heath Parasol gives Heath performance—as evidenced by the official results of the 1930 National Air Races. Note the Heath Parasol won first and second places in the light plane event.

Event 3—Civilian's Free-for-All (Open) 110 cu. in.:
FIRST—E. B. Heath, (Bristol Heath)—79:13 MPH.
SECOND—Delbert Koener (Heath Aero-Speed) 72:29 MPH.
THIRD—G. Palmquist (Bristol-Church mid-wing) 69:85 MPH.

The Heath Parasol is designed so that the wings can be used effectively, low wing, mid-wing, or Parasol style. Because experience has shown that the latter style gives the most versatile and stable performance, Heath Parasol's wings are placed in this position.

it is truly America's most popular sport plane.

Start Building Now

Take advantage of the long winter evenings—and start building your Heath Parasol now. Thousands have completed their Parasol in a remarkably short time and declare it a complete aviation course in itself, transforming dull winter evenings into hours of genuine pleasure. No technical training is necessary. Parts are shipped in 11 convenient progressive groups. \$12.00 brings the first shipment! Parts complete only \$199—and the Parasol ready to fly away costs only \$975. Don't delay another day. 10 cents in stamps or coin brings large illustrated booklet. Mail the coupon below today.

Heath Aircraft Corp., Dept. P1,
1721-9 Sedgwick St., Chicago, Ill.
Without obligation, please send me your large illustrated booklet. I enclose 10 cents for postage. I am particularly interested in:

- Building the Parasol for \$199.
 The complete Parasol for \$975.

Name.....
 Address.....
 City..... State.....

HEATH
 AIRCRAFT CORP., CHICAGO

"Say, Mister.... I Want Genuine JOHNSONS"



"I CAME here to get genuine JOHNSONS and I get them or you don't get my money, and I'm speaking for the bunch, too."

"You sure are," chorused Tom and Dick, and 'flashy' Bill, the left wing of the school hockey team said: "You couldn't get me on any other skate."

"Oh come, boys" smiled the dealer: "You can't tell me there can be all that difference in skates."

"We can't, eh?" snorted 'Speed' Grimes, "Well that just shows you don't know your skates. Why look here"—holding up his skates—"See that runner—it may not look much different to you than other runners, but oh, boy!—when you get on the ice you know the difference and I don't mean maybe. That runner is Vanadium tool steel—cold drawn—hard all the way through—tested for hardness with a Diamond point. That's why it holds its edge longer and saves money on sharpening. And see the way it's polished—just like a mirror. Dad says, and he's been a skater all his life, that no skate can be better than its runner—and that's why JOHNSON uses steel better than razor steel."

"You're right," said Bill, "But there's lots of other

ways NESTOR JOHNSON has other skates skinned a mile. See how finely the bell-shaped heel and front cups are made—see how perfectly the skate is balanced—and talking about balance, look at that shoe—that shoe is *made for skating*—see the narrow heel—the arch supporting counter under the instep? That's what holds and supports the foot straight when you skate—instead of giving you that wibbly wobbly feeling you always get when a skate is fastened to a shoe that only 'looks like a skating shoe.'"

"And believe me that perfect balance of skate and shoe makes all the difference in the world when you're playing hockey—well, let's be going, fellows."

"Hold on a minute boys, let me take your order and I'll fit you out with some genuine NESTOR JOHNSONS in a day or two."

"Sorry, old top, but we can't wait, we're going where Frank can get his JOHNSONS now. We want to get every minute of skating we can this weather. And remember that saying a skate is 'just as good' because you make more money on them, won't sell them to boys who know skates."

More People Skate on JOHNSONS Than Any Other Skate in the World

NESTOR JOHNSON is the All-American skate made in America for Americans. Way back in 1892, NESTOR JOHNSON started making these better skates in America. NESTOR JOHNSON was the first tubular skate. NESTOR JOHNSON made the *real* skate shoe popular. NESTOR JOHNSON is the skate chosen by the All-American hockey team—the skate of champions.

If you want the full joy of skating—if you want the finest skate on ice—be sure the name NESTOR JOHNSON is on the skate you buy. Choose NESTOR JOHNSONS and you're right first, last and all the time.

JOHNSONS are made for men, women, boys and girls in racer and hockey styles. Hockey for general skating. Racers for speed.

JOHNSONS

There is only one JOHNSON skate . . . for the original and genuine ask for and insist upon NESTOR JOHNSON

NESTOR JOHNSON NORTH STAR, *favorite of thousands*. Aluminum finish with shoes, per pair, \$10.00; Nickel plate, with shoes, per pair, \$12.00.
NESTOR JOHNSON FLYERS, *at a price all can pay*. Price complete with famous Starite shoe—Aluminum finish, \$7.00; Nickel plate finish, complete with shoe, \$8.00.

HARD TOP JOHNSONS, *for Men and Boys*. Aluminum finish, \$7.50 per pair; Chrome plate over nickel, \$8.50 per pair. Others to \$25.00 per pair. If your dealer has no NESTOR JOHNSONS left, write us.

NESTOR JO
1912 N. Sp
 Please enc
 Enclosed fi
Something
of skate.
 Enclosed fi

This One



QPDQ-UEB-DW2S

Name.....

Address.....

City..... State.....

Turning on water faucets pours Money into your hands

Why drink dirty, germ laden water?

Here, at last, is an amazing water filter that attaches to the faucet and removes instantly the germ laden dirt from drinking water. Housewives everywhere want this Filter the minute they see it. It is a health protection that is needed and should be in every home.

Scientists have proven that water filtration prevents such diseases as Erysipelas, Septicæmia and Diarrhea and actually lowers the death rate from Typhoid fever. It is a proven fact that in many communities the water that comes from drinking faucet is laden with disease germs.

Why continue to take chances with disease and death—why be subjected to danger and possible sickness by drinking raw, unfiltered water?

Dirty drinking water is a thing of the past the minute an Automatic Water Filter is installed. Saves buying expensive spring water. Now clear, clean water is within the reach of all.

Sample Free to Workers

We have arranged a plan that makes it possible for agents to start immediately making big money with the Automatic Water Filter. Good paying territory is open. Our plan enables those who are really interested to obtain their sample for nothing. Mail coupon today for Free Offer Plan.



Agents

If you are earning less than \$3.00 an hour and would like to make up to \$100 a week and even more, clip and mail the coupon today. The Automatic Water Filter offers quick sales and big profits. Every housewife in your territory is waiting for this health protector.

New invention purifies water instantly... at the faucet!

Just imagine a device that purifies water instantly at the faucet and yet can be attached in a few seconds! Think of the water run for ten minutes through the filter and find the filth to fill the bottom of a glass. When you see what this Filter does you will not want to do without it. It delivers pure, sparkling water, clear as crystal and free from germ laden filth.

FILTERS LIKE NATURE

It is just like bringing a bubbling spring into your kitchen. The principle of the Automatic Filter is just like nature. It forces the water thru crystal silica sand. The dirt and germs cannot pass thru the sand so the water that comes out of the faucet is clean, free from impurities, pleasing to the taste, and healthful to the body. Crystal Spring Water could be no more pure or healthful than the water that comes out of the Automatic Water Filter. It also prevents splashing.

Guarantee

It makes no difference where you live, or what kind of drinking water you have, the Automatic Water Filter will remove dirt and filth from it. We guarantee it to purify water, remove dirt and filth, protect against contamination and deliver pure crystal clear, sparkling water, or the trial costs you nothing.

MAIL THIS COUPON TODAY

Automatic Water Filter Co.,
Dept. 120, 2621 N. 3rd St., Milwaukee, Wisc.
Gentlemen:—You may send me full particulars of your free offer and big money-making proposition.

Name

Address

City State

**AUTOMATIC
WATER FILTER CO.**
MILWAUKEE, WISCONSIN

Popular Mechanics Magazine

200 E. Ontario Street, Chicago, U. S. A.

H. H. WINDSOR, Founder

H. H. WINDSOR, Jr., Editor and Publisher

London: Hachette & Cie.,
3 La Belle Sauvage, Ludgate Hill, W. C. 2

Paris: Hachette & Cie.,
111 Rue Reaumur

Melbourne: Gordon & Gotch
509-513 Little Collins St.

ISSUED MONTHLY

SUBSCRIPTION:

SINGLE COPY, 25 CENTS

In United States and its possessions, Canada, Cuba, Mexico, and all }
countries in the Pan-American Postal Union, per year, postpaid } \$2.50

To all other countries in the Postal Union 3.00

All subscriptions are discontinued at expiration. Please examine the date printed on your wrapper.

Entered as Second Class Matter Sept. 16, 1933, at the Post Office at Chicago, Illinois, under Act of March 3rd, 1879.

Entered as Second Class Matter at the Post Office Department, Canada.

Published monthly by POPULAR MECHANICS CO.

Copyright, 1930, by Popular Mechanics Co.

Copyright in Australia. Copyright in France

Vol. 55

Contents for January, 1931

No. 1

Special Features

The Training of a Police Horse	18
Why Go to the Arctic?	26
The Latest Electrical Witchcraft	36
With the Texas Rangers	45
Martyrs of the Air Conquest	50
Strange Adventures of Alpine Guides	58
A Fishing Fleet Takes to the Road	67
The World's Most Costly Sport	72
Iron Men under the Sea	82
The Latest Aerial Stunts	99
The Vanishing Herd	115
Accidents—home-accident deaths total twenty-four thousand	107
Air Mail—large pony-express stamp honors early riders	40
Airplanes	
ground catapult gives plane flying start	71
inflated-rubber plane	33
model flutters wings and flies straight up	81
muffler "chews up" sound waves	102
rain test shows resistance to storms	98
third-wing plane offers greater safety	41
Archaeology—mysterious circle of stones clue to Indian rites	80
Army, U. S.	
latest army planes suited to high altitudes	117
talkies to teach soldiers latest army methods	44
winter outfit for the army flyer	97
Automobiles, Accessories	
built-in tool chest	69
jacks installed permanently on car	47
oil change shown on gear-shift lever	119
one-man brake tester	104
preheater for engine plugs into light socket	116
rubber-metal running board	103
Automobiles, Design—auto has six wheels and twelve gear shifts	114
Automobiles, Truck—electric brakes for	33
Aviation	
better altimeter is needed for safe flying	43
with the keeper of a lighthouse of the air	34
Babies	
vacuum tube serves as night nurse	96
what makes the baby laugh	109
Bathing Beach—portable breakwater units protect	44
Bees—wear themselves out keeping warm in winter	105
Birds	
fish-catching birds kill enemies of trout	42
time told by birds' songs	77
Blood—discovery of groups wins Nobel prize	93
Blowtorch—and soldering iron combined	107
Boats and Boating	
ancient Roman barge raised	119
pilotless tugboat is run by remote control	71
steel tubes for hull cut building costs	120
Bomb—army aerial, blows top of hill	95
Bowling—all-metal balls	119
Buildings, Capitol—fire hose is used to clean	44
Cabin—blocks used instead of logs	69
Cables—electric, of aluminum reduces power loss	117
Camera—stomach's inside pictured by tiny	120
Camping—campers' cup has compass, mirror and magnifier	118
Cards, Playing—shuffler deals pack in few seconds	81
Casters—adjustable, end wobble in furniture	33
Clocks	
built of straw keeps good time	114
secret of "mystery," lies in glass shaft	81
shaped like a dog	70
Coal—man-made anthracite rivals work of nature	93
Cowboy—replaced by ditch rider as character of west	95
Crime—tear-gas gun used by police	70
Deafness—megaphone in metal tubing aids deaf	43
Diving—metal suit has phone and electric lights	92
Dogs—collect funds for aid of homeless canines	105
Door Lock—safety, also acts as bottle opener	71

[Continued on Page 4]

Cup. Campers 118

[Contents—Continued]

Earthquake—heavy river deposits cause of	107
Eggs—automatic sorter and candler	47
Eraser—run by electricity	112
Fertilizer—refuse from canning plants used for	77
Fire Fighting—electron fire scanner extinguishes blaze	77
Football—"talkies" of game help in training	66
Fort Dearborn—rebuilding tests engineers' skill	48
Fruit—dried, holds vitamin A	109
Garage—pipe ends danger from gas in closed	104
Gardening—lawn rake with rubber teeth	80
Gas—smelly, to save lives acts as signal	41
Glass—non-cutting flexible	80
Guns—recoil cushion for shotgun	118
Harbor Office—built like cylinder	108
Horsepower—how many have you?	78
Horses—harnessing is taught by small models	96
Household Devices	110
Iceberg—rifle shots shatter, to protect divers	97
Incinerator—portable burner for leaves	104
Incubator—homemade baby, keeps infant alive	105
Lathe—giant turning lathe is in use in Germany	78
Light Fixtures—wireless wall light	43
Lighting—miniature baseball park used in tests	103
Micrometer—electric	102
Motor Bus—has interchangeable motor and accommodates 53 passengers	94
Moving Pictures	
three-dimension movies seen in projection process	65
tower on wheels speeds up pictures	112
Office Equipment—typewriter desk and chair on tubular framework	107
Paints and Painting—lacquer for radio use	126
Photography	
photograph like bas-relief	69
ultraviolet pictures add to human knowledge	40
Piano—one-man piano mover fits on auto	98
Power Plant—sun is seen as future	47
Prison—glass replaces jail bars to stop smuggling	65
Radio—helpful hints from the radio lab	124
Radio, Aerials—an experimental underground antenna	129
Radio, Apparatus	
photo-electric cell and amplifier unit	123
portable signal generator	130
simple unit supplies well-filtered high power	127
Radio, Application—"war" pictures are sent from a plane by radio	113
Radio, Broadcasting—class for radio announcers	117
Radio, Installation—closet door	126
Radio, Loud Speaker	
directional speaker for outdoor use	123
dynamic baffle resembles fireplace screen	129
Radio, Reception	
homemade interference arrester	126
trap reduces short-wave interference	123
Radio, Television—keeping receiver in step	130
Radio, Tubes	
a.c. tube checker	121
operating a.c. tubes	123
Railroads	
first oil-electric rail car	77
rubber cushion absorbs shocks	92
screws are driven by power in laying rails	108
Reindeer—go on tour of United States	109
Rubber—new plants are discovered in Russia	79
Saws and Sawing	
arm for electric handsaw	118
power saw's carrying case used for workbench	97
Ships and Shipping	
hole blasted in harbor bed to bury sunken ship	103
light from radio to prevent collisions	102
radio iceberg finder sought to protect ships	114
Silo—like a vacuum cleaner	66
Smokers' Accessories—pouch for tobacco and pipe combined	43
Soldering—iron and torch combined in one	107
Sports—golfer and archer defeated by caster on fairways	108
Street Cleaning—rotary sweeper saves loading trucks	40
Submarine—the latest ins and outs of modern	106
Sugar—new variety of cane yields more	96
Sundial—and telescope combined	35
Telephone—message is recorded for absent owner	109
Telescope—resilvering five-ton reflector	42
Trees	
electric breeze rocks, to aid growth study	97
tree-planting machine	35
Tunnel—in granite to reveal new beauties in Yosemite	118
Wagon, Delivery—radio set in	65
Waste Basket—prize winning	39
Windmill—pumps water for six families	120
Windows—silencer for open	78
X-Ray—photographs of atoms speed work of science	98

AMATEUR MECHANICS

Automobiles	
extinguishing fire in carburetor	154
jacking the car out of mud	134
motor heat keeps windshield clear	145
Automobiles, Accessories	
extra switches on Ford wired to seat-base panel	152
holder keeps maps handy in car	143
Automobiles, Driving—a help for night driving	156
Automobiles, Fuel—simple device reduces gas consumption	158
Automobiles, Repairing	
clean contacts on Ford starter switch	135
curing rear-axle grease leak	147
tool for scraping carbon from piston rings	154
Boats and Boating—"roamer" a speedy outboard cruiser	136
Book Ends—modernistic, are easy to make	157
Churn—pump jack operates	152
Coaster Wagon—brake lever for	144
Furnace—artificial draft increases efficiency of	147
Drafting	
art-mounting corners used to hold drawing paper	153
fine adjustment for ruling pen	153
Games—inlaid backgammon board easy to make	131
Garage—car battery furnishes garage light	146
Heating and Ventilating—getting extra heat from the stovepipe	154
Ironing Board—wall bracket holds	155
Lamp, Health—electric heater can be converted into	135
Motor—mounting for small	156
Padlock—wooden flap keeps rain from entering	135
Photography	
drying large photo prints quickly	143
easily made print washer	152
lightning photos are easy to make	156
take your own picture with a graflex	155
Poultry—moth balls on roosts keep lice away	143
Refrigerator, Electric—shaving the electric bill	144
Saws and Sawing—saw-filing helps	153
Shoes—waterproofing	158
Steel Tape—cleaning a	144
Stencils—made from cut films	134
Telephone—improvised, for listening to the baby	145
Telephone Cabinet—is built in wall	148
Toys—automatic signal for toy electric train	146
Trays—unusual decoration for glass	154
Violin—guard for the bout	133
Watering Trough—automatic faucet for	144
Windows—eccentric stop for	147

SHOP NOTES

Angles—easy methods of laying out	162
Automobiles, Lubrication—lubricating Ford steering gear	172
Automobiles, Repairing	
effective puller for wheel bushings	161
quick and accurate method of fitting piston rings	164
spring compressor for overhead valves	165
Babbitt—ladle for carrying molten	172
Barrel—quick-acting hoist	175
Bent Iron—for the home craftsman	166
Blowtorch—flame deflector for	171
Cam—lifter made from carriage bolt	161
Doors—floor brackets for holding	163
Drafting—draftsman's data on T-square	176
Gold Leaf—the manipulation of	174
Litmus Paper—substitute for	176
Logs	
"choker" for dragging	171
X-rays useful in the lumber mill	160
Metals—cleaning steel and other hard metals	163
Photography—flashlight, made easy	159
Planer—setup blocks	174
Pulley—reducing wear from abrasive dust on belts	173
Saws and Sawing	
locknuts on power-jigsaw turnbuckles	175
power saw for the shop	173
Scales—removable blackboard on	176
Screen, Wire—claw clamps on counter help in measuring	164
Stamp, Rubber	
inked roller speeds up stamping	174
with curved face for bundles	161
Vise, Bench—support for handling long work	163
Welding—drawn-aluminum filler rods for aluminum	161
Windows—guards for store	173
Workbench—corrugated bottom for hardware drawer	176
Wrenches	
one-piece ratchet wrench	172
wall plate for holding	165

From Bent 1/66

WHOLESALE PRICES 1931 FEATURE RADIO VALUES LOWEST WHOLESALE PRICES

Tremendous Price Reductions

Never before in our many years of experience in radio merchandising have we been able to offer such real values—on such quality radio merchandise as you will find presented in this catalog. No matter what your radio requirements may be, you will find them offered in this large 168-page catalog in large variety. Dealers—set builders, and radio enthusiasts of every nature should have a copy of this remarkable catalog.

Buy Now and Save—Prices Are Down

If you are buying a new radio set—or if you contemplate replacing your old receiver with the new screen grid types, send for this catalog immediately. Prices are down to a new all time record. In the large assortment shown, you will find what you have been looking for—sets, accessories, kits or parts at lowest prices.

EVERYTHING
IN RADIO

✓ CHECK
THESE RADIO
VALUES FROM
OUR 168 PAGE
FREE CATALOG

MIDGET RADIO



Midget Radio
Modern screen grid Midget Receiver with approved five tube circuits

175¢ RETAIL
YOUR PRICE
\$34.75

One of the season's most popular types of receivers. Housed in a beautiful walnut midget cabinet, complete with five tube chassis and speaker, an outstanding value at the low price.

NEW AUTO RADIO

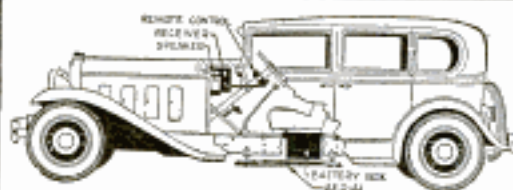

Enjoy your favorite radio programs as you drive. This new Roamer Auto radio blazes a new trail in its approach to perfection in circuit design.

100¢ RETAIL
YOUR PRICE
\$49.45

No need to miss your favorite program while you drive. Sporting events, news flashes, dance or opera—all available to you with this new Roamer Auto Radio. Concealed installation with remote control. R. C. A. licensed chassis. Universal brackets simplify installation in any car. Many special features make it an outstanding value.

THE NEW 8 TUBE SCREEN GRID SETS

Modern triple Screen Grid Receivers in beautiful consoles equipped with genuine Oxford Dynamic speakers at sensationally low prices.



110¢ RETAIL
YOUR PRICE
\$48.25

A representative value from our catalog. Beautiful walnut console, dynamic speaker with R. C. A. licensed Screen Grid eight tube chassis.

168 PAGE CATALOG FREE!

WRITE FOR YOUR COPY TODAY

Write for this remarkable catalog today. See for yourself the unusual values offered, over a thousand bargains, including such popular items as battery-operated receivers, super-heterodynes, remote control, electric time-switch receivers, phonograph-combinations, coin operated receivers, a remarkable variety of consoles, dynamic speakers, tubes, accessories, etc. No matter what your requirements, you will find them listed in this catalog. Clip the coupon and send for your copy today.

Everything New in Radio

Dealers, service men, set builders and radio enthusiasts everywhere should have a copy of this catalog. It is a veritable encyclopedia of all that's new and worthwhile in radio.

FREE CATALOG COUPON

Allied Radio Corporation,
711 W. Lake St., Dept. 466, Chicago

Gentlemen,

Please send me your 168-page FREE radio book of bargains. It is understood there is no obligation.

Name.....

Address.....

ALLIED RADIO CORPORATION

711 W. Lake Street Dept. 466 Chicago

Are YOU a Business Coward?

—and—does it show in your pay-check?

"You've had your chance!" It was the General Manager speaking . . .

"Two years ago I warned you that the only man who could hope to get ahead in this organization was the man with training.

"Merwin was only a bookkeeper then, you remember, but in his spare time he was studying Higher Accountancy. I knew what he was doing, and I told you then to keep your eye on Merwin.

"He's had three raises since. He has more than doubled his salary—and he earns every dollar I pay him.

"Last week I recommended him for Assistant Treasurer, and the Board elected him without a dissenting vote. We're mighty glad to have him in the group.

"But you, Jarvis—I hate to say it—you're a business coward. You knew what you would have to do to get out of the small-pay class. You were simply afraid to face the kind of effort and responsibility that could get you a substantial salary.

"And now it's too late. We've got to cut our overhead, and you're one of about fifty men that we can get along without. We could replace the lot of you tomorrow.

"For your own sake, Jarvis, take a tip from a man who has been through the mill, and this time get busy and learn to do something better than the other fellow.

"Jarvis, there's no end of opportunity in business, but the only man who cashes in these days is the man with the courage to get special training. The offices of this country are simply cluttered up with business cowards. It's easy for the man who trains—because the business coward is through before he starts."

Are YOU one of several million routine men who have been drifting along in a "low-pay" job—always wishing for more money, never acting?

Are YOU a business coward?

Over 640,000 ambitious men have asked themselves this question during the past nineteen years—and replied with a ringing "NO!"

In the quiet of their own homes, without losing an hour from work, these men have mastered the principles of business by working out the actual problems of business—under the direction of some of the ablest business men in their respective fields in America. Their record of achievement, under the "LaSalle Problem Method," is one of the most thrilling chapters in the romance of business.

These men were able to progress more rapidly by means of the "LaSalle Problem Method" than they could have done in any other way, because in their training they faced continually the very problems they must later face on the bigger job. They learned by doing.

Moreover, studying alone under the direct supervision of an expert instructor, they progressed as

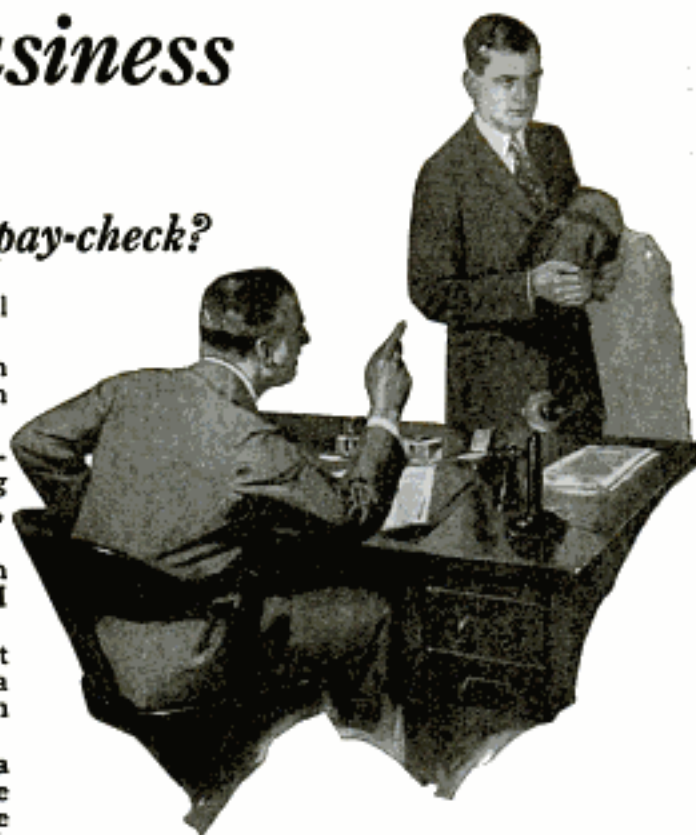

rapidly as their capacity allowed—and that progress was further speeded by the fact that every day they could see themselves developing. This fact took all the hardship out of study—changed it into a fascinating game, with always the goal ahead of increased opportunity and greater pay.

Whatever attitude you may have taken in the past, resolve today to face the problem of your business future squarely.

Within reach of your hand is a LaSalle coupon—and a pen. If the pen isn't handy, a pencil will do just as well. The coupon, checked and signed, will bring you without obligation a complete outline of the training you are interested in, together with full particulars of our convenient payment plan; also your free copy of the inspiring book, "Ten Years' Promotion in One."

It costs you nothing to get the facts—except the exercise of business courage. Will you put it off?—or put it over? Mail the coupon NOW.

— — — Find Yourself Through LaSalle! — — —

LaSalle Extension University

The World's Largest Business Training Institution

Dept. 164-R

Chicago

I would welcome an outline of the LaSalle plan, together with a copy of "Ten Years' Promotion in One," all without obligation.

- | | |
|---|---|
| <input type="checkbox"/> Business Management | <input type="checkbox"/> Law—Degree of LL.B. |
| <input type="checkbox"/> Modern Salesmanship | <input type="checkbox"/> Commercial Law |
| <input type="checkbox"/> Higher Accountancy | <input type="checkbox"/> Credit and Collection Correspondence |
| <input type="checkbox"/> Traffic Management | <input type="checkbox"/> Industrial Management |
| <input type="checkbox"/> Railway Station Mgm't | <input type="checkbox"/> Modern Foremanship |
| <input type="checkbox"/> Paper Salesman's Training | <input type="checkbox"/> Personnel Management |
| <input type="checkbox"/> Banking and Finance | <input type="checkbox"/> Expert Bookkeeping |
| <input type="checkbox"/> Modern Business Correspondence | <input type="checkbox"/> Commercial Spanish |
| <input type="checkbox"/> Business English | <input type="checkbox"/> C. P. A. Coaching |
| <input type="checkbox"/> Effective Speaking | <input type="checkbox"/> Stenotypy—Stenography |
| <input type="checkbox"/> Telegraphy | <input type="checkbox"/> Railway Accounting |

Name

Present Position

Address

If you're "On the Outside Looking in"

You need this Free Book

ARE you standing on the sidelines, wishing you were in Aviation . . . envying those who are already making Aviation history while holding down good jobs with fine futures? If so, remember this:— *Wishing won't get you into Aviation—but practical training will!* Walter Hinton's free book, "Wings of Opportunity," tells you a quick, sure, inexpensive way to get the necessary practical training—in your spare time, at home.

Hinton's personalized training and his free Employment Service are putting serious-minded, red-blooded men like you in good flying and ground jobs right along, at salaries of from \$40 to \$80 a week. Martin Co., Curtiss-Wright, Curtiss Flying Service, Alexander Aircraft, T. A. T., Fokker and scores of other leaders are employing Aviation Institute graduates. In one day alone, we had calls for more than forty men!

Many other industries have reached their saturation points—and can offer only small-pay jobs with no future. But Aviation is *just beginning to grow!* In Aviation your future can be just as big as you want to make it. So why sit back? Why drift into something else,



when a little foresight and judgment can put you right into the thick and pick of Aviation's opportunities and into a ground or flying job paying from \$40.00 to \$200.00 per week? Don't say it can't be done. We know it *can!* We're helping other fellows just like you to do it all the time.

Get the Facts—Write for This FREE Book Today

If you're 16 or over—and serious about wanting to get into Aviation, get a free copy of Walter Hinton's book. It tells how he can give you the vital facts, the necessary knowledge of plane-construction, engine-design, rigging, repairing, servicing, airport management, navigation, theory of flight, etc. If you want to learn to fly, his course can save you many times its cost in cash. It's interesting and easy to understand from the start and packed with facts that mean success for you—no matter what branch of Aviation you choose to enter. Mail the coupon today—right NOW.

Now District Traffic Agent for T. A. T.

"When I finished your course I became connected with T. A. T. and am happy to state that promotion has come very rapidly. I shall always be grateful to you for your interest and cooperation." C. E. McCollum, District Traffic Agent, T. A. T.—Maddux Air Lines.

"After completing your course I was engaged as Aeronautical Draftsman by a leading concern. I thoroughly recommend your training. It is complete in every detail!" Ira W. Bergen, Brooklyn, N. Y.

Robt. N. Dobbins, a Hinton Graduate, writes: "I cannot thank you enough for the assistance you gave me in getting my present position. Last week they promoted me to Chief Instructor at a salary increase of \$15 a week."

Aviation Institute of U. S. A., Inc.

WALTER HINTON, President

1115 Connecticut Avenue Washington, D. C.



FREE BOOK

Aviation Institute of U. S. A., Inc.,
1115 Connecticut Avenue,
Washington, D. C.

I am serious about wanting to get into Aviation. Please send me, without obligation of any kind, a free copy of Walter Hinton's book, "Wings of Opportunity."

Name.....
(Print clearly)

Address..... Age.....
(Must be over 16)

City..... State.....

301-V

Answer This Ad!

If You Want Quick Success and Big Pay In AUTOS



Earn Up to \$100 a Week

Get YOUR share of the \$7,000,000,000 spent every year on auto upkeep. **Just think of it**—more than 25,000,000 autos in the U. S. No wonder there are so many big pay jobs! Get into this fascinating game, now. Don't put it off another day. Get the facts. Mail coupon for big, FREE auto book. Learn of the countless opportunities in the World's Biggest Business where real jobs and big pay come quick. See how \$50—\$75—\$100 a week is possible for you now. Learn how "Job-Way" Training has brought big money—promotion—shops of their own to scores of men. Find out about my Employment Department—how it helps you get a good job in the auto business.

Morrison Did!

When Morrison of Parkersburg, West Virginia, wrote for my auto book he was working in a steel mill for low pay. In six short months he doubled his earnings and got into business for himself—even before he finished his "Job-Way" Training. You can have the same book that started Morrison on the road to success. Clip the coupon—and mail it today.

3 WORKING OUTFITS
also included **FREE** of extra charge if you set quick!

Learn at Home in Spare Time

"Job-Way" Training is the short cut to Auto Success. No need to quit your present job—no need to leave home—just use your spare time to prepare for a brilliant future—a real job paying up to \$100 a week. All you need is common schooling. I don't care if you never touched an auto before, I can train you at home. You should be able to make extra money quick—a few weeks after starting. Men from all walks of life who worked

long, hard hours for low pay are becoming garage owners, foremen and superintendents. If you like autos—if you're between 15 and 55—get the facts now. "Job-Way" Training covers everything about autos—Mechanical and Electrical Work, Starting, Lighting, Ignition, Welding, Vulcanizing, etc.—Everything you need to get in line for a big money job as an Electrical and Mechanical Auto Expert.

It's the trained man who gets the good jobs and "Job-Way" Training is COMPLETE, yet so simple, so easy that you get it quick.

Send Coupon for FREE Auto Book

Get my FREE Auto Book. Learn how "Job-Way" Training has brought success to hundreds. See what it can do for you. Find out how my Employment Department helps you get a good job—about the three big outfits you get. Read my money-back agreement, my aviation course offer and many other features.

B. W. Cooke, Directing Engineer
Motor Institute of America
Motor Institute Bldg. Dept. 4161
EVANSTON, ILLINOIS
(Chicago's Largest Suburb)



Do It NOW!

Don't delay another day. Clip the coupon before you turn this page. Take the first step to a big-pay auto job. Now.

B. W. Cooke, Directing Engineer,
MOTOR INSTITUTE OF AMERICA,
Motor Institute Bldg., Dept. 4161, Evanston, Ill.

Send me your free auto book. I want to succeed in the auto business. Tell me about "Job-Way" Training—about your Employment Department and your 3 testing and repair outfits offer. No obligation on my part whatever.

Name.....
Address.....
Town..... State.....
Age..... Occupation.....

What Will You Be Doing One Year From Today?

Three hundred and sixty-five days from now—what?

Will you still be struggling along in the same old job at the same old salary—worried about the future—never quite able to make both ends meet—standing still while other men go ahead?

One year from today will you still be putting off your start toward success—thrilled with ambition one moment and then cold the next—delaying, waiting, fiddling away the precious hours that will never come again?

Don't do it, man—don't do it. There is no greater tragedy in the world than that of a man who stays in the rut all his life,

when with just a little effort he could bring large success within his grasp.

Make up your mind today that you're going to train yourself to do some one thing well. Choose the work you like best in the list below, mark an X beside it, mail the coupon to Scranton, and we will send you, without cost or obligation, the full story of what the I.C.S. can do for you.

Right now you can decide where you will be this time next year.

Common sense will tell you that it is far better to send in this Success Coupon today than to wait another precious year and then wish you had!

Mail the Coupon for Free Booklet

INTERNATIONAL CORRESPONDENCE SCHOOLS, Box 5520-G, Scranton, Penna.

"The Universal University"

Without cost or obligation, please send me a copy of your booklet, "Who Wins and Why," and full particulars about the course before which I have marked X in the list below:

BUSINESS TRAINING COURSES

- | | | | |
|---|---|---|--|
| <input type="checkbox"/> Business Management | <input type="checkbox"/> Cost Accounting | <input type="checkbox"/> Advertising | <input type="checkbox"/> Mail Carrier |
| <input type="checkbox"/> Industrial Management | <input type="checkbox"/> Bookkeeping | <input type="checkbox"/> Business Correspondence | <input type="checkbox"/> Grade School Subjects |
| <input type="checkbox"/> Personnel Management | <input type="checkbox"/> Secretarial Work | <input type="checkbox"/> Show Card and Sign Lettering | <input type="checkbox"/> High School Subjects |
| <input type="checkbox"/> Traffic Management | <input type="checkbox"/> Spanish | <input type="checkbox"/> Stenography and Typing | <input type="checkbox"/> Cartooning |
| <input type="checkbox"/> Accounting and C.P.A. Coaching | <input type="checkbox"/> French | <input type="checkbox"/> Railway Mail Clerk | <input type="checkbox"/> Illustrating |
| | <input type="checkbox"/> Salesmanship | | <input type="checkbox"/> Lumber Dealer |

TECHNICAL AND INDUSTRIAL COURSES

- | | | | |
|--|--|---|---|
| <input type="checkbox"/> Architect | <input type="checkbox"/> Electric Car Running | <input type="checkbox"/> Automobile Work | <input type="checkbox"/> Highway Engineer |
| <input type="checkbox"/> Architectural Draftsman | <input type="checkbox"/> Telegraph Engineer | <input type="checkbox"/> Aviation Engines | <input type="checkbox"/> Chemistry <input type="checkbox"/> Pharmacy |
| <input type="checkbox"/> Building Foreman | <input type="checkbox"/> Telephone Work | <input type="checkbox"/> Plumber and Steam Fitter | <input type="checkbox"/> Mining Engineer |
| <input type="checkbox"/> Concrete Builder | <input type="checkbox"/> Mechanical Engineer | <input type="checkbox"/> Plumbing Inspector | <input type="checkbox"/> Navigation <input type="checkbox"/> Assayer |
| <input type="checkbox"/> Contractor and Builder | <input type="checkbox"/> Mechanical Draftsman | <input type="checkbox"/> Foreman Plumber | <input type="checkbox"/> Iron and Steel Worker |
| <input type="checkbox"/> Structural Draftsman | <input type="checkbox"/> Machine Shop Practice | <input type="checkbox"/> Heating and Ventilation | <input type="checkbox"/> Textile Overseer or Supt. |
| <input type="checkbox"/> Structural Engineer | <input type="checkbox"/> Toolmaker <input type="checkbox"/> Patternmaker | <input type="checkbox"/> Sheet-Metal Worker | <input type="checkbox"/> Cotton Manufacturing |
| <input type="checkbox"/> Electrical Engineer | <input type="checkbox"/> Civil Engineer | <input type="checkbox"/> Steam Engineer | <input type="checkbox"/> Woolen Manufacturing |
| <input type="checkbox"/> Electrical Contractor | <input type="checkbox"/> Surveying and Mapping | <input type="checkbox"/> Marine Engineer | <input type="checkbox"/> Agriculture <input type="checkbox"/> Fruit Growing |
| <input type="checkbox"/> Electric Wiring | <input type="checkbox"/> Bridge Engineer | <input type="checkbox"/> Refrigeration Engineer | <input type="checkbox"/> Poultry Farming |
| <input type="checkbox"/> Electric Lighting | <input type="checkbox"/> Gas Engine Operating | <input type="checkbox"/> R. R. Positions | <input type="checkbox"/> Mathematics <input type="checkbox"/> Radio |

Name..... Age..... Address.....

City..... State.....

*If You
Want a Job*



*or a
Hobby*



*that Pays
Well*



*Where You
can be Your
Own Boss*



*and Keep Your
Own Hours*



*learn
Illustrating*

SEND for our free catalog "A Road To Bigger Things." Learn how former Federal School graduates now earn larger incomes. See the work and comments of the fifty famous artists who have contributed to the Federal Course in Illustrating.

Opportunities in drawing have never been better. Art is a vital part of today's business. Successful magazine and newspaper artists are making fine incomes. Advertisers and publishers are paying large sums annually to those who are trained in Modern Art. Think of the money paid to artists for the

illustrations in this magazine alone. The Federal Course includes illustrating, cartooning, lettering, window card illustrating, etc.

TEST YOUR TALENT FREE

Why be content with a small income at routine work if art training may offer larger possibilities? Many people have a talent for art and do not realize it. That is why we enclose a test chart with our catalog. It finds out your ability. Fill out the coupon now. It may be the beginning of an art career which will enable you to earn a good income.

FEDERAL SCHOOL OF ILLUSTRATING

1131 Federal Schools Building



Minneapolis, Minnesota



Federal School of Illustrating,
1131 Federal Schools Building,
Minneapolis, Minnesota.

Please send me free book "A Road to Bigger Things" and Standard Art Test.

Name _____ Age _____ Occupation _____

Address _____

BIG PAY JOBS

open

for Every Radio Trained Man

Don't spend your life slaving away in some dull, hopeless job! Don't be satisfied to work for a mere \$20 or \$30 a week. Let me show you how to make Real Money in Radio—the Fastest-Growing, Biggest Money-Making Game on Earth!

THOUSANDS OF JOBS PAYING \$40 TO \$200 A WEEK!
Jobs as Designer, Inspector and Tester, paying \$3,000 to \$10,000 a year—as Radio Salesman and in Service and Installation Work at \$45 to \$100 a week—as Operator or Manager of a Broadcasting Station, at \$1,000 to \$5,000 a year—as Wireless Operator on a Ship or Airplane as a Talking Picture or Sound Expert—THOUSANDS OF JOBS PAYING \$40, \$70 AND ON UP TO \$200 A WEEK!

Learn Without Lessons in 60 Days

Coyne is NOT a Correspondence School. We don't teach you from books or lessons. We train you on the greatest outlay of Radio, Television and Sound equipment obtainable—on scores of modern Radio Receivers, huge Broadcasting equipment, the very latest, newest Television apparatus, Talking Picture and Sound Reproduction equipment, Code Practice equipment, etc. You don't need advanced education or previous experience. We give you—RIGHT HERE IN THE COYNE SHOPS—all the actual practice and experience you'll need. And because we cut out all useless theory, you graduate as a Practical Radio Man IN 60 DAYS' TIME.

TELEVISION and TALKING PICTURES

And now Television is on the way! Soon there'll be a demand for THOUSANDS of TELEVISION EXPERTS! The man who learns Television now can make a FORTUNE in this great new field. Get in on the ground floor of this amazing new Radio development! Come to Coyne and learn Television on the very latest, newest Television equipment.

Talking Pictures and Public Address Systems offer thousands of golden opportunities to the Trained Radio Man. Here is a great new Radio field just beginning to grow. Prepare NOW for these wonderful opportunities! Learn Radio Sound Work at COYNE on actual TALKING PICTURE and SOUND REPRODUCTION equipment.



No Books - No Lessons All Practical Work at Coyne

No Books! No Lessons! ALL ACTUAL PRACTICAL WORK. You build radio sets, install and service them. You actually operate great Broadcasting equipment. You construct Television Receiving Sets and actually transmit your own Television programs over our modern Television equipment. You work on real Talking Picture machines and Sound equipment. You learn Wireless Operating on actual Code Practice apparatus. We don't waste time on useless theory. We give you just the practical training you'll need—in 8 short, pleasant weeks.

EARN AS YOU LEARN

Don't worry about a job! You get Free Employment Service for Life. And don't let lack of money stop you. If you need part-time work while at school to help pay expenses, we'll gladly help you get it. Coyne is 31 years old! Coyne Training is tested—proven beyond all doubt. You can find out everything absolutely free. Just mail coupon for my big free book!

H. C. Lewis, Pres. **Radio Division** *Founded 1899*
COYNE ELECTRICAL SCHOOL
500 S. Paulina St. Dept. 11-1M Chicago, Ill.

H. C. LEWIS, President
Radio Division, Coyne Electrical School
500 S. Paulina St., Dept. 11-1M, Chicago, Ill.
Send me your Big Free Radio Book and all details of your Special Introductory Offer. This does not obligate me in any way.

Name

Address

City.....State.....

How Fred Fisher Makes \$30 a Week in Spare Time with his **TENOR BANJO**

Found Course Easy Right from Start;
Now Enjoys More Friends, More Parties

"Had no idea it was so easy! Nobody could go wrong with your clear, sure method. I now have more friends and never miss any parties. I have been earning \$30 a week in spare-time. There's always a job for a Tenor Banjoist."—Fred Fisher, 123 Ridge Street, Steelton, Pa.

YOU Can Learn Quick Right at Home to Make

Big Spare-Time Money

Why "wish" for friends, fun and ready cash when you can have them—quick! Our tested, easy system will teach you—in 1 to 3 months—to make \$5 to \$15 an evening spare-time playing; \$65 to \$100 a week or even more playing in orchestras, etc. Be popular, have all the extra money you want. Find out NOW about "The Tenor Banjo Play-Way to Popularity and Big Pay."

C. E. Samwell
20 Devonshire Ave., Brantford, Ont., (shown above/writes: "Was only quarter-way through Course when playing in one of the best orchestras here. The Tenor Banjo is the sure, easy way to Big Money. My playing now paying for \$550 Banjo. Owe success to you.")

FREE BOOK tells how

This inspiring book—that has shown countless others the short-cut to SUCCESS—will show you how to get the friends, popularity and money you want—QUICK! No obligation. Get the facts about the fascinating method that taught Fisher and Samwell and other prosperous Tenor Banjoists. No knowledge of music or notes necessary. No extras to buy. We teach everything—start at everything—you need. Clip and mail coupon at once.

Big Tenor Banjo Records and Outfit FREE
When You Enroll

with First Lesson

The same day we receive your enrollment for Course you are shipped a handsome, full-tone, professional-size Tenor Banjo worth \$20—Incase, Complete Outfit—and correct, fool-proof demonstration Phonograph Records of every selection in the Course!



Mail Coupon Now

A. F. Bloch, President,
New York Academy of Music,
Studio 1011,
100 Fifth Ave., New York City.

Dear Mr. Bloch: Please rush me your FREE Book telling how I too can make a Quick Success and Big Money with the Tenor Banjo.

Name.....

Address.....

34 Lesson

Drawing Course \$2.98

The biggest value you ever saw advertised anywhere



Haven't you often wished that you could draw cartoons, illustrate some idea, sketch some pretty face, etc.? You can do all of these things. One of America's most famous Cartoonists and Illustrators has developed a great, simple system for success in all branches of Commercial Art. This system has revolutionized the entire theory of drawing. It means that drawing can be as easy for you as writing—much simpler than learning shorthand, bookkeeping or typewriting. We are now placing this original system for learning Drawing, Art and Cartooning, consisting of 34 lessons with over 500 illustrations, within reach of every one. If you will devote a few hours each week to the Course WE ABSOLUTELY GUARANTEE that you will learn to draw and draw well before you have half finished the Course. If we fail to make this claim good, we will refund every cent paid us. By eliminating a large office force for answering correspondence, expensive catalogs, etc., we are enabled to make a price of \$2.98, the cheapest price ever known for a high-grade, home study course. Learn to draw. It is a big asset, no matter what field you are in.

Send No Money

Just order the course and on arrival \$2.98 pay postman

If you order the course at once, we will include a drawing outfit, consisting of artist's pencil, pens, paper, eraser, thumb tacks, etc., enabling you to go to work without any additional cost.

plus a few cents postage, payment in full for the entire Course and Drawing Outfit. If not entirely satisfied, return within five days and we will Refund Money. Address: **LEDERER SCHOOL of DRAWING, Dept. 812-B, Chattanooga, Tenn.** Orders from outside the U. S. A. are payable \$3.28 cash with order.

COLLEGE COURSES

AT HOME

Carry on your education. Develop power to initiate and achieve. Prepare for college. Earn credit toward a Bachelor degree or Teaching Certificates by correspondence. Select from 450 courses in 45 subjects including English, Mathematics, History, Education, Psychology, Economics, the Languages, etc. Write for catalog.

The University of Chicago

827 ELLIS HALL

CHICAGO, ILL.

YOUR FUTURE ASSURED



Now is the time to safeguard yourself against such periods of depression as we have been having. Many good, profitable trades are not subject to hard times or slack seasons—trades meeting everyday human needs, such as Mechanical Dentistry. Your age, circumstances, or lack of experience need not stop you. The way is open to you. A helpful booklet, "Choosing a Trade," will be sent you without cost. Your copy is waiting. Simply ask for Bulletin 2.

BODEE INSTITUTE, 1755 Broadway, N. Y.

1305 N. Broad St., Philadelphia

85 Court St., Brooklyn

ELECTRICITY RADIO WELDING AUTOMOBILES

PRACTICAL TRAINING ON MASSIVE LAY-OUT OF UP-TO-DATE EQUIPMENT
Oxy-acetylene and Electric Welding, Armature Winding, Power Plants, Switchboards, Transformers, Motors, Generators, Batteries, Radios and Automobiles. Write now for Free Catalog.

Coleman Electrical School, 1625 Main St., Kansas City, Mo.

"STAMMERING Its Cause and Cure"

You can be quickly cured if you stammer. Send 10 cents, coin or stamps, for 288-page cloth-bound book on Stammering and Stuttering. It tells how I cured myself after Stammering and Stuttering for 20 years. **BENJAMIN N. BOGUE**
1137 Beque Building, 1147 N. Illinois Street, Indianapolis



Learn DRAFTING



AN EDUCATIONAL INSTITUTION Chartered NOT FOR PROFIT » »

The American School, like the best resident schools and colleges, pays no dividends or income tax—puts back all tuition fees into instruction and employment service.

We have engaged noted Engineers of big companies and leading Universities to prepare this Drafting training—men who employ Draftsmen and know what instruction they need to get and keep a good position.

For one reasonable fee, payable in small monthly installments—we prepare you for entrance into the great prosperous industries by way of the Drafting room and without extra charge provide employment service both when you're half way through and when you finish—under money back penalty.

» » » It's a pass-port to all the big industries

Men are going into Drafting not only because it pays well—but because with a knowledge of making plans and reading blue-prints—they can break into Architecture, Building Construction, Electricity and Mechanical lines.

A good job—in industries with a real future—is open to any man with Drafting knowledge.

Quick Promotion for Office and Factory Workers

Where it might take you years to advance by practical experience alone, if you learn Drafting you can get a more important, better paid position right away—

If you have shop or construction experience, that will help you succeed as a Draftsman, because you'll have an advantage in knowing how things are done.

If you have office, sales or business experience you can cash in on that, too, in Drafting, because one angle of the work is contracts, estimates, materials and costs.

Men who have taken Drafting training in the past couple of years have stepped far ahead of their former associates already. They are making more money and have a better chance to advance rapidly.

Solve your Problem this way—

You'll find a high class, well-dressed, happy bunch of fellows in the Drafting rooms of Architects, Contractors and big Manufacturers. We'd like to tell you how much more interesting Drafting is than the routine work you're doing today—how each day's assignments are new and different from all previous jobs—we'd like to tell you how well-paid the work is—and how it leads rapidly to executive positions.

Drafting Book FREE

Best of all, Drafting is easy to learn, right in your own home, in spare time—requires no artistic talent nor more than a Grammar School education. Interesting proposition right now to ambitious men, leading to position when you're only half way through the course. Mail coupon for complete information and free book.



AMERICAN SCHOOL,
Dept. D-147,
Drexel Ave. & 58th St.,
Chicago, Ill.

Please send free and without the slightest obligation 36-page book about the opportunities in Drafting and your agreement to help me get a

Drafting Job when only half way through the course.

Name..... Age.....

St. No.....

City.....State.....

The American School

Dept. D-147

Drexel Ave. and 58th St.

CHICAGO, ILL.

There's Quicker, Bigger MONEY for YOU in POULTRY RAISING!



Wherever You Live—
Whatever You Do Now—
\$2,000 to \$5,000 a Year
Can Be Yours!

YOU Can Do What They Have Done

"Your Course on Poultry Raising is the most practical and complete in the country. You have opened up a pleasant and profitable way for me to gain an independent living."—S. Anderson, Bartington, R. I.

J. L. Mosher of Buffalo, N. Y., started at \$35 a week after 10th Lesson. E. O. Anderson of Phoenix, Ariz., writes: "Thanks to N. P. I. I got a job even before I finished your Course!"

Spare Time or Full Time YOU Can Cash-In BIG

The Poultry Industry is growing by leaps and bounds. Eggs and Poultry meat are commanding high prices—prices that mean real profits on every bird you raise—every egg your flock produces. Thousands of my students have turned to Poultry Raising for part-time extra money or full-time big pay. I'll show you how to start in a small way—in your own back yard—and make it pay—make your own investment multiply itself automatically. Or, if you want to work for someone else at a good salary—my FREE Employment Dept. will place you in one of the thousands of splendid positions open to trained poultrymen. Why wait? I'll PROVE that I can get you among the big money makers QUICK!

My Proved Methods Assure Success Right from START

All the "mystery," all the "secrets," all the guesswork are taken out of Poultry Raising by my sure, tested, proved successful methods. I will teach them all to you. Nothing left out, nothing for you to have to figure yourself. I make it easy for you. It's fascinating, healthful, pleasant, profitable. You'll be very sure too—I'll show you how to make \$1,000 to \$3,000 every hour of your spare time. What's more, I'll show you the way to a salary of \$5,000 a year AND UP! Start as small as you want; my methods will get the maximum profits out of your flock and make it grow automatically, into a sure source of steady big income for YOU.

FREE BOOK Shows Way to BIG PROFITS

My big new FREE book, "How to Raise Poultry for Profit," will amaze you! It brings evidence—plenty—absolute proof—of what I have done for thousands of others. My forty years' experience as Commercial Poultryman and former Senior Poultryman in the U. S. Dept. of Agriculture is yours for real Success and Independence. The Poultry Business needs you—and you need the profits that the poultry business brings. You need my book. Get it now! QUICKER, BIGGER MONEY. Do it this minute—don't delay a day. Get this coupon into the next mail!



48 Pages
of Money-
making FACTS

Get this FREE Book NOW!

Harry M. Lamont, Pres.,
NATIONAL POULTRY INSTITUTE,
Dept. 411-E, Washington, D. C.

Dear Mr. Lamont: Send me your FREE Book, "How to Raise Poultry for Profit." I want to know more about MY opportunity to make \$2,000 to \$5,000 a year, spare time or full time.

Name.....
Address.....
City.....State.....

YES

NEW YORK ELECTRICAL SCHOOL

Teaches all branches of Practical Electricity through the "Learn by Doing" Method. Enroll with N. Y. E. S. and gain a thorough understanding of the problems, a broad experience in applied engineering practice, and qualify quickly to follow an electrical career.

No books used. Day and evening classes open all year.

Write for FREE School Booklet

New York Electrical School
44 W. 17th St. New York

COMMERCIAL ART

Taught by Meyer Both, an internationally known art organization with 8,000 advertisers as active clients. This training—based on 30 years' resultful experience—transforms indefinite theory into definite fact. Prepare in spare time for a career in Art—a fascinating, lucrative profession open to both men and women. Write for illustrated

book telling of our successful students.

Meyer Both Co., Dept. 16, 20th & Michigan, Chicago, Ill.

MUSIC LESSONS IN YOUR HOME

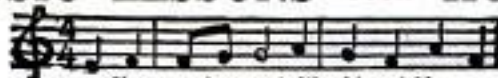

You can play music like this quickly

Write today for our FREE BOOKLET AND SAMPLE LESSON. It tells how to learn to play Piano, Organ, Violin, Mandolin, Guitar, Banjo, etc. Beginners or advanced players. You pay as you learn. Costs you only a few cents a day. Thousands of satisfied students. AMERICAN SCHOOL of MUSIC, 51 Manhattan Bldg., CHICAGO

Photography

for

PLEASURE or PROFIT



A fascinating hobby or a profitable business can now be yours. Prepare quickly at home under the personal guidance of leading experts in the fine art of photography. No experience necessary. Full or spare time. Many earn while learning. Our thorough studio method also qualifies you to fill a well paying position upon graduation. Send coupon now for FREE booklet, Opportunities in Modern Photography.

AMERICAN SCHOOL OF PHOTOGRAPHY
3601 Michigan Avenue Dept. 1351 Chicago, Ill.
Send FREE booklet, Opportunities in Modern Photography, and full information.

Name.....
Address.....
City.....State.....

If You Were DYING TO-NIGHT

and I offered you something that would give you ten years more to live, would you take it? You'd grab it. Well, fellows, I've got it, but don't wait till you're dying or it won't do you a bit of good. It will then be too late. Right now is the time. Tomorrow or any day, some disease will get you and if you have not equipped yourself to fight it off, you're gone. I don't claim to cure disease. I am not a medical doctor, but I'll put you in such condition that the doctor will starve to death waiting for you to take sick. Can you imagine a mosquito trying to bite a brick wall? A fine chance.

A Re-Built Man

I like to get the weak ones. I delight in getting hold of a man who has been turned down as hopeless by others. It's easy enough to finish a task that's more than half done. But give me the weak, sickly chap and watch him grow stronger. That's what I like. It's fun to me because I know I can do it and I like to give the other fellow the laugh. I don't just give you a veneer of muscle that looks good to others. I work on you both inside and out. I not only put big, massive arms and legs on you, but I build up those inner muscles that surround your vital organs. The kind that give you real pep and energy, the kind that fire you with ambition and the courage to tackle anything set before you.

All I Ask Is Ninety Days

Who says it takes years to get in shape? Show me the man who makes any such claims and I'll make him eat his words. I'll put one full inch on your arm in just 30 days. Yes, and two full inches on your chest in the same length of time. Meanwhile, I'm putting life and pep into your old backbone. And from then on just watch 'em grow. At the end of thirty days you won't know yourself. Your whole body will take on an entirely different appearance. But you've only started. Now comes the real work. I've only built my foundation. I want just 60 days more (90 in all) and you'll make those friends of yours who think they're strong look like something the cat dragged in.

A Real Man

When I'm through with you, you're a real man. The kind that can prove it. You will be able to do things that you had thought impossible. And the beauty of it is you keep on going. Your deep full chest breathes in rich pure air, stimulating your blood and making you just bubble over with vim and vitality. Your huge, square shoulders, and your massive muscular arms have that craving for the exercise of a regular he man. You have the flash to your eye and the pep to your step that will make you admired and sought after in both the business and social world.

This is no idle prattle, fellows. If you doubt me, make me prove it. Go ahead. I like it. I have already done this for thousands of others and my records are unchallenged. What I have done for them I will do for you. Come, then, for time flies and every day counts. Let this very day be the beginning of new life to you.

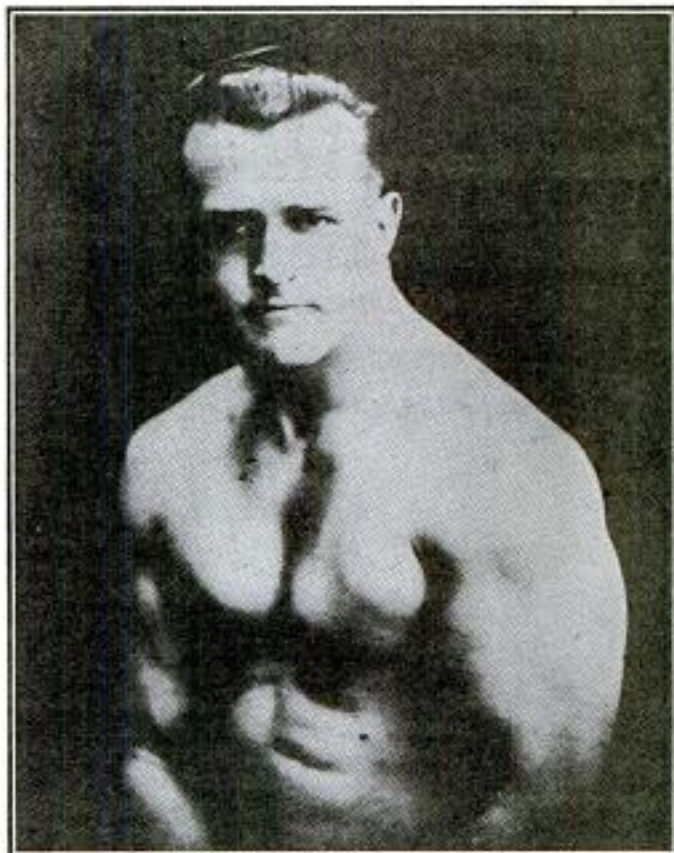

EARLE LIEDERMAN, The Muscle Builder

Author of "Muscle Building," "Science of Wrestling," "Secrets of Strength," "Here's Health," "Endurance," Etc.

SEND FOR
MY NEW
64-PAGE BOOK

"Muscular Development"

IT IS
FREE

What do you think of that? I don't ask one cent. And it's the peppiest piece of reading you ever laid your eyes on. You'll never blink an eyelash till you've turned the last cover. And there's 48 full-page photos of myself and some of my prize-winning pupils. This is the finest art gallery of strong men ever assembled. And every last one of them is shouting my praises. Look them over. If you don't get a kick out of this book, you had better roll over—you're dead. Come on, then. Take out the old pen or pencil and sign your name and address to the coupon. If you haven't a stamp, a postal will do. But snap into it. Do it now. Tomorrow you may forget. Remember, it's something for nothing and no strings attached. No obligation. GRAB IT!

EARLE LIEDERMAN
DEPT. 2001 305 BROADWAY, NEW YORK

EARLE LIEDERMAN,
Dept. 2001, 305 Broadway, New York City

Dear Sir:—Please send me, absolutely FREE and without any obligation on my part whatever, a copy of your latest book, "Muscular Development."

Name.....Age.....

Street.....

City.....State.....

(Please write or print plainly.)

The Truth about Voice

New Voice Book Discloses Startling Voice Facts

Sent Post-Paid for 30 Days FREE Reading No Money Down



KNOW THE TRUTH about YOUR VOICE



Eugene Feuchtinger
A. M.
Master of Voice
European Maestro

Send today—for 30 days free reading—for the most remarkable voice book ever written. This book has startled the whole voice world. Written by a man recognized the world over as a voice authority—a man with the courage to tell the TRUTH about voice, about the vocal organ and the real basic, fundamental truths about voice training. Advances astounding new method. Discloses startling facts that may save hundreds of dollars to every

man and woman seeking a strong, rich, compelling singing or speaking voice. Send for this most remarkable voice book today.

FREE 30 Days Reading

Certainly I could not afford to make you this liberal 30 days free reading offer if I did not KNOW what "The Truth About Voice" will do for YOU. Send for this book today. KNOW the truth about YOUR voice—a truth just as SIMPLE as it is astounding! Know WHY I actually guarantee to improve every man or woman's voice at least 100%. 30 days free reading to prove this! Then, if convinced, send only \$1.00—although you'll gladly admit that the book may be worth thousands to you. If not—return it—that's all! Mail coupon NOW—before the demand exceeds the supply!

Prof. Eugene Feuchtinger, Studio 13-51
Suite 29, 1810 Wilson Ave., Chicago, Ill.

Send me at once—for 30 days free reading—with no obligation to buy, your "The Truth About Voice" book. If after the free reading period I desire to keep the book I am to send you \$1.00. Otherwise, I have the liberty to return it with no further obligation.

Name

Address

Learn to Write

I Teach by Mail

Begin Today—Write for My FREE Book, I can make a good penman of you at home during spare time. Write for my FREE BOOK, "How to Become a Good Penman." It contains specimens and tells how others mastered penmanship by the Tanslyn System. Your name will be elegantly written on a card if you enclose stamp to pay postage. Write today for book.
F. W. Tanslyn, 418 Ridge Bldg., Kansas City, U.S.A.

LAW STUDY AT HOME

Become a lawyer. Legally trained men win high positions and big success in business and public life. Be independent. Greater opportunities than ever before. Big corporations are headed by men with legal training. Earn \$5,000 to \$10,000 Annually during spare time. Degree of LL.B. conferred. LaSalle students found among practicing attorneys of every state. We furnish all text material, including fourteen-volume Law Library. Low cost, easy terms. Get our valuable 64-page "Law Guide" and "Evidence" books FREE. Send for them NOW. LaSalle Extension University, Dept. 164-L Chicago. The World's Largest Business Training Institution

DENISON'S PLAYS

Musical Comedies, Operettas, Vaudeville Acts, Minstrels, Comedy Songs, Make-up Goods. Catalog Free

55 YEARS OF HITS

T. S. Denison & Co. 623 S. Wabash, Dept. 9 Chicago

TRI-STATE COLLEGE

B.S. degree in 2 years in Aeronautical, Civil, Electrical, Mechanical, Chemical, Administrative Engineering. Students who left H. S. can make up work. Tuition low. Catalog.

411 College Street
Angola, Indiana

POPULAR and how!

Learn jazz and classical music on SAXOPHONE

THE spotlight is yours as you play for dances and pep up parties with the mellow syncopation of your Saxophone. And now it's so easy to learn quickly this or any other instrument you favor—right at home—without any teacher—from actual notes. This remarkable home study method makes it unnecessary for you to postpone musical happiness and profit any longer. For you don't need to know one note from another to start playing at once. Cost of learning averages only a few cents a day, regardless of the instrument you select. Already over 600,000 people have become popular musicians this quick, easy way described in our Free Book. Mail coupon for it today. We will also include a Free Demonstration Lesson. No obligation. Write now. U. S. SCHOOL OF MUSIC, 71-A Brunswick Bldg., New York City.

Pick Your Course

Mandolin	Saxophone
Piano	Cello
Organ	Ukulele
Violin	Cornet
Banjo	Trombone

Or Any Other Instrument

U. S. SCHOOL OF MUSIC,
71-A Brunswick Bldg., New York City

Send me your amazing free book, "Music Lessons in Your Own Home," with introduction by Dr. Frank Crane, also Free DEMONSTRATION LESSON. This does not put me under any obligation. (Please write plainly.)

NAME

ADDRESS

INSTRUMENT..... Have you this inst.?

LOW PAY.. LONG HOURS.. ROUTINE.. NO FUTURE



Always worrying over money. Always skimping and economizing—going without the comforts and luxuries that every man **DESERVES** for his family and himself.



The Time Clock—a badge of hawk-like supervision and The Rut. A constant reminder that one is "just another name on the payroll."



Human cogs in a great machine. No chance to meet people, travel, or have interesting experiences. A long, slow, tiresome road that leads nowhere.



Always wondering what would happen in case of a "lay-off" or loss of job. No chance to express ability—no chance to get ahead. **COULD** there be a way out?

I Said "Good-bye" to It All After Reading This Amazing Book— Raised My Pay 700%!



Where Shall We Send Your Copy—Free?

WHEN a man who has been struggling along at a low-pay job suddenly steps out and commences to earn real money—\$5,000, \$7,500 or \$10,000 a year—he usually gives his friends quite a shock. It's hard for them to believe he is the same man they used to know—but such things happen much more frequently than most people realize. Not only one, but **HUNDREDS** have altered the whole course of their lives after reading the amazing book illustrated at the right.

True, it is only a book—just seven ounces of paper and printers' ink—but it contains the most vivid and inspiring message that any ambitious man can read! It reveals facts and secrets that will open almost any man's eyes to things he has never even dreamed of!

Remarkable Salary Increases

For example, R. B. Hansen, of Akron, Ohio, is just one case. Not long ago he was a foreman in the rubber-curing room of a big factory at a salary of \$160 a month. One day this remarkable volume, "The Key to Master Salesmanship," fell into his hands. And from that day on, Mr. Hansen clearly saw the way to say "good-bye" forever to low pay, long hours, and tiresome routine! Today he has reaped

the rewards that this little volume placed within his reach. His salary runs well into the 5-figure class—actually exceeding \$10,000 a year!

Another man, Wm. Shore of Lake Hughes, California, was a cowboy when he sent for "The Key to Master Salesmanship." Now he is a star salesman making as high as \$525 in a single week. L. H. Lundstedt, Chicago, read this free book—and raised himself from a stenographer to the head of a business with 600% increase in earnings. C. V. Champion of Danville, Illinois, raised his salary to over \$10,000 a year and became President of his company in the bargain!

A Few Weeks—Then Bigger Pay

There was nothing "different" about any of these men when they started. None of them had any special advantages—although all of them realized that **SALESMANSHIP** offers bigger rewards than any other profession under the sun. But, like many other men, they subscribed to the foolish belief that successful salesmen are born with some sort of "magic gift." "The Key to Master Salesmanship" showed them that nothing could be farther from the truth! Salesmanship is just like any other profession. It has certain fundamental rules and laws—laws that you can master as easily as you learned the alphabet.

City and traveling sales positions are open in every line all over the country. For years, thousands of leading firms have called on

the N. S. T. A. to supply them with salesmen. Employment service is free to both employers and members, and thousands have secured positions this way.

Free to Every Man

See for yourself **WHY** "The Key to Master Salesmanship" has been the deciding factor in the careers of so many men who are now making \$10,000 a year. Learn for yourself the **REAL TRUTH** about the art of selling! You do not risk one penny or incur the slightest obligation. And since it may mean the turning point of your whole career, it certainly is worth your time to fill out and clip the blank below. Send it now!

**National Salesmen's
Training Association**
Dept. A-103, N. S. T. A. Bldg., CHICAGO, ILL.

National Salesmen's Training Assn.,
Dept. A-103, N.S.T.A. Bldg.,
Chicago, Ill.

Without cost or obligation, you may send me your free book, "The Key to Master Salesmanship."

Name.....

Address.....

City.....State.....

Age.....Occupation.....



His Salary Was Raised while others were reduced

"Up to the time I enrolled for a course with the International Correspondence Schools, I had only a grade-school education. Since enrolling, I have advanced to a much better position, where my salary is nearly four times as much as I was making previously. I would not be able to hold my present position had I not taken your Course. Recently I received a nice increase in salary, while other men were being reduced."

There could be no better proof of the value of an I. C. S. course than that. It shows that the trained man is given preference over all others and paid more money, even in slack times, if his work deserves it. It shows that there are always bigger, better jobs open for men who have the foresight to prepare for them in spare time.

Why don't you study and get ready too? We'll be glad to help you if you will only make the start.

Choose the work you like best in the coupon below; then mark and mail it to the I. C. S. today. This doesn't obligate you in the least, but it will bring you information that will start you on a successful career. This is your opportunity.

Mail the Coupon for Free Booklet

INTERNATIONAL CORRESPONDENCE SCHOOLS
"The Universal University"

Box 5522-G Scranton, Penna.

Without cost or obligation, please send me a copy of your booklet, "Who Wins and Why," and full particulars about the subject before which I have marked X:

TECHNICAL AND INDUSTRIAL COURSES

- | | |
|--|--|
| <input type="checkbox"/> Architect | <input type="checkbox"/> Automobile Mechanic |
| <input type="checkbox"/> Architectural Draftsman | <input type="checkbox"/> Plumbing <input type="checkbox"/> Steam Fitting |
| <input type="checkbox"/> Building Estimating | <input type="checkbox"/> Heating <input type="checkbox"/> Ventilation |
| <input type="checkbox"/> Wood Millworking | <input type="checkbox"/> Sheet Metal Worker |
| <input type="checkbox"/> Contractor and Builder | <input type="checkbox"/> Steam Engineer |
| <input type="checkbox"/> Structural Draftsman | <input type="checkbox"/> Steam Electric Engineer |
| <input type="checkbox"/> Structural Engineer | <input type="checkbox"/> Civil Engineer |
| <input type="checkbox"/> Electric Wiring | <input type="checkbox"/> Surveying and Mapping |
| <input type="checkbox"/> Electrical Engineer | <input type="checkbox"/> Refrigeration |
| <input type="checkbox"/> Electric Lighting | <input type="checkbox"/> R. R. Locomotives |
| <input type="checkbox"/> Welding, Electric and Gas | <input type="checkbox"/> R. R. Section Foreman |
| <input type="checkbox"/> Reading Shop Blueprints | <input type="checkbox"/> R. R. Bridge and Building Foreman |
| <input type="checkbox"/> Telegraph Engineer | <input type="checkbox"/> Air Brakes <input type="checkbox"/> Train Operation |
| <input type="checkbox"/> Telephone Work | <input type="checkbox"/> Highway Engineering |
| <input type="checkbox"/> Mechanical Engineer | <input type="checkbox"/> Chemistry <input type="checkbox"/> Pharmacy |
| <input type="checkbox"/> Mechanical Draftsman | <input type="checkbox"/> Coal Mining Engineer |
| <input type="checkbox"/> Machinist <input type="checkbox"/> Toolmaker | <input type="checkbox"/> Navigation <input type="checkbox"/> Boilermaker |
| <input type="checkbox"/> Patternmaker | <input type="checkbox"/> Textile Overseer or Supt. |
| <input type="checkbox"/> Pipefitter <input type="checkbox"/> Tinsmith | <input type="checkbox"/> Cotton Manufacturing |
| <input type="checkbox"/> Bridge Engineer | <input type="checkbox"/> Woolen Manufacturing |
| <input type="checkbox"/> Bridge and Building Foreman | <input type="checkbox"/> Agriculture <input type="checkbox"/> Fruit Growing |
| <input type="checkbox"/> Gas Engines <input type="checkbox"/> Diesel Engines | <input type="checkbox"/> Poultry Farming <input type="checkbox"/> Radio |
| <input type="checkbox"/> Aviation Engines | <input type="checkbox"/> Marine Engineer |

BUSINESS TRAINING COURSES

- | | |
|---|--|
| <input type="checkbox"/> Business Management | <input type="checkbox"/> Business Correspondence |
| <input type="checkbox"/> Office Management | <input type="checkbox"/> Lettering Show Cards <input type="checkbox"/> Signs |
| <input type="checkbox"/> Industrial Management | <input type="checkbox"/> Stenography and Typing |
| <input type="checkbox"/> Personnel Management | <input type="checkbox"/> Complete Commercial |
| <input type="checkbox"/> Traffic Management | <input type="checkbox"/> Civil Service <input type="checkbox"/> Mail Carrier |
| <input type="checkbox"/> Accountancy <input type="checkbox"/> Cost Accountant | <input type="checkbox"/> Railway Mail Clerk |
| <input type="checkbox"/> C. P. Accountant | <input type="checkbox"/> Grade School Subjects |
| <input type="checkbox"/> Bookkeeping | <input type="checkbox"/> High School Subjects |
| <input type="checkbox"/> Secretarial Work | <input type="checkbox"/> College Preparatory |
| <input type="checkbox"/> Spanish <input type="checkbox"/> French | <input type="checkbox"/> Illustrating <input type="checkbox"/> Cartooning |
| <input type="checkbox"/> Salesmanship <input type="checkbox"/> Advertising | <input type="checkbox"/> Lumber Dealer |

Name.....

Address.....

City..... State.....

Occupation.....

If you reside in Canada, send this coupon to the International Correspondence Schools, Canadian, Limited, Montreal, Canada

BEDFORD YMCA TRADE SCHOOL

Aviation Mechanic
Flying
Airplane Welding
Airplane Drafting
Air Navigation
Aero Starting, Lighting, Ignition
Auto Mechanic
Machine Shop. Electric Welding
Oxy-Acetylene Welding
Radio Mechanic. Battery Repair
Mechanical, Architectural Drawing
Sign Painting. Show Card Writing
Window Dressing
Commercial Art. Fine Art
DAY AND EVENING SESSIONS
Write for Catalog 50
Brooklyn Engineering Institute
(Operated by Bedford Y. M. C. A.)
1125 Bedford Avenue, Brooklyn
New York City

Electrical Engineering

Training for men of ambition and limited time. Concise, comprehensive course in Theoretical and Practical Electrical Engineering including the closely related subjects of Mathematics and Mechanical Drawing. Students construct motors, install wiring,

test electrical machinery. Course designed to be completed in one college year by eliminating non-essentials.

THIRTY-SEVEN YEARS' successful experience assures you maximum training in minimum time.

Send for free catalog



Bliss Electrical School

131 TAKOMA AVE., WASHINGTON, D. C.

AVIATION INFORMATION FREE

Send us your name and address for full information regarding the Aviation and Airplane business. Find out about the many great opportunities now open and how we prepare you at home during spare time, in quality. Our new book "Opportunities in the Airplane Industry" also sent free if you answer at once.

AMERICAN SCHOOL OF AVIATION
3681 Michigan Ave Dept. 1351 CHICAGO



GOV'T
JOBS!
\$1500⁰⁰ to
\$3600⁰⁰
YEARLY!

For MEN—WOMEN
Age 18 to 55

Get on Uncle Sam's Payroll where strikes, hardships, politics, etc. will not affect you. Draw twelve months' pay every year and when old, retire on a pension the balance of your life. Stop worrying—enjoy life! Pick the position you want—it belongs to you just as much as to anyone else. If you don't get it it's your own fault. Over 900 different kinds of positions obtainable, in or outside work, local or traveling. Fill out coupon below, mail it today, and full particulars together with big list of other positions will be sent immediately.

- | | |
|--|--|
| <input type="checkbox"/> Ry. Mail Clerk | <input type="checkbox"/> Steno-Typist |
| <input type="checkbox"/> P. O. Laborer | <input type="checkbox"/> Immigrant Inspector |
| <input type="checkbox"/> R. F. D. Carrier | <input type="checkbox"/> Seamstress |
| <input type="checkbox"/> Special Agent | <input type="checkbox"/> Auditor |
| <input type="checkbox"/> Customs Inspector | <input type="checkbox"/> Steno-Secretary |
| <input type="checkbox"/> City Mail Carrier | <input type="checkbox"/> U. S. Border Patrol |
| <input type="checkbox"/> Meat Inspector | <input type="checkbox"/> Chauffeur-Carrier |
| <input type="checkbox"/> P. O. Clerk | <input type="checkbox"/> Watchman |
| <input type="checkbox"/> File Clerk | <input type="checkbox"/> Skilled Laborer |
| <input type="checkbox"/> General Clerk | <input type="checkbox"/> Postmaster |
| <input type="checkbox"/> Matron | <input type="checkbox"/> Typist |

OZMENT INSTRUCTION BUREAU, 444, St. Louis, Mo.

Send me FREE particulars How To Qualify for positions marked "X" Salaries, locations, opportunities, etc. Also big list of other positions.

NAME.....

ADDRESS.....

Like 600,000 others you too can learn music this easy A.B.C. way!

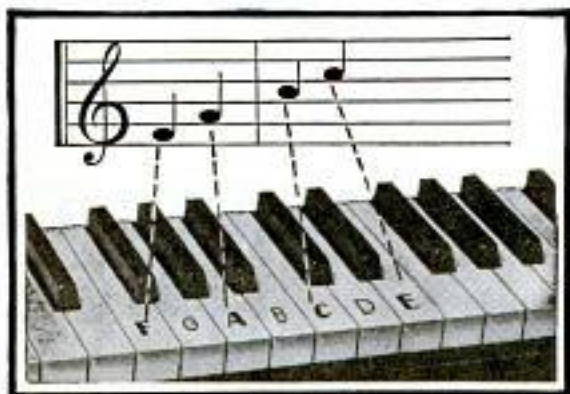

**You learn quickly
and easily at home
—without a teacher.**

JUST imagine! More than 600,000 delighted men and women have learned to play their favorite instruments this quick easy way.

Six hundred thousand—enough to put a six-piece orchestra in each of 100,000 cities and towns throughout the world! And every year fifty thousand more are joining our ranks—learning to play classics, ballads, and popular jazz—getting more fun and popularity out of life than they ever dreamt possible.

What more conclusive proof could you have of the amazing success of this new modern method, perfected by the U. S. School of Music? And what these thousands have done, you too can do. Don't say to yourself, "No, I haven't any musical ability. I couldn't learn to play." That's not true. Many of our most successful students never knew one note from another before taking this wonderfully simplified course—had never

touched an instrument—had never even dreamt they could play. And bear in mind you don't have to be born with special talent. A love of music is all you need. We'll do the rest.

Print-and-Picture Method

Why, it's just like playing a game. You can't go wrong, for every step, from beginning to end, is right before your eyes in print and pictures. Starting from the first lesson, it's as clear and easy as A. B. C. First you are *told* how to do a thing. Then a picture *shows* you how. Then you do it yourself and *hear* it. What could be simpler?

Most U. S. School of Music students learn twice as fast—even three times as fast—as those who learned by the old-fashioned plodding methods. Just think! No teacher. No dragging hours of tedious practice. No boresome scales. Right from the very start you play real tunes and melodies by note.

With the U. S. School method you learn right in your own home, in your spare time. And it's so inexpensive too. No matter which instrument you choose, the cost averages only a few cents a day.

Don't waste a day in finding out more about this amazing course. Surprise your friends. You will find yourself the center of admiring groups and there will be many good times in store for

you. A musician is always welcome at any party—and music is the best sort of entertainment to offer. Start now to enjoy that popularity and fun that you have been missing.

Free Booklet and Demonstration Lesson

If you are in earnest about wanting to join the crowd of entertainers and be a "big hit" at any party—if you really *do* want to play your favorite instrument, to become a musician whose services will be in demand—fill out and mail the convenient coupon asking for our Free Booklet and Free Demonstration Lesson. These explain our wonderful method fully and show you how easily and quickly you can learn to play at little expense. The Booklet will also tell you all about the amazing new *Automatic Finger Control*. Instruments are supplied when needed—cash or credit. U. S. School of Music, 71 Brunswick Bldg., New York City.

U. S. SCHOOL OF MUSIC,
71 Brunswick Building, New York City
Please send me your free book, "Music Lessons in your Own Home," with introduction by Dr. Frank Crane, Free Demonstration Lesson and particulars of your easy payment plan. I am interested in the following course:

Have You
.....Instrument?.....
Name.....
Address.....
City.....State.....

PICK YOUR INSTRUMENT

Piano	Violin
Organ	Clarinet
Ukulele	Flute
Cornet	Saxophone
Trombone	Harp
Piccolo	Mandolin
Guitar	'Cello
Hawaiian Steel Guitar	
Sight Singing	
Piano Accordion	
Italian and German Accordion	
Voice and Speech Culture	
Drums and Traps	
Harmony and Composition	
Automatic Finger Control	
Banjo (Plectrum, 5-String or Tenor)	
Juniors' Piano Course	

20 Years of Shirt-Sleeve Practice In ELECTRICITY



The Croft Library of Practical Electricity

**NEW
EDITION**
Revised
and
Enlarged

THIS is the electrical age, with unlimited opportunities for the man who has educated himself in the finer points of electrical practice. Fit yourself for a big-pay job by knowing electrical practice complete, including inside and outside work, central stations, and the whole subject. With the aid of the Croft books you can know electricity as experts know it and put yourself in line for an expert's pay.

Standard Electrical Training

The Croft Library is a complete electrical educator. It is founded on practice—on work as it is actually done. It is jammed from cover to cover with the kind of hard-headed facts you want. Written so that the beginner can easily understand it, yet so sound, so thorough, that it is the daily guide of 59,000 highly paid electrical workers and engineers. Croft tells you the things you need to know about motors, generators, armatures, commutators, transformers, circuits, switchboards, distribution systems—electrical machinery of every type—wiring for light and power—wiring of finished buildings—underwriters and municipal requirements—illumination in its every phase—the latest and most improved methods of lighting—lamps and lamp effects, etc.—how to do a complete job, from estimating it, to completion. Make no mistake about it—there are big jobs in electricity ready for you when you're ready for them. Thousands of men who have the Croft Library know that to be a fact. The Library itself, on a **FREE TRIAL BASIS**, will prove it to your own absolute satisfaction.

3000 Pages, 2100 Illustrations

In these volumes Croft teaches you electrical practice complete. He takes you in quick, easy steps from the simplest principles to the complete and economical operation of a great central station. He tells you all that he has learned in twenty years of shirt-sleeve practice. With these books at his elbow a man can learn as much about electricity in six months—good practical "bread and butter" stuff—as he would ordinarily learn in a lifetime of practice.

NO MONEY DOWN SMALL MONTHLY PAYMENTS

Fill in and mail the coupon attached and we will send you the entire set of seven volumes for ten days' Free Examination. We take all the risk—pay all the charges. You assume no obligation—you pay nothing unless you decide to keep the books. Then \$1.50 in ten days and the balance at the rate of \$2.00 a month.



FREE EXAMINATION COUPON

McGraw-Hill Book Co., Inc., 370 Seventh Ave., New York.

Send me for 10 days' free examination the Croft Library of Practical Electricity. If satisfactory I will send you \$1.50 in 10 days and \$2.00 monthly until the special price of \$19.50 is paid. If not wanted, I will return the books at your expense. (To insure prompt shipment write plainly and fill in all lines.)

Name.....
Address.....
City and State.....
Position.....
Company..... P. M. -1-31

Increase Your Earning Power

Apply time and labor-saving kinks to your work. Your efficiency will soon be recognized and you will be in line for advancement.

If you do machine shop work of any kind, sheet-metal work, painting, carpentry, auto repairing, farming, concrete work, plumbing, electrical work, welding, building, glass work, general repairing, tool-making, poultry raising, masonry or home repair work, get this

LIBRARY OF 6000 TIME AND LABOR SAVING IDEAS FOR SHOPMEN AND HANDYMEN

JUST PUBLISHED

SHOP NOTES for 1931

192 Pages
464 Illustrations
Price 50c

See partial list
of
contents below



Including the new 1931 issue illustrated above, there are now 13 volumes in the Shop Notes Library of 6,000 easily understood short cuts to every-day jobs. Here are just a few of the subjects taken from the latest issue.

- | | | |
|---|--|---|
| Auto Driving, Winter Hints | Growler for Armature Repair | Poultry Ranch for City Lot |
| Auto Trucks, Handy, for Paint Shop | Heater for Garage or Workshop | Roading and Platina, Ornamental |
| Band-Lalay Strips, Making | Horse Plans with Broad-as-Bit Squares Legs | Saws, Circular, Repairing |
| Belt Sander Reduces Labor | Inlays, Single Jointer in the Home Shop | Sawyer, Vertical, Made from Buffing Head |
| Bench, Portable, for Mechanic, Saves Time | Kitchen Steel, Metal, How to Make | Silver Solder, Use of |
| Blower for Lowering Fuel Cost | Laboratory Stand | Shaper for Home Shop |
| Book Ends, Hand Wrought, Making | Makes Workshop Tool Lamp Star, for Home | Space and Time Savers for the Shop |
| Cabriolet Leg, Cutting the | Lantern Illuminates Horse Numbers | Spiral Turnings, How to Make |
| Drawing Instruments, Homemade | Machine Chips, Vacuum Cleaner Removes | Stairway, Homemade |
| Fireless, Portable, How to Build | Machinist Tools, Running Several with One Electric Motor | Disappearing Water Heater for Sunny Climes |
| Furniture, Drawer Pulls for | Milling Machine Made from Shaper | Workbench, Handy, for Model Airplane Building |
| Gauge Glass, How to Install | Pipe Repair, Emergency | Table, Small Drum, Making |
| Grinding, Surface, on Drill Press | Plating Tricks Made Easy | Twist-Turning with Portable Router |

Each volume contains approximately 500 articles and 400 illustrations and has 192 or more pages. At the regular price of 50 cents per single volume this library costs \$6.50, but for a limited period we will supply the 13 vols. when ordered at one time at the special reduced price of only \$4.00.

SPECIAL OFFER COUPON

POPULAR MECHANICS PRESS,
200 E. Ontario St., Room P1, Chicago, Ill.

Send me, as per your special offer, the following books. I will pay postman price and small amount of postage. My money will be refunded if I am not satisfied. (Check what you want.)

- 1931 Shop Notes and Lathe Handbook, both for 95c.
 Complete Shop Notes Library (13 vols.) \$4.00.

Name.....
Street and No.....
City..... State.....

VOICE!



NOW
you can
have the
VOICE
you want!

100% Improvement Guaranteed!

No matter how hopeless your case may seem—send for free Voice Book. Discloses startling voice facts that may save you hundreds of dollars. Tells all about marvelous new SILENT Method of Voice Training. Increases Range. Improves quality. Banish huskiness—hoarseness. 100 per cent improvement *guaranteed*—or money back. Mail coupon *at once* for free book—the greatest voice book ever written—sent FREE with no obligation!

No matter how hopeless your case may seem — send at once for FREE Voice Book.
Mail Coupon Now!

Perfect Voice Institute
Dept. 13-51 1922 Sunnyside Ave., Chicago

Mail Coupon for Free Voice Book

Perfect Voice Institute, Dept. 13-51
1922 Sunnyside Ave., Chicago

Please send me FREE and without obligation, Prof. Feuchtinger's new book, "Physical Voice Culture." I have checked subject in which I am most interested.

Weak Voice Singing Stammering Speaking

Name

Address

City State

Easy home method quickly teaches HAWAIIAN GUITAR



Play all the latest hits just as the Hawaiians do! Have good times aplenty!

Win fame—friends—fortune! Play the Hawaiian Guitar!

Native Hawaiian expert directs you

You get expert instruction directed by a world-famous player and teacher, Prof. Walter Kolomoku. He quickly reveals to you the secrets of this fascinating instrument.

Learn at home in spare time

Study in spare time at home. Even if you don't know a note our method is so simple, plain and easy, you begin a piece your first lesson. In half an hour you can play it!

Only 4 Motions to learn. Then you can play any music—popular songs, classical, old-time melodies, native Hawaiian airs—or real jazz. You'll never be lonesome after you learn the Hawaiian Guitar.

Complete Course 52 lessons. Nothing omitted. Pictures explain every move. You are sure to learn—what we can do for others we can do for you. Over 50,000 successful students.

Payasyouplay We make it easy for you. Start with small first payment—then pay while learning. Costs only few cents per lesson. You only pay the cost of instruction—we furnish everything.

Sweet Toned HAWAIIAN GUITAR

GIVEN when you enroll

—with genuine seal grain Fabrikoid Cover and complete playing outfit. Reliable retailers ask \$18 to \$20 for a similar instrument and outfit without the fine Fabrikoid Case, which alone is valued at \$3.50.

TENOR BANJO and other courses

The same thorough instruction on the Tenor Banjo, Violin, Triple Tenor Guitar, Ukulele, Banjo Ukulele—well known instructors. Write for full information.

FIRST HAWAIIAN CONSERVATORY OF MUSIC, Inc.
9th Floor, Woolworth Bldg., Dept. 748, New York, N.Y.

Approved as a Correspondence School Under the Laws of the State of New York
Member National Home Study Council

Send This Coupon for Liberal Offer!

FIRST HAWAIIAN CONSERVATORY OF MUSIC, Inc.
9th Floor, Woolworth Bldg., Dept. 748, New York, N.Y.
Please mail full information about your 52-lesson Hawaiian Guitar Course. I am not obliged to enroll unless I want to.

Name _____
Address _____
City _____ State _____

\$1 Masonic Xmas Gifts

[Useful and attractive presents any man would be glad to receive]

The best value you ever saw for the money. Genuine leather, card case, gold corners, to hold 5 cards, also extra pocket. **MASONIC EMBLEM STAMPED IN GOLD FREE.** Name and other stamping 35 cents per line.
5 windows . . . \$1.00
9 windows . . . \$1.50
13 windows . . . \$2.00



A NOVEL MASONIC CHARM

A most mysterious watch charm of heavy plated gold. Shows the Square and Compass when revolved. Something different. Packed in an attractive box. Catalog suggests hundreds of other gifts. . . \$1.00

SOLID GOLD PINS, \$1.00

Just the right size. Latest style. A lasting remembrance and an appreciated present. Large variety—Masonic, Chapter, 32nd Degree, Shrine, Grotto.



Money Back If Not Satisfied
Send for Catalogue
Established 1859

Redding Masonic Supply Co.

200 Fifth Ave. Dept. P. M. New York

"Everything Masonic"



High School Course in 2 Years

This simplified, complete High School Course, specially prepared for home study by leading professors, meets all requirements for entrance to college, business, and leading professions.

20 Other Courses

Over 200 noted Engineers, Business Men, and Educators helped prepare the special instruction which you need for success. No matter what your inclinations may be, you can't hope to succeed without specialized training. Let us give you the practical training you need.

American School
Drexel Ave. and 58th St.
Dept. H-147, Chicago

Money Back When You Finish If Not Satisfied

American School, Dept. H-147 Drexel Ave. and 58th St., Chicago
Send me full information on the subject checked and how you will help me win success in that line.

- Architect
- Building Contractor
- Automobile Engineer
- Civil Engineer
- Structural Engineer
- Business Manager
- C. P. A. & Auditor
- Bookkeeper
- Electrical Engineer
- General Education
- Lawyer
- Mach. Shop Practice
- Mechanical Engineer
- Steam Engineer
- Draftsman & Designer
- High School Graduate

Name _____ Age _____
St. and No. _____
Town _____ State _____



Major Rockwell
Famous War Flyer
Who Will Teach You

Major Rockwell is a famous World War flyer, decorated with the Legion of Honor and the War Cross. He is now devoting himself to teaching Aviation, and he will train you for a position in this great new industry as only a Veteran World War Flyer can train you. Under Major Rockwell's guidance your future in Aviation is assured.

"I Will Train You at Home
LEARN TO EARN
300 to 400 a Month"

I offer you this easy, quick way to get into Aviation. There is a need for trained men, and this is your opportunity to enter this uncrowded, fascinating field with a bright future.

In a Few Short Months

Just devote about an hour a day to my Home Study Course, and in a few short months you can master the principles of Ground Training, which are necessary before you

take your place in any branch of Aviation.

In a few short months I will give you practical aviation training and prepare you for one of the better pay jobs open to men thoroughly trained in Aviation.

No Advance Education Necessary or Experience Needed

You don't need to have a high school or college education to master my course. You do not need to know anything about airplanes, motors or mechanics. My home course is thorough and complete. Everything is so clearly explained, with easy-to-understand text and pictures, that in a few short months you will be

able to grasp every fundamental principle of Aviation ground work and you will be well on the road to qualify for an important aviation job, that will later on lead into a job paying \$300 to \$400 a month. My Home Study Course will give you all the knowledge necessary to pass the government's written examinations for mechanics' or pilots' licenses.

AIRPLANE GIVEN!

I'm going to offer you an airplane. Rush coupon for full particulars on how you may get this airplane delivered to your home.

You Learn Principles of Aviation at Home Then Choose Any One of 40 Ground Jobs. My Home Study Course All You Need

When you have completed the ground training I will arrange for you to take your flying instruction at any licensed airport near your home at special reduced rates. Or, if you want, you can come here to Dayton and get training at a fine, well equipped airport. No matter where you learn to fly you can qualify for a pilot's license and a high pay flying job in passenger lines, mail service, and other important branches of flying.

Employment Service

After you graduate I assist you in getting a job without any cost to you. Right now the demand for trained men is greater than the supply. A place is ready for you!

Only Trained Men Can Qualify in Aviation

The big money in Aviation does not go to the novice or apprentice. Only TRAINED men can command the high salaries. Employers are glad to pay big money for men who know Aviation—builders, mechanics, service and maintenance men, and flyers. Let me prepare you for one of the many high salaried Aviation jobs open to the trained man. I will prepare you to take your place in the most fascinating, fastest growing industry in the world. Rush this coupon to me for a copy of my famous free book.

MONEY BACK AGREEMENT

I am so sure that you can learn Aviation with my help and step into a good Aviation job that if you are not satisfied when you have finished my course, I agree to return every penny of your tuition.

MAJOR ROBT L. ROCKWELL

THE DAYTON SCHOOL OF AVIATION

Desk M-1

DAYTON, OHIO

Get My No-Risk Plan
My Big Book
Explains ALL
Ill send it FREE



Major Rob't L. Rockwell
The Dayton School of Aviation
Desk M-1, Dayton, Ohio

Dear Major:—Please send me FREE and without obligation a copy of your famous book on Aviation; also your tuition and position offer.

Name.....

Address.....

Town..... State..... Age.....

WHY NOT GRASP SUCCESS

Study radio in your spare time at home



RCA Institutes students get first hand knowledge and training . . . and get it complete.

ARE you satisfied with the position you now hold? Do you feel that you're worth more money? Are you pleased with yourself, your work, your associates . . . and your future? What does next year hold for you . . . and the year after that?

Are you content to merely plod along through the best years of your life . . . or do you want to get into far pleasanter work . . . meet more interesting people . . . and get a well paid position?

The ambitious man ties his future to an industry that's developing rapidly . . . that's going up and up! Your life lies before you . . . will it be a losing game or a profitable adventure? . . . Will you GROW with a GROWING BUSINESS or will you waste your life and opportunities in an industry that is already fighting a losing battle.

If you are looking for a REAL opportunity . . . if you want to make the most of your life . . . to grasp the success that should be yours, then we say to you, "Study Radio."

Everyone knows that Radio is the fastest growing industry in the world today . . . countless opportunities are waiting for men who have the training and ability to grasp them. Where have you heard of any business that has developed as fast as this? Radio needs trained men and needs them NOW! Think of the future Radio offers you!

You can easily obtain the training you need under the direction of RCA Institutes, a division of Radio Corporation of America, which thoroughly trains men in every branch of radio and also assists them in obtaining employment. You learn radio by actual experience on the very latest types of radio equipment. You study under the direction of nationally known experts. You can learn all about radio servicing and selling, ship operating, shore station operating, radio telephony and telegraphy, and airplane radio equipment . . . also instruction in sound motion picture installation, maintenance and repair!

Study at Home In Your Spare Time

The RCA Institutes complete Home Laboratory Training Course gives you all you need to know about radio. The lessons are of absorbing interest . . . easy to learn. You rapidly progress, step by step . . . and you receive absolutely free the complete RCA Institutes Laboratory Equipment, a modern outlay of apparatus furnished to every student . . . enabling you to easily solve radio problems. This is the way for you to acquire, in your spare time, the commercial knowledge and ability that commands good pay.

Home Training Course By America's oldest and foremost Radio training organization

This home training course and free laboratory equipment is backed by more than 20 years' experience. A signed agreement by RCA Institutes assures you of absolute satisfaction . . . furthermore, if after taking this course you are not satisfied in every way, your money will promptly be returned to you.

Read this free book

Everything you want to know about Radio . . . Describes in detail the home training that has placed thousands of men in good paying positions. Forty fascinating pages of pictures and text, all about Radio.

RCA INSTITUTES, Inc., Dept. MP-1,
75 Varick St., New York, N. Y.

Gentlemen: Please send me your big FREE 40-page book which tells about the many opportunities in Radio and about your famous laboratory-method of radio instruction at home.

Name.....

Address.....

Occupation.....



Mail this coupon NOW... start on the road to success in radio TODAY!

READ HOW YOU CAN DO IT

Study radio in the finest equipped school in America

In order to make it easy for you to study radio RCA Institutes has opened six completely equipped schools throughout the country... at New York, Chicago, Boston, Baltimore, Philadelphia and Newark, N. J. Each of these six schools has the very last word in radio equipment. They all offer exactly the same training in day or evening classes... you study under the personal direction of RCA experts. In this way you learn at the very heart of radio itself, because you study under the direction of RCA... the great corporation that sets the standards for the entire radio industry. The very progress of radio is measured by the achievements of the famous engineers in the great research laboratories of the Radio Corporation of America.

Only training course sponsored by Radio Corporation of America

Graduates of these schools are thoroughly posted in all the very latest developments, the newest inventions and greatest discoveries in radio, because they study in the finest equipped schools in America. That's what RCA Institutes does for you... that's the kind of training you want... the practical, thorough knowledge that you need for success in radio.

BOARD OF MANAGERS OF RCA INSTITUTES, Inc.

The names of these men are known throughout the world as the greatest names in radio. Their experience will guide you in your training.

Chairman of the Board
GENERAL JAMES G. HARBORD

Chairman of the Board
Radio Corporation of America

President
RUDOLPH L. DUNCAN

Vice-President
F. R. BRISTOW

WILLIAM BROWN
Vice-President and
General Counsel
Radio Corporation of America

W. A. WINTERBOTTOM
Vice-President
RCA Communications, Inc.

CHARLES J. PANNILL
Vice-President
Radiomarine Corporation
of America

GEORGE S. DE SOUSA
Treasurer, Radio Corporation
of America

E. A. NICHOLAS
President, E. A. Nicholas, Inc.

A. E. REOCH
Vice-President
RCA Photophone, Inc.

CHARLES HORN
General Engineer
National Broadcasting Company

You get commercial training that prepares you for success in radio



Opportunities for Trained Men

Graduates frequently obtain positions shortly after graduation. Every graduate receives the thorough training that gives him the knowledge and the confidence to hold a good paying position.

Come in today... See for yourself!

Step into the nearest school and then you will know why it is that thousands of men have acquired the training that has enabled them to occupy well paid positions in radio. Meet the instructors, talk to the students, examine the equipment... convince yourself... see what radio can offer you, and what RCA Institutes can DO for you. We will be glad to meet you... glad to explain everything... to show you everything... without the slightest obligation on your part! Come in today and get a copy of our free book, or send for it by mail. See what our course has done for others and what it can do for you!



Send this coupon to the school most convenient for you to attend

RCA INSTITUTES, INC.

(A division of Radio Corporation of America)

RCA Institutes, Inc., operates resident schools, giving day and evening classroom instruction in the following cities. Mail the coupon to or call at the institute most convenient to you.

222 North Bank Drive, Chicago, Ill.
75 Varick Street, New York
899 Boylston Street, Boston
1211 Chestnut Street, Philadelphia
560 Broad Street, Newark, N. J.
1215 N. Charles Street, Baltimore

RCA Institutes, Inc.
Dept. MP-1.

Please send me catalog designating your resident school (classroom) instruction.

Name _____

Address _____

Occupation _____





There's the Man Who's Holding You Down

Yes, sir! There's the man! You see him every time you look in the mirror. His name isn't Brown or Smith or Jones but Y-O-U. He's your real boss. He's the man who decides whether your salary will be \$35 a week or \$100 or \$150.

If you want to get ahead there's just one sure way to do it—train yourself to do the day's work better than any other man in the office. Ability is bound to count. Your employer will be glad to pay you more money if you show him you deserve it.

A home-study course with the International Correspondence Schools will prepare YOU for the position you want in the work you like best. All it takes is an hour a day of the spare time that now goes to waste.

At least find out how by marking and mailing the coupon that has meant the difference between Failure and Success to so many other men. It doesn't obligate you in any way to fill in this coupon, yet it may be the means of changing your entire life. Do it—now!

Write for Free Booklet

INTERNATIONAL CORRESPONDENCE SCHOOLS
"The Universal University"

Box 5525-G, Scranton, Penna.

Without cost or obligation, please send me a copy of your booklet, "Who Wins and Why," and full particulars about the subject before which I have marked X:

TECHNICAL AND INDUSTRIAL COURSES

- | | |
|--|--|
| <input type="checkbox"/> Architect | <input type="checkbox"/> Automobile Mechanic |
| <input type="checkbox"/> Architectural Draftsman | <input type="checkbox"/> Plumbing <input type="checkbox"/> Steam Fitting |
| <input type="checkbox"/> Building Estimating | <input type="checkbox"/> Heating <input type="checkbox"/> Ventilation |
| <input type="checkbox"/> Wood Millworking | <input type="checkbox"/> Sheet Metal Worker |
| <input type="checkbox"/> Contractor and Builder | <input type="checkbox"/> Steam Engineer |
| <input type="checkbox"/> Structural Draftsman | <input type="checkbox"/> Steam Electric Engineer |
| <input type="checkbox"/> Structural Engineer | <input type="checkbox"/> Civil Engineer |
| <input type="checkbox"/> Electric Wiring | <input type="checkbox"/> Surveying and Mapping |
| <input type="checkbox"/> Electrical Engineer | <input type="checkbox"/> Refrigeration |
| <input type="checkbox"/> Electric Lighting | <input type="checkbox"/> R. R. Locomotives |
| <input type="checkbox"/> Welding, Electric and Gas | <input type="checkbox"/> R. R. Section Foreman |
| <input type="checkbox"/> Reading Shop Blueprints | <input type="checkbox"/> R. R. Bridge and Building Foreman |
| <input type="checkbox"/> Telegraph Engineer | <input type="checkbox"/> Air Brakes <input type="checkbox"/> Train Operation |
| <input type="checkbox"/> Telephone Work | <input type="checkbox"/> Highway Engineering |
| <input type="checkbox"/> Mechanical Engineer | <input type="checkbox"/> Chemistry <input type="checkbox"/> Pharmacy |
| <input type="checkbox"/> Mechanical Draftsman | <input type="checkbox"/> Coal Mining Engineer |
| <input type="checkbox"/> Machinist <input type="checkbox"/> Toolmaker | <input type="checkbox"/> Navigation <input type="checkbox"/> Boilermaker |
| <input type="checkbox"/> Patternmaker | <input type="checkbox"/> Textile Overseer or Supt. |
| <input type="checkbox"/> Pipefitter <input type="checkbox"/> Tinsmith | <input type="checkbox"/> Cotton Manufacturing |
| <input type="checkbox"/> Bridge Engineer | <input type="checkbox"/> Woolen Manufacturing |
| <input type="checkbox"/> Bridge and Building Foreman | <input type="checkbox"/> Agriculture <input type="checkbox"/> Fruit Growing |
| <input type="checkbox"/> Gas Engines <input type="checkbox"/> Diesel Engines | <input type="checkbox"/> Poultry Farming <input type="checkbox"/> Radio |
| <input type="checkbox"/> Aviation Engines | <input type="checkbox"/> Marine Engineer |

BUSINESS TRAINING COURSES

- | | |
|---|--|
| <input type="checkbox"/> Business Management | <input type="checkbox"/> Business Correspondence |
| <input type="checkbox"/> Office Management | <input type="checkbox"/> Lettering Show Cards <input type="checkbox"/> Signs |
| <input type="checkbox"/> Industrial Management | <input type="checkbox"/> Stenography and Typing |
| <input type="checkbox"/> Personnel Management | <input type="checkbox"/> Complete Commercial |
| <input type="checkbox"/> Traffic Management | <input type="checkbox"/> Civil Service <input type="checkbox"/> Mail Carrier |
| <input type="checkbox"/> Accountancy <input type="checkbox"/> Cost Accountant | <input type="checkbox"/> Railway Mail Clerk |
| <input type="checkbox"/> C. P. Accountant | <input type="checkbox"/> Grade School Subjects |
| <input type="checkbox"/> Bookkeeping | <input type="checkbox"/> High School Subjects |
| <input type="checkbox"/> Secretarial Work | <input type="checkbox"/> College Preparatory |
| <input type="checkbox"/> Spanish <input type="checkbox"/> French | <input type="checkbox"/> Illustrating <input type="checkbox"/> Cartooning |
| <input type="checkbox"/> Salesmanship <input type="checkbox"/> Advertising | <input type="checkbox"/> Lumber Dealer |

Name.....Age.....

Address.....

City..... State.....

Occupation.....

If you reside in Canada, send this coupon to the International Correspondence Schools, Canadian, Limited, Montreal, Canada

Learn AVIATION WHERE LINDBERGH STARTED!

Men, opportunities in aviation are unlimited. Airports, factories and transportation companies must have well trained pilots and mechanics! Leading air-transport companies pay an average of \$550 per month for pilots. Government licensed mechanics are in good demand. But first, you must be properly trained.

This School is Government Approved. We train you for licensed mechanic or pilot. \$50,000 worth of buildings and equipment. \$100,000 airport. Connected with large aircraft factory. Learn right here where Lindbergh learned. Reasonable Tuition. Part Time Employment Offered. Write for details today. (stating your age).

LINCOLN AIRPLANE & FLYING SCHOOL
205 Aircraft Bldg. Lincoln, Nebr.

OPPORTUNITIES IN

TRAFFIC MANAGEMENT

Conditions point to an unusual demand for trained traffic men, by transportation companies and industrial organizations. Men with scientific traffic training effect big savings for their firms—command big salaries.

Three Detroit Firms Pay Their Traffic Managers Over \$20,000 a Year

Prepare at home in your spare time, under supervision of traffic experts. Low cost; easy terms. "I would not take \$50,000 for my knowledge of traffic management," writes H. E. Stiffer, Traffic Manager, Marion Steam Shovel Co., Marion, Ohio. Send now for 64-page book—**FREE!** Chicago

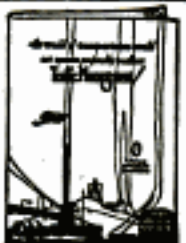

WORLD NEEDS PLUMBERS

Old style plumbers are fading like the horse and buggy. The world demands modern Plumbing and Skilled Trained Mechanics to do it. Unlimited, swift growing field. Make \$50 to \$100 a week or start own shop. We train you quick. Learn in 8 to 12 WEEKS to do any job with skill and science. Need no previous experience. Strictly tool using system. Opportunity knocks. Investigate today—amazing offer—low tuition. World's greatest school.

Write—

UNIVERSAL PLUMBING SCHOOL
2130 Troost Ave. Kansas City, Mo.



New Way to Improve YOUR ENGLISH



A command of effective English gives you added advantages and better opportunities. Poor English handicaps you more than you now realize. You can improve your English through Sherwin Cody's 100% self-correcting invention. If you are ever embarrassed by mistakes in grammar, spelling, punctuation, or pronunciation, this new free book "How You Can Master Good English—in 15 Minutes a Day" will prove a revelation to you. Send for it now. It is free. Address SHERWIN CODY SCHOOL OF ENGLISH
51 Searle Building Rochester, N. Y.

LEARN WATCHMAKING AND ENGRAVING

BY OUR PROFIT-SHARING PLAN
OUR GRADUATES SUCCEED



One of our Iowa students started in a very small way—now doing over \$40,000 a year. Another in Wisconsin, over \$10,000 the first year. Day or night classes. Call or write for FREE BOOK

Chicago School of Watchmaking, Dept. 6801, 543 W. Randolph St., CHICAGO

SONG REQUIREMENTS OF TALKING PICTURES



SONG WRITERS

Advance Royalty Payments, New Talking-Picture Song requirements, etc., fully explained in our free instructive book. Writers of Words or Music for songs may submit their work for free advice. We revise, compose, arrange and copyright music. Write today. Newcomer Associates, 1676-Y Broadway, New York

**\$8 Extra Each Night
for Reikane
Over \$1000 Extra
for Scarbro**

**This
Genuine
Hawaiian
Guitar
Comes
with
First
Lesson**



**Special Demonstration
Phonograph Records
Included**

We supply everything you need. With your very first lesson you receive FREE of extra cost a beautiful, rich-tone, genuine Hawaiian Guitar worth \$20 at any store—Kno-All Chart—complete Outfit of tuner, picks, etc., etc.—clear, easy instruction—and specially made Demonstration Phonograph Records in which Robert Yap, the famous Native Hawaiian, correctly plays each piece in the Course. No effort is spared—no stone left unturned—to help YOU become an expert and accomplished player quick.

Radio's Most Popular Instrument

Broadcasting Stations the country over are eager for Hawaiian Guitarists. The public demands this stirring, unique music. Radio is only one of many opportunities for the Hawaiian Guitarist to win popularity and prosperity quick! Our students have gained widespread reputations and are paid handsomely.



**YOU, too, Can Make Many
Friends and EASY, EXTRA
MONEY Quick with the HAWAIIAN GUITAR**

Look what Roy Reikane, Muir, Pa., writes: "Didn't know a note when I started Hawaiian Guitar. But it was easy to learn your way. Began making more friends right away. Now going strong; have been making \$5 to \$6 every evening and now have contract with theatre at \$8.00 per night. Have made over \$200 in 1 1/2 months." Then read this from Carlton E. Scarbro, Fitzpatrick, W. Va.: "Your Course and Service can't be beat. They're easy, understandable and full of help. Have become very popular since learning. Have played at opera houses and many parties—all told have made \$1,000 through your wonderful Course."

**Learn to Play the Real
Hawaiian Way—Quick—
Right at Home in Only
1 to 3 Months' Spare Time**

No previous musical training necessary; no long tiresome hours of practicing. The New York Academy of Music's amazing Hawaiian Guitar Course can teach you right at home, in 1 to 3 months' spare-time, to play this rich, melodious, romantic instrument. Every step is made clear and easy; progress is rapid yet training is thorough. It's like play to learn this pleasant, fascinating way.

**No Need to Wait for All the Fun and All the Money You
Want—Get This FREE BOOK Now!**

Here is the revealing Book that has shown thousands of others the way to make good with the Hawaiian Guitar. The book that has meant hundreds and hundreds of dollars—and dozens and dozens of new friends—for people who were right in your shoes just a few months ago. Yet you are welcome to a copy absolutely FREE. Learn at once how YOU can quickly get in line for plenty of fun, friends and EXTRA MONEY. It costs you nothing to find out. The big book explains everything, proves everything. The coupon below brings your FREE copy. Mail it today!

**Big Money for You
Full Time or Spare-Time**

Our students learn to cash-in quick. Playing in either an amateur or professional way, many make anywhere from \$15 extra money to \$100 full-time pay each week. We show you how to turn pleasure into profit—turn music notes into bank notes! Our FREE Book explains every step. Get it at once!

**Get this
FREE
BOOK
Now!**

**Makes \$200 in Spare-
Time**

"Had only finished my 7th lesson when I played at a Ball and made my first Five Dollars. Have made almost \$200 with my Hawaiian Guitar in spare-time."
—John B. McMullin, Cadet, Mo.

Paid \$8 for 4 Hours

"When I enrolled with you I didn't know one string from another. With first lesson, learned notes in just a few hours. Played first piece second evening. Now have plenty of good times and friends. Am making \$8.00 per evening for just 4 hrs. playing at dances."
—Gracyle St. Smith, Molokai, Oregon.

Popular Radio Artist

"Your Course is easy! Knew nothing of music before taking it, but now can play my piece. Have been broadcasting over station KVOO—have all the engagements I can fill—and am popular. Couldn't ask for more."
—Floyd Pook, Hubert, Okla.



Clip - Sign - Send

A. F. Bloch, President,
Hawaiian Studios 52011 of
NEW YORK ACADEMY OF MUSIC,
100 Fifth Ave., New York City.

Dear Mr. Bloch: Please send me at once your FREE Book, "How to Learn Hawaiian Guitar," showing me how to have popularity and Big Pay QUICK.

Name.....

Address.....

City..... State.....

if-

you pledge

**yourself to secrecy we will
teach you the secrets of**

**Real Professional
Magic**



Dr. Harlan Tarbell, internationally known magician and teacher of some of the world's greatest magicians.

Be a Magician!

**No Salesman Will
Bother You!**

For the first time in the history of Magic the age-old, sacredly guarded secrets of Mystic Art are being revealed. Now at last you can learn to be a Real Professional Magician. Yes, and you can learn this wonderful art *easily and quickly* AT HOME. You are taught the mysterious *Principles* by which the Professional Magician works. But before you can study, you must sign the Magician's Solemn Pledge of Secrecy. This means you are getting the *guarded secrets* of the Magic Profession.

**Tarbell System, Inc., Studio 13-51
1926 Sunnyside Avenue Chicago, Illinois**

**Tarbell System, Inc., Studio 13-51
1926 Sunnyside Avenue, Chicago, Ill.**

Gentlemen: Without any obligation send me your free literature and information all about your wonderful "Tarbell Course in Magic." Also tell me about your Low Price Offer and Easy Payment Plan.

Name

Address

Age

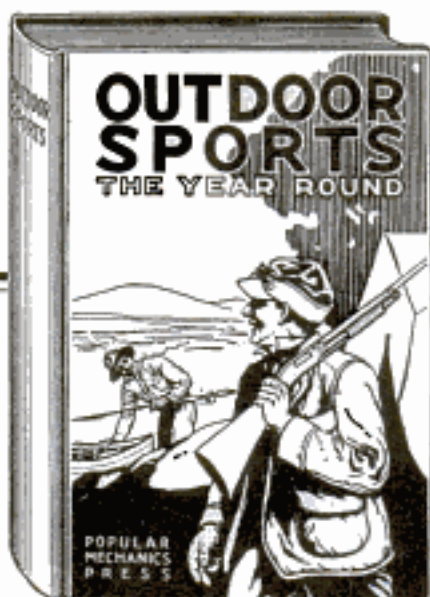

ENJOY Outdoor Sports THE YEAR ROUND

With the Aid of This Great Book

The new, revised and enlarged edition of *Outdoor Sports the Year Round*, just published by Popular Mechanics Press, contains hundreds of ideas for new and popular sports and pastimes as well as the old favorites.

Attractive to Young and Old Alike is the interesting variety for all seasons.

The intensive follower of a few sports will appreciate the wealth of suggestions that render the pursuit of any hobby more enjoyable. For example, for the hunter there are important details on the care and handling of guns; for the swimmer, complete instructions in fancy diving; for the camper, ideas that tend to make camping one hundred per cent comfortable and convenient; for the fisherman, many practical kinks, etc.

Winter Sport Enthusiasts

will be amazed at the large number of devices that furnish thrills and excitement. Probably the most unique feature of the book is the fact that it contains complete instructions that enable any handy man or boy to make sport devices or equipment at very little cost.

A Few of the Subjects:

Aquaplaning	Paddle Tennis
Archery	Pole Vaulting
Boats and Boating	Rifle, Sporting, How to Use
Camping Out, Tricks of	Shooting Blinds, How to
Diving, Fancy	Build
Fish Trophies, Mounting	"Shooting the Chutes"
Fishing Kinks	Shotgun, How to Use
Golf in Your Backyard	Skate-Sailing
Guns, How to Take Care of	Skins, Preparing for Mount-
Hunting	ing
Hurdle, How to Make	Skis and Ski Running
Ice Hockey	Sleds, Motor-Driven
Ice, Merry-Go-Round for	Snowshoes
Ice Sled for Sailing	Swim, Learning to
Ice Yacht	Target Shooting
Jitney Golf	Tennis-Court Backstop
Lawn-Tennis Marker	Toboggan Slide, Building
Merry-Go-Round	Trap Shooting
Model Airplane Building	Traps and Trapping
Night Croquet	Water Scooters
Outdoor Cooking	Water Skipper

352 Pages (large size, 7 x 10 in.)
650 Illustrations. Cloth Binding **Price \$2.00**

Mailed Postpaid upon receipt of price anywhere in the world. Will be sent C. O. D. anywhere in U. S. Simply pay postman price plus postage when he delivers the package.

**Popular Mechanics Press (Room P-12)
200 East Ontario St. Chicago, Ill.**



**MINERAL WICK OIL BURNER
LISTED AS STANDARD BY
UNDERWRITERS LABORATORY**

SCIENCE has Revolutionized the Cost of AUTOMATIC OIL HEAT



**Patented
LACO**

Mineral Wick.
Produces Gas
out of Oil right
in your own
home and
ELIMINATES

WASTE, SMOKE, AND SOOT.
Ends the high price of Oil Heat.



LACO Model F

New LACO Shuffler
perfects the atomizing
power oil burner type for heavy
oils and 24 West Coast Diesel Oil.
**LOW PRESSURE, LAZY
FLAME** that catches every drop of
oil—perfect atomization. Reduced
stack temperatures. Low Priced.
Quickly installed. Fully automatic
and handsomely designed and
finished. **WORLD'S LOWEST
PRICED BURNER OF ITS
KIND.**

Dealers Wanted

What an opportunity! Quantity
sales that have made as much as
**\$50,000 ANNUALLY FOR SOME
OF OUR DEALERS.** A Special
**SENSATIONAL PROFIT SHARING
PLAN** if you write us today on
your letterhead. Jobber territories
still open! Act quickly.

*Amazing Discovery of the LACO
MINERAL WICK makes oil heat
actually as cheap as coal—a luxurious
convenience sheer economy! No other
burner in the world like it.*

Again science has conquered! Now it relieves you forever of the responsibilities of furnace tending—cold wintry mornings, dirty ashes and coal, soot and smoke—all the old inconveniences are gone! Through the amazing invention of a foremost heating engineer, LACO has cut the price of an oil burner so **EVERY-ONE CAN AFFORD IT!** Then it burns oil with **SAVINGS** never before dreamed possible.

SPECIALLY HEAT-TREATED FIRE-CLAY Makes Gas Out Of Oil

The LACO MINERAL WICK, the greatest advance since the invention of the oil burner, is a specially selected fire-clay, subjected to a secret heat-treating process to make it porous and absolutely indestructible. Oil rises up through the red hot mineral wick and automatically changes into the **MOST PERFECT FUEL EVER DISCOVERED**—hydro-carbon gas. The hot gas, scientifically mixed with the exact amount of air—burns in suspension—a clean, smokeless flame of intense heat!

Waste Eliminated! Fuel Consumption Reduced!

Every drop of oil—every B. T. U.—is used to produce the hot gas. **WASTE, SMOKE, SOOT, GREASE**—all are **ELIMINATED.** Fuel costs are smashed to a fraction. What **SAVINGS!** What **COMFORT!** You can have them for only a few dollars down!

Completely Automatic

Laco comes to you with **FULL AUTOMATIC CONTROL**—room thermostat, and equipped with special safety features which make it as **SAFE** as an ordinary kitchen range. Brings the manifold advantages of both oil and gas heat, at a fraction of what you would expect to pay for either. It fits instantly into your present heating plant—regardless of type—without injury to your furnace, without the usual bricking of the fire-bowl.

Installed In Only An Hour

Don't suffer through another cold snap. Order Laco now—direct from this ad or from your dealer. **COMPLETELY INSTALLED IN ONLY AN HOUR**—any competent plumber or heating contractor can do it.

LACO JR. HEATS 2-8 Rooms as Low as \$70

Heat for the smallest home—a real power oil burner for small furnaces, parlor furnaces, parlor stoves, heatrolas, hot water heaters, etc., with Laco Jr. With or without automatic controls. Trouble free service. **OIL HEAT FOR A FRACTION OF A CENT AN HOUR.**

SPECIAL LOW WINTER PRICES—EASY PAYMENTS

Write immediately—now—for our **SENSATIONAL LOW PRICED MID-SEASON OFFER**, and the Laco easy payment plan. Install your burner now **PAY for it LATER.** 26 sizes and models. Simply tell us the type of heating system you have and the number of rooms you want to heat. Do it today!

LACO OIL BURNER CO.

One of the World's Largest Mfgs. of Industrial and Domestic Oil Burners

139 UNION STREET

GRISWOLD, IOWA, U. S. A.

There's A Better Living For Any Man of Limited Means and Education IN BARBERING



SHORT—PRACTICAL COURSE

*Protecting Laws Make It the Best Profession
in the Universe*

RALPH KUHLMAN has a Barber job on the Santa Fe running from Chicago to Los Angeles paying as high as \$60 a single trip. ARTHUR BAKER runs a shop in the exclusive great money district of Wall Street. He has accumulated a fortune. BOTH of these boys are MOLER GRADUATES. (Names of other graduates furnished on request.)

GOODNESS!!! GRACIOUS!!!

Why not learn a profession by enrolling in a school whose method of teaching and course of instruction is approved by all State Boards? There is a school near you. Write to the nearest one and see.

Standardized Branches Moler System of Colleges

139 E. 23rd St., New York City
512 N. State St., Chicago, Ill.
810 N. 6th St., St. Louis, Mo.
801 Main St., Kansas City, Mo.
206 E. 4th St., Cincinnati, Ohio
213 Huron Road, Cleveland, Ohio
559 Michigan Ave., Detroit, Mich.
1229-17th St., Denver, Colo.

1302 Douglass St., Omaha, Neb.
501 E. Water St., Milwaukee, Wis.
81 Forsyth St., N. W., Atlanta, Ga.
81 S. Second St., Memphis, Tenn.
1713 Commerce St., Dallas, Texas

Address Nearest Branch

Please send me without obligation on my part your Booklet B.

Name.....

Address.....

City.....State.....

BOYS! We'll GIVE You This

Here's great fun! A brand new type of repeating pistol. So realistic you couldn't tell it from real thing. Beautifully made, highly polished and bristled with a black grip. Shoots 50 fast shots at one loading—bang, bang, bang, zip, zip, zip! Don't confuse this great gun with cheap pistols. We guarantee this to please you. Over thousand rounds packed with each pistol. Get yours quick.

1000 Loud Shots
New Type Repeating Cap Pistol



A Really Great Offer

The Open Road for Boys Magazine is just crammed with blood tingling stories of aviation, high adventure on land and sea, deep mystery. 200,000 boys say these stories best published. Great departments, clubs, mechanics, contests galore with prizes for all. Regular subscription price \$1.00 a year. Send us \$1 each today and we will send you the magazine for a whole year and send you FREE (express collect—only few cents) this wonderful pistol and 1000 rounds of ammunition. We guarantee both magazine and pistol to please you 100% or money back. This is a great offer—a tremendous value. Hurry your order.

Open Road for Boys Magazine, Dept. CP, 130 Newbury Street, Boston, Mass.

LAW Free Book

Write today for FREE 64-page book, "THE LAW-TRAINED MAN", which shows how to learn law in spare time through the Blackstone home-study course prepared by 30 prominent legal authorities, including law school deans, and U. S. Supreme Court justices. Combination text and case method of instruction used. All material necessary furnished with the course, including elaborate 20-volume law library, delivered immediately upon enrollment. Many successful attorneys among our graduates. LL. B. degree conferred. Moderate tuition, low monthly terms. Money-back Agreement.

Write for free book today.

BLACKSTONE INSTITUTE, 307 N. Michigan Ave., Dept. 51, Chicago

BE AN ARTIST

WE CAN TEACH
YOU DRAWING in
your own home during your
spare time. Twenty-five years of
successful teaching proves our ability.

Write Today for Art Year Book

SCHOOL OF APPLIED ART
ROOM NO. 2 BATTLE CREEK MICH.

HOT PIANO

Ultra-modern Piano

Jazz taught by mail. Note or ear. Easy rapid lessons for adult beginners. Also Self-instruction system for advanced pianists. Learn 358 Bass Styles, 976 Jazz Breaks, hundreds of Trick Endings, Hot Rhythms, Sock, Stomp and Dirt Effects; Symphonic and Wicked Harmony in latest Radio and Record Style. Write for Free Booklet.

WATERMAN PIANO SCHOOL, 1828 W. Adams St., Los Angeles, Calif.

How To Get a Job in Engineering

An 80 page book, full of practical, helpful methods of obtaining a job in engineering—or, a better job than the one you now have. Sent postpaid for \$1.00.

WILSON ENGINEERING CORPORATION
Harvard Square Cambridge, Massachusetts, U. S. A.

Study LAW AT HOME

Lincoln did it! Also thousands of other great lawyers, politicians and business men. YOU, too, can become a lawyer or law trained businessman through home study guided by the successful practicing lawyers of our faculty. Write today for free book.

AMERICAN CORR. SCHOOL OF LAW
3601 Michigan Ave., Dept. 1351, Chicago

LEARN WATCHMAKING

and become independent. We help you secure a position. Easy to learn. Send for FREE CATALOG.

ST. LOUIS WATCHMAKING SCHOOL Dept. 5, ST. LOUIS, MO.

Wireless (Radio)

and Morse telegraphy taught thoroughly. School, oldest and largest endorsed by Telegraph, Radio, Railway and Government officials. Unusual opportunities. Expenses low—can earn part. Catalog free.

DODGE INSTITUTE, Jones St., Valparaiso, Indiana.



\$2500 Reward!

For the Capture of an Unknown Man

Twice he had entered the St. Clair Mansion. What was he after? Who? What was in danger?

Berteau, the famous operator, had warned St. Clair that the mysterious marauder would come again. And now—a noise in the passage! The creak of an opening door. A shot in the dark! A capture!

Is this wounded stranger the mysterious intruder? Who could tell? Yet Berteau identified the man without hesitation and won the \$2500 reward.

How did he do it? Easy enough for the Finger Print Expert. He is the specialist, the leader, the cream of experts. Every day's paper tells their wonderful exploits in solving mysterious crimes and convicting dangerous criminals.

More Trained Men Needed

The demand for trained men by governments, states, cities, detective agencies, corporations, and private bureaus is becoming greater every day. Here is a real opportunity for YOU. Can you imagine a more fascinating line of work than this? Often life and death depend upon finger print evidence—and big rewards go to the expert. Many experts can earn regularly from \$3,000 and more per year.

Learn at Home in Spare Time

And now you can learn the secrets of this science at home in your spare time. Any man with common school education and average ability can become a Finger Print Operator in a surprisingly short time.

FREE The Confidential Reports No. 38 Made to His Chief

Mail coupon now for free copy of confidential report Secret Service Operator No. 38 made to his chief. Get our big free book telling how you can become a real Finger Print Expert—gain fame and earn big rich rewards. Get our low prices and Easy Terms. But don't delay. Mail Coupon NOW!

Institute of Applied Science

Dept. 13-51 1920 Sunnyside Avenue, Chicago, Illinois

INSTITUTE OF APPLIED SCIENCE

1920 Sunnyside Ave., Dept. 13-51 Chicago, Ill.

Gentlemen:—Without any obligation whatever, send me free copy of Operator No. 38's confidential report, also your new, fully illustrated Free book on Finger Prints. Tell me all about your low prices and Easy Terms! Literature will NOT be sent to boys under 17 years of age.

Name

Address

Age



Says Good-bye to \$200 a Month

Now He Earns Better
Than \$10,000 a Year

At 45, C. J. Farris, of Memphis, Tenn., was earning \$200 a month as Credit Manager.

For years," he writes, "I did general accounting work for a large corporation, doing the physical work without an understanding of the underlying principles, which caused me untold worry and a constant unsatisfied position in connection with my service.

"Finally, as a way out, I enrolled for LaSalle home-study training in Higher Accountancy, and with the daily study of principles, and the solving of practical problems in Higher Accountancy under specialized instruction, came a rapid broadening of ability—a new self-confidence that put to rout the elements of fear and indecision."

And how quickly his income mounted!

Within a year came a "raise" to \$3,000—one year later, a more responsible position commanding \$5,000 salary—then, with the winning of his degree as Certified Public Accountant, his entrance into a highly profitable profession, and the building of his own highly successful accounting firm.

Send for Free Book—

"Accountancy, the Profession that Pays"

"I wish I could cry from a mountain top to young men everywhere, 'Educate yourself—prepare—qualify—for tomorrow your opportunity may come.'"

So writes Mr. Farris—and well he may, for right in his own experience he has proved the tremendous power of home-study training as an aid to progress.

Are you ambitious to make a real success in business—to fit yourself for positions paying \$3,000, \$5,000, \$10,000 a year, and even better? You do not need a knowledge of book-keeping to make your start. LaSalle trains you from the ground up, according to your individual needs. Low cost; easy terms.

If you are dissatisfied with your present equipment, you will find LaSalle's 64-page book, "Accountancy, the Profession that Pays," of the greatest help and inspiration—and—LaSalle will send it to you FREE. For the sake of a brighter future, clip and mail the coupon NOW.

— Find Yourself Through LaSalle! —

LaSalle Extension University

The World's Largest Business
Training Institution

Dept. 164-HR Chicago

I should be glad to have details of your salary-increasing plan as applied to my advancement in the business field checked below. Also a copy of "Ten Years' Promotion in One," all without obligation.

Higher Accountancy

- | | |
|---|---|
| <input type="checkbox"/> Business Management | <input type="checkbox"/> Modern Business Correspondence |
| <input type="checkbox"/> Modern Salesmanship | <input type="checkbox"/> Modern Foremanship |
| <input type="checkbox"/> Traffic Management | <input type="checkbox"/> Expert Bookkeeping |
| <input type="checkbox"/> Railway Station Mgmt | <input type="checkbox"/> C. P. A. Coaching |
| <input type="checkbox"/> Railway Accounting | <input type="checkbox"/> Business English |
| <input type="checkbox"/> Law—Degree of LL.B. | <input type="checkbox"/> Commercial Spanish |
| <input type="checkbox"/> Commercial Law | <input type="checkbox"/> Industrial Management |
| <input type="checkbox"/> Banking and Finance | <input type="checkbox"/> Effective Speaking |
| <input type="checkbox"/> Personnel Management | <input type="checkbox"/> Stenotypy—Stenography |
| <input type="checkbox"/> Credit and Collection Correspondence | <input type="checkbox"/> Telegraphy |

Name

Present Position

Address

BE A RAILWAY TRAFFIC INSPECTOR



RAILWAYS AND BUS Earn up to \$250 Monthly

Active men—19 to 55—needed at once in Railways and Bus Traffic Inspection. This steady, profitable work pays up to \$250 per month plus expenses. Interesting outdoor work. Travel or remain near home. We'll train you for this uncrowded profession and on completion of a few months spare time home instruction will assist you to a position paying from \$120 up per mo. or refund your tuition. Our free booklet tells what Traffic Inspection can do for you. Write for it today. Don't delay. Write

Standard Business Training Institute

Div. 2

Buffalo, N. Y.

NEW INDUSTRY NEEDS MEN

ELECTRIC REFRIGERATION needs you for sales service, installation and production jobs. Trained men earn up to \$60 and \$100 a week and more. Fast-growing field backed by General Motors, General Electric, etc. New, easy home training qualifies you quickly without textbooks. Praised by General Electric, Servel, Kelvinator, Copeland, Zerose and other manufacturers. Low cost—easy terms. Free employment service.

Valuable Book FREE

Contains big money facts—full details. Sent free—without obligation.

UTILITIES ENGINEERING INSTITUTE
4403 Sheridan Road Dept. 111

Chicago, Ill.

Anyone CAN LEARN

No talent or experience necessary. Fascinating work. Pays big money. Complete instruction book tells about Alphabets, Colors, How to Mix Paints, Show Cards, Window Board and Wall Signs, Ready-made letters, Gildings, Tricks of the Trade, also gives 100 Alphabets and Designs. Book bound in leather, 100% leather-bound edges, and four ball bearings. Show Card Form. Sent postpaid \$3.00. (C.O.D.) 10c extra.

Ogilvie Pub. Co., 57 Ross St., Dept. 20, N.Y. City

EARN MONEY IMMEDIATELY—
WE FURNISH EQUIPMENT TO START!!



WHY NOT spend Spring, Summer and Fall gathering butterflies, insects? I buy hundreds of kinds for collections. Some worth \$1 to \$7 each. Simple outdoor work with my instructions, pictures, price-list. Send 30 cents (not stamped) for my illustrated Prospectus before sending butterflies. MR. SUNCLAIR, DEALER IN INSECTS, San Diego, Calif. Dept. 6, Box 1424.



Minstrels

Unique First Parts for complete show with special songs and choruses. Make-up, Catalog free.

T. S. Denison & Co., 623 S. Wabash, Dept. 19 Chicago



BASHFUL?

"Shame on you!" Are you nervous, embarrassed in company of the other sex? Stop being shy of strangers. Conquer the terrible fear of your superiors. Be cheerful and confident of your future! Your faults easily overcome so you can enjoy life to the fullest. Send 25c for this amazing book.

RICHARD BLACKSTONE, B-471 Flatiron Bldg., N. Y.



Wonderful, new device; guides your hand; corrects your writing in a few days. Big improvement in three hours. No failures. Complete outline FREE. Write C. J. Orment, Dept. 34, St. Louis, Mo.

Drafting

will help you climb quickly to a Big Pay JOB

Business and industry today need draftsmen more than ever before. There could be no building, no progress without them. Modern mechanics, engineering, construction, rail-roading, aviation, building and manufacturing are constantly creating thousands of high-pay jobs for trained draftsmen. A tremendous field! Filled with unlimited opportunities and rich rewards. Drafting developed some of the world's greatest creative and inventive minds. High-position, fame, wealth have come to scores who used drafting as their foundation for success. For the ambitious young man of vision and a common school education no other vocation presents so many attractive possibilities. Investigate! You can learn drafting easily in spare time at home. No wide-awake draftsmen need wait years for success. Good pay right from the start—then up and up to a better job and still a bigger one according to one's ability to assume responsibility and do original creative work. If he designs something new or patentable his fortune is often made over night! It's been done time and time again! Every successful architect, engineer, contractor, inventor began with drafting.



\$5,000
a year and up

In no other line are there more \$5,000 and \$10,000 jobs waiting for trained men than in drafting. Chief draftsmen, consultants, executives, expert designers, layout men and department heads capable of supervising and directing a drafting force and assuming full responsibility are all highly paid. They know how to handle big, important assignments and plans which may involve the expenditure of millions. Often these key men become partners in the concern. Frequently they set up in business for themselves as architects, contractors, builders, manufacturers. Truly there is no limit to the success one may attain who takes full advantage of the opportunities thrown in the path of the expert, wide-awake draftsman.

\$3,600
a year and up

\$300 a month and up is readily commanded by draftsmen specially fitted for architectural, electrical, mechanical or structural work. Draftsmen usually specialize in a field which appeals most to their liking and aptitude. The opportunities are equally good in all specialized departments. Chicago TECH training includes specialization in any of the four big fields you may choose, and without extra tuition charge.

\$2,500
a year

Starting salaries vary from \$35 to \$50 a week. Thorough training assures swift promotion. No long years of waiting.

An Amazingly Easy Way to Learn

Nothing difficult about it . . . the simplest, shortest, step-by-step method you can imagine—the result of years of successful experience in teaching by mail and in our resident classes. Learn in spare time and evenings at home. Send for the Chicago TECH catalog of successes—engineers, architects, designers, builders, contractors, chief draftsmen, superintendents. Chicago TECH training was the ladder on which they climbed to big incomes. Low cost, easy terms. The first small tuition payment brings everything needed to start the course. Draftsman's table, all drawing instruments, tools, etc., a complete high-grade outfit furnished free of extra cost. Send coupon now for

Drafting Outfit FREE of Extra Cost

This exceptionally high-grade outfit, a \$25 value, complete in every respect, the same as used by expert draftsmen, is furnished without extra charge. Enrollment includes full equipment. No extras to buy. A small first payment under our easy installment plan brings at once everything needed to begin the course and assure rapid progress.



—tells everything you want to know—what to do and how to do it . . . to succeed quickly in practical drafting work. Opportunity is calling. This is the big chance you've long wanted. Grasp it today.

Big FREE Book on Drafting

Chicago Technical College,
Dept. A-204, 118 E. 26th St., Chicago, Ill.

Please send me postpaid, your big Free Book on Drafting, telling about opportunities and your College-Training-At-Home Plan. I have checked below the field in which I am particularly interested.

Architectural Mechanical Electrical
 Structural

Name.....Age.....

Address.....

City.....State.....

Check here if you prefer coming to Chicago to take our short resident day or evening course in Drafting.

Chicago TECHNICAL College

Dept. A-204, 118 E. 26th St., Chicago, Ill.

Architecture—Engineering—Drafting—Electricity—Building

We also offer complete resident day and evening classes in above subjects. Founded 1904, our College-Training-At-Home Plan is the result of 26 years experience in training men both in our Chicago College and by mail.

Take your pick



Operating on board ship gives you world-wide travel without expense and a salary of \$85 to \$200 a month besides.

Broadcasting Stations need trained men continually for jobs paying \$1,800 to \$3,000 a year.



Radio factories employ thousands. Salaries for well-trained men range from \$1,800 to \$5,000 a year.



Spare time set servicing is paying N. R. I. men \$200 to \$1,000 a year for their spare time. Earnings begin at once after enrolling.

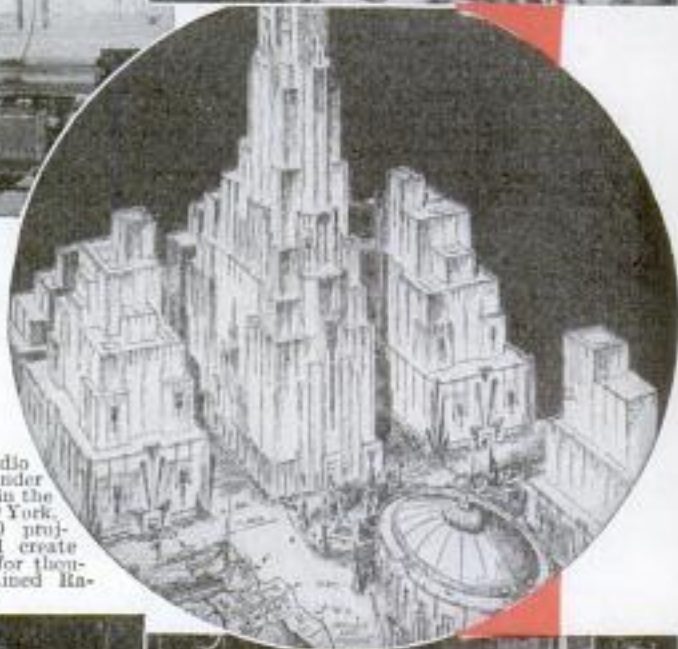

Amazing "Radio City", now under construction in the heart of New York. A \$250,000,000 project that will create employment for thousands of trained Radio workers.



Aviation is needing more and more trained Radio men. Operators employed through Civil Service Commission earn \$2,000 to \$2,800 a year.



Television—the coming field of many great opportunities—is covered by my course.



"Before I entered Radio I was making \$35 a week. Last week I earned \$110 servicing and selling Radios. I owe my success to N. R. I."
J. A. Vaughn,
3715 S. Kings Highway,
St. Louis, Mo.



Talking Movies—an invention made possible only by Radio—offers many fine jobs to well-trained Radio men, paying \$75 to \$200 a week.

"I have made more than \$400 each month and it really was your course that brought me to this."—J. G. Dahlstead, 1484 South 15th St., Salt Lake City, Utah.

You Must Have N.R.I. TRAINING TO BE A *Certified*

of These **BIG PAY** Radio Jobs

I'll Train You at Home in Your Spare Time

My Free Book Tells How—Send for It Today

RADIO is sweeping on to another astounding boom! Marvelous new developments, backed by enormous capital, are creating a tremendous new demand for more well-trained men. According to a recent article in the New York Times, William D. Terrell, Chief of the Radio Division of the U. S. Department of Commerce, says: "The Radio industry is far ahead of the supply of trained men in the field. We have well-paying positions in the government service that are going begging because there is no one to fill them."

That is why I urge you to send for my free, 64-page book, "Rich Rewards in Radio". It gives full information on the many opportunities to earn \$50, \$90, \$75 to \$100 a week in this fast-growing industry. It tells where the good jobs are, what they pay—and how, in your spare time, you can quickly fit yourself to get one through my amazingly simple 50-50 home-study training.

Many \$50 to \$100 a Week Jobs Opening Every Year

Many of my graduates are earning \$50 to \$100 a week. After completing my training you, too, should earn as good or even better pay. Hundreds of fine jobs are opening every year. Broadcasting Stations pay \$1,800 to \$5,000 a year to Radio engineers, operators and station managers. Radio manufacturers continually need testers, inspectors, foremen, engineers, service men, buyers, for jobs paying from \$1,800 to \$5,000 a year. Shipping companies use hundreds of operators, giving them world-wide travel, plus good pay and practically all expenses. Radio dealers and jobbers pay \$30 to \$100 a week to trained service men, salesmen, buyers and managers. Talking Movies pay as much as \$75 to \$200 a week to men with Radio training. And many trained men earn big money by opening a spare-time or full-time Radio sales and service business of their own.

Many Earn \$200 to \$1,000 in Spare Time, on The Side, While Learning

You stay right at home, hold your present job and learn in your spare time. Lack of high school education or Radio experience are no drawbacks. I teach you to begin making money shortly after you enroll. My new practical method makes this possible. I give you eight big laboratory outfits that teach you to build and service practically every type of receiving set made. Many of my students earn \$15, \$20, \$30 a week on the side while learning. Earle Cummings, 18 Webster St., Haverhill, Mass., writes: "I made \$375 in one month in my spare time, installing, servicing, selling Radio sets."

I Give You 8 Big Laboratory Outfits

You can build over 100 circuits with the Eight Big Laboratory Outfits that I give you. They make learning easy, fascinating, practical.

Television and Talking Movies Included

My training not only gives you a thorough knowledge of Radio—all you need to get and hold a good job—but also, upon graduation, you may take any one of my new advanced courses, without extra charge. They are Television, Aircraft Radio, Broadcasting, Commercial and Ship Radio Stations, Sound Pictures, Public Address Systems and Advanced Radio Servicing and Merchandising. You won't be a "one job" man when you finish my training. You'll know how to handle a job in any one of Radio's 20 different branches of opportunity.

The Only Way To Become A Certified Radio-Trician

You must have National Radio Institute Training to be a Certified RADIO-TRICIAN. The U. S. Government grants me exclusive right to give that valuable title to all who complete my training. It will help open the door to bigger pay in whatever branch of Radio you follow.

You don't risk a penny when you enroll with me. I back my training with a signed agreement to refund every cent of your money if, after completion, you are not satisfied with the Lesson and Instruction Service I give you.

Send For My Free Book—Today

Get the complete story of the many opportunities for trained men in radio today. Send for my free 64-page book of facts and photographs. It also contains full information on my course and tells what scores of graduates think of it. This book has put hundreds of fellows on the road to bigger pay and success. Why not you? Do yourself a favor—mail the coupon now for your free copy.

**J. E. Smith
Pres.
National Radio
Institute
Dept. 1 AP.
Washington, D. C.**



J. E. Smith, President



**\$100
a Week**

"My earnings in Radio are so many times greater than I ever expected they would be when I enrolled. They seldom fall under \$100 a week."—E. E. Winborne, 1414 W. 48th St., Norfolk, Va.

**\$800 in
Spare Time**



"Money could not pay for what I got out of your course. I did not know a single thing about Radio before I enrolled, but I have made \$800 in my spare time."—Milton J. Leiby, Jr., Topton, Pa.

Our Own Home

Pioneer and World's Largest Home-Study Radio training organization devoted entirely to training men and young men for good jobs in the Radio industry. Our growth has paralleled Radio's growth. We occupy over four hundred times as much floor space now as we did when organized in 1914.

MAIL THIS NOW!

J. E. SMITH, President
National Radio Institute, Dept. 1 AP,
Washington, D. C.

Dear Mr. Smith: Send me your book, "Rich Rewards in Radio", giving information on the spare-time and full-time opportunities to make big money in Radio; also your famous 50-50 method of home-study training. I understand this places me under no obligation and that no salesman will call.

NAME.....

ADDRESS.....

CITY.....STATE.....

**FREE
64 PAGE
BOOK**



RADIO-TRICIAN

"You won't be laid off!"



"It's tough when fellows get laid off. They've been cutting down some at our plant and everybody has been worried, wondering where the axe would fall next.

"It made me feel mighty good yesterday when the boss stopped and said he had a better job in mind for me. 'It's trained men like you we need around here,' he said, 'and it's too bad we must let some of the untrained go. If those fellows had used the foresight you did, and studied with the International Correspondence Schools, we'd be mighty glad to keep them too. Trained men never need to worry about their jobs around here!'"

Today, in all parts of the world, through training supplied by the International Correspondence Schools, thousands of men have made themselves so valuable that promotions and raises come to them regularly. In this modern age, it is the trained man who goes ahead! You can become a trained man! Why not find out how?

Just mark and mail the coupon today

INTERNATIONAL CORRESPONDENCE SCHOOLS

"The Universal University"

Box 5521-G, Scranton, Penna.

Without cost or obligation, please send me a copy of your booklet, "Who Wins and Why," and full particulars about the subject before which I have marked X:

TECHNICAL AND INDUSTRIAL COURSES

- | | |
|--|--|
| <input type="checkbox"/> Architect | <input type="checkbox"/> Automobile Mechanic |
| <input type="checkbox"/> Architectural Draftsman | <input type="checkbox"/> Plumbing <input type="checkbox"/> Steam Fitting |
| <input type="checkbox"/> Building Estimating | <input type="checkbox"/> Heating <input type="checkbox"/> Ventilation |
| <input type="checkbox"/> Wood Millworking | <input type="checkbox"/> Sheet Metal Worker |
| <input type="checkbox"/> Contractor and Builder | <input type="checkbox"/> Steam Engineer |
| <input type="checkbox"/> Structural Draftsman | <input type="checkbox"/> Steam Electric Engineer |
| <input type="checkbox"/> Structural Engineer | <input type="checkbox"/> Civil Engineer |
| <input type="checkbox"/> Electric Wiring | <input type="checkbox"/> Surveying and Mapping |
| <input type="checkbox"/> Electrical Engineer | <input type="checkbox"/> Refrigeration |
| <input type="checkbox"/> Electric Lighting | <input type="checkbox"/> R. R. Locomotives |
| <input type="checkbox"/> Welding, Electric and Gas | <input type="checkbox"/> R. R. Section Foreman |
| <input type="checkbox"/> Reading Shop Blueprints | <input type="checkbox"/> R. R. Bridge and Building Foreman |
| <input type="checkbox"/> Telegraph Engineer | <input type="checkbox"/> Air Brakes <input type="checkbox"/> Train Operation |
| <input type="checkbox"/> Telephone Work | <input type="checkbox"/> Highway Engineering |
| <input type="checkbox"/> Mechanical Engineer | <input type="checkbox"/> Chemistry <input type="checkbox"/> Pharmacy |
| <input type="checkbox"/> Mechanical Draftsman | <input type="checkbox"/> Coal Mining Engineer |
| <input type="checkbox"/> Machinist <input type="checkbox"/> Toolmaker | <input type="checkbox"/> Navigation <input type="checkbox"/> Boilermaker |
| <input type="checkbox"/> Patternmaker | <input type="checkbox"/> Textile Overseer or Supt. |
| <input type="checkbox"/> Pipefitter <input type="checkbox"/> Tinsmith | <input type="checkbox"/> Cotton Manufacturing |
| <input type="checkbox"/> Bridge Engineer | <input type="checkbox"/> Woolen Manufacturing |
| <input type="checkbox"/> Bridge and Building Foreman | <input type="checkbox"/> Agriculture <input type="checkbox"/> Fruit Growing |
| <input type="checkbox"/> Gas Engines <input type="checkbox"/> Diesel Engines | <input type="checkbox"/> Poultry Farming <input type="checkbox"/> Radio |
| <input type="checkbox"/> Aviation Engines | <input type="checkbox"/> Marine Engineer |

BUSINESS TRAINING COURSES

- | | |
|---|--|
| <input type="checkbox"/> Business Management | <input type="checkbox"/> Business Correspondence |
| <input type="checkbox"/> Office Management | <input type="checkbox"/> Lettering Show Cards <input type="checkbox"/> Signs |
| <input type="checkbox"/> Industrial Management | <input type="checkbox"/> Stenography and Typing |
| <input type="checkbox"/> Personnel Management | <input type="checkbox"/> Complete Commercial |
| <input type="checkbox"/> Traffic Management | <input type="checkbox"/> Civil Service <input type="checkbox"/> Mail Carrier |
| <input type="checkbox"/> Accountancy <input type="checkbox"/> Cost Accountant | <input type="checkbox"/> Railway Mail Clerk |
| <input type="checkbox"/> C. P. Accountant | <input type="checkbox"/> Grade School Subjects |
| <input type="checkbox"/> Bookkeeping | <input type="checkbox"/> High School Subjects |
| <input type="checkbox"/> Secretarial Work | <input type="checkbox"/> College Preparatory |
| <input type="checkbox"/> Spanish <input type="checkbox"/> French | <input type="checkbox"/> Illustrating <input type="checkbox"/> Cartooning |
| <input type="checkbox"/> Salesmanship <input type="checkbox"/> Advertising | <input type="checkbox"/> Lumber Dealer |

Name.....Age.....

Address.....

City.....State.....

Occupation.....

If you reside in Canada, send this coupon to the International Correspondence Schools Canadian, Limited, Montreal, Canada

Complete Drummer's Outfit

for as Little as \$35
HOME TRIAL
EASY PAYMENTS

YOU can quickly learn to play the drums, then popularity is yours. Invited everywhere. Chances to play in bands and orchestras. Free book of instruction given with each outfit. Amazingly small investment to start. Leedy drums are used and recommended by America's greatest professionals. Standard since 1886. You can own a complete Leedy outfit—Bass Drum, Snare Drum and Traps for as little as \$35. Home Trial, Easy Payments. Write for free booklet and special offer.

LEEDY MANUFACTURING CO.
108 Leedy Building
Elkhart, Ind.



Instruction Book Included

Mysterious Power of Pelmanism

Let us send you a free copy of "Scientific Mind Training." An instructive book which explains an amazing system of mind training already used by more than 650,000 people. It will show you how and why Pelmanism is the only system of teaching for developing all the mental powers at the same time. Endorsed by such distinguished men as Judge Ben H. Lindsey, Sir Harry Lauder, Jerome K. Jerome, Prince Charles of Sweden and hundreds of others. Write TODAY to

THE PELMAN INSTITUTE OF AMERICA

71 WEST 45th STREET DEPT. 61 NEW YORK CITY



Learn Public Speaking

At home—in spare time—20 minutes a day. Overcome "stage-fright," gain self-confidence, increase your salary, through ability to sway others by effective speech. Write now for free booklet, *How to Work Wonders With Words*. NORTH AMERICAN INSTITUTE, Dept. 4351, 3601 Michigan Avenue, Chicago, Illinois

Government Positions

Clerk Carriers, Rural Carriers, Railway Mail Clerks, Postmasters, Department Clerks, and many others. Splendid salaries, easy work, vacation with pay. Only common school education required. Examinations often. 44,817 appointed last year. Send for our Civil Service Catalog No. 6. COLUMBIAN CORRESPONDENCE COLLEGE, Washington, D. C.

ENGINEERING ELECTRICAL · MECHANICAL · STRUCTURAL and ARCHITECTURE

INTENSIVE PRACTICAL TECHNICAL COURSES. Degree in 2 years. Diploma in 1 year. Special short courses 6 Weeks to 4 Months in Electricity, Radio, Power Plant, Electric Refrigeration, Arcuate Welding, Wiring, Testing, Drafting, Welding. LOW TUITION. Expert instructors. Extensively equipped laboratories. Free lifetime employment service for graduates. Part-time work while attending. Write for new free illustrated catalog giving all facts. 29th year.

FINLAY ENGINEERING COLLEGE
1001 A Indiana Avenue
Kansas City, Missouri



1000 Hotel Positions Open!



Clifford Lewis

HOTELS, Restaurants, Clubs, Apartment Hotels, Institutions, Camps, Schools, Colleges, Hospitals, etc., everywhere need trained men. Over 70,000 high-class positions as Manager, Assistant Manager, Steward, Room Clerk, Purchasing Agent, Sports Director and scores of other executive positions, paying from \$2,500 to \$10,000 a year, are open each year in the hotels of the United States alone. Nearly two billion dollars' worth of new hotels, apartment hotels, clubs, restaurants and institutions being built this year will need over 200,000 trained men and women.

I WILL TRAIN YOU IN YOUR SPARE TIME

Through our Personal Coaching Plan, which adapts the instruction to your individual needs and requirements, you can qualify for a well-paid position in your spare time. At any time there are over 1,000 positions open. I put my students in touch with positions. All over the United States they are eagerly sought by the biggest and best hotels. Hotels start you at salaries up to \$2,500 a year with your living often included. If you want a steady, permanent position, with quick advancement, fascinating work, big pay, fine living, with meals and luxurious apartment often furnished **FREE**—you can find it in hotel work.

Opportunity Coupon 1000 Hotel Positions Open!

Lewis Hotel Training Schools,
Room DA-310, Washington, D. C.

Send me without obligation the FREE BOOK, "Your Big Opportunity," with details about Registration in the Lewis National Employment Bureau.

Name

Address

City.....State.....

**No
Previous
Experience Necessary**

We train you by mail in your spare time at home with the Lewis Personal Coaching Plan and put you in touch with big opportunities. All of your training under the personal supervision of Clifford Lewis, former U. S. Government Hotel and Restaurant Expert, who has been appointed Managing Consultant by over 300 hotels throughout the United States. Through Lewis Training, Harold Bennetts became Manager of a Wyoming hotel. L. V. Huckman became Assistant Cashier of a beautiful resort hotel although absolutely inexperienced in hotel work before taking the Lewis Course. Frederick Weber was appointed Storekeeper of a Kansas Hotel after he received his diploma from the Lewis Schools.

FREE BOOK GIVES FULL DETAILS

No matter what your present occupation is—there are opportunities for you in the big-paying hotel and institutional field. Many students have obtained splendid hotel positions paying as high as \$2,500 a year, even before they had finished the course. My Free Book—"Your Big Opportunity"—shows

how you can do as well and explains how you are registered in our National Employment Bureau free of extra charge. Mail the coupon at once for your free copy of "Your Big Opportunity," explaining our Money-Back Agreement and showing how we can train you for one of these splendid positions. Send for it today—NOW—before you forget.

LEWIS HOTEL TRAINING SCHOOLS

Room DA-310

CLIFFORD LEWIS, Pres.

Washington, D. C.

The Original and Only School of Its Kind in the World

MEN WANTED

20 to 35 years old

RADIO

First Lesson Free!

Broadcasting
Television
"Talkies"
Manufacturing
Service
Sales
Auto-Radio
Aviation

See how easy
to learn

See how quickly you can
get ready for well-paid
positions in fastest
growing, most prosperous
industry.

Big demand *right now*
from employers for broadcast operators, test-
ers, inspectors, service-men, designers, in-
stallers, and "trouble shooters."

\$40 to \$75 a week—and more!

With free radio lesson we'll send you our amazing com-
bined training and employment agreement—good for
help in securing a beginner's job, *when you're only half way*
through. Guarantees you help in finding a position, satis-
factory in salary, after you finish, or money refunded.

**A World of Opportunities
to Choose From**

Rockefeller is building a \$500,000,000.00 "radio center"
in New York. 20,000 movie theaters have gone "talkie."
Auto-Radio is selling like wild-fire. Midget sets are sell-
ing at rate of 10,000 a day! Aviation, television, serv-
icing, sales—all these mean highly paid jobs and plenty of
them. All you need to get one is the kind of training we
give you, backed by a real placement service.



RADIO TESTER
GIVEN

\$20.00 set analyzer and
trouble-shooting job-
tickets a part of this
training without extra
charge.

THE AMERICAN SCHOOL
Dept. R-147, Drexel Ave. & 58th St., Chicago

Please send me without cost or obligation, free radio lesson and
job ticket and radio bulletin.

Name.....Age.....

St. No.....

City.....State.....

Lesson FREE!
Mail Coupon

for free radio lesson and book
of thrilling facts about this
wonder-industry and how to
"break in."

American School
Dept. R-147, Drexel Ave.
& 58th St., Chicago



Get Strong!
**Eight Improved
Muscle Builders**
All for \$3.75



Easily master feats which now seem difficult.
If you want physical culture for health this
equipment is what you need. **SAVE AT LEAST
HALF!** We furnish ten solid sheet crossbar
adjustable to 200 lbs. resistance. Made of new
live extra strength rubber to give resistance
needed for pure muscle development. Pair of
patented hand grips develop powerful grip
and arm. Wall exercising parts develop back,
arms and legs. Head strap permits exercise
of neck muscles. Develop leg muscles with foot strap
—gives speed, endurance.
**Illustrated course shows
how to develop any part
of body.**

GUARANTEE
Entire satisfac-
tion guaranteed
or money back.

SEND NO MONEY

Send name and address. We send all by re-
turn mail. Pay postman \$0.75 plus postage.
(If you live outside U. S. A. price \$4.50 cash
with order.)

MUSCLE POWER CO., Dept. PM-1
150 Nassau St.
NEW YORK, N. Y.

STAMMER
Write for my free book "Millard's Advanced
Natural Corrective Course" and a free copy of
my speech magazine. 10,000 cases successfully treated.
Est. 24 years. Largest school for stammerers in world.
Millard Inst. of Normal Speech, 2517 Millard Bldg., Milwaukee, Wis.

LEARN WATCH REPAIRING



You can learn by our modern and original system
of instruction every part of the **Watch Repairing**
Trade at home as good or better than at a shop.
You can earn money while learning and secure a
well paying position or start in business after com-
pleting our course of instruction. Good watch
repairers are always in demand and earn from
\$20 to \$75 per week. For particulars apply to the
Wisconsin School of Watch Repairing
524 E. Mason St., MILWAUKEE, WIS.



Free Banjo Instructor
with the LUDWIG
HIP-TOP BANJO

A banjo by the famous makers of pro-
fessional instruments—with snappy
tone, big volume and playing qual-
ities that make it easy for you to
master quickly.

ONLY
\$19.85

Free Trial; Easy Payments. Complete self instructor
simple and easy to follow, free with every banjo. Send
now for literature and details; no obligation, of course.

LUDWIG AND LUDWIG
102B Ludwig Bldg., 1611-1627 N. Lincoln St., Chicago, Illinois

ANOTHER PARKS TRAINED STUDENT MAKES GOOD



The Story of Richard McMakin

Pilot for Big-Ben Beverage Corporation



"Mr. McMakin has demonstrated that he is thoroughly trained"

Limited Commercial Training at Parks

Classes McMakin as a "Top-Grade" Pilot

WE DON'T need to say much, in this advertisement. *The facts speak for themselves!* Here's another Parks graduate (February, 1930) that is a "top-grade" pilot. And don't forget! He took *only a Limited Commercial Course*—yet read again what his employer says of his training and ability. Isn't *this* the kind of training *you* want? Then, clip the coupon NOW, and get full information.

Parks Air College was one of the first to be licensed by the U. S. Department of Commerce as a fully accredited transport school

PARKS AIR COLLEGE

World's Largest and Finest Civilian Flying School
DIVISION OF DETROIT AIRCRAFT CORPORATION

Section 1-120 Parks Airport
EAST ST. LOUIS ILLINOIS

MAIL THE COUPON TODAY!

- - COUPON - -

PARKS AIR COLLEGE,
1-120 Parks Airport, East St. Louis, Ill.

Without cost or obligation to me,
please mail your illustrated catalog.

Name _____
Street address _____
City _____ State _____
Occupation _____ Age _____

I am interested in
Pilot's Course
Mechanic's Course

"You Improved My Saxophone Playing better than 100% in 3 Weeks"

Philip Sarvello



**Famous Saxophone Player
Leading Chicago Orchestra**

**Wind Instrument Players
ATTENTION
100%
Improvement
Guaranteed!**

For over ten years Sarvello had been troubled with "slow tongue" . . . In three weeks I improved his playing better than 100% . . . his "slow tongue" trouble left him . . . today he writes me: "What you have done for me is almost unbelievable . . . I also want to thank you for the wonderful improvement you have brought about in my singing voice as well" . . .

What I have done for Sarvello I GUARANTEE TO DO FOR ALL WIND INSTRUMENT PLAYERS! . . . and remember—I also guarantee to improve your singing voice 100%, too! . . . you know what a good singing voice means today to any orchestra player . . . BIG PAY AND FAME . . . Write at once for free literature telling all about my astounding method that guarantees at least 100% improvement or every penny of your tuition REFUNDED!

**Eugene Feuchtinger, Dept 93-51
Suite 29, 1810 Wilson Ave., Chicago, Ill.**

**EUGENE FEUCHTINGER, Dept. 93-51
Suite 29, 1810 Wilson Ave., Chicago, Ill.**

Please send me FREE and without obligation your free literature telling all about Prof. Feuchtinger's great method and his "Money Back" guarantee.

Name _____

Address _____

City _____

State _____

FREE BOOKS of BUSINESS HELPS

We publish over 200 Home Study Books, each a complete treatise of its subject. We have one or more for you. Books on

- | | |
|--|---|
| <input type="checkbox"/> Commercial Art | <input type="checkbox"/> Decoration |
| <input type="checkbox"/> Lettering | <input type="checkbox"/> Automobiles |
| <input type="checkbox"/> Advertising | <input type="checkbox"/> Battery Work |
| <input type="checkbox"/> Sign Making | <input type="checkbox"/> Electricity |
| <input type="checkbox"/> Radio | <input type="checkbox"/> Carpentry |
| <input type="checkbox"/> Aviation | <input type="checkbox"/> Building |
| <input type="checkbox"/> Painting | <input type="checkbox"/> Contracting |
| <input type="checkbox"/> Silk Screen Process | <input type="checkbox"/> Sheet Metal Work |

and many other subjects. All fully described in our FREE CATALOG. Check the subjects in which you are interested and write today.

FREDERICK J. DRAKE & CO., Publishers
Room 508—179 No. Michigan Blvd., Chicago
Drake books are for sale in all book stores.

ACCOUNTING

The uncrowded, highly paid profession of Accountancy offers marvelous opportunities to ambitious men and women. Send for our new book, "The Accountant—Who he is, What he does, How to become one," and the first easy lesson. Both will be sent free. In reply please state age and position.

INTERNATIONAL ACCOUNTANTS SOCIETY, Inc.
A Division of the
Alexander Hamilton Institute
Dept. 173, 3411 South Michigan Ave., Chicago, Ill.



DRAW ME And Win a Scholarship!

Copy picture free-hand twice size or larger. Use pencil crayon or ink. Print name and address on back. Mail to us. Every drawing graded. Students earning highest grades will receive as prize new complete Home-Study Course in Commercial Art, with professional tools and equipment. All others earning passing grades will receive scholarship awards. Offer open only to students over 16 years. Draw picture today. Mail at once.

CIRCLE ART ACADEMY of Indianapolis
639-4 Meyer-Kiser Bank Building Indianapolis, Ind.

BE AN OIL EXPERT!

New, easy, practical way to learn at home in spare time. Geology, Drilling Methods, Pipe Line Transportation, Refining and Marketing.

Write Today! FREE Book!

PETROLEUM ENGINEERING UNIVERSITY, Dept. 221, FORT WAYNE, IND.



"BECOME A LIGHTNING TRICK CARTOONIST"

Send \$1.00 for Laugh Producing Program of 21 Trick Drawings with instructions. Catalog of Chalk Talk Supplies Free.

BALDA ART SERVICE, Dept. 1, Oshkosh, Wis.

LEARN MECHANICAL DENTISTRY

EARN BIG MONEY—MEN NEEDED EVERYWHERE. This money-making business easily learned in a few months in day or evening sessions. Practical training, individual instruction. Easy terms. School highly endorsed. Write NOW for free catalogue P and special tool offer. Address **NEW YORK SCHOOL OF MECHANICAL DENTISTRY, 125 W. 31st St., New York**



AN EASY WAY TO SHAPE your NOSE

Anita Nose Adjuster shapes flesh and cartilage—quickly, safely, painlessly, while you sleep or work. Lasting results. Gold Medal Winner. Doctors praise it. 78,000 users. Write today for **FREE BOOKLET.**

ANITA INSTITUTE, A-12 Anita Bldg., Newark, N. J.

FREE Write For It TODAY!

NEW Helpful Pay-Raising Plan

My
Job-Securing
and
Pay-Raising
Plan
Engineer Dobe

Draw This JACK
any size you wish



and

Get This Rule FREE!



Hurry!

Send me copy of Jack. I want to see what kind of a Draftsman you will make. Copy it quick and I'll send you the Draftsman's Pocket Rule, free, right away.

Write to me. I will send you this new book. Not a catalog. My Pay-Raising Plan and Money-Making Advice. I can prove that John Savadge, trained by me, makes \$300 a month. Earl J. Dupree, trained by me, refused \$600 a month because he makes more in his own business. A. H. Bernier, trained by me, earns \$7000 to \$9000 a year. Arthur Dewalt, trained by me, makes more than \$400 a month. D. C. Stroop, trained by me, makes \$475 a month. L. V. Broughten, trained by me, makes \$300 a month. Now is the time to learn to be a draftsman. Get Free, "My Pay-Raising Plan." Send for it at once. Read this advertisement clear through. See for yourself how you can make real money as a draftsman. Read how much work there is.

I Train You at Home

My practical working method makes every step in learning drafting as clear as a moving picture. That's why I train you so fast to be a draftsman.

Money Back If Not Satisfied

I train you under a positive Money-Back Agreement. If my training does not satisfy you after you have finished you get every penny back.



You Get These Money-Making Tools

These Drawing Instruments and 14 other Tools furnished with my Course.

Earn While You Learn

You can start earning money a few weeks after beginning my training. I give you special work and tell you how to make money.

Money-Making Tools Furnished

You get these fine quality, genuine, imported draftsman's tools, just as soon as you become my student. No finer tools made for practical drafting work.

Employment Service

After training you I help you to get a job without charging you a cent for this service. Employers of draftsmen come to me for men because they know that men I train make good.

Draftsmen Needed In:

Auto Work

The automobile industry is one of the greatest in America. Thousands of draftsmen needed. I'll train you for the work.

Electricity

Electricity is the coming motive force of the world. Draftsmen are needed in every department of this fascinating work. I'll train you at home. Get a job here.

Aviation

Aviation is just in its infancy. It is bound to expand to enormous proportions. Draftsmen are essential to it. I'll train you quick at home for drafting position.

Motor Bus Work

Motor bus building and motor bus transportation have become leading world industries. Hundreds of draftsmen engaged in this work. I'll show you the way.

Building Work

There will always be building. No structure can be erected without plans drawn by draftsmen. I'll make you an architectural draftsman.

Age or Lack of Education
No Drawback

You do not need previous experience. You do not need to be a high school graduate. My practical home study course gives you just the training needed to become a practical draftsman.

If You Earn Less Than \$70 a Week Write Me Today!

ACT NOW

Before you put this Magazine Down let me send you "My Pay Raising Plan". Remember Draftsmen are needed everywhere. That's the kind of profession to get into. Mail this coupon today.

Engineer Dobe, 1951 Lawrence Avenue Div. 13-51 Chicago, Ill.

Mail Coupon—Get Free Rule!

ENGINEER DOBE

1951 Lawrence Ave., Div. 13-51 Chicago

Send me free rule; also send me free of all cost "My Pay-Raising Plan"—how to earn money while learning and proof of big money paying positions in big industries right now.

Name.....Age.....

Address.....

Post Office.....State.....

Learn Electricity IN LOS ANGELES

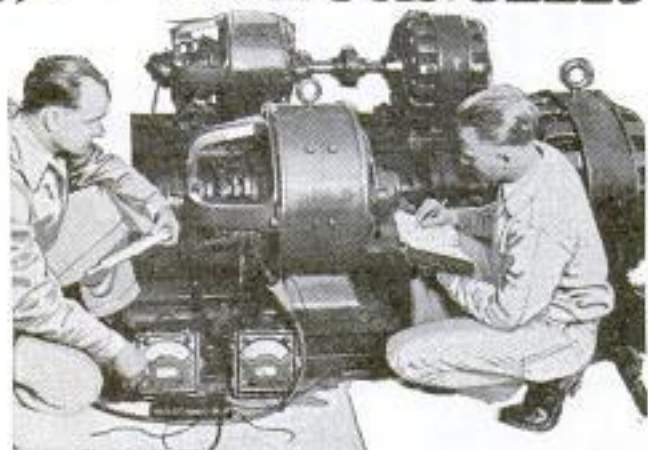

and LEARN IT RIGHT!

1. What Kind of a School Is NATIONAL?

NATIONAL is a Million Dollar institution—established in 1905—recognized throughout the electrical industry as one of America's foremost trade schools. NATIONAL offers practical, intensive training in all electrical branches. All technical essentials included. No age limit. No previous experience necessary. Life Scholarship privileges. Start any time of the year.

2. How Long to Learn Electricity?

NATIONAL properly trains you in the short time of 6 to 9 months. Upon completing this Condensed Course you are fully qualified as a Practical, Competent Electrician, and you have not risked your chances of employment because of inferior, incomplete instruction.

3. What Employment Service Does NATIONAL Guarantee? NATIONAL GUARANTEES to give unlimited and efficient Employment Service to students wishing to earn living expenses while learning; and to graduates getting started in the electrical field. This is the most any reputable school can be expected to do.

4. What Inducements Does NATIONAL Offer?

NATIONAL offers YOU the very best technical-practical training that money can buy at a cost within every man's reach. It does not offer to pay your railroad fare, room and board or other personal expenses, preferring to limit its activities to the PROPER TRAINING OF MEN FOR SUCCESS.

5. Why You Should Come to LOS ANGELES!

LOS ANGELES is the heart of the country's most rapid electrical development—as well as the world's most ideal city in which to live and prepare for success in electricity.

WRITE for FREE BOOK NOW!

NATIONAL Electrical School

Dept. 14-E, 4006 Figueroa St.,
Los Angeles, California.

Send me your big free illustrated catalog of
Electrical Opportunities showing how I can learn
quickly and get a Big-Pay Electrical Job.

Name.....
Address.....
Age..... City..... State.....



Instant Hot Water from any COLD WATER faucet

Simply attach a Hot Shot Electric Water Heater as shown in picture, plug cord in electrical outlet, turn switch and get an unlimited supply of pure, hot water instantly, at any desired temperature. A "Hot Shot" fits all faucets, can be moved from one faucet to another in a jiffy. A REAL necessity for homes, shops, garages, or anywhere hot water is desired. Sold at a price anyone can afford, a "Hot Shot" gives



Has Auto' magic Shot' of 5 - uses minimum amount of electricity; enamel - complete with Adapter for all faucets and waterproof, insulated cord. Fully Guaranteed. Write for low price.

Unlimited Hot Water Service

Desirable
Territory Open
To Responsible
Agents

Write at once for full information, descriptive literature, and low introductory price—less than one-fifth the cost of a small unit tank system. Write now—address:

Hot Shot Electric Water Heater Corp.
Dept. 500
520 N. Michigan Ave., Chicago, Ill.

FREE Radio Handbook

Write today for your copy of the new Radio Association handbook. Shows you easy ways to make money in Radio. Tells you how our members are clearing up \$2.50 an hour spare time. Write for Free Radio Handbook. Plans which need not cost you a cent and FREE RADIO HANDBOOK. RADIO TRAINING ASSOCIATION OF AMERICA Dept. PM-1 4812 Ravenswood Ave., Chicago

Learn Watchwork, Jewelrywork and Engraving A fine trade commanding a good salary, and your services always in demand. Address **Horological**, Dept. P, Bradley Institute, PEORIA, ILLINOIS, for our latest catalog.



Astrology Will You Be Lucky in 1931?

What do the Stars foretell for 1931? Would you like to know? Our Special 12-page Astrological Reading gives predictions, month by month—with exact days, dates and happenings for 1931 based on your Sign of the Zodiac. Consult it before making any change in home or business affairs, signing papers, love, marriage, seeking employment, plans in money, speculation, travel, friends, enemies, health, accidents, lucky days, etc. Send exact birthday with \$1.00 for reading.

FRANKLIN PUB. CO., 860 N. Clark St., Dept. 2901, Chicago

1931 Radio Catalog

RADIO BARGAINS

WHOLESALE DISCOUNTS

LOWEST PRICES

RADIO CATALOG 1931

Greatest Bargains shown at **REGULAR WHOLESALE TRADE DISCOUNTS!**

Nationally-advertised, guaranteed radio merchandise including the sensational **beamed LAVA VITE ALL ELECTRIC RADIO RECEIVER**, with tone control. Write at once for FREE 1931 Radio Bargain Catalog, showing complete selection. Don't buy until you see this wonder catalog!

WHOLESALE RADIO SERVICE CO.
Dept. A-11
38 Vesey St. New York

FREE!

Want a Steady U. S. Government Job?



RAILWAY POSTAL CLERKS COMMENCE \$1900 YEAR

Many U. S. Government Jobs Open to Men and Women 18 to 50

POST OFFICE CLERKS—IMMIGRANT INSPECTORS
RURAL CARRIERS GENERAL OFFICE CLERKS
INSPECTORS OF CUSTOMS—CITY MAIL CARRIERS

These are steady positions. Strikes, poor business conditions, lockouts or politics will not affect them. U. S. Government employees get their pay for full twelve months every year. There is no such thing as "HARD TIMES" in the U. S. Government Service.

RAILWAY POSTAL CLERKS

Railway Postal Clerks now get \$1900 the first year regular, being paid on the first and fifteenth of each month, \$79.16 each pay day. Their pay is quickly increased, the maximum being \$2700 a year, \$112.50 each pay day. They get extra allowance for hotel expenses when away from home.



PAID VACATIONS

Railway Postal Clerks, like all Government employees, are given a yearly vacation of 15 working days (about 18 days). On runs they usually work three days and have three days off duty or in the same proportion. During this off duty and vacation, their pay continues just as though they were working. When they grow old, they are retired with a pension. As Railway Postal Clerks are continually traveling, they have an excellent chance to see the country. Spring examinations expected.

CITY MAIL CARRIERS—POST OFFICE CLERKS

Clerks and Carriers commence at \$1700 a year and automatically increase \$100 a year to \$2100 with further increase to \$2300. They also have 15 days vacation. City residence is unnecessary. Many February examinations expected.

GENERAL CLERKS—FILE CLERKS

(Open to men or women 18 to 50)
Salary \$1260 and \$1440 to \$2500 a year. Pleasant clerical work in the departments and offices at Washington, D. C., and throughout the country.

WHAT WILL YOU EARN FIVE YEARS FROM NOW?

Compare these conditions with your present or your prospective condition, perhaps changing positions frequently, kicking around from post to pillar, no chance in sight for PERMANENT employment; frequently out of a position and the year's average salary very low. DO YOU EARN \$1900 EVERY YEAR? HAVE YOU ANY ASSURANCE THAT A FEW YEARS FROM NOW YOU WILL GET \$2700 OR MORE A YEAR EVERY YEAR?

GET FREE LIST OF POSITIONS

Fill out the coupon. Tear it off and mail it today—now, at once. DO IT NOW—This investment of two cents for a postage stamp may result in your getting a U. S. Government Job.



FRANKLIN
INSTITUTE
Dept. T174
ROCHESTER, N. Y.

Rush to me, entirely free of charge (1) a full description of the position checked below; (2) Free copy of illustrated 32-page book, "U. S. Government Positions and How to Get Them"; (3) Tell me how to get the Position checked.

MAIL COUPON TODAY

Railway Postal Clerk.....(\$1900-\$2700)
Post Office Clerk.....(\$1700-\$2300)
City Mail Carrier.....(\$1700-\$2100)
Rural Mail Carrier.....(\$2100-\$3300)
General Clerk—File Clerk.....(\$1260-\$2500)
Inspector of Customs.....(\$2100 Up)
Immigrant Inspector.....(\$2100 Up)

Name.....

Address.....

Use This Coupon Before You Mislay It—Write or Print Plainly



Mechanical Engineering

Learn at Home

MECHANICAL Engineering embraces the design, construction and operation of machines and machine tools. It is a profession which offers almost unlimited opportunities to men who combine natural mechanical ability with technical training.

For this is The Age of Machinery. Almost every convenience, luxury or necessity which we enjoy depends on machinery for its production or adaptability to our needs. Every new invention multiplies the opportunities for competent designers, builders, erecting engineers, etc.

One of the best ways to train yourself to secure a position as a Mechanical Engineer is through the home-study courses of the International Correspondence Schools.

These courses are complete and up-to-date, and especially arranged to meet the needs of the student who studies at home.

They are particularly helpful because they are written by well-known mechanical engineers with years of practical experience, who know the quickest, best way to solve every problem.

Just mark and mail the coupon and we'll gladly send you Free Booklets describing the I. C. S. courses in Mechanical Engineering or any other course in which you are interested.

INTERNATIONAL CORRESPONDENCE SCHOOLS

Box 5324-G, Scranton, Penna.

Without cost or obligation, please send me a copy of your booklet, "Who Wins and Why," and full particulars about the course before which I have marked X in the list below:

- | | |
|--|---|
| <input type="checkbox"/> Mechanical Engineering | <input type="checkbox"/> Toolmaking |
| <input type="checkbox"/> Mechanical Course | <input type="checkbox"/> Blacksmithing and Forging |
| <input type="checkbox"/> Drafting | <input type="checkbox"/> Patternmaking |
| <input type="checkbox"/> Mechanical Drawing | <input type="checkbox"/> Foundrywork |
| <input type="checkbox"/> Complete Shop Practice | <input type="checkbox"/> Machine Shop Practice |
| <input type="checkbox"/> Architect | <input type="checkbox"/> Plumber and Steam Fitter |
| <input type="checkbox"/> Architectural Draftsman | <input type="checkbox"/> Plumbing Inspector |
| <input type="checkbox"/> Building Foreman | <input type="checkbox"/> Foreman Plumber |
| <input type="checkbox"/> Concrete Builder | <input type="checkbox"/> Heating and Ventilation |
| <input type="checkbox"/> Contractor and Builder | <input type="checkbox"/> Sheet-Metal Worker |
| <input type="checkbox"/> Structural Draftsman | <input type="checkbox"/> Steam Engineer |
| <input type="checkbox"/> Structural Engineer | <input type="checkbox"/> Marine Engineer |
| <input type="checkbox"/> Electrical Engineer | <input type="checkbox"/> Refrigeration Engineer |
| <input type="checkbox"/> Electrical Contractor | <input type="checkbox"/> R. R. Positions |
| <input type="checkbox"/> Electric Wiring | <input type="checkbox"/> Highway Engineer |
| <input type="checkbox"/> Electric Lighting | <input type="checkbox"/> Chemistry <input type="checkbox"/> Pharmacy |
| <input type="checkbox"/> Electric Car Running | <input type="checkbox"/> Mining Engineer |
| <input type="checkbox"/> Telegraph Engineer | <input type="checkbox"/> Navigation <input type="checkbox"/> Assayer |
| <input type="checkbox"/> Telephone Work | <input type="checkbox"/> Iron and Steel Worker |
| <input type="checkbox"/> Civil Engineer | <input type="checkbox"/> Textile Overseer or Supt. |
| <input type="checkbox"/> Surveying and Mapping | <input type="checkbox"/> Cotton Manufacturing |
| <input type="checkbox"/> Bridge Engineer | <input type="checkbox"/> Woolen Manufacturing |
| <input type="checkbox"/> Gas Engine Operating | <input type="checkbox"/> Agriculture <input type="checkbox"/> Fruit Growing |
| <input type="checkbox"/> Automobile Work | <input type="checkbox"/> Poultry Farming |
| <input type="checkbox"/> Aviation Engines | <input type="checkbox"/> Mathematics <input type="checkbox"/> Radio |

BUSINESS TRAINING COURSES

- | | |
|--|---|
| <input type="checkbox"/> Business Management | <input type="checkbox"/> Business Correspondence |
| <input type="checkbox"/> Industrial Management | <input type="checkbox"/> Show Card and Sign Lettering |
| <input type="checkbox"/> Personnel Management | <input type="checkbox"/> Stenography and Typing |
| <input type="checkbox"/> Traffic Management | <input type="checkbox"/> English |
| <input type="checkbox"/> Accounting and | <input type="checkbox"/> Civil Service |
| <input type="checkbox"/> C. P. A. Coaching | <input type="checkbox"/> Railway Mail Clerk |
| <input type="checkbox"/> Cost Accounting | <input type="checkbox"/> Mail Carrier |
| <input type="checkbox"/> Bookkeeping | <input type="checkbox"/> Grade School Subjects |
| <input type="checkbox"/> Spanish <input type="checkbox"/> French | <input type="checkbox"/> High School Subjects |
| <input type="checkbox"/> Salesmanship | <input type="checkbox"/> Cartooning |
| <input type="checkbox"/> Advertising | <input type="checkbox"/> Illustrating |

Name.....

Address.....

City..... State.....

Occupation.....

If you reside in Canada, send this coupon to the International Correspondence Schools Canadian, Limited, Montreal, Canada



Dr. Arthur Frederick Sheldon

Founder of the science of successful salesmanship in 1902. Pioneer in "Human Engineering"—the creator of the idea of success through mastering of the Laws of right thinking—health—character analysis, etc.

SALESMANSHIP

The Sheldon Course selected by big companies and successful sales managers

J. C. Penney says: "Sheldon Course greatly benefited me. I recommend it . . ." H. S. Johnson, Vice-Pres. Armour & Co., says: "While President of Beatrice Creamery we used 50 Sheldon Courses with profit. 44 Sales Managers of Armour's have studied Sheldon. They build right thinking, create self-confidence. A pleasure to recommend the Sheldon Course."

Send for lessons on Salesmanship—Self-mastery and Compensation—free. See why SHEDDON SALES TRAINING is preferred by big sales executives of America. See how interesting, how powerful; how it will boost your earnings. Built for beginners as well as experienced salesmen.

SHEDDON SCHOOL Room 901-A 36 S. State St. CHICAGO

5 LESSONS FREE

FREE The Book

That has helped Thousands get Government Jobs!

Just send your name and address for my 32 page book, "HOW TO SECURE A GOVERNMENT POSITION." Tells all about Civil Service: If you are a citizen, 18 to 30, you can get a steady government job at \$1900 to \$3300 a year to start. I was official examiner for 8 years. You pick the job you want; I'll help you get it. Write today for a copy of my Free book.

A. R. PATTERSON,
Civil Service Expert, Patterson School
81 Wisner Building ROCHESTER, N.Y.



LEARN WRESTLING

Expert Taught at home, by mail, by greatest of all world's champions—Farmer Burns and Frank Gault. Be a wonderful athlete. Handle bigger, stronger men with ease. Learn the secrets of experts, Judo-Jitsu, Physical Culture. Have perfect health, fame, a perfect body admired by both sexes.

Send 10c (coin or stamps) for highly interesting booklet, 32 pages, illustrated, teeming with information. Tells how we teach, expert wrestling at home. Only 10c. Write now—State age.

FARMER BURNS SCHOOL
3371 Courtney Bldg., Omaha, Neb.

ARCHITECTURAL DRAFTING

by Carl Lars Svensen and Edgar Greer Shelton
House Planning Made Easy! This book gives you simple, clear instructions for making architectural drawings for every type of building—residence, store, school, etc. Shows how to indicate on the drawing each detail of design, also plumbing, heating, etc. Many sample layouts and photographs. 216 pages. Send no money. Pay the postman \$2.00 plus a few cents postage. Money back if not satisfied.

D. VAN NOSTRAND CO., 250B 4th Ave., New York

WELDING ELECTRIC ARC OXY-ACETYLENE

Taught by Actual Welding Practice.

No Finer Equipment Anywhere at Any Price. Pipe-Line, Sheet Steel, Structural Steel, Cast Iron, Aircraft and Commercial Welding, Cutting and Brazing. SEND NO MONEY FOR TRAINED WELDER!

Also Courses in Radio, Electricity and Automobiles
Full Information Free on Request.
Coleman Electrical School, 1628-X Main St., Kansas City, Mo.

NERVES?

Are You Always Excited? Fatigued? Worried? Gloomy? Pessimistic? Constipation, indigestion, acid stools, dizzy spells and irritability are caused by NERVE EXHAUSTION. Drugs, tonics and medicine cannot help you, sick or well! Learn how to regain Vice, Calmness and Self-Confidence. Send 25c for this amazing book.
RICHARD BLACKSTONE, N-471 PLATIRON BUILDING, N. Y.

WOES OF MARRIED LIFE

HERE'S HOW!

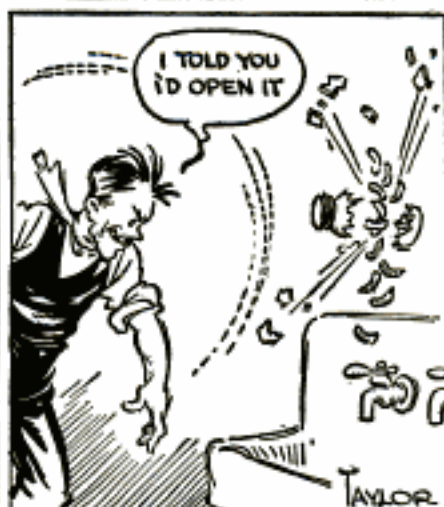

New Kind Of Invention

Opens Sealed Glass Jars and Bottles

LIKE MAGIC!!

MEN, honestly, what's the most money you ever made in your life? Have you any idea how it feels to make \$100 in a single week? Did you ever actually clean up as much as \$6 and \$8 in a single hour . . . spare-time?

We showed O. C. Gregg, Wyo., how to make \$20 in just 3 hours' spare time. D. C. Harris, Minn., made exactly \$42 in a single day with one of our Speedo inventions. E. T. Barclay, N. Y., cleaned up \$117 in 2 days. These of course are extraordinary and unusual records. Now we are offering an entirely new kind of opportunity that should easily prove one of the big-money leaders of all time. And why not? Just consider the cold-cash facts!

An Entirely New Kind of Device

There have been thousands of cheap, inefficient gadgets on the market. But, this is the one and only machine ever invented that opens sealed glass jars and bottles just like magic. It's an entirely virgin profit-field. In every home in America glass containers are being forced open every day. Jars are breaking. Hands are being cut. Food is being wasted. What woman will serve food to her family if she knows that even a tiny piece of glass has broken off and fallen into it? Yet everything from hammers and chisels, scissors and ice picks are being used to hammer and twist and pry open all sorts of sealed glass containers. Think of the trouble! The waste!

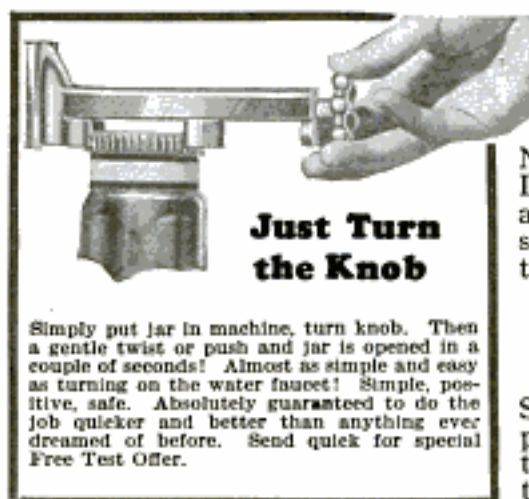

Just Turn the Knob

Simply put jar in machine, turn knob. Then a gentle twist or push and jar is opened in a couple of seconds! Almost as simple and easy as turning on the water faucet! Simple, positive, safe. Absolutely guaranteed to do the job quicker and better than anything ever dreamed of before. Send quick for special Free Test Offer.

The real danger! Then think of showing people how this can all be banished from their homes forever . . . and at a cost almost ridiculously low!

No wonder they buy on sight! Demonstrate to a group of women anywhere and they literally scramble over themselves to get the first order in.

Liberal Test Offer To Agents

Space here is limited. The complete facts about big money with this invention are waiting for those who know a good thing when they see it . . . AND ACT.

The coupon brings details of territory, sales outfit, FREE Test Offer, etc. Don't hesitate. This is red-hot. Get the coupon into an envelope, stick a 2c stamp on it, and shoot it along AT ONCE!

Central States Mfg. Co.

Dept. A-704, 4500 Mary Ave., St. Louis, Mo.

Central States Mfg. Co., Dept. A-704,
4500 Mary Ave., St. Louis, Mo.

Rush facts about Speedo glass Jar Opener and Free Test Offer.

Name.....

Address.....

Town.....State.....

Los Angeles,
CALIFORNIA
IS THE BEST PLACE TO
LEARN AUTOS



LOS ANGELES is the most fascinating city in the world... and the center of America's most rapid automotive industrial growth... the ideal city in which to live and train for success in the automobile industry.

Become a COMPETENT AUTO MAN

NATIONAL is an approved trade school, where in four to six months you may graduate as a practical and competent automobile man... prepared for employment in a gigantic industry where steady positions await students of this institution.

Train in this "SCHOOL OF SHOPS"

Competent instructors teach you thoroughly all branches of THE AUTO TRADES. You actually work on the latest models of all standard make automobiles, for NATIONAL is the most modern and completely equipped trade school in America. LIFE SCHOLARSHIP PRIVILEGES. Learn by NATIONAL'S famous "ACTUAL-SHOP" METHOD.

Learn this STEADY PAYING TRADE

The automotive industry offers ever increasing opportunities for trained men. Factory output increases yearly... and thousands of TRAINED AUTO MEN are needed to keep pace with the growth of this gigantic industry. Start training any time of the year.

Efficient EMPLOYMENT Service FREE

NATIONAL is a million dollar institution, 25 years old, boasting 22,000 graduates! No previous experience required... no age limit... start anytime. Unlimited employment service to those wishing to earn while they learn.

SEND FOR THIS BIG, FREE BOOK

NATIONAL AUTOMOTIVE SCHOOL
Dept. 14-A, 4006 Figueroa St.,
Los Angeles, California.

Send me, absolutely free, your big illustrated Catalog of Automotive Opportunities.

Name _____
Address _____
Age _____ City _____ State _____



NATIONAL AUTOMOTIVE SCHOOL

QUIT TOBACCO

No man or woman can escape the harmful effects of tobacco. Don't try to banish unaided the hold tobacco has upon you. Join the thousands of inveterate tobacco users that have found it easy to quit with the aid of the Keeley Treatment.

KEELEY Treatment For Tobacco Habit Successful For Over 50 Years

Quickly banishes all craving for tobacco. Write today for Free Book telling how to quickly free yourself from the tobacco habit and our Money Back Guarantee.

Home of the famous Keeley Treatment for Liquor and Drugs. Booklet sent on Request. Correspondence Strictly Confidential.
THE KEELEY INSTITUTE Dept. A-941 Dwight, Illinois



RUPTURES

Need firm but comfortable support

The patented Brooks Appliance retains securely without annoying springs or hard pads. Allows full body freedom. Worn and praised by active men and women in every walk of life. Over 3 million sold. Sent on 10 days' trial. Not obtainable through any store or agent in U. S., but made to individual measurements and sent direct from Marshall. Full information and free 28-page Rupture booklet sent in plain sealed envelope. Send for trial offer.



C. E. Brooks, Inventor

BROOKS APPLIANCE CO., 107F State St., Marshall, Mich.

RELIEVES PAIN QUICKLY

Have You a Troublesome Ailment?

INFRA-RED RAY LAMP



Send for Our Free Book

giving full information on Infra-Red Ray treatments in your own home for relieving rheumatism, sore throat, bronchial trouble, neuritis, sinus trouble, external hemorrhoids, rheumatism, tonsillitis, lumbago, and other ailments due to congestion. Infra-Red Rays penetrate deeply and restore active blood circulation. Quickly remove congestion. May be used safely by anyone. Attach to any light socket. Sent on approval, 30 days' trial. Write for outside. **WM. CAMPBELL CO. Dept. 1040, Alliance, O.**



How to Obtain A Better Looking Nose

Improve your personal appearance. My free book tells you how I guarantee to improve the shape of your nose by remodeling the cartilage and fleshy parts, quickly, safely, and painlessly, or refund your money. The very fine, precise adjustments which only my new patented Model 25 Nose Shaper possesses, make results satisfactory and lasting. Worn night or day. Over 100,000 users. Send for free book to **M. TRILETY, Pioneer Nose Shaping Specialist BINGHAMTON, N. Y. Dept. 197**

MOLES and WARTS

REMOVED PERMANENTLY



Rid your face, neck, arms and body of all unsightly moles and warts with "ANTI-MOLE." One application does it. Safe—easy to use—painless—leaves no scar. Used successfully by physicians, skin specialists and beauty experts for 28 years. Write for FREE booklet on treating all kinds of moles and warts. **Miller Co., 2445 South St., Lincoln, Nebr.**

Mounted Frogs



Mount Birds and Animals Be a TAXIDERMIST!

Mount and preserve PERMANENTLY just like LIFE, all kinds of BIRDS AND ANIMALS—both wild game and common and domestic specimens. Quickly Learned by Mail!

Amazing Profits and Pleasure in This Art

Learn easily and quickly in spare time AT HOME, from our reliable school—Taxidermy only taught for 27 years, over 100,000 graduates. Your success guaranteed.

Men, boys, women, be a taxidermy artist. It brings splendid profits, popularity, and simply wonderful fascination, fun, and entertainment for your lifetime. You will be delighted—send NOW for our unique FREE BOOK!

Need Money? Sportsmen

You can make BIG PROFITS in spare time, in Taxidermy. Mount and SKILL all kinds of specimens. Merchants eagerly buy groups for window display like the frogs above, or rabbits "getting married", squirrels in "barber shop", and hundreds of HUMANIZED common things your alert imagination suggests.

USEFUL AND ORNAMENTAL articles like sketches shown are easily made from birds and animals. The cost of mounting is SMALL—the frog orchestra costs \$1 and sells for \$40. Simply amazing profits in spare time. The market awaits you. Make your SPARE TIME bring the money you need. OPEN A SHOP. Own your own business. Thousands are doing it. SO CAN YOU! Don't pass this GREAT OPPORTUNITY.

FREE BOOK

Tells all about Taxidermy. Get your FREE copy today. 48 pages. 100 alluring pictures. Tells all about Taxidermy with its PLEASURE and PROFIT. Tells how YOU can be an EXPERT easily, quickly, and at small cost.

Mount your trophies—BIRDS, ANIMALS, GAME-HEADS, FISH. Tax skins and furs. Decorate your home and den with nature's finest art. Have your own MUSEUM. Mount for others. Sell your mounted game. EARN extra money for things you want—guns, boats, autos, radios, hunting trips, travel. Your GUN and ROD can earn you a fine income. Sportsmen soon know you and flood you with jobs.

Taxidermy is marvelous for BOTH WILD GAME AND DOMESTIC SPECIMENS. Suitable specimens are on every hand, easily secured. Sportsmen, do not throw away the finest parts of your trophies. Save them. Mount them. Have a delightful hobby. Be IMPROVED as a TAXIDERMIST. Earn a lot of EXTRA MONEY from your spare time.



The sketches above show merely a few of HUNDREDS of splendid useful articles you can make with Taxidermy. The commonest specimens can be HUMANIZED and become real art. Use squirrels, frogs, rabbits, cats, pigeons, sparrows, mice, guinea pigs, etc.; also wild game. These alluring and HUMAN-POSING art-gems win praise from everyone. EASILY SOLD AT FINE PROFITS.

NORTHWESTERN SCHOOL OF TAXIDERMISTRY, 3371 Elwood Bldg., OMAHA, NEB.

FREE BOOK Send Coupon!

Mail this coupon, or a postal or letter and this BOOK will be rushed to you by return mail POST-PAID—Free! No obligation on your part.

Grasp this OPPORTUNITY. It MAY mean your financial independence, and a life-time profitable business for you. Nothing like it. You will SURELY send at once for the FREE BOOK and INVESTIGATE. (State age).

NORTHWESTERN SCHOOL OF TAXIDERMISTRY, 3371 Elwood Bldg., Omaha, Neb.

Send me your free illustrated book "How to Mount Game." Also tell me how I may learn this fascinating art easily and quickly by mail. No obligation.

Name
Address

LEARN CARTOONING

AT HOME DURING SPARE TIME

with the course that has trained HUNDREDS of beginners successfully. The Landon Picture Chart Method of teaching ORIGINAL drawing by mail makes cartooning easy to learn. This school is a Member of The National Home Study Council. Write today for sample picture chart to TEST YOUR ABILITY and examples of the work of successful students now earning from \$50 to \$200 and more per week. Enclose 6c in stamps and STATE YOUR AGE.

THE LANDON SCHOOL, 2838 National Bldg., Cleveland, Ohio



TRAVEL—for 'UNCLE SAM'

RAILWAY POSTAL CLERKS

MAIL CARRIERS—POSTOFFICE CLERKS
GENERAL CLERKS—CUSTOMS INSPECTORS
\$1700 to \$3400 a Year for Life

No "lay-offs" because of strikes, poor business, etc.—sure pay—rapid advancement. Many other U. S. Government Jobs. City and country residents stand same chance. Common sense education usually sufficient.

STEADY WORK

Cut coupon and mail it before turning the page.

MEN—BOYS 18 to 45

Use Coupon Before You Lose It

COUPON

FRANKLIN INSTITUTE, Dept. T172, Rochester, N. Y. Rush to me, free of charge, (1) A full description of the position checked below; (2) 32-page book, with list of steady positions obtainable; (3) Tell me how to get the position checked.
 Railway Postal Clerk (\$1900 to \$2700) General Clerk (\$1250 to \$2100)
 Postoffice Clerk (\$1700 to \$2300) Customs Inspector (\$2100 up)
 City Mail Carrier (\$1700 to \$2100) Rural Mail Carrier (\$2100 to \$3300)

Name
Address



R. T. I. R. T. I. QUALIFIES YOU TO MAKE MONEY AND ITS SERVICE KEEPS YOU UP-TO-THE-MINUTE ON THE **R. T. I.**
 NEWEST DEVELOPMENTS IN RADIO, TELEVISION AND TALKING PICTURES

OPPORTUNITY

IS KNOCKING AT YOUR DOOR

RIGHT NOW
 from this GREAT FIELD of

RADIO
 TELEVISION
 TALKING PICTURES

BIG MONEY STEADY JOBS OFFERED and the Definite Way to Get Them

Good Jobs at Good Pay! Steady, Interesting Work! Fine Profits for your Spare Hours! Big Money as Your Own Boss! That's The Opportunity for you in Radio right Now!

Why? Because the great, fast-growing Radio industry has reached the stage where it must have many more trained men. Most of those now employed are untrained—they just "picked up" what they know about radio, and even many of them get good pay. But the *Big Pay Steady* jobs go to the *Trained Man*, and R. T. I. offers you the definite way to prepare for them. R. T. I. training is endorsed by Leading Radio Men and Radio Trade Associations.

R. T. I. TRAINS YOU AT HOME FOR THE BETTER PAID RADIO JOBS

Do you want to get into some branch of Radio where trained men can easily make \$40 to \$50 weekly—where some earn \$75 to \$100 per week—where trained, experienced men are selected for executive positions paying up to \$5,000 and \$10,000 yearly and more? Then, send for the R. T. I. Radio Opportunity Book. Find out how R. T. I. trains you at home for this well-paid work—you don't have to give up your present job—you learn quickly and thoroughly—just a little time needed at home—earn an extra \$10 to \$20 per week in spare hours while learning—Then step into radio and go steadily on up to the Big Money. No experience needed to start—R. T. I. starts you right.

LEARN TELEVISION and Talking Pictures TOO

Be prepared for Television! Learn Talking Picture Apparatus Installation, adjustment, etc. Both of these great branches of Radio are included in the R. T. I. practical training.

LEARN FROM LEADERS

Why does the radio industry want men trained the R. T. I. way? Because you learn under experts—leading men in different branches of Radio—well-known specialists of high standing.

FREE OPPORTUNITY BOOK

Remember you need no experience to start in Radio—R. T. I. starts you right—and helps you on to success. The big R. T. I. Radio Opportunity Book explains everything. If you are interested, send for it now. Don't wait. Use the coupon, or write, or telegraph to

RADIO & TELEVISION INSTITUTE

Dept. 11, 4806 St. Anthony
 Court, Chicago, Ill.



BROADCASTING
 Stations demand better trained men.



SERVICE
 Where R. T. I. training brings quick money.



TALKIES
 Studio and theatre apparatus requires trained men.



AUTO-RADIO
 Great field for men with R. T. I. training.



AVIATION
 Trained radio men needed more and more.



TELEVISION
 Great new branch of radio soon to call for many trained men.

R. T. I. HOME TRAINING includes all these and the other branches of Radio. You learn under F. H. Schnell, "The Ace of Radio," and the R. T. I. Advisory Board of prominent radio men.

R. T. I. R. T. I. TRAINS YOU AT HOME FOR A GOOD JOB OR A PROFITABLE PART TIME OR FULL TIME BUSINESS OF YOUR OWN



RADIO & TELEVISION INSTITUTE
 Dept. 11, 4806 St. Anthony Court, Chicago
 Send me Free and prepaid your BIG RADIO OPPORTUNITY BOOK, "Tune In On Big Pay" and full details of your three-in-one Home Training (without obligating me in any way).

Name.....

Address.....

City..... State.....

Classified Advertisements

WORLD'S BEST WANT AD MEDIUM

Advertisements in this section, 35 cents per word, each insertion, minimum 10 words, payable in advance.
To be printed under proper classification in February issue, copy should be in our office December 18th.

ADVERTISING AGENCIES

ADVERTISE—24 Leading Sunday newspapers, 21 words \$15.00. Excellent for obtaining help, salesmen, or business opportunities. Information 1,000 best paying dailies, mail-order weeklies, monthlies, mailing lists, everything. Free. Wade Agency, Great Northern Bldg., Chicago.

GET into advertising. Learn quickly at home. Experience unnecessary. New easy plan. No text books used. Practical work. Old established school. Send name and address for interesting free booklet. Page-Davis School of Advertising, Dept. 3431, 3011 Michigan, Chicago.

TIME Counts in applying for patents. See pages 126 and 127. Clarence A. O'Brien, Registered Patent Attorney, Washington, D. C.

ADVERTISING: 24 words 20 newspapers \$9; fifty weeklies \$5. Free list magazines, farm. LeGrand Agency, M34 West 33rd Street, New York.

OBTAIN canvassers, distributors through publication advertising. Martin, 270B West 43d, New York.

BEFORE Advertising get our catalog. No charge. 25 years in business. The largest classified agency in the world. Ankrum Advertising Agency, 100 No. LaSalle St., Chicago, Ill.

FREE—New 1930 Advertisers Rate Guide, 44 pages. Includes everything. Lowest rates. E. H. Brown Advertising Agency, 140 S. Dearborn, Chicago.

INCH Display advertisement 50 magazines year \$24. Wood's Popular Services, Atlantic City, N. J.

ADVERTISE in rural weeklies. Lists free. Meyer Agency, 4112 Hartford, St. Louis, Mo.

FOR ADVERTISERS

ADVERTISING: 20 Words, 50 magazines 60c; three insertions, \$1.20. Mailing Bureau, Lawndale, Calif.

ADVERTISE in country papers; low rates; lists free. Keator, Hartford Bldg., Chicago.

25 WORD Classified ad in five southern Negro newspapers (circulation 14,650)—Only \$1.00. R. L. Stricklen, Jr., Staunton, Va.

LAYOUTS For advertising is a useful handbook of 700 layout suggestions used in magazines, newspapers, booklets, folders, broadsides, letterheads and posters. Will save immense amount of time of any advertising man. Delivered to your door C. O. D. Simply pay postman \$3 and postage. Popular Mechanics Press, Room 801, 200 E. Ontario St., Chicago.

BUSINESS ADDRESSES

PROVIDENCE Address \$2.—Rhode Island's finest building. Rhode Island Mail Service, 917 New Industrial Trust Building.

MAILING LISTS

FRESH Agents monthly, national advertising 25¢ correct, 8-word statement each list, 1000 \$3.00. Clayton Dawson, Coshocton, O.

INFORMATION

ANY Information desired 25c coin and up. Fred Klotz, Reading, Pa.

CARTOONING. Complete course in. New book on How to Draw Funny Pictures with over 200 original illustrations by "Zim" has student begin with simple studies and work up to most difficult cartoon compositions. Delivered to your door C. O. D. Simply pay postman \$3 and postage. Popular Mechanics Press, Room 801, 200 E. Ontario St., Chicago.

LEARN Typewriting at home. Rational typewriting, brief course by Roselle (a Gregg publication) enables you to become proficient at typing without the aid of an instructor. 96 pages. Illustrated Cloth. Sent C. O. D. Pay postman price, \$1 and small amount of postage upon delivery. Popular Mechanics Press, Room 800, 200 E. Ontario St., Chicago, Ill.

YOUR Troubles solved, confidential advice, information any subject, \$1.00. National Service Bureau, P. O. Box 3303, San Francisco, Cal.

WILL Pay well for clipping or information about death ray or similar devices. Dr. Evans, Box 242, Callao, Peru, S. A.

AUTOMOBILES

TIME Counts in applying for patents. See pages 126 and 127. Clarence A. O'Brien, Registered Patent Attorney, Washington, D. C.

AUTO Trunks complete, or knocked down. Three prices. Box 1111, Taroma, Washington.

FAMOUS Halsey handbook—Prepares you to pass the examination for any grade of license for stationary, marine and Diesel engineers, firemen and boiler inspector in any state of the Union or any province of Canada. Flexible cover. Handy pocket size. Pay postman \$2.00 plus postage when he hands you the package. Popular Me-Mechanics Press, Room 801, 200 E. Ontario St., Chicago, Ill.

AUTO SUPPLIES

"SPRINGS of Silence"—Inexpensive Sets—Ford Chevrolet, Hudson, Essex, all cars—Ask automobile dealer—"Safety" mirror-hinge attached—chromium, \$2.00. Seat springs \$1.00 set, guaranteed. Catalog sent on request. Universal Spring Co., 550 Bond Ave., Grand Rapids, Mich.

IF You don't care how the "old bus" runs you'll not be interested in our carburetor attachment; but if you like a "peppy" car, with the greatly increased power, mileage and fire protection that \$2 will give, write us. Whirligig Co., 816 Ford Bldg., Detroit.

CHOKER Holder for model-A Fords. Regulates mixture same as big cars. Prepaid for quarter. Enormous profit for agents. Superior Machine & Mfg. Co., Albert City, Iowa.

PERMACHARGE: The new Permanent battery charger for motor cars. Easily installed. Connects with extension to light socket. List \$12.50. Territory open for dealers and jobbers. Permacharge Inc., 434 Pearl Road, Cleveland, Ohio.

HOTWATER Automobile heaters \$5.00 buy now save 69%. Box 128, Cumberland, Maryland.

TELOFLASH Spark plug. Reflects firing inside of engine. Saves gas, increases speed. Agents write Yale Mfg. Co., P-777 Phila., Pa.

ELECTRICALLY Heated crankcase oil heater, positive lubrication assured. Replaces oil drain plug, eliminates winter oil pump troubles. Battery \$2.50. 110 V. \$3.60. Agents wanted. Harold Gettgey, Wooster, Ohio.

ELECTRIC Arc welding proving profitable automotive shops. Easy payments on gasoline or electric. Hobart Brothers Welding Division, Box M-113, Troy, Ohio.

PROFITABLE Electric trouble shooting with new and reconditioned, attractively priced test benches. Easy terms, trial. Mitchell Company, Box M-112, Troy, Ohio.

NEW Auto parts 25-30%. Motors, rear-ends, radiators, wheels, generators, carburetors, brake lining 50%. Used parts 40-50% off. Brightman, 2065 Main St., Hartford, Conn.

RADIATORS: All standard makes at wholesale. Guaranteed. Send for prices. State make, model. Independent Radiator Co., 1119 So. Wabash, Chicago.

SHOP Notes for 1930. Get your copy now. Only a limited edition. Contains all the articles published in the Shop Notes department of Popular Mechanics Magazine during 1929. Send 50 cents. If you want the entire set of Shop Notes books consisting of 12 volumes including the 1930 number and 11 others issued previously we will send them C. O. D. at a special reduced price of \$3.75. Popular Mechanics Press, Room 802, 200 E. Ontario St., Chicago, Ill.

CHROMIUM Plating powder plates iron, steel, brass, copper and silver, without electricity or machinery. Guaranteed not to tarnish; ½ pint can \$1.50 prepaid. Gunmetal Co., Ave. J, Decatur, Ill.

AUTO SERVICE EQUIPMENT

RECONDITIONED Bargains in car washers, battery chargers, compressors, test benches, many only used few months. Easy terms and trial, guaranteed. Mitchell Electric, Box M-115, Troy, Ohio.

COMPRESSORS, Twin automatic, 8 hour battery chargers, 20-minute car washers, test benches, paint sprays, \$20 monthly. Pays for itself without investment. Guaranteed. Write Ken's Service, Box M-114, Troy, Ohio.

WET Auto motors started two minutes. Dollar for instructions. Thomas Seaton, Merchantsville, N. J.

FIFTEEN Capacity battery charger, direct from factory; guaranteed; 110 volts; money maker for owner \$27.34. Adams Barr Corporation, Columbus, Ohio.

NEW Electrical Dictionary. Complete up-to-date electrical dictionary with special radio words and terms together with illustrations of electrical symbols, radio diagrams and other wiring diagrams. 191 pages—Vest pocket size. Price only 35c postpaid. Popular Mechanics Press, Room 801, 200 E. Ontario St., Chicago, Ill.

MOTORCYCLES, BICYCLES & SUPPLIES

WINTER Clean-up sale—special offer! Free helmet, goggles, sweater, puttees, with every used Harley-Davidson. All models at new reduced prices. Send 4c in stamps for our catalog. Knuth's Harley-Davidson Agency, 2525 Food du Lac Avenue, Milwaukee, Wis.

MOTORCYCLE Bargains, lowest prices, bargain sheets for stamp, special aviators supplies, motorcycle accessories largest line in America, lowest prices. Largest motorcycle mail order house in the United States. Rochester Harley Davidson Corporation, 129 West Main St., Rochester, N. Y.

SEND 15c Today for latest used motorcycle catalog. Large stock. Real Bargains. Indian Motorcycle Sales, Kansas City, Mo.

HENDERSON, Evelstor, Harley, Indian used parts, engines, cheap. Conversion parts, Catalogue free. Ballak, 100 N. 12th St. Louis, Mo.

REPAIR With good used parts, save ½ or more, state parts needed, no lists, J. B. Dahl, 3661 Archer Ave., Chicago, Ill.

AVIATION

THE New Heath B-4 aircraft engine—the perfect motor for your light plane. Winner of the World's Championship at 1929 National Air Races. Absolutely free from all vibration and bearing difficulties. Delivers 50 horsepower at 3,000 R.P.M. Vastly superior to all other light plane motors yet costs only \$290 including propeller hub. Also rebuilt Heath Henderson motors in perfect condition as low as \$195. Fully guaranteed. 10 cents in stamps or coin brings large catalog. Heath Aircraft Corp., Dept. CL 20P, Chicago.

BUILD And fly the new Aeroford convertible glider. First and only glider easily converted into sporty two-passenger power plane by our patent conversion. Our Makit Kit contains all materials for only \$79.00. Sold in installments. Get our bigger, better blueprints showing latest ideas and aero shop-kinks: \$2.50 set. Aeroford Aircraft Corp., 1901 North American Bldg., Chicago.

PRACTICAL Flight Training is a splendid, thorough instruction book written by Lieut. Barrett Studley of the Naval Air Station at Pensacola. It is the official text book from which all U. S. naval flyers are trained. You can double the value of expensive instruction time in the air by a preliminary study of the subject from this book. Pay postman \$5 and postage when he delivers it to your door. Popular Mechanics Press, Room 802, 200 E. Ontario St., Chicago.

BANKRUPT Sale. Lifetime opportunity, secure airplane parts at less than 10c on the dollar, extraordinary values. Glider seats \$1.95, 13 gallon gas tanks \$2.95, 25000 feet air service altimeter \$3.95, hand pressure pumps \$1.50, tachometers 2400 RPM \$4.95, 3" red or green lenses 50c, 6, 8, or 12 cylinder aircraft magnetos \$6.50, Stromberg carburetors, original cost \$375.00—given away \$4.95. No junk, everything brand new. Box 213, Mineola, N. Y.

HEATH Parazols—Now fly your own plane! Start building the famous Heath Parazol for only \$12.00! Highest quality parts sent you in 11 convenient progressive groups. Cost of parts complete only \$199. Heath plans most complete and easiest to follow. 10 cents in stamps or coin brings large illustrated booklet. Heath Aircraft Corporation—Dept. CI 19P, Chicago.

SACRIFICE—Hall Scott 100 H.P. motors in original crates, \$225.00, cost government \$2,500.00. Bargain, helmet, wing emblem, both \$1.00. Smoother, Box 89; G. P. O., N. Y. C.

HEATH Aerial driven sleds are easy to build and give all the thrills of airplane performance on ice or snow. Complete blue prints for Ford or Motorcycle driven sleds only \$2.00. They have been designed for you to build by America's foremost aircraft engineers. In ordering—specify motor used. Heath Aircraft Corp., Dept. 17-P, 1721-9 Sedgewick St., Chicago.

APEN Glider motors; 10 h.p. 28 lbs., 3 1/2 x 2 3/4 Twin cylinder, castings \$75. Single \$45. List 10c. Agents wanted. Discount to machinists. P. O. Box 443, Berkeley, Calif.

BOYS, Girls, remarkable 10 weeks' simplified aviation course \$2.00 or 25c for first lesson. Increases knowledge of aviation 100%. Exams, pins, wings included. Guaranteed. Details free. National Young Fliers League, Box 49, Syracuse, N. Y.

AIR Navigation and meteorology—A practical book for every flyer. Capt. R. Duncan, the author, has presented the subject in a simple, non-technical way. 243 pages, illustrated. Delivered to your door C. O. D. Simply pay postman \$3 and postage. Popular Mechanics Press, Room 801, 200 E. Ontario St., Chicago.

EACH Heath propeller is made by skilled engineers to fit an individual job. That's why Heath propellers give added propulsion to sleds, boats and airplanes. They cost no more than ordinary propellers, yet are guaranteed to give better results. 4 cents in stamps brings propeller catalog. Heath Aircraft Corp., Dept. CL 18P, Chicago, Ill.

"IF You want to fly" let Alexander Klein, brilliant engineer, teach you. With great skill whole course of training has been simplified and made crystal clear. Remarkable book teaches in most practical and easily understood fashion. Recommended by skilled flyers. Sent C.O.D. anywhere in U. S. Simply pay postman \$2.50 and postage when delivered. Sent postpaid to any address upon receipt of price. Popular Mechanics Press, Room 801, 200 E. Ontario St., Chicago.

LIGHT Plane builders attention, get our latest literature on aircraft motors, and supplies, also used motor bargain list. If you want the best in propellers for light plane, sleds and boats, we have them. Send dime or stamps for latest literature. Sensenich Bros., Lititz, Pa.

TIME Counts in applying for patents. See pages 126 and 127. Clarence A. O'Brien, Registered Patent Attorney, Washington, D. C.

AIRPLANE Engines, 80 h.p. new, \$50, slightly used, \$40. Good for small planes and ice sleds. Also propellers. Smith, Box 1243, Houston, Texas.

MEAD Gliders and construction kits are preeminently successful. See page 114.

PHOTOGRAPHS of airplanes; All makes, brilliant, 7x10 heavyweight, 3 for dollar sent C.O.D. Special pursuit group of ten, \$3.00. John Stiles; Stoughton, Mass.

BUYERS Directory. Listing thousands bargains used airplanes, motors, jumping balloons, power gliders, equipment. 50c. Midwest Company, 603-7 Security Mutual, Lincoln, Neb.

BUILD The Russell monoplanes. The Sportplane Constructor book with full page blueprints, drawings, photographs, gives sizes, weights, materials, balance diagram, motors, flight instructions, etc., sent postpaid \$1.00. Russell Aircraft Co., Box 433, Toledo, Ohio.

HELIOS Motors; 35 hp. and 60 hp. radials, air cooled. Real, modern aviation motors, not made-over motorcycle or auto engines. Catalog, data etc. 10c. Aviation Service, 926 Broadway, New York.

AERODRIVE Sleds—blueprints, 4 different types and 1 boat type—the set only \$1. Single prints 25c; propellers: 4", \$8.75; 5", \$13.25; 6", \$16.50. Set blueprints primary glider, \$2.50. Ostergaard Aircraft, Dunning, Chicago.

HENDERSON And big V motors, metal tipped propellers \$9.95 each. Hibbs, Ft. Worth, Texas.

FLYING Simplified—Just out. Here is a remarkable non-technical book for beginners, prospective or advanced students that teaches in an easily understood manner all you can need to know to master the art of flying. Will save you many dollars when you learn to fly. Pay postman only \$1 and postage when book is delivered at your door C. O. D. Popular Mechanics Press, Room 802, 200 E. Ontario St., Chicago.

SEND 5c For bundle of balsa, reeds and price list on supplies. Aero Shop, 3050 Burling Ave., Detroit, Mich.

LEARN How aircraft engines work. Latest and most complete information is found in "Dyke's New Aircraft Engine Instructor." We unhesitatingly recommend this valuable book. Money refunded if not satisfied. Pay postman \$5.00 plus postage when delivered. Popular Mechanics Press, Room 801, 200 E. Ontario St., Chicago, Ill.

STUNT Flying—A new book of flight instruction that is different. The author, Capt. Richard Duncan, has developed in this book a unique system of practicing and working out your flight maneuvers on the ground. Use it and learn as other great flyers have done. Will save you hours of costly flying practice. 185 pages, 32 illustrations, cloth. Sent C. O. D. Pay postman price \$2.50 and small amount of postage upon delivery. Popular Mechanics Press, Room 806, 200 E. Ontario St., Chicago, Ill.

MODEL AIRPLANES

NEW Ideal "Eaglet" 20 in. Balsa Cabin Monoplane construction set, 50c postpaid. Ideal Company, 19 West 18th St., New York.

MECHANICAL Controls for model airplanes, make them loop, spin, spiral, figure eight, etc. Complete plans for quarter. Superior Machine & Mfg. Co., Albert City, Iowa.

AMAZING Aerial novelty. Travels hundreds of feet into air and returns. Launches model gliders parachutes from sky. Complete 5c. A. Van Pelt Novelties, Box 517, Grand Rapids, Mich.

BOOKS AND PERIODICALS

DISEASE. Its cause and prevention. Correct flying and eating—valuable booklet with wonderful information. Price 25c. Dr. Frank L. Hayes, Health Institute, 107-109 Stewart Street, Seattle, Washington.

HYNOTISM Easily learned. Lessons guaranteed. Postpaid \$1.10. Smith Pub. Co., Dept. 3, Springfield, Mass.

TECHNICAL Books, great variety, unusual offering. Send for bargain list. Also agricultural books. Barnes & Noble, Inc., 78 Fifth Ave., New York City.

BOOKKEEPING And accounting easily learned. Complete course \$1.00. Accounting Institute, Duluth, Minn.

ASTROLOGY Books—25c to \$4; send for free descriptive lists. H. C. Bullock, Box 1286, Providence, R. I.

PRACTICAL Waterworks from stream having 3 feet fall or more. Plans for building \$1.00. Hansen, Box 2, Ogden, Utah.

BEST Books for \$1. All formerly sold for \$2.50 to \$5 each. Select from the following list of guaranteed bargains. All brand new books: Woodcraft by Seton, Book of Letter Writing by Crowther, Etiquette by Elshler, Creative Chemistry by Sisson, Lawn Tennis by Tilden, also Revolt in the Desert by Lawrence, Trader Horn, White Shadows in South Seas by O'Brien, Count Luckner (The Sea Devil) and Outline of History by Wells. Delivered at your door C. O. D. Simply pay postman \$1 each and postage. Popular Mechanics Press, Room 801, 200 E. Ontario St., Chicago.

PICTURES AND POST CARDS

CALIFORNIA Redwoods, Columbia highway, Crater Lake! Photographs 3 1/2 x 5 1/2, 16 for 50c; three samples 10c. Parkside Photographs, Oregon City, Oregon.

GAMES, ENTERTAINMENTS AND PLAYS

PLAYS, Operettas, musical comedies and minstrels, comedy and talking songs, black-face skills, vaudeville acts, monologs, dialogues, recitations, juvenile plays and songs, musical readings, entertainments, make-up goods. Catalog free. T. S. Denton & Co., 623 So. Wabash, Dept. 11, Chicago.

READ Sealed Messages in Dark; messages retained by audience; burned message appears on black slate; spirit message appears on slate in sitter's presence; spirit rappings; spirits appear in the dark; answer questions written on folded papers while blindfolded. All this you can do with directions in "Behind the Scenes with The Mediums." 29 best secrets of mediums fully exposed. The best because most baffling, yet all easy to do. Send no money. Just write a postal. Pay postman \$1.50 and postal charges. Popular Mechanics Press, Room 801, 200 E. Ontario St., Chicago, Ill.

CHALK TALKS

LAUGH Producing program, \$1.00. Catalog free. Balda, The Cartoonist, Oshkosh, Wis.

MAGIC TRICKS, BOOKS AND JOKER NOVELTIES

MAGIC—Tricks, Books and Supplies. For amateurs as well as the great professionals. Anyone can learn through our instructions. Feature Acts in Mind-Reading, Spiritualism, Rope Ties, etc. Large illustrated professional catalog, 20c. Chicago Magic Co., 110 So. Dearborn St., Dept. B, Chicago, Ill.

FREE Magic catalog; Hundreds of mystifying tricks. Free with our Master System of 6 card tricks for only 10 cents. Name any card drawn from deck, etc. Wizard Magic Co., Dept. 15-8, Box 1055, Station "C", Los Angeles, Calif.

SEVEN Optimagical delusions. Five Magic catalogs 15c. Glimagics, Morgan Park, Chicago.

"THE Book of 1,000 Wonders" explains many mystifying tricks with coins, cards, handkerchiefs, etc. Also contains complete catalog magic tricks, jokes, puzzles, books, and imported novelties. Largest assortment, lowest prices. Amaze and mystify your friends. Send 10c today. Lyle Douglas, Station A-3, Dallas, Tex.

MAGIC Catalog 20c. Lynn, 195 Beach, Dept. 3, Jersey City, N. J.

25c STEEL Puzzle, illustrated folder 10c. Western Puzzle Works, St. Paul, Minn.

FAME. Popularity, high salaries await you in magic. Order now and get \$100 worth of Keller's professional stage illusions (explained) for \$1.00. Frank Moore, 1567 S. Oxford Ave., Los Angeles, California.

FREE Catalog magic, jokes, novelties. McColm, Box 125, Allenhurst, New Jersey.

CARD Tricks, coin tricks, hypnotism, ventriloquism. 4 instructive, 64 page books, 10c each. Geo. Fenner, 2401 Jefferson, Louisville, Ky.

35 CARD Tricks 25c. Magicatalogs 5c. Stringer, 2538 N. Halsted, Chicago.

BOOKS, Magic, herbs, incenses, imported novelties. Catalog, sample 10c. Marrelle Company, 159 N. State, Chicago.

TRICK Catalogue, 10c; Firecater, 30c. Oaks Magical Co., 548, Oshkosh, Wis.

ELECTRIC Fun! 200 stunts, 110 volts. \$1. Kutting Sons, Campbell, Calif.

200 TRICKS You can do—Mystify your friends; have loads of fun. This collection of tricks has been selected by Thurston for the average person. Neither unusual skill nor elaborate apparatus are required. Send for this 200-page illustrated book. Pay postman \$1 plus postage when delivered. If outside U. S. remit when ordering. Popular Mechanics Press, Room 801, 200 E. Ontario St., Chicago.

RADIO SETS AND SUPPLIES

WANTED: Men to work with National radio service organization, no selling scheme. Radio Doctors, Inc., 130 Essex Street, Salem, Mass.

SCREEN Grid electric six—chassis, tubes, dynamic speaker—in table cabinet, lowest prices. Get proposition, literature. Service Electric Company, Indianapolis.

NEW 300-Mile "pocket" radio, \$3.85. Complete with special loud receiver. No tubes or batteries required. Order direct. Spencer Laboratories, 116 Atlas, Akron, Ohio.

"WORLD" Receiver, \$1.25. Illustrated bargain catalogue, 10c. Neill Tasker, Shamokin, Pa.

RADIO Parts, kits, tubes. World's lowest wholesale prices. Wedel Co., Inc., Seattle, Wash.

TIME Counts in applying for patents. See pages 126 and 127. Clarence A. O'Brien, Registered Patent Attorney, Washington, D. C.

STAMP COLLECTING

SNAPS—Offer No. 1—300 different foreign 60 different U. S. stamps including \$1 and \$2 values, all for 25c. Offer No. 2—100 different foreign stamps from 100 different countries, including Africa, Asia, Australia, Europe, West Indies, etc., only 20c. Offer No. 3—Stamp album, providing spaces for 2200 stamps, with 700 illustrations, packet of 500 different stamps, 500 hinges and millimeter measure, all for only 50c, a big bargain. Free with each order, our pamphlet which tells "How to make a collection properly," also price list of albums—supplies and hundreds of bargains in sets and packets. Queen City Stamp Company, Room 38, 601 Rare Street, Cincinnati, Ohio.

HELLIGOLAND Has the most romantic history. This little island in the North Sea was for centuries bartered around between nations. Finally it was sold by England to Germany and it is now disappearing altogether from the face of the earth, being washed away by the sea. Helligoland issued its last stamp in 1879 and all Helligoland stamps catalogue high, but the old Government 50 years ago reprinted a small quantity and these are now very scarce. We offer 2 different ones together with 4 different Georgia, another hard to get country, total catalogue value over \$1.30 for only 10c to approval applicants. Globus Stamp Co., 214 Third Ave., New York City.

MYSTIC "Queer Country" Packet! Contains scarce stamps from the following strange lands: San Marino, Antioquia, Congo, Cyprus, Fiji Islands, Gwalior Hyderabad, Iceland, Jhird, Kenya, Uganda, Lebanon, Menaro, North Borneo, Nyassa, St. Thomas Prince, Eastern Roumelia, Slam, Sierra Leone, Tanganyika, Trinidad Tobago, Ubangi, Upper Volta, Wallis Futuna, Alacostis. Get this wonderful packet of "freak countries" and make your friends envious! Price only 10c to approval applicants! Write today, Mystic Stamp Company, (Dept. 8), Camden, N. Y.

101 DIFFERENT 10c To approval applicants only. Free list of bargain packets. Kansas City Stamp Co., Lee Bldg., Kansas City, Mo.

50 FRENCH Colonies, Alaouttes, Gabon, Caledonia, etc. with approvals 4c. Hollinbeck, 312 Marquette, Minneapolis.

25 AIRMAILS 10c; 1,000 Hinges 10c; animal packet 10c. Bargain packets, mixtures, approvals. Harvey Teeple, Decatur, Indiana.

WORLD'S Tiniest triangle (rare Guatemala Quetzal-Bird), also fine Nyassa triangle and big packet Yete, Vatican, Oceania, Uganda, etc., 5c with lists and approvals. Semisole Company, Druid, Baltimore, Maryland.

PACKET Rare diamond shaped stamps, 10c to approval applicants. J. Pawlczek, Pine Island, N. Y.

COLONIAL Airmail free with approvals. Mon'ar, 1553 Knox, Cincinnati, Ohio.

PAPA (Lakotol boat), Lebanon (air-mail), Zanzibar, Mesopotamia, Georgia, Congo, Morocco, Sudan, etc., in runder packet 60 different, 5c with approvals and lists. Monumental Company, Arlington, Baltimore, Md.

FREE Packet with approvals. Postage 4c. Reference, Mooney's Stamps, 1026 No. Kedzie, Chicago.

CLOSING Out duplicates of 40 years collecting stamps, 100 U. S. \$1.00, 50 comm. 40c, 200 foreign \$1.00. No junk. B. Cook, Detroit, Maine.

FREE 25 Stamps, all different, to approval applicants. John P. Miller, 188 East 75th, New York City.

FREE, 6 Different Luxembourg to approval applicants. E. D. Stann Co., 3905 Forest Park Ave., Baltimore, Md.

FREE—100 Different to approval applicants, postage 2c. Norman Floyd, Norman, Oklahoma.

NEW Greece commemoratives (six mint) 6c, with approvals. VanBeek, 1906 Central, Minneapolis, Minn.

STAMP Tongs given to purchasers of packet of 50 different stamps from 50 different countries, including Tannou Touva, Corea etc. 10c to approval applicants. Paul Revere Stamp Co., Box 40, Aster Station, Boston.

WRITE For our free illustrated price list. The illustrated Scott price list is the most complete offering of sets, packets, airmail and special packets, catalogs, albums, stock books and accessories ever made available to the stamp collector. It is beautifully illustrated throughout, and contains a wonderful range of offerings from 10c to hundreds of dollars. Free for the asking. Scott Stamp and Coin Co., 1 West 47th Street, New York, N. Y.

FREE! Largest stamp in the world! Fine packet 65 different stamps from Cape Verde, Jamaica, Mozambique, Syria, etc., including dying soldier, beautiful women, ships, maps, savages, airplane scenes, bird and animal stamps, for only 5c to approval applicants. Largest Stamp in the World (rare China Wild Goose Special Delivery) given absolutely free with each order. Supply limited! Send your 5c today! Western Philatelists, 6021 Harper Ave., M-1, Chicago.

BIG Parade—A packet of more than twenty all different better grade stamps showing exciting scenes and records of nations at war. Includes fire-pet hurler; the storming of a city; hand-to-hand bayonet struggle; bloody battle scenes; troop transport; red cross stamp; dying soldier; victory stamps; etc. Send for this thrilling "Big Parade" packet at once—limited supply. Only 10c to approval applicants. W. A. Rowell, 58 Cornhill, Boston, Mass.

200 DIFFERENT, 12c. Nassau stamp Co., 4182 Paul St., Philadelphia, Penna.

CONGO—Five Congo free to approval applicants. Bernard Karch, Middle River, Maryland.

BEGINNERS—Album, hinges, packet of stamps with approvals 20c. Electra Co., Mayberry, W. Va.

PACKET Rare stamps, each stamp cataloging 25c to \$1.00, 10c to approval applicants. Lunn Co., 73 West 116, New York.

50 UNUSUED Stamps 10c, 60c approvals. J. Novotny, Box 1115, Melrose Park, Ill.

ONLY 10c. 3 Beautiful 1930 Persian airm. and 2 Ecuador airm. Webers Stamp Shoppe, 1577 Park Avenue, Plainfield, N. J.

RADIO Stamps—Three radio station stamps, 10c. Chas. A. Philidus, 510 East 120th St., New York, N. Y.

U. S. MISSION. Good value 40c 10. foreign missions 1/2 lb. 40c, 4 Cayman 12c, 5 new Hebrides 12c, 4 Falkland 12c, 12 Slam 12c. Mechanical Co., 4512 North Racine, Chicago.

1000 MIXED U. S., old and new, 25c. Approvals. Weatherby, Willoughby, Ohio.

FREE—100 Different stamps to approval applicants. John Cooley, Fishers Island, N. Y.

WORTH While stamps try my collection makers 50c approvals. A. Kenagy, 113 West Point, Washington Court House, Ohio.

1009 STAMPS And perforation gauge 25c. Hawley, Johnson St., Lynn, Mass.

CHINA 12 Varieties 2c with approvals. Henry Hunt, Box 539, Chiro, Calif.

NEW Unused Iceland Parliamentary Celebration stamps to approval applicants 7c. Ten different ships and airplane stamps 9c, both packets 11c. Victoria Stamp Shop, 1458 Victoria, Chicago.

SEVEN Roman states 15c. Approvals. Halpern Brothers, Greenville, South Carolina.

5 SPAIN 1930 Columbus commemorative 5 cents. Co-Operative Stamp Co., 736 Euclid, St. Paul, Minn.

BRITISH Colonies on approval. Eastern Stamp Co., 3829 Veazey St., N. W., Washington, D. C.

APPROVALS At 1c. (and what approvals!) Sets at all prices. Interested? You should be! Julius Goldin, 926 Southern Boulevard, New York.

FREE—Genuine confederate bill to approval applicants. DuBois Stamp Company, 253 Merritts, N. E. Atlanta, Ga.

FREE Surprise packet with mixture 500 U. S. 3c. Drexel Stamp Shop, 5726 Drexel, Chicago.

LIBERIA Packet 2c to approval applicants. Welsh, Elmore, N. Y.

FREE Prizes! Big discounts! Wonderful approvals! Box 114, Minneapolis, Minn.

FREE! 5 Rare Slam to approval applicants. Winthrop Smith, 2611 Cedarvale Rd., Baltimore, Md.

1,000 ASSORTED U. S., 20c. 1,000 foreign, 20c. Sets all different. 50 British colonies 15c. 25 Netherlands 10c. 50 Africa 25c. 12 New Foundland 15c. 20 Argentine 10c. 25 Poland 15c. Post free. Popular Co., 4512 North Racine, Chicago.

ANCHERS \$\$\$ Outfit—only 12c! Fine triangle stamp; set German stamps with (pre-war) value forty million dollars (interesting!); perforation gauge, mm scale; airmail set; scarce stamp from smallest republic on earth; newspaper set packet good stamps and Transcane, Malay, Dutch Indies, etc. Entire outfit for 12c to approval applicants! (Nice pocket stock book, value 2c, with every order!) Ancher Stamp Co., Box 47, Rutherford, N. J.

1000 WELL Mixed stamps 10c silver. Willhorn, Box 344, Mineral Wells, Texas.

AIR Mails—30 different, unused 20c. F. Buffham, Lake Ave., Racine, Wis.

120 STAMPS 30 Different countries 10c. Lufbery, Port Orange, Florida.

ARGENTINA Reprints cataloging \$87.50 to approval applicants 10c. Fulmen, Columbia, Missouri.

1,000 DIFFERENT 60c with approvals. Hollinbeck, 312 Marquette, Minneapolis, Minn.

STAMPS—Wholesale—List free to dealers. C. J. Rose, Maywood, Ill.

UNITED States \$2 wines, catg. 40c and 50 diff. U. S. for 20c; 100 U. S. 27c; 30 Canada obsolete 12c. Robert Haynes, Point Place, Toledo, Ohio.

STAMPS, 100 All different. Postage 2c. Lists free. P. M. Quaker Stamp Co., Toledo, Ohio.

300 DIFFERENT Stamps 10c. Michael 942a So. 23rd, Bellwood, Ill.

1,000 CHOICE Mixture, 35c. 1c approvals, C. Ritchie, Watertown, So. Dak.

200 DIFFERENT 10c, 20 Turkey 10c. 60% discount approvals. Covert Stamp, 39 State, Rochester, N. Y.

WHOLESALE Catalog for dealers; 4c postage. Grossman, 102 W. 42nd, New York.

MEXICO: 11 Varieties 5c to approval applicants. Allen, Angola, Ind.

10 DIFFERENT Lots 10c including Liberia, Corea, etc. to approval applicants. Utterback, Dahlgren, Va.

35 AIR Mails and South America 5c to approval applicants. Lists free. Glendale Stamp Co., 1312P Linden, Glendale, Calif.

ZANZIBAR! Packet queer freakish stamps from Zanzibar, Holkar, Antioquia, Congo, Hyderabad, Gold Coast, Newfoundland, British colonies, Souamericans. Don't delay! Don't wait. This whooping packet free for 5c postage. Gray Stamp Co., Toronto, Canada.

APPROVALS That please. Nice premiums given. Howard, Clarks Falls, Conn.

24 VARIETIES Cuban stamps, 10 cents. List of stamps free. Chambers Stamp Co., 111P, Nassau, New York City, N. Y.

FREE! Curious set Azerbaijan, big illustrated lists, air mail, commemorative, pictorial, Premiums galore, 2c postage. Penna. Stamp Co., Greensburg, Penna.

20 DIFFERENT U. S. and foreign commemoratives showing Jefferson, Joan d'Arc, famous battles, heroes, the Holy concert, Cathedral, historic paintings etc. Beautiful assortment less than fifth catalog (with approvals) 10c. The Stamp Shop, Holland Bldg., St. Louis, Mo.

65 LIBERIA Etc., 2c with approvals. Central Exchange, Cedarburg, Wis.

STAMPS On approval 1/2c up. Dandy Premium free. Keigwin Stamp Co., Fernandina, Florida.

CAMEROONS, Ubangi! 41 French Colonials 5c to approval applicants. Sterling, 267 S. Broadway, Lexington, Ky.

100 SWITZERLAND Stamps well assorted 10 cents. Lufbery Stamp Co., Branford, Conn.

UNITED States \$2 present issue (catalogs 50c) for ten cents to approval buyers. State size of collection. United States price list free. Lebac, Redlion, Penna.

FREE Packet with bargain lists, postage 2c. Rheau, 8951 Bouthier, Montreal, Canada.

110 DIFFERENT Stamps, many unused, high values, free to collectors requesting our net approvals. Postage 2 cents Christensen, Milwaukee, Wis.

FREE Premium with approvals. A. Motzer, 1022 Liberty, Cincinnati, Ohio.

FREE Outfit 52 stamps, hinges, pocket wallet. Postage 4c. Approvals. Milton Anle, South Berkeley, Calif.

ILLUSTRATED United States list, price 50 cents; large, complete United States price list, 1930, free. Stanley Gibbons, 38P Park Row, New York City.

RARE Italy airmail—This beautiful Italian airmail stamp, also scarce Vatican City—the only stamps in the world ever issued by a Pope!—and a packet of 51 other fine stamps, including Spanish, Morocco (Oasis Scene), Venezuela, Nyasaland, etc. All for 5c to approval applicants. R. G. Howard, 245 Waverly Ave., Newton, Mass., 27 LIECHTENSTEIN 4c to approval applicants. Hagen, Box 129, Sioux Falls, S. Dak.

GENUINE Baden included in our packet 60 different stamps from Cilicia, Kenya Uganda, French Guinea cataloging 25c, Orange River Colony, Algeria, Shilling, Revenus, Syria, Nyasaland, etc. All for 5c to introduce our famous approvals, Viking Stamp Co., Sheepshead Bay Station, Brooklyn, N. Y.

150 GOOD Mixed foreign stamps, 3c. Stanton, East Lyme, Conn.

FREE 100 Different with 50% approvals. Send 2c postage. Erantion Stamp Shop, 2412 Noyes, Evanston, Ill.

33 1-3% COMMISSION. Sell our Stamps, sheet catalog value, \$1. Our price, \$2.00. Unsold stamps returnable. No investment required. References necessary. Lux Stamp Co., 865-C, Fairmont Place, Bronx, New York.

200 DIFFERENT 20c; 400, 50c; 1100 \$1; 2000 \$3. Fred Onken, 639 79th St., Brooklyn, New York.

STAMPS—100 Varieties, Africa, Brazil, Peru, Cuba, Mexico, etc., 10c; 25 different U. S. 25c; 1,000 mixed, 50c; 1,000 hinges, 15c. C. Stegman, 5911 Cote Brillante, St. Louis, Mo.

UNITED States stamps only on approval. Stamp House, 5 Franklin Gardens, Roxbury, Mass.

10 DIFFERENT United States 12c, 60% approvals. Seidenberg, Baroda, Mich.

FREE—\$1.00 U. S. postage Lincoln memorial free, if you write for our 56 page price-list of U. S. and foreign stamps, 2,000 illustrations and fine stamps on approval. Hussman Stamp Co., 620-3 Olive St., St. Louis, Mo.

BEST One cent approvals in America. F. Hand, 1117 So. 60th St., Phila., Pa.

ONLY 5c, 33 Different stamps including scarce Latvian triangular airmail stamps, 10 airmail, 12 United States (early issues, commemoratives, etc.) and 10 Canada. Approvals and illustrated price-list sent with each order. Curhan Stamp Company, Gloucester, Mass.

110 NEW Europe All Different, a wonderful collection cataloging several dollars, free to collectors requesting our Net Approvals. Postage 2 cents. Badger Stamp Co., Milwaukee, Wis.

FREE—Canada (15 Var.) for new applicant of my 1c, 2c and 3c approval, and also my 50% discount. Chas. W. Schmidt, P. O. Box No. 4832, Frankford Sta., Phila., Penna.

FREE! Triangles, airmail, Iceland and 50 others to approval applicants, including 2c postage. Hawkeye Stamp Co., Cedar Rapids, Ia.

PENNY Approvals that satisfy. Neil Gronberg, Box 5441, Philadelphia, Pa.

STAMPS Sent on approval at 70% discount. Reference required. Emory Renoll, Hanover, Pa.

ATTRACTIVE Approvals at 50% discount and 25% discount. Noemus Stamp Co., 312 East 23rd St., New York.

SPECIAL—500 Different stamps 25c to approval applicants. Ohio Stamp Co., Box 249, Cleveland, Ohio.

STAMP Album—The Modern Album is unsurpassed in usefulness. Spaces for 12,000 illustrations, 330 pages. Large size 9 1/2 x 11 inches. Cloth bound. Price only \$2. Either pay postman when delivered or if outside U. S. remit when ordering. Popular Mechanics Press, Room 801, 200 E. Ontario St., Chicago.

RARE COINS

COMMEMORATIVE half dollars uncirculated: Lincoln \$1.19; Pilgrim 99c; Monroe 99c; Bennington \$1.19. Five different broken bank bills 50c; Five different Confederate bills 50c; two different state bills 25c. Bargain price list and old coin 10c. Arcy, Box 243, Muskogee, Okla.

OLD Money wanted—Do you know that coin collectors pay up to \$100.00 for certain U. S. Coins? And high premiums for all rare coins? We buy all kinds. Send 4c for large coin folder. May mean much profit to you. Numismatic Co., Dept. H. Ft. Worth, Texas.

OLD U. S. coins bought. (Guaranteed prices paid). List 35 cents. National System, Westham, Conn.

AMERICAN Coins, bought, sold. Coin value booklet 25c. Frank Saro, 735 45th Street, Brooklyn, N. Y.

BY Return mail, six fine coins (one silver) very old, one dollar. E. Hoefel, 5427 Nottingham, St. Louis.

OLD Money wanted—Will pay \$100.00 for 1894 dime, S. Mint, \$30.00 for 1913 Liberty head nickel (not Buffalo). Big premiums paid for all rare coins. Send 4c for large coin folder. May mean much profit to you. Numismatic Co., Dept. H. Ft. Worth, Tex.

COMMEMORATIVE Half dollars, uncirculated, Pilgrim 95c. Stone Mountain 95c. Grant \$1.15. Bennington \$1.15. Old coin and price list 10c. Towns Davis, Box 1791, Huntington, West Virginia.

UNITED States commemorative coins and other coins for sale at low prices. List free. Ambrose J. Brown, 126 Washington St., Marblehead, Mass.

20 COINS 25c, 88 Coins \$1.00, Odderon, Box 831, Kansas City, Mo.

RARE United States and foreign coins, war medals and decorations. Indian Cent and catalogue 10c. Alexis Mengelle, Colorado Springs, Colorado.

GET Profit and pleasure in collecting old coins. Send 10c for large illustrated coin catalog. You'll be delighted with it. Send for it right now. B. Max Mehl, Numismatist, Mehl Bldg., Dept. P, Fort Worth, Tex. Largest Rare Coin Firm in the U. S.

UNITED States, Large cent, two-cent bronze, three-cent nickel and bargain list, 25c. Thirteen dates large cents, \$1.00. George Coffin, Greenwood Mountain, Me.

\$2 TO \$500 Each paid for hundreds of old coins. Keep all old money. It may be very valuable. Send 10 cents for illustrated coin value book, 42c. Prices guaranteed. Get posted. We buy and sell. Clarke's Coin Office, Box 5, Le Roy, N. Y.

OLD Coins, large fall selling catalog of coins for sale, free to collectors only. Catalog quoting prices paid for coins, ten cents. William Hesslein, 101A Tremont St., Boston, Mass.

5 DIFFERENT Fine bronze or nickel coin, 2 large crisp bank notes and catalog, 10c. Geo. Best, Box 283, Cedar Rapids, Iowa.

CALIFORNIA Gold—Quarter size, 27c; 5% size, 53c; 3c piece and catalog, 10c. Norman Shultz, Box 746, Salt Lake, Utah.

FOR BOYS

ERECTOR No. 10, with special motor, worth \$75, Special \$50. Julius Goldin, 926 Southern Boulevard, New York.

BULLETIN Furniture adds convenience, comfort and beauty to your home at very low cost. Any handy man can build a great variety of this space-saving furniture from the easily-followed instructions in our remarkable book, the only one on this subject. Delivered to your door C. O. D. Simply pay postman \$2.50 and postage. Popular Mechanics Press, Room 801, 200 E. Ontario St., Chicago.

CAMERAS AND PHOTO SUPPLIES

BARGAINS—A \$100 value, 3 1/4 x 5 1/4 compact Graflex with Kodak f: 6.3 Anastigmat lens \$44.50, 2 1/4 x 3 1/4 Voigtlander Acus with f: 4.5 Anastigmat lens, Ibsor shutter \$18.50. Hundreds of others listed in our Bargain book. Send for your copy now. Everything guaranteed. Central Camera Co., Dept. PM-1E, 230 South Wabash Ave., Chicago, Ill.

PERSONAL Photo greeting cards—Send 15c and negative for sample; includes colored tissue lined envelope, 7 inch colored enlargement from your own negative, in imitation leather easel frame, 75c, One roll film developed and six glossy prints, 20c. Send for Special bargain list. Rosanko Photo Finishing Co., 210 Bell Ave., Rosauke, Va.

TIME Counts in applying for patents. See pages 126 and 127. Clarence A. O'Brien, Registered Patent Attorney, Washington, D. C.

MAKE Money in photography. Learn quickly at home. Spare or full time. New plan. Nothing like it. Experience unnecessary. American School of Photography, Dept. 3432, 3691 Michigan Ave., Chicago.

LEARN "Transography" Photograph without films. Instructions \$1.00, guaranteed. Sample 10c. Koch's Studio, Collbran, Colo.

BOLL Developed and 6 glossy prints 20c, 12 glossy reprints 35c, 1931 Photo calendar from negative 10c, Artistically mounted 8x10 enlargement 40c, Young Photo Service, 405 Bertha St., Albany, N. Y.

CAMERAS—All makes—photographic supplies. Catalog free. Universal Photographers, 4 W. 33d St., New York.

LATEST Photo novelties from portraits, snapshots. Beautiful samples, 10c. National View, Winona, Minn.

YOUR Favorite kodak picture enlarged, size 3x7, 10c, Three for quarter, coin, Send best negative (film) today. Address Darmer Photo Lab., 221 Securities Bldg., Des Moines, Iowa.

HAVE You a camera? Write for free sample of our big magazine, showing how to make better pictures and earn money. American Photography, 116 Camera House, Boston, 17, Mass.

SAMPLE Enlargement—dime, and negative (returned). Trial roll, glossy prints, 25c silver. Brown, Warsaw, N. C.

MOTION PICTURES

SOUND Motion pictures! You must order this great and only authoritative text book on the subject by James Cameron, world's foremost authority. 400 pages crammed full of information on photo cells, Vitaphone, Moritone, Photophone, methods of recording maintenance. We are selling thousands of copies. Price, \$5.00 postpaid anywhere. Bass Bargaingram No. 202 just off the press. Red hot bargains in standard and 16 mm. motion picture cameras, projectors and accessories. Send 4c in stamps. Bass Camera Company, Motion Picture Headquarters, 1:9 West Madison St., Chicago, Ill.

BARGAINS—16mm, Model B Eastman Cine Kodak with f:1.9 lens \$95.00, 35mm, N. Y. Institute Motion Picture Camera with f:5 lens \$29.75, 35mm, Bell & Howell Kymo Camera with f:2.5 lens and case \$149.50. Hundreds of others listed in our bargain book. Send for your copy now. Everything guaranteed. Central Camera Co., 230 South Wabash Ave., Dept. PM-1E, Chicago, Ill.

CLIFTON Motion picture club. Write for free information. Clifton, N. J.

SPECIAL—1,100 Reels \$1.00 each. Order direct. No-Wat-Ka, Clifton, N. J.

FREE—Christmas bulletin. Standard picture rolls (25mm) for home, school, toy projectors, Hollywood Still-Film Studio, Box 1410, Hollywood, Calif.

BOYS—300 Feet film. Bottle cement 90c, Lowell Films, Allentown, Pa.

FILM Special—250 western, 250 comedy, 250 drama on 16 inch reel, bottle cement, \$6.00 value with this ad \$2.75 postpaid. Alton Films, Box 810, Kansas City, Mo.

BACK On job! Let's go. Free cement with every reel. Chicago Film Dealer, 6801 So. Carpenter St., Chicago.

MOVIES Standard and 16 mm. New low prices. New big selection. Lowest prices movie machines. Exclusive Home Films, 732 So. Wabash, Chicago.

WORLD'S Greatest "Passion Play" 16 MM. (new) 5 reels, Rent or purchase. Write Hemenway Film Co., 37 Church Street, Boston, Mass.

TIME Counts in applying for patents. See pages 126 and 127. Clarence A. O'Brien, Registered Patent Attorney, Washington, D. C.

NATURAL Color films, 100 ft. \$1.25 lists. Paragaphic, 227 49th, Union City, N. J.

ODD Reels \$1.75, Half reels \$1.25, News \$2.75 plus postage, 4 rolls news events \$1.10, Bargain lists, send stamps. Hoffman Film Service, 57 Broad, Albany, N. Y.

1,000 FEET Of film \$2.00, No lists. Sunset Film Exchange, 285 Turk St., San Francisco, Calif.

ONE Thousand feet film \$2.00. Portable machines and supplies. Big features sacrificed. Lists. Theatre Equipment Company, Box 324, Cincinnati, Ohio.

FEATURE Films \$1.50 reel, Machine \$17.50, Homelite \$45.00, Exchange, Abbott, Ark.

STAMP For film list, Box 77, Woodcliff Lake, New Jersey.

INTERESTED in movies, outdoor life, genealogy, educational research? Join us. Full particulars 10c. Inpa, 157 West Santa Barbara, Los Angeles, California.

FILMS And projectors. Stamp for list. Homer Shimp, 3116 Summit, Kansas City, Mo.

\$1,250 FOR Original photoplay story. Our sales department sold unknown author's first story for above amount. We revise, copyright and submit to studios stories for both silent and talking pictures. Being located in the heart of motion picture industry we know production requirements. Established 1917. Free booklet. Universal Scenario Company, 206 Meyer Bldg., West-end and Sierra Vista, Hollywood, Calif.

BE A Movie exhibitor—big opportunity—Only moderate capital required—Complete equipment at remarkably low prices. Write, Atlas Moving Picture Company, Dept. 7, 825 South Wabash Ave., Chicago, Ill.

MOVIE FILMS—100 feet Krazy Kat cartoon \$1.00 postpaid. Home Movies, Box 744, Minneapolis, Minn.

SEND me for big Christmas catalog. Films and equipment, and souvenir strips talkie film. Eastin Feature Films, Galesburg, Illinois.

FILMS, 300 Ft. \$1.00, reels \$1.95. List, Edgeworth Sales, Box 155, Blue Island, Ill.

TALKIE And movie producers are clamoring for new short story ideas, plots, etc. Perhaps you can write one that we can shape and sell for you. One writer (V. M.) received \$3,000. New York best market. Write for full particulars. Daniel O'Malley Company, Suite P, 1776 Broadway, New York.

FILMS 250 Feet full of action \$1.00. J. Brink, Box 208, Rock Bay Boston, Mass.

EARN Big money. Operate your own movie theatre. Small capital needed. Complete equipment at low prices. Catalog free. Monarch Theatre Supply Co., Box 2042 Memphis, Tenn.

MOVIE FILMS, 1,000 ft. reels, \$2.50 each; shipped anywhere on receipt of remittance. Particulars on request. Independent Films, 177 Golden Gate Ave., San Francisco, Calif.

SAVE Money. Movie cameras, \$25; projectors, \$25; Pathex camera, \$20; stereopticon, \$25; printing machine, \$15; 35m negative stock, 2 cents foot; 100 foot Eastman 16m negative, \$4.50; kodak, \$5. Typewriter, \$16. Cameras and films bought and exchanged. Ray, 206 W. 40th, New York.

TRADE AND TECHNICAL SCHOOLS

LEARN Watch repairing. Hiles School, 5330 Mission St., San Francisco.

BE A blue print reader. Men in your trade have succeeded. Write for facts. What's your trade? Carroll Hunsay, Drexel Bldg., Philadelphia.

LEARN "High-test" pipeline welding. \$77 weekly. Write quick. National Welding School, 711 Fairfax Airport, Kansas City, Kansas.

TELEGRAPHY

LEARN Wireless (Radio) and Morse telegraphy. School, oldest and largest; endorsed by telegraph, radio, railway and government officials. Expenses low—can earn part. Catalog free. Dodge's Institute, H Street, Valparaiso, Ind.

BUSINESS OPPORTUNITIES

DON'T Slave all your life. We will start you in business. Thousands are making their living abroad by doing knitting at home. Others got large flat machines adapted to make all kinds of knitted goods, such as stockings, from an infant's size to the largest lady's or man's, children's knitted suits, sweaters, scarfs, vests, caps, gloves, etc. Write for catalog. Anslie Knitting Machine Co., Inc., 738-750 Grand Street, Brooklyn, N. Y.

BIG Profits in home made candles. Earn \$35 to \$100 weekly at home, almost from first day. Practically no cash required. Successful manufacturer teaches trade secrets by mail. We furnish tools. Free booklet explains. Capital Candy School, Dept. K-5049, Washington, D. C.

ARTIFICIAL Marble sanitary flooring, instructions covering wood or cement flooring 1/2 inch thick, fireproof, all colors, low cost. Ornamental casting, concrete plaster papier-mache decorations, garden furniture, statuary, flexible molds, particulars and illustrations free. Chas. Mahler, Elmont, N. Y.

758 SECRETS Of odds and ends. Valuable information, interesting. Send one dollar. P. O. money order to Jos. Latkowski, Box 619 PM., Providence, R. I.

NEW Home money making business. Men or women. Sure quick profits. Permanent business. Fur-craft service quickly learned. No investment, no soliciting. Unlimited opportunities. Free book. Northwestern Fur Co., Box 4, Omaha, Nebr.

SUCCEED With your own products. Make them yourself. Formulas, processes, trade-secrets. Expert analytical service. Catalog free. B. Thaxly Co., Washington, D. C.

MAIL Order drug store. Let us supply your drug store wants. Mesqon Drug Store, Thiensville, Wis.

MANUFACTURING Business of your own. Large profits. Details free. National Lugs, 327 East Jefferson St., Los Angeles, Calif.

BIG Bunch mail. Year 15c. Money making opportunities. Pennell Standard, Covington, Kentucky.

START Home gift shop. Particulars free. Giftshop, Box 1236, Columbus, Ohio.

MAKE Illuminated signs, brush skill unnecessary. Sample 50c. Particulars free. Merriltype Signs, So. Berkeley, California.

OPPORTUNITIES Supreme. Mail order business home, anywhere. Tested plans. Teach all. Free circular. Price low. Emson Service, 251 Audubon Ave., New York, N. Y.

CONCRETE Building block manufacturing is your home town opportunity. Particulars free. Concrete Machine Co., 5 Main St., St. Louis, Mo.

500 BUSINESS Plans and manufacturers' formulas \$1.00. Circular. Hayes, 60 East 18th, Chicago.

MAKE Money manufacturing building materials, marble, granite, fireproof paint, flooring, roofing. No machinery. Cheap. Big profits. For formulas and latest methods, write Wm. Lang, 443 Washington, Peotland, Ore.

LEARN Marbleizing art, stone casting, sanitary floors artificial marble, Veneer over concrete, wood, anything. Flint-like hardness, glossy, all colors. Unlimited uses for this new industry. Inexpensive, send dime for samples. Cowell Institute, Grayling, Mich.

MAKE Money home. No peddling. Stamp brings literature describing over fifty ways. Co-Operative, 469-A, Ansonia, Conn.

MONEY Making opportunities—Read 174 page book to find yours. Send \$1.00 Circular free. E. T. O'Connor, Dept. 4, Roselle, Illinois.

SMALL Capital, large profits. Exceptional opportunity. Bryant, Box 583, Augusta, Ga.

HAVE Map of dead Mexican bandits treasure cache. Want someone to partly grubstake me for search. Will give half interest in find. References. Address Box 180, Augusta, Kansas.

\$100.00 WEEKLY in "fixit" service. Complete 43 lesson instruction course \$1.00. Houzate's "Fixit" Service, 1305 N. El Moline, Pasadena, California.

MANUFACTURE Your own goods. Own your business. Start at home. Information free. Business Service, Geneva, Ohio.

CRISPETTE Machine—Long-Eakins, A-1. \$110, cost \$350. Northsides Co., 1306 Fifth, Des Moines, Iowa.

DO You want a money making business? Light manufacturing at home. No peddling. For details, write, Artistic Products Co., 2601 Summit Avenue, Little Rock, Ark.

SCHEMER, Alliance, Ohio, 32p monthly, prints big \$-getters. Subscriber reports \$50,000 from one tin; another \$25,000 from three schemes; another \$10,000 from one formula. Get wise! Year, only \$1.00; 3 months, 25c.

\$150.00 MONTH in home doughnuts. \$15.00 pays for first 150 doz. Also finances new patented equipment. Write Runkell Products Co., 329 Trib. Annex, Minneapolis, Minn.

LEARN Watchmaking at home course \$35. U. S. School of Watchmaking, 1107 N. Mayfield, Chicago, Ill.

SCIENTIFIC Cooking mushrooms, even poisonous—Vat coating resists strongest acids. Permanent brass polishing, 50 cents; 25c each. Box 611, Los Angeles.

PROFITS in puppies—How to make money with dogs. New book, 37 chapters. Send no money. \$1. plus postage. Satisfaction guaranteed. Circular free. Mowbray Publishing Company, 2561 Riverside Avenue, Jacksonville, Florida.

BUSINESS Profession of your own and earn income in service fees. See Stephenson Laboratories, display ad page 120.

COMPOSITION Floor making earns industrious men \$12 and more daily if used as trade. Or make business of it with profits up to \$10,000 yearly. Openings everywhere. Semi-Tile, Box 43, Hollis, N. Y.

WE Start you in business, furnishing everything. Men and women, earn \$40 to \$100 weekly operating our original "New System Specialty Candy Factories." Begin home spare time. Unlimited opportunity. Valuable booklet free. W. Hilber Bagstale, Drawer 4, East Orange, N. J.

THIRTEEN Counts in applying for patents. See pages 126 and 127. Clarence A. O'Brien, Registered Patent Attorney, Washington, D. C.

AMATEUR Cartoonists—Earn \$25.00 week, spare time, copying cartoons for Advertisers. 3-Em Syndicate, Argyle, Wis.

BIG Profits operating "chain" of peanut, chewing gum, candy vending machines. Start small capital. Write, Robbins Corp., Dodworth Street, Brooklyn, N. Y.

SELL By mail successfully! I show you how. Handsome folder free; stamp appreciated. Busler, Box 205-A, Sta. A, Canton, Ohio.

BIG Money at home plating auto parts, reflectors, mirrors, chandeliers; by new method; experience unnecessary. Outfits furnished. Gunmetal Co., Ave. N, Decatur, Ill.

OPERATE Chain of vending and amusement machines. Be independent for life. Start small, grow big. P. Goodbody, 72 VanBerghe, Rochester, N. Y.

MICROBES Reilvered at home costs near 5 cents per square foot, you charge 75 cents. Profitable business plating like new, brass, worn-off autoprots, reflectors, tableware, stoves, etc. Outfits furnished. Details free. Sprinkle, Plater, 127, Marion, Ind.

250,000 ARTICLES Wholesale—directory 10c. W. Patterson Co., 4111 University, Des Moines, Iowa.

50 SUCCESSFUL Mailorder propositions; details red stamp. K. Home, 3919 Metropolitan, Chicago.

"ODD-THINGS"—Money making ideas; tips; plans; opportunities! New, different! Three months' trial, 25c. Year \$1.00. "Odd-Things Magazine," 720 Advance Bldg., Cleveland, Ohio.

SELL By mail! Start your own small business anywhere. Free folder tells how. No personal selling. Everything furnished. H. Horton, 2046 Jefferson Ave., St. Paul, Minn.

THANLY Formulas produce perfect products. All lines. Catalog free. B. Thaxly Co., Washington, D. C.

CLEARED \$1,000 two months, Gordon. Tested food—confection business. Men or women. Legitimate—pleasing. Experience unnecessary. Equipment furnished. Eakins, 2100 High St., Springfield, Ohio.

LEARN The collection business. Good income, quick results. Interesting booklet. "Skillful Collecting" free. National Collectors Assn., Long St., Newark, Ohio.

CHEMICAL Expert furnishes manufacturing formulas and processes with complete working directions. Reliable individual service only. No lists. Charges reasonable. Correspondence invited. Dr. Arthur Van-Heerden, 7651 Bennett, Chicago.

I MADE \$30 a week home. French breadmaking. 15 years' experience; free booklet tells. Ashbrook 67, Marengo, Ohio.

SIGNS And showcards easily painted. If you use Letter Patterns. Write for free samples. John Rahn, B2129 Nava Ave., Chicago.

AMATEUR Cartoonists: Sell your work. Write Smith's Service, PX1191, Wenatchee, Wash.

FREE Booklet describes 67 plans for making \$20-\$100 weekly in home or office business of your own. Elite Co., 84 Elizabeth St., New York.

FREE Book. Start your own little business anywhere, selling novelties by mail. My beginner's outfit contains everything required, novelties, circulars, instructions, etc. Descriptive book free. Hadwyl, 33A-74 Cortlandt St., New York.

SELL By mail. Books, novelties, bargains! Large profits. Particulars free. B. Elfee, 527 S. Dearborn, Chicago.

ANOTHER Famous \$5 book now \$1. The Story of Philosophy, by Will Durant. Is the latest popular book of modern times to be placed within the reach of everyone. You will want to add this to your library. The author has the knack of making the lives and opinions of great philosophers as interesting as dramas. 592 pages. Illustrated. Cloth. Sent C. O. D. Pay postman price \$1 and small amount of postage upon delivery. Popular Mechanics Press, Room 808, 200 E. Ontario St., Chicago, Ill.

A BUSINESS OF your own making—Sparkling Glass Name and Number plates, Checkboards, signs. Big book and sample free. E. Palmer, 510, Wooster, Ohio.

UNUSUAL—Uncommon specialties always sell best. Make these yourself from Miller's guaranteed formulas. Why work for others when others can be working for you? Latest eye-opening literature brings you many specialty propositions for you an independent business. Miller Chemist, 705-K Chemical Bldg., Tampa, Fla.

DELAWARE Charters; fees small; free forms. Chas. G. Guyer, Wilmington, Del.

CHEMICAL Expert will furnish formulas and trade secrets. All lines. Lists free. W. L. Cummings, Ph. D., 228 Gordon Ave., Syracuse, N. Y.

CHEMISTRY

TWENTY Dollars per day introducing Mulsol the new, wonderful external remedy. One hundred per cent profit. Pleasant, easy work. Fenway Laboratories, Box 2402, Boston, Mass.

BIG Profits in specialized formulas. Analysts, consultation. Any goods duplicated. Write Associated Chemists, Indianapolis, Ind.

CHEMICAL Analysis, processes, technical information. Robert Henderson, Laboratory, Madison, Maine.

HANDBOOK For Chemical Experimenters. Hundreds of interesting experiments; illustrated, 50c. Booklet of experiments, 15c. Pricelint, 5c. General Chemical Company, Box 397, Reading, Penna.

YOUR Chemical problem solved and formula or process furnished for Five dollars. Write me. W. Siedman Richards, Industrial Chemist, Box 2402, Boston, Mass.

CATALOG listing 2,500 Illustrations chemists' supplies, 5,000 chemical, 1,000 scientific books sent for 50c. Laboratory Materials Company, 643 E. 71st St., Chicago, Ill.

FORMULAS AND TRADE SECRETS

3,000 VALUABLE Formulas prepaid \$1.00 National Service, 3644 Tamarack, Cincinnati, Ohio.

IMITATION Honey, costs four cents a pound, formula \$1.00. H. Frame, Rockland, Ohio.

MY Photos and tonic formulae \$1.00. The Lone White Indian, Sandusky, Ohio.

FORMULAS All kinds. Catalog free. Clover Laboratories (P), Park Ridge, Ill.

THE World loves a winner. Do you realize one (1931 Model) formula is more valuable than hundreds overworked? The One 2 Three is registered U. S. Patent Office. We guarantee to raise nap on motor. Start crew cleaning upholstery in automobiles, homes and hotels, formula with instructions. One dollar (bill). Think! One 2 Three Products Co., Box 930, Savannah, Georgia.

FIRST Class metal polish. Formula 25c. M. C. Ladd, School, Va.

SUCCEEDED With your own products. Make them yourself. Formulas, processes, trade secrets. Expert analytical service. Catalog free. B. Thaxly Co., Washington, D. C.

SPARE Time money, manufacture photo frames, easily, with wood plastic. Guaranteed formula and plans, \$1. Tinkerwood, 1823 Payne Ave., Cleveland, Ohio.

FORMULAS, Chemical analysis, catalogue free. Herstein, Chemist, 46 Grand Ave., Grand Rapids, Mich.

MONEY Making formulas 3 cents up. List free. Empco Service, Box 748, Daxton, Ohio.

MONEY Making formulas, lowest prices. Lloyd Laboratories, 5566 Jackson, Chicago.

FREE Formula catalog. Illustrated. All lines. Western Chemical, Salem, Oregon.

MAKE And sell your own products. Fifteen valuable formulas \$1.00. Joseph H. Belfort, 4012 N. Keeler Ave., Chicago, Ill.

FREE Formulas—Free materials making \$32.00 worth of guaranteed highest class specialty-necessities. Thirty-third unequalled anniversary offers explains all. Miller, Chemist, 1707-G Jetton, Tampa, Fla.

ANY Formula, 50c. List free. Industrial Institute, Dept. 206, 64 West Randolph, Chicago.

GREATEST Formula bargain ever offered. Latest, best, selected sellers. Information free. Specialty Mfg. Service, 801 So. Farragut, Bay City, Mich.

500 FORMULAS And big illustrated catalog 25c. Ideal Book Shop, Park Ridge, Ill.

AGENTS WANTED

I START Men in a grocery business a new easy way. You use my money. Don't need to put up a penny of your own cash for stock. Expansion program now opens up many desirable opportunities also established trade. Hustlers make good money from the start increasing rapidly as they learn the business. Not a "chain" proposition but your own business. Buy on credit. Give credit if you wish. If honest and need more money write at once for application and details to McCornon & Company, Room L-6691, Winona, Minn.

RUN My oil agency. No investment required. I divide profits 50-50 every week. \$50 to \$200 weekly your share. Products nationally known. My partners made \$187,000 last year taking orders direct from farmers, auto owners, etc. All or spare time. Free selling equipment. Write quick. Central Petroleum Co., 614 Century Bldg., Cleveland, Ohio.

KNOW The joy of a bigger income. Our extensive line of household necessities offers men and women equal opportunity to clear \$75 weekly. Write B. & G. Rubber Co., Dept. 129, Pittsburgh, Pa.

MAKE \$28 Daily demonstrating automatic gaslighters, sample 25c. Gross \$8; doz. \$1. Rapid Mfg. 2772 Pitkin Ave., Brooklyn, N. Y.

\$50,000 PICTURE Man Friedman made canvassing: Get free circular Profits in portraits. Samples free. Picture Man Friedman, 109 West Austin Ave., Chicago.

SELL Men's neckwear—wonderful proposition. Astor-M, 39 East 28th, N. Y.

DISTRIBUTORS—Agents wanted! New imported Greek olive oil shampoos, Henekle Co., 420 Lexington Ave., New York.

SUCCEED With your own products. Make them yourself. Formulas, processes, trade secrets. Expert analytical service. Catalog free. B. Thaxly Co., Washington, D. C.

AGENTS—Here's something brand new and good for \$10 profit a day—any day in the week. Prepared doughnut flour—everything ready mixed. Makes delicious doughnuts in a jiffy. Simply add water and fry. Do housewives snap it up? Oh Boy! Does a duck take to water? Grab this while it's hot. Albert Mills, 8967 Monmouth, Cincinnati, O.

NEW—Different: "No-Tangle" ironing cord. Never kinks—saves electricity. Always out of way. Women amazed. Quick sales. Tremendous profit. "Outfit free to producers." Bestever Products Co., 700 Irving Park Station, Chicago.

CAN You sell bleach cream? Big pay. Box 492, Cincinnati.

SIDELINE? Write Ellarbee, Box 35, Beverly, Mass. Sample (novelties) 20c.

BE First to sell new patented dryer railroad, demonstration creates sensation, everybody buys, free samples. General Balmor of Co., Parkersburg, West Va.

MARVELOUS New liquidified graphite increases mileage, doubles motor life. All cars. Sensational demonstration. Money-back guarantee. 100% profit. Rare opportunity, exclusive distributors build permanent, unlimited business. Write quick details, territory. Froyl Co., 136 Main, La Crosse, Wis.

SELL Electric flash signs and other changeable signs to stores, for \$1.50 each and up. Over 300% profit. Particulars free. National Sign System, St. Louis, Mo.

AGENTS Buy direct guaranteed hosiery. Make 100% profit—Beat all competition. Men's latest fancy hose—doz. \$1.40-\$1.75. Ladies' silk hose, doz. \$3.50-\$6.00. Latest men's neckwear, doz. \$1.25-\$2.25-\$2.75. Superior Knitting Company, Dept. 31, New Haven, Conn.

MAGIC Gas equals gas 3c gallon. Harmless, guaranteed product. Used by largest bus companies. Circulars, labels, letter-heads with agent's name furnished. Particulars and proof free. P. A. Lefebvre & Co., Ltd., 31 Maple Gas Bldg., Alexandria, Ont.

ANOTHER Brand new Cruver sensation. Panel portraits sell on sight. Everyone wants them. Set your own profit. Free sample offer and full particulars. Cruver Mfg. Co., 24628 Jackson, Chicago.

LADIES silk hose \$2.00 dozen. 40c vanilla \$1.50 dozen. Sell both 50c. Samples 50c. Little's, Abbot, Ark.

YALE Vest pocket adding machine, made of metal. Agents sample one dollar, Yale Mfg. Co., Box 777 Phila., Pa.

AA-1 FOOD Manufacturer, nationally known, desires experienced crew organizers, with moderate capitals, act as exclusive distributors new, delightful fruit product. Also local agents to introduce. Vandenberg, Mgr., Room 2, 14th & Jackson, Omaha, Nebraska.

WONDER Hot pad; Heats itself. No hot water. No electricity. Stays hot 12 hours. Sells fast. Easily demonstrated. Outfit free to producers. Bestever Company, 895 Irving Park Station, Chicago.

NEW Can opener making agents rich. Will surprise you. Quick orders from agents, sample 25c. Alineds Mfg. Co., Box D26, Oak Park, Ill.

AGENTS: Stamping names on pocket-key protectors. Sample check with your name and address, 25c. Stamping outfits, Emblem checks, check-fobs, name plates. Hart Mfg. Co., Desk 2, 363 Degraw St., Brooklyn, N. Y.

NEW Rubber goods line. 47 money makers. Rubber rugs, cushions, bath mats, raincoats, rubber soles, aprons, baby goods, etc. Big profits, best values. Direct from Akron, the rubber city. Make up to \$90 weekly. Credit given. Write for catalog and free outfit offer. Kristee Mfg. Co., 1431 Bar St., Akron, Ohio.

NEW, Profitable—Sell auto step mats, Quality rubber with owner's name molded white. Details free. Ebonite Products, Dept. E-10, 895 Main, Akron, Ohio.

NEW Hand painted silk screen sign, retail stores, easy sales, particulars free, samples 20c. 8c retails 25c. D. 30, Lowy 8 W. Broadway, New York City.

EXCELLENT Trouser presser, \$1.25. Agents 70c. L. J. Widness, 461 Sumner Ave., Brooklyn, N. Y.

MAPLE Flavor concentrate, bottle yourself! 80% profit, furnish everything, sample \$1.00 makes four gallons. Valizon Products Company, Geneva, New York.

BIG Money easy, simply showing new Polly Wrench, 10 wrenches in one. Guaranteed fast seller. Sample furnished, Gellman Mfg. Co., Dept. 6-A, Rock Island, Ill.

SELLING Like blazes. Beautiful toilet goods assortment at \$1.75 with 24 inch pearl necklace free to your customers, 100% profit. Davis Products Co., 238 North Ave., Dept. 639, Chicago.

ELECTRIC Arc soldering. New, startling. Principle electric welding. Representatives, \$12.00 day easy, 100% profit. Sample \$2.00. Huribert Mfg. Co., Glendale, Calif.

100% PROFIT In new mystery cigar lighter. No flint or friction. What makes it light? No wind can blow it out. Retalls 50c. Sample and sales plan 25c. New Method Manufacturing Co., Box PM-1, Bradford, Pa.

300% PROFIT Selling Mystery Gas Lighter, Retalls 25c. Costs you \$1.00 doz. Sample free. Square Deal Mfg., Desk PM-15, Bradford, Pa.

ELECTRIC Water heater—New. Heats water instantly. Pocket size—retalls \$3.75. Two minute demonstration makes you \$1.95 profit. Lux-Viel, Dept. 193, Elkhart, Ind.

STRANGE New ironing cord! Prevents scorching. Saves electricity. Cannot kink or snarl. For telephones also. Up to \$25 daily. Samples furnished. Neverlost, Dept. 1-A, 4563 Ravenswood, Chicago.

OLIVER Cleared \$700 in 30 days with our line of books and bibles. Outfit free! Exclusive territory! Nichols Co., Dept. B39, Naperville, Illinois.

GET Our free sample case. Toilet articles, flavorings and specialties. Wonderful profitable. LaDerma Co., Dept. 80, St. Louis, Mo.

MAKE Big money with fast selling line of food products, prize motor and tractor oil-paints. Sure repeat orders. Write for free sample case. Loverin & Browne, 1608-H So. State, Chicago.

AGENTS—80c Profit on \$1.00 sales. Auto, furniture, metal, glass cleaner. Your name on labels. Free sample. Minute Kleen Laboratories, Dept. E, Evansville, Indiana.

PORTRAIT Men—Big new catalog guaranteed portraits, frames, medallions, photo pillows, household specialties, toilet preparations, food products. Wonderful proposition. Credit. James Bailey Co., Station C-1 Chicago.

AGENTS—Up to \$12 daily demonstrating men's, women's, children's finest hosiery. Definite wear warranted or replaced. Amazingly low prices, 100 styles, colors. Auto and hosiery given producers. Write quick! Wilkmit Hosiery Co., Dept. C-371, Greenfield, Ohio.

FREE Circulars describing thousands of money making opportunities showing you the way to independence and prosperity. Write today. Agraph Company, 1217 Avenue U, Brooklyn, N. Y.

175 TO 240%. New practical device keeps shirt smooth and in position. Unlimited field. Rapid seller. Every sale creates others. Sideline for belt and the salesman. Price 25c. \$1.25 dozen. Trix, 602, 7334 Woodward, Detroit.

CASH Paid for butterflies, insects. See *Sinclair Display Advertisement* on page 32.

OWN Your own business with everything you need furnished. Unlimited profits supplying over 100 daily-used necessities. Big demand brings steady sales, repeat profits. Liberal commissions daily. Get free samples and details now! Secretary, Dept. A-60, 2117 Franklin Avenue, St. Louis, Mo.

MANUFACTURE Hair tonic. We furnish ingredients, free labels. You add water and bottle. Also Vanilla Concentrate, flavoring. Macwood, P-925 Broadway, New York.

SALESMEN—Agents-distributors wanted. To handle fast selling \$1.00 razor blade sharpener. 200% profit. Introductory kit of free sharpeners \$1.00 prepaid. Amalgamated Corp., 605 Washington Blvd., Chicago.

TIME Counts in applying for patents. See pages 126 and 127. Clarence A. O'Brien, Registered Patent Attorney, Washington, D. C.

"ANTI-STEAM" Keeps windshield clear of steam, frost, sleet, rain and snow. Tested and approved by nationally known companies. High grade, unbeatable proposition. Unusual profits. Sold with money back guarantee. Free sample proves merit. Walter S. Doe & Co., Mfg. Chemists, Kent, Ohio.

250,000 ARTICLES Wholesale. Directory 10c. W. Patterson, 4111 University, Des Moines, Iowa.

AUTOMOBILE Specialties. Guaranteed formulas latest money makers. Lowest prices. Free lists. Murphy, Chemist, 1024 Douglas St., Los Angeles, Calif.

FLAVORING Extracts—bottle your self. Concentrated. Labels furnished. 600% profits. Whirlwind money-makers. Steady repeaters. Free offer. Thomas Manufacturing Company, Indianapolis, Indiana.

MIRRORS Resilvered at home. Costs near 5 cents per square foot; you charge 75 cents. Profitable business plating sub-parts, reflectors, tableware, stoves, refinishing metalware, etc. Outfits furnished. Details free. Write, Sprinkle, Plater, 128, Marion, Ind.

DOES 300% Profit interest you? World's best polishing cloth. Everybody buys. Sample free. Magcloth, 3317 Summit, Kansas City, Mo.

BIGGEST Surprise offer ever made. Be sure to answer this ad. My line of soaps, coffee, tea, spices, toilet articles, household specialties, pays you bigger profits. M. G. Roth, President, 2708 Dodier, St. Louis, Mo.

AGENTS—Can openers, new improved hand, wall, table models. Safety Products Co., 315 American Bank, Kansas City, Mo.

MAKE—Sell your own goods. Formula catalog free. Clover Laboratories, 178M, Park Ridge, Ill.

NEW Automatic clothes washer. Washes quickly and thoroughly. No rubbing. No electricity. Retail \$9.75. Guaranteed. Write Storm Royalty Co., 3601 Enright, St. Louis, Mo.

THE Magic Wire—Fastest selling novelty in existence. Sample 10c. American Specialty Company, Swampscott, Massachusetts.

200-200 A WEEK. Genuine gold letters for store windows. Easily applied. Free samples. Liberal offer to general agents. Metallic Letter Co., 438-B North Clark, Chicago.

THAXLY Formulas produce perfect products. All lines. Catalog free. B. Thaxly Co., Washington, D. C.

REPLATE Brass worn-off automobile parts, reflectors, bath room fixtures, worn spoons, forks, etc., with pure silver. Looks like new. Use U-Kan-Plate Polish. Positively no mercury; \$1.00 half pints. Post-paid. Satisfaction guaranteed. Agents wanted. Dept. A, U-Kan-Plate Co., Philadelphia.

SELL Housewives something they want. They are bound to be interested. A signed guarantee to reduce gas bills 25%. No competition. 400% profit. Station C, Box 25E, San Diego, Calif.

BIG Profit putting our gold sign letters on store windows, without experience. Samples. Consolidated, 69-T West VanBuren, Chicago.

MANUFACTURER Wants distributor for new "Pocket Radio," only \$3.85. "Sells itself with music." Pays 100% profit. Spencer Radio, Akron, Ohio.

SELL At once! 100 Blue Signs, Handy Container, \$3.50. Koehler's, 717 North Fourth, St. Louis, Mo.

AGENTS—Engraved name plates, signs, number plates etc., easily sold with large profits. Brett Bros., Winthrop, Mass.

THE Magnetic safety light Admiral Byrd used on his South Pole expedition is a big money maker now. It's an everlasting flashlight. No batteries required. All automobile drivers want them. Send for demonstrator. National Electric Corporation, 220 High St., Newark, N. J.

BIG Money applying gold initials on automobiles. Easiest thing today. No experience needed. \$1.45 profit every \$1.50 job. Free samples. "Bales," X-1043 Washington, Boston, Mass.

AGENTS—New shirt proposition. No capital or experience needed. Commissions in advance. Samples free. Madison Company, 566 Broadway, New York.

BIG Money and fast sales. Every owner buys gold initials for his auto. You charge \$1.50; make \$1.45. Ten orders daily easy. Write for particulars and free samples. American Monogram Co., Dept. 40, East Orange, N. J.

NO Dull times selling food! People must eat. Federal distributors make big money; up to \$1,000 yearly or more. No capital or experience needed; unsold goods may be returned. We furnish free sample case, license and free samples for customers—sure repeat orders. Exclusive territory. Ask now. Federal Pure Food Co., A2307 Archer, Chicago.

AGENTS—Moose corn and callous remover will build you a steady repeat business. Send today for pocket-size trial outfit. The Moss Company, 501 Searle Bldg., Rochester, N. Y.

OUR New card of 6c aspirin sells fast to stores. Over 100% profit. DeVore Mfg. Co., Desk C, Columbus, Ohio.

OUR Luminous crucifix and new luminous St. Theresa statue shine brilliantly in the dark. Sell on first demonstration. Write for prices. W. G. Hanson Co., 2543 So. State, Chicago.

"HOW To Secure Agents," a specially prepared booklet, tells of one of the most inexpensive methods in which to secure good live producing agents. It is free; write for your copy today! M. L. Rund, Mgr. Classified Advertising, Popular Mechanics Magazine, 200 E. Ontario St., Chicago, Ill.

AGENTS Everywhere making money with our line of kitchen specialties, demanded in all homes. Big earnings possible. Write today for details. P. Seed Filter Co., 333 Broadway, New York.

NEW Line Counter Displays, Aspirin, Plins, Chewing Laxative, Breath Gum, No-tartar, Siltone, etc. Steady Repeats. Over 100% Profit. Superba Co., W5, Baltimore, Md.

CHICAGO Expert valued \$3 stone at \$900. The diamond's only guaranteed rival. Greatest spare time, side-line article ever known! Amazing profits. \$5 pocket sample case free. Write quick. Mexican Gem Company, Dept. PM, Monterey, Calif.

FREE "Booklet of money making opportunities," new ideas, original plans, money making secrets and other valuable information. None require peddling or outfits. Elite Co., 84 Elizabeth St., New York.

SELL Stores 5c carded breathlets, etc. Lorrac Products, Albany, N. Y.

MAN in each town to plate auto parts, reflectors, bathroom fixtures, refinish beds, mirrors, chandeliers; by new method. No capital or experience required. Simple plan of manufacturing at home starts you in big money-making business. Outfit furnished. Free particulars and proofs. Gun Metal Co., Ave. H, Decatur, Ill.

CALIFORNIA Perfumed beads selling like hot cakes. Agents coinng money. Big profits. Catalog free. Mission Factory P, 2328 W. Pico, Los Angeles, Calif.

A BUSINESS Of your own—Making sparkling glass name and number plates, checkerboard signs. Big book and sample free. E. Palmer, 512, Wooster, Ohio.

WANTED: District manager to appoint agents. Unlimited opportunity. No canvassing. Mother Hubbard Products, 554U Congress, Chicago.

HOT Shot new electrical wizard starts cars, trucks, tractors without choke. Saves gas, oil. Sparks blue if ignition satisfactory, red if faulty. Agents cleaning up. Sample \$1.00. Details free. Beardon Mfg. Co., 158 Fulton, Peoria, Ill.

THIS Advertisement may make you thousands of dollars, if you write immediately for my "Eye-Opening" literature describing guaranteed formulas; valuable trade processes, money-making information how to easily make the world's best-selling specialties. All lines. Investment small. Profits immense! Start in your home, room or office. Make the good money you're entitled to. Dr. Liscombe Miller, Chemist, Tampa, Fla.

GENUINE Gold Leaf Letters anyone can put on store windows. Guaranteed to never tarnish. Large profits. Enormous demand. Free samples. Write today. Metallic Letter Co., 438-B North Clark, Chicago.

PHOTO Medallion men and women, the largest line of photo novelties in the world. Lowest prices, quickest service. Send for catalog showing over 200 money makers. Gibson Photo Jewelry Co., Inc., 833-837 Gravesend Ave., Brooklyn, N. Y.

GREATEST Opportunity; newest proposition. Build continually paying business in your own name. Household, Industrial, brushes, brooms, mops, dusters, fully guaranteed. New catalog, all net prices, no discount to bother with. Make as high as 300 per cent and over. Write today. Wire Grip Sanitary Brush Corp., 41 East 11th St., New York.

AGENTS—Clever Invention! Inkspoon makes every pen a fountain pen. Fast office seller; big profit, demand increasing everywhere. Exclusive territory offered. Sample free. H. Marui Company, Tribune Bldg., New York, N. Y.

WE Start you without a dollar. Soaps, extracts, perfumes, toilet goods. Experience unnecessary. Carnation Co., 641, St. Louis, Mo.

AGENTS—Make a dollar an hour. Seal Mendets, a patented patch for instantly mending leaks in all utensils. Sample package free. Collette Mfg. Co., Dept. 404, Amsterdam, N. Y.

15,000 PROFIT Making formulas. Following and many others: Accidents and emergencies, agriculture, alloys and amalgams, artist's materials, beverages, cements, glues, pastes, mezzalanes, bleaching, renovating, coloring metals, dyeing, glass, heat treatment of metals, household formulas, ice cream, confectionery, chewing gum, lardinary work, exterminating vermin, lubricants, paints, varnishes, photography, condiments, canning formulas, rubber, soap, candles, soldering, toilet preparations, perfumes, waterproofing, fireproofing, writing materials. Just write for "Scientific American Encyclopedia of Formulas." When postman hands you book pay \$2.50 and postal charges. Popular Mechanics Press, Room 891, 209 E. Ontario St., Chicago, Ill.

HIGH-GRADE SALESMEN WANTED

STOP Working for small pay—Own and operate a Rawleigh home service business; good anywhere, anytime the year around; you supply 200 home necessities; guarantee satisfaction or no sale; over 42 million sold 1929; thousands doing \$4,000 to \$6,000 annual business in Medicines, food, soaps, toilet preparations, stock-poultry supplies, all backed by \$17,000,000 industry; established 40 years; largest of its kind with 15 great factories and branches; selling experience unnecessary; practically no capital; credit if desiring; first send for full particulars—then decide. Rawleigh Co., Dept. A-N PPM Freeport, Ill.

NEW "Endless chain" selling plan guarantees you amazing profits and many repeat sales with America's greatest printing line. 40%-50% profit on every order. 101-page catalog shows 1001 printing necessities for every business. Also line of personal stationery, pictorial parcel post and shipping stickers, collection sticker system, advertising tags, drugist labels, etc. Thousands of free cuts. Lowest prices. Highest quality work. Main or sideline. Experience unnecessary. This is highest profit-maker of the year. Write quick for big new 1931 outfit. Kaiser-Blair, Inc., Dept. 253, Cincinnati, Ohio.

AUTO Accessory salesman. Profitable repeat business; exclusive territory; full or part time; new super tire patch; 5000 mile guarantee; 200% to dealers; 40% cash commission to salesman. Mason-Ryckoff Rubber Co., 229 West 19th St., Chicago.

SELL Nothing! \$170 weekly empty handed. \$500,000 punchboard firm announces new plan. No investment for anyone. Season starting. Hurry! K & S Sales, 4332A Ravenswood, Chicago.

EXTRA Money-Men calling on hotels, restaurants, confectioners, druggists. Get particulars of fast selling sideline sanitary menu covers. Liberal commissions. Sameco Company, Dept. P.M. Brookton, Mass.

SALESBOARD Men: whirlwind seller! \$15.00 profit every call. Repeat commissions. Beat season. Hurry! Puritan Mfg. Co. 2037 Charleston, Chicago.

CHRISTMAS—New Year! 100% profit for distributors and salesmen. Selling California juice bricks. All flavors: Port, Sherry, Champaigne, Burgundy, Orange, etc.—One brick makes one gallon juice. Every home, hospital, church, club a prospect. Write Vina Sano Co., 393 9th St., Dept. S-155, San Francisco, Calif.

\$8.00 DAILY On two \$3.75 orders. Free kit. Sample watch to producers. New deal guarantees merchants results. Sales Stimulators, Dept. 6H, 341 Madison, Chicago.

5c CARDER Nuts, aspirin, etc. Also low priced vending machines. All merchants buy. Steady repeats. Robbin Products, 21 Dodsworth St., Brooklyn, New York.

BUSINESS Stationery—largest line—Highest quality—quickest delivery—Biggest commissions. Liberal bonuses. Free copy-righted cuts every business. Experience unnecessary. Instructions and outfit free. David Lionel Press, 312 So. Hamilton, Dept. 190, Chicago.

RAD Debt service salesmen, sell service contracts. New original plan! Liberal commission, extra bonus. Protected territory. National Credit Service, Columbian Bldg., Washington, D. C.

SALESMEN—1000 Car washings for \$3.75. Remarkable invention washes cars faster, cleaner, cheaper. Over 100% profit for agents. Write to-day for free sample offer. Gy-ro Brush, Dept. AC-14, Ampere, New Jersey.

WONDERFUL Invention. Seals fifty envelopes minute. Sells on sight at \$2.25. Attractive trial offer. Square deal. Bank references. Kendall Sealer Co., Dept. C-26, East Jaffrey, N. H.

NEW And plenty different—Fast selling 5c-10c merchandise on attractive counter cards. 100% commission for you and dealers. Advertised by radio. No capital required. Catalog free. World's Products (Estab. 1921), 114 Central, Spencer, Ind.

NEW And original—A winter hazard eliminated. Salesmen are cleaning up selling Ace Windshield Defrosters. Guaranteed to keep drivers vision clear under all conditions. Sample kit one dollar. Rubber Products Company, Fort Worth, Texas.

SALESMEN—At last! New feature sells punchboards everywhere—Dealers wild with joy—prosperity bark again—profits enormous. Samples free. Puritan Novelty, 1467 Jackson Blvd., Chicago.

SALESMEN—Own your own business. Become independent. Experience unnecessary. Sell tires and auto accessories to garages, filling stations, tire stores, etc. Nationally advertised lines that repeat everywhere. Big commission. Write for particulars. Rubber Products Company, Fort Worth, Texas.

WANTED Salesmen, everywhere. Frame's peanut specialties. Rockland, Ohio.

\$18 TO \$25 Daily: biggest selling line of men's suits, \$11.95, \$14.50, \$16.95, \$19.95. Amazing values. Pure virgin wool overcoats, \$18.95. Also raincoats, slickers, topcoats and boys' suits. Biggest commission paid in advance. Liberal bonus. Free outfit. State age and selling experience. "Jim" Foster, Inc., Dept. 21, 2250 South Spaulding Ave., Chicago.

SALESMEN Selling stores handle Kolar-neat—new, patented. Holds soft collars in place. 10c seller—all stores selling to men will buy. Big commission. M. M. Bear, 4625 N. Racine Ave., Dept. 553, Chicago, Ill.

\$5 TO \$11.50 Per order including bonus every time you sell a finely tailored-to-order, all-wool suit at \$23.75 and up. Extra fine values. If you want to try, write. Everything furnished free. Pioneer Tailoring Co., Congress and Throop Sts., Dep. A-1117, Chicago.

SALESMEN—Wonderful sideline. 40% commission paid daily. Sells all merchants. Pocket outfit free. Willens Co., Dept. 337 2130 Gladys Ave., Chicago.

BIG Pay every day. Bonus every week. Adelite sells everywhere. New spectacular electric window display. Ever-changing colors, original posters, patented changeable letters defy imitation or competition. Special models for merchants, banks, etc. Instant seller. Big repeats, full commission. Write for thirty day demonstration offer. Display Products Co., 409A East 31st, Kansas City, Mo.

\$60-\$200 A WEEK. Genuine gold letters for store windows. Easily applied. Free samples. Liberal offer to general agents. Metallic Letter Co., 438-A North Clark, Chicago.

DUPILIGRAPH Reproduces handwriting, typesetting, drawings, neatly, rapidly, cheaply. Low priced, fast sales, liberal commissions. Dupiligraph, 13½ W. Main, Springfield, Ohio.

UNUSUAL Opportunity for mechanically inclined men with car. Establish independent business. Complete line socket wrenches, new automotive tools. Liberal commissions and discounts. York Co., 2040 Greenvier, Dent, PA-1, Chicago.

INTRODUCING Marti sanitary tooth brush. Sample fifteen cents postage prepaid. Martin Mfg. Co., 1204 S St., N. W., Canton, Ohio.

FRUIT Press, Brookfield, Ill. Pays 40% commission on printing. Free samples.

POOL Shooters, new fascinating vending machine. Merchants everywhere buy! Splendid sideline. Big profit makes! Free pocket outfit! Specialty Mfg. Co., W-617 W. Division, Chicago.

SALESMEN—Easy selling Die-U-Rat thru jobbers. 20% commission. Kills nothing but rats and mice. Rick Drug Co., Gallon, Ohio.

SPECIAL Advertising offer: Sell \$5 value quality toiletries for \$1; astonishing repeats; make \$13-\$50 daily. Paris Laboratories, 2621 Olive, St. Louis.

SELL Goodyear raincoats, \$2.95 up. Good-year Rainwear, 682 Sixth Avenue, New York.

BIG Profit putting our gold sign letters on store windows, without experience. Samples, Consolidated, 69-V West Van Buren, Chicago.

PUNCHBOARD Salesman—Most gigantic line ever featured. Vending machines, all kinds. Make high as \$28.00 on single order. Repeat commissions. Beautiful colored catalog free. Lion Mfg., Dept. 8, 308 W. Erie, Chicago.

WANTED District managers. Oldest organization of its kind in accident and health insurance. Write today for information. Dept. 18, Inter-State Business Men's Accident Ass'n, Des Moines, Iowa.

SALESMEN Sell tires and auto accessories to garages, tire stores, filling stations, etc. Established line repeats everywhere. Liberal commission. Write for particulars. Economy Rubber Prod. Co., 696 Burkhardt, Dorton, Ohio.

PUNCHBOARD Salesmen make big commissions, selling punchboards and vending machines. Reliable concern, established 20 years. Largest most complete catalog in colors, free. Best season now. Write to-day! Lincoln Sales, 116 S. Wells, Chicago, Dept. D.

SALESMEN—Become independent. Own your business; experience unnecessary. Selling our \$10,000 accidental death; \$50 accident; \$25 sick weekly benefits—\$18.00 yearly. Other amounts proportionate. Guaranteed steady income from renewals. \$250,000 deposited insurance department. Universal Policy, Dept. A, 716 Lefcourt Bldg., Newark, N. J.

SIDELINE SALESMEN WANTED

40-55% PROFITS Business stationery. 1001 styles. Lowest prices. New "endless chain" plan builds permanent business. Ideal side line. Experience unnecessary. Kaiser-Blair, Dept. 259, Cincinnati, Ohio.

HELP WANTED

IF You want a wonderful opportunity to make \$15 profit a day and get a new Ford sedan besides, send me your name immediately. No experience necessary. Particulars free. Albert Mills, 8968 Monmouth, Cincinnati, O.

CASH Paid for butterflies, insects. See Sinclair Display advertisement on page 52.

EDUCATIONAL AND INSTRUCTION

DON'T Prepare for any civil service examination without seeing our catalog. Free, Columbia Correspondence College, Washington, D. C.

DO You know that at a cost of practically nothing you may become a lifetime member of The Universal Educational System and study any of the best correspondence courses on any subjects you like and at any time? Write for members reference list and other particulars. Send 10c to insure immediate reply. Educational Sales Company, 1611 Great Northern Building, Chicago, Illinois.

BECOME A landscape architect. Un-crowded profession; wonderful opportunity for money-making. Easily mastered by mail. Earn while you learn. Est. 1916. Write for details. American Landscape School, 29A Plymouth Bldg., Des Moines, Iowa.

BOYS! Here's fun galore. Four large profusely illustrated books tell how to make almost everything you could want. Nearly 4,000 different articles are described (Think of it). Now \$2 per book or \$7 for the four if ordered at once. Just write a postal saying, "Send the Boy Mechanic Library." Pay postman \$7 and postage. For single books, specify either Book 1, 2, 3 or 4. Popular Mechanics Press, Room 801, 200 E. Ontario St., Chicago, Ill.

THE Ace of Cartoon Courses for only \$2.98. Particulars free. Carl Anderson School, Madison, Wis.

THE Outdoor season is here. Send for a copy of our book entitled "Outdoor Sports the Year Round." It is on making all sorts of devices for outdoor recreation. Pay postman price, \$1.50, and few cents postage when delivered. Popular Mechanics Press, Room 807, 200 E. Ontario St., Chicago.

FIREMEN, Brakemen, Baggage-men; colored train or sleeping car porters, \$150-\$250 monthly. Experience not necessary. 810 Railway Instruction Bureau, East St. Louis, Ill.

OUTDOOR Sports for everyone—Enjoy them all year round with aid of great new book just published by Popular Mechanics. This veritable encyclopedia not only furnishes hundreds of ideas for new and popular sports for every season of the year, but also gives complete instruction for making the necessary equipment at very small cost. 350 pages and 610 illustrations. Send to-day as book is full of thrills and excitement for fall and winter sport enthusiasts. Mailed postpaid anywhere for \$2., or will be sent C.O.D. to any address in U. S. Simply pay postman when delivered. Popular Mechanics Press, Room 812, 200 East Ontario St., Chicago.

ENGINEERING All branches. 50 cents each lesson. Engineering Simplified, 3950 Eastwood Avenue, Chicago, Ill.

U. S. GOVERNMENT Steady jobs. Men, Women, 18 up. \$105.00 to \$280.00 month. Steady work. Short hours. Paid summer vacation. Common education sufficient. Experience usually unnecessary. We coach you without leaving home. 32 page book with full particulars and sample coaching free. Write immediately. Today. Franklin Institute, Dept. T3, Rochester, N. Y.

LEARN Lacquer system of sign painting. Valuable new book gives complete description of methods, materials and equipment with hints and helps for sign shops. Covers latest in electric, neon tube, and daylight reflector signs, etc. Delivered to your door C. O. D. Simply pay postman \$3 and postage. Popular Mechanics Press, Room 801, 200 East Ontario St., Chicago.

PHOTOPLAY Talking picture and magazine stories wanted for revision, development and copyright. Sell on commission. Established 1917. Booklet free. Universal Scenario Company, 408 Meyer Bldg., Western and Sierra Vista, Hollywood, Calif.

DO Not sign up for a correspondence civil service coaching course for Government job without first learning the truth about these positions. H. F. Ward, Dept. A, 1609 W. 9th St., Los Angeles, Calif.

U. S. GOVERNMENT Wants men. \$1,700-\$1,900 and up at start. Railway mail clerk examination coming. Let our expert (former government examiner) prepare you for this and also rural carrier, post office, customs, internal revenue, and other branches. Write today for free booklet. Dept. 8, Patterson School, Rochester, N. Y.

WANTED Immediately, men-women, 18-55, qualify for permanent government positions. \$105-250 month; no government experience required. Paid vacations. Common education. Many needed soon. Write Ozment Inst., 191, St. Louis, Mo.

LEARN Rapid figuring from "Higher Arithmetic." Write for prospectus. F. A. Smith, 608 S. Dearborn St., Chicago.

GARDENING. There are many books on this subject but if you want the latest and most complete work covering flowers, vegetables, shrubs, trees, landscaping, the rock garden, the water garden, etc., for the average American home, you will send for Everybody's Garden by Frank A. Waugh. Sent C. O. D. 300 pages. Profusely illustrated. Cloth. Pay postman price, \$3.50 and small amount of postage upon delivery. Popular Mechanics Press, Room 801, 200 E. Ontario St., Chicago, Ill.

DOUBLE Entry bookkeeping 60 hours with 8 keys guaranteed. (Diplomas.) International Bookkeeping Inst., 8 Springfield, Mo.

CARTOONING—Let the world's most successful cartoonist tell you how to draw cartoons. Briggs in his new book gives every step in cartoon work and answers every question a beginner might ask. Elaborately illustrated. Pay postman price of book, \$3, and small amount of postage when he delivers the package C. O. D. Popular Mechanics Co., Room 801, 200 E. Ontario St., Chicago, Ill.

SHORT STORIES

SHORT Stories typewritten; placed on market. Booklet free. Hursh Service, Box P-1013, Harrisburg, Penna.

YOU Need a better grip on mathematics? Ask us to send you a copy of "Mathematics for the Practical Man," only \$1.50. By common sense methods it removes the mystery and difficulties so algebra and calculus are made simple. Assuming your knowledge is limited to arithmetic you quickly and easily gain a working knowledge of algebra, geometry, trigonometry and calculus. Simply pay postman when he hands you the package. Address Popular Mechanics Press, Room 801, 200 E. Ontario St., Chicago, Ill.

TYPEWRITERS AND SUPPLIES

TYPEWRITERS. Radios, motorcycles, \$5. Best \$25.00. Terms, lists, agents, Knights, 1502 Locust, St. Louis, Mo.

TYPEWRITERS—All standard makes \$10 up. Catalog free. Northwestern Typewriter Exchange, 121 N. Francisco Ave., Chicago.

TYPEWRITERS—All makes, guaranteed \$6 to \$33. Catalog free. Typewriter Exchange, Ada, Okla.

PRINTING, MULTIGRAPHING AND MIMEOGRAPHING

1000 ATTRACTIVE Colored envelope slips 200 words \$2.00; 5,000, \$5.50, prepaid. 5,000 tinted enamel folders, \$13.75. 5,000 6x9 circulars, \$7.50. All printing low prices. Samples. Goodprint, Harrisonburg, Va.

WE Print stationery, booklets, catalogs, circulars. Samples. Commercial Press, Batavia, Ohio.

250 WHITEBOND Letterheads and envelopes, \$2.49. Webster's Press, Fairland, Indiana.

GUMMED Labels, advertising devices, gift stationery, imprint circulars, rubber stamps. Request samples. McPherson Printing Works, Middletown, Conn.

\$2.95 THOUSAND Delivered. Letterheads, envelopes, statements, billheads, cards, handbills. Print anything. National, Goshen, Indiana.

250 LETTERHEADS And 100 envelopes, \$1.00; 200 letterheads, 8 1/2 x 11, 150 envelopes, \$2.00; 250 cards, \$1.00. Hoosier Print Shop, Portland, Ind.

1000 BUSINESS Cards \$2.75 postpaid. Samples. Miller, Printer, Narberth, Pa.

500 MIMEOGRAPHED Letters with printed letterhead \$3.50. Samples free. Reed Service, 1913 Mascher, Philadelphia.

LETTERHEADS. Envelopes, 500, \$1.10; 1,000, \$2.00; 5,000, \$8.00, plus postage. Samples. Coyle & Kimball, Newport, N. Y.

QUALITY Printing! Reasonable prices! Send for free standardized samples and prices. Folders, Circulars, Catalogs our specialty. Earnest Pantus, 525 South Dearborn, Chicago.

250 BOND Letterheads, envelopes, billheads, cards, \$1.35 each. Economic Press, Leonia, N. J.

PUBLICATIONS. Catalogs, stationery. Prices reasonable. Annville Printing Company, Annville, Penna.

PRINTING OUTFITS

PRINTING Outfits—Presses, type supplies, type novelties. Send stamp for catalog. Model Press, York, Penna.

PRINT Your own cards, stationery, circulars, advertising, etc. Junior Press \$5.90, Job presses \$11 up, power \$149. Print for others, big profit. Easy rules furnished. Write for free catalog and full information. Kelsey Co., R-11, Meriden Conn.

GUMMED LABELS

1,000 STICKERS, 15 Words, quick, 25c postpaid. Harvey Wolf, 6618F Quimby, Cleveland, Ohio.

1,000 PRINTED: Name, business, address 50c. JBS Company, Box 93, Holyoke, Mass.

DUPLICATORS AND DEVICES

YOU Can make 50 to 100 copies of a letter, notice, etc., at a cost of three cents on a Hoyer Quality Duplicator. Write for free trial offer. The Hoyer Duplicator Co., 909 Jackson Blvd., Chicago, Ill.

"EXCELLOGRAPH" Rotary stencil duplicator \$39.99. "Two-Faced" film duplicator \$6.00. Booklet free. Pittsburgh Typewriter Supply, Dept. 601, Pittsburgh, Pa.

STENCIL Duplicator, \$14.50 complete. General Stamping Works, 238 E. 24th St., New York.

RUBBER STAMPS

RUBBER Stamps, name, address 35c. Stamp Works, B22M, Auburn, Nebr.

FOR MEN

LOOSE Knitted Imported, hand made woolen underwear for outdoor men. H. T. Berg, Ashton, Idaho.

INTERIOR Wall decoration in a valuable new book covering all the modern methods of artistic wall treatments. Practical working instructions for both plain and decorative finishes are given. 451 pages, illustrated. Delivered to your door C. O. D. Simply pay postman \$4 and postage. Popular Mechanics Press, Room 801, 200 E. Ontario St., Chicago.

THAT Concrete Job. Don't be afraid to tackle it. With the instructions found in Popular Mechanics Concrete Handbook you can easily make 173 articles of utility and beauty ranging from ordinary steps to garden furniture. This book will be sent for only 98c plus postage C. O. D. Send your order today to Popular Mechanics Press, Room 801, 200 E. Ontario St., Chicago, Ill.

FOR THE HOME

POOL Tables. For home use. sizes 2 1/2 x 5, 3rd. No top, nice Xmas present, \$25 and \$50.00. Send for catalogue, S. Mueller, Box 5, Arcadia, Mo.

CEDAR Chests only \$11.49—"Red-I-Kut" complete with rich copper trim—you assemble and save half—send for pictures. Kuempel Furniture Company, Guttenburg Iowa.

RADIO Trouble Shooting—Covers all electric sets and television. Greatest book ever published from the point of view of assisting the repairman as well as showing how the radio owner can do his own repairing. 328 pages. Over 300 illustrations. Flexible. Pay postman price \$3 and postage when he delivers it. Popular Mechanics Press, Room 801, 200 E. Ontario St., Chicago, Ill.

REFRIGERATING Machine, homemade. Inexpensive to build. Gives better service than ice. This and 328 other practical articles in our book "Home Mechanics." Just ask for this and "Handbook for Women," containing 394 valuable household helps and pay postman 98 cents and postage for the two books. Popular Mechanics Press, Room 801, 200 E. Ontario St., Chicago, Ill.

FIELD GLASSES, TELESCOPES AND MICROSCOPES

\$5.00 GOVERNMENT Used field and marine glasses, powerful with carrying case, cost \$20.00. Send free list binoculars, field glasses, aeroplane cameras, lenses, musical instruments and government radio, sets and parts. Well's Curiosity Shop, 20 South Second St., Philadelphia, Pa.

IMPORTED Eight mile binoculars. Only \$7.50. Free trial. Literature. M. Tarres, 4732 Griscom, Philadelphia.

RAZORS AND BLADES

GILLETTE Blades honed, stropped, 1c each. Pette Wetterquist, Rockford, Ill.

BOATS AND LAUNCHES

BOATS—Build your own pleasure or work boat using our Ready Cut semi-assembled materials. Commence now and have ready for early spring. Cruisers, runabouts, outboard motor, sail and row. Send 10c for catalog. Brooks Boat Co., Inc., Box YV, Saginaw, Michigan.

ICE Yacht, 170 square foot. Complete building plans in December Rudder 35 cents. Rudder, 15 Murray Street, New York.

BUILD Your own boat—Complete directions make it comparatively easy. 14 different types for all purposes including row, motor, sail, canoe, out-board motor boats, etc. With this book is included "Outdoor Sports the Year 'Round" on making all sorts of devices for outdoor recreation. Pay postman \$1.98 plus postage when delivered. Popular Mechanics Press, Room 801, 200 E. Ontario St., Chicago.

BUILD Your own boat. Complete directions make it comparatively easy and you will not only save money but have lots of fun besides. The Outboard Motor Boat book covers 35 different types of the latest outboard motor, inboard motor, rowing, sailing boats, canoes, etc., with blueprints in addition to the instructions. Pay postman price, \$1, and few cents postage when delivered. Popular Mechanics Press, Room 801, 200 E. Ontario St., Chicago.

DIAMONDS, WATCHES AND JEWELRY

7 JEWEL Elgin or Waltham rebuilt watches \$1.50. Wm. Cox, Auburn, Ala.

ANTIQUES, WAR RELICS AND INDIAN GOODS

105 GOOD Indian flints for \$2.50 postpaid. Satisfaction guaranteed. Museum, Economy, Indiana.

SEND 5c For fine new list Indian relics, antique firearms. F. E. Ellis, Webster Groves, Missouri.

INDIAN Relics, Coins, Curios, Beadwork. Catalogue free. Vernon Lemley, Osborne, Kansas.

MUSIC AND MUSICAL INSTRUMENTS

"BANJOS" Should interest all musicians as account of the popularity of the banjo, as it easily increases a player's income illus. catalog of 48 pages free. The Bacon Banjo Co., Inc., Groton, Conn., U. S. A.

SONGWRITER'S Information service. Legitimate. Write, Harry Battersby, Revere, Mass.

SONG Poems arranged for publication. Expert services. Real proposition. Brennan, 11438 Broadway, N. Y.

SONGWRITERS Investigate, write French Farmer, NX6, Box 132, Cloverdale, Ind.

MUSICAL Instrument, new invention. Direct importers. United Importing Company, 32-M Union Square, New York.

SATISFACTION Guaranteed. Write Sequoia Songwriters Service, Sherman Branch, Los Angeles, Calif.

COMPOSERS—Verse or music. Brilliant opportunity. Write VanBuren, 2239 McClurg Bldg., Chicago.

SONG Poems wanted. A different proposition. Richard Broughton, Sioux Falls, S. D.

PLAY Piano by Ear. A sound system. Booklet free. Boucher's Harmony Studio, Ottawa, Can.

SONGWRITERS! Advance royalty payments, new talking picture song requirements, etc., fully explained in our free instructive booklet. Newcomer Associates, 1617-DD Broadway, New York.

SONG Poem writers: "Real" proposition. Hibbler, DL 2104 Keystone, Chicago.

DUO-FLEX reeds for clarinets and saxophones eliminate your reed troubles. Write for circular. Duo-Flex Reeds, 1204 1st Ave., Evansville, Ind.

POEMS Wanted. Work guaranteed. We publish. Great Eastern Song Bureau, Dept. 27, Thomaston, Me.

SONG Writers. Send for our "Publishing Agreement." McKinley Music Printers, 1501 E. 55th St., Chicago.

WRITE Songs. Big money and reputation. Write for information. J. Gordon Pub. Co., 201 N. Hoyle Ave., Chicago.

"MUSIC Composed" to words. Bauer Bros. (formerly of Sousa's Band), Oshkosh, Wis.

CORNETISTS—Trumpetists—Saxophonists—Clarinetists. Get "Free Printers." Name instrument. Virtuosi School, Buffalo, N. Y.

SEND Song poems, 50-50 plan. Indiana Song Bureau. (Brookside), Salem, Ind.

PHONOGRAPHS AND RECORDS

BUILD Phonograph radio. Parts catalog mailed for 10c. American Phonograph Co., 2602 Wesley, Berwyn, Ill.

PATENT ATTORNEYS

PATENTS—Write for free information, how to obtain a patent and record of invention—or send drawing or model for examination. Miller & Miller, Patent Attorneys (former Patent Office Examiners), 1006-A Woolworth Building, New York; 259 McGill Building, Washington, D. C.

PATENTS—Write for our free book, "How to Obtain a Patent" and Record of Invention Blank. Send model or sketch of invention for inspection and instructions free. Terms reasonable. See advertisement on pages 128 and 129. Victor J. Evans & Co., 931 Ninth, Washington, D. C.

INVENTORS—Write for free information on patents. No obligation. See page 129. Harry W. Johnson, McGill Bldg., Wash., D. C.

LACEY'S Patent Sense. Valuable book free. See ad page 130.

PATENTS Procured. Prompt, careful efficient service. Highest references. Moderate fees. Send sketch or model for actual search and advice. George P. Kimmel, Master of Patent Law, 51-A, Legal Bldg., Washington, D. C.

TIME Counts in applying for patents. See pages 128 and 127. Clarence A. O'Brien, Registered Patent Attorney, Washington, D. C.

DON'T Fail to patent your invention in Great Britain. Tremendous market for worth while products. I will secure patent, sell, or exploit invention for you. If you are not getting action on anything already patented consult me. Complete service. Moderate charges. Highest references. John Norworth, Bush House, London, England.

INVENTORS: Send for booklet telling how to patent and sell your inventions at lowest cost. Ralph Burch, Patent Lawyer, 909 F St., Washington, D. C.

CANADIAN Patent attorneys, consultants, booklet on request. Glen & Glen, Ottawa, Canada.

PATENTS. Send sketch or model for advice. Free book, "How to Obtain a Patent." Established thirty years. Highest references. Prompt service. Reasonable charges. Chandler & Chandler, 908 F Street, Washington, D. C.

INVENTIONS Patented and Exploited. Former patent office examiner; Master patent law. Benj. Webster, Esq., No. 15 East 26 Street, New York.

INVENTORS—Write for our Guide Book, "How to Get Your Patent," and Evidence of Invention Blank. Send model or sketch of your invention for our prompt examination and instructions free. Randolph & Co., Dept. 439, Washington, D. C.

LANCASTER Albin & Rommel, 221 Ouray Bldg., Washington, D. C. "Originality of the Form Evidence of Invention." Before disclosing your invention to anyone send for blank form to be signed and witnessed. Form and patent information bulletin free.

"INVENTOR'S Guide," valuable information, free. Frank Ledermann, Registered Attorney-Engineer, 1712 Woolworth Bldg., New York.

PATENTS Procured; trade marks registered—preliminary advice furnished without charge. Booklet and form for disclosing idea free. Irving L. McCathran, 704 International Bldg., Washington, D. C.

PATENTS. Booklet free. Highest references. Best results. Promptness assured. Watson E. Coleman, Patent Lawyer, 724 Ninth St., Washington, D. C.

PEREY S. WEBSTER, 203 Saving and Loan Bldg., Stockton, Calif. Patent booklet free.

ESTABLISHED 1864. Milo B. Stevens Company. Free booklet. Patents. Trade marks. Copyrights. Offices. Menadnock Block, Chicago; Barrister Bldg., Washington, D. C.

FOR INVENTORS

If You have a new, practical household invention or novel device, made mostly of metal, that can sell from \$1 to \$5 manufactured, send us sketch and description. Your confidence protected. If we can use it, will arrange for outright purchase or royalty. Burgess Manufacturing Company, Beaver Falls, Penna.

TO Inventors: We are in the market to purchase a good patent, preferably in the automobile accessory line. Will purchase outright or on a royalty basis. Purchasing Agent, 241 Front St., New York, N. Y.

WANTED—Toy inventions. Responsible manufacturer will pay royalty on new ideas for Toys. Must be something entirely new. May be made of wood or metal, preferably not too complicated. Submit drawings or working models when requested. Address Room B, c/o Popular Mechanics.

MANUFACTURER Of wire, cloth and metal specialties desires patents or ideas. Room 35, % Popular Mechanics Magazine, 200 E. Ontario St., Chicago.

1000 CHIEF Patent buyers; names, addresses, lines manufactured. Copyrighted late revision, \$1 postpaid. American Patents Corporation, Barrister Building, Washington, D. C.

NATION Wide search for best inventions now on. Write American Society of Inventors. Crosby Bldg., Buffalo.

LEARN Patent drafting \$1.00. Legal blanks. Wade Service, 2274-G Brooklyn Station, Cleveland, O.

INVENTIONS—Write for our free book "How to Obtain a Patent" and Record of Invention Blank. Send model or sketch of invention for inspection and instructions free. Terms reasonable. See advertisement on pages 128 and 129. Victor J. Evans & Co., 57 Ninth, Washington, D. C.

LACEY'S Patent Sense. Valuable book free. See ad page 130.

TIME Counts in applying for patents. See pages 128 and 127. Clarence A. O'Brien, Registered Patent Attorney, Washington, D. C.

INVENTORS: Now you can protect, sell or investigate the value of your inventions or ideas without spending a penny for patents or attorney fees. Save hundreds of dollars and many months delay. Inexpensive. Guaranteed. Write Inventors Protection Bureau, Dept. 25, 173 West Madison, Chicago.

INVENTOR'S Universal Educator: contains 900 mechanical movements; 50 perpetual motions; instruction on procuring and selling patents and selecting an attorney, etc. Suggests new ideas. Price \$1.00 postpaid in U. S. A. Address Dietrich Co., publishers, 602B Ouray Bldg., Washington, D. C.

We Are interested in any new invention or improvement on locks, safes, electric protection or any device for the prevention of burglary daylight holdup or fire resisting protection of records or valuables. Do not send models unless asked for, Room "D", % Popular Mechanics Magazine, 200 E. Ontario St., Chicago, Ill.

INVENTIONS Patented and Exploited. Former patent office examiner; Master patent law. Benj. Webster, Esq., No. 15 East 26 Street, New York.

LOW Cost manufacturing. Large plant completely equipped for blanking, drawing, stamping and wire forming in any finish. Can save you money on your product. Our figures will convince. Eastern States Products, Box 721, New Haven, Conn.

INVENTORS—Lacking capital write Harden Engineering Corporation, Kansas City, Mo.

PATENTS FOR SALE

HUMIDIFIES Smoking tobacco in all pocket tins; in cover. Transferable; saves tobacco, slight cost. Royalty. Sell. Allison Ladd, Box 218, Colorado Springs, Colo.

OUTRIGHT Or royalty. Combined dustpan and holder for brooms etc. Patent No. 1,598,168. Something new, very economical. Emil E. Kasser, 141 W. 119 Street, New York.

OUTRIGHT Or royalty—combined mop and wringer. W. A. Coderre, 200 So. 4th St., Marshall, Minn.

OUTRIGHT Or royalty. Combination lighter and hotwater fountain shaving brush. Heats water instantly. Holds stick soap in handle. Two repeat sales. Novelty sensation sells on sight. William Frazier, 1509 N. Park Ave., Philadelphia, Pa.

AIRPLANE Swing for children, cheaply and simply constructed, entirely safe, strongly made, light in weight. Room 31, c/o Popular Mechanics Magazine, Chicago, Ill.

OUTRIGHT Or royalty, newly improved humidifier rack. G. P. Alexander, 232 E. Michigan Ave., Jackson, Michigan.

PATENT For sale—New burglar alarm door stop. Cheap to manufacture. 100% profit. Chas. Verch, 43 Judson St., Albany, N. Y.

OUTRIGHT Or royalty paper clip. Protected by strong patents. Probably the best of its kind ever invented. Sam Tallman, Box 677, San Bernardino, Calif.

FOR Sale—Patent 1754139. Very simple toy of years of selling life, outright or royalty. Ed Yama, Sacramento, Calif., 1212 4th.

No. 1,728,500, **VALVE** For internal combustion motors. Easier opening, quicker exhaust. Joseph Mariorell, 1753 Walton Ave., Bronx, N. Y.

FOR Sale or active partner wanted. Patented electric automatic steam radiator for house heating purposes. Also heater for wash machines, also vest pocket electric cigar and cigarette lighter. Address, P. J. O'Neill, 14 E. 4th Street, Bethlehem, Pa.

KITCHEN Knife sharpener. Outright, royalty or interest for backing. Box 661 Rapid City, South Dakota.

PERCOLATOR Handle will not burn off can. Manufacture small cost. E. Terry, 23 E. 8th St., Oklahoma City, Okla.

THERMOSTATIC Alarm signal. Farmers, hotels, hospitals. Outright or royalty, reliable firms only. Heap, Yerington, Nev.

ROYALTY—Patent carburetor compact. No vibration or detonation or carbon, gets 80 to 100% more with gas consumption. Eliminates poison gases. E. Beasley, Box 28, Bagnell, Mo.

ON Royalty—Paving subgrade machine, nothing similar on market, works like carpenter's plane. Write, N. A. Waldrop, Covington, Tenn.

OUTRIGHT. Just patented. No. 1768914, Orange and grape-fruit, fancy basket carrier, for hotels, restaurants and homes. Unusually big demand. Ben Lempek, 509 E. 12th St., New York, N. Y.

TIME Counts in applying for patents. See pages 128 and 127. Clarence A. O'Brien, Registered Patent Attorney, Washington, D. C.

MANUFACTURERS—Get our complete list of inventions for sale. American Society of Inventors, Crosby Bldg., Buffalo.

INVENTORS—Cash in on your invention now! Don't delay the sale any longer! Send for a free copy of our specially prepared booklet, "Turn Your Patent Into Money," today! It contains helpful information for all inventors. M. L. Rund, Mgr. Classified Advertising, Popular Mechanics Magazine, 200 E. Ontario St., Chicago, Ill.

MODELS AND MODEL SUPPLIES

WE Develop ideas, design, build models and manufacture. Logan Machine Co., 652 Lake, Chicago, Ill.

MODEL Supplies. Iron, brass or aluminum castings for special parts or complete machines. Muncie Piston Co., Muncie, Ind.

NU-WAY Gasoline engines. Model engines and boilers, pumps, water motors, castings, blue prints, catalog 15-A postpaid 10c. Howard Engine & Mfg. Co., 2417 No. Ashland Ave., Chicago.

INVENTORS: Send us sketch or crude model of your idea. Crescent craftsmen will develop it into a practical working model. 30 years of successful experience and thousands of satisfied clients. Confidential service guaranteed. Bank references furnished. Free illustrated book: "Making Inventions Pay." Crescent Tool Co., Dept. 8-1, Cincinnati, Ohio.

TIME Counts in applying for patents. See pages 128 and 127. Clarence A. O'Brien, Registered Patent Attorney, Washington, D. C.

SCALE Model railroad supplies—not toys. For hobbies or railroad exhibition work. The first and only complete model railroad catalog in the country—35c with credit slip. Well illustrated, parts for five gauges. American Model Railway Company, New Rochelle, N. Y.

FIVE Large blueprints for miniature steam engines, stationary, marine type \$2.00. Model Machine Shop, 212 Price St., Rahway, New Jersey.

WE Make working models for inventors and do experimental work and carry a complete stock of brass gears and model supplies. Send for catalog. The Pierce Model Works, Tinney Park, Ill.

SHIP And yarm models fittings. Send dime for illustrated catalog No. 6. A. J. Fisher, 1092 Etowah Ave., Royal Oak, Mich.

WOODTURNING For amateurs. Excellent new course just published for the amateur and home work shop owner. Contains all the needed information and is well illustrated yet published to sell at the low price of 25 cents postpaid. Send for your copy today. Mail remittance with your order. Popular Mechanics Press, Room 807, 200 E. Ontario St., Chicago

MANUFACTURING

MANUFACTURING. Models, dies, stampings, brasswork, mechanical rubber moulds, vulcanizing. Circular free. Baum's Metal Specialties, Kansas City, Mo.

WIRE Goods made to order. Cooley Mfg. Co., 530 N. Western Ave., Chicago.

ECONOMICAL Manufacturing from sheet, bar, wire or tubing. Models, dies, special machinery. Swanberg, 5124 N. Kildare Ave., Chicago.

HAGSTROM Model & Tool Works, dies, tools, models, light manufacturing. Kansas City, Mo.

METAL Articles developed and manufactured. Model making. Reasonable prices and first class workmanship. W. F. Meyers Company, Bedford, Indiana.

PATTERNS—Wood and metal; models, tools, dies, metal stampings; brass, aluminum and white metal castings; general manufacturing. Modern Machine & Pattern Co., Terre Haute, Ind.

SPECIALIZE Complete manufacture, dies, tools, special machinery. Models made. Atlas Indicator Works, 821 W. Washington, Chicago, Ill.

SPECIAL Machinery or parts, dies, tools, metal specialties, models, special gears, stock gears and model supplies. Send for catalog. The Pierce Model Works, Tinley Park, Ill.

LOW Cost manufacturing. Large plant completely equipped for blanking, drawing, stamping and wire forming in any finish. Can save you money on your product. Our figures will convince. Eastern States Products, Box 721, New Haven, Conn.

DIES. Stamping and machine work. Walter Neubert, Ellsworth Ave., Jeannette, Pennsylvania.

DRAFTING SUPPLIES

DRAFTSMEN! Greener Calculator, only instrument to obtain results with speed and accuracy in addition, subtraction, and multiplication of feet, inches and fraction of inches as small as 1/32 up to 1000 feet. Price—Made of nickel silver with leather case and description of operation \$5.00. E. R. Greener, Box 1287, Pittsburgh, Pa.

BLUE PRINTS

INVENT wire and wood mechanical toys, send \$1.50 for blueprint. Walter Geddes Gilman Iron Works, New Hampshire.

MACHINERY, TOOLS & SUPPLIES

15"x6" SEBASTIAN Lathe \$150.00. No. 0 Cincinnati plain miller \$225.00. No. 60 Head grinder \$500.00. 15" Steptoe shaper \$200.00. 30"x18" Fildfield lathe \$750.00. Baldwin saw table \$100.00. Parks cabinet shop special, six machines in one \$165.00. 10" new drill press \$21.00. Air compressor, complete tank, motor, \$100.00. Write for catalog. Terms to suit. Cincinnati Machinery & Supply Co., 27 West Second St., Cincinnati, O.

LATHES—Woodturning. \$6.00 7 1/2" swing, 36" bed. Adjustable rest. Just out. Cotterman, 155 N. Union, Chicago.

ELECTRIC Bench grinder, drills, reamers, mill cutters, threading dies, snap gages. Lowest prices. Send stamp for list. Tool Crib, 150 Bennett St., Bridgeport, Conn.

BEARINGS, Hangers, pulleys, gears, supplies. Kirk Hardware, Box 365, Madison Sq. Sta., New York City.

BARGAINS New and reconditioned equipment. Chromium platers, grinders, compressors, all ball bearing. Payment terms. Write Hobart Platers, Box M-117, Troy, Ohio.

START Business of your own, small investment required, doing nickel, copper and silver plating. This work in big demand. Information free. Electro Platers Supply Co., 28 W. Second St., Cincinnati, Ohio.

ENGINES, MOTORS AND DYNAMOS

FOR Sale: One-sixth and one-fourth hp. electric motors, 60 cycle 110 volt a.c., slightly used. One-sixth hp., \$4.50; one-fourth hp., \$5.00. Cash with order. Maytag Chicago Co., 160 E. Illinois St., Chicago.

CONVERTERS, Brand new, 32v. or 110v. d.c. to 110v. a.c. for radio \$45.00. 1/4 hp. a.c. motors \$6.50; 1/2 hp. 110v. d.c. motors \$16.00. 1/2 hp. 32v. motors \$12.50. Also other sizes. Queen City Electric, 1736 Grand Avenue, Chicago.

BARGAINS 1/2 hp. Gasoline engines \$17. T. A. Eberhardt, 702 34th St., Milwaukee, Wis.

STEAM Engines—One h. p. \$18.00; 1/2, \$12.00. James Chambliss, Bessemer, Ala.

TIME Counts in applying for patents. See pages 120 and 127. Clarence A. O'Brien, Registered Patent Attorney, Washington, D. C.

AUTO Engines for power plants. We make necessary attachments. Candee-Smith Governor Co., 215 N. Los Angeles St., Los Angeles.

NEW 1/2 Horse, 110 volt alternating motors, \$6.50; some used, \$4.50. New 1-12 horse, 110 volt universal, \$2.75. New 1/2 hp.-e, 110 volt 3,450 speed alternating, \$10.50. Other bargains. Electrical Surplus Company, Dept. 12, 1911 Chicago Ave., Chicago.

COMPRESSORS, Twin cylinder, for small tire shops. Ducco spraying. J. Trockman & Sons, Inc., 110-112 Lincoln Ave., Evansville, Ind.

ELECTRICAL

RADIO Service and repair men, dealers, salesmen, experimenters and designers—you will find Drake's Radio Encyclopedia covering 1,700 subjects arranged especially for your use. 920 pages, 1,000 illustrations. Most comprehensive radio reference book published. Delivered to your door C. O. D. Simply pay postman \$6 and postage. Popular Mechanics Press, Room 801, 200 E. Ontario St., Chicago.

WOOD Turning on the lathe. Both interesting and fascinating. Send for a copy of Milton & Wohlers Course in wood turning. It gives you quickly a complete mastery of this manual art. 340 pages. Cloth. 141 plates. Sent C. O. D. Pay postman price \$1.50 and small amount postage upon delivery. Popular Mechanics Press, Room 805, 200 E. Ontario St., Chicago, Ill.

BENDING MACHINES

THE Famous Hossfeld "Wrenchless" Universal Iron Bender is the last word in bending machines. Bends metal, cold or hot, into most any conceivable shape, including Eye Belts and Automobile Spring Eyes. Bends up to 1" bars or 1 1/2" pipe cold. Also bends "Angle Iron." Thousands in use by all classes of trade, from the smallest shops to the largest railway systems. Write for circular and prices. Hossfeld Mfg. Co., Winona, Minn.

WELDING AND SOLDERING

ELECTRIC Arc welders—new and used. Terms and trial. Tell needs to Hobart Welders, Box M-116, Troy, Ohio.

WELDING Encyclopedia. The latest, completely revised 1930 edition of this famous book contains every known fact regarding every kind of welding. Covers such up-to-date subjects as aircraft welding, 542 pages. Illustrated. Flexibly bound. Sent C. O. D. Pay postman price, \$5 and small amount of postage upon delivery. Popular Mechanics Press, Room 806, 200 E. Ontario St., Chicago, Ill.

OXYGEN, Acetylene and hydrogen regulators, welding and cutting torches, all makes, about half price, guaranteed. J. M. Shevlin, P. O. Box 51, Reading, Pa.

ELECTRICAL Trouble shooting on the motor car and airplane. Don't trust to luck or guess work. Learn to make every motion count in testing and repairing. Send for our standard 400-page book for electricians and mechanics. 300 diagrams. Hundreds of practical tests. Pay postman \$4.00 plus postage when delivered. If outside U. S. remit when ordering. Popular Mechanics Press, Room 801, 200 E. Ontario St., Chicago.

SURVEYING INSTRUMENTS

ORDER Before January 31 and get 20% off. Rebuild transits and levels. All makes, rebuilt in our own factory. Sold on easy terms, fully guaranteed and subject to test. Don't delay—write today for list. M-51, Warren-Knight Co., Makers of "Sterling" Surveying Instruments, 136 North 12th St., Phila. Pa.

FARMS AND FARM LANDS

LAND Openings along the Great Northern Railway. Fertile productive improved farms, new land or good outcrop land. Opportunities in many kinds of farming; grain, livestock, dairying, fruit, poultry, small tracts or general farms in Minnesota, North Dakota, Montana, Idaho, Washington, and Oregon. Renters and owners get benefit of low prices, low interest, low taxes. We have free books on each state, can give accurate detailed information and help to find kind of location desired. Write E. C. Leedy, Dept. 557, Great Northern Railway, St. Paul, Minnesota. Low Homeseekers' rates.

INVEST In pecan in sunny Arizona. Substantial returns. Wonderful climate. Write I. Meskinens, Tolleson, Arizona.

250-ACRE Farm, 200 tillable; good buildings, good farm, capable of carrying 50 head of stock; cash \$10,000; terms \$12,000. Knowlton, Buffalo Cold Storage Co., Buffalo, N. Y.

CANADIAN Tax sale lands for a dollar an acre and up; small monthly payments. Farms, timber, hunting and fishing camps, minerals. Limited number of properties. Write at once for free illustrated booklet. Tax Sale Service, Room 613, 72 Queen St. West, Toronto, Canada.

120 ACRES, 700 Bu. potatoes, 120 cuts, 125 corn, vegetables, wood, implements, horses, 6 cattle, poultry included; state highway, 10-room house, barns, etc.; valuable wood, near lake and village, \$4,500, part cash. Picture page 27. Free catalog, 1000 bargains. Strout Agency, 253-P Fourth Ave., New York City.

WANTED To hear from owner having farm or unimproved land for sale. Give cash price. John Black, Chippewa Falls, Wis.

OZARKS—20 Acres, timbered, \$100, \$5 monthly. Poultry, hogs, fruit; fishing, hunting, trapping. Hubbard, 216 Grossman Bldg., Kansas City, Kansas.

OWN A Farm in Minnesota, Dakota, Montana, Idaho, Washington or Oregon. Crop payment or easy terms. Free literature; mention state. H. W. Byerly, 119 Northern Pacific Railway, St. Paul, Minn.

TEN Dollars monthly acquires five acres peaches, tungs, figs, oranges. Guaranteed care. Big returns. Suburban Orchards, Dept. M, Biloxi, Miss.

MONEY Made in Michigan potatoes. \$10 down now and easy terms buys land near markets, lakes, streams. Write today. Swigart & Co., P-601, 32 N. State St. Bldg., Chicago, Ill.

SELL Your property quickly for cash, no matter where located. Don't pay big commission. Particulars free. Real Estate Salesmen Co., Desk B, Lincoln, Nebr.

REDUCE Labor on your farm and increase income. One farmer writes he would not part with the information for \$100 if it could not be duplicated. Send today for our valuable "Farmers' Handbook" and get ready to put some of the 861 practical ideas into operation for your own benefit. Pay postman only 98 cents plus postage when delivered. Popular Mechanics Press, Room 808, 200 E. Ontario St., Chicago.

RABBITS

RABBIT And pheasant farming profitable industries. Complete instruction courses. Stock for sale. Breed catalogue 10c. Ransom Fur Farm, Geneva, Ohio.

RAISE Chinchillas from prize winning, championbred stock. De Sayda, Redbank, N. J.

MINK

MINK: World's finest. Northeastern Quebec. 15 years selective breeding. Send 25 cents for confidential feeding instructions complete ranching information photos. Sterling-Quebec Mink, Lake Placid, New York.

MUSKRAT Farming—The greatest book on one of the greatest opportunities today. Tells of the opportunity in this business and how to do everything in connection with the raising and marketing of muskrats. Pay postman only \$2.25 and postage when delivered or, outside U. S., remit when ordering. Popular Mechanics Press, Room 809, 200 E. Ontario St., Chicago.

DOGS AND PETS

NEWFOUNDLAND Registered pups, \$30 and up. Goodyear Kennels, Peella, Iowa.

ST. BERNARDS! Rare, beautiful thoroughbred puppies. Photos submitted, delivery guaranteed. Helveta Kennels, 181-P McKenna Ave., Montreal, Que.

ANIMAL World—Entirely different magazine for pet owners. Trial year 25c. 900 World Building, Baltimore, Maryland.

FOR Sale—20 choice select coonbonds cheap on trial. Kevill Kentucky Kennel, Kevill, Ky.

DOG Lovers—Every fact regarding every phase of dog training (all breeds) including psychology, obedience, guarding, swimming, rescue work, hunting, herding tricks, teaching tricks, finding lost articles, racing, war service, police dogs, sled dogs, etc., will be found in "Training the Dog," by Will Judy. Price only \$1.50. Pay postman when delivered or, if outside U. S., remit when ordering. Popular Mechanics Press, Room 809, 200 E. Ontario St., Chicago, Ill.

WANTED—MISCELLANEOUS

MAIL Us your discarded jewelry, gold crowns and bridges, watches, diamonds, silver, platinum. Money promptly mailed. Goods returned if offer refused. United States Smelting Works (The Old Reliable), Dept. 71, Chicago.

FOR SALE—MISCELLANEOUS

SAVE Money on watches. 17, 19 Jewel Elgins, Walthams, Hamiltons, brand new cases, low as \$17.50 each. List free. Smith, Box 641, Pittman, N. J.

ADDRESSOGRAPHS. Letter folders, multi-graphs, envelope sealers, duplicators, less than half price. Guaranteed. Pruitt Co., Suite 108, 190 N. LaSalle St., Chicago.

AVIATION—Every person seriously interested in this subject should make full use of the opportunity to learn aerodynamics with Alexander Klemin as his instructor, through his timely new book, "Simplified Aerodynamics." Heretofore this subject has been rather difficult for the thousands who need it but Klemin's method enables all to master it. Every pilot, mechanic, student needs this book. Pay postman price, \$1.50, and few cents postage when he delivers it. Order from Popular Mechanics Press, Room 807, 200 E. Ontario St., Chicago.

ROOTS AND HERBS

HERB Doctor Book—10 cents. 250 recipes to make herb medicine. Hazzard Company, Box 1, Vanderveer Park, Brooklyn, N. Y.

PERSONAL

ASTROLOGY Will reveal your future. Special 12-page astrological forecast gives predictions—month by month—with exact days, dates and happenings for 1931 based on your sign of the Zodiac. Consult it before making any change in home or business affairs, signing papers, love, marriage, employment, travel, speculation, "lucky days," etc. Know what to expect. Send exact birthdate with \$1.00. Franklin Publishing Company, 800 No. Clark St., Dept. 109, Chicago.

TRY Caloris for all skin irritations. 50c. C. Hurst, Box 3294, Miami, Fla.

13 FUNNY Unique love letters, 10c. Novelty circular and surprise gift, 4c. Economy Sales, Manchester, Iowa.

CREATE Suggestions of merits, for inventors. Men, women in every walk for households, clothing, all trades, farms, etc. Send two dimes. Money back on request. Theodore Roosevelt, Box 1741, Gary, Ind.

ASTROLOGICAL Readings know your future 1931. Ask two questions, send 25c and your birthdate. J. Jones, Box 202 N. 8th St., Detroit, Mich.

FREE Information! Mystify everyone. Dr. Cook, PM-2138 N. Lawndale, Chicago.

TATTOO Marks removed painlessly by mail. Vestrod, Box 76, Essington, Pa.

CASH'S Woven names. For marking men's, women's, children's clothing. Sample free. Quimette's Mail-Order House, 81 Holly, Dept. 20, New Bedford, Mass.

ASTROLOGER Can read your life. Test predictions for one year 20c, dimes or stamps. Send year and birthdate. G. Niemeyer, Box 243, Mays Landing, N. J.

TOBACCO Habit overcome or no pay. 500,000 used Superba to help stop cigarettes, cigars, chewing, pipe, snuff. Treatment sent on trial. Costs \$2.00 if successful. Superba Co., L34, Baltimore, Md.

FREE! Herbalist almanac. Over 500 herb medicine recipes for home use. Write for details. Botanic, 115 West 112th St., Chicago.

MISCELLANEOUS

CASH Paid for butterflies, insects. See Sinclair display advertisement on page 82.

PAINT Signs, show cards, complete course. Just cut. Alphabets, practice charts, instructions, etc., only \$2 (circular free). Learn a trade. Start now. Fouts Art Service, Liverpool, Illinois.

LEARN Drafting, tracing, blueprint reading, patent drafting, chart method \$1.00. Wade Service, 2271-H Brooklyn Station, Cleveland, O.

SPECIAL Advertising offer. Beautiful \$5 pearl necklace. Indestructible. Guaranteed. Only \$1. Ralph Brooks, Arkansas, Wisconsin.

PEN And pencil sets \$1.25. Ideal Christmas gift. Leather key case free. W. Kinney, 3539 Wilton, Chicago.

TIME Counts in applying for patents. See pages 126 and 127. Clarence A. O'Brien, Registered Patent Attorney, Washington, D. C.

TATTOOING Outfits. Illustrated catalogue, dime. Miller, Y431 Main, Norfolk, Va.

AMATEUR Cartoonists—Eason \$25.00 week, spare time, copying cartoons for advertisers. 3-M Syndicate, Argyle, Wis.

YOU Can save, by sending your magazine subscriptions to Porter's Publications, 9416x 115th St., Richmond Hill, N. Y., Lists Free.

LOCKSMITH Directory of manufacturers, dealers, etc. One dollar. Nugent, 30 North Third Street, Richmond, Va.

MIRRORS Resilvered at home. Costs near 5 cents per square foot; you charge 75 cents. Profitable business plating auto-parts, reflectors, tableware, stoves, refinishing metalware, etc. Outfits furnished. Details free. Write, Sprinkle, Plater, 238, Marion, Ind.

LEARN Today—earn tomorrow—one-day shocart system. Sample, particulars 10c. Straley Sign System, Springfield, Ohio.

KINKS For machinists. 419 discoveries. For mechanic, machinist or the man who tinkers at home. 287 illustrations. Send no money. Just write a postal asking for "Machinist's Kinks." When postman hands you book pay postage and price of book, \$1.50. Popular Mechanics Press, Room 801, 200 E. Ontario St., Chicago, Ill.

TATTOOING—Learn how with my outfits. Descriptive circulars sent anywhere. Scrut, Bonzey, 367 So. Main, Providence, R. I.

TATTOOING Outfits, supplies. Illustrated list free. "Waters," 965 Put-nam, Detroit.

AMATEUR Cartoonists: Sell your work. Write Smith's Service, PW1194, Wenatchee, Wash.

HOMEOPATHIC And biochemic preparations sent postpaid to all parts of the world. Booklets free. Halsey Bros. Co., 5547 Harvardwood Ave., Chicago. Established 1855.

TELL An army of 3,040,000 live readers all about your offer! If you have anything to sell, buy or exchange, or if you have any reasonable proposition, tell our readers all about it—they'll respond quickly. Our booklet "How to Create More Business" contains some very interesting, helpful facts. Write today for your copy—it's free. M. L. Rund, Manager Classified Advertising, Popular Mechanics Magazine, 200 E. Ontario St., Chicago, Ill.



FREE! of extra cost—send the coupon for details of our amazing new plan. It tells you how to get a big assortment of beautiful gifts that you can paint.



This Magic Box Turns Spare Time Into Money!

We show you how and give you the complete outfit illustrated above. Also we give you our Free Idea Book which has started hundreds making easy money! Mrs. H. L., Illinois, says: "I made \$100.00 on furniture in one week." Mrs. A. K., Virginia—"My sales were \$500.00 for five weeks. This is my first year." R. M. P., Illinois—"I did \$3,500 worth of business last year and over \$12,000 worth this year." D. W., New Mexico—"I would not take \$1,000 for my course." A real desire to make money is all you have to have to make a big success at Fireside work.—No tiresome study—You learn by doing. It is fun decorating beautiful gifts and furniture—the most fascinating pastime you can imagine. You make good money practically from the start. Our FREE book tells you how. Send the coupon for it!

No Experience Needed

You need no experience or business ability to succeed at Fireside work and make excellent

FIRESIDE INDUSTRIES

Dept. 66-A Adrian, Mich.

money. We help you and show you how. You can join now on the easiest plan ever offered. Get full details today. Coupon brings everything.

FREE Book on Decoration

Mail the coupon NOW for the beautiful new book on home decoration and money making. It's FREE! A new plan for starting you at good money at once will also be included. Do this at once—while there are openings for new members!

Fireside Industries
Dept. 66-A
Adrian, Mich.

Send me FREE book on decoration and details of your new plan. Also how to get the big artist's outfit.

GOOD FOR PLAN

Name.....
Address.....
City.....State.....

SAVE COAL!

New "Invisible Hand" Invention

CLOSES DOORS

S-I-L-E-N-T-L-Y!



A tremendous long standing need is now filled by a clever little invention called Close-A-Door. Adjustable to fit any door—works on pneumatic principle. Shuts door swiftly and securely as if moved by invisible hands—checks it in time to prevent SLAM! Saves doors, saves nerves, saves glass and saves fuel. AGENTS! Never before an invention with from 4 to 8 possible sales in every home—sell dozens in apartments, factories, offices and business establishments. Agents make sensational easy profits everywhere they go just show the clever miniature door demonstrator. Write at once for description of Close-A-Door and generous introductory offer. The Close-A-Door Co., 1531 Washington Ave., Dept. A-10, St. Louis, Mo.

Up To \$50 A DAY

With Tiny 'PHONE "MIKE"



Agents are cleaning up everywhere with a phone attachment that looks like a radio mike. Absolutely controls all sounds in your phone—ends the roar that keeps you from hearing clearly; makes it easy to hear even if your phone is in the noisiest factory. Yet also assures privacy—talk unheard, with people within five feet of you!

Write and find out how agents report earnings up to \$50 a day and even more with this tiny mechanical mystery. Big quantity orders from stores, offices, etc.; amazing sales plus double calls and sales. Write for FREE introductory offer and amazing Sales Guarantee.

STANDARD APPLIANCES, INC., Dept. A-90, 21 W. Elm St., Chicago, Ill.



DRAFTING

BOOKS SENT FREE!

ON APPROVAL

NEW 1931 EDITION

Only 15 minutes a day with these WONDER BOOKS will prepare you for a good drafting job in less than a year. Mechanical and architectural drafting from simple straight lines to important complex plans. A step at a time! Built especially for beginners, for men with only grammar schooling. Drafting room practice. PLUS ENGINEERING, made easy and clear. Includes complete course in blue-print reading.

Big Field Big Demand Big Pay

Competent draftsmen are urgently needed right now in all building and manufacturing lines at \$30.00 to \$100.00 a week. That's just the beginning—FOR DRAFTSMEN HAVE THE BEST CHANCES FOR ADVANCEMENT. Pleasant, fascinating work, easy to learn and do. Learn quickly with these books—send coupon for a set FREE and see for yourself.

A year's consulting membership in the American Technical Society now gives free to all readers of this famous cyclopedia of drafting. Many say that it is worth more than the cost of the books.

For Beginners

Written, so you can understand every word, by 22 famous engineers and architects. DeLuxe flexible binding, nearly 2,000 pages, 1516 blue-prints, charts and diagrams; prepares you for a good drafting job in mechanical or architectural lines. Sent for 10 days' free use if you mail coupon immediately.

SEND NO MONEY

Don't send a cent on this great offer. Your name and address, with that of your employer or other reference, will bring these books to you absolutely free for examination. Test them, read them, find out anything you want to know and then if you are not more than pleased send them back and you will not owe us one cent! If you decide to keep them, then pay only \$3.00 a month until the special introductory price of only \$19.50 is paid.

AMERICAN TECHNICAL SOCIETY

Dept. D-119, Drexel at 58th St., Chicago, Ill.

American Technical Society, Dept. D-119,

Drexel at 58th St., Chicago, Ill.

Send for 10 days' free use New 5 volume set of drafting. I will pay the few cents delivery charges. If I wish, I may return books in 10 days and owe you nothing but if I decide to keep them I will send \$2.00 after 10 days, then only \$3.00 a month until \$19.50, the special introductory price, is paid. Send 1931 edition.

Name.....

Address.....

Employer or Reference.....

Address.....

Properly Trained Men

Earn \$50 to \$200

—A WEEK

in the Aviation and Automobile Trades

Steady Work the Year Round

DO you want a position where you can make more money—have unlimited opportunities—advance surely and swiftly? Then get into the AUTOMOBILE OR AVIATION INDUSTRIES at once!

Today the largest manufacturing industry in the world is the Automobile Industry. There are more than 26,000,000 vehicles registered in the United States alone. And every one of them must be serviced regularly.

The Aviation Industry is a close second, being one of the fastest growing businesses in the country. Already there is more than \$400,000,000 invested in the Aviation Industry in America.

Think of the unlimited opportunities the future holds in either of these industries for the man who has the technical and practical knowledge to service these machines and ships. He is always in demand—he can practically name his own salary.



"Live Engine" Testing

Experience Not Necessary

For more than 21 years the Stewart Tech has been training inexperienced men of all ages to fill good-paying positions in these industries. All you need is a liking for mechanics and a willingness to learn. There are no more completely equipped workshops to be found anywhere. Our skilled instructors are the best obtainable.

You'll learn to locate trouble, take down, repair, rebuild and "tune up" standard makes of automobiles or airplanes in quick time, by doing actual work with proper tools on up-to-date equipment and real live motors.

Let us show you how we can start you on the road to a successful career. A thorough training is the starting point. Executive positions and opportunities to get in business for yourself will naturally follow.

FREE Employment Service

Easy Time Payments



Visit our school as soon as possible. See our thoroughly equipped shops. Let us tell you about our "Pay-as-you-go" plan and our free employment service. Call at once or mail the coupon below. It costs nothing to investigate and may mean thousands of dollars a year to you later.

Your opportunity is here

RIGHT NOW

STEWART TECHNICAL TRADE SCHOOL,
P. M. 1 Stewart Tech Building, 253-5-7 W. 64th St., New York, N. Y.

I am interested in knowing more about your courses on Auto and Aero Mechanics. Without obligation on my part please mail me further information.

Name.....

Street.....

City & State..... Age.....

Check your preference:
 Aero Mechanics Auto Mechanics

Be Vigorous — Manly Strongfort Tells How

You are blue, despondent and discouraged if you feel beaten in the game of life. You are giving in too easily.—Snap out of it.

—take a new grip on yourself. Join the big crowd of fellows all over the world who gave me a chance to talk things over with them confidentially and then took my advice and instruction and were led to joyous health, strength and courageous manhood.

Let Me Take Hold of You

Let me build up that body of yours into a fine, vigorous specimen of manhood. Let me eradicate all the taints and vitality-sapping ailments that come through excesses, a neglected body, over-work, or inherited weaknesses. I will build you up inch by inch until you are a real man inside and out—making you proud of your power, giving you confidence in your ability and filling you with eagerness for the physical and mental delights of life.

STRONGFORTISM Will Build You Up

Strongfortism has performed wonders for thousands of men all over the world. It is the basic science of health and strength—no doubt about it. For over 30 years I have demonstrated its value in body building.

Health in abundance will be yours—and dynamic energy will come with it—if you will listen to me and take up my Course in STRONGFORTISM. My unquestioned mastery of the human body, my proved ability to restore weakened men to health and strength by this system, qualifies me to diagnose your troubles and map out a Course that will speedily and certainly transform you.

Success Comes With Health

Without abundant health and dynamic strength you can't hope, in these speedy times, to score any success in life—to attract people to you, to win favor or affection or to get on in business. You can't expect advancement to the bigger jobs with higher pay. With a face radiating good cheer, backed by a poppy body full of energy and a mind chock full of ambition you can climb to any height—you can command success.

Pupils praise me as their teacher. They write letters full of thanks and joy for what I have done for them through STRONGFORTISM—just by following natural laws and giving their bodies a chance to help themselves as Nature intended.

SEND FOR MY NEW BOOK

"Promotion and Conservation of Health, Strength and Mental Energy"

This book of many pages and pictures is a revelation of priceless secrets about the human body—a storehouse of facts that will show you what has been and can be done for weak, sickly and underdeveloped men. Get this book right away.

STRONGFORT INSTITUTE

LIONEL STRONGFORT, DIRECTOR,
PHYSICAL AND HEALTH SPECIALIST
DEPT. 98 NEWARK, NEW JERSEY, U.S.A.

Free Confidential Consultation

Dept. 98, Newark, N. J.—Please send me absolutely free my copy of your book, "PROMOTION AND CONSERVATION OF HEALTH, STRENGTH AND MENTAL ENERGY." This does not place me under any obligation and no salesman is to call on me. I have marked (x) before the subjects in which I am most interested.

- | | | |
|---------------|-------------------|---------------------|
| .. Colds | .. Constipation | .. Weak Eyes |
| .. Catarrh | .. Biliousness | .. Falling Hair |
| .. Asthma | .. Torpid Liver | .. Poor Memory |
| .. Hay Fever | .. Indigestion | .. Rheumatism |
| .. Obesity | .. Nervousness | .. Poor Circulation |
| .. Headache | .. Deformity | .. Skin Disorders |
| .. Thinness | .. Insomnia | .. Despondency |
| .. Rupture | .. Heart Weakness | .. Round Shoulders |
| .. Neuritis | .. Short Wind | .. Lung Troubles |
| .. Neuralgia | .. Flat Feet | .. Increased Height |
| .. Flat Chest | | |

Name.....
Age..... Occupation.....
Street.....
City..... State.....

LEARN TO EARN this Big Pay

\$77 a week for expert welders and over 5000 are needed right now; Battery and Electrical experts wanted at \$300 a month; Auto Mechanics at \$50 a week up; aero ground mechanics at \$65 to \$100 a week. I can train you to fill one of these good jobs in a few weeks by the SWEENEY SYSTEM of Practical Training. You'll enjoy it, too. Use tools, not books.



Over 80,000 Successful Graduates

Sweeney graduates the world over are successful, independent and prosperous—own a business of their own or command highest pay. Be a leader in today's mechanical civilization—choose your trade—welder or vulcanizer, garage owner, mechanic, radio or electrical expert—Sweeney training makes you an immediate demand.

FREE BOOK This new illustrated book is the key to 10,000 opportunities. Tells all about mechanical trades, wages and present demand. Send name today and get also my new special offer.

SWEENEY Auto & Electrical School 1615-H Grand Ave.
Kansas City, Mo.

ENGINEERING — ELECTRICITY ARCHITECTURE — DRAFTING

Save time—enroll at this old established school of engineering. Enter any time, days or evenings. 1, 2 and 3 year courses. Diplomas and B. S. Degrees.



Special 4 months' practical course in Drafting. Other short courses. Low tuition—easy terms. Earn while you learn. Free employment bureau. Athletics. Successful graduates everywhere. Write for our free, illustrated 80 page "Blue Book." It gives you all the facts. Address the President, Charles W. Morey, B. S., M. E.

CHICAGO TECHNICAL COLLEGE
Lept. A-79 118 East 26th Street, Chicago, Ill.

Don't PEEL POTATOES

Agents!

This is brand new! Going like wild-fire! Offers a real chance for \$100 a week. Spare-time and full-time sales plans offered. Jump in on the ground floor! Write quick for big-money plans and Free Outfit offer.



An amazing new automatic invention now makes potatoes peel themselves! No more paring knives! No cut fingers! No mess, muss or waste! Here's something every woman understands and wants the instant she even hears about it! A mechanical marvel,

almost incredibly small and simple, yet does more than ten pairs of hands! Peels the biggest potato in only a few seconds at the mere turn of a crank! Costs little more than a couple of good paring knives. Pays for itself many times over in saving on potatoes. Test it yourself at once. Write now. Ask quick for Introductory Offer.

GUARANTY PRODUCTS CO.

Dept. A-80, Francis Bldg.
Washington at 16th St., St. Louis, Mo.



HAND-FORGING AND WROUGHT-IRON ORNAMENTAL WORK

Complete instructions, with photographs and drawings, for making the most attractive styles of ornamental iron work.

- | | | |
|-------------|---------------|--------------|
| Andirons | Grilles | Rosettes |
| Scroll Work | Leaf Work | Benches |
| Bulbs | Drawer Pulls | Door Plates |
| Windows | Door Knobs | Spiral Deco- |
| Fasteners | Fire Sets | ration |
| Lamps | Candle Sticks | Picture |
| Cast Racks | Chairs | Frames |

Thomas F. Googerty, the author, is one of the best-known makers of this type of metal work. The illustrations are all of work made by the author. Almost every page has one or more illustrations either made from drawings or from photographs. Anyone

interested in this type of work can soon develop his ability so that he can make these articles for his own use or for sale. There is a growing demand for articles of this type.

Send No Money Simply write a postal for this book of instructions, asking that "Hand-Forging" be sent C. O. D. When postman hands you the book, pay him the postal charges and \$2.00.

POPULAR MECHANICS PRESS, Room 701, 200 East Ontario St., Chicago, Illinois

Be A Photographer

Many Earn \$1,500 to \$10,000 a Year!

THERE'S big money—fascinating work for YOU in photography. Many photographers receive \$50 and even more for only one photograph. Photography today is one of the nation's most profitable professions—one that offers unequalled opportunities to the man or woman looking for interesting work, big pay and unlimited future.

IT'S ALL IN KNOWING HOW!

Now, at last, you can qualify yourself for this well-paid profession—in which you come in daily contact with society people, prominent business executives, theatrical stars and athletic luminaries. Be your own boss or secure a well-paid position. Many photographers have incomes ranging from \$1,500 to \$10,000 a year or more.

SUCCESS IS WITHIN YOUR GRASP!

Now it is up to you—if you want your share of this lucrative profession! Through our Simplified Plan you can master every phase of modern photography. Many of our students earn many times their tuition fee even while learning.

Many are winning success in "Still" and News Photography, Portrait Photography, Motion Picture Photography or Projection, or Photo-Finishing. We train you for the many fascinating branches of photography through our simplified method.

FREEBOOK GIVES FULL DETAILS!

Let us show you how you can qualify for a well-paid position or to open a business of your own. Send now for our BIG FREE BOOK giving full details.



N. Y. INSTITUTE OF PHOTOGRAPHY,
Dept. W-1414, 10 West 33rd Street, New York, N. Y.

Please send me your FREE Book and details about:

- Motion Picture Photography
 Motion Picture Projection
 "Still" Photography
 Photo-Finishing

Name.....

Address.....

City..... State.....

YOUR SUCCESS COUPON

RADIO BLUEPRINTS

The blueprints below include the best of Popular Mechanics tested circuits. When ordering, simply quote the numbers of blueprints desired and inclose proper amount addressed to Popular Mechanics Magazine, Radio Dept., 200 E. Ontario St., Chicago, Ill. Magazines containing full descriptions of the circuits can be obtained. Send 25 cents for each magazine desired, giving date of publication.

- No. 134, Edison Type B-Battery..... July 1928...25c
No. 138, Screen-Grid Perfect-Tone Six Receiver..... Nov. 1928...25c
No. 139, Simple Television Receiver... Dec. 1928...25c
No. 140, Power Amplifier and B-Supply for Television..... Jan. 1929...25c
No. 142, Two-Tube Screen-Grid Short-Wave Adapter..... Mar. 1929...25c
No. 143, Four-Tube Screen-Grid Receiver..... May 1929...25c
No. 144, Three-Tube Self-Contained A.C. Receiver..... Oct. 1929...25c
No. 145, One-tube S-G Set for Beginners Nov. 1929...25c
No. 146, Adjustable B-Eliminator... Nov. 1929...25c
No. 147, A-Eliminator for Set and Dynamic Speaker..... Dec. 1929...25c
No. 148, Adding Audio Stages to S. G. Receiver..... Dec. 1929...25c
No. 149, Plug-In Power Amplifier for use with any Broadcast Receiver, June 1930...25c
No. 150, Short-Wave Receiver Without Plug-In Coils..... Sept. 1930...25c
No. 151, Beginners Low Power S-W Transmitter..... June 1930...25c
No. 152, Portable Radio Amplifier for the Deaf..... July 1930...25c
No. 153, Low Cost Code and Phone Transmitter..... Sept. 1930...25c
No. 154, A. C. Screen-Grid DX Tuner..... Oct. 1930...25c
No. 155, Four-Tube D-X Receiver... Nov. 1930...25c
No. 156, Switchless Test Panel..... Nov. 1930...25c
No. 157, Building a Light-Sensitive Relay..... Dec. 1930...25c

Material Lists for any of the above instruments will be mailed free upon application.

Be a Civil Engineer!

Learn at Home!



Cyclopedia of Civil Engineering

7 great volumes.
2,800 pages.
1,600 illustrations.
New edition just off the press, by twelve of America's greatest engineers. Includes: Surveying, bridges, railroads, steel structures, municipal engineering, water supply, road building, etc.

Spanish grain flexible binding gold stamped.

Loaned Free!

To prove you can learn Civil Engineering at home in your spare time. And because no description here could do it justice, to let you see for yourself the scope and simplicity, the authority and quality of this great home reading course. Cost and terms are within your reach. Send no money—just mail the coupon.

Earn \$5000

a Year—and Up!

"CIVIL ENGINEERING"—in plain English written so you can understand it, even if you have only a limited education. Prepares you for a well-paid railroad structural or public works position. Covers every branch of Civil Engineering practice. At once a reading course for the ambitious student and an authoritative reference work for the experienced engineer. Borrow a set—free. Look over the first questions which help you master each subject quickly. Mail the coupon without obligation today!

American Technical Society
Dept. C-119 Chicago

American Technical Society,
Dept. C-119, Chicago.

I want to BORROW the CIVIL ENGINEERING Cyclopedia for 10 days FREE. I will gladly pay the few cents express, but I am to pay nothing for the loan of the 7 big volumes if I return them within 10 days. If I wish to keep them I will send you \$2 after the 10 days, then \$3 a month until special advertising price, \$29.80 is paid.

Name.....

Address.....

(Attach letter stating age, occupation, employer's and references' names and addresses.)

BRAND NEW
Genuine Model 3
CORONA
 LOWEST PRICE EVER OFFERED



\$2⁰⁰
DOWN
BALANCE
EASY
TERMS

HERE'S your chance to own that brand new Genuine Model 3 Corona you've wanted—on the easiest terms ever offered—at **LOWEST PRICE** ever offered! Complete in every detail; back spacer, etc., **MANUFACTURER'S GUARANTEE**. Recognized the world over as the finest, strongest, sturdiest, portable built. Try this wonderful portable typewriter—the same machine that has satisfied 500,000 users.

Yours for 10 Days' TRIAL
—Send No Money

Experience the joy this personal writing portable typewriter can give you! Use it 10 days! See how easy it is to run and the splendidly typed letters it turns out. Ideal for the office desk, home, traveling. Small, compact, light, convenient. Don't send out letters, reports, bills in poor handwriting when you can have this Corona at such a low price or on such easy terms. Remember these are brand new machines right out of the Corona factory.

Carrying Case Included
—If You Act Now

Leatheroid carrying case, offer, instructions, free on this offer. Send no money—just the coupon. Without delay or red tape we will send you the Corona. Try it 10 days. If you decide to keep it, send us only \$2, then \$3 a month until our special price of \$29.99 is paid. Now is the time to buy. Mail coupon today!



MONEY SAVED
By Using This Coupon

Smith Typewriter Sales Corp.
(Corona Division)

469 E. Ohio St., Chicago, Dept. 31

Ship me the Corona, F.O.B. Chicago. On arrival I'll deposit \$2 with express agent. If I keep machine, I'll send you \$5 a month until the \$29.99 balance of \$29.99 price is paid; the title to remain with you until then. I am to have 10 days to try the typewriter. If I decide not to keep it, I will repack and return to express agent and get my money back. You are to give your standard guarantee.

Name

Address

Employed by

Learn **SIGN**
 and **SHOW-**
CARD
WRITING

In spare time few hours weekly



FREE
 "Book of Facts"
 Write For It

Fascinating profession. Big opportunity in this fast-growing trade. Earn while you learn the sign arts. No talent or experience required. Be your own boss or obtain a good position. Learn show cards, posters, bulletins, signs, advertising layouts and allied subjects. We teach by mail or at our school. Quick results—easy to learn.

EARN \$50 TO \$200 WEEKLY

Otto C. Wiegand, Md., home-study graduate, made \$12,000 from his business in one year. Many successful graduates. Oldest and foremost school. Don't delay. Write for complete information.

DETROIT SCHOOL OF LETTERING

193 Stimson Ave.

Est. 1899

DETROIT, MICH.

FEET PAY

A business and profession that is a big income producer from the start.

Few weeks study starts you earning. Study and practice **FOOT CORRECTION** by mechanical means—not medical nor chiropody. **EASY HOME TRAINING** for men or women. Endorsed by practical Foot Men. Thousands of suffering feet need you. **MUCH TRADE WAITING**. Ask about Free Tuition Plan. Lincoln Correspondence Institute, Inc., 1500 A Walnut St., Philadelphia.

We Will Train You
in a Few Months



Day and Night
Schools in
Chicago, Detroit
Cleveland,
Boston, Phila.

No Books—
No Classes—

Wonderful
Future in this
Uncrowded
Field

Experts Earn Up To \$125 a Week
as Mechanical Dentists

We teach you to make rubber plates, crowns, bridge work, metal base dentures, etc., for dentists. After graduating you are ready for a job or can open your own laboratory. We assist you.

Big Demand for Men

Thousands of dentists everywhere send work to mechanical dentists. We train you quickly in day or night school for this uncrowded field. No classes—no books—no mechanical experience necessary.

Work your way thru school. We help you find a job to meet your expenses while taking our training.

FREE BOOK Send at once for interesting free book telling all about this thriving profession. Also details of our liberal offers. Write today!

McCARRIE SCHOOL OF MECHANICAL DENTISTRY,
 1338 S. Michigan Ave., Dept. 428, Chicago.

Without cost or obligation, send me your illustrated book on Mechanical Dentistry, and complete information as to my opportunities in dental laboratory work.

Name

Address

NOW FIX ANY MAKE OF

AUTO

SIX BIG AUTO BOOKS ALL SHIPPED FREE

on approval; whether you want to qualify as garage owner, auto repair expert or merely wish to know how to keep your own car 100% efficient, look at these books—they are sent to you for free examination. This brand new 1931 edition has been prepared by a large group of America's greatest automotive engineers. Anybody who can read will understand them, for this great automobile encyclopedia is a veritable gold mine of valuable facts. Take advantage of this great opportunity now; send in the coupon for FREE examination. You don't pay us a penny, you don't obligate yourself to pay anything unless you decide to keep the books. Just tell us you want to see them and the full set of 6 great volumes, just off the press, will be sent to you. Read them, look them over and prove to your own satisfaction that one fact alone, which you will find in them, may save you an expensive repair, or help you to a better job.

AVIATION MOTORS

In addition to being a complete encyclopedia of automobile engineering these books contain over 100 pages on Aviation Motors, and as they are just off the press they bring to you the newest and latest information obtainable. This alone makes these books invaluable to anyone.

NEW 1931 EDITION EVERY PAGE UP TO DATE

Imagine books which are so new that with the co-operation of the largest automobile manufacturers we have been able to bring every page right up to date—wiring diagrams, construction details, service problems—are all right up to the minute. Nowhere else that we know of can you get as complete and up to date information. Over a million dollars of resources have enabled us to give you the most up to date books on the subject ever published. You will find nearly 20 pages on front wheel drives alone. Everybody interested in automobiles in any way will welcome these books, especially on our

NO MONEY OFFER

This plan brings this valuable information within the reach of everyone. You don't send us a single penny; you don't have to pay us anything; just send your name and address and we will send you the complete set of 6 volumes specially bound in De Luxe Flexo covers. Read them carefully, keep them 10 days, find out anything you want to know and then if you want to keep them send \$2.00 then and \$3.00 per month until the special low price of only \$24.80 is paid. There is no further obligation.

Learn All About Autos

Get these 6 big new books on this liberal offer and learn all the things you want to know—carburetors, transmission, steering, springs, suspension, brakes, four-wheel drives, front-wheel drives, lubrication systems as well as over 100 pages on Aviation Motors—all of these subjects are fully covered. These complete and comprehensive auto books are yours, if you want them, on this easy plan. Send for your set now.

SEND NO MONEY

American Technical Society, Dept. A-119, Drexel Ave. at 58th St., Chicago, Illinois

I would like to see the new 6 volume 1931 edition of your automobile books but without any obligation to buy. I will pay the few cents delivery charges only and will examine the books and return them at your expense in 10 days unless I like them, in which case I will send you \$2.00 then and only \$3.00 per month until the special price of only \$24.80 is paid. You are to include free, consulting membership certificate in the American Technical Society. Send brand new 1931 edition.

Name.....
Street.....
City..... State.....
Employer's Name.....
Employer's Address.....

These books will be sent free immediately upon receipt of coupon with writer's name and address and that of his employer or other business man as a reference.



Jiffy Index

You don't have to read the books through, the special Jiffy Index enables you to put your finger on the information wanted in a jiffy.

American Technical Society Membership FREE

If you send now for this brand new 6 volume edition of automobile engineering we will include a consultation membership in this great organization. Our large staff of automobile and aviation experts will be ready to help you at all times—you can write or wire any time for special information—answers will be sent to you promptly WITHOUT COST. This membership is good for one full year.



You get **PROOF**
the first 7 Days
I can make this
NEW MAN
of YOU

**CHARLES
ATLAS**
"The World's
Most Perfectly
Developed Man"



I'VE helped thousands of men—
young and old—underweight and
overweight—weaklings and even
"strong men" and other physical de-
fectors who wanted MY KIND of Mus-
cle Power. Now I'll show YOU my quick,
sure way to build yourself a new body and
make "A NEW MAN" of yourself.

Spending just a few minutes a day in your
own home, doing what I tell you, without
tricky apparatus, starving or gorging, using
only my natural methods of *Dynamic-Tension*
—in ONE WEEK you begin to SEE and
FEEL the difference in your bodily condition
and physical appearance.

And my methods will dig down into your
system, banishing such ailments as constipa-
tion, pimples, skin blotches and the others
that do you out of the good things and good
times of life. If you're timid and bashful, you
lose all that—you have a new, more forceful
personality—you become a NEW MAN!

**FREE "Everlasting Health
and Strength"**

Do what my thousands of other pupils did—send
for a free copy of my 48-page book "Everlasting
Health and Strength." Learn how YOU too can win
the biggest prize in life—a handsome, healthy, husky
body. Address CHARLES ATLAS (Dept. 8A), 133
East 23rd Street, New York City.

**CHARLES ATLAS (Dept. 8A)
133 East 23rd Street, N. Y. C.**

I want the proof that *Dynamic-Tension* will make a New
Man of me—give me a healthy, husky body and big muscle
development. Send free book, "Everlasting Health and
Strength," and special "Proof-in-7-Days" Offer.

Name.....

Address.....

City and State.....
(Please print or write plainly)

Books on Many Practical Subjects

Popular Mechanics Press specializes in supplying the outstanding
best books on many subjects. As new books of merit appear, we
will revise the list accordingly.

- | | |
|---|--|
| ARCHERY
Modern.....\$3.00 | JOINT WIPING
(New Edition).....\$1.00 |
| ARCHITECTURAL
Design and Lettering...\$2.00 | KITES THAT FLY
How to Make.....\$1.25 |
| ARMATURE WINDING
Excellent new book...\$2.00 | LANDSCAPING
Practical.....\$2.50 |
| AUTO ENCYCLOPEDIA
Dyke's. (Covers New
Model A Ford).....\$6.00 | LATHE WORK (METAL)
and Drilling and Thread
Cutting.....\$1.00 |
| AVIATION
Everybody's Guide...\$2.00 | LETTER WRITING
Social and Business
Only.....\$1.00 |
| BIRD HOUSES
How to Make.....\$1.00 | LETTERING
Modernistic.....\$2.00 |
| BLUE PRINT READING
For Building Trades...\$1.25 | MACHINIST
Complete, Practical...\$3.00 |
| BOAT BUILDING
35 Popular Types, Out-
board Motor, Sail,
Row, etc.....\$3.00 | MAGIC
200 New Tricks for Am-
ateurs.....\$1.00 |
| BOY MECHANIC
Famous 4 Vol. Library,
4000 Things to Make, \$7.00 | MARKETING BY MAIL
Science of.....\$2.00 |
| BUILT-IN FURNITURE
Complete Instructions...\$2.50 | MASONS AND BUILDERS
Guides (4 Vols.).....\$6.00 |
| BUSINESS ETIQUETTE
Most valuable.....\$1.00 | MATHEMATICS
Made Easy for the Prac-
tical Man.....\$1.50 |
| CALCULATOR
Mathematical Ropp'a...\$1.00 | MECHANICAL DRAWING
Practical Course in...\$1.00 |
| CARBURETORS
Excellent book on all
makes.....\$2.00 | MODEL AIRCRAFT
Building and Flying...\$2.25 |
| CARPENTRY
Hand book of 336 Kinks...\$1.50 | OUTDOOR OPPOR-
TUNITIES
for Making a Living...\$2.00 |
| CHALK TALK
How to.....\$1.00 | OUTDOOR SPORTS
for All Year 'Round
New Edition.....\$2.00 |
| COLOR SIMPLIFIED
Practical new Book (for
Color Users).....\$3.50 | PAINTING
House (Best Methods)...\$2.00 |
| CONCRETE
173 Ways of Using
New Edition (Cloth)...\$1.00 | PLUMBING
500 Plain Facts for
Every Homeowner...\$1.50 |
| CONTRACT BRIDGE
at Sight.....\$1.00 | POULTRY RAISING
for Profit.....\$2.00 |
| DOGS
Care and Raising.....\$2.00 | PUZZLES
Amusing Mathematical...\$1.50 |
| ELECTRICITY
for Beginners.....\$1.50 | RABBITS
For Food and Fur...\$2.00 |
| ELECTROPLATING
Practical Results Easily
Obtained.....\$1.00 | RADIO
A.C. Guide, all Electric...\$1.50 |
| ENGLISH
Self-Improvement in...\$2.50 | SHOP NOTES
13 Vols. of 6000 Valu-
able Kinks.....\$4.00 |
| ETIQUETTE
New 500-Page Book,
Only.....\$1.00 | SLIDE RULE
How to use.....\$1.75 |
| FARMER'S BOOK
of 861 Kinks and Book
for Farmers' Wives...\$1.00 | STAMP ALBUM (Modern)
12,000 Varieties.....\$2.00 |
| FLYING
Simplified.....\$1.00 | STEEL SQUARE
Pocket Book, Practical...\$1.00 |
| FORMULAS
10,000 Money Making...\$4.00 | STORAGE BATTERIES
(New work) Best
on subject.....\$3.00 |
| FURNITURE (Mission)
Homemade (3 vols.)...\$3.00 | TOY MAKING
Complete Instructions...\$1.50 |
| GARDENS
1001 Questions An-
swered.....\$2.00 | TREASURES
Hunting Hidden.....\$2.00 |
| GLASS
Working.....\$1.75 | WALL DECORATION
(Interior) Newest
Methods.....\$4.00 |
| GLIDING
A B C of.....\$2.00 | WHITTLING
The Art of.....\$1.35 |
| HOME REPAIRS
Practical Book of.....\$2.50 | WIRING
House (New Book)...\$2.50 |
| HOME WORKSHOP
900 Different Things
to Make.....\$3.00 | WOOD TURNING (LATHE)
Practical Course in...\$1.50 |
| IGNITION
(High Speed) For
Garage Mechanics...\$3.50 | WOODWORKING SHOP
Modern Motor-Driven...\$1.00 |

Books sent C. O. D. anywhere in U.S.

Just check the books you want, write your name and address below,
and mail the advertisement. It is your order blank. When post-
man hands you books, pay him the price and few cents postage.
If outside the U. S. remit when ordering and include 10 cents per
book extra for postage. We have many other books on these and
2,000 other subjects. Catalog free.

Name.....

City.....State.....

Address.....

Mail to Popular Mechanics Press,
Room P1—200 East Ontario St., Chicago, Ill.

You Fellows Who Want Steady Work and Good Pay Get into

THE whole world—everything—depends on Electricity. That's why you are always sure of a steady job at good pay when you are a trained Electrical Man. Radio—Aviation—Movies—Manufacturing—Life itself—depend on Electricity and the trained men who handle it. Get into Electricity now, where the work is steady—the pay is good—and a real future waits for every man who is trained for this big opportunity.

Learn at Home — in Spare Time

I'll train you at home,—in your spare time. You work just as you are working now—at your same job. My famous "Work-Sheet and Job-Ticket" method guarantees you simplified, practical training along work-shop lines. In a few short months you can step out of your old job into a new job—into electrical work where you can be sure always of a good job and good pay.

Earn Extra Money While You Learn

To learn Electricity my way you don't have to be a College man, or even a High School graduate. With me, you get experience as you go along and make extra money while learning. I'll show you how,—and I'll give you, without extra cost, tools and apparatus to work with—6 Big Outfits in all.

Your Money Back If Not Satisfied

That's the written agreement under which I accept your enrollment. There's nothing like "Cooke" Training anywhere. It's the Training that big Electrical men are praising; it's the Training that employers recommend; it's the Training that one of our greatest Engineering societies has endorsed 100 per cent. **It's the Training for you.**

If You're Earning Less Than \$70 A Week—Investigate

Don't wait a minute! Find out how "Cooke" Training will help you. Mail coupon right now for my Big FREE Book of Facts. See the Six Big Working-Outfits I give you without extra charge. See the hundreds of pictures, the proofs, the Big-Pay letters of other "Cooke" Trained Men. Get this great free Book.

Send for it today. Clip, sign, and mail coupon RIGHT NOW!

L. L. COOKE, Chief Instruction Engineer

L. L. COOKE SCHOOL OF ELECTRICITY

Dept. 11
2150 Lawrence Ave.
Chicago, Illinois

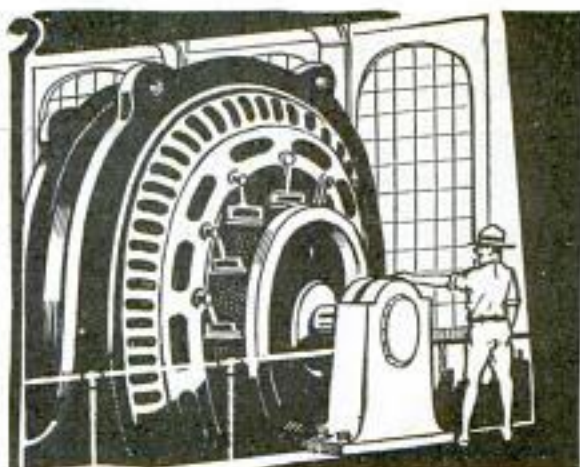

ELECTRICITY

THE **"DADDY"**
OF ALL TRADES
AND PROFESSIONS
GOOD JOBS
AWAIT YOU

If you
earn less
than \$70
a week
INVESTIGATE
ACT NOW

I'll train you at
home in a few
short months.
L. L. COOKE

FREE BOOK COUPON

L. L. COOKE, Chief Instruction Engineer,
Dept. 11, 2150 Lawrence Ave., Chicago, Ill.

Send me FREE and prepaid, your Big Book "Secrets of
Success in Electricity," with all details about your
Home Study Course in Electricity.

Name.....

Address.....

City.....State.....



\$30 A DAY

Dear Mr. Cooke:
I was making \$25
a week when I en-
rolled. Now with
my own Electrical
Shop I make as
high as \$30 a day.
A. J. Dalrossault,
225 Worcester,
Southbridge,
Mass.



\$1.50 AN HOUR

Dear Mr. Cooke:
I had to work like
a slave for 40c an
hour before I en-
rolled. Now,
thanks to you, Mr.
Cooke, I make
\$1.50 an hour.
G. W. Oprea,
4223 N. Meade Av.,
Chicago, Ill.

**6 BIG
OUTFITS**
NO EXTRA
COST

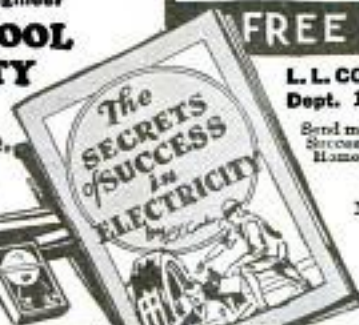

The "Cooke" Trained Man is the "Big Pay" Man

Learn These Easy Secrets of



HYPNOTISM ...or Pay Nothing!

SEE for yourself how easy it is to master the great science of Hypnotism—how quickly you can learn to bend people to your will—increase your earnings—and force others to give you the recognition, power, and admiration you deserve. I'll show you how to use this great force to help you master every situation or The Five Day Trial is FREE!

In just a few hours I'll teach you the hidden secrets of Hypnotism. You can use it to overcome obstacles, achieve your fondest ambitions and become MASTER of yourself, friends and acquaintances—either sex. Now you can quit being just one of the crowd. Through this stranger power you can learn how to stand out—dominate—to make your life what you want it to be.

In his startling NEW book, *The Science of Hypnotism*, the world famous hypnotist—Prof. L. E. Young—reveals the most carefully guarded secrets of this fascinating subject. He tells clearly all about the nine stages of Hypnotism, the Hypnotic Mirror, Mental Telepathy, how to select your subjects, magnetic healing, methods of hypnotizing, how to waken the subject, how to make money out of hypnotism!

Try 5 Days FREE — Send No Money

So confident are we that Prof. Young and his great book will quickly teach you the science of hypnotism, that we will send you a copy without one cent in advance! Simply clip and mail the coupon at left. When the book arrives pay the postman the special low price of \$2.50 plus few cents postage. Then test the powers of Hypnotism 5 days! If not amazed and delighted return the book and money will be refunded at once. FRANKLIN PUBLISHING CO., 800 No. Clark St., Dept. A-70, Chicago.

FRANKLIN PUBLISHING CO., Dept. A-70,
800 No. Clark St., Chicago, Ill.

Please send me your amazing new book—*The Science of Hypnotism*—by Prof. Young. When the book arrives, I'll pay the postman only \$2.50 plus postage. If I'm not satisfied after 5 days' trial, I may return the book and you are to refund my money.

Name.....

Street and No.....

Town.....

State.....

If you are likely to be out when postman calls, send \$2.50 with coupon and we'll pay delivery charges. Customers outside U. S. must send cash with order.



Mysteries of Hypnotism Revealed

How to Hypnotize at a Glance
Susceptible Subjects
How to Give an Exorcism
How to Make Others Obey You
Overcoming Bad Habits
Dozens of Hypnotic Feats
Hypnotism in Operations

WHY STAMMER?
Don't be a failure. Master perfect speech. Live a healthy, normal and happy life. Send for free book which tells you how.
THE LEWIS INSTITUTE, 12972 Woodward Ave., Detroit, Mich.

Learn Watchwork, Jewelrywork and Engraving

A fine trade commanding a good salary, and your services always in demand. Address **HOROLOGICAL**, Dept. P, Bradley Institute, PEORIA, ILLINOIS, for our latest catalog.

PATENTS

Booklet Free Highest References
Promptness Assured Best Results

Send drawing or model.

ALL BUSINESS GIVEN PROMPT AND PROPER ATTENTION

Listed Patent Lawyer in the latest editions of the Rand-McNally Directory of Bankers and Bonded Attorneys, published by Rand-McNally & Co., Chicago, Ill.; The Baggott & Ryall Directory of Guaranteed Attorneys, published by Legal Directory Corporation, Boston, Mass.; Fluigel's Law List, published by Legal Directory Publishing Co., St. Louis, Mo.; American Lawyers Annual, published in Cleveland, Ohio; Bankers Service Legal Directory, published by Bankers Service Co., Boston, Mass.; Eyre's Law List, 9 Park Place, New York City; Walters Legal Directory, Omaha, Nebraska, and the National Directory of Attorneys, Baltimore, Maryland.

WATSON E. COLEMAN,
REGISTERED PATENT LAWYER

Victor Building, 724 Ninth Street, N. W.
WASHINGTON, D. C.



Many Other Government Jobs Obtainable
Steady Work—No Layoffs—Paid Vacations
Common Education Sufficient
MEN—BOYS 18 to 45

Travel on "Uncle Sam's" Payroll \$158 TO \$225 MONTH

Mail Coupon Before You Lose It

FRANKLIN INSTITUTE, Dept. T179, Rochester, N. Y.

Sirs: Rush to me, without charge, (1) Full particulars, telling how to become a Railway Postal Clerk; (2) send copy of 32-page book, "How to Get U. S. Government Jobs," with list of many positions obtainable.

Name.....

Address.....

Play a Gibson
GUITAR

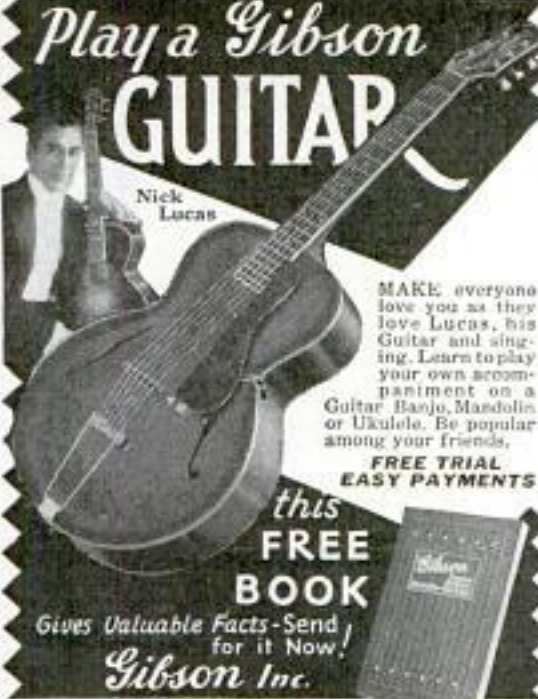

Nick Lucas

MAKE everyone love you as they love Lucas, his Guitar and singing. Learn to play your own accompaniment on a Guitar, Banjo, Mandolin or Ukulele. Be popular among your friends.

FREE TRIAL EASY PAYMENTS

this FREE BOOK

Gives Valuable Facts—Send for it Now!

Gibson Inc.

103 Parsons St., Kalamazoo, Mich.

Learn Aviation

AT

VON HOFFMANN ..SCHOOL..



THERE never was a better time to take up this all-absorbing, well-paying profession. It is a big, sound, growing business—one that is growing rapidly. Its future is bright and immediate. For those who prepare themselves now aviation rewards with high salaries and rapid advancements.

A practical method of easy payments is available for those who desire it.

The Von Hoffmann School is one of the pioneers of the industry and one of today's leaders. It has trained successful mechanics, famous pilots and record-holders. It teaches every phase of Aviation. Proper training at Von Hoffmann can be had in from six to twelve weeks. That training exceeds government requirements. It is given on all types of planes and with modern and complete ground equipment.

Located on the famous \$2,000,000 Lambert-St. Louis Airport.

U. S. Department of Commerce approved School for Transport, Limited Commercial and Private—Ground and Flying Courses.

Write for Our FREE Illustrated Catalog

It gives detailed information about the opportunities in Aviation, about the school, about the courses, about the low cost, and it tells you how to make your start in this great business. No obligation involved. Use the coupon below for convenience.



Von Hoffmann Aircraft School

137 Lambert-St. Louis Flying Field, St. Louis, Mo.

Von Hoffmann Aircraft School

137 Lambert-St. Louis Flying Field
St. Louis, Missouri. MAIL TODAY

Name.....

Address.....

City..... State.....

Age..... I am interested in

() FLYING COURSE () MECHANICS COURSE

() WELDING COURSE () HOME STUDY

Learn to PAINT SIGNS and SHOW CARDS

We quickly teach you by mail, or at school, in spare time. Enormous demand. Big future. Interesting work. Oldest and foremost school.

EARN \$50 TO \$200 WEEKLY

Otto Wieghard, Md., home-study graduate, made \$12,000 from his business in one year. John Vance, N.Y., gets \$25 for a show card. Crawford, B. C., writes: "Earned \$200 while taking course." Write for complete information.

DETROIT SCHOOL OF LETTERING
154 Stinson Ave. Est. 1899 Detroit, Mich.



Don't Be Afraid To Tackle That Concrete Job!

With the instructions found in the new, revised edition of Popular Mechanics Concrete Handbook you can make any of the following useful articles:



Garden Seats—Fountain and Basin—Flower Bases and Vases—Pedestals and Bird Baths—Ornamental Pools—Sanitary Drinking Fountain—Gateposts—Auto Driveway—Sidewalks—Boat Landings and Docks—Entrance and Garden Walks—Sidewalk Flagging—Narrow Curb Walks—Curbs and Gutters—Wall Coping—Steps—Garage Floor—Basement Floor—Fence Posts—Lawn Roller—Cistern—Chimney Cap—Refuse Burner—Culvert—Benches for Greenhouses—Tilt—Retaining Walls—Foundation Supports—Engine Foundations—Septic Tank—Toy Blocks—Forge—Fireproof Safe—Ice House—Watering Troughs—Milk House—Smokehouse—Silo—Horse Stalls—Hitching Post—Rural Mail Box Post—Cyclone Cellar

Build With Ease for Permanence and Beauty

This is a book of practical plans for using concrete about the home, farm or shop. For amateurs as well as contractors. In addition to the articles mentioned above the making of good concrete mixtures for various classes of construction is given; mechanical mixers and homemade tools are dealt with. All necessary form and mold making are covered as well as many other valuable pointers too numerous to mention here.

Simply write and ask us to send you this book. When postman hands you the package pay him \$1.00 plus the postage. If outside U. S., remit when ordering and include 15 cents extra for mailing.

POPULAR MECHANICS PRESS
Room P1 200 E. Ontario Street CHICAGO



Which Job do YOU Want

Lawyer



Auto Expert

Try for
it for
This

Men don't just fall into easy jobs of big pay positions—they prepare for the big chance before it comes. Make up your mind today what you want to be, then take the first step at once. You don't have to go to college to get ahead. Other men have gone there for you and have put the things they learned there and through years of practical experience into easily understood books which give you a short cut to a better and a bigger job. We have picked 10 of the best paying professions and have published for your benefit new editions of the most practical, the most valuable books we have ever printed on the subjects covered.

JIFFY INDEX

Our new Jiffy Index makes each book a quick reference work—no time need be wasted in search or study—put your finger on the facts you want instantly.

SHIPPED FREE

Words alone cannot describe the full value these books may be to you, so we ship Free for Examination. Pick the set you want, the price is plainly shown, but **Send No Money**; just your name and address, and the books will be sent promptly.

Take ten full days to read, test and examine them. You'll realize at once what a tremendous force for a better future they can be. After ten days you send only \$2.00; then \$3.00 per month until the balance is paid. **There Are No Interest Charges of Any Kind**; the price shown is the total cost.

Special Price List of Pay-Raising Books

Automobile Engineering, 6 volumes, over 2,500 pages, brand new 1931 edition.....	\$24.80
Practical Business Administration, 12 volumes, 3,400 pages, (Extra volume containing self quiz reading course of 80 lessons included free.) This is a complete business guide.....	39.80
Electrical Engineering, 8 volumes, 4,300 pages, 3,200 illustrations.....	34.80
Modern Shop Practice, 7 volumes, 2,600 pages, 2,670 pictures.....	29.80
American Law and Practice (with reading course), 13 volumes, 6,000 pages, illustrated.....	49.80
Sanitation, Heating and Ventilating, 4 volumes, 1,436 pages, 1,000 pictures.....	14.80
Drawing, 5 volumes, 2,000 pages, 1,546 pictures, blue prints, etc.....	19.80
Employment Management and Safety Engineering, 7 volumes, 1,800 pages, 450 illustrations, charts and diagrams.....	19.80
Architecture, Carpentry and Building, 5 volumes, includes 120-page book "Blueprint Reading" free, Special price—reduced from \$24.80.....	19.80
Civil Engineering (brand new), 7 volumes, 2,800 pages, 1,600 illustrations.....	29.80

MEMBERSHIP FREE

Anyone who takes advantage now of this opportunity to "Raise his Pay" will be given absolutely free, a certificate of membership in the American Technical Society, which entitles him to full consultation privileges with our experts in his chosen field. This is good for a whole year and is of tremendous value in solving special problems.

American Technical Society, Dept. X-119,
Drexel Ave., at 58th St., Chicago, U. S. A.

Please send me the set of.....

for Ten Days' examination. I will examine the books thoroughly and, if satisfied, will send \$2.00 within 10 days and \$3.00 each month (\$2.00 on telephony) until I have paid the special price of \$..... If I decide not to keep the books I will return them at your expense at end of 10 days and will owe you nothing.

Name.....

Address.....

Employed by.....

Address.....



Civil Engineer



Business Manager

way

LEARN TO PLAY GOLF

as CHAMPIONS Play It!

IMPROVE YOUR GOLF GAME AT HOME. Learn to drive straight down the fairway—to hit your "irons" perfectly—to approach and putt with deadly accuracy! It's amazingly simple when you follow detailed instructions and actual illustrations of every shot explained in the Book of Golf. Shows how every stroke is played by famous men and women champions. Money-back guarantee! Send \$1 for complete book today.

NATIONAL GOLFERS SCHOOL

2525 Milwaukee Ave. Chicago



Greatest Encyclopaedia Value Ever Offered
ENCYCLOPAEDIA BRITANNICA

Write for FREE Booklet

THE ENCYCLOPAEDIA BRITANNICA, Inc.
342 Madison Ave., New York City

Learn
ADVERTISING
at Home

Greater opportunities now in advertising. Learn easily and quickly in spare time. Practical work. No test books. Old established school. Low tuition—Easy terms. Send for free booklet of interesting information.

Page-Davis School of Advertising
Dept. 1351, 3601 Mich. Ave., Chicago



BUCHSTEIN'S FIBRE LIMB

is soothing to your stump—strong, cool, neat, light. Easy payments. Braces for all deformities.

Send for Catalog Today

B. BUCHSTEIN CO.
810 3rd Ave., So.
MINNEAPOLIS, MINN.

Surprise for Ruptured— 50,000 Given Away

WE have an amazing, free surprise for every ruptured person. We want to send you absolutely free a sample pad of Airtex, an amazingly new kind of material that helps heal rupture. We want to send you the most interesting free book you have ever read. No dope, no drugs, no barbarous springs or cruel leg straps. We want to show you the interesting possibility of actually discarding your old ox-harness, in ten days, or pay nothing. We want to tell you free about amazing Magic Dot that weighs less than a quarter. Instantly on or off. Write at once while this free offer lasts and learn about the remarkable system. New Science Institute, 2180 Clay Street, Steubenville, Ohio.

FREE Facts About Gland Failure



Do you know why many men are old at 40, while others are young at 70? Do you know why the prostate gland slows up and why it causes bladder weakness, sciatica, pains in the back, feet and legs? Write today for scientist's new book FREE. Learn just what these symptoms mean. Learn of a new kind of treatment. Learn how 100,000 men past 40 have found quick relief without medicine. Learn facts of priceless

value to you. Write now for an interesting, illustrated book, "The Destroyer of Male Health." Address W. J. Kirk, 2137 Morris Avenue, Steubenville, Ohio.

Get Into One Of These BIG PAY FIELDS



All practical work on real
Electrical machinery



Student working on Television
transmitter in
Coyne Radio Shops

Amazingly Easy Way to Get Into ELECTRICITY

Don't spend your life waiting for \$5 raises in a dull, hopeless job! Let me show you how to make up to \$60, \$70 and even \$200 a week, in Electricity — NOT BY CORRESPONDENCE, but by an amazing way to teach that makes you a practical Electrician in 90 days!

LEARN WITHOUT BOOKS IN 90 DAYS

No Books! No Lessons! You learn by doing actual electrical work right here in the Coyne Shops. You are trained on huge motors, generators, switchboards, transmitting stations, power plants, auto and airplane engines, etc. You don't need advanced education or previous experience. You qualify for real electrical work in 90 days!

Earn While You Learn

Don't worry about a job! You get FREE life-time Employment Service. And don't let lack of money stop you. If you need part-time work to help pay living expenses, I'll help you get it. Coyne is 31 years old. Coyne Training is tested. You can find out everything FREE. Just mail coupon below and I'll send you my BIG FREE ELECTRICAL BOOK, telling all about jobs—salaries, etc. This does not obligate you. Just send the coupon below!

MAIL THIS COUPON FOR BIG FREE ELECTRICAL BOOK

H. C. LEWIS, PRESIDENT
COYNE ELECTRICAL SCHOOL, Dept. 11-73
500 S. Paulina Street, Chicago, Illinois

Gentlemen: Please send me your big Free Electrical Book, with 151 illustrations. This does not obligate me.

Name.....

Address.....

City..... State.....

Learn RADIO TELEVISION TALKING PICTURES

Every branch of Radio is calling for trained men! 5,000 Service Men needed at once. Big call for Wireless Operators, both at Sea and in the Air. Many jobs open in Broadcasting Stations, Talking Picture and Sound Experts in great demand. And now Television is on the way! Soon there'll be a demand for thousands of Trained Men in this one branch alone. Say "good-bye" to \$25 and \$35 a week—get into Radio, where thousands of jobs are open, paying \$60 a week and up.

Not By Correspondence By Actual Work—in 8 Weeks

Come to Coyne and learn Radio in 8 weeks! NOT BY BOOKS OR CORRESPONDENCE, but by actual Radio work on actual Radio equipment — on scores of Radio receivers, huge Broadcasting equipment, the very latest Television transmitters, Code Practice apparatus, Talking Picture and Sound equipment, etc. No experience needed. You learn all branches of Radio in 8 weeks.

FREE EMPLOYMENT SERVICE

After you graduate, I'll help you get the Radio Job you want — and if you need part-time work while at school, I'll help you get that, too. Coyne has been training men since 1899. Let Coyne train you for a Big Pay Radio job! Mail coupon below for a copy of my BIG FREE RADIO BOOK, telling all about Radio, Television, Talking Pictures, Wireless, etc. This costs you nothing. Just mail coupon below.

MAIL THIS COUPON FOR BIG FREE RADIO AND TELEVISION BOOK

H. C. LEWIS, PRESIDENT
RADIO DIVISION, COYNE ELECTRICAL SCHOOL
500 S. Paulina St., Dept. 11-3H Chicago, Ill.

Gentlemen: Send me your Big Free Radio Book and all details of your Special Introductory Offer. This does not obligate me in any way.

Name.....

Address.....

City..... State.....

1914

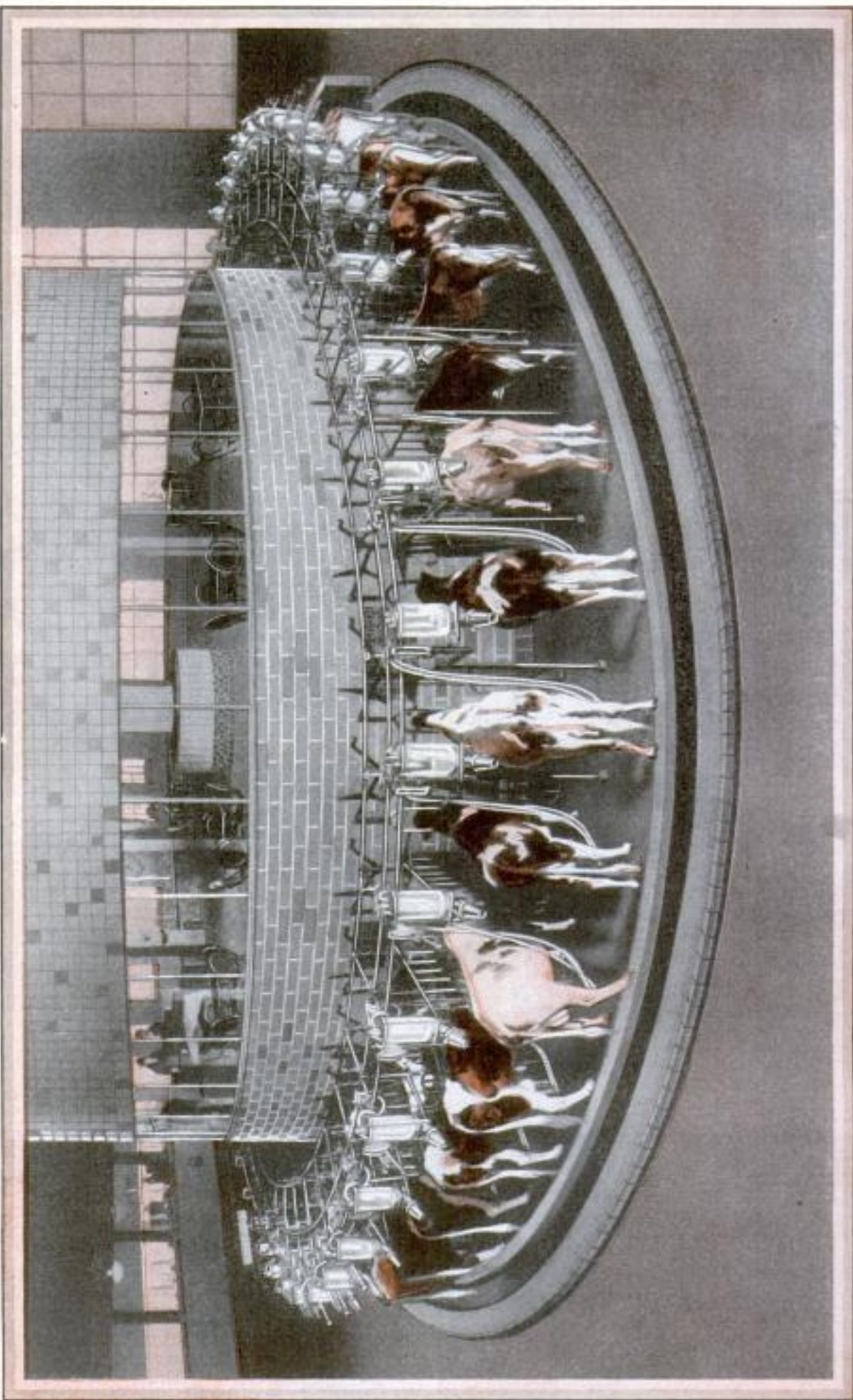

General View of the "Rotolactor," the Marvelous Merry-Go-Round Device on Which Fifty Cows Are Milked by Electricity; the Platform Revolves Slowly, the Cows Stepping On and Off One at a Time; the Cows Are Given Warm and Cold Showers, Dried with Electric Driers and Wiped with Individual Towels

Popular Mechanics Magazine

REGISTERED IN U. S. PATENT OFFICE

WRITTEN SO YOU CAN UNDERSTAND IT

Vol. 55

JANUARY, 1931

No. 1

SUPER MILK *from* Merry-Go-Round

By PAUL D. PADDOCK

FIFTY cows are bathed, dried and milked in twelve and one-half minutes in an air-conditioned palace on the Walker-Gordon farms at Plainsboro, N. J., where dairying methods are being revolutionized with the production of a super-milk, an improved system of farming and a milking device that puts a once prosaic task into the realm of a mechanical fine art.

The milker, privately tested for months, was introduced to the public just recently. Astounded visitors, comfortably seated in a glass-lined rotunda above the cows, saw a merry-go-round contrivance that promises to put the dairy barn of the future into the heart of the city. Cows, kept in healthful, sanitary surroundings with the aid of artificial sunlight and man-made climate, and eating foods extra-rich in the necessary ingredients, will be milked three times a day, and the product, germfree and far more nutritious than ordinary milk, will be quickly distributed without once touching human hands.

The milking merry-go-round, developed by Henry W. Jeffers after years of experiment and research, takes the hard work out of milking, saves time and makes it possible for a few men to handle hundreds of cows a day. More than 1,500 are

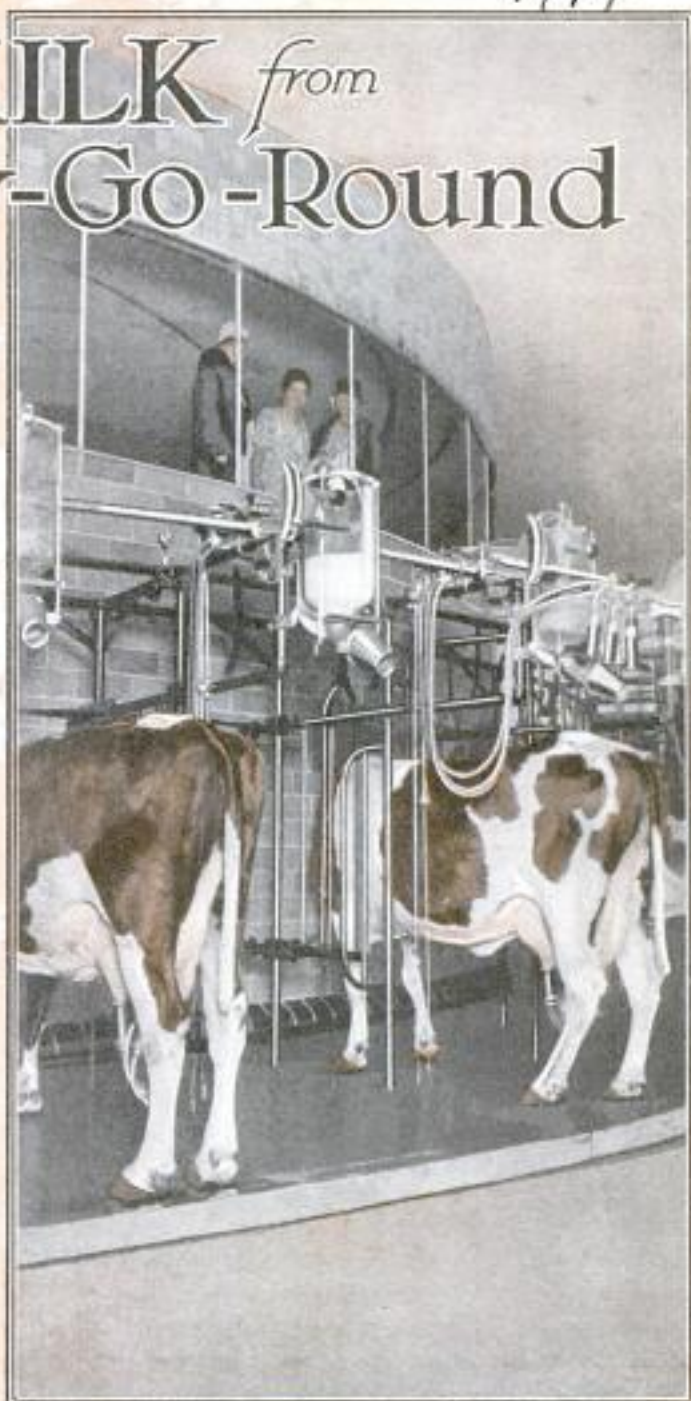

The Milk, Extracted by Milkers, Goes into Glass Cylinders above the Cows and Is Automatically Weighed and Recorded

milked three times a day on the Walker-Gordon farms. Incidentally, the machine is so adjusted that it stimulates the production of more and better milk. Here is how it works.

Paddock

1914 2



Cows walk from their barns some distance away, enter a tiled passage single-file and step, one by one, upon a slowly revolving platform, a "Rotolactor" as it is called. During the first few feet of the ride, the cow receives a warm and a cold shower and as she passes air driers, an attendant dries the udder and sides with a clean white towel. Each cow has her own towel.

Another attendant then draws a sample of milk for infection test by hand, and a DeLaval magnetic milker is attached. With every pulsation of the machine, the milk goes streaming up into a glass jar attached to uprights over the cow. By the time the Rotolactor has made one complete revolution, the cow has been thoroughly milked, and, as her stanchion is released, she steps off the platform and walks back to her barn. The cows are easily taught this routine and appear to enjoy the system. They do not leave their barns except to go to and from the milking platform.

The milk is released from the jar, automatically weighed and recorded and then

is drawn through sanitary pipes into the bottling rooms where it is made ready for distribution. A special aluminum cap for the bottles has been devised to promote further cleanliness. In case the sample of milk taken for a test, reveals any infection or disease, the cow will be tagged and her milk kept separate. The cow would immediately be given a thorough medical examination and, if conditions warranted, would be sent to a special hospital farm.

The rotating platform is so nicely balanced that a small electric motor furnishes sufficient power to turn it, and the magnetic milkers are adjusted to give from forty-five to forty-eight pulsations per minute, a rate con-

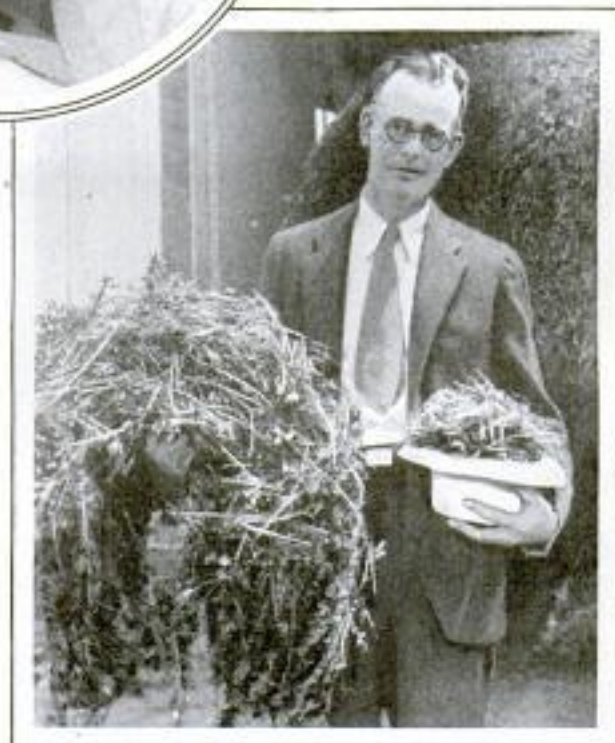

Giving the Cows Their Showers, Bacteria Counter, and Sample of Dehydrated Alfalfa in Hat

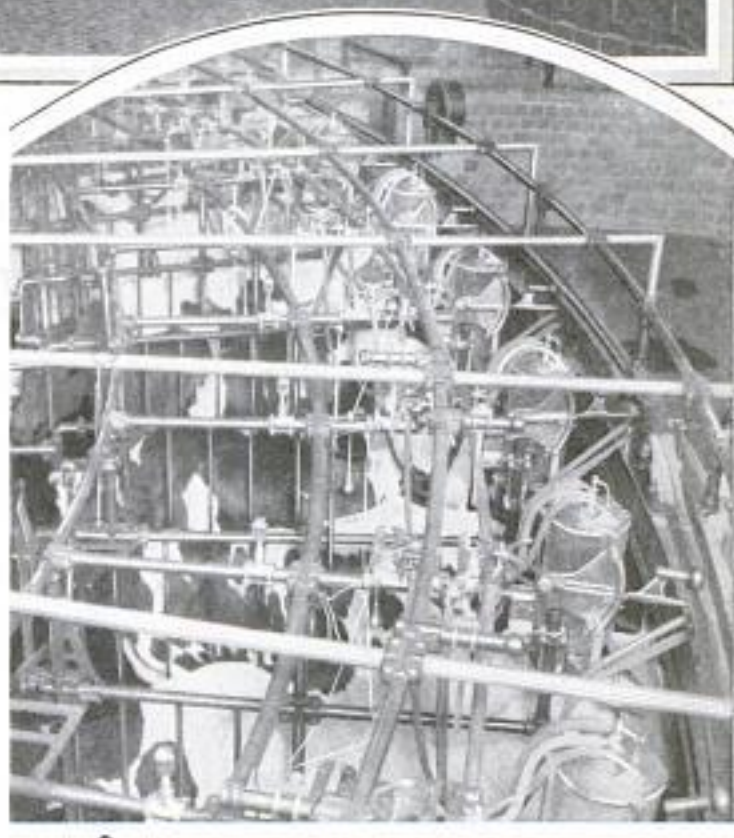
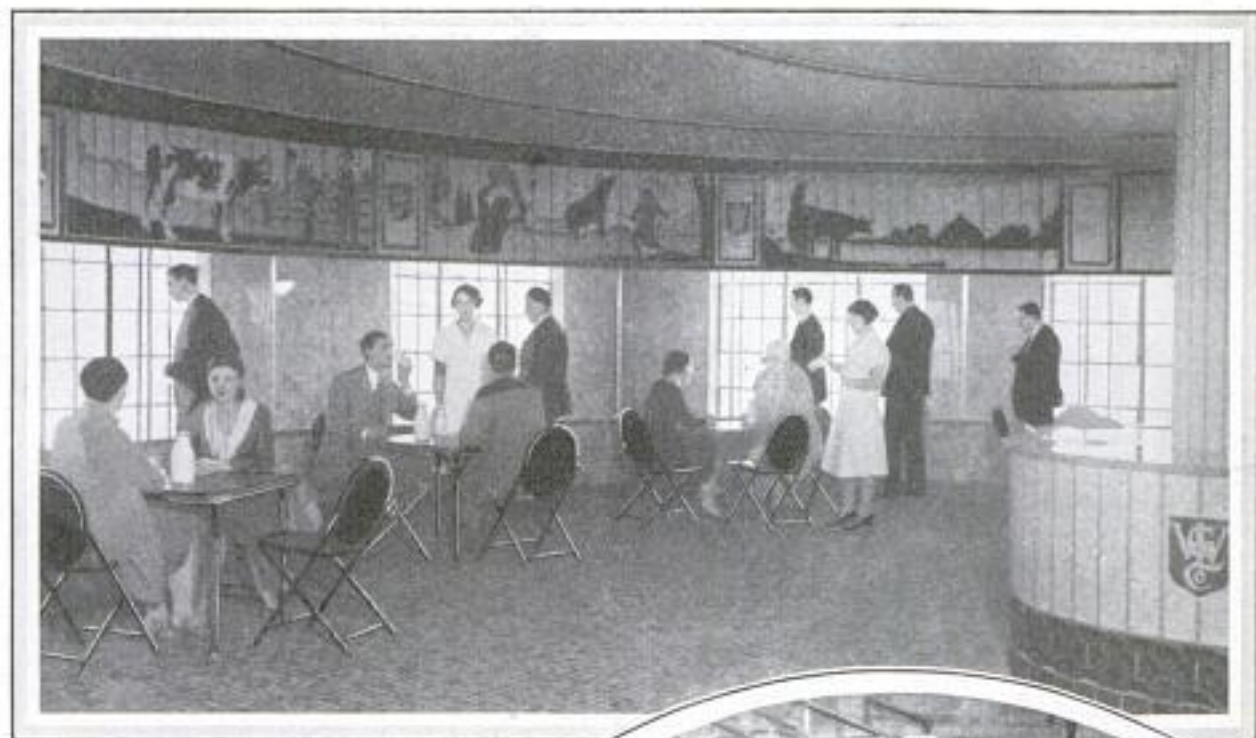

Room above the Milking Platform Where Visitors Gather Is Handsomely Decorated in Tiles; Below, Looking Down on the Cows and Machines

ducive to the best milking. The regularity of milking time, the even speed of the machine, the comfortable and quiet surroundings, and other factors, all encourage a maximum milk yield. Even the tiled walls are of a color that will add to the harmony of the entire installation, thus contributing a psychological aid to attendants and possibly to the cows as well, for it has been proved that the cow actually manufactures most of her milk during the operation of milking, and every factor that promotes her comfort and ease does its bit to stimulate a more abundant flow of milk.

This marvelous milking unit is only one of the interesting developments on the farm where the leading authorities of the country have been working for years under the direction of the Borden research foundation toward the production of a better milk. Regarding it as somewhat of a factory proposition, for the cow is essentially a miraculous living factory, the investigators started the "production line" with the soil.

They argued that a richer soil, improved with better fertilizers, would in turn produce crops having greater quantities of

healthful substances. The crops, in turn, would be specially treated. By an improved method of dehydration, for instance, the farms are furnishing the cows with alfalfa that contains several times the amount of vitamin A usually present in ordinary alfalfa hay. Other crops are dried and treated to increase their vitamin content.

before Optical Society of America

To Mr. and Mrs. Viggo von Prigel - 1893
Sacramento, Calif.



Christian Science Monitor 11/29/30

SUN'S TRAVEL IN DUST CLOUDS CAUSE OF ICE AGES

Solar-eclipse studies may reveal the cause of the earth's glacial periods. This is the opinion of Dr. Harlan T. Stetson, director of Perkins observatory, Ohio Wesleyan University, who has advanced a theory that dust clouds in space are responsible for the ice ages. He believes that the sun at times may travel through such clouds of cosmic dust, shadowing the sun's rays sufficiently to reduce the earth's temperature to glacial levels. By measuring the varying brightness of the sun's corona in eclipse after eclipse, he believes the cause of variations in light and heat reaching the earth can be determined.

MAP ON STEERING POST LATEST CITY GUIDE

Two Curved, Snakelike Horns Used by Ancient Vikings; Note the Flaring Ends, Resembling Radio Loud Speakers

HORN LIKE A LOUD SPEAKER SUMMONED VIKING TO WAR

Two curved and elongated horns used by the ancient Vikings of the eighth century have been sent recently to this country from Denmark. These snakelike instruments, nearly ten feet in length, were used to summon the Viking hosts to council and to war, or to signalize events of rare importance. They curl to a round, enlarged end to which is attached a sounding disk, somewhat resembling the modern radio loud speaker.

AIR TRANSPORT GROWS SAFER FLYING RECORDS SHOW

In line with the constantly increasing safety of military flying, there has been a corresponding improvement in the safety of scheduled air transportation, government records show. Comparing the first six months of 1930 with a like period for 1929, the reports state that last year, transport planes flew 384,152 miles to each accident, whereas in 1929, they flew but 150,842 miles to each accident.

1898

Dept. of Commerce
Aeronautics Branch

1859 Easily attached to the automobile wheel post, a reel map gives locations of important places in the city. Over 2,000 are listed, and the reel is turned by a crank. The guide is lighted at night with current from the battery system, and the printed reels are easily taken out for the substitution of new

Guide and one reel \$7.50

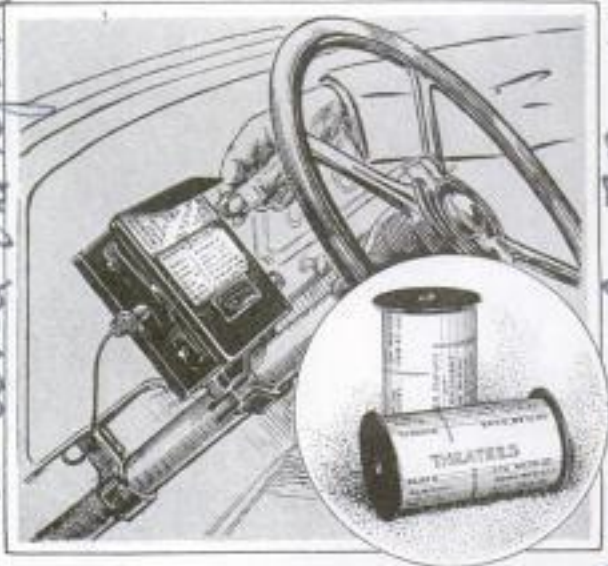

Drawing of the Street Guide Attached to the Automobile Steering Post, and View of the Rolls

ones, either blanks or special guides made by the car owner.

Cook's Guide, Inc.
172 E 73rd St.
New York City.

refill spools 75¢ to \$1.50 each

1892 Potsdam Model Shipbuilding School

POPULAR MECHANICS

MODEL LINERS BUILT TO CARRY FOUR PASSENGERS



Launching One of the Large-Scale Models Built at German School; Some of the Vessels Are Electrically Powered and Lighted, and Will Carry Several Passengers

At an interesting model-building school in Potsdam, Germany, young men are being taught how to construct large-scale models of real ocean liners and other craft. The replicas are powered by sail or motors and are large enough to carry one or more passengers. A model of the Lloyd steamer "Columbus," electrically powered and lighted, had sufficient room for four passengers. An electric stove and radio were additional features. Models of the "Hamburg," and the "Hindenburg," and various other boats have been made. The school aims to give its students practical and theoretical knowledge that will enable them to continue this line of work to become marine architects or engineers.

MIRAGE IS SEEN AT NIGHT BY LIGHTNING FLASH

Members of an exploring party on the edge of the Sahara desert were astonished recently during a thunderstorm at night, to see a range of snow-clad mountains outlined against the sky as the lightning flashed. The nearest range in that direction was the Atlas mountains, 500 miles

away, so the observers concluded that the lightning had produced a mirage, making the peaks plainly visible in this way. The phenomenon was repeated on another evening under almost identical conditions.

PISTON SLAP QUICKLY STOPPED BY AIR EXPANDER 1899

Eliminating slap without removing pistons from the block is accomplished with a pneumatic piston expander. It consists of a hammer operating on an air pressure of seventy-five pounds or more, and works by peening the skirt of the piston to fit the cylinder wall at the point where slap develops. A long handle with thumb control and a magnetic trouble lamp enable the task to be performed in comfort. The expander thus saves considerable time.



Piston Peening Tool

reported to French Academy of Sciences by M. Jean Eugeni

Waterbury Tool Co. Inc, 1039 Broadway, Albany, N.Y.

Model Engineer and Practitioner
Electronics 10/16/30

Bill by Prof. As W. Ritchey.

1898

Solar Observatorium
off. Pasadena
Calif

POPULAR MECHANICS

Daily Express 10/20/30
ENGINEERS TAKE LESSON
FROM SHIP WORM IN
1907 BORING TUNNEL



Testing Twenty-Inch Telescope That Has Tube But Fifty-Four Inches Long; It Reduces Distortion and Takes Sharp Photos

CLEARER VIEW OF STARS GIVEN BY SHORT TELESCOPE

Designed especially for star photography, a twenty-inch telescope for use at Miami, Fla., has mirrors so arranged that they reduce distortion and pictures of unusual sharpness can be taken. The photographs can be studied over their entire area with a microscope, so clear are the details. The usual refracting telescope with an aperture as large as the one in the new unit would require a tube more than thirty feet long but the special telescope's tube is but fifty-four inches in length.

MIRROR FOR AUTO-PIT LIGHT AIDS IN CAR REPAIRS

Automobile pits in an eastern service station are brilliantly illuminated on the inside by means of wall lamps and mirrors inclined at an angle to reflect the rays to the best advantage. The sides of the pit are also painted white as an additional aid to the workers.



Ship worms, which cause much damage to piers and ship timbers, taught the makers of London's first underground railways how to bore and line their tunnels to resist water. The worm makes a boring about half an inch in diameter, lining it with a limelike substance to keep out the water in the damp wood in which it lives. When engineers made the first attempts at underground passages, they had difficulty in keeping the water out of the London clay. By studying the technique of the ship worm, they learned that they could keep the bore dry by lining it as they progressed. In boring its passage, the worm bites away the wood which passes in small particles through its body and the same idea is in use today in the engineer's shield, a metal casing the size of the tunnel which moves forward at the same time as the electric drills which move the earth away.

AUTOMATIC CONTROL OF HEAT FOR EVERY RADIATOR

Individual control of the steam supply to each radiator in a two-pipe system is made possible with a thermostatic device which brings independent and automatic temperature control for each room. The device, known as a "radiatherm," does automatically what an expert operator would accomplish if he continually watched a thermometer and opened and closed a hand-control valve to regulate room temperature. The automatic control effects fuel saving because it maintains a predetermined constant temperature, regardless of changes in steam pressure or outside temperature, as long as an adequate heating system is in operation. The device is as easily installed as an ordinary radiator valve.



American Radiator Co
40 W. 40th St
New York

International Bus Corp.
Buffalo, N.Y.

1860

Copyrighted material

1896 Architects: Austin Co, 954 Union
Trust Bldg. Cleveland, Ohio.

A Million Dollar Windowless Plant

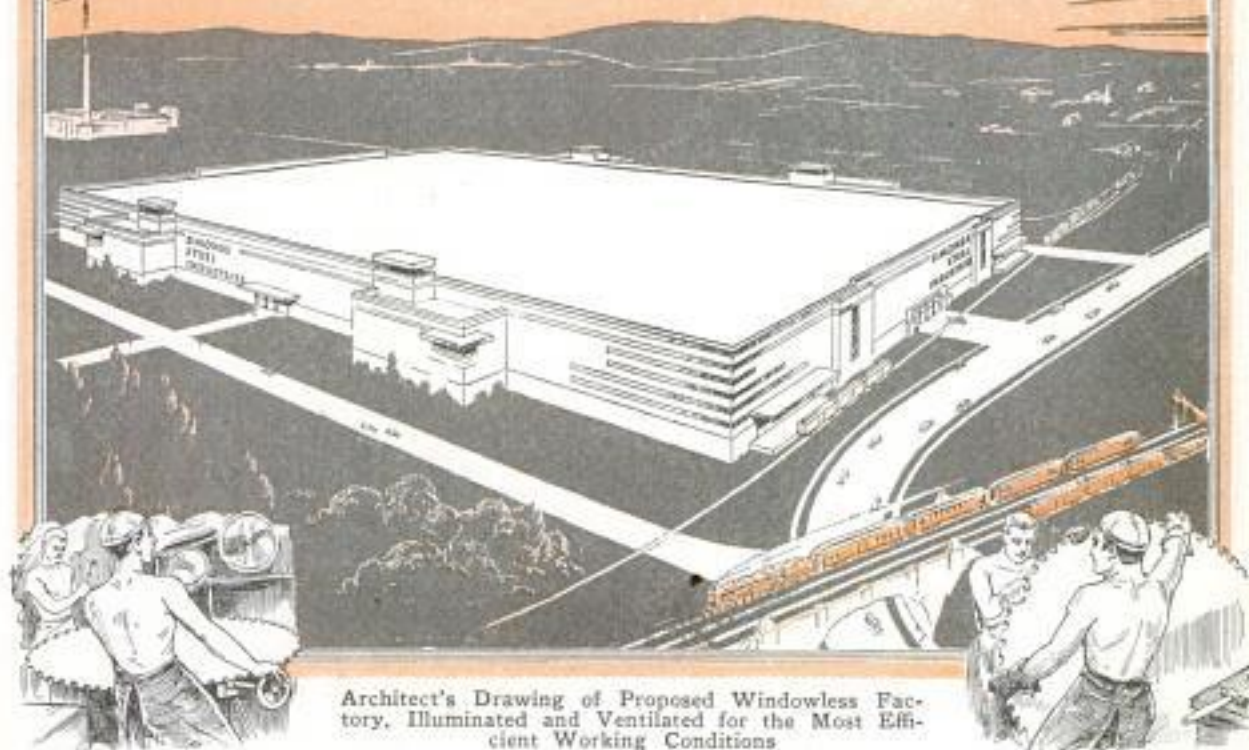

Architect's Drawing of Proposed Windowless Factory, Illuminated and Ventilated for the Most Efficient Working Conditions

WHAT is aimed to be the most efficient, and, unquestionably, will be the most amazing manufacturing plant in the world—is to be erected at Fitchburg, Mass., by the Simonds Saw and Steel company.

This million-dollar factory will have no windows or skylights, yet it will be lighted throughout with an efficiency four times greater than that of any other structure of its kind. There will be no dark corners and every last inch of the building will be lighted to the same adequate degree.

Not a single breeze will find its way into the plant, yet the inside air will be purer than the outside. Furnaces will roar at tremendous temperatures, but the workers will feel no uncomfortable heat. Oils, some of them mighty smelly, will boil as glowing metal is plunged into them, yet not a single odor will pollute the atmosphere. Grinding wheels whirling against hard steel will produce clouds of dust, but very few specks of it will float

through the air. The plant will be warm in the winter and cool in the summer.

The new plant will be a one-story structure, with ground dimensions of 570 by 360 feet and height of twenty-five feet. Every process from metal treating to shipping will be carried out on one floor. Electric power will be used. The building will be completed about March 1 and the plant will be running by June 1, this year.

"How did you happen to plan a windowless plant," Popular Mechanics Magazine asked G. K. Simonds, general manager of the corporation.

"We didn't," Mr. Simonds explained. "It was forced upon us. We simply started out, two years ago, to plan a plant in which conditions would be as nearly perfect as possible. Of late years, you know, most of the efforts of manufacturers have been directed toward the perfecting of their machinery and tools.

"We have not slighted this important item one jot, but have extended the search

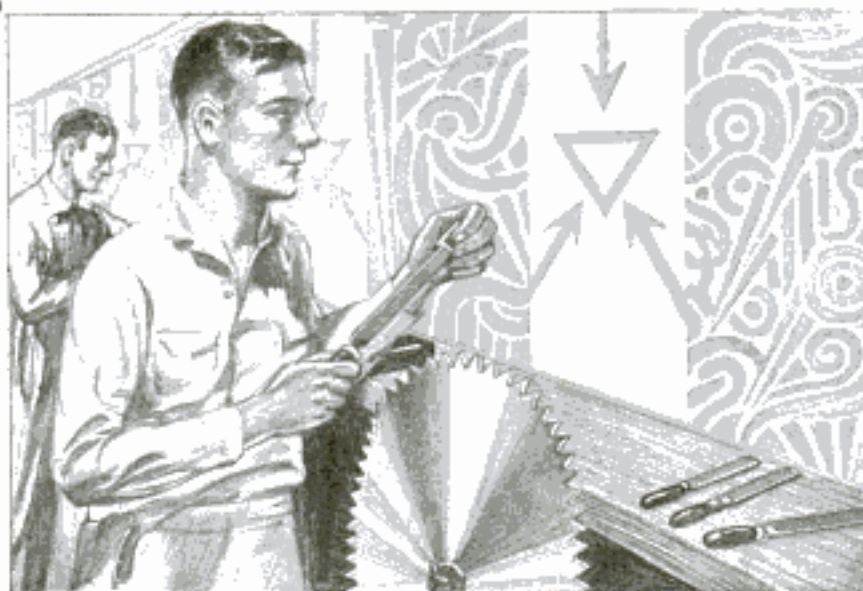

Artist's Conception of Wall Designs That May Be Used as "Rest Points" to Soothe the Eyes after Close Application to Tasks

for high efficiency to the human element. We figure that perfect workmen are even more important than perfect machines and work routing. No one can have perfect workers without perfect working conditions. That's what we are striving for.

"Side windows were ruled out very early in our planning. No factory can be lighted efficiently from the side walls. Next, we considered skylights with a north exposure. These offer some improvement, but still leave dark spots, and the light is not constant. An additional factor that made us rule out natural light was the realization that glass cannot possibly be soundproofed. Turning one-third of the wall space into glass windows increases the commercial noise more than two-thirds.

"The lighting system will be direct. The ceiling will be studded with a myriad of 1,000-watt ultraviolet-ray lamps. Adequate, uniform lighting increases speed and quality of manufacture. Furthermore, adequate lighting is the greatest of safety devices. In addition, the entire building will be insulated as efficiently as the best refrigerator. It will be kept at a constant temperature by an automatically controlled system. The inside air will be changed every ten minutes.

"The making of our products necessitates a great amount of noise. That harsh, loud noises contribute greatly to a lowering of human efficiency, is no longer debatable. Workmen may believe that

they become so used to noises that they are not affected by them, but our experiments show that the less noise we have, the greater and better the output.

"There is no harsher or more penetrating sound, nor one that rasps the nerves more than the dry-grinding of hard steel and the filing of saws. High-pitched sounds such as these are the hardest to reduce, but we have proved the possibility of lessening them more than sixty per cent. Low-pitched

sounds, such as the thud of a triphammer, will be reduced nearly eighty-five per cent, which comes close to eliminating them.

"From the color standpoint, the interior will present an aspect the like of which you have never seen in a manufacturing plant. The work of the color experts, oculists, and others is not as yet complete, but is far enough along so that I can state that blue and yellow will predominate. The walls near certain processes will probably be striped in red. These colors have been decided upon as best for production. All the nonworking parts of the machinery will be enameled yellow.

"No worker, glancing up from his job, will have to look at a blank wall. You know that, when your eyes are tired from reading or other close work, looking up and changing the focus for a few moments rests them greatly. Our expert mechanics do a great deal of fine work. Looking up at a blank wall makes a change of focus difficult and decreases the rest gained in a given time. So, when one of our workers glances up, his gaze will encounter one of a myriad of adjustment spots painted on the walls. These may be pictures, circles, diamonds or other designs; the best designs have not been determined finally as yet.

"When the plant is placed in operation the efficiency of our workers will be increased at least one-third. This means benefits to everyone concerned."

ROTOR WINGS ON PLANE TO BE TESTED IN EUROPE

Although first experiments with a so-called "rotor wing" plane ended in failure in this country, German aeronautical engineers are reported to be continuing

yet to be solved is reliable control. An experimental rotor ship was tested in this country not long ago and made a short flight on

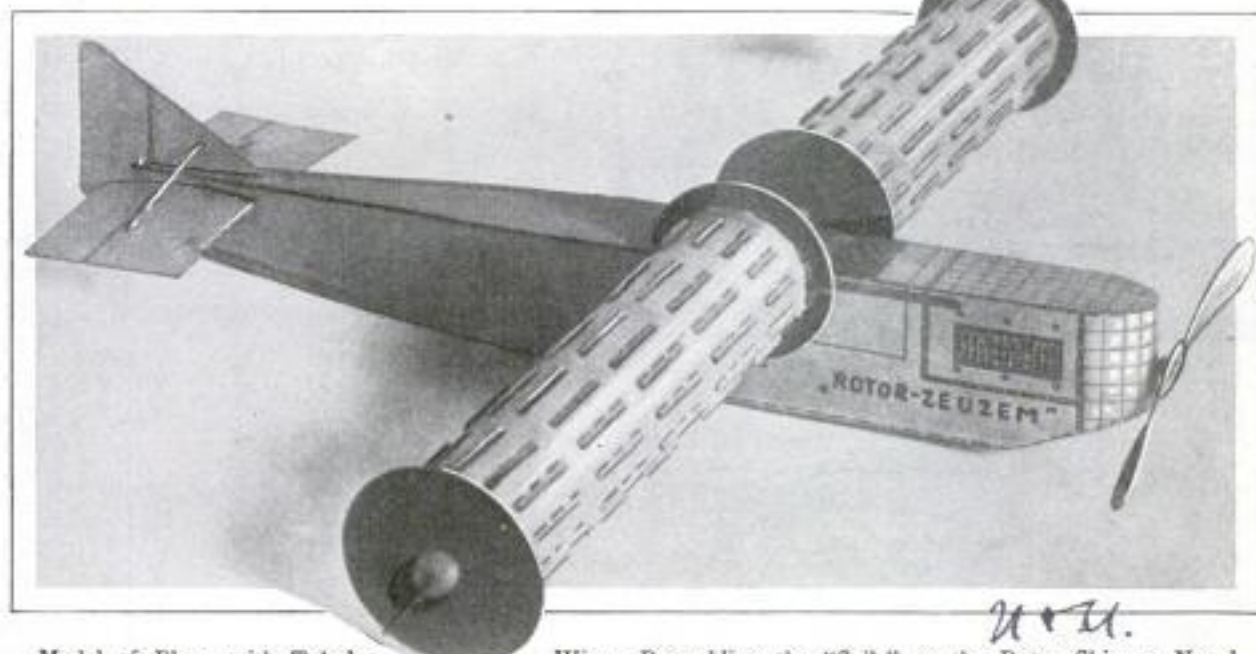

Model of Plane with Tubular Wings Resembling the "Sails" on the Rotor Ship; a Novel Advantage Claimed for the Plane Is That Goods Can Be Carried Inside the Wings

their tests with the design. The accompanying illustration shows a model plane of the type, the invention of Ernst Zeuzem, a well known German engineer. It incorporates some of the principles of the rotor ship which had slowly rotating columns instead of sails. The shape of the rotor wing is calculated to give ample lift, although one of the chief problems

Long Island sound. At a height of about eighteen feet, it went out of control and plunged into the water without injury to its two occupants. The rotor-plane wings have a smaller span than those of a plane of like size, thus simplifying the storage question and engineers believe that, with proper design, it will be able to lift more than the usual ship.

SODA FIZZ AS PNEUMONIA CURE IS SUCCESS IN TESTS

1932

Soda fizz, a combination of oxygen and carbon dioxide, administered through a common inhalator, has been used successfully in fighting pneumonia. Matthew S. Sloan, of the New York Edison company, said the treatment has been turned over to the medical profession after being used on 127 company employees. Of eighty-five patients treated in the preliminary stages, seventy recovered. The experiments were based on research carried out by Dr. Yandell Henderson, of Yale University, and while the method is not considered a general cure, it is believed to be a valuable aid in fighting the disease. The

mixture, among other things, has been found to aid in relieving heart strain.

BLOWTORCH FOR NATURAL GAS DOES NOT GO OUT

Using natural or artificial gas for fuel, a blowtorch and Bunsen burner that will

not blow out when the flame is properly adjusted, is now being used by the dental profession and in other trades. The natural-gas flame is hot enough to melt and fuse metals, and also can be used for lead burning, soldering and preheating.



Chicago Daily News
11/11/30.

Harster Mfg Co.
2916
Berkeley, Calif.

49's
~~1932~~

Designed by Louis Coataleri
Built by Sunbeam Motor Car Co
Wolverhampton, England.



Speeding



Alexander Winton's speed of one mile in fifty-three and one-half seconds, made in 1909, is a snail's pace compared to the records now made on land, water and in the air, and yet the present speeds, according to engineers and designers, are merely samples of the real speed that is still to come.

Nor have we long to wait for it. Prof. Herman Oberth, a responsible scientist with an international reputation, has experimented with a space rocket which will have a maximum speed of one mile per second. Ultimately it is hoped to construct a rocket which may be propelled across the Atlantic at a speed of 3,600 miles an hour.

What such speed means can be seen when

you consider that the earth revolves once upon its axis every day. At the equator, the earth's circumference is roughly 24,000 miles, so that there the earth, by turning once in twenty-four hours, moves at a speed of about 1,000 miles an hour. In Great Britain, being nearer the pole, there is less distance to turn and the same time to do it, so the speed is less. In fact, Britain is rotating in space at about 600 miles an hour.

As we already have machines capable of nearly 400 miles an hour, it is to be expected that it will not be long until an airplane is built capable of a speed equal to the world's turn in our own latitude. The effect of this would be that, if a pilot in such a machine flew west, he would

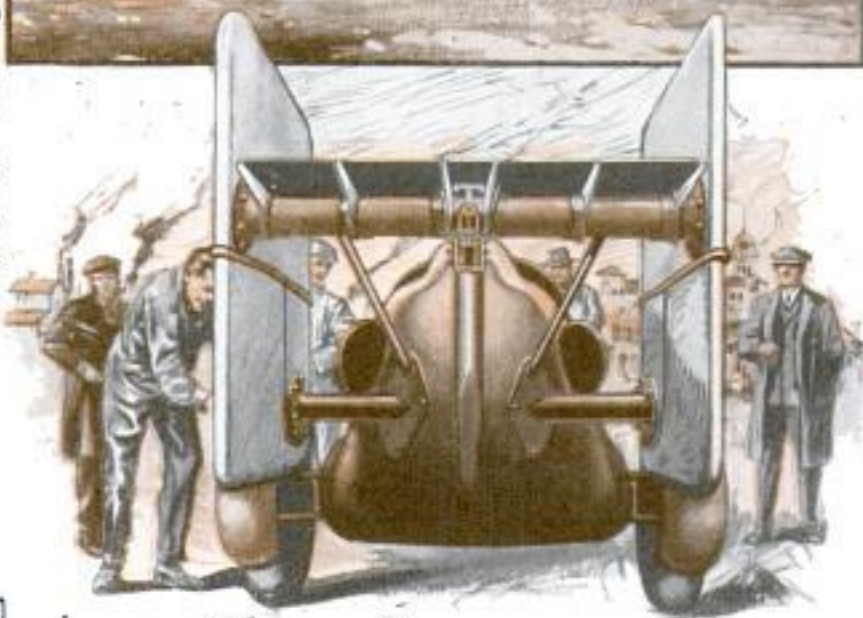

International

Front and Rear Views of Kaye Don's "Silver Bullet," Designed to Beat the Late Major Segrave's Record of Over 231 Miles an Hour

By ANTHONY WAYNE

JUST one hundred years ago, the first covered wagon left St. Louis for the far west and started the Oregon trail.

In 1860, the riders of the Pony Express were carrying news from St. Joseph, Mo., to the coast in thirteen days.

Today the west-to-east trip from the Pacific to the Atlantic has been made by airplane in twelve hours, twenty-five minutes and three seconds and by automobile in sixty-seven hours and thirty-eight minutes.

At a cost of millions of dollars, Schneider trophy planes have attained nearly 380 miles an hour, and Kaye Don's "Silver Bullet" is being groomed to better the late Maj. Segrave's record at Daytona Beach, Fla., of 231.36 miles an hour.

To be tried at Daytona Beach Fla.
between March 15 and 30

Back to Yesterday

exactly counterbalance the earth's spin, so that if he continued flying it would always be noon for him. Night would not exist.

Again, the distance from Liverpool to

Drawing of German Rail Car, Driven by Propeller and 400-Horsepower Airplane Engine

Tested at Hannover

Dr. Franz Krüchenburg, Station Director, Traffic Experimental Hannover

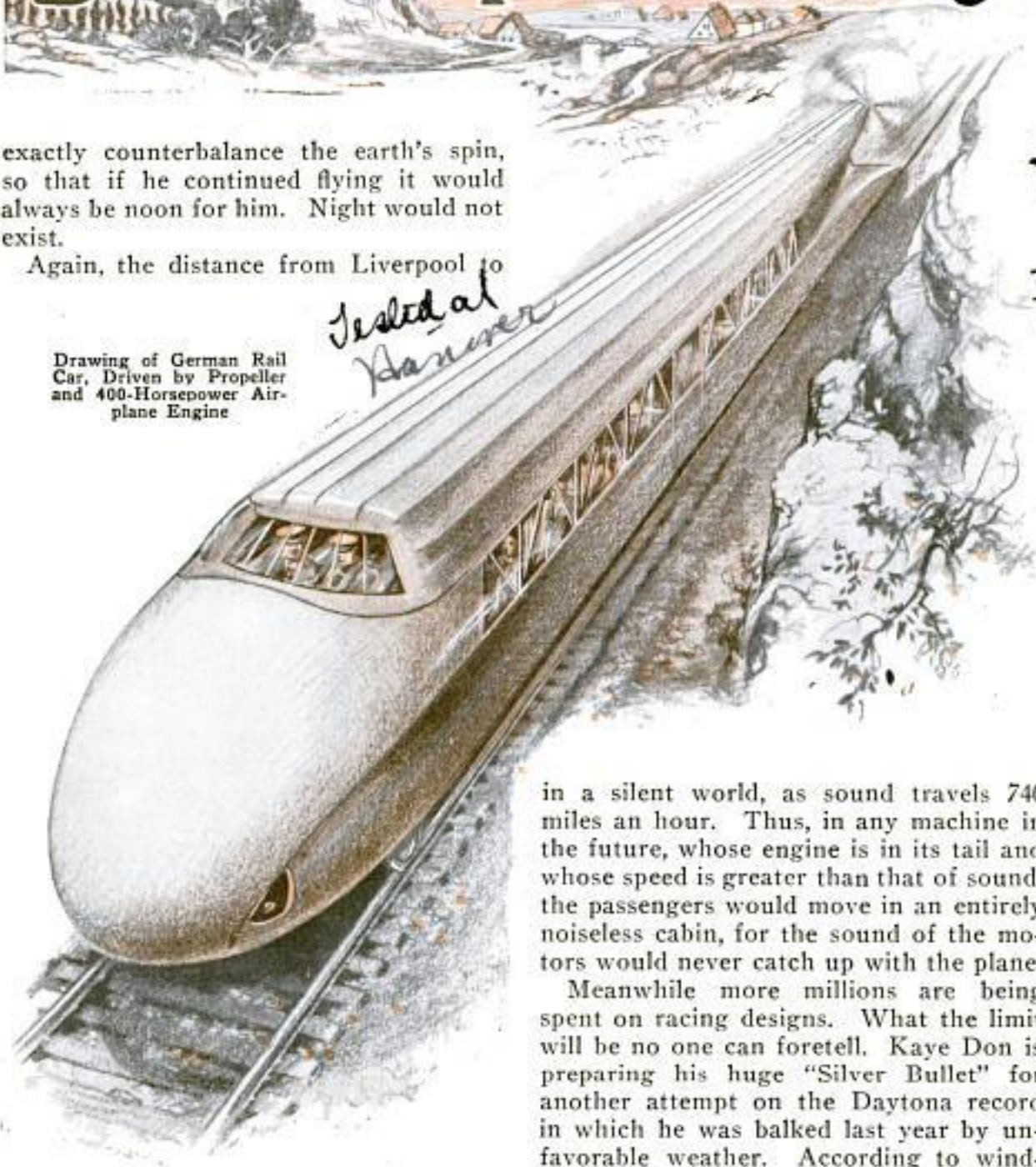

New York is roughly 3,000 miles, so that a space rocket, moving at 3,600 miles per hour, would make the journey in slightly more than forty-five minutes. Which means that if the rocket left London at six in the evening, it would arrive in New York at about 1:45 p.m., or some four hours before it started.

Then all high-speed travelers would live

in a silent world, as sound travels 740 miles an hour. Thus, in any machine in the future, whose engine is in its tail and whose speed is greater than that of sound, the passengers would move in an entirely noiseless cabin, for the sound of the motors would never catch up with the plane.

Meanwhile more millions are being spent on racing designs. What the limit will be no one can foretell. Kaye Don is preparing his huge "Silver Bullet" for another attempt on the Daytona record in which he was balked last year by unfavorable weather. According to wind-tunnel tests, there is no doubt that the car as it stands is capable of 300 or possibly 350 miles per hour. To drive the car 300 miles per hour only 1,050 horsepower is required. With a larger supercharger to permit the engines to develop their full 4,000 horsepower, the maximum speed is variously estimated as 400 to 475 miles per hour.

In order to appreciate the expense re-

445
12

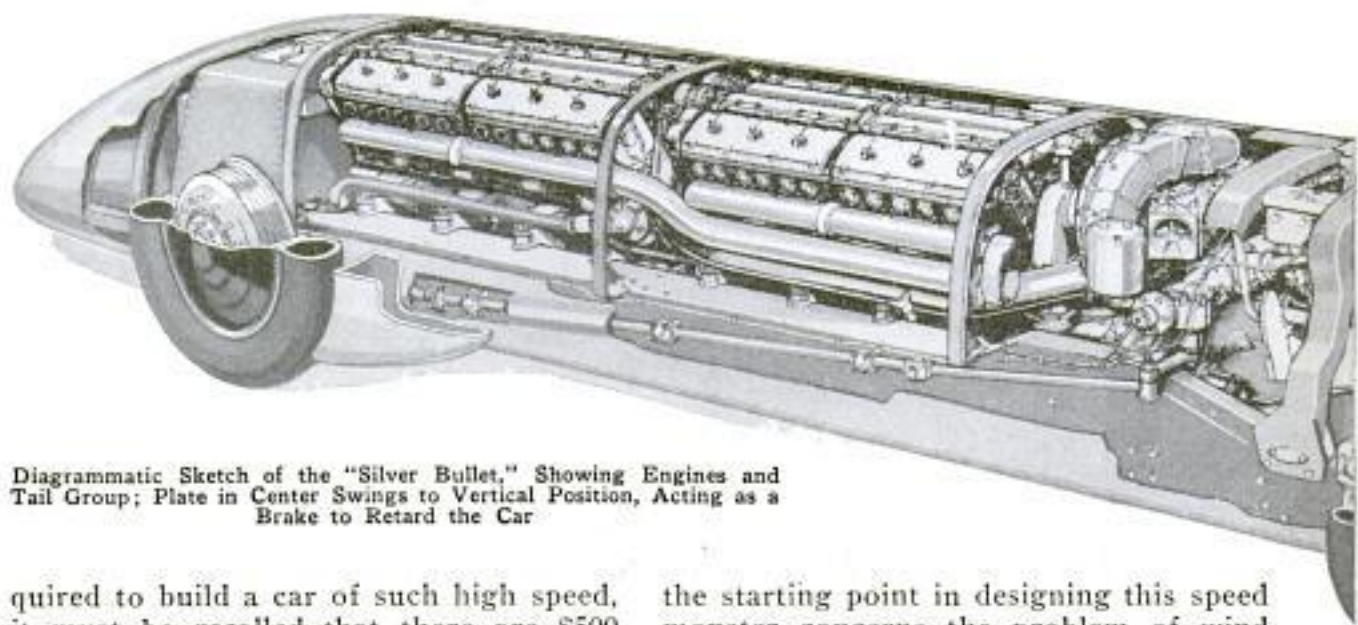

Diagrammatic Sketch of the "Silver Bullet," Showing Engines and Tail Group; Plate in Center Swings to Vertical Position, Acting as a Brake to Retard the Car

quired to build a car of such high speed, it must be recalled that there are \$500 automobiles which will run about seventy miles per hour, whereas the "Silver Bullet" cost 500 times this figure, or a quarter of a million dollars, for five to seven times the speed. The cheaper American cars cost less than twenty-five cents per pound, whereas Kaye Don's car, with a weight of 10,000 pounds, cost \$25 per pound—one hundred times as much.

The unprecedented cost of the "Silver Bullet" is due almost entirely to wind resistance. Were it not for the power required to force the car through the air, \$20,000 would amply cover the cost of a 400-mile-per-hour car. Therefore

the starting point in designing this speed monster concerns the problem of wind resistance. The lower the wind resistance of the car, the lower its cost for a given speed. Hence, although the car cost a huge sum, the money expended for an ultimate speed of, say, 400 miles would have been still greater had the wind resistance been higher.

Now, the one unalterable fact concerning the building of a one-man racing automobile is the width of the driver including room for his elbows while steering the car. This governs the width of the body. His elbows of course must be inside the car, not only because their wind resistance, if allowed to stick out, would seriously affect the maximum speed, but also because the rush of the wind at 400 miles might tear his arms from the steering wheel. Two years ago at Daytona Beach, the late Ray Keech while driving the "Triplex" at about 200 miles per hour hit a bump which threw his head into the wind stream at one side, and he had a brief but serious struggle to pull it back in—and Keech was an exceptionally strong man.

How low the driver is seated in the car also affects the wind resistance, and therefore

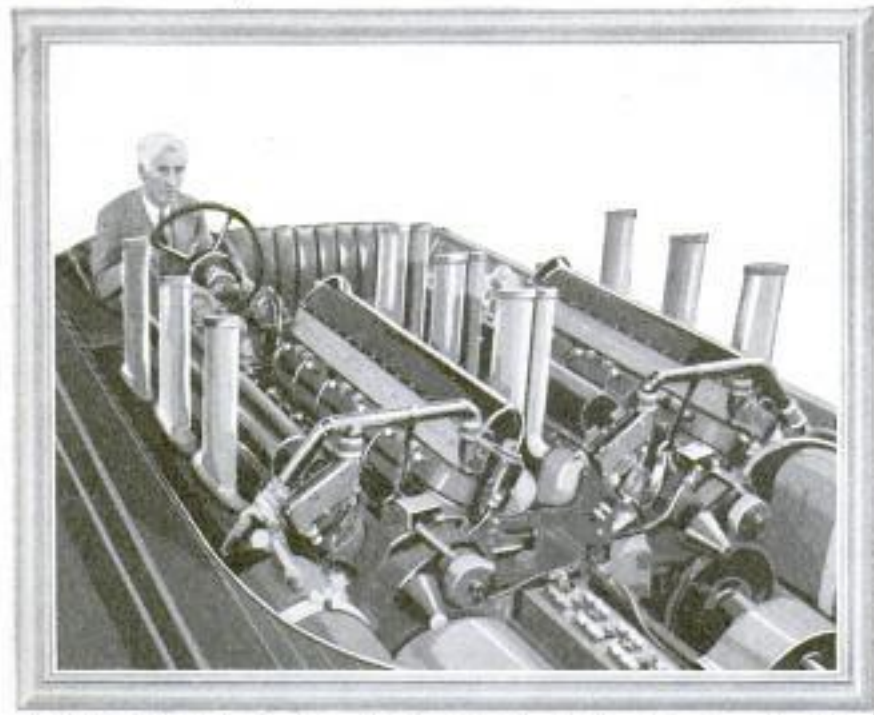

Gar Wood behind the Two Twelve-Cylinder Packard Engines in "Miss America VIII," in Which He Sped Over Ninety-Six Miles an Hour

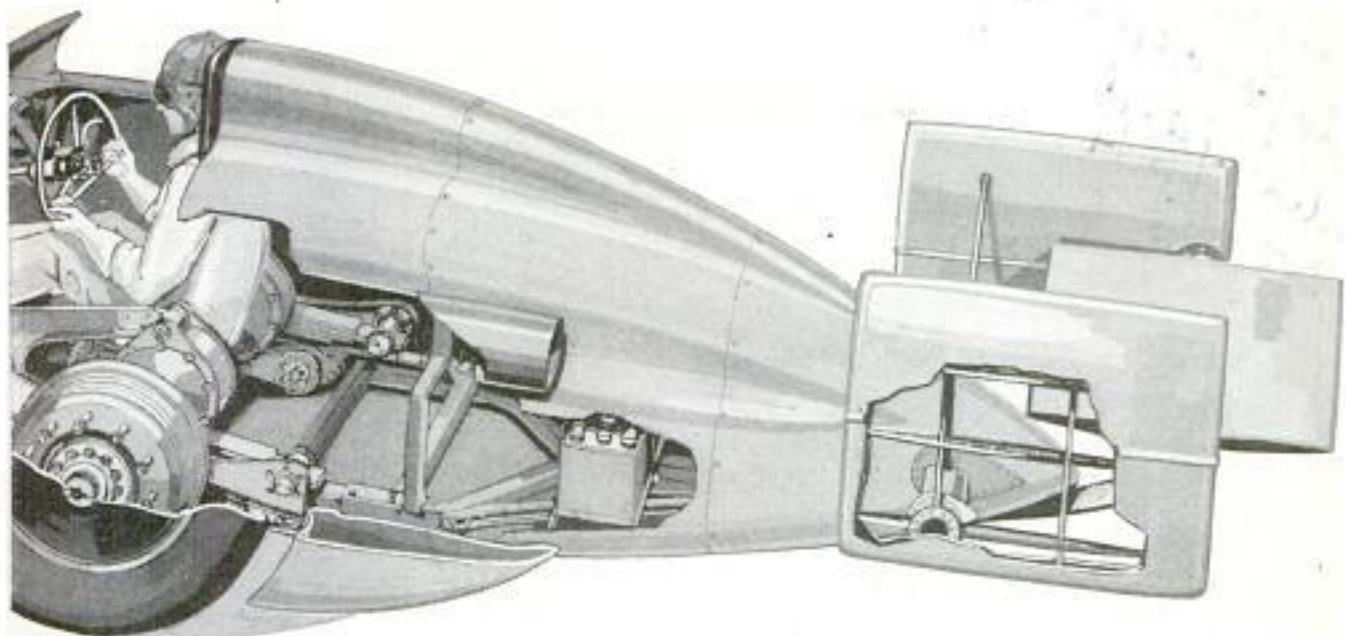

Kaye Don sits between two propeller shafts, whereas he would sit several inches higher if one propeller shaft were used. At first glance the body seems wider than necessary to accommodate the driver, but more careful inspection will show that the width of the upper portion is just sufficient for the driver and his arms, while the lower portion is somewhat wider in order to include the side members of the frame. To demonstrate how closely the car has been fitted around Kaye Don, let it be noted that Don had an asbestos suit specially made as a protection against fire, but the extra bulk of the suit made him too large for the car, and so he had to discard it for a conventional uniform of white duck.

The engines, of course, had to be specially built to "fit the driver," for there were no engines, sufficiently narrow and low, of suitable power. Likewise two engines had to be used, because one engine to replace the two would have been too broad and too high. Preliminary calculations showed that in order to provide 4,000 horsepower at 4,000 revolu-

tions per minute, two twelve-cylinder Vee-engines, with a bore and stroke of five and one-half by five and one-eighth inches, would be necessary, giving a total piston displacement of 2,922 cubic inches, whereas the average American passenger car has a piston displacement of about 250 cubic inches. With two twelve-cylinder engines, having the bore and stroke just mentioned, the width and height of the engines were satisfactory, and yet the length of the engines was not too great—as might have been the case if sixteen-

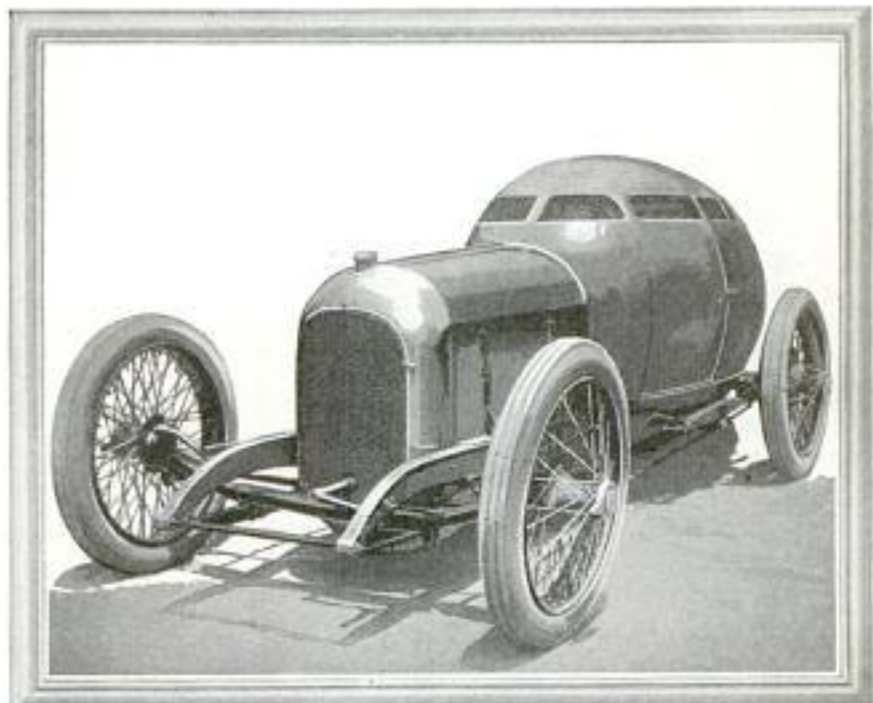

Barney Oldfield's "Golden Submarine" That Rolled at the Then Record-Breaking Speed of 125 Miles an Hour Fifteen Years Ago

445
14

Weight 1 ton each
developing 4800 hp
potential speed
300 mph.

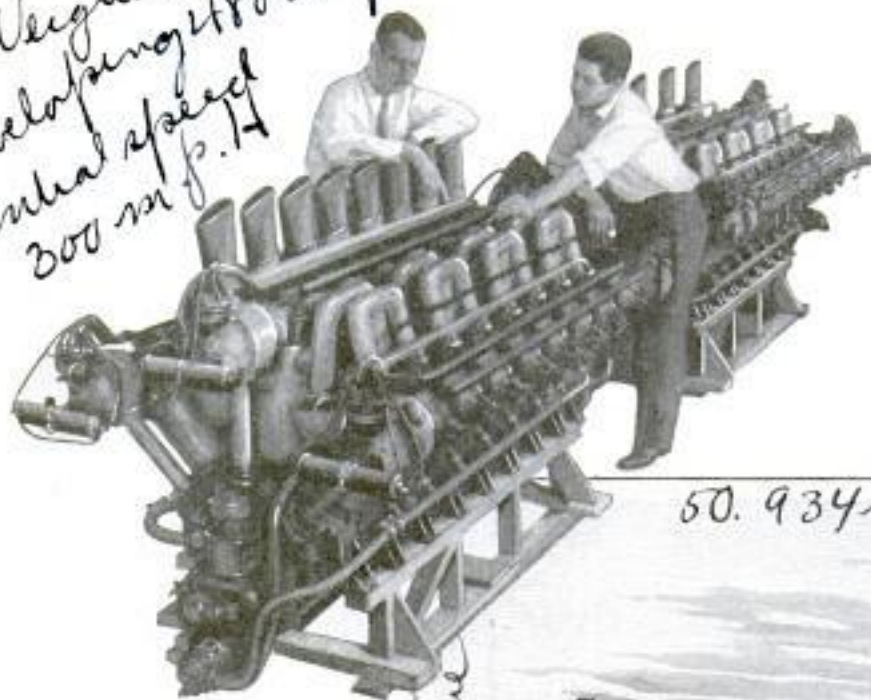

done, as, for example, wind-tunnel tests on body forms until the most desirable shape was found.

But what does speed mean to a man who has manufactured more of this commodity than any other individual? Let Harry A. Miller, of Los Angeles, answer.

"Speed on tracks, in water and in air," he ex-

50.934 mph



Century Hurricane
Boat
Elton F. H. Carter

cylinder engines had been used.

The two vertical fins at the rear of the car are designed to keep the car on a straight course, particularly if all four wheels should leave the ground. Fundamentally, they perform the same function as the feathers in the tail of an arrow. Between the vertical fins is an "air brake," consisting of a flat plate two and one-half feet square. It is pivoted crosswise, and while the car is running it is horizontal. When the driver wishes to stop, he releases a lock which permits the plate to swing up vertically, thus offering considerably added wind resistance to assist in stopping the car. Also its rearward pull could be used to steady the car in case it began to skid.

The cost of designing the car alone is a sizable figure, as can be imagined when it is stated that over 3,000 drawings were made, requiring a large engineering and drafting staff. Each of these drawings meant that somebody, somewhere, had to make a special part, usually out of special material. Perhaps there was a pattern to be made, then a casting to be molded and machined, or an expensive die to be built and a forging produced. In addition, considerable experimental work had to be

Giant Twenty-Four Cylinder Engines Built by Harry Miller; Below Ray Pregoner, Who Holds Outboard Speed Record of Over Fifty Miles

plains, "means that manufacturers will advance more rapidly in developing alloy steels. Many manufacturers send us parts to test. They know racers will give them tests few laboratories could reproduce."

And just what manner of men are these who look death in the face and laugh at it and then go out and turn in a speed of 200 miles an hour or better?

The question was once put to Fred J. Wagner, internationally famous race starter, who was quick to give their outstanding characteristic.

"Fearlessness," he said. "Absolute fearlessness! I have had opportunity, on and off the track for more than twenty-five years, to study the driver, and of the thousand and more that have come under my observation, I have known none that was not the personification of daring. Hairbreadth escapes from death they consider part of the day's work."

Outboard Motor Corp
Milwaukee, Wis

Mr Charles H. Derty,

POPULAR MECHANICS

101 Park Ave (2)

NEWSPRINT FROM PINE PULP
MAY ENRICH SOUTH 1921

15
1893

Herald Tribune
10/30/30.

White newsprint paper has been made successfully from slash pine, thus opening the prospect of a wholly American supply of both newsprint and high-grade book paper made from southern pine trees, possibly of all sorts. Southern pine long has been used to make yellow paper, but heretofore it was believed to contain too much resin to produce white paper. Slash pine, from which the samples of white paper were made, supposedly was the least capable of producing regular newsprint, but it whitened as easily and its fibers were as long as spruce. Experiments indicate that the same thing can be done with long-leaf and other pine.



Tiers of Wire Trays for Small Chicks and Pens for Larger Ones on a City-Lot Poultry Farm

REST TO FIT THE HEAD EASES WORK ON AUTO

1909

To enable work under a car in ease and comfort, a flexible headrest for the autoist now is available. It consists of a soft pad for the back of the head and is mounted on a wire frame. The device is held in place by a band fitting around the head, so that it may be worn constantly in the shop or used only as needed. It takes the place of bricks, blocks and creepers and often saves time in jacking and blocking up cars. The rest also has found favor



Work under the Automobile Can Be Done in Greater Comfort by Using the Headrest Shown

with tourists who use it in place of a pillow.

CHICKEN FARM ON A CITY LOT LIKE TENEMENT BUILDING

Applying the methods by which scores of families are able to live in comfort in an apartment building covering small ground area, a California poultry raiser is growing 3,000 chickens in the back yard of a city lot of average size. The chickens never set foot on the ground, and the feat is made possible through unusual devices for housing the poultry in a sanitary manner in restricted space. The eggs are hatched in an electric incubator, then the chicks are transferred from a brooder to wire-inclosed trays piled in tiers of four and holding 100 chicks each, feed and water being carried in racks. When they outgrow these quarters, the fowls are transferred to restricted pens, holding fifteen each, with wire floors and boarded tops, backs and sides. A latticed front enables them to obtain food and drink. With intensive feeding and no chance for loss of weight through exercise, the birds are placed on the market several weeks earlier than when given more freedom. This arrangement is suitable only when the chickens are marketed for meat, as laying hens require more exercise than can be obtained on the city lot

see article Feb. 19 30. 710

but pend.

#2100

no agent.

Sanitary Head Rest Co.
106 1/2 Easton Blvd.
Dallas, Texas

Scott + Muller
Poultry
California

1968 ALL-AIR LINE ACROSS COUNTRY CUTS TRAVEL TIME



Over a Canyon and Enjoying Luncheon in the Air; Views of the Transcontinental and Western Air Line

tion, but the schedules are arranged so that the planes operate in connection with fast trains for those who wish to ride by rail part of the way.

SMOKE LESSENS FIRE HAZARDS ON LARGE OIL TANKERS

Smoke brought from the fire boxes under the boilers and put in the same compartment with highly combustible petroleum products has been found effective in preventing explosions on oil tankers. The method also has been used with success to lessen the danger of explosion and fire for petroleum stores on land and for oil in the production and refining processes. The secret of lessening the combustion hazard with the product of a previous combustion depends upon the fact that smoke, or flue gas, is composed of a large amount of inert gases that will not react with oil or its vapors to cause an explosion. This gas, thoroughly cooled and cleaned of soot, is pumped into oil compartments to replace air.

Service has 502-22 4/2/30

Standard Oil Co. Phila.

H. H. Hall, Standard Oil Co., San Francisco, Calif. and A. E. Pew, Jr.

Transcontinental journeys may now be made on regular schedule in thirty-six hours, allowing a night's stop-over at a hotel between plane hops. Under recently adopted regulations, the line is allowed to carry both mail and passengers. The service was started to meet the increasing demand for through air transporta-

Mr. David Spence.
 in charge of guayule culture
 near Salinas, Calif.
 POPULAR MECHANICS
 1892

SCRUBBY BUSH YIELDS RUBBER ONLY IF UNCULTIVATED /88/

Guayule, an unimposing, scrubby desert bush of the sunflower family, and the source of America's new home-grown rubber, will produce only when left to fight nature for existence. It will not stand much coddling, and certain luxuries of cultivation, including irrigation, cause it to vegetate and produce an immense amount of worthless brush. If forced to endure a drouth of several months and to fight for a living, however, it produces a multitude of fine droplets of rubber all through its larger stems and roots, high-bred strains of the bush showing as much as eighteen per cent of the total weight in pure rubber. It was found growing wild in the arid desert regions of Mexico, and experiments have been conducted with hundreds of varieties in selecting the best rubber-producing strains for growing in the central valleys of California where there is comparatively little rain for months out of the year. Tests with guayule rubber in auto-tire formulas indicate that it is nearly equal to tropical rubber in tensile strength and elasticity.



Fourteen-Hole Miniature Golf Course Constructed by School Pupils to Assist Them in Mastering Geography

GOLF COURSE BUILT BY PUPILS TEACHES GEOGRAPHY

Pupils of a Sacramento, Calif., school have constructed a miniature golf course as an aid in mastering geographical and agricultural features of the United States. The fourteen-hole course is complete in every detail, the various sections representing parts of the country, and the hazards their agricultural products.

GLARE SHIELD ON AUTO LIGHT HELPS PREVENT ACCIDENTS

Automobile headlights are automatically adjusted to prevent glare when the car is going up or downhill with a shield now on the market. It is easily adjusted over the bulb and has a pendulum at the bottom. This tips the shield to the proper position to compensate for the angle of the car when it is ascending or descending. The device concentrates the rays on the road and is said to eliminate practically all the usual glare that sometimes causes serious accidents in driving.

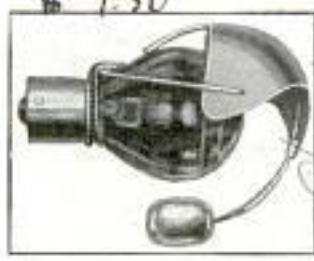

MECHANICS IN YACHT RACES BARRED FOR FUTURE /889

British and American yacht-racing authorities have agreed to eliminate the "mechanical" yacht which came into fame during the 1930 races for the America cup. Modifications provide that all class-J yachts, including all of the America cup contenders, must carry a mast weighing at least 5,500 pounds bare, that standing rigging shall not be set up or worked below the upper deck, and that the craft shall be fitted with "reasonable" living accommodations.

Bendixen Co, 51 E
 4 2nd St. New York

Kans City Star
 Copyrighted material

1466

Comt. John F. Coggswell
16 Edgemoor Road
Belmont, Mass

The Training of

By SGT. EDWARD KANE

of the Boston Police Department
as told to John F. Coggswell

THERE'S something about a man on horseback that gives him ascendancy over the pedestrian. Perhaps the feeling akin to fear that inspires the person on foot toward the mounted man is a flare-back to medieval days when the mark of superiority, on the highway or the battlefield, was the riding of a horse.

I have seen a line of foot officers forced into the middle of the street by a forward surge of a crowd. Then I have seen a single mounted man come along and force that same crowd back onto the sidewalk and make them stay there. At one of the greatest waterfront fires that we have ever had, two mounted policemen succeeded in holding a crowd of thousands in check and out of danger, when twenty-five foot officers had failed.

Motorcycles and automobiles play a big part in getting police officers where they are needed in



Policeman James Pryor in the Saddle, Teaching His Mount the Difficult Lesson of "Passing" to the Right, a Useful Maneuver in Handling Crowds; Note Position of Horse's Legs in Circles

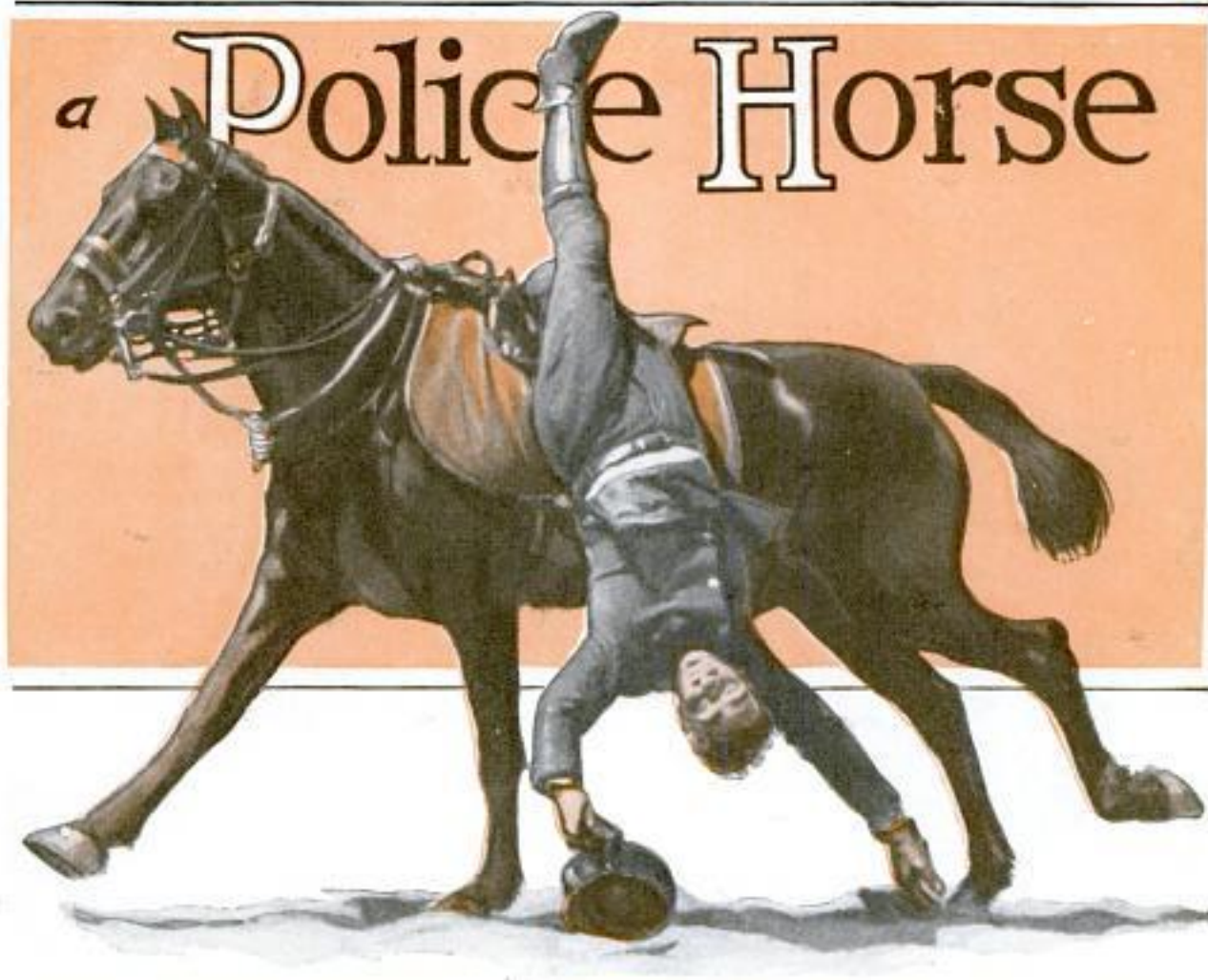

a Police Horse

Practicing Trick Riding; These Exercises Are Entertaining and Helpful to the Men and Are of Equal Benefit to the Horses in Getting Them Accustomed to Unexpected Maneuvers

a hurry. But nothing has been found, nor do I believe ever will be found, to take the place of a trained horse in handling a crowd, whether it be a violent mob, peaceful onlookers jamming the thoroughfare to view a parade, or a streetful of Christmas shoppers. But if that horse is not perfectly trained to his job, he is a menace instead of a protection to the citizens he and his rider are expected to look after.

It takes at least a year to train a horse in the elements of police work. Even when he has gone through days, weeks and months of schooling, he is still just a rookie when his rider takes him out for his first official day's work, as there are many angles of the job that he can learn by experience only. But before we start training him, we must get the horse, and there are few that, in type and temperament, are suitable to become police mounts.

A horse, to be acceptable for police duty, must stand about sixteen hands (sixty-

four inches) high, weigh in the vicinity of 1,000 pounds and be not over six years old. He must have almost perfect feet and strong, heavy legs. His chest must be deep, his withers low and his back just right for a saddle. Possessing these features, he presents the general conformation of a good saddle horse.

Once taken onto the force, the new horse enters into an increasingly strenuous course of preliminary training—sort of a grammar-school education. This course requires from three to five months, according to the intelligence of the animal. Every detail must be shown to him over and over again, for horses have no ability of progressive reasoning. They learn nothing except by experience.

In this period of his training, a police horse is either made or spoiled forever. The trainer must always keep the upper hand of his charge, but he must never frighten the horse or do anything that breaks his spirit. To strike or kick a

horse is, in our department, grounds for instant dismissal. Such treatment is not only cruel, but it also ruins a valuable piece of property.

The horse is taught his lessons by encouragement, not by punishment. He soon learns that if, from either dumbness or perverseness, he fails to master a prob-

lem, he will have to go over it again. And he also learns that his every achievement will be rewarded with a lump of sugar, a piece of apple or something else of which he is fond.

First, the recruit must be gaited. Saddle horses for private use are usually taught five gaits; the police horse learns but three—walk, trot and gallop. At the end of a "longeing" strap, attached to a "cavesson"—a headgear similar to a light halter—he is taught the proper gaits.

One officer holds the longeing strap while another leads the horse around in a circle. Then the animal is allowed to try it himself. Usually a young, green horse will hesitate or stand still. Then the assistant goes back to his head,



German Trainers Giving a Horse a Lesson in "Noise Endurance"; Reliable Police Horses Must Become Accustomed to All Sorts of Sounds; Below, Gait and Drill Practice at the End of a Strap

pats him and talks gently to sooth the pupil's nervousness, and starts him on his way again. Over and over, this is done, until the rookie horse understands what is required of him. Then he is ready to be taught how to trot and gallop and to change gaits.

In these first steps of making a police horse, infinite patience and gentleness are required. Almost always, the horse wants to do the right thing; the real problem is to show him what is wanted. Just like young-



© Underwood & Underwood
Mounted Policeman Taking Hurdle and Firing at Dummy during British Exhibit, and, Below, a Well-Trained Canadian Horse

four rubber cords pull in his chin and bring the arch into his neck. He is given very short doses of this at first—not enough to tire or fret him—and then the period is gradually lengthened. Soon he gets the habit of holding his neck arched at all times and nothing contributes more to fine appearance, unless it be the constant grooming that makes his coat shine like velvet.

Probably most readers have seen a police horse pushing back a refractory crowd. He puts his flank against those who refuse to move and shoves them aside just as

sters in school, some learn fast and some are mighty slow.

Besides earning a living by working—and working hard—a police horse is always on show as well, and the public demands that he put up just as good an appearance as the thoroughbreds in the horse-show ring. So, right from the start, we teach him to arch his neck. When he is back from his gait practice, he is given a few hours' rest and then fitted with another contraption so arranged that

a snowplow pushes snow off a road. To teach him to do this strongly, and yet in such a manner that he'll not trample or overthrow anyone, takes a lot of time, but it is worth it, as this is one of his most useful accomplishments. We call this "passing" to the right or left as the case may be, because, in order to execute the side movement, the horse must bring both fore and hind foot past those on the opposite side. A heavy pressure of the right knee against the horse's side sig-

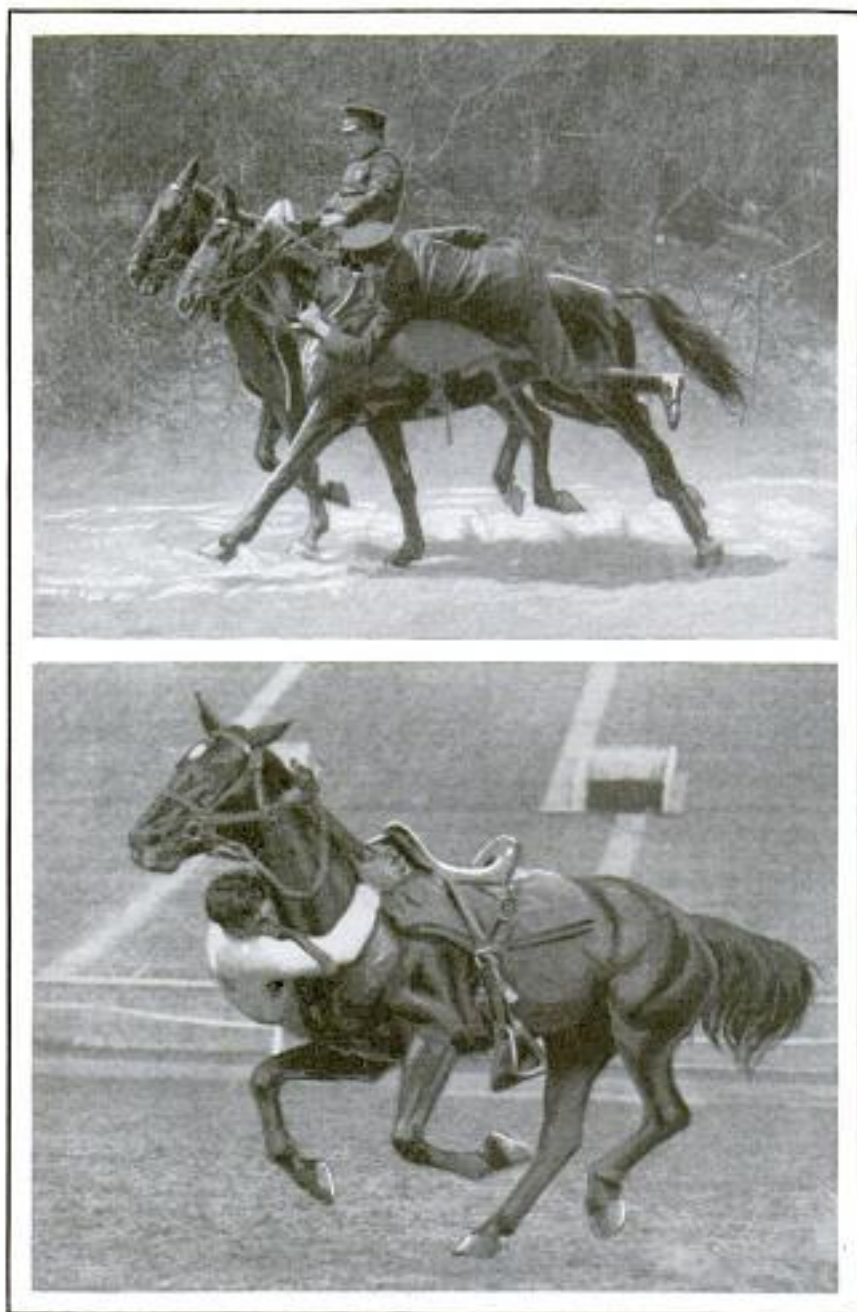

New York Reserve and State Police Officers in an Exhibition of Trick and Fancy Riding; in Such Stunts, Almost as Much Depends upon the Horse as upon the Man

nals for passing to the left; against the left side, for passing to the right.

His "high-school" course at an end, the recruit is ready to enter college training—the college of experience and hard knocks that teaches most of us nearly all we know. The police horse's college is the city streets; he must be made to become used to all sorts of traffic conditions for his life's work is in the rush and turmoil of the downtown sections, amid clatter and hubbub, where false moves caused by nervousness might result in injury to horse, rider or bystander.

Of course, it is not possible to take a rookie into the busy streets at the start. With one of our best and most patient riders in the saddle, he is started in outlying thoroughfares where traffic is light. If a police horse ever needs a friend, it is during this period of his training. That's why it is always carried out by finished horsemen, who have a real love for and understanding of the mounts.

The rider soon ascertains what items of traffic frighten the animal, and then he, kindly but firmly, shows the steed that there is nothing terrible about it. Gradually the rookie is worked into thicker and thicker traffic and soon is taking his jaunts through the downtown streets without show of fear.

When he gets out on his regular job, the police horse still has a few things to learn. He must be taught to stand still in spite of anything, when his rider leaves him. The officer starts this training by giving his horse the command and then moving off a few paces. If the horse follows, he is

led back and left again time after time. When he does stand and await the return of the officer, he is rewarded by a lump of sugar or some such tidbit, and soon learns what is required.

In the Boston department—and I believe this is the case the country over—no veteran police horse is ever sold. When he has passed his usefulness, he is sent to the S.P.C.A. farm and spends the remainder of his days browsing about green pastures and taking it easy. Which is but just pay for the full measure of loyal service he has rendered.

HUGE LAND PLANE TAKES CREW UNDER ITS WING

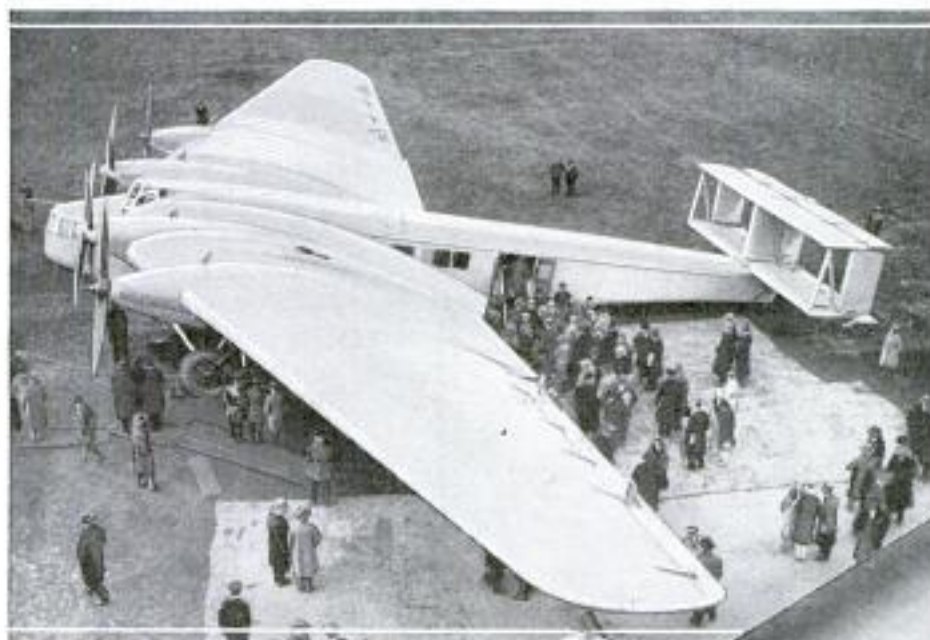

When He Was Last in Chicago, Dr. Hugo Junkers Told Popular Mechanics Magazine about His Plans for a Flying Wing; Here Is the Realization of What Was Then Largely a Dream; the Huge Plane Has Been Touring Europe and Attracted Thousands of Spectators Wherever It Landed

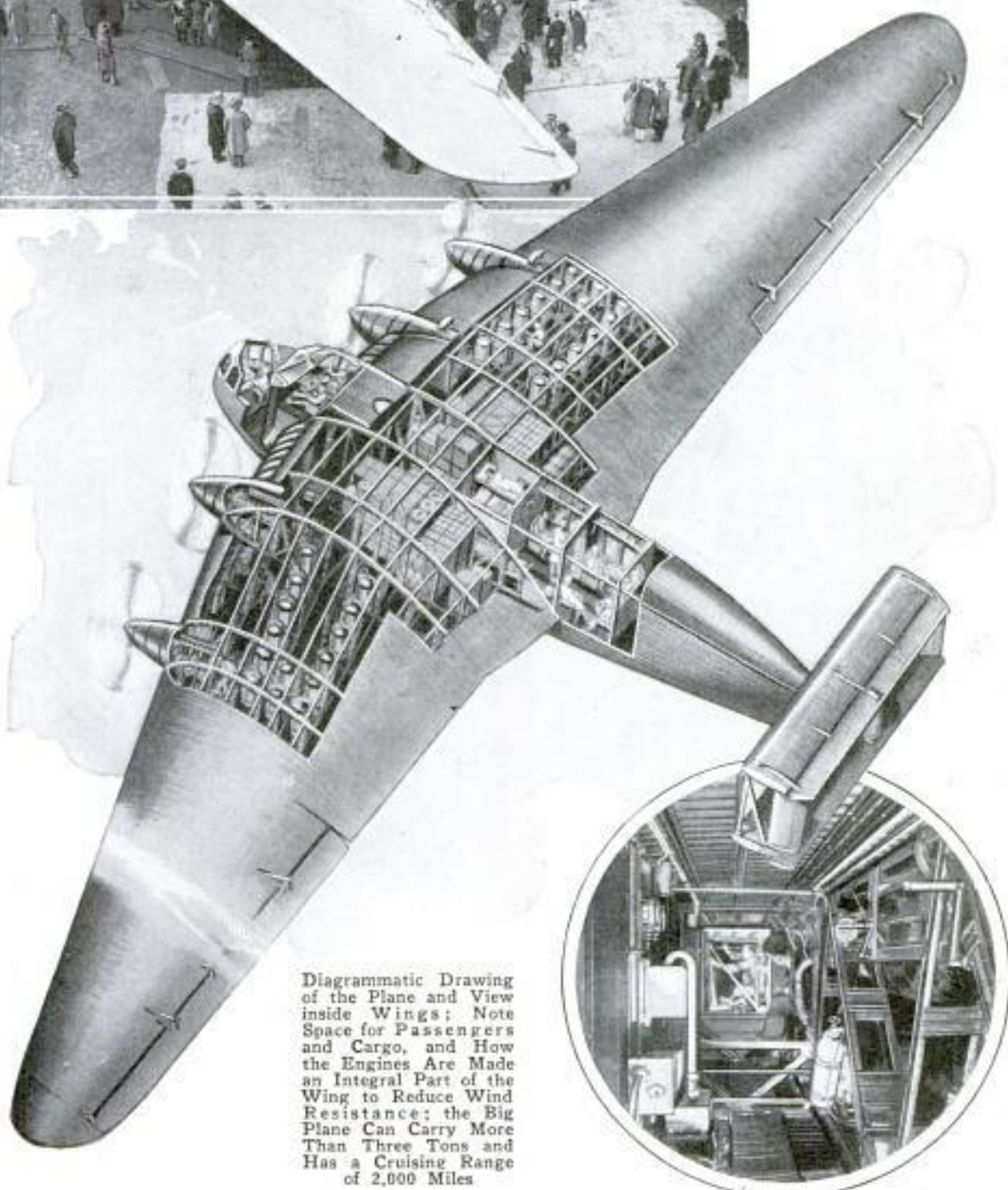

Diagrammatic Drawing of the Plane and View inside Wings; Note Space for Passengers and Cargo, and How the Engines Are Made an Integral Part of the Wing to Reduce Wind Resistance; the Big Plane Can Carry More Than Three Tons and Has a Cruising Range of 2,000 Miles

1831



Enjoying a Game of Miniature Golf on the Deck of the "Majestic"; the Greens and Hazards Are Portable for Quick Removal

**MIDGET GOLF ON SHIP DECK
LATEST TRAVEL SPORT**

Miniature golf has been added to the many sports that may be played at sea. One of the first steamers to install a course was the "Majestic," ample room being found on the huge decks for a layout similar to that used on the land courses. The fairways and greens are surrounded by rims in order to keep the balls from being lost overboard, something that has limited golf play when the seas are rough.

**TRAVEL BY TRAIN OR TROLLEY
1814 SAFER THAN AUTO**

Riding a street car is twenty-two times safer than an automobile, and a railroad train is thirteen times as safe as the auto, analysis of nation-wide accident statistics shows. These results were computed on the basis of passenger-mileage records and fatalities, as officially reported, and have led safety officials to suggest that auto drivers would do well to follow the practices which have made the street-car and railway lines so secure, if they would reduce the annual death toll. The records show that, throughout the country, automobiles travel 11,400,000 passenger-miles

U. S. Daily 11/3/30

to each fatality, railroads 16,450,000 and street cars 34,760,000. These figures include fatalities both to passengers and others. The results are more striking when considering the hazard to passengers only. For each passenger fatality, the automobile travels 20,840,000 passenger-miles, the railroad 270,240,000 and the street cars 455,000,000 miles.

**1833
GOLDFISH SKIN CAN
BE TANNED FOR
SHOEMAKING**

By a tanning process recently developed, shoes and slippers now can be fashioned of fish skins after the skins have been subjected to the curing methods like leather. One of the products of this process is a golden slipper in striking shades and colors, made entirely from tanned goldfish skins.



Golden Slipper Made of Goldfish Skins After They Were Subjected to Curing like Leather

H. Selman, shoe specialist

Levermore's Committee on Street and Highway Safety, Boston, Mass. 1814

Probably, Selman, shoe specialist, New York City

CHEMISTS AIDED IN WAR ON LEPROSY BY CELL STUDY 1882.

In the hope of finding a way to cure the disease, chemists have undertaken a study of leprosy germs just as they have been investigating the germs of tuberculosis. It has been found that the two maladies are related in that the germs that cause them belong to the same family, and they grow in the same kind of cells in the human body, although leprosy is confined largely to the skin. The research will be aided, it is expected, by the work of a Japanese professor who claims that he is able to produce leprosy in rats by inoculating the animals with germs from human victims of the disease. This is the first time such artificial cultivation of the malady has been accomplished. Rats that had been fed on a diet lacking certain vitamins, and therefore were in a weakened condition, contracted the disease after the inoculation. The study may also lead to the discovery as to why these vitamins protect against leprosy, and another avenue of attack against the disease may be opened.



British Army Tank Demonstrating Its Effectiveness by Smashing through a Thick Brick Wall at Top Speed

BRICK WALL CRUSHED BY TANK IN WAR MANEUVERS

British army officials recently demonstrated the power and efficiency of the latest type of war tanks, when one of these lumbering giants was aimed at a strongly constructed brick wall during maneuvers. The fortress on wheels hit the barrier with terrific force and smashed through the masonry as though it had been paper, just as it might, in similar fashion, knock down the enemy defenses in actual combat.

ELECTRIC WARMER FOR AUTO PLUGS IN LIGHT SOCKET

To facilitate starting in winter for the car kept in an unheated garage, an electric motor warmer now is offered which is plugged into a light socket, connected with the car and operated overnight. The heater is installed by drilling two holes, one in the cylinder head and the other in the cylinder block. The heating element, being contained in the water jacket, thus keeps the water in the radiator warm, which, in turn, heats the engine. The operating cost is practically negligible.

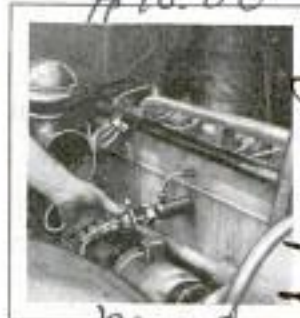

WRENCH FALLING FROM PLANE CAUSES METEORITE SCARE 1875

A farmer near Philadelphia recently heard a roar, a whistling sound, and then saw something hit the ground in a cloud of dust. A mineralogist hurried to the spot when the farmer telephoned that he believed a meteorite had fallen. Search showed that something had fallen, but the object was nothing but a wrench that had been dropped from an airplane flying at high altitude.

Eureka Mfg Co. 11525 Michigan Ave Chicago

Samuel S. Leonard Academy of Natural Sciences Philadelphia

Chaimong Chao w/ U.S. National Institute of Science Service 502-83

Vol in J. H. 10/21/35

1869

1819
11/4/36
4334 Michigan Ave
Desh Chaimong Chao Box 4334

Wade World

#10.00

pend.

1669 Cont. Iron Classman
55 W. 86th St
New York City.



Sketch of the Balloon with Sail in Which Andree Hoped to Reach the Arctic; Finding of Andree's Body and of Relics of Other Unsuccessful Northern Expeditions Attracts Fresh Interest in the Problems of Arctic Adventure

ICE vaults have cracked open and yielded the graves and equipment of nineteenth-century explorers whose death in the white wilderness had long been accepted.

A radio message out of the "dotted circle" told the story of Salomon August Andree, found on lonely White island. Several weeks later, Maj. L. T. Burwash, in a brilliant aerial dash over the north magnetic pole, found graves and relics of the John Franklin expedition on the shores of King William land.

When men leave their bones scattered

all over the Arctic, when a single party of 135 succumb to scurvy or privation, we are moved to ask the full meaning of Arctic exploration. Men have battled the Arctic for ten centuries, and it still is invincible, defiant.

The Alaskan gold rush is over, but the white north still lures men into a dismal empire of ice. The price of this adventure comes high; only the hardy survive, and the financial rewards are small. Even remembering the tragic death of past explorers, men are yet

determined to conquer the Arctic, if for no other reason than to learn the fate of lost expeditions.

The last of the great Arctic disappearances concerns Roald Amundsen, who had discovered the south pole and crossed the north pole in the "Norge." Thereafter it was no secret that he and Umberto Nobile had severed relations over a division of honors. Each sought to berate the other. Seeking to vindicate himself as airman and explorer, Nobile organized and led a new Arctic expedition in the airship "Italia." The craft came down on

Arctic?

the Arctic ice and, for some days, the crew was lost to civilization. Nations waited in trepidation. Amundsen was asked, more in jest than in seriousness, whether he would attempt to rescue Nobile. "Certainly," he declared without hesitation.

A few days later, a French Latham seaplane skimmed off the bay at Tromso, carrying Amundsen at the head of five men, bound for the bleak waste which held the "Italia." Events took an ironical twist. Another expedition found Nobile, but Amundsen never returned. The Arctic vastness closed over him. Down he came, no man knows where, and now his footprints are buried deep in snow.

The purpose behind most ex-



Courtesy Explorers Club

Above, Pilot W. E. Gilbert Entering Record of Flight during Which Relics, Supposed to Be from Sir John Franklin's Expedition of 1847, Were Found; Below, Artist's Conception of Sir Franklin's Last Stand

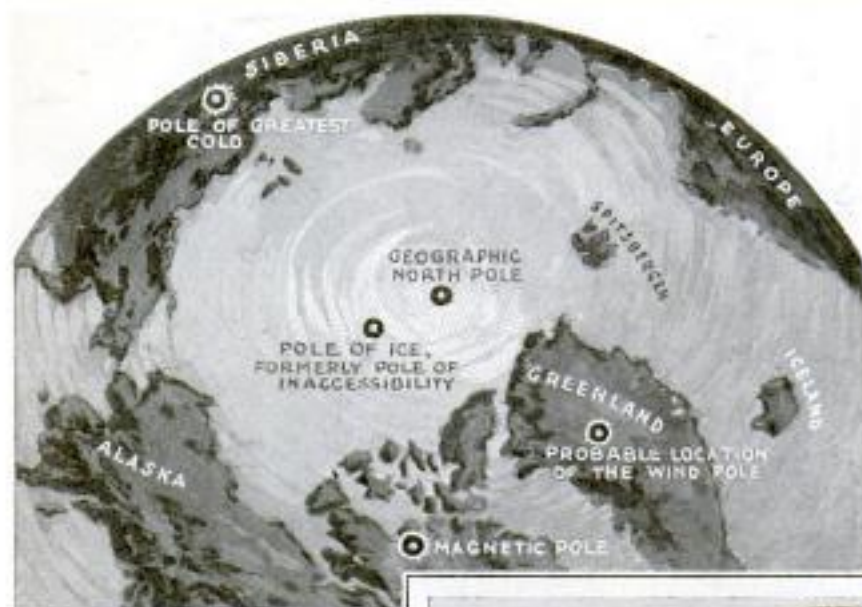

fringes of the ice pack.

The north's resources are not limited to hunting and fishing. Beyond the limit of trees, there are about 5,000,000 square miles of ice-free land. In favored places on the mainland and islands, plant life attains a luxuriance that surpasses all expectations. Western Ellesmore island and northwest Greenland are noted for their vegetation.

ploration is the extension of knowledge. With reference to the Arctic, it resolves itself into two classes, the kind which will ultimately allow man to adapt the region to schemes of colonization; secondly, the kind which enlarges on such general subjects as meteorology, glaciation, fishing, earth history, tides, currents and earth magnetism.

Does modern exploration pay? Take the case of Roald Amundsen's "Norge" expedition. At a cost of \$150,000 it was learned that the polar basin has a depth of about 12,000 feet, casting doubt on a notion that there is land on the European side of the pole. Also, this expedition explored about 100,000 square miles of unknown region.

Oil and furs first brought the Arctic into commercial importance. The most approachable lands have already been devastated and exploited by trappers. Hunting cannot last, but since the demand for pelts grows apace, it will be necessary to breed animals on Arctic farms. Unless governments step in, the whaling, seal and walrus industries also will suffer and need artificial stimulation. Of all Arctic animals, the polar bear will endure longest, because it lives remote from the



Above, Map Showing the Five Poles in the Arctic, and Below, Chart of the Air Routes, the Shortest Lines between Great Cities

Vast tundras are the natural breeding grounds of caribou, reindeer and muskox. Reindeer supply meat, leather, milk and clothing, and are the most valuable asset of peoples living in the Arctic's rim. In a classic experiment, the U. S. department of agriculture demonstrated that Arctic grazing grounds can support a good animal population; 1,280 reindeer introduced into Alaska before 1902 have multiplied into a herd of 500,000, and it is estimated that there is sufficient pasturage for another 2,500,000.

Within twenty years it is expected that Alaska will ship 1,000,000 carcasses of venison to the United States annually—the equivalent of 3,000,000 sheep. And what can be done in Alaska can be re-

peated in large areas of Canada and, possibly, Greenland. Stefansson calculates that the Arctic regions can support 100,000,000 reindeer and 500,000,000 muskox. Muskox is valuable for meat, leather and wool.

It is unlikely that important new lands will be discovered in the Arctic. The polar continent is mythical, since it is really a polar sea. However, there are many mysteries waiting. Nicholas land, found by Russians in 1913, has still to be investigated. The Beaufort sea, north of Alaska and to the west of the Canadian Arctic archipelago, has never been penetrated, and the mystery of Peary's Crocker land needs an explorer. There is strong possibility of new undiscovered islands in the Beaufort sea.

C. E. P. Brooks recently disclosed a remarkable relation obtaining between the amount of ice in the Labrador-Greenland currents and precipitation in the British isles. This is a definite result of Arctic exploration. Continued study of the fluctuation in the extent of Arctic sea ice may aid long-distance weather forecasting.

In September, 1930, Major Burwash charted the north magnetic pole by aerial camera for the first time. This presages a similar record for the four other poles recognized in the Arctic regions, namely, the geographic north pole, which faces

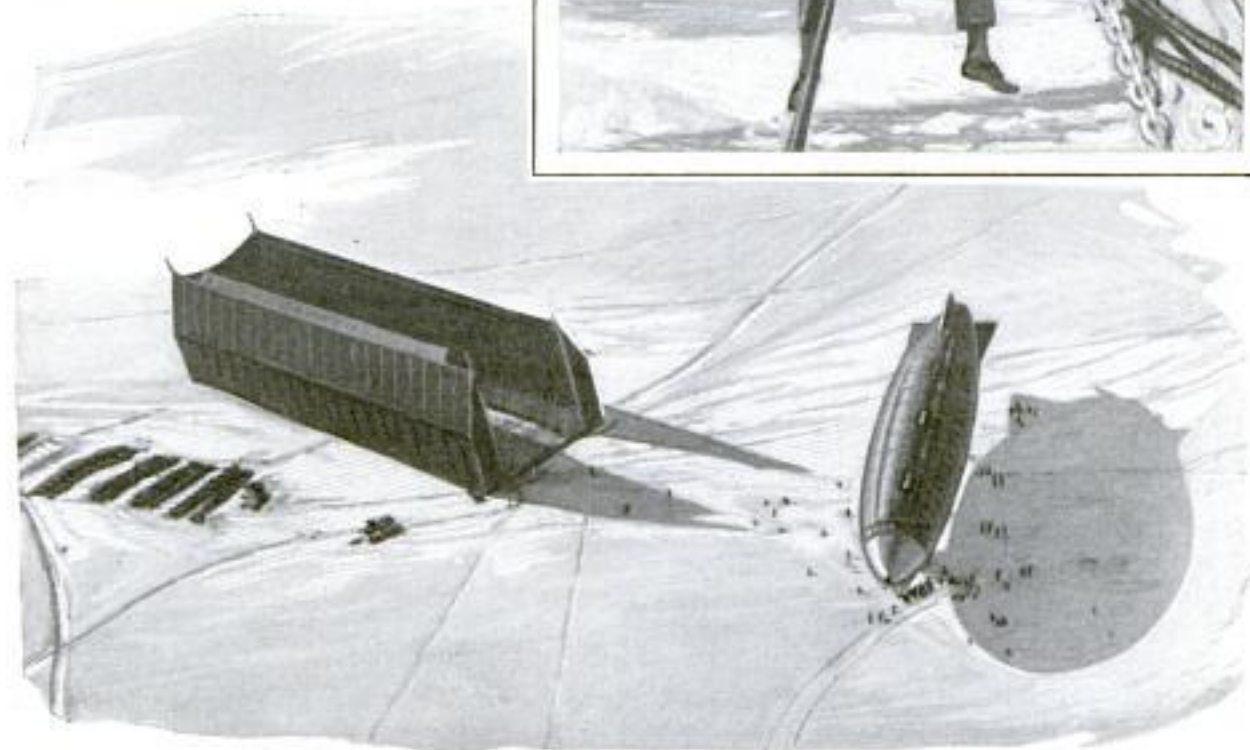
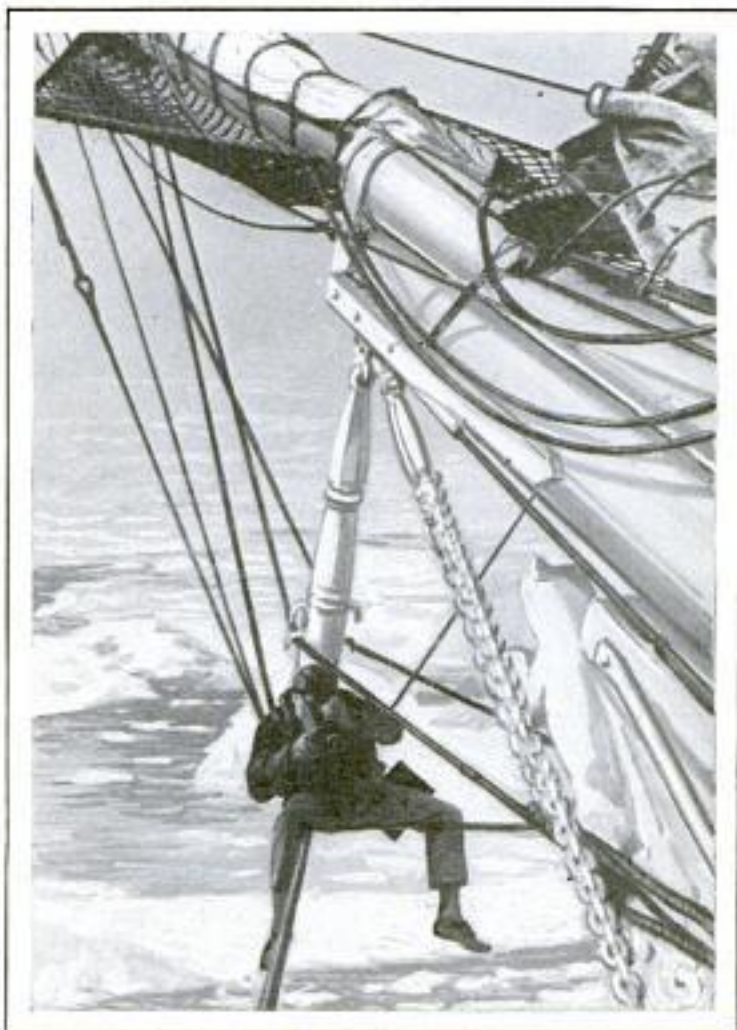

Perilous Photography in the Arctic; a Cameraman Recording Progress of Bear toward His Ship, and, Below, the Dirigible "Norge" and Its Hangar

1669
30



Members of the British Expedition to the Frozen North under Comm. Frank Waiseley; in the Future, Explorations from the Air Will Probably Supplement Many Tedious Ship Voyages Such as This

south in all directions; the ice pole, known as the pole of inaccessibility until Amundsen, Ellsworth and Nobile flew over it in 1926; the wind pole at about the center of Greenland, and the pole of cold.

The exact location of all these poles is indefinite. British and German expeditions are now seeking to pin the pole of wind on the map. The pole of cold is thought to lie on the Arctic circle in Siberia. The pole of ice is nearest the geographic pole, about seven degrees south of the meeting point of all meridians.

Two poles, the north pole and the magnetic pole, are shifting. The former wobbles in a circle having a radius of about forty feet. The magnetic pole shifts regularly in conformity with mysterious changes in the earth's magnetic core. Its position is generally stated as latitude 70 degrees north, longitude 97 degrees west, on the Canadian mainland at a spot called Boothia Felix, green and grassy in summer and blinding white in winter.

Trans-Arctic commercial transportation is also in the offing. The shortest route between Chicago and Calcutta is over the Arctic, as well as the shortest routes between New York and Yokohama, London and Seattle. These air lines will come as soon as long-distance aircraft are developed. Sir Hubert Wilkins will shortly examine the possibilities of submarine routes under the Arctic ice packs.

Intensive polar expeditions are planned for 1931 and 1932 to establish the first scientific observatories in the Arctic. It becomes more and more imperative to learn the effects of Arctic weather conditions on temperate zones. Each year 10,000,000,000 tons of air shift from hemisphere to hemisphere, and the only way to understand this eternal migration of fluids is to explore the Arctic.

☛ A motorcycle was exhibited recently in London whose saddle could be raised or lowered by pressure on the handlebars, and whose tires were inflated by pressure on the saddle.

The Alhambra
Kilns, Inc.

1897 Cont. C. S. Moore
3767 Alameda St. N.W.

1024 Westminster Washington, D.C.
SHINGLES MADE OF CLAY 1890 Alhambra Calif.

Clay shingles, water-proof as well as fire-proof, constitute a recent building product made in a variety of colors, sizes and shapes. They are fastened together with copper slating nails and can be laid in regular patterns or at random in different angles, thus giving a thickness of two or three layers. This thickness, with special hip and ridge tiles, makes the roof waterproof. The clay can also be treated to give an effect of great age.



Not a Prison Scene, but a View of a Nursery in Which Young Trees Are Protected from Direct Rays of the Sun by a Slat Roof

LOCKING KEYHOLE HELPS TO FOIL ROBBERS 1855

Keyhole Guard Providence R.I.

After locking the door, it is now possible to lock the keyhole as well with a small device that makes it impossible for a skeleton key or other instrument to be inserted. It fits inside the opening of a standard door lock and is, in effect, a detachable end for the doorkey and has a lug that, when opened, engages the side of the keyhole so that it cannot be withdrawn although the outer section of the key can be pulled out. The key cannot be withdrawn from the device when the lug is in the folded position.

Price - \$1.25

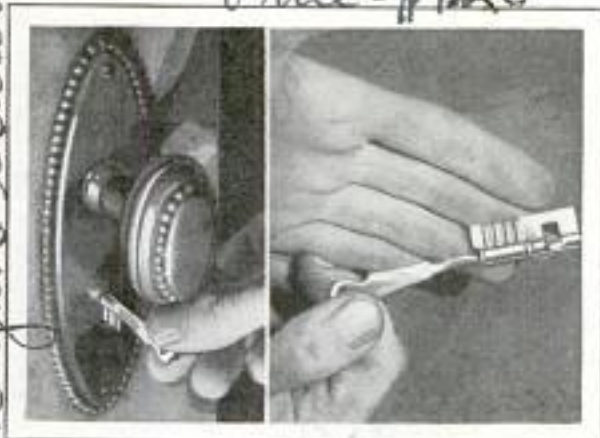

Keyhole Lock Attached to Doorkey Which Makes It Impossible to Insert a Skeleton Key

Dr. W. Shury, Hardware Supply Co., Iron, Ohio.

SLATS PROTECT YOUNG TREES FROM RAYS OF SUN

Young trees planted in the nurseries of the United States forest service are protected from the direct rays of the sun by a slat roof which permits sunlight to pass through the interstices without injury to the tender seedlings. When the sun is shining, the slats give a queer striped effect to the entire interior of one of these nurseries. After the plants have become sufficiently hardy, the slat covering is removed.

OYSTERS YEAR-ROUND FOOD WITHOUT DANGER 1894

Evidence that refutes the time-honored belief that oysters should not be eaten in the months without an "R" has been collected in France. In two coast cities where oysters are eaten the year round, typhoid falls in the four months without "R" in them. From this and other studies, it was decided there is no connection between eating oysters at any season and contracting typhoid fever.

Dr. J. Herber, 17th annual congress Public Hygiene Paris

Chicago Tribune

1995
32

Fortune

The Stars Motors, Ltd.
Wolverhampton, Eng.

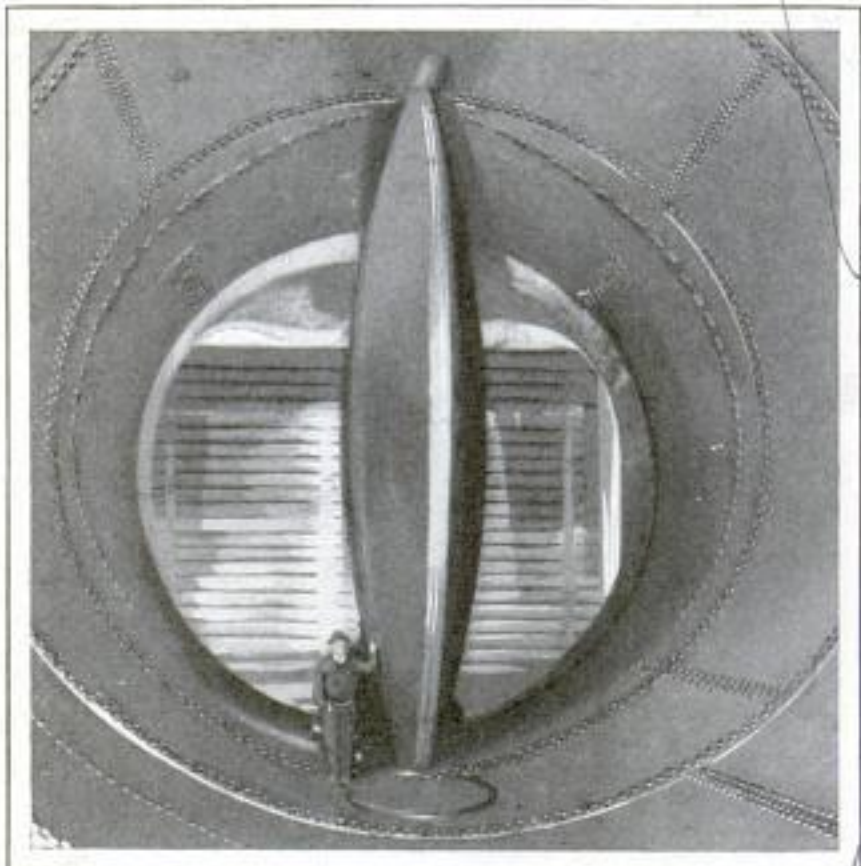

Huge Butterfly Valve in the Conowingo Hydroelectric Plant; It Weighs 136 Tons and Governs 54,000 Horsepower

"BUTTERFLY WING" IN DAM CONTROLS VAST POWER

A butterfly wing that governs 54,000 horses is one of the interesting details of the huge Conowingo hydroelectric plant on the Susquehanna river. This wing is not the fragile thing of nature but a 136-ton valve, shaped like a butterfly's wing and given that name because of its close resemblance to the natural object. When closed, the valve wing withstands a water pressure of more than 3,000,000 pounds, and, when it is open, it allows 180 tons of water to strike the water wheel each second and so generate as much power as 54,000 horses. Nearly 3,000 men worked

for two years to build the power dam and plant, which contains some of the largest water wheels that have ever been constructed.

SIGNAL WINDOW AIDS SEDAN DRIVER

1893

So that the driver can more easily make arm and hand traffic signals, a sedan is equipped with a drop window panel having a full-width horizontal section about six inches deep. This section is pivoted below the main part of the panel and is opened simply by pushing against it. This gives an aperture for the arm signals. It can be left open or quickly closed and, when the entire window is lowered with the

usual crank handle, the hinged drop panel is automatically returned to its vertical position.

IRON TAIL FOR MOTORCYCLIST REDUCES WIND SUCTION

1846

To reduce wind suction at his back when traveling at high speed, an Austrian motorcycle racer, during his training for the establishing of a world's record,

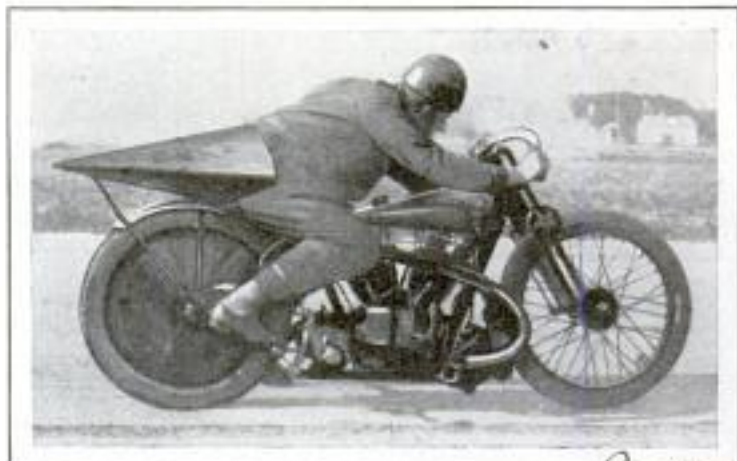

Motorcycle Rider with a Streamlined Iron Tail Attached to His Back, to Reduce Wind Suction behind Him

provided himself with a form of streamlining for his own body. The device consists of a conelike length of metal fastened to his back, the tip pointing to the rear. This tends to lessen the suction in the virtually airless space behind him.

Eddy Mayer

Automotive Industries 11/11/30

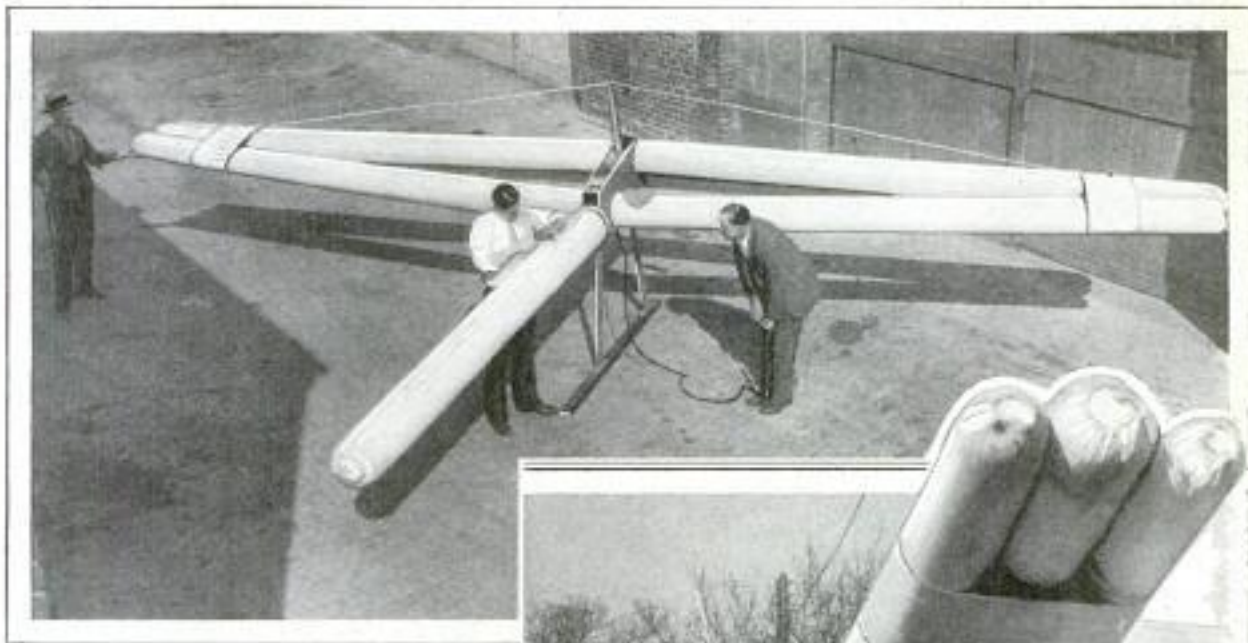

Rubber Airplane with Wings, Tail and Fuselage Made of Inflated Rubber Tubing; Note, at Right, That One Man Can Lift It

INFLATED-RUBBER PLANE CAN BE LIFTED BY ONE MAN 18/6

Radically different in appearance and construction from the ordinary type, a rubber airplane has been constructed by a Washington inventor. Wings, tail and fuselage are made entirely of rubber, covered with fabric. The rubber parts are kept rigid by inflating them with air, thus making the craft so light in weight that one man can lift it.



ADJUSTABLE CASTERS END WOBBLE IN FURNITURE 16 75

Adjustable casters or gliders now are available to eliminate the wobble in tables, radio cabinets, desks and other furniture without the necessity of placing



wedges or cardboard under the legs. A locking disk permits the caster to be adjusted at any position to meet the floor. A quarter-turn of this disk allows the adjustable caster to drop

to the floor, and a turn back tightens it in the required position.

ELECTRIC BRAKES FOR TRUCKS SERVE TRAILERS TOO 18 35

At a touch of a button, the brakes are set on automobile truck, and trailer too, through an electrical installation developed recently. Depressing the button anew releases the brakes. Current for the mechanism is taken from the storage battery and is consumed only when the brakes are being applied or released.

514 Adjustable Caster Co. Stock Exchange Bldg. Photo
 Mr. Andrew C. William
 Harry E. and Mrs. A. J. Lanning, Inc.
 Copyright © 1935

Electric Brake Co., Lansing, Mich.

WITH THE KEEPER OF A LIGHTHOUSE OF THE AIR



Clifford Laibly in Tiny Elevator That Runs to the Top of the Lindbergh Beacon, Which He Tends for the Guidance of Flyers

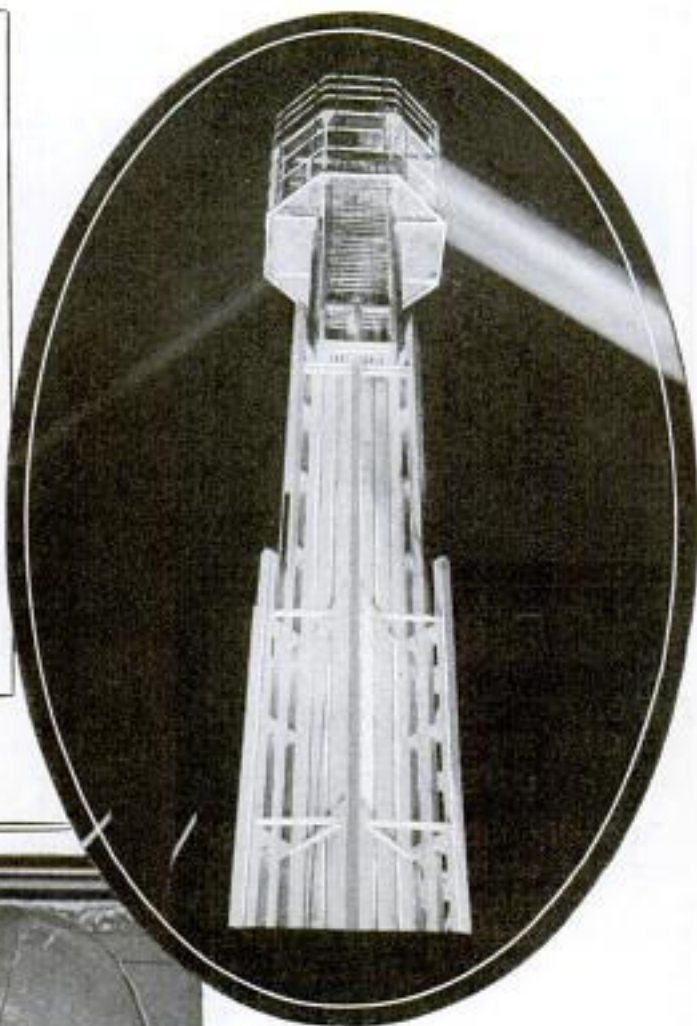

Night View of the Beacon Support, Looking Up into the Compartment Where the Light Revolves



Laibly at Phone Which Communicates with Watchman and Attendants of the Palmolive Building; at Right, About to Throw the Switch Which Turns on the Light; the Beacon Is Polished Daily, and, during the Time It Is Burning, the High-Intensity Carbons Are Changed Once an Hour; the Elevator Takes the Keeper About Twenty-Five Feet below the Light; the Remainder of the Journey He Climbs by Ladder; Warm Clothing Is Necessary during the Winter Watches



Science Service 501-C, 10/29/37

Announced by Prof Russell C. Hussey
U. of Michigan
SKELETONS OF ICE AGE
WHALES ARE FOUND
IN MICHIGAN, P. 28

Fossils of seagoing whales have been found in two localities in Michigan, one in the northern part of the state and the other not far from Ann Arbor. Prof. Russell C. Hussey, of the University of Michigan, believes that the animals swam inland by way of the St. Lawrence or the Hudson waterway some 20,000 or 30,000 years ago and became trapped in the comparatively shallow waters of the rivers at the edge of the retreating ice sheet. Unable to return to the ocean, they eventually starved to death. Their bones were cast up on the beaches and became covered with gravel from which they have been excavated. Both skeletons were in a good state of preservation.

TREE PLANTER SETS TEN
ACRES OF SEEDLINGS
IN ONE DAY 1802

Doing the work that ordinarily would require twenty men, a tree-planting machine is being employed to aid reforestation work in New York state. It can cover about ten acres a day, the trees being planted six feet apart. Two rows are placed simultaneously, the machine digging the hole and pressing the dirt about the seedlings. Two men operate the planter, which reduces the cost of setting out young shoots as compared with the slow hand process.



Tree-Planting Machine Which Can Cover About Ten Acres a Day, Doing the Work of Twenty Men

College of Syracuse, N.Y.
New York State

used in Madison and Chenango Counties

1814 Jones & Lamson
Machine Co.,
Springfield, Vt.



Combination Sundial and Telescope, Showing the Mirror and the Adjustable Eyepiece to the Left of the Man's Hat

TELESCOPE AND SUNDIAL ARE
COMBINED IN ONE

One of the latest decorative units for the lawn or garden is a combination sundial and telescope with which accurate time can be told and distant objects, including those of the heavens, studied. Images are reflected from a polished concave mirror through a prism and to a magnifying eyepiece. All the parts are easily adjusted so that the telescope can be used with accuracy and comfort by night or day. If desired, the mirror and eyepiece can be removed and taken indoors for safekeeping, but may be left outside without risk of damage, as they are thoroughly protected. Both dial and telescope are mounted in solid bronze. One of the novel uses for the telescope is for the study of birds.

More than 93,000 physical examinations of candidates for pilot licenses have been made by the government.

Chicago, 685 S. Leland Road
described several
New and

1939

The Latest Electrical



them out of lassitude. His words and acts opened the doors of a great laboratory where men practice witchcraft with electricity.

First, Doctor Grace relieved suspense by giving away the secret of his voice. Unlike the radio announcer, he was not talking into a visible microphone. But how should the students have known there was any other kind of a microphone? That was the reason for his coming—to reveal what had not been heard about.

"Well, here's my voice," he said, taking an object no larger than a

By DON GLASSMAN

THE PRESIDENT of a mid-western university was addressing several thousand students in the school's new auditorium. Acoustics were bad. He lifted his voice, but it could not convey his introduction of a speaker, Dr. Sergius P. Grace, assistant vice-president of the Bell telephone laboratories.

When Doctor Grace came forward, he met vacant stares. Students saw the speaker plainly, but did not expect to hear him. For a full minute he stood speechless. Noises gave way to an expectant hush.

Opening his mouth, the first syllable crashed like thunder. Doctor Grace had a voice that boomed, cracked and reverberated in every far corner. He roused



Doctor Grace Dialing Number That Is Reproduced as Speech, and Showing the Pocket Microphone

*referring to Western
Electric Co. 1935
Broadway, New York*

195 Broadway, New York City

1739



Giving School Children Hearing Test through Phonograph Device Developed in Bell Telephone Laboratories; Volume of the Sound Is under Constant Control

quarter out of his breast pocket. "It's a portable microphone, made to my order. I don't like to distract you, or to inconvenience myself, by having to remain on one spot. Microphone wires run down through my clothes to a contact on my heel."

This man is a detective, engineer, speaker, demonstrator, entertainer and sorcerer rolled into one. He takes the place of traveling magicians who roamed about the country thrilling people with their bag of tricks. Doctor Grace travels on behalf of the Bell laboratories, but instead of a bag, he carries a truckload of tricks.

Recently he was addressing a Chicago audience when he picked up a telephone and dialed. Before the spectators could catch another breath, they heard a voice from New York repeat in good English the exchange and number Doctor Grace dialed, thus: "S—— One Oh Oh Four."

It was the first demonstration of such unique communication. "I did it," he said, "to illustrate the trend in long-dis-

tance telephony. The use of dial phones for local calls paves the way for an extraordinary expansion of automatic telephony. Long-distance dial phones are still in the experimental stage, but when our leading exchanges get new equipment, it will be possible to dial a number 2,000 miles away, as well as one around the corner."

The apparatus which converts dial impulses into human speech is termed the "call announcer." It can be adapted to telephone exchanges. Telephone patrons will dial numbers, but the operator will hear them spoken. The whole arrangement is simplicity itself. The numbers were originally spoken into a moving-picture microphone by a young woman with a well-modulated voice. This strip of film, inserted into a machine, is the voice ready to speak any hour of the day. A dial impulse is trained to ask the film for a number, and a loud speaker makes the canned voice audible.

Everybody is familiar with devices to



improve the hearing of deaf people, but now comes a method for projecting speech electrostatically into the brain. Doctor Grace speaks a sentence into a telephone transmitter, and it comes to the audience through amplifiers. Simultaneously, part of the electrically reproduced speech is stored in a "delay" circuit. After remaining in "storage" for four and one-half seconds, the current returns as a high-voltage impulse and passes into Doctor Grace's body. Now he is the transmitter. He points his index finger into the ear of a man, who hears the original sentence repeated in his brain. No sounds are heard as this man receives Doctor Grace's voice, but he can testify that he has heard it distinctly.

"The eardrums and surrounding tissues are made to act as one plate of a condenser-receiver," explains Doctor Grace. "The vibrations impinging against the eardrum are interpreted by the brain as speech, or music, whatever the sound might be."

Inversion of speech is another trick in Doctor Grace's truckload. He holds a telephone transmitter to the mouth and speaks the cryptic sentence, "Fay-o-bonno Jay-cutt Play-a-feen Crink-a-nope." The transmitter is connected to apparatus which translates these unintelligible words into understandable English. Two seconds after the audience has heard the inverted speech spoken, the loud-speaker horns shout, "Allegheny Mountain Telephone company." In the event of war, inverted speech will become a major weapon of the belligerents. Inversion can take

place both from code to English and vice versa. Doctor Grace thinks that the inversion apparatus may also give grammarians the cue for a whole new language.

To invert speech, you merely turn the frequencies upside down so that high frequencies become low frequencies and vice versa.



Using the Artificial Larynx, and End of New Ocean Cable Which Contains 3,600 Wires

Using modulators, demodulators and filters, Doctor Grace reinverts gibberish into intelligible language.

Doctor Grace went on to describe the loading coil and telephone repeater, now employed on the toll and long-distance lines of the Bell system. These devices allow the passage of voice messages over wires no larger in diameter than an ordinary pin, whereas, under the old method, copper wires with the thickness of a lead pencil were necessary to perform the same service.

He brought out the recently developed high-power double-end vacuum tube, necessary for short-wave telephony across the Atlantic. "The receiving antennæ at Schooleys mountain, N. J., receive transatlantic impulses so weak," he said, "that a million of them would be necessary to light an ordinary incandescent lamp."

Creeping speech! Five feet above our heads hung a tightly wound metal spiral, similar to those used on screen doors. Doctor Grace pointed to it, then spoke into a telephone transmitter. He made a

1739

circular motion with his finger, indicating that his speech was creeping along the wire at a snail's pace. Not that we could see his voice slow down to a speed one-twenty-fifth of that with which it travels through air, but that we soon heard it. It required two seconds for the first word to come out of a loud speaker.



Transmitting Speech through the Finger Tips, and Device That Shows the Magnetic Properties of Metals

Next, this necromancer brought forth a device which enables dumb people to speak. The mechanical larynx, it is called. It includes an electrical ear and brain, as well as a mechanical lung. Any dumb person who at one time enjoyed the power of speech, can address himself to other persons or send his voice through the telephone. If one wants to create a basso-profundo voice, it is only a matter of turning a screw; likewise for the feminine voice.

It is possible for any person to speak words without making noises in his throat. The artificial larynx makes speech where there is none. The air waves created by jaw motions are transmitted into a rubber mouthpiece and thrown against a vibrating membrane. The speaker holds his artificial lung under his arm and against his chest. By gentle pressure of the hand,

this lung, acting as a bellows, feeds air into the short hose and aids in the amplification of waves coming from the mouth.

PRIZE-WINNING WASTE BASKET TO AID CITY CLEANLINESS

1794

Impressed by the fact that women, and men too, often dislike to raise the soiled lids of waste receivers on the city streets to deposit rubbish, James Herman, a student in the Art Institute of Chicago, designed a receptacle that would eliminate this objection and would invite co-operation in efforts toward city cleanliness. His suggestion won a \$500 prize, offered by the committee of twenty on street and outdoor cleanliness of the New York Academy of Medicine, over 195 other ideas submitted. Mr. Herman's basket can be attached to a pole or to a flat surface by a specially designed lock that prevents theft. The second prize went to Denzil Hinr, a student of Washington University.



Committee of Twenty on Street and Outdoor Cleanliness. 2 E 103rd St. New York

By W. E. Snyder and R. B. Bottoms.

LARGE PONY-EXPRESS STAMP HONORS EARLY RIDERS

1801



Large Pony-Express Stamp Placed on Cross-Country Mail Planes to Honor Early Riders

Commemorating the heroism of the early riders who blazed the first cross-country fast-mail trail in 1858, large replicas of the original pony-express stamp recently were placed on the transcontinental mail planes that today cover the same route. The pony-express riders traveled from the Atlantic to the Pacific in twenty-six days, and the mail planes cover virtually the same route today in thirty-six hours.

ULTRAVIOLET PICTURES ADD TO HUMAN KNOWLEDGE

Discovery of a new process of photography with the invisible ultraviolet rays promises theoretically about nineteen per cent more detail for certain kinds of objects. The latest method employs a microscope for the camera's eye. The rays have been used before to take photographs, and the recent development is the discovery of how to use another form of ultraviolet light for this purpose, that part of the invisible radiation which is nearest to vis-

ible violet light. Ultraviolet pictures of hollyhock pollen grains revealed new details that were not shown with the visible light, but a similar picture of a certain worm was less clear than one taken by white light. The worm was found to have a protective skin against the invisible rays.

HELIUM SUITED FOR HEATING AND ALSO COOLING

826

Helium, the non-inflammable gas used in dirigibles, also may be used in the future for both heating and cooling, as the result of experiments which have been reported to the American Chemical society. Because of its high conductivity of heat, helium is a good medium for circulation in heating and refrigeration systems. Used as a preservative for food, helium keeps other gases which encourage decay from reaching the perishables.

ROTARY SWEEPER FOR STREETS SAVES LOADING TRUCKS

1798

Street refuse is swept directly into cans with a rotary sweeper introduced in London. This saves handling loose material in trucks, reduces dust and saves time, as the machine need not be stopped for unloading. The cans, eighty-four of them in all, are arranged in rows. As they are filled, empty ones are substituted, the full cans being set aside for later hauling away and emptying.

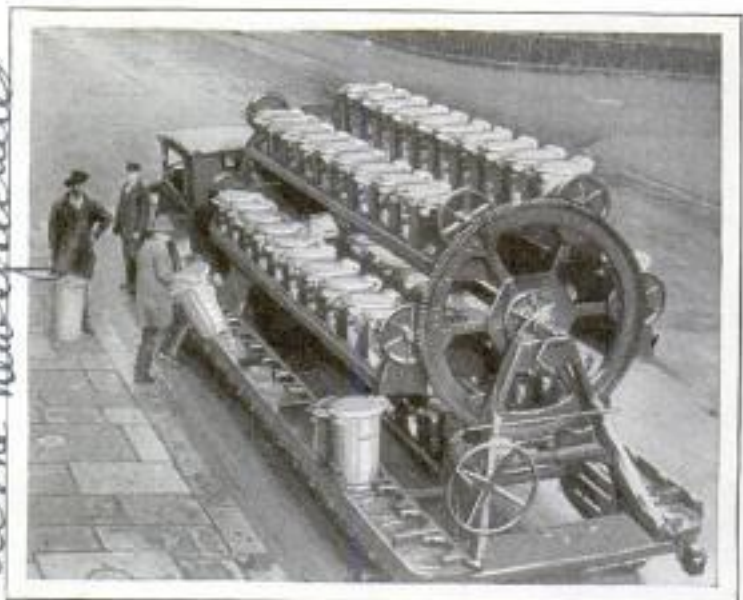

Rotary Street Sweeper Which Deposits Refuse Directly into Cans, Thus Saving the Handling of Loose Material

Chicago Tribune 10/31/30

Science News-Structure

reported to Optical Society of America at the Virginia by A.P.N. Truller and V. Foster, Eastman Kodak Co.

Copyright Kodak Co.

1934 d.w. & H Lanier

POPULAR MECHANICS

615 Madison Ave
Covington, Ky.

THIRD-WING AIRPLANE OFFERS GREATER SAFETY

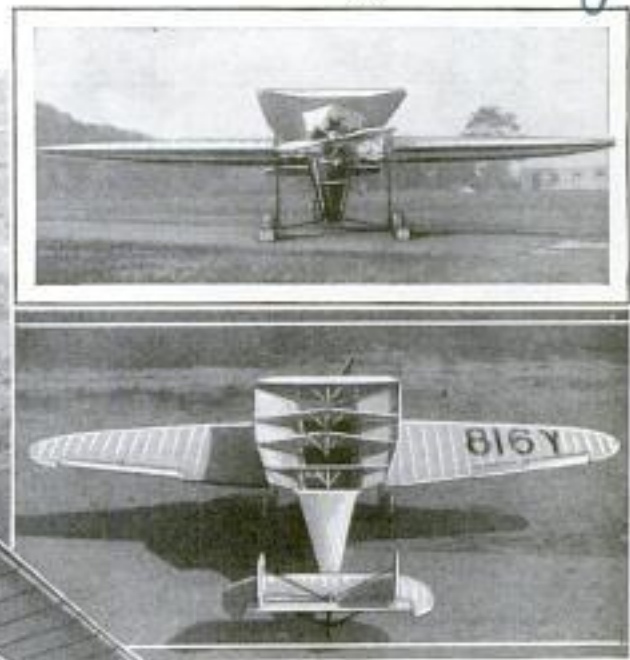
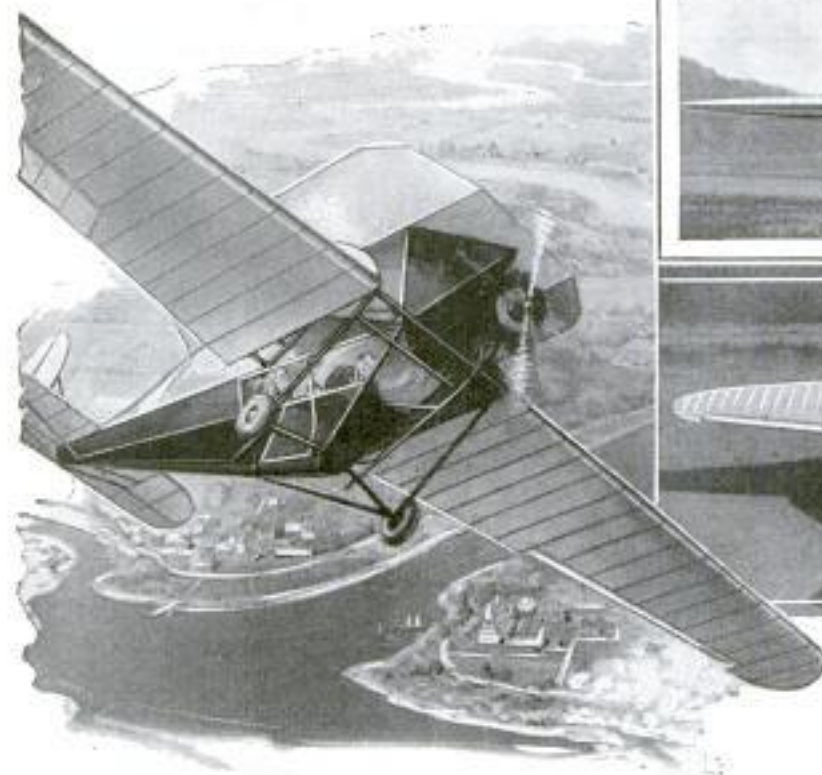

Front and Rear Views of the "Third-Wing" Airplane, and Sketch of It in Flight; Note the Buffers in the Air Cell

Interesting flying tests with an experimental airplane designed by Edward H. Lanier, Cincinnati inventor, has attracted attention to the unusual features of the ship and its performance. It is of monoplane design, but in reality has three wings, the main wing being separated from the fuselage by a gap of twenty inches on each side, and the top of the fuselage flares out to the sides, forming an open, hollow cell of high lifting efficiency. Within this cell are lateral air buffers which create an area of low pressure when the plane is in motion. Air, rushing up between the side wings, also increases the lift and gives greater stability both vertically and horizontally, the tests proved. In landing, the air cell on top of the fuselage has a retarding effect, due to suction, enabling landings at lower speeds than are possible with the usual plane. In taking off, the plane requires a run of little more than 100 feet and has left the ground at a speed of but thirty-two miles an hour. It lands with a roll of not much more than twenty feet under normal air conditions. Pilots declare that the plane is easily maneuvered and stable under adverse factors. Tests are to be

continued in an effort to reduce the weight of the plane and to increase its speed. Mr. Lanier has taken out patents on his designs and has others pending.

SMELLY GAS TO SAVE LIVES ACTS AS SIGNAL 18/8

Workers in metal mines are to be warned of fires by a gas of very disagreeable odor, which, in time of danger, is mixed with the fresh air in the ventilating shafts. In addition to the use of an odor as a signal, the American Standards association also provides that, in mines equipped with electric lights, these shall be flashed nine times in three series of three flashes each. Since trouble may develop in the electrical system, however, the miner's nose is relied on to detect danger. Experiments have been conducted with pleasant odors, but disagreeable smells were found to exert a much more positive effect. The odors, injected in the air lines, can be tolerated without much discomfort, as only a few parts per million parts of air are needed for their detection, and none of them can exert any harmful influence.

Technical Paper # 244
Bureau of Mines
Washington, D.C.
Copyrighted material
Fullerton

Survey Service News Bulletin
501. 03 10/28/36

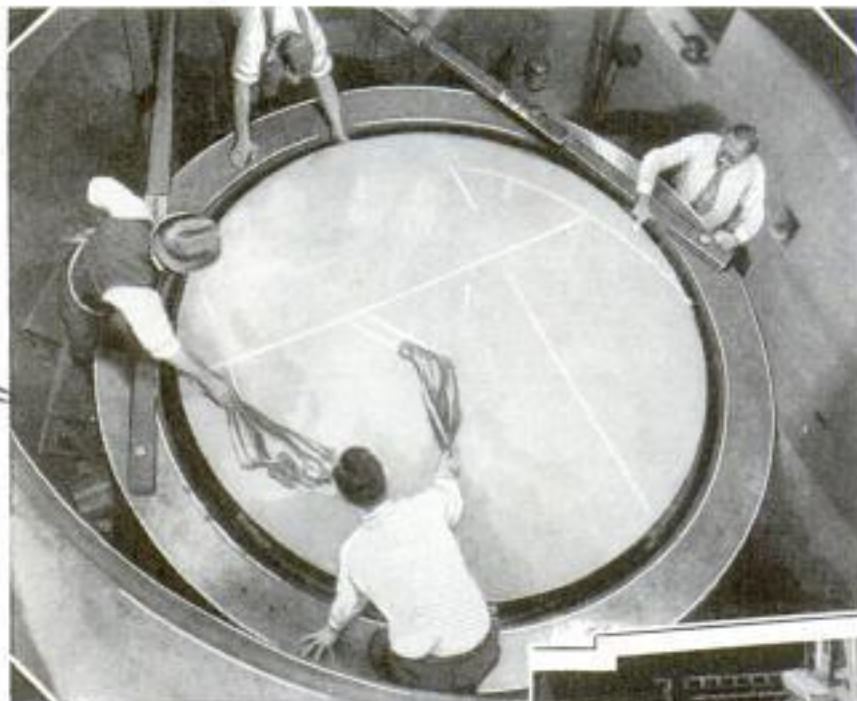

Removing Excess Material with Chamois Skins after Silvering the Mirror, and Looking Down into the Well

TELESCOPE'S FIVE-TON EYE IS RESTORED WITH SILVER

Treating the five-ton mirror of the huge reflecting telescope at Mt. Wilson with a fresh coating of silver, was the interesting task of expert workers recently. The huge unit had to be lowered into its well by means of the elevating screw and approximately twenty-four hours were required for the entire operation. It took two and one-half hours to lower the mirror and the same time to raise it back into position.

FISH-CATCHING BIRDS KILL ENEMIES OF TROUT

Hérons and other fish-eating birds are often blamed for killing game and commercial fish when, in fact, they usually benefit these varieties by destroying other more deadly enemies. The more valuable fish not only are fewer in number than the non-commercial kinds, but they inhabit deeper waters, are swifter, and hence harder for the birds to catch. The birds, feeding on what is common and easy to get, therefore catch many

more of the coarse fish, some of which are enemies of commercial varieties, than game fish, and feed likewise on insects, crustaceans, frogs, snakes and other creatures. Trout fry are much more likely to meet death from other fish than from birds, although the birds often get the blame. Except at fish hatcheries, it is probable, according to the biological survey of the department of agriculture, that fish-eating

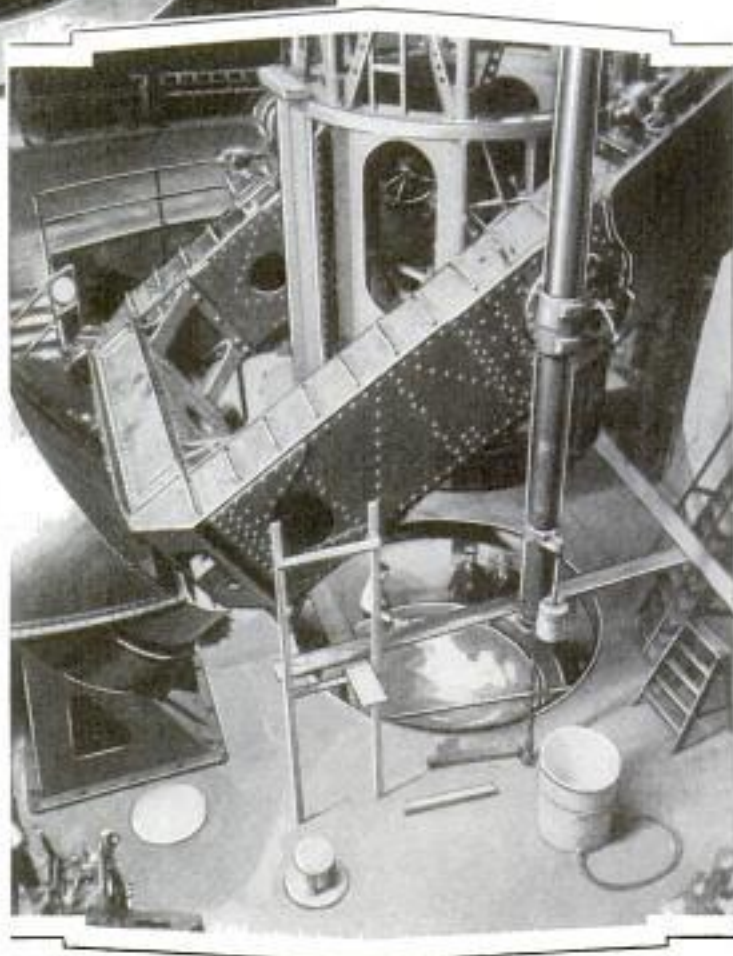

birds more than make up for the harm they do eating game fish by their destruction of other natural enemies of the whole fish tribe. An examination of the stomachs of 150 blue herons disclosed that only a few game fish were consumed, while scores of enemies of the commercial varieties were found, including other kinds of fish, snakes, bugs and beetles.

1991
 near Pasadena, Calif.
 100 inch telescope
 Cont. Art Bellberg
 The Oregonian, 1/20/09

1786

Calif

BETTER ALTIMETER IS NEEDED FOR SAFE FLYING 1836

Altimeters, as used on aircraft, still are subject to considerable error under certain conditions. On the day that the British dirigible "R-101" crashed in France, Dr. Hugo Eckener, designer of the "Graf Zeppelin," made a flight and found on landing that his altimeter still registered a height of 400 feet. This would indicate a considerable fall in barometric pressure on that day since the altimeter is simply a refined type of aneroid barometer indicating the height in feet due to the decrease in atmospheric pressure accompanying ascent. Unless during a flight the zero reading is constantly checked by readings from the ground over which flight is taking place, the zero reading throughout a trip corresponds to the ground-level reading at the point of departure. If the barometric pressure falls, or the ship passes from a region of high to one of low pressure, the altimeter will indicate a greater height than that at which the craft is actually flying. The speed of ascent or descent, particularly if rapid, causes the altimeter to err although after a time it returns slowly to the correct reading. This inaccuracy is difficult to estimate because the law governing the change is arbitrary rather than exact.

WIRELESS WALL LIGHT HIDES BATTERIES IN BASE 1807

\$1.50 *without base*



\$2.00 *complete*

Equipped with its own batteries as an integral part of the fixture, a wall light that is independent of the lighting circuit in the home now is available. It operates on two standard flashlight cells which are installed inside the lamp. The light has no wires and is attached with two small screws, or can be used as a portable unit. It also is suitable for installation in an auto as a dome light or for a boat cabin. In the home, it is handy for temporary or emergency illumination, for closets, stairways or attics.

Delta Electric Co.,
Marion, Ind.

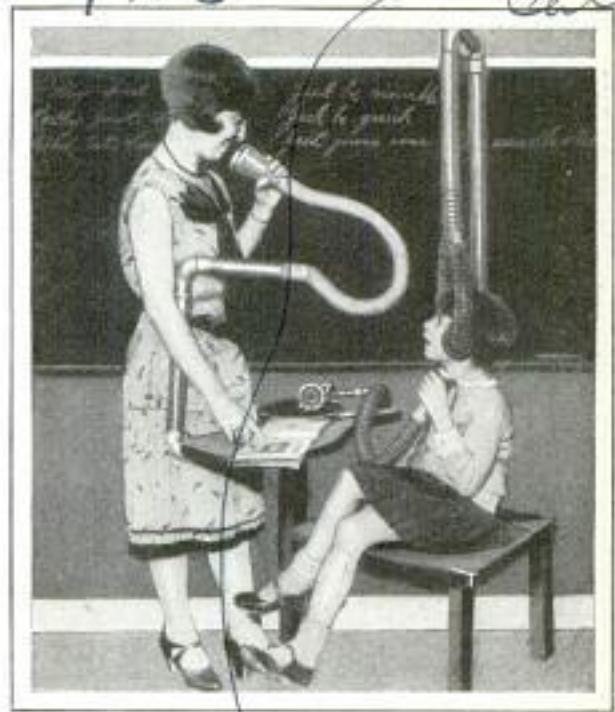

Amplifying Apparatus Consisting of a Megaphone in Metal Tubing for Aid of Partly Deaf

MEGAPHONE IN METAL TUBING AIDS DEAF TO HEAR

To enable partly deaf persons to hear, a California inventor, whose daughter is hard of hearing, has made a simple amplifying apparatus that is of particular use in schools for the deaf. It consists of metal-joint tubing containing a megaphone. The sound vibrations, intensified by confinement within the tube, reach the listener through earphones. A phonograph attachment to the megaphone makes it possible for the user to listen to music also.

POUCH FOR TOBACCO AND PIPE COMBINED IN ONE 1785

With an interlocking fastener at the top, a combination tobacco pouch and pipe holder has been introduced. The pipe is secured by a leather strap that has a snap button, and the stem rests in a compartment just below the space for the tobacco. There is room for a generous quantity of tobacco; the pipe is kept from getting lost, and the entire unit is of a size to fit the pocket.



Philip J. Loren
11-13 E 26th St
New York City

U.S. Slachy
10/22/30

1793



Firemen Giving the National Capitol Its Annual Bath by Turning Powerful Streams of Water on It

FIRE HOSE IS USED TO CLEAN THE NATION'S CAPITOL

Washington firemen are called on each year to give the national capitol its annual scrubbing. This is done by turning powerful streams of water on the structure from sidewalk to dome, washing off the year's accumulation of dirt and grime and leaving the building spick and span for the opening of congress.

TALKIES TO TEACH SOLDIERS LATEST ARMY METHODS

To instruct officers and enlisted men in various branches of the army service, the signal corps has begun the production of sound films to supplement the silent motion pictures that have been in use for instructional purposes for some time. After the World War, the army made about sixty-five movies of the silent variety and used them for lectures. Training methods have been revised and altered, making new films necessary in order to give the latest regulations, and the deci-

sion to incorporate the voice with the new pictures was made in the belief that the soldiers would learn more quickly, and that shorter films would be as effective, because the voice would interpret matters that would require extra scenes in the silent films; words of command will be given in many instances.

BEACH DEFENSE AGAINST SEA IS MADE UP OF MOVABLE UNITS

To protect the bathing beaches of the Baltic coast in Germany against encroachments or destruction by storm waves and spring tides, movable breakwater units have been used with success at several summer resorts. The units, shaped like curved overhanging baffle plates, are made of concrete and imbedded firmly in the sand in such manner that they present their concave surface to the water like a ship's bow. They are first placed a short distance

from the shore line and as the receding waves gradually build up sand behind them, they are moved farther out until the beach has been extended as desired.



Portable Breakwater Units Shaped Like a Ship's Bow, Which Protect Bathing Beaches from Waves

in charge of Army Pictorial Service

1780
Capt. Alonzo P. Johnson
Signal Corps acting officer

Lie Woche Berlin
Oct. 4. 1930 P. 1189

Germany

With the Texas Rangers



Capt. John R. Hughes, Second from the Left, Leads a Scouting Party along a Winding Trail; Photograph Taken near the Big Bend in the Rio Grande

By GEORGE W. GRAY, *Sparkhill, N.Y.*

A DUSTY automobile rattled northward on the road from the Shafter silver mines in west Texas. In the front seat sat two Texas rangers, returning from one of the emergency calls which frequently summon these officers to the Rio Grande border.

Suddenly the ranger captain touched the driver. "Stop her, Bill. There's something I want to take a look at."

The driver whistled in surprise as he saw the tall ranger bend down to examine a cluster of purple flowers. Presently he saw him dig the plant up and tie it snugly in his handkerchief. As he came back to the car the captain laid his find beside a box of ammunition. "Bill, if this transplants, I'm lucky," he said. It's a rare specimen."

And so it proved to be. Botanists at the state university were not familiar with the variety, and sent samples to the New York botanical gardens. There the plant was identified as a species of solanum—a rarity indeed, for it had never before been reported from any part of the States.

Seems odd doings for a Texas ranger, doesn't it? Spotting rare prairie plants hardly seems to go with spotting border bandits, protecting prisoners from lynch law, capturing desperadoes, and dealing with the fifty-seven other varieties of outlaw. For ninety years Texas rangers have been fearless regulators of the southwestern border, and between the bandits and the smugglers and the holdup men, their time has been pretty well occupied most of those years with fighting. An old pioneer etched the type when he said, "a ranger is a feller who can ride like a Mexican, trail like an Indian, and fight like the Devil."

Meet Capt. Roy W. Aldrich and you find a ranger who can qualify in many directions in addition to horsemanship, marksmanship, and an uncanny facility in dealing with bad men. A naturalist who has made a study of the plants, animals, and rocks of the southwest, a book lover who has assembled one of the most remarkable libraries of pioneer times to be found in any private collection, Cap-

tain Aldrich is a man of many hobbies. A few weeks after that incident on the Shafter road and when he spotted the rare weed, the governor of Texas sent officers to a certain town. It was the center of a new oil field, and its sudden prosperity had attracted the usual following of bad men. Crime flourished and the local officers did nothing, so Aldrich was told to take three men and clean up the town.

The party of four rangers arrived Saturday evening, and before midnight they had arrested eighty-seven men in one raid.

"How did you do it?" I asked the captain. "Weren't they armed?"

"After arresting them we picked up pistols all over the floor."

"But why should a gang of eighty-seven armed men drop their guns and surrender to four men?"

"Well, Sir, I don't know why they gave up. This was a hotel, with gambling on the third floor. We told 'em they were under arrest, and they seemed to agree with us, right off."

"But how did you make that arrest, captain?" I persisted.

"Shucks! We just went up there to the hotel. I sent two of my men up the fire escape to take 'em from the rear, and with the other ranger I pushed in the front way. We met a lookout man at the head of the stairs, and he ran—down

the steps. Saw our guns cocked, I reckon.

"It was a big room with eight or nine tables and other gaming outfits, foggy with smoke. 'Boys,' I said, 'we're rangers from headquarters in Austin, and there's two more of us back at the fire escape.' There were murmurs all over the room, and then the sharp clattering noise of guns falling to the floor. I reckon nobody wanted to be taken with a pistol on him."

Capturing eighty-seven men in one haul is one thing. Standing off a mob of a thousand is something different. This latter experience was in another Texas county where a woman and child had been killed. The murderer had been positively identified by a girl who had witnessed the crime. A mob threatened to lynch him, but the district judge was determined to keep the law in his own hands, so he telegraphed to Austin for rangers. Aldrich was sent with three men.

"After the trial," related Aldrich, "we came down the courthouse steps with the condemned man, taking him back to the jail. A thousand men and more were massed in the yard. They were in ugly mood. You could just feel it. Everybody seemed on edge. You can bet that we marched our prisoner across to the jail with our rifles cocked.

"Of course, it is sheer nerve that takes you through in a situation like that. We



Where Many of the Members of the Texas Rangers Are Recruited; One of the Cowboy Camps West of San Antonio during Meal Time about the Chuck Wagon

1548

1956 No further information available

POPULAR MECHANICS

simply looked at the ringleaders with an eye that meant business. If the crowd had pulled shooting irons and gone into action, we couldn't have lasted long. But we'd have got a good many of them too—and the leaders first—and they knew it."

Aldrich lives on his farm of 110 acres, in a fine old plantation house, in the outskirts of Austin. Animals vie with plants in making his home unique. When I last visited there, I saw deer, a prairie wolf, two javelins (wild hogs), a coon, a ringtail, skunks, squirrels, prairie dogs, chachalacas (Mexican pheasants), and an alligator—all living together in peace. The wild ducks fly up from the creek occasionally and disappear into the blue, but they always come back in a day or two and feed out of the captain's hand.

Upstairs in the plantation house are two immense rooms lined from floor to ceiling on all four walls with shelves of books—works of history, geography, hunting, sports, anthropology, zoology, botany and other sciences. The captain has tried to collect every book ever printed about the Texas rangers, and I suppose he has succeeded, for this corner of his library is packed. He has many rare volumes on Indian fighting and pioneer life.

AUTO JACKS INSTALLED ON CAR MAKE TIRE CHANGES EASY

Changing tires on the road is greatly simplified by the use of a set of jacks installed permanently on the auto. They are attached inside the bumper to the frame of the car, and raising a wheel is merely a matter of turning a crank inserted in the jack nearest the wheel to be repaired. The permanent set of jacks is inexpensive.



Permanent Jacks, Installed on Auto and Operated by a Crank, Save Time in Making Tire Changes

Dr. Malcolm Campbell
British racing driver



Sorter and Candler Which Automatically Tests Eggs, Weighs Them and Distributes Them into Five Different Grades

EGG SORTER AND CANDLER CAN TEST THOUSANDS DAILY

Five persons can sort and candle 60,000 eggs a day with the aid of an improved machine introduced in Germany. It automatically tests the eggs, weighs them and distributes them into five different grades for sale.

SUN IS SEEN AS POWER PLANT OF THE FUTURE

Solar radiation is expected by some scientists to represent the world's future power plant. One physicist has found that the sunshine falling on a house roof is sufficient to supply all the power requirements of the average household, if it could be utilized.

At present it is possible to draw electrical energy from solar radiation, but it is not economical to do so on a large scale. Solar radiation is equal to 7,000 horsepower an acre, and there is sufficient power in one storm to supply the needs of a country for a century, if it could be controlled, stored and converted into electrical energy.

1996
 Professor Adelaide University, Adelaide
 Dr. Paul Eschen
 Essen
 Benig + Tilgers
 Ministerstrasse 246
 Düsseldorf, Germany

REBUILDING OLD FORT TESTS ENGINEERS' SKILL



Above, Reproduction of Painting by Paul Strayer, Showing Original Building of Fort Dearborn, and, at Left, Model Reconstructed from Drawing by Capt. John Whistler Now in the War Department Files at Washington; Below, Scene of Present Building as Workers Are Reproducing the Old Fort for Display at the Chicago Centennial Celebration in 1933

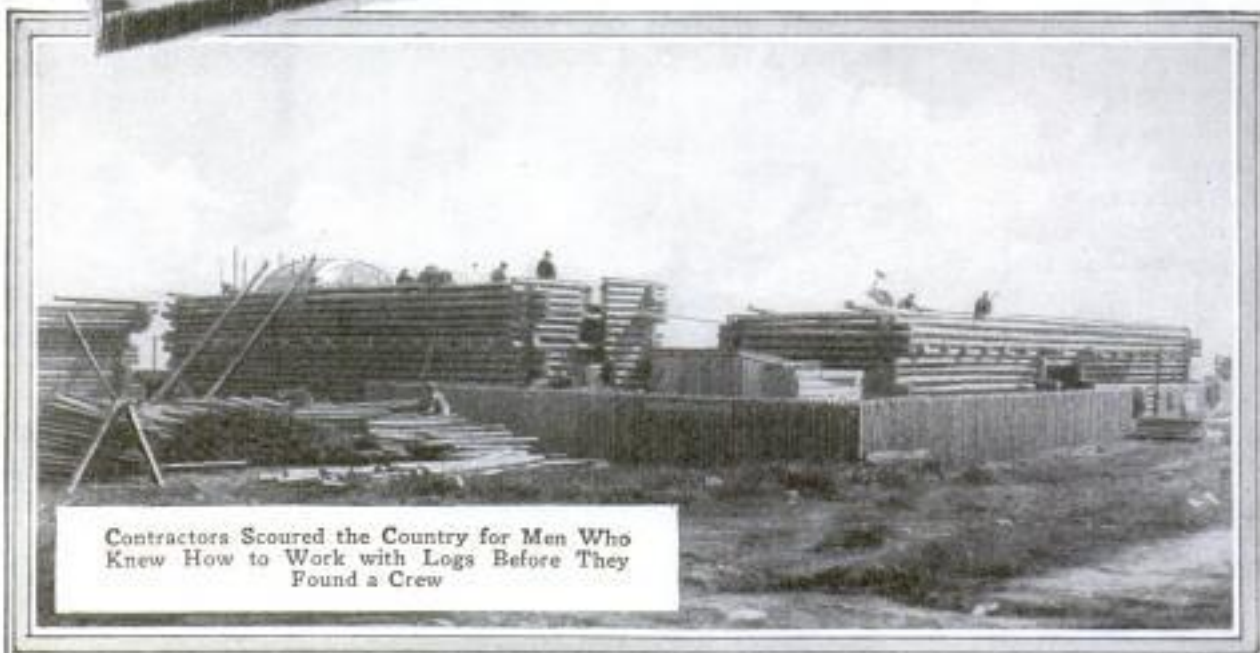

Contractors Scoured the Country for Men Who Knew How to Work with Logs Before They Found a Crew

1805

1772

LOST ART OF LOG BUILDING IS REVIVED FOR WORLD'S FAIR

Fort Dearborn, the historic log fort of early Chicago, is rising in replica, under the shadows of skyscrapers, for the city's centennial celebration in 1933. "I'd rather build twenty stories in steel than a job like this," said R. J. Sipchen, contractor in charge. "A skyscraper is simple in comparison. Why, building in logs is almost a lost art." Then he went on to explain some of the problems involved in faithfully reproducing the famous fort. In the first place, there was considerable difficulty in finding men who understood the art of working with logs. Then there was a hunt for suitable timber. Norway pine was located in the desired quantity and sizes not far from Duluth, Minn., and was transported to Chicago. The plans were drawn from an accurate model and from a sketch made by Capt. John Whistler, the grandfather of the famous artist. The builders of the original fort used man power exclusively, and workers on the replica were forced to follow the same practice except that horses were used to snake the logs into position. The whirr of an electric saw was about the only modern note during the construction, for nearly all the work was done with hand tools. More than 65,000 lineal feet of logs were dressed and shaped for the structure. To reproduce the effect of age, part of the bark was left on. Wooden pegs were used throughout, and the roofs were covered with split cedar shakes.

RUBBER CAP FOR MILK BOTTLE KEEPS CONTENTS CLEAN

Bottled milk and cream can be kept clean and free from germs by removing the paper cap on delivery and replacing it with a rubber cap which fits tightly over the top of the container. This cap can be sterilized by boiling, keeps the rim of the bottle clean and the contents free from ice-box odors, and also prevents spilling if the bottle is upset.



Harold Rubber Co.
69 Point St. Providence R. I.



Giant Egg Laid Centuries Ago by the Extinct Elephant Bird as Compared with a Hen's Egg

Wrote World

GIANT EGG OF ELEPHANT BIRD LAID MANY CENTURIES AGO

Worth more than its weight in gold, a rare and almost priceless specimen of the huge egg of the elephant bird has been brought to this country after having been dug from the sands of Madagascar, where it was laid many centuries ago. The bird that laid this egg is properly known as the *epyornis maximus*, and in legend was called "the bird as big as a mountain." The egg is thirty inches in circumference one way, and twenty-six and one-half inches the other.

LIGHTS IN WINTER TRICK BIRDS INTO FLYING NORTH

Further evidence that light and not a change of temperature, is a fundamental cause for bird migration, is presented by William Rowan, of the University of Alberta, who tricked crows into flying northward even in the winter. By reversing the seasons with artificial lights, he procured the effect of the longer days of spring, although winter was near. After a period of this treatment, the crows were released. Many of them flew north.

Reference to National Academy of Sciences by William Rowan

1612

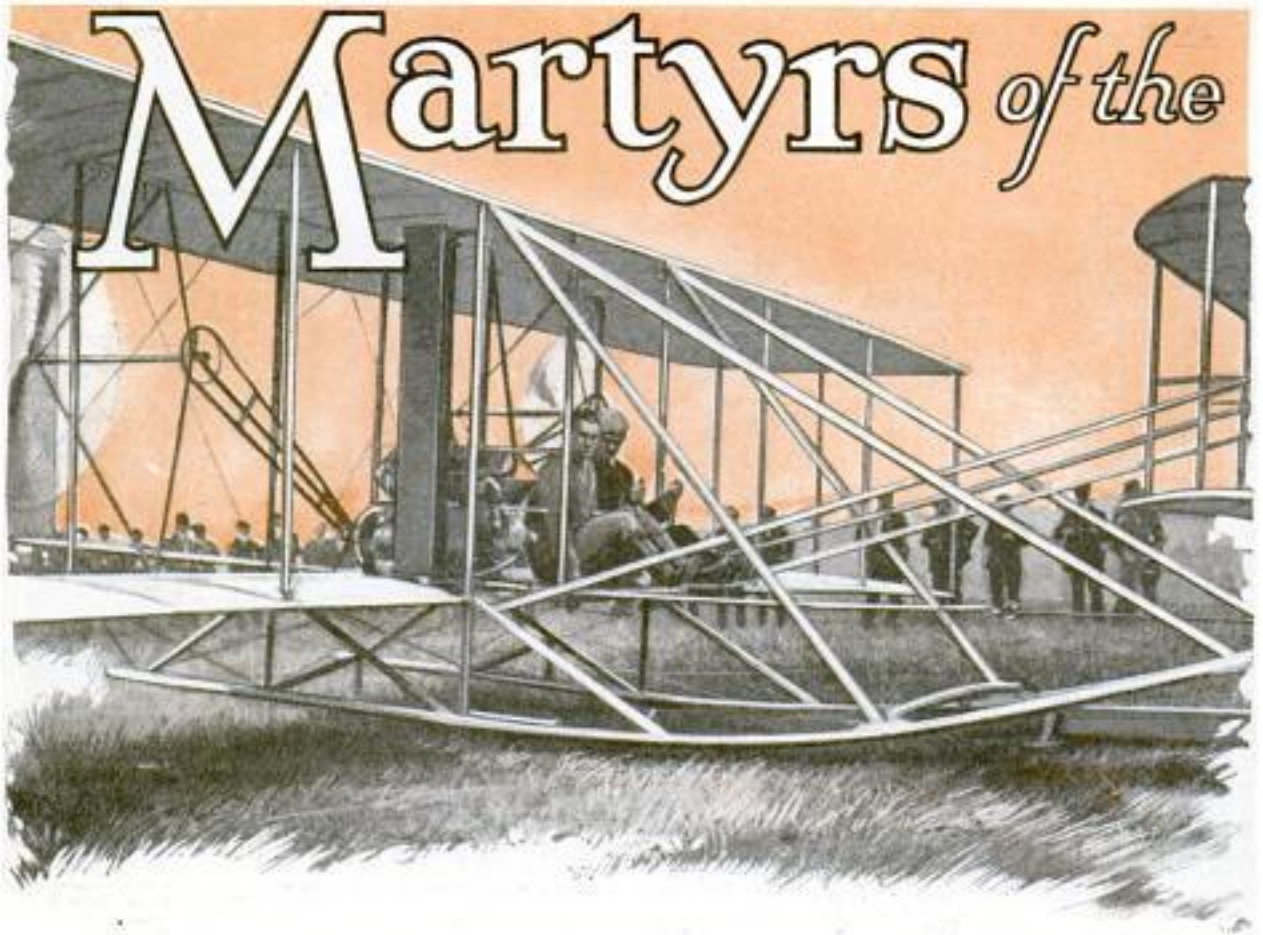

Lieut. S. T. Selfridge, at Left, in Old-Style Pusher Plane at Ft. Myer; Shortly After This Photograph Was Taken, He Crashed and Was Killed; the Accident Led to Important Improvement in the Plane's Design

By CORLEY McDARMENT, Langley Field, Va.

A GREAT silver-winged air liner roars over a flying field. It banks sharply into the wind, glides down for a perfect landing, and rolls up to the "line" where the passengers leave their upholstered seats and trip down the little ladder to the ground. Everything suggests safety and comfort.

But every bit of the safety, and most of the comfort, in that huge air liner was bought with the highest fee in human life of anything outside a war. All progress has required sacrifice. Many trains were wrecked and hundreds of people killed in forcing the birth of the automatic switch. Steamships have blown up or been wrecked upon shoals with heavy loss of property and life in forcing the birth of new engineering ideas or foghorns and lighthouses.

Aviation, the most spectacular factor in human progress, was born in death and has been reared in the lifeblood of martyrs. Nearly every little trick connected

with flying and airplane building has been learned by seeing men fall from the clouds to the earth.

"Let us avenge our dead!" exclaimed Bleriot, the great French flyer, in January, 1910, when he heard of the death of Delagrangre who plunged to earth because his engine bed was not strong enough to hold the motor. Aviators have been avenging their dead ever since.

Men have not easily learned to fly, nor have they been very apt at building flying machines. Almost every lesson in maneuver and manufacture has been driven home by tragedy. Sometimes the lesson was learned by death coming in dribbles, and at other times there was wholesale slaughter.

It took a lot of killings to find out for certain that an airplane needed a tail, that ailerons were necessary, that a rudder made for safety, that an engine bed had to be strong enough to hold the motor, that wing spars and ribs had to stand a lot of

Air Conquest

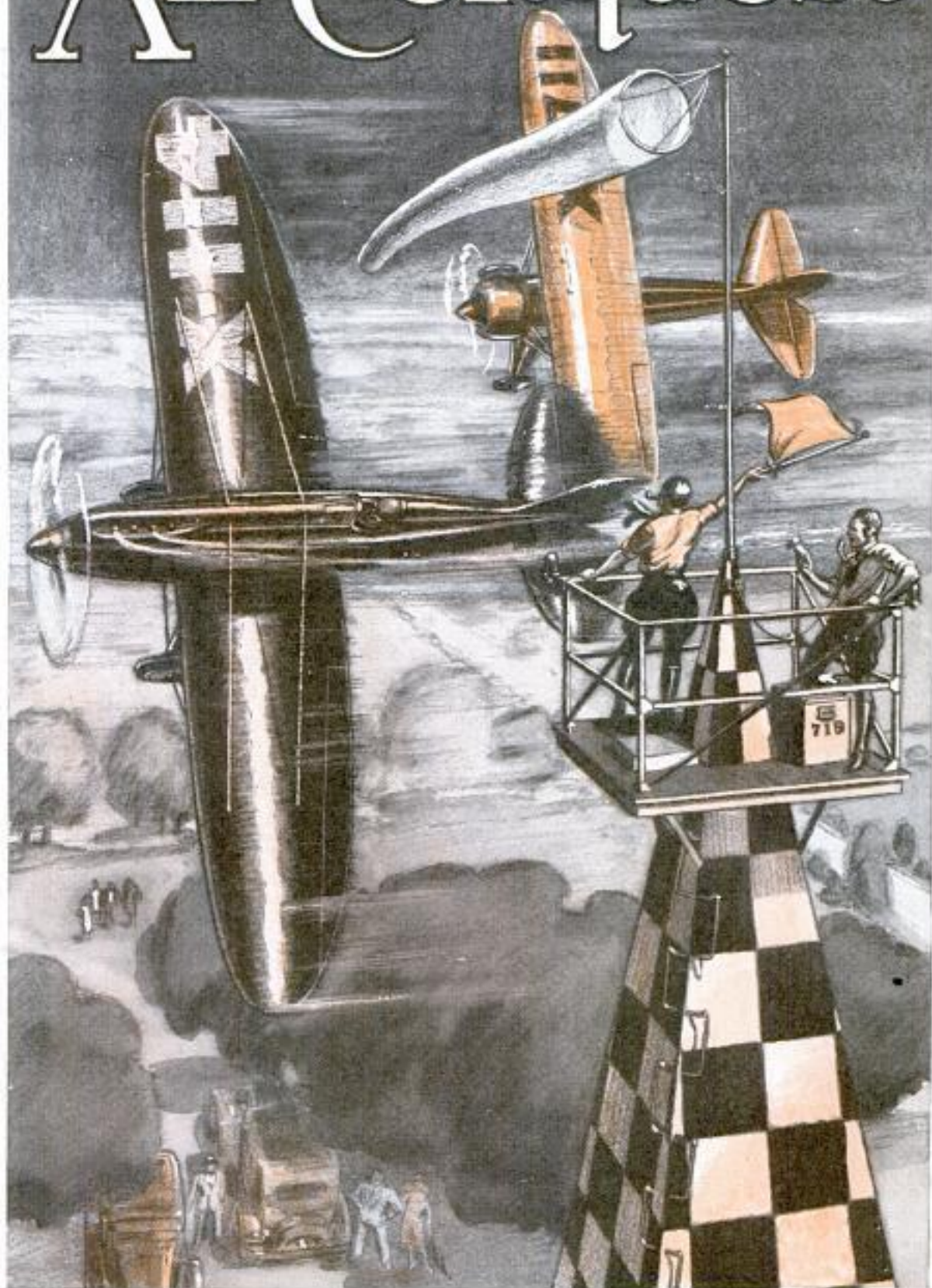

Rounding the Pylon in an Air Race; Artist's Drawing Showing How Planes Bank Steeply at Low Altitudes; Note Timer with Radio-Phone Apparatus Which Is Connected with Chief Timer's Office

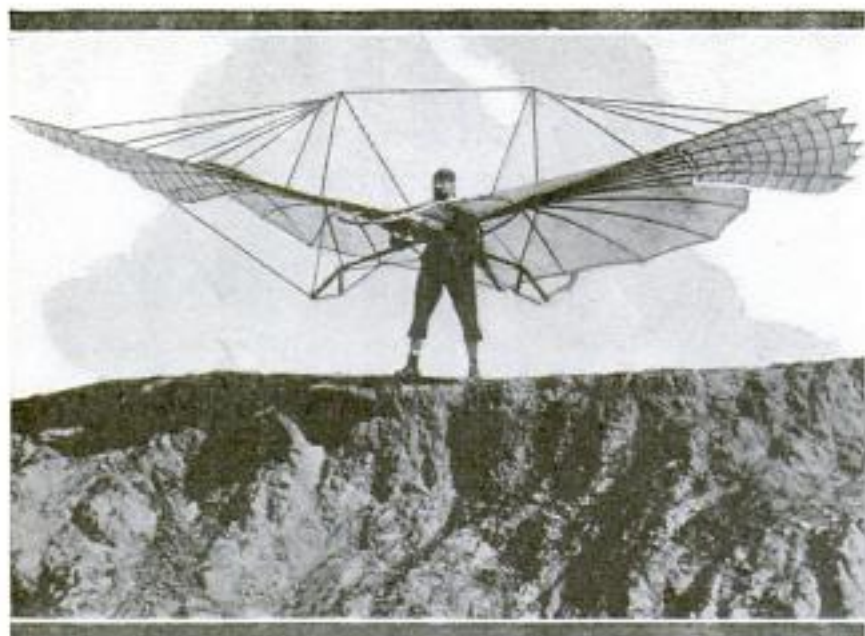

gaff, that hinge pins could break, that fittings could pull out and crystallize, that wing-tip flutter at high speeds had to be conquered, and that landing gears had to take a tremendous jolt. In the strictly flying end of aviation, it took a pile of dead to bring out the facts that a sideslip may be stopped by ruddering into it, that a tailspin may be checked by throwing the controls into neutral, that a downwind turn close to the ground is dangerous, that a stall may be tragic, that an airplane can easily toss a man out into the air if his safety belt is not buckled, that a sudden and steep zoom from a long fast glide may make a man unconscious, that there is no "flying instinct" in fog and darkness, that aerial navigation or "avigation" is necessary for long flights, that "dead-air" areas exist behind hills, that landings upon glassy water must be made with caution, that allowing a motor to get too cold in flight may cause stoppage at a critical moment, that the inclination to turn back to the field when a motor quits on the take-off is usually fatal, and

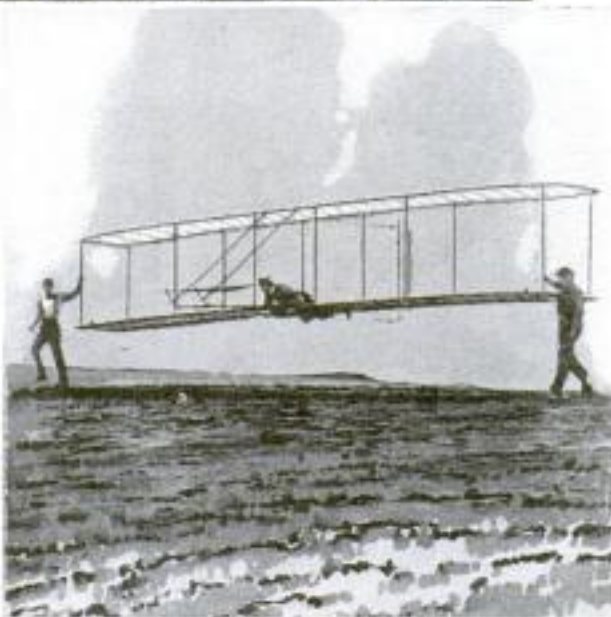

Center and Lower Photos
Courtesy U. S. Army Air
Corps



Otto Lilienthal's Glider; Wright Brothers' Glider of 1903, and Their Plane of 1908

that an obstacle on the landing field may be the cause of disaster.

From the earliest times men have been killing themselves in attempts to fly, but the real martyrdom of modern aviation did not begin until the nineties. On Aug. 10, 1896, Otto Lilienthal, a German scientist, was flying his glider in a strong wind. He had a line from his elevators to his head, but in a sudden gust of wind, he apparently failed to work his head properly and the glider came down, nose on, and killed the flyer. Lilienthal was using a curved-surface wing. He had made 2,000 flights with his gliders and proved that the curved wing would lift a man. His death pointed out that a better elevator control was necessary.

In 1908, one year after the Wright brothers had suc-

cessfully flown with powered gliders, or airplanes, Lieutenant Selfridge, of the U. S. army, made a flight with Orville Wright, at Ft. Myer, Va. One of the propellers struck a wire connecting the rudder and main planes. This put the rudder and one propeller out of action and the opposite propeller took all the power to one side. The result was a smash-up and Lieutenant Selfridge was killed. But from that day to this no wires have been placed on an airplane where the propeller could come in contact with them.

It is not possible to name all the martyrs of aviation outside of a book. There have been too many, and the causes of their martyrdom have often been complicated. But a peculiar thing about air accidents is the fact that the "reputation" which goes out about it has as much effect as the real cause.

Take the case of the "Eagle" crash in the summer of 1921, when Col. Archie Miller and six other prominent people were killed at Indian Head, Md. The real cause



of this airplane wreck will never be known. But the news went out to aviators via gossip that all the passengers were piled down on top of the pilot in the nose of the plane. Since that day, all big passenger planes have had the seats fastened to the floor and safety belts are on every seat. Some planes have two or more compartments

so that passengers cannot all fall forward in a heap if the plane gets into a dive. And the pilot is in a little compartment to himself.

In the case of the airship "Shenandoah," it was decided that a "line squall" helped break her up and dash her against the Ohio hills with fearful loss of life a few years ago. But the navigating gondola containing Commander Lowndowne and other officers was wrenched loose from the main body of the ship and fell free like a meteor. Since then airships have had that gondola built up so close to the main bag and fastened so securely that it is not likely another similar mishap could occur.

The beloved John Rodgers, navy commander, came in for a landing at Philadelphia one day in 1926, crashed and



Three Martyrs of Aviation, Cyrus Bettis, Lieut. Alexander Pearson, and Bust Skeel

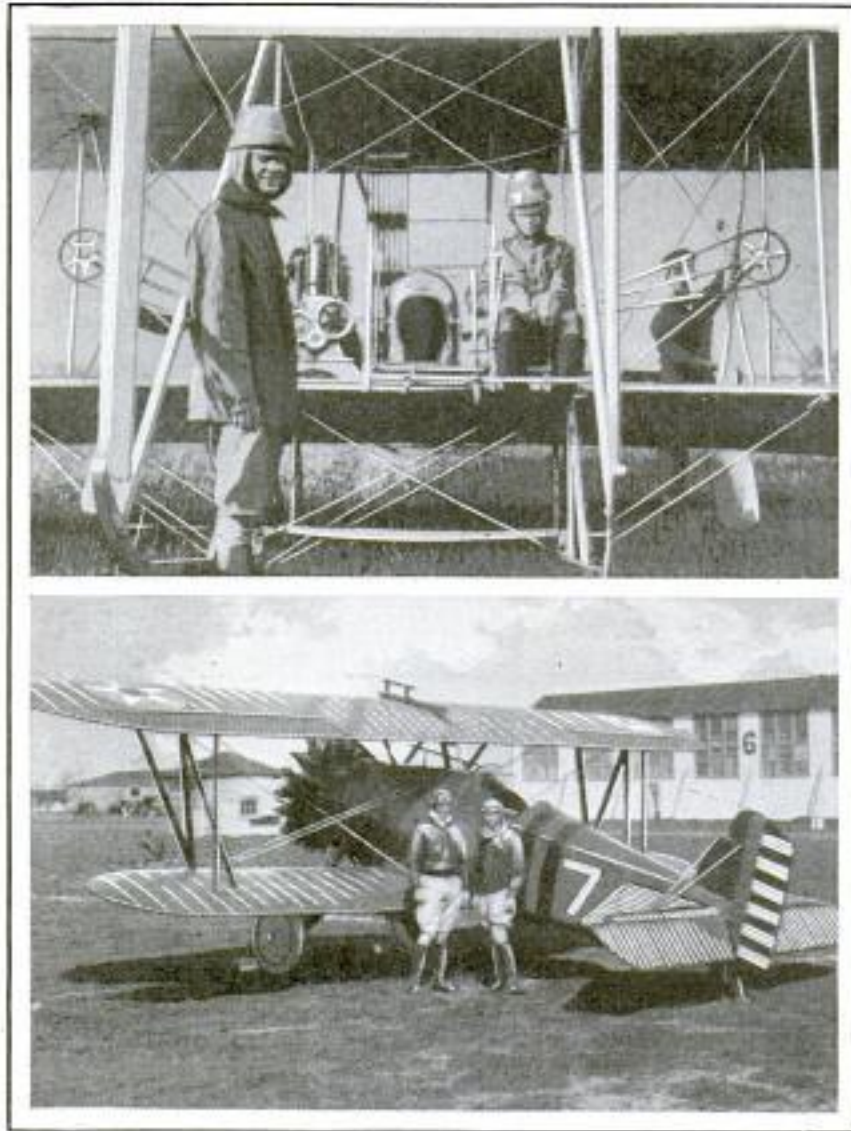

Nineteen Years of Plane Design; Top Photo Shows Ship of 1911; Below an Improved Army Plane of 1930

killed himself. He had to make an approach over water which was "glassy," and whatever the real cause may have been, the reputation was that the water deceived him, and every flying man of the navy remembers this incident and is chary of glassy water.

The death of Lieut. George Burgess and a newspaper correspondent, in the fall of 1925, in the Allegheny mountains between Washington, D. C., and Wheeling, W. Va., was one of a long string of accidents which had gone before in this "graveyard of cross-country flyers," and it hastened the establishment of weather stations and emergency landing fields in this area.

But the list goes on. It is not yet filled. Men and women are still sacrificing their lives in rounding out perfection in aviation. The great pioneers—the giants—

have gone before, but the roar of mighty motors in huge silver-winged air liners that speed across the sky, reverberates against the scene of the crashes that made the thing possible.

1858
**SLEEP ON SHAKING
BEDS TO STUDY
NOISE EFFECT**

Nine Colgate University students recently completed a period of nightly sleeping on vibrating beds while professors studied the effects of noise on rest and slumber. The "rumble" beds combined noise and vibrations in a way to imitate some of the sleeping obstacles of the machine age. The vibration produced was about equal to that experienced in a good automobile and was attained by hanging electric motors under the beds, allowing them to swing from the springs with their accessory apparatus. The noise was a hum a bit fainter than

conversational loudness, and both noise and vibration continued all night. Although subject to further test and verification, the experiments showed that sleeping under such conditions tended to induce more headaches, more circles under the eyes, more unsteadiness on the feet, more buzzing in the head during the day, and more irritation from ordinary things. Students said time dragged more, they were prone to laugh at common occurrences, had more desire to be alone and less to engage in conversation, and required more effort to start to do routine work. Early results indicated that the belief that one can get used to noises is erroneous, because the effects of the second week were more severe. Previous experiments showed that noise alone increased blood pressure during sleep.

*Conducted by Mr. Donald
A. Laird, of Colgate Univ.
Hamilton N.Y.*

Trinidad, Wash.
end of pipe line

1841 Lighted Cigarette

POPULAR MECHANICS Co. Ltd. 55

WHEAT CARRIED BY PIPE LINE
FROM FIELD TO MARKET

no further information

125 Pall Mall, London, S.W.1. Eng

Instead of hauling wheat eighteen miles over rough roads, several grain growers in the state of Washington send it from farm to railroad by pipe line. The grain slides through a one-inch galvanized iron pipe direct to the railroad station where sacking is done for some consignments, while in other instances wheat is run from the pipe directly into freight cars. Hauling costs about fifteen cents a bushel and the pipe-line method less than two cents.

ADJUSTABLE AIRPLANE WINGS
ARE CHANGED IN FLIGHT

Adjustable airplane wings whose thickness may be altered while the ship is in flight have been tested recently to demonstrate the inventor's claim that their variable angles facilitate maneuverability and control. Through a combination of adjustable ribs within the wing, controlled by turning a crank in the cockpit, the wings can be flattened for high-speed flying, or the angles increased by making



Removing Lighted Cigaret from the Coin-in-Slot Dispenser; the "Smoke" Is Ready in Five Seconds

READY-LIGHTED CIGARETS SAVE
USE OF MATCHES

Cigarets are sold ready-lighted from a coin-in-the-slot machine introduced in England. Within five seconds after dropping a penny, the cigaret is expelled into a convenient rack at the base. The apparatus is thoroughly protected against fire hazards.

METAL ALLOY FOR SMALL BOAT
IS LIGHTER THAN WOOD

Lighter than wood and impervious to sea water, a metal alloy known as "Birmabright" has been used with success by one English manufacturer in making small boats. The principal drawback to any kind of metal for small craft has always been that the parts must be so thin, to attain lightness, that insufficient metal is allowed for countersunk rivet holes or for welding. Enough thickness can be provided with aluminum, but it was found that this metal did not weld well for this purpose. The alloy has been used in building a sixteen-foot boat formed of three castings, and a twenty-two-foot craft built by a cast-framing system. One advantage of such boats is that they can be shipped in parts and assembled locally.



Adjustable Airplane Wing Whose Thickness May Be Altered to Increase Speed or Lifting Power

the wing section thicker for quick take-off, slow landing and added lifting power.

Rockeville Cirrus
Lyd. H. V. Rockeville
Los Angeles, Calif

217 A Mednick
no answer to letter

no U.S. agent known

The Birmingham Aluminum Casting Co. Ltd. Birmingham, England

Cont. Joseph B. Edgerton
Evening Star

1854 Washington, DC

1791
56

Roman Catholic at Prague
designed by Prof. J. Ševčík, Czechoslovak
Academy of Arts.



Thoroughly Modernistic Church at Prague Which, Except for the Crosses, Might Easily Be Mistaken for an American Factory

CHURCH LOOKS LIKE A FACTORY EXCEPT FOR CROSSES

Strikingly different in appearance from the conventional house of worship, a church thoroughly modernistic in design has been completed recently at Prague. The exterior of the structure might easily be taken for an American industrial plant, except for the glass-inclosed half-cylindrical column inside of which is the auditorium, and the crosses which surmount this section and a tower at the opposite end.

☐ A telephone that not only records a caller's communication, but also tells of the owner's absence and, in addition, can be used as a radio receiver, is the invention of a Swedish engineer.

no other refer.

GREATER FIRE RISK MAY RAISE PLANE INSURANCE RATE

Fire losses of airplane hangars and contents, which, during 1929, amounted to about \$690,000, jumped to approximately \$1,800,000 during the first six months of 1930, insurance statistics show. If the rate of increase continues, the cost of airplane insurance, which in the case of a small plane often averages seventeen per cent of the operating cost, may be raised even higher. Insurance companies have suggested that each airport designate an official as a safety engineer to enforce regulations against smoking in hangars, fueling of aircraft or motor vehicles there, and other uses involving fire hazard.

QUEER APPARATUS PLAYS COLOR

1840 MUSIC

Experiments in producing music or rhythm in a symphony of color, rather than sound, have been carried on for years with apparatus capable of repeating a limited number of colors in succession. Lately, however, there has been constructed in Prague, Czechoslovakia, a complicated mechanism, known as a kinetical light plastic, which permits the composition of colors in an arbitrary rhythm, thus making it possible to interpret musical notes in terms of shades of color. Probably the most curious and complicated part of the apparatus is the audio structure shown here.



Mrs. Prof. Ševčík, Mrs. Ševčíková and Mr. Ševčík

1864
 57

NO COATINGS KEEP WOOD FREE OF MOISTURE 188

Analysed 128 C. Effectiveness of Wood Moisture Resistance by Clearing Coatings in

While certain kinds of coating are more effective than others, none is able to protect wood completely from moisture absorption, the forest service has found after fifteen years of experimenting with all sorts of paints, varnishes, enamels and other materials. The tests showed that aluminum-leaf coatings mixed with paint or varnish were most effective, that a few asphaltic and bituminous paints had good moisture resistance and that the application of extra coats of spar varnishes gave better results. The addition of pigments to varnishes made them more resistant to moisture, the experiments revealed. The coatings were applied according to approved methods, and the results were tabulated.



Moving an Eight-Story Office Building Weighing 11,000 Tons; the View Shows the Structure After It Had Been Turned Around

EIGHT-STORY BUILDING MOVED BY EIGHTEEN MEN

Eighteen men recently moved an eight-story Indianapolis building weighing 22,000,000 pounds a distance of fifty feet in one direction, turned it around and rolled it a block in another direction to make room for a new structure. The building housed the general offices of a telephone company and 600 girl operators and other employees continued their work of answering calls as the building was moved. In the structure itself elevators ran, and gas, steam heat, water, electric power and sewage facilities were maintained through flexible connections. The average rate of movement was about fifteen inches an hour, but the occupants were unable to detect any motion.

SCHOOL GIRL'S FIGURE GUARDS PASSENGERS LEAVING BUS 1863

Children riding in school busses in one section of Indiana are protected from approaching traffic as they leave or enter the vehicle by the swinging figure of a school girl which projects from the rear of the bus on the left side. The brightly colored figure is four feet tall and bears a warning sign. When the bus is in motion, the warning is folded into the rear of the coach, and when it stops, the little girl is swung into visible position by a lever located in the driver's compartment.



Swinging Figure of Girl at Rear of School Bus Guards Children from Approaching Traffic

And J. C. Capinar, April 20 1903
 20 25 30
 Indiana Bell
 Submarine type cable here
 splices & telephone lines
 containing more than 200 ft. each

And Prof Esroyer Van Sluyin
 Supt. of School, Greenfield, Ind.

Strange Adventures



© J. Herbert Witham

By HAROLD T. WILKINS, *Esq.*

"A mountain guide has discovered thirteen skeletons lying in a gorge, near Remus, Switzerland, with rifles of an obsolete pattern lying alongside, where they are believed to have been for more than fifty years."—A recent news cable to London.

THIS grim story of a forgotten tragedy is one of a number of queer episodes and adventures in the strange happenings which daily befall Swiss professional Alpine guides and mountaineers, who, each spring and summer, rope themselves at the head and tail of a chain of tourists, hack steps in the snowy glaciers with their ice axes, and anxiously watch the visitors ascend the ice walls.

If the unfledged mountaineer shows he has not the "feel of the ice," and is likely to slip down to the edge of a dizzy precipice and imperil the lives of all, the guides hang on the taut rope, and carefully lift the amateur from one step to another, till he reaches safety on the sides of Schreckhorn or the icy Dent Blanche. The guide daily risks his life to give his party pleasure, or goes out of his way to save some climber in distress.

One famous guide recently told a story of a nightmare adventure he had when crossing alone a desolate and unfrequented glacier in the eastern Alps. He slipped and fell into a tremendous crevasse—an almost bottomless chasm in the ice. Luckily, a ledge caught him and broke his fall. When he recovered from the shock, he first congratulated himself on having no broken bones.

"I knew it was worse than useless to shout for help" he said. "Nobody ever passed that way;

for it is out of the usual track of summer visitors who climb the passes above the snow line. It was as though I lay at the bottom of a shaft in a very deep mine. Far, very far above me, I dimly glimpsed a pen point of blue sky. In desperation, I set to, and cut steps with my ice ax in

Colombiere 29 Beau Road, Derby Heath, Nr. London, Eng.

of Alpine Guides

the slippery walls of the crevasse; but I could get no foothold. Each time I tried to step up, I slipped back nearer to the chasm yawning under the ledge. I gave it up, and sat down in despair. Hours went by. All the food and drink in my rucksack was gone. I must have dozed off with the fatigue and worry. Suddenly I woke with a start. Voices sounded above. I yelled for aid. The blue patch at the top was blotted out. Somebody looked down. The head was withdrawn with a faint and encouraging shout. Soon a rope slipped down toward me. I clutched it and slipped the noose round my shoulders. Then I must have fainted; for when I came to, I was lying on the mush in the hot sunshine while someone poured brandy down my throat. With his three guides,



Top Photo Courtesy J. H. Witham; Lower, Courtesy P. Dressfuss

Above, Swiss Guide Exploring the Interior of a Crevasse in a Glacier to Find Bodies of Missing Climbers, and, Below, Alpine Party on Top of Crag in Gastlosen Range



Courtesy F. Rohr

Guides and Party Ascending a Peak in the Weisshorn Ridge of the Monte Rosa Alps; a Long Climb Is a Series of Separate Feats like This, Many of Them Hazardous

an English traveler, luckily for me, chanced to be crossing the lonely glacier, when one of the guides saw my alpenstock lying in a niche of the ice."

The Matterhorn's peak, 14,750 feet high, in the southern Alps, is famous for thrilling escapes and tragic happenings. The first English party to climb the Matterhorn were a well-known Alpine climber Edward Whymper, Lord Francis Douglas, a Mr. Hadow, Mr. Croz, Mr. Hudson, and two Swiss professional guides, father and son, named Taugwalder. Thousands of feet up, at the tail of the train, Hadow slipped on the ice and fell against Croz. Both men lost their balance, and dragged down Lord Douglas and Mr. Hudson. The taut rope snapped under the strain of the four bodies, leaving the guides and one Englishman safe at the head of the train. Hurling through the frozen air for 4,000 feet, the bodies of the four climbers smashed onto the Zermatt glacier below.

Herr Biner, well-known today as a

Zermatt chief guide, who, although only thirty-two years of age, has climbed the Matterhorn seventy times, speaks with a shudder of this tragic event which happened in the days of his father. He himself tells a story of a terrible adventure which befell him recently on another famous Swiss Alpine peak, the Dent Blanche.

"Along with an Englishman, I was caught in a howling blizzard on that peak, and for five or six hours, we battled on in the semidarkness. We stumbled on and struck a donkey-back ridge or col. Here, to save ourselves from hidden perils, we straddled the ridge like a horse's back. When the snow let up, we saw we were straddling a sort of tight-rope mount, on the tip of a precipice with a sheer drop on each side down to a glacier about 4,500 feet below! I started to hack out steps in the ice, but desisted when I found that every blow brought a dangerous shower of rock, stones and ice. To make matters worse, an electric storm broke, and for a

1607

long time the flashes played round that ridge. The Englishman slipped and fell, and I was obliged to slip over on my side of the ridge, to balance his weight, and save him from a fall of 4,500 feet. When we got back into the saddle again, we wormed our way painfully along till we reached a rock flank, or neck. I pushed him under a rock, and lay above him to keep him warm. A snowstorm buried us but when morning light broke, we crawled out of our cave to the safety of a hut close to a near-by glacier."

Another Swiss guide tells how he was one day, recently, summoned to the aid of climbers in distress on Mont Blanc. "M. Thoret, the pilot of the Air Union, was tak-



Courtesy Emile Gos

Above, the Matterhorn, the Waterloo of Many Climbers, and, Below, a Guide in a Mountain Hut

ers waving their handkerchiefs to him at the end of ice axes. He flew back to Chamonix airdrome, painted under his wings, "Don't move; help is on the way," returned to the peak where the climbers were marooned, flew low so that they could see him, and then rushed back and telephoned to us from the airdrome. We reached the two climbers, who were badly injured, and with great difficulty got them on our backs and carried them to the Torino hut, on the Col du Geant."

BEACON USED AS SCARECROW

To protect rice fields in Arkansas from wild fowl, experiments have been made with an airplane beacon. The brilliant light is calculated to frighten wild geese and ducks over a radius of several miles. Both red and white rays have been tested.

ing people for flights over the highest peaks in Europe when he saw these climb

My times 11/2

1861

Stuttgart, Ark.

*Arkansas Paver & Light Co
on farm of C. Cox, south*

1832



Spectrograph Apparatus at Northern Lights Observatory at Tromsø, Norway, Which Splits the Colors of the Northern Lights so That This Phenomenon Can Be Subjected to Study

NORTHERN LIGHT OBSERVATORY IS NEAREST THE POLE

To photograph and study the northern lights, an observatory has been constructed at Tromsø, Norway, through contributions from the Rockefeller fund and the Norwegian government. It is the farthest north of any observatory and is equipped with a spectrograph which splits the colors of the northern lights so that they may be subjected to scientific study.

GOLF SCORER ON CLUB SHAFT SAVES USING CARD

Easily attached to the shaft of the putter, a scoring device, consisting of two numbered metal strips that are turned about in grooves, simplifies the task of keeping a record of the strokes. When the total score reaches a number of two digits, the second strip is brought into use. Both are aligned with a white mark. The scorer does not interfere with play, is instantly



adjusted and the numbers are not likely to become disarranged by accident, although they can be turned with little difficulty. The base of the scorer is of a flexible material and is split so that the unit can be slipped on the club shaft.

OXYGEN BUBBLES FROM PLANT 1850 FATAL TO MOSQUITOES

Oxygen, usually essential to life, is fatal to mosquitoes in the wiggler stage, it has been found at Cornell University. The discovery introduces a bottom-growing plant, called chara, which gives off minute bubbles of oxygen. In pools of water where chara was growing, no mosquito larvæ were found, while others that contained no chara were prolific breeding places. It was thought that the oxygen produced by the plant might be responsible, and to prove it, mosquito larvæ were placed in jars filled with water. Oxygen bubbles were admitted to some of the containers, while the others were left undisturbed. In a few days, the larvæ from the jars without oxygen emerged as mosquitoes, but all in the other jars had died.

Germany uses motor engines at small stations to expedite the rearrangement of freight trains.

1824

Hugo Hahn
6030 City Hall, Chicago

Dr. Robert
Macherson and
E. N. Heinman

Attaca NY
Herald Tribune 11/2/30

11/5/30

ANIMAL TESTS TO GIVE FACTS FOR TRIPS IN ROCKETS

1895

Experiments on animals in large and small gravitational fields have been suggested as a preparation for travel through space to other planets by Dr. John O. Stewart, of Princeton University. Doctor Stewart suggested tests with animals or even men in a rotating cage where centripetal acceleration would simulate gravity. It has even been suggested, he added, that such a cylinder in a space ship might provide the passengers with an artificial gravitational field so the crew could work under normal conditions.

Associate prof. astronomical physics

WOODEN RAILROADS IN FOREST GIVE ACCESS TO TIMBER

1821

Wooden railroads, costing about one-tenth as much to build as a first-class highway, are being constructed into the forests of Oregon to give cheap access the year round to the lumber regions. These roads, with rails made entirely of wood, have been found to reduce the cost of transporting timber from \$3 to 50 cents a thousand feet. Under the old system, lumber could be hauled over gravel roads only about three months out of a year, while under the new, it can be transported the year round. The construction of the road is extremely simple. The bed is prepared as for an ordinary dirt road, and the ties are placed directly on the ground.

Arnold Auto Rail System



Wooden Railroad Cheaper than a Good Highway Built into the Timber Regions of Oregon

at Junction City Ore.



Portable Oxygen Apparatus Particularly Suited for Parachute Jumps from High Altitudes

PORTABLE "LUNG" FOR FLYERS TO AID HIGH FLIGHTS

Weighing but fourteen pounds, a portable oxygen apparatus that has several improvements over the usual units of its kind, is said to function so efficiently that flights to altitudes of at least 40,000 feet can be made without undue hazard or difficulty. Because of the lightness of the outfit, it can also be employed by parachute jumpers from great heights.

GREASED MOUNTAINS FORMED LANDSCAPE OF OREGON

1880

Lubricated mountains which have slid considerable distances to form a topography of great magnitude have been found by geologists in the John Day river area of interior Oregon. In one place great masses have moved toward the river, producing landslide pockets and lakes because the Columbia river lavas, hundreds of feet thick in places, poured over the John Day river clays, a formation easily softened by ground water. These clays then acted as a lubricant over which the heavy Columbia lava slid.

found by Dr. Edwin J. Hodge, Geologist, U.S. of Oregon.

Science Service news Bulletin 11/7/30 no. 502. B

Balloon perfected by

18 3/64

A. J. Isadore

POPULAR MECHANICS

3504 and 6, Chest St
St Louis, Mo



Jumping Balloon Whose Buoyancy Counterbalances Weight of Occupant, Allowing Him to Leap for Great Distances

OCCUPANT OF LEAPING BALLOON WALKS ON WATER

Probably the nearest approach to the seven-league boots of fairytale fame is offered by a jumping balloon, the invention of a California man. The balloon is so designed that its buoyancy can be made to counterbalance almost exactly the weight of the occupant, thus enabling him to walk, or more exactly, to jump, on water, with the aid of a staff, equipped with a buoyant ball, for propulsion.

BLOODSTAINS ARE SEEN AS AID IN CRIME DETECTION

A German expert is working on a way by which bloodstains may be classified as an aid in crime detection. For instance,

Veteran's Bureau
U.S. Daily 4/4/30

if the stains on the clothing of a suspect could be proved to be the same as the blood of the victim, the evidence would be considered important. Courts have recognized scientific tests to determine whether bloodstains were made by human blood or not, but so far, there has not been introduced a successful test which will accurately determine the blood group of stains that have become thoroughly dried. In certain European countries, it is now customary to determine the blood groups of persons concerned with crimes involving wounding, as such evidence is regarded as valuable even though stains cannot be positively identified.

AUTOISTS' DANGER AGE IS THE TWENTIES

Analysis of automobile accidents in California during the first six months of 1930 showed that drivers with two or more years experience figured in the greatest number of accidents. More than 12,000 drivers figuring in over 14,000 accidents had two or more years of driving to their credit. The "dangerous age" for motorists appeared to be from twenty to twenty-nine years, with 5,296 drivers in accidents in this age class. Drivers from thirty to thirty-nine came next with those from forty to forty-nine following.

U.S. Daily 4/4/30

BANDSAW WITH FIVE WHEELS TAKES LONGER BLADE



Fitted with five wheels instead of the conventional two, a bandsaw is now offered with two advantages over the ordinary kind. It accommodates a much longer blade

which will not dull so quickly, and a recess enables one to cut a wide board of great length squarely into two pieces.

Yates. American
Machine Co.
Bellevue, Wis.
Copyrighted material

Demonstrated at Venice, Los Angeles
Pat. # 1781,506

Summary of motorist studies

1778

**THREE-DIMENSION MOVIES SEEN
 IN PROJECTION PROCESS**

Successful stereoscopic motion pictures are still in the development stage, but a projection process recently demonstrated with still pictures suggests a way in which movies may achieve the full three dimensions in the future. Dr. Herbert E. Ives, of the Bell telephone laboratories, has explained the method which he and associates have developed. On the film are embossed narrow vertical ribs like those used on the amateur motion-picture color film. These ribs act as cylindrical lenses, directing the light, while the screen is made as a series of vertical glass rods and the picture is displayed from the back. Persons looking at it from the front obtain a true stereoscopic effect due to the action of the light from the film and through the glass screen. The method at present is not suited for motion pictures.

1767

**RADIO SET IN DELIVERY WAGON
 FOR CUSTOMERS' BENEFIT**

For the benefit of his customers, the driver of a bakery wagon in Buffalo, N. Y., has equipped the horse-drawn vehicle with a radio-receiving set. When he solicits orders, he also supplies his customers with the latest news flashes.



Bakery Wagon Equipped with Radio so the Delivery Boy Can Tell Customers the Ball Score

Conr. Elmer M. Hill
 139 Knowlton Ave
 Buffalo, N.Y.



Glass Window, Used Instead of Mesh Screen in Visitors' Room in Jail, to Stop Smuggling

**GLASS REPLACES JAIL BARS
 TO STOP SMUGGLING**

Plate-glass windows instead of the usual steel screens are used in the new Pasadena, Calif., city jail in the visitors' room to separate the prisoners from those who come to see them. Conversation between the prisoners and visitors is carried on through perforations in the steel wall below the windows through which they gaze at each other. These perforations are so arranged, however, that not even a pin can be smuggled through from a friend to a prisoner. Smuggling to prisoners was one of the hazards always faced when the screens were used in the visitors' room.

1782

FISH SCALER LIKE HAIR CLIPPER

Operated by a tiny electric motor, a machine that automatically removes the scales from fish has been invented by the head of a Florida fishing company. The scaler works somewhat like a hair clipper, slicing the scales from fish of any size as it comes in contact with them.

Japan has sixteen floating canneries for handling of crab meat.

Chas. Frank Welles.
 head of a fish company
 in Pensacola, Fla.

Broadway and Holly Sts.

Walter W. Max, Hall Baking Co., 231 Pittmore Ave.

Science Service 501-03 10/28/31

U.S. Daily 10/22/30.
**OUTPUT OF AUTOS AND WAGONS
 REVERSED IN FEW YEARS**

1779 Automobiles and horse-drawn vehicles take reverse positions on the production scales after a period of twenty-five years. In 1904, nearly 2,000,000 horse-drawn vehicles with a value of more than \$97,000,000 were manufactured, while only 199 automobiles were produced in this country. Last year, the total automobile output was 5,300,000 of an uncomputed value, while 122,734 horse-drawn vehicles, valued at \$10,323,535, were produced. The number of two-wheeled carts, farm trucks and public conveyances drawn by horses increased during the last year, and one of the features of the industry is that there is an increasing demand for more expensive hand and push carts.

**SILO LIKE A VACUUM CLEANER
 IS FILLED BY SUCTION**

1728 Operating on the same principle as a vacuum cleaner, a silo of galvanized iron, invented by a French engineer, is filled by suction. An electric or gasoline motor is connected with a tube which sucks the hay or other material to the top of the silo, then drops it inside. By this method a silo of ordinary size can be filled in half the time formerly required.

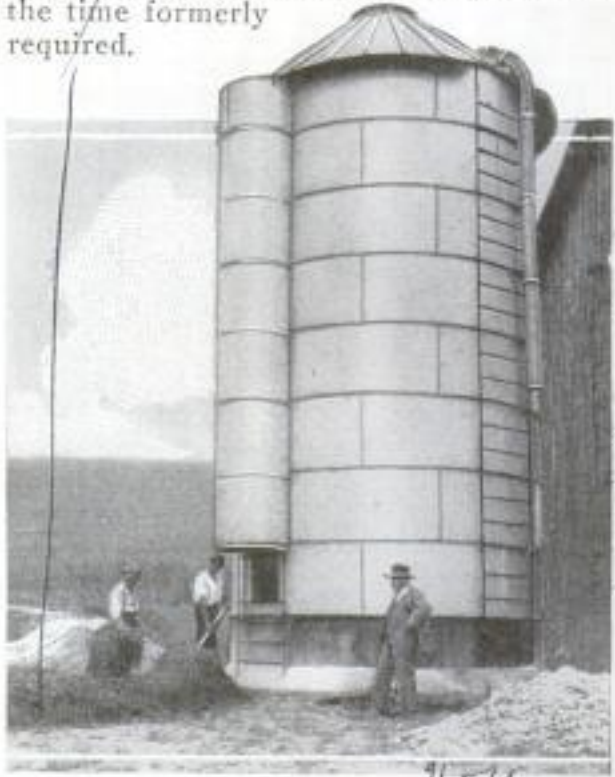

Galvanized-Iron Silo Filled by Suction, the Ensilage Being Drawn through a Pneumatic Tube

W. Esautier

Copyrighted material



Courtesy Bell & Howell
 Taking Movies of Football Formation While Coach Comments on Voice-Recording Machine

**"TALKIES" OF FOOTBALL GAME
 HELP IN TRAINING**

Athletic coaches have used motion pictures of football games for some time to analyze various formations and instruct the players, but this season, an advanced step was taken by L. W. St. John, athletic director of Ohio State University, who hit upon the idea of making a voice record as the movie was being filmed so that a more faithful description of the plays might be given. While the pictures were being taken, St. John dictated his comments, play by play, to a voice-recording machine commonly used in offices. A transcript of his story was then made in duplicate and read at the showing of the films, so that every player concerned could better understand the comments on his particular performance and the analysis of the plays. The cameras were run at a speed to make thirty-two exposures per second, semi-slow speed so that the movements could be studied more accurately. Movies are also being used to determine the best ways to teach runners and how they may improve their technique. In this case high-speed cameras were used and over 2,000 pictures studied.

E.A. Morrison, Eastman
 Teaching Film, worked with
 W.D. Jenni

16 mm. movie
 Camera

Football pictures made by
 Lorenzo Barber at N.W. Ohio State
 game at Lynch stadium

A Fishing Fleet

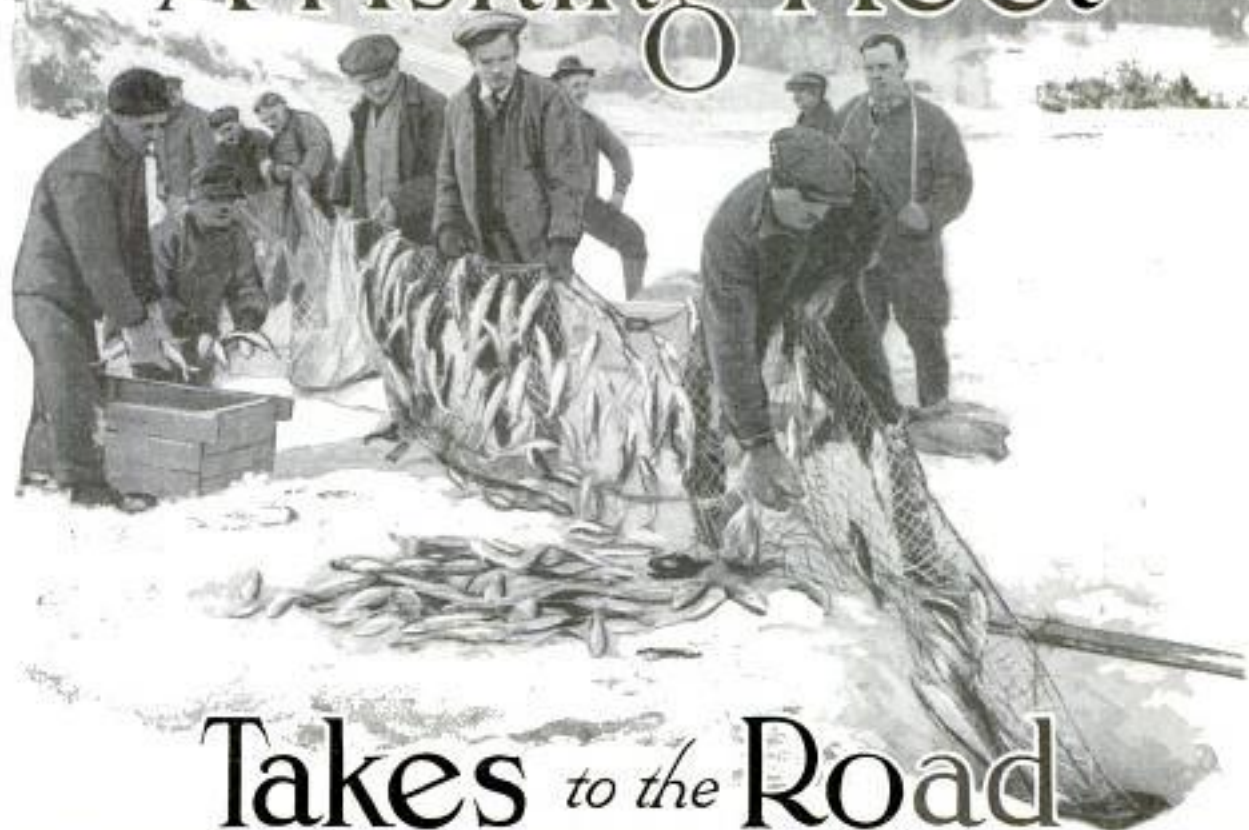

Takes to the Road

Sunday Visitors Giving a Herring Fisherman Aid in Hauling a Large Catch through a Hole in the Ice; Huge Quantities of the Fish Are Caught during the Winter

IT WAS early in the morning when an automobile dashed up to the buildings of a wholesale fish dealer in Duluth, Minn. Obviously the man at the wheel was in a hurry as he leaped from the car and rushed into the office.

"I want two more gill nets and I want 'em quick," he shouted to the clerk. "Got to get 'em set before dark. The herrin' have started runnin' by my place. Send out fifteen extra fish boxes on the mornin' load. Give me floats and leads for the nets, too, and let me get goin'."

Ten minutes later the nets were stowed in the rear of the car and the fisherman was speeding back toward his place seventy-five miles up the north shore of Lake Superior. In less than three hours, he was in his sheds making the nets ready for the water. Before dark, he had taken them in his outboard motorboat to the banks nearly a mile off shore and set them. The next morning they started to give a return on his investment.

That incident is characteristic of the speed of the unique business that has de-

veloped on Lake Superior's north shore—probably the only completely motorized and the swiftest-moving fishing industry in the country, if not in the world.

A few years ago, that fisherman would have been lucky to get his nets within ten days. He would have had to wait for the fishing tug that called once a week for his shipments—salt fish in kegs during the summer and frozen fish in gunny sacks in the winter—given the skipper the order and got along with insufficient equipment until the return of the vessel.

But now things have changed. The first twenty-seven miles of his homeward journey is over a broad concrete road running from Duluth to Two Harbors. For all practical purposes it traverses the very back yards of the fishing folks, who put out from the land in their small boats to set their nets and bring in their catch. And that means that the new road is giving commercial service to nearly a thousand families who make their living from the waters.

So, now, instead of a weekly, slow serv-

1594
68

POPULAR MECHANICS



son and his wife. Jans fished from French river, about halfway between Duluth and Two Harbors. He awoke one morning in December to see scudding clouds flying before a northwester and a hint of snow in the air. He must pull his nets quickly to land the night's catch. Even with the aid of his outboard motor, he knew that one man could not hope to handle a boat in that

ice, the fishermen are able to get supplies and market their fish daily. For the sluggish fishing boats have given way to a fleet of more than forty swift automobile trucks that act as a mother fleet to the small craft of the fishers. They leave Duluth and Two Harbors loaded with supplies, boxes, kegs and ice, and are back in a few hours loaded with fish fresh from the icy waters of Superior.

Trout, whitefish and herring, taken from the lake in the morning, can be delivered in Duluth by noon, in St. Paul and Minneapolis that night, and in Chicago the next morning. A few hours after that they are in the markets of other large middle-west cities, virtually as fresh as when taken from the water.

But the motorizing of the north-shore fishing industry hasn't taken the thrill and adventure out of the business. The motor trucks of the rival wholesalers race for market with just as much at stake as when the fishing schooners race in from the Grand Banks of the Atlantic. And still, as always has been and, perhaps, always will be, the heart of the industry is the man in the small boat. And when men take to the tossing waters in little craft, they are bound to meet with high adventure.

There was the experience of Jans Ever-

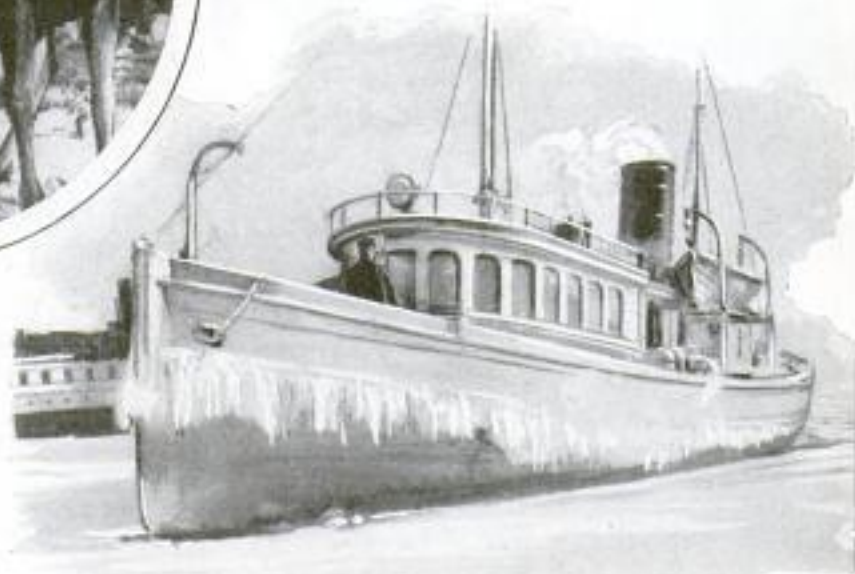

Calf Moose, a Pet of One of the Fishermen's Families, and Tug Plowing through Canal at Duluth for Winter Anchorage

son's partner was away. His wife volunteered to go with him. Hardly had they reached the net buoy, when the wind rose higher and the blizzard closed in about them. They abandoned their efforts to lift the net and started back. Their motor started, then coughed and stopped, nor could they get it going again. Each put out a pair of oars and tried to row in, but their strength gave out before they could cover the mile of wild water between the buoy and the shore.

They had to give up and let the craft fly before the storm. When, a few hours later, they brought up against a heaving ice pack on the south shore of the lake—twenty miles wide at this point—the wife was overcome by the cold and unconscious, and feeling had almost left Eversson's hands and feet. By this time the temperature was down nearly to the zero mark. Summoning all his remaining strength, he forced the boat through the ice cakes and finally made the strip of firm ice along the beach, already beginning

1769

to crack from the force of the waves. The struggle across the ice to the shore must have been a terrible ordeal, but Ever-son remembers little about it. A few hours later, a woodcutter, returning to his shack, found them lying in the snow, the fisherman's unconscious form across that of his wife, where he had fallen when the last of his strength ebbed away. It was several days before they could be gotten to a physician, but both lived to return to their north-shore home.

Fast transportation has added a new item to the harvest from the waters—iced fresh fish. Seldom a week, from the middle of March until late in December, that the fishermen of the north shore do not send out from 1,500 to 2,000 boxes of fresh fish, each box containing 100 pounds. Modern refrigeration makes it possible to ship the catch in perfect condition as far east as Pittsburgh, west to Denver and south to St. Louis and Kansas City.

BLOCKS USED INSTEAD OF LOGS TO CONSTRUCT CABIN, 1733

Logs have been sawed into eighteen-inch lengths instead of being used as entire units in the construction of an attractive cabin. The blocks are firmly set into mortar and form an interesting design somewhat resembling that produced by the use of uncut stone.



Blocks Sawed from Logs and Set into Mortar Form the Walls of This Attractive Cabin

Built by Henry Wood
New Palestine, Ind

BUILT-IN TOOL CHEST FOR AUTO FITS BEHIND TIRE RACK



Tool Chest Built into Body of Auto; the Spare-Tire Rack over It Makes It Invisible

Containing virtually every tool that might be required to repair any part of the car, an automobile recently exhibited in London has a tool chest built into the body. The tools fit into receptacles in a recess behind the spare-tire rack. When the rack is in place, the receptacle is entirely concealed, but when the spare is removed, a complete set of equipment for repairs is available in handy form.

PHOTOGRAPH LIKE BAS-RELIEF GIVES LIFELIKE EFFECT, 706

Some of the beauties of sculpture are being applied to photography by a special process which gives the illusion of a third dimension to a picture, causing the hair, features and form to stand out in bas-relief. Such photographs, in which the dimension of depth appears to be added, are called "sculptographs" and can be made from ordinary pictures, or even from snapshots.

Potem-poles of the American Indians were monuments to their dead and were not their idols.

Studio of Third Dimension Photography, 810
Copyrighted by [illegible] Chicago

Rolls Royce at Annual show

*my 95 m...
my 95 m...
my 95 m...*

*5 x 7 - \$7.50
5 x 10 - \$10.50*

177
709



Gun That Fires Tear-Gas Bomb, and One of Cartridges Used to Dislodge Barricaded Fugitive

TEAR-GAS GUN USED BY POLICE TO CAPTURE FUGITIVES

Guns that fire tear-gas bombs have been made a part of the equipment of the Los Angeles police. The weapons can be used to disperse rioters, but are intended particularly for dislodging fugitives who may barricade themselves in a building and threaten the lives of assaulting officers.

MAN-EATING TREE ONLY MYTH INVESTIGATORS FIND

Stories of a man-eating tree in Madagascar which obtains its nourishment by capturing and devouring human beings have been found by investigators to be without foundation in fact. The tales of man-eating trees are based on a letter written in 1878 by a traveler in Madagascar, who said a native tribe on the island worshiped a devil tree whose trunk was eight feet tall and resembled a thick pineapple standing on end. Huge leaves hung from the trunk like doors swung back on their hinges, and at the apex was a receptacle filled with an intoxicating fluid. Long hairy tendrils stretched out from

1806

The Pathfinder
quoted in Herald-Tribune
10/28/30.

the receptacle, and swirled and twisted upward in constant motion. The traveler said he saw the natives compel a woman to mount the cone and drink of the liquid, after which the tendrils seized and held her fast as the doorlike leaves closed and crushed her. Members of the Marshall Field anthropological expedition investigated the story, and while the tale of the tree was widely circulated, its location was never specified and no basis was found for a belief that such a plant ever existed. However, there are certain tropical trees that are very poisonous, and plants, such as the pitcher plant, entrap and consume insects, while in London there is exhibited a plant from India which consumes exceptionally large insects and even mice.

QUEER CLOCK TELLS THE TIME BY CHANGING SPOTS

A dog that tells the right time was exhibited in New York recently. It is a mechanical affair so arranged that white spots register what the hands on an ordinary clock reveal. The spot on the left indicates the hour and those on the right, the minutes. At the time the accompanying photograph was taken, the time was fifty-three minutes after one o'clock.

white - \$25.00. Black - \$28.50



Palmer House
Arcade 14.

Clock Shaped Like a Dog, Which Registers Time by the Changing White Spots in the Eyes

Blaine Krömer
Quaide Paris, importer
737 N Michigan

GROUND CATAPULT GIVES AIRPLANE FLYING START

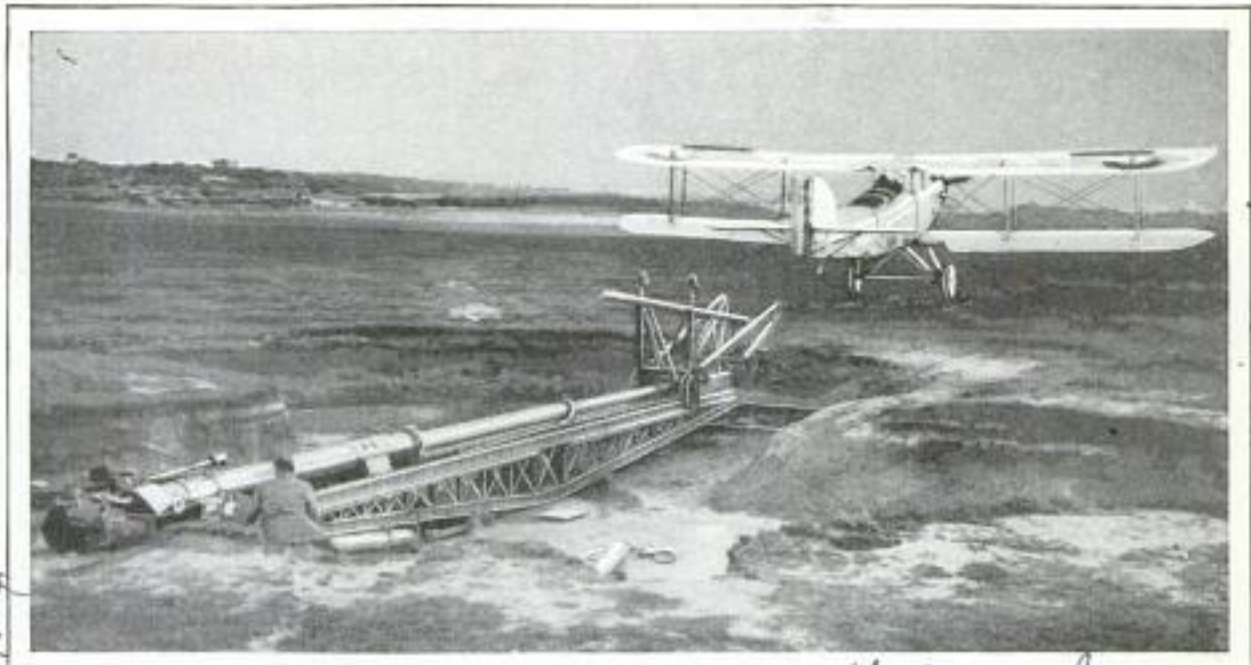

Airplane Being Launched into the Air at Flying Speed from a Ground Catapult; with This Apparatus, the Ship Needs No Long Runway to Gather Speed before a Take-Off

Wide World

Experiments with various types of airplane catapults are being conducted in England by the British royal air forces. One such device that has been tested consists of a metal framework from which the planes are launched into the air at flying speed. With this apparatus a ship is able to leave the ground without a long runway and can be launched in a region from which a take-off otherwise would be impossible.

Control of the propulsion machinery, one in the engine room of the tugboat, one in the pilothouse, and the third on the bridge of the car float.

SAFETY DOOR LOCK ALSO ACTS 1984 AS BOTTLE OPENER

Easily adjusted, a steel guard for the door lock fits on the inside of any hinged door to prevent its opening from the outside. It consists of two flat pieces held together by a short chain. One slips into the lock socket of the door and the other is fitted into any one of three slots provided. This part of the guard can also be used as a bottle opener. The device can be carried in the pocket or traveling bag and is always ready for use. No bolts or screws are needed.



PILOTLESS TUGBOAT IS RUN BY REMOTE CONTROL

Guided by remote control from the bridge of a boat in tow, an electric tugboat is being operated on the St. Lawrence river to tow car floats. An electric connection is made between the car float and the tugboat, and the pilot controls steering and all operations of the machinery on the tug from the float. The remote-control system was necessary because the tugboat is so small compared with the float, that a pilot on the tugboat was unable to see well enough to control the movements of both craft. The steel tugboat is 120 feet long and propelled by Diesel-electric drive. The steel float has a capacity of twenty-three cars. Three operating stations are provided for con-

Write our Bureau of Information, if you wish to know who makes or sells any article described in this magazine. Send no postage; the service is free.

Hammond Co. 305 Old Colony Bldg. Chicago

General Electric Co. Schenectady, N.Y.

Owned by Canadian Pacific Car & Passenger Equipment Co. + Passenger Prescott, Ont.

Albert B. Grenard, Ph.D. 1524 Chestnut St. Phila.

not in use. 5/10/31

American Shipbuilding Co. Schenectady, N.Y. Cleveland, Ohio.

17 44

Cont. Hon. Eschmann.
55 W. 86th St. New York

The World's Most



One of the Finest and Largest Yachts Afloat, J. P. Morgan's "Corsair"; It Cost Approximately \$3,000,000 and Is Luxuriously Equipped in Every Detail

FIVE THOUSAND North American yachtsmen went down to the sea in their own ships last year, carrying the emblems of 750 yacht clubs to every maritime nation on the globe. The princely sport of yachting adjusts itself to the most fabulous fortune.

There are half a dozen private yachts whose annual upkeep exceeds \$300,000. J. P. Morgan's 343-foot "Corsair" probably will have cost her owner a cool half million by her first birthday, March, 1931; her original cost was about \$3,000,000.

That sea yachting is now becoming a major American industry is shown by the fact that about 100,000 people are directly concerned with it. In five years, yachts in American waters have increased 150 per cent. And during 1930, when the country stagnated under financial depression, yacht building doubled. A single company was filling \$19,000,000 worth of

orders as against \$1,000,000 a few years previously.

These figures shake the faith of pessimists. The American is not content merely to earn money; he seeks ways of spending, too. And he is not content with being a landlubber; he craves sea adventure, but comfortable adventure. And so Yankee palaces are cruising to the ends of the earth, supplied with victuals and luxuries that were formerly the attributes only of monarchs.

About the strange whims of yachtsmen, stories are legion. But the most famous one concerns Henry Ford. His 202-foot yacht, the "Sialia," was too short; he wanted twenty-one feet added. So he summoned an architect and gave instructions. The "Sialia" was literally sawed in half, and a new section placed into her beam. Well satisfied with twenty-one

Costly Sport

more feet of sea room, Mr. Ford paid \$650,000 for the operation, which was \$50,000 more than the "Sialia's" original cost. The new section cost about \$30,000 per foot. Soon Mr. Ford tired of the "Sialia" and placed her on the market, but yachtsmen were wary, fearing she was not seaworthy. At length, she was sold.

Used yachts are sold for from \$50,000 up to \$2,000,000. The broker's



Courtesy Henry J. Gielow, Inc.

"Migrant," a 225-Foot Schooner, and Bronze Figurehead of the "Hi-Esmaro"

commission is seven per cent. In the long run, this is the most economical way to buy a floating home, for with proper care a yacht will last many years, allowance for replacement of movable parts, of course, being made. Astute sportsmen pick up some real bargains through brokers. Thus, A. M. Andrews bought Henry Ford's \$1,250,000 yacht for one-fifth that price.

A recent improvement in power yachting has been the change from steam to Diesel propulsion. For yachts below 200 feet, this change has brought so many advantages that no one would think of building a steam yacht that size any more. High-speed Diesels actually have increased a yacht's cruising range six times. Formerly 1,000 miles was considered a high range, but modern Diesel yachts cruise easily 6,000 miles. And the largest motor-driven pleasure boat ever built in

1744

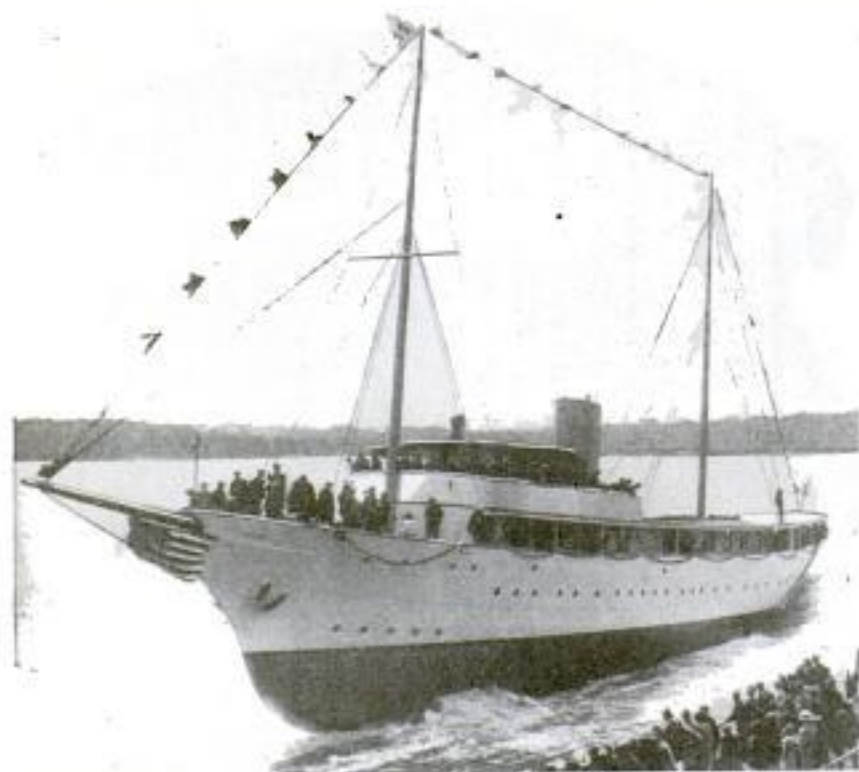

teen knots and high speed between fifteen and sixteen knots. Save in storms, she does not have to slow down to plow through heavy seas. Her stabilizers reduce roll and vibration.

Communication between different parts of the ship is by telephone. An automatic elevator carries passengers between decks. Electric refrigeration plants preserve foods at desired temperatures. Every part of the vessel can be ventilated, heated, chilled

the United States, "Hi-Esmaro," can almost travel around the globe without refueling. Her cruising range is 20,000 miles. With a reduction in size and weight, the Diesel engine makes it possible to increase a yacht's accommodations without lengthening her hull. Thus the 120-foot Diesel yacht offers as much usable space as the old 150-foot steam yacht. For a yacht as large as J. P. Morgan's "Corsair," a turbo-electric drive has been found most efficient.

Until recent years, the hull design in power yachts followed the design of sailboats. But with new power plants, architects can design fuller hull forms without sacrificing speed or efficiency. This means greater fuel-carrying capacity and steadiness in rough seas. An ultra-modern yacht employs gyroscopes for automatic steering. In foggy weather, her captain relies on a radio direction finder. Her cruising speed is about four-



Interesting Views of Two Launchings; Above, the "Placida" and, Below, Carl Tucker's "Migrant"

and lighted. The main deck may have a tennis court. The ship has a laundry for milady's finest lingerie, as well as for table linens and ordinary wearing apparel. Bathrooms are lined with tile. Staterooms, corridors and public rooms are expensively carpeted. Wall finishings may be fine stone, stucco plaster, mahogany, sandalwood, teak or oak. The main

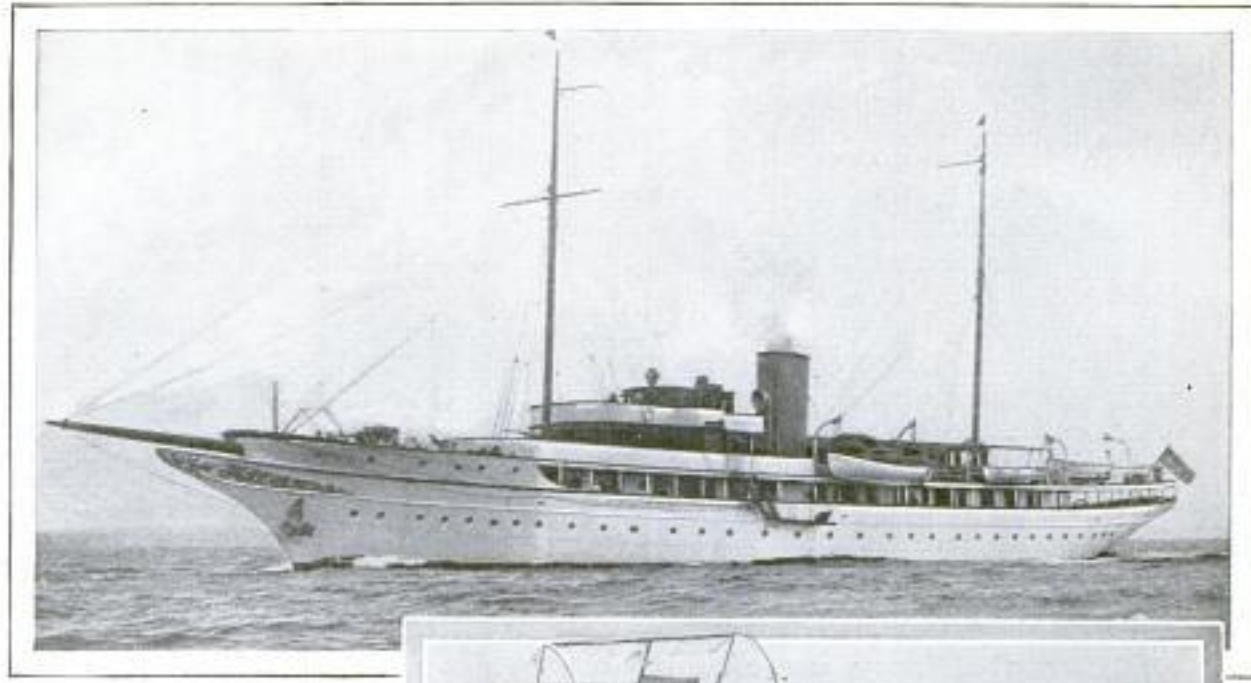

Another View of the "Hi-Esmaro," Motor-Driven Yacht with Long Cruising Range, Owned by H. Edward Manville; at Right, View on Board the "Frolic III," Express Cruiser Owned by Walter P. Chrysler, and, Below, the Luxurious Smoking Room of the "Cambriona," the Property of W. O. Briggs of Detroit; the "Frolic III" Has a Speed of More than Twenty-Eight Miles an Hour and Is Seventy-Five Feet Long.

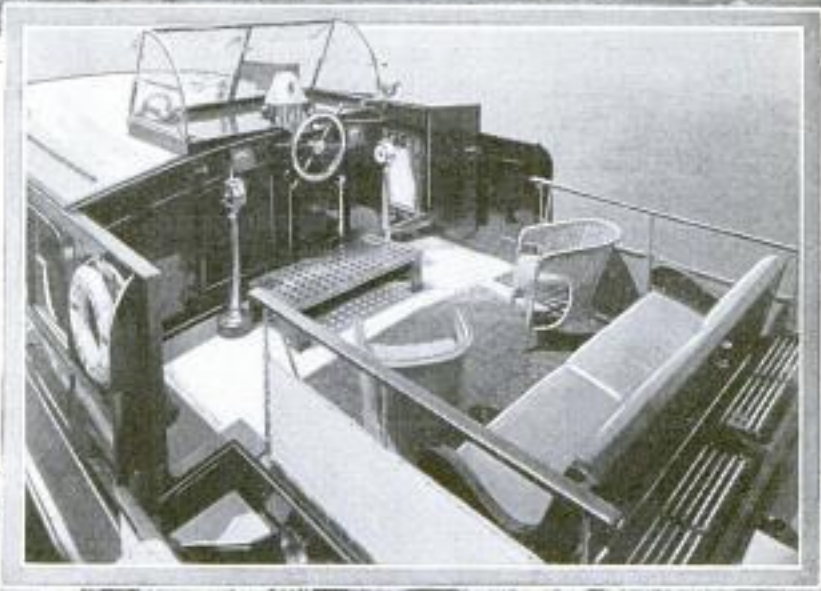

Lower Photos Courtesy John H. Wells, Inc.

saloon has a wood-burning fireplace. Entertainment is offered by radio, pipe organ, or a stewards' orchestra. The dining saloon may be converted into a ballroom. The ship carries her own evaporation and filtration plant for making drinking water from sea brine. Her wireless keeps in touch with the world's news.

Aside from mere recreation, the private yacht has been found to be the ideal refuge for business. In quiet and freedom from disturbance, commerce and finance can be discussed to the exclusion of all else.

More wealthy yachtsmen are pursuing exploring expeditions. Recently, W. K. Vanderbilt's "Ara" returned with a cargo of zoological trophies collected on a world cruise. Cornelia Crane's "Illyria" is exploring the Pacific ocean for the Field Museum of Natural History, and Julius Fleischmann's "Camargo" has undertaken to find the missing link in anthropology.

The Galapagos islands, off the South American coast, have been the haven of yacht explorers. Vincent Astor visited the islands with a staff of scientists in his "Nourmahal."

Eldridge Johnson, former president of Victor Phonograph company, will soon take a party of scientists to Easter island in a 265-foot yacht especially built for exploration.

To build a yacht below eighty feet costs about \$1,000 per foot. Above eighty feet, the cost runs up to about \$4,000 per foot. But seaworthy eighty-foot yachts can be picked from a broker's list for about \$50,000. Such a yacht would carry a crew of five: a captain, paid \$250 per month; engineer, \$175; two sailors at \$85, and a mess boy at \$80. Uniforms for the crew would cost about \$625 per season; insurance about \$1,500 per year, and winter storage about \$900. Fitting out, drydocking and such charges would total \$1,500.

Food for the crew would cost \$225 per month, and food for the owners \$3.50 per day per person. Two 100-horsepower engines would burn twenty-five gallons of fuel per hour. The season's lubricating oil would cost \$100, and all other incidentals \$500. Thus the season's operating budget would about equal that of a fine residence on land.

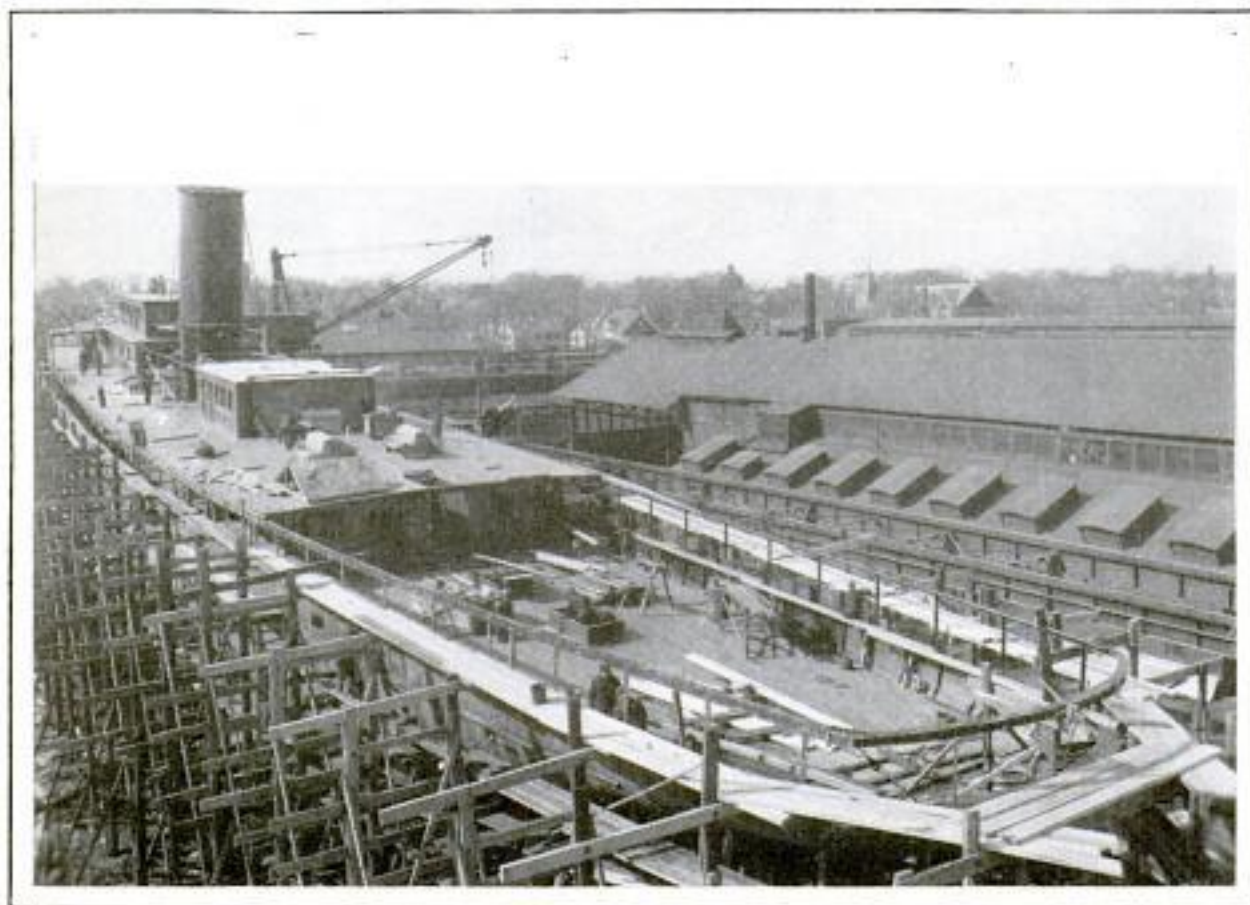

Scene before the Launching of the Spacious "Corsair" under Construction at Bath, Me.; in Addition to the High Original Cost of a Boat like This, the Maintenance Is Stupendous

An Erie railroad, 71 W. 2nd Ave
 Built by Westinghouse Electric
 POPULAR MECHANICS
 196
 East Pittsburgh Pa 77

FIRST OIL-ELECTRIC RAIL CAR ATTAINS HIGH SPEED



Oil-Electric Railway Car Which Operates under Its Own Power Supplied by Motors and Generators in Forward Compartment; It Can Travel at Eighty-Five Miles an Hour

Wide World

At Youngstown, Ohio, the first "twin-six" oil-electric railway car was placed in service recently, operating under its own power from energy supplied by motors and generators in the forward compartment. The car attains a maximum speed of eighty-five miles an hour and has a cruising speed of seventy miles an hour. It is seventy-five feet long.

next, followed by larks, the black-headed titmouse and, finally, the ordinary sparrows start between five and five thirty.

REFUSE FROM CANNING PLANTS USED FOR FERTILIZER 1781

Rich in nitrogen, a fertilizer is being made from the refuse of citrus-fruit canning plants in Florida. The skins, seeds and waste pulp are utilized as well as some of the whole fruit not suitable for canning.

Cond. E. So. Moore
 3767 Clifton St. N.W.
 Washington, D.C.

TIME TOLD BY BIRDS' SONGS IN MORNING HOURS 1812

By studying and identifying the different bird calls, a German naturalist is able to tell the approximate time during the early morning. He has found that the chaffinch sings at about half past one o'clock on summer mornings, and the black-cap calls an hour later with a song like that of the nightingale but shorter. Between half past two and three o'clock, the quail call, while the hedge sparrows are heard about half an hour later. The blackbirds are

FIRE-FINDING ELECTRIC "FLEA" EXTINGUISHES BLAZE 1787

Electrons, the smallest particles of matter known to science, have been put to work as fire fighters. L. W. Chubb, director of research of the Westinghouse laboratories, recently demonstrated this fire-finding electrical "flea." The device not only locates the source of a fire but also turns on an extinguisher which puts out the blaze.

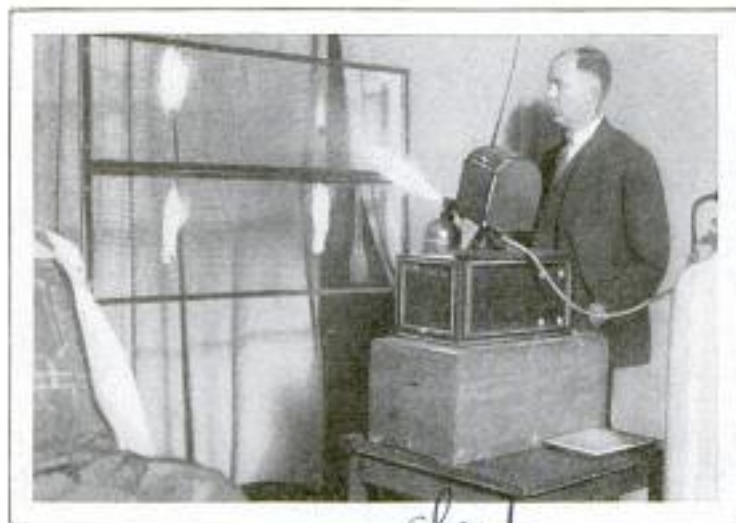

Electron Fire Scanner Which Utilizes Smallest Particles of Matter to Find Blaze and Turn on Extinguisher

Chubb

Demonstrated at American Institute of Electrical Engineers

Cond. Sec. H. Echhardt, 7528 Walnut St
 Philadelphia

Copyrighted material

1789

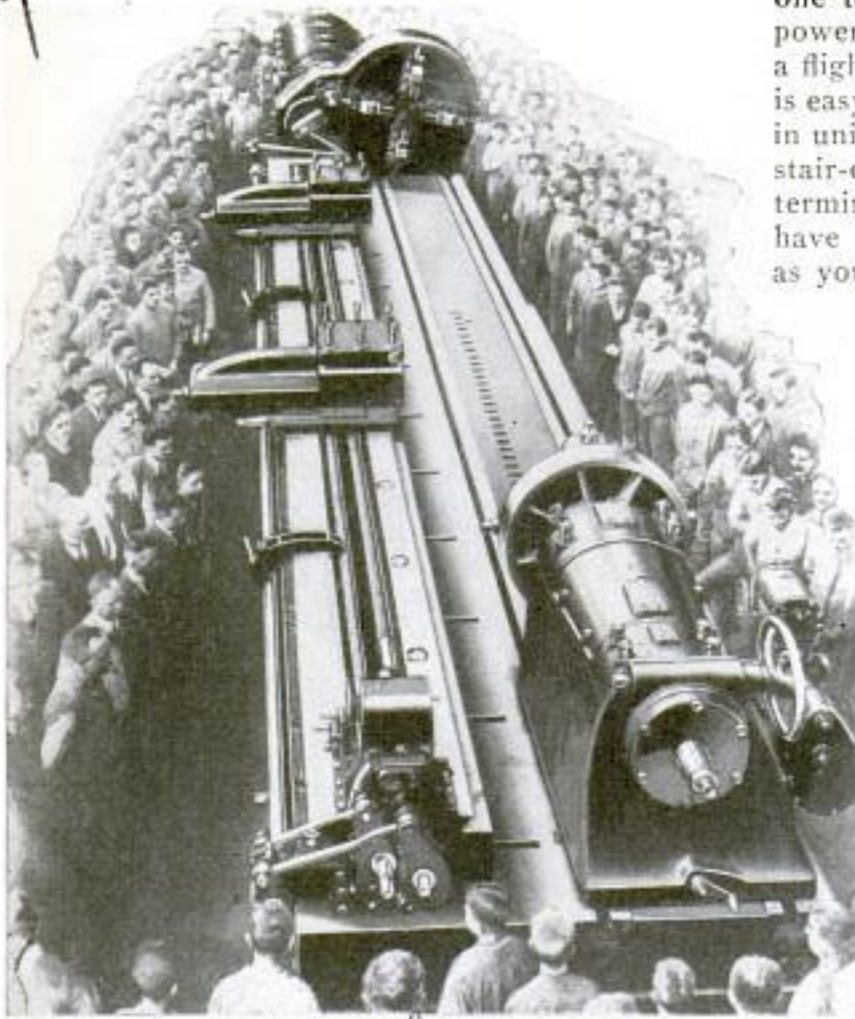

Giant Turning Lathe in Use in Germany; It Is More Than Thirty Feet Long and Is Operated by a 100-Horsepower Motor

BIG TURNING LATHE OPERATED BY POWERFUL MOTOR

One of the largest mechanical units of its kind has been built in Westphalia, Germany, where a huge turning lathe recently was placed in operation. Its over-all length is ten meters, or about thirty-two feet, and its heavy work requires a 100-horsepower for the running.

WHAT HORSEPOWER HAVE YOU? TOLD BY EASY TEST

How many horsepower have you? Interesting tests made at the Boeing school of aeronautics reduce the effort expended by human beings into the familiar terms of horsepower, and, incidentally, show the remarkable efficiency of a gasoline engine as compared with the body as a power plant. The human range is generally from

one to one and one-half horsepower in such a task as climbing a flight of stairs at top speed. It is easy to calculate human energy in units of horsepower, using the stair-climbing test as a basis. Determine your accurate weight, have someone time you exactly as you dash up the stairs at full speed, and measure the exact height of the stairs. Now divide the time, in seconds, into sixty, multiply the result by the height of travel and this product by your weight, then divide the result by 33,000. This gives the horsepower, as one horsepower is equivalent to raising 33,000 pounds one foot in one minute. The Boeing student with the highest rating was able to carry his own weight of 175 pounds up a fourteen-foot ladder in three seconds. This represents about one and one-half horsepower. Some internal-combustion engines deliver more than one horsepower for each pound of weight. If a

human being were equally efficient, he would be able to climb at a speed of more than 300 miles an hour.

SILENCER FOR OPEN WINDOWS, 1788 KEEPS OUT NOISES

Giving free access to fresh air, but keeping out street noises, a silencer for open windows is the invention of Hiram P. Maxim, known for other inventions to eliminate

noise. The silencer muffles the sound waves, and the anti-noise device is expected to be particularly useful in hospitals and in business offices in districts where traffic is heavy.



installed in National Bank at North
 90 Maxim Silencer Corp
 Hartford Conn
 410 Asylum St.

2/24/31
 Max Silencer

Copyrighted material

1678

NEW RUBBER PLANTS ARE DISCOVERED IN RUSSIA



Tires Manufactured of Rubber Derived from Plants Cultivated by Soviets



Spraying Plants Which Are Being Raised in Russia for Use in Rubber-Making Experiments; the Soviets Plan Great Development of Their Rubber Cultivations and Manufacture



Above, Laboratory Workers at Kiev, Testing Substance Extracted from Plants to Determine Its Rubber-Making Possibilities, and, at Right, Examining Roots of One of the Rubber-Producing Plants; Millions of Acres Have Been Planted with This and Other Varieties, While Still Larger Cultivations, under Irrigation, Are Contemplated



1976

Manufacture de produits Chimiques de
Place de Saint Sabain
Paris France



Above, Showing Flexibility of Non-Cutting Glass; Below, Flaky Fragments of a Broken Piece

NON-CUTTING FLEXIBLE GLASS PREVENTS ACCIDENTS

French railways and bus lines are experimenting with a flexible glass that does not cut when broken into pieces, with a view to adopting it for the windows of both railroad cars and busses. This flexible, non-cutting glass, called "securit," does not contain any wire reinforcement, and is unlike any other glass previously made, including the so-called shatter-proof glass in use in this country. The product is not made like ordinary glass, the principle involved being analogous to that employed in producing metals with a combination of hardness and flexibility. Upon being broken, the glass crushes into thousands of tiny pieces, something like gravel, that may be handled without fear of injury from cuts. It will bend considerably before breaking, and a small pane of it will support the weight of two men, due to its flexibility. A piece may be held in the hand and broken with a hammer without injury from the flying particles.

M. Falguere
Paris France

MYSTERIOUS CIRCLE OF STONES CLUE TO INDIAN RITES

1995
Resembling the famous Stonehenge of England, a series of circles of large sandstone slabs, set high on a cliff overlooking the Apishapa river in Colorado, indicates that the ancient Indians who inhabited the district may have practiced a form of sun worship. The stones, at first believed to have been a fort, have been studied by Prof. E. B. Renaud, of the University of Denver, who reports that they could never have been used for fortifications nor for marking off wigwams. Their size and arrangement show that they doubtless were used in connection with mystic rites, he declares. A slab fence, with an opening at one end, surrounds them, and at another circle site, there is an upright stone post in the center of each circle. This is the first find of stone circles in this part of the southwest, so far as can be determined.

RUBBER-PRONGED LAWN RAKE DOES NOT TEAR GRASS

1993
Lawn rakes with rubber teeth, instead of metal, now are being offered as having several advantages over the ordinary rake, both from a safety and utilitarian standpoint. The prongs, made of rubber like that used in automobile tires, resist wear, stay elastic, stand all kinds of distortion, and do not clog, break or rust. The teeth are fastened into a metal yoke, and when turned up while lying on the ground, can be stepped on without injury, and the handle will not fly up. The flexible teeth adjust themselves to irregular ground and sweep clean without tearing or uprooting the grass. They have a springy action that helps kick the leaves with each stroke, and are tough and wear-resisting, so the rake can be used freely on gravel, brick, concrete or dirt walks.



One of the rakes, weighted down, was dragged behind an automobile for twenty miles over all kinds of roads, as a test of its endurance, without damage to the teeth.

The Sabit Machine Co.
6536 Carnegie Ave
Cleveland, O.

Dr. Edward Peter Johnson, Chicago
no address available

1983 The Square Deal Co. Inc.
1646 Standard

1 Herald. 20 amper 11/27/30

MODEL PLANE FLUTTERS WINGS AND FLIES STRAIGHT UP 1849

Weighing only eight pounds and operated by a small electric motor, a model airplane, devised by a Chicago inventor, is said to be capable of vertical flight. Its wings are so adjusted that, as a rod to which they are fastened whirls, they flap like those of a bird, beating the air and folding up again a great many times a minute. Whether the idea can be adapted to useful sizes of planes, however, is an unsettled question.

SECRET OF "MYSTERY" CLOCK LIES IN GLASS SHAFT 1873

One of the treasures of the Franklin Institute is a clock with concealed works. It is one of the many forms of mystery clocks and was presented to Benjamin Franklin in France in 1770. There is but one hand, the hour hand; the dial is transparent, and the only connection to the base is a glass support, but the clock runs and strikes the hours. The mechanism is concealed in the base and operates the hand through a shaft which is concealed in a separate hollow glass tube inside the main glass support. This inner unit cannot be seen; hence the operation of the clock is somewhat of a mystery to the spectator.

Phila

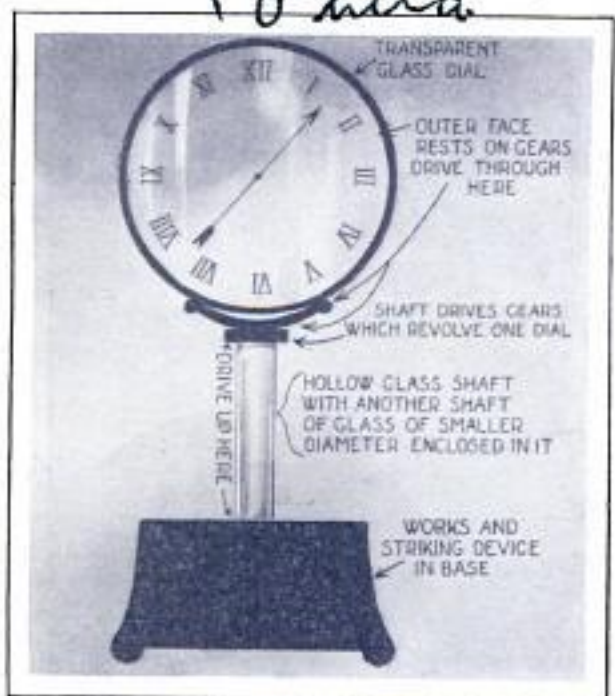

Revealing the Secret of the "Mystery" Clock; Diagram Showing Chief Parts of the Instrument

Cont. Esq. H. Eckhardt
4528 W. Walnut St. Phila



Card Shuffler Which Mixes the Pack and Deals Four Hands of Bridge in Twenty Seconds

BRIDGE CARD SHUFFLER DEALS PACK IN FEW SECONDS

Shuffling a pack of cards and dealing four hands of bridge in twenty seconds is the task performed by a little machine that takes the work out of card playing. Seven seconds are required to deal in this manner, and the shuffling is accomplished by simply repeating the process. The device weighs less than a pound, and the inventor estimates that it saves more than half an hour in one evening of bridge.

DURALUMIN WEAKENED BY FIRE WHICH CHAR'S PAINT 1853

Tests made to determine the effect of fire on duralumin airplane-wing beams reveal that the strength of the beams may be seriously impaired by fire which chars the paint covering the metal. Where the paint is only blackened, the weakening may be slight enough to permit keeping the metal in service. A test on tubular-steel fuselage members, obtained from a plane from which the fabric had been burned, indicated that the annealing effect of the heat improved the strength of the fuselage. In all cases where the paint is badly charred, however, insurance experts recommend that duralumin be replaced.

Cont. Joseph S. Edgerton
Evening Star Washington D.C.

Bank Bldg
Cleveland
Ohio
How to get a few pres
of U. S. Post Co. 2205
Cleveland, O.

\$395

1688

U.S. Navy - 1945

Iron Men



The Stranded Hull of a Wrecked Vessel Is Turned into a Schoolroom for Giving Practical Lessons in the Difficult and Dangerous Work of Salvage

Photos © Weltrundschau

under the Sea

WITH the depths at which divers can work safely being constantly increased, a unique school has been opened at Hamburg, Germany, to train men for this hazardous profession.

One hundred feet deep in the sea, the light is like that of a moonlight night; at 200 feet, like a starlight, while at 300 feet, divers say, it is too dark to see one's hands. Fish carrying their own lamps live a mile or more deep where the pressure of the water is equal to twenty or thirty thousand pounds to the square inch.

Mankind lives at the bottom of a sea of air, which presses on every square inch of the surface of our bodies with a weight of about fifteen pounds. This is at sea level and, as the pressure is evenly dis-



tributed, it makes no difference to us. But the pressure of air must be equal on all parts, otherwise things will happen.

With mouth and nose shut and lungs full of air, the naked diver goes down sixty feet or more, where the pressure on his body is thrice that of the atmosphere, but equally distributed. He stays a brief time to gather shell or sponge, then signals and is pulled to the top by a rope before the air in his lungs is used up. By deep breathing for a minute or two to wash carbonic acid out of his body, and by filling his lungs with oxygen, a naked diver can stay down four or even five minutes.

The diver fitted with helmet and water-tight dress and supplied with air by pipe and pump can go down to, and

Military Drill in Diving Suits; the Heavy, Clumsy Uniforms Do Not Lend Themselves to Snappy Formations, but the Squad Responds Just the Same

1682

stay long at greater depths because the pressure of the water outside is exactly balanced by that of the air forced inside his dress; he is in a bath of air which is well ventilated and equally presses upon all parts of him. The amount of air in the dress is exactly controlled by inlet and outlet valves fitted to the helmet and which the diver adjusts.

Heavily weighted as he is, to overcome the buoyancy of the air in his dress, the diver, by adjusting the

amount of air in his dress, makes himself light enough to move easily about on the bottom; too much air would of course float him up. A trick played on a novice is to pump air down so as to distend his dress and float him up. As he rises and the pressure of the water becomes less his dress becomes ballooned out and finally rigid with air, so that he cannot bend arm or leg and floats helpless on the surface.

For every thirty-three feet a diver goes down in the sea, an extra atmos-



Learning to Dismantle a Salvaged Wreck: Practice of This Sort Gives the Divers Valuable Training in Undersea Duties Where Mistakes Might Cost Lives and Property: the Men Become Familiar with Many Types of Boat Construction



Instructor Examining Helmet Locks Before Men Descend, to Make Sure the Suits Are Properly Adjusted

there—that is, fifteen pounds of air pressure—has to be forced down to him so as to balance the water pressure and ventilate his dress.

At 100 feet, then, the diver breathes air at four times the normal pressure and in time would dissolve four times as much nitrogen in his body fluid and fat; at 200 feet seven times, at 300 feet ten times, and so on.

The diver, if he works in compressed air long enough, becomes surcharged with gas just like a bottle of soda water,



Testing Explosives on Land to Make Sure They Will Work Right under Water



1688
86

Instruction in Sawing; Again the Practice on Land Gives the Divers Training for Work under Water; Severing Bolts, Heavy Timbers and Other Parts Is Often an Important Part in Submarine Salvage, and There Are Several Tricks to the Process Which Must Be Learned



A Brief Rest between Duties; in the Rear Is an Old-Fashioned Diving Bell Which Has Long Been in the Possession of One Family; It Has Been Replaced by Modern Units, Electrically Lighted and Equipped with Telephones and Air-Conditioning Devices, So That the Occupants Can Descend to Greater Depths

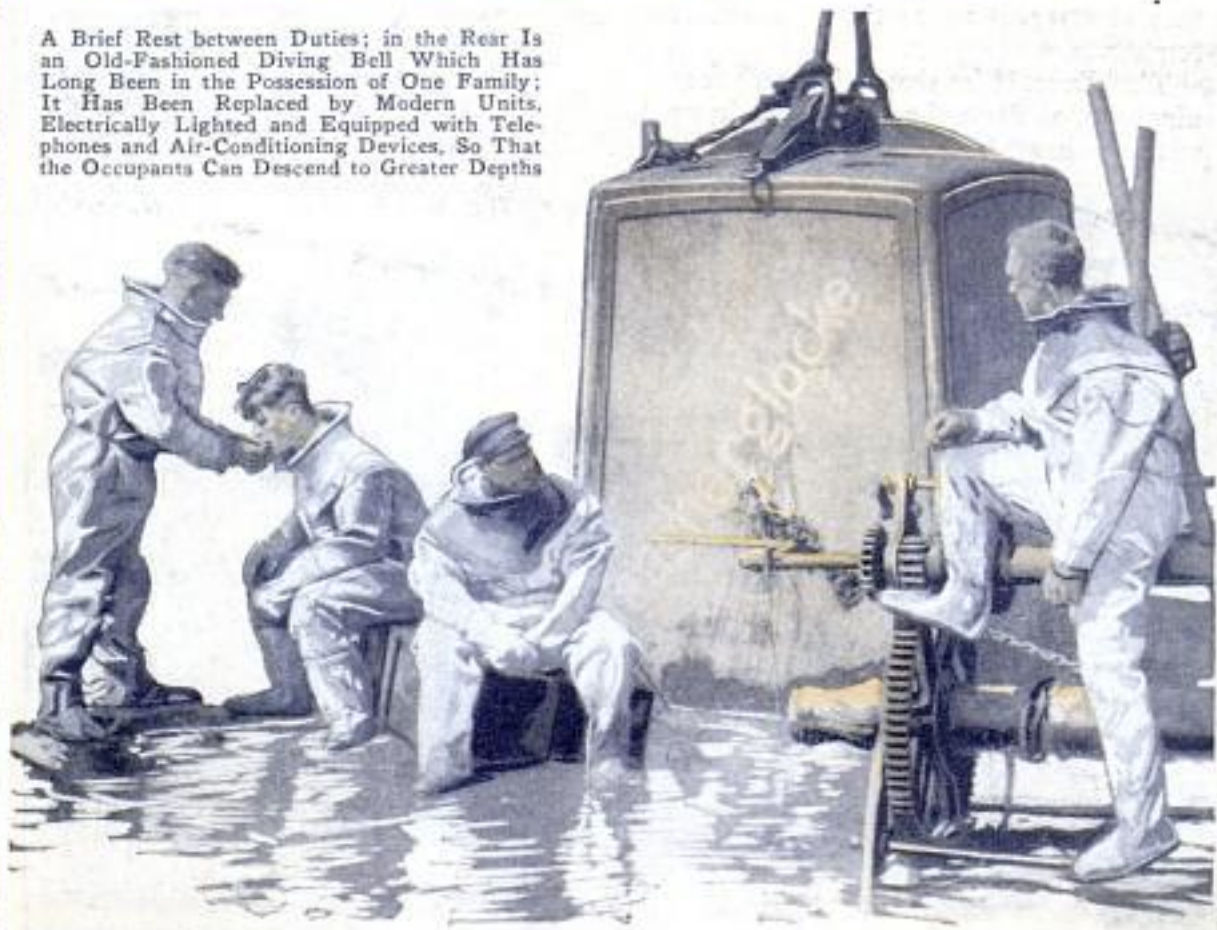



Making Final Preparations for a Descent, and, Below, Going down the Ladder with His Emergency Oxygen Outfit on His Back; Extra Tanks Such as This Add More Weight, but This Is Not an Objectionable Feature for Extra Weights Are Needed at Great Depths, and the Oxygen Container Serves a Double Purpose





Besides Practical Knowledge, Diving Students Are Required to Have a Certain Amount of Theory; Here the Men Are Learning How an Air Pump Functions; Below, Further Training in Dismantling an Old Wreck; an Important Detail of the Task Is to Learn to Handle Heavy Timbers without Damage to Lines or Suits



and if he comes up too quickly to the surface, the gas effervesces in his blood just as soda water. The gas set free in the blood, if sufficient in amount, may stop the circulation by filling the heart with froth and so kill the diver; if too little, it may cause mischief in the nervous system, resulting in paralysis, or it produces severe pains called "bends." The remedy for bends is to put the diver in compressed air again and make the bubbles of gas shrink up and go into solution, and then decompress him slowly, allowing time for the circulating blood to bring the excess of gas from the tissues to the lungs and then give it off quietly.

Recently the depths considered safe for diving have been almost doubled. Last summer two divers of the British navy went successfully to a depth of 300 feet. A depth of even 400 feet may soon be reached by divers wearing the ordinary diving dress, which allows efficient work to be done.

Of course, steel observation chambers, with men inside wearing an oxygen-breathing apparatus and breathing

at ordinary atmospheric pressure, may be lowered to far greater depths—even a mile if suitable gear could be devised. With the aid of thick glass windows and an arclight, the man inside might be able to observe and photograph the life in the depths, but he cannot do efficient work.

To prevent solution of much nitrogen gas in the body, the diver goes down quickly and works only for a short time in the greater depths. To

What Happens When the Diver Releases His Weights, Boots and Other Extra Equipment; He Bobs Out of the Water like a Cork, While an Instructor Stands By with a Line Ready in Case of Need



1688
90

allow the safe escape of the dissolved gas, he makes the ascent in stages, pausing as directed by telephone from above, hanging on his "shot" rope until ordered to come up another stage. Time is thus given for the excess of nitrogen to escape from his lungs.

The pressure of air in and outside the drum of the ear has to be equalized as the diver descends, by swallowing

or by a forced expiration, made with mouth and nose shut. A cold in the head may make this difficult, and pain is then felt in the ears. At, say, ten atmospheres' pressure there is ten times the volume of air in the helmet, and ventilation has to be made ten times as great to keep the carbonic acid exhaled by the diver from increasing in amount.

Thus, if one pump is sufficient for one atmosphere, ten pumps are needed for ten atmospheres. In old days, divers suffered from carbonic-acid poisoning, owing to ignorance of this fact and want of sufficient ventilation. To work the ten hand pumps, thirty-six men are needed. Steps are now being taken to prevent accumulation in the helmet of carbonic acid by chemically absorbing it and so eliminating the need of many pumps.

Since the "big money" in diving lies in salvage work, it is easy to see that the diver has first of all to know about ship construction. He has to know how to put on, or around, the hull heavy steel hawsers in absolute darkness, and he can have no doubt as to how and where and when to use dynamite. For this purpose, an old wreck is



Explaining the Purpose of the Different Parts of the Diving Suit; Examining the Heavy Soles of the Boots, and, Below, Adjusting Helmets





Close View of the Helmet; This Is the Most Important Part of the Outfit, as It Seals the Rest of the Suit

pulled on land, and with this ideal method of instruction, the pupil in the divers' school learns the things to be done and those to be left undone under water, in full daylight with neither a diver's suit to hamper his movements nor dangerous deep-sea animals to bother him. To learn the effectiveness of explosions, a special wall is built on which the different powders are tested. In shallow water, the diver learns quickly how to move around and how to handle the various apparatus hanging around him.

In deep-sea work, the crew handling the pump on board of the ship follow the diver's movements on the ocean ground by the bubbles, but the diver himself has to attend to the atmospheric valve of his suit; he has to regulate the upward pressure; he has to manipulate the line over which he communicates with the ship; he has to move in the same direction in which he is lowered to avoid being caught in the airline, and, besides, he has to attend to the work for which he descended.

Besides the practical work, there are other studies without which the diver could not afford to either start a big job or even obtain it. He has to know about the transparency of the water, the pressure in different depths, the

general condition of the ocean ground, the prevailing currents of water as well as wind, the meteorological handicaps, and many other things. He even has to know all the seven seas of the world, for he may be called one day to Egypt and the next to Scandinavia.

A first-class diver must have courage and ingenuity. Imagine a moment of sudden danger. There is no time for any kind of schedule or even quick planning, fractions of a second lost may mean instant death. Divers' wages vary greatly. Some have received as high as \$1,000 or more for a single day's work when recovery of a specially prized object or the rescue of human life was the goal. Salvage companies pay their divers an average of \$100 a month and \$50 for every dive.

There is always a demand for experienced divers. The shipyards need them and the shipping companies cannot do without them for repair and salvage work. The navy has at least one diver attached to the big units and to groups of the torpedo boats and destroyers. If a ship pulls out and a line is caught in the screws, if there are difficulties with the anchor, if something of value drops into the sea, if the hull is leaking, always the call goes out: "Diver over board."

Mr. Harry L. Bowdoin, Pres
 Subocean Salvage Corp.
 POPULAR MECHANICS
 732 149-19th Ave. Whitestone

see also 1932-911

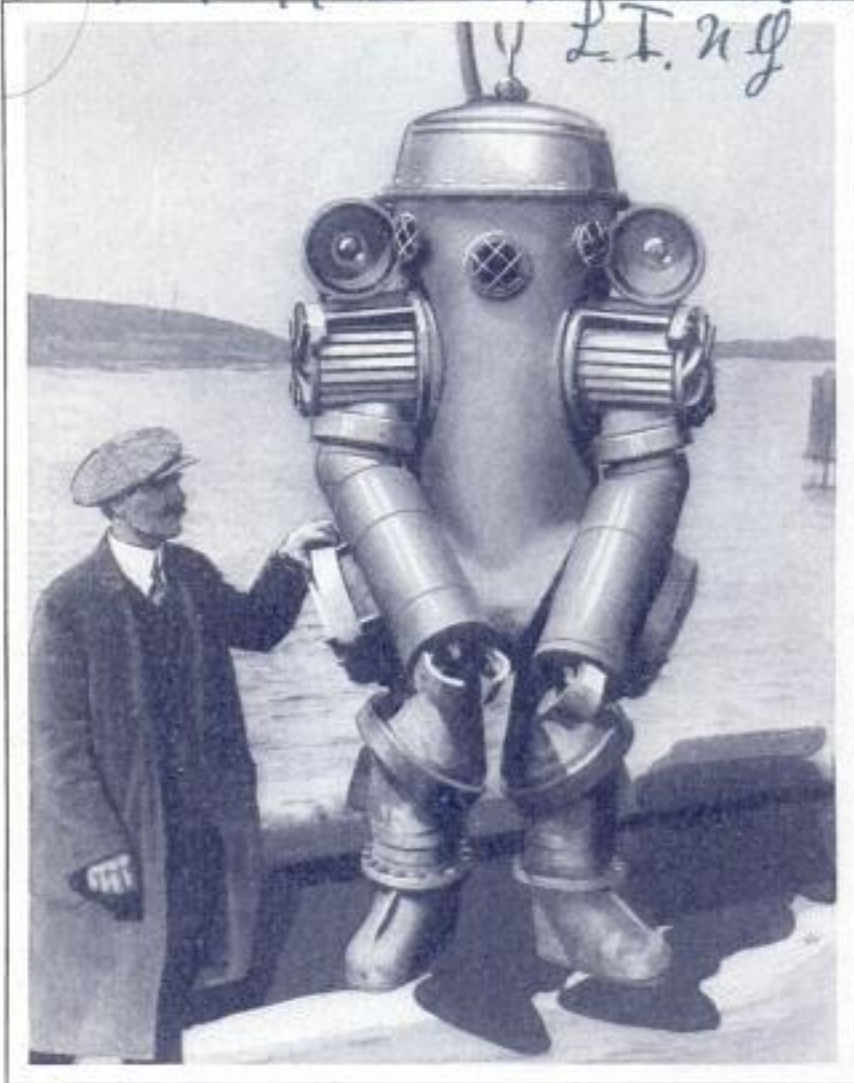

All-Metal Diving Suit Equipped with Telephone and Electric Headlights, for Salvage Operations at Depths of 200 Feet or More

wrecked vessels, and, for use with it an observation tank was built along somewhat similar principles to be operated by two men. It is intended to locate wrecks with a sonic finder, explore the wreckage from the observation tank, also equipped with powerful lamps, and do the actual salvage work with the diving suit after the valuables have been located from the tank.

**RUBBER CUSHION
 ABSORBS TRAIN
 SHOCKS**

Greater comfort for passengers is an advantage claimed for a rubber-cushioned railway-car wheel now being manufactured. It is much like the all-steel wheel, except that a cushion of uncured rubber is built between the hub and rim. A pocket inside the wheel holds the rubber pad which measures about two and one-half inches

**METAL DIVING SUIT HAS PHONE
 AND ELECTRIC LIGHTS**

Equipped with telephone and powerful electric lights, an all-metal diving suit, for salvage operations at depths of 200 feet or more, has recently undergone successful tests. The suit makes it possible to remain long at great depths, to move about freely, and to return quickly. Air is furnished through a cable, circulated through the suit and returned to the surface, thus making it possible for the diver to breathe air at atmospheric pressure. This makes decompression unnecessary when the diver is raised, and in the tests, a man was brought to the surface in one minute and fifty-two seconds after being in 210 feet of water for more than an hour. The suit was made for a company which expects to salvage the treasures of

thick and six inches wide, tapering toward the edges. Tests have shown that such wheels can be used for the drive-wheels of the largest locomotives. The cushion absorbs shocks and reduces side-sway, and when used on locomotives, makes starting smoother. After a rim has become worn, the hub is still good, and can be used again by fitting another cushion and rim to it. Heat developed by brakes is dissipated before reaching the rubber by slits cut in the outer section of the wheel. The wheel and the cushion are vulcanized together like a truck tire to the rim.



Mr. E. L. Maas
 engineer, Goodyear
 Fire & Rubber Co. Akron
 Ohio

MAN-MADE ANTHRACITE RIVALS WORK OF NATURE

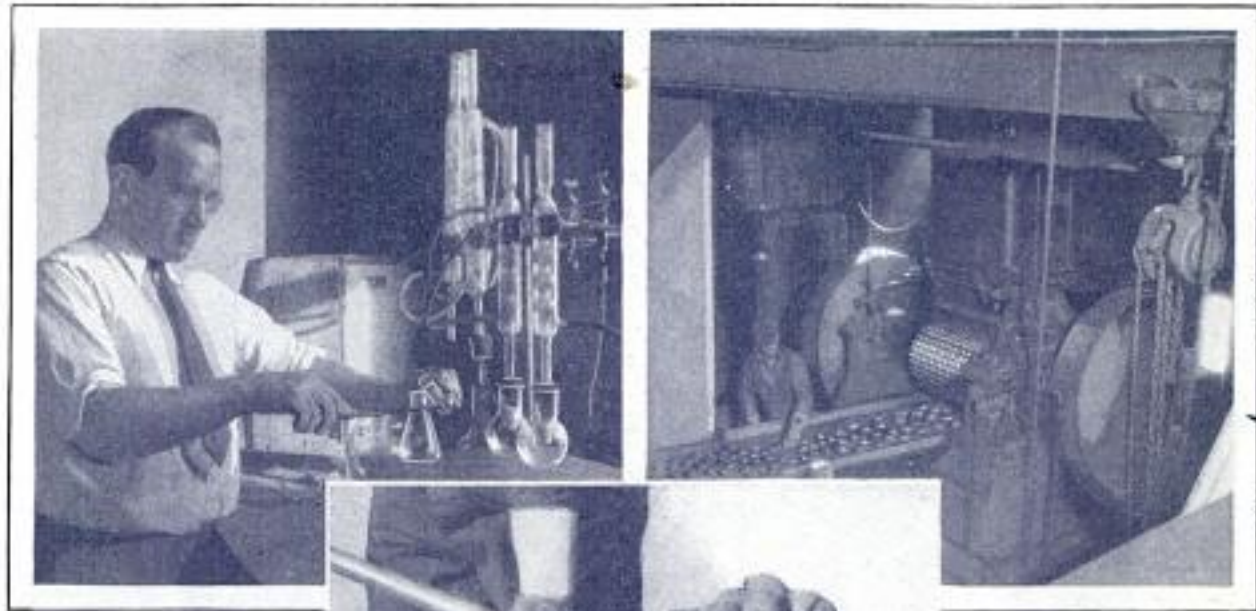

Nature spent thousands of years in forming anthracite coal but now it is being made in less than four hours from ordinary soft coal, which is converted into a hard, long-burning smokeless fuel that leaves less ash than natural anthracite, gives a hotter and more

Making Chemical Tests on the Briquettes; View of the Press and Shovelful of Briquettes

vention of Clarence S. Lomax. As the coal enters a carbonizer, or retort, from the top and descends to the bottom, it is progressively heated until it leaves at a temperature of some 750 degrees Centigrade. The heat drives off the volatile materials which are drawn by

even fire and is handled with less waste and with absolutely no dust. Incidentally, the product, which comes in small briquettes, sells for less than anthracite, and the patented manufacturing process yields larger quantities of valuable tar and richer gas than are obtained from ordinary coking operations. The process is the in-

suction into a separator, where, by an electrical method, the tar is literally knocked out of the gas. The gas goes into a gasometer and the tar into a cistern. The black char remaining is carbonized coal which is of such a plastic structure that it can easily be ground and sifted and then briquetted.

Corp. 643 N. Chicago
Michigan Ave

The President

DISCOVERY OF BLOOD GROUPS
WINS NOBEL PRIZE

York Ave 66th St
New York City
1844

Discovery that human blood is of four different types, and that blood of one group does not always mix well with that of another, has won the 1930 Nobel prize in medicine for Dr. Karl Landsteiner, of the Rockefeller Institute of Medical Research. Daily use of this discovery is made in blood transfusions, the bloods

of the prospective donor and patient being tested to determine if they belong to compatible groups. Incompatible groups, when brought together, often clump, or agglutinate, and such a condition often results in death. Doctor Landsteiner found that agglutination did not occur at random, but depended on certain definite properties of the blood, and it is on the basis of these properties that the four groups were formed.

Science Service news bulletin
500 8, 10/31/30

1636 Pickwick Motor Coach Works
 Ltd. Inglewood, Los Angeles, Calif

Chicago. Chester Es Moore, 100 N. La Salle
 Eastern representative

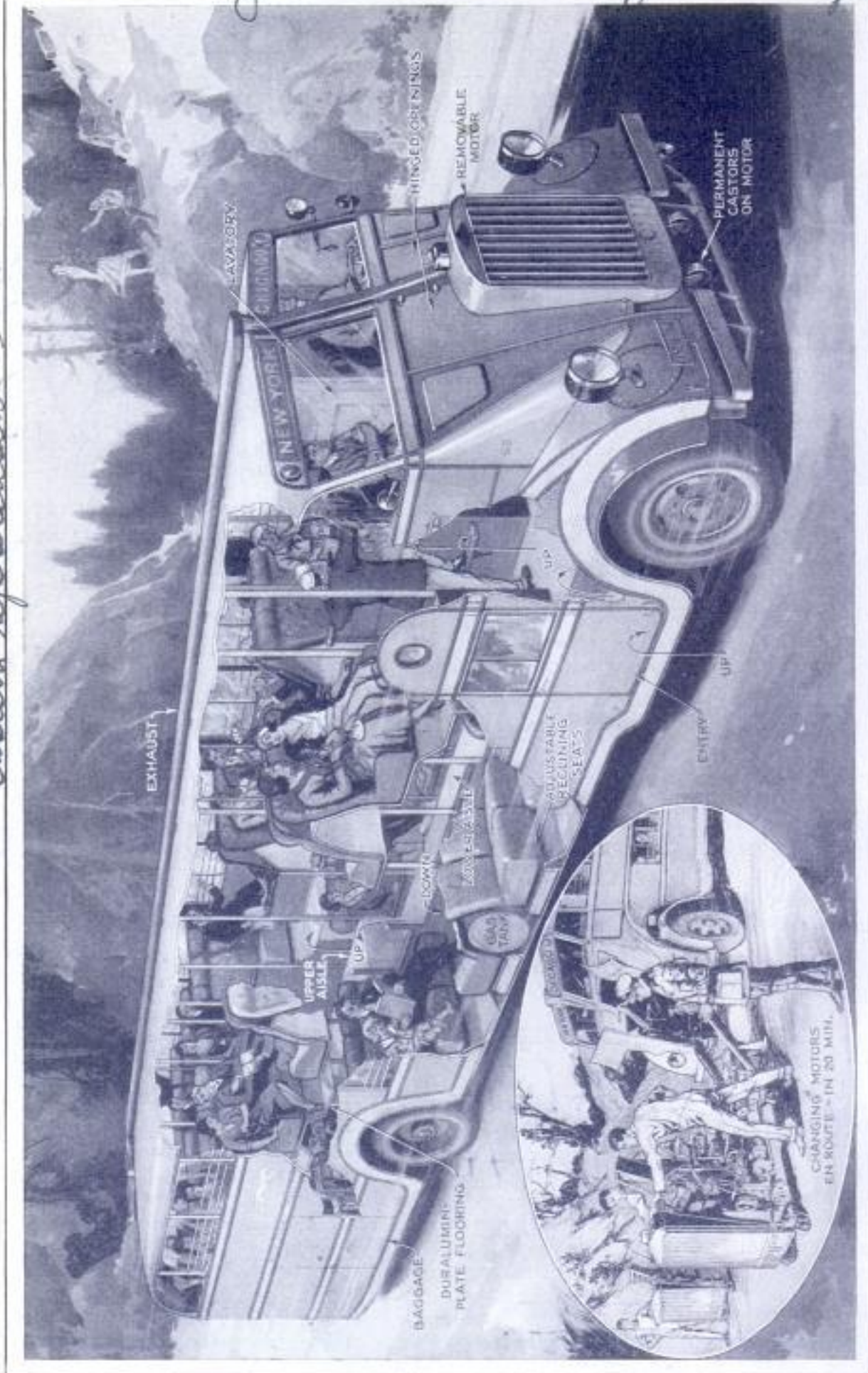

Artist's Drawing of Modern Motorcoach with Interchangeable Motors and Many Other Unusual Features; This Type of Coach Can Carry Fifty-Three Passengers. Twenty More than Older Busses of About the Same Size; Note Unusually Large Seat and Aisle Spaces

DITCH RIDER REPLACES COWBOY CHARACTER OF THE WEST 1852

Ditch riders are replacing cowboys as colorful and picturesque figures of the new west. Instead of watching cattle, the ditch riders guard millions of acre-feet of water delivered annually to more than 40,000 farms on twenty-seven government projects. Throughout the irrigation season, the rider may be seen daily at his task on any of the 16,557 miles of canals, ditches and drains supplying water to waiting farmers. He dresses like the cowboy with boots, spurs and sombrero and often carries a gun to wage war on rattlesnakes and coyotes. A spade, a grubhoe and a water-delivery record book are standard equipment. A canal break to him is as serious as a stampede to the cow puncher, and often he rides steadily for the entire irrigation period of four months without a day off. Where orchard land is valued at \$1,000 an acre, a half hour of uncontrolled water milling through a break may mean damage of thousands of dollars. The rider makes many halts to take gauge readings, to investigate seepage conditions and to clear the canal of obstructions. The allocation of water calls for infinite care as deliveries are computed to the fraction of an acre-foot. Behind the ditch riders are the hydrographic experts in the mountains, estimating in advance each season's probable water supply, the reservoir tenders who watch over government dams, and the operation and maintenance engineers.

ONE-TON ARMY BOMB BLOWS TOP OFF GRANITE HILL 1830

The terrific force of one of the large demolition bombs used by the army was illustrated recently when a one-ton projectile of this kind was dropped from an airplane. It was aimed at and struck the top of a granite hill, blowing a huge



Episodes in a Bomb's Life; the Big Missile Ready for the Plane, in Flight, and Tearing the Top off a Granite Hill

crater and scattering debris over a wide area. Making the bombs, preparing them for use, installing them in their carriages under the planes and, finally, releasing them at the proper instant, are the tasks of a special division of the air corps. Target practice is usually conducted without firing real bombs, but occasionally live ones are used to test not only the marksmanship of the men but the quality of the explosives as well.

ⓄThe ban on the importation of parrots, established during the parrot-fever outbreak, has been lifted.

Detachment, 88th
Observation Squadron
U.S. Army Air Corps

16 73
96

8 Marlinton

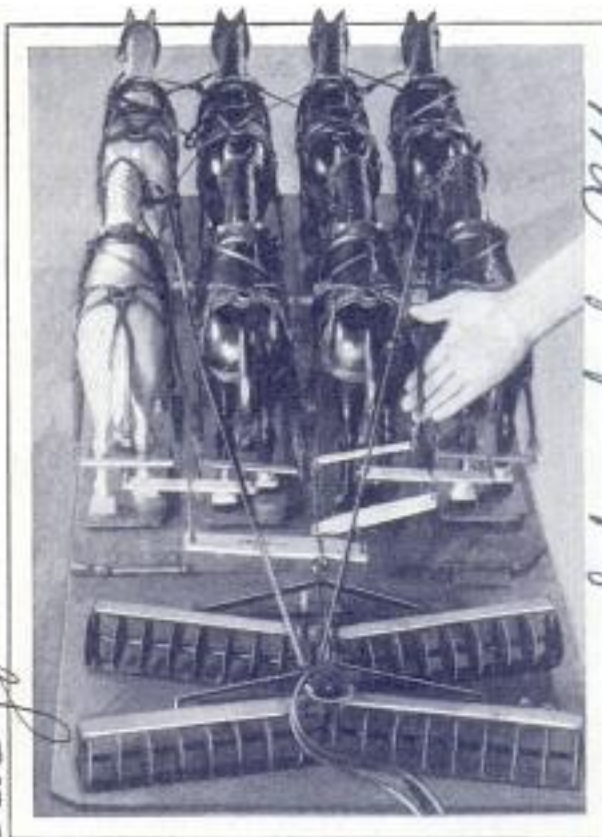

Miniature Horses Demonstrate Team Hitching; Note the Spreaders Which Distribute the Task Evenly

HARNESSING HORSES IS TAUGHT BY SMALL MODELS

Various complicated hitches in grouping horses into large units are demonstrated to farmers by the Horse Association of America with the aid of miniature animals, sets of harness and farm machinery. Based on department of agriculture figures and estimates, this organization declares that more than 107,000,000 acres of land would be devoted today to maintaining animal motive power if the horse and mule ratio to population had kept pace with the 1900 ratio. Instead, less than 53,000,000 acres is used for this purpose, the rest being devoted to the production of grain, much of which represents surplus. From 1920 to 1930, the organization estimates that horses and mules have decreased by more than 7,000,000 in this country, this number of animals formerly requiring more than 18,000,000 acres of land for maintenance, and blames the decrease in horses for part of the grain surplus.

822 Exchange Ave
Chicago

1843
Schenectady, N.Y.

VACUUM TUBE BECOMES NURSE FOR BABY AT NIGHT

At least one father has solved the problem of caring for the baby at night by assigning a vacuum tube the task. The father, an engineer with the General Electric company, places the baby in a separate room with a telephone transmitter as a microphone beside the crib. The infant's cries are carried to the amplifier and loud speaker beside the father's bed, whereupon the father turns on a phonograph without getting out of bed and the recorded lullaby sounds through a loud speaker near the crib. If the lullaby fails to soothe, then only must personal attention be given.

NEW VARIETY OF SUGAR CANE YIELDS MORE PER ACRE

A new variety of cane that yields one ton per acre more of sugar than any other known kind and is free from the mosaic disease which has depleted many of the fields of the south, has been developed by government scientists. The variety is a cross produced from other kinds after extensive tests. Because the new cane has proved its ability to resist disease, it will probably be successfully cultivated in the heavier types of soil to be found in the cane belt, and although its crooked stalks and heavier fibers may add to harvesting and milling costs, this is expected to be offset by the increased yield.



Testing Juice of the New Variety of Sugar Cane Which Yields More per Acre and Resists Disease

Mr. W. Brandley
Sugar cane district
Coul. John L. Coontz
714 Jefferson St. N.W.
Washington, D.C.

1714 Cont. Dr. Corley
P. McHarmeril 97

ELECTRIC BREEZE ROCKS TREES TO AID GROWTH STUDY 1712.

Every day for the last two and one-half years, three dozen Monterey cypress trees, far removed from their native California, have been swaying back and forth in a mechanical breeze while Prof. William S. Cooper, of the botany department of the University of Minnesota, seeks to determine how unusual weather conditions affect their growth. The breeze, produced by an electric motor which moves a sliding frame attached to the trunks of the trees, "doubles" for the Pacific coast winds and has enabled Professor Cooper to prove that sides of the trees not opposed to the strain have added almost ten times as many cells as the other sides. This experiment contradicts the popular belief that a tree exposed to the wind from one direction will compensate for the strain by adding cells in a plane in the direction of the strain. Professor Cooper believes that the growth is a result of hampering cell activity due to the strain imposed. This is much greater on the sides which sway. "Gravity seems to affect the trees, making them gradually assume an elliptical shape," said Professor Cooper. "I have several trees growing horizontally in which all the new rings are below the original trunk."

Chicago - E. B. Wagner 590 Magnolia Circle

POWER SAW'S CARRYING CASE USED FOR WORKBENCH 1723

110 or 220 a.c. 60-cycle



\$125.00

Combining portability and power, an electric saw is so constructed that its carrying case can be used as a workbench when the saw is in operation. All tools and gauges can be locked in the case, which weighs seventy-five pounds

packed. The saw is mounted directly on the shaft of the motor and the case has an adjustable cover for angle cutting, while the rip gauge may be used on either side of the saw.

The Reid-Way Co,
Cedar Rapids, Iowa.



Winter Outfit for the Army Flyer; Note the Face Mask and Warm Flying Suit and Moccasins

ARMY FLYER'S WINTER OUTFIT CONTAINS NINE PIECES

To keep the army flyer comfortable in zero and subzero temperatures, an exceptionally warm winter outfit has recently been approved for military aviators. It consists of a blanket-lined flying suit, warm winter helmet, a mask for the face, goggles, a pair of two-finger gloves, fleeced-lined moccasins and the regulation parachute seat pack and harness.

RIFLE SHOTS SHATTER ICEBERG TO PROTECT DIVERS 1764.

By means of rifle shots, workmen shattered a large iceberg that threatened to wreck divers' scows anchored off Juneau, Alaska. A huge berg had drifted from a glacier over the cables used by the divers. Steam tugs worked unsuccessfully for an entire day in an effort to dislodge it. At last, armed with rifles, the workers opened a barrage on the big berg and finally made a deep fissure in its center. This caused the ice to break and split up into smaller sections which soon drifted harmlessly out to sea.

Cont. F. W. Fichler
5021-12th St. N.E.
Seattle, Wash

1901

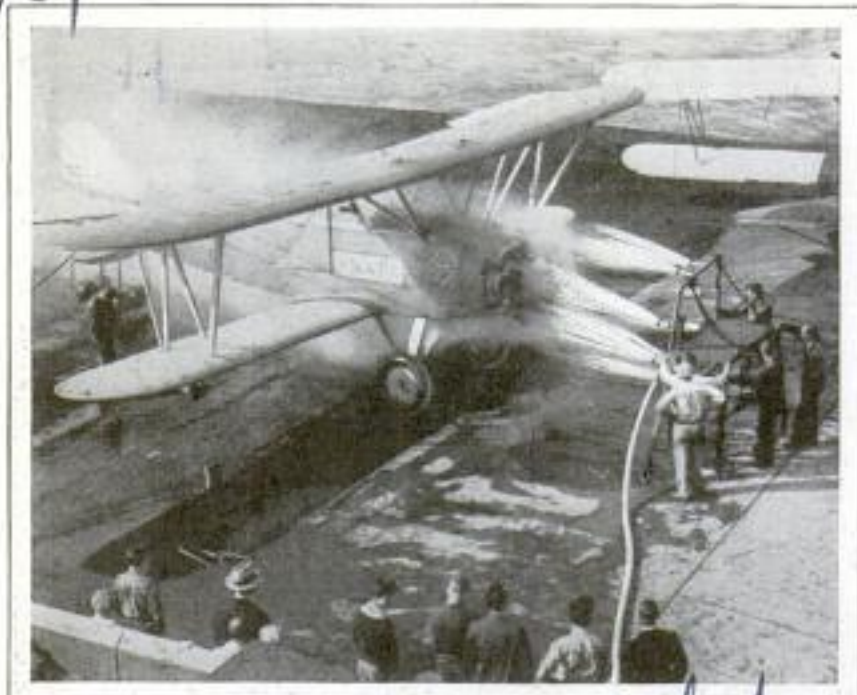

Giving the Storm Test to an Airplane Motor Equipped with Rain Protectors; Water under Pressure Is Turned on the Running Engine

RAIN TEST FOR PLANE SHOWS RESISTANCE TO STORMS

In order to test the resistance to violent downpours of an airplane engine equipped with rain protectors, several streams of water under high pressure were turned on the motor while it was running at full speed in a recent demonstration in Chicago. The engine ran for nearly half an hour with the hose shooting water at it to simulate conditions the plane would encounter in flight in a heavy rain.

X-RAY PHOTOGRAPHS OF ATOMS SPEED WORK OF SCIENCE

Development of an X-ray tube which makes "snapshots of atoms" in one minute instead of the 100 hours or so usually required for such work, is heralded as a great aid to science in that it opens up a wider field of research and industrial development. Dr. George L. Clark, professor of chemistry at the University of Illinois, where the tube was devised, explains that it can be used in studying how cellulose is made over into artificial silks and thus help in improving the material; how cancers are formed and how they grow, and how gallstones originate and develop. X-ray photographs of atomic changes would be useful in practically

Herald Tribune 10/18/30

Dr. G. Clark, University of Illinois

every chemical process except where the changes take place instantaneously, Doctor Clark points out. The tube does not photograph the actual atoms, but rather the patterns and arrangements they form. The pictures are not the familiar shadow photographs.

1743

ONE-MAN PIANO MOVER FITS ON AUTO

With the aid of a simple apparatus now on the market, one man can move and load a piano. The outfit is made of steel piping, rods and angle iron and fits on the rear

of coupes or roadsters. It consists of a lifting platform and standards which are attached to the running boards and support the platform. When the piano has been moved up on the platform, it is swung back to position for carrying by means of a ratchet crank. The weight is equalized between the bumpers and the running board so that there is no undue stress on any part of the car. Besides being useful for pianos, the rig may also be employed



Movable Metal Platform Attached to Auto, by Which One Man Is Able to Load and Move a Piano

in transporting radio sets, refrigerators and other large articles.

Agden Patent Research Co. Agden, Utah

15677 Cont. John Le County, 714
Jefferson St. N. W., Washington, DC

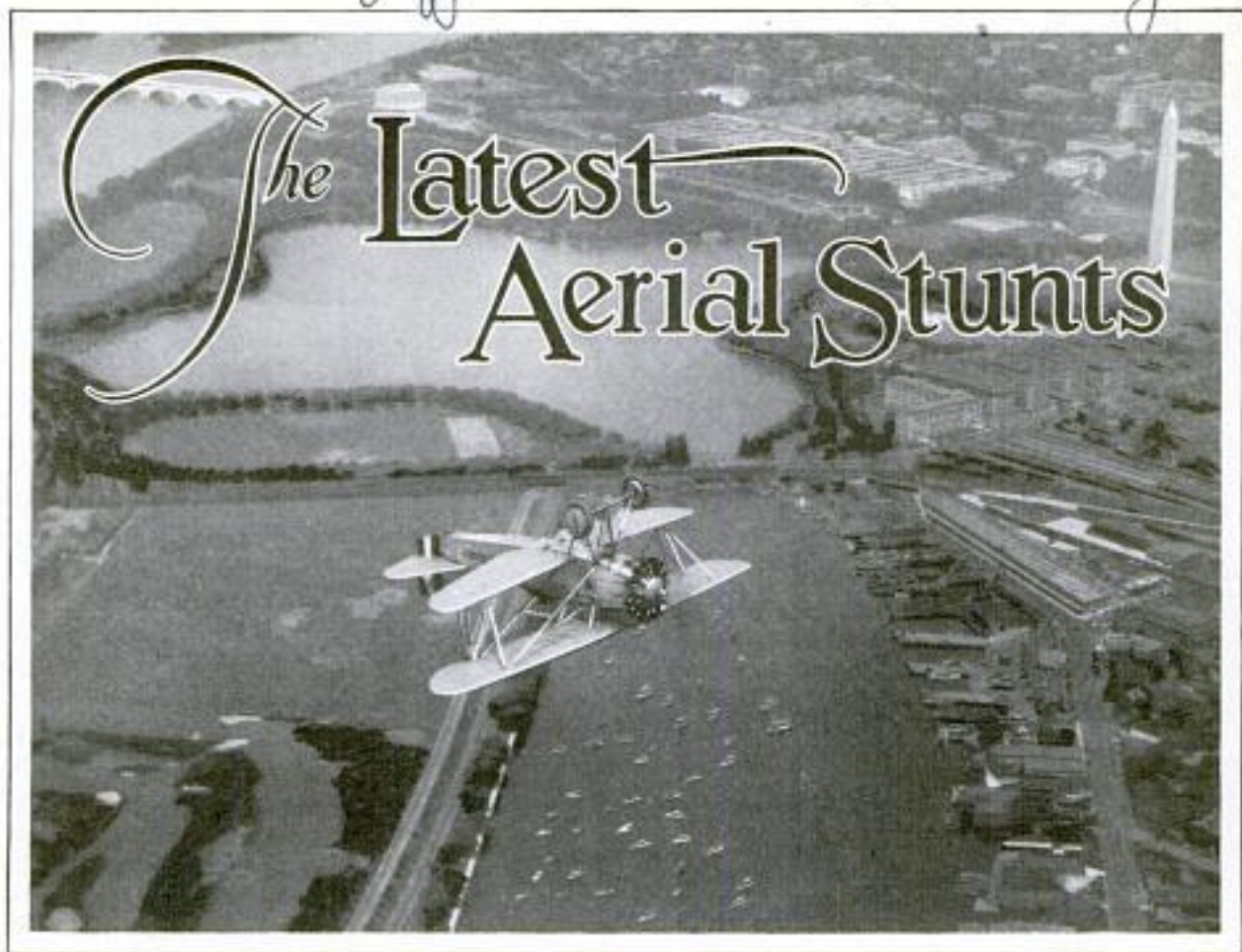

Lieutenant Gardner's Plane during Spectacular Maneuvers over Washington; a Splendid View of the Ship in Inverted Position at the Top of a Loop; Safe Altitude Is an Essential in Stunting

APPARENTLY defying all the laws of gravity, three navy planes dived with terrific speed over the naval air station at Anacostia not long ago and developed three spectacular feats of aerial acrobatics never before accomplished, besides practicing six other maneuvers almost equally death-defying.

Two of these new formations, known as the "reverse loop" and "push-over," were entirely new, while the third consisted of a bewildering five-minute period of upside-down flying at a speed of 120 miles per hour that, for close-range inverted flying, is believed to be unparalleled. This was No. 9 of the stunts.

How were these difficult feats performed, how prepared for and what were the ticklish situations experienced by the flyers in developing these sensational maneuvers? Such were the questions asked of Lieut. M. B. Gardner, leader of the navy squadron which performed them, with the help of Lieuts. A. P. Storrs and F. M. Trapnell. Lieut. Gardner explains:

"For our program of aerial acrobatics we started out by diving on the field in standard Vee-formation from a height of 2,500 feet, the leader (myself) flying upside down while the other two maintained normal position down to a height of 500 feet. Next we pulled right out of this formation into a climbing turn and then I signaled for formation No. 2 to begin. At this point, I rolled, right side up, out of the climb to an altitude of 1,000 feet. Now, of course, all three of us were flying right side up. Whereupon we did some wing-overs, dipping into what is known as an exaggerated chandelle, really a heavily banked climbing turn of about ninety degrees.

"Formation No. 3 consisted of a series of loops starting at about 2,000 feet and ending at an altitude of approximately 500 feet. These loops were in formation, one right after the other.

"Then came, as No. 4, a curious little aerial stunt, called 'leapfrog.' In this the trio of planes goes into echelon formation

which is broken by the leader who does a snap roll toward the other two planes, rolling up and over them. This places him in the rear and leaves No. 2 plane in first position for a similar leap over him and the third plane.

"Maneuver No. 5, a newcomer into the field of aerial acrobatics, is also accom-

plished from an echelon formation—planes arranged in the form of steps. Starting at an altitude of 3,000 feet and ending at around 500 feet, the name of this maneuver is the push-over, so-called because the leading plane actually pushes over in the first half of an outside loop, coming out on its back closely followed by the

other planes in the same formation. All three planes complete the maneuver in echelon formation on their backs.

"Before explaining just how the push-over originated, probably I had better describe maneuver No. 6, since it is a corollary to No. 5. From the inverted echelon position of this last maneuver, the leader pulls out and loops normally, followed by the other two planes in what is called a 'squirrel-cage' loop. In other words, all three planes are in the same loop, spaced approximately 120 degrees apart. Recovery from this maneuver is accomplished by all three planes flying off on their backs from the top of any one loop.

"Now for the origin of the push-over. My team



Composite Photograph Showing Navy Planes in Formation; the Three Above Are About to Start the "Push-Over" and "Leapfrog" Stunts; Those Below Are in the Standard Vee Formation

mates and myself conceived the idea of devising some variation of the squirrel-cage loop which would be novel as well as spectacular. So for many hours over the naval air station at Anacostia, we practiced the squirrel cage, finally coming upon the push-over idea.

"No doubt, most experienced flyers are familiar with the 'slow roll,' which was our maneuver No. 7. One might sum it up by saying that it is a variation of the familiar snap roll though a prettier maneuver by far. It is executed as follows: Starting at an altitude of 1,000 feet, and maintaining that height throughout, execute a slow roll in a Vee-formation. Comparing this with a snap roll, the main difference lies in the fact that the slow roll utilizes half again as much speed; the plane is controlled all the way through the roll by the ailerons only, the actual rolling movement being much slower.

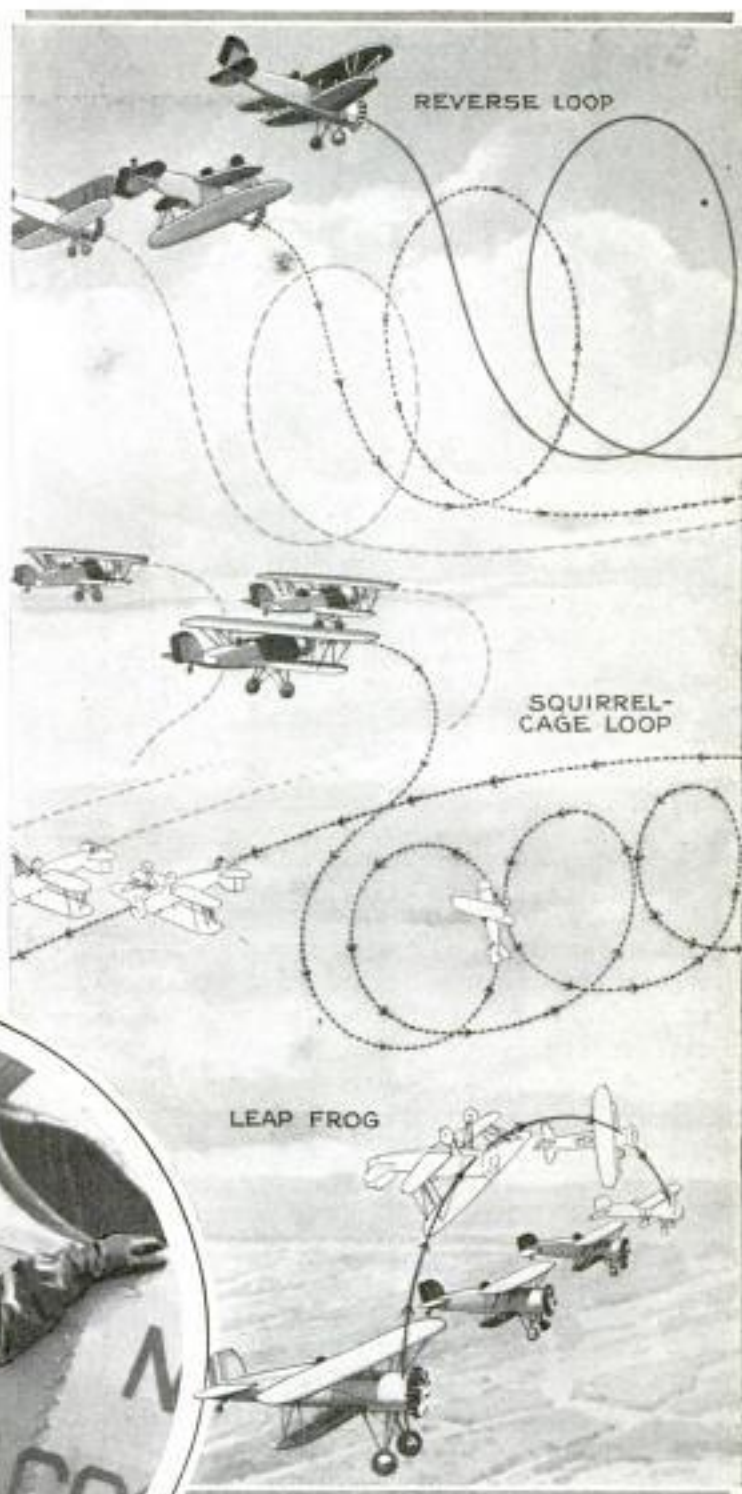

Diagram of Three Difficult Maneuvers, and Lieutenant Gardner, Leader of the Navy's Trick Group

"Maneuver No. 8 was one developed by myself and my mates in recent weeks which had never before been performed. We call this a reverse loop, and I consider

it one of the most difficult aerial feats because every manipulation of the controls is the exact reverse of normal. Starting at an altitude of about 3,000 feet, the three planes execute a loop in Vee-formation with the leader flying upside down. As the leader does a complete outside loop, the other two pilots simultaneously execute normal loops. All planes finally come out of this maneuver at an altitude of about 2,000 feet."

**MUFFLER FOR AIRPLANE MOTOR
"CHEWS UP" SOUND WAVES**



Muffler for Airplane Motor, Which "Chews Up" Sound Waves from Engine and Deadens the Noise

Invented by a woman, a muffler to ~~deadens noises from an airplane motor~~ underwent operating tests recently. A series of fans inside the muffler represents the heart of the device. It is claimed these fans "chew up" the sound waves from the engine and draw in the exhaust gases without impairing the efficiency of the motor.

AN ELECTRIC MICROMETER

Replacing the ordinary micrometer and optical methods of measuring very thin objects, such as fine wires, a recently developed German electrical micrometer is accurate to the ten-thousandth of a millimeter, and demands little skill to operate. The instrument consists essentially of an anvil, spindle, indicator and lamp, the latter being lighted by means of an ordinary pocket battery. The indicator is set to the diameter of the wire to be checked, and this sets the distance between spindle and anvil to the correct measurement. When the wire is drawn over the anvil to touch the spindle, the lamp lights if the diameter of the wire is too great to pass between the two, so that the instrument, thus set, serves as a "not-go" gauge. To

measure the wire, the spindle is adjusted so that the wire, passed between spindle and anvil, will cause the lamp to flash momentarily. The diameter of the wire can then be read directly on the indicator.

Chicago Daily News 10/22/30

DIN OF MODERN CITY WORSE

1754 THAN LION'S ROAR

Auto horns, riveting machines, steam shovels, trucks, and other units, create a din that is louder than thunder at three miles' distance and drowns out the roar of the lion, scientists have discovered. Forty per cent of the auto horns were found louder than a lion's voice and were even worse than riveters. While the city din does not inspire terror as does a wild animal's roar, city noises, physicians have proved, are a contributing cause to deafness, produce irregular heart rhythm, cause unnecessary fatigue and seriously interfere with the development of children.

**LIGHT FROM RADIO TO PREVENT
1705 COLLISIONS OF SHIPS**

Designed to prevent collisions of ships when visibility is poor, a fog-navigation compass utilizes the very sensitive cathode-ray oscillograph tube to transform wireless signals from near-by vessels into visible beams of light. The apparatus changes the signals into a spot of light on a screen which becomes a beam indicating to the navigator the directions other ships are pursuing.

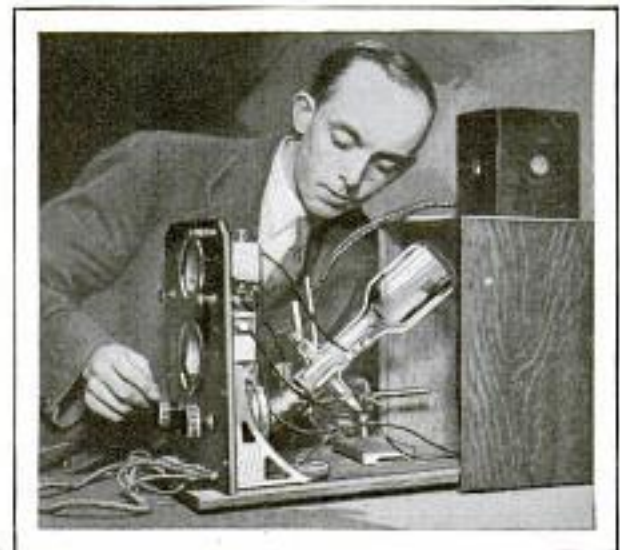

Sensitive Cathode-Ray Oscillograph Tube, Which Forms Heart of a Fog-Navigation Compass

Exhibited at Central Hall, London, Eng.

*Miss Eldorado Jones
formerly of Indiana, d. l. l.
besting plane in world*

Patented in Germany

*Illustrierte Technik
No. 41 P. V. 10/4/30*

**LADYBUGS TO DESTROY
PESTS ARE MINED
IN MOUNTAINS** 1965

Mining ladybug beetles has become a profitable occupation for many mountain rangers who seek small dens and caves along rocky ledges of the Pacific coast states where these insects are found during the early winter months. Ladybugs originally were imported from China by western vegetable and fruit growers because they prey on the aphids and larvae of harmful insects. In the fall these beetles migrate to the Pacific coast slopes, where they try to avoid the chill of nights by huddling in swarms in crevices and under rock piles. Collectors wait until just before dawn when the insects are dormant, then explore the crevices and piles of rock, scooping the captives into pasteboard boxes. They are placed in a temperature equal to their hibernation locality, and in the following spring are distributed to farmers and fruit growers.

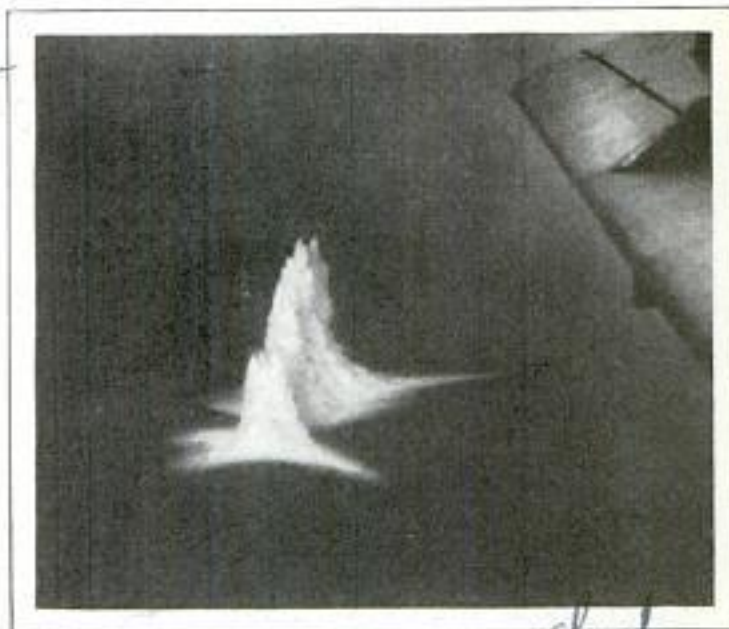

Aerial View of Explosion of 50,000 Pounds of Dynamite in New York Harbor to Make a Grave for a Sunken Ship

**HOLE BLASTED IN HARBOR BED
TO BURY SUNKEN SHIP**

Fifty thousand pounds of dynamite were exploded recently on the bottom of New York harbor to blast a grave for the wreck of the sunken ship "Fort Victoria," and bury it so deep that it would no longer be a menace to navigation. An unusual photograph of the explosion was obtained from an airplane above the scene, and showed a great geyser of water spouting into the air from the force of the blast.

1958
**BASEBALL PARK IN MINIATURE
USED IN LIGHTING TESTS**

Experiments with the latest methods of athletic-field illumination for night games are carried on by the General Electric company with the aid of a miniature baseball park, complete in every detail and provided with half a dozen floodlight towers. The model is a replica of the Des Moines, Iowa, baseball park which was illuminated for night playing, and is one-thirty-second of the actual size.

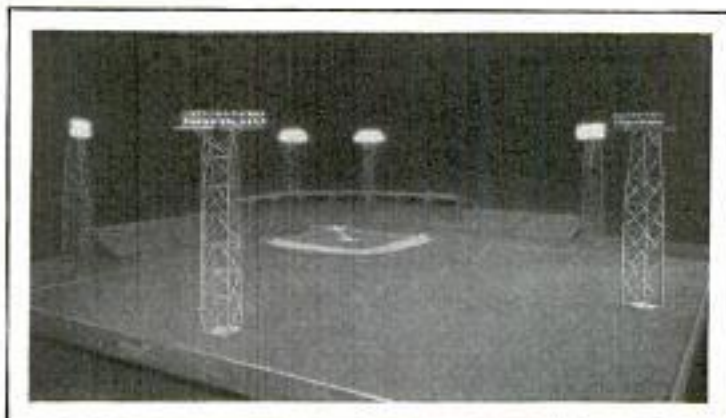

Miniature Baseball Park, One-Thirty-Second of Actual Size, Where Illumination for Night Sports Is Studied

The tiny steel towers represent originals ninety feet high, and are about thirty-four inches tall. They carry floodlights which are, in reality, flashlight lamps and reflectors.

at Nela Park,
Cleveland, Ohio.

1957
RUBBER-METAL RUNNING BOARD

Rubber is now being cured to the metal running boards of automobiles by a heating process, instead of the usual cementing method, resulting in permanent adhesion that makes the rubber and metal

virtually a single unit. Greater durability and improved appearance are among the advantages claimed. In addition, the hazard of loose covering, which often catches a heel, is eliminated by the process.

Developed by B. F. Woodruff
Cleveland, Ohio.

1724
104

Columbian Steel Tank Co.
1401 W. 12th
Kansas City, Mo.

Basic Science
Research Laboratory
University of Cincinnati

POPULAR MECHANICS



Portable Trash Burner in Which Leaves Can Be Destroyed without Doing Damage to the Lawn

PORTABLE BURNER FOR LEAVES
CLEANS LAWN QUICKLY

Leaves and other lawn rubbish are disposed of quickly with a portable trash burner which consists of a cylinder mounted on a wheeled frame which in turn is supported by two wheels. The outfit, built entirely of metal, can be pulled about the lawn and the rubbish thrown in, after which the trash is burned without damage to the grass.

ONE-MAN AUTO-BRAKE TESTER
SAVES TIME AND LABOR

Saving both time and labor, a testing gauge and pedal depressor makes it possible for one man to test automobile

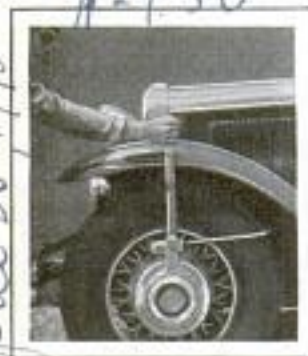

brakes and correct their faults. The outfit consists of the pedal depressor used to set the brakes, adaptable rings to fit on any type of wheel hub, a lever with the gauge attached to it, and a tire hook. With the brakes set and the wheel under test off the ground, the operator pulls on the lever until the wheel turns, the gauge registering the torque or pull necessary

to turn the wheel. This makes it possible to adjust all brakes to the same pressure, and the gauge pointer reveals imperfections in the lining or on the drum, so that their location can be marked.

BRIGHT COLOR OF RED PEPPERS
PRESERVED WITH OZONE

Red peppers will not bleach if kept in a dark, damp place and given daily doses of ozone. Scientists, investigating a way to stop the loss due to the fading of the colors of the peppers while in storage, found that the red pigment bleached when exposed to light or when the peppers were very dry. When stored in a dark, damp chamber, however, they were attacked by mold. Ozone, even as little as one-tenth of one per cent for ten minutes a day, was found to stop the mold from forming, while the darkness and moisture prevented fading. Ozone tends to bleach the peppers if they are very dry, however, the tests indicated.

PIPE ENDS DANGER FROM GAS
IN A CLOSED GARAGE

Danger of being overcome by carbon-monoxide gas while working with a running car in a tightly closed garage is prevented by a gas eliminator which attaches to the exhaust. It consists essentially of a flexible hose attached at one end to a pipe which extends through the wall of the garage, and at the other to the exhaust, thus allowing the gases to be discharged outside the building.

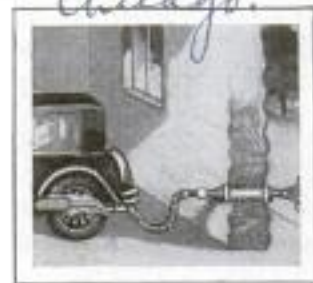

ZOO TRAIN HAULS SIGHT-SEERS
THROUGH AFRICAN JUNGLE

Tourists who wish to get a close-up of wild animals of the African jungle in their native habitat are taken through hundreds of miles of the Sabi game reserve in the northern Transvaal on sight-seeing trains made up of observation cars and lookout posts. The trains travel about twenty miles an hour within a few feet of roaming

Krugersdorp National Park
Copy of material

1264, 790
April 30, 1918
Brake. Outfit Co.
1340 Howard St.
San Francisco, Calif.

Science Service 499 St. 10/18/50 735

lions, elephants, buffalo, crocodiles, hippopotami, zebras and other jungle denizens. Lookout balconies are located at each end of the cars, and a man with a whistle rides in the locomotive, blowing one blast when he sights game to the right of the track, and two blasts for animals on the left. Sluggish hippopotami are observed floundering in a pretty river where the train enters the great zoo park in which the animals are protected by law. Often the beasts can be observed tracking down their quarry, and quite frequently the train itself is challenged by a jungle beast. Recently a hippopotamus charged a locomotive, but a cloud of hissing steam caused it to swerve and vent its wrath on a crowd which scattered precipitately. An elephant also attacked a moving train but did little damage, and a lion, pursuing an antelope, leaped on the hood of an automobile and smashed the windshield.

DOG COLLECTS FUNDS FOR AID OF HOMELESS CANINES / 727

Homeless and friendless canines of Chicago and vicinity have been provided with shelter, food and care by an animal lover who has established a dog refuge, called "Orphans of the Storm," near that city. Some of the dog inmates of the refuge have been trained to help in raising funds to care for still other homeless animals. One large and gentle dog wears a harness to which is attached a coin holder, and goes about soliciting pennies for the refuge from children.



Dog Wearing Harness and Coin Holder Which Solicits Pennies from Children for Dog Refuge

at Deerfield, Ill.

HOMEMADE BABY INCUBATOR KEEPS INFANT ALIVE / 729



Homemade Baby Incubator, Consisting of a Market Basket, Electric Light Bulb and a Blanket

One Detroit baby whose growth was retarded by a lung infection was kept alive for several weeks in a homemade incubator that operated on the same principle as the hospital incubators in which tiny infants are placed. A market basket, a large electric light bulb and a blanket were the essential parts of the homemade heater, in which the baby lived and gained one pound in three months.

BEEES WEAR THEMSELVES OUT KEEPING WARM IN WINTER / 708

Bees which do not have sufficient winter protection from cold wear themselves out trying to keep warm by constantly flapping their wings, just as people wave their arms to generate heat. Bees cannot replace or repair worn-out tissues like other living creatures, and every flap of their wings brings them nearer death, bee experts have found. They form in clusters in the hive to keep warm, fitting so tightly that those on the outside act as insulators. Unless the hives are protected with packing cases and windbreaks, the bees age and die more rapidly because of their exertion, being replaced by young bees and creating a condition which beekeepers call the "spring dwindles."

A. B. Sloan, State College of Agriculture, Ithaca, N.Y.

Verad, Tribune 10/15/30

Probably Haslock Electric Mech

THE LATEST INS AND OUTS OF MODERN SUBMARINE

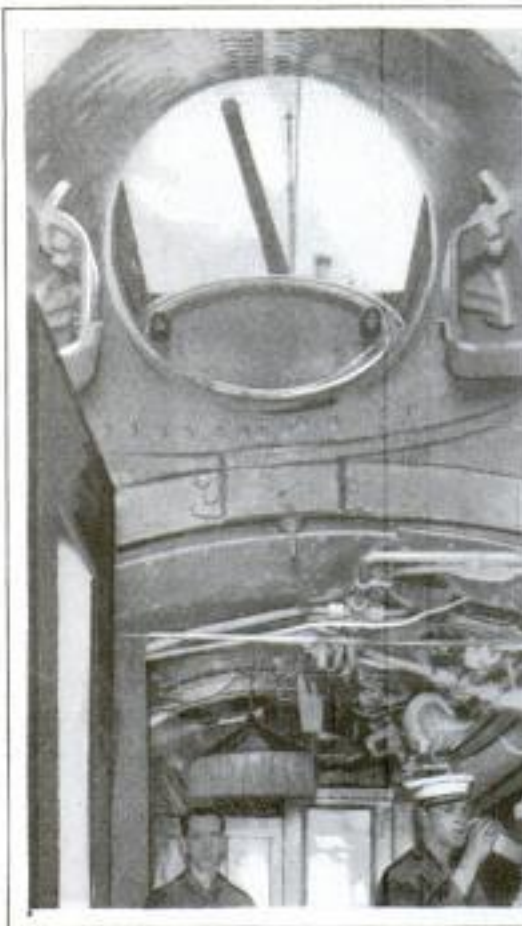

Interior View through the Fore Hatch; Some of These Photographs Were Taken with a Newly Developed Flashlight, Ignited by a Pocket Battery and Free from Fire Hazard; Note the Efficient Utilization of All Space

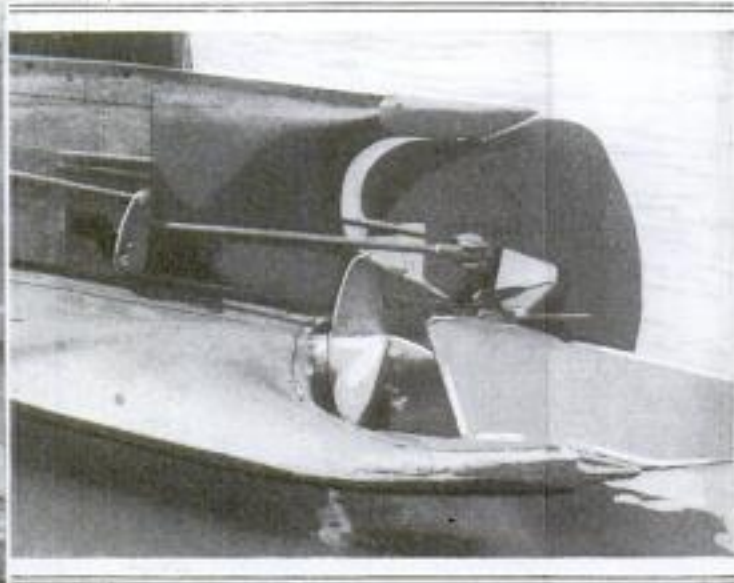

Few Persons Have Seen the Stern of a Submarine Out of Water: This View Shows the Propellers, Rudder and Hydroplanes Which Somewhat Resemble the Elevators on an Airplane; This Particular Craft Is an English Submarine



At Left, Another View of the Stern, Showing the Striking Resemblance to an Airplane, the Hydroplanes Corresponding to the Elevators; Note Height of Rudder and Position of Propellers; Hull Is Like Fuselage of a Plane; Above, Looking through the Torpedo Tubes; a Rear Door Is Being Opened

Wide World

1951

shown at Business Show.

**HEAVY RIVER DEPOSITS
CAUSE OF SOUTHERN
EARTHQUAKE**

1963

Millions of tons of sediment deposited around the delta at the mouth of the Mississippi river, are believed by Dr. William Bowie, of the United States coast and geodetic survey, to have been responsible for the slight earthquake that shook New Orleans and vicinity not long ago. He explains that the earth is in a normal state of balance, the mountain ranges maintaining a state of equilibrium with the lower regions, usually of heavier materials. If soil is shifted in tremendous quantities and becomes centered in a comparatively restricted area, the earth seeks to restore the balance by movements of the strata. Such slight disturbances may be felt as earthquakes, and they are really blessings in disguise, for if the balance adjustment were not made in this fashion, a much more severe quake might occur later. Measurements made around the delta region and the Gulf of Mexico indicate that the territory normally is in a state of equilibrium.

1762

**HOME-ACCIDENT DEATHS TOTAL
TWENTY-FOUR THOUSAND**

Home is not as safe as it is popularly supposed to be. A survey made by a large insurance company shows that, last year, 24,000 persons lost their lives as a result of accidents in their homes. Falls were responsible for more than one-third of the accidents and one-half of the number of persons involved were elderly. Children's playthings caused a great number of the serious falls. Burns caused by stoves and scalding water, shocks from electricity, leaky gas and poisonous medicines, often improperly marked, also reaped a heavy death toll.



Typewriter Desk and Chair Mounted on Tubular Framework Which Increase Both Comfort and Efficiency

**TYPEWRITER DESK AND CHAIR
ON TUBULAR FRAMEWORK**

Typewriter desks and chairs mounted on tubular frames now are being offered as the most modern in office equipment. The desks are nearly unbreakable, the chairs are mounted on one curved tubular frame and the entire equipment offers both comfort and efficiency. Despite the metal base, the desk is light in weight and is particularly useful in typing on a machine with a long carriage.

**SOLDERING IRON AND TORCH
COMBINED IN ONE** 1750

For building and repairing radio sets, mending leaky pans, and for many other tasks about the house and shop, a combination soldering iron and blowtorch saves extra equipment, space and labor. It burns gasoline and is safe and simple to adjust. The fuel cost is a fraction of a cent per hour.



Combination Soldering Iron and Blowtorch Which Burns Gasoline and Is Simple to Operate

Science Service News Bulletin 500-03. 10/21/38

Herald Tribune 10/21/38

6 suggested by... to...
July 19, 30

Royal Typewriter

Wynans Bureau
Labor Department

Justrite Mfg Co 2061
Southport Ave Chicago

Rheinische Maschinenfabrik

108

Windhoff & Co.

POPULAR MECHANICS

1671

Rheinische Westphalen Germany

Portable Power Outfit That Drives Home the Screws Holding Rails in Place

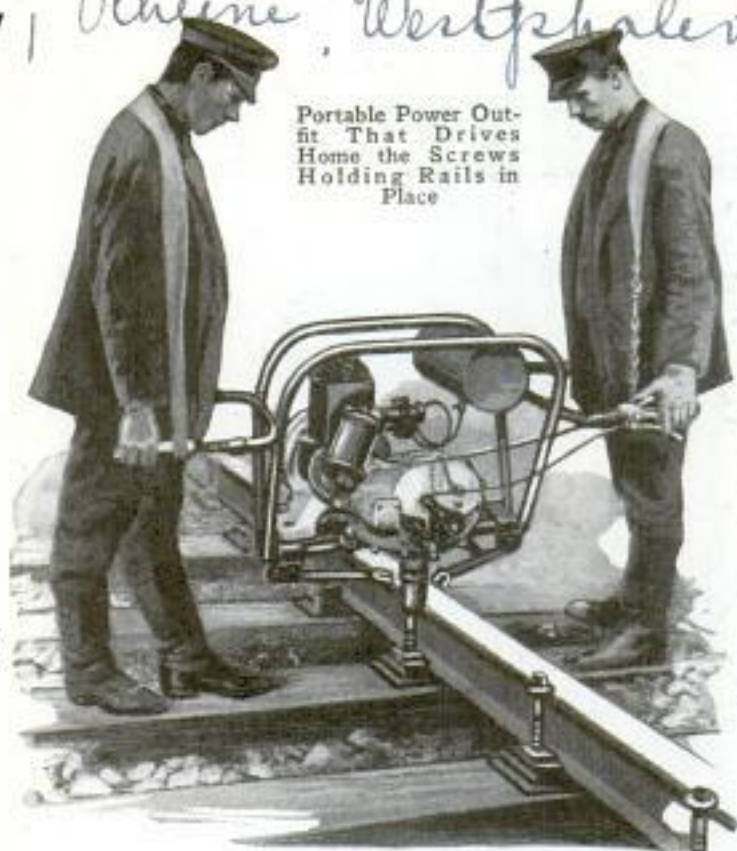

weight for work on the fairways, and another much lighter for the delicate task on the greens. A regulation bait-casting target was placed on each green beside the golf cup, and a nine-inch bull's-eye target for the archer. The five holes totaled 1,798 yards and the caster took twenty-five shots, or one over his par which had been established at twenty-four. The golfer had a score of twenty-two, two strokes over the par set for him, and the archer made a score of twenty, three over par.

HARBOR OFFICE BUILT LIKE CYLINDER IS GLASS-INCLOSED

1698

Designed along maritime lines, a cylindrical harbor office has been constructed at the new docks at Ymuiden in the Netherlands. The building looks like a series of cylinders piled on top of each other, the size decreasing as the stack grows taller. The circular building, with its various glass-inclosed levels, was found to be more efficient for the purpose than a structure of conventional design.

SCREWS ARE DRIVEN BY POWER IN LAYING RAILS

Portable power equipment is being produced in Germany for driving the screws that hold the rail plates to the sleepers in track construction. The outfit consists of a two-cycle gasoline engine, mounted in a steel tubing frame with handles for carrying, and weighs about ninety pounds. When a screw is driven home, which takes only ten seconds, the motor stops automatically, preventing damage to the screw or machine. Otherwise the motor is controlled through a flexible cable by a lever on one of the handlebars.

GOLFER AND ARCHER DEFEATED BY CASTER ON FAIRWAYS

1656

To determine which sport required the most skill and accuracy, a seasoned golfer, a practiced archer and an experienced bait caster, each using his favorite implements, recently played five holes of golf over a regulation course in Vermont, the caster winning in this particular case. The golfer carried the usual paraphernalia for this sport, the archer was equipped with a bow of forty-two pounds' pull, and the caster had two rods, one with a four-ounce

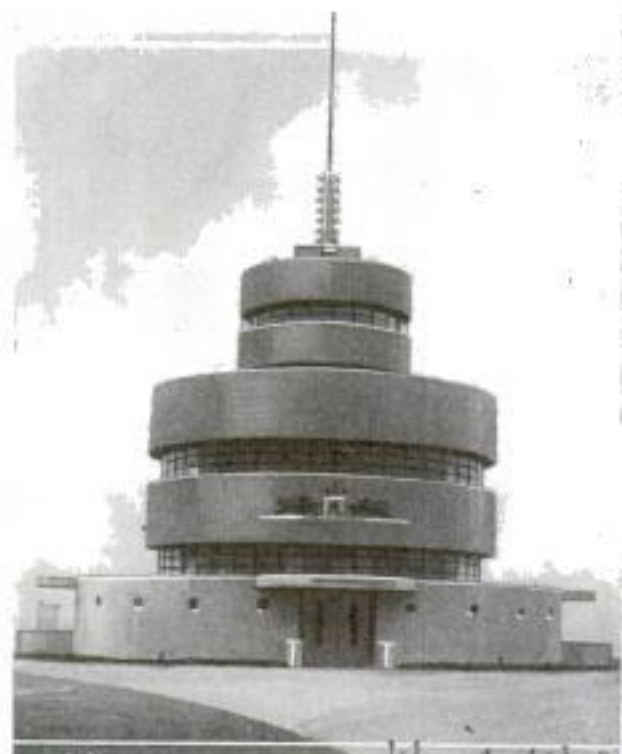

This Circular Building, Constructed along Maritime Lines, Is a Harbor Office in the Netherlands

Wide World

annual meeting. The American Tool and Hoe Co., at True Temper Iron, Wallingford, Vt.

Copyrighted material

no U.S. agent known

Science Service 499. C. 10/15/36

WHAT MAKES THE BABY LAUGH?

Repetition of words or of an action not funny in itself, one of the favorite mirth provokers of the vaudeville comedian, will get a laugh from almost any six-months-old baby. A study of the first causes of laughter in infants, made by Dr. C. W. Valentini, professor in an English university, disclosed that delight in getting food was the first cause of laughter, the smile coming when the baby was thirty-nine days old. At ten weeks, babies laugh when they hear others laugh, or when tickled, and soon after laugh when they see a bright object. Surprise causes laughter at about eighteen weeks, and unusual happenings in connection with what is familiar, such as hearing the father speak in a falsetto voice, somewhat later. The laugh of accomplishment, such as standing alone, appears at about the time amusement is provoked by mere repetition.

PHONE MESSAGE IS RECORDED FOR ABSENT OWNER

Telephone users in Belgium and Switzerland now may leave a message for the person called if he is absent when his telephone rings. The attachment which makes this possible is called a "telephonograph" and is a combination telephone and telegraph instrument on which the person calling, by means of a prearranged system of code, can signal a message to the absent party. This message is recorded on the automatic telegraph apparatus attached to the telephone, and is transcribed on a tape unrolling from the recorder. The absent person reads the message on the tape upon arriving home.

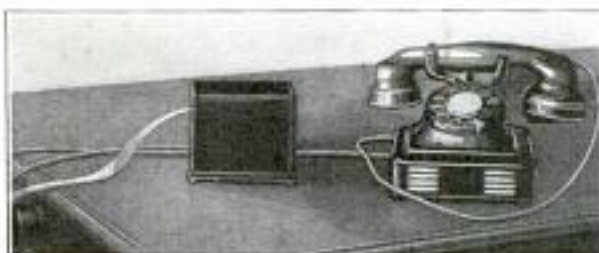

Apparatus Which Takes a Telephone Message on a Tape When the Party Called Is Absent

Used by governments of Belgium and Switzerland



Herd of Reindeer on a Transcontinental Tour of the United States; the Animals Were Shipped from Alaska for the Holiday Season

Wide World

ALASKAN REINDEER GO ON TOUR OF UNITED STATES

Visible proof that the Santa Claus of the present day has plenty of motive power is being offered to children of the United States in the form of a large herd of Alaskan reindeer which arrived in Seattle recently on the first lap of a transcontinental tour. The animals are to be used in eastern cities for Christmas publicity.

DRIED FRUIT HOLDS VITAMIN A

Dried fruit, even though sulphured and dipped in lye, retains large amounts of the important vitamin A, tests at the University of California have shown. Experiments with apricots, prunes and peaches proved that these fruits contain relatively large quantities of the vitamin, even though thoroughly dried. By feeding rats known to be deficient in the A vitamin, research workers found fruits dried by various methods showed different vitamin content. The sulphured dehydrated fruit appeared to retain the largest vitamin percentage.

Berkeley.
Copyrighted Material

1710
by Mr. Regner Day Morgan
and Anna F. Wild

1450

New Conveniences



Connected to the Gas Line, This Handy Incinerator Is Installed beneath the Range or in Any Other Convenient Place; It Radiates Practically No Heat, Does Not Emit Odors, and Is Safe and Economical



Puller and Turner for Hot Pans Prevents Burned Arms When Reaching into the Oven



Here Is an Adjustable Metal Rack That Fits on Edge of Shelf in Medicine Cabinet for Toilet Articles Such as Shown



An Easy Way to Sharpen Scissors; the Tool Is Attached, as Shown, through the Narrow Slots, Then Pressed Hard against the Blades While They Are Closed as in Cutting; after Repeating Two or Three Times, the Scissors Are in Good Condition for Work

Combination Floor Mop and Polisher; Both Are Operated with the Same Handle, the Mop Part Being Removable as Illustrated; to Polish, the Mop and Handle Are Snapped in Place and the Entire Unit Moved About, the Polishing Being Done by the Broad Base of the Unit



1480

for Your Home



Rotary Orange Juicer Is Easily Operated and Extracts Thoroughly; Just Turn the Handle and Hold Half Against Center



Fitted over Ordinary Bathtub, This Folding Canvas Rack Permits Giving the Baby a Pleasant and Cleansing Shower; the Water Runs Off Immediately

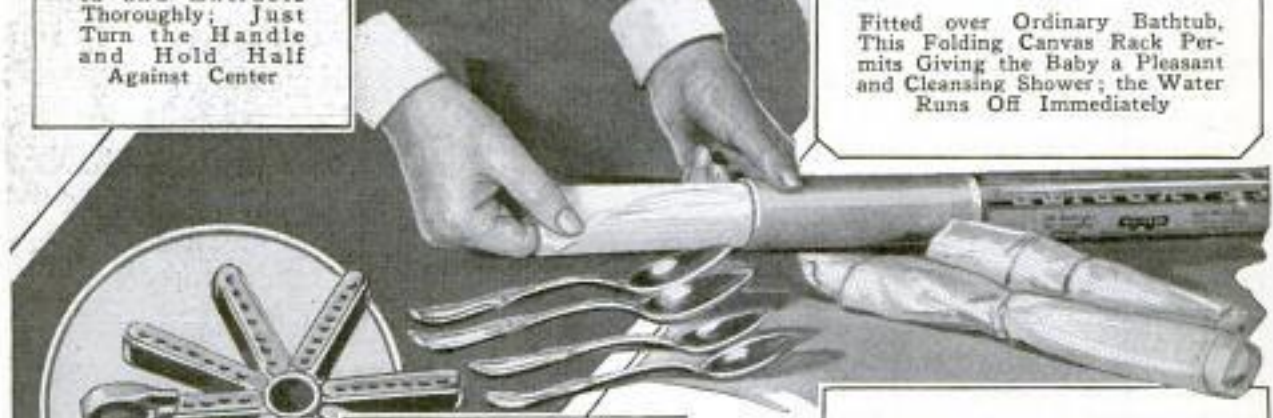

Above, Chemically Treated Tissue Wrapper Keeps Silver from Tarnishing; Below, Shields to Protect Housewife's Shoes



To Prevent Accidental Extinguishing of the Gas Jet; the Guard Slips over the Burner and Protects the Flame, Should Liquids Boil Over and Put Out the Rest of the Jet



112
 1695
 Pictures electrical dept
 MOVIE TOWER ON WHEELS
 SPEEDS UP PICTURES

1672
 energy for factory purposes. Near Florence, Italy, iron-incased shafts, 500 feet deep, have been sunk to tap a region of volcanic earth. The steam rushes up the pipes at high pressure and is conducted directly to turbines which operate electric generators supplying power to four cities. In Iceland, steam from a volcano which extends under the sea is used to supply heat, and in Chile and Bolivia, a company has been formed to harness a great volcano in the Andes mountains. The energy developed by the molten lava and steam is to be converted into electric power amounting to about 400,000,000 kilowatts to operate the mountain railways and silver and copper mines of the region. The steam from this volcano is so free from impurities that it can be run directly into turbines without installing costly cleaning apparatus. Passengers traveling by air from Singapore to Java pass directly over one small but active volcano which provides an awe-inspiring spectacle. Another volcano, Solfatara, near Naples, recently broke into flame and steam after 700 years of inactivity, and the authorities of the city tried to tap its energy through a large iron pipe, but found that the metal was corroded quickly. Efforts now are made to find a non-corrosive material so the city may use volcanic power to run its tramway system and light its streets.



A Tower on a Truck Used in the Movies for Quick Transportation and Elevation of Cameras

Moving-picture cameras and microphones for talking pictures are quickly transported from one location to another by one California movie company with the aid of an electric perambulator equipped with a hydraulic lift. The outfit looks like a tower on a truck, and is provided with platforms at various elevations for both directors and cameras. Cameras and microphones can be moved laterally and horizontally many feet in a few seconds, thus speeding up the filming of pictures.

HARNESSING A LIVE VOLCANO FOR HEAT AND POWER

176
 Live volcanoes in various parts of the world have been harnessed by man to furnish both heat and power. Steam jetting from fissures near the main crater of the famous Etna volcano in Sicily has been piped to heat an observatory near by, and efforts are being made to tap the

ERASERS RUN BY ELECTRICITY USED IN PRINTING TRADE

For large drafting rooms and printing offices, a German manufacturer furnishes motor-driven erasers, suitable for pencil, india and printing inks. The motors are suspended from the ceiling, and from each issue two flexible cables, terminating at the lower end in the eraser fixture which contains a rounded conical head of soft or hard rubber. There is also a head containing both, so mounted that a twist of the hand brings one or the other in contact with the paper.



Schmidt + Witzel
 Maulbrunn, Württemberg
 Germany

1713

Col. L. Corley Jr. Department
Langley Field
Hampton Va

POPULAR MECHANICS

"WAR" PICTURES ARE SENT FROM A PLANE BY RADIO

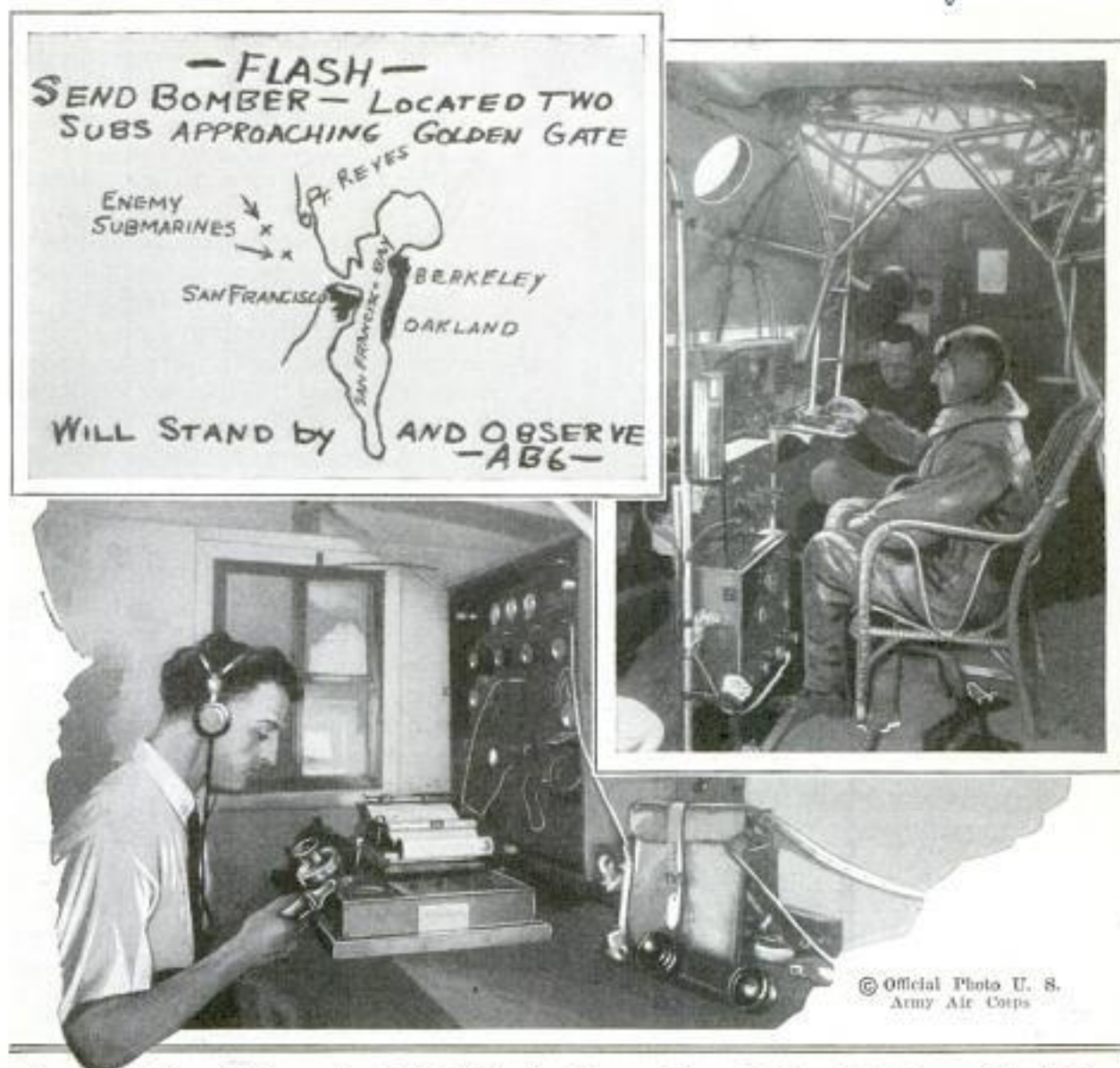

© Official Photo U. S.
Army Air Corps

Upper Left, Map and Message Sent by Television from Plane to Ground Station After Observer Sighted Two Submarines; Right, Radio Apparatus on Plane, and, Below, Receiving the Picture

Television pictures transmitted from an army observation plane were recently employed to locate and destroy theoretical enemy submarines intent on reaching the Golden Gate and San Francisco. The observation plane was sent out to find the "enemy" vessels, particularly submarines, known to be proceeding toward the harbor. The plane was equipped with a radio-television sending apparatus and was operating with a ground station far inland where army commanders worked on war maneuvers. The trained observer saw the telltale spear-head wake of two submarines on the water below, although the vessels were so deep that their periscopes were under water. The observer

then made a sketch of the terrain below, showing San Francisco, the Golden Gate and the bay, and two crosses marking the position of the boats. On the map he printed a request for a bombing plane and then transmitted the sketch by television to the ground station, where the picture was handed to a bombing crew. The bombing plane was enabled to reach the scene and drop a hypothetical load of depth bombs before the boats had proceeded a mile.

Write our Bureau of Information if you wish to know who makes or sells any article described in this magazine. Send no postage; the service is free.

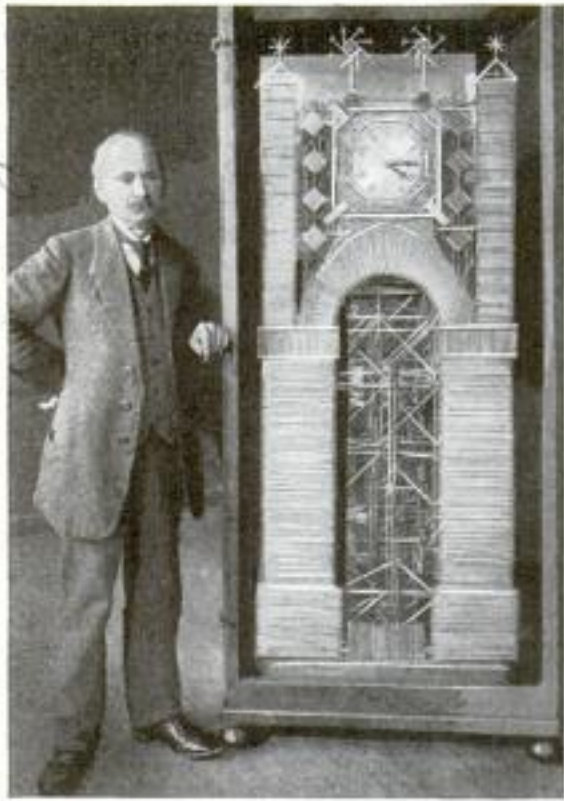

Clock Made of Straw Which Keeps Accurate Time; a German Spent Fifteen Years Building It

BIG CLOCK BUILT OF STRAW KEEPS GOOD TIME

Fashioned of straw, a large clock, constructed by a German artisan, is said to keep accurate time. The maker devoted his spare time over a period of fifteen years to the task.

AUTOMOBILE HAS SIX WHEELS AND TWELVE GEAR SHIFTS

Six wheels, six brakes, eight speeds forward and four reverse, five axles and no frame are features of an automobile built in Czechoslovakia of such unusual construction that one has been brought to this country for experimental purposes. It was originally made for the use of German army



Six-Wheeled Auto for Traveling Rough Ground; It Has Five Axles, Eight Forward Speeds and Four Reverse

officers in crossing shell-torn ground. The car has four driving wheels that are designed to contact at all times with the most irregular contours, making the machine particularly useful in traveling bad roads or across sections where there are no roads. The twelve gear shifts offer a wide range of power and the maximum speed is about forty miles an hour. A horizontal air-cooled four-cylinder engine powers the car. It is built on a nine-inch tube which carries the propeller shaft. In line are the transmission and two differentials, one for each set of driving wheels. Each driving wheel has its individual axle, connected to the differential by a universal joint.

RADIO ICEBERG FINDER SOUGHT TO PROTECT SHIPS

Efforts are still being made to devise a practical iceberg finder that will give infallible warning to an ocean liner of the presence of the danger, and its direction and distance in plenty of time to change the course. Radio has been of some aid in preventing a repetition of a disaster such as sunk the "Titanic" eighteen years ago, but even this medium is not entirely successful. The coast-guard ice patrol, by means of radio, is able to warn vessels of the presence of icebergs it can locate, but no instrument has been found sufficiently practical to pay for its installation on liners themselves. Sounding apparatus has been made which will detect icebergs a mile or so distant, but such apparatus is not very successful because of the speed of modern ships and the lack of accuracy in measuring the distance. The

development of the radio compass, or direction finder, however, would enable rescue ships to reach a boat in collision with a berg much more quickly than was possible at the time when the "Titanic" sank.

11/22
 Max Wolf of Upper Silesia Germany
 made in Czecho. Slovakia
 "Tatra. Car"
 745

one owned by Thompson Products Co., Detroit, Mich.

Chicago Tribune
 10/19/30

1615 James Montagues, R. 304,
465 Bay St. Toronto
20 Anb Canada

The VANISHING HERD

CLOUDS of dust hung over the ground and drifted higher as the thudding of thousands of hoofs in rapid motion traveled like thunder across the countryside.

Far off, could be seen a black mass advancing rapidly. A pony dashed past, a lone cowboy in the saddle. Coming closer to the herd of stampeded animals could be seen more cowboys, racing alongside. The charging black mass kept on, its leaders headed off by the cowboys toward a wooden fence.

The occasion was not many years ago. The stampede took place this autumn, as it did last autumn. Canada's cowboys were rounding up the world's second largest herd of buffalo at Wainwright Park, in the rolling prairies of eastern



Splendid Head of a Buffalo in National Park, at Wainwright, Alberta, and, Below, Herding the Animals into Wading Corral

Alberta, where from four to six thousand head roam in a pasturage of 100,000 acres.

The herd has grown from 709 animals which the Dominion bought in 1907. In fact, so large are the herds now that it has become necessary during the past few years to have an annual roundup. It occurs during the early autumn. Then scenes, such as were frequent not more

than fifty years ago, become realities of today. The thousands of buffalo, fear-maddened into a stampede, are driven by expert cattlemen into the corrals. The calves are branded and the yearlings shipped to the largest game preserve on the continent, Wood Buffalo Park, at the boundary of the Northwest Territories and Alberta, which covers 17,000 square miles.

This novel undertaking of giving the former monarch of the plains his freedom again was begun in 1925, and has been continued yearly since, until now there are more than 10,000 animals, including those shipped north this autumn. The animals which used to roam in millions over the plains from the Gulf of Mexico to the Arctic shore, mercilessly shot almost to extinction, are coming back again in

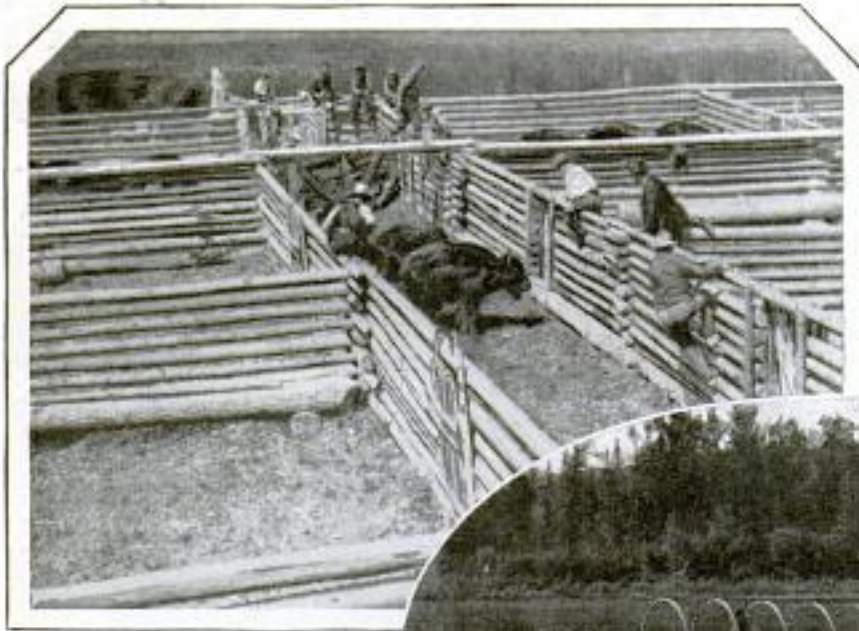

Buffalo Awaiting the Next Step in Their Journey to Wood Buffalo Park, and Patrol Boat on Duty in the Park



To preserve the buffalo is not enough for the Dominion. Modern civilization must find some use for everything. So Canada has decided that the buffalo will help raise a range breed of cattle that will be able to stay out on the prairies all year round.

growing numbers and may mean the revival of the popularity of the buffalo steak.

As a matter of fact, buffalo steaks are already to be found in western Canadian restaurants as well as in some places in the adjoining states of this country in the autumn, when expert riflemen and fast-shooting rifles pick off the older members of the Wainwright herd. Buffalo robes and coats are also coming into style again as each year a number of these animals are slaughtered.

Little real progress was made until the yak, an animal from far away Thibet, was brought in as an intermediary. This beast seemed to be the link between the buffalo and domestic cattle. As soon as a product is obtainable from this triple ancestry, the effort will be made to breed out the yak blood. The "cattalo" produced in the latter experiments promise well; they have good coats and excellent flesh.

PREHEATER FOR AUTO ENGINE PLUGS INTO LIGHT SOCKET

1941
Operating from a light socket in the garage, an electric preheater for the automobile engine keeps the motor above freezing in zero weather at "low heat," and on "high heat" will warm an engine to summer temperature in five or ten minutes. The heat-

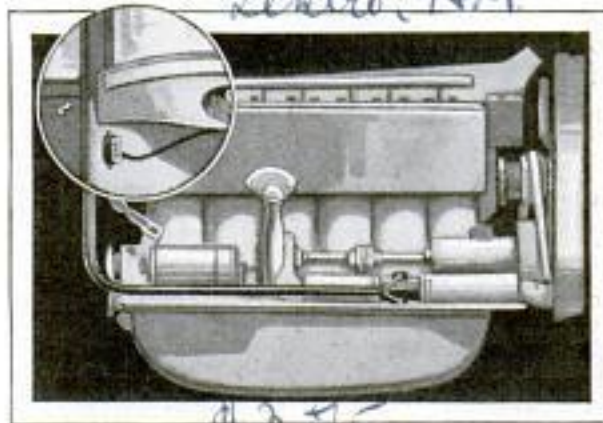

Showing Installation of Electric Preheater for Auto Engine Which Operates from Light Socket

ing element, which provides easy starting and saves batteries, slips into the lower hose connection, a cable extending from the unit to a switch installed in the door frame under the dash. It costs little to operate and can be installed in only a few minutes.

Our Bureau of Information is for you; use it as often as you please.

*Electric Steam, Inc.
Jackson, Mich.*

Lengths 15-mile to get plant
with electrical machinery. Mass.

1938

**ELECTRIC CABLE OF ALUMINUM
REDUCES POWER LOSS** 1947

Aluminum wound over steel, has been used instead of copper in a 220,000-volt transmission line, 126 miles long, in the east. The cable is one and three-eighths inches in diameter but, despite its large size, weighs only one pound to the foot, and reduces power losses resulting from corona, the luminous discharges of energy commonly experienced with all high-voltage transmission lines.



College Class in Radio Broadcasting Listening to a Student Announcer at the Microphone

**RAILROAD CARS IN GAY COLORS
PREVENT AUTO ACCIDENTS** 1949

To reduce the number of accidents resulting from automobiles crashing into the sides of railroad trains at crossings, the cars of the Canadian National railway have been painted in bright colors. The gay hues in contrasting shades are visible for a considerable distance. Self-propelled cars are also equipped with warning bells and whistles in addition to being painted in bright reds and yellows.

**LATEST ARMY PLANES SUITED
TO HIGH ALTITUDES** 1952

Latest fighting equipment of the United States army air forces includes 131 single-seater biplanes that are exceptionally speedy and powerful. These machines, fully loaded, weigh 2,700 pounds and can climb 33,000 feet without reaching their limit. The little craft can do better than 180 miles an hour.

Wasp, powered
single seater



One of Latest Type Army Fighting Planes, Capable of Reaching High Altitudes and with a Speed of Over 180 Miles an Hour

**CLASS FOR RADIO ANNOUNCERS
ENROLLS FIRST STUDENTS**

Radio announcing this year made its debut as a college study when the University of Iowa enrolled students for a course in broadcasting. The class uses the school's radio station to train each individual in diction, quality of voice and other requisites of the efficient broadcaster.

**RADIUM'S RAYS PIERCE STEEL
TEN INCHES THICK** 1583

X-ray photographs of steel ten inches in thickness can now be obtained by the use of radium. With the usual X-ray equipment it has been impossible to penetrate steel more than four inches. The latest equipment, besides making it possible to examine thick steel girders and battleship hulls for defects, also offers advantages in portability and simplicity over the usual equipment. The method, which has been developed by the naval research laboratory, consists in trapping the gas which radium is continually giving off in a tube, surrounding the tube with glass and grouping the steel to be examined on the outside. The rays pass through the thick metal with sufficient strength to make usable photographs.

discovered by R. D. Merrill
Dr. E.lean Brad. Barrett
Naval Research Laboratory, at Washington.

Boeing Airplane Co.
Sergeant Station, Seattle Wash

*Seamless Rubber Co
 New Haven, Conn*

**ARM FOR ELECTRIC HANDSAW
 IMPROVES QUALITY OF WORK.**



Radial Arm for Electric Handsaw Which Converts a Portable Outfit into a Handy Bench Unit

Designed to convert a portable electric handsaw into a table or bench unit, a radial arm now on the market fits almost any type and promotes greater accuracy and ease in many operations. The arm is provided with clamps and brackets for holding the saw, which is quickly adjusted; it reduces vibrations especially when cutting tile, building stone and other hard materials, and in mitering, beveling and similar tasks, the saw is securely locked against movements.

**TUNNEL IN GRANITE TO REVEAL
 NEW BEAUTIES IN YOSEMITE**

Travelers will be able to see the Yosemite valley from a new vantage point with the completion of a proposed 4,000-foot tunnel through the solid-granite valley wall, 500 feet above the bottom and beginning at a point about one and one-half miles from the Bridal Veil falls. It will emerge on the side of Black Turtle dome. The tunnel will be twenty-four feet wide, twenty feet high, electrically lighted and ventilated through openings in the side of the cliff and by means of the natural draft. In addition to the roadway for automobiles, there will be a footpath for hikers. Near Black Turtle dome, the

roadway will be widened into a broad parapet from which a panoramic view over the valley may be enjoyed. The tunnel alone will cost about \$400,000. It is part of a \$2,000,000 reconstruction program which is expected to be finished for the season of 1932.

**RECOIL CUSHION FOR SHOTGUN
 HELPS IMPROVE AIM**

To take up the recoil of the shotgun, a special pad that protects the shoulder and arm, has been devised. It is easily attached to the gun and, having no slots or other obstructions, is claimed not to depress or elevate the muzzle. The outside is a solid-rubber cushion. Inside is a mass of spongy material of a special chemical compound to absorb the shock. The recoil is evenly dissipated, there are no holes or openings to collect dirt, and the shoulder surface cannot skid or slip.

**CAMPERS' CUP HAS COMPASS
 MIRROR AND MAGNIFIER**

For campers, hunters and others, a metal cup that has a compass and mirror on the bottom and a magnifying glass on the top, has been introduced. The unit is collapsible, weighs less than two ounces, and is made in aluminum or nickelplated brass. When extended, the cup is nearly three inches high.



Collapsible Drinking Cup for Campers That Contains a Compass, Mirror and Magnifying Glass

Aluminum or nickel plated brass. \$2.00.
no shoe
 American Thermo Ware Co
 Inc., 16 Warren St
 New York

1911
 Cont. A Lewis Brevet,
 Box 141, San
 Francisco, Calif.

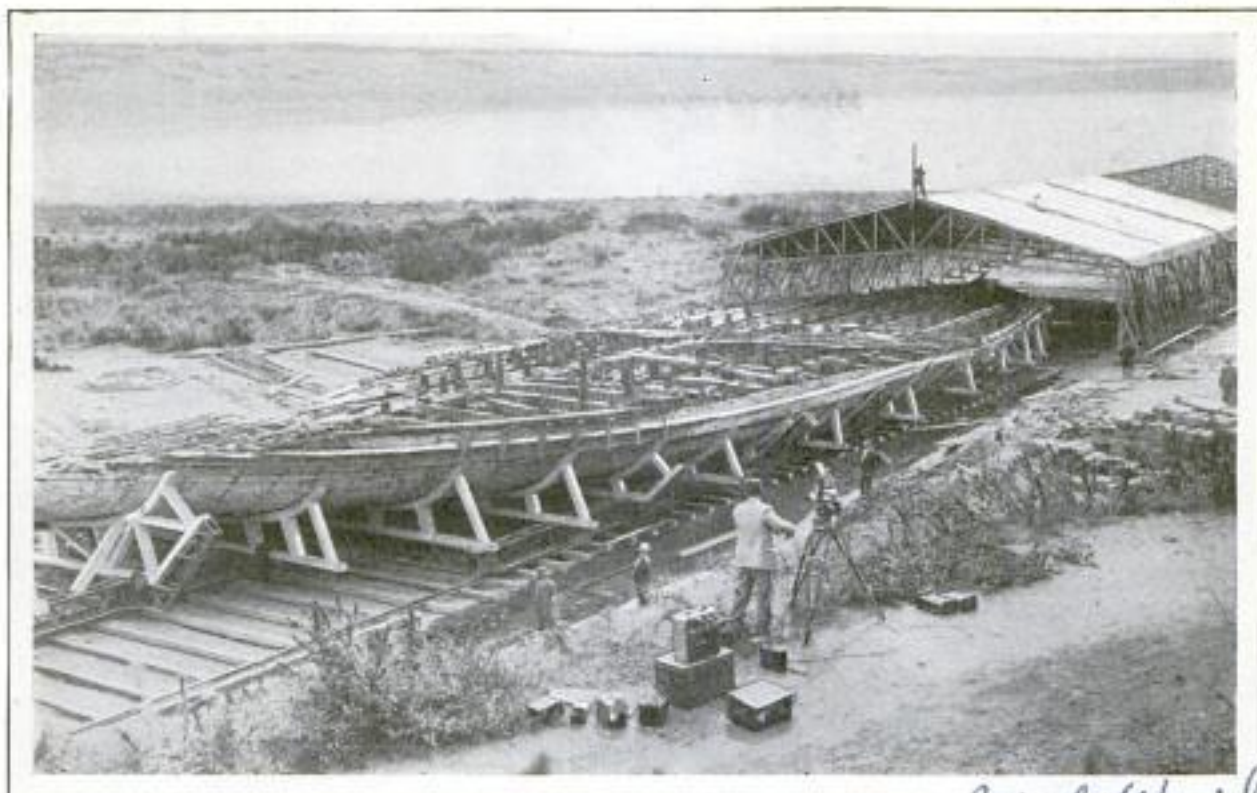

Ancient Roman Barge Which Once Was a Floating Palace of the Emperor Caligula; Lake Nemi, Where It Has Lain for 2,000 Years, Recently Was Pumped Out to Bring It to View

ANCIENT ROMAN BARGE RAISED AFTER TWENTY CENTURIES

After lying on the bottom of Lake Nemi in Italy for nearly 2,000 years, one of the barges of the Roman emperor Caligula has been exposed by pumping the water from the lake. The boat, some 200 feet long, was once a floating palace. The hull of the vessel is exceptionally well preserved. A shed is being built around the craft to protect it.

ALL-METAL BOWLING BALLS AS ELASTIC AS WOOD 1726

All-metal bowling balls are being used in France, where they have been found to offer the elasticity, resistance to shock and balance that it had been thought could be found only in wood. Heretofore French bowlers have been using wooden balls covered with steel sheeting, the all-metal ones being produced by welding. Two hemispherical shells of thick, beaten-out sheet iron, symmetrically beveled, are welded together and the hollow interior is filled, through a small opening, with a substance of uniform density, and having an elasticity equal to that of wood. The

perfected by Mr. B. Butti, French engineer.

opening then is closed with a pin, cut and riveted, and the ball is finished in a lathe and channeled, presenting an equilibrium considered by many to be superior to that of the wooden ball. The metal balls are of the same size and weight.

TIME FOR OIL CHANGE SHOWN ON GEAR-SHIFT LEVER 1742

Visible warning of the mileage at which oil should be changed is given to the motorist in an oil meter which is an integral part of a crystal ball for the gear-shift lever. The ball makes sticking of tags on the speedometer unnecessary, as the meter is set, when oil is changed, to the figure when it is to be changed the next time. It is a sturdy instrument and has no parts likely to get out of order.



Twenty-nine cities now are equipped with police radio systems.

Adams Campbell Co., Ltd.
1728 S. Los Angeles St.
Los Angeles, Calif.

1684

120

Built by J. W. Horne
Western man

Built by Bradford
Electric Co
Kansas City, Mo.

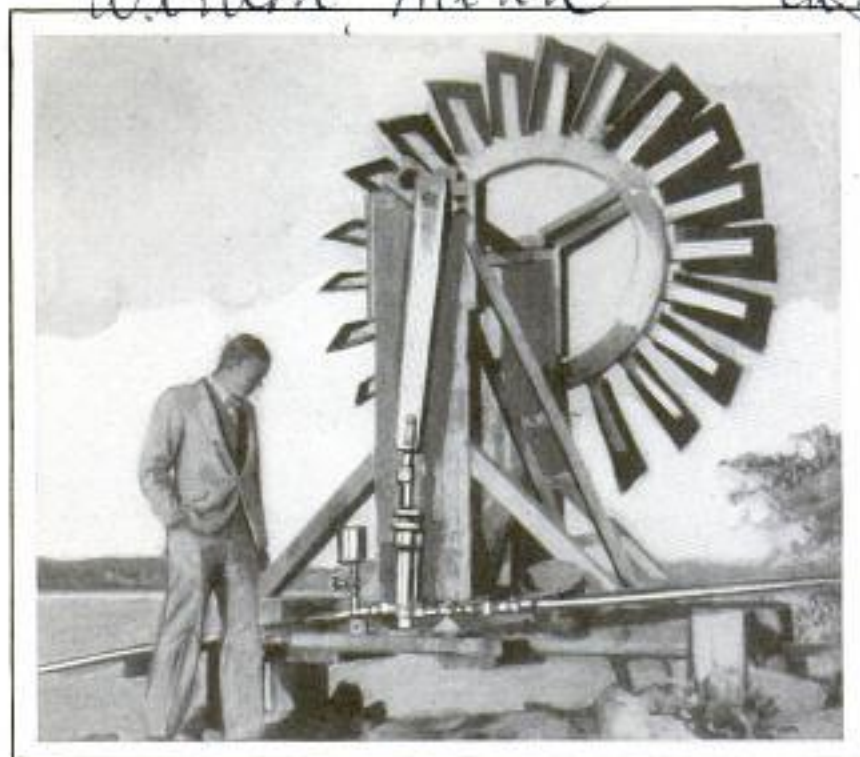

Breezes Furnish the Motive Power for This Wind Wheel Which Pumps Water from a Lake to the Home of a Family Living Near By

WIND WHEEL PUMPS WATER FOR SIX FAMILIES

To replace a gasoline pump for drawing water from a lake to his home, a Minnesota man has made a pump that derives its power from the wind. It is similar in principle to the windmill pumps used on farms, the frame having been built from waste lumber pulled from the lake, while the blades are of coated metal. The little windmill revolves easily in even a slight breeze and is capable of pumping enough water to supply six average families.

STEEL TUBES FOR BOAT HULL CUT BUILDING COST

Steel tubing is being widely used for electrical conduits, airplane construction and other purposes, and now has proved its value in boat building. A western company has constructed a craft with a steel-tube hull for service on the Mississippi river. Approximately 500 feet of one-half-inch tubing were used, the members being joined by welding. The frame was then covered with sheet metal and all seams welded. An estimated saving of twenty-five per cent over wood on a production basis was possible by employing

Steel and Tubes, Inc.
224 E 131st St
Cleveland Ohio

the tubes. Without passengers or freight, the boat draws only two inches of water and is claimed to attain a speed of fifty miles an hour with proper power.

STOMACH'S INSIDE IS PICTURED BY TINY CAMERA

Photographing the inside of the stomach is accomplished with a tiny camera, known as a "gastrophotor." It is about two inches long and is inserted while attached to a stomach pump. It has an upper and lower "eye," each provided with four films about an eighth of an inch square. Between

the two is an electric bulb which gives a 12,000-candlepower cold light. It has no lenses, but uses pinhole exposures for making pictures after virtually being swallowed by the patient. An X-ray apparatus is employed to observe the position of the apparatus in the stomach.



Tiny Camera on the End of a Stomach Pump Which Takes Pictures of Interior of Stomach

Dr. W. Dr. John
D'Alenka
Vienna

A.C. TUBE CHECKER

SIMPLE TO MAKE

By D.A. Brown

AN alternating-current tube tester that can be built at a cost of about \$10 will meet the need for an inexpensive portable checker, and many radio experimenters will have all the necessary parts on hand. It must be understood that an a.c. tube tester of this type cannot be adapted for testing screen-grid tubes without adding greatly to the cost of construction and a number of changes in design. On the other hand, the wide range of tubes that can be checked with this simple instrument embraces 226, 227, 171, 171-A, 112, 112-A, 201-A, 280, 281, 210, 250, and 213-types.

This list includes several tubes not usually provided for in many expensive a.c. checkers, and, although the test is not complete in every detail, it will enable the user to identify good or poor tubes very quickly and accurately.

An a.c. tube checker has the advantage that no batteries are necessary for its operation. The average checker, taking its filament-current supply from a storage battery, is not very satisfactory for testing tubes of the a.c. type. The current required for these tubes is high, and they take various voltages at different current ratings. Therefore, placing a resistor in the circuit of a battery-operated checker is not very good practice, as the voltage requires changing with different types of tubes whose current drain is too high to be furnished from a battery. In addition, it has the advantage of portability and may be placed in operation very quickly by merely plugging it into any outlet socket supplying 110 volts a.c.

The various parts are mounted on a bakelite panel, $\frac{3}{16}$ by 6 by $8\frac{1}{2}$ in. The four-prong and five-prong tube sockets are of the subpanel-mounting type. Two holes, $1\frac{1}{8}$ in. in diameter, for



mounting these sockets are cut in the panel in the location shown. The 0-to-25 milliammeter, which is mounted directly below the sockets, requires a hole of a diameter which will depend on the type and make of meter used. The filament-heating transformer is a standard type with the various taps arranged to supply the voltages required. The two 500-ohm resistors are of the 2-in., 25-watt wire-wound type. They are connected as shown in Fig. 1, one resistor being shunted across the paralleled plate and grid terminals of the sockets and the other in series with the milliammeter and plate terminals. These resistors are supported clear of the panel and instruments to which they are connected by soldering the terminals of the shunt resistor directly to the plate of one socket and the grid of the other. The second 500-ohm resistor is connected to the plate end of the first with a suitable

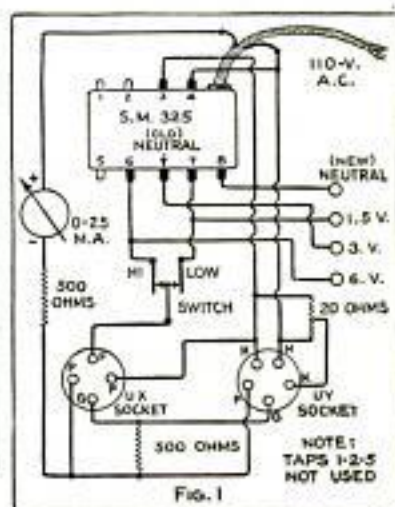

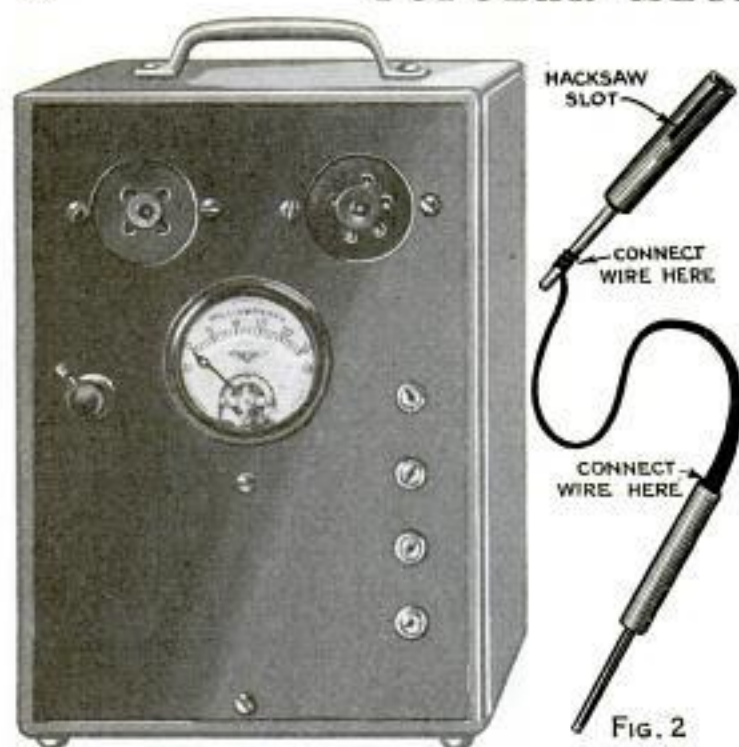

length of busbar wire, the other end being connected directly to the negative side of the milliammeter.

The 20-ohm center-tapped resistor is connected directly across the heater terminals of the five-prong socket, the center point going to the cathode of this UY-socket. The switch is a standard type single-pole, double-throw, commonly used for changing from long to short antenna in present-day sets. It is employed to change the voltage on the UX-socket from 1.5 volts for the type-226 tube to from 5 to 6 volts for the 171, 210, 280, and other tubes, whose voltage ratings range from 5 to 7 volts. It is understood that some types of tubes will be operating under normal voltage ratings, but the checker will show a good reading to indicate a good tube.

The four midget cord-tip jacks, mounted along the side of the panel as shown in the photo, are to furnish current for tubes of the type having the heater terminals on the side or top, a further advantage not available in the usual tube checker. The connectors for testing tubes of this type are shown in Fig. 2, and are made by soldering flexible leads to phone tips or midget plugs. The flexible leads are about 6 in. long, and a hacksaw cut is made in one of the plugs on each connector so that they will fit tightly on the tube heater terminals. The only precaution to be taken when testing tubes of this

type is to be sure to apply the voltage specified by the manufacturer; this, as a general rule, is 3 volts.

Mount the transformer near the end of the panel, as shown in the photo at the lower right on page 121, with the output terminals toward the milliammeter. The 110-volt a.c. supply lead to the primary of the transformer is tapped on each side for the lead to the milliammeter on one side and the lead to the heater terminal on the UY-socket and tap No. 4 on the other. The remaining heater connection is taken from tap No. 3. It will be noted that the neutral tap on the secondary of the transformer indicated as the "old neutral" now becomes

the 3-volt terminal, and the neutral is shifted to tap No. 8. Taps Nos. 7 and 6 now supply the 1.5 and 6 volts respectively.

Rubber-insulated flexible hookup wire is used for all connections, and the completed tester may be mounted in a simple wood carrying case in the manner shown in the upper photo on this page.

To operate the tube checker, plug the cord in an a.c. lighting socket and note the type of tube to be tested. Tubes of the 226-type reading less than 15 milliamperes should be replaced. These tubes require 1.5 volts; therefore, be sure that the switch is thrown to the low side before inserting the tube in the socket. For all other tubes a reading of 15 milliamperes or more indicates a good tube; if less, the tube should be replaced. For the Kellogg or McCollough tubes, or similar



types having the heaters on the side or top, apply the heater voltage to the heater terminals from the pin jacks on the panel.

Operating A.C. Tubes

When a 226-tube is used in an audio system, the transformer tap is not the best means of obtaining electrical balance in the filament circuit. A variable center-tapped resistance will give better results. The same resistance serves the like purpose also with the 227-tube. Ground all transformer cases and cores and twist all filament leads, and bear in mind that grid-bias voltages are required on all a.c. tubes. The 226-tube should not be employed as a detector, the 227 being the best for this use. When shunting a tapped resistor across the filament, for obtaining the best circuit balance to prevent hum, connect it directly at the tube-socket terminals.

Trap Reduces Short-Wave Interference

A simply built wave trap will reduce interference from near-by short-wave transmitters. A coil consisting of 4 turns of about No. 8 copper wire is wound on a form, 3 in. in diameter, and shunted across a .001-mfd. variable condenser. This device is mounted on the window, as shown in photo, and connected in the receiving antenna as a wave trap. It tuned to the offending wave when the plates were almost all in. Many signals could be copied, the writer found, and stations worked satisfactorily which previously could not be made out at all. The very high value of the capacity used is believed by the writer to be an important feature; when not required, the trap can be shunted out.—C. A. Briggs, Washington, D. C.

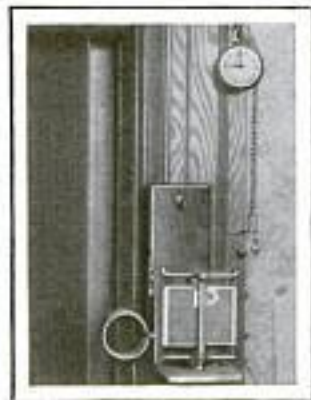

For further information on any radio construction article write to the radio department; this service is free.



Dynamic Speaker with Double Air Column for Directional Public Address

Directional Speaker for Outdoor Use

The directional air-column device adapted to the dynamic speaker shown in the photo was designed for the purpose of directing sales announcements and radio programs to cars approaching along a highway. The dynamic speaker is mounted on a sturdy support behind a small baffle and the extended wings at the rear are a part of the baffle. The double-horn arrangement may be made of sheet metal in the manner shown and decorated to suit the builder. Melvin Johnson, of Maywood, Calif., who originated the idea, is shown with the installation.

Photo-Electric Cell and Amplifier Unit

A unit that operates a relay when light falls on the photo-electric cell is now available. The cell, together with an amplifier tube, is mounted on an aluminum box which contains the necessary coupling devices and wiring. The unit responds to light influence in less than .001 second, and may be applied to many tasks which otherwise require tiresome watching by the human eye. These include the rapid counting or sorting of objects the shadow of which falls on the cell, the automatic ringing of alarms, and many similar uses.



Westinghouse Electric
 & Mfg. Co. East Pittsburgh
 Pa.

Aero Products, 4611, Ravenswood, Chicago

HELPFUL RADIO

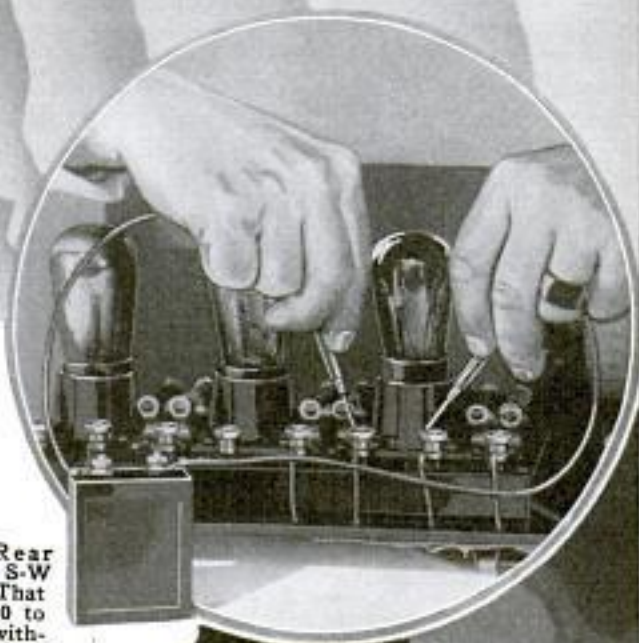
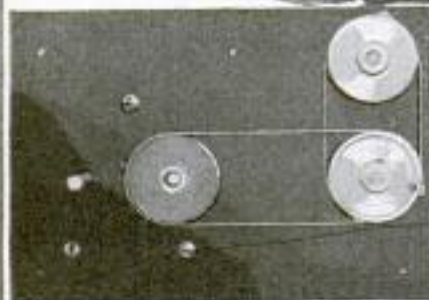
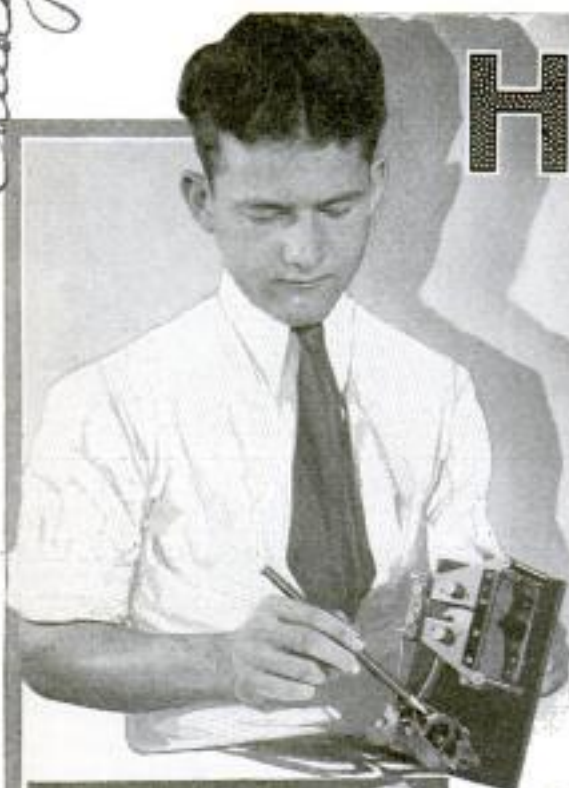

Top, Left, Rear View of New S-W Tuning Unit That Covers from 20 to 100 Meters without Changing Coils, Showing Small Variometer and Special Double Condenser Which is Inde-

pendently Tuned; Below, Control Panel with Belt and Pulleys; Right, Testing for Hum with 1-Mfd. Condenser across Plate-Voltage Taps Supplied by B-Eliminator; When Located, Condenser is Permanently Connected

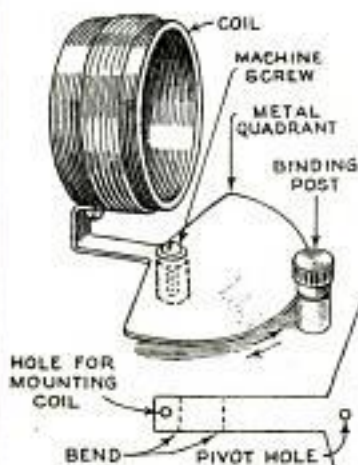

Left, a Simply Constructed Coupling Device for Coils Used in Oscillators, and Similar Devices, Where It is Necessary to Obtain the Desired Degree of Coupling by Experiment; the Best Position Found, the Coil is Locked in Place with the Binding Post; the Quadrant is Cut from Scrap Aluminum and Drilled as Shown in Lower Sketch

Right, a Neat Method of Mounting Small Home-made Choke Coils That Must Be Insulated from the Metal Chassis; Also Handy for Mounting By-pass Condensers as Shown

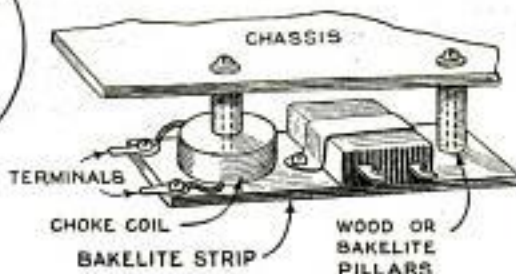

Above, with a Tapered Reamer, Small Holes Can Be Quickly Enlarged in Metal Bases; the Photo Shows an Aluminum Baking Pan Used for a B-Eliminator Base, the Holes Along the Side Being Enlarged to Pass Insulated Binding Posts

HINTS from the LAB.

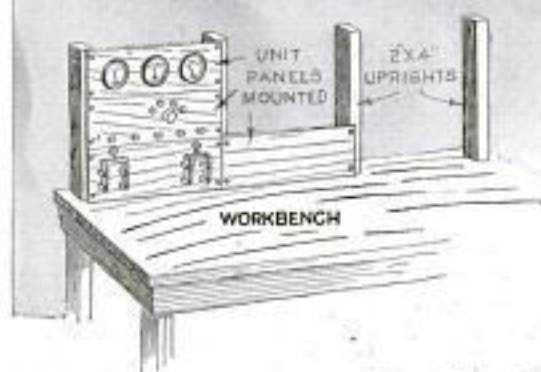

Top, Left, Handy Instrument-Panel Mounting Arrangement for the Workbench; Right, Building a Sturdy Channel and Strap-Iron Rack for a Short-Wave Transmitter of Unit Design; Angle-Iron Brackets Support the Shelves at Any Desired Height; Lower Left, a Simple Method of Making Interchangeable Choke Coils, Mayonnaise Jars or Screw-Top Glass Vials Supplying the Winding Form and the Screw Cap a Permanent Base; the Coil Terminals Are Brought Down to Fahnestock Clips

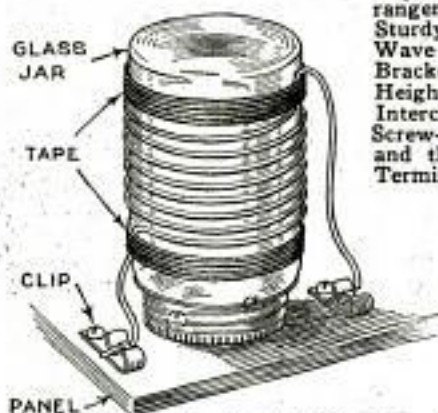
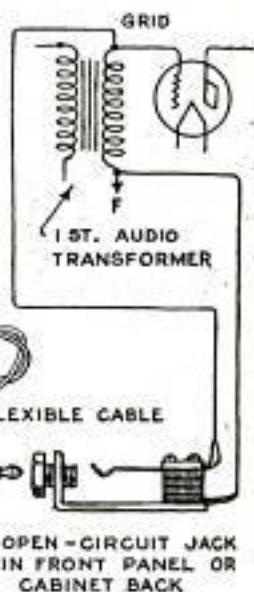

Right, Homemade Portable Remote Control; When in Use, Regular Volume Control on Set Is Turned Full On; Below, Connecting Filament-Heating Transformers in Parallel to Obtain the Added Current Necessary to Supply More Tubes Than One Transformer Can Handle; When Connected, Place a Three-Volt Flashlight Bulb across the Output and Insert Both Line Plugs; If Bulb Lights, the Secondaries Are Correctly Poled, If Not, Reverse One Plug; When Correctly Poled Connect Both Input Leads to One Plug and Take Center Tap from Added Transformer

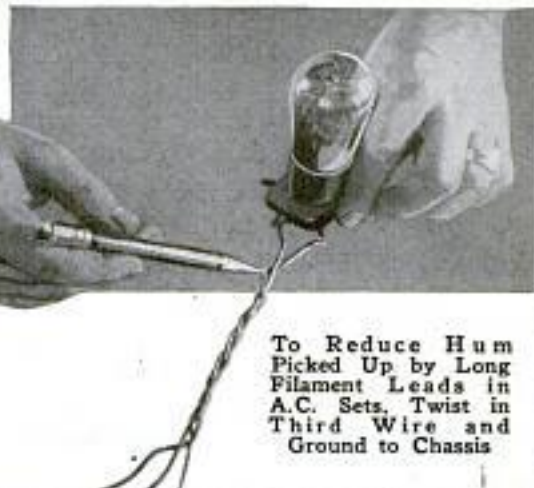
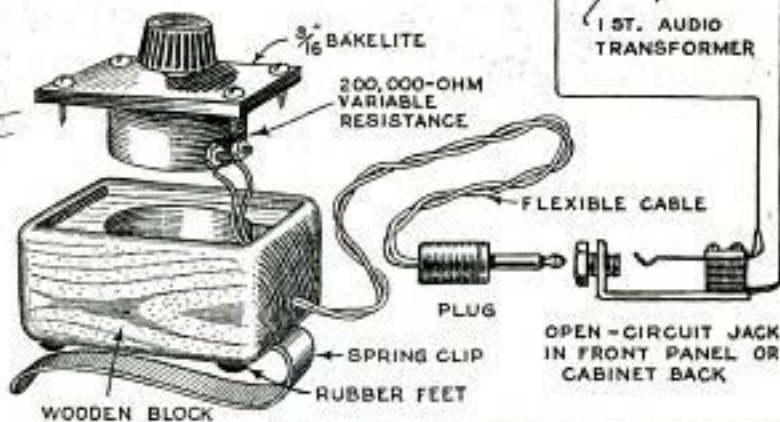

To Reduce Hum Picked Up by Long Filament Leads in A.C. Sets, Twist in Third Wire and Ground to Chassis



Right, Rear View Showing Method of Mounting Receiver and Speaker; Center, Cutting Speaker Grill with Hacksaw; Left, Completed Installation

Closet-Door Radio Installation

The problem of room for the radio receiver in an apartment often tests the ingenuity of the tenant. One radio fan solved the problem by installing the outfit on a door. If the owner of the building objects to mutilating the door panel, it may be temporarily removed and a piece of ply wood substituted, which is stained or painted to correspond. The speaker grill may be cut in the panel. When the grill is completed it should be backed with gold cloth pasted on the back of the panel. For those who would not care to cut an ornamental grill, a square section of the panel may be cut out and covered at front with either a picture or a decorative tapestry. A pair of shelf brackets support the receiver shelf at the rear as shown. Holes are now drilled for the shafts of the various receiver controls as well as an opening for the dial escutcheon at the proper height. These holes must be accurately located before the door panel is drilled. In this case, the speaker was screwed directly to the door panel at the rear, but sometimes it may be necessary to make a small shelf for the speaker. In either case, the door panel will provide an excellent baffle. If there is no light socket available in the closet for the operation of the set, a small hole should be drilled near the base of the door so as to pass the cord to a baseboard outlet in the room.

The antenna and ground connections can be made in the same manner.

Lacquer for Radio Use

Clear lacquer is useful for coating coils, cementing the turns together and holding them securely. By winding a coil on a cardboard form, giving it a coat of lacquer and then stripping out the form and applying a coat to the inside, a good substantial self-supporting low-loss coil is achieved. The same material can also be used for "doping" linen diaphragm speakers,

thinning it out as may be required, and as a cement for securing the edges of speaker cones. While busbar type of wiring has failed to retain its popularity against the insulated straight-line style, busbars are still occasionally useful for special circuits. Lacquer, either clear or colored, can be used for insulating and identifying busbar circuits. Summing up, a small can of lacquer will form a useful addition to the radio workbench.

A Homemade Interference Arrester

To stop interference at the power line as far as possible from the receiver, is important, as the noise reduction in the speaker depends entirely upon this distance. A serviceable device for this purpose consists of two r.f. chokes wound of 5 lb. of No. 10 s.c.c. enameled wire each, in coils 2 in. thick and about 7 in. in diameter. These chokes are used in series, one in each side of the line. One terminal of each is connected to the main, and the other to the service wires. A pair of high-voltage condensers of .25-mfd. capacity, or larger, are connected in series across the line on the main side, with their mid-point grounded. This device should be inclosed in a rainproof metal can of ample proportions. In many cases this device will cut out as much as 60 per cent of power-line noises.

SIMPLE UNIT SUPPLIES WELL-FILTERED HIGH POWER

By FRANK L. BRITTIN

DETAILED information regarding the construction of a practical and inexpensive source of pure d.c. at high voltage has been rather difficult for the experimenter to obtain, and since the Federal Radio Commission has ruled out raw and poorly filtered d.c., it becomes necessary that experimenters and radio amateurs understand just what is required. This information in simplified form is now available to all in the unit to be described.

From time to time various well-filtered low-power units have been described, such as the power supply for the low-power "S-W Transmitter for Beginners" that appeared in the June, 1930, issue as well as a number of well-designed B-eliminators. It is commonly known that a B-eliminator must be well filtered or the results obtained on a broadcast receiver will not be



up to standard. A good B-eliminator provides an excellent source of plate supply for small S-W transmitters for that reason.

The high-power unit described in this article is merely a grown-up B-eliminator useful as a source of pure d.c. for advanced types of amateur S-W transmitters, public-address amplifier supply, and any service where a small d.c. current at high voltage is required.

No attempt has been made to assemble it in the compact form common to B-eliminators. Plenty of room is provided between the various parts, which are arranged on a breadboard layout, to insure good ventilation and cool operation. An output of

of

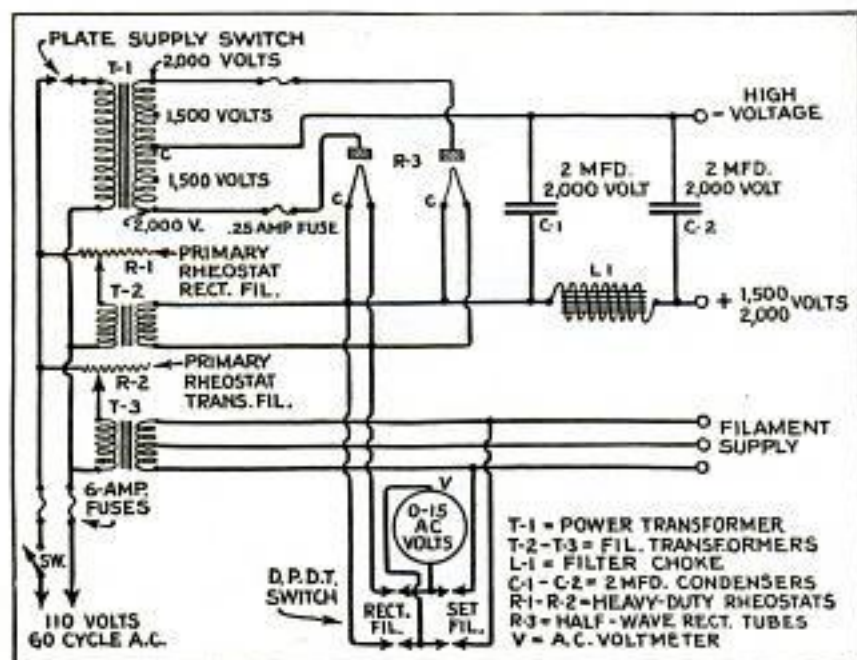

either 1,500 or 2,000 volts pure d.c. is available by merely shifting the taps on the power transformer, providing an unusually flexible source of supply. The filament voltage for the rectifier tubes, and any other tubes to be supplied, is also adjustable by means of the heavy-duty filament rheostats mounted at each end of the front panel. These voltages are easily checked with the double-pole, double-throw switch and a.c. voltmeter, which may be quickly thrown across the secondaries of either of the filament-heating transformers.

With a 30-henry, 300-milliamp. choke, the unit delivers 2,000 volts at 400 watts, and the current available is 200 milliamp. This is sufficient for the operation of a $\frac{1}{4}$ -kw. tube or to run a 50-watt speech amplifier and oscillator. Enlarged diagrams and a detailed material list are available to all.

The instruments are assembled on a $\frac{3}{4}$ by 16 by 21-in. baseboard as shown in the photo on this page. The simplified wiring diagram is given directly below this photo and the

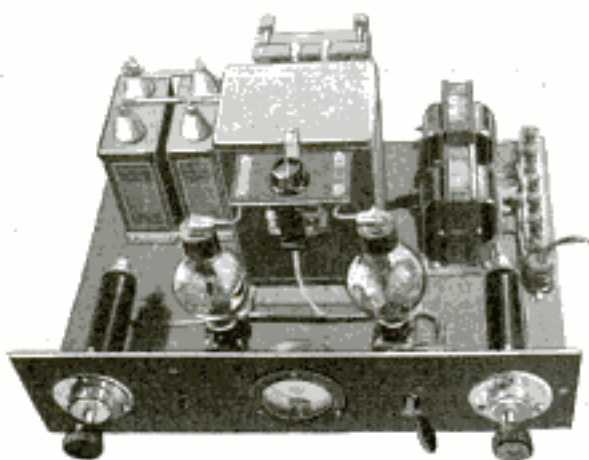

on page 127 for those who prefer it to the simplified form. The photo at the right shows a close-up of the two half-wave rectifier tubes. These tubes are rated up to 3,000 volts, 1.7 amp. filament current; 250 milliamp. normal; and 10 volts are required for the filament. However, any half-wave rectifier tubes of similar rating may be used, such as 566 or 866. The tubes used in this model are connected with the filaments in parallel, and the lead to the filter or positive-plate lead is hooked to the filament, so that the tube-filament pins indicated as cathode are used for this lead. The cathode pin is indicated on the base of each rectifier tube with an arrow; the .25-amp. fuses indicated are supplied with these tubes. The center tap on the filament-heating transformer, supplying these tubes, is not used.

The bakelite front panel is $\frac{3}{16}$ by $5\frac{1}{4}$ by 21 in. in dimensions, and an additional bakelite strip is mounted above the baseboard for the five large binding posts at the right. The 6-amp. fuse block and snap

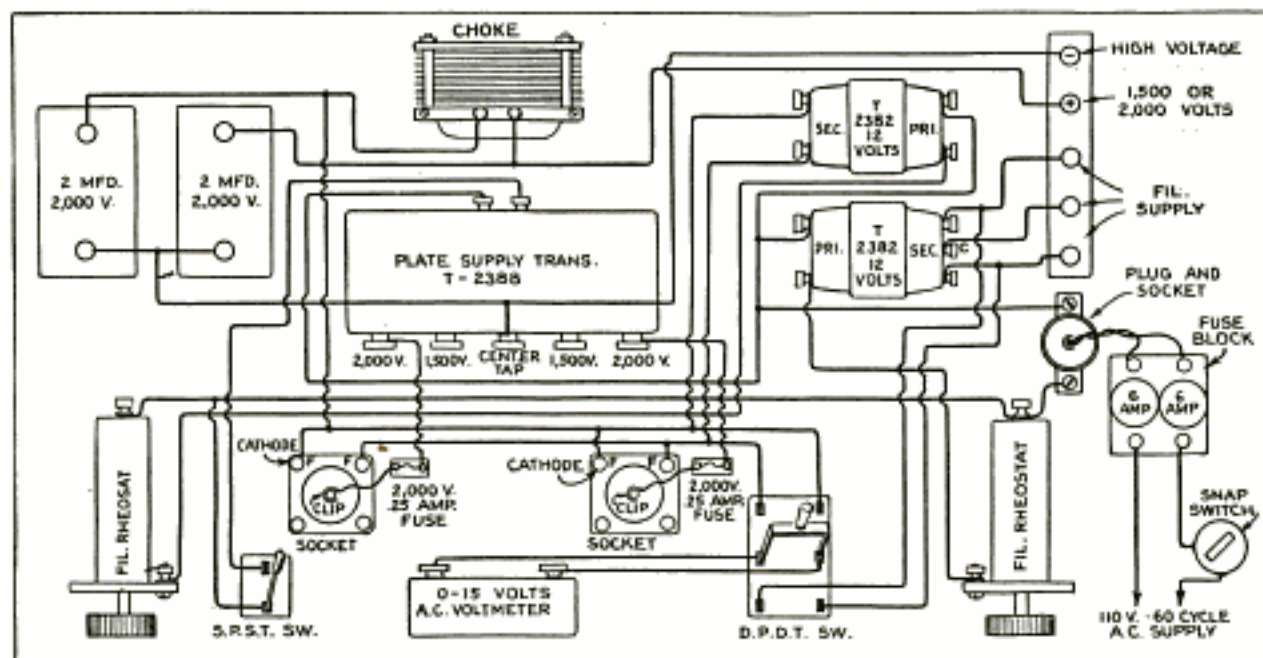

parts are arranged as nearly as possible in their actual positions on the baseboard. The schematic circuit diagram is given

switch, shown in the simplified wiring diagram, are not mounted on the baseboard, but should be placed at a conven-

ient point near the unit. The single-pole, single-throw switch is used to turn on the plate supply after the rectifier tubes are well heated. During operation periods, the rectifier tubes should be left lighted, and the plate-supply switch should be turned on and off as required.

Saving Time in Tube Boosting

Tubes of the 199 or 201-A type may be boosted in groups of three or four at a time, if a multiple gang of sockets is available. Wire the terminals of all the positive and negative A-leads together. Solder the paralleled filaments to flexible leads terminating in a plug made from a discarded tube base, and insert the plug in the tube-booster socket. This will enable you to pep up as many tubes at one time as the gang sockets will hold.

Dynamic Baffle Resembles Fireplace Screen

To realize the full possibilities of a good dynamic speaker it is necessary to have a fairly large baffle, which also harmonizes with the home furnishings. I designed the illustrated baffle to meet these conditions. The board proper is made of two-ply celotex covered with tapestry, and the frame is designed to resemble a fireplace screen. The baffle may be decorated in oils or covered with wallpaper, but the tapestry selected conformed best with the color scheme of my living room. Another advantage of the tapestry was that it could be used to cover the baffle hole cut for the speaker without interfering with the operation of the instrument. The framework is of American walnut and is suggestive of the English influence in design. The molding, worked into the circular frame, was all done by hand. The baffle is 3 ft. high and 3 ft. wide. The construction of the shelf for the speaker is very simple.—H. G. Schif, Colorado Springs, Colo.



Front and Rear Views of Homemade Dynamic-Speaker Baffle

An Experimental Underground Antenna



Right, Coil Wound on Pickle Bottle; Left, Completed Assembly

The underground antenna is not a new idea, a number of varieties having been offered to the public, some of which worked about as well as an ordinary overhead antenna while others were great disappointments. However, there is still a wide interest in the subject and, in some cases where local interference proves difficult to overcome with ordinary means, the set owner is willing to try out anything that may prove helpful. The underground antenna shown in the photo is simple to make and install. It consists of a number of turns of insulated wire, wound around a pickle bottle in the form of a coil. This bottle is placed inside a quart fruit jar. Insulated wire, preferably of a shielded type, is used as a lead-in, and the jar is then buried in wet earth.

The writer has obtained good results in overcoming local interference. If a pickle bottle of suitable size is not available, a length of fiber tubing may be utilized instead. Sometimes it is best to disconnect the ground wire from the receiver when using the device.—Bernard L. Kobel, Frankfort, Ind.

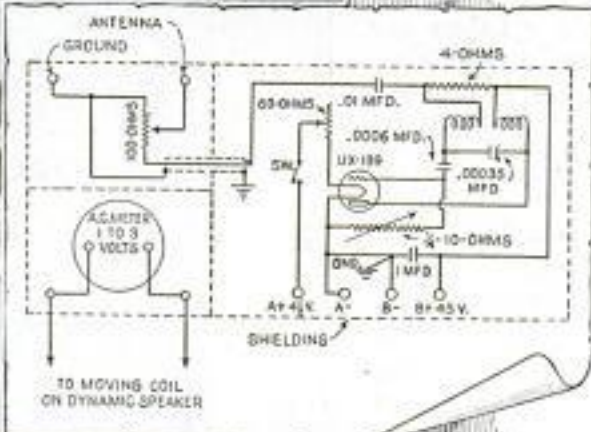
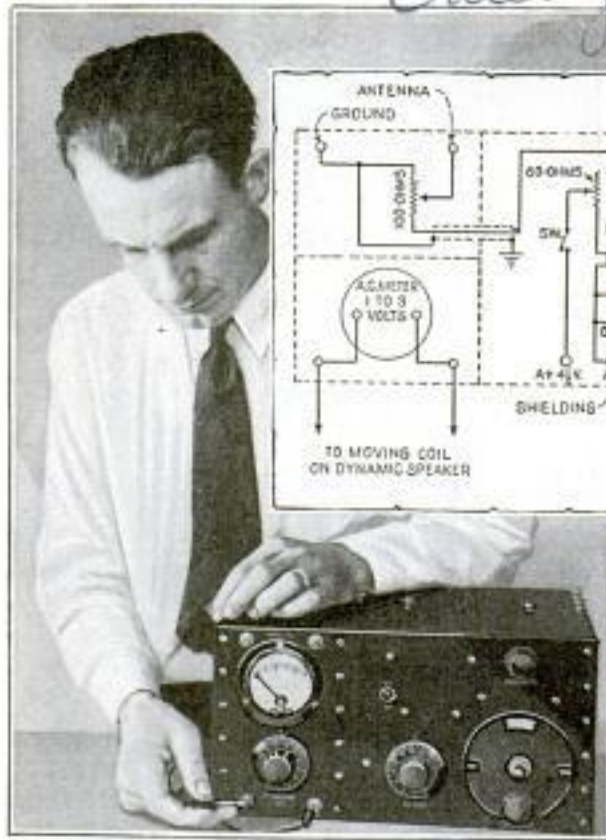

Connecting Voice Coil of Speaker across Output Meter; Above, Schematic Circuit Diagram

Portable Signal Generator

The shielded signal generator shown in the accompanying photo has been designed to enable dealers and service men to check and aline ganged condensers accurately. It also can be used to determine the sensitivity of receivers, and to check the output of tubes, speakers or audio transformers, as well as to check the calibration of any set. The oscillator consists of an r.f. generator operating over a range of 550 to 1,500 kilocycles; a 199-tube is used and means are provided to modulate the output of the oscillator over the required musical range. In the lower section of this shielded compartment there is space for the necessary batteries. A fractional part of

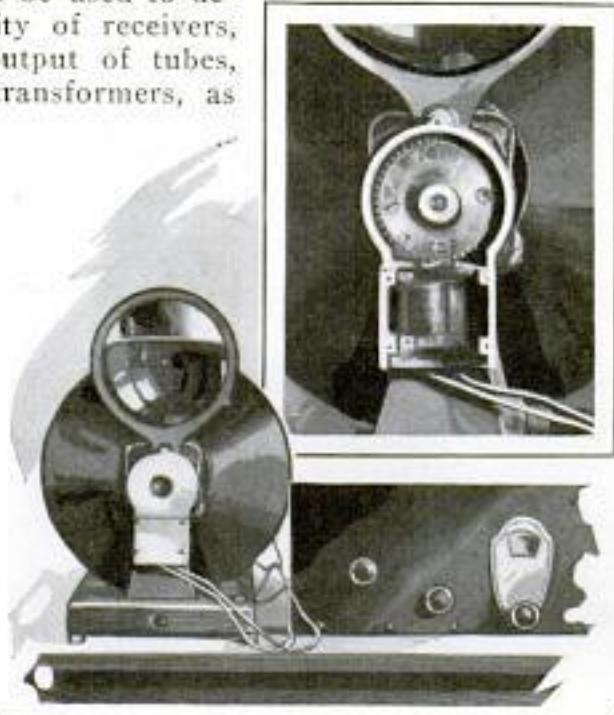

Synchronizing Device, with Cover Removed to Show Mechanism, and Television Connected to S.W. Receiver

the output of the oscillator is tapped off, and by means of a shielded cable, this output is carried over into the attenuator compartment. This output may be varied to suit the requirements. The meter, connected across the voice coil of the speaker, indicates the output in volts. The meter can also be used for measuring low a.c. voltages, such as the filament voltages of tubes.

Keeping Television Receiver in Step

To keep the television receiver in perfect step with the transmitter without regard for a common a.c. power system has been one of the problems in the way of practical home television. The manual method of obtaining and maintaining synchronism is obviously unsatisfactory. The synchronous motor method, whereby an a.c. power system, common to both receiver and transmitter, is used, is most effective, but unfortunately is not available in all parts of the country. The device used in connection with the small television shown in the photos automatically synchronizes the receiving end with the transmitter by means of the usual radiovision signal. It takes the form of a small attachment that fits on the front bracket and scanning-disk shaft. An extra synchronizing amplifier is necessary in the receiver to supply the 720-cycle energy to drive the device. The synchronizer speeds up or retards the motor, acting as a governor.

Jenkins Television Corp.
370 Claremont Ave
Larchmont, N.Y.

*"Winning Backgammon" 1.50
 gives finer points of game. Official rules
 and instructions for duplicate backgammon*



AMATEUR MECHANICS

Inlaid Backgammon Board Easy to Make

THE OLD GAME of backgammon has returned to favor, and bids fair to supplant bridge in the hearts of many devotees. The inlaid book-type board, described in this article, should make a hit with any backgammon fan, and is comparatively easy to make, since, contrary to most inlaid jobs, the construction en-

tirely eliminates the necessity of routing. The first step in making the board is to cut 12 pieces each from holly and ebony, to the dimensions shown in Fig. 1, with the grain running lengthwise of the points, as they are called. A simple method of cutting these points on the power saw is shown in Fig. 2. Tilt the crosscut guide

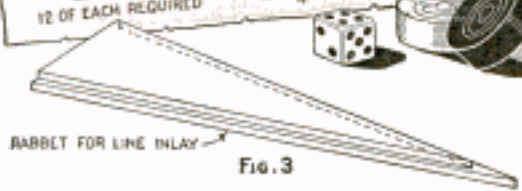
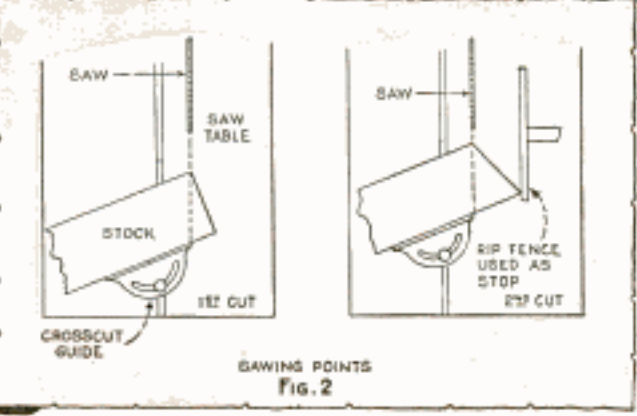
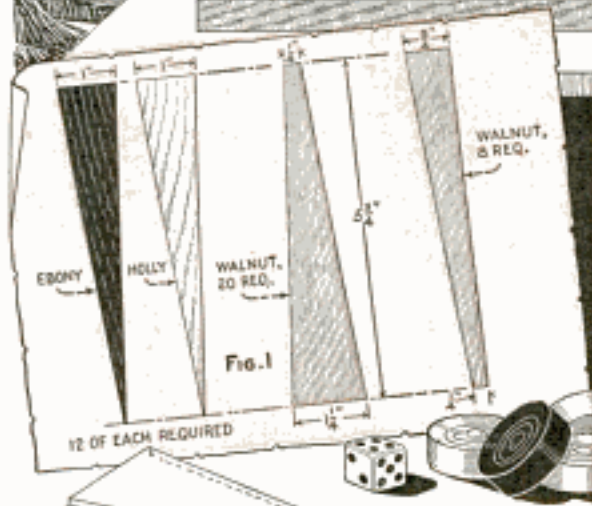
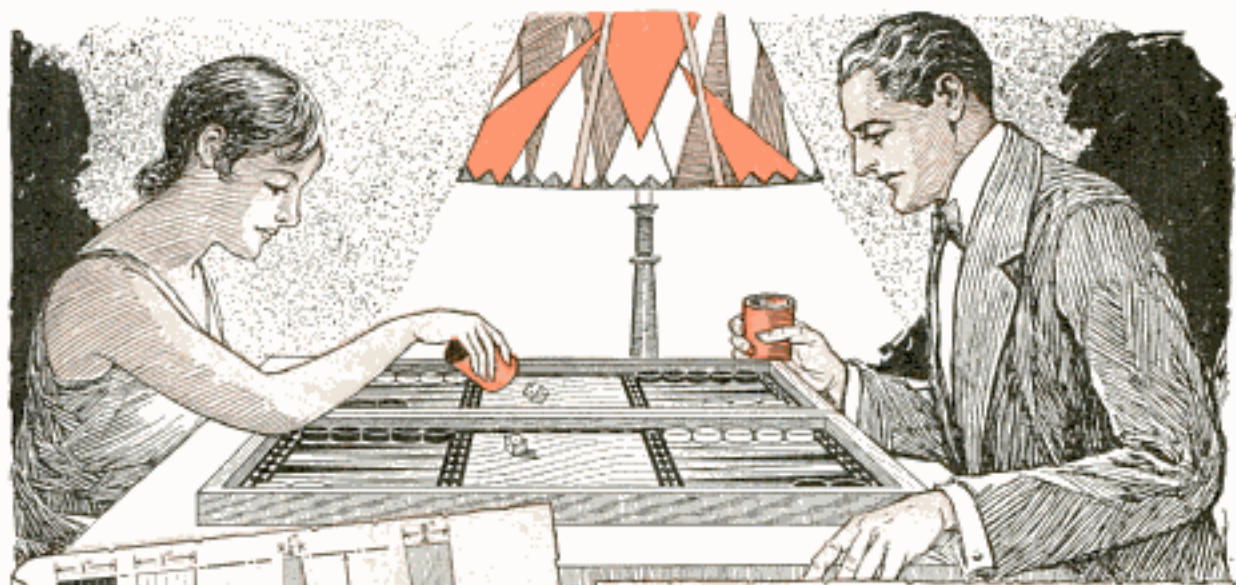

to the angle required to cut one side of the point, then saw off the end of the stock as shown in the first-cut drawing. Turn

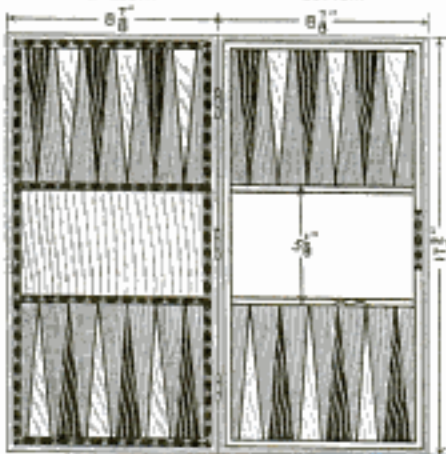
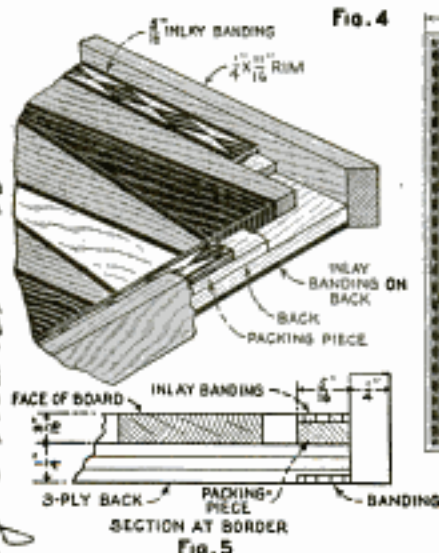
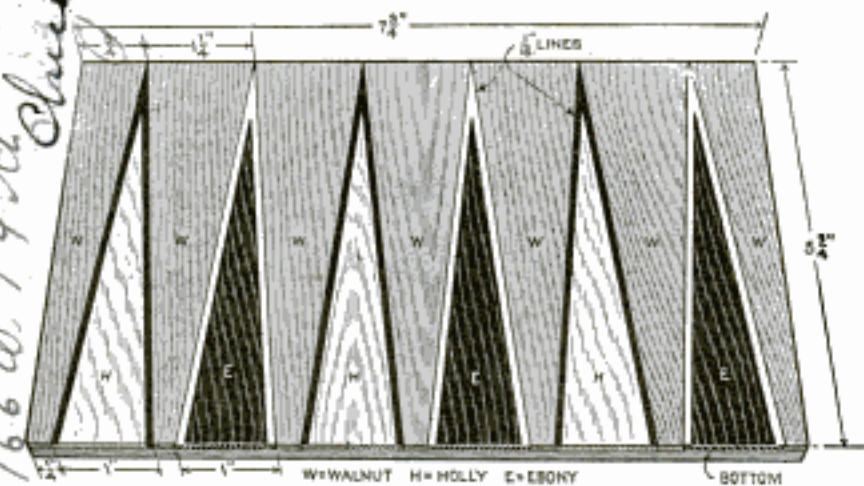

Fig. 4

Fig. 6

the stock over and adjust the rip fence, with the long point of the stock against it, until the length of the point base, when cut, will be exactly 1 in., then make the second cut as shown. To cut off another point exactly similar to the first, merely turn the stock over and cut again. By this means all the points are cut exactly alike. The walnut pieces that go between the points on the board are cut in a similar manner, to the dimensions given in Fig. 1.

After cutting, the holly and ebony points are rabbeted on the edges, as shown in Fig. 3, to take the 1/16-in. celluloid "white-line" and "black-line" inlay bandings sold by marquetry-supply houses. It will be seen that when the points are assembled on a base, with the walnut triangles between, as shown in Fig. 4, the rabbets on the edges of the points form grooves to take the white and black lines, without any routing.

The backing on which the pieces are glued down may be a piece of three-ply, one side walnut, 8 3/8 by 17 1/4-in., or a solid

piece of 1/4-in. walnut. Before assembling, run a 5/16-in. rabbet right around the outer edge of this piece, on the walnut side, if three-ply is used, or on what will be the underside if solid stuff. This rabbet, when the rim is applied, forms the groove for the 5/16-in. inlay banding shown in the back view, Fig. 8, and in section, Fig. 5. One assembly of points is glued down at each end of the bottom board, 5/16 in. from the end, and then the centerpiece, shown in Fig. 7, is glued between them, the rabbets at each end of this piece also automatically forming grooves for inlay banding. It will be noticed, in Fig. 6, that a holly point on one end of the board is assembled opposite an ebony point on

the other end, and so on across the board. Notice also, in the same drawing, that the alternate arrangement of the points is carried out across the other section of the board. When assembling, use good glue, and be careful that none of the pieces slip when clamped. When dry, glue in the white and black lines, being careful to get close joints at the apex of each point, then glue in the inlay-banding edging and the banding strips across the face of the board. It is well to have all the lining and inlay banding on hand before starting the job, so that the rabbets can be cut to suit the thickness of the stock, which varies a trifle now and then. When fitting the banding to the edges of the boards, try to match the pattern at the mitered corners as closely as possible. Scrape and sand each inlaid surface level and smooth.

Turn the board over, and glue and brad on the 1/4 by 1 1/16-in. walnut rim, keeping the bottom edge of the rim level with the center of the board, thus forming the groove for the banding on the back, and mitering the corners as indicated in Fig. 8. Glue in the banding on the back, Fig.

166 W. 74th St. Chicago
 Marguery Corp. / Park Ave. New York
 Krenzel & Lutenberg
 d. a. n.

8; then sand and scrape the surface of the board, banding and rim down to a level surface. The other section of the board is assembled in a similar manner, and then the two sections are hinged together, and the rims fitted, if necessary, so that they close with a good joint. Remove the hinges for finishing the pieces.

There is enough distinction between the woods used in the design for the wood to be finished natural, to prevent trouble in staining. Apply one coat of thin shellac, allow it to dry; then two coats of good cabinet varnish, rubbed down between coats, will provide a good finish. For a rubbed finish, give a coat of rubbing varnish, allow it to dry at least 48 hours, then rub, in one direction, with fine pumice powder and rubbing oil on a thick felt, using a rubbing brush in the corners. Rub just enough to take the gloss off, wipe clean, and apply another coat. Rub this down as before, then repolish with rottenstone and oil.

If you want the walnut portions of the board darker than the natural finish, it will be necessary to go over all the inlaid bandings, the holly and the ebony with shellac, applied with a fine brush, and allow it to dry, so that the stain used on the walnut will not affect the other woods. After staining, apply a coat of shellac all over, allow this to dry, and then proceed with the varnishing as described above.

Guard for the Violin Bout

Proper bowing, when playing a violin, is an art acquired only after considerable practice. The greatest trouble lies in the student's inability to draw the bow at right angles to the strings. Failure to

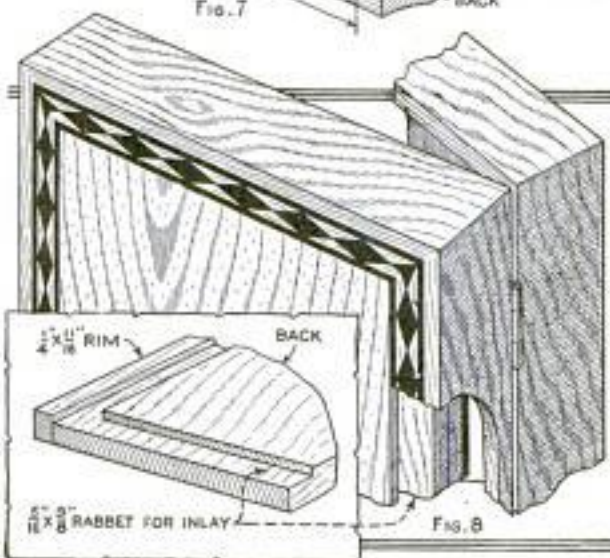
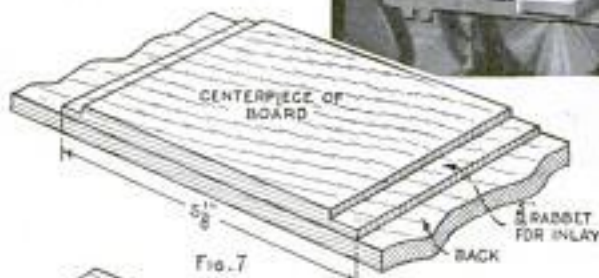

do this results in the bow striking the right bout of the violin instead of clearing it. The friction of the rosined bow hair leaves a deposit of rosin on the edge of the bout, which accumulates very rapidly with every misjudged stroke. In time, the edge of the bout becomes worn, begins to roughen and finally splinters. Besides

defacing the violin, the hair of the bow catches on the splintered edge, resulting in broken bow hair and an increased mutilation of the edge of the bout. A violin, at all valuable, should be protected against this abuse. A strip of adhesive tape, fastened to the edge of the bow, is the solution, and does not affect the tone of the instrument. When soiled, the tape is removed, and the edge of the bout cleaned with any of the preparations sold for cleaning stringed instruments. Do not steam the tape or apply hot water, as such practice will soon ruin the varnished surface.—Henry B. O'Connell, West Haven, Conn.

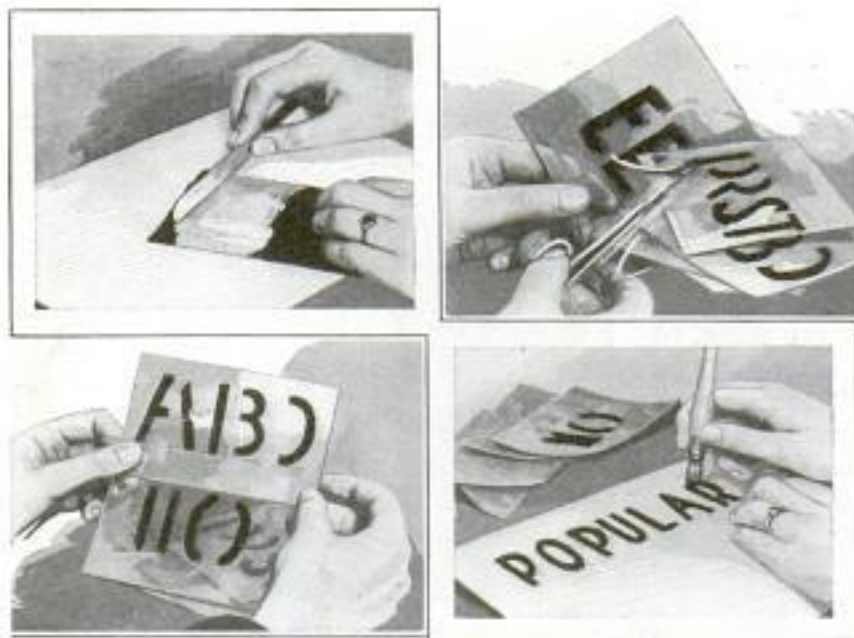

Letter Stencils Can Be Made of Ordinary Cut Films by Scraping Off Emulsion, Outlining Letters on the Film, Then Cutting Out as Shown

Stencils Made from Cut Films

With the lettering stencils shown in the photos, anyone can make good-looking show cards and signs in much less time than would be necessary by the usual free-hand method. First, get some old cut films from a photographer. Soak them in hot water to which a little washing soda has been added. After the emulsion has softened, lay the films on a smooth surface and scrape off the emulsion with a knife, after which the film should be dried. Cut letters of the desired size from a newspaper or magazine, or scratch the outlines freehand on the films. Then, with a pair of small scissors, cut out the letters. In the case of certain letters, such as A, B, D, O, P, Q and R, it is necessary to leave connecting links between the parts so that the entire letter will not be cut out. The lettering itself is done with oil or water colors, sparingly applied with a short-bristled brush. A ruler

or guide line is used to keep the letters uniform, and the spacing should be kept the same.

Shellac Keeps Insects from Book Covers

Every year thousands of dollars worth of books are destroyed, or their appearance marred, because two kinds of insects, roaches and silver fish, have a decided liking for the starch used in ordinary cloth bindings. A simple treatment will protect them against these marauders, which are particularly troublesome in warm climates. Get

some ready-prepared white shellac and dilute three parts of it with one part of wood alcohol. Apply this to cloth covers with a soft brush, but do not use the solution on leather bindings as they are damaged by it. If you have trouble from molds, add one 5-gr. tablet of bichloride of mercury to 1 pt. of the dilute shellac. This mixture is, of course, poisonous and should be so labeled.

Jacking the Car Out of Mud

One of the simplest methods of getting a car out of a mud hole, which does not require the use of anything that cannot readily be obtained when in such an emergency, is shown in the drawing. Get two pieces of wood, about 2½ ft. long, and slip them between the spokes of each rear wheel as indicated, tying them in place if some rope is available. Then shift into gear and start slowly.

By so doing, the wheels will jack themselves out. Of course, care must be taken not to move



Pieces of Wood between Spokes of Auto Wheels Help to Jack Car Out of a Mud Hole

ahead so far that the piece of wood will jam in the fender. In some cases it may be necessary to set the brakes while the piece of wood straddles a rut and then fill in the hole from which the wheel was just removed.—Jerry C. Jarvis, Palmer, Massachusetts.

Clean Contacts on Ford Starter Switch

On motor cars, the operation of the starter can be greatly improved during cold weather by polishing the contact surfaces in the switch. This is very easily done on the model-A Ford. The starter foot button is unscrewed and the four screws that hold the switch to the motor are removed. The switch can be tipped up enough to permit polishing the contact spring in it without removing the battery cable. However, the cable can easily be removed after the switch is taken off the top of the starter, as there will then be more room to swing the wrench and less trouble in grounding the current.—E. T. Gunderson, Jr., Humboldt, Iowa.

Wooden Flap Keeps Rain from Entering Padlock and Freezing

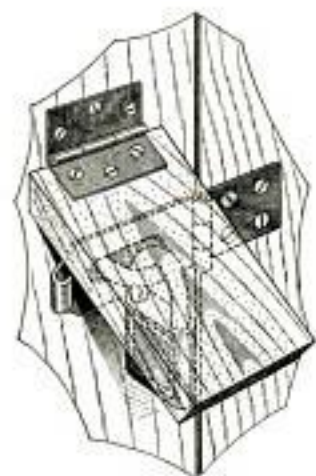

the lock. This flap is rather heavy and therefore not likely to be blown up by the wind, as would be the case if an ordinary rubber flap were used.

Padlocks used outdoors often become filled with water and then freeze, causing considerable trouble. To prevent this, hinge a piece of 1 by 6-in. wood to the door directly above the lock, so that the water will run down the flap instead of getting on



It Takes Just a Few Minutes to Convert an Electric Heater into an Infra-Red-Ray Lamp



Electric Heater Can Be Converted into Infra-Red-Ray Lamp

Those who would like to have an infra-red-ray lamp for therapeutic purposes, but cannot afford one of the more expensive types, can use a cheap electric heater for the purpose by making a few alterations. A suitable heater can be bought for about \$2. One having a deep bowl or reflector is preferable as the rays will be more concentrated, which is desirable. Remove the wire guard that incloses the heater element, unscrew the latter and substitute an infra-red-ray element, which can be obtained in either the carborundum form or as a lamp. It is advisable to cut a heavy-duty 110-volt rheostat in the line so that the full voltage is not immediately applied to the element or lamp, the life of which is thereby decreased. A rheostat for this purpose can be purchased at any well-stocked radio store. Infra-red rays penetrate more deeply than ultraviolet rays, and there is no danger of burns owing to overexposure, as is the case with the latter.

ⓂTo make enamel adhere to any bright tin surface, rub the surface first with a rag dampened with some cut muriatic acid, such as used for soldering flux.

should be as deep as possible

*Curran Electric Co
340 W. Huron
Chicago*

*resistance power
rheostat - any radio supply store*



"ROAMER" A Outboard

OUR cruiser begins to take on the appearance of something really smart with the addition of the cabin sides and beams to be described this month. Partly filling that long open space between the forward deck and the transom board does something to the lines of the half-finished cruiser, something which means all the difference between mere hull and real boat.

Starting out, make two frames similar to the one shown in Fig. 1, one for the starboard (right) side of the boat, the other for the port (left) side. Fig. 2 shows how these sections are fastened into place immediately forward of frame 5, with four $1\frac{3}{4}$ -in. No. 10 screws through the lower support into the floor, and one $\frac{1}{4}$ -in. bolt through the side member into the long beam piece. These frames should be tied across the top with a temporary piece of timber held in place with clamps. Of course, you will use the level and the square in putting up these end sections; also, you must check the lengthwise and crosswise level of the boat before commencing work on any part of the cabin.

The frames may be covered immediately after they are fastened, using 6-in. widths of $\frac{3}{8}$ -in. mahogany, scored with two sawcuts to resemble narrow strips of plank-



FIG. 1 SHOWING CONSTRUCTION OF REAR CABIN FRAME

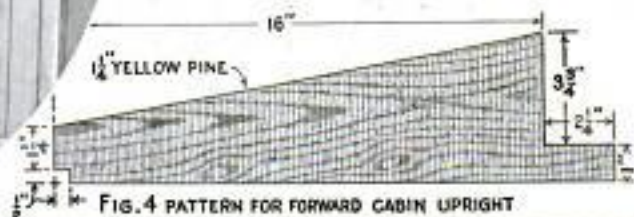
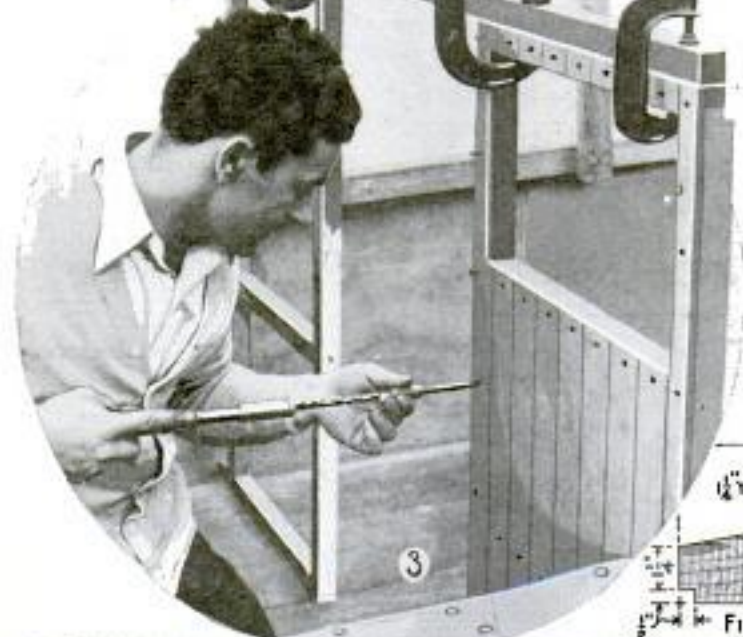

FIG. 4 PATTERN FOR FORWARD CABIN UPRIGHT

Speedy Cruiser

Part 4
by Sam Brown

ing. The edges of joining widths should be slightly beveled to carry out the sawcut effect. Fig. 3 shows how the planking is cut off flush all around, extending from the floor up to the window opening and then up to the top edge of the frame. Fastenings should be No. 6 brass screws, 1 in. long. For a really neat job, these should be countersunk and plugged. Driven flush, however, they make a more solid binding between the siding and framework.

Fig. 4 gives the pattern for the 18¼ in. long uprights at the forward end of the cabin. A study of these pieces and the places where they are

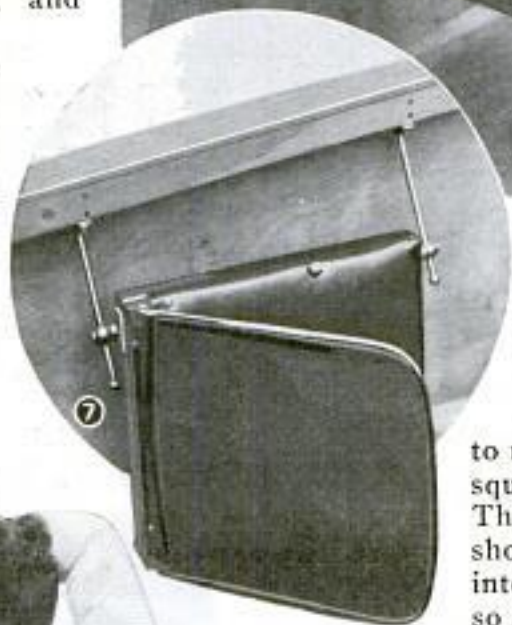

to fit will show you that practically all of the edges must be beveled in order to make possible a square, plumb fit. These uprights should be bolted into place, and also screwed from the underside of the decking. Midway between rear and forward uprights are bolted two pieces of 2½ by 1¼-in. yellow pine, one on each side of the boat. Fig. 5 shows all of the uprights in place. Notice that the forward posts are temporarily braced with light diagonal pieces to hold them plumb.

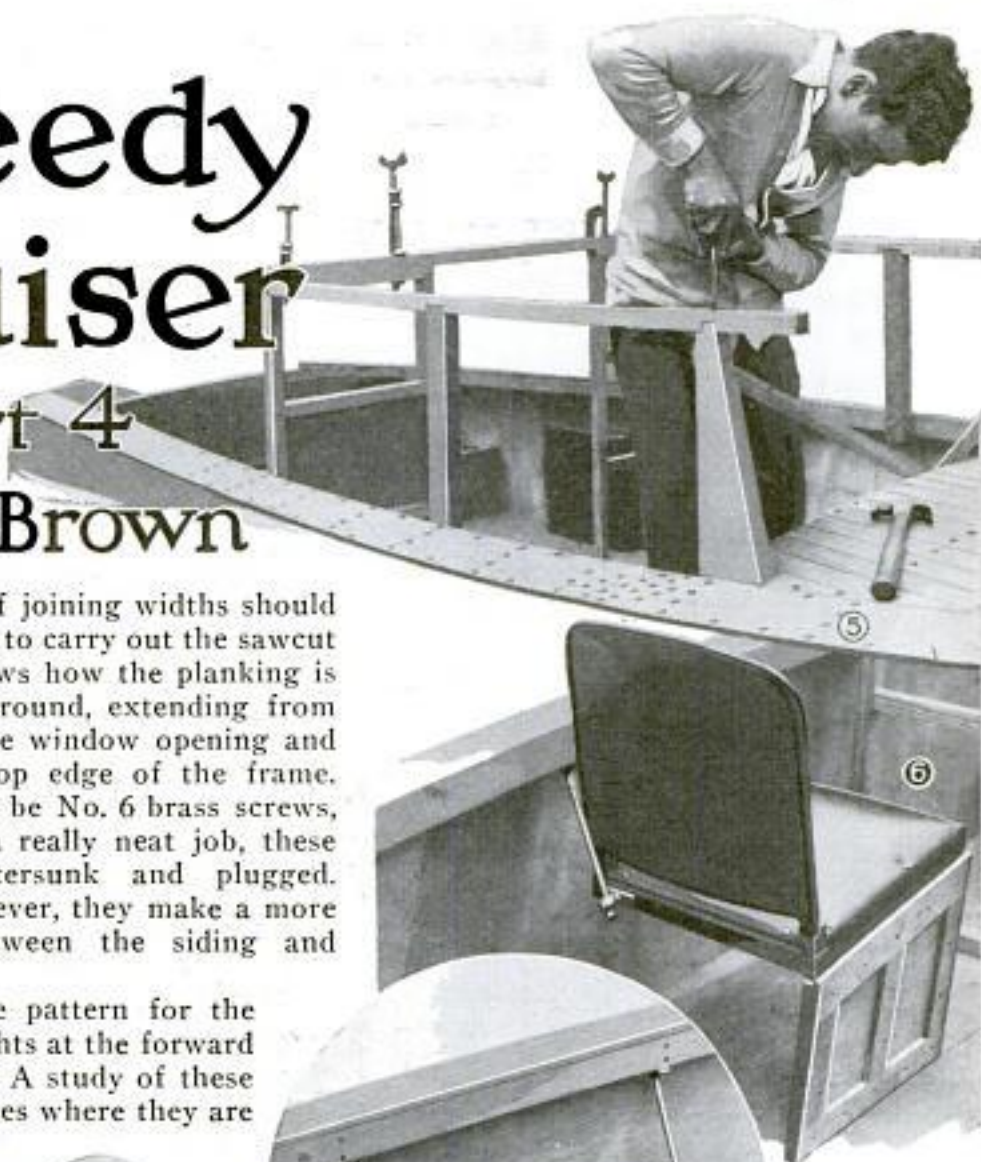

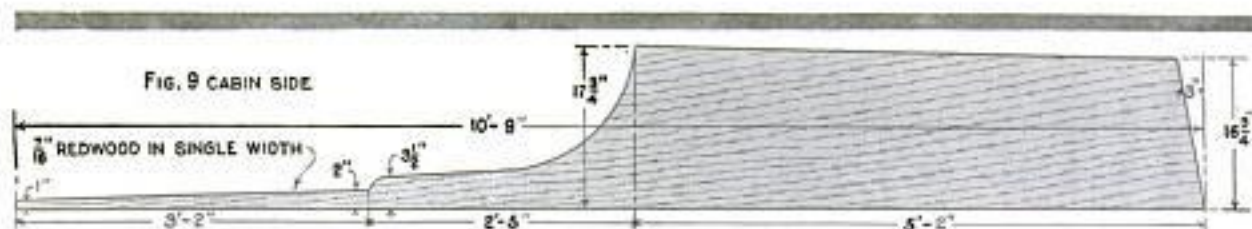

Two curved pieces are used to top the uprights, as shown in Fig. 5, and these pieces should be half-notched to fit. The proper curve for these pieces is the same as the curve on the deck immediately below it. Notice that the forward end is not cut off flush, but left projecting several inches to furnish timber for the sunvisor to be described later.

One other piece, a beam to span the two front uprights, is necessary to complete the cabin framework, as may be seen in Fig. 10. This piece is straight along the bottom, curved up 1/4 in. along the top, and is notched out at each end to slip over the cabin sidepieces. These notches must be cut on a bevel so that the forward face of the piece will be in line with the forward edge of the front uprights.

Forgetting all about the cabin framework, let's take a look at the pilot's seat. This is nothing more nor less than one of the folding seats carried in seven passenger automobiles. Your local junk dealer or auto wrecker can probably supply you. Details of how the seat is converted for marine use are shown in Figs. 6, 7 and 8. Fig. 6 shows the seat open; Fig. 7 shows it half closed. As can be seen in the pictures, two window regulators are used to support the seat from the long deck beam. The wooden support on the inside edge is fastened to the seat with two hinges, as shown in Fig. 8, and this support serves in the same capacity as the original front support which is found on the seat as used in automobiles. Because of the wide variations in these seats, no rules for their conversion can be given. However, it is easy. Get the seat, get the window regulators, and you will soon get the idea of this simple and practical folding seat.

The proper shape for the cabin siding, which also extends back to form the coam-

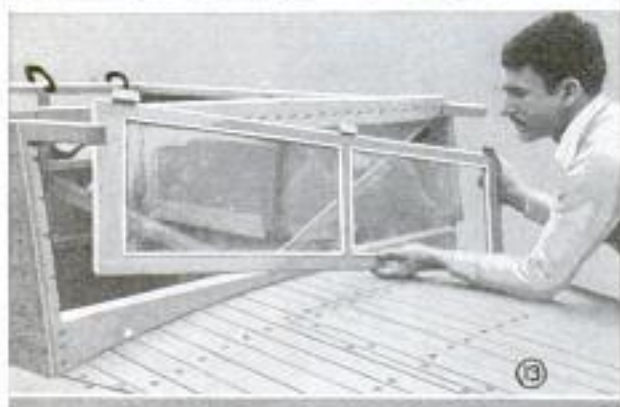
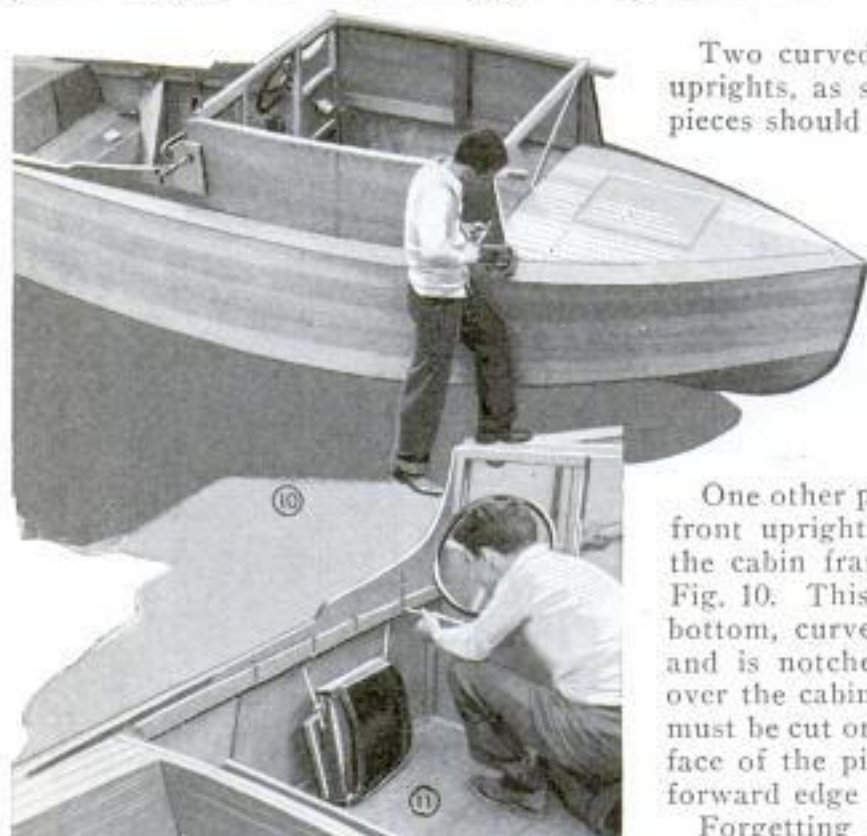

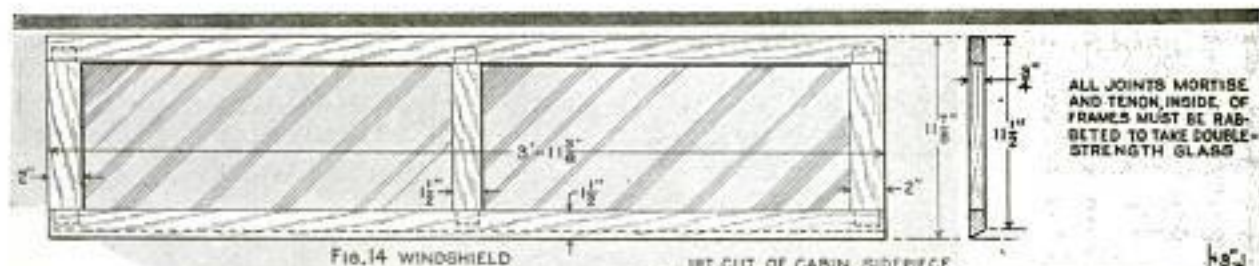

FIG. 14 WINDSHIELD

ALL JOINTS MORTISE AND TENON, INSIDE OF FRAMES MUST BE RABBETED TO TAKE DOUBLE-STRENGTH GLASS

ing, is shown in Fig. 9. If these pieces are cut from redwood, each side can usually be fashioned from a single width of timber; if mahogany or other wood is used, it is necessary to join two strips to get the required width. Each piece is fastened into place with $1\frac{1}{4}$ -in. No. 6 brass screws, as shown in Fig. 10. The lower edge of the cabin side is faced on the inside with 3-in. strips of mahogany, and these are fastened with screws to both cabin side and beam strip. Sufficient timber should be left projecting beyond the forward uprights to overlap the windshield framework, which is to go on later.

The coaming, that is, the extension of the cabin sides to the rear, is held in place with galvanized braces, set into both coaming and deck beam, as shown in Fig. 11. An inner piece of $\frac{3}{8}$ -in. stuff is used to face this piece on the inside, this inner strip extending $\frac{3}{4}$ in. below the deck beam. The two sections are held together and to the hull by double-ended bolts, fitting from side to side and inserted through the metal braces between the two pieces, as in Fig. 12. Both ends of each bolt are fitted with a cup washer. Cup washers are used also on screws which fasten the inside coaming strip to the deck beam, but these are not put in until after the varnishing or painting has been completed.

Consider, now, the forward end of the cabin, as shown in Fig. 13. Notice that a piece, cut to fit the deck and beveled on the top side, is fitted on top of the deck from one forward upright to the other. This piece is of $\frac{3}{4}$ -in. mahogany and measures 1 in. across at its narrowest part, widening gradually to follow the arch of the deck. The top of the windshield frame is likewise made of $\frac{3}{4}$ -in. mahogany, and this piece is notched at either end to slip

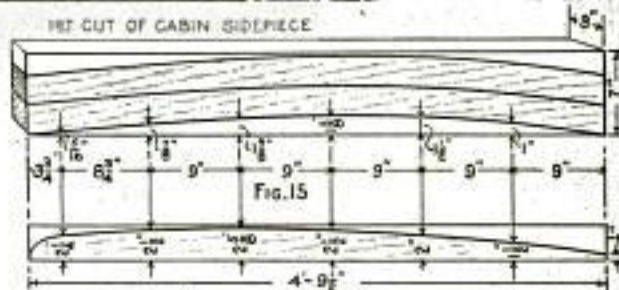
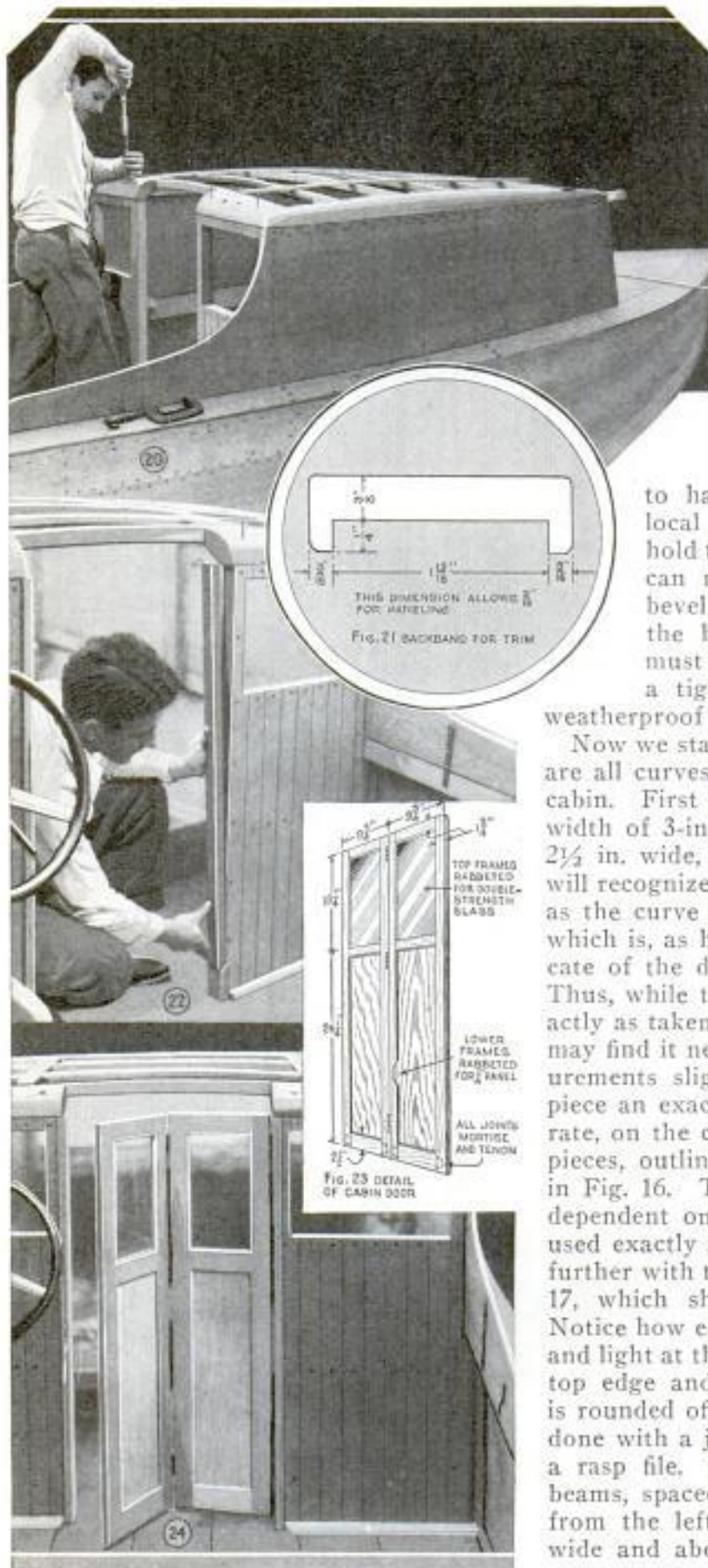

FIG. 15



FIG. 16





over the lengthwise cabin beams. Two $\frac{1}{2}$ -in. widths of mahogany, fastened directly onto the face of the forward uprights, complete the window framework. All of these pieces are securely screwed, the bottom piece being held by screws inserted from the underside of the deck.

Fig. 14 gives the proper dimensions for the windshield—a two-window affair. Unless you are quite skilled at wood-working, it is advisable

to have this turned out at the local mill. Three brass hinges hold the windshield in place. You can readily understand that the bevel on the window frame and the bevel on the window itself must be the same in order to make a tight-fitting and thoroughly weatherproof joint when window is closed.

Now we start work on two pieces which are all curves—the top sidepieces for the cabin. First outline and cut from a 7-in. width of 3-in. thick redwood, two pieces $2\frac{1}{2}$ in. wide, as shown in Fig. 15. You will recognize this curve as being the same as the curve on the topside cabin beam, which is, as has been mentioned, a duplicate of the deck curve directly below it. Thus, while the dimensions given are exactly as taken from the original boat, you may find it necessary to change the measurements slightly in order to make the piece an exact fit on either side. At any rate, on the curved edge of each of these pieces, outline and cut the shape shown in Fig. 16. These measurements are not dependent on any others, and should be used exactly as given. Before going any further with this explanation, look at Fig. 17, which shows the pieces going on. Notice how each side is heavy at the back and light at the front, and how the outside top edge and rear corner of each piece is rounded off. This rounding-off is best done with a jackplane, following up with a rasp file. The notches for the cabin beams, spaced $3\frac{3}{4}$, $8\frac{3}{4}$, 9, 9, 9 and 9 in. from the left side of Fig. 16 are $\frac{3}{4}$ in. wide and about the same depth. These

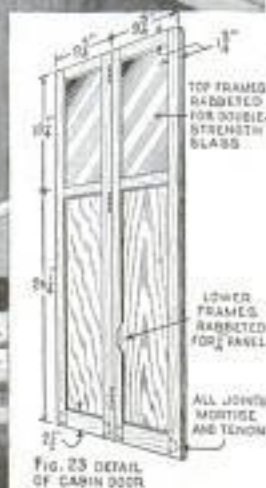

are shown in Fig. 18. Fastening these molded pieces into place is simply a matter of long galvanized screws, countersunk as in Fig. 17.

The cabin beams come next. These are cut from $\frac{3}{4}$ -in. red elm or yellow pine and are $1\frac{1}{8}$ in. wide. There are six beams, as can be seen in Fig. 19. The arch of these beams gradually increases from front to back. Beam 1, immediately behind the windshield frame, has a rise of $\frac{1}{8}$ in., beam No. 2 a rise of $\frac{1}{4}$ in., and so on, increasing $\frac{1}{8}$ in. for each succeeding beam. Beam 3, being an important timber in later cabin work, is cut from $1\frac{1}{4}$ in. stock instead of the thinner lumber. All beams should be rounded on the underside, or capped with $\frac{3}{4}$ -in. half-round molding.

The connecting timbers that hook the final beam to the rear of the cabin are pieces of 3-in. square redwood, planed down to large quarter-round blocks, and then fastened into place, as in Fig. 20. The underside of each of these endpieces is cut on a straight bevel from the underside of the rear beam to the top edge of the rear frame.

Pieces of double backband stock, of the size shown in Fig. 21, are used to form a facing for the cabin doorway, as shown in Fig. 22. Fig. 23 gives all the necessary dimensions for the double door used on this craft. It is made from $\frac{3}{4}$ -in. mahogany. Here, again, it is advisable to let the lumber mill handle the work on this job. The door is fastened in place with six brass hinges, three of these to allow the left-hand section to double back on the right section, and the other three to let the door swing to the inside of the cabin, as shown in Fig. 24.

You have probably noticed that the steering wheel is in place in most of these photographs. This is the familiar short type especially designed for use on outboard craft and carried by all leading boat-supply houses. Its installation needs but little explanation, being merely a matter of a hole through the rear cabin siding and four bolts to hold the outfit in place, these being backed with a suitable block of $1\frac{1}{4}$ -in. yellow pine, as shown in Fig. 25. Observe the diagonal braces in this photograph, likewise repeated on the opposite side of the cabin back, to prevent the frames from edging inward.

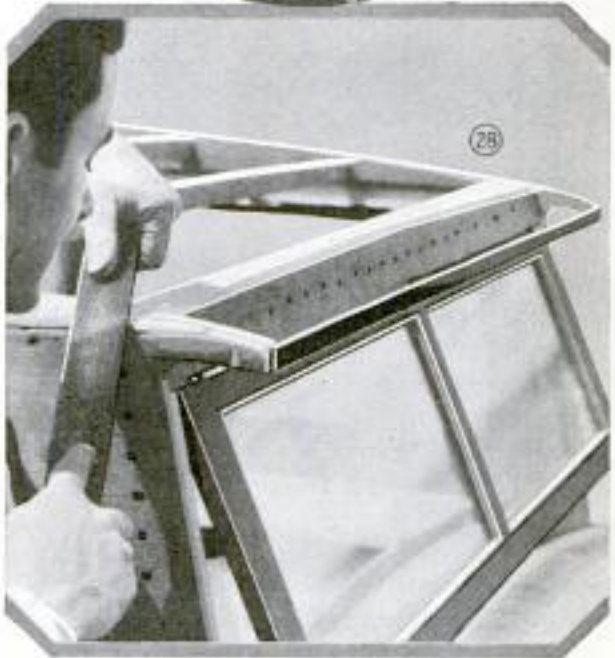
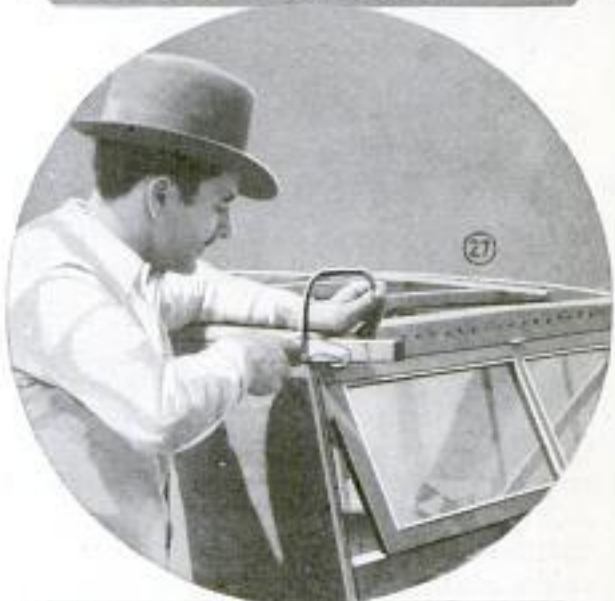
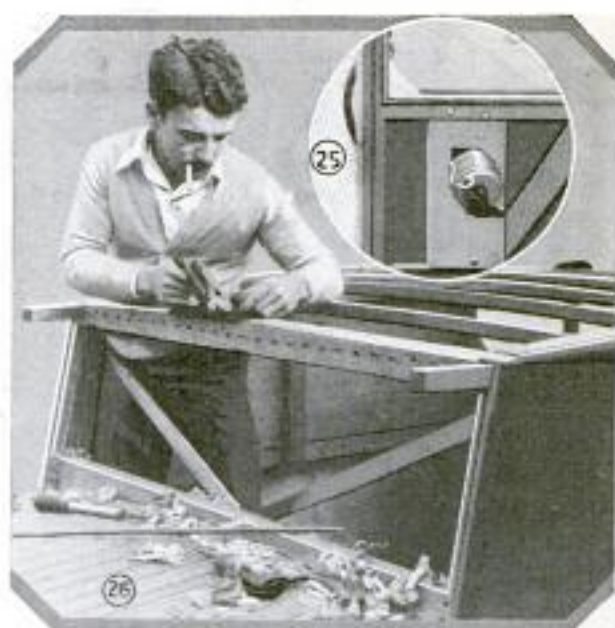

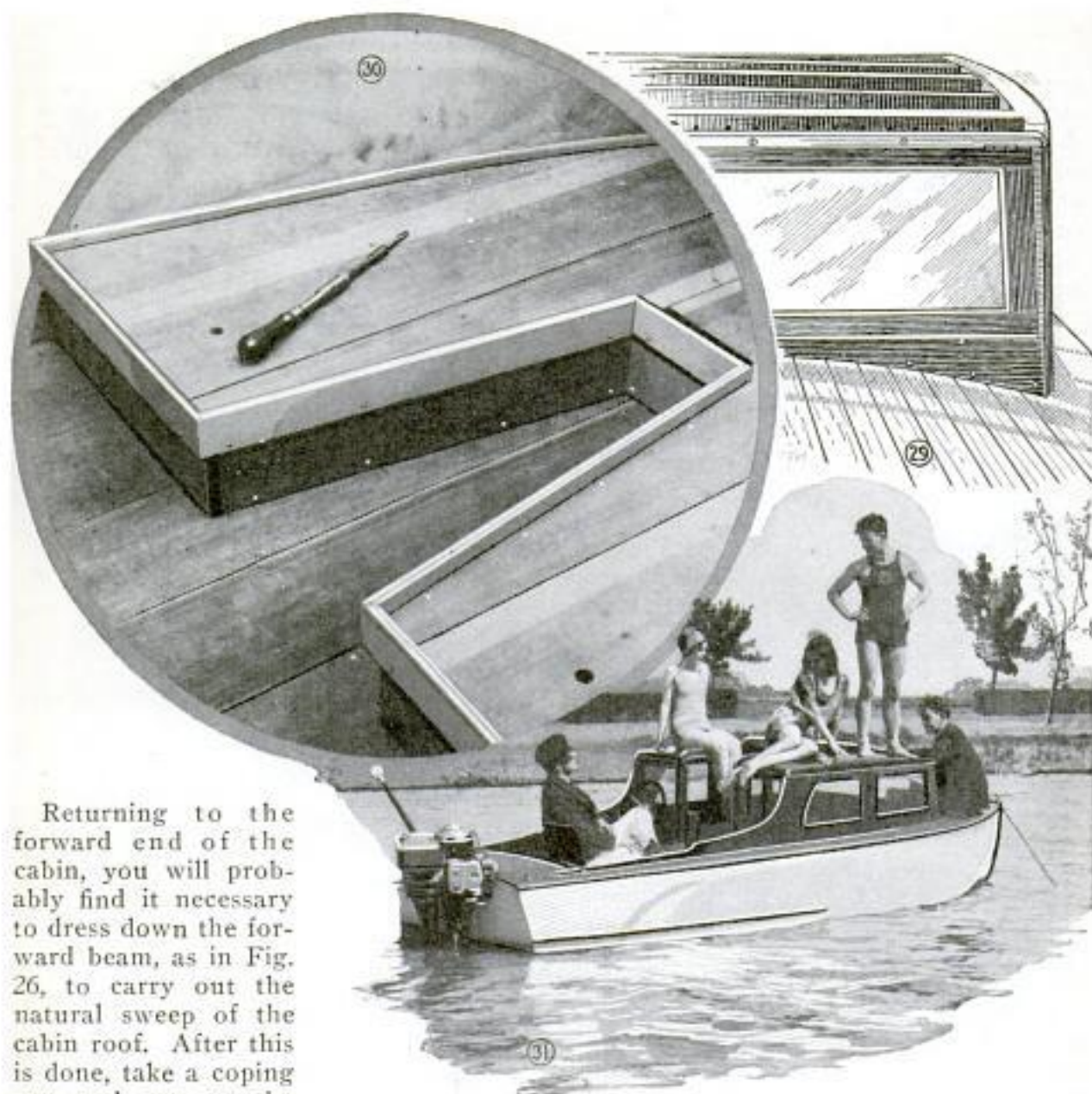

Returning to the forward end of the cabin, you will probably find it necessary to dress down the forward beam, as in Fig. 26, to carry out the natural sweep of the cabin roof. After this is done, take a coping saw and cut out the sunvisor supports to the shape indicated in Fig. 27; then shim up the top and outside of these "ears" and rasp to shape to carry forward the natural sweeps of the sides and roof of the cabin, as shown in Fig. 28. Notice, in this picture, how the two ears are spanned with a $\frac{3}{4}$ -in. width of strap iron. This is faced with a $\frac{3}{4}$ -in. square strip of wood to form a nailing strip for the top upholstery, as shown in Fig. 29.

Before closing this month, we may as well put on the trim strips around the bunks. These are $\frac{5}{8}$ by 3-in. mahogany, rounded on the top side. Fig. 30 shows how they are placed and fastened with 1-in. round-head brass screws. Notice also in this photograph that strips of $\frac{3}{4}$ -

in. quarter-round mahogany are used to trim the bunks where they butt up against the panel board. Similar quarter-rounds should also be used all around the flooring, both inside and outside the cabin. If the floor is to be covered with linoleum, these pieces should be but temporarily attached. Later, when the linoleum is laid, they can be permanently fastened.

Next month will bring "Roamer" to a conclusion; so, get busy now with sandpaper in preparing the boat for the various paint and varnish coats. Never can there be too much sandpapering done on this or any other boat, and starting now and doing a little bit now and again makes it a far more cheerful job than one long grind.

Drying Large Photo Prints Quickly

When drying large photo prints, it is customary to place them between two pieces of heavy cardboard to prevent curling, but this method has the disadvantage of requiring practically all day for the prints to dry thoroughly. A much better way, and one that dries them out in an hour, is as follows: Get a few large sheets of heavy mattboard, obtainable from any lumber dealer. Place the prints between two sheets of such board and lay them on a table on a few blocks of wood to provide free circulation of air. Being porous, the mattboard absorbs the excess water on the prints, thus allowing the air to penetrate, which helps to dry the prints quickly. Large sheets of mattboard can be had for about 30 cents each, and can be used repeatedly without warping.

Moth Balls on Roosts Keep Lice Away

Moth balls have been found highly effective in keeping lice out of a poultry house. The roosts were fitted with blocks, each of which accommodated just one hen and thus prevented crowding. A hole, large enough to receive one moth ball, was then drilled in each block and also in the roost between the blocks, as shown in the drawing. In attaching the blocks woodscrews were used, these being driven in from the underside of the roosts. It seems that lice cannot endure the strong odor of the moth balls.



Moth Balls Held in Holes Drilled in Roosts Keep Lice Away from Hens

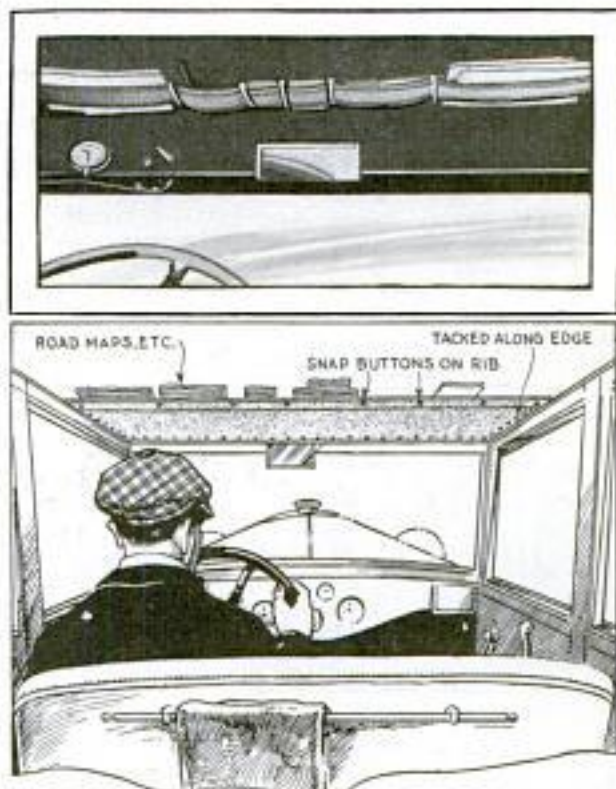

Two Methods of Providing a Convenient Place for Keeping Road Maps, Etc., in the Car

Holder Keeps Maps Handy in Car

It is usually rather difficult to find a suitable place to carry maps, pipes, cigarettes, matches, etc., in your automobile. Simple methods of providing a convenient place for these items that will not interfere in any way with the movements of the driver or other occupants, are shown in the drawing and photo. A strip of wide, elastic fabric is stretched across the top and is fastened as indicated. One method to fasten it is to use tacks and snap buttons, and consequently this is a more permanent installation than the one shown in the photo where safety pins are used to hold it in place. In the latter method the pins are spaced apart so that each intervening space will accommodate an object for which the space is intended.

Drying Colored-Silk Dresses

When drying colored-silk wash dresses, turkish towels are helpful in absorbing moisture and preventing the colors from running, according to government experts. Use three towels, one below, one between the front and back, and one on top. Then roll up firmly and leave the garment this way until it is dry enough to iron.—E. G. Moore, Washington, D. C.

Brake Lever for the Boy's Coaster Saves Shoe Leather

Most coaster wagons have one disadvantage and that is the absence of a brake

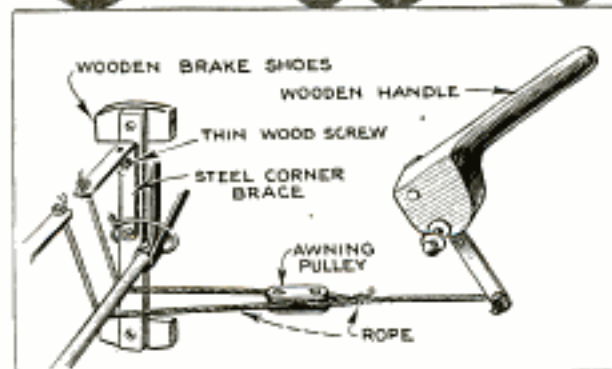
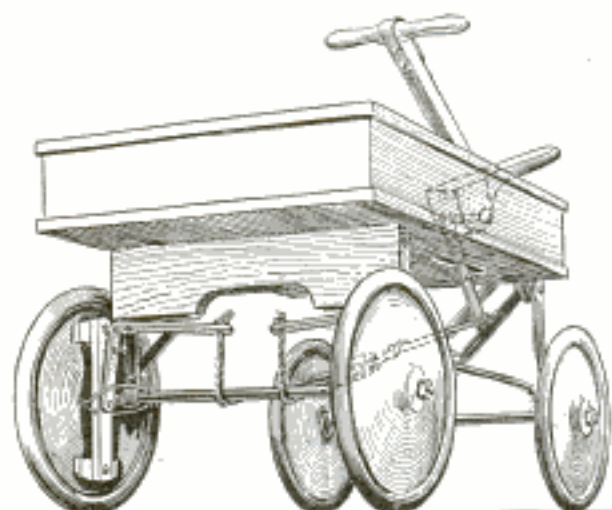

Homemade Brake for the Boy's Coaster Wagon Proves a Saving on Shoe Leather

lever, which necessitates or rather encourages the user to drag his feet on the sidewalk. This practice is extremely hard on shoe leather, and the needless wear can be prevented by making a hand brake as shown in the illustration. It consists of a piece of wood with a wooden block at either end to apply pressure to the inside of the wheels, this design being intended for use on disk wheels only. To hold the brakes loosely in position, a cleat is nailed to the underside of the body, just above the axle, and two corner braces are pivoted to the ends of the cleat with screws. The lower end of each brace is similarly pivoted to the brake with a screw, while a second screw is used to hold the brake in a vertical position. A wire loop is also used to hold the assembly in place, the wire being threaded through a small hole in the crosspiece of the brake and slipped around the rear axle. When the end of the horizontal part of the corner brace is

pulled down, the brake should be forced against the wheel. An L-shaped lever is then pivoted to the inside of the cart as indicated, the lower end projecting through the floor. A piece of stout rope connects this end of the lever to an awning pulley, while another length of rope is slipped through the pulley. The ends of the latter are brought under the rear axle and tied to the ends of the corner braces. Obviously the action of pulling the lever causes a pull on the braces which forces the brakes against the wheels. The pulley is used to equalize the pull to both wheels.

Cleaning a Steel Tape

If your steel tape is rusty and the figures hard to read, mix about $\frac{1}{2}$ oz. of emery dust with 2 oz. of vaseline. Rub this briskly on the tape with a piece of flannel until the tape is clean. After wiping off the paste, rub the tape with mercury ointment, which can be purchased at any drug store. Frequent use of this ointment will always keep the tape bright.—R. C. DeMay, Akron, Ohio.

Automatic Faucet for Watering Trough

Stock-watering troughs can be kept filled with water automatically by installing a ball cock and float as shown in the drawing. As soon as the level of the water drops to a certain point, the cock opens and supplies water until the float again closes it. It is advisable to build a strong frame inclosure over the end of the tank where the water is supplied, in order to prevent any injury to the apparatus.—R. D. Rose, Clayton, Miss.

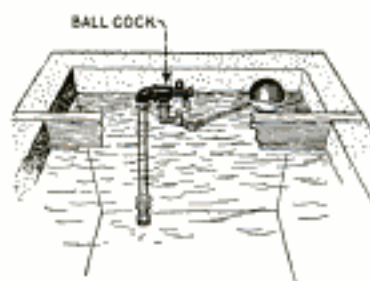

Shaving the Electric Bill

When defrosting your electric refrigerator it is needless to turn off the current overnight and allow the entire box to become warm. Simply turn off the electric current, take out all the ice trays and with a long-handled dish mop swab out

the compartments, using cold or lukewarm water, but not hot water. Repeat the operation three or four times, using fresh water each time and allowing a few minutes between each swabbing. You will find the ice around the front of the compartment has softened and is loose enough to permit it to be removed with the fingers. Never use a pick or any other tool for this purpose. Then swab the bottom of the ice compartment in the same manner. The layer of ice will loosen and may be removed with the fingers in large sections. The layer of ice on the sides will be softened by this time and by carefully inserting the fingers at the bottom of the compartment, you can loosen the side layers of ice and remove them in large pieces. The ice on the mechanism at the top of the compartment may be removed in the same way, being careful not to interfere with any of the tubing, etc. After washing the trays, the current can again be turned on. After you have once defrosted your refrigerator in this manner, you will find it a simple task, the whole operation consuming less than 45 minutes. Do not try to remove any of the ice, however, until it is sufficiently softened to be picked off without the least violence.

Motor Heat Keeps Windshield Clear

It is a comparatively easy matter to prevent sleet and rain from freezing on the windshield by directing some of the warm air around the motor against the glass. This can be done by merely loosening the rear clip on one side of the hood and inserting a small block of wood, such as a piece of 2 by 4-in. stock, under the rear edge as shown in the illustration. The warm air coming out of the opening strikes the windshield and prevents ice formation.—Dick Hutchinson, Ithaca, N. Y.



Warm Air Directed against the Windshield Prevents Rain and Sleet from Freezing

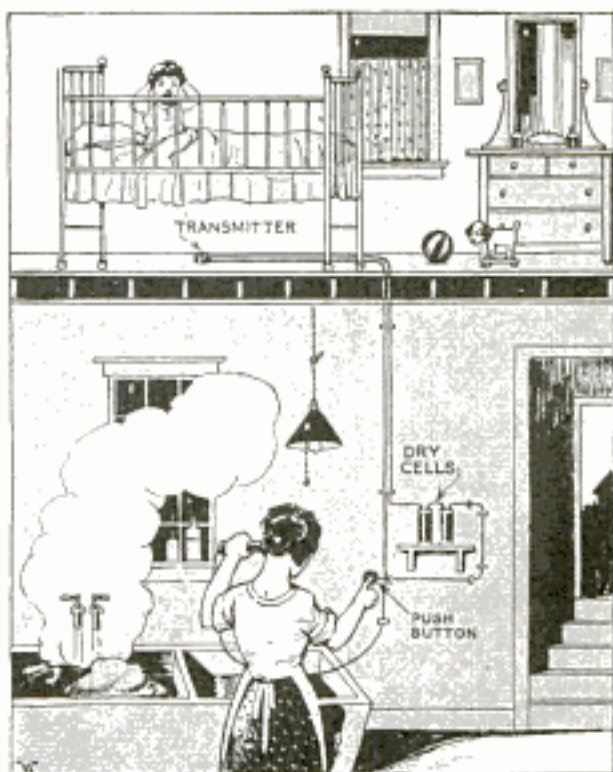

Mother Need Not Run Upstairs to Find Out When Baby Wakes; She Just Listens on the Telephone

Improvised Telephone for Listening to the Baby

Running up and down stairs a number of times on washdays in order to find out whether or not the baby was awake, was eliminated by improvising a telephone system from the baby's room to the laundry. A small microphone was placed underneath the cot, and the two wires were run into the laundry, where connections were made to dry cells, a push button and a receiver. When the push button is pressed the circuit is closed, the dry cells furnishing enough energy to permit the transmitter to pick up the sounds in the child's room and convey them to the receiver. Such an installation costs only a few dollars and will save countless steps.—Mrs. Norma M. Jones, Oak Park, Ill.

204 S. Jerome Ave

Telephone transmitter

Car Battery Furnishes Garage Light

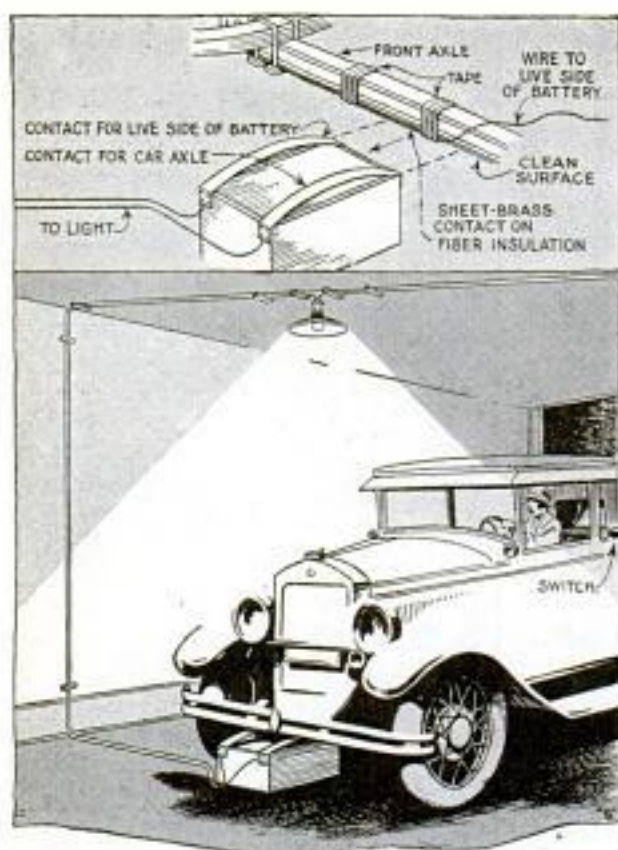

Here Is an Unusual Method of Automatically Lighting the Garage

In the absence of electric lighting in your garage, a satisfactory light, sufficient for closing the doors, etc., can be provided by the car battery. Without using an extension cord to a lamp socket on the car, the illustrated method makes the connection automatically when the car is driven into the garage, even eliminating the need of getting out to turn on a switch. A weighted box is provided with two strips of spring brass, tacked to the side and extending over the top as shown in the detail. When the box is set on the floor, the height of the strips must be such that the axle of the car will make contact with both. A wire is connected to each contact strip and is run to a lamp socket attached to the ceiling, or in any other suitable position. It is advisable to provide a switch also in one of the lines, although this is not shown in the drawing. At the point where the underside of the axle makes contact with one of the strips, a piece of sheet fiber or other insulation is applied, and over this a strip of brass or copper, both being securely bound to the axle with tape. A length of wire is then connected to the underground

side of the battery and to the brass strip under the axle, the wire being soldered to the strip. Now, as the axle itself is part of the grounded side of the lighting system and the brass strip is connected to the ungrounded side, electric current from the storage battery is available when a connection is made between these two points, as is done when the car is driven onto the spring strips on the box. Of course, the car must be driven into exactly the same position each time to assure proper contacts, and care must be taken, in making this installation, that the bumper, radiator shell or any other piece of metal except the axle does not touch both contacts on the box, or a short circuit will result. Instead of extinguishing the light by pushing the car back off the contacts, merely throw the switch open, but be sure to close it again when taking the car out of the garage so that the circuit will be made automatically when returning.—George F. Read, Everett, Mass.

Automatic Signal for Toy Electric Train

An automatic crossing signal for a toy electric train, using an old doorbell, is easy to make. The two outside tracks form one conductor for the current while the middle track forms the other. Both outer tracks are connected electrically and mechanically by means of pressed-tin ties, but the middle rail is insulated from the two outer ones. By prying back the punched sections of the ties that clamp one of the side rails, small strips of heavy tough paper or light cardboard can be inserted, as indicated, to insulate this rail from the other outside one.



A piece of cardboard is also provided around the end of the insulated side rail to prevent it from making contact with adjacent track sections.

The tie is then pressed back in place, holding the cardboard securely in place around the rail. Further insulation may be obtained by removing the steel pins used to connect this rail with the next sections and substitut-

ing matchsticks. By the use of a clamp provided with the train, connections can be taken from the middle rail and the insulated side rail to the bell. The insulation on the rail prevents a complete circuit and the bell is silent. But as the train passes over this section, connection is made from the insulated rail to the wheels, through the cars to the set of wheels on the other side, and to the opposite rail, completing the circuit with the result that the bell rings. As the train leaves the insulated section of track, the bell is again silent. A resistance may be used in series with the bell to cut down the current.—B. Moeddel, Jr., St. Bernard, Ohio.

Curing Rear-Axle Grease Leak

Here is an effective cure for grease leaking out of the front end of a rear-axle-pinion housing. This part usually is fitted with a felt grease retainer or metal

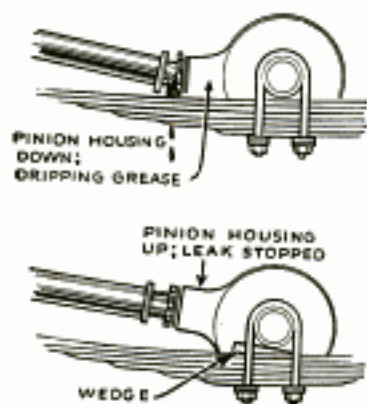

washer to keep the lubricant in the housing. But as the springs sag, the front end of the pinion housing which carries the weight of the driveshaft, frequently sags also, making it impossible to

hold grease. Re-arching the springs, or installing new ones, is a cure, but a better one is as follows: Get a pair of wedges for tipping the front axle to cure wheel shimmy. Loosen the U-bolts that hold the rear axle to the springs and drive in the wedges so that the front end of the pinion housing is raised.

Artificial Draft Increases Efficiency of Furnace

A common fault with hot-air furnaces is their inability to deliver heat to the windward side of the house. My furnace was no exception, and besides was too small to heat the house properly. To remedy these conditions I purchased an old vacuum cleaner for \$1.50, sawed off the handle and connected the long cord to the basement lighting circuit, which was

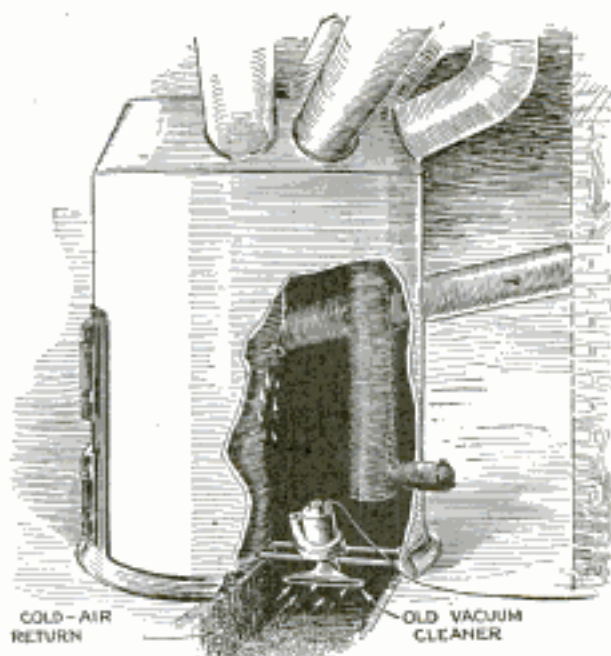

Artificial Draft Forced through Furnace by Old Vacuum Cleaner Heats House Quickly

controlled by a switch in the kitchen. Then I hung the blower in the enlarged cold-air return pit so that the intake was well off the bottom to avoid picking up dust. The outlet was directed upward so that it blows directly against the hottest spot in the firebox, forcing the warmest air away through the pipes to the rooms above. When the wind is from the north, the registers in the south rooms are closed so that all the hot air must pass up to the north rooms whence it flows through the house. It has been found that this arrangement warms up the house in a short time and maintains an even temperature.—Chester S. Emmert, Denver, Colo.

Eccentric Stop for Windows

On windows that have no sash weights to keep them open, the stop shown in the illustration will take their place. It is just a hardwood disk with a hole drilled through it off center, to receive a screw with which it is fastened to the window frame. Turning the disk one way or the other frees it from contact with the sash or jams it.—Charles H. Willey, West Concord, N. H.

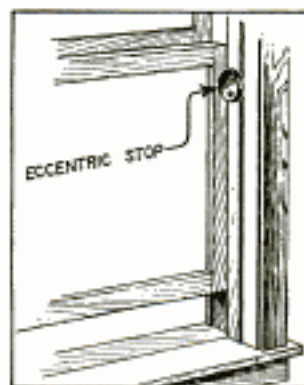

#506

Telephone Cabinet

by R.O. Buck

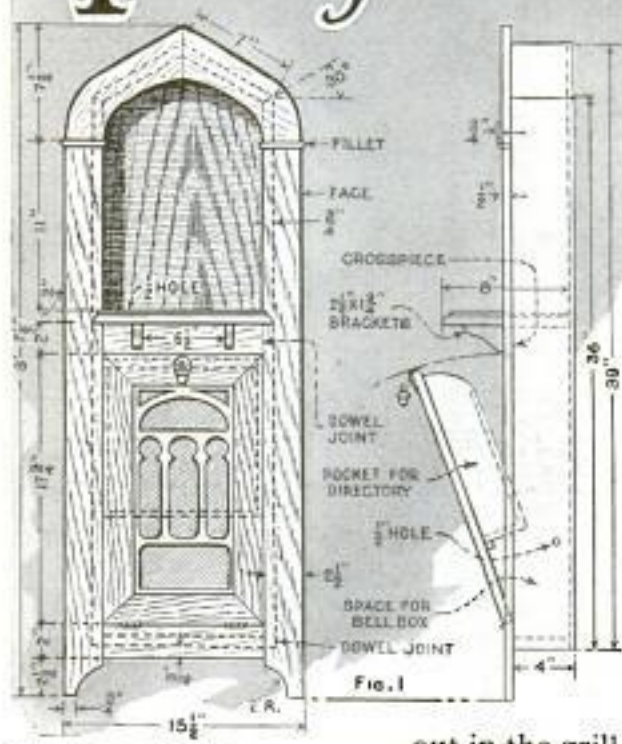

MOST built-in telephone cabinets are rather boxlike affairs that are suitable for use only in the kitchen, but the cabinet illustrated and described in this article can be placed in any room in the house, is easily installed and is both handsome and practical. The telephone rests in an arched alcove, on a shelf, which extends from the wall sufficiently to enable you to write on it if need be. The lower compartment is made to contain the directory and bell box, and is sufficiently large to take the directories used in Chicago and New York. The cloth-backed grill makes the sound of the bell audible practically as well as if it were outside. The Gothic-arch motif, which has been carried

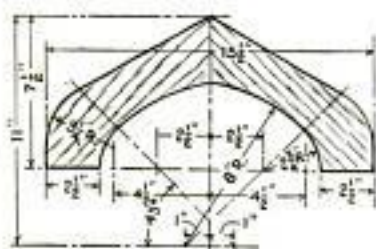
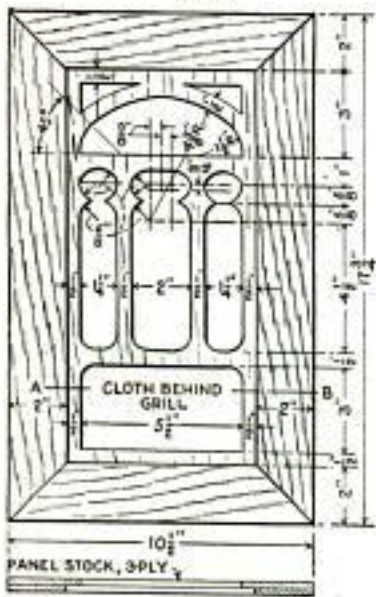

Fig. 2



SECTION THROUGH A-B
Fig. 3

out in the grill as well as above, gives a very pleasing effect. Wood of the same kind as is used for the trim in the room in which the telephone is located, should be used for the cabinet, so that the finish may be made to match. If an enameled finish has been used on the trim, any close-grained hard or soft wood may be used. It is not advisable to use yellow pine, however, as the grain is likely to show through the enamel, regardless of the number of coats applied. The fabric behind the grill may be gold cloth, tapestry or any of the materials commonly used in the grills of radio cabinets.

The first step in the construction is the cutting of all the stock to approximate or rough size, so that the job may go forward in an orderly manner. After this has been completed, the sides, top and bottom pieces of the 3/4 by 4-in. frame should be planed to size and the inner faces smoothed and sanded. A 1/4-in. rabbet should be cut on the back edges of all of the frame pieces with the exception of the crosspiece. If the sides and tops of the frame are cut a little longer than necessary, it will be much easier to saw the 30° bevels on the ends to form the joints, and it may be necessary to dress the bevels with a plane to insure a reasonably tight joint. The bottom and sides of the frame should be assembled first, then the crossrail that goes under the shelf may be used as a spacer while the top pieces are being fitted and assembled. Strips of scrap lumber, tacked diagonally across the edges of the frame, will keep it rigid and square during the process of assembly. Both glue and nails are advisable in fastening

is Built in Wall

the top pieces to the sides, the nails being driven parallel with the sides of the frame. Holes for the nails should be drilled if hardwood is used. After the top pieces are fastened, the crosspiece which has been used for a spacer may be nailed into place, as indicated on Fig. 1.

The $\frac{1}{4}$ -in. three-ply backing should now be fitted, carefully smoothed and sanded on the front face, and nailed into place with $\frac{3}{4}$ -in. brads. This will make the frame sufficiently rigid so that the strips across the front may be removed.

The shelf has a formed edge which adds greatly to the attractiveness of the cabinet. After the stock has been cut to the shape shown in Fig. 4, a deep cut should be made around the edge with a marking gauge set to $\frac{1}{2}$ in. A $\frac{1}{8}$ -in. cut should also be made on the thickness, measuring from the top down. With a backsaw and chisel, cut away this $\frac{1}{8}$ by $\frac{5}{8}$ -in. portion entirely around the curved portion. Finish up the molding with a plane, file and sandpaper as shown. After the shelf has been well sandpapered, bore a $\frac{1}{2}$ -in. hole near one of the back corners for the phone cord, then fit to frame and nail into place. Note that a 1 by $\frac{1}{2}$ -in. notch is left to insert the face pieces on each side of the shelf. Fig. 8 shows how this part of the job will look.

The face consists of the pieces which cover the joint between the frame and the plastered wall, also the center and bottom crossrails shown on the figures. The face should be framed up as a unit and jointed, but should not be nailed to the frame until the frame has been installed in the wall; it should, however, be tacked into place temporarily so that it may be well fitted.

The sidepieces should be planed to size first and the arched end cut with a coping saw, as shown on Fig. 2. One face and both edges of these pieces should be smoothed and sanded. The crossrails should next be made and jointed to the rails with $\frac{1}{4}$ -in. dowels at each joint,

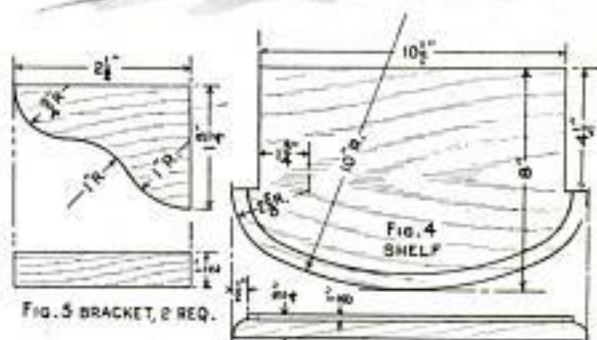

FIG. 5 BRACKET, 2 REQ.

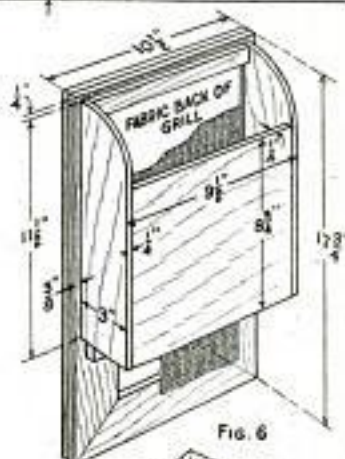

FIG. 6

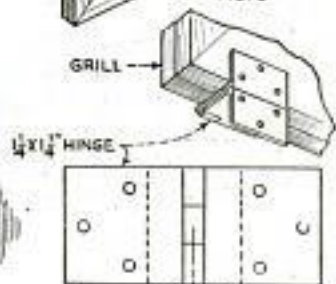

FIG. 7

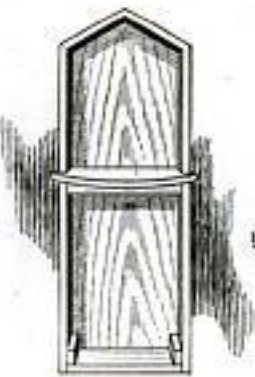

FIG. 8

properly glued. Be sure to square and gauge the centers for the dowel holes so that they will line up and make a true joint. The face should now be tacked into place as suggested above. The fillet blocks (Fig. 1) form the joint between the arch and the sidepieces, without glue, so as to take up irregularities caused by shrinkage and swelling. After the assembly has shown that the joint at the top of the arch is true and tight, a spline joint should be made at this place as follows: Gauge from the face of both pieces a distance of $\frac{1}{4}$ in. in along the jointed edge. Along this line, make a saw cut $\frac{1}{2}$ in. deep with the saw in your kit that makes the widest kerf or cut. In this kerf insert and glue a thin piece of wood to keep the two pieces of the arch even and level. The grain of the spline should run across the joint. Retack the arch to the frame.

The door for the directory and bell-box cabinet is made in the form of a grill. The design shown in Fig. 3 should be worked out full size and traced onto a piece of panel, preferably of plywood. The panel should be cut and fitted to the opening in the face surrounding the cabinet. With a coping or scrollsaw, cut away the portions indicated in the pattern and smooth the edges of the cut-outs with a file and sandpaper. To add rigidity as well as good appearance to the grill, a mitered frame is fastened to the front face of the grill panel with glue and brads, all nailing being done from the back. The drawing above on this page shows the cabinet at this stage in the construction.

The pocket for the telephone directory may be made of any $\frac{1}{4}$ -in. soft wood. The construction and dimensions of this part are shown in Fig. 6. The pocket is fastened to the back of the grill door with screws, so that it may be removed to install or replace the grill fabric. See lower photo on this page.

The hinging of the door may be done in either of two ways; an ornamental surface hinge may be used or a desk hinge may be bent as shown in Fig. 7. The former is much the simpler and easier method, but the latter has the advantage of housing and practically concealing the hinges.

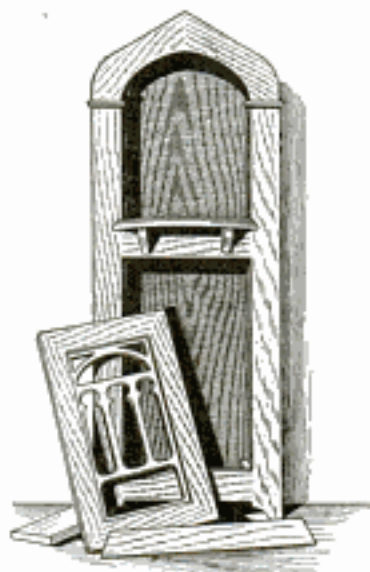

The cabinet is now ready for cleaning up, sanding with No. 0 or 00 sandpaper, and finishing. As suggested at the beginning, the cabinet should be made to match the woodwork or trim of the room, both as to material and finish. The finishing cannot be completed in the shop, however, as it will be

necessary to do some nailing when the case is installed, which means holes to fill and cover. If the finish is enamel, your matching problem is greatly simplified. Your decorator can give you the information needed for matching or closely matching stained woodwork.

After locating the place on the wall where you are planning to make the installation, check carefully to be sure that there are no pipes, flues or other obstructions in the walls. Tap on the wall with a hammer to locate the position of the studs. If possible, locate the cabinet between two studs. If this is not possible on account of poor spacing, at least arrange so that only one stud will be cut, if near a door or window where the stud spacing is unequal. Mark out on the wall an outline of the frame, with the shelf placed 32 in. above the floor. Care must

be taken to make the lines plumb. Cutting out the plaster is not difficult with a keyhole saw to start the cut, followed by an old crosscut saw. After the hole is made through the lath and plaster, the cabinet should be fitted into place between the studs by wedging. (Be sure telephone connections are brought

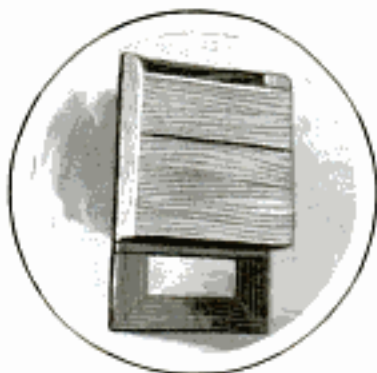

through the box before the cabinet is nailed into place.) If the cabinet is not between

studs, pieces of studding will have to be set in on each side of the opening for nailing. This will be more easily accomplished, if the plaster that sticks through between the lath on the inside is cut away flush with the lath, along the edges where the studs are to be placed.

The installation of the telephone in the cabinet can be done by one of the telephone company's service men or may be done with ease by the home craftsman, provided the rules of the telephone company will permit. The bell box is opened with a screwdriver inserted in what appears like a lock, but is really a machine screw. Inside you will find a series of binding posts to which the various leads are attached. Make a diagram of the position of these posts and the colored wire that is run to each, then disconnect all leads, separate the phone cord and house leads from the box and string the wires through the holes in the cabinet. The three-wire line which comes up from the basement should be pulled through the hole in the side of the cabinet, shown in Fig.

1. The location of this hole is not specified, as it is to be drilled where convenient. After this line wire has been pulled through the frame, the cabinet may be permanently nailed into place. The cord from the telephone should be carried through the hole in the back corner of the shelf to the bell box. Reconnect these leads to their respective binding posts and the installation is complete. This cabinet

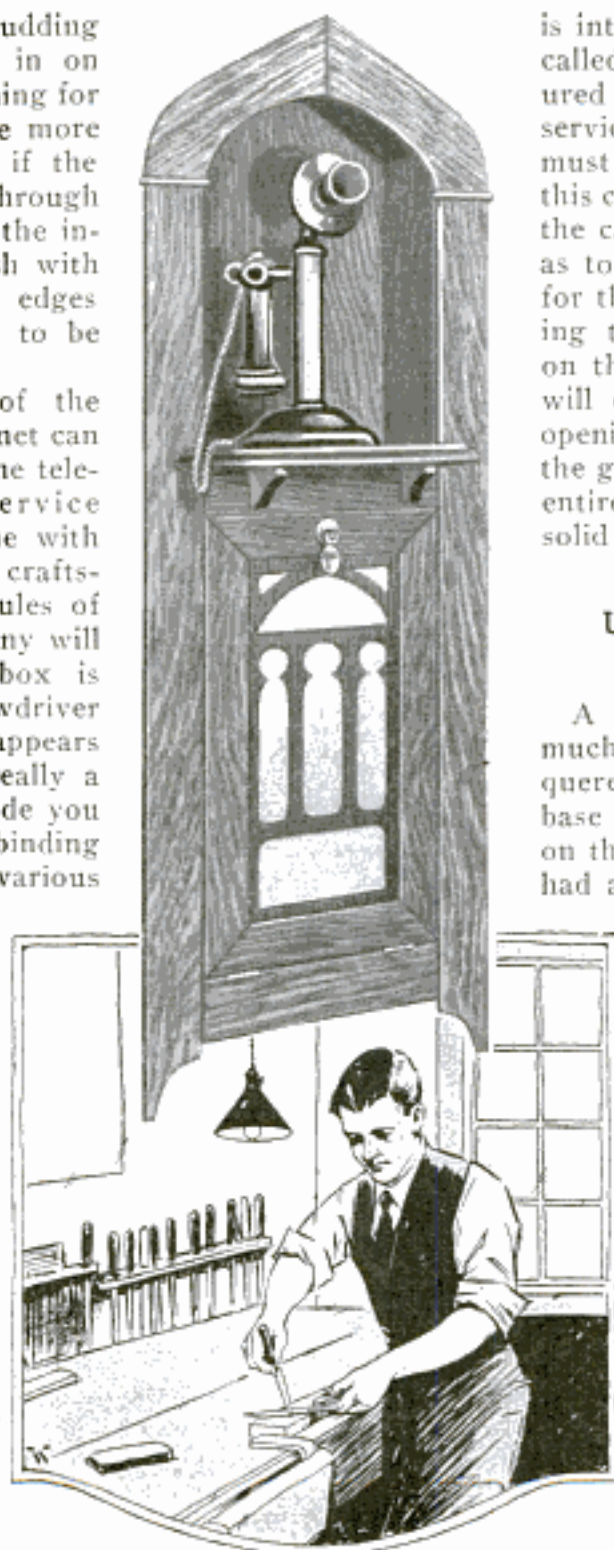

is intended for use with so-called unlimited and measured service. If coin-box service is used, the coin box must be left outside. In this case, it is suggested that the cabinet be shortened so as to provide cabinet space for the directory only, leaving the bell and coin box on the wall as usual. This will eliminate the large opening at the bottom of the grill, or if preferred, the entire door may be made a solid panel.

Unusual Finish on Lacquered Table

A table that attracted much attention was lacquered apple-green with a base color of dull old-rose on the top. The whole top had a delicate lacy pattern outlined in dim gold, which gave an artistic as well as very unusual effect. This was obtained by using rose-point machine-made lace, stretched tightly over a frame, as a stencil. After the base color has dried thoroughly, the frame is laid upon it, and it is sprayed with platinum bronze mixed with clear lacquer. A coat of clear lacquer is applied last. The lace can be

used many times as it dries smoothly in the frame. The resulting pattern is much finer and more delicate than can be made with a cut stencil.

☞ There is no necessity for destroying a sealed, stamped envelope if you wish to re-examine the contents before mailing; simply steam the flap open and use a little library paste to seal it again.

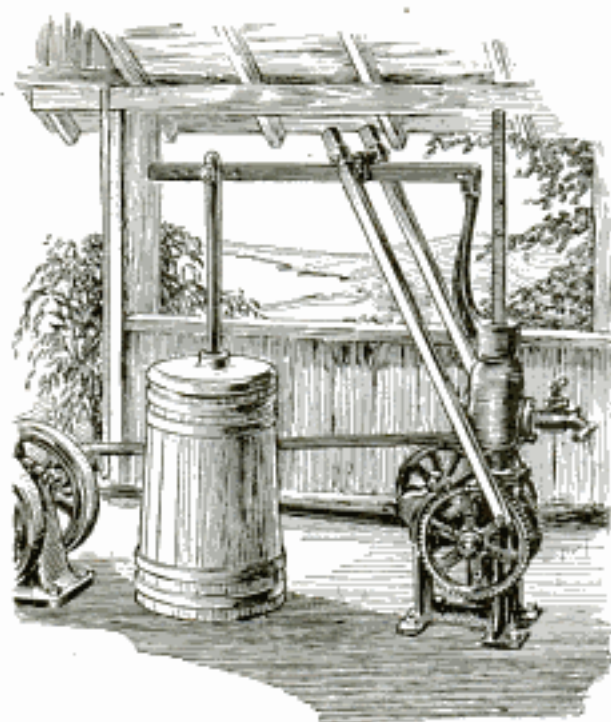

Hand-Operated Churn, Actuated by Means of a Pump Jack, Saves Time and Labor

Pump Jack Operates Churn

Farmers who use the type of hand churn shown in the illustration, can lighten their labor by connecting it to the pump jack. A connecting rod or walking beam, made of a piece of suitable hardwood, is pivoted to the rigid part of the pump to which the handle is fastened when the latter is used, and also to the top of the churn plunger rod. The pump jack is also pivoted to the walking beam at the point indicated.

Extra Switches on Ford Wired to Seat-Base Panel

Many owners of the model-A Fords find the lack of an instrument board for mounting extra switches a drawback. Its lack, however, is a blessing in disguise, as the panel between the front seat and the floor makes an excellent substitute. When placed there, the switches are as convenient to operate as they be on the instrument board, and are much easier to wire. The lead for the battery supply can be run down through one of the holes in the metal floor of the tool tray under the seat. From there it may go direct to the battery, or, preferably, run forward parallel to the tail-light wire, and be connected to the cut-out on the generator, as the ammeter will then show the drain when

the extra lights are used. The push-pull type of switch is satisfactory for the purpose, but a toggle switch is easier to operate if you wear gloves. In mounting toggle switches, the proper "off" position is with the lever down. A 2-way toggle switch, now obtainable, makes it possible to use one switch for two lamps, but they must be lamps that will not be used at the same time. Such a toggle switch is handy for a parking light on one side, and a back-up light on the other. For roadsters and coupes without rumble seats, a light in the luggage compartment is a convenience. A phone jack may be installed alongside the switch, and phone plugs attached to the end of a trouble-lamp cord, or an extension camping light. The earlier A-models do not have parking lights. In most localities only a tail light is required while parking at night. If the lead to the tail light is tapped and a separate lead with a switch is run to the battery, the tail light may be turned on independently of the headlights, and will still be operated automatically by the switch controlling the headlights. Switches may also be mounted on the fiber panel just in front of the door on the left side of the car, which will be handy for the driver to reach, but they must then be mounted so that it will not be difficult to wire them. In this case a ground-return lead is necessary.—J. W. Grosdidier, San Diego, Calif.

Easily Made Print Washer

Any pan or tray can be used for a print washer and the water can be kept running into it through a piece of tubing of suitable length, as shown in the drawing. On the edge of the tray a removable bracket is attached to hold the tube, which extends up to the faucet and down to the bottom



of the tray. A funnel slipped into the upper end of the tube makes it easy to catch the water without splashing.

Preventing Wood from Warping

Wood stored for any length of time should be protected against the weather so that it will not warp. As the cut ends are more porous and will absorb moisture quickly, a coating of shellac should be applied. It is best to keep wood in a warm, dry place and care should be taken to have it exposed evenly. Experiments have shown that the top piece on a pile of lumber will warp overnight during a rain-storm. Warping is caused by the unequal expansion of the wood when it absorbs moisture. Long pieces should be set on end to assure an equal exposure.—Wm. P. Mack, Chicago.

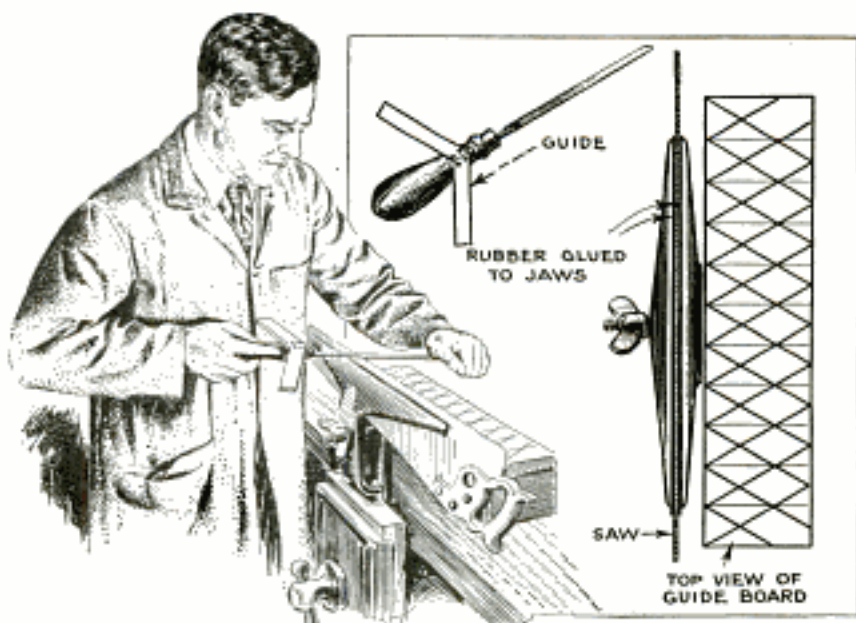

By Making Guide Marks on the Bench as Well as the File, the Beginner Will Be Able to File Saws as Well as Experts

Fine Adjustment for Ruling Pen

When working on drawings in which several thicknesses of ruled lines are used, it is necessary to match the width on a piece of scrap paper when a change is made. A much better method is to make a file mark on the adjusting screw of the pen, remembering the position of the mark for lines of different widths. This kink will be found to give accurate results and will save considerable time.—Frank E. Gray, Sparks, Nevada.

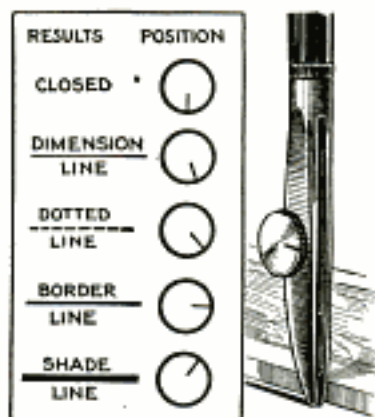

Saw-Filing Helps

While filing saws, the vibration is not only hard on the ears, but it dulls the file as well. This can readily be prevented by gluing a strip of rubber on each jaw of the saw vise. Another help to the beginner, which may also be used to ad-

vantage by old hands, is a guide board for holding the file at the same angle with each stroke. This board is placed behind the vise and the angles marked about 60° both ways. Marks are also made straight across for use with rip-saws. Small pieces may be nailed onto the handle of the file, to enable the operator to hold the file at the same angle as it is easier to watch these pieces than the file.—Lloyd Moore, Chariton, Iowa.

Art-Mounting Corners Used to Hold Drawing Paper

Instead of using thumbtacks for fastening drawing paper to the board, art-mounting corners will be found handy if the sheets of drawing paper used are all of the same size. Glue four of these corners to the drawing board, and it will then be a quick and easy matter to remove and replace the paper. It has been found possible to use one set of corners for fifty sheets of paper. They lie flat and do not interfere with the use of the T-square or triangles any more than the usual thumbtacks.—Walter W. Mallett, Olympia, Wash.

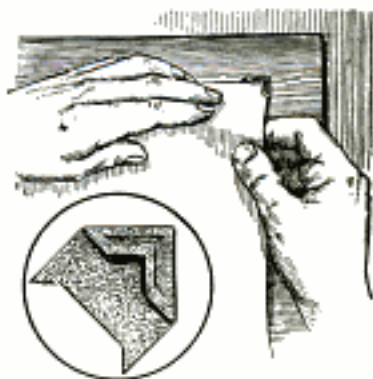

Getting Extra Heat from the Stovepipe

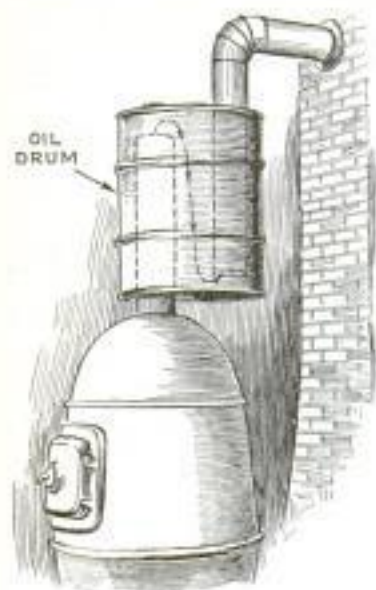

Usually the heat passing through the stovepipe and chimney is practically wasted, but with the arrangement shown in the drawing much of it is radiated into the room. Take an oil drum and put two lengths of stovepipe inside as shown; then mount the drum over the stove, and brace it to obtain the necessary rigidity. The path of the smoke and hot air through the drum and up the chimney is indicated by arrows.

Unusual Decoration for Glass Trays

For decorating glass trays, an unusual effect can be obtained by using a number of photos of faces or parts of faces, including the eyes. Colored prints from magazines are particularly effective for this purpose. After cutting them out in various shapes, arrange them according to the method indicated in the photo, pasting them on a piece of cardboard.



Extinguishing Fire in Auto Carburetor

Flames of a burning carburetor, ignited by backfiring or from any other

cause, may be extinguished with safety in the following manner: Let the engine continue to run. Get out, lift up the hood and turn off the gas supply to the carburetor. Then run the motor faster so that the gas remaining in the carburetor will be used up by the motor as quickly as possible, instead of letting it burn up. Do not attempt to smother the flame by means of a blanket, for the moment you confine the gas vapor you provide the right condition for an explosion. —Mart Banke, Detroit, Mich.

Tool for Scraping Carbon from Piston Grooves

When installing new piston rings, it is necessary to remove all traces of carbon in the piston grooves. To do this, the tool illustrated will be found quick and handy. It consists of a holder made somewhat like a

spanner wrench, one end of which is slotted and provided with a screw to hold a short piece of broken ring that fits the groove exactly. The end of the piece of ring used for scraping is ground off at right angles, to make contact with the entire surface to be scraped.—George A. Luers, Washington, D. C.

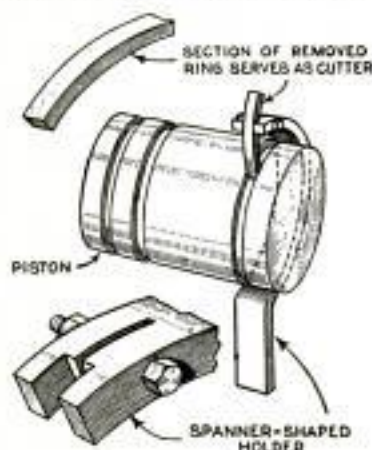

Painting Cement and Concrete

All non-drying oils are more or less destructive to cement, and saturation with raw linseed oil would slowly disintegrate it, but oil paints will dry on the surface without affecting the cement if applied in the following manner: The cement work should be at least one summer old before it is painted. The first thing to do is to wash the surface thoroughly with a 7 or 8-per-cent solution of muriatic acid, followed by a good wash of clean water. The surface must then be given time to dry perfectly. In painting, use considerable more turpentine

than is ordinarily the case, and very little drier. Boiled linseed oil is preferable to raw. For the priming coat, the paint should be used thin. It should also contain so much turpentine that it is almost flat, increasing the quantity of oil for each succeeding coat. Each coat should have about 48 hours to dry before applying the next. If water color or calcimine is preferred, the cement should also be washed and prepared as above. When the surface is dry, it should be given a sizing of equal parts of acetic acid and alum.—Charles R. Whitehouse, Boston, Mass.

Take Your Own Picture with a Graflex

Ordinarily the only objection to a graflex camera is that it is almost impossible for the operator to get in the picture himself. This objection can readily be overcome by providing the attachment shown in the drawing, which consists of a small lever, pivoted at the upper corner of the plate as indicated, the lever being bent over, drilled and tapped to take the cable release. The lever swings freely on its pivot, which is a screw in the trigger plate, and when it is desired to use the camera in the regular way, the lever is depressed, which pushes down the camera trigger, so that, when snapshooting, it is only necessary to remove the cable release. Any attachment that will operate a push cord may be used when the operator desires to get into the picture.—Robert L. Rankins, Springfield, Ohio.

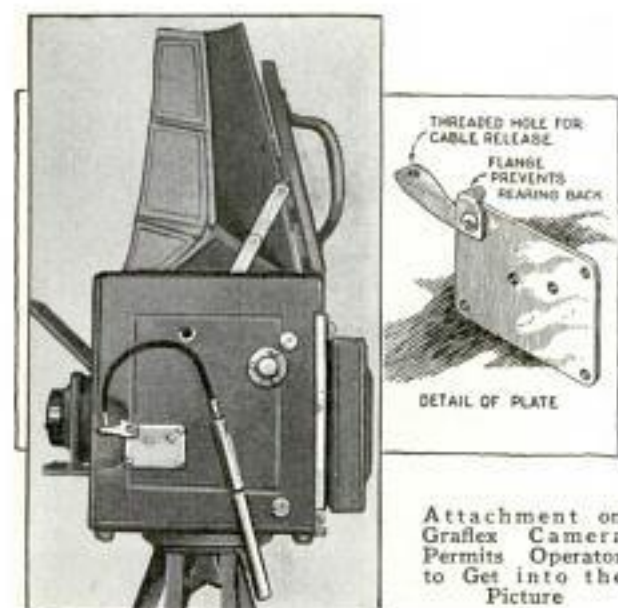

Angle-Iron Bracket on End of Ironing Board Hooks on Screws in the Wall

Wall Bracket Holds Ironing Board

To hold an ironing board rigidly against a wall, get a piece of angle iron, a couple of inches longer than the width of the board. Drill holes through one side of the angle iron so that it can be attached to the end of the board with screws. Drill two holes in the other side, near the ends, and file slots from the latter as shown. These holes must be large enough to be slipped over the heads of two screws driven into the wall, while the slots will just fit over the shanks of the screws. The method of using a board equipped with such a bracket is plainly shown, the bracket being merely engaged with the screws in the wall. Only one supporting leg is necessary at the other end and this can be made to fold against the bottom of the board when not in use.

Precaution against Wastebasket Fire

One precaution against fire, which is often overlooked, is to take care not to set a waste-paper basket on the side of the desk where you keep the ash tray. A lighted cigaret stub may accidentally fall into the basket by being knocked off the edge of the ash stand.



Photo of Lightning Flash Taken from a Point 125 Feet from the Water Tower in the Center with Ordinary Camera

Lightning Photos Are Easy to Make

Photography of lightning by the amateur is a comparatively easy matter. A cheap box camera will produce just as good results in this kind of photography as expensive cameras. All that is necessary is to focus the camera for distant objects, point it in the direction of the most frequent flashes, open the shutter and leave the camera undisturbed for the duration of the storm, this, of course, being possible only with night storms. The photo shows the result of a half-hour exposure, and is a record of a violent electrical storm in southern Idaho. The water tank that is silhouetted against the horizon is 120 ft. high and is located a quarter of a mile from the point where the camera was placed. Some idea of the magnitude of the flashes can be gained from the fact that one of them shattered a tree about a mile away.

Mounting for Small Motor



For mounting a small electric motor, a universal holder, frequently used for cameras, will be found highly convenient, as the motor can be set in almost any position desired. Of course, a sheet-metal

bracket must be made to fit the motor, and the bracket must be drilled and tapped to take the screw of the holder.—H. Pack, San Francisco, Calif.

Tinning Iron and Steel

Iron and steel articles can easily be tinned by using the following method: First remove the scale from the piece by dipping it in a solution of raw muriatic acid, leaving it there until the piece turns white. Then dip it into a solution of raw muriatic acid, cut with zinc shavings until the acid will dissolve no more. This will leave a thin zinc deposit on the piece. Allow it to dry, then dip it into the molten tin, solder or lead. If a first coat is not satisfactory, dip in the cut acid, dry, and dip into the molten metal again. This method has proved extremely satisfactory. Of course, the proper precautions against accidents should be observed when dipping the articles into the molten metal.—Charles R. Whitehouse, Boston, Mass.

A Help for Night Driving

When making stops or left turns, it is customary to hold one's hand out of the car as a warning to motorists in the rear. An ordinary license bolt with a red-glass head



makes an effective signal that is quickly noticed, by mounting it on a ring as shown in the photo.—H. Fowler, Rogers, Ark.

When the bag of a vacuum cleaner gets very dirty, put on the hose for blowing, hold the end out of the window and start the vacuum cleaner; this is sure to clean out the inside much better than can be done by shaking the bag.

THESE MODERNISTIC BOOK ENDS ARE EASY TO MAKE

Here is a modified modernistic design in book ends which should appeal to the home craftsman for its simple and attractive lines. The whole thing consists merely of two or three pieces of scrap wood, some babbitt and a few screws, all to be found in most home shops.

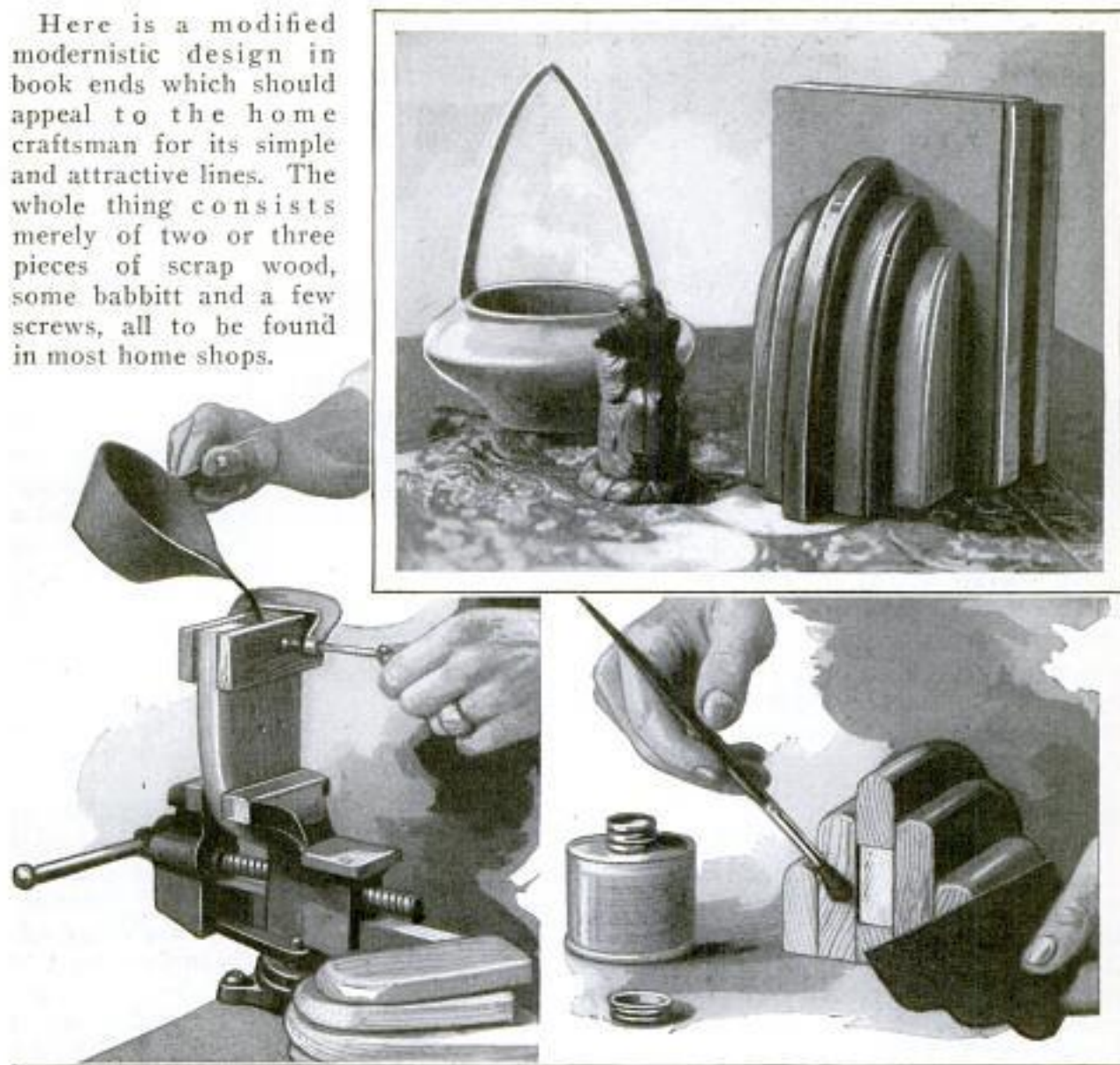

Simple Though They Are to Make, These Modernistic Book Ends Present a Very Attractive Appearance When Finished; Left, Shows the Method of Weighting; Right, the Felt Being Glued in Place

In making these book ends, start by cutting, from $\frac{3}{8}$ or $\frac{3}{4}$ -in. lumber, two of the larger pieces shown in the detail and four of each of the others. You will notice that the bottom end of the larger pieces is cut out into a dovetail shape. This cut is to take the babbitt which forms a weight to keep the book end in place. The manner of pouring the metal is shown in one of the photos, two blocks being clamped around the opening and the babbitt poured in. Babbitt hardens very quickly; it will not scorch the edges of the wood in the slightest. The dovetail, of course, prevents the metal from falling out when hard.

The five pieces of wood which form each end must be assembled so that no screws or nails are visible. This can best be done by fastening the two intermediate pieces to the central piece with screws, then spinning on the outer pieces on screws which have previously been inserted from the inside edge of the intermediate blocks, in the manner shown in the sectional drawing.

A strip of black felt, cut to shape and glued to the bottom of each book end, completes the job. Before fastening this in place, however, the ends should be taken apart again for painting. Each block may be painted in a different color,

*ac Blanche & Co
217 N. Dearborn Chicago
H. O. Baker & Co. Duquesne
Green Lawns All Winter in the South*

*Vaughan's Seed Store
1020. Randolph Chicago
Italian Eye Lenses
Wm. W. Chace Valved
474 S. W. Lake
Brooklyn N.Y.*

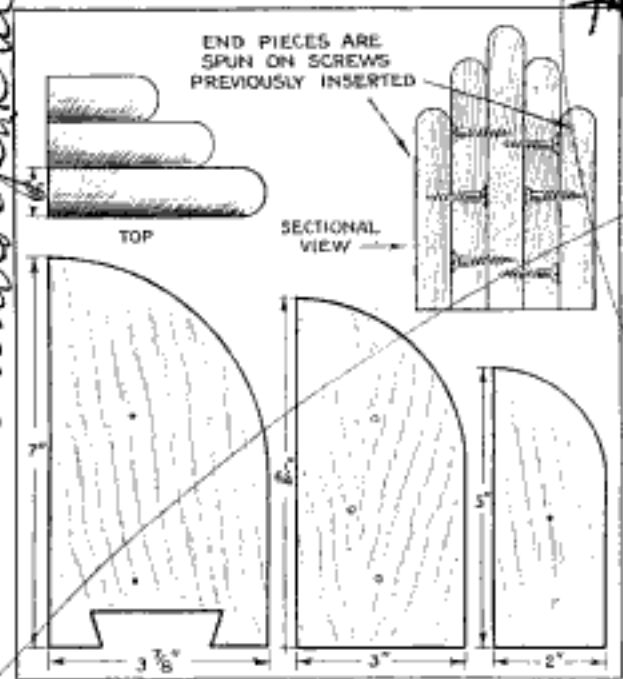

or in shades of the same color. If the book ends are to be painted in a single shade, it will not be necessary to take the pieces apart for painting; separate colors, however, are almost impossible to apply after the wood pieces are put together.—Ralph T. Moore, Columbus, Ohio.

Waterproofing Shoes

Waterproofing shoes which are to be worn outdoors during the winter is a simple and inexpensive job. About 1 or 2 oz. of beeswax and 8 oz. of petroleum jelly are needed for the job. The department of agriculture recommends that the ingredients be melted together by warming carefully and stirring. The grease should be applied warm but not hot. It is important to get plenty of grease on the edge of the sole and welt, as this is where most shoes leak. The best way to proceed is to set the shoe in a pan and pour in the melted grease. If the shoes have rubber heels, these are left outside.

Beautiful green lawns all winter are now common in Florida, and can be had in all of the southern states by seeding Italian rye grass any time during the fall or winter. Specialists of the department of agriculture recommend that this grass be sown on lawns with no preparation whatever except leveling as may be necessary. In the spring, when the regular grass starts growing, the Italian rye will die.

Simple Device Reduces Gas Consumption of Auto

Here is a gas saver that is worth making. It is especially designed for use on model-A Fords, although the idea is applicable to any car or gas engine. Get a piece of flat steel, 1/4 by 1/2 by 1 in. in dimensions. Drill a 3/16-in. hole through one end, as indicated in the detail, and drill a 3/16-in. hole through the piece lengthwise, connecting with the first hole. A piece of thermostatic metal, .015 in. thick, 1/4 in. wide and 2 in. long, is then obtained and a ball formed at one end to fit over the 3/16-in. hole snugly. The other end of this piece is driven into a slot cut in the side of the drilled piece, and it is then bent over to a U-shape so that the ball fits the hole at the end as indicated. The shank of a screw, to be used for holding the device in place, is turned down to allow passage of air, and the gasket between the coupling at the carburetor is cut away for the same purpose.

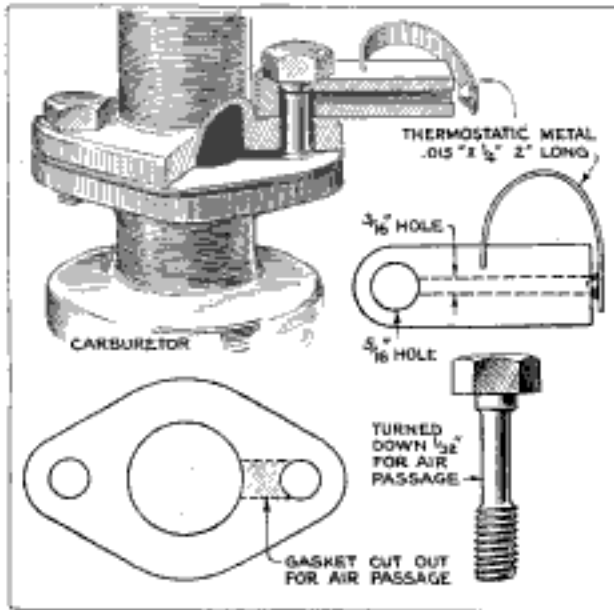

Thermostatic Gas Saver Acts When Motor Heats Up

When completely assembled, the device will not permit the entrance of air when the motor is cold, but as soon as it heats up, the piece of thermostatic metal draws away from the opening and allows the air to enter, which causes a leaner mixture and thus effects a saving of gas.—A. E. Sanford, Los Angeles, California.

SHOP NOTES



Flashlight Photography Made Easy

By W. E. BURTON

MAKING flashlight photographs without noise, smoke, odor or the danger of fire, and in so short a time that subjects have no chance to move, look scared or close their eyes—this dream of photographers everywhere has been realized in the development of a new lamp that promises to revolutionize flashlight photography. The lamp consists of a standard 100-watt clear-glass lamp base and bulb. Inside the bulb are three things that, together, produce the illumination. They are a short filament coated with a substance that gives off a shower of sparks when heated, a quantity of very thin aluminum foil, which, in a crumpled condition, fills much of the bulb space, and an atmosphere of pure oxygen that is reduced to somewhat below normal pressure.

When current from a dry cell, storage battery

or house-lighting system is sent through the lamp, the filament glows, ignites the aluminum foil either directly or through the sparking material, and the foil burns almost instantly, producing an intense light. This action takes place in about one-hundredth of a second, making instantaneous flashlight pictures possible.

After the bulb is used, it is discarded. The slight added cost as compared with

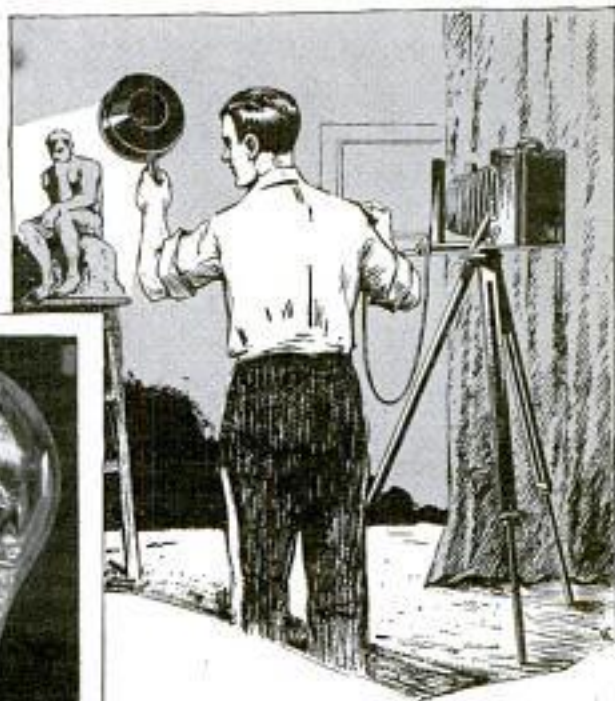

Center, the New Flashlamp; Left, a Simple Homemade Holder Designed for Interior Work; if Used without a Stand, It May Be Hung Almost Anywhere by the Hook and Slotted Bracket

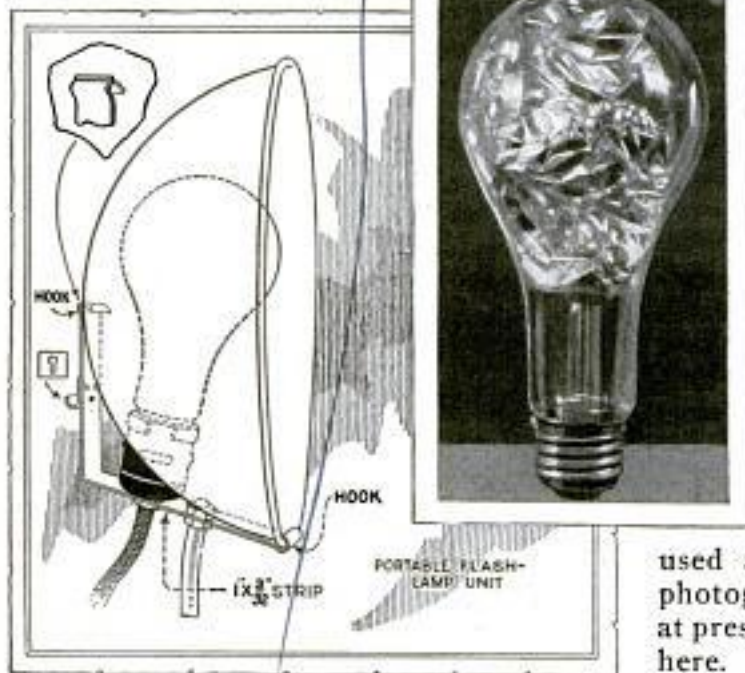

other flashlight materials is offset by the fact that the lamp can be used anywhere. To use the lamp, the photographer may make his own holder, at present, and two simple types are shown here. It is absolutely essential, to obtain

General Electric Co, Schenectady 159
 any photo supply house

*also photo flash bulb Burke & James, Chicago
 223 W Madison*

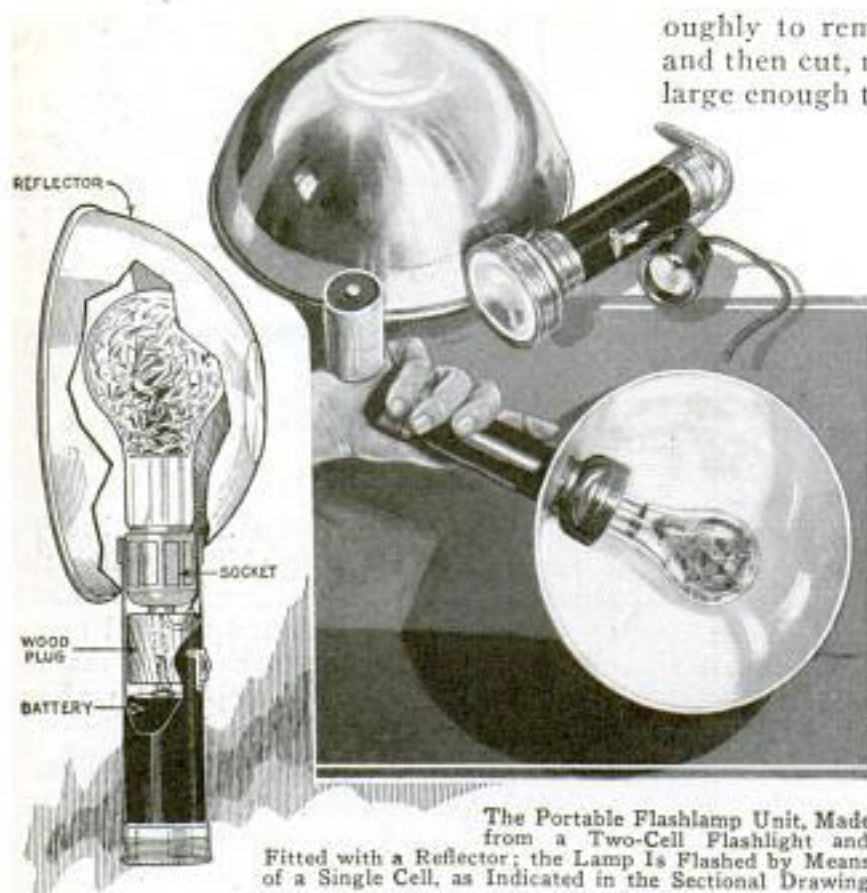

The Portable Flashlamp Unit, Made from a Two-Cell Flashlight and Fitted with a Reflector; the Lamp Is Flashed by Means of a Single Cell, as Indicated in the Sectional Drawing

the maximum efficiency, that an aluminum reflector, preferably parabolic, be used.

In photographing interiors, several of the bulbs can be screwed into the sockets of overhead, portable or side-wall fixtures, and set off by operating the room switch. From an aluminum reflector, at least 10 in. in diameter, a quantity of strip brass, a socket and a few odds and ends, a simple and compact portable holder can be constructed. Several of these can be connected in parallel and suspended from a cord or mounted on music stands. An arrangement suggested by engineers who developed the lamp is shown on page 159.

Perhaps the most convenient device, especially where one flash bulb, held in the hand, is to be used, is a modified electric flashlight like the one shown in the photographs and drawings. This was also designed by the lamp engineers.

The handle is a two-cell tubular flashlight case and is equipped with an aluminum reflector. You can use a 25-cent aluminum mixing bowl with almost as good results as a true parabolic reflector.

In constructing the "gun," make a matt surface on the mixing bowl interior by letting a quantity of strong lye solution stand in it for an hour. Then wash thor-

oughly to remove the black deposit, dry, and then cut, not far from the edge, a hole large enough to receive the flashlight case.

The case illustrated happened to be fitted with an extra-large lens, but the small-lens type will do just as well. Fasten the case to the reflector by the most convenient method.

Into the reflector end of the tubular handle, place a standard weatherproof lamp socket. The G. E. 13X-161 Textolite socket is ideal, being of the correct outside diameter. Solder one socket wire to the brass strip that runs from the flashlight switch to the bulb end. Pass the other wire through a wood plug, placed inside the tube just below the socket. This plug is necessary to hold the

single battery cell in position. The center contact of the cell rests against a wood or machine screw that is forced into the hole in the wood plug so that it makes contact with the wire. Fasten the socket firmly by means of cement or screws. Place a battery cell in the case, screw the lower cap into place, and you are ready to operate the gun.

By watching the new flashlamp operate, you may believe that the light is insufficient. That is because the foil is consumed so quickly that your eyes do not have time to gauge the quantity accurately. The great speed of the lamp has led to a suggestion that it could be used for making photographs of wild animals, burglars or other objects whose motion is to be arrested.

X-Rays Useful in the Lumber Mill

As a means of examining logs and trees, the X-ray is meeting with considerable success. Its purpose is to detect borers and inner decay, enabling proper precautions to be taken in time to prevent the loss of infected trees. Of even greater value is its use in veneering mills in revealing the nature of the grain. Logs

Rochester, N.Y.

having a straight grain are not nearly as valuable as those with curly grain. Thus, if the grain in a log can be seen, it is much easier to make a selection and to set prices. Many curly-grained logs command high prices, but before the use of the X-ray for the purpose, the buyer and seller have always had to guess at the probable worth of a log, with the result that a buyer sometimes found himself with a poor log on his hands at the price of a fancy one, or vice versa.—John E. Hyler, Peoria, Ill.

Drawn-Aluminum Filler Rods for Aluminum Welding

The use of cast filler rods for welding aluminum presents numerous difficulties. During the last ten years manufacturers have changed the composition of many castings, so that they are no longer cast aluminum but cast lynite, which does not contain zinc but copper instead, the latter making a tougher and more rugged casting. I have found that it is much better on these castings to use drawn-aluminum filler rods with which a good welding job can be made.—Mart Banke, Detroit, Mich.

15749 Wells St.

Cam Lifter Made from Carriage Bolt



The illustrated tool will be found useful for a variety of purposes, especially for lifting the cams on some types of ignition systems. It is made from an ordinary $\frac{1}{4}$ or $\frac{5}{16}$ -in. carriage bolt by cutting off three sides of the head as indicated.—R. Hadley, Fairfield, Conn.

When a driveshaft has to be removed from a model-A Ford, the banjo housing should be immersed in hot oil to expand it; then it is an easy matter to force the shaft off.

When a driveshaft has to be removed from a model-A Ford, the banjo housing should be immersed in hot oil to expand it; then it is an easy matter to force the shaft off.



U-Shaped Hook and a Pinch Bar Are Used to Pull a Wheel Bushing

Effective Puller for Wheel Bushings

A simple but effective puller for a wheel bushing is shown herewith. It consists of a prybar and a U-shaped spring hook, made from $\frac{3}{8}$ -in. steel rod, the ends of the hook being turned up to form claws. The bar is rested on the edge of the brake drum and the short end is caught in the hook; with the leverage supplied by the long end, moderate pressure on the bar then pulls out the bushing without difficulty.—G. A. Luers, Washington, D. C.

Stamp with Curved Face for Bundles

Irregularities on the surface of bundles make it difficult to get a clear impression with the use of an ordinary flat rubber stamp. By removing the rubber from the stamp, filing the wood down to a curved surface and then replacing the rubber, it will be found that the bundles can be stamped more clearly and without the risk of blotching. The reason for this is that the stamp can then be rolled over irregular surfaces, causing contact at all points.—Kenneth B. Murray, Sturgis, Mich.



Easy Methods of Laying Out Angles

Laying out angles is usually done by means of a protractor. However, the

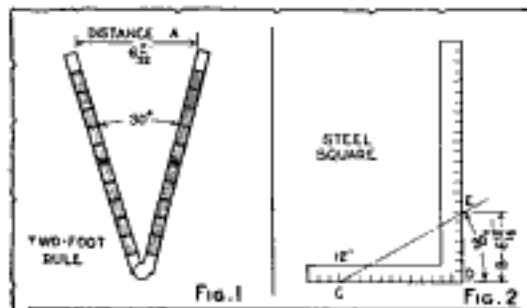

Fig. 1

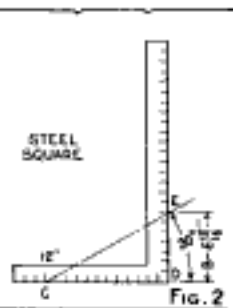

Fig. 2

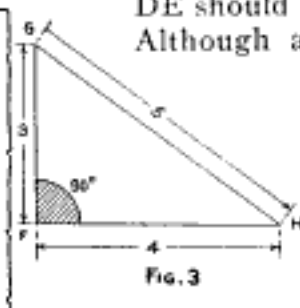

Fig. 3

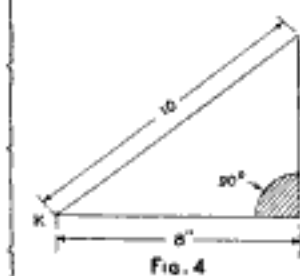

Fig. 4

BY TWO-FOOT RULE			BY STEEL SQUARE		
ANGLE DEGREES	DISTANCE A	FRACTIONS	ANGLE DEGREES	DISTANCE B	ROOF PITCH
5	1.05	1 1/16	5	1 1/2	
10	2.09	2 1/8	10	2 3/4	
15	3.13	3 1/4	15	3 3/4	
20	4.17	4 1/4	18° 25'	4 -	1/2 PITCH
25	5.19	5 1/2	20	4 3/4	
30	6.21	6 1/2	22 1/2	4 3/4	
35	7.22	7 1/2	25	5 1/2	
40	8.20	8 1/4	26° 33'	6 -	1/2 PITCH
45	9.18	9 1/4	30	6 3/4	
50	10.14	10 1/4	33° 45'	8 -	1/2 PITCH
55	11.08	11 1/4	36	8 1/2	
60	12.00	12 -	40	10 1/2	
65	12.90	12 3/4	45	12 -	1/2 PITCH
70	13.77	13 3/4	50	14 1/2	
75	14.61	14 1/2	53° 7'	16 -	1/2 PITCH
80	15.43	15 1/2	55	17 1/2	
85	16.21	16 1/2	60	20 1/2	
90	16.97	16 3/4			

carpenter is quite frequently confronted with the problem of laying off a certain angle on the job. This may be readily done by the use of a 2-ft. rule, or a steel square, following the method described in this article and the dimensions given in the accompanying table. To lay off any angle given in the table by means of a 2-ft. rule, open the rule in the middle until the distance between the inside corners is equal to the distance A given in the table for the particular angle desired. Thus, in Fig. 1, the rule is shown to be open at 6 7/16 in., and the angle formed equals 30°. To lay off an angle by means of a steel square, set the tongue or blade of the square along the line CD. Point C, which is fixed at the 12-in. mark, is the point of intersection of the two sides of the angle. Lay off the distance DE equal to the distance B, given in the table

for the corresponding angle, and draw line CE. The angle DCE will be the required angle and will be approximately correct. For an angle of 30° the distance DE should be 6 15/16 in., as shown in Fig. 2. Although a right angle may be readily determined by means of a square, it frequently happens that one is called upon to lay off a square corner when a square is not available. This can be done by using an ordinary rule or even a plain stick without any graduations at all. To do this, first lay off a triangle whose sides are 3, 4 and 5 units or multiples thereof. The right

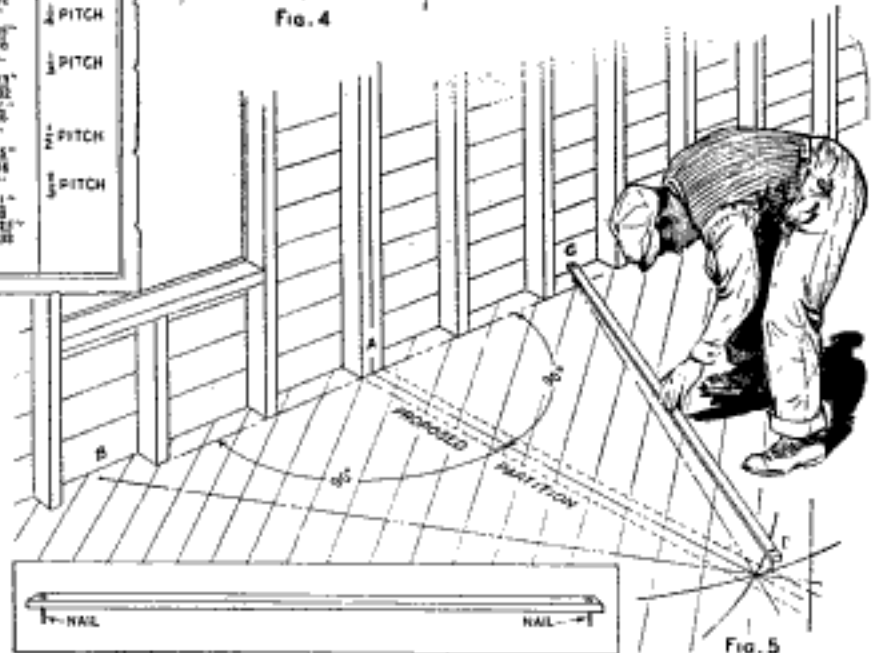

Fig. 5

Here Are Some Easy and Practical Methods of Calculating Angles and Determining Right-Angle Position of Proposed Partitions

angle is always opposite the longest side. This is shown in Fig. 3. Line FG is laid off 3 units long, either inches, feet, yards, or any other convenient unit. At point F, lay off another line FH, 4 units long, as nearly at right angles as can be determined. Measure across the ends of the two lines and adjust them until the distance GH equals 5 units. The angle GFH is then a right angle. In Fig. 4, the sides of the triangle are 6, 8 and 10 units long, which are multiples of 3, 4 and 5. These dimensions make a larger triangle but its sides are proportional to those shown in

Fig. 3. This method, generally known as the "6, 8 and 10" rule, is frequently used in large jobs, such as the laying out of foundations. Another method, which will be found convenient when erecting partitions or similar work, where large angles and dimensions are dealt with, is shown in Fig. 5. In this instance, it is desired to erect a partition at right angles to the wall. On the center line of the plate, from which the partition is to extend, lay off equal distances on both sides of point A, determining the points B and C. Take a stick of any suitable length, preferably a little over half the length of the proposed partition, and measure off distance CD, driving nails at points C and D through the stick and using one for the pivot and the other for a scribe. Fixing the stick at C describe an arc with the scribe end. Repeat this operation from point B to locate point D. Now with a straightedge or chalk line, draw line AD which will be the center of the partition, and will be at right angles to the wall.—L. Perth, Chicago, Ill.

Bench Support for Handling Long Work

When handling long material in the bench vise, an extra support, which is adjustable, will be found highly convenient. The support shown in the illustration consists of a piece



of flat iron welded to the end of a length of pipe. Large staples, screwed to the bench leg as indicated, allow vertical movement of the pipe, and one of the staples is drilled and tapped for a thumbscrew, which is used for locking the support at any desired height.—Jos. C. Coyle, Englewood, Colo.

☐ In testing solder, hold it close to the ear and bend it; if it does not give out a cracking sound, it is of an inferior grade.

Floor Brackets for Holding Doors



Weight of Door, When Placed in These Brackets, Causes Them to Grip It Tightly

A pair of hinged floor brackets, made of good hardwood as shown in the drawing, will be found highly convenient by the carpenter whose job it is to set or hang doors. Each bracket is made in two parts, hinged together in the center. The hinged ends are cut out so that the edge of the door can be slipped between them, and when this is done, the weight of the door causes the halves of the bracket to grip it securely.—Chas. H. Willey, Concord, N. H.

Cleaning Steel and Other Hard Metals

Steel that has become rusty and dirty can be cleaned in the following way: Mix together water, 1 gal., caustic potash, 3 oz., trisodium phosphate, 3 oz., and sodium cyanide, $\frac{1}{2}$ oz. After stirring well, heat the solution to a temperature of approximately 200° F. Immerse the articles to be cleaned in the bath, holding them with a piece of wire so that the hands will not get in the solution. After immersion, dip the piece in clean hot water and then in clean cold water. Then dry it off in sawdust if available. An article washed in this way will be as clean as when new.—Charles R. Whitehouse, Boston, Mass.

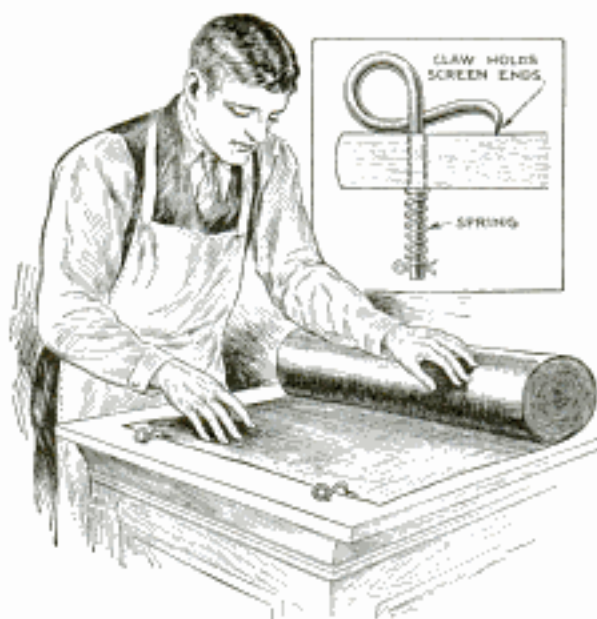

Claw Clamps on Counter Hold End of Wire Screen While It Is Being Measured

Claw Clamps on Counter Help in Measuring Screen

Wire screen, which has a tendency to roll up when laid on a counter, can be held down at one end by means of a pair of claw clamps. Two 8-in. lengths of heavy-gauge wire are bent to the shape shown in the detail, one end being filed to a sharp point and the other drilled to receive a small cotter pin. Holes are drilled through the workbench or counter to receive the lower end of the clamps, which are pushed through from the top, after which a coil spring and washer are slipped over the end, and the pin inserted. The spring keeps the point of the clamp tightly against the top of the bench. In use, one end of the wire screen is slipped under the two clamps so it can be unrolled as far as desired and cut off. If several lengths of the same size are needed, a suitable weight is kept at the loose end to prevent it from rolling back,

while the starting end remains held under the clamps.—G. E. Hendrickson, Argyle, Wisconsin.

Quick and Accurate Method of Fitting Piston Rings

When refitting a motor with piston rings, the usual practice is to fit each ring individually, filing off a little at a time, until the ring enters the cylinder with a sufficient gap to take care of the expansion. A better method is to gauge each cylinder bore with an inside micrometer, and mark the size on your paper pad in inches and decimals. Examination of a worn cylinder will disclose the fact that when new rings are needed they should be made to fit the worn part of the bore, and advantage must be taken of the expansion factor in order to make the ring just so large as to barely pass through the worn parts of the bore, that is, without leaving too large a gap. The rule for the expansion allowance is .00075 in. for each inch in diameter of the ring. When anything is measured on the circumference with a tape line, the possible error of measurement is reduced to practically one-third, and when the bore has been accurately measured, it becomes easy to figure out the exact circumference of the ring,

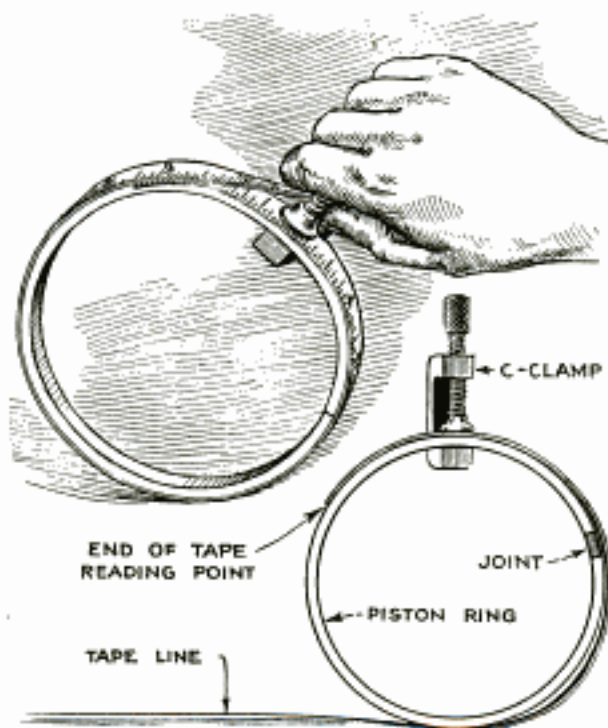

Careful Measurements Are Necessary in Order to Make Piston Rings Fit Accurately

while making allowance for expansion, etc. As the readings on the circumference are taken with a tape line, with the graduations on the outside, allowance must be made for the thickness of the tape line, and this allowance must be three times the thickness of the tape. When a cylinder is worn in excess of the expansion factor, and the ring must pass through an unworn part, either at the top or lower part of the cylinder, the ex-

pansion factor is ignored. The method of using the tape line for measuring the circumference is as follows: Take a line, preferably one broken off at an even inch, and clamp it to the ring as shown in the drawing, placing the clamp a short distance from the gap, and about 2 in. from the end of the tape line. Allow the end to overlap the side of the ring slightly, draw the tape around the ring and bring the ends of the ring together by drawing the tape up tightly. The circumference can now be easily read and the exact amount of the ring's oversize determined. The excess amount is filed off from one ear of the lap joint, a feeler being used to measure the reduction, after which the remaining ear is filed down until the two meet in a light, tight fit. Upon trying the ring, it will be found to be a perfect fit, and the other rings are then filed to the same dimensions, providing all the bores are alike in size. If not, allowance is made for the difference. The formula for the circumference measurement of the ring is as follows: Circumference is equal to the diameter of the cylinder times 3.1416, plus three times the thickness of the tape line and, in the case of an unworn cylinder, the expansion factor of .00075 in. for each inch of the ring's diameter.

Wall Plate for Holding Wrenches

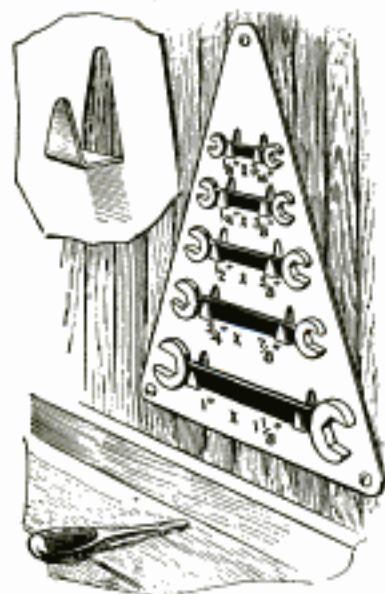

After laying off the exact position the wrenches are to occupy, sections of the metal are punched out with a cold chisel, and bent outward to form holders.—Charles H. Willey, West Concord, N. H.

For holding open-end wrenches, the illustrated wall plate will be found convenient and, in addition, neat in appearance. Take a piece of sheet metal, cut it to a triangular shape and drill a hole at each corner so it can be screwed to the wall.

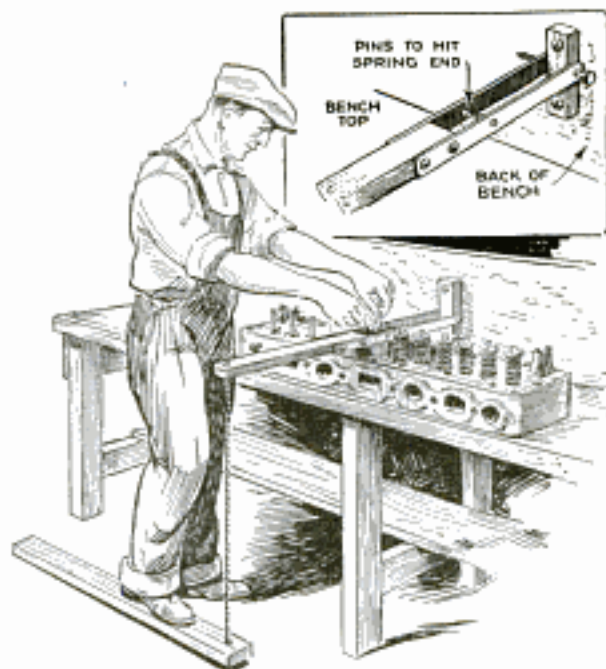

Compressor for Valve Springs of the Overhead Type Is Operated by Foot

Spring Compressor for Overhead Valves

Removing the overhead valve spring on a motor, when it is necessary to grind valves, is often a rather difficult task. However, a device similar to the one shown in the illustration, can easily be made in the home garage, and will simplify the work considerably. Fasten a block to the back of the bench or wall as shown in the detail, or use one of the garage studs. Two pieces of $\frac{1}{8}$ by 1-in. flat iron, about 18 in. long, are fastened to a piece of wood, and two pins are provided in these lengths of strap iron to fit over the valve springs. The extending ends are pivoted to the block on the wall, forming a lever which can be moved up and down. To compress a valve spring, the pins are slipped over the valve stem and directly against the edge of the spring. Then pressure on the lever holds the spring down and allows the retaining pin to be removed. It will be found handy to attach a length of rope to the end of the lever so that a tread can be used to hold the lever down, while both hands are free to extract or insert the pin.

☞ To detect a crack in a casting, apply oil to the suspected surface, wipe off and paint with alcohol and whiting mixed in equal parts; the alcohol evaporates and cracks are indicated by the oil marks on the whiting.

Swedish wrought iron -
 Swedish American Steel Corp
 429 Kent Ave
 Brooklyn N.Y.

Bent Iron for

by Robert Gregg

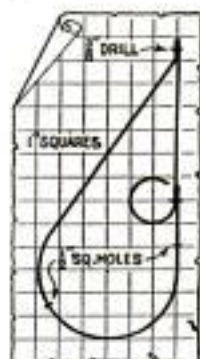
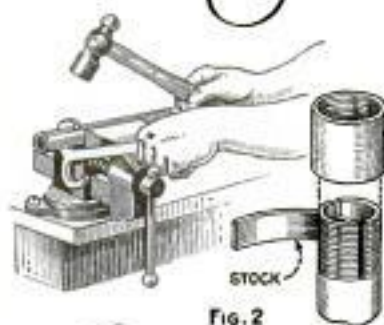

THE HOME craftsman who is a little tired of the sharp angles and straight lines of the modernistic period, and a trifle "stale" on constant woodworking, will find much that is appealing in bent-iron work. Working with ordinary tools and with cold iron, the average workman will find that attractive all-metal pieces for the home or garden can be fashioned both easily and cheaply.

Bent iron should be particularly popular with the home worker in view of the fact that all of the materials used can be procured in almost any locality. Strap iron in graduated sizes is usually carried in stock by all good hardware stores. The various

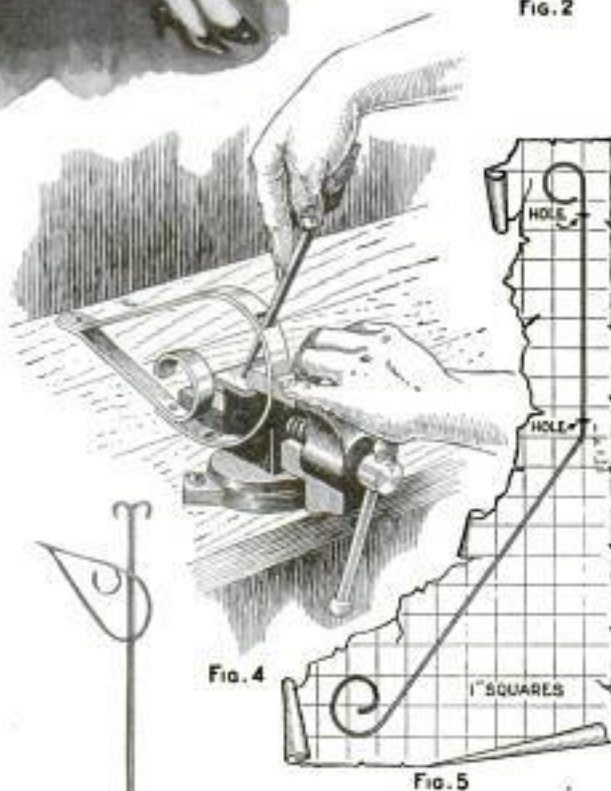

other pieces of square and round stock are generally available at the same place, as are also the rivets and bolts used in assembling the different pieces.

As in every other craft, it is advisable to start with something comparatively easy, the bridge lamp shown in Fig. 1, for example. The stem of this is a 50-in. length of $\frac{1}{2}$ -in. square iron, with 2 in. of one end split in half with a hacksaw and hammered into a circular shape around a piece of pipe, as at the left in Fig. 2. The lamp arm is fashioned from $\frac{1}{8}$ by $\frac{3}{4}$ -in. strap iron, bent to the shape shown in Fig. 3 and fastened with a single rivet at the point indicated. A simple bending tool is a long pipe nip-

the Home Craftsman

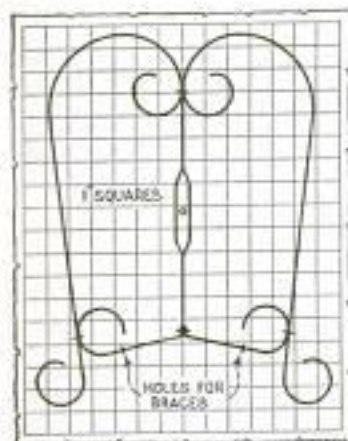

Fig. 7

With a Little Care and Ingenuity, the Home Craftsman Can Make Many Worth-While Things in Iron; the Pieces Shown in This Article, While Simple Enough for the Beginner, Will Teach All That Need Be Known for the Making of More Ambitious Projects

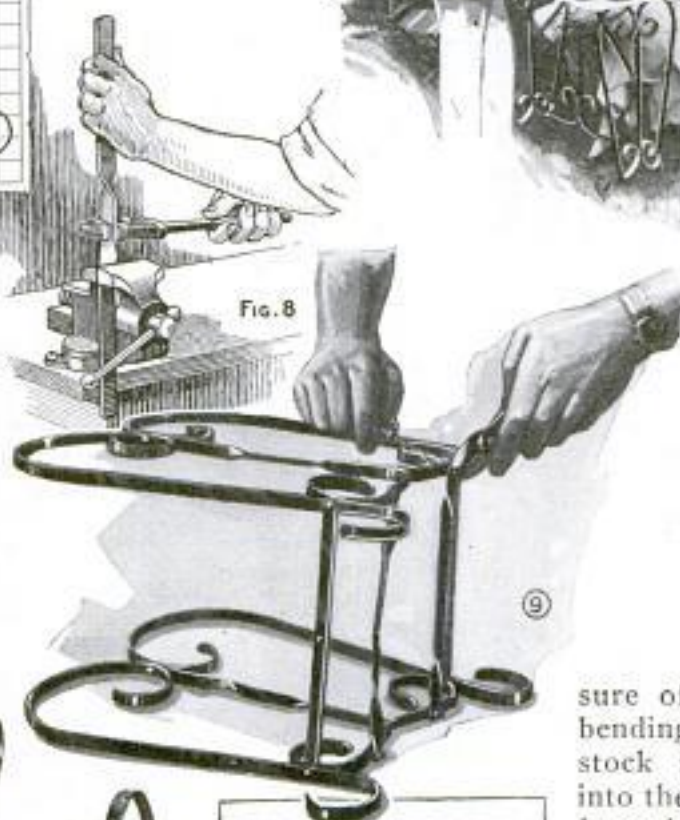

Fig. 8

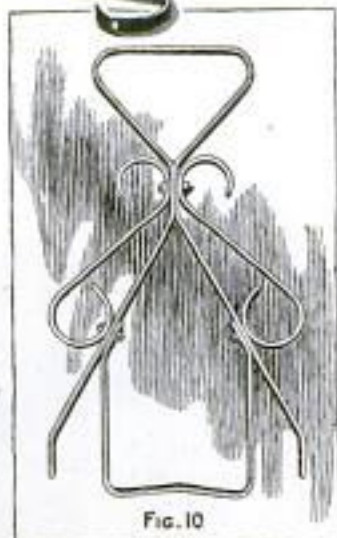
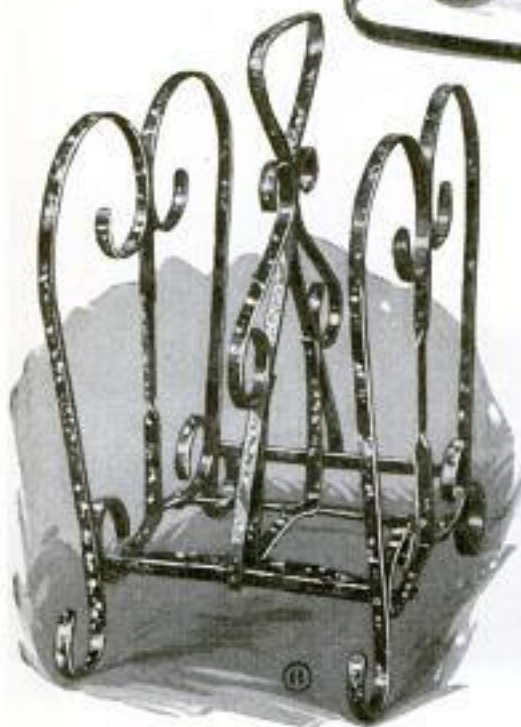

Fig. 10

curved parts of the split upper end, which must be hammered. A few light blows with the

ple, Fig. 2, slotted down to about twice the width of the iron being bent and fitted with a coupling or cap screwed on the end to prevent it from spreading under the pressure of the stock when bending. The end of the stock is simply slipped into the slot, and the iron bent by taking small "bites," although bends of small radius can be made by pulling the iron around the pipe. Various sizes of nipples may be used.

Both ends of the piece should be neatly rounded with a file in order to harmonize with the round edges of the strap-iron stock and the general sweeping lines of the lamp. The actual bending is done by hand, with the exception of the two



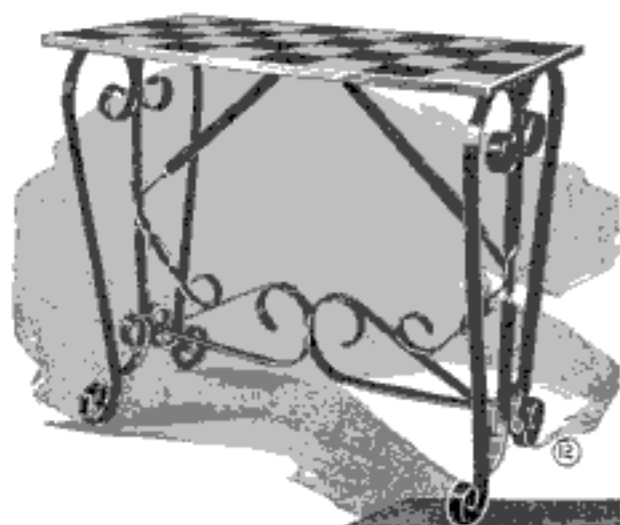

hammer may also be necessary in obtaining a nice inside curve on the piece. If hammered at all—and this applies to all work—the blows must be light, and the piece should be well backed against some round surface, such as a short piece of pipe. Graceful curves are an impossibility otherwise.

A $\frac{1}{2}$ -in. hole is drilled through the piece at the points indicated, and these holes are worked square with a file in the manner shown in Fig. 4, care being taken that the file is at all times pointed toward the opposite hole in order that the cuts may be beveled properly. The holes must not be made too large—a fit which will permit the sliding of the piece along the stem but not so loose that it will refuse to stay in place, is required.

The legs for the lamp, four in number, are fashioned from $\frac{3}{8}$ by $\frac{3}{4}$ -in. flat stock, shaped as shown in Fig. 5. Constant checking is required in order that the four legs may be exactly alike. Wood molds can often be used to good advantage. The strips may be placed side by side and curved in one operation by means of two strips of wood clamped on either side of the metal pieces. The

legs are fastened to the lower end of the stem with small bolts, as in Fig. 6. Rivets can be used if desired, but these are more difficult to work and do not improve the appearance of the fastening to any great extent.

Finishing the lamp is merely a matter of paint, together with a standard light socket, which is screwed into a hole drilled through the end of the light arm. The cord hangs free, as is usual with lamps of this variety.

The magazine rack, which completes the group shown in Fig. 1, offers something a trifle more advanced, but by no means difficult. Each end is composed of five pieces of $\frac{1}{8}$ by $\frac{1}{2}$ -in. strap iron, curved to shape and assembled according to Fig. 7.

All free ends should be neatly rounded. The twist in the center stem of each end is turned to shape with a heavy wrench, as shown in Fig. 8. The two ends are held together with four 9-in. crosspieces, two of these being spanned across the outside and two across the bottom, as pictured in Fig. 9. Both sidepieces are from straight stock, while the bottom crosspieces are given a full twist at either end. All preliminary assembling should be done with bolts, as it is usually necessary to remove the pieces for drilling, proper shaping, etc. Not until the

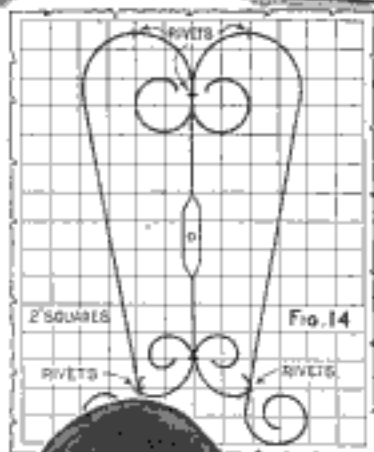
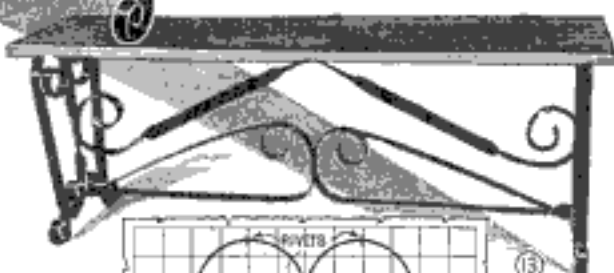

whole thing is adjusted properly should the final riveting be done. The handle for the rack, $15\frac{3}{4}$ in. high, is shaped and fastened according to Fig. 10, and then fastened to the center of the stand as in Fig. 12.

When the final bolt has been turned in, the pieces should be checked for balance, both individually and as a whole; then the bolts may be removed, one by one, to allow of the substitution of small rivets. If desired, the original assembling bolts may be left in place. If such a procedure is followed, the ends of the bolts should be snipped off close to the nut and lightly tapped with a ball-peen hammer. Fig. 11 shows the finished job done in black japan splashed with cream paint.

After constructing the magazine rack, it will be a simple matter to fashion the really charming table and bench shown in the headpiece and Figs. 12 and 13. Both of these are made from $\frac{3}{16}$ by 1-in. strap iron throughout and assembled in



Fig. 17

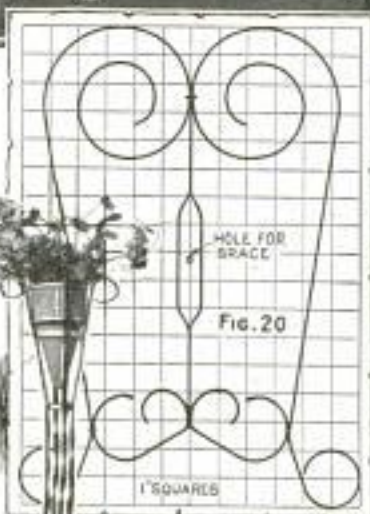
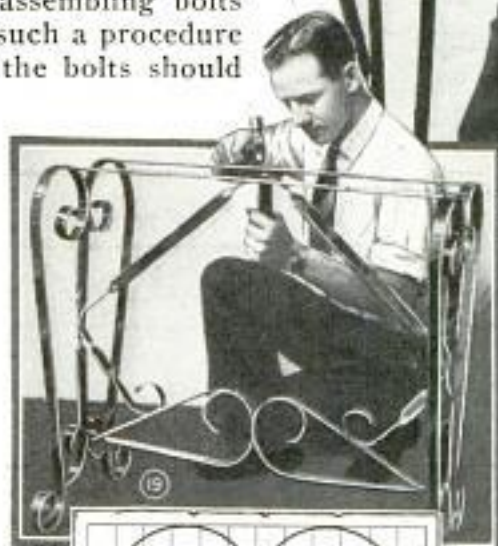

Fig. 20



much the same manner as the rack just described. Fig. 14 gives the shapes and manner of assembling the curved pieces which go to make each end of the table. Hammering must be resorted to in bending this heavier stock, especially on the short pieces. These should be shaped around a length of iron pipe, about 2 in. in diameter, as shown in Fig. 15. The long pieces may be bent by hand around a wood mold, or, around a pegging of heavy spikes, as shown in Fig.

16. The spikes must be driven fairly close together on short curves, as otherwise slight angularities are bound to occur.

The four curved portions which make each end, together with the straight center stem, are fastened together temporarily with bolts, and it is apparent that the lower crossbrace must be ready for assembling at the same time. This is made in two pieces, each $15\frac{3}{4}$ in. long and $5\frac{7}{8}$ in. high over all, as shown in Fig. 17. The table is braced at the top with two straight lengths of slightly heavier stock, as in Fig. 18. These straps are fastened to the

underside of the curved end-pieces and then bent up slightly to come flush with the top of the table.

A final brace, fastening to a short crossbar between the top braces and joining onto the ends and lower cross-pieces, completes the iron work on the table, as pictured in Fig. 19. The single twists in this piece are put in with a heavy wrench as previously described.

After careful checking, the various pieces may be riveted together. The top, shown in Fig. 12, consists of a shallow galvanized-iron pan in which are set thirty-two 4-in. tile blocks in orange and cream, surrounded with a $\frac{1}{2}$ -in. white border. The iron work should be painted a solid black or dark gray, with perhaps a contrasting touch of silver applied to the short curved pieces in each end.

The bench to match is made in a similar manner. Each end should be shaped according to the diagram shown in Fig. 20. Because of the longer span between legs, $45\frac{1}{2}$ in. as compared to $31\frac{1}{2}$ in., the cross spans and diagonal truss should be made from slightly heavier iron. Notice, too, that a different-shaped diagonal is used on this piece, Fig. 13. If the two pieces are to make a matched set, the painting should be the same, and the top would be in tile as before. Fig. 13 shows the piece finished with a stained and varnished hardwood top, which may be more to the liking of many amateur craftsmen.

The flower-vase holder shown in Fig. 21 is a fairly simple project, being merely a matter of four twisted legs, three rings, and two crossbraces. The most difficult portion of this stand is the twisted legs.



Fig. 23

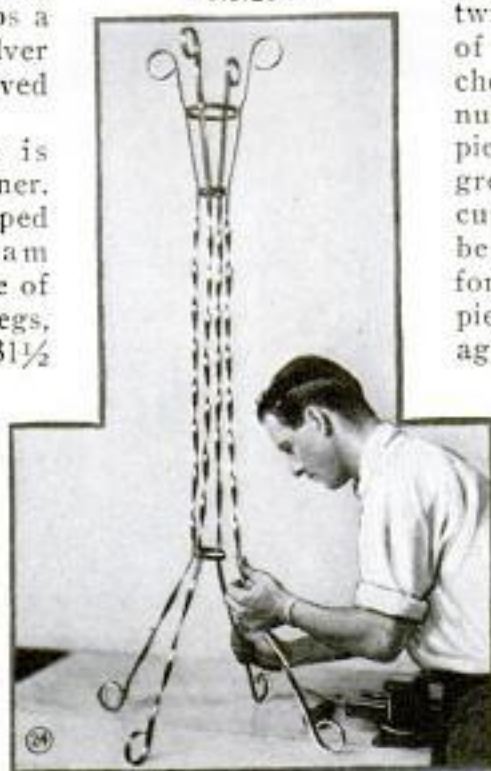

It is quite possible to twist the $\frac{1}{8}$ by $\frac{1}{2}$ -in. stock with a wrench, as shown in Fig. 22, but such a method usually throws the piece off to one side or the other. More accurate results can be obtained by gripping one end of the metal in a lathe chuck, and fastening the other end to the lathe tailstock, running the lathe at a slow speed or pulling it around by hand. Lacking the lathe, good results can be obtained by using the weighted arrangement shown in Fig. 23. The weight must be of a size in keeping with the stock being twisted. Using such a method, it is usually possible to get a length of twists which will need no straightening out as is usually the case in vise-twisted pieces. Regardless of the method used, careful check must be kept on the number of twists given each piece in order that some degree of balance may be secured. All four legs should be cut to the same length before starting work on the piece, and later shaped to agree with the general arrangement in the photographs.

With the legs twisted to the proper shape, it is a simple matter to drill the pieces and insert the rings, as shown in Fig. 24. The joints may be lapped at the ends, and the bolt or rivet inserted through the overlapping sections, or the ends may

be brazed together to form a solid ring. The size is immaterial. Before starting, it is advisable to purchase the vase to be used, and then make the pieces to fit. The stand shown in the photographs is 54 in. high, but lower stands are sometimes more desirable, especially if used indoors. For outdoor use, the piece may be made

as tall as may seem fit, although anything larger than the one shown in the pictures would demand heavier iron stock. The two short braces seen in Fig. 21 can be twisted by using a vise and wrench, or with a heavy breast drill. As with the other pieces, the first assembling should be done with bolts, removing these later for the final assembly with rivets after the piece has been trued up and found satisfactory.

Tradition demands that all bent-iron work be finished black. However, many excellent effects can be obtained through a judicious use of color. Solid tones of green and red lend color to the pieces when backed against a sunroom or garden setting. A marbled effect, which is quite pleasing, can be produced by lightly daubing the piece with cream paint over the initial coating of black. This method was used on the bridge lamp and magazine rack shown in the headpiece. Two colors may often be used, as pictured in the table design, the short curves at the bottom of each end being silvered to contrast with the black which was used solid on the rest of the piece.

It is needless to say that the color combinations are almost endless. An excellent finish for iron work to be used outdoors consists of thin coatings of linseed-oil varnish burned off over a charcoal fire. The varnish will first go up in smoke with a strong formation of soot, and finally burn up entirely. The process is repeated three or four times, that is, after one coating of varnish is burned off a new one is applied, until the iron assumes a uniformly deep-black color. The process is completed by rubbing the iron with a rag well saturated with varnish. The black turns completely dull, and forms an excellent protective covering.

"Choker" for Dragging Logs

My boys and I have a job in the woods cutting lath bolts and pulpwood. The sticks are cut to 8-ft. lengths, vary from 4 to 12 in. in diameter, and it is necessary to bunch them up in piles along the road. Some of the larger sticks are quite heavy and, as we had no lug hooks, customarily used for the purpose of moving them, I made a "choker" that filled the bill. I got a hardwood sapling, about 3 in. in diam-

eter and 4 ft. long, bored two holes 1 in. apart in the middle, and twisted two



This "Choker," Which Takes the Place of Lug Hooks, Makes It Easy to Drag Logs

strands of telephone wire together long enough to make a 12-in. loop. Both ends of the wire were slipped through the holes, bent down about 2 in. and stapled. Giving the lug stick half a turn will cross the wire so that it holds the log securely.—J. J. Brindos, Big Falls, Minn.

Flame Deflector for the Blowtorch

In order to properly heat the gluepot or to melt metals in crucibles, it is often necessary to direct the flame of a blowtorch vertically. The stand shown in the



photo will serve as a flame deflector for this purpose. A 1-in. iron elbow is drilled and tapped for the threaded end of a $\frac{3}{8}$ -in. steel standard, and the other end of the standard is threaded into the iron base.

The torch is set on the base with the nozzle nearly touching the elbow.—W. C. Wilhite, Hornsby, Illinois.

One-Piece Ratchet Wrench

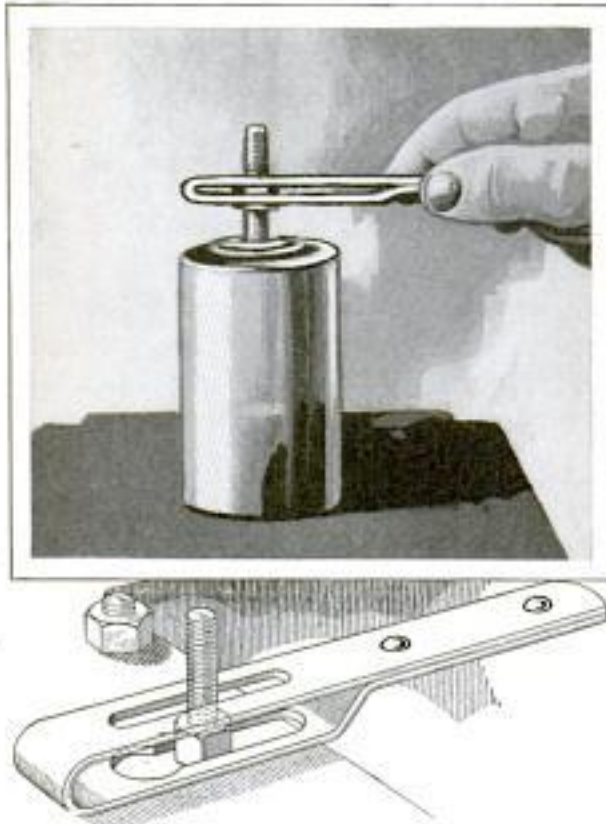

Simple Ratchet Wrench Made in One Piece from Length of Flat Iron

Driving a well-fitting nut a considerable distance on a screw that is in a position where a wrench cannot be turned all the way around, can be easily done by means of a ratchet wrench. A cheap wrench of this type is shown in the illustration, and can be made by any shop hand. It is simply a piece of flat metal with two slots cut in it, one of which clears the screw while the other fits the flats of the nut. The latter slot ends in a hole large enough to clear the nut. Then the strip is bent double, as shown, and the ends are riveted together to form a handle. In use, the top of the wrench rests on the nut and the latter is turned with a back-and-forth action, to engage or clear the nut.

Lubricating Ford Steering Gear

On model-A Fords, the roller thrust bearings on the steering spindles often collect grit and do not turn freely under load. The sector shaft becomes dry, and the small bearing at the top end of the steering column drags. Place a jack under the front axle to take the load off the wheels. The lightest oil that can be

handled by the pressure gun at hand is forced into the grease fitting on the upper end of the spindles. The steering wheel is turned back and forth, and the dirty oil that comes out of the joints about the thrust bearing is wiped off. As soon as the oil issues clear, apply a little light grease with the gun. The sector shaft is freed by forcing grease from the worm-gear case, or spraying penetrating oil in the back of the sector arm on the outside of the frame. As the Gemmer steering gear on the later cars have no Zerk connection on the sector-shaft bearing, a $\frac{1}{4}$ -in. nipple is turned into the filling hole on the wormgear case. The pressure should be applied gradually, and the steering wheel turned often to assist the grease in working along the shaft. The bearing in the steering column just under the wheel can be oiled with light oil applied a drop at a time, and then the wheel is turned to spread it.—E. T. Gunderson, Jr., Humboldt, Iowa.

Ladle for Carrying Molten Babbitt from Distant Point

It often happens that a bearing has to be babbitted a considerable distance from the place where the babbitt is melted. This necessitates carrying the ladle at arms length, using both hands, and besides, one must keep both eyes on the ladle in order not to spill the metal. By the time the bearing is reached, the babbitt may have cooled off too much for pouring.

For such jobs, the special ladle shown in the drawing will be found useful. It is cut out of a square can and a cover is brazed to the top of the uncut half. A handle is made from a length of steel rod and brazed to the container. This can is not used for melting the babbitt but to carry it to the place where it is needed. When filling the ladle and when pouring the metal, it is held as shown at the left, but between melting pot and work it is carried upright in one hand, with the metal as shown at the right.—Harry Moore, Hamilton, Can.



Reducing Pulley Wear from Abrasive Dust on Belts

Belts running in a place where the air is full of abrasive dust often wear away the surface of the pulleys, particularly at the crown. Although it is general practice to run belts with the slack side on top, it is often best to drive with the tight side on top, which increases the life and efficiency of the belt and pulleys. Where there is an extreme amount of abrasive dust flying around, and the slack side of the belt is at the bottom, the belt flap, or vibration, which always occurs on this side, will tend to shake the dust off the belt and thus prevent it from being carried around the pulleys and causing wear when the belt slips. When the tight side of a swiftly moving belt is at the bottom it presents a good place for dust to gather. In such cases the advantage gained by having the slack side on top is easily offset by the longer belt and pulley life and the increased efficiency by running the belt with the slack side on the bottom.

Portable Power Saw for the Shop

In plants and on construction jobs where it is more convenient to move the bench saw to the work than to bring the work to the saw, the arrangement shown in the photo will prove a time and money saver. The bench saw usually comes mounted on a wooden stand. This is in turn placed on a frame of 2 by 4-in. stock, with two of the longitudinal members at the top projecting 2 ft. to serve as handles. One end is mounted on iron wheels, and the other on legs, also of 2 by 4-in. stock, making the bench level. The outfit is trundled like a wheelbarrow. A 100-ft. length of heavy, insulated cable, and a few power connections are provided so that the saw can be used anywhere.

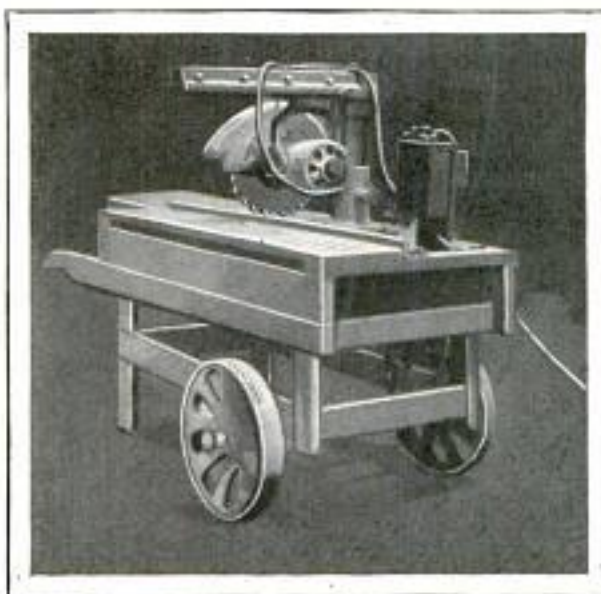

Power Saw Mounted on Wheeled Truck So That It Can Be Readily Moved About



Guards Inside of Store Window Can Be Drawn Up Out of Sight during the Day

Improved Window Protection

Window guards that slide vertically on inside tracks, as indicated, are easily lowered at night, while, during the day, they are hoisted out of the way and hidden by the drapery across the upper part of the window. The horizontal rails are drilled at each end to fit vertical rods which are rigidly fastened along the sides of the window. In this way the guard can be slid up or down without hitting the window. Light, strong ropes are tied to the upper rail of each guard and are brought over pulleys driven into the ceiling, all of them connected to one length of rope, which is readily accessible from the inside of the store. —Dan Courtney, Chicago, Ill.

☛ Paraffin rubbed on a grinding wheel while in motion will permit aluminum to be ground without clogging the wheel.

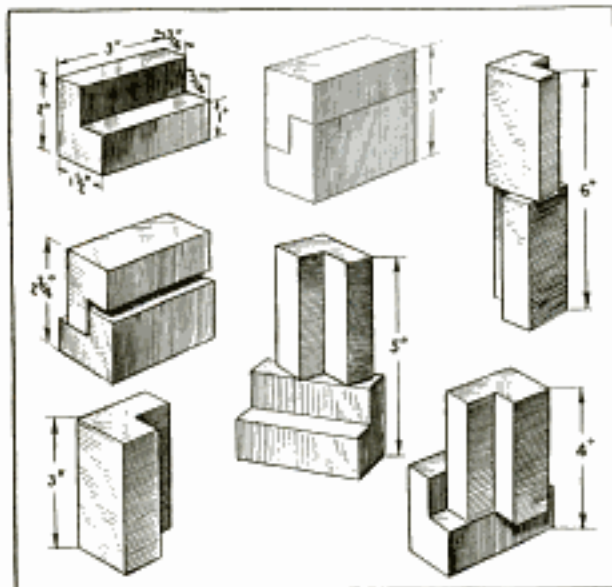

Handy Pair of Setup Blocks for the Planer Gives Eight Heights

Planer Setup Blocks

Machined from mild steel according to the dimensions shown in the illustration, a pair of setup blocks for the planer, will be found to give 8 heights when arranged in the various positions indicated. Any machinist who has much planer work to do will greatly appreciate a couple of these blocks and the time saved by their use will more than justify the time spent in making them.—Chas. H. Willey, Concord, New Hampshire.

Inked Roller Speeds Up Stamping

Inking of rubber stamps in the shipping room of a small factory was accomplished quickly by the roller shown in the drawing. A long rack on the wall holds the stamps in the usual way, and, just below it, a long felt-covered roller is mounted. In this case the roller was merely a length of broomstick and the piece of felt was sewed end to end. With the roller properly saturated with ink, it is the work of but a second to select any stamp from the rack and ink it while it is being taken down.—G. E. Hendrickson, Argyle, Wisconsin.

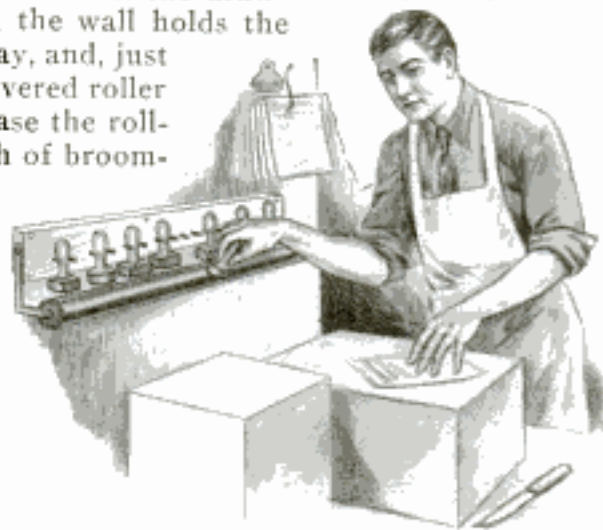

Inked Roller under Stamp Holder Saves Time in the Shipping Room

The Manipulation of Gold Leaf

In gilding on glass, it is necessary to size the surface with water size, flowing plenty on until it runs off in quite a stream; onto this the expert swings his leaf, and it lands somewhere on the outlines of the lettering—he is not particular just how accurately, so that the letter is covered; and when he has all the letter spaces covered, with perhaps a great deal of space not included with the letters, he permits it to become dry. The leaf settles down flat on the glass. There are several brands of gold leaf, grading according to amount of pure gold contained and the intended use. One variety is made expressly for gilding on glass, another for gilding on wood. The difference is mainly in the degree of thinness. One layer of leaf makes a good job on wood, while on glass two layers make a better job than one. For exterior gilding the medium shade of gold leaf does best; the pale-colored leaf contains silver, hence tarnishes from gas or smoke. Water gilding is that in which the leaf is laid on a size composed of isinglass, or glue and water; oil gilding is done on a size composed of oxidized linseed oil. Water size is for gilding on glass, and oil size for gilding on wood. Oil size may also be used on certain textiles, and other surfaces, just as water sizes are sometimes used in decorative work. Water-size gilding is burnished as soon as the size and leaf are dry, by rubbing with a wad of raw cotton; the same with oil-size gilding. One book of gold leaf will

gild $1\frac{1}{2}$ sq. ft. of surface. Varnish impairs the luster and color of gold leaf. If varnish must be applied, first coat it with pale shellac. Gold leaf is injured by dampness and cold. If gilded work is varnished before it is perfectly dry it will show scratches. To avoid this, apply a thin coat of white shellac, which will soon dry, and

upon this the coat of varnish may be laid. To remove gold leaf from any part where not desired, as in letter gilding or lining, use a dampened chamois skin. In oil-size gilding, if the size is too fresh it will drown the gilding or injure its luster. Better have the size too dry than too wet. If too dry, breathe upon it, which will give sufficient "tack" to the size to hold the leaf. Where two pieces of leaf overlap they will often cause a joint to show and this may be removed by gently stippling it with the tips of a bristle brush. To prevent laps showing on very smooth surfaces, have the size quite tacky. When gilding becomes dull from gases and smoke, its color may be restored by a weak solution of sulphuric acid. To prevent gold leaf from adhering where not wanted, as when letters of gold are to be made on a painted, or other, surface, a raw potato, cut in two and rubbed over the parts that are to resist the leaf, may be employed.

Locknuts on Power-Jigsaw Turnbuckles Keep Tension of Saw Arms

When small jigsaws are run by motor, it is often found that the turnbuckle, used for holding the tension of the saw arms, tends to loosen because of vibration. A locknut on either end of the turnbuckle will remedy this trouble. One end of the

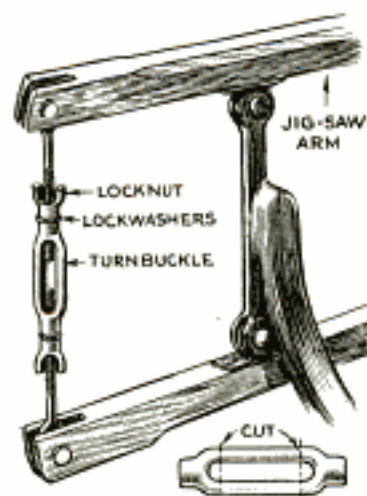

turnbuckle is made for a right-hand thread and the other for a left-hand thread, and as it is usually impossible to get a left-hand nut from the hardware dealer the following method can be resorted to: Get an extra turnbuckle of the proper size and cut off the ends. The resulting improvised wingnuts are driven against either end of the regular turnbuckle and a small lock washer is provided between them.—Lester P. Young, Culver, Ind.

Quick-Acting Barrel Sling



Pointed Brackets, Pivoting on Ring, Make a Quick and Efficient Barrel Hoist

Handling barrels quickly and easily is the feature of the sling shown in the illustration. It consists of a ring on which two brackets are pivoted. Each bracket is made of a piece of $\frac{3}{8}$ or $\frac{1}{2}$ -in. flat iron, forged to the shape indicated in the detail and slipped over the ring while they are hot, after which they are bent over still farther so that they will not come off again. Steel points are provided on the flat surface of the bracket which makes contact with the barrel side. These points are threaded at one end and are driven into tapped holes drilled in the bracket. The ring should be slightly larger than the largest diameter of the barrel. A hole, drilled in the end of each bracket, permits the attachment of a rope. In use, the ring is lowered over the barrel, and when the rope is pulled upward, the brackets lock against the side of the barrel. As a precaution against slipping, the ring and hooks should be engaged just below the center part of the barrel.

☛ Cover the exposed parts of a damp clay runner with oil, preferably kerosene, before pouring in melted babbitt.



A Handy Feature on These Scales Is the Detachable Blackboard

Removable Blackboard on Scales

A Wisconsin produce buyer, who does much of the weighing of poultry, hides, etc., in a cold storehouse, uses a detachable blackboard and scale-sheet holder as shown in the drawing. All figuring at the time of weighing is done on the blackboard and, when the check is to be made out, the board is easily removed from the sockets provided in the top of the scale and taken to the office where it can be used for reference. As an additional convenience, the blackboard allows the figuring to be made large and readable, even though the operator may be wearing gloves at the time.—G. E. Hendrickson, Argyle, Wis.

Substitute for Litmus Paper

A chemical indicator to take the place of litmus paper can be made from the juice of elderberries. About two handfuls of the berries are pulped by squeezing between the hands and the juice collected in a cup. The juice should be screened through a cloth to remove solid particles and wax. The next step is to cut up strips of white blotting paper or white rags into rectangles, about $\frac{1}{4}$ in. wide and 3 in. long. These are dipped in the clear red elderberry juice and dried. In order to determine whether a liquid is acid or alkaline, add a drop of the berry juice to the liquid and insert one of the prepared strips. Like litmus paper, it will remain red in

acids and turn blue in weak alkalis. One can test this out with washing soap and vinegar.—Alan Osbourne, Boston, Mass.

Corrugated Bottom for Hardware Drawer

By placing a piece of corrugated sheet iron in the bottom of a shallow bench drawer, it becomes an easy matter to pick up small hardware with the fingers. This material is also useful to make holders for drills and reamers, using the sheet iron in inclined racks at the back of the workbench.—C. H. Willey, Concord, N. H.

Draftsman's Data on T-Square

Draftsmen who like to have their calculating data as handy as possible will appreciate the method shown in the drawing. A length of light sheet metal a little wider than the T-square, is drilled with small holes and attached with screws to the back of the square. Before doing this, however, the edges are bent over so that a strip of celluloid can be slipped between them and will be kept in place. Tables,

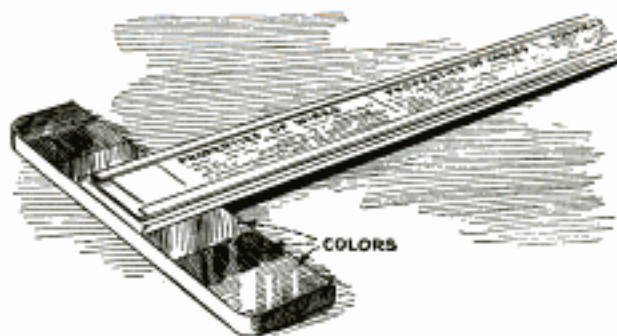

Sheet-Metal for T-Square Holds Draftsman's Data, Covered with Celluloid Strip

formulas and other data can then be slipped under the celluloid, where they will be kept clean.—H. Henricksen, Hoboken, N. J.

Helps for Home and Shop

YOU CAN MAKE IT—One hundred illustrated articles telling how to make toys, furniture and dozens of other things from old boxes and odd pieces of lumber. Price Ten Cents.

POPULAR WOODTURNING—Especially written for the amateur, this book should be in the kit of every home workshop owner. Price Twenty-Five Cents.

MODERN HOME INTERIORS—Crammed full of suggestions for the home owner who likes to make his own built-in conveniences. Price Ten Cents.

Order any of the above from The Librarian, Popular Mechanics Magazine, 200 E. Ontario St., Chicago, enclosing the proper amount in stamps or coin.

“.. then a shift to *slow speed* for easy drilling through”

MANY a time you have burred the hole . . . snapped your drill—and no fault of yours!

“Yankee” No. 1435, a new *two-speed* hand drill, takes care of these ticklish jobs with small drills in thin metal—or thick.

Only 11 inches long! And the only small drill that gives you high speed for fast work and then a shift to slow speed for easy drilling through.

Avoids jamming. Makes holes true, smooth, free of burrs. Saves drills. Saves time and bother. Fast or slow speed, or tool locked, at a finger-touch.

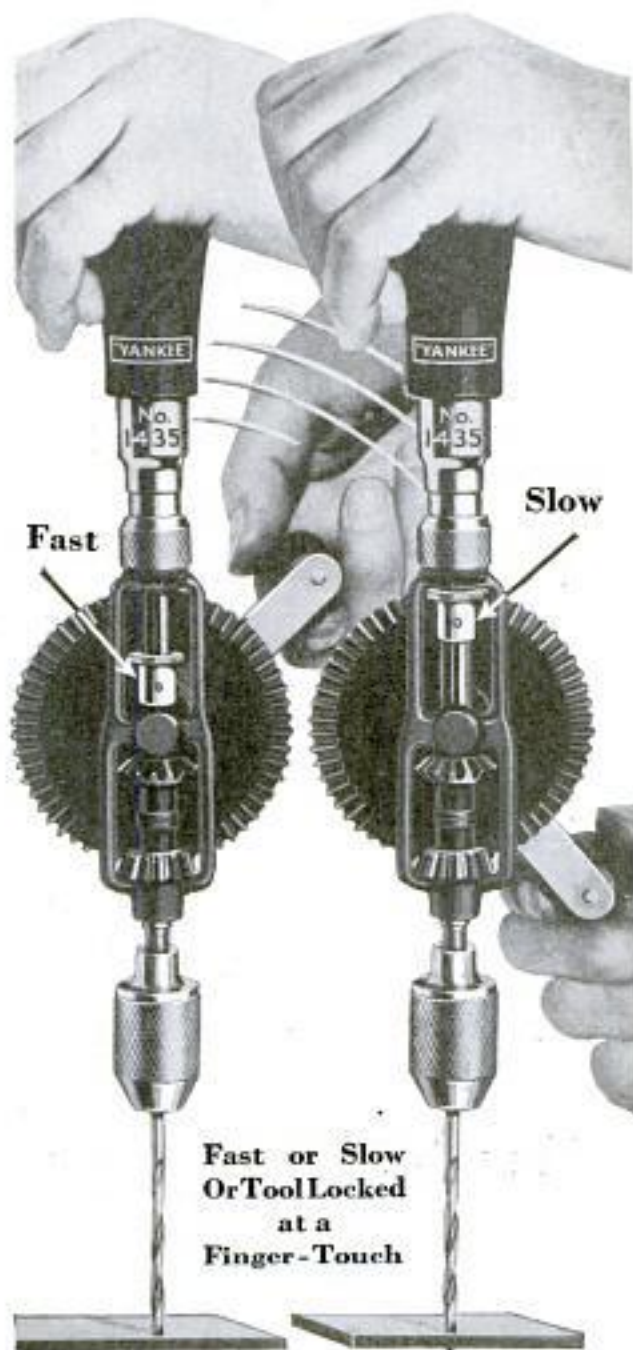

“Yankee” No. 1530 Ratchet Hand Drill (above) and No. 1555 Ratchet Breast Drill (below) have five ratchet adjustments, including “Yankee” Double Ratchet for continuous drilling where crank can be moved only to and fro. They work where other drills cannot be operated.

No. 1530, \$ 5.25
No. 1555, \$11.00



“YANKEE” TOOLS

—TO HELP YOU MAKE THINGS—



NORTH BROS. MFG. CO., Philadelphia, U. S. A.

I want to know all about tools that save time and effort: You may send your book showing pictures of “Yankee” Tools and the ingenious ways they work: Breast, Hand, Chain and Bench Drills, and Bit Braces with “Yankee” Ratchet, Adjustable-Tension Push Drills, Vises, Etc.

Name..... Address..... (pm)

NEW American Flyer Train—Offers New Realism, Power and Fun-Making Features



Mail Coupon for Colorful 48-Page Train Book—FREE!

Over 7½ million proud and happy boy owners testify to American Flyer's leadership. Get the catalog and compare the *new* exclusive fun making features and superior construction. Remote-control-reversing and automatic ringing bell locomotives—cars with real brass window frames and fittings—longest and heaviest freight cars—high speed trucks—remote-control track switches—more realistic bridges, stations, tunnels and automatic equipment. Remember they cost no more. Dads, too, make railroading a hobby.

AMERICAN FLYER MFG. CO.
2250 S. Halsted Street, Chicago, Ill.
Please send me without cost your colored catalog.

Name

Address

City State

American Flyer
Trains Electric Trains Mechanical Trains

RAISE CHINCHILLA
AND NEW ZEALAND WHITE
FUR RABBITS **Make Big Money**
We Supply Stock
and pay you following prices for all you raise:
Chinchillas average \$5 each—New Zealand
Whites \$2 each. 32-page illustrated book, catalog
and contract, also copy of *Fur Farming* maga-
zine, tells how to raise rabbits for big profits, all for 10c. Address:
OUTDOOR ENTERPRISE CO., Box 1021 Holmes Park, Missouri

If you're going to build a glider



... BUILD IT RIGHT!!

Don't waste your time and money groping for materials. **\$15 STARTS YOU.** The regular KNOCKDOWN KIT, \$89.50 COMPLETE, can now be purchased in installments of six convenient self-sufficient groups. Each part is numbered to correspond with blue prints and complete instructions for assembling your glider. **THERE IS NO GUESS WORK:** You know in advance that your ship will give you gliding at its best. **GLIDING IS A YEAR-ROUND SPORT;** why postpone the thrills that are waiting for you? Our beautiful new catalog describes and illustrates Rhon Ranger Kits, tells how you can buy and build one, contains practical suggestions on forming your club and learning to fly, lists our supplies and accessories. Ten cents brings it to you by return mail.

MEAD GLIDERS

Dept. B-6 12 S. Market St. Chicago, Ill.

BE the Electrical DEALER IN YOUR TOWN



M A N!
HERE'S the greatest money-making opportunity you ever put your hands on! Get in your own big pay electrical dealer business. No cash required—no experience! And clean up on our sensational plan that will pay you \$300, \$500 and more a month clear profit.

EXPERIENCE NOT NEEDED

Anyone with pep and perseverance can get in this business and make good money every day in the year. Your office is under your hat. We furnish everything, and, by our plan, you make the most amazing profits you ever heard of.

Write us today for details. You make big profits on the finest line of guaranteed Irons, Heating Pads in colors, other fastest selling electrical appliances. No heavy samples. No stock investment. Our copyrighted factory co-operation plan brings you profits while you sleep. Only plan of its kind in America.

NO INVESTMENT

We are an old-established manufacturer, highly rated with mercantile agencies. Our plan is bringing success, financial independence to hundreds of wide-awake men in their own communities. Season now starting. This is the biggest repeat business opportunity you ever dreamed of. Write today while the iron is hot. The plan is new and your territory is untouched. All details FREE.

THE WHITE BEAUTY ELECTRIC MFG. CO.
(Ravenswood Sta.)
4416 No. Western Ave. Dept. 311 Chicago, Ill.

\$10.00 DOWN
Brings this Lathe to You

Lathes \$6.00 to \$75.00. Largest line of small lathes in America. Send ten cents for 32 page catalog No. DH1 of lathes, drill presses, benchsaws, jigsaws, bandsaws, etc.

SYPPER-ARCON CO. 1524 Fernwood Toledo, Ohio

Popularity

comes quickly when you learn to play a band instrument. For quick advancement and greater musical success start on an easy-playing Conn. The choice of Sousa and the world's greatest artists. Many exclusive improvements at no added cost!

FREE TRIAL, EASY PAYMENTS
Write for details and free book. Mention instrument. **C. G. CONN, Ltd.**
131 Conn Building Elkhart, Indiana

FREE TRIAL



SPORT

of a thousand thrills!

MOTORCYCLING is the sport of sports — just brimming over with the freedom, the zip, the thrills that the red-blooded he-man wants.

No cooped-in motoring for him — he wants the independence, the mastery of roads and traffic, that only the motorcycle can give him. He wants the wind in his face, and the blood zipping through his veins, and the thrill of speed tickling his spine!

For him — and for all you lovers of the outdoors — the 1931 Harley-Davidson is the best motorcycle ever built. It gives more of what you want in motorcycling — Sport of a Thousand Thrills.

Let your nearest Harley-Davidson Dealer show you the 1931 models and explain his Pay-As-You-Ride Plan.

HARLEY-DAVIDSON

Motorcycles

Mail the
Coupon for
free literature

HARLEY-DAVIDSON MOTOR CO.
Dept. P. Milwaukee, Wis.
Interested in your motorcycles. Send literature.

Name _____

Address _____

My age is 16-19 years. 20-30 years. 31 years
and up. under 16 years. Check your age group.



**Mends
1,001
Things**

**Makes
1,001
Things**



DISCOVER

**This New Wood—you just
mould with your hands**

THIS new kind of wood that so expertly mends a thousand and one things and makes almost anything that can be made from natural wood or modeling clay is really an amazing adventure.

You've never used anything like it Though it handles just like putty . . . it quickly hardens into wood you can carve, plane, saw and work with any wood-working tool. It won't crack, splinter or crumble. It's actually wood—Plastic Wood—sold by paint, hardware and department stores.

Big Book of Uses—FREE

Just fill in and mail this coupon and we'll send you a great big, profusely illustrated book of 48 pages crammed full of interesting uses for this remarkable new kind of wood that handles like putty, hardens into wood and comes in 9 different colors. Send for your copy **FREE**—today.



The A. S. BOYLE COMPANY, Dept. 1-PM-2
Cincinnati, Ohio

Send me—free—big, illustrated book of uses for PLASTIC WOOD.

Name.....

Street.....

City..... State.....



"I Will Now Make It Disappear"

"Will someone in the audience kindly lend me a handkerchief? Thank you, Now watch." Stage your own magic shows. Pick things out of the air. Change color of silk in empty tube. Make the famous Houdini Chain Escape yourself just like he did. You can do these and dozens of other amazing tricks with Knapp Master Magic Sets. Get one for Christmas and be a real magician. If your dealer hasn't these sets order from us.

Send for free booklet—"Secrets of Master Magic."

Master Magic Sets

Set No. 1.....\$1.00

Set No. 2.....\$3.50

(Illustrated)

Set No. 3.....\$5.00

(Denver & West,

\$1.15, \$3.75, \$5.50)

Knapp Electric (Div. P. H. Malloy &
Co., Inc.), Dept. M-1, 3029 E. Wash.
St., Indianapolis, Ind.



**KNAPP
Master Magic**



Good and Good for You.



Build Model Ships of the Better Kind

U. S. Destroyer Preston
Flying Cloud
Constitution
Spanish Galleon, Etc.

We can supply construction sets and all sorts of parts, such as semi-finished hulls, blocks, deadeyes, flags, anchors, steering wheels, capstans, figure heads, guns, blue prints, books, etc.,

for building real fine scale models of the U. S. Destroyer Preston, Flying Cloud, Constitution, Spanish Galleon, Viking, Baltimore Clipper, Mississippi steamboat, Bluenose, Mayflower and many others. Also special construction sets for racing sail boats, power boats, model steam engines, boilers, propellers, etc., and fine tools for the model maker. New large 56-page photographically illustrated ship model booklet has just been released. This booklet contains valuable information and hints for building ship models, in addition to prices and full description of the above articles. Many people only slightly interested in models have become greatly enthused upon receiving this booklet. A copy will be sent postpaid upon receipt of 15 cts. (coin preferred).



MODEL SHIP SUPPLY CO., Dept. B, Mineola, N. Y.

STARRETTS and the NEW STOCK TICKER

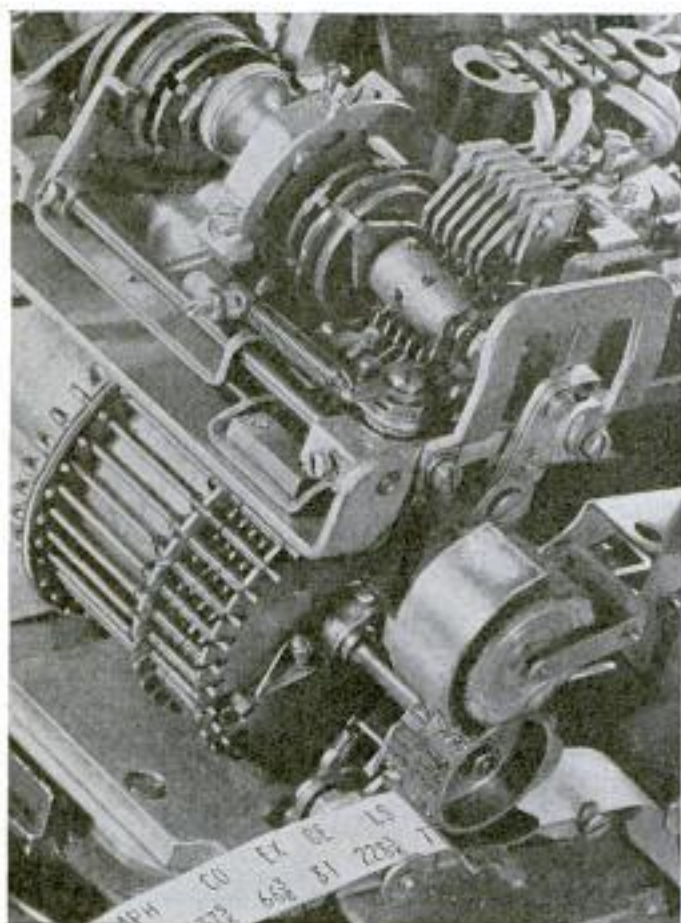

The stock ticker no longer ticks—it runs so fast that the ticks merge into a soft, sustained murmur. The new ticker receives 4000 electrical impulses a minute. From these, it prints 500 characters, with deadly accuracy.

The new stock ticker, like almost all modern machines, gets most of its efficiency and accuracy from the use of fine tools—tools like Starretts. Skilled machinists entrusted with the building of such complex machines choose Starretts because they must have the finest precision, and because they like the extra convenience and dependability that they find in Starrett Tools.

Precision and convenience—if that is what you are looking for in your work, you too will like Starrett Tools. Among the 2500 different Starrett Tools, you are sure to find many that will make your work easier and surer, worthier of your pride and pleasure in doing things quickly and well. Let us send you a free copy of the new Starrett Catalog No. 25 "AP." A valuable reference book, it will give you many suggestions for improving and speeding up your work. Send the coupon.

Close-up of one of the 10,000 High Speed Stock Tickers recently put into operation by Western Union—receives and prints New York Stock Exchange quotations 40% faster.

Right—Starrett Combination Square No. 33, Starrett Micrometer No. 530.

Right—below—Starrett Calipers Nos. 79 and 73, Starrett Universal Bevel Protractor No. 359, Starrett Hack Saw No. 153, Starrett Universal Dial Test Indicator No. 196.

Below—the coupon. Slip it in an envelope for your free copy of Starrett Catalog No. 25 "AP."

THE L. S. STARRETT COMPANY
ATHOL, MASSACHUSETTS

Please send me Starrett Catalog No. 25 "AP."

Name

Street

City State

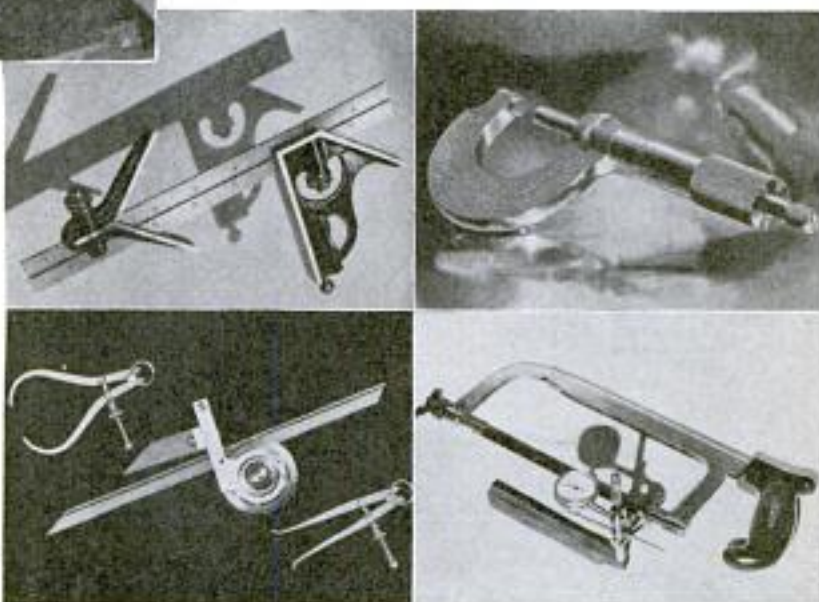

Use Starrett Tools



Hands Up!

If you're a fellow who thinks work-stained hands have to stay that way, I'll bet you've never tried **LAVA SOAP**. Lava's pumice-filled lather gets the dirtiest hands clean in 58 seconds - and won't harm the skin.



George, the Lava Soap Man



Model No. 1
Only \$1

This Kingsbury Silver Arrow Flying Plane, Model No. 1, is a work of a flyer. Zooms 'way over horizons on long, continuous flights. Wings adjustable to insure flying under all conditions and help resist snags-ups. Not a construction toy but fully built. A moment to assemble and it's ready to fly. Built wood wings; aluminum brass, propeller; powerful elastic motor. Wing spread 18 in. \$1. (West of Miss., \$1.10). Other models, racing and cabin, \$2 to \$3.50.

If you desire cannot supply you, send your order to us.

Join Silver Arrow Club and become a Master Pilot.

KINGSBURY MFG. CO., 83M Myrtle Ave., Keene, N. H.

KINGSBURY Motor TOYS



FREE Novelty movie scope shows motion picture of Silver Arrow flight. Also complete toy catalog.

SEND 10c for Kingsbury One Wheel Dabbler Toy ESKIMO. Set of 4, 35c.



For Christmas

See it FLY!

ALADDIN PORTABLE ELECTRO-PLATER



Introductory
AGENTS OFFER
\$0.50

Instantly Applies Real Nickel

Also Electrically Plates Brass, Copper, Silver, Gold, Etc. With the inexpensive Aladdin Outfit you can easily nickel plate the nickel on your car and do a good job of it. The Aladdin Outfit is also a home necessity.

MAKE BIG PROFITS WITH THE ALADDIN

Whether you are interested in the Aladdin for yourself or should you wish to go into business putting real nickel on autos or doing metal plating in your neighborhood, or if you would like to act as our agent in your territory, write us immediately for free particulars.



P. J. F. BATENBURG CO.

DEPT. 197

RACINE, WISCONSIN

ALL BALSAM!

A realistic scale model of a one-place low-wing sport plane. Wing spread 15 in., weight only 3/8 oz. Takes off under own power. Flies 140 feet consistently.



New all-balsa construction makes this model lighter, stronger, better-looking and far easier to build. Everything packed. Nothing to draw or measure. No tools or skill required. Set includes die-stamped aluminum propeller, disc wheels, rubber motor, quick-drying cement, balis, clear directions and all other material. Nothing else to buy. Complete set, postpaid in U. S. and Canada, \$1.50. Satisfaction or money back. Order now.

The Midland Model Works, Dept. E, Chillicothe, Ohio
(We cannot accept stamps or C. O. D.'s.
No catalogue except with set.)

MOVIES In Your Home



Our marvelous, practical Movie Machines sell as low as \$3.75 postpaid, and use same size film as big theatres. We also have wonderful films at lowest prices—with a new film exchange service.

Don't Miss This! Write NOW for Free Catalogue.

PARAMOUNT MANUFACTURING CO.
Dept. G-35, BOSTON, MASS.



PUSH THE BUTTON and have

Electric Light Anywhere

COMPLETE, 110 volt, ELECTRIC LITE PLANT for Farms, Camps, Ranches and Summer Homes. Operates on gasoline and generates electricity. RUNS HOUSEHOLD APPLIANCES AND LIGHTS. A Simple Sturdy plant. \$139
INSTALL IT YOURSELF. Wiring and lights for seven rooms \$17.50. Also other models. Direct Current or Alternating Current to 2000 Watts. Write for circular.

D. W. ONAN & SONS
62 Royalston Av., Minneapolis, Minn.

New Model SOUTH BEND LATHES

Back Geared Screw Cutting Precision Lathes
on Easy Payments

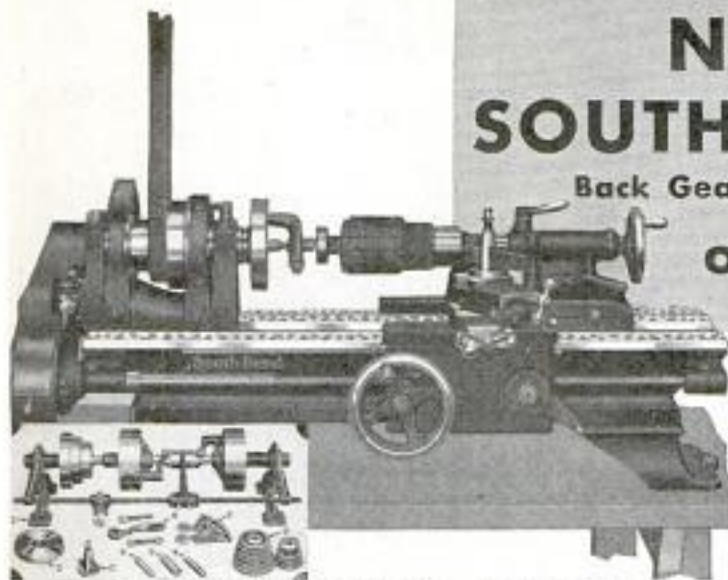

9" x 3' New Model Junior South Bend Bench Lathe **\$169**

Prices of Other Popular Size 9" Junior Lathes

Size of Lathe	Shipping Weight	Countershaft Drive	Down Payment	12 Monthly Payments Each
9" x 2½'	350 lbs.	\$163.00	\$32.60	\$11.41
9" x 3½'	400 lbs.	\$175.00	\$35.00	\$12.25
9" x 4'	425 lbs.	\$182.00	\$36.40	\$12.74
9" x 4½'	450 lbs.	\$190.00	\$38.00	\$13.30

Send Now for These Books "How to Run a Lathe" 25c Postpaid

Latest Edition of this famous work, contains 160 pages, with more than 300 illustrations. Simplest, most complete and practical book on lathe operation. Shows how to handle 400 different types of lathe jobs as practiced in the modern machine shop. Sent postpaid for only 25 cents; coin or stamps of any country accepted.

Auto Mechanics' Service Book No. 66 25c Postpaid

This 96 page book illustrates and tells how to do 150 automobile service jobs on one machine. Intensely valuable and practical.

Catalog No. 91-A, Free

This 104 page book illustrates and describes the 96 different sizes and types of New Model South Bend Lathes. Send the coupon now for your copy, free.

Only **\$33.80** Down

\$11.83 per month for 12 months for this 9" x 3' New Model Junior South Bend Back Geared, Screw Cutting Bench Lathe with countershaft and equipment. Wt. 375 lbs.

You can install any of the 96 sizes and types of South Bend Precision Lathes on similar easy terms. The new models have improvements which make them more than ever the outstanding lathe values in the world. They are practical for the finest and most accurate production and tool work in the modern plant, machine shop and all classes of metal working industries.

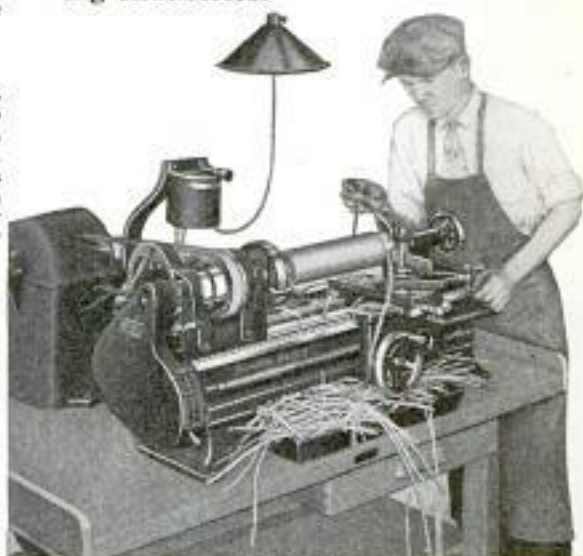

9" x 3' New Model Junior Horizontal Motor Driven Bench Lathe **\$254**
Weights 465 lbs., complete

\$50.80 down payment, \$17.78 per month for 12 months.



SOUTH BEND LATHE WORKS

631 E. Madison St., South Bend, Ind., U.S.A.

Lathe Builders for 24 Years — Over 50,000 South Bend Lathes in Use

SOUTH BEND LATHE WORKS

631 E. Madison St., South Bend, Indiana, U.S.A.

Gentlemen: Please send me books checked

- "How to Run a Lathe" (25c)
 Auto Mechanics' Service Book (25c)
 Catalog No. 91-A (Free)
 Easy Payment Plan

Name _____

Address _____

City _____ State _____

Yes! It's a new **Try any outfit—**
RADIO! **30 days**
Free BEFORE
 YOU BUY



Many
other
styles

Factory to you
SAVE to 50%

SUPER Screen Grid
Push-Pull Latest
Electric Radios

Enjoy a powerful new 1931
 Miraco outfit for 30 days
 —at our risk. No obligation
 to buy. Get Send-No-
 Money, Amazing Special
 Factory-to-You Offer

MIRACO
 TRADE MARK REGISTERED

11th
 Successful Year

Compare with Costliest Sets!
 America's big, old, reliable Radio
 Factory springs its 11th anniversary
 sensations! Latest SUPER
 Screen Grid, perfected
 Push-Pull, Super Dynamic
 Electric AC sets of finest
 construction with costliest
 features—Varitone and
 automatic sensitivity
 control and no hum—at
 astounding low factory prices.
 Clever new cabinets—big, vari-
 ous—exclusive designs. Com-
 pare with costliest radios—un-
 less 100% delighted with Miraco's sharp
 selectivity, **HIGHER, CLEARER TONE**
 and **DISTANCE-GITTING**, don't buy!
 Delighted thousands report programs
 from Coast to Coast with tone and power
 of expensive outfits. Full year's guar-
 anty. Play safe, insure satisfaction, save
 lots of money—deal direct with big, old
 factory—pioneers in fine set making—11th
 successful year. Write and be convinced!

SUPER
Screen Grid
\$49.88
 COMPLETE
 less tubes

Send postal or coupon.
 Amazing 'Send No Money'
 Offer. No Obligation.

Free
 NAME
 ADDRESS

USER-AGENTS!
 Exclusive Territory.
 Big Money. No Risk.

MIDWEST RADIO CORPORATION
 Pioneer Builders of Sets—11th Year
 807-CJ Miraco Dept., Cincinnati, Ohio
 Send Amazing Special Factory Offer.
 Interested in Agents' Proposition



NEW-LITE
 ELECTRIC MIRROR

A thoughtful Gift for Man or Woman

The average home lacks a satisfactory light for shaving or close inspection of face, teeth or throat. NEW-LITE casts brilliant light directly on the face, which, in turn, is reflected in the mirror; perfect lighting with no blinding rays. Easily adjusted to any angle.

Order NEW-LITE Today

Settle several of your gift problems with NEW-LITE. Never before so wonderful a light for shaving—for facial care and make-up. NEW-LITE costs less than ordinary wall or pedestal mirrors, without the NEW-LITE feature. Finest nickel-plated wall model \$5; Pedestal model, with handsome old ivory base, \$10. The "missing link" between light and mirror. Where else such value, such originality in a gift at \$5 or \$10. If not at your dealer's order direct. You must be pleased. If your NEW-LITE is not entirely satisfactory, return it and money will be refunded.

W. A. SCHURMANN MFG. CO.
 1643 Walnut St. Chicago



Build your own outboard hydroplane motor or sail boat. Use our plans or knock-down frames and machined parts. Many models to select from. Write for new catalog. Please enclose 10c for catalog.
J. B. WELCH, Inc., Dept. B, 1351 41st St., Milwaukee, Wis.

Build a CLOCK for Pleasure or Profit!

FREE BOOK
 of Clock Making,
 Money Making
 Ideas. Gives details,
 prices of instru-
 ments, parts.
 Write NOW for
 copy!

Shows How YOU Can Make Fine
 Clocks Right at Home

—for yourself, or to sell at Big Profits. We furnish instructions, parts. Works \$1.25 up! others with chains, all prices. Make one or assemble parts. Copies on demand for Mantel, Bench, Grandfather's Clocks. Write for Special Blue Print Offer, FREE Catalog.

AMERICAN CHIME CLOCK COMPANY
 1670-F Ruffner St. Philadelphia, Pa.

8" Band Saw \$13.95
 Only → → → **13.95**

Here It Is. An Ace of An Up-To-Date Band Saw. Just What You Have Been Looking For!

A Band Saw that is guaranteed to give the same results as the larger and more expensive machines now on the market.

Has hardened and ground shafts—saw guides made of tool steel— $\frac{1}{4}$ " Atkins Silver Steel Saw Blade—will cut wood up to $2\frac{1}{4}$ " thick and light metal. A real machine made to last a life time, and carries a guarantee of satisfaction or money refunded. With Endless "V" Belt and Motor Pulley \$15.00.

Up-To-Date Machine Works
 Dept. 10, 2909-15 So. Wabash Ave.
 CHICAGO, ILL.

Rider Agents Wanted

Select from 44 Styles, colors and sizes of Mead bicycles. Ride and exhibit sample RANGER and make money.

Factory to Riders! We ship on approval for 30 Days' Free Trial, direct from FACTORY. Get our marvelous offers. Easy Payments. \$5 down.

Tires lamps, horns, wheels, parts, equipment, and repairs at half usual price. Established 35 years.

Mead CYCLE COMPANY
 DEPT. X110, CHICAGO



Make Your FORD Into The "ACE"

GET READY FOR SPRING—BUILD YOUR ACE NOW—
\$599 Red-i-Kut life size patterns Famous snap-fit RED-I-KUT life-size patterns and picture instructions show how you can easily convert your Ford into this Fast, Sassy, Sport-Car as thousands have done with easily obtained materials. No need to lay up the car. Makes wonderful 4-passenger car. Send 10c coin for actual photo of sport car and name material of choice. **Send \$1.00 for 25.00 up—RED! Steel "Sassy-Lo" truss, Top, Windshield and many speed necessities. ORDER RIGHT NOW and get a real thrill.**

38-inch Easy Riding Seat
KUEMPEL COMPANY, 128 Kuempel Bldg., GUTTENBERG, IOWA

MOTORCYCLES

Pay As Low As \$2.00 per Week
 Hendersons, Harley-Davidsons, Indians
 Slightly used and rebuilt. Hundreds to select from. Send 10c for list today.
MYEROW BROS. CO., 15 Berkeley St., Boston, Mass., U. S. A.

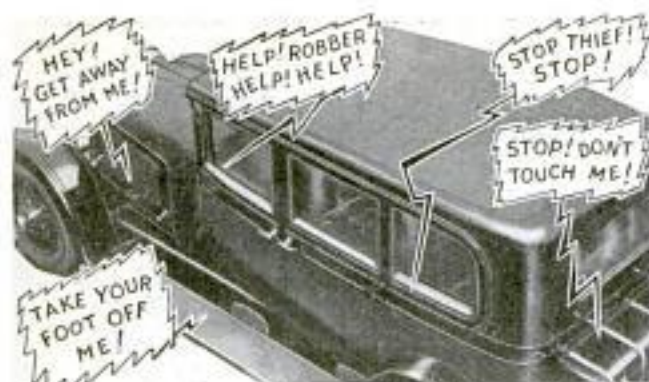

Astonishing Electrical Invention Protects Your Car from Thieves ...Automatically!

THIS unquestionably is the queerest, most incredible invention since the first discoveries of radio! A magical, automatic watchman that actually is far more than human! Never sleeps, rests or gets tired! Stands guard over your entire car from spare tire to headlights and steering wheel! Endorsed by police! Approved by Motor Associations! Now offered on generous 5-day free-test basis!

A Startling, Uncanny Money-Maker for AGENTS!

What makes it work? "Where on earth did you get it?" "Bet you five dollars he's got someone hiding in there!" "It simply can't be true." A running fire of comment like this breaks out whenever and wherever this new invention is exhibited. And why not? When no one ever heard of such a startling, uncanny device before! In fact few people would even dare to dream there could be such a thing! So this, men, is something really NEW, something to grip the imagination of everyone, something that sells to every autoist on sheer novelty alone. Distributors, "star" salesmen, every man who wants to double and triple his present income should note carefully the above facts.



A
Mere Handful

DEVIL DOG



Write Today for Free Money Making and Sample Offer

Northwest Electric Corp., Dept. A-10, Pukwana, S. Dak.

CLASS PINS

FREE CATALOG

Either pin, silver plate... 35¢ ea.
Sterling silver or gold plate... 50¢ ea.
for 2 colors enamel, any 3 or 4 letters & dates

Lower Prices on Open Lots

BASTIAN BROS. CO. 601 BASTIAN BLDG. ROCHESTER, N. Y.

Big 3 ft. Telescope Five Sections. Brass bound. Powerful Lenses. 10-Mile range. Special Eye Piece for looking at the Sun, included FREE. Can be used as a Microscope. Guaranteed. Big Value. Postpaid. \$1.75. C. O. D. 16¢ extra. **Banner & Company, 7-48, Trenton, N.J.**

VEST POCKET ADDING MACHINE

Adds, Subtracts, Multiplies, Divides. Does work of \$500 machine. Not a toy. Million dollar capacity. Simple and accurate. Guaranteed 5 years.

FREE TRIAL \$2.50
—SEND NO MONEY— Total Cost

Just name and address. We will ship Calculator immediately. On delivery pay postman \$2.50 (plus few cents postage). (If outside U. S. send cash.) 10¢ additional to Louisville, Ky. If not satisfied after 10 days' trial you get your money back. **THOUSANDS OF SATISFIED USERS**. Write for Agents' Proposition. **BABY CALCULATOR MACHINE CO.** (Mfrs.) P. O. Box 1118, Dept. 31, CHICAGO, ILLINOIS

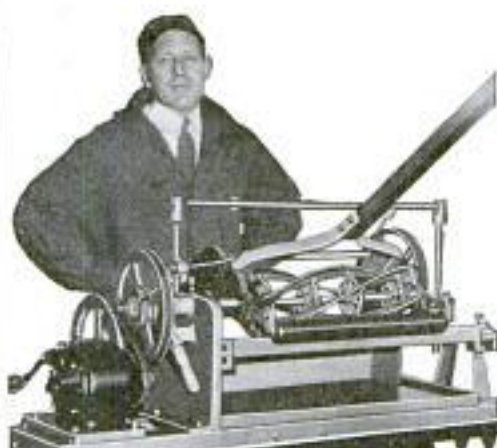

This Is the Way! To Make MONEY.

That is what hundreds of men are saying about the Foley Electraken Lawn Mower Sharpener business they have started. Last year Woodmaney earned \$25 to \$30 a day. Morse earned \$1520 in five months.

Start Your Own Cash Business at Home Now!

There is no other method for sharpening lawn mowers to compare with the Foley. You can turn out perfect work quickly and easily. Simply put the lawn mower in the machine and turn on the power—the Foley Electraken System *automaticall* sharpens ALL blades at once.

Foley Electraken Lawn Mower Sharpener

Uses same system as the leading lawn mower factories. Sharpens all sizes and types of lawn mowers. Costs you only 1¢ a job and you get \$1.00, \$1.25, \$1.50 each. Walter Dambek writes, "I purchased a Foley Electraken Lawn Mower Sharpener three weeks ago and have already made enough money to pay for the machine and all expenses..."

Big Profits Can Be Earned

There is plenty of business waiting for you. People would rather have their lawn mowers sharpened the Foley way because they cut better and stay sharp longer. YOU can start this business in spare time and make **BIG MONEY!** Small investment—easy monthly payments. Spring will soon be here—There will be lots of business for you—Investigate NOW!

Send for Complete Information Today



Foley Manufacturing Co.

1506 Foley Bldg., 11 Main St. N. E., Minneapolis, Minn.

Tell me how I can start my own Cash Business and make **Big Profits** with the Foley Electraken Lawn Mower Sharpener.

Name.....

Address.....

City.....State.....

UNIVERSAL SPEED SAW

Amazing New Attachment Fits Any Electric Drill

Just slip it into the chuck, and, presto—your cutting job is done. Saws thru wood or metal in a jiffy—any direction, any angle—no vibration, no noise. Files as fast. Works where other saws can't reach—auto floor boards, pipes, hard-to-get-to places. Quickly pays its way for every auto mechanic, electrician, plumber, machinist and carpenter. No kit in up-to-date without it now. Complete only \$15.

Every Bench Needs This Powerful New MOTOR SAW

Not a mere jig saw, but a sturdy, accurate machine capable of doing heavy as well as fine jobs—cross cutting, ripping, mitering, beveling, scroll, design and sign work, up to 3 in. thick—without stalling or even slowing down. One saw instead of several ever ready for every kind of cutting. No unhooking of blades, no table obstructions. Nothing like it at the low price of \$38.

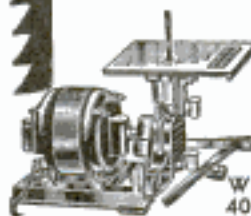

UNIVERSAL MOTOR SAW

Write for details naming saw or better, order today!
WYZENBEEK & STAFF, Inc.
401 S. Hoyne Ave., CHICAGO



MOULDS

For Making Toy Soldiers, Indians, Cowboys, Animals, etc.

With one Mould you can make many HUNDREDS OF CASTINGS, whole Armies. Outfits, including material for casting, enamel paints and everything complete. \$5.00. Easy enough for any boy to make and great fun for grown-ups. Sport for the whole family. Write for illustrations of dozens of patterns you can make.

MAKE-A-TOY COMPANY, Dept. E, 1696 Boston Road, N. Y. City

HERE'S THE TOOL

for cutting sheet metal, gaskets, wire, leather, linoleum, canvas, etc. An indispensable tool in every household and workshop.

This Crescent Snip is entirely drop-forged of special analysis steel. It has many new features and carries an unconditional guarantee. Ask your hardware dealer for Crescent Snip No. S47.

For Catalog write

Crescent Tool Company
210 Harrison Street
JAMESTOWN, N. Y.

75¢
7 inch

8 sizes 7 to 14 inches proportionally priced.



CRESCENT and Smith & Hemenway TOOLS

Cal. 30-40 Six Shot



KRAG CARBINE

All the qualities of a high price rifle. In fine used condition, all working parts guaranteed for one year. Send today for our Free 60-page illustrated catalog of money saving values; Guns, Ammunition, Outlets, Sports and Gov't goods.

Deposits received on all orders. Money refunded if not satisfactory.

W. Stokes Kirk, Dept. P. M-13, 1627 N. 10th St., Phila., Pa.

Price
\$9.75

Keds

At \$1.00, \$1.25, \$1.50;
\$1.75 and up to \$4.00.



United States Rubber Company

Fastest Cutting



Saws 15 Cord
a Day

Now—Get My Greatest Log Saw Offer

It's easier, now, than ever before to own this fastest-cutting, easiest-to-operate, most powerful Log Saw. Now, you can make big money sawing firewood, stave-bolts, for shingle timber, etc. WRITE TODAY for FULL DETAILS.

350 Cuts a Minute! Take any size log—in a few seconds it's all sawed up—without any hard work!

Puts the OTTAWA Working For You!



Try 30 DAYS OTTAWA

—ONE WHOLE MONTH to use the OTTAWA at your own expense. Every saw shipped on trial. Backed by 10-Year Guarantee

FREE Send me your name and address on a postcard today for my wonderful new edition of the "Wood Sawing Encyclopedia." Be sure to investigate—it will help you to make big money.
C. E. WARNER, Pres., OTTAWA MFG. COMPANY
1745-L Wood Street - - - Ottawa, Kansas

Make Big Money—Wood selling at \$3 a cord brings owner \$45.00 a day. Go into the wood business. Don't let the lack of ready money stop you—Remember, we sell on very easy terms.

To Save You Freight—and get your machine to you a few days after your order, I ship from factory or nearest to you of 4 BRANCH HOUSES.

FREE
Wood
Sawing
Encyclopedia



An excellent Christmas gift for your Craftsman friend

Diam. 2" Wt. 2 1/4 oz.

IN THIS SMALL CUP IS COILED A SIX-FOOT STEEL RULE!

Sounds unbelievable, doesn't it? But your hardware dealer will gladly demonstrate other unique qualities of this most remarkable of all modern tool inventions.

The FARRAND RAPID RULE

Patented in U. S. Nos. 1,402,589 & 1,730,199
Write to factory for booklet and six-inch sample

HIRAM A. FARRAND, Inc. West St., Berlin, N. H.

BURN YOUR NAME ON TOOLS

WITH THE ARKOGRAF

PROTECT YOUR TOOLS FROM THEFT

Write with electricity your name or design on the hardest and finest tools and instruments, or any metal, like writing on paper with pen or pencil.
Complete Outfit \$3.50—Prepaid Anywhere
Interesting Illustrated circular free. Write today. Agents wanted.
ARKOGRAF PEN CO., 1171 E. Stark St., Portland, Oregon



Write for Free Instructions

"HOW TO SOLDER PERFECTLY"

VULCAN ELECTRIC HEATER CORP.
Dept. M 225 Varick St. New York City
Makers of VULCAN ELECTRIC SOLDERING TOOLS
Ask your dealer about them.



TOOL CHESTS For Machinists and Toolmakers

All the latest styles in new
catalog. Free.

H. Ferstner & Sons

405 Columbia St. Dayton, Ohio



Dandy
Xmas
Gift
20c each
lineal
foot

MASTER INTERLOX SLIDE RULE

Every kind of Inside Measurement. Just slide out the MASTER 100 it reaches from step to step. No guessing. Quick results. Looks rigid in use. Without equal for Outside measure, too.

Dealers and Agents Wanted

MASTER RULE MFG. CO., Inc., 821 E. 136th Street, NEW YORK CITY



New Book *Cutting drawer opening in apron of new bench, with ATKINS Silver Steel Rip and Compass Saws*
Tells

How to Build a Workshop Bench, Tool Box, Saw Horses and Wall Cabinet

YOU'LL get a big thrill building your own home workshop outfit, with the expert aid of this new ATKINS Saw Book. It gives simple diagrams and step-by-step instructions for making saw horses . . . a small folding bench . . . a large, modern work bench . . . a tool box and seat . . . and a handy wall cabinet.

And to help you do accurate joinery in all your projects, the book shows the easy ways to cut and fit 24 types of wood joints.

Other features point out the pleasure in home-crafting . . . how to start a shop . . . what tools to select . . . where to get job plans to build over 200 projects . . . how to sharpen saws . . . and so on. Finally, are shown the leading ATKINS Silver Steel Saws and Saw Tools for use in workshops, with facts why these world-famous saws cut so much faster and easier, and far outlast ordinary saws.

Mail the Coupon

This book is a real home shop manual—brimful of time-and-money-saving information. Thousands are sending for it. Get your copy now. It's worth dollars to you—beginner or expert—but costs only a dime. Use the coupon.

THE ATKINS SAW BOOK for Home Craftsmen



TELLS HOW TO

Start a Home Shop
Select the Correct Saws & Tools
CUT and FIT the 24 Most-Used WOOD JOINTS

Build a Work Bench, Tool Box, etc.

Suggests 300 Things to Make

10c

E. C. ATKINS and Company, Est. 1857
426 South Illinois Street, Indianapolis, Ind.

I enclose a dime for the new ATKINS SAW BOOK for Home Craftsmen. (PRINT below.)

Name.....

Street.....

City.....State.....

WOULD YOU LIKE TO OWN THE BEST TOOLS MADE?



Let Us Send You This Brand New 56 page Cornwell Catalog—FREE

Whether one tool or a kit, you will find what you want in the Cornwell Catalog. Every one specially designed by master tool makers. Every one individually hand made. Every one carrying this guarantee—"If you ever see a tool as good, your money will be refunded."

World Known for Their Strength

This catalog will describe the amazing tests which prove the terrific shocks, strains and pressures these tools will stand. The strength of a Cornwell Tool is phenomenal—forged right in the metal by the special Cornwell process which involves the action of heat and the tempering by oil—from Chrome Molybdenum Steel.

Test One Out—They're Guaranteed

Mechanics have used Cornwell Tools for 10 years. They are known the world over. They have the two great requisites of a real tool—the most efficient shape for handling and a toughness so noticeable that they are recognized by the strongest mechanic's tools known. Send for this completely illustrated catalog today. Test out a Cornwell Tool! Remember the above guaranteed.

CORNWELL QUALITY TOOLS

THE CORNWELL QUALITY TOOLS CO., Dept. Z1, Mogadore, Ohio. (Formerly at Cuyahoga Falls, O.) Send me new illustrated catalog with prices on full line of CORNWELL Hand-Made Tools.

.....Where Employed
 Name.....
 Address.....
 City.....State.....

MAKES A COMPLETE MACHINE SHOP

\$1.75 without chuck
\$2.25 with chuck

Fastens directly on motor shaft, no pulleys or belts necessary. Holds grinders, buffs, saws, wire scratch brushes, drills, etc. Seesaws on pulley. Made to fit 1-1/2" shafts. State size. Postage prepaid if remittance accompanies order.

Special application motors and generators built. Write requirements.

United Electric Motor Co., 178 Centre St., Dept. C-31, New York

LOWEST PRICES IN OUR HISTORY



CASH OR YOUR OWN TERMS
 My new low prices are the sensation of the engine world. You can now buy one of the world's finest engines for the price you would usually pay for an "ordinary" engine. A Lifetime WITTE will do more work in a day—costs only a few cents for fuel—than several men. It's the cheapest hired man on earth. 312,896 in use all over the world.

DIRECT FROM FACTORY-TO-YOU
 My latest engines are the finest ever built; Enclosed—Self Oiling with Timken Roller Bearings that never require adjustment, guaranteed for the life of the engine. Also Pumps and Sawing Outfits. SAVE the dealer's profit—SAVE the expenses and salaries of traveling salesmen and SAVE the usual "extras" added to the selling price. Remember: you SAVE \$20 to \$200 when you buy from WITTE.

FREE ENGINE BOOK AND CHART
 Write today for my new ENGINE BOOK and CHART. Prices now lower than ever before.

WITTE ENGINE WORKS
 1741 OAKLAND AVE. KANSAS CITY, MO.
TIME TESTED SINCE 1870

The PRODUCTO Electric Work Shop Combination



\$89.90

A sturdier home work shop—completely equipped. Send for circular.
THE PARKS WOODWORKING MACHINE COMPANY
 Dept. P-31, 1530 Knowlton St., Cincinnati, Ohio
 Canadian Factory: 338 Notre Dame East, Montreal



COX HOLDFAST SCREW DRIVER



Mr. Mechanic—This is the tool you need. Saves time and patience. Holds the screw, nut, set-screws, etc., securely until you are ready to release, releasing by a pull on handle. You have always wanted a tool like this—order one before you forget it, stating whether for heavy or light work, and length you require. 4 inch, 6 inch, 9 inch or 12 inch over all. Price 50c, 65c, 75c, and \$1.00 each. Agents wanted.

S. J. COX MFG., Dept. F, FRANKLIN, PA.

New 19" Jig Saw

Here is the most for the money you have ever been offered. A heavy, well-built tool that will handle an astonishing variety of work. Cuts 2 1/4" oak, rips 36" boards, all with 1/4 horse motor. Mechanically right. Why fool with miniatures when this real job costs no more? Send for circulars DAL.

SYPHER-ARCON CO.
 1524 Fernwood Ave., Toledo, Ohio



EASY-TO-BUILD COACHES



In a few hours with a small hammer you can put together TALLY-HO. Paris cut to fit, with clear instructions. Also George Washington Coach. Either \$4.95 C. O. D. plus postage. Money order outside U. S. A. Horses \$5 pair.

Send .15 (coin) for '31 Catalog

ROY HANCOCK
 323 Douglas Avenue, Portsmouth, Va.

Make it out of PRESWOOD

The all-purpose board for lining concrete forms, paneling walls, making outdoor signs, toys and many other articles. Write for FREE booklet L-1, listing over eighty of Preswood's uses.

MASONITE CORPORATION, 111 W. Washington St., Chicago, Ill.

AGENTS 500% PROFIT GENUINE GOLD LEAF LETTERS

S guaranteed to never tarnish. Anyone can put them on stores and office windows. Enormous demand, large profits. Paul Clark says: Smallest day \$28.70. R. L. Reel made \$920 in two months. Write today for free sample and liberal offer to general agents.

METALLIC LETTER CO. 433-B N. Clark St., CHICAGO

\$100 COACH MODEL FOR \$4.98

THAT ANY SCHOOL BOY CAN BUILD IN A FEW HOURS

AN EXCELLENT CHRISTMAS GIFT—PROFITABLE PASTIME



Size: 24" long;
8" high;
6" wide.

We supply you with all the parts, cut to fit and ready to assemble, with a diagram and instruction sheet written so that anyone may easily follow. Each part is numbered and the corresponding numbers on the diagram show you just where to place them. No tools are needed except a small tack hammer. Beside the model of the George Washington Coach illustrated at left we have parts for the following: **Tally-Ho; Devonport to London coach; Deadwood stage coach, Covered wagon . . .** at \$4.98 each (less horses).

Guarantee: If after assembling our coach model according to our instructions you are not satisfied, return it to us and we will immediately refund your money. You to be the sole judge.

Realizing the demand for coach models but that the prices charged by exclusive stores are too high for most people, we have made it possible for everyone to own one or more of these early conveyances which helped write the country's history.

HISTORICAL COACH MODELS, Inc.
Dept. PM, 2206 Fairmount Ave., Philadelphia, Pa.

Historical Coach Models, Inc., Dept. PM
2206 Fairmount Ave., Philadelphia, Pa.

Sirs: Please send me complete parts, cut to fit and ready to put together for:

George Washington Coach ; Tally-Ho ; Devonport to London Coach ; Deadwood Coach ; Covered Wagon ; Send me FREE CATALOG

I agree to pay the postman \$4.98 plus postage. Foreign orders to be accompanied by U. S. money order or check.

NAME.....

ADDRESS.....

CITY.....STATE.....

AGENTS AND SIGN MEN

Earn up to \$100 Weekly, and over, Putting up
OUR GENUINE GOLD LEAF SIGN LETTERS

R

—on store and office windows, board signs, trucks and glass signs. We also make to order script signs and business emblems singly or by the thousands. A permanent business. No capital or experience required. Big demand in every City. Samples and Literature Free.

CONSOLIDATED SIGN LETTER CO. 71-X W. Van Buren
CHICAGO, ILLINOIS

MOTORCYCLES

Direct to you at wholesale prices

Send 10c today for the latest
Illustrated Bulletin and Confidential Price List of
Guaranteed Indians Harley's Hendersons SuperX etc.
(Sold on easy terms if desired)

CRANDALL CYCLE CO. 826-28 State St. Shipments to all
Motorcycles Since 1905 Springfield, Mass. Paris of the world

Kills pain!
Sloan's Liniment

AMAZING NEW GUN

Men all over the country are turning to this full size automatic high power rifle using round steel shot. Light. Speedy. Sporting arm balance and precision.

TRY THE **BENJAMIN**
25 SHOT AUTOMATIC
"THE MYSTERY RIFLE"

OUTSHOOTS ALL OTHERS

Companion to the world famous Benjamin Single Shot. Same effective compressed air action with 25 shot automatic feed. 10 to 12 rapid fire shots on one pumping. Price \$10.00. Benjamin Single Shot Air Rifle \$5.00. Ask your dealer for demonstration or write for details and "BB MAGIC" FREE.

BENJAMIN AIR RIFLE CO., 605 North Broadway, St. Louis, Mo.

**BB
MAGIC**

MODERN STERLING HOME only \$797



GET BOOK
69 Model
Homes and
Floor Plans

Insulated • Weather Stripped •
Glass Knob Doors • Medicine Cabinet •
Ironing Board, etc.

Never before such values. Shown above is a typical example. We ship the lumber cut to fit, freight paid to your station. You can build the home yourself, and save money, from plans we furnish. Material highest quality. No extras! Cut at mill saves one-third labor cost, makes tighter, warmer, sturdier home. Customers claim savings from \$300, to \$2000, over local estimates.

New Modern Features include Johns-Mansfield insulation, Bronze Weatherstripping, 1 panel inside doors with glass knobs, Medicine Cabinet, Built-in Ironing Board, Etc. Large discount for cash. Terms if you wish. Send for Beautiful Color Book of new Sterling homes, and learn how little buys a home this modern way.

INTERNATIONAL MILL & TIMBER CO.
3513 S. Wemona Ave., Bay City, Mich.

COLOR BOOK OF
Sterling
Home Plans
25c

PATENT

Protect Your Ideas

Take the First Step Today

If you have a useful, practical, novel idea for any new article or for an improvement on an old one, you should communicate with a competent Registered Patent Attorney AT ONCE. Every year thousands of applications for patents are filed in the U. S. Patent Office. Frequently two or more applications are made for the same or substantially the same idea (even though the inventors may live in different sections of the country and be entirely unknown to one another). In such a case, the burden of proof rests upon the last application filed. Delays of even a few days in filing the application sometimes mean the loss of a patent. So lose no time. Get in touch with me at once by mailing the coupon on the opposite page.

Prompt, Careful, Efficient Service

This large, experienced organization devotes its entire time and attention to patent and trade mark cases. Our offices are directly across the street from the U. S. Patent Office. We understand the technicalities of patent law. We know the rules and requirements of the Patent Office. We can proceed in the quickest, safest and best ways in preparing an application for a patent covering your idea. Our success has been built on the strength of careful, efficient, satisfactory service to inventors and trademark owners located in every state in the Union.

NO CHARGE for Information On How to Proceed

The booklet shown here contains valuable information relating to patent procedure that every inventor should have. And with it I will also send you my "Record of Invention" form on which you can sketch your idea and establish its date before a witness. Such evidence may later prove valuable to you. Simply mail the coupon and I will send you the booklet, and the "Record of Invention" form, together with detailed information on how to proceed and the costs involved. Do this NOW. No need to lose a minute's time. The coupon will bring you complete information entirely without charge or obligation.

My Offices
Just Across
Street From
U.S. Pat. Office



Above is a view of my drafting and specification offices where a large staff of experienced experts are in my constant employ. All drawings and specifications are prepared in my offices.

NEWS

Inventors Write for these Free Books

Strict Secrecy Preserved

All communications, sketches, drawings, etc., are held in strictest confidence in strong, steel, fireproof files, which are accessible only to authorized members of my staff. Feel free to write me fully and frankly. It is probable that I can help you. Highest references. But **FIRST**—clip the coupon and get my free book. Do **THAT** right now.

Clarence A. O'Brien

Registered Patent Attorney

Member of Bar of: Supreme Court of the United States; Court of Appeals, District of Columbia; Supreme Court, District of Columbia; United States Court of Claims.

Practice confined exclusively to Patents, Trademarks and Copyrights

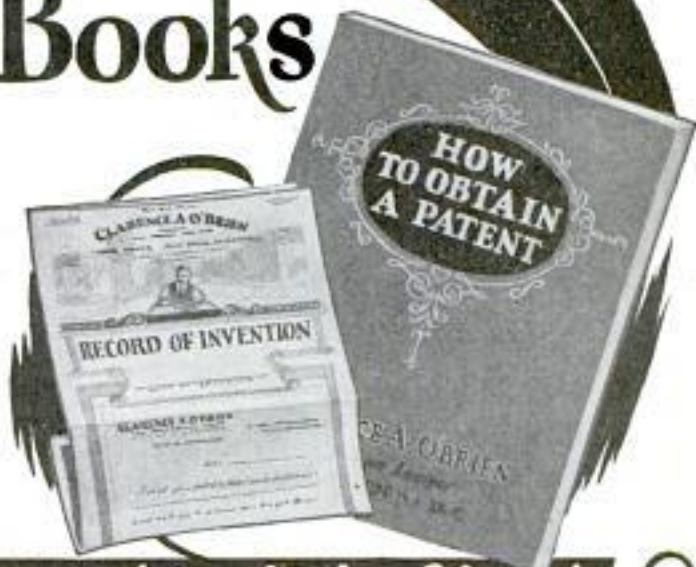

Clip this Coupon and Mail it Now!

CLARENCE A. O'BRIEN, Registered Patent Attorney
70-C Security Savings and Commercial Bank Bldg.
Washington, D. C.

(Or, Suite 1106, Dept. A-7, Woolworth Bldg., New York City)

Please send me your free book, "How to Obtain a Patent," and your "Record of Invention" form without any cost or obligation on my part.

Name.....

Address

(Important—Write or print name plainly and address office nearest you)

PATENTS TRADE MARKS COPYRIGHTS

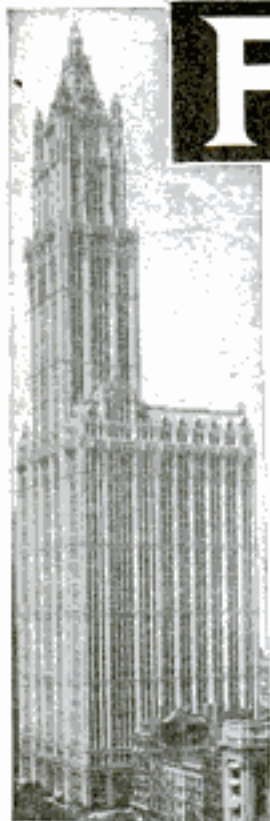

Our New York Office
Suite 1007 Woolworth Bldg.



Our Philadelphia Office
626 Fidelity Phila. Trust Bldg.



VICTOR BUILDING
Our New Building Nearly Opposite U. S. Patent
Office Specially Erected by Us for Our Own Use



Have You An Idea?

Our Offer: FOR THE PROTECTION OF YOUR INVENTION

YOUR FIRST STEP—The Inventor should write for our blank form "RECORD OF INVENTION." A sketch and description should be made on this Blank, signed, witnessed, then returned to us. We also give our opinion as to whether the invention comes within the Patent Office definition of a patentable invention. This "Record of Invention" will serve as "proof of conception." *There is no charge or obligation for this service.*

Our Five Books Mailed Free to Inventors
Our Illustrated Guide BOOK

How to Obtain a Patent

Contains full instructions regarding U. S. Patents, Our Methods, Terms, and 100 Mechanical Movements illustrated and described.

Our Trade Mark Book

Shows value and necessity of Trade Mark Protection. Information regarding *Trade Marks and unfair competition in trade.*

Our Foreign Book

We have Direct Agencies in Foreign Countries, and secure Foreign Patents in shortest time and lowest cost.

Progress of Invention

Description of World's Most Pressing Problems by Leading Scientists and Inventors.

Payment of Fees in Installments

It is not necessary that the total cost for the preparation and prosecution of a patent be paid in one payment. Our custom is to permit our clients to pay for their applications in three installments as the preparation of the application progresses in our office. This plan makes the payments easy for the inventor.

We Regard a Satisfied Client as our best advertisement, and furnish anyone, upon request, lists of clients in any state for whom we have secured patents.

*Highest References—Prompt Service
—Reasonable Terms*

VICTOR J. EVANS & CO.

Patent Attorneys, Established in 1898

Main Offices: 789 9th St., N. W., Washington, D. C.

Nearly Opposite U. S. Patent Office

DELAYS ARE DANGEROUS IN PATENT MATTERS

IMPORTANT! To Avoid Delay!

YOU SHOULD HAVE YOUR CASE MADE SPECIAL IN OUR OFFICE to save correspondence, secure protection and early filing date in the Patent Office. To secure **special preparation** of your case send \$25.00 on account with model or sketch and description of invention. If the invention is not patentable we will return fee less cost of search.

We Assist our Clients to Sell their Inventions.



MAIN OFFICE, VICTOR J. EVANS & CO.—VICTOR BUILDING, WASHINGTON, D. C.

Our Large, Comprehensive Organization has been established for 30 years and offers Prompt, Efficient and **Personal Service** by experienced Patent Lawyers and Draftsmen. Every case is in charge of a Specialist who has been selected for his knowledge and experience in certain lines of invention. Our Lawyers practice in all U. S. Courts and defend clients in suits involving Patents, Trademarks and Copyrights. All Communications, Sketches, Drawings, etc., preserved in fireproof Files, strictly **Secret and Confidential**. We shall be glad to have you consult us or to answer any questions in regard to Patents, Trademarks or Copyrights without charge or obligation.

**FREE
COUPON**

VICTOR J. EVANS & CO.
PATENT ATTORNEYS *Established
in 1898*

NEW YORK OFFICES
1007 Woolworth Bldg.

CHICAGO OFFICES
Suite 1640-42 Conway Bldg.

PHILADELPHIA OFFICES 828 Fidelity Phila. Trust Bldg.

PITTSBURGH OFFICES
514 Empire Bldg.

SAN FRANCISCO OFFICES
1010 Hobart Bldg.

MAIN OFFICES: 789-9th Street, N. W., WASHINGTON, D. C.

Gentlemen: Please send me *Free of Charge* your books as described on preceding page.

Name

Address



Our Chicago Office
Suite 1640-42 Conway Bldg.



Our Pittsburgh Office
Suite 514 Empire Building



Our San Francisco Office
Suite 1010 Hobart Building

PATENTS

Booklet Free Highest References
Promptness Assured Best Results

Send drawing or model.

ALL BUSINESS GIVEN PROMPT AND PROPER ATTENTION

Listed Patent Lawyer in the latest editions of the Rand-McNally Directory of Bankers and Bonded Attorneys, published by Rand-McNally & Co., Chicago, Ill.; The Baggott & Ryall Directory of Guaranteed Attorneys, published by Legal Directory Corporation, Boston, Mass.; Flugel's Law List, published by Legal Directory Publishing Co., St. Louis, Mo.; American Lawyers Annual, published in Cleveland, Ohio; Bankers Service Legal Directory, published by Bankers Service Co., Boston, Mass.; Eyre's Law List, 9 Park Place, New York City; Walters Legal Directory, Omaha, Nebraska, and the National Directory of Attorneys, Baltimore, Maryland.

WATSON E. COLEMAN,
REGISTERED PATENT LAWYER

Victor Building, 724 Ninth Street, N. W.
WASHINGTON, D. C.

PATENTS

To the Man with an Idea

PATENTS Procured. Trade Marks Registered. —A comprehensive, experienced, prompt service for the protection and development of your ideas. Preliminary advice gladly furnished without charge. Booklet of information and form for disclosing idea free on request.

IRVING L. McCATHRAN, Patent Lawyer
Formerly with and successor to RICHARD B. OWEN
704 International Bldg., Washington, D. C.
41-E Park Row, New York City

TRADE-MARKS
REGISTERED

INVENTORS

who derive largest profits know and heed certain simple but vital facts before applying for Patents. Our book *Patent-Sense* gives those facts; sent free. Write LACEY & LACEY, 635 F Street N. W., Dept. 5, Washington, D. C. Estab. 1869.



BOW LEGS?

THIS GARTER (Pat'd)
Makes Trousers Hang Straight
If Legs Bend In or Out

Free Booklet—Plain Sealed Envelope
THE T. GARTER CO., Dept. E
South Bend, Ind.

PATENTS

PROTECT YOUR IDEAS

Write today for FREE BOOKLET, HOW TO OBTAIN A PATENT and RECORD OF INVENTION—or send Drawing or Model of your Invention for Examination.

Promptness Assured with Best Results

MILLER & MILLER
REGISTERED PATENT ATTORNEYS

Former Members Examining Corps U. S. Patent Office
Dept. A-1006 Woolworth Bldg. New York
255 McGill Building Washington, D. C.



PATENTS

TRADE-MARKS

Don't Lose Your Rights
To Patent Protection

Before disclosing your invention to anyone send for blank form "EVIDENCE OF CONCEPTION" to be signed and witnessed.

LANCASTER, ALLWINE & ROMMEL
480 Ouray Bldg. WASHINGTON, D. C.
Originators of forms "Evidence of Conception."

PATENTS

Trade Marks, Copyrights, Patent Litigation Handbook with illustrations, 100 mechanical movements. Sent free on request.

ALBERT E. DIETERICH

Successor to Fred G. Dieterich & Co.
formerly member Examining Corps, U. S. Patent Office

REGISTERED
PATENT LAWYER and SOLICITOR
621-A, Ouray Bldg.
30 Years' Experience Washington, D. C.

TRADE MARKS PATENTS COPY-RIGHTS

BEST RESULTS. LOW FEES. PARTIAL PAYMENT PLAN

Write today for free information—No obligation, sending sketches and description of invention.

HARRY W. JOHNSON

Registered Patent and Trade Mark Attorney
FORMERLY MEMBER EXAMINING CORPS U. S. PATENT OFFICE
Member of the Bars: Supreme Court of the District of Columbia, The Court of Appeals of the District of Columbia, and the U. S. Court of Customs and Patent Appeals.
219 MCGILL BUILDING, WASHINGTON, D. C.

DO YOU

WANT a new business profession of your own, with all the trade you can attend to? Then become a foot correctionist, and in a few weeks earn big income in service fees,—not medical nor chiropody—easy terms for home training, no further capital needed, no goods to buy, no agency. Address

Stephenson Laboratory, 1 Back Bay, Boston, Mass.



GEARS

In Stock—Immediate Delivery

Gears, speed reducers, sprockets, thrust bearings, flexible couplings, pulleys, etc. A complete line is carried in our Chicago stock. Can also quote on special gears of any kind. Send us your blue prints and inquiries.

Write for Catalog No. 10
CHICAGO GEAR WORKS
769-773 W. Jackson Blvd. CHICAGO, ILL.

Why not
have the best?

NORTHLAND SKIS

... skillfully and scientifically made from selected woods, are first choice among good skiers. They're best for running, jumping, or general use. The deerhead trademark identifies them. Write for booklet "How to Ski."

Northland Ski Mfg. Co.
World's Largest Ski Mfrs.
95 Merian Pl.
St. Paul,
Minn.



AN INCOME BUILDER

Two distinct lines in one. For either salesmen or those mechanically inclined.

\$50⁰⁰ Value for \$6⁰⁰

with profits accordingly large.

We can provide you with unlimited quantities of all leading makes of electric vacuum cleaners at sensationally low prices; each guaranteed perfect in action and appearance. Such extreme value and profit offers any man of average intelligence a splendid income even for spare time.

FREE VAC COURSE

To our associates we give in bound book form, free expert advice and seldom disclosed instructions in building and servicing all vacs. Through this free training you may readily develop a permanent, well-paying business all your own. From our immense resources we supply all needs. At trifling cost and no risk you can prosper with us, the originators. Oldest and largest in the line. Literature tells all.

URON ASSOCIATED INDUSTRIES

1392 ENGINEERS BUILDING, CLEVELAND, OHIO

AGENTS! SELLS LIKE WILD FIRE



New Improved window washer eliminates all muss wherever there is glass to be cleaned. Approved by Good Housekeeping and Household Searchlight. Restricted territory. Write today.

CARTER PRODUCTS CORPORATION, 998 Front Street, Cleveland, Ohio

Catch Fish!

Fels, Mink, Muskrats with our new folding galvanized STEEL WIRE TRAP. Write for our FREE TRAP OFFER and Bargain Catalog. \$1 Box of our famous Fish Bait FREE to introduce our traps. WALTON SUPPLY CO., 3502 JUNIATA AVE., ST. LOUIS, MO.



DIAMONDS-WATCHES

AMAZING VALUES

ON CREDIT AT CASH PRICES

Genuine blue white Diamonds, perfect-cut and of fiery brilliancy—imported direct and sold direct to you.

HOW TO ORDER

State article desired—name of employer—kind of work you do—how long in position—age—married—where live—how long there. STRICTLY CONFIDENTIAL. Send first payment, OR goods sent Prepaid for your FREE EXAMINATION if desired.

CREDIT TERMS:

One-tenth down; balance weekly, semi-monthly or monthly at your convenience.

SEND FOR FREE CATALOG
2,000 Illustrations



No. 906—Fiery blue white Diamond, in beautiful mounting of solid 18-K white gold . . . \$75.00
\$1.75 a Week



No. 941—Blue white Diamond set in square top ring of solid 18-K white gold . . . \$50
\$1.25 a Week



No. 942—Sparkling blue white Diamond, square top ring of solid 18-K white gold, \$37.50
\$1.00 a Week



No. 952—Woman's Elgin Wrist Watch, very smart, \$32.50
\$3.25 Down; \$3.25 a Month



No. 911—"Lone Eagle," man's strap watch, 15-jewel Bulova movement, mesh band . . . \$37.50
\$5.75 Down; \$3.75 a Month

LOFTIS
BROS. & CO. EST'D 1858

THE OLD RELIABLE ORIGINAL CREDIT JEWELERS
Dept. H-894 108 North State St., Chicago, Ill.
Stores in Leading Cities

USE THE MACHINES THE EXPERTS USE ... H & A JOINER IT COSTS NO MORE

Surprise your friends with your fine, expert pattern and cabinet work. You can do it with the H & A Joiner. This unusually accurate machine lets you take out perfect planing, jointing, beveling, and rabbeting work. Finest construction. Ball bearing motor driven equipment. Plugs right in the light socket. Read immediately for reasonable price and catalog of H & A woodwork- ing equipment. FREE. Write today.



HESTON & ANDERSON 601 STONE ST. FAIRFIELD - IOWA

PATENTS SECURED TRADE-MARKS REGISTERED

High-class professional service for Inventors and Trade-Mark Users is necessary for PROPER PROTECTION. We Offer you our facilities on Reasonable Terms. If you have an invention send us a model or sketch and description and we will give you our OPINION whether your invention comes within the provisions of the Patent Laws. Our book, "HOW TO GET YOUR PATENT" and Record of Invention Certificate sent on request. DELAYS are DANGEROUS in Patent Matters.

Terms Reasonable.

Best References.

WRITE TODAY

RANDOLPH & COMPANY, Patent Attorneys

301 VICTOR BUILDING, WASHINGTON, D. C.

Name.....

Address.....

LUMINOUS PAINT

Make Your Watches, Clocks, Etc., Visible by Night

The very latest discovery in the scientific world, Liberto, practically unobtainable except at an exorbitant price, we have at last succeeded in producing this remarkable LUMINOUS PAINT, which, applied to the surface of any article, emits rays of white light, rendering it perfectly visible in the dark. THE DARKER THE NIGHT, THE MORE BRILLIANT IT SHINES. Quite simple to use. Anyone—you can do it. A little applied to the dial of your watch or clock will enable you to tell the time by night. You can coat the bezels or switch plates of your electric lights, match boxes, and innumerable other articles; make your own Luminous Cigarettes, Luminous Rebarrels, etc. Small bottle, price 25c. Larger sizes, 50c and \$1 postpaid. JOHNSON SMITH & CO. Dept. 809 RACINE, WIS.



Cigarette Maker
Roll your own and save money. Better and quicker; saves more than half. Use your favorite brand of tobacco. Neat, useful, handy. Pocket size, weighs 3 1/2 oz. Made entirely of metal, nickel plated. 25c, 3 for 65c.



GOOD LUCK RING
Very striking, quiet and unobtrusive. Silver finish; skull and crossbones design; two brilliant, flashing gems sparkle out of the eyes. Said to bring good luck. Only 25c post.



Exploding Cigarettes
Box contains ten genuine cigarettes of excellent quality. They appear so real, but when each cigarette is about smoking smoked, the victim gets a very great surprise as it goes off with a loud BANG! A great tooth provoker yet entirely harmless. Price 25c per box.



U. S. BABY TANK

It goes with real Yankee Pep—by its own power. Most remarkable toy ever invented. By drawing the Tank backward, either with the hand or over the knee or table and then pushing it down, it will crawl along, overcoming all obstacles, in the same life-like manner as the larger tank that proved so deadly in the great war. What makes it go is mechanism of a motor, for there is no mechanism to wind up as is usually understood with mechanical toys, yet this tank will keep chugging along ten times longer than the ordinary run of toys. It will perform dozens of the most wonderful stunts; 2 1/2 inches long. Price only 25c postpaid. Postage Stamps accepted in payment of all orders.

NOVELTY BADGES



Kissing Permit 10c. Garter Inspector 10c. Two very novel metal badges, nickel plated, that you can wear, giving you fun out of all proportion to their trifling cost. 10c, each badge, 3 for 25c, or 75c per doz. postpaid anywhere.

MAGIC MADE EASY 250 TRICKS 10c

An excellent little book containing 250 Fun and Tricks with cards, cards, handkerchiefs, eggs, rings, glasses, etc. So simple that a child can perform them. Fully illustrated. Sent postpaid, to any address for only 10c, 3 copies for 25c, p.p.d.

Other Books on Magic You Should Have:
 Miller's Great Book of Magic..... 25c
 Magic for the Amateur Magician..... 25c
 125 Tricks with Cards..... 25c
 Conjuring Tricks and Social Entertainer..... 25c

MIDGET BIBLE

GREAT CURIOSITY Realizable in the World. Size of a postage stamp. 200 Pages. Said to bring good luck to the owner. A genuine work of art. Must be seen to be appreciated. Make good money selling them to friends, stores, acquaintances, etc. PRICE 15c each, 3 for 40c, 12 for \$1.35, 100 for \$7.50. Also obtainable in Leather Binding, with gold edges. Price 50c each, 3 for \$1.25, \$4.50 per doz. Magnifying Glass for use with Midget Bible 45c.



STAGE MONEY

With a bunch of these bills, it is easy for each person of limited means to appear prosperous by flashing a roll of these bills at the proper time and peeling off a genuine bill or two from the outside of the roll, the effect created will be found to be all that can be desired. Prices, postpaid: 40 Bills 25c, 120 for 50c, or \$3.50 thousand postpaid.



JOHNSON SMITH & CO.

Dept. 809 RACINE, WIS.
A De Luxe Edition of our new CATALOG mailed on receipt of 25c. Handsome binding. Bigger and better than ever. Only book of its kind in existence. Nearly 600 pages of all the latest tricks in magic, the newest novelties, puzzles, games, sporting goods, rubber stamps, unusual and interesting books, curiosities in seeds and plants, etc., unobtainable elsewhere. Remit by Cash, Money Order, Check or unused U. S. Canceled and Foreign Stamps for all articles listed above.

BLANK CARTRIDGE PISTOL

Protection against Burglars, Tramps, & Dogs. Special Offer 1 Blank Cartridge Pistol 100 Blank Cartridges 1 500-pair Novelty Catalog **ONLY \$1.50**

Well made and effective, modified on latest type of Revolver; appearance alone is enough to scare a burglar. When loaded it may be as effective as a real revolver without danger to life. It takes standard .22 Cal. Blank Cartridge—obtainable everywhere. Special cash with order offer: 1 Superior quality Blank Cartridge Pistol, 100 Blank Cartridges, and our new 500-page De Luxe Catalog of latest novelties; all for **ONLY \$1.50**. Shipped by Express only. Cannot get by parcel post. Extra Blank Cartridges 50c per 100. Special Holder (Cowboy Type) for pistol 50c. No U. S. D. shipments.

LOOK 35¢ LOOK Wonderful instrument.

Greatest thing yet. Nine separate articles in one. Everybody delighted with it. Odd, Curious and Interesting. Lots of pleasure as well as very useful. It is a double Microscope for examining the wonders of nature. It is also an Opera Glass, a Stereoscope, a Burning Lens, a Reading Glass, a Telescope, a Compass, a pocket Mirror, and a Laryngoscope—for examining eye, ear, nose and throat. It is worth all the cost to locate even one painful cinder in the eye. Folds flat and fits the pocket. Something great—you need one. Don't miss it. Sent by mail. **Only 35c or 3 for \$1.00**

THROW YOUR VOICE

Into a trunk, under the bed or anywhere. Lots of fun fooling the teacher, policeman or friends.

THE VENTRILO
a little instrument, fits in the mouth out of sight, used with above for Bird Calls, etc. Anyone can use it.

Never Fails. A 16-page course on ventriloquism, the Ventrilo. **ALL FOR 10 CENTS**

PISTOL CIGARETTE CASE

It looks like a deadly weapon, but it is merely a novel Cigarette Case. This clever contrivance has proved itself better than the real thing in many an awkward encounter. Great fun "sticking up" your friends. They squirm and protest it might be loaded. Pull the trigger and the slide flies open disclosing the cigarettes. Well made, light and compact. Weight only 2 ounces.

PRICE **25c** POSTPAID

MAGICIAN'S BOX OF TRICKS

Apparatus and Directions for a Number of Mysterious Tricks. Enough for an Entire Evening's Entertainment. **\$1.00**

Anyone Can Do Them

It is great fun with your friends. Get this Conjurer's Assistant and you will be the latest sensation follow in your district. It contains the apparatus for ten first-class tricks, including THE MAGIC BALL AND VASE TRICK (a wooden ball is placed inside, and upon replacing the lid has disappeared and is found in someone else's pocket); THE HINDOO TRICK CARDS (can be made to change completely no less than five times); DISAPPEARING COIN BOX (a coin, placed in the wooden box, vanishes entirely or changes into a coin of another denomination); THE GLASS GLOBE TRICK (a globe is dropped into a glass of water and when the water is poured out the globe has vanished and is found somewhere else); THE HINDOO FACTORY FROM THE MOUTH TRICK (a seemingly endless supply of colored paper ribbons comes out of your mouth); the DISAPPEARING HANDKERCHIEF (a handkerchief held in the hand mysteriously vanishes); the WIZARD'S RING COIN TRICK; the ENCHANTED BOTTLE (a coin is placed in a bottle and when the bottle is turned upside down it is able to make it lay down); the GREAT HAT AND DICE TRICK (a large dice is placed on top of a hat, disappears, and is found underneath yet no one has touched the hat), and last, but not least, the GREAT PHANTOM CARD TRICK, or two from five leaves nothing. Full instructions are sent for performing each trick. In addition to the above, a number of other feats and illusions are fully explained for which you can easily make or procure the necessary apparatus. Price complete \$1.00 postpaid. Postage Stamps accepted. JOHNSON SMITH & CO., Dept. 809, RACINE, WIS.

Wonderful X-Ray Tube

A wonderful little instrument producing optical illusions both surprising and startling. With it you can see what is apparently the bones of your fingers, the lead in a lead pencil, the interior contents in a pipe stem, and many other similar illusions. Price 10c, 3 for 25c.

SURPRISE MATCHES

More fun than fighting with your wife. Look just like ordinary matches. As the victim tries to light one he gets quite a surprise. Price 10c per box, 3 boxes for 25c, 12 for 75 cents.

Motto Ring
Lots of harmless fun and amusement wearing a motto ring. Made in platinum filled with the reversible placards, with wording on same, as illustrated. Only 25c Postpaid.

Swear Off Tobacco

Let Us Help You Banish the Tobacco Habit

QUICK RESULTS

Trying to quit the tobacco habit unaided is often a losing fight against heavy odds, and may mean a distressing shock to the nervous system. So don't try it! Make the tobacco habit quit you.

It doesn't make a particle of difference whether tobacco has been used for a single month or fifty years, or how much, or in what form—whether it be cigars, cigarettes, pipe, plug, fine cut, or snuff. Tobacco craving usually begins to decrease after the very first dose—there's no long waiting for results.

Tobacco Redeemer contains no habit-forming drugs of any kind and is safe, quick, pleasant, and thoroughly reliable.

Not a Substitute

Tobacco Redeemer is in no sense a substitute for tobacco, but is a radical, efficient treatment. It helps to quiet the nerves, and makes one feel better in every way. If you really want to quit the tobacco habit—get rid of it so completely that when you see others using it, it should not awaken the slightest desire in you—you should at once begin a course of Tobacco Redeemer treatment for the habit.

Our Positive Guarantee

A single trial should convince the most skeptical. Our legal, binding, money back guarantee goes with each full treatment. If Tobacco Redeemer fails to banish the tobacco habit when taken according to the plain and easy directions, money will be cheerfully refunded upon request.

Let Us Send You Convincing Proof

If you are a slave of the tobacco habit and want to find a sure quick way of quitting "for keeps," you owe it to yourself and to your family to mail the coupon today or send your name and address on a postal, and receive our free booklet on the injurious effects of tobacco on the human system and positive proof that Tobacco Redeemer does quickly relieve the habit for most users.

Newell Pharmacal Company
Dept. 300, Clayton Station, St. Louis, Mo.



Free Book Coupon

NEWELL PHARMACAL CO.

Dept. 300 Clayton Station St. Louis, Mo.

Please send, without obligating me in any way, your free booklet regarding the tobacco habit and proof that Tobacco Redeemer has relieved the tobacco habit in thousands of cases. If it fails my money will be refunded.

Name.....

Street and No.....

Town..... State.....



Boys! Here's Fun Galore

Zip! Here they come! Around a turn and down the home stretch to cross the finish line with a last furious burst of speed!

You want things that will "GO"—things you can race with—scooters, pushmobiles, small autos with motorcycle engines, wind wagons, etc.—Whether on spinning wheels or glistening runners—fast ice yachts, skis, toboggans, bobsleds, motor driven sleds and snow speedsters.

You air-minded boys enjoy gliders and model airplanes.

Turn your back yard into a regular amusement park with all these thrillers—ferris wheels, roller coasters, merry-go-round swings, etc.

How fascinating to imitate the big engineers and make small water wheels, pile drivers, aerial cableways and other things that "work."

When at camp or on the water you need plenty of ideas for new ways of having fun. Here are dozens such as water bicycles, push boats, water coasting toboggans, water games, etc.

On rainy days and other times when working in your home shop you have the hardest time finding interesting things to make. Here are any number such as electric locomotives, motion picture cameras, wood turning lathes, etc.

But why try to describe this great

Boy Mechanic Library

Boys, it simply cannot be done. You must actually have these books in your hands and see them before you can begin to realize that the four big volumes contain enough interesting things to last you until you are a grown-up man.

THINK OF IT!

4000 Worth While Things to Make and Do

Don't envy the other boys on account of the things they have. Be the boy in your neighborhood to make the others wonder where you get all your ideas—and it doesn't cost a lot of money, either. These wonderful books show you how to take parts from old cast-off things and perhaps get a few cents' worth of material from a hardware store—or have a blacksmith or shop man help you bend some iron, and thus make something that works just as well as though you had paid several dollars for it. Best of all—you get the thrill of having "Made It Yourself."

Everything is pictured out and made easy. Don't try to get along without these books any longer. Save or earn the money to buy them right away.

The complete library of 4 volumes, each book 7x10x1½ inches and with 460 Pages. **Price \$7.00**

or single volumes at \$2 each. Each volume complete in itself.

Books are numbered: 1, 2, 3 and 4. State the ones you want when ordering. Sent postpaid when remittance is sent with your order, or will be sent C. O. D. anywhere in the U. S. Pay postman price plus extra postage for this service.

POPULAR MECHANICS PRESS

200 E. Ontario St. Room P 1 CHICAGO, ILL.



WHAT A THRILL!

All the locals and
the world at your
finger tips!!!

PILOT SUPER D. C. \$29.50
WASP A. C. \$34.50

For short wave and regular broadcast reception nothing equals this set that has made history in "round-the-world" communication. Shipped in kit form with full set of tubes and simple instructions for easy assembly. A. C. model, \$34.50. Battery model, \$29.50. Power Pack for A. C. set, \$18.40, including Rectifier Tube. Other A. C. tubes, \$9.50. Tubes for D. C. set, \$8.25. Typical 20th Century values—where you get everything in radio at lowest prices. Send 25% deposit, balance C. O. D. plus transportation. Speaker extra. Power Pack extra.

SEND FOR
CATALOG
and FREE
RADIO
GIFT



20th CENTURY
MAIL ORDER CORP.

238 S. Wells St.
Chicago, Ill.

MOTORCYCLES

Wonderful Bargains

Small Deposit—Liberal Terms
Indians Harley-Davidsons Ace
and Henderson

Send 10 cents for Bulletin A.
Motorcycles shipped to all parts of the world.

WALKER-INDIAN CO., 1309 Boylston St., Boston, Mass.

Learn to PAINT SIGNS and SHOW CARDS

We quickly teach you by mail, or at school, in spare time. High demand, big future. Interesting work. Oldest, foremost school. **EARN \$50 TO \$200 WEEKLY**

Otto Wiegand, Md., home-study graduate, made \$12,000 from his business in one year. John Vasson, N. Y., gets \$25 for a show card. Crawford, B. C., writes: "Earned \$280 while taking course." Write for complete information.

DETROIT SCHOOL OF LETTERING
150 Stimson Ave. Est. 1899 DETROIT, MICH.

FREE "Book of Facts" — Write For It

Send for copy of catalog describing over

1500 GOOD TOOLS

GOODELL-PRATT COMPANY, Greenfield, Mass.

Boils 50 Gallons

In Less Than Hour

No Other Compares With This

Improved Oil Burner

Use Ordinary Kerosene or Coal Oil

(Burns Outdoors as Well as Indoors?)

THE most remarkable Kerosene Burner ever built. Boils down apple cider, maple syrup, molasses, etc., in half the ordinary time. Ideal burner for dairies, butchers, indispensable on the farm.

PRODUCES TERRIFIC HEAT WITH
SILENT BLUE FLAME

**NO NOISE
SMELL
SMOKE
SOOT**



So efficient it produces twice the amount of heat of City gas at half the cost. So simple anyone can install and operate. Double generator assures continuous operation without shut-downs. Nothing to wear out, starts in a jiffy, will last a life time. Every burner guaranteed fully. Write for special introductory price and free catalog of outdoor utility and kitchen stove oil burners.

HOME MFG. CO., Dept. 5113, 20 E. Kinzie St., CHICAGO



Here's
an Amazing New
Business THAT PAYS
UP TO
\$1,000 A MONTH

MEN, here is a real, red hot money-making opportunity! It's a chance to jump into business for yourself and make more money every week than the average man makes in a month.

Surprising as it may sound, we actually put you in a business, with the first day's profits often running from \$18 to \$55. \$350 to \$600 the first month is not unusual for ambitious men.

Cut in on the Big Money

All you need is the ambition to make real money. We supply you with complete equipment to make and sell that famous new food specialty—Brown Bobby—a greaseless doughnut baked by electricity!

It's a crispy, flaky, delicious new kind of doughnut cooked without one drop of oil or grease. Easily digested by everyone. More appetizing than old-style doughnuts ever were. Costs less to make. Sells four times as fast. No baker's skill required. Just add water to our prepared "Mix." You can open a shop; rent cheap floor space in a grocery, delicatessen, lunch-counter, drug store, etc. Or start at home—and make up to \$250 your very first week.



"I made \$3,000 in 3 months from my greaseless doughnut business!" — T. Chas. Minch, Fla.

Start At Once ANYWHERE!

Men and women everywhere are starting in this business daily! YOU cannot afford to delay! Details will gladly be sent without obligations of any sort. Such an amazing money maker may never come your way again. So fill in and send the coupon at once! TODAY!

FOOD DISPLAY MACHINE CORP.

Dept. 3A 500 N. Dearborn St. Chicago, Ill.

Food Display Machine Corp.,

Dept. 3A, 500 N. Dearborn St., Chicago, Ill.

Gentlemen: Please send me the plan by which I can cash in on Brown Bobby, the Greaseless doughnut. It is understood that this obligates me in no way whatever.

Name.....

Address.....

City.....State.....

A CLIPPER SHIP for \$4.50 BUILD FOR PLEASURE OR PROFIT



An Ideal Christmas Gift

We supply all the necessary parts, cut and numbered, ready to put together. Instructions show full details how each numbered part fits into another. You can't go wrong. A few hours pleasant pastime and you will have a beautiful and valuable model. We also have parts for the SANTA MARIA—LA PINTA—MAYFLOWER—FLYING CLOUD—all at \$4.50 each—CONSTITUTION (Old Ironsides) \$5.98—Flying Cloud with Electric Lights, \$5.98.

CLOUD—all at \$4.50 each—CONSTITUTION (Old Ironsides) \$5.98—Flying Cloud with Electric Lights, \$5.98.



COACH MODELS

Like our Ship Models all Coach Model parts are cut and numbered ready to put together, with instructions showing full details how each part fits into another. We have kits for the following coach models—TALLY-HO—GEORGE WASHINGTON'S PRIVATE COACH—DEADWOOD STAGE COACH—DEVONPORTY to LONDON—PRINCETON to PHILADELPHIA—all at \$4.95 each (see below), Boxes \$2.00 per pair.

UNEMPLOYMENT need not worry you. There is a ready market for ship and coach models right in your own neighborhood—All kits shipped same day order is received. MINIATURE GOLF SETS in knockdown form are also sold by us and are described in our illustrated folder.

Literature on any of the above models gladly sent on request. GUARANTEE—If after assembling any of our models according to our instructions, you are not satisfied, return it to us and we will refund your money. Foreign orders must be accompanied by U. S. Money Order or check.

C. J. BIERBOWER Dept. PM 3216 Spring Street PHILADELPHIA, PA.

Originator of Build-your-own-ship-models.
C. J. BIERBOWER, Dept. P.M., 3216 Spring St., Philadelphia, Pa.

Please send me all parts, cut to fit and ready to put together for the following: Clipper Ship, Santa Maria, La Pinta, Mayflower, Flying Cloud, Constitution, Devonport to London, Princeton to Philadelphia, George Washington Coach, Deadwood Stage Coach, Tally Ho, Washington Coach, Deadwood Stage Coach, Devonport to London, Princeton to Philadelphia, for which I will pay the postman the above prices plus a few cents postage.

Please send me literature pertaining to.....
Name.....
Address.....
City.....



WOOD WORKING MACHINES

Portable—Heavy-duty
Accurate—Sturdy
Moderately Priced

Scientific design, honest materials and workmanship—these qualities obtainable at extremely moderate prices have made Crescent Machines popular where known and used. You can depend on them for high efficiency, economy, convenience and utmost safety. Made in every desired type and size, for shops, wood working plants, schools and amateur use.

We build:

- Band Saws
- Saw Tables
- Self Feed Rip Saws
- Shapers
- Jointers
- Planers
- Planers and Matchers
- Universal Variety Saws
- Disk Grinders
- Cylinders
- Tables
- Swing Saws
- Berms
- Tenoners
- Hollow Chisel Mortisiers
- Variety Wood Workers
- Universal Variety Workers

Send for increasing list and prices.



THE CRESCENT MACHINE CO., 93 Columbia St., Leetonia, Ohio

SAMPLES OF 33 RARE WOODS

20 Cabinet Woods—\$1.00

Sets labeled and postpaid. Lumber domestic and imported, panels, veneers, inlay woods, turning squares, and supplies. Send 5c stamp for large illustrated catalogue.

Craftsman Wood Service Co., PM-166 W. 74th Street, Chicago, Illinois.

Ideal Xmas Gift
Prepaid \$3.75

LIGHTWEIGHT COMPRESSED MODEL AIRPLANE MOTORS AND GLIDER GASOLINE ENGINES

Model Builders' Handy Man supplies, gears, materials, books, castings. 3,000 price listings. Illustrated Cat. No. 28—25c coin. Glider details with Catalogue.

AMALGAMATED CORP. 605 Washington Blvd. CHICAGO, ILL.

CONDON'S GIANT TOMATO EVERBEARING



"QUEEN OF THE MARKET." Big Money Maker. Large, solid fruit; excellent canner. To introduce to you our Northern Grown Live Seeds and Plants, we will mail you 125 seeds of Condon's Giant Everbearing Tomato and our **FREE** Big 1931 Catalog of Seeds, Plants, Shrubs, 192-Page Book tells how, and when to plant. Send 2c stamp to cover postage. 1931 Prices Lower Than Ever.

CONDON BROS., Seedsmen
Rock River Valley Seed Farm
Box 186 ROCKFORD, ILLINOIS

INCREASE YOUR POULTRY PROFITS!

By proper Breeding, Feeding, Housing, Culling and Marketing **AMERICAN POULTRY JOURNAL** tells how to do it, and in addition a series of **COLORED PICTURES** with explanatory text tell and show many things you should know. They are not just colored pictures of birds but pictures of an educational nature, something never before shown by a poultry paper. 12 issues of *American Poultry Journal* contain about 1000 pages—Price 25c a year—5 years \$1.

AMERICAN POULTRY JOURNAL, 14-536 S. Clark St., CHICAGO

80 BREEDS Chickens, ducks, geese and turkeys.

Pure bred hardy northern raised Gold Seal stock Fowls, eggs, baby chicks, lowest prices. 49 years experience and my Valuable 100 page Catalog and Breeders' Guide Free

W.A. Weber Co. Box 28, Mankato, Minn

RAISE PIGEONS and RABBITS FOR PLEASURE AND PROFIT

Over 20 varieties of Pigeons. Also Rabbits. Send 10c for illustrated catalog and full information.

W. V. MOORE, BOX A, STERLING, ILL.

NEW LOW CHICK PRICES

40 BEST VARIETIES; Large, Strong, Vigorous, Quick Maturing, Heavy egg production. New Colored Book with NEW LOW PRICES; chicks, fowls, eggs, supplies, etc. Best references. "Fair Play" and "Money-Back" Guarantees. Write for new book.

GREAT WESTERN HATCHERY Box 52 SALINA, KANSAS



WONDERFUL NEW BOOK FREE

Nation's Great Poultry Manual. Tells how you can make money with **BERRY'S CERTIFIED CHICKS**, Rightbred Fowls and Supplies. Also facts about Housing, Feeding, Diseases, Remedies, etc. **NEW LOW PRICES** and **VERY BEST QUALITY**. Write today for Free Catalog.

BERRY'S POULTRY FARM Box 29 Clarinda, Iowa

10 FREE CHICKS

With each 100 ordered before Mar. 1st. Chicks delivered any time. \$1.00 down rest C.O.D. Write for catalog and attractive prices.

Kentucky Hatchery, 398 West 4th St., Lexington, Ky.

SQUAB BOOK FREE

Send PR squabs for rich trade. Sold by millions at higher prices than elsewhere. Send two-cent stamp for postage on latest free 48-p. book how to breed and profit by new fast sales method.

Plymouth Rock Squab Co., 634 H St., Melrose, Mass.

ACCREDITED PURE BRED POULTRY

Big, two-colored **FREE** book tells all about Famous **SUNFLOWER STRAINS** of Poultry, Hatching Eggs, **BABY CHICKS**, Brooders, Houses, Supplies. **LOW PRICES** for Accredited and Exhibition Matings. Beautiful book sent **FREE**. Write **BERRY BROTHERS**, Box 40, Atchison, Kans.

70 BREEDS Chickens, ducks, geese, turkeys,

high quality and most profitable. Fowls, Eggs, Baby Chicks and Incubators at reduced prices. America's great plants—since 1893. Valuable 100 page Poultry book and catalog **FREE**.

R.F. NEUBERT Co., Box 878, Mankato, Minn.

RUNNER DUCK AND ANCONA BOOK

Tells about best money making combination—**Runner's Ancona** lay at 4-2 months. Heavy **WINTER LAYERS**. Big white eggs. Get started with better quality chicks, eggs and fowls at **LOW PRICES**. Beautiful booklet of facts **FREE**.

BERRY'S POULTRY FARM, Box 108, CLARINDA, IOWA



Be a "Success" with a Sax

EXTRA MONEY for spare-time work; social popularity; good pay for having a good time; you can be successful with a Buescher saxophone.

**LEARN
in 3
WEEKS**

And it's so easy. Master scales first hour; play tunes first week; join a dance band in 90 days. Three lessons, given, start you right off.

The rest is easy. Success assured.

**FREE
TRIAL**

Take any Buescher instrument home for a week's free trial. Test yourself on a saxophone, trumpet, trombone, or clarinet. See what you can do. No obligation to buy. Send postal today for beautiful catalog of your favorite instrument. Easy terms arranged. Write today sure.

BUESCHER BAND INSTRUMENT CO.
110 Buescher Bldg., Elkhart, Ind.

BUESCHER

DRIVE SAFELY AT NIGHT

New 67,000 candlepower Speedlight ends all glare danger, yet prevents dim-light crashes. Drive 60 miles an hour safely! Agents cleaning up big with it.

Write for particulars to
SPEEDLIGHT CO. Dept. 822 1131 Belmont Ave., Chicago, Ill.

FREE TOOL BOOK

"The Disston Saw, Tool and File Book" tells how to choose, use, and care for tools, file and set saws, etc. Every tool user needs it. Henry Disston & Sons, Inc., Dept. M, Philadelphia. Canadian Factory, Toronto.

A NEW HOUSE WIRING MANUAL

PRACTICAL — PLAINLY WRITTEN

BY J. G. WOLBER AND O. K. ROSE
Cass Technical H. S., Detroit, Mich.

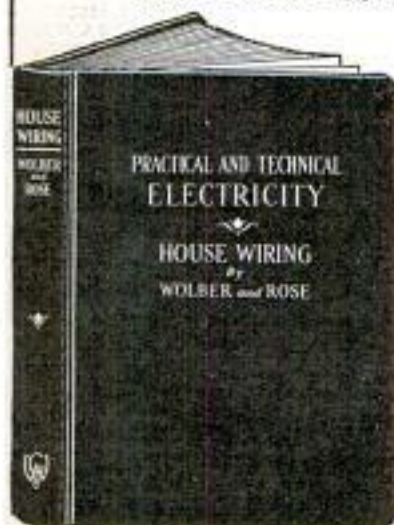

This book is the result of the author's fifteen years of industrial experience and of teaching. The material accumulated during this period of time has been worked over and over until in the author's opinion it was ready for publication.

320 Pages
662 Illustrations
Size 7 1/2 x 5 1/4 inches
Flexible Binding
Price \$2.50 Postpaid
Will be sent C. O. D. anywhere in U. S. or possessions.

**POPULAR
MECHANICS
PRESS**
Room P 1
200 E. Ontario
St., Chicago

Yours Without Cash



Lone Eagle
\$3750

*Miss
America*
\$3750

Buy Direct — at lowest cash prices on easy payments. You wear while paying. Watch sent for you to see and examine without one penny down.

RAILROAD WATCHES

Let us send you our beautiful watch catalogue showing the Famous Santa Fe Mogul Railroad Watch, and the 21-jewel Santa Fe Special in both 16 and 12 sizes. Buy Direct and save 1/3 to 1/2 your money. Also the new 60 hour Bunn Special. Catalogue sent FREE.

DIAMOND RINGS

Write for our New Diamond Ring of Romance and Bu-loya Wrist Watch Catalogue showing marvelous new designs. Never have we been able to offer such beautiful diamond rings and artistic dependable watches at such low prices. The catalogue is sent FREE!

Ask for our Special Spot Cash Offer. Good for 30 days only.

SANTA FE WATCH COMPANY

Dept. 16, Thomas Bldg.

TOPEKA, KANSAS

To SANTA FE WATCH CO.,
Dept. 16, Thomas Bldg., Topeka, Kansas

Please send me catalogue I have checked:

- Railroad and dress pocket watches
Ladies' and men's wrist watches
Ladies' and men's Diamond Rings

Name

Address.....City.....

The Very Latest in Bench Machinery!



New Jig Saw

Large, massive and heavy. 20" capacity.utton for work. Runs smooth as silk. Equipped with improved hold-down shoe and automatic blower.

TWENTY consecutive, successful years of designing and building power tools are behind every BOICE-CRANE machine. The sum total of this long experience is represented in each unit of our improved 1931 line. It is the very latest in Bench Machinery.

Fully illustrated and described in our new, large 52-page catalog. FREE for the asking. Write for it.



Table
17-Inch
Dia.

New Shaper. Weighs 80 pounds. Extremely low price. Write for our special Shaper circular.

A Shop Without Cost—Get Our Plan!

We need BOICE-CRANE demonstrating shops in hundreds of towns. Yours may be open. Affords an opportunity to equip your shop in return for pleasant, fascinating demonstrations. No selling. No hunting for prospects. No collecting. Nothing to do but show the design, construction, accuracy and speed of BOICE-CRANE **Handisaws, Lathes, Jointers, Band Saws and Jig Saws.** You do the demonstrating, we do the selling. When sales are made in your territory, you get liberal commissions. It's a splendid proposition. Get the details. Write for our new plan. Be sure to state county wanted when you write. Address

W. B. & J. E. BOICE

Dept. PM-1G

Toledo, Ohio

WORLD-WIDE

SHORT WAVE RECEIVER

ONLY \$6.45

Span the World with this Set!

A new radio thrill for you! Listen in DIRECT to London, Paris, Berlin, Buenos Aires and other broadcasting stations throughout the world via short waves. Enjoy unique foreign programs from strange lands. Your ordinary receiver cannot tune in these low wave stations. **WORLD-WIDE RECEIVER** gets 14 to 550 meter stations with surprising clarity. **SEND NO MONEY!** Just write your name and address on a postcard and ask us to send you this wonderful guaranteed short wave set. Pay postman \$6.45 plus a small delivery charge. All orders west of Rockies must be accompanied by \$1.00 deposit. Foreign countries \$2.00 extra, postpaid. Write today for new catalog of radio bargains.

CHAS. HOODWIN CO.

4240 Lincoln Ave., Dept. A.2

CHICAGO

Miniature Golf Course GIVEN



BOYS Here is your chance to get a **MINIATURE GOLF COURSE** consisting of 9 Holes and obstacles, 4 balls, 4 clubs. Play it indoors or outdoors, Summer or Winter. Given as a reward for distributing only 12 imitation oil painting pictures on special 25¢ offer and remitting the \$3 you collect. Write today for pictures. We trust you.

C. M. Thomas, 337 W. Madison St., 11691, Chicago



GIANT TELESCOPE \$1.75

5 SECTIONS—3FT. LONG

See Miles Away! Distant people and objects seem close. Over 3 ft. long, brass bound. Made in Europe. Bbls. of fun. Thousands pleased.

Send No Money! On arrival pay Postman special price, only \$1.75, plus postage. Two for \$3.25. (Or send price and we pay postage.) Satisfaction guaranteed or money back. Send today. **BargainHouse, 549 Washington St., Dept. 10, Chicago**

FREE Strong leatherette Carrying Case and Solar Eye Piece and view the sun.

GET RID OF THE TRUSS

—take the first step NOW, by writing for Mr. Stuart's 48-page



book on RUPTURE, and **FREE** test of the herbal factor—"PLAPAO." Learn how to close the hernial opening so the rupture can't come down. The book explains. **STUART'S ADHESIF PLAPAO-PADS** are different—No straps, buckles or springs attached. Easy to apply, comparatively inexpensive and comfortable. Thousands have successfully treated themselves at home without hindrance from work, most obstinate cases conquered.

Process of recovery is natural, so afterwards no further use for trusses. Awarded Gold Medal and Grand Prix.

Send No Money—Just name and address on postal card NOW—TODAY. Address: **—PLAPAO CO., 34 Stuart Bldg., St. LOUIS, MO.**

**THOMPSON
BOATS**

CATALOG FREE!

The Best that skill and experience can produce—at real money-saving prices. Prompt shipment from factories to you!

Outboard
Motor Boats
\$60.00
and up

A complete line of real fast, safe and sea-worthy boats for family use. Also fastest racing models.

Rowboats
\$48.00
and up

Improved models. Safe and seaworthy. Strong and durable. Easy to row and handle with oars.

Canoes
\$50.00
and up

Three models and four lengths. Including non-sinkable suspension canoes.

Motor
Boat
\$745

Mahogany Runabout. 16 and 18 ft. Speed 25 to 35 mi. per hr. Complete with 4-cycle motor installed, including electric starter and reverse gear.

CATALOG FREE—SAVE MONEY—ORDER BY MAIL.
Please state the kind of boat you are interested in (44)

TWO LARGE FACTORIES
THOMPSON BROS. BOAT MFG. CO.
213 Ann St. (Write to) 113 Elm St.
PESHIGO, WIS. (Either Place) CORTLAND, N.Y.



Earn \$10 to \$35 A Week EXTRA

FREE PLAN Helps You Start

Hundreds of men have started their own profitable business right at home in their spare time with the Foley Automatic Saw Filer. Everett Myers, shown above, writes, "... I banked \$161.66 in one month which was accomplished in spare time ..."

Start a Permanent Business of Your Own in Spare Time

Many men who started in business for themselves in spare time have had to give up their other job and devote all their time to their saw filing business because they got so much business they could not handle it all in spare time. Brunick Serdinsky writes, "... I started business in my spare time and now have the best saw filing business in this community and have earned \$3000 in the past year. ..."

FOLEY AUTO MATIC SAW FILER

FILES ALL KINDS OF SAWS

This one machine files all kinds of hand saws, band saws and circular saws better than the most expert hand filer. Work done on the Foley is always satisfactory to your customers. Very simple and easy to operate. No eye-strain. Boys of 14 and men of 70 are making money with the Foley.

**\$10
Brings
It to You**

Start Now—Make Big Profits

Have a steady, cash business the year 'round. No Canvassing—Repeat Customers. Costs less than 3c to file a saw and you get 50c or more for each job. Others are making good money. YOU can too.

Mail Coupon for FREE PLAN

Foley Manufacturing Co.

209 Foley Bldg., 11 Main St., N.E., Minneapolis, Minn.

Please send me FREE PLAN and tell me how I can make extra money in my spare time with the Foley Filer.

Name.....

Address.....

AUTO REPAIRMEN EARN GREATER PROFITS

Get your share of the big money being spent on automobile upkeep.

Put improved time, labor and money-saving ideas to work in your shop to-day. Take advantage of our special bargain offer and secure 3 valuable kink books at a reduced price.

1. 334 Valuable Discoveries made by auto mechanics in our **Automobile Repairman's Handbook**. 337 Illustrations.

2. 301 Ways to use drills, drill presses, taps and dies more effectively in our **Drilling and Thread Cutting Handbook**. 298 Illustrations.

3. 259 Kinks furnished by the most expert Lathe Operators in our **Lathe Handbook**. 212 Illustrations.

Special Offer—These 3 books (regular price 50 cents each, \$1.50 value) are offered for a limited time for only 98 cents plus postage. Pay postman C. O. D. when he delivers or if outside U.S. send 98 cents and 15 cents extra for postage.

POPULAR MECHANICS PRESS

Room P1

200 E. Ontario St.

CHICAGO



The WORLD'S LARGEST RADIO STORE

Practically everything in Radio— including all the latest 1931 features— is listed in our cut-sale catalog just out. We have slashed the prices on all sets and equipment, passing along to you the marvelous price-savings made possible by the buying power of the World's Largest Radio Store.

WHOLESALE PRICES

You reap the benefit of lowest wholesale prices on New Humless, Screen Grid A. C. sets, battery operated sets, beautiful and artistic consoles, dynamic speakers and phono-combinations, tubes, parts, kits and all kinds of accessories. The prices are almost unbelievable.

FREE CATALOG

We are nationally known as the lowest priced of all reliable Radio houses, and we frankly state we have never before offered such values. Send today for this catalog of smashing bargains, and save money on all your radio supplies.

**CHICAGO SALVAGE
STOCK STORE**
509 So. State St.
CHICAGO, ILL. Dept. 568

*The Place to
Save Money On
RADIO*

OFFICIAL BOY SCOUT MODELS

20 YEARS' PROFESSIONAL experience in testing are back of all supplies sold by us.

Colorless Waterproof Aero Glue
Selected Balsa Wood
Special Paper and Silk
Finest Rubber in Spools

Send for complete list

AERO MODEL COMPANY
Dept. M-1 111 North Wacker Drive CHICAGO

NO JOKE TO BE DEAF

—EVERY DEAF PERSON KNOWS THAT



George P. Way made himself hear, after being deaf for 25 years, with Artificial Ear Drums—his own invention. He wore them day and night. They stopped head noises and ringing ears. They are invisible and perfectly comfortable. No one sees them. Write for his true story, "How I Got Deaf and Made Myself Hear." Also booklet on Deafness. Address: George P. Way, Inc., 901 Reform Building, Detroit, Michigan



Artificial Ear Drum

New Complete "Wonder" Workshop

\$18³⁰ BUY DIRECT. SAVE 35% TO 50%
12" Band Saw \$29.25 to \$37.05
Lathes 21.00 to 29.25
4" to 36" Scroll Saw 4.80 to 13.44
6" BB Jointer . . . 55.00 to 74.25
Home Workshop—11"-3 spd. lathe,
7" saw table, 8" scroll saw . . . 54.00



All Without Motors

Write for Circular:

S & B MFG. CO.

4611 W. 20th St. CHICAGO, ILL.

861 PRACTICAL IDEAS for REDUCING FARM LABOR and INCREASING INCOME



One farmer writes: "I would not take \$100 for my copy if I could not secure another."

The Handbook for Farmers contains: 138 ideas for the farm shop, 35 on fencing, 98 on auto, truck and tractor, 61 on farm buildings, 36 on field machines, 48 on concrete work, 22 on orchard work, 23 on painting, 15 on live stock, 34 on poultry, 54 on garden work, 25 on electrical work, 22 on farm tools, 16 on hunting, fishing and trapping, 140 household helps

**394 HELPFUL
KINKS to LIGHTEN
the LABOR of the FARMER'S WIFE**

The Handbook for Women contains: 83 kitchen and dining room helps, 17 on garden and flowers, 19 on sewing and mending, 37 on furniture, pictures and fixtures, 38 on laundry and cleaning, 32 on house cleaning, 12 on music, 14 on sleeping rooms, 11 on care of children, 16 on lights, 9 on photography, 14 on clothing and shoes, 23 on house temperatures, 12 on water and drains, 10 on insect pests, and 47 miscellaneous.

**BOTH BOOKS
SENT C. O. D.**

anywhere in U. S. for \$1.48 plus the few cents postage. If outside U. S. send remittance and books will be postpaid.

POPULAR MECHANICS PRESS
Room P-1, 200 E. Ontario St., Chicago



A SHIP MODEL OR COACH MODEL for \$4⁹⁸

You Can
Build
One



FREE
Illustrated
Catalog



All parts are cut to fit and ready to put together with diagrams and instructions so clear that with only a small hammer you can complete the work in a few hours. The kits contain everything needed. The hulls of ships and the bodies of coach models are made of California Redwood which can be given a beautiful finish, making a real ornament.

All models sent C. O. D. plus a few cents postage by parcel post to anywhere in the United States and Canada. Other foreign orders must be accompanied by check or money order.

MINIATURE SHIP MODELS, Inc.

Dept. RT, Perkasi, Penna.

Canadian Office: 90 King Street West, Toronto

From our former address in Philadelphia we have, during the past five years, supplied ship model parts to thousands of satisfied customers. As a result of growing demand we have located in our new factory.

Santa Maria.....	27" long.....	\$4.98
Mayflower.....	26" long.....	4.98
Constitution.....	33" long.....	6.98
Flying Cloud.....	30" long.....	6.98
La Pinta.....	26" long.....	4.98
Concord Coach.....	16" long.....	4.98
Covered Wagon.....	20" long.....	4.98

Miniature Ship Models, Inc., Dept. RT,
Perkasi, Pennsylvania.

Please send me complete parts, cut to fit and ready to put together for model.....

I will pay postman \$..... plus a few cents postage.

Name.....

Street or R. F. D.....

City.....

State.....

Only 8 Sales a Day Nets You \$116 a Week

Profits on larger size run higher. Unusual earning opportunity for ambitious men. No experience necessary; we teach. Part or full time.

FUGO World's Simplest Fire Extinguisher

Automatic and instantaneous action. Within reach of every home, shop, store, theatre, garage, car owner, etc. Even smallest place needs two or more. Exclusive territory to producers. You get your pay every day. Write for full details.

The National Formetal Co.
6535 Metta Ave. Cleveland, O.



THREAD CUTTING LATHE

12" Band Saw
Powerful, Practical, Not a Toy.
Price only \$30.00.

Write today for Booklet and prices on these and other Machines.



ROSSBACHER MACHINE CO.
1816 A Fernwood Avenue Toledo, Ohio

Boys Fly the IDEAL EAGLET



Construction
Outfit
50c
Postpaid

A Perfect Model of a Commercial Plane. All balsawood (not cardboard) with many features of expensive models. Easy, quick construction; everything ready to put together; weighs 1 oz. complete. Files like a big one! Get one now and have some real fun!

Send 5c for Big 48-pg. catalog and Special Circular Showing Many New Ideal Models.

Ideal Aeroplane & Supply Company, Inc.
26 West 19th Street, New York City

BUILD YOUR OWN AUTOMATIC ELECTRIC REFRIGERATOR

Why pay \$200.00 and upwards? You can use your present ice-box - We supply special parts - Costs only \$34.00 complete - Easily made - No special tools required - Operating cost, quality and size of machine same as well known makes - Complete blue-prints and thorough instructions - \$1.00



B.&L. ENGINEERING Co. 62 Greenville Ave. Jersey City, N.J.

Mobiloil

Start a Business of Your Own EARN \$150. to \$300. PROFIT MONTHLY -

Mechanics, Repair Men, Filling Stations, Garages are all making big money with "8-Hour Battery Charging"—requires small space. Practically no investment. Any one can operate. Charges batteries in $\frac{1}{2}$ the time with $\frac{1}{2}$ the current bill. Recommended by car and battery makers. Every car driver a customer.

30 DAYS' TRIAL—Pay out of Profit Terms

Other profitable businesses built with HB 20-minute Car Washes, Test Bench Service, Spray Painting and Arc Welding. HB won't cost you a cent. Easily pays for itself out of profits and leaves a handsome salary besides. Full particulars if you check the items below and mail to—

HOBART BROTHERS, Box M11, Troy, Ohio



HB AIR COMPRESSOR
\$12. MONTHLY



HB CAR WASHER
\$24. MO.



HB PAINT SPRAY
\$10. MO.



HB TEST BENCH
\$16. MO.



HB CHARGER
\$16. MO.

STARTLING NEW INVENTION!

The Perfect Fountain Pen Screw Peg Makes This Pen Work Perfectly

The peg as shown below holds point firmly and regulates flow of ink. By screwing the peg tight against the point ink flow is reduced, by loosening it a trifle the ink flows more freely, therefore will not blot or clog. Excellent for all writing purposes. Makes carbon copies. Nothing to get out of order. Socket of pen covers two-thirds of point, consequently will write instantly and ink will not dry on point. Point easily removed.

**I
D
E
A
L
A
S
X
M
A
S
G
I
F
T**

Comes packed in attractive holly box, Ladies' or men's style. Beautiful colors.

**GUARANTEED
A LIFETIME**

**MONEY BACK IF NOT
PLEASED**

SELLS FOR \$1.25

SAMPLE

**60c DOZ.
\$6.42**

**FREE WHOLESALE
CATALOG**

showing over 600 fast sellers from many parts of the world. Many ideal Xmas gifts, articles for the home, office specialties, school supplies, etc., are shown at wholesale prices. **WRITE FOR YOUR COPY NOW.**

SPORS IMPT. CO.

1130 Main St. Lesueur Center, Minn.

GET DOLLARS FROM AUTO-GAS FUMES

New auto invention turns crank case gas fumes into power—speed—miles. Reduces running costs. Increases efficiency. 1,000 being distributed for advertising purposes. Send name, address, make of car. No obligation.

H. W. ROBINSON & CO. 903 MAJESTIC BLDG. DETROIT, MICH.

Do Your PRINTING

Cards, stationery, circulars, advertising, labels etc. Save money. **Print for Others, Big Profits;** easy rules sent. Do Raised Printing like Engraving. Junior Press, \$5.50, Job Presses \$11 up, Power \$149. Write for free catalog or fill in and mail coupon. **The Kelsey Co., C-37, Meriden, Ct.** Please send me free catalog of your printing presses and all details.

Name _____
Address _____
City or Town & State _____

Successful Selling by Mail

There *IS* a way—a sure way—know what to sell; how to sell with investment needed to assure success. **NO OCCASION** for doubt or worry. The new masterpiece treatise—the mature experience mail sales specialists and advertising counsellors of national reputation called "The Price of Admission" opens new portals of profit for you in selling by mail.

New. Very Different. Authentic. Dependable
Handsome four-page folder describes treatise in detail. Yours for one red stamp.

F. S. McBURNEY, Wilkinsburg, Pennsylvania

POWER GENERATOR for

**SHORT WAVE
BROADCASTING \$750**
Reg. Price was \$75



U. S. Gov. power generator for radio transmitting made by Westinghouse. Ideal for Amateur Broadcasting. Limited quantity purchased from U. S. Gov. Signal Corps. 250 to 350 meters, 200 watts, 100 Volt, R P M 4500. Can be connected direct, belt driven or wind propelled for Aeroplanes. Guaranteed new and perfect. Worth \$75.00, but while they last, only \$7.50, charges prepaid. Send check or money order.

NATIONAL JOBBING & EXPORT COMPANY
192 N. CLARK ST. Dept. 22 CHICAGO, ILL.

NEW ZEP-LITES FOR YOUR AUTO!

Give Zep-Lites for Christmas

Install these beautiful chrome-plated lamps on your fenders and radiator cap for safer night driving. Racy lines. Redside lens on left lamp, green on right. Add class to any car. Complete with bulbs, wiring, etc. Easily installed. Write today for free illustrated folder.

Terpedo Light Co., 581 St. Clair Ave., Detroit, Mich.

Dealers and Agents Wanted

WE PAID \$93.00 TO KIMBALL FOR ONE WEEKS WORK

You can do as well. Show our all-wool union-made tailored-to-measure suit samples. **Biggest cash profits daily,** besides liberal bonus. Wonderful values—smarter styles. Easy orders. **FREE OUTFIT** of nearly 100 large swatches and instructions. No experience required.

PIONEER TAILORING CO., Dept. A-1116 Congress and Throop Sts., Chicago, Ill.

**All Wool
SUITS
\$23.75**

A Real 6" Bench Saw

Heavy cast metal TABLE, 8"x11 1/2" rigid and strong. Heavy duty 5/8" bearings with rollers for adjustment. Maximized steel (range on shaft for true running. Best 1/2" pulley. Table instantly removable to use STAND for grinding, buffing or polishing wheels, or for drum or disc sander. Oil well lubrication. Shipped by express. Money back if not satisfied.

Send for free catalog on this and other C-A Equipment
C-A MANUFACTURING CO.
213 E. South St. Indianapolis, Ind.

See Table Stand & Pulley

DEAFNESS IS MISERY



Many people with defective hearing and Head Noises enjoy conversation, go to Theatre and Church because they use Leonard Invisible Ear Drums which resemble Tiny Megaphones fitting in the Ear entirely out of sight. No wires, batteries or head piece. They are inexpensive. Write for booklet and sworn statement of the inventor, himself deaf.



A. O. LEONARD, Inc., Suite 699, 70 5th Ave., New York

New Units, New Features, New Improvements in Complete 1931 "Delta" Woodworking Line



No more drudgery—no more tedious hand work when you use "Delta" motor-driven tools. Working with wood becomes a real pleasure with the help of these time-saving, efficient, practical machines.

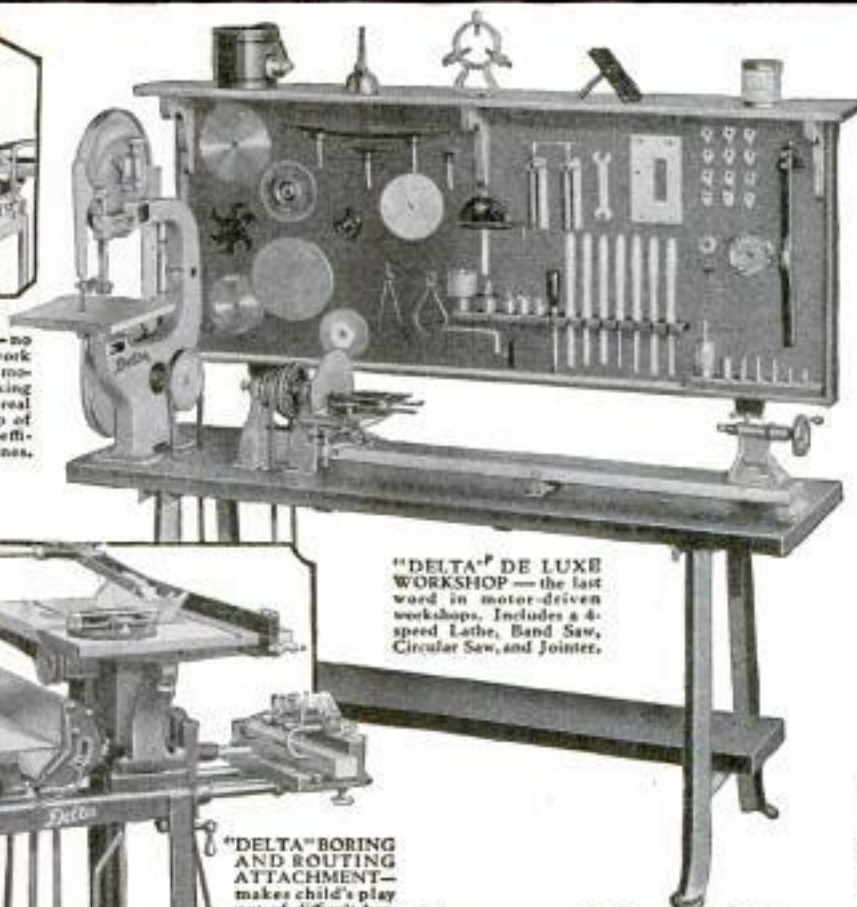

"DELTA" DE LUXE WORKSHOP—the last word in motor-driven workshops. Includes a 4-speed Lathe, Band Saw, Circular Saw, and Jointer.



"DELTA" BAND SAW has many exclusive features. Provided with special extra-safe guard. Furnished with or without stand.

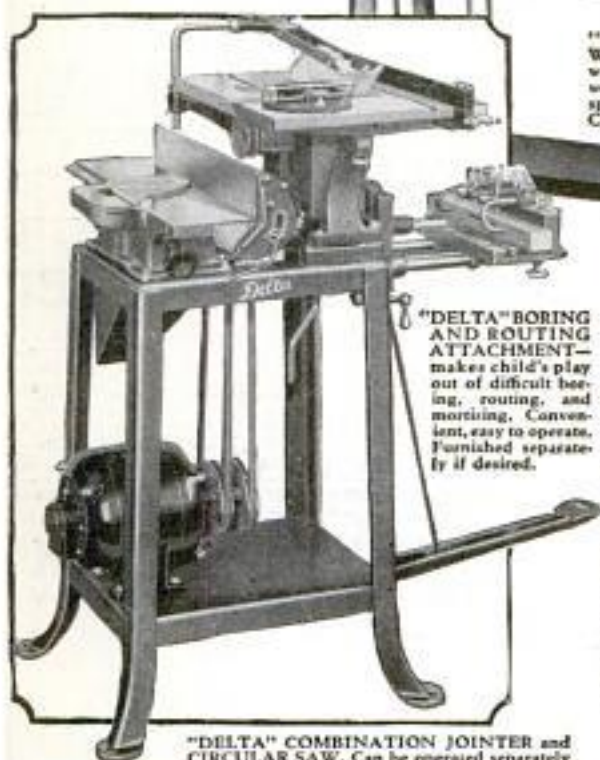

"DELTA" BORING AND ROUTING ATTACHMENT—makes child's play out of difficult boring, routing, and mortising. Convenient, easy to operate. Furnished separately if desired.

Practical Motor-Driven Woodworking Equipment Now Within Reach of All

Again "Delta" blazes the trail toward woodworking efficiency with the announcement of its new 1931 line! Now are available at astonishingly low price levels a complete series of compact, rugged woodworking machines incorporating numerous exclusive constructional features. Each unit embodies the practical, efficient design, the careful workmanship, the dependable quality of materials—for which the "Delta" trademark stands. The new "Delta" Boring and Routing Machine, the "De Luxe" Workshop, the new "Delta" Band Saw, as well as the improved "Handi-Shop" are but a few of the Delta Units that will be of intense interest to all those who work with wood. All units now operate with either electric or gasoline motor power.

Make Things Quickly and Easily With These Modern Motor-Driven Tools

They save time and labor, and produce better work for artisans, farmers and mechanics. Up-to-date craftsmen everywhere are flocking to motor-driven woodworking equipment to eliminate tedious hand labor. And for full or spare-time work, "Delta" Units quickly pay for themselves.

10-Day Trial EASY TERMS

Send coupon today for free illustrated literature describing the new 1931 "Delta" line. Also details of 10-Day Trial Offer and Easy Payment Plan.

DELTA SPECIALTY COMPANY
Division of DELTA MFG. CO.
1661-67 Holton Street Dept. A.131
MILWAUKEE, WISCONSIN

Delta Specialty Co., 1661-7 Holton St., Milwaukee, Wis., Dept. A.131

Gentlemen: Please send me FREE illustrated literature describing 1931 "Delta" line and details of 10-day Trial Offer and Easy Payment Plan. (Check items of particular interest.)

- "De Luxe" Shop Routing Machine
 Handi-Shop Jointer
 Band Saw Circular Saw
 Line-Shaft Shop Moulding Cutter

Name.....

Address.....

Age.....

"DELTA" HANDI-SHOP—A complete, compact, practical motor-driven workshop. Popular priced. Includes equipment for wood-turning, circular-sawing, scroll-sawing, boring, sanding, grinding and buffing

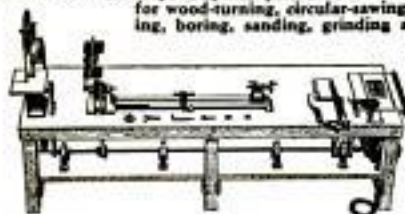

"DELTA" LINE-SHAFT SHOP

Includes 4-speed Lathes, Band Saw, Jointer and Circular Saw. Operates with either gasoline or electric motor. Very efficient.

IF YOU CAN USE AN EXTRA \$20.00 BILL

write for
this

FREE BOOK

You can save \$20.00 in no
time by using

SMOOTH-ON No. 1

to do your own household
repairing—and in addition
you will have that proud "I-did-it-myself" feeling.

Here is what one enthusiast did with two 35 cent cans:—A \$25 lamp stand loose in base, two big leaks in heating furnace smoke pipe, loose hammer handle, and three loose hooks in tiled bathroom wall were all put into good usable condition at an average cost of 10 cents each for the seven repairs—and \$20.00 easily saved over what would have been paid to professional fixers or for new parts.

By using Smooth-On to make dozens of the simple repairs necessary in every home, you can save enough to pay your radio upkeep, buy yourself or your wife a camera, a bull pup or some other pleasure-giving article that you would otherwise hate to spend the money for.

The free Smooth-On Repair Book will show you how an astonishing number of home and automobile repairs are as easy for you to make as for somebody else, also how you can make cellar walls, concrete floors, etc., water and damp proof with Smooth-On No. 7.



Mail the coupon for a free copy and
get Smooth-On No. 1 in 7-ounce or 1 or
6-pound can from any hardware store.

SMOOTH-ON MFG. CO.
Dept. 37, 574 Communipaw Ave.
JERSEY CITY, N. J.

Do it with **SMOOTH-ON**

SMOOTH-ON MFG. CO., Dept. 37,
574 Communipaw Ave., Jersey City, N. J.

Please send the free Smooth-On Repair Book.

Name.....

Address.....

Return this coupon for a
FREE copy of Booklet

1-31

Boys—

REGISTERED TRADE MARK
CHEMCRAFT
THE CHEMICAL OUTFIT

brings you real
fun with the
wonders of
chemistry!



This is
No. 2
\$2.00

YOU can learn about science of chemistry and have a lot of fun
at the same time—with a CHEMCRAFT Outfit. Work all
kinds of interesting, useful experiments and perform many amazing feats of
chemical magic. CHEMCRAFT is the original chemistry set; the most complete,
accurate and scientific. Has more and better experiments, superior chemicals and
apparatus. CHEMCRAFT gives the most for the money—for the best chemistry fun,
get CHEMCRAFT.

Select Yours from These Fine Outfits

No. 1—\$1.00	No. 3½—\$3.00	No. 10—\$10.00
No. 2—2.00	No. 8 — 3.00	No. 15— 15.00

No. 25—De Luxe Chemical Laboratory.....\$25.00
(Nos. 5, 10, 15 and 20 come in handsome wood cabinets)

Ask for CHEMCRAFT by name—and look for the name CHEMCRAFT on the box—then
you will get the best chemistry set.

Try Chemistry for 25c

Get CHEMCRAFT JUNIOR and do lots
of interesting experiments and magic
tricks. Complete outfit and instructions
postpaid for 25c.

Free Magazine for Boys

Contains experiments you can do at
home; also ideas on chemistry and wood-
working. Send for your free copy right
away.

The PORTER CHEMICAL COMPANY

96 East Washington Street, Hagerstown, Md.

New Orange Juicer



Clever new machine ends squeezing,
straining, seeding, necessary with old-
type juicers. Simply turn handle, gives up 25%
more juice. Priced amazingly low. Housewives,
hotels, restaurants, etc., buy on sight. Big com-
mission—up to \$4 an hour full time, spare time.
Write quick for BIG MONEY offers!

KWIKWAY PRODUCTS, Inc.
Dpt. A-120, 1415 Pine St., St. Louis, Mo.

366 SHORT CUTS FOR

CARPENTRY WORK

Popular Mechanics Carpenter's Handbook is filled
with illustrated short cuts and improved methods for
doing all sorts of carpentry work and odd jobs. Each idea
was discovered by a practical man in the course of his work.
Each idea is practical, a time-saver, a money-saver. The
229 Pictures are so clear that in many cases, the picture itself
explains the short cut. This new book is a book for profes-
sional carpenters, for amateurs, and for boys. It is destined
to be just as popular as the many other handbooks published
in recent months. This new book is beautifully bound in golden
brown cloth, is a handy size, and sells for the remarkably
low price of \$1.50.

Send No Money Simply write a postal saying
that you want Popular Me-
chanics Carpenter's Handbook. It will be sent C. O. D. and
you may pay the postman the price of the book and the few
cents postage when he delivers the book to you. If you live
outside the U. S. or if you are not at home when the postman
delivers your mail, send \$1.50 with your order.

POPULAR MECHANICS PRESS

Room 710, Popular Mechanics Bldg., 200 E. Ontario Street, Chicago, Ill.

WE START YOU IN BUSINESS

Eakins Co., 128 High St., Springfield, O.

Mail at once your free catalog about
how to make big profits in the
Crispette business with little capital.



Name.....

Address.....

\$1000 a Month Profits Possible

Copyrighted material

A NEW TRACTOR FROM YOUR OLD FORD

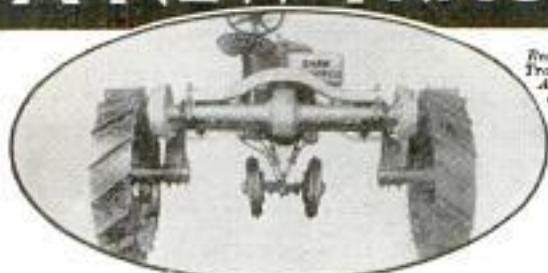

Rear view of SHAW Tractor showing HIGH ARCH. Clears tall corn, cultivating 2 rows at once.

EASY TO BUILD—WE TELL YOU HOW!



Special designed fan keeps engine cool always.

For Model "T" and "A" Fords, and Chevrolets

NEW HIGH ARCH MODEL — 30-INCH CLEARANCE

The SHAW'S Massive Traction Wheels give firm footing on spongy soil.



SHAW pulling two 12-in. moldboard plows.



George E. Walters, Prospect Plains, N. J., discing with SHAW-Tractorized Ford. Handles a disc harrow at rate of 12 acres per day.

DOES ALL FARM WORK!

HAVE a powerful, dependable tractor at amazingly low cost. A tractor which, tests have proved, does all farm power work as well as an expensive tractor. All you need is an old Model "T" or "A" Ford, or Chevrolet . . . and the inexpensive SHAW Tractor Equipment.

New HIGH ARCH feature makes SHAW-Tractorized Ford or Chevrolet especially suitable for cultivating corn. Straddles 30-in. stalks, cultivating 1 or 2 rows at once, without touching.

Amazing Performance . . . The SHAW cultivates 15 to 20 acres per day. Handles 16-in. plow nicely. Many use two 12-in. plows. Easily pulls 7-ft. disc harrow. Pulls five 31-in. lawn mowers. Pulls heavy, steel road drag. Can also be used for discing, seeding, hauling, etc. And need never be idle! When not in field, can be kept busy running feed grinders, wood saws, pumps, etc. Does more for small amount of money invested than any other tractor on market.

Easy to Attach SHAW Equipment in a short time, with monkey wrench and screw driver. You don't have to be a mechanic. We furnish all parts. Provide complete, easy-to-follow instructions, with illustrations. Equipment can be fitted to either full length chassis (shown above) or to sawed-off chassis.

Pays for Itself . . . the SHAW-Tractorized car is such a remarkable time, labor and money-saver, it usually pays for itself in one short season. With moldboard plow turns about 5 to 10 acres per day, depending on the equipment.

Special Low Introductory Price on new HIGH ARCH Model. Less than regular low factory price. **For short time only!** . . . until we get a number of them on the market. So act quickly . . . and save! Mail Coupon for details and price . . . at once!

SHAW MFG. CO.
4501 Center St., GALESBURG, KANSAS



SHAW DU-ALL Garden Tractor equipped with Briggs and Stratton engine. Fine for small farms, truck gardens, estates. Write for details.

Surprisingly Low Cost to own a SHAW-Tractorized car. SHAW Equipment is priced astonishingly low! If you haven't an old Ford, you can pick up an old Model "T" Ford or Chevrolet for \$15 to \$25; or a Model "A" Ford chassis, which has had the body wrecked, very cheap. Many early Model "A" Fords now being converted into SHAW Tractors. SHAW Equipment, bought now for a Model "T" Ford, can be used later on a Model "A."

FREE LITERATURE!

Coupon below brings FREE Literature containing full information, and Special Low Introductory Price on new HIGH ARCH Model. Also FREE 32-page SHAW DU-ALL Garden Tractor Catalog, and Generous Offer to Agents, on request. Mail Coupon today!



MAIL COUPON NOW!

SHAW MFG. CO., 4501 Center St., Galesburg, Kansas.

Please send me the FREE Literature checked below. I understand there is no obligation on my part.

Literature on Making Ford or Chevrolet into a Tractor. Big 32-Page SHAW DU-ALL Tractor Catalog. Generous Offer to Agents.

Name.....

Address.....

Town..... State.....

LOWEST PRICES in years for KALAMAZOO Quality

Save 1/3 to 1/2

New FREE book quotes **Lowest Prices in Years** for Kalamazoo quality. **Only \$5 Down** on any stove, range or furnace. 200 styles and sizes. Coal and Wood Ranges, Furnaces \$55⁴⁵ Up



Gas and Combination Ranges, Heaters and Furnaces, 24-hour shipments. 30-day FREE Trial. Satisfaction or money back. 30 years in business. 750,000 customers. Write today for FREE book.



Ranges \$38⁵⁵ Up

Kalamazoo Stove Co., Mfrs.
391 Rochester Avenue
Kalamazoo, Mich.

**"A Kalamazoo
Direct to You"**

HOPPE'S Gun Cleaning Pack, \$1.

Keeps guns free from rust and fouling. Contains Hoppe's No. 9 Solvent, Lubricating Oil and Gun Grease. Enough for 6 seasons. At all dealers or direct. 10c brings you sample No. 9 and new 16-page Guide for Gun Protection.

FRANK A. HOPPE, Inc. 2309 N. 8th St., Phila., Pa.



It's a BULOVA—Sent with a Mesh Band! For \$1.00

TAKE 12 MONTHS TO PAY

Send \$1.00 with order and tell us a little about yourself: (A) How long at present address, (B) Age, (C) Married or Single, (D) Name of Employer, (E) Position, (F) How long employed. All information held **strictly confidential**. We make no direct inquiries of anyone—not even from your employer.

10 Days Free Trial—Satisfaction Guaranteed

This genuine Bulova watch comes to you postage paid—no C.O.D. to pay on arrival. You take no risk—satisfaction guaranteed or money back.

Estab.
1895

\$29⁷⁵
DGS-

15 jewel BULOVA gent's wrist watch. White Gold filled case; "dust-tite" protector; radium dial and hands; latest woven mesh wristband. Guaranteed. \$1 now. \$2.39 a too. Nationally advertised each price, no extra charge for credit.

Catalog New catalog of genuine diamonds, standard nationally advertised watches, fine jewelry. Write for it now.

ROYAL DIAMOND & WATCH CO.

ADDRESS DEPT. 11 N 170 BROADWAY, N.Y.

BUSINESS BOOKS TO INCREASE YOUR PERSONAL EFFICIENCY

Rational Typewriting, Brief Course \$1.00

(Gregg System.) Ideal for individual study without the aid of an instructor.

Personal Efficiency \$2.00

By JAMES S. KNOX. Deals largely with the development of personality, one of the big factors in successful salesmanship.

Making the Business Speech Effective . . \$2.00

By HARRY C. SPILLMAN. Practical suggestions for speech making, with outlines and analyses by one of the country's foremost orators.

Personality—Studies in Personal Development . . \$1.50

By HARRY C. SPILLMAN. A wholesome, vigorous book on the development of personal efficiency.

Gregg Shorthand Manual \$1.50

By R. S. GREGG. A complete exposition of the Gregg System of Shorthand.

Gregg Speed Studies \$1.20

By J. R. GREGG. A combined supplementary book and dictation course dealing with speed and accuracy.

Salesmanship and Business Efficiency . . . \$2.50

By JAMES S. KNOX. A companion book to the author's other book "Personal Efficiency."

Any of the above books sent C.O.D. anywhere in the U. S. A. Simply pay postman price and the few cents postage when he delivers the package. If outside U. S., send remittance with order.

POPULAR MECHANICS PRESS

Room P-1 200 East Ontario Street CHICAGO

BLUEPRINT READING For the Building Trades



Every man who is ambitious to learn the last detail of blueprint reading will want this new book which is thorough, complete and up-to-the-minute. Written in a clear, non-technical manner. An ideal working tool for apprentices, teachers, students, carpenters, bricklayers, etc.

Over 100 pages—50 plans and illustrations.

Cloth—Price \$1.25 postpaid

Popular Mechanics Press

Room P 1

200 E. Ontario St. Chicago

What Do You Do When You Cannot Find the Book You Want ?

Don't give up in despair. Send for a copy of the unique catalog published by Popular Mechanics Press. It contains 5000 books listed alphabetically under 2000 main subjects and sub-headings—literally from A to Z—Abrasives Manufacture to Zoologist and everything in between.

FREE UPON REQUEST

Send for your copy today

POPULAR MECHANICS PRESS

200 E. Ontario Street, CHICAGO



No. 11
without Ratchet Stop

No. 11RS
with Ratchet Stop

Range 0 to 1" by thousandths
of an inch



True Value!

— a moderately priced
micrometer of
Brown & Sharpe Quality

For the man who wants a first quality, reliable micrometer caliper at a moderate price, there is no better "buy" than a Brown & Sharpe No. 11.

Careful workmanship, clean cut graduations and the Brown & Sharpe high standard of accuracy make the No. 11 a very desirable micrometer.

The distinctive shape of the frame permits measuring over projections or in shallow slots — a feature which appeals to most mechanics. Frame has a durable japan finish.

The popularity of Micrometer No. 11 is due to the convenience of the tool and the exceptional quality available for a moderate price.

Have your dealer show you Micrometer No. 11 and ask him for our Small Tool Catalog No. 31 describing over 2300 useful tools. If he cannot supply you, write us. Dept. P. M., Brown & Sharpe Mfg. Co., Providence, R. I., U. S. A.

Other Popular Brown & Sharpe Tools

Toolmakers'
Clamp
No. 756

Fillet and Radius
Gauge
No. 627

Combination
Square
No. 401

Vest Pocket
Speed Indicator
No. 746

Outside Spring
Calliper
No. 811



Brown & Sharpe Tools

"WORLD'S STANDARD OF ACCURACY"

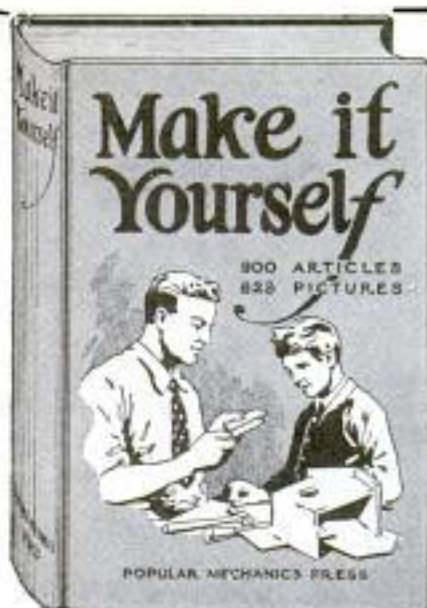

For Your Home Workshop

You should have a copy of this book recently published by Popular Mechanics entitled

Make It Yourself

The home mechanic, whether young or old, amateur or professional, will take pride and delight in making many of the things described therein.

Both father and son will find fascination and an association of interest in making useful and ornamental articles for mother to admire upon their completion.

900 Articles All Different

There are attractive ship models, a great variety of toys that operate themselves by means of an ingenious application of mechanical principles, novel amusement devices for indoors and outdoors, for both water and land, unique designs in furniture for children, scores of useful appliances for the home, things of beauty and utility for lawn and garden, etc.

Special articles instruct the amateur mechanic in the care and use of tools, special tools for special purposes, how to read and use plans, how to solder, the making of a handy work bench, cuts, joints and methods in woodworking, automobile repairing, installing radio equipment, house wiring, fixture hanging, working in glass, leather, metal, celluloid, lathe work, utilizing parts of old machines to make equipment that would be expensive to buy, etc.

Some of the Articles:

Tools for the Home Mechanic	Monorail Coaster
Ship Model Maker's Tools	Writing Cabinet
Build Your Own Ship Model	Workbench
Ship Model Plans	Tea Wagon
Water Sprite	Radio Apparatus
Puzzles	Lawn Canopy
Crazy Clown	Camp Car
Walking Wampus	California Cooler
Winter Toboggan Slide	Musical Instruments
Colonial Bric-a-Brac	Hedge Trimmer
Merry-Go-Twist	Homemade Baseball Game
Wiggling Pup	Small Turbine Motor
Black Cat Bench	Tools from Sewing Machines
Christmas Toys	Small Valves
Skating Whirligig	Bench Lathe
Venetian Swing	Auto Glare Shield
Bird Houses	Sesaw Merry-Go-Round
	Ferris Wheel

480 Pages — 823 Illustrations. Price \$3.00

Mailed Postpaid upon receipt of price anywhere in the world. If you reside in U. S., Hawaii, Porto Rico, Alaska or Mexico, we will send the book by mail C. O. D. if you prefer. Simply pay postman when he delivers the package.

POPULAR MECHANICS PRESS (ROOM P-7)
200 East Ontario St. Chicago, Ill.

The Model A Ford Car

is treated in a special supplement to the latest edition, the 15th, of

Dyke's Auto Encyclopedia

For 15 years "Dyke's" has been the one recognized and undisputed authority on the Automobile. Each succeeding edition has surpassed the last one. Now comes the greatest book of all—the wonderful 15th Edition—A. L. Dyke's crowning triumph—the super auto book of all times.

Some "High Spots" of the New Book!

1,249 pages covering every known auto fact.
4,200 Pictures, Plans, Diagrams and Charts.
15,000 lines of Index by which you can instantly locate any subject you want.
A new section of "Trouble Shooting" Charts in Colors to enable you to quickly locate any major or minor trouble on any car.
Special instructions on testing and adjusting every part of the automobile.
Specifications of Gasoline Passenger Cars, Trucks and Tractors.



Specifications for Replacements, Accessories, Interchangeable Parts and Equipment.

Large colored Combination Chart which shows the working principles of the Automobile.

Large Charts showing the working principles of Trucks and Tractors.

Cloth \$6.00; Limp American Morocco \$7.50

Sent postpaid upon receipt of price.

Will be sent C. O. D. if preferred to any address in the U. S.

POPULAR MECHANICS PRESS
Room P-7
200 E. Ontario St.,
Chicago

NEED A BETTER GRIP ON MATHEMATICS?



SEND for a copy of "Mathematics for the Practical Man," only \$1.50. By common sense methods it removes the mystery and difficulties so that algebra and even calculus are made simple.

Assuming your knowledge is limited to arithmetic you quickly and easily gain a working knowledge of Algebra, Geometry, Trigonometry and Calculus. Simply pay postman price of book plus the postage when he hands you the package.

Popular Mechanics Press
Room P 10
200 E. Ontario Street, Chicago

Mathematics Made Easy by ROPP'S CALCULATOR AND SHORT-CUT ARITHMETIC

Shows the Answer as Quickly as a Watch shows the Time to all Problems likely to occur in the Office, Store, Shop, Bank, Farm, or Factory.

Over 2,000,000 Sold

Explains and simplifies every principle in Arithmetic, Mechanics, and Mensuration.

PRICES POSTPAID

Desk Size, Flexible Keratol Binding..... \$2.00
Pocket Size, Art Leather Binding..... \$1.00
Pocket Size, Cloth Binding, \$0.50

POPULAR MECHANICS PRESS
Room P10 200 E. Ontario St. CHICAGO

New Model SOUTH BEND LATHES

Back Geared Screw Cutting Precision Lathes FOR EVERY INDUSTRIAL USE

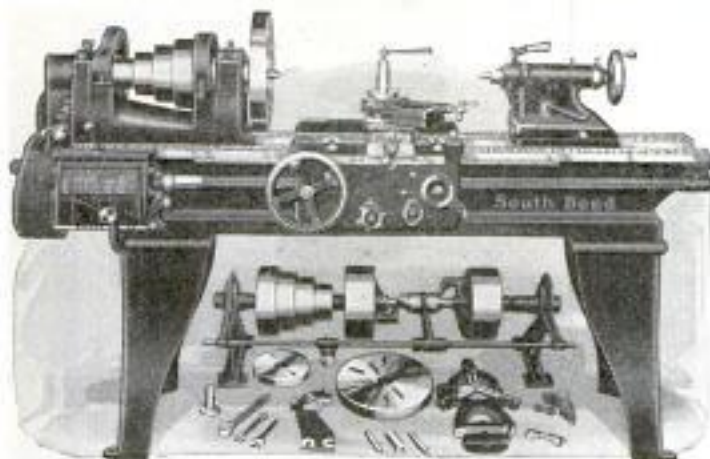

16" x 6' Quick Change Gear
New Model South Bend Lathe **\$598**

Prices of Other Quick Change Gear Lathes

Size of Lathe	Shipping Weight	Countershaft Drive	Silent Chain Motor Drive
9" x 3'	490 lbs.	\$294.00	\$398.00
11" x 4'	725 lbs.	\$359.00	\$498.00
13" x 5'	1110 lbs.	\$443.00	\$602.00
15" x 6'	1550 lbs.	\$543.00	\$720.00
16" x 8'	2035 lbs.	\$638.00	\$817.00

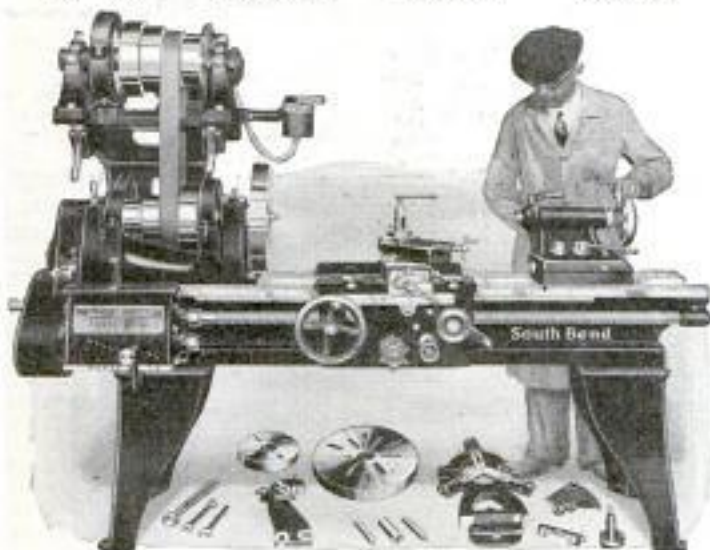

18" x 8' Quick Change Gear Silent Chain
Motor Driven Lathe with Motor
and Equipment as shown . . . **\$997**

The South Bend Lathe Works is represented by machinery dealers and importers throughout the world who carry South Bend Lathes in stock.

South Bend Lathe Works

632 E. Madison St., South Bend, Indiana, U.S.A.
Lathe Builders for 24 Years—Over 50,000 South Bend Lathes in Use

OUTSTANDING leaders in every field of American Industry use South Bend Lathes in production and tool room work. The new model South Bend Lathes are built in 96 sizes and types, 9" to 18" swing, 3' to 12' bed length—a type for every requirement.

More than 50,000 South Bend Lathes are used by industries in 78 countries. Recent purchasers are:

American Tel. and Tel. Co.
General Electric Company
General Motors Corporation
International Harvester Co.
National Cash Register Co.
New York Central R. R.
Olympic Steamship Company
Pratt and Whitney Aircraft Co.
Radio Corporation of America

Write for These Books

"HOW TO RUN A LATHE"
25c Postpaid

Latest edition of this famous work, contains 160 pages and more than 300 illustrations. Simplest, most complete and practical book on lathe operation. Shows how to handle more than 400 different types of lathe jobs as practiced in modern machine shops. Sent postpaid for only 25 cents; coin or stamps of any country accepted.

Catalog No. 91-A
Free

This 104 page book illustrates, describes and prices the 96 different sizes and types of new model South Bend Lathes. Send coupon for your copy, free.

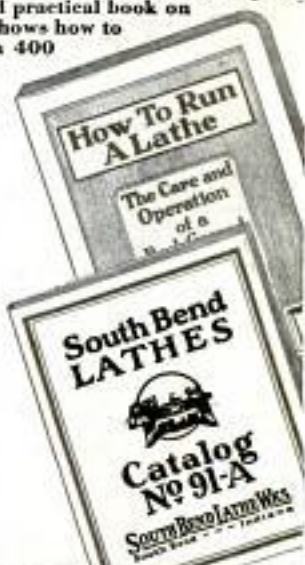

SOUTH BEND LATHE WORKS

632 E. Madison St. South Bend, Ind. U.S.A.

Gentlemen: Please send me book checked.

- "How to Run a Lathe" (25c)
 Catalog No. 91-A (Free)

Name _____

Address _____

City _____

State _____



Isn't she worth fighting for?

SHE believes in you and trusts you and she's depending on you to fight some of her battles for her.

As wife or mother, she can't go out in the world and earn the money necessary to support a family in comfort. That is your job.

Are you fair to her when you let the days drift by without making a real effort to get ahead? Is it right to ask her to scrimp and save and deny herself when with just a little grit and effort you could provide her with the comforts and luxuries she would like to have?

Think this over—then act! Decide today that you are going to get the special training that is becoming more and more necessary in every line of business.

There is an easy, fascinating way to do it. Right at home, in the spare time that now goes to waste, the International Correspondence Schools will prepare you for advancement and more money.

At least find out how by marking and mailing the same salary-raising coupon that has meant so much to so many other men in just your circumstances.

It doesn't cost you a penny or obligate you in any way to do this, but it may be the means of changing your entire life. Do it now. Do it for HER.

Mail Coupon for Free Booklet

INTERNATIONAL CORRESPONDENCE SCHOOLS
"The Universal University"
Box 5523-G, Scranton, Penna.

Without cost or obligation, please send me a copy of your booklet, "Who Wins and Why," and full particulars about the subject before which I have marked X:

TECHNICAL AND INDUSTRIAL COURSES

- | | |
|--|--|
| <input type="checkbox"/> Architect | <input type="checkbox"/> Automobile Mechanic |
| <input type="checkbox"/> Architectural Draftsman | <input type="checkbox"/> Plumbing <input type="checkbox"/> Steam Fitting |
| <input type="checkbox"/> Building Estimating | <input type="checkbox"/> Heating <input type="checkbox"/> Ventilation |
| <input type="checkbox"/> Wood Millworking | <input type="checkbox"/> Sheet Metal Worker |
| <input type="checkbox"/> Contractor and Builder | <input type="checkbox"/> Steam Engineer |
| <input type="checkbox"/> Structural Draftsman | <input type="checkbox"/> Steam Electric Engineer |
| <input type="checkbox"/> Structural Engineer | <input type="checkbox"/> Civil Engineer |
| <input type="checkbox"/> Electric Wiring | <input type="checkbox"/> Surveying and Mapping |
| <input type="checkbox"/> Electrical Engineer | <input type="checkbox"/> Refrigeration |
| <input type="checkbox"/> Electric Lighting | <input type="checkbox"/> R. R. Locomotives |
| <input type="checkbox"/> Welding, Electric and Gas | <input type="checkbox"/> R. R. Section Foreman |
| <input type="checkbox"/> Reading Shop Blueprints | <input type="checkbox"/> R. R. Bridge and Building Foreman |
| <input type="checkbox"/> Telegraph Engineer | <input type="checkbox"/> Air Brakes <input type="checkbox"/> Train Operation |
| <input type="checkbox"/> Telephone Work | <input type="checkbox"/> Highway Engineering |
| <input type="checkbox"/> Mechanical Engineer | <input type="checkbox"/> Chemistry <input type="checkbox"/> Pharmacy |
| <input type="checkbox"/> Mechanical Draftsman | <input type="checkbox"/> Coal Mining Engineer |
| <input type="checkbox"/> Machinist <input type="checkbox"/> Toolmaker | <input type="checkbox"/> Navigation <input type="checkbox"/> Boilermaker |
| <input type="checkbox"/> Patternmaker | <input type="checkbox"/> Textile Overseer or Supt. |
| <input type="checkbox"/> Pipefitter <input type="checkbox"/> Tinsmith | <input type="checkbox"/> Cotton Manufacturing |
| <input type="checkbox"/> Bridge Engineer | <input type="checkbox"/> Woolen Manufacturing |
| <input type="checkbox"/> Bridge and Building Foreman | <input type="checkbox"/> Agriculture <input type="checkbox"/> Fruit Growing |
| <input type="checkbox"/> Gas Engines <input type="checkbox"/> Diesel Engines | <input type="checkbox"/> Poultry Farming <input type="checkbox"/> Radio |
| <input type="checkbox"/> Aviation Engines | <input type="checkbox"/> Marine Engineer |

BUSINESS TRAINING COURSES

- | | |
|---|--|
| <input type="checkbox"/> Business Management | <input type="checkbox"/> Business Correspondence |
| <input type="checkbox"/> Office Management | <input type="checkbox"/> Lettering Show Cards <input type="checkbox"/> Signs |
| <input type="checkbox"/> Industrial Management | <input type="checkbox"/> Stenography and Typing |
| <input type="checkbox"/> Personnel Management | <input type="checkbox"/> Complete Commercial |
| <input type="checkbox"/> Traffic Management | <input type="checkbox"/> Civil Service <input type="checkbox"/> Mail Carrier |
| <input type="checkbox"/> Accountancy <input type="checkbox"/> Cost Accountant | <input type="checkbox"/> Railway Mail Clerk |
| <input type="checkbox"/> C. P. Accountant | <input type="checkbox"/> Grade School Subjects |
| <input type="checkbox"/> Bookkeeping | <input type="checkbox"/> High School Subjects |
| <input type="checkbox"/> Secretarial Work | <input type="checkbox"/> College Preparatory |
| <input type="checkbox"/> Spanish <input type="checkbox"/> French | <input type="checkbox"/> Illustrating <input type="checkbox"/> Cartooning |
| <input type="checkbox"/> Salesmanship <input type="checkbox"/> Advertising | <input type="checkbox"/> Lumber Dealer |

Name.....

Address.....

City..... State.....

Occupation.....

If you reside in Canada, send this coupon to the International Correspondence Schools, Canadian, Limited, Montreal, Canada

MAKE

\$25

A DAY

Get yours! Have steady work and big pay 52 weeks a year. Bosses lay you off. Work for yourself and keep going. No thrill like it.

BE A FLOOR SURFACING MAN AND MAKE BIG MONEY

Keep busy all winter. Crawford, Colo., made \$134.35 in 74 hours. Ivory, Pa., made \$400.00 on one job. Nowood, Ark., made \$75.00 in 12 hours. Start now. No experience needed. Big demand everywhere for surfacing old and new floors. All you need is an American High Production Sander or a Handy Sander. No office, furniture, help or other expense. By our easy payment plan few dollars starts you. Balance as you earn it. Nice, sweet, easy, warm, inside work all winter.

THIS IS YOUR CHANCE

Be your own boss. Get the big, easy, steady, sure money. Keep going—no layoffs. Keep all the profits on your labor. We start you, furnish complete plans for getting business, instructions, advertising, circulars with your name, prices to charge, etc. Write now.

The American Floor Surfacing Machine Company

523 S. St. Clair St.
TOLEDO,
OHIO

Painting—Decorating Sign Making Art Work

Whatever help you may need along these lines, here is a list of books to choose from. They will enable you to do better work.

House Painting Methods.....	\$2.00
Mixing of Colors and Paints.....	2.00
Graining and Marbling.....	.75
Automobile Painting.....	1.50
Interior Wall Decoration.....	4.00
New Stencils and Their Use.....	1.25
Furniture, Furniture Finishing, Decoration and Patching.....	5.00
Wood Finishing, Plain and Decorative.....	2.00
The Ross Crane Book of Home Furnishing and Decoration.....	3.00
New Hardwood Finishing.....	1.50
The Lacquer System of Sign Painting.....	3.00
Art of Show Card Writing.....	4.00
Studio Handbook—Letter and Design.....	3.00
How to Draw Funny Pictures.....	3.00
Layouts for Advertising.....	3.00
Chalk Talk and Crayon Presentation.....	1.25

NO RISK ORDER PLAN

Pick out any of the above books you want and send us your order with remittance. We will mail the books postpaid. If, for any reason, you are not satisfied with your purchase, return to us and your money will be refunded. Address:

POPULAR MECHANICS PRESS
Room P1—200 E. Ontario St., Chicago, Ill.

FREE TRIAL
Send No Money

Only 12¢ a Day

Soon Pays for this

GUARANTEED

UNDERWOOD

(Refinished)

Save $\frac{1}{2}$ Mfg's. Price
Orgl. Price

Be your own salesman and save \$50.10. Sell yourself during the 10 day FREE trial on the amazing Bargain this World Famous Underwood really is. The finest—the most popular model ever built. Use and enjoy the Underwood as your own for full 10 days—at our risk. Write all your business letters and personal correspondence you wish—see the beautiful, neat, accurate work it does. Compare its sparkling, bright and shiny looks with any brand new Typewriter costing twice as much.



NOW ONLY \$49.90

On Easy Terms

Regular \$100 Model

Through an exceedingly fortunate deal, direct with the manufacturer, we offer this World-Famous Underwood No. 5 (Standard \$100 office model) all completely refinished and renewed for only \$49.90 on the easiest terms ever offered. **Save yourself over $\frac{1}{2}$ the manufacturer's original price!** by dealing direct with us. Sell yourself—during our 10 day FREE trial offer. No one to influence you—no red tape. Simply try the Underwood at our risk.

Complete Touch Typewriting Course FREE!
Learn Touch Typewriting Free!

Make "Good" money every week in full or spare time with your typewriter. Big possibilities and steady pay for stenographers or typists doing work for local business houses. Every grocery, druggist, general merchant and lawyer has constant need for spare or full time typists and stenographers. We furnish complete (Home-Study) Course of the famous Van Sant System, during this offer. Easily and Quickly learned—Fully Illustrated.



Special

International Typewriter Exchange
231 W. Monroe St., Chicago, Ill., Dept. 101

Please send special offer on Underwood No. 5, F.O.B. Chicago; for 10 days' Free Trial. If I am satisfied and keep it I will send \$3.50 a month until the sensational low price of \$49.90 is paid. Otherwise I may return it within 10 days, Express Collect. It is understood this Free Trial request does not obligate me to keep the typewriter.

Name.....Age.....

Address.....

Town.....State.....

2 Million Users

Think of it—2,000,000 satisfied users of the famous Underwood No. 5 paid \$100 for their typewriters. We are offering these very same typewriters, beautifully refinished and renewed, at actually less than $\frac{1}{2}$ the manufacturer's original price. Terms are **NOW** easier than ever before—less than 12¢ a day (in easy payments of only \$3.50 per month). **NO MONEY DOWN—10 days' Free Trial.** Every machine carries our Written Guarantee of perfect satisfaction and workmanship.

Fully Guaranteed

Why pay more when you can now own this fine typewriter at the sensational low price of only \$49.90 (direct to you) and on the easiest terms ever offered—**NO MONEY DOWN.** Every machine **fully** Guaranteed and sent on 10 days' Free Trial—at our risk. Don't delay—fill in and send coupon **AT ONCE!**

Modern Features

Standard 4-row Keyboard (84 Characters)
2-Color Ribbon
Back Spacer
Ribbon Reverse
Tabulator
Automatic Release
Shift Lock Key

You Actually Save \$50.10

Our direct to you selling policy saves you over \$50 from the Mfg's. original price of this genuine Underwood. Expensive old time methods of traveling salesmen, commissions, and dealers throughout the country now all eliminated. **You get the benefit of this saving.** We ship direct to you. Only by accepting our Free Trial offer can you actually see and realize the **amazing bargain** this Underwood really is. Send No Money—No Deposit of any kind—just use the coupon.

International Typewriter Exchange
231 W. Monroe St. Dept. 101 Chicago, Illinois

World Famous Radio Receivers

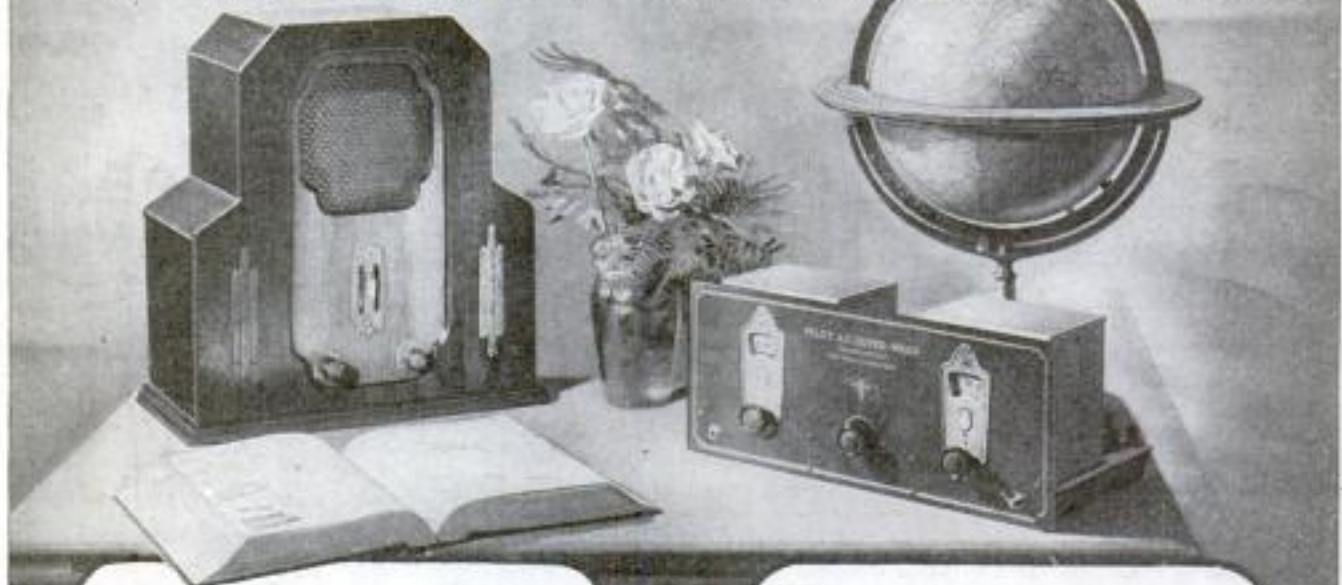

Console Quality

in a Midget Broadcast Receiver
You Can Place Anywhere

PILOT MIDGET

This attractive two-tone walnut miniature A. C. receiver has proved the equal of high priced consoles in many locations throughout the country. Because—it embodies console features; 2-224 Screen Grid stages, 1-224 Screen Grid Power detector, 1-227 Audio stage, 1-245 Power Audio output stage and specially designed electro dynamic speaker. A super powered 280 voltage supply gives trouble-free operation from any 110-20 volt house current line.

Pilotron tubes are standard equipment because Pilot retailers know none are more reliable.

PRICE
Complete in
Modernistic
Cabinet

\$59.50
less tubes

For World-Wide Radio Reception

Short and Long Waves, 14 to 300 Meters

PILOT Super-Wasp

Rev. J. W. Nilson, Bolongue, Congo-Belge Africa says: "Here in the heart of Africa I have received 9LD, JB, 2BL, 3SW, AFK, PCJ, WGY (W2XAF), WRNY (W2XAL) and more stations on loud speaker with my Pilot Super-Wasp."

David W. J. Jones, Brisbane, Australia says: "I have received on my Super-Wasp all the test transmissions between W2XAF (Schenectady, U. S. A.) and VK2ME (Sydney NSW), Aero, ICT Holland, GSSW England and Sydney—London phone service."

Austin R. Baldwin, St. Raphael (Var.) France, says: "I heard from KDKA 25.4 meters. We will now rebroadcast a concert from London." Shortly after the music from London came in clearly, having twice crossed the Atlantic."

Pilot Super-Wasp Comes in KIT FORM
which can be assembled in a few hours

BATTERY SET KIT

\$29.50

Kit K-110: The battery-operated Super-Wasp. Batteries and Tubes extra.

A. C. SET KIT

\$34.50

Kit K-111: The A.C. Super-Wasp. Use your own ABC pack or Pilot K-111, specially designed for the Super-Wasp. Power Pack and Tubes extra.

**PILOTRON
RADIO
TUBES**

ENDORSED BY
PROFESSIONALS



PILOT RADIO & TUBE CORPORATION

LICENSED UNDER
RCA PATENTS

It Dealers Everywhere or Write to

PILOT RADIO & TUBE CORPORATION
LAWRENCE, MASS.

Chicago Office:
231 S. Wells Street

New York Office: 325 Broadway
OFFICES IN PRINCIPAL COUNTRIES OF THE WORLD

San Francisco Office:
1278 Mission Street

New WORKACE WOODWORKER

Complete 5 Foot Electric Workshop



Enjoy Leisure Hours or Add to Your Income . . .

Relax from everyday cares — enjoy the pleasure and profit of the famous Workace Woodworker. Under the magic of the whirring saw, planer, jig saw, lathe, sander, drill, grinder and buffer, you can make hundreds of useful articles from raw lumber. Make furniture, household necessities; work out your own ideas with your own complete electric woodshop. Workace is a real man-size machine. Carpenters, pattern shops, school shops and others use it for saving time and handwork. Sturdy, accurate, easy to set up for any operation.

There's no better hobby for a man—no better gift for a growing boy. Workace provides a man building outlet for youthful energy and enthusiasm. Man or boy will appreciate this wonder machine. Only \$9.00 down will bring it. Send coupon for full size illustration and complete details.

8
Motor Driven
MACHINES
FOR THE PRICE
OF ONE

Operates from Electric Light Socket

\$9.00
DOWN
\$9.00 A MONTH
FOR 10 MONTHS
OR **\$89.00** CASH

What You Get

8" Circular Saw
4" Planer - - - - 6" x 36" Lathe
Jig Saw Attachment
8" Disc Sander - - - - 6" Buffer
5" Emery Grinder
1/2" Drill Chuck
1/2 h.p. G.E. Motor, 110 volt, A.C.
50 or 60 cycle - - Endless "V" Belt
2 Two-Stepped "V" Pulleys
10 ft. Cable with Separable Plug
Planer Guard, Saw Guard, Splitter
Cast Iron Base for Assembling
All Units.

The Planer and Circular Saws are each complete units and may be purchased separately at the correspondingly low price of \$25.00 each.

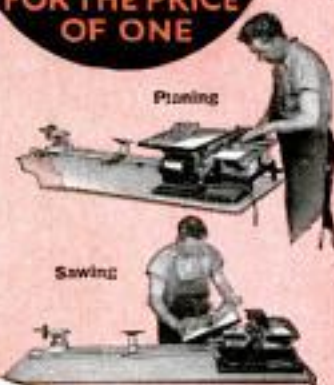

FREE OFFER

With the new model Workace Woodworker we include the Jig Saw attachment, planer guard and saw guard and splitter—a total of \$14.00 extra value—FREE. You get \$18.00 worth of machinery for \$39.00 with easy terms if you want them.

The Workace Woodworker is made by J. D. Wallace & Co. — world's largest manufacturers of portable woodworking machines. Their vast experience and resources make it possible to offer such amazing value.

Ask About these Workace Machines

Workace Shop Woodworker
Workace Planer Saw - Workace Radial Saw - Workace Kut'n Jigger - Workace Jig Saw - Workace Planer - Workace Bandsaw - Workace Electric Shaper.

Send for Special Bulletins on these machines.

Send coupon for full size illustration of Workace

J. D. WALLACE & COMPANY
Adams Street at California Avenue, Chicago, Ill.
11 W. 42nd St., New York City - - - 268 Market St., San Francisco, Calif.

MAIL COUPON NOW!

J. D. Wallace & Co., Adams St. at California Av., Chicago
11 W. 42nd St., New York City, 268 Market St., San Francisco

Please send me full size illustration and particulars about the Workace Woodworker.

Name.....

Firm.....

Address.....

Consult telephone directories for branch addresses in other cities.

You Play This Instrument On the Day You Get It!



Are You *Inside* or *Outside* This Picture? *Something to think about!*

Ralph Smith, Chicago, played the Xylorimba 20 minutes at a wedding; his pay was \$20.

The musical Hallmans, Reading, Pa., average \$65 a week in sparetime.

Sam Herman, celebrated xylophonist—member of "The Eight Victor Artists"—famous for their Victor Records and concert tours—became the player that he is without the aid of a teacher.

If as someone has said, "Life is what we make it," are you entirely satisfied with *your* life? Is your presence *demand*ed at gatherings, parties and dances or are you just "among those present"? Are you having the fun and pleasure that some of the fellows are having? Are you able, when you feel so inclined, to add \$5 to \$25 to your bank roll in exchange for an evening of work that is "play"?

No? Then by all means look into this opportunity! Just imagine! Here is an instrument that makes a "hit" wherever you take it and yet is the easiest of all instruments to play! No teacher—no finger or lip exercises—no tiresome practice. Five minutes after you get your Xylorimba, you can play a simple melody—even if you can't read a note of music right now. In an amazingly short time you are dazzling friends and relatives with snappy dance numbers, dreamy waltzes, rhythmic popular selections.

Xylorimba numbers are *always* popular. That is why they are so much in demand at parties and dances, in radio studios and on the stage. Everyone envies the fellow who plays them. That might just as well be you.

FIVE DAYS' TRIAL—A YEAR TO PAY— this, briefly, is the bona fide offer of the world's largest manufacturer of xylophonic instruments. I take the risk because I want you to have the same chance that has placed hundreds of others on the road to more fun, friends and profit than they ever had before. Summer and winter, you, as a xylorimbist, are able to create your own music, please your friends, make big extra-time money! *A lifetime of musical joy* in exchange for the determination to investigate!

BIG BOOK FREE!

With these things in mind, I suggest for your own sake that you send in the coupon. By return mail I will forward **WITHOUT COST**, the big Deagan book that tells all about the Deagan line—the money some fellows are making with Deagan instruments—the free easy lessons—the 5-day free trial offer—the wonderful easy payment plan. There is no cost and no obligation. Simply fill in and mail the coupon. There is one way to be sure a thing will be done—that way is to do it **AT ONCE**. *Today* is as good a day as any.

J. C. DEAGAN, Inc., Dept. 451, 1770 Berens Ave., Chicago
Send me without obligation, details of Free Trial offer and easy-payment plan on the Deagan Xylorimba.

Name _____
Address _____

**START
TO PLAY
VERY FIRST
DAY!**

**NO
TIRESOME
PRACTICE**

**5 DAYS
TRIAL
IN YOUR
OWN
HOME**

**FUN,
PROFIT,
POPULARITY**

**No
Teacher**

**A YEAR
TO PAY**

Copyrighted material