

# POPULAR MECHANICS

## MAGAZINE

WRITTEN SO YOU CAN UNDERSTAND

REG'D. TRADE MARK, GREAT BRITAIN, NO. 410426

REG. U.S. PAT. OFF.

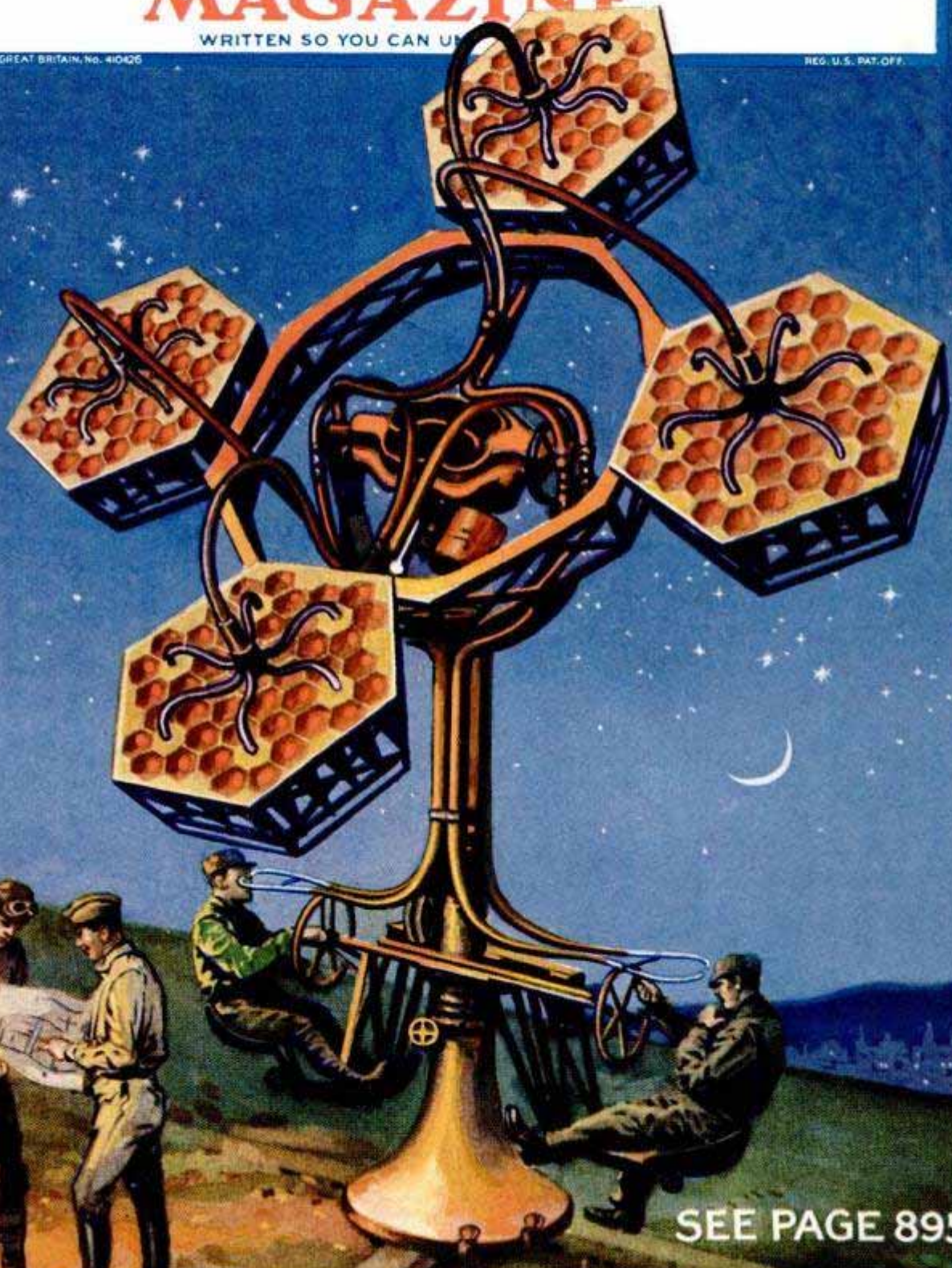

SEE PAGE 895

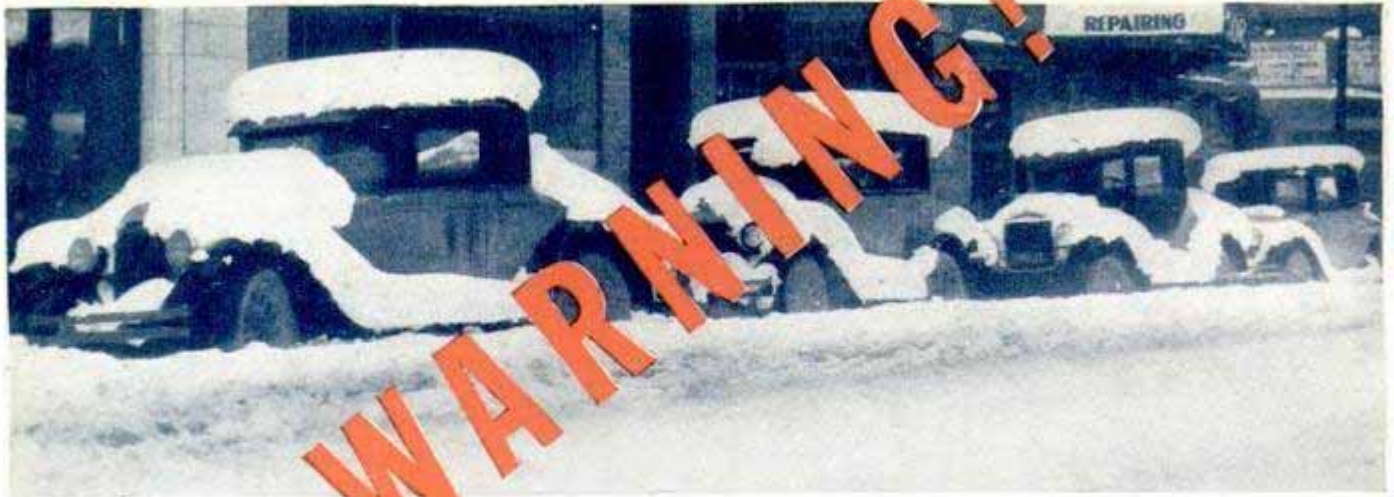

# From below freezing to almost boiling in 5 minutes!

It takes "double-range" Mobiloil to protect your engine from this gruelling winter wear.

These extremes of temperature require your oil to do its job under vastly different working conditions. Mobiloil Arctic meets these conditions because it is a *double-range* oil. It flows freely even below zero. This gives you easy starting and sure circulation. Yet it keeps its rich body and gives full lubrication at hot running temperatures.

If you are using a heavy summer oil, at freezing temperatures, your oil becomes thick and cold-stiffened. The oil can not circulate promptly. Then a few moments of "dry" running brings deadly wear to your engine.

If you use an ordinary "winter oil" you may get easy starting.

But many such oils are merely thinned oils. When your engine heats up, they fail to give protective lubrication.

Mobiloil Arctic stands alone among winter oils because it does not compromise with winter cold or with engine heat. It is the *double-range* winter oil.

Play safe this winter. Have your Mobiloil dealer drain your crankcase and refill with Mobiloil Arctic today! Then ask him for Mobiloil "CW" for your gears. On coldest days Mobiloil "CW" remains soft and cushions each gear tooth from wear. You will be delighted at the new ease with which your gears engage.



## VACUUM OIL CO.

We invite you to listen to the Mobiloil Concert, broadcast each Wednesday evening at 8:30, E. S. T., from WEAJ and 29 associated stations.

# Mobiloil

**ARCTIC** for your engine

**"CW"** for your gears

# BOYS!! a college education!

## ENROLL IN THE FISHER BODY CRAFTSMAN'S GUILD

984 awards valued at \$50,000  
offered for excellence in craftsmanship

How would you like a Scholarship to your favorite University or College, *with all expenses paid for four years?* This opportunity is open to you when you enroll in the Fisher Body Craftsman's Guild. And there are no fees or dues of any kind connected with membership.

Like the famous Craft Guilds of olden times, the Fisher Body Craftsman's Guild was founded to honor and advance the art of fine workmanship. But never in the history of the world have boys enjoyed such opportunities for reward and self-advancement as this modern Guild now offers you!

In addition to four University Scholarships of four years each, valued at \$5,000 apiece, there are 980 other substantial awards, bringing the combined value to more than \$50,000! Included are trips to the world's greatest automobile center, with recognition leading to careers in industry, as well as numerous awards in gold amounting to \$16,000.

### *Awards go to boys building the finest model Napoleonic Coaches*

To compete for the awards, each member of the Guild will be required to build a miniature model coach whose design is taken from two world-famous coaches used by Napoleon. Detailed drawings and instructions on how to

build it at every step will be supplied by the Guild.

The best coaches will be selected by an honorary Board of Judges, consisting of distinguished University Educators and headed by Daniel C. Beard, National Boy Scout Commissioner. The awards will be equally divided among two groups, one group for boys of 12 to 15 years, inclusive, and the other for boys of 16 to 19 years, inclusive. In this way, every member will have an equal opportunity to share in the valuable awards.

### **ENROLL NOW, WITH NEAREST GENERAL MOTORS DEALER**

If you are between the ages of 12 to 19 years, inclusive, just go to any Dealer for Cadillac-La Salle, Buick, Oldsmobile-Viking, Oakland-Pontiac or Chevrolet cars, and ask him to enroll you in the Guild. There are no fees or dues. In a few days, you will receive your membership certificate, button, and complete drawings of the miniature model Napoleonic coach that you will build.

The door of opportunity is wide open for any boy with the energy and enterprise to enter and take his place in the Fisher Body Craftsman's Guild.

Hurry. See a General Motors Car Dealer today and enroll!

### FISHER BODY CRAFTSMAN'S GUILD

Sponsored by FISHER BODY CORPORATION *Division of General Motors*

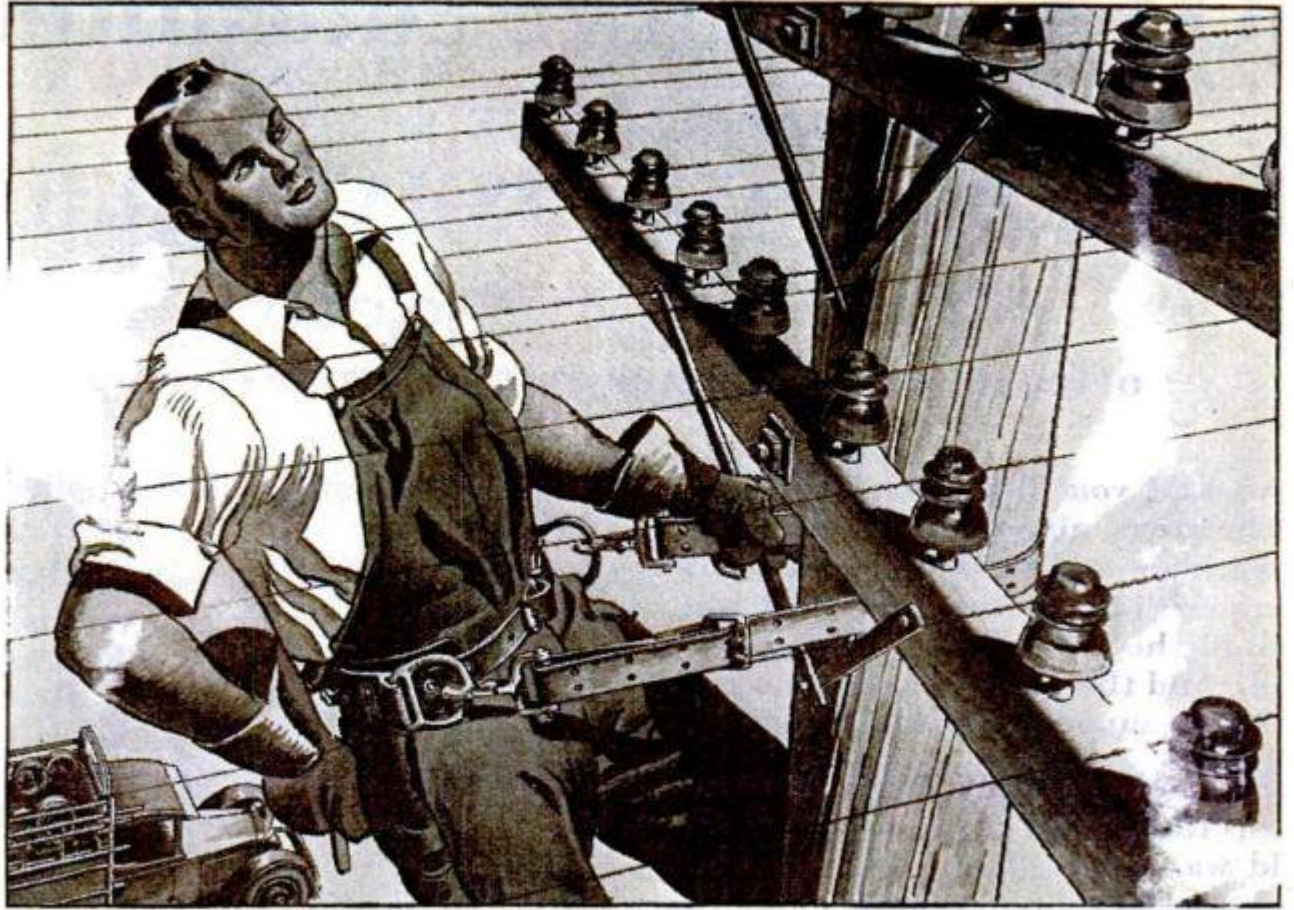

# The continent that became a neighborhood

*An Advertisement of the American Telephone and Telegraph Company*

THROUGH slim wires etched against the sky . . . through cables laid in the earth under cities and fields . . . millions of Americans, miles or days' journeys apart, speak to each other as readily as though they stood face to face.

Over his telephone, a housewife in a Wisconsin town inquires about a dress pattern from a friend who lives nearby. Over his telephone, a business man in Philadelphia talks to another in Denver. Over her telephone, a mother in Kansas asks her son at college fifty miles away if he will come home for the week-end. Over his telephone, a cabinet member in Washington gives instructions to an assistant in Seattle. Regardless of distance and the complexity of modern living, they talk directly and immediately with any one, anywhere, at any time they choose.

The function of the Bell Telephone

System is the vital one of making it possible to maintain social and business contacts in cities that contain many times more people than this nation once boasted . . . a neighborhood which the Census reports hold 127 million people. Year after year from its beginning, the Bell System has increased its facilities, its personnel and its usefulness. Looking ahead and planning for the future, it has forwarded the growth of this nation by meeting its communication needs fully and economically. Today it overcomes the hindrances of distance and time . . . and unifies a civilization geared to the habit of instantaneous communication.

Because it serves all who call on it, by enriching their lives and helping to make their enterprises more successful, the telephone plays an increasingly useful part in the every-day activities of the American people.



# Popular Mechanics Magazine

200 E. Ontario Street, Chicago, U. S. A.

H. H. WINDSOR, Founder

H. H. WINDSOR, Jr., Editor and Publisher

London: Hachette & Cie.,  
3 La Belle Sauvage, Ludgate Hill, W. C. 2

Paris: Hachette & Cie.,  
111 Rue Reaumur

Melbourne: Gordon & Gotch  
509-513 Little Collins St.

ISSUED MONTHLY

SUBSCRIPTION:

SINGLE COPY, 25 CENTS

In United States and its possessions, Canada, Cuba, Mexico, and all }  
countries in the Pan-American Postal Union, per year, postpaid } . . . . \$2.50

To all other countries in the Postal Union . . . . . 3.00

All subscriptions are discontinued at expiration. Please examine the date printed on your wrapper.

Entered as Second Class Matter Sept. 15, 1905, at the Post Office at Chicago, Illinois, under Act of March 3rd, 1879.

Entered as Second Class Matter at the Post Office Department, Canada.

Published monthly by POPULAR MECHANICS CO.

Copyright, 1930, by Popular Mechanics Co.

Copyright in Australia. Copyright in France

Vol. 54

Contents for December, 1930

No. 6

## Special Features

From Paddle Wheel to Electric Drive	898
High-Flying Mechanics	906
When Seeing Is Deceiving	915
Man's Mightiest Monument	920
They Get Their Man	929
Man-Made Star Guides Flyers	941
Flying Photographers Aid Engineers	947
What Is a Cloudburst?	953
Ir Davy Jones' Locker	962
Prophets and Their Prophecies	970
Raising the "Hindenburg"	995
Acoustics—clothes absorb sound	928
Agricultural Implements—farm-waste chopper helps improve the soil	928
Airplanes	
air-filled bags save planes in water landings	977
are found at night by glow of exhaust	914
engine fitted with wings seeks speed mark	926
plane in flight takes fuel from speeding auto	950
plane propelled by rockets	940
route wild horses	987
variable-wing monoplane	945
Airship—six million rivets in	918
Archaeology—solution of Mayan mystery	904
Atmosphere—how high up does the atmosphere extend	983
Atoms—huge towers draw lightning to smash	974
Automobiles	
one of world's first autos	940
rubber dough ends squeaks in bodies	993
wax and polish prevent auto sunburn	914
Automobiles, Accessories	
all doors lock at once by pressing button	951
bumper saves lives of pedestrians	992
celluloid curtain shields eyes	918
coat hanger keeps clothes tidy	951
extension for brake lever facilitates operation	966
footrest and folding table for	998
supercharger for small car increases acceleration	960
Automobiles, Cleaning—fountain-brush washer attached to garden hose	919
Automobiles, Design—aircraft lines add to speed and power	949
Automobiles, Lighting—service station on wheels	982
Automobiles, Tires—spare tire on swinging arm	985
Aviation	
one-way traffic for planes over London	981
robot air pilot keeps plane on true course	950
wind tunnel makes its own flying weather	978
Baldness—caused by arsenic and lead is curable	939
Basketball—coin-in-slot	987
Bench Grinder—drill sharpener is attached to	999
Boats and Boating	
auto converted into yacht	938
folding boat easily carried on auto trailer	987
Bottles—rubber stopper for withstands pressure	913
Bridges	
arches floated into position	913
skyscraper, to span San Francisco bay	902
Buildings—apartments built in circles	917
Bullets, Hydrogen—at a speed of 37,000 miles a second	925
Camel—shipped by airplane across Mediterranean	977
Chandelier—neon tubes give almost white light	946
Checks—alteration of, shown by ultraviolet light	942
Church—like giant pipe organ	928
City—most ancient American	955
Clocks	
huge, built of flowers keeps accurate time	914
lion roars and cock crows from cathedral tower	986
Coal—microbes found in	940
Cotton—field duster covers sixty rows at a time	959
Desert—sandstorm detector	925
Disease—pneumonia aid is found in cranberry bogs	982
Divers—go down deeper with aid of chamber	904
Diving	
banner carried by high diver fails to save his life	960
robot diver to help salvage sunken treasure ships	944
Electric Heater—with a fan gives warm or cool air	986

[Continued on Page 4]

Electricity  
from 20 881

Druggie  
Chopper, farm waste 928 967

Lightships 946

1 by 10 946

[Contents—Continued]

Exerciser—body swings in the frame of queer . . . . . 994  
 Fireboat—tiny, used to fight inaccessible blazes . . . . . 925  
 Football—automatic timer aids kicker . . . . . 939  
 Fruit Jar—screw-cap opener removes lid easily . . . . . 981  
 Glass  
 is considered a liquid . . . . . 918  
 tinted, aids in make-up and saves face . . . . . 951  
 Gliders—on ball-bearing post trains student flyers . . . . . 993  
 Golf  
 automobile-tire hazard on miniature course . . . . . 989  
 nine-hole table course . . . . . 982  
 pool is combined with, on miniature course . . . . . 999  
 set for parlor putting combined with ash tray . . . . . 993  
 stroke gauge helps player improve game . . . . . 998  
 Gun Sight—for birds in flight . . . . . 938  
 Guns, Ordnance—mortar railway gun to aid in defend-  
 ing coast . . . . . 951  
 Health—oxygen breathing room aids pneumonia victims . . . . . 952  
 Heating and Ventilating  
 flame balanced on air jet in firebox of boiler . . . . . 955  
 heat generated by motors used to warm buildings . . . . . 952  
 Horseshoes—fifteen tons of, collected by blacksmith . . . . . 939  
 Household Devices . . . . . 990  
 Insects—colored lights used in war against . . . . . 982  
 Invention—world's greatest hoax recalled by models . . . . . 986  
 letter—is dictated to coin-in-slot machine . . . . . 944  
 Lightning—picture of flash taken from airplane . . . . . 992  
 Lightning, Artificial—tests on high-tension line insu-  
 lators . . . . . 944  
 Loud Speaker  
 on upper deck of city motor coach . . . . . 997  
 produces chimes without bells . . . . . 918  
 Mailbags—give theft alarm if stolen in transit . . . . . 987  
 Metals—electric eye sorts by light reflections . . . . . 988  
 Mittens—for hunters leave gun fingers free . . . . . 977  
 Music—made by electricity . . . . . 994  
 Navy, Australian—gun turret used as "spare" . . . . . 919  
 Nuts—leak-proof, aids storage of fluids . . . . . 989  
 Oil Fields—failing, revived by action of water . . . . . 981  
 Paper—from seaweeds . . . . . 999  
 Photo-Electric Cell—magic "eye" for opera aids light-  
 ing effects . . . . . 943  
 Piano—"silent," is audible only to the player . . . . . 928  
 Pipe Lines—protected with expansion joint . . . . . 985  
 Plants—spraying under the leaves . . . . . 997  
 Poison Ivy—relieved by new drug . . . . . 940  
 Power Line—leaks detected by airplane patrol . . . . . 988  
 Power Plant—floating . . . . . 959  
 Radio  
 clock control tunes stations in advance . . . . . 918  
 hints and kinks from the radio lab . . . . . 1004  
 Radio, Aerial—light-socket antenna kink . . . . . 1010  
 Radio, Application  
 how heavens may be explored by radio beams . . . . . 988  
 radio waves start milking machine in test . . . . . 978  
 you can build this light-sensitive relay . . . . . 1000  
 Radio, Batteries—how to alter a.c. eliminators for d.c.  
 operation . . . . . 1006  
 Radio, Loud Speaker—sponge remedies "squawk" in . . . . . 1003  
 Radio, Receivers—short-wave receiver in unit form . . . . . 1006  
 Radio Reception  
 it's easy to locate man-made static sources . . . . . 1008  
 simple device for improving selectivity . . . . . 1007  
 Radio, Tubes—protecting tubes that are lighted by 32-  
 volt supply . . . . . 1007  
 Railroads—razing rail depot tests skill of engineers . . . . . 958  
 Ruler—rolling, saves eyes and time . . . . . 978  
 Safety Devices and Measures  
 down safety lane . . . . . 979  
 warning sign also gives road directions . . . . . 944  
 Ships and Shipping—huge fog siren on lightship op-  
 erated by air . . . . . 946  
 Smoke—photographic smoke finder . . . . . 994  
 Smokers' Accessories—valve in stem of pipe ends "bite" . . . . . 943  
 Spray Gun—for metal tinning . . . . . 989  
 Steel Tower—one mile high is found practical . . . . . 913  
 Tennis—mechanical "partner" permits practice alone . . . . . 981  
 Time—where the earth's surface begins—and ends . . . . . 928  
 Tornado—man looks inside of, and tells what he saw . . . . . 917  
 Traffic—elevated highway for autos . . . . . 955  
 Transportation—a pageant of transportation shows over  
 twenty centuries of travel . . . . . 956  
 Ultraviolet Rays—given off by ordinary gas stove . . . . . 966  
 Vase—rubber, for flowers . . . . . 918  
 Vibrator—portable electric . . . . . 952  
 Watch—that shows the date . . . . . 959  
 Weather  
 electric light in balloon tells wind direction . . . . . 939  
 long-distance weather seen in polar trips . . . . . 946  
 Whistles—train and steamer . . . . . 938  
 Wood—flame and waterproofing agent for . . . . . 998

AMATEUR MECHANICS

Animals, Miniature—made from pipe cleaners . . . . . 1015  
 Automobiles, Accessories  
 alcohol dripped on windshield prevents ice . . . . . 1030  
 clothes rack attached to auto top . . . . . 1028  
 hookless fastener used on radiator cover . . . . . 1032  
 Automobiles, Fuel—blowing into the tank starts this  
 siphon . . . . . 1035  
 Automobiles, Repairing—elastic supports for door pock-  
 ets . . . . . 1025  
 Bed—frame keeps covers off injured foot . . . . . 1035  
 Birds—squirrel-proof feed box . . . . . 1026  
 Boats and Boating—"Roamer" a speedy outboard  
 cruiser . . . . . 1018  
 Camera, Stereoscopic—cheap box cameras take stereo-  
 scopic views . . . . . 1014  
 Cartesian Diver—diver submerges only at master's will . . . . . 1029  
 Clock—large dial fitted to small clock . . . . . 1036  
 Clothespin Bag—hangs on line . . . . . 1034  
 Countersink—improvised . . . . . 1035  
 Drain Trap—flatiron used to thaw out frozen . . . . . 1028  
 Filter—efficient, easy to make . . . . . 1025  
 Fire Fighting—cheap substitute for hand fire grenade . . . . . 1032  
 Fish and Fishing—fish saved by wet hands . . . . . 1013  
 Furnace, Brazing—adjustable . . . . . 1036  
 Games—"tumbler golf" for your parlor . . . . . 1030  
 Garage—keeping motor warm in cold garage . . . . . 1027  
 Hammer—made of pipe holds supply of tacks . . . . . 1037  
 Hydrant—lantern in barrel prevents freezing . . . . . 1037  
 Kitchen Table—"roll-away" cover for . . . . . 1013  
 Letters—using paper clips in . . . . . 1029  
 Lights—store light controlled from outside . . . . . 1029  
 Magic—topsy-turvy match is clever bit of magic . . . . . 1033  
 Matches—brick makes handy holder . . . . . 1038  
 Monograms—preventing corrosion in deep engravings . . . . . 1027  
 Musical Instruments—breaking in stringed instruments . . . . . 1038  
 Nutcrackers—grotesque figures crack nuts . . . . . 1017  
 Pastry—guards for pie display on counter . . . . . 1015  
 Pen Light—finger grip holds . . . . . 1031  
 Photography  
 photographing close-ups with Graflex camera . . . . . 1017  
 single switch controls both lights in darkroom . . . . . 1027  
 trick photograph made with mirror . . . . . 1038  
 Potato Bin—an improvised . . . . . 1034  
 Safety Devices and Measures—carrying a danger sig-  
 nal on highways . . . . . 1026  
 Ship Models—making small boats for . . . . . 1016  
 Stamps, Postage—handy method of removing . . . . . 1028  
 Table, Bridge—lamps for . . . . . 1032  
 Telephone  
 made from oilcans . . . . . 1016  
 padlocking the . . . . . 1031  
 Toboggan—made of corrugated sheet steel . . . . . 1031  
 Tools—tool clamps wire on hose . . . . . 1013  
 Toys—amusing, easy to make . . . . . 1011  
 Wheelbarrow—runner for . . . . . 1037  
 Workbench—paper roll supplies continuous covering . . . . . 1036

SHOP NOTES

Automobiles, Accessories—oil cooler for model-A Ford . . . . . 1050  
 Automobiles, Repairing  
 Ford valve guide removes carbon from valve stems . . . . . 1047  
 heat treatment removes deep auto dents . . . . . 1049  
 removing spindle-bolt bushings . . . . . 1053  
 rubber disk catches valve-reamer cuttings . . . . . 1048  
 Book Ends—making a pair of hand-wrought . . . . . 1044  
 Building Paper—holder for . . . . . 1053  
 Concrete—rubber shield protects worker from flying  
 chips . . . . . 1054  
 Dowel—jig for boring holes true . . . . . 1048  
 Drawing Table—a cheap and practical . . . . . 1051  
 Drill Press—extension chuck . . . . . 1053  
 Electrolytic Rectifier—increasing capacity of . . . . . 1055  
 Grain Spout—clothespin holds sack on . . . . . 1055  
 Ice Pick—hose holder offsets danger of carrying . . . . . 1042  
 Inlay Banding—making band-inlay strips . . . . . 1039  
 Loading Platform—balanced skid for . . . . . 1054  
 Logs—hauling attachment for the farm wagon . . . . . 1050  
 Oil Drum—mounting for garage . . . . . 1042  
 Photography  
 photographic reflector easy to make . . . . . 1043  
 stretching photos cut too short . . . . . 1048  
 Pipes, Water—simple device for thawing electrically . . . . . 1056  
 Power Hammer—converting a tripod drill into . . . . . 1043  
 Sander—old auto parts make good disk . . . . . 1052  
 Saws and Sawing—extra handle increases comfort in  
 using a saw set . . . . . 1043  
 Sheet Metal Machines—revolving table for . . . . . 1055  
 Steam Engine—reabbtting bearings . . . . . 1054  
 Steel—cutting self-hardening . . . . . 1048  
 Trestle—carpenter's, aids in ripsawing . . . . . 1055

Lightship gas for dentures 883

See page 884 for 946

Actual motion 946

Road, corrugated iron

# How I MADE UP for JOHN'S Shrunken PAY CHECK

*How a Little  
Home  
Business  
Brought  
Independence  
to This Man  
and Woman*

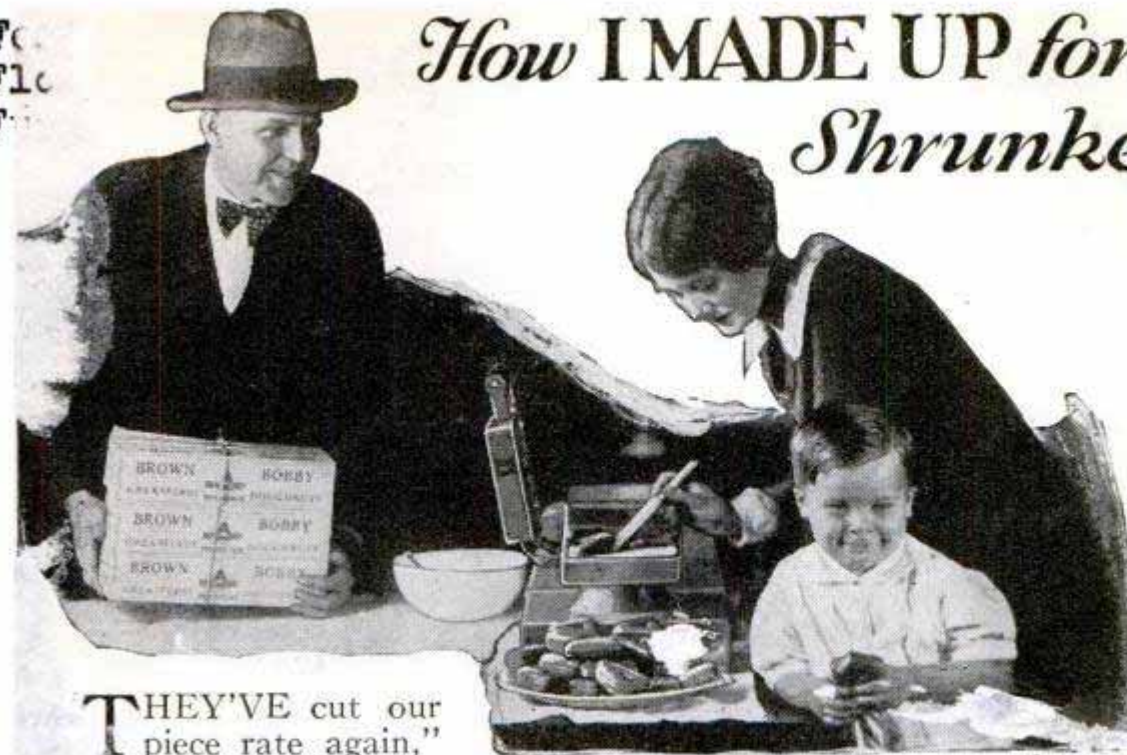

THEY'VE cut our piece rate again," I said bitterly as the family ate his supper. "I've been working at top speed and then only making a living, but now—"

It had been hard enough before but now—with John's pay check even smaller—I feared it would be impossible to see ends meet.

I fingered through the pages of a magazine and saw an advertisement telling women at home were making \$15.00 a week supplying Brown Bobby greaseless doughnuts.

"Can't you do the same?" I asked. "Why can't you do what others have done. Investigate!" I did. In a few days I received details of the Brown Bobby plan. It seemed too good to be true because I showed now I, without neglecting my housework or little Jimmy could easily make money.

To tell the story short, I went into the business without telling John. I passed out sample Brown Bobbys to my friends, gave out a few samples around restaurants, lined up a couple of grocery stores. In my first week, I sold 238 dozen Brown Bobbys at an average profit of 15c a dozen.

When John brought home his next pay check, he threw it down on the table and said gloomily, "I'm sorry, honey, but it's the best I can do."

"It's not the best you can do, darling, and

I almost cried when I told him of the money I had made selling Brown Bobbys. It was the happiest moment of my life.

Inside of three weeks John quit his job at the factory to devote all his time to Brown Bobbys. Now we are dissatisfied at less than \$150.00 a week.

Women interested in making \$15.00 to \$50.00 in their spare time are invited to write for details of the Brown Bobby plan to FOOD DISPLAY MACHINE CORP., Dept. 312, Chicago, Ill.

## MEN, TOO! Make Big Money

Men, here is a real, red hot money-making opportunity! It's a chance to jump into business for yourself and make more money every week than the average man makes in a month. Surprising as it may sound, we actually put you in a business, with the first day's income often running from \$18 to \$55. \$350 to \$600 the first month is not unusual for ambitious men.

### CUT IN ON THE BIG MONEY

All you need is the ambition to make real money. We supply you with complete equipment to make and sell that famous new food specialty—Brown Bobby—a greaseless doughnut baked by electricity!

### Goodwin Sells \$157.00 Worth in One Day

BROWN BOBBYS going big. Sold \$157.00 worth today. Last Saturday, our sales amounted to \$100.00, and the Saturday previous \$112.00. This certainly indicates that our business is rapidly increasing, and unquestionably will grow to great proportions.—William Goodwin.

### Stephens Clears \$20.00 Profit First Day

BROWN BOBBYS a sensation. Selling like wildfire. Keeping me busy night and day to supply demand. My first day's sales from one machine netted me \$20.00 clear profit. In the short time I have been operating I have sold over five thousand dozen BROWN BOBBYS. Selling all four machines can produce.—Stephens

### Start At Once ANYWHERE!

Men and women everywhere are starting in this business daily! YOU cannot afford to delay. Send the coupon at once! TODAY!

FOOD DISPLAY MACHINE CORP.,  
Dept. 312, 500-510 N. Dearborn St., Chicago, Ill.

Write

This One

Name

Address

City



56YP-6FO-6T20

# When they cut the pay roll

*~ will you be hunting for another job?*

It usually comes like a bolt from the blue—

You are called into the manager's office—he looks troubled, worried—reluctantly he explains that business isn't holding up, he has more men than he needs. *And what can he do?*

Suddenly it dawns on you that you're being politely told you're through!

No more security for you—no more steady money coming in—and in your pocket, perhaps, only enough to last out the month!

*You're cut off—and you've got to start selling your ability in competition with thousands of other men in the same fix!*

**W**HAT assurance is yours that when the "axe" falls, it will not hit you?

What assurance is yours that if you are suddenly thrown out of employment—through no fault of yours—you can always get back in, at an attractive salary?

Thousands of men—in every large city in America—are face to face with that problem now.

Upon some the "axe" has already fallen. They are trying as best they can to sell their services, yet they find themselves faced with the fact that the market is flooded with men who can offer just as much as they.

### **Men Who Are Never Fired** **—Steadily Promoted**

For thousands of others, however, the "axe" has not the slightest terror. Regardless of how drastically their employers chop the pay roll, they know they will steadily advance—either with the companies they now are serving or with others which need precisely what they have to offer.

For how can it be otherwise?

Suppose, for example, you could point to a cut of freight costs from

four per cent of gross sales to two per cent, on a sales volume running into the millions—as did W. H. Story, experienced, successful traffic manager for an Ohio corporation...

Or suppose you could point to some twenty-seven suggestions you had already made to your company, representing savings from \$20 to \$75 daily—as did J. R. Hollingsworth, in charge of a shift of men at one of the big factories in Akron...

Or suppose, as a trained salesman, you could increase the sales in your territory 50 per cent—as did I. A. Gould, Michigan district manager for the Smith Agricultural Chemical Company, Columbus, Ohio.

Or suppose that the balance sheet of your employer showed that—through your knowledge, as accountant, of the various factors that determine the success of a business enterprise—you had turned a loss

into a profit—as did E. W. Neir, manager of the Hotel Rowe, Grand Rapids.

Or suppose you could demonstrate specialized ability in Personnel Management, say, or Business Correspondence, or any one of a dozen other attractive fields of business where good men are always in demand and where proved ability quickly finds its reward in increased responsibility and increased pay.

How could any business man who was blessed with sense be persuaded to part with your services—*when very clearly those services were showing him a handsome profit!*

Can you afford to side-step so important a matter any longer—when at home, without losing an hour from work or a dollar of pay, you can *make your position sure, can steadily equip yourself for greater earning power?*

### **The Secret of Success** **PREPAREDNESS!**

On the coupon indicate the training that most clearly meets your need—fill in your name, address and present position, and place the coupon in the mail.

It will bring you—free—an attractive book clearly outlining the opportunities in the business field of your choice, together with a free copy of "Ten Years' Promotion in One," the book that has started thousands of men on the shorter path to a bigger income.

Do you mean what you say when you say that you want to get ahead?

*Prove it by what you do with this coupon—NOW!*

PAY ROLL		
NO.	NAME	SALARY
42	J. B. Brown	50.00
43	J. H. Smith	75.00
44	C. A. Carter	50.00
45	H. W. Perry	22.50
46	W. H. King	30.00
47	C. H. Smith	35.00
48	D. W. Collins	22.50

## LaSalle Extension University

THE WORLD'S LARGEST BUSINESS TRAINING INSTITUTION

### Find Yourself Through LaSalle!

LA SALLE EXTENSION UNIVERSITY

Dept. 1264-R

CHICAGO

I would welcome an outline of the new LaSalle plan, together with a copy of "Ten Years' Promotion in One," all without obligation.

- |                                                                               |                                                  |                                                            |
|-------------------------------------------------------------------------------|--------------------------------------------------|------------------------------------------------------------|
| <input type="checkbox"/> Business Management: Managerial, Sales and Executive | <input type="checkbox"/> Railway Accounting      | <input type="checkbox"/> Banking and Finance               |
| <input type="checkbox"/> Higher Accountancy                                   | <input type="checkbox"/> Modern Business Corres. | <input type="checkbox"/> Credit and Collection             |
| <input type="checkbox"/> Expert Bookkeeping                                   | <input type="checkbox"/> Paper Salesmanship      | <input type="checkbox"/> Correspondence                    |
| <input type="checkbox"/> C. P. A. Coaching                                    | <input type="checkbox"/> Law: LL.B. Degree       | <input type="checkbox"/> Business English                  |
| <input type="checkbox"/> Modern Salesmanship                                  | <input type="checkbox"/> Commercial Law          | <input type="checkbox"/> Effective Speaking                |
| <input type="checkbox"/> Traffic Management                                   | <input type="checkbox"/> Industrial Management   | <input type="checkbox"/> Commercial Spanish                |
| <input type="checkbox"/> Railway Station Mgmt.                                | <input type="checkbox"/> Modern Foremanship      | <input type="checkbox"/> Telegraphy—Railway and Commercial |
|                                                                               | <input type="checkbox"/> Personnel Management    |                                                            |

Name

Present Position

Address





# Just as EASY as it looks

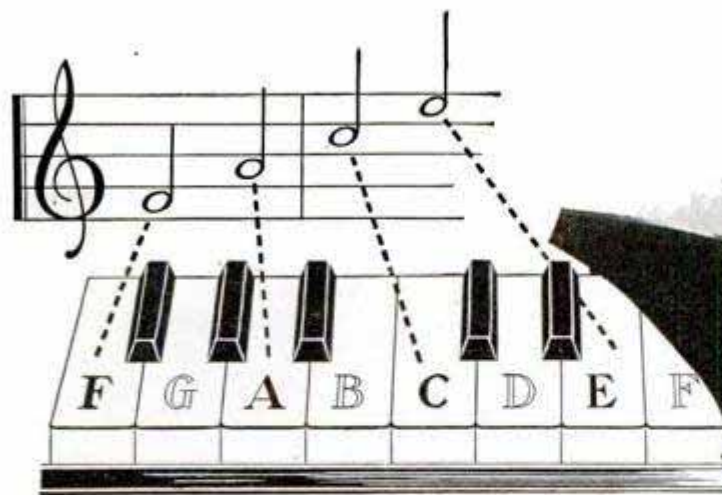

*to become a popular musician  
this delightful, simple as A-B-C way*

STOP cheating yourself out of musical good times. Stop thinking that learning music is nothing but one grinding session of monotonous exercises and harsh-sounding scales after another . . . months and years of difficult and dry-as-dust theory the thumb of a private

Let others talk you into any such thing. It's ridiculous! And we've added it to the complete list of over 600,000 enthusiastic students who have learned to play their favorite instrument right at home—without a teacher.

## You're Never in Hot Water

Take a look at the above diagram. Looks easy, doesn't it? Well, it's every bit as simple as it looks. First a note—then a letter. Plenty of clear instructions tell you how each bar is played—lots of diagram pictures show you how, then you do it yourself and hear it. Everything to make learning a joy. Nothing to make you lose patience. No headaches. In fact, the U. S. School of Music has made the reading and playing of music so downright simple that

you don't have to know one note from another to begin.

## Play Real Tunes From the Start

Your first thrill comes with your very first lesson. For you are given a piece with a real melody to play by actual notes. Dreamy waltzes, heart-throbbing ballads, stirring marches, sparkling sonatas, restful etudes follow in short order. No standing still. Progress is rapid. In this way, you become a capable performer months sooner than you could ever expect to the old-fashioned way. Yet, no matter what instrument you select, the cost of learning is the same—just an average cost of only a few cents a day.

Not only that, you receive all the music you need at no extra cost. With every lesson comes a specially selected and graded piece, which is yours to keep, enjoy and play to your heart's content.

## Play the "Blues" Away

How can you be content to sit around at party after party and listen to others do all the playing—hear them receive all the compliments—see them showered with admiration, attention, invitations—when your lifelong ambition to become a popular musician is now so easy to realize. Get in the musical "swim" yourself. Watch the singing, happy crowds gather around you as you play the latest syncopation. Experience the personal satisfaction that comes from being able to play "when," "where" and "what" you like for your own amusement and the entertainment of others.

Don't be afraid to begin your lessons at once. Over 600,000 people

learned to play this modern way—and found it as easy as A-B-C. Forget that old-fashioned idea that you need special "talent." Just read the list of instruments in the panel, decide which one you want to play, and the U. S. School will do the rest. And bear in mind, no matter which instrument you choose, the cost in time will average the same—just a few cents a day. No matter whether you are a mere beginner or already a good performer, you will be interested in learning about this new and wonderful method.

## Send for Our Free Book and Demonstration Lesson

Our wonderful illustrated Free Book and our Free Demonstration Lesson explain all about this remarkable method. They prove just how anyone can learn to play his favorite instrument by note in almost no time and for just a fraction of what old, slow methods cost. The booklet will also tell you all about the amazing new *Automatic Finger Control*.

Read the list of instruments to the left, decide which you want to play, and the U. S. School of Music will do the rest. Act NOW. Clip and mail this coupon today, and the fascinating Free Book and Free Demonstration Lesson will be sent to you at once. No obligation. Instruments supplied when needed, cash or credit. U. S. School of Music, 712 Brunswick Bldg., New York City.

U. S. SCHOOL OF MUSIC,  
712 Brunswick Bldg., New York City.

Please send me your free book, "Music Lessons in Your Own Home," with introduction by Mr. Frank Crane, Free Demonstration Lesson and particulars of your easy payment plan. I am interested in the following course:

.....Have you Instr? .....

Name.....

Address.....

City.....State.....

### PICK YOUR INSTRUMENT

- |                                     |           |
|-------------------------------------|-----------|
| Piano                               | Violin    |
| Organ                               | Clarinet  |
| Ukulele                             | Flute     |
| Cornet                              | Saxophone |
| Trombone                            | Harp      |
| Piccolo                             | Mandolin  |
| Guitar                              | Cello     |
| Hawaiian Steel Guitar               |           |
| Sight Singing                       |           |
| Piano Accordion                     |           |
| Italian and German Accordion        |           |
| Voice and Speech Culture            |           |
| Harmony and Composition             |           |
| Drums and Traps                     |           |
| Automatic Finger Control            |           |
| Banjo (Plectrum, 5-String or Tenor) |           |
| Juniors' Piano Course               |           |

# BE AN AUTO EXPERT

## EARN up to \$5000 A YEAR



Learn Autos  
the new easy interesting  
JOB-WAY



From  
\$30  
a Week  
to  
\$90  
a  
Week!

W. S. Yancy, Perla, Arkansas, was making only \$30 a week when he wrote for my Book. Today he's earning \$90 a week! You can get the same book FREE! Just clip the coupon — and mail it today!

### Read My Money-Back Agreement!

Learn about the 14 "Job-Way" Features shown in my big Free Auto Book. Also about my Money-Back Agreement. Be sure to get the book and see how easily you can get in line for a Job paying up to \$100 a week!

### Clip Coupon for Free Auto Book!

Say good-bye to low pay! Get into the Auto Business, where big pay — extra money — raises — come quick! A brilliant future awaits you in the World's Biggest Business.

### LEARN AT HOME In Spare Time

If you're earning a cent less than \$50 a week, clip that coupon now. Learn how \$50 — \$75 — even \$100 a week is now possible for you. See how I train you, right at home, in every branch of Auto Work, quickly and easily. Find out about this Training which boosted Yancy's salary from \$30 a week to \$90 a week!

### Experience, Education, Not Necessary!

All you need is common schooling — and it makes no difference if you never touched an auto before. Men from all walks of life who worked long, hard hours for low pay, are now becoming Garage Owners, Foremen and Superintendents. If you like autos, if you're between 15 and 55 — get the facts now! "Job-

Way" Training covers everything about Autos — Mechanical and Electrical — everything you need to get in line for a Big Pay Job as an Auto Expert! It's the trained man who gets the good jobs and "Job-Way" is complete Training, yet so simple and so easy that you get it quick.

### 3 Testing and Repair Outfits also included FREE of extra cost — If You Act At Once!

Right now I am offering an Electrical Experimental Outfit, equipment for a Portable Electric Test Bench, and 381 Auto Wiring Diagram Charts to students. Send coupon now.

### Auto Book FREE!

Send for this big new book. Take the first step to a Big Pay Job!



### MAIL THIS COUPON!

MOTOR INSTITUTE OF AMERICA. B. W. COOKE, Dir. Engineer  
Motor Institute Bldg., Dept. 3169, Evanston, Ill.

Send me your FREE Auto Book. Also proof that I can succeed in the Auto Business. Tell me about "Job-Way" Auto Training — about your Employment Department, and about your 3 Testing and Repair Outfits and Aviation Course Offer. No obligation on my part whatever.

Name.....

Address.....

Town.....State.....

Age.....Occupation.....

### Get Full Particulars of AVIATION

Find out how my Employment Department **Course Offer** helps you get a Good Job — Raises in Pay — and Promotions. Get all the details of my offer of a complete, ground-school Aviation Course which I am making to men who enroll.

Address me **B. W. COOKE** Directing  
Personally **Engineer**

**MOTOR INSTITUTE OF AMERICA**

Motor Institute Bldg., Dept. 3169, Evanston, Ill.

# DRAFTING

## Learn at Home



DRAFTING is one of the best professions a young man can choose because it pays good salaries and it is the stepping stone to even better positions. Many leading architects, mechanical engineers and electrical engineers got their start at the drafting board.

There is no easier way to learn Drafting than through the International Correspondence Schools. The practical value of these courses is shown by the success of I. C. S. students and also by the fact that employers are constantly writing us for trained men. We receive more calls for I. C. S. draftsmen than for graduates of any other course.

F. E. King was "a poorly paid clerk" when he enrolled for the I. C. S. Drafting Course.

By study, industry, and perseverance he became Chief Draftsman of the U. S. Steel Furniture Company, of Syracuse. He is now earning more in a day than he used to earn in a week.

A. J. Hutchins became Chief Draftsman for the American Strawboard Company and increased his salary 300%—also as a result of I. C. S. training.

There is no doubt that Drafting offers a real opportunity to ambitious men and it will pay you to investigate it. Just mark and mail the coupon and we'll gladly send you a booklet telling all about the I. C. S. courses in Drafting or any other subject in which you are interested.

### INTERNATIONAL CORRESPONDENCE SCHOOLS, Box 5515-G, Scranton, Penna.

*"The Universal University"*

Without cost or obligation on my part, please send me a copy of your 48-page booklet, "Who Wins and Why," and tell me how I can qualify for the position, or in the subject, *before* which I have marked an X:

- Mechanical Drawing  
 Draftsman's Course

- Structural Drafting  
 Architectural Drawing

- Architect  Building Foreman  
 Concrete Builder  
 Contractor and Builder  
 Structural Engineer  
 Electrical Engineer  
 Electrical Contractor  
 Electric Wiring  
 Electric Lighting  
 Electric Car Running  
 Telegraph Engineer

- Telephone Work  
 Mechanical Engineer  
 Machine Shop Practice  
 Toolmaker  Patternmaker  
 Civil Engineer  
 Surveying and Mapping  
 Bridge Engineer  
 Gas Engine Operating  
 Automobile Work  
 Aviation Engines

- Plumber and Steam Fitter  
 Plumbing Inspector  
 Foreman Plumber  
 Heating and Ventilation  
 Sheet Metal Worker  
 Steam Engineer  
 Marine Engineer  
 Refrigeration Engineer  
 R. R. Positions  
 Highway Engineer

- Chemistry  Pharmacy  
 Coal Mining Engineer  
 Navigation  Assayer  
 Iron and Steel Worker  
 Textile Overseer or Supt.  
 Cotton Manufacturing  
 Woolen Manufacturing  
 Agriculture  Fruit Growing  
 Poultry Farming  
 Mathematics  Radio

#### BUSINESS TRAINING COURSES

- Business Management  
 Industrial Management  
 Personnel Management  
 Traffic Management  
 Accounting and C. P. A. Coaching

- Cost Accounting  
 Bookkeeping  
 Secretarial Work  
 Spanish  French  
 Salesmanship  
 Advertising

- Business Correspondence  
 Show Card and Sign Lettering  
 Stenography and Typing  
 English  
 Civil Service

- Railway Mail Clerk  
 Mail Carrier  
 Grade School Subjects  
 High School Subjects  
 Illustrating  Cartooning  
 Lumber Dealer

Name.....Age.....

Street Address.....City.....

State.....Occupation.....

*If you reside in Canada, send this coupon to the International Correspondence Schools Canadian, Limited, Montreal, Canada*

# McSweeney's Easy Way to a New Job at Big Pay.



J. H. McSWEENEY

McSweeney Training makes you independent of hard times, strikes, shut downs. There always is a demand for the trained man. McSweeney teaches trades that never will be replaced by mechanical equipment. Easily and quickly you learn all about General Electricity, Automotive Mechanics, and Radio. Never was opportunity greater for the man who knows how.

## EIGHT WEEKS — THEN | TWELVE WEEKS — THEN

a job that should pay from \$50.00 to \$100.00 a week in the Automotive or Radio field. Learn to earn through McSweeney Shop-Plan Training. Trained men are needed everywhere. Eight weeks fits you to start on the big new Automotive or Radio job.

a job in that most fascinating and interesting electrical field. Learn to master the juice. Electricity has shown the way to national progress. Get out of the low pay class before electricity takes your job. Learn to earn through electricity.

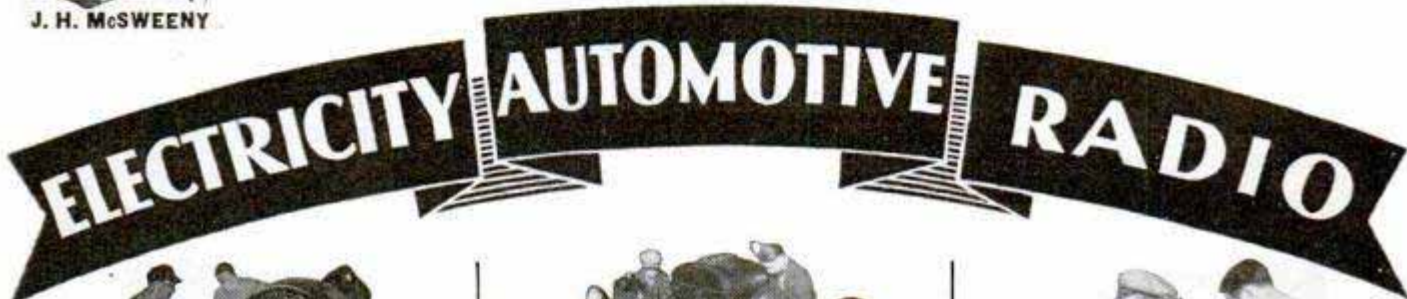

Learn to control, master, and apply that magical juice which rules the universe. Be a McSweeney-Trained electrical man. Learn in twelve short weeks what you have imagined it would take years to grasp. Electricity eventually will take your job. Join forces with it now while there is still time.



Every motor propelled vehicle—automobile, truck, tractor—requires constant service. The fewer cars sold, the more service required keeping the old ones running. Hard times are the automotive mechanic's good times. There never yet has been a let-up in automotive mechanical work.



Learn all about our newest invention—Radio. Opportunities galore. Get in on the ground floor. We have one of the most up-to-date radio schools in America. McSweeney's Radio plan makes the big pay man. Our Radio School uses the same system that has given our automotive and electrical schools their national reputation.

### Mail This Coupon for FREE Book

J. H. McSweeney, Pres.,  
McSWEENEY SCHOOLS,  
Dept. C-10-N, Chester at 30th St., Cleveland, Ohio.

Without cost or obligation, send me your big FREE book and full details of your special tuition offer. (Check school interested in.)

Electrical     Automotive     Radio

Name .....

Street .....

Town ..... State ..... Age .....

### NO BOOKS — NO LESSONS

In my shops we use equipment and tools instead of books. Students actually work on equipment. It is not hidden behind glass cases. You overhaul and repair every piece of mechanical equipment in our shops. Fifty Thousand men we have trained can attest to the advantage of having a practical training.

### Guarantee of Satisfaction

You take no risk. I am so positive that you will make a big success after taking my training that I guarantee to train you until you are permanently placed in a good job at good pay. Mail coupon for big FREE Book and remarkable tuition offer if you are over 16 years of age. Act today.

J. H. McSweeney.

# McSWEENEY

ELECTRICAL  
AUTOMOTIVE  
RADIO

# SCHOOLS

Dept. C-10-N

Chester at 30th St., Cleveland, Ohio

# SAY FELLOWS — LEARN ELECTRICITY.

Let me tell you in my big FREE BOOK how I can train you quickly for jobs leading to salaries of \$60.00 to \$200.00 a week. NOT BY CORRESPONDENCE. NOT BY BOOKS, But, on real electrical machinery RIGHT HERE IN MY SHOPS in 90 DAYS. You don't need advanced education or electrical experience. If you need to EARN WHILE LEARNING I'll help you get a part time job and when you graduate I'll give you lifetime employment service. Right now I'm including at no extra cost my AVIATION ELECTRICITY course as well as my RADIO course. MAIL THE COUPON today for my big FREE BOOK. It tells you the whole story.

sincerely,  
H. C. Lewis



**COYNE**  
ELECTRICAL SCHOOL

H. C. LEWIS, Pres., Dept. 90-72 Est. 1899  
500 So. Paulina St., Chicago

**FILL OUT - MAIL TODAY!**

H. C. LEWIS, Pres.  
COYNE ELECTRICAL SCHOOL, Dept. 90-72  
500 S. Paulina St., Chicago, Ill.  
Dear Mr. Lewis: Please send me your Free Book.

Name .....

Address .....

City..... State.....

**\$85**

**a Week for McCarty**

Kenneth McCarty, South Haven, Mich.—former \$18 week clerk — now orchestra Tenor Banjoist coining \$85 weekly.



**\$278**

**Extra for McGriff**

J. P. McGriff, Hawkinsville, Ga., playing for dances and movies, has already earned \$278 in spare-time.



**\$100**

**a month extra for Abbott**

L. G. Abbott, Williston, N. D., "happiest fellow in town," cashing-in BIG every month.



**You Can Make Real Cash Quick this Easy Fascinating Way**

**TENOR BANJO Pays Big**

McCarty, McGriff and Abbott are only three out of thousands of my students who have made more money and friends through my amazingly simple, rapid method of learning to play the Tenor Banjo. Most of them had never read a note or touched a string—but my clear, interesting instruction has made them top-notchers socially and financially. Now I'm ready to do the same thing for YOU!

**Have Friends, Fun and EXTRA MONEY—Learn at Home in 1 to 3 Mos.**

The Tenor Banjoist has all the friends, all the invitations, all the good times he wants. And he makes BIG MONEY — spare-time or full-time. Parties, dances, entertainments, orchestras — all of them want the melodious, snappy music of this favorite instrument. YOU can cash-in on such popularity; make yourself the most popular one in town; put plenty of good round dollars into your pocket too! And you can do it in 1 to 3 months' spare-time study at home—actually be playing your first tune within the first half hour!

**Get this Big FREE Book Now—Tells How**

"The Play-Way to Popularity and Big Pay" is the book that has started thousands toward popular, prosperous Success! It brings all the proof and facts about my astounding course—describes the wonderful Tenor Banjo and Outfit I send you—shows how you too can have more friends, fun and EXTRA CASH this easy way. Get this big book quick; no obligation. Don't put it off, don't delay. Mail the coupon at once!



**This \$20 TENOR BANJO**

**Complete Outfit and Phonograph Records Come with 1st Lesson**

The same day I receive your "O. K."—telling me that you want to get in line quick for good times and good pay—I'll send you at no extra cost this splendid, professional size, full-tone Tenor Banjo worth \$20: Complete Outfit of pick, tuner, strings; Gain-time Chart; rapid progress lessons and instructions — and Demonstration Phonograph Records of every selection in the course, showing you exactly how to play each note, each tune. No long, tedious practicing or "scales." Instead, real fun—easy, fascinating! Get the FREE Book first — get the facts! Send coupon now!

**Clip-Sign-Send!**

A. F. Bloch, President  
NEW YORK ACADEMY OF MUSIC  
Studio 1120, 100 Fifth Avenue,  
New York City.

Please send me FREE Book on Tenor Banjo Success — "The Play-Way to Popularity and Big Pay."

Name.....  
Address.....  
Age.....



*Learn to Write*

**I Teach by Mail**

I can make a good penman of you at your home during spare time, no matter where you live or how poorly you now write. My simplified system has shown thousands of others the way to good penmanship during the past thirty-five years—it can and WILL do the same for YOU!

Beautifully Illustrated Book  
"HOW TO BECOME A GOOD PENMAN" FREE!

It contains information, testimonials and beautiful specimens of penmanship, showing what others have accomplished by the Tamblin System. (Your name elegantly written on a card if you enclose stamp.) Write today. Address

F. W. TAMBLIN  
418 Ridge Bldg., Kansas City, Mo., U. S. A.

*F. W. Tamblin*

**STAMMER**

Write for my free book "Millard's Advanced Natural Corrective Course" and a free copy of my speech magazine. 10,000 cases successfully treated. Est. 24 years. Largest school for stammerers in world. Millard Inst. of Normal Speech, 2317 Millard Bldg., Milwaukee, Wis.

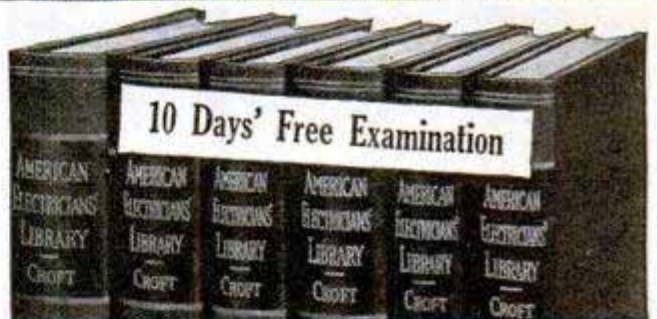

**Get into the electric wiring field—big demand—big money!**

The whole wiring field covered. Kinks; helps; short cuts; practical, on-the-job electrical data, written particularly to help wiremen, trouble shooters, maintenance men, armature winders, electrical contractors and students.

**American Electricians' Library**  
6 volumes, 2000 pages, illustrated, \$17.50 payable \$1.50 in ten days and \$2.00 a month

The books tell you all you must know about conduit wiring, armature winding, wiring for lighting circuits and switches, wiring for machinery, circuit troubles, circuit testing, or electrical machinery erection. Through a study of this great set you can push yourself into a big-pay job for life.

**See it FREE—Send no money—ACT**

**FREE EXAMINATION COUPON**

McGRAW-HILL BOOK CO., Inc.  
370 Seventh Avenue, New York

Send me the American Electricians' Library for 10 days' free examination. If satisfactory, I will send you \$1.50 in 10 days and \$2 monthly until the full price, \$17.50, is paid. If not wanted, I will return the books at your expense.

Name.....  
Address.....  
City and State.....  
Position.....  
Company..... PM-12-30

We have placed machinists, carpenters, masons, plumbers, railroad men, office clerks, farmers and even laborers in fine Drafting Jobs under this plan. Mail coupon for details of our remarkable offer.



# Men Who Work With Their Hands Make the Best DRAFTSMEN



## -and we'll back them with this EMPLOYMENT CONTRACT

We are looking for more ambitious young fellows with factory, building-trade or any other kind of mechanical experience to prepare for and help place in well-paid Drafting positions. Such men, we find, are unusually successful as Draftsmen, because they know how things are done, and that's a priceless asset to the man who makes the blueprint plans. Get in touch with me and I'll tell you how you can cash in on your entire past mechanical experience.

### Drafting Is Logically Your Next Move!

Of course you realize the biggest handicap to mechanical work is that you're limited in earning capacity to the output of your two hands, as long as you live. Even the skilled mechanic earning \$50 to \$60 a week has reached his limit. He can never earn more and when he gets old he will earn less. So I don't blame any man for wanting to get away from this futureless outlook. For wanting to get into something where he can use his head as well as his hands—where he will be paid for what he **knows**, instead of only for what he **does** . . . You know enough about blueprints to understand that PLANS govern every move in factory and construction job. The Draftsman who makes them is several jumps ahead of the workman who follows them. And so I want you to know that DRAFTING is a logical, natural PROMOTION from mechanical and building work—better-paid, more interesting—just the kind of work you'd enjoy doing.

### Get Our NO-RISK PLAN

The way to a fine Drafting job for you—is easier than you think. It takes no "artistic talent" or advanced education. Thousands of men no smarter than you, with no more education or ability, have learned it quickly and you can, too. With the co-operation of some of the biggest employers and engineers in the U. S., we have worked out a plan to prepare you for Drafting work in your spare time at home—then to help you get a fine position when you're only half way through the course. Mail the coupon and we'll be glad to tell you all about this lifetime chance.

**THE AMERICAN SCHOOL**  
Dept. D-947, Drexel Ave. and 58th St., Chicago, Illinois



### 36-Page Drafting Book—FREE

Tells how easy Drafting is to learn—how interesting the work is—what remarkable opportunities are open for Draftsmen right now. Mail coupon for a copy—without cost or obligation.

AMERICAN SCHOOL, Dept. D-947, Drexel Ave. & 58th St., Chicago, Ill.

Please tell me, without cost or obligation, about your training and employment service in line marked X below.

**DRAFTING**

- Architecture     Civil Engineering
- Building         Auto Engineering
- Electrical Engineering
- Business Management
- Accounting
- Mechanical Engineering
- Shop Superintendent
- Foremanship
- High School in 2 years
- Structural Steel

Name \_\_\_\_\_

St. No. \_\_\_\_\_

City \_\_\_\_\_ State \_\_\_\_\_

Age \_\_\_\_\_ Occupation \_\_\_\_\_



"I have landed a job with the Pacific Tel. and Tel. Co. in Seattle, and I must say that I am greatly indebted to the American School for my success. You have done all that you promised in helping me obtain employment."

T. C. White  
Seattle, Wash.



"I have obtained a position as a junior draftsman with the Muncie Oil Engine Co., and so far I like the work real well. I appreciate your aid in obtaining this position very much."

M. N. Bareham  
Muncie, Ind.

# Learn to make more money



*Be a*

# Radio Expert

Hundreds of fine jobs paying \$50, \$60, \$75 a week and plenty of them paying \$100 a week are opening every year in Radio. No wonder. In the short period of a few years Radio has taken its place among the world's greatest industries. Its amazing growth has astounded the world. You can't enjoy the good things of life—a home, an automobile, money in the bank—on \$25, \$35 or \$40 a week. Why be satisfied with that for more than the short time it takes to get ready for Radio.

**I'll show you how to make \$10 to \$25 a week extra on the side while learning**

One month from today you can be making more money. The day you enroll I will show you how to do Radio jobs in your neighborhood. G. W. Page, 1807 21st Ave., S., Nashville, Tenn., made \$935 in his spare time while taking his course.

**I will train you at home in your spare time. You must be satisfied**

Hold your job. Give me only part of your spare time. I'll bring my training to you. I give you the parts for a home experimental laboratory, six big outfits, without extra charge. Further, I will refund every penny of your money if you are not satisfied upon completion with the lessons and instruction service I give you.

**Act NOW. Get "Rich Rewards in Radio"**

This 64-page book points out the money-making opportunities in the different branches of Radio such as broadcasting, operating on board ship which gives you a world-wide travel without expense, how to start a spare-time or full-time Radio business of your own, Radio in Aviation, openings with dealers and manufacturers and many others. Clip the coupon.

J. E. SMITH, President,  
Dept. ONPP

National Radio Institute, Washington, D. C.

**Mail this Coupon at Once**

J. E. Smith, Pres.,  
National Radio Institute, Dept. ONPP  
Washington, D. C.

Dear Mr. Smith: Without obligating me, send "Rich Rewards in Radio" explaining your training and Radio's opportunities for bigger success.

Name \_\_\_\_\_ Age \_\_\_\_\_

Address \_\_\_\_\_

City \_\_\_\_\_ State \_\_\_\_\_

# NEW INDUSTRY NEEDS MEN

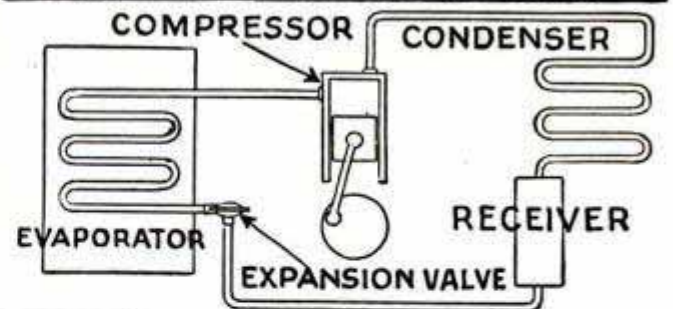

## ELECTRIC REFRIGERATION Calls You!

Newest American Industry needs men for \$200 to \$1,000 a month jobs in production service, installation and sales. Fastest growing, money-making field—backed by General Motors, General Electric, etc. New easy home training qualifies you for big pay job. This training endorsed by Servel, Kelvinator, Copeland and other large manufacturers.

**Get Valuable New Book—FREE**

Our new illustrated book—*Rich Rewards in Electric Refrigeration*—just off the press, reveals amazing plan to ambitious men. Sent absolutely free, without obligation. Be the first in your locality to get into this new magic industry. Write today!

UTILITIES ENGINEERING INSTITUTE  
4403 Sheridan Road, Dept. 1120, Chicago, Ill.



# Learn to Dance

You can learn all the modern dances—the latest Tango Steps, the new Fox Trot Steps, dreamy Waltzes, smart Collegiate Steps and the popular Society Steps at home easily and quickly. New chart method makes dancing simple as A-B-C. No music or partner required. Learn anywhere, any time. Win new popularity. Be in demand at parties. If you took these same lessons privately, they could cost at least \$20.00.



**SEND NO MONEY**  
Just send your name and address. We'll ship the complete course—285 pages, 52 illustrations—without one cent in advance. When the package arrives, hand postman only \$1.98, plus delivery charges. Try this new method for five days. Money back if you are not delighted. Send your name now.

FRANKLIN PUB. CO., 800 N. Clark St., Dept. 9427, Chicago

# Be a Traffic Manager

**Big Pay—Big Opportunity**

Big business needs trained traffic men. At least three Detroit manufacturers pay their traffic managers better than \$20,000 a year. Train in your spare time for this highly profitable profession. Low cost; easy terms. Write now for valuable 64-page book—FREE.

LaSalle Extension University, Dept. 1264-T, Chicago

# LEARN WATCHMAKING

and become independent. We help you secure a position.

Easy to learn. Send for FREE CATALOG.

ST. LOUIS WATCHMAKING SCHOOL Dept. 3, ST. LOUIS, MO.

# THIS SECRET SERVICE BOOK

**Sent FREE for 30 Days Reading No Money Down**

**Actual Crime Cases**

**If You Act Quick!**—We will send you postpaid and FREE for 30 days reading—this stirring, gripping book on Crime Detection, Secret Service and Identification Work. Written by outstanding authority. You follow the operator straight through as he unravels some of the most baffling cases that have ever confronted officials. Nothing like it ever before. Send no money. If you decide to keep it, send me only \$1.00. If not, return it. That's all. But **WRITE TODAY—before this offer is withdrawn.** Book will not be sent to boys under 17 years of age.

T. G. Cooke, Book Dept. 13-59 1920 Sunnyside Ave., Chicago, Ill.



# How Strong Are You? Can You Do These Things?

*Lift 200 lbs. or more overhead with one arm; bend and break a horseshoe; tear two decks of playing cards; bend spikes; chin yourself with one hand.*

**C**AN you do any of them? I can and many of my pupils can. It is remarkable the things a man really can do if he will make up his mind to be strong. It is natural for the human body to be strong. It is unnatural to be weak. I have taken men who were ridiculed because of their frail make-up and developed them into the strongest men of their locality.

## I Want You for 90 Days

These are the days that call for speed. It once took four weeks to cross the ocean—now it takes less than one. In olden days it took years to develop a strong, healthy body. I can completely transform you in 90 days. Yes, make a complete change in your entire physical make-up. In 30 days I guarantee to increase your biceps one full inch. I also guarantee to increase your chest two inches. But I don't quit there. I don't stop till you're a finished athlete—a real strong man. I will broaden your shoulders, deepen your chest, strengthen your neck. I will give you the arms and legs of a Hercules. I will put an armor plate of muscle over your entire body. But with it come the strong, powerful lungs which enrich the blood, putting new life into your entire being. You will be bubbling over with strength, pep and vitality.

## A Doctor Who Takes His Own Medicine

Many say that any form of exercise is good, but this is not true. I have seen men working in the factories and mills who literally killed themselves with exercise. They ruined their hearts or other vital organs, ruptured themselves or killed off what little vitality they possessed.

I was a frail weakling myself in search of health and strength. I spent years in study and research, analyzing my own defects to find what I needed. After many tests and experiments, I discovered a secret of progressive exercising. I increased my own arms over six and a half inches, my neck three inches and other parts of my body in proportion. I decided to become a public benefactor and impart this knowledge to others. Physicians and the highest authorities on physical culture have tested my system and pronounced it to be the surest means of acquiring perfect manhood. Do you crave a strong, well proportioned body and the abundance of health that goes with it? Are you true to yourself? If so, spend a pleasant half hour in learning how to attain it. The knowledge is yours for the asking.

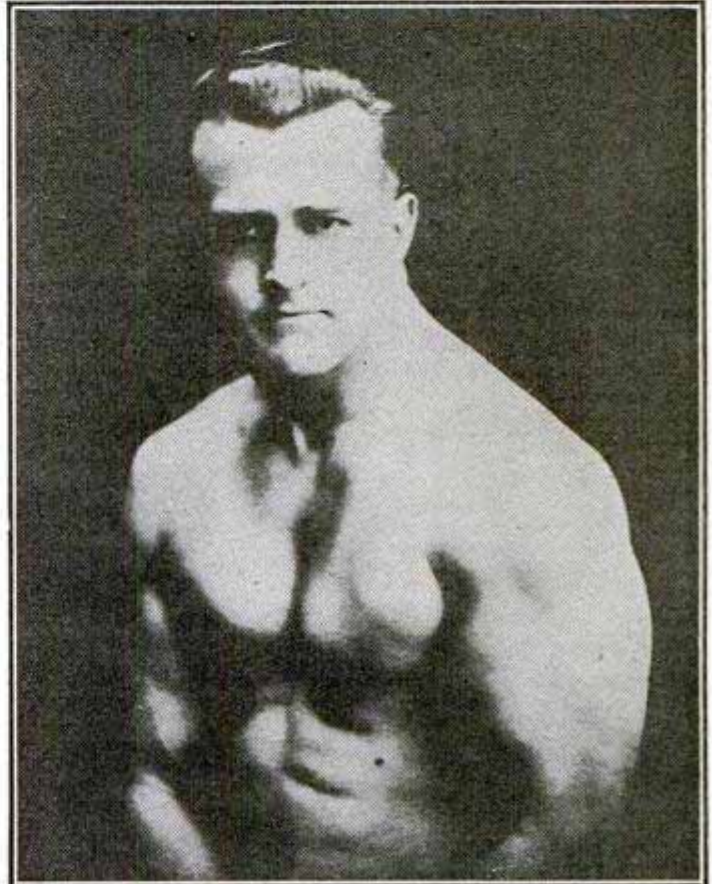

**EARLE LIEDERMAN, The Muscle Builder**

*Author of "Science of Wrestling," "Muscle Building," "Secrets of Health," "Here's Health," "Endurance," Etc.*

SEND FOR  
MY NEW  
64-PAGE BOOK

# "Muscular Development"

IT IS  
FREE

It contains forty-eight full page photographs of myself and some of the many prize winning pupils I have trained. Some of these came to me as pitiful weaklings, imploring me to help them. Look them over now, and you will marvel at their present physiques. This book will prove an impetus and a real inspiration to you. It will thrill you through and through. This will not obligate you at all, but for the sake of your future health and happiness, do not put it off. Send today—right now, before you turn this page.

**EARLE LIEDERMAN**  
DEPT. 2012 305 BROADWAY, N. Y. CITY

EARLE LIEDERMAN,  
Dept. 2012, 305 Broadway, New York City

Dear Sir:—Please send me without any obligation on my part whatever, a copy of your latest book, "Muscular Development." (Please write or print plainly.)

Name.....Age.....

Street.....

City.....State.....



## The only man who could talk to the Superintendent

"Soon after I began studying," a student wrote to us the other day, "we had a change in management at our plant. I certainly was glad then that I had decided to study in my spare time. For, thanks to my I. C. S. course, I was the only man in the organization who could talk to the Superintendent in his own language. As a result, I was promoted over men who had been here from ten to twenty years. My salary has been increased 90% in the last ten months."

That's a true story of what just one I. C. S. student has done. There are thousands of others. Every mail brings letters from men and women telling of promotions and increases in salary due directly to spare-time study.

One hour a day, spent with the I. C. S. in the quiet of your own home, will prepare you for success in the work you like best. Yes, it will! Put it up to us to prove it.

Mail this Coupon for Free Booklet

### INTERNATIONAL CORRESPONDENCE SCHOOLS

"The Universal University"  
Box 5516-G, Scranton, Penna.

Without cost or obligation, please send me a copy of your booklet, "Who Wins and Why," and full particulars about the subject before which I have marked X:

#### TECHNICAL AND INDUSTRIAL COURSES

- |                                                                              |                                                                              |
|------------------------------------------------------------------------------|------------------------------------------------------------------------------|
| <input type="checkbox"/> Architect                                           | <input type="checkbox"/> Automobile Mechanic                                 |
| <input type="checkbox"/> Architectural Draftsman                             | <input type="checkbox"/> Plumbing <input type="checkbox"/> Steam Fitting     |
| <input type="checkbox"/> Building Estimating                                 | <input type="checkbox"/> Heating <input type="checkbox"/> Ventilation        |
| <input type="checkbox"/> Wood Millworking                                    | <input type="checkbox"/> Sheet Metal Worker                                  |
| <input type="checkbox"/> Contractor and Builder                              | <input type="checkbox"/> Steam Engineer                                      |
| <input type="checkbox"/> Structural Draftsman                                | <input type="checkbox"/> Steam Electric Engineer                             |
| <input type="checkbox"/> Structural Engineer                                 | <input type="checkbox"/> Civil Engineer                                      |
| <input type="checkbox"/> Electric Wiring                                     | <input type="checkbox"/> Surveying and Mapping                               |
| <input type="checkbox"/> Electrical Engineer                                 | <input type="checkbox"/> Refrigeration                                       |
| <input type="checkbox"/> Electric Lighting                                   | <input type="checkbox"/> R. R. Locomotives                                   |
| <input type="checkbox"/> Welding, Electric and Gas                           | <input type="checkbox"/> R. R. Section Foreman                               |
| <input type="checkbox"/> Reading Shop Blueprints                             | <input type="checkbox"/> R. R. Bridge and Building Foreman                   |
| <input type="checkbox"/> Telegraph Engineer                                  | <input type="checkbox"/> Air Brakes <input type="checkbox"/> Train Operation |
| <input type="checkbox"/> Telephone Work                                      | <input type="checkbox"/> Highway Engineering                                 |
| <input type="checkbox"/> Mechanical Engineer                                 | <input type="checkbox"/> Chemistry <input type="checkbox"/> Pharmacy         |
| <input type="checkbox"/> Mechanical Draftsman                                | <input type="checkbox"/> Coal Mining Engineer                                |
| <input type="checkbox"/> Machinist <input type="checkbox"/> Toolmaker        | <input type="checkbox"/> Navigation <input type="checkbox"/> Boilermaker     |
| <input type="checkbox"/> Patternmaker                                        | <input type="checkbox"/> Textile Overseer or Supt.                           |
| <input type="checkbox"/> Pipefitter <input type="checkbox"/> Tinsmith        | <input type="checkbox"/> Cotton Manufacturing                                |
| <input type="checkbox"/> Bridge Engineer                                     | <input type="checkbox"/> Woolen Manufacturing                                |
| <input type="checkbox"/> Bridge and Building Foreman                         | <input type="checkbox"/> Agriculture <input type="checkbox"/> Fruit Growing  |
| <input type="checkbox"/> Gas Engines <input type="checkbox"/> Diesel Engines | <input type="checkbox"/> Poultry Farming <input type="checkbox"/> Radio      |
| <input type="checkbox"/> Aviation Engines                                    | <input type="checkbox"/> Marine Engineer                                     |

#### BUSINESS TRAINING COURSES

- |                                                                               |                                                                              |
|-------------------------------------------------------------------------------|------------------------------------------------------------------------------|
| <input type="checkbox"/> Business Management                                  | <input type="checkbox"/> Business Correspondence                             |
| <input type="checkbox"/> Office Management                                    | <input type="checkbox"/> Lettering Show Cards <input type="checkbox"/> Signs |
| <input type="checkbox"/> Industrial Management                                | <input type="checkbox"/> Stenography and Typing                              |
| <input type="checkbox"/> Personnel Management                                 | <input type="checkbox"/> Complete Commercial                                 |
| <input type="checkbox"/> Traffic Management                                   | <input type="checkbox"/> Civil Service <input type="checkbox"/> Mail Carrier |
| <input type="checkbox"/> Accountancy <input type="checkbox"/> Cost Accountant | <input type="checkbox"/> Railway Mail Clerk                                  |
| <input type="checkbox"/> C. P. Accountant                                     | <input type="checkbox"/> Grade School Subjects                               |
| <input type="checkbox"/> Bookkeeping                                          | <input type="checkbox"/> High School Subjects                                |
| <input type="checkbox"/> Secretarial Work                                     | <input type="checkbox"/> College Preparatory                                 |
| <input type="checkbox"/> Spanish <input type="checkbox"/> French              | <input type="checkbox"/> Illustrating <input type="checkbox"/> Cartooning    |
| <input type="checkbox"/> Salesmanship <input type="checkbox"/> Advertising    | <input type="checkbox"/> Lumber Dealer                                       |

Name.....Age.....

Address.....

City.....State.....

Occupation.....

If you reside in Canada, send this coupon to the International Correspondence Schools, Canadian, Limited, Montreal, Canada

**Play a Gibson GUITAR**

Nick Lucas

MAKE everyone love you as they love Lucas, his Guitar and singing. Learn to play your own accompaniment on a Guitar, Banjo, Mandolin or Ukulele. Be popular among your friends.

**FREE TRIAL EASY PAYMENTS**

**this FREE BOOK**

Gives Valuable Facts—Send for it Now!

**Gibson Inc.**

1203 Parsons St., Kalamazoo, Mich.

## Electrical Engineering

Training for men of ambition and limited time. Concise, comprehensive course in Theoretical and Practical Electrical Engineering including the closely related subjects of Mathematics and Mechanical Drawing. Students construct motors, install wiring,

test electrical machinery. Course designed to be completed in **one college year** by eliminating non-essentials. **THIRTY-SEVEN YEARS'** successful experience assures you maximum training in minimum time.



Send for free catalog

## Bliss Electrical School

122 TAKOMA AVE., WASHINGTON, D. C.

## WORLD NEEDS PLUMBERS

Old style plumbers are fading like the horse and buggy. The world demands modern Plumbing and Skilled Trained Mechanics to do it. Unlimited, swift growing field. Make \$50 to \$100 a week or start own shop. We train you quick. Learn in 8 to 12 WEEKS to do any job with skill and science. Need no previous experience. Strictly tool using system. Opportunity knocks. Investigate today—amazing offer—low tuition. World's greatest school.



Write—**UNIVERSAL PLUMBING SCHOOL**  
2130 Troost Ave. Kansas City, Mo.

## ART COMMERCIAL ART

Taught by Meyer Both, an internationally known art organization with 8,000 advertisers as active clients. This training—based on 30 years' resultful experience—transforms indefinite theory into definite fact. Prepare in spare time for a career in Art—a fascinating, lucrative profession open to both men and women. Write for illustrated

book telling of our successful students. Meyer Both Co., Dept. 16, 20th & Michigan, Chicago, Ill.

## LEARN WATCH REPAIRING



You can learn by our modern and original system of instruction every part of the Watch Repairing Trade at home as good or better than at a shop. You can earn money while learning and secure a well paying position or start in business after completing our course of instruction. Good watch repairers are always in demand and earn from \$50 to \$75 per week. For particulars apply to the Wisconsin School of Watch Repairing 166 Mason St., MILWAUKEE, WIS.

# IT ISN'T SUCH A BUM WORLD AFTER ALL!!



WHEN YOU WORK UNDER A SIMON LEGREE STRAW BOSS WITH A TIME CLOCK STARING AT YOU ALL THE TIME—



AND YOU NEVER HAVE ANYTHING IN YOUR POCKETS EXCEPT A HOLE—

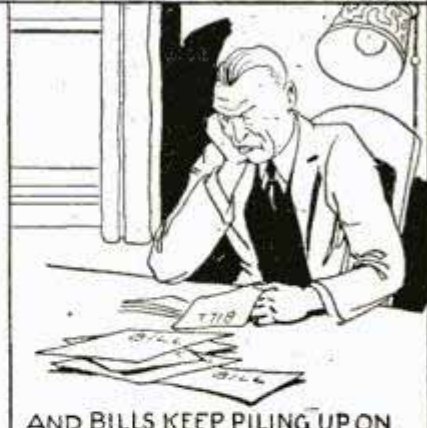

AND BILLS KEEP PILING UP ON YOU TILL YOU CAN'T SEE HOW IN THE SAM HILL YOU'RE EVER GOING TO GET OUT OF DEBT—



AND THEN YOU FIND IN A LITTLE BOOK THE KEY TO SECRETS WHICH HAVE MADE THOUSANDS COMFORTABLY WELL OFF AND EVEN RICH—



AND YOU START USING THOSE SECRETS YOURSELF AND LEARN WHAT IT IS TO REALLY MAKE BIG MONEY AS A SALESMAN—



OH FELLERS IT ISN'T SUCH A BUM WORLD AFTER ALL

## When Men Raise Their Pay \$3,000 to \$7,000 a Year ...After Reading This Little Free Book!

A MARVELOUS little free book is bringing vital news to thousands of men today and making momentous changes in their lives. Just sixty-four pages—about seven ounces of paper and printers' ink; but there are thousands of men holding down big-pay jobs all over the United States and Canada with earnings running up to \$10,000 a year, and even bigger, who started by reading this great book.

Take, for instance, Frank J. Walsh, of Ludlow, Massachusetts. Just a few years ago, Walsh was struggling along on \$1,000 a year. In just one evening, reading this little free volume, he made the change in his life that raised his pay over 600%.

About the same time that Walsh was getting his start two other men—C. V. Champion of Danville, Illinois, and R. B. Hansen of Akron, Ohio—were reading it too. Both were factory hands at the time—but today both of them are presidents of prosperous and growing companies with incomes over \$10,000 a year! Just lately a California cowboy named William Shore spent an evening reading this book, in a ranchhouse. It wasn't many months later that he told us of one week when he made \$525 clear, as a salesman.

Men from all walks of life—men who never dreamed they could master the secrets of salesmanship—regular fellows just like anybody else, without any extra advantages of money or education—that's what these men are. This little book, and the marvelous N. S. T. A. Demonstration Method, are specially planned to help just that kind of men—ambitious average fellows. The N. S. T. A. does something which people said could not be done—it makes salesmen—successful high power earners, out of average men with normal every-day brains. It has proved that

salesmen do not have to be "born." It teaches, in easy, yet thorough lessons, right in your home, the secrets which great salesmen have spent years on the road to learn.

You can't keep a good man down—not if he really is a good man and will take advantage of his opportunities to rise in life. This book, "The Key to Master Salesmanship" brings ambitious men the chance they've all been looking for—the chance to get away from dull routine time-clock jobs at low pay. It shows them the way to a free employment service which gives N. S. T. A. members the pick of over 50,000 high-pay jobs every year.

Right now this book, "The Key to Master Salesmanship," which showed these men how to get started on the road to success and independence, will be mailed as a gift to any ambitious man—absolutely free and without obligation. Why not see for yourself what amazing paying secrets it contains? There is no better way to invest a two cent stamp! Simply fill out and mail the coupon to us today.

### NATIONAL SALESMEN'S TRAINING ASSOCIATION

Dept. W-103, N. S. T. A. Bldg., Chicago, Illinois



National Salesmen's Training Association, Dept. W-103, N. S. T. A. Bldg., Chicago, Ill.

Please send me free and without obligation my copy of "The Key to Master Salesmanship" and full details of your Free Employment Service and other special Earn While You Learn features.

Name.....  
 Address.....  
 City..... State.....  
 Age..... Occupation.....

# There's A Better Living For Any Man of Limited Means and Education IN BARBERING



**SHORT—PRACTICAL COURSE**  
*Protecting Laws Make It the Best Profession  
in the Universe*

RALPH KUHLMAN has a Barber job on the Santa Fe running from Chicago to Los Angeles paying as high as \$60 a single trip. ARTHUR BAKER runs a shop in the exclusive great money district of Wall Street. He has accumulated a fortune. BOTH of these boys are MOLER GRADUATES. (Names of other graduates furnished on request.)

**GOODNESS!!! GRACIOUS!!!**

Why not learn a profession by enrolling in a school whose method of teaching and course of instruction is approved by all State Boards? There is a school near you. Write to the nearest one and see.

## Standardized Branches Moler System of Colleges

139 E. 23rd St., New York City  
512 N. State St., Chicago, Ill.  
810 N. 6th St., St. Louis, Mo.  
801 Main St., Kansas City, Mo.  
206 E. 4th St., Cincinnati, Ohio  
215 Huron Road, Cleveland,  
Ohio  
559 Michigan Ave., Detroit,  
Mich.  
1229-17th St., Denver, Colo.

1302 Douglass St., Omaha, Neb.  
501 E. Water St., Milwaukee,  
Wis.  
81 Forsyth St., N. W., Atlanta,  
Ga.  
81 S. Second St., Memphis,  
Tenn.  
1713 Commerce St., Dallas,  
Texas

### Address Nearest Branch

Please send me without obligation on my part your Booklet B.

Name.....

Address.....

City.....State.....

## \$1 Masonic Xmas Gifts

[Useful and attractive presents  
any man would be glad to receive]

The best value you ever saw for the money. Genuine leather, card case, gold corners, to hold 5 cards, also extra pocket. **MASONIC EMBLEM STAMPED IN GOLD FREE.** Name and other stamping 35 cents per line.  
5 windows . . . \$1.00  
9 windows . . . \$1.50  
13 windows . . . \$2.00



### A NOVEL MASONIC CHARM

A most mysterious watch charm of heavy plated gold. Shows the Square and Compass when revolved. Something different. Packed in an attractive box. Catalog suggests hundreds of other gifts. . . \$1.00

### SOLID GOLD PINS, \$1.00

Just the right size. Latest style. A lasting remembrance and an appreciated present. Large variety—Masonic, Chapter, 32nd Degree, Shrine, Grotto.



Money Back If Not Satisfied  
Send for Catalogue  
Established 1859

## Redding Masonic Supply Co.

200 Fifth Ave. Dept. P. M. New York

"Everything Masonic"

## YOUR FUTURE ASSURED



Now is the time to safeguard yourself against such periods of depression as we have been having. Many good, profitable trades are not subject to hard times or slack seasons—trades meeting everyday human needs, such as Mechanical Dentistry. Your age, circumstances, or lack of experience need not stop you. The way is open to you. A helpful booklet, "Choosing a Trade," will be sent you without cost. Your copy is waiting. Simply ask for Bulletin 2.

**BODEE INSTITUTE, 1755 Broadway, N. Y.**  
1305 N. Broad St., Philadelphia 85 Court St., Brooklyn

## Learn Watchwork, Jewelrywork and Engraving

A fine trade commanding a good salary, and your services always in demand. Address **HOROLOGICAL**, Dept. P, Bradley Institute, PEORIA, ILLINOIS, for our latest catalog.

## AVIATION Information FREE

Send us your name and address for full information regarding the Aviation and Airplane business. Find out about the many great opportunities now open and how we prepare you at home, during spare time, to qualify. Our new book "Opportunities in the Airplane Industry" also sent free if you answer at once.

**AMERICAN SCHOOL OF AVIATION**  
3601 Michigan Ave. Dept. 1359 CHICAGO

## BE AN ARTIST

WE CAN TEACH  
YOU DRAWING in  
your own home during your  
spare time. Twenty-five years of  
successful teaching proves our ability.  
Artists receive large salaries.

Write Today for Art Year Book

**SCHOOL OF APPLIED ART**  
ROOM NO. 2 BATTLE CREEK MICH.



# OIL HEAT

## now cheap as coal!

**SAVE  
\$150.  
OR MORE**

No need to pay a high price for an automatic oil burner! The Laco is fine enough for the finest homes. Yet cheap enough for anybody to buy! Fully guaranteed—built of best materials—has many EXCLUSIVE features—yet priced \$150 lower than many other burners of the same heating capacity.



Laco NL Model Mineral Wick Oil Burner. 100% Automatic. 6 sizes — one for smallest home, one for largest commercial building!

PROVEN by years of use in THOUSANDS of homes. Clean—quiet—safe—cheap to operate. Takes oil heat out of the luxury class.



### Burns Every Atom of Oil

Other power burners convert liquid air to a spray by means of air pressure. The tremendous air pressure required throws costly unburned oil and heat out of the chimney. Makes oil burning a luxury for the rich. The Laco Mineral Wick changes oil to gas—mixes the gas with air (96% gas, 4% air) and burns it in suspension with a clean hot flame. Absolutely NO WASTE. Now oil heat is within the reach of all!

### A Power Burner for Small Homes—\$70

Laco Jr., the world's lowest priced power burner, heats 5-8 rooms. Only \$70. Fits arcolas, parlor stoves, small furnaces, etc. Burns little as 1/2 pint oil per hour. GUARANTEED. Save. Other non-automatic power burners up to \$98—big enough for largest homes. Fully automatic burners \$165 up. Get full details of this low-priced line of guaranteed power burners.

Realizing that it was WASTE that made oil burning costly, an American engineering genius spent years perfecting a device to burn oil without waste. His amazing invention—The Laco Mineral Wick—found only in the Laco Oil Burner, positively burns oil WITHOUT SMOKE, SOOT, GREASE, or other WASTE. A tank of oil lasts longer. Every drop of fuel is converted into useful heat. Now—at last—oil heat is really cheap as coal!

The Laco Oil Burner is 100% Automatic. Electric controls, safety devices, room thermostat. Trouble free. Simple. No complicated adjustments necessary. Simply set the room thermostat at temperature desired—the Laco will keep your whole home at that temperature with below-zero weather outside!

### Safer than a Stove

Automatic devices prevent oil overflow. Explosion impossible! Actually safer than a kitchen stove. Every burner DOUBLE INSPECTED at the factory—then, as an extra GUARANTEE OF SAFETY, each burner has the "Inspected and approved" label of the Underwriters' Laboratories. Complies with all local ordinances—all insurance requirements. No Ignition System. No electric or city-gas ignition needed. The Laco generates its own gas for the LOW FLAME pilot light. The LOW FLAME operates for as little as 1/4c an hour.

### Any Man Can Install—QUICKLY

The Laco is so easy to install many of our users install their own. So quick, that you can install a Laco in coldest weather without inconvenience. Draw the coal fire—the house won't have time to completely cool off before the Laco is supplying OIL HEAT.

### Guaranteed

One of the world's largest oil burner manufacturers—with many years reputation for honesty and fair dealing—with sales running into the MILLIONS—with THOUSANDS of satisfied users in every part of the globe—backs the Laco with a WRITTEN GUARANTEE. You're safe in buying a Laco!

### Easy Terms

The Laco costs little to buy—little to operate. The smallest home can afford this amazingly economical burner. Install now; pay only a small amount down; Balance on easiest terms.

**Save \$150 or More  
Special Low Price if you WRITE NOW**

Big demand keeps Laco prices DOWN. Other burners of the same heating capacity sell for \$150 more. You can SAVE \$150 in FIRST COST and MANY HUNDREDS OF DOLLARS IN FUEL ECONOMY if you order your Laco now! Write today for COMPLETE DETAILS of our sensational low price offer.

## NEW MODEL F—WORLD'S LOWEST PRICED HEAVY OIL BURNER



Completes the Laco line. 2 years ahead of other makes in design. Burns 24

West Coast Diesel and other cheap heavy industrial oils that have Begged

a Market for Years. 100% automatic. Electric room thermostat. Lazy Flame combustion Eliminates All Waste; reduces stack temperatures 50%. The first really different—really economical—atomizing burner. Many patented features. Get the Facts today!

## DEALERS WANTED QUICK

Laco makes Everybody a prospect. 26 sizes and styles of burners. One for every heating plant—for every pocketbook. Beat competition on price, quality, and freedom from trouble. No wonder Laco dealers make up to \$50,000 a year! Chance for rated dealer, or man with limited capital to invest, to make big money right away. Territories going fast. Write today. Tomorrow may be too late.

**LACO OIL BURNER CO., 138 Union St., GRISWOLD, IA.**

# Pick Your Own Job!

## I'll Help You To Get It

### RAILWAY POSTAL CLERK

\$1900 to \$2700 a year

### POST OFFICE CLERK

\$1700 to \$2100 a year  
Special Clerks at \$2200 to \$2300

### CITY MAIL CARRIER

\$1700 to \$2100 a year

### R. F. D. MAIL CARRIER

\$1800 to \$2300 a year

### INTERNAL REVENUE and CUSTOMS HOUSE POSITIONS

\$1140, \$1680, to \$3000 a year and up  
Extra Pay for Overtime

### POSTMASTER

\$1200 to \$2500 a year

### DEPARTMENTAL CLERK

\$1440 to \$1620 a year and up to \$3000 a year

**IMPORTANT NOTICE**—Railway Postal Clerks' examination coming. Average yearly pay with allowances is \$2759.

**N**O special experience required to get one of these attractive Government positions. All you need is to pass an examination—and it is easy if you prepare for it. And that's my business. For eight years I was a Secretary Examiner. Since then I have helped thousands into well-paid Government positions, and I can help you get there too. I know **how to train you** to get highest rating in Civil Service Examinations, which will qualify you for first positions open. You get the job you're after within a year of passing examinations—or it **costs you nothing.**

## Good Pay, Short Hours, Steady Work

Get rid of the bugaboos of hard times, strikes, lay-offs, job-hunting that you must always worry about in ordinary jobs. Don't stick in the low-pay jobs that start you off in a rut and keep you there. Work for Uncle Sam in a fine position you can't lose for any religious, political, or personal reasons. Here's a wonderful position you can easily get that pays you from \$1900 to \$3300 a year to start; where there are no strikes or lockouts, where you get vacations with pay, retirement pensions, 8-hour day, automatic yearly salary raises, unlimited opportunities for quick advancement and many other advantages you can't get anywhere else!

## FREE My New Book "How To Secure a Gov't Position"

If you are a citizen, eighteen or over, you can get the Civil Service Position you want. Write today for my new free book that tells all about the Civil Service—the jobs open, what you must do to get the job, the pay, the vacation, and all the big advantages of Government Positions. Find out just how I can help you land a steady good-paying position in the Civil Service in Washington, travelling, or near your home. Mail the coupon or a postal today.

**A. R. PATTERSON, Civil Service Expert**  
**PATTERSON SCHOOL**  
812 Wisner Bldg., Rochester, N. Y.

**PATTERSON SCHOOL, 812 Wisner Building,**  
Rochester, New York.

Please send me your big free book and tell me how I can secure a position with the U. S. Government paying me \$1,900 to \$3,300 a year, with excellent chance for rapid advancement. This doesn't cost me a penny.

Name.....

Address.....

City..... State.....

## BOOK ON GLIDING

By an Eminent Authority

"The Book of Gliders" by Edwin W. Teale. Complete information on this great sport. Just what is wanted by enthusiastic followers of gliding, student and expert gliders, aviators, schools of gliding, etc. A textbook and a thrilling story. Entertaining and practical. Prepared by an authority who has built and flown gliders for 10 years. Covers: Flying Without Motors; The History of Gliding; How a Glider Flies; Types of Gliders; How to Choose a Spot for Gliding; How to Launch a Glider; How to Fly a Glider; Soaring; Cloud Flying; Winning a Pilot's License; How to Build a Glider; How to Organize a Glider Club; How to Hold a Glider Meet; and hundreds of other subjects. Intro. by W. H. Bowlus, America's Glider Champion. 378 pp. 17 Chapters. 32 Illus. 78 Diagrams. 12 Charts. Complete. Thorough. Easily understood. Only \$2.50. At all bookstores or direct. Order today. If not satisfied return book in 5 days, money refunded. Send for FREE descriptive circular.

E. P. Dutton & Co., 286 Fourth Ave., New York

## COLLEGE COURSES

### AT HOME



Carry on your education. Develop power to initiate and achieve. Prepare for college. Earn credit toward a Bachelor degree or Teaching Certificates by correspondence. Select from 450 courses in 45 subjects including English, Mathematics, History, Education, Psychology, Economics, the Languages, etc. Write for catalog.

The University of Chicago

E27 ELLIS HALL

CHICAGO, ILL.

## Anyone CAN LEARN

No talent or experience necessary. Fascinating work. Pays big money. Complete instruction book tells about Alphabets, Colors, How to Mix Paints, Show Cards, Window Board and Wall Signs, Ready made letters, Gliding, Tricks of the Trade, also gives 100 Alphabets and Designs. Book bound in flexible int. leather-gold edging, and four ball bearing Show Card Pens. Sent postpaid \$3.00. (C.O.D.) 10c extra.

Ogilvie Pub. Co., 57 Res St., Dept. 20, N.Y. City

**EARN MONEY IMMEDIATELY—**  
**WE FURNISH EQUIPMENT TO START!!**

You can be quickly cured, if you

## STAMMER

Send 10 cents for 288-page book on Stammering and Stuttering. "Its Cause and Cure." It tells how I cured myself after stammering 20 yrs. B. N. Bogue, 11136 Bogue Bldg., 1147 N. Illinois St., Indianapolis.

## WELDING ELECTRIC ARC OXY-ACETYLENE

Taught by Actual Welding Practice.

No Finer Equipment Anywhere at Any Price. Pipe-Line, Sheet Steel, Structural Steel, Cast Iron, Aircraft and Commercial Welding, Cutting and Brazing. SPLENDID OPPORTUNITIES NOW FOR TRAINED WELDERS. Also Courses in Radio, Electricity and Automobiles. Full Information Free on Request.

Coleman Electrical School, 1628-X Main St., Kansas City, Mo.

## Wireless (Radio)

and Morse telegraphy taught thoroughly. School, oldest and largest; endorsed by Telegraph, Radio, Railway and Government officials. Unusual opportunities. Expenses low—can earn part. Catalog free. DODGE INSTITUTE, Jones St., Valparaiso, Indiana.



Wonderful, new device, guides your hand; corrects your writing in a few days. Big improvement in three hours. No failures. Complete outline FREE. Write C. J. Ozment, Dept. 34, St. Louis, Mo.



**New!**



*Patented*

# Just A Twist Of The Wrist Banishes Old-Style Can Openers to the Scrap Heap and BRINGS AGENTS UP TO \$6 AND \$8 IN AN HOUR!

**W**OMEN universally detest the old-style can opener. Yet in every home in the land cans are being opened with it, often several times a day. Imagine how thankfully they welcome this new method—this automatic way of doing their most distasteful job. With the Speedo can opening machine you can just put the can in the machine, turn the handle, and almost instantly the job is done.

## End This Waste and Danger

You undoubtedly know what a nasty, dangerous job it is to open cans with the old-fashioned can opener. You have to hack your way along slowly—ripping a jagged furrow around the edge. Next thing you know, the can opener slips. Good night! You've torn a hole in your finger. As liable as not it will get infected and stay sore a long time. Perhaps even your life will be endangered from blood poisoning! You may be lucky enough to get the can open without cutting yourself. But there's still the fact to consider that the ragged edge of tin left around the top makes it almost impossible to pour out all of the food. Yet now, all this trouble, waste and danger is ended. No wonder salesmen everywhere are finding this invention a truly revolutionary money maker!

to snag your fingers—all in a couple of seconds! It's so easy even a 10-year-old child can do it in perfect safety! No wonder women—and men, too—simply go wild over it! No wonder Speedo salesmen have sold to every house in the block and have made up to \$8 in an hour.

## Generous Free Test Offer

Frankly, men, I realize that the profit possibilities of this proposition as outlined briefly here may seem almost incredible to you. So I've worked out a plan by which you can examine the invention and test its profits without risking one penny.

Get my free test offer while the territory you want is still open—I'll hold it for you while you make the test. I'll send you all the facts about salesmen making up to \$100 and even more in a week. I'll also tell you about another fast selling item that brings you two profits. All you risk is a 2c stamp—so grab your pencil and shoot me the coupon right now.

**CENTRAL STATES MFG. CO., Dept. W-704,  
4500 Mary Ave. (Est. over 20 years) St. Louis, Mo.**

### AGENTS!



**Full Time  
\$265  
in a  
Week**

"Here is my record for first 30 days with Speedo:  
June 13, 60 Speedos;  
June 20, 84 Speedos;  
June 30, 192 Speedos;  
July 6, 288 Speedos.  
I made \$265 in a week."  
M. ORNOFF, Va.

**SPARE TIME  
\$9 First Half Day**

"The first afternoon I received my Speedo outfit I made \$9."

MRS. R. SPAIN, Kas.

**PART TIME  
\$20 in 3 Hours**

"I worked about three hours and took 25 orders. This brought me \$20 profit."  
O. C. GREGG, Wyo.

## A "Million Dollar" Can Opening Machine

The Speedo holds the can—opens it—flips up the lid so you can grab it—and gives you back the can without a drop spilled, without any rough edges



Central States Mfg. Co.,  
4500 Mary Ave., Dept. W-704,  
St. Louis, Mo.

Rush me your FREE TEST OFFER.

Name.....

Address.....

City..... State.....

Check here if interested only in one for your home.



# SHOW CARD LETTERING

## Learn at Home

HERE is the very course you need if you want to get a good paying position as a Show Card Letterer or Sign Letterer, or have a business of your own. This course is complete and practical, arranged to meet the needs of the student who studies at home.

H. L. Wood, a clerk, made more than \$700 "on the side" before he had completed his course and also won \$125 in prizes. Harry William Lord writes that he has more than doubled his salary as a result of studying this I. C. S. course in spare time.

There is no doubt that Show Card Lettering and Sign Lettering offer a real opportunity to ambitious men and women. Just mark and mail the coupon and we'll gladly send you a booklet telling all about the I. C. S. course in Show Card Lettering, or any other subject in which you are interested.

### INTERNATIONAL CORRESPONDENCE SCHOOLS Box 5517-G, Scranton, Penna.

Without cost or obligation, please send me a copy of your booklet, "Who Wins and Why," and full particulars about the course before which I have marked X in the list below:

- |                                                           |                                                 |                                                                         |
|-----------------------------------------------------------|-------------------------------------------------|-------------------------------------------------------------------------|
| <input type="checkbox"/> ILLUSTRATING                     | <input type="checkbox"/> SHOW CARD LETTERING    | <input type="checkbox"/> CARTOONING                                     |
| <input type="checkbox"/> Business Management              | <input type="checkbox"/> Advertising            | <input type="checkbox"/> Business Correspondence                        |
| <input type="checkbox"/> Industrial Management            | <input type="checkbox"/> Stenography and Typing | <input type="checkbox"/> English <input type="checkbox"/> Civil Service |
| <input type="checkbox"/> Personnel Management             | <input type="checkbox"/> Railway Mail Clerk     | <input type="checkbox"/> Mail Carrier                                   |
| <input type="checkbox"/> Traffic Management               | <input type="checkbox"/> Common School Subjects | <input type="checkbox"/> High School Subjects                           |
| <input type="checkbox"/> Accounting and C. P. A. Coaching | <input type="checkbox"/> Lumber Dealer          | <input type="checkbox"/> Spanish <input type="checkbox"/> French        |
| <input type="checkbox"/> Cost Accounting                  |                                                 |                                                                         |
| <input type="checkbox"/> Bookkeeping                      |                                                 |                                                                         |
| <input type="checkbox"/> Secretarial Work                 |                                                 |                                                                         |
| <input type="checkbox"/> Salesmanship                     |                                                 |                                                                         |

### TECHNICAL AND INDUSTRIAL COURSES

- |                                                  |                                                                             |
|--------------------------------------------------|-----------------------------------------------------------------------------|
| <input type="checkbox"/> Architect               | <input type="checkbox"/> Automobile Work                                    |
| <input type="checkbox"/> Architectural Draftsman | <input type="checkbox"/> Airplane Engines                                   |
| <input type="checkbox"/> Building Foreman        | <input type="checkbox"/> Plumber and Steam Fitter                           |
| <input type="checkbox"/> Concrete Bulldger       | <input type="checkbox"/> Plumbing Inspector                                 |
| <input type="checkbox"/> Contractor and Builder  | <input type="checkbox"/> Foreman Plumber                                    |
| <input type="checkbox"/> Structural Draftsman    | <input type="checkbox"/> Heating and Ventilation                            |
| <input type="checkbox"/> Structural Engineer     | <input type="checkbox"/> Sheet-Metal Worker                                 |
| <input type="checkbox"/> Electrical Engineer     | <input type="checkbox"/> Steam Engineer                                     |
| <input type="checkbox"/> Electrical Contractor   | <input type="checkbox"/> Marine Engineer                                    |
| <input type="checkbox"/> Electric Wiring         | <input type="checkbox"/> Refrigeration Engineer                             |
| <input type="checkbox"/> Electric Lighting       | <input type="checkbox"/> R. R. Positions                                    |
| <input type="checkbox"/> Electric Car Running    | <input type="checkbox"/> Highway Engineer                                   |
| <input type="checkbox"/> Telegraph Engineer      | <input type="checkbox"/> Mining Engineer                                    |
| <input type="checkbox"/> Telephone Work          | <input type="checkbox"/> Pharmacy                                           |
| <input type="checkbox"/> Mechanical Engineer     | <input type="checkbox"/> Chemistry                                          |
| <input type="checkbox"/> Mechanical Draftsman    | <input type="checkbox"/> Iron and Steel Worker                              |
| <input type="checkbox"/> Machine Shop Practice   | <input type="checkbox"/> Textile Overseer or Supt.                          |
| <input type="checkbox"/> Toolmaker               | <input type="checkbox"/> Navigation <input type="checkbox"/> Assayer        |
| <input type="checkbox"/> Patternmaker            | <input type="checkbox"/> Cotton Manufacturing                               |
| <input type="checkbox"/> Civil Engineer          | <input type="checkbox"/> Woolen Manufacturing                               |
| <input type="checkbox"/> Surveying and Mapping   | <input type="checkbox"/> Agriculture <input type="checkbox"/> Fruit Growing |
| <input type="checkbox"/> Bridge Engineer         | <input type="checkbox"/> Poultry Farming                                    |
| <input type="checkbox"/> Gas Engine Operating    | <input type="checkbox"/> Mathematics <input type="checkbox"/> Radio         |

Name.....  
 Address.....  
 City.....State.....  
 Occupation.....

If you reside in Canada, send this coupon to the International Correspondence Schools Canadian, Limited, Montreal, Canada

# Increase Your Earning Power

Apply time and labor-saving kinks to your work. Your efficiency will soon be recognized and you will be in line for advancement.

If you do machine shop work of any kind, sheet-metal work, painting, carpentry, auto repairing, farming, concrete work, plumbing, electrical work, welding, building, glass work, general repairing, tool-making, poultry raising, masonry or home repair work, get this

## LIBRARY OF 6000 TIME AND LABOR SAVING IDEAS FOR SHOPMEN AND HANDYMEN JUST PUBLISHED

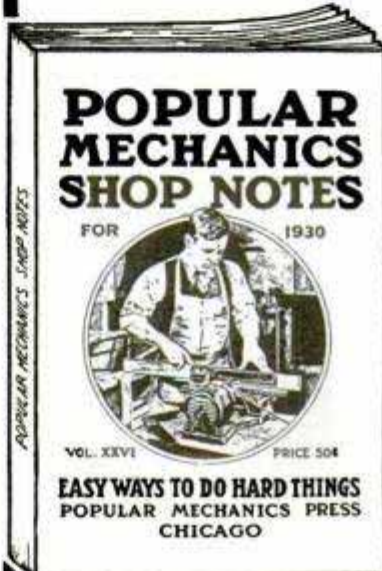

## SHOP NOTES for 1930

192 Pages  
415 Articles  
377 Illustrations  
See partial list of contents below

Including the new 1930 issue illustrated above, there are now 12 volumes in the Shop Notes Library of 6,000 easily understood short cuts to every-day jobs. Here are just a few of the subjects taken from the 415 articles in the latest issue.

- |                                           |                                     |                                                         |
|-------------------------------------------|-------------------------------------|---------------------------------------------------------|
| Animal Traps, Care of                     | Concrete Fountain Water, Cooler for | Sanding on the Lathe Saw Mount for Home-Shop            |
| Barrel Method of Slinging                 | Furniture, Refinishing Old          | Saws, Keeping Fit                                       |
| Bench Light, Convenient                   | Furniture, Restoring                | Speedsaw, Ball-Bearing                                  |
| Bench Saw, Getting Most Out of            | Damage                              | Switch for                                              |
| Boatwain's Chair Rigging                  | Hackaws, Power, for Small Shops     | Stainless Steel, Soldering "Sugi" Finish, How to Apply  |
| Bookcase, Modern                          | Hoist, Light and Strong             | Summer House, Japanese                                  |
| Brass Fixtures, Cleaning                  | Household Shortcuts                 | Templates, Making Accurate                              |
| Builders' and Contractors' Kinks          | Ice Cutter, Engine-Driven           | Tinners, Paint Scraper for                              |
| Cams Jig for Layout of Conveyor, Portable | Outboard Motor, Super-charger for   | Toolrest, Sliding, for Emery Wheel                      |
| Speeds Lending                            | Package Sealer, Home-made           | Tools for Home Mechanics                                |
| Dadging on Small Power Saws               | Pipe Holder, Hammered-Copper        | Towed Car Steered by Tow Bar                            |
| Decorating with Pastry Gun                | Power Saw Made from Buffing Head    | Wood, Plastic Filler for Workshop, Homemade Combination |
| Disk Sander Making                        | Power Shears Made in Small Shop     |                                                         |
| Ellipse, How to Lay Out                   | Sand Disk for Small Lathes          |                                                         |
| "Exercises", Electric                     |                                     |                                                         |
| Farmers, Labor-Saving Kinks for           |                                     |                                                         |
| "Flagstones", Making                      |                                     |                                                         |

Each volume contains approximately 500 articles and 400 illustrations and has 224 Pages. At the regular price of 50 cents per single volume this library costs \$6.00, but for a limited period we will supply the 12 vols. when ordered at one time at the special reduced price of only \$3.75.

### SPECIAL OFFER COUPON

POPULAR MECHANICS PRESS,  
200 E. Ontario St., Room P12, Chicago, Ill.

Send me, as per your special offer, the following books. I will pay postman price and small amount of postage. My money will be refunded if I am not satisfied. (Check what you want.)

1930 Shop Notes and Lathe Handbook, both for 98¢.  
 Complete Shop Notes Library (12 vols.) \$3.75.

Name.....  
 Street and No.....  
 City.....State.....





**Major Rockwell  
Famous War Flyer  
Who Will Teach You**

Major Rockwell is a famous World War flyer, decorated with the Legion of Honor and the War Cross. He is now devoting himself to teaching Aviation, and he will train you for a position in this great new industry as only a Veteran World War Flyer can train you. Under Major Rockwell's guidance your future in Aviation is assured.

**"I Will Train You at Home  
LEARN TO EARN  
\$300 to \$400 a Month"**

I offer you this easy, quick way to get into Aviation. There is a need for trained men, and this is your opportunity to enter this uncrowded, fascinating field with a bright future.

**In a Few Short Months**

Just devote about an hour a day to my Home Study Course, and in a few short months you can master the principles of Ground Training, which are necessary before you

**take your place in any branch of Aviation.**

In a few short months I will give you practical aviation training and prepare you for one of the better pay jobs open to men thoroughly trained in Aviation.

**No Advance Education Necessary or Experience Needed**

You don't need to have a high school or college education to master my course. You do not need to know anything about airplanes, motors or mechanics. My home course is thorough and complete. Everything is so clearly explained, with easy-to-understand text and pictures, that in a few short months you will be

able to grasp every fundamental principle of Aviation ground work and you will be well on the road to qualify for an important aviation job, that will later on lead into a job paying \$300 to \$400 a month. My Home Study Course will give you all the knowledge necessary to pass the government's written examinations for mechanics' or pilots' licenses.

**Glider Course  
No Extra Cost**

To all students who enroll now we will include a Glider Course without extra charge. This course has been prepared in accordance with the correct principles of glider construction and operation and is a very valuable addition to your knowledge of Aviation. Enroll at once and get the Glider Course.

**You Learn Principles of Aviation at Home  
Then Choose Any One of 40 Ground Jobs.  
My Home Study Course All You Need**

When you have completed the ground training I will arrange for you to take your flying instruction at any licensed airport near your home at special reduced rates. Or, if you want, you can come here to Dayton and get training at a fine, well equipped airport. No matter where you learn to fly you can qualify for a pilot's license and a high pay flying job in passenger lines, mail service, and other important branches of flying.

**Employment  
Service**

After you graduate I assist you in getting a job without any cost to you. Right now the demand for trained men is greater than the supply. A place is ready for you!

**Only Trained Men Can Qualify in Aviation**

The big money in Aviation does not go to the novice or apprentice. Only TRAINED men can command the high salaries. Employers are glad to pay big money for men who know Aviation—builders, mechanics, service and maintenance men, and flyers. Let me prepare you for one of the many high salaried Aviation jobs open to the trained man. I will prepare you to take your place in the most fascinating, fastest growing industry in the world. Rush this coupon to me for a copy of my famous free book.

**MONEY BACK AGREEMENT**

I am so sure that you can learn Aviation with my help and step into a good Aviation job that if you are not satisfied when you have finished my course, I agree to return every penny of your tuition.

**MAJOR ROB'T L. ROCKWELL**

**THE DAYTON SCHOOL OF AVIATION**

**Desk Z-1**

**DAYTON, OHIO**

**Get My No-Risk Plan  
My Big Book  
Explains ALL  
I'll send it FREE**



**Major Rob't L. Rockwell  
The Dayton School of Aviation  
Desk Z-1, Dayton, Ohio**

Dear Major:—Please send me FREE and without obligation a copy of your famous book on Aviation; also your tuition and position offer.

Name.....  
Address.....  
Town..... State..... Age.....

# VOICE

**NOW! you can have the VOICE you want!**



## 100% Improvement Guaranteed!

No matter how hopeless your case may seem—send for free Voice Book. New SILENT Method of Voice Training. Increases Range. Improves quality. Banish huskiness—hoarseness. 100 per cent improvement *guaranteed*—or money back. Mail coupon *at once* for free booklet—the greatest voice booklet ever written—sent FREE with no obligation!

Perfect Voice Institute, Dept. 13-59  
1922 Sunnyside Ave., Chicago

### Mail Coupon for Free Voice Book

Perfect Voice Institute, Dept. 13-59  
1922 Sunnyside Ave., Chicago

Please send me FREE and without obligation, Prof. Feuchtinger's new book, "Physical Voice Culture." I have checked subject in which I am most interested.

Weak Voice  Singing  Stammering  Speaking

Name .....

Address .....

City ..... State .....

## ENGINEERING — ELECTRICITY ARCHITECTURE — DRAFTING

Save time—enroll at this old established school of engineering. Enter any time, days or evenings. 1, 2 and 3 year courses. Diplomas and B. S. Degrees.



Est. 1903

Special 4 months' practical course in Drafting. Others short courses. Low tuition—easy terms. Earn while you learn. Free employment bureau. Athletics. Successful graduates every-

where. Write for our free, illustrated 80 page "Blue Book." It gives you all the facts. Address the President, Charles W. Morey, B. S., M. E.

**CHICAGO TECHNICAL COLLEGE**  
Dept. R-78 118 East 26th Street, Chicago, Ill.

## TRI-STATE COLLEGE



B. S. degree in 2 years in Aeronautical, Civil, Electrical, Mechanical, Chemical, Administrative Engineering. Students who left H. S. can make up work. Tuition low. *Catalog.*

4120 College Street Angola, Indiana

## Write and Speak MASTERLY ENGLISH



Learn correct English with Sherwin Cody's new invention. No rules to memorize. Like a fascinating game. Spare-time study, 15 minutes each day, quickly gives you command of English. Send for free booklet "How You Can Master Good English in 15 Minutes a Day." Write today.

Sherwin Cody School of English, 512 Searle Bldg., Rochester, N. Y.

## HOT PIANO Ultra-modern Piano



Jazz taught by mail. Note or ear. Easy rapid lessons for adult beginners. Also Self-instruction system for advanced pianists. Learn 358 Bass Styles, 976 Jazz Breaks, hundreds of Trick Endings, Hot Rhythms, Sock, Stomp and Dirt Effects; Symphonic and Wicked Harmony in latest Radio and Record Style. Write for Free Booklet.

WATERMAN PIANO SCHOOL, 1826 W. Adams St., Los Angeles, Calif.



## Send for my Book STRONG ARMS And BROAD SHOULDERS for 25c coin or 30c stamps

Illustrated with 20 full-page half-tone cuts, showing exercises that will quickly develop, beautify and gain great strength in your shoulders, arms and hands, without any apparatus.

Equal to a \$20.00 Course

Prof. ANTHONY BARKER  
1235 6th Avenue Studio K New York City



## "BECOME A LIGHTNING TRICK CARTOONIST"

Send \$1.00 for Laugh Producing Program of 23 Trick Drawings with Instructions. Catalog of Chalk Talk Supplies Free. BALDA ART SERVICE, Dept. 1, Oshkosh, Wis.

## SONG WRITERS!



SUBSTANTIAL ADVANCE ROYALTIES are paid on work found acceptable for publication. Anyone wishing to write either the words or music for songs may submit work for free examination and advice. Past experience unnecessary. New demand created by "Talking Pictures" fully described in our free book. Write for it Today. NEWCOMER ASSOCIATES

759 Earle Building, New York, N. Y.



# RADIO is BOOMING

## Pick the Job You Want and Fill It . . . in a Few Months!

By means of an actually proven kind of home study training sponsored by the Radio Corporation of America, hundreds of ambitious fellows are today enjoying financial independence in work that is thrilling.

Radio needs you. Opportunities are begging for men. Good money . . . fascinating work . . . adventure galore! Read all about this tremendous modern industry . . . send for this magnificent free book. Mail the coupon now!

*Prepare  
at Home*

Only an hour or so a day is all you need. This Big League training prepares you for success in all phases of radio . . . manufacturing, servicing, selling, ship and shore broadcasting, photo-radiograms, radio equipment. Our graduates are in demand everywhere . . . because they are posted right up to the minute in everything in Radio. Radio's progress each year is measured by the accomplishment of the great engineers at work in the research laboratories of the Radio Corporation of America. This world-wide organization sets the standard for the industry . . . and stands back of every lesson in the course! A signed agreement by the president of the school assures you of absolute satisfaction upon completion of the training—or your money will be promptly refunded.

**RCA INSTITUTES, INC.**  
(A division of Radio Corporation  
of America)

**THE ONLY COURSE IN RADIO SPONSORED BY RCA**



**RCA INSTITUTES, INC.**  
Dept. PM-12  
75 Varick St., New York, N. Y.

**GENTLEMEN:** Please send me your big FREE 40-page book which tells about the brilliant opportunities in Radio and about your famous laboratory-method of guaranteed radio instruction at home.

Name \_\_\_\_\_

Address \_\_\_\_\_

# if-

**you pledge**

yourself to secrecy we will  
teach you the secrets of

**Real Professional**

# Magic



*Dr. Harlan Tarbell, internationally known magician and teacher of some of the world's greatest magicians.*

## Be a Magician!

**No Salesman Will Bother You!**

For the first time in the history of Magic the age-old, sacredly guarded secrets of Mystic Art are being revealed. Now at last you can learn to be a Real Professional Magician. Yes, and you can learn this wonderful art *easily and quickly* AT HOME. You are taught the mysterious *Principles* by which the Professional Magician works. But before you can study, you must sign the Magician's Solemn Pledge of Secrecy. This means you are getting the *guarded secrets* of the Magic Profession.

**Tarbell System, Inc., Studio 13-59  
1926 Sunnyside Avenue Chicago, Illinois**

**Tarbell System, Inc., Studio 13-59  
1926 Sunnyside Avenue, Chicago, Ill.**

Gentlemen: Without any obligation send me your free literature and information all about your wonderful "Tarbell Course in Magic." Also tell me about your Low Price Offer and Easy Payment Plan.

Name .....

Address .....

Age .....

## PLAY DRUMS •• Easily Quickly ••



With easy-playing Ludwig drums you develop a fine roll quickly. Brilliant tone that snaps out wins instant admiration. Leading professionals use Ludwigs. Complete outfits from \$34.50 up.

**FREE TRIAL; Easy Payments.** Self-Instructor free with every outfit. Write now for catalog and details.

## LUDWIG & LUDWIG

1202 D Ludwig Building  
1611-27 N. Lincoln St., Chicago, Ill.

## BECOME AN EXPERT ACCOUNTANT

Executive Accountants and C. P. A.'s earn \$3,000 to \$10,000 a year. Thousands of firms need them. Only 9,000 Certified Public Accountants in the United States. We train you thoroughly at home in spare time for C. P. A. examinations or executive accounting positions. Previous experience unnecessary. Training under the personal supervision of William B. Gastenholz, A. M., C. P. A., and a large staff of C. P. A.'s, including members of the American Institute of Accountants. Write for free book, "Accountancy, the Profession that Pays." LA SALLE EXTENSION UNIVERSITY, Dept. 1264-H, CHICAGO The World's Largest Business Training Institution

## ENGINEERING ELECTRICAL MECHANICAL STRUCTURAL and ARCHITECTURE

**INTENSIVE PRACTICAL TECHNICAL COURSES.** Degree in 2 years. Diploma in 1 year. Special short courses 6 Weeks to 4 Months in Electricity, Radio, Power Plant, Electric Refrigeration, Armature Winding, Wiring, Testing, Drafting, Welding. **LOW TUITION.** Expert instructors. Extensively equipped laboratories. Free life-time employment service for graduates. Part-time work while attending. Write for new free illustrated catalog giving all facts. 29th year.



**FINLAY ENGINEERING COLLEGE**  
1001 A Indiana Avenue Kansas City, Missouri

## Learn Advertising at HOME

Send your name and address for free booklet giving interesting information and vital facts about Advertising. Find out how we prepare you at home, in your spare time, for the opportunities open in this fascinating business. Practical work. No text books. Old established school. Successful graduates everywhere. Just the plan you have always wanted. Write today. No obligation.

**PAGE-DAVIS SCHOOL OF ADVERTISING**  
Dept. 1359, 3601 Michigan Ave. Chicago, U. S. A.

## LEARN WATCHMAKING AND ENGRAVING

**BY OUR PROFIT-SHARING PLAN OUR GRADUATES SUCCEED**

One of our Iowa students started in a very small way—now doing over \$30,000 a year. Another in Wisconsin, over \$10,000 the first year. Day or night classes. Call or write for FREE BOOK

Chicago School of Watchmaking, Dept. 6701, 549 W. Randolph St., CHICAGO

# BASHFUL?

"Shame on you!" Are you nervous, embarrassed in company of the other sex? Stop being shy of strangers. Conquer the terrible fear of your superiors. Be cheerful and confident of your future! Your faults easily overcome so you can enjoy life to the fullest. Send 25c for this amazing book.

**RICHARD BLACKSTONE, B-4712 Flatiron Bldg., N. Y.**

## Learn Photography at HOME

Make money taking pictures. Prepare quickly during spare time. Also earn while you learn. No experience necessary. New easy method. Nothing else like it. Send at once for free book, OPPORTUNITIES IN MODERN PHOTOGRAPHY and full particulars.

**AMERICAN SCHOOL OF PHOTOGRAPHY**  
Dept. 1359 3601 Michigan Ave. Chicago, U. S. A.

# \$16 the first night for playing!

**M**OST of the world works for a living—works hard, too. But that doesn't mean **you** have to. Why not **play** for a living? Do something you like to do, and make it pay you big money. Plenty of men and women who had a hard time to get along six months ago—are now making from \$50 to \$100 a week—playing their Hawaiian Guitars. And they didn't know how to read a single note of music when they came to me.

## America's Most Popular Music

The haunting, soft, melodious strumming of the Hawaiian Guitar is America's most popular music. Everywhere orchestras are looking for men and women who can play the Hawaiian Guitar. Everywhere those who have mastered the Hawaiian Guitar are getting paid more and more money. Roy Reikane writes in, "I have made \$200 extra money in 6 weeks playing my Hawaiian Guitar." Carlton E. Scarbro recently wrote me, "I have made \$1,000 since I took your course." Granville Smith writes, "I make \$8 a night and play only 4 hours."



One of the Dozens of Photo helps sent with each Course

Hundreds of such letters have come in. But let me tell you about my short-cut to good times and big pay—my simplified method of learning to play the Hawaiian Guitar at home in a few weeks. A new method—so easy to understand—so much fun to learn—that even a child can pick it up. (We have successfully taught children only 8 years of age.)

## Pictures Instead of Words, Teach You

I don't care if you have never read a note in your life, or don't know what a Hawaiian Guitar looks like. All I ask is that you **like** music. My methods are so clear and easy to understand that you will actually play a real melody after the very first lesson. Sounds uncanny, doesn't it? Here's how I do it.

With your lessons I send dozens of photographs showing just how to place your fingers, how to strum the strings. My Kno-All and Master charts teach you to read notes almost automatically. It's as simple as learning your A B C's over again. Some of our students become finished musicians the first month, others take a little longer, but they all learn with surprising speed.

## Lonesome? It's a Sure Cure!

Once you have mastered the Hawaiian Guitar, the world lies waiting at your feet. You can travel anywhere, meet the best people, live in real style and comfort, and gain a host of friends. All this is yours, waiting for you, if you are willing to spend a few minutes a day with me for a few short weeks.



## We Send You Regular Phonograph Records of Every Piece in the Course

And we don't miss a single bet. To make sure that you can't go wrong, we send you a whole set of regular phonograph records, on which is recorded every melody you learn to play while taking the course. These aid you to correct minor mistakes, and assure you of perfect technique. With these records to guide you—the tiniest error in your playing is quickly corrected. These records come absolutely free with the course and are an excellent addition to your home music as well.



## This is what Prutzman Did

"A friend asked me if I could play the Hawaiian Guitar. I told him I'd only been playing for a few weeks, but he said, 'Come along anyway, and play at the dance. I made out very well, and was paid \$16 for my first night's work. And I see more opportunities ahead.'" — RALPH PRUTZMAN, Leighton, Pa.



We Give You this genuine HAWAIIAN GUITAR WORTH \$20

## Send for FREE BOOK IT SHOWS YOU HOW

Everything is explained. Every last bit of proof is given you. It shows you just how you can master the Hawaiian Guitar at home in double-quick time. How you risk absolutely nothing to learn. How I send everything you need.

Get on the road to Big Pay and Pleasure Today. Write Now!

A. F. Bloch, President, Hawaiian Studios, 52120 of New York Academy of Music, 100 Fifth Avenue, New York City.

Without obligation, send me FREE BOOK "The Hawaiian Way to Popularity and Big Pay," with facts on how I can make BIG MONEY, spare-time or full-time.

Name.....Age.....  
 Address.....  
 City and State.....

# BE A RAILWAY TRAFFIC INSPECTOR



## RAILWAYS AND BUS Earn up to \$250 Monthly

Active men—19 to 55—needed at once in Railways and Bus Traffic Inspection. This steady, profitable work pays up to \$250 per month plus expenses. Interesting outdoor work. Travel or remain near home. We'll train you for this uncrowded profession and on completion of a few months spare time home instruction will assist you to a position paying from \$120 up or refund your tuition. Our free booklet tells what Traffic Inspection can do for you. Write for it today. Don't delay. Write

**Standard Business Training Institute**  
Div. 2 Buffalo, N. Y.

# Genuine UNDERWOOD Below 1/2 Price

Easiest  
Terms  
—  
Pay  
only  
10c  
a Day



Famous  
No. 4 Model

**NOW ONLY** **\$1 DOWN**

## Standard 4-Row Keyboard



Think of it! Only \$1.00 brings the World's most famous Underwood Typewriter for 10 days' free trial. Lowest price and easiest terms ever offered. Pay only 10c a day on easy monthly payment plan. This is the full size standard Underwood 4-row keyboard typewriter, manufactured to sell for \$100.00.

Do not confuse this 4-row standard office model Underwood with other frail machines originally costing only one-half as much.

### Typewriting Course FREE

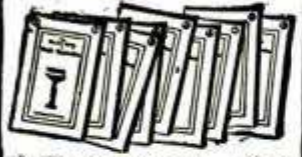

We teach you free. Complete Home Study Course of the famous Van Sant Speed Typewriting System, fully illustrated, easily learned, used in schools, business offices, everywhere.

### Easy Terms 10 Day FREE Trial

This late model Underwood, specially priced at \$39.90 (cash) is the lowest price ever quoted; has modern improvements, including 4-row keyboard, two-color ribbon, back spacer, ribbon reverse, tabulator, release, shift lock and many other improvements. Beautifully refinished and renewed. Looks and operates like brand new.

### INTERNATIONAL TYPEWRITER EXCHANGE 231 West Monroe St., Chicago, Ill., Dept. 1201

I enclose \$1 deposit. Send Underwood No. 4 F.O.B. Chicago at once for 10-day Trial. If I am not perfectly satisfied I can return it Express Collect and get my deposit back. If I keep it I will pay \$3.00 a month until I have paid \$44.90 in full.

Name.....Age.....  
Address.....  
Town.....State.....

## LEARN MOTION PICTURE OPERATING

Complete Home Study Course With the privilege of attending our school, for free practical training on Western Electric Sound Equipment.  
WRITE FOR FREE BOOKLET  
**CALIF. OPERATORS SCHOOL**  
103 N. Rowan Ave., Los Angeles, Cal.



## Learn Public Speaking

At home—in spare time—20 minutes a day. Overcome "stage-fright," gain self-confidence, increase your salary, through ability to sway others by effective speech. Write now for free booklet, *How to Work Wonders With Words*.  
**NORTH AMERICAN INSTITUTE, Dept. 1359**  
3601 Michigan Avenue, Chicago, Illinois

## WHY STAMMER? Don't be a failure. Master perfect speech. Live a healthy, normal and happy life. Send for free book which tells you how. THE LEWIS INSTITUTE, 12962 Woodward Ave., Detroit, Mich.

# NERVES?

Are You Always Excited? Fatigued? Worried? Gloomy? Pessimistic? Constipation, indigestion, cold sweats, dizzy spells and bashfulness are caused by NERVE EXHAUSTION. Drugs, tonics and medicines cannot help weak, rich nerves! Learn how to regain Vigor, Calmness and Self-Confidence. Send 25c for this amazing book.  
**RICHARD BLACKSTONE, N-4712 FLATIRON BUILDING, N. Y.**

# MAKE MUCH MONEY

Making and Selling Your Own Products. Formulas, Processes, Trade-Secrets. All lines. Automobile Specialties. Cleaning, Polishing Compounds. Food Products. Toilet Preparations, etc. Expert Analytical Service. Catalog, circulars free.

**B. THAXLY CO., Washington, D. C.**

Do You Want To Have  
and Keep

# A BETTER JOB

Let Me Train You For It

Copy This Jack

Send sketch at once, if you are 16 or more. I will mail you entirely free Draftsman's Pocket Rule and "My Job-Securing and Pay-Raising Plan." Opportunities for draftsmen are bigger than ever. →

## JOBS HERE:



Copy me and get Ivorine Rule Free. — Jack

**Auto Work**  
The automobile industry is one of the greatest in America. Thousands of draftsmen needed. I'll train you for this work.

**Electricity**  
Electricity is the coming motive force of the world. Draftsmen are needed in every department of this fascinating work. I'll train you at home. Get a job here.

**Motor Bus Work**  
Motor bus building and transportation have become leading world industries. Hundreds of draftsmen engaged in this work. I'll show you the way.

**Aviation**  
Aviation is just in its infancy. It is bound to expand to enormous proportions. Draftsmen are essential to it. I'll train you quick at home for drafting position.

**Building Work**  
There will always be building. No structure can be erected without plans drawn by draftsmen. I'll make you an architectural draftsman at home.

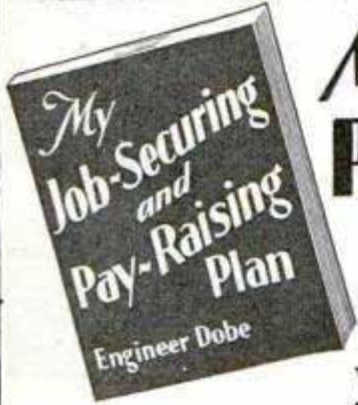

## My Job-Securing Pay Raising Plan FREE



Here are the tools you get

I send you these fine imported money-making tools as my student.

Why work all your life for small pay and with little chance for a raise or promotion? I'll train you for higher class, cleaner work. Leading to salaries of \$60—\$70 and up to \$100 a week. Get my Job-Securing and Pay-Raising Plan NOW.

This is a very valuable book for young men who want bigger pay. It is not a catalog, but my Job-Securing and Pay-Raising Plan and Money-Making Advice. I prove that John Savadge, trained by me, makes \$300 a month. Earl J. Dupree, trained by me, refused \$600 a month because he makes more in his own business. A. H. Bernier, trained by me, earns \$7,000 to \$9,000 a year. Arthur De Walt, trained by me, makes more than \$400 a month. D. C. Stroop, trained by me, makes \$475 a month. L. V. Broughten, trained by me, makes \$300 a month. No previous experience needed. You don't have to be a high school graduate.

### I Train You at Home

My practical working method makes every step in learning drafting as clear as a moving picture. That's why I train you so fast to be a draftsman.



**Mail this COUPON If You Earn Less Than \$70 a Week**

Mail this coupon now, and I will send you "My Job-Securing and Pay-Raising Plan", Drafting Book and Draftsman's Pocket Rule—postpaid and free.

**ENGINEER DOBE, 1951 Lawrence Avenue Div. 13-59 Chicago, Ill.**

### Money Back If Not Satisfied

I train you under a positive Money-Back Agreement. If my training does not satisfy you after you have finished you get every penny back.

### Earn While You Learn

You can start earning money a few weeks after beginning my training. I give you special work and tell you how to make money.

### Employment Service

After training you I help you to get a job without charging you a cent for this service. Employers of draftsmen come to me for men because they know that men I train make good.

## FREE JOB-SECURING PLAN

**ENGINEER DOBE, Div. 13-59 1951 Lawrence Ave., Chicago**

Send me free of all cost, "My Job-Securing and Pay-Raising Plan", also FREE Drafting Book and Draftsman's Pocket Rule. All FREE.

Name \_\_\_\_\_ Age \_\_\_\_\_  
 Address \_\_\_\_\_  
 Post Office \_\_\_\_\_ State \_\_\_\_\_



## Salary Increased from \$112 to \$400 a Month

"My I. C. S. course in Cost Accounting was of great practical help in enabling me to install a cost system in a plant having somewhat unusual problems. It also helped me to get my B.C.S. degree from a resident commercial school and in preparing for the C.P.A. examination. My salary was \$112 a month when I enrolled. It is now \$400 a month, with a generous allowance for traveling expenses."

That's a true story of what spare-time study has done for just one man. There are thousands of others. Why don't you take up a home-study course with the International Correspondence Schools and prepare yourself to earn more money? You can do it if you really try.

It doesn't cost you a penny or obligate you in any way to mark and mail the coupon, but that one simple step will bring you information that will help you to get out of the rut and make good in a big way.

**Write Today for Free Booklet**

### INTERNATIONAL CORRESPONDENCE SCHOOLS

"The Universal University"

Box 5518-G, Scranton, Penna.

Without cost or obligation, please send me a copy of your booklet, "Who Wins and Why," and full particulars about the subject before which I have marked X:

#### TECHNICAL AND INDUSTRIAL COURSES

- |                                                                              |                                                                              |
|------------------------------------------------------------------------------|------------------------------------------------------------------------------|
| <input type="checkbox"/> Architect                                           | <input type="checkbox"/> Automobile Mechanic                                 |
| <input type="checkbox"/> Architectural Draftsman                             | <input type="checkbox"/> Plumbing <input type="checkbox"/> Steam Fitting     |
| <input type="checkbox"/> Building Estimating                                 | <input type="checkbox"/> Heating <input type="checkbox"/> Ventilation        |
| <input type="checkbox"/> Wood Millworking                                    | <input type="checkbox"/> Sheet Metal Worker                                  |
| <input type="checkbox"/> Contractor and Builder                              | <input type="checkbox"/> Steam Engineer                                      |
| <input type="checkbox"/> Structural Draftsman                                | <input type="checkbox"/> Steam Electric Engineer                             |
| <input type="checkbox"/> Structural Engineer                                 | <input type="checkbox"/> Civil Engineer                                      |
| <input type="checkbox"/> Electric Wiring                                     | <input type="checkbox"/> Surveying and Mapping                               |
| <input type="checkbox"/> Electrical Engineer                                 | <input type="checkbox"/> Refrigeration                                       |
| <input type="checkbox"/> Electric Lighting                                   | <input type="checkbox"/> R. R. Locomotives                                   |
| <input type="checkbox"/> Welding, Electric and Gas                           | <input type="checkbox"/> R. R. Section Foreman                               |
| <input type="checkbox"/> Reading Shop Blueprints                             | <input type="checkbox"/> R. R. Bridge and Building Foreman                   |
| <input type="checkbox"/> Telegraph Engineer                                  | <input type="checkbox"/> Air Brakes <input type="checkbox"/> Train Operation |
| <input type="checkbox"/> Telephone Work                                      | <input type="checkbox"/> Highway Engineering                                 |
| <input type="checkbox"/> Mechanical Engineer                                 | <input type="checkbox"/> Chemistry <input type="checkbox"/> Pharmacy         |
| <input type="checkbox"/> Mechanical Draftsman                                | <input type="checkbox"/> Coal Mining Engineer                                |
| <input type="checkbox"/> Machinist <input type="checkbox"/> Toolmaker        | <input type="checkbox"/> Navigation <input type="checkbox"/> Boilermaker     |
| <input type="checkbox"/> Patternmaker                                        | <input type="checkbox"/> Textile Overseer or Supt.                           |
| <input type="checkbox"/> Pipefitter <input type="checkbox"/> Tinsmith        | <input type="checkbox"/> Cotton Manufacturing                                |
| <input type="checkbox"/> Bridge Engineer                                     | <input type="checkbox"/> Woolen Manufacturing                                |
| <input type="checkbox"/> Bridge and Building Foreman                         | <input type="checkbox"/> Agriculture <input type="checkbox"/> Fruit Growing  |
| <input type="checkbox"/> Gas Engines <input type="checkbox"/> Diesel Engines | <input type="checkbox"/> Poultry Farming <input type="checkbox"/> Radio      |
| <input type="checkbox"/> Aviation Engines                                    | <input type="checkbox"/> Marine Engineer                                     |

#### BUSINESS TRAINING COURSES

- |                                                                               |                                                                              |
|-------------------------------------------------------------------------------|------------------------------------------------------------------------------|
| <input type="checkbox"/> Business Management                                  | <input type="checkbox"/> Business Correspondence                             |
| <input type="checkbox"/> Office Management                                    | <input type="checkbox"/> Lettering Show Cards <input type="checkbox"/> Signs |
| <input type="checkbox"/> Industrial Management                                | <input type="checkbox"/> Stenography and Typing                              |
| <input type="checkbox"/> Personnel Management                                 | <input type="checkbox"/> Complete Commercial                                 |
| <input type="checkbox"/> Traffic Management                                   | <input type="checkbox"/> Civil Service <input type="checkbox"/> Mail Carrier |
| <input type="checkbox"/> Accountancy <input type="checkbox"/> Cost Accountant | <input type="checkbox"/> Railway Mail Clerk                                  |
| <input type="checkbox"/> C. P. Accountant                                     | <input type="checkbox"/> Grade School Subjects                               |
| <input type="checkbox"/> Bookkeeping                                          | <input type="checkbox"/> High School Subjects                                |
| <input type="checkbox"/> Secretarial Work                                     | <input type="checkbox"/> College Preparatory                                 |
| <input type="checkbox"/> Spanish <input type="checkbox"/> French              | <input type="checkbox"/> Illustrating <input type="checkbox"/> Cartooning    |
| <input type="checkbox"/> Salesmanship <input type="checkbox"/> Advertising    | <input type="checkbox"/> Lumber Dealer                                       |

Name.....Age.....

Address.....

City.....State.....

Occupation.....

If you reside in Canada, send this coupon to the International Correspondence Schools, Canadian, Limited, Montreal, Canada

# BEDFORD YMCA TRADE SCHOOL

Aviation Mechanic  
Flying  
Airplane Welding  
Airplane Drafting  
Air Navigation  
Aero Starting, Lighting, Ignition  
Auto Mechanic  
Machine Shop. Electric Welding  
Oxy-Acetylene Welding  
Radio Mechanic. Battery Repair  
Mechanical, Architectural Drawing  
Sign Painting. Show Card Writing  
Window Dressing  
Commercial Art. Fine Art  
DAY AND EVENING SESSIONS  
Write for Catalog 50  
Brooklyn Engineering Institute  
(Operated by Bedford Y. M. C. A.)  
1125 Bedford Avenue, Brooklyn  
New York City



Mechanical and flying instruction under Government licensed experts. Training for all types of licenses. Day or evening. Work out part of your tuition.

2000 Allegheny Ave., Phila., Pa.

## W.M. PENN AIRCRAFT SCHOOL



### YOU CAN DO IT!

Famous Violin Maker sells genuine "Strad" Patterns, Instruction Book, Fine Woods, Ready-made Parts, Kits, etc.

C.C. FRASER, BOX 14, Sta. C, Grand Rapids, Mich.

## LEARN RADIO - this easy, practical way!

Here is a set of books which covers the needs of the amateur as well as the commercial dealer and service man. The library embodies a thorough home-study course and a constant reference in daily radio problems.

### RADIO CONSTRUCTION LIBRARY

By JAMES A. MOYER, Director, University Extension, and JOHN F. WOSTREL, Instructor, Radio Engineering, both of Massachusetts Department of Education

3 volumes, 993 pages, 6x9, 561 illustrations

Here, step-by-step information is given on all types of hook-ups, including short-wave receivers, wiring, trouble shooting, rebuilding, principles of vacuum tubes, construction of loud speakers, etc. It is a library which should be in the hands of every serviceman, dealer and amateur.

10 DAYS' FREE TRIAL

No Money  
Down—  
Pay in  
Small  
Monthly  
Sums

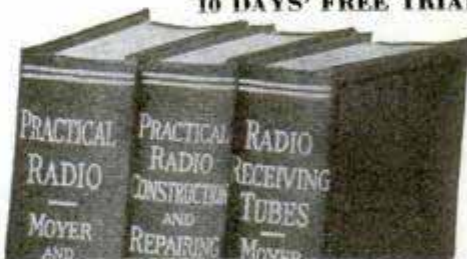

### FREE EXAMINATION COUPON

McGraw-Hill Book Co., 370 Seventh Ave., New York

Send me the Radio Construction Library, three volumes, for 10 days' free examination. If satisfactory I will send \$1.50 in 10 days and \$2.00 a month until \$7.50 has been paid. Otherwise I will return the books.

Name.....

Home Address.....

City and State.....

Position.....

Name of Company..... PM-12-30





# Railway Postal Clerks

\$158 Month First Year

Raise to Maximum of \$225 Month

Many Other U. S. Government Jobs Open to Men and Boys 18 to 45

POST OFFICE CLERKS RURAL MAIL CARRIERS CITY MAIL CARRIERS  
PROHIBITION AGENTS CUSTOMS INSPECTORS

These are steady positions. Strikes, poor business conditions, lockouts or politics do not affect them. U. S. Government employees get their pay for full twelve months every year. There is no such thing as "HARD TIMES" in the U. S. Government Service.

### ALLOWANCE FOR HOTEL EXPENSES

Railway Postal Clerks now get \$1900 the first year regular, being paid on the first and fifteenth of each month. \$79.16 each pay day. Their pay is increased \$100 and \$150 a year. The maximum is \$2700 a year. \$112.50 each pay day. They get extra allowance for hotel expenses when away from home. Many Spring Examinations expected.

### PAID VACATIONS

Railway Postal Clerks, like all Government employees, are given a yearly vacation of 15 working days (about 18 days). When on runs they usually work 3 days and have 3 days off duty or in the same proportion. During this off duty and vacation, their pay continues just as though they were working. When they grow old, they are retired with a pension. As Railway Postal Clerks are continually traveling, they have an excellent chance to see the country.



### CITY MAIL CARRIERS—POST OFFICE CLERKS

Clerks and Carriers get \$1700 the first year regular and automatically increase \$100 a year to \$2100 with further special increase to \$2300. They also have 15 days' vacation. Many February Examinations expected. City residence is unnecessary.

### What Will You Earn 5 Years From Now?

Compare these conditions with your present or your prospective condition, perhaps changing positions frequently, kicking around from post to pillar, no chance in sight for PERMANENT employment; frequently out of a position and the year's average salary very low. DO YOU EARN \$1900 EVERY YEAR? HAVE YOU ANY ASSURANCE THAT A FEW YEARS FROM NOW YOU WILL GET \$2700 OR MORE A YEAR, EVERY YEAR?



FRANKLIN INSTITUTE  
Dept. S174  
ROCHESTER, N. Y.

Rush to me entirely free of charge 32 page book with (1) a full description of the position checked below; (2) a list of U. S. Government jobs now obtainable; (3) tell me how to get the position checked.

- Railway Postal Clerk.. (\$1900-\$2700)
- Post Office Clerk..... (\$1700-\$2300)
- City Mail Carrier..... (\$1700-\$2100)
- Rural Mail Carrier..... (\$2100-\$3300)
- General Clerk and File Clerk..... (\$1260-\$2500)
- Inspector of Customs..... ( \$2100 up )
- Prohibition Agent..... (\$2300-\$2800)
- Immigrant Inspector..... ( \$2100 up )

Name.....

Address.....  
Use This Coupon Before You Mislaid It—Write or Print Plainly

### Get FREE List of Positions

Fill out the coupon. Tear it off and mail it today—now, at once. DO IT NOW—This investment of two cents for a postage stamp may result in you getting a U. S. Government Job.

# Easy home method quickly teaches HAWAIIAN GUITAR



Play all the latest hits  
just as the Hawaiians do!  
Have good times aplenty!

Win fame—  
friends—fortune! Play the  
Hawaiian  
Guitar!

## Native Hawaiian expert directs you

You get expert instruction directed by a world-famous player and teacher, Prof. Walter Kolomoku. He quickly reveals to you the secrets of this fascinating instrument.

**Only 4 Motions** to learn. Then you can play any music—popular songs, classical, old-time melodies, native Hawaiian airs—or real jazz. You'll never be lonesome after you learn the Hawaiian Guitar.

## Complete Course

52 lessons. Nothing omitted. Pictures explain every move. You are sure to learn—what we can do for others we can do for you. Over 50,000 successful students.

**Payasyouplay** We make it easy for you. Start with small first payment—then pay while learning. Costs only few cents per lesson. You only pay the cost of instruction—we furnish everything.

## Learn at home in spare time

Study in spare time at home. Even if you don't know a note our method is so simple, plain and easy, you begin a piece your first lesson. In half an hour you can play it!

## Sweet Toned HAWAIIAN GUITAR

# GIVEN when you enroll

—with genuine seal grain Fabrikoid Cover and complete playing outfit. Reliable retailers ask \$18 to \$20 for a similar instrument and outfit without the fine Fabrikoid Case, which alone is valued at \$3.50.

## TENOR BANJO and other courses

The same thorough instruction on the Tenor Banjo, Violin, Tiple, Tenor Guitar, Ukulele, Banjo Ukulele—well known instructors. Write for full information.

**FIRST HAWAIIAN  
CONSERVATORY OF MUSIC, Inc.**  
9th Floor, Woolworth Bldg.,  
Dept. 748, New York

Approved as a Correspondence School Under  
the Laws of the State of New York

Member National Home Study Council



## Send This Coupon for Liberal Offer!

**FIRST HAWAIIAN CONSERVATORY OF MUSIC, Inc.**  
9th Floor, Woolworth Bldg., Dept. 748, New York, N.Y.  
Please mail full information about your 52-lesson Hawaiian  
Guitar Course. I am not obliged to enroll unless I want to.

Name \_\_\_\_\_

Address \_\_\_\_\_

City \_\_\_\_\_ State \_\_\_\_\_

# Books on 65 Practical Subjects

Popular Mechanics Press specializes in supplying the outstanding best books on many subjects. As new books of merit appear, we will revise the list accordingly.

- AERODYNAMICS**  
Simplified. Just out... \$3.50
- AIRCRAFT ENGINES**  
Dyke's New Instructor  
Best Engine Book... \$5.00
- ARCHERY**  
Bows and Arrows for Boys \$0.75
- ARCHITECTURAL**  
Design and Lettering... \$2.00
- ARMATURE WINDING**  
Excellent new book... \$2.00
- AUTO ENCYCLOPEDIA**  
Dyke's. (Covers New  
Model A Ford)... \$6.00
- AVIATION**  
Practical new book on flight  
training... \$5.00
- BIRD HOUSES**  
How to Make... \$1.00
- BLUE PRINTS**  
How to Read... \$2.00
- BOAT BUILDING**  
35 Popular Types, Out-  
board Motor, Sail,  
Row, etc... \$3.00
- BOY MECHANIC**  
Famous 4 Vol. Library,  
4000 Things to Make. \$7.00
- BUILT-IN FURNITURE**  
Complete Instructions... \$2.50
- CARBURETORS**  
Excellent book on all  
makes... \$2.00
- CARPENTRY**  
Hand book of 336 Kinks. \$1.50
- CHALK TALK**  
How to... \$1.00
- COLOR SIMPLIFIED**  
Practical new Book (for  
Color Users)... \$3.50
- CONCRETE**  
173 Ways of Using  
New Edition (Cloth)... \$1.00
- CONTRACTOR**  
Building Cost Estimator. \$2.00
- DOGS**  
Care and Raising... \$2.00
- ELECTRICITY**  
Practical—all branches. \$2.00
- ELECTROPLATING**  
Practical Results Easily  
Obtained... \$1.00
- ENGLISH**  
Self-improvement in... \$2.50
- ETIQUETTE**  
New 560-Page Book.  
Only... \$1.00
- FARMER'S BOOK**  
of 861 Kinks and Book  
for Farmers' Wives... \$1.00
- FLYING**  
Stunt Flying... \$2.50
- FORMULAS**  
10,000 Money Making. \$4.00
- FURNITURE (Mission)**  
Homemade (3 vols.)... \$3.00
- GARDENS**  
1001 Questions An-  
swered... \$2.00
- HOME REPAIRS**  
Practical Book of... \$2.50
- HOME WORKSHOP**  
900 Different Things  
to Make... \$3.00
- IGNITION**  
(High Speed) For  
Garage Mechanics... \$3.50
- JOINT WIPING**  
(New Edition)... \$1.00
- KITES THAT FLY**  
How to Make... \$1.25
- LANDSCAPING**  
Practical... \$2.50
- LATHE WORK (METAL)**  
and Drilling and Thread  
Cutting... \$1.00
- LETTER WRITING**  
Social and Business  
Only... \$1.00
- MACHINIST**  
Complete, Practical... \$3.00
- MAGIC**  
200 New Tricks for Am-  
ateurs... \$1.00
- MASONS AND BUILDERS**  
Guides (4 vols.)... \$6.00
- MATHEMATICS**  
Made Easy for the Prac-  
tical Man... \$1.50
- MECHANICAL DRAWING**  
Practical Course in... \$1.00
- MECHANISMS INGENIOUS**  
—For Designers  
and Inventors... \$5.00
- MODEL AIRCRAFT**  
Building and Flying... \$2.25
- OUTDOOR OPPOR-  
TUNITIES**  
for Making a Living... \$2.00
- OUTDOOR SPORTS**  
for All Year 'Round... \$1.50
- PAINTING**  
House (Best Methods)... \$2.00
- PLUMBING**  
500 Plain Facts for  
Every Homeowner... \$1.50
- POULTRY RAISING**  
for Profit... \$2.00
- PUZZLES**  
Amusing Mathematical. \$1.50
- RABBITS**  
For Food and Fur... \$2.00
- RADIO**  
Trouble Shooting. Covers  
All-Electric Sets and  
Television... \$3.00
- SHOP NOTES**  
12 Vols. of 6000 Valu-  
able Kinks... \$3.75
- STAMP ALBUM (Modern)**  
12,000 Varieties... \$2.00
- STEEL SQUARE**  
Pocket Book, Practical. \$1.00
- STENCILS**  
How to Use... \$1.25
- STORAGE BATTERIES**  
(New work) Best  
on subject... \$3.00
- TOY MAKING**  
Complete instructions... \$1.50
- TREASURES**  
Hunting Hidden... \$2.50
- WALL DECORATION**  
(Interior) Newest  
Methods... \$4.00
- WHITTLING**  
The Art of... \$1.35
- WIRING**  
House (New Book)... \$2.50
- WOOD TURNING (LATHE)**  
Practical Course in... \$1.50
- WOODCRAFT**  
590 Page Book on  
Forestry, Campercraft,  
Scouting, etc., by  
Seton... \$1.00

## Books sent C. O. D. anywhere in U.S.

Just check the books you want, write your name and address below, and mail the advertisement. It is your order blank. When post-man hands you books, pay him the price and few cents postage. If outside the U. S. remit when ordering and include 10 cents per book extra for postage. We have many other books on these and 2,000 other subjects. Catalog free.

Name \_\_\_\_\_

City \_\_\_\_\_ State \_\_\_\_\_

Address \_\_\_\_\_

Mail to Popular Mechanics Press,  
Room P12—200 East Ontario St., Chicago, Ill.



# FREE BLUE PRINTS

AND FREE BOOK "HOW TO READ BLUE PRINTS"

## SHOW YOU THE WAY TO

# 9 BIG PAY JOBS

- |                                                        |                                                                                 |
|--------------------------------------------------------|---------------------------------------------------------------------------------|
| <b>1</b> Building Superintendent — \$5,000 to \$12,000 | <b>6</b> Building Estimator — \$6,000 to \$10,000                               |
| <b>2</b> Building Inspector — \$4,800 to \$8,000       | <b>7</b> Real Estate Expert — \$5,500 to \$12,000                               |
| <b>3</b> Appraiser — \$6,000 to \$10,000               | <b>8</b> Construction Foreman — \$4,500 to \$8,500                              |
| <b>4</b> Material Buyer — \$5,000 to \$7,500           | <b>9</b> CONTRACTOR AND BUILDER IN A BUSINESS OF YOUR OWN — \$5,000 to \$12,000 |
| <b>5</b> Material Salesman — \$5,000 to \$12,000       |                                                                                 |

**FIND OUT HOW**  
 Easy it is to Make  
 Up to \$12,000 in a Year

Learn to read Blue Prints this amazing new way! Get into the world's richest industry—Building! See how quickly and easily you can train to make up to \$12,000 a year! My FREE Book "How to Read Blue Prints" discloses all the so-called "mysteries" of Blue Print Reading—also gives some startling facts about the nine best jobs in America. Don't send one penny—just mail the coupon!

**N**O longer need you spend years trying to pick up the "mysteries" of Blue Print Plan Reading. For now a quick, sure, practical method has been perfected that has made thousands of men Blue Print Experts in a surprisingly short time.

This is no ordinary "school course." It is practical from start to finish. It is based on many sets of real Blue Prints—plans that would cost thousands of dollars if purchased from architects. Twenty famous experts in all lines of construction work talk over these Blue Prints with you in plain, simple language. Show you every detail. Explain every short cut. Tell you the "secrets" of quick, accurate estimating. Explain Superintending. Give you for the first time many inside facts and money-making methods used by the "Giants" of the Building Industry.

This is the kind of training that quickly puts men into high-salaried jobs—or into profitable contracting businesses of their own. Yet now you get it right at home in only 2 or 3 months. It requires no extensive education. If you can read and understand what is written here you can easily master it. See what this training has done for others: Bartholomew, Calif., became a contractor at an increase of over 300% his first year; Blair, Okla.,

stepped up to Superintendent at 100% increase; Dickerson, R. I., increased his salary 700% in 12 months; Marchand, La., says: "My income has increased 200% and I now have more contracting work than I can do."

Over seven billion dollars will be spent this year in new construction! No wonder, then, such tremendous opportunities are open to you when you have this "head-work" training in Blue Prints.

If you want more money—real big money! Then choose a "Blue Print" job in Building. Clerk or Salesman, Carpenter or Bricklayer, here is the one field where there are unlimited opportunities for advancement.

So accept my FREE gift of a complete set of real working Blue Prints, and my fascinating Book "How to Read Blue Prints" that tells all the interesting and instructive facts about Blue Print Plans. Don't send one penny—pay no C. O. D.—It's all FREE. Just fill out and mail the coupon today—NOW!

**TWO BOOKS also**

**FREE**



**IF YOU LIVE NEARBY**

Visit our big day or evening school attended by over 1000 Builders. You can get the same training at home by mail—same plans, lessons and instructors. Your spare time is enough.

**Chicago Technical School for Builders—Dept. R-143, Chicago Tech. Building, 118 East 26th Street, Chicago, Ill.**

Please send me your free book, "How to Read Blue Prints," and complete set of real Blue Prints. I understand these are mine to keep without obligation. It is also understood that no salesman will call on me.

Name.....  
 Address.....  
 City.....State.....  
 Age.....Occupation.....

**Chicago Technical SCHOOL for BUILDERS**

Dept. R-143, 118 East 26th St., Chicago, Ill.



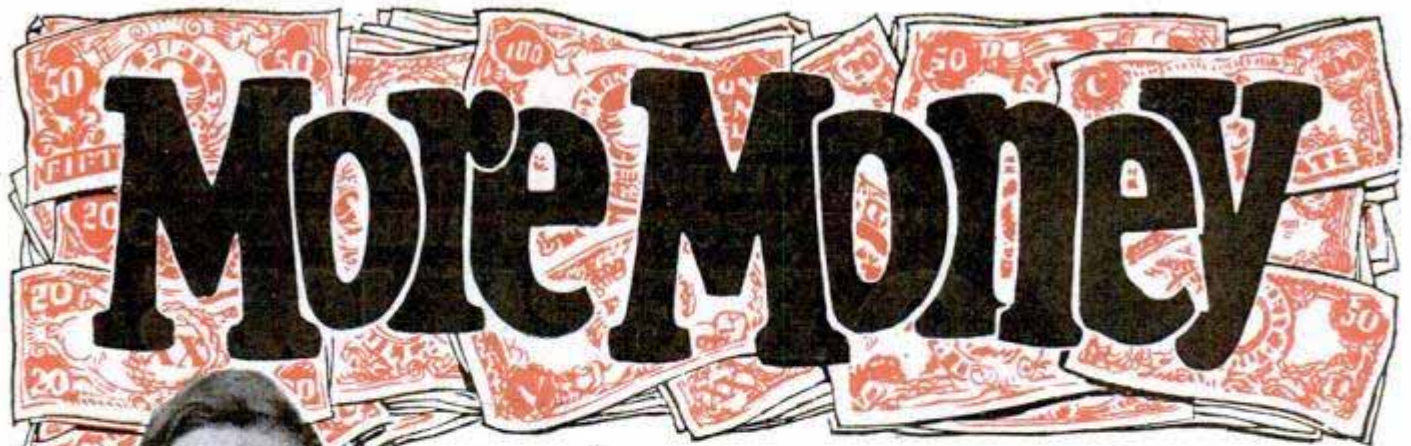

## Be a Trained Radio Expert

If you're earning a penny less than \$50 a week, get my free book of information about the Radio business. Trained Radio Experts are needed in more than twenty different lines of this new and growing profession (three hundred thousand new openings created by the swift growth of Radio in past few years). Why go along at \$25 or \$35 or \$45 a week all your life? Study Radio and after only a short time land yourself a REAL job with a REAL future! Be a man who has money in his pocket and in the bank—don't scrimp and scrape for the rest of your days.

## Salaries of \$50, \$75 & \$100 a Week Not Unusual in Radio

The good positions in Radio pay all the way from \$50 to \$100 a week—and some pay \$200, and even \$250 a week. Suppose you don't climb to the very top but that you do advance to a position that pays you \$125 a week, year in and year out. Any chance to make that much where you are now? Then send for my free book, and learn about a field where there's some real opportunity.

## Money Back If You Aren't Fully Satisfied

I'll give you all the training you need to get into any line of the Radio business. And I back up this training by a signed agreement to refund every penny you pay me if upon completion of my course you are not satisfied with the lessons and instruction service I give you.

Where good men, if they have the right training, can work their way into really big salaried jobs!

## Eight Big Laboratory Outfits Given You To Help You Learn

I teach you both the "why" and the "how" of Radio. You learn to DO a thing, and you learn WHY it's done. I send you, WITHOUT EXTRA COST with your course, eight big laboratory outfits of material to experiment and work with. These outfits are the real thing—not toys. The parts they contain will build approximately one hundred different Radio circuits. With all this material you do practical work from start to finish of your training. You get your hand in, and you get confidence in yourself. Then when you run into a Radio problem later on, on the job, you KNOW you can do it because you've already done it with these eight outfits of laboratory material. With me you don't learn to be a "paper Radio Expert"—you learn to be the kind of expert that shows his worth on the payroll. Full details in my big book—sent free.

Send For Free Book of Information



Broadcasting Stations offer fascinating jobs paying from \$1,500 to \$5,000 a year.



Radio factories employ thousands. Salaries for well trained men range from \$1,500 to \$5,000 a year.



Spare time set servicing is paying N. R. I. men \$200 to \$1,000 a year. Earnings begin almost at once after enrolling.



Operating on board ship gives you world-wide travel without expense and a salary of \$85 to \$200 a month besides.

**YOU**  
must have  
**NRI** training  
to be a  
**CERTIFIED**  
**RADIO-TRICIAN**

see  
coupon  
next  
page

# for you in Radio

## Learn Quickly, Easily Train at Home in Spare Minutes

Stay home! Hold your job! I'll bring your Radio training to you, and you can learn in your spare time after work. No need to go to a strange city and live for months on expense when you learn my way. You study in the quiet of your own home. As for this training—it's written just as I would talk—in straightforward, every-day, understandable language. You'll get it, and you'll get it quickly—in a few months' spare time—because I've made it so clear and interesting! No particular education needed—lots of my successful students didn't finish the grades.

## Many Earn \$10, \$20, \$25 Weekly Right Away "On the Side"

Deloss Brown, South St., Foxboro, Mass., made \$1,000 from spare-time Radio jobs before he even finished my course. H. W. Coblenz, Washington, averaged \$45 a week; Leo Auchampaugh, 6432 Lakewood Ave., Chicago, made \$500 before graduation; Frank Toomey, Jr., Piermont, N. Y., made \$833 while taking the course. All this done IN SPARE TIME away from the regular job, while these fellows were still studying the course—and they're only a few of hundreds. As soon as you start this training I begin teaching you practical Radio work. Then a few weeks later, I show you how to make use of it in spare time, so you can be making \$10, \$20, \$25 a week "on the side," all the while you're learning.

## 64-Page Book Sent Free for the Asking

My big book of Radio information won't cost you a penny, and you won't be under any obligation by asking for it. It's put hundreds of fellows on the way to big pay and brighter futures. Sending for it has been the turning-point where many a man has made his start toward real Success. Get it. See what it's going to mean to you. Send coupon TODAY!

Address: **J. E. SMITH, President**  
National Radio Institute

Dept. ONP

Washington, D. C.

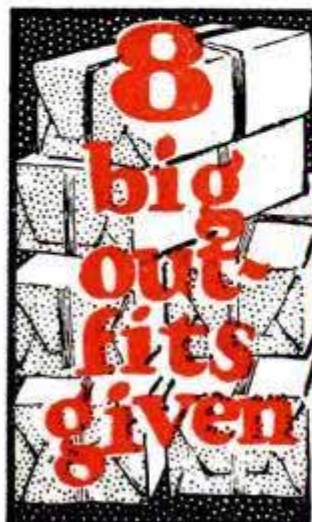

## Mail This Now

J. E. Smith, President,  
National Radio Institute,  
Dept. ONP, Washington, D. C.

Dear Mr. Smith: Kindly send me your big free book, "Rich Rewards in Radio," giving all information about the big-money opportunities in Radio and how you will train me to take advantage of them. I understand this places me under no obligation, and that no salesmen will call on me.

Name.....

Address.....

Town.....State.....

## Hundreds of fine jobs opening in Radio every year

Radio needs more trained men to take care of its rapid growth. Every year there are many fine jobs for men with the right training in broadcasting stations, commercial land stations, Radio factories, with Radio dealers and jobbers, with shipping companies which offer world-wide travel and good pay. Besides there are countless opportunities to have a spare time or full time business of your own.

Talking movies, Television and many other new and recent developments in and uses for Radio are increasing the need for trained men continually. This is best proved by the fact that the Employment Department of the National Radio Institute is getting three times as many calls for our graduates this year as it did last.

## Your Choice of 5 New Advanced Courses if You Act Now

My training not only gives you a thorough knowledge of Radio—all you need to get and hold a good job—in addition, you may take any one of my new advanced courses, without extra charge. They are Television, Aircraft Radio, Broadcasting Commercial and Ship Radio Stations, Sound Pictures and Public Address Systems, and Advanced Radio Servicing and Merchandising. You won't be a "one job" man when you finish my training. You'll know how to handle a job in any one of Radio's 20 different branches of opportunity. Send for my free book now.

Find out about my methods that have increased the earnings of so many others. Mail the coupon today.



This big 64-page book, printed in two colors, crammed with interesting facts and photos about money-making opportunities in Radio, sent free to everyone who clips the coupon. No obligation by sending for the book—it's absolutely free. One of the most valuable books about Radio ever written.



# You Can Learn HYPNOTISM

... or No Cost

## Try FREE 5 Days!

**DON'T** be unpopular, lonesome, or unhappy a minute longer. Now you can make your life what you want it to be—now you can win admiration, success and big money—through the strange power of hypnotism. I'll show you how to use this great force to help you master every situation or *The Five Day Trial is FREE!*

In just a few hours I'll teach you the hidden secrets of Hypnotism—the methods used by the great operators—the amazing things you can accomplish once you understand this mighty power. You can use it to overcome obstacles, achieve your fondest ambitions and become **MASTER** of yourself, friends and acquaintances—either sex. See for yourself how Hypnotism can banish fear, worry and opposition—improve your memory—increase your earnings—and force others to give you the good things in life you deserve!

In his startling **NEW** book, *The Science of Hypnotism*, the world famous hypnotist—Prof. L. E. Young—reveals the most carefully guarded secrets of this fascinating subject. He not only explains the methods of noted hypnotists, step by step—but tells clearly all about the nine stages of hypnotism, the Hypnotic Mirror, Mental Telepathy, how to select your subjects, magnetic healing, methods of hypnotizing, how to waken the subject, how to make money out of hypnotism!

**Try 5 Days FREE—  
Send No Money**

So confident are we that Prof. Young and his great book will quickly teach you the science of hypnotism, that we will send you a copy without one cent in advance! Simply clip and mail the coupon below. When the book arrives pay the postman the special low price of \$2.50 plus few cents postage. Then test the powers of Hypnotism 5 days! If not amazed and delighted return the book and money will be refunded at once! Mail the coupon now.

**FRANKLIN PUBLISHING CO.  
Dept. W-70, 800 N. Clark St., Chicago**

### Mysteries of Hypnotism Revealed

- How to Hypnotize at a Glance
- Susceptible Subjects
- How to Hypnotize by Telephone
- How to Give an Entertainment
- How to Make Others Obey You
- Overcoming Bad Habits
- How to do Dozens of Hypnotic Feats
- Use of Hypnotism in Operations

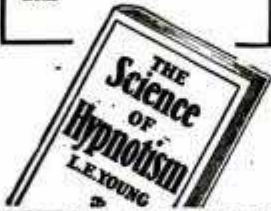

Franklin Publishing Co., Dept. W-70,  
800 N. Clark St., Chicago, Illinois

Please send me your amazing new book—*The Science of Hypnotism*—by Prof. Young. When the book arrives I'll pay the postman only \$2.50 plus postage. If I am not satisfied after 5 days' trial, I may return the book and you are to refund my money.

Name.....

Street and No.....

Town..... State.....

If you are likely to be out when postman calls, send \$2.50 with coupon and we'll pay delivery charges. Customers outside U. S. must send cash with order.

# FREE BOOKS of BUSINESS HELPS

We publish over 200 Home Study Books, each a complete treatise of its subject. We have one or more for you. Books on

- |                                              |                                           |
|----------------------------------------------|-------------------------------------------|
| <input type="checkbox"/> Commercial Art      | <input type="checkbox"/> Decoration       |
| <input type="checkbox"/> Lettering           | <input type="checkbox"/> Automobiles      |
| <input type="checkbox"/> Advertising         | <input type="checkbox"/> Battery Work     |
| <input type="checkbox"/> Sign Making         | <input type="checkbox"/> Electricity      |
| <input type="checkbox"/> Radio               | <input type="checkbox"/> Carpentry        |
| <input type="checkbox"/> Aviation            | <input type="checkbox"/> Building         |
| <input type="checkbox"/> Painting            | <input type="checkbox"/> Contracting      |
| <input type="checkbox"/> Silk Screen Process | <input type="checkbox"/> Sheet Metal Work |

and many other subjects. All fully described in our **FREE CATALOG**. Check the subjects in which you are interested and **write today**.

**FREDERICK J. DRAKE & CO., Publishers**  
Room 508—179 No. Michigan Blvd., Chicago  
Drake books are for sale in all book stores.

## ELECTRICITY RADIO WELDING AUTOMOBILES

**PRACTICAL TRAINING ON MASSIVE LAY-OUT OF UP-TO-DATE EQUIPMENT**  
Oxy-acetylene and Electric Welding, Armature Winding, Power Plants, Switchboards, Transformers, Motors, Generators, Batteries, Radios and Automobiles. Write now for Free Catalog.

**Coleman Electrical School, 1628 Main St., Kansas City, Mo.**

## MUSIC LESSONS IN YOUR HOME

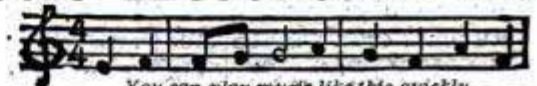

*You can play music like this quickly*

Write today for our **FREE BOOKLET AND SAMPLE LESSON**. It tells how to learn to play Piano, Organ, Violin, Mandolin, Guitar, Banjo, etc. Beginners or advanced players. You pay as you learn. Costs you only a few cents a day. Thousands of satisfied students.  
**AMERICAN SCHOOL OF MUSIC, 51 Manhattan Bldg., CHICAGO**



## High School Course in 2 Years

This simplified, complete High School Course, specially prepared for home study by leading professors, meets all requirements for entrance to college, business, and leading professions.

## 20 Other Courses

Over 200 noted Engineers, Business Men, and Educators helped prepare the special instruction which you need for success. No matter what your inclinations may be, you can't hope to succeed without specialized training. Let us give you the practical training you need.

**American School**  
Drexel Ave. and 58th St.  
Dept. H-647, Chicago

## Money Back When You Finish If Not Satisfied

American School, Dept. H-647 Drexel Ave. and 58th St., Chicago  
Send me full information on the subject checked and how you will help me win success in that line.

- |                         |                          |
|-------------------------|--------------------------|
| ....Architect           | ....Electrical Engineer  |
| ....Building Contractor | ....General Education    |
| ....Automobile Engineer | ....Lawyer               |
| ....Civil Engineer      | ....Mach. Shop Practice  |
| ....Structural Engineer | ....Mechanical Engineer  |
| ....Business Manager    | ....Steam Engineer       |
| ....C. P. A. & Auditor  | ....Draftsman & Designer |
| ....Bookkeeper          | ....High School Graduate |

Name..... Age.....

St. and No.....

Town..... State.....

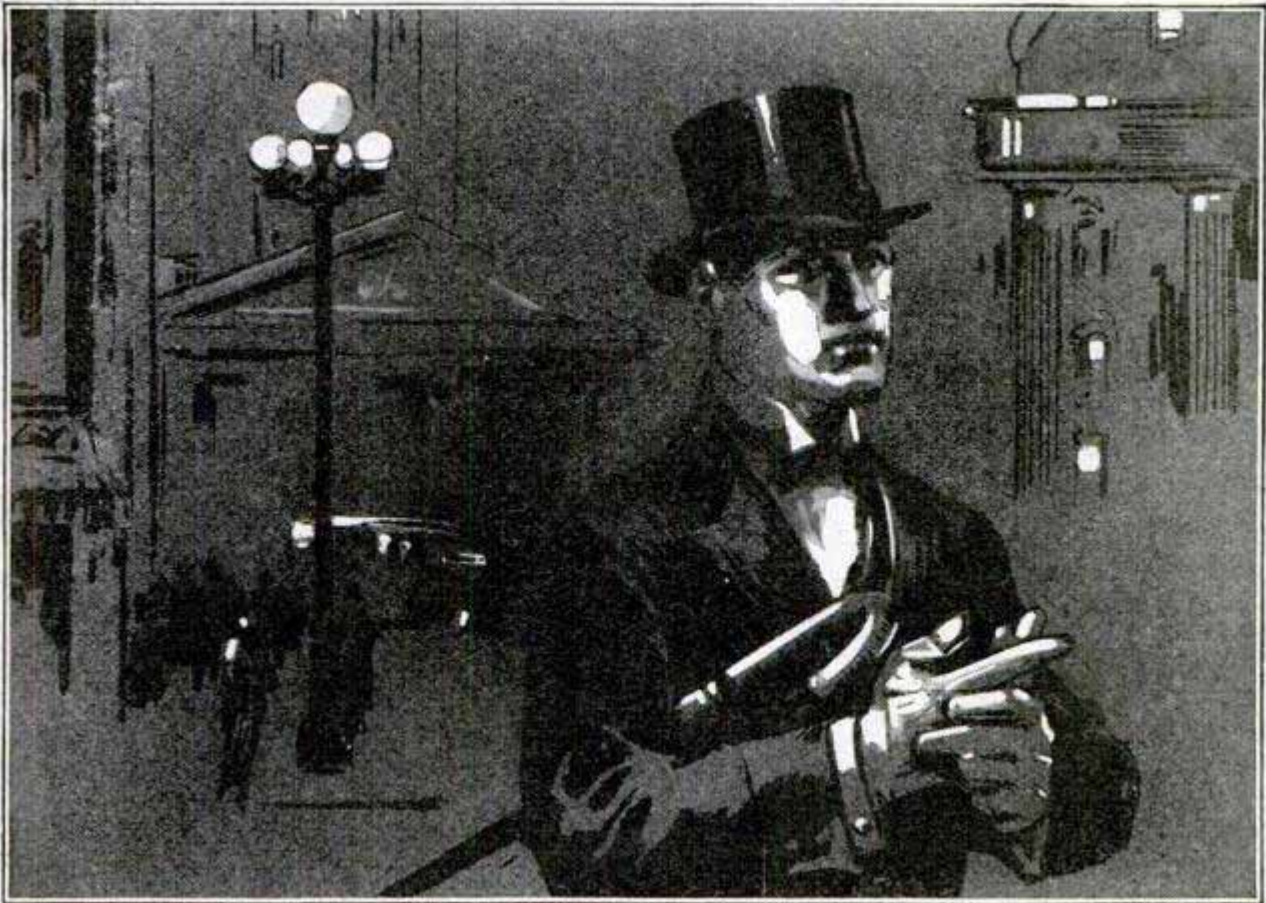

# Follow this Man!

*Secret Service Operator 38 Is on the Job*

Follow him through all the excitement of his chase of the counterfeit gang. See how a crafty operator works. Telltale finger prints on the lamp stand in the murdered girl's room! The detective's cigarette case is handled by the unsuspecting gangster, and a great mystery is solved. Better than fiction. It's true, every word of it. No obligation. Just send the coupon.

## **FREE** The Confidential Reports No. 38 Made to His Chief

And the best part of it all is this. It may open your eyes to the great future for YOU as a highly paid Finger Print Expert. More men are needed right now. This school has taken men just like you and trained them for high official positions. This is the kind of work you would like. Days full of excitement. Big salaries. Rewards.

**Earn \$3000 a Year and Up**  
*You study at home in spare time*

No advance education is needed. Any man who can read and write, and think can make good. A wonderful book tells all about what others have done. Shows pictures of real crimes and the men who solved them. We'll send you a FREE copy with the free reports. Get our low prices and easy terms. Mail the coupon.

**INSTITUTE OF APPLIED SCIENCE**  
1920 Sunnyside Ave., Dept. 13-59 Chicago, Illinois

### INSTITUTE OF APPLIED SCIENCE

1920 Sunnyside Ave., Dept. 13-59 Chicago, Illinois

Gentlemen:—Without any obligation whatever, send me your new, fully illustrated Free Book on Finger Prints, also FREE Copy of operator No. 38's confidential report. Tell me about your low prices and easy terms. Literature will NOT be sent to boys under 17 years of age.

Name .....

Address .....

Age .....



If you're  
"On the  
outside  
looking in"

You need this  
**FREE Book**

ARE you standing on the sidelines, wishing you were in Aviation . . . envying those who are already making Aviation history while holding down good jobs with fine futures? If so, remember this:—Wishing won't get you into Aviation—but practical training will! Walter Hinton's free book, "Wings of Opportunity," tells you a quick, sure, inexpensive way to get the necessary practical training—in your spare time, at home.

Hinton's personalized training and his free Employment Service are putting serious-minded, red-blooded men like you in good flying and ground jobs right along, at salaries of from \$40 to \$80 a week. Martin Co., Curtiss-Wright, Curtiss Flying Service, Alexander Aircraft, T. A. T., Fokker and scores of other leaders are employing Aviation Institute graduates. In one day alone, we had calls for more than forty men!

If you're 16 or over—and serious about wanting to get into Aviation, get a free copy of Walter Hinton's book. It tells how he can give you the vital facts, the necessary knowledge of plane-construction, engine-design, rigging, repairing, servicing, airport management, navigating, theory of flight, etc. If you want to learn to fly, his course can save you many times its cost in cash. It's interesting and easy to understand from the start and packed with facts that mean success for you—no matter what branch of Aviation you choose to enter. Mail the coupon today—right NOW.

Aviation Institute of U. S. A., Inc.,  
1115 Connecticut Avenue, Washington, D. C.

Please send me a free copy of "Wings of Opportunity," telling how I can get into Aviation quickly. 301-T

Name \_\_\_\_\_  
Print Clearly

Address \_\_\_\_\_ Age \_\_\_\_\_  
(Must be over 16)

City \_\_\_\_\_ State \_\_\_\_\_



After completing your course I was engaged as Aeronautical Draftsman by a leading concern. I thoroughly recommend your training. It is complete in every detail.—Ira W. Bergen, Brooklyn, N. Y.

Another Hinton Graduate, John J. Morton of Bayport, L. I., writes that he secured a position with the Sikler Flying Service at \$50 a week, immediately after we recommended him for it.

Another graduate, Robt. N. Dobbins, was made Mechanic for Curtiss-Wright Flying Service at Valley Stream, L. I., at a salary of \$75 a week after he completed L. Hinton's course.

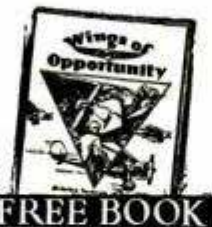

## Amazing New Money Maker

**PANTS PRESSED in 10 Seconds**

**Wonderful Opportunity to Make \$89 a Week**

New! New! New! Just invented — amazing electrical device presses pants before you count ten. Puts in razor edge creases instantly, even while pants are being worn. Automatic jaws electrically heated, press both sides of trousers at same time. Saves scores of dollars in pressing bills. Saves clothes. Pays for itself in two weeks. Will last years.

**100% Quick Profit**

Millions waiting for RED LION Electric Trousers Presser. Up to \$89 a week easy. Illinois man makes \$288 in one week. Pennsylvania agent earns \$72 in 4 days. 3 minute dramatic demonstrations. No experience needed to succeed big. Write or wire for generous starting offer—sent ABSOLUTELY FREE. Do it this minute.

The Munny Manufacturing Co.  
Dept. E-8, 817 Main St.  
Cincinnati, Ohio

## Government Positions

Clerk Carriers, Rural Carriers, Railway Mail Clerks, Postmasters, Department Clerks, and many others. Splendid salaries, easy work, vacation with pay. Only common school education required. Examinations often. 44,817 appointed last year. Send for our Civil Service Catalog No. 6. **COLUMBIAN CORRESPONDENCE COLLEGE, Washington, D. C.**

## LAW STUDY AT HOME

Be independent. Earn \$5,000 to \$10,000 annually. We guide you step by step—furnish all text material, including fourteen-volume Law Library. Degree of LL. B. conferred. Low cost, easy terms. Get our valuable 64-page "Law Guide" and "Evidence" books free. Send for them NOW.

LaSalle Extension University, Dept. 1264-L Chicago

## A NEW CAR in 30 MINUTES



Get the BEAUTY and LUSTRE of a NEW PAINT JOB at a small fraction of the cost. Do it Yourself with NUKAR. NOT a Wax. NOT a Paint. NOT a Polish. This New Chemical discovery instantly restores Original Color to dull faded cars, and gives a Beautiful, Brilliant, Mirror-Like Lustre that lasts for months. Does not hold Dirt or Dust. Actually makes old Shabby Cars look NEW. No rubbing—No hard work. Flows on like water from a sponge. No Waiting—No Delay—Drive a NEW CAR the same day. Results Guaranteed.

**MEN! Amazing Cash Profits**  
Are being made by Agents, Distributors and Service Station operators. Get in on the biggest thing in the automobile business today. Earn up to \$50 a day. Full or part time. Millions of cars need NUKAR. Makes a Sensational sales compelling Demonstration. We back you to the limit with powerful Sales Cooperation and give you FREE—a Business Start that Money could not Buy. Let us send Prepaid and without charge a FREE SAMPLE and our Big Book in colors. Act NOW. Write TODAY.

**ATLAS SOLVENT CO.** Morgan Park Sta. 52 CHICAGO, ILL.







# BE AN ARTIST!

## — and be your own boss

If you like to draw, why drudge when success and a good income may be yours through art training? Publishers pay millions of dollars yearly for illustrations. Many successful Federal Students are earning from \$2500 to \$6000 a year — some even more.

If you hold yourself down to a routine job you may always do uncongenial work. But if you like to draw and are willing to train your talent, your art ability may help you to success in life.

Through the Federal Course in Illustrating more than fifty famous artists give you the benefit of their methods of Illustrating, Cartooning, Lettering, Poster Designing, Window Card Illustrating. You may learn through the experience of these successful artists how to bring your own drawings to a professional standard. They understand the methods that make art pay well.

You can keep your present position while gaining your art training. Through the Federal Course you learn

## FEDERAL SCHOOL OF ILLUSTRATING

12130 Federal Schools Building  
Minneapolis :: Minnesota

at home in your spare time. Hundreds of Federal Students have already proved by their professional success the value of this home study instruction.

### Vocational Art Test—Free

Find out about your drawing ability by sending in the Free Vocational Art Test we offer. Just write your name, age and address on the coupon and we will send this Test together with a copy of the book "A Road To Bigger Things" without charge or obligation. Why drudge at uncongenial work when the chance to plan your own work and be your own boss may be yours through Art Training? It is important that you take your first step out of the rut by mailing the coupon now.



Federal School of Illustrating,  
12130 Federal Schools Building,  
Minneapolis, Minnesota.

Please send me free book, "A Road To Bigger Things," and Standard Art Test.

Name \_\_\_\_\_

Age \_\_\_\_\_ Occupation \_\_\_\_\_

Address \_\_\_\_\_

# The Truth about Voice

**New Voice Book Discloses Startling Voice Facts**

**Sent Post-Paid for 30 Days FREE Reading No Money Down**



**KNOW** *The TRUTH about* **YOUR VOICE**



Eugene Feuchtinger  
A. M.  
Master of Voice  
European Maestro

Send today—for 30 days free reading—for the most remarkable voice book ever written. This book has startled the whole voice world. Written by a man recognized the world over as a voice authority—a man with the courage to tell the TRUTH about voice, about the vocal organ and the real basic, fundamental truths about voice training. Advances astounding new method. Discloses startling facts that may save hundreds of dollars to every

man and woman seeking a strong, rich, compelling singing or speaking voice. Send for this most remarkable voice book today.

**FREE 30 Days Reading**

Certainly I could not afford to make you this liberal 30 days free reading offer if I did not KNOW what "The Truth About Voice" will do for YOU. Send for this book today. KNOW the truth about YOUR voice—a truth just as SIMPLE as it is astounding! Know WHY I actually guarantee to improve every man or woman's voice at least 100%. 30 days free reading to prove this! Then, if convinced, send only \$1.00—although you'll gladly admit that the book may be worth thousands to you. If not—return it—that's all! Mail coupon NOW—before the demand exceeds the supply!

Prof. Eugene Feuchtinger, Studio 13-59  
Suite 29, 1810 Wilson Ave., Chicago, Ill.

Send me at once—for 30 days free reading—with no obligation to buy, your "The Truth About Voice" Book. If after the free reading period I desire to keep the book I am to send you \$1.00. Otherwise, I have the liberty to return it with no further obligation.

Name .....

Address .....



## Have Fun Making Money

Yes, You Can—Anybody Can make a lot of money right at home and, what's more, have real fun doing it. We show you how, we furnish everything necessary on an easy basis.

**Costs Nothing** to learn about our plan; all details are given you free. Write today for beautifully illustrated idea book telling all about our methods which have made so many women independent. Learn how easy it is to make from \$10 to \$25 per week in the most delightful home work you can imagine.

**Don't miss this opportunity!** Write Now. It's FREE. FIRESIDE INDUSTRIES, Dept. 66-W, Adrian, Mich.

## LAW HIGH-GRADE INSTRUCTION BY CORRESPONDENCE

College, Post Grad, and Bar Ex. Rev. Courses. Law has attracted more keen, brainy men than any other calling. Send today for catalog. Low cost, easy terms. Standard texts. Degrees. Dept. 801, Reaper Block CHICAGO, ILL.

## MAKE THEM TAKE FORM YOUR THOUGHTS

Turn your thoughts into real things. Make them alive in realization of your desires and dreams. Make your life over again. The ROSICRUCIANS KNOW how A FREE BOOK will tell you the first, simple steps in mentally creating a new life—and demonstrating a new power in your inner-self. LIBRARIAN M. B. V., Rosicrucian Brotherhood San Jose, Calif.



## 1,000 Hotel Positions Open!

HOTELS, restaurants, clubs, apartment hotels, hospitals, institutions, camps, schools and colleges everywhere need trained men and women. Over 70,000 high-class positions as Manager, Assistant Manager, Steward, Room Clerk, Sports Director and scores of other executive positions paying \$2,500 to \$10,000 a year open annually in the hotels of the United States. Nearly two billion dollars' worth of NEW HOTELS, APARTMENT HOTELS, CLUBS AND INSTITUTIONS being built this year will need over 200,000 trained men and women. Hotels start you at salaries up to \$2,500 a year, with living usually included. At any time there are over 1,000 positions open.

### Previous Experience Unnecessary

You can have one of these fascinating, big-pay positions. Through the Lewis Personal Coaching Plan your instruction is individually guided by hotel experts who adapt your training to your previous experience and education. Age is no obstacle—young and old alike can win success. A good grade-school education is all you need. We train you in your spare time and put you in touch with big opportunities. All of your training under the personal supervision of Clifford Lewis, who has been appointed Managing Consultant by over 300 hotels throughout the United States. Our students employed by leading hotels everywhere. Send coupon today for Free Book, "Your Big Opportunity," explaining our Money-Back Agreement, and showing how we can train you for one of these splendid positions.

### FREE BOOK COUPON

LEWIS HOTEL TRAINING SCHOOLS,  
Room CW-385, Washington, D. C.

Send me without obligation the Free Book, "Your Big Opportunity," and details of your Personal Coaching Plan.

Name .....

Address .....

City ..... State .....



# HERCULES STEAM ENGINE

## GIVEN

### Superb Xmas Offer!

Here's a wonderful offer. "Little Hercules" special steam engine. Made by "Weeden," world's leading maker. This engine is of fine quality and highly finished in bright colors. Has heavy fly wheel, smooth-running piston and heavy cylinder. Strong boiler and fittings. Large fire box. Pulley wheel that will run mechanical toys like Erector, Meccano, etc. Runs on alcohol or canned heat. A big, POWERFUL, high-quality steam engine. Just what you've been waiting for—and you can have it FREE! Read special offer.

### SENSATIONAL STORIES

The Open Road for Boys is a 50-page boys' magazine just crammed brimful of thrills. The kind of blood stirring stories you've been looking for. Tales of high adventure on land and sea. Air stories that take your breath away, of war pilots in deathly combat above the clouds, of mail pilot heroes. Sport stories, school stories, tales of distant jungle lands, etc. No other magazine has stories like these. Best joke page published. World-wide correspondence club, friends in foreign lands, stamps, boy mechanic, tells you how to make all the things you want. OPEN ROAD PIONEER CLUB: best dope on hunting, fishing, camping. Contests galore with prizes for all. Extra money. One whale of a magazine say 200,000 readers. Red blooded stories for red blooded he boys. Read special offer.

**Special Offer** Regular subscription price to Open Road for Boys is \$1 a year (half of others). To make new friends we will send you the magazine for a whole year, twelve fat issues for \$1—and send you this wonderful steam engine FREE. This is a great offer. Act quickly.

### ASK DAD NOW

Don't wait. Get your steam engine and have your fun right now. Ask Dad. He'll tell you Weeden means top quality and he'll tell you what a grand offer this is. Send coupon today. Back comes your steam engine and your first thrilling issue of the Open Road for Boys Magazine. Or order several for dandy Christmas gifts. Send separate slip with each order. Satisfaction guaranteed or money back.

Open Road for Boys Magazine—Dept. P. 12  
130 Newbury Street,  
Boston, Mass.

Friends: Here's my dollar (\$1). You bet I want to grab this offer! Rush my steam engine to me and put me down for a year for the OPEN ROAD FOR BOYS.

Name.....  
Street.....  
Town or City..... State.....

Canadian Postage 25c extra. Foreign 50c extra.

USE  
COUPON

ORDER SEVERAL FOR XMAS GIFTS

# LEARN CARTOONING

AT HOME DURING SPARE TIME

with the course that has trained HUNDREDS of beginners successfully. The Landon Picture Chart Method of teaching ORIGINAL drawing by mail makes cartooning easy to learn. This school is a Member of The National Home Study Council. Write today for sample picture chart to TEST YOUR ABILITY and examples of the work of successful students now earning from \$50 to \$200 and more per week.

Enclose 6c in stamps and STATE YOUR AGE.

THE LANDON SCHOOL, 2838 National Bldg., Cleveland, Ohio



## LAW <sup>Free</sup> Book

Write today for FREE 64-page book, "THE LAW-TRAINED MAN", which shows how to learn law in spare time through the Blackstone home-study course prepared by 80 prominent legal authorities, including law school deans, and U. S. Supreme Court justices. Combination text and case method of instruction used. All material necessary furnished with the course, including elaborate 25-volume law library, delivered immediately upon enrollment. Many successful attorneys among our graduates. LL. B. degree conferred. Moderate tuition, low monthly terms. Money-Back Agreement.

Write for free book today.

**BLACKSTONE INSTITUTE**, 307 N. Michigan Ave. Dept. 59 Chicago

## ACCOUNTING

New revised Course now ready. Booklet and first lesson sent free. No obligation.

International Accountants Society, Inc.  
A DIVISION OF THE  
Alexander Hamilton Institute  
Dept. 181 3411 So. Michigan Ave. Chicago, Ill.

## WANT A STEADY JOB?

### RAILWAY POSTAL CLERKS

MAIL CARRIERS—POSTOFFICE CLERKS  
GENERAL CLERKS—CUSTOMS INSPECTORS

### \$1700 to \$3400 a Year for Life

No "lay-offs" because of strikes, poor business, etc.—sure pay—rapid advancement. Many other U. S. Government Jobs. City and country residents stand same chance. Common sense education usually sufficient.

### STEADY WORK

## MEN—BOYS

### 18 to 45

Use Coupon Before You Lose It

COUPON

**FRANKLIN INSTITUTE, Dept. S179, Rochester, N. Y.**  
Rush to me, free of charge, (1) A full description of the position checked below; (2) 32-page book, with list of positions obtainable; (3) Tell me how to get the position checked.

<input type="checkbox"/> Railway Postal Clerk (\$1900 to \$2700)	<input type="checkbox"/> General Clerk (\$1200 to \$2100)
<input type="checkbox"/> Postoffice Clerk (\$1700 to \$2300)	<input type="checkbox"/> Customs Inspector (\$2100 up)
<input type="checkbox"/> City Mail Carrier (\$1700 to \$2100)	<input type="checkbox"/> Rural Mail Carrier (\$2100 to \$3300)

Name.....  
Address.....

**BRAND NEW**  
**Genuine Model 3**  
**CORONA**  
 LOWEST PRICE EVER OFFERED



**\$2.00**  
 DOWN  
**BALANCE**  
**EASY**  
**TERMS**

**HERE'S** your chance to own that brand new Genuine Model 3 Corona you've wanted—on the easiest terms ever offered—at **LOWEST PRICE** ever offered! Complete in every detail; back spacer, etc., **MANUFACTURER'S GUARANTEE**. Recognized the world over as the finest, strongest, sturdiest, portable built. Try this wonderful portable typewriter—the same machine that has satisfied 500,000 users.

**Yours for 10 Days' TRIAL**  
**—Send No Money**

Experience the joy this personal writing portable typewriter can give you! Use it 10 days! See how easy it is to run and the splendidly typed letters it turns out. Ideal for the office desk, home, traveling. Small, compact, light, convenient. Don't send out letters, reports, bills in poor handwriting when you can have this Corona at such a low price or on such easy terms. Remember these are brand new machines right out of the Corona factory.

**Carrying Case Included**  
**—If You Act Now**

Leatheroid carrying case, oiler, instructions, free on this offer. Send no money—just the coupon. Without delay or red tape we will send you the Corona. Try it 10 days. If you decide to keep it, send us only \$2, then \$3 a month until our special price of \$39.90 is paid. Now is the time to buy. Mail coupon today!



**MONEY SAVED**  
**By Using This Coupon**

**Smith Typewriter Sales Corp.**  
**[Corona Division]**  
**469 E. Ohio St., Chicago, Dept. C-3**

Ship me the Corona, F.O.B. Chicago. On arrival I'll deposit \$2 with express agent. If I keep machine, I'll send you \$3 a month until the \$37.90 balance of \$39.90 price is paid; the title to remain with you until then. I am to have 10 days to try the typewriter. If I decide not to keep it, I will repack and return to express agent and get my money back. You are to give your standard guarantee.

Name .....

Address .....

Employed by .....

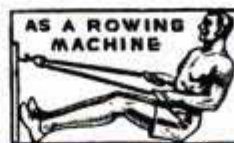

**10 CABLE EXERCISER**

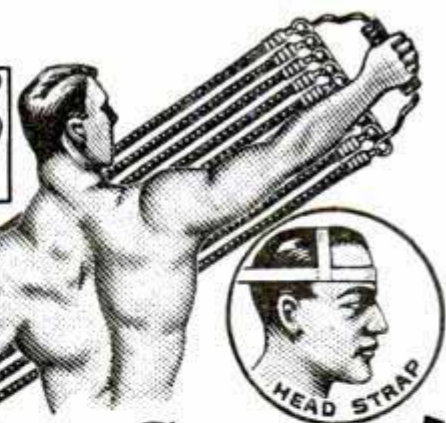

**Get Strong!**  
**Eight Improved**  
**Muscle Builders**  
**All for \$3.75**

Easily master feats which now seem difficult. If you want physical culture for health this equipment is what you need. **SAVE AT LEAST HALF!** We furnish ten cable chest expander adjustable to 200 lbs. resistance. Made of new live extra strength rubber to give resistance needed for sure muscle development. Pair of patented hand grips develop powerful grip and arm. Wall exercising parts develop back, arms and legs. Head strap permits exercise of neck muscles. Develop leg muscles with foot strap—gives speed, endurance. Illustrated course shows how to develop any part of body.

**GUARANTEE**  
 Entire satisfaction guaranteed or money back.

**Send No Money**

Send name and address. We send all by return mail. Pay postman \$3.75 plus postage.

**MUSCLE POWER CO.**

Dept. PM-12  
 150 Nassau Street  
 New York

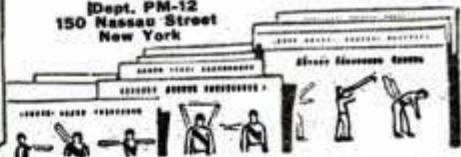

**How to Obtain A Better Looking Nose**

**Improve your personal appearance**  
 My free book tells you how I guarantee to improve the shape of your nose by remodeling the cartilage and fleshy parts, quickly, safely, and painlessly, or refund your money. The very fine, precise adjustments which only my new patented Model 25 Nose Shaper possesses, make results satisfactory and lasting. Worn night or day. Over 100,000 users. Send for free book to **M. TRILETY, Pioneer Nose Shaping Specialist** BINGHAMTON, N. Y. Dept. 197

**don't WORRY**

Why put up with years of needless discomfort and worry? Try a Brooks Automatic Air Cushion. This marvelous appliance permits the opening to close, yet holds rupture securely, comfortably—day and night. Thousands report amazing results. Light, neat-fitting. No hard pads, metal girdle or parts to chafe or gouge. Patented in U. S. and 13 foreign countries. Try one 10 DAYS WITHOUT A PENNY'S RISK. You'll be delighted. Free book on Rupture and convincing facts mailed postpaid in plain sealed envelope. Address

ABOUT



**BROOKS APPLIANCE CO., 107F State St., Marshall, Mich.**

# QUIT TOBACCO

No man or woman can escape the harmful effects of tobacco. Don't try to banish unaided the hold tobacco has upon you. Join the thousands of inveterate tobacco users that have found it easy to quit with the aid of the Keeley Treatment.



## KEELEY Treatment For Tobacco Habit Successful For Over 50 Years

Quickly banishes all craving for tobacco. Write today for Free Book telling how to quickly Free yourself from the tobacco habit and our Money Back Guarantee.

Home of the famous Keeley Treatment for Liquor and Drugs. Booklet Sent on Request. Correspondence Strictly Confidential.  
**THE KEELEY INSTITUTE Dept. A-940 Dwight, Illinois**

# LUCKY TIGER

**FOR HAIR AND SCALP!**



A single application stops that miserable itching. A single bottle corrects scalp irritations. A Proven Germicide, delicately perfumed, safe for adults and children. World's largest seller at Druggists, Barbers, Beauty Parlors.

**GUARANTEED**

# NO JOKE TO BE DEAF

**—EVERY DEAF PERSON KNOWS THAT**

George P. Way made himself hear, after being deaf for 25 years, with Artificial Ear Drums—his own invention. He wore them day and night. They stopped head noises and ringing ears. They are invisible and perfectly comfortable. No one sees them. Write for his true story, "How I Got Deaf and Made Myself Hear." Also booklet on Deafness. Address



Artificial Ear Drum

George P. Way, Inc., 612 Hofmann Building, Detroit, Michigan

# Dentists Need Men



Experts Earn up to **\$125<sup>00</sup>** a week

## Make Crowns, Plates, Bridgework, etc. for Dentists

We teach you to make rubber plates, crowns, bridge work, metal base dentures, etc., for dentists. After graduating you are ready for a job or can open your own laboratory. We assist you.

### Demand for Men

Thousands of dentists everywhere send work to mechanical dentists. We train you quickly in day or night school for this uncrowded field. No classes—no books—no mechanical experience necessary. Work your way thru school. We help you find a job to meet your expenses while taking our training. Railroad fare allowed to nearest school.

### MAIL COUPON FOR FREE BOOK

McGARRIE SCHOOL OF MECHANICAL DENTISTRY, 1338 S. Michigan Ave., Dept. 425, Chicago.

Without cost or obligation, send me your illustrated book on Mechanical Dentistry, and complete information as to my opportunities in dental laboratory work.

Name.....  
 Address.....

# Electricity

*At your fingers' ends*

JUST OFF THE PRESS

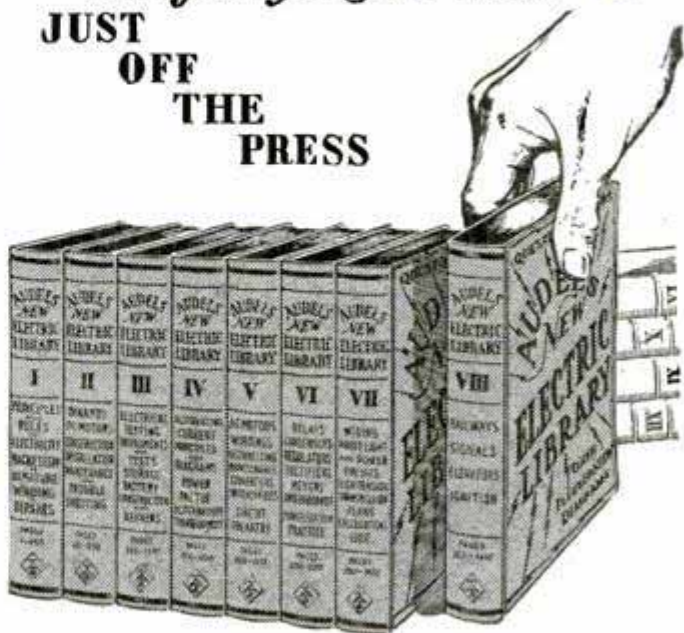

If you need a thorough working knowledge of **Electricity**, it can be easily obtained by spare time reading. When you know the facts—they mean more money and a better position.

Don't guess or take chances with Electricity; for here you have a practical and entirely up-to-date Electrical reference and home study system at a very reasonable cost.

The many questions that crop up are quickly and accurately answered.

## AUDELS NEW ELECTRIC LIBRARY

New from Cover to Cover: Covering thousands of electrical subjects with: Questions, Answers, Diagrams, Facts and Figures relating to: Magnetism, Armature Winding, Dynamos, D-C Motors, Maintenance and Trouble Shooting Tests, Storage Battery, Alternating Current, Power Factor, Transformers, A-C Motors, Windings, Converters, Switches and Fuses, Relays, Condensers, Rectifiers, Meters, Power Station Practice, House, Light and Power Wiring, High Tension, Calculations, Code, Electric Railways, Elevators, Gas Engines, Auto and Aero Ignition, Radio, Telephone, Telegraph, Motion Pictures, Talkies, Lighting, Electric Refrigeration, X-Ray, Welding, Pumps, Compressors, Appliances, An Electric Calculator, Practical Mathematics, A New Electric Dictionary.

### No Money Unless You Are Satisfied

Send for first book on week's trial at publisher's risk. If you are satisfied, you pay \$1.50, otherwise return book. Book Two and following numbers are sent on free trial on our Book-A-Month service.

Audels New Library will contain 12 books, price \$1.50 each. 8 volumes now ready—4 in preparation.

*If you desire more information send for Electric Folder (free)*

### MAIL THIS COUPON TODAY

**THEO. AUDEL & CO.**  
 65 W. 23rd St., New York City.

Mail Vol. I, Electric Library on 7 days' free trial. If O.K. I will remit \$1.50, otherwise I will return it. I also request you to mail one book each month on same terms. No obligation unless I am satisfied.

Name.....  
 Address.....  
 Occupation.....  
 Employed by..... P.M.



LOS ANGELES is the most fascinating city in the world... and the center of America's most rapid automotive industrial growth... the ideal city in which to live and train for success in the automobile industry.

#### Become a COMPETENT AUTO MAN

NATIONAL is an approved trade school, where in four to six months you may graduate as a practical and competent automobile man... prepared for employment in a gigantic industry where steady positions await students of this institution.

#### Train in this "SCHOOL OF SHOPS"

Competent instructors teach you thoroughly all branches of THE AUTO TRADES. You actually work on the latest models of all standard make automobiles, for NATIONAL is the most modern and completely equipped trade school in America. LIFE SCHOLARSHIP PRIVILEGES. Learn by NATIONAL'S famous "ACTUAL-SHOP" METHOD.

#### Learn this STEADY PAYING TRADE

The automotive industry offers ever increasing opportunities for trained men. Factory output increases yearly... and thousands of TRAINED AUTO MEN are needed to keep pace with the growth of this gigantic industry. Start training any time of the year.

#### Efficient EMPLOYMENT Service FREE

NATIONAL is a million dollar institution, 25 years old, boasting 22,000 graduates! No previous experience required... no age limit... start anytime. Unlimited employment service to those wishing to earn while they learn.

**SEND FOR THIS BIG, FREE BOOK**

NATIONAL AUTOMOTIVE SCHOOL  
Dept. 94, 4006 Figueroa St.,  
Los Angeles, California

Send me, absolutely free, your big illustrated  
Catalog of Automotive Opportunities.

Name \_\_\_\_\_

Address \_\_\_\_\_

Age \_\_\_\_\_ City \_\_\_\_\_ State \_\_\_\_\_



**NATIONAL AUTOMOTIVE SCHOOL**

**YES**

## NEW YORK ELECTRICAL SCHOOL

Teaches all branches of Practical Electricity through the "Learn by Doing" Method. Enroll with N. Y. E. S. and gain a thorough understanding of the problems, a broad experience in applied engineering practice, and qualify quickly to follow an electrical career.

No books used. Day and evening classes open all year.

*Write for FREE School Booklet*

**New York Electrical School**  
44 W. 17th St.      New York

**PATENT DRAFTING \$1** Make correct patent drawings of your ideas. Work for inventors and patent attorneys. Spare time. Easy, profitable and fascinating home work. Mechanical, Electrical, Design and Trade Mark drawing thoroughly explained, with over 400 illustrated small mechanical parts. **FREE**—Information and list of LEGAL BLANKS. Wade Service, 2274-B, Brooklyn Station, Cleveland, Ohio

**S HORTHAND IN 30 DAYS**  
Boyd, the wonderful easy system, 150 words a minute guaranteed. Send today for Catalog and sample lesson.  
**CHICAGO HOME STUDY SCHOOLS**  
801 Reaper Block Chicago, Ill.

**Learn Watchwork, Jewelrywork and Engraving** A fine trade commanding a good salary, and your services always in demand. Address **Horological**, Dept. P, Bradley Institute, PEORIA, ILLINOIS, for our latest catalog.

## BOYS! We'll GIVE You This

**1000 Loud Shots**  
New Type Repeating Cap Pistol



Here's great fun! A brand new type of repeating pistol. So realistic you couldn't tell it from real thing. Beautifully made, highly polished and burnished with jet black grip. Shoots 50 fast shots at one loading—bang, bang, bang, rip, rip, rip! Don't confuse this great gun with cheap pistols. We guarantee this to please you. One thousand rounds packed with each pistol. Get yours quick.

**A Really Great Offer**  
The Open Road for Boys Magazine is just crammed with blood tingling stories of aviation, high adventure on land and sea, deep mystery. 200,000 boys say these stories best published. Great departments, clubs, mechanics, contests galore with prizes for all. Regular subscription price \$1.00 a year. Send us \$1 cash today and we will send you the magazine for a whole year and send you **FREE** (express collect—only few cents) this wonderful pistol and 1000 rounds of ammunition. We guarantee both magazine and pistol to please you 100% or money back. This is a great offer—a tremendous value. Hurry your order.

Open Road for Boys Magazine, Dept. CP, 130 Newbury Street, Boston, Mass.

# NOW FIX ANY MAKE OF

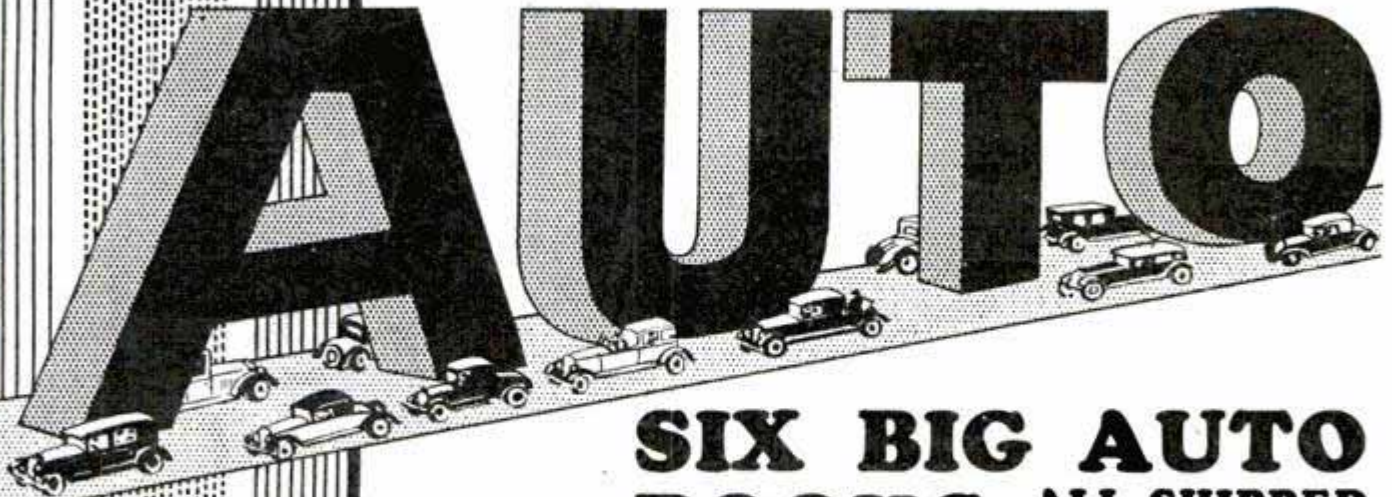

## SIX BIG AUTO BOOKS ALL SHIPPED FREE

on approval; whether you want to qualify as garage owner, auto repair expert or merely wish to know how to keep your own car 100% efficient, look at these books—they are sent to you for free examination. This brand new 1930 edition has been prepared by a large group of America's greatest automotive engineers. Anybody who can read will understand them, for this great automobile encyclopedia is a veritable gold mine of valuable facts. Take advantage of this great opportunity now; send in the coupon for FREE examination. You don't pay us a penny, you don't obligate yourself to pay anything unless you decide to keep the books. Just tell us you want to see them and the full set of 6 great volumes, just off the press, will be sent to you. Read them, look them over and prove to your own satisfaction that one fact alone, which you will find in them, may save you an expensive repair, or help you to a better job.

### AVIATION MOTORS

In addition to being a complete cyclopedia of automobile engineering these books contain over 100 pages on Aviation Motors, and as they are just off the press they bring to you the newest and latest information obtainable. This alone makes these books invaluable to anyone.



## NEW 1930 EDITION EVERY PAGE UP TO DATE

Imagine books which are so new that with the co-operation of the largest automobile manufacturers we have been able to bring every page right up to date—wiring diagrams, construction details, service problems—are all right up to the minute. Nowhere else that we know of can you get as complete and up to date information. Over a million dollars of resources have enabled us to give you the most up to date books on the subject ever published. You will find nearly 20 pages on front wheel drives alone. Everybody interested in automobiles in any way will welcome these books, especially on our

## NO MONEY OFFER

This plan brings this valuable information within the reach of everyone. You don't send us a single penny; you don't have to pay us anything; just send your name and address and we will send you the complete set of 6 volumes specially bound in De Luxe Flexo covers. Read them carefully, keep them 10 days, find out anything you want to know and then if you want to keep them send \$2.00 then and \$3.00 per month until the special low price of only \$24.80 is paid. There is no further obligation.

### Learn All About Autos

Get these 6 big new books on this liberal offer and learn all the things you want to know—carburetors, transmissions, springs and spring suspensions, brakes, four-wheel drives, front-wheel drives, lubrication systems as well as over 100 pages on Aviation Motors—all of these subjects are fully covered. These complete and comprehensive auto books are yours, if you want them, on this easy plan. Send for your set now.

## SEND NO MONEY

American Technical Society, Dept. A-919, Drexel Ave. at 58th St., Chicago, Illinois

I would like to see the new 6 volume 1930 edition of your automobile books but without any obligation to buy. I will pay the few cents delivery charges only and will examine the books and return them at your expense in 10 days unless I like them, in which case I will send you \$2.00 then and only \$3.00 per month until the special price of only \$24.80 is paid. You are to include free-consulting membership certificate in the American Technical Society. Send brand new 1930 edition.

Name.....  
 Street.....  
 City..... State.....  
 Employer's Name.....  
 Employer's Address.....

These books will be sent free immediately upon receipt of coupon with writer's name and address and that of his employer or other business man as a reference.



### Jiffy Index

You don't have to read the books through, the special Jiffy Index enables you to put your finger on the information wanted in a jiffy.

### American Technical Society Membership FREE

If you send now for this brand new 6 volume edition of automobile engineering we will include a consultation membership in this great organization. Our large staff of automobile and aviation experts will be ready to help you at all times—you can write or wire any time for special information—answers will be sent to you promptly WITHOUT COST. This membership is good for one full year.



- 1—Von Hoffmann Student Flight Hangar.
- 2—Von Hoffmann Storage and Service Hangar.
- 3—Von Hoffmann Ground School and Office.
- 4—Von Hoffmann Student Home.
- 5—Present Site of Army and Navy Hangars.
- 6—Air Mail Hangar.

## There Is a Future for YOU in AVIATION

A practical method of easy payments is available for those who desire it.

Located on the famous \$2,000,000 Lambert-St. Louis Airport.

U. S. Department of Commerce approved School for Transport, Limited Commercial and Private—Ground and Flying courses.



"Red" Jackson — twice holder of the World's Endurance Record — a Von Hoffmann graduate

Aviation is a sound, big business—a business full of opportunities for men with foresight. Many young men, such as you, have already fitted themselves. Today they are holding good paying positions of importance. The need for more trained men is constantly increasing. Government figures show that the Aviation business is growing at the average rate of 60% a year. This means that both pilots and ground men are needed. You can be one of them if you prepare yourself now.

### Proper Training Can Be Had Easily and Quickly

Compared with any other business, Aviation training takes but a very short time. In the Von Hoffmann School the training you get exceeds government requirements. It is thorough and practical. This school is a leader. Late types of planes and modern and complete ground equipment only are used. Because of the reputation of the school, Von Hoffmann graduates find ready employment.

### Write for Illustrated Catalog

It gives detailed information about the opportunities in Aviation—about the school—about the courses—about the low cost—and it tells you how to make your start in this great business. No obligation involved. Use the coupon below for convenience.

## Von Hoffmann Aircraft School

136 Lambert- St. Louis Flying Field — St. Louis, Mo.

**VON HOFFMANN AIRCRAFT SCHOOL**  
136 Lambert-St. Louis Flying Field  
St. Louis, Missouri. MAIL TODAY

Name .....

Address .....

City ..... State .....

Age .....

I am interested in

( ) FLYING COURSE      ( ) MECHANICS COURSE

( ) WELDING COURSE    ( ) HOME STUDY

# 1931 Radio Catalog

## RADIO BARGAINS

### WHOLESALE DISCOUNTS

### LOWEST PRICES

**Greatest bargains shown at REGULAR WHOLESALE TRADE DISCOUNTS!**

Nationally-advertised, guaranteed radio merchandise, including the sensational **bonded LAFAYETTE ALL ELECTRIC RADIO RECEIVER**, with tone control. Write at once for **FREE 1931 Radio Bargain Catalog**, showing complete selection. *Don't buy until you see this wonder catalog!*

**WHOLESALE RADIO SERVICE CO.**  
Dept. M-11  
38 Vesey St. New York

# FREE!

### Factory to Rider

Save \$10 to \$25 on the Mead Bicycle you select from 44 Styles, colors and sizes.

### 30 Days' Free Trial

We ship on approval. If not satisfied after trial return the bicycle. **EASY PAYMENTS. \$5 down on RANGER Bicycles.**

**Tires** lamps, wheels, equipment at half usual prices. Write for marvelous new prices, wonderful 30 day trial offer and terms.

**Mead Cycle Company** Write us today for free catalog  
Dept. T.110 Chicago



## BOOKS! Bargain FREE Catalog

25,000 books of all publishers. Fiction, educational, scientific, etc. Old time favorites and latest "big sellers." 36 years of quick satisfying service to public, private and school libraries. Hundreds of thousands of individual customers. Whether interested in one or many books, send postcard today for new catalog "**Bargains in Books.**"

**THE BOOK SUPPLY COMPANY, Dept. 81**  
564-566 West Monroe St., Chicago, Illinois

Write for catalog Today



# U.S. GOV'T JOBS!

\$1500<sup>00</sup> to \$3600<sup>00</sup> YEARLY!

**For MEN—WOMEN**  
Age 18 to 55

Get on Uncle Sam's Payroll where strikes, hardtimes, politics, etc. will not affect you. Draw twelve months' pay every year and when old, retire on a pension the balance of your life. Stop worrying—enjoy life! Pick the position you want—it belongs to you just as much as to anyone else. If you don't get it it's your own fault. Over 900 different kinds of positions obtainable, in or outside work, local or traveling. Fill out coupon below, mail it today, and full particulars together with big list of other positions will be sent immediately.

- |                                            |                                              |
|--------------------------------------------|----------------------------------------------|
| <input type="checkbox"/> Ry. Mail Clerk    | <input type="checkbox"/> Steno-Typist        |
| <input type="checkbox"/> P. O. Laborer     | <input type="checkbox"/> Immigrant Inspector |
| <input type="checkbox"/> R. F. D. Carrier  | <input type="checkbox"/> Seamstress          |
| <input type="checkbox"/> Special Agent     | <input type="checkbox"/> Auditor             |
| <input type="checkbox"/> Customs Inspector | <input type="checkbox"/> Steno-Secretary     |
| <input type="checkbox"/> City Mail Carrier | <input type="checkbox"/> U. S. Border Patrol |
| <input type="checkbox"/> Meat Inspector    | <input type="checkbox"/> Chauffeur-Carrier   |
| <input type="checkbox"/> P. O. Clerk       | <input type="checkbox"/> Watchman            |
| <input type="checkbox"/> File Clerk        | <input type="checkbox"/> Skilled Laborer     |
| <input type="checkbox"/> General Clerk     | <input type="checkbox"/> Postmaster          |
| <input type="checkbox"/> Matron            | <input type="checkbox"/> Typist              |

**OZMENT INSTRUCTION BUREAU, 444, St. Louis, Mo.**  
Send me **FREE** particulars How To Qualify for positions marked "X" Salaries, locations, opportunities, etc. Also big list of other positions.

NAME.....

ADDRESS.....



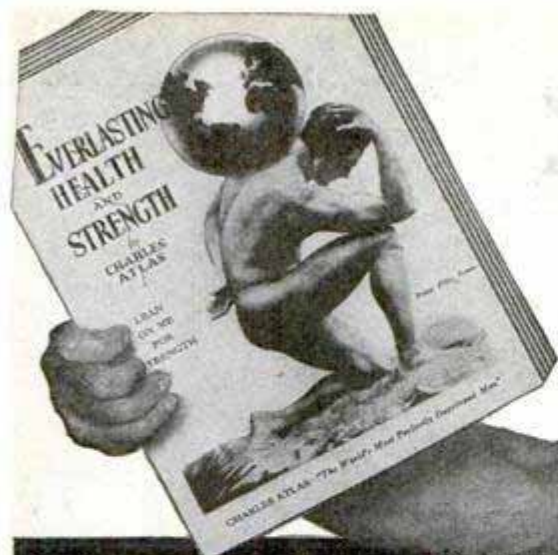

(Latest Photo)  
CHARLES ATLAS  
Today

# FREE-

the **BOOK** that has shown **20,000** others the way to **BIG MUSCLES!**

Reveals the secrets that won me the title of "The World's Most Perfectly Developed Man." . . . Tells how YOU can win a handsome, healthy, HUSKY body—my quick Dynamic-Tension way!

—By **CHARLES ATLAS**  
"The World's Most Perfectly Developed Man"

**J**UST jot down your name and address on the coupon below, mail it to me—and I'll send you absolutely free of charge a copy of my big new book.

Then read the fascinating story of how I take underdeveloped, no-muscle men of all ages and give them big, powerful muscles, increased measurements, amazing strength and endurance—all in a few minutes of leisure time daily at home.

### Easy My Way

No tiring apparatus my way — my natural *Dynamic-Tension* method does the work. No pills, "rays," fussy dieting, or other unnatural "schemes." In my free book I explain the principles of *Dynamic-Tension* that I discovered and used to build myself up from a 97-lb. WEAKLING to the CHAMPION of them all—"The World's Most Perfectly Developed Man."

I've helped thousands of other men, youngsters and oldsters, fat and skinny. Some were weak, run-down specimens that looked like scarecrows before I

showed them my QUICK way to add weight, get smooth, even layers of powerful muscle and the handsome, evenly-balanced proportions that you see in my own photos.

### PROOF That You Can Be This NEW MAN

Now I'll give YOU the PROOF in only 7 DAYS that I can turn you, too, into an "Atlas Champion"—make a NEW MAN of you—give you a handsome, HUSKY BODY, give you big, POWERFUL MUSCLES, put on POUNDS of firm flesh, or if you are fat pare you down to FIGHTING TRIM.

And with this NEW FIGURE I'll give you NEW HEALTH—the through-and-through health that rids you of constipation, pimples, skin blotches and that half-alive, played-out feeling that does you out of the good times and the good things of life.

### Edition Limited—Send for Free Book at Once

Why be only 50% of the man you can be? Join the regiment of Atlas Cham-

pions that stretches clear across the United States. Send NOW for a free copy of my new book containing scores of pictures of myself and the others who have used my secret methods. Then become the NEW MAN I'll prove you CAN be. Don't delay—mail the coupon NOW for YOUR free copy of my new book. Address CHARLES ATLAS, (Dept. 812) 133 East 23rd Street, New York City.

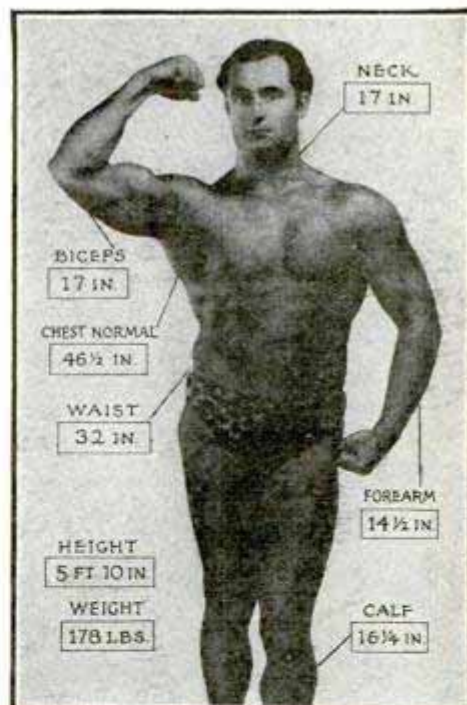

**CHARLES ATLAS, [Dept. 812]**  
133 East 23rd Street, New York City

Send me a free copy of your book "Everlasting Health and Strength" that shows how I can win big muscles and a handsome healthy body. Mail to:

Name.....  
(Please write plainly)

Address.....

City.....State.....

**- FOR STEADY WORK & BIG PAY-LEARN**

**ELECTRICITY**  
*The "DADDY" of THEM ALL*  
 RADIO - TELEVISION - AVIATION - IGNITION



Be wise—be foresighted—if it's good pay you want—a steady job with a real future—answer the call of **Electricity**—the "daddy" of them all—the giant of American industry—one of the world's greatest employers of well paid men.

Learn **Electricity** first—learn it easily and quickly in your spare time—the **L. L. Cooke way!** Prepare yourself to step into a steady job, where others easily earn **\$60 to \$100 a week** and more, in Radio and Television, Electrical Contracting, Power Plant Work, Aircraft and Automotive Electricity, or Talking Movie work.

Today as never before **Electricity**, on which all other industries depend, offers amazing opportunities! Get into this big pay field—**act now**—learn **Industrial Electricity!** It's the key to success in the most interesting, best paying work in the world—and it's remarkably easy to learn the **L. L. Cooke way.**

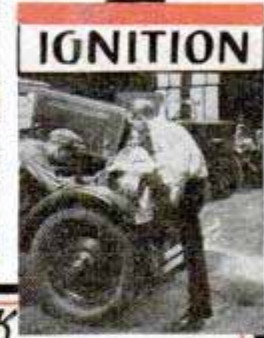
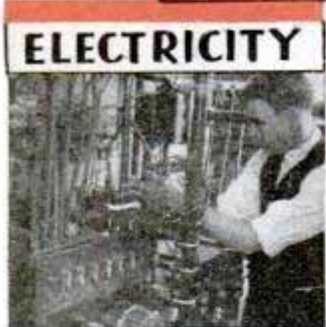

**Learn Electricity the Cooke Way and you learn them all . . . . .**

Practical Electricity, Radio, Television, Aircraft and Auto Electricity. It's the great **ALL-IN-ONE** Training — made easy by the famous Work Sheet and Job Ticket Method. You **learn by doing!** Six Big Outfits of Tools and Apparatus furnished **without extra cost.**

Write to "headquarters" for advice and information—investigate the school that is now preparing hundreds of men, and has prepared thousands, just like yourself, for big pay jobs in the world's greatest industries. **Don't wait**—mail the coupon for Big **FREE Opportunity Book**—**today!**

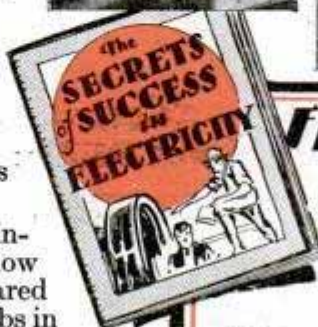

**FREE BOOK**

**L. L. Cooke School of Electricity, Dept. 19, 2150 Lawrence Ave., Chicago.**

Without obligation, send me your book "Secrets of Success in Electricity" and tell me about your **ALL-IN-ONE** Training—your Money Back Agreement and Job Service.

Name.....  
 Street.....  
 City..... State.....

**L. L. COOKE SCHOOL OF ELECTRICITY**  
 Dept. 19      2150 Lawrence Ave.      CHICAGO

# Classified Advertisements

WORLD'S BEST WANT AD MEDIUM

Advertisements in this section, 35 cents per word, each insertion, minimum 10 words, payable in advance. To be printed under proper classification in January issue, copy should be in our office November 18th.

**ADVERTISING AGENCIES**

**ADVERTISE**—24 Leading Sunday newspapers, 24 words \$15.00. Excellent for obtaining help, salesmen, or business opportunities. Information 1,000 best paying dailies, mail-order weeklies, monthlies, mailing lists, everything. Free. Wade Agency, Great Northern Bldg., Chicago.

**GET** Into advertising. Learn quickly at home. Experience unnecessary. New easy plan. No text books used. Practical work. Old established school. Send name and address for interesting free booklet. Page-Davis School of Advertising, Dept. 343-C, 3601 Michigan, Chicago.

**ADVERTISE** Nationally. Classified book American newspapers free. Brantley Agency, Salisbury, N. C.

**ADVERTISING**: 24 words 20 newspapers \$9; fifty weeklies \$5. Free list magazines, farm. LeGrand Agency, M34 West 33rd Street, New York.

**OBTAIN** Canvassers, distributors through publication advertising. Martin, 276B West 43d, New York.

**BEFORE** Advertising get our catalog. No charge. 25 years in business. The largest classified agency in the world. Ankrum Advertising Agency, 100 No. LaSalle St., Chicago, Ill.

**FREE**—New 1930 Advertisers Rate Guide, 44 pages. Includes everything. Lowest rates. E. H. Brown Advertising Agency, 140 S. Dearborn, Chicago.

**INCH** Display advertisement 50 magazines year \$24. Wood's Popular Services, Atlantic City, N. J.

**ADVERTISE** In rural weeklies. Lists free. Meyer Agency, 4112 Hartford, St. Louis, Mo.

**TIME** Counts in applying for patents. See pages 140 and 141. Clarence A. O'Brien, Registered Patent Attorney, Washington, D. C.

**FOR ADVERTISERS**

**ADVERTISING**: 20 Words, 50 magazines 60c; three insertions, \$1.20. Mailing Bureau, Lawndale, Calif.

**ADVERTISE** In country papers; low rates; lists free. Keator, Hartford Bldg., Chicago.

**25 WORD** Classified ad in five southern Negro newspapers (circulation 14,650)—Only \$1.00. R. L. Stricklen, Jr., Staunton, Va.

**ADDRESSES**—Every business line Germany's—reasonable. International, 1205 Diversey, Chicago.

**ADVERTISE** 53 Magazines, old and reliable Syndicate; 3c word; \$3.00 inch. List free. Evans King Co., Box 672P, Wilmington, Delaware.

**MAILING LISTS**

**FRESH** Agents monthly, national advertising 98% correct. Sworn statement each list, 1000 \$3.00. Clayton Dawson, Coshocton, O.

**SALES PROMOTION**

**ANYTHING** Can be sold by advertising. Let us help you! Banning, Times Building, Watertown, N. Y.

**AGENCIES WANTED**

**A WELL**—Established reliable firm requires novelty and other agencies for Oriental markets. Gibson Craig-Carmichael Co., Hongkong.

**AUTOMOBILES**

**CAR** Owners: Save big money by doing your own repair work. Simple as A. B. C. when you have "My Automobile," new 400-page, 227-diagram "how-book" just written by famous automotive engineer. No matter what make or model your car is, this book will tell you how to locate troubles, and exactly what to do to keep your car in A-1 condition every minute of the time. Will repay its cost every month in the year and add fifty percent to the life of your car. Price, postpaid only \$3.50. Money back on request. Order today from Scientific Book Corporation, Dept. P, 15 East 26th Street, New York, N. Y.

**AUTO** Trunks complete, or knocked down. Three prices, Box 1111, Tacoma, Washington.

**TIME** Counts in applying for patents. See pages 140 and 141. Clarence A. O'Brien, Registered Patent Attorney, Washington, D. C.

**AUTO SUPPLIES**

**"SPRINGS** of Silence"—Inexpensive Sets—Ford Chevrolet, Hudson, Essex, all cars—Ask automobile dealer—"Safety" mirror-hinge attached—chromium, \$2.00. Seat springs \$1.00 set, guaranteed. Catalog sent on request. Universal Spring Co., 550 Bond Ave., Grand Rapids, Mich.

**EVERY** Auto, or radio owner should have our new Improved Triple Freezometer. Tests alcohol, glycerine, anti freeze and batteries accurately. Government standard. One instrument replacing two. \$1.00 (bill) postpaid. Freezometer Co., Collegeville, Penna.

**HOTWATER** Automobile heaters \$5.00 each complete with all fittings shipped C.O.D. heavy material will outlast any car, no nauseating odors. P. O. Box 128, Cumberland, Md.

**HOTWYPE**, An electrically heated, windshield wiper blade, fits all cars. Easily installed. Keeps windshield clear of sleet and snow. Price \$2.50. Splendid Christmas gift proposition to agents. Benj. D. Ballantine, 10 Main St., Fitchburg, Mass.

**MAGNETIC** Trouble light for automobile, \$1.00. P. C. Thomson, Elmira, N. Y.

**CHROMIUM** Plating powder plates iron, steel, brass, copper and silver, without electricity or machinery. Guaranteed not to tarnish; ½ pint can \$1.50 prepaid. Gunmetal Co., Ave. J, Decatur, Ill.

**MARK** Your tools finest steel name stamps. Send \$2.00 print name. Ferriot Bros. Inc., 911 Yale Street, Akron, Ohio.

**PROFITABLE** Electric trouble shooting with new and reconditioned, attractively priced test benches. Easy terms, trial. Mitchell Company, Box M-1203, Troy, Ohio.

**ELECTRIC** Arc welding proving profitable automotive shops. Easy payments on gasoline or electric. Hobart Brothers Welding Division, Box M-1204, Troy Ohio.

**NEW** Auto parts 25-50%. Motors, rear-ends, radiators, wheels, generators, carburetors, brakelining 50%. Used parts 40-80% off. Brightman, 2065 Main St., Hartford, Conn.

**RADIATORS**: All standard makes at wholesale. Guaranteed. Send for prices. State make, model. Independent Radiator Co., 1119 So. Wabash, Chicago.

**ELECTRIC** Arc soldering. New, startling. Principle electric welding. Representatives, \$12.00 day easy, 100% profit. Sample \$2.00. Huribert Mfg. Co., Glendale, Calif.

**AUTO SERVICE AND EQUIPMENT**

**COMPRESSORS**, Twin automatic, 8 hour battery chargers, 20-minute car washers, test benches, paint sprays, \$20 monthly. Pays for itself without investment. Guaranteed. Write Ken's Service, Box M-1205, Troy, Ohio.

**"FIFTEEN** Capacity battery charger, direct from factory; guaranteed; 110 volts; money maker for owner \$27.34. Adams Barr Corporation, Columbus, Ohio.

**RECONDITIONED** Bargains in car washers, battery chargers, compressors, test benches, many only used few months. Easy terms and trial, guaranteed. Mitchell Electric, Box M-1206, Troy, Ohio.

**MOTORCYCLES, BICYCLES & SUPPLIES**

**MOTORCYCLE** Bargains, lowest prices, bargain sheets for stamp, special aviators supplies, motorcycle accessories largest line in America, lowest prices. Largest motorcycle mail order house in the United States. Rochester Harley Davidson Corporation, 129 West Main St., Rochester, N. Y.

**HARLEY** Davidson bargains at a tremendous sacrifice. All models and prices. Guaranteed. Send 4 cents in stamps for our catalog. "Money Saving Motorcycle Bargains." The Knuth Co., 2525 Fond du Lac Ave., Milwaukee, Wis.

**MOTORCYCLE** Parts, new and used. Lists free. Tower Cycle Co., Pine Lawn Mo.

**REPAIR** With good used parts, save ½ or more state parts needed, no lists. J. B. Dahl, 3661 Archer Ave., Chicago, Ill.

**GET** Our prices on used motorcycles before you buy. We can save you money. Buffalo's reliable Harley-Davidson Dealer, Cumberland-Young, Inc., 1454-58 Main St., Buffalo, N. Y.

**HENDERSON**, Excelsior, Harley, Indian used parts, engines, cheap. Conversion parts. Catalogue free. Ballak, 100 N. 12th St. Louis, Mo.

**AVIATION**

**\$79.00** BUYS Aeroford glider of approved design in "knock-down" form which you can assemble with few simple tools. Our makit kit includes everything: high grade materials cut and marked for easy construction; large blueprints; instructions. This Glider weighs 140 lbs.; carries 300 lbs.; wing span 32 ft. Tested by well known expert aeronautical engineer. Send \$40.00 deposit with order; pay \$39.00, plus shipping charges, when delivered. Set blueprints \$2.50. Shipments made in order of receipt of deposits. Order now for early delivery. Aeroford Aircraft Corporation, 1900 North American Bldg., Chicago.

**NEW** Book! Henley's, ABC of gliding and sailing, by Major V. W. Page, price \$1.50 paper binding, \$2.00 cloth. Leading types of Gliders and Sailplanes, their construction, control and launching described. Instructions are given for forming a glider club and for building a strong yet simple primary glider, including working drawings, 294 pages, 72 illustrations. Circulars of this book and our six other important new aviation books, sent on request. Norman W. Henley Pub. Co., 2 West 45th St., New York

**HEATH** Propellers will give your ice sled, wind buggy, or airplane greatly increased performance. Every Heath propeller is backed by 22 years experience and is designed especially for the job on which it will be used. That's why we can guarantee it will give superior performance. Costs no more than ordinary, stock propellers, 4 cents in stamps brings catalog. Heath Aircraft Corp., Dept. CL15P 1721-9 Sedgwick St., Chicago.

**\$80** BUYS New airplane motor in original factory box. 80 horsepower. Nine cylinder. Weighs 265 pounds. Completely equipped; magneto, carburetor, propeller hub, oil gauge, switch, and throttle levers for cockpit. Fine for two seater sportplane or aerosled. Also other bargains. Allison Airplane Co., Lawrence, Kansas.

**CONVERTED** Henderson and Harley motors, hub, propeller, magneto ready to fly \$45.00 up. L. L. Toalson, 710 N. Cherry St., San Antonio, Texas.

**HEATH** Parasols—Start building America's most popular sport plane now for only \$12. Aviation's most sensational offer! Parts sent you in 11 conveniently progressive groups—as you need them. Heath plans declared clear and easy to follow by hundreds of enthusiastic builders everywhere. Send 10 cents today for large illustrated booklet. Heath Aircraft Corp., Dept. CL16P 1721-9 Sedgwick St., Chicago.

**PHOTOGRAPHS** of airplanes: All makes, brilliant, 7x10 heavyweight, 3 for dollar sent C.O.D. Special pursuit group of ten, \$3.00. John Stiles; Stoughton, Mass.

**PRIMARY** Glider, new built N. G. A. plans. Price \$1.00. Shop Dept., Roosevelt School, Gary, Indiana.

**AIRPLANE** Motors and propellers. 28 to 200 horsepower. Bargains. Smith, Box 1343, Houston, Texas.

**AVIATION** Helmet, wing emblem, both \$1.00. Box 89, G. P. O., N. Y. C.

**MAKE** The world's cheapest 35 h.p. motor using Ford or Chevrolet Engine. Send 10c for circulars. Heine Motor Works, Orwigsburg, Pa.

**SOUVENIRS** of our national hero Colonel Chas. Augustus Lindbergh. One wing rib; one instrument board; one fuselage compression strut; all of exact size and material as used in plane that Colonel Lindbergh learned to fly. Also a photograph of the same airplane. All for \$1.00. Lincoln Aircraft Co., Inc., Lincoln, Neb.

**OX5** MOTOR One hundred thirty five dollars. Glenn Kneeland, Chapin, Illinois.

**THE New Heath B-4 Aircraft Engine**—the very latest development in light plane motor design. Holds title of world's champion by defeating finest American and European motors at National Air Races. Delivers 30 horse-power at 3,000 R.P.M. Yet costs only \$300 fully equipped including propeller hub. Also completely rebuilt Heath Henderson motors in excellent condition as low as \$195. Fully guaranteed. 10 cents in stamps for illustrated catalog. Heath Aircraft Corp., Dept. CL14P 1721-9 Sedgwick Street, Chicago.

**NEW Hall Scott motor \$250.00**—OX5 reconditioned \$45.00. L. L. Toalson, 710 N. Cherry St., San Antonio, Texas.

**COMPLETE Ground school course in three lessons for \$10.** Write for information. National Aviation Correspondence School, Petersburg, Virginia.

**BUYERS Directory**, listing thousands bargains used airplanes, motors, jumping balloons, power gliders, equipment. 50c. Midwest Company, 603-7 Security Mutual, Lincoln, Nebr.

**HELIOS Motors**: 35 hp. and 60 hp. radials, air cooled. Real, modern aviation motors, not made-over motorcycle or auto engines. Catalog, data etc. 10c. Aviation Service, 926 Broadway, New York.

**HEATH Aerial Driven Sleds** give all the thrills of airplane performance on ice or snow. Complete blueprints for Ford or motorcycle driven sleds only \$2.00 per set. These plans take all the guesswork out of building as they are designed by America's foremost aircraft engineers. In ordering specify motor used. Heath Aircraft Corp., Dept. CL13P 1721-9 Sedgwick Street, Chicago.

**"IF You want to fly"** let Alexander Klein, brilliant engineer, teach you. With great skill whole course of training has been simplified and made crystal clear. Remarkable book teaches in most practical and easily understood fashion. Recommended by skilled flyers. Sent C.O.D. anywhere in U. S. Simply pay postman \$2.50 and postage when delivered. Sent postpaid to any address upon receipt of price. Popular Mechanics Press, Room 801, 200 E. Ontario St., Chicago.

**MOTORS, Propellers, hubs, for iceboats and lightplanes, cheap.** Circular 10c. Storms Aviation, Spartanburg, S. C.

**AVIATION Helmet—Wing emblem, both \$1.00.** Smookler, Box 89, G.P.O., N. Y. C.

**AIRPLANE Design, drafting, airport management.** These are the "big" jobs. Learn at home, receiving personal guidance of a leading aeronautic engineer. Send for free catalogue. U. S. Aircraft Engineering School, Goodrich Building, Kansas City, Mo.

**AERODRIVE Sleds—blueprints, 4 different types and 1 boat type—the set only \$1.** Single prints 25c; propellers: 4', \$8.75; 5', \$13.25; 6', \$16.50. Set blueprints primary glider, \$2.50. Ostergaard Aircraft, Dunning, Chicago.

**TIME Counts in applying for patents.** See pages 140 and 141. Clarence A. O'Brien, Registered Patent Attorney, Washington, D. C.

**BUILD The Russell monoplane.** The Sportplane Constructor book with full page blueprints, drawings, photographs, gives sizes, weights, materials, balance diagram, motors, flight instruction, etc., sent postpaid \$1.00. Russell Aircraft Co., Box 455, Toledo, Ohio.

**HENDERSON And big V motors, metal tipped propellers \$9.95 each.** Hibbs, Ft. Worth, Texas.

**SEND 5c For bundle of balsa, reeds and price list on supplies.** Aero Shop, 3050 Hurbit Ave., Detroit, Mich.

**BIGGEST. Best catalog model airplanes; parts, supplies; 5c postpaid.** Ideal Company, 19 West 18th St., New York.

#### MODEL AIRPLANES

**CLEVELAND Designed—the standard of comparison for Model Aircraft.** Large notebook—catalog, 25c. Airplane kits, 59c to \$6.60. Drawings, 15c to \$4.00. Supplies. Cleveland Models, 1866P, West 57th, Cleveland, Ohio.

**4-6-8 CYLINDER Compressed air motors and scale models 10c for catalogue.** Miniature Aircraft Corp., 83 Low Terrace, New Brighton, N. Y.

#### BOOKS AND PERIODICALS

**1,000,000 CLOTH Bound books, 15c each, average 190 pages.** Popular movie novels, thrilling detective mysteries. Rex Beach, Edgar Wallace, Sabatini, etc. Unbelievable value. 7 books \$1.00, 16 books \$2.20. Our selection or circular sent. Satisfaction guaranteed. Lester Lewis Finkel, Concourse Building, Concourse East, Jersey City, N. J.

**GREATEST Underground wonder of the world, Carlsbad Cavern, N. Mexico.** Send \$1.00 for the book. It's history and geology. Shockey & Shockey, Moriarty, N. Mex.

**ASTROLOGY Books—25c to \$4; send for free descriptive lists.** H. C. Bullock, Box 1286, Providence, R. I.

**STANDARD Handbooks, authentic texts, instruction.** All trades, professions. Illustrated catalog. International, 159 Madison, Memphis, Tenn.

**THREE Months trial subscription 10c.** Liberty Mail Order Digest, North 11th, Sheboygan, Wis.

**PRACTICAL Waterworks from stream having 3 feet fall or more.** Plans for building \$1.00. Hansen, Box 2, Ogden, Utah.

**INDUSTRIAL Alcohol.** Complete directions for making. Fully illustrated. \$2.50. Spon & Chamberlin, 120 P.M. Liberty St., New York.

**OUTDOOR Sports for everyone—Enjoy them all year round with aid of great new book just published by Popular Mechanics.** This veritable encyclopedia not only furnishes hundreds of ideas for new and popular sports for every season of the year, but also gives complete instruction for making the necessary equipment at very small cost. 350 pages and 650 illustrations. Send to-day as book is full of thrills and excitement for fall and winter sport enthusiasts. Mailed postpaid anywhere for \$2., or will be sent C.O.D. to any address in U. S. Simply pay postman when delivered. Popular Mechanics Press, Room 812, 200 East Ontario St., Chicago.

#### PICTURES AND POSTCARDS

**AUTOGRAPHED Photographs movie stars, 5x7—4 for 25c.** Robinson, 334 N. San Pedro St., Los Angeles.

#### GAMES, ENTERTAINMENTS AND PLAYS

**PLAYS, Operettas, musical comedies and minstrels, comedy and talking songs, black-face skits, vaudeville acts, monologs, dialog, recitations, juvenile plays and songs, musical readings, entertainments, make-up goods.** Catalog free. T. S. Denison & Co., 623 So. Wabash, Dept. 11, Chicago.

**COMIC Stunts for that next party.** Catalogue 10c. Swivel, 114 Huntington, New Brunswick, N. J.

**BURLESQUE Miniature golf, screamingly funny game.** Plays anywhere. Delightful gift. Complete \$1, postpaid. Hollywood Game Service, Box 1494, Hollywood, California.

**PUT-POOL! Latest indoor Miniature Golf sensation.** Small investment, highly profitable. Write for particulars. Marshall Company, Rome, Ga.

#### CHALK TALKS

**LAUGH Producing program, \$1.00.** Catalog free. Balda, The Cartoonist, Oshkosh, Wis.

#### MAGIC TRICKS, BOOKS AND JOKER NOVELTIES

**MAGIC—Tricks, Books and Supplies.** For amateurs as well as the great professionals. Anyone can learn through our instructions. Feature Acts in Mind-Reading, Spiritualism, Rope Ties, etc. Large illustrated professional catalog, 20c. Chicago Magic Co., 140 So. Dearborn St., Dept. B, Chicago, Ill.

**"THE Book of 1,000 Wonders"** explains many mystifying tricks with coins, cards, handkerchiefs, etc. Also contains complete catalog magic tricks, jokes, puzzles, books, and imported novelties. Largest assortment, lowest prices. Amaze and mystify your friends. Send 10c today. Lyle Douglas, Station A-5, Dallas, Tex.

**MAGIC Catalog 20c.** Lynn, 105 Beach, Dept. 3, Jersey City, N. J.

**250 MAGIC Tricks explained, 25c.** American Specialty Co., Swampscott, Mass.

**STAGE Money, Harold Lloyd goggles, trick cards, assorted games, swish bird warblers and Boscos magic cards.** All for quarter. Irving Levy Company, 818 Cass Street, La Crosse, Wisconsin.

**TRICK Catalogue, 10c; stage money, 50 bills 20c.** Oaks Magical Co., Dept. 548, Oshkosh, Wis.

**NOVELTY Sent free with catalog magic and jokes.** McColm, Box 125, Allenhurst, New Jersey.

**FREE Magic catalog: Hundreds of mystifying tricks.** Free with our Master System of 6 card tricks for only 10 cents. Name any card drawn from deck, etc. Wizard Magic Co., Dept. 15-R, Box 1055, Station "C", Los Angeles, Calif.

**SEVEN Optimal delusions.** Five Magic catalogs, 25c. Gilmagico, Morgan Park, Chicago.

**ELECTRIC Fun! 200 stunts, 110 volts, \$1.** Kutting Sons, Campbell, Calif.

#### RADIO SETS AND SUPPLIES

**THE 1931 Neotone automobile radio.** The last word in auto radio receivers. Screen grid circuit, remote control, distance, volume, clarity. Write for circular. Agents wanted. Schiffmann Brothers, 3840 N. Ashland Ave., Chicago.

**NEW 300-Mile "pocket" radio, \$3.85.** Complete with special loud receiver. No tubes or batteries required. Order direct. Spencer Laboratories, 116 Atlas, Akron, Ohio.

**"WORLD" Receiver, \$1.25.** Illustrated bargain catalogue, 10c. Neill Tasker, Shamokin, Pa.

**TIME Counts in applying for patents.** See pages 140 and 141. Clarence A. O'Brien, Registered Patent Attorney, Washington, D. C.

#### STAMP COLLECTING

**SNAPS—Offer No. 1—300 different foreign 60 different U. S. stamps including \$1 and \$2 values, all for 25c.** Offer No. 2—100 different foreign stamps from 100 different countries, including Africa, Asia, Australia, Europe, West Indies, etc., only 20c. Offer No. 3—Stamp album, providing spaces for 2200 stamps, with 700 illustrations, packet of 500 different stamps, 500 hinges and millimeter measure, all for only 50c, a big bargain. Free with each order, our pamphlet which tells "How to make a collection properly," also price list of albums—supplies and hundreds of bargains in sets and packets. Queen City Stamp Company, Room 36, 604 Race Street, Cincinnati, Ohio.

**MYSTIC "Queer Country" Packet!** Contains scarce stamps from the following strange lands: San Marino, Antioquia, Congo, Cyprus, Fiji Islands, Gwallor Hyderabad, Iceland, Jhind, Kenya, Uganda, Lebanon, Monaco, North Borneo, Nyassa, St. Thomas Prince, Eastern Roumelia, Stam, Sierra Leone, Tanganyika, Trinidad Tobago, Ubangi, Upper Volta, Wallis Futuna, Alouites. Get this wonderful packet of "freak countries" and make your friends envious! Price only 10c to approval applicants! Write today. Mystic Stamp Company, (Dept. 8), Camden, N. Y.

**THRILLING War scenes.** A packet of all different stamps showing exciting scenes and records of nations at war. Include siege guns; firing squad; mounted troops; prisoners of war; fire-pot hurlers; hand-to-hand bayonet struggle; bloody battle scenes; troop transport; red cross stamp; dying soldier; victory stamps, etc. Send for this thrilling "Big Parade" packet at once—limited supply. Only 10c to approval applicants. W. A. Rowell 58 Cornhill Boston Mass.

**ANCHERS \$88 Outfit—only 12c!** Fine triangle stamp; set German stamps with (pre-war) value forty million dollars (interesting!); perforation gauge, mm scale; airmail set; scarce stamp from smallest republic on earth; newspaper set packet good stamps and Transvancore, Malay, Dutch Indies, etc. Entire outfit for 12c to approval applicants! (Nice pocket stock book, value 25c, with every order!) Ancher Stamp Co., Box 47, Rutherford, N. J.

**FREE! Largest stamp in the world!** Fine packet 65 different stamps from Cape Verde, Jamaica, Mozambique, Syria, etc., including dying soldier, beautiful women, ships, maps, savages, airplane scenes, bird and animal stamps, for only 5c to approval applicants. Largest Stamp in the World (rare China Wild Goose Special Delivery) given absolutely free with each order. Supply limited! Send your 5c today! Western Philatelists, 6021 Harper Ave., M-12, Chicago.

**FREE! Curious set Azerbaijan, big illustrated lists, air mail, commemorative, pictorial. Premiums galore, 2c postage.** Penna. Stamp Co., Greensburg, Penna.

**PARK Outfit—10 fine articles, 10c.** Stamp from the world's smallest republic, Andorra, Zambesia, Malay Tiger, Cannibal stamps from French Africa and Belgian Congo, Morocco Airmail, Syrian provisional, used; packet of hinges, gauge and millimeter scale. Entire outfit for only ten cents to applicants for Park perfect approvals. Any grade to suit your collection. Park Stamp Co., 589 Beacon St., Boston, Mass.

**FREE Packet stamps to approval applicants.** Baker Stamp Co., 14 Avalon, Detroit, Mich.

**APPROVALS That please.** Nice premium given. Howard, Clarks Falls, Conn.

**24 VARIETIES Cuban stamps, 10 cents.** List of stamps free. Chambers Stamp Co., 111P, Nassau, New York City, N. Y.

**AIR Mail, Liberia Triangle, tiger, ship, savage, etc.; over 100 stamps 10c to all requesting approvals.** Elmer, 192A Washington St., Boston.

20 DIFFERENT U. S. and foreign commemoratives showing Jefferson, Joan d'Arc, famous battles, heroes, the Holy convent, Cathedral, historic paintings etc. Beautiful assortment less than fifth catalog (with approvals) 10c. The Stamp Shop, Holland Bldg., St. Louis, Mo.

65 LIBERIA Etc., 2c with approvals. Central Exchange, Cedarburg, Wis.

GET Good stamps! Five beautiful new airmails, Persia, Spain, fifteen other fine stamps, 15c with choice approvals. Rose-dale Stamp Company, Box 1733, Winnipeg, Canada.

FREE—First Liechtenstein airmail stamp to general approval applicants. Good references please. Westchester Stampco, 58 Larchmont Avenue, Larchmont, New York.

WANTED—Nineteenth century Albany covers especially patriotic, registration, foreign use, display advertising special deliveries. W. L. L. Peltz, 82 State St., Albany, N. Y.

111 STAMPS with approvals 4c. Hollister, 3523 N. Seeley, Chicago, Ill.

STAMPS On approval 1/4c up. Dandy Premium free. Kergwin Stampco, Fernandina, Florida.

SEND 5c Postage for free watermark detector, perforation gauge and complete set of Latvia. Request approvals. Blackhawk Stamp Co., Beloit, Wisconsin.

FREE—Premium to new approval customers. A. Motzer, 1022 Liberty, Cincinnati, Ohio.

PRECANCELS Large packet 25c. Three first flight covers 25c. M. Bowyer, Retreat, Penna.

START A stamp collection. Get list of "Nuggets" the ever popular 5 and 10c stamp packets. Special Christmas offer. H. Schoenling, 109 Post Street, Petaluma, Calif.

ORDER Our "Hi-Quality" one cent approvals. You'll want more. Illini Stampco, 103 S. Bussey, Urbana, Illinois.

AFRICAN Triangle set, also Abyssinia, Congo, etc. 10c to approval applicants. Jamieson, Box 131, Flint, Michigan.

LARGEST Lists published, thousands of stamps to select from. Every stamp guaranteed. Also approvals priced to 6 cents. Columbia Stamp Co., 7618 85th Road, Woodhaven, N. Y.

1,000 DIFFERENT Europe \$28.86 value, only 1 dollar. Splendid approvals! Josef Wendt, Neumarkt, Opf. Germany.

\$1.75 CATALOGUE Value, Newfoundland stamps, 25c. Rose, Box 1323P St. Johns, Newfoundland.

1009 STAMPS And perforation gauge 19c. Hawley, Johnson St., Lynn, Mass.

STAMP Bulletin. Published monthly. Fine stamp offerings. Illustrated authoritative information. Free to advanced collectors. Reimers, 30 N. LaSalle, Chicago.

CANADA Jubilee, catalogue over \$63.00. Absolutely free. Particulars with approvals. The Canuck, Box 683, Toronto, Canada.

SIAM—Five fine free to approval applicants. Bernard Karch, Middle River, Maryland.

PREMIUM 2c, Penny approvals. White Rose, Box 93P, York, Penna.

VARIETY Packet free with approvals. Monjar, 1553 Knox, Cincinnati, Ohio.

1000 MIXED U. S. 25c. One pound U. S. 55c. 100 different U. S. \$1. Approvals, Weatherby, Willoughby, Ohio.

SEND For priced-list stamps for collections. E. T. Parker, Bethlehem, Pa.

20 ODD Countries 10c. Carl Schulz, 301 1/2 South Catalina, Los Angeles, Calif.

NOW On sale. 1931 edition Scott's Standard Postage Stamp Catalogue, cloth bound \$2.00; with thumb index \$2.50. postage extra, shipping weight 3 lbs. Many gift suggestions are listed in our latest price list. Send for free copy. Scott Stamp and Coin Co., 1 West 47th Street, New York.

CAMEROONS, Ubangi! 41 French Colonials 5c to approval applicants. Sterling, 367 S. Broadway, Lexington, Ky.

FREE Surprise packet with 25 French colonies 10c with approvals. Drexel Stamp Shop, 5726 Drexel, Chicago.

UNUSUAL Offer: 3 triangles, African (raht), Confederate essays, world's prettiest stamp, others from Corea, Manchuria, etc., everything 10c to approval applicants. Earl Tyler, Royal Oak, Mich.

WORTHWHILE Packet and useful souvenir free to approval applicants. Bourque, 571 Western, Lynn, Mass.

1000 WELL Mixed stamps, 10c. Lester-Marie Co., Box 1244, Chicago, Ill.

CAYMAN Islands—Astounding packet from Cayman Islands, thirty other unique, interesting, beautiful distant land stamps (richly colored unusual designs). Hurry! Rush! Get yours now! Free for 5c postage Empire Stamp, Toronto, Can.

APPROVALS At 1c. (and what approvals!) Sets at all prices. Interested? You should be! Julius Goldin, 926 Southern Boulevard, New York.

FAR-A-WAY Land's packet. Including Zanzibar, San Marino, Orange River, Africa, Rhodesia, Hong Kong, Transvaal, Malay, Triangle, air mails, etc. Only 10c to approval applicants. McEwen, 755 Wilson, Columbus, Ohio.

U. S. Mission, good value 40c lb. Foreign Mission, 1/2 lb. 40c. 50 British Colonies, 15c. 4 Cayman, 12c. 4 Falkland, 12c. 7 Jamaica, 12c. 5 New Hebrides, 12c. 12 New Foundland, 12c. 10 Stam, 10c. 50 Sweden, 20c. 4 Virgin, 12c. All post free. Mechanical Co., 4512 North Racine, Chicago.

SUMSPESHUL—1000 Mixed. Many countries, 25c. Splendid 50% approvals. Webster, Box 11, Tremont Sta., New York.

MYSTERY Set. Send 3c. Great Value. Globe Stamp Co., 919 Guardian Bldg., Cleveland, Ohio.

FREE! Fiume triangle, and 50 others. Tatham Stampco, D8C, West Springfield, Mass.

STAMP Collector's magazine, America's favorite stamp monthly. Sample copy free. Philatelic Publishing Co., 15 John, New York.

50 UNITED States, all different early \$1. R. Gilmore, 110 Brook, Hartford, Conn.

105 DIFFERENT, Including British, French, Portuguese colonies, stamp book, perforation gauge, 6c to approval applicants. Crotty, Elliot Place, Jamaica Plain, Mass.

100 SWITZERLAND Stamps well assorted 10 cents. Lufbery Stamp Co., Branford, Conn.

WORLD'S Tiniest triangle (rare Guatemala Quetzal-Bird), also fine Nyassa triangle and big packet Tete, Vatican, Georgia, Uganda, etc., 5c with lists and approvals. Seminole Company, Druid, Baltimore, Md.

GIBRALTAR: 5 Var. 5c. 150 Germany 10c. Allion, Angola, Ind.

FREE—World's largest stamp, catalogs 75c, to applicants for approvals, 60% discount. Charles Cleaveland, 806 No. Humphrey Ave., Oak Park, Illinois.

THOUSANDS Of good stamps at one cent or better on approval. Geo. Schoenfeld, Wausau, Wis.

100 CLASSY U. S. Stamps, \$1.00; 100 cheaper, 30c. 1000 Mixed precancels, \$1.25. Philatelic Mission, Santa Rosa, Calif.

25 SWEDEN With approvals 8 cents. Co-Operative Stamp Co., 736 Euclid, St. Paul, Minn.

UNITED States \$2 present issue (catalogs 50c) for ten cents to approval buyers. State size of collection. United States price list free. Leduc, Redlion, Penna.

BRITISH Colonial sensation including Natal, Transvaal, Cape Good Hope, Victoria; also 5 different triangles. Everything 10c to approval applicants. Gordon, Box 87, East Orange, New Jersey.

TRY Our sets on approval. Free set to applicants. Pickwick Stamp Company, Rahway, N. J.

FREE Packet with bargain lists, postage 2c. Rheauem, 8951 Routhier, Montreal, Canada.

TRADE Common-stamp for priceless backbone exercise. "Proverbs", San Jose, Calif.

100 DIFFERENT United States 40c. Webers Stamp Shoppe, 1377 Park Avenue, Plainfield, N. J.

1000 ASSORTED United States, 25c. Auburn Stamp Co., Syracuse, N. Y.

COLLECTORS Worthy the name are most proud of their number one stamps, meaning the very first stamp issued by a Country. We give free 2 different stamps catalogue number one to approval applicants who send 10c for our superb Colonial package containing 25 different stamps, many of extremely small colonies. It pays to deal with Globus. Our approvals are much better than the average, and cheaper. Write today. Globus Stamp Co., 214 Third Avenue, New York City.

PENNY Approvals, 5,000 Sudan, Congo, Nyassa, Liberia, etc. Also 14,000 averaging 1 1/2c. Philatelic Exchange, Huntington, W. Va.

110 DIFFERENT Stamps, many unused, high values, free to collectors requesting our net approvals. Postage 2 cents Christensen, Milwaukee, Wis.

BEST One cent approvals in America. F. Hand, 1117 So. 60th St., Phila, Pa.

120 DIFFERENT Including U. S. commemoratives, only 4 cents. Illustrated price list and approvals sent with each order. Tricity Stampco, Rock Island, Ill.

FREE Outfit 52 stamps, hinges, pocket wallet. Postage 4c. Approvals. Milton Angle, South Berkeley, Calif.

RARE Italy airmail—This beautiful Italian airmail stamp, also scarce Vatican City—the only stamps in the world ever issued by a Pope!—and a packet of 51 other fine stamps, including Spanish, Morocco (Oasis Scene), Venezuela, Nyassaland, etc. All for 5c to approval applicants. R. G. Howard, 245 Waverly Ave., Newton, Mass.

27 LIECHTENSTEIN 4c To approval applicants. Hagen, Box 129, Sioux Falls, S. Dak.

60% DISCOUNT Approvals, Premiums. References. J. Novotny, Box 1115, Melrose Park, Ill.

BEGINNERS Outfit. Stamp album has spaces for 3500 stamps, nicely illustrated, 300 Different stamps, 1000 hinges, 50c, post free. Price list free. W. Grosser, 1721 North Harding, Chicago, Ill.

GENUINE Baden included in our packet 60 different stamps from Cilicia, Kenya Uganda, French Guiana cataloging 25c. Orange River Colony, Algeria, Shilling Revenue, Syria, Nyassaland, etc. All for 5c to introduce our famous approvals. Viking Stamp Co., Sheepshead Bay Station, Brooklyn, N. Y.

STAMPS! 102 Different 2c; 1000 hinges 7c; Steel stamp tongs 3c; Watermark Detector 2c; Album (2800 spaces) 20c. Approvals sent. Tatham Stampco, West Springfield, Mass.

AIRMAILS—26 Different 10c to approval applicants. Northwestern Stamp Company, 589 Marshall St., Milwaukee, Wis.

SENSATIONAL Bargain: 3 different triangle sets, etc. 10c to approval applicants. Dalrymple, 1106 Prospect Place, Brooklyn, N. Y.

UNITED States stamps sent on approval. Send me your want list also references. Price list of sets free. M. G. Hanna, 432 Wood St., Pittsburgh, Pa.

150 GOOD Mixed foreign stamps, 3c. Stanton, East Lyme, Conn.

UNITED States \$2 wines, catg. 40c and 50 diff. U. S. for 25c; 100 U. S. 37c; 30 Canada obsolete 15c. Robert Haynes, Point Place, Toledo, Ohio.

FREE 100 Different with 50% approvals. Send 2c postage. Evanston Stamp Shop, 2412 Noyes, Evanston, Ill.

ILLUSTRATED United States list, price 50 cents; large, complete United States price list, 1930, free. Stanley Gibbons, 38P Park Row, New York City.

33 1-3% COMMISSION. Sell our Stamps, sheet catalog value, \$4. Our price, \$2.00. Unsold stamps returnable. No investment required. References necessary. Lux Stamp Co., 805-C, Fairmont Place, Bronx, New York.

300 DIFFERENT 20c; 600, 50c; 1100 \$1; 2000 \$3. Fred Onken, 630 79th St., Brooklyn, New York.

BE A SPORT. Take a chance, send me a dime and see what I shall send you. If not satisfied, dime refunded. A. E. Anderson, 815 Carroll St., Brooklyn, N. Y.

STAMPS—100 Varieties, Africa, Brazil, Peru, Cuba, Mexico, etc., 10c; 25 different U. S. 25c; 1,000 mixed, 50c; 1,000 hinges, 15c. C. Stegman, 5941 Cote Brillante, St. Louis, Mo.

UNITED States stamps only on approval. Stamp House, 5 Franklin Gardens, Roxbury, Mass.

BEAUTIFUL Picture stamps sent free. Paul Cornish, Schenectady, N. Y.

40 DIFFERENT United States 12c. 60% approvals. Seidenberg, Baroda, Mich.

FREE—\$1.00 U. S. postage Lincoln memorial free, if you write for our 56 page price-list of U. S. and foreign stamps, 2,000 illustrations and fine stamps on approval. Hussman Stamp Co., 620-3 Olive St., St. Louis, Mo.

ONLY 5c. 33 Different stamps including scarce Latvian triangular airmail stamps, 10 airmail, 12 United States (early issues, commemoratives, etc.) and 10 Canada. Approvals and illustrated price-list sent with each order. Curhan Stamp Company, Gloucester, Mass.

110 NEW Europe All Different, a wonderful collection cataloging several dollars, free to collectors requesting our Net Approvals. Postage 2 cents. Badger Stamp Co., Milwaukee, Wis.

105 CHINA, Etc., 2c. Album (500 Illustrations) 3c. Bullard, 446 Tremont, Boston.

CANADA Airmail stamp free if you ask for approvals and send 15c for 25 different airmails or 30 different Canada and Newfoundland; both packets only 25c. We list 329 countries in our dime packets. Lists free. Special bargains, 500 different, 25c; 1,000 different, 75c; 2,000 different \$2.50. Victoria Stamp Co., London, 4, Canada.

FREE—Canada (15 Var.) for new applicant of my 1c, 2c and 3c approval, and also my 50% discount. Chas. W. Schmidt, P. O. Box No. 4832, Frankford Sta., Phila., Penna.

203 DIFFERENT Catalog \$4.25 only 7c with approvals. L. W. Hudson, Plainfield, N. J.

FREE! Triangles, airmail, Iceland and 50 others to approval applicants, including 3c postage. Hawkeye Stamp Co., Cedar Rapids, 39, Iowa.

200 DIFFERENT 10 cents. 25 airmail 10 cents. 60% discount approvals. Covert Stamp, 39 State, Rochester, N. Y.

301 DIFFERENT 10c To approval applicants only. Free list of bargain packets. Kansas City Stamp Co., Lee Bldg., Kansas City, Mo.

PENNY Approvals that satisfy. Nell Gronberg, Box 5441, Philadelphia, Pa.

STAMPS Sent on approval at 70% discount. Reference required. Emory Renoll, Hanover, Pa.

ALBUM, 1,000 Hinges, 200 foreign, 25 Cuba, 25 Japan, 35c. Postpaid. Burtiss Company, Saratoga, N. Y.

ATTRACTIVE Approvals at 50% discount and 25% discount. Noemus Stamp Co., 312 East 23rd St., New York.

SPECIAL—500 Different stamps 25c to approval applicants. Ohio Stamp Co., Box 249, Cleveland, Ohio.

#### RARE COINS

SPECIAL Prices on United States commemorative half dollars in uncirculated condition. Columbian 69c; Lincoln \$1.19; Pilgrim 99c; Grant \$1.23; Monroe \$1.09; Lexington \$1.17; Sequel \$1.29; Huguenot \$1.59; Oregon \$1.29; Maine \$1.39; Bennington \$1.19; Stone Mountain \$1.09; Trade Dollars \$1.15; Half cent 32c; large cents 10c; Eagle cents 9c; white cents 5c; 2c bronze 8c; 3c nickel 9c; 3c silver 15c; half dime 15c; 20c piece 65c. Bargain price list and old coin 10c. Arey, Box 483, Muskogee, Okla.

CALIFORNIA Gold quarter 27c, Half 52c, \$3 gold \$6.50, 50c Crawford \$1, Confederate 50c \$5 or \$10 10c. A. Wylie, 365 Wheaton, Ill.

COINS! Curious! stamps! Copy the collector, 5c. Northwest's greatest hobby Journal. Collector, P-252, Franklin, Minn.

OLD Money wanted—Do you know that coin collectors pay up to \$100.00 for certain U. S. Cents? And high premiums for all rare coins? We buy all kinds. Send 4c for large coin folder. May mean much profit to you. Numismatic Co., Dept. H, Ft. Worth, Texas.

15 DIFFERENT Fine foreign coins 25c Oddehon, Box 681, Kansas City, Mo.

18 DIFFERENT Foreign coins, 25c. 28 different, 50c. California gold quarter size, 26c. Willbert W. Bishoff, Box 7441, No. Kansas City, Mo.

RARE United States and foreign coins, war medals and decorations. Indian Cent and catalogue 10c. Alexis Mengelle, Colorado Springs, Colorado.

GET Profit and pleasure in collecting old coins. Send 10c for large illustrated coin catalog. You'll be delighted with it. Send for it right now. B. Max Mehl, Numismatist, Mehl Bldg., Dept. P, Fort Worth, Tex. Largest Rare Coin Firm in the U. S.

COMMEMORATIVE Half Dollars uncirculated, 1920 Pilgrim, 1921 Pilgrim, \$1.00 each. Grant, Bennington, \$1.25 each. Huguenot, Sesquicentennial, \$1.60 each. Isabella Quarter, \$1.40. Old coin and price list, 10c. Towns Davis, Box 1791, Huntington, W. Va.

UNITED STATES. Large cent, two-cent bronze, three-cent nickel and bargain list, 25c. Thirteen dates large cents, \$1.00. George Coffin, Greenwood Mountain, Me.

\$2 TO \$500 Each paid for hundreds of old coins. Keep all old money, it may be very valuable. Send 10 cents for illustrated coin value book, 4x6. Prices guaranteed. Get posted. We buy and sell. Clarke's Coin Office, Box 5, Le Roy, N. Y.

OLD Coins, large fall selling catalog of coins for sale, free to collectors only. Catalog quoting prices paid for coins, ten cents. William Hesselein, 101A Tremont St., Boston, Mass.

3 DIFFERENT Fine bronze or nickel coin, 2 large crisp bank notes and catalog, 10c. Geo. Best, Box 283, Cedar Rapids, Iowa.

CALIFORNIA Gold—Quarter size, 27c; 3/8 size, 53c; 3c piece and catalog, 10c. Norman Shultz, Box 746, Salt Lake, Utah.

#### FOR BOYS

EARN Christmas money. Order 50 sets Christmas seals. Sell for 10c each. When sold return \$3.00 and keep \$2.00. St. Nicholas Seal Co., Dept. 433PM, Brooklyn, New York.

MONEY Prizes—Amateur cartoonists. Particulars 25c. Meyer, Boys—GPO, Box 471, N. Y.

#### CAMERAS AND PHOTO SUPPLIES

FREE—Our latest bargain book listing hundreds of slightly used cameras, kodaks, lenses and accessories at great savings. Send for your copy now. Central Camera Co., Dept. PM-12D, 230 South Wabash Ave., Chicago, Ill.

PERSONAL Photo greeting cards—Send 15c and negative for sample; includes colored tissue lined envelope, 7 inch colored enlargement from your own negative, in imitation leather easel frame, 75c. One roll film developed and six glossy prints, 20c. Send for Special bargain list. Roanoke Photo Finishing Co., 210 Bell Ave., Roanoke, Va.

KODAK And movie films developed free. Write for details. P. O. Box 2089G, Atlanta, Ga.

GERMAN Cameras, lenses, Barttro, 6436 La Riba Way, Los Angeles, Calif.

PHOTO Novelties made from your photo or snapshot. Mirrors—Holiday greetings—Calendars, etc. 10c brings beautiful samples. National View, Winona, Minn.

TIME Counts in applying for patents. See pages 140 and 141. Clarence A. O'Brien, Registered Patent Attorney, Washington, D. C.

KODAK Film developed 5c roll, prints 5c each. Trial offer. Photo Christmas greeting card from any negative 10c. 8x10 mounted enlargement 40c. Young Photo Service, 405 Bertha St., Albany, N. Y.

YOUR Favorite kodak picture enlarged, size 5x7, 10c. Three for quarter, coin. Send best negative (film) today. Address Darmer Photo Lab., 221 Securities Bldg., Des Moines, Iowa.

MAKE Money in photography. Learn quickly at home. Spare or full time. New plan. Nothing like it. Experience unnecessary. American School of Photography, Dept. 3431, 3601 Michigan Ave., Chicago.

HAVE You a camera? Write for free sample of our big magazine, showing how to make better pictures and earn money. American Photography, 116 Camera House, Boston, 17, Mass.

SAMPLE Enlargement—dime, and negative (returned). Trial roll, glossy prints, 25c silver. Brown, Warsaw, N. C.

#### MOTION PICTURES

SOUND Motion pictures! You must order this great and only authoritative text book on the subject by James Cameron, world's foremost authority. 400 pages crammed full of information on photo cells, Vitaphone, Movietone, Photophone, methods of recording maintenance. We are selling thousands of copies. Price, \$5.00 postpaid anywhere. Bass Bargaingram No. 199 just off the press. Red hot bargains in standard and 16 mm. motion picture cameras, projectors and accessories. Send 4c in stamps. Bass Camera Company, Motion Picture Headquarters, 179 West Madison St., Chicago, Ill.

\$1,250 FOR Original photoplay story. Our sales department sold unknown author's first story for above amount. We revise, copyright and submit to studios stories for both silent and talking pictures. Being located in the heart of motion picture industry we know production requirements. Established 1917. Free booklet. Universal Scenario Company, 206 Meyer Bldg., Western and Sierra Vista, Hollywood, Calif.

WESTERNS \$1.75 Reel, 500 feet \$1.00. Jersey Film Co., Box 62, E. Rutherford, N. J.

BE A Movie exhibitor—big opportunity—Only moderate capital required—Complete equipment at remarkably low prices. Write, Atlas Moving Picture Company, Dept. 7, 825 South Wabash Ave., Chicago, Ill.

FREE. Our latest bargain book listing hundreds of slightly used motion picture cameras and accessories at great savings. Send for your copy now. Central Camera Co., 230 South Wabash Ave., Dept. PM12D, Chicago, Ill.

MOVIE Cameras, projectors, film, accessories, professional and amateur. Catalog free. Universal Photographers, 10 W. 33rd St., New York.

MOVIE Films—100 feet Krazy Kat cartoon \$1.00 postpaid. Home Movies, Box 744, Minneapolis, Minn.

ODD 1000 Foot reels \$2.00. Two reel westerns \$5.00. Big stock being sacrificed. Lists. Remington, Box 524, Cincinnati, O.

WORLD'S Greatest "Passion Play" 16 MM. (new) 5 reels. Rent or purchase from Hemenway Film Co., 37 Church Street, Boston, Mass.

SEND 10c For big Christmas catalog. Films and equipment, and souvenir strips talkie film. Eastin Feature Films, Galesburg, Illinois.

FILMS, 300 Ft., \$1.00, reels \$1.95. List. Edgeworth Sales, Box 155, Blue Island, Ill.

FILMS For toy machines (standard) complete features 45c up. Alton Films, Box 810, Kansas City, Missouri.

TIME Counts in applying for patents. See pages 140 and 141. Clarence A. O'Brien, Registered Patent Attorney, Washington, D. C.

TALKIE And movie producers are clamoring for new short story ideas, plots, etc. Perhaps you can write one that we can shape and sell for you. One writer (V. M.) received \$3,000. New York best market. Write for full particulars. Daniel O'Malley Company, Suite P, 1776 Broadway, New York.

EARN Big money. Operate your own movie theatre. Small capital needed. Complete equipment at low prices. Catalog free. Monarch Theatre Supply Co., Box 2042 Memphis, Tenn.

325 FEET \$1.10. Odd reels \$2.25. Bargain lists. Hoffman Film Service, 57 Broad, Albany, N. Y.

MOVIE Films, 1,000 ft. reels, \$2.50 each; shipped anywhere on receipt of remittance. Particulars on request. Independent Films, 177 Golden Gate Ave., San Francisco, Calif.

SAVE Money. Movie cameras, \$25; projectors, \$35; Pathex camera, \$20; stereopticon, \$25; printing machine, \$75; 35mm negative stock, 2 cents foot; 100 foot Eastman 16mm negative, \$4.50; kodak, \$5. Typewriter, \$16. Cameras and films bought and exchanged. Ray, 266 W. 46th, New York.

#### TRADE AND TECHNICAL SCHOOLS

LEARN Watch repairing. Hiles School, 5330 Mission St., San Francisco.

BE A blue print reader. Men in your trade have succeeded. Write for facts. What's your trade? Carroll Rumsay, Drexel Bldg., Philadelphia.

#### TELEGRAPHY

LEARN Wireless (Radio) and Morse telegraphy. School, oldest and largest; endorsed by telegraph, radio, railway and government officials. Expenses low—can earn part. Catalog free. Dodge's Institute, H Street, Valparaiso, Ind.

#### BUSINESS OPPORTUNITIES

IF You are really looking for a real, sure-enough, money-making opportunity, in a good paying business of your own, in your own community, ask us to write you what there is in store for you in the clean, money-making business of sharpening all makes of safety razor blades and cutlery with Heimerdinger Automatic Sharpener. Same as used by big razor blade manufacturers and by many wide-awake, money-making men, the world over, who are "cleaning up" with it. Address, W. C. Heimerdinger, 116 W. Market St., Louisville, Ky.

COWELL Institute; Teaches marbleizing, all branches. Also how to enamel with a brush, put on like paint. Concrete products, wood, plaster etc., Wallboard so finished can be cut, nailed, fitted, perfectly. Novelties, picture frames, statuary, garden furniture, all with glossy face finish. (see samples) Flintlike hardness, inexpensive, indestructible. Anyone can do. Also sanitary floors over old or new. Plastic, warmer, never cracks or dusts. Full instructions first order. Send dime for samples and illustrated circulars. Cowell Institute, Grayling, Mich.

POSITION Open! Nationally known food manufacturer offers one man or woman in each community position to distribute trial packages Pure Fruit Concentrate for making fruit jelly without fruit juices. (Not a gelatin). Big pay. Working outfit \$3.60. Sample 25c. Appointments going fast! I want workers, not curiosity seekers. Also want exclusive agents. New! Write today. Vandenberg, Mgr. Dept. PM, 14th and Jackson Streets, Omaha, Nebraska.

SCREW-HOLDING Screw drivers! Remove, insert screws from inaccessible places. Factories, garages, electricians, mechanics, auto, radio owners buy on sight. Exclusive territory. Free trial. Manufacturer, 1708, Winthrop Bldg., Boston.

**DON'T** Slave all your life. We will start you in business. Thousands are making their living abroad by doing knitting at home. Others got large flat machines adapted to make all kinds of knitted goods, such as stockings, from an infant's size to the largest lady's or man's, children's knitted suits, sweaters, scarfs, vests, caps, gloves, etc. Write for catalog. Ainslie Knitting Machine Co., Inc., 738-750 Grand Street, Brooklyn, N. Y.

**WE** Start you in business, furnishing everything. Men and women, earn \$40 to \$100 weekly operating our original "New System Specialty Candy Factories." Begin home spare time. Unlimited opportunity. Valuable booklet free. W. Hillier Ragsdale, Drawer 4, East Orange, N. J.

**BIG** Profits operating "chain" of peanut, chewing gum, candy vending machines. Start small capital. Write, Robbins Corp., Dodworth Street, Brooklyn, N. Y.

**SELL** By mail successfully! I show you how. Handsome folder free; stamp appreciated. Busler, Box 205-A, Sta. A, Canton, Ohio.

**OPERATE** Dignified business at home. Over sixty proven plans. No peddling. Information free. Co-Operative Co., 469-A, Ansonia, Conn.

**RELIABLE** Connections wanted for introduction all classes Chinese products. Write with references. Gibson Craig-Carmichael Co., Hongkong.

**MAGAZINE** Subscriptions at less than publishers prices. Bargain catalogue free. Elliot Donner, 246 Peshine Avenue, Newark, N. J.

**85 BUSINESS** Plans, 425 Manufacturing formulas, all lines, \$1.00, circular. Hayes, 60 East 18th, Chicago.

**BIG** Money at home plating auto parts, reflectors, mirrors, chandeliers; by new method; experience unnecessary. Outfits furnished. Gunmetal Co., Ave. N, Decatur, Ill.

**LEARN** The collection business. Conducted property is very remunerative. Supplies and tuition at small initial cost. North West Protective Service, 500 Beatty St., Vancouver, B. C.

**\$100.00 WEEKLY** Possible in "Fixit" Service. Forty three lesson course, \$1.00. Houlgate's "Fixit" Service, 1305 N. El Molino, Pasadena, California.

**BARBECUE** Machine for kitchens, camps, lunch rooms; hand-operated, \$22.50. Address Midget Barbecue Machine Co., 3023 Daleford, Canton, Ohio.

**736 MONEY-MAKING** Secrets, recipes, formulas only \$1.00. Send stamp, interesting literature. Jos. Latkowski, Box 619PM, Providence, R. I.

**EARN** Big money at home—We show you how. No canvassing. Write today; Crescent Picture System. Box 731, Hub Station, Kenosha, Wisconsin.

**OWN** Your own business. Our successful business plans, which we sell at sensible prices, show you how to build a profitable spare time business. Room 8, 468A Yonge Street, Toronto, Ontario, Canada.

**OPERATE** Chain of vending and amusement machines. Be independent for life. Start small, grow big. P. Goodbody, 72 VanBergh, Rochester, N. Y.

**I MADE** \$50 weekly, renewing upholstery, rugs, etc. Free booklet. Dr. W. Abell, Alhambra, Calif.

**A BUSINESS** of your own. Particulars free. E. Stampor, 2707 N. Central Pk, Chicago, Ill.

**MIRRORS** Resilvered at home costs near 5 cents per square foot, you charge 75 cents Profitable business plating like new, brassy, worn-off autoparts, reflectors, tableware, stoves, etc. Outfits furnished. Details free. Sprinkle, Plater, 127, Marion, Ind.

**CHARTERS:** Delaware; best, cheapest; free forms. Colonial Charter Co., Wilmington, Del.

**250,000 ARTICLES** Wholesale—directory 10c. W. Patterson Co., 4111 University, Des Moines, Iowa.

**EARN** Big money during spare time. 15 plans 25c coin. Berg, A-430 Davidson, Bridgeport, Conn.

**\$3 GEM** Valued \$900 by Chicago expert! The diamond's only guaranteed rival! Enormous profits; instant sales. To prove claims we'll mail 1 carat \$5.00 perfect blue-white gem for only \$1.00! Write for catalogue and free \$5.00 sample case proposition. Mexican Gem Company, Dept. PP, Monterey, Calif.

**START** Mail order business. Instructive literature free. Nagel, 1329 Olive, Indianapolis, Ind.

**PARTNER** Small investment. H. Greening, West Bloomfield, Wis.

**MINIATURE** Gold mine—Save 50% and up—Build now but avoid costly mistakes. Our blue-prints, instructions, specifications for 18 sporty holes, indoors or outdoors \$20.00. Golf Construction Service, 2448 Prairie Ave., Chicago.

**PATENT**—Fortune in stop-direction signal on autos visible all around. Sale or royalty. F. Cox, 536 Rush St., Chicago.

**PROFITABLE** New business enterprises are available that will surprise you. Postal brings valuable information. National Business Service, Geneva, Ohio.

**MR. Dealer** and Distributor: Occasionally a real Mail-Order-Seller is brought to your attention. Such a 100% hit is "Everybody's Jiffy Calculator." Sample and particulars 10c. Thorsen Publ. Co., 1415 Otto, Chicago.

**BUSINESS** Profession of your own and earn income in service fees. See Stephenson Laboratories, display ad page 144.

**PUTT-POOL!** Latest indoor Miniature Golf sensation. Small investment, highly profitable. Write for particulars. Marshall Company, Rome, Ga.

**BIG** Profit selling light specialties. Everybody buys. Oscar Hansen, Lista, Guadalupe, Mexico.

**SOUTHERN** Barbecued Pork, cooked on kitchen stove. Full instructions, recipes barbecue sauce and Brunswick stew \$1.00. Williams Cafe, Hogansville, Ga.

**50 SUCCESSFUL** Mailorder propositions; details red stamp. K. Home, 3949 Metropolitan, Chicago.

**ANY** Handy man can start furniture refinishing, painting, handyman shop on nearly nothing; mostly all profit. John Braceland, 1439 So. Ninth, Philadelphia, Pa.

**"SCHEMER,"** 32p monthly, prints big \$-getting schemes, ideas, formulas. Subscriber reports \$10,000 from one copy; another \$25,000 from three. Try your luck! Three copies only 25c. Patterson, Pub., Box 749-P, Alliance, Ohio.

**SUCCEED** With your own products. Make them yourself. Formulas, processes, trade-secrets. Expert analytical service. Catalog, circulars free. B. Thaxly Co., Washington, D. C.

**"ODD-THINGS"**—Money making ideas; tips; plans; opportunities! New, different! Three months' trial, 25c. Year \$1.00. "Odd-Things Magazine," 720 Advance Bldg., Cleveland, Ohio.

**15c PUTS** Your name on big mail, wholesalers, manufacturers list one year. Pennell Standard, Covington, Kentucky.

**SELL** By mail! Start your own small business anywhere. Free folder tells how. No personal selling. Everything furnished. B. Horton, 2046 Jefferson Ave., St. Paul, Minn.

**START** A candy kitchen. Instructions \$1.00. Mailing Bureau, Lawndale, Calif.

**THAXLY** Formulas produce perfect products. All lines. Catalog free. B. Thaxly Co., Washington, D. C.

**MAKE** Your own products, employ agents yourself. Toilet articles, soap, extracts. We furnish everything. Valuable book free. National Scientific Laboratories, 1935W Broad, Richmond, Va.

**TIME** Counts in applying for patents. See pages 140 and 141. Clarence A. O'Brien, Registered Patent Attorney, Washington, D. C.

**CAPITAL**—For copy, the "Promoters' Hand Book," a leaflet on financing; an eye opener for capital seekers. Send \$1.00 to Amster Leonard, East Orange, N. J.

**CLEARED** \$4,000 two months, Gordon. Tested food-confection business. Men or women. Legitimate—pleasing. Experience unnecessary. Equipment furnished. Eakins, 2140 High St., Springfield, Ohio.

**LEARN** The collection business. Good income, quick results. Interesting booklet, "Skillful Collecting" free. National Collectors Assn., Long St., Newark, Ohio.

**CHEMICAL** Expert furnishes manufacturing formulas and processes with complete working directions. Reliable individual service only. No lists. Charges reasonable. Correspondence invited. Dr. Arthur Van-Heeden, 7051 Bennett, Chicago.

**I MADE** \$30 A week home. French breadmaking. 15 years' experience; free booklet tells. Ashbrook 67, Marengo, Ohio.

**SIGNS** And showcards easily painted. If you use Letter Patterns. Write for free samples. John Rahn, B2120 Neva Ave., Chicago.

**AMATEUR** Cartoonists: Sell your work. Write Smith's Service, PX1194, Wenatchee, Wash.

**DELAWARE** Charters; fees small; free forms. Chas. G. Guyer, Wilmington, Del.

**FREE** Book. Start your own little business anywhere, selling novelties by mail. My beginner's outfit contains everything required, novelties, circulars, instructions, etc. Descriptive book free. Hadwil, 33A-74 Cortlandt St., New York.

**CHEMICAL** Expert will furnish formulas and trade secrets. All lines. Lists free. W. L. Cummings, Ph. D., 228 Gordon Ave., Syracuse, N. Y.

**ARTIFICIAL** Marble sanitary flooring, instructions covering wood or cement flooring 1/2 inch thick, fireproof, all colors, low cost. Ornamental casting, concrete, plaster, papier-mache decorations, garden furniture, statuary, flexible molds, particulars and illustrations free. Chris. Mahler, Huntington, N. Y.

**SELL** By mail. Books, novelties, bargains! Large profits. Particulars free. B. Elfeo, 525 S. Dearborn, Chicago.

**A BUSINESS** Of your own making—Sparkling Glass Name and Number plates. Checkerboards, signs. Big book and sample free. E. Palmer, 540, Wooster, Ohio.

**UNUSUAL**—Uncommon specialties always sell best. Make these yourself from Miller's guaranteed formulas. Why work for others when others can be working for you? Latest eye-opening literature brings you many specialty propositions for you an independent business. Miller Chemist, 706-K Chemical Bldg., Tampa, Fla.

**FREE** Booklet describes 67 plans for making \$20-\$100 weekly in home or office business of your own. Elite Co., 84 Elizabeth St., New York.

**AMATEUR** Cartoonists earn \$25.00 week, spare time, copying or tracing cartoons for advertisers. 3-Em Syndicate, Argyle, Wis.

### CHEMISTRY

**BECOME** Full fledged chemist—thousands of opportunities—learn at home. Home laboratory set given—apparatus and chemicals. Write for free book. Chemical Institute, 19 Park Place, Dept. P-110, New York.

**CHEMICAL** Analysis, processes, technical information. Robert Henderson, Laboratory, Madison, Maine.

**BIG** Money in Manufacturing. Easily made formulas with long profits. Analysis, Ideas developed. Associated Chemists, Indianapolis, Indiana.

**"HANDBOOK** For Chemical Experimenters." Hundreds of interesting experiments; illustrated. 50c. Booklet of experiments, 15c. Pricelist, 5c. General Chemical Company, Box 397, Reading, Penna.

**YOUR** Chemical problem solved and formula or process furnished for Five dollars. Write me. W. Stedman Richards, Industrial Chemist, Box 2402, Boston, Mass.

**CATALOG** listing 2,500 illustrations chemists' supplies, 5,000 chemical, 1,000 scientific books sent for 50c. Laboratory Materials Company, 643 E. 71st St., Chicago, Ill.

### FORMULAS AND TRADE SECRETS

**MAKE** And sell your own products. Fifteen valuable formulas \$1.00. Joseph H. Belfort, 4012 N. Keeler Ave., Chicago, Ill.

**FREE** Formulas—Free materials making \$32.00 worth of guaranteed highest class specialty-necessities. Thirty-third unequalled anniversary offers explains all. Miller, Chemist, 1707-G Jetton, Tampa, Fla.

**ANY** Formula, 50c. List free. Industrial Institute, Dept. 206, 64 West Randolph, Chicago.

**FREE** Formula catalog describing all lines. Western Chemical, Salem, Oregon.

**FORMULAS**—3c Up, list free. Empeo Service, Box 748, Dayton, Ohio.

**MERCUROCHROME** Stain remover formula wanted that will quickly remove stains from clothing, hands. One bottle treatment preferred. State particulars. George L. Brockman, 707 Ridge, LaPorte, Indiana.

**NEWEST** Formulas. Guaranteed, tested. Catalog free. Imperial Laboratories, Edwardsville, Ill.

**MAKE** Novelties, photo frames, with simple molds. Plans and formula \$1. Tinkerwood, 1823 Payne Ave., Cleveland, Ohio.

**SUCCEED** With your own products. Make them yourself. Formulas, processes, trade-secrets. Expert analytical service. Catalog, circulars free. B. Thaxly Co., Washington, D. C.

**GREATEST** Formula bargain ever offered. Latest, best, selected sellers. Information free. Specialty Mfg. Service, 801 So. Farragut, Bay City, Mich.

**500 FORMULAS** And big illustrated catalog 25c. Ideal Book Shop, Park Ridge, Ill.

**FORMULAS** All kinds. Catalog free. Clover Laboratories (P), Park Ridge, Ill.

**MAKE** Your own products, employ agents yourself. Toilet articles, soap, extracts. We furnish everything. Valuable book free. National Scientific Laboratories, 1935W Broad, Richmond, Va.

#### AGENTS WANTED

**I START** Men in a grocery business a new easy way. You use my money. Don't need to put up a penny of your own cash for stock. Expansion program now opens up many desirable opportunities also established trade. Hustlers make good money from the start increasing rapidly as they learn the business. Not a "chain" proposition but your own business. Buy on credit. Give credit if you wish. If honest and need more money write at once for application and details to McConnon & Company, Room 1-6612, Winona, Minn.

**YOUR Opportunity**, answer quick. Biggest line shirts, ties, hose sold direct. Highest commissions, lowest prices. Outfits free to hustlers. Ebroclo Shirt Company, 2000 Elm, Greensboro, N. C.

**NEW—Different:** "No-Tangle" ironing cord. Never kinks—saves electricity. Always out of way. Women amazed. Quick sales. Tremendous profit. "Outfit free to producers." Bestever Products Co., 700 Irving Park Station, Chicago.

**OUT** Of work? Here's a real money-making job for you. Sell unusual line of rubber products: 20 popular items. Every home and business a prospect. Big catalog free. Bond Products Co., 605 Mary Ave., Cleveland, Ohio.

**"ANTI-STEAM"** Keeps windshield clear of steam, frost, sleet, rain and snow. Tested and approved by nationally known companies. High grade, unbeatable proposition. Unusual profits. Sold with money back guarantee. Free sample proves merit. Walter S. Doe & Co. Mfg. Chemists, Kent, Ohio.

**250,000 ARTICLES Wholesale.** Directory 10c. W. Patterson, 4111 University, Des Moines, Iowa.

**ALL** Good agents with bad feet get free trial Kleen-Foot Balm, if it cures, sell the world. Eastern Laboratory, Mather Bldg., Washington, D. C.

**SELL** Mats with names for advertising big commission. Write Durable Rubber Company, Dept. E, 1140 Broadway New York City.

**AUTOMOBILE** Specialties. Guaranteed formulas latest money makers. Lowest prices. Free lists. Murphy, Chemist, 1024 Douglas St., Los Angeles, Calif.

**IMPORT** Your own goods; German export magazine, published in English, offers numerous bargains latest novelties; opportunity for obtaining profitable agencies; copy, 60c. Square Deal Supply, P-246 Fifth Ave., New York.

**BIG** Money daily selling shirts, ties, underwear, Sox, raincoats, lumberjacks, sweaters, leather coats, mackinaws, coveralls, pants, children's play suits. Outfit free! Experience unnecessary. Nimrod Co., Dept. 8, 4922-28 Lincoln Ave., Chicago.

**FLAVORING** Extracts—bottle yourself. Concentrated. Labels furnished. 600% profits. Whirlwind money makers. Steady repeaters. Free offer. Thomas Manufacturing Company, Indianapolis, Indiana.

**WONDERFUL** Powdered hand soap takes off all dirt and grease quick, without injuring skin; sanitary shaker can, nickel top; everybody buys; sure repeater; exclusive territory; get into business for yourself. Sample free. Cowell, 827, Central Exchange, Kansas City, Mo.

**AGENTS** Coining money with new mystery "Vaporizing Cup." Sleeps colds away like magic. Fits over electric light bulb. Call on homes, drug stores. Salesmanager, L-129 N. Halsted, Chicago.

**ELECTRIC** Water heater—New. Heats water instantly. Pocket size—retails \$3.75. Two minute demonstration makes you \$1.95 profit. Lux-Visel, Dept. 93, Elkhart, Ind.

**MAKE** Up to \$485.50 extra before Christmas. Sell finest quality Cino neckwear and silk mufflers. Amazingly low prices. Newest, snappy patterns—rich materials—splendid workmanship. Write for free samples. Cincinnati Neckwear Co., Dept. 8, Cincinnati, Ohio.

**AGENTS—Men**, earn up to \$12 daily wearing fine felt hats and selling fringes. Smartest styles. Latest shades. \$2 to \$5 saving on every hat. Outfit free. Taylor Hat and Cap Mfrs., Dept. JC-135, Cincinnati, Ohio.

**DIRT** Removing mop wringers. Wonderful construction. H. K. Christensen Mfgs., Ft. Atkinson, Wis.

**SELL** To Ladies by mail. \$1.50 clear profit on \$2.00 orders. Complete operating details 20c. W. B. Terrill, Brookfield, Mo.

**JUST** Out—Cement-on rubber soles. Cut shoe bills in half. Outwears leather. Keep feet dry—prevent slipping. Comfortable. Also 47 other rubber specialties. Big money for agents. Outfit free. Write Kristee Mfg. Co., 1262 Bar St., Akron, Ohio.

**MIRRORS** Resilvered at home. Costs near 5 cents per square foot; you charge 75 cents. Profitable business plating auto-parts, reflectors, tableware, stoves, refinishing metalware, etc. Outfits furnished. Details free. Write, Sprinkle, Plater, 128, Marion, Ind.

**AGENTS:** Free catalog 200 household specialties, toilet preparations, food products, remedies, portraits, frames, photo pillows, medallions, religious goods, pictures, Christmas cards. Credit. James C. Bailey Co., Station C-12, Chicago.

**CAN** You sell a beautiful \$7.50 gift box toilet goods for \$1? Over 200% profit. Write for particulars. Universal Laboratories, Dept. P, Dallas, Texas.

**DELICIOUS** Cakes in a jiffy! Amazing new product. Scientifically prepared. Contains all ingredients. Simply add water and bake. No failures. Sensational seller. Big profits. Wonderful repeater. Investigate sure. Albert Mills, 5373 Monmouth, Cincinnati, O.

**KNOW** The joy of a bigger income. Our extensive line of household necessities offers men and women equal opportunity to clear \$75 weekly. Write B. & G. Rubber Co., Dept. 473, Pittsburgh, Pa.

**THROW** Away messy liquids, powders, pastes. Brisko Polishing Cloth shines all metals like magic. Instant 25c seller. Tremendous profits. Sample free. Brisko, South Shaftsbury, Vt.

**ADDING** Pencil. Adds mechanically—almost human. Get sample immediately and make money easy and fast. Everybody interested. Add-O-Graph Co., Dept. 25, Sallito, Miss.

**BIGGEST** Surprise offer ever made. Be sure to answer this ad. My line of soaps, coffee, tea, spices, toilet articles, household specialties, pays you bigger profits. M. G. Roth, President, 2708 Dodier, St. Louis, Mo.

**AGENTS—80c** Profit on \$1.00 sales. Auto, furniture, metal, glass cleaner. Your name on labels. Free sample. Minute Kleen Laboratories, Dept. 7, Evansville, Indiana.

**MAKE** Big money with fast selling line of food products, prize motor and tractor oils—paints. Sure repeat orders. Write for free sample case. Loverin & Browne, 1602-G So. State, Chicago.

**MEN** And women. Make \$15.00 daily selling underwear, hosiery, sweaters, raincoats, shirts, overcoats, sheep-lined coats, leather vests, bathrobes. Northern Sales, 101 So. Wells, Chicago.

**STRANGE** New ironing cord! Prevents scorching. Saves electricity. Cannot kink or snarl. For telephones also. Up to \$25 daily. Samples furnished. Neverknot, Dept. 12-A, 4503 Ravenswood, Chicago.

**\$2.98 RAINCOAT** Line pays record-breaking profits. Flashy new numbers. Season on. Experience unnecessary. Outfit free. American, 3908AD Lincoln Ave., Chicago.

**300% PROFIT** Selling Mystery Gas Lighter. Retail 25c. Costs you \$1.00 doz. Sample free. Square Deal Mfg., Desk PM-14, Bradford, Pa.

**100% PROFIT** In new mystery cigar lighter. No flint or friction. What makes it light? No wind can blow it out. Retail 50c. Sample and sales plan 25c. New Method Manufacturing Co., Box PM-12, Bradford, Pa.

**AGENTS—Can** openers, new improved hand, wall, table models. Safety Products Co., 315 American Bank, Kansas City, Mo.

**JUST** Invented—New washing machine. No motors or moving parts. Automatically cleans entire washing. Fully guaranteed. Retail price \$9.50. Your profit 100%. Protected territory. Preston Mfg. Co., Dept. CP-12, St. Louis, Mo.

**JUST** Invented—New oil burner, fits any stove or furnace. Burns cheap oil. Fully guaranteed; 100% profit. Free sample offer. Protected territory. International Heating Co., Dept. 509, St. Louis, Mo.

**MAKE—Sell** your own goods. Formula catalog free. Clover Laboratories, 178M, Park Ridge, Ill.

**NEW** Electric flashing sign just out—Changeable letters. Beautiful Neon color effect. Three sizes and styles. Unbreakable. Guaranteed. Every merchant buys on sight. 100% profit. Protected territory. Preston Mfg. Co., Dept. S-587, St. Louis, Mo.

**NEW** Automatic clothes washer. Washes quickly and thoroughly. No rubbing. No electricity. Retail \$9.75. Guaranteed. Write Storm Royalty Co., 3601 Enright, St. Louis, Mo.

**AUTOMATIC**, Recoiling telephone pencils. New, attractive, practical. Three for one dollar. Jaffe, 254 West 31st St., New York.

**AGENTS** Buy direct guaranteed hosiery at lowest mill prices. Men's latest fancy hose doz. \$1.40, \$1.75. Ladies' French Heel silk hose doz. \$3.50, \$6.00. Catalog free. Superior Knitting Company, Dept. 34, New-Haven, Conn.

**MULZOL**, New, wonderful external remedy. 100% profit for the first one hundred men to introduce it. Exclusive territory. Fenway Laboratories, Box 2402, Boston, Mass.

**THE** Magic Wire—Fastest selling novelty in existence. Sample 10c. American Specialty Company, Swampscott, Massachusetts.

**BIG** Money selling Dieodor foot and body powder. Repeat orders assured. Sample free. Box 25c. Dieodor Co., 112 Fremont St., Lowell, Mass.

**OLIVER** Cleared \$700 in 30 days with our line of books and bibles. Outfit free! Exclusive territory! Nichols Co., Dept. B35, Naperville, Illinois.

**WANT** Distributing agent for Hanslick, powdered handsoap; removes anything from the hands without injury to skin; everybody a customer; great opportunity for hustler to get in business; sample free. Solar Products Co., J2144 So. Troy, Chicago.

**MAKE** Your own products, employ agents yourself. Toilet articles, soap, extracts. We furnish everything. Valuable book free. National Scientific Laboratories, 1935W Broad, Richmond, Va.

**\$60-200 A WEEK.** Genuine gold letters for store windows. Easily applied. Free samples. Liberal offer to general agents. Metallic Letter Co., 438-B North Clark, Chicago.

**BIG** Proposition; no canvassing. Asco, Box 1081, Washington, D. C.

**SELL** Dustless ash can covers to householders who ask for demonstrations. No house to house canvassing. Woodworth Specialties, Binghamton, N. Y.

**NEW** Dollar novelty, small, light weight, universal sale, big profit. Wonderful Christmas item. Schack Co., 15 West 44th St., New York.

**NEW** Deal—100% profit. Money returned on all goods unsold, end of thirty days. Money back to customer if article does not make good. Investment, \$6.00. Balz Mfg. Co., Box 262, Bedford, Va.

**EXCELLENT** Trouser presser, \$1.25. Agents 70c. L. J. Widness, 461 Sumner Ave., Brooklyn, N. Y.

**SELLS** Like hot cakes, big profits. New laundry preparation, perfumes clothes lastingly while washing them. Working sample 10c. Sunset Laboratories, Lynbrook, New York.

**PORTRAIT** Men—Big new catalog guaranteed portraits, frames, medallions, photo pillows, household specialties, toilet preparations, food products. Wonderful proposition. Credit. James Bailey Co., Station C—Chicago.

**AGENTS—Marvelous** invention—Nail File—fits, files and shapes each nail separately, single operation. Whirlwind seller. Huge earnings. Territories open. Sell drug, hardware, stationery and gift shop trade. Send 35c for sample dozen mounted on display card. \$2.25. Datzit Nail File Company, Philadelphia.

**ARE** You old at forty? See our advertisement on page 136 of this issue. The Electro Thermal Company, 2136 Morris Ave., Steubenville, Ohio.

**NEW**, Profitable—Sell auto step mats. Quality rubber with owner's name molded white. Details free. Ebonite Products, Dept. U-40, 895 Main, Akron, Ohio.

**JUST** Out wonderful low priced can opener. Agents making money. Sample 25c. All-needs Mfg. Co., Box 26, Oak Park, Ill.

**"DAIQUIRI"** Havana cigars—Superior quality—25 delivered at your home \$4.00—Cuban Products Co., Box 2238, Havana, Cuba.

**AGENTS—Up** to \$12 daily demonstrating men's, women's, children's finest hosiery. Definite wear warranted or replaced. Amazingly low prices. 100 styles, colors. Auto and hosiery given producers. Write quick! Wilkmit Hosiery Co., Dept. C-3712, Greenfield, Ohio.

**THAXLY** Formulas produce perfect products. All lines. Catalog free. B. Thaxly Co., Washington, D. C.



**BIG Money easy, simply showing new Polly Wrench.** 10 wrenches in one. Guaranteed fast seller. Sample furnished. Gellman Mfg. Co., Dept. 6-Z, Rock Island, Ill.

**AGENTS.** Everybody wants "Little Bill." 500,000 sold last year. 6 easy sales daily brings you from \$43 to \$127 weekly. Free gift to your customers makes it easy to obtain orders. Write quick. Redins, 6046 Superior, Cleveland, O.

**I WILL send you \$20 stock of food products, home necessities, on 30 days' credit.** Send no money until you dispose of goods and collect your profits of \$8.28. This starts you in big money business. Harley Co., Dept. W-2015, Cleveland, O.

**MAKE Your own products, employ agents yourself.** Toilet articles, soap, extracts. We furnish everything. Valuable book free. National Scientific Laboratories, 1935W Broad, Richmond, Va.

**REPLATE Brassy worn-off automobile parts, reflectors, bath room fixtures, worn spoons, forks, etc., with pure silver.** Looks like new. Use U-Kan-Plate Polish. Positively no mercury; \$1.00 half pints. Post-paid. Satisfaction guaranteed. Agents wanted. Dept. A, U-Kan-Plate Co., Philadelphia.

**MAKE \$2 An hour, new household appliance needed in every home. 100% profit.** Good Christmas item. Remarkable seller. Merry Maid Mfg. Co., Dept. 24, Cedar Rapids, Ia.

**PLACE Showcards in windows.** Beginners kit free. Big money. Easy work. No investment. Permanent income. Advertiser Company, 2516 Olive Avenue, Long Beach, California.

**ONE Demonstration sells this new product for every home. Large profits.** Particulars free. General Floor Corporation, 4010 W. Madison St., Chicago, Dept. P12.

**NEW Signs, price tickets and changeable signs.** Wonderful selection for Christmas and all year. Used in all businesses; \$1.00 samples. 25c. P. Franklin Co., 3322 3rd Ave., New York.

**BIG Profit putting our gold sign letters on store windows, without experience.** Samples. Consolidated, 69-T West VanBuren, Chicago.

**MARVELOUS New liquidified graphite increases mileage, doubles motor life.** Cars, trucks, tractors, distributors wanted. Write Pvroil Co., 127 Main, LaCrosse, Wis.

**SUCCEED With your own products. Make them yourself.** Formulas, processes, trade-secrets. Expert analytical service. Catalog, circulars free. B. Thaxly Co., Washington, D. C.

**MANUFACTURER Wants distributor for new "Pocket Radio," only \$3.85.** "Sells itself with music." Pays 100% profit. Spencer Radio, Akron, Ohio.

**FASTEST Xmas sellers, rhinestone initial belt buckles, etc., beat 'em all for quick easy orders.** Big commission daily. Pocket outfit free. Chaton, 606 Blue Island, Chicago.

**SELL Housewives something they want.** They are bound to be interested. A signed guarantee to reduce gas bills 25%. No competition. 400% profit. Station C, Box 25E, San Diego, Calif.

**1,000% PROFIT Manufacturing perfumes.** Sample 10c. George Ross, 6521 Kenwood Ave., Chicago.

**TIME Counts in applying for patents.** See pages 140 and 141. Clarence A. O'Brien, Registered Patent Attorney, Washington, D. C.

**SELL At once! 100 Blue Signs, Handy Container.** \$3.50. Koehler's, 717 North Fourth, St. Louis, Mo.

**AGENTS—Engraved name plates, signs, number plates etc., easily sold with large profits.** Brett Bros., Winthrop, Mass.

**THE Magnetic safety light Admiral Byrd used on his South Pole expedition is a big money maker now.** It's an everlasting flashlight. No batteries required. All automobile drivers want them. Send for demonstrator. National Electric Corporation, 220 High St., Newark, N. J.

**BIG Money applying gold initials on automobiles.** Easiest thing today. No experience needed. \$1.45 profit every \$1.50 job. Free samples. "Ralco," X-1043 Washington, Boston, Mass.

**AGENTS—New shirt proposition.** No capital or experience needed. Commissions in advance. Samples free. Madison Company, 566 Broadway, New York.

**BIG Money and fast sales.** Every owner buys gold initials for his auto. You charge \$1.50; make \$1.45. Ten orders daily easy. Write for particulars and free samples. American Monogram Co., Dept. 40, East Orange, N. J.

**GET Our free sample case.** Toilet articles, flavorings and specialties. Wonderfully profitable. LaDerma Co., Dept. A, St. Louis, Mo.

**OUR Luminous crucifix and new luminous St. Therese statue shine brilliantly in the dark.** Sell on first demonstration. Write for prices. W. G. Hannan Co., 2543 So. State, Chicago.

**NO Dull times selling food! People must eat.** Federal distributors make big money; up to \$3,000 yearly or more. No capital or experience needed; unsold goods may be returned. We furnish free sample case, license and free samples for customers—sure repeat orders. Exclusive territory. Ask now. Federal Pure Food Co., A2307 Archer, Chicago.

**AGENTS—Mosco corn and callous remover will build you a steady repeat business.** Send today for pocket-size trial outfit. The Moss Company, 504 Searle Bldg., Rochester, N. Y.

**OUR New card of 5c aspirin sells fast to stores.** Over 100% profit. DeVore Mfg. Co., Desk C, Columbus, Ohio.

**YOU Make 300% profit selling changeable signs to stores; six lines, three colors, cost 35c, sells \$1.50.** Robinson sold 18 signs in four hours. Particulars free. National Sign System, St. Louis, Mo.

**"HOW To Secure Agents,"** a specially prepared booklet, tells of one of the most inexpensive methods in which to secure good live producing agents. It is free; write for your copy today! M. L. Rund, Mgr. Classified Advertising, Popular Mechanics Magazine, 200 E. Ontario St., Chicago, Ill.

**AGENTS Everywhere making money with our line of kitchen specialties, demanded in all homes.** Big earnings possible. Write today for details. P. Seed Filter Co., 353 Broadway, New York.

**BESTEVER Powdered Hand Cleaner.** Removes Grease—Paint—Ink instantly. Sells fast. Sample Free. Bestever Co., 400 Irving Park Station, Chicago.

**NEW Line Counter Displays, Aspirin, Flints, Chewing Laxative, Breath Gum, Nottartar, Silkstone, etc. Steady Repeats.** Over 100% Profit. Superba Co., W5, Baltimore, Md.

**CHICAGO Expert valued \$3 stone at \$900.** The diamond's only guaranteed rival. Greatest spare time, side-line article ever known! Amazing profits. \$5 pocket sample case free. Write quick. Mexican Gem Company, Dept. P.M. Monterey, Calif.

**MAKE Your own products, employ agents yourself.** Toilet articles, soap, extracts. We furnish everything. Valuable book free. National Scientific Laboratories, 1935W Broad, Richmond, Va.

**SELL Men's neckwear—wonderful proposition.** Astor-M, 39 East 28th, New York.

**FREE "Booklet of money making opportunities,"** new ideas, original plans, money making secrets and other valuable information. None require peddling or outfits. Elite Co., 84 Elizabeth St., New York.

**SELL Stores 5c carded breathlets, etc.** Lorrax Products, Albany, N. Y.

**POLMET Polishing Cloth** removes tarnish from metals without the use of liquid, paste or powder. Our agents say it sells like "hot cakes." Retails 25c; sample free. Gale & Co., Inc., 15 Edinboro St., Boston, Mass.

**AMAZING Profits showing new table cloth.** Looks like linen. Wash like oilcloth. No laundering. You just take orders. We deliver. Pay daily. Sample free. Bestever, 231 Irving Park Station, Chicago.

**SELL 3A Garage door holders, simple, automatic, quickly installed.** Interests garage owners, builders, everybody. Exclusive territory proposition. Knowlson-Stevenson Co., Ann Arbor, Mich.

**MAN In each town to plate auto parts, reflectors, bathroom fixtures, refinish beds, mirrors, chandeliers; by new method.** No capital or experience required. Simple plan of manufacturing at home starts you in big money-making business. Outfit furnished. Free particulars and proofs. Gun Metal Co., Ave. H, Decatur, Ill.

**CALIFORNIA Perfumed beads selling like hot cakes.** Agents coining money. Big profits. Catalog free. Mission Factory P, 2328 W. Pico, Los Angeles, Calif.

**DOES 300% Profit interest you? World's best polishing cloth.** Everybody buys. Sample free. Magicloth, 3317 Summit, Kansas City, Mo.

**A BUSINESS Of your own—Making sparkling glass name and number plates, checkerboard signs.** Big book and sample free. E. Palmer, 512, Wooster, Ohio.

**WANTED: District manager to appoint agents.** Unlimited opportunity. No canvassing. Mother Hubbard Products, 554U Congress, Chicago.

**THIS Advertisement may make you thousands of dollars, if you write immediately for my "Eye-Opening" literature describing guaranteed formulas; valuable trade processes, money-making information how to easily make the world's best-selling specialties. All lines. Investment small. Profits immense! Start in your home, room or office. Make the good money you're entitled to.** Dr. Liscombe Miller, Chemist, Tampa, Fla.

**GENUINE Gold Leaf Letters anyone can put on store windows.** Guaranteed to never tarnish. Large profits. Enormous demand. Free samples. Write today. Metallic Letter Co., 438-D North Clark, Chicago.

**PHOTO Medallion men and women, the largest line of photo novelties in the world.** Lowest prices, quickest service. Send for catalog showing over 200 money makers. Gibson Photo Jewelry Co., Inc., 833-837 Gravesend Ave., Brooklyn, N. Y.

**GREATEST Opportunity; newest proposition.** Build continually paying business in your own name. Household, industrial, brushes, brooms, mops, dusters, fully guaranteed. New catalog, all net prices, no discount to bother with. Make as high as 300 per cent and over. Write today. Wire Grip Sanitary Brush Corp., 41 East 11th St., New York.

**AGENTS—Clever Invention! Inkspoon makes every pen a fountain pen.** Fast office seller; big profit, demand increasing everywhere. Exclusive territory offered. Sample free. H. Marul Company, Tribune Bldg., New York, N. Y.

**WE Start you without a dollar.** Soaps, extracts, perfumes, toilet goods. Experience unnecessary. Carnation Co., 641, St. Louis, Mo.

**AGENTS—Make a dollar an hour.** Sell Mendets, a patented patch for instantly mending leaks in all utensils. Sample package free. Collette Mfg. Co., Dept. 404, Amsterdam, N. Y.

**15,000 PROFIT Making formulas.** Following and many others: Accidents and emergencies, agriculture, alloys and amalgams, artist's materials, beverages, cements, glues, pastes, muclages, bleaching, renovating, coloring metals, dyeing, glass, heat treatment of metals, household formulas, ice cream, confectionery, chewing gum, lapidary work, exterminating vermin, lubricants, paints, varnishes, photography, condiments, canning formulas, rubber, soap, candles, soldering, toilet preparations, perfumes, waterproofing, fireproofing, writing materials. Just write for "Scientific American Encyclopedia of Formulas." When postman hands you book pay \$5.50 and postal charges. Popular Mechanics Press, Room 801, 200 E. Ontario St., Chicago, Ill.

#### HIGH-GRADE SALESMEN WANTED

**NEW Endless chain selling plan guarantees you amazing profits and many repeat sales with America's greatest printing line.** 40-55% profit on every order. 104-page catalog shows 1001 printing necessities for every business, including personal stationery, pictorial parcel post and shipping stickers, collection sticker system, advertising tags, druggist labels, etc. Thousands of free cuts. Lowest prices. Highest quality work. Main or sideline. Experience unnecessary. This is biggest profit-maker of the year. Write quick for new free 1931 outfit. Kaiser-Blair, Inc., Dept. 241, Cincinnati, Ohio.

**A "NATURAL" for direct selling.** For best baking results flour must be aerated by several siftings. A tedious task with the old-time sifter. Ask any woman. The Arkvale Multi-Sifter, a beautiful patented device, sifts flour the equivalent of six times at one simple, speedy operation. A proven "natural" for which there is an existing need and demand. If you want up to \$100 weekly easier than you have ever earned it before, write today for complete information. Arkvale Household Specialties, Dept. A, Dodge City, Kan.

**NEW And aplenty different—Fast selling 5c-10c merchandise on attractive counter cards.** 100% commission for you and dealers. Advertised by radio. No capital required. Catalog free. World's Products (Estab. 1921), 109 Central, Spencer, Ind.

**SELL Business printing.** Hundreds of standardized items with illustrations, complete selling outfit for real workers, full repeat. A national service. All Trade Printing Service, 1112 N. Second St., Rockford, Ill.

**WONDERFUL Invention.** Seals fifty envelopes minute. Sells on sight at \$2.25. Attractive trial offer. Square deal. Bank references. Kendall Sealer Co., Dept. C-25, East Jaffrey, N. H.

**WANTED—Salesmen-Dealers.** Selling experience unnecessary, but only reliable people need apply. We supply everything—products, sales outfits, sales and service methods that get the most business everywhere. Superior Rawleigh quality, old established demand, lowest prices, guarantee of satisfaction or no sale, makes quick sales. 200 home and farm necessities, all guaranteed best values. If you are willing to work steady every day for good pay, write for information how to start your own business with our capital. W. T. Rawleigh Co., Dept. L-RPPM, Freeport, Ill.

**\$18 TO \$25 Daily;** biggest selling line of men's suits, \$11.95, \$14.50, \$16.95, \$19.95. Amazing values. Pure virgin wool overcoats, \$18.95. Also raincoats, slickers, topcoats and boys' suits. Biggest commission paid in advance. Liberal bonus. Free outfit. "Jim" Foster, Inc., Dept. 213, 2250 S. Spaulding Ave., Chicago, Ill.

**SELL Nothing,** earn up to \$170 weekly empty handed. No sample case to tote. Oldest and largest punchboard firm, established 20 years, rated \$500,000, announces amazing new plan. Salesmen cleaning up! No one invests a penny. We even pay express charges. Unsaleable merchandise returnable. Big season now here. Full commission repeat business. Grab this quick! K. & S. Sales Co., 4381-A Ravenswood, Chicago.

**BRAND New union label printing line.** Largest assortment cuts and specialty items in country at half price. 72 hour delivery. Big commissions advanced. Sensational bonus offer. Experience unnecessary. Outfit free. Northwestern, 625M Jackson, Chicago.

**FIFTY Million homes** want unbreakable drinking tumblers before Christmas. Two quarters bring you yours. Brown Co., 503 Morgan Bldg., Detroit.

**BUSINESS Stationery—Largest line—Highest quality—Quickest delivery, biggest commissions, liberal bonuses.** Free copyrighted cuts every business. Experience unnecessary. Instructions and outfit free. Willens Co., Dept. 335, 2130 Gladys Ave., Chicago.

**BIG Money daily** selling shirts, ties, underwear, Sox, raincoats, lumberjacks, sweaters, leather coats, mackinaws, coveralls, pants, children's playuits. Outfit free. Experience unnecessary. Nimrod Co., Dept. 65, 4922-28 Lincoln Ave., Chicago.

**SALESMEN—Wonderful sideline.** 40% commission paid daily. Sells all merchants. Pocket outfit free. David Lionel Press, 312 So. Hamilton, Dept. 181, Chicago.

**SALESMEN Wanted—Exclusive territories** open for line of electric tools for contractors, garages, industrials. Manufactured by nationally known concern. Straight commission. Men are making \$400 per month and more. Give past experience and references. Room R. % Popular Mechanics Magazine, Chicago, Ill.

**NEW, Startling, amazing!** Ten to twenty-five dollars a day easily earned. Home protection \$250 to \$1,000 at death; ages ten to eighty. Not insurance, but a society furnishing protection at cost. Write American Benefit Corp., Managers, Myers Bldg., Springfield, Ill.

**ATTENTION, Salesmen.** Big profits assured in selling the old reliable Richmond Fire Extinguisher. The best and easiest selling fire fighter made. Always ready for use. Priced right. Free refills. Every one a prospect. Richmond Chemical Company, Silver Springs, Md.

**EXCEPTIONAL Opportunity.** \$75 weekly. Write Farrand Chemical Co., Tyrone, Pa.

**AMAZING.** New, patented, fountain auto brush. Great demand, agents, distributors opportunity. Practical, priced right. Huge profits, sample \$2.00 returnable. Modern Auto Washer Co., Gillespie, Illinois.

**BIG Opportunity** for salesmen with car. New, low priced, automobile hot-ignition gas-saver. Cumberland Manufacturing Co., Cumberland, Md.

**CALIFORNIA Grape juice bricks!** 100% profit for salesmen! For distributors! One brick makes one gallon; all flavors; Port, Sherry, Burgundy, etc., juice. Every home, hospital, drug and grocery store prospects. Write, Vino Sano Co., San Francisco, Calif., Dent. S-126, 235 9th Street.

**POOL Shooters,** new fascinating vending machine. Merchants everywhere buy! Splendid sideline. Big profit maker! Free pocket outfit! Specialty Mfg. Co., W-617 W. Division, Chicago.

**VIRGIN Field Super-quiet radio-motor generators.** Play A.C. radios on farm lighting systems any voltage. Write for Bulletin 101-C. Rapco, 1447 East Anaheim, Wilmington, California.

**MAGAZINE Salesmen—Our contracts** ranging from \$3.95 to \$7.80 are sold with exceptionally attractive premiums, materially helping salesmen earn \$60.00 to \$100.00 weekly. Write for particulars. Geographical Publishing Co., 621 Plymouth Court, Chicago.

**PUNCHBOARD Salesmen.** New plan sells every merchant. Better terms, bigger commissions. Sure repeat orders with full commission. Experience unnecessary; outfit free! A. J. Novelty Co., 161 W. Washington, Chicago.

**MAKE 33 1/3%** on fastest selling sales plan on market—90% repeats—sells everywhere all the time—Plan endorsed by biggest merchandisers in country—Adaptable for every class of business—Every merchant prospect—Sells on sight. Salesmen making up to \$150.00 weekly. Want money quick—Get action, write today. Washington Sales, 157 W. Washington, Chicago.

**AUTO Tabs** sell freely to auto dealers, garages, etc. Dealers' name attractively imprinted. Salesmen now selling up to 25,000 tabs per week. Good commissions paid promptly. Thermo Co., Norfolk, Virginia.

**SPECIAL Advertising offer:** Sell \$5 value quality toiletries for \$1; astonishing repeats; make \$15-\$50 daily. Paris Laboratories, 2624 Olive, St. Louis.

**SELL Merchants** big \$12 value for \$5.75 and pocket \$2.00 cash. More on repeats. Free kit. Sales Stimulators, Dept. 5H, 339 W. Madison, Chicago.

**MEN—Women!** Sell sensational \$1.50 golf game for home playing. Big profits for Christmas. Sample offer. Noveltoy Corporation, 215 N. Racine, Dept. 31, Chicago.

**SALESMEN To place dealers** for large manufacturing company on Television products. Sales Manager, 308 Michigan Square Bldg., Chicago, Ill.

**ARE You old at Forty?** See our advertisement on page 136 of this issue. The Electro Thermal Company, 2136 Morris Ave., Steubenville, Ohio.

**SALESMEN Making big money** selling improved shirts with unshrinkable non-curling collar. Four shirts, \$5.00. Liberal commission. Exclusive "Made-To-Measure" line. Free necktie with order. Menzin Shirt Company, Bridgeport, Conn.

**BRAND New idea.** 1930 Christmas Card line. Amazing seller. Experience unnecessary. Full-part time. Samples free. Windermere, (Established 1900) 6702 Dorchester, Chicago.

**ADVERTISING Salesmen** can make \$200 a week selling our established line of syndicated house organs. Big repeat commissions. Satisfied clients in 39 states. Write for particulars. The Eastman Folks, South Bend, Ind.

**PUNCHBOARD—Hurrah.** New protection plan opens "closed" territory, creating tremendous demand. Dealers jubilant. Business booming. Commissions enormous. Outfit free. Puritan Co., 1407 Jackson Blvd., Chicago.

**LIVEWIRE Salesmen—Sell** cask 1,020 pieces white dishes, \$40; commission, \$8; cask decorated dishes, 1,020 pieces, \$60; commission, \$10. Baker Pottery, Salisbury, N. C.

**SELL Stores** our vending machines and 5c carded specialties. Over 15 quick-selling products. Robbin Products, 21 Dodworth Street, Brooklyn, N. Y.

**DO You want a snap?** Sell our effective premium business building plans to merchants everywhere. Big front money and 100% repeats. Write today and you'll be with us to stay. D. & H. Premium Co., Dent. D., 118 So. Wells, Chicago.

**SALESMEN—Easy selling Die-U-Rat** thru jobbers. 20% commission. Kills nothing but rats and mice. Rick Drug Co., Gallion, Ohio.

**SALESMEN: Our men** earning \$15-\$40 daily selling to stores. Sayers Systems, Est. 1895, 2813 Sheffield, Chicago.

**SELL** Goodyear raincoats, \$2.95 up. Good-year Rainwear, 682 Sixth Avenue, New York.

**BIG Profit** putting our gold siren letters on store windows, without experience. Samples. Consolidated, 69-V West Van Buren, Chicago.

**PUNCHBOARD Salesman—Most gigantic** line ever featured. Vending machines, all kinds. Make high as \$28.00 on single order. Repeat commissions. Beautiful colored catalog free. Lion Mfg., Dept. 8, 308 W. Erie, Chicago.

**WANTED District managers.** Oldest organization of its kind in accident and health insurance. Write today for information. Dept. 18, Inter-State Business Men's Accident Ass'n, Des Moines, Iowa.

**BIG Pay every day.** Bonus every week. Adelite sells everywhere. New spectacular electric window display. Ever-changing colors, original posters, patented changeable letters defy imitation or competition. Special models for merchants, banks, etc. Instant seller. Big repeats, full commission. Write for thirty day demonstration offer. Display Products Co., 409A East 31st, Kansas City, Mo.

**\$60-\$200 A WEEK.** Genuine gold letters for store windows. Easily applied. Free samples. Liberal offer to general agents. Metallic Letter Co., 438-A North Clark, Chicago.

**PUNCHBOARD Salesmen** make big commissions, selling punchboards and vending machines. Reliable concern, established 20 years. Largest most complete catalog in colors, free. Best season now. Write today! Lincoln Sales, 116 S. Wells, Chicago, Dept. D.

**SALESMEN—Become independent.** Own your business; experience unnecessary, selling our \$10,000 accidental death; \$50 accident; \$25 sick weekly benefits—\$10.00 yearly. Other amounts proportionate. Guaranteed steady income from renewals. \$250,000 deposited insurance department. Universal Policy, Dept. A, 716 Lefcourt Bldg., Newark, N. J.

**SALESMEN Sell tires** and auto accessories to garages, tire stores, filling stations, etc. Established line repeats everywhere. Liberal commission. Write for particulars. Economy Rubber Prod. Co., 606 Burkhardt, Dayton, Ohio.

#### SIDELINE SALESMEN WANTED

**40-55% PROFITS** Business stationery. 2000 styles. Lowest prices. New "endless chain" plan builds permanent business. Ideal side line. Experience unnecessary. Kaeser-Blair, Dept. 246, Cincinnati, Ohio.

#### HELP WANTED

**ARE You tired of hard work,** long hours and small pay? Get out of the rut! I'll show you how to be your own boss and make \$15 profit a day. Simple, pleasant work. No capital required. Particulars free. Albert Mills, 5374 Monmouth, Cincinnati, O.

**STUDENTS.** College students or high school seniors who wish to make extra money. No canvassing. Sayles Supply Corporation, 220 Fourth Ave., New York City.

**SHOE Shiners:** Make more money shining shoes scientifically the right way. The Scientific Shoe Shine. Particulars free. Scientific American Cleaner, 432 Tenth, New Kensington, Pa.

#### EDUCATIONAL AND INSTRUCTION

**ABUNDANT Money** and fine position in community for you. Women or men. Study and practice foot correction. Help foot troubles by mechanical and orthopedic means. Few weeks study puts you in position to earn. No cutting. Practical, pleasant, profitable. Send for latest offer and free tuition plan. Lincoln Correspondence Institute, Inc., 1500 A Walnut St., Philadelphia.

**"CARTOONING & Advertising art."** Six separate books, 100 lessons, 1,000 illustrations, 66,000 words, patented "lift-out" cover, complete \$5.00. Nothing like it in history of art publishing. Free specimen pages. No salesman sent. Fox, 417 Fifth Ave., New York City.

**FIREMEN, Brakemen, Baggage men;** colored train or sleeping car porters, \$150-\$250 monthly. Experience not necessary. 810 Railway Instruction Bureau, East St. Louis, Ill.

**ACETYLENE Pipeline welders** earn \$77 weekly. Thousands men needed this year and next. Free information. National Welding School, 710 Fairfax Airport, Kansas City, Kan.

**MEN—Women.** 18 up. Want a government job? \$105.00 to \$280.00 month. Steady work. Short hours. Paid summer vacation. Common education usually sufficient. Experience usually unnecessary. We coach you without leaving home. 32 page book with particulars and sample coaching free. Write immediately—Today. Franklin Institute, Dept. S3, Rochester, N. Y.

**GREGG Shorthand—Complete,** simple instruction, guaranteed, 25c week. Nation School, 53 Sanford Place, Newark, N. J.

**PENMANSHIP** By mail. Request free folder. Your signature six beautiful styles 10c. Meub. Box 194-IM, Pasadena, Calif.

**BOOKKEEPING** Or accounting self taught. New method. Text and materials for either course \$2.00, both \$3.00. Send no money. Pay postman. Accounting Institute, 404, Duluth, Minn.

**PHOTOPLAY** Talking picture and magazine stories wanted for revision, development and copyright. Sell on commission. Established 1917. Booklet free. Universal Scenario Company, 406 Meyer Bldg., Western and Sierra Vista, Hollywood, Calif.

**STENOGRAPHY**—Bookkeeping, 50c. Self-instructive, 200 subjects. Write, Marr, B605, Nashville, Tenn.

DO Not sign up for a correspondence civil service coaching course for Government job without first learning the truth about these positions. H. F. Ward, Dept. A, 1609 W. 9th St., Los Angeles, Calif.

**COMPLETE** Civil service courses. Exercises, questions, answers. 234 pages, \$2.50. Seaboard Service Co., Baltimore, Md.

**LEARN** Aircraft and pipeline welding, automobiles, electricity. Low tuition. Steversons, 2908A Main, Kansas City Mo.

**U. S. GOVERNMENT** Wants men, \$1,700-\$1,900 and up at start. Railway mail clerk examination coming. Let our expert (former government examiner) prepare you for this and also rural carrier, post office, customs, internal revenue, and other branches. Write today for free booklet. Dept. 8, Patterson School, Rochester, N. Y.

**WANTED** Immediately, men-women, 18-55, qualify for permanent government positions, \$105-250 month; no government experience required. Paid vacations. Common education. Many needed soon. Write Ozment Inst., 101, St. Louis, Mo.

**LEARN** Rapid figuring from "Higher Arithmetic." Write for prospectus. F. A. Smith, 608 S. Dearborn St., Chicago.

**BECOME** A landscape architect. Uncrowded profession; wonderful opportunity for money-making. Easily mastered by mail. Earn while you learn. Est. 1916. Write for details. American Landscape School, 29 Plymouth Bldg., Des Moines, Iowa.

**DOUBLE** Entry bookkeeping 60 hours with 8 keys guaranteed. (Diplomas.) International Bookkeeping Inst., 8 Springfield, Mo.

#### TYPEWRITERS AND SUPPLIES

**KNIGHT'S** Typewriters, 1502 Locust, St. Louis, Mo., \$5.00 best \$25.00 terms. Agents wanted.

**TYPEWRITERS**—All makes, guaranteed, \$6 to \$34. Catalog free. Typewriter Exchange, Ada, Okla.

**TYPEWRITERS**—All standard makes \$10 up. Catalog free. Northwestern Typewriter Exchange, 121 N. Francisco Ave., Chicago.

#### PRINTING, MULTIGRAPHING AND MIMEOGRAPHING

**\$2.95 THOUSAND** Delivered. Letterheads, envelopes, statements, billheads, cards, handbills. Print anything. National, Goshen, Indiana.

**DISTINCTIVELY** Different printing service. Proof and striking evidence, free. Hundreds illustrated cuts. Battlefield Press, Gettysburg, Penna.

**DISTINCTIVE**—"Neargraveure" processes printing—samples. Solidays, Knox, Ind.

**LETTERHEADS** (8½x11"), Envelopes (3½x6½"), Cards (2x3½"), each \$2.50 1000 plus postage; remit \$1.00—1000, balance COD. Miller, 2805 Kellogg, Wichita, Kansas.

**LETTERHEADS**—Envelopes, \$3.80. 3¼x6 folders, \$1.75. Circulars, \$2.25. Specialty Shop, Fargo, N. D.

**BETTER** Printing at 10-25% saving. Estimates gladly given. Mailway, 246 5th Ave., New York.

**1000 BUSINESS** Cards \$2.75 postpaid. Samples. Miller, Printer, Narberth, Pa.

**500 MIMEOGRAPHED** Letters with printed letterhead \$3.50. Samples free. Reed Service, 1913 Mascher, Philadelphia.

**250 EACH**, Bond letterheads, envelopes, cards, \$2.75. Gibson's Printery, Box 262, Philadelphia.

**200 LETTERHEADS**, 100 Envelopes, printed, \$1.00. Abbott Printery, Oswego, Kans.

**1000 HALFSIZE** Letterheads, \$2.00 Postpaid. Stamm Works, Auburn, Nebr.

**5000 ENAMEL** Folders, \$13.75; 5000 8x9 circulars, \$7.50. Form letters, stationery—all printing, low prices. Samples. Goodprint, Harrisonburg, Va.

**200 LETTERHEADS** And 100 envelopes, \$1.00; 200 letterheads, 8½x11, 150 envelopes, \$2.00; 250 cards, \$1.00. Hooster Print Shop, Portland, Ind.

**OUR** Standardized plan makes it possible to print house organs and magazines at one-third ordinary prices. We print more than 1,100 different publications. Samples and particulars free. National Publishers Press, Grand Rapids, Mich.

**1000 BUSINESS** Cards \$2 postpaid. Samples free. "Colorpress," Indianapolis, Ind. Inc.

**LETTERHEADS**, Envelopes, 500, \$1.10; 1,000, \$2.00; 5,000, \$8.00, plus postage. Samples. Coyle & Kimballs, Newport, N. Y.

**500 LETTERHEADS** And envelopes \$2.95. Billheads, circulars, labels, tags. Samples. Ware, Box 357, Ft. Madison, Iowa.

**QUALITY** Printing! Reasonable prices! Send for free standardized samples and prices. Folders, Circulars, Catalogs our specialty. Earnest Fantus, 525 South Dearborn, Chicago.

**250 BOND** Letterheads, envelopes, billheads, cards, \$1.35 each. Economic Press, Leonis, N. J.

**PUBLICATIONS**, Catalogs, stationery. Prices reasonable. Annville Printing Company, Annville, Penna.

**500 BUSINESS** Cards \$1.00. Attractive samples free. Hanzer's, Magnolia, N. J.

#### PRINTING OUTFITS AND SUPPLIES

**COMPLETE** Printing outfits, presses, type, ink, paper, supplies. Write for free catalog. Kelsey Co., B-11, Meriden, Conn.

**PREUSED** Printing presses and supplies. Lists 2c stamp. Popular Bargains, Richland, Pa.

**PRINTING** Outfits—Presses, type supplies, type novelties. Send stamp for catalog. Model Press, York, Penna.

#### ADDING MACHINES

**NEW** \$3.50 Automatic adding machine. Adds, subtracts, multiplies, absolutely accurate. Capacity \$999,999.99. Fully guaranteed. 75,000 pleased users. Makes adding easy, positive, quick. Eliminates mistakes. Saves time. Postpaid \$3.50. Bassett Co., 1458-J, Hollywood Ave., Chicago.

**HOME** Work simplified. Lightning calculator. Not a toy. Price \$2. John Butterfield, 394 Bay Street, Toronto, Canada.

#### GUMMED LABELS

**1,000 PRINTED**: Name, business, address 50c. JBS Company, Box 93, Holyoke, Mass.

**500 ADDRESS**, 25c. Stanley, 35 Kirkland Street, Boston.

#### DUPLICATORS AND DEVICES

**YOU** Can make 50 to 100 copies of a letter, notice, etc., at a cost of three cents on a Heyer Quality Duplicator. Write for free trial offer. The Heyer Duplicator Co., 909 Jackson Blvd., Chicago, Ill.

**"EXCELOGRAPH"** Rotary stencil duplicator \$39.00. "Two-Faced" film duplicator \$6.00. Booklet free. Pittsburgh Typewriter Supply, Dept. 601, Pittsburgh, Pa.

**STENCIL** Duplicator, \$14.50 complete. General Stamping Works, 238 E. 24th St., New York.

#### RUBBER STAMPS

**RUBBER** Stamps—Name, address, 35c. Newman & Son, Auburn, Nebr.

#### FOR MEN

**6-in-1** SIX Color pencil! Absolutely unique—writes red, green, blue, black, yellow and purple. Ideal for draughtsmen, office workers, etc. Prepaid only \$1.00. Multi-write, 1030 Childress, St. Louis, Mo.

#### FOR THE HOME

**POOL** Tables. For home use, sizes 2½x5, 3x6. No toy, nice Xmas present, \$35 and \$50.00. Send for catalogue, S. Moeller, Box 5, Arcadia, Mo.

**CEDAR** Chests only \$11.65—"Red-I-Kut" complete with rich copper trim—you assemble and save half—send for pictures. Kuempel Furniture Company, Guttenburg Iowa.

**N-U-HEAT** Fireplace, valuable information, 2623 Exposition Place, Los Angeles, California.

#### FOR SMOKERS

**CIGAR** Smokers—50 of our hand made Havana filled cigars \$2.00 special this month we will include a sample of our higher priced cigars. Ideal for Christmas. Buy from manufacturer, send \$1.00, balance C.O.D. La Schuler Cigar Factory, 1444 N. Corlies St., Philadelphia, Pa.

#### FIELD GLASSES, TELESCOPES AND MICROSCOPES

**\$5.00 GOVERNMENT** Used field and marine glasses, powerful with leather case, cost \$20.00. Send free list. Field glasses, binoculars, aeroplane cameras and lenses, also musical instruments. Well's Curiosity Shop, 20 South Second St., Philadelphia, Pa.

**IMPORTED** Eight mile binoculars. Only \$7.50. Free trial. Literature. M. Tarres, 4732 Grissom, Philadelphia.

#### RAZORS AND BLADES

**GILLETTE** Blades honed, strooped, 1c each. Petter Wetterquist, Rockford, Ill.

**GILLETTE** Style razor blades, 12, 50c, 100, \$2.25. Greco, 166 Melrose St., Brooklyn, N. Y.

#### BOATS AND LAUNCHES

**BOATS**—Build your own pleasure or work boat using our Ready Cut semi-assembled materials. Commence now and have ready for early spring. Cruisers, runabouts, outboard motor, sail and row. Send 10c for catalog. Brooks Boat Co., Inc., Box YY, Saginaw, Michigan.

**COMPLETE** Building plans V-bottom Runabout Trout, 16 to 19 feet, speed 25 miles, October Rudder 35 cents. Rudder, 15 Murray Street, New York.

**RACING** Hydroplanes—Special, nearly Kom-pleted racing models, class B, \$37.50; class C, \$47.50. Gorenflo Boat Works, Biloxi, Miss.

#### ANTIQUES, WAR RELICS AND INDIAN GOODS

**5000 PREHISTORIC** Indian arrows, 25 for \$3.00, 4 bird points \$1.00, 2 gem points \$1.00, battle axe \$2.50, belt \$1.75, 5 spears \$2.50, 5 war arrows \$1.75, lance \$1.25, hoe 75c, Hematite axe \$15.00, Obsidian or Agate arrows \$4.00, triangular arrow 50c hammer \$2.50, drill \$1.50. R. Heike, Jr., Pontiac, Ill.

**INDIAN** Love bracelets postpaid \$1.00 with pamphlet explaining symbols. Made of 900 fine coin silver hand work. Catalogue 25 cents. The Wigwam, Colo. Springs, Colo.

**SEND** Ten cents for large curio lists, Indian relics, old arms, etc. N. Carter, Elkhorn, Wisc.

**SEND** 5c For fine new list Indian relics, antique firearms. F. E. Ellis, Webster Groves, Missouri.

**INDIAN** Relics, Coins, Curios, Beadwork. Catalogue free. Vernon Lemley, Osborne, Kansas.

#### PRECIOUS STONES

**MOSS** Agates—ring sets, brooches, charms, etc. Beautiful set for ring \$1.00. Agate Shop, 131 Lewis, Billings, Montana.

#### MUSIC AND MUSICAL INSTRUMENTS

**"BANJOS"** Should interest all musicians on account of the popularity of the banjo, as it easily increases a player's income. Illus. catalog of 48 pages free. The Bacon Banjo Co., Inc., Groton, Conn., U. S. A.

**SONGWRITER'S** Information service. Legitimate. Write, Harry Battersby, Revere, Mass.

**POPULAR** Sheet music, ten cents each. Satisfaction guaranteed. "Together"; "Star of My Dreams"; "Who's That Somebody Else." Superior Studio, Fountain Square, Cincinnati, Ohio.

**SONG** Poems arranged for publication, recording and talkie pictures. Brennen, 11656 Broadway, N. Y.

**COMPOSERS**—Verse or music. Brilliant opportunity! Write VanBuren, 2209 McClurg Bldg., Chicago.

**PLAY** Piano by Ear. A sound system. Booklet free. Boucher's Harmony Studio, Ottawa, Can.

**SONGWRITERS**—Poems, melodies, wonderful opportunity. Legitimate. Tommie Malie, PM-4215 North Ave., Chicago.

**VIOLIN** Making plans free for particulars. Rodell Music House, New Bedford, Mass.

**SONG** Poems commercialized. Your opportunity! Write, Beaver, 1257 Elm, Green Bay, Wis.

**SONGWRITERS!** Advance royalty payments, new talking picture song requirements, etc., fully explained in our free instructive booklet. Newcomer Associates, 1647-DD Broadway, New York.

**SONG** Poem writers: "Real" proposition. Hibbeler, D1, 2104 Keystone, Chicago.

**PLAYER** Roll artist exposes secrets. New book hot sales \$2.00. J. Lawrence Cook, 409 Edgewood Ave., New York City.

**GUARANTEED** Results. Write Sequoia Songwriters Service, Sherman Branch, Los Angeles, Calif.

**DUO-Flex** reeds for clarinets and saxophones eliminate your reed troubles. Write for circular, Duo-Flex Reeds, 1204 1st Ave., Evansville, Ind.

**SONG** Poems wanted, marketing proposition, if suitable. Clifford Studio, 4562 Hollywood Blvd., Hollywood, Calif.

**POEMS** Wanted. Work guaranteed. We publish. Great Eastern Song Bureau, Dept. 27, Thomaston, Me.

**SONG** Writers. Send for our "Publishing Agreement." McKinley Music Printers, 1501 E. 55th St., Chicago.

**WRITE** Songs. Big money and reputation. Write for information. J. Gordon Pub. Co., 201 N. Hoyne Ave., Chicago.

"MUSIC Composed" to words. Bauer Bros. (formerly of Sousa's Band), Oshkosh, Wis.

**CORNETISTS—Trombonists—Saxophonists—Clarinetists—Get "Free Pointers." Name instrument. Virtuoso School, Buffalo, N. Y.**  
SEND Song poems, 50-50 plan. Indiana Song Bureau. (Brookside), Salem, Ind.

#### PATENT ATTORNEYS

**PATENTS**—Write for free information, how to obtain a patent and record of invention—or send drawing or model for examination, Miller & Miller, Patent Attorneys (former Patent Office Examiners), 1006-A Woolworth Building, New York; 262 McGill Building, Washington, D. C.

**DON'T** Fail to patent your invention in Great Britain. Tremendous market for worth while products. I will secure patent, sell, or exploit invention for you. If you are not getting action on anything already patented consult me. Complete service. Moderate charges. Highest references, John Norworth, Bush House, London, England.

**PATENTS** Procured. Prompt, careful efficient service. Highest references. Moderate fees. Send sketch or model for actual search and advice. George P. Kimmel, Master of Patent Law, 54-L, Legal Bldg., Washington, D. C.

**PATENTS** Obtained at low cost. Free booklet. See page 144. Write today. Harry W. Johnson, McGill Bldg., Washington, D. C.

**INVENTORS:** Send for booklet telling how to patent and sell your inventions at lowest cost. Ralph Burch, Patent Lawyer, 900 F St., Washington, D. C.

**CANADIAN** Patent attorneys, consultants, booklet on request. Glen & Glen, Ottawa, Canada.

**TIME** Counts in applying for patents. See pages 140 and 141. Clarence A. O'Brien, Registered Patent Attorney, Washington, D. C.

**LACEY'S** Patent Sense. Valuable book free. See ad page 144.

**PATENTS**—Write for our free book, "How to Obtain a Patent" and Record of Invention Blank. Send model or sketch of invention for inspection and instructions free. Terms reasonable. See advertisement on pages 142 and 143. Victor J. Evans & Co., 934 Ninth, Washington, D. C.

**PATENTS.** Send sketch or model for advice. Free book, "How to Obtain a Patent." Established thirty years. Highest references. Prompt service. Reasonable charges. Chandler & Chandler, 908 F Street, Washington, D. C.

**INVENTIONS** Patented and Exploited. Former patent office examiner; Master patent law. Benj. Webster, Esq., No. 15 East 26 Street, New York.

**INVENTORS**—Write for our Guide Book, "How to Get Your Patent," and Evidence of Invention Blank. Send model or sketch of your invention for our prompt examination and instructions free. Randolph & Co., Dept. 430, Washington, D. C.

**LANCASTER, Alwine & Rommel, 221 Ouray Bldg., Washington, D. C.** "Originators of the Form Evidence of Conception." Before disclosing your invention to anyone send for blank form to be signed and witnessed. Form and patent information bulletin free.

**INVENTOR'S** Adviser with mechanical movements sent free. Labiner, 15 Parkrow, New York.

**"INVENTOR'S** Guide," valuable information, free. Frank Ledermann, Registered Attorney-Engineer, 1712 Woolworth Bldg., New York.

**PATENTS** Procured: trade marks registered—preliminary advice furnished without charge. Booklet and form for disclosing idea free. Irving L. McCathran, 704 International Bldg., Washington, D. C.

**PATENTS.** Booklet free. Highest references. Best results. Promptness assured. Watson E. Coleman, Patent Lawyer, 724 Ninth St., Washington, D. C.

**PERCY S. WEBSTER, 203 Saving and Loan Bldg., Stockton, Calif.** Patent booklet free.

**ESTABLISHED 1864.** Milo B. Stevens Company. Free booklet. Patents. Trade marks. Copyrights. Offices, Monadnock Block, Chicago; Barrister Bldg., Washington, D. C.

#### FOR INVENTORS

**INVENTOR'S** Universal Educator: contains 900 mechanical movements; 50 perpetual motions; instruction on procuring and selling patents and selecting an attorney, etc. Suggests new ideas. Price \$1.00 post-paid in U. S. A. Address Dietrich Co., publishers, 602B Ouray Bldg., Washington, D. C.

**YOUR** Idea is worth something. We help you improve, manufacture and distribute it. Advertising specialties and toys preferred. You are legally protected while transacting with us. F. C. Canode Mfg. Co., 515-17 So. Laflin St., Chicago.

**INVENTORS**—Lacking capital write Harden Engineering Corporation, Kansas City, Mo.

**PATENT** Drafting easily learned, \$1.00. See "Wade" ad, page 44.

**WE** Are interested in any new invention or improvement on locks, safes, electric protection or any device for the prevention of burglary daylight holdup or fire resisting protection of records or valuables. Do not send models unless asked for. Room "D", % Popular Mechanics Magazine, 200 E. Ontario St., Chicago, Ill.

**INVENTIONS** Patented and Exploited. Former patent office examiner; Master patent law. Benj. Webster, Esq., No. 15 East 26 Street, New York.

**LOW** Cost manufacturing. Large plant completely equipped for blanking, drawing, stamping and wire forming in any finish. Can save you money on your product. Our figures will convince. Eastern States Products, Box 721, New Haven, Conn.

**INVENTORS:** Now you can protect, sell or investigate the value of your inventions or ideas without spending a penny for patents or attorney fees. Save hundreds of dollars and many months delay. Inexpensive. Guaranteed. Write Inventors Protection Bureau, Dept. 23, 173 West Madison, Chicago.

**TIME** Counts in applying for patents. See pages 140 and 141. Clarence A. O'Brien, Registered Patent Attorney, Washington, D. C.

**LACEY'S** Patent Sense. Valuable book free. See ad page 144.

**INVENTIONS**—Write for our free book "How to Obtain a Patent" and Record of Invention Blank. Send model or sketch of invention for inspection and instructions free. Terms reasonable. See advertisement on pages 142 and 143. Victor J. Evans & Co., 157 Ninth, Washington, D. C.

**ROYALTY** Paid for inventions of automobile and airplane parts and accessories, and household appliance, by metal goods manufacturer, maintaining international selling organization. Also manufacturing taken on contract. Box 549, Middletown, Conn.

#### PATENTS FOR SALE

**OUTRIGHT** Or royalty, screw plug for plastic walls. (Screw machine product.) Alfred Schmitt, 604 Klotter Ave., Cincinnati, Ohio.

**PATENTEE** Of aeroplane with excellent new safety features in stability and soaring capacity wants partners to finance exploitation, here and in Europe. Offers under "unlimited speed." Jos Elger, 33 Wahconah, Pittsfield, Mass.

**WANTED** Partner to pay patent fee, several inventions. Half interest. Frank Warner, 946 N. Clark St., Chicago, Ill.

**OUTRIGHT** Or royalty. Detachable golf spike, No. 1758991. Joseph Tagler, 1021 W. 50th St., Los Angeles, Calif.

**PATENT** For sale on work holding device. Patent issued June 17, 1930. Arthur Brown, Lake City, Iowa.

**PATENTS** For sale or lease. Kitchen tool, sells in every kitchen. Sample supplied to any reliable manufacturer. Charles W. Willey, Box 96, Birnie, Manitoba, Can.

**INVENTIONS.** Outright or royalty. Household necessities. Box 135, Richmond, Va.

**PARTNER**—You pay patent fee—half interest, inventions. B. F. Gossweiler, St. Cloud, Minn.

**ATTENTION, Mfgs.** Improved pneumatic coal cutting machine invention for sale. Inquire, Gerald Goesser, 106 Arthur Ave., Endicott, N. Y.

**PATENT** Sacrificed: Oiling system for internal combustion engines. Box 551, Jackson, Tenn.

**BATHTUB** Shower shield spray control. George Alexander, 25 Brocton, Minn.

**FOR** Sale. Patented automatic wire coat hanger forming device makes one hundred and fifty hangers per minute. R. Knable, 507 W. 32nd St., Chicago, Ill.

**FINANCE** My invention 50-50 basis. I Meskmons, Tolleson, Ariz.

**FOR** Sale: 3-color fountain pen. Patent pending. Noack, 16409 120 Ave., Jamaica Park, Long Island, N. Y.

**OUTRIGHT,** Just patented, No. 1768914, Orange and grape-fruit, fancy basket carrier, for hotels, restaurants and homes. Unusually big demand. Ben Lempek, 509 E. 12th St., New York, N. Y.

**AIRPLANE,** Safety device. Prevents crash fires. Frank Knapp, Portsmouth, Ohio.

**PATENT** No. 1,723,130, Lingerie clasp. Cash or royalty. Write W. T. Greene, 938 Barrister Building, Washington, D. C.

**OUTRIGHT.** Table oil cloth display rack that measures, rolls and cuts cloth in one operation. D. W. Johnson, 1615 F St., Lincoln, Nebr.

**PATENT** No. 1,695,135, Safety razor cleaner. Outright. Address W. T. Greene, 937 Barrister Building, Washington, D. C.

No. 1,728,500, **VALUE** For internal combustion motors. Easier opening, quicker exhaust. Joseph Martorell, 1785 Walton Ave., Bronx, N. Y.

**FOLDING** Stretcher. Wooden household article. Adjustable sizes. H. Cook, 1628 Catharine St., Philadelphia, Pa.

**MANUFACTURERS**—Get our complete list of inventions for sale. American Society of Inventors, Crosby Bldg., Buffalo.

**CANADIAN** Patent. Triangular foldable rule. New idea in folding. U. S. Pending. Arthur Gabrielson, 2533 2nd Ave., So. Minneapolis, Minn.

**TIME** Counts in applying for patents. See pages 140 and 141. Clarence A. O'Brien, Registered Patent Attorney, Washington, D. C.

**MANUFACTURERS** Looking for new inventions should write W. T. Greene, 939 Barrister Building, Washington, D. C.

**FOR** Sale—Patents, improved flour sifter and improved snare. Outright or royalty. Harry Nakagawa, Tanana, Alaska.

**INVENTORS**—Cash in on your invention now! Don't delay the sale any longer! Send for a free copy of our specially prepared booklet, "Turn Your Patent Into Money," today! It contains helpful information for all inventors. M. L. Rund, Mgr. Classified Advertising, Popular Mechanics Magazine, 200 E. Ontario St., Chicago, Ill.

#### ELECTRICAL

**FOR** Sale burglar alarms. Daly, 3003 Cleinview Ave., Cincinnati, Ohio.

#### MODELS AND MODEL SUPPLIES

**SCALE** Model railroad supplies—not toys. For hobbies or railroad exhibition work. The first and only complete model railroad catalog in the country—35c with credit slip. Well illustrated, parts for five gauges. American Model Railway Company, New Rochelle, N. Y.

**INVENTORS:** Send us sketch or crude model of your idea. Crescent craftsmen will develop it into a practical working model. 30 years of successful experience and thousands of satisfied clients. Confidential service guaranteed. Bank references furnished. Free illustrated book: "Making Inventions Pay." Crescent Tool Co., Dept. S-12, Cincinnati, Ohio.

**POWER** Models. Steam and gasoline engines, accessories, supplies, metals for model-makers. Catalog 35c. Chas. Cole, 1355 Church St., Ventura, Calif.

**MODELS**—Small and medium size. Experimental work, tools and dies for light manufacturing. Dependable Tool & Mfg. Co., 3445 No. Racine Ave., Chicago.

**FIVE** Large blueprints for miniature steam engines, stationary, marine type \$2.00. Model Machine Shop, 212 Price St., Rahway, New Jersey.

**WE** Make models, dies, and manufacture. 652 Lake, Chicago.

**TIME** Counts in applying for patents. See pages 140 and 141. Clarence A. O'Brien, Registered Patent Attorney, Washington, D. C.

**SHIPMODELER.** Magazine of the ship model makers' club. Sample copy 20 cents. 55A, Middagh St., Brooklyn, N. Y.

**YOUR** Ideas developed. Models made to exact specifications, also light manufacturing our specialty. Howell Machine Works, 128 N. Jefferson St., Chicago.

**WE** Make working models for inventors and do experimental work and carry a complete stock of brass gears and model supplies. Send for catalog. The Pierce Model Works, Tinley Park, Ill.

**SHIP** And yacht model fittings. Send dime for illustrated catalog No. 6. A. J. Fisher, 1002 Etowah Ave., Royal Oak, Mich.

**MODEL** Steam engines and boilers for miniature power boats. Boat and boiler fittings. New catalog 15c. Model Machine Shop, 212 Price St., Rahway, N. J.

**THE** Modelmaker. An illustrated magazine devoted to practical model making. Sample 10c. Modelmaker, 122 P.M. Liberty St., New York.

#### MANUFACTURING

**MANUFACTURING.** Models, dies, stampings, brasswork, mechanical rubber moulds, vulcanizing. Circular free. Baum's Metal Specialties, Kansas City, Mo.

LET Us work out your models, manufacture your articles, and catalogue same. The Henter Corporation, Elliptonville, N. Y.

**METAL ARTICLES** developed and manufactured. Model making. Reasonable prices and first class workmanship. W. F. Meyers Company, Bedford, Indiana.

**PATTERNS**—Wood and metal; models, tools, dies, metal stampings; brass, aluminum and white metal castings; general manufacturing. Modern Machine & Pattern Co., Terre Haute, Ind.

**DIES**, Stamping and machine work. Walter Neubert, Ellsworth Ave., Jeannette, Pennsylvania.

**SPECIALIZE** Complete manufacture, dies, tools, special machinery. Models made. Atlas Indicator Works, 821 W. Washington, Chicago, Ill.

**WIRE** Goods made to order. Cooley Mfg. Co., 530 N. Western Ave., Chicago.

**SPECIAL** Machinery or parts, dies, tools, metal specialties, models, special gears, stock gears and model supplies. Send for catalog. The Pierce Model Works, Tinley Park, Ill.

**LOW** Cost manufacturing. Large plant completely equipped for blanking, drawing, stamping and wire forming in any finish. Can save you money on your product. Our figures will convince. Eastern States Products, Box 721, New Haven, Conn.

#### MACHINERY, TOOLS & SUPPLIES

16"x6" SEBASTIAN Lathe, \$150.00; No. 1 Brown & Sharpe univ. milling machine, \$185.00; No. 60 Heald grinder, \$500.00; 24" Hendy shaper, \$250.00; 36"x18" Fifield lathe, \$750.00; 36" Cordesman band saw, \$95.00; 18" Fay pony planer, \$100.00; Crescent universal woodworker, six machines in one, \$300.00; Quincy air compressor, \$65.00; 10" new drill press, \$21.00. Write for catalog. Terms to suit. Cincinnati Machinery & Supply Co., 27 West Second St., Cincinnati, Ohio.

**BRAND** New standard approved two-wheel ball-bearing grinders, complete \$19.50. 1/4 h.p. AC motors \$6.50 32v motors with emery, buffer and drill chuck \$7.00. 1/2 h.p. 32v, \$12.50; 3/4 h.p. \$19.00. Large stock motors and generators. Queen City Electric, 1736 Grand Avenue, Chicago.

**WOODWORKING** Machinery catalogue mailed gratis. Address: Edgar G. Bickler, 222 West Fourth Street, Cincinnati, Ohio.

**BARGAINS** New and reconditioned equipment. Chromium platers, grinders, compressors, all ball bearing. Payment terms. Write Hobart Platers, Box M-1207, Troy, Ohio.

**LATHE**, Bench, run less than ten days, chucks, tools, counter, complete, nothing else to buy. Big discount for quick, cash sale. Write Box 481, Gainesville, Texas.

1000 DRILLS, 1000 Threading dies, 500 reamers, 200 milling cutters. Send stamp for list, "Tool-Crib", 150 Bennett St., Bridgeport, Conn.

**FOR** Sale 12 Miller Falls Power Hack Saws at 1/2 price \$35.00. Send stamp for circular. Every garage needs one, "Tool-Crib", 150 Bennett St., Bridgeport, Conn.

**CASTINGS** For lathes, grinders, and drilling machines. New improved patterns. Keneipp & Son, Mt. Carmel, Ill.

**CONCRETE** Building block machines and molds. Easy payments. Catalog free. Concrete Machine Co., 5 North Main St., St. Louis, Mo.

**CASTINGS** For lathes, grinders, drilling machines. Special Xmas offer. Keneipp & Son, Mt. Carmel, Ill.

**START** Business of your own, small investment required, doing nickel, copper and silver plating. This work in big demand. Information free. Electro Platers Supply Co., 28 W. Second St., Cincinnati, Ohio.

#### ENGINES, MOTORS AND DYNAMOS

**MINNEAPOLIS** Electric motor, 110 volts, 15 volts secondary to operate drafts and dampers on furnaces and forced draft blowers, \$25.00. Motor driven blowers for forced drafts, \$26.50. One day thermostatic clock, \$15.00. Wexler Heat Regulator Company, 243 Canal Street, New York, N. Y.

**TIME** Counts in applying for patents. See pages 140 and 141. Clarence A. O'Brien, Registered Patent Attorney, Washington, D. C.

**NEW** 1/4 Horse, 110 volt alternating motors, \$6.50; some used, \$4.50. New 1-12 horse, 110 volt universal, \$2.75. New 1/2 horse, 110 volt 3,450 speed alternating, \$16.50. Other bargains. Electrical Surplus Company, Dept. 12, 1911 Chicago Ave., Chicago.

**COMPRESSORS**, Twin cylinder, for small tire shops. Duce spraying. J. Troekman & Son, Inc., 110-112 Lincoln Ave., Evansville, Ind.

**CHEAP** Gas power, from auto engines, but they need governing. We make the governors—all engines, easily installed, \$10.00. Circulars. Candee-Smith Governor Co., 215 No. Los Angeles St., Los Angeles.

**FOR** Sale: One-sixth and one-fourth hp. electric motors, 60 cycle 110 volt a.c., slightly used. One-sixth hp., \$4.50; one-fourth hp., \$5.00. Cash with order. Charles Kratsch, Inc., 160 E. Illinois St., Chicago.

#### BENDING MACHINES

**THE** Famous Hossfeld "Wrenchless" Universal Iron Bender is the last word in bending machines. Bends metal, cold or hot, into most any conceivable shape, including Eye Bolts and Automobile Spring Eyes. Bends up to 1" bars or 1 1/2" pipe cold. Also bends "Angle Iron." Thousands in use by all classes of trade, from the smallest shops to the largest railway systems. Write for circular and prices. Hossfeld Mfg. Co., Winona, Minn.

#### WELDING AND SOLDERING

**ELECTRIC** Arc welders—new and used. Terms and trial. Tell needs to Hobart Welders, Box M-1208, Troy, Ohio.

**OXYGEN**, Acetylene and hydrogen regulators, welding and cutting torches, all makes, about half price, guaranteed, J. M. Shevlin, P. O. Box 51, Reading, Pa.

#### SURVEYING INSTRUMENTS

**A** GREAT Opportunity—20% off on orders received this month for rebuilt transits and levels. All makes, rebuilt in our own factory and fully guaranteed. Sold on easy terms. Subject to test. Write today for list M-412. Warren-Knight Co., Makers of "Sterling" Surveying Instruments, 136 North 12th St., Phila., Pa.

#### FARMS AND FARM LANDS

**PROSPERITY**—Independence for you on a Western Dakota Farm, a well selected dairy, grain, or diversified farm or stock ranch in Western North or South Dakota offers a real chance for independence. If you're working for wages or are dissatisfied with your present location, you'll find more contentment, more comfort on the farm today than ever before. Prices are low, terms easy. The Milwaukee Road wants only to help new settlers get best land values for their money; guard them against any misrepresentation. Our Agricultural Agents, having carefully investigated these lands, will gladly advise you the kind of farming suited to each locality—and continue to advise you after settlement. Only a successful farmer is a benefit to The Milwaukee Road. These rich lands vary—from level to slightly rolling, good for tractor or horse farming—to rough or hilly land good for grazing. Prices vary with location and quality, from \$5 to \$25 per acre, unimproved; from \$15 to \$40 per acre, improved. We recommend only land where corn, wheat, flax, oats, barley, alfalfa, alfalfa seed, sweet clover, vegetables, small fruits grow profitably, where stock, poultry, hog raising and dairying are proven successes. Good roads, railroads, markets, schools, churches, good neighbors. Ask questions. Write now for free, illustrated booklet. Tell us the kind of farm you wish, crops or stock you want to raise. All questions reliably answered. No obligation. Low Homeseekers' Rates. Write R. W. Reynolds, Commissioner, The Milwaukee Road, 942-M Union Station, Chicago, Illinois.

**LAND** Openings along the Great Northern Railway. Fertile productive improved farms, new land or good outcrop land. Opportunities in many kinds of farming; grain, livestock, dairying, fruit, poultry, small tracts or general farms in Minnesota, North Dakota, Montana, Idaho, Washington, and Oregon. Renters and owners get benefit of low prices, low interest, low taxes. We have free books on each state, can give accurate detailed information and help to find kind of location desired. Write E. C. Leedy, Dept. 537, Great Northern Railway, St. Paul, Minnesota. Low Homeseekers' rates.

**OZARKS**—20 Acres, timbered, \$100. \$5 own a home. Jarrell, Mt. Vernon, Ill.

**OAZRKS**—20 Acres, timbered, \$100. \$5 monthly. Poultry, hogs, fruit; fishing, hunting, trapping. Hubbard, 216 Grossman Bldg., Kansas City, Kansas.

**OWN** A Farm in Minnesota, Dakota, Montana, Idaho, Washington or Oregon. Crop payment or easy terms. Free literature; mention state. H. W. Byerly, 119 Northern Pacific Railway, St. Paul, Minn.

**CENTRAL** Ohio; wonderful farm; 1432 acres fully improved and equipped. J. F. O'Brien & Co., Provident Bank Bldg., Cincinnati, Ohio.

**TEN** Dollars monthly acquires five acres pecans, tungs, figs, oranges. Guaranteed care. Big returns. Suburban Orchards, Dept. M, Biloxi, Miss.

**WANTED** Hear from owner having farm for sale. Cash price, particulars, John Black, Chippewa Falls, Wis.

**EASTERN** Pennsylvania farms near Philadelphia. Write for bulletin giving prices, sizes and descriptions. Wilson George, Quakertown, Pa.

**HOMESTEAD** Free western land. Any state list 25c. Reanos Newton, Murray, Ky.

**GRAPEFRUIT** Orchards winter vegetable land semitropics of Texas easy terms one acre up agents wanted. Frank Phillips, owner, San Benito, Texas.

**MONEY** Made in Michigan potatoes. \$10 down now and easy terms buys land near markets, lakes, streams. Write today. Swigart & Co., P-601, 32 N. State St. Bldg., Chicago, Ill.

**SELL** Your property quickly for cash, no matter where located. Don't pay big commission. Particulars free. Real Estate Salesmen Co., Desk B, Lincoln, Nebr.

#### RABBITS

**RAISE** Fur rabbits. We buy all you raise. Send 10c for catalog, contract, etc. Goldenrod Fur Farms, Lincoln, Nebr. Dept. PM.

**RAISE** Chinchillas from prize winning, championbred stock. De Sayda, Redbank, N. J.

**RABBIT** Supplies—America's exclusive Rabbit supply house. Free catalogue. Desk 11, National Rabbit Supply Company, 1126 North Dearborn Street, Indianapolis, Ind.

**ANGORA** Wool rabbits. Pedigreed. Wool in demand. The Cedars, Angora Wool Farm, Elias S. Payne, 221 Union Snokomish, Wash.

**MONEY** Making rabbits on easy terms. A small deposit—pay balance out of stock shipped us on contract. Write Stahl, Dept. 216, Holmes Park, Mo.

**RAISE** Rabbits, pigeons, guinea pigs for us. Stock supplied on credit terms. Catalogue. Contract 10c. Houcks, Tiffin, Ohio.

**RAISE** Fur bearing rabbits—We buy all you raise, paying as high as \$15 each. Send for free catalog. Brand Farms, Box 167, New Orleans, La.

**RAISE** Rabbits, \$2.00 pound, information dime. Eastern Rabbitry, New Freedom, Pa.

**RABBITS**—Giant Silver Fox and Chinchillas reduced prices on account of room for winter. High Quality Fur Farm, Harvard, Nebr.

#### MUSKRATS

**FUR**—Farmers, dealers, exporters: Bargains, deodorized skunks, splitcaps, starblacks, stripers; also opossums, coons, minks, muskrats, fitch, rabbits, pigeons, guinea-pigs; lowest prices. Furnish any amount. Write or wire. Brown's Kennels, White Hall, Md.

#### MINKS

**HIGH** Grade stock. Folder on breeding, dime. LaBar's Mink Farm, Austin, Minnesota.

#### DOGS AND PETS

**SELECTED** Coonhounds, combination fur hunters, fox-hounds gun-and-field broken beagles, rabbit-hounds. Dog-foods, medicines, hunting-horns, supplies. Free catalog P. M. Riverview Kennels, Ramsey, Ill.

**WHITE** Collies and other colors. Beautiful and useful. Dept. P, Shomont Kennels, Monticello, Iowa.

**FOR** Sale—Get my price on Coon Hounds and Combination Tree Hounds. Young partly trained tree hounds, coon hound pups, Fox and Wolf hounds. High class deer hounds, Ace high Rabbit hounds. Vergel Becket, Havana, Ark.

**50** BEAGLES, Rabbit-hounds, foxhounds, coonhounds, skunk, opossum, squirrel, groundhog, dogs, setters, pointers, pet and farm dogs. Trial. Catalogue 10c. Brown's Kennels, White Hall, Md.

**FOR** Sale—20 choice select coonhounds cheap on trial. Kevill Kentucky Kennel, Kevill, Ky.

**SAVE** Your valuable dogs with Adams' famous black tongue remedy; No-Mo for running fits and mange; all 'round worm expeller; \$1 each. Money Back Guarantee. P. Adams, Ramsey, Ill.

**REGISTERED** Bloodhounds \$25. Training bloodhounds leaflet 25c. Reasbeck, Van-kleeck Hill, Ontario, Canada.

#### WANTED—MISCELLANEOUS

**MAIL** Us your discarded jewelry, gold crowns and bridges, watches, diamonds, silver, platinum. Money promptly mailed. Goods returned if offer refused. United States Smelting Works (The Old Reliable), Dept. 71, Chicago.

**FOR SALE—MISCELLANEOUS**

**ADDRESSOGRAPHS**, Letter folders, multi-graphs, envelope sealers, duplicators, less than half price. Guaranteed. Pruitt Co., Suite 108, 190 N. LaSalle St., Chicago.

**WE Buy coins, stamps, old documents.** Harry Kelso, Pittsburg, Kansas.

**WATCHMAKERS** Lathe for sale at a bargain. R. Jaegermann, 5815 Easton Ave., St. Louis, Mo.

**PERSONAL**

**CASH'S** Woven names. For marking men's, women's, children's clothing. Sample free. Ouimette's Mail-Order House, 81 Holly, Dept. 20, New Bedford, Mass.

**INDEBTEDNESS**—Are you in debt? Pay creditors through our plan. Proven successful six years. Operates anywhere. Send dollar bill for complete service. Satisfaction guaranteed or money returned. Absolutely confidential. Mutual Service Corporation, 521 McKnight Bldg., Minneapolis, Minn.

**FREE Astrology horoscope**—Send birthdate and postage for free life reading. King Supply Co., 335 Taylor, Topeka, Kansas.

**ASTROLOGER** Can read your life. Test predictions for one year 20c, dimes or stamps. Send year and birthdate. G. Niemeyer, Box 228, Mays Landing, N. J.

**INGROWING Nails** painless home correction. Refund guarantee. Information free. Eugene Eaton, Bandon, Oregon.

**TOBACCO Habit** overcome or no pay. 500,000 used Superba to help stop cigarettes, cigars, chewing, pipe, snuff. Treatment sent on trial. Costs \$2.00 if successful. Superba Co., L84, Baltimore, Md.

**FREE! Herbalist almanac.** Over 500 herb medicine recipes for home use. Write for details. Botanic, 145 West 112th St., Chicago.

**13 FUNNY Love letters.** Read two ways. Nothing vulgar, but a barrel of fun. 10c set. Economy Sales Co., Dept. P, Manchester, Iowa.

**LIFE Reading.** 1931 forecast; advice on business, occupation, health, love, marriage, etc.; complete \$1. Character outline 25c; send birthdate. M. Kleman, 96 Eaton St., Winnipeg, Man.

**WILL Send true account of almost miraculous subconscious care** when run over by an automobile! Also explanation very peculiar experiment, demonstrating your own subconscious, which governs your health! Send 25c; or better \$1 and will include wonderful manuscript, "To Health, Happiness, Success!" Elmer Dwigkins, 28 First, Alhambra, Calif.

**STUBBORN** Skin afflictions including ringworm, eczema, cleared up few weeks otherwise money refunded. Treatment \$2.00. Circular free. Furrhold Co., 1128 81st St., Brooklyn, N. Y.

**BULGARIAN Doctor's famous dandruff formula** only \$1.00. L. Sisco, (Pharmacist) 217 East Main St., Lansing, Mich.

**FRENCH Narcissus perfume** of irresistible charm. \$3 bottle sent postpaid for \$1. Joseph Goodwin, Box 315, Lexington, N. C.

**HYPNOTIZE Instantly.** Particulars free. Dr. Lonk, (Hypnotist), PM-2945 North Ridgeway, Chicago.

**LETTERS Mailed from Canada** for 15c coin. Reliable service. P. O. Box 381, Quebec, Canada.

**MISCELLANEOUS**

**OIL Painting** anyone can learn. Start studio, teach, demonstrate. Inexpensive instruction. Particulars free. Hughes, Box 1264-M, Los Angeles, California.

**EXCHANGE**—Radios and accessories for shotguns and rifles. A. M. Boyd, 300 First Ave., Dept. PM, Watervliet, N. Y.

**HAND Painted, hand lettered** scented sachets, to enclose with gift, 10c each. H. Hurst, 7502 Kingston Ave., Chicago, Ill.

**PROSPECTOR'S Mineral collection.** 100 different minerals about one inch square in compartment case. Price postpaid \$15.00. Camp Novelty Co., Box 204, Estes Park, Colo.

**A BILLION Ideas.** This is the title of our remarkable catalog of books along practical lines. Arranged alphabetically by subjects for easy reference. If you have not received it, send for a copy. You will find hundreds of subjects you cannot usually locate in book stores or public libraries. Sent free upon request. Popular Mechanics Press, Room 807, 200 E. Ontario St., Chicago.

**SEASHELLS**—Beautiful collection of over 30 varieties—postpaid \$2.00. Order now. H. Schoeningh, 109 Post Street, Petaluma, Calif.

**MIRRORS Resilvered** at home. Costs near 5 cents per square foot; you charge 75 cents. Profitable business plating auto-parts, reflectors, tableware, stoves, refinishing metalware, etc. Outfits furnished. Details free. Write, Sprinkle, Plater, 288, Marion, Ind.

**QUIT Tobacco easy.** Harmless home remedy. Ni-Ko System, Ojai, California.

**LEARN Today—earn tomorrow—**one-day shocard system. Sample, particulars 10c. Straley Sign System, Springfield, Ohio.

**BEAUTIFUL, Uncommon, Central American "hulpliles"** (shawls), bright colors. Will decorate nicely your piano, table, etc. 25 cents brings generous samples of different fabrics. Miss Virginia Herrera, Apartado 297, San Salvador, Central America.

**TATTOOING**—Learn how with my outfits. Descriptive circulars sent anywhere. Sergt. Bonzey, 367 So. Main, Providence, R. I.

**RUBBER Shoe laces.** They ease your feet. Sample pair P.P. 10 cents. Try them. The "Tool-Crib" Co., 150 Bennett St., Bridgeport, Conn.

**FOUNTAIN Pens:** Ladies, gents size. Guaranteed 2 years; will last lifetime. Satisfaction or money back; \$5 value for \$1.25. Bryant, Box 583, Augusta, Ga.

**YOU Can save,** by sending your magazine subscriptions to Porter's Publications, 9416a 115th St., Richmond Hill, N. Y. Lists free.

**TATTOOING Outfits, supplies.** Illustrated list free. "Waters," 965 Put-nam, Detroit.

**TIME Counts** in applying for patents. See pages 140 and 141. Clarence A. O'Brien, Registered Patent Attorney, Washington, D. C.

**AMATEUR Cartoonists:** Sell your work. Write Smith's Service, PW1194, Wenatchee, Wash.

**HOMEOPATHIC** And biochemic preparations sent postpaid to all parts of the world. Booklets free. Halsey Bros. Co., 5547 Ravenswood Ave., Chicago. Established 1855.

**AMATEUR Cartoonists** earn \$25.00 week, spare time, copying or tracing cartoons for advertisers. 3-M Syndicate, Argyle, Wis.

# SPORTSMEN

## Read This Offer!

Send the **COUPON** and receive a magnificent Sportsmen's Book telling you how to learn to MOUNT GAME-HEADS, BIRDS and ANIMALS. You can NOW be your own Taxidermist. Our school has over 100,000 graduates throughout the world. You can now learn AT HOME in SPARE TIME.

## Mount Your Own Trophies!

Hunting and Fishing have entered a new era. All true sportsmen now kill fewer specimens, but DOUBLE their interest by mounting their trophies. The secrets of Taxidermy (mounting birds and animals) are now revealed. YOU CAN NOW LEARN TAXIDERMY FOR YOURSELF. Be a Taxidermy artist. Mount birds, animals, game-heads, fishes, tan skins and make beautiful rugs and robes. Easily and quickly learned in your own home. Adorn your home and den with nature's finest ART. If you enjoy hunting—you will enjoy Taxidermy MORE.

**Big Profits** Do you want to MAKE MORE MONEY? Then give your SPARE TIME to Taxidermy. Make \$50 to \$250 a month by mounting for others or selling your mounted specimens, or go into business—open a Taxidermy shop of your own, and earn \$3,000 to \$8,000 a year.

# This Book FREE

Every Sportsman should have this marvelous book. You can right now, while this edition lasts, get a copy Free and prepaid by mailing the coupon NOW. Only limited number free—Send Today. Nothing like it. Just off the press. Contains 48 large pages and cover in brilliant colors. More than 100 photos of splendid game specimens and masterpieces of the National Museum at Washington. Brim full of interest to every sportsman. And think of it, this valuable unique and artistic book can be had now, by Sportsmen for the asking.

## Mail the Coupon!

If you want to preserve your trophies; if you desire to make money from your spare time, if you are a nature lover—send the coupon and receive your copy by return mail. State your AGE.

N.W. School of Taxidermy, 3379 Elwood Bldg., Omaha, Neb.



### N. W. School of Taxidermy

3379 Elwood Bldg., Omaha, Neb.

Send me your free illustrated book "Sportsmen and Their Trophies." Also tell me how I may learn this fascinating art easily and quickly by mail. No obligation.

Name \_\_\_\_\_ Age \_\_\_\_\_

Address \_\_\_\_\_



# PARKS-TRAINED MEN MAKE "TOP GRADE" AIR PILOTS

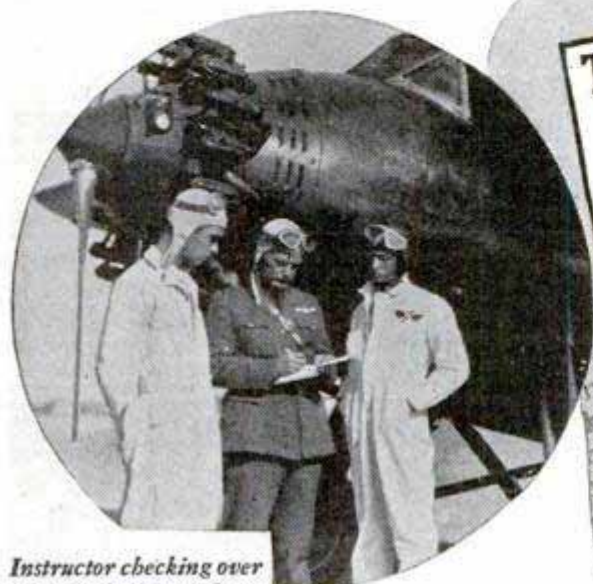

Instructor checking over record of pilot students at Parks Air College and giving helpful information as every Parks instructor is able to give these well-trained students.

**T**O make good money, get good training. The Government survey shows that "top grade" pilots make an average of \$550 per month—and Parks-trained men make top grade pilots! At Parks you buy the best training to be had—and qualify for the best-paying positions. You're money ahead in the end. Parks Air College is the alma mater of many of the country's best-known, best-paid men engaged in aviation. Its graduat-

ing classes, today, are distinguished more than ever before by the type of student who will make a name for himself.

Do you want men like this for associates? Do you want the kind of an education that is equipping men to be tomorrow's leaders in aviation? Then sit down now and mail the coupon below!

**TOP GRADE AIR PILOTS  
EARN \$550 A MONTH**

**Night Mail Flyers, However, Exceed Average by \$300 Monthly.**

By Associated Press.

WASHINGTON, August 19.—Average monthly wages now being earned by airplane pilots of the highest capability class range around \$550 per month.

The aeronautic branch of the Commerce Department ascertained the flight pay as a result of a survey of payrolls of air mail and passenger carrying enterprises for the first six months of 1930 and the last half of 1929. The pilots in this service are holders of the highest class of license and training. Much experience and training. Most all cases, earnings of based upon mileage indicated

## PARKS AIR COLLEGE

DIVISION OF DETROIT AIRCRAFT CORPORATION

1220 Parks Airport

EAST ST. LOUIS  ILLINOIS

•• COUPON ••

PARKS AIR COLLEGE,  
1220 Parks Airport, East St. Louis, Ill.

Without cost or obligation to me,  
please mail your illustrated catalog.

Name \_\_\_\_\_

Street address \_\_\_\_\_

City \_\_\_\_\_

State \_\_\_\_\_

Occupation \_\_\_\_\_

Age \_\_\_\_\_

I am interested in  
Pilot's Course   
Mechanic's Course

# Learn Electricity IN LOS ANGELES

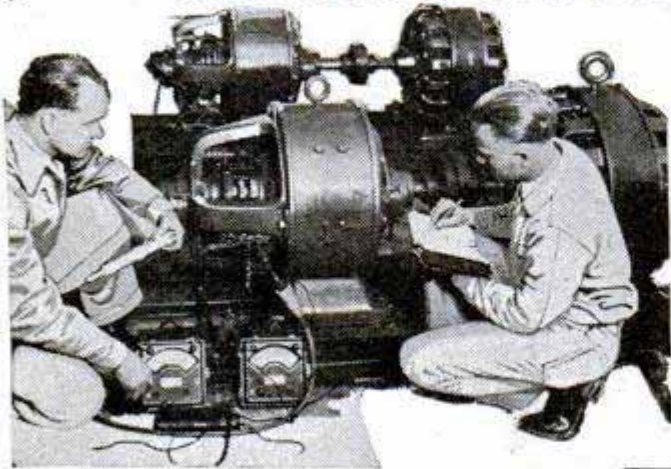

## and LEARN IT RIGHT!

### 1. What Kind of a School Is NATIONAL?

NATIONAL is a Million Dollar institution—established in 1905—recognized throughout the electrical industry as one of America's foremost trade schools. NATIONAL offers practical, intensive training in all electrical branches. All technical essentials included. No age limit. No previous experience necessary. Life Scholarship privileges. Start any time of the year.

### 2. How Long to Learn Electricity?

NATIONAL properly trains you in the short time of 6 to 9 months. Upon completing this Condensed Course you are fully qualified as a Practical, Competent Electrician, and you have not risked your chances of employment because of inferior, incomplete instruction.

### 3. What Employment Service Does NATIONAL Guarantee?

NATIONAL GUARANTEES to give unlimited and efficient Employment Service to students wishing to earn living expenses while learning; and to graduates getting started in the electrical field. This is the most any reputable school can be expected to do.

### 4. What Inducements Does NATIONAL Offer?

NATIONAL offers YOU the very best technical-practical training that money can buy at a cost within every man's reach. It does not offer to pay your railroad fare, room and board or other personal expenses, preferring to limit its activities to the PROPER TRAINING OF MEN FOR SUCCESS.

### 5. Why You Should Come to LOS ANGELES!

LOS ANGELES is the heart of the country's most rapid electrical development—as well as the world's most ideal city in which to live and prepare for success in electricity.

**WRITE for FREE BOOK NOW!**

## NATIONAL Electrical School

Dept. 94, 4006 Figueroa St., Los Angeles, California.

Send me your big free illustrated catalog of Electrical Opportunities showing how I can learn quickly and get a Big-Pay Electrical Job.

Name.....  
 Address.....  
 Age..... City..... State.....



# Learn SIGN and SHOW-CARD WRITING

In spare time few hours weekly



**FREE "Book of Facts" — Write For It**

Fascinating profession. Big opportunity in this fast-growing trade. Earn while you learn the sign arts. No talent or experience required. Be your own boss or obtain a good position. Learn show cards, posters, bulletins, signs, advertising layouts and allied subjects. We teach by mail or at our school. Quick results—easy to learn.

### EARN \$50 TO \$200 WEEKLY

Otto C. Wiegand, Md., home-study graduate, made \$12,000 from his business in one year. Many successful graduates. Oldest and foremost school. Don't delay. Write for complete information.

### DETROIT SCHOOL OF LETTERING

193 Stimson Ave. Est. 1899 DETROIT, MICH.

## DENISON'S PLAYS

Musical Comedies, Operettas, Vaudeville Acts, Minstrels, Comedy Songs, Make-up Goods. Catalog Free

**55 YEARS OF HITS**

T.S. Denison & Co. 623 S. Wabash, Dept. 9, Chicago

## LEARN MECHANICAL DENTISTRY

SEND FOR FREE BOOK



### Earn Big Money—Steady Work

Don't waste the best years of your life. Learn this money-making business in a few months in Day or Evening sessions. Big Demand. Practical training. Individual instruction. Easy terms. Railroad fare allowed—no extra cost. Write NOW for catalog P and special tool offer. New York School of Mechanical Dentistry 125 West 31st Street New York



## Photography Needs Trained Men!



Many well-paid, worthwhile positions open annually in motion picture and photographic field. Entire industry growing by leaps and bounds. One large moving picture company alone reports profits of \$8,434,000 for first six months of this year.

## Good Pay for "Still" Photographers

"Still" Photographers and photo-finishers wanted everywhere. We teach you at home or in our studios to take advertising and commercial photographs, art poses and portraits—show you how you can win success in this uncrowded industry.



## Movie Cameramen in Demand



Thrills, adventures—an opportunity to see the world await you as motion picture cameraman! Or, be a well-paid motion picture projectionist. Free book tells how you can qualify for any branch of this fascinating profession. Send for it TODAY.

NEW YORK INSTITUTE OF PHOTOGRAPHY Dept. V-1445 10 West 33rd Street, New York City

## Mail Coupon for FREE BOOK

Without obligation send me a copy of your FREE book and details about how I can qualify for the branch of photography checked.

Motion Picture Cameraman  Projectionist  
 "Still" Photographer  Photo-Finisher

Name.....  
 Address.....  
 City..... State.....



# A TALKING PICTURE FOR RUPTURED PEOPLE!



## Scientist Tells How New 4oz. Invention Often Ends Truss Handicaps Quickly



In December, 1925, after more than 100 experiments in his laboratory, an Ohio Scientist finally developed and perfected the idea that has greatly helped rupture treatment.



Physicians praised this new discovery. Tests on cases of long standing showed good results in many instances. Dr. J. B. Walkinshaw of West Virginia expresses himself as above when he saw the appliance.



The new device was placed in the hands of 10,000 rupture sufferers. They were amazed at its tininess and feather-like lightness. Soon the astonishing stories of the results received began to be reported.



One of the astonishing cases reported was a man 80 years old who had been ruptured for 50 years. His report showed that his rupture no longer handicaps him, which Mr. Buck terms "a remarkable achievement."



Another man, T. M. Connon, ruptured for years, reports that he takes part in athletics without fear of harm, and teaches boxing and wrestling after working long hours every day as a barber.



Relief at last—hundreds of rupture sufferers tell how Magic Dot System has brought back the enjoyment of life.



People in all sections of the civilized world have heard about the Magic Dot System and are sending to America for it. From every section of the Globe come reports telling of the astonishing results received.



Thousands of free samples of material, showing how an important part of Magic Dot System is made, have been given to rupture victims. The inventor also offers newest Efficiency Model on 10-day Trial by Actual Wear to all ruptured who mail the coupon.

### Free Sample of Material and 10 Days' Trial Offer

Once a rupture victim tries this amazing comfort system, he usually never wants to return to cruel pressing devices of any sort. Hence this amazing offer of newest Efficiency Model—10 days' trial by actual wear. Mail coupon for full details. John G. Homan, New Science Institute, 2179 Clay Street, Steubenville, Ohio.

John G. Homan,  
New Science Institute,  
2179 Clay St., Steubenville, Ohio

Send me full details of your 10-Day Trial By Actual Wear offer on your newest Efficiency Model—also free sample of the "button rupture" material. This does not obligate me.

Name.....

Address.....

City.....State.....



Here is Edwin McTeer (address on request) and some of his work. The crude pen drawing was made before he had any training and the striking story illustration (worth \$100) was made after he took the Federal Home Study Course.

# He did it— Why don't you?

Edwin McTeer is only one of the hundreds of young men (and young women, too) who are succeeding in commercial art with the help of the practical training offered by the Federal Home Study Course. Well trained artists earn \$50, \$75, \$100, \$150 a week and more.

## Success In Commercial Art

begins with a liking for drawing and the ambition to follow through with the right training. Mr. McTeer was thirty years old when he clipped a coupon like the one at the bottom of this ad, and took up the Federal Course. He progressed rapidly, increasing his earnings each year until at the end of five years he was making around \$10,000 a year. Read what he wrote us:

"I was not very talented when I entered this training with you people as you certainly know, and I had not even had high school training and I know any one with a love for the work can accomplish even more than I if they will just let you people, the Federal Schools, help them.  
"I suppose you remember I opened my own independent commercial art studio, and to make a long story short, my earnings are now at the rate of over \$10,000.00 a year."

## Send For "Your Future"

If you like to draw—send for book "Your Future" and find out what amazing progress you can make with the right art training. Use the coupon now, giving age and occupation.

**Federal School**  
of Commercial Designing

Dept. D, Federal Schools Bldg.  
Minneapolis, Minnesota.

Please send me "Your Future."

Name.....  
Age..... Present Occupation.....  
Address.....

# PREVENT FATAL NIGHT CRASHES

And Get In On This **BIG PROFIT Opportunity!**



An amazing "two-beam" light invented by a famous light engineer now gives drivers complete safety at night. Road is bright as day for 1000 feet—yet secret principle absolutely prevents glare! Kinney of Chicago made \$96 in one day! Big territories—a fat share of 23 million prospects. Write today for full facts about this amazing safety Speedlight and find out about wonderful money-making sales proposition.

**SPEEDLIGHT COMPANY**

821 Monroe Street LaPorte, Indiana

**67,000 BEAM CANDLE POWER  
ONE FIFTH OF MILE OF LIGHT  
NO GLARE**

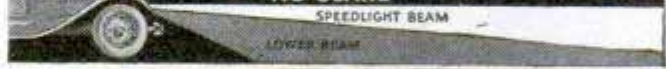

## LEARN EXPERT WRESTLING



Taught at home, by mail, by greatest of all world's champions—Farmer Burns and Frank Gotch. Be a wonderful athlete. Handle bigger, stronger men with ease. Learn the secrets of experts, Jiu-Jitsu, Physical Culture. Have perfect health, fame, a perfect body admired by both sexes.

Send 10c (coin or stamps) for highly interesting booklet, 32 pages, illustrated, teeming with information. Tells how we teach expert wrestling at home. Only 10c. Write now—State age.

**FARMER BURNS SCHOOL**  
3379 Courtney Bldg., Omaha, Neb.



## AN EASY WAY TO SHAPE your NOSE

Anita Nose Adjuster shapes flesh and cartilage—quickly, safely, painlessly, while you sleep or work. Lasting results. Gold Medal Winner. Doctors praise it. 78,000 users. Write today for **FREE BOOKLET.**

**ANITA INSTITUTE, 1212 Anita Bldg., Newark, N. J.**



## There's Quicker, Bigger MONEY for YOU—in POULTRY

**Earn \$2,000 to \$5,000 a Year or Have a Business of Your Own!**



Whether you want a job at good pay or a highly profitable business of your own—the Poultry Industry offers you more than any other. There's a shortage of poultry meat and eggs—a shortage of trained poultrymen. I'll train you quickly at home—to fill a good job in Poultry—and our FREE Students' Employment Dept. will help you get one.

**Spare Time or Full Time YOU Can Cash-in BIG**  
No matter where you live—city, town or country—or what you do now, my proved methods will assure your success right from the start. I'll help you make from \$2,000 to \$5,000 a year and UP! And, if you choose to start your own business, I'll show you how to make your tiny investment multiply itself automatically. What I've done for thousands of others I can do for you.

**FREE Book Shows Way to Big Pay and BIG Profits**

Mail coupon below TODAY—for my Big NEW FREE Book, "How to Raise Poultry for Profit." My forty years of experience are yours. The Poultry Industry needs YOU. You need my book. Get it—and get in line for the BIG Money that's waiting for you in POULTRY.

## Mail NOW for FREE Book

**NATIONAL POULTRY INSTITUTE, Dept. 411-D  
Washington, D. C., Att'n: Harry M. Lamson, Pres.**

Dear Mr. Lamson: Send me your FREE Book, "How to Raise Poultry for Profit." I want to know more about my opportunity to make \$2,000 to \$5,000 a year, spare or full time.

Name.....  
Address.....

# WELDERS

**5,000  
Pipe Line  
Welders  
Needed  
Today**

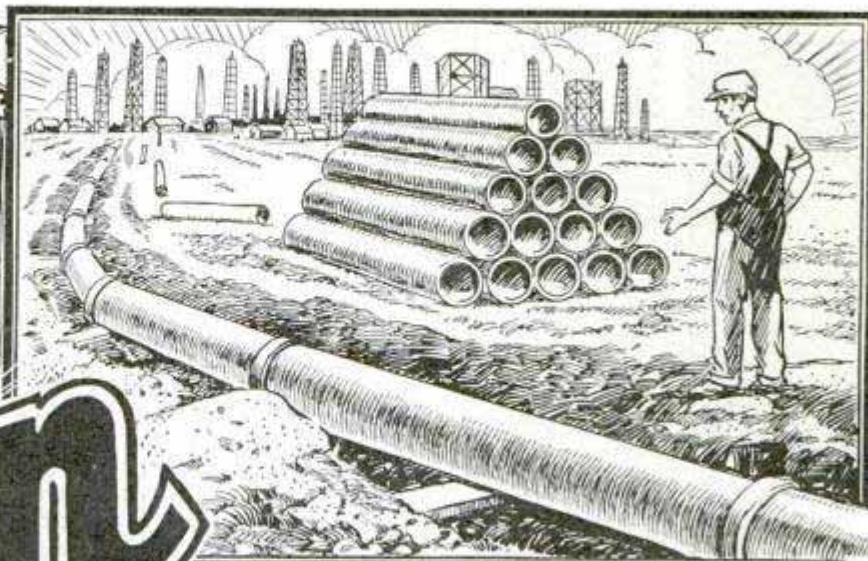

# Learn

## \$77 A WEEK!

**Tell It to  
Sweeney**

Man—don't talk to me about hard times. Trained men can clean up right now. I'm getting more calls for good welders every day than I can supply. There's over 100,000 miles of steel pipe line being laid from Texas and Oklahoma to the Atlantic Coast to carry gas, oil and petroleum products because pipe lines haul this freight at one-tenth the cost of rail transportation. It is making jobs for thousands of welders—in fact at present 5,000 welders are needed at once. Come now and fit yourself in a few weeks for a welding job at \$12.50 a day.

### SWEENEY SYSTEM "Learn by Doing"

If you are mechanically inclined, if you like to work with tools, you will learn under the "SWEENEY SYSTEM" by actually doing the work on the most complete gas engine and electrical equipment made. You'll get dirty and greasy, but you'll learn through the SWEENEY SYSTEM OF PRACTICAL TRAINING that fits you for the big pay jobs waiting for Sweeney Trained Men.



**Airplane Mechanic  
\$85<sup>00</sup> to \$125<sup>00</sup> a week**

SWEENEY GROUND SCHOOL is a thorough course in practical airplane mechanics. Airplane mechanics are in great demand. Five men on the ground need to keep one man in the air. Learn by doing. Construction and repair of planes—all about motors—recovering wings, etc. Mechanics and Engineers earn from \$50 to \$125 a week. Riggers earn \$50 to \$75. You work on latest type equipment and become a skilled man in a great new business. Mechanics and ground men always assured of interesting, profitable, steady work.

### Send Name Today for New Special Offer!

What trade are you interested in—what appeals to you? Get the facts on big present opportunities. Write me a personal letter today or simply use coupon below. Get my big free book that tells everything. I'll give you full details about big pay jobs and make you a new special offer that will surprise and delight you. But I must hear from you right away. Do it now!

### Big Pay to Men Who Know How

The biggest salaries in the history of the Automotive and Electrical business are being paid to men who "know how." The SWEENEY trained man is in demand everywhere. If you are mechanically inclined, COME RIGHT NOW TO THE SWEENEY SCHOOL. YOU'LL LEARN everything about all kinds of automobiles, tractors, oxy-acetylene welding, vulcanizing, battery work, electrical work, building and repairing radio sets and in a few weeks be able to cash in on your time. No previous experience or education is needed. You only need to be willing to work. THE SWEENEY SYSTEM OF TRAINING IS PRACTICAL FROM START TO FINISH. No books are used, no dry lectures. You work with your hands on the most complete equipment. From your very first day in the school you do actual work on live engines—THE SWEENEY SYSTEM is the original "LEARN BY DOING" method.

**He Says**

**YOU CAN  
MAKE BIG  
MONEY**

No "if or ands" about it—you can make big money as soon as you can qualify



through Sweeney Training for the good jobs now open.

Welding is only one of the present opportunities. The Electrical, Radio, Battery, Aviation and Automotive trades need men and pay well for trained hands. Electrical Experts get \$175 a month up; Radio and Battery experts \$150 month up; Auto Mechanics are paid \$50 to \$75 a week.

I've raised the salaries of thousands of other fellows. I've been in business here 23 years and trained over 85,000 men for big money and success. I can do it for you. You know as well as I do that training counts, so decide now to come and fit yourself for big pay. Just a few pleasant weeks here and then there's a good job paying big money ready for you.

E. J. SWEENEY, President

**LEARN A TRADE**

# Sweeney

**AUTOMOTIVE & ELECTRICAL SCHOOL**  
1615-G GRAND AVE., KANSAS CITY, MO.

**Emory J. Sweeney, President,  
1615-G Grand Ave., Kansas City, Mo.**

Dear Mr. Sweeney:—Please send me your new free catalogue and full details of the big jobs now open for men with Sweeney training, also the special offer you mentioned.

Name.....

Address.....

State..... Age.....

# Win Admiration for Your Physique — Strongfort Tells How



**STRONGFORT**  
Builder of Men

You may have brains; you may have ability to burn; you may be ever so talented; you may be clever—but none of these, or all combined, will match the magnetism, the compelling power, the hypnotism of a beautifully developed, well-rounded-out, muscular, powerful body. *There isn't anything in the world that will more instantly win you favor, of both men and women, than a splendid physique.*

Test this assertion for yourself—in any group of men or women—in high or low society—in business places or workshops—in sport or on the stage—and see what happens when the man of fine physical presence enters the group, or the room. Instantly all eyes are centered upon him! Immediately men ask one another who it is! Every woman seeks an introduction! *Admiration is universal.*

## Gain Magnetic Manhood

If you are lacking in rugged strength; if your powers are sagging; if you no longer feel peppy and eager for action; if your day's work drags on you; if you do not enjoy company; if your love affairs are failures; just take my advice and let me pull you up and out of this shameful discouraging condition.

I don't care what brought you to this pitiful plight—neglect, abuse, excess, disease or common ailments like catarrh and constipation—I can brace you up and make a real he-man of you—that's as sure as you are reading this message of hope.

*Your ailments, your weaknesses, your lack of manliness will disappear almost magically under my instruction, and you will see the dawn of a new day from the moment you take up my Course in*

# STRONGFORTISM

## The Up-to-date Science of Health and Strength

—recognized the world over as the best method of strengthening the bodily organs and removing disease and weakness. *I urge you to be frank with me—take me into your confidence and tell me all about your troubles and what you lack in health and strength. When you become my pupil you should realize you are selecting for your instructor the world's outstanding athlete and strong man whose perfect bodily development won honors in many countries.*

*Lionel Strongfort's methods, as used to develop his own body, will be revealed to you. After you have enrolled your case will be individually analyzed and charted and a plan of development and restoration outlined for your particular case, with special personal directions and suggestions.*

## I Give You More Than Mere Muscle

Big, bulging muscles, without a properly developed body, internally as well as externally, get you nowhere. They won't eradicate weakness and disease. They won't make you cheerful and hopeful, as Strongfortism will. Don't be fooled by pretenders. Come to the teacher whose lifetime background proves him to be the outstanding exponent of true physical culture and real health building.

## There's Hope In My Free Book

Send for my latest revised and illustrated edition of "Promotion and Conservation of Health, Strength and Mental Energy," telling how I built up my own body—how I can build up your body. This book is priceless—and it is yours FREE for the asking. Fill in the coupon and mail it right away. Note—No drugs, pills, dope or apparatus are prescribed in this Course in Strongfortism. Only a few minutes of your time in the privacy of your own room are required.

# STRONGFORT INSTITUTE

LIONEL STRONGFORT, DIRECTOR.  
Physical and Health Specialist for 30 Years  
Dept. 85, NEWARK, N. J., U. S. A.

— Send This Coupon —

### FREE CONFIDENTIAL CONSULTATION

Mr. Lionel Strongfort, Strongfort Institute, Dept. 85, Newark, N. J.—Please send me absolutely free my copy of your book, "Promotion and Conservation of Health, Strength and Mental Energy."

My Ailment Is.....

Name.....

Age..... Occupation.....

Street.....

City..... State.....

# NOW... ANOTHER MILLION DOLLAR SHAVING INVENTION



"Once-in-lifetime" business opportunity now offered ambitious men by I. L. Rhodes, who put over Kriss Kross Stropper, biggest success of its kind in America.

## Samples Sent FREE — Write Today

**I.** L. RHODES' invention brought salesmen over a million dollars in profits. Now he has another great money-maker, destined to revolutionize shaving and make small fortunes for men who join him now. Nothing like it ever before announced. 1-minute sales, big commissions, repeat business, low price, national advertising, etc. No experience required. Work full time or spare hours. Learn also about sensational new money-making plan on Kriss Kross Stropper, the amazing machine that ends buying razor blades and assures keen, cool, quick shaves forever. Pays up to \$150 a week without selling. Simply place on free trial. Guaranteed profits offer—no risk—new low price. Territories closing fast. Without obligation, write today for full details and free sample of new invention. I. L. Rhodes, Pres., Dept. W-3715, 1418 Pendleton Ave., St. Louis, Mo.

**MAKES \$66 IN ONE DAY**

H. King earned \$66 in one day. Emil Ham \$200 in 4 days. Find out how you can do the same.



# Astrology

## Will You Be Lucky in 1931?

What do the Stars foretell for 1931? Would you like to know? Our Special 12-page Astrological Reading gives predictions, month by month—with exact days, dates and happenings for 1931 based on your Sign of the Zodiac. Consult it before making any change in home or business affairs, signing papers, love, marriage, seeking employment, raises in salary, speculation, travel, friends, enemies, health, accidents, lucky days, etc. Send exact birthday with \$1.00 for reading.

FRANKLIN PUB. CO., 800 N. Clark St., Dept. 2900, Chicago

# New Orange Juicer



Clever new machine ends squeezing, straining, seeding, necessary with old-type juicers. Simply turn handle, gives up 25% more juice. Priced amazingly low. Housewives, hotels, restaurants, etc., buy on sight. Big com' missions—up to \$6 an hour full time, spare time. Write quick for BIG MONEY offers!

KWIKWAY PRODUCTS, Inc.  
Dpt. W-120, 1415 Pine St., St. Louis, Mo.

# NEW MYSTERY INVENTION

## Closes Any Door Without SLAM



No longer need anyone tolerate the noisy nerve-wrecking nuisance of slamming, banging doors. Close-A-Door, an astonishing new invention, closes any door and keeps it closed. Shuts it swiftly and securely without noise or jar. Prevents damage to doors—breakage of glass—drafts which endanger health and waste fuel. Creates a furor of interest everywhere.

### EASY MONEY FOR AGENTS

Veteran salesmen are astounded at the ease with which Close-A-Door sells. Prospects galore everywhere! Every home, store, office can use 4 to 8—factories, apartments, by the dozen! \$10 to \$25 possible on a single sale! Easy big earnings the year round. Write as once for details.

THE CLOSE-A-DOOR COMPANY  
Dept. W-10 1531 Washington Ave., St. Louis, Mo.

# BIG PAY JOBS

*open*

## for Every Radio Trained Man

Don't spend your life slaving away in some dull, hopeless job! Don't be satisfied to work for a mere \$20 or \$30 a week. Let me show you how to make Real Money in Radio—the Fastest-Growing, Biggest Money-Making Game on Earth!

**THOUSANDS OF JOBS PAYING \$60 TO \$200 A WEEK**

Jobs as Designer, Inspector and Tester, paying \$3,000 to \$10,000 a year—as Radio Salesman and in Service and Installation Work at \$45 to \$100 a week—as Operator or Manager of a Broadcasting Station, at \$1,800 to \$5,000 a year—as Wireless Operator on a Ship or Airplane as a Talking Picture or Sound Expert—THOUSANDS OF JOBS PAYING \$60, \$70 AND ON UP TO \$200 A WEEK!

## Learn Without Lessons in 60 Days

Coyne is NOT a Correspondence School. We don't teach you from books or lessons. We train you on the greatest outlay of Radio, Television and Sound equipment in any school—on scores of modern Radio Receivers, huge Broadcasting equipment, the very latest, newest Television apparatus, Talking Picture and Sound Reproduction equipment, Code Practice equipment, etc. You don't need advanced education or previous experience. We give you—RIGHT HERE IN THE COYNE SHOPS—all the actual practice and experience you'll need. And because we cut out all useless theory, you graduate as a Practical Radio man IN 60 DAYS' TIME.

## TELEVISION and TALKING PICTURES

And now Television is on the way! Soon there'll be a demand for THOUSANDS of TELEVISION EXPERTS! The man who learns Television now can make a FORTUNE in this great new field. Get in on the ground floor of this amazing new Radio development! Come to Coyne and learn Television on the very latest, newest Television equipment.

Talking Pictures and Public Address Systems offer thousands of golden opportunities to the Trained Radio Man. Here is a great new Radio field just beginning to grow. Prepare NOW for these wonderful opportunities! Learn Radio Sound Work at COYNE on actual TALKING PICTURE and SOUND REPRODUCTION equipment.

## No Books - No Lessons All Practical Work at Coyne

No Books! No Lessons! ALL ACTUAL PRACTICAL WORK. You build radio sets, install and service them. You actually operate great Broadcasting equipment. You construct Television Receiving Sets and actually transmit your own Television programs over our modern Television equipment. You work on real Talking Picture machines and Sound equipment. You learn Wireless Operating on actual Code Practice apparatus. We don't waste time on useless theory. We give you just the practical training you'll need—in 8 short, pleasant weeks.

## EARN AS YOU LEARN

Don't worry about a job! You get Free Employment Service for Life. And don't let lack of money stop you. If you need part-time work while at school to help pay expenses, we'll gladly help you get it. Coyne is 31 years old! Coyne Training is tested—proven beyond all doubt. You can find out everything absolutely free. Just mail coupon for my big free book!

H. C. Lewis, Pres. **Radio Division** *Founded 1899*  
**COYNE ELECTRICAL SCHOOL**  
500 S. Paulina St. Dept. 90-3H Chicago, Ill.

**H. C. LEWIS, President**  
**Radio Division, Coyne Electrical School**  
500 S. Paulina St., Dept. 90-3H, Chicago, Ill.  
Send me your Big Free Radio Book and all details of your Special Introductory Offer. This does not obligate me in any way.

Name.....  
Address.....  
City.....State.....



# BOYS

## HERE'S YOUR CHANCE IN AVIATION

**NO CASH COST**

Boys everywhere (and men too) who act at once, can learn all the fundamentals of aviation at no cost. Here is a great book, "A B C of Aviation," written by Major Victor W. Page, world-famous authority, well-known to readers of Popular Mechanics. This book, written in plain, everyday English, tells you everything you want to know about Aviation—all the fundamentals from A to Z.



### LIKE COMPLETE GROUND COURSE

A big book this, with 143 pages and over 100 drawings. Tells you why planes fly, describes features of all landing types, dirigibles, flying-boats, engine types. In a word—a complete ground course. A costly book—you may have it free.

## A GREAT XMAS GIFT!

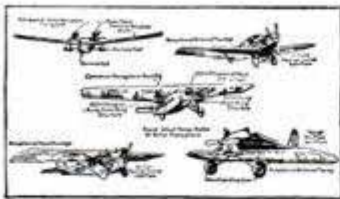

### WONDERFUL AIR STORIES

12 thrilling issues!

The Open Road for Boys is a large magazine, crammed with unusual stories of high-daring in the air, on land and sea, mystery stories that'll make your blood run. Sport stories, mechanics, contests and great prizes. The most unusual stories in America.

**Special Offer!** Regular subscription price for Open Road for Boys Magazine is \$1.00 a year. Send us \$1.00 today and we'll send you the Open Road for Boys Magazine for a whole year, and the great book, "A B C of Aviation" free. Hurry your order. A fine Christmas gift!

OPEN ROAD PUBLISHING CO.  
Department 21 Canadian postage 25c extra  
130 Newbury Street, Foreign 50c extra  
Boston, Mass.

Inclosed please find \$1.00 for which send me a year's subscription to the Open Road for Boys Magazine and the great book, "A B C of Aviation." (Use separate sheet of paper for additional orders.)

Name.....  
Street.....  
City or Town..... State.....

### 34 Lesson

## Drawing Course \$2.98

The biggest value you ever saw advertised anywhere . . . . .



Haven't you often wished that you could draw cartoons, illustrate some ideas, sketch some pretty face, etc.? You can do all of these things. One of America's most famous Cartoonists and illustrators has developed a great, simple system for success in all branches of Commercial Art. This system has revolutionized the entire theory of drawing. It means that drawing can be as easy for you as writing—much simpler than learning shorthand, bookkeeping or typewriting. We are now placing this original system for learning Drawing, Art and Cartooning, consisting of 34 lessons with over 500 illustrations, within reach of every one. If you will devote a few hours each week to the Course WE ABSOLUTELY GUARANTEE that you will learn to draw and draw well before you have half finished the Course. If we fail to make this claim good, we will refund every cent paid us. By eliminating a large office force for answering correspondence, expensive catalogs, etc., we are enabled to make a price of \$2.98, the cheapest price ever known for a high-grade, home study course. Learn to draw. It is a big asset, no matter what field you are in.

### Send No Money

Just order the course and on arrival \$2.98 pay postman

If you order the course at once, we will include a drawing outfit, consisting of artist's pencils, pens, paper, erasers, thumb tacks, etc., enabling you to go to work without any additional cost.

plus a few cents postage, payment in full for the entire Course and Drawing Outfit. If not entirely satisfied, return within five days and we will Refund Money. Address:

**LEDERER SCHOOL of DRAWING, Dept. 798-S, Chattanooga, Tenn.**  
Orders from outside the U. S. A. are payable \$3.28 cash with order.

Earn Big Money

## DRAFTING

### TOOL DESIGNING—ENGINEERING

Send your name at once and we will send full particulars of big pay jobs as draftsmen, tool designers, engineers. School directed by Col. J. G. Vincent, Eddie Stinson, other famous engineers and endorsed by prominent universities. Our course used by world's largest auto factories. Learn at home or in Detroit. Big Catalog with full particulars free if you write at once.

DETROIT SCHOOL OF APPLIED SCIENCE  
8203A Woodward Ave. Detroit, Mich.

**FREE BOOK**

## Mysterious Power of Pelmanism

Let us send you a free copy of "Scientific Mind Training." An instructive book which explains an amazing system of mind training already used by more than 650,000 people. It will show you how and why Pelmanism is the *only* system of teaching for developing all the mental powers at the same time. Endorsed by such distinguished men as Judge Ben B. Lindsey, Sir Harry Lauder, Jerome K. Jerome, Prince Charles of Sweden and hundreds of others. Write TODAY to

THE PELMAN INSTITUTE OF AMERICA

71 WEST 45th STREET DEPT. 612 NEW YORK CITY



**Minstrels**

Unique First Parts for complete show with special songs and choruses. Make-up. Catalog Free.

T. S. Denison & Co., 623 S. Wabash, Dept. 19 Chicago



## FREE Radio Handbook

Write today for your copy of the new Radio Association handbook. Shows you easy ways to make money in Radio. Tells you how our members are cleaning up \$3.00 an hour spare time. Write for Membership Plan which need not cost you a cent and FREE RADIO HANDBOOK.

RADIO TRAINING ASSOCIATION OF AMERICA  
Dept. PM-12 4513 Ravenswood Ave., Chicago

## Big Money in Fur-Craft

For Men and Women



Make \$50 per week in your spare time in this wonderful new work. No selling. No capital needed. Spare or full time. Your earnings start AT ONCE. Greatest method ever devised to QUICKLY increase your income. **FREEBOOK** Write AT ONCE for free book which tells how. No obligation. N. W. FUR CO., Box 3379, Omaha, Neb.

# Ingenious New Auto-Invention Turns Gasoline Fumes into Dollars



**Something  
New  
Different  
Successful!**

You can now drive your car on gasoline fumes! My new auto invention makes this possible. It puts waste gas from crank case back to work in a new way. Cuts operating costs in half. Increases motor efficiency. Stops oil dilution. Prevents wear. Gives your motor more power and pep. Makes starting easier. Is actually saving thousands of dollars for auto-owners everywhere. Not a

gimcrack carburetor contraction for which extravagant claims are made but a genuine invention of real merit—the product of years of scientific research.

Nothing like it ever before—new—different—successful! I have set aside one thousand for distribution to readers of Popular Mechanics under my new plan. The cost will be charged to advertising.

**Special  
Offer to  
Readers of  
Popular  
Mechanics**

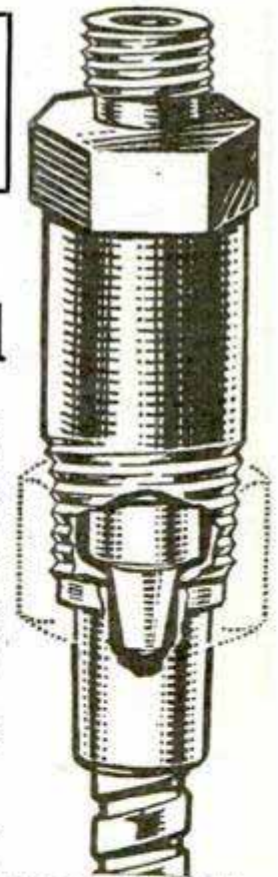

**\$\$\$  
IN GAS  
FUMES!**

Extract dollars from your crank case! Utilize gasoline fumes! Stop oil dilution! Save wear! Increase mileage and motor efficiency! Reduce repair bills! Make gasoline fumes work FOR you instead of AGAINST you!

## 1000 Duo-Vaporators to be distributed for Advertising Purposes

The object is to make this auto necessity more widely known as quickly as possible. Every user is a booster and this distribution will prove to be the best advertising investment I have ever made.

Accept my liberal offer. Use the gasoline fumes you are now wasting. Increase your mileage. Many car owners are getting almost incredible results with the Duo-Vaporator. **REPORTS SHOW MILEAGE INCREASES RANGING FROM 35% TO 60%—WITH 15% TO 20% MORE SPEED.**

**Save money.** Experience the pleasure of operating a "smooth-as-silk" motor that starts instantly in any weather—purrs contentedly—pulls without effort and remains cool as a cucumber.

### EASILY FITTED WITH A WRENCH

May be speedily installed. No cutting or drilling. Use only a wrench. When fitted, forget it. Entirely automatic in action.

Transforms gasoline fumes into power—speed—miles. Stops oil dilution. Saves wear on pistons, pinions, and other vital parts. Keeps spark plugs clean. Interested? Of course you are! Print name and address plainly in coupon, detach and mail today. This places you under no obligation and commits you to NOTHING.

H. W. ROBINSON

### SIGN AND MAIL THIS COUPON

To H. W. ROBINSON & COMPANY  
Box 1018, Detroit, Michigan

My Name is.....

My Address is.....

My Car is a..... Model.....

# Boys Get This Curtiss Falcon

Complete Kit With All Materials and Directions FREE to Subscribers

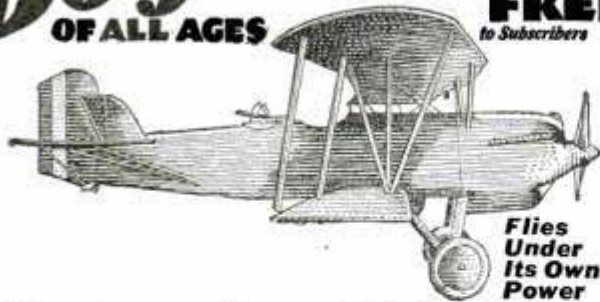

Flies Under Its Own Power

Here you are, Son—and Dad! Here's the easy and quick way to dig right into learning aviation. First, you get all the materials and directions for making a prize-winning model—the Curtiss-Falcon, one of the most popular airplanes in the U. S. Mail Service.

## Given with National Power Glider

At the same time, we send you the Golden Wings and membership card in the A. B. A. (Aviation Boosters of America). All these come to you at once with your year's subscription to the liveliest, most complete aviation magazine published—the National Power Glider.

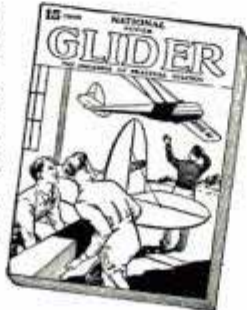

## Join the A. B. A.—Get the Golden Wings

Boys—this is a **real** flying magazine and no mistake. Starts you on making models. Then by easy stages through the theory and practice of gliding. And finally a complete home study course in aviation by Major Purcell of the U. S. Army Reserve—theory and practice complete. Easy to read, learn and follow. This course alone is worth many times the price of a year's subscription.

You boys are the Lindberghs and Rickenbackers of the future. Wright got his start fooling around with toy airplanes as a boy. Aviation isn't solved yet by any means. We want a plane that will land right side up in the back yard—somebody's going to make it for America. Maybe you have the miracle hidden away in your head right now. Practice, reading, study and enthusiasm may bring it out.

## SEND NO MONEY

Curtiss-Falcon model, Golden Wings and membership card free! If you haven't the \$1.50 handy, send this coupon anyhow—you'll have it in a few days when the postman gets to your house.

National Power Glider, 370 7th Avenue, New York, N. Y.

Send me National Power Glider, monthly for 1 year; and the Curtiss-Falcon complete Kit, Golden Wings and A. B. A. Membership Card, without extra charge. I will pay postman \$1.50 and postage charges. My satisfaction guaranteed.

Name.....

Address.....

City..... State..... 18

(Postage free if you prefer to send the \$1.50 with this coupon.)

# Learn AVIATION WHERE LINDBERGH STARTED!

Men, opportunities in aviation are unlimited. Airports, factories and transportation companies must have well trained pilots and mechanics! Leading air-transport companies pay an average of \$550 per month for pilots. Government licensed mechanics are in good demand. But first, you must be properly trained.

**This School is Government Approved.** We train you for licensed mechanic or pilot. \$250,000 worth of buildings and equipment. \$100,000 airport. Connected with large aircraft factory. Learn right here where Lindbergh learned. Reasonable Tuition. Part Time Employment Offered. Write for details today, (stating your age).

**LINCOLN AIRPLANE & FLYING SCHOOL**  
204 Aircraft Bldg. Lincoln, Nebr.

## FREE BOOK CATALOG

Send today, without obligation, for our new 72 page catalog, describing books on more than one hundred and fifty practical and scientific subjects, including books on Aviation, Automobiles, Air Brakes, Alloys, Electricity, Horology, Heating, Hydraulics, Model Making, Metallurgy, Radio, Ship Models, Soaps, Perfumes, Recipes, Plumbing, Inventions, Tanning, Television, etc. Norman V. Henley Publishing Co., Dept. 412, 2 W. 45th St., New York, N.Y.

## Learn to PAINT SIGNS and SHOW CARDS

We quickly teach you by mail, or at school, in spare time. Enormous demand. Big future. Interesting work. Oldest and foremost school. **EARN \$50 TO \$200 WEEKLY**  
Otto Wiegand, Md., home-study graduate, made \$12,000 from his business in one year. John Vasco, N.Y., gets \$30 for a show card. Crawford, B. C., writes: "Earned \$200 while taking course." Write for complete information.



**DETROIT SCHOOL OF LETTERING**  
154 Stimson Ave. Est. 1899 Detroit, Mich.



# DRAFTING

BOOKS SENT FREE ON APPROVAL NEW 1930 EDITION

### For Beginners

Written, so you can understand every word, by 22 famous engineers and architects. DeLuxe flexible binding, nearly 2,000 pages, 1546 blue-prints, charts and diagrams; prepares you for a good drafting job in mechanical or architectural lines. Sent for 10 days' free use if you mail coupon immediately.

Only 15 minutes a day with these WONDER BOOKS will prepare you for a good drafting job in less than a year. Mechanical and architectural drafting from simple straight lines to important complex plans. *A step at a time!* Built especially for beginners, for men with only grammar schooling. Drafting room practice, PLUS ENGINEERING, made easy and clear. Includes complete course in blue-print reading (Building).

### Big Field Big Demand Big Pay

Competent draftsmen are urgently needed right now in all building and manufacturing lines at \$50.00 to \$100.00 a week. That's just the beginning—FOR DRAFTSMEN HAVE THE BEST CHANCES FOR ADVANCEMENT. Pleasant, fascinating work, easy to learn and do. Learn quickly with these books—send coupon for a set FREE and see for yourself.

A year's consulting membership in the American Technical Society now given free to all readers of this famous encyclopedia of drafting. Many say that it is worth more than the cost of the books.

## SEND NO MONEY

Don't send a cent on this great offer. Your name and address, with that of your employer or other reference, will bring these books to you absolutely free for examination. Test them, read them, find out anything you want to know and then if you are not more than pleased send them back and you will not owe us one cent. If you decide to keep them, then pay only \$3.00 a month until the special introductory price of only \$19.80 is paid.

**AMERICAN TECHNICAL SOCIETY**  
Dept. D-919, Drexel at 58th St., Chicago, Ill.

**American Technical Society, Dept. D-919**  
Drexel at 58th St., Chicago, Ill.

Send for 10 days' free use New 5 volume set of drafting. I will pay the few cents delivery charges. If I wish, I may return books in 10 days and owe you nothing but if I decide to keep them I will send \$2.00 after 10 days, then only \$3.00 a month until \$19.80, the special introductory price, is paid. Send 1930 edition.

Name.....

Address.....

Employer or Reference.....

Address.....



# Deaf-Dumb-Blind

## Yet "He" STOPS Auto Thieves

What in the world IS this uncanny new discovery that so instantly terrifies auto thieves? Thieves fear it worse than poison. Its terrible power literally "petrifies" them. They cannot even remove a thing. Now your car can be absolutely safe, anywhere you leave it. Don't confuse this queer new invention with anything you ever saw. It is not a bell. Not a lock. Not an explosion. Not an electrical shocker. Not a poison gas. Yet the deadly fear it puts into thieves throws them into a panic. It works automatically the instant anyone even touches your car. Cannot injure innocent persons. Recommended by police and insurance companies. No bigger than your hand. Costs only one penny a year to operate. Almost never wears out. The cheapest, surest theft insurance you can buy. And that's not all. Excites and amuses everybody. Have lots of fun with your friends.



## Mysterious New Invention Offers Agents Up To \$40 a Day

So startling, so absolutely new, so peculiar is this strange discovery that agents who have already taken it on are smashing daily profit records. The greatest crowd gatherer you ever saw. The minute you demonstrate this clever invention people are bewildered. They want to know how it "stiffens," "hypnotizes," "shell shocks" thieves. The need for this scientific protection is so great—the big profit possibilities are so almost unlimited and easy—that now we will actually pay you just to demonstrate this amazing thief chaser. You don't need to sell a single one to make this money. Just stand on the street by your car and make it perform its magic wonders that set your audience agog and bring quick profits. No use wasting your time any longer with "piker" propositions. \$40, \$50, \$75 a day is not too much to expect, is it? If we did not feel sure that you could make as much money as other men with this uncanny new discovery we certainly would not be willing to offer you pay just for demonstrating it. The protection it gives—its utter queerness—its strange power to put fear into thieves—and the fun it gives motorists make it the easiest, fastest selling, biggest money-making opportunity for you in many years.

## We Pay You Just To Show It To Motorists

The market is so tremendous—orders are pouring in so fast—that we can afford to do almost unheard of things for our local distributors. Not only will we pay you just for testing it, but we will actually send you a Free Sample offer for your own car so that your car and accessories will be protected and to start you demonstrating it. Yet that's not all. We actually offer to pay you cash for merely testing it on your car. Now we have territories for 1,600 more county distributors and 100 district managers on this generous pay plan. With our nation-wide advertising plans ready to start at once, distributors should be literally flooded with orders. We have worked out a new plan so that you don't have to do any selling or demonstrating to car owners to make big money.

### Mail Coupon for FREE SAMPLE OFFER

Rush the coupon for your Free Sample offer—offer to pay for demonstrating and plan that gets you big money without doing any selling or demonstrating to car owners. Send no money. Just coupon. This is not an order. Nothing will be sent C. O. D. This Sample Offer is yours free of all cost. Just mail coupon now.

Allied Industries, Inc.,  
5299 Garver Bldg., Des Moines, Iowa.

I accept your generous Free Sample offer of your amazing new thief "hypnotizer" with understanding that this offer costs me nothing now or ever. Nothing will be sent C. O. D. and I am not obliged in any way to buy anything or to become your distributor. You also offer to actually pay me for just testing it on my own car. Please send details of your offer of Pay for Demonstrating it, and also your plan that offers me big money even without demonstrating or selling to car owners. If I become your local distributor you agree to give me exclusive territory.

Name.....  
Address.....  
City..... State.....

1624

Padlock

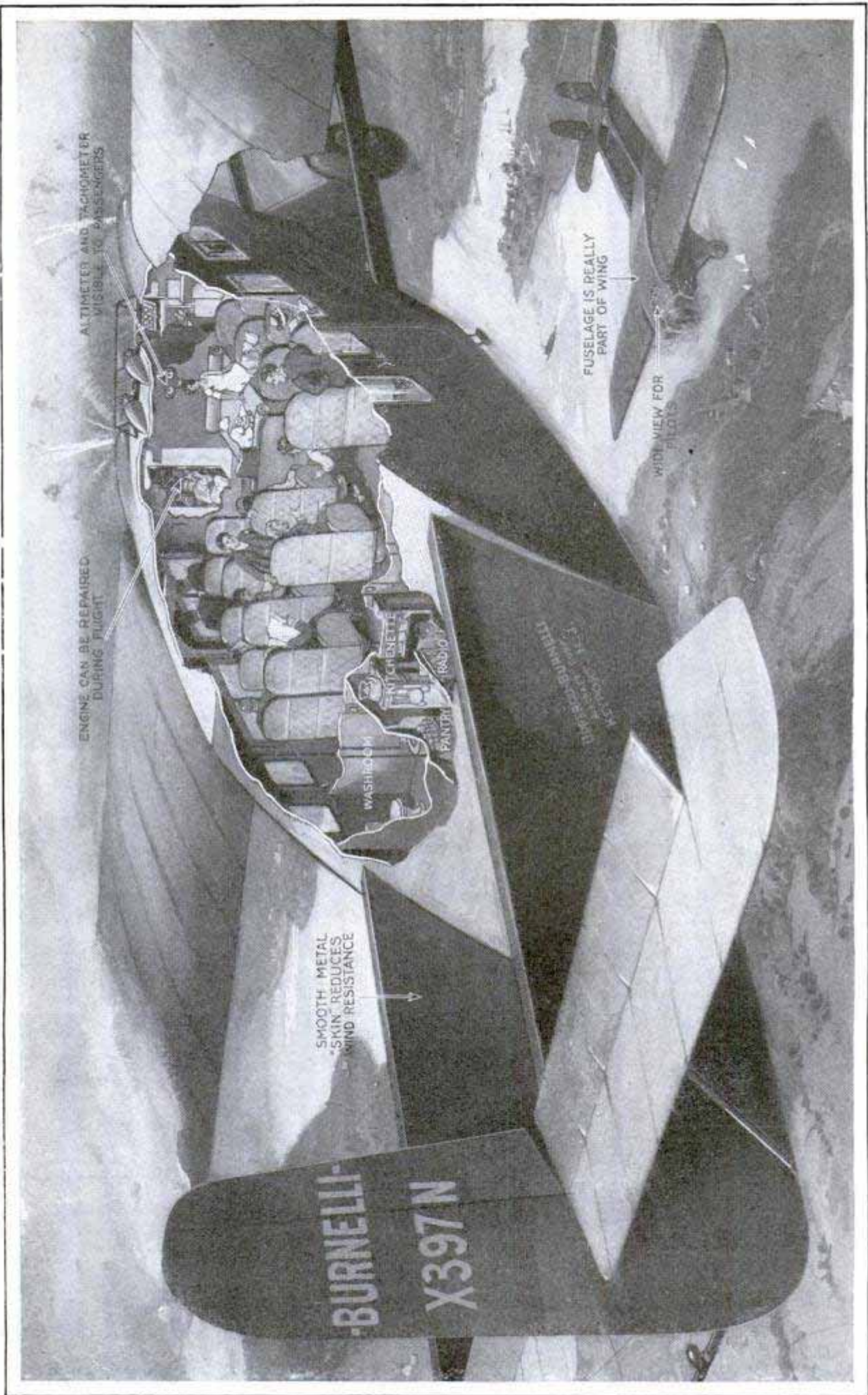

Artist's Drawing of Upperco-Burnelli Transport Plane, Powered with Two Motors; It Can Cruise with Full Load at 100 Miles an Hour on One Engine; This Ship Is a Close Approach to the So-Called "Flying Wing"

# Popular Mechanics Magazine

REGISTERED IN U. S. PATENT OFFICE

WRITTEN SO YOU CAN UNDERSTAND IT

Vol. 54

DECEMBER, 1930

No. 6

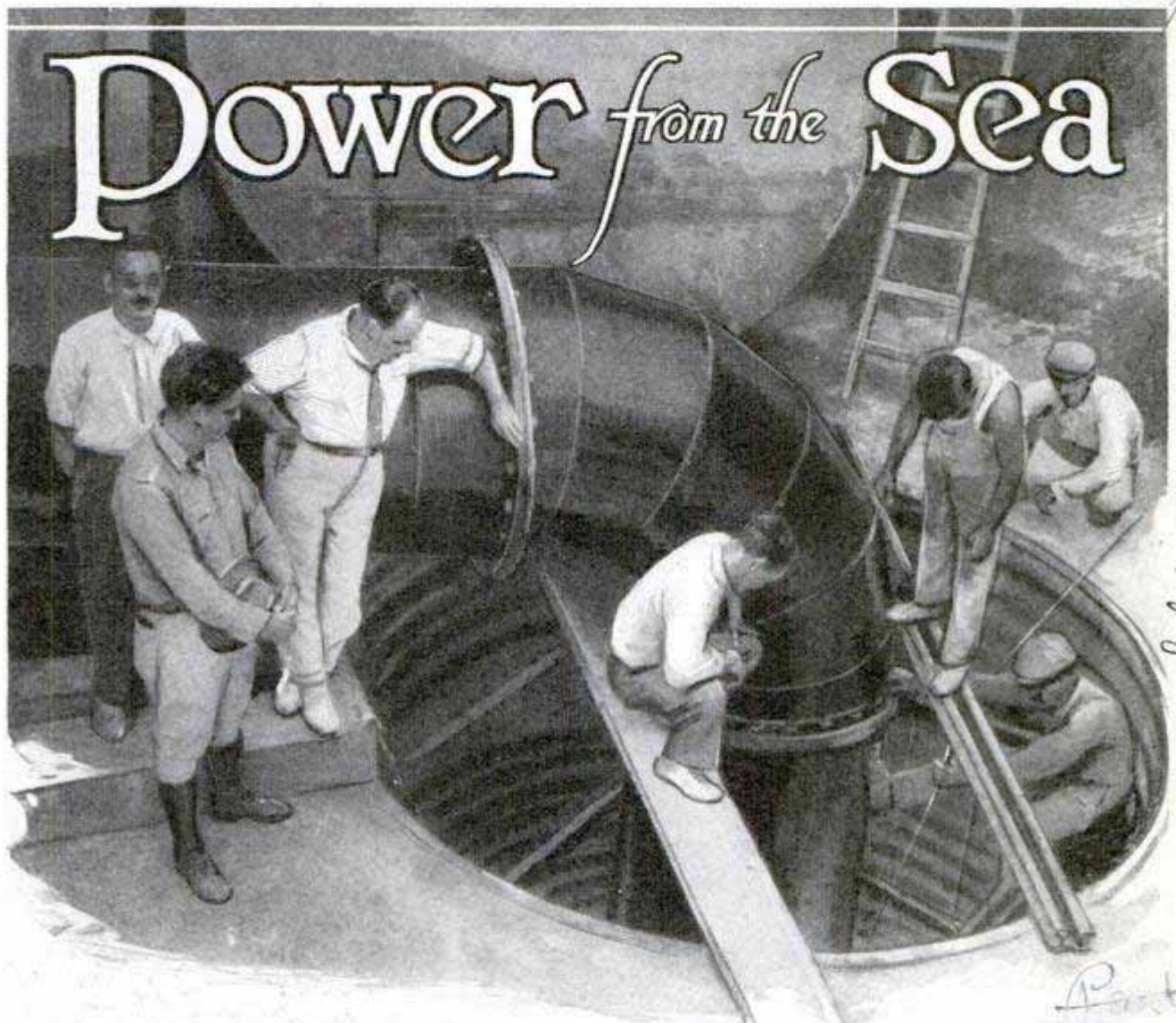

1624  
see Sept. 1930. 448  
Sept. 1932. 401

Members of Professor Claude's Staff Examining Well into Which Great Sea Tube Leads; the Joint Shown Here Connects the Tube with the Pumps Which Force Water through the Steam-Generating System

**G**EORGES CLAUDE dips his hand into the Gulf Stream. The water is warm. At sea level water boils at 212 degrees. But on a mountain the boiling point may be 180 degrees. The result in both cases is steam—power—motion.

From these simple steps, Professor Claude, after five years of effort, has succeeded in harnessing the energy in tropical water, and producing enough of it to light forty 500-watt bulbs and keep them burning.

From his laboratory on the sea's edge at Matanzas, Cuba on October 1, he reported that his turbine had generated more than twenty horsepower. The fol-

lowing day his enthusiasm found expression in a cablegram to Popular Mechanics Magazine, saying:

"Yesterday we ran for the first time a plant seeking at the sea bottom a particle of its boundless thermic energy. Our expectations are justified. The modest twenty kilowatts generated until now, under adverse conditions, are a prelude to powerful installations already projected, and an assurance that human industry will not perish some day for lack of mechanical energy to animate it."

It is common knowledge that temperature varies greatly as one descends in the sea. At Matanzas bay, Claude found that

Cont. Elvin Klassman, 881  
55 W. 86th St. New York

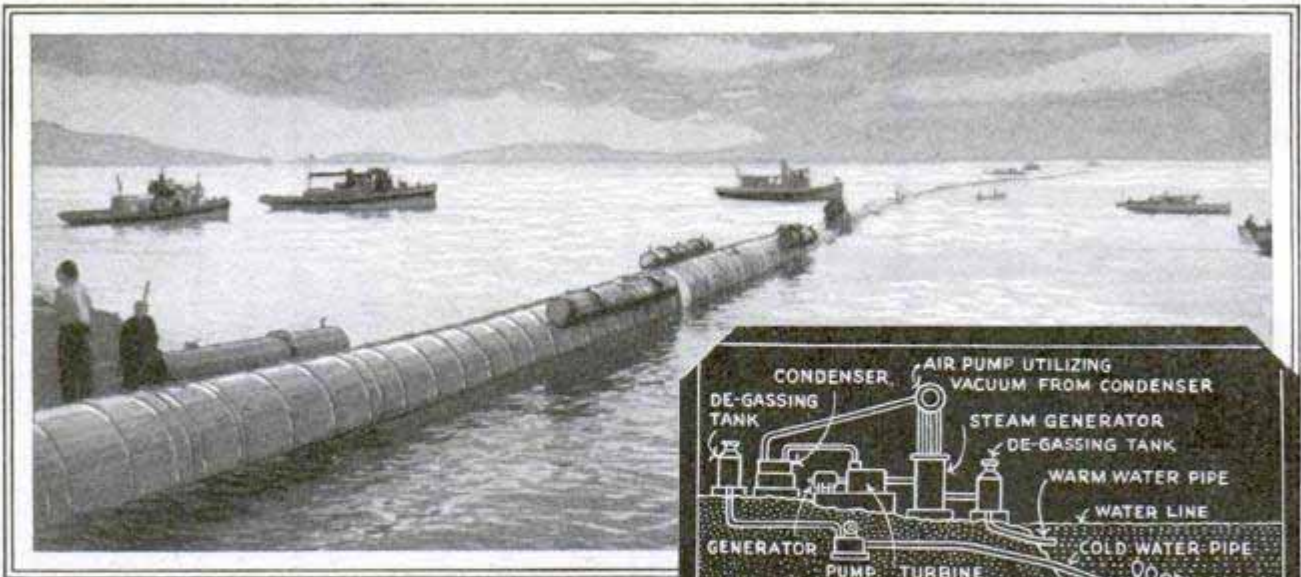

Floating a Mile of Pipe into the Sea, and Diagram Showing How Plant Works

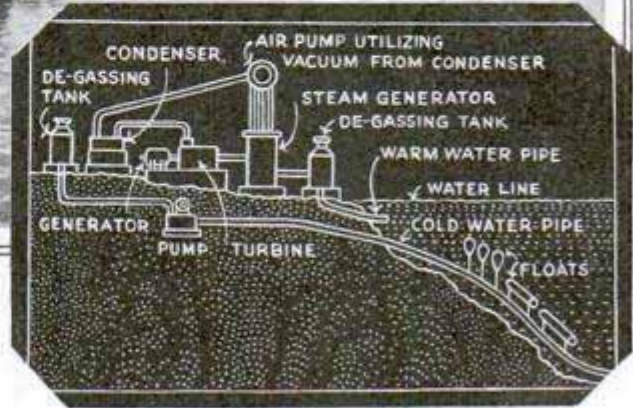

the surface water varies between seventy-nine and eighty-six degrees Fahrenheit, while at 2,000 and more feet below, the temperature is constant at forty degrees.

In a steam engine, burning fuel converts water into hot vapor. But Claude utilizes another principle, namely, that warm water vaporizes in a vacuum. If air pressure is reduced sufficiently, water will boil even at room temperature.

Having found a way to generate steam, he can run a turbine, but in order to keep a constant vacuum, he must find a way to condense the steam and reduce its volume. Everybody knows what happens when one holds a cold glass over a steaming tea kettle. Drops of water condense on the surface. That was Claude's cue. If he mixed steam with cold water, condensation would follow. And that is why he introduces cold water into his process.

This is the way it works: Surface water and water from a depth of 2,000 feet are brought to the shore plant. A pump forces surface water into a low-pressure boiler where it boils at seventy-eight degrees. The steam generated turns a turbine. The exhaust goes to a chamber where the water from 2,000 feet condenses it and perpetuates a vacuum. The vacuum allows water to boil at seventy-eight degrees, and so the process is continuous.

The Matanzas plant, Claude says, is merely a beginning to what might be done with the energy now going to waste. He speaks of a continental refrigerating system to make power plants on the North African shore to cool the Sahara desert, irrigate its vast reaches and make it habitable. He would also industrialize France's tropical empire with a chain of sea-power stations. He predicts that tropical peoples will adjust temperature to their own likings. Public utilities may sell ice at one-twentieth the present cost.

These dreams exercise Claude's mind.

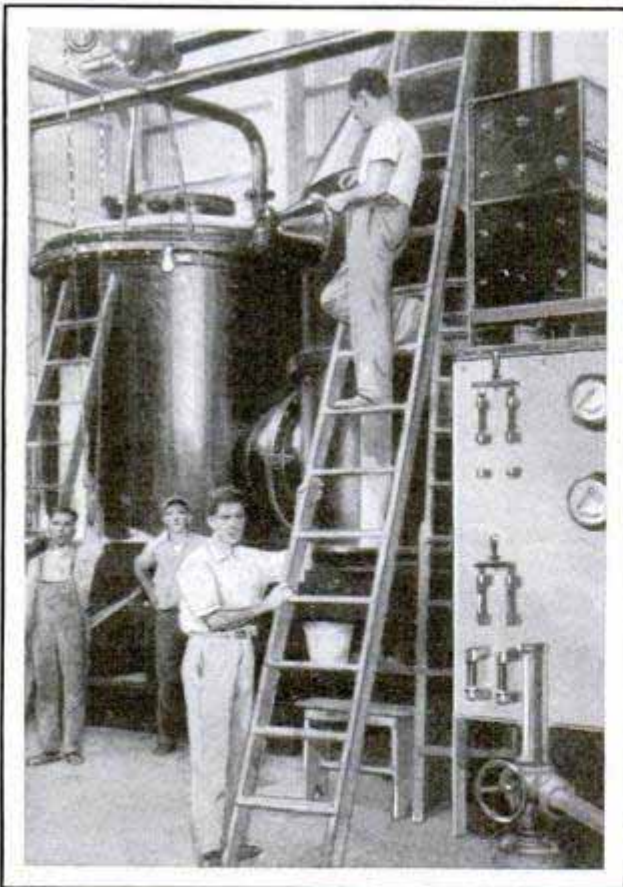

Hot-Water Purifier and Boiler in Which Steam Is Generated; Switchboard Controls Motors and Pumps

Each dream is the birth of an invention. Are they fantastic? Not more so than Claude's neon lights fifteen years ago. Four hundred million dollars have already been invested in his ideas. He invented a method of manufacturing liquid air. He captured two rare gases from the atmosphere, krypton and xenon; the latter has sold for \$13,650 a quart. The Muscle Shoals dam is built around his nitrogen-fixation process. He took acetylene gas out of the laboratory and made it a commodity. He devised a process for manufacturing synthetic ammonia. The transatlantic telephone and telephoto process make use of his neon tubes. During the war, he mixed liquid oxygen and lamp-black and produced a most deadly explosive. He taught the allies how to load liquid chlorine into shells. In aeronautics, he invented an instrument for locating enemy batteries through sound waves.

**MATCHLESS LIGHTER FOR GAS IS AID TO DENTISTS 1683**

Automatic lighters to ignite the gas jet in the dentist's office now is being offered to replace the old-style alcohol lamp. It consists of a small metal tube with a finger grip attached. Inside the tube is a spring bearing against a flint. This in turn presses on a striker wheel which, when revolved,

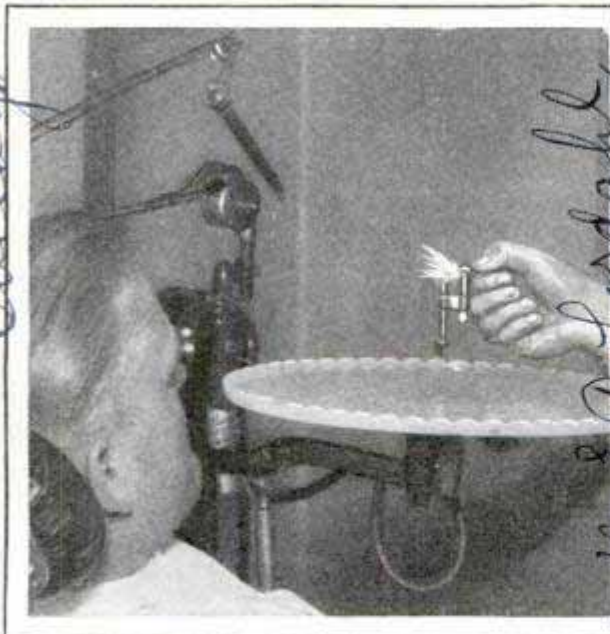

Automatic Lighter Containing Flint and Striker Wheel to Ignite Gas Jet in Dentist's Office

throws a series of sparks into the escaping gas, igniting it.

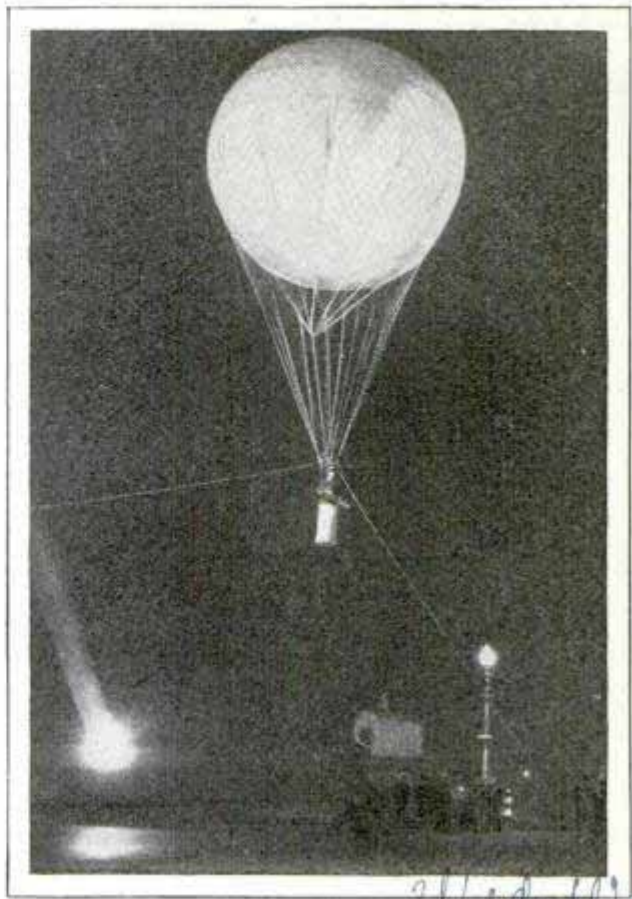

Los Angeles Traffic Officer Directing Auto Travel from Captive Balloon above a Boulevard

**COP DANGLING FROM BALLOON DIRECTS AUTO TRAFFIC**

Los Angeles motorists were startled recently when an aerial-traffic officer, dangling from a captive balloon fifty feet above the street, began directing traffic on one of the busiest boulevards. The lofty perch for the officer was tried as an experiment in order to afford better visibility and thus allow him to keep traffic moving at a faster clip by anticipating the requirements of the approaching lines of cars.

**EXTRA-THIN RUBBER GLOVES HELP SURGEON OPERATE 1703**

Surgeons' rubber gloves, so thin that they do not lessen the sensitiveness of the fingers, and yet so strong that they withstand the severe usage to which they are put, are being manufactured by a recently developed process. The material is prepared, by a method somewhat akin to the process of electroplating of metals, directly from the rubber latex. The thin rubber is said to have unusual age-resisting properties and to be unaffected even by repeated sterilizations.

*Cmd. K. J. Kerch, 6916 Lakewood Ave Chicago*

*Dr. A. Lordahl, 214 S. Grand St. Chicago*

*Wideworld*

*A. Smith*

*App. Dr. A. Lordahl, Dentist*

*Muller Rubber Co Akron, Ohio*

1638

2672, Los Angeles, Calif

LIVE TREES ON THEATER STAGE SERVE AS SCENERY

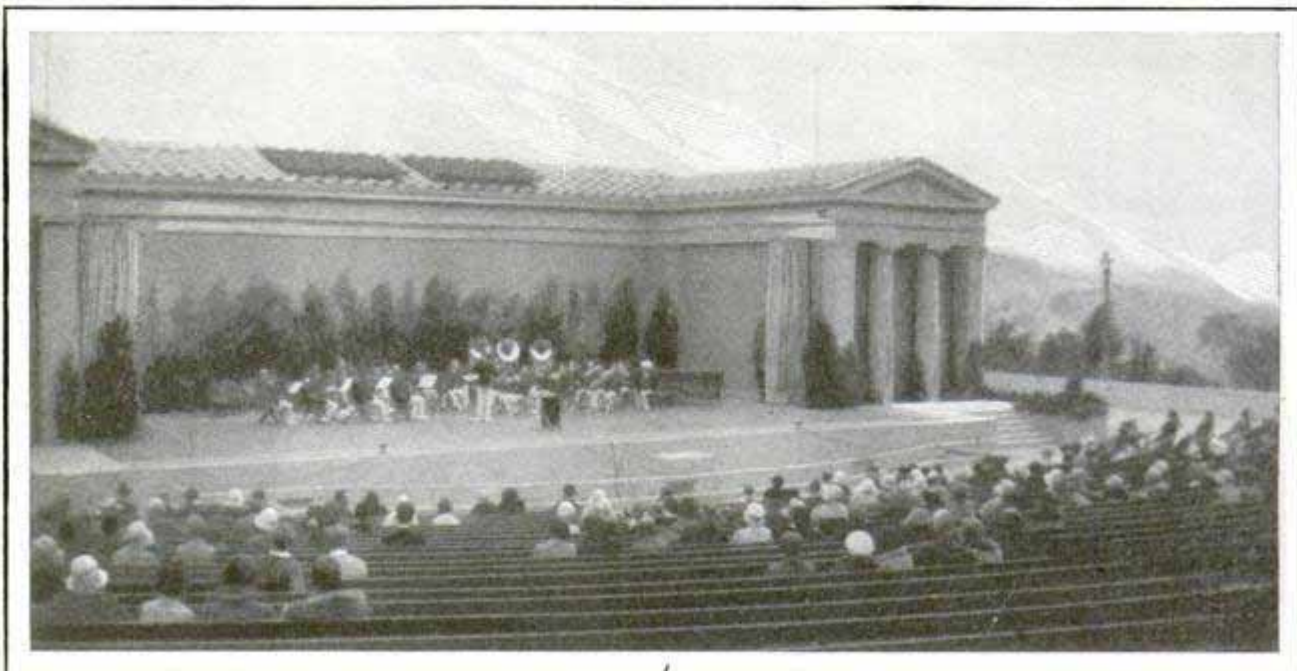

Living Trees Used as Stage Decorations in the Greek Theater at Los Angeles; Palms and Other Varieties Are Planted in Boxes so They May Be Shifted About for Scenic Effects

Living trees replace the usual painted ones on the stage of the recently opened Greek theater in Los Angeles. Palms, pepper trees and other varieties are planted in boxes so that they may be moved about for different scenic effects.

MAGNET TEST ON WELDINGS REVEALS DEFECTS

Parts that have been electrically welded can now be tested without knocking them apart or destroying costly pieces of metal by means of a magnetic apparatus introduced by the Westinghouse research laboratories. The outfit is portable and re-

quires comparatively little skill to operate. On butt welds, for instance, the seam is bridged by a large horseshoe magnet, and the magnetic field explored with a meter. By passing the meter over the weld and watching a pointer, the quality of the weld may readily be determined. The gauge compares the magnetizing forces across the weld with those of the steel plate. If the two are about the same, the weld is good, if not, the weld is inferior, and the meter will tell just how bad it is. The method has advantages over previous testing processes in that it operates regardless of the depth of the fault.



Magnetic Apparatus and Gauge Being Used to Test Efficiency of an Electric Welding Job

AIR VALVE FOR LOUD SPEAKER IMPROVES TONE QUALITY

Compressed air is being used in one large loud-speaker unit employed principally for auditoriums and outdoor broadcasting to increase volume and improve tone quality. An air valve, connected to a small compressor, is placed close to the vibrating reed of the speaker unit, and from it extends the horn that finally emits the sound. As the amplified signal from the radio set or phonograph causes the reed to vibrate, the sensitive air valve is opened and closed in accordance with the frequency of the sound produced. Each time the valve is opened, a minute jet

S. P. Watt

Carl Pittsburgh

Hoovenare Corp, 122.5th Ave, 169

Hoovenare Corp 122.5th Ave

of air escapes, the sequence of these jets forming, for instance, a musical note of considerable volume.

**ELECTRIC NOSE DETECTS GAS AND GIVES WARNING**

Smelling by electricity is accomplished, in effect, by an apparatus which explores gas-filled chambers and indicates its findings in terms of nearness to explosibility. The electric "nose" bears no resemblance to any ordinary proboscis, but consists of a long exploring tube to be inserted in the suspected place. This tube sucks vapors, by means of an aspirator bulb, into a case containing an air-tight chamber with heated platinum wires. The changing resistance of the wires as various gases pass over them causes a tiny indicating needle to register on a dial. The nose can be poked into the holds of vessels, and into tanks, sewers and conduits suspected of containing dangerous gases. The instrument is also useful in testing for leaks in pipelines carrying crude oil or natural gas.

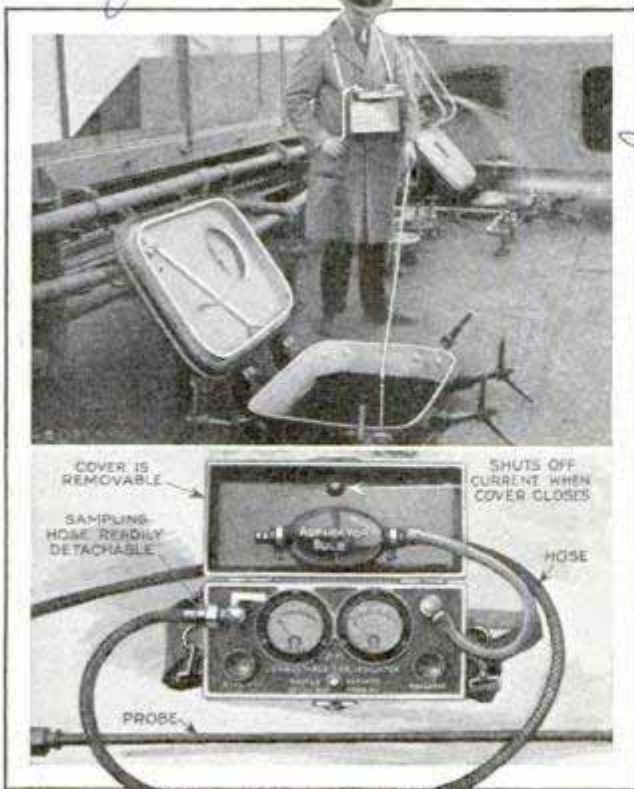

Electric "Nose" Which Sucks Vapors into an Artificial "Lung" That Indicates Explosibility



Corrugated-Iron Base for Brick Highway; Sheets of Iron Have Been Found Both Durable and Economical

**BRICK ROAD ON A METAL BASE MAKES LASTING HIGHWAY**

Traffic of the future may move over iron highways if continued tests with metal road bases are as successful as early experiments near Springfield, Ill. Here an iron base for a brick road has been found to be economical and virtually indestructible. First the road is carefully rolled, then sheets of rust-resisting corrugated iron are spread and on top of the base a sand cushion. After the bricks are laid, an asphalt filler is poured between the interstices. The base, aside from its durability, offers sufficient flexibility to meet all changes in temperature without breaks or cracks. When the sheets are laid parallel, the edges are turned down to grip the road, and at the curb turned up.

**SHORT NAMES FOR TOWNS**

At least two towns in the United States are easy to remember, and postal clerks, especially, appreciate their two-letter simplicity. They are Ai in Georgia and Uz in Kentucky. West Virginia seems to lead in the number of towns with short names, many with but three letters being found. Among these are Van, Gip, Ona, Hur, Oka, Ira, Pax, Sun, Due, Hoy, Rio, Fry, Tad, Mud, Sod, Man and Dan. Postoffice names include such queer ones as Ink, Igo, Gas, Fob, Cid, Duo, Aid, And and Ojo.

*1659*  
*Wheeler, Metropolitan*  
*Bank Bldg. Washington*  
*see*  
*Antenn & Rotary Highways*  
*Magazine of Middle West*  
*Ohio*  
*Supervised by Truman & Flath*  
*County Dept. of Highway*  
*me Langman County*  
*American*  
*Rolling Mill Co.*  
*and others*

*Johnson Williams,*  
*118 Esmond St*

*Carl Slough Lloyd*  
*Patent Office*

1613  
886

54, Oldbalsdale Road,  
POPULAR MECHANICS  
Streatham, London S.W. 16 Eng

Morris apparatus

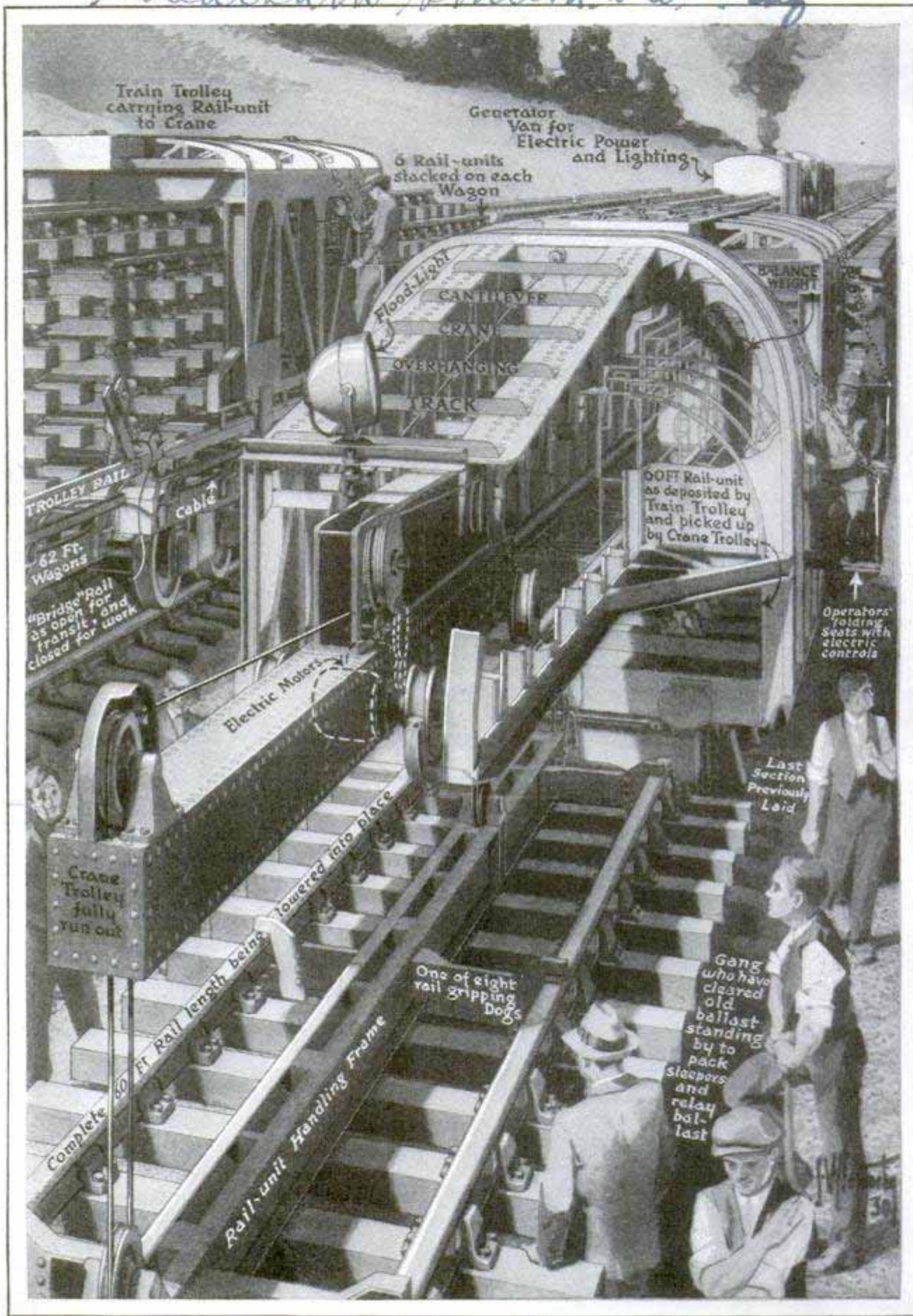

© Popular Mechanics Magazine  
How Railroad Tracks Are Laid in England; the Machine Handles Whole Sections at One Time at the Rate of Not Less Than 200 Yards an Hour; an Electric Crane Is the Chief Power Unit



and New Orleans

1653

by Mississippi

Dr. C. E. W. Edgren, M.D., University of Pennsylvania, Philadelphia  
Dr. George H. Eckhardt, M.D., University of Pennsylvania, Philadelphia

**STUDY OF DISEASE AIDED BY MOVIES OF HEARTBEATS**

By means of apparatus developed at the University of Pennsylvania, photographs of human heartbeats are now being made so that more accurate studies of the organ may be conducted in the treatment and diagnosis of various disorders. This has been possible because contraction and expansion of the heart muscles are attended by definite electrical disturbances in the body. These actions precede each beat of the heart by a small fraction of a second and can be measured and recorded. At the same time, by means of X-ray apparatus, the outer edge of the heart is photographed on moving film. The register of the beats and the X-ray film are then superimposed and photographed together, giving a graph of the actual movements of the organ. The galvanometer, which registers the electrical disturbances caused by the beating of the heart, is not affected by the X-ray outfit using high voltage.

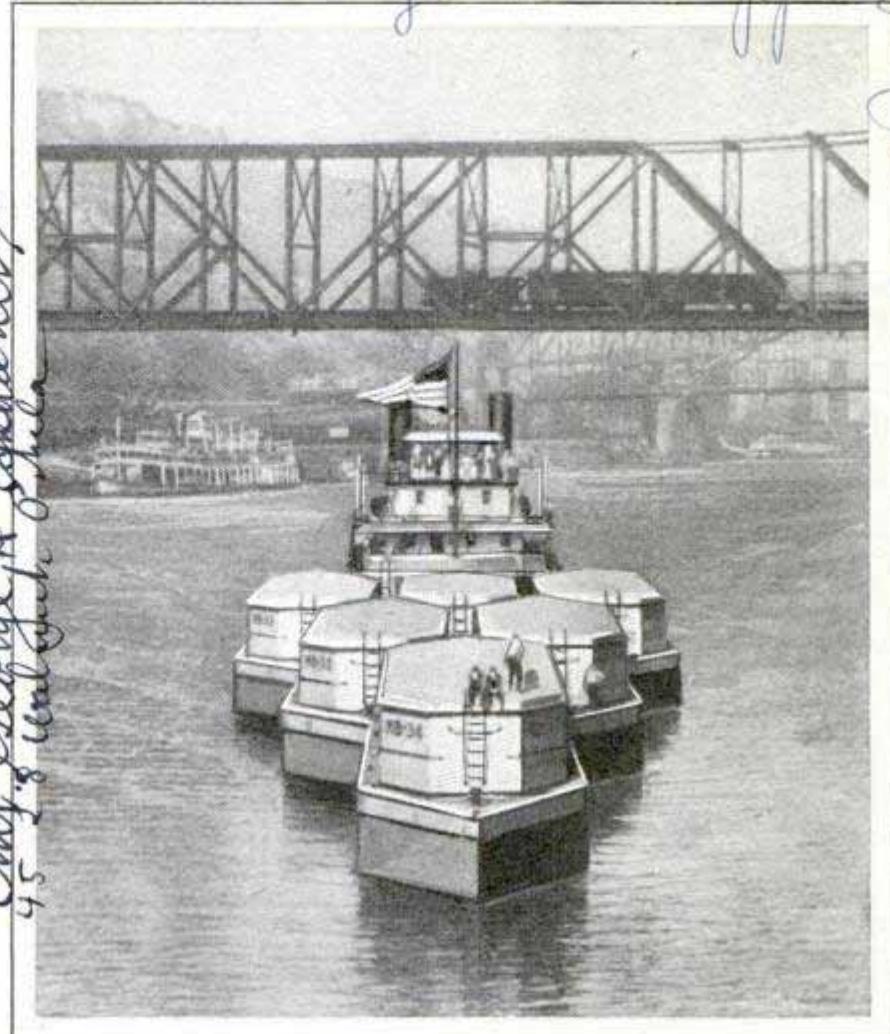

River Barges with Pointed Bows and Sterns Which Make It Possible to Tow Them in Clusters in Wedge-Shaped Formation

Dr. C. E. W. Edgren, M.D., University of Pennsylvania, Philadelphia

**BARGES WITH POINTED BOWS OPERATE IN CLUSTERS**

Barges with pointed bows and sterns are being operated on the Ohio and Mississippi rivers, these boats replacing the ordinary barge with its "duckbill" bow. The sharply pointed ends make it possible to tow the barges in clusters by arranging them in a wedge-shaped formation which decreases water resistance and allows them to move in a compact unit.

**WINDOWS IN EARS OF RABBITS SHOW GROWTH OF CELLS** 1666

Through glass "windows" introduced in the ears of rabbits, scientists now are able for the first time to study over an extended period the microscopic details of the growth of living tissue in a warm-blooded animal. It is hoped that the method, developed at the University of Pennsylvania school of medicine, will yield information regarding the manner in which abnormal cellular reactions occur in infectious diseases, including tuberculosis, tumors and cancerous growths. A transparent, double-walled chamber, or window, is introduced into a small hole in the ear of the rabbit.

**LAMP SHINES INSIDE THE BODY TO TREAT DISEASE** 1692

Ultraviolet-ray treatments for the interior of the body as well as the exterior are now possible with the aid of a lamp which a German physician has introduced. With it is combined an optical system whereby the attendant can observe the effects of the instrument upon the internal organs.

Chicago Tribune  
10/8/30

Dr. Westmann  
Berlin.

Illustration Tech. 10/11/30

16 49  
888

Pageant at  
Cotborough Androme

Built by C. B. Repp  
Plainfield N.J.

POPULAR MECHANICS



Bombing Plane Swooping Down in an Attack on a Land-Going "Dreadnaught" Mounted on a Truck during a Recent British Air Show

WARSHIP MOUNTED ON TRUCK  
TARGET FOR PLANES

As a target for bombing planes during a recent British air pageant, a "dreadnaught" was mounted on a truck and driven across a field while the air raiders attempted to score hits by dropping "duds" from overhead. The land-going warship was not as large as a regulation battleship, and its maneuverability on the field also made it a difficult target.

ELECTRIC NUTCRACKER SAVES  
OIL-BEARING KERNELS

Palm nuts, which grow in profusion in tropical countries, and are extremely rich in oil, have been made available for a wide variety of uses by the invention of an electric nutcracker, weighing two tons, which is necessary to remove the almost impenetrable shells. In the jungles, the natives have long used the nuts, after

hours of laborious work in cracking them, for food and drink, for the oil which furnished them with artificial light, and for brilliant-hued paints as well as for medicinal purposes. After several years of experiment, a motor-driven machine was built which will crack the nuts without crushing the kernels, and will separate the kernels from the husks and shells. The nuts are dumped into a large hopper of the six-foot machine and are fed through tubes to heavy plungers exerting a pressure up to 16,000 pounds a square inch. The cracked nuts pass to a sievelike table which agitates them to separate the kernels. Similar machines, operated by hand, water or horse power, also are built. The cohune nut, a variety of the palm nut, contains sixty to seventy per cent by weight of

high-grade vegetable oil which is used in the manufacture of soap, candies, butter substitutes, paints, salad oils, and for general cooking purposes. The residue is used for cattle food, and the nutcracker handles about 100 tons a day.

SMALL X-RAY TUBE OPERATES  
AT HIGH VOLTAGE

Less than two inches in diameter and only four inches long, the smallest commercial X-ray tube in use has been made in the General Electric research laboratories. Despite its diminutive size, the tiny tube operates at 56,000 volts.



Dr. W. L. Coolidge  
Schenectady, N.Y.

Licensee - Palm Oil Co  
Broadway New York

Wed World

1622 D. Adams

# A \$25,000,000 Mile

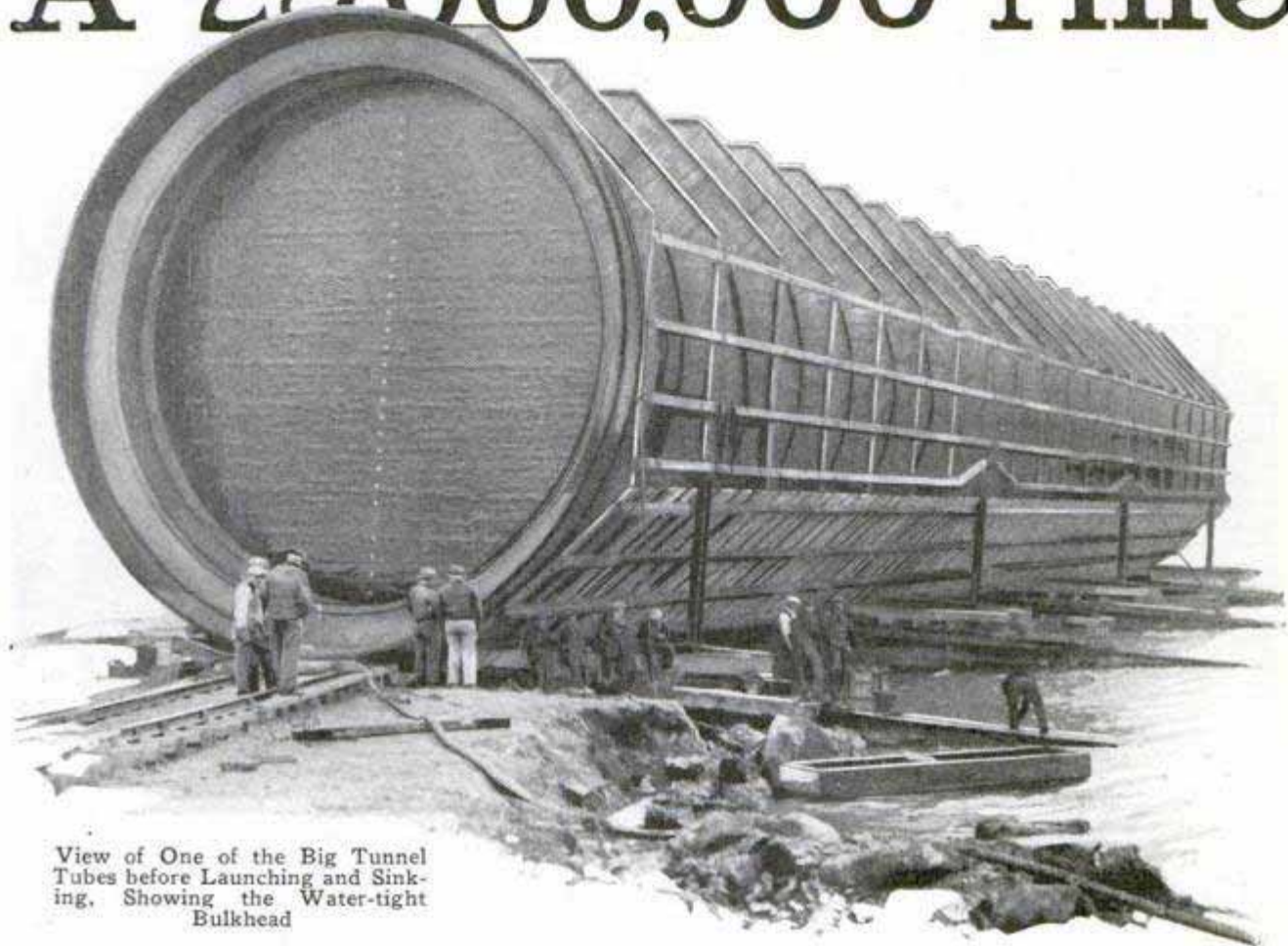

View of One of the Big Tunnel Tubes before Launching and Sinking, Showing the Water-tight Bulkhead

**A**UTOS now are whizzing between the United States and Canada through the first international vehicle tunnel ever constructed. A mile long, breeze-swept by gigantic fans, gleaming like a rifle barrel and as clean as a tiled kitchen, this latest engineering triumph that connects Detroit with Windsor, Ont., links the nations together.

Every foot of the \$25,000,000 submarine mile reflects the romance and daring of engineering. Tons of steel and concrete tubes were floated like corks and sunk in a ditch at the bottom of the river. A 250-ton shield, the largest ever constructed in this country, was pushed through yards of clay to score a perfect bull's-eye with an invisible mark deep under the Detroit river. Massive sections of the tunnel, nearly as long as a city block and weighing thousands of tons, were submerged and linked together as accurately as boiler pipes. A hole under the river, but much of it was constructed on dry land, then launched and sunk at the busiest shipping scene in all the world. In season, three

boats pass each moment, 27,000 a year, at this point on the Detroit river, more than ply the Welland, Suez and Panama canals combined, but the work, requiring nearly three years, was finished without a single interruption to regular traffic.

Like one of nature's own caverns, this man-made cave has been built for the ages. Steel in the tunnel, engineers predict, will possibly rust away within three centuries, but the concrete shell will grow harder for 1,000 years until it becomes an everlasting monolith. Reflectors for the subway's nearly 600 lamps are of a special metal that will never grow dim and never need polishing. Illumination is so effective that drivers do not need to use their headlights. The twenty-two-foot roadway, which can accommodate 1,000 cars in either direction each hour, has been constructed of one of the most durable materials known—granite—2,000,000 blocks of it set in tar on concrete and designed to last for centuries.

Autoists, driving through the tunnel, see a beautifully lighted, curving passage

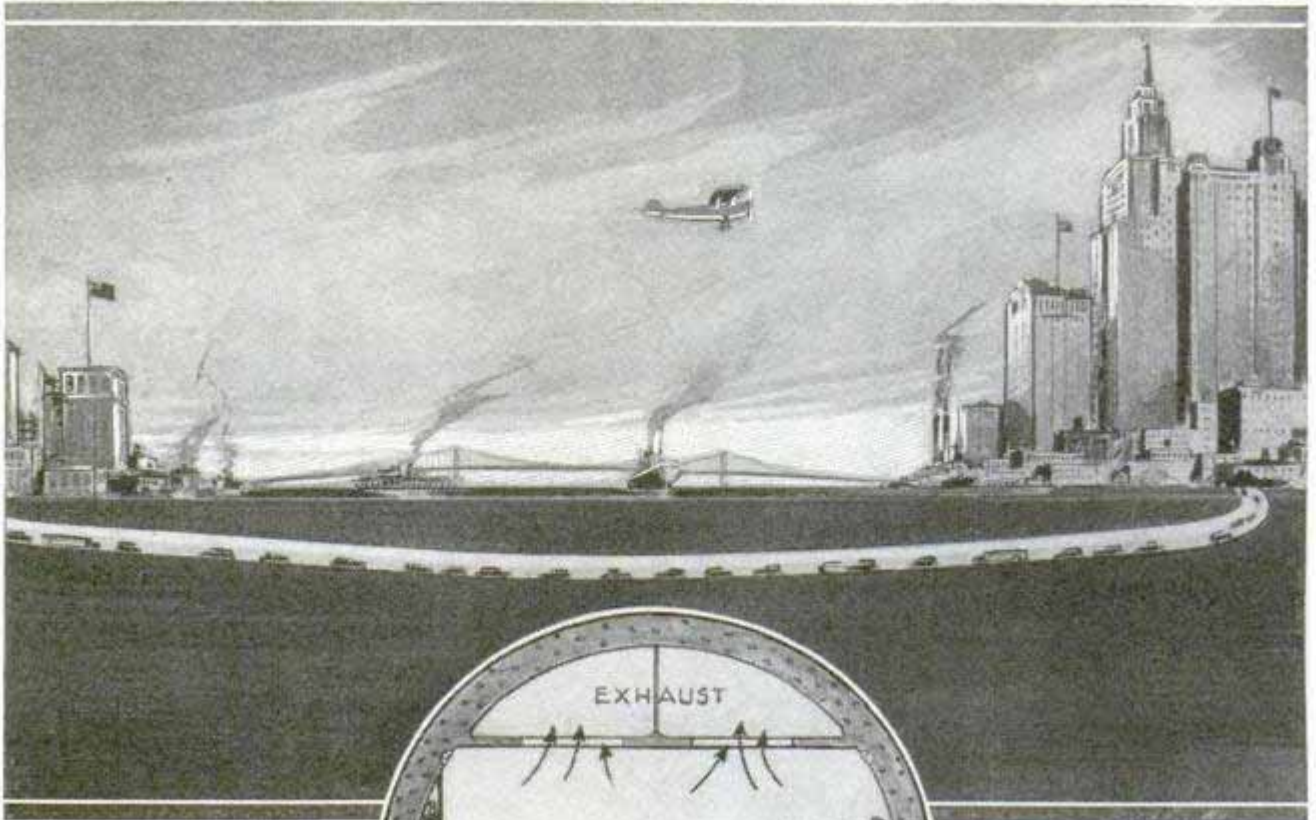

of uniform appearance with a bronze plate marking the boundary line between the United States and Canada. There is nothing to indicate that three entirely different methods of construction have been followed and that

parts of the subway were once floated down the river like big boats. The side walls, gleaming in the radiance of big lamps numerous enough to illuminate a city of hundreds of homes, tell a story also. They are lined with a special glazed metal, set in tilelike units, a material devised especially for this job. In part of the passage, there is another interesting feature. For the first time in a tunnel of large size, steel has been employed instead of iron or wood for the lining. This was done to effect a great saving in weight and expense.

As he speeds under the river, the motorist breathes air which is purer than that in the average city street during rush hours. It comes in through ducts at the bottom of the passage and is withdrawn through outlets at the top, the circulation being set up by the big fans, twelve in

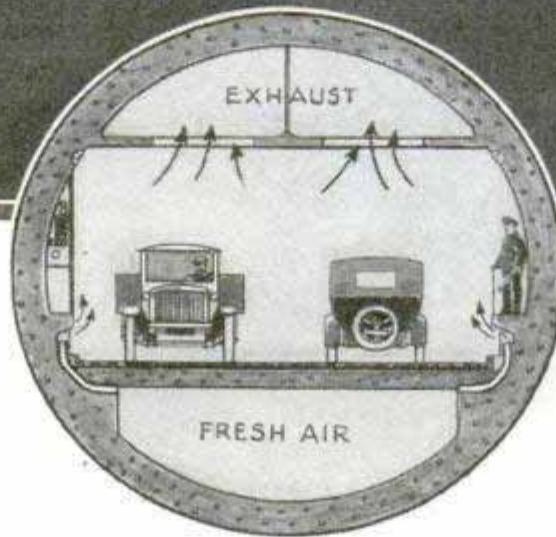

Artist's Sketch of Tube before Completion, and Sectional View to Illustrate Air Circulation

each of the two ventilating houses, one on the Canadian and one on the American side. Each house ventilates half of the tunnel. The fans, driven by motors of nearly 1,900 combined horsepower, effect over forty complete changes of the

air inside the passage every sixty minutes.

Attendants are stationed along the way to summon aid in case of breakdown or accident, and to be on the watch for fires. Motorists are forgetful and are likely to enter the tunnel without sufficient gasoline to complete the trip, short as it is, so arrangements have been made to rush tanks of gasoline to stalled cars.

One of the most interesting details of the tube is the way in which the freshness of the air is tested. This is a continuous operation and, should the percentage of carbon monoxide rise to the danger point, a warning bell rings automatically. A small quantity of the air exhausted from the tunnel is drawn off and passed through chemical apparatus which records the percentage of carbon monoxide on a moving chart. In case of an excessive amount, alarm is sounded at once.

Science Service 497.09/29/30

Research Lab  
Lloyd Garrison

Wm. Williams  
Nelech  
St. Louis, Mo  
891

**SKIN KILLS GERMS OF DISEASE**

That the skin is more than a mere protection against infectious disease and a covering for the body has been demonstrated by doctors of the Illinois state department of health. Tests have shown that the skin kills various disease germs. Broth cultures containing bacteria were applied to the skin of human subjects. Within a few moments, from ninety to ninety-five per cent of the bacteria were killed. Typhoid germs were among the most readily destroyed in this manner. The results were obtained, however, only on clean skin.

1619



Airplane with Folding Wings and Guarded Propeller to Travel on Ground or in the Air

**SUNKEN GARDENS TO ENHANCE BEAUTY OF WASHINGTON**

Planned more than thirty years ago by sculptors, artists and architects now dead, work has finally been started, after many delays, on the sunken gardens about the base of the Washington monument in the national capital. The beautiful shaft is to be further enhanced by elaborate landscaping, terracing and foliage surrounding the monument, thus providing an attractive setting when the memorial is approached from any direction.

1694

**WINGS ON FLYING AUTO FOLD BACK AGAINST BODY**

Designed to speed through the air at seventy-five miles an hour, or to bowl along a highway at a similar clip, a flying automobile that combines air and ground transportation has been made by a St. Louis inventor. The airplane-automobile is powered with a four-cylinder engine developing forty horsepower, and has wings so constructed that they can be folded back for ground travel. Thus it may be possible with it to take a trip by air, land at an airport, fold the wings, and drive home through crowded streets to store the machine in a garage. The propeller is incased in a protective screening for safety on the ground, and there is a steering wheel for ground travel and a control stick for air riding. The craft has three wheels attached like airplane landing gear.

Model of Design for Sunken Gardens Which Will Surround the Washington Monument

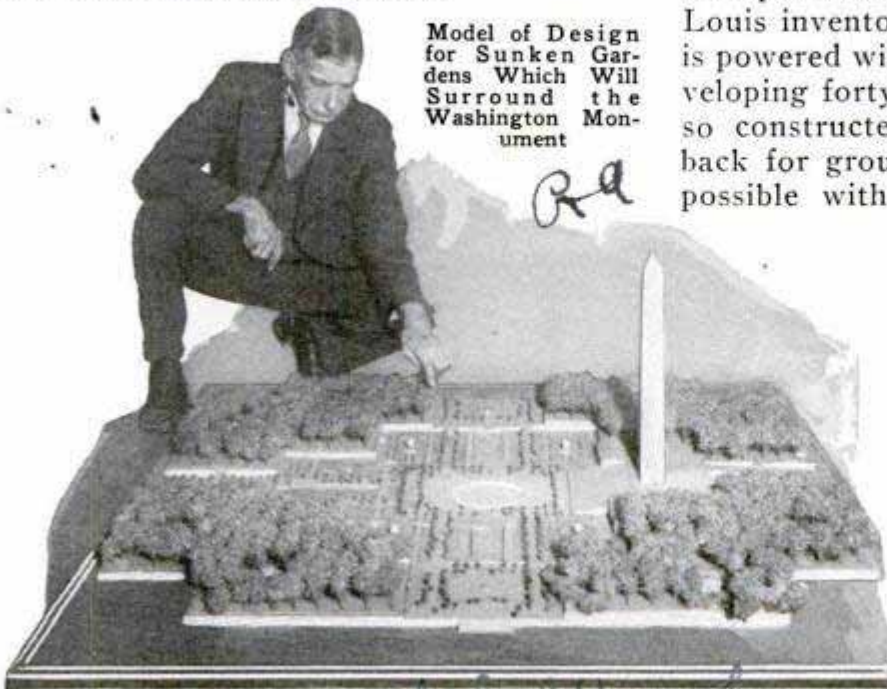

Model made by Wm. L. Partridge consultant

165 7

892

Colombie 29 Beau Road  
Berley Heath near London, Eng

POPULAR MECHANICS

Vickers  
Barrow in dunes  
England  
Vickers  
Armstrong  
Ltd.  
Vickers  
Barrow in dunes  
England

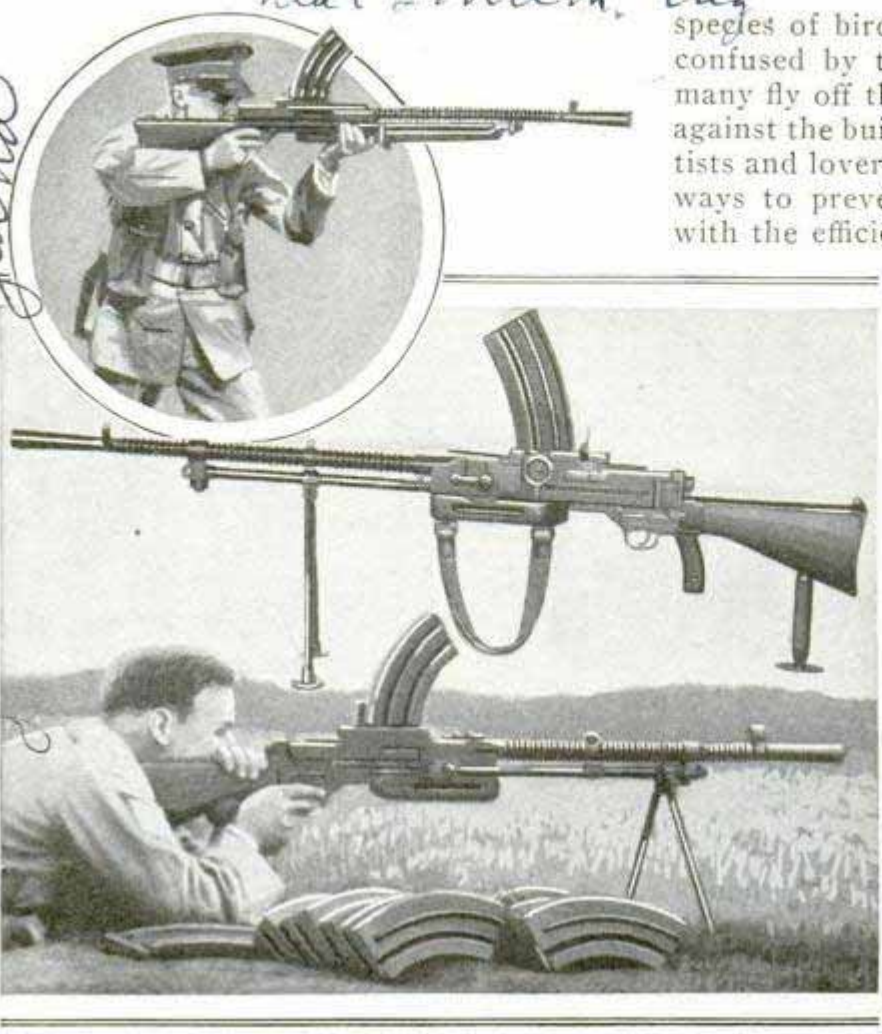

Combined Rifle and Machine Gun Converted from One Type to Another by Throwing a Lever; It Fires 300 Rounds a Minute

Courtesy Vickers, Ltd.

### RIFLE-MACHINE GUN INCREASES EFFICIENCY OF INFANTRY

Converting every infantryman in an army into a machine gunner, a combined rifle and machine gun has undergone successful tests recently in England. By moving a lever near the trigger, the weapon can be used either as an ordinary rifle or as an automatic gun. Employed in the latter capacity, it is mounted on a bipod and fires 300 rounds a minute. As a rifle, it can fire ninety aimed shots a minute. It can shoot 1,500 rounds without stopping and without cooling.

### BIRDS CONFUSED BY CITY LIGHTS DURING NIGHT MIGRATIONS

Floodlighted buildings, beacons and other lights in city areas are costing the lives of many birds. In the spring and fall, during the annual migrations, some

species of birds fly by night. Apparently confused by the lights over a large city, many fly off their course, dash themselves against the buildings and are killed. Scientists and lovers of birds have been seeking ways to prevent this without interfering with the efficiency of the lights. The use of audible warnings has been suggested, but birds are as often attracted as repelled by noises, hence these might defeat the purpose of the experiment. On some structures it would be possible to adjust nets so that the birds would be stopped before they had struck the sides. While the lights are believed to attract some birds, the chief menace is thought to lie in the fact that the brilliance blinds them to obstructions they otherwise would be able to avoid. Many varieties fly at comparatively low altitudes at night, just above the height of the tree tops, and they are thus in range of the city skyscraper and other obstacles. An experiment with the net idea is to be tried on a Chicago skyscraper where a beacon has been installed.

### SCOOTER LIKE ROLLER SKATE HAS RUBBER TIRES

Some of the features of roller skates are included in a scooter intended for children older than those interested in the ordinary scooter. The scooter skate has three rubber wheels, two in the rear and one in front, the wheels holding a metal base which forms a support for the foot. A toe clamp makes straps unnecessary and an adjusting device fits the roller to any foot.



1693

Paddock

Brinkman Engineering Co.

1625

*Com. John J. Cooney  
714 Jefferson St. NW  
Washington D.C.*

GHOSTLY VOICES BROUGHT FROM BOTTOM OF SEA



Patient inside Compression Chamber at Washington Navy Yard, Testing Undersea Telephone That Works without Batteries and Is Not Affected by Water; Instrument Promises Great Aid in Rescues



Above, Remarkable Photograph of Diver in Action, Using the Batteryless Telephone, and, at Right, Pose to Show How Instrument Would Be Used in Actual Operation; Man on Left Is Communicating with the Diver; the Line Is a Combination Lifeline and Telephone Cable, and Voice Is Amplified through Special System That Gives the Effect of a Loud Speaker

*Telephone Div.  
A. S. Davis  
418.6th St.  
Pittsburgh Pa*

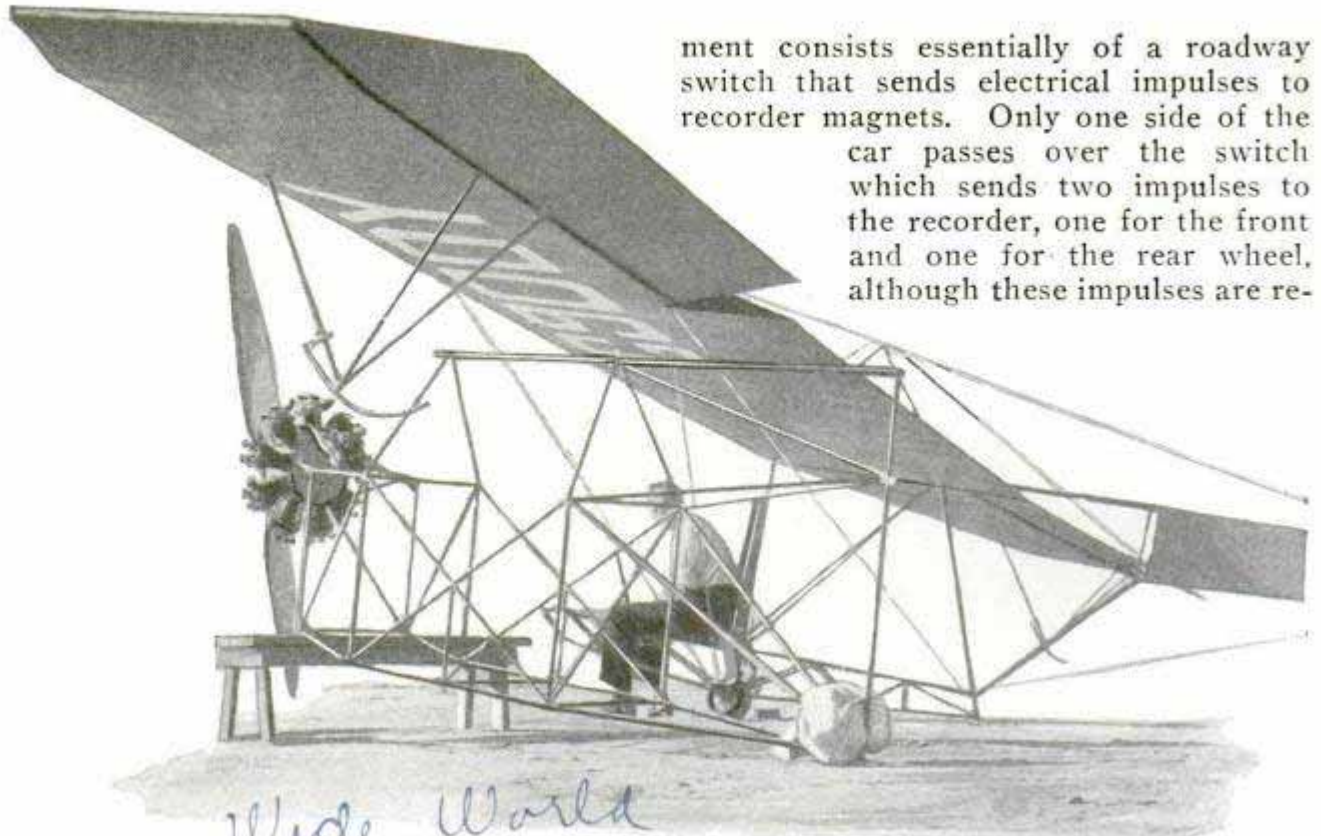

Interchangeable Plane Which Can Be Converted from a Glider to an Airplane by Attaching the Wings and Frame Forming the Glider to a Fuselage Which Contains the Engine

**GLIDER CONVERTED INTO PLANE BY ATTACHING FUSELAGE**

To enable student pilots to master the principles of flying in a short time, a Los Angeles aviation engineer has built an interchangeable plane which can be converted from a glider into an airplane and back again in a short time. When the beginner takes the controls, the ship is a glider, consisting of little more than the wings and a frame for the seat and landing gear. When he has mastered gliding, he moves the lifting surface of his craft onto a motored fuselage, and immediately has a forty-horsepower airplane with a top speed of eighty-five miles an hour. With this convertible equipment, the inventor claims, the student can learn to fly after four hours of instruction, and when the craft is used as an airplane, it can be flown for less than a dollar an hour.

**PASSING AUTOS ARE COUNTED BY AUTOMATIC RECORDER**

To keep an accurate record of all vehicles passing a given point, an automatic traffic recorder is being used on some toll bridges and at other points. The equip-

ment consists essentially of a roadway switch that sends electrical impulses to recorder magnets. Only one side of the car passes over the switch which sends two impulses to the recorder, one for the front and one for the rear wheel, although these impulses are re-

corded as one. The record, on a tape, shows the count of the vehicles, the time of day in minutes and hours, and the day of the month. A push button, pressed when a six-wheeled truck or four-wheeled vehicle with a trailer passes, makes provision for these additional impulses by printing the letter "T" before the count. Different-colored inks or identifying letters are used where a battery of the recorders are installed, thus keeping a record for each traffic lane.

**ELECTRIC MANICURING OUTFIT SAVES TIME OF USER**



Time for a manicure is reduced to fifteen minutes, instead of the half hour ordinarily required, by the use of an electric outfit. It consists of a flexible shaft with an opening in the end into which various attachments fit. All operations from filing to buffing are performed by the set.

attachments fit. All operations from filing to buffing are performed by the set.

*Joseph Byrne*  
11 W. 42nd St. N.Y.C.

*A B Green*

*Wide World*

*1676*

*Butte Electric Mfg. Co.  
856 Johnson St. San Francisco Calif*



4007 Seagoing Motorboat Resembling a Hydroplane Pontoon; a Robot Steers While the Lone Occupant Sleeps

ENGRAVING PLATES OF RUBBER

Rubber is being used instead of metal for printing plates, and one authority predicts that the material will be used in at least two-thirds of all commercial work. Rubber is adaptable to any type of printing except halftones and may be used for water color or ink printing. Syndicate matter, usually furnished to newspapers on traditional metal "boiler plate," is now being distributed on rubber plates. Among the advantages claimed for rubber are elimination of exact sketching and coloring for reproduction, softer colors, more even distribution of ink, less consumption of ink and a general reduction in cost.

ROBOT TO STEER MOTORBOAT ON OCEAN VOYAGE

Resembling the pontoon of a seaplane in design, a twenty-one-foot motorboat, steered by a robot pilot while the lone occupant sleeps, has been built to attempt a 2,227-mile voyage from Santa Monica bay to Honolulu. It has a forty-four-inch beam and thirty-six-inch draft. The builder estimates his craft will have a speed of forty miles an hour.

Seagoing Motorboat Resembling a Hydroplane Pontoon; a Robot Steers While the Lone Occupant Sleeps



Wm. Burgess, Anatas Sergt. 476 to Air

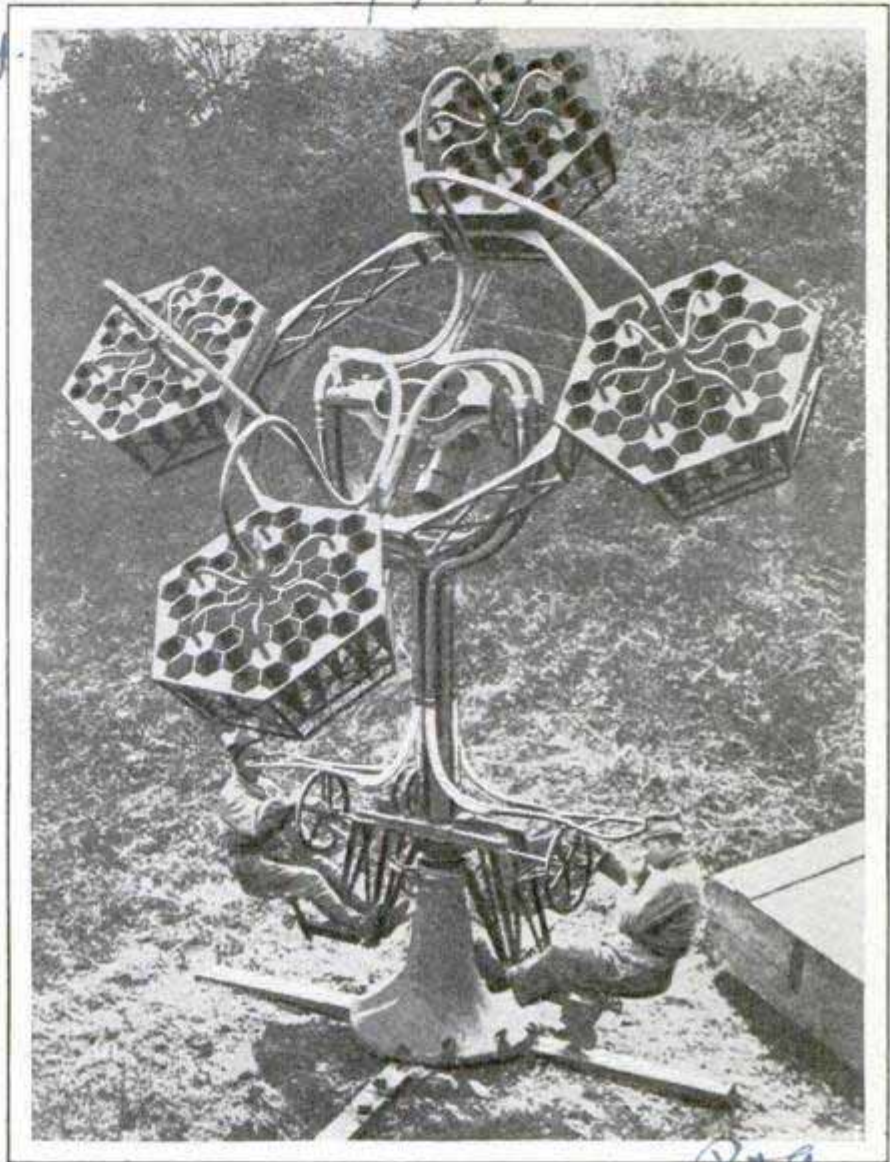

Airplane Finder Which Locates Ships in Flight, and Registers Their Altitude, Speed and Distance from the Apparatus

HUGE "EAR" LOCATES PLANES AND TELLS THEIR SPEED

Resembling a huge metal sunflower, an airplane finder is being employed by the French aerial forces. It locates airplanes in flight, and automatically registers their flying speed, altitude and distance from the finder.

To reduce the smoke evil, the General Electric company has designed an electrical trap which consists of a series of plates installed in the chimney and subjected to high-voltage current; in a few hours, the soot settles on the plates and is removed by a water spray.

Demonstrated by Chicago

Rubber Engraving

1444

1762

Pa



Miniature Golf and Billiards Combined in a Table Game; Golf Balls Are Shot with Billiard Cues over the Fairways

**BILLIARDS AND GOLF COMBINED  
LATEST TABLE GAME**

Thrills of miniature golf and billiards both are enjoyed in a table game now on the market. Regular golf balls are used and billiard cues take the place of clubs. Thus combined golf and billiard skill is necessary to send the balls through the various hazards and into the holes. If desired, the course can be set up on the floor and clubs used.

**DROUTH CAUSES FISH LOSS  
IN NINETEEN STATES**

Millions of fish were destroyed by the drouth last summer in at least nineteen states, and, although rescue activities helped preserve the stocks in some localities and there was an unusually successful hatch of bass, the bureau of fisheries predicts that there will be a shortage of fish in many streams for some time to come. Fish that were not killed by the entire drying up of streams, were stranded in small pools where they became easy prey to snakes and other animals, and, in some cases, the smaller ones were devoured by the larger fish, driven to cannibalism by the shortage of food. The depletion of the fish supply will not have an appreciable effect on the commercial situation, however, the bureau declares, for the reason that the shortage is confined main-

ly to the inland streams where most of the fishing is done by sportsmen or private owners.

**TRACTOR-DRAWN  
SHREDDER FOR  
VINEYARDS**

Clearing vineyards or orchards of brush is simplified with a shredder which is pulled by a tractor. The brush is picked up by means of a rake, and, as the tractor moves forward, it is thrown into a revolving cylinder studded with teeth and knives which cut the vines to bits thus making it easy to plow them under and giving the vineyard the advantages of a good fertilizer and mulch. Disposing of grape vines has always presented a problem, and the usual method of laboriously gathering them and then burning has been found costly. The shredder, which converts the waste into

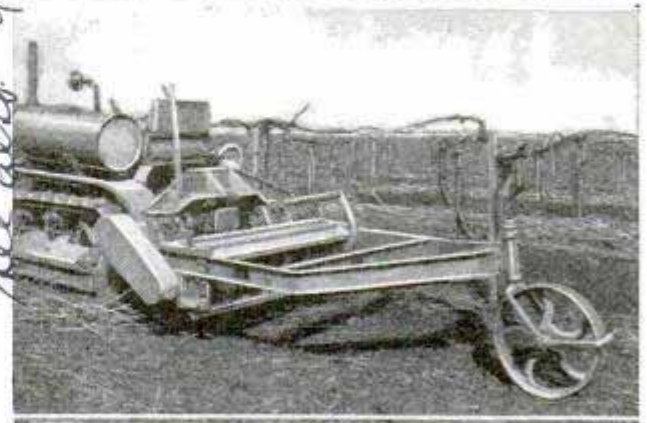

Grapevine Shredder Which Cuts Up Brush, Like That Shown Above, so It Can Be Plowed Under

fertilizer, covers about five or six acres an hour.

*Valley Foundry & Machine Works, Inc.*

*U.S. Daily 10/20/30*

*1680*

*see also 928*

*1617  
Wester. of ...  
Co., Inc., 188 W. 4th St. New York*

# EUROPE IN THIRTY HOURS IS HOPE OF INVENTOR

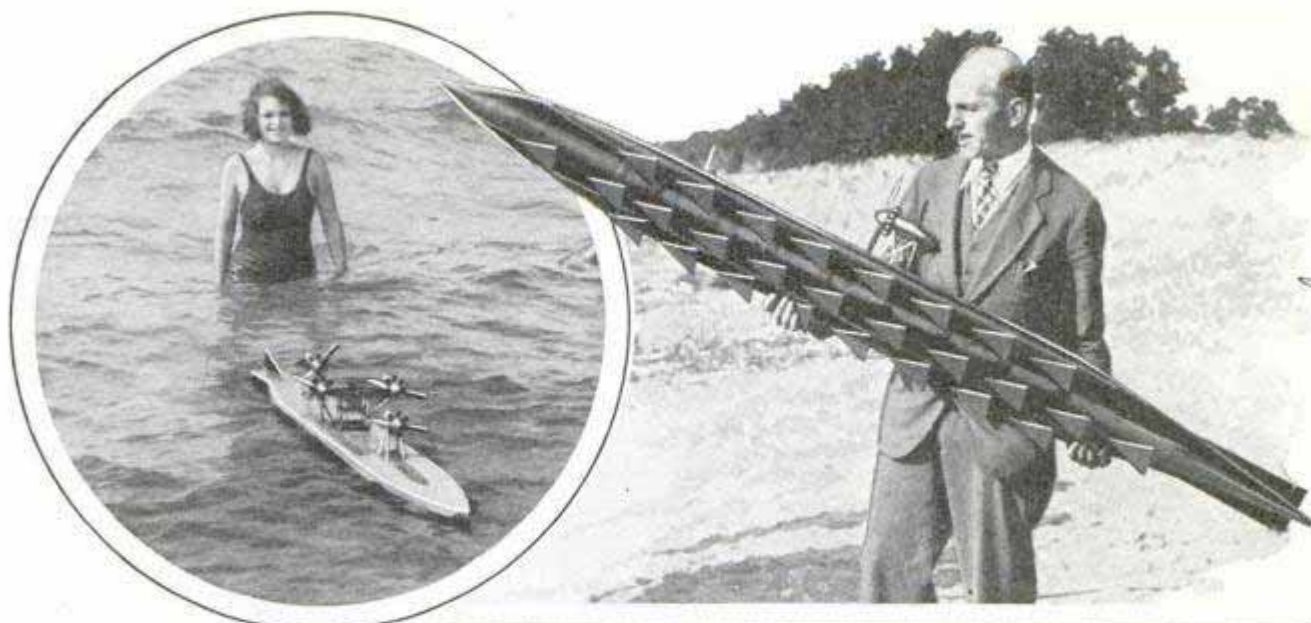

*Letter rec'd  
11/18/30*

Six-Foot Model of a Hydro-Speedboat Driven by Airplane Propellers; at Right May Be Seen the Three Stabilizing Keels with Their Triangular Fins Which Help Maintain Balance

Successful tests recently were conducted with a six-foot model of a proposed 750-foot hydro-speedboat embodying principles of both air and seacraft. Three stabilizing keels run the length of the craft, triangular fins being attached to them to keep the boat on an even keel when riding the waves. The hollows formed by the keels lessen water resistance and increase speed. The boat is powered with four Diesel engines on top of the craft, which transmit power to air propellers of a type similar to those used on airplanes. The speedboat is steered like an airplane, and the inventor believes that it will be possible to cross the Atlantic in thirty hours with the full-size ship.

trapped inside the United States, none has ever been recovered outside the national boundaries. Some ornithologists believe they winter in the little-known Rain forest of the Amazon river in Brazil. Their disappearance led to a legend of many years ago that they hibernated beneath the waters of lakes and marshes, a belief not yet entirely erased from the popular mind, although science always has scoffed at it.

## PUTTING TRAP REPLACES HOLE

*162B* IN PARLOR GOLF GAME *1623*

Indoor golf now can be played in the parlor without the use of improvised holes with unnatural inclines leading to them. Instead, a putting trap, which catches and holds any ball that would be holed on a regular green, is employed. The trap, of the same diameter as a regulation hole cup, consists of two disks which are held in parallel position under slight spring tension. The trap is adjustable to retain either the old or new size balls.



Several of the traps placed on the rug form a miniature course in the living room with furniture for the hazards. The traps also may be used on the lawn.

## TREK OF CHIMNEY SWIFTS STILL IS MYSTERY

*1609*

Where do chimney swifts spend the winter? This question offers a mystery of the air that probably will not be solved until the forests of the Amazon valley have been explored thoroughly. These birds start south from the United States about the first of October, journeying to the Gulf states and continuing to some point much farther south. They have been seen in Haiti and in Mexico, but this was not their ultimate destination. Little numbered identification tags have been placed on more than 30,000 swifts to solve the mystery, and, while many have been

*U.S. Biological Survey*

*Brookline Mass*

*Frederick C. Lincoln  
Asst. Biologist in charge  
of bird banding work*

*Beckley, Balston Co.  
42 W. 22nd Chicago*

*and Max, their  
Lester, Cor. L.I. New York*

613 Spreckels Theatre Bldg  
San Diego, Calif

1324

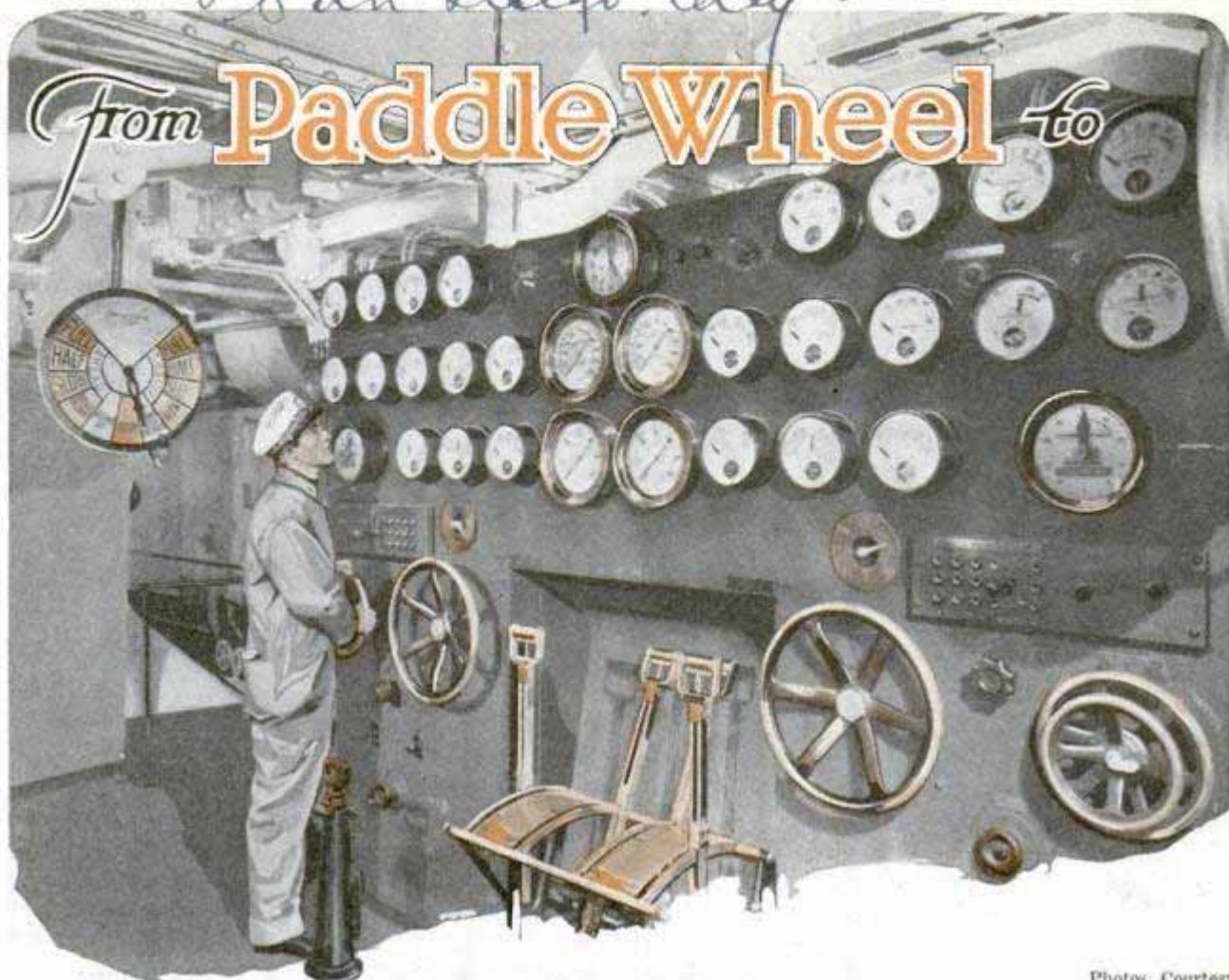

Photos Courtesy

By JOHN L. DRAPER

**F**ROM the deck of the windjammer of just a few years ago to the express liner of today is a long step, but it has been made in a comparatively short space of time.

In the old days it was helm down, sheets let rip, and the canvas thundering aloft to the chant of shouted orders and old sea cries—a task to bring her up and an hour's work to pay off, trim sail, coil down and stand out to sea again.

Today, with 60,000 tons on one keel, sail replaced by sweating stokers, stokers by oil burners and turbine electric drive, guided by two fingers on a three-foot wheel on the bridge, one jangle of the engine room telegraph does the trick. In place of the "dipsey," or deep lead, is the ticking "fathometer." In less than one hundred fathoms of water it is furnishing the navigator with four accurate soundings each second.

Below decks, the engine room manifests as little in the way of motion as your automobile engine when you lift the hood.

A tugboat is, in one sense, more satisfying because things are going up and down. But the engine room of a liner packs 17,000 horses into the space of a ten-room apartment. Only when you stand by one of the giant propeller shafts and watch its polished roundness winking in the light, do you get any sense of anything actually happening. It is not quiet, but there is no clash or clangor—just a constant rushing noise.

Four men stand facing the control board, their attention fixed on the many switches and dials whose faces tell the story of the ship's power from steam turbines to propellers. Behind them stand the chief engineer and the relief electrician, both checking the signals clanging down from the bridge. The "California," one of the three largest American-built merchantmen, is making port.

"Clang!—clangclang! Half astern!" Two assistant electricians, notebooks in hand, acknowledge on the telegraphs the signal from the bridge, then

# Electric Drive

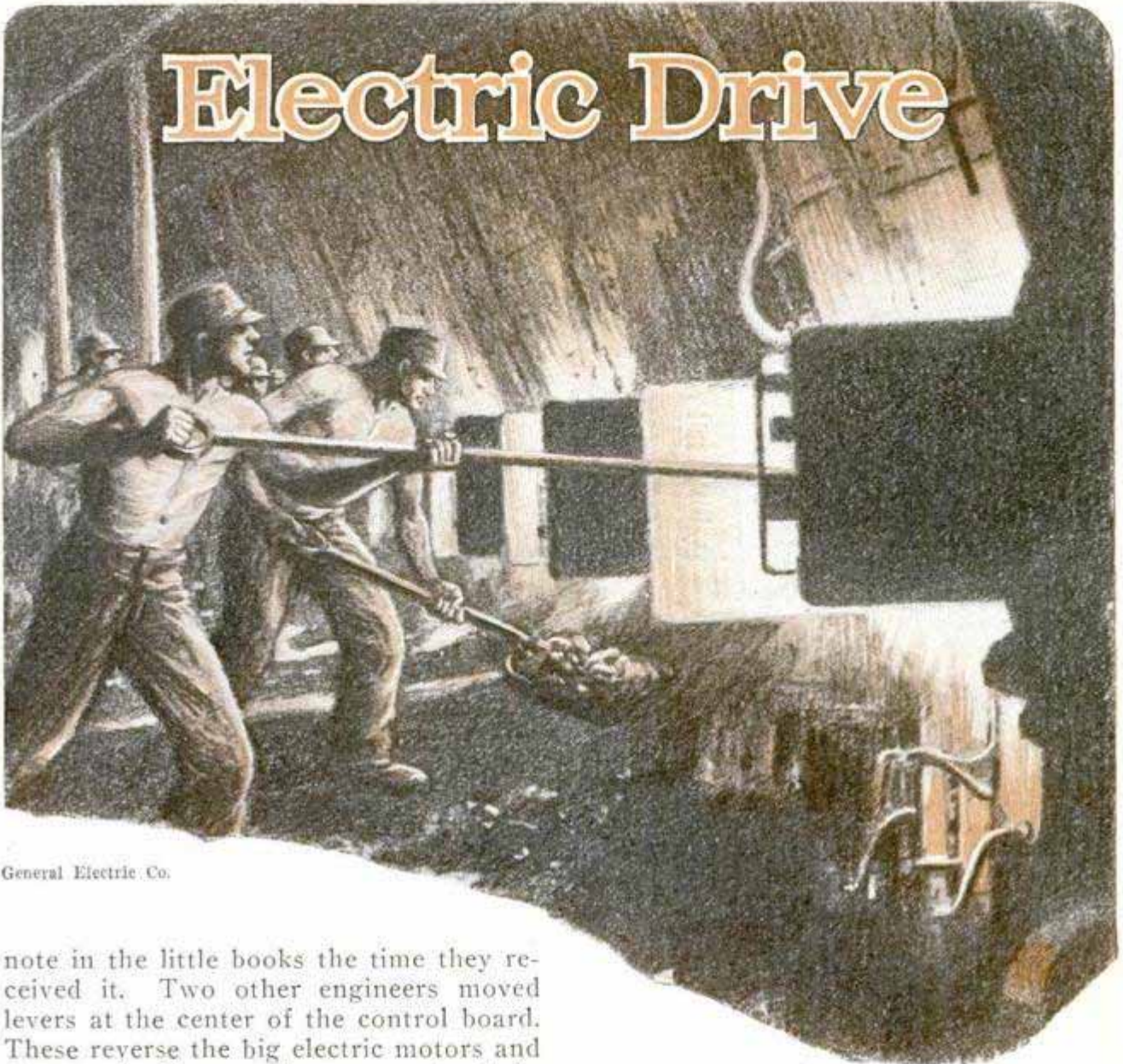

General Electric Co.

note in the little books the time they received it. Two other engineers moved levers at the center of the control board. These reverse the big electric motors and slow up the liner as she prepares to dock.

On the board Chief Engineer E. W. Bence reads the story of all the power plants that help drive the ship during the intricate maneuvers. The turbines, motors and generators—at once gigantic and delicate—sing their songs of power on the thirty-two delicate instruments that measure each change. A single slip and the 602-foot liner might crash into the dock. The twin screws, turning in reverse, slow up the vessel. Again a new command, "Stop!" and after a brief interval, "Slow ahead!" On the revolution counter the hand descends slowly to the right until the propeller is turning thirty-two revolutions a minute, one-fourth its maximum speed. Only the port screw is turning to drive the stern of the ship starboard toward the dock.

Suddenly a great clattering of bells on

both telegraphs echoes around the corners of the metal walls, the indicators move up and down to the section marked "finished with engines." The chief engineer waves his hand to his assistants, levers are shoved into neutral and the crew leaves the board. The big liner is safely at dock.

As I rode at sea aboard the "California," I was conscious of no motion in the machinery. There was no sound other than the steady hum of the turbines, generators and motors. Yet 17,000 horsepower passed by the two main driving motors through 200-foot shafts direct to the screws. So delicately are these powerful engines of steam and electricity balanced that a five-cent piece placed on its edge over the bearing of one of the motors remained in its position several minutes.

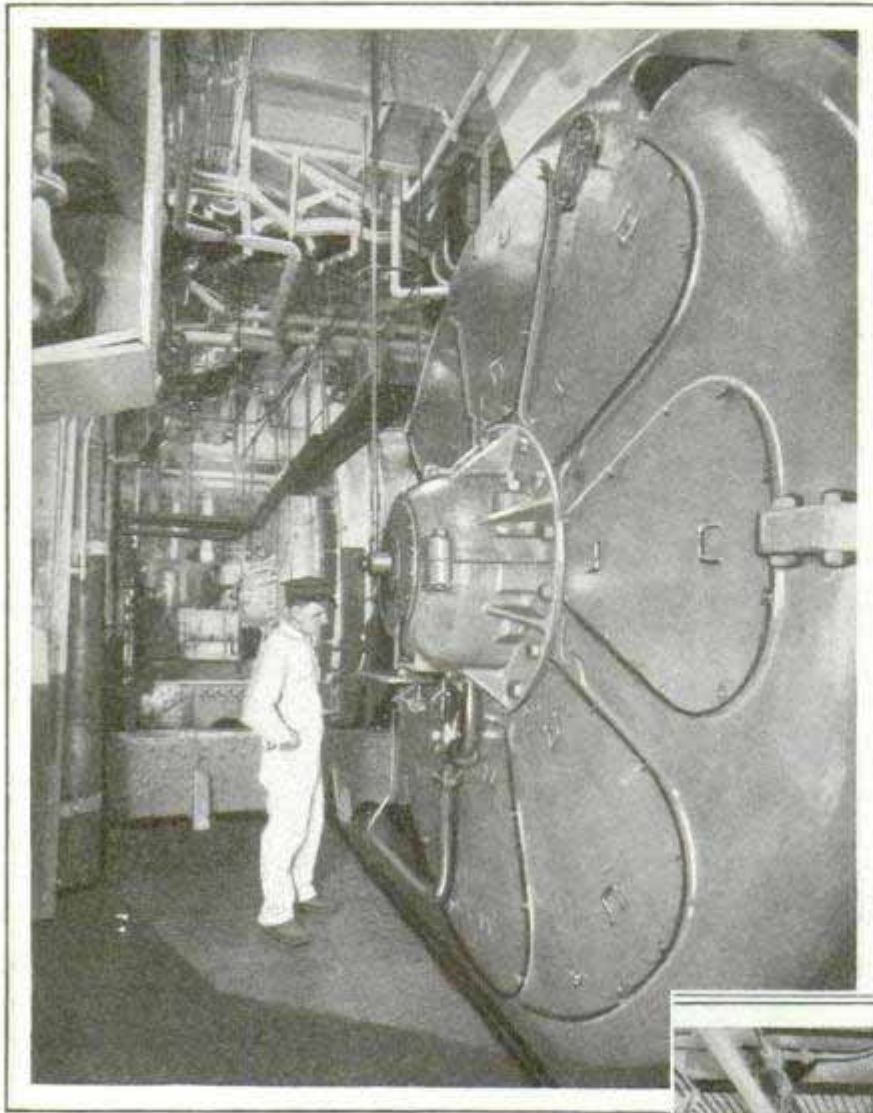

Courtesy General Electric Co.

The chief engineer of one of these electric giants of the sea—the most modern in international marine construction—moves around the engine rooms in spotless blue, directing the activities of twenty-five engineers while 500 passengers are conscious only that a luxurious liner carries them swiftly to their destination. So revolutionary are these electrically propelled ships—the three plying between New York and the Pacific coast are the “California,” “Virginia” and “Pennsylvania”—that for the future, in Mr. Bence’s opinion, they have relegated to the limbo of the past steam-driven ships.

“These vessels,” Mr. Bence told me, “are the largest American-built ships and the world’s biggest commercial vessels propelled by turbo-electric drive. The twin driving motors, although coupled directly to the driving shafts, can be changed from full speed ahead to full speed astern or the reverse in fifteen sec-

onds. Even then passengers on deck near the stern of the ship are not conscious of throbbing or heavy vibration.

“While at sea, only one man is needed to answer the telegraph and handle the board. He marks each movement and the time in order that there may be no misunderstanding later. During runs at sea, changes with the engines are infrequent, but when we maneuver into port orders sound down from the bridge rapidly.

“Here”—he pointed to the telegraph, a circular disk marked into sections in each of which was printed words indicating the orders sent down—“is the only place on the ship we do not trust to

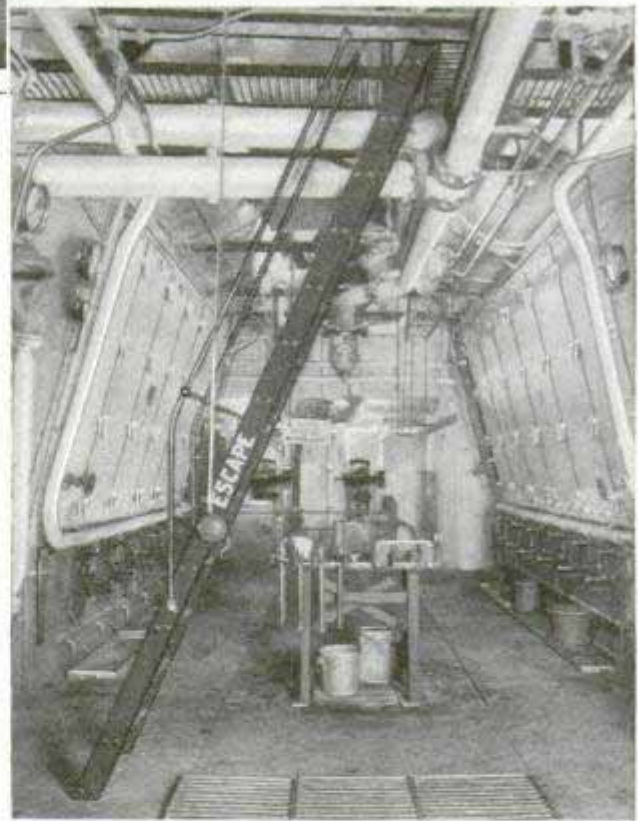

Above 8,500-Horsepower Motors in U.S.S. “Virginia,” and View of Vessel’s Boiler Room; the Motors Are Coupled Directly to the Driving Shafts

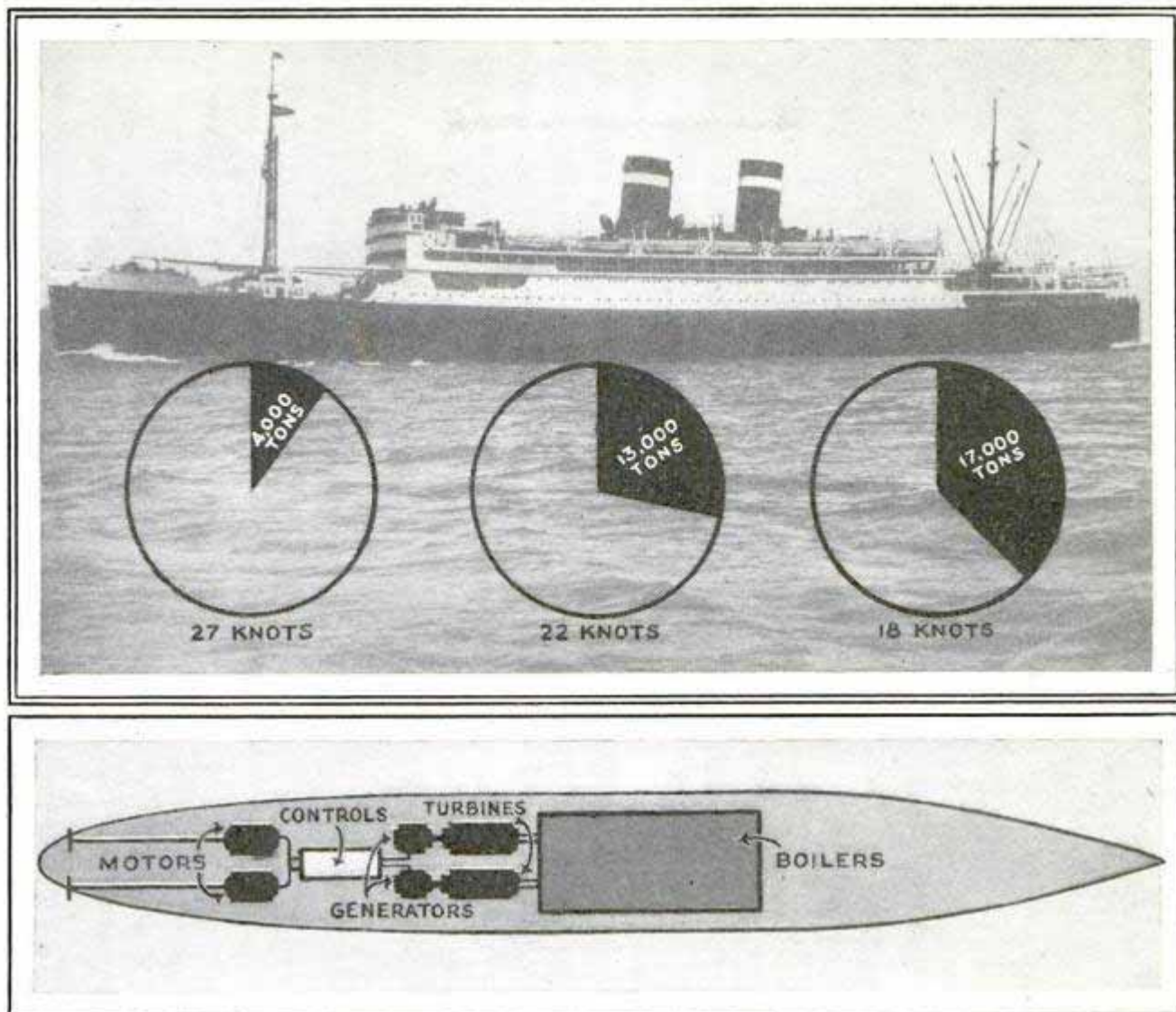

Diagrams Showing Cost of Speed; a Vessel like the "Mauretania," of 43,000 Tons' Displacement, Has Only 4,000 Tons for Revenue-Producing Purposes When Equipped for Speed of Twenty-Seven Knots; at Twenty-Two Knots, It Would Have 13,000 Tons, and at Eighteen Knots, 17,000 Tons for Passengers and Freight

electricity. The man on the bridge moves a handle which is connected to our telegraph by chain. The indicator moves as the chain transmits the order. Since it is manually operated it cannot be wrong. Then the assistant electrician moves the handle to the same point. This informs the bridge we have received and understood the order.

"A steam engineer is required to run a plant of this sort. Once the electricity is made, it becomes merely a matter of handling switches. Manufacturing the power is the process that really counts. Here we begin with boilers that make the steam that turns the turbines that drive the generators that supply electricity to the motors. These motors stand eighteen feet high and for each motor revolution the propeller revolves once.

"The principle of electric drive differs

from the old method in that the whole power 'manufactured' by the motors is exerted directly to the end of the propeller shaft. On a steam-driven ship you might have an engine turning 2,000 revolutions a minute geared down to a propeller shaft turning 120 revolutions a minute. Here you would lose much of the power in the gearing.

"In the 'California,' turbines turn 2,800 revolutions a minute but they have no connection with the propellers. They merely manufacture the product that enters the driving motors through wires, serving a complete duplication on each side of the ship. Each turbine drives a generator that supplies electricity to the motor on each side. This is economical in that for cruising speeds at sea only one set of generators need be used."

At a sudden stroke, in the "California"



Chief Engineer E. W. Bence of the U.S.S. "California," Showing Size of Propeller Shaft, and, Inset, Diagram Illustrating Distribution of Weight in a Liner of 60,000 Tons' Displacement

and her sister ships, engineers have abandoned the old principle of supplying motive power to ships. The enormous horsepower generated aboard the "California" equals the manpower of 557,172 men. The turbines work twenty-four hours a day and power from the big generators is equal to the manpower of cities the size of Norfolk, Richmond, Newport News, Roanoke, Lynchburg and Petersburg combined.

"Practically," explains Mr. Bence, "electrical transmission gives us a simple and practical means of speed reduction between the high-speed turbines and the slow-speed propellers in almost any ratio we may need. Propellers are reversed, not by reversing the turbines, but by simple changes of electrical connection. The electric drive can be made noiseless whereas gears always make more or less noise.

"So successful have these early ships

been that they have been copied. Seven or eight are being built in Europe and as many more are planned in the United States."

### FRISCO-BAY BRIDGE HIGHEST OVER TIDEWATER

1614. Towering 500 feet above the water at its pinnacle, the world's highest bridge over tide-water is to span San Francisco bay, linking the western metropolis with cities on the eastern shore of the bay, Berkeley, Oakland and Alameda. The structure, costing \$72,000,000, will accommodate ten lanes of automobiles and interurban electric traffic on double decks, each fifty-seven feet between curbs. Six lanes of automobiles will move on the upper deck and four below, two of which will carry interurban trains.

Channel spans will have a clearance of 214 feet above the high-tide mark, eighty-one feet more than Brooklyn bridge. Four main spans and the necessary approach spans will extend from San Francisco for 8,600 feet across the main channel to Goat island. From Goat island, at an elevation of 175 feet, the structure will cross a subsidiary channel with a single 750-foot span, continuing eastward on a steel trestle to the Oakland waterfront, this second section being 10,470 feet long. The maximum clearance of 214 feet will be provided between the two center spans in the main channel. Main spans will rest on concrete piers, 200 feet square, each pier being divided into four sections. Seven years will be required to complete the structure, and by 1940, it has been estimated that it will be carrying annually about 9,000,000 automobiles and 20,000,000 passengers as well as some 50,000,000 interurban and transcontinental travelers.

Carl Tom White  
Box 44, Alameda



**LETTERS PICTURES OF MOUTH  
IN ORIGINAL ALPHABET**

That the shapes of the letters of the alphabet were first suggested by the positions of the mouth in pronouncing them is the theory advanced by Sir Richard Paget, an authority on speech. The letter "O," for instance, represented the rounded mouth; "A" suggests parted lips, especially in its original form for it was first written on its side; "M" represents two closed lips, and the letter "I" pictures the raised tongue not quite touching the palate, the dot above the letter indicating the gap, while "L" and "T" are made with the tongue actually in contact with the palate.

*London Eng.*

**"MIKE" ON PHONE MOUTHPIECE  
CUTS OUT NOISE**

Easily attached to the telephone mouthpiece, a microphone unit now on the market amplifies or modulates the voice of the speaker or shuts out interfering noise as well. This makes it possible to hear another person with less difficulty even in noisy places, and at the same time enables the speaker to talk softly or even to whisper, so that persons in the same room cannot hear, but the person at the other end of the line can. Slight pressure on a small button at the top of the unit eliminates disturbing noises, so that only the voice on the line can be heard.

*Foto Mike*



*7250*

**HOTEL CARRIED OVER DESERT  
ON BACKS OF CAMELS**

*1452*

Camels were used recently to carry a hotel, piecemeal, across 500 miles of desert to an oasis in North Africa that had been selected as a site. Each camel carried about 200 pounds, and a caravan made the trip in forty-five days, so that many trips were required to transport all the hardware, windows, doors, glass, linen and other building materials and equipment. Only the brick could be made at the oasis.

*The French Line  
with aid of French*



Electric Coffee Roaster with Which the Modern Housewife Can Prepare Her Own Fresh Blend

**AN ELECTRIC COFFEE ROASTER  
FOR USE IN THE HOME**

Modern housewives now can roast their own coffee in their homes with a small electric roaster which plugs into any light socket. The roaster, which insures fresh coffee at all times with little labor, consists essentially of a heating element and a revolving drum turned with a crank.

*One purchased through*

**GAS LIGHTER FOR FURNACE  
MAKES QUICK FIRE**

To save fuel and to make a fire in the furnace quickly, a gas line is attached to the house supply system and passed between the grates. The fuel is ignited by touching a match to the jet. This system saves dumping the grates when starting a new fire, makes the use of kindling unnecessary and reduces dust. The attachment is also provided with a spiral unit which is placed on to form an efficient flue cleaner, the gas flame helping to burn off the soot.



*84 25*

*Quick Lite Mfg Co,  
8540 Elmer Blvd,  
Cleveland, Ohio*

*Standard Appliances, Inc. 21 W. Elm Chicago*

*9130130  
1630  
9130130  
Grove Company  
Saver, Hall  
London & C  
3. Eng  
Ireland, London & C  
Mignores Saver  
Hill, London & C  
Ireland, London & C  
Sandley, Frary & Clark. New Britain, Conn.  
Chauncey, Rogers & Lybber  
on London Eng*

904

*Leads the way!*

*Vincent Square Manson*

**DIVERS GO TO GREATER DEPTHS WITH AID OF CHAMBER**

1564



the diver's air pipe and breast rope and takes off his helmet. The lower door of the chamber is then closed and the container hoisted clear of the water. Subsequently, the pressure inside is lowered. To assist in becoming rid of nitrogen that has formed in the system during his time under water, the diver breathes oxygen while in the chamber. The decompressing process made possible by the use of the chamber, eliminates the harmful effects ordinarily suffered by dives to great depths. With this apparatus, dives to depths of fifty-eight fathoms have been made.

Views of the Compression Chamber Used by British Divers; Dives to Fifty-Eight Fathoms Have Been Made with It

Sea dives, to greater depths than hitherto have been possible in ordinary diving clothes, have been accomplished by men in the British navy with the aid of a compression chamber recently introduced. The chamber, lowered to a depth that corresponds to the diver's first stop on his way up, is entered through the lower end while an attendant disconnects

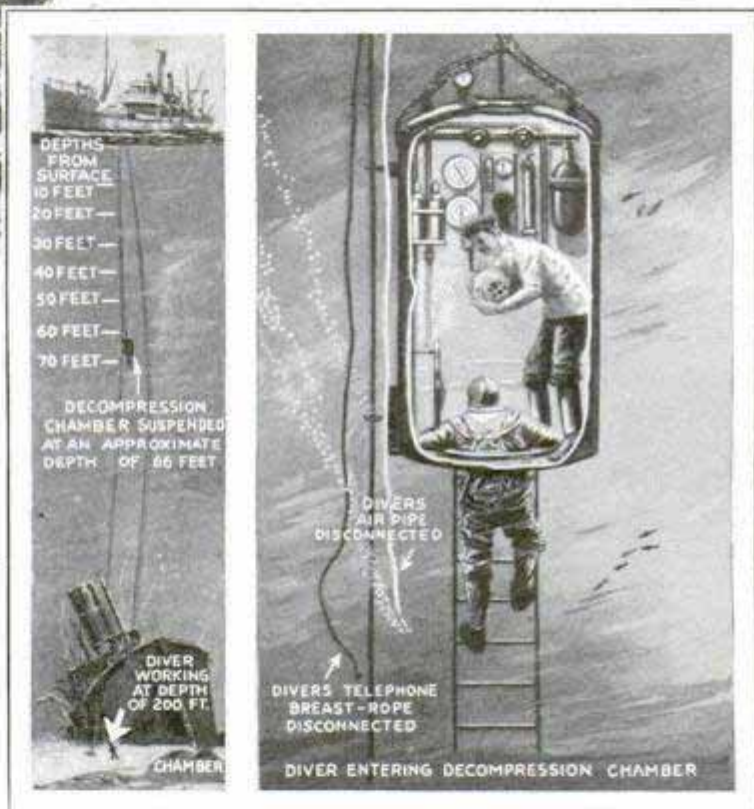

*Science Service News 499. A*

**SOLUTION OF MAYAN MYSTERY IS SEEN IN CAVES**

1620

Scientists have been trying for years to piece together the story of the Mayas as revealed in the ruins of their pyramids, temples and monuments, and now the investigators are confronted with a new problem, a series of vast caverns in Yucatan which extend for many miles. Pictures and inscriptions on the walls indicate that the caves have been visited by human beings, but so far, archaeologists have been unable to decipher the marks or establish the time when they were

carved. Were the caverns used for burial places or for religious rites? Science cannot tell. There is no evidence that they were used for human habitation, although this is a possibility. A swathed mummy was reported to have been found in one of the caves, but the discovery has not been verified. Who were the people that first used the subterranean passages, and what purpose did the caves serve? Few of the many caverns have yet been explored. They are beautifully frescoed with stalactites and stalagmites, and these formations, in many places, have almost completely obscured the carvings.

*Don Luis Rosado Vega, Director, Museo Arqueologico e Historico de Yucatan*

*See me  
Spring 1930  
10/2/30*

*what Road Congress  
in Washington*  
**PAVEMENTS OF RUBBER BRICKS  
STAND HEAVY WEAR**

Blocks of rubber, set in a concrete base for a street pavement in 1923, have successfully withstood heavy traffic in Glasgow, Scotland, only one minor defect having been reported. This was the breaking away of the cap of one block from its tread. In London, rubber paving has been in use on New Bridge street since 1926. Although a number of the blocks have had to be renewed, the minor defects that developed did not impede traffic in any way. Between eight o'clock in the morning and eight o'clock at night, nearly 18,000 vehicles pass over the street, and there is considerable night traffic as well. The paving was laid at a cost of about \$22 a square yard, without foundation.

**SHIP'S PROW FOR RESTAURANT  
HELPS DRAW TRADE** 654

Patrons of a San Francisco restaurant that specializes in sea foods, enter by gangplank through a portal closely resembling the prow of the "Nina," one of the ships in the fleet of Christopher Columbus. The atmosphere of the sea is further reflected by timbered pier heads, with railings of wrought iron and woven ropes. On the inside, there are also a sun deck, cabin nooks and a steering wheel.



Ship's Prow Which Forms Entrance for Sea-Food Restaurant; the Interior Also Reflects the Marine Atmosphere

*Bernstein & Fish  
Esrotto*



© P. & A.

Metal Coat and Shield Worn by Polish Police Which Protect Upper Part of Body

**COATS AND SHIELDS OF METAL  
PROTECT POLISH POLICE**

During recent voting riots in Poland, the police were equipped with metal coats and shields for protection. The cuirass worn by the Polish officer resembles the bullet-proof vest that is well known in this country, except that it extends below the hips, while the shield protects the neck and head.

**MAGNETIC IRON PENCIL  
WRITES ON STEEL** 641

Magnetized writing was demonstrated recently by a scientist who fashioned a pencil out of a piece of magnetized iron and scratched with it on a thin plate of hardened steel. In this manner he transmitted some degree of magnetism to the plate after which iron filings were dusted on it. When the plate was held in perpendicular position, the loose filings dropped off, but the magnetized parts of the plate retained their portions, making the writing on the plate clearly visible in the filings that remained.

*Prof. Thompson  
of Gortsch du Jute  
Journal & Franklin*

1287

# The High Flying

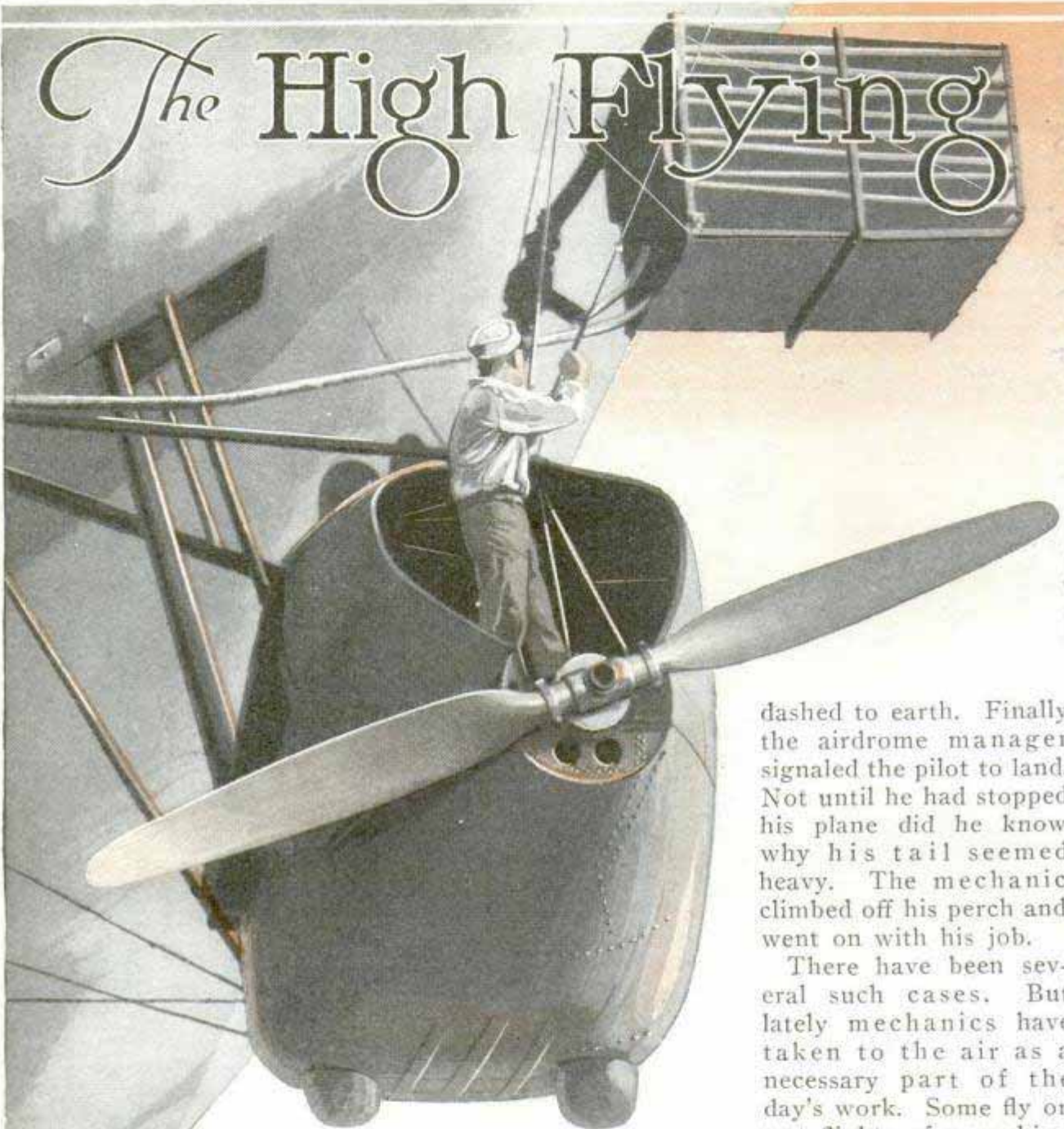

Repairing One of the Gondola Braces on the "Los Angeles" While the Airship Was in Flight; Photograph Taken by Another Member of the Crew

dashed to earth. Finally the airdrome manager signaled the pilot to land. Not until he had stopped his plane did he know why his tail seemed heavy. The mechanic climbed off his perch and went on with his job.

There have been several such cases. But lately mechanics have taken to the air as a necessary part of the day's work. Some fly on test flights of new ships.

Distance flyers usually carry one or more mechanics able to make any emergency repairs.

When Capt. Frank Hawks set a non-stop record between Los Angeles and New York, in 1929, he had 375 gallons of extra fuel stowed in five-gallon cans in the cabin forward. The cabin was crammed full of the cans when the mechanic, Oscar Grubb, was squeezed in and the door closed. Clear across the continent, Grubb opened cans and pumped fuel for the voracious engine. Pumping his way across the continent, his only recollection was of fumes that nearly asphyxiated him. In his spare time he cut up

By ORVILLE H. KNEEN, 1287

*Rockaway Parkway*  
SOME time ago a mechanic in Vienna was working on top of a fuselage, at the tail. Suddenly the craft bounded forward. The startled mechanic was just able to grasp the framework as the pilot, unaware of his unwilling stowaway, took the air.

Clinging with a death grip, he tried to attract the pilot's attention, as did spectators who expected momentarily to see him

*Valley Stream N.Y.*

# Mechanic

empty cans to make more room. He had no time to eat during those hectic eighteen hours of storms, fog, high winds and terrific speed.

It was the American refueling endurance flight that evolved the flying mechanic into a daring mid-air repairman. The "Question Mark," which began the contest, had a narrow catwalk on each side of the motor, on which Staff Sergeant Roy W. Hooe stood while he cleaned and changed sparkplugs. He tried to find the cause of trouble when the motor began missing badly, but the ship was then unstable and he had to desist from his search.

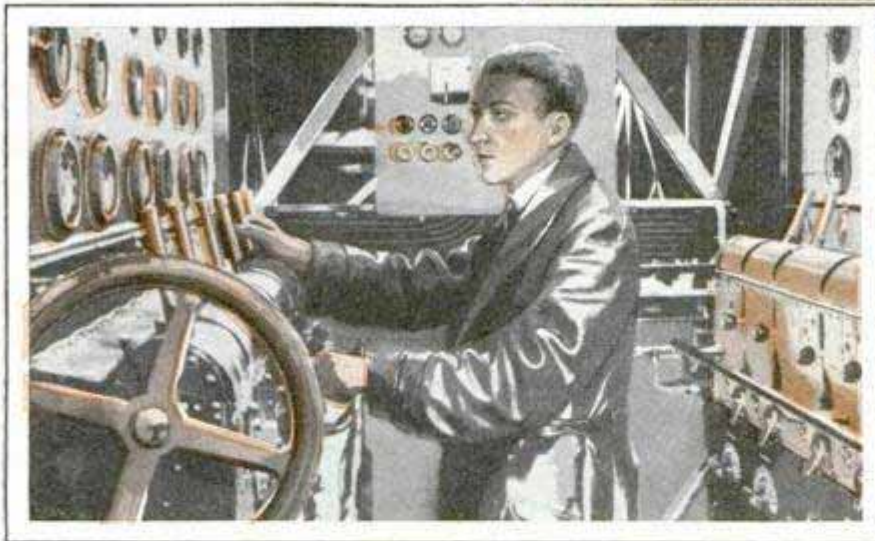
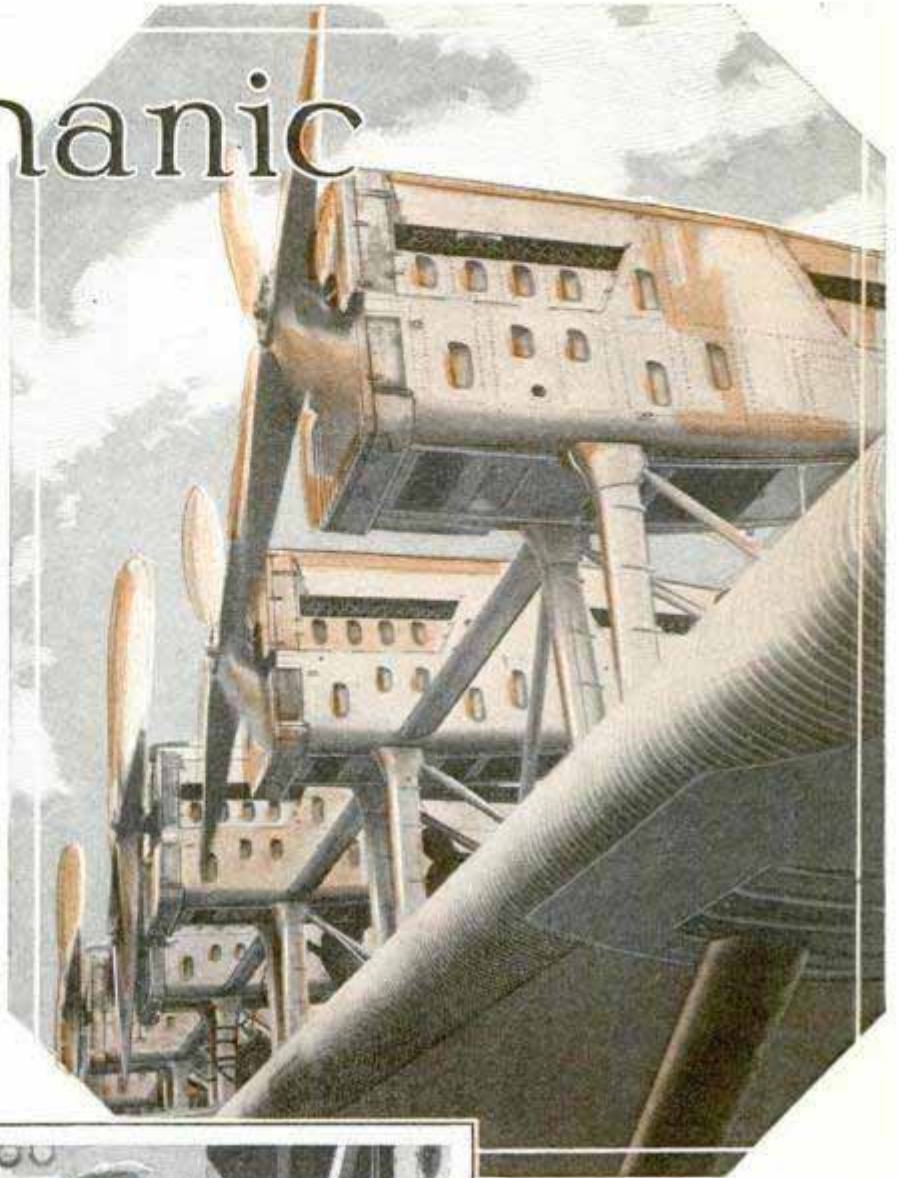

Some of the Driving Units of the Giant Seaplane, the Dornier "Do-X," and View inside the Craft's Control Room

For later refueling flights, therefore, plans were made to make repairs in flight. On the "Fort Worth," which next broke the record, James Kelly, former cowboy, wore a parachute as he tended the motor 2,000 feet above the airport. He not only changed sparkplugs and greased rocker

arms at sixty miles an hour, while balanced on his narrow plank, but he also installed a new tachometer shaft.

On the St. Louis "Robin," "Red" Dale Jackson did the catwalking, and he added a safety feature. "To check the motor," he related, "I would open the door of the cabin on either side and climb out on the six-inch wide running-board catwalk,

which extended forward to within three inches of the propeller blades. The wind, far more than the height above the ground, made this difficult. For protection there were two rods rigged as railings outside me, and I had a safety belt with a ring which slid along the lower of these

rods. Once I was in position, it was not so hard to do the work, because old man O'Brine certainly did hold the ship steady. He knew that one slip by me, standing there without a parachute, would mean certain death."

Even more spectacular, to the thousands watching below, was his trip to the tail. Forest O'Brine, at the controls, said it was even worse to watch than when "Red" went out on the catwalk. Jackson climbed out on top of the fuselage, and then slid back, the pilot "feeling" his progress by his elevator control. The repairs completed, Jackson swung over on his stomach astride the fuselage, put his feet against the stabilizers, and worked his way forward into the cabin.

But the worst was yet to come. At 3:00 a.m. on the eighth day, when only half through the long grind, the motor started cutting out and vibrating heavily. "Red" was asleep. He awoke instantly, and in a few moments was out on the catwalk, flashlight in hand. He changed spark-plugs in two lower cylinders. He had hardly got back when the motor again went bad. He checked over the magnetos and oil-soaked wiring, and burnt his hands severely. He kept on in spite of this, for the flight was in imminent danger. The breaker points of the left-hand magneto he found to be grounded in the base. While it rotated at high speed, he fished out a small piece of wire, and the motor

settled down to its steady roar. After a while a pushrod began spraying oil, and this was mended. Once O'Brine got a gasoline shower bath when the refueling planes suddenly were separated by the backwash from another plane. Their light 170-horsepower motor was apparently as good as ever when they landed, after 420 hours seventeen minutes aloft.

The "City of Chicago" monoplane, piloted by John and Kenneth Hunter, had a catwalk on which Kenneth, a former wing walker and parachute jumper, "doctored up" ailing cylinders and kept all parts lubricated. One of his exploits was clearing the tail of masses of paper, string and other debris which had blown back and caught in wires, rudder and stabilizers, with imminent danger of clogging the controls. Kenneth crawled out, head first, from the hatch, slid backward on the fuselage, and hung to a rope while he cleared away the debris. A lurch of the plane would have pitched him off, and he wore no parachute.

During the night of July 1, the motor coughed and spluttered. At 2:00 a.m. John went out on the catwalk and put a new breaker into the magneto, restoring the steady drone. On July 3, an engine holding-down bolt dropped out. Kenneth obtained a new one and from the catwalk put it into place.

The next attempt to break the Hunters' record of 553 hours, at Roosevelt field,

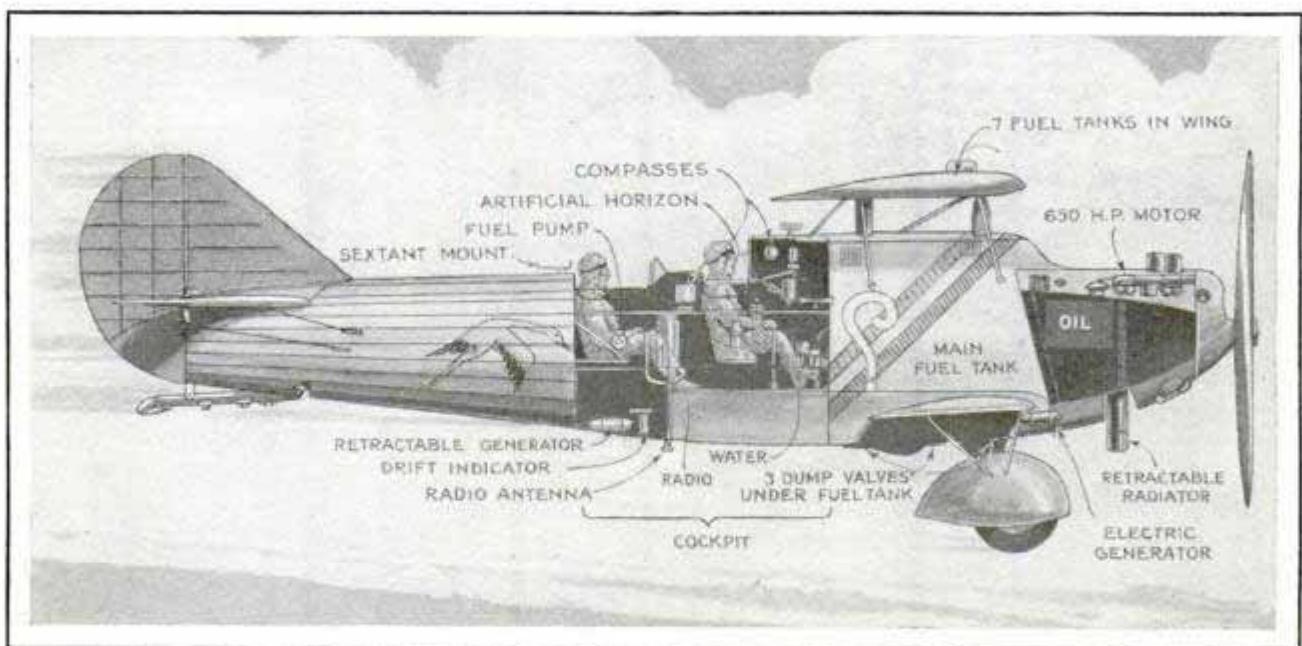

Diagram of Captain Coste's Now World-Famous "Question Mark," the First Airplane to Make a Non-Stop Trip from Paris to New York



Captain Frank M. Hawks over Los Angeles in His Fast "Texaco No. 13" Monoplane in Which He Has Made Several Transcontinental and Shorter Trips in Record-Breaking Time

almost came to grief before it was half completed. The motor began to miss badly. Changing sparkplugs failed to remedy it. Finally a battery was sent up, for possible use, and the plane climbed to a high level while the mechanic crawled out of the window onto the catwalk.

Hanging to a short rope with one arm, he put one foot on the propeller, to prevent its turning with the wind as the engine was cut off and the plane glided. He then installed a new breaker-point assembly, restoring power at once. By a higher climb, a repair job of five or ten minutes could thus be made.

A couple of years ago, the "Graf Zeppelin," on its way across the Atlantic, ran into a storm and lost some 717 square yards of fabric from the underside of the port stabilizing fin. This occurred about 1,000 miles from Bermuda. The speed was cut in two, and two helmsmen, one of them Knut Eckener, son of the commander, volunteered for the dangerous and unique job of re-covering the fin.

They crawled out on top of the great air cruiser, then made their way to the

damaged fin. Buffeted by wind and rain, they clung to the framework and made an emergency repair job, running imminent risk of being pitched headlong into the sea. Earlier in this voyage, while over the Madeira islands, a mechanic climbed out on top of a motor gondola to repair a damaged oil tank.

Oddly enough, the British dirigible "R-100," on its way to Canada in July of this year, had almost exactly the same accident while over the St. Lawrence river. A sudden strain ripped the fabric from the underside of the port fin. A rigger, named Flatters, crawled out through the torn hole and made the fabric fast to the undamaged part.

The great Dornier "Do-X," which flew on one test flight with 169 persons aboard, is the first aircraft to provide mechanics and facilities for regular repairs in flight. A tunnel in the huge wing leads to the six nacelles which carry the twelve tandem motors. An engine man at each nacelle starts his two engines with compressed air. The four men in the outer nacelles stay there during flight. There are

*Dissolved in... Royalties Corp. 22  
Robbins Pres 185 N Wabash  
Chicago*

1284



Inspecting the Wright 300-Horsepower Engine of the Mendell and Reinhart Plane before Trying for 1,000-Hour Endurance Record

twelve American motors, each of 600 horsepower.

The great airliners, airplanes and airships of the near future will carry spare parts, repair mechanics and equipment to provide for all ordinary repairs in flight. Possibly even a spare motor can be carried. A round trip across the continent will take twenty-four hours or less, with huge airliners refueled in air to save time. Anthony H. G. Fokker said recently:

"It is now certain that, as the size of the plane increases, the engines will be made more accessible to provide facilities for making minor repairs in the air. It may be possible in the future, on larger planes, to transfer complete engines, and even crews."

### MICROPHONE IN GASOLINE TANK CATCHES A THIEF

1640

Using a microphone for a burglar alarm, an Englishman in India recently caught a thief who had been pilfering gasoline from his private tank. The microphone was attached to the tank and two wires were extended to the owner's bedroom. When a gurgling sound was transmitted, the owner dashed to the tank and found a native filling a can.

### LIGHTWEIGHT TILE IN COLORS MADE AT LOW COST

1590

Earthenware and tile, light in weight and brilliant in color and design, are being made in Germany, and the process is being introduced in this country since it is less expensive than ordinary methods of tile making. The product is known as "sedilith" and is in reality an artificial stone, composed of sand and lime and a chemical to act as binder. Neither heat nor pressure are used in making the tile, yet they are waterproof and weather-resistant. The product is lighter than stone, concrete, porcelain or clay tile and has greater tensile strength. The liquid material is poured in molds and hardens in twenty-four hours without warping, so that masks, statuary and moldings retain a clean-cut appearance. The coloring processes are likewise inexpensive. The tile can be made anywhere, once the equipment is obtained.

*no info. available. 12/16/31*

### ELECTRIC BELT SANDER CUTS WITHOUT RIPPLES

Assuring an extra-smooth finish through the use of a flexible pad, an electric belt sander can now be employed on wood, metal or stone

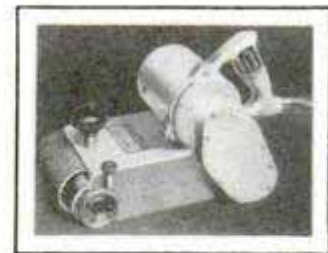

surfaces. The front roller is adjusted on an eccentric shaft with spring tension which permits quick changing of belts. Tension is controlled by a handwheel, and a thumbscrew adjustment provides perfect alinement of the belt on the rollers. The machine is well balanced, and ball bearings are used throughout. The motor is air-cooled and the belt runs with a free speed of 1,700 feet per minute. The weight is only eighteen pounds.

*See Technical Journal  
Franklin Institute 107,  
3-27  
Shilsaw Inc  
3310 Elston Ave*



ANIMALS IN AMERICA FIFTY THOUSAND YEARS AGO



© Field Museum of Natural History

Reproduction of Painting Depicting Beasts and Birds of Prey, Now Extinct, Surrounding a Tar Pit and Fighting for the Privilege of Feeding on the Animals That Have Become Mired in the Pit

Until only a few years ago, animals were sometimes trapped in asphalt pits near Los Angeles, being unable to extricate themselves after falling into the sticky substance. There is abundant evidence that the pits formed a natural hunting ground for wild animals some 50,000 years ago. Saber-toothed tigers, wolves and vultures of species now extinct fought to claim the carcasses of other animals that had perished in the asphalt. A painting representing a possible scene at the pits, has been made by Charles R. Knight for the Field Museum of Natural History. It shows three saber-toothed tigers devouring a carcass and defending their prey from a flock of vultures.

cushion center, and is installed by removing one screw from a door hinge, inserting it through a hole in the cushion and replacing the screw. This holds the door firmly on a cushion of rubber and stops the squeaks by eliminating the friction

ULTRA-SHORT RAYS IN RADIO ACT LIKE LIGHT 1528

Ultra-short radio waves, having a length of four inches, or one-tenth of a meter, and less, have been produced by a German scientist and have been found to have very individual characteristics. They are undamped, absolutely unmixed with waves of other lengths, and follow strictly the laws of light rays as to reflection and in many other important respects. Particularly interesting is their penetration. Without appreciable loss in strength, waves of fourteen-centimeter length pass through a layer of paper one-half centimeter thick, or the same thickness of hard rubber and paraffin oil, but are almost entirely stopped by distilled water. One of the immediate practical applications of such waves may be to radio "light-houses" where their purity and obedience to optical laws have obvious advantages over the longer waves.

AUTO-DOOR RATTLES STOPPED WITH AIR CUSHIONS 162

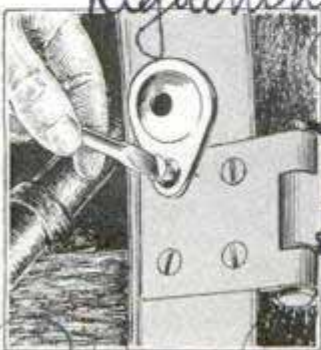

Pneumatic cushions made of rubber now are provided to stop the rattles that often develop in automobile doors. The squeak eliminator is a rubber tab with an air-

*Technical 8/28/30*  
*Illustration*  
*Physical Institute Erlangen, Germany*  
*Dr. Karl Kohl, member of Field*

*R. J. Lock & Co. 343 N. Esay St*

Mrs. John E. Wallace  
 315 W. 40th, Los Angeles, Calif.  
 912  
 2030 Carrizosa St.  
 Los Angeles, Calif.

POPULAR MECHANICS

3504  
 Berwyn, Ill.



Golf Scorer on Club Handle Which Punches Holes in a Score Card to Keep Track of Strokes

**GOLF SCORER ON CLUB HANDLE KEEPS STROKE COUNT**

Attached to the golf-club handle where it is not in the way and does not interfere with the stroke, a unit that registers the score has been introduced. With each stroke, the player presses a little button which punches a card at the indicated number of the hole. This saves using a pencil. At the end of the game, the player has a graphic record of the score shown in small perforations in the card, which is taken out and preserved if desired.

**LAKE TO COVER TOWN ON SITE OF BAGNELL DAM**

Linn Creek, a village of 550 inhabitants in central Missouri, will be buried under sixty feet of water when Bagnell dam starts impounding the waters of the Osage river as the final step in a \$30,000,000 hydroelectric project. The people of this town are moving out as are those occupying about one-third of Warsaw, Mo., which likewise will be under water. About 1,400 farms, forty-two cemeteries and thousands of acres of timber land will be covered by this man-made lake, which will supply the water for a plant generating more than 200,000 horsepower. The

Union Electric Light  
 & Power Co.

dam is to extend 140 feet above rock bottom, and the level of the lake will be 108 feet above the water below the dam. A state highway will run over the top of the dam, and the lake will be 140 miles long. Linn Creek, county seat of Camden county, contains about 100 buildings most of which have been bought by the power company and will be destroyed or moved. One of the biggest tasks is the moving of the cemeteries, entailing search for relatives of the dead all over the world.

**AIR TO SMOOTH RAIL SHOCKS WITH NEW ABSORBER**

Atmospheric pressure is utilized initially on both sides of the piston in a pneumatic shock absorber adapted to automobiles, and also for heavy-duty work such as busses and railway cars. The air pressure on either side of the piston increases very rapidly upon movement in either direction until a predetermined pressure is reached, at which time the air is by-passed to the opposite side of the piston so that pressure is built up for the snubbing action. This prevents the quick recoil of the springs which would occur should a partial vacuum be established in the snubbing direction. The apparatus also prevents axle roll, making steering easier, and absorbs the shocks before they are transmitted to the steering mechanism. For trains, the same principle is used except that the train line or an auxiliary line of compressed air is employed for initially applying a considerable pressure on each side of the piston when it is in its normal position.

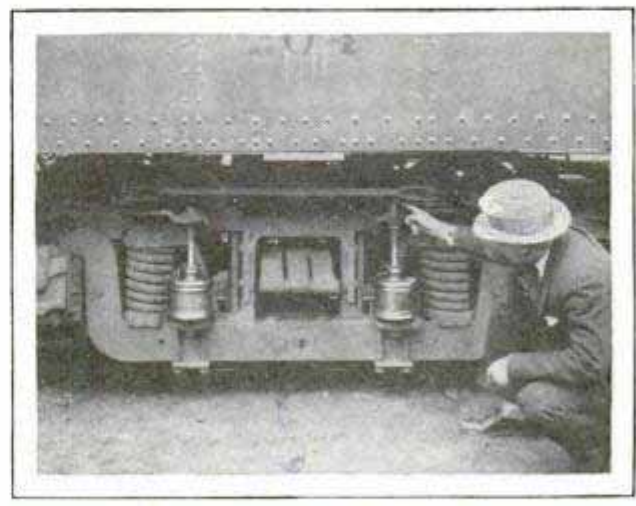

Pneumatic Shock Absorber on Railroad Car Which Utilizes a Cushion of Air to Eliminate Jars



To the Right Is a Form for a 600-Foot Concrete Bridge Arch Being Conveyed into Position on Pontoons; at the Left, One of the Completed Arches of the 2,600-Foot Bridge

*Wide World*

**ARCHES FOR CONCRETE BRIDGE FLOATED INTO POSITION**

When work was started on a 2,600-foot concrete bridge near Brest, France, one of the problems faced by engineers was the placing in position of three 600-foot arches. After the first arch had been finished, a huge arched form for the central one was made and floated into place on pontoons. After the form was in position, the job of pouring the concrete was comparatively simple.

3,250 cubic yards of concrete. The steel members would be joined by arc welding because that process would be the most economical for both construction and maintenance, and would insure extra stiffness, due to the absence of slip and play in the joints.

**RUBBER STOPPER FOR BOTTLES WITHSTANDS PRESSURE**

*1569*



*3 for 10-4*

Rubber bottle stoppers that will withstand a pressure of fifty pounds are proving particularly useful for retaining carbonated beverages. The cork is of flexible rubber with a grooved surface and a hollow center, and a protecting top that turns down over the edge of the bottle. Action of the grooves and the turn-down top combine to cause the stopper to grip the glass firmly and thus effectively prevent escape of the gas with which the beverage is charged.

**STEEL TOWER ONE MILE HIGH IS FOUND PRACTICAL**

*1560*

If such a structure would be of any value, it is entirely practical from an engineering standpoint to construct a steel tower one mile high. Such a structure, according to Gilbert D. Fish, structural engineer for the Westinghouse Electric and Manufacturing company, would require 19,000 tons of steel, would stand on a base 528 feet square and have four main posts, each composed of a cluster of columns arranged in the form of a square with twenty-foot sides and tied together with diagonal members. Each post would rest on a foundation, twelve feet thick and eighty-five feet square, containing

*Herald Tribune 9/21/30*

*before the section American Welding*

*Sun Rubber Co. Barberton, Ohio*



Floral Clock in an English Garden; the Mechanism Is under the Hands; Flowers around the Border Indicate the Minutes

### HUGE CLOCK BUILT OF FLOWERS KEEPS ACCURATE TIME

In an English garden a Cheltenham watchmaker has made a large floral clock that keeps accurate time. The clock is set in a fenced plot of ground with decorative borders. The operating mechanism is in a base in the center to which metal hour and minute hands are attached. Numerals on the clock's "face" are made of flowers and about the circumference are sixty small flowers to represent the minutes as the hands revolve over them.

as the sunburned skin. Appearance of the finish is altered by the weather in two ways. First, a thin film of dirt accumulates and is baked on the finish by the sun and engine heat, and the finish itself becomes dull from exposure. Ultraviolet rays are most destructive to the finish, just as they are to the skin that burns. There are two ways of prolonging the life of the finish, for even the best finishes of today do not last forever. One way is to protect the finish from the sun as much as possible, and the other is to wax and polish the body. Aside from protecting the surface, the wax does not permit the penetration of the ultraviolet light. For this reason waxing in summer is even more important than in winter, but the wax should be applied only on an entirely clean surface which has been polished.

fra-red rays which are invisible but are able to penetrate fogs and clouds. A detector instrument, sensitive to these rays, searches the heavens for them, and when they are picked up, it is turned until the highest reading is obtained. When this is ascertained, the device is known to be trained on the ship. The readings on the course and altitude dials then are transmitted to anti-aircraft guns. With this apparatus, there is no brilliant searchlight beam, which often only aids the enemy birdman in locating his objective.

### WAX AND POLISH PREVENT AUTO SUNBURN

1533

Automobile finishes suffer from sunburn just as the skin does, and, unless properly protected, the finish behaves in much the same manner

1566

### PLANES ARE FOUND AT NIGHT BY GLOW OF EXHAUST

To locate airplanes in flight at night, an instrument similar to the apparatus used by astronomers to measure the heat intensity of distant stars has been built. The hot exhaust pipes of a plane give off in-

Black has succeeded blue as the favorite color for automobiles.

*Capt. Edwin Lay  
Langley Field Va.*

*Motor Life  
Sept. 1930*

# When Seeing is Deceiving

THE familiar saying "seeing is believing" might well be changed to "seeing is deceiving." It is taught from childhood to university that we see with our eyes, and this is the truth but not the whole truth. Indispensable as are the sense organs in gaining an acquaintance with the world within which we live, yet they alone do not determine how extensive or how accurate that acquaintance is.

There is a mind behind the eye which guides in gathering information, and gives value and order to the exercise of the sense of sight or vision. How true this is of vision—the most in-

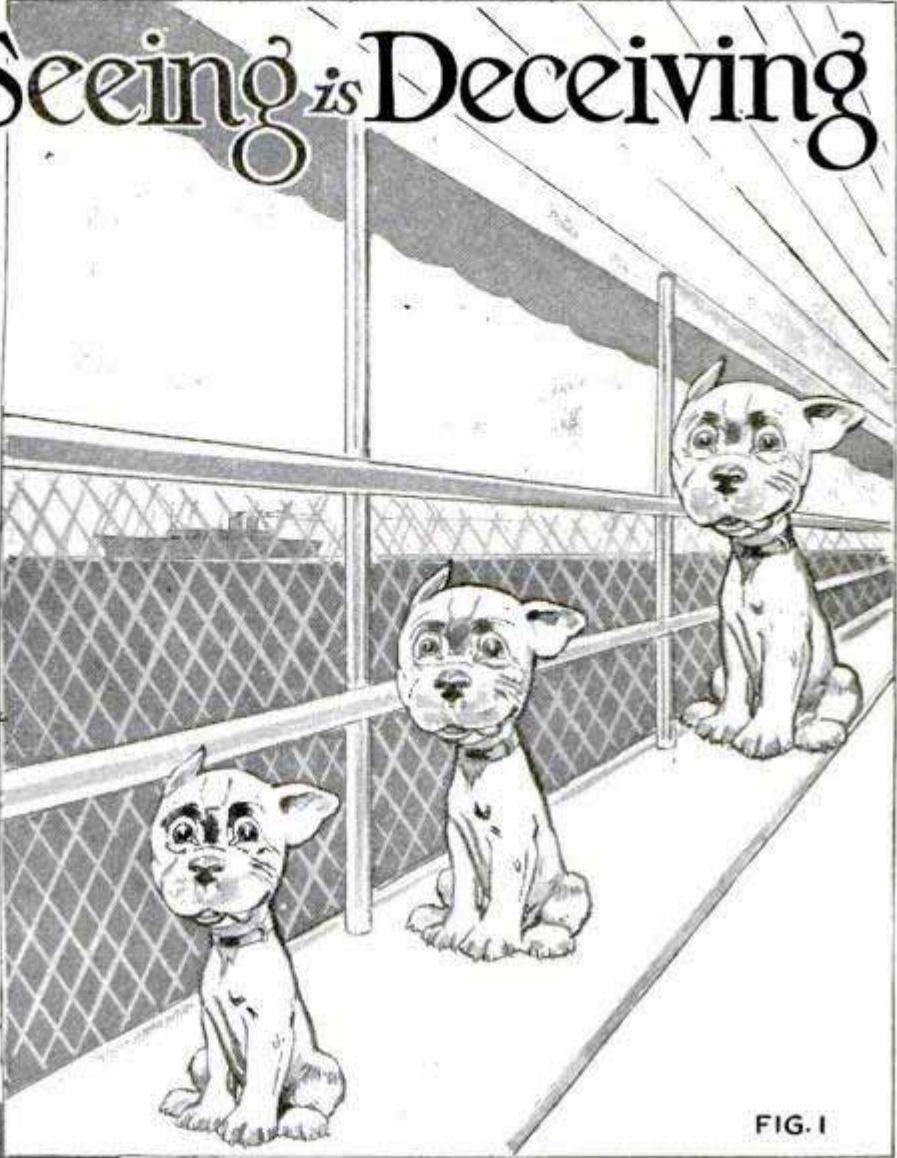

FIG. I

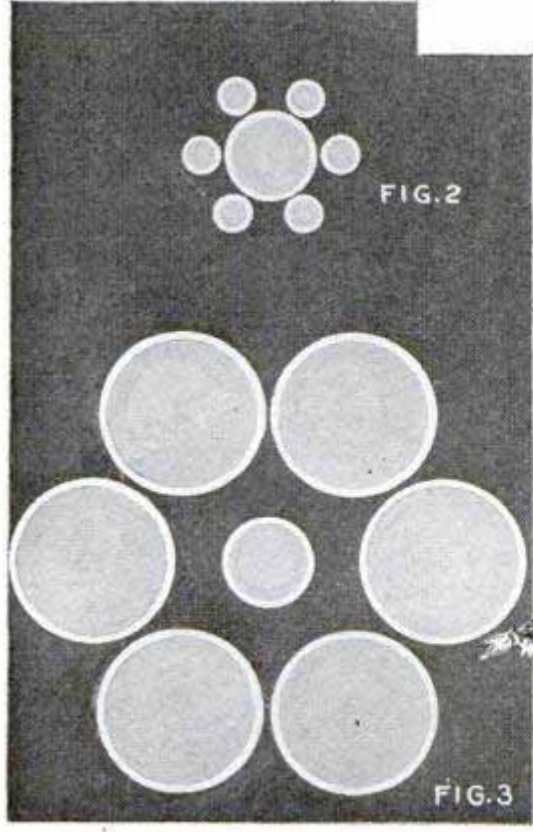

FIG. 2

FIG. 3



tellectual of all the senses of man, the one in which mere acuteness of the sense organ counts least and the training in observation most!

Seeing or observing is a double process, partly objective or outward and partly subjective or inward—the picture mysteriously transferred to the mind's representative, the brain, where it is received and affiliated with other images.

The importance of the mind's eye in ordinary vision is also well illustrated in cases where we see or seem to see what is not really present, but what for one cause or another is natural to suppose is present. For illustration, take the word "Detroit" in one of the drawings. We see only the general outline of the word, and the detailed features are supplied from within; in this case, it is the expected that happens.

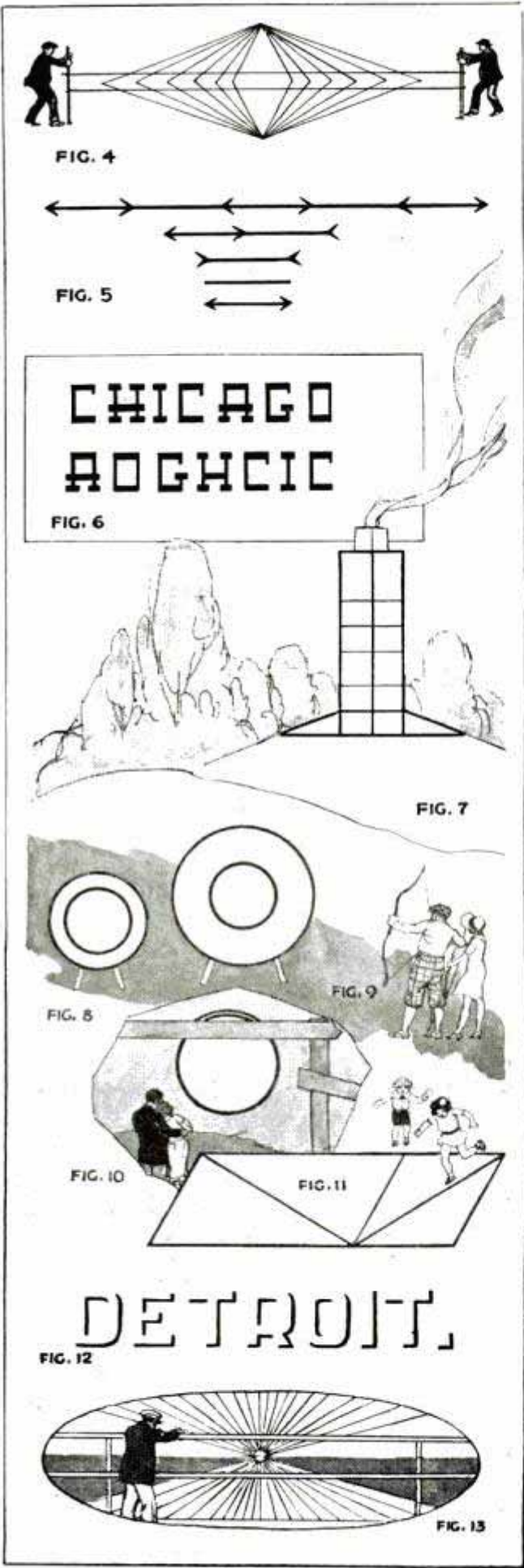

The center circles of Figures 2 and 3 are exactly the same size, although the center circle in Figure 2 appears much larger than the center circle in Figure 3 because of the size and positions of the circles surrounding them. In Figure 4, the two horizontal lines are parallel but appear to diverge toward the ends due to the oblique lines intersecting them.

Despite all precautions taken in observation of many illusions of length or size, it often becomes necessary to employ an objective quantitative test or measuring device, and only by the application of such a device can the fallacy of the illusion be determined. In Figure 5 are a number of lines drawn between arrow heads, and in each case, every line between the arrow heads is equal. No one would judge these lines as equal, but by applying a rule, their equal length will be disclosed.

The fact that we can perceive at once only as many items as can be unified in one total impression, may be shown by Figure 6. Glance at each of the two groups of seven letters. The first group is perceived at a glance, the second series can not be fully perceived at once.

Vertical lines seem longer than horizontal lines, as illustrated in Figure 7. Here, the bottom horizontal line is exactly the same length as any one of the three vertical lines although it appears much shorter.

The inside circles of Figures 8 and 9 are exactly the same size, although the inside circle of Figure 8 appears much larger than the inside circle of Figure 9. In Figure 10, the lower arc above the parallel lines is a portion of the circle.

In Figure 11, the large parallelogram is divided into two smaller ones and a diagonal placed in each. The diagonals are equal in each parallelogram, although the diagonal on the left appears to be much longer.

The word "Detroit," Figure 12, appears at a distance as a double-bordered letter word, but upon careful examination, it is found to be made up of a single border of lines. We see only the general physiognomy of the word when we glance at it, and the detailed features of the word are supplied from within.

In Figure 13, the two broad lines are

*farmer near Greensburg, Kans  
to Alvin A. Justice*

*Weather Bureau Office  
at Dodge City, Kans*

*Science Service New Bulletin 495-10 9/18/30*

parallel, but they certainly appear to diverge from the center, due to the numerous lines intersecting them at different angles.

In Figure 1, we have three dogs, all identical in size and shape, but due to perspective, we see the one farthest from us as being the largest and the one nearest as being the smallest.

In general, we do not see things as they are; that is, the intellect does not correctly interpret the messages of the visual sense, although sometimes the optical mechanism of the eye is directly responsible for the illusion. In other words, none of our conceptions and perceptions are quite adequate, but fortunately most of them are adequate for practical purposes.

### MAN LOOKS INSIDE A TORNADO AND TELLS WHAT HE SAW

Probably the only man who has ever seen the inside of a tornado and lived to tell it, is a Kansas farmer whose experience has been reported to the weather bureau at Washington. He noticed the approach of a dark cloud consisting of three tornadoes, and hurried his family to the cyclone cellar, then paused at the entrance to watch the largest and nearest of the funnel-shaped clouds, ready to duck inside if necessary. As he watched, he saw the lower end of the tornado rise, the tip gradually ascending until the great

shaggy end of the funnel was directly over his head. There was a screaming, hissing sound coming from the funnel, and as he gazed upward, the farmer was astonished to be able to peer through the center of this funnel directly into the heart of the disturbance. The funnel opening he estimated at about 100 feet in diameter, and he looked up through this for about half a mile, the spectacle being made visible by vivid flashes of lightning which zigzagged from side to side of the whirling wall of clouds. Around the lower rim of the great vortex, smaller tornadoes were forming and breaking up, and these made the hissing noise. The rotation of the great twister was counterclockwise, but the small whirls moved both ways. The opening appeared entirely hollow, except for something that looked like a detached wind cloud which moved up and down constantly.

### APARTMENTS BUILT IN CIRCLES FIND FAVOR IN GERMANY

Circular housing plans for apartment buildings are finding favor in Germany. In a suburb of Leipzig an architect has constructed more than a score of apartment buildings, built in three concentric circles to form one large unit. The buildings are constructed in circular segments, and two common drives run diametrically through the settlement, with tributaries branching to the various buildings.



More Than Twenty Apartment Buildings Are Contained in This Circular Housing Plan Carried Out in Leipzig, Germany; the Units, in Concentric Circles, Have a Street System in Common

*Keystone*

*Rudolph Wurlitzer Co  
120 W 43rd St  
New York City*

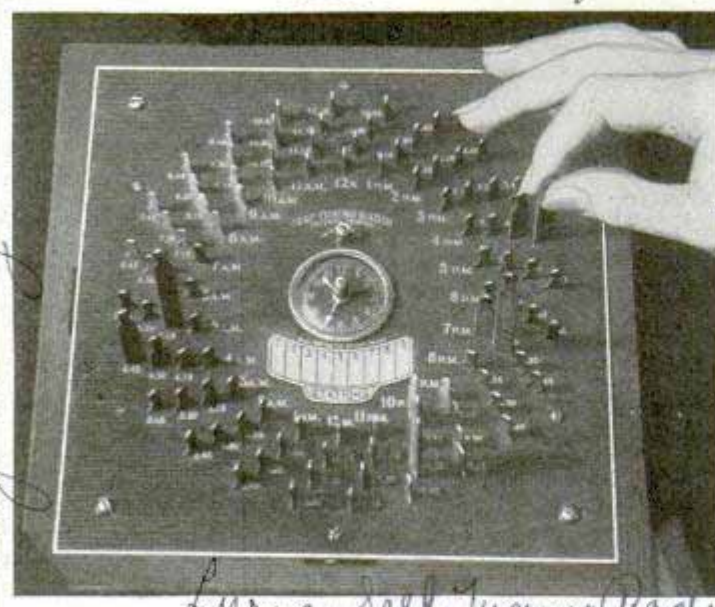

Radio Control Board Which Turns Set On and Off and Tunes in Stations at Any Time Designated

**RADIO-CLOCK CONTROL TUNES STATIONS IN ADVANCE**

Making radio entirely automatic in operation, an electric clock with a control-board attachment makes possible the tuning in of stations chosen in advance. By a system of plugs on the control board, the set can be turned on or off at any designated time selected in advance, and any station desired can be tuned in at any designated time, thus enabling the setting of the control board to pick up the programs desired from different stations for an entire evening.

**RUBBER VASES FOR FLOWERS DO DOUBLE DUTY**

Flower vases of rubber answer a double purpose, for they not only are unbreakable, but can be shaped to conform to the length of the flower stems placed in them. By a mere pressure with the palm of the hand, the rubber vase can be elongated for the long-stemmed flowers, or shortened for other kinds. They are made in sev-



*1552*

*J.B. Kleibert Rubber Co  
485-5th Ave*

eral different solid colors as well as in mottled effects to suit individual tastes.

**GLASS IS CONSIDERED A LIQUID**

Glass is a liquid and not a solid, in the opinion of George W. Morey, of the Carnegie Institution at Washington. He describes it as being in a state of "suspended animation" and suggests that, because of the limited number of ingredients in the world that will produce this effect, it is little wonder that the secrets of making glass were so zealously guarded in early times, and that the product has been shrouded in mystery and secrecy from the beginning.

The three substances that make glass, lime, soda and sand, must be mixed in the right proportions or the material becomes worthless. It is only recently that scientists have determined the true nature of glass.

**CELLULOID CURTAIN FOR AUTO SHIELDS EYES**

For the windshield or rear window of the auto, a glare shield now is available to shade the eyes from sun or lights of other cars. It is a celluloid curtain on a frame that is attached to the glass with vacuum cups. It rolls up out of the way when not in use, and is attached or taken from the windshield in a second.



**SIX MILLION RIVETS IN AIRSHIP**

Workmen building the navy's newest Zeppelin-type airship "Akron," are driving 6,500,000 rivets into the framework without striking a single blow. The rivets are made of aluminum alloy instead of steel, and are squeezed into place instead of being pounded by compressed air or electric hammers.

*Goodyear Zeppelin  
Air*

*See service here 495-500*

*121 E 4th  
Assessors Office*

*Myneapolis Minn*

*map Co, Inc.*



**SPEAKER PRODUCES CHIMES WITHOUT ANY BELLS**

Chimes without bells and a reproduction of the booming of Old Ben in London are two of the features heard regularly by residents of Camden, N. J., through a giant loud speaker in the courthouse tower, 300 feet above the street. The speaker has an audible radius of from two to six miles and programs can be broadcast through it to an entire city, using either a microphone or phonograph records. From an ordinary inexpensive record, chimes of a famous Belgian carillon are reproduced, and another instrument gives the effect of a huge bell striking the hours. A small box, less than a foot square, supplies this sound through oscillations. On three sides of the tower are banked 180 loud speakers with a capacity of 600 watts, arranged at angles. Through the speaker a mayor can make a proclamation, or a band or orchestra concert can be offered for the entire population.

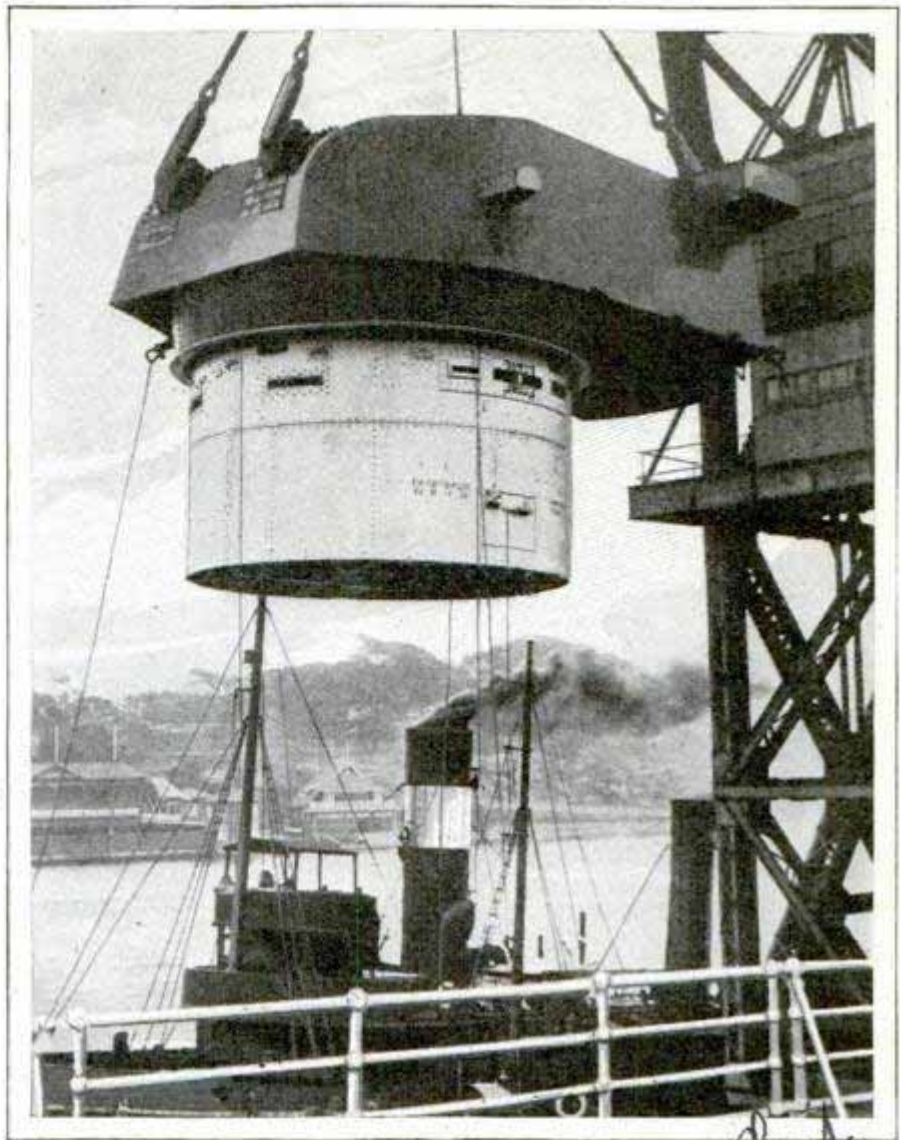

Unloading a Ninety-Ton Gun Turret in the Harbor of Sydney; the Australian Navy Expects to Use This Huge Mounting as a "Spare"

**GUN TURRET USED AS "SPARE" BY AUSTRALIAN NAVY**

Like the careful motorist, the Australian navy believes in carrying a "spare," although in the navy's case it is a gun turret that is the emergency equipment. The huge turret, weighing more than ninety tons, was unloaded recently in the harbor at Sydney after it had figured in diplomatic correspondence because foreign powers had photographed it while the vessel that carried the mounting was on its way to Australia through the Mediterranean.

**FOUNTAIN-BRUSH AUTO WASHER ATTACHED TO GARDEN HOSE**

Washing the car is simplified with a fountain brush of soft bristles having a long handle which attaches to any garden hose. The brush removes all dirt quickly and thoroughly. It is also suited for washing the outside of windows, etc.



Fountain-Brush Auto Washer with a Long Handle Which Can Be Attached to Garden Hose

Modern Auto Washer Co

Chicago, Ill.

1554

\$3.00 brush refiller \$1.00

pat. pend.

D.W.

185

# Man's Mightiest

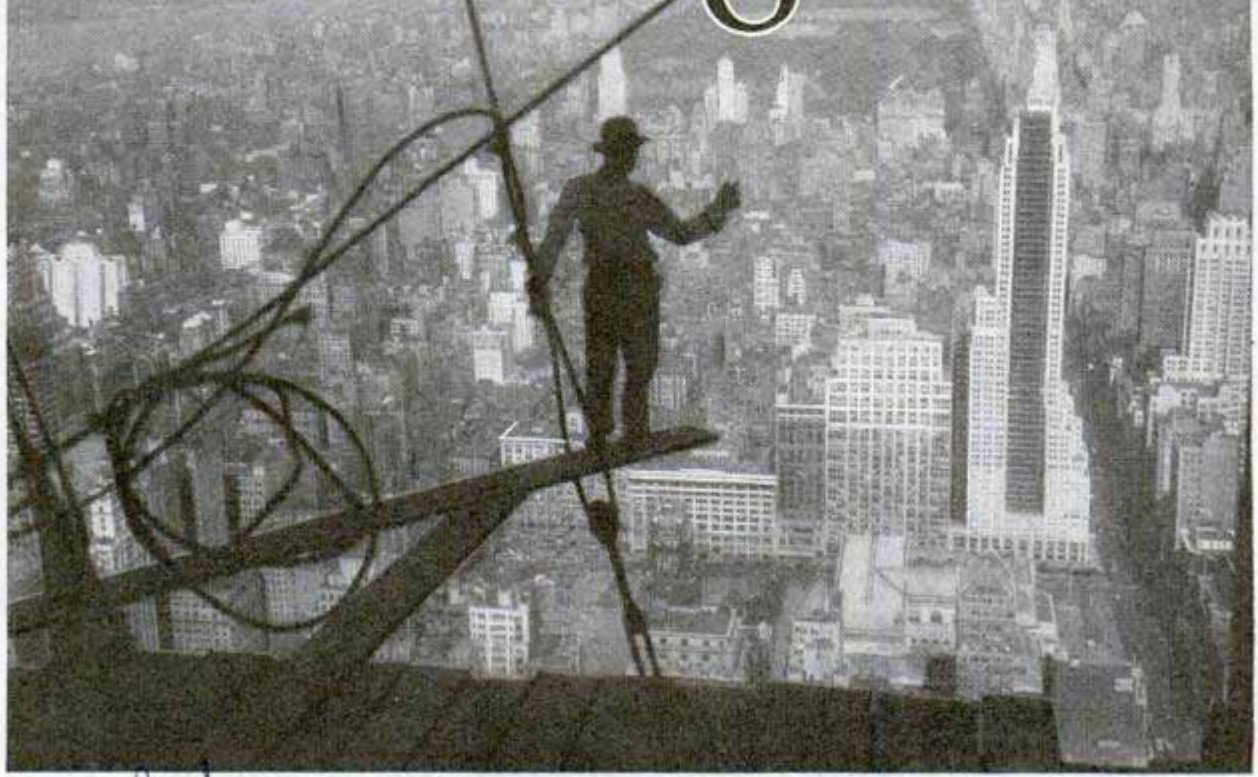

Workman Gazing over Manhattan from the Eighty-Eighth Floor of the Empire State Building; When Completed, This Building Will Be the Tallest Man-Made Structure in the World

**V**ISIBLE fifty miles out at sea, 100 miles from an airplane and seventy miles north of New York, a \$50,000,000 miracle of glass, steel, chromium, aluminum, limestone and granite commands the horizon and staggers the imagination.

Not a mirage, but a colossus of modernity, is this, the highest structure ever reared by mankind, fulfilling myriad prophecies on time, space and infinity.

The Empire State building, 1,250 feet from sidewalk to aviation beacon, ushers in the age of Babylonian pinnacles and presages severe restrictions on the term "skyscraper." One thousand feet above Fifth avenue, on the eighty-fifth story, you can see how this new Goliath dwarfs so-called skyscrapers of twenty stories.

Beginning at the ground floor, the Empire State occupies a site of 83,725 square feet, or 197 by 425 feet. The main setback, sixty feet, occurs above the fifth story. From the sixth story, there is a sheer rise of almost 1,000 feet, all sur-

mounted by an airship mooring mast 200 feet high. The total volume is 37,000,000 cubic feet, 2,000,000 square feet of rentable space for 20,000 tenants, and enough spare room for 15,000 visitors.

These mammoth proportions fade, however, before the distinction of being the first building constructed to accommodate aircraft and their passengers. The Empire State's mooring mast may not be used for three years, but everything will soon be in readiness. Exhaustive studies are now being made of various types of mooring machinery. The 200-foot mast is faced with glass and chrome-nickel steel. The framework is reinforced and fastened rigidly to the main building skeleton. A fifty-ton jolt would not injure the mast or substructure, and it is doubtful whether any dirigible at ease could jar this anchorage.

R. H. Shreve, the architect, intends to follow new developments in mooring machinery. He referred to the graphic il-

# Monument

Illustration of the mooring-tower head at St. Hubert's airport, Canada, which appeared in the October issue of Popular Mechanics, saying that it would be installed if no improvements are made while the choice is pending. Meanwhile, the tip of the mast will be an aviation beacon, which will be discarded when the type of mooring apparatus is selected and installed.

The building's elevator contracts involve an expenditure of \$3,000,000. No firm ever before attempted a 1,000-foot elevator altitude in a building, and the project necessitates elaborate experimental work. Certain phases of construction will cost the elevator builders three times what they receive, the difference being charged to laboratory overhead. What must they do? Construct electrical equipment for sixty-six high-speed signal-controlled self-leveling elevators. One battery of express cars will make no stops below the sixtieth story, and it will reach that height in less than one minute! The main shafts will not go above the eightieth story. A separate battery will serve floors above.

The Empire State's steel frame weighs in excess of 58,000 tons, the largest single order ever placed in building construction. Loads on individual columns also break all previous records. Several columns bear 10,000,000 pounds each.

Weight is one of the principal factors in skyscraper construction, and in this case the architects were driven to a new type of exterior construction. For the first time, they made extensive use of aluminum and chrome-nickel

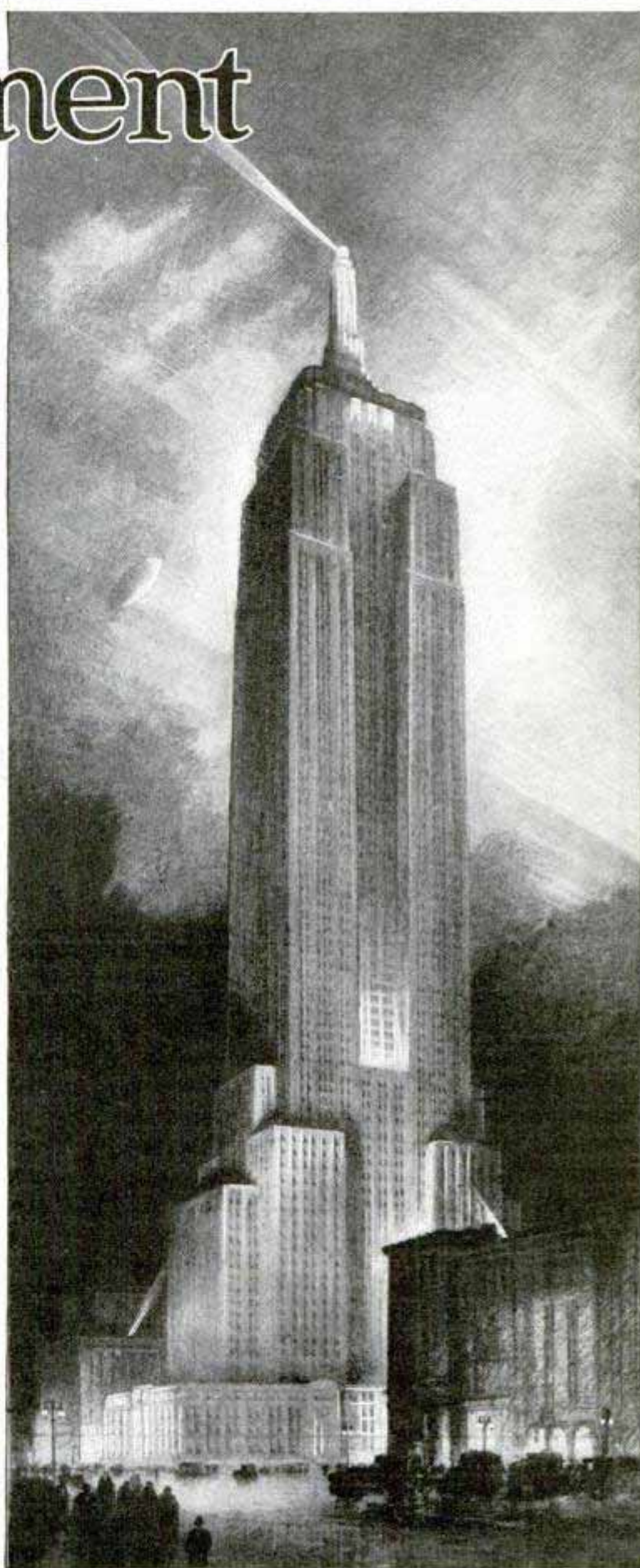

Architect's Drawing of the Empire State Building, Which Will Be 1,250 Feet High to Tip of the Aviation Beacon

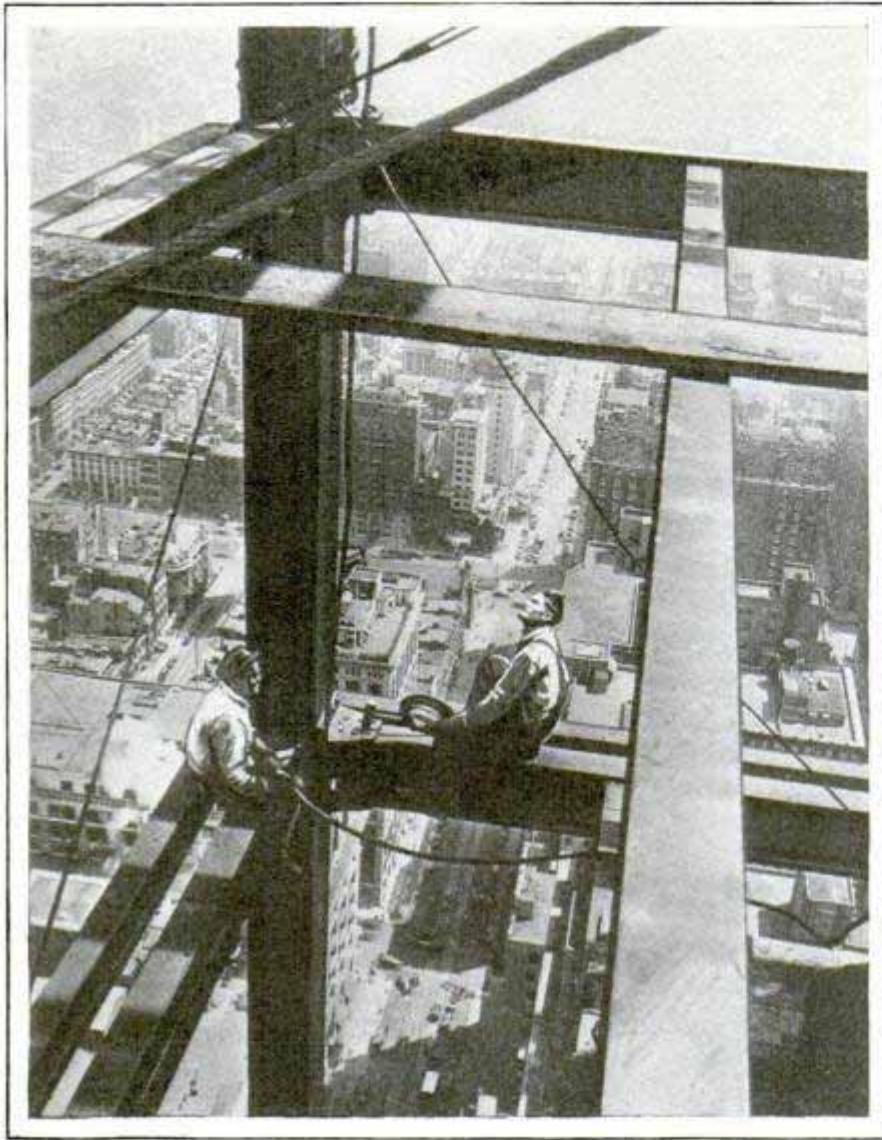

Riveters Are Here Shown at Work on the Mammoth Structure 900 Feet above Street Level; It Will Be 200 Feet Higher than the Eiffel Tower

ordinary stone-faced building has about one cubic foot of stone for each fifty cubic feet of building. The Empire State has one cubic foot of stone for every 200 cubic feet of building.

The use of metal, aside from the saving of weight, means an economy of space too. No radiator projects beyond the wall surface, and ventilating ducts are also concealed.

Whoever saw the construction of this super-building witnessed a miracle of organization, efficiency and precision. Enormous interest charges, insurance fees and tax assessments were in force, and the running costs of \$10,000 a day made minutes the most indispensable items in the venture.

At the peak of construction, 5,000 men were employed on the job. In building-material plants all over the world, thousands of other men had to

steel in exterior facing. Below the steel window frames, cast aluminum spandrels, finished dull, are used, and between windows, polished fluting of rust-resisting chrome-nickel steel. White limestone covers the rest of the steel.

On exterior alone, the use of metal reduces the weight of walls fifty per cent. Thus it was possible to run the building up 1,250 feet without straining the steel skeleton or overloading the foundation. The Empire State could have gone much higher, but under the present economic balance, a height beyond 1,250 feet would have been unprofitable.

The architects devised still another innovation when they made the 6,400 windows integral parts of the wall. They are almost flush with the stone facing. This invention made it possible to simplify the stonework and reduce its cost. The

ship their products on time. Thousands of others were engaged in nothing more than transportation.

The arrival of 58,000 tons of steel, 10,000,000 bricks and 200,000 cubic feet of stone, besides daily deliveries of 5,000 bags of cement, 450 cubic yards of sand and 300 bags of lime, did not interfere with passenger or vehicle traffic around this building.

With so much material constantly arriving, it was necessary to dispatch trucks like trains. Three minutes might mean \$100 to the contractor. Drivers learned their routes so well that they could snake their way through congested districts with a minimum of delay. A hundred trucks drove toward the building site at one time. Some were running under the Hudson river; others crossed from New Jersey on ferryboats, and still others came across

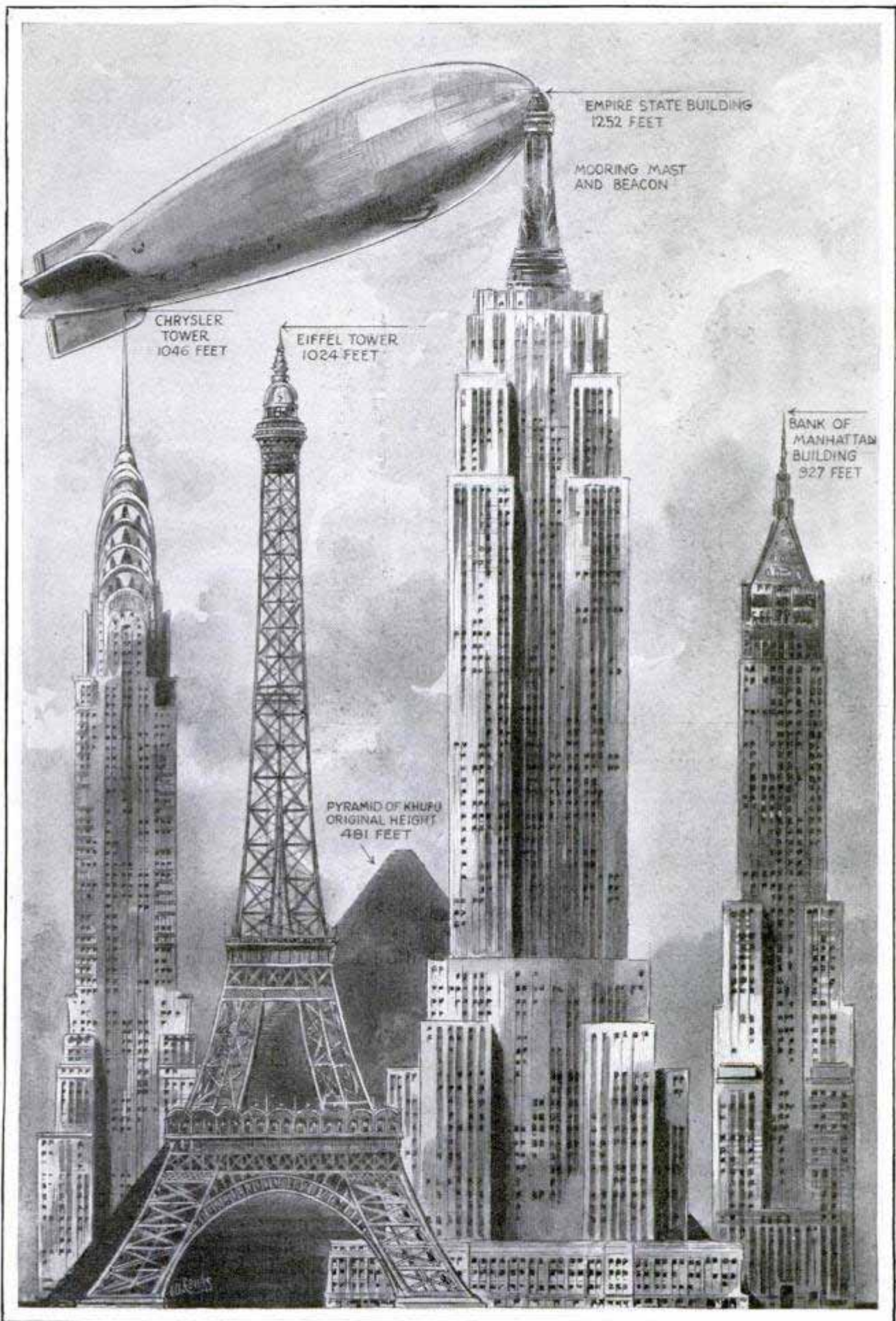

Drawing Showing Comparative Heights of the Empire State Building, Which Will Be the Tallest Man-Made Edifice, and Other Tall Structures of the World, Including the Pyramid of Khufu



senger elevator dives only four and a half miles per hour and gives a giddy sensation to riders. Mine hoists were introduced to Fifth avenue by the Empire State. The innovation saved many thousands of dollars in time and equipment. At a breakneck speed of 1,320 feet per minute, the hoists streaked up and down their shafts like phantoms, making no more noise than a modern passenger elevator. No man was allowed, nor would he dare, ride one, for the sensation would be similar to falling through space. At each floor a track-distribution system was installed. Materials in cars were stopped, rolled off, switched, and dumped—3,000 pounds per shipment.

bridges. If they started too early, it was almost as bad as if they arrived too late, for the unloading space, of course, was rather limited.

The din of steam hammers, air hammers, riveting machines and hoists filled the air above, while trucks on the first floor discharged their loads of sheet iron, bales of wire, spools of cable and miles of brass water pipe. Then distribution commenced. The novelty of distributing bulky material by mine-railway system had never occurred to builders before. But here was no ordinary building, and when engineers calculated that the normal hoist carries only 1,500 pounds at eighty feet a minute, they were puzzled how to supply 290 bricklayers, 384 brick laborers and 225 carpenters with materials on upper floors. Their problem was to double not only the capacity but the speed of each hoist. Engineer detectives were sent west to the deep copper mines and there they saw lifts literally leaping out of the earth at fifteen miles an hour, carrying a dead load of 3,000 pounds! An express pas-

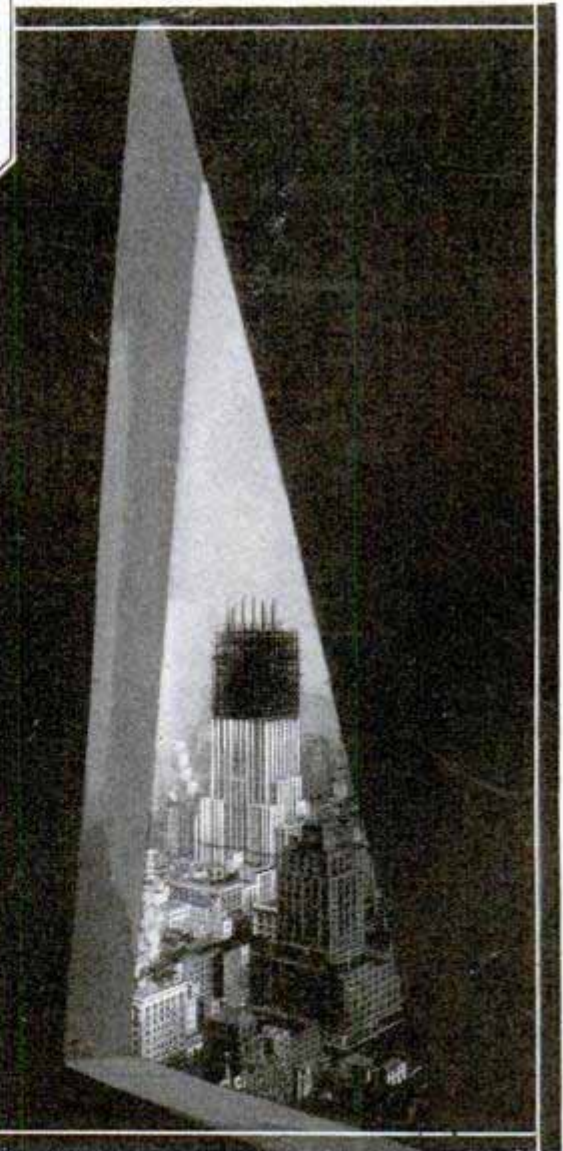

Above, Riding the "Ball." Below, Unfinished Structure Seen from Modernistic Window of Chrysler Tower

THIRTY-SEVEN-THOUSAND-MILE A SECOND BULLETS

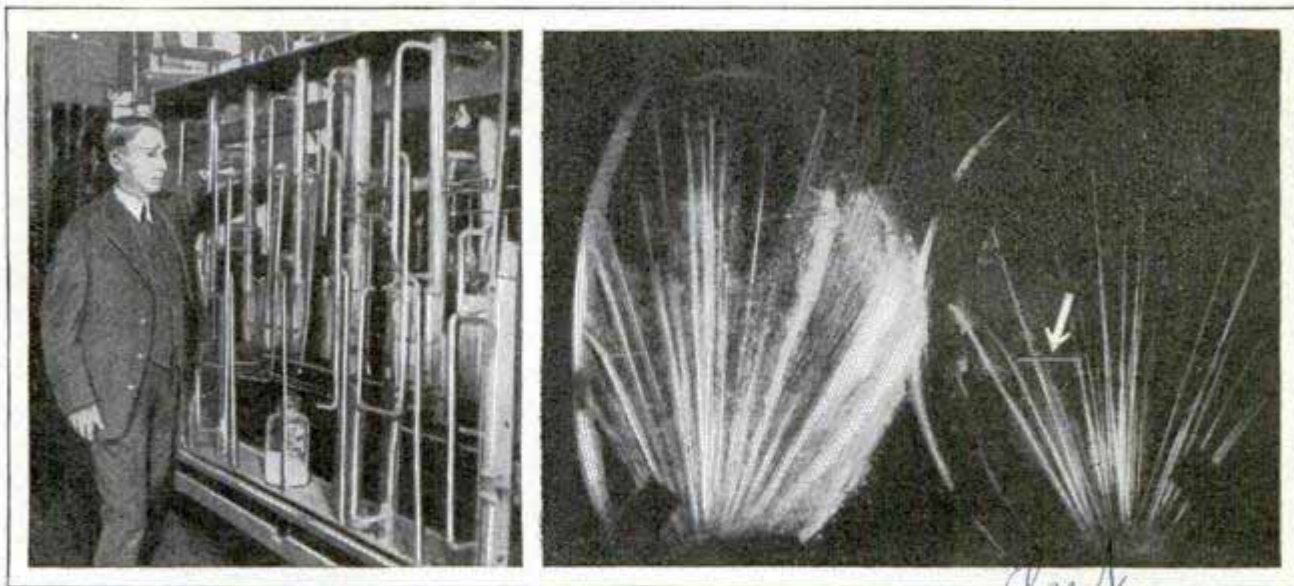

Left, Apparatus Which Fires Hydrogen "Bullets" at Atoms in Effort to Release Atomic Energy; Right, Arrow Points to Hydrogen Nucleus Traveling 10,000 Miles a Second

*Washington, D.C.*  
 Science is now bombarding the atom with a "machine gun" firing hydrogen "bullets" at a speed of 37,000 miles a second in an effort to break up this elemental unit of all matter and release the potential energy it possesses, which some estimate as sufficient to do the work of all the world. The National Academy of Sciences in ~~New York~~ is sponsoring a machine with which the almost infinitesimal atom is being attacked. This formidable piece of apparatus shoots hydrogen atoms at the atoms of other elements in efforts to break up the latter and solve a problem that has long intrigued science. Pictures have been obtained of one of these hydrogen "bullets" when the nucleus was traveling at the rate of 10,000 miles a second, or more than half a million miles a minute.

desert air, and through telephone apparatus connected with the instrument they heard one day a peculiar beating noise which was found to herald the rising of a sandstorm. The explorers then constructed an improved instrument, known as an "atmoradiograph," expressly to give warning of such storms.

TINY FIREBOAT USED TO FIGHT INACCESSIBLE BLAZES *1579*

Tiny fire tugs have joined the ranks of miniature golf courses and small automobiles. These little boats, hardly larger than a fair-sized rowboat, are being used in Boston to fight pier blazes which often are inaccessible to large craft.

DESERT SANDSTORM DETECTOR

*1511*  
 Quite by chance, three French scientists recently found a reliable means of warning tribesmen, troops and voyagers of the approach of sandstorms in the desert. The men had erected an instrument to observe the movements of flying insect hordes through the



Tiny Fireboat Which Has Been Found Highly Useful in Boston in Fighting Pier Blazes Which Often Are Almost Inaccessible

*Col. Francis Liggett  
 of Canadian Legation  
 11 Rue d'Alsace*

1568- by E. M. Laid

Abraham Ches



as a pylon racer, and can fly in a vertical bank around a closed course almost as easily as other ships negotiate level courses. Because of its size, only enough fuel for an hour's flight is normally carried. It has a wing spread of nineteen feet, and the cockpit is eighteen inches wide.

FADING OF COLORS DEPENDS ON DYE

1589

Conditions which cause fading in colored fabrics are dependent on the type of dye used, and not on the color of the cloth. It has often been believed that yellow colors fade more easily than others, but experiments by the bureau of standards show this is not the case. The chemical type of the dye, and not its color, is the big factor in determining its ability to withstand fading from light or washing. While there is no such thing as an absolutely fast dye, dyes that retain their shades when subjected to the conditions for which they were intended, and for the time intended, may be considered fast. Fading

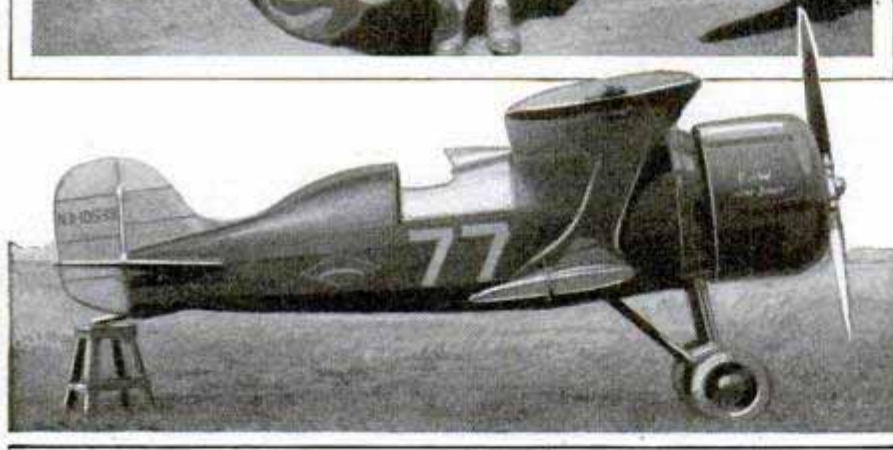

Above, an Old, and Below, the Latest Type of Speed Plane; the Little Ship Below Is Virtually All Engine and Weighs 1,400 Pounds

ENGINE FITTED WITH WINGS SEEKS SPEED MARK

A 500-horsepower engine equipped with a pair of wings—that, in brief, describes a tiny airplane with which Lee Shoenhair, speed pilot, hopes to lessen the time required to move from one point to another. In tests, the little biplane, that is virtually all motor, averaged 201.91 miles an hour around a five-mile triangular course, but was unable to make the turns at full throttle. The plane was built around the engine, everything being kept to the minimum in size. It was designed primarily

is much affected by the humidity of the atmosphere, and dyes exposed to the sunlight in California and Arizona, do not fade as quickly as when placed under similar conditions in the east. There is no relationship between the fading of a dye in sunlight and fading when laundered. A few withstand both tests, but a great majority do not fade under one condition although they do in the other. In the bureau of standards tests, a washing machine is used which tests twenty samples of dyed cloth at a time, and other samples are exposed to artificial light simulating sunlight in its effects.

Designed by Laid

Barby 9/24/30

W. H. Appel, Chief, Textile Section, Argonne and



## WHERE THE EARTH'S SURFACE BEGINS—AND ENDS

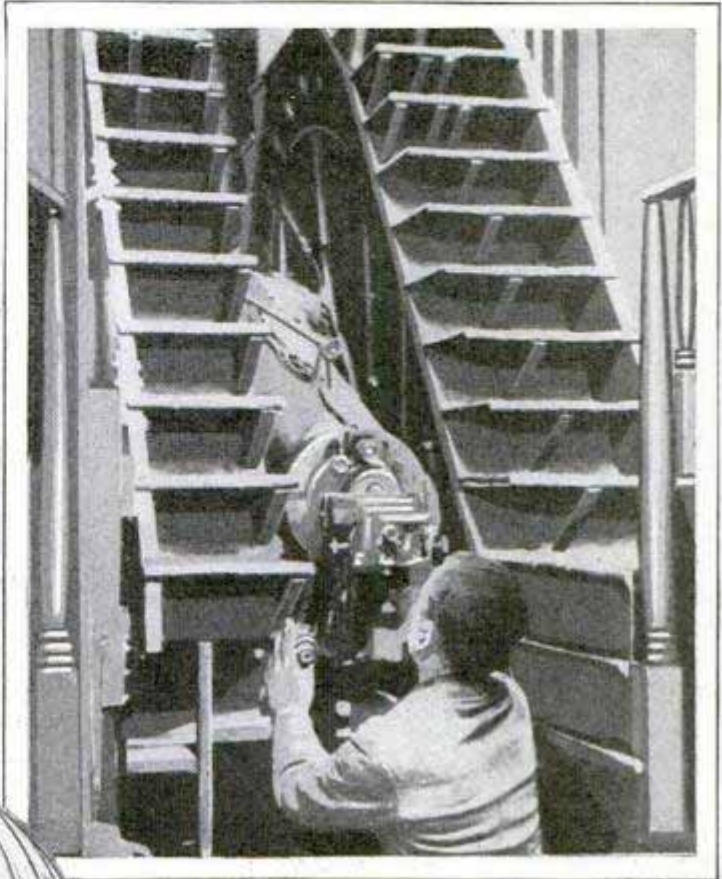

Upper Left, Tablet at Greenwich, England, Marking "Longitude 0"; from This Imaginary Line, the Rest of the Globe Is Marked into Units; Above, Telescope Facing Due South and Alined with Greenwich Meridian; by the Passing of Stars across a Thread in the Eyepiece, Greenwich Mean Time Is Computed

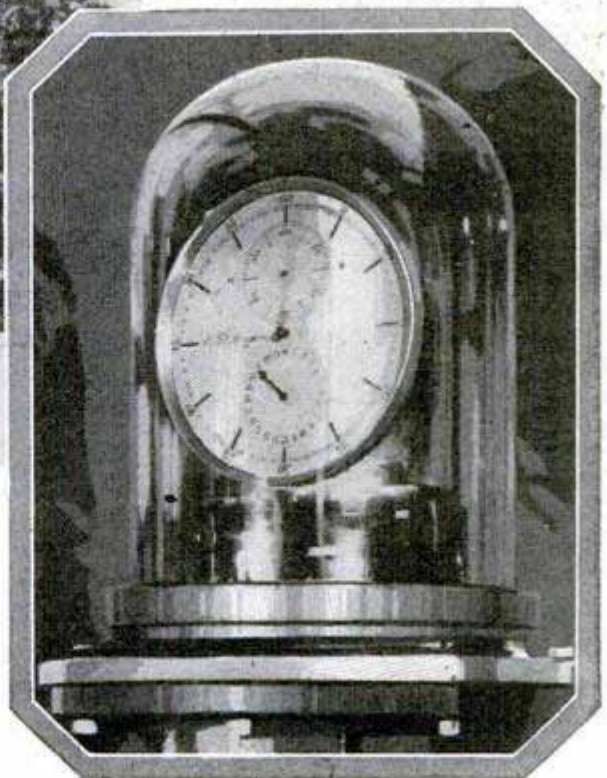
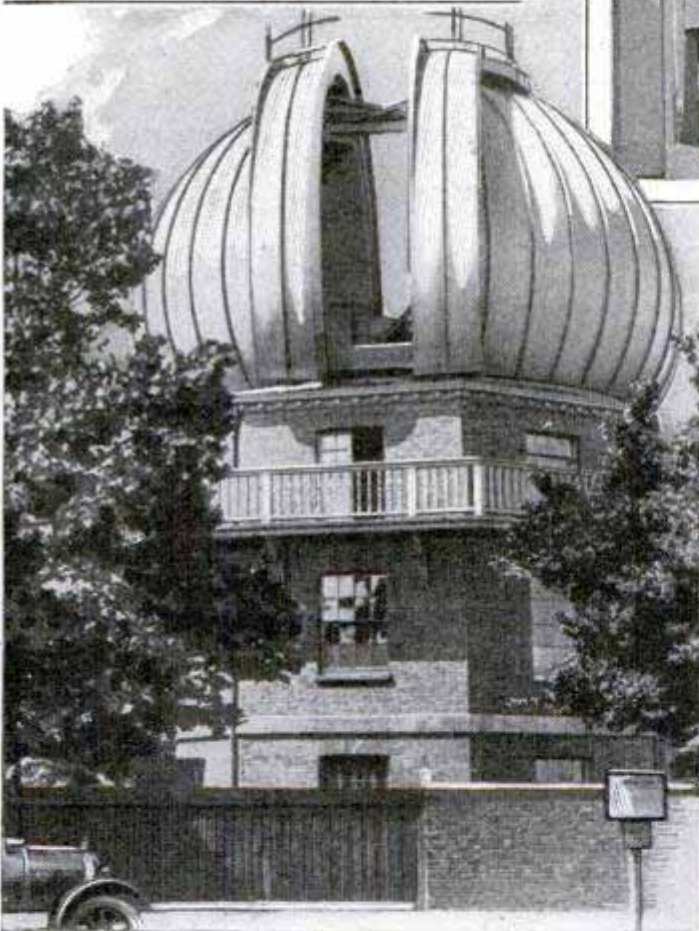

Above, Observatory at Greenwich, England, Containing a Great Telescope Which Is Part of the Elaborate Equipment Used by Scientists to Tell the Time of the World; Greenwich Meridian, Designated as "Longitude 0," Is the Official Starting Point of the Earth's Surface; from It Meridians Differing by Fifteen Degrees Each Have Been Marked Off on the Globe, East and West; Right, Standard Sidereal Clock at Greenwich Which Never Varies More than One-Fiftieth of a Second; It Is Kept in a Sealed Glass Case at an Even Temperature of Sixty Degrees

*dnb*

*Patented by me & Chumie Rochester, N.Y. 94 Crouch St*

**CHURCH LIKE GIANT PIPE ORGAN IN DANISH CAPITAL**

*1545*

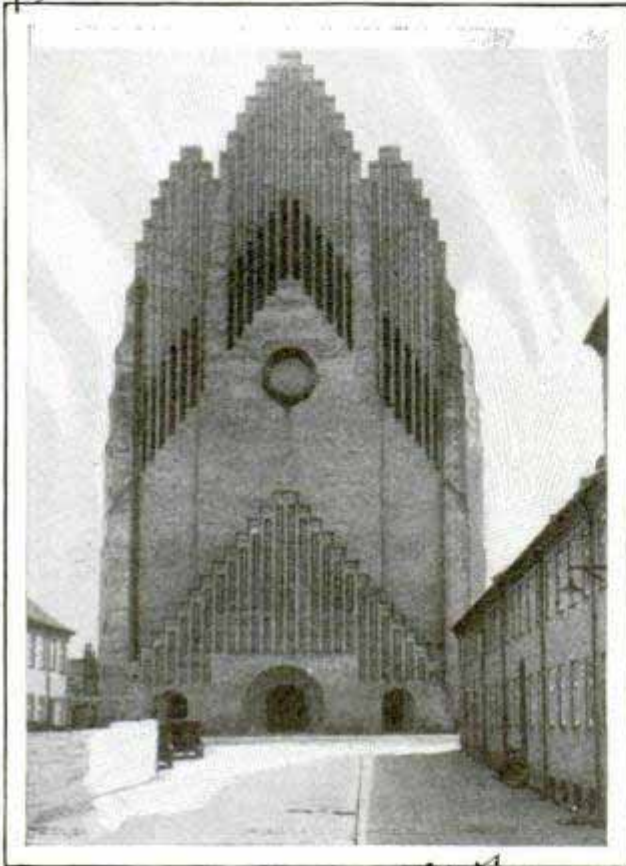

An Example of Modern Architecture Is This Copenhagen Church Resembling a Huge Pipe Organ

Towering at the end of a street in Copenhagen is a massive church built after the modernistic trend of architecture to resemble a huge pipe organ. It stands at the end of a street lined with brick houses which add to the illusion of a great outdoor organ with the front wall of the church forming the pipes. It is named the Grundtvig church.

**CLOTHES ABSORB SOUND**

*1561*

Audiences in a theater or talking-picture house absorb more sound in winter than in summer, due to the increase in clothing in the colder season. For this reason actors must speak louder to winter audiences, and the loud-speaking talking-picture equipment must be tuned to higher volume in winter. The quality of clothing worn by an audience, experts of the bureau of standards have found, is a large factor in determining the length of time

required for sounds to fade away. Experiments also have shown that theaters equipped with soft velvet-covered spring seats require more volume because the seats absorb sound to a high degree.

**"SILENT" PIANO IS AUDIBLE ONLY TO THE PLAYER**

*1494*

Using tuning forks as substitutes for the usual strings, an eastern inventor has patented a piano which can be made audible only to the player and instructor, or turned on for others at will. This is accomplished through a series of audio cells and a set of earphones. The sound can be confined to the phones if desired so that neighbors need not be disturbed by practicing or playing at late hours. Another advantage claimed for the instrument is that it does not have to be tuned as the forks hold their pitch and the piano can also be made smaller and lighter, the tuning forks needing less support than the strings in the usual instrument.

**FARM-WASTE CHOPPER HELPS IMPROVE THE SOIL**

*1542*

To reduce bulky waste, after harvesting crops, to a fine mulch for the improvement of the soil, a chopper operated by a tractor has been introduced. Spinning steel disks cut the refuse into shreds so that it can be more easily plowed under and mixed to nourish the soil. The attachment illustrated here is being used to cut up pineapple stumps on a large plantation.

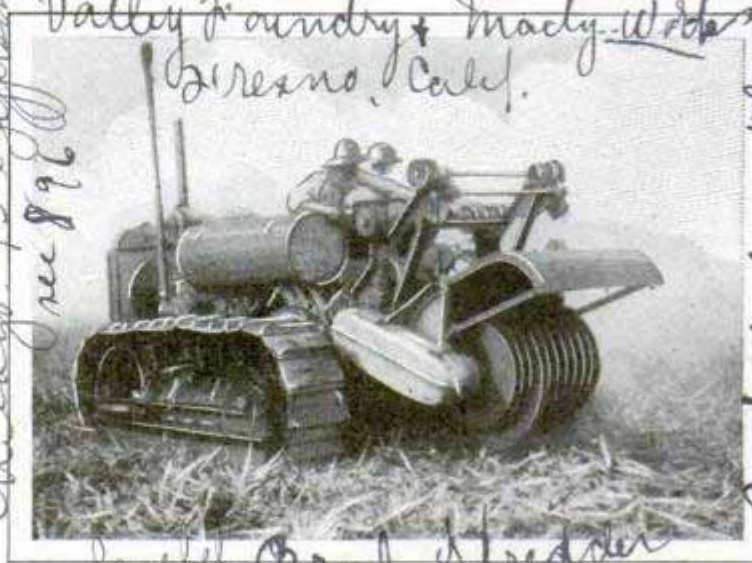

Disk Chopper Run by Tractor Which Cuts Up Farm Waste so It Can Be Plowed Under to Nourish the Soil

*Valley Foundry & Mach. Works, Fresno, Calif. Perfection in plantation Honolulu, I. I. Isabel Ornel Shredder Caterpillar Tractor Co. San Francisco, Calif.*

*wind og birkene*

*Patented by me & Chumie Rochester, N.Y. 94 Crouch St*

*Herald Tribune 9/21/20*

*H. Christy*

# They Get Their Man

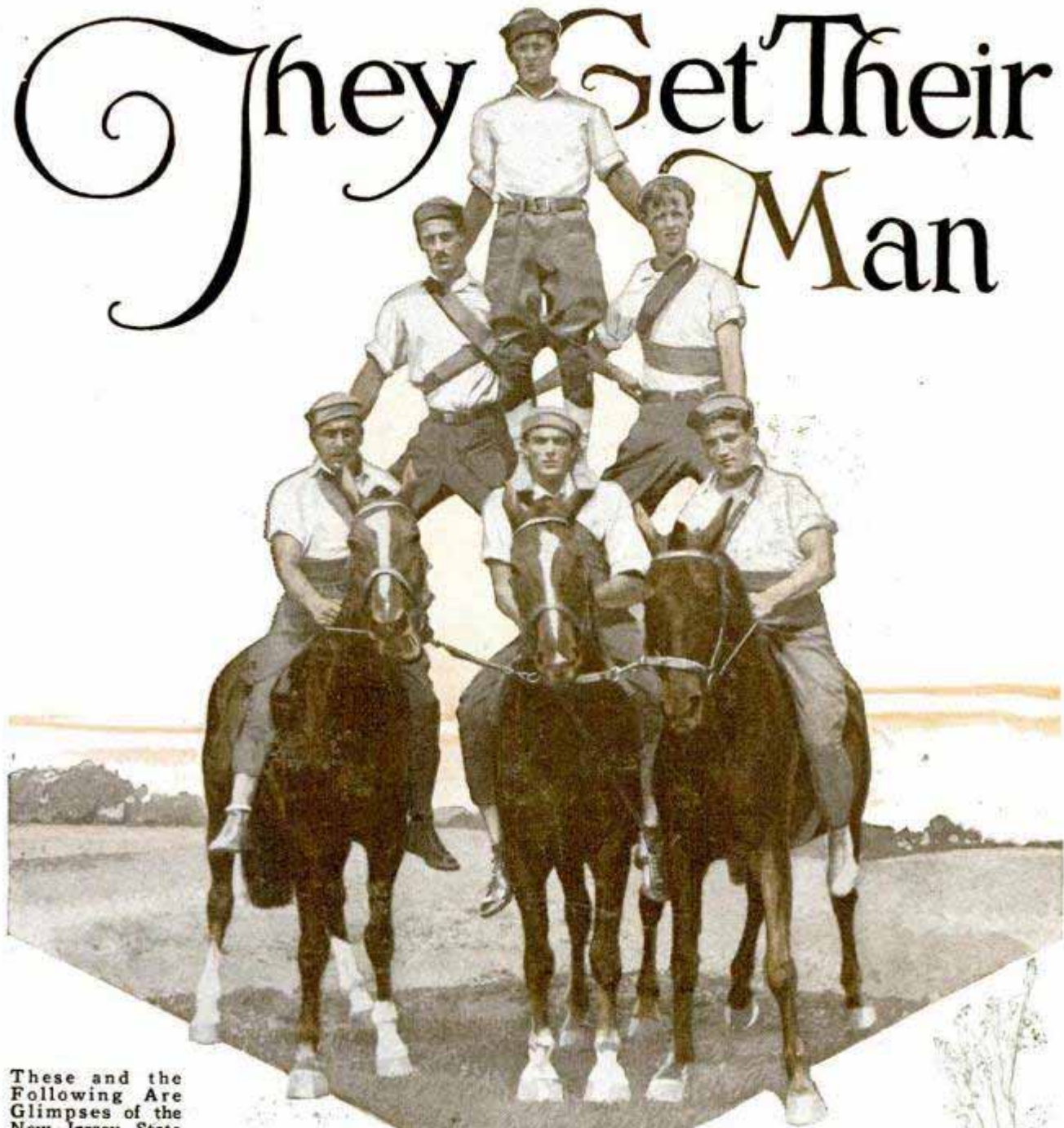

These and the following are glimpses of the New Jersey State Police Training School at Trenton; Pyramid Horseback Riding and Driving Motorcycles through Narrow Space at High Speed



Write Capt - William Nichol  
commanding officer



Above, Giving Instruction in the Proper Method of Taking Fingerprints and Identifying Them; State Police, Co-operating with Other Bodies, Must Be as Well Versed as Any Arm of the Law if Efficient Results Are to Be Obtained; at Right, Capt. William Nicol, Commanding Officer of the Training School; He Was Awarded the Distinguished Service Cross, the Croix de Guerre and the Distinguished Service Medal of the State of New Jersey for His Actions in the World War; Below, Limbering-Up Exercises of a Mounted Group; the Horses Are Almost as Well Trained as the Men and Seem to Enjoy Their Training and Service Duties; the Corps Is Made Up of a Select Group of Men Chosen on the Basis of Rigorous Physical and Other Examinations, and, Before They Go on Actual Patrol Duty, the Men Serve Three Months under Intensive Training to Fit Them Physically and Mentally for the Work Ahead



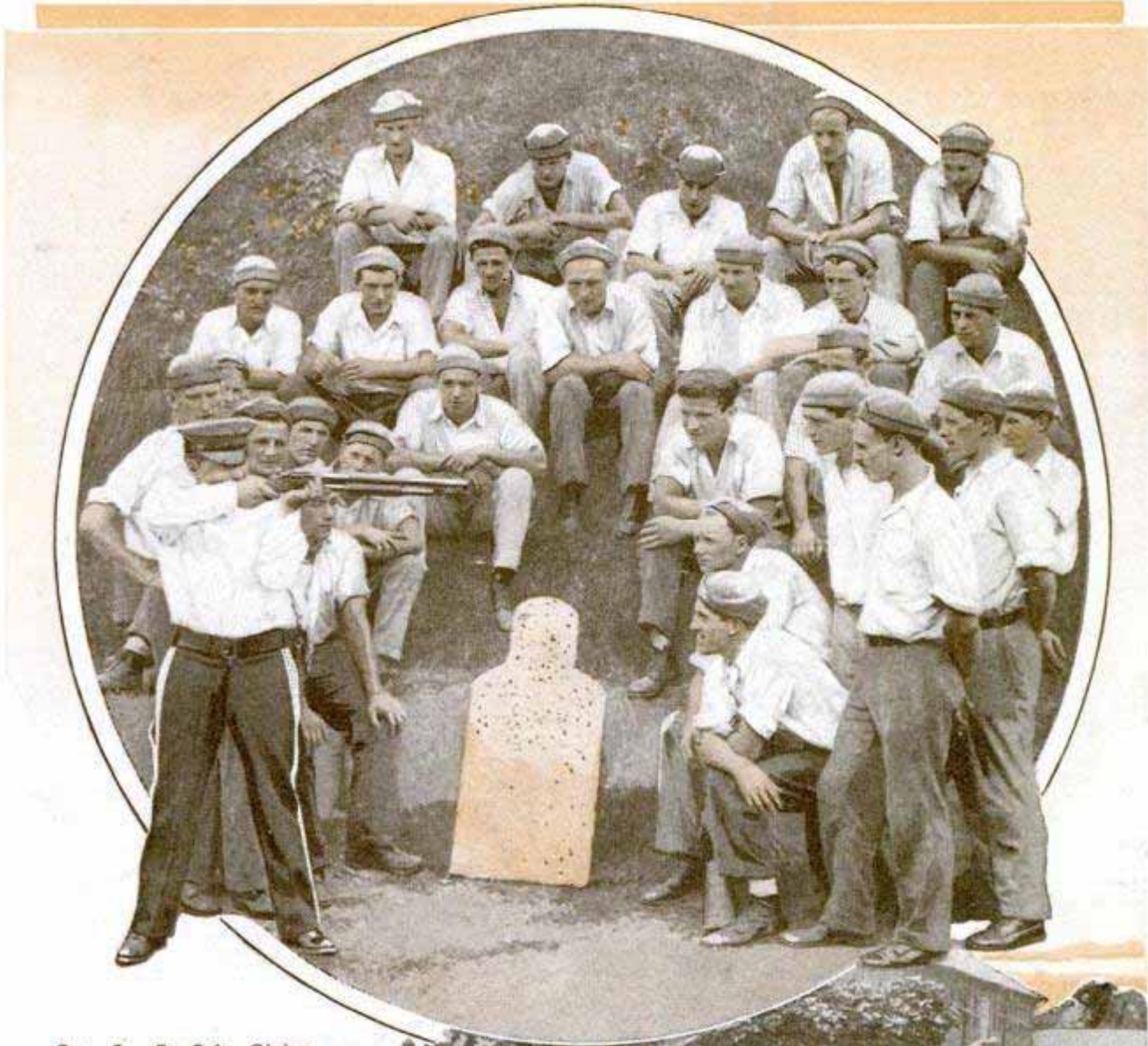

Sgt. L. C. Salz Giving Recruits a Lesson in the Proper Handling of a Riot Gun during Instruction on Pistol Range

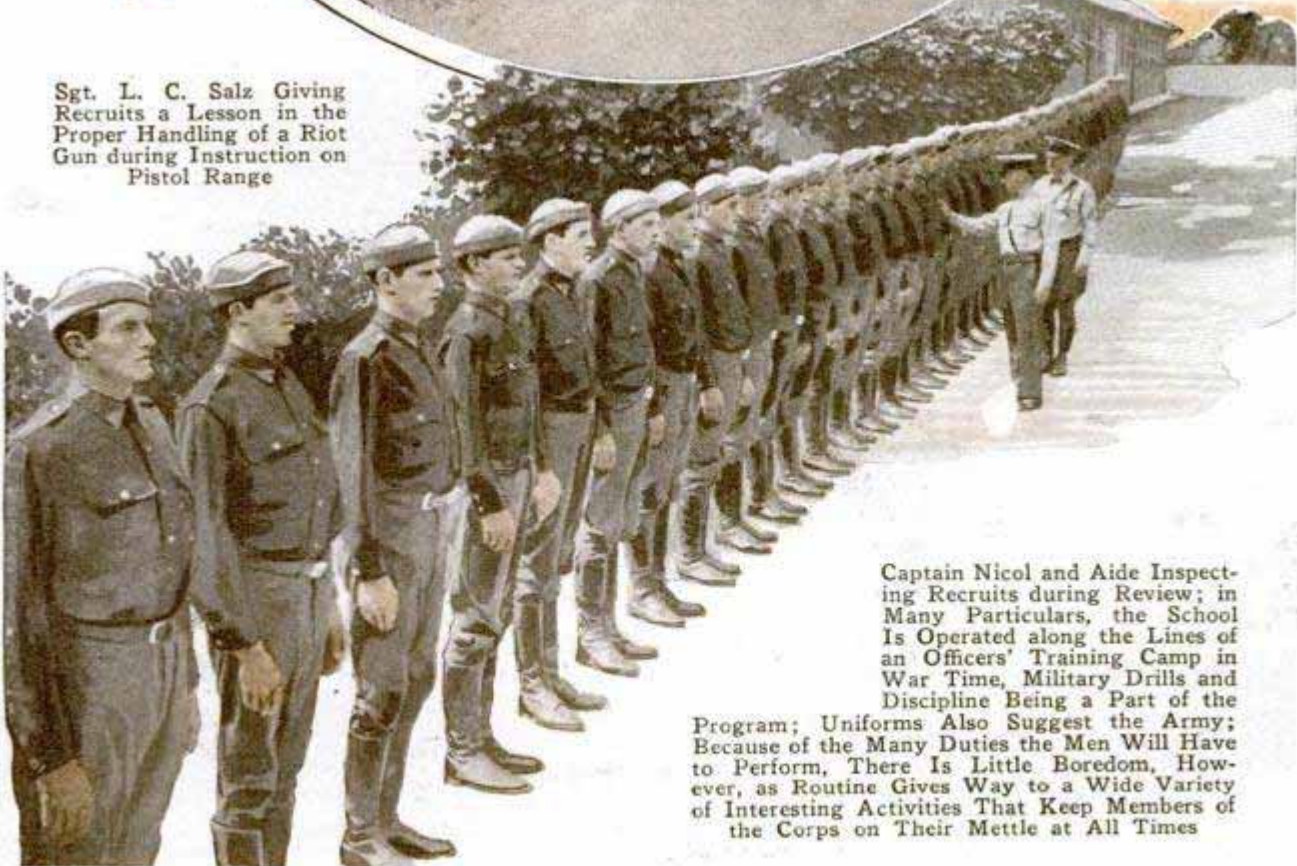

Captain Nicol and Aide Inspecting Recruits during Review; in Many Particulars, the School Is Operated along the Lines of an Officers' Training Camp in War Time, Military Drills and Discipline Being a Part of the Program; Uniforms Also Suggest the Army; Because of the Many Duties the Men Will Have to Perform, There Is Little Boredom, However, as Routine Gives Way to a Wide Variety of Interesting Activities That Keep Members of the Corps on Their Mettle at All Times

1976



Candidate for the School Arriving at Headquarters; Leaving the Storeroom with an Outfit of Clothing, a Scene Recalling Army Days, and Ready for Motorcycle Duty; There Are Plenty of Hazards in an Ordinary Policeman's Work; a State Highway Officer, Patrolling a Wide Area with a Motorcycle, Is Subjected to Unusual Dangers; He Is Therefore Taught to Be an Expert Rider and Motorcycle Mechanic; Special Need for Good Eyesight Requires Severe Vision Tests, Only the Best Being Able to Meet the Rigid Requirements; along with These Demands the State Has Found That Well-Fitting Uniforms and Other Equipment Are a Definite Aid to the Men, and Only the Finest Outfits Obtainable Are Issued to the Accepted Men

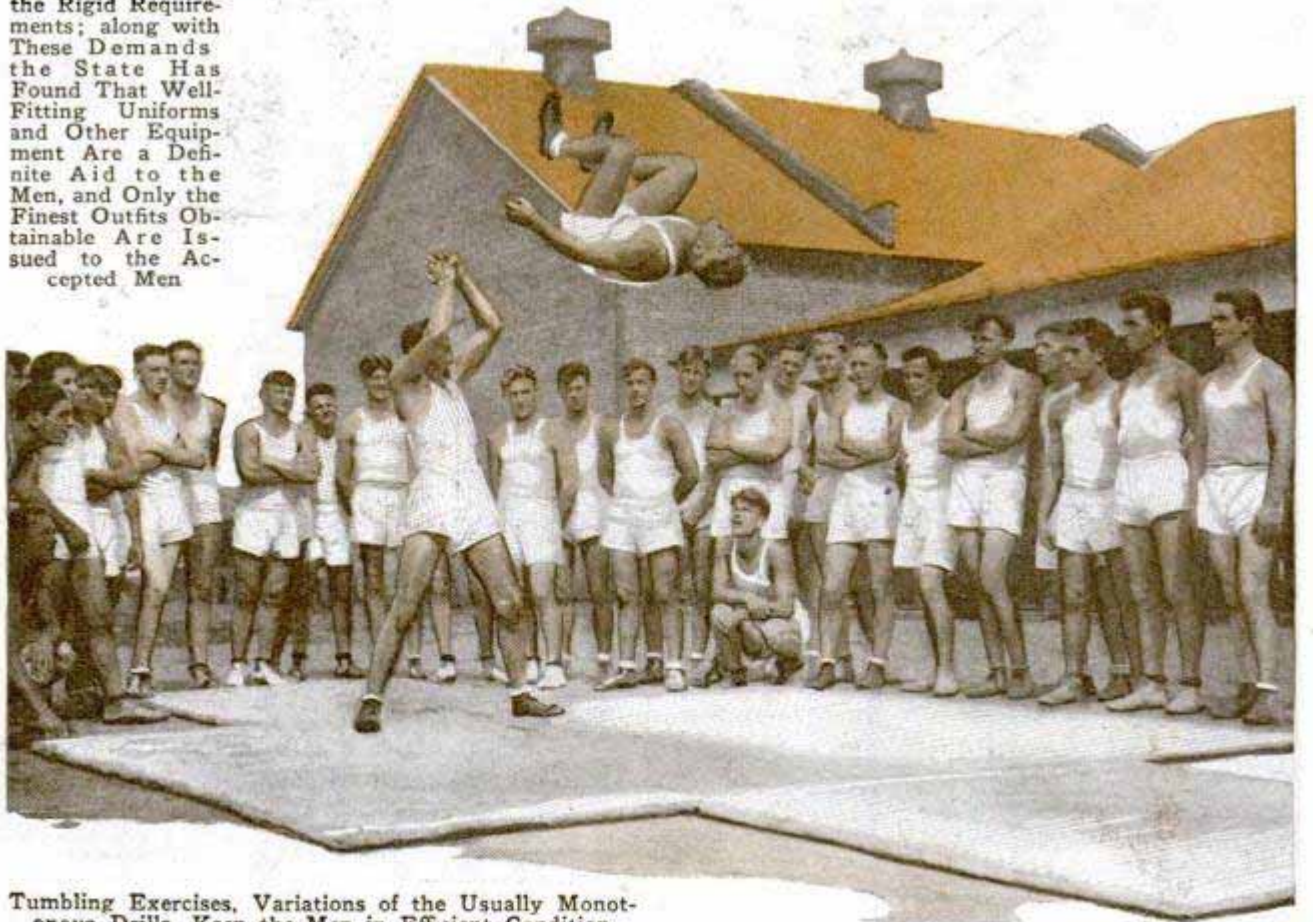

Tumbling Exercises, Variations of the Usually Monotonous Drills, Keep the Men in Efficient Condition

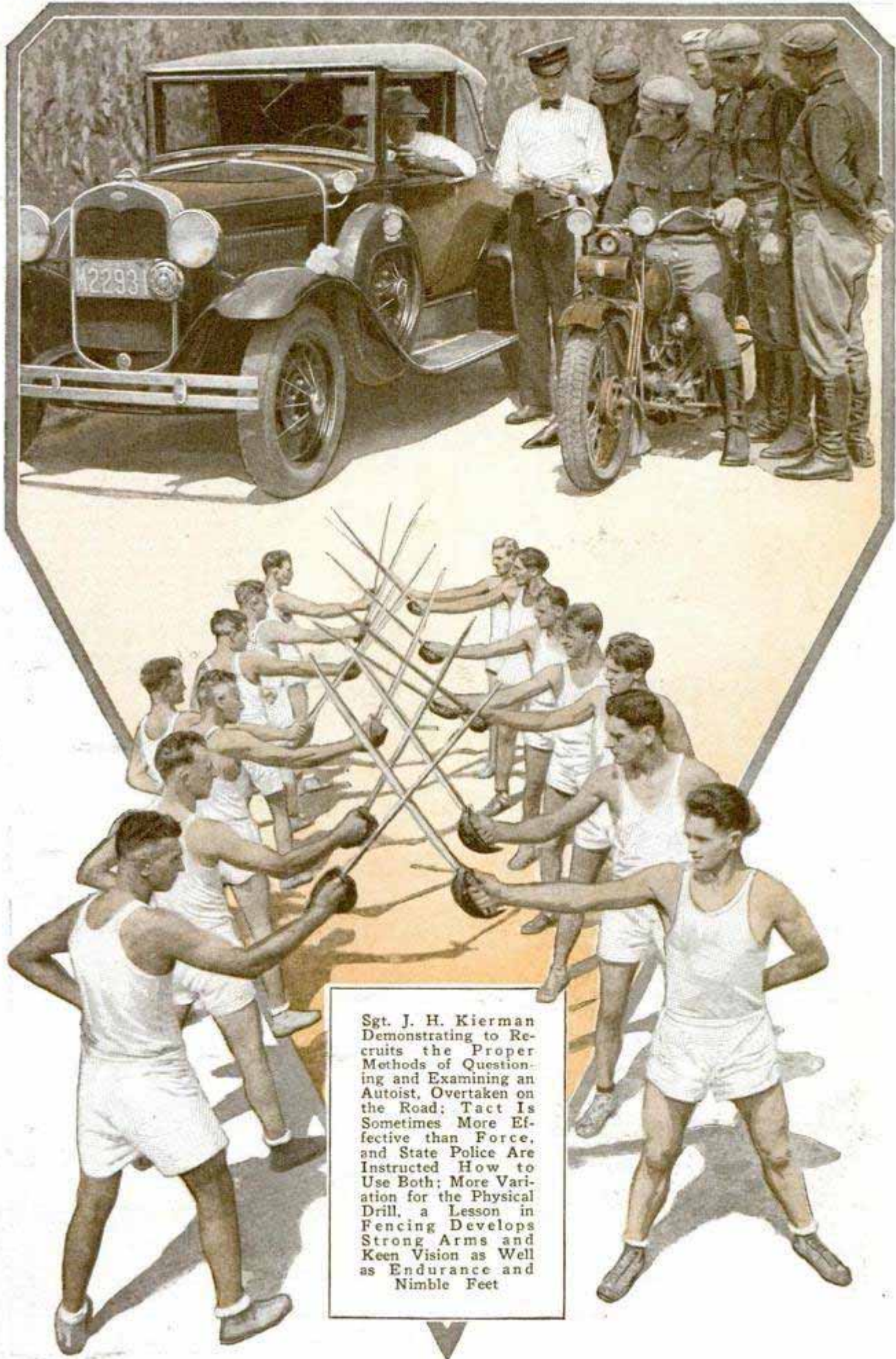

Sgt. J. H. Kierman  
 Demonstrating to Re-  
 cruits the Proper  
 Methods of Question-  
 ing and Examining an  
 Autoist, Overtaken on  
 the Road; Tact Is  
 Sometimes More Ef-  
 fective than Force,  
 and State Police Are  
 Instructed How to  
 Use Both; More Vari-  
 ation for the Physical  
 Drill, a Lesson in  
 Fencing Develops  
 Strong Arms and  
 Keen Vision as Well  
 as Endurance and  
 Nimble Feet

14 40  
934



Sgt. J. H. Westphalen Teaching the Prone Pressure Method of Artificial Respiration, an Effective Way to Revive Persons Apparently Drowned or Overcome by Lightning and Other Shocks; the Highway Police Are Trained to Be Experts in the Most Efficient Methods of First Aid in Accidents of All Kinds; at Left, While There Are Many Forms of Exercise, All Valuable for Improving the Physical Condition, Few Have Been Found Better for the Hardy than Boxing



Sergeant Salz Instructing a Class in Pistol Practice; of Late Years, More Attention Has Been Devoted to This Branch of Training than Ever Before; Scientists Have Studied the Needs of the Police Departments and Have Produced Special Targets, Moving and Stationary, That Help Develop a Steady Arm, an Accurate Eye and Quickness on the "Draw"



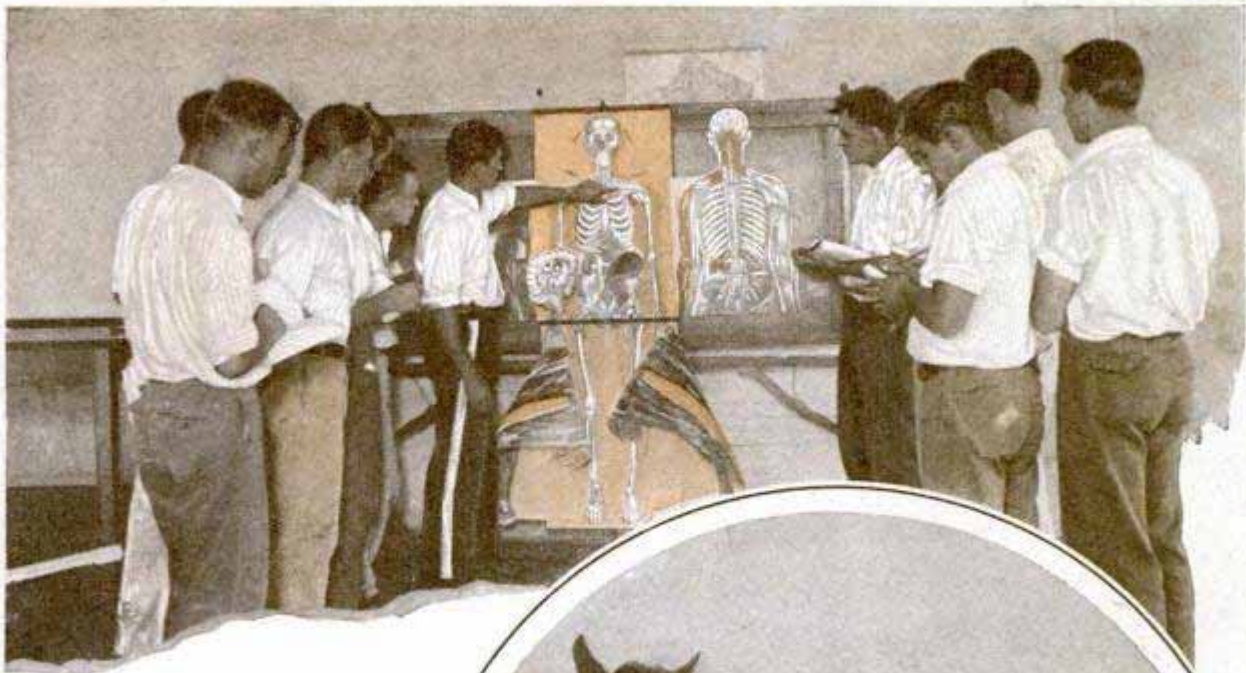

Further Instruction in First Aid; Teaching Recruits the Skeleton Structure of the Human Body so That They Will Be Better Able to Identify Broken Bones and Aid Accident or Other Victims; in Circle, Veterinary Work; Just as the Motorcycle Men Must Be Able to Take Care of Their Machines, so Must the Mounted Men Be Able to Tend Their Horses

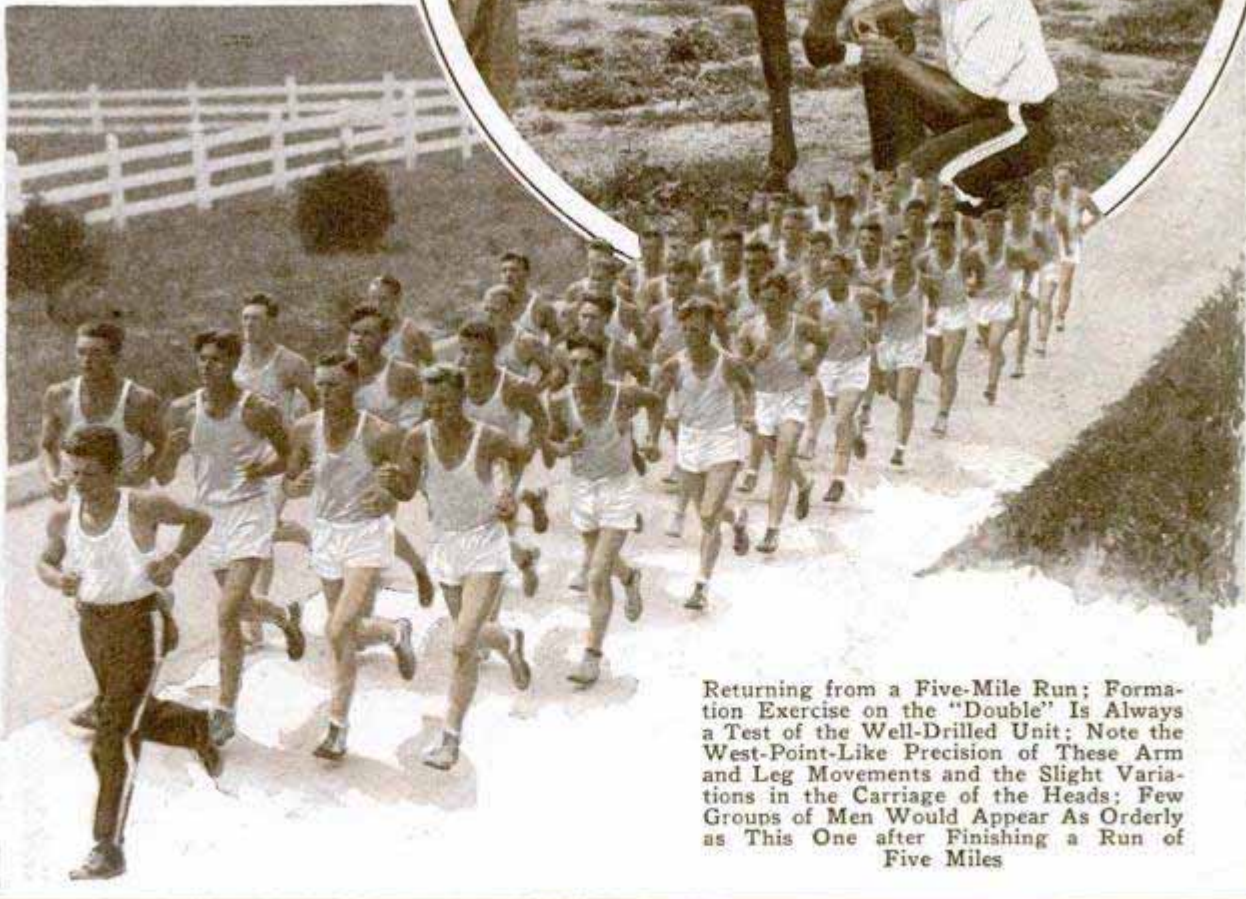
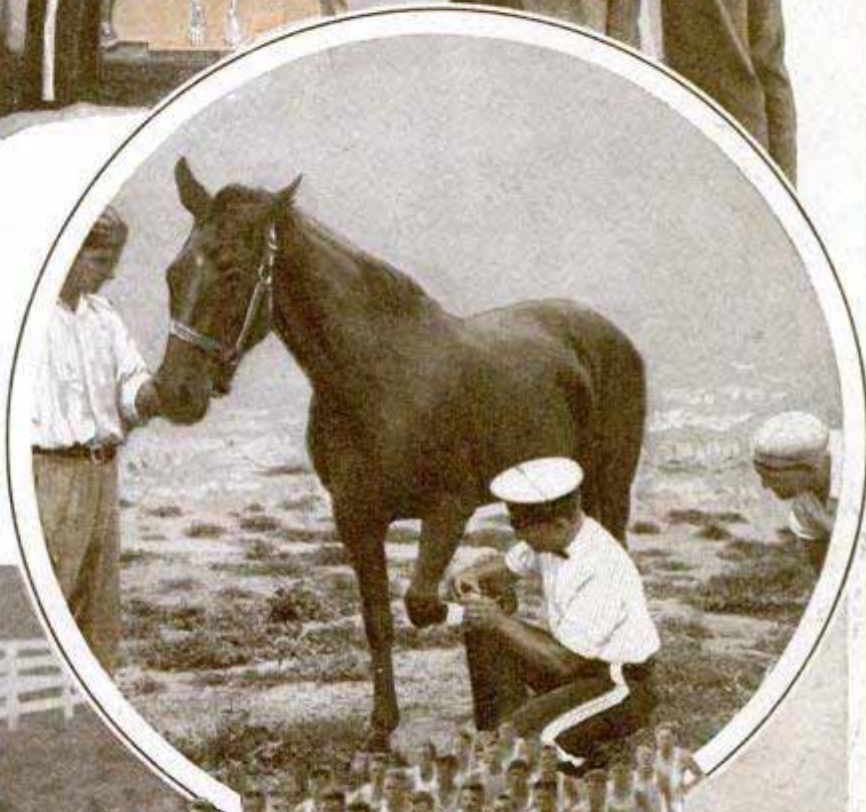

Returning from a Five-Mile Run; Formation Exercise on the "Double" Is Always a Test of the Well-Drilled Unit; Note the West-Point-Like Precision of These Arm and Leg Movements and the Slight Variations in the Carriage of the Heads; Few Groups of Men Would Appear As Orderly as This One after Finishing a Run of Five Miles

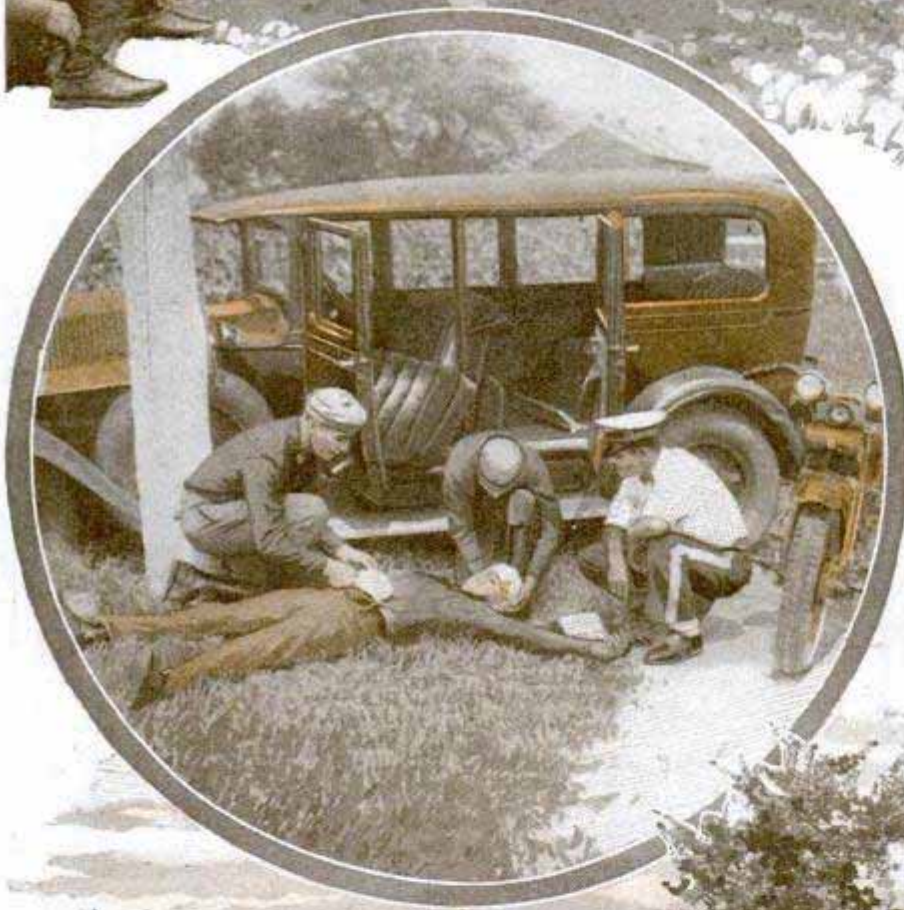

Motorcycle Men Learn to Take Their Machines Apart and Put Them Together Again without Having Anything Left Over; Emergency Repairs and Immediate Diagnosis of Trouble Are Essential Many Times, Hence the Emphasis on This Part of the Training; in Circle, First-Aid Practice on the Road in a Simulated Automobile Accident, and, Below, "Column Left"; Army-Drill Methods Have Been Found Superior in Teaching Quickness and Obedience to Orders and a Sense of Co-operation with the Other Fellow, Two Essentials to a Well-Trained and Efficient Body of Men





Sergeant Westphalen Teaching Another Interesting and Important Subject, the Art of Jiu-jitsu, so That the Policemen Will Be Able to Handle Their Man After They Catch Him; at Right, a Product of Three Months' Training, a State Highway Policeman in Full Uniform, Erect and Ready for Duty, Trained in a Wide Variety of Duties and Sufficiently Experienced to Meet the Situation with a Good Background of Physical Preparedness and Keen Mental Abilities; Below, a Moment of Relaxation; Recruits Have Their Own Miniature Golf Course and Find the Exercise a Welcome Relief to Mind and Muscles after the More Rigorous Work of the Day; after the Three Months of Intensive Training, Exercises and Drills Are Continued, but More Moderately, to Keep the Members of the Department in Good Physical and Mental Trim at All Times

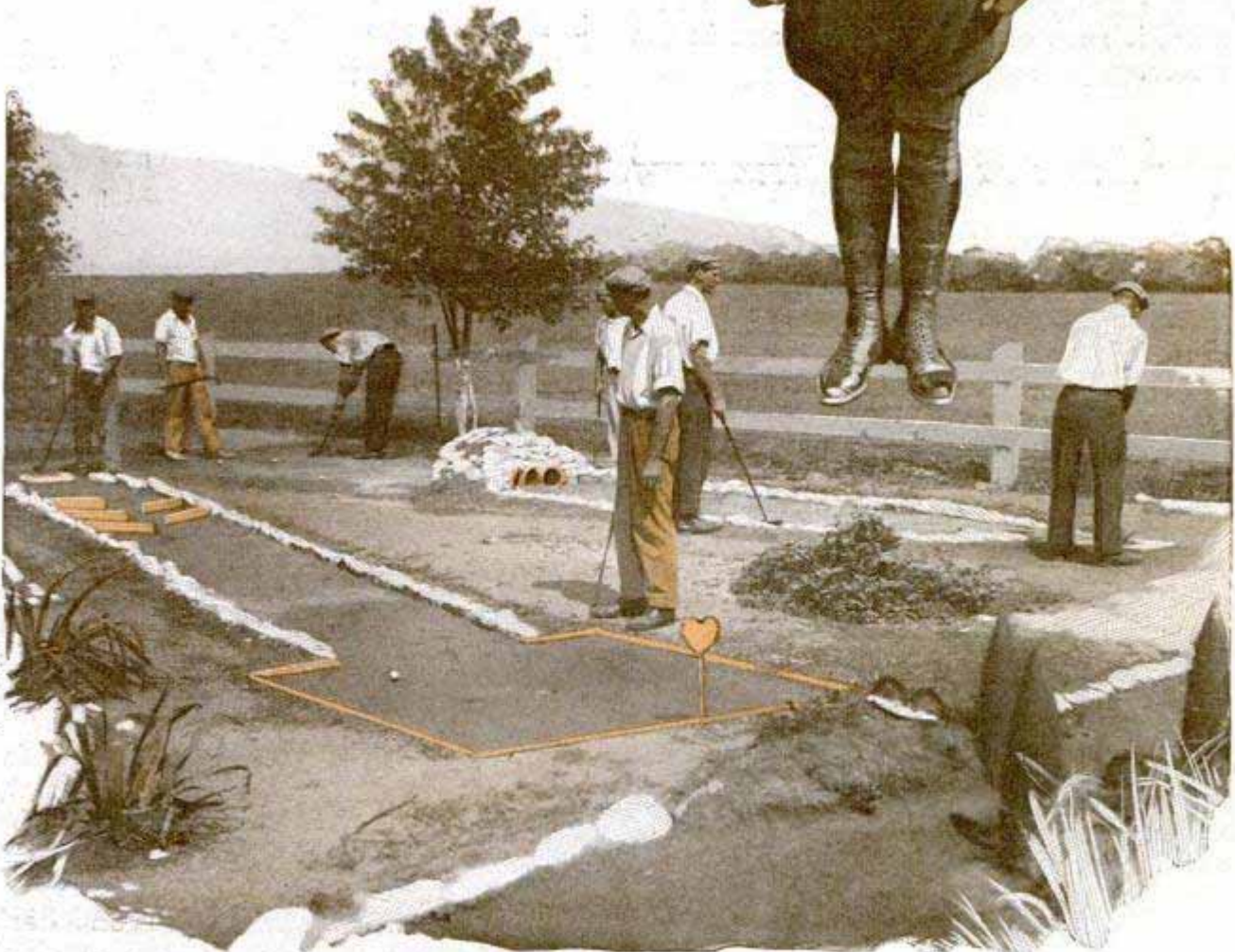

1454

*Brooklyn N.Y.*

**AUTO CONVERTED INTO YACHT BY LOWERING PONTOONS**

to other vessels that the ship is not in a position to maneuver, or may signify a minor mishap that temporarily has disabled the vessel. Gongs or sirens indicate fire at sea. The whistle is not used. The single train whistle is blown before a stop, a relic of old days when

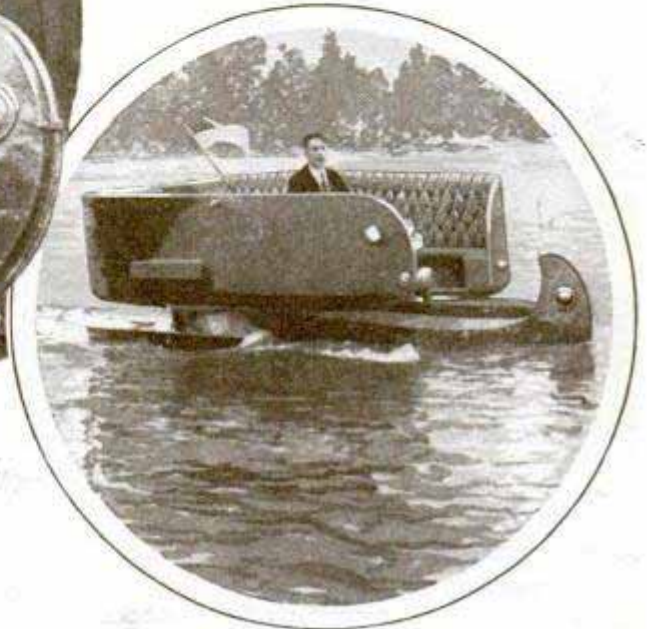

Above, a Seagoing Auto with Pontoons Being Lowered; Right, the Auto Transformed into a Yacht

Pontoons, which are lowered into position by pressing a lever, convert an automobile of unconventional appearance into a yacht that bears little resemblance to the ordinary boat. When used as an auto, it runs on three wheels, and in the water on pontoons.

**TRAIN AND STEAMER WHISTLES HAVE OWN LANGUAGE**

Train and boat whistles speak an interesting language to the person who understands them. A steamer approaching another from behind and desiring to pass to starboard, sounds one blast of its whistle. The ship to be passed will reply with a single blast, signifying the signal has been understood. If the overtaking boat desires to pass to port, it gives two blasts which are answered by two. Similar signals are blown by approaching ships when so close that there is danger of misunderstanding. Three short blasts of a boat's whistle indicate that the engines are running full speed astern. One long blast is given on leaving a pier and on inland waters when approaching a bend in the river. In fogs, long blasts of four to six seconds' duration, at intervals of not more than a minute, are blown. A distress signal is given by four or more short blasts, but it does not necessarily mean a catastrophe. It may be a warning

brakes were applied by hand and the single blast gave the command to the brakeman. Two blasts indicate starting, three to back. One long and three short blasts at night when the train is stopped order the flagman to leave the train and go back with flares, lantern and torpedo. Five long blasts tell him the train is going to start again.

**GUN SIGHT FOR BIRDS IN FLIGHT INSURES CORRECT AIM**

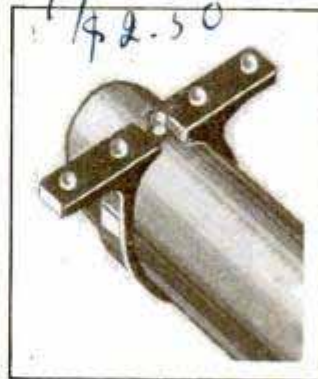

Duck hunters, accustomed to the trial-by-error method of judging the proper "lead" to be given when aiming at a bird in flight, now have this difficult problem solved for them with a sight which can be

mounted on any type of gun barrel. The fixture clamps around the end of the barrel and contains two brass beads on a horizontal frame extending to right and left of

*Burley Sight Co  
Rockville Idaho*

*Holiday Oct. 1930*

*1541*

*1599*

*72.50*

Discovered by Dr. C. A. Meyer, (301) 1919  
newly discovered and former Professor

the regular gun sight. These extra sights enable the hunter to establish automatically the distance he should fire in front of his moving target to score a hit. The sight is easily removed when not needed.

**BALDNESS CAUSED BY ARSENIC AND LEAD IS CURABLE** 1574

Growing use of arsenic and lead in modern civilization is responsible for an increasing type of baldness for which a remedy has been found recently by chemists. Arsenic is used in spraying fruits and vegetables and is found in foods, drugs and beverages, while lead is found in spray residues, in drinking water and in the air. Baldness caused by these agencies is confined to a sharply circumscribed area from which the hair falls quickly, sometimes in a few hours and quite often in a few days. Chemists have found a successful treatment for this particular form of scalp ailment which tests have shown to be highly satisfactory.

**AUTOMATIC TIMER AIDS KICKER IN FOOTBALL PRACTICE** 1603

To aid the kicker in getting the ball away within the specified time limits, an automatic football timer was used with success in training the Harvard squad. The ball, held by the passer, rests on a horizontal arm of the device, known as a "coachamatic." When the ball is snapped the arm goes up, releasing a mechanism which rings a bell two seconds later. The

*Coachamatic*



Football Timer Which Rings a Bell Two Seconds After the Ball Has Been Snapped by Passer

backfield man is expected to have the ball before the bell rings.

*Dr. Vic Kennard  
Harvard Kicking Coach*

**FIFTEEN TONS OF HORSESHOES COLLECTED BY BLACKSMITH** 1611



Fifteen Tons of Old Horseshoes Collected by a Village Blacksmith in the Past Twelve Years

Twelve years ago the village blacksmith of Hopkinton, N. H., began piling up discarded horseshoes outside his shop and the stack has been growing ever since. Today he estimates he has fifteen tons of old shoes in the collection, which is about ten feet high, all of them removed from the feet of his equine customers with his own hands.

*Joseph E. Seery*

**ELECTRIC LIGHT IN BALLOON TELLS WIND DIRECTION** 1500

For night weather observations, a California man has devised a wind-direction indicator consisting of a small balloon which carries a parachute with two dry cells and a small bulb attached. When the balloon reaches too high an altitude or bursts for any other reason, the parachute allows the cells and lamp to float to the ground without injury to any persons or damage to property. The device is also considered safer, because it cannot start forest fires as is sometimes the case when flares or candles are employed.

*Wm. M. Little,  
Chief Meteorologist*

*San Francisco, Oakland, Calif.*

medical Assn by  
Dr. Paul de Lamson, Nashville, Tenn

working with Dr. Randolph  
W. Dillmore, anator

1604

see Aug 1929 - 203  
Mar. 1929 - 457

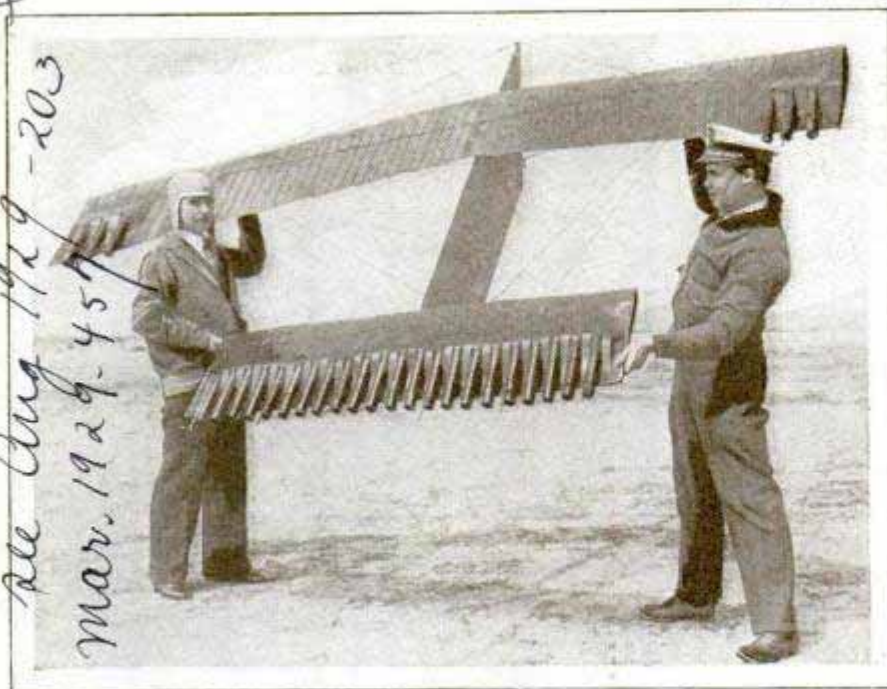

Model of an Airplane Propelled by Rockets, Some of Which Furnish the Driving Power and the Rest Act as Stabilizers

### PLANE PROPELLED BY ROCKETS AT TEN MILES A MINUTE

Airplanes propelled by rockets are being planned after tests with a flying model of a two-passenger ship using rockets for power. The model, built to withstand speeds up to 650 miles an hour, or more than ten miles a minute, is all-metal in construction and is powered with thirty-eight steel-cylinder rockets, ten furnishing the driving power and the rest supplying stabilizing and balancing action. It is estimated that more than twenty horsepower can be developed by the model, which is expected to soar to a height of six miles at record-breaking speed and then glide to the ground.

### MICROBES FOUND IN COAL

Living, brilliant-hued bacteria have been found in coal that is millions of years old, and appear to have lived there ever since the coal was formed. Great microscopic magnification is necessary to see the coal bugs, which are frequently egg-shaped, but may be quite elongated, some of the latter being brilliantly iridescent. Given a chance to reproduce in a cultivating medium, the microbes grew to millions in a few hours. Bacteria also have been found in specimens of pre-Cambrian rocks, usually estimated to have been formed over 200,000,000 years ago.

1539

by Dr. C. W. Lipsman,  
University of California

### IVY POISONING IS RELIEVED BY NEW DRUG

1596

Poisoning from poison ivy or poison oak is now being treated by neutralizing the active element of this unpleasant plant. Toxicodendrol, the irritating agent, can be made non-poisonous by changing its chemical composition so that the proportion of oxygen is increased, and this is accomplished by benzoyl peroxide, a non-irritating, non-poisonous substance. When benzoyl peroxide powder is dusted over the affected area,

and kept in place by a light bandage, the itching disappears in about twenty minutes and does not return for several hours after a single application. It is not a certain cure in all cases, but it does relieve the itching and prevents further spread of the poison.

Lucidol Corp 293 Larkin  
Buffalo N.Y

### ONE OF WORLD'S FIRST AUTOS FINDS PLACE IN MUSEUM

1602

One of the world's first automobiles, a German car built in 1888 by Karl Benz, has been obtained by Henry Ford for his museum. Mr. Ford purchased the early ancestor of the modern car after examining an even earlier model, a machine that was built in 1885, which is now displayed in a Munich museum.

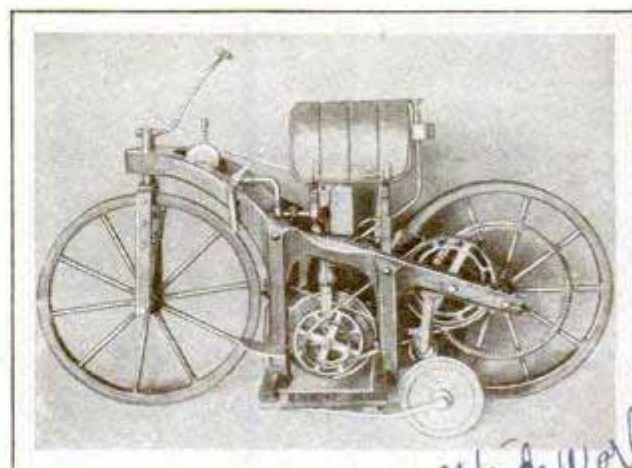

An 1888-Model Auto Built by Karl Benz and Recently Purchased by Henry Ford for His Museum

Wide World

# Man-Made Star Guides Flyers

CIVILIZATION is constantly reaching back into the centuries for old ideas to meet modern needs. An outstanding example is the sun-flash aircraft beacon on top of the LaSalle-Wacker building, one of Chicago's newest skyscrapers. It incorporates an idea employed by engineers of ancient times in constructing the Pharos or primitive lighthouse that marked the entrance to the harbor of Alexandria, Egypt.

The early builders adjusted sheets of polished metal to reflect the rays of the sun and to send the gleam of the burning

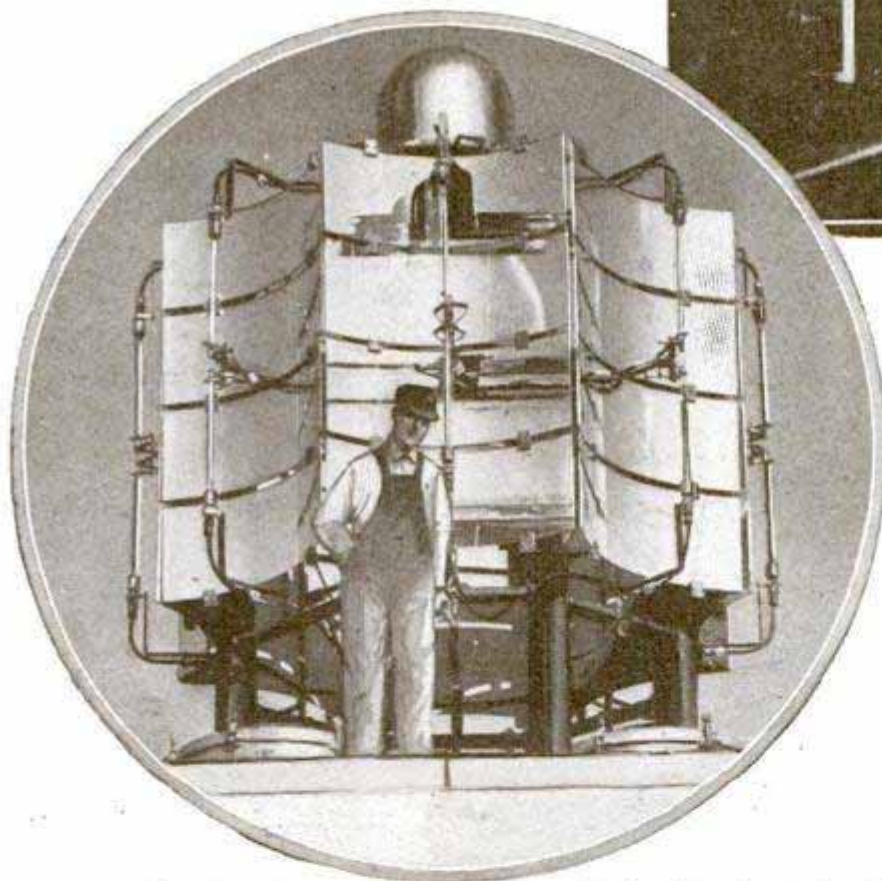
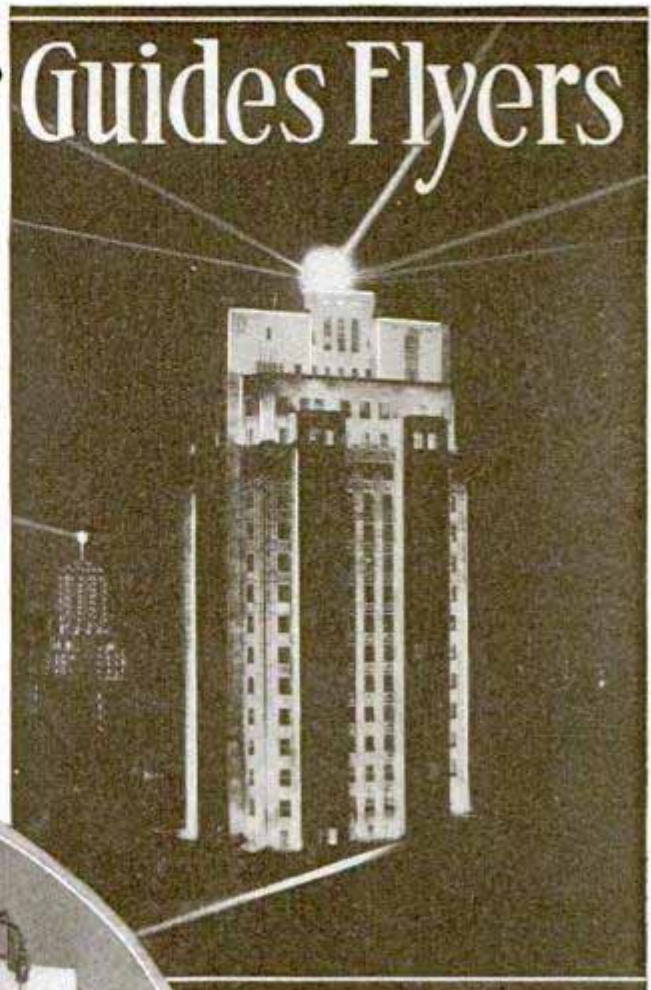

Above, the Sun-Flash Beacon at Night; Below, Some of the Parabolic Mirrors Which Reflect Sunshine by Day and Neon Lights at Night

torches in the lighthouses far to sea at night. In the same way, A. N. Rebori, architect and designer, has used parabolic mirrors to intensify and reflect the rays of the sun and of neon-gas tubes at night. While the beacon does not compare in candlepower with some of the huge searchlights used for guiding air-

craft, its efficiency has been amazing. Recently, an aviator, leaving Toledo, Ohio, at dark, saw a peculiar orange-red gleam from an altitude of slightly more than 5,000 feet. He followed it all the way to Chicago and discovered its source atop the LaSalle-Wacker building. The distance was approximately 285 miles.

This sun-flash beacon is fixed and has eight sides, corresponding to the main points of the compass. On each side is a curved mirror, five feet high and so adjusted that it intensifies the light some thirty times. Neon-gas tubes are installed in front of each mirror so that the effect at night is an illuminated compass that serves not only as a beacon but as a warning light to keep pilots from flying too close to the building.

*Designed by General Electric Co.  
C. H. Rebori, Architect, Engineer*

1425  
942

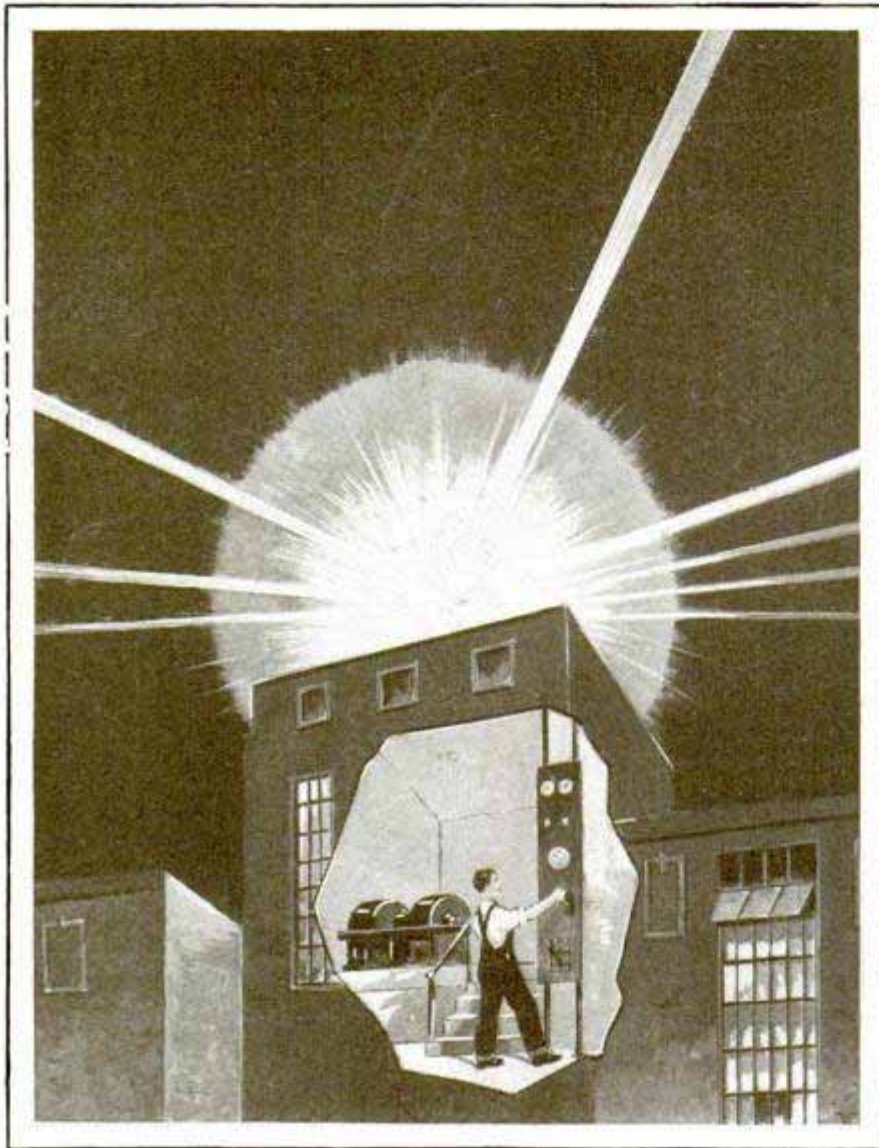

Drawing Showing How a Small Motor Supplies Power for the Big Light, Which Can Be Operated for About Fifteen Cents an Hour

Between the eight beams of red light that have a vertical arc of 180 degrees, are white rays from eight searchlights of 8,000,000 candlepower each, producing the effect of an illuminated crown for the lofty skyscraper. These white rays are projected at about fifteen degrees above the horizon, while the red light is distinctly visible from directly above, an advantage over the usual single searchlight of the revolving type, which often cannot be seen by an aviator flying high above it.

Power for the beacon is provided by a twenty-five horsepower motor, driving a fifteen-kilowatt generator on the forty-first floor of the building. Performance to date indicates that the light can be operated for as little as fifteen cents an hour for current, and it is not costly to service as it needs little attention, once the mirrors and tubes are properly adjusted and

focused. The apparatus is so constructed that the lights can be made to appear as revolving. This is accomplished by a rotary switch.

Aviators and others are familiar with the reflective power of glass, and flyers especially attest the need of beacons during the day as well as by night. It is proposed to install smaller beacons of the sun-flasher type along air routes. Even on cloudy days, they would reflect and intensify the light, making the markers visible at great distances, so that a pilot, unfamiliar with the way, would have less difficulty in keeping his course.

Set on dangerous mountain tops and other hazardous places, the beacons would serve the double purpose of guides and warning lights. Extensive tests have shown that the peculiar orange-red cast of the neon-gas tubes is one of the most effective colors in

penetrating fogs and mists, and the added intensity of the light as sent from the sun-flash beacon, due to the mirror idea, makes it doubly efficient. Mr. Rebori and the General Electric company are making further experiments with the beacon to increase its effectiveness and to develop a type that can be widely employed for the good of aviation.

#### ALTERATION OF CHECK SHOWN BY ULTRAVIOLET LIGHT

Check paper treated with *æsculin*, a white powder obtained from the bark of the horse-chestnut tree, enables a bank teller to detect with ease erasures and changes in checks written on such paper. *Aesculin* is fluorescent, or glows, when placed under ultraviolet light, and an erasure shows up as a dark spot.

*Patented by J. Block  
Julian Block  
123 2 mechanics*



MAGIC "EYE" FOR OPERA AIDS LIGHTING EFFECTS

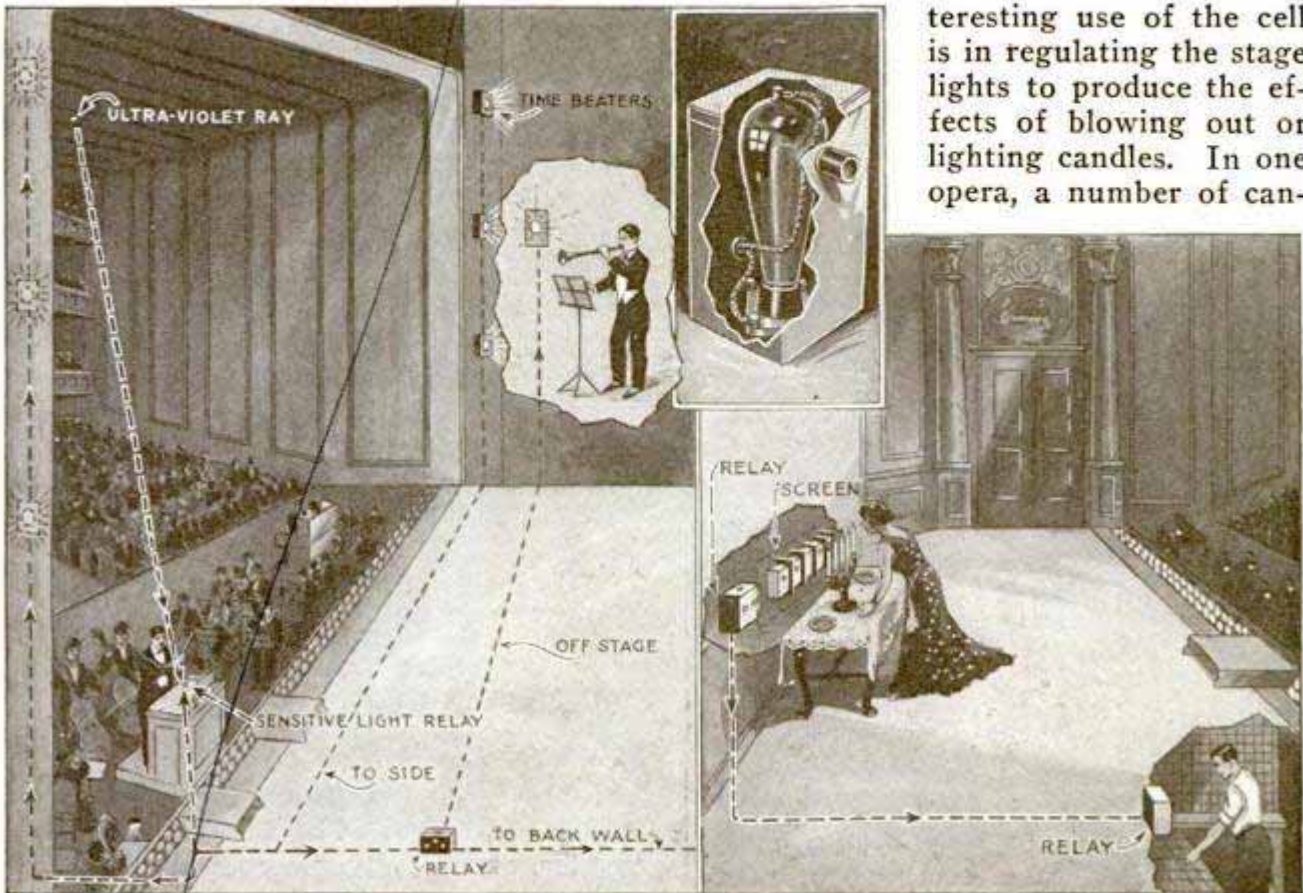

teresting use of the cell is in regulating the stage lights to produce the effects of blowing out or lighting candles. In one opera, a number of can-

Artist's Drawing Showing Use of the Photo-Electric Cell on the Stage of the Chicago Civic Opera Company; the Unit Helps the Conductor Beat Time for Off-Stage Groups and Operates Lights

Two difficult stage problems, accurate regulation of lighting intensity and beating time for orchestras or musicians behind the scenes, have been solved by engineers of the Chicago Civic Opera company and of the General Electric company, with the aid of the photo-electric cell. In many of the productions, music off stage is an essential part of the performance and there is usually some difficulty in keeping exact time with the orchestra in front. The tempo formerly was picked up by some one standing concealed in the wings and relayed back, or the conductor tapped the time on a lighting indicator. Neither of these methods proved wholly satisfactory and a better way has been found with the photo-electric unit. It is installed in the conductor's desk in such a position that, as he swings his baton, his arm will pass over it and will intercept a beam of invisible ultraviolet light, shining from the ceiling. These interruptions, in a cadence that gives the exact time of the music, breaking the ray of light, causes the cell, in turn, to operate time beaters backstage. Another in-

dles are extinguished. There is a hidden cell behind each one which operates a number of stage lights. As the candles are extinguished or lighted the cells affect the stage lights to produce realistic changes of the illumination.

VALVE IN STEM OF PIPE TRAPS MOISTURE AND ENDS "BITE" 1563

Ending the "bite" and providing a cooler smoke, a pipe now is provided with a trap in the form of a valve in the stem held in an upright position by a spring.

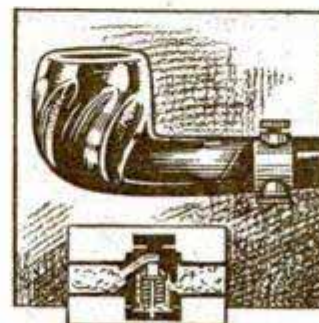

When the smoker is drawing, the valve opens to pass the smoke, but when he stops, the valve shuts, effectively blocking the bowl from the stem and keeping out all moisture.

It is impossible to blow through the pipe which remains dry and odorless. The trap is easily removed for cleaning.

*200 S Clark*

*West Coast Specialties  
4059 Soodwin Ave*

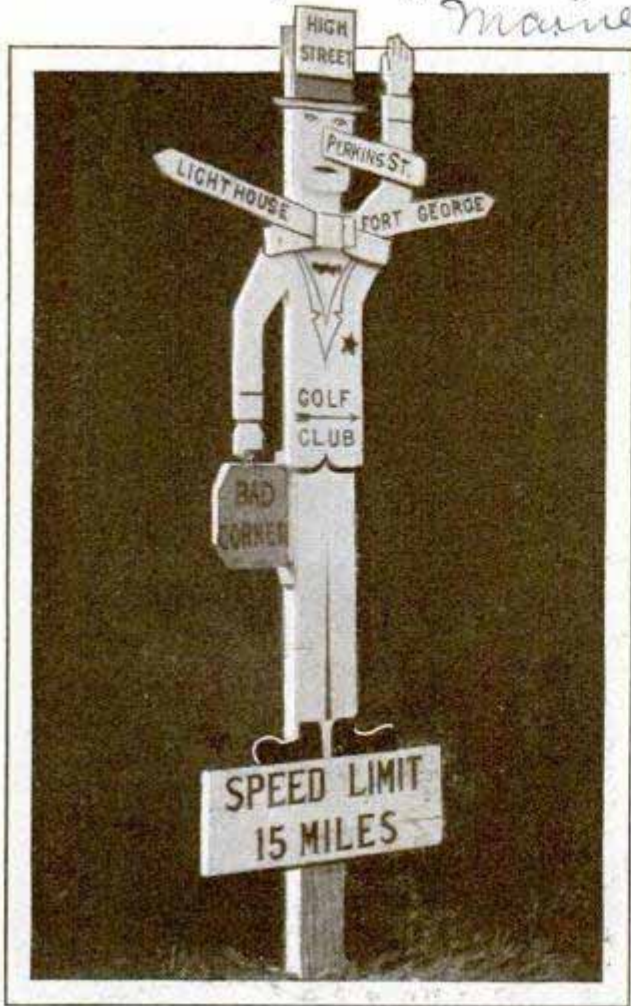

Highway Sign Resembling a Man, Which Warns of a Bad Corner and Gives Other Road Directions

**WARNING SIGN ALSO GIVES ROAD DIRECTIONS**

To catch the eye of the passing motorist, a roadway sign resembling a human form stands on the outskirts of Castine, Me. The marker warns of a dangerous corner, and also directs the way to various near-by points, and gives other helpful information.

**ROBOT DIVER TO HELP SALVAGE SUNKEN TREASURE SHIPS**

Attempts will be made soon with a robot diving apparatus to recover treasure estimated at \$50,000,000 which has lain at the bottom of Navarino bay, Messenia, Greece, for more than 100 years. The wealth is contained in the ships of the Turkish-Egyptian fleet, sunk in 1827 by the Russian, English and French fleets. The flagship alone contained more than \$1,000,000 in money and precious objects worth even more. The ships now lie in thirty-two fathoms of water, and previous

salvage efforts have failed because divers have been unable to descend to that depth to work on wrecks. Now there has been made a diving suit in which, it is stated, a man can go down 250 fathoms and work for ten hours without ill effects. It resembles a robot figure having arms and legs three feet long, and is made of light alloy, containing much magnesium. The occupant can eat, drink, smoke, and even write with perfect freedom. He can also kneel, lie on his back or face downward, and rise without trouble. The "hands" are like the antennæ of the crab, and the diver can pick up coins or shackle an eye to a spring with them. The obstacle of great pressure has been overcome by placing between moving members of the joints a cushion of oil which is non-compressible and readily displaceable.

**TALKING LETTER IS DICTATED TO COIN-IN-SLOT MACHINE**

Letters that talk soon can be sent from street-corner recording booths, where the sender, on depositing a coin in a slot machine, can dictate his message on a phonograph disk. He then slips the disk in a container and drops it in a mail box. The recipient listens to the words of the sender by "playing" the record on a phonograph. Coin-in-the-slot recording booths for taking such messages now are being planned along the lines of the automatic-photograph galleries already established.



Slot-Machine Booth, Where a Letter Is Dictated on a Phonograph Record and Mailed

1595  
 Herald-Examiner  
 9/12/30

1605  
 Sewery Clark Suller  
 940 Hollywood Blvd  
 Hollywood, Calif.

Joseph Salerni  
 Testad al Sillet  
 Studio Hollywood

PLANE WITH VARIABLE WING MAKES FLYING SAFER



Variable-Wing Monoplane Which Depends on Compressed Air to Alter the Angle of Incidence of the Wings; Hydraulic Cylinders Which Lift the Wings Serve as Shock Absorbers in Landing

With fifteen feet of copper tubing and two valves as his chief aids, Waldo D. Waterman, famous pilot, has developed a variable-wing monoplane which promises interesting results in greater safety and efficiency in aviation. As demonstrated in repeated trials, the plane gains some eighteen miles an hour in top speed, has greater stability, rides more easily in bumpy air and can be landed more easily than the usual type. The wheels of the Waterman ship are rigidly attached to the wing and the compressed-air shock absorbers are in the wing struts. Each wing is hinged at an angle of approximately twenty-five degrees to the line of flight. At the start, the wing is horizontal, but in the air an amazing change takes place. The wing assumes a curved appearance, that is, the tips rise until there is a dihedral angle of fifteen degrees and a

change of over five degrees in the angle of incidence. In a few moments, the wing may straighten out to its original horizontal shape, then curve again. Waterman accomplishes this chiefly by means of the valves and the copper tubing. Compressed air, taken from the engine starter, is led into the shock-absorbing units. When they are full of air, they hold the wing in a horizontal position. Simply by releasing the air, the pressure in the shock-absorbing cylinders is decreased, allowing the tips of the wing to come upward. This gives a low angle of attack for maximum efficiency at high speed. A turn of a valve again causes air to be pumped back into the shock absorbers and the wing is straightened out for a landing. The air-filled cylinders also help absorb shocks and bumps in the air, so that the plane has greater stability.

Los Angeles, Calif

et

Staten Island  
NY

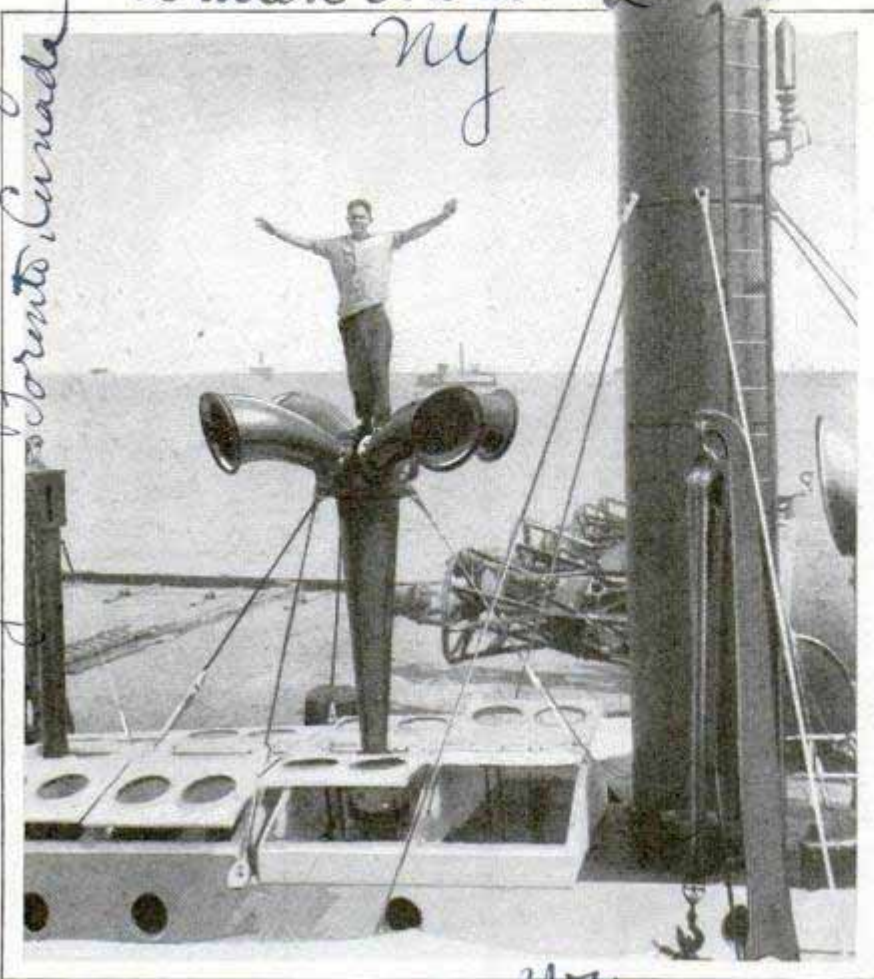

The Man Is Standing on a Huge Fog Siren of a Modern Lightship; the Horn Is Air-Operated and Is Set to Sound Automatically

wide extending around the earth. The winds, scientists estimate, have a total energy of twenty billion horsepower-hours, and as their comings and goings are accurately predicted over areas where weather-observation stations are now established, an extension of the area under constant observation obviously would permit more accurate forecasts of winds and other conditions.

**NEON CHANDELIER GIVES ALMOST WHITE LIGHT**

Neon tubes, long used for electric-display purposes, now have been adapted to chandeliers for interior illumination. Neon tubes of different colors are combined in the chandelier to give a nearly white light which has been found to offer

good illumination and also to be more restful to the eyes than ordinary lights.

**HUGE FOG SIREN ON LIGHTSHIP OPERATED BY AIR**

Rising almost to the top of its funnel, a huge fog siren with a cluster of four bell-shaped horns is part of the equipment of one of the most modern United States lightships, now stationed off Fire island near New York. The big horn is air-operated and can be set to sound at designated intervals, being controlled automatically.

**LONG-DISTANCE WEATHER SEEN IN POLAR TRIPS**

Weather men will be able to predict rainfall and drouths months in advance as a result of polar explorations, especially in the Antarctic, according to Dr. Isaiah Bowman, of the American Geographical society. It is estimated that there is a shift of ten billion tons of air from hemisphere to hemisphere between the months of January and July each year, an amount equivalent to a mass of air thirty miles



Chandelier Composed of Neon Tubes in Different Colors, Which Combine to Give a White Light

Claude Neon Federal Co  
225 N. Michigan Ave

Compressed air diaphan  
Mr. J. P. Northey, Metropolitan Bldg  
Toronto, Canada  
Sirena Service #495-E  
9/17/30  
540  
before meeting of National Academy of Science

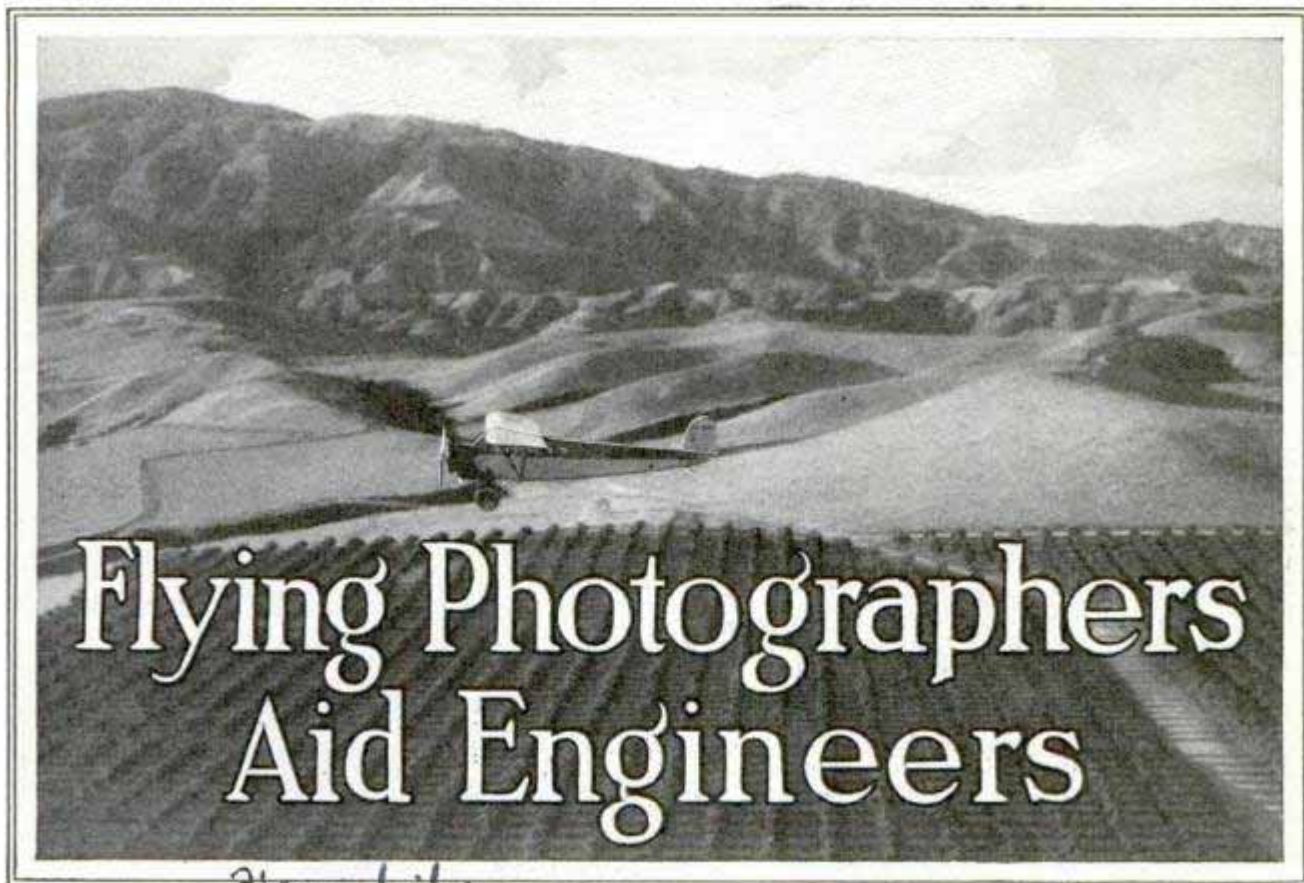

*Marchild*  
Aerial Mapping Plane in Flight above San Fernando Valley near Los Angeles; the Aerial Camera Is Placed in a Cradle Which Allows the Lens to Protrude through a Hole in the Floor

**R**ECENTLY two American aviators hopped off from Esperanza, in southern Sonora, and nosed their ship toward the interior of Mexico. Flying about 140 miles directly inland, they reached the Yaqui river valley—a virgin territory of 100,000 acres of rich soil.

This region had long been watched by engineers, who realized the immense possibilities if a dam could be built to store the waters of the turbulent Yaqui. Several survey parties had attempted to explore the narrow canyon out of which the river emerges, but failed because of the inaccessibility of the place, and because of the warlike Yaqui Indians, who fiercely resent any intrusion by the white man.

The Americans carried with them a large aerial camera, mounted in a cradle, with a huge lens protruding through a hole in the floor. Back and forth across the valley they flew, describing a series of parallels and snapping photographs at regular intervals. Three and a half hours later, they were back in Esperanza. Technicians developed and printed the pictures and fitted them into a "mosaic," or composite photograph, of the entire re-

gion. Consulting engineers studied the maps thus compiled. The pictures of the valley answered many questions regarding the proper distribution of the water. They told what primitive irrigation had already been contrived by the Yaquis themselves—a question that had never been answered fully because of the hostility of the Indians. The pictures enabled the engineers to estimate the potential storage capacity and to narrow the choice of possible dam sites down to two.

Thus is aerial photography finding new applications daily in an infinite variety of industries. The engineer has forsaken his transit and chain and has taken to the air. He has found that a few hours' flight with a camera can tell him more than half a dozen crews of surveyors can learn in a month's work out in the field. The geologist has abandoned his pack outfit in favor of the speedy aeroplane. He has learned that he can study fault lines and general topographic features better from an altitude of 15,000 feet, than by laboriously trudging over the ground itself.

Among the first to discover the possibilities of the new science were the major oil companies. A geologist was glancing

1464

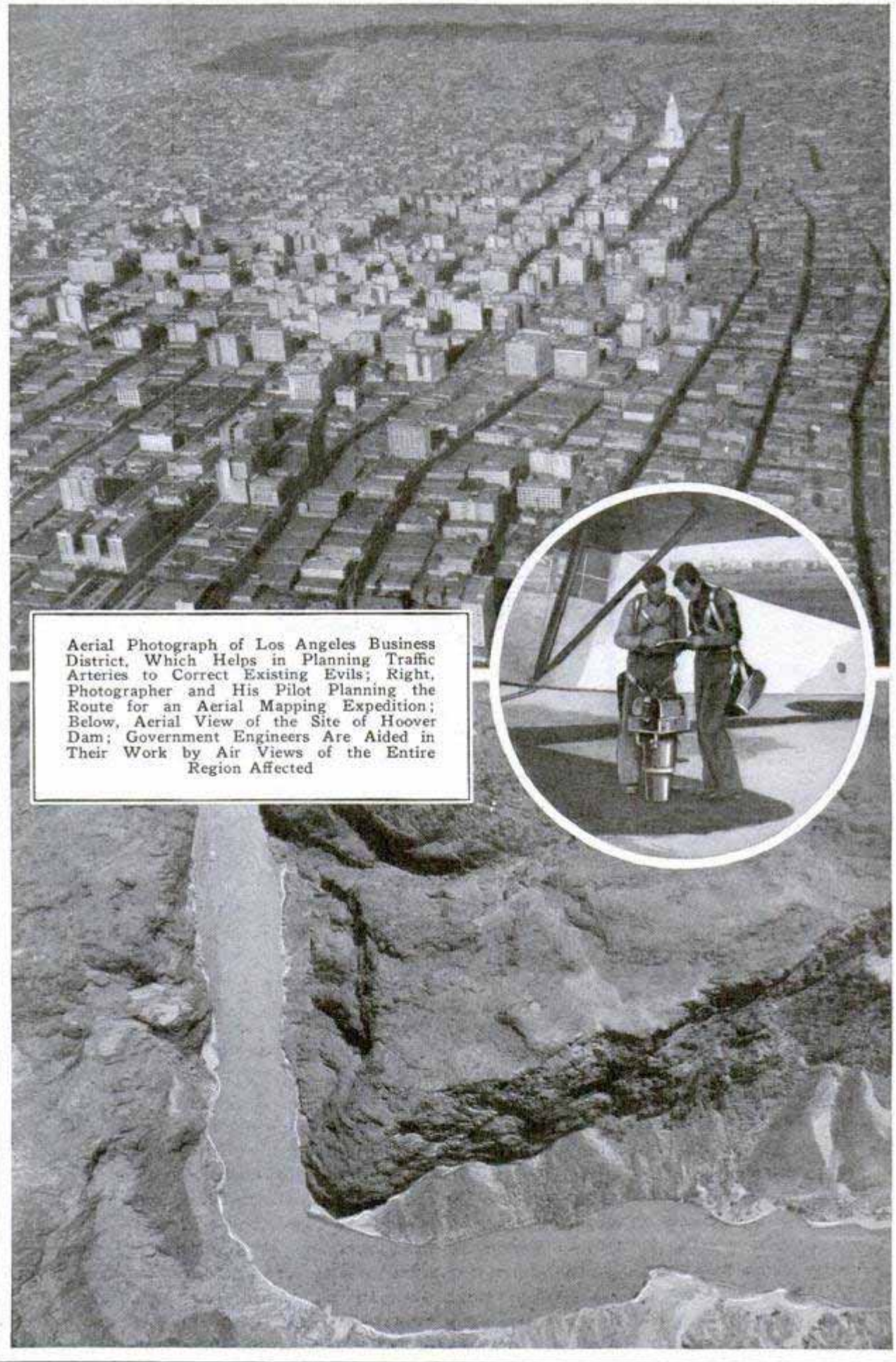

Aerial Photograph of Los Angeles Business District, Which Helps in Planning Traffic Arteries to Correct Existing Evils; Right, Photographer and His Pilot Planning the Route for an Aerial Mapping Expedition; Below, Aerial View of the Site of Hoover Dam; Government Engineers Are Aided in Their Work by Air Views of the Entire Region Affected

over air maps of a barren desert area, when he discovered certain markings indicating features he had never noticed on ordinary geological maps. He placed duplicate prints of the photo under a large reflecting apparatus that projected them in relief, like the old family stereoscope of parlor-album days. Given a third dimension by the stereoscope, the picture brought out clearly a fault line which indicated a characteristic oil-bearing structure. Successful drilling operations proved that the method was accurate.

Because it is swift, accurate and reliable, and, above all, because it is a means of helping big business to make ten dollars grow in the same time that one grew before, the fledgling industry of aerial photography has grown swiftly. Ten years ago it was merely a novelty developed during the war for reporting enemy troop movements and locating ammunition dumps.

Since then, its growth has been incredibly rapid. Companies specializing in the work have grown from one-man, one-ship outfits to complete organizations with large staffs and their own fleets of aeroplanes. An official of one of the largest commercial companies recently remarked that it would not be long until their files will include photos of the whole state of California. The same thing is rapidly becoming true all over North America. The daring flyers of the navy have mapped the wilds of Alaska.

Eventually you will be able to go into the office of a large aerial-mapping concern and get a photograph of any spot on the continent that you may designate. For Canada, the Philippines, Mexico, the remotest parts of the globe, all are yielding up their secrets under the eagle eye of the flying photographer.

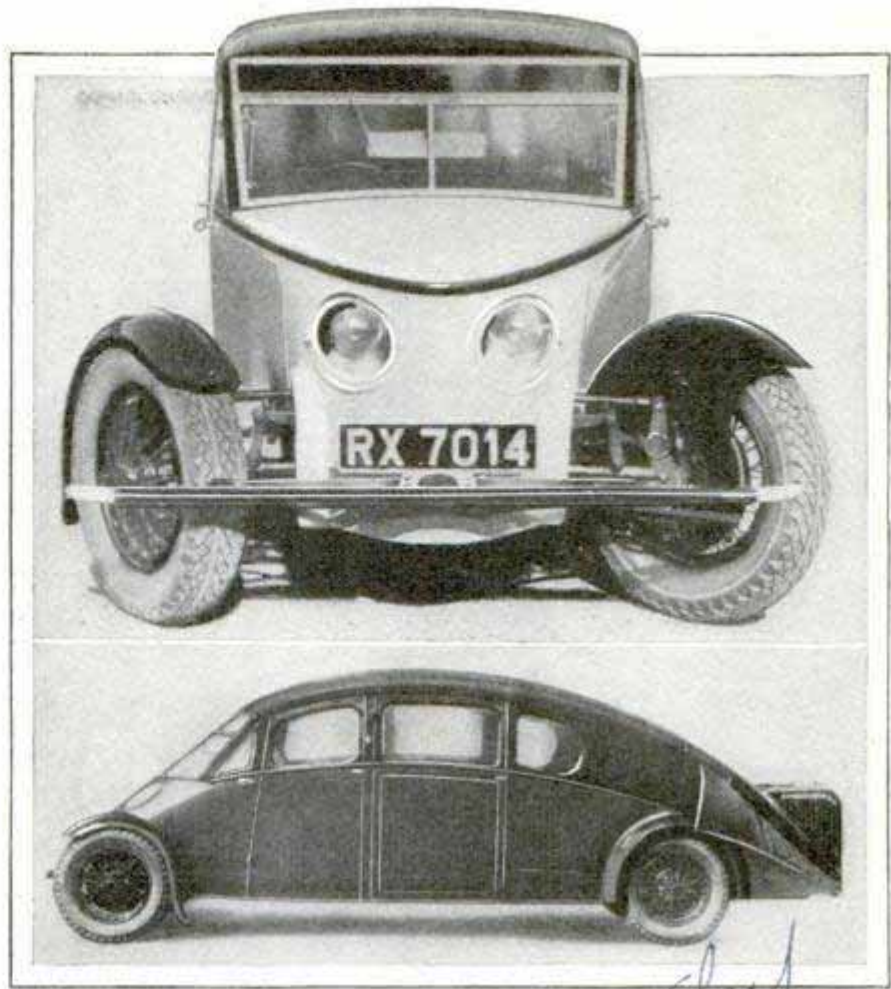

Streamlined Automobile Body Designed Like a Dirigible; the Unusual Shape Was Found to Effect a Fifty-per-Cent Fuel Saving

## AIRCRAFT LINES ADD TO AUTO'S SPEED AND POWER

Streamlining similar to that employed in building the British dirigible "R-100" has been used by Sir Denistoun Burney, designer of the airship, in making an automobile body which reduces wind resistance to a minimum. The streamlining has been found to save fifty per cent in gas consumption, and about fifty per cent of the horsepower required to propel an ordinary car on a level road. The engine is built in the rear, and the spare wheels are carried in the doors. The front wheels have a fifty-degree lock, enabling sharp turns, and the lamps are recessed so that they form an unbroken curve with the body lines.

☞ Popular Mechanics Magazine does not publish the name of the maker or seller of any device described in its pages, but this information will be furnished free by our Bureau of Information.

# ROBOT AIR PILOT KEEPS PLANE ON TRUE COURSE

*developed by Royal Aircraft Establishment England*

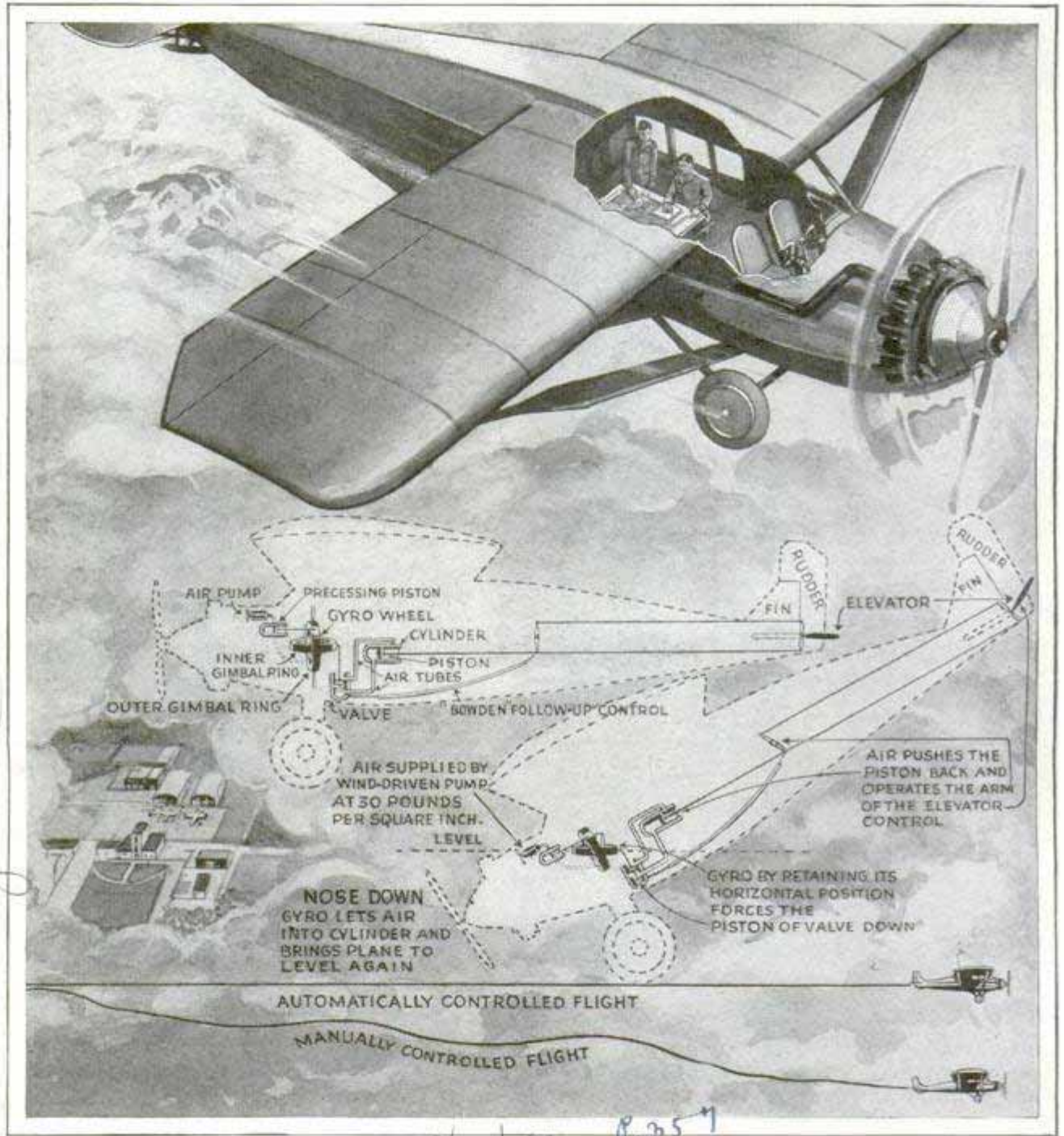

8/30/1930 8.35

Drawing Showing How a Robot Air Pilot Keeps a Plane in Level Flight without Human Interference; a Gyroscope Is the Robot's Brain, and It Works the Controls by Compressed Air

Successful tests have been concluded in England with a robot air pilot which automatically keeps an airplane flying in a straight course for hundreds of miles without assistance from any human agency. The apparatus, known as a pilots' assister, operates much more precisely than the most skilled human flyer and is expected to be invaluable in cross-country flights in fog and clouds. During tests, pilots set a course and then flew for more than 400

miles without touching the controls, being able to leave their seats and attend to other duties without so much as glancing at the many instruments which ordinarily must be watched constantly. The control depends for its sense of direction and level on a gyroscope driven by compressed air. Any deviation from level flight in a straight course causes the gyroscope to operate valves and pistons which, in turn, manipulate the controls.



Seymour Gordon, Curator of Minerals  
 Academy of Natural Sciences, Philadelphia

**TINTED GLASS AIDS  
IN MAKE-UP AND  
SAVES FACE**

1501

Used for some time in laboratories to help filter lights, a special glass has been adapted to the theater. Employed in the spotlight, it is said to diffuse a light that brings out the natural flesh tints so that the actors do not have to place so much reliance on make-up. The glass is known as "illusion pink" in the theater, and owes its color to two rare metals.

**AUTO COAT HANGER  
KEEPS CLOTHES  
TIDY**

1592

Intended for the automobile, but equally handy in the home, is a coat hanger that is attached or detached in an instant. It consists of a strip of leather in which are cut two parallel slots through which the hook of the hanger passes and is held firmly in position. The leather strip contains a snap fastener which is attached to a screw stud placed in the woodwork wherever convenient. At the top of the strip is a metal spring clip that serves to hold hats, maps or papers.

*Auto Valet*

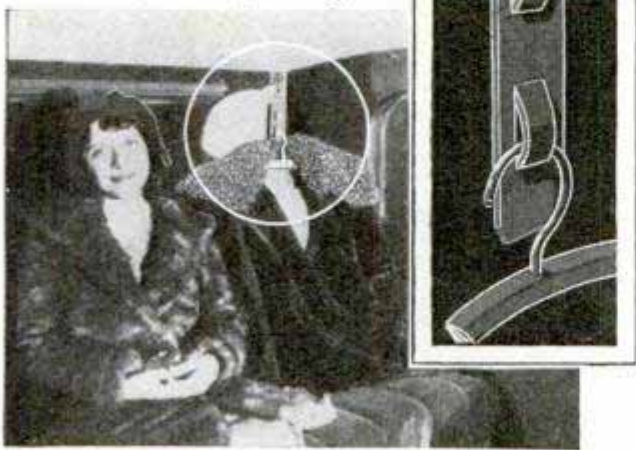

Coat Hanger for the Auto Fastened to a Leather Strap Which Is Attached in an Instant

Walter B. King  
520 Mercantile Bldg

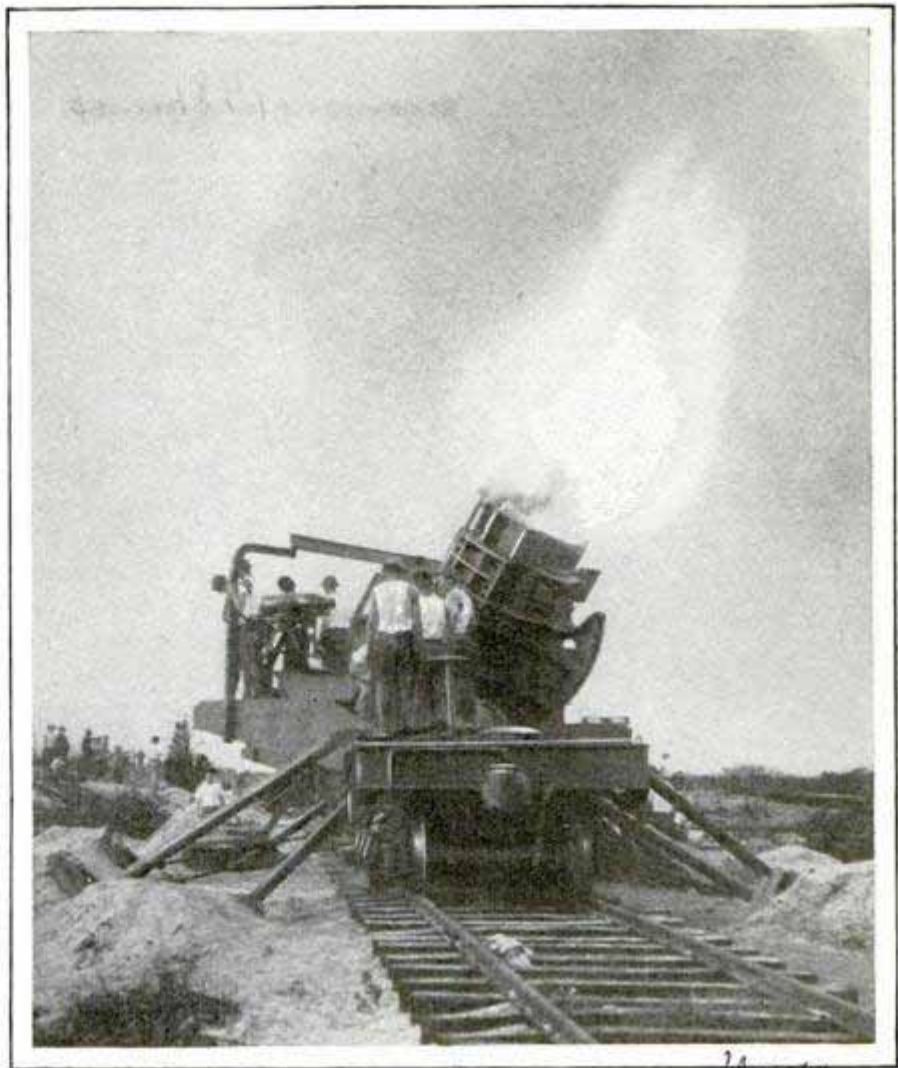

Twelve-Inch Mortar Railway Gun Which Can Fire a Projectile Nine Miles; It Is Intended for the Defense of the Atlantic Coast

**MORTAR RAILWAY GUN TO AID  
IN DEFENDING COAST**

Intended to attack invading battleships along the Atlantic coast, a twelve-inch mortar railway gun recently underwent successful tests. The weapon, which offers the advantage of speedy portability, fires a missile which travels to a height of about 1,700 feet, and has a range of from one to nine miles.

**ALL AUTO DOORS LOCK AT ONCE  
BY PRESSING BUTTON**

1488

By pressing a button, all the doors of the automobile can be locked at once with a special locking assembly now available. The doors also may all be locked simultaneously by turning a key in the right front door. Although all the doors are locked from the outside, any or all may be opened from the inside as usual. The locking is done electromagnetically.

Kingston Product Co,  
Berkens, Ind

Chicago 3300 DuSarna Ave

1572 952

4156 W. Washington St.  
Los Angeles, Calif.



Small Portable Electric Vibrator Which Contains No Motor but Operates from Lighting Circuit

**PORTABLE ELECTRIC VIBRATOR RUN FROM LIGHT PLUG**

Giving a fast rate of vibration without the violent shaking produced by oscillation, a portable electric machine, so small that it can easily be carried in a small traveling bag, is now available. It is without a motor and operates from the electric-light circuit, consisting of a heavy coil surrounded by laminations. These act as a magnetic unit, creating the flow of vibrations through spring steel to which are riveted iron arms for attaching the belt for body or the head cap for neck-and-scalp massage. It has no moving parts or gears to get out of order, requires no oil or adjusting and offers a flow of 6,000 vibrations a minute on a fifty-cycle current, using no more electricity than is needed to light a sixty-watt lamp. When more tension is applied to the body belt, the vibrations increase in strength, but do not exceed the limit beyond which they might be unsafe.

Motorists paid \$431,636,464 in gasoline taxes in 1929.

**HEAT GENERATED BY MOTORS USED TO WARM BUILDING**

Heating effects of electrical rotating machinery are no longer entirely lost because temperature increases caused by resistance, eddy currents and magnetic effects in direct-current and synchronous motors and generators are being used to warm the buildings housing the equipment. In recent installations, sheet-metal hoods collect the air warmed by the revolving machinery and transfer it to ducts which carry it where it can be used for heating. In the summer it is exhausted in the open to keep the building cool. Made to take advantage of the ventilation characteristics of the machinery, the hoods greatly reduce windage losses.

**OXYGEN-BREATHING ROOM AIDS PNEUMONIA VICTIMS**

One Chicago hospital has been equipped with an oxygen room for the treatment of persons suffering from pneumonia, asphyxiation and other critical ailments of the respiratory system. The patient is given a supply of oxygen mixed in proper proportions through the special apparatus with which the quarters are equipped. There are only about half a dozen such rooms in the country.

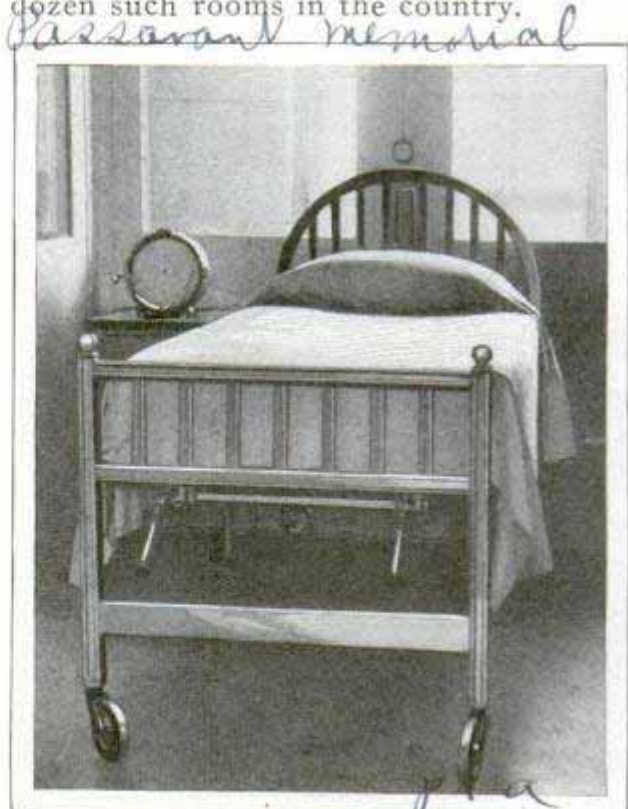

Oxygen-Breathing Room in a Chicago Hospital for Treatment of Persons Suffering from Pneumonia

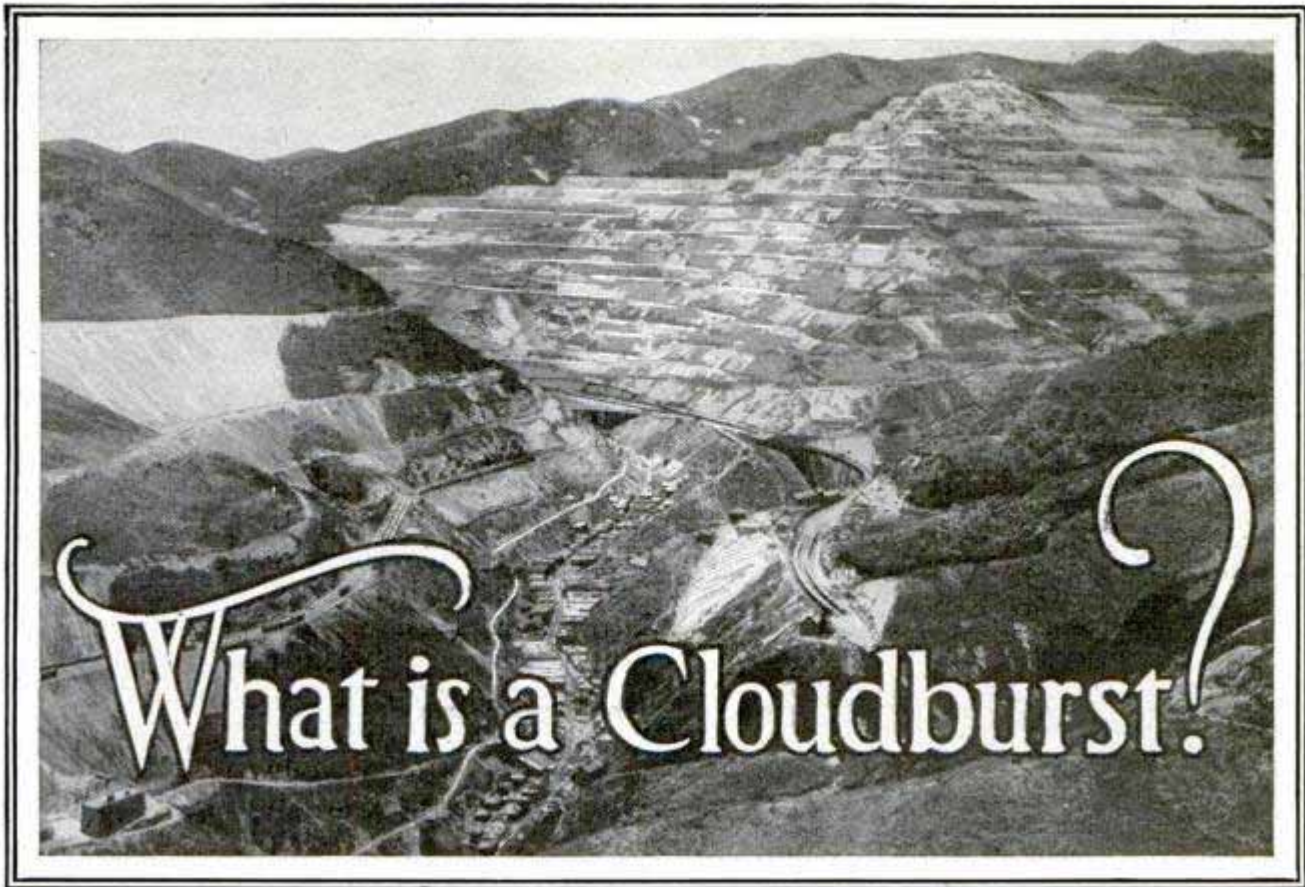

View of Bingham Canyon, Utah, Which Was the Scene of a Devastating Torrent Only a Few Months Ago; in the Background May Be Seen One of the Largest Open-Cut Copper Mines in the World

By C. F. TALMAN

*Photo-gram Co.  
Box 840, Washington, D. C.*

SEVERAL destructive cloudbursts are reported every year in the United States. Last fall, while the most severe drouth in American history was at its height, two of these events made first-page news in the daily press. One took place in the twin towns of Nogales, on both sides of the boundary between Arizona and Mexico, where semi-desert conditions usually prevail. A sudden downpour during the night converted the streets into raging torrents and a score of people were drowned.

In the other case, a temporary river, several feet deep, roared down the single long street of Bingham Canyon, Utah, below the world-famous open-cut mine of the Utah Copper company. Three houses were washed away and mud was piled up, in places, to a height of eight feet. Bingham, like Nogales, is located in a normally semi-arid region, and it is in such regions that some of the most remarkable downpours on record have occurred. A cloudburst is an excessively heavy local downpour of rain, of comparatively brief duration. In its intensity and

its concentration in space and time, it bears much the same relation to a wide spread heavy rainstorm as does a tornado to an ordinary cyclonic storm. The name of the phenomenon is popular rather than scientific and no hard-and-fast definition of this name has ever been adopted.

Of course, we know today that a cloud is merely a collection of very fine droplets and not a coherent mass, such as might be subject to any process of rupture. Moreover, modern research has revealed the fact that the clouds contain surprisingly little water. The very densest clouds are probably not more than one part water to 30,000 parts air, and it is computed that, if a huge thundercloud several miles in depth were, through a miracle, precipitated en masse to the ground at the maximum speed of falling rain, the resulting rainfall would be decidedly less intense than often occurs in so-called cloudbursts.

One of the fastest showers ever measured with an automatic rain gauge was that of May 1, 1908, at Porto Bello, on the Isthmus of Panama, in which 2.47 inches fell in three minutes. This rate of fall

was surpassed on April 5, 1926, at Opid's Camp, in the San Gabriel mountains of California, when 1.02 inches of rain—equivalent to 115 tons of water per acre—fell in one minute. This remarkable down-pour was caught by two automatically recording gauges, standing side by side, and as their records agreed, the figure just quoted is entirely trustworthy.

While this figure stands, for the time being, as a world record so far as actual measurements go, it certainly does not represent the greatest possible intensity of rainfall in a cloudburst. Evidence of much more excessive falls is supplied by the huge holes, known as "cloudburst cavities," found after cloudbursts at places

where they were evidently produced by the direct impact of the falling water and not by rapid run-off from some adjacent area. Observers have described these cavities in some cases as resembling the work of the hydraulic "giant" used by gold miners.

Eyewitnesses of cloudbursts have frequently described the water as coming down in masses or streams, rather than in drops. The earlier scientific attempts to account for these tremendous down-pours assumed that the water was due to rapid condensation in the vortex of a tornado or waterspout, and hence the name "waterspout" was formerly often applied to a cloudburst, even when it occurred far from any body of water. The rainfall attending a tornado is doubtless sometimes of cloudburst intensity, but the majority of cloudbursts are now believed to be the product of thunderstorms. Violent uprushing currents of air always occur at the front of an advancing thunderstorm. Moisture in the air drawn into the storm by these currents condenses as it rises on account of the cooling of the air by expansion, but the upward blast is so strong that for a time the water is prevented from falling as rain.

If the rising currents are weakened at some point, a large accumulation of water is permitted to fall at one time. This is especially likely to occur when a traveling thunderstorm, which is fed by rising

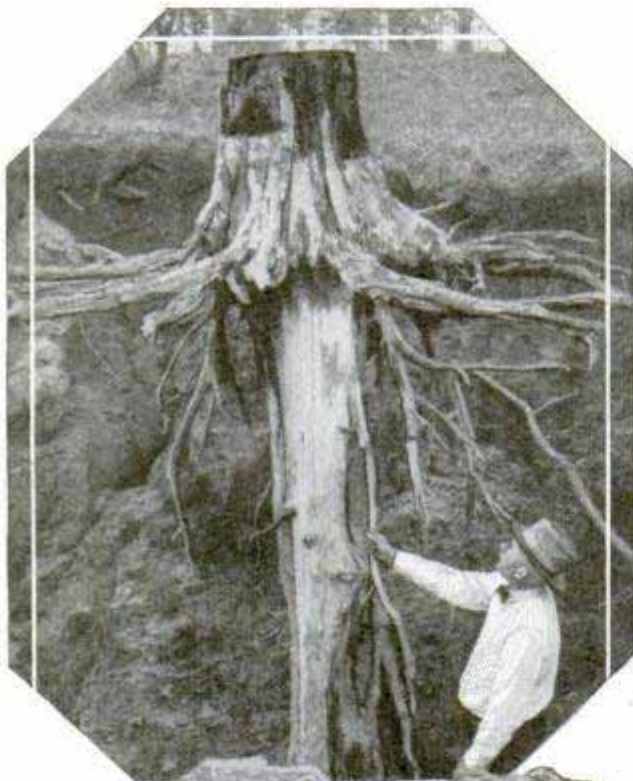

Above, Remarkable Example of What a Cloudburst Did to a Hillside; Below, "Toadstool Park" in the Bad Lands of Nebraska, Where Heavy Rains Have Sculptured the Earth into Weird Forms

streams of air from over-heated ground, passes over the cooler surface of a mountain, so that its supply of warm air is temporarily cut off. This would explain the special frequency of cloudbursts in mountainous regions.

The rainfall and runoff of cloudbursts produce their most striking effects in lands where the normal rainfall is so light that there is little or no vegetation to protect the ground from washing. The weirdly sculptured landscapes of the Bad Lands are the result of occasional torrential showers in a region where dry weather is generally prevailing.

A cloudburst is rarely a welcome event, but one that happened near Lake City, Colo., in the summer of 1929 scoured the hillsides and laid bare valuable deposits of ore, starting a small gold rush to the locality. A similar downpour many years ago in the same region is said to have brought to view several million dollars' worth of gold and silver.

**FLAME BALANCED ON AIR JET IN FIREBOX OF BOILER**

Just as a light celluloid ball may be balanced on a vertical jet of air beneath it, so an inferno of fiery coals is kept aloft and flaming in the firebox of a large boiler by a draft of air entering below the grate. Crushed coal is used for fuel, the light particles being carried high up in the firebox, while the larger, heavier ones remain nearer the grating through which air enters. The heavy ashes drop out of the suspended fire. Very inexpensive operation and the use of cheaper fuels are claimed for the system, wood refuse having been burned satisfactorily and several installations being in successful operation.

Douglas Henderson  
220 48th St. (2)  
New York



Aerial View of New York's Elevated Highway along the Hudson River, Where Autos Travel without Interference from Cross Traffic

**ELEVATED HIGHWAY FOR AUTOS SPEEDS NEW YORK TRAFFIC**

Automobile traffic in New York is being speeded up by the construction of elevated highways above the streets for fast travel. One such overhead lane extends north and south along the Hudson river waterfront where cars can travel at a fast clip without interference from cross traffic

**MOST ANCIENT AMERICAN CITY**

Santo Domingo, capital of the Dominican republic, is the oldest city in the new world settled by Europeans, but Panama City, founded by the Spanish in 1519, claims to be the oldest white settlement on the mainland of the Americas. There are, however, older cities of native origin. Mexico City, according to Aztec tradition, was settled about 1325.

Cook H. L. Kauffman  
1445 Elm St.  
Denver Colo

in report & Technical Paper and Paper Industry Assn.

Wide World

553

A PAGEANT OF TRANSPORTATION IN FRANCE



Changing Styles in Travel Were Reviewed at a Transportation Pageant Held in Granville, France, Recently; in the Photograph Above Are Shown an Egyptian Palanquin and a Roman Chariot, While at the Left Is a "Litter de Luxe" of the Middle Ages; Persons in the Procession Wore Costumes of the Periods Represented, So That the Event Gave an Interesting Picture of the Changes in Dress as Well as in Vehicles; the Earliest Chariots Were Commonly Used in Warfare; They Were without Springs, Generally Carried Two Men and the Wheels Were of Wood Strengthened with Metal and Often Had Bronze Tires; the Assyrians Are Credited with the Addition of a Scythe or Sharp Knife to the Axles to Help Cut Down the Enemy in a Charge

© P. & A.

How Beauty Rode in Olden Days; the Bearers Were Experts at Keeping Step to Give an Even Motion

SHOWS OVER TWENTY CENTURIES OF TRAVEL



Above, a Modern Locomotive beside a Tiny Buddicum Engine, Built in 1840 and Which Has Been in Service between Granville and Paris for Seventy-Five Years; at Right, an Early Model of the Automobile; Its Top Is Borrowed from the Horse-and-Buggy Days; Note the Smaller Front Wheels and the Steering Grips Operated from the Right Side; Remarkable Improvements in Design Constitute One of the Chief Triumphs in Motor-Vehicle Progress, a Development Second Only to the Gain in Mechanical Efficiency of Engines and Other Parts

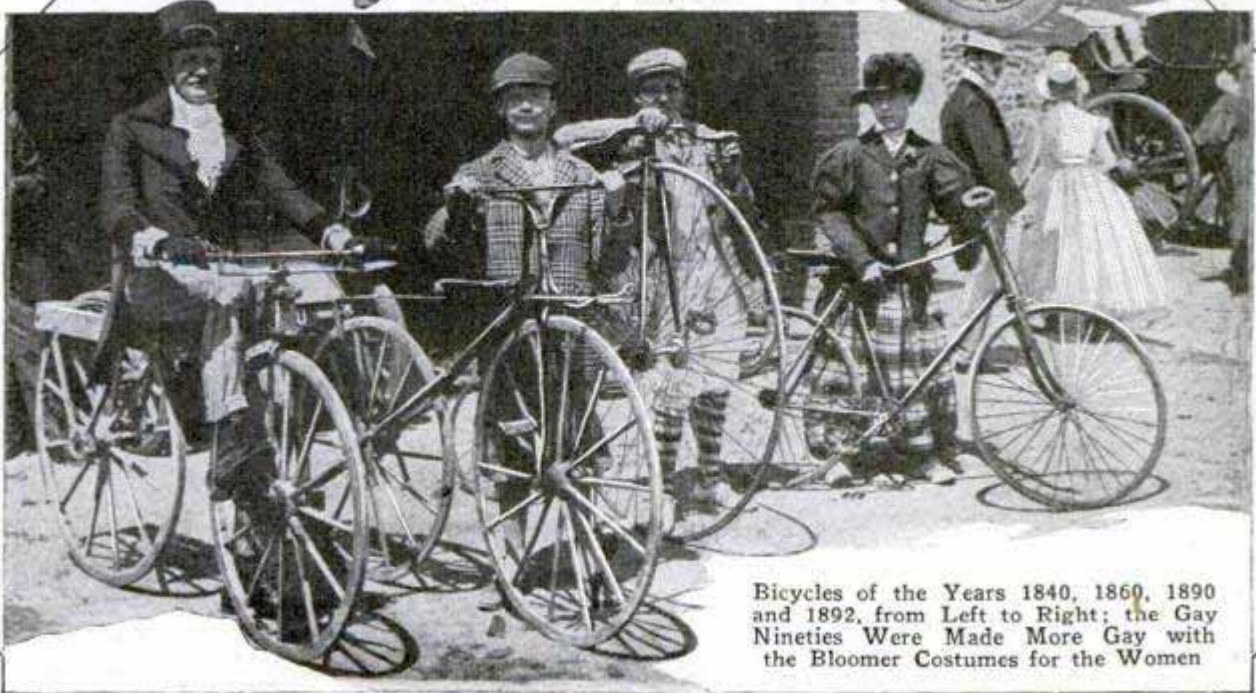

Bicycles of the Years 1840, 1860, 1890 and 1892, from Left to Right; the Gay Nineties Were Made More Gay with the Bloomer Costumes for the Women

# RAZING RAIL DEPOT TESTS SKILL OF ENGINEERS

Razing the largest train shed in the United States and replacing it with mod-

ern platform canopies; removing three miles of passenger platform and rebuilding it with concrete; shifting twenty-eight railroad tracks; setting 60,000 square feet of terrazzo floor and spreading in the neighborhood of 100,000 square feet of hard plaster, under more ordinary conditions, wouldn't be so much of a job for

building wreckers and constructors to pull off in a year's time. But in rebuilding the spacious concourse of the South Station in Boston, conditions were far from ordinary. In number of passengers arriving and departing, this station stands third in the country. Each day more than 100,000 people traverse its platforms and the concourse; 535 trains arrive and depart every twenty-four hours—a train every three minutes. The big problem involved was to carry out the modernization of the station without in any way delaying the stream of traffic. In doing it,

*75 50  
Cmt. John F. Coggeswell, 16 Edgemoor Road, Boston, Mass*

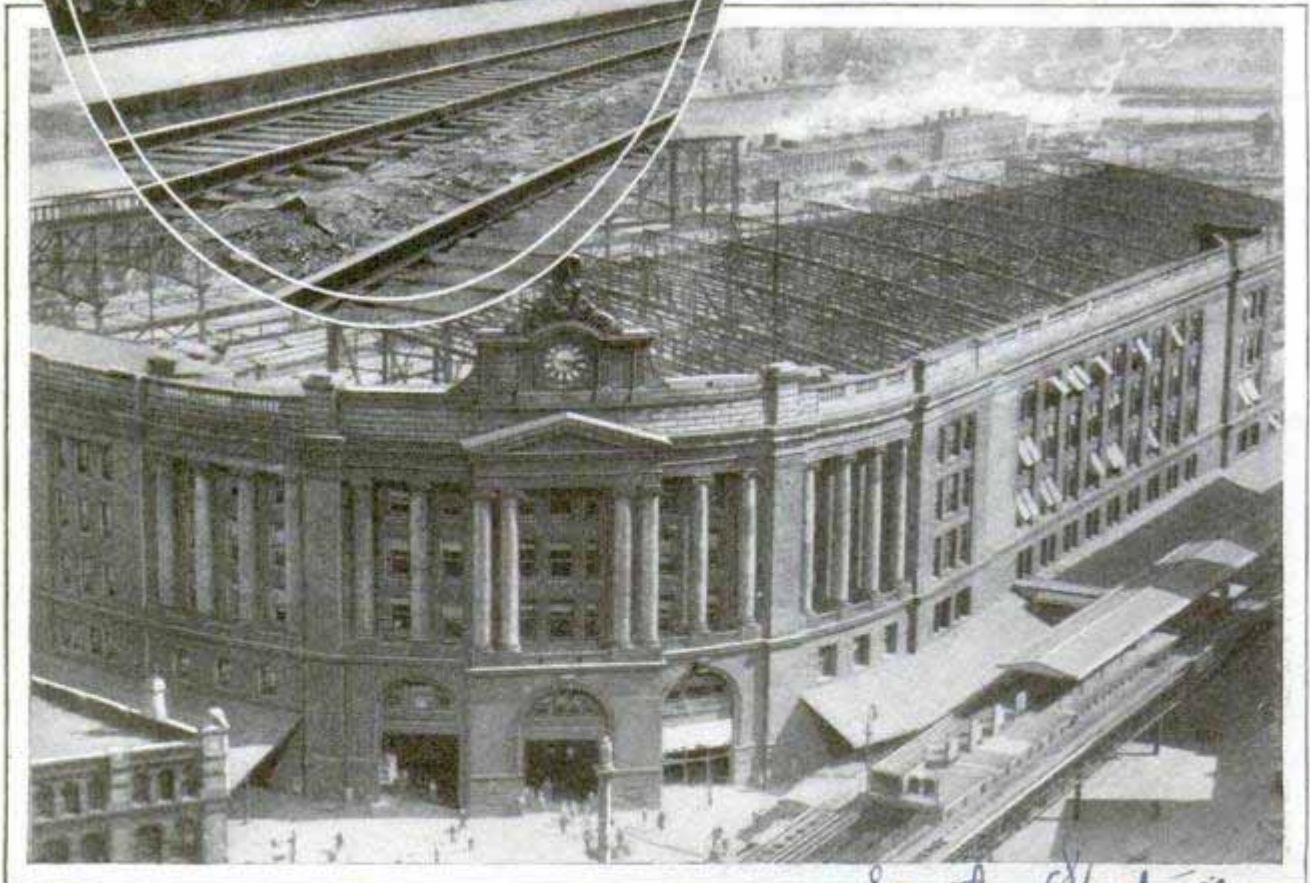
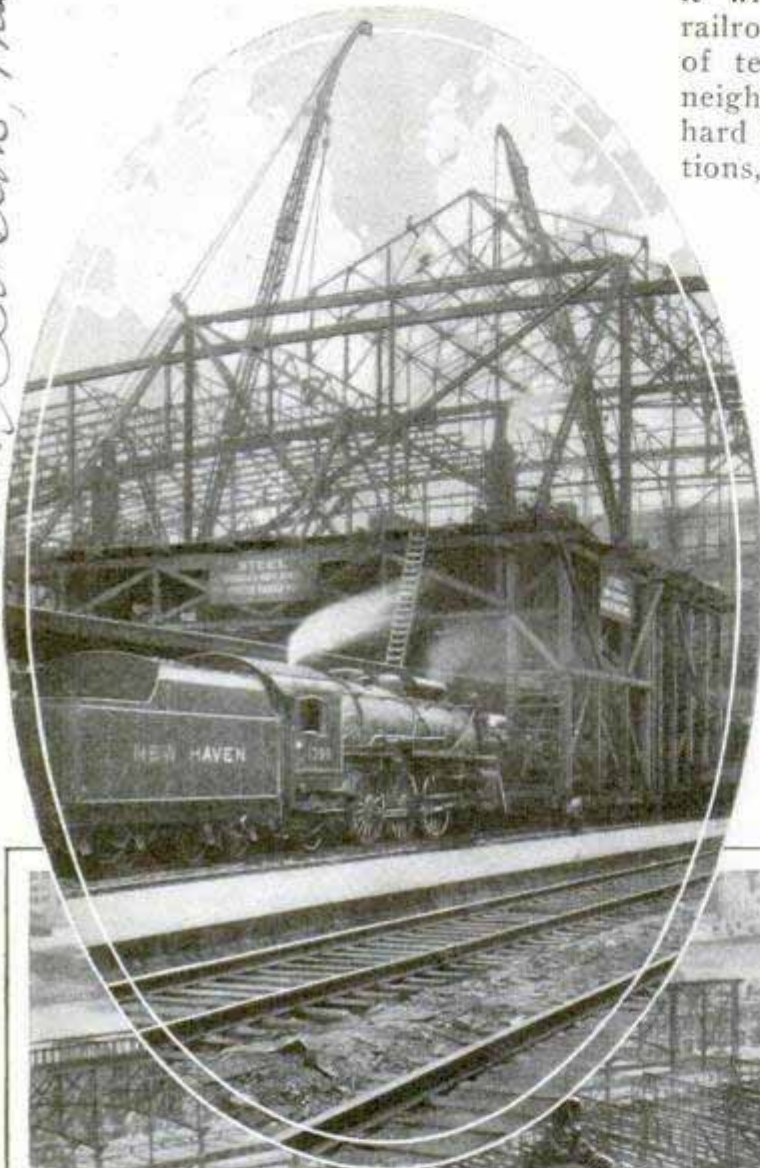

Above, Close-Up of Movable-Derrick Mount Used in Demolishing a Boston Train Shed without Interfering with Trains; Below, Station with Center Section of Train-Shed Steel Removed

*South Station*



WATCH THAT SHOWS THE DATE  
GIFT FROM WASHINGTON?

*Model Airplane Shop  
120 E Second St.  
Peru Ind.*

several new methods were evolved and some records were made. The removal of the big train shed was the most spectacular piece of work. An eighty-five foot boom was the longest practicable to use, so the derricks had to be mounted forty feet above the tracks. Tearing down and rebuilding the mounts each time a move was necessary would have consumed too much time, so two special mounts on sixteen railroad trucks, wide enough to span four tracks, were constructed. A secondary set of wheels allowed sideways movement across the platforms without dismantling the derricks. The contractors estimate that the use of the movable mounts saved six months of work. Installation of the modern canopy coverings—or butterfly awnings—for the platforms kept pace with the removal of the shed, so that passengers would not be exposed to the weather.



Old Watch with Four Dials and Five Hands; It Shows Days of the Week and Date of the Month

**COTTON-FIELD DUSTER COVERS SIXTY ROWS AT A TIME**

Covering sixty rows at a time, a mechanical cotton duster used by southern growers is able to treat twenty-five acres an hour, or 200 acres a day. The duster is mounted on the rear end of a tractor, close enough to the driver so that he can control the flow of calcium arsenate. A fan, housed below the hopper, and the agitators inside the hopper are driven through shafts and gears by the power take-off. The hopper holds 150 pounds of poison dust which passes through an adjustable cone by gravity and suction action by the blower.

*McCormick Steering*

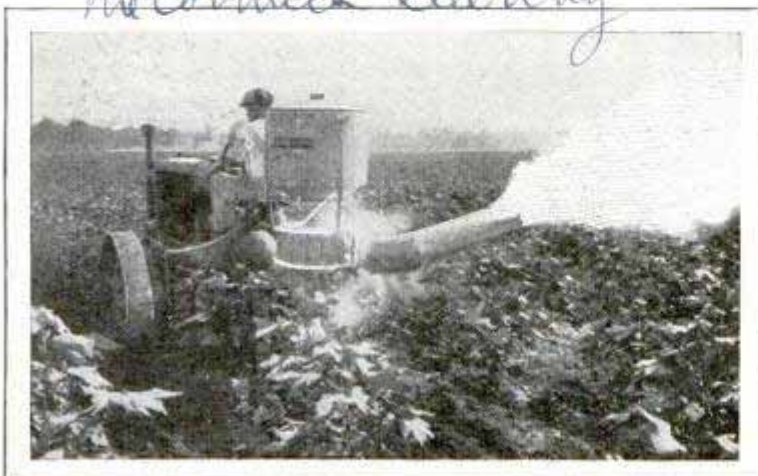

Cotton Duster Operated by Tractor, Which Sprays Sixty Rows at a Time and Covers Twenty-Five Acres an Hour

In the private collection of an Indiana man is a watch that may be the identical timepiece which Washington presented to Lafayette as a token of his appreciation of the services rendered by the famous Frenchman. That a watch was given is a matter of record, and it is also a fact that the present was stolen from Lafayette's quarters. The collector's watch fits the description of the historic timepiece, experts say. It has four dials and five hands. One of the dials records the days of the month and another the days of the week. A miniature portrait bust of Washington appears on the upper side of the face. It is in colors and is considered a masterpiece of craftsmanship.

**FLOATING POWER PLANT**

To serve cities and industries along the New England coast, the former shipping board steamer "Jacona" is being converted into a floating electric-power plant. A 20,000-kilowatt turbine generator is being installed on board the vessel, which will transmit electricity to places unable to obtain sufficient power from land plants because of their location.

*International Harvester Co., 606 S Michigan Ave  
Cant. Hugh Lloyd  
Capitol Hill Station*

*American comes engines  
line, Marysville  
Mich*

15  
960  
78

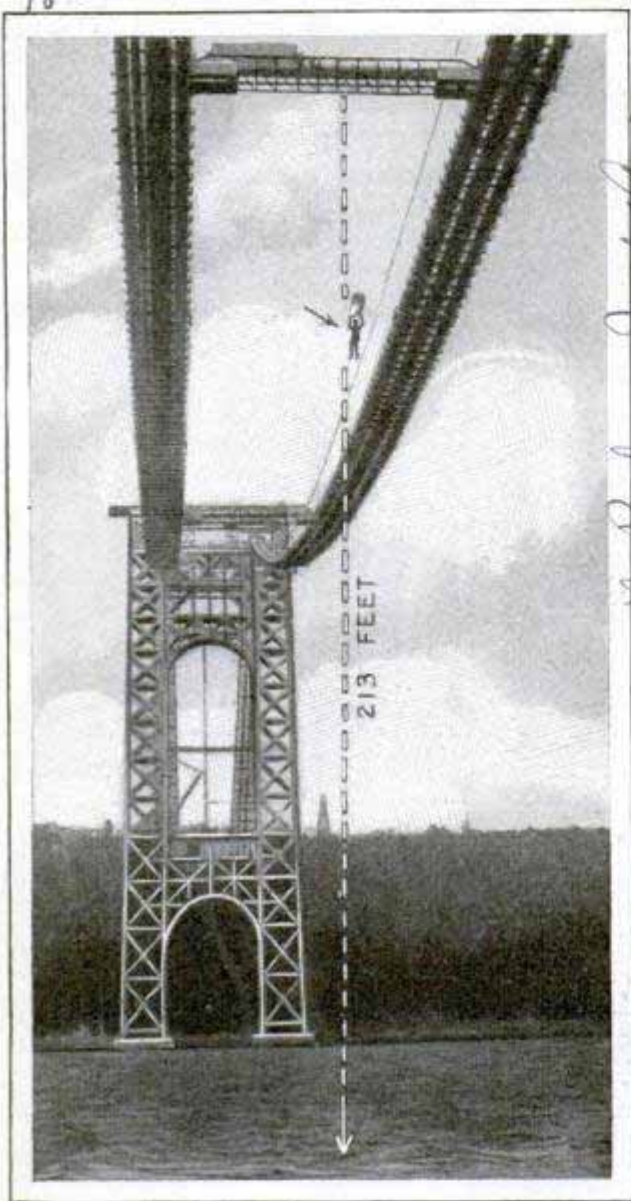

© P. & A.

High Diver Shown as He Jumped from Hudson River Bridge; He Was Killed in the 213-Foot Plunge

**BANNER CARRIED BY HIGH DIVER FAILS TO SAVE HIS LIFE**

Attempting a 213-foot dive from the center of the Hudson river bridge in New York City, Norman J. Terry, a stunt performer, lost his life when a blue banner which he carried failed to keep him in a perpendicular position until he struck the water, as he had expected. He jumped, head first, from the center span, remaining in perpendicular position until a few feet above the water when his trailing banner apparently hit dead air, flipping the diver on his back, which was broken when he struck the water.

**SUPERCHARGER FOR SMALL CAR INCREASES ACCELERATION**

*1478  
the Patavia model*

Superchargers intended particularly for small automobiles, and especially for model-A Fords, now are available. The device fits over the regular carburetor and is clamped into place. Increases of thirty per cent in acceleration, ten per cent in speed, and ten per cent in mileage are among the claims made for the charger when applied to small stock cars. Power for the supercharger, which supplies a perfect mixture of gasoline and air for firing in the cylinders, is derived from the crankshaft.

**PLANE IN FLIGHT TAKES FUEL FROM SPEEDING AUTO**

*1593*

Fuel was transferred successfully from a speeding automobile to an airplane in flight above it in a recent test at Alameda, Calif. The automobile headed into the wind as the plane approached, and when both were traveling at approximately the same speed, the ship was nosed down until the pilot was able to grasp the handle of a five-gallon can of gasoline held upward for him by one of the occupants of the open car. The success of the experiment was due primarily to the comparatively low speed which the small plane was capable of making. This craft, weighing only 450 pounds, and with a wing spread of thirty-four feet, has a landing speed of about thirty-one miles, and when flying into the face of even a ten or twelve-mile wind, its actual speed over the ground is cut to about twenty miles an hour.

*Arsona C-2 plane*



Here Is an Airplane Refueling on the Wing, the Pilot Snatching a Can of Gasoline from a Speeding Automobile

*Cont. Tom White  
000744, Alameda  
Calif*

1660

POPULAR MECHANICS 961  
16 Edgemoor Road, Belmont, Mass

# MODELING GLASS FLOWERS SOON TO BE A LOST ART



Left, Glass Model of Cotton Plant in Bloom; Right, Coffee-Plant Model; In Circle, Repairing Crack in a Model; Below, the Clove Plant

The world is about to list another lost art, one that came into being less than a half century ago and yet is doomed to pass within a few short years. For Rudolph Blaschka, maker of the famous glass models of flowering plants in the Ware collection at Harvard University, has passed his seventy-third birthday and feels that he has few more working years ahead of him. And there is no one else in the world who knows how to make glass flowers like his. Many master workers have tried to duplicate the products of the art started by Leopold Blaschka, father of Rudolph, forty-five years ago. All of them have failed. For a Blaschka model is as the flower itself; root, stalk and bloom are there in faithful detail.

Just recently, there arrived from the Blaschka studio at Hosterwitz, near Dresden, Germany, a consignment of twenty-five specimens representing the entire product of six years' work by the artist-glassworker. Perhaps another genius,

capable of carrying on the work, will rise after Rudolph Blaschka has passed on. He has promised to leave behind complete written details of how the glass is fused upon the tiny wires and how the coloring is attained. But Louis Bierweiler, who is devoting his life to the preservation and cataloging of the collection, as

the Blaschkas have to its creation, points out that even with this detailed information at his command, it will take a most extraordinary person to add to the collection specimens worthy of a place beside the work of the two masters.

## BULLS ARE SHOD LIKE HORSES TO PREVENT SORE FEET 1551

Ranchers in Nevada are putting shoes on their bulls to prevent sore feet among the animals which roam the rocky fields. A special bull shoe of two pieces is used by the blacksmiths because of the cloven hoofs of the cattle. The animals are placed in a frame which prevents them from attacking the blacksmiths.

Cml. Frank S. Reynolds  
615 West RR Ave.

125 2

# In DAVY JONES'

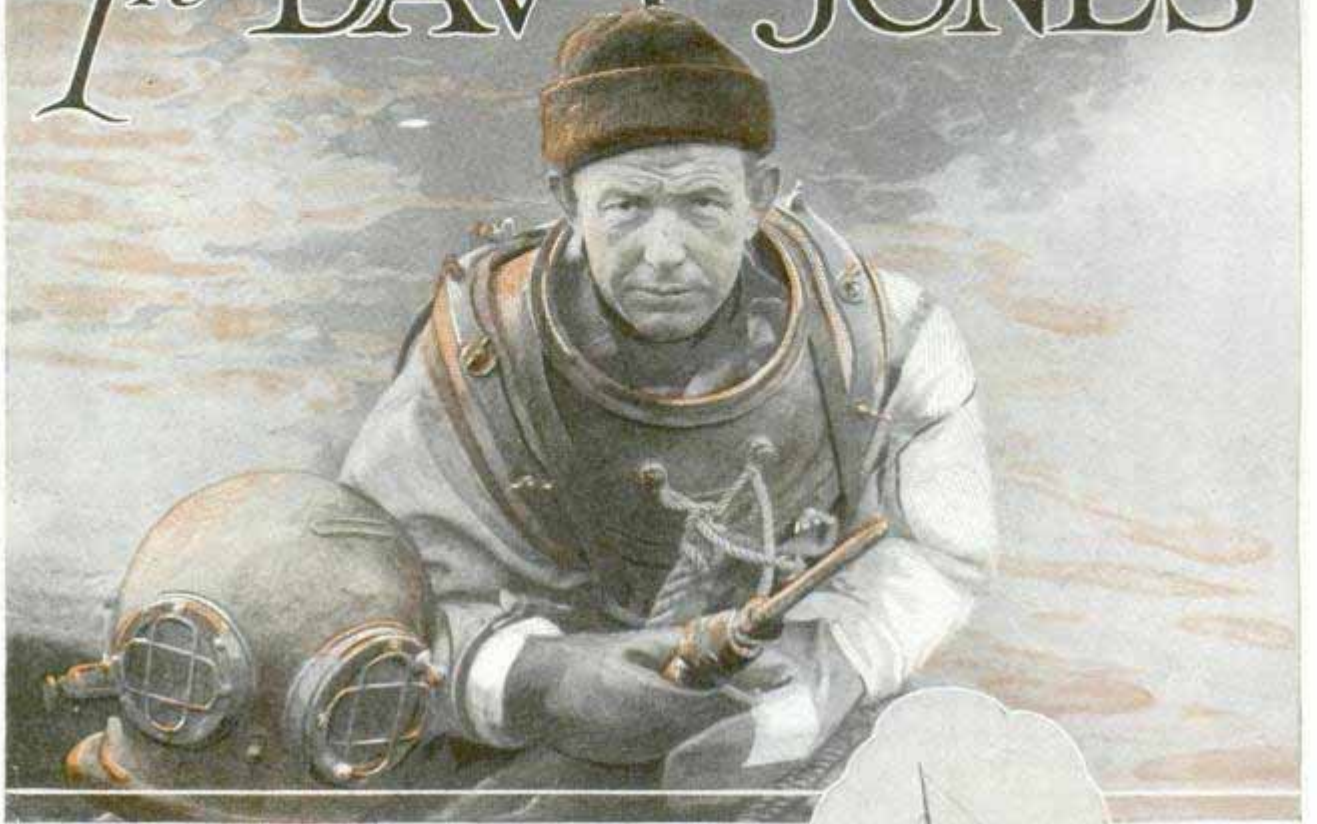

Diver, Expert in Salvage Work, About Ready to Descend with Torch That Cuts under Water; Below, a Freighter Beached by Storm

By DON GLASSMAN, 55 W

*Bath New York*  
**A** FRIGID tide swept out of Long Island sound and snarled at the west end of Fisher's island, where the government was building a lighthouse. A ridge of granite shaped like a turtle's back was the construction base. They called it Race Rock because the water literally races across the granite bottom. Nothing could buck the current. Derricks, tugs, lighters and other man-made structures snapped their anchorage. A veteran diver was pulled out half dead from fighting for a foothold. Engineers found a substitute in Alfred Pahlberg, a young sailor. They lowered him in the teeth of a raging sea, and he joined the seven-ton blocks into a foundation that resists the elements to this day.

Race Rock lighthouse, near the

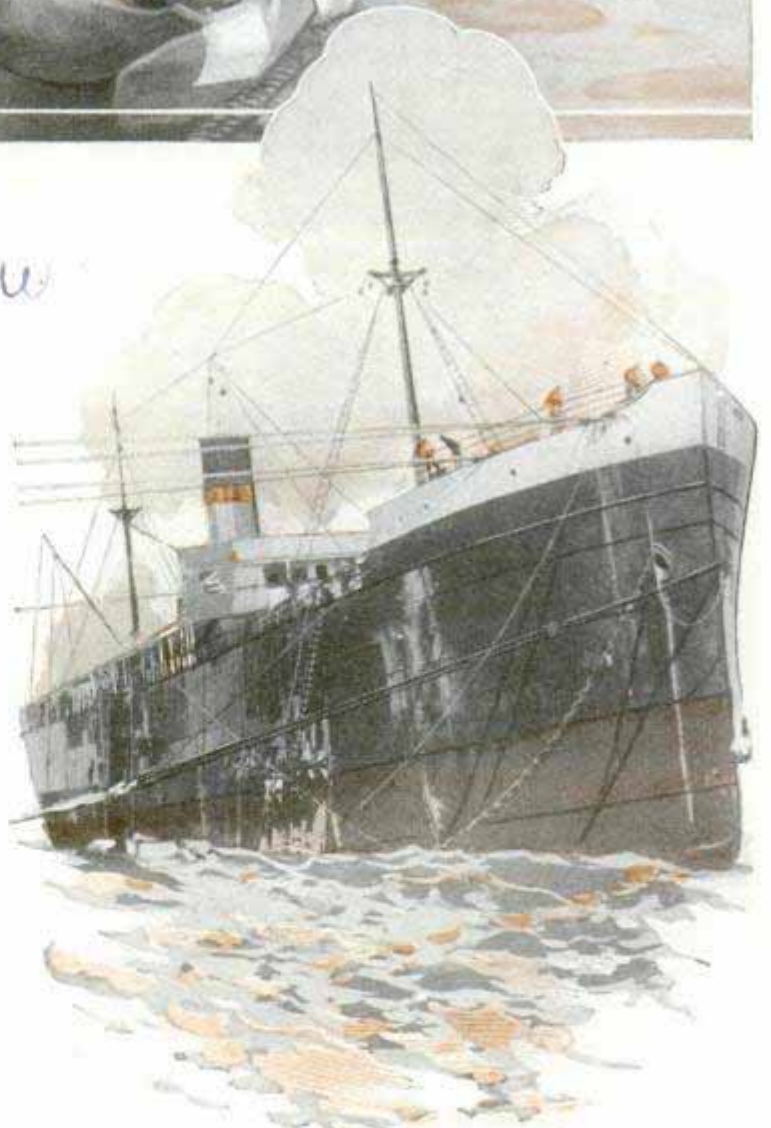

Courtesy Merritt, Chapman and Scott Corp.

# LOCKER

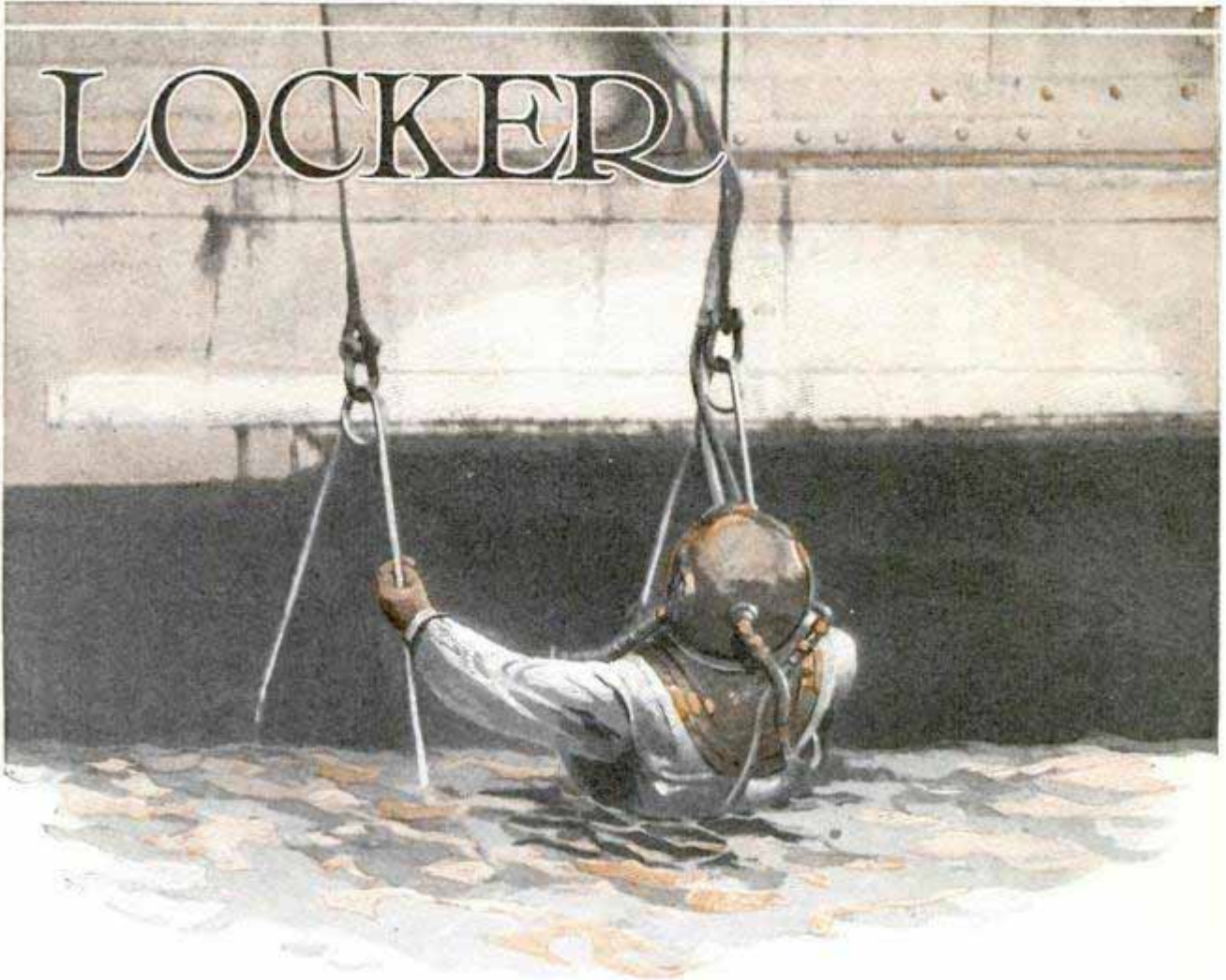

Lieut. Commander Ellsberg, U. S. N., Retired, Who Went Down to the "S-4"; He Was Caught in the Wreckage but Freed Himself by Inflating His Suit with Air from the Air Tube

harbor of New London, is a monument to Alfred Pahlberg, master diver, now eighty-three years old. When the sea retreats, and geologists examine the footprints turned to rock, they will find his impression more abundant than all others. The ocean bottom, from Canada to Key West, thousands of square miles, bears the imprint of his iron shoes.

This son of Neptune has walked the sea floor for fifty-six years, and is still a familiar figure on the New London docks. His hair and beard turned snow-white, he will not go home and call it a good half century's work. He patches worn diving suits, repairs helmets, and casts a wistful eye at young divers off for a stroll on the sea bottom.

In thousands of dives, Pahlberg thinks his challenge to death was almost met when he dived once on a wrecked vessel and her cargo of scrap steel. A clam-shell bucket would bite into the heap and hoist a load to the surface. The bucket

did not work to satisfaction, and Pahlberg went to investigate. In shifting about, his hose and line became tangled with the bucket's block, and when the winch began to haul it up, Pahlberg felt his air hose taut and the life line all twisted in the cable. Sixty feet to the surface, and the water like blue ink! The air supply could hardly sustain him. The worst part of his predicament was that he couldn't signal, and if his tender had chosen to raise the bucket, the air line would have snapped. But a tender has an uncanny sense of what goes on beneath the surface, and this one felt that he ought to ease the tension on the clam shell. He did, and Pahlberg was able to unknit the knots.

While working on the foundation of Race Rock lighthouse, he recalls that an assistant was trying to drop a chain on the end of a long boat hook. Pahlberg saw it coming down, and reached for it. Just then, a wave tossed the rowboat. Boat



where near her keel, a ragged hole had been torn in her hull, but it defied discovery. The suction pump snaked its way down from the surface, and Pahlberg caught its nozzle. Painfully he slogged

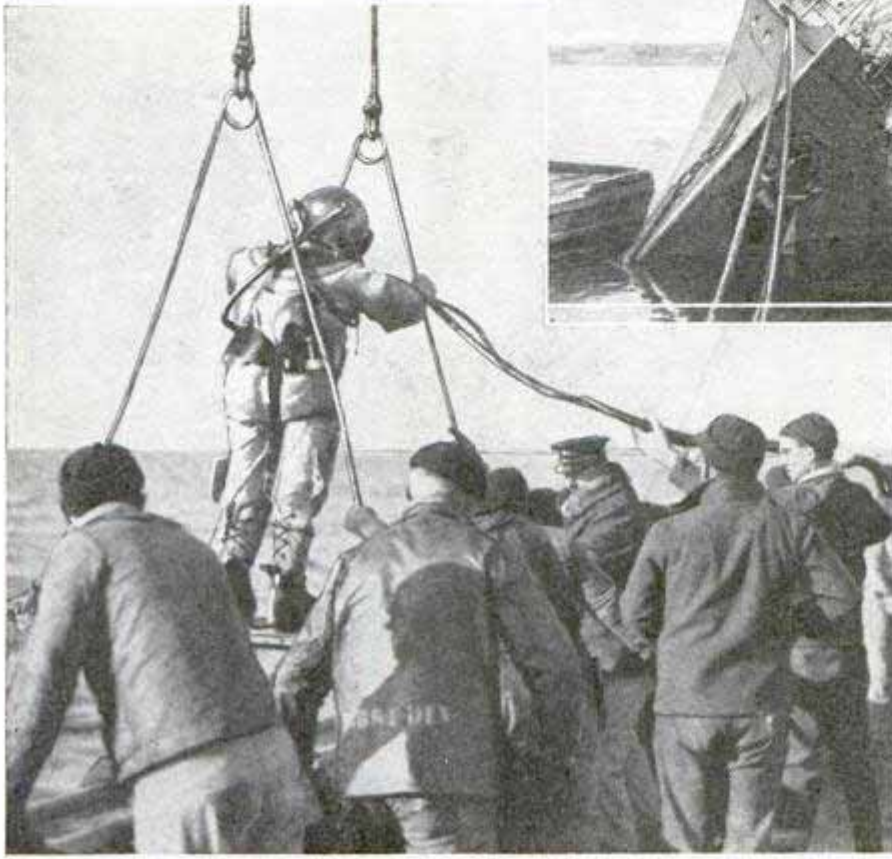
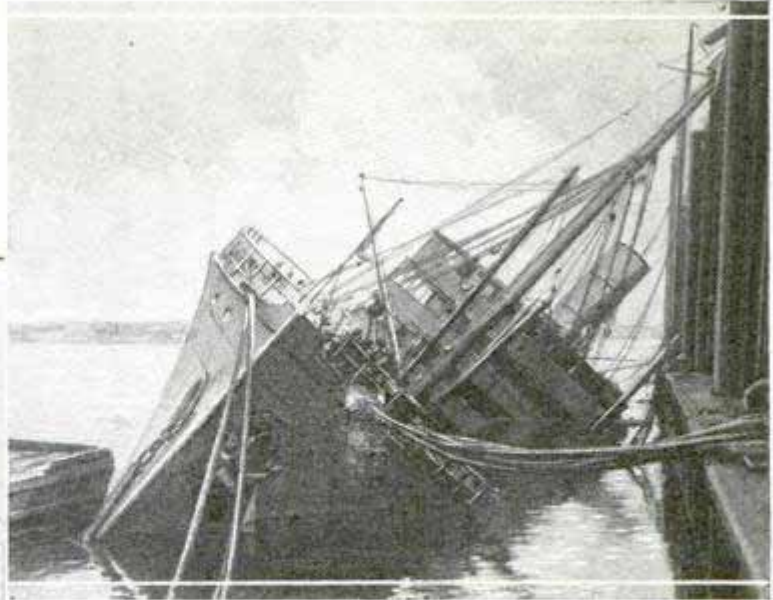

Courtesy Merritt, Chapman and Scott Corp.

The S. S. "Ponce," Sunk at Her New York Dock, and, Below, Diver Frank Crilley Being Lowered to the "S-4"

through the ooze and buried the intake about amidships. He signaled. The wire-wrapped hose stiffened and with a bubbling snort the suction ripped into the tons of mud and gulped hungrily. On turning, Pahlberg felt his foot lifted and drawn toward the nozzle. It was caught in the suction and held firmly against the intake, but fortunately his iron and lead shoe was too large. He signaled to stop the suction, but the tender misunderstood, and thought the diver wanted to come up. Pahlberg received a tug on the life line and that threw him off balance, and he fell, his entire weight falling on the caught foot. The suction held on tenaciously; his ankle snapped like a thread; bones and tendons were wrenched. All his weakening efforts availed nothing. He gave a despairing signal at the life line. By this

time the men above understood the message and the pumps stopped.

One of the largest submarine construction projects had to do with the South Union depot, in Boston. Over a site of fifty acres many gangs of men swarmed about doing odd jobs, but on the edge of the site, Pahlberg and another diver worked for months to clear the channel along the line of a large wall that was to keep the sea from encroaching on the station. When the tide

was low, they would dive down with a four-inch suction pump, which made the silt piles vanish as if by magic.

The ordinary diver's costume is a one-piece suit of tough rubber fabric. When inflated, it is smooth and easily slips away from projections which might tear it. In general, says Pahlberg, diving outfits have not changed since he first began diving. He used one type of helmet for twenty years. The present type has a valve which the diver manipulates and allows the escape of as much air as he pleases. Another improvement has been on the pumps, but in some cases it still is necessary to pump by hand. The deeper the dive, the more air pressure necessary, until, at a depth of 270 feet, about 120 pounds are needed.

Once Pahlberg was kneeling on the

1252

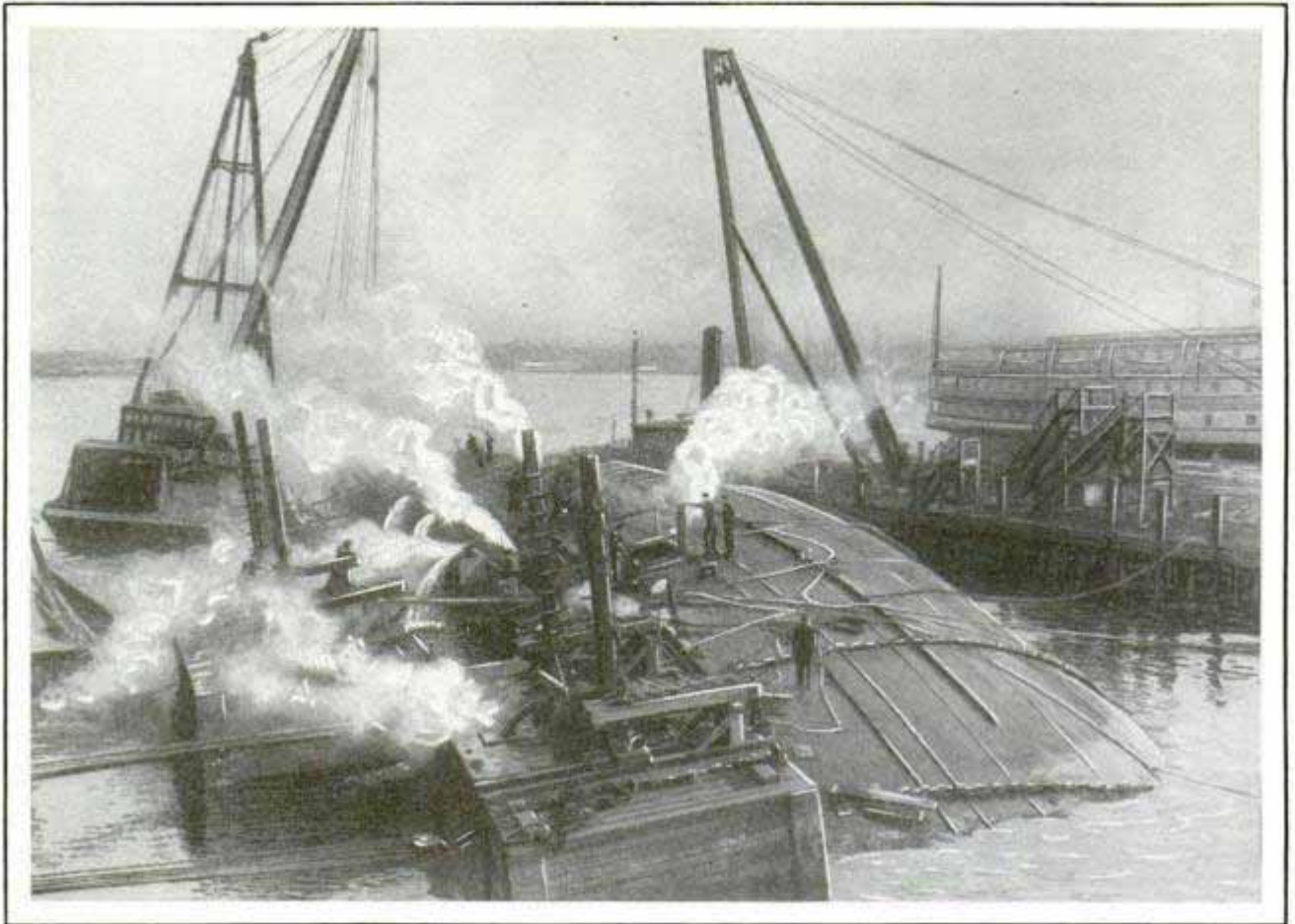

Derricks Tackling an Overturned Freighter; Salvage at the Docks Is Usually Less Hazardous than in the Open Sea but Often Is Just as Difficult

ocean floor, and happened to rest on an oyster shell. It cut a hole in his suit and he felt the water gush around his unprotected body. The air came down to him with just enough pressure to keep the water level at his chin. He felt no necessity for raising an alarm, but continued at his work. In fifteen minutes, he signaled to come up, and to the surprise of other veterans, told of working at a depth of thirty feet with water up to his chin.

Besides ships, a diver goes after many smaller objects. Pahlberg has recovered a lost watch on the ocean bed.

### ULTRAVIOLET RAYS GIVEN OFF BY ORDINARY GAS STOVE

Ordinary gas stoves, in which the clay radiants are heated to incandescence by means of Bunsen gas flames, are excellent sources of infra-red radiation. Owing to their low temperatures, however, these radiants, even when covered with special materials claimed to emit ultraviolet rays, do not give off enough of such radiation to make them useful for healing purposes.

It has been established that the intensity of ultraviolet light emitted by a gas stove is only a minute fraction of that of similar ultraviolet waves in sky radiation.

### AUTO BRAKE-LEVER EXTENSION WITHIN EASY REACH

For Ford cars with the button-type emergency brake, an extension brake handle as an accessory brings the lever within easy reach of the fingertips. It consists of a rod set at right angles to the standard lever, the top resting on the release button. A pull on the extension handle depresses the button and allows the brake to be set, and a touch releases it. It can be attached in a few minutes.



It can be attached in a few minutes.

*Moto Meter Range + Equipment Corp.*

*NY branch at Ft. Cypress Island*

*U.S. Navy 9/19/50*

*Bureau of Standards*



1617 POPULAR MECHANICS 967  
*Heinen Air Yacht Corp., Atlantic City*  
**DIRIGIBLE AIR YACHT HAS AN AUTOMOBILE CABIN**

Carrying four persons at a speed of sixty-five miles an hour, a tiny dirigible suited to the needs of an average family has been built to sell for about \$10,000. The craft is 104 feet long, twenty-seven feet in diameter, and has a gas capacity of 39,000 cubic feet. It is inflated with hydrogen, and has a streamlined twenty-two-foot mahogany cabin, in the nose of which is a 100-horsepower air-cooled motor which drives the propeller. The little air yacht is without girders, buckling being prevented by a lower compartment into which air is forced before a flight with an ordinary vacuum cleaner. After the ship is in flight, this compartment is kept filled by an air scoop above the cabin. No ground crew is required, the craft being landed easily anywhere and moored by one man to a post or other anchorage. The gondola is mounted on caster wheels, allowing the ship to swing in the wind, and, if caught in a gale, the dirigible has a zipper arrangement in the bag which rips open when the mooring cable is pulled with violence, thus causing the bag to collapse. The ship can be slowed without losing buoyancy, and the average person can

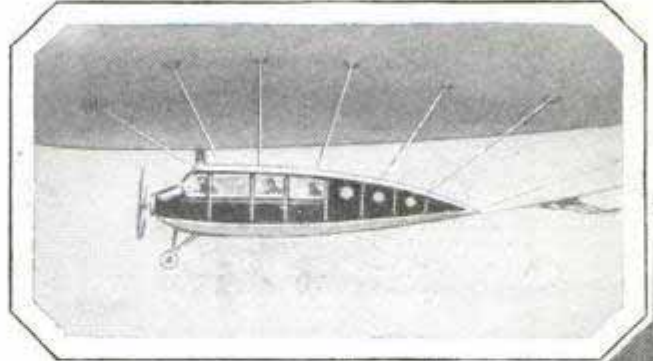

Two Views of Cabin of a Tiny Dirigible Moderate in Price; Note Landing Wheels Which Convert It into an Auto Trailer



learn to manipulate it in a few days. Its weight is about 1,700 pounds, and the useful load 850 pounds. The hull is of rubberized and aluminized-cotton fabric. The engine is equipped with a self-starter and the vessel has a cruising radius of about 250 miles, carrying three passengers. When the bag is deflated, it can be stored in the gondola, and the cabin on its wheels then can be used as an ordinary trailer to an automobile.

**SUN'S RAYS ARE USED TO KILL RUINOUS BARK BEETLES**

Solar heat has proved of economic value in the control of bark beetles and other destructive forest-tree insects. Tests by the department of agriculture show that the bark of a lodgepole-pine log will sizzle at from 110 to 120 degrees when the sun has warmed the surrounding air to only eighty degrees, and this temperature

is fatal to the insects. Bark temperatures of 140 degrees have been observed when the air temperature was only eighty-nine degrees. Bark beetles are among the most destructive insects attacking western pines, all species causing a timber loss estimated at \$20,000,000 annually. The method of killing the beetles by exposing felled logs to the sun for four or five days has been found much simpler and less expensive than burning the bark off the logs

*Technical Bulletin 195. J. Control of Mountain Pine Beetle in Lodgepole Pine by Use of*

*Wm. H. Josell*

*described in Les March*

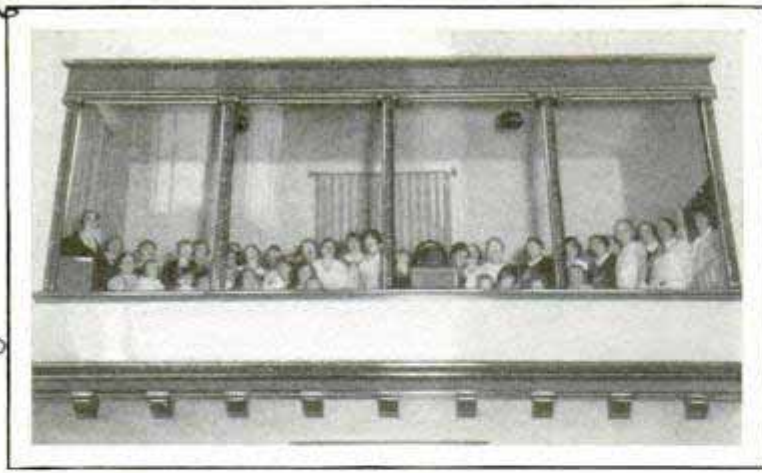

Soundproof Room in a Church for Mothers and Babies; Restless Infants Cannot Be Heard by the Congregation

### SOUNDPROOF ROOM FOR BABIES ADDED TO CHURCH

Mothers may bring their babies to a Los Angeles church without fear that their cries will disturb the rest of the congregation. Above the foyer of the church has been built a soundproof room for mothers. The compartment has a glass front facing the auditorium and is equipped with a public-address system, so that mothers may hear the music and the sermon through loud speakers while caring for their children.

### STEEL SHIELDS FOR RADIATORS KEEP THE WALLS CLEAN

Steel shields for radiators not only hide the unsightly heating equipment from view, but also keep walls and draperies from becoming soiled. A felt-edged steel strip near the bottom of the radiator extends from radiator to wall and keeps the moist, dust-laden air from being drawn up in this fuellike aperture. Concealed water receptacles in the shields control humidity, and circulation is governed and fuel is saved by delivering the warmed air at the proper levels. Low inclosures are suitable for window seats and decorative objects may

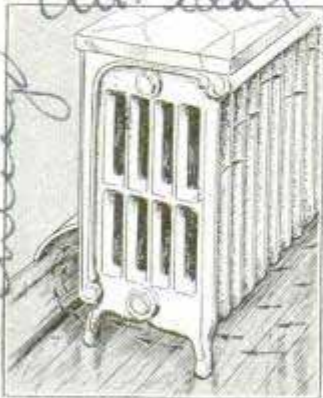

be placed on the higher models, which are in many designs.

### CHEMICAL SUBSTITUTE FOR ICE SERVES TO COOL DRINKS

Drinks and other liquids are cooled by a chemical instead of ice. The substance is placed in a cone-shaped container which, in turn, is submerged in the glass or goblet. The inner chamber has a cover so that the chemical cannot come in contact with the drink. The substance is mixed with water and the cooling action is hastened by stirring the mixture to speed up dissolving. The chemical may

be used repeatedly by placing it in a shallow dish after each operation and exposing it to the sun to crystallize it again. The method has been found especially successful in tropical regions where ice is difficult to obtain.

### FLAT-TIRE WARNING SOUNDED BEFORE DAMAGE IS DONE

Audible warning of auto-tire deflation before the tire becomes flat is provided by an alarm which attaches to each tire valve. It consists of a heavy spring placed around the valve stem, outside the rim but inside the casing. This is compressed and the stem forced outward as the tire is inflated. After the tire is mounted, a mechanism is attached to the valve stem and clamped into position. This mechanism carries an arm to which is attached a clapper and chain. The arm is latched into position extending toward the hub of the wheel, but when the tire deflates, the latch is released and the arm flies free, striking the underside of the fender with each revolution of the wheel, thus calling attention to the leaking tire. The warning is set for the pressure carried by the tire, and may be reset at the danger point after a slow leak develops so that the car can be driven farther, but a signal will still be given if serious deflation occurs. The device does not interfere with tire testing or inflation.



*Anti Flat Co., 3030 Tracy Av. Kansas City, Mo.*

*160*  
*Sh. John's Evangelical*

*American Metal Products Corp*  
*514, 540 p. Michigan*  
*168*

*same address*  
*Archer Steel Corp, same address*  
*Dr. W.*

1648

A.W. James S. Eschinger

FISHING MACHINE PUMPS CATCH FROM THE WATER

Hydraulic Fishing Co.  
206 Broadway New York

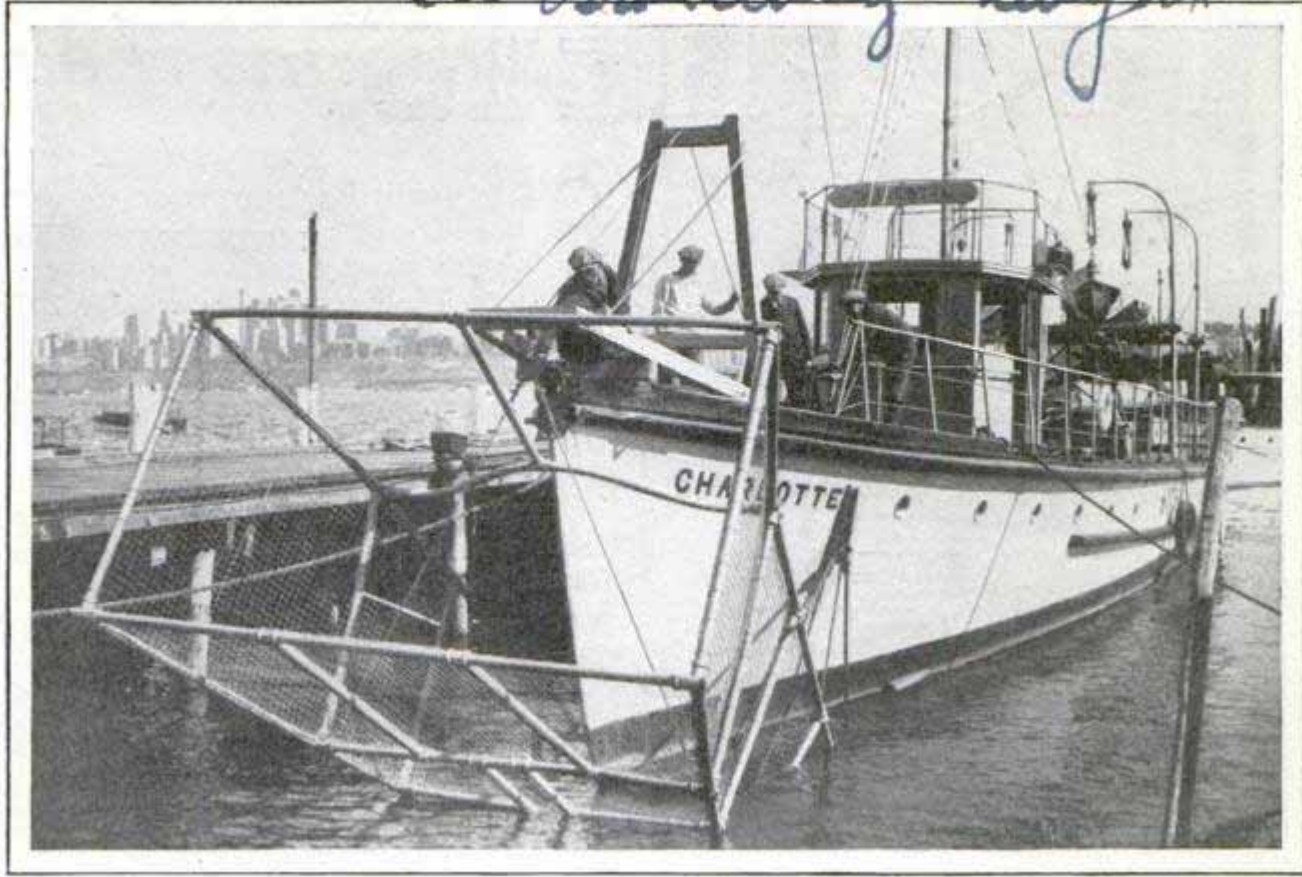

Boat remodelled by U.S. Boat Corp.  
Edgewater, Md.

Boat Which Has Been Converted into a Fishing Machine and Pumps the Fish from the Water onto the Deck; in the Foreground Is a Net Which, When Lowered, Acts as a Chute for the Catch

Catching fish at the rate of about twenty tons an hour is the feat boasted by a former submarine chaser which has been converted into a fishing machine. The craft has been fitted with a pipe, two feet in diameter, which extends beneath the water line and to which is attached a centrifugal pump. The pump creates a vacuum in the tube, thus literally sucking the fish into the boat. A net, acting like a cattle chute in the stockyards, is lowered about two openings in the bow connected with the pipe, and the pump is started, drawing air, water and fish into the tube where they are seized by the stream of water and shot to the deck in the stern of the boat. There the fish are dumped into a net. The principle is the same as used in the ordinary sand sucker employed to clean ports and river beds, except that the pump in a sand sucker is inside the main tube, and with the fishing machine it is outside. The machine will do the work of ten ordinary fishing boats, and with five men instead of twenty. At first, the boat is not to be used to catch edible fish, but to snare the inedible kind from which dry

scrap, fertilizer and oil are obtained. The craft is equipped with a standard six-cylinder engine and an eight-horsepower motor to operate the pump.

AUTOS RIDE ON MULES' BACKS INTO FOREIGN LANDS

1647

Camels and mules, primitive means of transportation in many remote countries, are working themselves out of jobs by delivering knocked-down American automobiles to regions otherwise inaccessible. Pack mules carry the disassembled autos into Colombia, about twenty-five different packages making up one car. For the heavier parts two mules are used, the chassis or other unit resting on two bars laid across their backs. Camel caravans are used to deliver cars in both India and Australia. Often a car, when finally delivered to its owner, has traveled by train, ocean steamer, railroad, and finally on mule back.

U.S. Starby  
10/2/30

An outboard motorboat recently attained a speed of 50.93 miles an hour.

Hydraulic Fishing Co.  
206 Broadway

1465

St. New York

# PROPHETS *and their*

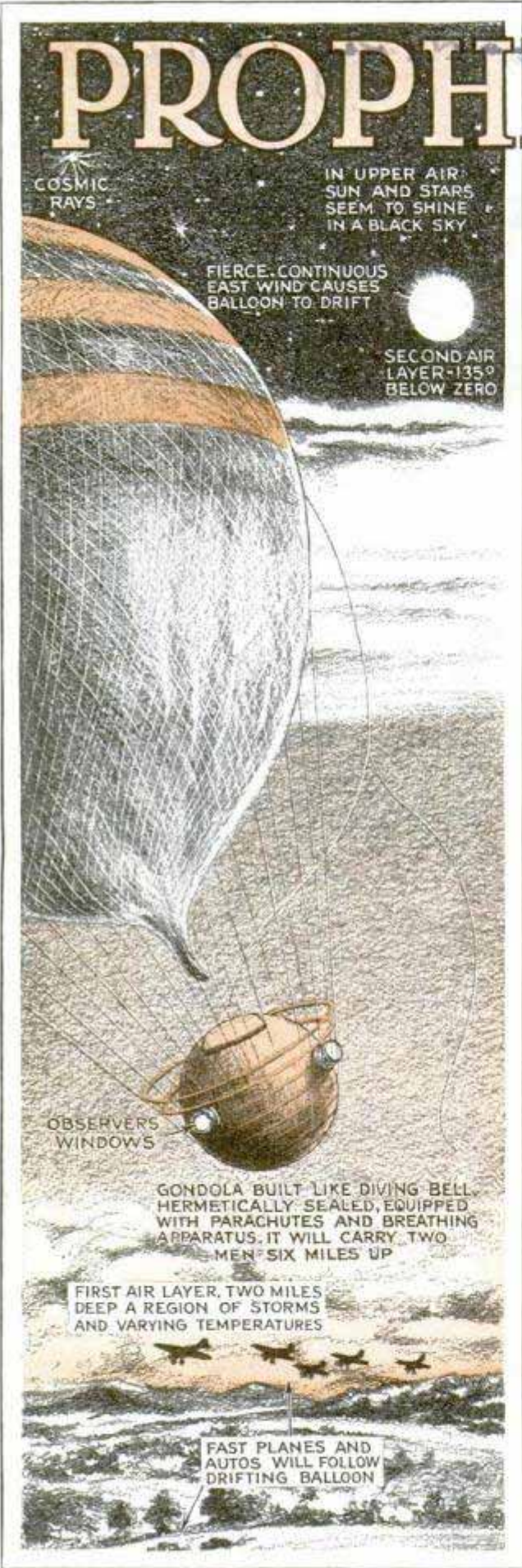

OUR twentieth-century marvels revive memories of prophets, for they foretold that these inventions would come. Automobile tires guaranteed for 20,000 miles and more remind one that Charles Goodyear prophesied that vulcanized rubber could be made as tough as flexible steel.

Watch multi-motored ships fly with the grace of birds, and parachutists plunge from a plane at several miles' altitude. Then fetch a volume of Leonardo da Vinci and note his drawing of a "tent-roof" parachute, and diagrams of airplanes constructed on the principles of bird flight.

When a chance street excavation exposes thousands of telegraph and telephone cables, we see another reality born of prophecy. In 1878, Thomas A. Edison, a former Morse operator turned inventor, predicted long-distance telephony even before Bell's invention had gone into use. He said:

"The telegraph company of the future—and that no distant one—will be an organization having a huge system of wires, central and subcentral stations, managed by skilled attendants whose sole duty it will be to give wires proper repair, and give, by switch or shunt arrangement, prompt attention to subscriber number 923 in New York when he signals his desire to have private communication with subscriber number 1001 in Boston for three minutes."

Inventors, however, are not prophets of the first magnitude. Sweeping discoveries often come from the imaginations of poets, playwrights and fiction writers. Three modern writers, Jules Verne, H. G. Wells and George Bernard Shaw have inspired inventors. Fifteen years ago, Shaw described television that made possible the transmission of moving images and voices. The invention was demonstrated this year in Schenectady by Dr. E. F. W. Alexanderson. Wells humanized Einstein's "fourth dimension" in a fiction story, "The Time Machine," published before the relativity theory gained currency.

Balloon with Air-Tight Metal Gondola, in Which European Scientists Hope to Explore Upper Air

# PROPHECIES

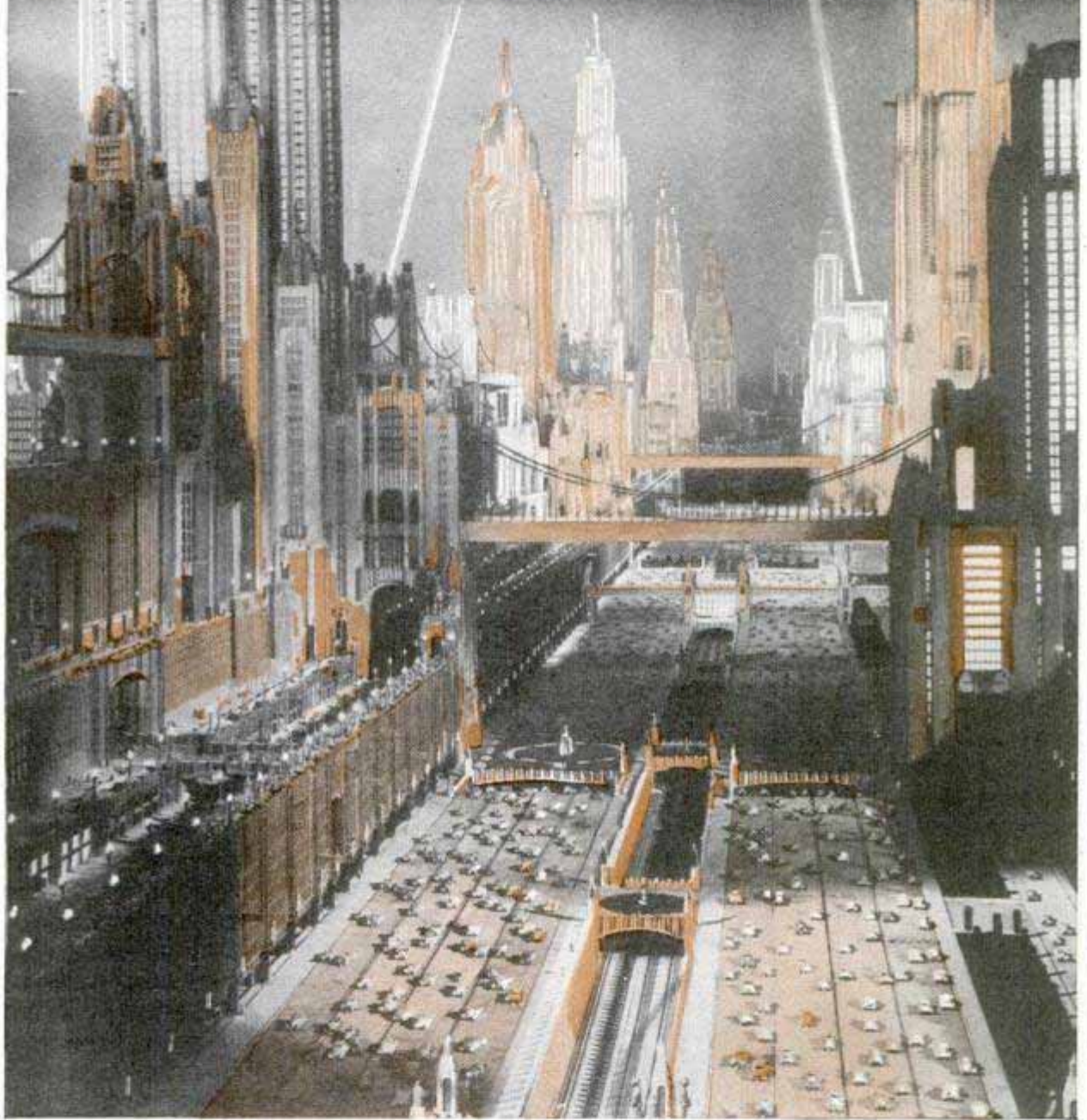

Model in Miniature of the City of the Future as Conceived by the Staff of a Musical Production; This Model, with Nine Traffic Levels and Sky-Piercing Buildings, Cost \$250,000

As for Jules Verne, he is the major prophet of modern civilization. In the strict sense, he was a scientist as well as fiction writer. He studied nature's laws with great industry and observed their application everywhere. His descriptions of airplanes, submarines, rockets and engines aroused jeers and hoots, and his defense was, "Man can achieve what man can imagine."

Recently, the French Geographical so-

ciety celebrated the centenary of Jules Verne's birth, and paid especial tribute to him for contributions to aeronautics. While Otto Lillienthal was making his first flights in a glider, Verne drew a vivid word picture of a flying machine, "The Albatross," and in a now little-known book described what he believed would be the airplane of the future. His story, "Five Weeks in a Balloon," brought out Verne's individual theories for me-

1465972

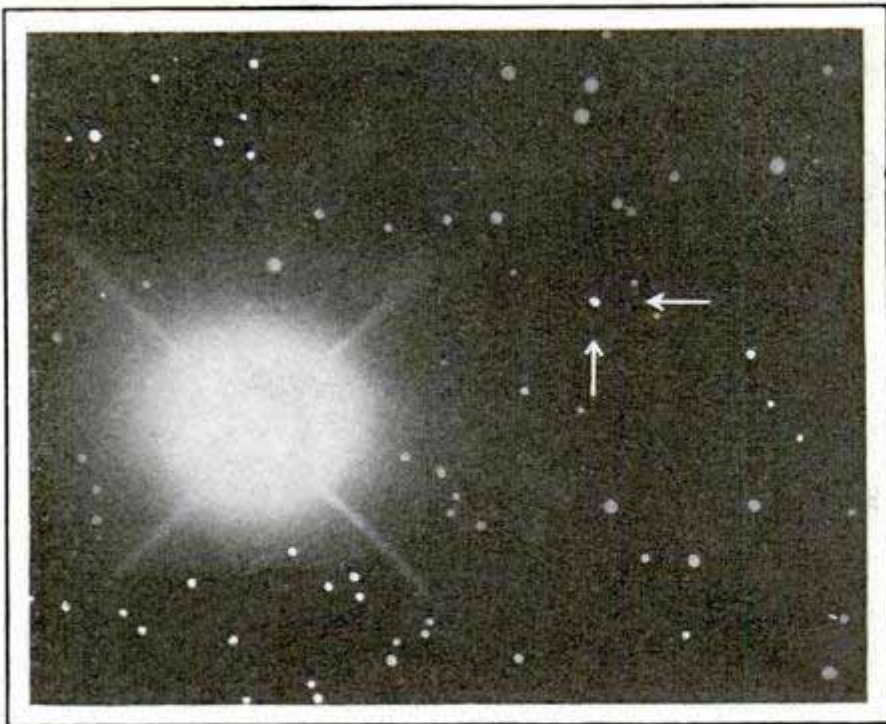

Arrows Point to New Planet Found in 1930, Although Its Existence Was Predicted Many Years Ago by the Late Percival Lowell

"Around the World in Eighty Days" started globe-trotting marathons by men and women competing for prize purses. But eighty days is a snail's pace in modern travel. The "Graf Zeppelin" circumnavigated the globe in twenty-one days and seven hours.

Verne foresaw the skyscraper age. Advertisements, he said, would be projected on clouds. And they are! Sky-writing is now fairly common, too. Twenty years after Verne forecast the use of selenium in the transmission of pictures, it came about.

The great oracle passed away in 1905, living long

enough to see a few of his ideas turned into actual inventions, but hardly realizing what great work he had done. Some of Verne's ideas are still in the fiction stage. For instance, he visualized travel between the earth and the moon, as well as around the moon; descent to the abysmal sea bottom (William Beebe has reached a depth of 1,426 feet); the manufacture of electric motive power for ships by using dissolved sodium in sea water, and the exploitation of submarine mines with submarine ships. Verne's helicopter has appeared, although not commercially.

The creative imagination appears at the oddest moments and places. There exists an amazing book, "Looking Backward," written in 1886 by Edward Bellamy. As its title suggests, this novel projects itself backward from the year 2000 A.D. The author describes musical broadcasting with such fidelity that it is hard to believe he never heard the radio. One of the characters touches "one or two screws and at once the room was filled with the music of a grand organ anthem."

There are prophets who sit at desks and peer into nowhere. The annihilation of time and space with mathematics is the triumph of the imagination over man's environment. We see it best in astronomers. There was Percival Lowell. With nothing at hand but paper and pencil, he

Modern exploration recognizes a heavy debt to Verne. The Wilkins-Ellsworth transpolar submarine expedition was what Verne prophesied when he described the submarine voyages of Captain Nemo in the "Nautilus." And Sir Hubert Wilkins, in veneration of the Frenchman, has named the recommissioned submarine "O-12" "Nautilus," and as such she will invade the unknown polar sea.

As to utilizing the thermal energy in sea water, a practical experiment is now being made at Matanzas bay, Cuba, by Georges Claude, the French engineer, who concedes that the first inspiration for his work came from Verne's fiction.

Just after finishing "Twenty Thousand Leagues under the Sea," Verne happened to see a travel poster, and the flash of its color gave him the incentive for a novel that brought him everlasting fame.

see Aug 1931  
Pages 257  
April, 1931

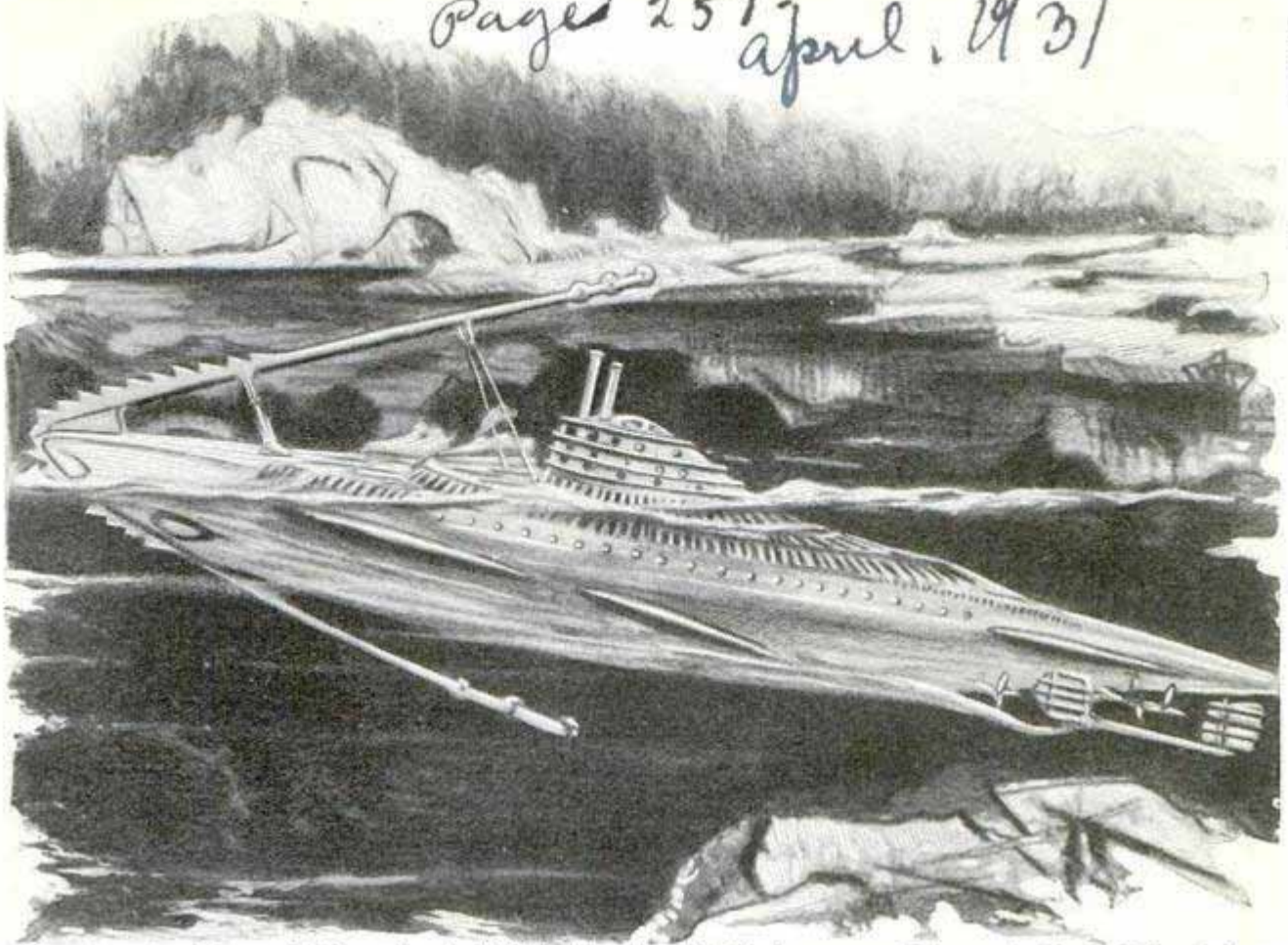

see April 1939-577

Drawing of a Proposed Submarine, in Which Scientists Would Attempt a Trip to the North Pole, Going under the Ice When Necessary; Note the Hook with Its Teeth to Cut through Ice

explored space 3,000,000,000 miles away and discovered a ninth planet, "Pluto"! He found it in his mind and believed it to exist. But it is not enough for a prophet to have discovered something—he must make it acceptable to everybody else. So Lowell wrote his prophecy as one would file a will.

Lowell died in 1916. But the search for "Pluto" was carried on in observatories all over the earth. Fourteen years they searched, and then came astronomy's greatest moment of the century. A photographer at Flagstaff, Ariz., found a spot on one of his negatives. He flashed the news, and soon observatories in England, France, Germany and Italy verified the truth in Lowell's prophecy.

Of modern inventors, none was more astute than the late Charles P. Steinmetz, chief consulting engineer of the General Electric company. In 1915, describing the new electrical age, he said that when its use becomes universal, it will be against the law to have a fire in any part of the city. The government will prohibit fires, because they are dirty, dangerous and unsanitary. Big central power plants will

do away with the hauling of coal from mines and railroad yards, and steam power may be generated by setting veins of coal on fire. The home will have no kitchen ranges, no cellar furnaces, no steam-power plants or gas engines. With electrical heating, we will simply set the gauge at the desired temperature.

It seemed ridiculous for this man to talk about international broadcasting in 1915, and millions of people hearing concerts in their homes. Yet, in the past seven years, the public bought 13,000,000 radio sets, and, in this country alone, the audience is calculated to be 50,000,000 persons. And because talking pictures had been a hoax ever since Edison's kinetophone, people were dismayed to hear Steinmetz say that the motion picture and talking picture would be perfectly synchronized. It has come about very rapidly.

To predict that private homes would have electrical heating, refrigerating and ventilating plants also seemed absurd. The home ventilating plant is a new vogue, but electrical icemen are found in one out of every ten families.

### HUGE TOWERS DRAW LIGHTNING TO SMASH ATOM

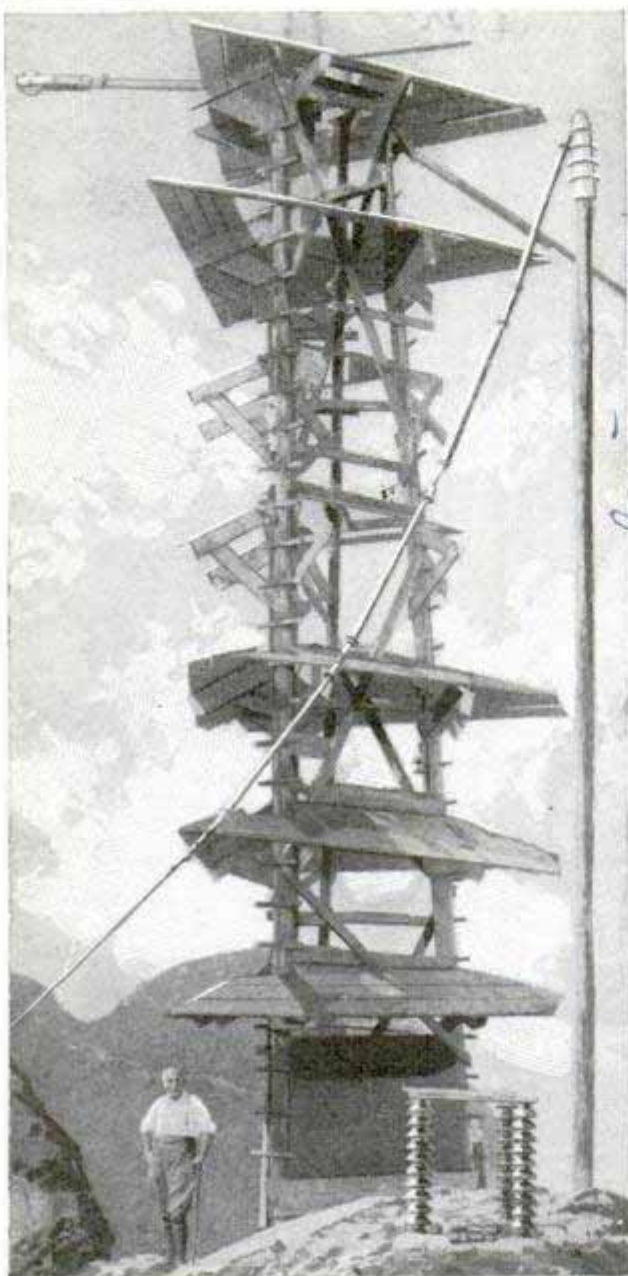

*Generalized*

University of Berlin scientists are continuing their attempts to harness lightning in an effort to develop an electric current much stronger than any ever before produced by man. Through the use of a huge vacuum tube, the scientists hope to capture electric energy sufficient for the disruption of an atom. In the effort to draw from 5,000,000 to 6,000,000 volts of electricity from the air, the Germans have strung a 2,000-foot cable between two towers on mountain peaks in the Swiss Alps, where storms are frequent and violent. Scientists now generally accept the theory that an atom of matter consists of a number of electrons held together by a charge of positive electricity. Electrons move at a speed estimated at 160,000 miles a second and a few pounds of matter contain more energy than we could extract from millions of tons of coal. The problem is how to obtain sufficient energy to release the force of the atom, and therefore this attempt.

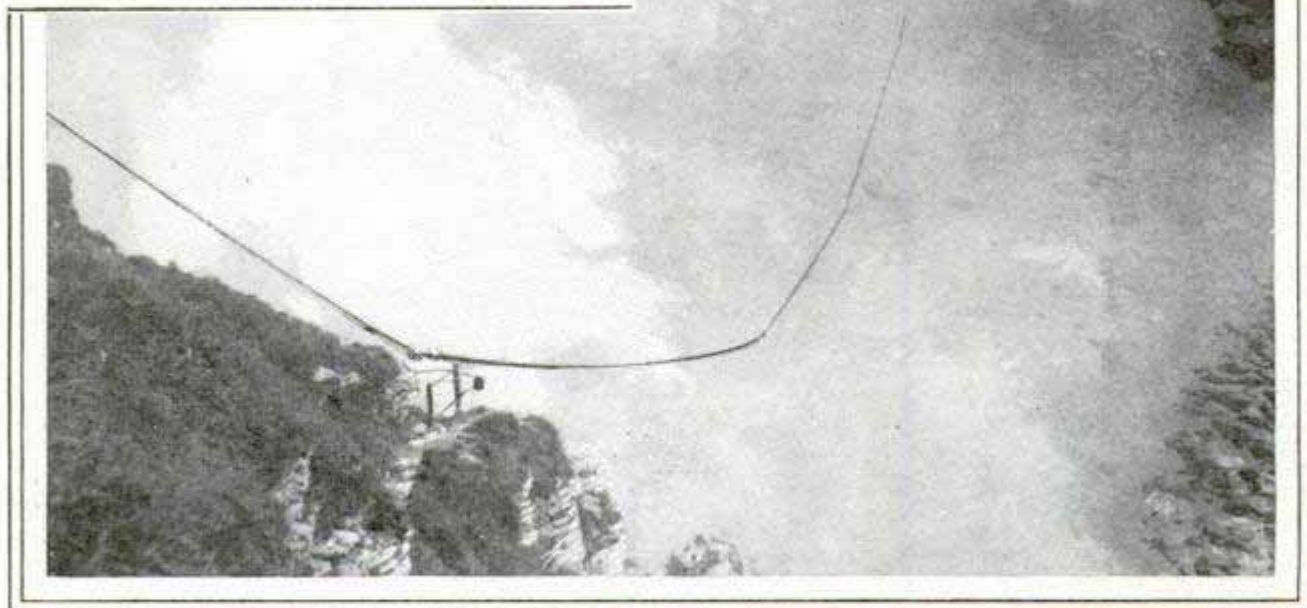

Above, One of Two Towers in the Swiss Alps between Which a Cable, Shown Below, Has Been Strung in an Effort to Trap a Charge of Lightning Powerful Enough to Smash an Atom



*Illustrated at Bellevue Hospital, New York*  
**ARTIFICIAL LUNG ON WHEELS PROVES LIFE-SAVER**

With the aid of the latest type of respirator, or artificial-breathing machine, a young woman nurse in St. Luke's hospital, Chicago, was kept alive for weeks while battling with a malady which had paralyzed her lung muscles. Persons overcome by gas, pneumonia and other victims have been treated in the cabinet which has just been introduced to the hospital world and which has been acclaimed as one of the most effective emergency aids yet devised. A metal chamber, with a sliding base upon which the patient is placed, an electrically operated pump, a gauge and a valve are the chief parts of the outfit. The patient is placed on the sliding bed, shoved into the cabinet and the shield tightly locked. A rubber collar, which fits so snugly that almost no air can pass, is adjusted about the patient's neck. A switch is turned, and the cabinet begins its work. This consists in simply creating a vacuum condition inside the chamber at regular intervals. The pump draws the air out, a valve opens and the air rushes back of its own accord. The vacuum causes the lungs to expand. When the air goes into the cabinet again, the chest and lungs are compressed, thus creating, artificially, natural breathing.

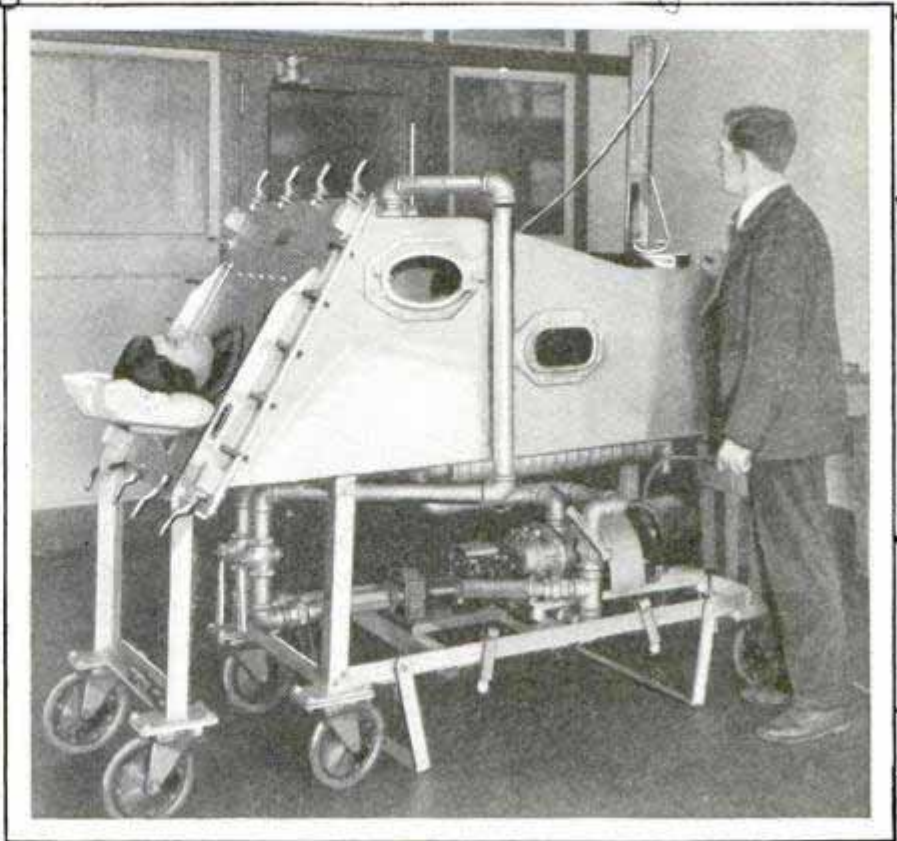

Patient in an Artificial-Breathing Machine, Which Contracts and Expands the Lungs When the Patient Cannot Breathe Naturally

extensively in making and repairing cabinets, furniture, boats, radios, airplanes, gunstocks, automobiles, trunks and bags.

**PLANE MOTOR MORE EFFICIENT THAN AUTOMOBILE ENGINE** 1479

Comparison of the practical efficiency of airplane and automobile motors gives the advantage to the former. An engine of one high-priced car under test developed eighty horsepower at 3,300 revolutions per minute, and weighed 700 pounds, or eight and three-quarter pounds per horsepower. An airplane engine, equally well known, develops 525 horsepower at 1,900 revolutions, or one horsepower for every one and one-quarter pounds of weight. The auto engine operates on an average of about twenty-five to thirty-five per cent capacity, while a plane motor operates at seventy-five to 100 per cent capacity. Some airplane engines have done 200,000 miles at full throttle and still are working smoothly, while the average automobile engine, after 50,000 miles at thirty per cent throttle, has outlived its major usefulness.

**GLUE FROM COW'S MILK** 1696

Casein glue, used in virtually all work likely to be exposed to the weather because it is waterproof, has as its main constituent the dried curd of ordinary cow's milk. It is made in powdered form and is virtually free from odor. It is mixed with equal parts of water and is now prepared in such form that it stays liquefied for an entire day while formerly the limit was about fifteen minutes. Ordinarily it is applied with a stiff brush and is used

*Capt. Ernest S. Swanson  
 Russia Cement Co.*

*Boeing Co.  
 Bulletin*

*Warren F. Collins  
 555 Huntington Ave.  
 Boston*

Thermoproof Eagle Picher Lead Co Adley Radio Ltd '99 Mortimer & Co London, W. 1, England  
134 N. La Salle Chicago

London wireless post



Portable Radio Set for Policemen, Which Transforms Each Officer into Broadcasting Station

### RADIO FOR EVERY POLICEMAN TO WAR ON CRIME

Every London "bobby" will be his own broadcasting station if British policemen are equipped with portable radio sets, recently invented by an Englishman and equipped with both receiving and transmitting apparatus. The set, contained in a small case, fits on the policeman's belt and weighs less than five pounds. An opening in the side of the receiver allows the beams of one of the tubes to shine through, giving a better light than afforded by the ordinary electric flashlight. The case contains a two-tube sending and receiving set, batteries and a 100-foot concealed aerial. A wire running from the box to a specially designed helmet completes the equipment, which has a sending radius of from ten to twenty miles.

### LEAD COAT ON THEATER WALL IMPROVES ACOUSTICS

Lead slack, a by-product of lead processing, is being used in theaters to improve the acoustics for talking pictures. Building-board panels, covered with glue, were set in the walls and the lead was applied to the glue, after which window screening was placed over the panels and fastened with decorative molding strips. The paneling is employed to suit the acoustic peculiarities of the building being treated, for

Adelphi, Clark St and Estes Inc

870 Esary St San Francisco, Calif

if too many are used, all the sound is deadened. Soft lights give the panels an appearance of mural decorations.

### FIRST SPEED LAW IN AMERICA

1598 America's first speed law was passed by the board of selectmen in Boston, in 1757, and limited traffic to a foot-pace on Sundays. This ordinance recited that "coaches, sleighs, chairs and other carriages" were being driven with great rapidity through the streets, and interfering with the Sabbath worship. If the walking pace were exceeded, the ordinance exacted a fine of ten shillings from "the master of the slave or servant so driving."

### MICROPHONE PICKS OUT SOUND AT WHICH IT IS POINTED

1627 Resembling a big loud speaker, a huge microphone which picks up only those sounds toward which it is pointed is being used in the making of talking motion pictures. The directional microphone has a great advantage over other sound equipment, since it eliminates much of the extraneous noises which the ordinary recording apparatus would pick up.

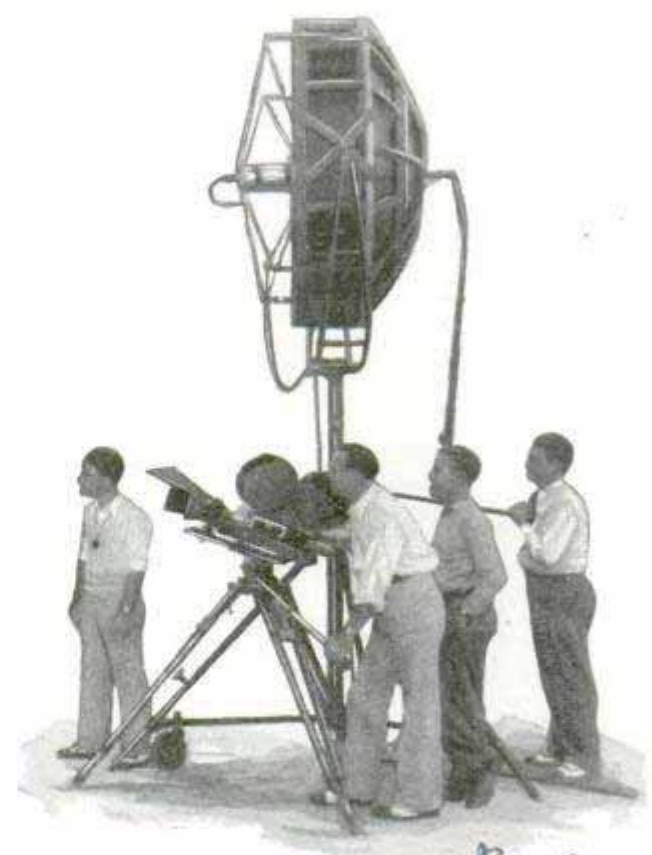

Directional Microphone, Used in Movies, Which Picks Out Only Sounds at Which It Is Pointed

Used by RKO

**CAMEL SHIPPED BY AIRPLANE  
ACROSS MEDITERRANEAN** 1531

With the distinction of being the first of its species to enjoy an air journey, a camel arrived recently at Ostia after an airplane flight across the Mediter-

The Camel Coming Down the Runway Has Just Completed an Airplane Journey across the Mediterranean, Probably the First Animal of Its Kind to Take Such a Trip; It Was Sent to the Rome Zoo

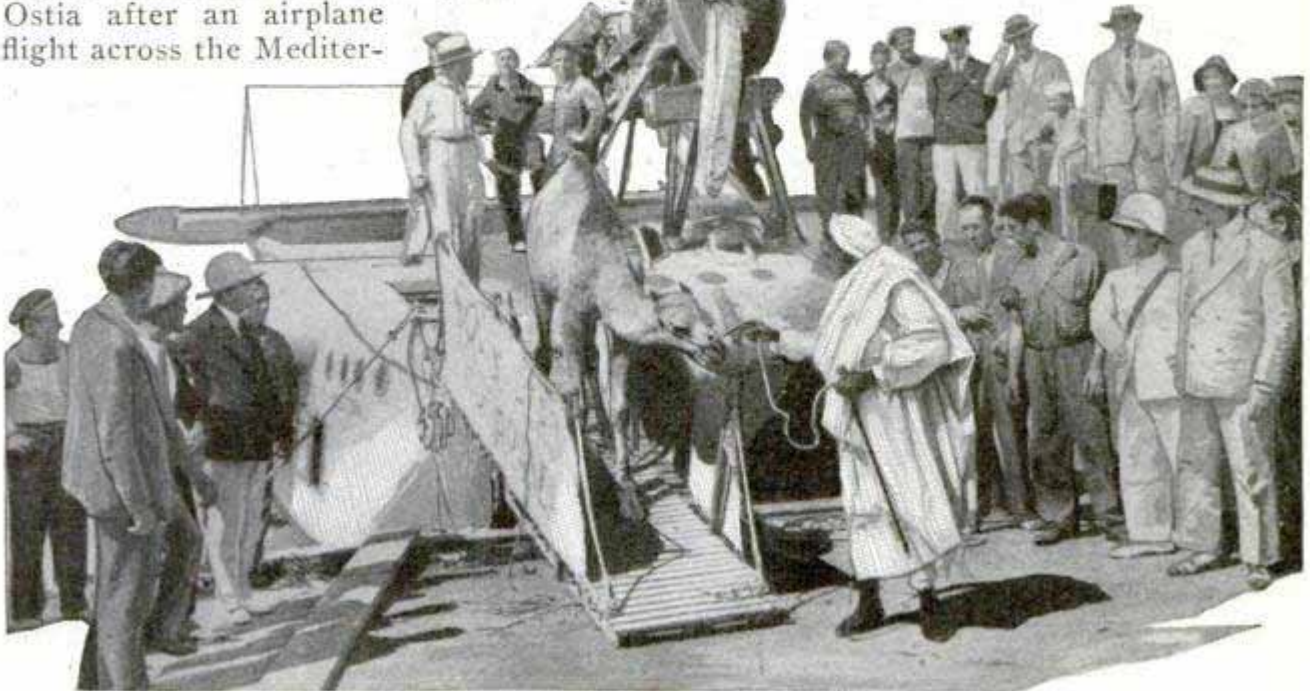

anean. It was consigned to the zoo at Rome and was the gift of an Italian who chartered a passenger hydroplane to deliver it. It stood the air trip of four hours and a half without any apparent ill effects.

**AIR-FILLED BAGS SAVE PLANES  
IN WATER LANDINGS** 1497

Flotation gear has been adopted by the United States navy for its land planes to enable pilots to make a forced landing in deep water without undue risk of a fatal accident. The pilot of a bombing plane, so equipped, in time of emergency merely pulls a control lever which governs the automatic inflation of bags which keep the ship afloat when it alights. The bags are contained in a small compartment on each side of the fuselage. Each compartment has a panel door opening outward and downward, and in each is folded a bag of heavy gas-proof fabric, one side being permanently attached to the fuselage. The two bags are connected by steel tubing with a steel flask charged with compressed air or non-inflammable gas. A lever beside the pilot controls this air supply. When the pilot pulls it, the bags are inflated in thirteen seconds, and the doors

*Compressed Air Bag.*

*Wide World.*

to the compartments open automatically to release them. When the plane alights, it settles down until all but the top of the fuselage and the upper wing are submerged, the inflated gear keeping it on top of the water indefinitely in this position. The depth at which the ship floats enables it to rise and fall with the waves, thus riding out fairly heavy swells.

**MITTEN FOR HUNTERS LEAVES  
GUN FINGERS FREE** 1543

Intended particularly for hunters, a wool mitten that leaves the fingers free to control a gun without exposing them to the cold is being offered to sportsmen. Either right or left palm contains a folding flap, permitting the wearer to thrust the fingers through this opening without removing the mitten. When the fingers are withdrawn inside the mitten, the flap closes to provide the usual warmth.



*Wigwam*  
*Hayd Knit Hosiery Co.*  
*Sheboygan, Wis.*

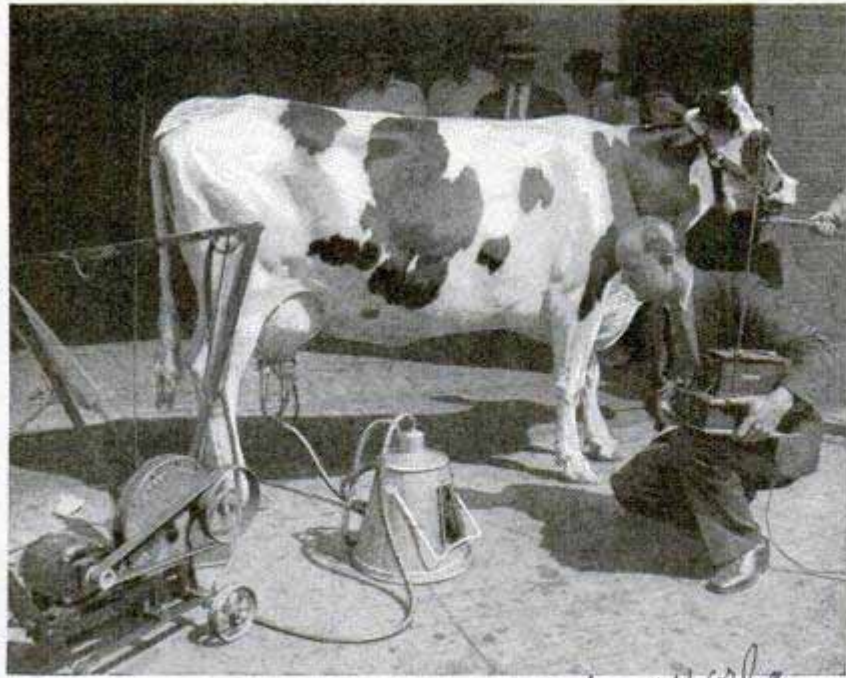

Milking a Cow by Radio; the Milking Machine Attached to the Animal's Udder Is Being Operated by Radio Impulses

**RADIO WAVES START MILKING MACHINE IN TEST**

While the time has not yet come when the farmer can milk his cows by turning on his radio, a cow recently was milked by wireless control in a demonstration of a special milking machine. The radio milker operated five times as fast as the ordinary milking machine. The radio-control set was equipped with an aerial four and one-half feet long, and a similar aerial was hooked to the milking machine.

**WIND TUNNEL MAKES ITS OWN FLYING WEATHER**

Conditions encountered by an airplane flying through a winter storm can be created artificially in a refrigerated wind tunnel at Akron, Ohio, where full-scale airplane parts can be tested. Air is driven at speeds up to eighty-five miles an hour through an elliptical jet, eighteen by thirty-six inches in size. In the slow-speed end of the tunnel are 780 feet of ammonia piping, capable of reducing the air temperature to below zero. A series of water jets enables engineers to produce sleet in any quantity desired, thus creating, on the surface of a wing or other part, an inch of ice in less than two min-

utes. Study of the ice formation on exposed surfaces, and other low-temperature phenomena, is carried on through glass windows.

**ROLLING RULER SAVES EYES AND TIME**

Geared to the drawing paper with means for accurate spacing, or measuring of spaces, a rolling parallel ruler operates as accurately as a micrometer in gauging minute distances, and saves time and eyestrain in such work. When locked, the ruler lies rigidly on the paper, and for a great

variety of work replaces the T-square, scale and dividers. It contains two dials, one on its face for reading comparatively long distances, and another attached to a worm gear on the side for small or micrometer spacings. By raising one end of the worm shaft, the worm is disengaged and the ruler can be moved any distance, the spacing being read on the face dial. When the worm is engaged, the ruler is ready for the final and more accurate work. The worm, when locked in position, serves as a brake to prevent the ruler from rolling off a sloping drawing board. For precision work, its accuracy is well within one one-thousandth of an inch.

*Micrometer Rolling Parallel*

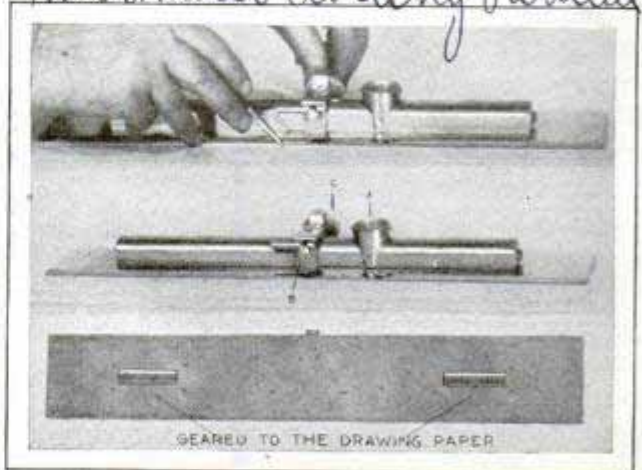

Rolling Ruler Which Is in Effect an Accurate Micrometer; Measurements Are Shown on Dials

*Alpha Instrument Co., 2103 K St N.W., Wash., D.C.*

*Maurice J. Franckel, radio engineers, St. Louis photo.*

*B. D. Goodrich Rubber Co.*

*Carl Walter & Burton, 1032 Florida Ave*

*155*

*1550*

*Wide World*

*1526*

# Down Safety Lane

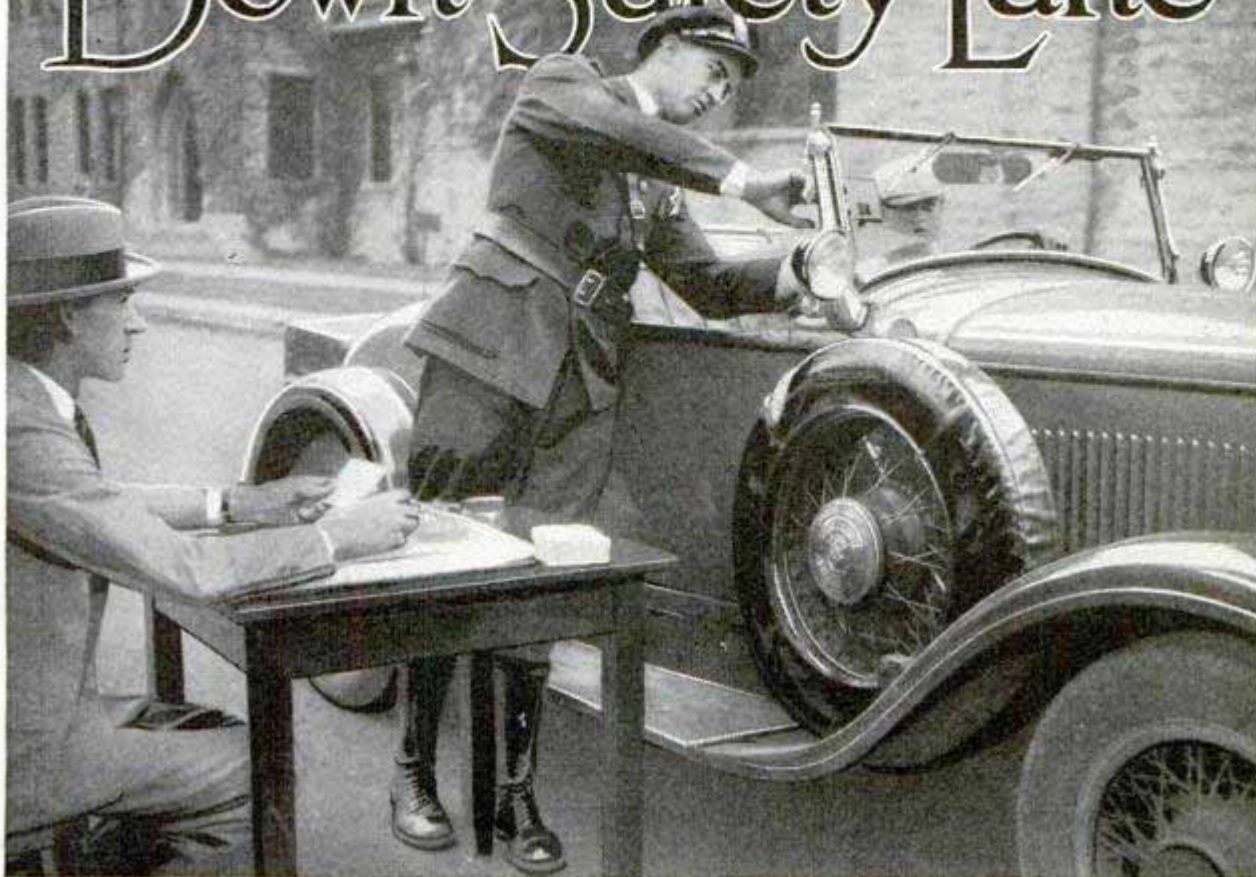

Evanston Policeman Pasting "O.K." Sticker on Auto Windshield, Signifying That the Car's Brakes, Headlights and Other Accessories Are Safely and Correctly Adjusted

*Illinois*

By PAUL D. PADDOCK

**T**O PROMOTE greater safety in motoring, a unique proving-ground service, to quickly and accurately check the condition of automobiles, is being introduced throughout the country. In a fifteen-minute free ride of a block or less, the driver gains information that may save him and others from injury or death.

Maybe he thought his "bus" was in tip-top shape, but a little trip down "safety lane" convinces him that brakes, lights, steering wheel or other parts need attention. An astounding result of the examinations so far conducted shows that less than ten out of every hundred cars on the road are in satisfactory condition. Accurate tests indicate that nearly three-fourths of the more than 23,000,000 passenger cars and the 3,000,000 trucks in service in the country today are operated in a condition that invites accidents.

Safety lane is simply a program of easy

but vital tests of car brakes and other equipment, developed from the recommendations of the American Automobile association and the National Safety council. The lane is set up in any convenient town or city street or in a service station. Tests are conducted under the auspices of police departments, safety organizations, chambers of commerce or associations of service men and, wherever given, are being eagerly taken. The public has received it as a sort of sporting proposition, and the fortunate car driver whose machine passes with a perfect grade is given a coveted "O.K." sticker.

At the entrance to safety lane, the car is registered, its owner's name and address, the make and license number being entered on a card issued in duplicate. At stop No. 2, check is made of tail, parking and stop lights. At the next halt, attendants wheel two headlight testers into

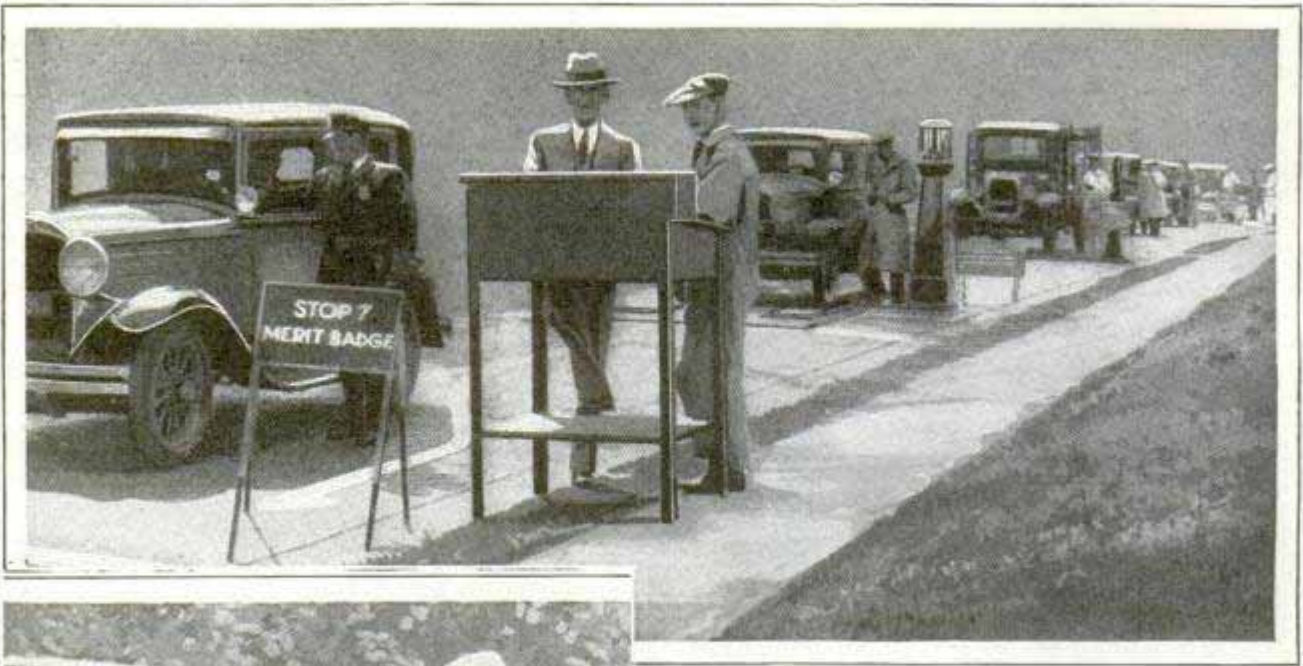

*Springfield, Ill.* Courtesy Weaver Manufacturing Co.  
 comes one of the most important tests, that of the brakes. The car is driven upon a corrugated runway and at a signal from the attendant, the brakes are quickly applied. The results are indicated within a glass chamber on the brake-testing gauge. Four tubes of a red liquid are so adjusted that the red rises in each to a level corresponding to the effort put forth by each brake. If all four are equally adjusted the four columns of red will be at the same height.

Drivers of cars that need adjustments are advised to have the necessary corrections made at their service station and may return with their car for another trip through the lane. In many communities, police keep a record of all cars tested. In case a driver neglects hav-

EVANSTON OFFICIAL SAFETY TEST		No. 1448	
Sponsored by EVANSTON SAFETY COUNCIL, and EVANSTON POLICE DEPT., Bureau of Accident Prevention.			
NAME _____		LICENSE No. _____	
ADDRESS _____		MAKE OF CAR _____	
YES <input type="checkbox"/> BY _____ CERTIFICATE ISSUED NO <input type="checkbox"/> DATE _____			
WHEEL ALIGNMENT 		HEADLIGHTS HIGH BEAM _____ LOW BEAM _____ O.K. _____ L.T. _____ S.A.T. _____	
<b>TEST CARD</b>			
HORN _____ WINDSHIELD WIPER _____ REAR VIEW MIRROR _____ STEERING WHEEL _____ BRAKES _____		REAR _____ FRONT _____ EACH GRADUATION REPRESENTS 20% VARIATION	

Line of Cars in Safety Lane, Testing the Headlights, and Test Card Issued in Evanston; Punch Marks Indicate Findings

position and in a few seconds note if the lamps are correctly aimed and focused. Drive on, and at stop No. 4 is a gauge which tells if the wheels are in correct alignment, whether they turn in or out. This machine is accurate to the fraction of an inch. It tells a story that will help save the autoist useless wear on tires and the possibility of an accident. At this stop another little gauge is used to show if there is excessive play in the steering wheel.

A few feet on, and horn, windshield wiper and rear mirror are inspected; then

ing a necessary adjustment made and is involved in an accident later, the police have information that may be of aid in fixing the responsibility for the crash and the just punishment that should be imposed.

An extensive safety-lane campaign has been conducted recently in Evanston, Ill., in connection with that city's celebration

of a safety campaign that last year resulted in the reduction of fatal automobile accidents by more than sixty-two per cent, and the estimated saving of seven lives. More than 400 automobiles were tested daily. Only six to ten automobiles out of every hundred were found to be O.K. In some cases the safety-lane examinations were amplified by psychological tests on drivers who seemed to be incompetent to operate cars. These tests were conducted by the Northwestern University.

**FAILING OIL FIELDS REVIVED BY ACTION OF WATER** 1496

The fact that oil and water do not readily mix has been turned to good purpose in some of the failing fields in New York and Pennsylvania where old wells have been made to flow again by flooding with water. The process is simple. Water is pumped into wells under pressure with the result that oil is forced through the sands into other wells that have been abandoned but have not been flooded. Oil so recovered is said to be of superior quality, and experts estimate that some of the wells thus treated will have a commercial life of thirty to fifty years in the future.

**SCREW-CAP FRUIT JAR OPENER REMOVES LID EASILY** 1448



Loosening the screw-cap tops of fruit jars is made easy with an opener which operates automatically. It fits the tops of all jars and tightens its grip as greater leverage is applied. The same tool can be used to tighten the tops during canning.

Names and addresses of manufacturers of articles described in

this magazine will be furnished free by our Bureau of Information.

Vaughan Novelty  
Mfg. Co. Chicago Ill. U.S.A.

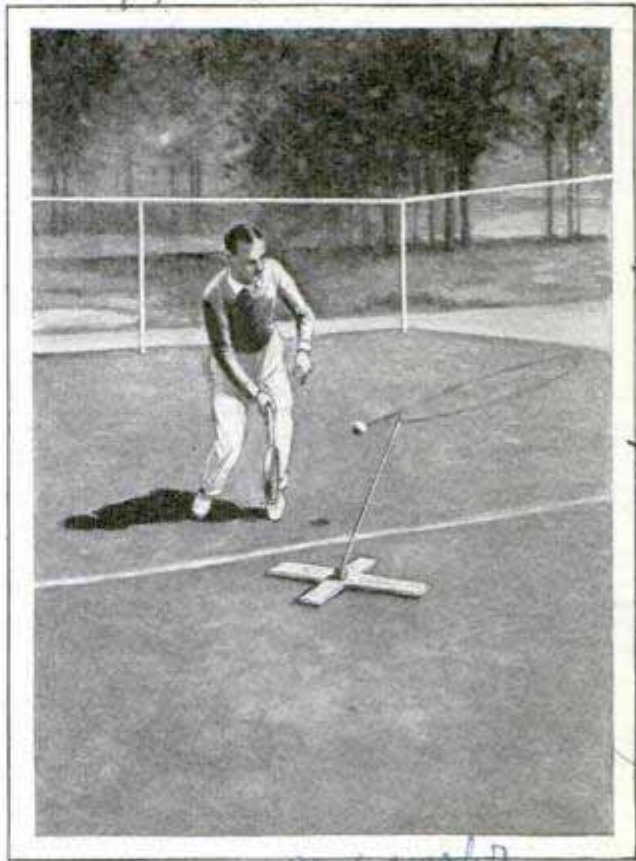

Mechanical Tennis Partner, Consisting of Ball Attached by Elastic to an Adjustable Rod

**MECHANICAL TENNIS "PARTNER" PERMITS PRACTICE ALONE**

To permit a tennis player to practice alone, a Frenchman has invented a mechanical "partner" for the courts. It consists of a light base on which is mounted a ball joint carrying a steel rod, to the end of which is attached an elastic cord fastened to a regulation tennis ball. The player strikes the ball in any desired direction, and it is returned by the elastic, bounces on the ground, and is again struck. The inclination of the rod can be adjusted by means of the ball joint in the base, so that all the fundamental strokes, drive, backhand or smash, can be practiced at will.

**ONE-WAY TRAFFIC FOR PLANES FLYING OVER LONDON** 1486

Deciding that the sky streets above London are overcrowded, the air ministry has put into effect a one-way traffic system for airplanes to prevent the possibility of collisions in the air. Pilots flying between two airdromes only four miles apart, must go thirty-five miles under the new regulations. The flyers do not regard the orders with great enthusiasm.

Chicago Tribune  
9/13/30.

Home Facette Press  
R. Broquedis  
60, Rue Saint Didier, Paris 17<sup>e</sup>, France

NINE-HOLE TABLE GOLF COURSE GIVES THRILLS OF REAL GAME

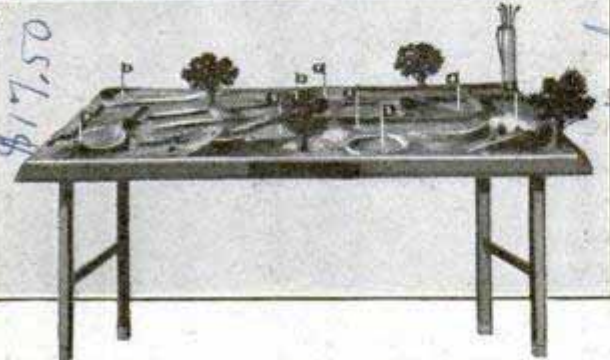
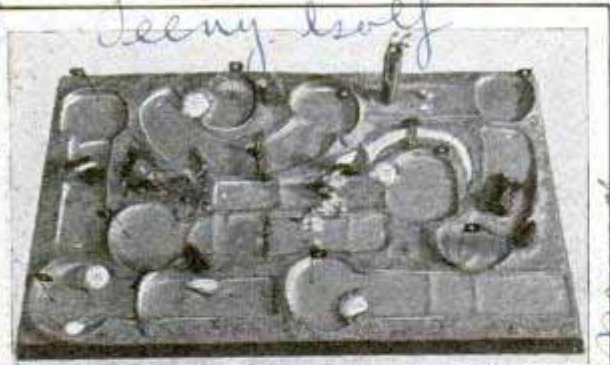

Miniature Golf for the Home; the Table Model Provides Nine Holes; the Legs Can Be Folded Up

Set on sturdy legs, a table-size nine-hole golf course has been introduced. It is durably constructed of a synthetic wood and has enough hazards and opportunities for skillful shots with miniature clubs to satisfy lovers of the real game. Miniature trees add to the attractive appearance of the playing field. The legs fold and the course is over two feet wide and three and one-half feet long.

COLORED LIGHTS USED IN WAR AGAINST INSECTS

Colored lights are being used as the latest electrical weapon in protecting California's crops from insects. Color preferences of insects are tested with a device shaped like a wagon wheel, with eight long compartments arranged like spokes around a large central chamber. One end of each chamber opens into the central one, and the other end is fitted with an electric lamp and color screen, so that each can be flooded with a different color of light plainly visible in the central chamber. Thousands of insects of the same family are placed in the central chamber, and all compartments are lighted, each a different color. The insects enter the chamber having the greatest color attrac-

tion for them, and thus investigators are able to determine what colors certain insects like and which they shun. After such a test, two courses are open, the pests can be attracted by their favorite color and exterminated, or the color they avoid can be used to repel them from orchards or grain fields.

PNEUMONIA AID IS FOUND IN CRANBERRY BOGS

Scientists of the Rockefeller Institute for medical research are reported to have found a substance that promises protection against pneumonia in the cranberry bogs of New Jersey. The soil there yields a bacillus from which the substance is extracted. It attacks the outer coating of the pneumonia germ. Experiments on mice showed that the substance protected the animals from the disease and cured others which had been inoculated.

SERVICE STATION ON WHEELS AIDS NIGHT AUTOISTS

One Los Angeles youth is making money in his spare time by servicing the cars of motorists whose lights are not functioning properly. He has a motorcycle equipped with a service kit and a supply of auto lamp bulbs, and, at sundown, stations himself beside a busy boulevard. As soon as he detects a car with a dark bulb in head or tail light, he overhauls the driver, requests him to pull up to the curb, then offers to replace the bulb in a minute to avert possible arrest for the motorist. He averages from fifty to eighty dollars a week.



Motorcyclist Equipped with Supply of Auto Lamp Bulbs; He Makes Light Repairs at the Roadside

Edward Phillips

whole - without legs \$1.50  
" with legs \$10.00 - 199  
18-hole table - pull

note. Chromatic Light  
discovered by Prof W. Berkeley Cal  
of California

215, 4th Ave  
New York City

and Rene Dubos

See my self

pat. pend.

Science Service  
New Bulletin  
9/13/30

1495 York Ave #664  
New York

Cont. Sec. J. Rosner  
Los Angeles, Cal  
10 or 20 43



## HOW HIGH UP DOES THE ATMOSPHERE EXTEND?

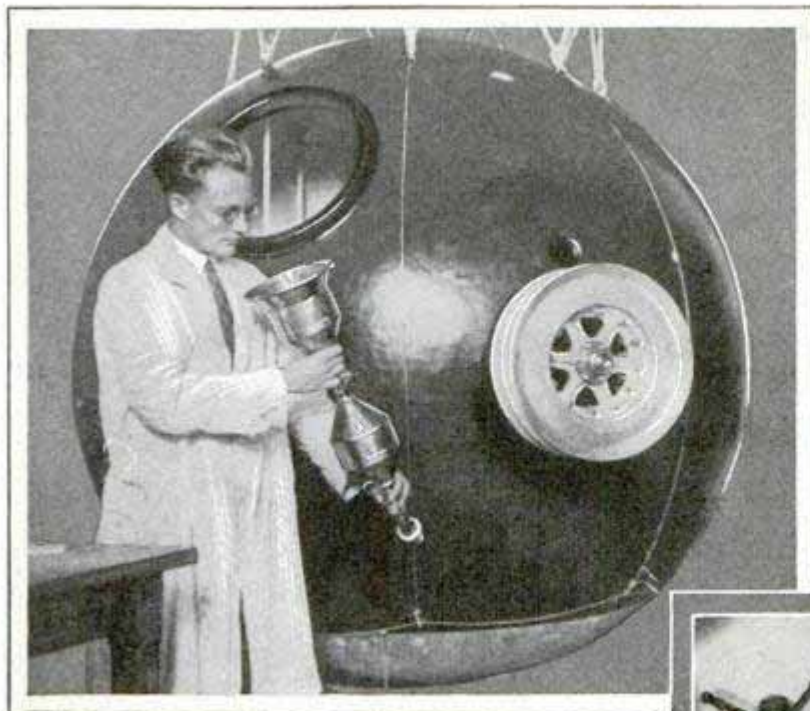

Exterior and Interior Views of the Air-Tight Metal Gondola of a Free Balloon in Which Two Europeans Tried Unsuccessfully to Rise Ten Miles



Existence of an atmosphere at an estimated height of 125 miles is indicated by observations of shooting stars. For about twenty miles up, the composition of the air is nearly the same as at the earth's surface, says Dr. W. J. Humphreys, of the weather bureau, except that the upper region contains little water vapor and less oxygen, although it is rather rich in ozone. The temperature is estimated at about sixty-five degrees below zero. At greater heights the atmosphere becomes richer in the lighter gases, and poorer in the heavier ones. At about fifty miles, the air is highly ionized, which is of vital importance to long-distance radio communication. Auroras stop at a height of about sixty miles, but extend out for about 400 miles and are electrical phenomena induced in some way by the sun. Science recently has been interested in the attempt of two Europeans, Prof. Auguste Piccard, Brussels university physicist, and an assistant, to explore the upper air. They intended to ascend 52,000 feet in a free balloon to which was attached an air-tight metal sphere as a gondola for the passengers, but failed in their initial effort when the balloon refused to leave the ground. The ten-mile ascension, for the purpose of studying cosmic rays,

radio activity and the ionization of the earth's atmosphere, is to be tried again later, the first failure being attributed to bad weather conditions and the weight of the metal gondola, which is 220 pounds. This sphere is seven feet in diameter and contains, besides the many instruments used, an air-making machine to generate oxygen, and heating apparatus to counteract the low temperatures. The sphere also is fitted with an appliance to equalize inside and outside air pressures. The balloon has a capacity of 18,000 cubic yards of hydrogen gas, but is only partly inflated, the big bag expanding as it rises.

☐ Those wishing further information on anything described in the editorial pages can obtain it by addressing Bureau of Information, Popular Mechanics Magazine.

129.9

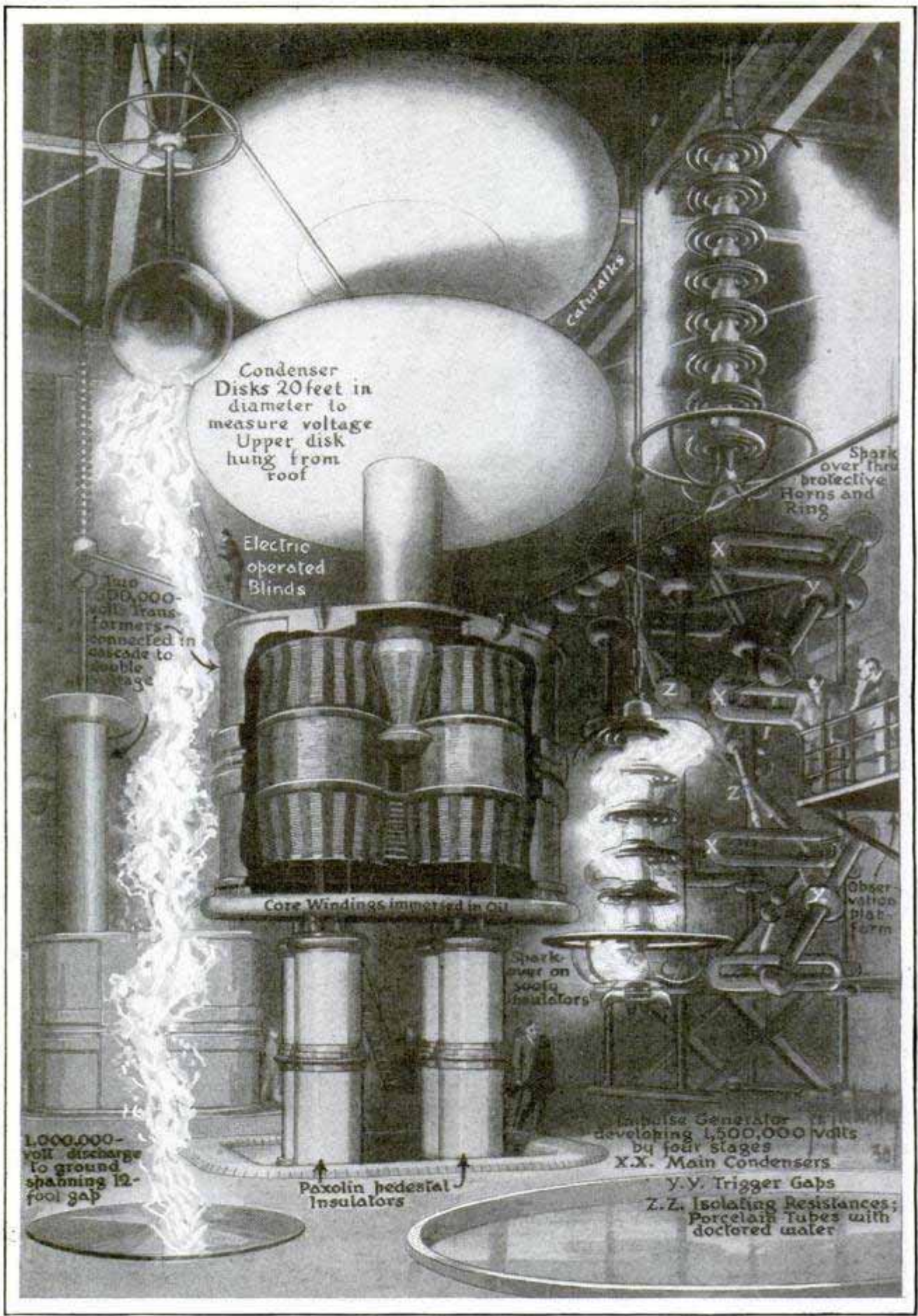

© Popular Mechanics Magazine

Artist's Drawing of Huge Generator and Apparatus Which Supplies Current Up to 2,000,000 Volts for Artificial Lightning Tests on High-Tension Line Insulators and Equipment in Manchester, England

Trafford Park

**LION ROARS AND COCK CROWS FROM CATHEDRAL TOWER**

One of the most remarkable clocks in the world will be that to be mounted in a 140-foot tower forming part of the Messina cathedral, now being reconstructed after being devastated by the earthquake of 1908. At the top of the tower will be seen a bronze lion, twelve feet high, erect on its hindlegs, which are jointed. Between its front paws the animal will hold a banner with the arms of the city, and at midday the lion will wave the banner, lift up his head and roar as he lashes his tail. Under the lion will be a cock of bronze, eight feet high, which will crow to salute the dawn, noon and the hour of sunset. The lion stands between the figures of two women, representing legendary characters, who strike the hours of the day on sets of bells. When the lion finishes his noonday roar, a scene is enacted below him, an angel bearing a scroll to the Virgin and being replaced by Saint Paul and four ambassadors who take away the scroll. Underneath this scene is another representing the seasons of the year with the figures in motion.

Smith-weld (A. O. Smith) and pipe (A. O. Smith) Milwaukee Wis.



Corrugated-Steel Expansion Joint for Pipe Line, Which Allows It to Contract or Expand

**PIPE LINES ARE PROTECTED WITH EXPANSION JOINT**

To overcome the tendency of large pipe lines to part or buckle from expansion and contraction, a corrugated steel expansion joint is used with the electric-arc all welded pipe. The joint is of rolled sheet steel with three large corrugations, one joint being used for each 300 feet of pipe. Each joint allows from three to four inches of contraction or expansion. Improved machinery is speeding up the laying of these large lines. One construction unit comprises a gasoline-operated wheel digger which opens one and one-quarter miles of trench a day, a tractor equipped with winch and steel boom for pipe laying, two dynamos to supply current for welding and several smaller tractors for speeding up the work.

Used by Montasia Payer Co. in line from Cabin Creek natural gas field to Wellington, N. D.

**SPARE TIRE ON SWINGING ARM GIVES ACCESS TO ENGINE**

To provide easy access to the engine and for speedy demounting, a spare-wheel carrier set on a swinging arm is adaptable to production-made cars. The carrier consists of the swinging arm fitted to the wheel carrier at the outer end and housed over a swiveling cap joint. Wheel lugs are screwed into a faceplate mounted on the carrier arm. A coiled spring pushes the mounting and the wheel and tire away from the hood when a special lock is released, the spring lifting the entire assembly free of the indented well in the frame or fender, and pushing it out of the way.

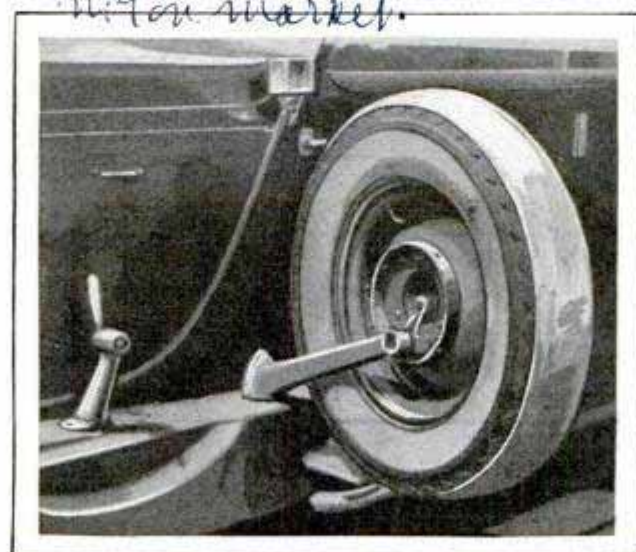

Swinging Arm for Spare Wheel, Which Turns Automatically to Give Access to the Engine

Built by engineering Dept. Hupco Motor Co. for motor

Ten cents worth of electricity will do a man's work for a day.

Handled by Laying Co. The Engineering Co.

437  
**WORLD'S GREATEST HOAX RECALLED BY MODELS**

Tucked away in the museum of the Franklin Institute in Philadelphia are two innocent-looking models, yet one of these

that the learned committee appointed by the legislature after long and baffling study found that Mr. Readhefer's machine was really operated by a small boy turning a crank in a room below that in which the experiment was made. Mr. Readhefer retired into oblivion and the model found its way into the Franklin Institute.

Years later, John W. Keeley began to attract attention with a device which he claimed was operated by a force hitherto unknown to science, and capitalists became interested in the contraption which was to derive its power from the disinte-

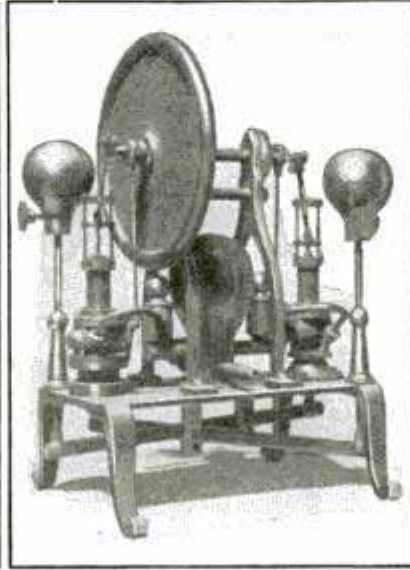
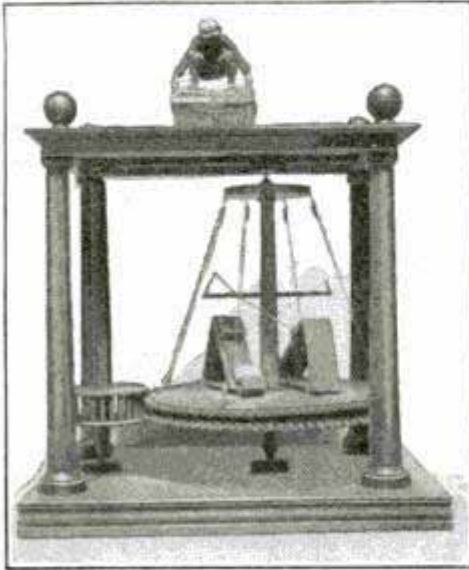

Models of Two "Perpetual-Motion" Machines That Deceived Hundreds: One Was Operated by a Hidden Boy, the Other by Compressed Air

was sufficient to cause the legislature of Pennsylvania to pass an act authorizing the appointment of a committee to look into the possibilities of the invention, while the other was responsible for losses to investors estimated in the millions. The first was the invention of Charles Readhefer, for which he claimed the power of self-motion. The inventor was subtle in his argument, and even today it must be read twice before its lack of logic is perceived. "A loaded wagon will run down hill," he reasoned. "If a hill is steep enough, and the hill is capable of moving out from under the loaded wagon, then if the wagon is prevented from moving except in a vertical direction, it will push the hill from under it." This much seems clear and obvious, but now comes the hitch. "Now in this so-called perpetual-motion machine there are two hills or inclined planes mounted on opposite sides of a wheel, which wheel is horizontal and its axis vertical. There are loaded wagons on the inclined planes, and as the wagons cannot go down the planes, but are held by a complicated system of levers, and the planes cannot move from under the wagons, therefore, the effort to do what both are prevented from doing results in a constant push and the wheel is driven around by this power." Suffice it to say

gration of a few drops of water. The Keeley Motor company was organized with a capital of \$5,000,000. Unlike most inventors, Keeley had no education whatever, but was a very forceful speaker. Nothing much came of this project and what happened to the money will always remain a mystery. Undismayed, Keeley later announced the invention of a hydrovacuo engine, using a vacuum in connection with water pressure. Scientists examined the machine, one part of which had what Keeley claimed was a wire attached to it. During the examination this "wire" was cut and found to be a hollow tube. The mystery was solved, since this tube carried compressed air.

1534  
**ELECTRIC HEATER WITH A FAN  
GIVES WARM OR COOL AIR**

Warm air in winter and cool air in summer is circulated by an electric heating appliance consisting essentially of a heating element with radiator cast in one aluminum unit, behind which



*American Foundry  
Equipment Co.*

5021-212th Ave  
Seattle Wash

are mounted the motor and fan, the unit being contained in a small cylindrical case available in different colors. It directs either warm or cool air to the point where needed, the fan operating independently of the heater to furnish a supply of cool air in summer.

1463

### AIRPLANES ROUT WILD HORSES

Airplanes were used recently to frighten wild horses from canyons and thickets in eastern Oregon. By swooping from windward toward the animals, they were scared and routed, and cowboys thus corraled 1,000 of them. These horses, once in demand in the west, have had their usefulness destroyed by the automobile, and now are considered a nuisance by ranchers of several states. Hence they are rounded up and the carcasses are sent to Europe, where the meat is in demand.

1536

### COIN-IN-THE-SLOT BASKETBALL PLAYED LIKE REAL GAME

Basketball now has joined the list of sports played by slot machine. The coin-in-the-slot game is competitive and is played by two persons. It consists of an inclosed court with two goals. The ball always rolls into small depressions in the



Slot-Machine Basketball Game That Requires Skill; Levers Flip the Ball Toward the Baskets

court. Two levers, one manipulated by each player, control the ball's movements, flipping the lever when the ball rests in a depression and causing it to jump toward a basket. The levers, however, are so arranged that varying pressure is required to shoot the ball from different points, thus requiring skill and training.

Filmoscope Mfg Co  
35 E Wacker Drive

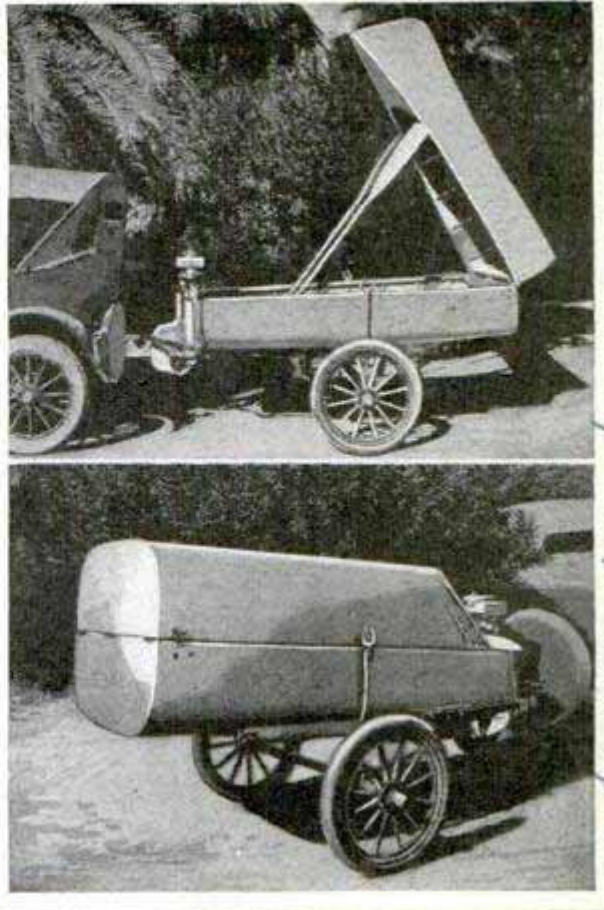

Trailerboat

Two Views of Folding Boat on Auto Trailer; When Folded, It Provides Space for Baggage

### FOLDING BOAT EASILY CARRIED ON AUTO TRAILER

For the tourist or vacationist who seeks the water, a folding boat and trailer for transporting it provide an easy means of taking the boat on a trip with the car, the boat also offering a commodious space for luggage en route. The boat, when folded, occupies no more space than the ordinary trailer, and is a seaworthy craft in the water, being adaptable to sails, oars, in-board or outboard motors, or to a combination of these powers.

### MAILBAGS GIVE THEFT ALARM IF STOLEN IN TRANSIT

1532

Mailbags that give audible and visible warnings when anyone attempts to tamper with them are being used in England to frustrate theft of pouches. The bags are strapped to a platform of compressed springs connected to the electrically operated alarm system. An attempt to loosen the straps or dislodge the bags completes a circuit, setting off a siren and lighting a red lamp in the driver's compartment.

Express 9/9/35

1519

# HOW HEAVENS MAY BE EXPLORED BY RADIO BEAMS

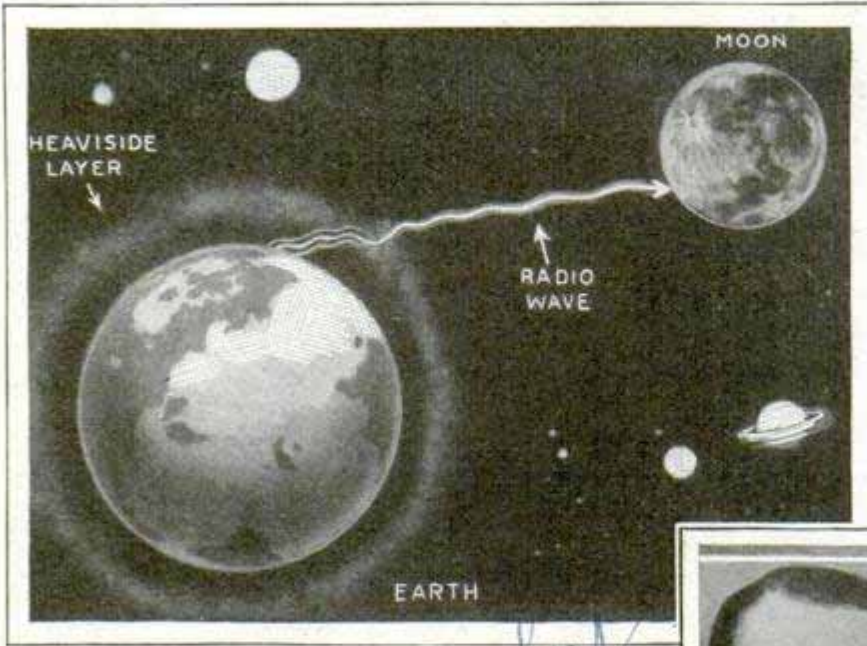

Drawing Showing How Marconi Believes Beam Waves May Travel to the Moon; Right, Path of Ordinary Radio Waves, and Insert of Marconi

believed that the beam wave can travel in a straight line and penetrate the ionized layer of air and then continue on into space. Just how far such waves go is purely conjectural, but some estimates are from 25,000,000 to 48,000,000 miles. This is a comparatively short range, when judged by distances in the universe, but it would

Radio waves of the beam type may be used to explore the outer reaches of space for millions of miles and solve some of the secrets of the universe. Guglielmo Marconi, known as the father of radio, in a recent address in Italy expressed the belief that the beam waves travel far beyond the layer of air surrounding the earth, thus differing from the two kinds of radio waves that are purely terrestrial—the ground wave that follows the surface of the earth, and the echo wave that leaps to the "Heaviside layer" of ionized air some 100 miles above the earth. It is now

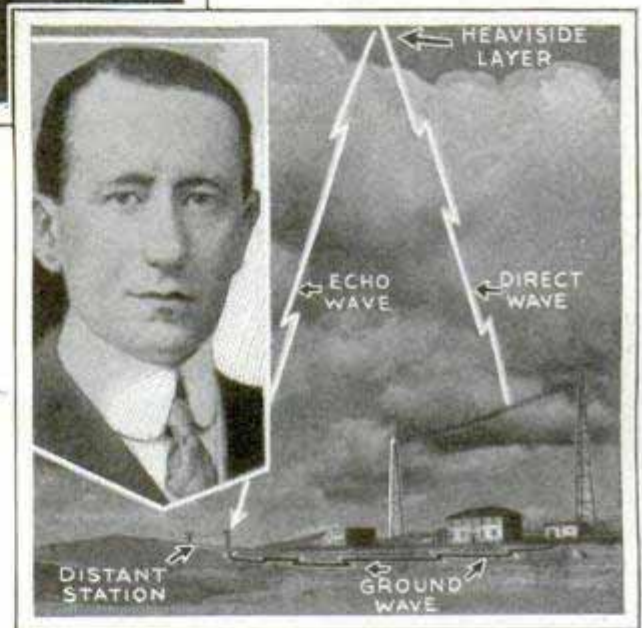

reach many heavenly bodies that are near neighbors of the earth.

## ELECTRIC EYE SORTS METALS BY LIGHT REFLECTIONS

Saving of valuable minerals and metals of industry now wasted may be possible through the use of a photo-electric cell, or electric eye, to separate and sort them. Prof. Roy W. Drier, of the Michigan College of Mining and Technology, has made an experimental apparatus that thus classifies metals by providing for particles of the material under test to fall upon a moving, black, endless belt. They pass under a constant source of light, a part of which is reflected back to a photo-electric cell by the material itself. Some particles reflect more light than others

and thus set up different currents through the cell, these currents being amplified to operate a mechanism that removes the metal whose reflection index is either above or below a certain value.

## POWER-LINE LEAKS DETECTED BY AIRPLANE PATROL

Airplanes flying over electric transmission lines can detect power leaks by using a special form of trouble locator now employed by one St. Louis power company. The planes fly low over the lines, and the apparatus not only detects a leak instantly, but shows at which tower it is to be found so repair can be made at once.

*by American Chemical Society*

*Houghton, Mich*

*524*

*Science Service News Bulletin 495. U. S. 15/30*

*1482*  
*Union Electric Light & Power Co.*  
*over 9/19/30*

Columbian Steel Tank Co.  
1401 W. 12th, Kansas City, Mo. 146c

POPULAR MECHANICS  
no. 146c

at Messrs. Jack Hills Machinery, Old Kent Road, London Eng.

This enables one plane to patrol long distances and it is now proposed that the ship also carry repair parts ready to be dropped overboard where a leak is found. In an emergency a repair crew would also be carried in the plane and sent down in parachutes at the point where the trouble was detected.

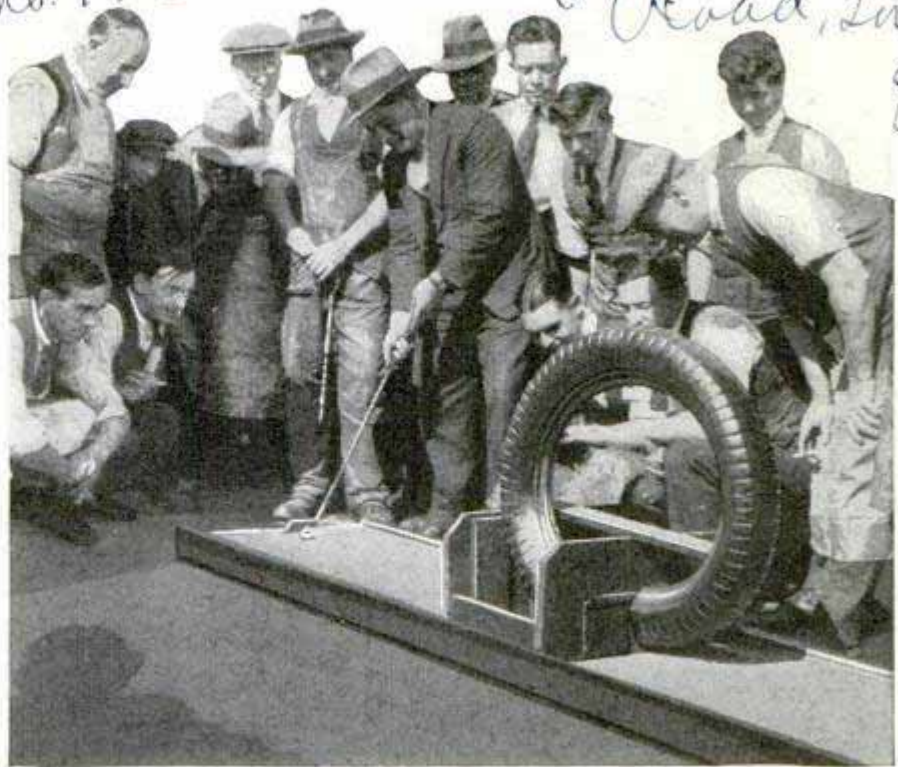

### LEAK-PROOF NUT AIDS STORAGE OF FLUIDS

1514

Problems of storing liquids in bolted tanks have been greatly simplified by the use of a leak-proof nut that makes such tanks available for storing and transporting many more liquids than have been thus carried heretofore. Instead of depending on the ragged edges of packing torn by the bolt as it was driven through to make it leak-proof, the latest method utilizes a recessed nut and gasket and a machine-punched hole for the bolt. The gasket is placed over the bolt on the outside, and the recessed nut presses over it firmly when tightened. Many types of

© Planet News, Ltd.

Automobile-Tire Hazard on Miniature Golf Course; the Ball Is Expected to Follow the Inside of the Rim and Drop into a Hole Below

packing and gaskets can be used, depending on the nature of the liquid to be stored, and it is unnecessary to retighten bolts after they have been once put in place.

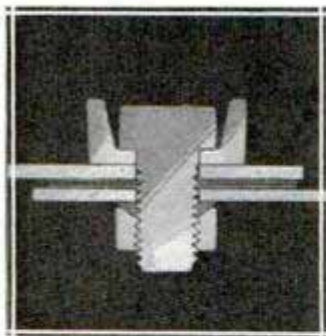

### OLD AUTO TIRE IS GOLF HAZARD ON MINIATURE COURSE

400

Miniature golf-course designers are taxing their ingenuity to provide difficult and unusual hazards for the players as the game becomes more popular, and one English course has an old automobile tire standing on end to harry the golfer. He is expected to shoot his ball against the

### SPRAY GUN FOR METAL TINNING ELIMINATES USE OF ACID

Tinning of all common metal surfaces can be accomplished without the use of acid by applying a tinning compound with a spray gun which is a combination of air nozzle and gas flame. As the metal surface is heated, the compound is released by trigger action, and the flow regulated according to the need. Corrosion and rust caused by the use of acids are prevented, and the operator is not subjected to the harmful fumes as the material used is free from any injurious substances. It speeds up the work in auto-body and fender-repair shops, and also is used in tinning bearings for babbitting and in the repair of cracked cylinder blocks.

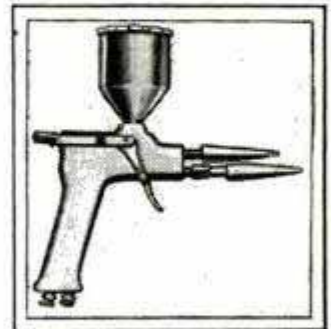

Tinite Corporation  
700 Sales Machines, etc.

1257

# Making Home Tasks

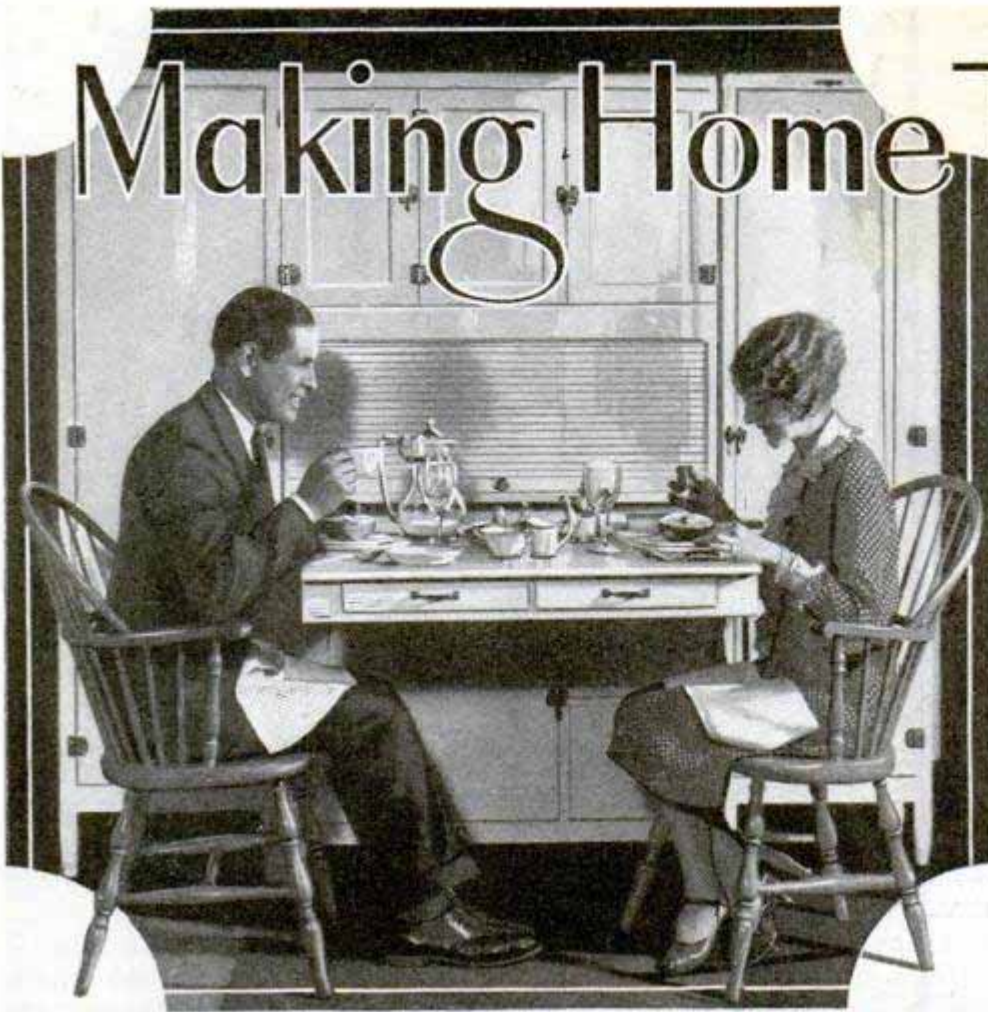

This Kitchen Cabinet Has Dining Table That Slides Out as Shown, Besides the Regular Porcelain Work Top; There Are Two Drawers for Silverware and an Electric Outlet for the Percolator or the Toaster



At Left, Wire Holder Saves Time and Work in Boiling Eggs and, Below, Handy Clamp for Lifting Pots and Pans from Stove

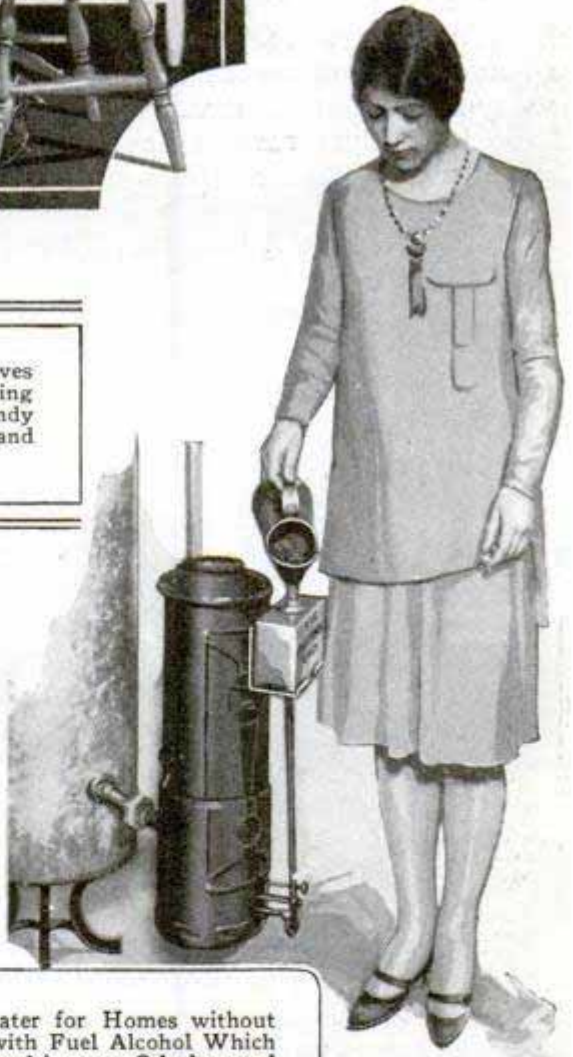

Above, Water Heater for Homes without Gas Is Operated with Fuel Alcohol Which Is Quickly Converted into an Odorless and Smokeless Flame; It Is Said to Be Absolutely Safe, Not Expensive and Is Always Ready for Service



# a Pleasure

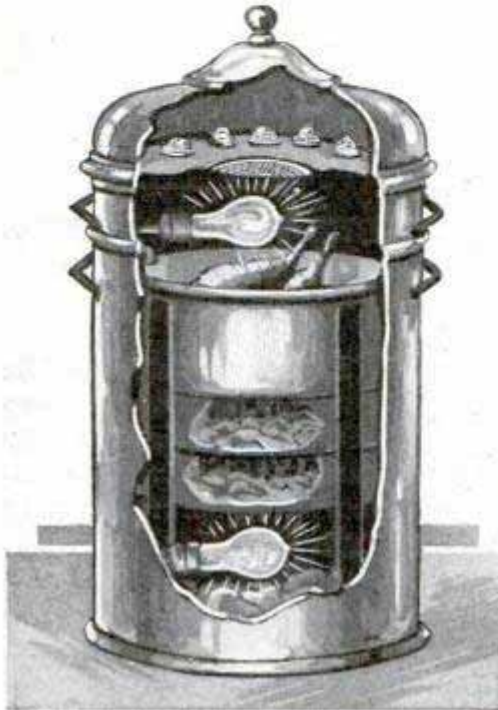

Electric-Light Stove Cooks Whole Meal at Once and Uses Little Current



Pillow Tops and Other Coverings Easily Removed When Adjusted with Interlocking Fasteners

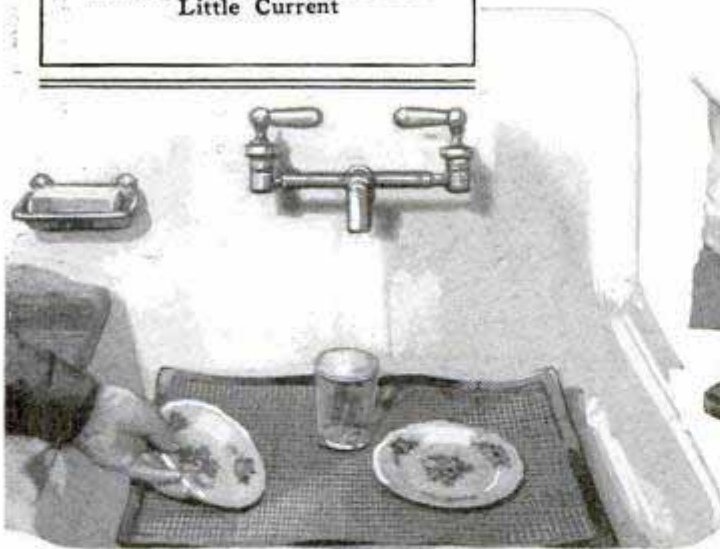

Rubber Mat for Sink Protects Dishes from Breaking; the Cords Imbedded in Fabric Swell, Affording a Gripping Surface for Slippery, Soap-Covered Articles; It Is Easily Cleaned and Also Protects the Sink

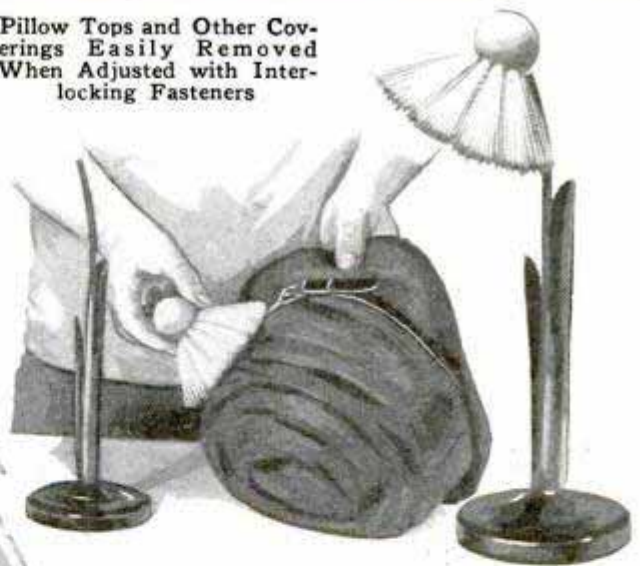

Above, Hat Brush and Holder in One; Below, Polisher of Chamois Cloths



Mr. John A. King Jr.  
311 N. Edgewood Ave  
Dallas Texas

1503

Mr. Kaho, staff photographer  
for Dallas Morning News

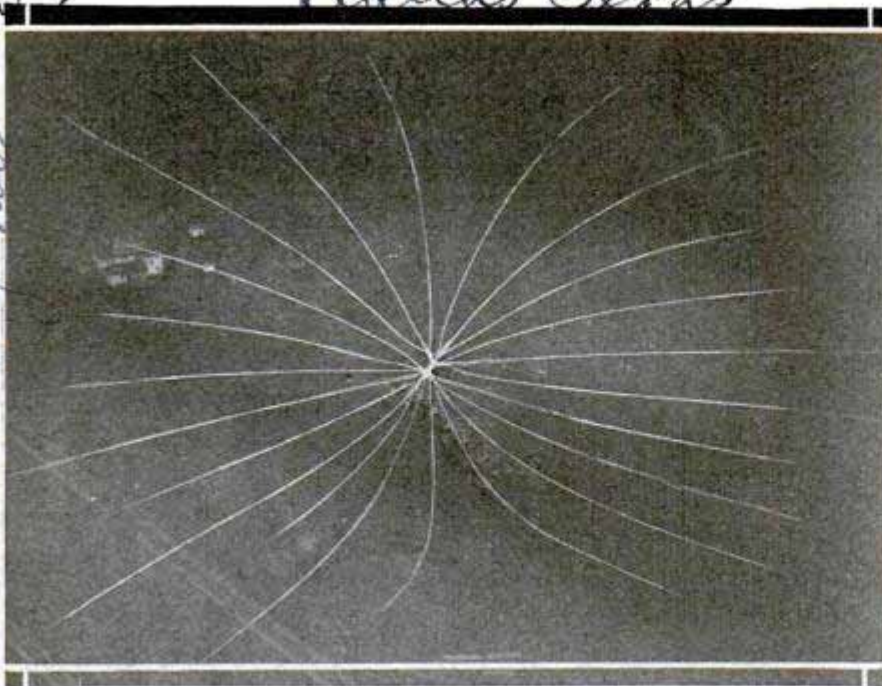

Picture of a Lightning Flash Taken from an Airplane; Note the Converging Positive and Negative Charges and the Connecting Line

### PICTURE OF LIGHTNING FLASH TAKEN FROM AIRPLANE

One of the most unusual pictures of a flash of lightning ever recorded was obtained recently by a photographer for a Dallas newspaper who snapped a photograph of a bolt of lightning from an airplane as the electrical discharge took place below the ship and almost directly under it. The photographer was taking pictures of a flying field when a thunder shower came up, and the flash occurred just as he snapped his camera for a shot of the field. When developed, the plate appeared to have been overexposed, and looked as if shattered by a blow near the center. It was not broken, however, the illusion being only in the exposed sensitized covering. It showed white lines starting from a score of points near the four edges of the plate, all converging toward a point near the center, and growing heavier as they converged. Close examination showed thirteen lines joined in one large white spot, and nine converged at another spot, the spots being connected by a heavier line. Scientists said each line represented an electric charge, some converging

mezey

Illustrated by G. Schantz

into one larger charge of positive form, and the others of negative potential. The jumping of a spark across the gap between these built-up charges represented the lightning, shown by the one heavy white mark. Beyond the lightning flash, the plate showed the ground scene.

1475

### BUMPER FOR AUTO SAVES LIVES OF PEDESTRIANS

Life-saving automobile bumpers which scoop up pedestrians run down by cars recently were demonstrated before a group of automotive engineers. The bumper, intended to save the victim of an accident from injury or death, is attached to the front of the car like the ordinary one except in case of an accident. When an accident is imminent, the driver releases the bumper by pressing a pedal in the floor. This causes the bumper to drop down and open a padded shield which extends from the top of the radiator, in order to catch the victim in the pad at the moment the auto hits him.

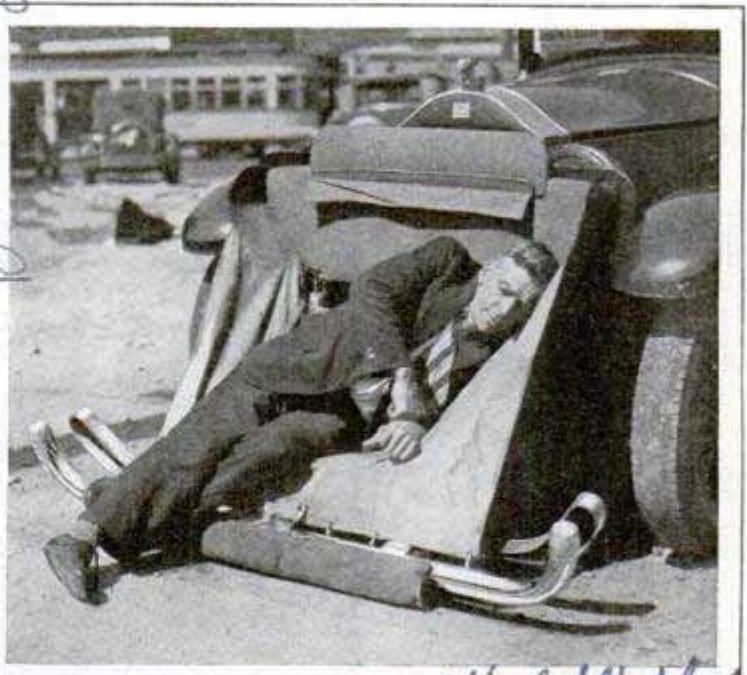

Life-Saving Auto Bumper Which Drops When the Driver Presses a Pedal and Scoops Up the Accident Victim

Wide World

Dr. Jos A. Schantz  
1546 Jay St.

*1457*  
**SINGING OF FOREST IS EXPLAINED BY AIR CURRENTS**

In a large forest in France, during calm summer days when the verdure is the seat of rapid evaporation, a harmonious sound is often heard which has caused the peasants to refer to the woods as a singing forest, and to look upon the phenomenon as something supernatural. The harmonic sounds are produced by air currents set up in the forest itself, the effect being similar in a way to the vibrations of a vast aeolian harp. Musical sounds also have been heard rising from some forests in England, particularly by the occupants of balloons drifting overhead on a calm day.

**RUBBER DOUGH ENDS SQUEAKS IN AUTOMOBILE BODIES** *1506*

Rubber dough, a plastic material, is being employed in the assembly of automobile bodies, to make them quiet originally and to prevent the little squeaks that most bodies develop after a period of use. In its original state, the rubber dough is a comparatively free-flowing liquid, and when applied to wood or metal body parts, spreads evenly over the surface. Then, when the body goes through the paint ovens, the rubber solution expands to fill every hollow and crevice and form a cushion of soft rubber between surfaces. It remains soft during the life of the body. It also is employed as an insulator of sound, retarding the transmission of noise from one part of the structure to another.

**GLIDER ON BALL-BEARING POST TRAINS STUDENT FLYERS** *1520*

Student flyers are able to master the first principles of controlling an airplane or sail plane without danger of accident to themselves or their ship by using a type of ground plane recently introduced

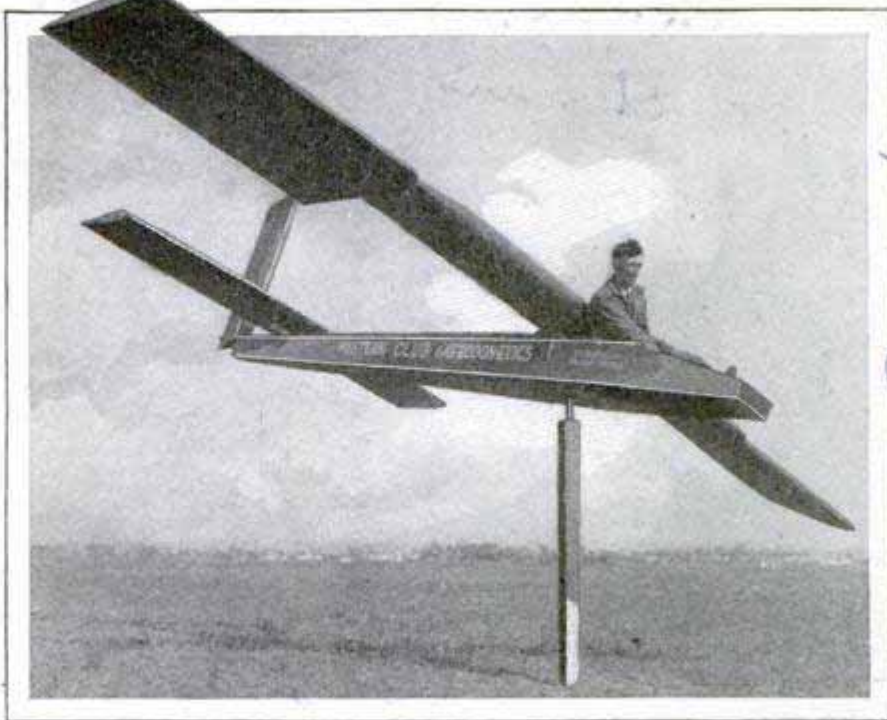

Glider Mounted on Post with Ball-Bearing Top, Which the Student Can Control Like a Real Ship without Fear of Accident

in Los Angeles. This ship for beginners is a glider of regulation size, mounted on a post with ball-bearing top. It has all the controls of a free glider and the student can do anything in it that he can do in a sail plane in flight. After mastering the controls, the beginner is blindfolded, and his reactions to the motions of the glider determine his progress.

**GOLF SET FOR PARLOR PUTTING COMBINED WITH ASH TRAY**

For those who like to practice golf at home, even in bad weather, a parlor golf-tree set now is available. It combines a golf putting stand with an ash tray. The metal stand is three feet high, and contains spaces for three putters, which are part of the equipment, and three golf balls. In the base of the stand are three holes serving as targets for the balls, thus making of the set a complete miniature golf course, if the rug is used for the green.

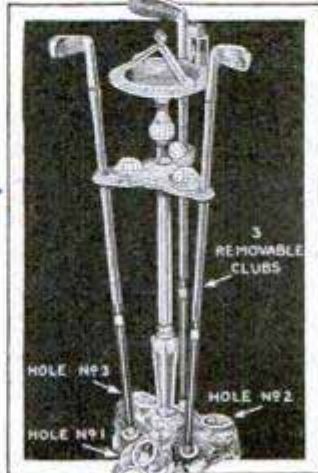

Wellington - Stone 6  
466 W Superior

*R. J. Vanderbech Co. New York Central Bldg. N.Y.C.*

*Owned by Western Club of Aero-Nautics Los Angeles Calif*

*\$1.50 each in lots of 6 or more*

145 - Citizens League, St. Louis, Mo



Camera Actuated by Time Clock, Which Takes Pictures of Smoking Chimney at Minute Intervals

PHOTOGRAPHIC SMOKE FINDER WORKS WITH TIME CLOCK

Detecting violations of city smoke-abatement regulations, and making a permanent record of them, is the purpose of a photographic smoke finder used in St. Louis. The instrument consists of a specially constructed camera, combined with an electric time-clock arrangement that takes photographic exposures automatically, once a minute, for a period of four hours. The resulting film shows how much smoke any chimney emits and for how long a period. Strips of the film are sent to violators of smoke laws with requests that they take steps to remedy conditions. The film, besides depicting the amount of smoke being emitted, also shows its density.

MUSIC MADE BY ELECTRICITY TO SURPASS PRESENT KIND

Electrons, which can be made to whistle like a piccolo, roll like a drum, or imitate the human voice, are destined to give free rein to the imaginative musician of the future. Dr. A. N. Goldsmith, vice-president of the Radio Corporation of America, believes electricity can produce tone effects never heard before, and open an entirely new field of musical interpretation. Music of the past has been produced mechanically, but that of the future will

depend on electrical vibrations corresponding to musical tones of any desired quality or timbre, and produced by coils of wire and vacuum tubes linked with loud speakers. Hammers, strings, pipes and reeds are limited in scope and possibilities as compared with electrically produced music, which in no way will displace the artist but give the musician an even wider scope, Doctor Goldsmith believes. The control of alternating current to produce notes and sequences of notes will not depend for volume on the physical strength of the performer, and the mode of control can be almost anything desired, keyboard, string, fret-board, or merely waving the hand. By electrical means, any tone quality capable of perception by the human ear will be obtainable. This will enable the imitation of any instrument now known, and the production of tonal effects never before heard, for any desired pitch or volume is possible. Doctor Goldsmith adds, however, that the development of such music will be a task of many generations.

1483 BODY SWINGS IN THE FRAME OF QUEER EXERCISER

Permitting the body to assume an unusually large number of positions, an exercise frame somewhat resembling a gyroscope in principle is used by a gymnasium instructor in Vienna. It consists of an upright support to which are attached two revolving frames, one within the other.

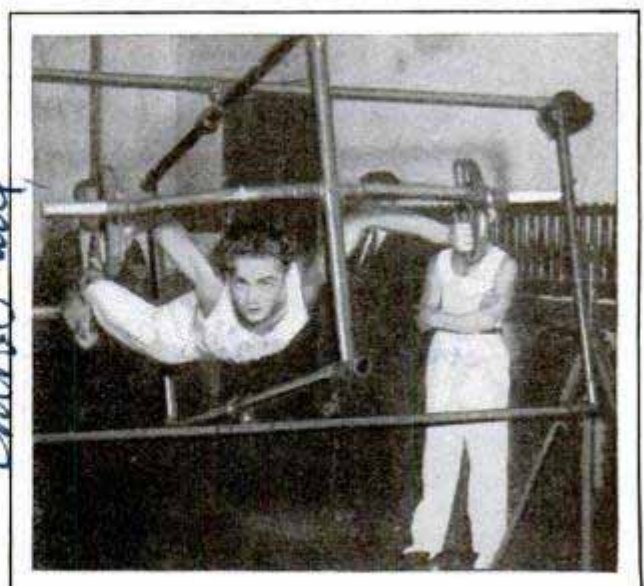

Gyroscopic Exercise Apparatus, Consisting of Two Revolving Frames, One within the Other

1454

Emb. Paul

W. J. James 9/1/30

# Raising the "Hindenburg"

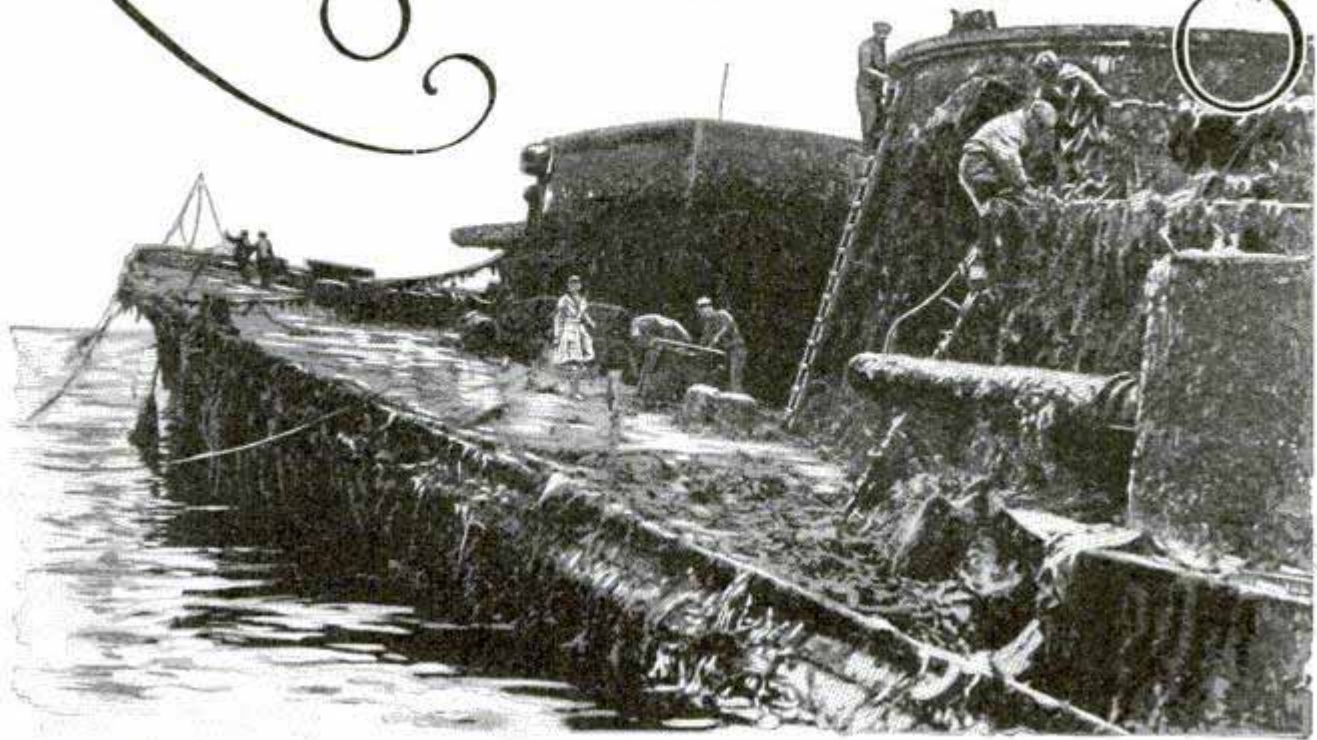

Covered with Seaweed and Barnacles, the Huge Hull of the "Hindenburg," Scuttled at Scapa Flow, Is Here Partly Raised during the First Attempt to Salvage Her

By HAROLD T. WILKINS

THE lives of 240 men, working night and day with a battery of fifteen electric and five oil pumps, and a stake of \$1,175,000, have recently been risked in an attempt to tear out of the clutches of Davy Jones the prize of 28,000 tons of valuable iron and steel and non-ferrous metals represented by the barnacled hull of the former German dreadnought battleship "Hindenburg" which, for eleven years, has been lying in a forest of seaweed at Scapa Flow, Britain's war-time naval base.

After six and a half years' expenditure of human effort, backed up by the latest appliances known to the science of salvage, Davy Jones has been beaten, and the weed-swathed, sea-stained battleship has been raised to the surface, and made fast, till she can be towed to the ship-breakers' yard, where she will be reduced to scrap. The story of the fight with the sea for the possession of these thousands of tons of scrap metal is a thrilling one.

Four attempts had been made to raise the "Hindenburg" far enough above the water on an even keel, so as to tow her up the sound and beach her where the

wreckers could break her up for the valuable scrap. Great rents in her hull had been patched up, her port covers screwed home, and her valves and pipes plugged with concrete and wood; and then it was found that she sunk deeper in the ooze of the sea bed, while tons of mud had seeped through the ports into her interior. Divers went down, unscrewed the porthole covers and blew a powerful jet of water onto the mud, so as to eject it from the hull.

Tugs then towed into position over the sunken battleship two great floating docks or pontoons, which had been made by cutting in two a huge cylindrical floating and submersible dock, 400 feet long by 130 feet wide, surrendered by the Germans at the end of the World War. By a strange irony of fate, this great dock, intended by the Germans to receive and test their war-time U-boats, has now been converted into pontoons to lift the sunken German high-seas fleet from the waters of Scapa Flow.

The pontoons were moored on each side of the sunken warship, while divers went down to pass heavy steel cables under the

*Mr London England*

*Esq. Colomberie  
29 Ocean Road, Bexley Heath*

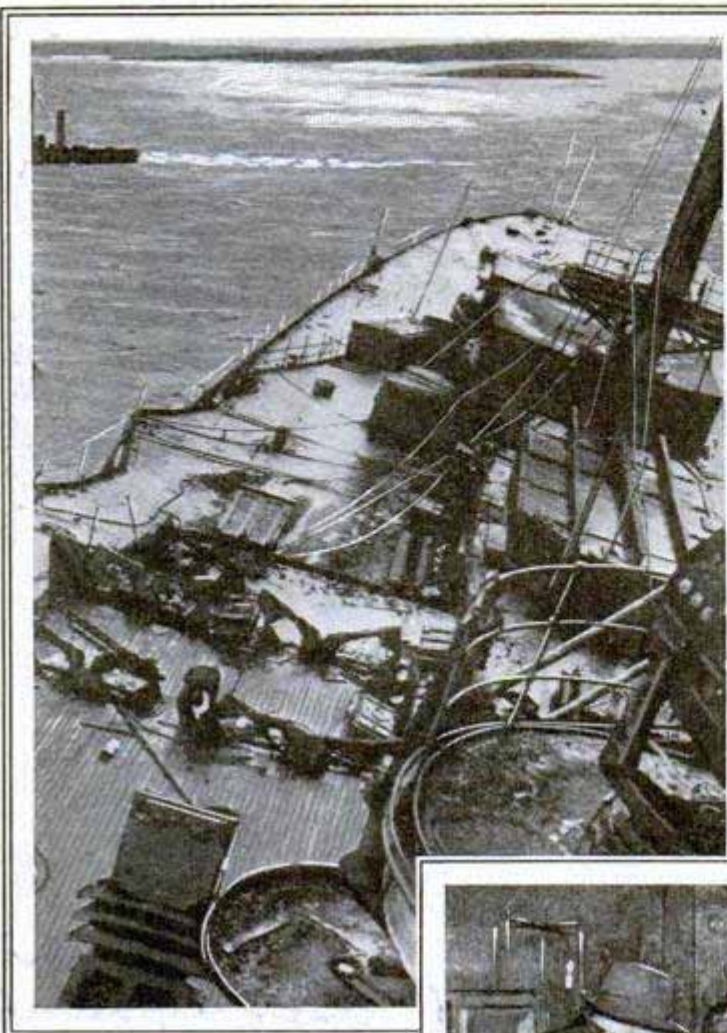

hull, both ends of the cables being reeved round blocks and winches on the pontoons' decks. Now, tricky Davy Jones took a hand in the affair. A gale blew in from the Atlantic, and squalls of rain drenched the salvors while they watched breathlessly the timbers of the upper deck creep minute by minute above the water till the guns, barnacled and trailing seaweed, emerged, and a diver nailed the red ensign to the "Hindenburg's" flag staff.

The prize was in the salvors' grasp and men shook each other by the hand, while the pumps were working at top speed expelling 10,000 tons of water an hour from the hull of the "Hindenburg"—when she was seen to list. Slowly, she heeled over to an angle of thirty degrees, threatening death if she toppled over and plunged to

the bottom. Nothing for it, but to reflood her and send her back to the sea bed, while despairing salvors calculated their six months' loss of work, night and day, of 200 men.

Followed two other attempts in succeeding years—Davy Jones allowing a few months in the summer of each year when winds and waters are calm enough for work to be done—and the stake was doubled, until the anxious salvors were faced with the prospect of great loss, or the alternative of moderate profit, if luck sided with them at the turn of the gamble with the sea. If the salvage firm decided at the eleventh hour to withdraw from the game and "cut its losses," certain ruin would follow. The men had gone too far to back out of the venture.

The "Hindenburg's" bridge and

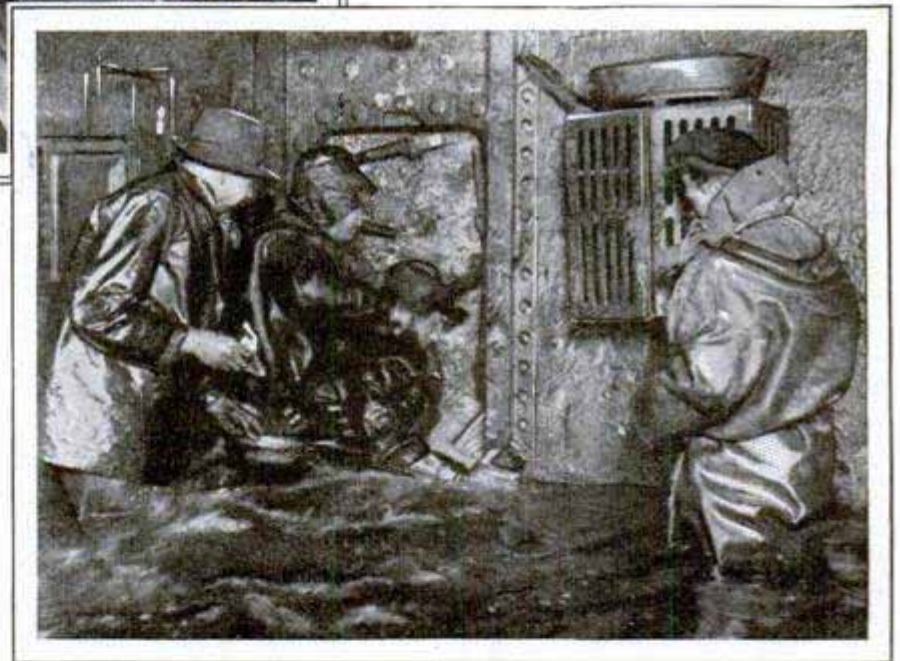

Above, Looking Down on the Deck from a Gun Turret, and, Below, Stopping a Leak in One of the Cabins

Courtesy Sport and General

remaining funnel stood just above high-water mark, and under her stern to port the salvors laid down a great bed of submarine concrete, weighing more than 600 tons. Poking above the water over the stern of the "Hindenburg" was a steel shaft, like a chimney, inside which was located an underwater pumping station. When the pumps got to work at the bow end of the sunken ship, the expelled water

lightened the hull, so that the stern pivoted around and had a tendency to pull the warship over on to her side. This tendency the salvors sought to counteract by the installation of the pump in the steel chimney shaft and the concrete bed to the port or left side of her stern. The divers could not make the sunken warship water-tight, and there was a constant battle going on between the pumps expelling the water under strong jets of compressed air, and the leaks letting the sea back into the ship.

Battle was joined with Davy Jones at high tide exactly eleven years after the ship had been sunk. Once more the hull emerged and all seemed going well, till, just at high-water mark when the tide was exerting its full effect in buoying up the "Hindenburg," she heeled over dangerously, and Mr. Cox, the salvors' president, watching with tense, white face, the issue of the long fight, reluctantly ordered the divers to quit the warship and the pumps to stop.

"We must postpone the attempt to raise the 'Hindenburg' till we have built another concrete bed, this time on the starboard or right side of her hull," he told Popular Mechanics Magazine's representative. "I reckon it will take two or three weeks for the concrete to harden enough and that the next round will be the last, and we shall have beaten Davy Jones' locker."

Exactly thirty-one days later, the second bed of concrete had hardened sufficiently to stand the terrific weight of the "Hindenburg's" hull, and then the pumps were again started and began to pour out fifty tons of water each minute from the submerged ship. In the evening, a diver went down and reported that the "Hindenburg" was rising clear of the bottom. Bit by bit, she floated nearer the surface, rising at the rate of six to seven inches every fifteen minutes, till, by midnight, her after turrets were clear of the water, and a flag was flying at the mast four feet above the surface of the sea, at her stern.

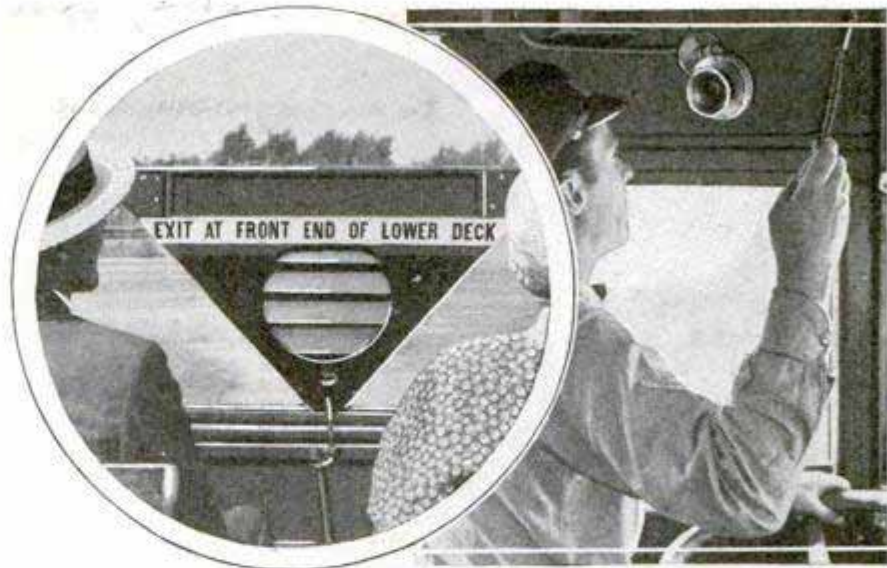

Loud Speaker on Upper Deck of Motor Coach, and Driver Calling Streets for His Passengers

### LOUD SPEAKER ON UPPER DECK OF CITY MOTOR COACH

For the benefit of passengers occupying the upper decks of Chicago motor coaches, these busses have been equipped with loud speakers and a system of light signals operated by the driver. The coaches are operated by one man who serves as driver and collector. He speaks into the microphone to announce streets and danger points to the upper-deck patrons, and pulls a cord which causes a red light to flash as a warning to his passengers to remain seated when the bus approaches a viaduct or low bridge.

### SPRAYING UNDER THE LEAVES KEEPS INSECTS AWAY

To water and spray potted plants, a small sprayer which has the advantage of reaching under leaves where parasites



lurk, is now offered. It resembles somewhat a lemon squeezer with handles to exert pressure. At one end of the handles is a perforated bulb which contains the liquid, and pressure on the handles forces

an oval plunger into contact with the bulb, causing the liquid to be expelled in the form of a fine spray.

*Lenox Misty Sprayer  
Mfg. Co. 3 E 104 St. N.Y.*

14711  
998

*Indianaapolis Publishing Co. 1700 N. Dearborn St. Chicago, Ill.*



One of the Latest Aids to the Golf Player, a Gauge That Registers Distance and Quality of Shots

### GOLF-STROKE GAUGE HELPS PLAYER IMPROVE GAME

For outdoor or indoor use, a golf-stroke registering gauge now on the market tells the player how far the ball would have gone from the tee, shows if the shot was hooked or sliced and gives other helpful information to aid the player in constructive practice. The instrument rests on the ground or floor without fastenings, weighs seventeen pounds, has a rubber-tired base and is so arranged that the ball is screwed tightly to a projecting arm which rotates on a ball-bearing axle. Yardage is indicated at once on a meter opening at the top. If the ball is topped or lofted, the fact is indicated immediately in small openings on the right side while hooks and slices are registered in the same way at the left. The arm is strongly constructed of steel and is balanced with mer-

cury, while the entire mechanism rotates on an axle also, to help absorb the shock and improve the "feel." The gauge is accurate, easy to use and is intended especially for home or office use during days when play outdoors is not practical.

### FLAME AND WATERPROOFING AGENT FOR WOOD

Fire and waterproofing of woods and textiles is expected to be greatly simplified through the recent development of a series of products under the general name of "arclor," which is a derivative of the chemical compound diphenyl, a milky-colored substance made by uniting two benzene molecules. By adding chlorine in various amounts to this chemical the new series is obtained, ranging in variety from a watery substance to a light amber-colored solid. Commercially, the compound is expected to be used for protective coatings, water and flame-proofing, molding, electrical insulation, adhesives, printing inks, artificial leather, leather finishing, textile finishing, sealing waxes and chewing gum. It is more expensive when used for fireproofing wood than when common mineral salts are used, but it does not leave the wood brittle and lifeless, causing it instead to gain in strength and become a superior product.

### FOOTREST AND FOLDING TABLE FOR THE AUTOMOBILE

Converting the automobile into a tea room for a quick lunch is made possible by a folding table which, when not in use, serves as a footrest for passengers in the rear seat. The interior fitting is attached to the floor of the car, and, when folded, rests at an angle to provide an excellent rest for the feet. When used as a table, the base is turned against the floor and the legs are extended to support the top.

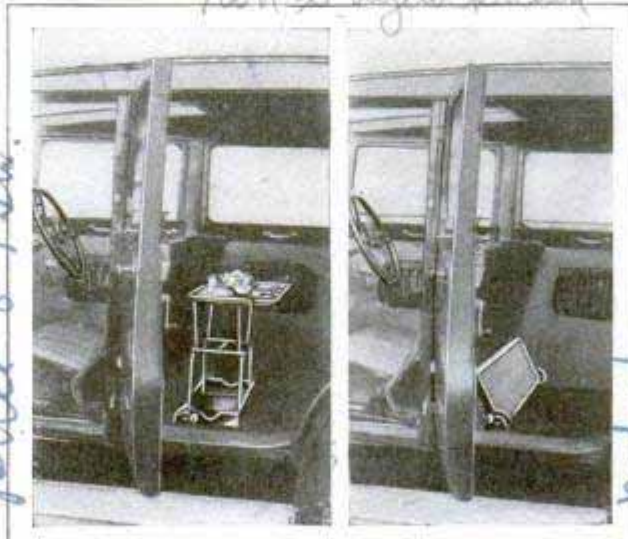

Collapsible Tea Table for the Auto, Which, When Folded, Is Converted into a Footrest

*1201 N. Dearborn Bldg. Indianapolis Ind.*

*Chemist*

*Chrysler, Ltd. Bayard H. Birmingham, Ala.*



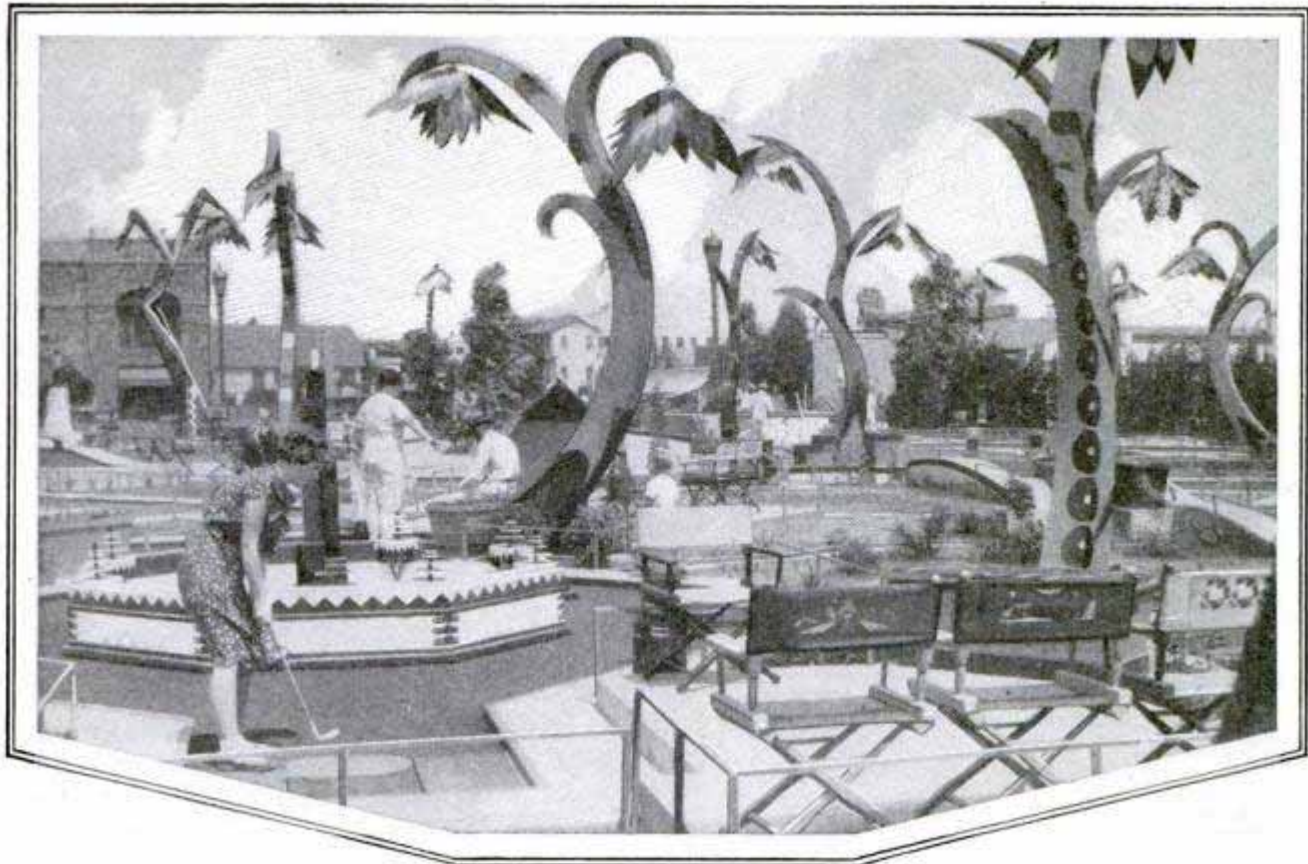

Elaborate Miniature Golf Course Carried Out in Modernistic French Design; One of the Unusual Features Is a Large Lake and Lily Pond with Underwater Illumination at Night

**POOL IS COMBINED WITH GOLF ON BARNYARD COURSE**

*Mary Pickford*

A California miniature golf course which has been made for the private use of a moving-picture actress, is carried out in a modernistic French design. It has a large lake and lily pond with underwater illumination, and artistic bridges and effects, all of the modernistic trend. Among the unusual decorative effects are a number of huge artificial plants. As a variation of miniature golf, a pasture-pool or barnyard-golf course has been opened in Los Angeles. The hazards are made up of various barnyard animals which squawk, moo or quack in realistic fashion when the ball rolls down their throats to the green. The game combines pool and golf, the handle of the putter being used like a billiard cue in teeing off.

half an hour, and at remarkably low cost, at a factory in Siberia. Sixteen kinds of paper, as well as cardboard and glue, have been obtained, and the principal by-product is a fireproof substance that can be made into tile.

**DRILL SHARPENER IS ATTACHED TO A BENCH GRINDER**

For use with a six-inch bench grinder, an inexpensive drill-sharpening attachment now is being offered. It will grind all two-lip drills from the smallest up to thirteen-sixteenths of an inch in diameter. The adjustments for varying diameter and



clearance are made easily, and no mechanical skill is required to operate it. The grinder is mounted on ball bearings and the abra-

sive wheels are balanced to remove vibration. The machine does accurately and almost automatically what heretofore has been done in haphazard fashion, resulting in drill breakage, waste of power and poor workmanship.

**1510. PAPER FROM SEaweEDS**

Seaweed is being used for the manufacture of several grades of paper by a process evolved by a Russian engineer. By means of machinery especially constructed for using seaweed, this material can be converted into paper in less than

*Velijeff*

*Wallace & Co. 134 S. California*

*Wapakat. d. na, 7-22-26 Meade St*

*Feb Bits 9/13/30.*

*Putabygh, Pa \$120.00 f. d.*

Newark Office  
 \$7.50 w/ 226 W. Madison  
 Newark

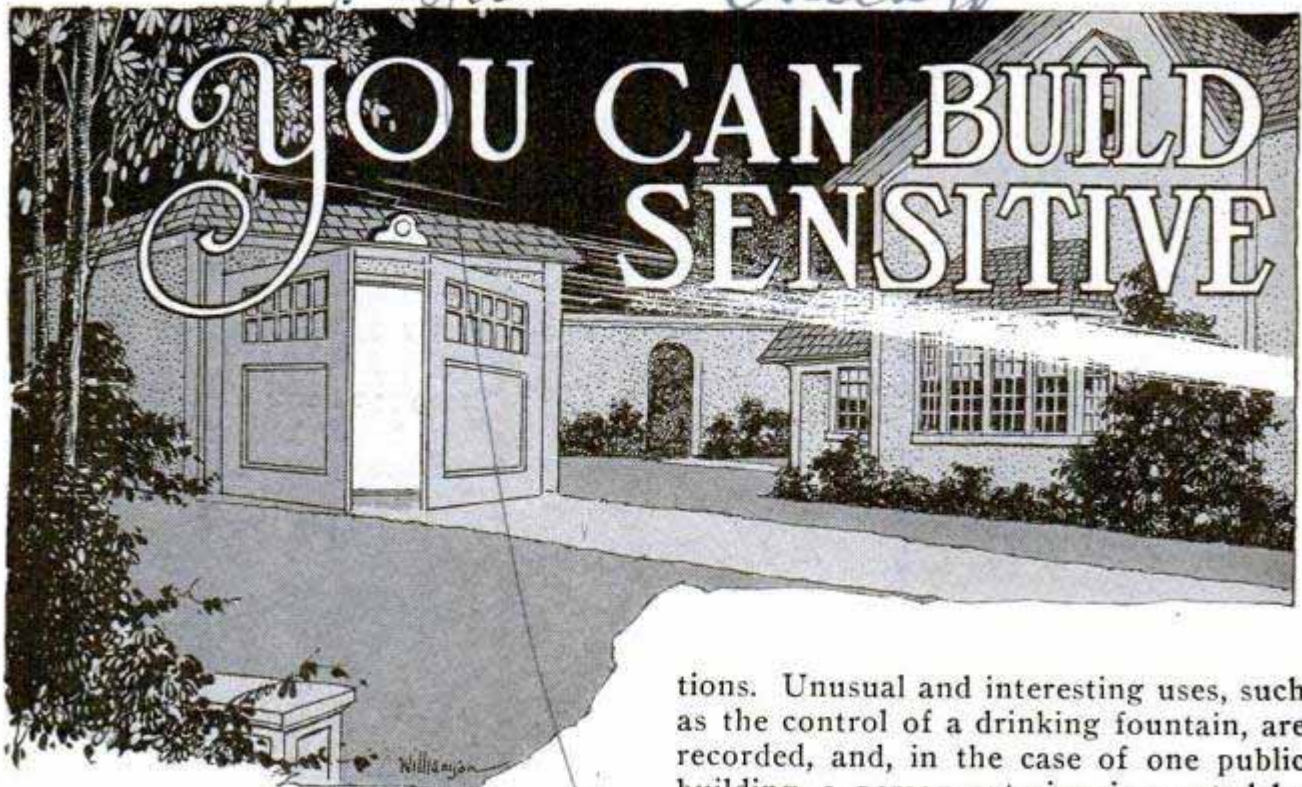

**A**LTHOUGH this relay is very simple, its application is extremely valuable. It has been adapted to various methods of train control, burglar alarms, automatic machinery, color sorting, counting moving objects and numerous other applica-

tions. Unusual and interesting uses, such as the control of a drinking fountain, are recorded, and, in the case of one public building, a person entering is greeted by a pleasant voice which says, "good morning, please sign the register and pass on"; a light-sensitive relay and an electrically operated phonograph do the trick. A garage can be lighted and the doors opened merely by directing the beam of a spotlight upon the light-sensitive relay as the car comes up the drive. All that is necessary in this case is the relay and an electrically driven device for opening the doors.

The relay consists of a light-sensitive cell, more commonly known as a photo-electric cell. This cell converts light rays, when directed through its window, into electrical current. The current from the cell is then applied to the input of a vacuum tube and amplified several hundred times. In the output circuit of the vacuum tube is connected a small, sensitive current relay, which is thus operated indirectly by light applied to the photo-electric cell.

You will note that the relay described here has been built in two parts, a small

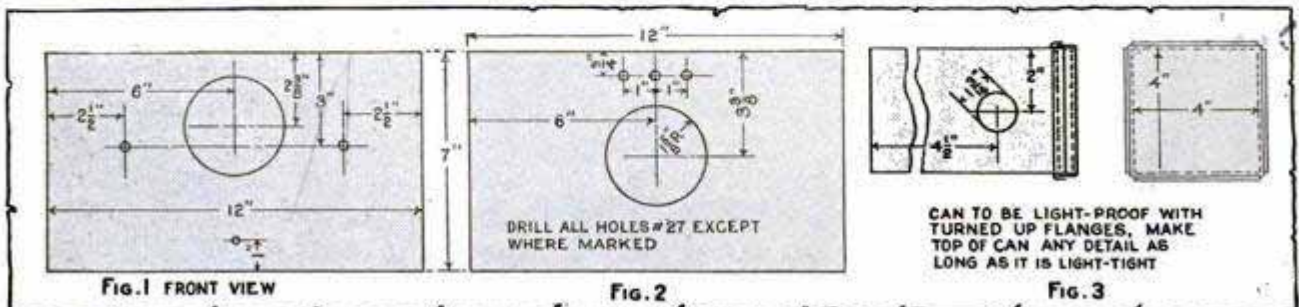

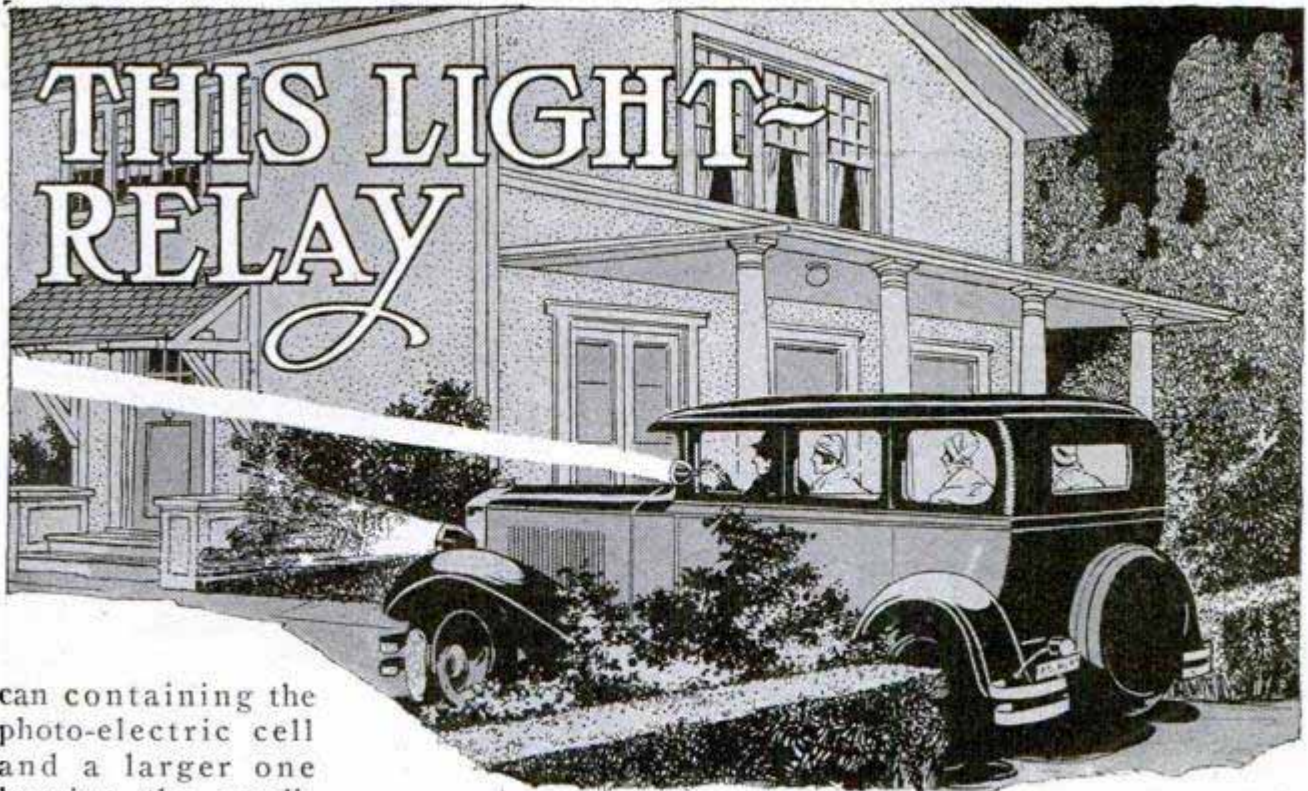

can containing the photo-electric cell and a larger one housing the amplifier, controls and necessary batteries for operation. The reason for this is apparent, as it enables the user to place the cell in almost any position, or direction, without moving the large amplifier.

The large metal box may be made of either copper or aluminum and measures 12 in. long, 7 in. wide and 7 in. high. The front detail is shown in Fig. 1, the size of the hole depending on the make of milliammeter used. Fig. 2 shows the detail of the top cover, on which the sensitive relay is mounted with its three control points brought out to insulated binding posts mounted toward the rear, as shown in the photos. This No. 1 relay is a d.c. flush type adjusted to make con-

tact at zero and 2 milliamp., respectively, and its position in the circuit is shown in Fig. 4.

The light-proof can for the photo-electric cell is detailed in Fig. 3 and it will be noted, in the photo above, that a short metal hood is soldered around the hole in the side of the can to assist in concentrating the light beam on the cell. This cell box is made of light metal and is just large enough to house the cell and its standard X-type four-prong socket. The housing boxes are both finished in black crystalline enamel.

The simplified wiring diagram is given

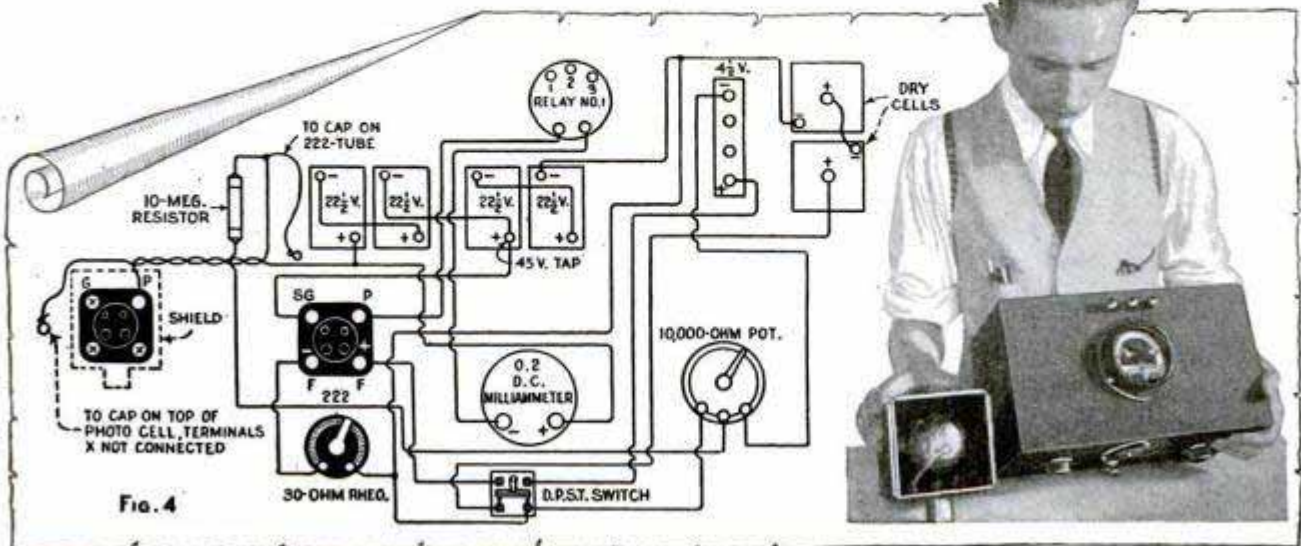

in Fig. 4, and the parts are shown as nearly as possible in the same positions as they occupy in the boxes. All controls are mounted on the front, where they are easily accessible. For the sake of simplicity the switch that breaks the 3-volt and 4½-volt battery circuits is shown as a knife-blade type in Fig. 4. This switch, however, may be any of the standard two-circuit panel-mounting types, double-pole, single-throw. A complete list of materials is available upon application.

Mount all of the instruments and complete as much of the wiring as possible before placing the batteries in position.

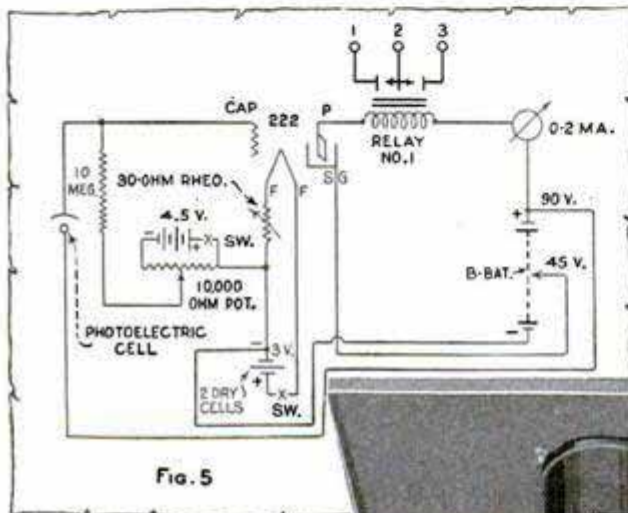

Fig. 5

Use well-insulated flexible hookup wire for all leads and make these leads as short as possible except the two leading to the posts on the relay mounted on the cover. These leads should terminate in lugs so that they can be quickly detached when it is necessary to remove the cover.

The four small 22½-volt B-batteries are arranged on the bottom of the can at the rear and are held in position by means of a strip of fiber or bakelite which is fastened to the side of the can at the left with a small bracket and at the right by a long threaded rod through the strip and the bottom of the can. The 4½-volt battery and the two dry cells for the 3-volt battery then fit snugly at the right of the B-batteries as shown. Be very careful

not to let any of the relay terminals become shorted on can when removing lid.

As shown in the diagram, a screen-grid tube is used, with 45 volts on the screen and 90 volts on the plate. The 4½-volt C-battery is shunted with a 10,000-ohm variable resistor of the potentiometer type, making it possible to vary the bias on the tube from 0 to 4½ volts negative. The filament current for the tube is supplied by the two dry cells. The two-circuit switch breaks both the filament current and C-bias, thus preventing the current drain on the C-battery which would occur because the potentiometer is shunted across it. Relay No. 1 used in this instrument will break up to and including 100 milliamp., for such purposes as controlling receivers or for the operation of any apparatus within this current-drain limit. For heavier currents it is necessary to make this relay break the larger relay, No. 2, as shown in Fig. 7, and in this case a 6-volt battery is connected in series with the second relay as shown.

The sensitivity of relay No. 1 may be varied, making it possible to break the circuit with the slightest trace of light, or with a fairly intense beam. For example, adjust the meter to about 1.9 milliamp. and note that the relay is almost closed. This will have to be done with the photo-electric cell receiving a small and constant amount of light. Now, exposing the cell to a very small increase of light, such as that reflected from one's shirt, or

reflected to the cell from a piece of white paper, as shown in the photo on page 1003, will click the relay shut.

To make the relay less sensitive, simply apply more C-bias and cut the plate current down; it will then be noted that it is necessary to direct considerably more light on the cell in order to increase the plate current enough to operate the relay. This is necessary when the constant room light is of normal strength and also applies when the device is operated out of doors. After a few simple experiments

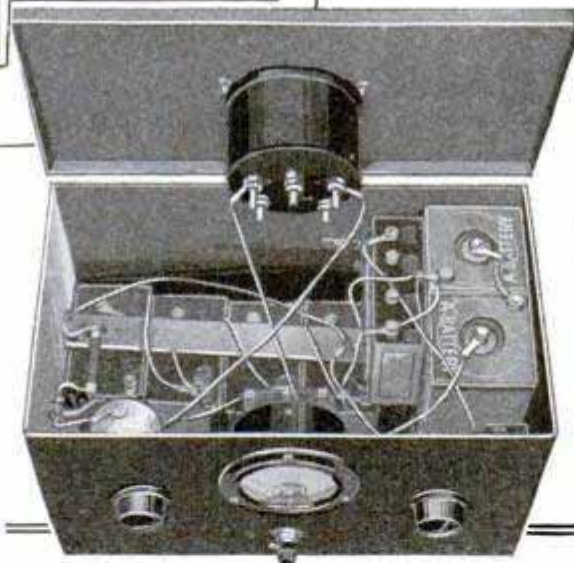

the builder will find that the adjustment of the relay is very simple, and he can make or break circuits at will.

A layout diagram for a color-matching box is shown in Fig. 6. The photo-electric cell is placed in one section of this light-tight box and an ordinary mazda lamp in another compartment to serve as a constant light source. The windows are of clear glass and the box should be made of metal and well grounded. The light is focused through the lens on a piece of material inserted in the testing slot, and light from the material is reflected to the cell. The various pieces of material to be compared are then inserted in the testing slot, one at a

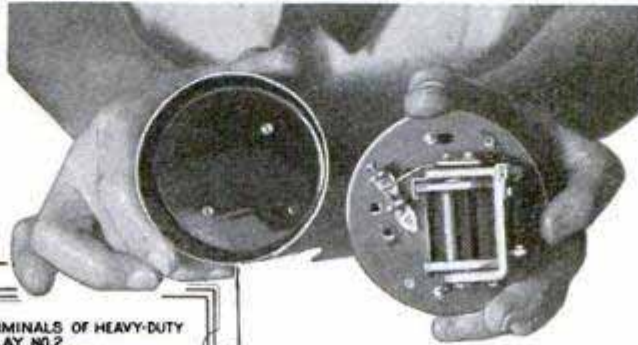
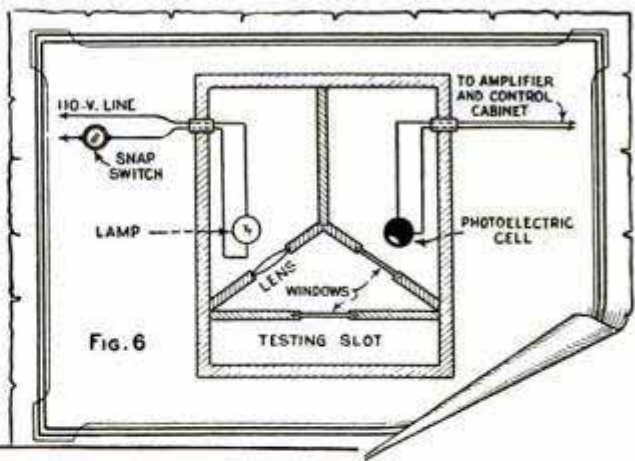

and very inexpensive. With this added relay it is possible to break heavier loads and control the operation of small motors and many electrically

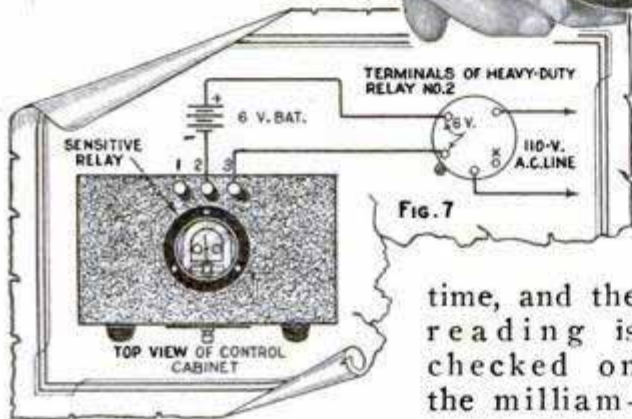

time, and the reading is checked on the milliammeter of the

amplifier which is in the control box.

Color screens, obtainable from the photographers' supply houses, may be used for greater accuracy if desired. Several different color screens may be used to check both samples, and if the meter readings are the same with each sample as checked through the screens, the colors are identical. The screens slide over the testing-slot window. It is not possible to cover the many useful applications in this article but the suggestions given will enable the builder to work out interesting adaptations and experiments for himself.

One precaution that the user should take, is not to subject the cell to very strong light, as this will ionize the cell, shortening its life and reducing its sensitivity. Also bear in mind that the milliammeter serves as a check and warning of overloads on the relay. At the first indication of overloading add relay No. 2, shown in Fig. 7. This is a rugged relay

operated devices about the home. The terminal marked X on this relay corresponds in effect to post 1 on relay No. 1 and permits the operator to either make or break the circuit as he wishes or to make one circuit and break another. In all cases, however, the No. 2 post on relay No. 1 is a fixed connection, or, in other words, the unbroken line, and the other side of the line is the pivot point for the make-and-break contacts.

### Sponge Remedies "Squawk" in Loud Speaker

The writer, having a loud speaker that had a tendency to squawk or blast on certain notes, found a simple means of stopping the trouble, and the idea may be of benefit to others. The cause is usually some movable part that vibrates violently at a particular frequency. Speakers having thin metal diaphragms between the pole pieces, driving a small cone, are sometimes subject to this trouble. The remedy is a small piece of rubber sponge, about  $\frac{1}{2}$  in. square, wedged next to the diaphragm. If this does not stop the trouble, try it on the other side of the diaphragm, or on both. A little experimenting will locate the vibrating part.—J. D. Disbrow, Cleveland, Ohio.

# Hints and Kinks



Above, Locating Trouble in Power Unit with Neon Tester for High-Voltage Circuits; Below, an Easily Made Jig to File Off Machine Screws Evenly without Damaging Threads; Left, a Small Vacuum Cup, Mounted as Shown, Makes an Excellent Device for Adjusting Delicate Apparatus without Adding Hand Capacity

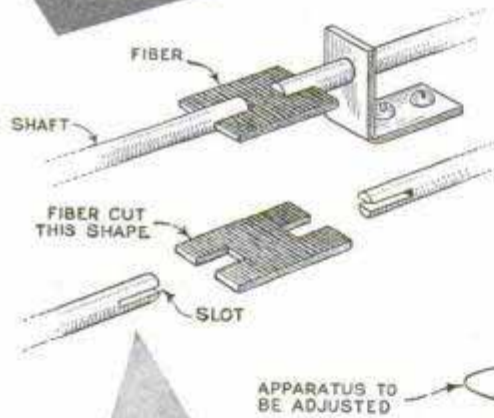

APPARATUS TO BE ADJUSTED

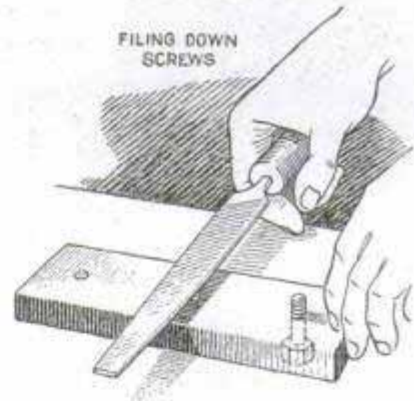
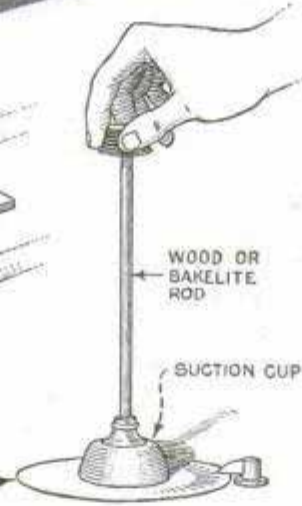

Upper Left, Insulated Shaft Coupling for Short-Wave Receivers; Lower Left, with Power On, Touch Cord Tips Together to Determine Amount of Dynamic-Speaker Hum; Right, Mounting Binding Posts on Small Parts for Experimental Circuits

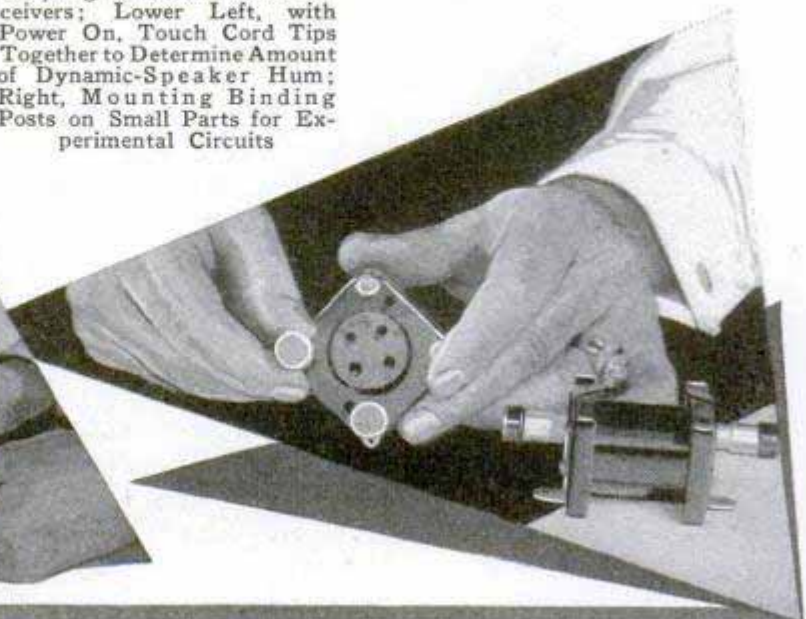

# from the Radio Lab.

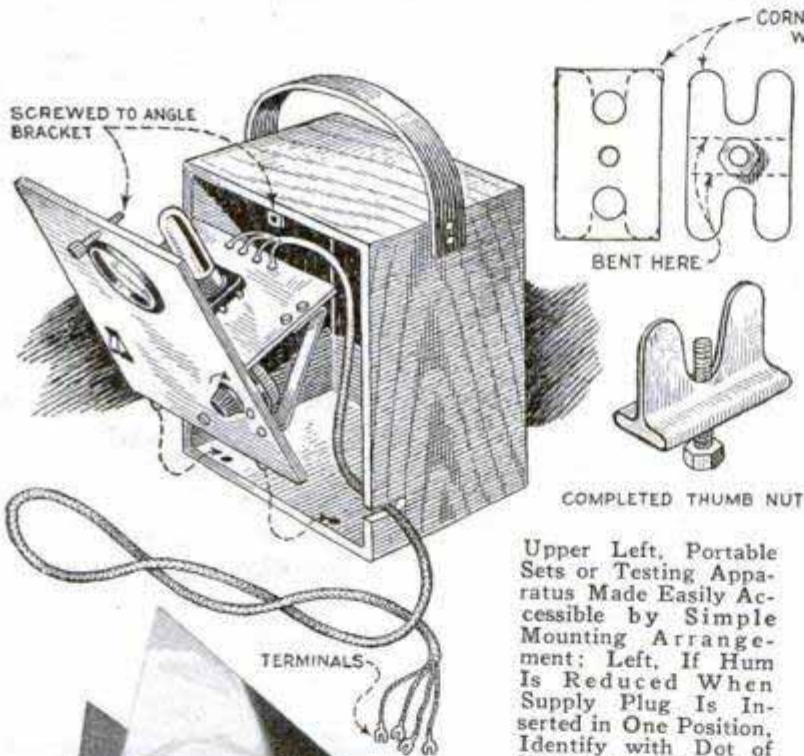

Above, for Accurate Receiver Tests Tubes Should Be Checked under Actual Operating Conditions; Left, a Handy Thumbnut for Quick Connections May Easily Be Made from Light Sheet Metal, Drilled and Cut as Shown; Bending the Sheet Metal over the Brass Nut Prevents It from Turning; If Stronger Construction Is Desired, Solder Nut to the Stock

Upper Left, Portable Sets or Testing Apparatus Made Easily Accessible by Simple Mounting Arrangement; Left, If Hum Is Reduced When Supply Plug Is Inserted in One Position, Identify with Dot of White on Plug and Socket; Right, Cone Speakers Need Occasional Adjustment for Atmospheric Changes

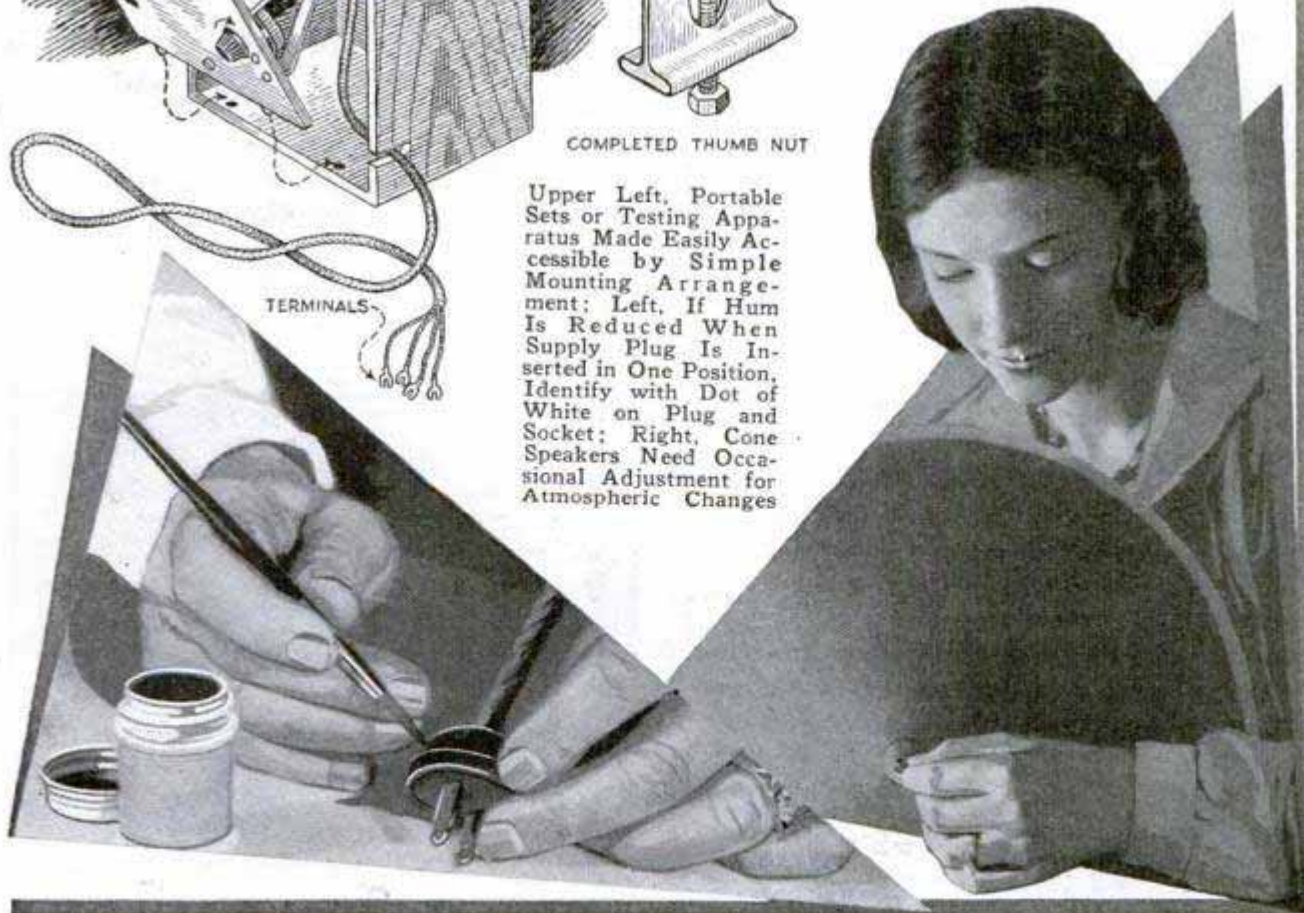

## How to Alter A.C. Eliminators for D. C. Operation

Many radio listeners, who have moved from districts supplied with 60-cycle a.c.



to localities where the power supply is d.c., find that their eliminators are no longer

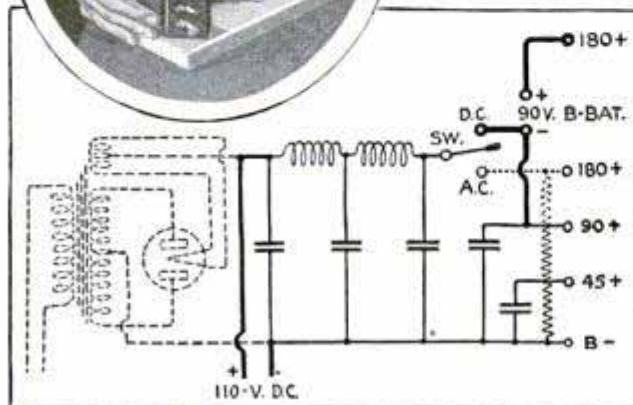

Power-Pack Eliminator Assembly for A.C. and, Below, Diagram Showing Connections for D.C. Operation

suitable for operating the receiver. The circuit diagram explains the nature of the changes that must be made in an a.c. eliminator to convert it to d.c. The dotted lines indicate the parts which are removed, and the heavy lines the connections added. The transformer and rectifier tube are no longer used, but the choke and the entire filter section of the eliminator are retained. The filter section consists of the various filter condensers, choke coils and voltage divider. This voltage divider appears at the front in the insert photo and happens to be a housed adjustable type. The next two units are the filter-condenser blocks, and the power transformer is at the rear. The choke coils in this case are in the transformer housing, the terminals being marked No. 1 for the input, C for center tap and No. 2 for the output. Find the C-lead between the tube-filament supply terminals of the power transformer; it will be found that this lead goes to the input terminal of the choke coil where the positive 110-volt d.c. lead is to be connected. Trace the C-lead from the high-voltage secondary of the power transformer, which will be found between terminals marked H and H on the case, and connect the negative

d.c. lead as shown. To find the polarity of the d.c. line, hold the bared ends of the supply line about 1 in. apart in a glass of salt water. Tiny bubbles will immediately appear at both ends, but more about the negative terminal. By means of the single-pole, double-throw switch the operator may quickly change from d.c. to a.c. operation at will; this switch may be omitted and the new connections made direct if desired. In either case it is necessary to make the change shown in the voltage divider as the approximate 100-volt output, when operated on the d.c. supply, will not give the correct voltages at the various taps as when formerly connected. If the original output was 180 volts, it will be necessary to connect two 45-volt B-batteries in series and insert them as shown, cutting out the original 180-volt tap. In case the total output was originally only 135 volts, only one 45-volt unit is necessary. The taps below 90 will supply the same voltages as before. The added batteries will have a long life and will be found to be very quiet in operation.—Elmore B. Lyford, New York City.

## Short-Wave Receiver in Unit Form

The short-wave receiver illustrated is a new unit assembly which allows maximum flexibility and the use of two, three or four units together as complete receivers. The simplest arrangement is the detector stage and audio unit combined. To this may be added the first r.f. stage, and later the second r.f. stage. For maximum range and audibility, the complete four units are suggested. Each unit is

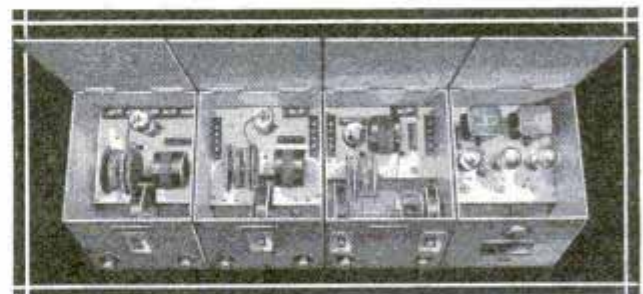

Unit Type Short-Wave Receiver, Showing Hinged Lids Raised to Show Internal Construction

in an individual aluminum case, with hinged top and sloping front panel. The cases afford double shielding between the units, so essential in high-frequency receiver design.

*C. B. Leuty, Pa.*



## SIMPLE DEVICE FOR IMPROVING SELECTIVITY

An old bakelite socket of the UV-type, a .00035-mfd. variable condenser, a piece of scrap

consists of a single winding, a primary of 10 turns must be added near the filament end of the

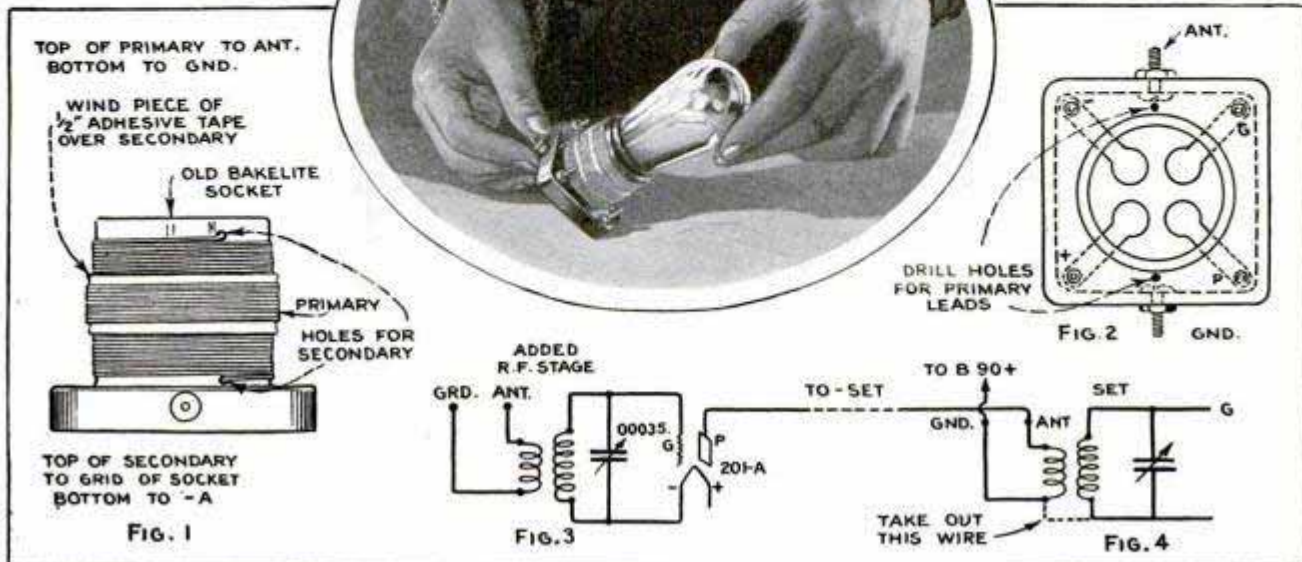

panel material fastened to a small base-board, and a little wire, is all that is necessary to construct a very useful r.f. stage. This may be connected to any battery-operated receiver and will work very nicely if instructions are carefully followed. The coils are wound on the bakelite shell of the socket as shown in Fig 1, No. 28 d.s.c. or d.c.c. wire being used. The base of the socket is drilled to take two small brass machine screws and nuts to act as antenna and ground binding posts, as shown in Fig. 2. Wind as many turns as possible in a single layer on the form for the secondary, leaving  $\frac{1}{16}$  in. space at the top. The top end of the secondary goes to the grid post of the socket and the bottom to negative-A. A strip of adhesive tape,  $\frac{1}{2}$  in. wide, is wound around the secondary, and the primary, consisting of 30 turns, is wound over this tape. The top of the primary winding is connected to the antenna post and the bottom to the ground post.

Before you attempt to make the connections shown in Fig. 3, examine the antenna-coupling coil in the receiver, Fig. 4, to see just how it is constructed. If it consists of a primary and secondary coil joined together, as indicated by the dotted line, this wire should be cut away to separate the two coils. If the antenna coil

coil, so that the original coil becomes the secondary. One end of the primary winding, formerly the ground end, is taken to the 90-volt B-tap, and the antenna end is connected to P of the added socket. A 201-A tube is used in this socket, and its filament supply is obtained direct from the A-battery with a suitable filament-control ballast or rheostat in one side of the supply line.

#### Protecting Tubes That Are Lighted by Thirty-Two-Volt Supply

When the 32-volt farm-lighting current is used to light the filaments of the radio tubes through a resistor, cutting the supply down to 6 volts, there is some danger of burning out the vacuum tubes owing to the possibility of the lighting circuit becoming grounded. This rather expensive loss may be avoided by connecting a large fixed condenser, of about 2 mfd., in series with the ground lead from the set. This does not interfere in any way with good reception and isolates the radio set from a direct ground, thus preventing possible short circuits.

☞ For further information on any radio construction article write to the radio department; this service is free.

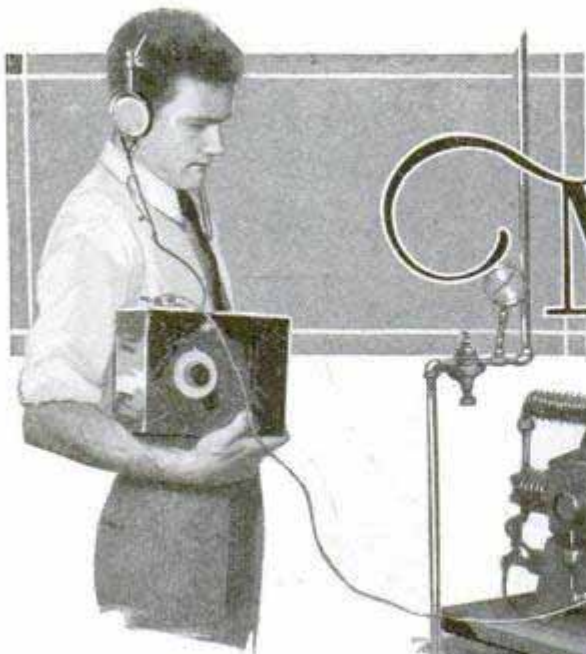

# It's Easy Man-Made

insulators that have allowed the line to drop down onto crossarms. Power lines running through or near trees are frequent offenders, as during wind and sleet storms leaks commonly occur. In towns and cities, power-line leaks will be found in defective transformers located in some near-by alley; poor grounds are also sources

**I**NTERFERENCE, especially the "man-made" variety, is in some instances so bad that it is impossible to use a radio receiver at certain times. The trouble in most every case is caused by some electrical device located in the near vicinity of the receiver. Refrigerators, vacuum cleaners, fans, oil burners, washing machines and, in fact, any electrically operated device may be the offender. An additional and very common cause of interference, especially in rural districts,

of annoying interference, and all such man-made static makers are quite difficult to locate unless the investigator equips himself with some such portable device as the one illustrated and described in this article.

The simple "interference hound" described here is a detector of the non-regenerative type, followed by one stage of audio in order to build up the signal strength in the phones to something like that picked up by the receiver in the home. It is designed to tune over the entire broadcast band, where the interference causes the trouble.

The instrument may be built into any of the large commercial stage-shields, but the one shown in the photos was housed in a homemade copper box, 7 by 9 by 4½ in., as detailed in the diagrams shown in Fig. 1. The back is made removable to permit the operator to get at the tubes and batteries when necessary. The completed instrument weighs only 8¾ lb. and can be carried about with ease. The rear-view photo and simplified wiring diagram, Fig. 2, show the arrangement of the various parts. The sockets for the two type-199 tubes are of the subpanel-mounting type, but in this case they are elevated above the base of the can by means of 1-in. lengths of fiber tubing. Two of these supports are used for each socket and 1¼-in.

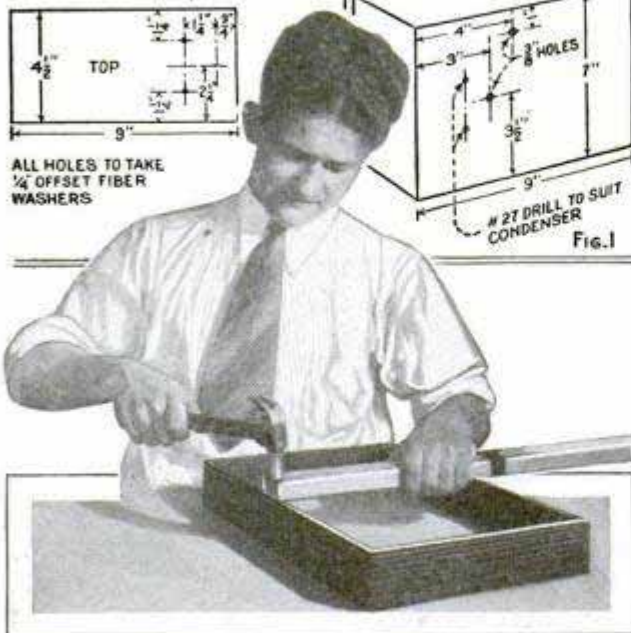

are power-line leaks. These leaks may be caused by leaking insulators, or broken

# to Locate Static Sources

by  
**J.O. Barnes**

brass machine screws hold the assembly to the base of the can in the position shown in the photo.

The two small 22½-volt B-batteries are placed on end and fit snugly in the left end of the can. A thin strip of metal, 1 in. wide and 9 in. long, is bent over for ¼ in. to form a retaining bracket to hold the B-batteries in position, as shown in the photo. This strip is cut back along the ¼-in. bend for 1 in. at each end and the narrow section is cut away from these ends to permit a ¾-in. right-angle bend at the ends for fastening the strip to the can.

The filament-lighting battery consists of one 4½-volt C-battery mounted first on the base of the can at the right, and it is held in position by a 1 by 1-in. bracket. One end of this bracket is drilled to take the positive terminal of this filament battery and the other end is drilled to take a short machine screw which fastens the bracket to the can. This makes the can the positive side of the filament battery, therefore the positive filament posts of the two tube sockets are connected directly to the can. The negative end of the B-battery is connected to the socket-mounting bracket screw which makes the B-negative A-positive connection to the can.

The front of the can is now drilled for mounting the variable condenser and the filament battery switch. The variable condenser just clears the 4½-volt battery and is mounted in the position shown so that the rotor plates turn out toward the center of the can.

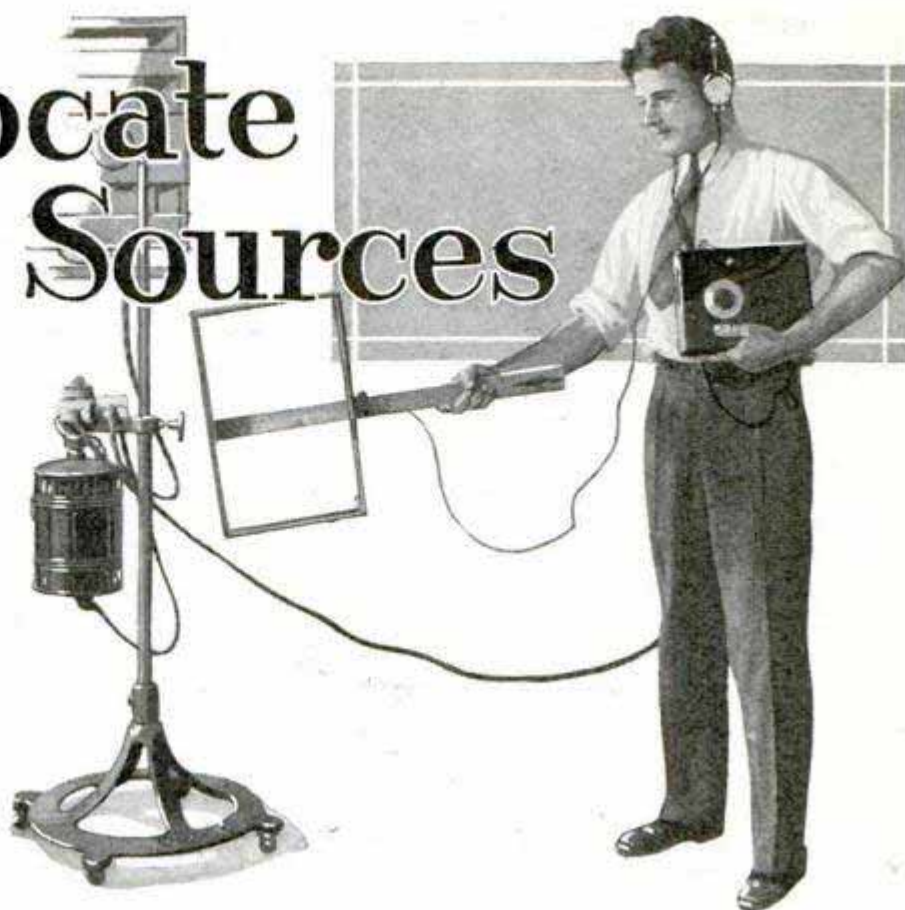

The coil for the tuned input is wound on a cardboard or bakelite tube, 1½ in. in diameter and 2½ in. long. Sixty turns of No. 32 enameled wire is wound on the tube, and the start and finishing ends of

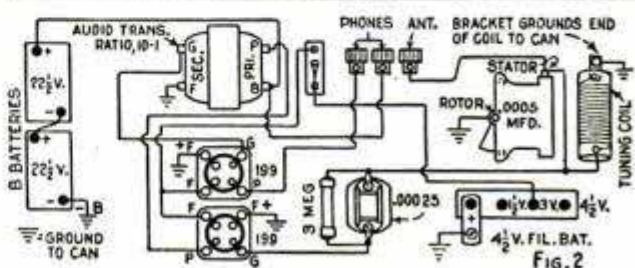
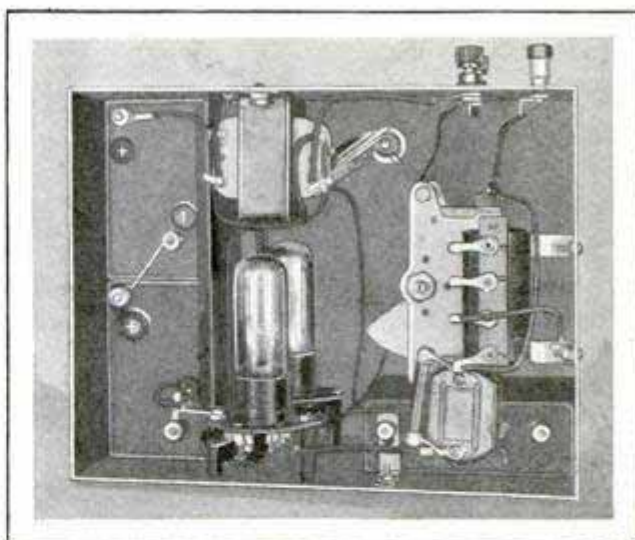

the coil are soldered to lugs mounted under short brass machine screws at each end. The coil shown in the photo was a manufactured type provided with extra taps which were not used in this circuit. Fig. 2 shows the coil at the right; note that the coil is grounded to the can on the mounting bracket at one end and the free end of the coil goes to the stator of the variable condenser and to the grid-leak and condenser of the detector tube. This gridleak and grid-condenser assembly is supported directly by the free-end termi-

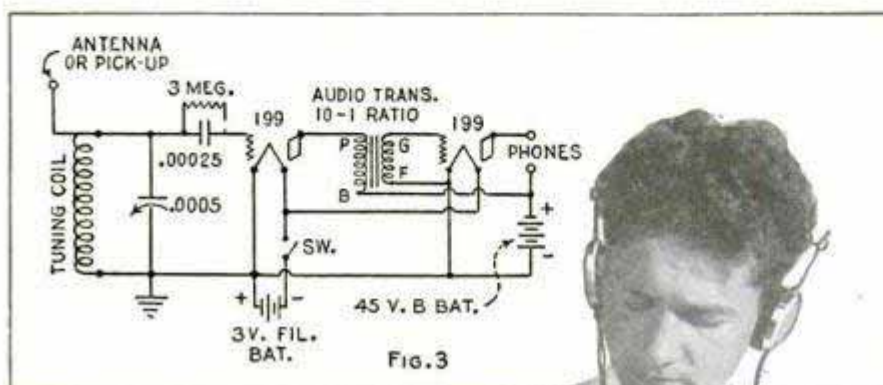

Fig. 3

nal lug mounted on the coil form.

The audio-frequency amplifying transformer is an inexpensive, unshielded, replacement type having a ratio of 10 to 1. It is mounted upside down to the top of the can, directly above the tube sockets. All wiring should be done with flexible insulated hookup wire. The filament switch shown in the simplified wiring diagram is a single-pole, single-throw type and is shown in this manner for simplicity; this type can be used by the builder, or any standard battery switch as desired.

The high ratio of the audio transformer is necessary for high gain, the response of which is not important, inasmuch as quality is of no concern. The binding posts for the phones and for the antenna or pick-up device are mounted on the top of the can, as shown in the photo on this

page, and must all be carefully insulated from the can. This can be done by drilling holes slightly larger than necessary for the binding posts and using fiber washers above and below the top of the can to hold the posts away from the metal. When mounting and insulating posts in this manner, test each post with a voltmeter or phones in series with a small battery, to be sure that they are not grounded to the can, before wiring them into the circuit.

The antenna or feeler may be a simple loop wound on a frame, as shown in the photo on page 1008. A sectional bamboo fishing rod will make an excellent extension handle for a small loop when using it near power lines, but for the usual application a short wood handle will answer the purpose. In some cases, a feeler in the form of a single wire from this post and a small glass insulator on the opposite end with a hook fastened to it may be hooked directly onto the apparatus to be tested, giving a greater strength to the received signal, where the noise seems to be too feeble with the pick-up coil. This method, however, is not to be used around power lines, as the loop, even though quite a distance away

from sources of power-line interference, will pick up a good loud signal.

### Light-Socket Antenna Kink

When using a light-socket antenna device consisting of a small fixed condenser, it is a good plan to connect a common 110-volt low-amperage fuse in series with the device to prevent burning out the coils in the set. Unless this precaution is taken, the condenser may break down and short-circuit the house-lighting current to the ground, causing serious injury to the set.—Harry L. Wynn, Derry, Pa.

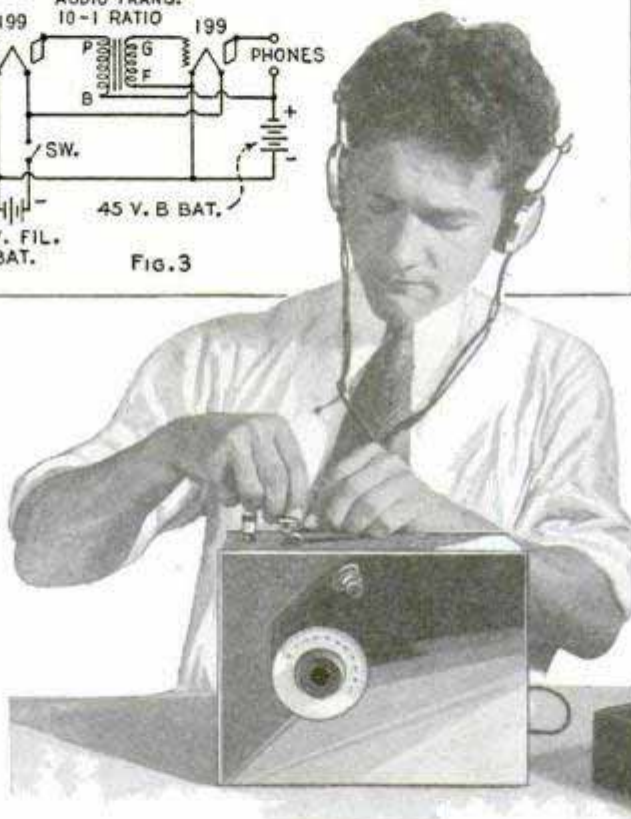

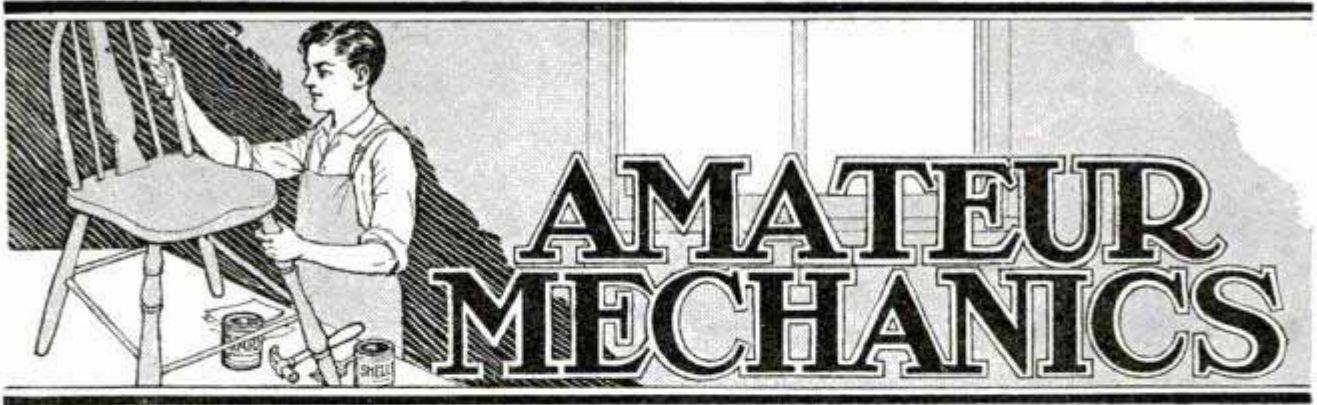

## Amusing Toys Easy to Make

**T**ONY, the climbing monkey, climbs a rope in much the same manner as his live prototype, the organ-grinder's monkey, who is frequently seen on the city streets. Just pull the string and the monkey will climb to the top, the friction on the nails between his legs being greater than that of the felt between his hands. The moment you slacken the cord, the elastic bands pull the legs up, allowing the little fellow to get a fresh grip. Pulling the cord and then letting it slacken a little, pulling and slackening, etc., is the method used in making him climb. The legs, arms and body are cut from  $\frac{1}{2}$ -in. basswood. Each part is filed and sandpapered smooth

until all saw marks have been removed. Place the arms in the proper position and fasten them to the body rigidly by means of two 1-in. finishing nails or brads. The legs must be pivoted at the hips as shown,  $\frac{3}{4}$ -in. nails being



This Wooden Monkey Climbs a Cord in Real Monkey Fashion; Any Boy Handy with Tools Can Make It

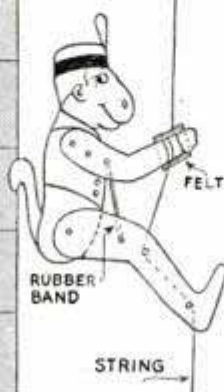
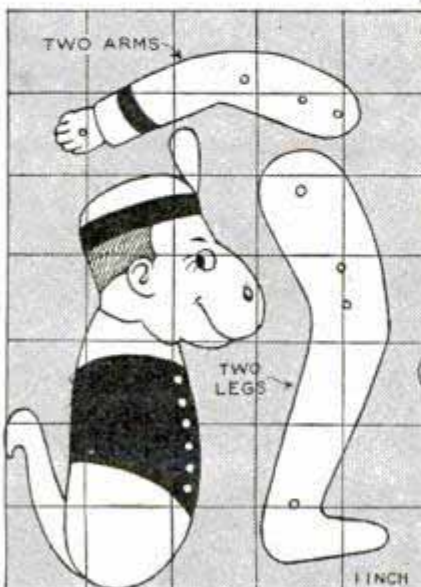

used. Cut two  $\frac{1}{2}$ -in. square pieces of felt to fit between the hands and glue and brad these pieces in place. Fasten a rubber band from each arm to the leg on the same side so that the band will hold the leg practically parallel to the arm. Drive two more nails through the legs at the points indicated, and then pass a length of strong cord between the legs, over the nails and between the felt grips of the hands, just as shown.

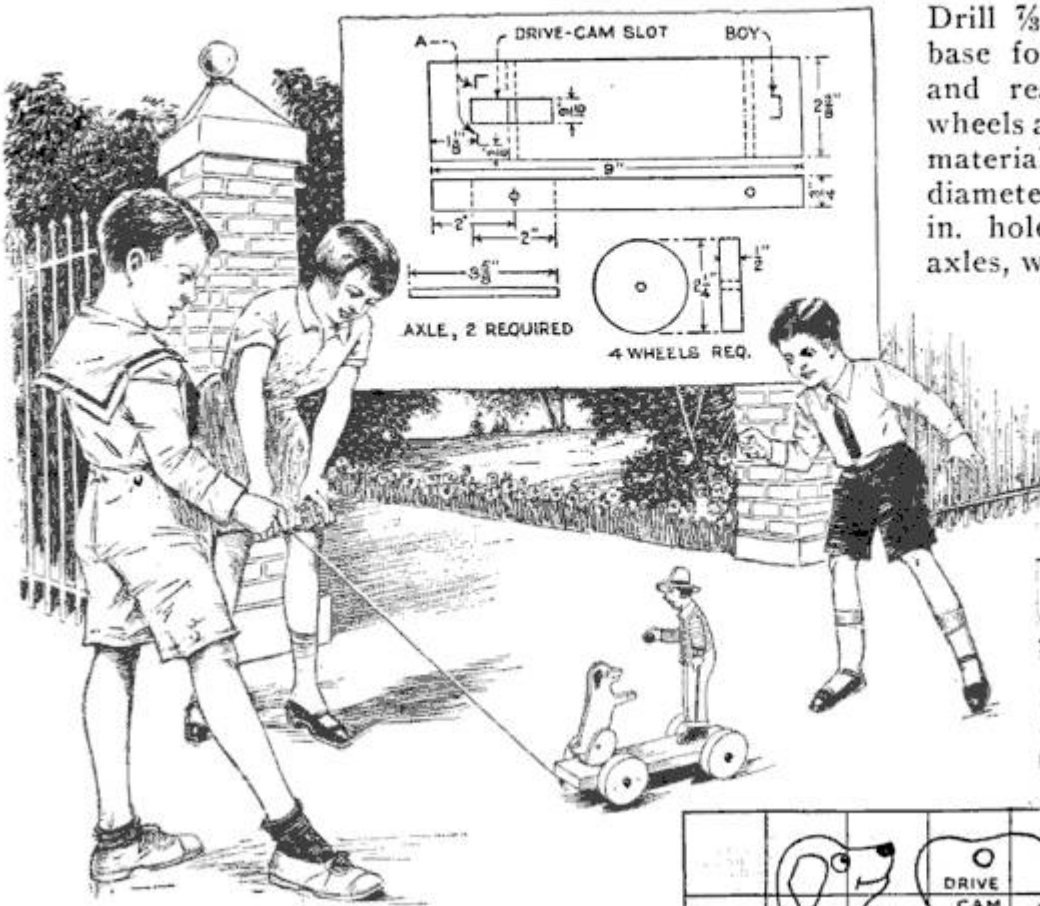

Here Is a Wooden Pup That Jumps Up for a Bite to Eat, Just Like a Real Dog

Another animated wooden toy, which has been found highly amusing to the youngsters, is the begging pup shown in the second illustration. It is so constructed that it moves up and down when the cart on which it is mounted is pulled along, producing the same motion as a live puppy jumping for a bite to eat. To produce this effect, the dog is operated by means of a cam driven by a dowel rod which forms the axle of the rear wheels. The puppy stands erect during one half turn of the wheels, sits down during a quarter turn and rises during the last quarter turn, coming down immediately and starting all over again. The pattern is drawn full size and can be traced directly onto the wood. Use  $\frac{1}{2}$ -in. basswood for all parts except the base. Cut out the parts with a coping saw and smooth all the irregularities produced by the saw with a file, followed by a medium grade of sandpaper. Drill  $\frac{3}{16}$ -in. holes in the legs and body, and also in the cam. Cut the base out of material about  $\frac{3}{4}$  in. thick, 9 in. long and  $2\frac{3}{4}$  in. wide. The location and size of the slot to be cut in the base for the cam are shown in the drawing.

Drill  $\frac{7}{32}$ -in. holes in the base for both the front and rear axles. The wheels are cut from  $\frac{1}{2}$ -in. material, are  $2\frac{1}{4}$  in. in diameter and have a  $\frac{3}{16}$ -in. hole drilled for the axles, which are cut from  $\frac{3}{16}$ -in. dowel-rod material,  $3\frac{5}{8}$  in. long. To assemble the

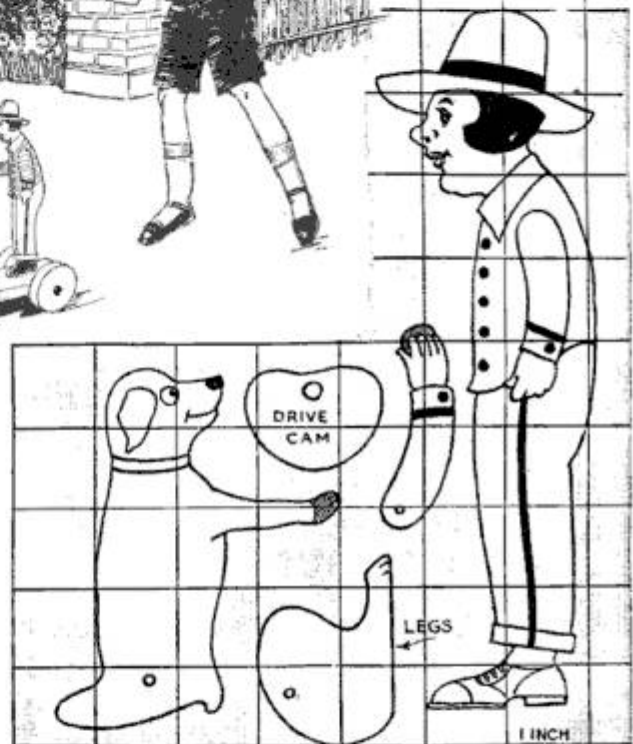

toy, first place the cam in the slot in the base, slide the axle through the hole in the base and the cam, and out through the opposite side of the base far enough so that the wheels can be glued on the ends. A drop of glue will hold the wheels and cam in place. In order to get the correct motion of the puppy, it is necessary to glue the hind legs at the exact location shown by "A" in the upper detail of the drawing. The holes in the legs should be directly over the axle. Use a  $\frac{3}{16}$ -in. dowel rod to pivot the body in place, gluing the ends in the holes drilled in the legs. Allow the body of the dog to move freely. The figure of a standing boy is similarly cut out of  $\frac{1}{2}$ -in. basswood. One arm is extended as if feeding the dog but the arm is securely fastened to the body. Use either paint or lacquer to decorate the toys over a good priming coat of shellac.

### Electric Fan Prevents Photos from Sticking to Ferrotypes Plates

When applied to ferrotypes it is quite customary to dry the photographic prints in the sun or in a drier, which often bakes the prints onto the surface and results in a large percentage of loss when removing them. Prints seldom if ever stick to the ferrotypes if an electric fan is used to direct a current of air against them. When dry, the prints usually drop off the plates or can readily be removed. The saving in paper and time is far greater than the cost of the fan and the current to run it. Of course, your ferrotypes must be perfectly clean or the prints will stick under any circumstances.

### Tool Clamps Wire on Hose

The tool shown in the drawing is used for applying wire on hose when binding it to couplings, or to bind together bundles of drill rod or round stock. It consists of a screw handle, a tapped cross-member with two holes to receive the wire and setscrews to hold the wire tight, and a guide block to hold both the wire and the end of the screw, a seat being drilled on the top side for the latter. The wire is looped double, and the ends are fastened in the crossmember by the setscrews. The handle is then tightened, and the whole device swung over toward one side, which

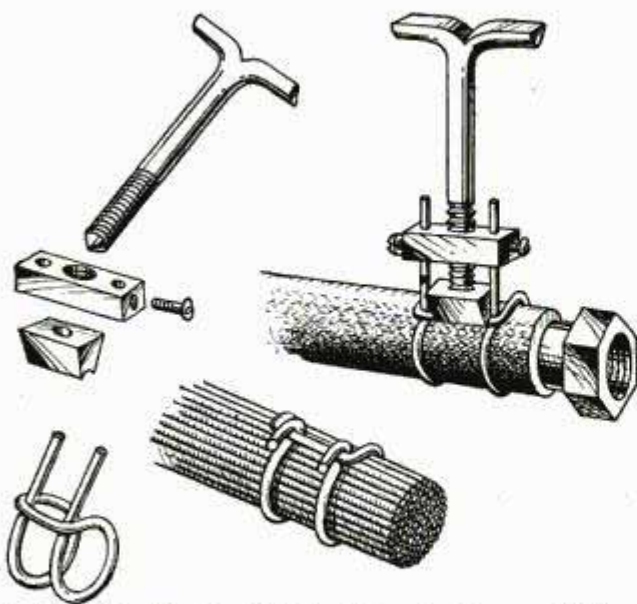

Easily Made Tool for Binding Wire to Hose and Tying Bundles of Drill Rod

action ties the wire as indicated.—Chas. H. Willey, West Concord, N. H.



Oilcloth Table Cover Rolled Up on a Curtain Rod When Not in Use

### "Roll-Away" Cover for the Kitchen Table Mounted on Shade Roller

Oilcloth, mounted on a window-shade roller, so that it can be rolled up against the wall out of the way, as shown in the drawing, makes an ideal covering for the kitchen table. The oilcloth should be mounted with the shiny surface passing over the top of the roller. A hem should be sewed at the outer edge of the oilcloth for a window-shade stick. Art transfers or stencils will add materially to the appearance of the cover.—C. M. Perkins, Laguna Beach, Calif.

### Fish Saved by Wet Hands

Millions of small fish may be saved each year to grow into large fish if anglers would follow one simple rule: Wet the hands thoroughly when taking little fish off the hook preparatory to releasing them. The fish should be handled gently and released under water, not thrown back. A dry hand destroys the protective film on the fish's body, which, once removed, permits fungus to attach itself to the body of the fish, and eventually kills it.—John B. Behrends, Chicago, Ill.

## CHEAP BOX CAMERAS TAKE STEREOSCOPIC VIEWS



Homemade Stereoscopic Camera and Device for Operating Shutters at the Same Time

of one trip is directly transmitted to the other. The drawing also shows how the two cameras are fastened together side

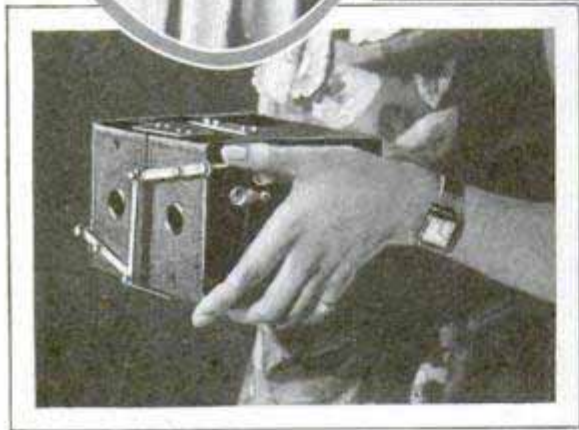
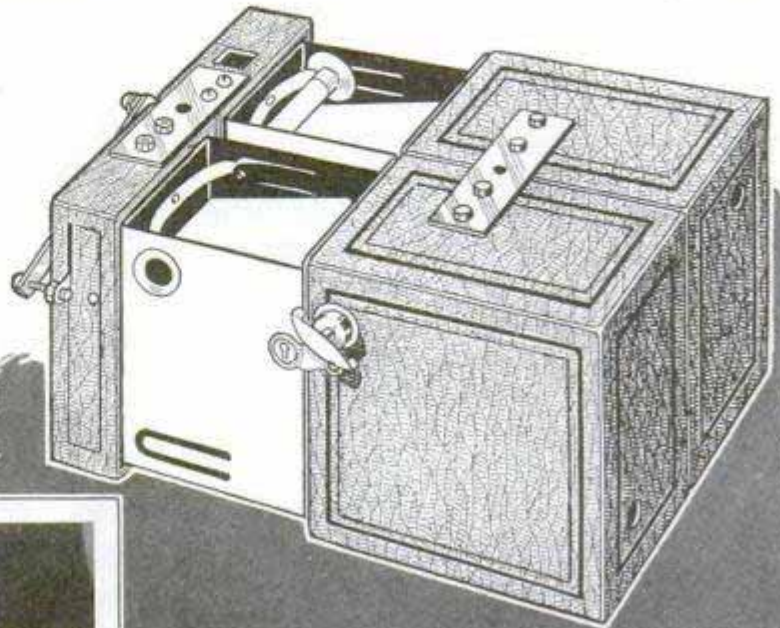

Two small box cameras, fastened together with brass strips so that the lenses are  $2\frac{1}{2}$  in. apart, make an excellent stereoscopic camera. It enables you to make photos of your vacation trip which will be more realistic than ordinary views. Usually the cost of stereoscopic photography has prohibited many from enjoying its advantages, but the cost of this outfit is so low that such objections are entirely eliminated as the cameras can be purchased for \$1 each at almost any drug store. It is a comparatively easy matter to make a tripping mechanism that will operate both shutters simultaneously, which is absolutely necessary, especially when taking a photo of a moving object. The left-hand detail clearly shows this mechanism, which consists of three flat brass links pivoted end to end, the two on the outside being pivoted to the front, as indicated, and connected to screws on the shutter trips. In this way, the movement



by side, it being necessary to reverse them so that one will be upside down, on account of the film-winding nuts, which must be on the outside. Four brass plates are used to hold them together rigidly, two at the top and two at the bottom, and if desired, a nut may be soldered to one of the bottom plates to fit a tripod screw. It is essential to arrange the plates as shown so that the backs of the cameras can be conveniently removed in order to permit the insertion and removal of the films. If a little judgment is used in selecting scenes to photograph, surprising results can be obtained. The object of interest should be located in the immediate foreground with a satisfactory background to set it off.



If the object is too far in the background, the stereoscopic effect will not be so pronounced.

Mounting the photos must also be done with extreme care, placing the right-hand photo on the right side of the card that fits the holder of the stereoscope, and the left-hand photo on the left side. It may be well to clip the pictures on the card with ordinary paper clips until the best arrangement is obtained. Trim off the edges of the prints and, when properly adjusted, paste them down with rubber cement, which will not cause the card to warp. The size of the card is 3 by 6½ in., and the corners are rounded. If you have some stereoscopic cards on hand, the photos can be attached to the back. To obtain the best results the photos, when mounted, should be separated by not more than ½ in. If they are too far apart, or if one is lower than the other, they will not merge together properly. The lenses of the stereoscope act as prisms and bend the light rays to a common focus, thereby merging both photos into one. The realistic effect of stereoscopic views is obtained by taking both photos from slightly different angles in the same manner as our eyes. This causes the objects photographed to appear free-standing as in nature, or, in other words, a three-dimension effect is obtained which gives stereoscopic views their peculiar "depth."—Arthur O. Hein, Chicago, Ill.

#### Miniature Animals Made from Pipe Cleaners

Miniature animals, such as dogs, horses, etc., that may be used as toys or for decoration, can be made by merely twisting ordinary pipe cleaners to the proper shape.

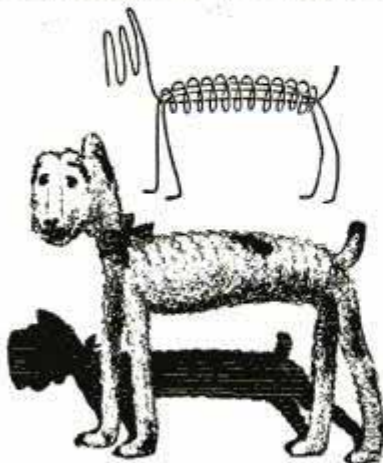

Ink spots make the eyes, nose and mouth, and a colored ribbon is fastened about the neck. The drawing shows an example of the work.—I. R. Hammer, Burlington, Iowa.



Pies Displayed on Restaurant Counter Protected by Bent Wooden Guards

#### Guards for Pie Display on Counter

Wooden guards, bent to a semicircular form having a radius a few inches larger than that of an ordinary pie, are used for protecting the latter when set on a restaurant counter for display. Small brass angles are used to hold the guard to the counter securely, and a piece of plate glass can be placed over the guard, to keep out falling crumbs and make the display sanitary. In this way, the pies are set right before the customers, and the proprietor claims that the idea pays.

#### Starting Small Screws

There is often a good deal of time and patience lost when starting tiny screws. A screwdriver is not serviceable for the purpose and holding them with the fingers is very awkward. A good method is as follows: Pare down the end of a match stick just enough to fit snugly into the slot in the screw head. Then moisten the end of the stick, put it into the slot and start the screw. A good hold is possible because the wetted match stick swells in the slot. Very small screws can be started in this way.

☛ A deep-red stain for wood can be made from alkanet root, ½ oz., and turpentine, 2 fluid ounces.



Small Boats for Model Ships That Resemble Real Ones Can Be Made from Visiting Cards

### Making Small Boats for Ship Models

In making fittings for ship models, one of the most tedious jobs is the construction of small boats which will bear resemblance to the real thing. After considerable experimenting, I found that they could be made from visiting cards with very little trouble. The method of doing this is as follows: Cut a card to the approximate shape shown in the detail. After a few trials it will be found easy to produce the desired flare and curvature of the gunwale. Mark off pencil lines to represent the ribs inside and on these paste narrow strips of thin blotting paper, then similar strips for the rails over the ribs. Press the work in a vise to bed it down properly. Then cut a narrow strip of passe-partout paper, crease it lengthwise over a thick piece of cardboard and lap it along the gunwales. A few small nicks will prevent wrinkling. Fold the boat along the center line, roll it around a pencil to make it a bit more flexible and bind the bow and stern ends together with small pieces of gummed tissue paper. A little manipulating with the fingers will accomplish whatever final shaping is necessary. Paste another narrow strip of blotting paper from stem to stem for the keel. Shellac the boat inside

and out to stiffen it and then paint it, putting on enough paint at the bow and stern to hide the tissue-paper binding strips. Cut the thwarts from strips of stiff cardboard and set them in place with a dab of glue on the underside at each end. These boats are better than wooden ones.—A. V. McDermott, New York City.

### Odd Telephone Made from Oilcans

Two neighboring farmers who had no telephones, established communication between them by means of a long wire tied at either end to an ordinary oilcan as shown in the illustration. A hole is punched or drilled in the center of the bottom of each can, and the wire is passed through the holes, after which a knot is tied at the end to prevent the wire from slipping out again. The wire is stretched between the cans and does not touch anything between the terminals. Consequently, vibration of the can bottom, which is caused by sound, is instantly transmitted over the wire to the opposite can bottom, which, acting as a diaphragm, converts the vibration back into sound. A hand bell or cow bell is used to attract attention before starting a conversation. This odd telephone system has been found practical over a distance of 300 yards, crossing a small river which separates the farms. Two methods of mounting the oilcans are shown. Each is used both as a receiver

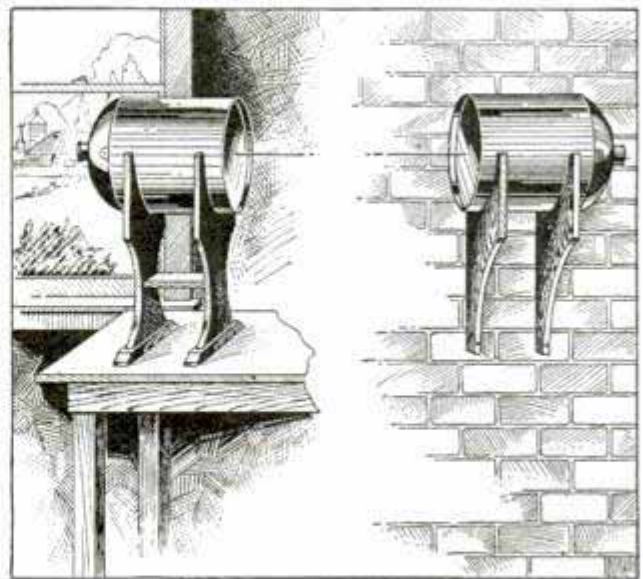

Oilcans Which Provided Terminals for a Mechanical Telephone Line

and as a transmitter.—James Wilson, Montreal, Can.

Importer Charles L. King, 210-212 W. 42nd St., New York City. 1017  
 similar one

**Grotesque Figures Crack Nuts**

The grotesque nutcrackers shown in the photo, as can readily be seen, are really useful besides being ornamental. They are carved out of hardwood, and the jaws in five of the models shown are pivoted so that, when opened, the nut can be

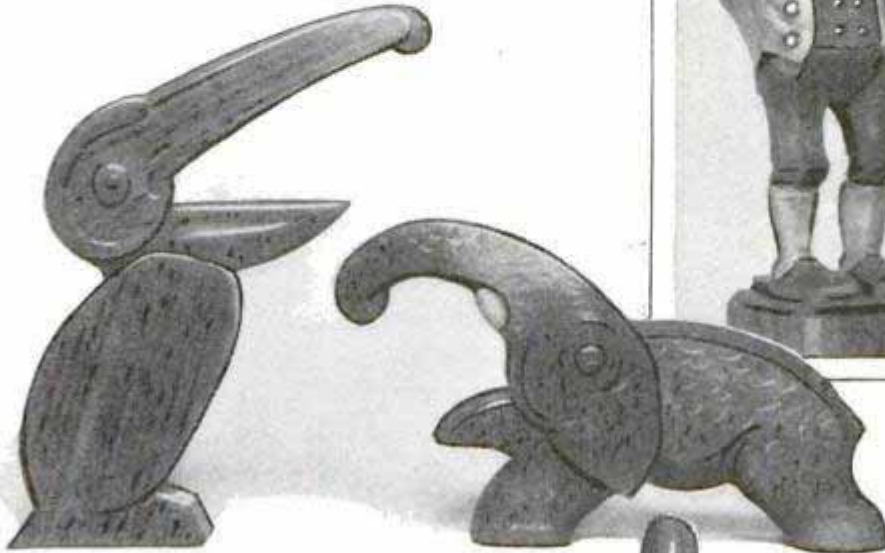

Useful and Ornamental Nutcrackers Made of Hardwood; the Nuts Are Cracked between the Jaws

slipped between them and sufficient leverage is provided for breaking the shell. The sitting clown, however, is pivoted at his feet and cracks the nuts by "sitting" on them. Anyone who likes to tinker with tools can easily make these nutcrackers and they will be found highly suitable for Christmas gifts.



**Photographing Close-Ups with Graflex at Twenty-Four Inches**

Owners of Graflex cameras, not possessing a portrait attachment, often wish to take a close-up of a person or object. A simple method of doing this without the expense of purchasing a portrait attachment, and one that has been found to give good results, is as follows: The removable lens mounting, with which most of these cameras are equipped in order to permit cleaning the reflecting mirror, is taken off with the lens in it, and the whole assembly is reversed. Close the mounting cover in the reversed position and the camera is

ready for close-ups. By experiment it has been found that it is possible to obtain good, clear photos as close as 30 in. from the photographed object with the large diaphragm openings, and up to 24 in. with the small openings. This method has the advantage of reproducing the photographed object about one-third normal size. After the picture has been taken, lift out the lens and mount, and return them to their normal position, so that the camera will again be ready for regular work. Ordinarily, 5 or 6 ft. is the minimum focusing distance of a single-bellows Graflex, but on such close-ups the details of small objects do not stand out clearly. With the method just described the minutest design can be brought out clearly. —Kenneth Keith, Chicago, Ill.

# "ROAMER" A Speedy



WITH work to be done this month, "Roamer" begins to take on the appearance of a finished runabout. However, this hull does not make a good outboard runabout, and should not be built as such. "Roamer" makes an excellent runabout if powered with an inboard engine, and a good sedan cruiser with an outboard motor, but is decidedly unsatisfactory as an outboard runabout. There is considerable beam amidships which quite handily takes care of the weight of the cabin in the sedan-cruiser design



*Cypress is O. K. for inside when on bottom instead of redwood, but is not particularly suited for outer skin*

# Outboard Cruiser

Part 3— by Sam Brown

or the weight of an inboard motor in a runabout design. Putting an outboard motor at the stern without the compensating weight of the cabin is something which can be done only by sacrificing the balance of the hull. If you desire to convert this craft into an inboard runabout, now is the time to put in the longitudinal beams to form the engine bed.

Flooring for the cruiser is  $\frac{5}{8}$ -in. redwood, used in 6 or 8-in. widths. Before this can be fastened, additional crosswise supports, one between each of the frames, must be placed, as shown in Fig. 1. These are notched to

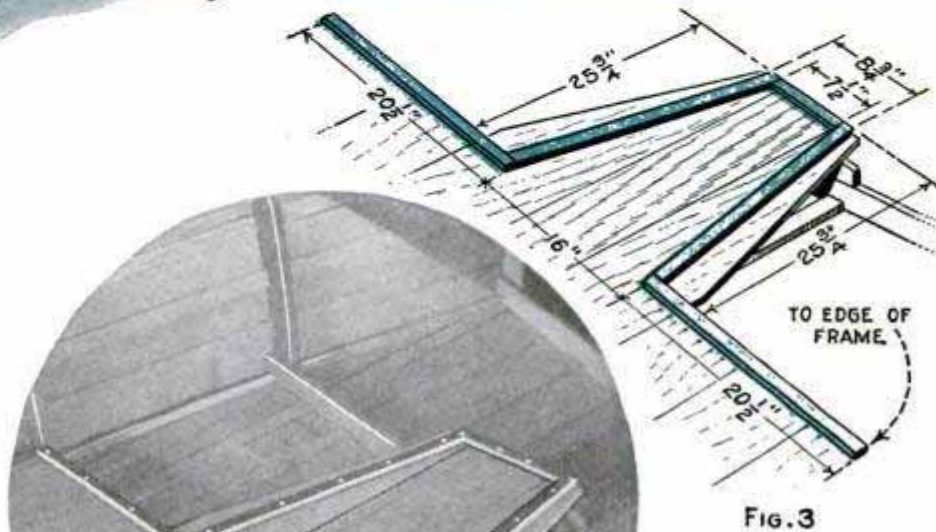
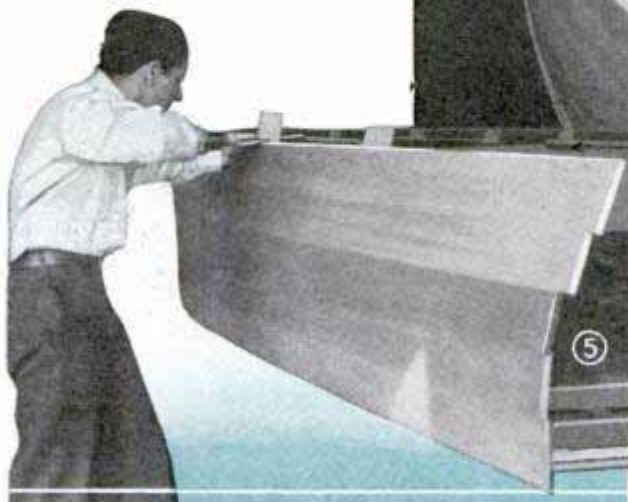
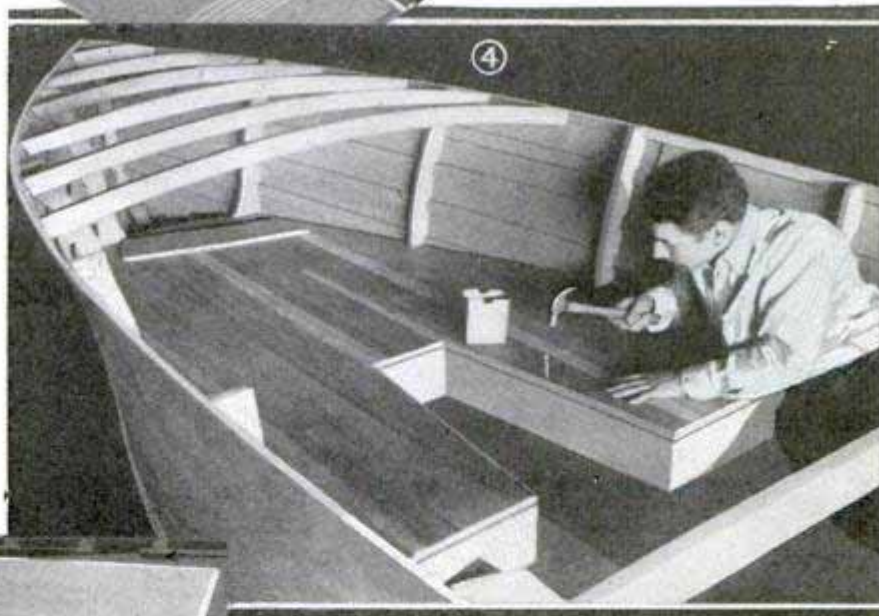
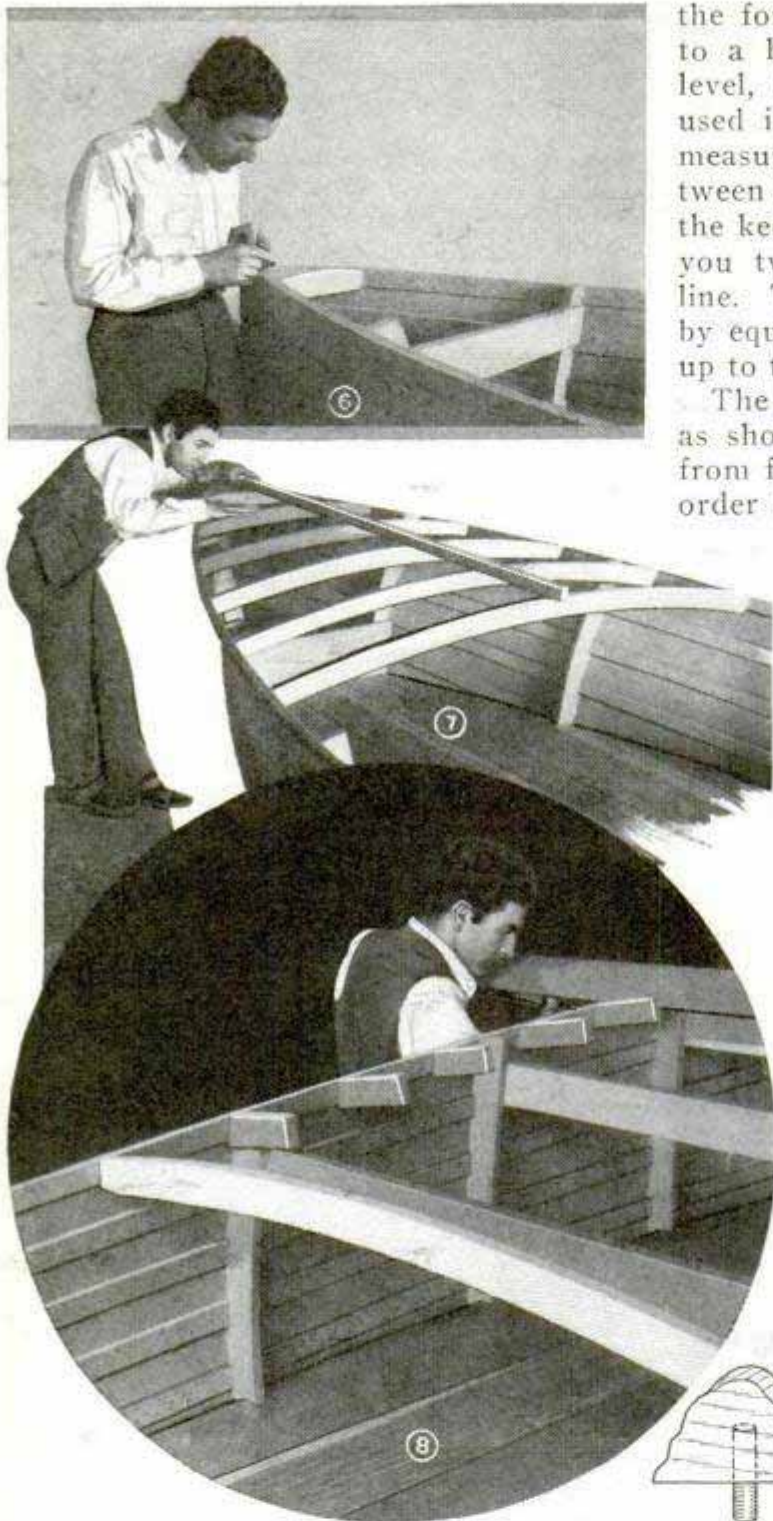

FIG. 3

Pieces of  $\frac{5}{8}$  by  $1\frac{1}{4}$ -in. Stock Shown Nailed to Floor Are Nailing Strips for Sides of Bunks



fit over the keel and chine, then fastened into position with galvanized nails. Since the frames are not level on top, they must be shimmed up with suitable pieces to bring all of the floor beams level, a level line being automatically secured by blocking up the rear end of the boat to a height of 28 in. above the floor level, and



the forward end, at the end of the keel, to a height of  $21\frac{3}{8}$  in. above the floor level, the same measurements as were used in setting up the framework. Or, measuring up  $1\frac{3}{8}$  in. from the keel between frames 7 and 8, and  $3\frac{1}{2}$  in. up from the keel between frames 4 and 5 will give you two points to determine the level line. The level line crosswise is obtained by equalizing the distance from the floor up to the chine on each side.

The flooring is simply nailed in place, as shown in Fig. 2. The central plank, from frame 7 forward, is left unnailed, in order to get at the bottom of the boat.

The flooring does not extend to the stern, being stopped on an intermediate beam between frames 7 and 8. Neither does the floor extend to the stem, but is stopped at frames 4 and 3, to form the shape shown in Fig. 3. The pieces of  $\frac{5}{8}$  by  $1\frac{1}{4}$ -in. lumber, shown nailed on the floor, are supports to which the bunk sides are fastened. To these strips are nailed the 5-in. widths of  $\frac{5}{8}$ -in. redwood which form the sides of the bunks. Frames 1, 2 and 3 are spanned across with pieces of 1 by 2-in. lumber to carry out the level line formed by the bunk side-pieces, and the whole thing is floored with  $\frac{5}{8}$ -in. redwood, as in Fig. 4. Three planks, one in the center of each leg of the "A" and one in the main body of the bunk, are left unnailed to furnish

lids for the locker spaces below. The extreme nose of the boat is floored with  $\frac{3}{8}$  by  $1\frac{1}{2}$ -in. strips of redwood, extended from chine to chine.

Now for the deck beams. Commence by cutting off the tops of the frames flush with the planking, Fig. 5. Then, from 10 by 5 by  $2\frac{1}{4}$ -in. yellow pine, cut a three-sided piece which will fit exactly into the nose of the boat. This block should be securely screwed  $\frac{1}{2}$  in. above the line of the top planking, and then dressed down, as indicated in Fig. 6,

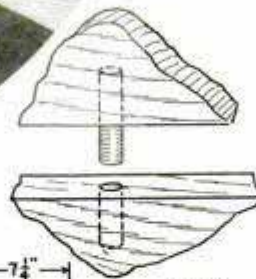

FIG. 9

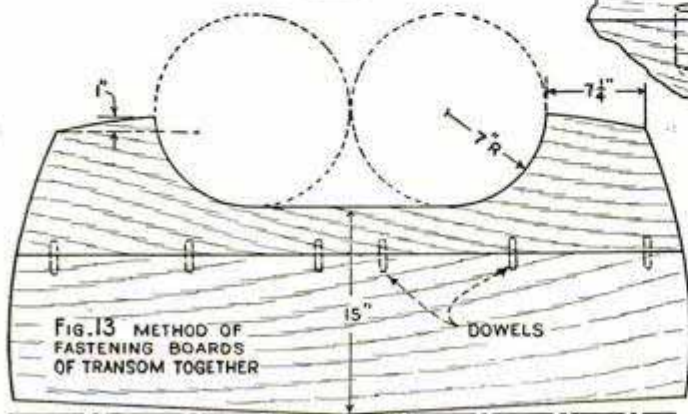

FIG. 13 METHOD OF FASTENING BOARDS OF TRANSOM TOGETHER

to show a rise of  $\frac{1}{2}$  in. in the center.

There are five main beams on the forward deck, spaced on  $10\frac{1}{2}$ -in. centers, measuring from the rear of the block just fastened. The center of the final beam should measure  $62\frac{1}{2}$  in. from the extreme nose of the boat. These beams are cut from  $\frac{3}{4}$ -in. elm, and should be uniformly 2 in. wide throughout their arcs. The curve of the beams gradually becomes greater as the distance spanned becomes wider, the extreme arc on the final beam being  $2\frac{1}{2}$  in. The arc of the intermediate beams can be easily obtained by using two pieces of straight timber, one lengthwise, as in Fig. 7, and another from side to side at the beam station. Mapping out the curves can best be done with a light piece of straight-grained, uniform wood, spanned from end to end of the required curve and held up at the center to the required height of the arc. Each beam end is butted directly against the top batten, and fastened from the outside with two  $1\frac{3}{4}$ -in. No. 8 brass screws.

Extending aft from these main beams, the deck supports consist of short sections at 10-in. intervals, which carry out the same arc as the final crosswise beam. You should constantly check this arc by using a board, as in Fig. 8, with the proper curve outlined upon it. Fitting these short beams usually requires considerable re-cutting and beveling, and for that reason the free ends should not be cut to the exact dimensions until the beams are all in place. The exact dimensions of these short pieces are variable. Starting with a doubling piece immediately behind the final crosswise beam, which is  $5\frac{1}{4}$  in. long, each of the two succeeding beams is increased  $\frac{1}{8}$  in. over the one before, that is,  $5\frac{3}{8}$  in. and  $5\frac{1}{2}$  in.; and then, the ten succeeding beams are each decreased  $\frac{3}{16}$  in. over the one before to make the thirteenth beam (10 in. or thereabouts behind frame 7)  $3\frac{5}{8}$  in. long. In sawing them to these dimensions

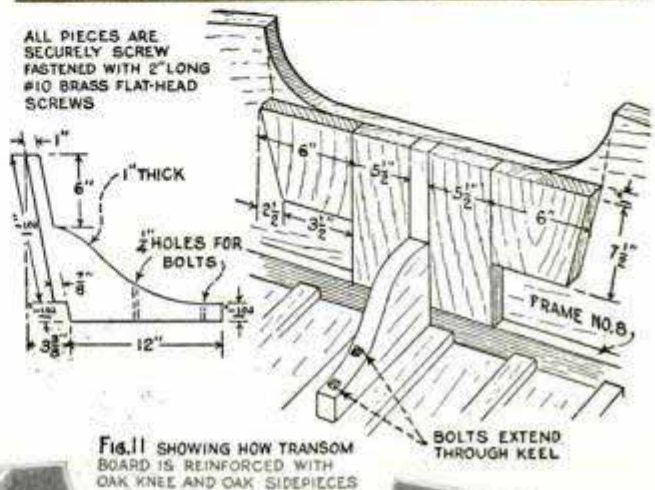
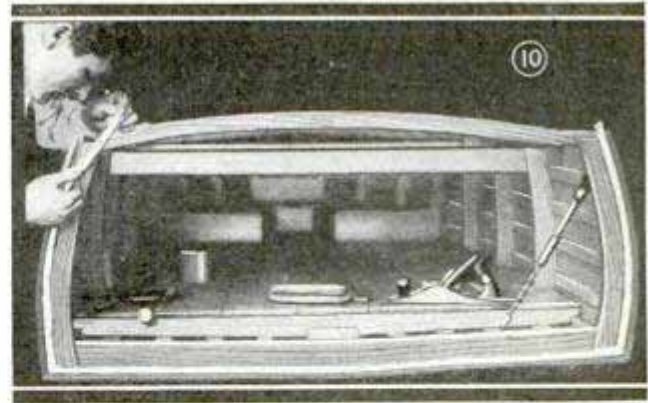
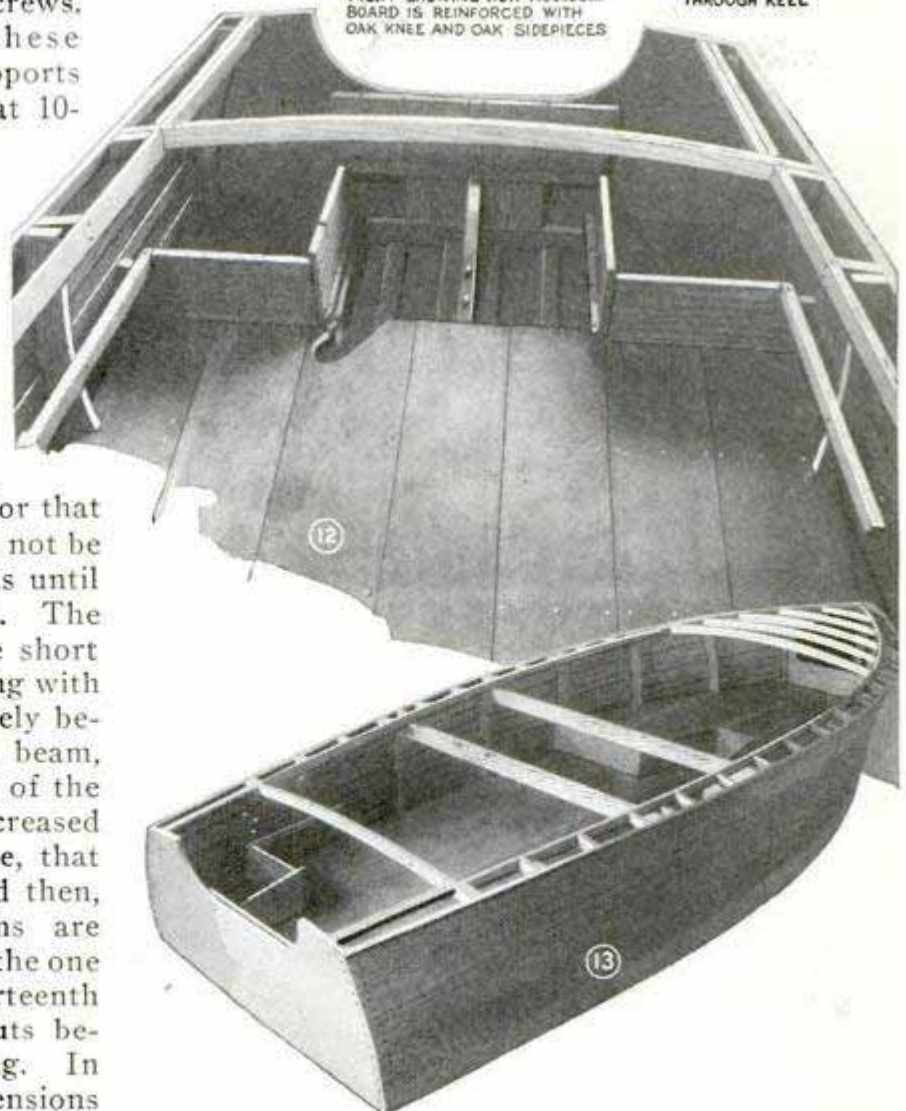
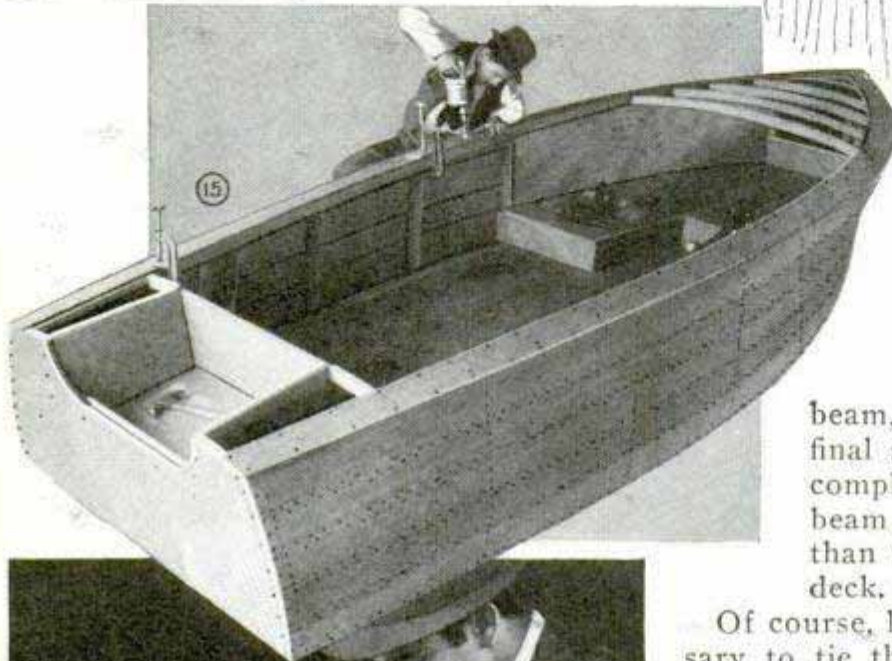
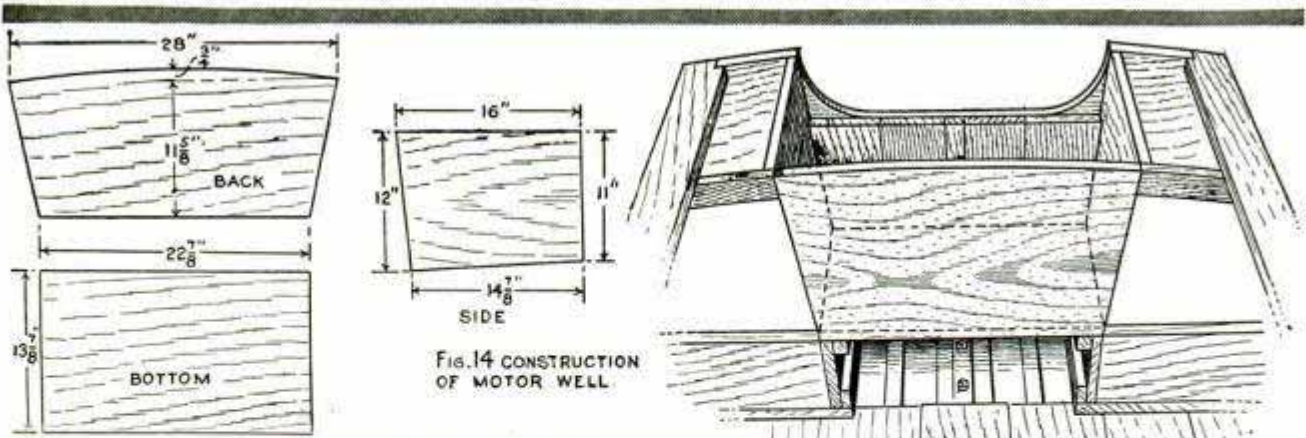

FIG. 11 SHOWING HOW TRANSOM BOARD IS REINFORCED WITH OAK KNEE AND OAK SIDEPICES





after they have been fastened, make sure that each end is plumb, and you will be saved considerable annoyance in the later fitting of the cabin supports.

One other crosswise beam, immediately behind the final short beam, is necessary to complete the cross supports. This beam carries out a trifle less arc than the final beam on the main deck.

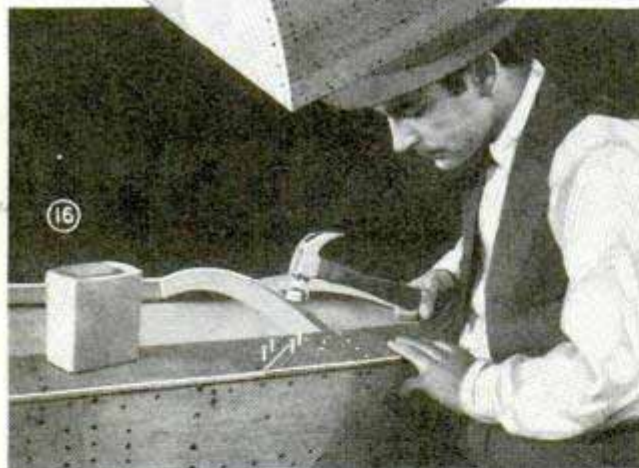

Of course, lengthwise beams are necessary to tie these crosswise supports together. A strip of  $\frac{5}{8}$  by 2-in. elm is used across the ends of the short beams, and the line formed by this piece,  $5\frac{1}{4}$  in. in from the side of the boat at frame 3, is carried out by a centerline along short  $\frac{3}{4}$  by  $1\frac{1}{2}$ -in. pieces toenailed between the main deck beams, as can be plainly seen in Fig. 13.



The transom or stern board will require a piece of mahogany or oak, about 52 by 23 by  $\frac{7}{8}$  in. A piece of this size is usually unobtainable, so use two pieces, fastening them together with  $\frac{1}{2}$ -in. dowels, as in Fig. 9. Keep this joint high so that it will be above the waterline. This board must be fitted inside the planking, and tight up against frame 8. The exact outside shape is best obtained by trimming the plank ends to within 1 in. of the frame, then fitting the transom against the cut ends and penciling around it along the inside of the planking. With perhaps a slight variation, depending on the motor used, the upper portion of the board will be



of the shape shown in Fig. 9.

Before putting the transom into place, it is necessary to calk the inside of the frame with cotton, as shown in Fig. 10, in order to insure a watertight job. The fastenings are flat-headed brass screws of suitable length. If you contemplate a paint finish, these should be driven flush; if you are thinking of a varnish job, they should be counterbored with a  $\frac{3}{8}$ -in. bit and the holes plugged with suitable crossgrain wood plugs. These are held in place with shellac or waterproof glue. They should be selected for color, and should be so inserted as to carry out the original grain of the board.

The transom, in itself, is not strong enough to withstand the constant vibration of the average outboard motor, and must be reinforced with an oak knee and sidepieces, as shown in Fig. 11.

You can now continue the deck beaming to the rear of the boat, as shown in Fig. 12. Notice that each corner of the boat is floored over, and that two 7-in. and two 6-in. widths of redwood are used to form the risers for the motor well and battery-locker compartments. The  $\frac{3}{4}$  by  $1\frac{1}{2}$ -in. strips of wood along the sides of the boat are supports for the rear seat, but this is not put in until later.

Fig. 13 is a general view of the boat at this stage. Completing the motor well is simply a matter of a floorboard, two sides and a back, as shown in Fig. 14. It is necessary to cut the crosswise beam, letting the back of the well carry the arc across from side to side and joining the beam at each end.

The first step in putting on the deck consists in applying the two long strips of  $\frac{3}{8}$ -in. mahogany which run the full length of the boat, as shown in Fig. 15. Because of the wide arc of these pieces, they must be put on in two



sections, the joint occurring immediately behind the last forward beam, as shown in Fig. 16. This joint should be neatly butted on a bevel and securely fastened to a wood block underneath. Fig. 17 shows how each of the two sides is joined at the nose of the boat. Fastenings for the decking consist of 1-in. galvanized nails, countersunk in  $\frac{3}{8}$ -in. holes, which are later plugged with wooden boat plugs. No great pains need be taken to get a perfect fit on these side deck pieces, since most of the trimming, except on inside forward and rear edges, can be done with a plane and drawknife after the wood is securely fastened.

The rest of the decking on the boat is cut from 8-in. widths of mahogany, each piece scored with three saw-cuts to imitate narrow strips of planking. These widths are laid lengthwise, as shown in Fig. 18. The edges of joining widths should be slightly beveled in order to carry out the cut-planking effect, and

this beveling should also be done along the entire inside edge of the long outside piece where it joins the saw-cut planking. All joining edges and all saw cuts should be filled with regular seam composition, which is elastic and does not crack under contraction and expansion.

A hatch in the forward deck is quite convenient, both as a means of ventilation and for seating a passenger. This should be cut as the planking is being laid. Fig. 19 shows its simple construction—merely a matter of sawing the center beam, and

edging in the lid and the opening with suitable pieces of timber.

A craft of this type looks best if the inside is covered, as shown in Fig. 20;  $\frac{3}{16}$ -in. mahogany was used on this boat, but any stock fiber board will serve. Light strips of wood are fastened to the floor to furnish a support for this paneling.

"Roamer" should carry a gasoline tank of at least 10-gal. capacity. Fig. 21 shows how this tank, a wide, flat type,

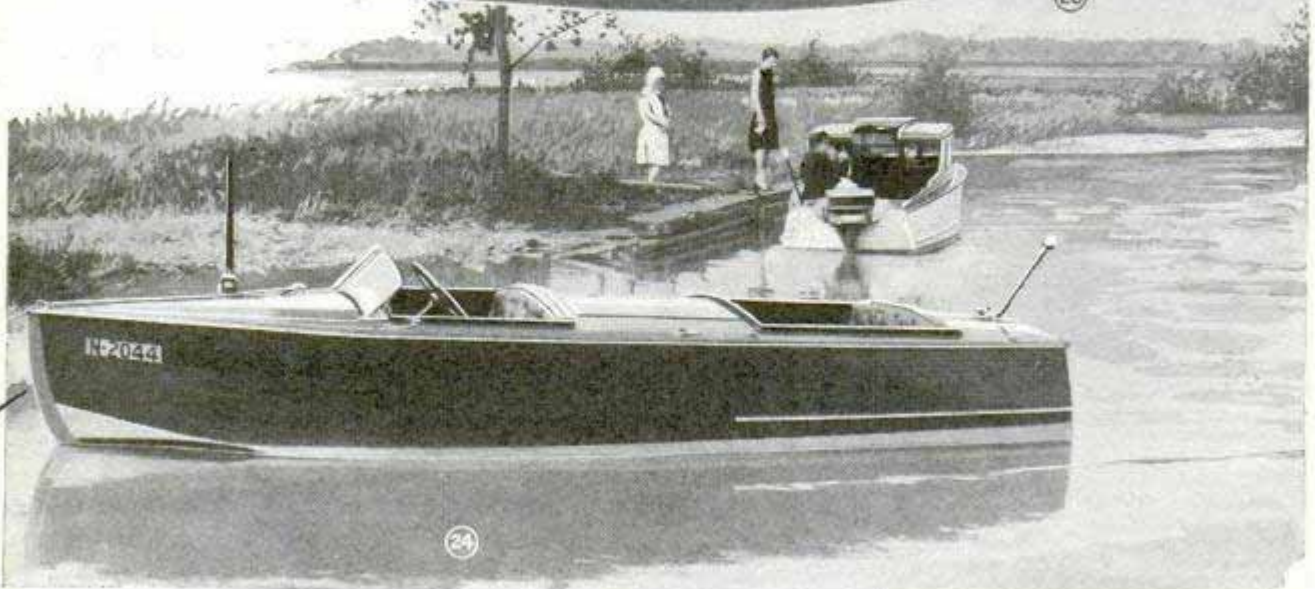

Roamer. see Boat Book

is carried under the rear seat. The flooring and one well support must be cut to allow the feed line to enter one of the side-locker spaces. Other details on the gasoline feed will be described in a later article.

Fig. 22 shows the riser for the front of the seat. This should be rounded on the top side and carried 2 in. above the actual 6-in. seat level. The main idea of this picture, however, is the seat back, which consists of three equal pieces of  $\frac{5}{8}$ -in. redwood, the center piece being fastened permanently and the two outside pieces hinged at the bottom edge to permit entrance into the lockers. The top side corner of each of the two outside pieces must be notched out,  $\frac{1}{2}$  in. down and in from the long deck beam, to permit fitting of the coaming strip, to go on later. Experience has shown that these seats might well be 4 or 5 in. higher without detracting from the appearance of the boat, while adding a lot to its comfort.

Fig. 23 is your outboard runabout—unfortunately an impossibility. Notice, however, the neat appearance of the same hull in the double cockpit, inboard-runabout design, shown in Fig. 24.

(To Be Continued)

### Elastic Supports for Auto Door Pockets

Door pockets used with seat covers are usually rather difficult to apply so that they will lie flat and also allow the hand to be inserted. To overcome this trouble tack the side of the cover to the door only at the top and bottom and attach elastic webbing between the edge of the door and the outer edge of the pocket, as shown. When the hand or contents is removed from the pocket, the elastic will draw the cover flat against the door again.—E. T. Gunderson, Jr., Humboldt, Iowa.

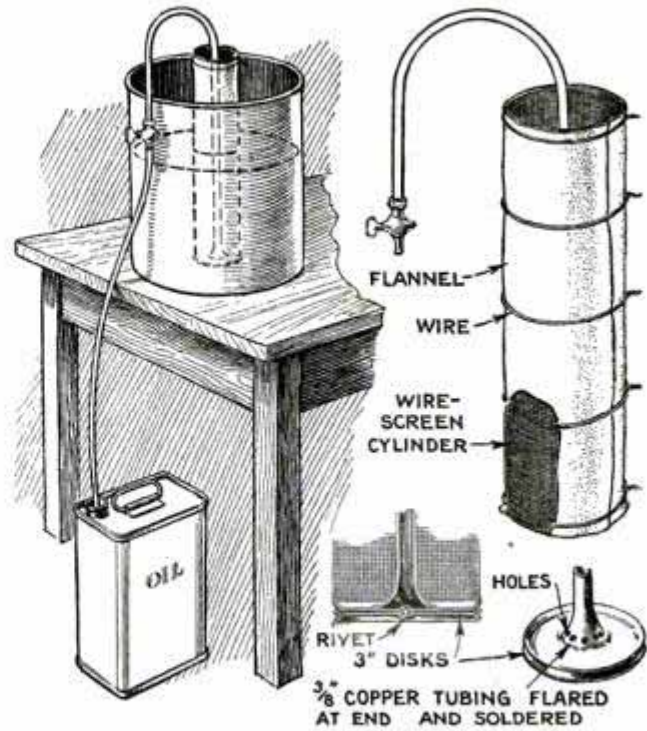
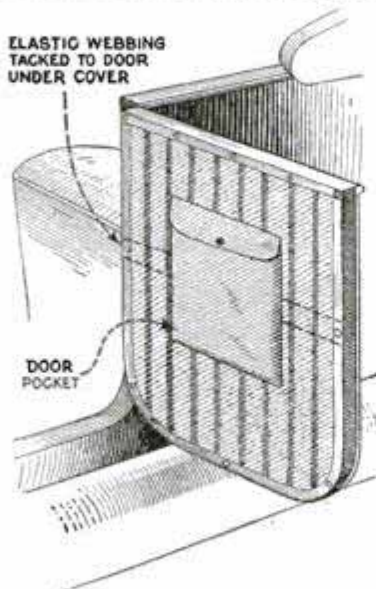

Easily Made Filter for Straining Dirty Gasoline and Old Oil and Even Homemade Beverages

### Efficient Filter Easy to Make

A simple filter, which will remove all sediment from dirty gasoline or engine oil and can also be used in making beverages, is shown in the illustration. It filters the liquid at the source and, because of its large area, is comparatively rapid in action. Two tin disks, about 3 in. in diameter, are riveted together. The tops of tin cans, cut with the roller type of can opener, are suitable for this purpose. A 3-in. length of  $\frac{3}{8}$ -in. copper tubing is bent as shown, the straight end being flared out to about  $\frac{3}{4}$  in. and then soldered to the center of the disks. Small holes are drilled around the base, as indicated in the lower detail, and a shut-off cock is fitted to the other end of the tube. A length of copper or galvanized wire screen is rolled into a cylinder to fit snugly over the disks. It is wrapped tightly over the disks with copper wire and then soldered. The screen is next wrapped with about  $1\frac{1}{2}$  yd. of outing flannel and tied with cord. The material of old cement sacks is even superior to flannel. The filter is placed into the fluid to be filtered and the siphon is started. The shut-off cock regulates the flow. The slower the flow is, the more thorough the filtering will be.

☛ A pencil eraser will polish a gold piece and make it look fresh from the mint.

## SQUIRRELS CANNOT GET AT THIS FEED BOX



Mr. Squirrel Can't Get At the Food on This Bird-Feeding Platform, Which Runs on a Length of Wire and Can Be Reached without Going Outdoors

ed of almost any kind of lumber, or an ordinary grocery box will do. A couple of small galvanized-iron pulleys and a length of galvanized-iron wire, about  $\frac{1}{8}$  in. in diameter, are used to suspend the box in the open. Two screwhooks are driven into the ridge of the roof for attachment to the pulleys. A wire is slipped through the pulleys, one end is attached to the house near a window or door, and the other end, at a slightly lower level, to a tree or any other convenient object. A string, tied to the box, serves to pull it within reach to replenish the food supply without going outdoors. A slight shove sends the box down the wire. Loose food is placed in the bottom of the box, but

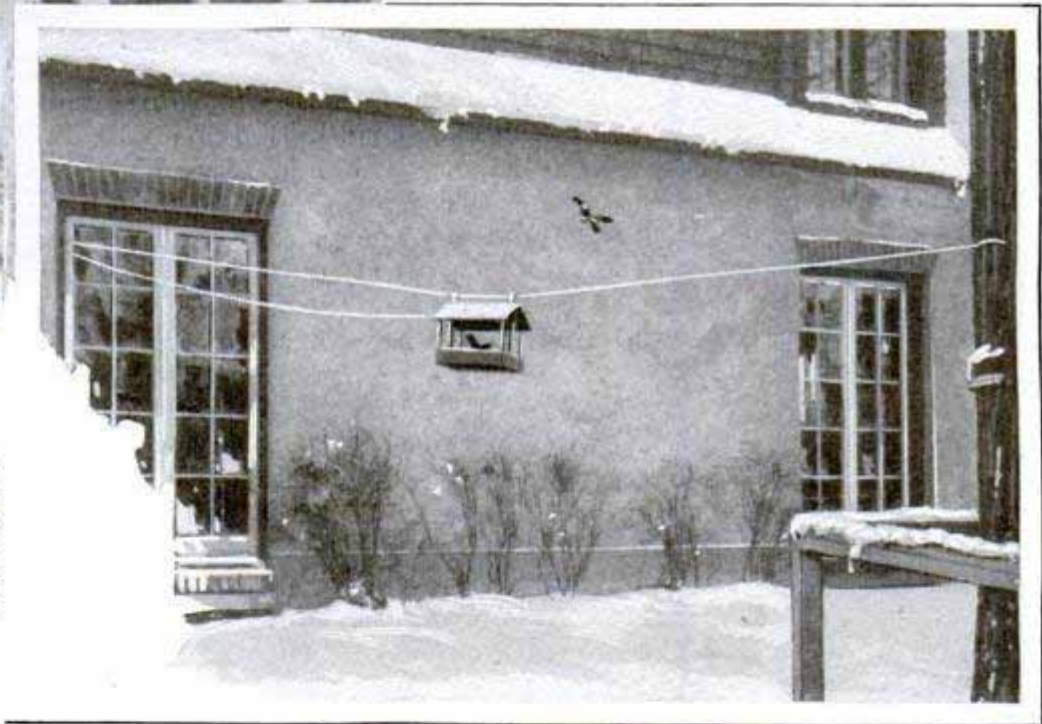

Here's good news for the winter birds: a squirrel-proof feed box. The materials required to make it are simple and inexpensive. The box itself can be construct-

pieces of suet, which are much prized by most birds during the winter, should be tied to the uprights.—Robert H. Moulton, Glencoe, Ill.

### Carrying a Danger Signal on Highways

A farmer living along a well-traveled highway became concerned with the safety of his little girl, who walked occasionally along the highway after dark to the nearest village, about a mile distant. He hit upon a simple danger signal, which anyone can use. Two red celluloid disks,

connected together with two lengths of cord were hung over the girl's shoulders so that one disk would hang in front and the other behind. The light of approaching cars was reflected by the disks, which thus provided a warning to the motorists. The idea was found entirely successful, and the little girl walks on the road in comparative safety.

### Preventing Corrosion in Deep Engraved Monograms

Engraved initials on watches, rings and other jewelry often penetrate to the base metal beneath, which is then subject to corrosion. In the case of wrist watches, the green corrosion gets on the wearer's wrist. This can be prevented, and the appearance of the jewelry greatly improved, by the following process: Dissolve some paraffin in benzine; place a small quantity on a dry cloth and with it lightly rub over the surface of the engraved article, being careful not to allow any of the solution to get into the lettering. For intricate designs, use a small camel's-hair brush. The article can then be plated by any of the processes described on page 516 of the September, 1930, issue of Popular Mechanics. The portions to be plated should be thoroughly cleaned before the paraffin solution is applied. Remove the works from a watch case before submerging it in the plating solution. The plating will only adhere to the exposed metal portions of the lettering.—Kenneth Murray, Sturgis, Mich.

### Single Switch Controls Both Lights in Darkroom

In order to eliminate the need of two separate switches to control the bright and red lights of the darkroom, it will be found much handier to use only one switch for the purpose. A two-circuit electrolier snap switch is obtained, the upper half of the contact poles are removed, and the circuits wired according to the diagram. Mount the switch in a position handy when working and you will find this wiring a great time saver.—J. W. Bee, Baltimore, Md.

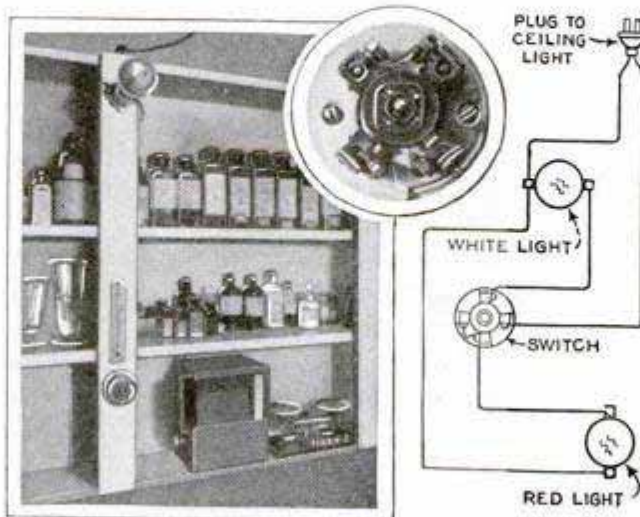

Electrolier Snap Switch Controls Both Lights in Photographer's Darkroom

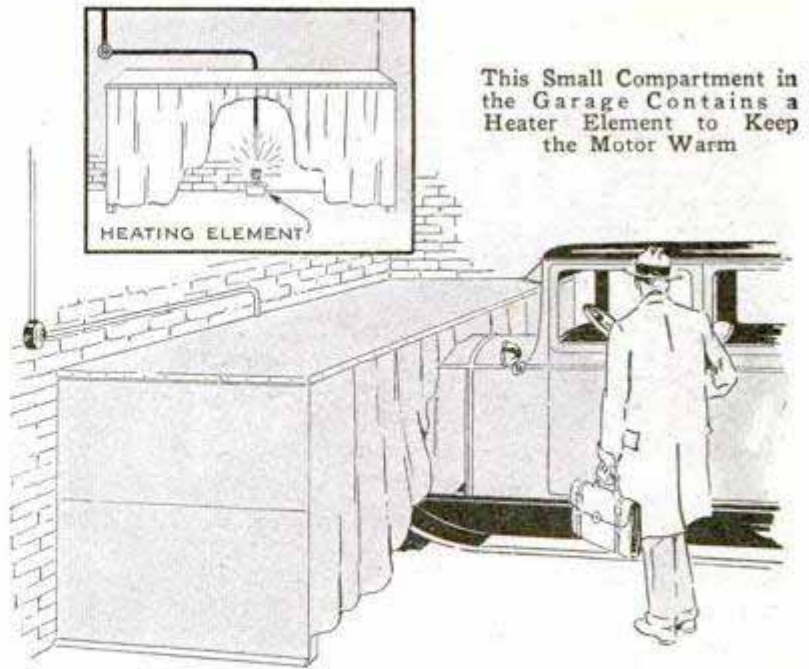

### Keeping Motor Warm in Cold Garage

It is unnecessary to heat the whole garage in order to keep the motor warm. The drawing shows a simple method of heating a small compartment just large enough to accommodate the hood of the car. A shelf is constructed just high enough for the hood to pass under it. It can be made of wood, wallboard or even large pieces of corrugated board obtained from old cartons. A curtain of heavy canvas, cut to fit over the hood and fenders, is draped in front of the shelf. Inside of the compartment a 250-watt heater element is installed, mounted directly on a porcelain base. A copper reflector is not needed. Provide a switch on the wall in a convenient location. In use, the front of the car is driven under the curtain so

that there is little chance for the warm air to escape, and the switch is then turned on. This will keep the chill out of the motor and makes it easy to start.—Dick Cole, Los Angeles, California.

☛ If your wardrobe trunk isn't in use, it makes a handy towel cabinet for the bathroom.

### Clothes Rack Attached to Auto Top

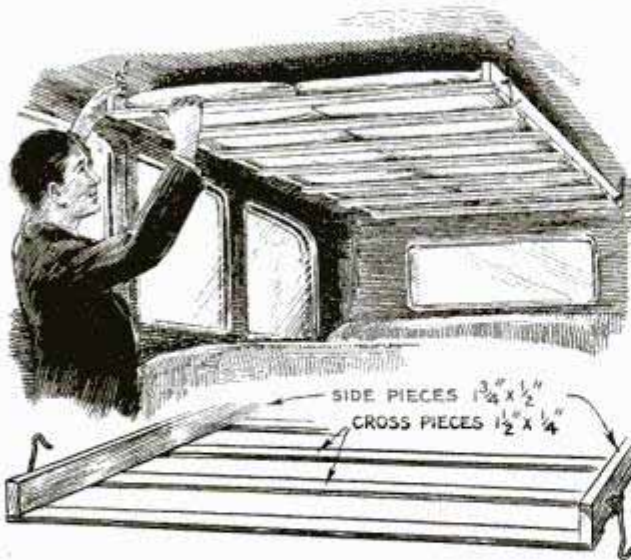

This Rack Holds Your Clothes Out of the Way and Prevents Getting Them Wrinkled

When quite a bit of luggage is carried along, as is usually the case on a camping trip, the illustrated rack will be found highly convenient for keeping the clothes, as it utilizes space not otherwise needed. It consists of two sidepieces with thin slats screwed across them to fit inside of the car. Screwhooks are used to hold the rack to the car top as shown. The clothes are neatly laid on the rack and it is then fastened in place. Besides the saving of considerable space, effected by the rack, it has the advantage of keeping the clothes from being wrinkled.—R. W. Calder, Chicago, Ill.

### Handy Method of Removing Stamps

To remove postage stamps from mis-directed envelopes, take an empty ink bottle, clean out thoroughly and drill a  $\frac{1}{8}$ -in. hole through the cork. Then fasten a



small piece of thick cloth over the cork, cementing it at the edges with waterproof glue. Fill the bottle with warm water, insert the cork, and then place it upside down on the stamp, as shown. In

this way just enough water will be fed to the stamp to saturate it, loosening the mucilage so that the stamp can be removed without risk of tearing it.—E. W. Cornell, Adrian, Mich.

### Winter Use for the Lawn Roller

Time and energy are saved by making the common lawn roller work when the snow is piled high. This new use for the lawn roller is in keeping sidewalks clear of drifted snow. Immediately after a snow storm, pack down the snow by rolling. The operation requires only a few minutes and gives a smooth, hard surface for walking. This can be continued several times, once after each snowfall. When the packed snow finally reaches too great a thickness it is easily and quickly removed in great chunks with a shovel, and without any great expenditure of effort.

### Flatiron Used to Thaw Out Frozen Drain Trap

If it happens that the drain trap of your bathtub freezes, place an electric iron on top of the trap as shown in the drawing, plug the cord into an outlet and await results. It will take only a very short time to melt the ice inside.

This method has been found much quicker than pouring boiling water into the drain. Of course, the adjacent pipes

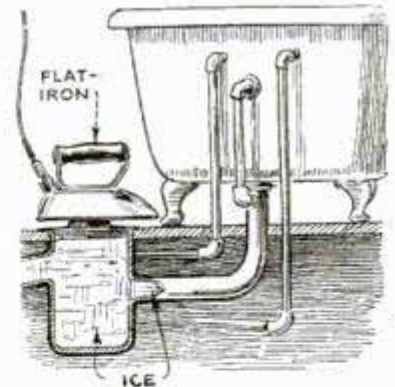

carrying waste water will most likely also be frozen and it will take longer to melt the ice in these pipes. The object of using an electric iron for this purpose instead of a blowtorch, is that the trap is usually made of lead and the heat of a torch might melt the lead. If the pipes leading from the trap are accessible in the basement and are not of lead, a torch may be used on them if desired.—H. H. Siegele, Emporia, Kans.

☛ A small art-gum eraser will remove dirt on your fingernails without discomfort.

### Diver Submerges Only at Master's Will

Holding the bottle in the right hand, the Cartesian diver's master can make him sink or rise, apparently, by moving a finger of the other hand up and down, although the latter does not touch the bottle. The secret is pressure exerted by the right hand on the bottle, which forces a little water up into the inverted vial, thus increasing its displacement, or weight, and causing it to sink. Seemingly a glass bottle will not yield to pressure. However, a flat 16-oz. bottle used by druggists will give slightly, and if the vial is properly balanced the slightest increase in its displacement will make it dive.

A small pill bottle, about 2 in. long, should be filled about three-fourths full of water and inverted in the large bottle. The latter should be filled to the top in this process, and water later poured off until it stands about  $\frac{1}{2}$  in. from the bottom of the cork. The small vial should be balanced so that it barely floats. Experiment will determine the correct amount of water required.

The diver can be elaborated by painting the outside, somewhat as shown, with oil paints, and attaching arms and legs cut from thin rubber, and secured with ambroid, or model-airplane cement.

The small vial can be made to dive by pressing gently on the cork of the larger bottle, but this gives the trick away somewhat more quickly than when the pressure is exerted on the bottle sides. When pressure is exerted on the cork, any size of bottle can be used for the container, from a gallon jug down.

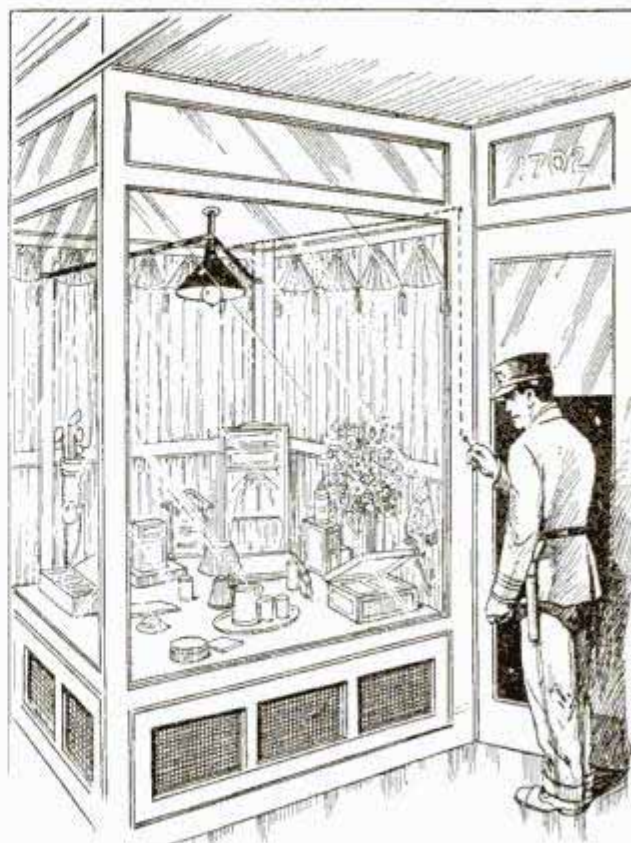

Pull-Chain Socket with Cord Running through Window Frame Permits Control from Outside

### Store Light Controlled from Outside

Wishing to provide illumination in his store window but not desiring to keep the light burning all night, one store owner installed a pull-chain socket, and a cord attached to it was then run through the window frame so that it could be reached from the outside. In this way the night watchman or policeman can pull the light on and off, or a nocturnal window shopper can satisfy his desire.—William C. Lsonse, Victoria, B. C.

### Using Paper Clips in Letters

When mailing letters to which checks or other matter is attached with paper clips, the clip should be so placed that, when the letter is folded, it will be at the bottom of the envelope. The reason for this is that the stamping wheels of the canceling machines often clog if they meet any obstruction, and, as a result, not only the letter is damaged, but usually several following it are badly torn before the operator has time to shut off the small motor which drives the machine. Irregular, very large or bulky letters are post-marked separately with a hand stamp—J. M. Kline, Harlingen, Tex.



"Tumbler Golf" in the Parlor Is an Interesting Pastime When You Can't Play Outdoors

### "Tumbler Golf" for Your Parlor

The next time rain keeps you from the greens, or a new diversion must be obtained for a party, try "tumbler golf." It will provide entertainment and good practice. Place an ordinary tumbler at the edge of the parlor carpet or rug. Move the chairs and other obstacles toward the side of the room. Place a standard golf ball 18 in. in front of the opening and try to putt it into the tumbler, giving yourself three chances. If you succeed the first time, credit yourself with three extra shots for the next position, or six shots in all. If you fail the first time and succeed the second, you get but five shots from the second point. With the third failure you are out. After placing the ball from the 18-in. point, you move it to a new position twice as distant

away as the first, or 36 in. from the target, and repeat the process. Every time you move to a new position you automatically acquire three chances at the tumbler, plus the number of shots you had left over from previous positions. Thus you may arrive at the other side of the room by increasing the distance each time you move. The player who travels the greatest distance, before using up all of his shots, wins.

### Eliminating Pinholes in Castings

In making steel dies with a steel core in order to mold solid-babbitt bearings, there was only .015 in. allowance inside and outside for finishing. When finishing the castings, we found that they were full of small pinholes just under the surface. To get rid of them, both the steel die and core were first heated and then the inside of the die and the outside of the core painted with blue clay, pulverized very fine and mixed with water to a thin paste. This is applied with a small brush to the hot die and core quickly, as it will dry as soon as it touches the hot steel. This paint allows the gases to escape from the metal and eliminates all the holes.—H. K. Ellis, Cincinnati, Ohio.

### Alcohol Dripped on Windshield Prevents Ice

By mounting a small tank filled with denatured alcohol on the windshield frame, and leading a slender tube to a position just above the wiper, as shown in the illustration, a small amount of alcohol will run out and the wiper will spread it evenly over the glass, preventing the formation of ice on the windshield. Of course, it is necessary to provide a small valve to control the flow of alcohol. The best method of mounting the tank is to use spring clips so that it will be easy to remove the tank to refill it.

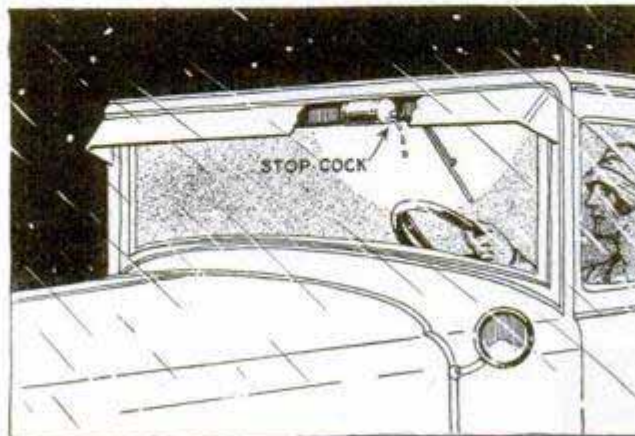

Small Can Supplies Alcohol on Windshield to Prevent Ice Formation



### Old Garden Hose Can Be Used as Electric Conduit

As a substitute for electrical conduit, especially where the wires are to be run for a distance underground, as in providing lighting for rock gardens, etc., odd lengths of old garden hose will be found useful. Such hose, when it is too weak to withstand water pressure, still makes satisfactory moisture-proof insulation for wiring. All cracked and split portions should be wrapped with electricians' tape and will then last for many years. Additional protection can be obtained by coating the hose with any asphaltum base paint. One advantage of this homemade conduit lies in its extreme flexibility.—Harry W. Wyckoff, Monterey, Calif.

### Finger Grip Holds Pen Light

The convenient type of flashlight known as the fountain-pen light can be made handier still by the addition of the wire clip shown in the drawing. When one must have a light, yet have both hands free, the clip is slipped over the light and the extensions gripped under the second and third fingers. In this position the



light will not be in the way at all nor interfere with the free use of the fingers. On some makes of this type of light, the pocket clip serves as a switch, and in this case it will be necessary to use a rubber band to keep the switch down when in use.—M. L. Harmon, South Bend, Ind.

### Coasting Toboggan Made of Corrugated Sheet Steel

Made of corrugated sheet steel such as is used for roofing, the toboggan shown in the drawing has all the usual requirements for coasting. The corrugations run lengthwise and the front end is bent to the

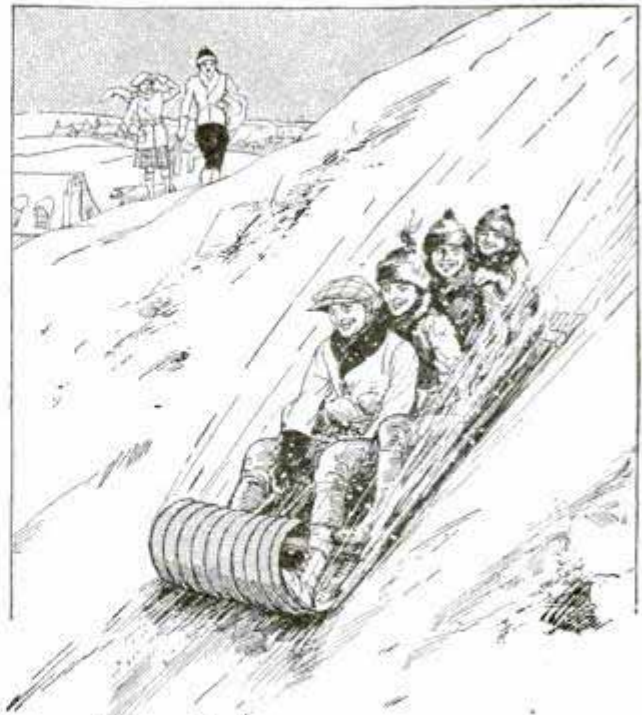

Toboggan Made of Corrugated Sheet Steel and Braced with Hardwood Crosspieces Is Easy to Make

desired curvature, by means of a set of bending rolls at a sheet-metal shop. Hardwood cleats are laid across the width of the sheet, one at each end and two spaced equidistantly between the end ones, and suitable braces are provided between the two front cleats to give the necessary rigidity, which will help greatly to preserve the shape of the sled. To attach the cleats, holes are drilled and countersunk in the sheet steel for flat-head screws, which are driven in from underneath.—A. C. Cole, Chicago, Ill.

### Padlocking the Telephone

There are times when it is desirable to have a lock on the telephone. For this purpose it has been found best to use a small adjustable lock of the kind shown in the illustration. It is passed through the two holes in the receiver hanger so that the latter cannot be removed. The advantage of this method is that it requires no alterations on the telephone.—R. J. Bailie, New York City.

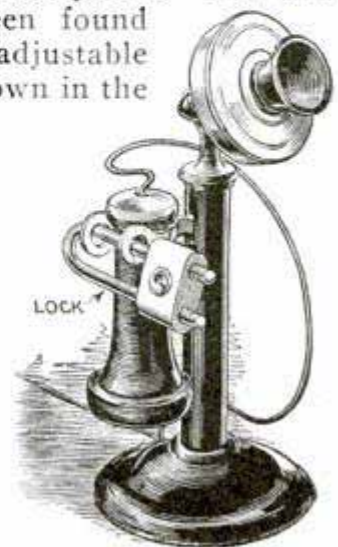

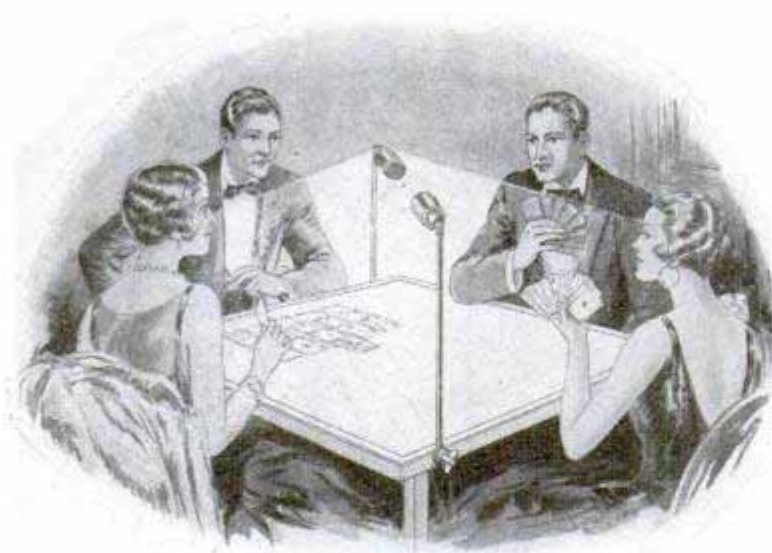

Homemade Fixtures Which Are Attached to Card Table Provide Correct Illumination

### Lamps for the Bridge Table

Two lamps attached to the bridge table will be found a convenient source of illumination, an extension cord being provided so that the bridge table can be placed anywhere and the cord plugged in at the nearest outlet. The standards holding the lamps are merely 18-in. lengths of  $\frac{3}{8}$ -in. brass tubing of suitable thickness. Flanges may be provided at the bottom to permit attachment to the table top near the corners or the lower end of the tubing slit open, flattened and drilled to receive a screw for fastening it to the edge of the table as shown. In case flanges are used, a hole is drilled through the table top directly under the end of the tubing for the wire to pass through. At the top end of the tubing an elbow and nipple are used in connection with suitable sockets, which may be of the candelabra or the intermediate type. Small tin cans may be used for shades, although the writer found small automobile ash cups handy for the purpose.—Myron L. Harmon, South Bend, Ind.

### Cheap Substitute for Hand Fire Grenade

A quart bottle filled with a saturated solution of ordinary salt water makes a cheap and effective substitute for a fire grenade. When thrown into the midst of a blaze, the bottle breaks and the salt forms a coating on all objects that the water touches, making them nearly incombustible.—Kenneth Keith, Chicago

### Hookless Fastener Used on Radiator Cover

Many of the late-model cars are fitted with automatic shutters on the radiator, but even so a padded hood cover has not lost its usefulness when the car stands in the cold for any length of time. I had the padded cover on my car fitted with hookless fasteners on the drop flap so that it could be closed snugly. Originally short straps with snap fasteners held the curtain roll open, but these would often become unfastened and the curtain would fall down, making it necessary to climb out and open

it again. In order to overcome this trouble, I fitted two softly coiled flat springs in the hems of the drop curtain as shown in the drawing. The springs were obtained from a discarded toy automobile. Quite unintentionally this arrangement made a semiautomatic shutter. The hookless fasteners held the cover closed when the motor was idle, but as soon as the motor was started, the vibration caused the cover to roll up slowly. So it was not necessary for me to climb out over a snowdrift to open the flap, nor could it

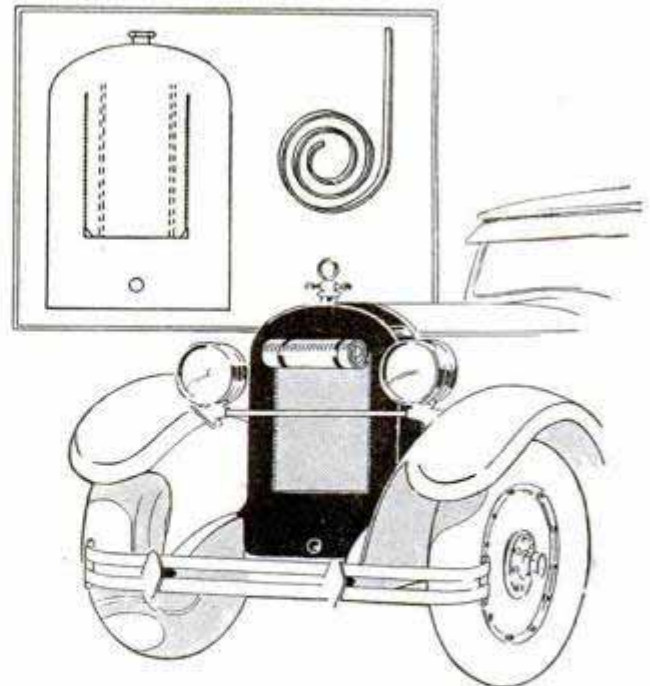

Coiled Springs Keep the Radiator Cover Open While Hookless Fasteners Keep It Closed

close itself while the car was running.—Dick Cole, Los Angeles, Calif.

## TOPSY-TURVY MATCH IS CLEVER BIT OF MAGIC



"The Quickness of the Hand  
Secret of the Mystery of the  
ditional Head, Drilled to Fit the

This capital little bit of magical equipment is capable of effects which never fail to puzzle even the most wide-awake people. Here is magic which you can carry around in your vest pocket, yet it is instantly available when a good trick is in order.

The whole apparatus consists of a small metal or cardboard tube, of such proportions as to enable an ordinary safety match to slide through freely. The tube should be a trifle longer than the match. The trick consists in dropping an ordinary match into this tube, head down, yet, upon the tube being lifted, the match is seen to be standing head up!

There is no secret in the tube—the whole trick lies in the match. This has a head at each end, one of which is detachable, being a genuine head of a similar match very carefully hollowed out so that the end of a stick can be temporarily fitted onto it. The hollowing out of the dummy head can be done best by using a small drill in the manner shown in one of the photos. The drill should be worked very slowly, and, even then, it is advisable to

Deceives the Eye." The Simple  
Topsy-Turvy Match Is an Ad-  
"Dead End" of the Magic Stick

hold the match head with a rag to safeguard the fingers against a sudden blaze. Sometimes it is possible to twist the head from a

match with the fingers alone, but this does not give a clean pocket as does the drilling method.

Once the dummy head has been drilled out, it is fitted onto the end of an ordinary match, as shown, care being taken, of course, that both heads are the same color.

Several excellent effects are possible with this rather curious match, the "topsy-turvy" effect being the most popular. In performing this number, the match is held between the first finger and thumb of the right hand, the genuine head being uppermost, and completely hidden between the ball of the thumb and first finger. The match is inserted into the tube in such a way that the genuine head is covered right up to the last. When finally dropped, the waiting finger and thumb of the left hand grip the dummy head in precisely the same manner as the right hand originally concealed the real head, and the cover being removed, the match is seen to



Dropping the Match into the Mysterious Tube Which Makes It, Apparently, Stand on Its Head; Inset, Match Ready for Action

be reversed entirely. In drawing it from the left hand for inspection, the false head is left between the thumb and finger. A little study will soon show you that the tube can then be transferred back to the left hand, and the two, tube and dummy head, quite naturally placed in your most convenient pocket.

Another excellent effect with the same equipment is the "match reincarnation" number, although this effect destroys the dummy head. In effect, the head is cut from an ordinary match, and the headless stick is then wrapped in a piece of paper. The head is burned, and the ashes sprinkled on the paper. On opening the packet, the match is found

to be quite normal, with head in place. The secret, of course, is the same as in the previous number. The real head is held by the fingers, and it is the removable head which is burned.

### An Improved Potato Bin

Much of the dirt that usually accumulates in a potato bin, and also most of the loss caused by rot and sprouting, can be eliminated if the bin is built a bit differently. Ordinarily, potatoes are merely tossed into a bin and those at the bottom have very little chance of getting any ventilation. Therefore, the bin should be constructed with an inclined bottom and an opening should be provided along the lower side. In this way the potatoes on the bottom will be used first. Furthermore, as the potatoes roll down the inclined bottom they will turn over so that the air circulates freely among them. The bin should be built with large slots in three sides. The back side may be tight. At the side where the opening is, a rail should be built so that the potatoes will not roll on the floor.

### Clothespin Bag Hangs on Line

In order to have a clothespin bag convenient where it will always be in reach, make it adaptable to be hung on the line as shown in the drawing. It consists of an ordinary clothes hanger and a small pillow case, meal bag or other cloth bag that will fit on the hanger. A hole cut in the side, with the edges neatly sewed over, makes it easy to insert or remove the pins. The bag is easily pushed along the line.—Jos. C. Coyle, Englewood, Colorado.



Clothes Hanger and Small Bag Make a Handy Clothespin Holder

### Correct Water Level in Cooling Tank Prevents Souring of Milk

Forty-two years of dairying and not one can of milk sour during the last thirty-five years, is the record of William Knobloch, veteran dairyman of Arthur, Ill. He never uses ice to keep the milk cool, but depends on the water in his cooling tank. Prior to 1895 he frequently experienced having his milk sour in the cans, but noticed that the cream on top of the milk soured first. As a result of this observation he began filling the cans only three-quarters full in order to have the cream below the water line of the cooling tank. When this plan was put into effect the trouble was completely eliminated.

### Blowing into the Tank Starts This Siphon

Taking advantage of the fact that the gasoline tank is airtight if the cap is fitted with a gasket, it is an easy matter to start a siphon by blowing through a tube soldered to an extra cap, which is carried along for the purpose. The cap is also drilled for the siphon tube itself, as shown in the illustration. Use a rubber or cork gasket, screw the extra cap on the filling spout tightly and blow into the first length

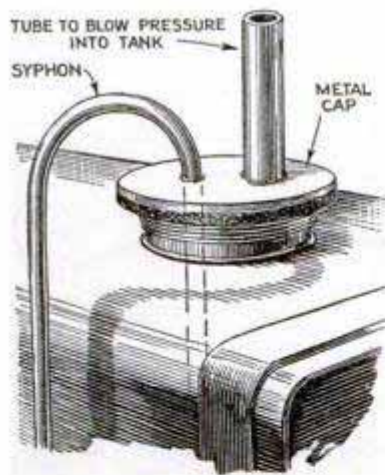

of tubing, which should be about  $\frac{1}{2}$  in. in diameter. The siphon tube should extend nearly to the bottom of the tank so that it will be possible to remove almost all the gasoline.

### Old Mop under the Wheels of an Auto Gives Traction

A new use for an old mop has been discovered by drivers for a large taxicab company. With the handle cut down to a few inches, the mop is carried in the tool kit and, when slipped under a rear wheel, gives the bit of traction needed to get out of a slippery hole.



Bed Covers Can Be Kept off Injured and Tired Feet with This Wooden Frame

### Frame Keeps Covers off Injured Foot

Anyone who has spent some time in bed with an injured foot will appreciate a device that keeps the covers off the foot and thus relieves it of considerable pressure. Get two 1-in. boards sawed to a semi-circular shape with slots cut in each so that they will fit each other crosswise. No nailing is necessary.—W. H. Martin, San Antonio, Texas.

### Improvised Countersink

On a cabinet job away from the shop it was necessary to use a countersink and as none was available, the emergency method shown here was resorted to. The head of a flat-head screw was cut off and a cut made on its edge, raising a sharp burr to act as a cutting edge when the head was inserted in the hole and turned by a screwdriver, countersinking the holes.

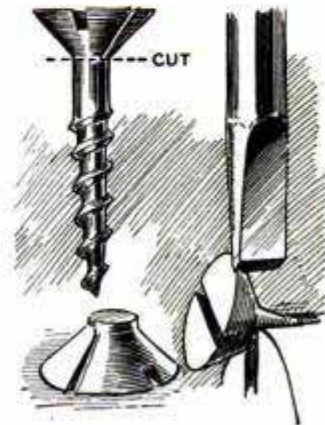

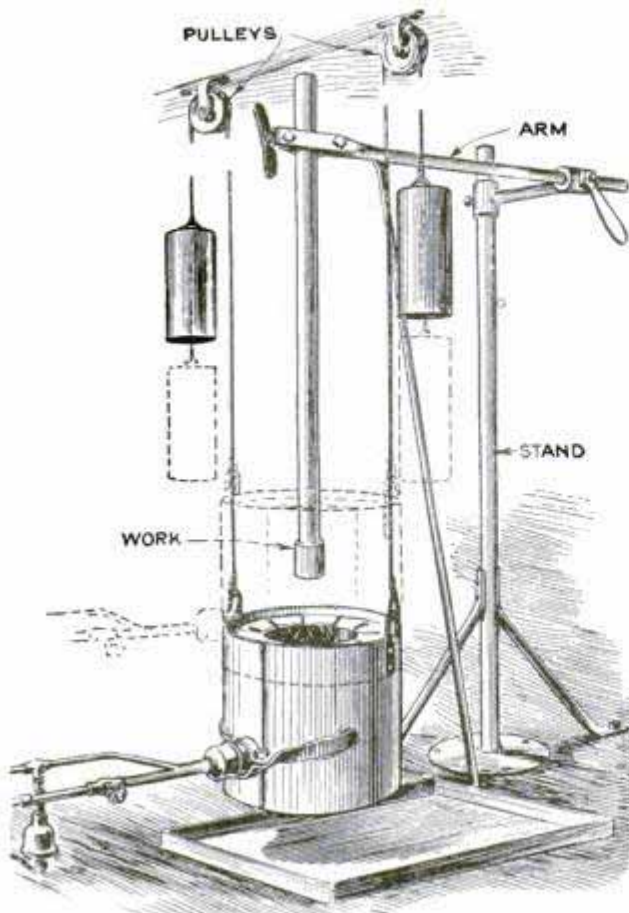

Small Brazing Furnace Suspended from Pulleys Is Adjustable to Suit the Work

### Adjustable Brazing Furnace

In brazing collars on copper piping in a Denver plant it was found practical to suspend the brazing furnace from small wire cables, passing them over 4-in. pulleys attached to the ceiling and provided with suitable counterweights. The pot is made of  $\frac{1}{8}$ -in. sheet metal with a hook welded to each side near the top, and lined with fire brick. A hole is drilled through the bottom for a length of pipe and the gas burner is inserted near the bottom. The pipe to be brazed is clamped vertically in the arm of a simple stand, made of old pipe, and the brazing furnace is raised up to the collar while used.—J. C. Coyle, Denver, Colo.

### Large Dial Fitted to Small Clock

A large clock with a face about 2 ft. in diameter, was constructed by using a dollar alarm clock to operate the hands. The glass and hands were first removed from the clock and brass extension tubes were provided on the posts of the hour and minute hands. These extension tubes give the necessary projection through the

large clock face to accommodate the large hands. Each tube should be snugly fitted to the post, one inside of the other, and the inner tube must be longer than the outer one. For the face cut a disk of sheet metal about 2 ft. in diameter. Paint it white and letter the hour figures in black or, if desired, the face can be painted black and the figures applied with radium paint. Directly behind the disk fasten the clock by means of suitable screws. The large hands should be cut from sheet aluminum and are drilled to fit snugly on the ends of the tubing.

### Paper Roll Supplies Continuous Bench Covering

Keeping a small workbench top clean is an easy matter with the arrangement shown in the drawing. Two brackets for holding a roll of kraft paper are screwed securely to the left end of the bench and two brass guards at either end hold the paper flat. When the bench needs recovering, tear off the soiled piece and pull out a new section of paper. It is not necessary to purchase complete rolls of paper; just go to a merchant who uses heavy wrapping paper and obtain a few



Roll of Kraft Paper Makes It Easy to Keep the Bench Cover Clean

remnants containing 40 or 50 ft. of paper.—Earle M. Guild, Attleboro, Mass.

### Using Stoplight for Backing Light

The late design of rear lamps on the model-A Ford has a yellow lens for the stop signal. This projects a powerful beam behind, which is very useful when backing at night. A single-hole pull or toggle switch, placed on the dash, makes it easy to turn the light on when needed. One wire from the switch is run under the gasoline tank and into the terminal box on the dash, the other wire being led through a small hole in the dash, on the left side, and then back with the standard wires to the stoplight switch. Armored wire with heavy insulation should be used for the purpose.

### Lantern in Barrel Prevents Hydrant from Freezing

Outside hydrants can be protected against frost by simply placing a keg or barrel over them and placing a lighted lantern inside, as shown in the drawing. To provide proper ventilation for the lantern, drill two holes in the bottom of the keg and insert pipes as shown. The lower outlet of the intake pipe should be near the ground level, while the lower opening on the other pipe should be a foot higher, to insure circulation. Elbows and nipples at upper ends of the pipes prevent snow and rain from entering.—James F. Hobart, Dunedin, Fla.



### Runner for the Wheelbarrow

By applying a runner to the wheelbarrow, it will be much handier to use during winter, especially when it is necessary to push it through loose snow. It consists of a piece of wood a trifle wider than the wheel rim or tire. To this runner a length of flat iron of the same width is attached, leaving both ends projecting,

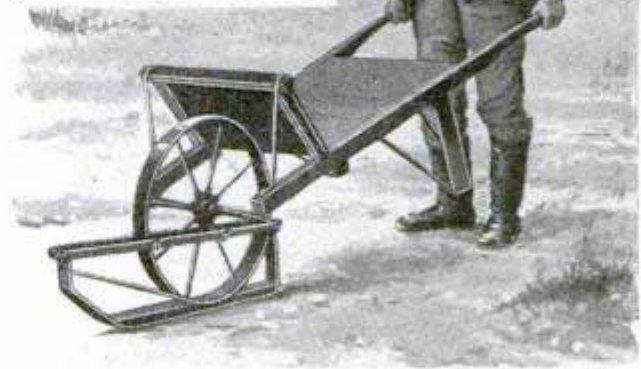
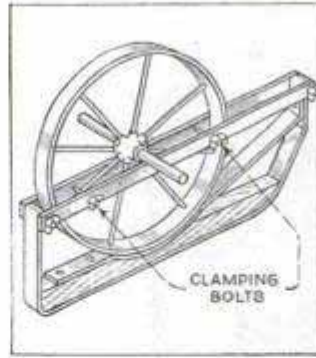

Runner Applied to the Wheel Makes a Wheelbarrow Easier to Use during Winter

after which the ends are bent upward and eyes formed to accommodate bolts. Two pieces of flat iron, drilled the same size as the eyes, are then used as crosspieces to provide the necessary rigidity. An extra length of flat iron, the same size as the runner, is then bent and attached to form a seat for the wheel. Besides using bolts with wingnuts at the ends of the crosspieces, two additional bolts are used to clamp them onto the wheel.

### Hammer Made of Pipe Holds Supply of Tacks

Made of pipe and fittings, the handy hammer shown in the illustration holds a large supply of tacks, ready for use when needed. The caps used on the head are ground to a flat surface and a wooden plug is driven into the handle so that the tacks will not get into the head. Another wooden plug is used to close the open end of the handle.—W. D. Cockburn, Woodstock, Can.





Mirror Placed under Photo Gives the Illusion of Water into Which Bathers Seem to Leap

### Trick Photograph Made with Mirror

Apparently leaping into a deep pool and caught by the camera in mid-air, the trio of bathers make an interesting photograph, especially as there was no water within sight when the photo was taken. The upper half of the picture is a truthful reproduction but was "shot" on the lawn. When making an enlargement, a mirror was laid on a table, and the photo, trimmed down just below the slight rise in the ground, was placed on the mirror. The reflection of the photo in the mirror gives the illusion of water.

### Breaking In Stringed Instruments

By placing new, stringed instruments close to a radio loud speaker, it is possible to break them in effectively, thus greatly improving their tone quality. A violin already broken in is quite expensive, and this method enables anyone to purchase a cheaper instrument and break it in himself. Tune the instrument properly and set it on a shelf directly in front of the loud speaker, or if this is impossible,

on the shelf that holds the speaker. Perhaps there is enough space in the radio cabinet to hold the instrument or else it can be laid on top of the cabinet. The vibrations of the loud speaker are transmitted to the instrument, which responds in what is called a "sympathetic vibration." After a few weeks of such treatment the instrument will be found to have a much better tone than at first. It is advisable to retune the strings every few days. Some instruments, such as cellos, bass viols and even violas, require a good dynamic loud speaker to age them as described above, as an ordinary magnetic speaker does not deliver the low tones possible with

a dynamic. The longer you break the instruments in the better the tone quality will be. If a guitar is kept on the same shelf as the speaker, the tone of the instrument seems to improve from month to month.

### Brick Makes Handy Match Holder

A face brick, having two holes through the core as shown, makes a good match holder for the office desk, one hole being used for live matches and the other for those already used. The brick is set on a piece of linoleum or other similar material, cut slightly larger than the brick.

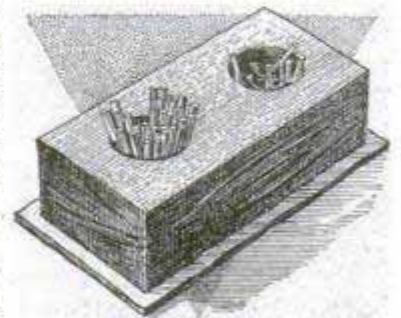

The rough surface of the brick makes a good striker that never wears out. It can be given an application of gold bronze to make it more attractive, and may be used also as a cigaret holder. —John G. Hanna, Dunedin, Fla.



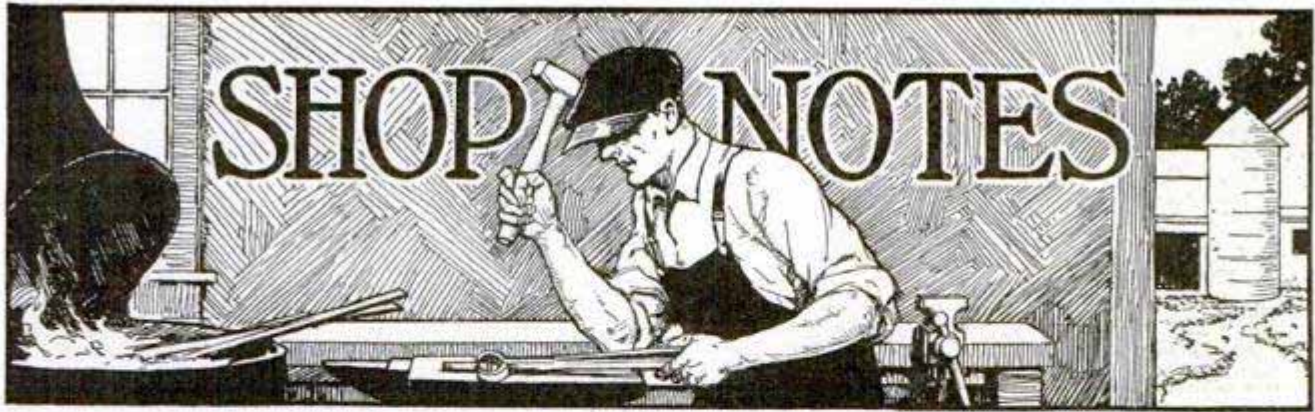

## Making Band-Inlay Strips

By W. CLYDE LAMMEY

**T**HOUGH inlay strips, commonly known as "bandings," are obtainable commercially, it is often desirable or necessary that we have a special form, length, or width that cannot be purchased ready-made, or that cannot be obtained quickly enough to suit. Though an inlaid band appears to be a difficult piece of work, it is comparatively easy to make where one has at hand a small saw table on which the parts can be accurately cut to size. A built-up block from which about a dozen thin inlay strips may be cut, all of the same figure, can be made in a few minutes.

Figs. 1 and 2 show a number of designs which can be made without becoming involved in an intricate

process. If the woods are carefully selected and cut accurately to size, the result is a highly colored band that will inlay beautifully, and suitable fancy woods in a wide range of quality, size and thickness are more easily obtained than the made-up bands.

The design shown at A, Fig. 1, is made up of two woods,  $\frac{1}{8}$ -in. ebony and  $\frac{1}{16}$ -in. white-holly veneer. First the stock must be carefully selected for uniformity, and one edge jointed true. To joint the holly, the edge of the piece must be clamped between two supporting strips, locked in the bench vise and planed off by hand. The ebony strip may be jointed either by hand or with the small power jointer. If the throat opening in the saw table is wider than  $\frac{1}{4}$  in., it will be necessary to make a new throat block of wood with an opening of about  $\frac{3}{16}$  in.

The width of the built-up block from which the inlay strips are to be cut depends on the amount of inlay in the design required. If the block is 3 in. wide

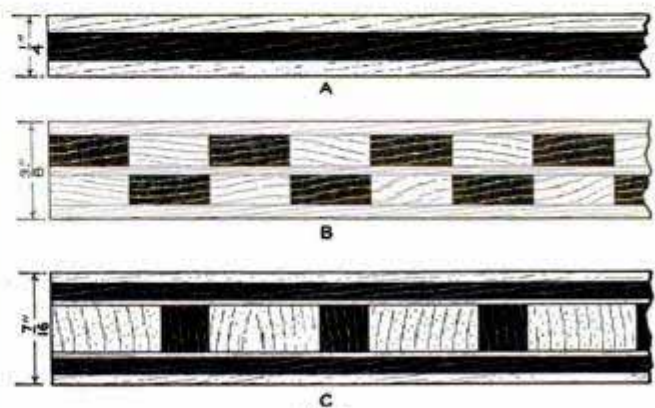
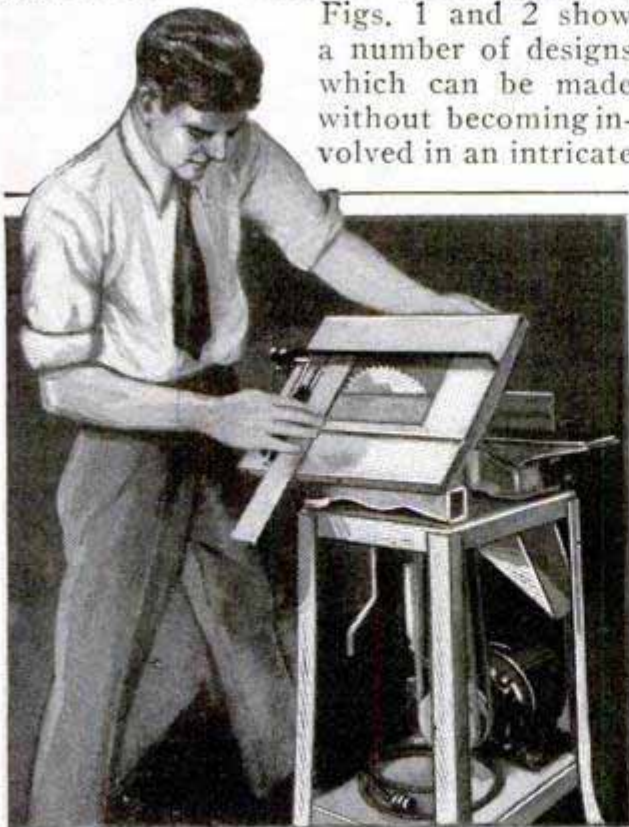

FIG. 1

Cutting the Ends of the Mitered Core Blocks for the Design Shown in D, Fig. 2; Right, Several Simple Banding Designs

and 24 in. long and the inlay bands are ripped to  $\frac{1}{8}$ -in. width, then, allowing  $\frac{1}{16}$  in. on each piece for the saw kerf and an additional  $\frac{1}{8}$  in. for inconsistencies in width, we can cut fifteen inlay strips from the single built-up block, or 30 ft. in all.

Assuming that this is the amount required, rip two strips from the holly, each 3 in. wide and 24 in. long. Rip one strip from the ebony stock the same width and length as the holly strips. Get two pieces of hardwood, each piece about 26-in. length and  $3\frac{1}{2}$ -in. width, for use as clamping cauls. Glue the three strips together as shown, with a liberal coating of glue. Place the work between the cauls and draw very tight with six heavy C-clamps, evenly spaced. When dry, remove the clamps and joint one edge of the work. Then

place this edge against the ripping fence of the saw and rip the strips to  $\frac{1}{8}$ -in. thickness as needed. Use a "planer" saw blade if possible when ripping the block into strips, or at least a saw blade with a very fine set.

The second design, B, is a more elaborate form. The core of this design consists of alternate strips of ebony and white holly,  $\frac{1}{8}$  in. thick, with a  $\frac{1}{28}$ -in. veneer of holly between. The holly and ebony core stock is cut across the grain into strips  $\frac{1}{2}$ -in. width and 3-in. length and is laid crosswise. The drawing of form B in Fig. 3 shows clearly how the core is assembled between the  $\frac{1}{16}$ -in. facing strips of holly. For a built-up block, 24 in. long, 48 pieces of holly, cut to  $\frac{1}{2}$ -in. width, and the same number of ebony will be needed, both  $\frac{1}{8}$  in. thick and 3 in. wide. These may be cut by first ripping the stock into 3-in. strips, then setting the ripping fence just  $\frac{1}{2}$  in. from the saw, and using the fence as a stop to gauge the length of each piece cut. Assemble in the manner shown in Fig. 3. Be very careful that the small pieces which make up the core

are correctly placed and that they do not shift when the work is glued and clamped.

Design C, Figs. 1 and 3, is an ornate band for a large ground. The top and bottom are first built up as separate units in the same way as design A, save that the core is  $\frac{1}{16}$ -in. ebony or amaranth and the facing strips  $\frac{1}{28}$ -in. holly. Glue up and clamp both facing strips at once, placing a sheet of paper between them so that they do not stick together. The core of the finished inlay is made

up of  $\frac{1}{8}$  by  $\frac{3}{8}$ -in. pieces cut across the grain from  $\frac{3}{8}$ -in. amaranth, and alternated with  $\frac{1}{8}$  by  $\frac{1}{8}$ -in. ebony squares, also sawed across the grain. The manner of building the inlay block is clearly shown in Fig. 3. When sawing the small parts, use a saw blade with very little set and bring up the ripping fence as a stop to gauge

the length. When ripping off the inlay bands from these more complicated patterns it is necessary to be very careful that the band does not break up. It should be held firmly and moved slowly against the saw.

Pattern D, Fig. 2, looks especially well when inlaid vertically. Its construction is essentially the same as that at B, save that the parts of the core are cut at an angle of 45 degrees at the ends and are laid opposite, two of the same color, with a thin strip of holly between. The light-colored blocks, A, are cut from boxwood and these as well as the ebony blocks may be cut from either  $\frac{1}{8}$  or  $\frac{1}{4}$ -in. stock. When the blocks are cut from  $\frac{1}{4}$ -in. stock the finished band will be about  $1\frac{1}{16}$  in. wide.

The parts are first ripped to 3-in. width. The saw table is then tilted to 45 degrees and the ripping fence set  $\frac{1}{2}$  in. from the saw if the stock is  $\frac{1}{8}$ -in. thickness; if  $\frac{1}{4}$ -in., then set the fence  $\frac{3}{4}$  in. from the blade. Be particular about the setting and do not change it until all the pieces have been cut. Miter one end of the piece

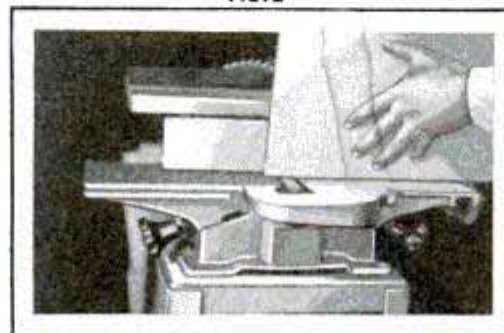
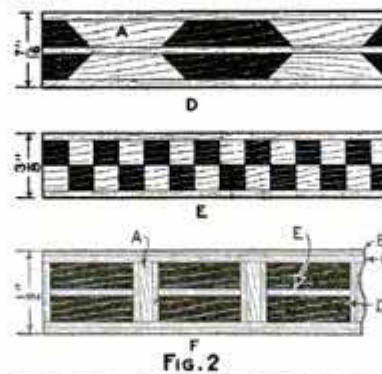

Three More Elaborate Banding Designs; Below, Jointing the Edge of the Built-Up Stock before Ripping

*Sh Milwaukee Wis.*

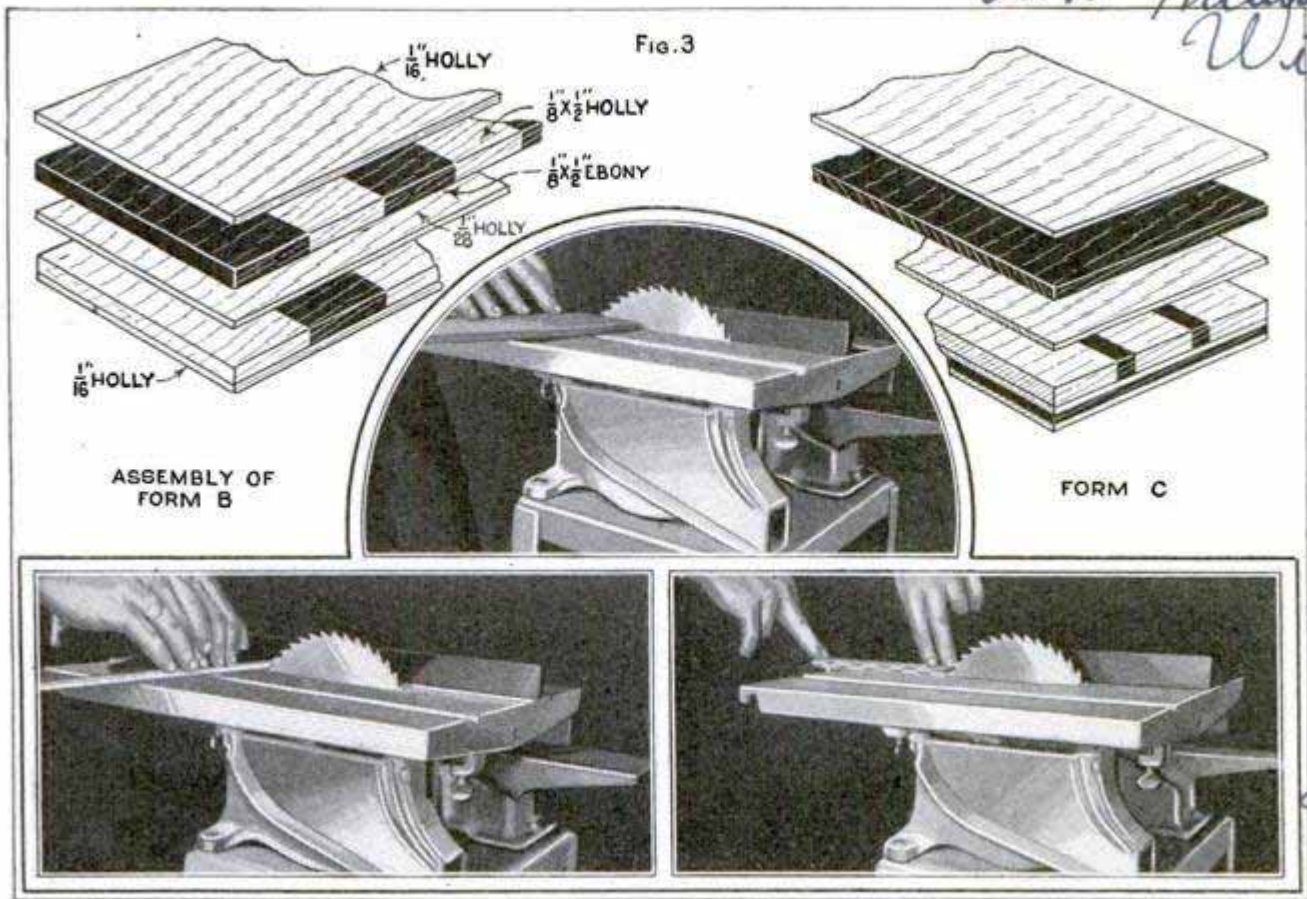

*and joints are mounted together on all sides and driven by angle's hps. electric motor gear drive*

Center Photo, Cutting Off Ebony Core Stock to Width; Left, Sawing Off Vertical Cores for Design F, and Right, Ripping a Finished Block, Design B, to Thickness for Bands

first, then turn it over and slide the mitered end against the ripping fence, and so on until the required number has been cut. Use a narrow strip to push the pieces clear of the blade when they have been cut off. Then assemble the parts as in Fig. 2 and clamp in the same manner as described for those preceding.

Pattern E, Fig. 2, is similar to design B, save that the center strip of the core is omitted and, instead of being rectangular, the core blocks are square. These may be either  $\frac{1}{8}$  or  $\frac{1}{4}$  in. square with  $\frac{1}{16}$ -in. facing strips, according to the width of the inlay band desired. Otherwise the procedure is essentially the same as that described in making design B.

The last pattern, F, in Fig. 1, is somewhat more elaborate. The vertical core blocks, A, are first built up and consist of three members, an outer facing of  $\frac{1}{28}$ -in. holly veneer strips over a core of either amaranth or tulip,  $\frac{1}{8}$  in. thick. Blocks D are black ebony,  $\frac{1}{8}$  in. thick and  $\frac{3}{4}$  in. long. With a center strip, E, of  $\frac{1}{28}$ -in. thickness, the length of the vertical blocks, A must be very slightly less than  $\frac{9}{32}$  in., but owing to the glue films between, it will

be safe to cut these to exactly  $\frac{9}{32}$ -in. length. Hence the part A is first built up as a three-ply strip, the grain of the core running in the direction indicated on the blocks to a width of 3 in. Then the blocks are cut off to the length of  $\frac{9}{32}$  in.

The center core, consisting of parts D and E, is glued up to 3-in. width, the facings of  $\frac{1}{8}$ -in. black ebony over a center core of  $\frac{1}{28}$ -in. holly. This is sawed into rectangular blocks  $\frac{3}{4}$  in. long. The complete core is then assembled in the form shown in F, with two facing strips on each side, strip C being cut from  $\frac{1}{16}$ -in. boxwood and strip B from  $\frac{1}{20}$ -in. holly. The gluing and clamping is done in the same manner described before.

The thicknesses given on the patterns A, B, C, D, E and F are only approximate as the woods are sometimes slightly off the exact dimension in thickness. For this reason it is necessary when inlaying to be extremely careful about the width of the groove in which the band is to be inlaid. Where the groove is cut with the dado on the power saw, first test the setting of the head on a piece of waste. If the groove is slightly too narrow, place thin,

paper shims over the saw spindle and between the cutters of the head, and try again. Make sure that the head is carefully tightened after the paper shims are added. Make trial grooves in the waste, either taking out or inserting more shims between the cutters of the head, until the inlay band is a light fit in the groove so that it will not be necessary to force it unduly when inlaying. Handle the thin strips carefully and avoid bending or dropping them. Rough handling will break up the pattern.

When finishing, do not sand the inlay band, especially if the parts of the core are black ebony, as the sanding will work the black dust into the lighter wood. It is best not to sand any inlay composed of several highly colored woods, for this reason. Always finish with a sharp cabinet scraper, and blow off the dust; do not rub it off. Even when a brush is used, some of the dust will be worked into the lighter wood.

It will be noted that on all the patterns the facings are white holly. For this reason the bands are suitable only for inlaying on a ground of dark color, such as walnut. Where it is desired to inlay the band on a light-colored ground, the facing strips should be a wood of reddish coloring, such as amaranth or vermilion. All these woods are readily obtainable and one can get a considerable selection of the thicknesses required at nominal cost.

☐The more absorbent woods require a priming coat that is rich in linseed oil, with a small amount of turpentine added; while the less absorbent woods need less oil but more turpentine to help the oil penetrate the wood.

## Oil-Drum Mounting for Garage

The illustration shows a cheap and simple way to mount an oil drum in the home garage.

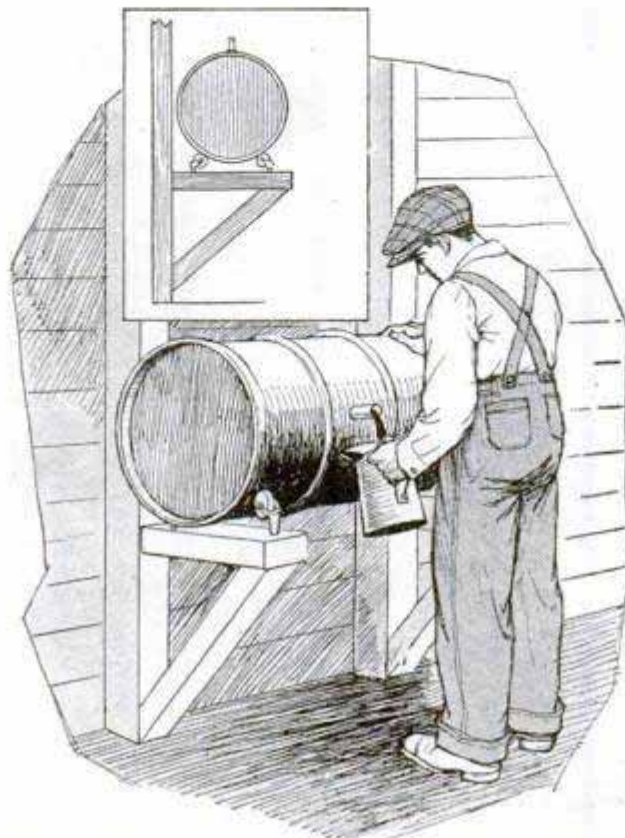

Simple Mounting for 15-Gal. Oil Drum Makes Dispensing Easy and Prevents Waste

In my own case, I mounted the brackets on the wall, since my garage was a frame structure, but in a brick garage the drum can be mounted on a floor stand. Four old bed casters are used as rollers for the drum. A 1¼ by 6-in. nipple replaces the side screw bung in the drum, and this is covered by a tire-patch container when the drum is not in use. To draw off oil, all that is necessary is to remove the cover and, using the nipple spout as a handle, roll the drum forward until the

oil runs freely. When the container is filled, the drum is rolled back.—N. G. Hall, Port Angeles, Wash.

## Hose Holder Offsets Danger of Carrying an Ice Pick

Carrying an ice pick in one's pocket, as is common practice, is more or less dangerous. A practical method of carrying it without this objection is shown in the accompanying photo.



Get a length of old garden hose that will fit snugly in the rule pocket of your overalls. Slit the top end of the hose so that the handle of the ice pick will wedge into it

to hold it in place securely. The point will then be inside the hose where it can do no harm.—Frank W. Bentley, Jr., Missouri Valley, Iowa.

### Photographic Reflector Easy to Make

A cheap and quickly made reflector for taking interior portraits, etc., can be made in a few minutes, and has many advantages over the regular white cheesecloth reflectors generally used for the purpose. Get a piece of heavy cardboard or wallboard of the dimensions of the reflector desired, and some large sheets of ordinary tinfoil, such as are commonly used to wrap 8 by 10-in. plates. Coat the cardboard on one side with glue and spread the tinfoil over the coated surface, being careful to leave it slightly crumpled. Do not smooth it out evenly. If smoothed, the tinfoil reflection is too concentrated and brilliant, but when slightly crumpled the foil gives thousands of tiny reflections.

### Extra Handle Increases Comfort in Using a Saw Set

When compressed, the handles of the usual saw set are so close together that it is rather tiring on the hand to use it. This trouble was eliminated by attaching a piece of wood to one of the handles. Two holes were drilled through one handle and wood screws were then driven into the wooden grip from the inside. Of course, the extension should be cut and sanded perfectly smooth.—G. M. Beerbower, Hollywood, Fla.

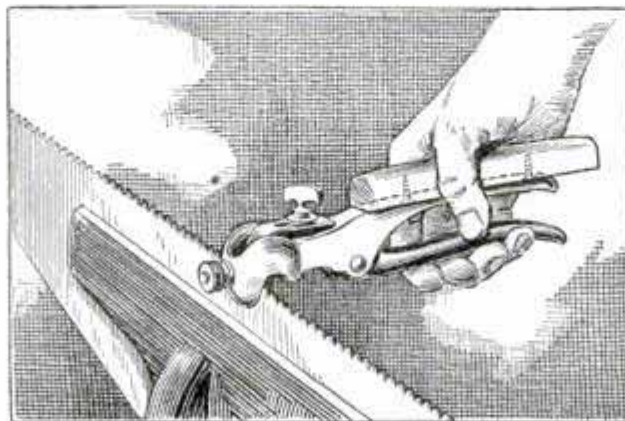

Extra Grip Attached to Handle of Saw Set Makes It Easier to Use

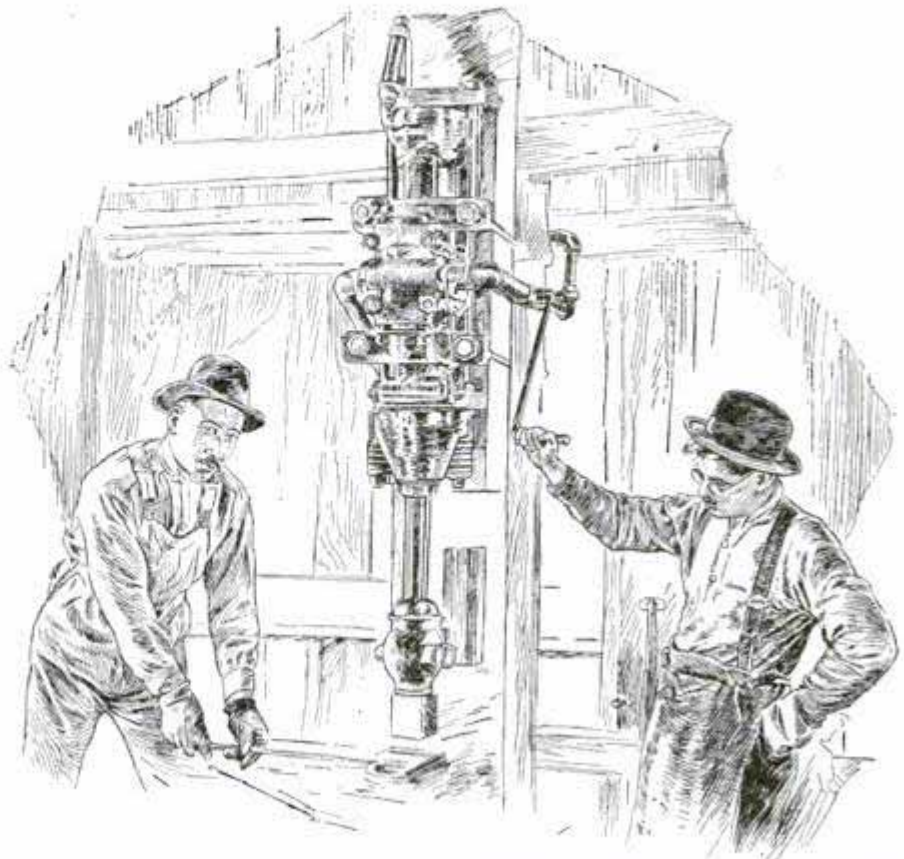

Tripod Drill That Was Converted into a Power Hammer and Used in a Small Shop for Making Small Forgings

### Converting a Tripod Drill into a Power Hammer

In a small shop, a large number of light forgings were being made out of  $\frac{3}{4}$ -in. round stock by hand, which was rather slow. To speed up the work, a large tripod drill, that had been used for drilling grout holes in a power-dam foundation, was converted into a power hammer. This was accomplished by clamping the drill to an upright post that was imbedded firmly into a concrete base having an anvil block independent of the post, onto which the anvil dies were clamped. The rotating device was removed, a guide provided for the upright post and a bar clamped to the piston head, keeping the hammer die in the ram in alignment with the bottom dies in the anvil block. By using special swaging dies of different sizes, a wide range of forge work can be accomplished.

# Making a Pair of

*By L.D. Perry*

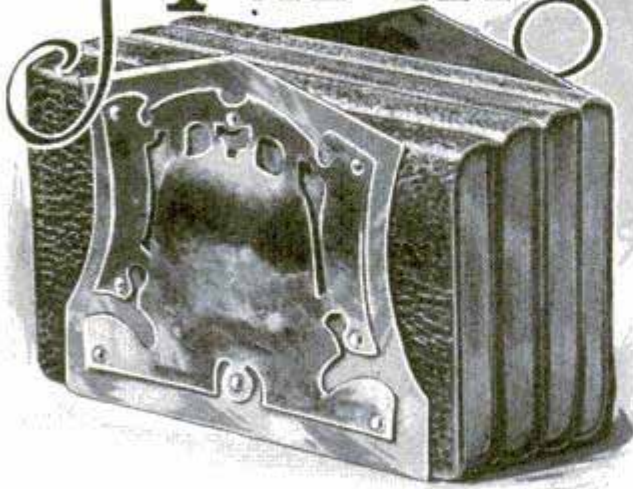

THE craftsman will find no handwork more fascinating and interesting than the making of artistic articles of copper or brass. After a little preliminary experience with these metals the worker will be surprised by the ease with which fine articles may be produced. Little equipment is actually needed other than the usual tools found in the small workshop.

Copper and brass are sold by the pound, and the dealer will cut the metal to any size required for a slight extra charge. For the book ends described here No. 18 and 20 gauge are specified. The 18-gauge metal is the thicker and is necessary to use in the ends to assure proper support for the books. The 20-gauge stuff is used for the designed pieces to be riveted or "applied" to the ends, as indicated in Fig. 1. A slightly thinner gauge may be used for these if the workman happens to have such metal. Rivets may be of either brass or copper, the latter preferred.

The first operation is to make a pattern for the ends. This is done as illustrated in Fig. 3. A piece of fairly stiff, tough paper is folded once. One half of the pattern is drawn upon it, the dimensions being taken from Figs. 1 and 3. The pattern is then cut out with a pair of scissors.

The design for the applied pieces is drawn next. A piece of tough paper is folded once and the squared lines are drawn

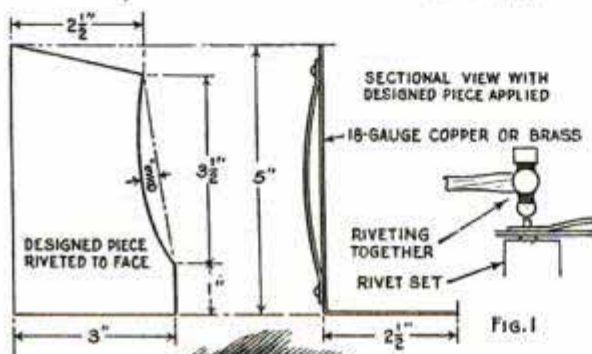

Fig. 1

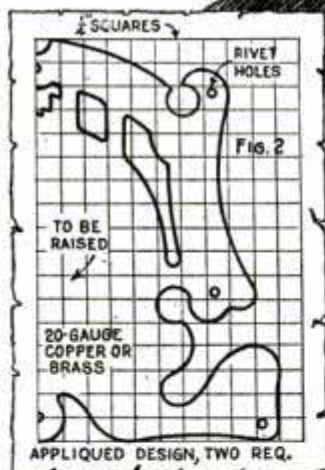
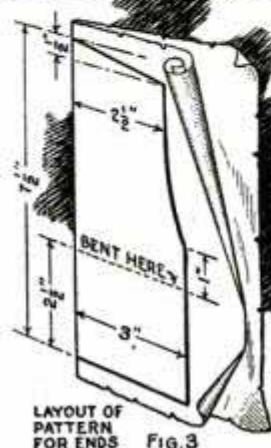

Fig. 2



LAYOUT OF PATTERN FOR ENDS Fig. 3

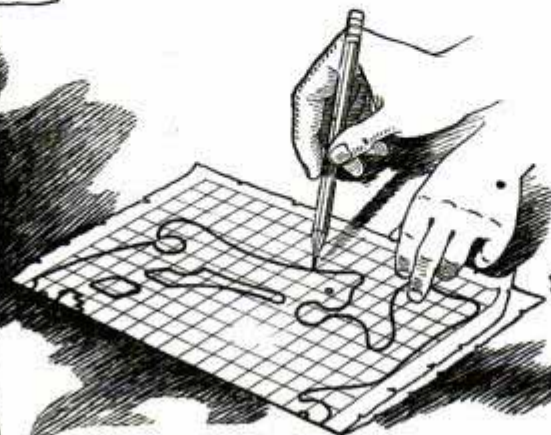

Fig. 4 SKETCHING DESIGN

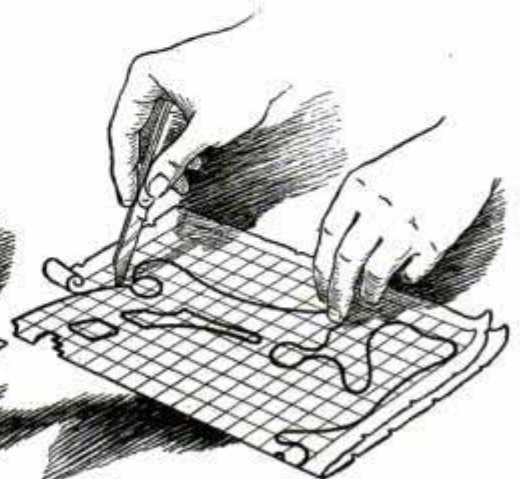
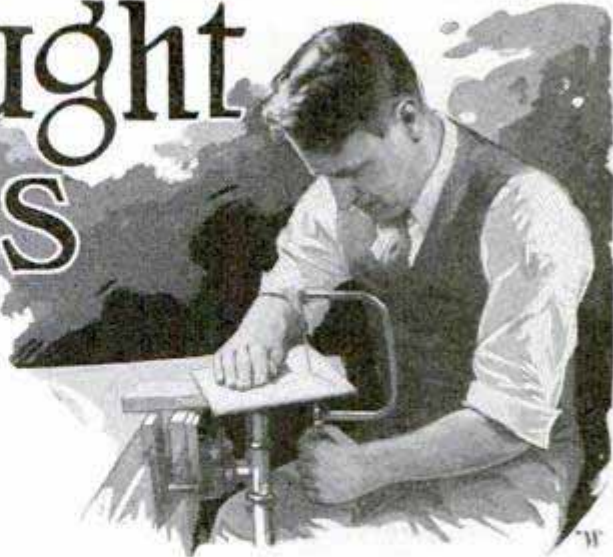

Fig. 5 CUTTING OUT THE DESIGN

# Hand-Wrought Book Ends



upon it as shown in Fig. 4. The design from Fig. 2 is reproduced on these squares, or an original design may be substituted, then cut out, as shown in Fig. 5, with a sharp pocket or sloyd knife. The paper should be laid over a soft-wood block, or hard paper, so that the cuts are made clean and sharp. A duplicate design should be made from the original and trimmed in the same way. The back pattern and the duplicate designs are now ready for use when the metal is prepared for them.

Two pieces of No. 18 gauge metal are next cut for the ends. These should be a little larger than the pattern, and are smoothed out by striking a series of blows with a mallet. To do this, each piece is laid upon an anvil, iron block or level bench top. When they are trued up, the pattern is laid upon each and the outline is penciled or scratched on the metal. The outline is then closely followed with the tinner's snips, shearing away all excess metal. This process is shown in Fig. 6.

The pieces are again smoothed out, placed in the vise and the edges are filed down to the line with a smooth file. The file should be operated in the direction of the edge, as shown in Fig. 7, not cross-wise. Should the vise have rough faces on the jaws, it is necessary to protect the metal with wood blocks, for scratches and abrasions are very difficult to remove.

Next the pieces for the design are cut and smoothed with the mallet. One side of each paper design is coated with very thin glue, and glued to the metal. The paper should be pressed down firmly and allowed to dry, then the rivet holes and the piercings are marked with a center punch, Fig. 8. These marks prevent the drill from "traveling" over the metal and thus making unsightly marks.

The holes are next drilled with a hand

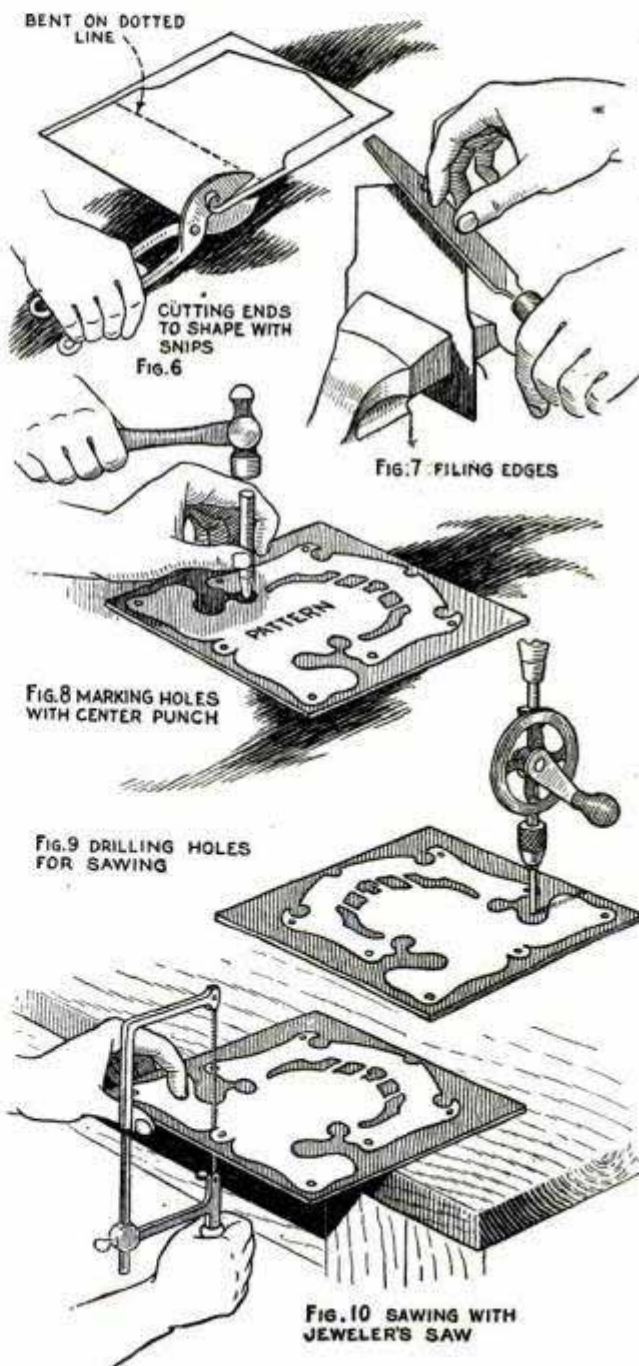

drill as shown in Fig. 9, or on a drill press, if one is available. The size of the drill to use is determined by the size of the interior cuts or piercings. In no case is a drill larger than  $\frac{1}{8}$  in. required. In this particular pattern the same drill as used for the rivet holes may be used for the others. Rivets should fit the holes snugly. They should be tried out on a scrap piece to be sure that a drill of the right size is selected.

The design is next cut out with a jewelers' saw. Curved snips can be used for part of the outline but practically all will need to be done with the saw. Fig. 10 shows how the operation is performed. One end of the saw is fastened in the frame with the teeth pointing down and away from the frame. Cutting is done on the downstroke. The frame is adjustable so that when the other end of the saw is fastened with the setscrew it may be given the right tension by an adjustment of the setscrew at the rear of the frame. The beginner will probably break a number of saws until he learns the "feel" of the operation, and takes easy, steady strokes, and learns how to continue to saw as he turns sharp corners.

On the interior cuts one end of the saw is first fastened to the frame, the saw is then passed through one of the holes, and the other end is held by the setscrew or clamp. When the cut is finished, one end is released, inserted in another hole, and sawing continued. When all sawing has been completed, each piece in turn is held in a vise or against the bench top and the edges are filed with needle-point files, as shown in Fig. 11. These files are very fine and come in sets of assorted shapes. A file should be used which conforms to the outline of the part of the design to be filed. Any burrs on rivet holes which may have been left from drilling should be removed with emery cloth.

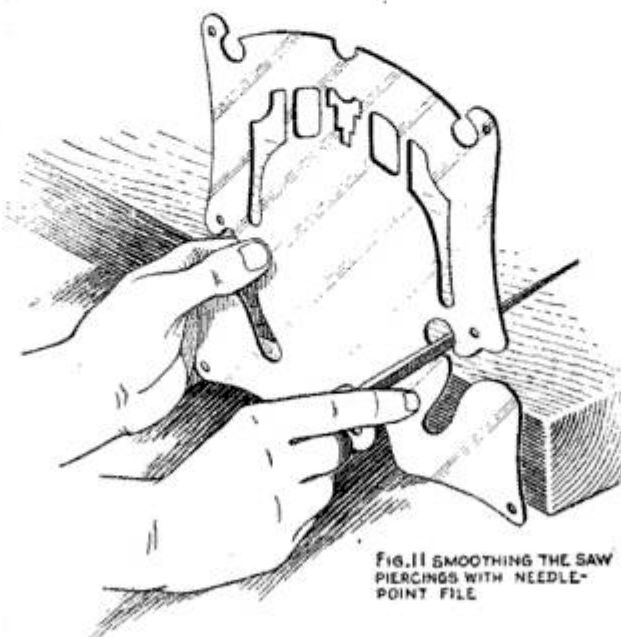

The paper is now removed by soaking the pieces in water. The center area of the design is raised slightly or "domed," as the process is called. This gives a certain character to the book ends and makes them much more effective in appearance than if the design were left flat. This is done by placing the design on a sandbag, Fig. 12, and striking the parts to be raised with a round-nosed mallet. Do not raise them too much; only about as shown in Fig. 1. The pieces are finally flattened out around the edges

by placing each on

an iron block and striking with a mallet, as shown at Fig. 13.

The ends and the designed pieces are now ready to be riveted together, Fig. 14 showing how this is done. First the designed piece is placed on the end in the right position and the rivet holes on the lower piece are marked through the holes of the designed piece, then drilled. When the rivet, as shown in Fig. 14, has been driven through both pieces, the end is clipped off fairly close with side-cutting pliers and is then "set" by placing the head in the depression in the rivet set and hammering over the end. When finished, the place of setting should barely show. When all the rivets have been placed and set, the ends will then appear as in Fig. 15.

The right-angle bend for the support of books is made over the edge of the bench or anvil. It is then made fairly sharp by striking with a mallet against a sharp corner.

The completed ends are cleaned by immersion for a few minutes in a solution known to the art-metal worker as "pickle." This solution is made of one part sulphuric acid and fifteen parts water. It should be kept in a crockery jar. The articles should be thoroughly rinsed after they have been taken out of the pickle, preferably in running water. They may



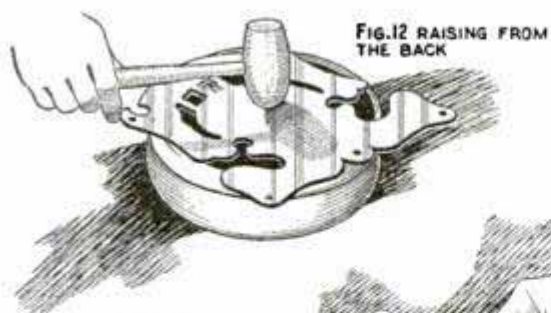

FIG. 12 RAISING FROM THE BACK

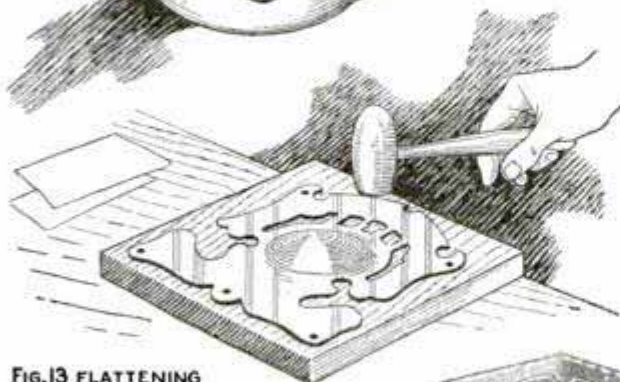

FIG. 13 FLATTENING THE EDGES

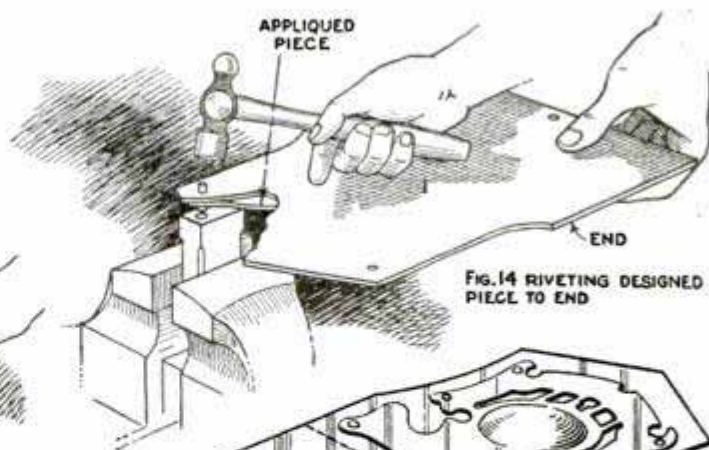

FIG. 14 RIVETING DESIGNED PIECE TO END

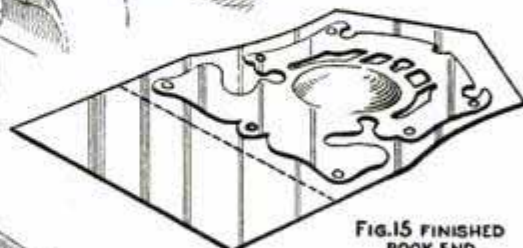
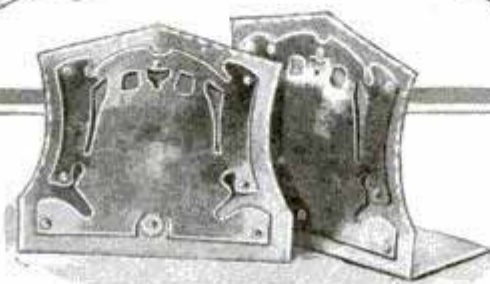

FIG. 15 FINISHED BOOK END

then be quickly dried by placing them in clean sawdust. Before a finish is applied, the metal should be scoured, in one direction only, with a fine grade of emery cloth or steel wool. The finish will be unsatisfactory unless the metal is perfectly clean, and free from oil and grease and even fingermarks.

Copper and brass may be finished bright and allowed to assume the color that comes through exposure to the air, but normally some finish should be applied. One of the simplest and most effective methods of coloring copper is through the application of heat. After the article of copper has been cleaned, it is passed slowly over a gas flame or Bunsen burner, until the colors appear. Different colors appear as the temperature of the copper increases. In order, the following colors appear: orange-red, purple, brassy, dark red, dark purple, and chestnut. The article should be removed from the flame at the right time and allowed to cool slowly. If the color is not satisfactory, the copper may be cleaned in the pickle again and the heat treatment continued until the color is satisfactory.

Oxidized-copper effects may be produced by painting on the following solution with a soft brush: a small lump of potassium sulphide dissolved in 1 pt. of water to which is added six drops of ammonia. If the color is too dark more water is added to the solution. Antique



effects on brass are produced by applying butter of antimony and allowing it to dry. For dull brass, apply the following solu-

tion with a brush: 12 parts of hydrochloric acid and 1 part ferric oxide. To produce a green color on brass, immerse the article in the following solution:  $\frac{1}{2}$  lb. sal ammoniac and  $\frac{1}{2}$  lb. sulphate of copper dissolved in 2 qt. boiling water.

Colors produced by any of the solutions mentioned and by heat are not permanent unless protected with some finishing agent. Wax may be applied while the metal is warm, and after it has cooled, it is polished by brisk rubbing with a soft cloth. Lacquer also is a good finish. It is applied very thin with a soft brush and allowed to dry.

#### Ford Valve Guide Removes Carbon from Valve Stems

An old discarded valve guide from a model-A Ford, can be used for cleaning valve stems of carbon. Simply work the valves back and forth through the guide. The application of a little valve-grinding compound will hasten the work.—R. M. Sheldon, Dallas, Tex.

☛ In grinding, a fast work speed will wear out the wheel faster than a slower work speed; the speed should be adjusted so as to secure the longest life of wheels consistent with efficient production.

### Jig for Boring Dowel Holes True



On a job of making a number of odd-size cupboard doors by hand, it was found impossible to bore holes for dowels true in both directions until a piece of the stile was used as a guide, as shown in the illustration. The block was cut square and a strip of

wood nailed to the side of the block to project over the door stile, after which the whole assembly was held firmly in a vise. The same method was also used in boring holes for mortises for locks in doors. In this case a strip of wood was nailed on either side of the block and the latter was then simply held in place with the left hand.—G. M. Beerbower, Hollywood, Fla.

### Cutting Self-Hardening Steel

Self-hardening steel is too hard to be worked into special shapes, often required in the shop. Although brittle, it can be forged if treated with care. When red-hot it can be filed, although it is generally poor practice to file hot metals. When self-hardening steel is bought in bars, which must be cut up to the proper tool lengths, there is nearly always quite a bit of waste involved, unless a friction saw is used, and this is usually not part of the equipment in the average shop. Many workers break off pieces by holding the bar in a vise and using a large wrench, but the irregular fracture which results must then be ground down to shape, which is wasteful. The same objection holds true in cases where the corners and sides are nicked on an emery wheel and the fracture then effected. When hot, the bar can be cut with a cold chisel on an anvil with much less waste than by the two methods

just mentioned, but the best method is to grind a groove on one side of the bar only, and to make light nicks in the adjoining two sides, leaving the fourth side untouched; then break off the piece. The advantage of this method is that the general shape of the tool edge is formed by such grinding, and it will then require very little more grinding to finish it.

### Stretching Photos Cut Too Short

Practically all photographers and photo finishers have wasted time and material when their print trimmer has slipped a notch and the print is cut too short to fit the frame. To avoid the necessity of making a new print proceed as follows: Place the print in water and let it soak well. Then put it on a ferrotype plate and squeegee it with heavy pressure. From experience, I have found that a print will stretch from  $\frac{3}{8}$  to  $\frac{3}{4}$  in. per foot by following this method, depending on whether it is single or double-weight paper. Since the average framed photograph is 5 by 7 in. or over, this added length will generally be sufficient.—Kenneth Keith, Chicago.

### Rubber Disk Catches Valve Reamer Cuttings

When reaming auto valves, it is a good idea to provide a rubber disk, cut from an old inner tube, on the lower end of the reamer shank, to retain the cuttings and prevent them from getting into the combustion chamber, where they would cause excessive wear on the cylinder wall. The disk should be a trifle larger than the valve port and should be kept as tightly as possible against the underside so that no cuttings will get past it. When pulled out, all the cuttings will come with the disk.—F. J. Wilhelm, Cincinnati, Ohio.

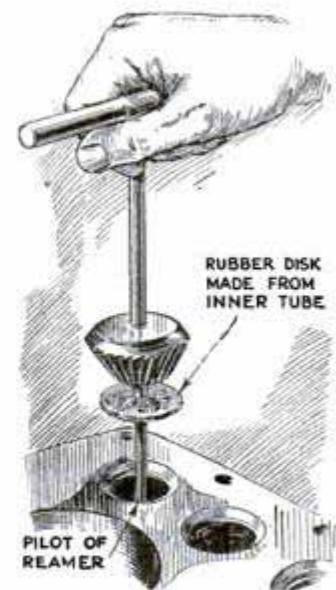

## HEAT TREATMENT REMOVES DEEP AUTO DENTS

Ordinary pounding out with a dolly block and hammer will usually remove dents in automobile fenders and body panels satisfactorily,



block underneath immediately and start pounding out the heated spot. Only ordinary skill is required to do this, but one general rule should be observed, namely, that the metal should be pounded out in a steadily

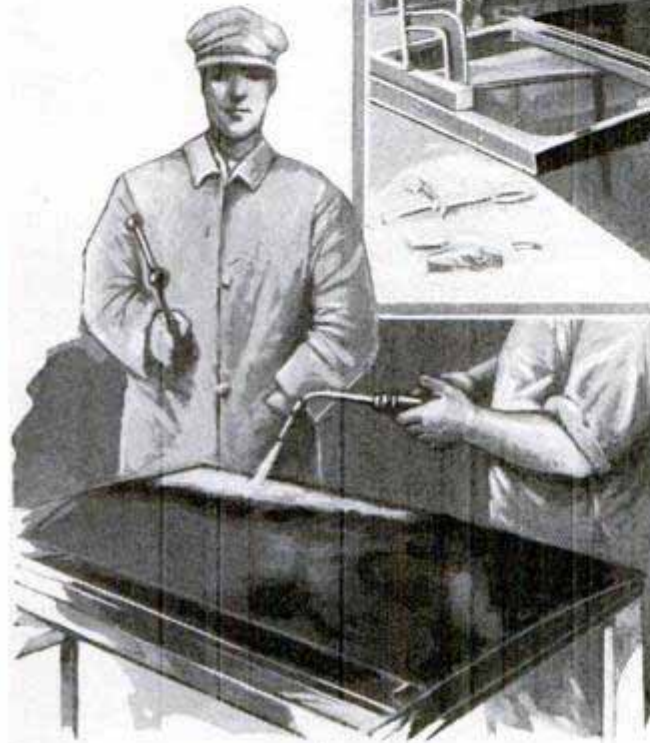

When Car Panels or Other Parts Are Badly Dented, the Metal Can Be Shrunk by Heat Treatment before Pounding Out to Prevent Wrinkling and Bulging

ily, but when the dents are so deep that the metal actually has stretched, it is impossible to get a smooth surface without wrinkles and bulges. In such cases the metal can be shrunk by heat. Remove the paint or lacquer about the dented spot and shine it up with a coarse file and sandpaper. Apply the heat with a torch, covering a small spot, about the size of a silver dollar, at a time and bringing the metal to a cherry-red. Place the dolly

diminishing circle. Then heat another spot and continue in the same way. Under the blows of the hammer the metal can actually be seen to shrink until it becomes as taut and smooth as a new piece. All that remains to be done is to sand off the spot in order to remove any burnt paint, etc., before covering with enamel or lacquer, using a sander as shown in the upper photograph.—Kenneth Murray, Sturgis, Mich.

### Wooden Guard Prevents Water from Splashing in Gas Engine

The water hopper or jacket on many types of small gas engines frequently allows the water to splash out, particularly when the engine is mounted on a cart where the vibration is more noticeable than it is in the case of a stationary engine. A satisfactory and practical method

of keeping the water in the box in spite of vibration is as follows: A rectangular piece of  $\frac{1}{2}$  or  $\frac{3}{4}$ -in. wood is cut and laid on the surface of the water. The piece is first cut just a trifle smaller than the inside dimensions of the tank, but it must then be cut in several pieces in order to get it through the opening. The block does not interfere with pouring in fresh water and it rises as the box is filled.

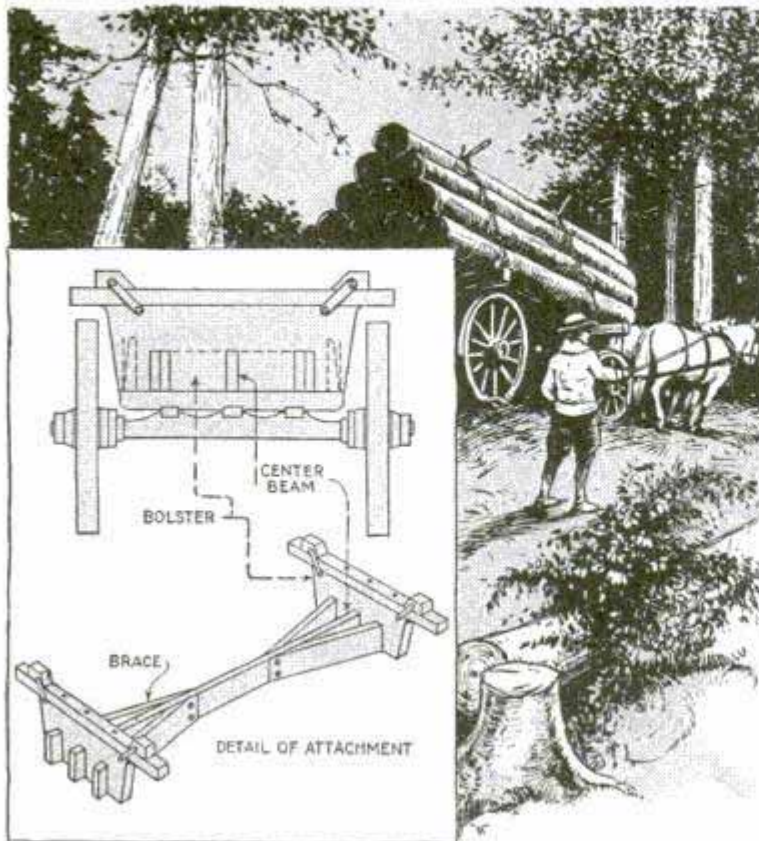

Hardwood Bolsters Fitting over Standards Make Attachment for Hauling of Logs

### Log-Hauling Attachment for the Farm Wagon

An ordinary farm wagon cannot be used successfully in hauling logs without the aid of an attachment of some kind. To convert their farm wagons into suitable log wagons, a number of Mississippi farmers have adopted the use of an attachment of the kind indicated in the drawing. Two bolsters are made of seasoned hardwood and mortised to fit over the standards, at the same time resting firmly on top of the regular bolsters. For additional strength and sturdiness, the bolsters are connected by means of a strong beam of timber securely bolted in the center of each, and braced as shown. With this arrangement it is possible to pile on a good load of logs without endanger-

ing the wagon. This device can readily be removed without unbolting any braces.

### Vent Your Dies to Get Sharp Impressions

Many pressmen have spent hours and days in the endeavor to produce sharp and full impressions on figured pattern work. A simple method, which gives good results, is to vent all the large and deep recesses of figured dies with a small drill. This allows the air inside to escape when the blow is struck, and produces a perfect impression with only one-half the force that is necessary in unvented dies.—Kenneth Keith, Chicago.

### Oil Cooler for Model-A Ford

It is an easy matter to make an effective oil cooler for your model-A Ford, from a length of copper tubing and two fittings, which will prevent the oil from thinning on long or fast drives, and thus assure the delivery of a quantity of cool oil to the valve-chamber reservoir at all times. The oil-line plug directly below the carburetor is removed and an L-fitting inserted. A  $\frac{1}{4}$ -in. hole is drilled and tapped in the valve-chamber cover, about 1 in. from the right edge, and an I-fitting installed. About 8 turns of  $\frac{1}{4}$ -in. copper tubing are wound in a 5 or 6-in. spiral. A large thermos

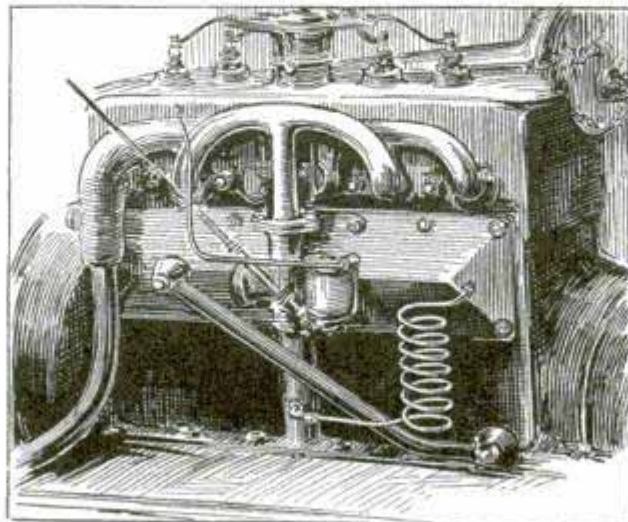

Copper Coil Installed on Ford Motor Keeps Oil Cool on Long and Fast Drives

bottle will be found handy to use as a form for bending the tubing. The ends of the tubing are then connected to the fittings. Although the coil is rigid, a support may be provided, if desired. The air forced backward by the fan strikes the coil and cools the oil.—W. Allen Taft, Jr., Salisbury, Connecticut.

# A Cheap and Practical Drawing Table

By RALPH T. MOORE

A DRAWING table is, of course, an absolute necessity to the draftsman or the artist, and is, besides, a very useful adjunct to the home worker. Here is one which possesses all the sturdiness of the studio table, yet it can be knocked down in an instant, packed into a 4 by 7½ by 31½-in. space, and thus easily transported to any place where it becomes necessary to do the work on the location.

The construction work on the table is started by cutting, from ¾-in. white pine, four pieces of the size and shape shown in the drawing, in which each square represents 1 in., two pieces from each pattern. These are to be drilled with ¼-in. holes at the points indicated. The center por-

tion of each of the two large pieces is then chiseled out, as shown in the photo at the right, the cut being 7/16 in. deep and 2 in. wide. The 31½ by 2 by 7/8-in. uprights for the table are half-lapped at one end to fit into these cuts, as indicated in the photo below the sketch.

This photo also shows the 21 by 2 by 7/8-in. crosspiece which is fitted between the uprights at the bottom. Each end of this piece is fitted with a screw bolt, one end of which is threaded like a wood screw, the other like a bolt. The bolt end is clipped between the jaws of a vise, and the screw end turned into the wood, as shown in the photo, page 1052. The crossbar is then fitted into place, a hole

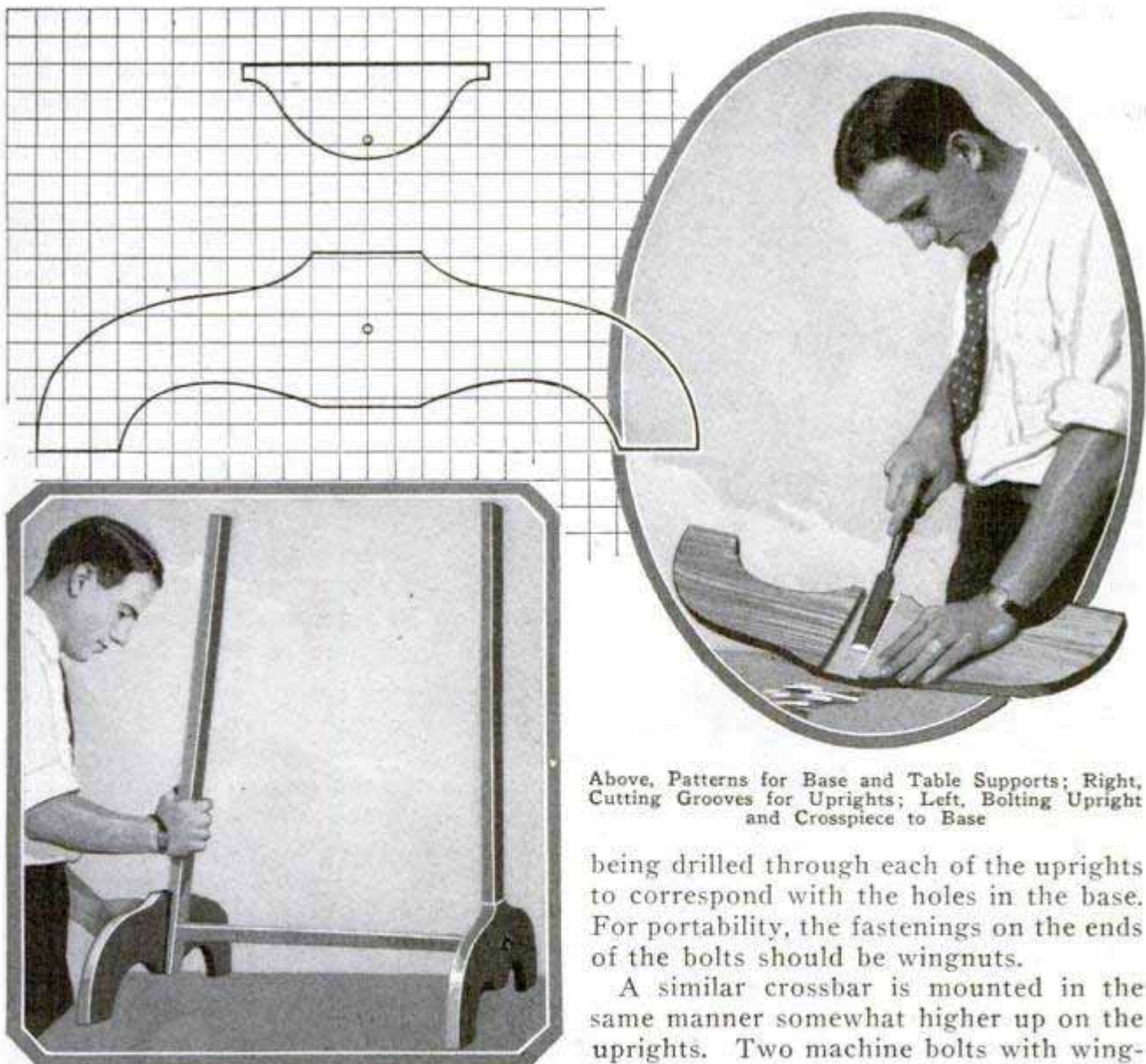

Above, Patterns for Base and Table Supports; Right, Cutting Grooves for Uprights; Left, Bolting Upright and Crosspiece to Base

being drilled through each of the uprights to correspond with the holes in the base. For portability, the fastenings on the ends of the bolts should be wingnuts.

A similar crossbar is mounted in the same manner somewhat higher up on the uprights. Two machine bolts with wing-

nuts are used to hold the semi-circular pieces to the tops of the uprights, as shown in the assem-



Center, Screwing Bolt into End of Crosspiece; Left, Table Assembled, Showing Fastening of Top Pieces; Right, Table with Drawing-Board Top in Place

I have used a board of this kind for many years, carrying it back and forth to different

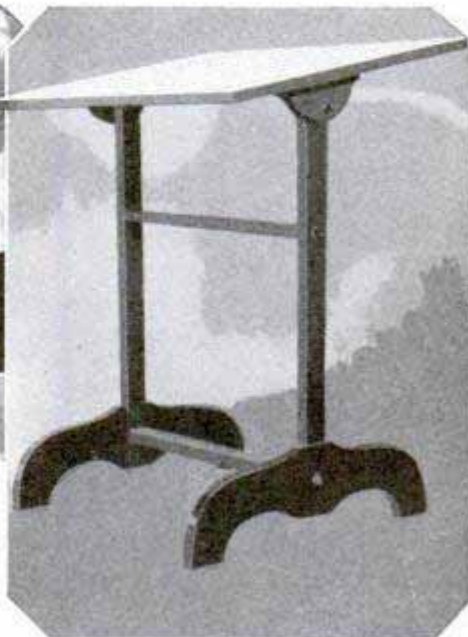

bly photos. Ordinary wood screws are inserted through the ends of these pieces and into the drawing board to complete the job.

jobs, and I find it gives excellent service. You will find that it is perfectly steady, which most portable tables are not, and can be taken down in a few minutes.

### Old Auto Parts Make Good Disk Sander

Mounted in an inverted position on a sturdy wooden base, a discarded model-T Ford block, to which the crankshaft and flywheel are still attached, makes an excellent disk sander for the small shop. Because of the weight and true-running qualities of the flywheel, the sander is really a precision machine. The block,

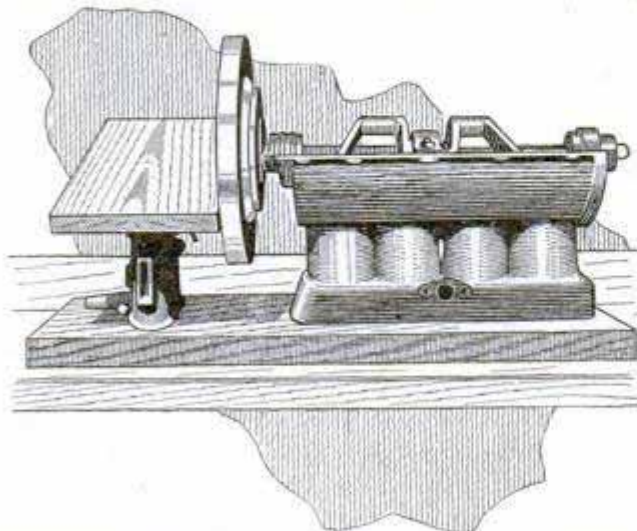

Old Block Equipped with Crankshaft and Flywheel Makes a Good Disk Sander

after the valves and camshaft have been removed, is fastened to the base by means of the studs formerly used to hold the cylinder head. The main-bearing caps are drilled to permit oiling and the machine is driven by a belt attached to the fan pulley. A suitable table, which can be set at various angles, is provided to hold the work, and securely attached to the base as shown in the illustration.—A. C. Wilson, Columbia Cross Roads, Pa.

### Wire on Refrigerator Cut-Out Switch Indicates Its Position

Some electric refrigerators on the market have a circuit breaker that switches off when the electricity in the house is cut off, when the motor overheats, etc. The handle of the circuit breaker is then in the "neutral" position and has to be moved to the "off" and then to the "on" position in order to start the motor again. When the motor is located on the top of the refrigerator, the circuit-breaker switch can readily be seen, but in many refrigerators the motor and switch are located under-

neath, and then the housewife has no means of knowing whether the switch is on or off until she finds the box defrosted and the ice cubes gone. To remedy this trouble, I fastened a length of stiff wire to the circuit-breaker handle and extended it through one of the ventilating fins in the front cover of the motor compartment. In this way the end of the wire, which extended about  $\frac{1}{8}$  in. beyond the fin, could readily be seen, and its position naturally shifts with the handle of the switch to which it is attached. "On" and "off" marks can be penciled on the outside to indicate the position of the wire. In this particular case the switch was located near the front cover, but if it is placed elsewhere, equally satisfactory arrangements can be made in a similar manner.—Jesse M. Myer, St. Louis, Mo.

### Drill-Press Extension Chuck

In a shop where the only drill equipment is a vertical press, an extension chuck attachment has been found highly useful for some jobs that are too heavy to be lifted on the table or too big to go between the table and the spindle. The extension is made to take a chuck similar to the one on the press to go through the clearance hole in the table, and to be gripped in the drill-press chuck. With such an attachment, many jobs that would otherwise have to be sent out can

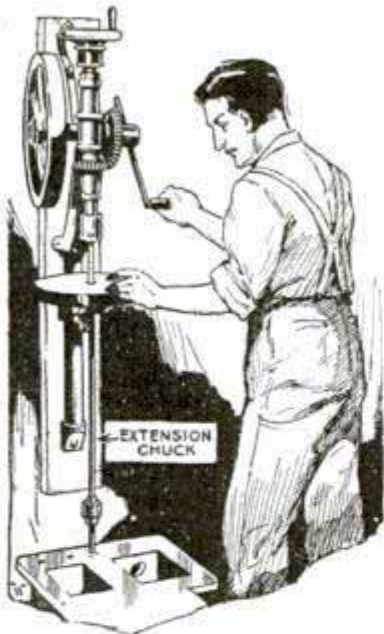

easily be taken care of by blocking them up on the floor as shown. The clearance hole in the table can be bushed to serve as a guide if necessary.—Harry Moore, Hamilton, Can.

☐ When replacing belts put them on the driver wheel first.

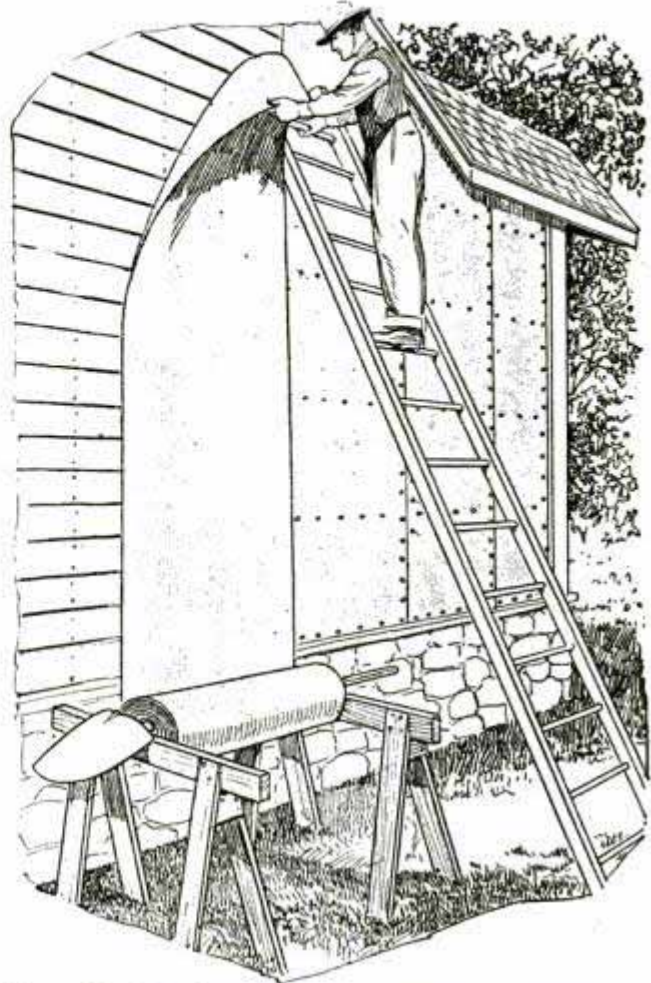

Long-Handled Shovel Makes It Easy to Handle Rolls of Building Paper

### Holder for Building Paper

When tacking building paper to the side of a house, it is often rather difficult to handle the roll if it is left lying on the ground. To overcome this trouble, run a long-handled shovel through the roll and support the two ends on sawhorses. The blade of the shovel prevents the handle from sliding or turning on one horse, and two nails driven on either side of the handle where it rests on the latter, prevent that end from moving. It is then an easy matter to pull the paper to the position where it is to be tacked on the wall. When you come to a window, paper right over it and cut the opening later.

### Removing Spindle-Bolt Bushings

To remove worn spindle-bolt bushings on automobiles, try the following method: A U.S.S. tap of the correct size is used to cut threads in the old bushings. Then screw a bolt of the right size into the threaded bushings and a hammer can be used to drive them out.

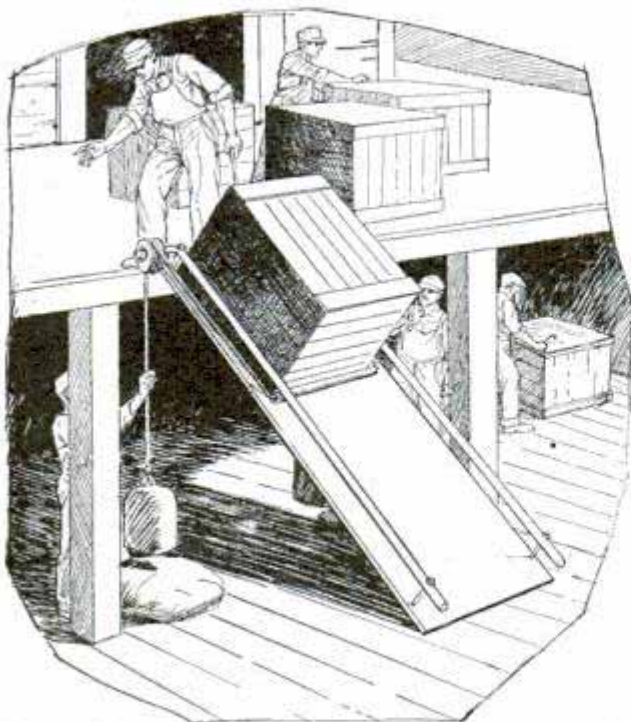

Steep Skid with Suitable Counterweights Used for Lowering Heavy Loads

### Balanced Skid for the Loading Platform

In places where a skid is required to lower heavy boxes or there is not sufficient space to use one having an easy grade, it is possible to employ one with a steep grade, if a counterweight is provided as shown in the drawing. The skid proper is made of  $\frac{3}{8}$ -in. steel plate, and it may be necessary to mount it on 2-in. stock, depending on the weight of the loads it has to carry and on its length. At each corner of the skid a hole is drilled, and two guide rails, also drilled, are attached to the skid by short posts as shown, using spacing collars between the two. Before assembling, the rails are bent outward at right angles at the top to take a light grooved wheel held in place by means of a pin at the side. Next, a length of tube is cut off that fits nicely between the skid and the rails, and a wire rope of suitable length is passed through this and over the pulleys, the ends finally being fastened to the weights beneath. Care should be taken to see that

the counterweights drop on a soft pad to prevent sudden shocks to the skid.—Harry Moore, Hamilton, Can.

### Rebabbiting Steam-Engine Bearings

A mechanic rebabbitted the crankshaft bearings of his stationary steam engine without experiencing any subsequent trouble through false alinement. He raised the crankshaft and placed a piece of leather, about  $\frac{1}{8}$  in. thick, in the bottom half of each bearing to compensate for loss of metal through friction. He then let the shaft down and prepared the upper halves by removing the old metal, replacing them subsequently and pouring the babbitt. After they had been removed, peened and scraped so that they fitted properly, he raised the crankshaft again, and removing the pieces of leather, he prepared the lower halves for the babbitt and replaced the leather to avoid marring the bearing surfaces of the shaft against the stripped iron. He then reassembled all the parts, raised the shaft up against the rebabbitted upper halves, blocking it in position, and again removed the leather. The upper bearings were then removed to make the lower ones easy of access, and the latter were rebabbitted after puttying. These were then peened and scraped, and the whole reassembled.

### Rubber Shield Protects Worker from Flying Chips

Flying chips, produced by a star drill or cold chisel on stone or cement, can be prevented from injuring the worker by using a rubber shield. Take a piece of rubber, removed from an old inner tube, and cut a small hole in the center so that it can be slipped over the tool. Keep it near the point, as indicated, and you will not be troubled by chips as they are all stopped by this shield.—Frank W. Bentley, Jr., Missouri Valley, Iowa.

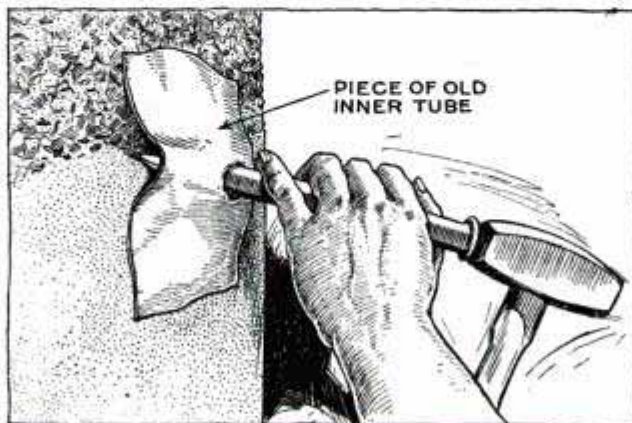

Rubber Shield Cut from Old Inner Tube Stops Flying Chips of Concrete



### Increasing Capacity of Electrolytic Rectifier

A close study of an aluminum electrolytic rectifier while in operation will show that there is an accumulation of hydrogen bubbles on the aluminum element. If the cell is allowed to stand idle for five minutes, the bubbles will disappear. If an ammeter is connected in the output circuit and then the alternating current turned on, the meter will show a higher reading for the first few seconds and the current will then taper down to about one-fourth of the initial rate. This reduction is caused by hydrogen covering the plate, which increases the resistance of the electrolyte at the surface of the aluminum. This is the same thing that happens to certain primary cells and is called "polarization." By using a simple method of causing the hydrogen to leave the aluminum, the capacity can be greatly increased. This is done by slitting the aluminum plate from the bottom up to within  $\frac{3}{8}$  in. of the top, to form strips or ribbons about  $\frac{1}{4}$  in. or less in width. The hydrogen does not seem to have any tendency to cling to the many edges now presented, but quickly rises to the surface as fast as generated. This slitting will increase a cell's output four times.—Clinton C. Hubbell, Norwalk, Conn.

### Clothespin Holds Sack on Grain Spout



Instead of using hooks to hold sacks on a grain spout, try the method shown in the drawing. A narrow flange of molding is nailed around the edge of the spout and an ordinary clothespin hung in a convenient position. After the mouth of the sack is brought over the molding, the clothespin is slipped over the projecting edge of the sack, holding it in place. This method is also preferable to the use of hooks, as the latter cause considerable wear on the sacks.—G. E. Hendrickson, Argyle, Wis.

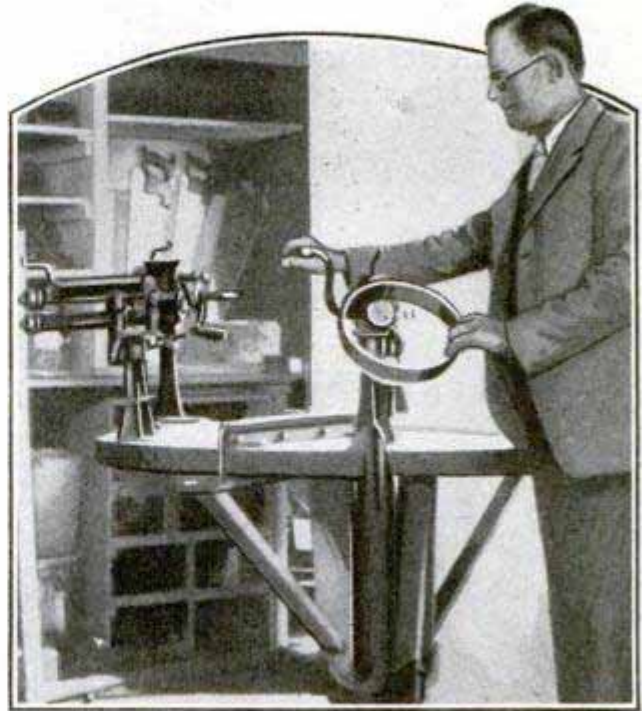

Revolving Table for Sheet-Metal Machines Saves Space in Small Shop

### Revolving Table for Sheet-Metal Machines in Small Shop

A Missouri plumber and sheet-metal worker saves a great deal of space in his shop by using a revolving tool table, as shown in the photo. It is made from a discarded windmill head, braced and pivoted on a suitable base, which can readily be improvised. Several sheet-metal bending machines are mounted on the table and each can be turned to the most convenient position for the worker. The table is located in a corner of the shop, and is a real space-saving feature.

### Carpenter's Trestle Aids in Ripsawing

For ripsawing, the ends of a divided trestle, as shown in the drawing, make a firm support. Such a trestle also will be found handy for many other jobs around the woodworker's shop. For example,

when using long glue clamps, these can be laid in the opening, the gluing job resting flat on the trestles. — H. Lemaster, Maryville, Missouri.



### Simple Device for Thawing Water Pipes Electrically

Water pipes, frozen in places inaccessible to applications of flame or hot water,



Quick Method of Thawing Out Frozen Water Pipes by Electricity

or in which these methods would be injurious to the surroundings, can be cleared quickly and safely by means of a device constructed as follows: Bind the bare wires at one end of a length of lampcord to the end of a stick which is long enough to reach the frozen pipe. Wrap a piece of cloth a few times around the end of the stick so that it completely covers the bare wires. At the further end of the cord fit an attachment plug with both the leads under one screw of the plug, leaving one terminal dead. Insert the plug into a near-by socket, dip the cloth-wrapped end of the stick into saturated salt water and apply to the pipe as indicated. If there is no action, the plug or wires connected to it must be reversed. With proper connection, the contact of the wet semi-conducting cloth with the pipe will be attended by hissing and clouds of steam from the heat generated at the surface of the pipe by the passage of the current between the cloth and pipe. The current consumption is not more than 6 or 7 amp.

and will clear a pipe in a few seconds. Do not make a direct connection between the wire and the pipe, which may accidentally occur if the rag slips down or wears out.—Dexter W. Allis, Everett, Massachusetts.

### Corncobs Make Good Building Insulation

Where corncobs are available, houses and barns can be insulated against heat and cold at very low cost. This insulation seems to be fully as effective as ground cork, often used for the purpose, but the cost of the cobs is negligible compared with that of the latter. Farmers who have plenty of cobs at hand and their own feed grinders, have no expense whatever except their labor. The cobs should be reasonably dry and should be ground in the grinder to about the fineness of ordinary chicken feed. For convenience in handling, the cobs should be run from the grinder into sacks. The ground cobs, which are light in weight like cork, are then poured between the hollow walls of the building. They are also spread out to a thickness of about 4 in. in the attic, over the ceiling of the rooms directly underneath. This is done, of course, before the attic is floored. A few pounds of moth balls, evenly distributed, will discourage insects and rodents, although, if desired, all openings can be blocked off with concrete. Even if the openings are open, rodents attempting to tunnel up the side walls would be smothered by the loose mass of ground cobs. Besides, there is very little possibility of cobs catching fire, as an experiment in an old shed showed that the ground cobs actually smothered fire when an attempt was made to ignite them.—R. F. Starzl, Le Mars, Iowa.

### Helps for Home and Shop

**YOU CAN MAKE IT**—One hundred illustrated articles telling how to make toys, furniture and dozens of other things from old boxes and odd pieces of lumber. Price Ten Cents.

**POPULAR WOODTURNING**—Especially written for the amateur, this book should be in the kit of every home workshop owner. Price Twenty-Five Cents.

**MODERN HOME INTERIORS**—Crammed full of suggestions for the home owner who likes to make his own built-in conveniences. Price Ten Cents.

Order any of the above from the Librarian, Popular Mechanics Magazine, 200 E. Ontario St., Chicago, enclosing the proper amount in stamps or coin.

# To practical men, give "Yankee" Tools

Three different size screw-drivers in one.



To bore holes for screws, a man needs a "Yankee" Automatic Push Drill No. 41—with eight sizes of drill-points, 1/4" to 1 1/4". Price, \$2.60.



"Yankee" No. 15—a ratchet driver, has thumb-turn on blade for starting wabby little screws with thumb and forefinger. Price (4 in. blade), 80c.



No. 90 is a husky "Yankee" plain screw-driver that stands all sorts of use and abuse. Price (8 in. blade), 75c.



The finest tool on earth of its kind is "Yankee" Ratchet Bit Brace No. 2100. Price (10 in.), \$8.20. Lucky man, who gets a "Yankee" Bit Brace.

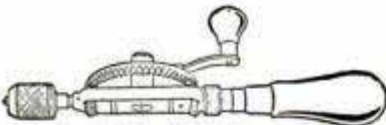

"Yankee" No. 1530 Ratchet Hand Drill (above), and No. 1555 Ratchet Breast Drill are fine gifts for motorists. These drills have five ratchet adjustments; they work where others can't. Price: No. 1530, \$5.25; No. 1555, \$11.00.

"Yankee" Tool Set No. 105 — ratchet tool holder with nine attachments. For the man who works on radio and home electric appliances. Price, \$3.25.

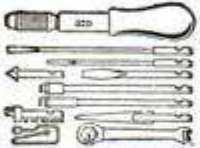

A real man-to-man gift—"Yankee" Tools. The finest there are! Ingenious . . . interesting. Yet inexpensive enough to buy for your whole list of men. Ask your hardware man to recommend the most useful "Yankee" Tools for mechanic, handyman, or the man who tinkers in his home workshop.

"Yankee" Spiral Ratchet Screw-driver No. 30-A drives all sizes of screws, simply by pushing on the handle. Price, \$3.00, including three bits of varying sizes.



# "YANKEE" TOOLS

MAKE BETTER MECHANICS

NORTH BROS. MFG. CO., Lehigh Avenue, Philadelphia, U. S. A.

Readers of Popular Mechanics, who like to own good tools, are invited to send this coupon for "Yankee" Tool Book (free) illustrated with action pictures of "Yankee" Tools in use, showing how these ingenious tools save time and labor.

Name.....

Address..... (pm)

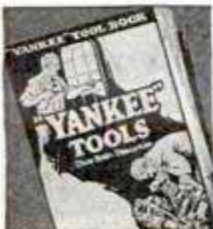

# 5 days

## *to try the car you buy*

**T**HE famous Studebaker Pledge grants you this privilege to guarantee your satisfaction—drive the used car you buy *five days* before you decide. If you are not satisfied, you may return the car and apply your payment on *any* car in your Studebaker dealer's stock—new or used.

In addition to this five-day driving trial, the Studebaker Pledge further protects you by placing a 30-day guarantee on all Certified cars—and by insisting that all Pledge-backed cars carry their lowest prices in plain figures.

The people who have bought hundreds of thousands of Pledge-backed cars from Studebaker dealers were "sold" on the honesty and fairness of this Studebaker used car sales policy. You can have this same assurance of satisfaction with *your* used car purchase if you, too, buy under the terms of the famous Studebaker Pledge. See your Studebaker dealer first—you will avoid future regrets.

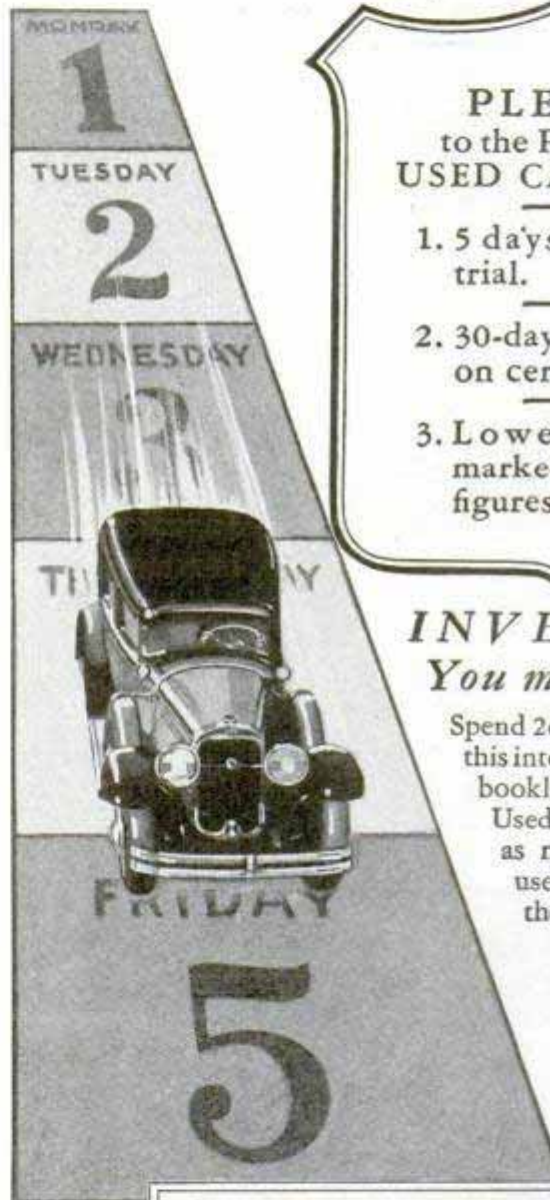

### PLEDGE to the Public on USED CAR SALES

1. 5 days' driving trial.
2. 30-day guarantee on certified cars.
3. Lowest price marked in plain figures.

**INVEST 2¢ ...  
You may save \$200**

Spend 2c now for your copy of this interesting and instructive booklet, "How to Judge a Used Car"—it may save you as much as \$200 on the used car you buy. Mail the coupon now!



# Studebaker

*Builder of Champions*

THE STUDEBAKER CORPORATION OF AMERICA  
Div. 1512, South Bend, Indiana

Please send me copy of "How to Judge a Used Car."

Name.....

Street.....

City..... State.....

*Hello boys!* With your own hands build models of the world's greatest inventions

Sensational No. 7½ Motorized

**ERECTOR**

Builds the Motor Truck \$15.00



Boys! Days are coming which you'll never forget! Days of Real exciting sport! Days when your friends will flock from miles around to see the things you build! Just lift the lid of the chest that holds my new improved Number 7½ Erector. In this one big box is Everything you need to build, one after another, realistic operating models of practically every great mechanical invention known to man.

Whatever you name—you can build it with Erector. Automobiles, Steam Shovels, Locomotives, Airplanes, Ferris Wheels, Traveling Cranes. Hundreds of other wonders of the age.

After you've built them with your own hands, just hook them up to the powerful Erector electric motor, and the model you have built begins to hum with action! It operates just like the big ones engineers construct.

Take Dad to any good store where toys are sold. Let him see Erector. Before you know it he'll want to build things with it himself. It's a sure way to get The World's Greatest Toy for Christmas. Send today for the Erector Mystic Mind-Reader. New, startling and amazing. Use the coupon.

*A.C. Gilbert*

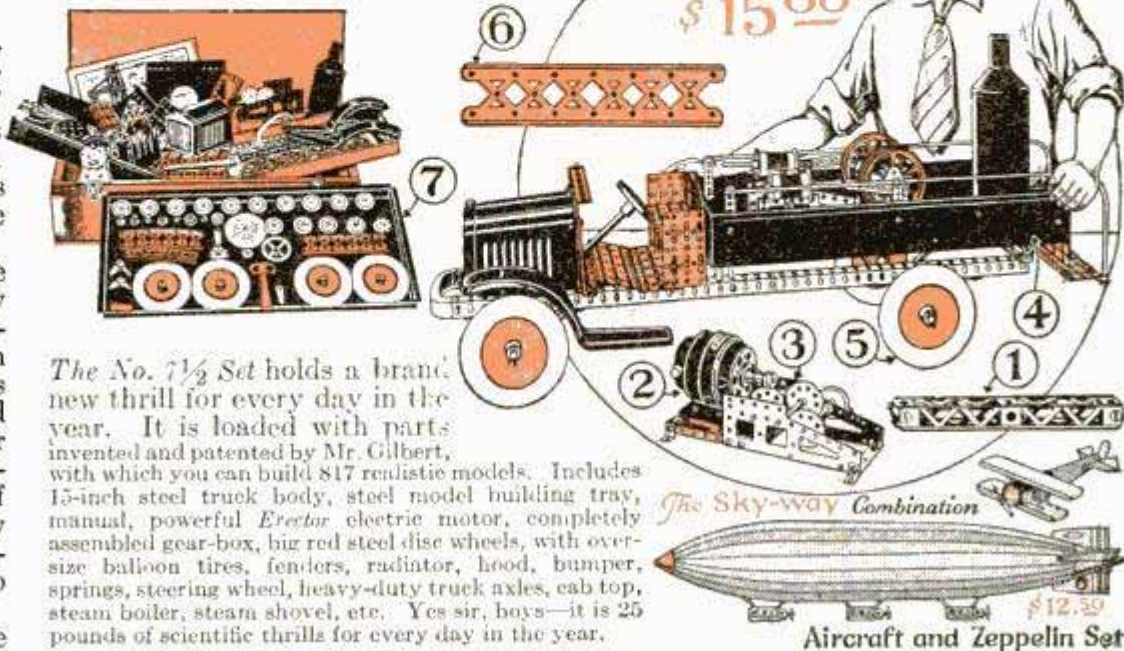

The No. 7½ Set holds a brand new thrill for every day in the year. It is loaded with parts invented and patented by Mr. Gilbert, with which you can build 817 realistic models. Includes 15-inch steel truck body, steel model building tray, manual, powerful Erector electric motor, completely assembled gear-box, big red steel disc wheels, with over-size balloon tires, fenders, radiator, hood, bumper, springs, steering wheel, heavy-duty truck axles, cab top, steam boiler, steam shovel, etc. Yes sir, boys—it is 25 pounds of scientific thrills for every day in the year.

**Why the New 1930 ERECTOR is the world's greatest Toy**

- 1 Patented Erector Girder.** A real genuine girder like engineers use. The interlocking edge, a novel, exclusive Erector feature, eliminates bending and makes it possible to connect two girders, sturdy and strong, with a single bolt and nut, and a four-piece square girder with two screws only. (In all Erector Sets.)
- 2 Patented Erector Motors.** Powerful Battery Motor in No. 4, 6, 7, 7½ and 8. Famous Polar Cub 110-volt Universal Motor in No. 9 and 10.
- 3 Patented Assembled Gear Box.** Adaptable to every possible gear combination, and for reversing movements. Convertible into 3-drum hoisting engine. Standardized for use with either battery or 110-volt Motor. Included assembled in the Famous No. 4 Set and up.
- 4 Heavy Steel Truck Body,** 15 in. long. Exclusive Erector feature. In No. 7½ Set and up.
- 5 3¼ in. Solid Steel Disc Wheels with Balloon Tires.** An exclusive Erector feature. In No. 7½ and up.
- 6 Patented Big Giant Channel Girders,** straight and curved. Electrically baked in brilliant red. Exclusive Erector feature. In No. 7 and up.
- 7 Large Steel Model Building Tray,** pierced with Erector standard holes. Patent pending. Exclusive Erector feature. In No. 6 and up.

**New Erector Zeppelin Features**

Patented Erector Zeppelin Girder, Silver Bag, Gondolas, Propellers, Stabilizers, Rudders, etc.

**Exclusive Mechanical Wonder Features**

Duplex Plate, Cam, Flat and Cone Pulleys, Quarter and Internal Gears, Eccentric Loop, etc.

**Exclusive Erector Airplane Features**

Fuselage, Wings, Cylinders, Propellers, Stabilizers, Rudder, Pontoon, Struts, Nose, Swivel.

**Sensational Automotive Features**

Truck Body, Fenders, Radiator, Hood, Axles, Steering Wheel and Knuckle, Springs, Bumper, Heavy Duty Disc Wheels, etc.

**Many Other Countless Features**

Builds four-foot Zeppelin with landing mast and nineteen different types of airplanes. Monoplanes, Biplanes, etc. Includes fuselage, wings, gondolas, silver Zeppelin bag, propellers—everything you need to build these realistic ships of the sky. Especially designed by Mr. Gilbert for boys who already have the Sensational No. 7½.

**Famous ERECTOR Sets**

DANDY BEGINNER'S SET No. 1.....	\$ 1.00
THE ADVANCED No. 3.....	2.50
The Famous No. 4.....	5.00
ERECTOR ELECTRICAL SET No. 3005.....	5.00
ERECTOR AIRPLANE SET No. 45.....	5.00
The Wonderful No. 6.....	7.50
THE BIG GIRDER SET No. B.....	9.50
The New Big No. 7.....	10.00
The Trail Blazing No. 8.....	25.00
THE GIANT No. 9.....	35.00
THE DELUXE SET No. 10.....	50.00

Also Manufacturers of the famous BIG BOY TOOL CHESTS, GILBERT CHEMISTRY and MYSTO-MAGIC

**COME ON FREE BOYS—**

To the First 100,000 lucky boys who send in this coupon

**A. C. GILBERT'S MYSTIC MIND READER**

It knows all. It tells all. You ask. It answers. You won't believe your eyes! Free, boys, with the Gilbert Toy Catalog.



The A. C. Gilbert Co., 196 Erector Square, New Haven, Conn. Please send me free copy of A. C. Gilbert's Mystic Mind Reader and Gilbert Toy Catalog.

Name.....  
Street.....  
City.....State.....

# Boys—there's no fun like Chemistry

*but for the Best and Most Chemistry fun be sure this name is on the set ...*



No. 2—  
Contains 29 chemicals and pieces of apparatus. Manual of instruction explains 180 different experiments.

Price \$2.00

REGISTERED TRADE MARK

# CHEMCRAFT

THE CHEMICAL OUTFIT

## Be a Boy Chemist!

**LEAD YOUR CLASS IN CHEMISTRY!** *Surprise Everybody with Your Chemical Knowledge and Your Marvelous Chemical Tricks.*

**C**HEMICAL experimenting is the finest fun you ever had. There's always something new and different to do. You can make soap, ink and paint; dye and bleach cloth; test foods, water and metals, and produce hundreds of chemical changes and reactions just like a real chemist. You can perform chemical magic tricks, too, and astonish your friends. It's great fun and shows you useful things about the Science of Chemistry. It's easy with Chemcraft, because Chemcraft is the best chemistry outfit; the original, most complete, accurate and scientific.

**CHEMCRAFT** IS COMPLETE CHEMISTRY!—Chemcraft contains more and better experiments, superior chemicals and apparatus. All branches of chemistry are included: Inorganic and Organic Chemistry, Electro Chemistry, Industrial Chemistry, Household Chemistry, Glass Blowing, Mineralogy, Metallurgy, Food Chemistry and many other subjects. Get Chemcraft, and experiment with all branches of Chemistry!

No. 10—in wood cabinet with removable tray. 85 chemicals and pieces of apparatus, with separate test tube rack. More than 500 experiments can be worked.  
Price.....\$10.00



No. 3½—contains 43 chemicals and pieces of apparatus, and more than 265 experiments are explained, including many chemical tricks. Each experiment can be repeated many times.  
Price.....\$3.50

No. 5—the most popular outfit! 54 chemicals and pieces of apparatus in handsome wood cabinet. More than 360 experiments and tricks explained in the Manual.  
Price.....\$5.00

### Seven Wonderful Sets to Select From—from \$1.00 to \$25.00

Get Chemcraft this year—tell everybody that's what you want. Look for Chemcraft in any store where toys are sold. Look for the name Chemcraft on the box so you will be sure to get the set that gives the most for the money. If the one you want is not obtainable in your local store, we will send it, fully prepaid upon receipt of price.

#### Try Chemistry for 25c

Get Chemcraft Junior and do lots of experiments and magic tricks. Complete outfit and instructions, postpaid for 25c.

#### Free Magazine for Boys

Contains experiments you can do at home; also ideas on Chemistry and Woodworking.  
**SEND FOR YOUR FREE COPY NOW.**

**THE PORTER CHEMICAL COMPANY**

94 East Washington Street, HAGERSTOWN, MD

**Calipers**

Nos. 79 and 73—Yankee type—stiff bow insures accuracy furnished with solid or quick-adjusting spring nut—perfect feel

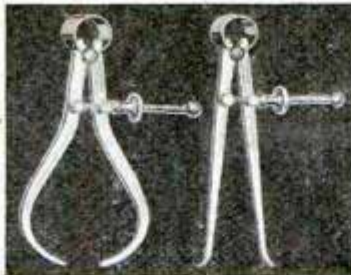

**Drill Point Gage**

No. 22C—combines drill point gage, hook rule, plain rule, depth gage, try square, slide caliper—a handy, accurate tool.

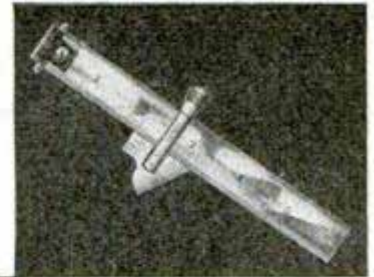

**Micrometer**

No. 224-AA—four interchangeable anvils—range of 0 to 4 inches by thousandths—decimal equivalents on thimble—black enamel frame.

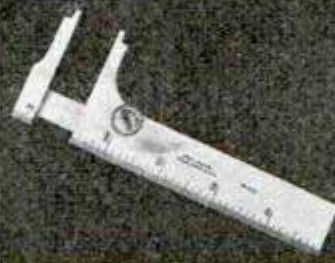

**Slide Caliper**

No. 425—inside and outside measurements—thumb lock—graduated in 32nds and 64ths—furnished in 3" or 5" sizes—fits pocket

**Pocket Tape**

No. 500—furnished in 3, 5, 6, 8, and 10-ft. lengths, graduated in inches and 16ths—nickel plated case—rounded edges.



**Micrometer**

No. 230—cut-away frame—lock nut and ratchet stop—range of 0 to 1 inch in thousandths—finest accuracy and feel.

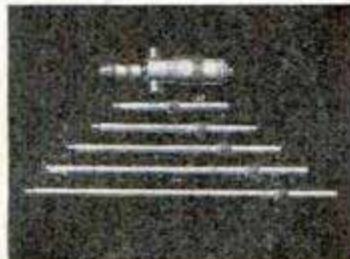

**Inside Micrometer**

124-A—six interchangeable rods—inside measurements from a to 8" by thousandths—lock screw—may be furnished with handle.



**Speed Indicator**

No. 104—determines r. p. m. of shafting, etc.—frictionless bearing—two extra rubber spindle tips—accurate at any speed.

**Micrometer**

No. 436—moderate price—black enamel frame—equivalents on thimble—may be furnished with or without lock-nut and ratchet stop.



**Combination Square**

No. 23—for machinists and carpenters—blade of good hard steel—graduated in 8ths, 16ths, 32nds, and 64ths—eight handy tools in one.

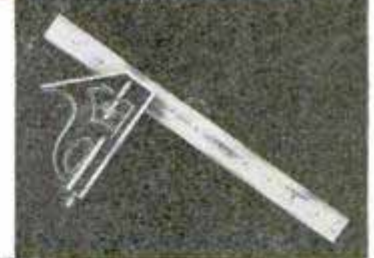

**Depth Gage - Hook Rule**

No. 236H—combines hook rule, depth gage, caliper, and handy protractor—graduated 32nds and 64ths—inexpensive and handy tool.



**Micrometer Depth Gage**

No. 440A—three interchangeable rods give range of 0 to 3 inches by 1000ths—with or without ratchet stop—a splendid tool of finest accuracy.



**Use  
Starrett  
Tools**

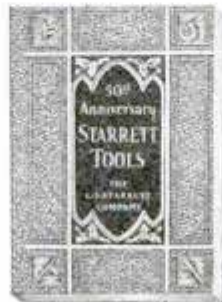

**SEND FOR FREE BOOK**

These fine Starrett Tools are fully described and priced, with many more, in the new Starrett Catalog No. 25 "AP." This valuable reference book is free. Send the coupon.

THE L. S. STARRETT CO., Athol, Mass.  
Please send me Starrett Catalog No. 25 "AP."

Name.....  
Address.....  
City..... State.....

# NEVER MIND!



## Savogran Crack Filler will fix it!

FIXTURES pulling out—tiles cracked, loose, or missing—there's another job for Savogran Crack Filler. Mix the powder with water, press into place, paint to match the surrounding surface, and the damage disappears for good!

Savogran Crack Filler makes permanent repairs to wood, stone, metal, tile, and plaster. It *will not shrink!* Keep a can on hand for the hundreds of odd jobs that are always coming up. At hardware and paint stores.

Made by the makers of Painters' Savogran, the triple value cleaner that strips, cleans, and bleaches in one operation. Removes dirt and grease like magic, softens hard paint brushes, saves hard work.

Send for your *free* copy of "How to Repair and Refinish Furniture"—full of useful information!

### BIG ONE-POUND CAN

**30c** The 35-lb. pressed steel pail (for large users) costs \$7.70; 5-lb. can \$1.25; 1-lb. can 30c. No solvents to buy—no waste. The biggest value on the market!

**SAVOGRAN COMPANY**  
DEPT. M-12, INDIA WHARF, BOSTON, MASS.



# SAVOGRAN CRACK FILLER

REG. U.S. PAT. OFF.  
PAT. APP. FOR

## WILL NOT SHRINK!

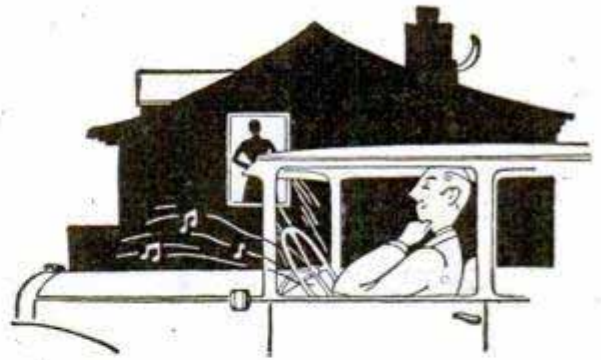

## When SHE is still dressing at 9 for an 8:30 show... start the Crosley ROAMIO

Such primping! Will she ever be ready? Missed the whole first act by this time! etc., etc., etc. You know you can't hurry her, but you can enjoy yourself while waiting. Just start your CROSLY ROAMIO Automobile Radio Receiving Set. That fight you wanted to see is coming in just as though you had a ringside seat. Side-splitting jokes—latest song hits—symphonies—all at your fingertips with a CROSLY ROAMIO. And instead of being nervous and irritable, you'll start the evening off in the highest of spirits—ready to have the time of your life.

The CROSLY ROAMIO is extremely selective and sensitive. You'll easily get your favorite programs. The automatic volume control maintains a practically uniform volume, even on distant stations. You lock the CROSLY ROAMIO just as you do your automobile. It uses Screen Grid tubes, Neutrodyne circuit, and employs the latest type Crosley dynamic-power speaker.

The CROSLY ROAMIO can quickly and easily be installed in your car no matter what its make. It fits snugly and conveniently under the dash entirely out of the way. It will give you hours of satisfying pleasure and delightful relaxation. Consider, too, that the price of this marvelous set is amazingly low. Go to your nearest Crosley dealer today—see the CROSLY ROAMIO—hear it—drive with it. Or write for circular and name of nearest Crosley distributor who will arrange for installation. The CROSLY ROAMIO is recommended for use in motor boats and cruisers.

### THE CROSLY RADIO CORPORATION

1300-D Arlington St.

CINCINNATI

Home of "the Nation's Station"—WLW

Also manufacturers of Crosley A. C., D. C. and Battery Radio Receivers and the famous AMRAD RADIO

### YOU'RE THERE WITH A CROSLY CROSLY RADIO

### 30 Days' Free Trial on all MEAD Bicycles

New RANGER Models now ready for delivery direct from our factory. Astonishing new prices and terms. Do not buy until you get them.

RIDER AGENTS WANTED to ride and exhibit sample. Save big money. Many models, styles.

Tires wheels, lamps, horns, equipment at *half usual prices*. Easy Payments. Write for our marvelous prices and terms.

**Mead CYCLE COMPANY** Write us today for free catalog  
DEPT. T110 CHICAGO



## Keds

At \$1.00, \$1.25, \$1.50,  
\$1.75 and up to \$4.00.



United States Rubber Company

## ALL BALSAs!

A realistic scale model of a one-place low-wing sport plane. Wing spread 15 in., weight only 2/8 oz. Takes off under own power. Flies 140 feet consistently.

New all-balsa construction makes this model lighter, stronger, better-looking and far easier to build. Everything marked. Nothing to draw or measure. No tools or skill required. Set includes die-stamped aluminum propeller, disc wheels, rubber motor, quick-drying cement, balsas, clear directions and all other material. Nothing else to buy. Complete set, postpaid in U. S. and Canada, \$1.00. Satisfaction or money back. Order now.

The Midland Model Works, Dept. E, Chillicothe, Ohio  
(We cannot accept stamps or C. O. D.'s.  
No catalogue except with set.)





# Give a hint to Dad—"a LIONEL"

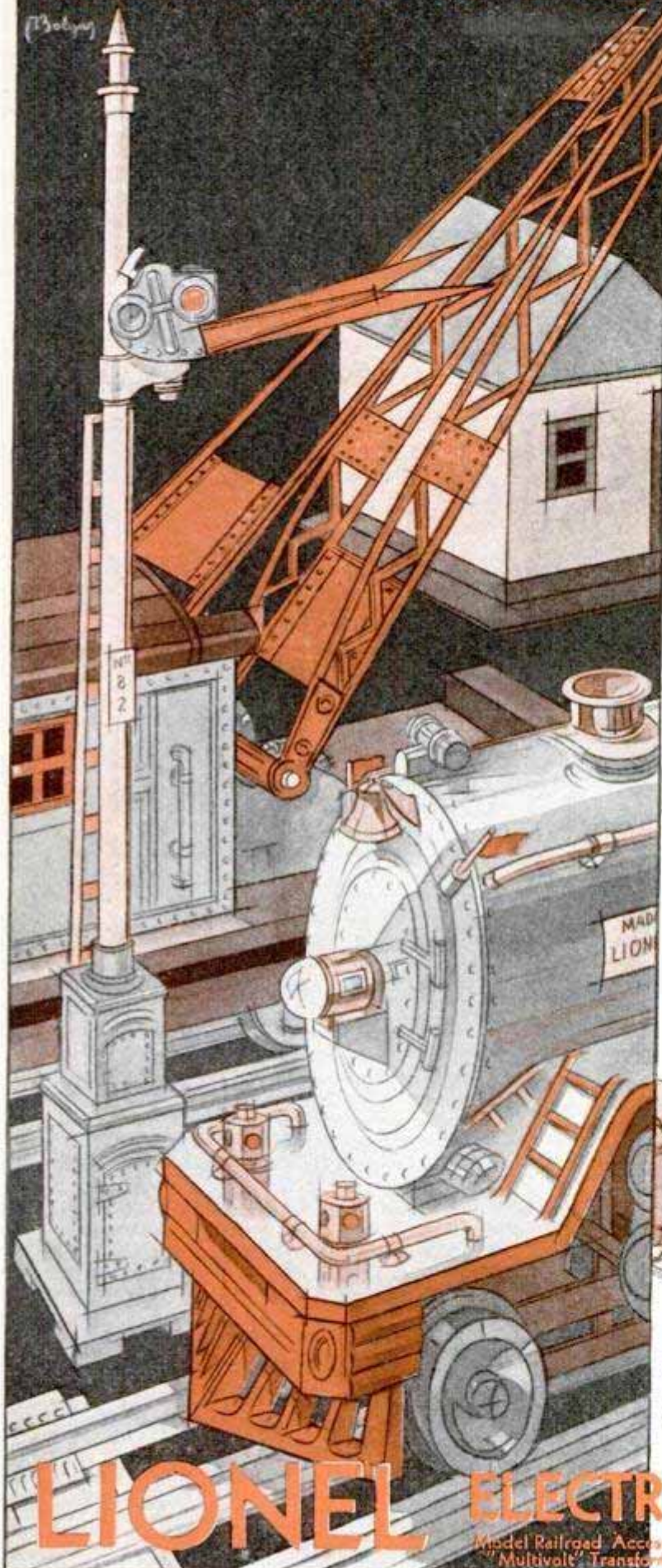

**T**ELL Dad all about Lionel trains—point out to him the difference. Show him how real and life-like they are in appearance. Tell him why they are swifter, more powerful than any other trains.

Tell Dad about the marvelous precision with which Lionel locos are made. Explain to him the Lionel "distant-control" feature by which trains can be started, stopped, reversed, or switched from track to track without ever touching the train.

Dad will understand!

Get the **FREE** Lionel railroad planning book and catalog and show Dad the hundreds of realistic Lionel accessories, the magnificent trains, and the swift, powerful locomotives.

*See Lionel Trains demonstrated at your local dealer's. Lionel Railroads priced from \$7.00 to \$350.00. (Prices slightly higher in Far West.)*

**FREE!**

*A beautiful 48-page Lionel railroad planning book and catalog—illustrated in full colors.*

## ON THE RADIO

Starting November 14

*Every Friday night, 6:00 to 6:30 Eastern Standard Time, "Uncle Don" and his Lionel Engineers' Club over stations WOR (New York), WLW (Cincinnati) and WBBM (Chicago).*



**THE LIONEL CORPORATION**

Dept. 3, 15-17-19 E. 26th St.  
New York City

# LIONEL ELECTRIC TRAINS

Model Railroad Accessories  
Multivolt Transformers

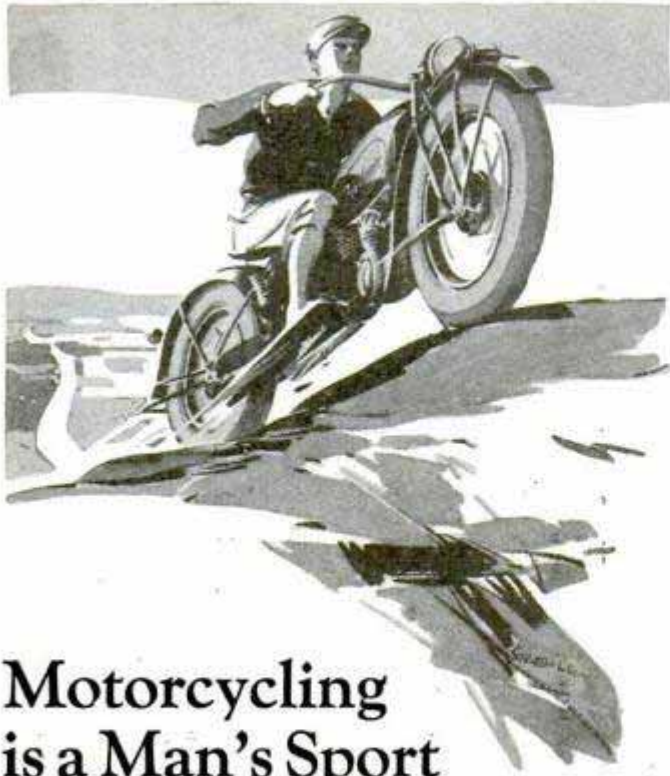

# Motorcycling is a Man's Sport when you drive an Indian

A motorcycle is a *man's* vehicle ... a trusty companion for the open road. Settle yourself in the comfortable saddle of an Indian—feel the pulsing power of its husky motor ... glide down the road, weave safely through slow traffic, pass 'em all on the hills, cruise quietly on the by-roads, go places no car can go—that's motorcycling!

## Economical

Motorcycling is inexpensive sport with an Indian—costs are less than 2c a mile for gas, oil, tires and upkeep—no garage needed.

An Indian is easy to own—write for our Easy Payment Plan ... a small weekly payment does it.



Desirable dealer territories are open ... if interested write for our Dealer Franchise.

# Indian MOTORCYCLES

INDIAN MOTORCYCLE CO., 6C12, SPRINGFIELD, MASS.

Please send folder on Indian Motorcycles and details of your easy payment plan. I am..... years old.

NAME .....

ADDRESS .....



*Hand him one!*

Who?  
Your grocer or druggist.  
What?  
A dime. Why?  
For a cake of LAVA SOAP that'll get your hands so clean in 58 seconds your wife will think you've rented a new pair.



*George, the Lava Soap Man*

Takes the dirt, but leaves the skin

## AGENTS AND SIGN MEN

Earn up to \$100 Weekly, and over, Putting up OUR GENUINE GOLD LEAF SIGN LETTERS



—on store and office windows, board signs, trucks and glass signs. We also make to order script signs and business emblems singly or by the thousands. A permanent business. No capital or experience required. Big demand in every City. Samples and Literature Free.

CONSOLIDATED SIGN LETTER CO. 71-X W. Van Buren CHICAGO, ILLINOIS

**WE PAID \$93.00**

TO KIMBALL FOR ONE WEEKS WORK



You can do as well. Show our all-wool union-made tailored-to-measure suit samples. Biggest cash profits daily, besides liberal bonus. Wonderful values—smartest styles. Easy orders. FREE OUTFIT of nearly 150 large swatches and instructions. No experience required.

PIONEER TAILORING CO., Dept. Z-1116 Congress and Throop Sts., Chicago, Ill.

**All Wool SUITS \$23.75**

# COMPLETE DRILL MOTOR HOME WORKSHOP SET

You'll prefer this **Red Jacket** compact—improved

Enjoy the thrill of your new skill in making things this modern motorized way!

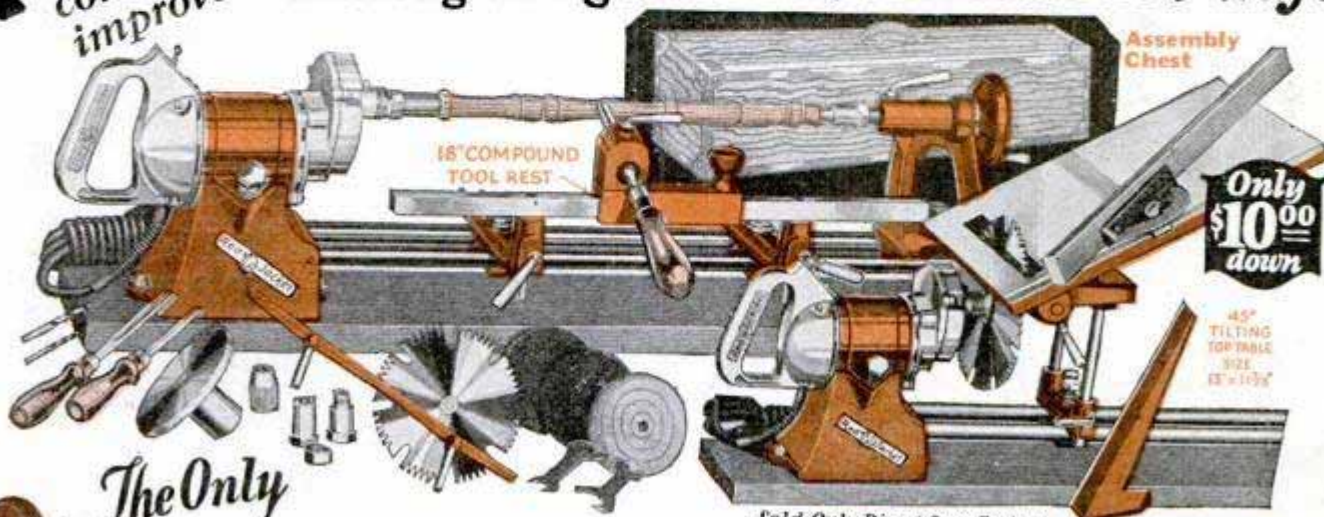

Assembly Chest

18" COMPOUND TOOL REST

Only \$10<sup>00</sup> down

45° TILTING TOP TABLE SIZE 12" x 12"

Sold Only Direct from Factory

## The Only Complete Interchangeable Power Shop - Improved Features - Exclusive Advantages

The right kind of tool-equipment is even more necessary than your own ability and desire. Now, you can do the things you long have wanted to—at home in your own modern motorized work shop—with this new, improved Waco Red Jacket Wonder-Shop. No other compares with it in its complete, interchangeable, power features, efficiency, exclusive advantages and quality.

### Join the Happy Family of Waco Wonder-Shop Workers

Red Jacket Equipment is designed, tested, approved and guaranteed by Wm. L. Aylward, a nationally known craftsman and manufacturer who has developed his own life's hobby into a cooperative association of thousands of amateur and professional craftsmen. He invites you to join. He will instruct, guide and help you. A new zest in doing things awaits you.

The new 1930 Red Jacket Combination brings you the powerful Red Jacket Master Drill Motor with direct drive to the Waco Craftsman's Wood Turning Lathe (capacity 9" x 36"), Compound and 18" Rests, Tilting Top Mitre Saw with both depth and side gauges, Sander Disk, Scroll and Jig Saw, improved Band Saw, and all accessories for both portable and stationary power drilling, buffing, grinding and cleaning. Attaches to light socket. Converts your work bench into a complete private tool and machine shop—a complete chest full of electrically driven tools for your own private use.

### Add New Special Equipment Any Time as Desired

Take your choice of four different assemblies to fit your present ideas and uses. Any time you wish to expand or add new special equipment you can do so. The Waco Red Jacket Assortment is the most complete available anywhere. *Avoid Imitations!* Waco Red Jacket is the pioneer—foremost in the field—sold only direct from the factory; not through stores.

### Professional Quality and Efficiency

The choice of professional as well as home craftsmen. Red Jacket Shops are making money for their owners all over the country. You can be one of the Red Jacket Guild chain and market your products if you want under our new plan.

### Buy It NOW On Easy Terms

Only \$10 down. Easy monthly payments. Liberal discount for cash. No hardship to own a Waco Red Jacket. You can make it more than pay its way in profits if you want, as well as in the pleasure of doing things for yourself.

Make Them Yourself!



### Special Craft Course FREE

All there is to know about handcraft methods, raw materials, carving, turning, sawing, designing, etc., etc., is taught you by correspondence. **FREE Blue Prints**

**The WACO GUARANTEE**  
If it is not what you want when you get it—send it back.

45° Tilt - Top Table Band Saw

Buffer and Grinder Assembly

Belt Drive Jig Saw

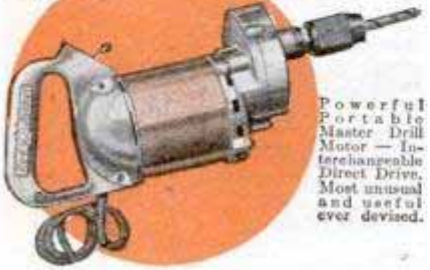

Powerful Portable Master Drill Motor—Interchangeable Direct Drive. Most unusual and useful ever devised.



Auxiliary Head Stock—For any kind of power hook-up.

## Send NOW This Coupon for Interesting Literature

**FREE** Detailed descriptions and specifications. You will be surprised and fascinated by the possibilities afforded. Just see what you can make and do. Fill in and MAIL TODAY.

**WACO TOOL WORKS, Inc.**  
5216 W. Kinzie St., Chicago, Ill.  
Manager, Dept. 509: Please send me all free information and literature on Red Jacket Assemblies and FREE Services.

Name.....  
Address.....  
City and State.....



## "Things to do with PLASTIC WOOD"

[Reg. U. S. Pat. Off.]

This is a 48-page illustrated booklet that gives in detail many practical, every day uses of Plastic Wood that facilitate repairs and save many dollars on bills. The best methods of use, and the properties of Plastic Wood, are described to enable every man or woman to obtain the utmost benefits from this amazing product, that handles like putty and hardens into wood. The booklet is sent by mail for 10 cents.

### Household Uses

Furniture repairs, the filling of holes and cracks, out-of-door uses—there are forty of these described with simple, easy directions that anyone can follow.

### Automobile Body Repairs

Rotted tops, body dents, loose fixtures—the booklet explains practical methods of numerous repairs made easy with Plastic Wood.

### Boats

Boat uses of Plastic Wood are innumerable, and every boat owner will value the book for the specific directions and suggestions that it contains.

### Model Making

For model ships, model coaches, home modeling and woodcarving, Plastic Wood permits refinements that benefit every modeler. Numerous results are pictured in "Things to do with Plastic Wood."

Tube 25c — 1/4-lb. can 35c — 1 lb. can \$1.00  
Solvent, 25 cts. and 50 cts.

At Hardware and Paint Stores

Send 10 cts. for the above booklet to

The A. S. Boyle Co., Mfrs.

1934 Dana Ave.

Cincinnati, Ohio

## Get this for CHRISTMAS

MODEL  
No. 1

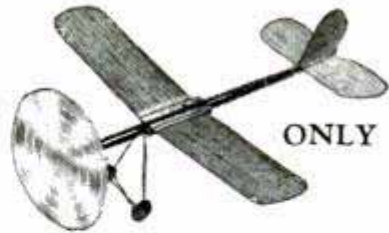

ONLY \$1.

## SEE IT FLY!

**B**OYS! This Kingsbury Silver Arrow Flying Plane, Model No. 1, is a wow of a flyer. Zooms 'way over housetops, diving, dipping, banking on long, continuous flights. Wings are adjustable to insure flying under all conditions and to help resist smash-ups. Not a construction toy but fully built. A moment to assemble and it's ready to fly. Balsa wood wings; aluminum braces, propeller; powerful elastic motor. Wing spread 18 in. A plane that really flies. Only \$1. (West of Miss. \$1.10.) Other models, racing and cabin types, at \$2 to \$3.50. If your dealer cannot supply you, send your order to us.

Join the Silver Arrow Club and become a Master Pilot.  
Kingsbury Mfg. Co., 83-L Myrtle Ave., Keene, N. H.

## KINGSBURY MOTOR DRIVEN TOYS

FREE! Novelty  
Movie Scope  
Shows motion picture of  
Silver Arrow flying.  
Also complete toy catalog.



SEND 10c for this  
Kingsbury Steel Disc  
Wheel, Balloon Tire  
Eraser. Set of 4, 35c.

## HARD-TO-SHAVE MEN TOUGH BEARD? Make Shaving Twice as Easy TENDER SKIN? With Amazing Barber's Secret SORE NECK? DULL RAZOR?

5,575 wiry bearded men with the very toughest beards are wanted to make honest home test of remarkable formula used by master barbers coast to coast. Softens beard instantly, prevents cuts or scratches, makes razor edge last twice as long. Smooths the face. 31 million PREP shaves prove comfort, economy of barber's secret. Secure my Home Test size, prove PREP a veritable miracle beard softener on your beard. Mail ten cents for liberal size jar PREP and special Test Report offer. Limited number. Act now.

**BILL BOYD, 2115 Second Boulevard, Detroit, Michigan**



**Big 3 ft. Telescope** Five Sections. Brass bound. Powerful Lenses. 10-Mile range. Special Eye Piece for looking at the Sun, included FREE. Can be used as a Microscope. Guaranteed. Big value. Postpaid, \$1.75. C. O. D. 15c extra. **Benner & Company, 1-43, Trenton, N.J.**

## AMAZING NEW GUN

Men all over the country are turning to this full size automatic high power rifle using round steel shot. Light. Speedy. Sporting arm balance and precision.

## TRY THE BENJAMIN 25 SHOT AUTOMATIC "THE MYSTERY RIFLE"

OUTSHOTS  
ALL OTHERS



Companion to the world famous Benjamin Single Shot. Same effective compress air action with 25 shot automatic feed. 10 to 12 rapid fire shots on one pumping. Price \$10.00. Benjamin Single Shot Air Rifle \$5.00. Ask your dealer for demonstration or write for details and "BB MAGIC" FREE.



BENJAMIN AIR RIFLE CO., 605 North Broadway, St. Louis, Mo.

*Hello Boys!*  
REG. U.S. PAT. OFF.

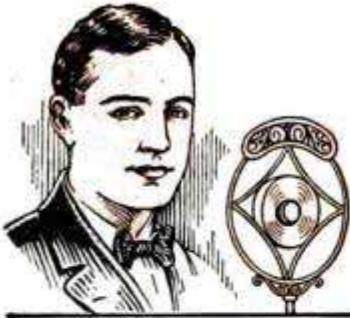

# Now you can BUILD

## Those Things You Want

**\$10.00** This big red brass-bound chest, 26 items, and 2 instruction books. It's 18 pounds of useful scientific tools. A Saw, a Plane, a Brace and Bit, Chisels, and dozens of other he-man tools for the boy builder.

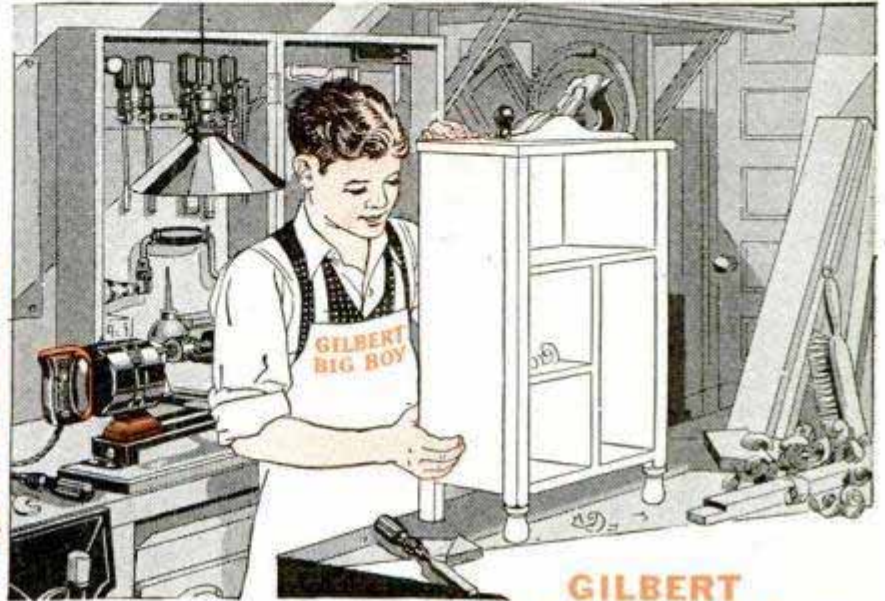

**New Electric Lathe**

**GILBERT "Big Boy" Tool Chests BOY'S SIZE**

Your own furniture for your own room! A boat you can row yourself! A bird house! A house for your dog! A thousand other things you've always wanted.

You don't have to ask for them any more. You can build them all yourself and give Mother and Dad the surprise of their lives.

All you need is my BIG BOY TOOL CHEST. Just lift the lid, put on the sporty carpenter's apron, call in your pals and show them how a real builder goes to work. My Boy Builder's Plan Book shows exactly how each thing is made. There's a tool for every purpose. I know what you need and I've built these tools for real service.

Look over my Big Boy Tool Chests and the New Electric Lathe (now reduced to \$19.50) at any good store. Tell Dad you want to branch out and be a builder right away. You can start right in making Christmas presents for the whole family.

Portable type for home or commercial use. Practical, efficient. Powered by Polar Cub Universal 110-volt motor, A.C. or D.C. Mounted on 30-in. bed complete with tail stock, two centers, slide rest, wrench, 1/4-in. drill bit, turning tool, 1/4-in. arbor to receive attachments and fitted with three jaw chuck, key operated. Chuck takes round shank drills up to and including 1/4-in. diameter. Pistol grip handle, toggle switch. Motor easily detached from lathe for use as portable drill. Lathe turns wood up to 7 in. diameter and 18 in. long. Grinding, polishing, sanding, buffing attachments supplied separately. Size, 34x9x5 1/2 ins. Packed individually, corrugated container. 25 lbs.... **Price \$19.50**

**FREE** —We have a few extra copies of the Big Plan Book for the Boy Builder. You can have one if you get this coupon to us in time. Fill it out and rush it into the mail today. A complete Big Boy Tool Chest catalog comes with it. **DON'T DELAY.**

- No. 701—For the little fellow. Contains 11 pieces with Plan Book.... **Price \$1.00**
- No. 701E—Dandy set for the beginner. Contains 12 pieces with Plan Book. **Price \$1.50**
- No. 702—Practical young carpenter's set. 16 pieces with Plan Book.... **Price \$2.50**
- No. 707—Handy practical set for boys. 19 pieces including Plan Book.... **Price \$3.50**
- No. 765—Feature Set in Boy's size group. Dandy set. 24 pieces. Real tools for practical service. Packed in big red chest with Plan Book..... **Price \$5.00**

**DAD'S SIZE**

- No. 780—Household Treasure Chest. 26 pieces of real he-man tools including big 16-in. Cross-cut Saw, 15-in. Steel Level and 7 3/4-in. Block Plane. A regular outfit. Two Plan Books. Packed in brass-bound chest. **Price \$10.00**
- No. 785—Handy Carpenter Set. Practical, selected, high grade tools. 33 pieces, two Plan Books, 15-in. Steel Level, 16-in. Cross-cut and Dandy Keyhole Saw, also 10-in. Bench Plane. Packed in brass-bound chest. **Price \$15.00**
- No. 790—Feature Set of "Big Boy" Line. 35 pieces including 10-in. Plane, Ratchet Brace, 15-in. Level, 20-in. Cross, 18-in. Rip, and Dandy Keyhole Saws. Two Plan Books. Every needed tool for master builders. Packed in big red chest, brass-bound corners and lock..... **Price \$25.00**

**Also Manufacturers of Famous ERECTOR and Chemistry Sets—Mysto Magic—Motors, Etc.**

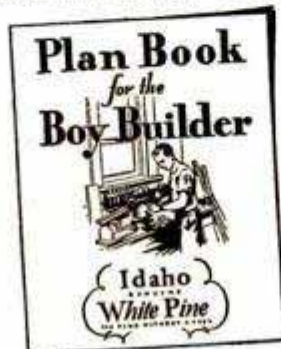

**THE A. C. GILBERT COMPANY,**  
161 Erector Square,  
New Haven, Conn.

Please send me free copy of Plan Book.

NAME.....  
STREET.....  
CITY.....  
STATE.....

*A.C. Gilbert*

Don't bother  
to "make this  
simple test"



**B**UT if you must convince yourself, try some ordinary tobacco in an old pipe. Note result in chalk on the bottom of your left shoe.

Then try some ordinary tobacco in your favorite pipe. Note on other shoe. Finally, try some Sir Walter Raleigh smoking tobacco in any good pipe. You won't have to note it anywhere, for you'll notice with the very first puff how much cooler and milder it is. It stays so, right down to the last puff in the bowl—rich, mellow and fragrant. Your regular tobacconist has Sir Walter, of course. Try a tin—today.

#### How to Take Care of Your Pipe

(Hint No. 11) Some smokers believe that oil on the bowl of a pipe keeps it bright and shiny. Temporarily the bowl is brightened, but it soon gets dull again. A brisk rub with a soft cloth will do wonders, especially if the pipe is warm. Send for our free booklet, "How to Take Care of Your Pipe." Brown & Williamson Tobacco Corporation, Louisville, Kentucky, Dept. 84. (In Canada, 3810 St. Antoine St., Montreal.)

**SIR WALTER  
RALEIGH**  
Smoking Tobacco

IT'S 15¢—and it's milder



50¢ QUALITY

**LISTERINE  
Shaving  
Cream**

NOW **25¢** Men who know  
quality have for  
years paid double  
what it costs now.

### MOVIES In Your Home



Our marvelous, practical Movie Machines sell as low as \$3.75 postpaid, and use same size film as big theatres. We also have wonderful films at lowest prices—with a new film exchange service.

Don't Miss This! Write NOW for Free Catalogue.

**PARAMOUNT MANUFACTURING CO.**  
Dept. G-34, BOSTON, MASS.

### AGENTS 500% PROFIT GENUINE GOLD LEAF LETTERS



guaranteed to never tarnish. Anyone can put them on stores and office windows. Enormous demand, large profits. Paul Clark says: Smallest day \$28.70. R. L. Reel made \$920 in two months. Write today for free sample and liberal offer to general agents.

**METALLIC LETTER CO. 443-B N. Clark St., CHICAGO**

### 10 Days Trial and 10 Months to Pay on any Mead Instrument

Select your own payment terms. Make money playing in local orchestras. Be the "life" of the party wherever you go. Mead instruments are easy to play and a joy to learn. Free instruction book—new simple method. Send a postcard TODAY for free instrument catalog with marvelous offers and terms.

**MEAD** CYCLE CO.  
DEPT 254-X CHICAGO



# A New Thrill *at every turn*



**M**OTORCYCLING is one sport you never tire of. New thrills — new adventures — await you at every bend in the road. Every mile has a joy of its own. Every trip brings a new pride in the eager power — the effortless speed — the easy handling—of your Harley-Davidson.

One ride astride a 1931 Twin will make you an enthusiast. No more

cooped-up cars for you! Only the freedom and road-mastery of the motorcycle — a Harley-Davidson — will satisfy you. And how little it costs!

Let your local Harley-Davidson Dealer show you the 1931 Twins and Single — and tell you about his Pay-As-You-Ride Plan. Go see him today!

Mail the Coupon for new literature illustrating the wonderful 1931 models.

## **HARLEY-DAVIDSON** *Motorcycles*

**MAIL THIS COUPON**

HARLEY-DAVIDSON MOTOR COMPANY  
Dept. P., Milwaukee, Wis.

Interested in your motorcycles. Send literature.

Name.....

Address.....

My age is  16-19 years,  20-30 years,  31 years and up,  
 under 16 years. Check your age group.

# Every Boy Wants An American Flyer Train

Send for the  
48 Page Colored  
Train Book  
**FREE!**



This catalog shows the new Steam and Electric type locomotives that *outpull all others*—Remote-Control-Reversing and Automatic Bell Ringing Locomotives—Cars with real Brass Window Trim and Fittings—Largest and Heaviest Freight Cars and many other exclusive features.  
Get the catalog and compare—American Flyers lead in Fun-making features and are years ahead of all other trains. Remember they cost no more. Dads, too, make railroading a hobby.

AMERICAN FLYER MFG. CO.  
2248 S. Halsted Street, Chicago, Ill.  
Please send me without cost your colored catalog.

Name.....  
Address.....  
City..... State.....



**LE PAGE'S GLUE** Take your choice—Liquid, Hard or Waterproof—and all LePage's!

**STRANGE INVENTION!**  
**PAYS YOU IMMENSE PROFITS**  
**NEW FIELD for AGENTS**

Sell only device in the world that prevents kinking, snarling and tangling of telephone and electric iron cords. Housewives and business men buy 1 to 50.

**NEW KIND OF CORD SET FREE**  
Every Neverknot Salesman is given FREE the complete Neverknot Switch Plug Cord Set pictured. This new kind of ironing cord automatically coils itself out of the way and a new kind of switch plug prevents scorching and saves electric bills. This set is a "gold mine" for house-to-house workers. It's different and it's yours free if you work for us. Don't delay! Send now for free offer.

NEVERKNOT CO. Dept. 12-V  
4503 Ravenswood, Chicago

**The Plug That Saves Electric Bills.**

**New FREE BOOK**  
New Styles - New Colors  
Now only \$5.00 DOWN  
ON ANY RANGE, HEATER OR FURNACE

**SAVE 1/3 to 1/2**  
New FREE book quotes **Factory Prices.** Now only \$5 Down on any stove, range or furnace. Year to pay. Choice of 5 colors in New Porcelain Enamel Ranges. New Cabinet Heaters—\$38.25 up. 200 styles and sizes. Cash or easy terms. 24-hour shipments. 30-day FREE trial. 360-day test. Satisfaction guaranteed. 30 years in business. 750,000 customers. Write today for FREE book.

**Cabinet Heaters \$38.25 up**  
**Ranges \$37.50 up**

**KALAMAZOO STOVE CO.**  
391 Rochester Avenue  
Kalamazoo, Mich.

**"A Kalamazoo Direct to You"**

**MOTORCYCLES**

**WE WILL TRUST YOU**  
Pay As Low As \$2.00 per Week  
Hendersons, Harley-Davidsons, Indians  
Slightly used and rebuilt. Hundreds to select from.  
Send 10c for list today.

**MYEROW BROS. CO., 15 Berkeley St., Boston, Mass., U. S. A.**

**MOULDS**  
For Making Toy Soldiers, Indians, Cowboys, Animals, etc.

With one Mould you can make many HUNDREDS OF CASTINGS, whole Armies. Outfits, including material for casting, enamel paints and everything complete, \$5.00. Easy enough for any boy to make and great fun for grown-ups. Sport for the whole family. Write for illustrations of dozens of patterns you can make.

**MAKE-A-TOY COMPANY, Dept. E, 1696 Boston Road, N. Y. City**

**Only 8 Sales a Day Nets You \$116 a Week**

Profits on larger size run higher. Unusual earning opportunity for ambitious men. No experience necessary; we teach. Part or full time.

**FUGO World's Simplest Fire Extinguisher**

Automatic and instantaneous action. Within reach of every home, shop, store, theatre, garage, car owner, etc. Even smallest place needs two or more. Exclusive territory to producers. You get your pay every day. Write for full details.

**The National Formetal Co.**  
6535 Metta Ave. Cleveland, O.



# New Model SOUTH BEND LATHES

Back Geared Screw Cutting Precision Lathes  
on Easy Payments

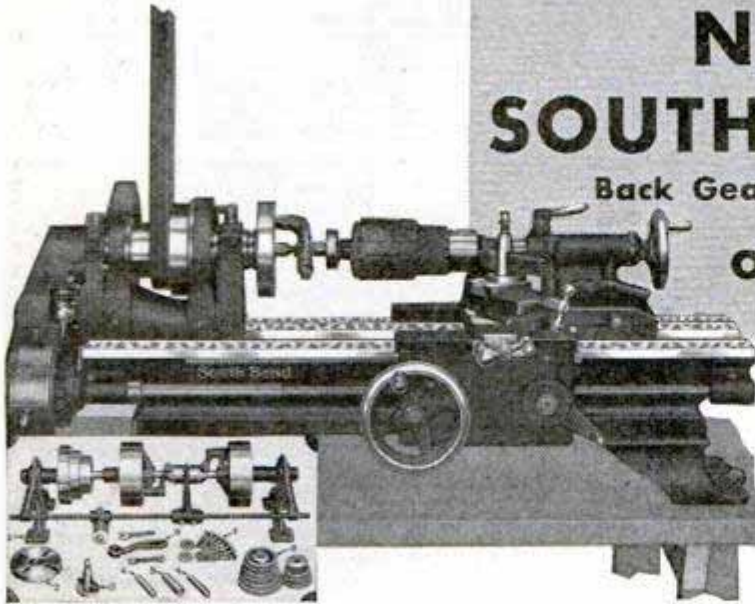

9" x 3' New Model Junior South Bend Bench Lathe **\$169**

Prices of Other Popular Size 9" Junior Lathes

Size of Lathe	Shipping Weight	Countershaft Drive	Down Payment	12 Monthly Payments Each
9" x 2½'	350 lbs.	\$163.00	\$32.60	\$11.41
9" x 3½'	400 lbs.	\$175.00	\$35.00	\$12.25
9" x 4'	425 lbs.	\$182.00	\$36.40	\$12.74
9" x 4½'	450 lbs.	\$190.00	\$38.00	\$13.30

**Only \$33.80 Down**

\$11.83 per month for 12 months for this 9" x 3' New Model Junior South Bend Back Geared, Screw Cutting Bench Lathe with countershaft and equipment. Wt. 375 lbs.

You can install any of the 96 sizes and types of South Bend Precision Lathes on similar easy terms. The new models have improvements which make them more than ever the outstanding lathe values in the world. They are practical for the finest and most accurate production and tool work in the modern plant, machine shop and all classes of metal working industries.

Send Now for These Books  
"How to Run a Lathe"  
25c Postpaid

Latest Edition of this famous work, contains 160 pages, with more than 300 illustrations. Simplest, most complete and practical book on lathe operation. Shows how to handle 400 different types of lathe jobs as practiced in the modern machine shop. Sent postpaid for only 25 cents; coin or stamps of any country accepted.

Auto Mechanics' Service Book No. 66  
25c Postpaid

This 96 page book illustrates and tells how to do 150 automobile service jobs on one machine. Intensely valuable and practical.

Catalog No. 91-A, Free

This 104 page book illustrates and describes the 96 different sizes and types of New Model South Bend Lathes. Send the coupon now for your copy, free.

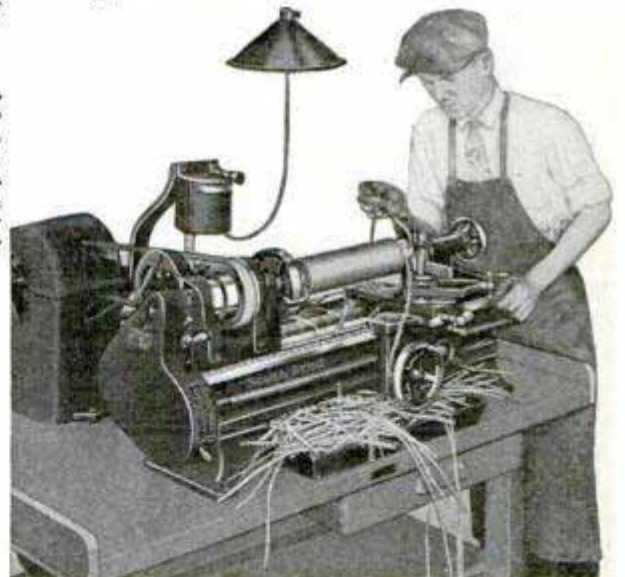

9" x 3' New Model Junior Horizontal Motor Driven Bench Lathe **\$254**  
Weights 465 lbs., complete

\$50.80 down payment, \$17.78 per month for 12 months.

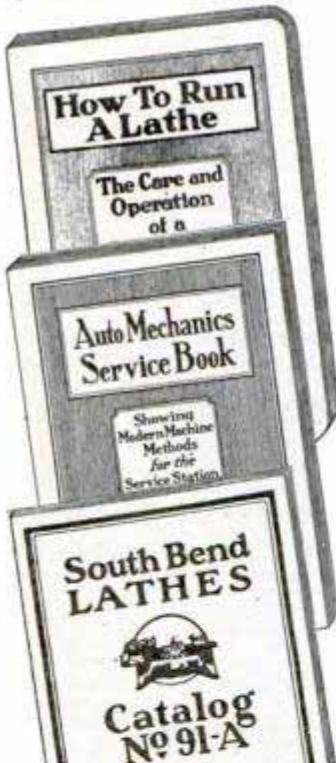

# SOUTH BEND LATHE WORKS

628 E. Madison St., South Bend, Ind., U.S.A.

Lathe Builders for 24 Years — Over 50,000 South Bend Lathes in Use

**SOUTH BEND LATHE WORKS**

628 E. Madison St., South Bend, Indiana, U.S.A.

Gentlemen: Please send me books checked

- "How to Run a Lathe" (25c)
- Auto Mechanics' Service Book (25c)
- Catalog No. 91-A (Free)
- Easy Payment Plan

Name \_\_\_\_\_

Address \_\_\_\_\_

City \_\_\_\_\_ State \_\_\_\_\_

Yes! It's a new **RADIO!** Try any outfit—**30 days Free** BEFORE YOU BUY

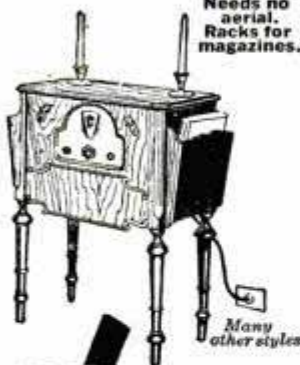

Needs no aerial. Racks for magazines.

**Factory to you SAVE to 50% SUPER Screen Grid Push-Pull Latest Electric Radios**

Enjoy a powerful new 1931 Miraco outfit for 30 days—at our risk. No obligation to buy. Get Send-No-Money, Amazing Special Factory-to-You Offer

**MIRACO**  
TRADE MARK REGISTERED

**SUPER Screen Grid \$49.88 COMPLETE less tubes**

Compare with Costliest Sets! America's big, old, reliable Radio Factory springs its 11th anniversary sensations! Latest SUPER Screen Grid, perfected Push-Pull, Super Dynamic Electric AC sets of finest construction with costliest features—Varitone and automatic sensitivity control and no hum—at astounding low factory prices. Clever new cabinets—big variety—exclusive designs. Compare with costliest radios—unless 100% delighted with Miraco's sharp selectivity, RICHER, CLEARER TONE and DISTANCE-GETTING, don't buy! Delighted thousands report programs from Coast to Coast with tone and power of expensive outfits. Full year's guaranty. Play safe, insure satisfaction, save lots of money—deal direct with big, old factory—pioneers in fine set making—11th successful year. Write and be convinced!

11th Successful Year



Send postal or coupon. Amazing 'Send No Money' Offer. No Obligation.

**USER - AGENTS!** Exclusive Territory. Big Money. No Risk.

MIRACO Radio Set in Case to You **Free**

NAME \_\_\_\_\_

ADDRESS \_\_\_\_\_

**MIDWEST RADIO CORPORATION**  
Pioneer Builders of Sets—11th Year  
807-88 Miraco Dept., Cincinnati, Ohio  
Send Amazing Special Factory Offer.  
 Interested in Agents' Proposition

**Do Your PRINTING**  
Cards, stationery, circulars, tags, labels, advertising, etc. Save money. Print for others, big profits; easy rules sent. Will do popular Raised Printing like Engraving. Junior Press, \$5.90. Job Presses \$11 up, Power \$149. Write for free catalog. **THE KELSEY CO., Y-37, Meriden, Conn.**

**FREE Radio Bargain CATALOG**



20th Century MAIL ORDER CORP.  
238 S. Wells Chicago, Ill.

**and FREE RADIO GIFT**

Make 20th Century your headquarters for everything in radio. Lowest prices assured. Every article guaranteed. Complete equipment for regular and short wave receivers and transmitters. Sets, Parts, Kits, Pilotron Tubes and other Pilot Radio products. Send for catalog NOW.

**GENUINE PILOT PRODUCTS**



**AMAZING 60th ANNIVERSARY OFFER**

**NO MONEY DOWN—A YEAR TO PAY**

312,896 Farmers Helped Me Build This New Lifetime WITTE . . . Now I'm Going to Help the Farmers . . .

With my new plan you can learn for yourself how much money a Lifetime WITTE can make for you . . . how much time and labor it will save . . . either your own or hired help. Prove these facts on your own place . . . before you pay me a single penny. It's the most liberal engine offer ever made.

**FACTORY-TO-YOU PRICES**

On my latest engines, the best ever made . . . Enclosed—Self Oiling—with Timken Roller Bearings that never require adjustment, guaranteed for a lifetime! Saves Fuel and Oil. It's the cheapest hired man on earth.

**Engine Comparison Chart—FREE**

Don't buy ANY engine until you get this Chart. Then, compare and decide which engine will give you the most value for your money.

**A Lifetime WITTE for Every Power Need**

Write today for my new free ENGINE BOOK and COMPARISON CHART and my amazing No MONEY DOWN offer.

**WITTE ENGINE WORKS**

1749 Oakland Ave. Kansas City, Mo.

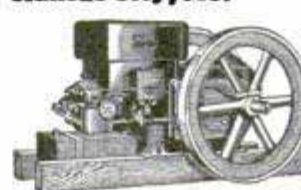

**FREE Engine Book and Comparison Chart**

TIME TESTED SINCE 1870

**BOW LEGS?**



THIS GARTER (Pat'd) Makes Trousers Hang Straight If Legs Bend In or Out Free Booklet—Plain Sealed Envelope **THE T. GARTER CO., Dept. E South Bend, Ind.**

**MOTORCYCLES**  
Direct to you at wholesale prices  
Send 10c today for the latest Illustrated Bulletin and Confidential Price List of Guaranteed Indians Harleys Hendersons SuperX etc.  
(Sold on easy terms if desired)

**CRANDALL CYCLE CO., 826-28 State St. Shipments to all Motorcycles Since 1905 Springfield, Mass. parts of the world**

**POPULARITY this Year for Christmas**



WHAT FINER gift than a sweet-toned, easy-playing Pan-American instrument, that enables you to play tunes immediately . . . join the band or orchestra in a few weeks . . . win popularity, extra income. Choose any instrument. Pan-Americans are factory guaranteed, moderately priced. **FREE TRIAL; Easy Payments.** Write for details; name instrument.

**PAN-AMERICAN**  
Rand Instrument and Case Co.  
1203 Pan-American Bldg., Elkhart, Ind.



# \$100 COACH MODEL FOR \$4.98

THAT ANY SCHOOL BOY CAN BUILD IN A FEW HOURS

## AN EXCELLENT CHRISTMAS GIFT—PROFITABLE PASTIME



Size: 24" long;  
8" high;  
6" wide.

We supply you with all the parts, cut to fit and ready to assemble, with a diagram and instruction sheet written so that anyone may easily follow. Each part is numbered and the corresponding numbers on the diagram show you just where to place them. No tools are needed except a small tack hammer. Beside the model of the George Washington Coach illustrated at left we have parts for the following: **Tally-Ho; Devonport to London coach; Deadwood stage coach, Covered wagon . . .** at \$4.98 each (less horses).

**Guarantee:** If after assembling our coach model according to our instructions you are not satisfied, return it to us and we will immediately refund your money. You to be the sole judge.

Realizing the demand for coach models but that the prices charged by exclusive stores are too high for most people, we have made it possible for everyone to own one or more of these early conveyances which helped write the country's history.

**HISTORICAL COACH MODELS, Inc.**  
Dept. PM, 2206 Fairmount Ave., Philadelphia, Pa.

**Historical Coach Models, Inc., Dept. PM**  
2206 Fairmount Ave., Philadelphia, Pa.

Sirs: Please send me complete parts, cut to fit and ready to put together for:

George Washington Coach ; Tally-Ho ; Devonport to London Coach ; Deadwood Coach ; Covered Wagon ; Send me FREE CATALOG

I agree to pay the postman \$4.98 plus postage. Foreign orders to be accompanied by U. S. money order or check.

NAME.....

ADDRESS.....

CITY.....STATE.....

## Make Your FORD Into The "ACE"

GET READY FOR SPRING—BUILD YOUR ACE NOW—

\$5.99 Red-I-Kut life size patterns  
Class—Snap



38-inch Easy  
Riding Seat

Famous sure-fit RED-I-KUT life-size patterns and picture instructions show how you can easily convert your Ford into this Fast, Saucy, Sport-Car as thousands have done with easily obtained materials. No need to lay up the car. Makes wonderful 4-passenger car. Send 10c coin for actual photo of sport car and new manual of distinctive sport car patterns from \$4.50 up—“RED” Steel “Seag-Lo” trous. Top, Windshields and many speed necessities. ORDER RIGHT NOW and get a real thrill.

KUEMPEL COMPANY, 127 Kuempel Bldg., GUTTENBERG, IOWA

## MOTORCYCLES

Wonderful Bargains

Small Deposit—Liberal Terms  
Indians Harley-Davidsons Ace  
and Henderson

Send 10 cents for Bulletin A.  
Motorcycles shipped to all parts of the world

WALKER-INDIAN CO., 1309 Boylston St., Boston, Mass.



## Make BIG Money

In Your Own  
Cash Business

Men and women can easily make EXTRA MONEY at home in spare time. Build up a permanent, repeat CASH BUSINESS of your own. Everybody likes Delicious electro-baked Do-Nuts. No experience necessary. Start in your own kitchen. No fuss—no bother. We furnish everything, including special recipes.



**FREE PLAN** Write for it today. Tells you how to make BIG MONEY. 100% Profit with the Ringer Electric Do-Nut Machine.

**RINGER DO-NUT CO.** 27 Main St. N. E. MINNEAPOLIS, MINN.

## Card to Matchbox Trick



Mystify Your Friends With This Trick.  
Only 10 Cents

“Say, fellows, watch me! I will now change this playing card into a matchbox, right before your eyes.” Get this amazing trick today (only 10 cents) and mystify your friends. Or buy a complete Knapp Master Magic Set and be a real magician. Perform dozens of mystifying tricks, including those of famous magicians, NEVER BEFORE EXPOSED. Make money. Stage magic shows all your own. Hours of fun.

SEND FOR FREE Booklet  
—“Secrets of Master Magic.”

SEND 10 CENTS for this trick.

Set No. 1.....\$1.00

Set No. 2.....3.50

Set No. 3.....5.00

(Denver & West, \$1.15, \$3.75, \$5.50)

AT ALL STORES

Set No. 1. Contains: Guess-where; Magic Pencils; Aladdin's Matches; The Disappearing Coin; Card to Match Box; The Chinese Safety Pin; The Changing Card; The Vanisher; Secrets of Master Magic (Instruction Book). \$1.00

**KNAPP**  
**Master Magic**

Knapp Electric (Div. P. R. Mallory & Co.), Inc.  
Dept. M-12, 3029 E. Washington St., Indianapolis, Ind.

Send Free Booklet—“Secrets of Master Magic.”  
 Send Matchbox trick. Dime enclosed.  
 Send Set No.....  Money enclosed.  I'll pay postman.

Name.....

Address.....

# DIAMONDS, WATCHES for CHRISTMAS

THE BEST CHRISTMAS GIFT  
OF ALL—A DIAMOND RING

Genuine Diamonds of fiery brilliancy; solid 18-k white gold rings of finest artistry. New low prices. CASH OR CREDIT.

Send for  
**FREE Catalog**

2000 Illustrations

**Elite Wedding Rings, platinum—only \$15.75. In solid 18-k white gold \$5.00. Diamond set wedding rings, 3 Diamonds, \$12.75; 5 Diamonds, \$18.75; 7 Diamonds, \$25.00.**

**CREDIT TERMS: 1-10th down; balance weekly, semi-monthly or monthly at your convenience.**

**HOW TO ORDER**—State article desired—name of employer—kind of work you do—how long in position—age—married—where live—how long there. **EVERYTHING IS CONFIDENTIAL.** Send first payment, OR goods sent for your **FREE Examination** on request. **MONEY BACK IF NOT SATISFIED. Wear While You Pay.**

**No. 950**—Bracelet Watch, solid 14-k white gold, 15 Jewels, \$5 Kreisler mesh bracelet included, **\$22.50. On Weekly Terms.**

**No. 927**—Elgin "Legionnaire." **\$19. On Weekly Terms.**



**No. 849**  
Fiery blue white Diamond, solid 18-k white gold ring \$98.  
**\$2.50 A WEEK**



**No. 917**  
Sparkling blue white Diamond, solid 18-k white gold, exquisitely designed, \$48.50.  
**\$1.25 A WEEK**



**No. 914**  
Men's ring. Fiery blue white Diamond; solid 18-k white gold ring \$73.50  
**\$1.75 A WEEK**



**No. 930**  
Blue white Diamond; solid 18-k white gold square top ring  
**\$23.85 ON WEEKLY TERMS**



The **NATIONAL JEWELERS** Stores in Leading Cities

**LOFTIS** BROS & CO. EST'D 1858

Dept. G-894  
108 N. State Street  
Chicago, Ill.

The man who studies gets ahead. Popular Mechanics Press will advise you what books to read to advance in your trade. 200 East Ontario Street, Chicago, Illinois.

# Get the NEW IDEAL EAGLET for Christmas!

Construction  
Outfit

**50¢**



Finest little ship you ever saw; flies with the best of them! 20 in. Wing-span, full-fuselage Cabin type. Made of Read-cut Balsawood (not cardboard) with built-up wings, formed balsa propeller with nosing, wood wheels, finished metal parts—everything ready for construction. Demountable wings; weighs 1 oz. complete. It's a beauty and a GREAT Flier! Get yours now!

## 24 Inch IDEAL ROBIN



This is a high-class Model and a winner in any crowd! 24 in. Wing-span, demountable wings, 2 in. wheels, radial engine mounting. Made of Balsawood. Everything stamped and formed ready for quick construction. Set contains varnish, dope, cement, full-size plans and diagrams, and complete instructions. Complete ..... **\$3.50**  
The **FALCON Monoplane**—a modified "V" type fuselage model that's a sure winner in any company..... **\$1.50**  
The **AMERICAN EAGLE**—a low-wing, fast-flying model that will still be in the air when more delicate models are junked. It's a beauty, too. Complete Construction Set..... **\$2.50**  
Ask your dealer for these IDEAL Model Airplanes, or send your order direct to us. We guarantee satisfaction.

Get the big, 48-page IDEAL catalog and New Christmas Circular Showing the latest Models..... **5¢**

**Ideal Aeroplane & Supply Company, Inc.**  
26 West 19th Street, New York City

## RELIEVE PAIN QUICKLY

WITH

### Infra Red Ray Health Lamp

As these rays penetrate deeply into the tissues they create an active circulation of the blood. Relieve Rheumatism, Bronchitis, Neuritis, Sinus Catarrh, Asthma, Lumbago, and many other ailments with soothing Infra Red Rays.

**30 DAYS' FREE TRIAL**

Write today for FREE book giving full information.

**HEALTH LAMPS, INC.**

Dept. 23 Alliance, Ohio



INFRA RED RAY HEALTH LAMP

[[ Send for full size illustration of machine ]]

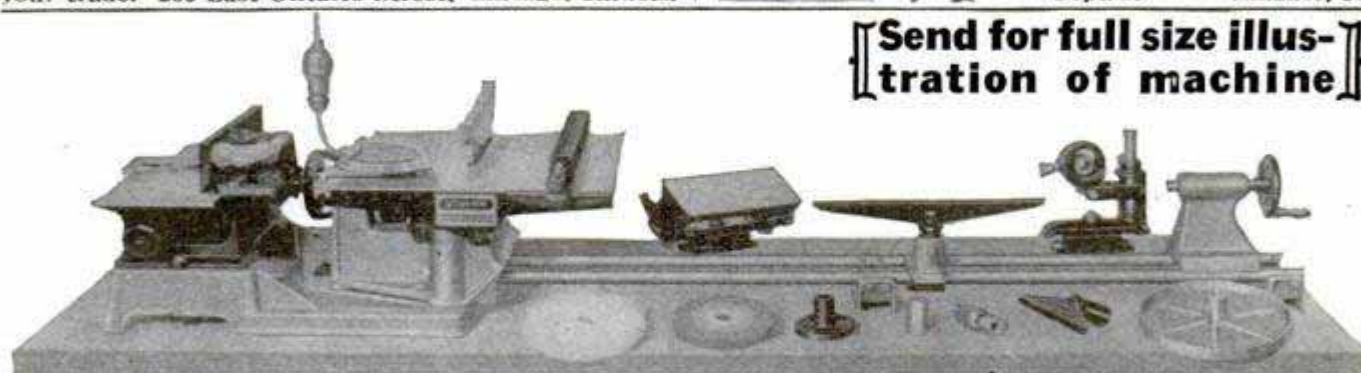

# New Model WORKACE WOODWORKER COMPLETE 5 FT. ELECTRIC WOODSHOP FOR HOBBY OR INCOME

**FREE**  
JIG SAW & GUARDS

\$14.00 worth of extra value free if you act quickly.

Make hundreds of things with the Workace Electric Woodworker. Under the magic of the saw, planer, jig saw, lathe, sander, drill, grinder and buffing wheel (all included in the Workace Woodworker) raw lumber is easily converted into furniture, household necessities and countless other articles. Work out your ideas with your own complete electric workshop for fun or profit.

There's no better gift for the growing boy than Workace. It provides a wholesome man-building outlet for his energy and enthusiasm. Man or boy will appreciate Workace. \$9.00 down will bring it. Send now for details.

**\$9.00** DOWN

and \$9.00 A Month for 10 Months

**\$89.00** CASH

**J. D. WALLACE & CO., Adams St. and California Ave., Chicago, Ill.**

Write Name and Address on blank space below

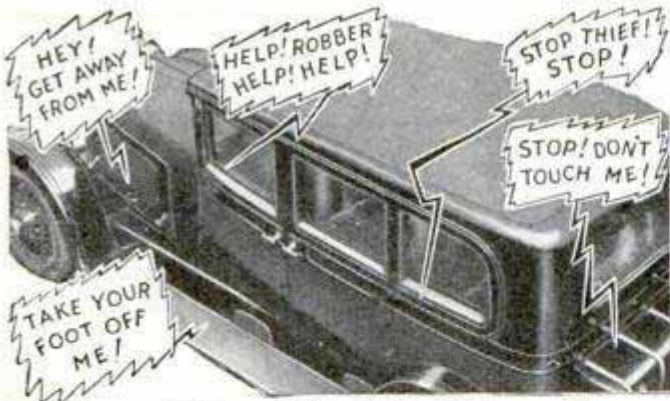

## Astonishing Electrical Invention Protects Your Car from Thieves ...Automatically!

THIS unquestionably is the queerest, most incredible invention since the first discoveries of radio! A magical, automatic watchman that actually is far more than human! Never sleeps, rests or gets tired! Stands guard over your entire car from spare tire to headlights and steering wheel! Endorsed by police! Approved by Motor Associations! Now offered on generous 5-day free-test basis!

## A Startling, Uncanny Money-Maker for AGENTS!

"What makes it work?" "Where on earth did you get it?" "Bet you five dollars he's got someone hiding in there!" "It simply can't be true." A running fire of comment like this breaks out whenever and wherever this new invention is exhibited. And why not? When no one ever heard of such a startling, uncanny device before! In fact few people would even dare to dream there could be such a thing! So this, men, is something really NEW, something to grip the imagination of everyone, something that sells to every autoist on sheer novelty alone. Distributors, "star" salesmen, every man who wants to double and triple his present income should note carefully the above facts.

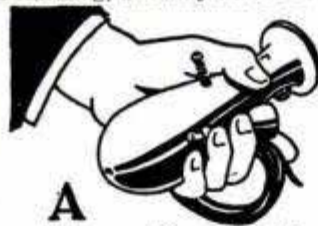

A Mere Handful

## DEVIL DOG



Write Today for Free Money Making and Sample Offer

Northwest Electric Corp., Dept. W-10, Pukwana, S. Dak.

### INTRODUCING THE NEW HEATH B 4 ENGINE

A new era of safety in the light plane field has been introduced by the new Heath B 4 engine—winner of the world's championship at the 1930 National Air Races. Backed by 7 years of constant development, the new Heath B 4 is an air cooled engine delivering 30 H. P. at 3000 R.P.M. Absolutely free from all bearing and vibration difficulties. Priced less than ordinary motors—only \$300 fully equipped including propeller hub. Fully guaranteed. 10 cents in stamps or coin brings large illustrated booklet.

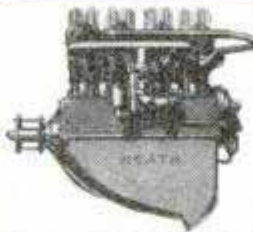

HEATH AIRCRAFT CORP.  
Dept. PM12A, 1721-9 Sedgwick St., Chicago, Ill.



## PUSH THE BUTTON and have Electric Light Anywhere

COMPLETE, 110 volt, ELECTRIC LITE PLANT for Farms, Camps, Ranches and Summer Homes. Operates on gasoline and generates electricity. RUNS HOUSEHOLD APPLIANCES AND LIGHTS. A Simple Sturdy plant. \$139. INSTALL IT YOURSELF. Wiring and lights for seven rooms \$17.50. Also other models, Direct Current or Alternating Current to 2000 Watts. Write for circular.

D. W. ONAN & SONS  
40 Royalston Av., Minneapolis, Minn.

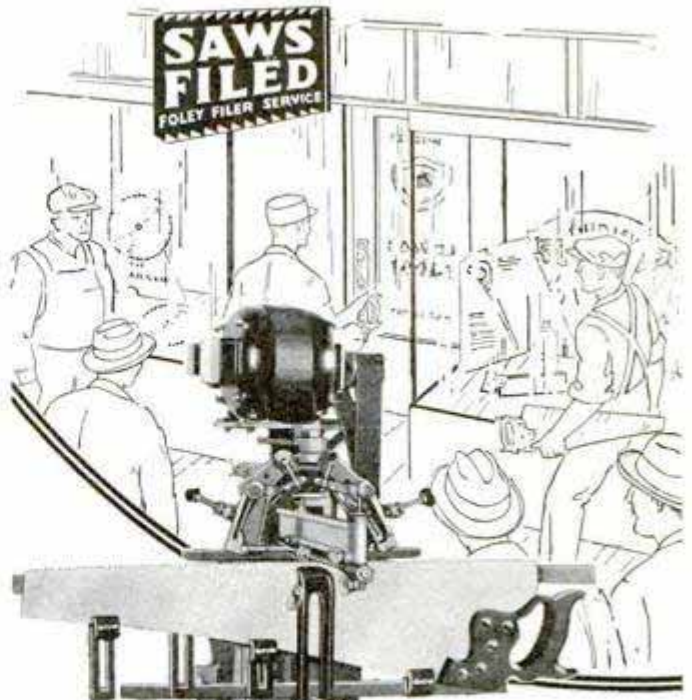

## Make Big Profits Filing Saws by Machine

Have your own fine paying business! Steady, repeat customers will soon help you build a permanent, profitable clientele. Easy to get started in spare time. J. W. Cremeans writes, "I have a Foley Filer and it is a money-maker."

## FOLEY AUTO MATIC SAW FILER Files Hand, Band and Circular Saws

This ONE machine files all kinds of saws better than the most expert hand filer. It evens all teeth at the same time it files, automatically. Foley-filed saws cut better and faster, and stay sharp longer.

## No Experience Necessary

Easy and simple to operate. With just a little practice, you can turn out perfectly filed saws. FREE PLAN helps you get started. Send coupon for complete information.

MAIL THIS COUPON for FREE PLAN

### Foley Manufacturing Co.

208 Foley Bldg., 11 Main St. N.E., Minneapolis, Minnesota

Please send me FREE PLAN telling how I can start my own Saw Filing Business with the Foley.

Name.....

Address.....

Here's a Real Machine!

# PARKS PRODUCTO ELECTRIC WORK SHOP COMBINATION

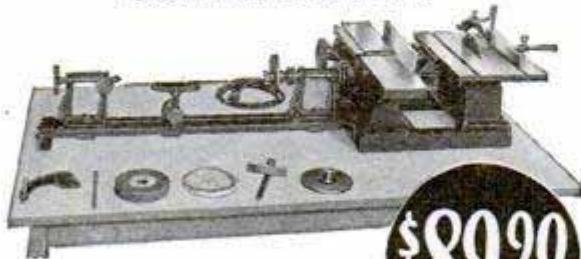

**A Sturdier and More Complete Home Work Shop**

**\$89.90**

A complete outfit includes 8" cast iron circular saw, 4" cast iron planer, 3-speed 6" x 36" lathe with angle steel adjustable bed, boring attachment, emery wheel, buffing wheel, sand disc and 1/3 H. P. motor mounted on sliding base. All machines completely guarded. Priced complete with motor.

Send coupon for descriptive circular.



**TROJAN  
12" Band Saw  
\$34.90**

Without motor, base and guard

**SMOOTH-ALL  
4" Bench Planer  
\$33.90**

Without motor and base

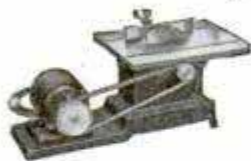
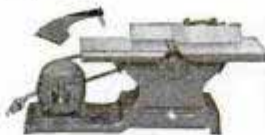

**PREMIER  
Bench Circular Saw  
\$29.90**

Without motor and base

**THE PARKS WOODWORKING MACHINE CO.**  
Dept. X-12, 1530 Knowlton St., Cincinnati, Ohio

Good woodworking machines since 1887

Canadian Factory: 338 Notre Dame East, Montreal

Name..... City.....

Address..... State.....

**PARKS**  
WOODWORKING MACHINES

## ALADDIN PORTABLE ELECTRO-PLATER

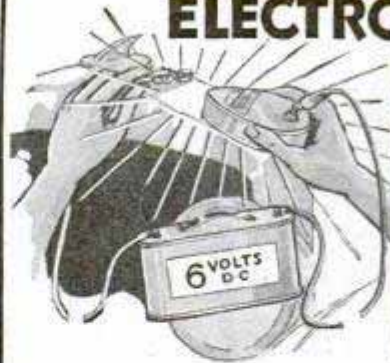

**Introductory  
AGENTS  
OFFER**  
**\$0.50**

**Instantly Applies Real Nickel**

Also Electrically Plates Brass, Copper, Silver, Gold, Etc. With the inexpensive Aladdin Outfit you can easily nickel plate the nickel on your car and do a good job of it. The Aladdin Outfit is also a home necessity.

**MAKE BIG PROFITS WITH THE ALADDIN**

Whether you are interested in the Aladdin for yourself or should you wish to go into business putting real nickel on autos or doing metal plating in your neighborhood, or if you would like to act as our agent in your territory, write us immediately for free particulars.



**P. J. F. BATENBURG CO.**

DEPT. 195

RACINE, WISCONSIN



**BETTER Practical  
GIFTS for Christmas**

GERSTNER Tool Chests are practical, desirable, and ideal. TOOLMAKERS and MACHINISTS, choose your own gift from our Free Catalog.

*Gerstner & Sons*

484 Columbia St. Dayton, Ohio

## COX HOLDFAST SCREW DRIVER

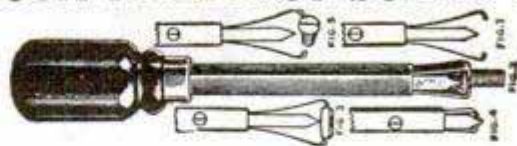

Mr. Mechanic—This is the tool you need. Saves time and patience. Holds the screw, nut, cotterpin, etc., securely until you are ready to release, releasing by a pull on handle. You have always wanted a tool like this—order one before you forget it, stating whether for heavy or light work, and length you require. 4 inch, 6 inch, 9 inch or 12 inch over all. Price 50c, 60c, 75c, and \$1.00 each. Agents wanted.

**S. J. COX MFG., Dept. F, FRANKLIN, PA.**

**BURN YOUR NAME ON TOOLS**

## WITH THE ARKOGRAF

**PROTECT YOUR TOOLS FROM THEFT**  
Write with electricity any name or design on the hardest and finest tools and instruments, or any metal, like writing on paper with pen or pencil. **Complete Outfit \$3.50**—Prepaid Anywhere. Interesting illustrated circular free. Write today. Agents wanted. ARKOGRAF PEN CO., 1171 E. Stark St., Portland, Oregon



## SOLDERALL

METAL IN PASTE FORM

The only convenient metal solder



Every Electrical Connection needs Solderall for perfect reception. **25¢**  
The SOLDERALL CO., NEWARK, N.J.

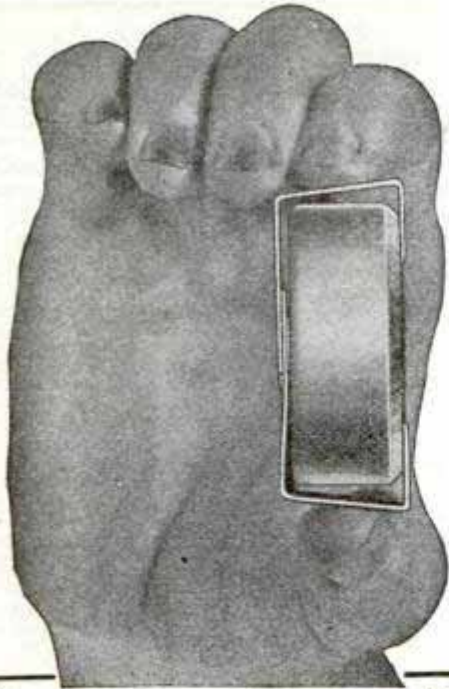

An excellent Christmas gift for your Craftsman friend

Diam. 2" Wt. 2 1/4 oz.

**IN THIS SMALL CUP IS COILED A SIX-FOOT STEEL RULE!**

Sounds unbelievable, doesn't it? But your hardware dealer will gladly demonstrate other unique qualities of this most remarkable of all modern tool inventions.

**The FARRAND RAPID RULE**

Patented in U. S. Nos. 1,402,589 & 1,730,199  
Write to factory for booklet and six-inch sample

**HIRAM A. FARRAND, Inc. Fifth St., Berlin, N. H.**

**THREAD CUTTING LATHE**



12" Band Saw  
Powerful. Practical. Not a Toy.  
Price only \$30.00.  
Write today for Book-let and prices on these and other Machines.

9" Swing  
30" between centers

A REAL LATHE  
For School, Home or Factory.

**ROSSBACHER MACHINE CO.**  
1516 A Fernwood Avenue Toledo, Ohio

**ONE-MAN SAW MILL**

**\$39 BRINGS IT TO YOU**

Makes lumber, shingles, cross ties, fence posts, laths, fruit and vegetable crates and boxes, dimension blanks for furniture, etc. Splits blocks into fir, wood. Needed by farmers, timber owners, contractors. Pays for itself in a week, or on one job. Guaranteed. Sold direct from factory. Write today for Special Offer and Free Book "How To Make Lumber."

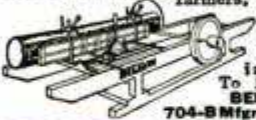

To BELSAW MACHINERY CO.  
704-B Mfgs. Ex. Bldg., Kansas City, Mo.

The **TOOL** the World has been waiting for

**\$19.95**

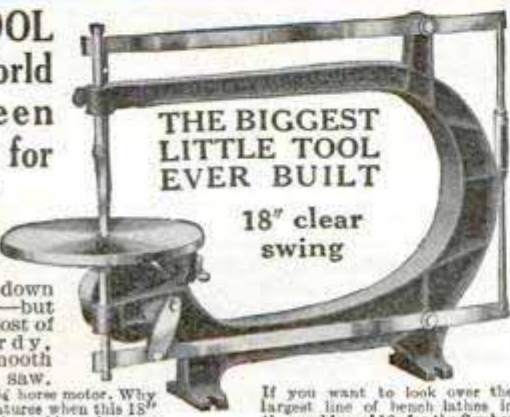

**THE BIGGEST LITTLE TOOL EVER BUILT**

18" clear swing

Not just a down payment—but the whole cost of this sturdy, powerful, smooth running jig saw. Requires only 1/4 horse motor. Why fool with miniatures when this 18" job with 9" tilting table and strong one piece frame costs no more.  
**SYIPHER-ARCON CO.**

If you want to look over the largest line of bench lathes in the world send 10c for the Sypher DALL catalog of 32 pages.

**1524 Fernwood Av., Toledo, O.**

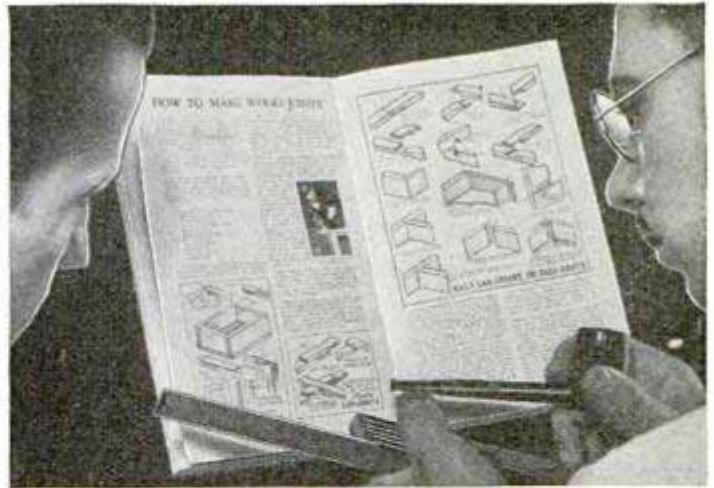

**"It Showed Me How to Make Good Joints"**

**T**his new ATKINS Book, with simple directions and clear diagrams, makes it easy for me to do projects requiring accurate joinery—those I used to pass up. Now I can cut and fit dado, dovetail or dowel joints like an expert."

This "home workshop manual" also gives helpful hints on starting a shop, selecting the best saws and tools, and keeping them properly; shows you how to build a pair of handy saw horses, a better work bench, and a new tool cabinet. Next, a complete reference list of job plans for over 200 articles. Finally, a section showing scores of the world famous ATKINS Silver Steel Saws and Saw Tools, so that you can decide which ones you want and then see them at your hardware store.



Saving shoulder of half splice joint with ATKINS Silver Steel Back Saw No. 2.



Saving half-blind dovetails with ATKINS Silver Steel Dovetail Saw.

Send Coupon for a Copy



The great demand for this new book is making the first edition go fast! Better mail the coupon today to get your copy promptly. It costs only a dime, but is worth dollars to every home craftsman, beginner or expert. Clip the coupon now!

**TELLS HOW TO**  
Start a Home Shop  
Select the Correct Saws & Tools  
**CUT and FIT the 24 Most-Used WOOD JOINTS**  
Build a Work Bench, Tool Box, etc.  
Suggests 200 Things

**E. C. ATKINS and Company, Est. 1857**  
426 South Illinois Street, Indianapolis, Ind.

I enclose a dime for a copy of the new ATKINS SAW BOOK for Home Craftsmen.

Name.....

Address.....

My dealer is.....

# Amazing NEW TOOL VALUE

An Automatic Push Drill Carrying in the Handle Eight Sizes of Drill Points

Pick out the size drill you want from the separate numbered compartment. Insert it in the steel jaws. Place drill point where you want hole. Push



—push—and presto, you have a smooth clean hole. The handiest tool ever invented for household use. Made by one of America's leading makers of fine tools. Show this ad to your dealer and secure drill for \$1.25 or mail coupon to us and drill will be sent postpaid c. o. d. \$1.40.

## AN IDEAL CHRISTMAS GIFT

USE THE COUPON TODAY!

Goodell-Pratt Company, Greenfield, Mass.

Please send me a No. 188 Automatic Drill. I will pay postman \$1.40.

Name .....

Street .....

City ..... State .....

Nothing under \$2.00 ever bought such a good tool!

# OLD MONEY and stamps WANTED



**POST YOURSELF!** It pays! I paid J. D. Martin, Virginia, \$200 for a single copper cent. Mr. Manning, New York, \$2,500 for one silver dollar. Mrs. G. F. Adams \$740 for a few old coins. I want all kinds of old coins, medals, bills and stamps. I pay big cash premiums.

**WILL PAY \$100 FOR DIME**  
1894 S. Mint; \$50 for 1913 Liberty Head Nickel (not buffalo) and hundreds of other amazing prices for coins. Get in touch with me. Send 4c for Large Illustrated Coin Folder and further particulars. It may mean much profit to you. Write today to

NUMISMATIC COMPANY OF TEXAS  
Dept. 324 FORT WORTH, TEXAS  
[Largest Rare Coin Establishment in U. S.]

## Build a CLOCK for Pleasure or PROFIT!

**FREE BOOK** Shows How YOU Can Make Fine Clocks Right at Home  
of Clock Making, Money Making ideas. Gives details, prices of movements, parts. Write NOW for copy!

—for yourself, or to sell at Big Profits. We furnish instructions, parts. Works \$1.65 up; others with chimes, all prices. Make case or assemblable parts. Cash-in on demand for Mantel, Banjo, Grandfather's Clocks. Write for Special Blue Print Offer, FREE Catalog.

**AMERICAN CHIME CLOCK COMPANY**  
1670-E Ruffner St. Philadelphia, Pa.

## CLASS PINS 35

FREE CATALOG  
Either pin, silver plate... 35/ea.  
Sterling silver or gold plate... 50/ea.  
For 2 colors enamel, any 3 or 4 letters & dates

Lower Prices on Dozen Lots  
BASTIAN BROS. CO. 861 BASTIAN BLDG. ROCHESTER, N. Y.

## 8" Band Saw \$13.95 Only

Here It Is. An Ace of An Up-To-Date Band Saw. Just What You Have Been Looking For!

A Band Saw that is guaranteed to give the same results as the larger and more expensive machines now on the market.

Has hardened and ground shafts—saw guides made of tool steel— $\frac{1}{4}$ " Atkins Silver Steel Saw Blade—will cut wood up to 2  $\frac{1}{2}$ " thick and light metal. A real machine made to last a life time, and carries a guarantee of satisfaction or money refunded. With Endless "V" Belt and Motor Pulley \$15.00.

**Up-To-Date Machine Works**  
Dept. 120, 2909-15 So. Wabash Ave.  
CHICAGO, ILL.

## Makes Old Ford a Tractor

Now you can convert that old Ford car into a useful farm tractor without altering any Ford parts. We furnish the traction wheels, drive gears and auxiliary axle and mountings, ready to clamp on to the Ford frame. Pulls 16" plow.

We supply a Belt Pulley also

Write for Free Particulars.  
**Shaw Mfg. Co., Dept. PM12, Galesburg, Kan.**

## Brown & Sharpe Tools

"World's Standard of Accuracy"

Send for Catalog No. 31 describing 2300 Precision Tools.  
Brown & Sharpe Mfg. Co., Providence, R. I., U. S. A.

## FREE TOOL BOOK

"The Disston Saw, Tool and File Book"

tells how to choose, use, and care for tools, file and set saws, etc. Every tool user needs it.

Henry Disston & Sons, Inc., Dept. M, Philadelphia. Canadian Factory, Toronto

# DIAMONDS

(Sent Free Examination)

## here 60% of Market Prices

10 large loan firms combined (world's oldest, largest association of its kind—rated over \$1,000,000.00), loans money on diamonds. A few such loans not repaid. Diamonds originally sold by outstanding jewelers. Of course we can loan but a fraction of real values. You get the advantage in Unpaid Loans at cash prices you can try to match at full 60% more. Every liberal privilege.—Examination free—No obligation to buy.

**Free List of Unpaid Loan Diamond Bargains** Every diamond accurately described. Radically low prices for any quality, any size. Written guaranteed amounts you can borrow (like Insurance Policy loan guarantee). Get full details of free examination offers. You don't risk a penny. A century old house (references: Bank of Pgh., Union Trust Co., 3rd Nat'l Bank). Lists limited—Send now.

For **FREE LIST** write today to . . . **Jos. DeRoy & Sons, Opp. P. O., 1999 DeRoy Bldg., Pittsburgh, Pa.**



Unpaid Loans  
Low as  
**\$60**  
per Carat



# A NEW GENERAL UTILITY CHISEL

No. 175-1" **75¢** Retail



**ALL STEEL UNBREAKABLE**

A new general utility chisel combining cutting design and blade keenness with the rugged strength of all steel construction!

Nothing to loosen, nothing to break—the unique webbed handle affords an excellent grip and provides maximum strength without weight or bulkiness.

Heads specially hardened to prevent chipping; blades hardened all the way through. Furnished in three sizes, 3/4, 1 and 1 1/4 in. Black lacquer finish with red head. Ask your hardware dealer for Crescent wood chisel No. 175.

**CRESCENT TOOL CO., JAMESTOWN, N. Y.**

**CRESCENT and Smith & Hemenway TOOLS**

## BOYS! MAKE BIG MONEY Build Bird Houses



Join the happy family of ambitious boys who are having heaps of fun and making lots of money building, erecting, and selling my famous Grandpa Bird Houses. Start now—accept my *Special Holiday Offer*. Send only \$1 for my simple instructions and big collection of copyrighted *Work-Shop Plans*, including song bird habits, money making tips, and sales information. Unusual value—all complete for \$1. Act now!

**GEORGE J. BREIDERT, 1043 N. Elmwood Ave., Oak Park, Ill.**

Learn to **PAINT SIGNS and SHOW CARDS**

We quickly teach you by mail, or at school, in spare time. Big demand. Big future. Interesting work. Oldest, foremost school.

**EARN \$50 TO \$200 WEEKLY**

Otto Wiegand, Md., home-study graduate, made \$12,000 from his business in one year. John Wessoe, N. Y., gets \$25 for a show card. Crawford, B. C., writes: "Earned \$200 while taking course." Write for complete information.

**DETROIT SCHOOL OF LETTERING**  
150 Stimson Ave. Est. 1899 DETROIT, MICH.

**FREE "Book of Facts"**

Write For It

**FREE Plans for Ski Jumping Tower and Tournament**  
Rules sent to any Sports Club.

**60 SIZES WOODS & STYLES**

**STRAND SKI**

America's most thrilling winter sport. Strand Ski the recognized leader for 33 years. Used by expert jumpers all over the world. Also Strand quality Hard Maple toboggans in lengths from 4 to 12 feet.

**SPECIAL OFFER: Standard 8 ft. Hickory Skis \$3.25**  
**Special Factory Price, Only \$3.25**

**M.A. STRAND SKI CO.** 128 STRAND ST. NEW RICHMOND, WIS.  
**LARGEST SKI FACTORY ON EARTH**

# \$500

## GIVEN AWAY

**W**E mean it. You have a chance to win a money prize of \$250! How? Simply by telling us what you think is the best possible use for our new product, *Handi-Wood*.

### 23 cash prizes

In addition to the big first prize of \$250 cash, we are offering 22 other prizes. Anybody can win. Nothing could be more useful in a hundred different ways than *Handi-Wood*. Imagine a paste that handles like putty—yet hardens quickly into strong wood! You can use it for practically everything from plugging a drafty window to repairing a boat. And the man, woman, or child who can think of the most unique use for this product gets the \$250 first prize!

Think a minute. Have you ever fixed anything—a chair or a table, perhaps—in some unusual way? A way that was perfectly practical—yet no one but you ever thought of it before? Just apply the experience you've already had—and try for the first prize. If you miss it, you have 22 other chances to win.

### It's easy—send for rules

No work to this contest—it's all fun! Simply mail the coupon and we'll send you complete information. Then work out your best ideas, and send them in to us. You can count on the makers of *Creo-Dipt Stained Shingles* to give your entry a fair chance at first prize.

*Handi-Wood* is sold by leading lumber, paint and hardware dealers everywhere. Ask the one nearest you. Meanwhile, mail the coupon today.



# HANDI-WOOD

MAIL COUPON TODAY FOR DETAILS OF CONTEST

CREO-DIPT COMPANY,  
1653 Oliver Street, North Tonawanda, N. Y.

I'd like to win \$250. Please send me complete information about prize contest for best uses of *Handi-Wood*.

Name \_\_\_\_\_

Address \_\_\_\_\_

# FREE The Road to Understanding For Men Past 40



W. J. KIRK

**WHY** is 40 the "dread age" for many men? What is the "intimate" disorder that often robs them of vitality, vigor, joy of living? This daring free book answers these vital questions. Mail coupon for Free Copy.

**WHY** are many men past 40 suddenly afflicted with a dangerous ailment, that if neglected, may lead to wretched old age or perhaps grave surgery? The Free book answers this and other questions every man past 40 should know.

**WHY** do so many middle aged men suffer backache, leg and foot pains, sciatica, bladder trouble, night rising, chronic constipation and other so-called old-age ailments? Find the answer in the Free book.

**HOW** can one again frequently know the joy of living, get swift, lasting relief and feel 10 years younger in 7 days? Mail the coupon and learn how an amazing new drugless treatment is used and endorsed by prominent specialists.



## The Truth About Prostate Gland Trouble

Many men mistake these dangerous and distressing ailments for approaching old age and live lives of misery, when by simply re-stimulating a tiny gland—called the prostate—they might be enjoying youthful pep, vim, and health. Already 100,000 men have tested the merits of a new drugless method of gland stimulation perfected by a scientist with offices in Ohio, California and England. Now many physicians, specialists, hospitals and sanitariums use and endorse it, for prostate gland failure. It is not a medicine, drug, massage, diet, exercise or violet ray. Its relief is not only usually quick—but lasting. Many users say it cleared up their distressing symptoms and made them feel 10 years younger in 7 days. Now it will be sent to you on a guarantee that if it doesn't do the same for you, pay nothing. If you want to know the joy of living, mail the coupon for your Free copy of "The Destroyer of Male Health."

**W. J. KIRK, President**  
2136 Morris Ave. STEUBENVILLE, OHIO

If you live West of the Rockies, address The Electro Thermal Co., 303 Van Nuys Building, Dept. 21-N, Los Angeles, Calif. In Canada, address The Electro Thermal Co., Desk 21-N, 53 Yonge St., Toronto, Can.

**W. J. KIRK, President,**  
2136 Morris Ave., Steubenville, Ohio.

Send free copy of your darling book, "The Destroyer of Male Health." Also facts about your Free Trial.

Name .....

Address .....

City.....State.....

# AMAZING BURNER

Use **Ordinary Kerosene**  
The most startling heat producing burner ever made. Indispensable on the farm, in factory, for boiling, cooking, and heating. Ideal for butchers, dairies, repair shops, stoves, boilers, ovens, cooking equipment and numerous other uses. Will boil any quantity desired in half the usual time.

# TERRIFIC HEAT!

**NO NOISE SMELL SMOKE SOOT**  
SILENT BLUE FLAME



Think of it! Improved oil burner produces twice the heat of city gas at half the cost. Regulate to any degree desired. So simple. Easily installed and operated. Double generator assures continuous operation without shut-downs. Nothing to wear out. Starts in a jiffy. Will last a lifetime. Every burner guaranteed fully to give complete satisfaction.

"I would not take \$500 for it if I could not get another," writes J. H. Cox, Mich. "It is worth its weight in gold and is the best on the market," J. B. Ashcraft, O. "Produces terrific heat and saves lots of kerosene." H. C. Kistler, Pa.

**Also Burners for Cook Stoves and Heaters**  
Let us send you our catalog of Improved Therm-O-Gas Burners. **HOME MFG. CO., Dept. 5013, 20 E. Kinzie St., Chicago**



**FLY A CURTISS ARMY HAWK**  
2-ft. Flying Scale Model simple to build. Set complete with blueprint and instructions \$3.00. National Models guaranteed to fly.  
29 North Avenue Dept. C3

Here's a real Xmas Gift for amateur aviators. Other interesting models for you to build.  
2-ft. Vought Corsair... \$3.00  
2-ft. Lockheed Sirius... 3.00  
2-ft. Boeing P. 12-B.... 3.75  
2-ft. Sikorsky Amphibian..... 2.75  
Full Size Blueprints.... .50  
Illustrated 32-page Catalogue..... .05  
**NATIONAL MODEL AIRCRAFT & SUPPLY CO.**  
New Rochelle, N. Y.

Cal. 30-40 Six Shot **KRAG CARBINE** Price **\$9.75**  
All the qualities of a high price rifle. In fine used condition, all working parts guaranteed for one year. Send today for our Free 60-page illustrated catalog of money saving values; Guns, Ammunition, Cutlery, Sports and Gov't goods.  
Deposit required on all orders. Money refunded if not satisfactory  
**W. Stokes Kirk, Dept. P. M-12, 1627 N. 10th St., Phila., Pa.**

## DEAFNESS IS MISERY

Many people with defective hearing and Head Noises enjoy conversation, go to Theatre and Church because they use Leonard Invisible Ear Drums which resemble Tiny Megaphones fitting in the Ear entirely out of sight. No wires, batteries or head piece. They are inexpensive. Write for booklet and sworn statement of the inventor, himself deaf.

**A. O. LEONARD, Inc., Suite 699, 70 5th Ave., New York**

## NOW a BAND SAW for Your Workshop

**Guaranteed Satisfaction**  
Think of it. Turn out all your own home woodwork with the precision, accuracy, and speed of an expert cabinet maker. Beautiful work. The New H & A Band Saw does it. No vibration. No chattering. No galloping. Absolutely safe. Suitable for industrial use. Handles greatest variety of jobs. Powerful. Sturdy. Portable. Motor driven. Sensational Low Price.  
**A Complete Line of Machines For Your Home Shop**  
Send for full information and catalog of complete line, including wood lathes, rip saws, jointers, scroll saws—everything you need for home or commercial workshop. Do it now!  
**HESTON & ANDERSON**  
612 Kirkwood Ave. FAIRFIELD, IOWA  
**FREE Catalog**



# Is Tobacco Hurting You?

Look the facts square in the face, Mr. Tobacco User. You may think tobacco is not hurting you.

That is because you haven't as yet, perhaps, felt the effects of the nicotine poison in YOUR system. For you know that nicotine, as absorbed into the system through smoking and chewing tobacco, is a slow working poison. Slow, yes—but sure.

Tobacco lowers efficiency. It slows a man down. Makes it harder to concentrate the mind on work. Tobacco users seldom have the amount of "pep" and energy of those who do not use the weed. There's many a man older than you in years who is younger in energy, simply because he lets tobacco alone.

Some day, probably, you will realize to what an alarming extent tobacco does undermine the system.

When your hands begin to tremble—  
and your appetite begins to fail—  
and your heart seems to "skip a beat" now and then—  
and slight exertion makes you short of breath—  
then you have a right to suspect that  
**TOBACCO** is getting the upper hand.

Any well-informed doctor will tell you that these are only a few of many symptoms of tobacco poisoning.

And YOU know that the use of tobacco in any form is an expensive, utterly useless habit. You know you ought to quit.

## Tobacco Habit Banished In Many Cases—Let Us Help You

It doesn't make a particle of difference whether tobacco has been used for a single month or fifty years, or how much, or in what form—whether cigars, cigarettes, pipe, plug, fine cut, or snuff. In most cases, Tobacco Redeemer removes all craving for tobacco in any form in a very few days. Not the slightest shock to the nervous system. The tobacco craving will usually begin to decrease after the very first dose—there is no long waiting for results.

Tobacco Redeemer contains no habit-forming drugs of any kind and is quick, safe, pleasant and thoroughly reliable.

It is in no sense a substitute for tobacco. It helps to quiet the nerves and makes one feel better in every way.

### Our Guarantee

A single trial will convince you. Our legal, binding, money-back guarantee goes with each full treatment. We will refund every cent you pay for the treatment if, after taking it according to the easy-to-follow directions, it should fail to banish the tobacco habit completely.

### SEND Free Proof

Coupon for Free Proof  
Let us send you our free booklet on the injurious effects of tobacco, together with testimonial letters from men all over the country telling how they have been absolutely freed from the tobacco habit by this simple home treatment. You could not ask for stronger proof than the evidence we will gladly send on request. Just mail the coupon—or a postal will do.

**NEWELL PHARMACAL CO.**

Dept. 300 Clayton Station St. Louis, Mo.



## Free Book Coupon

**NEWELL PHARMACAL CO.**

Dept. 300 Clayton Station St. Louis, Mo.

Please send, without obligating me in any way, your free booklet regarding the tobacco habit and proof that Tobacco Redeemer has relieved the tobacco habit in thousands of cases. If it fails my money will be refunded.

Name.....

Street and No.....

Town..... State.....

# LUMINOUS PAINT

**Make Your Watches, Clocks, Etc., Visible by Night**  
 The very latest discovery in the scientific world. Hiberto, practically unobtainable except at an exorbitant price, we have at last succeeded in producing this remarkable LUMINOUS PAINT, which, applied to the surface of any article, emits rays of white light, rendering it perfectly visible in the dark. THE DARKER THE NIGHT, THE MORE BRILLIANT IT SHINES. Quite simple to use. Anyone—you can do it. A little applied to the dial of your watch or clock will enable you to tell the time by night. You can coat the push buttons or switch plates of your electric lights, match boxes, and innumerable other articles; make your own Luminous Crucifixes, Luminous Hoarings, etc. Size of bottle, 1. Largest sizes, 50c and \$1 postpaid. JOHNSON SMITH & CO. Dept. 808 RACINE, WIS.



**Cigarette Maker**  
 Roll your own and save money. Better and quicker; saves more than half. Use your favorite brand of tobacco. Net, useful, handy. Pocket size, weighs 1/2 oz. Made entirely of metal, nickel plated. 25c, 3 for 65c.



**GOOD LUCK RING**  
 Very striking, quaint and uncommon. Silver finish; skull and crossbones design, two brilliant, flashing gems sparkle out of the eyes. Said to bring good luck. Only 25c post.

**Exploding Cigarettes**  
 Box contains ten genuine cigarettes of excellent quality. They appear so real, but when each cigarette is about one-third smoked, the victim gets a very great surprise as it goes off with a loud BANG! A great mirth provoker yet entirely harmless. Price 25c box.

Rubber Cigarettes 20c box  
 Rubber Chewing Gum, 10c  
 Rubber Matches 10c



**U. S. BABY TANK**  
 It goes with real Yankee Pep—by its own power. Most remarkable toy ever invented. By drawing the Tank backward, either with the hand or over the floor or table and then placing it down, it will crawl along, overcoming all obstacles, in the same life-like manner as the larger Tank that proved so deadly in the great war. What makes it go is something of a mystery, for there is no mechanism to wind up as is usually understood with mechanical toys, yet this tank will keep plodding along ten times longer than the ordinary run of toys. It will perform dozens of the most wonderful stunts; 2 1/2 inches long. Price only 25c prepaid. Postage Stamps accepted in payment of all orders.

## NOVELTY BADGES



**Kissing Permit 10c** Two very novel metal badges, nickel plated, that you can wear, giving you fun out of all proportion to their trifling cost 10c, each badge, 3 for 25c, or 75c per doz, postpaid anywhere.

## MAGIC MADE EASY 250 MAGIC TRICKS 10c



As a little book containing 250 Parlor Tricks, tricks with cards, coins, handkerchiefs, paper, ribbons, glasses, etc. So simple that a child can perform them. Profusely illustrated. Sent postpaid, to any address for only 10c, 3 copies for 25c postpaid. 4 Other Books on Magic You Should Have: Heller's Great Book of Magic.....25c  
 Magic for the Amateur Magician.....25c  
 125 Tricks with Cards.....25c  
 Entertaining Tricks and Social Entertainer.....25c

## MIDGET BIBLE



**GREAT CURIOSITY** Unavailable in the World. Size of a postage stamp. 200 Pages. Said to bring good luck to the owner. A genuine work of art. Must be seen to be appreciated. Make good money selling them to friends, church acquaintances, etc. PRICE 15c each, 3 for 40c, 12 for \$1.35, 100 for \$7.50. Also obtainable in Leather Binding, with gold edges. Price 50c each, 3 for \$1.25, \$4.50 per doz. Magnifying Glass for use with Midget Bible. 15c.

## Wonderful X-Ray Tube



A wonderful little instrument producing optical illusions both surprising and startling. With it you can see what is apparently the bones of your fingers, the lead in a lead pencil, the interior opening in a pine stem, and many other similar illusions. Price 10c, 3 for 25c.

## STAGE MONEY



With a bunch of these bills, it is easy for each person of limited means to appear prosperous by flashing a roll of these bills at the proper time and peeling off a genuine bill or two from the outside of the roll, the effect created will be found to be all that can be desired. Prices, postpaid: 40 Bills 20c, 120 for 50c, or \$3.50 thousand postpaid.

## SURPRISE MATCHES

More fun than fighting with your wife. Look just like ordinary matches. As the victim tries to light one he gets quite a surprise. Price 10c per box, 3 boxes for 25c, 12 for 75 cents.



**Motto Ring**  
 Lots of harmless fun and amusement wearing these rings. Made in platinum finish to resemble platinum, with wording on enameloid, as illustrated. Only 25c Postpaid.

## BLANK CARTRIDGE PISTOL



Protection against Burglars, Tramps, & Dogs. Special Offer: 1 Blank Cartridge Pistol, 100 Blank Cartridges, 1 500-page Novelty Catalog \$1.50 ONLY. The Lot Shipped by Express Only. Cash With Order Only. Well made and effective, modelled on latest type of Revolver; appearance alone is enough to scare a burglar. When loaded it may be as effective as a real revolver without danger to life. It takes standard .22 Cal. Blank Cartridge—obtainable everywhere. Special cash with order offer: 1 Superior quality Blank Cartridge Pistol, 100 Blank Cartridges, and our new 550 page De Luxe Catalog of latest novelties; all for ONLY \$1.50. Shipped by Express only. Cannot go by parcel post. Extra Blank Cartridges 50c per 100. Special Hoister (Cowboy Type) for pistol 50c. No C. O. D. shipments.

## LOOK 35c LOOK Wonderful Instrument.



Everybody delighted with it. Odd, Curious and interesting. Lots of pleasure as well as very useful. It is a double Microscope for examining the wonders of nature. It is also an Opera Glass, a Stereoscope, a Burning Lens, a Reading Glass, a Telescope, a Compass, a pocket Mirror, and a Laryngoscope—for examining eye, ear, nose and throat. It is worth all the cost to locate even one painful cinder in the eye. Folds flat and fits the pocket. Something great—you need one. Don't miss it. Sent by mail. Only 35c or 3 for \$1.00.

## THROW YOUR VOICE



Into a trunk, under the bed or anywhere. Lots of fun fooling the teacher, policeman or friends. **THE VENTRILO** a little instrument, fits in the mouth out of sight, used with above for Bird Calls, etc. Anyone can use it.

Never Fails. A 16-page course on ventriloquism, the Ventrilo. ALL FOR 10 CENTS

## PISTOL CIGARETTE CASE



It looks like a deadly weapon, but it is merely a novel Cigarette Case. This clever contrivance has proved itself better than the real thing in many an awkward encounter. Great fun "sticking up" your friends. They squirm and protest it might be loaded. Pull the trigger and the slide flies open disclosing the cigarettes. Well made, light and compact. Weight only 2 ounces. PRICE POSTPAID 25c

## MAGICIAN'S BOX OF TRICKS



Apparatus and Directions for a Number of Mysterious Tricks. Enough for an Entire Evening's \$1.00 Entertainment.... Anyone Can Do Them. It is great fun mystifying your friends. Get this Conjuror's Cabinet, and you will be the cleverest fellow in your district. It contains the apparatus for ten first-class tricks, including The MAGIC BALL AND VASE TRICK (a wooden ball is placed inside, and upon replacing the lid has disappeared and is found in someone else's pocket); The HINDOO TRICK CARDS (can be made to change completely no less than five times); DISAPPEARING COIN BOX (a coin, placed in the wooden box, vanishes entirely or changes into a coin of another denomination); The GLASS GOBLET TRICK (a coin is dropped into a glass of water and when the water is poured out the coin has vanished and is found somewhere else); THE RIBBON FACTORY FROM THE MOUTH TRICK (a seemingly endless supply of colored paper ribbons comes out of your mouth); THE DISAPPEARING HANDKERCHIEF (a handkerchief held in the hand mysteriously vanishes); THE WIZARD'S RING COIN TRICK; THE ENCHANTED BOTTLE (no one but yourself is able to make it lay down); THE GREAT HAT AND DICE TRICK (a large dice is placed on top of a hat, disappears, and is found underneath yet no one has touched the hat), and last, but not least, the GREAT PHANTOM CARD TRICK, or two from five leaves nothing. Full instructions are sent for performing each trick. In addition to the above, a number of other feats and illusions are fully explained for which you can easily make or procure the necessary apparatus. Price complete \$1.00 postpaid. Postage Stamps accepted. JOHNSON SMITH & CO., Dept. 808, RACINE, WIS.

**LATEST CATALOG**  
 Dept. 808 RACINE, WIS.  
 A De Luxe Edition of our new CATALOG mailed on receipt of 25c, handsome binding. Bigger and better than ever. Only book of its kind in existence. Nearly 600 pages of all the latest tricks in magic, the newest novelties, puzzles, games, sporting goods, rubber stamps, unusual and interesting books, curiosities in seeds and plants, etc., unobtainable elsewhere. Remit by Coin, Money Order, Check or unused U. S., Canadian and Foreign Stamps for all articles listed above.

# Now-an Electric FLASH SIGN

Priced So Low that it  
**OFFERS AGENTS UP TO**  
**\$30 a Day**

Sells for  
**\$7.50**  
YOUR  
PROFIT **\$2.50**

The livest money maker in the field today for agents. Hundreds of thousands of stores have waited for this kind of a sign invention. The peculiar orange-red brilliancy, that so closely approximates the famous neon invention you see daily—but at only a fraction of the price—and with many distinct features. Flashes on and off. Messages can be changed instantly. Local agents reaping "fortunes." No money to invest in stock. Just make clever 2-minute demonstration and take orders. We deliver. Your profit \$2.50, plus liberal cash bonus paid weekly.



## We Lend You Sample

for demonstrating. Send no money for this generous offer—just write. Unbreakable—light weight—beautiful—looks like \$100.00. Every large and small store a ready prospect. A future is waiting for you. Will you take it? Write today to **Williams Name Plate Sign Co., 30 North La Salle St., Dept. 4-L, Chicago, Ill.**

## BIG SIX-TUBE RADIO GIVEN

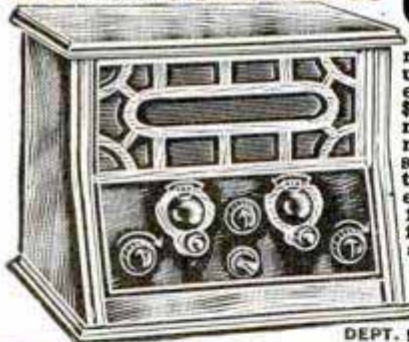

Big 17x22x13 inch radio set, licensed under R. C. A. Patents. Regular price \$60. Greatest premium offer ever made. Given for selling only 12 bottles Perfume at 25c each, giving Perfume Novelties free and remitting as per plan in catalog. Send no money. We trust you.

TREVAUX  
PERFUME CO.  
DEPT. 5E78 CHICAGO

## INCREASE YOUR POULTRY PROFITS!

By proper Breeding, Feeding, Housing, Culling and Marketing **AMERICAN POULTRY JOURNAL** tells how to do it, and in addition a series of **COLORED PICTURES**

with explanatory text tell and show many things you should know. They are not just colored pictures of birds but pictures of an educational nature, something never before shown by a poultry paper. 12 issues of **American Poultry Journal** contain about 1000 pages—

Price 25c a year—5 years \$1.  
**AMERICAN POULTRY JOURNAL, 14-536 S. Clark St., CHICAGO**

## WONDERFUL NEW BOOK FREE

Nation's Great Poultry Manual. Tells how you can make money with **BERRY'S CERTIFIED CHICKS**, Highbred Fowls and Supplies. Also facts about Housing, Feeding, Diseases, Remedies, etc. **NEW LOW PRICES** and **VERY BEST QUALITY**. Write today for Free Catalog.  
**BERRY'S POULTRY FARM Box 29 Clarinda, Iowa**

## SQUAB BOOK FREE

Breed PR squabs for rich trade. Sold by millions at higher prices than chickens. Send two-cent stamp for postage on latest free 48-p. book how to breed and profit by new fast sales method.

Plymouth Rock Squab Co., 634 H St., Melrose, Mass.

## BOYS..... Believe it or not An AUTOMATIC Pilot

That works every control in a model plane. Ascends any altitude—flies itself—Be the first with the latest. Build and fly the Pilot-Plane. Illustrated Booklet in colors containing complete information 25c (no stamps). Address—**ELTON McCARDLE CO., Dept. P. M. 12, 566 Seventh Ave., New York City.**



# "Not Another Cent!"



"You're getting all you're worth—for the work you're doing. If you want a raise, you'll have to learn higher class work—on your own time—not mine."

Hard words from the boss. But I took it on the chin. That night at home, looking over my new *Mechanics'* magazine I read a little ad that promised a "soft" job; big pay; clean, honorable work—if I would get down and practice evenings for 3 months. I tore out that coupon, and today—

## I'm Doing Swell



Playing with a dance band is like getting paid for having fun. I've doubled my pay working 3 or 4 evenings a week. Good-by dirty overalls. Good-by grind. This is a cinch. And I thought I was musically dumb.

## What's the Matter with You?

Why don't you step out of the overalls and into a "white collar" job? You don't have to be talented. Learn any instrument in a few weeks' spare-time practice. Double your income, treble your social position. Make big money—big friends.

Mail coupon below for catalog of your favorite instrument, saxophone, trumpet, trombone, clarinet; then take an instrument home on six days' free trial. Test yourself before you buy. See what you can do. No obligation. Mail coupon NOW.



# BUESCHER

BUESCHER BAND INSTRUMENT COMPANY  
1210 Buescher Block, Elkhart, Indiana B55

Gentlemen: Without obligating me in any way, please send complete catalog of (check which) trumpets  trombones  saxophones  clarinets . Mention any other

Name.....

Address.....

Town..... State.....

# PATENT

## Protect Your Ideas

### Take the First Step Today

If you have a useful, practical, novel idea for any new article or for an improvement on an old one, you should communicate with a competent Registered Patent Attorney AT ONCE. Every year thousands of applications for patents are filed in the U. S. Patent Office. Frequently two or more applications are made for the same or substantially the same idea (even though the inventors may live in different sections of the country and be entirely unknown to one another). In such a case, the burden of proof rests upon the last application filed. Delays of even a few days in filing the application sometimes mean the loss of a patent. So lose no time. Get in touch with me at once by mailing the coupon on the opposite page.

### Prompt, Careful, Efficient Service

This large, experienced organization devotes its entire time and attention to patent and trade mark cases. Our offices are directly across the street from the U. S. Patent Office. We understand the technicalities of patent law. We know the rules and requirements of the Patent Office. We can proceed in the quickest, safest and best ways in preparing an application for a patent covering your idea. Our success has been built on the strength of careful, efficient, satisfactory service to inventors and trademark owners located in every state in the Union.

### NO CHARGE for Information On How to Proceed

The booklet shown here contains valuable information relating to patent procedure that every inventor should have. And with it I will also send you my "Record of Invention" form on which you can sketch your idea and establish its date before a witness. Such evidence may later prove valuable to you. Simply mail the coupon and I will send you the booklet, and the "Record of Invention" form, together with detailed information on how to proceed and the costs involved. Do this NOW. No need to lose a minute's time. The coupon will bring you complete information entirely without charge or obligation.

My Offices  
Just Across  
Street From  
U.S. Pat. Office



Above is a view of my drafting and specification offices where a large staff of experienced experts are in my constant employ. All drawings and specifications are prepared in my offices.

# NEWS

*Inventors*  
*Write for these*

**Free  
Books**

**Strict Secrecy Preserved**

All communications, sketches, drawings, etc., are held in strictest confidence in strong, steel, fireproof files, which are accessible only to authorized members of my staff. Feel free to write me fully and frankly. It is probable that I can help you. Highest references. But **FIRST**—clip the coupon and get my free book. Do **THAT** right now.

**Clarence A. O'Brien**

*Registered Patent Attorney*

Member of Bar of: Supreme Court of the United States; Court of Appeals, District of Columbia; Supreme Court, District of Columbia; United States Court of Claims.

Practice confined exclusively to Patents, Trademarks and Copyrights

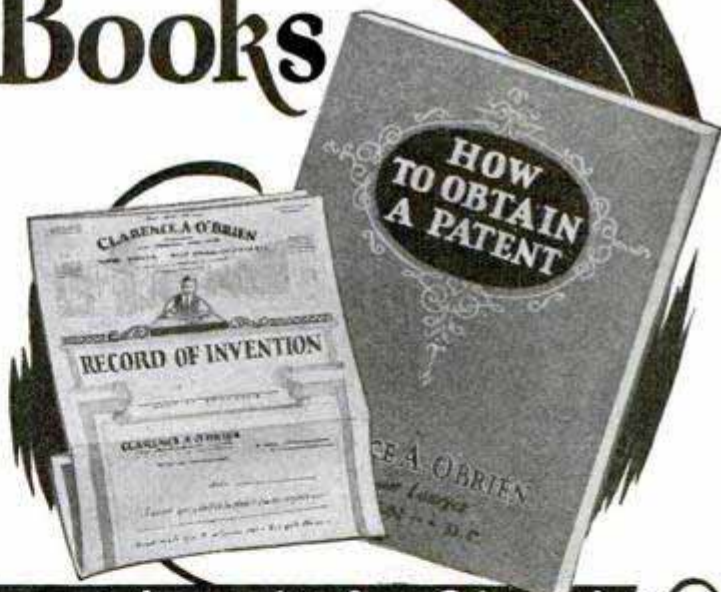

**Clip this Coupon and Mail it Now!**

**CLARENCE A. O'BRIEN, Registered Patent Attorney**  
70.B Security Savings and Commercial Bank Bldg.  
Washington, D. C.

(Or, Suite 1106, Dept. A-6, Woolworth Bldg., New York City)

Please send me your free book, "How to Obtain a Patent," and your "Record of Invention" form without any cost or obligation on my part.

Name.....

Address.....

(Important—Write or print name plainly and address office nearest you)

# PATENTS TRADE MARKS COPYRIGHTS

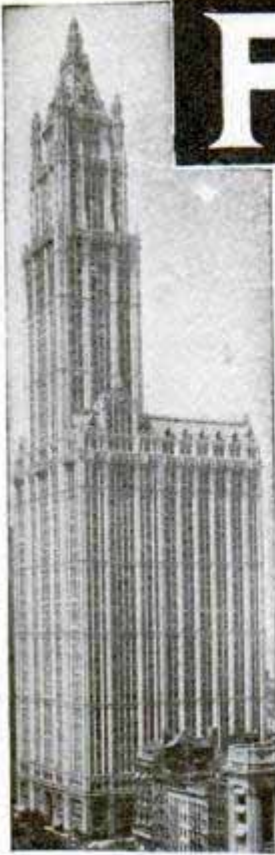

Our New York Office  
Suite 1007 Woolworth Bldg.



Our Philadelphia Office  
828 Fidelity Phila. Trust Bldg.



**VICTOR BUILDING**  
Our New Building Nearly Opposite U. S. Patent  
Office Specially Erected by Us for Our Own Use



## Have You An Idea?

**Our Offer:** FOR THE PROTECTION  
OF YOUR INVENTION

**YOUR FIRST STEP**—The Inventor should write for our blank form "RECORD OF INVENTION." A sketch and description should be made on this Blank, signed, witnessed, then returned to us. **We also give our opinion** as to whether the invention comes within the Patent Office definition of a patentable invention. This "Record of Invention" will serve as "proof of conception." *There is no charge or obligation for this service.*

## Our Five Books Mailed Free to Inventors

*Our Illustrated Guide BOOK*

## How to Obtain a Patent

Contains full instructions regarding U. S. Patents. Our Methods, Terms, and 100 Mechanical Movements illustrated and described.

## Our Trade Mark Book

Shows value and necessity of Trade Mark Protection. Information regarding *Trade Marks and unfair competition in trade.*

## Our Foreign Book

We have Direct Agencies in Foreign Countries, and secure Foreign Patents in shortest time and lowest cost.

## Progress of Invention

Description of World's Most Pressing Problems by Leading Scientists and Inventors.

## Payment of Fees in Installments

It is not necessary that the total cost for the preparation and prosecution of a patent be paid in one payment. Our custom is to permit our clients to pay for their applications in three installments as the preparation of the application progresses in our office. This plan makes the payments easy for the inventor.

*We Regard a Satisfied Client* as our best advertisement, and furnish anyone, upon request, lists of clients in any state for whom we have secured patents.

*Highest References—Prompt Service  
—Reasonable Terms*

# VICTOR J. EVANS & CO.

Patent Attorneys, Established in 1898

Main Offices: 789 9th St., N. W., Washington, D. C.

*Nearly Opposite U. S. Patent Office*



# DELAYS ARE DANGEROUS IN PATENT MATTERS

## IMPORTANT! To Avoid Delay!

YOU SHOULD HAVE YOUR CASE MADE SPECIAL IN OUR OFFICE to save correspondence, secure protection and early filing date in the Patent Office. To secure **special preparation** of your case send \$25.00 on account with model or sketch and description of invention. If the invention is not patentable we will return fee less cost of search.

**We Assist our Clients to Sell their Inventions.**

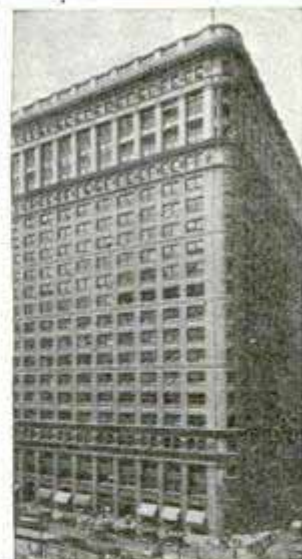

Our Chicago Office  
Suite 1640-42 Conway Bldg.

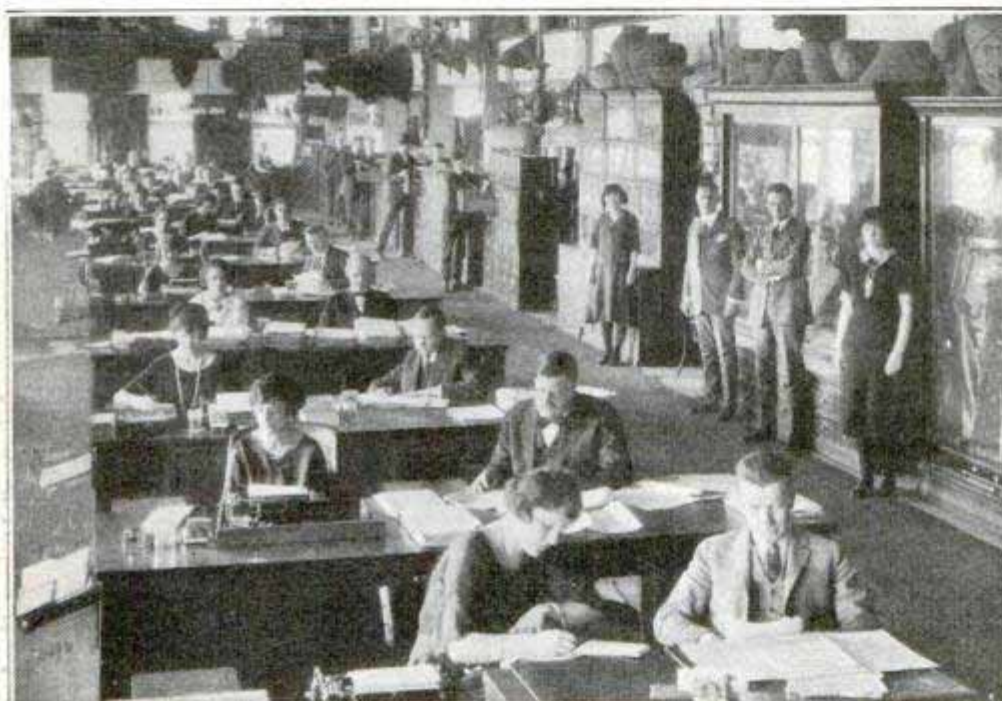

MAIN OFFICE, VICTOR J. EVANS & CO.—VICTOR BUILDING, WASHINGTON, D. C.

Our Large, Comprehensive Organization has been established for 30 years and offers Prompt, Efficient and **Personal Service** by experienced Patent Lawyers and Draftsmen. Every case is in charge of a Specialist who has been selected for his knowledge and experience in certain lines of invention. Our Lawyers practice in all U. S. Courts and defend clients in suits involving Patents, Trademarks and Copyrights. All Communications, Sketches, Drawings, etc., preserved in fireproof Files, strictly **Secret and Confidential**. We shall be glad to have you consult us or to answer any questions in regard to Patents, Trademarks or Copyrights without charge or obligation.



Our Pittsburgh Office  
Suite 514 Empire Building



Our San Francisco Office  
Suite 1010 Hobart Building

**FREE  
COUPON**

**VICTOR J. EVANS & CO.**  
**PATENT ATTORNEYS** *Established  
in 1898*

NEW YORK OFFICES  
1007 Woolworth Bldg.

CHICAGO OFFICES  
Suite 1640-42 Conway Bldg.

PHILADELPHIA OFFICES 828 Fidelity Phila. Trust Bldg.

PITTSBURGH OFFICES  
514 Empire Bldg.

SAN FRANCISCO OFFICES  
1010 Hobart Bldg.

MAIN OFFICES: 789-9th Street, N. W., WASHINGTON, D. C.

Gentlemen: Please send me *Free of Charge* your books as described on preceding page.

Name .....

Address .....

# PATENTS

Booklet Free Highest References  
Promptness Assured Best Results

Send drawing or model.

## ALL BUSINESS GIVEN PROMPT AND PROPER ATTENTION

Listed Patent Lawyer in the latest editions of the Rand-McNally Directory of Bankers and Bonded Attorneys, published by Rand-McNally & Co., Chicago, Ill.; The Baggott & Ryall Directory of Guaranteed Attorneys, published by Legal Directory Corporation, Boston, Mass.; Flugel's Law List, published by Legal Directory Publishing Co., St. Louis, Mo.; American Lawyers Annual, published in Cleveland, Ohio; Bankers Service Legal Directory, published by Bankers Service Co., Boston, Mass.; Eyre's Law List, 9 Park Place, New York City; Walters Legal Directory, Omaha, Nebraska, and the National Directory of Attorneys, Baltimore, Maryland.

**WATSON E. COLEMAN,**  
REGISTERED PATENT LAWYER

Victor Building, 724 Ninth Street, N. W.  
**WASHINGTON, D. C.**

# PATENTS

## To the Man with an Idea

PATENTS Procured. Trade Marks Registered. —A comprehensive, experienced, prompt service for the protection and development of your ideas. Preliminary advice gladly furnished without charge. Booklet of information and form for disclosing idea free on request.

**IRVING L. McCATHRAN,** Patent Lawyer  
Formerly with and successor to **RICHARD B. OWEN**  
704 International Bldg., Washington, D. C.  
41-E Park Row, New York City

## TRADE-MARKS REGISTERED

# PATENTS

As one of the oldest patent firms in America we give inventors at lowest consistent charge, a service noted for results, evidenced by many

well-known Patents of extraordinary value. Book, Patent-Sense, free. Lacey & Lacey, 635 F St. N. W., Dept. 5, Wash., D. C. Estab. 1889



## RAISE CHINCHILLA AND NEW ZEALAND WHITE

**FUR RABBITS** Make Big Money We Supply Stock

and pay you following prices for all you raise: Chinchillas average \$3 each—New Zealand Whites \$2 each. 32-page illustrated book, catalog and contract, also copy of Fur Farming magazine, tells how to raise rabbits for big profits, all for 10c. Address **OUTDOOR ENTERPRISE CO.,** Box 1021 Holmes Park, Missouri

# PATENTS

## PROTECT YOUR IDEAS

Write today for FREE BOOKLET, HOW TO OBTAIN A PATENT and RECORD OF INVENTION—or send Drawing or Model of your Invention for Examination.

Promptness Assured with Best Results

**MILLER & MILLER**  
REGISTERED PATENT ATTORNEYS

Former Members Examining Corps U. S. Patent Office  
Dept. A-1006 Woolworth Bldg. New York  
255 McGill Building Washington, D. C.



# PATENTS TRADE-MARKS

Don't Lose Your Rights  
To Patent Protection

Before disclosing your invention to anyone send for blank form "EVIDENCE OF CONCEPTION" to be signed and witnessed.

**LANCASTER, ALLWINE & ROMMEL**  
480 Ouray Bldg. WASHINGTON, D. C.  
Originators of forms "Evidence of Conception."

# PATENTS

Trade Marks, Copyrights, Patent Litigation Handbook with illustrations, 100 mechanical movements. Sent free on request.

**ALBERT E. DIETERICH**

Successor to Fred G. Dieterich & Co.

formerly member Examining Corps. U. S. Patent Office

REGISTERED

**PATENT LAWYER and SOLICITOR**

621-A, Ouray Bldg.

30 Years' Experience Washington, D. C.

TRADE  
MARKS

PATENTS

COPY-  
RIGHTS

BEST RESULTS. LOW FEES. PARTIAL PAYMENT PLAN

Write today for free information—No obligation, sending sketches and description of invention.

**HARRY W. JOHNSON**

Registered Patent and Trade Mark Attorney

FORMERLY MEMBER EXAMINING CORPS U. S. PATENT OFFICE

Member of the Bars: Supreme Court of the District of Columbia, The Court of Appeals of the District of Columbia, and, the U. S. Court of Customs and Patent Appeals.

219 MCGILL BUILDING, WASHINGTON, D. C.



# GEARS

In Stock—Immediate Delivery

Gears, speed reducers, sprockets, thrust bearings, flexible couplings, pulleys, etc. A complete line is carried in our Chicago stock. Can also quote on special gears of any kind. Send us your blue prints and inquiries.

Write for Catalog No. 10

**CHICAGO GEAR WORKS**

769-773 W. Jackson Blvd., CHICAGO, ILL.

# DO YOU

WANT a new business profession of your own, with all the trade you can attend to? Then become a foot correctionist, and in a few weeks earn big income in service fees,—not medical nor chiropody—easy terms for home training, no further capital needed, no goods to buy, no agency. Address

Stephenson Laboratory, 1 Back Bay, Boston, Mass.

# A Shop Like This Without Cost!

This is a typical BOICE-CRANE layout. Shops like this dot country. We need more. Read our great plan, and you'll know why.

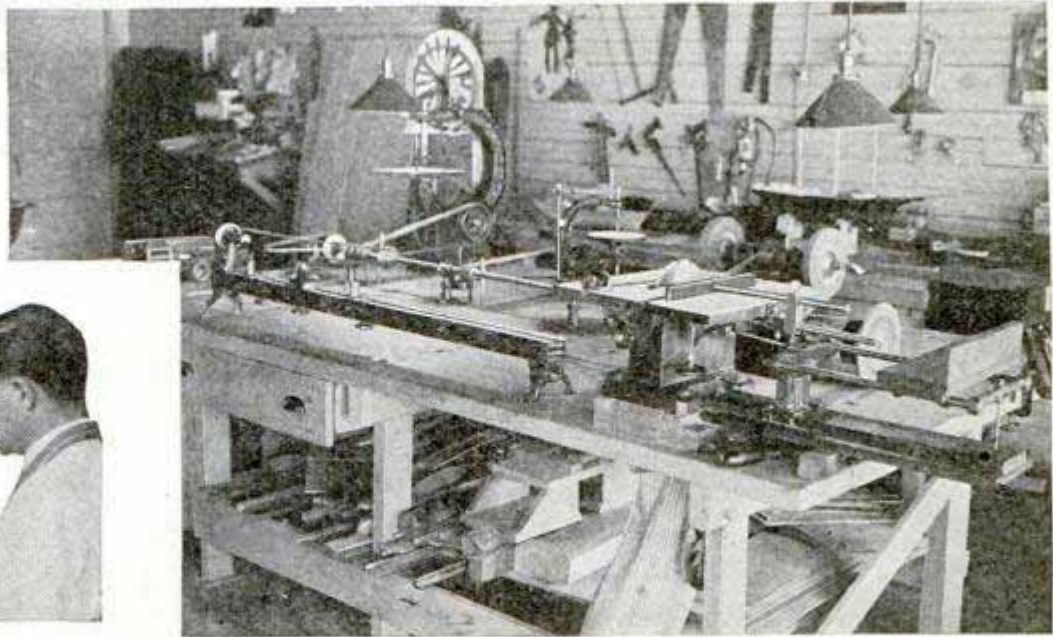

Picture above shows our sturdy, smooth-running Band Saw. Made in two sizes—12 in. and 14 in.

## Just Out!



Large, powerful 20-in. Jig Saw. Nothing like it. Heavy and sturdy. Catalog tells all.

## New Shaper

Here's value! A real Shaper for only \$49! Other BOICE-CRANE machines priced equally low. It's great to show this equipment. To show is to sell. Our plan explains everything.



Table 17-inch Dia.

## Wonderful New Plan

The trend is toward power tools. Thousands of men interested. Letters pour in asking for catalog, low prices and easy terms. We reply promptly. Then more letters come. Men want to SEE our equipment operating. They ask if we have home shops nearby where they may personally inspect BOICE-CRANE machines.

## Demonstrators Needed Everywhere

Our plan calls for BOICE-CRANE home Demonstrating Shops in all parts of nation. Gives you an opportunity to equip your shop complete in return for few hours' fascinating demonstration to prospects. No selling. No hunting for prospects. No collecting. Nothing to do except show your machinery to interested men in your territory. We pay liberal commissions when they buy.

## There's Nothing to Stop You Now

You need power tools—want power tools. Our machines ideal—fast, sturdy, accurate and dependable. Why not have them? Write for our liberal proposition. Get full details of our great plan.

## Complete Information by Return Mail

Season now on in full blast. Saws humming. Lathes turning. Band Saws zooming. Joiners buzzing. Toys, novelties, etc. being made easily and quickly. Get started too. Rush name and address now. Complete information and big 52-page catalog FREE by return mail.

**W. B. & J. E. BOICE, Dept. PM-12F, Toledo, Ohio**

# PATENTS SECURED TRADE-MARKS REGISTERED

High-class professional service for Inventors and Trade-Mark Users is necessary for PROPER PROTECTION. We Offer you our facilities on Reasonable Terms. If you have an invention send us a model or sketch and description and we will give you our OPINION whether your invention comes within the provisions of the Patent Laws. Our book, "HOW TO GET YOUR PATENT" and Record of Invention Certificate sent on request. DELAYS are DANGEROUS in Patent Matters.

Terms Reasonable.

Best References.

.....WRITE TODAY.....

**RANDOLPH & COMPANY, Patent Attorneys**

**301 VICTOR BUILDING, WASHINGTON, D. C.**

Name.....  
Address.....

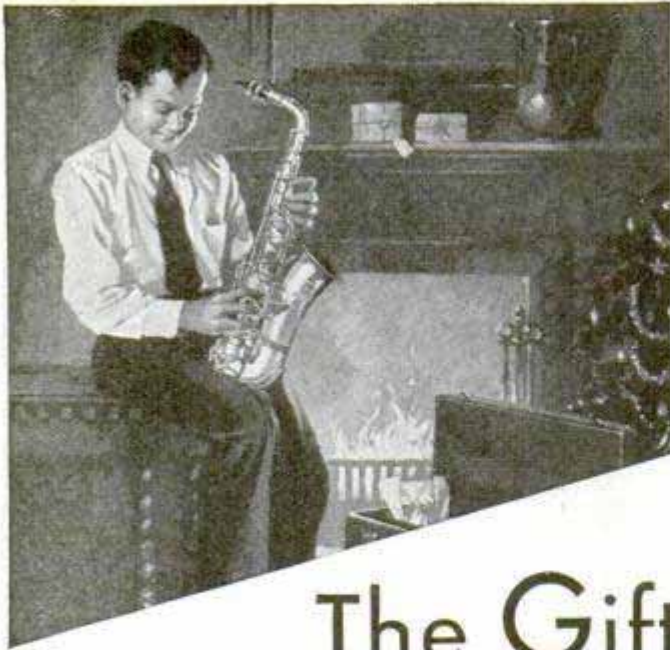

# The Gift You've Always Wanted

**S**TART on the sure road to popularity this Christmas. Select a Conn Saxophone, Cornet, Trombone or other band instrument for quicker progress and greater musical success.

Conns are easiest to play; most perfect in tone. Choice of Sousa and the world's greatest artists. Many exclusive improvements. All without added cost.

Beginners play tunes from the start. You can be ready for band or orchestra in 4 to 6 weeks. Then you'll know what real popularity means. Invitations to exclusive parties. Chances to travel and earn extra money. Fun, that lasts a lifetime.

**Free Trial, Easy Payments**  
You may have a Conn on 6 days' free, home trial. Prove its superiority and your own talent, without risk. Easy payments if desired. Write today for full information and interesting **FREE BOOK** on whichever band or orchestra instrument you wish to play. Mention instrument.

C. G. CONN, *Inc.*, 1231 Conn Bldg.  
Elkhart, Indiana

# CONN

WORLD'S LARGEST  
MANUFACTURERS OF  
BAND INSTRUMENTS



## AMAZING SCREW HOLDING SCREW DRIVER



Here, at last, is a practical screw driver that holds the screw itself, through a simple mechanical attachment. It is truly a one-handed tool and works as quick as a flash. It does away with the necessity of the other hand holding the screw and makes it easy to get into places that were formerly impossible to get into.

### Agents Wanted to Make Big Money

The agency for the Jiffy-Tite Screw Driver is something worth while. Factories, garages, mechanics, electricians, electric light companies, radio and auto owners buy quantities on sight. Western Electric, Philco and other nationally known corporations are users. The tool is simple and practical and is made in two sizes for all purposes. Men report earnings as high as \$15 to \$20 a day and even more. **VALUABLE EXCLUSIVE TERRITORY STILL OPEN.** Write quick for **FREE TRIAL OFFER.**

### JIFFY-TITE MFG. CO.

1720 Winthrop Bldg. Boston, Mass.

### SAMPLES OF 33 RARE WOODS

20 Cabinet Woods - \$1.00 ONLY 200

Sets labeled and postpaid.  
Lumber domestic and imported, panels, veneers, inlay woods, turning squares, and supplies.  
Send 5c stamp for large illustrated catalogue.

Craftsman Wood Service Co.,  
PM-166 W. 74th Street,  
Chicago, Illinois.

### A Real 6" Bench Saw

Heavy cast metal TABLE, 8"x13"; rigid and strong. Heavy duty 5/8" bearings with means for adjustment; machined steel flange on shaft for true running. Real "V" pulley. Table instantly removable to use STAND for grinding, buffing or polishing wheels, or for drum or disc sander. Oil well lubrication. Shipped by express. Money back if not satisfied.

**\$7.35**

C-A MANUFACTURING CO.  
213 E. South St., Indianapolis, Ind.

SEND FOR FREE PORTFOLIO OF SPECIMEN PAGES

### The NEW WORLD BOOK

Encyclopedia

Published by W. F. Quarrie & Co., Dept. 159-C, 154 E. Erie St., Chicago, Ill.

### Build Model Ships of the Better Kind

U. S. Destroyer Preston  
Flying Cloud  
Constitution  
Spanish Galleon, Etc.

We can supply construction sets and all sorts of parts, such as semi-finished hulls, blocks, deadeyes, flags, anchors, steering wheels, capstans, figure heads, guns, blue prints, books, etc., for building real fine scale models of the U. S. Destroyer Preston, Flying Cloud, Constitution, Spanish Galleon, Viking, Baltimore Clipper, Mississippi steamboat, Bluenose, Mayflower and many others. Also special construction sets for racing sail boats, power boats, model steam engines, boilers, propellers, etc., and fine tools for the model maker. New large 56-page photographically illustrated ship model booklet has just been released. This booklet contains valuable information and hints for building ship models, in addition to prices and full description of the above articles. Many people only slightly interested in models have become greatly enthused upon receiving this booklet. A copy will be sent postpaid upon receipt of 15 cts. (coin preferred).

**MODEL SHIP SUPPLY CO., Dept. A, Mineola, N. Y.**



# A 1-Ton Grip in a Split Second

—in all sizes

**Automatic Lock-Grip  
Ratchet Wrench**

**EIFEL-FLASH  
PIERRENCH KIT**

**"The  
Pocket  
Machine  
Shop"**

Parallel Pliers and  
Speed Vise—Plus.  
Gives your hands  
the grip of  
20 hands and out  
grips a 40-lb. vise.



## Does the Work of 30 Tools

Replaces other tools weighing 60 lbs., and costing \$50, yet this 24-oz. Master Kit slips into your pocket. A 1-second change of gear jaws 1, 2 and 3 does it.



1—Universal—for all  
plier work. Nut  
wrench, vise and  
clamp. Does things  
no other tool can do.



2—For all pipe work,  
tubing, chewed nuts  
in tight places, hard  
steel shafting, ball  
bearings, etc.



3—For all wire and  
chain jobs, spring  
making, fence work,  
etc. Has wire cutter.  
Quick, positive action.

**Distributors  
— Agents**

Make big money  
all year—full or  
part time.

**\$75 to \$200 Week**

Check here  
for details.

**This Angle Screwdriver**



**FREE**

Tempered spring steel—7 powerful edges—  
large and small—101 uses—sent FREE with  
125 picture story of "The Pocket Machine  
Shop." Merely write name and address on  
margin of ad and mail.

**THE FLASH SALES CORP'N**

Dept. PMK 4809 N. Ashland Ave., CHICAGO

You never know when or where  
you may need **SMOOTH-ON NO. 1**

so keep a can  
in the house

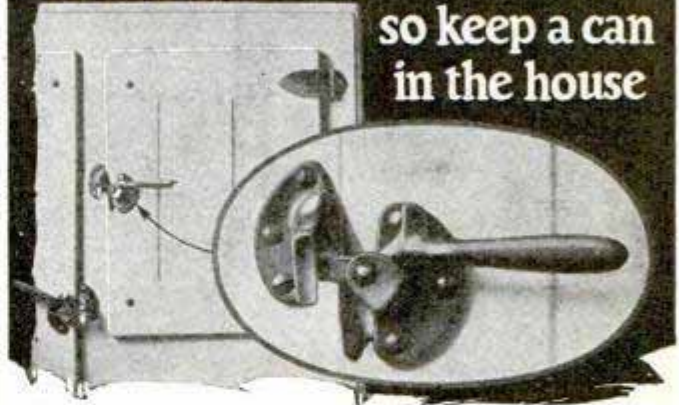

A 50-lb. block of ice dropped on this icebox handle, bent the lever, stripped the screws and splintered the wood. Larger screws could not be used and the lock could not be shifted. A new door seemed necessary. Instead the owner fitted the splinters back, filled the screw holes with about 5 cents worth of Smooth-On No. 1, and put back the screws. When the Smooth-On metallized, the lock became strong as new. The repair will last as long as the icebox.

Any handy man can make equally practical home and automobile repairs with Smooth-On No. 1 and avoid a repair bill every time. Use it to stop leaks

in steam, water, gas, oil or stove pipes, mend cracks, breaks or leaks in furnaces and boilers, radiators, tanks, sinks, pots and pails, make loose handles tight on umbrellas, knives, hammers, brushes, drawers, etc., tighten loose screws, hooks, locks, door knobs, etc.

Automobile repairs:—Making cracked water jackets and pumps good as new, stopping leaks in radiator, hose connections, gas tank and gas, oil and exhaust lines, making a fume-proof joint between exhaust pipe and tonneau heater, tightening loose headlight posts, keeping grease cups, hub caps and nuts from loosening and falling off, etc.

To get perfect results, write for and use the Smooth-On Repair Book.



Write for  
**FREE BOOK**



Get Smooth-On No. 1 in 7-oz., 1-lb. or 5-lb. tins at any hardware store or if necessary direct from us.

**Do it with SMOOTH-ON**

SMOOTH-ON MFG. CO., Dept. 37,  
574 Communipaw Ave., Jersey City, N. J.

Please send the free Smooth-On Repair Book.

Name.....

Address.....

12-30.....

## BUILD YOUR OWN AUTOMATIC ELECTRIC REFRIGERATOR

Why pay \$200.00 and upwards? You can use your present ice-box and increase its food capacity—Costs only \$34.95 complete—Easily made—No special tools required—Operating cost, quality and size of machine same as well known makes—Complete blue-prints and thorough instructions—\$1.25

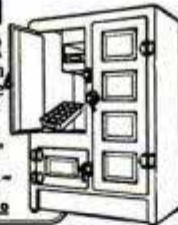

B.&L. ENGINEERING Co. 62 Greenville Av. Jersey City, N.J.

**22 CAL. RIFLE**  
**GENUINE LEATHER RUGBY**  
**GIVEN**  
BIG 22 Hamilton Rifle or large REGULATION size genuine tough leather Football. Simply GIVE AWAY FREE 20 dainty Perfume Novelties with 20 large bottles of LIQUID PERFUME at 15c a bottle, and select your gift as per offers in Catalog. We let you give perfume novelties free which makes selling easy. **DON'T SEND A PENNY, ROBERT MORE CO., Dept. 14E78, Chicago**

## Catch Fish!

Eels, Mink, Muskrats with our new folding galvanized **STEEL WIRE TRAP**. Write for our **FREE TRAP OFFER** and Bargain Catalog. \$1 Box of our famous Fish Bait FREE to introduce our traps. **WALTON SUPPLY CO., 3502 JUNIATA AVE., ST. LOUIS, MO.**

## LOUIS XV HISTORICAL COACH MODEL

A beautiful ornamental lamp or radio antenna lamp for your radio, mantel, table, etc. Wonderful gift for all occasions. Designed by world's most famous Artist. Cast in aluminum and bronzed. Can be assembled and decorated in less than one hour. Length of Coach over wheels 16 1/4 inches.

Prices for complete set of parts with art glass for windows—Ornamental Lamp \$4.45—Radio Antenna Lamp \$4.95. Prices for Coaches already assembled and beautifully decorated—Ornamental Lamp \$7.90—Radio Antenna Lamp \$8.90. Book Ends, Coach design, finished and decorated \$1.50 per pair. **SANTA MARIA SHIP—Cast Aluminum, half ship, height 12". Handsomely decorated \$2.00. Unfinished \$1.25.** Will ship C. O. D. plus postage. Send check or U. S. money order with foreign orders.

Art Service Dept. No. 61 **MODERN MACHINE & PATTERN CO.** Terre Haute, Indiana

# Get Into The Shoe Business Without Investment!

We start you. Earn big money with our remarkable direct-to-wearer plan. Making profits is easy when you show splendid Tanners Line of Shoes and Hosiery for men, women and children.

**FOOTWEAR SERVICE** for

## Everybody Needs Shoes

Shoes are an absolute necessity—and Tanners Quality shoes at our low prices are a necessity that sells to the same customers again and again. Big advance commissions mean your profits come easy. We tell you how and where to sell.

## We Supply Everything

We furnish everything you need to do a big business in your territory—set you up in a big and profitable shoe business without investment. We furnish you a \$40.00 outfit containing actual shoes and hosiery—a larger variety of styles and sizes than any store can carry. Our patented measurement system insures perfect fit. Anyone can use this system correctly.

## No Experience Necessary.

Makes no difference what you have been doing—you can make a big success of this business if you will honestly try. Write for big FREE book "Getting Ahead" and \$40.00 Selling Outfit containing Actual Shoes and Hosiery.

## Mail This SUCCESS Coupon!

Tanners Shoe Co.,  
8712 C Street, Boston, Mass.

Without obligation on my part, send me my FREE copy of "Getting Ahead." Tell me how to secure \$40.00 Outfit of Shoes and Hosiery. I will take good care of this Outfit.

Name .....

No. .... Street .....

Town ..... State .....

# NEW VEST POCKET ADDING MACHINE

Guaranteed 5 yrs.

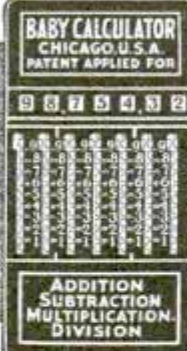

## ADDS, SUBTRACTS, MULTIPLIES, DIVIDES

Costs only \$2.50 each, yet does work of \$100 machine. Not a Toy but a real adding machine that everyone should carry. Made of steel and indestructible. Million dollar capacity. Fits in pocket. Weighs 8 ounces. Will not make mistakes. So simple child can operate. Instructions furnished. Be modern in dealing with figures—order your machine today.

## Free Trial

### SEND NO MONEY—

Just name and address. We will ship Calculator immediately. On delivery pay postman \$2.50 (Plus few cents Postage.) (If outside U. S. send cash.) 10c additional in Leatherette Case. If not satisfied after 10 day trial you get your money back. THOUSANDS OF SATISFIED USERS. This is the lowest priced practical calculator made. "Why pay more for inferior imitations?" Order from this ad.

**\$2.50**  
Total Cost

### Mail Coupon Today

BABY CALCULATOR MACHINE CO. (Manufacturers)  
Dept. 71, P. O. Box 1118, CHICAGO, ILL., U. S. A.  
 I am enclosing \$2.50—send adding machine prepaid.  
 Send Adding Machine C. O. D. \$2.50 plus 18c postage. (10c additional in Leatherette Case)

Name .....

Address .....

City ..... State .....

**AGENTS** Write for big commission and territory proposition.

# LIFETIME GUARANTEED POLISHED POINTS AND RUBBER

sponge in cap, make our pens sell faster and write better than any other on the market. A trial order will convince you. MONEY BACK IF NOT PLEASED

**\$6240 MADE BY JOS. CHAI SELLING OUR PENS**

No. 1 Pen as illustrated sells for \$1.25

Sample 35c  
Doz. \$2.75  
Gross \$29

Or send \$1 for 4 assorted samples

SEND \$1 FOR 4 ASSORTED NECKLACES

FREE our Wholesale catalog showing over 500 fast selling specialties from many parts of the world. WRITE FOR IT.

**SPORS IMPORTING COMPANY**  
1030 MAIN ST. LESUEUR CENTER, MINN.

No. 63

Black and white, pen and pencil set. Pen fitted with 14kt. gold iridium point. Sample 89c—DOZ. \$9.92.

No. 5p, 15" necklaces, DOZ. 95c—GROSS \$8.95.

No. 55p, graduated choker, DOZ. \$1.44—GROSS \$16.56.

No. 33p, 24" necklace, DOZ. \$1.56—GROSS \$16.80.

(All resemble genuine pearl necklaces)



# Save Your Feet

When all else fails end your suffering with the flexible "no metal"

**Heefner ARCH SUPPORT**

WRITE FOR FREE BOOKLET

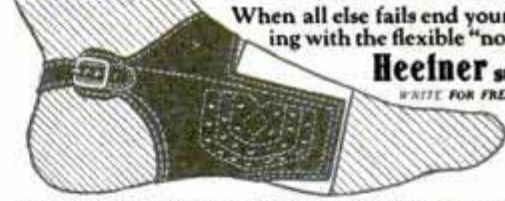

HEEFNER ARCH SUPPORT CO., 678 M. E. TAYLOR BUILDING, LOUISVILLE, KY.

## BUCHSTEIN'S FIBRE LIMB



Send for Catalog Today

is soothing to your stump—strong, cool, neat, light. Easy payments. Braces for all deformities. D. BUCHSTEIN CO. 610 3rd Ave., So. MINNEAPOLIS, MINN.

## Make it out of PRESWOOD

The all-purpose board for lining concrete forms, paneling walls, making outdoor signs, toys and many other articles. Write for FREE booklet L-12, listing over eighty of Preswood's uses.

MASONITE CORPORATION, 111 West Washington Street, Chicago, Ill.

# Palmolive Shaving Cream

"5 New Delights for Men"



## BUILD BYRD'S BARK

Send for "City of New York," true scale model, with hull sanded, decks attached. 33" overall. Includes blueprint, wheels, binnacle, propeller, ladders, mast and spar wood, line, chocks, bits, blocks. Mail 15c for details and catalog.

ROY HANCOCK  
323 Douglas Ave. Portsmouth, Va.

# WORLD-WIDE

**ONLY**  
**\$6.45**



**SHORT**  
**WAVE**  
**RECEIVER**

**Span the World with this Set!**

A new radio thrill for you! Listen in DIRECT to London, Paris, Berlin, Buenos Aires and other broadcasting stations throughout the world via short waves. Enjoy unique foreign programs from strange lands. Your ordinary receiver cannot tune in these low wave stations. **WORLD-WIDE RECEIVER** gets 14 to 550 meter stations with surprising clarity. **SEND NO MONEY!** Just write your name and address on a postcard and ask us to send you this wonderful guaranteed short wave set. Pay postman \$6.45 plus a small delivery charge. All orders west of Rockies must be accompanied by \$1.00 deposit. Foreign countries \$2.00 extra, post-paid. Write today for our parts catalog.

**CHAS. HOODWIN CO.**

4240 Lincoln Ave., Dept. M.2

**CHICAGO**

**RELIEVES PAIN QUICKLY**

Have You a Troublesome Ailment?



**INFRA-RED RAY LAMP**



**Send for Our Free Book**

giving full information on Infra-Red Ray treatments in your own home. for relieving neuralgia, sore throat, bronchial trouble, neuritis, sinus trouble, catarrh, asthma, rheumatism, tonsillitis, lumbago, and other ailments due to congestion. Infra-Red Rays penetrate deeply and restore active blood circulation. Quickly remove congestion. May be used safely by anyone. Attach to any light socket. Sent on approval. 30 days' trial. Write for catalog. **WM. CAMPBELL CO., Dept. 1040, Alliance, O.**

**STEINER COMBINATION WOODWORKER \$45.00**



**Belt Sander, Saw, Grinder, Drill**  
Has 1/4 H. P. Motor, switch, cord and plug. 3x24 in. sander, 6-in. adjustable saw, 5x1 1/2 in. grinder for any tool or drill. Takes up to 1/4 in. drills. Operates many other tools. Bronze bearings, endless belt, polished table. Size 20x20. Weight 60 lbs. Highest grade—lowest price. Satisfaction guaranteed. Order now or write for circular P.

**STEINER-FULTON PROD. CORP.**  
5751 Easton Ave. St. Louis, Mo.



**EXACT INSIDE MEASURE**

Every kind of inside measurement. Just slide out the MASTER till it reaches from stop to stop. No guessing. Quick results. Locks rigid in use. Without equal for outside measure, too. Dealers and Agents Wanted

**MASTER RULE MFG. CO., Inc., 821 E. 138th Street, NEW YORK CITY**

**Dandy Xmas Gift**  
20c each lineal foot



**A CLIPPER SHIP FOR \$4.50**

We supply all the necessary parts, cut and numbered, ready to put together. Instructions show full details how each numbered part fits into another. You can't go wrong. A few hours of pleasant pastime and you have a beautiful ship model. We also supply parts for the Santa Maria, the La Pinta, the Mayflower for \$4.50, and Flying Cloud, for \$4.50. Constitution (Old Ironsides) \$5.98.

**ALSO COACH MODELS for \$4.98 and MINIATURE GOLF SETS IN KNOCKDOWN FORM** (shown in our new catalog). Models sent C. O. D. plus a few cents postage. Foreign orders must be accompanied by U. S. money order or check.

**C. J. BIERBOWER, Dept. P. M., 3216 Baring Street PHILADELPHIA, PA.**  
*Originator of Build Your-Own-Skip Model*

C. J. BIERBOWER, Dept. P. M., 3216 Baring Street, Philadelphia, Pa.

Please send me complete parts, cut to fit and ready to put together for the following: Clipper ship [ ]; Flying Cloud [ ]; Constitution [ ]; Santa Maria [ ]; La Pinta [ ]; Mayflower [ ]; Coach Model [ ]; Miniature Golf Set [ ]. Please send me information pertaining to.....

Name.....  
Address..... City..... State.....

Yours Without Cash





**Lone Eagle**  
\$3750



**Miss America**  
\$3750

**SEND NO CASH!**—Just Mail Coupon! Nationally advertised Cash Price on Liberal Credit—and you can wear your jewelry without delay! Order now for Christmas!

## RAILROAD WATCHES

Let us send you our beautiful watch catalogue showing the Famous Santa Fe Mogul Railroad Watch, and the 21-jewel Santa Fe Special in both 16 and 12 sizes. Also the new 60 hour Bunn Special. Catalogue sent FREE.

## DIAMOND RINGS

Write for our New Diamond Ring of Romance and Bu-loya Wrist Watch Catalogue showing marvelous new designs. Never have we been able to offer such beautiful diamond rings and artistic dependable watches at such low prices. The catalogue is sent FREE!

Ask for our Special Spot Cash Offer. Good for 30 days only.

**SANTA FE WATCH COMPANY**  
Dept. C-6, Thomas Bldg. TOPEKA, KANSAS

---

**To SANTA FE WATCH CO., Dept. C-6, Thomas Bldg., Topeka, Kansas**

Please send me articles I have checked:  
 "Miss America"  "Lone Eagle"  or "Santa Fe Chief" watch  as featured in your advertisement. Send me watch catalogue  Diamond Catalogue . Catalogues sent FREE. Postage Prepaid.

Name.....  
 Address..... City.....

# The WORLD'S LARGEST RADIO STORE

Practically everything in Radio—including all the latest 1931 features—is listed in our cut-sale catalog just out. We have slashed the prices on all sets and equipment, passing along to you the marvelous price-savings made possible by the buying power of the World's Largest Radio Store.

## WHOLESALE PRICES

You reap the benefit of lowest wholesale prices on New Humless, Screen Grid A. C. sets, battery operated sets, beautiful and artistic consoles, dynamic speakers and phono-combinations, tubes, parts, kits and all kinds of accessories. The prices are almost unbelievable.

## FREE CATALOG

We are nationally known as the lowest priced of all reliable Radio houses, and we frankly state we have never before offered such values. Send today for this catalog of smashing bargains, and save money on all your radio supplies.

### CHICAGO SALVAGE STOCK STORE

The Place to  
Save Money On  
RADIO

509 So. State St.  
CHICAGO, ILL. Dept. 567

## A New Business in Your Town.

A delightful, dignified and fascinating business. Make and sell Crispettes. Delicious confection. Young and old like them. Come again and again for more. Easy to make. I supply everything. Raw material plentiful and cheap. Profits big. No town too small. Start now.

**Quick Success Possible** anywhere—cities, towns, villages; open a little retail store; or, begin at home; wholesale to stores, grocers, bakers, druggists, parks, baseball games, picnics, wayside stands.

**Exceptional (not average) Profits**—\$11,265 sales in 3 months reported by California man. New Jersey \$4,000 profits in less than two months. Revel of Michigan wrote: "Made \$25 on my first day." A. Leib of Montreal wrote: "My sales averaged \$400 per week."

**We Start You in Business** for little money. Supply machines, secret formulas, and raw material. Little capital starts you. No experience needed.

Write for "Book of Facts"—it's free, contains success letters from others—shows their places of business, tells how to start.

**SALES**  
**\$606.81**  
One Week Ending July 20 1929  
W. H. ADAMS  
OHIO

**AVERAGING**  
**\$3000.00**  
PROFIT FOR 3  
SUMMER MONTHS  
Report July 24 1929  
**E. R. NABOR**  
MASSACHUSETTS

**LONG EAKINS CO.**  
1228 High St., Springfield, Ohio

## AGENTS! SELLS LIKE WILD FIRE

FILL RESEPIOR WITH WATER. HOLDS ENOUGH TO CLEAN 40 WINDOWS.

WATER FEEDS THRU FELT TO WINDOW FRAME



REMOVABLE RUBBER SQUEEGEE DRIES, CLEANS, POLISHES WITH ONE STROKE

RUST-PROOF. FOOL-PROOF. LASTS FOR YEARS.

REMOVE CAP AND INSERT BROOM HANDLE FOR HIGH WINDOWS.

New improved window washer eliminates all muss wherever there is glass to be cleaned. Approved by Good Housekeeping and Household Searchlight. Restricted territory. Write today.  
**CARTER PRODUCTS CORPORATION, 998 Front Street, Cleveland, Ohio**

## SILVER ACE



The Best  
Christmas Gifts

Deluxe flying models and building kits, from 50c to \$11.50. *Boy Scouts of America Official Kits.* Junior Air Service Ground Course of 50 Booklets, with 2000 pictures, teaching all about Aviation—\$24.50 per set.

Catalog 5c

**AERO MODEL COMPANY**  
Dept. M32 111 North Wacker Drive CHICAGO



**XMAS GIFTS** Your Choice Sent for \$1.00

**10 MONTHS TO PAY**

Direct diamond importations and large volume sales make possible these unusual values in perfect, genuine blue-white diamonds and standard watches.

**10 DAYS' FREE TRIAL**  
Send only \$1. with order and your choice comes to you on 10 days' free trial—no C. O. D. to pay on arrival. No interest—no red tape. After examination take 10 months to pay balance. Satisfaction absolutely guaranteed or money back.

**ALL TRANSACTIONS STRICTLY CONFIDENTIAL**

**Diamond Wrist Watch**

**EO 34... \$25**  
Engraved 18K Solid White Gold solitaire ring; fiery, genuine blue-white diamond. Only \$2.40 a month.

**EO 8... \$37.50**  
Two (2) genuine diamonds and 8 emeralds or sapphires set in engraved 14K Solid White Gold Case. Guaranteed 15-Jewel movement. Pierced Flexible "Wristacrat" bracelet with sapphires or emeralds. Only \$3.65 a Mo.

**EO 39... \$48.50**  
18K Solid White Gold lady's ring; first quality genuine blue-white diamond, 6 matched diamonds on sides. Only \$4.75 a mo.

**EO 5... \$29.75**  
IT'S A BULOVA Guaranteed 15-Jewel Gent's Bulova watch. White gold filled case, "dust-tite" protector; radium dial and hands; woven mesh wrist band. Only \$2.88 a Mo.

**Catalogue FREE to Adults**

New catalog of genuine diamonds—Bulova, Elgin, Waltham, Hamilton, Howard Illinois watches; fine jewelry, silverware; special prices. Write now for Free Copy.

**ESTABLISHED 1895**

**ROYAL DIAMOND & WATCH CO.**  
ADDRESS DEPT. 11-M, 170 BROADWAY, N.Y.

# SICK OF BLADE PROMISES?



Send for  
**DOC DURHAM**  
with his hollow ground Blade

**GO AHEAD**—if you must. Try every blessed razor and blade on the market. Then, when your head's in a whirl, let Durham-Duplex blades restore your faith in humanity and give you something to swear by, not at. Durham-Duplex blades are better now than ever. The latest output are a revelation in long-lasting keenness. Their hollow-ground edges are the finest in over twenty years...and that's saying plenty!

Package of 5 Blades 50c or get a razor and one blade for a quarter at your dealers or DURHAM-DUPLEX RAZOR CO., Jersey City, New Jersey. Canadian address 50 Pearl Street, Toronto.

Name \_\_\_\_\_  
Address \_\_\_\_\_

Present this coupon to your dealer or send to Durham-Duplex Razor Co., Jersey City, N. J. with 25c and get a genuine Durham-Duplex razor and blade.

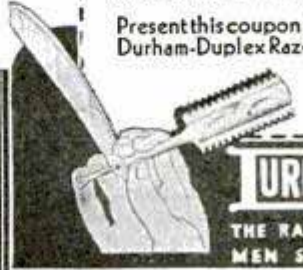

**DURHAM-DUPLEX**  
THE RAZOR WITH THE BLADES  
MEN SWEAR BY — NOT AT

**ELECTRIC MOTOR**  
winding models show winding and connections in plain sight. Make your own or rewind motors for your own use or for profit. In use all over the world. Quick, easy way. Write Dept. DPM, Gaines Bros. Send dime for circulars. Box 481 Gainesville, Texas

**Send for FREE BULLETINS**

**CRESCENT WOOD WORKING MACHINES**

Modern Design . . Quality Built . . Moderately Priced . .  
For Factories . . Schools . . Amateur Work Shops

**We build:**

Band Saws	Disk Grinders
Saw Tables	Cut-off Tables
Self Feed Rip	Swing Saws
Saw	Borers
Shapers	Tenoners
Jointers	Hollow Chisel
Planers	Mortisiers
Planers and	Variety Wood
Matchers	Workers
Universal	Universal Wood
Variety	Workers
Saws	

High efficiency, accuracy, simplicity, safety, economy of operation are outstanding features of Crescent Machines. Portable machines operate from light socket. Big line of machinery for heavy production work in factories. Send for our interesting bulletins, well illustrated, clearly written.

The Crescent Machine Co., 93 Columbia St., Leetonia, O.



**A CHRISTMAS TIP FOR DAD**

**M**AYBE Dad doesn't know how you have your heart set on an instrument for Christmas. Maybe he doesn't realize the fun and good fellowship you can get out of belonging to an orchestra or band—how you can earn extra spending money—how you may even get started on a pleasant, well paying and successful career through being able to play.

Of course you don't like to tell him outright that a **KING** would make you the finest kind of a Christmas present. Well, if he should "happen" to read this advertisement you would probably find just the instrument you want under the old tree on Christmas morning.

You can fix it so he'll read this. Then he'll know that a King is sold on easy payment terms and on ten days' free trial if desired. Cleveland and American Standard instruments—lower in price—are sold on the same convenient terms. Write for new combined catalog, featuring three popular lines, and special folder on the particular instrument you are interested in.

**KING** For a Day  
Forever

**THE H. N. WHITE CO.**  
5212-78 Superior Ave., Cleveland, Ohio  
Makers of KING, Cleveland and American Standard Band Instruments.

Wide Range of Prices to Meet All Requirements

The H. N. White Co.,  
5212-78 Superior Ave., Dept. 4-B, Cleveland, Ohio

Kindly send me new combined catalog and full information.

Instrument I am interested in.....  
Name.....  
Address.....  
City.....State.....

**Electric Portable Sprayer**

Sprays Paint, Varnish, Duco, Enamel, Lacquer, etc., by Electricity.

Attach to light socket, turn on switch and paint the power way. Does work of 5 men.

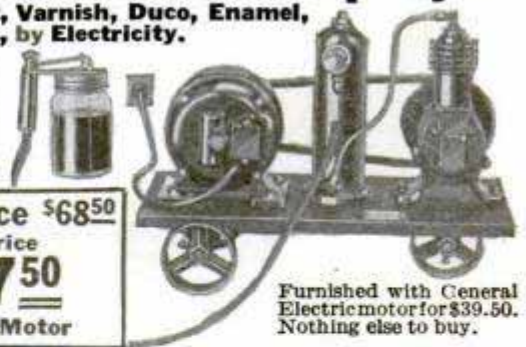

Reg. Price \$68.50  
our Price  
**\$27.50**  
without Motor

Furnished with General Electric motor for \$39.50. Nothing else to buy.

Has Kellogg air cooled compressor that operates spray gun continuously at 30 to 40-pound pressure. Outfit includes air filter tank pressure gauge, pop-off valve, connectors, 12 feet of hose and spray gun. Entire outfit mounted on all steel base on 3 steel wheels. Weight 70 lbs. Send \$5.00 deposit with order—balance C. O. D. Write for circular.

**NATIONAL JOBBING AND EXPORT CO.**  
192 N. Clark Street Dept. 11 CHICAGO, ILL.

**GIVEN** **BIG MOVIE MACHINE**

**T**HIS Large Size Movie Machine operates on same principles as expensive professional models, uses standard size films same as big theatres. Imported double Convex Lenses show large, clear pictures. Complete outfit furnished—enough for a full hour's show, including Tom Mix film, etc. Easy to operate, guaranteed for life. Just send for 12 large Bottles of *Paris Perfume* that sells at 25 cents each. This is a real bottle size 5 1/2 inches. We also send 12 *Perfume Novelties* which you give away free of charge and Easy Plans for obtaining **MOVIE Machine**. Send no money. We trust you.

**TREVAUX Perfume Co.**  
Dept. 7E78 CHICAGO

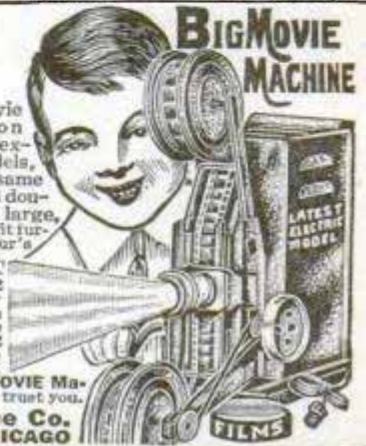

**Play Golf in Your Own Home All Year for 35c**

A marvelous new golf hole. Makes carpet putting the same as a grass green. Have your own indoor course. Limitless possibilities for fun and improvement of putting. Year round entertainment at home. Everybody plays. Portable. One hole 35c; set of 4 holes packed in box \$1.00. Prepaid. **Ideal Christmas Gift.**



**H. & H. PRODUCTS COMPANY**  
4992 Melrose Ave., LOS ANGELES, CALIF.

Fastest Cutting



**Saws 15 Cords a Day**

**Now—Get My Greatest Log Saw Offer**

**ONLY \$39**

It's easier, now, than ever before to own this fastest-cutting, easiest-moved, most powerful Log Saw. Now, you can make big money sawing firewood, stove-bolts, ice, shingle timber, etc. **WRITE TODAY for FULL DETAILS.**

**350 Cuts a Minute!** Take any size log—in a few seconds it's all sawed up—without any hard work!

**Puts the OTTAWA Working For You!**



**Try 30 DAYS OTTAWA**

—ONE WHOLE MONTH to use the OTTAWA at your own sawing. Every saw shipped on trial. **Backed by 10-Year Guarantee**

**Make Big Money—**Wood selling at \$3 a cord brings owner \$45.00 a day. Go into the wood business. Don't let the lack of ready money stop you—Remember, we sell on very easy terms.

**To Save You Freight—**and get your machine to you a few days after your order, I ship from factory or nearest to you of 4 BRANCH HOUSES.



**FREE** Send me your name and address on a postcard today for my wonderful new edition of the "Wood Sawing Encyclopedia." Be sure to investigate—it will help you to make big money.

**C. E. WARNER, Pres., OTTAWA MFG. COMPANY**  
1745-L Wood Street - - - Ottawa, Kansas



**Prepaid \$3.75**  
**Ideal Xmas Gift**



**LIGHTWOOD COMPRESSED MODEL AIRPLANE MOTORS AND GLIDER GASOLINE ENGINES**

Model Builders Handy Man Supplies, gears, materials, books, castings. 3,000 price listings. Illustrated Cat. No. 28—25c coin. Glider Engine Prices with Catalogue.  
**AMALGAMATED CORP. 605 Washington Blvd. CHICAGO, ILL.**



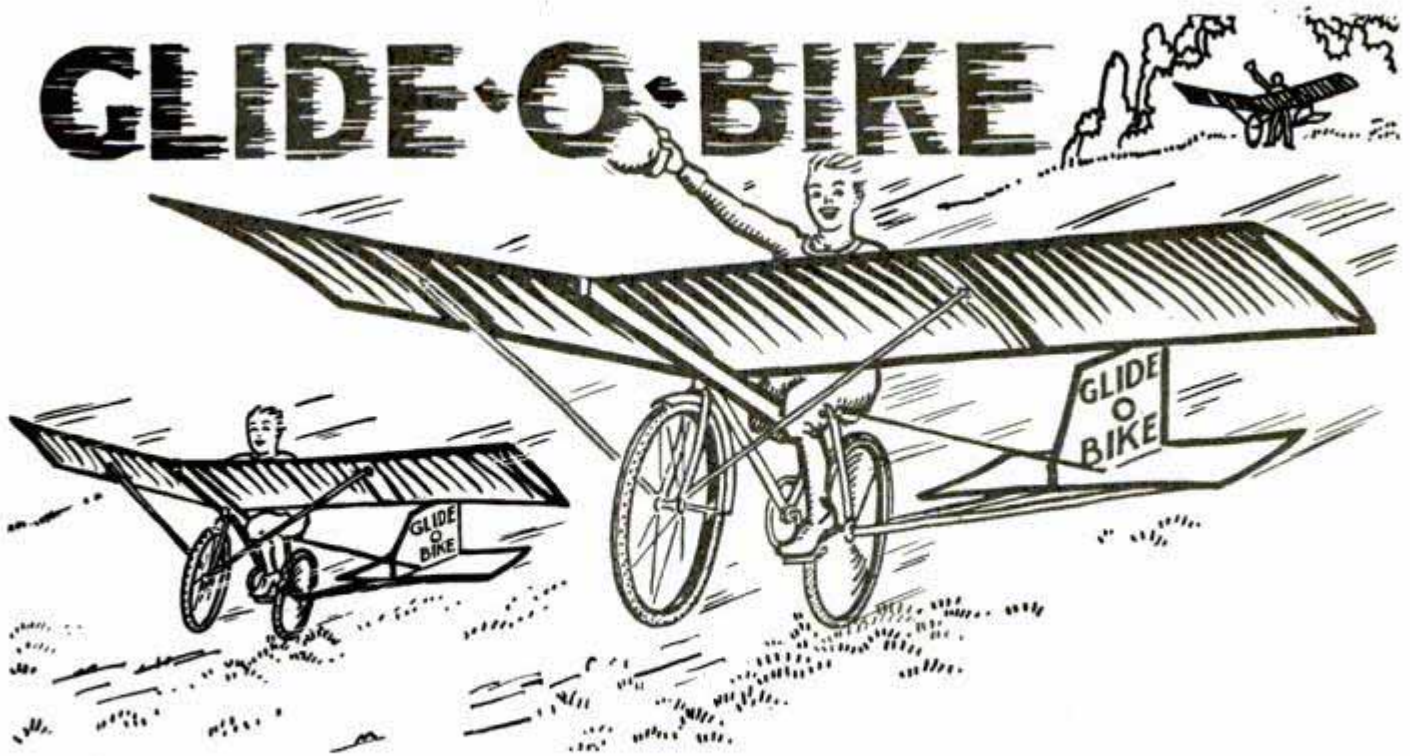

## Do You Have a Bike?

**I**F SO, you can soon have a Glide-O-Bike! Now, every boy can get the "feel" of the air. And at a reasonable cost. Quickly attached to, or detached from, an ordinary bicycle. The Glide-O-Bike will bank, stall, ground-loop, etc. Get the thrills of flying without leaving the ground. Its safety is readily seen, since only the front wheel leaves the ground when sufficient forward speed is attained, the rear wheel remaining on the ground for power. The first time in the history of aviation that so much fun is placed within the reach of everyone who rides a bicycle. An ideal Xmas gift for the air-minded boy.

### Boys Make Money

Many boys are making big money by having a miniature Glide-O-Bike airport and getting 10c to 25c for each ride from other boys. In this way you can have plenty of spending money and lots of fun, too.

With each set of plans, you also get without additional cost, a long list of air terms every boy should know and full instructions how to start and operate your Glide-O-Bike airport. Start now and be the first in town to own one. You can make it in your back yard or work shop. Only a few simple tools are necessary. The logical step between model building and glider construction.

### Construction Set

This set can be assembled in 2 or 3 hours. Has all of the difficult parts already shaped. After being once assembled, it is then quickly attached to your bicycle. Construction is of high grade materials and comes in combination colors of red and green. This makes a very attractive job. When you get it assembled, watch the crowds gather. Dozens of boys will want one.

**Special factory price—only \$25. f.o.b. Dallas, Texas, U. S. A.**

Exclusive territory now available to reliable parties. State what territory wanted. Failure to act quickly may cause you to lose the best territory. Why worry about the business depression?



(Above) The famous Nelson Glide-O-Bike, photos and descriptions of which have recently appeared in the leading scientific magazines of America and Germany.

**Glide-O-Bike Company,  
Lock Box 266, Dallas, Texas.**

I am enclosing \$....., please send me

- ( ) Plans and Specifications—25c.  
( ) Construction Set—\$25.

Name.....

Street.....

Town..... State.....

Make of Bicycle.....

Express Office.....

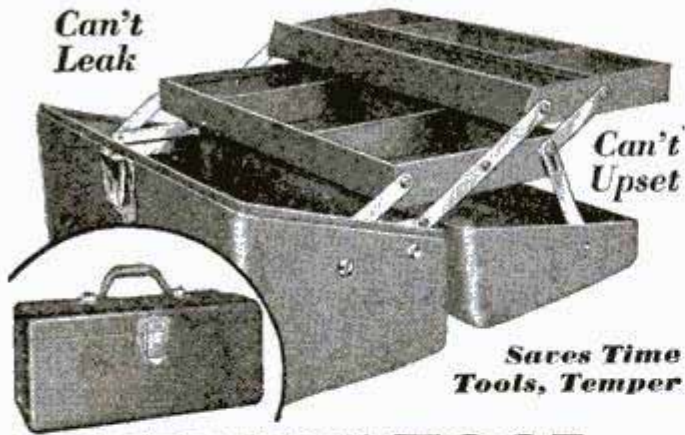

## EVERY TOOL IN SIGHT... IN REACH

What a tool box! All but hands you the tool you want. Trays automatically lift and spread out before you as lid is opened. Single motion closes everything. Deep drawn from lead coated steel; no seams; leak proof. Lid opens level with box, can't upset. Finished inside and out with a heavy coat of baked enamel, olive green. Strong, rust-proof lock. At your dealers or shipped postpaid upon receipt of price.

**2 popular styles**  
Guaranteed to be as represented

No. 616. 16 inches long, 7 inches high, 6 1/2 inches wide. Fitted with lock, rust proof. Two trays, as shown in the above illustration. **\$6.50**

No. 316. 16 inches long, 6 1/2 inches high, 6 1/2 inches wide, with only one tray. Finish and fittings are the same as the above. **\$5.25**

## OUTING'S TOOL and TACKLE BOXES

MAIL THIS COUPON →



OUTING MANUFACTURING CO. 04  
1205 Jackson Street, Elkhart, Indiana

Please send me catalog-folder of your Automatic tackle and tool boxes.

My dealers' name is.....

My name is.....

Address.....

Town..... State.....

## BILD-O-PLANE

Instructive and amusing construction set for building miniature scale model of the famous D-H 4B Army Bomber. These are the smallest scale models on the market for the price. Wing spread 13 inches. Complete including 3 inch hand carved wood propeller and aluminum exhaust pipes, nicely finished and painted. A real Xmas present for the boy.

Postpaid for One Dollar

Dept. 1. MONROE MODEL AIRCRAFT Fruitland Park, Florida

Name..... Address.....

# AN INCOME BUILDER

two distinct lines in one. For either salesmen or those mechanically inclined.  
**\$50.00 Value for \$6.00**

with profits accordingly large. We can provide you with unlimited quantities of all leading makes of electric vacuum cleaners at sensationally low prices; each guaranteed perfect in action and appearance. Such extreme value and profit offers any man of average intelligence a splendid income even for spare time.

### FREE VAC COURSE

To our associates we give in bound book form, free expert advice and seldom disclosed instructions in building and servicing all vacs. Through this free training you may readily develop a permanent, well-paying business all your own. From our immense resources we supply all needs. At trifling cost and no risk you can prosper with us, the originators. Oldest and largest in the line. Literature tells all.

**URON ASSOCIATED INDUSTRIES**  
1302 ENGINEERS BUILDING, CLEVELAND, OHIO

Agents Making Up to \$40.00 a Day

## A \$12.50 SUN LAMP Sensation

You can make a killing with this new Solray Health Lamp at \$12.50. As powerful and beneficial as \$90 lamps. Generates both ultra-violet and infra-red rays. Guaranteed. Everyone a prospect. Liberal commission. No competition. Write for details of FREE Trial Offer by which you can get demonstrator lamp without risking a cent. Act quick! Write or wire



**THE SOLRAY CO., Inc.**  
Dept. 1359, 217 E. Illinois St., Chicago

STATEMENT OF THE OWNERSHIP, MANAGEMENT, CIRCULATION, ETC., REQUIRED BY THE ACT OF CONGRESS OF AUGUST 24, 1912, of Popular Mechanics Magazine, published monthly at Chicago, Ill., for October 1st, 1930

State of Illinois, County of Cook, ss.  
Before me, a notary public in and for the state and county aforesaid, personally appeared H. H. Windsor, Jr., who, having been duly sworn according to law, deposes and says that he is the editor and business manager of the Popular Mechanics Magazine and that the following is, to the best of his knowledge and belief, a true statement of the ownership, management, etc., of the aforesaid publication for the date shown in the above caption, required by the Act of August 24, 1912, embodied in section 411, Postal Laws and Regulations, printed on the reverse of this form, to wit: First. That the names and addresses of the publisher, editor, managing editor, and business manager are: Publisher, Popular Mechanics Co., 200 East Ontario St., Chicago, Ill. Editor, H. H. Windsor, Jr., 200 East Ontario St., Chicago, Ill. Managing Editor, L. K. Weber, 200 East Ontario St., Chicago, Ill. Business Manager, H. H. Windsor, Jr., 200 East Ontario St., Chicago, Ill. Second. That the owner is: (If owned by a corporation, its name and address must be stated and also immediately thereunder the names and addresses of stockholders owning or holding one per cent or more of total amount of stock. If not owned by a corporation, the names and addresses of the individual owners must be given. If owned by a firm, company, or other unincorporated concern, its name and address, as well as those of each individual member, must be given.) H. H. Windsor, 200 East Ontario St., Chicago, Ill.; H. H. Windsor, Jr., 200 East Ontario St., Chicago, Ill. Third. That the known bondholders, mortgages, and other security holders owning or holding 1 per cent or more of total amount of bonds, mortgages, or other securities are: (If there are none, so state.) None. Fourth. That the two paragraphs next above, giving the names of the owners, stockholders, and security holders, if any, contain not only the list of stockholders and security holders as they appear upon the books of the company but also, in cases where the stockholder or security holder appears upon the books of the company as trustee or in any other fiduciary relation, the name of the person or corporation for whom such trustee is acting, as given; also that the said two paragraphs contain statements embracing affiant's full knowledge and belief as to the circumstances and conditions under which stockholders and security holders who do not appear upon the books of the company as trustees, hold stock and securities in a capacity other than that of bona fide owner; and this affiant has no reason to believe that any other person, association, or corporation has any interest direct or indirect in the said stock, bonds, or other securities than as so stated by him. H. H. WINDSOR, Jr., Editor and Publisher. Sworn to and subscribed before me this 29th day of September, 1930. J. GRAHAM, Notary Public. (My commission expires June 16, 1932.)



## Start a Business of Your Own EARN \$150. to \$300. PROFIT MONTHLY -

Mechanics, Repair Men, Filling Stations, Garages are all making big money with "8-Hour Battery Charging"—requires small space. Practically no investment. Any one can operate. Charges batteries in 1/2 the time with 1/2 the current bill. Recommended by car and battery makers. Every car driver a customer.

### 30 DAYS TRIAL—Pay out of Profit Terms

Other profitable businesses built with HB 20-minute Car Washer, Test Bench Service, Spray Painting and Arc Welding. HB won't cost you a cent. Easily pays for itself out of profits and leaves a handsome salary besides. Full particulars if you check the items below and mail to—

**HOBART BROTHERS, Box M120, Troy, Ohio.**

 <b>HB AIR COMPRESSOR</b> \$12. MONTHLY	 <b>HB CAR WASHER</b> \$24. MO.	 <b>HB PAINT SPRAY</b> \$20. MO.	 <b>HB TEST BENCH</b> \$16. MO.	 <b>HB CHARGER</b> \$16. MO.
-------------------------------------------------------------------------------------------------------------------------------	-----------------------------------------------------------------------------------------------------------------------	------------------------------------------------------------------------------------------------------------------------	-------------------------------------------------------------------------------------------------------------------------	----------------------------------------------------------------------------------------------------------------------

# New Units, New Features, New Improvements in Complete 1931 "Delta" Woodworking Line



No more drudgery—no more tedious hand work when you use "Delta" motor-driven tools. Working with wood becomes a real pleasure with the help of these time-saving, efficient, practical machines.

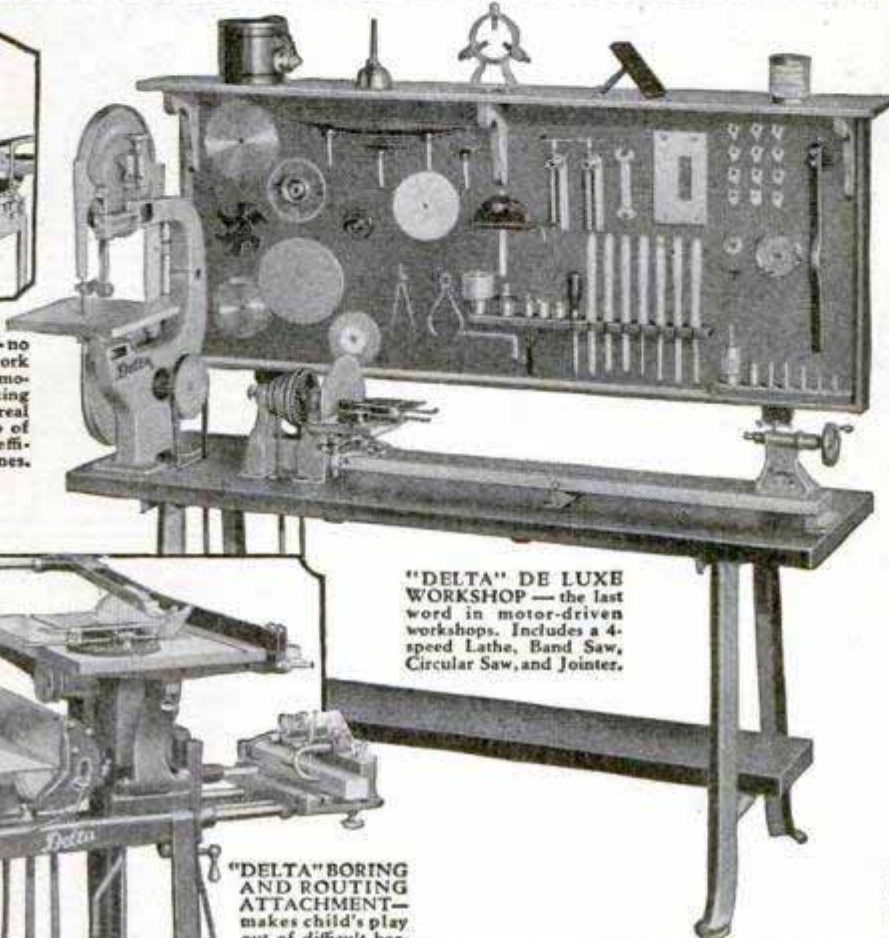

"DELTA" DE LUXE WORKSHOP—the last word in motor-driven workshops. Includes a 4-speed Lathe, Band Saw, Circular Saw, and Jointer.



"DELTA" BAND SAW has many exclusive features. Provided with special extra-safe guard. Furnished with or without stand.



"DELTA" BORING AND ROUTING ATTACHMENT—makes child's play out of difficult boring, routing, and mortising. Convenient, easy to operate. Furnished separately if desired.

"DELTA" COMBINATION JOINTER and CIRCULAR SAW. Can be operated separately or together—no interference. Furnished with or without motor.



"DELTA" HANDI-SHOP—A complete, compact, practical motor-driven workshop. Popular priced. Includes equipment for wood-turning, circular-sawing, scroll-sawing, boring, sanding, grinding and buffing

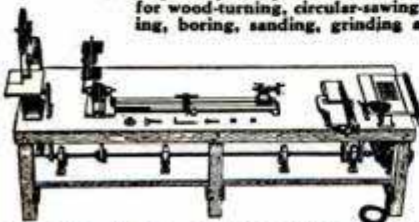

"DELTA" LINE-SHAFT SHOP

Includes 4-speed Lathe, Band Saw, Jointer and Circular Saw. Operates with either gasoline or electric motor. Very efficient.

## Practical Motor-Driven Woodworking Equipment Now Within Reach of All

Again "Delta" blazes the trail toward woodworking efficiency with the announcement of its new 1931 line! Now are available at astonishingly low price levels a complete series of compact, rugged woodworking machines incorporating numerous exclusive constructional features. Each unit embodies the practical, efficient design, the careful workmanship, the dependable quality of materials—for which the "Delta" trademark stands. The new "Delta" Boring and Routing Machine, the "De Luxe" Workshop, the new "Delta" Band Saw, as well as the improved "Handi-Shop" are but a few of the Delta Units that will be of intense interest to all those who work with wood. All units now operate with either electric or gasoline motor power.

## Make Things Quickly and Easily With These Modern Motor-Driven Tools

They save time and labor, and produce better work for artisans, farmers and mechanics. Up-to-date craftsmen everywhere are flocking to motor-driven woodworking equipment to eliminate tedious hand labor. And for full or spare-time work, "Delta" Units quickly pay for themselves.

## 10-Day Trial EASY TERMS

Send coupon today for free illustrated literature describing the new 1931 "Delta" line. Also details of 10-Day Trial Offer and Easy Payment Plan.

**DELTA SPECIALTY COMPANY**  
Division of DELTA MFG. CO.  
1661-67 Holton Street Dept. A-1230  
MILWAUKEE, WISCONSIN

Delta Specialty Co., 1661-7 Holton St., Milwaukee, Wis., Dept. A-1230

Gentlemen: Please send me FREE illustrated literature describing 1931 "Delta" line and details of 10-day Trial Offer and Easy Payment Plan. (Check items of particular interest.)

<input type="checkbox"/> "De Luxe" Shop	<input type="checkbox"/> Routing Machine
<input type="checkbox"/> Handi-Shop	<input type="checkbox"/> Jointer
<input type="checkbox"/> Band Saw	<input type="checkbox"/> Circular Saw
<input type="checkbox"/> Line-Shop	<input type="checkbox"/> Moulding Cutter

Name \_\_\_\_\_

Address \_\_\_\_\_

Age \_\_\_\_\_

# 500 RADIO BARGAINS



**Sets - Kits  
Parts and  
Accessories  
at Lowest  
WHOLESALE  
Prices!**

The new Allied Catalog brings you all the 1931 marvels of Radioland — Screen Grid, Tone Control, A. C. Humless all-electric sets, Mantel Sets, battery sets, slot machine radio, the new auto radio, beautiful consoles, dynamic speakers, and every known part and accessory.

## WHOLESALE PRICES

Rock-bottom wholesale prices on everything. All standard sets and equipment. Big values. Astounding savings. Every radio buyer **must** have this book.

## Get This FREE Book Today

168 pages of such values as you never saw before . . . over 500 illustrations. The Wonder Book of Radiofield. Write for it today. It's FREE.



MIDGET RADIO



AUTO RADIO



CONSOLE RADIO

# ALLIED RADIO CORPORATION

711 W. Lake St. Dept. 366 Chicago

## SHARPEN RAZOR BLADES WITH A MAGNET!



**6 Months' Shaves From ONE Blade!**

Amazing new principle in blade sharpening. Renews razor blades to unheard-of keenness in 6 seconds without stropping, honing or crank turning. Gives swifter, smoother shaves.

**UP TO \$90.00 A WEEK — E - A - S - Y !**

Salesmen call the Monroe Magnetic Sharpener the "Wonder Box", because it coins money for them. A dozen sales a day are easy. You make up to \$1.30—over 100% profit—on each. Thousands of men in your community are waiting for this marvelous new aid to greater shaving comfort, as a result of our Nation-wide Advertising.

**FREE OFFER**—To every man answering this ad we offer a Monroe Magnetic Sharpener FREE. Get full details of this amazing money-making proposition. Write today.

**MONROE SPECIALTY CO.**

119 W. 23rd St., Dept. F-12, New York City



**See Miles Away!** Distant people and objects seem close. Over 3 ft. long, brass bound. Made in Europe. Bbls. of fun. Thousands pleased.

**Send No Money!** On arrival pay Postman special price, only \$1.85, plus postage. Two for \$3.50. (Or send price and we pay postage.) Satisfaction guaranteed or money back. Send today. **Bargain House, 549 Washington St., Dept. 1, Chicago**

**FREE**  
Strong leatherette Carrying Case and Solar Eye Piece to view the sun.

## FREE Radio Handbook

Write today for your copy of the new Radio Association handbook. Shows you easy ways to make money in Radio. Tells you how our members are cleaning up \$3.00 an hour spare time. Write for Membership Plan which need not cost you a cent and **FREE RADIO HANDBOOK**.

**RADIO TRAINING ASSOCIATION OF AMERICA**  
Dept. PMA-12 4513 Ravenswood Ave., Chicago



**HERE THEY ARE  
Ship Models and  
Coach Models  
YOU CAN BUILD ONE**



**FREE Illustrated Catalog**

We furnish the parts, all cut to fit and ready to put together with full instructions and diagrams.

No tools required except a small hammer. When it is finished you will have a beautiful ornament for your radio cabinet or mantel.

**Write for Catalog**  
Ship models \$4.98 and \$6.98 each  
Coach models \$4.98 each

All models sent C. O. D. plus a few cents postage by parcel post to anywhere in the United States and Canada. All foreign orders must be accompanied by check or money order.

**MINIATURE SHIP MODELS, INC.**  
Dept. RT, Perkasio, Penna.  
Canadian Office: 90 King Street West, Toronto

# New Model SOUTH BEND LATHES

## Back Geared Screw Cutting Precision Lathes

### FOR EVERY INDUSTRIAL USE

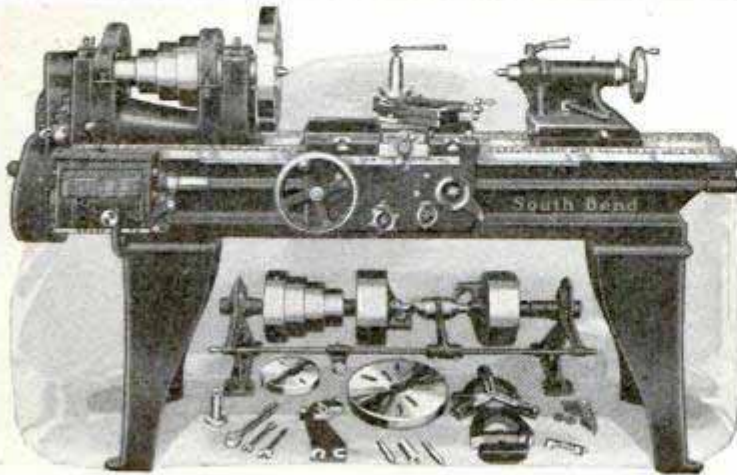

16" x 6' Quick Change Gear **\$598**  
New Model South Bend Lathe

#### Prices of Other Quick Change Gear Lathes

Size of Lathe	Shipping Weight	Countershaft Drive	Silent Chain Motor Drive
9" x 3'	490 lbs.	\$294.00	\$398.00
11" x 4'	725 lbs.	\$359.00	\$498.00
13" x 5'	1110 lbs.	\$443.00	\$602.00
15" x 6'	1550 lbs.	\$543.00	\$720.00
16" x 8'	2035 lbs.	\$638.00	\$817.00

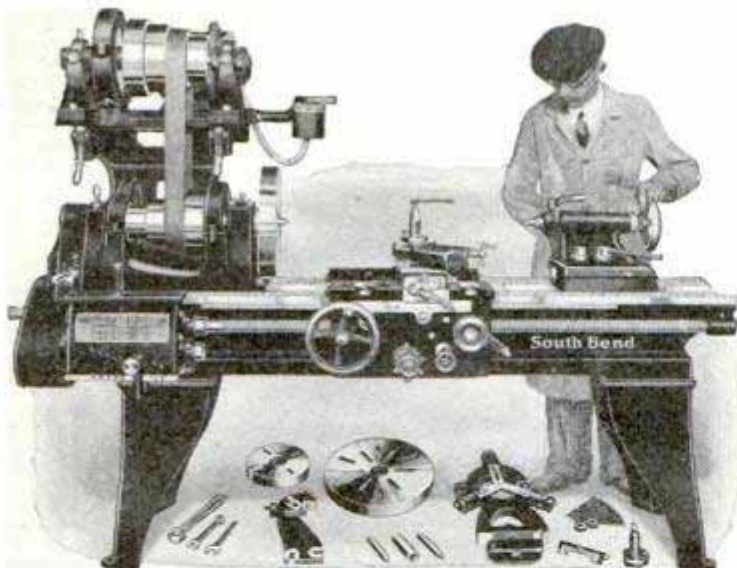

18" x 8' Quick Change Gear Silent Chain  
Motor Driven Lathe with Motor **\$997**  
and Equipment as shown . . .

The South Bend Lathe Works is represented by machinery dealers and importers throughout the world who carry South Bend Lathes in stock.

## South Bend Lathe Works

630 E. Madison St., South Bend, Indiana, U. S. A.  
Lathe Builders for 24 Years—Over 50,000 South Bend Lathes in Use

**O**UTSTANDING leaders in every field of American Industry use South Bend Lathes in production and tool room work. The new model South Bend Lathes are built in 96 sizes and types, 9" to 18" swing, 3' to 12' bed length—a type for every requirement.

More than 50,000 South Bend Lathes are used by industries in 78 countries. Recent purchasers are:

*American Tel. and Tel. Co.  
General Electric Company  
General Motors Corporation  
International Harvester Co.  
National Cash Register Co.  
New York Central R. R.  
Olympic Steamship Company  
Pratt and Whitney Aircraft Co.  
Radio Corporation of America*

### Write for These Books

**"HOW TO RUN A LATHE"**  
25c Postpaid

Latest edition of this famous work, contains 160 pages and more than 300 illustrations. Simplest, most complete and practical book on lathe operation. Shows how to handle more than 400 different types of lathe jobs as practiced in modern machine shops. Sent postpaid for only 25 cents; coin or stamps of any country accepted.

**Catalog No. 91-A**  
Free

This 104 page book illustrates, describes and prices the 96 different sizes and types of new model South Bend Lathes. Send coupon for your copy, free.



#### SOUTH BEND LATHE WORKS

630 E. Madison St., South Bend, Ind. U.S.A.

Gentlemen: Please send me books checked.

- "How to Run a Lathe" (25c)  
 Catalog No. 91-A (Free)

Name \_\_\_\_\_

Address \_\_\_\_\_

City \_\_\_\_\_

State \_\_\_\_\_



## “Why, Bill—here’s an extra \$20!”

“Yes, Betty, I’ve had another raise! Twenty dollars—think of it! That’s a thousand more a year. We can have the new furniture now, dear, and save more than ever, besides. You certainly were right about that International Correspondence Schools Course. You said I’d make some headway, once I had the training. And studying at home in my spare time wasn’t hard, either.

“Remember, I said the Boss had been talking to me about technical points, and that I was able to answer his questions? He told me today that the I. C. S. people had written him about my course. He’s been watching my work, and he decided this week that I was ready for promotion.

“This is only the start, dear. Nobody can stop me now, for I’ve got the training to handle my job and the job ahead.”

Thousands of I. C. S. students are earning promotion and increased pay through spare-time study. Your employer is watching you. If he sees you have the training for a bigger job, you’ll get it.

One hour a day, spent with the I. C. S. in the quiet of your own home, will prepare you for success in the work you like best. Put it up to us to prove it.

### Mail this Coupon for Free Booklet

#### INTERNATIONAL CORRESPONDENCE SCHOOLS

“The Universal University”

Box 5519-G, Scranton, Penna.

Without cost or obligation, please send me a copy of your booklet, “Who Wins and Why,” and full particulars about the subject before which I have marked X:

#### TECHNICAL AND INDUSTRIAL COURSES

- |                                                                              |                                                                              |
|------------------------------------------------------------------------------|------------------------------------------------------------------------------|
| <input type="checkbox"/> Architect                                           | <input type="checkbox"/> Automobile Mechanic                                 |
| <input type="checkbox"/> Architectural Draftsman                             | <input type="checkbox"/> Plumbing <input type="checkbox"/> Steam Fitting     |
| <input type="checkbox"/> Building Estimating                                 | <input type="checkbox"/> Heating <input type="checkbox"/> Ventilation        |
| <input type="checkbox"/> Wood Millworking                                    | <input type="checkbox"/> Sheet Metal Worker                                  |
| <input type="checkbox"/> Contractor and Builder                              | <input type="checkbox"/> Steam Engineer                                      |
| <input type="checkbox"/> Structural Draftsman                                | <input type="checkbox"/> Steam Electric Engineer                             |
| <input type="checkbox"/> Structural Engineer                                 | <input type="checkbox"/> Civil Engineer                                      |
| <input type="checkbox"/> Electric Wiring                                     | <input type="checkbox"/> Surveying and Mapping                               |
| <input type="checkbox"/> Electrical Engineer                                 | <input type="checkbox"/> Refrigeration                                       |
| <input type="checkbox"/> Electric Lighting                                   | <input type="checkbox"/> R. R. Locomotives                                   |
| <input type="checkbox"/> Welding, Electric and Gas                           | <input type="checkbox"/> R. R. Section Foreman                               |
| <input type="checkbox"/> Reading Shop Blueprints                             | <input type="checkbox"/> R. R. Bridge and Building Foreman                   |
| <input type="checkbox"/> Telegraph Engineer                                  | <input type="checkbox"/> Air Brakes <input type="checkbox"/> Train Operation |
| <input type="checkbox"/> Telephone Work                                      | <input type="checkbox"/> Highway Engineering                                 |
| <input type="checkbox"/> Mechanical Engineer                                 | <input type="checkbox"/> Chemistry <input type="checkbox"/> Pharmacy         |
| <input type="checkbox"/> Mechanical Draftsman                                | <input type="checkbox"/> Coal Mining Engineer                                |
| <input type="checkbox"/> Machinist <input type="checkbox"/> Toolmaker        | <input type="checkbox"/> Navigation <input type="checkbox"/> Boilermaker     |
| <input type="checkbox"/> Patternmaker                                        | <input type="checkbox"/> Textile Overseer or Supt.                           |
| <input type="checkbox"/> Pipefitter <input type="checkbox"/> Tinsmith        | <input type="checkbox"/> Cotton Manufacturing                                |
| <input type="checkbox"/> Bridge Engineer                                     | <input type="checkbox"/> Woolen Manufacturing                                |
| <input type="checkbox"/> Bridge and Building Foreman                         | <input type="checkbox"/> Agriculture <input type="checkbox"/> Fruit Growing  |
| <input type="checkbox"/> Gas Engines <input type="checkbox"/> Diesel Engines | <input type="checkbox"/> Poultry Farming <input type="checkbox"/> Radio      |
| <input type="checkbox"/> Aviation Engines                                    | <input type="checkbox"/> Marine Engineer                                     |

#### BUSINESS TRAINING COURSES

- |                                                                               |                                                                              |
|-------------------------------------------------------------------------------|------------------------------------------------------------------------------|
| <input type="checkbox"/> Business Management                                  | <input type="checkbox"/> Business Correspondence                             |
| <input type="checkbox"/> Office Management                                    | <input type="checkbox"/> Lettering Show Cards <input type="checkbox"/> Signs |
| <input type="checkbox"/> Industrial Management                                | <input type="checkbox"/> Stenography and Typing                              |
| <input type="checkbox"/> Personnel Management                                 | <input type="checkbox"/> Complete Commercial                                 |
| <input type="checkbox"/> Traffic Management                                   | <input type="checkbox"/> Civil Service <input type="checkbox"/> Mail Carrier |
| <input type="checkbox"/> Accountancy <input type="checkbox"/> Cost Accountant | <input type="checkbox"/> Railway Mail Clerk                                  |
| <input type="checkbox"/> C. P. Accountant                                     | <input type="checkbox"/> Grade School Subjects                               |
| <input type="checkbox"/> Bookkeeping                                          | <input type="checkbox"/> High School Subjects                                |
| <input type="checkbox"/> Secretarial Work                                     | <input type="checkbox"/> College Preparatory                                 |
| <input type="checkbox"/> Spanish <input type="checkbox"/> French              | <input type="checkbox"/> Illustrating <input type="checkbox"/> Cartooning    |
| <input type="checkbox"/> Salesmanship <input type="checkbox"/> Advertising    | <input type="checkbox"/> Lumber Dealer                                       |

Name.....Age.....

Address.....

City.....State.....

Occupation.....

If you reside in Canada, send this coupon to the International Correspondence Schools, Canadian, Limited, Montreal, Canada

## Earn Big Profits Making Keys

### BUILD A PERMANENT BUSINESS OF YOUR OWN!

One girl took in \$98.30 her first week! Be independent. Let us show you how!

WRITE TODAY

Duplicate any type of key in one minute. Make new keys from lock number. New patented key cutting machine is simple, easily operated and fully guaranteed. No experience is needed. A boy or girl can cut perfect keys with it. Everyone needs keys. Be the one to fill the demand in your territory. Full information FREE, regarding machine and liberal time payment plan.



Beisser Key Machine Co.

3919 Woodward Ave.

Detroit Michigan

WRITE for FREE CIRCULAR

## MOLES and WARTS



### REMOVED PERMANENTLY

Rid your face, neck, arms and body of all unsightly moles and warts with “ANTI-MOLE.” One application does it. Safe—easy to use—painless—leaves no scar. Used successfully by physicians, skin specialists and beauty experts for 28 years. Write for FREE booklet on treating all kinds of moles and warts. Miller Co., 2445 South St., Lincoln, Nebr.



Build your own outboard hydroplane motor or sail boat. Use our plans or knock-down frames and machined parts. Many models to select from. Write for new catalog. Please enclose 10c for catalog. J. B. WELCH, Inc., Dept. B, 1351 41st St., Milwaukee, Wis.

## New Complete “Wonder” Workshop

**\$18.30 BUY DIRECT. SAVE 35% TO 50%**  
 12" Band Saw \$29.25 to \$37.05  
 Lathes 21.00 to 29.25  
 4" to 36" Scroll Saw 4.80 to 13.44  
 6" BB Jointer ... 55.00 to 74.25  
 Home Workshop—11" 3 spd. lathe, 7" saw table, 8" scroll saw ..... \$4.00



Write for Circular  
**S & B MFG. CO.**  
 4611 W. 20th St. CHICAGO, ILL.

## \$10.00 PER MONTH BUYS Fibre-Life Limbs



NEXT TO NATURE. BRACES MADE TO ORDER. AGENTS WANTED. FREE FIBRE SAMPLE  
**WORMAN CO.** 252-P HENNEPIN AVE., MINNEAPOLIS, MINN.

KEEP POSTED ON RADIO PROGRESS

JOIN THE RADIO INTERNATIONAL GUILD

—now has 60,000 members—who exchange information and tips of value to experimenters, set builders, service men. Also personal news and short wave gossip—membership fifty cents for a year, including subscription to official organ RADIO DESIGN—well known contributors make this quarterly livest of Radio publications. Send 50¢ today and receive current issue together with membership button, identification card and R. I. G. certificate.

Radio International Guild, Box PM12 Lawrence, Mass.

Enclosed find 50c. Enroll me as a member of the R. I. G. Send button and Radio Design for one year.

Name.....

Address.....



# Auto Owners Now Save Millions of Gallons of Gas

A new invention called the Whirlwind is actually saving millions of gallons of gasoline for automobile owners. Those who have installed this amazing device on their cars report almost unbelievable gasoline savings. They also report more speed and power, quicker starting and reduction of carbon.

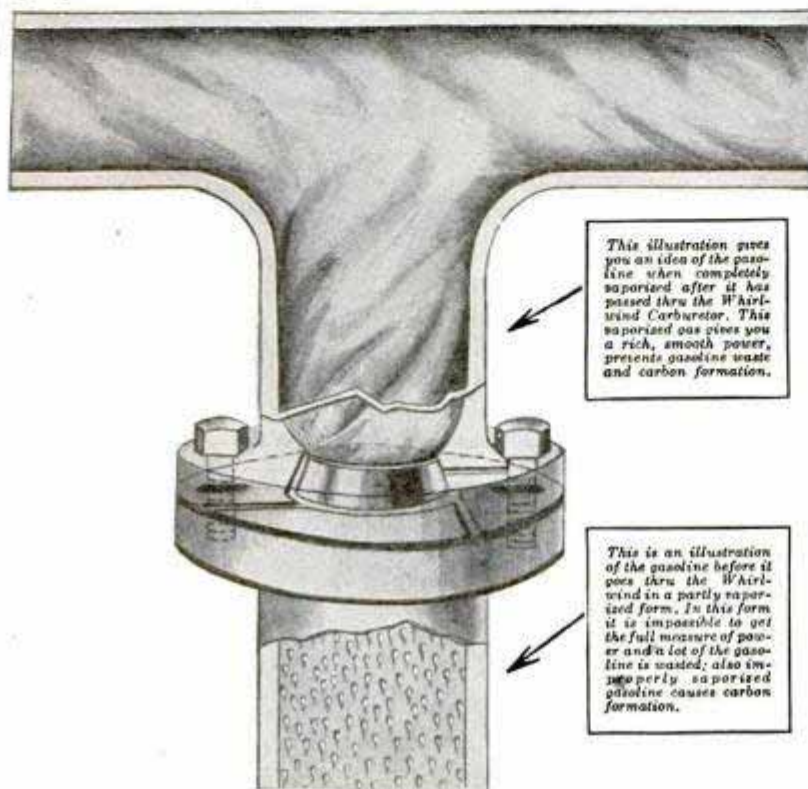

This illustration gives you an idea of the gasoline when completely vaporized after it has passed thru the Whirlwind Carburetor. This vaporized gas gives you a rich, smooth power, prevents gasoline waste and carbon formation.

This is an illustration of the gasoline before it goes thru the Whirlwind in a partly vaporized form. In this form it is impossible to get the full measure of power and a lot of the gasoline is wasted; also improperly vaporized gasoline causes carbon formation.

The marvelous thing about this Whirlwind is that it works as well on all makes of cars. Reports are received from owners of practically every known make of automobile from Fords to Lincolns and they are all equally enthusiastic in their praise.

## FITS ALL CARS

In just a few minutes the Whirlwind can be installed on any make of car, truck or tractor. It's actually less work than changing your oil or putting water in the battery. No drilling, tapping or changes of any kind necessary. It is guaranteed to work perfectly on any make of car, truck or tractor, large or small, new model or old model. The more you drive the more you will save.

## SALESMEN AND DISTRIBUTORS WANTED TO MAKE UP TO \$100.00 PER WEEK

Whirlwind men are making big profits supplying this fast selling device that car owners cannot afford to be without.

### GUARANTEE

No matter what kind of a car you have—no matter how big a gas eater it is—the Whirlwind will save you money. We absolutely guarantee that the Whirlwind will more than save its cost in gasoline alone within 30 days, or the trial will cost you nothing. We invite you to test it at our risk and expense. You are to be the sole judge.

## WHIRLWIND MFG. CO.

DEPT. 999-410-A THIRD ST.

MILWAUKEE, WISCONSIN

Good territory still open. Sample offer and full particulars sent on request. Just check the coupon.

## Free Trial Coupon

Whirlwind Mfg. Co.,  
999-410-A Third St., Milwaukee, Wis.

Gentlemen: You may send me full particulars of your Whirlwind Carbureting device and tell me how I can get one free. This does not obligate me in any way whatever.

NAME.....

ADDRESS.....

CITY.....

COUNTY..... STATE.....

Check here if you are interested in full or part time salesman position.

*The Greatest Thrill in Radio . . .*  
**WORLD WIDE SHORT WAVE RECEPTION**



**The Best Short Wave Reception Unit**  
**• PILOT Super-Wasp**

(A. C. OR D. C. SHORT WAVE KIT—14 TO 500 METERS)

It is not only home set builders who are buying the thousands of Super-Wasps Pilot is shipping every week. The fellows who relay messages all over the world for the sheer joy of it—the *Licensed Radio Amateurs*—are also adopting Super-Wasp as their official outfit for receiving broadcasts, talk and code.

These experts, who developed short waves before any manufacturer knew anything about them, know why Super-Wasp is superior. They are convinced that the feature Pilot pioneered of putting a Screen Grid, TRF stage ahead of the detector gets more stations than their own old straight regenerative sets. They know too that in a few hours they can produce a neater receiver for their operator's table with the inexpensive Super-Wasp Kit than if they bought expensive separate parts and experimented till they worked right.

You can tell a leader by how many followers he has. Pilot Super-Wasp's success is proved by its many imitators. Remember, Pilot Super-Wasp covers from 14 to 500 meters, giving you practically all the regular broadcasting channels as well as short waves. And don't overlook the fact that Pilot products are known *personally* to more users throughout the world than any others and that every single Pilot product is made in the largest factory in the world owned and operated by a radio manufacturer.

**BATTERY SETS  
 IN KIT FORM**

**\$29.<sup>50</sup>**

Kit K-110: The battery-operated Super-Wasp. Batteries and Tubes extra.



**A. C. SETS  
 IN KIT FORM**

**\$34.<sup>50</sup>**

Kit K-115: The A.C. Super-Wasp. Use your own ABC pack or Pilot K-111, specially designed for the Super-Wasp. Power Pack and Tubes extra.

**PILOT RADIO & TUBE CORP.**  
 OFFICES IN PRINCIPAL COUNTRIES  
 OF THE WORLD



**FACTORIES: LAWRENCE, MASS.**  
 Chicago Office: 234 S. Wells Street  
 San Francisco Office: 1278 Mission Street  
 New York Office—525 Broadway

**PILOT SUPER-WASP RADIO**  
 FOR LONG AND SHORT WAVE RADIO RECEPTION

- ALASKA
- CANADA
- GREENLAND
- MEXICO
- COSTA-RICA
- GUATAMALA
- HONDURAS
- PANAMA
- SALVADOR
- BERMUDAS
- CUBA
- WEST INDIES
- HAITIAN REPUBLIC
- COLOMBIA
- GUIANA
- VENEZUELA
- ARGENTINA
- BRAZIL
- URAGUAY
- BOLIVIA
- CHILE
- ECUADOR
- ENGLAND
- IRELAND
- FRANCE
- BELGIUM
- GERMANY
- HUNGARY
- SWITZERLAND
- POLAND
- RUSSIA
- CIBALTAR
- ITALY
- PORTUGAL
- SPAIN
- BULGARIA
- RUMANIA
- TURKEY
- ARABIA
- PERSIA
- INDIA
- CEYLON
- JAVA
- PHILIPPINE ISLAND
- SIAM
- CHINA
- JAPAN
- ALGERIA
- EGYPT
- MOROCCO

# Start to Play Very First Day

This Year Give Yourself  
*Lifelong Fun*  
*Profit and*  
*Popularity*



## PARENTS!

What greater gift can you confer on your children this year than lifelong fun and entertainment?

Love of music means love of home, an appreciation of the finer things in life. Here is a chance to give your boy or girl that love without the tedious practice that most instruments require. The Xylorimba is easy to play. No teacher is needed. Practice is actually a joy.

Remember, the Xylorimba is the guaranteed product of a company established nearly half a century ago—a company that stands back of every promise it makes.

THINK of the best Christmas gift you have ever received. Multiply the pleasure it gave you by ten, and still you have only an idea of the joy you can give yourself this Christmas if you act at once.

## Start to Play the Very First Day!

Haven't you, like millions of others, envied the fellows who "bring down the house" with snappy xylophone or xylorimba numbers? Haven't you longed to create your own music, to be looked up to wherever you go, to be able to make real money in spare time? If you have, this ad spells O-p-p-o-r-t-u-n-i-t-y. The xylorimba—wonderful for home, in demand at dances and gatherings—is nevertheless *the easiest of all instruments to play*. In fact, on the very day you get yours you play simple melodies, even if you can't read a note of music right now. In a few weeks you astonish your friends and family. *All your life* you have the joy that comes to those who can entertain.

### Plays 20 Minutes; Gets \$20!

Ralph Smith, Chicago, played twenty minutes at wedding; his "pay" was \$20. Altho only 12, Turk McBee, Jr., plays big-time vaudeville exclusively. Harry Breuer, New York, has

made thousands of friends thru his xylophone selections on the radio. L. E. Hallman, Reading, Pa., writes: "Made \$300 in 5 weeks—spare time."

And now J. C. Deagan, Inc., (world's largest manufacturer of xylophonic instruments) has made it so easy to own a xylorimba that nothing stands in your way. Sizes and styles to fit every age and pocketbook. A five-day free trial that eliminates risk. Free, easy lessons that make teacher unnecessary—and, best of all, such easy payments that they are hardly noticed.

## Will You Investigate?

Everyone wants to be popular. Everyone wants to make extra money. Everyone wants to be *center of attraction* at gatherings. But these advantages don't come by themselves. Opportunities must be seized. This is *your* opportunity—will you pass it up without investigation? The accompanying coupon will bring our big FREE book to your door. It tells all about the Deagan line, the free trial, the easy payments. Remember, no cost or obligation! Simply fill in and mail the coupon—but do it before it slips your mind. Today is as good a day as any. Do it NOW!

YOUR  
MAGIC

KEY

to Popularity

Send for  
BIG FREE  
Book!

Mail  
Now!

J. C. DEAGAN, Inc.  
Dept. 3459, 1770 Berntau Avenue, Chicago

Please send me full details on the Free Trial offer and easy payment plan of the Deagan Xylorimba.

Name \_\_\_\_\_ Address \_\_\_\_\_  
City \_\_\_\_\_ State \_\_\_\_\_

# PEEL POTATOES WITH A CRANK!

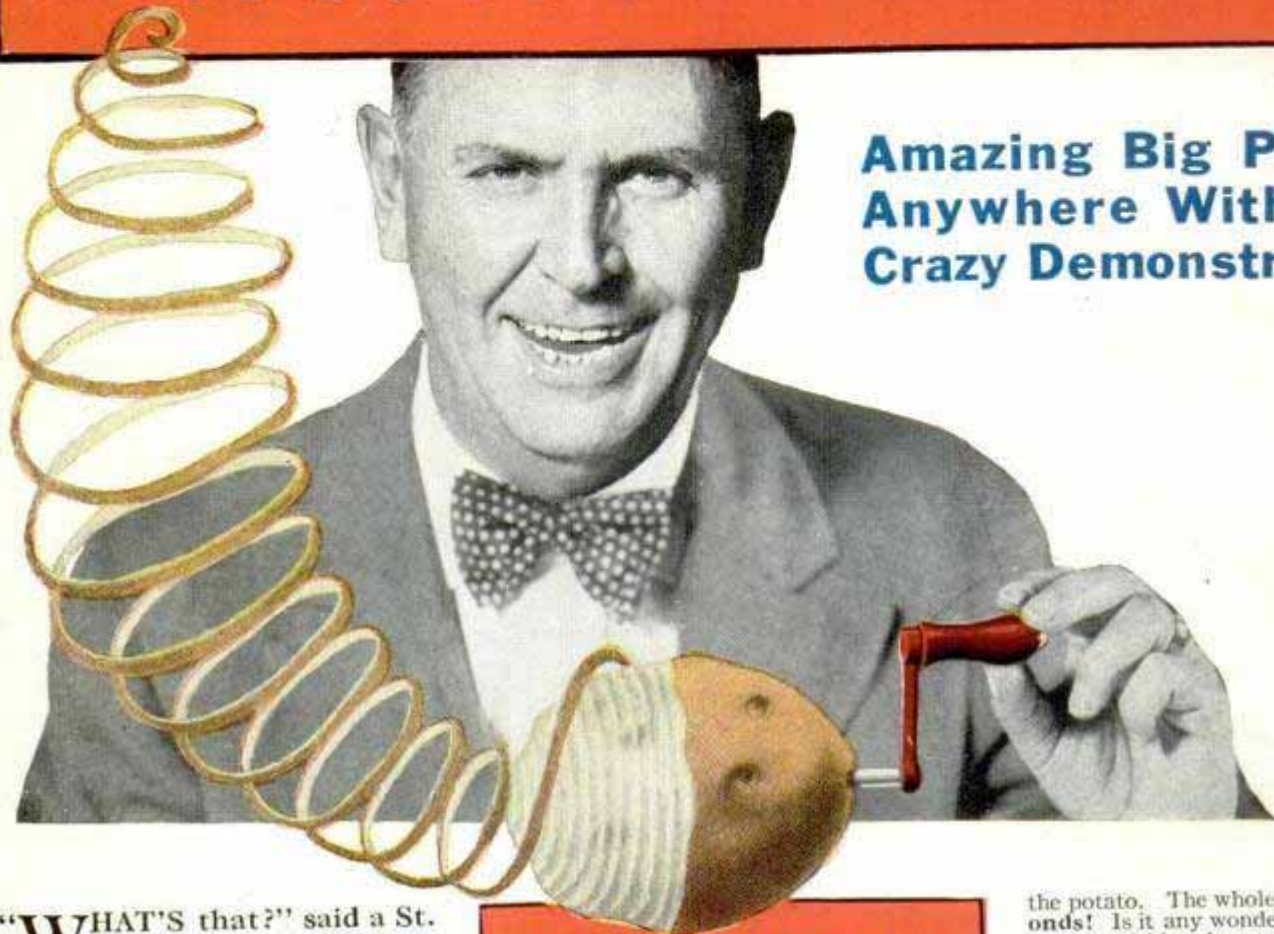

**Amazing Big Profits Anywhere With This Crazy Demonstration!**

**“WHAT’S that?”** said a St. Louis banker. “Peel potatoes with a crank! It’s absolutely incredible. Just another inventor’s crazy pipe-dream. Why, I know a lot of women who would pay you ten dollars apiece for such a gadget and figure they had a bargain.”

But now, at last, this “crazy” invention not only is a tested and proved reality. It has been improved and simplified so it can be sold at a price every home can afford. Yet pays demonstrators **real** profits on every sale. No wonder sales people in recent tests have made as high as \$10 and \$12 in a single hour with this amazing new wonder-worker!

## Startles Everyone . . . In 10 Short Seconds!

Until they actually see it demonstrated right before their very eyes, people simply can’t believe that a little crank now makes potatoes peel themselves. Every day in every home potatoes have to be peeled. With a paring knife the old way it is a hard, sloppy, tiresome, slow job. Wasteful, too. Fingers are cut and scarred every day. Every woman knows that paring potatoes makes her hands ugly. Nine out of ten women consider that peeling

## YOUR CHANCE FOR \$100 A WEEK!

Men, here is by far the newest, and most amazing invention that has appeared in many years. You old-timers don’t need to be told this. I’ll bet that I hear from nearly every smart, experienced salesman in the business who happens to read this announcement. I want spare-time workers and inexperienced people to write also. All I ask is an opportunity to show you why this is a real chance for \$100 a week. Use the coupon.

potatoes is the nastiest, most distasteful drudgery in her kitchen. Now imagine showing all these millions of women an amazing, new automatic way to banish paring knives. End cut fingers. No more work, trouble, mess or waste! For every five potatoes you peel this new way you get one free. Why, even for spare-time demonstrators the profit possibilities are tremendous . . . up to \$6, \$8, \$10 for a single hour’s efforts!

## How This Invention Works

This amazing new potato peeling invention is almost incredibly small and simple in construction. Yet its uncanny speed and dexterity are nothing short of magic! It peels potatoes of any shape or size in just a few seconds. Even works on odd-shaped, “warty,” crooked potatoes! And works with such astonishing speed that it does more than ten pairs of human hands. When you turn the little crank the potato starts to spin. Then a tiny, patented “goose-neck” invention travels automatically across the surface of the potato. It shuttles back and forth. Slips up and down and around. In and out of depressions so swiftly that your eye can hardly follow it. All the while it strips a tissue-thin surface layer from

the potato. The whole job is finished in seconds! Is it any wonder that women who see this astonishing demonstration are interested instantly! Or that they buy so fast that salesmen can make almost any amount of money within reason that they go after?

## Send at Once for Introductory Sample Offer

Right now while this proposition is still wild-fire new and territories open in every state you are offered the chance to test this invention without obligation. An unusually liberal sample offer lets you make the 10-second demonstration test of your profits among friends and neighbors. Learn at once why this is a real chance for up to \$100 a week almost anywhere. Use the coupon. You are not asked to risk one penny—except your 2c stamp. Your name and address on the coupon, at once puts you on the trail to the hottest money-maker offered in many moons. Shoot it back and you’ll get action QUICK!

**GUARANTY PRODUCTS CO.**  
Dept. W-80, Francis Bldg.  
Washington at 16th St., ST. LOUIS, MO.

Guaranty Products Co., Dept. W-80,  
Francis Bldg., Washington at 16th St.,  
St. Louis, Mo.

Rush your introductory sample offer and  
all money-making details without obligation  
to

Name.....

Address.....

Town.....State.....