

POPULAR MECHANICS

MAGAZINE

WRITTEN SO YOU CAN UNDERSTAND IT

REG. TRADE MARK, GREAT BRITAIN, NO. 410425

REG. U.S. PAT. OFF.

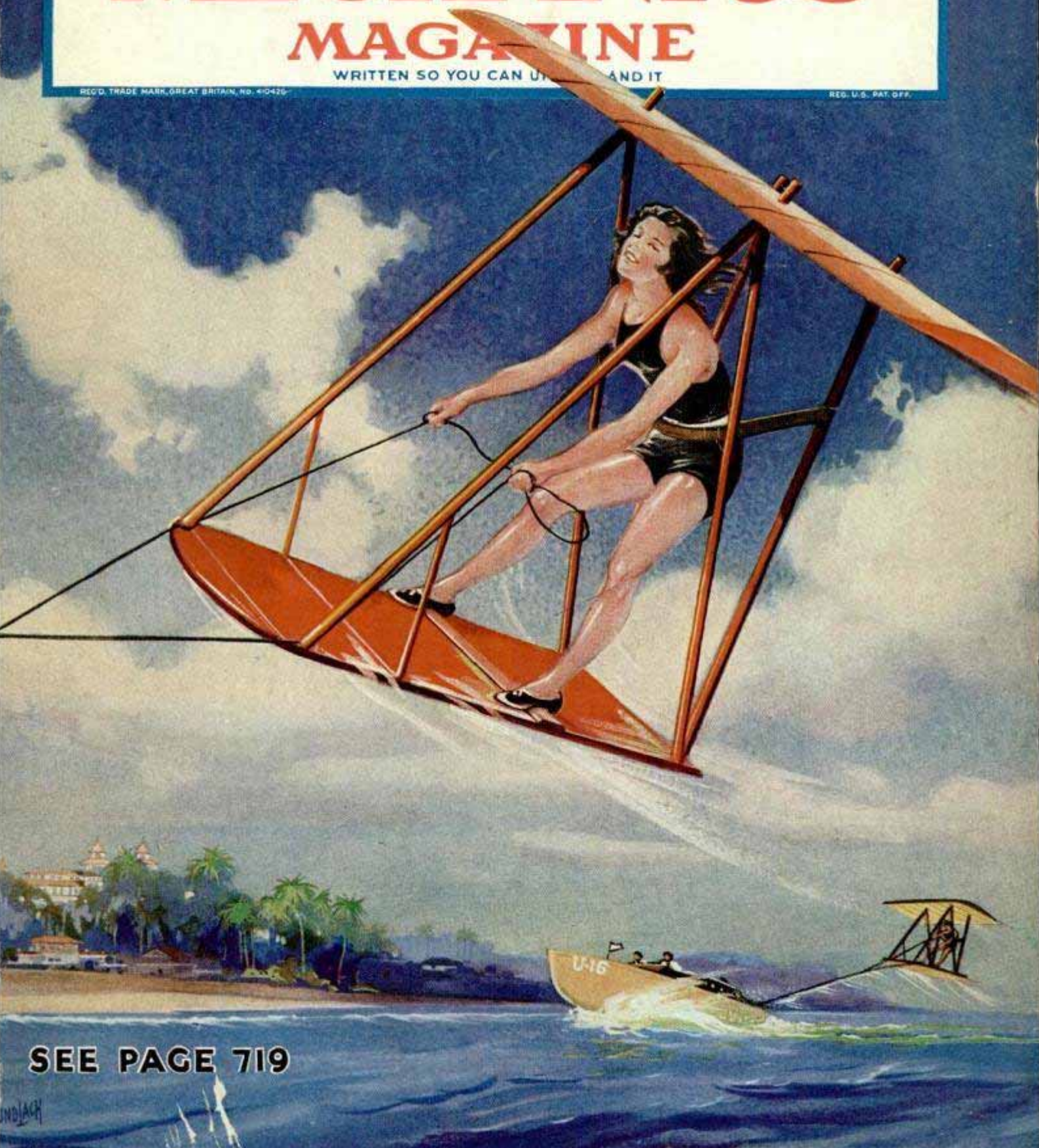

SEE PAGE 719

INDIACH



Faster

—than the Twentieth Century to Chicago!

Faster

—from Coast to Coast than the Fastest Train!

Faster

—than the Fastest Train from New York to Miami!

CANNON BALL BAKER—one of the most famous road racers in America—has broken 19 road records with a stock model Franklin—lubricated with Mobiloil.

This proves, in a dramatic way, what thousands of motorists have already discovered about the New Mobiloil in their own cars, under run of the road conditions.

This proved performance stands behind every quart of Mobiloil. The record of performance behind Mobiloil is greater

than that of any other oil in the world.

To make a practical performance record of long engine life and smooth economical running in your own car, drive in where you see the Mobiloil sign. Have the Mobiloil dealer drain and refill your crankcase with the grade of Mobiloil especially recommended for your car.

VACUUM OIL COMPANY

Makers of high-quality lubricants for all types of machinery



Mobiloil



Protects You for 12 Months against **ACCIDENT** and **SICKNESS!**

No Medical Examination

MEN and WOMEN

**FROM AGES 16 to 70
ACCEPTED**

No Dues or Assessments

SUPPOSE you meet with an accident or sickness tonight—will your income continue?

Remember, few escape without accident—and none of us can tell what tomorrow holds for us. While you are reading this warning, somewhere some ghastly tragedy, flood or fire, some automobile or train disaster is taking its toll of human life or limb. **Now Is the Time to Protect Yourself.**

If you suddenly become ill—would your income stop? What if you suffered from lobar pneumonia, an appendicitis operation, or any of the many common ills, which are covered in this unusual policy; wouldn't you rest easier and convalesce more quickly if you knew that our company stood ready to help lift from your shoulders, the distressing financial burdens in case of a personal tragedy? **Protect yourself Now!**



A \$10 Bill

PAYS

\$10,000
PRINCIPAL SUM

\$10,000
Loss of Hands, Feet or Eyesight

\$25 WEEKLY
BENEFIT

**for Stated Accidents
and Sicknesses**

Doctor's Bills, Hospital Benefit, Emergency Benefit and other new and liberal features to help in time of need—all clearly shown in policy. This is a simple and understandable policy—without complicated or misleading clauses.

MAIL THIS



COUPON NOW

FREE BOOKLET—"Cash or Sympathy"

Mail the Coupon before it's too late to protect yourself against the chances of fate picking you out as its next victim.

Largest and Oldest Exclusive Health and Accident Insurance Company in America

Under direct Supervision of 48 State Insurance Departments
ESTABLISHED OVER 43 YEARS

NORTH AMERICAN ACCIDENT INSURANCE CO.

688 Wallach Bldg., Newark, New Jersey.

North An
688 Wall
Gentle
let "Cast

Name...

Address.....

City.....

State.....

This One



ZEJ8-RQT-R8J4

AGENTS wanted for New Territory

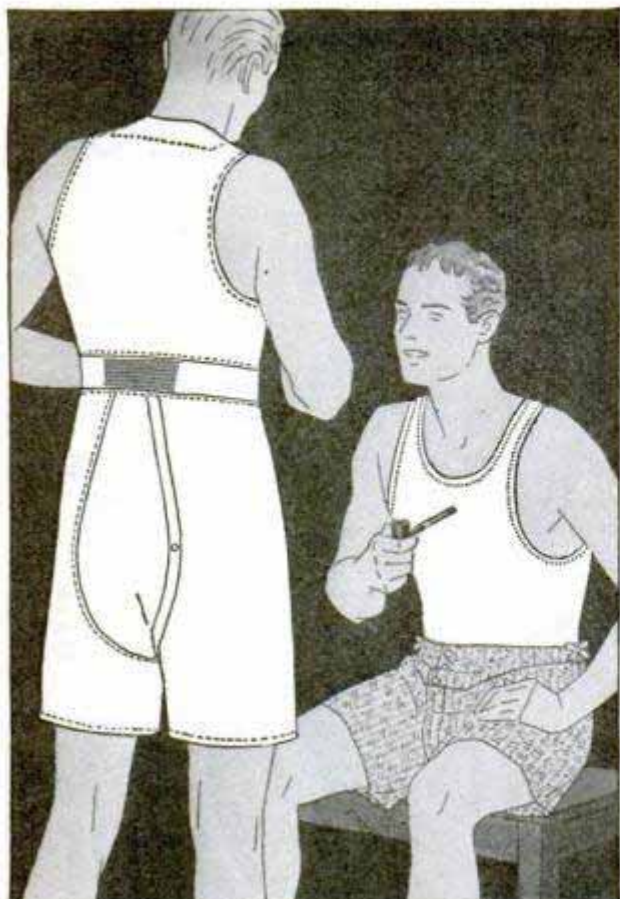

At left: Samsonbak Union Suit with patented tug-of-war belt, only \$1. Others from 75c to \$2. At right: Smart, new shirt and shorts, at 50c, 75c and \$1. White and colors. Wide choice of fabrics.

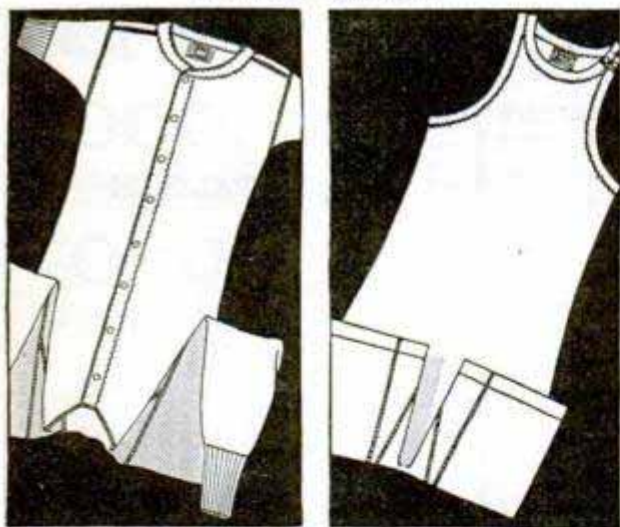

Elastic-knit Lightweight Union Suits of finest quality for summer wear in mild climates, \$1 to \$1.50.

Knit Athletic Union Suit—shoulder-button style—of fine combed yarn knitted to comfortable measurements, \$1.

PICK YOUR STYLE

NAME YOUR PRICE

HERE'S HANES SUMMER
UNDERWEAR THAT FITS EXACTLY

FOR more than a quarter of a century, the whole great HANES organization has kept its eyes on *fit!* Big, roomy, full-sized garments—in appropriate materials, of course—are the only guarantee of hot-weather comfort. They let the air get to your skin, keeping it dry and cool. Then, too, HANES fits every style and fabric preference a man can have—as well as every man's purse.

HANES garments are designed and built by specialists in men's and boys' underwear. You can be sure of solid comfort whatever your chassis measurement or displacement may be. If your regular dealer hasn't the complete 1930 line, write to P. H. Hanes Knitting Company, Winston-Salem, North Carolina.

HANES UNDERWEAR

FOR MEN AND BOYS

FOR EVERY SEASON



Popular Mechanics Magazine

200 E. Ontario Street, Chicago, U. S. A.

H. H. WINDSOR, Founder

H. H. WINDSOR, Jr., Editor and Publisher

London: Hachette & Cie.,
3 La Belle Saurage, Ludgate Hill, W. C. 2

Paris: Hachette & Cie.,
111 Rue Reaumur

Melbourne: Gordon & Gotch
509-513 Little Collins St.

ISSUED MONTHLY

SUBSCRIPTION:

SINGLE COPY, 25 CENTS

In United States and its possessions, Canada, Cuba, Mexico, and all }
countries in the Pan-American Postal Union, per year, postpaid } \$2.50

To all other countries in the Postal Union 3.00

All subscriptions are discontinued at expiration. Please examine the date printed on your wrapper.

Entered as Second Class Matter Sept. 15, 1903, at the Post Office at Chicago, Illinois, under Act of March 3rd, 1879.

Entered as Second Class Matter at the Post Office Department, Canada.

Published monthly by POPULAR MECHANICS CO.

Copyright, 1930, by Popular Mechanics Co.

Copyright in Australia. Copyright in France

Vol. 53

Contents for May, 1930

No. 5

Special Features

Trailing Animal Gangsters	722
The Tricks of Fancy Diving	730
The "West Point" of the Air	737
Money from Farm Waste	755
How Eyes Tell Lies	759
When the Mountain Moves	763
A Ten Cent Store Edison	771
Does Electricity Help Crops?	779
Docking the World's Greatest Liner	786
"Camera!"—Feeding the News Reels	794
The World's Most Famous Play	803
Is Our Climate Changing?	817
Airplanes	
economical speed hundred miles	758
"Hyving wing" successful in first tests	781
ice detector for, flashes red signal	821
load and discharge freight from moving planes	798
quiet motor saves gasoline	775
shock recorder measures landing strain	790
Automobiles—Accessories	
ash tray, fitting vest pocket, handy for motorist	807
auto license-plate holder adjustable in size	801
crankcase ventilator eliminates odors	775
luggage rack on spare tire folds when not in use	767
rubber shackles eliminate rattling	813
umbrella and case fit back of seat	727
Automobiles—Driving—hobble limits speed of auto being delivered	802
Automobiles—Racing—4,000 horsepower seeks record	768
Automobiles—Repairing—spark-plug cleaner removes carbon quickly	769
Automobiles—Tires—repair gum seals cuts in treads quickly	809
Aviation	
airplane flown backward and upside down	785
continuous-arch hangar has no beams or girders	758
dot and dash path guides planes in landing	766
trolley pole flash is basis of fog signal tests	775
Ballroom—river steamer is orchestra platform	784
Birds—hummingbirds build nest on scaffold	761
Boats and Boating	
boat jumps over logs, helps lumbermen	769
motorboat has stern drive and reverse gear	777
slip-float for motorboat contains bungalow	753
Brain—tester reveals time required to think	762
Building—like war-time tank houses Russian factory	778
Card Games—bridge score on table edge is out of way	729
Church—of glass and steel is all windows	736
Clock—alarm turns on light	765
Clothes Hanger—suction grip, attaches anywhere	783
Cradles—for infant oysters aid culture	726
Crime—tricks of gangsters shown by dummy gunmen	767
Diamond—diggers in footrace to mark claims	728
Dyes—for detection of germs to be standardized	800
Electric Drill—two-plate, contains drawer oven	784
Electric Outlets—add to, with cone plug	807
Electrical Appliances—floor scrubber, waxer and polisher	800
Electricity	
electric spark brighter and hotter than sun	774
hogs killed by in German packing plant	809
interior of earth explored with	728
Element—unknown, is found in two minerals	790
Fish and Fishing—there is money in farming of brook trout	808
Floor Drain—made accessible for easy cleaning	791
Fountain Pen—holder in cane	753
Fruits—bottled without fermentation	791
Garage—built of glass helps sell autos	754
Gardening	
gang-plow hoe cultivates and weeds at same time	775
long-handled weed cutter operated with one hand	816
Gardens—Japanese—built in western setting	757
Gauges	
graduated-rod depth gauge for hole measurements	769
telescoping gauge measures inside dimensions	767
Glass	
house, eighteen-story, with concrete frame	822
walls offer privacy to steel homes	813

[Continued on Page 4]

Cane fountain pen 753 floor scrubber and polisher 800

[Contents—Continued]

Paper coats with ten 724

July 793

Weed cutter 816

Golf	home, practice target may be used anywhere	809
	supporting rack for bag does work of caddy	721
Gymnasium—electrified		810
Hair—growth stimulated by fan and light rays		727
Hat—with transparent brim for sports wear		783
Heating and Ventilating		
	big burners speed up heating of kerosene stoves	761
	electrically heated bottle to supplant furnace	757
	heat radiated from walls by panel warming	816
	wall-register electric fan speeds up heating	776
Household Devices		814
Ice—Artificial—skating rink accommodates thousands		812
Lamps—spring clamp for light bulb fastens anywhere		757
Lantern, Magic—lets speaker stand before screen		807
Light		
	artificial, for wheat matures crop earlier	729
	night scene at Monte Carlo shows beauty	721
Lighting—ballroom transformed by magic changing of color		776
Map, Roll—for airplane pilot attaches to wheel		799
Marshes—plant builds new territory by filling		721
Meat—test cuts by tasting 2,000 samples		768
Memorandum Roll—for desk phone		791
Motor Bus—cast-off, serves as lunchroom		821
Motor Cylinders—pulverized coal burned in		822
Motor Truck has three wheels		754
Motor Truck—traveling electrical show		785
Moving Pictures		
	flickerless use multiple lenses	800
	noiseless shoes and jewels for the talkies	728
	portable sound-movie outfit	777
Museum—windmill converted into		729
Music—printer requires no engraving		725
Navy, U. S.—first of "Treaty Cruisers" placed in service		758
Office Supplies—hand-operated duplicator makes stencil copies		784
Oil—poured on waves steadies navy's big guns		726
Paintings—rare, are restored with aid of microscope		793
Pests—tiny monster has million-dollar appetite		782
Phonograph—records, why used needles damage		822
Photography—projector aids in catching of fugitives		778
Pipe Line—leaks located with war instruments		802
Prison—box seats in prison school help keep order		801
Prospecting—it's easy to locate hidden metals		824
Radio		
	aircraft antenna shielded by fire partition	753
	detecting interference with a street car	828
	filters, homemade power-line	827
	helpful tips from the radio laboratory	830
	reception separating interfering stations	832
	shock absorbers end vibration	793
	static to be forecast like the weather	727
	transformers protecting unmounted	826
	tubes, "Pentode," give more power	781
	using ground as temporary antenna	832
	winding kink	829
Railroads—markers set in floor guide passengers to trains		800
Roofing—that resembles tile has slate surface		793
Rubber, sponge has variety of uses		813
Safety Devices and Measures—rope stretcher aids rescue work in mines		765
Screwdriver—ribbed blade prevents slipping		783
Shears—long handle on grass shears makes work easy		768
Ships and Shipping—U. S. enters race for blue ribbon of Atlantic		725
Soil—used for insulating		783
Sugar cane planter travels 15 miles an hour		785
Telephone		
	light clamps on dial phone illuminating numbers	761
	telephone men trapped in sunken subs	792
Touring—motor hotel brings luxury to adventurers		823
Trap Shooting—hand trap throws targets for shotgun practice		769
Typewriter		
	built into piano transposes music	802
	has conquered many languages	807
Wind—penetrates brick wall		821
Windows—reversible casement window easily cleaned		762
Wire—used to cut marble slabs		754
Wood		
	liquid, is fireproof and comes in colors	801
	microscopic, structure provides dress designs	816

AMATEUR MECHANICS

Automobiles—Accessories		
	sections of inner tube protect auto bumper	862
	tool rack in auto truck	856
	tourists' stove heated by exhaust gas	857
	windshield screen prevents entrance of insects	835
Automobiles—cleaning electric connections		841
Automobiles—Repairing		
	alcohol removes carbon in motors	860
	breather-pipe oil fumes can be used to advantage	838
	remedy for grease leakage at gear shift lever	859
	remedy for rattling windows	858
Bird House—airplane		860
Boats and Boating—locking oars in a rowboat		859
Camping—folding table for holding cooking utensils		849
Candles—keeping straight in holders		861
Clocks—grandfather you can build		852
Fish and Fishing—backlash stop for fly-casting reel		834
Garden Tools—sap holder for long-handled		859
Gates—simple support will prolong life		850
Hamper—attractive, easily made		833
Haystack—easy method of cutting		861
Heater—electric, you can make this		846
Hogs—holder for ringing		847
Homes—"The Fo'c'sle"—a shipshape summer cottage		842
Lamps		
	homemade modern	858
	pull made of wallpaper	856
Lawn Mower—rake attached to, saves time and work		851
Lumber—should be stored flat		857
Photography		
	dull prints made on glossy paper	862
	substitute for focusing cloth	841
Piston-ring grooves, quick cleaner for		862
Posts		
	graduated auger tells depth of hole	849
	preventing fence posts from rotting	859
Rifles—sight is improved by reversing		850
Screen Door—separate exit for children in		851
Signs—novel sign post for home owners		850
Soap—holder for cleaning small parts		841
Statuettes—attractive, easy to make		836
Swimming—self-retrieving cable slide for bathers		848
Swimming Pools—prevent infection from chemicals in		838
Tar Bucket—holding on roof		835
Tent		
	collapsible ridgepole for	860
	hookless fastener for	862
Toys—sand motor runs dancing monkey		839
Tractor—motometer installed on		862

SHOP NOTES

Automobiles—Lubrication—for closed-car window frames		869
Automobiles—Repairing		
	handy clamp for welding fenders	869
	holder for repair of auto bearings	873
	temporary repair for broken battery cable	873
Belt—old tire prevents slipping		865
Blueprints and Photostats—how to improve		879
Boiler—lid lifter and holder		871
Buffer—canvas puts edge on tools		879
Camera—spring clips hold lens-board screws		877
Cash Register—drop bottom baffles holdups		874
Clamp—for holding sheet metal against a wall		868
Door-Latch—detachable plate holds open		873
Drill Press—surface grinding on		867
Garage—handy rear-end rack for		877
Greenhouse—concrete potting benches for		878
Heater—water, for sunny climes		875
Inlays—simple, will improve your work		863
Lawn Hydrant—cement drip block saves		879
Oil Container—for tempering		868
Screwdriver—sidehold increases leverage		871
Shaper—makes good miller		870
Soldering—clips hold seams while		874
Spring Hanger—used on air tools		865
Steel Balls—for flaring ends of tubing		869
Tanks—chemical, arrangement for regulating temperature of		879
Welding—rod carrier		866
Wood Turning—twist-turning with portable router		872

Rubber and you P58
... with heart P75

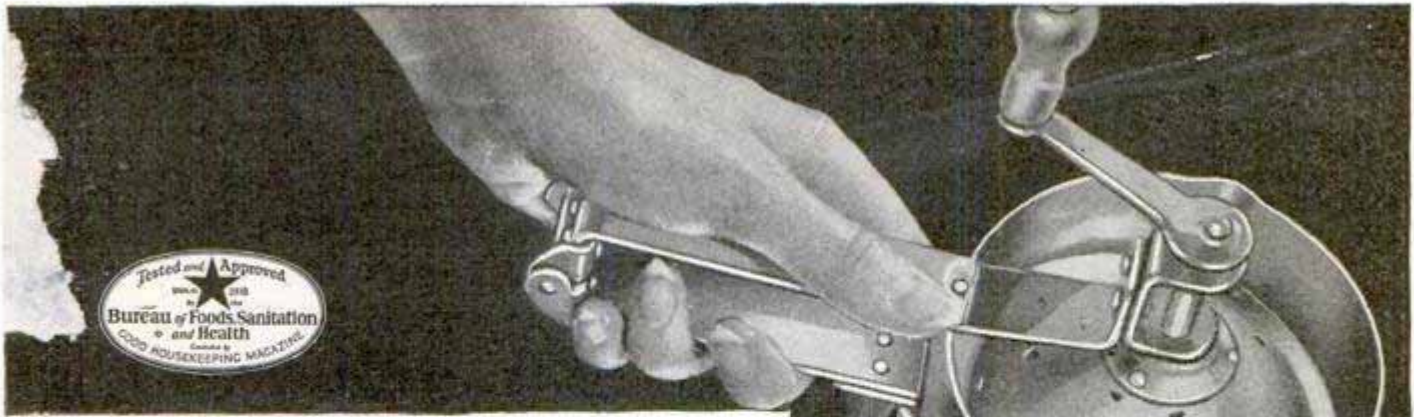

Orange Juice...

Without Squeezing Straining or Seeding

Amazing New Way

GOLDMINE

FOR AGENTS!

Here's the very thing that housewives, restaurants, soda fountains, orange stands have long been looking for—a juicer which will give you the best priced electric machine within the range of a few dollars.

Each orange juice is a goldmine. It is the most refreshing, invigorating, and healthful beverage that can be prepared at any time of the day. It is the only beverage that compares all sorts of fruits for its healthful qualities. It is the only beverage that relieves constipation, stomach troubles, and especially bottle babies, especially bottle babies. It is the only beverage that gives you the most amount of orange juice for your money. It is the only beverage that one or more of hundreds of thousands of Americans are using today.

Up to now, the only way to get orange juice was by squeezing the fruit on the machine. This was hard work, and the juice was soiled—the hands—wasted—most of the juice and almost all of the pulp in which are most of the precious, health giving vitamins. Housewives had to use these makeshifts, however, if they were to have any orange juice at all. There was nothing better they could afford to buy.

3 Minute Demonstration Clinches Sales Easily

Now—into this wonderful ready-made market comes KWIKWAY—the modern orange (and lemon) juicer that meets every requirement. So simple a child can operate it—requires no strength or squeezing with the hands. Sanitary—no juice on hands. Easily cleaned—just rinse under cold water faucet. And, most important of all gets 25% more juice than other devices and all the rich, golden pulp. Any housewife can see these many advantages at a glance and realize instantly that KWIKWAY will actually pay for itself in a very short time through the extra juice it gives. A speedy 3-minute demonstration puts the story over and makes housewives eager to buy nine times out of ten. Besides, KWIKWAY finds ready sale in drug stores—hotels, restaurants, and every

place where beverages are served. It is so easy to show how it equals or surpasses the work of electrical machines—works just as quickly—as easily—without mechanical complications but at a mere fraction of the cost.

No wonder agents already established should be reaping a golden harvest—cleaning up as never before in all their lives! It is a veritable miracle the way KWIKWAY brings the dollars rolling in! Many desirable territories are still open all over the country but are going fast. Waste no time—mail the attached coupon at once to obtain full information about this amazing invention and the extraordinary money-making opportunity it offers you.

**KWIKWAY PRODUCTS, INC., Dept. E-120
1415 Pine Street, St. Louis, Mo.**

KWIKWAY PRODUCTS, Inc.,
Dept. E-120, 1415 Pine St., St. Louis, Missouri.
Gentlemen:—Please tell me all about KWIKWAY and your sure-fire plans for increasing my income.

Name

Address

City State.....

Are You Satisfied With Your Work ~And Your Pay?

If you're satisfied with your work—and your pay check is all you desire—stop reading—this is not addressed to men who are satisfied.

If you're trying to look ahead—hoping for promotion that's slow to come—needing more money—willing to work for it but not getting it—then—read every word. This may be the turning point in your life.



THERE is a business profession you can acquire at home—studying in your spare time. It pays—in money and prestige—it puts you in touch with big things—with business leaders. It holds the immediate reward of materially increased pay—it opens opportunities for rapid advancement to real positions—and it offers the ready possibility of a business of your own as a public accountant.

Accountancy—the modern business profession

Now don't get Accountancy confused with bookkeeping—the bookkeeper is the private in the business army—the Accountant the officer—and each gets paid in proportion.

Today Accountants deal with the most vital problems of business—the Costs—the Controls—Income and Tax matters—is it any wonder that where bookkeepers are paid a living wage, trained accountants earn up to \$10,000.00 and more a year?

Any question about its possibility for you? Then read the facts about these three men—facts picked from thousands of similar stories in our files—men and women who chose LaSalle home study training to open up this profitable profession.

From plumber to bank auditor

He was beginning to get badly discouraged—this mid-western plumber, 32 years old—eleventh grade education—drawing a small salary—without increase for several years—no chance for advancement in sight.

But a few months of LaSalle training opened up a bookkeeping job. A year later he became an accountant for an auto concern with two bookkeepers under him. Now he is auditor for one of the largest banks in his state and his income is 325 percent larger than when he began accountancy with LaSalle. And even greater opportunity is ahead.

Railway clerk becomes assistant auditor general

"How can I get out of this rut and win bigger success?"

That was the burning question of an untrained railway clerk. He was in Canada—34 years old and drawing down a mighty slim salary. He analyzed himself and his qualifications—he studied the path ahead—he investigated the experiences of men already at the top. He found that the chief difference between these successful men and himself was trained ability—that without training he was about as far as he could go.

He sent us a coupon just like the one at the bottom of this page—he considered carefully the information that coupon brought him—he enrolled for LaSalle training in Accounting—and he began climbing—slowly but steadily.

Today he is Assistant Auditor General of one of the world's great railway systems—and the future is bright.

"Good-bye time clock, I'm my own boss now"

Down in southeastern Ohio, a young bank teller toiled away in his cage, looking forward along the usual slow path of advancement—a path especially

slow for the man who has no special training and only loyal, routine service to offer an employer.

Today, this man, yet in his early twenties, owns a flourishing public accounting business with four other accountants on his staff, has the respect and liking of the leaders of his community, is his own boss, and has an income of which men much older than he would be proud. The LaSalle coupon started him.

Would you like to join this profitable profession?

You can—if you have the ambition and the will to prepare. But the first step is to get the facts—send the coupon.

Our new illustrated booklet, "Accountancy, the Profession that Pays," will open up to you a complete view of the accounting field—its problems, opportunities—will show you how its leaders work, what they expect of its future, what they demand in the men and women who are to become their co-workers and successors. In addition, it gives full information about our training in accounting, so that you may know and estimate it for yourself.

The booklet is absolutely free of cost or obligation—all you need do is to tell us on the coupon where to send your copy.

Find Yourself Through LaSalle

LaSalle Extension University

The World's Largest Business Training Institution
DEPT. 564-HR CHICAGO

Opportunities in Accountancy—Check below and we will send you copy of "Accountancy, the Profession that Pays," also copy of "Ten Years Promotion in One," all without obligation.

Higher Accountancy:

Other LaSalle Opportunities: If more interested in one of the other fields of business indicated below, check here:

- | | | |
|--|--|--|
| <input type="checkbox"/> Business Management | <input type="checkbox"/> Industrial Management | <input type="checkbox"/> Expert Bookkeeping |
| <input type="checkbox"/> Modern Salesmanship | <input type="checkbox"/> Personnel Management | <input type="checkbox"/> C. P. A. Coaching |
| <input type="checkbox"/> Traffic Management | <input type="checkbox"/> Modern Foremanship | <input type="checkbox"/> Business English |
| <input type="checkbox"/> Railway Station Mgm't | <input type="checkbox"/> Business Correspondence | <input type="checkbox"/> Commercial Spanish |
| <input type="checkbox"/> Railway Accounting | <input type="checkbox"/> Credit and Collection | <input type="checkbox"/> Effective Speaking |
| <input type="checkbox"/> Law: Degree of LL.B. | <input type="checkbox"/> Correspondence | <input type="checkbox"/> Telegraphy |
| <input type="checkbox"/> Commercial Law | <input type="checkbox"/> Banking and Finance | <input type="checkbox"/> Stenotypy—Stenography |
| | | <input type="checkbox"/> Paper Salesman's Training |

Name

Present Position

Address



POCKET EDUCATORS

For all BUILDERS AND MECHANICS



Read Audels Pocket Educators for advancement and profit in your work. Every mechanic in the building trades should have this inside trade information at his fingers' ends. Learn the scope and possibilities of your profession. Any job can be done better if you are well informed. To earn more, learn more.



AUDELS CARPENTERS AND BUILDERS GUIDES—4 VOLS. \$6



\$1 PER MO.

Inside Information for Carpenters, Builders, Joiners, Building Mechanics—all Woodworkers. **1600 pages; 3700 diagrams; flexible; pocket size.** Short-cut instructions, new methods, ideas, solutions, plans, systems—money saving suggestions. An easy progressive course for the apprentice. A practical daily helper and Quick Reference for the master worker. A Helping Hand to Easier and Better Work and Better Pay. To get this aid for yourself, simply fill in and mail the FREE COUPON below.

INSIDE TRADE INFORMATION ON:

How to use steel square; How to file and set saws; How to build furniture; How to use mitre box; How to use chalk line; How to use rules; How to make joints; Carpenters' arithmetic; Mensuration problems; Estimating strength of timbers; How to set girders and sills; How to frame houses and roofs; How to estimate costs; How to build houses, barns, garages, bungalows, etc.; How to read and draw plans; Drawing up specifications; How to excavate; How to use settings 12, 13 and 17 on the steel square; How to build hoists and scaffolds—skylights; How to build stairs; How to put on interior trim; How to hang doors; How to lay floors; How to paint.

"Audels Guides worth four times their price—handy too as carry them in pocket for reference." **W. J. Bates, Knoxville, Pa.**



\$1 PER MO.

AUDELS PLUMBERS AND STEAMFITTERS GUIDES—4 VOLS. \$6

A new set—just out! A practical, illustrated, Reference Library and Study-Course for Master Plumbers, Journeymen and Apprentice Steamfitters, Gas Fitters and Helpers, Sheet Metal Workers, Draughtsmen, Master Builders, Engineers and all Building Trade Students. **1670 pages; 3642 diagrams; flexible; pocket size.** Guides explain all the principles, advances and short cuts of the Plumbing and Heating trade. Contains instructions on how to figure and estimate jobs. Use FREE COUPON below to examine, without obligation, this valuable work.

INSIDE TRADE INFORMATION ON:

Soldering, tinning, joint wiping, bending, beating, Pipe—iron—steel, threading, Mathematics, tables, physics, Materials—iron, steel, copper, brass, lead, tin, antimony, Sheet metal—galvanized—plate. Sanitation, syphonage, tanks, Drainage, sewage, purification, Fixtures—bath—kitchen, Pipe fittings, soil pipe, tools, Laying out work, Roughing, Screwed fittings, flanges, joints, Pipe bending, examples, Elbows, Heating, ventilation, refrigeration, Water supply, mains, wells, tanks, Gas-fittings, Underwriters, Sheet metal work, problems, methods, Brazing, heating, lead burning, Welding, various welds, methods, Blacksmithing, forges, tools.

"Audels Guides are practical, easy to understand, reliable. Cover the field in plain language." **W.F. Arminger, Annapolis, Md.**



\$1 PER MO.

AUDELS MASONS AND BUILDERS GUIDES—4 VOLS. \$6

A new, complete, illustrated trade reference library, for Bricklayers, Cement Workers, Plasterers, Tile Setters and Stone Masons, including a practical outline of Steel Construction. **1100 pages; 2067 diagrams; flexible; pocket size.** A practical Trade Assistant explaining modern methods of masonry construction. Easy to understand and apply. A reliable and authentic reference work and study-course for Master Journeyman and Young Mechanic. Use FREE COUPON below and find out for yourself, without obligation, whether this set will benefit you.

INSIDE TRADE INFORMATION ON:

Bricklaying, tools, materials; Brick designs, patterns, bonds; Setting frames and foundations; Mortars, scaffolds, estimating; Mortars and mortar mixing; Tile setting, mosaic, hollow tile; Straight edge test, troweling; How to figure brick work; Safe loads, piers, chimneys; Boiler settings, anchors, fire stops; Labor tables; Concrete, forms; How to figure concrete work; Stucco—on old and new buildings; Plastering—wood lath—metal; Plasterers agreement; Plastering on various surfaces; Stonemasonry; Cutting, finishing, estimating stone; Derricks, rigging; Steel construction; Fire proof; How to read blue prints.

"Audels Masons Guides are the best books on the subject. Have laid brick 12 years and am able to judge." **H.A. Sonnett, Corliss, Pa.**



PRACTICAL ELECTRICITY — 1 VOL. \$4

Audels Handy Book of Practical Electricity is a simplified Ready Reference and Study Course in one pocket size, leather bound volume—for Engineers, Professional Electricians and Students. **1040 pages; 2600 diagrams; flexible red leather bound.** A reliable authority and handy helper for every electrical worker. Contains important and valuable wiring diagrams, calculations, machine sketches, helps on maintenance and repair. Use this FREE COUPON today and find out, without obligation, how this handy book will help you in your daily work.

Complete in one handy, red leather bound volume

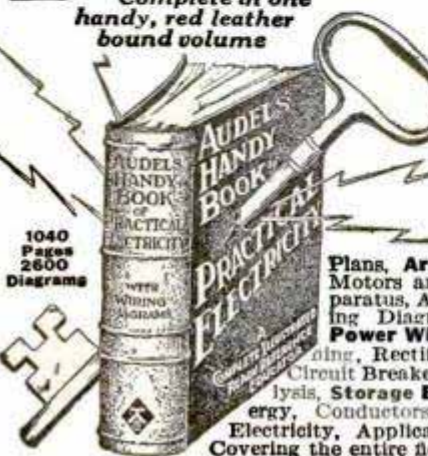

1040 Pages 2600 Diagrams

INSIDE TRADE INFORMATION ON:

Electro-Therapeutics, X-Rays, Shocks, Welding, Brazing, Radio Hook-ups, Motion Pictures, Telephone, Telegraph, Cranes, Bells, Elevators, Pumps, Tools, Ship Drive, Railways, Vehicles, Automobile Electric Systems, Ignition, Generation, Lighting, Plant Management, Power Plans, Armature Winding, Repairing, A. C. Motors and Apparatus, D. C. Motors and Apparatus, Alternator Construction, Dynamos, Wiring Diagrams, Sign Flashers, Cable Splicing, Power Wiring, Outside Wiring, Switches, Lighting, Rectifiers, Converters, Transformers, Fuses, Circuit Breakers, Rheostats, Electro Plating, Electrolysis, Storage Batteries, Magnetism, Electrical Energy, Conductors, Insulators, Static, Dynamic, Radio Electricity, Applications, Ready Reference and Index Covering the entire field of Modern Electricity.

Learn More and You Will Earn More!

Know your job and you'll never be without one. The skilled man is always in demand. Knowledge is power. Learn your trade thoroughly by easy reading. This coupon is your opportunity for advancement and better pay. You risk nothing in sending for Audels Guides for free examination. Send it NOW!

FREE EXAMINATION COUPON

THEO. AUDEL & CO., 65 W. 23 ST., NEW YORK CITY

Please mail me for free examination the books marked (x) below. If I find them satisfactory, I agree to mail \$1 in 7 days, on each set ordered, and to further mail \$1 monthly on each set until I have paid the purchase price.

- 4 CARPENTERS GUIDES \$6 | 4 PLUMBERS GUIDES \$6
 4 MASONS GUIDES \$6 | 1 ELECTRICIANS HANDY BOOK \$4

NAME

ADDRESS

OCCUPATION

EMPLOYED BY..... 5T30

5,000

Radio Service Men Needed Now!

The replacing of the old battery operated receivers with all-electric Radios has created a tremendous country-wide demand for expert Radio Service Men. Thousands of trained men are needed quick!



30 Days of R. T. A. Home Training

enables you to cash in on this latest opportunity in Radio

\$40 to \$100
a week
Full Time
\$3.00 an hour
Spare Time

Ever on the alert for new ways of helping our members make more money out of Radio, the Radio Training Association of America now offers ambitious men an intensified training course in Radio Service Work. By taking this training you can qualify for Radio Service Work in 30 days, earn \$3.00 an hour and up, spare time; prepare yourself for full-time work paying \$40 to \$100 a week.

More Positions Open Than There Are Trained Men to Fill Them

If you were qualified for Radio Service Work today, we could place you. We can't begin to fill the requests that pour in from great Radio organizations and dealers. Members wanting full time positions are being placed as soon as they qualify. 5,000 more men are needed *quick!* If you want to get into Radio, earn \$3.00 an hour spare time or \$40 to \$100

We furnish you with all the equipment you need to become a RADIO Service Man!

a week full time, this R.T.A. training offers you the opportunity of a lifetime.

Radio Service Work a Quick Route to the Big-Pay Radio Positions

Radio Service Work gives you the basic experience you need to qualify for the big \$8,000, \$10,000 to \$25,000 a year Radio positions. Once you get this experience the whole range of rich opportunities in Radio lies open before you. Training in the Association, starting as Radio Service Man, is one of the quickest, most profitable ways of qualifying for rapid advancement. ¶ If you want to get out of small-pay, monotonous work and cash in on Radio quick, investigate this R.T.A. training and the rich money-making opportunities it opens up. No special education or electrical experience necessary. The will to succeed is all you need.

Mail Coupon for No-Cost Training Offer

Cash in on Radio's latest opportunity! Enroll in the Association. For a limited time we will give to the ambitious man a No-Cost Membership which need not . . . should not . . . cost you a cent. But you must act quickly. Filling out coupon can enable you to cash in on Radio within 30 days, lift you out of the small-pay, no-opportunity rut, into a field where phenomenal earnings await the ambitious. You owe it to yourself to investigate. Fill out coupon NOW for details of No-Cost Membership.

The Radio Training Association of America
4513 Ravenswood Ave., Dept. PM-5 Chicago, Ill.

The Radio Training Association of America
4513 Ravenswood Ave., Dept. PM-5 Chicago

Gentlemen: Please send me details of your No-Cost training offer by which I can qualify for Radio Service Work within 30 days. This does not obligate me in any way.

Name _____

Address _____

City _____ State _____

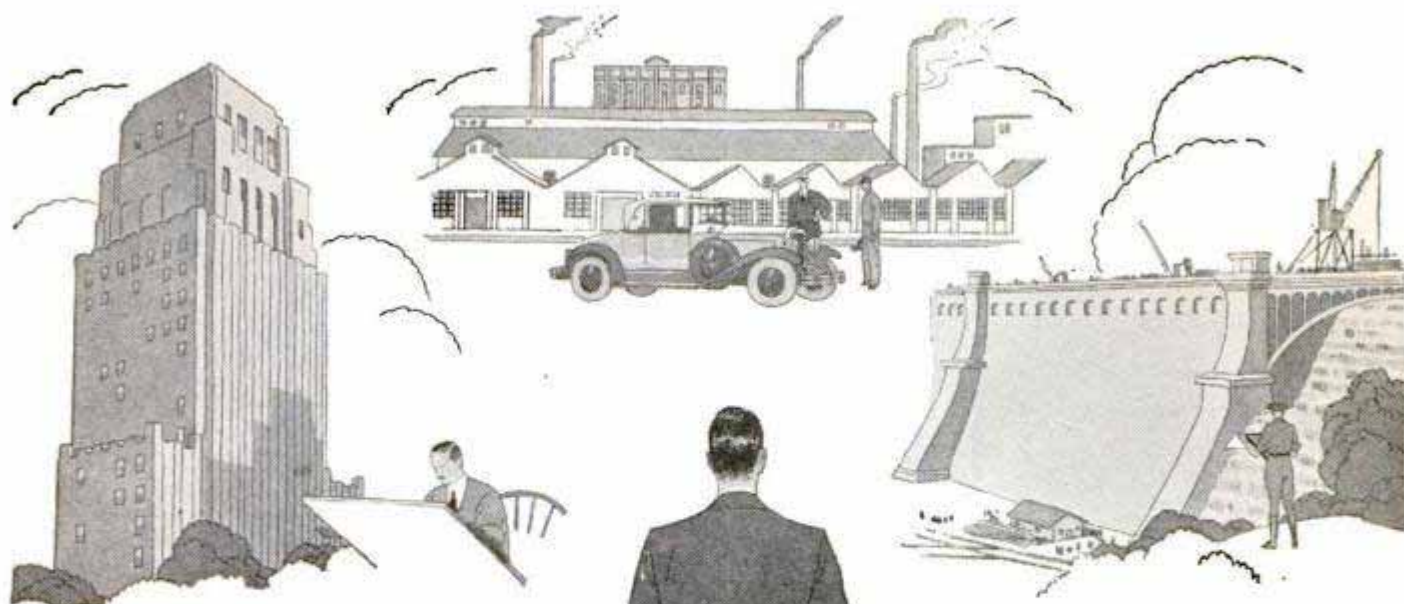

Better Men than You?

A BACKWOODS BOY who could barely read and write studied with the International Correspondence Schools and became one of the foremost architects of his state.

A laundry employee spent his evenings in home study with the I. C. S. and is now a famous builder of hydro-electric plants.

A railroad worker took the International Correspondence Schools course in Mechanical Engineering, and his name today is one of the greatest in the automobile world.

Thousands upon thousands of men have risen to better jobs and bigger salaries as a result of I. C. S. instruction. What did they have, that you haven't? Better minds? More education? More money? More courage? Not for a minute. All that they have done, you can do.

You *can*. But *will* you?

It costs nothing to find out how the I. C. S. can train you, in spare time, for a well-paid position in the work you like best. Mark and mail the coupon today!

INTERNATIONAL CORRESPONDENCE SCHOOLS, Box 5680-F, Scranton, Penna.

"The Universal University"

Without cost or obligation on my part, please send me a copy of your 48-page booklet, "Who Wins and Why," and tell me how I can qualify for the position, or in the subject, before which I have marked an X:

BUSINESS TRAINING COURSES

- | | | | |
|---|--|---|---|
| <input type="checkbox"/> Business Management | <input type="checkbox"/> Cost Accounting | <input type="checkbox"/> Business Correspondence | <input type="checkbox"/> Mail Carrier |
| <input type="checkbox"/> Industrial Management | <input type="checkbox"/> Bookkeeping | <input type="checkbox"/> Show Card and Sign Lettering | <input type="checkbox"/> Railway Mail Clerk |
| <input type="checkbox"/> Personnel Management | <input type="checkbox"/> Secretarial Work | <input type="checkbox"/> Stenography and Typing | <input type="checkbox"/> Grade School Subjects |
| <input type="checkbox"/> Traffic Management | <input type="checkbox"/> Spanish <input type="checkbox"/> French | <input type="checkbox"/> English | <input type="checkbox"/> High School Subjects |
| <input type="checkbox"/> Accounting and C.P.A. Coaching | <input type="checkbox"/> Salesmanship | <input type="checkbox"/> Civil Service | <input type="checkbox"/> Illustrating <input type="checkbox"/> Cartooning |
| | <input type="checkbox"/> Advertising | | <input type="checkbox"/> Lumber Dealer |

TECHNICAL AND INDUSTRIAL COURSES

- | | | | |
|--|--|---|--|
| <input type="checkbox"/> Architect | <input type="checkbox"/> Telegraph Engineer | <input type="checkbox"/> Aviation Engines | <input type="checkbox"/> Pharmacy |
| <input type="checkbox"/> Architectural Draftsman | <input type="checkbox"/> Telephone Work | <input type="checkbox"/> Plumber and Steam Fitter | <input type="checkbox"/> Mining Engineer |
| <input type="checkbox"/> Building Foreman | <input type="checkbox"/> Mechanical Engineer | <input type="checkbox"/> Plumbing Inspector | <input type="checkbox"/> Navigation <input type="checkbox"/> Assayer |
| <input type="checkbox"/> Concrete Builder | <input type="checkbox"/> Mechanical Draftsman | <input type="checkbox"/> Foreman Plumber | <input type="checkbox"/> Iron and Steel Worker |
| <input type="checkbox"/> Contractor and Builder | <input type="checkbox"/> Machine Shop Practice | <input type="checkbox"/> Heating and Ventilation | <input type="checkbox"/> Textile Overseer or Supt. |
| <input type="checkbox"/> Structural Draftsman | <input type="checkbox"/> Toolmaker | <input type="checkbox"/> Sheet-Metal Worker | <input type="checkbox"/> Cotton Manufacturing |
| <input type="checkbox"/> Structural Engineer | <input type="checkbox"/> Patternmaker | <input type="checkbox"/> Steam Engineer | <input type="checkbox"/> Woolen Manufacturing |
| <input type="checkbox"/> Electrical Engineer | <input type="checkbox"/> Civil Engineer | <input type="checkbox"/> Marine Engineer | <input type="checkbox"/> Agriculture |
| <input type="checkbox"/> Electrical Contractor | <input type="checkbox"/> Surveying and Mapping | <input type="checkbox"/> Refrigeration Engineer | <input type="checkbox"/> Fruit Growing |
| <input type="checkbox"/> Electric Wiring | <input type="checkbox"/> Bridge Engineer | <input type="checkbox"/> R. R. Positions | <input type="checkbox"/> Poultry Farming |
| <input type="checkbox"/> Electric Lighting | <input type="checkbox"/> Gas Engine Operating | <input type="checkbox"/> Highway Engineer | <input type="checkbox"/> Mathematics |
| <input type="checkbox"/> Electric Car Running | <input type="checkbox"/> Automobile Work | <input type="checkbox"/> Chemistry | <input type="checkbox"/> Radio |

Name..... Street Address.....

City..... State..... Occupation.....

If you reside in Canada, send this coupon to the International Correspondence Schools Canadian, Limited, Montreal, Canada

Hawaiian Guitar

GIVEN

to our Students

This Hawaiian Guitar expert and professor wants the opportunity to welcome you as a student so you will quickly learn how to play a Hawaiian Guitar—yes, you will be able to play just like the native Hawaiians. To get you started and help your musical success, which will bring you popularity, you will receive a beautiful Hawaiian Guitar, the same as the one pictured, when you enroll. Our short cut method of instruction will enable you to play a piece almost from the first lesson. Rush coupon for full particulars today and we will reserve a Hawaiian Guitar for you.



Worth \$20

Learn to Play Quickly

With our short cut method of instruction you will quickly learn how to play Hawaiian Guitar, which will bring you popularity and social success. You learn to play from notes. If you never had any musical training, you will quickly get on, because our experts have perfected a course of home instruction which is as simple as learning A, B, C's.



PICTURE and PHONOGRAPH RECORD METHOD EASY We don't depend upon printed lessons only for your success, but we furnish pictures of our professors playing, diagrams, charts and phonograph records for each lesson. This practically brings our professors from our studio to your home and enables you to listen to their playing just as if they were actually in front of you. To prove this is easy, we will send you your first lesson free.

RUSH COUPON—Send No Money

So positive are we that you will become one of our students, we will send free, without obligation, our first lesson. Also receive our free big book which gives particulars about our course. Write for your free book and your free lesson today.

HAWAIIAN STUDIO No. 52050, of New York Academy of Music, 100 Fifth Avenue, New York, N. Y.

Please rush your free book, "How to Learn Hawaiian Guitar," and my first free lesson. Also reserve a Hawaiian Guitar for me. This obligates me in no way whatever.

Name.....

Address.....

ALWAYS A DEMAND for Skilled Tree Experts

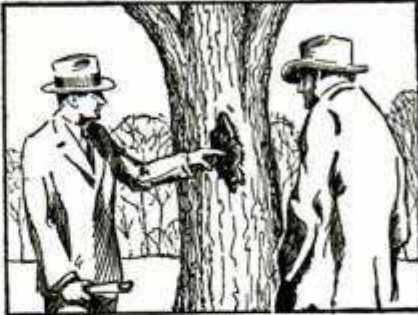

The only method that restores Tree Health NATURE'S WAY

Big money—opportunities both in America and abroad. Anyone can learn. Little spare time home study. City park departments, private estates, forestry companies, telephone companies, fruit growers, tree surgery companies need trained tree experts at all times. Profitable healthy work. Write.

VAN YAHRES TREE SURGERY SCHOOL
Dept. P., Westbury, New York

COLLEGE COURSES

AT HOME



Carry on your education. Develop power to initiate and achieve. Earn credit toward a Bachelor degree or Teaching Certificate by correspondence. Select from 450 courses in 45 subjects, including English, Mathematics, History, Education, Psychology, Economics, the Languages, etc. Write for catalog.

The University of Chicago

427 ELLIS HALL

CHICAGO, ILL.

Learn to PAINT SIGNS and SHOW CARDS

We quickly teach you by mail, or at school, in spare time. Enormous demand. Big future. Interesting work. Oldest and foremost school.

EARN \$50 TO \$200 WEEKLY

Otto Wiegand, Md., home-study graduate, made \$12,000 from his business in one year. John Vascoe, N.Y., gets \$25 for a show card. Crawford, B. C., writes: "Earned \$200 while taking course." Write for complete information.

DETROIT SCHOOL OF LETTERING
154 Stimson Ave. Est. 1899 Detroit, Mich.



WORLD NEEDS PLUMBERS

Old style plumbers are fading like the horse and buggy. The world demands modern Plumbing and Skilled Trained Mechanics to do it. Unlimited, swift growing field. Make \$50 to \$100 a week or start own shop. We train you quick. Learn in 8 to 12 WEEKS to do any job with skill and science. Need no previous experience. Strictly tool using system. Opportunity knocks. Investigate today—amazing offer—low tuition. World's greatest school.

Write—

UNIVERSAL PLUMBING SCHOOL
2130 Troost Ave. Kansas City, Mo.



Learn Watchwork, Jewelrywork and Engraving

A fine trade commanding a good salary, and your services always in demand. Address **Horological**, Dept. P, Bradley Institute, PEORIA, ILLINOIS, for our latest catalog.

GOV'T. POSITIONS

\$35 TO \$75 WEEKLY

- | | | |
|----------------------|-------------------------|-------------------------|
| NEW MEN WOMEN | () Ry. Mail Clerk | () Steno-Typist |
| | () Prohibition Agent | () Immigrant Inspector |
| | () R. F. D. Carrier | () Seamstress |
| | () Special Agent | () Auditor |
| | () (Customs Inspector) | () Steno-Secretary |
| | () City Mail Carrier | () U. S. Border Patrol |
| | () Meat Inspector | () Chauffeur-Carrier |
| | () P. O. Clerk | () Watchman |
| | () File Clerk | () Skilled Laborer |
| | () General Clerk | () Postmaster |
| () Matron | () Typist | |

MENT INSTRUCTION BUREAU, 111 Arcade Bldg., St. Louis, Mo. Send me FREE particulars How To Qualify for positions marked "X". Salaries, locations, opportunities, etc. ALL SENT FREE.

NAME.....
ADDRESS.....

AGE 18 TO 55



**Fellows I Have
Trained Will Tell
You That You,
Too, Can Cash
In On**

ELECTRICITY

Not By Correspondence

"First I enrolled with a School teaching Electricity by correspondence. I tried to work out several lessons, but quit when I saw your ad telling how you taught Electricity by actual work. I didn't have much money when I went to Coyne, but through your Employment Department I was able to work for my room and board. Three days after graduating you got me a good job with a Battery and Electric Shop, and a year later I bought a Shop of my own. I now have a \$1300 car and a thriving business—all paid for."

George W. Stoneback, Illinois.

Lands a Job at \$8,000 a Year

"Before going to Coyne, I was an ordinary mechanic. Now I make \$300.00 a month, and am accepting a new position the first of the year as Chief Electrician at \$8,000 a year. Any man who works for me will have to be a Coyne graduate."

Stanley Zurawski, Michigan.

From \$20.00 a Week to \$100.00 a Week

"Before going to Coyne, I had worked in a garage for five years at \$20.00 a week. I had no advanced education and didn't know a volt from an ampere. Yet I graduated in three months with a grade of 98%. Since I left Coyne, I have jumped from \$20.00 to \$100.00 a week, and am still going strong. I owe all my success to the practical training I got in the Coyne Shops."

Harry A. Ward, Iowa.

"I knew nothing about Electricity, before I went to Coyne," says Nolan H. McCleary. "I had no advanced education and so little money that I could never have stayed at school, if Mr. Lewis hadn't gotten me a part-time job. Yet I finished the course in twelve weeks, and the School immediately placed me in a fine electrical job. Now I am Chicago District Manager of the largest electrical concern of its kind in the world."



NOLAN H. McCLEARY
Chicago District Manager
Beardsley-Wolcott Co.

making more money than I ever dreamed of making before I went to Coyne. I am convinced that there is but ONE RIGHT WAY to learn electricity and that is the way of the Coyne School—BY DOING ACTUAL ELECTRICAL WORK YOURSELF UNDER EXPERT INSTRUCTORS, ON FULL-SIZE, RUNNING ELECTRICAL MACHINERY AND EQUIPMENT."

For thirty years Coyne has been training men for responsible, Big-Pay electrical jobs—NOT BY BOOKS OR CORRESPONDENCE, but by an amazing method that teaches you practical Electricity in 90 days. You need no advanced education or previous experience. I don't care if you don't know an armature from a generator; if you're sixteen years old or forty. IT MAKES NO DIFFERENCE! I will prepare you for a fascinating, Big-Pay electrical job in twelve weeks' time. I will allow you your railroad fare to Chicago—help you get part-time work while at school—and give you every assistance in locating just the job you want when you graduate.

Says You Can Make \$60.00 to \$200.00 a Week

Before going to Coyne, I made 30 cents an hour. I borrowed the money for my tuition and you got me a part time job that took care of my expenses. I graduated in twelve weeks, returned home and started doing wiring on contract. In a year's time, I had paid for my schooling, bought a car and had a nice shop of my own. In your catalog you say a fellow can make \$60.00 to \$200.00 a week. I have done better. In July I made \$150.00 to \$200.00 a week and I have made as high as \$75.00 a day."

Joseph F. Hartley, West Virginia.

His Advice— "Go To Coyne"

"Some fellows try to learn Electricity by just working at it. Others send away for correspondence courses in it. But my advice to anyone who really wants to learn Electricity is TO GO TO COYNE. They have all the electrical equipment right in the school that you will ever see in the field. NO PICTURES OR USELESS THEORY. They show you just how to do everything you will have to do on the job." R. M. Ayers, Louisiana.

Nothing Compares to Practical Training

"Before going to Coyne, I took a correspondence course in Electricity, but it was too deep for me and I lost interest. Then I got your catalog, saw how you let the student actually work on electrical equipment, and decided to go to Coyne. At that time I was only making \$9.00 a week. Now I make \$68.00 a week straight time, have a Hudson car and own my home—where before I could hardly pay rent." D. G. Emmerson, Michigan.

Let me send you the same Big Free Book that brought success and Big Pay to all these men—Simply mail the coupon

Find out how QUICKLY and EASILY you can land a Big-Pay Electrical Job! IT COSTS NOTHING TO INVESTIGATE! Just mail the coupon and let me send YOU the same Big Free Book that started all these other fellows on the road to success. This doesn't cost you a cent, nor does it obligate you in any way. GET THE FACTS. Mail the coupon—NOW!

COYNE ELECTRICAL SCHOOL
H. C. LEWIS, President Founded 1899
500 S. Paulina Street Dept. 50-72 Chicago, Illinois

MAIL THIS COUPON NOW!

COYNE ELECTRICAL SCHOOL, H. C. Lewis, Pres.
500 S. Paulina St., Dept. 50-72, Chicago, Ill.

Dear Mr. Lewis:—Without obligation send me your big free catalog and all details of Railroad Fare to Chicago, Free Employment Service, Radio, Aviation Electricity, and Automotive Courses, and how I can "earn while learning."

Name

Address

City State



High School Course in Two Years!

You Want to Earn Big Money!

And you will not be satisfied unless you earn steady promotion. But are you prepared for the job ahead of you? Do you measure up to the standard that insures success? For a more responsible position a fairly good education is necessary. To write a sensible business letter, to prepare estimates, to figure cost and to compute interest, you must have a certain amount of preparation. All this you must be able to do before you will earn promotion. Many business houses hire no men whose general knowledge is not equal to a high school course. Why? Because big business refuses to burden itself with men who are barred from promotion by the lack of elementary education.

Can You Qualify for a Better Position

We have a plan whereby you can. We can give you a complete but simplified high school course in two years, giving you all the essentials that form the foundation of practical business. It will prepare you to hold your own where competition is keen and exacting. Do not doubt your ability, but make up your mind to it and you will soon have the requirements that will bring you success and big money. YOU CAN DO IT.

Let us show you how to get on the road to success. It will not cost you a single working hour. Write today. It costs you nothing but a stamp.

American School

Dept. H-547 Drexel Ave. and 58th St., Chicago

American School

Dept. H-547 Drexel Ave. and 58th St., Chicago
Send me full information on the subject checked and how you will help me win success.

- | | |
|-----------------------------|---------------------------|
|Architect |Business Law |
|Building Contractor |Lawyer |
|Automobile Engineer |Machine Shop Practice |
|Automobile Repairman |Mechanical Engineer |
|Civil Engineer |Shop Superintendent |
|Structural Engineer |Employment Manager |
|Business Manager |Steam Engineer |
|Cert. Public Accountant |Foremanship |
|Accountant and Auditor |Sanitary Engineer |
|Bookkeeper |Surveyor (& Mapping) |
|Draftsman and Designer |Telephone Engineer |
|Electrical Engineer |Telegraph Engineer |
|Electric Light & Power |High School Graduate |
|General Education |Wireless Radio |
|Vocational Guidance |Undecided |

Name.....

Address

LEARN the BANJO at Home under HARRY RESER the World's Greatest Banjoist



The Famous Leader of the Widely Broadcasted

CLICQUOT CLUB ESKIMOS

offers an amazingly simple Banjo Course by mail which anyone, even without musical talent, can master at home in a few spare hours. Positions, fingering and chords thoroughly illustrated and explained. Students and Professionals heartily endorse this Simplified Home Method. Costs only few cents a day. Special Banjos for Students.

BE POPULAR—MAKE MONEY

At home, parties, or week-end gatherings, the banjo player has many friends. Also, the banjo is vitally essential in the dance orchestra of today. Banjoists make big money. Learn more about this inexpensive course.

Send for my FREE ILLUSTRATED BOOKLET

HARRY RESER, Banjo Studio No. 23
148 West 46th Street, New York, N. Y.

Harry Reser
famous radio entertainer, phonograph recording artist, teacher of Tenor Banjo, orchestra leader and composer of banjo music, guarantees your success or money back.



I Teach by Mail

Begin Today—Write for My FREE Book, I can make a good penman of you at home during spare time. Write for my FREE BOOK "How to Become a good Penman." It contains specimens and tells how others mastered penmanship by the Tamblin System. Your name will be elegantly written on a card if you enclose stamp to pay postage. Write today for book. F. W. Tamblin, 418 Ridge Bldg., Kansas City, U.S.A.

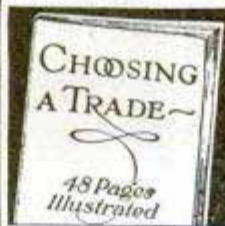

SENT ON REQUEST

Helpful discussion of this important problem and of fastest growing of Mechanical Trades—Mechanical Dentistry. Easily learned. Of interest to men of all ages. Send for Bulletin 2.

BODEE INSTITUTE

1755 Broadway, New York
1305 N. Broad St., Philadelphia
85 Court St., Brooklyn

BE AN ARTIST

WE CAN TEACH YOU DRAWING in

your own home during your spare time. Twenty-five years of successful teaching proves our ability. Artists receive large salaries.

Write Today for Art Year Book

SCHOOL OF APPLIED ART
ROOM NO. 2 BATTLE CREEK MICH.



IF YOU STAMMER

Write for my free book "Millard's Advanced Natural Corrective Course" and a free copy of my speech magazine. 10,000 cases successfully treated. Est. 24 years. Largest school for stammerers in world. Millard Inst. of Normal Speech, 2317 Millard Bldg., Milwaukee, Wis.

Study LAW AT HOME

Lincoln did it! Also thousands of other great lawyers, politicians and business men. YOU, too, can become a lawyer or law trained businessman through home study guided by the successful practicing lawyers of our faculty. Write today for free book.

AMERICAN CORR. SCHOOL OF LAW
3601 Michigan Ave., Dept. 1355, Chicago

Learn Photography at HOME

Make money taking pictures. Prepare quickly during spare time. Also earn while you learn. No experience necessary. New easy method. Nothing else like it. Send at once for free book, OPPORTUNITIES IN MODERN PHOTOGRAPHY and full particulars

AMERICAN SCHOOL OF PHOTOGRAPHY
Dept. 1355 3601 Michigan Ave. Chicago, U. S. A.

3 BIG PAY FIELDS

Learn ELECTRICITY A BIG PAY JOB

Electricity and Radio now pays hundreds of trained men \$60, \$75, \$100, up to \$200 a week. The world's Greatest businesses. Billions—not millions—but billions of dollars are spent in them yearly. Now is the time to get away from low pay!

Learn in Only 3 Months in Great Greer Shops on Real Equipment

Mine is not a correspondence course. You start any day or any evening. It is practical, easy, quick, fascinating training. You learn on great, running live equipment in tremendous Greer Shops. Electricity is the fastest growing industry in the world—Radio a close second, and yet in its infancy, is a billion dollar industry. Trained men by scores needed for positions up to \$250 a week. Find out now about my great shops training.

You Get Real Help to Big Jobs

My big Employment Department gets jobs for Greer men. You get this help before and after graduation. Don't let money hold you back. Get my free book. Learn how I get you ready so Employers gladly pay you what you are worth.

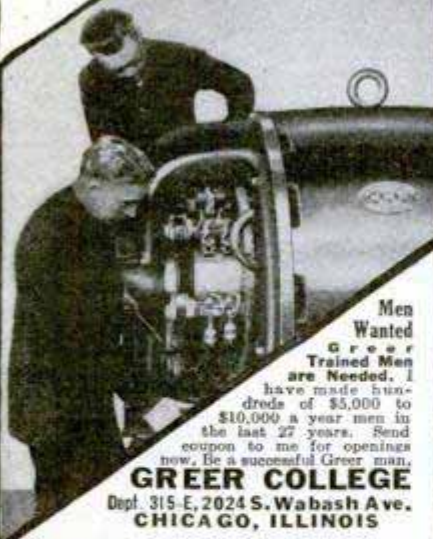

Men Wanted Greer Trained Men are Needed. I have made hundreds of \$5,000 to \$10,000 a year men in the last 27 years. Send coupon to me for openings now. Be a successful Greer man.

GREER COLLEGE
Dept. 315-E, 2024 S. Wabash Ave.
CHICAGO, ILLINOIS

FREE Electrical Book

Erwin Greer, President,
Dept. 315-E, 2024 So. Wabash Ave.,
Chicago, Illinois.

Send Free Book and details of Special offer, without obligation to me.

Name.....
Address.....
State..... Age.....

Big Money in AUTOS

OWN YOUR OWN BUSINESS

Be your own boss. Learn it all. Big men draw big money because they know the whole business. You can't make big money by just doing one single little thing. Factories pay a very ordinary salary to "Jones" who screws on nut number 39, because they can quickly teach someone else to do it just as well.

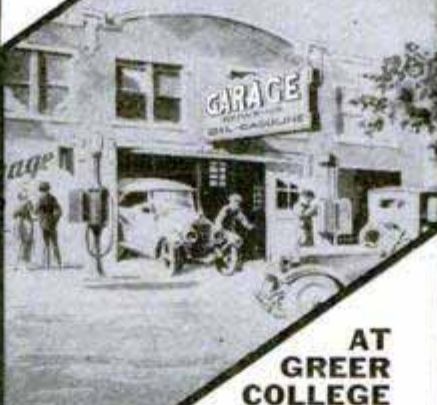

AT GREER COLLEGE

you learn how to boss the job.

Quickest, Easiest of Ways to Become Expert

I'll allow your fare here free of extra cost, then help you to a job while learning. Then I not only fit you to get a big pay job, but I'll help you hold it. Young and old, educated and uneducated, experienced and inexperienced, have found Greer Shops training easy, fascinating and valuable. You learn on big, actual full size equipment like you will work on out on the big pay job. Coupon below brings details. Don't delay! Get my free book now!

GREER COLLEGE
Dept. 315-A, 2024 S. Wabash Ave.
CHICAGO, ILLINOIS

FREE Auto Book

Erwin Greer, President,
Dept. 315-A, 2024 So. Wabash Ave.,
Chicago, Illinois.

Send Free Book and details of Special offer, without obligation to me.

Name.....
Address.....
State..... Age.....

Get into AVIATION

You know the vast opportunities. Greer offers the way to get them. Now is the time.

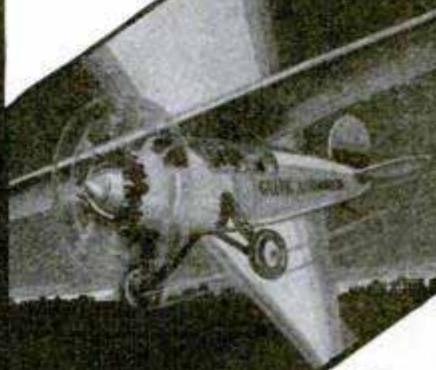

You Learn to Fly by Flying

The 27 years' growth of Greer College, thru genuine service, speaks for itself. From 1902, to the present tremendous plant including three modern buildings and three airports in the Chicago area. Real endorsement by satisfied students and graduates have made this possible. Aviation enthusiasts come to marvel at the tremendous outlay of motors, planes, instruments, wood and metal working equipment, welding and ignition shops. Many more have come to consult our Chief Aviation Engineer, C. L. Laird, regarding airplane design and construction.

Get My Free Book "Winning Your Wings"

Learn how my students prepare for amazing opportunities in this most fascinating and alluring profession—Aviation. Learn about my great shop and field training. Rates are reasonably low because of our large enrollment. Mail the coupon below for full details of my free employment offer and the many ways I help you to pilot's and mechanic's license.

Now All Can Learn to Fly
My shop training plan equips you for any branch of Aviation. Get the details today.

GREER COLLEGE
Dept. 315, 2024 S. Wabash Ave.
CHICAGO, ILLINOIS

FREE Aviation Book

Erwin Greer, President,
Dept. 315, 2024 So. Wabash Ave.,
Chicago, Illinois.

Send Free Book and details of Special offer, without obligation to me.

Name.....
Address.....
State..... Age.....



He Kept the Job He Liked

—and increased his salary 73%

W. A. Day, of Woonsocket, R. I., wanted more money. But he liked his job—didn't want to change—made up his mind to get more money *right where he was*.

That meant that he must make himself worth more money to his employer—and that, in turn, meant training.

His first step was to enroll with LaSalle for home-study training in Higher Accountancy. Four months later he enrolled also for training in Modern Business Correspondence. Two years later he had completed both courses, had enlisted the aid of LaSalle in preparing for C. P. A. examinations, and was pursuing a LaSalle elective in Construction Company Accounting. More recently he enrolled for LaSalle training in Business Management.

"I entered upon the study of these courses," writes Mr. Day, "with the sole idea of increasing my business knowledge for the benefit of my own particular firm and with the desire to lay a foundation for the future. In this I am sure that I have succeeded. In actual results I have received a salary increase of exactly 73.3% since the date of my first enrollment, but I consider this equal to 100% in the average case, for I have earned this increase without changing my position."

Send for Salary-Doubling Plan

Are you in earnest when you say that you want to get ahead?

Then send today for full particulars of the LaSalle Salary-Doubling Plan. The coupon brings it to you free, together with a 64-page book setting forth the opportunities in the business field in which you most prefer to win success. *This book shows you how you can quickly turn those opportunities to your advantage.*

"Tomorrow" means "next week"—"next month"—never! Clip and mail the coupon NOW!

— Find Yourself Thru LaSalle! —

LA SALLE EXTENSION UNIVERSITY

The World's Largest Business Training Institution
Dept. 564-R Chicago

I should be glad to learn about your salary-doubling plan as applied to my advancement in the business field checked below. Send also copy of "Ten Years' Promotion in One," all without obligation.

- Business Management
- Higher Accountancy
- Modern Salesmanship
- Traffic Management
- Railway Station Management
- Law—Degree of LL.B.
- Commercial Law
- Industrial Management
- Modern Foremanship and Production Methods
- Personnel and Employment Management

- Banking and Finance
- Modern Business Correspondence and Practice
- Expert Bookkeeping
- C. P. A. Coaching
- Business English
- Commercial Spanish
- Effective Speaking



Name

Present Position

Address

ENGINEERING IN 2 YEARS



B. S. degree in Aeronautical, Civil, Electrical, Mechanical, Chemical and Administrative Engineering. Intensive courses, half usual time. Students who left high-school can make up work. Living costs and tuition low. Enter classes Sept., Jan., March or June.

Ask for catalog.

450 College Street, ANGOLA, INDIANA

TRI-STATE COLLEGE

HOT PIANO

Ultra-modern Piano



Jazz taught by mail. Note or ear. Easy rapid lessons for adult beginners. Also Self-instruction system for advanced pianists. Learn 358 Bass Styles, 976 Jazz Breaks, hundreds of Trick Endings, Hot Rhythms, Sock, Stomp and Dirt Effects; Symphonic and Wicked Harmony in latest Radio and Record Style. Write for Free Booklet.

WATERMAN PIANO SCHOOL, 1826 W. Adams St., Los Angeles, Calif.

LEARN WATCH REPAIRING



You can learn by our modern and original system of instruction every part of the **Watch Repairing Trade** at home as good or better than at a shop. You can earn money while learning and secure a well paying position or start in business after completing our course of instruction. Good watch repairers are always in demand and earn from \$50 to \$75 per week. For particulars apply to the **Wisconsin School of Watch Repairing** 166 Mason St., MILWAUKEE, WIS.

Make Big Money! Learn Autos



AT HOME Say good-by to low pay. Send for FREE Auto Book. See how I train you easily and quickly at home, in spare time for a JOB paying up to \$75 a week in Auto Business, where extra money, big pay and raises come QUICK! Read about my Employment Service, Aviation Course, and other features you get. Write today! B. W. Cooke, Directing Engineer Motor Institute of America, Dept. 3165 Motor Institute Building, Evanston, Illinois

Learn Advertising at HOME

Send your name and address for free booklet giving interesting information and vital facts about Advertising. Find out how we prepare you at home, in your spare time, for the opportunities open in this fascinating business. Practical work. No text books. Old established school. Successful graduates everywhere. Just the plan you have always wanted. Write today. No obligation.

PAGE-DAVIS SCHOOL OF ADVERTISING
Dept. 1355 3601 Michigan Ave. Chicago, U. S. A.

BE AN OIL EXPERT!

Trained geologists, drillers, refiners, salesmen are at a premium! New, easy, practical way to learn at home in spare time! Write Today! FREE Book!

PETROLEUM ENGINEERING UNIVERSITY, Dept. 225, FORT WAYNE, IND.

WELDING—The Busy Big-Pay Trade

We teach ambitious men by actual welding practice.

—OXY-ACETYLENE and ELECTRIC ARC—
Pipe-line, Sheet Steel, Structural Steel, Aircraft, Cast-Iron, Aluminum and Commercial Welding. Cutting, Brazing and Plating. Splendidly Equipped to Teach You Right Rapidly and at Reasonable Rates

A Free Booklet for You—Write for It Now.

COLEMAN ELECTRICAL SCHOOL, 1628-X Main Street KANSAS CITY, MO.

How Strong Are You?

Can You Do These Things?

Lift 200 lbs. or more overhead with one arm; bend and break a horseshoe; tear two decks of playing cards; bend spikes; chin yourself with one hand.

CAN you do any of them? I can and many of my pupils can. It is remarkable the things a man really can do if he will make up his mind to be strong. It is natural for the human body to be strong. It is unnatural to be weak. I have taken men who were ridiculed because of their frail make-up and developed them into the strongest men of their locality.

I Want You for 90 Days

These are the days that call for speed. It once took four weeks to cross the ocean—now it takes less than one. In olden days it took years to develop a strong, healthy body. I can completely transform you in 90 days. Yes, make a complete change in your entire physical make-up. In 30 days I guarantee to increase your biceps one full inch. I also guarantee to increase your chest two inches. But I don't quit there. I don't stop till you're a finished athlete—a real strong man. I will broaden your shoulders, deepen your chest, strengthen your neck. I will give you the arms and legs of a Hercules. I will put an armor plate of muscle over your entire body. But with it come the strong, powerful lungs which enrich the blood, putting new life into your entire being. You will be bubbling over with strength, pep and vitality.

A Doctor Who Takes His Own Medicine

Many say that any form of exercise is good, but this is not true. I have seen men working in the factories and mills who literally killed themselves with exercise. They ruined their hearts or other vital organs, ruptured themselves or killed off what little vitality they possessed.

I was a frail weakling myself in search of health and strength. I spent years in study and research, analyzing my own defects to find what I needed. After many tests and experiments, I discovered a secret of progressive exercising. I increased my own arms over six and a half inches, my neck three inches and other parts of my body in proportion. I decided to become a public benefactor and impart this knowledge to others. Physicians and the highest authorities on physical culture have tested my system and pronounced it to be the surest means of acquiring perfect manhood. Do you crave a strong, well proportioned body and the abundance of health that goes with it? Are you true to yourself? If so, spend a pleasant half hour in learning how to attain it. The knowledge is yours for the asking.

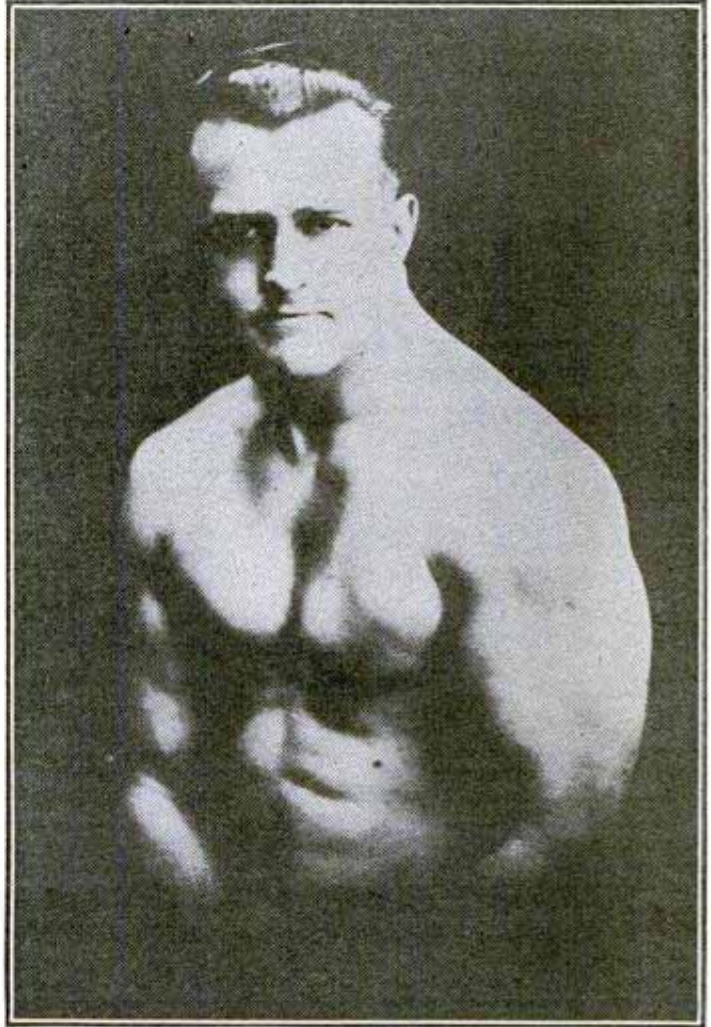

EARLE LIEDERMAN, The Muscle Builder

Author of "Science of Wrestling," "Muscle Building," "Secrets of Strength," "Here's Health," "Endurance," Etc.

SEND FOR
MY NEW
64-PAGE BOOK

"Muscular Development"

IT IS
FREE

It contains forty-eight full page photographs of myself and some of the many prize winning pupils I have trained. Some of these came to me as pitiful weaklings, imploring me to help them. Look them over now, and you will marvel at their present physiques. This book will prove an impetus and a real inspiration to you. It will thrill you through and through. This will not obligate you at all, but for the sake of your future health and happiness, do not put it off. Send today—right now, before you turn this page.

EARLE LIEDERMAN
DEPT. 2005 305 BROADWAY, N. Y. CITY

EARLE LIEDERMAN,
Dept. 2005, 305 Broadway, New York City

Dear Sir:—Please send me without any obligation on my part whatever, a copy of your latest book, "Muscular Development." (Please write or print plainly.)

Name..... Age.....

Street.....

City..... State.....

Learn Electricity IN LOS ANGELES

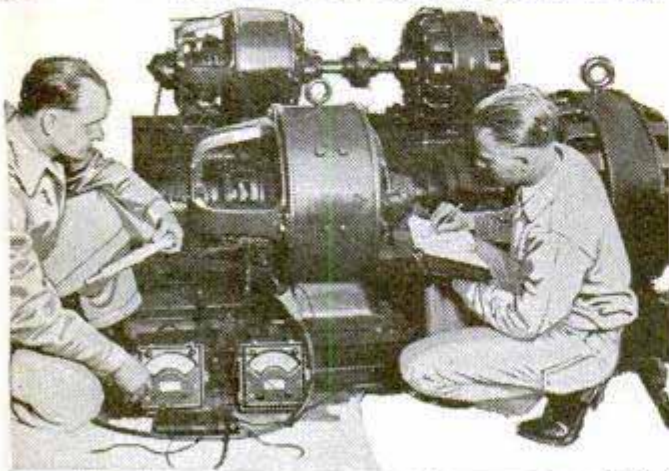

and LEARN IT RIGHT!

1. What Kind of a School Is NATIONAL?

NATIONAL is a Million Dollar institution—established in 1905—recognized throughout the electrical industry as one of America's foremost trade schools. NATIONAL offers practical, intensive training in all electrical branches. All technical essentials included. No age limit. No previous experience necessary. Life Scholarship privileges. Start any time of the year.

2. How Long to Learn Electricity?

NATIONAL properly trains you in the short time of 6 to 9 months. Upon completing this Condensed Course you are fully qualified as a Practical, Competent Electrician, and you have not risked your chances of employment because of inferior, incomplete instruction.

3. What Employment Service Does NATIONAL Guarantee?

NATIONAL GUARANTEES to give unlimited and efficient Employment Service to students wishing to earn living expenses while learning; and to graduates getting started in the electrical field. This is the most any reputable school can be expected to do.

4. What Inducements Does NATIONAL Offer?

NATIONAL offers YOU the very best technical-practical training that money can buy at a cost within every man's reach. It does not offer to pay your railroad fare, room and board or other personal expenses, preferring to limit its activities to the PROPER TRAINING OF MEN FOR SUCCESS.

5. Why You Should Come to LOS ANGELES!

LOS ANGELES is the heart of the country's most rapid electrical development—as well as the world's most ideal city in which to live and prepare for success in electricity

WRITE for FREE BOOK NOW!

NATIONAL Electrical School

Dept. 543, 4006 Figueroa St., Los Angeles, California.

Send me your big free illustrated catalog of Electrical Opportunities showing how I can learn quickly and get a Big-Pay Electrical Job.

Name.....

Address.....

Age..... City..... State.....



IF—



you pledge yourself to secrecy we will teach you the secrets of real professional

Magic

\$250 to \$1000 a Month

For the first time in the history of Magic the age-old sacredly guarded secrets of the Mystic Art are being revealed. Now at last you can learn to be a Real Professional Magician. Yes, and you can learn this wonderful art easily and quickly AT HOME. You are taught the guarded secrets of the Magic Profession. But before you study, you must sign Magician's Solemn Pledge of Secrecy.

WRITE Send for Details!

Send today for free literature telling all about amazing NEW Course in Magic. Get our Low Prices, Easy Terms. Write today stating your age.

Tarbell System, Inc., Dept. 13-55
1926 Sunnyside Ave., Chicago, Ill.

You can be quickly cured, if you

STAMMER

Send 10 cents for 288-page book on Stammering and Stuttering. "Its Cause and Cure." It tells how I cured myself after stammering 20 yrs. B. N. Bogue, 11129 Bogue Bldg., 1147 N. Illinois St., Indianapolis.

It's a GUITAR!

BE popular with today's most favored instrument, the sweet-toned Gibson. You hear it everywhere, on the radio, records, in vaudeville and ballrooms. EASY to learn; you play tunes quickly. Play and sing together; just with "her," or with the crowd.

You'll have the spotlight!



Gibson

GUITARS - MANDOLINS BANJOS and UKULELES

Carson Robison, pictured here, and many other famous radio and record stars use Gibsons, the "Music Pals of the Nation."

FREE Trial; Easy Payments. Send the coupon for complete information and copy of the Free Book "The Road to Happiness." Check the instrument which interests you.



GIBSON, INC., 503 Parsons St., Kalamazoo, Mich.

Please send free book and details of trial offer on instrument checked.

Name.....

St. or R. F. D.....

City, State.....

GUITAR BANJO MANDOLIN UKULELE

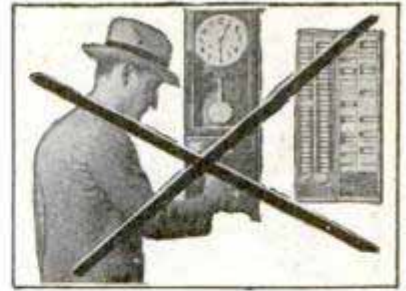
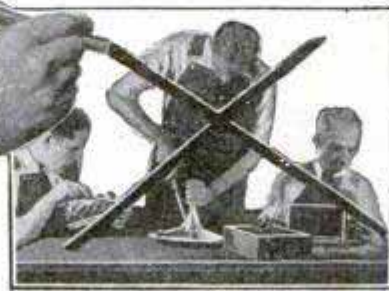
**LOW PAY****LONG HOURS****NO FUTURE****PINCHING PENNIES**

Life Began Over Again for Me

..when I Raised My Pay \$6,000 a Year Thanks to This Little Book

Now—In A Special 1930 Limited Edition—This Remarkable Man-Building, Salary-Raising Volume Is Offered Free of Charge To Every Ambitious Man. It Contains A Wealth of "Inside Information" That Has Never Been Revealed In Print Before. If You Ever Aspire To Commence Earning \$5000 to \$10,000 A Year, Read It Without Fail.



Where Shall We Send Your Copy-FREE?

FREEDOM at last! No more endless days of dull routine and punching time-clocks morning, noon and night! No more skimpy pay envelopes just big enough to keep a man going from week to week. And best of all—no more pinching pennies and existing without the good things of life that every man **DESERVES** for his family and himself!

When a man suddenly steps out of a small-pay job where he has been dragging along for years, and commences to earn \$150 or \$200 a week—his whole world seems to change almost overnight. Everything looks different. People who scarcely noticed him before begin to regard him with new importance.

For example take Charles Barth, 2019 Wilmot Street, Philadelphia. A while ago, life seemed like a pretty dreary proposition to him. Unskilled—forced to labor 12 hours a day—his most strenuous efforts never brought him more than \$50 a month! Then one day a certain little book fell into his hands. It opened his eyes to money-making possibilities he never dreamed existed—and from that day on, he clearly saw the way to say "goodbye" forever to long hours, low pay and **THE RUT!** Things happened swiftly after that. Today his pay has

jumped to \$5000 a year—\$450 a month—with the brightest kind of prospects for the future!

UP THE LADDER FAST!

One man's luck? Not a bit of it. Dozens and hundreds of others have raised their pay to \$5000—\$7500 and even \$10,000 a year after reading this remarkable little book. For example, one of these men is E. F. Caughey of Pampa, Texas. Formerly a railroad construction worker he was only making \$2.86 a day. Today his salary has climbed to as much as \$300 a month. . . . And C. V. Champion of Danville, Illinois, raised his pay to over \$10,000 a year and became president of his company to boot!

A FEW WEEKS—THEN BIGGER PAY

There was nothing "different" about any of these men when they started. None of them had any special advantages—although all of them realized that **SALESMANSHIP** offers bigger rewards than any other profession under the sun. But, like many other men they subscribed to the foolish belief that successful salesmen are born with some sort of "magic gift." "The Key to Master Salesmanship" showed them that nothing could be farther from the truth! Salesmanship is just like any other profession. It has certain fundamental rules and laws—laws that you can master as easily as you learned the alphabet.

City and traveling sales positions are open in every line all over the country. For years, thousands of leading firms have called on the N. S. T. A. to supply them with salesmen. Last year requests for over 50,000 were received. Employment service is free to both employers and members, and thousands have secured positions this way.

FREE TO EVERY MAN

See for yourself WHY "The Key to Master Salesmanship" has been the deciding factor in the careers of so many men who are now making \$5000 to \$10,000 a year. Learn for yourself the **REAL TRUTH** about the art of selling! You do not risk one penny nor incur the slightest obligation. And since it may mean the turning point of your whole career, it certainly is worth your time to fill out and clip the blank below. Send it now!

NATIONAL SALESMEN'S TRAINING ASSOCIATION

Dept. E-102
N. S. T. A. Building, CHICAGO, ILL.

National Salesmen's Training Assn.,
Dept. E-102, N. S. T. A. Bldg.,
Chicago, Illinois

Without cost or obligation you may send me your free book, "The Key to Master Salesmanship."

Name.....

Address.....

City.....State.....

Age.....Occupation.....

Why it will Pay You to Come to Chicago Tech

Chicago Tech is a college for ambitious men—a college that *you* will want to go to if you've the will to work for success. Loafers don't come here. But serious, hard working fellows find in this college what they need to build a real future . . . a money-making future.

Degree and Diploma Courses—College Grade

Here's why it will pay you. It offers degree courses . . . regular technical training at half cost and almost one-half the usual time. Instruction in practical subjects only without wasting time on those you can never cash in on.



For Success—these 4 fields

Training in the four biggest fields of opportunity, **DRAFTING, ARCHITECTURE, ENGINEERING AND ELECTRICITY**—the fields where a degree and training really mean something in money-making possibilities.

This old established College

Twenty-six years of experience behind you . . . to give you what you will need when you get out in the Technical fields. Every subject under the supervision of specialists.

Here in Chicago

The advantages that only a resident school located here in Chicago can give you. Building activities going on all the time . . . right in the center of the world's greatest industrial metropolis—where you can see every day with your own eyes what's going on in the technical fields. Part time positions to help defray expenses. Personal contact with instructors. College activities, athletics.

We have a special plan for men who have not finished high school. Send the coupon—it brings all the facts.

Send for Free 80-Page Blue Book!

This book points the way to success in the Technical fields through college training. It brings you all the facts about the great opportunity that awaits you at Chicago Technical College. Send in the coupon now . . . there is no obligation!

CHICAGO TECHNICAL COLLEGE

Dept. E-78, Chicago Tech. Bldg.

118 East 26th St.

CHICAGO, ILL.

Chicago Technical College
Dept. E-78, 118 E. 26th St., Chicago

I want to know how I can get a degree or diploma and be college trained in Drafting, Engineering, Architecture and Electricity in less time and with less cost. Send me your Blue Book, free, without a cent cost to me.

Name.....

Address.....

City.....State.....

Books on 65 Practical Subjects

Popular Mechanics Press specializes in supplying the outstanding best books on many subjects. As new books of merit appear, we will revise the list accordingly.

- AIR NAVIGATION AND METEOROLOGY**
Every flyer needs.....\$3.00
- AIRCRAFT ENGINES**
Dyke's New Instructor
Best Engine Book....\$5.00
- ARCHITECTURAL**
Drafting.....\$2.00
- ARITHMETIC**
Rapid.....\$1.50
- ARMATURE WINDING**
Excellent new book...\$2.00
- AUTO ENCYCLOPEDIA**
Dyke's. (Covers New Model A Ford).....\$6.00
- AVIATION**
Practical new book on flight training.....\$5.00
- BIRD HOUSES**
How to Make.....\$1.00
- BLUE PRINTS**
How to Read.....\$2.00
- BOAT BUILDING**
35 Popular Types, Outboard Motor, Sail, Row, etc.....\$3.00
- BOY MECHANIC**
Famous 4 Vol. Library, 4000 Things to Make. \$7.00
- BUILT-IN FURNITURE**
Complete Instructions..\$2.50
- CARBURETORS**
Excellent book on all makes.....\$2.00
- CARPENTRY**
Hand book of 336 Kinks.\$1.50
- CHALK TALK**
How to.....\$1.00
- COLOR SIMPLIFIED**
Practical new Book (for Color Users).....\$3.50
- CONCRETE**
173 Ways of Using New Edition (Cloth) . \$1.00
- CONTRACTOR**
Building Cost Estimator.\$2.00
- DIESEL ENGINES**
(New Work). Best Authority.....\$5.00
- DOGS**
Care and Raising.....\$2.00
- ELECTRICITY**
Practical Lessons in...\$2.50
- ELECTROPLATING**
Practical Results Easily Obtained.....\$1.00
- ENGLISH**
Self-Improvement in...\$2.50
- ETIQUETTE**
New 560-Page Book. Only.....\$1.00
- FARMER'S BOOK**
of 861 Kinks and Book for Farmers' Wives..\$1.00
- FLYING**
Simplified.....\$1.00
- FORMULAS**
10,000 Money Making \$4.00
- FURNITURE (Mission)**
Homemade (3 vols.)...\$3.00
- GARDEN (Everybody's)**
Answers every question.\$3.50
- HOME REPAIRS**
Practical Book of.....\$2.50
- HOME WORKSHOP**
900 Different Things to Make.....\$3.00
- INVENTIONS (American)**
Popular History of 2 vols. Reduced to...\$5.00

- INVESTMENT**
Policies that pay By Ray Vance.....\$4.00
- JOINT WIPING**
(New Edition).....\$1.00
- KITES THAT FLY**
How to Make.....\$1.25
- LANDSCAPING**
Practical.....\$2.50
- LATHE WORK (METAL)**
and Drilling and Thread Cutting.....\$1.00
- LETTER WRITING**
Social and Business Only.....\$1.00
- MACHINIST**
419 Kinks for.....\$1.50
- MAGIC**
200 New Tricks for Amateurs.....\$1.00
- MASONS AND BUILDERS**
Guides (4 vols.).....\$6.00
- MATHEMATICS**
Made Easy for the Practical Man.....\$1.50
- MECHANICAL DRAWING**
Practical Course in...\$1.00
- MODEL AIRCRAFT**
Building and Flying...\$2.25
- OUTDOOR OPPORTUNITIES**
for Making a Living...\$2.00
- OUTDOOR SPORTS**
for All Year 'Round...\$1.50
- PAINTING**
House (Best Methods)..\$2.00
- PLUMBING**
500 Plain Facts for Every Homeowner...\$1.50
- POULTRY RAISING**
for Profit.....\$2.00
- POWER WIRING (D. C.)**
Electrical (Just Out)...\$3.50
- PUZZLES**
Amusing Mathematical.\$1.50
- RABBITS**
For Food and Fur....\$2.00
- RADIO**
Trouble Shooting. Covers All-Electric Sets and Television.....\$3.00
- ROPE SPINNING**
Only Book on Subject..\$1.50
- SHOP NOTES**
14 Vols. of 6000 Valuable Kinks.....\$4.25
- STAMP ALBUM (Modern)**
12,000 Varieties.....\$2.00
- STEEL SQUARE**
Pocket Book, Practical.\$1.00
- TELEVISION**
See what you hear....\$2.75
- TOY MAKING**
Complete Instructions..\$1.50
- TREASURES**
Hunting Hidden.....\$2.50
- WIRING**
House (New Book)....\$2.50
- WOOD TURNING (LATHE)**
Practical Course in...\$1.50
- WOODCRAFT**
Famous 590 Page Book by Ernest Thompson Seton; Only.....\$1.00

Books sent C. O. D. anywhere in U.S.

Just check the books you want, write your name and address below, and mail the advertisement. It is your order blank. When post-man hands you books, pay him the price and the postal charges. If outside the U. S. remit when ordering and include 10 cents per book extra for postage. We have many other books on these and 2,000 other subjects. Catalog free.

Name.....

City.....State.....

Address.....

Mail to Popular Mechanics Press,
Room P5—200 East Ontario St., Chicago, Ill.

In this FREE BOOK

a World-Famous Flier shows how *You* can get into

AVIATION

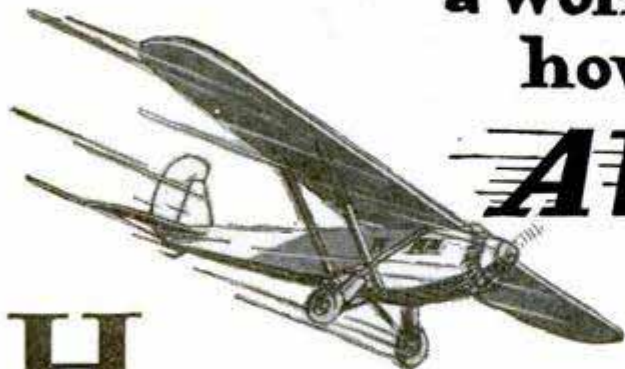

HERE is the book that tells you straight from the shoulder what Aviation offers YOU. You've been wondering how to break into the field—wanting all the facts, all the information. Here it is! A story more exciting, more thrilling, more inspiring than fiction—yet a man-to-man message of FACTS from cover to cover. Walter Hinton—hero of history-making flights—gives you the brass tacks of Aviation Today. He shows you exactly *where* your opportunities lie—exactly *what* to do to make the most of them—exactly *how* to fit yourself for them. Here is a book for men with too much backbone to stay chained to a small-pay job—too much adventure in their blood for a humdrum grind—too much good sound business sense in their heads to let this opportunity of a lifetime outgrow them!

The Richest, Fastest Growing Industry the World Has Ever Known

You haven't heard anything about this being a "bad year" for Aviation! Men like Ford, DuPont—millionaires—are investing fortunes in the field. Cities everywhere are building more airports; 24-hour shifts are racing construction on new plane and equipment plants. Air lines, air service of every kind is doubling and redoubling itself almost while you watch! There's no doubt about there being BIG PAY plus a real future for YOU in Aviation. Your one sure move is to get the right training—Quick!

You Must Be 18 or Over

To take an active part in Aviation you must be at least 18 years of age. If you are under 18, please do not ask for Lieut. Hinton's Book because it will not interest you.

Aviation Is Ready, Hinton Is Ready—Now It's Up to YOU

Right at home in spare-time Hinton will teach you all the essential facts about plane construction, rigging, repairs, motors, instruments, theory of flight, navigation, commercial Aviation. Whether you plan to fly, or to cash-in on one of the more than forty Big-Pay ground jobs, you must have this ground-work to land the job you want at the pay you expect. Learn just where you stand and what first steps to take. This Free Book tells how. Clip the coupon and send it TODAY. Hinton will rush your book by return mail.

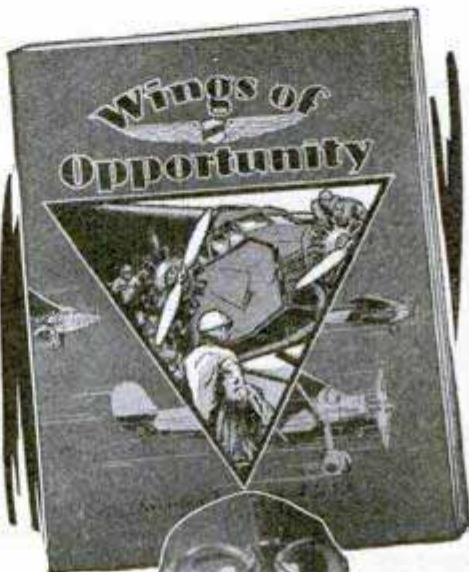

40

Jobs on the Ground for Each One in the Air

Fliers are in demand—certainly! But for every man in the air, trained men are needed in over 40 highly-paid jobs on the ground. Hinton's training gives you your ground-work to earn real money as one of these:

Engineers, Designers and Draughtsmen, Pilots, Engine and Plane Mechanics, Riggers, Electricians, Welders, Instrument Makers, Wood and Metal Workers, Plane and Motor Inspectors, Airport Operators, Radio Experts, Assemblymen, Aerial Surveyors and Photographers, Aerial Transport Managers, Salesmen.

Walter Hinton

Trail-blazer, pioneer, explorer, author, instructor, AVIATOR. The first man to pilot a plane across the Atlantic—the famous NC-4—and first to fly from North to South America. The man who was a crack flying instructor for the Navy during the War; who today is training far-sighted men for Aviation. Hinton is ready to back YOU up to the limit. His Book is yours FREE for the coupon below.

Rush Back to Washington!

Walter Hinton, Pres.,
Aviation Institute of U. S. A.,
1115 Conn. Ave., Washington, D. C.

301-G

Dear Lieut. Hinton: Send me your FREE Book telling how I can train under you right at home for Aviation.

Name.....

Street..... Age.....
(must be over 18)

City..... State.....

Aviation Institute of U. S. A.

Walter Hinton, President

1115 Connecticut Ave., Washington, D. C.





“Mary, I Owe It All to You”

“Mr. WILLIAMS called me into his office today and told me he was going to raise my salary \$50 a month.

“I am glad to give you this opportunity,” he said, “for the best reason in the world. You deserve it.

“You may not know it, but I’ve been watching your work since the International Correspondence Schools wrote me that you had enrolled for a course of home study. Keep it up, young man, and you’ll go far. I wish we had more men like you.”

“And to think, Mary, I owe it all to you! I might still be drudging along in the same old job at the same old salary if you hadn’t urged me to send in that I. C. S. coupon!”

How about you? Are you always going to work for a small salary? Are you going to waste your natural ability all your life? Or are you going to get ahead in a big way? It all depends on what you do with your spare time.

More than 180,000 men are getting ready for promotion right now in the I. C. S. way. Let us tell you what we are doing for them and what we can do for you.

Mail the Coupon Today

INTERNATIONAL CORRESPONDENCE SCHOOLS
Box 5683-F, Scranton, Penna.

Without cost or obligation, please send me a copy of your booklet, “Who Wins and Why,” and full particulars about the course before which I have marked X in the list below:

TECHNICAL AND INDUSTRIAL COURSES

- | | |
|--|---|
| <input type="checkbox"/> Architect | <input type="checkbox"/> Automobile Mechanic |
| <input type="checkbox"/> Architectural Draftsman | <input type="checkbox"/> Aviation Engines |
| <input type="checkbox"/> Building Foreman | <input type="checkbox"/> Plumber and Steam Fitter |
| <input type="checkbox"/> Concrete Builder | <input type="checkbox"/> Plumbing Inspector |
| <input type="checkbox"/> Contractor and Builder | <input type="checkbox"/> Foreman Plumber |
| <input type="checkbox"/> Structural Draftsman | <input type="checkbox"/> Heating and Ventilation |
| <input type="checkbox"/> Structural Engineer | <input type="checkbox"/> Sheet-Metal Worker |
| <input type="checkbox"/> Electrical Engineer | <input type="checkbox"/> Steam Engineer |
| <input type="checkbox"/> Electrical Contractor | <input type="checkbox"/> Marine Engineer |
| <input type="checkbox"/> Electric Wiring | <input type="checkbox"/> Refrigeration Engineer |
| <input type="checkbox"/> Electric Lighting | <input type="checkbox"/> R. R. Positions |
| <input type="checkbox"/> Reading Shop Blueprints | <input type="checkbox"/> Highway Engineer |
| <input type="checkbox"/> Telegraph Engineer | <input type="checkbox"/> Chemistry |
| <input type="checkbox"/> Telephone Work | <input type="checkbox"/> Pharmacy |
| <input type="checkbox"/> Mechanical Engineer | <input type="checkbox"/> Coal Mining Engineer |
| <input type="checkbox"/> Mechanical Draftsman | <input type="checkbox"/> Navigation <input type="checkbox"/> Assayer |
| <input type="checkbox"/> Machine Shop Practices | <input type="checkbox"/> Iron and Steel Worker |
| <input type="checkbox"/> Toolmaker | <input type="checkbox"/> Textile Overseer or Supt. |
| <input type="checkbox"/> Patternmaker | <input type="checkbox"/> Cotton Manufacturing |
| <input type="checkbox"/> Civil Engineer | <input type="checkbox"/> Woolen Manufacturing |
| <input type="checkbox"/> Surveying and Mapping | <input type="checkbox"/> Agriculture <input type="checkbox"/> Fruit Growing |
| <input type="checkbox"/> Bridge Engineer | <input type="checkbox"/> Poultry Farming |
| <input type="checkbox"/> Gas Engine Operating | <input type="checkbox"/> Mathematics <input type="checkbox"/> Radio |

BUSINESS TRAINING COURSES

- | | |
|--|---|
| <input type="checkbox"/> Business Management | <input type="checkbox"/> Business Correspondence |
| <input type="checkbox"/> Industrial Management | <input type="checkbox"/> Show Card and Sign Lettering |
| <input type="checkbox"/> Personnel Management | <input type="checkbox"/> Stenography and Typing |
| <input type="checkbox"/> Traffic Management | <input type="checkbox"/> English |
| <input type="checkbox"/> Accounting and C. P. A. Coaching | <input type="checkbox"/> Civil Service |
| <input type="checkbox"/> Cost Accounting | <input type="checkbox"/> Railway Mail Clerk |
| <input type="checkbox"/> Bookkeeping | <input type="checkbox"/> Mail Carrier |
| <input type="checkbox"/> Secretarial Work | <input type="checkbox"/> Grade School Subjects |
| <input type="checkbox"/> Spanish <input type="checkbox"/> French | <input type="checkbox"/> High School Subjects |
| <input type="checkbox"/> Salesmanship | <input type="checkbox"/> Cartooning |
| <input type="checkbox"/> Advertising | <input type="checkbox"/> Illustrating |
| | <input type="checkbox"/> Lumber Dealer |

Name.....

Address.....

City..... State.....

Occupation.....

If you reside in Canada, send this coupon to the International Correspondence Schools Canadian, Limited, Montreal, Canada

BE A RAILWAY TRAFFIC INSPECTOR

Earn up to \$250 PER MONTH Plus Expenses

THERE'S a steady position and a future in Railway Traffic Inspection for active men 19-55 years old. It's healthful, outdoor work with regular hours. Pays up to \$250 per month plus expenses. Unlimited opportunities—meet high railway officials—travel or remain near home.

Big Demand for Trained Men

For over eleven years, we have been training men for this permanent, profitable profession.

Railways look to us for men. We'll train you in a few weeks' spare time home instruction, and upon completion, assist you to a position paying \$120 to \$150 per month plus expenses, or refund your tuition. Rapid salary advances with experience to \$175, \$200, \$250.

Send for free booklet today

It tells all about Traffic Inspection—how we started hundreds of men to big pay jobs—what it can do for you—how we can assist you to a salaried position with rapid advancement. Send for it now! Don't delay.

STANDARD BUSINESS TRAINING INSTITUTE
Div. 2 BUFFALO, N. Y.



ENGINEERING ELECTRICAL MECHANICAL STRUCTURAL and ARCHITECTURE

INTENSIVE PRACTICAL TECHNICAL COURSES. Degree in 2 years, Diploma in 1 year. Special short courses 6 Weeks to 4 Months in Electricity, Radio, Power Plant, Electric Refrigeration, Armature Winding, Wiring, Testing, Drafting, Welding. **LOW TUITION.** Expert instructors. Extensively equipped laboratories. Free life-time employment service for graduates. Part-time work while attending. Write for new free illustrated catalog giving all facts. 29th year.

FINLAY ENGINEERING COLLEGE
1001 A Indiana Avenue Kansas City, Missouri



U.S. GOVERNMENT JOBS.

\$1260 to \$3400 YEAR

Men—Women 18 to 50

Steady Work Paid Vacations

Common Education Sufficient

Mail Coupon today—SURE

FRANKLIN INSTITUTE
Dept. J 171
ROCHESTER, N. Y.

Rush to me, entirely free of charge 32-page book with: (1) A full description of the position checked below; (2) A list of U. S. Government Jobs Obtainable.
 Railway Postal Clerk.....(\$1900 to \$2700)
 Postoffice Clerk.....(\$1700 to \$2300)
 City Mail Carrier.....(\$1700 to \$2100)
 Inspector of Customs.....(\$2100 up)
 General Clerk-File Clerk.....(\$1260 to \$2500)

Name.....



BE AN ARTIST!

— and be your own boss

IF you like to draw, why drudge when success and a good income may be yours through art training? Publishers pay millions of dollars yearly for illustrations. Many successful Federal Students are earning from \$2500 to \$6000 a year — some even more.

If you hold yourself down to a routine job you may always do uncongenial work. But if you like to draw and are willing to train your talent, your art ability may help you to success in life.

Through the Federal Course in Illustrating more than fifty famous artists give you the benefit of their methods of Illustrating, Cartooning, Lettering, Poster Designing, Window Card Illustrating. You may learn through the experience of these successful artists how to bring your own drawings to a professional standard. They understand the methods that make art pay well.

You can keep your present position while gaining your art training. Through the Federal Course you learn

FEDERAL SCHOOL OF ILLUSTRATING

5130 Federal Schools Building
Minneapolis :: Minnesota

at home in your spare time. Hundreds of Federal Students have already proved by their professional success the value of this home study instruction.

Vocational Art Test—Free

Find out about your drawing ability by sending in the Free Vocational Art Test we offer. Just write your name, age and address on the coupon and we will send this Test together with a copy of the book "A Road To Bigger Things" without charge or obligation. Why drudge at uncongenial work when the chance to plan your own work and be your own boss may be yours through Art Training? It is important that you take your first step out of the rut by mailing the coupon now.

Federal School of Illustrating,
5130 Federal Schools Building,
Minneapolis, Minnesota.

Please send me free book, "A Road To Bigger Things," and Standard Art Test.

Name _____

Age _____ Occupation _____

Address _____



"When All Other Methods of VOICE Training Have Failed—

I urge you to try this NEW Silent Method of Voice Training . . . it saved—restored my voice after other methods failed."

Pompeo Tomasin

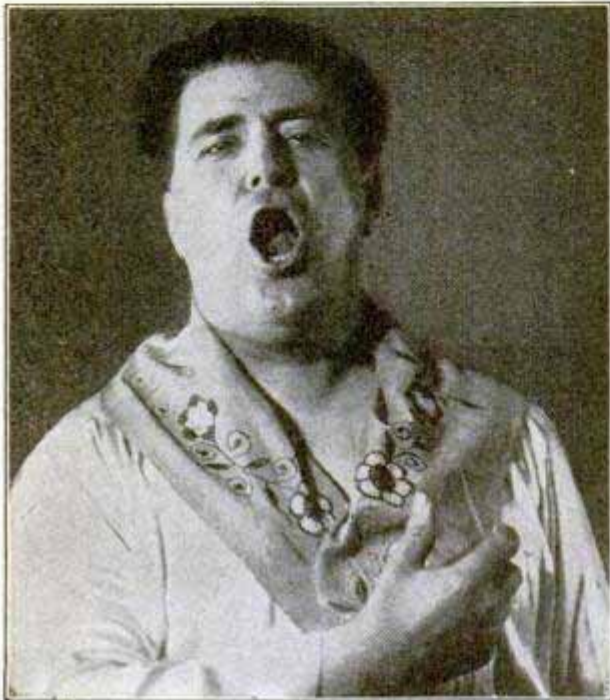

Famous Italian Tenor

100% Improvement Guaranteed!

If you, too, have found other methods failed to develop or improve your voice—don't be discouraged!—Write for free Voice booklet telling all about this tried and proved Silent Method of Voice Training that has worked seeming miracles for this famous Italian tenor and scores of other men and women. Take the first step toward the voice you've longed for—**mail coupon!**

**Perfect Voice Institute, Dept. 13-55
1922 Sunnyside Ave., Chicago**

Mail Coupon for Free Voice Book

**Perfect Voice Institute, Dept. 13-55
1922 Sunnyside Ave., Chicago**

Please send me FREE and without obligation, Prof. Feuchtinger's new book, "Physical Voice Culture." I have checked subject in which I am most interested.

Weak Voice Singing Stammering Speaking

Name

Address

City

State

Electrical Engineering

Training for men of ambition and limited time. Concise, comprehensive course in Theoretical and Practical Electrical Engineering including the closely related subjects of Mathematics and Mechanical Drawing. Students construct motors, install wiring,

test electrical machinery. Course designed to be completed in one college year by eliminating non-essentials. **THIRTY-SEVEN YEARS'** successful experience assures you maximum training in minimum time.



Send for free catalog

Bliss Electrical School

115 TAKOMA AVE., WASHINGTON, D. C.

MUSIC LESSONS IN YOUR HOME



You can play music like this quickly

Write today for our **FREE BOOKLET**. It tells how to learn to play Piano, Organ, Violin, Mandolin, Guitar, Banjo, etc. Beginners or advanced players. You pay as you learn. Costs only a few cents a day. Thousands of satisfied students.

AMERICAN SCHOOL of MUSIC, 51 Manhattan Bldg., CHICAGO



Wonderful, new device, guides your hand; corrects your writing in a few days. Big improvement in three hours. No failures. **Complete outline FREE.** Write C. J. Ozment, Dept. 34, St. Louis, Mo.



easily, permanently corrected. Win happiness and success. Ask for full information and special photograph record. Send dime for postage
12972 Woodward Ave., LEWIS INSTITUTE, Detroit

Building, repairing and servicing of modern radio receiving sets . . .

RADIO CONSTRUCTION LIBRARY

By **JAMES A. MOYER**, Director, University Extension, Massachusetts Department of Education and **JOHN F. WOSTREL**, Instructor, Radio Engineering, Massachusetts Department of Education

3 volumes, 993 pages, 6 x 9, 561 illustrations
Here is a set of books which covers the needs of the amateur as well as the commercial dealer and service man. The library embodies a thorough home-study course and a constant reference in daily radio problems. Step-by-step information is given on all types of hook-ups, wiring, trouble shooting, rebuilding, as well as the underlying principles of vacuum tubes. It is a library which should be in the hands of every serviceman, dealer and amateur who is genuinely interested in radio.

FREE TRIAL

No Money Down—Pay in Small Monthly Sums

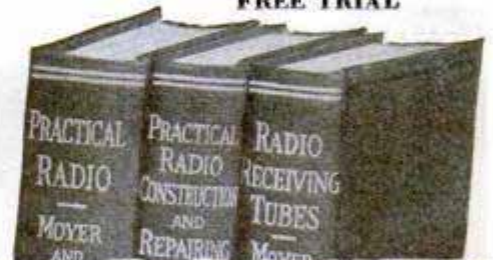

FREE EXAMINATION COUPON

McGRAW-HILL BOOK CO., 370 Seventh Ave., New York

Send me the Radio Construction Library, three volumes, for 10 days' free examination. If satisfactory I will send \$1.50 in 10 days and \$2.00 a month until \$7.50 has been paid. Otherwise I will return the books.

Name

Home Address

City and State

Position

Name of Company P.M. 5-30

now! take your place in

AVIATION



LET THIS WORLD-WAR FLYER TRAIN YOU AT HOME

Major Robert L. Rockwell stands high in the Aviation history of the World War. He is now devoting himself to helping men get the right start in Aviation. Let him train you for this great new industry and your future in Aviation is assured.

If You Are Under 48

To take an active part in Aviation, with an idea to a real future ahead of you, you should be under 48 years of age to make your start. If you are under that age just mail the coupon and I will tell you just what I can do to help you get into this fascinating big pay field.

LEARN AT HOME

"EASY TO START"
"FLY YOURSELF"

Major Robert L. Rockwell Says . . . Get Your Ground School Instruction AT HOME

My home-study course is compiled to prepare you in the fundamental knowledge of Aviation necessary to rapid progress. Without leaving your present job or spending a lot of money, you can, in a few short months, complete my home-study course and equip yourself with a solid foundation of Aviation knowledge required before flying, or filling any well-paid ground job.



Soloed in 7 Hours

Dear Major: Your excellent advice prevented me from taking up Aviation the wrong way when I wanted to learn flying first. After I had completed your ground course, which thoroughly prepared me in the principles of flight, I was able to solo in 7 hours. I always will be glad to tell anyone that I am a Rockwell trained man.

Sincerely, WM. C. RICKELS.

I'll Help You Get a Good Paying Job

I train men right along for jobs as mechanics, riggers, electricians, welders, plane and motor inspectors, airport operators, radio experts, aerial photographers, transport managers and salesmen. Due to the demand for trained men it is easy for me to give you employment assistance.

Manager of Big Company

Dear Major:—The main thing about your individual method of instruction is that you not only gave me a thorough knowledge of Aviation, but you also showed me how to capitalize on what I learned. I am now General Manager for International Air Surveys and making three times what I ever earned before. I will always be a booster for your method of training.

FLOYD PROTHERO.



Major R. L. Rockwell, Dayton School of Aviation
Desk V-1 Dayton, Ohio

Pay FOR YOUR FLYING TRAINING with your GROUND JOB EARNINGS

Mail Coupon for BIG FREE BOOK

Major R. L. Rockwell,
Dayton School of Aviation,
Desk V-1, Dayton, O.

Dear Major: Please send me your FREE book on AVIATION AND YOUR REMARKABLE TUITION OFFER. I AM NOT OBLIGATED.

Name.....
Address.....
Town..... State..... Age.....



If you have not the ready cash for flying instruction after completing my home study course, I will help you get a job at a hangar where you can pay for your flying instruction out of your ground job earnings. But, whether you pay for your flying instructions or earn it, the important thing is to get started with your preliminary training at once.

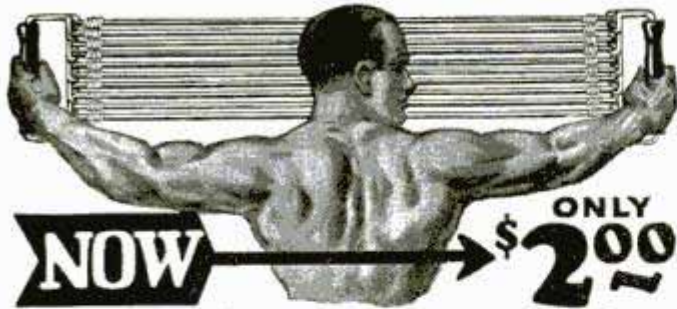

NOW → **ONLY \$2.00**

Giant Chest Expander

and

Progressive Exerciser

Be a muscular marvel. Have the muscles of a superman. Become strong for your health's sake or to astound your friends with extraordinary feats which only men of giant strength can do. In a few short weeks you will easily do stunts which now seem difficult—then real muscles and strength will

Send No Money
Use This Money Saving Coupon

be yours—and yours to keep. If you want exercise to just keep in good shape you can reduce the strength of the Progressive Exerciser by eliminating as many cables as you wish. If you want great resistance so as to build up big solid muscles then use the full strength.

How the Giant Chest Expander and Progressive Exerciser is Made

The Giant Chest Expander and Progressive Exerciser is made with new live, springy rubber so as to give it long wearing and great resisting qualities. Do not pay more for an exerciser that has forty or less rubber strands to each cable. Get the best and most durable. The Giant Progressive Exerciser has 50 strands of the finest rubber procurable to each cable.

Free Instructions

We do not think it enough to send you an exerciser worth double what we ask, so for a limited time, we will also include instructions absolutely free. These instructions are interesting and simple to follow—they show you the short cut to health and strength. Order today before this wonderful offer is withdrawn.

Your Guarantee

The Giant Chest Expander is sold with a guarantee that you will say it is the finest you ever saw or your money back.

5 Cables or double 10 Cables for strength for

\$2 The double strength exerciser has resistance of over 200 lbs. **\$4**

How to Order—Send No Money

Sign your name and address to coupon below and get your Giant Exerciser at the present low introductory price by return mail. The price is made low because we want everyone to enjoy muscles and strength at the lowest possible cost. Don't pay more—order from us—get the most for your money. Use coupon now.



PROGRESSIVE EXERCISER CO.,
4095 Langdon Bldg.,
Broadway and Duane Street, New York

Please send Your 10 cable Progressive.
 Your 5 cable Exerciser.

Check the Exerciser you want, and it will be sent you by return mail. Pay postman introductory price, plus few cents postage on arrival. It is understood that if you are not entirely satisfied with your exerciser you may return it within 5 days and get your money back.

Name.....

Street.....

City..... State.....

If you live outside the United States, send cash with order.

BEDFORD YMCA TRADE SCHOOL

Aviation Mechanic
Flying
Airplane Welding
Airplane Drafting
Air Navigation
Aero Starting, Lighting, Ignition
Auto Mechanic
Machine Shop. Electric Welding
Oxy-Acetylene Welding
Radio Mechanic. Battery Repair
Mechanical, Architectural Drawing
Sign Painting. Show Card Writing
Window Dressing
Commercial Art. Fine Art
DAY AND EVENING SESSIONS
Write for Catalog 50
Brooklyn Engineering Institute
(Operated by Bedford Y. M. C. A.)
1125 Bedford Avenue, Brooklyn
New York City

LAW STUDY AT HOME

Become a lawyer. Legally trained men win high positions and big success in business and public life. Be independent. Greater opportunities now than ever before. Big corporations are headed by men with legal training. Earn **\$5,000 to \$10,000 Annually**. We guide you step by step. You can train at home during spare time. Degree of LL.B. conferred. LaSalle students found among practicing attorneys of every state. We furnish all text material, including fourteen-volume Law Library. Low cost, easy terms. Get our valuable 64-page "Law Guide" and "Evidence" books FREE. Send for them NOW. LaSalle Extension University, Dept. 564-L, Chicago
The World's Largest Business Training Institution

LEARN TO Mount Birds

We teach you At Home by Mail to mount Birds, Animals, Heads, Tax Furs and Make Eggs. Be a taxidermy artist. Easily, quickly learned by men, women and boys. Tremendously interesting and fascinating. Decorate home and den with beautiful art. **Make Big Profits from Spare Time Selling Specimens and Mounting for Others.**
Free Book—Beautiful book telling all about how to learn taxidermy sent Free if you state your AGE. Send Today. You will be delighted.
Northwestern School of Taxidermy 3375 Elwood Bldg., OMAHA, NEB.

10c NEW SCIENTIFIC WONDER
3 for 25c "X-RAY" CURIO

SILVER ONLY

BOYS You apparently see thru Clothes, Wood, Stone, any object. Bones in Flesh. **FREE—PKG. RADIO BIG FUN**
PICTURE FILMS. Takes pictures without camera. "You'll like 'em." 1 pkg. with each 25c order.
MARVEL MFG. CO. Dept. 31 NEW HAVEN, CONN.

NERVES?

Are You Always Excited? Fatigued? Worried? Gloomy? Pessimistic? Constipation, indigestion, cold sweats, dizzy spells and bashfulness are caused by **NERVE EXHAUSTION.** Drugs, tonics and medicines cannot help weak, sick nerves! Learn how to regain Vigor, Calmness and Self-Confidence. Send 25c for this amazing book
RICHARD BLACKSTONE, N-475 FLATIRON BUILDING, N. Y.

BOYS—A Pistol Sling Shot!

NOTHING LIKE IT BEFORE!
Cocks and shoots like a real pistol. Special aiming sights and extra heavy pure gum rubbers enable you to shoot with power and accuracy of the best air guns. Ideal for indoor and outdoor target practice. Shoots stones, marbles, lead balls, etc. Sample shot **\$1.00 FREE.** Scientifically and practically made to last a life time. Pin a dollar bill or money order to this advertisement and mail today. If not satisfied, return within five days and your money will be promptly refunded.

R. B. SPECIALTY CO.
Dept. E-345, 220 E. 3rd Street, CINCINNATI, OHIO

"DON'T! You'll make him the laughing stock of the place"

but when he started to play the piano . . .

WHAT a glorious night! Henri's quaint restaurant was crowded with joyful parties. Tonight, John Brent was giving a party for eight in honor of Helen Thompson's engagement. Dick Peters had recommended Henri's as a splendid place to dine and dance. And Dick was right.

"What's that in your pocket, Dick? Your will?" asked John.

"No, that's just some sheet music I bought on the way over," returned Dick.

"What in Heaven's name are you doing with sheet music? Going to use it as wall-paper?" exclaimed John.

"Why, I'm learning to play the piano. Didn't you know?"

"Oh boy! Listen to that! You couldn't learn to play in a thousand years."

Dick looked at John with an amused smile on his face.

"What would you give to hear me play?" he asked calmly.

"A ten dollar bill if you'll go up there right now and play that piano. What do you say?" exclaimed John with triumph in his voice.

"You're on," replied Dick, quick as a flash. "I'll take you up on that little dare. But not here—wait 'til we get home tonight."

"No, sir, you'll win or lose that bet right now. Come on, fellows, let's take him right up to the piano and we'll settle it here."

"Don't be foolish, boys, you'll only make us the laughing stock of the place," begged one of the girls.

Heedless of Dick's pleading, they dragged him to the platform and placed him at the piano. By this time the unusual goings on had caught the attention of everyone in the restaurant. Now Dick realized that he had to go through with it. So summing up all his courage and with a sudden burst of confidence, he broke into the chorus of the latest Broadway hit.

John gasped. He couldn't believe his ears. Everyone at the table sat in open-mouthed amazement as Dick sat there playing one snappy number after another. It wasn't until the regular orchestra returned that they allowed Dick to step from the piano. Amid the din of applause,

he went back to the table, only to be swamped with questions. But Dick refused to tell them the secret of his newfound musical ability, in spite of all their begging.

Going home that night Dick finally gave in.

"Well, John, I've put one over on you. I learned to play by myself, without a teacher."

"What? That's impossible! Tell me more."

Dick Tells His Secret

Dick then explained how he had always longed to be able to play some musical instrument. One day he chanced to see



a U. S. School of Music advertisement offering a Free Demonstration Lesson. Sceptically he sent in the coupon. When the Free Demonstration Lesson came he saw how easy it was. Why, it was just like A-B-C. He sent for the entire course and almost before he knew it, he was playing real tunes and melodies. And the lessons were such fun, too. Almost like playing a game.

* * * *

This is typical of the success of countless thousands who have learned music this easy way. You, too, can now learn to play—right at home—in half the usual time. You can't go wrong with this simple new method. Forget the old-fashioned idea that you need special "talent." Just read the list of instruments, decide which one you want to play, and no matter which instrument you choose, it will average only a few cents a day.

Send for Free Booklet and Demonstration Lesson

Our wonderful illustrated Free Book and our Free Demonstration Lesson explain all about this remarkable method. They prove just how anyone can learn to play his favorite instrument by note—playing real tunes from the very start. It also explains all about the amazing new *Automatic Finger Control*. Act NOW. Clip and mail this coupon today! No obligation. Instruments supplied when needed, cash or credit.

PICK YOUR INSTRUMENT	
Piano	Violin
Organ	Clarinet
Ukulele	Flute
Cornet	Saxophone
Trombone	Harp
Piccolo	Mandolin
Guitar	Cello
Hawaiian Steel Guitar	Sight Singing
	Piano Accordion
	Italian and German Accordion
	Voice and Speech Culture
	Drums and Traps
	Harmony and Composition
	Automatic Finger Control
	Banjo (Plectrum, 5-String or Tenor)

**U. S. School of Music,
75 Brunswick Bldg.,
New York City**

U. S. SCHOOL OF MUSIC,
75 Brunswick Bldg., New York City
Please send me your free book, "Music Lessons in Your Own Home," with introduction by Dr. Frank Crane, Free Demonstration Lesson and particulars of your easy payment plan. I am interested in the following course:

.....

..... Have you Instr.?

Name.....

Address.....

City..... State.....

MEN

EARN \$100

While LEARNING BARBERING



The Simplest Work in the World to Learn
SHORT—PRACTICAL COURSE
Protecting Laws Make It the Best Profession in the Universe

ART STEFFEN paid his way through a two year course of Aviation by Barbering. He came to Moler's from an Automobile Job.

RALPH KUHLMAN has a Barber job on the Santa Fe running from Chicago to Los Angeles paying as high as \$60 a single trip. A short while ago he was a farm hand.

ARTHUR BAKER runs a shop in the exclusive great money district of Wall Street. He has accumulated a fortune. He learned at Moler's.

60,000 have done as well as these boys. It is better than the average man does and it is so easy..

GOODNESS!!! GRACIOUS!!!

anybody can barber and it's put within your easy reach. There is a school near you. Write to the nearest one and see.

Standardized Branches

Moler System of Colleges

139 E. 23rd St., New York City.
 512 N. State St., Chicago, Ill.
 810 N. 6th St., St. Louis, Mo.
 801 Main St., Kansas City, Mo.
 206 E. 4th St., Cincinnati, Ohio.
 215 Huron Road, Cleveland, Ohio.
 559 Michigan Ave., Detroit, Mich.

109 S. 15th St., Omaha, Nebr.
 501 E. Water St., Milwaukee, Wis.
 81 Forsyth St., N. W., Atlanta, Ga.
 81 S. Second St., Memphis, Tenn.
 912 Main St., Dallas, Texas.

Address Nearest Branch

Please send me without obligation on my part your Booklet B telling how I may earn \$100 and my meals while learning barbering.

Name.....
 Address.....
 City.....State.....

Increase Your Earning Power

Apply time and labor-saving kinks to your work. Your efficiency will soon be recognized and you will be in line for advancement.

If you do machine shop work of any kind, sheet-metal work, painting, carpentry, auto repairing, farming, concrete work, plumbing, electrical work, welding, building, glass work, general repairing, tool-making, poultry raising, masonry or home repair work, get this

LIBRARY OF 6000 TIME AND LABOR SAVING IDEAS FOR SHOPMEN AND HANDYMEN

JUST PUBLISHED

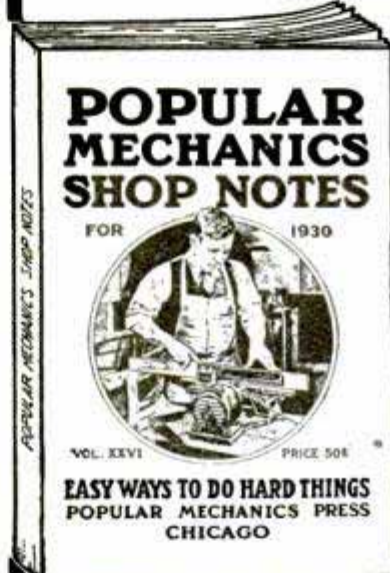

SHOP NOTES for 1930

192 Pages
 415 Articles
 377 Illustrations

See partial list of contents below

Including the new 1930 issue illustrated above, there are now 14 volumes in the Shop Notes Library of 6,000 easily understood short cuts to every-day jobs. Here are just a few of the subjects taken from the 415 articles in the latest issue.

- | | | |
|---|-------------------------------------|---|
| Animal Traps, Care of | Concrete Fountain Water, Cooler for | Sanding on the Lathe |
| Barrel Method of Slinging | Furniture, Refinishing Old | Shop Mount for Home |
| Bench Light, Convenient | Furniture, Restoring Damaged | Saws, Keeping Fit |
| Bench Saw, Getting Most Out of | Hoekaw, Power, for Small Shops | Scrollsaw, Ball-Bearing |
| Boatswain's Chair Rigging | Hoist, Light and Strong | Speedboas, Automatic |
| Bookcase, Modern | Household Shortcuts | Switch for |
| Brass Fixtures, Cleaning | Ice Cutter, Engine-Driven | Stainless Steel, Soldering |
| Builders' and Contractors' Kinks | Outboard Motor, Super-charger for | "Sugi" Finish, How to |
| Cams Jig for Layout of Conveyor, Portable | Package Sealer, Home-made | Apply |
| Speeds Loading | Pipe Holder, Hammered-Copper | Summer House, Japanese |
| Dadoing on Small Power Saws | Power Saw Made from Buffing Head | Templates, Making |
| Decorating with Pastry Gun | Power Shears Made in Small Shop | Accurate |
| Disk Sander Making | Sand Disk for Small Lathes | Tinners, Paint Scraper for |
| Ellipse, How to Lay Out | | Toolrest, Sliding, for Emery Wheel |
| "Exercise", Electric | | Tools for Home Mechanic |
| Farmers, Labor-Saving Kinks for | | Towed Car Steered by Tow Bar |
| "Flagstones", Making | | Wood, Plastic Filler for Workshop, Homemade Combination |

Each volume contains approximately 500 articles and 400 illustrations and has 224 Pages. At the regular price of 50 cents per single volume this library costs \$7.00, but for a limited period we will supply the 14 vols. when ordered at one time at the special reduced price of only \$4.25.

SPECIAL OFFER COUPON

POPULAR MECHANICS PRESS,
 200 E. Ontario St., Room P5, Chicago, Ill.
 Send me, as per your special offer, the following books. I will pay for books C. O. D. when they arrive. My money will be refunded if I am not satisfied. (Check what you want.)

1930 Shop Notes and Lathe Handbook, both for 98c.
 Complete Shop Notes Library (14 vols.) \$4.25.

Name.....
 Street and No.....
 City.....State.....

NEW WAY TO PAINT WITHOUT OIL

Discovery of Paint Expert CUTS COST 75%

NOW comes the most revolutionary paint discovery in years! A marvelous paint formula developed after years of research and now offered by a noted Kansas City paint manufacturer successfully applies the cement principle to paint. The result is an amazing new kind of paint without oil at only one-fourth the cost!

Entirely Different

Not only is this paint discovery the most economical paint ever produced but also it eliminates nine-tenths of the tiresome work of oil and lead mixing. It comes in the form of a dry powder—the most economical form possible for minimum wastage. It produces a perfect paint that is weatherproof, fireproof, durable and sanitary for both outside and inside painting. And it is ideal for wood, brick, stucco and stone surfaces, spreading evenly and

thoroughly. Yet it saves users 75% in cost.

My Guarantee on Every Can

Thanks to the inventive genius that made this astonishing new kind of paint possible, a tremendous profit opportunity is created for plain, honest men in every walk of life everywhere! Agents in every nook and corner of America are cleaning up to \$90 a week and more just showing shrewd users "easy to carry" samples and taking orders.

No wonder sales are quick and easy and the profits bigger than you ever dreamed possible! All about you are paint users who are accustomed to buying ordinary paint that costs four times as much to use as this new paint without oil. Just imagine their surprise and delight, then, when you show them a sensational discovery that saves them 75%! Man, when you see for yourself how anxious buyers are to take advantage of this discovery you'll understand why agents are making the money of their lives.



Mr. George R. Humphrey

President of the Farm & Home Paint Company, nationally-known paint manufacturers, who personally backs up sensational announcement of new paint without oil. Read the facts for yourself—then mail coupon for free sample and details at once!



Agent Makes \$638.42 in 1 Month Send Coupon for FREE SAMPLE

How would you like to pocket \$638.42 in less than 30 days, like Jim Blerins of Arkansas, a plain fellow like yourself did? Or make \$32.83 clear profit in 4 hours, the record of C. E. Sullivan of Michigan! And look at J. A. Cartier, a Minnesota man, who pocketed \$125.00 in one week! Not to speak of the other splendid marks set by many others, most of them without previous experience.

You'll have to admit that you'd have to go a long way before you'd find a money-making opportunity to equal the one now before you. Think of it! All around you are paint users, folks naturally interested in any discovery that assures them substantial savings. With such a tremendous market before you—with a product to offer that assures superlative painting results with less work and at one-fourth the usual cost—is there any reason in the world why you cannot start right out and get your share of the quick, easy money waiting to be grabbed up in your locality?

Get The Amazing Facts NOW!

You owe it to yourself to investigate this opportunity at once. Almost a half million dollars in profits have been divided among happy agents by the Farm



& Home Paint Company, manufacturers of a complete line of quality paints offered at the lowest possible prices. The coupon below brings you a generous sample of "Paint Without Oil"—FREE! Also details of amazing liberal money-making plan that brings agents up to \$90.00 a week and more the year 'round. If you want this kind of money, write at once while this discovery is still BRAND NEW and selling like wild-fire everywhere.

Farm & Home Paint Company
Dept. E-10, Kansas City, Missouri.

Farm & Home Paint Company,
Dept. E-10, Kansas City, Mo.

Send me at once without cost or obligation FREE SAMPLE of your amazing new paint without oil and full details of your money-making plan.

Name.....
Address.....
City.....State.....



A giant plane dips and soars across the sky, leaving against the brilliant blue the one word
ELECTRICITY

Men stop and gaze at the huge letters written so gracefully thousands of feet above the earth. Somewhere an electrical expert has groomed the giant plane for its flawless flight . . . every wire tested . . . every electrical device in perfect running order.

Today industry is as dependent upon the expert electrician as the powerful plane tracing the magic name over countless cities and towns. To him come the profits of industry and commerce. You, too, can be an electrical expert. Write today for the 48-page booklet.

NEW YORK ELECTRICAL SCHOOL

44 West 17th St., NEW YORK

MAIL TODAY

THE NEW YORK ELECTRICAL SCHOOL
44 WEST 17TH STREET, NEW YORK

Please send me **FREE** your 48-page booklet. It is understood that this request puts me under no obligation.

Name

Address

TAMBURITZA

FUN—POPULARITY
Easy To Play

Good times—Extra money from spare time—popularity—entertain or play in orchestras—Thrill at playing your favorite music. For solos or instrumental combinations, none surpass the beautiful Tamburitza in richness of tone or volume.



FILLS EVERY NEED—Not a novelty—but a high-class, moderately-priced, string instrument you will play for years. Comes complete with easy-playing instructions. Write today for information on these Tamburitzas: Tenor-Soprano-Cello-Bass-Alto.

IRA M. PETERSIME & SON, Dept. PM5, Gettysburg, Ohio

A Card Case Any MASON Would Be Proud To Own



Protects your lodge cards, \$1 auto license, passes, etc. **1** under isinglass windows, ready to be seen at a glance. A genuine leather, 5-window sturdy card case, extra pocket—snap button—gold corners, for only \$1. Stamped with Masonic Emblem in heavy gold **FREE**—Same price without emblem. Name and other stamping 35c a line extra. Larger cases, 9 windows \$1.50. 13 windows \$2. *Send for Catalogue.*

REDDING MASONIC SUPPLY CO.
200 Fifth Ave., Dept. P.M., New York

AVIATION INFORMATION FREE

Send us your name and address for full information regarding the Aviation and Airplane business. Find out about the many great opportunities now open and how we prepare you at home, during spare time, to qualify. Our new book "Opportunities in the Airplane Industry" also sent free if you answer at once.

AMERICAN SCHOOL OF AVIATION
3601 Michigan Ave. Dept. 1355 CHICAGO

SONG WRITERS!



SUBSTANTIAL ADVANCE ROYALTIES are paid on work found acceptable for publication. Anyone wishing to write either the words or music for songs may submit work for free examination and advice. Past experience unnecessary. New demand created by "Talking Pictures" fully described in our free book. Write for it Today. **NEWCOMER ASSOCIATES**
759 Earle Building, New York, N. Y.

See the Craters in the MOON!

Astronomical and Terrestrial TELESCOPE
Magnifies 30 Times

Own a genuine Astronomer's Telescope. See thousands of miles away. Make sun, moon, planets, stars your next door neighbors. Moon Craters, Sun Spots, Eclipses, Comets enlarged 30 times. Strange thrills!

Price Only \$3.95

Hours of fun looking at scenery, games, bathing beauties. Great for trips and voyages. Made like telescopes used in observatories. Gerding wrote: "Moon seemed 10 yards away!"

EARN \$10 A DAY
Charge 25c to look at the moon.

See Landscapes, Games, Ocean Scenes Enlarged 30 Times!

Diameter 2 inches. Special friction adjustment for focusing. Adjustable bracket and clamp can be fastened to chair, fence, branch, etc. Finest materials. Will last lifetime.

5 Days' Free Trial
Rush only \$1.00 now. Pay balance (\$2.95 plus postage) when postman delivers. Keep 5 days. If not delighted, return telescope and money will be refunded.

ROLL-O SPECIALTY CO.
Dept. E-305
220 E. 3rd St. Cincinnati, Ohio

A GENUINE 240 POWER MICROSCOPE!
Sent for Only \$100



An educational and entertaining instrument that enables all to see and know life invisible to the naked eye. Thrills and fun galore! See tiny bugs grow to proportions of great elephants. See plant and mineral life reveal amazing wonders in form and color. Made just like microscopes used by physicians, scientists etc. Now only \$3.98. Could easily sell for \$10 and \$20 more. Adjustable lens of 240 power! Send only \$1.00. Pay balance (\$2.98 plus postage) when postman delivers. If not satisfied, return in 5 days, and money will be refunded.

IDEAL FOR STUDENTS!

A wonderful help in studying science, botany, etc. Never before has such a wonderful instrument been offered at such an amazingly low price of \$3.98.

DEALERS AND TEACHERS WRITE FOR OUR PROPOSITION!

R. B. SPECIALTY COMPANY
 Dept. E-336, 220 E. 3rd St., Cincinnati, Ohio

QUIT TOBACCO

Don't try to banish unaided the hold tobacco has upon you. Thousands of inveterate tobacco users have, with the aid of the Keeley Treatment, found it easy to quit.

KEELEY TREATMENT FOR TOBACCO HABIT

Quickly banishes craving for tobacco. Successful for over 50 years. Write today for FREE BOOK and particulars of our MONEY-BACK GUARANTEE.

THE KEELEY INSTITUTE, Dept. A-933, Dwight, Ill.
 Home of the famous Keeley Treatment for Liquor and Drugs. Booklet Sent on Request. Correspondence Strictly Confidential.



NO JOKE TO BE DEAF
—EVERY DEAF PERSON KNOWS THAT



I make myself hear, after being deaf for 25 years, with these Artificial Ear Drums. I wear them day and night. They stop head noises and ringing ears. They are perfectly comfortable. No one sees them. Write me and I will tell you a true story, how I got deaf and how I make you hear. Address



GEO. P. WAY, Artificial Ear Drum Co. (Inc.)
 80 Hoffman Bldg., Detroit, Mich.

BOW LEGS?

THIS GARTER (Pat'd) Makes Trousers Hang Straight If Legs Bend In or Out
 Free Booklet—Plain Sealed Envelope
THE T. GARTER Co., Dept. E
 South Bend, Ind.



WHY BALD?
At 40?



Try **Lucky Tiger** for hair and scalp—a proven germicide. A trial will convince. Delightfully perfumed. World's largest seller at Barbers and Druggists.

LUCKY TIGER

BASHFUL?

"Shame on you!" Are you nervous, embarrassed in company of the other sex? Stop being shy of strangers. Conquer the terrible fear of your superiors. Be cheerful and confident of your future! Your faults easily overcome so you can enjoy life to the fullest. Send 25c for this amazing book.
RICHARD BLACKSTONE, B-475 Flatiron Bldg., N. Y.



CORRECT Your NOSE!

Improve your appearance with the ANITA NOSE ADJUSTER. Shapes flesh and cartilage—quickly, safely and painlessly, while you sleep. Results are lasting. Doctors praise it. 68,000 users. Write for 30-Day TRIAL OFFER and FREE BOOKLET.

ANITA INSTITUTE, 512, Anita Bldg., Newark, N. J.

\$25,000 worth of 1929 cars for you to work on!

Students at work on 1929 Packard Str. 8. Other 1929 Models include: Buick, Study, Marmon, Auburn, Nash, Geo, Essex, De Soto, Chev., Ford, Oakland—and 11 more chassis.

Learn Autos IN LOS ANGELES

and LEARN IT RIGHT!

1. NATIONAL—America's Best Equipped Auto School

NATIONAL is a Million Dollar institution—established in Los Angeles in 1905—recognized throughout the automotive industry as one of America's foremost trade schools. NATIONAL offers practical, intensive training in all automotive branches. No age limit. No previous experience necessary. You learn by "Actual-Shop" Methods. Life Scholarship privileges. Start any time of the year.

2. NATIONAL Qualifies YOU to Make Good

NATIONAL properly trains you in the Auto Trades in the short time of 4 to 6 months. Upon completing this Condensed Course you are fully qualified as a Practical, Competent Automobile man, and you have not risked your chances of employment because of inferior, incomplete instruction.

3. NATIONAL Guarantees YOU Efficient Employment Service

NATIONAL GUARANTEES to give unlimited and efficient Employment Service to students wishing to earn living expenses while learning; and to graduates getting started in the automobile field. This is the most any reputable school can be expected to do.

4. NATIONAL'S Training in Every Man's Reach

NATIONAL offers YOU the very best technical-practical training that money can buy at a cost within every man's reach. It does not offer to pay your railroad fare, room and board or other personal expenses, preferring to limit its activities to the PROPER TRAINING OF MEN FOR SUCCESS.

5. Come to LOS ANGELES—the Playground of America!

LOS ANGELES is the heart of the country's most prosperous automobile section—as well as the world's most ideal city in which to live and prepare for success in the auto game.

WRITE for FREE BOOK NOW!

National Automotive School

NATIONAL AUTOMOTIVE, Dept. 734, 4006 Figueroa St., Los Angeles, Calif.

Send me, absolutely free, your big illustrated catalog of Automotive Opportunities.

Name.....
 Address.....
 Apt.....City.....State.....

Your future assured!

National Automotive
 LOS ANGELES

PATENTS

Booklet Free **Highest References**
Promptness Assured **Best Results**

Send drawing or model for preliminary examination and advice.

ALL BUSINESS GIVEN PROMPT AND PROPER ATTENTION

Listed Patent Lawyer in the latest editions of the Rand-McNally Directory of Bankers and Bonded Attorneys, published by Rand-McNally & Co., Chicago, Ill.; The Baggott & Ryall Directory of Guaranteed Attorneys, published by Legal Directory Corporation, Boston, Mass.; Flugel's Law List, published by Legal Directory Publishing Co., St. Louis, Mo.; American Lawyers Annual, published in Cleveland, Ohio; Bankers Service Legal Directory, published by Bankers Service Co., Boston, Mass.; Eyre's Law List, 9 Park Place, New York City; Walters Legal Directory, Omaha, Nebraska, and the National Directory of Attorneys, Baltimore, Maryland.

WATSON E. COLEMAN,
 REGISTERED PATENT LAWYER

Victor Building, 724 Ninth Street, N. W.
WASHINGTON, D.C.

Write and Speak

MASTERLY ENGLISH



Learn correct English with Sherwin Cody's new invention. No rules to memorize. Like a fascinating game. Spare-time study, 15 minutes each day, quickly gives you command of English. Send for free booklet "How You Can Master Good English in 15 Minutes a Day." Write today. Sherwin Cody School of English, 55 Searle Bldg., Rochester, N. Y.

LEARN WATCHMAKING

and become independent. We help you secure a position.

Easy to learn. Send for FREE CATALOG.

ST. LOUIS WATCHMAKING SCHOOL

Dept. 5,

ST. LOUIS, MO.



"BECOME A LIGHTNING TRICK CARTOONIST"

Send \$1.00 for Laugh Producing Program of 23 Trick Drawings with Instructions. Catalog of Chalk Talk Supplies Free. BALDA ART SERVICE, Dept. 1, Oshkosh, Wis.

Who Wants to Win an Auto?

STUDEBAKER—BUICK—NASH! Your choice!

OR \$2000.00 CASH

Thousands of dollars in new autos and grand prizes will positively be given to advertise and make new friends for my firm. Choice of Studebaker or Buick or Nash new 4-door sedan delivered free, or \$2000.00 cash. Also Oldsmobile, Pontiac, Chevrolet, Fords, diamonds, other fine prizes and cash will be given. No problems to do. No fine writing required. No words to make. No figures to add. Bank guarantees all prizes.

Pick Your Lucky Star!

All the stars in the circle are exactly alike except one. That star is different to all the others and it may be a lucky star for you. Can you pick it out? If you can, mark the different star and send the circle to me at once along with your name and address. A prompt answer can start you on the way to win the great \$2000.00 prize.

BE PROMPT—WIN \$650.00 EXTRA

Someone like you who wins the prize and will write me at once can get \$650.00 cash just for being prompt, so you may thank your lucky stars if you send your answer right off. No risk. Nothing to buy. Nothing hard to do. Over \$7000.00 in valuable prizes will be given. Send today and I will show you just how you can get your choice of these splendid new sedans or \$2000.00 cash, without cost! All win plan! A reward for everybody! SEND NO MONEY! Answer AT ONCE.

Address GEO. WILSON, DEPT. 144, AUGUSTA, MAINE



Learn Watchwork, Jewelrywork and Engraving

A fine trade commanding a good salary, and your services always in demand. Address **HOROLOGICAL**, Dept. P, Bradley Institute, PEORIA, ILLINOIS, for our latest catalog.



Minstrels

Unique First Parts for complete show with special songs and choruses. Make-up. Catalog Free.

T. S. Denison & Co., 623 S. Wabash, Dept. 29 Chicago



TRAVEL - for 'UNCLE SAM'

RAILWAY POSTAL CLERKS
MAIL CARRIERS—POSTOFFICE CLERKS
GENERAL CLERKS—CUSTOMS INSPECTORS
\$1700 to \$3400 a Year for Life

No "lay-offs" because of strikes, poor business, etc.—sure pay—rapid advancement. Many other U. S. Government Jobs. City and country residents stand same chance. Common sense education usually sufficient.

STEADY WORK

Cut coupon and mail it before turning the page.



MEN—BOYS 18 to 45

Use Coupon Before You Lose It



COUPON

FRANKLIN INSTITUTE, Dept. J175, Rochester, N. Y. Rush to me, free of charge, (1) A full description of the position checked below; (2) 32-page book, with list of positions obtainable; (3) Tell me how to get the position checked.
 Railway Postal Clerk (\$1900 to \$2700) General Clerk (\$1260 to \$2100)
 Postoffice Clerk (\$1700 to \$2300) Customs Inspector (\$2100 up)
 City Mail Carrier (\$1700 to \$2100) Rural Mail Carrier (\$2100 to \$3300)

Name

Address

SHAME ON YOUR WEAKNESS!

Why Be Despised When You Can Be Admired?



LIONEL STRONGFORT

Dr. Sargent, of Harvard, declared that Strongfort is unquestionably the finest specimen of physical development ever seen.

strong can afford to be without this book. I've packed the experience and research of a lifetime of physical and health building into "Life's Energy Through Strongfortism." It is priceless! In it are plain facts that will astonish you. It will tell you frankly how you can make yourself over into a vigorous specimen of vital manhood, with 100% pep, power and personality. It doesn't mince words. It will show you how to be true to the best that is within you—teach you how to be a real fellow. It is a man-builder—a success-maker and a life-saver. Just check the subjects on the free consultation coupon on which you want special confidential information. Send for your copy of this book right now—TODAY!

STRONGFORT INSTITUTE

LIONEL STRONGFORT, DIRECTOR.

Physical and Health Specialist For Over 30 Years
 Dept. 43 NEWARK, N. J., U. S. A.

Here's something that ought to make you sit up and take notice if you are lacking in energy, pep and staying powers. "Physical weakness is a crime"—many states say so when they require certain physical qualities in applicants for marriage licenses. "Physical weakness is a crime"—the United States Army and Navy say so when they put you through a rigid physical examination before enlistment. Big corporations say so, too, by insisting on higher physical standards in their employees.

There is no place for you if you are a weakling!

If you are a nervous, timid, fidgeting, shambling fellow, you are not wanted anywhere—you don't attract men or women—you repel them. You can't indulge in the ordinary pleasures of life. You can't enter sporting contests—you lack the energy and stamina of the athlete. You don't get on in school or college—the fellows won't stand for your ailing and complaining, and your mental gloom. You can't hold down a good job—you are too languid and pepleless. Your outlook on life is marred by fits of the blues.

Nature Exacts a Terrible Penalty

when you've gone too far with her. She whips you into such a state of debility and despair that you become a miserable specimen of a man—an object to be pitied or shunned.

You won't get anywhere experimenting with drugs, dope and booze to stimulate the system. Gymnastic apparatus, stretching, pulling and lifting machines often aggravate your condition. Starvation diets may merely weaken you more. Electrical and many other trumped-up treatments, muscle manipulation, baths, ordinary physical culture, forced deep breathing, mystics—all fail to get to the cause of your weaknesses and diseases.

Nature only can help you. Nature is supreme in the regulation, restoration and revitalizing of the human body. But you must give Nature a chance—you must help her—and this you can do most certainly, most effectively through my Course in

STRONGFORTISM

—Science of Health and Strength—

Strongfortism isn't an experiment. There's no guesswork about it. It was through the methods I used in developing my own body until I won the world's record as the finest specimen of muscular development and championships in feats of great strength, in Europe and in the United States, that I constructed the science of *STRONGFORTISM*. It is through it that I reclaim wrecked and weak men, make them into new beings and give them a body and arms of which they can boast.

I require you to use no apparatus. No drugs or medicines are prescribed. No inconvenient hours are required. Only a little of your time in the privacy of your own home is necessary to follow my easily understood instructions—and, oh man, how glad you'll be that you listened to me, once you start on my Course. It means a *new day* for you, that's sure as you're alive.

You can banish your weakness. You can be a man to be feared in physical combat. There is no doubt about it. I can prove it if you'll just sit down and tell me frankly that you are willing to be guided by what I tell you.

Send this coupon

Free Confidential Consultation

Mr. Lionel Strongfort, Strongfort Institute, Dept. 43, Newark, N. J.—Please send me absolutely free my copy of your book, "LIFE'S ENERGY THROUGH STRONGFORTISM." This does not place me under any obligation. I have marked (x) before the subjects in which I am most interested.

- | | | |
|-------------|-----------------|-------------------------|
| .. Catarrh | .. Constipation | .. Weak Heart |
| .. Colds | .. Rheumatism | .. Lung Troubles |
| .. Asthma | .. Nervousness | .. Round Shoulders |
| .. Headache | .. Overweight | .. Stomach Disorders |
| .. Rupture | .. Weak Back | .. Increased Height |
| .. Thinness | .. Weak Eyes | .. Muscular Development |
| .. Pimples | .. Short Breath | .. Great Strength |
| .. Insomnia | | |

Other Ailments.....

Name.....

Age..... Occupation.....

Street.....

City..... State.....



His Salary Was Raised while others were reduced

"Up to the time I enrolled for a course with the International Correspondence Schools, I had only a grade-school education. Since enrolling, I have advanced to a much better position, where my salary is nearly four times as much as I was making previously. I would not be able to hold my present position had I not taken your Course. Recently I received a nice increase in salary, while other men were being reduced."

There could be no better proof of the value of an I. C. S. course than that. It shows that the trained man is given preference over all others and paid more money, even in slack times, if his work deserves it. It shows that there are always bigger, better jobs open for men who have the foresight to prepare for them in spare time.

Why don't you study and get ready too? We'll be glad to help you if you will only make the start.

Choose the work you like best in the coupon below; then mark and mail it to the I. C. S. today. This doesn't obligate you in the least, but it will bring you information that will start you on a successful career. This is your opportunity.

Mail the Coupon for Free Booklet

INTERNATIONAL CORRESPONDENCE SCHOOLS
Box 5682-F, Scranton, Penna.

Without cost or obligation, please send me a copy of your booklet, "Who Wins and Why," and full particulars about the course before which I have marked X in the list below:

TECHNICAL AND INDUSTRIAL COURSES

- | | |
|--|---|
| <input type="checkbox"/> Architect | <input type="checkbox"/> Automobile Mechanic |
| <input type="checkbox"/> Architectural Draftsman | <input type="checkbox"/> Aviation Engines |
| <input type="checkbox"/> Building Foreman | <input type="checkbox"/> Plumber and Steam Fitter |
| <input type="checkbox"/> Concrete Builder | <input type="checkbox"/> Plumbing Inspector |
| <input type="checkbox"/> Contractor and Builder | <input type="checkbox"/> Foreman Plumber |
| <input type="checkbox"/> Structural Draftsman | <input type="checkbox"/> Heating and Ventilation |
| <input type="checkbox"/> Structural Engineer | <input type="checkbox"/> Sheet-Metal Worker |
| <input type="checkbox"/> Electrical Engineer | <input type="checkbox"/> Steam Engineer |
| <input type="checkbox"/> Electrical Contractor | <input type="checkbox"/> Marine Engineer |
| <input type="checkbox"/> Electric Wiring | <input type="checkbox"/> Refrigeration Engineer |
| <input type="checkbox"/> Electric Lighting | <input type="checkbox"/> R. R. Positions |
| <input type="checkbox"/> Reading Shop Blueprints | <input type="checkbox"/> Highway Engineer |
| <input type="checkbox"/> Telegraph Engineer | <input type="checkbox"/> Chemistry |
| <input type="checkbox"/> Telephone Work | <input type="checkbox"/> Pharmacy |
| <input type="checkbox"/> Mechanical Engineer | <input type="checkbox"/> Coal Mining Engineer |
| <input type="checkbox"/> Mechanical Draftsman | <input type="checkbox"/> Navigation <input type="checkbox"/> Assayer |
| <input type="checkbox"/> Machine Shop Practice | <input type="checkbox"/> Iron and Steel Worker |
| <input type="checkbox"/> Toolmaker | <input type="checkbox"/> Textile Overseer or Supt. |
| <input type="checkbox"/> Patternmaker | <input type="checkbox"/> Cotton Manufacturing |
| <input type="checkbox"/> Civil Engineer | <input type="checkbox"/> Woolen Manufacturing |
| <input type="checkbox"/> Surveying and Mapping | <input type="checkbox"/> Agriculture <input type="checkbox"/> Fruit Growing |
| <input type="checkbox"/> Bridge Engineer | <input type="checkbox"/> Poultry Farming |
| <input type="checkbox"/> Gas Engine Operating | <input type="checkbox"/> Mathematics <input type="checkbox"/> Radio |

BUSINESS TRAINING COURSES

- | | |
|--|---|
| <input type="checkbox"/> Business Management | <input type="checkbox"/> Business Correspondence |
| <input type="checkbox"/> Industrial Management | <input type="checkbox"/> Show Card and Sign Lettering |
| <input type="checkbox"/> Personnel Management | <input type="checkbox"/> Stenography and Typing |
| <input type="checkbox"/> Traffic Management | <input type="checkbox"/> English |
| <input type="checkbox"/> Accounting and C. P. A. Coaching | <input type="checkbox"/> Civil Service |
| <input type="checkbox"/> Cost Accounting | <input type="checkbox"/> Railway Mail Clerk |
| <input type="checkbox"/> Bookkeeping | <input type="checkbox"/> Mail Carrier |
| <input type="checkbox"/> Secretarial Work | <input type="checkbox"/> Grade School Subjects |
| <input type="checkbox"/> Spanish <input type="checkbox"/> French | <input type="checkbox"/> High School Subjects |
| <input type="checkbox"/> Salesmanship | <input type="checkbox"/> Cartooning |
| <input type="checkbox"/> Advertising | <input type="checkbox"/> Illustrating |
| | <input type="checkbox"/> Lumber Dealer |

Name.....

Address.....

City..... State.....

Occupation.....

If you reside in Canada, send this coupon to the International Correspondence Schools Canadian, Limited, Montreal, Canada

Learn SIGN and SHOW-CARD WRITING

In spare time few hours weekly

FREE
"Book of Facts"
Write For It

Fascinating profession. Big opportunity in this fast-growing trade. Earn while you learn the sign arts. No talent or experience required. Be your own boss or obtain a good position. Learn show cards, posters, bulletins, signs, advertising layouts and allied subjects. We teach by mail or at our school. Quick results—easy to learn.

EARN \$50 TO \$200 WEEKLY

Otto C. Wiegand, Md., home-study graduate, made \$12,000 from his business in one year. Many successful graduates. Oldest and foremost school. Don't delay. Write for complete information.

DETROIT SCHOOL OF LETTERING

193 Stimson Ave. Est. 1899 DETROIT, MICH.

Learn MECHANICAL DENTISTRY in 10 Months!



Men and Women can do this at home in their spare time. As much as \$100 weekly and even more is made by trained mechanical dentists. Steady work. Earn big money in a profession. Write for FREE particulars about our easy but complete Home Study Course.

AMERICAN SCHOOL OF MECHANICAL DENTISTRY
Dept. A-4 150 E. South Temple St., SALT LAKE CITY, UTAH

WHY NOT spend spring, summer and fall gathering butterflies, insects? Simple and intensely interesting outdoor work with my instructions, illustrations, price list. I buy hundreds of species for collections. Some worth \$1 to \$7 each. Before sending any butterflies, send 10c (not stamped) for my Illustrated Prospectus. It certainly would be wise to send for it right away before you turn this page, or you may forget. So—send right away.



MR. SINCLAIR, DEALER IN INSECTS,
Dept. 6, Box 1424, San Diego, Calif.

BIG Demand for Skilled Mechanics!

The entire country is calling for skilled mechanics! Good pay—steady work—good opportunities for advancement! Master this fascinating trade with the aid of the

AMERICAN MACHINISTS' LIBRARY

6 volumes—2,000 pages—2,500 illustrations

(A combined home-study course and reference library)

This library of machine shop practice was written for practical men. It gives you the best methods for every kind of machine shop work. It explains machine tools and their operation, tool work, gears and grinding, jigs and fixtures, automatic screw machines, their tools, punches, dies, etc. Plainly written—completely illustrated—the best kind of help to the machine-shop man who wants to advance himself.

Free TRIAL

No money down—only 7c a day



FREE EXAMINATION COUPON

McGraw-Hill Book Co., Inc., 370 Seventh Ave., New York
Send me for 10 days' free examination, the AMERICAN MACHINISTS' LIBRARY. If satisfactory, I will send \$1.50 in 10 days and \$2 monthly until the special price of \$17.50 is paid. If not wanted, I will return the books at your expense.

Signed.....

Address.....

City and State.....

Position.....

Company..... P. M. 5-30

- takes only 8 weeks to get a big job



George Smith owns an agency and repair shop in West Alexandria, Ohio. He makes \$200 a week.



C. E. Gillespie has charge of a fleet of trucks and tractors for the State Highway Commission, due to McSweeney training.

and Earn \$75 to \$125 a Week as Auto or Aviation Expert

Learn the auto and tractor business by the McSweeney method, then step out and get a good job at \$75 to \$125 a week or open your own repair shop and make up to \$10,000 a year. Trained men are needed everywhere. Opportunities galore! Eight weeks' training fits you to open repair shop or to go on with one of the big firms waiting for trained men. Read what George Smith and C. E. Gillespie have done. Hundreds of other McSweeney trained men can tell as interesting facts. Every month McSweeney men who complete their training are taking the place of half-trained and incompletely self-trained men.

Satisfaction Guaranteed!
I guarantee satisfaction. I guarantee to continue giving you my practical training until you are able to hold a first-class automotive or electrical job.

AVIATION Course

AVIATION is paying tremendous incomes to trained men! Coupon brings complete details about complete course in Aviation. Learn on real airplane engines under experienced instructors. Ask about special course in FLYING. Don't miss this remarkable opportunity. Save by enrolling at once. The sooner you start the sooner you will be ready to earn big pay or get into business for yourself.

Learn in Only 8 Weeks

Simple, thorough, practical shop methods. You learn the "why" of everything you do, then learn to do it right. You do real work with real tools and real equipment. No book studying. Very little schooling necessary. Any man from 16 to 60 can learn. Write today for Big Special Limited Time Tuition Offer. No facilities for colored students. Write for Big, Illustrated Book FREE!

McSWEENEY

Auto, Tractor and Aviation **SCHOOLS**

Dept. A-10-E, Chester at 30th St., Cleveland, Ohio



MAIL COUPON FOR FREE BOOK

McSWEENEY AUTO, TRACTOR AND AVIATION SCHOOLS, Dept. A-10-E, Chester at 30th St., Cleveland, O.

Without cost or obligation, send me your big FREE book on Autos and Aviation, also full details of your special tuition offer.

Name.....
Street.....
Town..... State.....

\$ 1 9 0 0 T O \$ 2 7 0 0 A Y E A R



MANY OTHER U. S. GOVERNMENT POSITIONS

Customs Clerks City Mail Carrier
Rural Carriers City Postal Clerks

MEN—BOYS 18 OR OVER

Short Hours Pleasant Work
Rapid Advancement Permanent Employment
Long Vacation with Pay

Mail Coupon Now. Act at Once.

DO IT TODAY. TOMORROW YOU MAY FORGET.

FRANKLIN INSTITUTE, Dept. J173, Rochester, N.Y.

Rush to me entirely free of charge: 32 page book, with list of U. S. Gov't Jobs obtainable and particulars telling how to get the job here checked.

Railway Postal Clerk	(\$1900-\$2700)
Post Office Clerk	(\$1700-\$2300)
City Mail Carrier	(\$1700-\$2100)
Rural Mail Carrier	(\$2100-\$3300)
Prohibition Agent	(\$2300-\$2800)
Inspector of Customs	(\$2100 up)
Immigrant Inspector	(\$2100 up)

VALUABLE COUPON

Name.....
Address.....

There is a job for you in Aviation

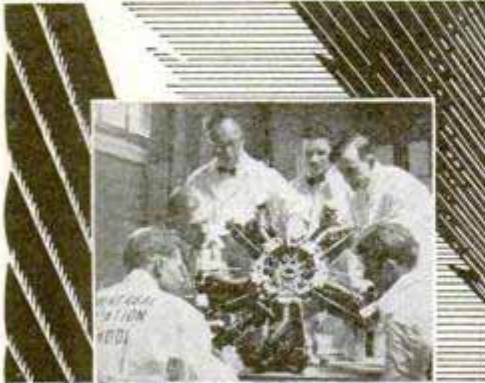

Practical shop work in a Universal School.

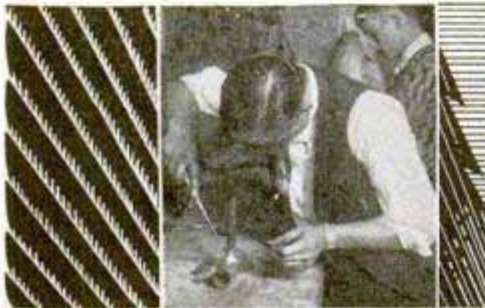

Many graduates of the Universal welding course are employed at good pay in airplane factories.



A typical class room in one of the schools of this national system.

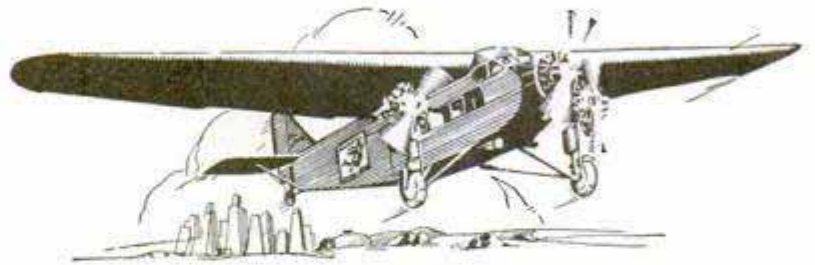

At least 10 hours training in tri-motor planes is a part of the regular transport pilot's course

Let us help you find it

Do you want to become a pilot? A mechanic? A welder? Do you want to enter the business end of aviation? Then send in the coupon with the information which we ask and let us advise you how to realize your ambitions.

How We Assist Ambitious Men
When you return the coupon, we study your qualifications. If you need special training to reach your goal, we tell you just what kind you should have. We send you, with our advice, an attractive book telling all about aviation and describing the kinds of training offered in this national system of government approved aviation schools.

A National Employment Service
Universal Aviation Schools are a division of the American Airways, Inc., the world's largest air transportation system. This system is constantly opening new routes and employing additional men. Universal graduates are given first consideration whenever new men are employed. And other large air transportation systems, airplane manufacturers and aviation supply houses, knowing the high type of training offered in Universal Aviation Schools,

turn to our employment department for men with aviation training.

Why Universal Students Rank High

Universal Aviation Schools are among the few that are government rated and approved. This means that all equipment, instructors and methods of instruction in Universal Schools meet the Department of Commerce requirements. In addition, to retain government approval, these schools must turn out graduates who meet the department's high standards. For this reason only men with satisfactory qualifications are accepted in Universal Aviation Schools. Among the courses offered are: Flying, Mechanics, Welding and General Aviation Business Administration. Also an excellent home study course in Aviation.

How to Start in Aviation

Mail the coupon giving full details on all questions asked. We will tell in reply what training you need and send you the book, "Aviation—What It Means to You." This book gives qualifications required of students, cost of training and all information you should have. If you want a place in aviation, fill in the coupon and mail.



INFORMATION BLANK

Fill in and mail

UNIVERSAL AVIATION SCHOOLS,
1047-56 Boatmen's Bank Bldg., St. Louis, Mo.
Please advise me what training I should take.
I prefer position as Pilot.....
Mechanic....., Welder....., Office Work.....
Name..... Age.....
Address.....
City..... State.....
Telephone Number.....
My past experience is.....

C-4-35

Universal Aviation Schools

A DIVISION OF AMERICAN AIRWAYS, INC.

Operating Company of The Aviation Corporation

A National System of U. S. Government Approved Schools



Only
\$200
 down

BRAND NEW

CORONA GENUINE Model #3

Lowest Price — Easiest Terms



HERE'S your chance to own that *brand new* Genuine Model 3 Corona you've wanted—on the easiest terms ever offered—at **LOWEST PRICE** ever offered. Complete in every detail; back spacer, etc. *Manufacturer's Guarantee*. Recognized the world over as the finest, strongest, sturdiest portable built.

S. Joveton writes: "It truly is a wonderful machine. I am very pleased with it and find it very simple to work although it is the first typewriter I have ever used."

Don P. Fina, composer and pianist says: "Corona has helped me put my songs over and is still doing it. I find it just the thing for writing words to songs and for all correspondence to the profession."

F. J. Barsuglia, Jr., writes: "I am very well pleased with your little Corona and I must say I do not know what I would really do without it. It works like a charm and has every convenience of a larger machine."

Mrs. G. Bernstein says: "Allow me to thank you for prompt delivery of the Corona. I am delighted with it and know I shall derive great pleasure from its possession."

Yours for 10 DAYS' TRIAL

Try this wonderful portable typewriter—the same machine that has satisfied 500,000 users. Experience the joy this personal writing portable typewriter can give you! Use it ten days! See how easy it is to run and the splendidly typed letters it turns out. Ideal for the office desk, home, traveling. Small, compact, light, convenient. Don't send out letters, manuscripts, reports, bills in poor handwriting when you can have this Corona at such a low price on such easy terms. Remember these are *brand new* machines right out of the Corona factory.

Carrying Case Included If You Act Now!

Leatheroid carrying case, oiler, instructions included on this offer. Send no money—just the coupon. Without delay or red tape we will send you the Corona. Try it 10 days. If you decide to keep it, send us only \$2—then \$3 a month until our special price of \$39.90 is paid. Now is the time to buy. Mail coupon today!



Save Money—Use this Coupon

Smith Typewriter Sales Corp., (Corona Division)
 469 E. Ohio St., Chicago, Ill. Dept. 35

Ship me the Corona, F. O. B. Chicago. On arrival I'll deposit \$2 with express agent. If I keep the machine, I'll send you \$3 a month until the \$37.90 balance of \$39.90 price is paid; the title to remain with you until then. I am to have 10 days to try the typewriter. If I decide not to keep it, I will repack and return to express agent and get my money back. You are to give your standard guarantee.

Name

Address

Employed by



BIG MONEY FOR YOU

KNOW ELECTRICITY AS EXPERTS KNOW IT

Sending in the coupon below may mean the difference between going on struggling and striving—or it may mean that with a few minutes a day properly applied, you can fit yourself for a bigger job.

Thousands of men have done just this—increased their knowledge, increased their earning power, increased their chances of profit. You can do the same. Big things are ahead in the electrical field. The electrical expert has first call, and can name practically any salary and get it. You can do this, if first you fit yourself for a "big-pay" job by knowing electricity as the experts know it.

THE CROFT LIBRARY OF PRACTICAL ELECTRICITY

You do not need to go to college, you do not need to waste a lot of time learning unnecessary things. The Croft Library (59,000 sets now in use) gives you the practical side in condensed form. Just a few minutes a day of pleasant, interesting reading will teach you all you should know to step into the expert's shoes and into his salary. Thousands upon thousands have done just this—have sent the coupon, started on the high-road to success.

LIMITED OFFER—SEND NO MONEY

It is impossible to describe all of the information contained in these books—or tell you of the concise way in which the hundreds of subjects are handled, such as circuits, armatures, commutators, transformers, switch boards, distribution systems, electrical machinery—in fact, how to do a complete job from estimating to completion. The books are filled with plans, pictures. They furnish a continual source of ready reference.

They are handsomely bound in flexible Keratol. The edition we offer amounts to a complete course in electricity. Not in a lifetime could you gain by experience alone the knowledge that has been brought together by Terrell Croft in these seven books.

You must see them and you can see them—absolutely FREE of all cost. Send no money. You are obligated in no way. We will ship the books to you for free examination and trial. Then if you decide to keep this library and use it to fit yourself for a bigger job, send only \$1.50; the balance in small monthly payments. You will never miss the money, and you will see as thousands of others have, that it is the best investment you ever made. Just clip the coupon, mail it, and the books will be forwarded to you immediately.

FREE 10 DAY TRIAL



McGraw-Hill FREE EXAMINATION COUPON

McGraw-Hill Book Co., 370 Seventh Ave., New York

Send me the seven volumes of the New Croft Library of Practical Electricity on approval for 10 days' free examination. At the end of that time I will either return the books or remit a first payment of \$1.50 and \$2.00 a month for 9 months.

Name.....
 Home Address.....
 City and State.....
 Position.....
 Name of Company..... P.M. 550

FREE BOOKS of BUSINESS HELPS

We publish over 200 Home Study Books, each a complete treatise of its subject. We have one or more for you. Books on

- | | |
|--|---|
| <input type="checkbox"/> Commercial Art | <input type="checkbox"/> Decoration |
| <input type="checkbox"/> Lettering | <input type="checkbox"/> Automobiles |
| <input type="checkbox"/> Advertising | <input type="checkbox"/> Battery Work |
| <input type="checkbox"/> Sign Making | <input type="checkbox"/> Electricity |
| <input type="checkbox"/> Radio | <input type="checkbox"/> Carpentry |
| <input type="checkbox"/> Aviation | <input type="checkbox"/> Building |
| <input type="checkbox"/> Painting | <input type="checkbox"/> Contracting |
| <input type="checkbox"/> Silk Screen Process | <input type="checkbox"/> Sheet Metal Work |

and many other subjects. All fully described in our FREE CATALOG. Check the subjects in which you are interested and write today.

FREDERICK J. DRAKE & CO., Publishers
 Room 508—179 No. Michigan Blvd., Chicago
 Drake books are for sale in all book stores.

Learn AVIATION

WHERE LINDBERGH STARTED!

Come to Lincoln—where "Lindy" learned. Come to the famous Lincoln School!

No other civilian airplane school in America offers mechanical and flying training on such elaborate equipment at anywhere near our reasonable charge. Over \$250,000 worth of buildings and equipment. A modern \$100,000 airport. Expert instructors. Plenty of new production, government licensed training planes, including a new Travel Air transport cabin ship. Mechanical School is tied in with a large airplane factory. Pilots government licensed. Write today for details, stating age!

Lincoln Airplane & Flying School
 200 Aircraft Bldg. LINCOLN, NEBR.

LEARN TO PLAY

VIOLIN, TENOR BANJO, HAWAIIAN GUITAR, BANJO, CORNET, UKULELE, BANJO UKULELE, GUITAR, BANJO MANDOLIN, BANJO GUITAR, MANDOLIN, SNARE DRUM, FIELD DRUM, PIANO or ORGAN at home this new and "easy to learn" way. No teacher or talent required. Entirely different from any "chart" or "diagram" system. Lessons are so simplified most pupils play by note after only 10 lessons. Thousands of men, women, boys and girls have learned to play quickly by our Home Study method. Your opportunity to become popular and play for profit or pleasure. A few cents a day pays for lessons. Pay while you learn. Write to-day for full particulars. No obligation. Instruments except Piano and Organ furnished at cost if desired.

CHICAGO CORRESPONDENCE SCHOOL OF MUSIC, INC.
 1632 No. Halsted St., Dept. 74 Chicago, Ill.

YOU CAN OIL PAINT

Amazing new method teaches men or women to earn after first lesson. OIL PAINT photos—portraits, landscapes or art subjects. Earn \$18 to \$50 and more a week. OIL PAINT OUT-FIT GIVEN. Send now for free illustrated book. PICTORIAL ART STUDIOS Inc. Dept. MP. 2926 Broadway, Chicago, Ill.

"Pick YOUR Government Job"



Work for Uncle Sam. Get good pay, regular increases, vacations and sick leave with pay, steady advancement, pension. Send for my free book "How to Secure a Government Position"—tells about all jobs, near home or traveling, the money, what you need to know and how to get posted. Forget job hunting.

IMPORTANT NOTICE—Railway Postal Clerk examination coming. Yearly pay with allowances averages \$2759.00. Prepare yourself NOW. Send coupon at once.

A. R. Patterson, Civil Service Expert
PATTERSON SCHOOL, 85 Wisner Bldg.
 Rochester, N. Y.

Please send me, without obligation, your free book "How to Secure a Government Position."
 Name.....
 Address.....

R. T. I. R. T. I. QUALIFIES YOU TO MAKE MONEY AND ITS SERVICE KEEPS YOU UP-TO-THE-MINUTE ON THE **R. T. I.**
 NEWEST DEVELOPMENTS IN RADIO, TELEVISION AND TALKING PICTURES



BIG MONEY NOW!

More to Come

Radio now offers ambitious men the greatest Money-Making Opportunity the world has ever seen! Hundreds of trained service men are needed by radio dealers, jobbers, and manufacturers!

A "trained" Radio "Service and Repair" man can easily make \$40 and \$50 a week, and it's very common for a "trained" man with experience to make \$75 a week, and up.

BIG MONEY for spare-time Radio Work is easily made in every city and village. You can now qualify for this Big-Pay work quickly through R. T. I. Get the Big Money Now and go up and up in this Big Pay field. The Radio industry calls for More Men, and R. T. I. supplies what the industry wants you to know.

Supervised by Radio Leaders

R. T. I. training is prepared and supervised by prominent men in radio, television and talking picture engineering; distributing; sales; manufacturing; broadcasting, etc. These men know what you must know to make money in Radio. You learn easily in spare time at home with the R. T. I. wonderful combination Testing Outfits, Parts, Work Sheets, Job Tickets. It is easy, quick and practical—covers everything in Radio—includes Talking Pictures and the latest in Television.

\$80—\$70—\$50—PER WEEK AND UP. That's what R. T. I. training leads to. Send for the R. T. I. Book.

No Experience Needed

ALL YOU NEED is the ambition and the ability to read and write. The Radio industry needs practical trained men. Remember, R. T. I. makes it easy to earn spare time money while you learn at home.

More to come

THE MEN who get into this Big-Money field now will have an unlimited future. Why? Because this billion dollar Radio industry is only a few years old and is growing by leaps and bounds. Get in and grow with it. \$10 to \$25 per week and more is easily made in spare hours while you are preparing for Big Money. TELEVISION, too, will soon be on the market, so the leaders say. Be ready for this amazing new money-making field. Remember, R. T. I. "3 in 1" home-training gives you all the developments in Television and Talking Picture Equipment, together with the complete Radio training.

Warning

Do not start R. T. I. training if you are going to be satisfied to make \$15 or \$20 per week more than you are now. Most R. T. I. men will make that much increase after a few weeks. There is no reason to stop short of the Big Money Jobs or the Big Profits in a spare time or full time business of your own. No capital needed. Get started with R. T. I. now. Make money while you learn at home.

R. T. I. Book Now FREE

The thrilling story of Radio, Television and Talking Pictures is told with hundreds of pictures and facts—its hundreds of big money jobs and spare time money-making opportunities everywhere. Send for your copy now. **USE THE COUPON.**



Let **F. H. SCHNELL** and the **R. T. I. Advisory Board** Help You

Twenty years Radio experience. First to establish two-way amateur communication with Europe. Former Traf. Mgr. of American Radio Relay League. Lieut. Com. U.S.N.R. Inventor, designer, consulting Radio engineer.

Assisting him is the R. T. I. Advisory Board, composed of men prominent in the Radio Industry. These men know Radio and will help you succeed in their field.



THE R. T. I. ADVISORY BOARD. These men are executives with important concerns in the radio industry—manufacturing, sales, service, broadcasting, engineering, etc., etc. They supervise R. T. I. Work Sheets, Job Tickets, and other training methods.

RADIO & TELEVISION INSTITUTE
 Dept. 15
 4806 St. Anthony Ct. Chicago

RADIO & TELEVISION INSTITUTE
 Dept. 15, 4806 St. Anthony Court, Chicago
 Send me Free and prepaid your **BIG BOOK** "Tune In On Big Pay" and full details of your three-in-one Home Training (without obligating me in any way).

Name.....
 Address.....
 City..... State.....

R. T. I. R. T. I. TRAINS YOU AT HOME FOR A GOOD JOB OR A PROFITABLE PART TIME OR FULL TIME BUSINESS OF YOUR OWN



An ELECTRICAL Job

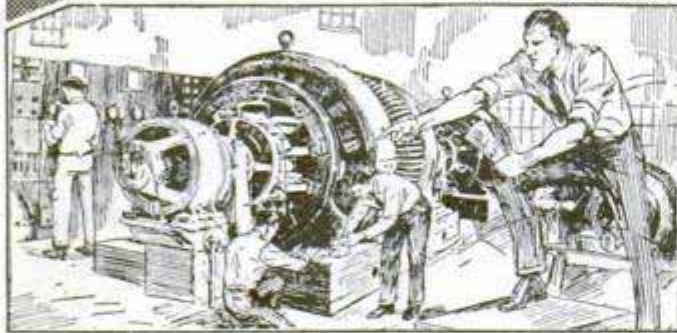

when you're only Half Way Through!



Gentlemen:
Thanks to the consistent effort of the American School I have found an entirely satisfactory job doing Electrical construction and maintenance work.
(Signed)
W. B. McClellan,
Mason City, Iowa



"I have accepted employment with the Iowa Railway and Light Corporation starting at \$125.00 per month, who wrote me a letter suggesting an interview.
Thanking you very much for your splendid co-operation, I remain, Yours truly,
(Signed)
Glen Vandeknar,
Leighton, Iowa

During the past few months we have placed HUNDREDS of our graduates and also students when only half through the course—in well-paid Electrical positions. These men are now on the high road to a real future in the world's greatest business—some in power plants—some in Electrical factories—others in the business or drafting or selling or radio end.

Go After the Big Money

The big Electrical Utility magnates have just laid down a TWO-BILLION DOLLAR program of new projects before President Hoover. Remember, that's in addition to the billions already invested and the millions of men already employed in Electricity.

Just think—how light, power, railroads, radio, telephone, telegraph, all manufacturing, automatic devices, home appliances—now depend on Electricity. That's a wonderful line to get into—because it has no "hard times" or unemployment.

And now it's easy to break into Electricity. In your spare time, right at home, you can now quickly master WIRING, MOTORS, GENERATORS, POWER PLANT EQUIPMENT and other fascinating branches of the work—and almost before you realize it, we'll be recommending you for your first Electrical position.

WHO ELSE Wants a Good Electrical Job?

The letters shown at the left are just typical of HUNDREDS we'd like to show you. We want to tell you more about the wonderful chances waiting for you in Electricity—our fastest growing industry. Mail coupon for an interesting proposition we are making right now to ambitious men.

American School Dept. E-547, Drexel Ave. and 58th St., CHICAGO

AMERICAN SCHOOL, Dept. E-547, Drexel Ave. and 58th St., Chicago, Ill.

Please send me without cost or obligation your Electrical bulletin, and tell me about your combined training and employment service in line marked X below.

- | | | |
|--|---|---|
| <input type="checkbox"/> Drafting | <input type="checkbox"/> ELECTRICAL ENGINEERING | <input type="checkbox"/> Business Management |
| <input type="checkbox"/> Architecture | <input type="checkbox"/> Accounting | <input type="checkbox"/> Mechanical Engineering |
| <input type="checkbox"/> Building | <input type="checkbox"/> Shop Superintendent | <input type="checkbox"/> Foremanship |
| <input type="checkbox"/> Structural Steel | <input type="checkbox"/> High School in 2 years | |
| <input type="checkbox"/> Civil Engineering | | |
| <input type="checkbox"/> Auto Engineering | | |

Name.....
St. No.....
City.....State.....
Age.....Occupation.....

34 Lesson Drawing Course \$2.98

The biggest value you ever saw advertised anywhere

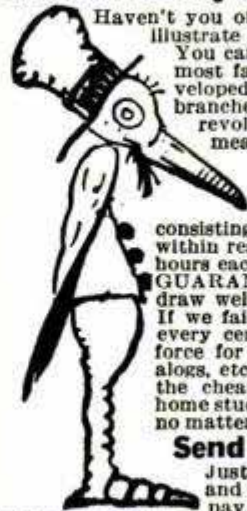

Haven't you often wished that you could draw cartoons, illustrate some idea, sketch some pretty face, etc.? You can do all of these things. One of America's most famous Cartoonists and Illustrators has developed a great, simple system for success in all branches of Commercial Art. This system has revolutionized the entire theory of drawing. It means that drawing can be as easy for you as writing—much simpler than learning shorthand, bookkeeping or typewriting. We are now placing this original system for learning Drawing, Art and Cartooning, consisting of 34 lessons with over 500 illustrations, within reach of every one. If you will devote a few hours each week to the Course WE ABSOLUTELY GUARANTEE that you will learn to draw and draw well before you have half finished the Course. If we fail to make this claim good, we will refund every cent paid us. By eliminating a large office force for answering correspondence, expensive catalogs, etc., we are enabled to make a price of \$2.98, the cheapest price ever known for a high-grade, home study course. Learn to draw. It is a big asset, no matter what field you are in.

Send No Money

Just order the course and on arrival \$2.98 pay postman plus a few cents postage, payment in full for the entire Course and Drawing Outfit. If not entirely satisfied, return within five days and we will Refund Money. Address: LEDERER SCHOOL of DRAWING, Dept. 582-U, Chattanooga, Tenn. Orders from outside the U. S. A. are payable \$3.28 cash with order

If you order the course at once, we will include a drawing outfit, consisting of artist's pencils, pens, paper, erasers, thumb tacks, etc., enabling you to go to work without any additional cost.

ELECTRICITY WELDING AUTOMOBILES

PRACTICAL TRAINING ON MASSIVE LAY-OUT OF ELECTRICAL EQUIPMENT Aircraft Oxy-Acetylene and Electric Welding, Armature Winding, Power Plants, Switchboards, Transformers, Motors, Generators, Batteries, Radio and Automobiles. Write now for Free Catalog. Coleman Electrical School, 1628 Main St., Kansas City, Mo.

Government Positions

Census Clerks, Clerk Carriers, Rural Carriers, Railway Mail Clerks, Postmasters, Department Clerks, and many others. Splendid salaries, easy work, vacation with pay. Only common school education required. Examinations often. 37,976 appointed last year. Send for our Civil Service Catalog No. 6. COLUMBIAN CORRESPONDENCE COLLEGE, Washington, D. C.

Boys-Girls CHOCOLATE BAR FREE
Rush name and address for full size 5c new Milk Chocolate Bar just out. Chance to make money selling to friends. Pure milk chocolate. Entirely new delicious flavor. Answer at once. Send no money. Milton Gordon Chocolate Co., Dept. 1003, CINCINNATI, OHIO

Powerful Muscular Chest



GRIP AND ARMS COMPLETE COURSE AND APPARATUS \$1.00

Get Strong! Newly perfected apparatus; small enough for pocket, yet powerful—gives amazing results. Tremendous resistance. Builds muscular chest, arms, grip. Complete course and equipment \$1.00 postpaid. Guaranteed. Attach name, address to One Dollar bill. Order at introductory price.

MUSCLE POWER CO. Dept. PM-5, 150 Nassau St., New York



LAW Free Book

Write today for FREE 64-page book, "THE LAW-TRAINED MAN", which shows how to learn law in spare time through the Blackstone home-study course prepared by 80 prominent legal authorities, including law school deans, and U. S. Supreme Court justices. Combination text and case method of instruction used. All material necessary furnished with the course, including elaborate 25-volume law library, delivered immediately upon enrollment. Many successful attorneys among our graduates. L. B. degree conferred. Moderate tuition, low monthly terms. Money-Back Agreement.

Write for free book today. BLACKSTONE INSTITUTE, 307 N. Michigan Ave. Dept. 55 Chicago



"Give me 7 days to prove
that you can build a healthy,
husky body like mine"

-CHARLES
ATLAS

A Challenge to You

from the
"WORLD'S MOST PERFECTLY
DEVELOPED MAN"

ONCE I was a puny, cringing weakling with muscles you couldn't find if you looked for them. I was not only timid, I was always ailing, always tired, only *half-alive*. Now I hold the championship title, "*The World's Most Perfectly Developed Man*."

YOU, TOO, can win my kind of muscle-power—get this new health, strength and energy—acquire this new, more forceful personality! I'll tell you my secrets of *Dynamic-Tension* that gave me my amazing development. I'll give you my whole system, the very same methods that I used and that thousands of my pupils have applied with the same sure-fire results. I'll give you the PROOF—in your first 7 days under my direction—that YOU can be this NEW MAN!

My time-tested, scientific, NATURAL methods go right to the source of true health and body-building in their job of giving you a new body and making a new man of you. In addition to giving you might and muscle I show you how to add weight or smooth off bulging fat to give you my kind of handsome, balanced development.

NO part of your body is slighted by my system. My methods dig down to the root source of your troubles and quickly banish such irritating ailments as constipation, blotchy or pimply skin, frequent colds, various nervous disorders, etc. And all I ask is 15 minutes a day of your spare time, right in your own home, following my simple instructions—without apparatus, special foods, pills, "rays" or any other contraptions.

If you are not 100% PROUD of your body, do just this—send me your name and address on my coupon printed at the right. On receipt I'll send you *absolutely free* a copy of my 48-page book "*Everlasting Health and Strength*." Then read all about my methods, look at the fine pic-

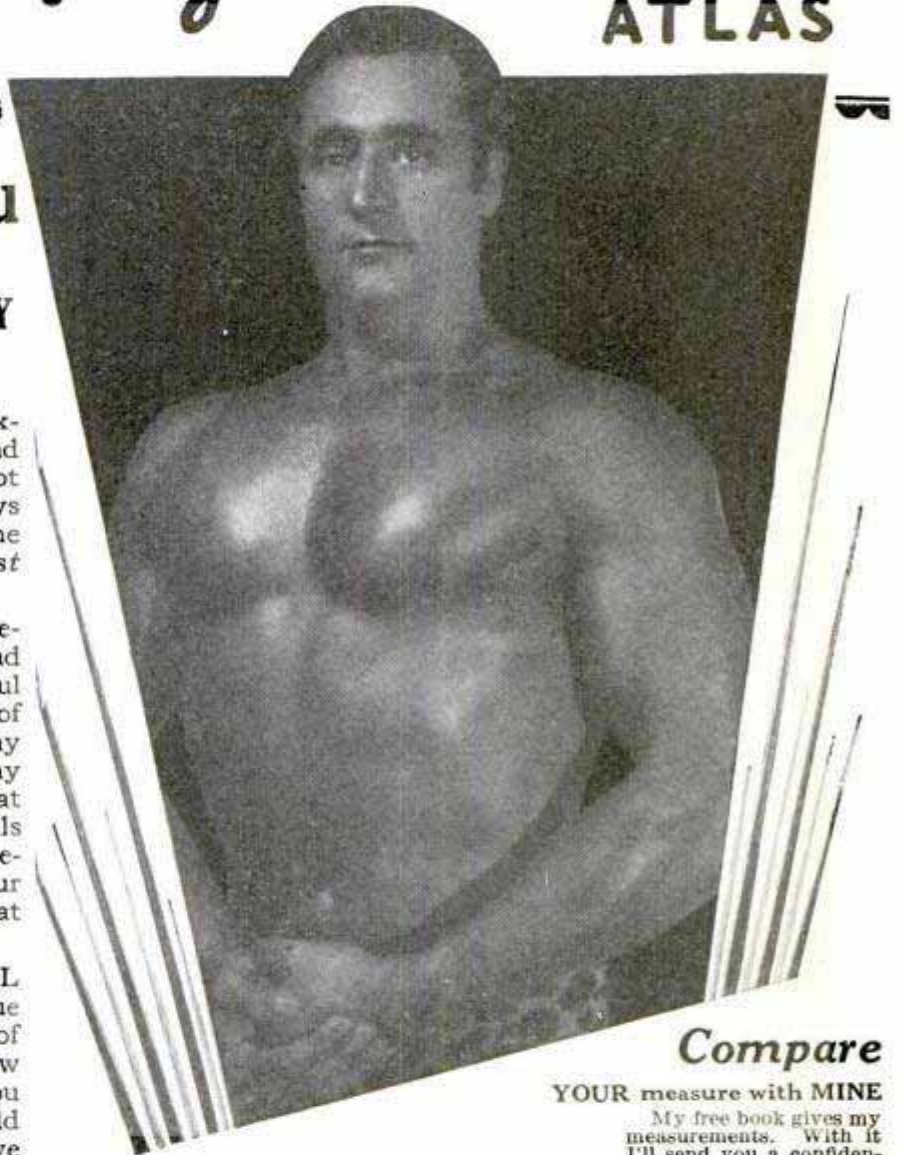

Compare

YOUR measure with MINE

My free book gives my measurements. With it I'll send you a confidential chart for yours. Then compare your measurements with mine and learn how I can make a NEW MAN of YOU—how you can add weight, increase measurements, develop powerful muscles, conquer timidity, get new vitality and tireless energy. Mail coupon for my free book and this confidential chart.

tures of myself and the scores of others who have used my methods so successfully. Read what I did for these others—*what I can do for you*—and how you get the proof in your first seven days.

It will cost you only a 2c stamp to mail the coupon to me and get all the information. Invest that two cents NOW—to win the biggest prize on earth—a handsome, healthy, HUSKY body! Send the coupon to CHARLES ATLAS, 171 Madison Avenue (Dept. 85), New York, N. Y.

FREE Fill in and mail this coupon to me at once and I will send you a free copy of "*Everlasting Health and Strength*" and a confidential chart for your measurements. Mail to CHARLES ATLAS, (Dept. 85) 171 Madison Ave., New York

Your Name.....
Address.....
City & State.....



Radio Inspectors
\$2000 to \$4500
a year

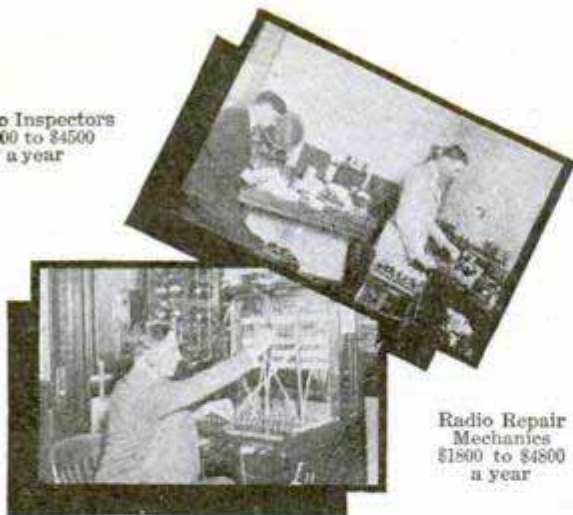

Radio Repair
Mechanics
\$1800 to \$4800
a year

SUCCESS IN RADIO

Depends upon Training

...You Get that Training
with RCA Institutes Inc.

Regardless of who you are . . . how old you are . . . where you live or what you do . . . You, too, can make a success in radio because RCA Institutes *trains you for success*. This is the *only* school backed by the Radio Corporation of America . . . the foremost radio organization in the world today! A serious shortage of trained men exists right now. Thousands of men are needed. Broadcasting stations, manufacturing plants, retail, and wholesale dealers, as well as ships at sea and planes in the air are now waiting for men like you . . . men who have the will as well as the knowledge to make good. They know that the graduate of RCA Institutes has the knowledge and ability to hold a good position in radio. Inside information about radio . . . quickly and easily yours. We have received hundreds of letters similar to this . . . Each letter a "true story" of success in radio. You get your lessons and criticisms direct from RCA . . . the very source of radio achievement . . . the organization that made Radio what it is today . . . that sponsors every lesson in this course.

Remarkable Outlay of Apparatus included with this famous Laboratory Training Course

Learn to solve every radio problem such as repairing and servicing fine sets, by actual experience with the famous RCA Institutes outlay of apparatus . . . A complete assortment of parts assembled for your help and instruction by RCA experts. Here is training that you cannot duplicate elsewhere, at any price.

RCA Graduates Find It Easy to Fill Good Radio Jobs

For more than 20 years, there has been a radio job for practically every graduate who wished one. RCA Institutes students are actually trained for success in Radio . . . That is the *only purpose of this organization* and that is why students make such rapid progress in Radio. Every student receives an agreement signed by the president of this school assuring absolute satisfaction upon completion of the course . . . or money refunded.

Clip this Coupon NOW!

RCA INSTITUTES, INC.

Formerly
Radio
Institute of
America

SPONSORED BY



RCA INSTITUTES, Inc.
Dept. PM-5, 75 Varick Street, New York.

Gentlemen: Please send me your FREE 40-page book which illustrates the brilliant opportunities in Radio and describes your laboratory-method of instruction at home!

Name _____

Address _____

Why Good Dancers Are Popular

Every one wants to dance with the person who knows the smart new steps!

Through my new method you can learn the latest, most popular steps in *one evening*—right in your own home, without music, partner, teacher. Simple as taking one step after another.

Thorough—takes you from the very beginning to this season's newest dances and all their variations.



Regular \$5.00 Course **Now Only \$2.98**

5 Day Trial—Free Would cost you \$24.00 if taken at a Studio. Practice in your spare time—surprise your friends—with your new-found popularity.

400,000 have already become accomplished, versatile dancers this easy way. Your success is guaranteed! To prove it I will send you my dancing course *without one penny in advance!* Just send your name and address and when the package arrives give post-man only \$2.98, plus delivery charges, and this famous course is yours. Try for 5 days—*money back if not delighted!* Don't delay—act now and be a good dancer soon.

ARTHUR MURRAY Studio 129, 7 East 43rd Street
NEW YORK, N. Y.

LEARN MECHANICAL DENTISTRY

Earn Big Money—Steady Work
You can EARN WHILE LEARNING this modern money making business and become independent. Big demand. You learn by doing actual work in rubber and gold. Easy terms. Individual instruction. Day and night school. Railroad fare allowed—no extra cost. Write NOW for catalog P.

NEW YORK SCHOOL OF MECHANICAL DENTISTRY
147 W. 33rd Street
NEW YORK

SEND FOR FREE BOOK
YOUR SUCCESS

Every Family should own this Newest, Greatest
ENCYCLOPAEDIA BRITANNICA
Write for FREE Booklet
THE ENCYCLOPAEDIA BRITANNICA, Inc.
342 Madison Ave., New York City

Anyone CAN LEARN

No talent or experience necessary. Fascinating work. Pays Big Money. Complete instruction book tells about: Alphabets, Colors, How to Mix Paints, Show Cards, Window Board and Wall Signs, Ready made letters, Gilding, Tricks of the Trade, also gives 100 Alphabets and Designs. Book bound in flexible int. leather-gold edges, and four ball bearing Show Card Pens. Sent postpaid \$3.00. (C.O.D.) 10c ex. Ogilvie Pub. Co., 57 Rose St., Dept. 20, N.Y. City

EARN MONEY IMMEDIATELY—WE FURNISH EQUIPMENT TO START!!

6 Ft. LONG Large 6-foot air bag with inflators, parachute and complete instructions for flying. Send name and we will send 6 of our new reprints of wonderful oil painting pictures to dispose of on special 25c offer. Send \$1.50 you collect and for this service we'll send this wonderful Airship with instructions free.

C. M. Thomas, 337 W. Madison St. 5-K-91 Chicago

WASHES CARS in A JIFFY!

Here's the cleverest invention of the age! GY-RO washes cars CLEAN without *chemicals, soap or spray!* Water pressure from garden hose makes it operate. And in the *easiest, simplest manner ever!* Whirling brush cuts right through dirt and road film—car becomes spotlessly clean in a jiffy. Saves autoists valuable time and a nasty job. They buy GY-RO on sight. **USEFUL IN EVERY HOME**—Cleans screens, walls, etc., like new.

100% PROFIT FOR AGENTS!
AGENTS WANTED AT ONCE. Valuable territories still open. No experience needed. Exceptionally large profits for hustlers. Car owners, garages, service stations, etc., are prospects. **COSTS NOTHING TO START.** Send name and address for full particulars.

GY-RO BRUSH COMPANY, Dept. E-14, Ampere, N. J.

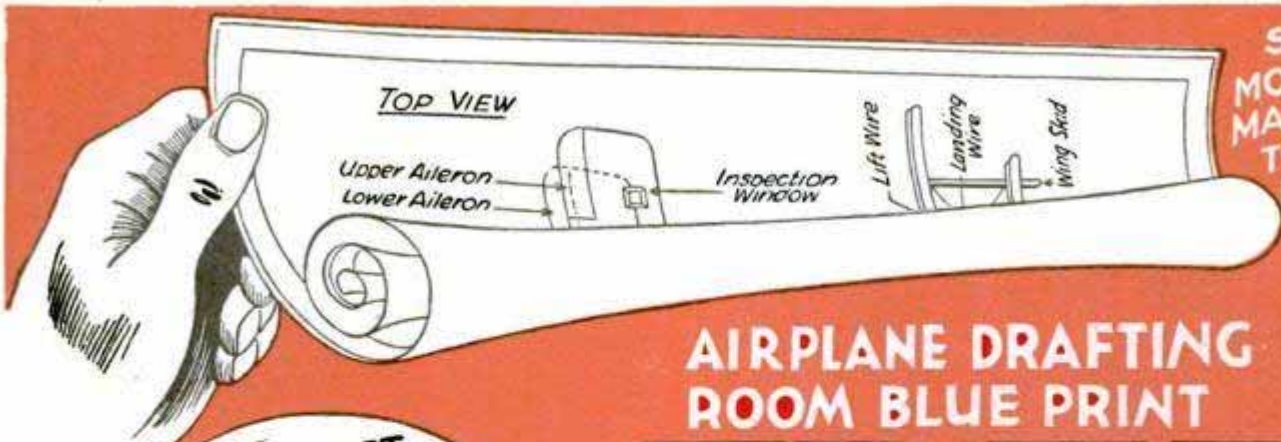

AIRPLANE DRAFTING ROOM BLUE PRINT

FREE



Learn to be an airplane designer. I will train you **RIGHT IN YOUR OWN HOME**. Here's your opportunity to get into the big money earning branch of Aviation—Designing airplanes. Copy the airplane picture shown here and mail to me with coupon below. If I think you show talent for this work and really want to train for a big pay position in aviation, I will mail you direct from my drafting room an airplane blueprint in three views with all main parts named and explained.

GET INTO AVIATION

through the Front Door—the Drafting Room

LEARN AERO-DRAFTING

If you want to fit yourself for a start toward making big money in AVIATION — get into the creative end of this rapidly growing industry. There are good airplane designers today who get \$12,000 a year — *think of it* — \$1,000 a month. Let me train you in Aero-Drafting — and put you in line for a position like this. Remember, you don't need flying or mechanical experience to become an Aero-Draftsman.

I Train You AT HOME!

No need to quit your present job or leave home to get in line for a Draftsman's position at **BIG PAY**. I give you practical training by my working method right in your home!

YOU GET THESE TOOLS AT ONCE!

I send them with my training. No extra charge!



I Train You at Home—Engineer Dobe

If You Earn Less Than \$70 a Week
MAIL COUPON



FREE Blue Print Coupon

ENGINEER DOBE, Div. 13-55
1951 Lawrence Ave., Chicago, Illinois

I want to get into Aviation through the Drafting Room. Here's my copy of Airplane sketch. Send me the blue print and your free books "Successful Draftsmanahip" and "My Pay-Raising Plan," all Free to me.

Name _____ Age _____
Address _____
Town _____ State _____

Age or lack of education, no drawback. If you can read and write, clip coupon **TODAY** and learn what I can do for you!

Mail Coupon NOW!

ENGINEER DOBE 1951 Lawrence Ave., Div. 13-55 Chicago, Ill.

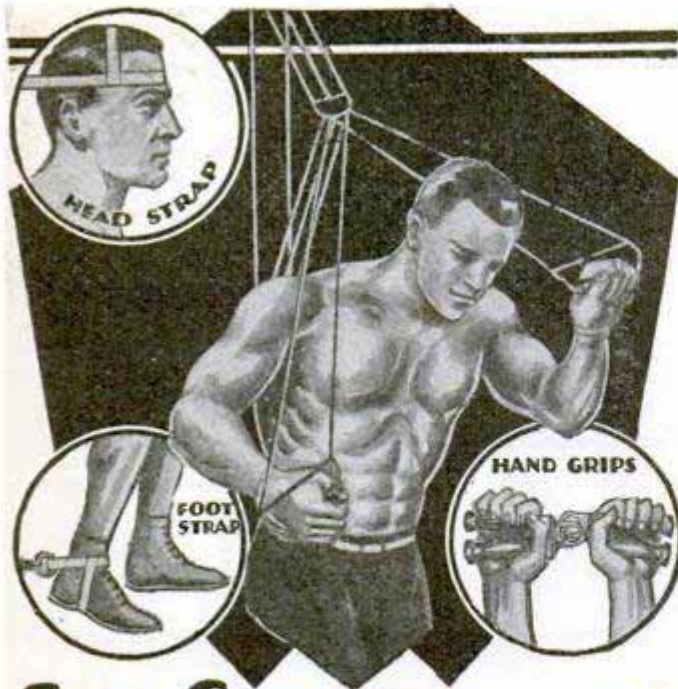

GET STRONG with these 6 improved Muscle Builders—All for \$5.00

Realize your ambition and develop muscles of a super-man. **Get strong!** Easily master feats which now seem difficult—or if you want physical culture for your health's sake, this equipment is what you need. With this special offer you **save at least half.** We furnish 10 cable chest expander adjustable to 200 lbs. resistance. Made of new live extra strength, springy rubber so as to give resistance you need for real muscle development. You also get a pair of patented hand grips for developing powerful grip and forearms. We include wall exercising parts which permit you to develop your back, arms and legs—a real muscle necessity. The head strap permits you to exercise muscles of your neck. Develop leg muscles with foot strap furnished. This gives speed, endurance. In addition you get specially written course containing pictures and diagrams showing how to develop any part of your body.



Send No Money

Sign name and address to coupon and rush to us. We send everything by return mail. Pay postman \$5.00 plus postage. (If you desire, send money or det. now and we pay postage.)



CRUSADER APPARATUS CO.,
Dept. 105, 44 Parker Ave., Maplewood, N. J.

I accept your offer. Send me everything described in your advertisement by return mail. I will pay postman \$5.00 plus postage on arrival. It is understood if I am not entirely satisfied after examination I can return the goods and you will refund my money.

Note:—No C. O. D. Orders to Foreign Countries or Canada.

Name.....

Street.....

City..... State.....

Will Grow Your Hair Or Cost Nothing

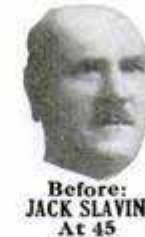

Before: JACK SLAVIN At 45



After: JACK SLAVIN At 65

You all know Jack Slavin, formerly Middleweight Champion Boxer of Australia and America. He's now 65, but when he was 45 he was bald. See untouched photos at sides. When he was touring Asia the Sultan of Johore introduced him to a Hindu Prince who, in jest, attempted to pull the few straggling hairs that remained at his temples. Jack was angry, and to appease his anger the Prince handed him a formula, saying: "Here, this will grow your d....hair." Imagine his delight when it DID.

He has used this formula and treatment for 14 years with success on thousands of bald heads.

It is guaranteed to grow hair on your head, stop falling hair, eliminate dandruff and relieve itching scalp, or your money will be refunded—every cent of it.

There is no need for you to suffer from baldness any more. Send NOW for free information. Sent in plain sealed wrapper without obligation.

SLAVIN INST., Dept. 4, 860 Caxton Bldg., Chicago, Ill.

Save Your Feet



When all else fails end your suffering with the flexible "no metal" **Heefner ARCH SUPPORT**
WRITE FOR FREE BOOKLET

HEEFNER ARCH SUPPORT CO., 675 M. E. TAYLOR BUILDING, LOUISVILLE, KY.



How to Obtain A Better Looking Nose!

Improve your personal appearance. My new Model 25 Nose Shaper is designed to improve the shape of the nose by remoulding the cartilage and fleshy parts, safely and painlessly. This is accomplished thru the very fine and precise adjustments which only my patented Model 25 possesses. Results are lasting. Can be worn at night, or during the day. Money refunded if not satisfied after thirty days' trial. Write for free booklet to

M. TRILETY, Pioneer Nose Shaping Specialist
Dept. 61 BINGHAMTON, N. Y.

BE HANDSOME!

Improve your features. Develop your personality. Attain that clean-cut appearance for less than you pay for even a bottle of hair oil. Send 30¢ for that amazing book "Actors' Appearance Secrets."

THE CULTURE COMPANY, 1200 Linwood, Oklahoma City, Okla.

TRUSS USERS

STUART'S ADHESIVE PLAPAO-PADS are patentably different—being mechanico-chemico applicators—made self-adhesive purposely to keep the muscle-ionic called "PLAPAO" continuously applied to the affected parts, and to minimize danger of slipping and painful friction. The fabric is soft as velvet, and being adhesive—

—clings closely to the body—



—without straps, buckles or springs.

Easy to apply, comparatively inexpensive and comfortable

For almost a quarter century stacks of sworn testimonials from many different countries report success, without delay from work. Process of recovery natural, after which no further use for a mechanical support. Test of the remedial herbal factor "PLAPAO" sent you absolutely **FREE**

No charge for it now or ever. Write name on coupon **NOW**, and mail **TODAY**.

Plapao Co., 2621 Stuart Bldg., St. Louis, Mo.

Name.....

Address.....

FREE — Trial Plapao — FREE

FREE BOOK ON MIND TRAINING

An instructive book which explains an amazing system of mind training already used by more than 700,000 people.

Let us send you a free copy of "Scientific Mind Training." It will show you how and why Pelmanism is the *only* system of teaching for developing *all* the mental powers at the same time. Endorsed by such distinguished men as Edgar Wallace, Sir Harry Lauder, the late Jerome K. Jerome, Prince Charles of Sweden and hundreds of others. Write TODAY to

THE PELMAN INSTITUTE OF AMERICA
71 WEST 45th STREET SUITE E-206 New York City



MAGIC
TRICKS
PUZZLES
JOKE NOVELTIES

AMAZE AND MYSTIFY YOUR FRIENDS!

For only 10c you can get a copy of the famous "Book of 1000 Wonders." It explains many mystifying tricks with Coins, Cards, Handkerchiefs, etc., you can do, without skill or practice. You will be popular, entertaining, the center of attraction wherever you go. You can make extra money giving short magical programs for schools, churches, clubs, parties, theatres, etc. Send 10c today for this 100-page book which also contains Catalog of Tricks, Jokes, Puzzles, etc., all easily learned.

LYLE DOUGLAS, Station A-10, DALLAS, TEXAS

TELEGRAPHY

(Morse and Wireless) and RAILWAY ACCOUNTING, taught thoroughly. Big salaries. Tremendous demand. Oldest, largest school. Endorsed by Telegraph, Railway, Radio, and Government officials. Expenses low—opportunities to earn large portion. Catalog free. **DODGE INSTITUTE, Jones St., Valparaiso, Ind.**

ATTRACTIVE NEW BINDERS

For **POPULAR MECHANICS MAGAZINE**

Your choice of colors: blue, green, brown, red or black in beautiful and durable art binders at \$1.25 *postpaid*. Your name in gold on front cover for 25 cents extra. Address **POPULAR MECHANICS CO., 200 E. Ontario St., CHICAGO**



NOSE Beautified

NO OPERATION

****30 DAY HOME TRIAL****

Dr. Josephs Nose Corrector can make your nose beautiful by moulding flesh and cartilage to desired shape. Worn night or day in absolute comfort. Amazing and lasting results in shortest time. **FREE BOOKLET** tells all. Write today.

DR. JOSEPHS, Inc.
Dept. E-18 Irvington, N. J.



IN ELECTRIC REFRIGERATION

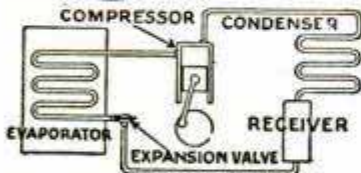

America's biggest new industry—electric refrigeration—needs men to fill jobs paying \$200 to \$1,000 a month. General Motors, General Electric, and others investing billions. Millions of machines being sold to homes, theaters, factories, stores, etc. Thousands of

jobs open in production, installation, service and sales which ordinary mechanics can't fill without special training in electric refrigeration.

EASY TO LEARN AT HOME

Learning electric refrigeration is now amazingly simple thru a new easy home training endorsed by authorities. Highly praised by Servel, Kelvinator, and other leading refrigerator manufacturers. **GET FREE BOOK.** Utilities Engineering Institute, 4403 Sheridan Road, Dept. 150, Chicago.

Utilities Engineering Institute,
4403 Sheridan Road, Dept. 150, Chicago, Ill. **FREE!**
Without obligation, send me free information book.

Name.....
Address.....
City.....State.....

Easy home method quickly teaches HAWAIIAN GUITAR



Play all the latest hits just as the Hawaiians do! Have good times plenty!

Win fame—friends—fortune! Play the Hawaiian Guitar!

Native Hawaiian expert directs you

You get expert instruction directed by a world-famous player and teacher, Prof. Walter Kolomoku. He quickly reveals to you the secrets of this fascinating instrument.

Learn at home in spare time

Study in spare time at home. Even if you don't know a note our method is so simple, plain and easy, you begin a piece your first lesson. In half an hour you can play it!

Only 4 Motions to learn. Then you can play any music—popular songs, classical, old-time melodies, native Hawaiian airs—or real jazz. You'll never be lonesome after you learn the Hawaiian Guitar.

Complete Course 52 lessons. Nothing omitted. Pictures explain every move. You are sure to learn—what we can do for others we can do for you. Over 50,000 successful students.

Payasyouplay We make it easy for you. Start with small first payment—then pay while learning. Costs only few cents per lesson. You only pay the cost of instruction—we furnish everything.

Sweet Toned HAWAIIAN GUITAR

GIVEN when you enroll

—with genuine seal grain *Fabrikoid* Cover and complete playing outfit. Reliable retailers ask \$18 to \$20 for a similar instrument and outfit without the fine *Fabrikoid* Case, which alone is valued at \$3.50.

TENOR BANJO and other courses

The same thorough instruction on the Tenor Banjo, Violin, Tiple, Tenor Guitar, Ukulele, Banjo Ukulele—well known instructors. Write for full information.

FIRST HAWAIIAN CONSERVATORY OF MUSIC, Inc.
9th Floor, Woolworth Bldg., Dept. 748, New York

Approved as a Correspondence School Under the Laws of the State of New York
Member National Home Study Council



Send This Coupon for Liberal Offer!

FIRST HAWAIIAN CONSERVATORY OF MUSIC, Inc.
9th Floor, Woolworth Bldg., Dept. 748, New York, N.Y.
Please mail full information about your 52-lesson Hawaiian Guitar Course. I am not obliged to enroll unless I want to.

Name.....
Address.....
City.....State.....

Astounding Offer Made on GREAT VOICE BOOK

30
DAYS
FREE
Reading



This Special Offer is Made to Men and Women who Want to Know the TRUTH about their VOICES.

Most remarkable book ever written on VOICE... written by one of the world's greatest voice authorities. Discloses startling FACTS about the VOICE, the vocal organ and voice training that may save hundreds of dollars to every man and woman seeking a strong, rich compelling singing or speaking voice. Know the TRUE possibilities of YOUR VOICE. Send for this great book today—for 30 days' free reading. Then, if you keep it, send only \$1.00. Otherwise, return it. That's all. Send no money now—just mail the coupon.

E. FEUCHTINGER
Suite 29,
1810 Wilson Ave., Chicago, Ill.

Prof. EUGENE FEUCHTINGER, Studio 13-55
Suite 29, 1810 Wilson Avenue, Chicago, Ill.

Send me at once — for 30 days free reading — with no obligation to buy, your "The Truth About Voice" Book. If after the free reading period I desire to keep the book I am to send you \$1.00. Otherwise I have the liberty to return it with no further obligation.

Name _____

Address _____

Cut Down Your Fuel Costs!



Here it is. Griswold, the WORLD'S LOWEST PRICED, cheapest-to-operate, Oil Burner. Burns oil and air the new way, by means of Patented indestructible Mineral Wick. SMASHES FUEL COSTS. Brings you the carefree happiness and comfort of clean, even oil heat at amazing low cost. No more ashes, smoke, soot, or grease.

Silent Automatic Guaranteed

Any Housewife Can Operate It!

Specially equipped with Siphonic Constant Level Valve, makes it SAFEPROOF AGAINST MISTAKES in operation. Prevents overflowing or flooding burner and banishes housewife's dread of putting it out of order. Quiet. Complies with all ordinances. Guaranteed. Fits every stove or furnace.

Plugs in Lightsocket

Anybody can install the Griswold. Plugs in your lightsocket. Takes only a few hours. COMPLETELY AUTOMATIC with room temperature control. Only a few simple adjustments. Nothing to get out of order. Send for complete information now. Wonderful opportunity for wide-awake dealers. Make \$10,000 TO \$50,000 annually. Special offer if you act now! Write today.

Griswold Oil Burner Co.
3007 N. Union St., Griswold, Iowa
U. S. A.

Dealers Wanted

30 Days' Free Trial on all MEAD Bicycles

New RANGER Models now ready for delivery direct from our factory. Astonishing new prices and terms. Do not buy until you get them.

RIDER AGENTS WANTED to ride and exhibit sample. Save big money. Many models, styles.

Tires, wheels, lamps, horns, equipment at half usual prices. Easy Payments. Write for our marvelous prices and terms.

Mead CYCLE COMPANY DEPT. G110, CHICAGO

Write us today for free catalog



THE JUST S'POSIN' BOOK
FOR CARTOONISTS AND HUMAN BEINGS.
"THE LAUGH OF A LIFETIME."
SEND NOW!
STUDIO OF NICK NICHOLS
157 EAST ERIE, CHICAGO ILL.

IN COIN

BIG PAY

CAMERA MEN- PHOTOGRAPHERS

BE A MOVIE OPERATOR
Projector Given
We teach you at home. Big demand by Movie & Vaudeville Theatres.

Camera Given FREE BOOK explains opportunities as Motion Picture Camera Man, Portrait, Commercial or News Photographer or in your own business. Learn at Home or in our great New York Studios.

Write for Free Book and Job Chart.
N. Y. Institute of Photography, 10 W. 33d St., N. Y. Dept. L-1404

Let Me Make YOU OVER!

Big Muscles Quick!

LOOK at those two pictures! Which are YOU? A puny run-down weakling, scorned by your fellow-men, avoided by the girls, ashamed to show yourself in a bathing suit? Snap out of it, friend! Take a look at that big boy at the right and cheer up. That's the way TITUS builds men. And YOU'RE NEXT.

It's So EASY to Be Strong

Just give me 30 days and see the amazing change. New health — new strength — new energy—all in a few minutes a day! Why be a weakling when it's so EASY to be strong? One man writes me: "I never put on muscles so fast in all my life!" Another says: "I never thought that I could ever improve like I have." Still another writes that muscles "seem to grow overnight." Hundreds of letters like these PROVE that you, too, can be strong. Remember, I don't just promise you muscles, I GUARANTEE them.

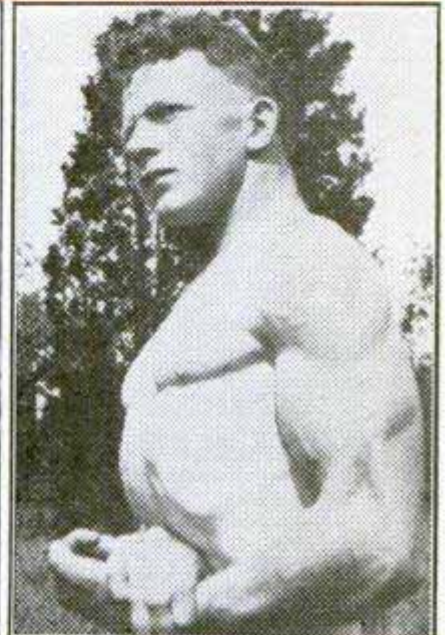
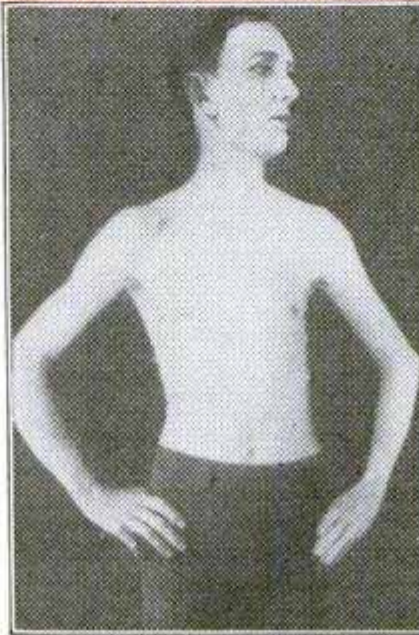

A Titus Built Body for YOU

I GUARANTEE to put 5 inches on your chest — 2 inches on your arms—a couple more on your legs! And that's not all! I'm going to build you a magnificent pair of broad, athletic shoulders—a massive, muscular neck—a mighty herculean back! And THAT'S not all! I'm going to make you over inside, too. I'll strengthen your internal organs, put new health and energy into every cell of your body! What a MAN you'll be! I don't just promise these miracles—I GUARANTEE RESULTS. Just give me a few minutes a day and watch those muscles GROW!

Shoot that coupon to me. Get your FREE copy of my big book "Miracles in Muscles." It's filled with Titus's own secrets for making muscles grow!

WEAR THIS MEDAL

Strong men all over the world wear it as a badge of manhood. Made of solid statuary bronze and given to you free.



Mail this coupon TO-NIGHT!

Get Your FREE Copy of My Amazing Book NOW

Is your body worth a 2c stamp? Then tear off that coupon and shoot it in the mail TODAY. By return mail you'll get my big, illustrated book — one of the most inspiring, most amazing books you've read. Chock-full of muscle-building facts, packed with pictures of men rebuilt. Read how, in just a few minutes a day at home, YOU can develop MIGHTY MUSCLES OF STEEL. No cost, no obligation, no salesman will call, RUSH the coupon.



TITUS
853 Broadway
NEW YORK CITY

TITUS, Dept. M-150,
853 Broadway, New York, N. Y.

Dear Titus: Okay, send that wonderful, big illustrated book of yours, "MIRACLES IN MUSCLES." Get it to me by return mail, without the slightest cost or obligation on my part.

Name.....
Address.....
Town..... State.....

Swear Off Tobacco

Let Us Help You Banish the Tobacco Habit

QUICK RESULTS

Trying to quit the tobacco habit unaided is often a losing fight against heavy odds, and may mean a distressing shock to the nervous system. So don't try it! Make the tobacco habit quit you. It does quit many of those who take **Tobacco Redeemer** according to directions.

It doesn't make a particle of difference whether tobacco has been used for a single month or fifty years, or how much, or in what form—whether it be cigars, cigarettes, pipe, plug, fine cut, or snuff. In most cases, **Tobacco Redeemer** removes all craving for tobacco in any form in a few days. Tobacco craving usually begins to decrease after the very first dose—there's no long waiting for results.

Tobacco Redeemer contains no habit-forming drugs of any kind and is safe, quick, pleasant, and thoroughly reliable.

Not a Substitute

Tobacco Redeemer is in no sense a substitute for tobacco, but is a radical, efficient treatment. After finishing the treatment, there is usually no desire to use tobacco again or to continue the use of the remedy. It helps to quiet the nerves, and makes one feel better in every way. If you really want to quit the tobacco habit—get rid of it so completely that when you see others using it, it should not awaken the slightest desire in you—you should at once begin a course of **Tobacco Redeemer** treatment for the habit.

Our Positive Guarantee

A single trial should convince the most skeptical. Our legal, binding, money back guarantee goes with each full treatment. If **Tobacco Redeemer** fails to banish the tobacco habit when taken according to the plain and easy directions, money will be cheerfully refunded upon request.

Let Us Send You Convincing Proof

If you are a slave of the tobacco habit and want to find a sure quick way of quitting "for keeps," you owe it to yourself and to your family to mail the coupon today or send your name and address on a postal, and receive our free booklet on the injurious effects of tobacco on the human system and positive proof that **Tobacco Redeemer** does quickly relieve the habit for most uses.

Newell Pharmacal Company
Dept. 300, Clayton Station, St. Louis, Mo.



Free Book Coupon

NEWELL PHARMACAL CO.

Dept. 300 Clayton Station St. Louis, Mo.

Please send, without obligating me in any way, your free booklet regarding the tobacco habit and proof that **Tobacco Redeemer** does positively relieve the tobacco habit in most cases. If it fails your money will be refunded.

Name.....

Street and No.....

Town..... State.....



Tobacco Tells on Nervous System



Tobacco Ruins Digestion



Tobacco Stunts Boy's Growth



Tobacco Robs Man of Vitality



Tobacco Steals from You the Pleasures, Comforts, Luxuries of Life

“Robot”

Amazing Rupture Discovery *Buttons Rupture Automatically*

The world has recently been startled by scientists' creation, the robot. The robot is a mechanical man which performs automatically many human functions such as talking, answering the telephone, running a typewriter, etc. Now an Ohio genius has created a device for ruptured people which he calls "Robo-truss" because it acts automatically, almost like a human hand, to button rupture. Already it is being used by more than 50,000 people. Read below how this marvelous invention works and how you may receive a free sample which shows how it is made.

Invention of American Scientist Weighs Only 4 Ounces



CAN you imagine a device that weighs only about four ounces that breathes air, bends like a human hand, supports rupture

just like you would with the tip of your finger? People who have been ruptured for years and have put up with tight strapping, gouging pads, leg straps and poorly constructed trusses will hardly be able to believe their eyes when they see this tiny Robo-truss. There are no rubber bands, no tight strapping necessary. Instead, Robo-truss is literally buttoned on, so that its handlike action retains rupture in the one right spot, flexes and moves with the body and yet it is so light, that the wearer may forget that he has it on. Another great new feature of the device is the fact that it is washable—soap and hot water as often as you like makes it sanitary and clean.

Medical authorities say that the ordinary truss will not cure ruptures except in rare instances. It is too early to tell

the exact percentage of cases in which Robo-truss will bring about cures but it is definitely known that many users have reported cures. One man reports his rupture healed in four weeks, a rupture of many years standing. Others report results that seem almost as miraculous. The parents of many children have reported that it was even unnecessary to wear this little feather-weight appliance after a few weeks or months for the protrusions had disappeared.

Robo-truss is for reducible ruptures. You will want to find out immediately about this modern invention. If you will send the coupon below, you will receive a free sample of the porous, air-breathing material which is so ingeniously used. You will also learn how you can wear the Efficiency Model for 10 days' trial at the inventor's risk. Modern science at last has brought you real rupture relief. You will not want to lose a day in finding out all about it. So mail the coupon right now.

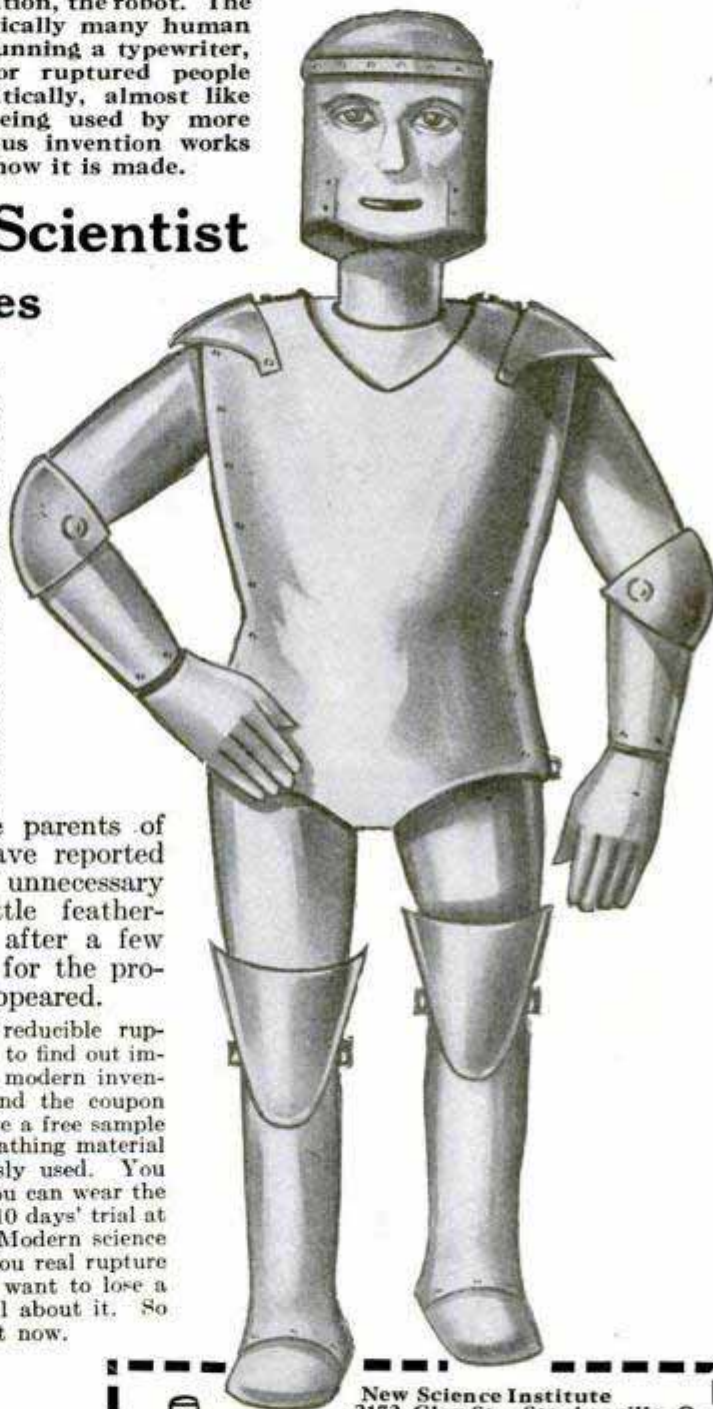

10 Days' Trial by Actual Wear!

The inventors will actually send the newest Efficiency Model to all ruptured for ten days' trial by actual wear—you to be the judge. They are also distributing free samples of this air cell material to those who mail the coupon. Mail coupon today. There is no cost or obligation.



New Science Institute
2172 Clay St., Steubenville, O.

Send me at once full description of Robo-truss, a free sample of its air-breathing material, and the offer on your Efficiency Model of 10 days' trial by actual wear. This does not obligate me in any way.

Name.....

Address.....

City..... State.....

You Fellows Who Want BIG PAY

Get into

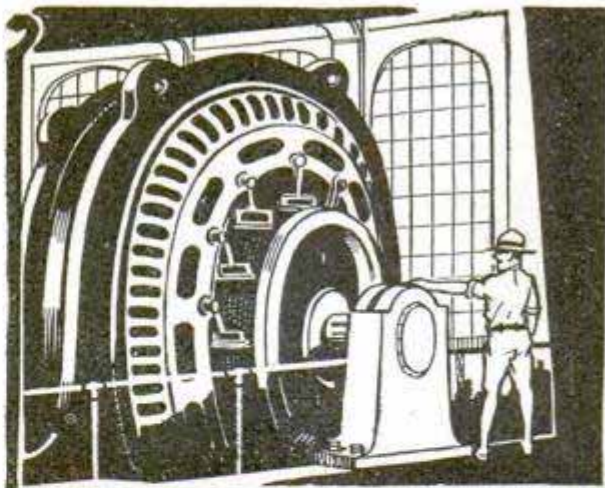

ELECTRICITY

WHY earn \$15 or \$20 or \$30 a week, when in the same six days as an Electrical Expert, when so many men are earning \$60 to \$100, do it easier and not work half so hard? Why should you remain in a small-pay, no-future job that offers no chance for big promotion—no chance for big income? Fit yourself for a real job. **Get Into Electricity.** That's where the big money is being made, and always will be made.

Electricity — The Big Pay Field

Today even the ordinary Electrician—the "screw driver" kind—is making money—big money. But it's the trained man—the Electrical Expert,—who makes the really big money,—\$10 to \$20 a day—\$60 to \$100 a week. Be a Big-Pay man, yourself. Get in line, now, for one of these "Big-Pay" Jobs.

I'll Train You At Home

I'll train you at home,—in your spare time. You work just as you are working now—at your same job. My now famous "Work-Sheet and Job-Ticket" method, guarantees you simplified, practical training along work-shop lines. In a few short months you can step out of your old job into a new job—into electrical work where you can be a Big-Pay man in this Big-Pay field.

You Earn As You Learn

To learn Electricity my way you don't have to be a College man, or even a High School graduate. You can read, You can write. That's enough. With me, you get experience as you go along and make good money while learning. I'll show you how,—and I'll give you, without extra cost, tools and apparatus to work with—6 Big Outfits in all.

Money Back If Not Satisfied

That's what I agree to do. And back of me in this agreement stands the Chicago Engineering Works, a \$2,000,000 Illinois Corporation. There's nothing like "Cooke" Training anywhere. It's the Training that big Electrical men are praising; it's the Training that employers recommend; it's the Training that one of our greatest Engineering societies has endorsed 100 per cent. **It's the Training for you.**

If You're Earning Less Than \$70 A Week — Investigate

Don't wait a minute! Find out today why "The Cooke Trained Man is the Big-Pay Man", everywhere! Find out how "Cooke" Training will help you boost your pay! Mail coupon right now for my Big FREE Book of Facts. See the Six Big Working-Outfits I give you without extra charge. See the hundreds of pictures, the proofs, the Big-Pay letters of other "Cooke" Trained Men. Get this great free Book. Send for it today. Clip, sign, and mail coupon RIGHT NOW!

L. L. COOKE, Chief Instruction Engineer

**L. L. COOKE SCHOOL
OF ELECTRICITY**
Dept. 15
2150 Lawrence Ave.
Chicago, Illinois

Send for my Big FREE Book that shows how other men stepped into fine jobs paying

\$60 to \$100 A WEEK

If you earn less than \$70 a week
INVESTIGATE
ACT NOW



I'll train you at home in a few short months.
L. L. COOKE

FREE BOOK COUPON

L. L. COOKE, Chief Instruction Engineer,
Dept. 15, 2150 Lawrence Ave., Chicago, Ill.

Send me FREE and prepaid, your Big Book "Secrets of Success in Electricity," with all details about your Home Study Course in Electricity.

Name _____
Address _____
City _____ State _____

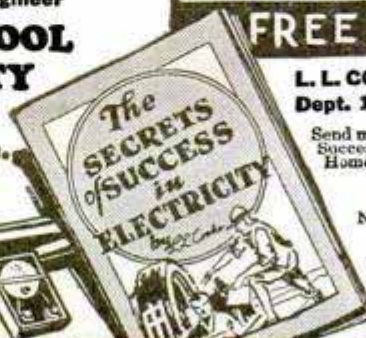

\$30 A DAY
Dear Mr. Cooke: I was making \$25 a week when I enrolled. Now with my own Electrical Shop I make as high as \$30 a day. A. J. Daigneault, 225 Worcester, Southbridge, Mass.



\$1.50 AN HOUR
Dear Mr. Cooke: I had to work like a slave for 45c an hour before I enrolled. Now, thanks to you, Mr. Cooke, I make \$1.50 an hour. G. W. Oprea, 4220 N. Meade Av. Chicago, Ill.

**6 BIG
OUTFITS**
NO EXTRA
COST



The "Cooke" Trained Man is the "Big Pay" Man

Classified Advertisements

WORLD'S BEST WANT AD MEDIUM

Advertisements in this section, 35 cents per word, each insertion, minimum 10 words, payable in advance. To be printed under proper classification in June issue, copy should be in our office April 18th.

ADVERTISING AGENCIES

THE Big Idea. What may be an idea now may be the germ of a nation-wide business later. Get our views and suggestions for developing your business. In our 45 years in advertising, we have helped to build numerous small advertisers into widely known success. Guenther-Bradford & Co., Newspaper-Magazine Advertising, 15 E. Huron St., Chicago, Ill. Our Advertisers' Pocket Guide sent on request.

GET into advertising. Learn quickly at home. Experience unnecessary. New easy plan. No text books used. Practical work. Old established school. Send name and address for interesting free booklet. Page-Davis School of Advertising, Dept. 3435, 3601 Michigan, Chicago.

TIME Counts in applying for patents. See pages 140 and 141. Clarence A. O'Brien, Registered Patent Attorney, Washington, D. C.

ADVERTISE—24 Leading Sunday newspapers, 24 words \$15.00. Excellent for obtaining help, salesmen, or business opportunities. Information 1,000 best paying dailies, mail-order weeklies, monthlies, mailing lists, everything. Free. Wade Agency, Great Northern Bldg., Chicago.

BEFORE Advertising get our catalog. No charge. 25 years in business. The largest classified agency in the world. Ankrum Advertising Agency, 100 No. LaSalle St., Chicago, Ill.

ADVERTISE in southern Negro newspapers for real results. Write R. L. Stricklen, Jr., Box 661, Staunton, Va.

FREE—New 1930 Advertisers Rate Guide, 44 pages. Includes everything. Lowest rates. E. H. Brown Advertising Agency, 140 S. Dearborn, Chicago.

OBTAIN Canvassers, distributors through publication advertising. Martin, 276B West 43d, New York.

ADVERTISE in rural weeklies. Lists free. Meyer Agency, 4112 Hartford, St. Louis, Mo.

INCH Display advertisement 50 magazines year \$24. Wood's Popular Services, Atlantic City, N. J.

FOR ADVERTISERS

ADVERTISE, 200 Country newspapers, 28 words, \$7.50. Lists free. Roberts, Box 82, Monroe, Wis.

ADVERTISING: 20 Words, 50 magazines 60c; three insertions, \$1.20. Mailing Bureau, Lawndale, Calif.

"HAVE The right one, write your fortune with the right one." For descriptive folder—"Sloganseribé," Brookhaven, Ga.

70 WORDS—Insert 50 magazines, \$2.10. Empire Agency, Shawano, Wis.

ADVERTISE in country papers. Lists free. Low rates. Keator, Hartford Bldg., Chicago.

SALES PROMOTION

SPECIALIZE Writing sales letters, advertisements and folders. Satisfaction guaranteed. Ray Maurice Thompson, 504 W. Glenaven, Youngstown, Ohio.

TYPING SERVICE

MANUSCRIPTS, Books, neatly typed, 45c thousand words. Research; articles, addresses prepared, reasonable. Berry, 210 W. 43rd, New York, N. Y.

LET Me do your typewriting; 50c thousand words. 335 Rockwall, Tex.

AUTOMOBILES

TIME Counts in applying for patents. See pages 140 and 141. Clarence A. O'Brien, Registered Patent Attorney, Washington, D. C.

DYKE'S Famous Automobile Encyclopedia—Latest edition. Fully revised to cover all latest facts regarding newest developments in automobile field, including new Model A Ford. Information given on repairing and adjusting every part of all motor cars. How to find trouble and fix it. 1,250 pages. 4,200 illus. Price, cloth, \$6. Flexible Morocco \$7.50. Pay postman price and postage when he delivers book. Popular Mechanics Press, Room 801, 200 E. Ontario St., Chicago.

AUTOMOBILE SUPPLIES

BOON To motorists—Preserve and keep finish on top and body of your car looking new by using "Weatherguard." Gives beautiful lustrous polish, makes old finishes look like new. ½ pound can "Weatherguard," ¼ pound can "Nickeline," finest metal polish, six yards polishing cloth, postpaid, \$1.00. Guaranteed or money back. Perfect Products Laboratory, R. D., 77A, Atlantic Highlands, N. J.

MOTORISTS, Attention: Enjoy a hot meal when you stop. The Conklin Exhaust Cooker roasts, steams or boils as you ride. Fuel costs nothing. No time lost. Have healthful, better tasting food without waiting when your mealtime comes. Cooks breakfast, dinner and supper. Quickly installed by anyone. Send \$5.00. Agents wanted. Conklin Mfg. Co., Box 475, Palm Beach, Fla.

MARVELO'S Non-glaring headlight attachment positively takes glare out of headlights and gives better distribution of light on road. Send \$2.50 for sample pair and be convinced. Money-back guarantee. Special offer to agents. Roth No Glare Lite Co., 1603 Hand Ave., St. Paul, Minn.

SAVE Money on auto and truck repairs. Gears, axles, bearings, motor and transmission parts at 50 to 75% off factory list prices. Satisfactory parts guaranteed. Prompt service. Price lists free. Century Parts Co., 1712 Lafayette Ave., St. Louis, Mo.

AUTOMOTIVE Tools and mechanics' specialties. Representatives wanted. Greene, Dover, Mass.

WHIRLGAS Carburetor Booster adds "pop," power, speed; saves gas, oil; no carbon. Applied wrench few minutes. Mailed C. O. D. \$2; any car; give make, year. Whirigas Co., 816 Ford Bldg., Detroit.

USED Air compressors, automatic. Reconditioned, guaranteed like new. Shipped trial easy payments. Also used testers, car washers, chargers, sprayers. Box M-852, Troy, Ohio.

NEW 2-Wheel steel trailers, bronze bearings, wood wheels, worth \$125. Close out \$15. H. E. Skinner, 2409 N. Ashland Ave., Chicago.

AUTO Parts new and used. Lowest prices. Bankrupt supplies: motors, wheels, radiators, gears, generators, carburetors, brake lining 50%. Brightman, 2065 Main St., Hartford, Conn.

"SPRINGS Of silence."—Universal anti-rattler. For the noisy 4 wheel brake rods all cars. Ask your dealer. Universal Spring Co., Grand Rapids, Mich.

BATTERY Shop—How to run. Most complete and authoritative information ever compiled on tools needed, shop equipment, charging methods, opening batteries, work on plates, jars, case, etc. Covers auto, radio and farm lighting batteries. Send for big 550-page book and pay postman \$5.00 plus postage when he delivers same. If outside U. S. remit when ordering. Popular Mechanics Press, Room 801, 200 E. Ontario St., Chicago.

AUTO SERVICE EQUIPMENT

PROFITS in 8-hour battery charging or 20 minute car washing. Install equipment practically no investment. Bargains in reconditioned buffers, grinders, compressors, sprays, are welders. Box M-854, Troy, Ohio.

KINKS For machinists. 419 discoveries. For mechanic, machinist or the man who tinkers at home. 287 illustrations. Send no money. Just write a postal asking for "Machinist's Kinks." When postman hands you book pay postage and price of book, \$1.50. Popular Mechanics Press, Room 801, 200 E. Ontario St., Chicago, Ill.

SHOP Notes for 1930. Get your copy now. Only a limited edition. Contains all the articles published in the Shop Notes department of Popular Mechanics Magazine during 1929. Send 50 cents. If you want the entire set of Shop Notes books consisting of 15 volumes including the 1930 number and 74 others issued previously we will send them C. O. D. at a special reduced price of \$4.50. Popular Mechanics Press, Room 802, 200 E. Ontario St., Chicago, Ill.

SAVE Money—Garage equipment reconditioned guaranteed like new. Bargains test stands, chargers, compressors, car washers. Shipped trial easy terms. Box M-853, Troy, Ohio.

MOTORCYCLES, BICYCLES AND SUPPLIES

DO You want real value in a reconditioned Harley-Davidson motorcycle at lowest possible price? Real guaranteed money back bargains and not mere claims? Do you want to buy direct from factory distributor carrying largest stock and enjoying highest endorsement of Harley-Davidson Motor Co.? Then send for catalog from Heinz Motor Co., 609 W. North Ave., Baltimore, Md.

MOTORCYCLE Bargains, lowest prices, bargain sheets for stamp, special aviators supplies, motorcycle accessories largest line in America, lowest prices. Largest motorcycle mail order house in the United States. Rochester Harley Davidson Corporation, 129 West Main St., Rochester, N. Y.

REPAIR With good used parts, save ½ or more, state parts needed, no lists. J. B. Dahl, 3661 Archer Ave., Chicago, Ill.

HARLEY Davidson bargains at a tremendous sacrifice. All models and prices. Guaranteed. Send 4 cents in stamps for our catalog. "Money Saving Motorcycle Bargains." The Knuth Co., 2525 Fond du Lac Ave., Milwaukee, Wis.

CHAINS, Sprockets have double life with perfect oiler. Fits all motorcycles. \$3.50 postpaid. Thos. Johnson, 615 Stilwell, Port Arthur, Tex.

LARGEST Motorcycle house in middle west. Send 15c for latest used motorcycle catalog. Indian Motorcycle Sales, Kansas City, Mo.

FOR Sale tandem bicycle frames only \$10. McDougald, Kanawha, Iowa.

HENDERSON, Excelsior, Indian, Harley used parts and engines cheap. Ballak & Co., 100 N. 12th, St. Louis, Mo.

AVIATION

LATEST Aviation books. Modern Aircraft, 900 pages, 500 engravings. Price \$5.00. Everybody's Aviation Guide, 256 pages, 140 illustrations. Price \$2.00. ABC of Aviation, 160 pages, 150 illustrations. Price \$1.00. Modern Aviation Engines, 2,000 pages, more than 1,000 engravings in two large volumes. Price \$9.00 for the set. All these books are written by Major Victor W. Page. Also the latest book on the subject of "Aerial Navigation and Meteorology," by Capt. Lewis A. Yancey, who made the famous flight from Old Orchard, Maine, to Rome, Italy; 350 pages, 102 illustrations. Price \$4.00. You make no mistake in ordering any of these books. Some of them are used in 200 schools for instruction purposes. Any of these books sent prepaid on receipt of price, or C. O. D. plus postal charges. Norman W. Henley Publishing Company, 2 West 45th St., New York, Dept. 45.

KNOW That the motor you purchase for your light plane will fly it. Worthless motorcycle motors are being offered as aircraft motors. Heath Henderson motors are guaranteed to fly and 7 years constant flying has proved this. 10c in stamps or coin brings large illustrated booklet. Heath Aircraft Corp., Dept. P-5, 1721 Sedgwick St., Chicago.

PROPELLERS, 3', \$5.50; 4', \$8.75; 5', \$13.25; 6', \$16.50; special Henderson, \$12.50; sportplane parts; glider parts; converted Hendersons, \$95.00 upward. Blueprints "Aerodrive" boat, only 50c. Ostergaard Aircraft, 4303 N. Narragansett, Chicago.

GLIDERS, Complete detailed glider plans, \$5.00 outline drawing. Bill of material, information 25c. Chicago Glider Co., 3344 No. Whipple St., Chicago, Ill.

GLIDERS, Crawford powered gliders using motorcycle engine will carry 200 lb. pilot. Blue prints detailed \$5.00 complete set. Price list of parts, materials, etc., on request. Propellers, 4', \$6.00; 5', \$10.00; 6', \$14.00. Crawford Motor and Airplane, Seal Beach, Calif.

165hp. GNOME Airplane motor left. \$65; 50 hp. gnome 7 cylinder \$98; 100 hp., \$75. Pennsylvania Aero Service, 155½ Dennick, Youngstown, Ohio.

GLIDER Supplies—In stamps for aeronautical supply catalog listing all material needed to construct any type glider. Heath Aircraft Corp., Dept. P-5, 1721 Sedgwick St., Chicago.

HEATH Parasol is America's most popular sport plane because you obtain more flying hours at less money than any other plane ever produced. 10c in stamps or coin brings large booklet. Heath Aircraft Corp., Dept. P-5, 1721 Sedgwick St., Chicago.

SEND 5c For bundle of balsa, reeds and price list on supplies. Aero Shop, 3030 Huribut Ave., Detroit, Mich.

AIRPLANE Engine Encyclopedia, 547 pages, descriptions and illustrations of all the world's aircraft engines. Published 1921. A valuable educational and reference book. A limited number at reduced price, \$5.00, check or money order. H. Hutchings, 2036 Melrose Ave., Dayton, Ohio

AIRPLANES, Monoplanes, biplanes; all types, lowest prices. Motors 30 to 300 hp., new and used; at big discounts. State your needs. Aviation Service, 925 Broadway, New York.

AVIATION Books—Complete 24-page illustrated catalog covering every phase of subject, sent free upon request. Popular Mechanics Press, 200 E. Ontario St., Chicago, Ill.

TIME Counts in applying for patents. See pages 140 and 141. Clarence A. O'Brien, Registered Patent Attorney, Washington, D. C.

\$175 WILL Build our beautiful steel fuselage, Henderson powered monoplane. Plans \$1. Also two place planes, wings, parts. Literature 10c. Barney Snyder, Rochester, Ind.

SIMPLEX Air Model Co., Auburn, Mass. Send five cents for supply booklet.

BUILD And fly model aircraft. Complete instructions cover all types including tournament prize winners. Lindbergh's famous "Spirit of St. Louis" and others. Great sport and very instructive. Official handbook approved by leading flyers, government officials and others. Sent C. O. D. anywhere in U. S. Simply pay postman \$2.25 and postage when delivered. Sent postpaid to any address upon receipt of price. Popular Mechanics Press, Room 801, 200 E. Ontario St., Chicago.

HENDERSON Engines—For light aircraft use. Yours converted. Folder 10c. Ballak & Co., 100 N. 12th St., St. Louis, Mo.

BUILD Your own glider! Complete blueprints \$2.75 postpaid. Send 5c for latest price list of parts and materials for this marvelous new training glider. Write today! Mead Gliders, 10 S. Market St., Chicago, Ill.

BUILD And fly a real airplane. No technical knowledge of construction necessary. Annard Aircraft Company, Dept. G, St. Paul, Minn.

PROPELLERS, 4', \$7.50; 5', \$12.00; 6', \$15.00; "winddriven" light plant radio and automobile battery charger blueprints, \$5.00. Kingsick Propeller Co., Optima, Okla.

AVIATORS' Goggles, lowest prices; 24 page catalog free for stamp. Rochester Harley Davidson Corp., 129 West Main St., Rochester, N. Y.

NEW 80 hp. Le Rhone airplane motor, original crate, (government) complete, \$75. H. E. Skinner, 2409 N. Ashland Ave., Chicago.

GLIDER Model, wing spread over three feet. Controlled from ground. New, startling, instructive circular on request. Speed-Dee Model Co., Box 80, Jamaica, N. Y.

NEW Rhone motor. \$175; used \$65. Albert Latshaw, Grand Bay, Ala.

BIPLANE \$650. Complete gliders. Catalog 10c. Vance Aircraft Co., Fresno, Calif.

TURNBUCKLES 15c, 20c, 25c. Blueprints German glider \$3.00. Aeroplane hub complete fits auto engines \$1.00. Aeroplane seats \$1.00. 2 pair aviator's goggles \$1.00. Wheels \$3.50. All types sportplane motors. Fuselage with tail unit \$35.00. Booklet 5c. Hopkins Aeroplane Co., Box 124, Hopkins, Minn.

BOYS: Get a pursuit tractor kit complete 35c. No stamps. Send 5c for price list. W. & J. Aeroplane Shop, 200 Maple St., Wyandotte, Mich.

GET The latest sportplane constructor book. Full of blueprints, photographs, drawings, detail instructions, etc. Postpaid \$1.00. May save you hundreds. Circular free. Russell Aero, Box 455, Toledo, Ohio.

BIGGEST. Best catalog model airplanes; parts, supplies; 5c postpaid. Ideal Company, 19 West 18th St., New York.

"IF You want to fly" let Alexander Klein, brilliant engineer, teach you. With great skill whole course of training has been simplified and made crystal clear. Remarkable book teaches in most practical and easily understood fashion. Recommended by skilled flyers. Sent C.O.D. anywhere in U. S. Simply pay postman \$2.50 and postage when delivered. Sent postpaid to any address upon receipt of price. Popular Air Mechanics Press, Room 801, 200 E. Ontario St., Chicago.

BOOKS AND PERIODICALS

4TH EDITION, revised "Radio Theory and Operating," by Mary Texanna Loomis. The standard radio text and reference book of America, 992 pages, 800 illustrations, flexible binding. Price \$3.50 postage paid. For sale by hundreds of book dealers throughout America and many foreign countries. Or may be purchased direct from the publishers. Send check or money order to Loomis Publishing Company, Dept. 18, Washington, D. C.

HYPNOTISM Easily learned. Lessons guaranteed. Postpaid \$1.10. Smith Pub. Co., Dept. 3, Springfield, Mass.

INDUSTRIAL Alcohol. Complete directions for making. Fully illustrated. \$2.50. Spon & Chamberlain, 120 Liberty St., New York.

YOU Need a better grip on mathematics? Ask us to send you a copy of "Mathematics for the Practical Man," only \$1.50. By common sense methods it removes the mystery and difficulties so algebra and calculus are made simple. Assuming your knowledge is limited to arithmetic you quickly and easily gain a working knowledge of algebra, geometry, trigonometry and calculus. Simply pay postman when he hands you the package. Address Popular Mechanics Press, Room 802, 200 E. Ontario St., Chicago, Ill.

BEST Books for \$1. All formerly sold for \$2.50 to \$5 each. Select from the following list of guaranteed bargains. All brand new books: Woodcraft by Seton, Book of Letter Writing by Crowther, Etiquette by Eichler, Creative Chemistry by Slosson, Lawn Tennis by Tilden, also Revolt in the Desert by Lawrence, Trader Horn, White Shadows in South Seas by O'Brien, Count Luckner (The Sea Devil) and Outline of History by Wells. Delivered at your door C. O. D. Simply pay postman \$1 each and postage. Popular Mechanics Press, Room 801, 200 E. Ontario St., Chicago.

PICTURES AND POSTCARDS

FRENCH Lovers photos, love scenes, fellows and girls. Taken from life poses. Imported direct from France. 12 for \$1.00. Joy Sales, Station A, Box 53, New Haven, Conn.

PARIS, Lovers photos, passionate love scenes of French girls and fellows taken from life poses. Imported direct from France. 12 for \$1.00 or 50 for \$3.00. Cartoon booklet free. Sea-Breeze Novelty House, West Haven, Conn. Dept., (PM-MA).

"FRENCH Art," mirrors, novelties, etc., 2 illustrated catalogs, 25c (coin); money refunded if dissatisfied. Photo Sales, Box 744-R, Chicago, Ill.

ART Pictures—220 all different. 160 samples \$1.00. Particulars 10c. Howard Sales Co., Dept. 15, Box 529, San Francisco, Calif.

GAMES, ENTERTAINMENTS AND PLAYS

PLAYS, Musical comedies and revues, minstrels, comedy and talking songs, black-face skits, vaudeville acts, monologs, dialogues, recitations, entertainments juvenile plays and songs, musical readings, make-up goods. Catalog free. T. S. Denison & Co., 623 So. Wabash, Dept. 11, Chicago.

PUPPET Theatre. Easy to make, fun to use. Proscenium, 19x32 inches, and 24 different stage settings in beautiful colors, to mount and cut out, with plans, \$3. Cut-out puppets for "Cinderella" 50c. Miniature Theatre Guild, Gary, Ind.

READ Sealed Messages in Dark; messages retained by audience; burned message appears on black slate; spirit message appears on slate in sitter's presence; spirit rappings; spirits appear in the dark; answer questions written on folded papers while blindfolded. All this you can do with directions in "Behind the Scenes with The Mediums," 69 best secrets of mediums fully exposed. The best because most baffling, yet all easy to do. Send no money. Just write a postal. Pay postman \$1.50 and postal charges. Popular Mechanics Press, Room 801, 200 E. Ontario St., Chicago, Ill.

MAGIC TRICKS, BOOKS AND JOKER NOVELTIES

FOUR Intricate perplexing puzzles which your friends will be unable to solve although you do them before their eyes. Neatly constructed of wood, 4x4 inches in size and highly colored. 35c each or four for one dollar postpaid with solutions. Rex Puzzle Co., 3704 W. 59th Pl., Chicago, Ill.

TRICKS With cards. Easy to do. Produce any card called for. Name any card drawn from pack. 6 tricks for 25 cents, including large catalog listing over 600 tricks. Wizard Magic Co., Dept. 15-M, Box 1055, Station "C," Los Angeles, Calif.

MAGIC! Tricks, cards, books, illusions, etc. Catalog free. Geo. Fenner, Louisville, Ky.

FREE, Eight big magic tricks. Send postage. Ernest Pearson, Turner, Oreg.

"THE Book of 1,000 Wonders" explains many mystifying tricks with coins, cards, handkerchiefs, etc. Also contains complete catalog magic tricks, jokes, puzzles, books, and imported novelties. Largest assortment, lowest prices. Amaze and mystify your friends. Send 10c today. Lyle Douglas, Station A-5, Dallas, Tex.

SEVEN Optimagical delusions. Five magi catalogs, 25c. Gilmagico, Morgan Park, Chicago.

MAGIC—Tricks, Books and Supplies. For amateurs as well as the great professionals. Anyone can learn through our instructions. Feature Acts in Mind-Reading, Spiritualism, Rope Ties, etc. Large illustrated professional catalog. 20c. Chicago Magic Co., 140 So. Dearborn St., Dept. B, Chicago, Ill.

MAGIC, 64 Guarded professional secrets, 23 card tricks, 1930 catalog, for 50c. Edward Kay Magic Shop, 8834 Commercial Ave., Chicago, Ill.

IGKI-IGK Puzzle. Greatest teaser for mechanical minds yet invented. With instructions. 25 cents. No stamps. Igki-igk Novelty Co., Dallas, Tex.

MAGIC Catalog 20c. Lynn, 105 Beach, Dept. 3, Jersey City, N. J.

YOU Can become a handcuff king. Enormous salaries are paid in vaudeville. Interesting, mystifying. Full instructions 50c. Particulars free. L. Ricker, 2458 South St. Louis Ave., Chicago, Ill.

ELECTRIC Fun! Seventy stunts, 110 volts, \$1. Chemical fun, magic, hundred effects, \$1. Kutting Sons, Campbell, Calif.

200 TRICKS You can do—Mystify your friends; have loads of fun. This collection of tricks has been selected by Thurston for the average person. Neither unusual skill nor elaborate apparatus are required. Send for this 200-page illustrated book. Pay postman \$1 plus postage when delivered. If outside U. S. remit when ordering. Popular Mechanics Press, Room 801, 200 E. Ontario St., Chicago.

CHALK TALKS

LAUGH Producing program, \$1.00. Catalog free. Balda, The Cartoonist, Oshkosh, Wis.

CHALK-TALK Your way to popularity. Audiences at your feet if you learn how to entertain with a few simple pictures. Little artistic ability needed. "How to Chalk Talk" tells what to say and what to draw. Profusely illustrated. Make money giving chalk talks. Just order on a postal. Pay postman \$1.00 and postage when delivered. Popular Mechanics Press, Room 801, 200 E. Ontario St., Chicago, Ill.

RADIO SETS AND SUPPLIES

\$5 RADIOS All makes Atwater-Kent, Majestic, R. C. A., and others. Hundreds—world's best makes. Used, new and rebuilt. Going at \$5 to \$65. Many formerly priced at \$150 to \$300. Amazing bargains. Backed by responsible guarantee and 30 years' experience. Write for big free list today. Brown's Radio Exch., Dept. E, 3018 East 91st St., Chicago.

NEW 300-Mile "pocket" radio, \$3.85. Complete with special loud receiver. No tubes or batteries required. Order direct. Spencer Laboratories, 116 Atlas, Akron, Ohio.

TIME Counts in applying for patents. See pages 140 and 141. Clarence A. O'Brien, Registered Patent Attorney, Washington, D. C.

RADIO Trouble Shooting—Covers all electric sets and television. Greatest book ever published from the point of view of assisting the repairman as well as showing how the radio owner can do his own repairing, 328 pages. Over 300 illustrations. Flexible. Pay postman price \$3 and postage when he delivers it. Popular Mechanics Press, Room 801, 200 E. Ontario St., Chicago, Ill.

RADIO Transmitting and receiving parts, kits and tubes. Wedel Company, Jobbers, Seattle, Wash.

RADIO Crystals. Bulk, packed. Specials made. Manufacturers write. Allen Industries, Independence, Mo.

NEW Government broadcasting radio sets, also receivers; cost \$138. To close out \$25 each. H. E. Skinner, 2409 N. Ashland Ave., Chicago.

RADIO Service and repair men, dealers, salesmen, experimenters and designers—you will find Drake's Radio Cyclopaedia covering 1,700 subjects arranged especially for your use. 920 pages. 1,000 illustrations. Most comprehensive radio reference book published. Delivered to your door C. O. D. Simply pay postman \$6 and postage. Popular Mechanics Press, Room 801, 200 E. Ontario St., Chicago.

STAMP COLLECTING

MYSTIC "Queer Country" Packet! Contains scarce stamps from the following strange lands: San Marino, Antioquia, Congo, Cyprus, Fiji Islands, Gwalior Hyderabad, Iceland, Jhind, Kenya, Uganda, Lebanon, Monaco, North Borneo, Nyassa, St. Thomas Prince, Eastern Roumelia, Siam, Sierra Leone, Tanganyika, Trinidad Tobago, Ubangi, Upper Volta, Wallis Futuna, Alaouites. Get this wonderful packet of "freak countries" and make your friends envious! Price only 10c to approval applicants! Write today. Mystic Stamp Company (Dept. 8), Camden, N. Y.

FREE! Largest stamp in the world! Fine packet 65 different stamps from Cape Verde, Jamaica, Mozambique, Syria, etc., including dying soldier, beautiful women, ships, maps, savages, airplane scenes, bird and animal stamps, for only 5c to approval applicants. Largest Stamp in the World (Rare China Wild Goose Special Delivery) given absolutely free with each order. Supply limited! Send your 5c today! Western Philatelist, 6021 Harper Ave., M5, Chicago.

HOWARD'S Big value packet set of 6 unused Piume (1922 issue, cat. 89c) picturing Romulus and Remus with wolf-mother; and ancient Roman slave ship. Also 57 other interesting stamps from Alaouites, Costa Rica (pirate ship); France (Joan of Arc); Tacna-Arica, Uruguay (teru-teru bird); commemorative, airmail, triangle, "too-late" stamps, etc. Cat. value over \$2.00. All for 10c to approval applicants. Robert G. Howard, 245 Waverley Ave., Newton, Mass.

THRILLING War scenes. A packet of all different stamps showing exciting scenes and records of nations at war. Includes siege guns; firing squad; mounted troops; prisoners of war; fire-pot hurlers; hand-to-hand bayonet struggle; bloody battle scenes; troop transport; red cross stamp; dying soldier; victory stamps, etc. Send for this thrilling "Big Parade" packet at once—limited supply. Only 10c to approval applicants. W. A. Rowell, 58 Cornhill, Boston, Mass.

500 DIFFERENT Stamps for 25c. Big collection from Bosnia, Crete, Epirus, Honduras, Iceland, Kenya, Liberia, Malta, Nyassa, Quellimane, Siam, Zambesia and other "hard" countries. Catalog value \$10. Price 25c to approval applicants! Bargains. 1,000 different 79c; 15 triangles 49c; 100 British colonies 30c; 100 French colonies 35c; 100 Portuguese colonies 50c. Five packets for \$2.00! Illustrated lists free. Loma Stamp Co., 4231 42d St., San Diego, Calif.

ANCHERS \$\$\$ Outfit—only 12c! Fine triangle stamp; set German stamps with (pre-war) value forty million dollars (interesting!); perforation gauge, mm scale; airmail set; scarce stamp from smallest republic on earth; newspaper set; packet good stamps and Travancore, Malay, Dutch Indies, etc. Entire outfit for 12c to approval applicants! (Nice pocket stock book, value 25c, with every order!) Ancher Stamp Co., Box 126, Rutherford, N. J.

TO Get acquainted, we offer 10 stamps cataloging over \$5.00 including one 75 year old classic for only 10c to approval applicants. We are approval headquarters and carry a stock of several million stamps at the lowest prices. It pays to deal with Globus, Globus Stamp Co., 214 Third Ave., New York City.

15c WILL Bring you new Iceland triangle airmail—just out, and 1,000 imported stamp mounts. Weber's Stamp Shoppe, 1377 Park, Plainfield, N. J.

300 DIFFERENT Stamps from all over the world absolutely free to approval applicants. Sedgwick Co., Dept. C, 515 Sedgwick Drive, Syracuse, N. Y.

TEN Siam free with surprising one-cent approvals. Philip Goldstein, 1520 Ocean Ave., Brooklyn, N. Y.

SCARCE Hawaii stamp given! Rare set of 4 Albania, 1914 issue (cat. \$1.27), bearing portrait of Scanderberg—the man who slew 3,000 Turks with his own hand; also 52 other interesting stamps from Alaouites, Grand Liban, Quellimane, etc. Total cat. value nearly \$2.50. All for 10c to approval applicants! Scarce unused 1893 Hawaiian stamp given with each order. Send today. Crown Stamp Co., 1120 Biltmore Ave., Pittsburgh, Pa.

100 DIFFERENT Foreign stamps from 100 different foreign countries, including Africa, Asia, Australia, Europe, West Indies, etc., for only 20c. Free with each order, our pamphlet which tells "How to Make a Stamp Collection Properly," together with our price lists of albums, supplies and hundreds of bargains in sets, packets, etc. Queen City Stamp and Coin Co., Room 36, 604 Race St., Cincinnati, Ohio.

FOR Limited time only. 21 varieties Belgian parcel postage stamps, two complete sets, from 5c to 3 franc, from 70c to 5 franc values; (catalog No. 838 to No. 858 inclusive) value \$1.14, will be sent to collectors who apply for our approval sheets and also enclose 10c coin. Keigwin Stamp Co., Ferdinandina, Fla.

WICK'S Canadian stamp mixture. 1,000 well assorted, over 40 varieties high values, rare precancels and cancellations. Large packet Newfoundland, New Brunswick with each order. Also price lists and premiums. Best approvals. Price post free, \$1.00. Wick's Stamp Co., Brantford, Ontario.

SCARCE Hawaii free! Rare set of 4 Albania, 1914 issue (cataloging \$1.27) and 52 other stamps from Alaouites, Lebanon, Quellimane, etc., total catalog value about \$2.50. Price only 10c to approval applicants. Scarce unused Hawaii free with each order. Send today! Crown Stamp Co., 1120 Biltmore Ave., Pittsburgh, Pa.

SPECIAL Oriental packet 85c to approval applicants furnishing references. J. Sainsbury, 35 Thomas St., St. Catharines, Can.

FINE Approvals ¼c up. Oare, 992 Michigan, Columbus, Ohio.

ALBUM 1,000 Hinges, 200 foreign, 25 Cuba, 25 Japan, 35c. Burtiss Company, Saratoga, N. Y.

25 AIRMAIL Stamps free with 3 mos. subscription to latest stamp paper published for 25c. Stamp News, 1476 Broadway, New York City.

UNITED States \$2 present issue (cataloging 50c) for ten cents to approval buyers. State size of collection. Leduc, Redlion, Penna.

SAVE Money. Stamps ¼c up. Babcock, 407 East Fort, Detroit, Mich.

300 DIFFERENT, 20c; 600, 50c; 1,100, \$1; 2,000, \$3. Fred Onken, 630 79th St., Brooklyn.

ILLUSTRATED Descriptive U. S. list, price 50c; also our 1930 32-page price list free. Stanley Gibbons, 38P Park Row, New York City.

155 DIFFERENT "Hard Country" packet, Zanzibar, Iraq, Airmails, etc., 10c. Big free stamp offer with each order. Glendale Stamp Co., 1342G Linden, Glendale, Calif.

SEND For my price list on sets. M. G. Hanna, 432 Wood St., Pittsburgh, Pa.

AIRMAILS! 25 Different 10c. Splendid approvals 50%. Webster Stamp, Tremont Sta., Box 11, New York.

CAYMAN Islands—Astounding packet from Cayman Islands, thirty other unique, interesting, beautiful distant land stamps (richly colored unusual designs). Hurry! Rush! Get yours now! Free for 5c postage. Empire Stamp, Toronto, Can.

100 DIFFERENT Stamps free to approval applicants for my popular approvals. Ed. Gunter, 2820 Main St., Davenport, Iowa.

FREE! 101 Different Mexico, etc.! Supreme. 1928½ S. Trumbull, Chicago.

FREE—1,000 Mixed U. S. stamps. Particulars 2c. Weatherly, Willoughby, Ohio.

BEAUTIFUL Bicolored set Spain, four values, containing pictures of king and Pope Plus, offered to approval applicants for only 5 cents. Eveningside Stamp Company, Milford, Conn.

15 DIFFERENT Confederate essays, 15c. Watermark detector free! Tatham Stamp Co., 49 Van-horn, W. Springfield, Mass.

NEWFOUNDLAND—Set of 5 caribou 10c or set of 10 from Montenegro 10c to approval applicants. DeLisle, 762 Harding Ave., San Jose, Calif.

FREE: 55 Different stamps including rare Mauritius revenue, Iraq, Gold Coast, Sudan, Trinidad Tobago, Travancore, Orange River colony, etc. Absolutely free to approval applicants enclosing 4c for mailing. Viking Stamp Co., Sheepshead Bay Station, Brooklyn, N. Y.

BEAUTIFUL Triangular 1930 Iceland air mail, 7c. Penna. Stamp Co., Greensburg, Pa.

100 DIFFERENT U. S. 25c; 1,000 mixed, 25c; 1,000 different \$1.00; 100 Canada or U. S. 12c. Burton, Madison, N. Y.

DANDY Approvals. Charity set free. William Monjar, 1551 Knox, Cincinnati, Ohio.

FREE! 100 Different to approval applicants, 2c postage. Evanston Stamp Shop, 2412 Noyes, Evanston, Ill.

100 DIFF. U. S., many commemoratives, no revenues or cut squares., \$1.00. Illustrated pricelist of packets and sets of foreign stamps free. A. Gunesch, 9719 Prairie Ave., Chicago.

POLAND 50 Different cat. \$1.25, net 12c. Soviet Russia, 50 different, cat. \$4.00, net 27c. W. Stamp Co., 150 E. 7th St., New York.

50 ALL Different stamps to approval applicants 6c. A bargain. W. H. Peck, Woodland, Calif.

STAMPS—100 Varieties, Africa, Brazil, Peru, Cuba, Mexico, etc., 10c; 25 different U. S. 25c; 1,000 mixed, 40c; 1,000 hinges, 15c. C. Stegman, 5941 Cote Brillante, St. Louis, Mo.

75 STAMPS From 75 countries for 25c. Lists free. Sunshine Stamp Co., 549 East Maryland St., St. Paul, Minn.

FREE Stamps with approvals. 2c postage. Harvey Teeple, Decatur, Ind.

BEAUTIFUL Set 6 Ceylon, watermark detector, stamp wallet and perforation gauge only 12c to approval applicants. Bourque, 571 Western, Lynn, Mass.

100 FOREIGN Stamps 5 cents. Lufbery Stamp Co., Branford, Conn.

FREE—5 Airmails, 2 Confederate prints, 20 unused to approval applicants sending 10c. Buckley, P35 West 5th, Dayton, Ohio.

25 AIRMAIL 9c To approval applicants. Stamp Shop, 685 Broadway, Newark, N. J.

BIG 10c Bargain: Pair stamp tongs; water-mark detector; set scarce Greece Red Cross; fine packet 55 different British and French colonies, including Egypt, Newfoundland, birds, scenery, animals, map stamps, etc. All for 10c to approval applicants. Highland Stamp Co., 62 Woodcliffe Road, Newton Highlands, Mass.

STAMP Bulletin. Published monthly. Fine stamp offerings. Profusely illustrated. Authoritative information. Sent free to advanced collectors. Reimers Co., 30 N. La Salle St., Chicago.

CANADA Airmail stamp free if you ask for approvals and send 15c for 25 diff. airmails or 30 diff. Canada and Newfoundland; both packets only 25c. We list 329 countries in our dime packets. Lists free. Special bargains—500 diff. 25c; 1,000 diff. 75c; 2,000 diff. \$2.50. Victoria Stamp Co., London, 4, Canada.

200 DIFFERENT 8c. Lists free. Midwest Stamp Co., Kemper Bldg., Kansas City, Mo.

HUNDRED Different and three \$1.00 U. S., 10c. Approvals. Vaclav Bilek, 644 Cass, Chicago.

STAMP Collectors Magazine. Finest monthly stamp paper. Write for free sample copy. Philatelic Publishing Co., Inc., 15 John St., New York, N. Y.

UNITED States, biggest stock, lowest prices, large list free. Reliant Stamps, 65 Nassau, New York.

SPECIAL—500 Different stamps 25c to approval applicants. Ohio Stamp Co., Box 249, Cleveland, Ohio.

300-300-300! ALL Different stamps (catalog over \$6.00). 300 hinges; 5 approval sheets; duplicate stamp album; perforation gauge; millimeter scale and ruler, to approval applicants only for 20c. Edgewood Stamp Co., Dept. PM, Milford, Conn.

FREE—200 Different stamps, if approvals requested. Postage 4c. Berkeley Stamp Co., South Berkeley, Calif.

ESTABLISHED 30 Years. Best line of approvals. Premium. Hub Stamp Co., 45 Bromfield, Boston, Mass.

ATTRACTIVE Approvals at 50 % discount and 25 % discount. Noemus Stamp Co., 312 East 23rd St., New York.

40 DIFFERENT United States 12c. 60% approvals. Seldenberg, Baroda, Mich.

U. S. STAMPS Only on approval; give reference. Stamp House, 39 Torry, Dorchester, Mass.

¼c APPROVALS, including Liberia, Nyassa, etc. Also 14,000 averaging 1¼c. References. Philatelic Exch., Huntington, W. Va.

BEST One cent approvals in America. F. Hand, 1117 60th St., Philadelphia, Pa.

212 DIFFERENT Stamps including U. S. \$2. Dominica, Syria, etc. Catalog \$4.90, only 15c. Robert Haynes, Point Place, Toledo, Ohio.

105 CHINA, Etc., 2c. Album (500 illustrations) 3c. Bullard, 446 Tremont, Boston.

ONLY 5c. 33 Different stamps including scarce Latvian triangular airmail stamps, 10 airmail, 12 United States (early issues, commemoratives, etc.) and 10 Canada. Approvals and illustrated pricelist sent with each order. Curhan Stamp Company, Gloucester, Mass.

FREE! Loose leaf postage stamp album at rate of 8 pages each month given with subscription to monthly journal. Send 2c stamp for prospectus. United Stamp Co., Marquette Bldg., Chicago, Ill.

FREE, 6 Different Luxembourg to approval applicants. E. D. Stamp Co., 3905 Forest Park Ave., Baltimore, Md.

55 DIFFERENT including scarce countries to approval applicants 4c. Richard Lamprecht, Valparaiso, Ind.

STAMPS Sent on approval at 70% discount. Reference required. Emory Renoll, Hanover, Pa.

COVERTCO Packet, 200 different stamps 10 cents, with 60% discount approvals. Covert Stamp, 39 State, Rochester, N. Y.

FREE—\$1.00 U. S. postage old issue free, if you write for our 56 page price-list of U. S. and foreign stamps, 2,000 illustrations. Also fine but cheap stamps on approval. Hussman Stamp Co., 620-3 Olive St., St. Louis, Mo.

FREE—Canada (15 Var.) for new applicant of my 1c, 2c and 3c approval, and also my 50% discount. Chas. W. Schmidt, P. O. Box No. 4832, Frankford Sta., Phila, Penna.

110 DIFFERENT Stamps, many unused, high values, free to collectors requesting our net approvals. Postage 2 cents. Christensen, Milwaukee, Wis.

PENNY Approvals that Satisfy. Neil Gronberg, Box 5441, Philadelphia, Pa.

FREE! 115 Different stamps to approval applicants, 2c postage. Paige Stamp Co., Oak Park, Ill.

110 NEW Europe All Different, a wonderful collection cataloging several dollars, free to collectors requesting our Net Approvals. Postage 2 cents. Badger Stamp Co., Milwaukee, Wis.

FREE! Triangles, airmail, Iceland and 50 others to approval applicants including 3c postage. Hawkeye Stamp Co., Cedar Rapids, 59, Iowa.

118 STAMPS Free with approvals. L. W. Hudson, Plainfield, N. J.

STAMPS, 100 all different. Postage 2c. Lists free. P. M. Quaker Stamp Co., Toledo, Ohio.

24 VARIETIES Cuban stamps, 10 cents. List of 6,000 low-priced stamps free. Address Chambers Stamp Co., 111P, Nassau St., New York City, N. Y.

FREE!—20 Different Argentine. Approvals. List. Send 4c today for postage, etc. Renter, Santa Ana, Calif.

STAMP Album—The Modern Album is unsurpassed in usefulness. Spaces for 12,000 illustrations, 330 pages. Large size 9 1/4 x 11 inches. Cloth bound. Price only \$2. Either pay postman when delivered or if outside U. S. remit when ordering. Popular Mechanics Press, Room 801, 200 E. Ontario St., Chicago.

RARE COINS

SPECIAL Prices on United States commemorative half dollars in uncirculated condition: Lincoln, \$1.19; Maine, \$1.27; Pilgrim, 89c; Grant, \$1.23; Monroe, 97c; Hugenot, \$1.49; Lexington, \$1.19; Norse American, \$1.29; California, \$1.79; Sequi, \$1.29; Oregon, \$1.29; Bennington, \$1.19; trade dollars, \$1.15; 10 large cents, 79c; 10 white cents, 49c; 10 flying eagle cents, 73c; 10 2c bronze, 79c; 10 3c nickels, 89c; 5 half dimes, 67c; beautiful mothers day medal, 25c; foreign coins: Belgium, 5c; France, 5c; Italy, 6c; Germany, 3c; Roumania, 9c; Greece, 9c; Palestine, 15c; Chile, 15c; Peru, 15c; Argentine, 9c; Turkey, 9c; Norway, 9c; Finland, 5c; Denmark, 8c; Sweden, 8c; Russia, 9c; Hungary, 7c; Austria, 9c; Mexico, 5c; Brazil, 15c; Dominican, 10c; Salvador, 15c; India, 10c; Japan, 12c; China, 5c; Columbia, 10c; Nicaragua, 17c; Netherland, 7c; old coin and bargain price list 10c. Arcy, Box 483, Muskogee, Okla.

OLD Money wanted—Will pay fifty dollars for nickel of 1913 with Liberty head (no buffalo). We pay cash premiums for all rare coins. Send 4c for large coin folder. May mean much profit to you. Numismatic Co., Dept. H, Fort Worth, Tex.

ANCIENT Roman bronze coin, foreign, 5c silver; large crisp bank note and catalog 20c. Geo. Best, Box 283, Cedar Rapids, Iowa.

600 UNASSORTED Foreign coins, \$5.00; 100, \$1.00. Romancoinshop, Springfield, Mass.

SEND 10c For old coin and list. J. Daurer, Route 3, South Bend, Ind.

10,000,000 MARK And list 10c. Greenclay, Box 2551, Denver, Colo.

15 DIFF. fine coins, 25c; 25 diff., 50c. W. Bishoff, Ottawa, Kans.

THOUSANDS Of dollars paid for old coins. List 5c. Romancoinshop, Springfield, Mass.

UNITED States half dollars 1831 to 1836 fine, 80 cents each. Price list free. Towns Davis, Box 1791, Huntington, W. Va.

15 DIFFERENT Coins, 25c; 60 different coins, \$1.00. Oddehon, Box 681, Kansas City, Mo.

UNITED States. Large cent, two-cent bronze, three-cent nickel and bargain list, 25c. Thirteen dates large cents, \$1.00. George Coffin, Greenwood Mountain, Me.

\$2 TO \$500 Each paid for hundreds of old coins. Keep all old money, it may be very valuable. Send 10 cents for illustrated coin value book, 4x6. Prices guaranteed. Get posted. We buy and sell. Clarke's Coin Office, Box 5, Le Roy, N. Y.

RARE United States, foreign coins, war medals, Chinese coin and catalog 10c. Alexis Mengelle, Colorado Springs, Colo.

CALIFORNIA Gold—Quarter size, 27c; 3/8 size, 53c; 3c piece and catalog, 10c. Norman Shultz, Box 746, Salt Lake, Utah.

GET Profit and pleasure in collecting old coins. Send 10c for large illustrated coin catalog. You'll be delighted with it. Send for it right now. B. Max Mehl, Numismatist, Mehl Bldg., Dept. P, Fort Worth, Tex. Largest Rare Coin Firm in the U. S.

OLD Coins, large fall selling catalog of coins for sale free to collectors only. Catalog quoting prices paid for coins, ten cents. William Hesselein, 101A Tremont St., Boston, Mass.

CAMERAS AND PHOTO SUPPLIES

BARGAINS, Save 25 to 60% on the used outfits and accessories listed in our latest free Bargain Book. Every item is guaranteed and sold on ten days' trial. Money refunded if you are not fully satisfied. Send for your copy right now. Central Camera Co., 230 South Wabash Ave., Dept. P. M. 5D, Chicago, Ill.

KODAK Film developed, six Neutone prints 25c. Enlargements. Ace Photo Service, Dept. C, Hoisington, Kans.

SAVE Money. Movie cameras, \$25; projectors, \$35; Pathex camera, \$20; stereopticon, \$25; printing machine, \$75; 35m negative stock, 2 cents foot; 100 foot Eastman 16m negative, \$4.50; kodak, \$5. Typewriter \$16. Cameras and films bought and exchanged. Ray, 266 W. 46th, New York.

SAMPLE Enlargement—dime, and negative (returned). Trial roll, glossy prints, 25c silver. Brown, Warsaw, N. C.

YOUR Favorite kodak picture enlarged, size 5x7, 10c. Three for quarter, coin. Send best negative (film) today. Address Darmer Photo Lab., 221 Securities Bldg., Des Moines, Iowa.

HAVE You a Camera? Write for Free sample of our big magazine, showing how to make better pictures and earn money. American Photography, 116 Camera House, Boston, 17, Mass.

FILMS Developed. Special Trial Offer. Any Size Kodak film developed 5c, prints 3c each. Trial 6x10 Enlargement in handsome folder 40c. Overnight Service. Roanoke Photo Finishing Co., 209 Bell Ave., Roanoke, Va.

MAKE Money in photography. Learn quickly at home. Spare or full time. New plan. Nothing like it. Experience unnecessary. American School of Photography, Dept. 3431, 3601 Michigan Ave., Chicago.

KODAK Films developed 5c roll. Prints 3c each. Trial offer. 8x10 enlargement 25c. Young Photo Service, 405 Bertha St., Albany, N. Y.

TIME Counts in applying for patents. See pages 140 and 141. Clarence A. O'Brien, Registered Patent Attorney, Washington, D. C.

MOTION PICTURES

BARGAINS, Save 25 to 60% on slightly used motion picture outfits and accessories listed in our latest free bargain list. Every item is fully guaranteed and money will be refunded if you are not satisfied after ten days' trial. Send for your copy right now. Central Camera Co., 230 South Wabash Ave., P. M.-5D, Chicago, Ill.

SOUND Motion pictures! You must order this great and only authoritative text book on the subject by James Cameron, world's foremost authority. 400 pages crammed full of information on photo cells, Vitaphone, Movietone, Phototone, methods of recording maintenance. We are selling thousands of copies. Price, \$5.00 postpaid anywhere. Bass Bargaingram No. 199 just off the press. Red hot bargains in standard and 16 mm. motion picture cameras, projectors and accessories. Send 4c in stamps. Bass Camera Company, Motion Picture Headquarters, 179 West Madison St., Chicago, Ill.

START A movie show. Moving picture machines and complete accessories at lowest prices. Send for bargain list and catalog M. Movie Supply Co., 844 Wabash Ave., Chicago.

SEE Yourself in the movies. New Pathe home movie outfits at lowest cost. The Wambaugh Co., Goshen, Ind.

KODAK Films developed. Special trial offer. Films developed 7c, prints 2c each. Wineholt, 3, Woodbine, Pa.

300 FEET Good film, 90c. 125 feet Charlie Chaplin, 75c. Star Films, Allentown, Pa.

FILMS, Standard gauge, 250 ft. good western, comedy or action, \$1.00 postpaid. Home Movies, Box 744, Minneapolis, Minn.

GOOD Film—300 feet \$1.00. Other bargains. Samples, particulars for stamp. Eastin Films, Galesburg, Ill.

SOUVENIRS—Movietone, RCA telephone talkie film, 35c. Eastin Films, Galesburg, Ill.

TIME Counts in applying for patents. See pages 140 and 141. Clarence A. O'Brien, Registered Patent Attorney, Washington, D. C.

SACRIFICING Ten thousand reels films, every description, \$2.00 reel up. Lists. Lowe, Box 524, Cincinnati, Ohio.

STAR Films, 1,000 ft. films, \$1.00. 38 Arthur St., Clifton, N. J.

FILMS (New) Technicolor 50 ft. sent \$1.00. Worth \$12.50. Westerns, Indians, no lists. Hemenway Film Co., 37 Church St., Boston, Mass.

\$1,250 FOR Original photoplay story. Our sales department sold unknown author's first story for above amount. We revise, copyright and submit to studios stories for both silent and talking pictures. Being located in the heart of motion picture industry we know production requirements. Established 1917. Free booklet. Universal Scenario Company, 206 Western and Santa Monica Bldg., Hollywood, Calif.

\$1.00 POSTPAID For new book Motion Pictures with the Baby Cine. Also free literature on this new Pathe Automatic Motion Picture Camera and Projector. Send \$1.00 today to Motion Picture Headquarters, Bass Camera Company, 179 West Madison St., Chicago, Ill.

LEARN Motion picture theatre management as a business or profession. Big opportunities. Theatre Managers Institute, Elmira, N. Y.

WESTERNS, \$3.00 Reel. Rebuilt projectors bargains. Marshall Films, Rome, Ga.

300 FEET Good film, 90 cents. Star Films, Allentown, Penna.

BE A movie exhibitor. Big opportunity Only moderate capital required. Complete equipment at remarkably low prices. Write Atlas Moving Picture Co., 825 So. Wabash, Chicago, Ill.

MOVIE Films, 1,000 ft. reels, \$2.50 each; shipped anywhere on receipt of remittance. Particulars on request. Independent Films, 177 Golden Gate Ave., San Francisco, Calif.

FILMS, Machines, Stamp for list. Box 255, Hickman Mills, Mo.

TRADE AND TECHNICAL SCHOOLS

DRAFTSMEN! Be an expert. Our method trains you quickly. Books and tools furnished. Write for illustrated catalog. Columbia School, 204S Drexel Bldg., Philadelphia.

BE A blue print reader. Men in your trade have succeeded. Write for facts. What's your trade? Carroll Rumsay, Drexel Bldg., Philadelphia.

LEARN Morse and wireless telegraphy. Big salaries. Tremendous demand. Expenses low, can earn part. Catalog free. Dodge's Institute, Fern St., Valparaiso, Ind.

WATCH Repairing and making shows how to clean and repair all kinds of watches. 214 page book with over 200 illustrations. Pay postman \$3 and postage when he delivers book. Popular Mechanics Press, Room 801, 200 E. Ontario St., Chicago, Ill.

OUR Extension course covers entire subject of radio. Graduates allowed three months finishing course free at the college. Tuition charge moderate. Have always placed graduates at pay ranging \$150 to \$300 monthly from the start. Write for catalog. Loomis Radio College, Dept. 7-A, Washington, D. C.

HILES Watchmaking and engraving school. The largest and best equipped school in the west. 5330 Mission St., San Francisco, Calif.

BUSINESS OPPORTUNITIES

WITHOUT Exception most profitable opportunity ever offered. Unlimited possibilities—plan unique—unbelievable results; small investment for instructions and advertising only; no stock to carry; permanent income; no effort required; starts paying over-night. Anyone can succeed with this most profitable business under our free guidance. For full particulars write Mutual Service Corporation, Desk K, 522 McKnight Bldg., Minneapolis, Minn.

BIG List of information tells where to get all kinds of offers, propositions and ideas. Where to get reliable advice on selling by mail. Where to get the best formulas for making almost anything. And much other valuable information. Only 50c. Marden Co., Box 25, Astor Station, Boston, Mass.

SMALL Capital starts profitable route peanut and gum vending machines. Particulars free. Robbins Corp., Dodworth St., Brooklyn, N. Y.

SURE-HOLD Broom holders sell at sight. Sample 10c. Door holders—hold the door open that is always swinging shut. Sample 25c. Beautiful brass door knockers. 75c (store price \$2.50). Big profits. M. Lenor Essig, Newark, Ohio.

SCREW-HOLDING Screw driver! Amazing new patent! Factories, garages, electricians, mechanics, auto, radio, owners buy on sight! Removes, inserts screws instantly! Your profit 75c each. Exclusive territory. Free trial offer! Millenco, 1565 Spring Lane, Boston.

MIRRORS Resilvered at home. Costs near 5 cents per square foot; you charge 75 cents. Profitable business, plating like new, brass, worn-off auto parts, reflectors, tableware, stoves, etc. Outfits furnished. Details free. Sprinkle, Plater, 127, Marion, Ind.

"MAIL Order Selling" magazine. Contains new ideas each month. 3 months' subscription 25c. One year \$1.00. Mail Order Selling, Brookfield, Ill.

CHARTERS: Delaware; best, cheapest; free forms. Colonial Charter Co., Wilmington, Del.

SUCCEED With your own products. Make them yourself. Formulas, processes, trade secrets, all lines. Catalog free. B. Thaxly Co., Washington, D. C.

"NADEN News," the modern mail order trade journal, contains tips, plans, formulas; copy 10c. Naden, 2001 Burlingame, Detroit, Mich.

EARN More money. We show you how. Catalog free. Specialty, Box 28, Rumford, Me.

"ODD-THINGS"—Money making ideas; tips; plans; opportunities! New; different! Three months' trial, 25c. Year \$1.00. "Odd-Things Magazine," 720 Advance Bldg., Cleveland, Ohio.

SELL By mail—Large profits. No capital. Free particulars. Bonton, 417 Grand St., Buffalo, N. Y.

SELL Information—books, mail circulars spare time. We furnish everything. Instructions; sample circulars 25c. Nagel, 1329 Olive, Indianapolis, Ind.

MAKE Extra money, sell auto trunks, make them yourself, a fraction of manufacturers' price, plans, instructions and metal fasteners, \$1.00. Makeze System, 107 Portage Ave., Highland Park, Mich.

"MONEY Making business chances. Book \$1.00. Free premium, circulars. C. White, 8717 Blaine, Cleveland, Ohio.

LAUGHING Mirror shows get the money at parks, carnivals, fairs, celebrations. Small outlay, big returns. C. J. Murphy, Elyria, Ohio.

"LIBERTY Bell" contains valuable information; copy and interesting mail 10c. Geo. Bell, Murfreesboro, Tenn.

"WEATHER-LOX" — Carpenters everywhere sell and install "Weather-Lox." Wonderful invention. One agency made \$21,000 first six months with \$94.00 capital. Write Hickman-Bryant Corp., Washington, D. C.

UNUSUAL Business never heard of before—employed men wanted spare time my representative each town. No selling. Lawrence Harris, Lawrence, Kans.

PRINTING Plant with established mail order business. Has wonderful future with no competition. Price \$1,500 on terms. Hathaway, Rolling Prairie, Ind.

CAN You draw? Spare time profits a plenty. Not a correspondence course. Samples and particulars 10c. Straco, 1013 Mulberry, Springfield, Ohio.

DON'T Sell for others. Employ agents. Make your own products. Toilet articles, soap, extracts. Valuable book free. National Scientific Laboratories, 1935W Broad, Richmond, Va.

\$15 DAILY Profit sharpening lawn mowers. Particulars. Hoof Mfr., 2317 Bloomington, Minneapolis, Minn.

SELL By mail! Start your own small business anywhere. Free folder tells how. No personal selling. Everything furnished. B. Horton, Metropolitan Bldg., St. Paul, Minn.

DON'T Work for others all your life. Start "on your own." Operate a sample and circular distributing bureau. My instructions teach you this business from A to Z. Particulars. Wagner, Box 457-a, Palo Alto, Calif.

TIME Counts in applying for patents. See pages 140 and 141. Clarence A. O'Brien, Registered Patent Attorney, Washington, D. C.

BUSINESS Profession of your own and earn income in service fees. See Stephenson Laboratories, display ad page 144.

250,000 ARTICLES Wholesale. Supply sources 10c. W-Pattersons, 4111 University, Des Moines, Iowa.

WE Start you in business, furnishing everything. Men and women, earn \$40 to \$100 weekly operating our original "New System Specialty Candy Factories." Begin home spare time. Unlimited opportunity. Valuable booklet free. W. Hillyer Ragsdale, Drawer 4, East Orange, N. J.

CHEMICAL Expert furnishes manufacturing formulas and processes with complete working directions. Reliable individual service only. No lists. Charges reasonable. Correspondence invited. Dr. Arthur VanHeeden, 7051 Bennett, Chicago.

"SCHEMER," Alliance, Ohio, subscribers surely succeed. One reports \$25,000 from three schemes; another \$10,000 from one formula. Try your luck! Three copies, 96pp, 25c.

DISTRIBUTOR For auto specialty that is a necessity. More power, less gas, sells \$2.00. Large profits. Smith Specialty Co., 1842 S. Highland Ave., Berwyn, Ill.

I MADE \$30 A week home. French breadmaking. 15 years' experience; free booklet tells. Ashbrook 67, Marengo, Ohio.

UNUSUAL—Uncommon specialties always sell best. Make these yourself from Miller's guaranteed formulas. Why work for others when others can be working for you? Latest eye-opening literature brings you many specialty propositions for you an independent business. Miller, Chemist, 706-K Chemical Bldg., Tampa, Fla.

FIFTY Successful mailorder products, sales plans. K. Home, 3949 Metropolitan, Chicago.

MAN Or woman. Tested business. Has made more than \$1,000 monthly profits. Legitimate, dignified, pleasing. Experience unnecessary. We supply everything. Long-Eakins, 2060 High St., Springfield, Ohio.

MAIL Order business your opportunity. Brenner's famous hand books by expert 28 years' experience show how to start selling articles you make or buy—all or part time—small capital. Fascinating, profitable. Set eleven books, \$3.25. Brenner Company, 1607 P. Sanson, Philadelphia. Sample book, 25c, pay \$3 for other ten if satisfied.

\$20.00 PER 100 Stamping keytags. Sample and instructions 25c. Ruth Tag Co., Wheelersburg, Ohio.

ARTIFICIAL Marble sanitary flooring, instructions covering wood or cement flooring ½ inch thick, fireproof, all colors, low cost. Ornamental casting, concrete, plaster, papier-mache decorations, garden furniture, statuary, flexible molds, particulars and illustrations free. Chris. Mahler, Huntington, N. Y.

CONCRETE Building block manufacturing, is your home town opportunity. Particulars free. Concrete Machine Co., 5 Main St., St. Louis, Mo.

SEND For free 24-page illustrated catalog of all latest and best books on aviation. Special lists classified by subjects and recommended by well-known aviation authorities are a helpful feature of this catalog. Popular Mechanics Press, 200 E. Ontario St., Chicago.

LEARN Marbleizing. The greatest discovery in cement composition. With our processes it can be brushed on like paint. Resembles polished marble, veined perfectly, flintlike hardness, veneers over any concrete products, wallboard, lumber. Inexpensive, anyone can do. 200% profits; wonderful opportunity. Address Cowell Institute, Grayling, Mich.

YOU Can't lose; send dime for sure winner novelties. Rickatson, Dover, N. H.

UNPATENTED Ideas can be sold. I tell you how and help you make the sale. Free particulars (copyrighted). Write W. T. Greene, 910 Barrister Bldg., Washington, D. C.

MAKE Big profits with a fur farm in your backyard. Chinchilla rabbits, muskrat, mink. Write for facts. 252 Conrad's Ranch, Denver, Colo.

AMATEUR Cartoonists: Sell your work. Write Smith's Service, PX1194, Wenatchee, Wash.

THAXLY Formulas produce perfect products. All lines. Catalog free. B. Thaxly Co., Washington, D. C.

SIGNS And showcards easily painted. If you use Letter Patterns. Write for free samples. John Rahn, B2120 Neva Ave., Chicago.

CHEMICAL Expert will furnish formulas and trade secrets. All lines. Lists free. W. L. Cummings, Ph. D., 223 Gordon Ave., Syracuse, N. Y.

SELL By mail! Books, novelties, bargains! Large profits! Particulars Free! B-Elfco, 525 South Dearborn, Chicago.

FREE Book. Start your own little business anywhere, selling novelties by mail. My beginner's outfit contains everything required, novelties, circulars, instructions, etc. Descriptive book free. Hadwil, 3A-74 Cortlandt St., New York.

LEARN The collection business. Good income, quick results. Interesting booklet, "Skillful Collecting" free. National Collectors Assn., Long St., Newark, Ohio.

A BUSINESS Of your own making—Sparkling Glass Name and Number plates. Checkerboards, signs. Big book and sample free. E. Palmer, 540, Wooster, Ohio.

DELAWARE Charters; fees small; free forms. Chas. G. Guyer, Wilmington, Del.

FREE Booklet describes 67 plans for making \$20-\$100 weekly in home or office business of your own. Elite Co., 84 Elizabeth St., New York.

MECHANICS, Painters, carpenters, start furniture refinishing, painting, handyman shop on nearly nothing; winning plan brings customers quickly. John Braceland, 1439 So. Ninth, Philadelphia, Pa.

15,000 PROFIT Making formulas. Following and many others: Accidents and emergencies, agriculture, alloys and amalgams, artist's materials, beverages, cements, glues, pastes, mullages, bleaching, renovating, coloring metals, dyeing, glass, heat treatment of metals, household formulas, ice cream, confectionery, chewing gum, lapidary work, exterminating vermin, lubricants, paints, varnishes, photography, condiments, canning formulas, rubber, soap, candies, soldering, toilet preparations, perfumes, waterproofing, fireproofing, writing materials. Just write for "Scientific American Encyclopedia of Formulas." When postman hands you book pay \$5.50 and postal charges. Popular Mechanics Press, Room 801, 200 E. Ontario St., Chicago, Ill.

TELEGRAPHY

MORSE Duplex telegraph sets, complete (\$350 value), a steel at \$50. H. E. Skinner, 2409 N. Ashland Ave., Chicago.

LEARN Morse and wireless telegraphy. Big salaries. Tremendous demand. Expenses low, can earn part. Catalog free. Dodge's Institute, H St., Valparaiso, Ind.

CHEMISTRY

A COMPLETE Chemical service, chemical analyses, technical processes and formulas, researches, consultations by mail. Robert Simpson, Public Chemist, 306 Weightman Bldg., Philadelphia, Pa.

RESEARCH Chemist furnishes formulas for every purpose. Chemical and bacteriological examinations. Satisfaction guaranteed. J. F. Mazur, 941 20th, Lorain, Ohio.

CHEMICAL Analysis, processes, technical information. Robert Henderson, Laboratory, Madison, Me.

CATALOG Listing 2,500 illustrations chemists' supplies, 5,000 chemicals, 1,000 scientific books sent for 50c. Laboratory Materials Company, 643 E. 71st St., Chicago, Ill.

"HANDBOOK For Chemical Experimenters." Hundreds of interesting experiments: illustrated, 50c. Booklet of experiments, 15c. Pricelist, 5c. General Chemical Company, Box 397, Reading, Penna.

YOUR Chemical problems solved and formula or process furnished for \$5.00. Write me. W. Stedman Richard, Industrial Chemist, Box 2402, Boston, Mass.

FORMULAS AND TRADE SECRETS

MANUFACTURING Processes that will give your product distinction and build up your business. Either you are in need of a new product to add to your present line or to start a new business on. It will pay you to write us stating your requirements. Complete analytic service. Nelsco Laboratories, Inc., 5401 Cicotte, Detroit, Mich.

"INSTANTO"—Effortless, instantaneous automobile refinisher, 50c. Any formula, 50c. Catalog free. Industrial Institute, Dept. 201, 64 West Randolph, Chicago.

INEXPENSIVE Ice-making formula. Machinery unnecessary. 50c. Nell Tasker, Shamokin, Penna.

SAWDUST, Chemicals makes marble flooring. Directions \$1. Universal Supply Co., 777 Boulevard, Bayonne, N. J.

SEVENTEEN Different solder formulas \$1.00. Gardner, B-77, Little Rock, Ark.

SUCCEED With your own products. Make them yourself. Formulas, processes, trade secrets, all lines. Catalog free. B. Thaxly Co., Washington, D. C.

DON'T Sell for others. Employ agents. Make your own products. Toilet articles, soap, extracts. Valuable book free. National Scientific Laboratories, 1935W Broad, Richmond, Va.

"RUNONO" Seals broken threads, stops runs in silk hosiery, liquid silver plating polish, and 24 other late formulas \$1.00. G. W. Donahoo, Honda, Calif.

BREWERS Yeast; tool marking ink, leather dressing, tire paint, silver polish, make paint fireproof, 50c each, all \$2.00. Woodcroft, 121 Carson St., Jackson, Mich.

FREE Formulas—Free materials making \$32.00 worth of guaranteed highest class specialty-necessities. Thirty-third unequalled anniversary offers explains all. Miller, Chemist, 1707-G Jetton, Tampa, Fla.

500 FORMULAS And big illustrated catalog 25c. Ideal Book Shop, Park Ridge, Ill.

FORMULAS All kinds. Catalog free. Clover Laboratories (P), Park Ridge, Ill.

10,000 MONEY-MAKING Formulas. Tells you how to make and sell almost everything under the sun; cosmetics, muclage, anti-freeze solutions, battery solutions, beverages, cheese, chewing gum, cleaning preparations, extracts, hair preparations, inks, bluing, leather polish, mirrors, perfumes, polishes, typewriter ribbons, carbon paper, washing powders, liquid soap, and hundreds of other profitable articles. Send no money. Just write a postal for "Henley's 20th Century Book of Formulas." Pay postman postage and \$4. Popular Mechanics Press, 200 E. Ontario St., Room 802, Chicago.

AGENTS WANTED

STOP Working for small pay; own and operate a Rawleigh home service business; good anywhere, anytime the year around; you supply 200 home necessities; guarantee satisfaction or no sale; over 42 million sold 1929; thousands doing \$4,000 to \$6,000 annual business in medicines, food, soaps, toilet preparations, stock-poultry supplies, all backed by \$17,000,000 industry; established 40 years; largest of its kind with 17 great factories and branches; selling experience unnecessary; practically no capital; credit if deserving; first send for full particulars—then decide. Rawleigh Co., Dept. E-N-PPM, Freeport, Ill.

QUICK Easy sales. Simple cleaning device. Experience unnecessary. Average profit \$1.00. 15 to 20 sales per day. Free sample offer. Old reliable organization. MacLeod Co., 2640 Greenview, Dept. PM5, Chicago.

\$75.00 WEEKLY! Selling famous fandangos nationally known tailored auto seat covers. Protects health, upholstery, clothing—beautifies car. Low prices. Experience unnecessary. Free outfit. National Products, E1610 S. Michigan Ave., Chicago.

AGENTS—Delicious soft drinks in concentrated form! Each 25c bottle makes 32 glasses. Eight popular flavors. Tremendous demand. Wonderful chance to make \$15 profit a day. Particulars free. Albert Mills, 5192 Monmouth, Cincinnati, Ohio.

I START Men in a grocery business a new, easy way. You use my money. Don't need to put up a penny of your own cash for stock. Expansion program now opens up many desirable opportunities, also established trade. Hustlers make good money from the start, increasing rapidly as they learn the business. Not a "chain" proposition, but your own business. Buy on credit. Give credit if you wish. If honest and need more money, write at once for application and details to McConnon & Company, Room L-6605, Winona, Minn.

NEW Invention sells to every auto owner and garage. Big profit for agents and distributors. Utilities Co., 370-F, Fergus Falls, Minn.

AGENTS—Up to \$12 daily. Introducing hosiery guaranteed 6 months or replaced. 126 styles, colors for men, women, children. Lowest prices. Producers earn auto and own hose. Outfit furnished. Wilknet Hosiery Co., Dept. C-9231, Greenfield, Ohio.

AGENTS 400% Profit selling new automatic gas lighter. Sample 25c. Particulars free. Handy Mfrs., 62 Covert Ave., Stewart Manor, Long Island, N. Y.

FREE Trousers—Free outfit. \$15.00 daily writing orders. Guaranteed greatest tailored-to-measure pants value; bigger commission; wonderful sideline. Dept. 438-A, Hutchins Pants Co., Cincinnati, Ohio.

WE Pay more for your evenings and spare moments than any agency firm. You can use balance of day calling on wholesale trade. Demonstrate and sell automobile radiator cleaner, get two-thirds of all you take in. Send 25c full sized package; try on your own or neighbor's car. If you don't take up agency, quarter refunded. A. Dana Chemical, 120 N. Liberty, Baltimore, Md.

REMNANT Store, 1514 Vine St., Cincinnati, Ohio. Greatest dry goods bargains on earth. Agents and dealers.

IT'S New, fast-selling money-making! Combination kitchen tool. Write Castle Service, Hagerstown, Md.

SHOES Completely resoled for 3c a pair! Amazing new preparation makes new shoes out of old in few minutes. Take orders. \$20 to \$40 daily easy. Write for territory and free sample offer. Perfect Mfg. Co., Dept. Z-506, 220 E. 3rd, Cincinnati, Ohio.

\$100 OR More made each week selling automobile enamels; get our proposition. Industrial Paint & Varnish Co., Dallas, Tex.

BIG Money daily, selling shirts of all kinds, neckwear, underwear, Sox, pajamas, sweaters, raincoats, coveralls, pants, children's playuits. Experience unnecessary. Outfit free! Nimrod Co., Dept. 8, 4922-28 Line-In Ave., Chicago.

PORTRAIT Men, you can make money anywhere selling our guaranteed portraits. Send for free frame catalog. Portrait Agents' Supply Co., Dept. F, LaPorte, Ind.

OLIVER Cleared \$700 in 30 days with our line of books and Bibles. Outfit free! Exclusive territory! Nichols Co., Dept. B-5, Naperville, Ill.

SELL Stores salted nut meats, potato chips, packed in cellophane. Big profits; steady repeat orders; exclusive territory. Sunshine Products, 4411 Lisbon Ave., Milwaukee, Wis.

AGENTS: 60c To 67½c profit on \$1.00 sales. Quick sales, repeat orders, selling famous Ho-Ro-Co Iron Tonic. Also full line remedies, toilet articles, food products, daily necessities. M. G. Roth, Pres., 2852 Dodier, St. Louis, Mo.

MIRRORS Resilvered at home. Costs near 5 cents per square foot; you charge 75 cents. Profitable business plating automats, reflectors, tableware, stores, refinishing metalware, etc. Outfits furnished. Details free. Write Sprinkle, Plater, 128, Marion, Ind.

AGENTS Make \$10 daily with our new adjustable waterproof aprons and fifty other fast sellers. B. & G. Rubber Co., Dept. 441, Pittsburgh, Pa.

WHERE To buy thousands of articles wholesale. New directory. Agents wanted. Pruitt, Brookfield, Ill.

MANUFACTURE Auto specialties: Battery charging electrolyte, radiator seal, hand soap, puncture plugger, glass cleaner. Get my free list. John Mickman, Chemist, St. Paul, Minn.

AGENTS: Sell typewriter ribbons, all machines; liberal profit. High quality insurance repeats. Carbon & Ribbon Co., Harrison, N. Y.

MEN Wanted—to demonstrate and take orders direct from motorists. Amazing magnetic trouble light. Sticks on metallic surfaces. Our men earn as high as \$75.00 weekly. Write for demonstrator. Magno, Beacon Bldg., Dept. 165, Boston, Mass.

SALES Agency offered to ambitious men pays splendid income. Complete line men's shirts, ties, underwear, hosiery. No investment. We furnish everything, deliver, collect. Guarantee satisfaction. Earn shirts and ties. Cash bonuses. Write today. Dept. 85, Quaker Shirt, 1107 Broadway, New York.

TEST Alcohol. Complete home outfit detects poisons. Simple and effective. Real money maker for agents. John Mickman Laboratories, St. Paul, Minn.

FREE "Unheardof Booklet" describes daily problems. Increases income 300%. Art-Craft Co., Kossuth Ave., New York.

NEW! Rubber soles—Cement on instantly. Never loosen. Outwears leather. Waterproof. Sells fast. Big repeater. Test at my expense. Bestever Co., 193 Irving Park St., Chicago.

GENUINE Gold Leaf Letters anyone can put on store windows. Guaranteed to never tarnish. Large profits. Enormous demand. Free samples. Write today. Metallic Letter Co., 438-D North Clark, Chicago.

SELL Household brushes. 100% profit. Free gift brushes. Send for sample case offer. National Fibre Broom Co., St. Louis, Mo.

DON'T Sell for others. Employ agents. Make your own products. Toilet articles, soap, extracts. Valuable book free. National Scientific Laboratories, 1935W Broad, Richmond, Va.

NEW Profitable—Sell auto step mats. Quality rubber with owner's name molded white. Details free. Ebonite Products, Dept. E-80, 895 Main, Akron, Ohio.

MAKE More money with Standard. Sell a famous, old line of food products, toilet preparations and household necessities that sell on sight. Repeat orders sure. No experience or license needed. Sample outfit supplied at no cost. Biggest commissions and extra bonuses to workers. Exclusive territory contract. Get the money-making habit now. Write Standard Co., 1203-U Race St., Philadelphia, Pa.

AMAZING Nulustre polishing cloth, cleans, shines all metals—eliminates liquid, paste, powder polishes. Big profits, quick seller—whole or part time. Samples free. Shef Mfg. Co., 20 Shef Bldg., Weehawken, N. J.

SELL Paper plates, spoons, napkins, cups, to road stands, lunch rooms, bakeries; for lodge and church suppers, etc. Big profits. Puritan Products Company, Trumbauersville, Pa.

MAKE \$2.00 Now every hour. Sell every home wonderful preparation; mends hosiery and clothing without sewing. Invisible. Results guaranteed. Send for free sample of work. Queen City Lab., PM-5, Cincinnati, Ohio.

BUILD Your own business. Sell shirts and ties. No investment needed. Big selling sales outfit free. Liberal commissions. Write Public Service Mills, 523CF 30th St., West New York, N. J.

AGENTS Earn \$8 day. Sell new line guaranteed hosiery. Latest shades. Big sellers. Extra commission. Earn silk hose for your own use. Write quick. Silknet Hosiery Co., Dept. 1831, Dayton, Ohio.

SOAP Agents—Our Oriental Vegetable soap best seller—repeater. Big profits; exclusive territory; permanent business. Write quick. Indianapolis Soap Co., Dept. 52, Indianapolis, Ind.

NEW Invention, easiest thing ever sold. Inexpensive washer for autos. Car owners eager to buy on demonstration. No competition. Big profits. Plomo Specialty Mfg. Co., Dept. C, Cleveland, Ohio.

EARN More pay the Quaker way. Take orders, complete line men's shirts, ties, underwear, hosiery. Remarkable values. All quick sellers. Big commissions. Earn your shirts, ties, cash bonuses. Satisfaction guaranteed. Complete outfit free. Write today. Dept. S500, Quaker, 1107 Broadway, New York.

SUCCEED With your own products. Make them yourself. Formulas, processes, trade secrets, all lines. Catalog free. B. Thaxly Co., Washington, D. C.

SELL Business cards, good profits; ask for samples. New England Card Co., Box 129, Boston (Chelsea), Mass.

\$150 MORE Monthly; spare moments; whirlwind seller; immense profits. Davila, Box 1495, San Juan, Porto Rico.

SHOES Completely resoled for 3c a pair! Amazing new preparation makes new shoes out of old in few minutes. Take orders—\$20 to \$40 daily easy. Write for territory and free sample offer. Perfect Mfg. Co., Dept. ZC-506, 220 E. 3rd, Cincinnati, Ohio.

SELL "Prevents-Runs." 50c item. 500% profit. Prevents runs in silk hose. Specialty Mfg., 127A South Broadway, Los Angeles, Calif.

SALESMEN—1,000 Car washings for \$3.75. Remarkable new invention washes cars faster, cleaner, cheaper. 100% profit for agents. Write today for free sample offer. Gy-ro Brush, Dept. EC-14, Ampere, N. J.

SELLING Like blazes. Beautiful toilet goods assortment at \$1.75 with 24 inch pearl necklace free to your customers. 100% profit. Davis Products Co., 238 North Ave., Dept. 630, Chicago.

SELL Furniture slip-covers. New shoe soles formula 25c. Grogg Co., 312 Northwestern, Springfield, Ohio.

SELL New signs, embossed price tickets, and changeable signs. Wonderful selection; used in all businesses; information free. \$1.00 worth samples 25c; be first in territory, send \$5 for 100 best assorted signs, \$3.00 for 50. Sell 30c each. P. Franklin Co., 3322 3rd Ave., New York.

HAN-DEE Cloth quickly polishes all metals. One minute's demonstration convinces. Men everywhere snapping up this rapid money maker. Retail 25c. Sample free. Ruskin Company, 1501 Euclid, Cleveland.

AMSCO Magnetic health belts, \$15; guaranteed; Ionacos, used, \$15; new, \$20. M-Amsco Mfgs., 721 18th St., Oakland, Calif.

EVERY Woman buys the Jiffy polishing roll, best kitchen article out. Large commission. U. Lavine, 562 Page Blvd., E. Springfield, Mass.

AGENTS And salesmen: Our line repeats—auto owners, housewives and dealers. "Quick Trick" automobile dry wash cloth a winner by itself. Sample free. Manufacturers since 1906. Walter S. Doe & Co., Kent, Ohio.

MAKE And sell your own goods. Expert chemist tells how. Profits \$15 daily. Send stamp for 44 page book. B. Mystic Company, Stamford, Conn.

STRANGE New ironing cord! Prevents scorching. Saves electricity. Cannot kink or snarl. For telephones also. Up to \$25 daily. Samples furnished. Neverknot, Dept. 5-A, 4503 Ravenswood, Chicago.

AMAZING New invention. Electric water heater. Sells for \$3.75. Heats water almost instantly. Make big money. Write today. Lux-Visel Company, Dept. 23, Elkhart, Ind.

\$20 A DAY Easy, all or part time selling greatest line of shirts, underwear, hosiery, neckwear. Lowest prices. Big commissions. Write today for big free outfit. Carter Welch, Mgr., 227 W. Van Buren, Dept. 513, Chicago.

AGENTS—Make a dollar an hour. Sell new kind of sharpeners. Sharpens all knives and tools quickly. Demonstrating sample 10c. Premier Mfg. Co., Dept. 103, Detroit, Mich.

MEN Making \$78 to \$119 weekly showing home owners beautiful 4-color illustrations of our dependable guaranteed trees, shrubbery, etc; pay weekly; everything furnished free; experience unnecessary; full-part time; permanent. Perry Nurseries, R-5, Rochester, N. Y.

NEW Kind of automatic window washer. Sensational seller. Agents make \$1.40 profit on single sale. 15 to 25 sales per day easy. Write National Industries, 67 E. Lake St., Dept. 155, Chicago.

CASH Paid for Butterflies, Insects. See Sinclair Display Advertisement on page 32.

TIME Counts in applying for patents. See pages 140 and 141. Clarence A. O'Brien, Registered Patent Attorney, Washington, D. C.

AGENTS Buy direct at lowest mill prices. Men's latest fancy hose, doz. \$1.45-\$2.00; ladies' Pointex silk hose, doz., \$4.25-\$7.00. Catalog free. Superior Knitting Company, Dent, 34, New Haven, Conn.

MAIL Order News, America's pioneer mail-trade magazine, published 27 years. Brimful with money-making suggestions for agents, mail order men, and opportunity seekers. Send 25c for copy. May be worth fortune to you. Mail Order News, 11 West 42nd, New York.

FREE Circulars describing thousands of money-making propositions, showing you the way to independence and prosperity. Write today. Agrah Company, 479 Ralph Ave., Brooklyn, N. Y.

SELL "Runsnomore." Prevents "runs" in silk hosiery. Sells itself. 1200% profit. Mix yourself. Instructions 10c. Nelson Francis, Gaylord, Minn.

CHICAGO Expert valued \$3 stone at \$900. The diamond's only guaranteed rival. Greatest spare time, side-line article ever known! Amazing profits. \$5 pocket sample case free. Write quick. Mexican Gem Company, Dept. PM, Monterey, Calif.

NEW Electric flashing sign. Just out—changeable letters. Beautiful Neon color effect. Unbreakable. Guaranteed. Every merchant buys on sight. Retail \$13.50. 100% profit. Protected territory. Preston Mfg. Co., Dept. 8-42, St. Louis, Mo.

FREE "Unheard of Booklet" describes daily problems. Increases income 300%. Art-Craft Co., Kossuth Ave., New York.

DISTRICT Manager to appoint agents. Metal household necessity. Speedy seller. Box 549, Middletown, Conn.

DISTRIBUTORS Sell sensational steel slide-visors for comfort and safety. 20,000,000 motorists need them. Adjustable to 90% cars. Instantly installed without tools. Low priced. Nothing like them. Patented. Act quickly if you want to make big money. Write or wire. Pritchard Products, Atlantic Beach, Fla.

MOTOR Oil 10c quart. Put oil-peg in crankcase and cut oil bills less than half. Just out, nothing like it. Absolutely no competition. Wonderful money maker. Write today for sample, pay postman one dollar on arrival. Agents wanted everywhere. Pritchard, Atlantic Beach, Fla.

BIG Money easy, simply showing new Polly wrench. 10 wrenches in one. Guaranteed! Fast seller. Sample furnished. Gellman Mfg., Dept. 6-S, Rock Island, Ill.

EASY To sell groceries, paints, auto oils to consumers. Steady, profitable work. Experience unnecessary. Credit given. Valuable outfit free. Loverin & Browne, 1602X So. State, Chicago.

NO Excuse to be out of a job. Hundreds of firms need representatives in every community in the U. S. Send for sample copy of Opportunity Magazine, E-750 N. Michigan Ave., Chicago. Your whole future may lie between the covers of this magazine.

AGENTS Wanted: To sell rope making machines to make your own rope with from binder twine. Every farmer or user of rope needs and will buy one. Send one dollar for a machine. Louis O. Berg Company, Dept. PM, Madison, Minn.

SELL Changeable signs to stores. Size 14x24. Six lines. Cost 35c, sells \$1.50. Two signs postpaid \$1.00. Particulars free. National Sign System, St. Louis, Mo.

DON'T Sell for others. Employ agents. Make your own products. Toilet articles, soap, extracts. Valuable book free. National Scientific Laboratories, 1935W Broad, Richmond, Va.

DOES 300% Profit interest you? World's best polishing cloth. Everybody buys. Sample free. MagiCloth, 3317 Summit, Kansas City, Mo.

GOLD Window letters pay 1,000%. Instructions. Johnston Co., Quincy, Ill.

SELL By mail! Start your own small business anywhere. Free folder tells how. No personal selling. Everything furnished. A. Horton, Metropolitan Bldg., St. Paul, Minn.

BIG Money demonstrating famous Dupont Launderless Tablecloth. Also \$2.98 trench coats, and full line waterproof necessities. Samples free. American 724AH Roosevelt, Chicago.

STEEL Toy ropes for motorists. Sells \$1.50. Sample 60c postpaid. Mack Mfg. Co., 1570 Elmhurst, Detroit, Mich.

TOOL Salesmen selling to automobile mechanics. Unlimited possibilities in the sale of our easily sold line of special automobile tools. Write for information. Art Tool Manufacturing Company, Cleveland, Ohio.

NEW Carbon remover. Agents make 100%. Sells \$1.00, sample 25c. Universal Sales, Niles, Ohio.

AGENTS—Men, women, big money selling needle threaders to housewives. For particulars and prices write L. Miller, Box 3, Tremont Station, New York City.

NEW! Different! Milady's Novelty Clothes Brush. Rainbow colors create instant sales. Hadleigh made \$24 first day. Free sample. L. Jensen Co., 304 S. Dearborn, Chicago.

JUST Invented—new washing machine. No motors or moving parts. Automatically cleans entire washing. Fully guaranteed. Retail price \$9.50 Your profit 100%. Protected territory. Preston Mfg. Co., Dept. CP-5, St. Louis, Mo.

AGENTS—Men, earn up to \$12 daily wearing fine felt hats and selling friends. Smartest styles. Latest shades. \$2 to \$5 saving on every hat. Samples free. Taylor Hat and Cap Mfrs., Dept. WC-135, Cincinnati, Ohio.

MAKE \$20 To \$35 a day selling imprint book matches, spare or full time; big repeat business; every merchant a prospect. Start taking orders immediately. Send \$1.00 deposit for elaborate selling portfolio containing actual book match samples of 24 individual copyrighted designs. Write Imprint Book Match, 877 Meigs St., Dept. 115, Rochester, N. Y.

AMAZING Invention prevents auto accidents; you can earn \$60-\$75 weekly; unlimited field; quick cash profits; sells to stores, subagents; big self-seller. Free folder explains. Peerless Novelty Co., Grand Haven, Mich.

BRING Home the bacon selling Christy's Iron Rust and Stain Remover. Sells like blazes. Write for free sample. Christy, Inc., 6567 Broadway, Newark, N. Y.

"HOW To Be Successful Agent." Full information book \$1.00. Perle, 639 A, Greene Ave., Brooklyn, N. Y.

DIAMOND Point push hoe—replaces old fashioned hoe. Sells easily at \$1.50. Everyone likes it. Write today. Exclusive territory. Ideal Products Co., 157 North Townsend St., Los Angeles, Calif. Dept. B.

NEW Invention—Cleans wallpaper easily. Write Superior Specialties, Springfield, Ill.

JUST Out: Cement-On Rubber Soles. Cut shoe bills in half. Outwears leather. Keep feet dry; prevent slipping. Comfortable. Also 47 other rubber specialties. Big money for agents. Outfit free. Write Kristee Mfg. Co., 1835 Bar St., Akron, Ohio.

UNUSUAL Income. Every community. Sell homes, shops, theatres, stores, banks, schools, etc., the new Fugo, world's simplest fire protection. No sales experience necessary; we teach you. Part or full time. Act quick! The National Formetal Co., 6547 Metta Ave., Cleveland.

PHOTO Medallion men and women, the largest line of photo novelties in the world. Lowest prices, quickest service. Send for catalog showing over 200 money makers. Gibson Photo Jewelry Co., Inc., 833-837 Gravesend Ave., Brooklyn, N. Y.

MEN Or women sell made-to-order house-dresses. One dollar profit per sale—two sales per hour. Merrie Marie, Salt Lake, Utah.

AGENTS—Mosco Corn and Callous Remover will build you a steady repeat business. Send today for pocket-size trial outfit. The Moss Company, 504 Searle Bldg., Rochester, N. Y.

FREE "Booklet of money making opportunities." new ideas, original plans, money making secrets and other valuable information. None require peddling or outfits. Elite Co., 81 Elizabeth St., New York.

NEW Electro-magnetic auto lamp. Sticks anywhere on car. An everlasting flashlight. Big money making opportunity; agent's demonstrator \$2. (on approval). Will sell itself on sight or return it. Exclusive territory for steady producers. Write today. National Electric Corporation, 230 High St., Newark, N. J.

AGENTS—No peddling necessary to make \$20 to \$100 weekly in home or office. Send for free booklet describing 67 money making opportunities. Elite Co., 84 Elizabeth St., New York.

400% PROFIT Selling perfumes. Melrose Works, Box 731, Chicago, Ill.

ENGRAVED Name plates, signs, numbers, desk plates, store window signs, etc.; profits large. Brett Bros., Winthrop, Mass.

SELL Stores 5c carded breathlets, etc. Lorrae Products, Albany, N. Y.

ENGRAVED Nameplates, signs, numbers, initial, desk, city nameplates. Big profits. Hilton Specialty, 90 Stewart, Providence, R. I.

AGENTS Make \$100 weekly with the only perfect reducing remedy, externally. Money back guarantee. Closed territory. Columbia Laboratories, 102 Murray St., Newark, N. J.

BIG Profits selling only guaranteed electric waffle iron for \$2.75. Everybody buys. Supreme Products E, 8 So. Dearborn, Chicago.

WANTED: District manager to appoint agents. Unlimited opportunity. No canvassing. Mother Hubbard Products, 554U Congress, Chicago.

WHIRLWIND Seller. Mystery silverware polishing cloth in tin cans. Sample free. Mohler, Onamia, Minn.

A REAL Surprise await you! Get details of our premium deals, which make sales easy! Foods, toiletries, remedies, all guaranteed. Togstad Corp., 32 Punton St., Kokomo, Ind.

BIG Profits, quick repeats, placing Aspirin, Notartar, Plints, Silktone, other self-selling counter cards with dealers. Over 100% profit. Sterling Co., H7, Baltimore, Md.

CHEXARUN: Latest invisible fluid, stops silk hosiery runs. Make this yourself also many unusual, biggest-selling specialties using Miller's guaranteed formulas. Investment small. Profits immense. Miller, Chemist, 706-L Chemical Bldg., Tampa, Fla.

DON'T Sell for others. Employ agents. Make your own products. Toilet articles, soap, extracts. Valuable book free. National Scientific Laboratories, 1935W Broad, Richmond, Va.

LOIDLAC Forever ends automobile polishing and repainting; instantly restores colors. Guaranteed, sun-water-weather proof. Make this yourself; also other high-class automobile specialties from my unequalled guaranteed formulas. Miller, Chemist, 1706, Tampa, Fla.

AGENTS: Stamping names on pocket-key protectors. Sample check with your name and address, 25c. Stamping outfits, Emblem checks, check-fobs, name plates. Hart Mfg. Co., Desk 2, 303 Degraw St., Brooklyn, N. Y.

80c PROFIT On \$1.00 sales. Wonderful cleaner for automobiles, furniture, metal and glass. Fast repeater. Your name on labels. Exclusive territory. Free sample. Minute Kleen Laboratories, Dept. E, Evansville, Ind.

FLAVORING Extracts—Bottle yourself Concentrated. Labels furnished. 600% profit! Whirlwind moneymakers! Free offer! Thomas Manufacturing Company, Indianapolis, Ind.

"HOW To Secure Agents," a specially prepared booklet, tells of one of the most inexpensive methods in which to secure good live producing agents. It is free; write for your copy today! M. L. Rund, Mgr. Classified Advertising, Popular Mechanics Magazine, 200 E. Ontario St., Chicago, Ill.

400% PROFIT—Build a permanent business with giant temporary transfers and permanent window letters in colors and gold. Sell every store and office. Exclusive territory. Sample free. Print-A-Sign, Akron, Ohio.

WANT Distributing agent for Hanslick, powdered handsoap; removes anything from the hands without injury to skin; everybody a customer; great opportunity for hustler to get in business; sample free. Solar Products Co., 32144 So. Troy, Chicago.

GET Our free sample case. Toilet articles, flavorings and specialties. Wonderfully profitable. LaDerma Co., Dept. A, St. Louis, Mo.

\$60-200 A WEEK. Genuine gold letters for store windows. Easily applied. Free samples. Liberal offer to general agents. Metallic Letter Co., 438-B North Clark, Chicago.

GREATEST Opportunity; newest proposition. Build continually paying business in your own name. Household, industrial, brushes, brooms, mops, dusters, fully guaranteed. New catalog, all net prices, no discounts to bother with. Make as high as 300 per cent and over. Write today. Wire Grip Sanitary Brush Corp., 41 East 11th St., New York.

AGENTS: Free catalog 200 household specialties, toilet preparations, food products, remedies, portraits, frames, photo pillows, medallions, religious goods, pictures, damask tablecloths. Credit. James C. Bailey Co., Station C1, Chicago.

SELL Koehler's blue signs. Cost 3/4c, sells for 20c. Koehler, 717 N. Fourth, St. Louis, Mo.

\$50,000 PICTURE Man Friedman made canvassing. Beginners can make \$100.00 weekly with my sales talk. Experienced men make more. Free book "Profits in Portraits" explains. Sample free. Picture Man Friedman, Dept. 8, 109 West Austin, Chicago.

CALIFORNIA Perfumed beads selling like hot cakes. Agents coining money. Big profits. Catalog free. Mission Factory P, 2328 W. Pico, Los Angeles, Calif.

WE Start you without a dollar. Soaps, extracts, perfumes, toilet goods. Experience unnecessary. Carnation Co., 641, St. Louis, Mo.

BIG Money and fast sales. Every owner buys gold initials for his auto. You charge \$1.50; make \$1.34. Ten orders daily easy. Write for particulars and free samples. American Monogram Co., Dept. 40, East Orange, N. J.

SELL Housewives something they want. A necessity. Reduces gas bills 25%. New in your territory. No competition with this guaranteed gas saving device. Exclusive sales rights. 400% profit. Box 18E, East San Diego, Calif.

AUTOMOBILE Specialties. Guaranteed formulas for all latest money makers. Low-cost prices. Write for free lists. Murphy, Chemist, Tujunga, Calif.

FREE "Unheard of Booklet" describes daily problems. Increases income 300%. Art-Craft Co., Kossuth Ave., New York.

NO Dull times selling food. People must eat. Federal distributors make big money; many over \$3,000 yearly. No capital or experience needed; guaranteed sales; unsold goods may be returned. We furnish you with license, sample case and free samples for customers. Repeat orders sure; exclusive territory. Ask now! Federal Pure Food Co., A2307 Archer, Chicago.

BIG Money applying gold initials on automobiles. Easiest thing today. No experience needed. \$1.45 profit every \$1.50 job. Free samples. "Balco," X-1043 Washington, Boston, Mass.

SELL Men's neckwear—wonderful proposition. Astor-M, 39 East 28th, New York.

DON'T Sell for others. Employ agents. Make your own products. Toilet articles, soap, extracts. Valuable book free. National Scientific Laboratories, 1935W Broad, Richmond, Va.

AGENTS—Make a dollar an hour. Sell Mendits, a patented patch for instantly mending leaks in all utensils. Sample package free. Collette Mfg. Co., Dept. 404, Amsterdam, N. Y.

GOLD-LEAF Window letters and script signs; no experience; 500% profit; samples free. Consolidated, 69-T West Van Buren, Chicago.

POLMET Polishing Cloth removes tarnish from metals without the use of liquid, paste or powder. Our agents say it sells like "hot cakes." Retail 25c; sample free. Gale & Co., Inc., 15 Edinboro St., Boston, Mass.

AGENTS—New shirt proposition. No capital or experience needed. Commissions in advance. Samples free. Madison Company, 566 Broadway, New York.

THAXLY Formulas produce perfect products. All lines. Catalog free. B. Thaxly Co., Washington, D. C.

AGENTS Wanted—On a fast selling 25c item for the kitchen, costs you 8 1/2c. Sample sent parcel post prepaid for 10 cents. P. Seed Filzer Mfg. Co., Inc., 353 Broadway, New York.

MAN in each town to plate auto parts, reflectors, bathroom fixtures, refinish beds, mirrors, chandeliers; by new method. No capital or experience required. Simple plan of manufacturing at home starts you in big money-making business. Outfit furnished. Free particulars and proofs. Gun Metal Co., Ave. H, Decatur, Ill.

A BUSINESS Of your own—Making sparkling glass name and number plates, check-boards signs. Big book and sample free. E. Palmer, 512, Wooster, Ohio.

AMAZING Profits showing new table cloth. Looks like linen. Wash like oilcloth. No laundering. You just take orders. We deliver. Pay daily. Sample free. Bestever, 231 Irving Park Station, Chicago.

AGENTS — Clever Invention! Inkspoon makes every pen a fountain pen. Fast office seller; big profit, demand increasing everywhere. Exclusive territory offered. Sample free. H. Marui Company, Tribune Bldg., New York, N. Y.

BIG Profits! Fast sales! \$9.75 automatic washing machine. Guaranteed. Write Storm Royalty Co., 3601 Enright, St. Louis, Mo.

REPLATE Brass worn-off automobile parts, reflectors, bath room fixtures, worn spoons, forks, etc., with pure silver. Looks like new. Use U-Kan-Plate Polish. Positively no mercury; \$1.00 half pints. Postpaid. Satisfaction guaranteed. Agents wanted. Dept. A, U-Kan-Plate Co., Philadelphia.

LEARN To draw pictures that have a real money value. Art now plays a leading part in the creation and distribution of every commodity. Valuable new book "Modern Illustration" teaches making illustrations for catalogs, books, newspapers and short stories, headings, labels, trade marks, advertisements, posters, etc. Delivered to your door C. O. D. Simply pay postman \$2.50 and postage. Popular Mechanics Press, Room 801, 200 E. Ontario St., Chicago.

HIGH-GRADE SALESMEN WANTED

A SPLENDID Side line—We sell pass books, check covers, coin bags, etc., mainly to banks. They are centrally located and do business quickly. Little time is lost. Our samples are light, compact, easily carried. Sales run into money. Items repeat well; commission is liberal, and all paid immediately. We also have an excellent line of advertising novelties for merchants. Our quality is good, the variety extensive, the styles interesting. Line is big enough to devote your whole time if you wish. We are manufacturers, own our buildings, been in business fifteen years, make thirteen thousand sales a year, ship to every state. You could work wherever you happen to be. Correspondence invited. Continental Bank-Supply Co., Mexico, Mo.

A SIDE Line that beats your main line. High class salesmen to call on manufacturers, wholesalers, retailers or professional men with very unusual and profitable side-line. Established business. Our men take 3 to 5 new and renewal contracts daily \$10 to \$75 each. No samples to carry. We bill and ship direct. Your commission half amount billed. You get full credit on repeat orders without callbacks. Most exceptional opportunity for right man. Commonwealth Company, 508 S. Dearborn, Chicago.

BONUS Check for you. Adelite, the sure-fire seller. A new, spectacular electric window display; ever-changing colors, knock-out set of business and holiday posters; patented changeable letter system defying imitation. Fat commissions in your pocket every night. Bonus check on Saturday. Dignified work calling on merchants and better business houses. Special model for banks. Repeat orders credited. Special thirty day trial demonstrator offer. Display Products Co., 409-A East 31st St., Kansas City, Mo.

DOUBLE Pay for your "over-time" by amazing new chain selling system. Beginner (Schoen of Ohio) made \$1,500 in four months last summer. Sell paint, roofing, etc., from million-dollar factory at wholesale prices, easy credit terms to homeowners, factories, dairies, farmers, etc. Permanent position good for \$3,000 to \$8,000 a year. Outfit, training free. Progress Paint Co., Dept. 121, Cleveland, Ohio.

SALESMEN. Wonderful sideline. 40% commission paid daily. Sells all merchants. Pocket outfit free. Willens Co., Dept. 296, 2130 Gladys Ave., Chicago.

MANUFACTURER And distributor of shoes and hosiery wants salesmen. Big-money opportunity. No experience necessary. No investment. Consolidated Shoe System, Dept. C-36, Eau Claire, Wis.

BIG Money daily, selling shirts of all kinds, neckwear, underwear, Sox, pajamas, sweaters, raincoats, coveralls, pants, children's play suits. Experience unnecessary. Outfit free! Nimrod Co., Dept. 65, 4922-28 Lincoln Ave., Chicago.

BIG Commission daily selling office building directories and new changeable-letter display signs to hotels, banks, merchants. Signotype, Dept. 14, 544 Washington, Chicago.

WRITE Quick for new "Snow-Ball Plan" which brings immediate cash incomes to beginners and experienced salespeople. Take orders for America's best known line of personalized stationery, greeting cards, etc. We pay big commission in cash every day and supply everything you need to start with. Write Dept. 802-A, The Process Corp., Troy at 21st St., Chicago.

"GOOD Luck" elephant cigarette dispenser. Twist tall for cigarette. Ornamental. Easy sales. Big profits. Midwest Novelty Company, 1499 University, St. Paul, Minn.

A PAYING Position open to representative of character. Take orders shoes-hosiery direct to wearer. Good income. Permanent. Write now for free book "Getting Ahead." Tanners Shoe Mfg. Co., 2005 C St., Boston, Mass.

NEW Specialty—Sells every business. Four \$15 sales daily pay \$288 weekly. World's largest firms, Bell Telephone, Sears Roebuck, etc., use it. Smallest business needs it. Customer guaranteed cash return ten times price paid. Protected by \$20,000.000 surety company. Repeats. No competition. Walker made \$165 first day. F. E. Armstrong, Pres., 2012E, Mobile, Ala.

\$100 WEEKLY. New spark plug burns 50% air, eliminates carbon, starts car instantly, increases power, speed, pickup, mileage. Sensational seller. Animated Spark Plug Co., Dept. A, 128 N. Wells, Chicago.

FINANCIAL Independence and income for life without extra work. Enjoyed by our distributors because they have stopped selling slow or non-repeating articles, joining our organization marketing a product which sells on sight and repeats indefinitely. Needed by all business and professional men. 240% initial profit. Repeat commissions without call-backs. Only high class salesmen wanted. No house to house peddling. Brand new. Unusual. Copyrighted. The Commonwealth Co., 508 So. Dearborn, Chicago.

SALESMEN To take orders for real home cooked chicken, exclusive territory, sure repeat business. Delicatessens, sandwich shops, groceries, drug stores. Sure sales; excellent sideline. Scharrer & Co., 2102 S. Compton, St. Louis, Mo.

HIGH Grade printed and process embossed business stationery and Christmas cards. Low prices with liberal commissions. Buckeye Thermographers, 1108 Adams, Toledo, Ohio.

NEW And plenty different. Fast selling 5c-10c merchandise on attractive counter cards. 100% commission for you and dealers. Advertised by radio. No capital required. Catalog free. World's Products (Estab. 1921), 64 Central, Spencer, Ind.

MONEY Every minute every day. Anyone can sell printing with our elaborate free outfit. 106 fast-selling items. Free illustrations. Our prices beat competition. Big commissions paid daily. Sell every merchant, manufacturer, bank, doctor, etc. Full time or sideline. Write for details. All-Trades Printing Service, 241 Second, Rockford, Ill.

\$200.00 MONTHLY Salary and \$10,000 yearly commissions, easy, sure, sell "Travel Policy." Death benefit \$10,000. Disability \$20.00 weekly. Free premium makes easy selling. \$3.65 yearly. Everybody 16 to 70 buys. No medical examination. \$16,000.00 claims paid. American Peoples League, Dept. 1512G, 134 N. LaSalle, Chicago.

SELL New substitute for suspenders and belts. Every man good prospect for several. Protected territories. Write for sample. Yevaco Products, Inc., York, Pa.

COMMISSIONS Up to 55%! Experience unnecessary. Nationally known printing stationery line. Over 1,000 absolute necessities for every business. Lowest prices. Guaranteed quality. Thousands free cuts. 1930 outfit now ready. Kaeser & Blair, Inc., Dept. 218, Cincinnati, Ohio.

WONDERFUL Invention. Seals fifty envelopes minute. Sells on sight at \$2.25. Attractive trial offer. Square deal. Bank references. Kendall Sealer Co., 440 Sansome, San Francisco, Dept. C-18.

\$18 To \$25 Daily; biggest selling line of men's suits, \$11.95, \$14.50, \$16.95, \$19.95. Amazing values. Pure virgin wool overcoats \$18.95. Also raincoats, slickers, topcoats and boys' suits. Biggest commissions paid in advance. Liberal bonus. Free outfit. "Jim" Foster, Inc., Dept. 25, 2250 S. Spaulding Ave., Chicago, Ill.

SELL Nothing, earn up to \$170 weekly, empty handed. No samples to tote. Oldest and largest punchboard firm, established 20 years, rated \$500,000, announces amazing new plan. Salesmen cleaning up. No one invests a penny. We even pay express charges. Unsalable merchandise returnable. Big season now here. Full commission repeat business. Grab this quick. K&S Sales Co., 4359 Ravenswood, Chicago.

\$10 DAILY! \$5 Spare time! Selling auto accessories, tire repair materials to garages, stores, filling stations, etc. Territories protected. Liberal commissions. Economy Rubber Products Co., 606 Burkhardt, Dayton, Ohio.

BIG Commission placing our \$25.00 Reward Corn Cure with drug, shoe, department, general stores, shoe repair and barber shops. Reliable Specialty Corporation, Buffalo, N. Y.

"SALESMEN Need no License." Full information book \$1.00. Perle, 639 A, Greene Ave., Brooklyn, N. Y.

POOL Shooter. New fascinating vending machine. Merchants everywhere buy! Splendid sideline. Big profit maker! Free pocket outfit! Specialty Mfg. Co., W-617 W. Division, Chicago.

LIBERAL Proposition to salesmen with cars. Establish independent business. Amazing introductory offer. Socket wrenches and other time-saving tools. York Co., 2640 Greenview, Dept. 25PM, Chicago.

300% PROFIT Selling Mystery Gas Lighter. Retail 25c. Costs you \$1.00 doz. Sample free. Square Deal Mfg., Desk PM7, Bradford, Pa.

DON'T Sell for others. Employ agents. Make your own products. Toilet articles, soap, extracts. Valuable book free. National Scientific Laboratories, 1935W Broad, Richmond, Va.

\$2.75 CASH Commission on sale. Latest styles raincoats, sportswear, jackets. Lowest prices. Complete sales outfit free. \$1.00 bag given. Dunco, 12 Williams St., Boston.

BRAND New union label printing line. Largest assortment cuts and specialty items in country at half price. 72 hour delivery. Big commissions advanced. Sensational bonus offer. Experience unnecessary. Outfit free. Northwestern, 625-R Jackson, Chicago.

BIG Money showing \$2.98 trench coats and DuPont's Launderless Tablecloths. Samples free. American, 724AL Roosevelt, Chicago.

FREE Trousers: Free outfit. \$15.00 daily writing orders. Guaranteed greatest tailored-to-measure pants value; bigger commission; wonderful sideline. Dept. 438-S, Hutchins Pants Co., Cincinnati, Ohio.

TYPEWRITER Specialty. Pays \$1.50 profit per unit. Average sale 2 units. Exclusive. Easy seller. Speedkey, 27 Columbus Place, Brooklyn, N. Y.

TURN Non-productive hours into cash. A side line suitable for all types of business but especially for automobile lines. Liberal commission. Splendid earnings for earnest workers. Pocket outfit free. G. Felsenthal & Sons, 4112 W. Grand Ave., Chicago.

SELL Non-alcoholic tube flavors. Thos. J. Feruson, 7426 Richmond Maplewood, Mo. Mo.

ADVERTISING Pencils sell fast to every line of business. New line. Quick cash commission plan. Main or sideline. Free pocket outfit to real salesmen. Chicago Graphite Co., 130 So. Clinton, Chicago.

SALESMEN: Our varied line enables us to offer you a sideline for almost any class of trade. State territory and class of trade called on, also references. Bradford & Co., Inc., St. Joseph, Mich.

DAILY Cash! \$25.00 sale. \$15.00 is yours. Merchants amazed at wonderful results! Big repeat commission income. Free kit. Sales Stimulators, Inc., 339 W. Madison, Chicago.

PUNCHBOARD Salesmen. Up to \$10,000 yearly. New line. All fast sellers. Lowest prices. Full commission on repeat business. Catalog free. Puritan Novelty, 1409 Jackson, Chicago.

COVERALL Salesmen—Lettered garments, \$3.25. Commission 75c. Write for sample. Blue Bar Sales, 844 Dorr, Toledo, Ohio.

SELL 3A Garage door holders, simple, automatic, quickly installed. Interests garage owners, builders, everybody. Exclusive territory proposition. Knowlson-Stevenson Co., Ann Arbor, Mich.

80c PROFIT On \$1.00 sales. Wonderful cleaner for automobiles, furniture, metal and glass. Fast repeater. Your name on labels. Exclusive territory. Free sample. Minute Kleen Laboratories, Dept. E, Evansville, Ind.

PUNCHBOARD Salesman—Most gigantic line ever featured. Vending machines, all kinds. Make high as \$28.00 on single order. Repeat commissions. Beautiful colored catalog free. Lion Mfg., Dept. 8, 308 W. Erie, Chicago.

FREE Booklet describes 67 plans for making \$20-\$100 weekly in home or office business of your own. Elite Co., 84 Elizabeth St., New York.

SELL Goodyear raincoats; \$2.95 up. Goodyear Rainwear, 682 Sixth Ave., New York.

PUNCHBOARD Salesmen make big commissions, selling punchboards and vending machines. Reliable concern, established 20 years. Largest most complete catalog in colors, free. Best season now. Write today! Lincoln Sales, 116 S. Wells, Chicago, Dept. D.

WANTED District managers—Capable men to represent us in prosperous territories with direct home office contract. Our organization is the oldest of its kind in the health and accident business and offer exceptionally remunerative compensation. Write today for information. Dept. 18, Inter-State Business Men's Accident Association, Brown Bldg., Des Moines, Iowa.

\$60-\$200 A WEEK. Genuine gold letters for store windows. Easily applied. Free samples. Liberal offer to general agents. Metallic Letter Co., 438-A North Clark, Chicago.

SALESMEN—Four \$15.00 sales to merchants net you \$40.00 daily. Sayers Systems, 2813 Sheffield, Chicago, Ill.

SALESMEN—Become independent. Own your business; experience unnecessary. Selling our \$10,000 Accidental Death; \$50 Accident; \$25 Sick Weekly Benefits—\$10.00 yearly. Other amounts proportionate. Guaranteed steady income from renewals. \$250,000 deposited Insurance Department, Universal Policy Dept. A, 40 Clinton St., Newark, N. J.

EARN \$100.00 Weekly selling our \$1.500 accident and registration policy for \$1.00 per year. E. W. Shaw Company, Insurance Bldg., Denver, Colo.

GOLD-LEAF Window letters and script signs; no experience; 500% profit; samples free. Consolidated, 69-V West Van Buren, Chicago.

HELP WANTED

SELL For success. Electrical accessory. Numbers needed, every house, business place. Old and new installations. Wholesale and retail orders. No store competition. Send 25c sample and particulars. Write now. Art Marble, 318 A South Camac, Philadelphia.

WOMEN: To introduce new, fast selling imported sanitary necessity. Two sales daily nets you \$51.00 weekly. No deliveries; no collections; no experience or capital required. Write Daintymaid, PM-530, Meriden, Conn.

YOU Are wanted to resilver mirrors at home. Profitable business, plating auto-parts, tableware, etc. Write Sprinkle, Plater, 287, Marion, Ind.

STOP Slaving for wages! Here's a wonderful opportunity to be your own boss and make \$15 profit a day. No capital or experience required. Particulars free. Albert Mills, 5193 Monmouth, Cincinnati, Ohio.

GOLDEN Opportunity—Make at least \$10.00 per day, full, spare time. Sell \$10.00 yearly accident, sickness policy. \$25.00 weekly benefits, \$10,000.00 principal sum, doctor, hospital. Ages 16-70. Large commissions. Renewals. Imperial, Dept. 229 Hamm Bldg., St. Paul, Minn.

ARE You old at forty? See our advertisement on page 72 of this issue. The Electro Thermal Company, 2129 Morris Ave., Steubenville, Ohio.

CASH Paid for Butterflies, Insects. See Sinclair Display Advertisement on page 32.

WOMEN: To introduce new, fast selling imported sanitary necessity. Two sales daily nets you \$51.00 weekly. No deliveries; no collections; no experience or capital required. Write Mary Coleman, P-331, Meriden, Conn.

IMPORTED Mexican diamonds guaranteed life time; get prices. Salesmen wanted. National Sales Company, Marfa, Tex.

MANUFACTURER Wants distributor for 300-mile \$2.00 "Pocket" Radio. "Sells itself with music." Pays 100%. Spencer Radio, Dept. 10, Akron, Ohio.

PRACTICAL Flight Training is a splendid, thorough instruction book written by Lieut. Barrett Studley of the Naval Air Station at Pensacola. It is the official text book from which all U. S. naval flyers are trained. You can double the value of expensive instruction time in the air by a preliminary study of the subject from this book. Pay postman \$5 and postage when he delivers it to your door. Popular Mechanics Press, Room 802, 200 E. Ontario St., Chicago.

EDUCATIONAL AND INSTRUCTION

LEARN Show card writing and sign painting; be independent. The Howard System teaches this fascinating profession. Earn \$75 to \$100 weekly. Start shop of your own. Complete instructions sent post-paid, \$2.00. M. Diaso, 1546 C St., Fresno, Calif.

WORK For "Uncle Sam." Life jobs with U. S. government. Steady work. \$105.00-\$280.00 month. Men-women, 18-50. Thousands 1930 appointments. Many examinations coming. Common education usually sufficient. Experience unnecessary. We prepare you without leaving home. List positions and full particulars free. Write today sure. Franklin Institute, Dept. J3, Rochester, N. Y.

ELECTRICAL Trouble shooting on the motor car and airplane. Don't trust to luck or guess work. Learn to make every motion count in testing and repairing. Send for our standard 493-page book for electricians and mechanics. 300 diagrams. Hundreds of practical tests. Pay postman \$4.00 plus postage when delivered. If outside U. S. remit when ordering. Popular Mechanics Press, Room 801, 200 E. Ontario St., Chicago.

RAILWAY Postal clerks. \$158.00-\$225.00 month. Steady. Spring examinations likely. Common education. Men 18-35. Particulars free. Write immediately. Franklin Institute, Dept. J14, Rochester, N. Y.

FIREMEN, Brakemen, baggagemen; colored train or sleeping car porters, \$150-\$250 monthly. Experience not necessary. 810 Railway Instruction Bureau, East St. Louis, Ill.

DON'T Prepare for any civil service examination without seeing our catalog. Free. Columbian Correspondence College, Washington, D. C.

LEARN Exact and rapid figuring from "Higher Arithmetic." New easy methods; write for prospectus. F. A. Smith, 608 S. Dearborn St., Chicago.

LEARN How aircraft engines work. Latest and most complete information is found in "Dyke's New Aircraft Engine Instructor." We unhesitatingly recommend this valuable book. Money refunded if not satisfied. Pay postman \$5.00 plus postage when delivered. Popular Mechanics Press, Room 801, 200 E. Ontario St., Chicago, Ill.

LEARN Music shorthand. Box 193, Pismo Beach, Calif. Copy 25c. Stamps not accepted.

DOUBLE Entry bookkeeping 60 hours with 8 keys; guaranteed. (Diplomas.) International Bookkeeping Inst., 8 Springfield, Mo.

BECOME A landscape architect. Uncrowded profession; wonderful opportunity for money-making. Easily mastered by mail. Earn while you learn. Est. 1916. Write for details. American Landscape School, 29 Plymouth Bldg., Des Moines, Iowa.

THE Age of the Air is Here. For reliable information on both airplane building and flying we recommend "Aeroplane Construction and Operation," by Rathbun, a book used in government schools. All features of construction treated. Send no money. Pay postman \$2.50 and postage. Popular Mechanics Press, Room 801, 200 E. Ontario St., Chicago, Ill.

U. S. GOVERNMENT Wants men, \$1,700-\$1,900 and up at start. Railway mail clerk examination coming. Let our expert (former government examiner) prepare you for this and also rural carrier, post office, customs, internal revenue, and other branches. Write today for free booklet. Dept. 8, Patterson School, Rochester, N. Y.

WANTED Immediately, men-women, 18-55, qualify for permanent government positions, \$105-\$250 month; no government experience required. Paid vacations. Common education. Many needed soon. Write Ozment Inst., 101, St. Louis, Mo.

PHOTOPLAY Talking picture and magazine stories wanted for revision, development and copyright. Sell on commission. Established 1917. Booklet free. Universal Scenario Company, 406 Western and Santa Monica Bldg., Hollywood, Calif.

JUST Out—First book on all-electric radio sets—clear, interesting and non-technical. Covers dynamic speakers, also. Written by Kenneth A. Hathaway, Tech. Adviser, Chicago Daily News. 120 pages, cloth, illustrated. Pay postman \$1.50 plus postage upon delivery. Popular Mechanics Press, Room 801, 200 E. Ontario St., Chicago, Ill.

TYPEWRITERS AND SUPPLIES

TYPEWRITERS—All standard makes \$10 up. Catalog free. Northwestern Typewriter Exchange, 121 N. Francisco Ave., Chicago.

TYPEWRITERS—All makes, guaranteed, \$7 to \$33. Free catalog. Dee Typewriter Exchange, Ada, Okla.

ADDING MACHINES

NEW \$3.50 Automatic adding machine. Adds, subtracts, multiplies, absolutely accurate. Capacity \$999,999.99. Fully guaranteed. 75,000 pleased users. Makes adding easy, positive, quick. Eliminates mistakes. Saves time. Postpaid \$3.50. Bassett Co., 1458-F, Hollywood Ave., Chicago.

PRINTING, ENGRAVING AND MULTIGRAPHING

500 EACH Hammermill bond letterheads and envelopes \$2.90. Patton Company, 534 Paxton Block, Omaha, Nebr.

SEND For beautiful label catalog. Eastern Label Co., Clintonville, Conn.

500 GUMMED Stickers, printed, 25c. Kalata, 471 Elm, Buffalo, N. Y.

LETTERHEADS (8 1/2 x 11) and envelopes, 100 each, printed for \$1. Free samples. Universal Printing, 1111 Smith St., Bay City, Mich.

1,000 BUSINESS Cards \$2.25; 1,000 bond letterheads and envelopes \$7.00. Webster's Press, Farmland, Ind.

NEW, Illustrated letterheads \$2.50 thousand postpaid. Inquire about distinctively different new printing service. Battlefield Press, Gettysburg Penna.

TINTED Enamel folders, 3 1/2 x 6, 5,000, \$13.75. All printing low prices. Samples. Goodprint, Harrisonburg, Va.

PARTICULAR? "Neargrave"—500 letterheads with envelopes \$5.55 postpaid. Samples. Solldays, Knox, Ind.

200 CARDS And beautiful case, \$1.00. James Pierce, 6138 Ingoquois, Detroit, Mich.

PRINTING—General, done right. Low prices. Owen Press, Westmont, Ill.

5,000 BOND Letterheads, 8 1/2 x 11, \$9.00, 5,000 circulars, 5 1/2 x 8 1/2, \$9.00. We save you money. Hilton Printery, 137 Front St., Worcester, Mass.

PUBLICATIONS, Catalogs, stationery. Prices reasonable. Annville Printing Company, Annville, Penna.

200 LETTERHEADS, 100 Envelopes, printed \$1.00. Abbott Printery, Oswego, Kans.

1,000 BUSINESS Cards, \$2.75 postpaid. Samples free. John Miller, Montgomery Ave., Narberth, Pa.

PRINT Anything. Lowest prices. Highest quality. Catalog free. National Printing, Goshen, Ind.

OUR Standardized plan makes it possible to print house organs and magazines at one-third ordinary prices. We print more than 1,100 different publications. Samples and particulars free. National Publishers Press, Grand Rapids, Mich.

200 LETTERHEADS And 100 envelopes \$1.00. 200 letterheads, 8 1/2 x 11, 150 envelopes \$2.00. 250 cards \$1.00. Hoosier Print Shop, Portland, Ind.

WE Print stationery, booklets, catalogs, circulars. Samples. Commercial Press, Batavia, Ohio.

QUALITY Printing! Reasonable Prices! Send for Free Standardized samples and prices. Folders, Circulars. Catalogs our specialty. Earnest Fantus, 525 South Dearborn, Chicago.

250 BOND Letterheads, Envelopes, Billheads, Cards, \$1.35 each. Economic Press, Leonia, N. J.

PRINTING OUTFITS AND SUPPLIES

PREUSED Printing presses and supplies. Lists 2c stamp. Popular Bargains, Richland, Pa.

PRINT Your own cards, stationery, circulars, advertising, etc. Junior press \$5.90; job presses, \$11; rotary, \$149. Print for others; big profit. Easy rules furnished. Write for catalog presses, type, paper, etc. Kelsey Company, Q-11, Meriden, Conn.

PRINTING Outfits—Presses, type supplies, type novelties. Send stamp for catalog. Model Press, York, Penna.

GUMMED LABELS

50 ASSORTED Chromo cards 75c. Eastern Label Co., Clintonville, Conn.

1,000 PRINTED: Name, business, address 50c. JBS Company, Box 93, Holyoke, Mass.

RUBBER STAMPS

RUBBER Stamps made to order. Kankakee Rubber Stamp Works, Kankakee, Ill.

RUBBER Stamps! Name, address, two lines 25c; three lines 35c. DeLuxe Stamp Works, B572M, Auburn, Nebr.

MUSIC Stamps, metal checks, notarial seals. Walt, Karstaedt, Dayton, Ohio.

DUPLICATORS AND DEVICES

YOU Can make 50 to 100 copies of a letter, notice, etc., at a cost of three cents on a Heyer Quality Duplicator. Write for free trial offer. The Heyer Duplicator Co., 909 Jackson Blvd., Chicago, Ill.

"EXCELLOGRAPH" Portable rotary stencil printing duplicators \$39. Terms. Description, testimonials, printed samples, free. Pittsburgh Typewriter Supply Co., Dept. 531, Pittsburgh, Pa.

"RAPIDOGRAPH" Rotary Stencil Duplicator, duplicates typewriting, handwriting, drawings. Complete \$25.00. Samples free. General Stamping Works, 238 E. 24th St., New York.

FOR THE HOME

NEW Leader clothes pressing machine, gas, weight 1,000 lbs., complete. Cost \$350. To close out \$75. H. E. Skinner, 2409 N. Ashland Ave., Chicago.

NEED Extra money? Home weaving pays. Free book. Union Looms, Boonville, N. Y.

CEDAR Chests only \$11.65—"Red-i-Kut" complete with rich copper trim—you assemble and save half—send for pictures. Kuempel Furniture Company, Guttenberg, Iowa.

FOR Your home workshop. You need course in wood turning, 340 pages, illustrated; the best book covering thoroughly all phases of wood turning on the lathe with 80 models to construct. Delivered to your door C. O. D. Simply pay postman \$1.50 and postage. Popular Mechanics Press, Room 801, 200 E. Ontario St., Chicago.

PLUMBING Facts that will save you dollars—Get 500 plain facts worth knowing about the plumbing and heating systems in your home. Remarkable book enables you to save on plumbing bills. Money back if not satisfied. Pay postman \$1.50 plus postage when delivered. Popular Mechanics Press, Room 801, 200 E. Ontario St., Chicago.

FOR MECHANICS

ELECTRIC Paint "Sprayit" at less than 1/2 price. Nationally advertised, master model. Purchased entire factory surplus. Indispensable for painting, for fine smooth finish. Ideal for garages, repair shops, and odd jobs. Used for paint, enamel, varnish, shellac, bronzing, liquid lacquers and other solution. Does work of 10 men. Regular price \$31.50. Our price only \$14.50, complete with 3 nozzles, cord and plug. Guaranteed new and perfect condition. Get one while they last. Also Westinghouse exhaust fans. 12 in. 6 blades, 110 volt, 60 cycle, a.c., with adjustable panel. Finished in Duco Ivory. Regular price \$39.50. Our price \$14.50. Send check or money order today. National Jobbing & Export Co., Dept. 24, 192 N. Clark St., Chicago, Ill.

ATTENTION—Home mechanics: We sell unusual cabinet hardware, chest trimmings, tea wagon wheels and casters, big line small hinges, locks, etc. Upholstering supplies, electrical hardware, knocked down cedar chests, etc. Send ten cents stamps for catalog. Thurston Manual Training Supply Company, Jobbers and Manufacturers, Anoka, Minn.

YOUR Initials cut onto your tools, traps, dog collar, key ring tag and other private possessions identify you as the owner; will settle disputes, will locate lost articles. Send only eighty-three cents for regular \$1.50 value—three 1/4" steel marker stamps. Stamps accepted. Adams-Barr, Columbus, Ohio.

BEST Opportunity for profit in 8-hour battery charging. Practically no investment, easy terms. Bargains in reconditioned car washers, paint sprays, compressors. Write today. Box M-855, Troy, Ohio.

FAMOUS Bailey Handbook—Prepares you to pass the examination for any grade of license for stationary, marine and Diesel engineers, firemen and boiler inspector in any state of the Union or any province of Canada. Flexible cover. Handy pocket size. Pay postman \$2.00 plus postage when he hands you the package. Popular Mechanics Press, Room 801, 200 E. Ontario St., Chicago, Ill.

FOR SMOKERS

SMOKE On me free—I'll send you free big generous sample Old Green River pipe tobacco. Enjoy the mild mellow tasty natural tobacco flavor. See how smooth and satisfying. No obligation. Send today. Pete Moberly, Box 775, Owensboro, Ky.

NEW Electrical Dictionary. Complete up-to-date electrical dictionary with special radio words and terms together with illustrations of electrical symbols, radio diagrams and other wiring diagrams. 191 pages—Vest pocket size. Price only 35c postpaid. Popular Mechanics Press, Room 801, 200 E. Ontario St., Chicago, Ill.

GUNS, FISHING TACKLE AND SPORTING GOODS

SPORTING Goods, baseball, boxing, tennis, golf, rifles, shotguns, binoculars, etc. Send stamps for big catalog. Hudson, W-52 Warren St., New York.

BOYS! Here's fun galore. Four large profusely illustrated books tell how to make almost everything you could want. Nearly 4,000 different articles are described (Think of it). Now \$2 per book or \$7 for the four if ordered at once. Just write a postal saying, "Send the Boy Mechanic Library." Pay postman \$7 and postage. For single books, specify either Book 1, 2, 3 or 4. Popular Mechanics Press, Room 801, 200 E. Ontario St., Chicago, Ill.

DIAMONDS, WATCHES AND JEWELRY

21 JEWEL Watches, Elgin movement, \$15.
L. D. Speake, Cooper, Tex.

LATEST And best House Wiring book—just published—This new book of over 250 pages and 600 illustrations represents 15 years of work in perfecting the material for the best House Wiring manual it is possible to produce. The work of two men high up in the fields of mechanical arts and electricity. Price \$2.50 postpaid. Sent C. O. D. anywhere in the U. S. or possessions. Popular Mechanics Press, Room 802, 200 E. Ontario St., Chicago, Ill.

BOATS AND LAUNCHES

AQUAPLANES. Build your own. Send 10c stamps for pamphlet on aquaplaning and knockdown offer. Box 101, Coney Island, Brooklyn, N. Y.

18 FOOT Fast runabout shark. Complete plans (price 35 cents) in April Rudder, oldest boating paper in the world. Catalog of boat plans free. The Rudder, 15 Murray St., New York.

BUY An original world-famous Century Kid at a great saving. A wonderful three-passenger outboard hydroplane originally priced at \$250.00. Save more than \$100.00 on a new boat. J. B. Welch, 724 31st St., Milwaukee, Wis.

PROPELLERS. Pumps, stuffing boxes, bearings, etc. Wm. H. Baker, Pond St., Quincy, Mass.

BUILD Your own boat—Complete directions make it comparatively easy. 14 different types for all purposes including row, motor, sail, canoe, out-board motor boats, etc. With this book is included "Outdoor Sports the Year 'Round" on making all sorts of devices for outdoor recreation. Pay postman \$1.98 plus postage when delivered. Popular Mechanics Press, Room 801, 200 E. Ontario St., Chicago.

RAZORS AND BLADES

GILLETTE Blades sharpened to velvet edge, 1c each. Petter Wetterquist, Rockford, Ill.

30 NEW Gillette razor blades \$1.00 postpaid, each blade guaranteed. Nowak System, 703 Lincoln Ave., Milwaukee, Wis.

ANTIQUES, WAR RELICS AND INDIAN GOODS

MILITARY Medals for your collection. Illustrated catalog 10c. Craig Dare, 670 E. 42d, Brooklyn, N. Y.

SEND 5c For fine new list Indian relics, antique firearms. F. E. Ellis, Webster Groves, Mo.

FIELD GLASSES, MICROSCOPES AND TELESCOPES

\$5.00 GOVERNMENT Field glasses with leather case. Send free list binoculars, field glasses, cameras, lenses and musical instruments. Well's Curiosity Shop, 20 South Second St., Philadelphia, Pa.

MINERALS, SEMI-PRECIOUS STONES

WE Are dealers in mineral specimens and polished semi-precious gems for educational and cabinet display purposes. Price lists, table of birth stones and list of gem minerals free with order for PM Specials. Six assorted rough and polished minerals \$1, or four genuine, polished gem stones \$1 postpaid, labeled; satisfaction guaranteed. The Gem Shop, Box 373, Wolf Creek, Mont.

PHONOGRAPHS AND RECORDS

BUILD Your own phonograph, radio; phonograph parts; catalog mailed for 10c. American Phonograph Co., 3602 Wesley, Berwyn, Ill.

MUSIC AND MUSICAL INSTRUMENTS

HARMONICA—Even a child can learn to play popular melodies on the harmonica in 5 minutes with the help of a new device invented by Walter Peterson. The Kentucky Wonder Bean, of WLS fame. The special combination price of \$1.50 includes this wonderful new invention and a genuine Hohmer harmonica. Postpaid. Send your order today to Walter Peterson, 2425 North Rockwell St., Chicago, Ill.

SONGS Composed and arranged, ready for publication. Submit poems. Brennan, 11654 Broadway, New York.

DUO-FLEX Reeds for clarinets and saxophones, only invention affecting blowing quality, softer tones with ease, eliminate your reed troubles now. Money refunded if not satisfied. Per doz., clarinet, \$2.50; soprano, \$2.75; alto, \$3.00; C melody, \$3.00; tenor, \$3.50. Duo-Flex Reeds, 1204 First Ave., Evansville, Ind.

SONG Poem writers: "Real" proposition. Hibbeler, D1, 2104 Keystone, Chicago.

ACCEPTABLE Song poems wanted. Beaver, 1257 Elm, Green Bay, Wis.

QUALITY Composing \$15 complete. Lon Healy, Liberty Theatre, Colorado Springs. Writer of "Arizona Rose" Feist, "Backsteer" song Harding, "Colorado Rose" Shapiro-Bernstein.

COMPOSERS—Verse or music. Brilliant opportunity. Write VanBuren, 2015 McClurg Bldg., Chicago.

VIOLIN Making. For particulars write Redell Music House, New Bedford, Mass.

SONG Poems solicited. A different proposition. Richard Broughton, Sioux Falls, S. Dak.

"BANJOS" Should interest all musicians on account of the popularity of the banjo, as it easily increases a player's income. Illus. catalog of 48 pages free. The Bacon Banjo Co., Inc., Groton, Conn., U. S. A.

GUARANTEED Results. Write Sequoia Songwriters Service, Sherman Branch, Los Angeles, Calif.

SONGWRITERS: Submit your song-poem or complete song! Will return it immediately if not acceptable! Chester A. Escher, Music Publisher, 125 West 45th St., New York City.

PLAY Piano by ear. A sound system. Particulars free. Boucher's Harmony Studio, Ottawa, Can.

SONGWRITERS—Arranging, composing. Free booklet. Tucker, 330 Wadsworth, New York.

SONGWRITERS: Substantial advance royalties are paid on publisher's acceptance. New booklet, "Song Requirements of Talking Pictures," sent free. Newcomer Associates, 790 Earl Bldg., New York.

POEMS Wanted. Work guaranteed. We publish. Great Eastern Song Bureau, Dept. 27, Thomaston, Me.

SEND Song poems, 50-50 plan. Indiana Song Bureau, (Brookside), Salem, Ind.

VIOLINS, Deep, mellow, soulful—on credit. Easy terms for wonderful instrument. Get details today. Gustav F. Henning, 302 University Building, Seattle, Wash.

CORNETISTS—Trombonists—Saxophonists—Clarinetists. Get "Free Pointers," Name instrument. Virtuosi School, Buffalo, N. Y.

"MUSIC Composed" to words. Bauer Bros. (formerly of Sousa's Band), Oshkosh, Wis.

SONG Writers. Send for our "Publishing Agreement." McKinley Music Printers, 1501 E. 55th St., Chicago.

WRITE Songs. Big money and reputation. Write for information. J. Gordon Pub. Co., 201 N. Hoyne Ave., Chicago.

PATENT ATTORNEYS

PATENTS Procured. Prompt, careful efficient service. Highest references. Moderate fees. Send sketch or model for actual search and advice. George P. Kimmel, Master of Patent Law, 54-E Legal Bldg., Washington, D. C.

TIME Counts in applying for patents. See pages 140 and 141. Clarence A. O'Brien, Registered Patent Attorney, Washington, D. C.

LACEY'S Patent Sense. Valuable book free. See ad page 144.

PATENTS—Write for our free book, "How to Obtain a Patent" and Record of Invention Blank. Send model or sketch of invention for inspection and instructions free. Terms reasonable. See advertisements on pages 142 and 143. Victor J. Evans & Co., 934 Ninth, Washington, D. C.

PATENTS Procured; easy terms; advice and booklet free. H. Sanders, 7 Rand McNally Bldg., Chicago.

CASH From good inventions—patented or unpatented. Booklet free. Write today. Chartered Institute of American Inventors, Barrister Bldg., Washington, D. C.

UNPATENTED Ideas can be sold. I tell you how and help you make the sale. Free particulars (copyrighted). Write W. T. Greene, 906 Barrister Bldg., Washington, D. C.

LANCASTER. Allwine & Rommel, 221 Ouray Bldg., Washington, D. C. "Originators of the Form Evidence of Conception." Before disclosing your invention to anyone send for blank form to be signed and witnessed. Form and patent information bulletin free.

SELL Your invention before patenting. Write for free particulars. W. T. Greene, 901 Barrister Bldg., Washington, D. C.

INVENTOR'S Adviser with mechanical movements sent free. Labiner, 15 Parkrow, New York.

REGISTERED Patent attorney-engineer. Expert in chemical and mechanical patent matters. Former patent examiner. Correspondence invited. A. Ponack, 401 Homer Bldg., Washington, D. C.

INVENTIONS Patented; confidential advice; inventions developed—representative for Blair Tool and Machine Corp.; trademarks registered. Edward Gottlieb, Patent Attorney, 5 Beekman St., New York.

PATENTS Procured; trade marks registered—preliminary advice furnished without charge. Booklet and form for disclosing idea free. Irving L. McCathran, 704 International Building, Washington, D. C.

INVENTORS Service Bureau will send booklet and give you free advice concerning the proper procedure for obtaining patents on easy payment plan and at least expense. Dept. B, Union Trust Bldg., Washington, D. C.

PATENTS, Trade-Marks, Designs. This firm has 27 years' experience and gives expert personal service at reasonable rates. We properly protect your invention. Write for free information and exact cost of procuring patent before proceeding. John B. Thomas & Co., 902 F St., N. W., Washington, D. C.

INVENTORS: Send for booklet telling how to patent and sell your inventions at lowest cost. Ralph Burch, Patent Lawyer, 900 F St., Washington, D. C.

ESTABLISHED 1864. Milo B. Stevens Company. Free booklet. Patents, Trade marks. Copyrights. Offices, Monadnock Block, Chicago; Barrister Building, Washington, D. C.

INVENTORS—Write for our Guide Book, "How to Get Your Patent," and Evidence of Invention Blank. Send model or sketch of your invention for our prompt examination and instructions free. Randolph & Co., Dept. 430, Washington, D. C.

PATENTS. Prompt personal service. Write for information. Albert E. Dieterich, Registered Patent Lawyer, 621½ Ouray Bldg., Washington, D. C.

PATENTS. Send sketch or model for advice. Free book: "How to Obtain a Patent." Established thirty years. Highest references. Prompt service. Reasonable charges. Chandlee & Chandlee, 910 F St., Washington, D. C.

PATENTS. Booklet free. Highest references. Best results. Promptness assured. Send model or drawing for preliminary examination. Watson E. Coleman, Patent Lawyer, 724 Ninth St., Washington, D. C.

"INVENTOR'S Guide," valuable information, free. Frank Ledermann, Registered Attorney-Engineer, 1712 Woolworth Bldg., New York.

PATENTS—Write for free instructions. Send drawing or model for examination. Carl Miller, Registered Patent Attorney (former Patent Office examiner), 259 McGill Bldg., Washington, D. C.

PERCY S. WEBSTER, 203 Saving and Loan Building, Stockton, Calif. Patent booklet free.

FOR INVENTORS

METAL Goods manufacturer desires meritorious articles to manufacture. Die castings, stampings, chrome and nickel plating, enameling, color spraying, assembling, under one roof. National reputation for excellence; low operating costs. International selling organization. Box 549, Middletown, Conn.

INVENTORS Wanted: Royalties paid ideas developed. Will manufacture and commercialize. Models and drawings prepared. Urbano Company, 561 Howard St., San Francisco, Calif., U. S. A.

IF You have a good, sound patent or pending patent to sell, write immediately American Patents Corporation, Barrister Bldg., Washington, D. C.

INVENTORS—New ideas wanted. Investigate before patenting. J. Douglass, Licensed Professional Engineer, Canandaigua, N. Y. (New York State Licenses).

TIME Counts in applying for patents. See pages 140 and 141. Clarence A. O'Brien, Registered Patent Attorney, Washington, D. C.

LACEY'S Patent Sense. Valuable book free. See ad page 144.

INVENTIONS—Write for our free book "How to Obtain a Patent" and Record of Invention Blank. Send model or sketch of invention for inspection and instructions free. Terms reasonable. See advertisements on pages 142 and 143. Victor J. Evans & Co., 157 Ninth, Washington, D. C.

I SELL Patents. Established in 1900. A nationally-known service. Experienced, respected. Why take chances Charles A. Scott, 773PM Garson Ave., Rochester, N. Y.

INVENTORS. Share benefits of national mutual aid society. For information write American Society of Inventors, Crosby Bldg., Buffalo.

WE Sell patents by presenting them personally to manufacturers. Largest firm in U. S. Send description of patent or invention for examination. Harry G. Green & Company, 180 West Washington St., Chicago.

UNPATENTED Ideas can be sold. I tell you how and help you make the sale. Free particulars (copyrighted). Write W. T. Greene, 907 Barrister Bldg., Washington, D. C.

SELL Your invention before patenting. Write for free particulars. W. T. Greene, 902 Barrister Bldg., Washington, D. C.

BIG Money made with good inventions. Get yours into action by sending full details to manufacturer with two large plants. G. W. MacDow, 200 Dartmouth St., Boston, Mass.

INVENTIONS Wanted—Patented, unpatented. If you have an idea for sale write Hartley, Box 928, Bangor, Me.

LOW Cost manufacturing. Large plant completely equipped for blanking, drawing, stamping and wire forming in any finish. Can save you money on your product. Our figures will convince. Eastern States Products, Box 721, New Haven, Conn.

GET Your own patents. Legal blanks, complete instructions \$1. Cutting Sons, Campbell, Calif.

INVENTIONS—Have you conceived one? There is a long, winding road to travel before your vision of rewards can be realized. Send for the new book "Inventions and Patents, Their Development and Promotion" by an eminent authority. It is designed to guide the inventor on his way and help him avoid pitfalls. Will be sent C. O. D. Pay postman \$2.50 plus postage when he hands you the package. Popular Mechanics Press, Room 802, 200 E. Ontario St., Chicago.

INVENTORS Universal - Educator - contains 900 mechanical movements; 50 perpetual motions. Tells how to obtain and sell patents. Suggests new ideas. Explains how to select your attorney and avoid patent sharks. Price (revised edition) \$1.00 postpaid. Albert E. Dieterich, 621 Ouray Bldg., Washington, D. C.

INVENTORS—Cash in on your invention now! Don't delay the sale any longer! Send for a free copy of our specially prepared booklet, "Turn Your Patent Into Money," today! It contains helpful information for all inventors. M. L. Rund, Mgr. Classified Advertising, Popular Mechanics Magazine, 200 E. Ontario St., Chicago, Ill.

PATENTS FOR SALE

WINDOW Clothes drier. E. Desrosiers, 222 Paine Ave., New Rochelle, N. Y.

FOR Sale—Patent on closet bowl ventilator and quick closing ball cock. Should be in every household, hotel and apartment. W. L. Lowe, Marion, Iowa.

TWO Meritorious garage door, bar type locking devices. Patents applied for. Cash, royalty. D. Spikings, 4947 N. Keystone Ave., Chicago, Ill.

OUTRIGHT Or royalty; patented roofing and rafter level. R. H. Wildman, Dumas, Miss.

COLLAPSIBLE Or folding table for use in automobile. For sale on royalty basis. Patent pending. L. Riesche, 3022 Belmont Ave., Chicago, Ill.

PATENT Pending. window screen, easy to manufacture, useful for the public. L. Kalano and T. Palka, 1121 Sycamore St., Wyandotte, Mich.

BOATBUILDING Revolutionized by new machine. Does work of 50 men. Teigland, Haddonfield, N. J.

PATENT Pending; Facing, boring, cutting of toolholder with steady rest. Address Anton Goesser, 2406 Trussit Ave., Youngstown, Ohio.

STRAIN Insulator for radio receiving or broadcasting. Always dry. Water proof, dust proof. No induction. Can't ground. U. S. patent allowed. Others pending. J. F. Phillips, 455 9th Ave., New York, N. Y.

TIME Counts in applying for patents. See pages 140 and 141. Clarence A. O'Brien, Registered Patent Attorney, Washington, D. C.

NEW Plaster electric lamp pedestal. Patent pending. Outright or royalty. Ralph W. Steece, Spencer, Iowa, Box 494.

"DRAPERY Chute," recently invented. Stamped metal. Saves time and material hanging draperies. Royalty. Anna Pich, 236 N. Hamilton Ave., Indianapolis, Ind.

ATTRACTIVE Automaton doll just invented; patent right for sale. Tadakuma, 3261 Folsom St., Los Angeles, Calif.

COMBINATION Motor truck, concrete and mortar mixer; establishing a new mixing principle and will prove a big money maker to manufacturer. Chas. Payne, 27 Fulton Ave., Waukegan, Ill., U. S. A.

INVENTORS—Cash in on your invention now! Don't delay the sale any longer! Send for a free copy of our specially prepared booklet, "Turn Your Patent Into Money," today! It contains helpful information for all inventors. M. L. Rund, Mgr. Classified Advertising, Popular Mechanics Magazine, 200 E. Ontario St., Chicago, Ill.

MODELS AND MODEL SUPPLIES

TIME Counts in applying for patents. See pages 140 and 141. Clarence A. O'Brien, Registered Patent Attorney, Washington, D. C.

MODEL Steam engines and boilers for miniature power boats. Boat and boiler fittings. New catalog 15c. Model Machine Shop, 212 Price St., Rahway, N. J.

BLOCKS, Deadeyes, belaying pins, steering wheels, scale fittings. 11 W. 48th, New York City.

PRODUCERS Of results. Mechanical and consulting engineers. Our specialty models in metal. Designing, developing, building special machinery, manufacturing, experimental work, patterns, castings and model supplies. Reasonable rates. Inventors see or write us. 25 years in this work. The Johns Engineering Co., 1382 E. 17th St., Cleveland, Ohio, Dept. F.

THE Modelmaker: An illustrated magazine devoted to practical model making. Sample 10c. Modelmaker, 122 Liberty St., New York.

SHIP Model fittings. Send dime for illustrated catalog No. 6. A. J. Fisher, 1022 Etowah Ave., Royal Oak, Mich.

LET Our experience be your guide. Models that are models; tools and equipment for economic manfg. Patterns of all types; manufacturing in all branches. Satisfaction guaranteed. United Machinery Company, Cincinnati, U. S. A.

WE Make working models for inventors and do experimental work and carry a complete stock of brass gears and model supplies. Send for catalog. The Pierce Model Works, Tinley Park, Ill.

MANUFACTURING

ECONOMICAL Manufacturing from sheet, bar, wire or tubing. Models, dies, special machinery. Swanberg, 5124 N. Kildare Ave., Chicago.

MANUFACTURING Models, dies, stampings, brasswork, one or thousands. Circular free. Baum's Metal Specialties, Kansas City, Mo.

LOW Cost manufacturing. Large plant completely equipped for blanking, drawing, stamping and wire forming in any finish. Can save you money on your product. Our figures will convince. Eastern States Products, Box 721, New Haven, Conn.

SPECIAL Machinery or parts, dies, tools, metal specialties, models, special gears, stock gears and model supplies. Send for Catalogue. The Pierce Model Works, Tinley Park, Ill.

WIRE Goods made to order. Cooley Mfg. Co., 530 N. Western Ave., Chicago.

BLUEPRINTS

SPORTSMEN Save money. Blueprints; instructions. Make canoe; cabin; fire-place; boat trailer; leather-craft; house-car; rustic furniture; shanty-boat, 50c each. Tourist Camp Guide, 35c. Circulars free. Wood, Redbank, Chattanooga, Tenn.

MACHINERY, TOOLS AND SUPPLIES

16"x8" VON WYCK Lathe, \$175.00; No. 134 Valley City plain milling machine, \$350.00; No. 60 Heald grinder, \$275.00; 24" Hendy shaper, \$250.00; 15" Smith & Mills crank shaper, \$225.00; 36"x18" Fifield lathe, \$750.00; 20" silver upright drill press, \$60.00; Quincy air compressor with tank, \$65.00; 10" bench drill press, new, \$23.00. Terms to suit. Write for catalog. Cincinnati Machinery & Supply Co., 27 West Second St., Cincinnati, Ohio.

CONCRETE Building block machines and molds. Easy payments. Catalog free. Concrete Machine Co., 5 North Main St., St. Louis, Mo.

START Business of your own, small investment required, doing nickel, copper and silver plating. This work in big demand. Information free. Electro Platers Supply Co., 28 W. Second St., Cincinnati, Ohio.

NEW Port. Steel forges, complete, \$7.50; power grindstone frames, \$5. Klein's splicing clamps, pair 60c. Sperry compasses in leather case (\$10 value) each \$1. H. E. Skinner, 2409 N. Ashland Ave., Chicago.

LATHE, Emery stand, and drill press castings, two popular sizes. Splendid design. Stuart Kenelpp, Mt. Carmel, Ill.

SAVE Money—Automatic air compressors, constant potential battery chargers, reconditioned, guaranteed like new. Real value—shipped on trial easy terms. If can use, Box M-856, Troy, Ohio.

BRAND New bench type power filing machines. Price \$20.00 each. Botwinik Bros., Inc., 67 Water St., New Haven, Conn.

BENCH Drill, blue prints, \$1.50. T. Telfer, 9081 Crane Ave., Detroit, Mich.

NEW Starrett tool set. Cheap. List. Bargains tools and hardware. Catalog free. Fox, 345 East 18th St., New York.

MACHINERY, Lathes, drill presses, millers, shapers, grinders and motors. Klauer Machinery Co., 320 South Third St., St. Louis, Mo.

ENGINES, MOTORS AND DYNAMOS

BRAND New motor bargains. ¼ hp. a.c., \$7.50; ¼ hp. universal motors, \$5.00; 32v. motors, ¼ hp., \$8.50; one-third hp., \$12.50. Write for prices on larger motors, also generators. Queen City Electric, 1736 Grand Ave., Chicago.

TIME Counts in applying for patents. See pages 140 and 141. Clarence A. O'Brien, Registered Patent Attorney, Washington, D. C.

USED Arc welders, air compressors, buffers, grinders, reconditioned like new. Shipped on trial and easy terms. If you need good guaranteed equipment. Write today. Box M-857, Troy, Ohio.

NEW ¼ Horse gasoline engines, \$18.00; with 32 volt 5½ ampere generator and belt, \$26.00. ¼ horse alternating, 1750 speed motors, \$7.00; 1/3 horse, \$10.50; ½ horse, 3450 speed, \$16.50. Other bargains. Electrical Surplus Company, Dept. 12, 1911 Chicago Ave., Chicago.

FOR Sale: One-sixth and one-quarter hp. used elec. motors—60 cycle, 110 volt—a.c., good running condition. \$4.50 and \$5.00 respectively. Cash with order. Maytag-Chicago Co., 160 E. Illinois St., Chicago, Ill.

ELECTRIC Motor winding models and instructions. Gaines Bros., Gainesville, Tex.

GOVERNORS (Ours) will control any make of auto engine at any speed desired. Easy to install. \$10 C. O. D. Circulars. Candee-Smith Governor Co., 215 North Los Angeles St., Los Angeles.

EDISON Phonograph motors with speed governor. Universal, \$5.00 plus express 10 lb. Geo. Schulz, Calumet, Mich.

STEAM Engines—One h. p. \$18.00; ½, \$12.00. James Chambliss, Bessemer, Ala.

BENDING MACHINES

THE Famous Hossfeld "Wrenchless" Universal Iron Bender is the last word in bending machines. Bends metal, cold or hot, into most any conceivable shape, including Eye Bolts and Automobile Spring Eyes. Bends up to 1" bars or 1½" pipe cold. Thousands in use by all classes of trade, from the smallest shops to the largest railway systems. Write for circular and prices. Hossfeld Mfg. Co., Winona, Minn.

WELDING AND SOLDERING

START In highly profitable are welding business, practically no expense. Our constant are welder starts you on road to success. Easy monthly terms, liberal trial on money back guarantee. Write today. Box M-858, Troy, Ohio.

SOLDERING And Brazing, by Yates, gives all the necessary "kinks" that will enable you to solder successfully. 90 pages, 64 illustrations. Delivered to your door C. O. D. Simply pay postman 75 cents and postage. Popular Mechanics Press, Room 801, 200 E. Ontario St., Chicago.

SURVEYING INSTRUMENTS

ODOMETERS, Land measuring precision instruments, made by Kueffel & Esser, in leather case, worth \$25. Close out \$5. H. E. Skinner, 2409 N. Ashland Ave., Chicago.

FARMS AND FARM LANDS

LAND Opening—The Great Northern Railway serves an agricultural empire in Minnesota, North Dakota, Montana, Idaho, Washington and Oregon. These states abound in opportunities for small farmers or large operators to rent or purchase a farm at lowest prices and best terms of many years. Every kind of farming, grain, livestock, dairying, fruit, poultry; large acreage or small suburban tracts, rich cutover or high producing irrigated land. Write for free Zone of Plenty book with detailed information. Low homeseekers' rates. E. C. Leedy, Dept. 457, St. Paul, Minn.

TEN Acres, fruits, poultry; New house, near town, Lake Michigan, \$900.00. Easy payments. Hill, 5748 Harper, Chicago.

OZARKS—20 Acres, poultry land, \$100, \$5 monthly. Fishing, hunting, trapping. Other bargains. Hubbard, 216 Grossman Bldg., Kansas City, Kans.

BARGAIN! 20 Acres, Ozarks, \$100, \$5.00 monthly. Alfred Fisher, Hannibal, Mo.

CHOICE Cabin sites on Mantrap lake, Minnesota. Hunting, fishing, \$5.00 down. Chinn, 1534 Searle, Des Moines, Iowa.

MONEY Made in Mich. potatoes. \$10 down now and easy terms buys land near markets, lakes, streams. Write today. Swigart & Co., P-601, 32 N. State St. Bldg., Chicago, Ill.

PECAN—Orange-Fig groves "On the Gulf." Monthly payments. Guaranteed care. Big, quick returns. Suburban Orchards, Dept. M., Biloxi, Miss.

SELL Your property quickly for cash, no matter where located. Don't pay big commission. Particulars free. Real Estate Salesmen Co., Desk B, Lincoln, Nebr.

EASTERN Pennsylvania farms near Philadelphia. Write for bulletin giving prices, sizes and descriptions. Wilson George, Quakertown, Pa.

REDUCE Labor on your farm and increase income. One farmer writes he would not part with the information for \$100 if it could not be duplicated. Send today for our valuable "Farmers' Handbook" and get ready to put some of the 861 practical ideas into operation for your own benefit. Pay postman only 98 cents plus postage when delivered. Popular Mechanics Press, Room 808, 200 E. Ontario St., Chicago.

SEEDS, PLANTS AND TREES

PLANT Assortment, 200 cabbage, 200 onions, 200 tomatoes, 25 pepper, 25 eggplant prepaid \$1.25. Prompt shipment, satisfaction guaranteed. Jacksonville Plant Co., Jacksonville, Tex.

DOGS AND PETS

AQUARIUMS. Fancy fishes for pleasure and pastime. Water plants, etc. Catalog free. German Aquarium, 3823 N. Richmond, Chicago.

ENGLISH Shepherds, fox terriers, collies, police. Ed Barnes, Fairfield, Nebr.

WHITE Collies and other colors. Beautiful and useful. Dept. P, Shomont Kennels, Monticello, Iowa.

FOR SALE. Minks, squirrels, raccoons, foxes, ferrets, muskrats, ginseng, rabbits, skunks, wolf pups, opossums. B. Tippman, Caledonia, Minn.

DOG Lovers—Every fact regarding every phase of dog training (all breeds) including psychology, obedience, guarding, swimming, rescue work, hunting, herding flocks, teaching tricks, finding lost articles, racing, war service, police dogs, sled dogs, etc., will be found in "Training the Dog," by Will Judy. Price only \$1.50. Pay postman when delivered or, if outside U. S., remit when ordering. Popular Mechanics Press, Room 809, 200 E. Ontario St., Chicago.

RABBITS

BRED Guaranteed chinchilla pedigree does at \$6.00 each. Soon after receiving them you should have at least six youngsters per doe. Full particulars how to care for and make good profits. These rabbits the choice pick of over twenty thousand Chins. Champion bucks used. Write Mt. Fore-t, 226 Bagley Ave., Detroit, Mich.

FINE Income from rabbits under our contract. Build your own big business. Free particulars. Aulabaugh Fur Farms, Box 9 Waterloo, Nebr.

RABBITS—Registered chinchilla bred does \$5.00, bucks \$4.00. Order from Ad. Wisniewski's Rabbitry, Hawkins, Wis.

GIANT Silver fox and chinchilla rabbits. Hi Quality Fur Farm, Harvard, Nebr.

RAISE Chinchilla fur rabbits for profit. Our free circulars start you right. Midland Hills Fur Farms, 301 Ridgeway, Little Rock, Ark.

RAISE Fur rabbits. We pay \$4.00 for those raised from our stock. Send 10c for catalog, contract, etc. Goldenrod Fur Farms, Inc., Dept. PM, Lincoln, Nebr.

RAISE Rabbits for us. Guaranteed market. Beautiful Chinchilla chokers, \$8.50. Breeders, Furrers, Packers. Northlands Fur & Packing Co., Rhinelander, Wis.

MAKE Big profits with Chinchilla rabbits. Real moneymakers. Write for facts. 852 Conrad's Ranch, Denver, Colo.

MUSKRATS

MAKE Money from muskrat fur—Raise muskrats in dry land pens or hutches. Get the facts. 652 Conrad's Ranch, Denver, Colo.

MUSKRAT Farming—The greatest book on one of the greatest opportunities today. Tells of the opportunity in this business and how to do everything in connection with the raising and marketing of muskrats. Pay postman only \$2.25 and postage when delivered or, outside U. S., remit when ordering. Popular Mechanics Press, Room 809, 200 E. Ontario St., Chicago.

POULTRY

NEW Gas brooders, complete, \$15; 50 egg elec. incubators, \$15; 250 egg elec. incubators, \$45. 25% factory cost. H. E. Skinner, 2409 N. Ashland Ave., Chicago.

WANTED—MISCELLANEOUS

MAIL Us your discarded jewelry, gold, crowns and bridges, watches, diamonds, silver, platinum. Money promptly mailed. Goods returned if offer refused. United States Smelting Works (The Old Reliable), Dept. 71, Chicago.

SCRAP Gold and silver refined. Returns made on actual recovery with refining charge only 5%. Colorado Refining and Research Corporation, Box 68, South Denver, Colo.

ELECTROPLATING—Complete, practical instructions for beginners in copper, nickel, silver and goldplating with suggestions on how to enter this business. Pay postman only \$1 and postage when this book is delivered at your door. Popular Mechanics Press, Room 801, 200 E. Ontario St., Chicago.

FOR SALE—MISCELLANEOUS

LET'S Swap! What've got? What've want? Trial, two dimes. Swap Bulletin, Detroit.

ADDRESSOGRAPHS. Letter folders, multigraphs, envelope sealers, duplicators, less than half price. Guaranteed. Pruitt Co., Suite 108, 190 N. LaSalle St., Chicago.

WATCHMAKERS Lathe for sale at a bargain. R. Jaegermann, 5815 Easton Ave., St. Louis, Mo.

BUILT-IN Furniture adds convenience, comfort and beauty to your home at very low cost. Any handy man can build a great variety of this space-saving furniture from the easily-followed instructions in our remarkable book, the only one on this subject. Delivered to your door C. O. D. Simply pay postman \$2.50 and postage. Popular Mechanics Press, Room 801, 200 E. Ontario St., Chicago.

\$4,223.00 PROFIT From a town lot in one year. H. Cecil Sheppard tells you his disastrous and profitable experiences in raising chickens from the start until in the sixth year he took the above net profit. He would have gladly paid \$100 for this information during the first years. Send for his book. Price only \$1. Pay postman when delivered, or, if outside U. S., remit when ordering. Popular Mechanics Press, Room 801, 200 E. Ontario St., Chicago.

PERSONAL

MEN'S Beautiful natural color 14-K gold filled flat band Belcher ring mounted with one of the finest 1-K imitation diamonds ever discovered only \$3.47. Ladies' beautiful pierced openwork engagement ring same material or best Sterling silver with finest small imitation diamond one real dazzling beauty only \$2.47. Rush your order, stating ring size. Pay when received. Guaranteed satisfactory or return within one week and money refunded. Beautiful dazzling stick pin free with either ring if ordered within one week from date of this magazine. Importing Co., Box 201, Farmingdale, S. Dak.

AIR Navigation and meteorology—A practical book for every flyer. Capt. R. Duncan, the author, has presented the subject in a simple, non-technical way. 243 pages. Illustrated. Delivered to your door C. O. D. Simply pay postman \$3 and postage. Popular Mechanics Press, Room 801, 200 E. Ontario St., Chicago.

DREAMS: Ten thousand dreams interpreted by Gustavus Hindman Miller. Your dreams are in this book, 617 pages alphabetically arranged, most exhaustive work. Dreams do have a significance; also great social entertainer. Beautifully bound in cloth postpaid for only \$1.50; money refunded if unsatisfactory. Frank A. Lohagen, 1378 Humboldt Ave., Milwaukee, Wis.

THE Truth about Florida—written by an impartial observer. Sid Coles, Mount Dora, Fla. Postpaid \$1.

INGROWING Nails corrected; immediate relief or money refunded. Folder free. Eugene Eaton, D106, Bandon, Oreg.

MAIL, Stamps, puzzle; moviestar photo, 10c. Belmont Shoppe, PM-93, Downers Grove, Ill.

LIFE Reading. 1930 forecast; advice on business, occupation, health, love, marriage, etc.; complete \$1. Character outline 25c; send birthdate. M. Kleman, 96 Eaton St., Winnipeg, Man.

BORN Clairvoyant will reveal your future. Five questions answered for \$1.00. "Arlitt," Post Lock Box 278, Wilmington, Mass.

LETTERS Mailed from here for 10c each. Forwarding 15c silver. Foster Service, 1443 W. 82nd, Chicago, Ill.

TATTOO-MARKS Removed painlessly by mail. Vestfold, Box 76, Essington, Pa.

HYPNOTIZE Anyone instantly. Information free. Dr. Lonk, PM-2945 North Ridgeway, Chicago.

KNOW Thyself—The stars reveal your fate and fortune; trial reading for dime. Psycalite Studio, Dept. 14, Box 2, Brookline, Mass.

AIRPLANE Welding—Just out. Only book on new subject vital to all mechanics. Big demand for men thoroughly familiar with the work. Get into this big, new, unlimited field. Complete, illustrated book will be delivered to your door C. O. D. Simply pay postman \$3.50 plus postage. Popular Mechanics Press, Room 801, 200 E. Ontario St., Chicago.

MANY Are earning \$50 a week and more, buying dental gold, false teeth, jewelry, antiques, etc., and selling to us. Buy and mail to us and learn gradually this profitable business. Robert Uhler, 207 Jefferson Ave., Brooklyn, N. Y.

STANTON'S Foot powder relieves sweating, burning, tender feet. Box 50c. John Stanton, Allegheny County Hospital, Woodville, Pa.

MISFIT? Get into that work for which you are naturally fitted. My course, "Your Vocational Indicators," will solve your vocational problem. Don't stay in the "Rut"—Find thyself! Free particulars. The M. C. F. System, Lock Box 183, Cameron, Wis.

TRY Pyra-zol for pyorrhea, trench mouth, sore and bleeding gums. Guaranteed. \$2.00 bottle. Everglades Co., Okeechobee, Fla.

SPECIAL Information 4c. Novelties, opportunities. C. H. Martin, Gap, Pa.

FREE! Herbalist almanac. Over 500 herb medicine recipes for home use. Write for details. Botanic, 145 West 112th St., Chicago.

EXERCISES For the eyes that magnetize and strengthen and prevent the wearing of glasses with advancing years. Price complete \$1.00. Paul Jewell, Walker, Minn.

ADVICE. Information 25c coin up. Experience. Ref. Fred Klotz, Reading, Pa.

OUTDOOR Opportunities. You can make a good living raising rabbits, guinea pigs, milk goats, silver foxes, ferrets, white rats, white mice, dogs, cats, pigeons, pheasants, bantams, canaries, bees, frogs, mushrooms, ginseng and golden seal on a small amount of land. Send for valuable book of instructions called "Outdoor Opportunities." Pay postman \$2 and postage. Popular Mechanics Press, Room 801, 200 E. Ontario St., Chicago, Ill.

MISCELLANEOUS

MIRRORS Resilvered at home. Cost near 5 cents per square foot; you charge 75 cents. Profitable business plating autoparts, reflectors, tableware, stoves, refinishing metalware, etc. Outfits furnished. Details free. Write Sprinkle, Plater, 288, Marion, Ind.

IN Your home shop use our remarkable book called "Make It Yourself." Contains a great variety of 900 worth white things to make, all fully illustrated and explained. For the home mechanic, whether young or old. Delivered to your door C. O. D. Simply pay postman \$3 and postage. Popular Mechanics Press, Room 801, 200 E. Ontario St., Chicago.

LETTERS Mailed from New York, Boston, 15c. Norton Service, 516 West 142d St., New York.

ARE You old at forty? See our advertisement on page 72 of this issue. The Electro Thermal Company, 2129 Morris Ave., Steubenville, Ohio.

NEW Government pulmotors for reviving victims, gas, ammonia, drowning, etc., worth \$45. Close out \$10. H. E. Skinner, 2409 N. Ashland Ave., Chicago.

HOMEOPATHIC And Biochemic preparations sent postpaid to all parts of the world. Manual and booklet free. Halsey Bros. Co., 5447 Ravenswood Ave., Chicago, Ill. Established 1853.

CASH Paid for Butterflies, Insects. See Sinclair Display Advertisement on page 32.

TIME Counts in applying for patents. See pages 138 and 139. Clarence A. O'Brien, Registered Patent Attorney, Washington, D. C.

NEW 25 Gal. navy coffee urns, nickeled, complete, \$35. H. E. Skinner, 2409 N. Ashland Ave., Chicago.

"THAT'S It what life can make so bright!" Sensational song, 30c per copy. Send coin or stamps to W. Grigolio, Smith River, Calif.

WIN Prize contests. Fortunes in contests by newspapers, magazines, merchants, manufacturers. Mail 50c list 50 contests, prizes, details. T. Norton, 516 W. 142d St., New York.

BY Using "Superior," guaranteed wet proof and preservative for leather footwear, you wear invisible rubbers. Once tried always used. Prepaid 50c half pint. Swan Brothers, Corry, Pa.

SELL Oil paintings for 50c. Good profit. Seaman Studio, 2104 Liberty, Terre Haute, Ind.

BARGAIN Circular No. 10. Wholesale novelties. Send stamp. Kant, 246P Third Ave., Pittsburgh, Pa.

LEARN Tattooing. Instruction catalog, dime. Miller, V431 Main, Norfolk, Va.

MEXICAN Made holsters, lariats, horse-hair articles; rattlesnake belts. Send four cents for illustrated list. Tex-Mex Leather Co., 309 Esperson Bldg., Houston, Tex.

TATTOOING Outfits, supplies. Illustrated list free. "Waters," 965 Put-nam, Detroit.

AMATEUR Cartoonists: Sell your work. Write Smith's Service, PW1194, Wenatchee, Wash.

AMATEUR Cartoonists earn \$25.00 week, spare time, copying or tracing cartoons for advertisers. 12 months contracts. 3-M Syndicate, Argyle, Wis.

CUTS Anybody can make. Simple, cheap process, \$1.25. Specimens, particulars, 2c stamp. M. Day, Windfall, Ind.

TELL An army of 3,000,000 live readers all about your offer! If you have anything to sell, buy or exchange, or if you have any reasonable proposition, tell our readers all about it—they'll respond quickly. Our booklet "How to Create More Business" contains some very interesting, helpful facts. Write today for your copy—it's free. M. L. Rund, Manager Classified Advertising, Popular Mechanics Magazine, 200 E. Ontario St., Chicago, Ill.

LEARN CARTOONING

AT HOME DURING SPARE TIME

with the course that has trained HUNDREDS of beginners successfully. The Landon Picture Chart Method of teaching ORIGINAL drawing by mail makes cartooning easy to learn. This school is a Member of The National Home Study Council. Write today for sample picture chart to TEST YOUR ABILITY and examples of the work of successful students now earning from \$50 to \$200 and more per week.

Enclose 6c in stamps and STATE YOUR AGE.

THE LANDON SCHOOL, 2838 National Bldg., Cleveland, Ohio



\$7,346.00 in PRIZES!

FIND THE MISTAKES!

Every year we spend over \$150,000.00 on prize offers like this to advertise and expand our business. Here is our latest offer with \$7,346.00 in prizes—a magnificent list of 24 breath-taking prizes! Any man, woman, boy or girl in U. S. A. outside of Chicago, Illinois, may submit an answer.

BE QUICK!

BE CAREFUL!

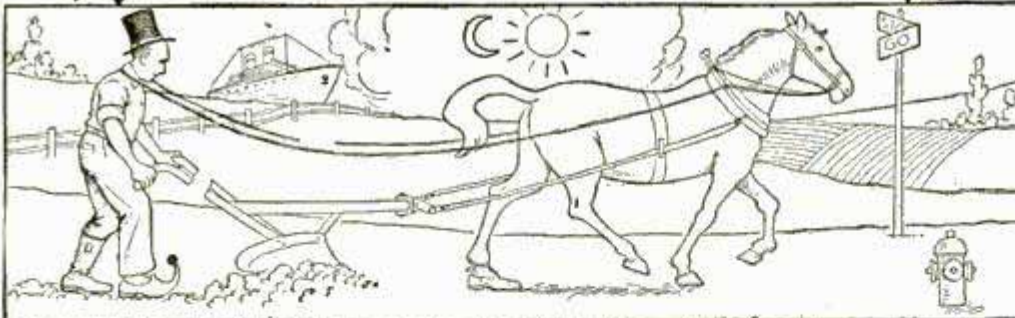

buy a thing to win. This is our way of advertising. Solve this puzzle and learn how you can win. Duplicate prizes paid in case of ties.

ADDITIONAL \$500.00 FOR PROMPTNESS

Hurry now! Solve the puzzle above correctly and receive at once the Certificate I will send, which will be good for \$500.00 if you are prompt and win first prize, making total first prize \$1845.00. Don't delay! We have given over 60 automobiles already, and you can win this time. It costs you nothing, so send your answer right now.

ARTHUR MESKE, DEPT. 143

510 N. DEARBORN STREET, CHICAGO, ILLINOIS

SEVEN BIG NEW SEDANS GIVEN

IN drawing the picture shown here, the artist made several mistakes on purpose—so don't be fooled! How many of these mistakes can you find? What objects are wrong, out of place, etc.? If you can find 7 mistakes you will qualify for this extraordinary opportunity. Mark the mistakes you find on the picture and send it to me, or write them down in a letter or on a post card.

You May Win Nash Sedan or \$1845.00

Imagine winning Nash Sedan or \$1845.00—first prize in this latest offer! And besides, 6 other big new Sedans for the next 6 prizes—beautiful new Oldsmobile, De Soto, Pontiac, Essex, Whippet, and Chevrolet. ONLY THIS ONE PUZZLE TO SOLVE, and you risk no money and don't have to



Prices Are Surprisingly Low

SPECIAL TEN HOUR FLYING COURSE	\$200.00
PRIMARY AVIATION COURSE	\$275.00
SPORTSMAN'S COURSE (Qualifies for private pilot's license)	\$450.00
PROFESSIONAL COURSE (Qualifies for Limited Commercial license)	\$875.00
TRANSPORT COURSE (Qualifies for Transport license)	\$2500.00
MECHANIC'S COURSE	\$95.00
WELDING COURSE	\$135.00

Clip and mail the coupon today. Join the ranks of Success.

JOIN THE RANKS OF THE SUCCESSFUL AVIATORS WHO WIN THEIR WINGS AT MARSHALL FLYING SCHOOL, INC., THE ORIGINAL "COLLEGE OF THE AIR"

Marshall training fits students for positions of leadership in Aviation. Enroll now and lay the foundation for a successful future.

MARSHALL FLYING SCHOOL, Inc.
190 English Street Marshall, Missouri

Marshall Flying School, 190 English Street, Marshall, Missouri.

I am interested in aviation training. Please send without obligation your descriptive booklet, "Win your Wings."

Name.....

Address.....

City and State.....

I Made \$57 a Day

(For 5 Solid Years!)

I made a fortune with this "fool idea"—Learn my money-making secret—Be a Real Estate Specialist—Get Into This Million Dollar Business—Start at home—in spare time—My free book tells how

I MADE \$100,000 in less than five years.

When I started I had just a five dollar bill and a "fool" idea. I lived in a cheap room, wore cheap clothes and had all I could do to keep out of debt. Everybody laughed at me but I went ahead just the same.

With my "Fool" idea in less than two years I was making nearly \$1,000 a month. And for five solid years, I averaged a profit of over \$57 a day!

When I realized that my system had made me a successful Real Estate Specialist I began to teach others my methods. And they too began to make so much money they thought it was a dream. My free book—yours for the asking—tells my whole story and the stories of others who have succeeded my way.

A Billion Dollar Business

The amazing thing about Real Estate is that 65% of the total wealth of the entire nation is invested in it. Yet you can become a Real Estate Specialist in your spare time at home. You need not carry any "stock"—you need not invest a penny in an office; you need not buy machinery. Real Estate does not go out of style; in the past 20 years it has increased 300 per cent in value. There are 10,000,000 properties for sale or exchange all the time. Real Estate is a pleasant business. You are outdoors or indoors as

you prefer. It is a business in which women have succeeded as well as men, and old people as well as young.

What Others Have Done

I do not care who you are, how old or young you are or how big a failure you have been, the Real Estate business offers you the biggest opportunity of your life to earn big money. Just read these few instances of what others have done:

Thos. E. Mone, Jr., was an insurance solicitor, went into the Real Estate business my way and earned \$40,000 in two years. **Al West**, who was a former book-keeper, made \$3,200 in fifteen days as a Real Estate Specialist by following my plans. **Mrs. Carrie Marshall**, who was a Stenographer, learned my Real Estate methods and sold \$17,000 worth of property in one week and has deals pending totalling over \$300,000. **Mrs. M. McGinley**, a woman 65 years old, with an invalid husband and no capital to start with, began working with a Real Estate Company following my method. Her first deal amounted to \$35,000. **H. Irving Andrews**, formerly a painter, made \$12,000 in two months. **H. G. Stewart**, formerly a salesman, made \$14,400 commission in his first six months. **E. M. Corby**, formerly an agent, averaged \$2,000 a month. And **Morris Horwitz**, who used to be a printer, made \$9,000 in nine months.

I could go on telling about clerks, book-keepers, waiters, steel workers, laborers, who have made tremendous profits in the real estate business my way. You'll find their stories in my free book. It will do



your heart good to read them—and it will do your POCKETBOOK good to HEED them.

Just Send for Free Book

Mail the coupon below for my book. That's the first step.

That's what **W. G. Records** did, and followed it by making \$925 in one month. That's what **Jack Flesch** did, and made \$232 in 4 days. That's what **F. C. Gordon** did, and made \$1,390 on his first deal.

You will find my book the most amazing reading that has ever come into your hands. It will tell you how to go in business for yourself, be your own boss, come and go as you please, and earn big money all the time that you are doing it, whether in spare time or full time. It shows letters from people which will make you ashamed of your present earnings. Don't doubt! Don't hesitate! Don't delay! Write to me at once so that I can send you my amazing free book about the cleanest, most wholesome, fast-

est growing business in the world. You owe it to yourself and to your family to get this book. Mail the coupon right now. It doesn't cost you a penny. You will never forgive yourself if you turn your back on this unusual chance to win success. Address President, American Business Builders, Inc., Dept. EE-44, 205 East 42 Street, New York.



H. G. Stewart former salesman, made \$14,400 commission in his first six months, following my methods.



Chas. F. Worthen made \$8,500 in 17 weeks with my remarkable real estate system.



Mrs. J. H. Hastings made \$248 on her first deal, following my plan for business success.



Thos. E. Mone, Jr., an insurance solicitor, went into the Real Estate business my way and earned \$40,000 in two years.



W. E. Shoop former weaver, made \$6,000 on his first deal.

Mail Coupon
→
for FREE Book

PRESIDENT,
American Business Builders, Inc.,
(Business Established 1917—Authorized Capital \$500,000)
Dept. EE-44, 205 East 42 Street,
New York, N. Y.

Mail me your free book telling how you made \$100,000 in a new kind of real estate business—how others are making big money—and how I can do the same.

Name.....
(Please print or write plainly)

Address.....

City..... State.....

Learn All About AUTOS



6 BIG AUTO BOOKS
All Shipped **FREE**
ON APPROVAL

Whether you want to qualify as garage owner, auto repair expert or merely wish to know how to keep your own car 100% efficient, look at these books—they are sent to you for free examination. This brand new 1930 edition has been prepared by a large group of America's greatest automotive engineers. Anybody who can read will understand them, for this great automobile cyclopedia is a veritable gold mine of valuable facts. Take advantage of this great opportunity now; send in the coupon for FREE examination. You don't pay us a penny, you don't obligate yourself to pay anything unless you decide to keep the books. Just tell us you want to see them and the full set of 6 great volumes, just off the press, will be sent to you.

New 1930 Edition

Imagine books which are so new that every page is right up to date—wiring diagrams, construction details, service problems—are all right up to the minute. Nowhere else that we know of can you get as complete and up to date information. Over a million dollars of resources have enabled us to give you the most up to date books on the subject ever published. You will find nearly 20 pages on front wheel drives alone. Everybody interested in automobiles in any way will welcome these books, especially on our

AVIATION MOTORS

In addition to being a complete cyclopedia of automobile engineering, these books contain over 100 pages on Aviation Motors, and as they are just off the press they bring to you the newest and latest information obtainable. This alone makes these books invaluable to anyone.

No Money Offer

This plan brings this valuable information within the reach of everyone. You don't send us a single penny; you don't have to pay us anything; just send your name and address and we will send you the complete set of 6 volumes specially bound in De Luxe Flexo covers.

Send No Money—Just the Coupon

American Technical Society, Dept. A-519,
Drexel Ave. at 58th Street,
Chicago, Illinois.

I would like to see the new 6 volume 1930 edition of your automobile books but without any obligation to buy. I will pay the few cents delivery charges only and will examine the books and return them at your expense in 10 days unless I like them, in which case I will send you \$2.00 then and only \$3.00 per month until the special price of only \$24.80 is paid. You are to include free consulting membership certificate in American Technical Society. Send brand new 1930 edition.

Name.....
Street.....
City..... State.....
Employer's Name.....
Employer's Address.....



\$100 to \$500 A Week is Earned by Cartoonist Today

DO YOU LIKE TO DRAW?

Billy Hon's Famous Cartoon Book Will Teach You A Simple—Complete—Interesting Course in Cartooning, consisting of 30 lessons illustrated with over 300 original drawings by one of America's famous cartoonists. No better course at any price. Sent postpaid any place on earth for only \$1.

Satisfaction Guaranteed.

BILLY HON'S CARTOON STUDIO,
P. O. Box 967 (P) HOLLYWOOD, CALIF.

U. S. Government Clerks

Many Clerks for general clerical work in the departments at Washington and at government offices throughout the country will be appointed during 1930. Men—women, 18 to 50. \$1260 to \$2500 a year. Now is the time to get ready. Full particulars and list Government Jobs—FREE. Write today SURE. Immediate action is necessary.

FRANKLIN INSTITUTE

Dept. J-704

Rochester, N. Y.



ELECTRIC MOTOR

winding models show winding and connections in plain sight. Make your own or rewind motors for your own use or for profit. In use all over the world. Quick, easy way. Write Dept. DPM, Gaines Bros., Box 481, Gainesville, Texas

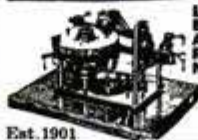

CODE TELEGRAPH Morse or Radio AT HOME WITH THE AUTOMATIC Omnigraph

Leads quickly to big money jobs of Aviation, Ships and Railroads. Your Future is SECURE. Many Young Men Holding Important Jobs. Models \$17 to \$35. Catalog. Now. Omnigraph Mfg. Co., 810 E. 39th St., P.S., Brooklyn, N. Y.

Est. 1901

INVENTORS—Read the marvelous history of American Invention, the most impressive record in the annals of human achievement. A very limited edition of Waldemar Kaempfert's Popular History of American Invention in 2 vols. 1034 Pages. Over 500 Illustrations. Cloth. \$5 per set postpaid (just half price of original edition.)

Popular Mechanics Press, 200 E. Ontario St., Chicago

No reason why you shouldn't. Easy Lessons show you how. 5 days' free trial in your own home. A year to pay.

THE whole world seems different when you learn to play and now you can play the most spectacular of all instruments—the Deagan Xylorimba. No long waiting. No finger or lip exercises. No tiresome practice. Start to play the very first day even if you can't read a note of music right now. Soon you'll be the "hit" of every party. Maybe, like the Musical Hallmans (Reading, Pa.) you'll make \$65 a week spare time.

Our Big FREE Book tells all about the free trial offer, the easy lessons, the wonderful payment plan. No cost or obligation—send in coupon today.

J. C. Deagan, Inc., Dept. 1455, 1770 Berneau Ave., Chicago
Send me, without obligation, full details of Free Trial offer and easy payment plan of the Deagan Xylorimba.

Name.....

Address.....

Be A RADIO EXPERT



Seldom under \$100 a week

"My earnings in Radio are many times greater than I ever anticipated they would be when I enrolled. They seldom fall under \$100 a week. My profits for the past three months were \$577, \$645, \$465. If your course cost 4 or 5 times more I would still consider it a good investment. You give a man more for his money than anybody else."

E. E. Winborne,
1414 W. 48th St., Norfolk, Va.



Making \$400 a month

"I really believe that every man should take your course in Radio. If he has anything in him at all there is every chance for him to get some place. The field is getting bigger and better every day. I was making good money but could see the opportunities in Radio. Believe me, I am not sorry, as I have made more money than ever before. I have made more than \$400 each month."

J. G. Dahlstead,
1484 So. 15th St., Salt Lake City, Utah.

Many make \$50 to \$200 a week

WE GIVE YOU 8 OUTFITS OF RADIO PARTS FOR A HOME EXPERIMENTAL LABORATORY

This one feature of our course is a practical Radio education in itself. You get as much practical experience repairing sets in a few months as the average man in the field gets in two to four years. You can build over 100 circuits. You learn how different makes of sets work, why they work, how to make them work when they are out of order.

Photo below is rear view of 8 Outfits assembled into a 5-tube Screen Grid tuned Radio Frequency Set.

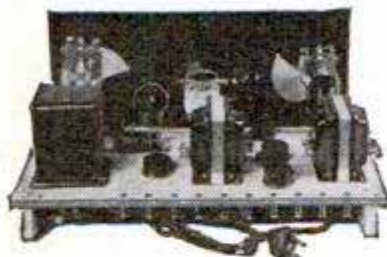

OUR HOME

See the picture of it on the right. It is owned and entirely occupied by the National Radio Institute, Pioneer Home Study Radio School, founded in 1914. We have specialized in training men and young men for the good jobs in Radio for over 15 years. All our time, all our resources are devoted to this one subject. Visitors are always welcome.



Why slave your life away for \$25, \$35 or \$40 a week in a no-future job? You are foolish to be satisfied with less than \$50, \$60 and \$75 a week for more than the short time it takes to get ready for Radio. That's what good Radio jobs pay. And \$50 to \$75 a week is only the beginning for an ambitious, aggressive fellow. Many quickly advance to \$100 and \$150 a week.

Radio's growth is opening hundreds of fine jobs every year

Radio continues to grow and expand fast. Approximately ten million receiving sets have been sold. Many more will be sold in the future. Radio's use on board ship, for international communication, in Aviation, Talking Movies, is opening hundreds of fine jobs every year. Many start in Radio at two and three times former salaries.

Make extra money repairing sets while learning

Every neighborhood needs one or more men who know how to repair various makes of sets. Many N. R. I. students make \$200 to \$1,000 in their spare time while learning doing this. We show you many different jobs that you can do, beginning with ten jobs, common in most every neighborhood, the day you enroll. Frank Golden, 629 Walnut Street, Newark, N. J., says: "I made over \$900 in my spare time in about ten months."

Save money. Learn at home in your spare time

Hold your job until you are ready for Radio. Our 50-50 method of training — half from Lesson Books and half from practical experiments using eight Outfits of Radio

parts, given without extra charge, makes learning at home easy, fascinating, practical. It gives you practical experience while learning. You don't have to be a high school or college graduate. Many successful graduates didn't finish the grades.

Your money back if not satisfied

Our training is right up-to-the minute with Radio's latest uses and developments. Home experiments in Television, Radio's use in Talking Movies, in Aviation, Screen Grid Tube Sets, A. C. Sets, and other late applications and uses of Radio sets and principles are included. It fits you for jobs in Factories, Broadcasting Stations, Commercial Land Stations, on board ship, Research Laboratories, spare time or full time Radio business of your own and many other jobs. We will refund every penny of your money upon completing our Lessons and Instruction Service if they were not satisfactory.

64-page book of facts Free

Send the coupon for "Rich Rewards in Radio." It tells you about Radio's opportunities for a good job and how to make money in your spare time while learning, also about N.R.I. Lifetime Employment Service to graduates and other features. Get it. Read it. Then you can decide one way or the other. Everyone interested in making more money should read it.



National Radio Institute
Dept. OEP
16th and U Sts., N. W.
Washington, D. C.

MAIL THIS COUPON AT ONCE!

National Radio Institute, Dept. OEP
16th and U Streets, N. W.
Washington, D. C.

Gentlemen:—Send me your book "Rich Rewards in Radio." I understand this request does not obligate me and that no agent will call.

Name.....
Address.....
City.....State.....

He Left His Calling Card

—Telltale Finger Prints!

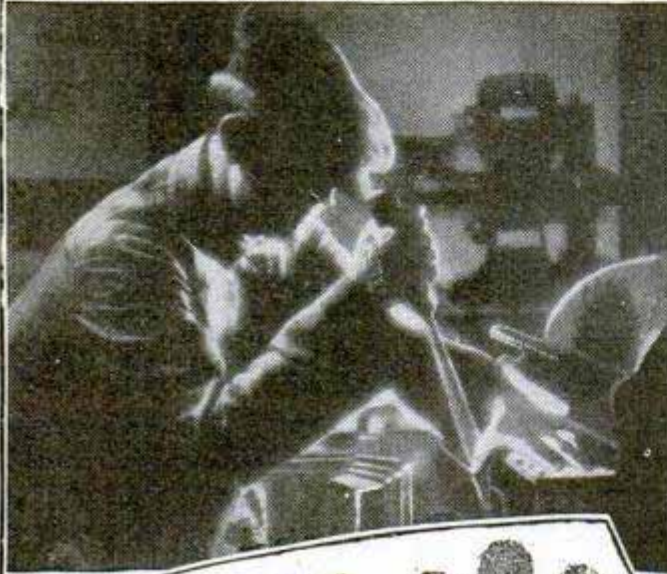

Written In Blood!

Three bloody finger prints on the cash register!

He might as well have left his calling card — his doom was already written! Get this gripping story. Send for—

The Confidential Reports No. 38 Made to His Chief—FREE!

Follow him—see how he unravels gripping mysteries! Gruesome Tragedies! Hair-Raising Climaxes! Think of it! Real Secret Service Operator gives you "inside dope". Mail coupon quick!

\$2500—\$10,000 a Year

The knock of opportunity! Send for this confidential report of Operator No. 38. Send for our big "Finger Print" catalog. And the best part of it all is this: It may open your eyes to the great future for YOU as a highly paid Finger Print Expert. More men are needed right now. This school has taken men just like you and trained them for high official positions. This is the kind of work you would like. \$2,500.00 to \$10,000 a year. Days full of excitement. Big salaries. Rewards.

WRITE and I'll send the Free Report Operator No. 38 made to his chief—also a wonderful illustrated book telling of the future awaiting you as a Finger Print Expert.

Institute of Applied Science

1920 Sunnyside Avenue, Dept. 13-55 Chicago, Ill.

Mail This NOW for Free Book

Institute of Applied Science, Dept. 13-55
1920 Sunnyside Ave., Chicago, Ill.

Without any obligation whatever, send me Report Operator No. 38 made to his chief; also your FREE book, "Finger Prints"; and full particulars about your Low Prices and Easy Terms.

Name

Address

City and State Age



—and it Brought Him
1129 Cool Shaves
from One Single Blade!

Another Triumph for KRISS-KROSS. The Most Amazing Shaving Invention Ever Patented! Mr. T. Liddle, Of Illinois, Wrote Recently, "I Have Been Using One Of Your Stoppers Since May, 1924. I Shave Every Morning And I Am STILL ON MY FIRST BLADE!" Read Astonishing Details, Then Act At Once For Real Shaving Joy.

NO wonder KRISS-KROSS marks such a radical advance in shaving comfort and economy! For now at last it has captured a secret that has baffled scientists for years! It actually reproduces mechanically the diagonal flip-flop master-barber's stroke that gives razor blades the keenest cutting edge that steel can take. Pressure decreases automatically. And in just 11 seconds you are ready for the coolest, slickest shave you ever had!

GET FREE OFFER

And now—to introduce his sensational device that makes old blades keener than new—we are giving free an amazing new kind of razor. Instantly adjustable to any angle. Comes with 5 new-process blades. Find out all about this astonishing offer. No obligation. Just fill out and mail the coupon today.

KRISS-KROSS CORPORATION
1418 Pendleton Avenue,
Dept. E-3714, St. Louis, Mo.

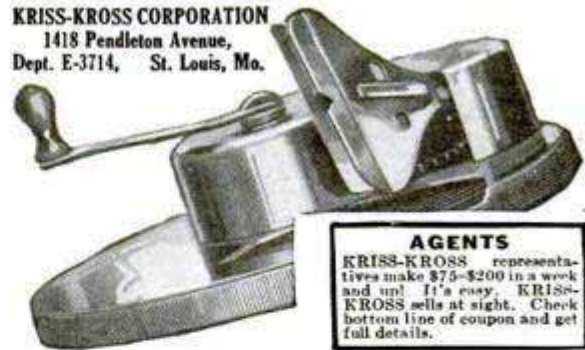

AGENTS

KRISS-KROSS representatives make \$75-\$200 in a week and up! It's easy. KRISS-KROSS sells at sight. Check bottom line of coupon and get full details.

BLUEPRINT READING

For the Building Trades



Every man who is ambitious to learn the last detail of blueprint reading will want this new book which is thorough, complete and up-to-the-minute. Written in a clear, non-technical manner. An ideal working tool for apprentices, teachers, students, carpenters, bricklayers, etc.

Over 100 pages—50 plans and illustrations.

Cloth—Price \$1.25 postpaid

Popular Mechanics Press
Room P 5
200 E. Ontario St. Chicago

A FRANTIC CALL FOR MEN WHO CAN READ BLUE PRINTS OF BUILDINGS

Leads Quickly to Jobs Paying up to \$12,000 a Year . .

See how easy it is to get in the building game. Nowhere else does such simple training count for so much. Nowhere else can a man make up to \$12,000 a year so quickly and so easily. Nowhere else are there so many countless thousands of openings as there are with contractors, builders, and real estate firms, who are constantly calling for men who can read blue prints. Six billion dollars a year is spent for building. Trained men are at a premium in this gigantic industry. Untold thousands are needed at steady salaries far above the scale wage.

90

DAYS EASY TRAINING PUTS YOU IN THE BILLION DOLLAR BUILDING FIELD

NO longer is it necessary to start at the bottom of the building trades and spend years to work up. Now you can get three years' training in three months. There are no barriers to your success in the great outdoor building field. You do not need more than a common school education. We train you at home, in spare time, by the fascinating blue-print method with lessons that are as easy to read as your newspaper.

These tested plans come to you from one of the oldest and largest schools of building construction and superintendence in the country. This course is endorsed by leading contractors and master builders. These tested, practical plans and lessons are the kind of training that puts men in high salaried jobs and in profitable building and contracting businesses of their own. You learn from actual blue print plans—from practical building experts—you learn how to read all the plans, estimate the costs and supervise the entire construction of a building—you learn everything a contractor has to know when he undertakes the construction of a building.

Amazing opportunities are open to you when you know blue prints, plans, estimating and construction. There is building superintending—the best outdoor profession on earth—that pays handsome salaries and often a bonus for efficient work. Clifford Scholl went from clerk to Asst. Superintendent at 49% increase in salary in 8 months. Thousands of builders and contractors need men like Clifford Scholl.

IF YOU LIVE IN OR NEAR CHICAGO

Visit our School for Builders, open day or evening. Thousand men attend each year. Enter any time. You can get the same training at home, by mail. Same plans; same lessons; same instructors. The Coupon brings all facts FREE.

Every Job Must Have a Contractor

The building field is wide open for men who want to go into business for themselves. Henry Mehl, Pa., a policeman, now owns his own contracting business. Burgert, Ill., stepped into a foremanship at 200% increase in salary. Busch, Kan., writes, "I have been offered \$300 a month several times." Boyes, Can., writes, "Your school has increased my wages 40% already." Patrick, Mich., says, "My salary has been increased 92%." Marchand, La., writes, "I am getting along fine. My salary is now increased 196%."

Chicago Technical SCHOOL for BUILDERS

Dept. E-143, 118 E. 26th Street, Chicago, Ill.

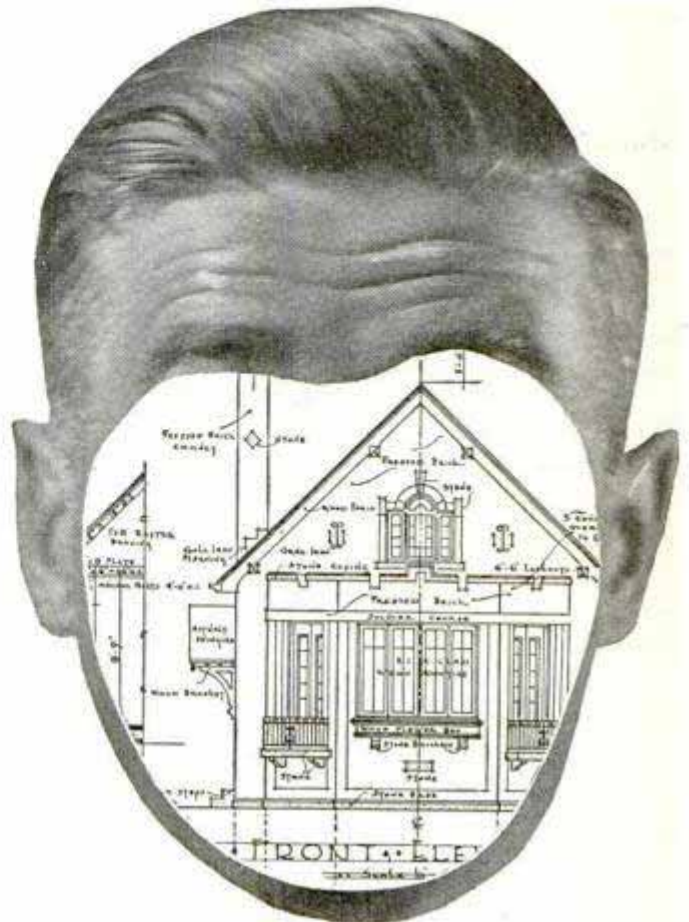

If you really want more money—if you hope to own a business of your own—get into the building business . . . no matter what your job is now. No overcrowding in this tremendous field—room for thousands every day. Why buck competition in crowded industries where only a few men can succeed?

Clerk or carpenter—office man or bricklayer—salesman or superintendent—it makes no difference. You can get into the building business quickly . . . easily. Or if you are in it at present, get this training now, that you must have for success.

FREE Book and Blue Prints

Simply mail the coupon below for an intensely interesting free book "How to Read Blue Prints," and actual blue print plans. Get these facts before you. See what amazing opportunities open up for you in the Billion Dollar Building Field. Don't wait or delay. Act now. Simply mail the coupon below.

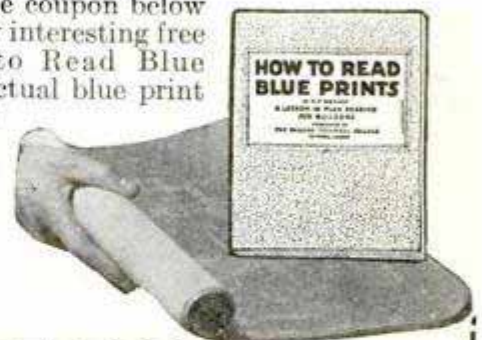

Chicago Technical School for Builders,
Dept. E-143, 118 E. 26th Street, Chicago, Ill.

Send me, without obligation, your free book, "How to Read Blue Prints" and full details of the course and the opportunities in the Building Field. It is understood that no salesmen will call on me.

Name
Address
City State
Age Occupation

Learn to Earn
 \$50 to \$150 PER WEEK
Big Opportunities Open for Sweeney Trained Men
 If you are mechanically inclined, if you prefer to work with tools, you will learn under the "Sweeney System" by actually doing the work. Everything about all kinds of automobiles, welding, vulcanizing, battery, electrical and aviation ground work. No experience or education needed. No books are used. You get to work on complete gas engines, tractors and electrical equipment unsurpassed in any school. You'll get dirty and greasy but you'll learn by the Sweeney System that fits you for big pay jobs at \$50 per week and up that are awaiting Sweeney Trained Men.
FREE BOOK Send name for Auto and Aviation catalog and Special Offer. Actual photos—lists high pay jobs.
LEARN A TRADE
Sweeney
 Automotive Electrical Aviation School
 16150 P GRAND AVE., KANSAS CITY, MO.

NEED A BETTER GRIP ON MATHEMATICS?
 SEND for a copy of "Mathematics for the Practical Man," only \$1.50. By common sense methods it removes the mystery and difficulties so that algebra and even calculus are made simple.
 Assuming your knowledge is limited to arithmetic you quickly and easily gain a working knowledge of Algebra, Geometry, Trigonometry and Calculus. Simply pay postman price of book plus the postage when he hands you the package.
Popular Mechanics Press
 Room P5
 200 E. Ontario Street, Chicago

BREAKFAST NOOK and 26 other splendid articles of Built-In Furniture in our new book on this subject. 198 pages. Illustrated. Price \$2.50 Postpaid.
POPULAR MECHANICS PRESS, 200 E. Ontario St., Chicago

Let us recommend the best books to study on any subject. Popular Mechanics Press, Chicago, Illinois.

If you solve this SIMPLE PUZZLE

YOU WILL QUALIFY for the Opportunity to Win \$2035

To advertise our business we are giving away 150 prizes—the first prize is \$1,330.00 and \$705.00 extra, making a total of \$2,035.00 in cash, or, if you wish, a new Buick 4-door Sedan and \$705.00 extra in cash. There are many other valuable prizes, including automobiles and cash prizes. A total of 150 prizes altogether and duplicate prizes will be paid in case of ties.

FIND THE TWIN FLYERS
 Grouped about this advertisement are eight pictures of a famous woman flyer. Two of these pictures are just alike. All the others differ in some detail. If you can find the twins—the two pictures that are exactly the same—just send their numbers on a post card or letter along with your name and address. Study carefully the helmets, goggles, chin-straps and coat collars. Send your answer with your name and address right now, today! That's all.

\$705.00 for PROMPTNESS
 We are not only giving the 150 grand prizes totaling thousands of dollars, but are also giving an additional \$705.00 in cash for promptness to the winner of the first prize if he or she has been prompt. Thus the first prize winner will receive the new Buick Sedan and \$705.00 in cash, or \$2,035.00 in cash. Winner's choice. Nothing for you to buy, now, later or ever. No more puzzles to solve. Send no money, but qualify today. ANYONE WHO ANSWERS THIS PUZZLE CORRECTLY AND QUALIFIES MAY WIN PRIZES OR CASH.

Any person living in the United States outside of Chicago may send an answer to this puzzle, except employees of our company or their relatives; winners of automobiles or first prizes in any of our previous offers, or their relatives. Send your answer TODAY.

B. A. BLACK, Advertising Manager
 Room 360, 504 N. Dearborn St., Chicago

Think of it! Genuine UNDERWOOD

Yours for 10 Days TRIAL

Yes—this world-famous Underwood is yours for full 10 days. See for yourself the *real bargain* it is. See how beautiful and new it looks—compare its neat, perfect work—without obligation.



Buy Direct at Below 1/2 Mfg's Original Price

Now **\$1** Only



My unchallenged direct sale price and easy terms on this genuine Underwood refinished No. 4 is the lowest ever offered. While they last—less than half (1/2) the manufacturer's original price—and easy terms besides. Do not confuse this genuine late model Underwood with inferior or frail machines worth only one-half as much. This is the full sized standard Underwood with 4-row keyboard and late improvements, manufactured to sell originally for \$100. **Fully Guaranteed** in writing.

on Easy Terms

Easy Terms—Only 10c a Day

Think of it—a genuine late model Underwood reduced to \$39.90 (Cash). A saving of over \$60 by acting now. Send only \$1 deposit for a 10-day Trial. Then only 10c a day on my easy year-to-pay plan. And you use and enjoy your typewriter all the time. This Underwood all rebuilt and refinished like new is without question the greatest value ever offered at this rock-bottom price. (See column to right for its many outstanding features and improvements.)



Limited Quantity—Send at Once!

This exceptional bargain offer is for a very limited time only. Remember, every typewriter is sent on 10-days' Trial and Fully Guaranteed.

International Typewriter Exchange,
231 West Monroe St., Chicago, Ill., Dept. 594.

Please send the Underwood No. 4 F.O.B. Chicago at the special reduced price for 10-day Trial. I am enclosing \$1.00 deposit with the understanding that if I am not perfectly satisfied I can return it Express Collect and get my deposit back. If I keep it I will pay \$3 a month until I have paid \$44.90 (term price) in full.

Name..... Age.....

Address.....

Town..... State.....

FREE Complete 9-Piece Office Supply Set and Typewriting Course

We teach you speed typewriting free. Complete Home Study Course of the Famous Van Sant Speed Typewriting System, fully illustrated, easily learned. We also give complete office supply set free during this sensational sale.

12 REASONS WHY this is the Greatest Value Ever Offered

1. **Genuine Underwood**
2. **Standard 4-row Keyboard**
3. **2-color Ribbon**
4. **Back Spacer**
5. **Ribbon Reverse**
6. **Tabulator**
7. **Automatic Release**
8. **Shift Lock**
9. **Lowest Price**
10. **Easiest Terms**
11. **10-Day Trial**
12. **Fully Guaranteed**

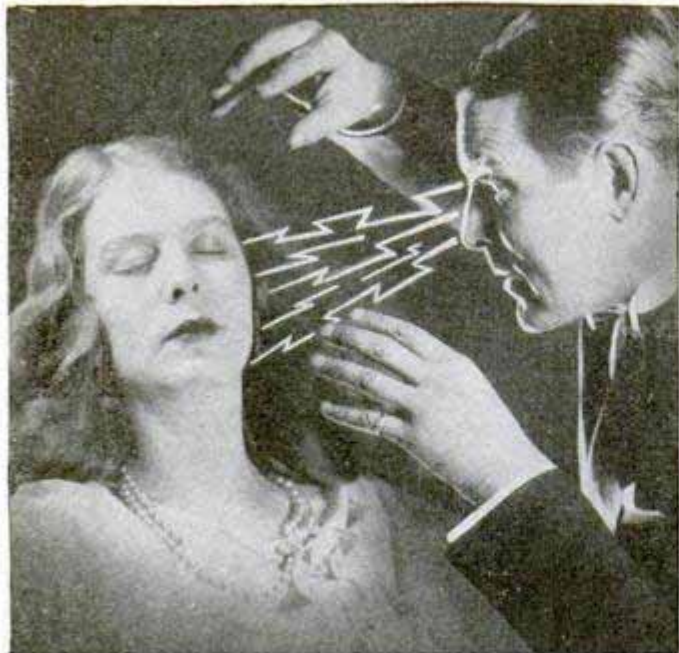

See How Easy You Can Learn HYPNOTISM TRY FREE 5 DAYS!

SEE for yourself how easy it is to master the great science of Hypnotism—how quickly you can learn to bend people to your will—banish fear, worry and opposition—increase your earnings—and force others to give you the recognition, power, and admiration you deserve. I'll show you how to use this great force to help you master every situation or **The Five Day Trial is FREE!**

In just a few hours I'll teach you the hidden secrets of Hypnotism—the methods used by the great operators—the amazing things you can accomplish once you understand this mighty power. You can use it to overcome obstacles, achieve your fondest ambitions and become MASTER of yourself, friends and acquaintances—either sex. Now you can quit being just one of the crowd—now you need not be unpopular, lonesome or unhappy a minute longer. Through this strange power you can learn how to stand out—dominate—to make your life what you want it to be!

In his startling NEW book, *The Science of Hypnotism*, the world famous hypnotist—Prof. L. E. Young—reveals the most carefully guarded secrets of this fascinating subject. He not only explains the methods of noted hypnotists, step by step—but tells clearly all about the nine stages of Hypnotism. The Hypnotic Mirror, Mental Telepathy, how to select your subjects, magnetic healing, methods of hypnotizing, how to wake the subject, how to make money out of hypnotism!

**Try 5 Days FREE—
Send No Money**

So confident are we that Prof. Young and his great book will quickly teach you the science of Hypnotism, that we will send you a copy without one cent in advance! Simply clip and mail the coupon below. When the book arrives pay the postman the special low price of \$2.50 plus few cents postage. Then test the powers of Hypnotism 5 days! If not amazed and delighted, return the book and money will be refunded at once.

FRANKLIN PUBLISHING CO.,
Dept. E-70, 800 No. Clark Street, Chicago, Illinois

Mysteries of Hypnotism Revealed

How to Hypnotize at a Glance
Susceptible Subjects
How to Hypnotize by Telephone
How to Give an Entertainment
How to Make Others Obey You
Overcoming Bad Habits
How to Do Dozens of Hypnotic Feats
Use of Hypnotism in Operations

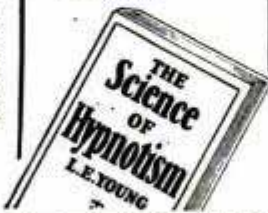

Franklin Pub. Co., Dept. E-70,
800 No. Clark St., Chicago, Ill.

Please send me your amazing new book—*The Science of Hypnotism*—by Prof. Young. When book arrives, I'll pay the postman only \$2.50 plus postage. If I am not satisfied after 5 days' trial, I may return the book and you are to refund my money.

Name.....
Street and No.....
Town.....State.....

If you are likely to be out when postman calls, send \$2.50 with coupon and we'll pay delivery charges. Customers outside U. S. send cash with order.

Become a Trained Radio-Technician



RADIO INDUSTRY

Pleads For "Registered" Radio Experts



MICHAEL ERT,
President, Michael
Ert, Inc., and Past
Pres. Wis. Radio
Trade Assn. and
Pres. Federated
Radio Trade Assn.

Opportunity beckons as never before in the Radio Industry. Good paying positions, interesting work, a chance to become independent—radio offers all this and more to ambitious men who seize the opportunity NOW!

Radio Trade Association Approves S. of E. Radio Graduates

The Wisconsin Radio Trades Ass'n now compels every radio service man to pass severe examinations and become registered. Dealers are tired of untrained, incompetent help. Radio trade associations the country over are planning to follow Wisconsin's example. *The School of Engineering is the only institution in the country whose course is approved by a radio trade association.* Graduates of the S. of E. are "registered" without examination—14 S. of E. men successfully employed by R.C.A. Photophone, Inc.

Most Thorough Practical Radio Course in America

Here in this big splendidly equipped electrical school (from which Station WISN is operated) you can secure in three months the most thorough, the most compact and practical radio training offered anywhere. Covers entire field of radio! Complete course includes Radio Laboratory Practice, Radio Telephony Theory, Radio Transmission, Code Instruction, Electrical Mathematics, Service and Installation, Radio Sales and Merchandising. Daily broadcasting from WISN. All training is 100% practical. You learn everything in three short months!



TELEVISION INCLUDED

Complete Radio Course also includes study of fundamentals of Television and latest developments in that gigantic new field. Enables anyone to keep up with progress of this new industry.

EARN WHILE YOU LEARN

Not only do we help place our men after graduation, but we can help arrange for part-time employment for ambitious men who can finance their tuition. This will cover part if not all of your living expenses while you are taking the Radio Course at the School of Engineering.

SEND FOR FREE BOOK

Send today without obligation, for FREE catalog describing the wonderful opportunities in radio, the three month Radio Course, and details of our Earn While You Learn Plan.

SCHOOL of ENGINEERING of Milwaukee

School of Engineering
Milwaukee, Wis.

Dept. P. M. 530

Without obligation, please send me FREE Book describing your 3 months Radio-technician course and full details of your "Earn While You Learn Plan."

Name.....

Address.....

City.....State.....

Oil Heat Revolutionized

NEW LACO MODEL "F"

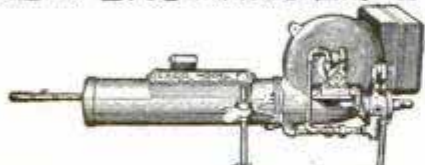

Burns HEAVY OILS

WONDERFUL INVENTION BURNS OIL NEW WAY!

Oil Heat Cut to Fraction of Present Prices

Now—after a hard winter—lifting heavy, dirty coal—chopping wood—turn your thoughts to NEXT Fall and Winter. DECIDE NOW to free yourself from drudgery! The LACO—the Ford of the Oil Burners—will do it for you!

The LACO is the WORLD'S LOWEST PRICE OIL BURNER. Nothing like it. Burns AIR with oil to smash fuel costs. SAVES by burning ALL the oil—waste, soot, grease eliminated. Works on the NEW PATENTED MINERAL WICK PRINCIPLE—only the LACO offers this advantage.

The LACO
Mineral Wick
Automatic Burner



BURNS
DISTILLATE

Hot Water All Summer—Warm Homes Next Fall!



The LACO Junior

Get this amazingly ECONOMICAL Oil Burner and enjoy the convenience of CHEAP hot water for all the home needs this summer. Fits parlor stoves, room circulators also.

THE COOK STOVE BURNER gives you the convenience and clean heat equal to CITY GAS but at a MERE FRACTION OF THE COST. Something you never before dreamed possible. Safer than gas as you can leave it on indefinitely and nothing happens. Get our sensational prices and full information.

7 SIZES . . . LOW AS \$14

Fits any Furnace or Stove

A new heating system unnecessary. Installs easily in few minutes right into any hot-air, hot-water, steam or vapor-heat system—any range, stove, or parlor heater.

Install Now — Payments Later

The smallest down payment—easiest terms. Special proposition if you order now.

Get Full Information

The Laco complies with all ordinances. Lasts a lifetime. Automatic control of safety—safer than ordinary kitchen range. Quiet. A marvel of economy and heating efficiency.

Write Now for Unusual Low-Price Introductory Offer

Please state kind of heating plant you now have. Get our sensational offer now.

Dealers Wanted Quick

We want rated men in territory still open—but also the man who will invest a small amount in demonstrators, then go out and sell. The season is just beginning—the opportunity represents \$10,000 to \$50,000 a year. Write us now.

Heavy Oils Burned by the NEW LACO MODEL F

No matter where you live or the kind of oil available there is a LACO that will heat your home at a cost so low that it just doesn't pay to use coal any more. The new LACO MODEL F ATOMIZING BURNER burns the heavy oils—any grade of fuel oil up to kerosene that is above 28 gravity on Medium Continent Oil or 24 West Coast Diesel Oil. Heats any size building or home. Deluxe model gives DOUBLE CONTROL of heat. Telechron Time Motor—no clock to wind—can be set so heat increases or decreases automatically to whatever temperature you want during the various times of the day or night. Safety absolutely controlled—ignition cut-off works on as little as two seconds fire lagging. Noiseless. Economical. Write for low introductory price.

Laco Oil Burner Co., 131 Union Street, Griswold, Iowa

LEARN Electricity This New Practical Way

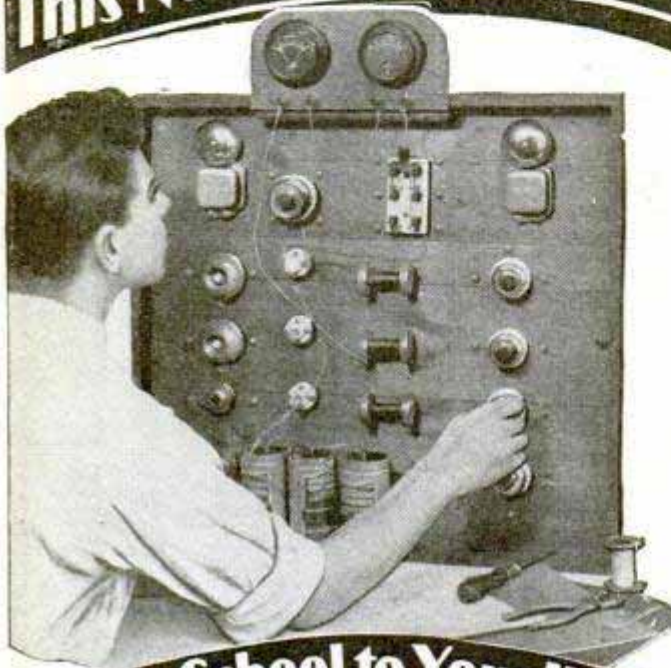

Brings School to Your Home

Patented new Unit-Board System brings full-sized electrical equipment right into your home. Enables you to "learn by doing." Now you can train at home for all electrical fields under supervision of the engineers of America's great Electrical School. Fascinating—Easy—Practical. Nothing else like it.

Train Under Skilled Engineers for Opportunity and Big Earnings!

Splendid opportunities await you in Radio, Television, Talking Movies, Power, Lighting, Automotives, and Aviation. Electrically-trained men earn \$3,000 to \$10,000 a year in these new, fast-growing fields. Tremendous demand for men with practical ELECTRICAL TRAINING. Through our exclusive Home-Shop Laboratory Plan you get same training, same methods, same faculty that have made School of Engineering world-famous. Not a mere correspondence school but great Electrical College, recognized by leading manufacturers, with graduates holding important electrical posts all over the world.

FREE! SEND COUPON for 48-Page Book

Write today for FREE illustrated 48-page book giving full details of how you can train at home for Electricity by the wonderful new Home-Shop Laboratory Method. No obligations. Please mention age when you write.

Dept. 38, Extension Division



SCHOOL of ENGINEERING of Milwaukee

EXTENSION DIVISION, Dept. 38,
163 East Wells Street, Milwaukee, Wisconsin.

Please send me without obligation FREE 48-page Illustrated Book showing how I can train at home for Electricity by your wonderful new Home-Shop Laboratory Method. Also full details of your "Earn While You Learn" Plan.

Name.....

Address.....

Age.....



Men Past 40! Don't Wait for This Gland to Ruin Your Health

Are you still up to your old ability and ambition, or are you starting to slip—the victim of uneasy pains—soreness in back, legs and feet—sleepless, because of constant night rising? See how thousands are repelling the cause of these painful symptoms—the insidious gland disorder that attacks two-thirds of men past middle age according to scientific authority.

THOUSANDS of men today are suffering from an unsuspected and insidious gland weakness. Thousands of them, victimized by pains and soreness in back and leg muscles—by mental depression, "blues" and loss of memory—by loss of physical resistance and endurance, think that they suffer the pangs of premature old age. Others made sleepless by nightly risings—as many as three up to twenty times in a night—think they suffer from "bladder trouble."

Yet today other thousands, who once suffered the same agonizing, debilitating symptoms, know the real reason for their former sufferings. They have learned the sensational story of the tiny prostate gland which so often victimizes men in or past-middle age. They also know the equally sensational facts about a new drugless, non-surgical method which brings the aid of science to the relief of these pains and annoyances.

Certain eminent doctors say that this tiny gland, the prostate, is swollen and inflamed in two out of three men past a certain middle age. For years dangerous gland surgery seemed to be the only way to treat the swollen gland. But today an amazing method—an easy, scientific use of a great natural health-force, which any man can use right in his own home, is in thousands of cases relieving men of their pains and re-activating this gland to proper functioning.

Find out today how this tiny gland, which causes so much misery to older men, can be relieved. An amazing new book, "The Destroyer of Male Health," just off the press, is now being given free to men of middle age who send for it. No obligation. Send for this book today and get these vital facts. The coupon will bring it.

FREE BOOK!

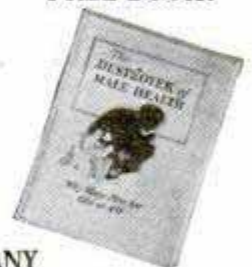

THE ELECTRO THERMAL COMPANY
2129 Morris Avenue, Steubenville, Ohio
Western Address: Dept. 21-F, 303 Van Nuys Building, Los Angeles, California

THE ELECTRO THERMAL COMPANY,
2129 Morris Ave., Steubenville, Ohio.
Western Address: Dept. 21-F, 303 Van Nuys Bldg.,
Los Angeles, Calif.

Without obligation to me, please send me your sensational! FREE book "The Destroyer of Male Health," and details of the new treatment.

Name.....

Address.....

City..... State.....

Young Men

your future depends upon your training

You, who receive instruction now, will be the ones piloting ships, building, repairing and testing them a few months hence—providing you receive the proper training. In no other industry is thorough and practical training so essential as in aviation. The School of Von Hoffmann will give you this training. For years this pioneer school of the air has been constantly alert to the necessity of keeping abreast of the rapid advancements in this great industry. Vision and foresight has kept Von Hoffmann's a great school with a single purpose—to make each individual graduate the finest type of pilot or mechanic.

Graduates of the School of Von Hoffmann succeed in aviation because the courses go beyond the Government requirements, and employers know that they have been thoroughly and practically trained for immediate positions. We feel that this is necessary if our students are to maintain the high standards for which Von Hoffmann graduates are noted. That is the reason Von Hoffmann graduates are filling responsible positions throughout the industry—are making good. Our courses cover actual flying, theoretical instruction, aero navigation, airplane instruments and practical shop training in airplane structure and repair of various type planes—motor construction, adjustment and repair of different type motors including both water and air cooled. A Government rated school located on a \$2,000,000 airport—comfortable quarters at the school and plenty of activity. Let us tell you about our liberal time payment plan. Send today for our new illustrated catalog. Make your start in aviation—mail the coupon NOW!

VON HOFFMANN AIRCRAFT SCHOOL

U. S. Gov't Approved School for Transport
Limited Commercial Private Pilot, Ground & Flying

129 Lambert — St. Louis Airport, ST. LOUIS, MISSOURI



Instruction is given on a variety of late types of Government Licensed modern aircraft, open and cabin types. Each instructor has been rigidly examined and licensed by the Department of Commerce as an instructor—which means that he not only has the knowledge, but the ability to impart it—to instruct students in conformity with Government License regulations. Every flight instructor is a transport pilot with two to five thousand hours in the air, and enjoys a wide reputation as a thorough instructor, an efficient pilot, and a safe flyer.

VON HOFFMANN AIRCRAFT SCHOOL,
129 Lambert—St. Louis Airport,
St. Louis, Mo.

Please mail FREE information at once.

Name.....

Address.....

City..... State.....

Age..... I am interested in

- Flying Course
- Mechanics Course
- Welding Course
- Home Study

FREE BOOK CATALOG

Send today, without obligation, for our new 72 page catalog, describing books on more than one hundred and fifty practical and scientific subjects, including books on Aviation, Automobiles, Air Brakes, Alloys, Electricity, Horology, Heating, Hydraulics, Model Making, Metallurgy, Radio, Ship Models, Soaps, Perfumes, Recipes, Plumbing, Inventions, Tanning, Television, etc.
Norman V. Henley Publishing Co., Dept. 54, 2 W. 45th St., New York, N.Y.

Wrestling Book FREE

Learn to be an expert wrestler. Know scientific wrestling, self-defense, and jiu-jitsu. Develop a splendid physique, and have perfect health. Join this popular school and learn by mail. The famous world's champions—the marvelous **Frank Gotch and Farmer Burns** offer you a wonderful opportunity. Wrestling is easily and quickly learned at home by mail. Men and boys write now for splendid free book. Learn all the science and tricks. Be able to handle big men with ease. Accept this wonderful offer NOW. Send for free book today, stating your age.
Farmer Burns School of Wrestling, 3375 Range Bldg., Omaha, Neb.

Big Profits Charging Batteries

5 Down!
Starts You. Let me show you how to make big money in the battery charging business. I've prepared a free book explaining all details. My charger is years ahead of ordinary chargers—will handle 50 per cent more batteries. Get into a business of your own with a very small investment. Write for my book today.
C. F. Holmes, Chief Engineer
INDEPENDENT ELECTRIC WORKS
Dept. P. M., 4912 North Clark St., Chicago
Write for FREE BOOK

SOLVES PRACTICAL PROBLEMS QUICK!

EASY SHOP MATHEMATICS —

Strength of Materials—Applied Mechanics

3 BOOKS IN ONE!

Answers Given!

A new and different textbook covering three highly important subjects in a concise, yet thorough and practical manner. The 45 years' experience in instructing well qualified the author, Frederic W. Dobe, Consulting Engineer of national note, for the task.

375 Working Diagrams

Only practical problems have been used and these are worked out to completion and correct answer given for checking. Wherever necessary problems are illustrated by diagrams. For ambitious students, draftsmen and practical shop men, this book will be found an invaluable aid to advancement. Enthusiastically endorsed by engineers and educators.

Size, 5 1/2 x 8 1/2 inches; 183 pages; 375 illustrations; Full Cloth Binding; Price \$2.50.

Your regular bookseller can supply you. If ordered direct, add 15c for postage and packing.
Dobe Engineering Service, 1953 Lawrence Avenue, Chicago.

DRAW CARTOONS

Cartoonists earn from \$50 to \$250 per week—some even more. Remarkable *Circle System of Drawing* teaches you in half the usual time. Students from all parts of the world are enrolling for this exceptional instruction. *Personal criticism* service and up-to-the-minute instruction make it easy for National students to attain success. Send for interesting **BOOKLET** and **SAMPLE LESSON PLATE** explaining full details of the Course and what National students are accomplishing. No salesman will call.

The National School of Cartooning, 623 Penton Bldg., Cleveland, Ohio

TURN YOUR TALENT INTO MONEY



FREE!

Body Chart

If you will mail the coupon below, this Anatomical and Physiological Chart will be mailed to you without one cent of expense. It shows the location of the Organs, Bones of the Body, Muscles of the Body, Head and Vertebra Column and tells you how the nerves radiate from your spinal cord to all organs of the body. This chart should be in every home.

Where Is That PAIN?

It may be in the neck, back, hips, stomach, liver, legs or arms. Wherever it is, the chart will help to show you the location and cause of your ailment. For instance, this chart will help you locate verminiform appendix pains. Hundreds of lives might have been saved if people had known the location and character of the pain and had received proper attention.

Stop that Pain

By Relieving the Cause with

**Violet Ray - Vibration
Ozone - Medical Electricity**

The Four Greatest Curative Powers Generated by This

Great New Invention!



Elco Health Generators at last are ready for you! If you want more health—greater power to enjoy the pleasures and delights about you, or if more beauty is your desire—write! Ask for the book on these inventions which has just been prepared. It will be sent to you without cost. It tells you how Elco Health Generators aid you in leaving the lethargy and hopelessness of bad health and weakness behind forever. Re-vitalise yourself. Bring back energy. Be wholly alive. Write today!

Here's What Elco Users Say—

"Wouldn't take \$1000 for my Elco."
"Has done me more good in 2 weeks than doctors did in three years."
"Cured my Rheumatism."
"Cured my stomach trouble."
"Cured my weakness."
"Now I sleep soundly all night."
"Thanks to Elco my strength and vigor are back."
"No more pain."
"Colds never bother me now."
"Chronic Constipation banished."



These great new inventions generate Violet Ray, Vibration, Electricity and Ozone—combined or separate. They operate on the electric light in your home or on their own motive power at less than 50 cents per year. Elco Health Generators are positively the only instruments which can give you in one outfit Electricity, Violet Ray—Vibration and Ozone—the four greatest curative agents. Send the coupon below. Get the Free Book NOW!

MAIL COUPON for FREE BOOK

Do not put this paper down without sending the coupon. Don't go on as you are with pains and with almost no life and energy. You owe it to yourself to be a better man or woman. You were put here to enjoy life—not just to drag through it. So do not rest another day until you have put your name on the coupon here. That will bring the whole story of these great new inventions. Do it today—now.



Lindstrom & Co. [Makers of Therapeutic Apparatus since 1892.]
2322 Indiana Avenue Dept. 13-55 Chicago
Please send me your free book, "Health—Power—Beauty" and full information of your 10-day Free Trial Offer.

Name.....
Address.....

AUTO REPAIRMEN EARN GREATER PROFITS

Get your share of the big money being spent on automobile upkeep.

Put improved time, labor and money-saving ideas to work in your shop to-day.

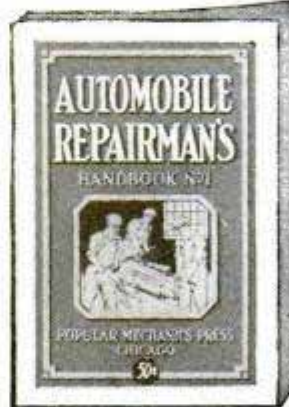

Take advantage of our special bargain offer and secure 3 valuable kink books at a reduced price.

1. 334 Valuable Discoveries made by auto mechanics in our **Automobile Repairman's Handbook**. 337 Illustrations.

2. 301 Ways to use drills, drill presses, taps and dies more effectively in our **Drilling and Thread Cutting Handbook**. 298 Illustrations.

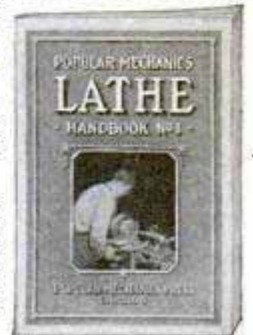

3. 259 Kinks furnished by the most expert Lathe Operators in our **Lathe Handbook**. 212 Illustrations.

Special Offer—These 3 books (regular price 50 cents each, \$1.50 value) are offered for a limited time for only 98 cents plus postage. Pay postman C. O. D. when he delivers or if outside U. S. send 98 cents and 15 cents extra for postage.

POPULAR MECHANICS PRESS

Room P 5

200 E. Ontario St.

CHICAGO

Don't Be Afraid To Tackle That Concrete Job!

With the instructions found in the new, revised edition of Popular Mechanics Concrete Handbook you can make any of the following useful articles:



Garden Seats—Fountain and Basin—Flower Boxes and Vases—Pedestals and Bird Baths—Ornamental Pools—Sanitary Drinking Fountain—Gateposts—Auto Driveway—Sidewalks—Boat Landings and Docks—Entrance and Garden Walks—Sidewalk Flaggings—Narrow Curb Walks—Curbs and Gutters—Wall Coping—Steps—Garage Floor—Basement Floor—Fence Posts—Lawn Roller—Cistern—Chimney Cap—Refuse Burner—Culvert—Benches for Greenhouses—Tile—Retaining Walls—Foundation Supports—Engine Foundations—Septic Tank—Toy Blocks—Forge—Fireproof Safe—Ice House—Watering Troughs—Milk House—Smokehouse—Silo—Horse Stalls—Hitching Post—Rural Mail Box Post—Cyclone Cellar.

Build With Ease for Permanence and Beauty

This is a book of practical plans for using concrete about the home, farm or shop. For amateurs as well as contractors. In addition to making all the articles mentioned above the making of good concrete mixtures for various classes of construction is given; mechanical mixers and homemade tools are dealt with. All necessary form and mold making are covered as well as many other valuable pointers too numerous to mention here.

Simply write and ask us to send you this book. When postman hands you the package pay him \$1.00 plus the postage. If outside U. S. remit when ordering and include 15 cents extra for mailing.

POPULAR MECHANICS PRESS
Room P5 200 E. Ontario Street CHICAGO

**LEARN
AT
HOME**

HOW TO REPAIR RADIO SETS IN YOUR NEIGHBORHOOD

Many make \$10 to \$30 a week in spare time



Get some of the easy money for yourself that people pay for making their sets work right. Every neighborhood needs several men who can be depended on to repair all makes of sets. It's easy to pick up \$200 to \$1,000 a year in spare time. I'll show you how to do the jobs and how to get them. My course thoroughly covers repairing, building and installing sets.

**Radio also needs full time men
Many make \$50 to \$100 a week**

Broadcasting Stations use engineers, operators, station managers and pay \$1,800 to \$5,000 a year. Manufacturers employ testers, inspectors, foremen, engineers, service men, buyers and managers and pay up to \$15,000 a year. Shipping Companies use hundreds of operators, give them world wide travel with living expenses included and \$85 to \$200 a month besides. Radio Dealers and Jobbers (there are over 35,000) are continually on the lookout for good service men, salesmen, buyers, managers and pay \$30 to \$100 a week for good men. Talking Movies pay as much as \$75 to \$200 a week to men with Radio training. My book tells about other opportunities.

**I will train you inexpensively
at home in your spare time**

Hold your job. Give me part of your spare time. You don't even have to be a high school or college graduate. Many of my most successful graduates, now making two,

three and four times what they were getting before, didn't even finish grade school. No previous training or experience necessary. My 50-50 method—half from lessons and half from home laboratory experiments makes learning at home fascinating, easy.

Money back if not satisfied

I will refund your money if you are not satisfied with my Lesson Texts and Instruction Service when you have finished my course. Write for "Rich Rewards in Radio." It tells you about the opportunities to make money in your spare time and also about the good jobs that are opening in Radio every year. After you have read it, you can decide one way or another. Find out what Radio offers you. Do it TODAY.

**J. E. SMITH, Pres., Dept. OEPP
National Radio Institute
Washington, D. C.**

**I give you extensive
practical Radio experience
with my home experimental
laboratory**

My 8 Outfits of Radio parts, given without extra charge, show you from actual experience how different makes of sets work, why they work, how to make them work when they are out of order. You get as much practical knowledge in a few months as the average man in the field gets in two to four years. You learn the working principles of and experiment with the circuits used in Atwater-Kent, Crosley, Stewart-Warner, Philco, Radiola and practically every well known set on the market today.

MAIL THIS 64 PAGE BOOK OF FACTS FREE

**J. E. SMITH, Pres., Dept. OEPP
National Radio Institute
Washington, D. C.**

Dear Mr. Smith:—Send me your book "Rich Rewards in Radio." I understand this request does not obligate me in the least and that no representative will call on me.

Name.....
Address.....
City.....State.....

LIFETIME EMPLOYMENT SERVICE TO GRADUATES INTERESTED IN FULL TIME JOBS



1,000 Hotel Positions Open!

HOTELS, restaurants, clubs, apartment hotels, hospitals, institutions, schools and colleges everywhere need trained men. Over 70,000 high-class positions as Manager, Assistant Manager, Steward, Room Clerk, Sports Director and scores of other executive positions paying \$2,500 to \$10,000 a year open annually in the hotels of the United States. Nearly one and three quarter billions of dollars' worth of NEW HOTELS, CLUBS AND INSTITUTIONS being built this year will need over 200,000 trained men and women. Hotels start you at salaries up to \$3,500 a year with living usually included. At any time there are over 1,000 hotel positions open.

Previous Experience Unnecessary

You can have one of these fascinating, big-pay positions. Through our Simplified Home Study Plan we quickly qualify you for a well-paid position. Age is no obstacle—young and old alike have equal chance for success. A common school education is all you need. All of your training under the personal supervision of Clifford Lewis, who has been appointed Managing Consultant by over 300 hotels throughout the United States. Send coupon today for Free Book, "YOUR BIG OPPORTUNITY," explaining our Money-Back Agreement and showing how we can train you for one of these splendid positions.

FREE BOOK COUPON

**LEWIS HOTEL TRAINING SCHOOLS,
Room CG-385, Washington, D. C.**

Send me without obligation the Free Book, "Your Big Opportunity."

Name.....
Address.....
City.....State.....



There's Quicker, Bigger MONEY for YOU—in POULTRY

**Earn \$2,000 to \$5,000 a Year or
Have a Business of Your Own!**



Whether you want a job at good pay or a highly profitable business of your own—the Poultry Industry offers you more than any other. There's a shortage of poultry meat and eggs—a shortage of trained poultrymen. I'll train you quickly at home—to fill a good job in Poultry—and our FREE Students' Employment Dept. will help you get one!

**Spare Time or Full Time
YOU Can Cash-in BIG**

No matter where you live—city, town or country—or what you do now, my proved methods will assure your success right from the start. I'll help you make from \$2,000 to \$5,000 a year and UP! And, if you choose to start your own business, I'll show you how to make your tiny investment multiply itself automatically. What I've done for thousands of others—I can do for you.

**FREE Book Shows Way to
Big Pay and BIG Profits**

Mail coupon below TODAY—for my Big NEW FREE Book, "How to Raise Poultry for Profit." My forty years of experience are yours. The Poultry Industry needs YOU. You need my book. Get it—and get in line for the BIG Money that's waiting for you in POULTRY.

Mail NOW for FREE Book

**NATIONAL POULTRY INSTITUTE, Dept. 411-K
Washington, D. C., Att'n: Harry M. Lamon, Pres.**

Dear Mr. Lamon: Send me your FREE Book, "How to Raise Poultry for Profit." I want to know more about my opportunity to make \$2,000 to \$5,000 a year, spare or full time.

Name.....
Address.....

Get a Grip of - - S T E E L



Send Only 25c for My Double Strength Krusher Grip

INCREASE the size and strength of your arm without further delay. A strong grip is the barometer of your personality. With each KRUSHER GRIP I will give

FREE

a beautiful illustrated booklet filled with handsome pictures. It tells you how you can possess a manly figure packed with energy and power. How to put inches on your chest, neck, arms, and legs and get a body as shapely as Sandow.

Fill in the coupon, mail it with 25c and get this **FREE BOOKLET** and my Double Strength **KRUSHER GRIP**—the finest thing you've ever seen for building up the hands, wrists and forearms.

This **KRUSHER GRIP** can give you a grip of steel. I guarantee it. Your money back if it fails.

THE JOWETT INSTITUTE OF PHYSICAL CULTURE

422 Poplar St.

Scranton, Pa.

Dear Mr. Jowett: 4E
Enclosed is 25 cents for your double strength Krusher Grip, with which I am to receive your illustrated booklet **FREE**.

Name.....
Address.....
.....

BE A MOTION PICTURE OPERATOR
LEARN TALKING EQUIPMENT
THRILLING WORK **BIG PAY**

Make big money in this easy and pleasant work. Big demand for trained operators. Write Today!
MOTION PICTURE OPERATORS SCHOOL
61 Sproat St. Detroit, Mich.

SQUAB BOOK FREE

Breed PR squabs for rich trade. Sold by millions at higher prices than chickens. Write for free 48-p. book telling how to do it and how to profit by new sales method which gets the big money.
PLYMOUTH ROCK SQUAB CO., 634 H Street, Melrose Highlands, Mass.

RAISE CHINCHILLA
AND NEW ZEALAND WHITE
FUR RABBITS Make Big Money
We Supply Stock and pay you following prices for all you raise:
Chinchillas average \$3 each—New Zealand Whites \$2 each. 32-page illustrated book, catalog and contract, also copy of Fur Farming magazine, tells how to raise rabbits for big profits, all for 10c. Address
OUTDOOR ENTERPRISE CO., Box 1021 Holmes Park, Missouri

MAKE MONEY RAISING SQUABS
Highest market ever known. Breeders shipped everywhere. Homers, Carneaux, White Kings a specialty. All other breeds. Send 10 cts for 32 page catalog and price list.
Allston Squab Co. 61 N. Beacon Street ALLSTON, MASS.

RAISE PIGEONS AND RABBITS For Pleasure and Profit
OUR FREE BOOKLET TELLS YOU HOW.
Over 20 varieties of Pigeons. Also Bantams.
W. V. MOORE, Box A, STERLING, ILL.

Information on any book free. Write Popular Mechanics Press, Chicago, Ill.

DRAFTING
BOOKS SENT FREE!

Only fifteen minutes a day with these **WONDER BOOKS** will prepare you for a good Drafting job in less than a year! Mechanical and Architectural Drafting from simple straight lines to important, complex plans, a step at a time! Built especially for beginners, for men with only grammar schooling. Drafting room practice plus engineering made easy and clear!

Big Field—Big Demand—Big Pay!

Competent Draftsmen are urgently needed right now in all building and manufacturing lines at \$50 to \$100 a week. That's just the beginning—for draftsmen have the best chance for advancement! Pleasant, fascinating work, easy to learn and do. Learn quick with these books—send coupon for a set **FREE**, and see for yourself!

A year's Consulting Membership in the American Technical Society now given free to all readers of this famous Cyclo-pedia of Drafting. Many say that's worth more than cost of books.

American Technical Society
Dept. D-519, 58th & Drexel Ave., Chicago

FREE If you send for these great Drafting Books NOW we will include without cost a complete volume "Blueprint Reading" containing 120 pages durably bound in cloth and also a complete portfolio of 58 plates covering the basic orders of architecture. These plates are drawn to scale and are very valuable.

American Technical Society
Dept. D-519, 58th & Drexel Ave., Chicago
Send for 10 days' free use 4-volume set of **DRAFTING**. In return for mailing this coupon promptly send absolutely **FREE** "Blueprint Reading" (Building) 120 pages, 69 illustrations, also a complete portfolio of 58 plates. I will pay the few cents delivery charges. If I wish I may return books in 10 days and owe you nothing. But if I prefer to keep them I will send \$1.50 after 10 days, then \$2.00 a month until \$14.50 (special reduced price) is paid.

Name.....
Address.....
Employed by.....
Address.....

**There's Big Money
for You in
RADIO
Television — Talking Movies**

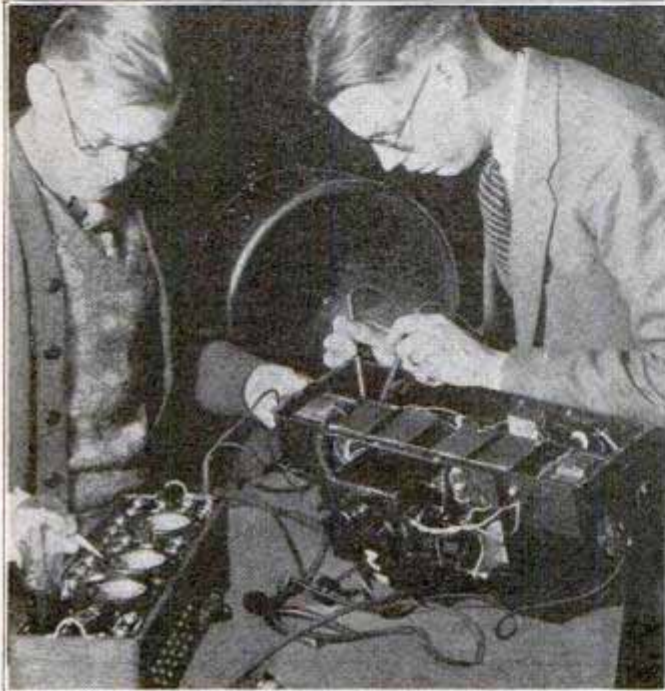

**Leading Radio Engineers
Train You at Home**

to quickly enter these fields where real opportunities await you. Thousands of radio trained men are needed by Broadcasting Stations, Radio manufacturers, Radio distributors, Radio dealers, Talking Movie Companies, Aviation Concerns and shipping companies. Salaries range from \$1800 to \$10,000 a year and more. Also splendid opportunities to go into profitable radio business for yourself. Be your own boss. Hundreds of School of Engineering graduates now hold important positions in leading radio and talking movie companies.

Complete Outfit Given

Full-sized equipment right in your home enables you to get practical training. You learn how to become a radio expert under the supervision of the radio engineers of the famous School of Engineering of Milwaukee from which station WISN and Amateur Station W9SO are operated. Training covers every branch of Radio including Television and Talking Movies.

Get the FREE Facts

Mail coupon below today for full FREE particulars of the Extension Division, "Radio Training" with special Home Laboratory. Full information as to how you can train for BIG EARNINGS in RADIO, TELEVISION and TALKING MOVIES. No obligations. Please mention age.

Extension Division, School of Engineering

163 E. Wells St., Dept. 39, Milwaukee, Wis.

Extension Division, School of Engineering,
163 E. Wells St., Dept. 39, Milwaukee, Wis.
Please send me, without obligation, FREE particulars of the Extension Division "Radio Training," including complete Home Laboratory.

Name.....Age.....

Address.....

Dentists Need Men

Pay Up to
\$125 a Week



**Make Crowns, Plates,
Bridgework, etc., for Dentists!**

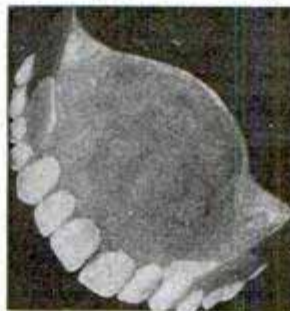

Learn by doing actual dental jobs, with tools and materials. No books to study. All instruction is private.

**Jobs for Students
While Learning**

Work your way thru school. We help you get a job so that you can earn your expenses and part of tuition. R. R. fare allowed to our nearest school.

FREE BOOK

tells about this fascinating profession and the success of our graduates. Send coupon today.

Learn Mechanical Dentistry in a few months of practical training in one of our finely equipped schools. Qualify for a big pay job or a dental laboratory and earn up to \$10,000 a year.

**Endorsed by
Dentists
and Laboratories**

We have hundreds of letters from dentists and from laboratory owners praising work of our graduates, and endorsing the thorough training we give. After taking the impressions, dentists usually send cases to trained laboratory men to make the plates, crowns, bridgework, etc., and pay good prices. Nearly 70,000 dentists in U. S. & Canada offer uncrowded field for McCarrie Graduates.

**McCarrie School of Mechanical Dentistry
1338 S. Michigan Ave., Dept. 392, Chicago, Ill.**

McCARRIE SCHOOL OF MECHANICAL DENTISTRY
1338 S. Michigan Ave., Dept. 392, Chicago.

Without cost or obligation, send me your illustrated book on Mechanical Dentistry, and complete information as to my opportunities in dental laboratory work.

Name.....

Address.....



DOUBLE the earning power of your two hands by learning DRAFTING

While you're looking around for a line of work that pays better—that offers a real future—why not at the same time—

—consider a line like Drafting—where the work is interesting and pleasant—where your associates are the kind of real fellows you'll be proud to know—where positions are plentiful—where you'll have a chance to get experience that will lead to positions as Superintendent—Engineer—Contractor?

It won't take you any longer to learn Drafting than to operate an intricate machine.

—but the Draftsman's pay is 50% higher to double that of the expert mechanic.

—simply because men who can create plans of buildings and machinery are doing a higher paid kind of work than the workmen who follow the blue-print—because in Drafting they build things "on paper"—figure costs, estimate materials—

A Good Job when you're half way through the Course

Ten BILLION Dollars is to be spent in new building construction—two BILLIONS for new electrical projects—BILLIONS more in manufacturing lines.

—that means thousands of new Drafting positions that have to be filled—so if you'll get ready we'll be glad to help you to a satisfactory position and salary when you finish.

But you don't have to wait until you finish to cash-in—we'll help you get a good job when you're only half way through—

Student Starts at \$140 a month

Arthur F. Saxon—formerly a clerk—only half way through his course writes concerning position we helped him get: "Am entering service of Blaw-Knox Co. at \$140 a month—certainly consider the cost of the course the best investment I ever made."



**Mail
Coupon
for
FREE
Drafting
Book**

THE AMERICAN SCHOOL
Dept. D-547—Drexel Ave. and 58th St.,
Chicago.

Without cost or obligation send me 36-page
Drafting Book, and tell me about your com-
bined training and employment service.

Name.....

Address.....

BUILT-IN FURNITURE

Adds Beauty and Convenience to Your Home



With the plans and directions given in this new book by Edwin M. Love any handy man will be able to build the various pieces of popular space-saving furniture.

These useful and ornamental cabinets are easily added to an old house and many are designed to be built into odd nooks and recesses.

The construction is very simple as the walls offer support and no structural alteration of either floors or walls is necessary.

Stock sizes of material are specified in each instance. The home owner will be able to alter designs if necessary to suit available space.

That practically every adaptation of built-in furniture is covered by this book is shown by the following list of contents.

General Details of Construction—Portable Buffet—Recess Buffet—Corner China Closets—Clothes Closet Linen Cabinet—Furnishing a Clothes Closet—Bathroom Cabinet—Linen Closet—Mantel Shelves—Bookcases—Writing Desk—Seats—Indirect Lighting Fixtures—Sewing Cabinet—Corner Kitchen Cupboards—Breakfast Nook—Bathtubs—Laundry Porch Furnishings—Dining Table—Dressing Table—Radio Set—Phonograph—Safe—Shaving Cabinet—Cupboard and Drainboard Cabinet—Clothes Chute—Wood Box—Work Bench and Tool Cabinet—Mortise and Tenon and Dado Joints—Wood Dowels—Bending Small Moldings—Driving Nails and Screws—Care of Tools.

198 pages. Size 7x10 In. Fully illustrated. Price \$2.50 postpaid.

Popular Mechanics Press

Room P 5

200 E. Ontario St.

Chicago, Ill.

Outdoor Opportunities

How to raise rabbits, guinea pigs, milch goats, silver foxes, ferrets, white rats, white mice, dogs, cats, pigeons, pheasants, bantams, canaries, bees, frogs, mushrooms, gin-seng and golden seal for profit. Practical 250-page book with 120 illustrations. Will be sent C. O. D. When postman hands you the package, pay him \$2 plus the postage.

POPULAR MECHANICS PRESS

Room P 5

200 E. Ontario St.

CHICAGO

A NEW HOUSE WIRING MANUAL

PRACTICAL — PLAINLY WRITTEN

BY J. G. WOLBER AND O. K. ROSE

Cass Technical H. S., Detroit, Mich.

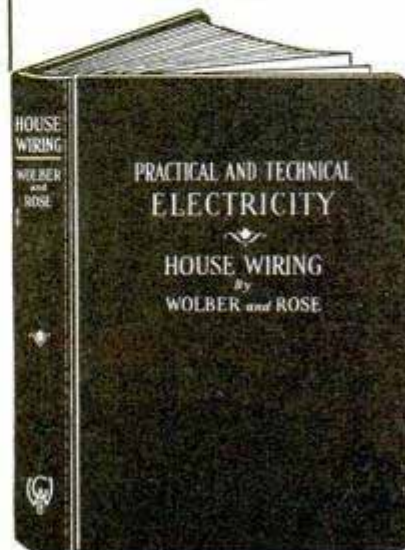

This book is the result of the author's fifteen years of industrial experience and of teaching. The material accumulated during this period of time has been worked over and over until in the author's opinion it was ready for publication.

320 Pages
662 Illustrations
Size 7 1/4 x 5 1/4 inches
Flexible Binding
Price \$2.50 Postpaid
Will be sent C. O. D. anywhere in U. S. or possessions.

**POPULAR
MECHANICS
PRESS**

Room P 5

200 E. Ontario
St., Chicago

POSTAL LIFE'S *Start-Off* Policy



Low-Priced and Within the Reach of Every One—

It Helps One Starting a Business

It Helps Starting His Profession

It Helps Starting Any Life Work

It Helps Starting a Home

The Policy creates a substantial estate AT ONCE for a small sum. One is thus enabled to get his affairs on a basis of successful production with adequate insurance protection and without strain.

Premium Rate for Age 30

\$10.76 per thousand if paid annually; \$0.99 per thousand if paid monthly.

These rates reduced by dividends, 9½ % of annual premium being guaranteed each year

Not a few facing the exigencies of life, the chances one has to run, feel the need of adequate life insurance—*more than they are now carrying*. This policy is provided for such. It is most appropriate—at the start of a career one has more to think of than himself. He needs the protecting arm of life insurance for his dependents—who is without them? When he "harvests his crop," when his "years of increase" have come, it then takes on a higher accumulative form with a higher premium, which he can then better afford.

The Postal Life is always concerned to do what is appropriate in thinking out insurance problems for its patrons. That's why it announces the Start-Off Policy for those who need this modified form.

Based on its experience of twenty-four years the advantages of the Postal Life's way of doing business and its economies are now being strikingly shown. Conditions in the Company that have contributed to low cost of insurance will continue to improve. Policyholders tell a very satisfying story and are increasing the Company's prestige everywhere. It operates under the strict requirements of New York State, and is subject to the United States postal authorities everywhere.

"Double Indemnity" covering Accidental Death and "Total and Permanent Disability" benefits are also furnished to Postal policyholders who can qualify for them, and at low rates of premium.

Illustration for one age 30—Amount \$1,000

An additional annual premium of \$1.25 will provide Double the amount of the Policy if death is caused by accident.

An additional annual premium of \$2.48 will provide a monthly income for you of \$10.00—if you become Permanently and Totally Disabled before age 60.

An additional annual premium of \$0.36 will provide for the Waiver of life insurance premiums during the period of disability. No deduction on account of Total and Permanent Disability will be made from the proceeds of the Policy, in any settlement. The above rate applies in connection with the Modified Whole Life policy for \$1,000 at age 30, as above.

9½ % Dividends GUARANTEED

and contingent dividends as earned

Call at the Company's office, write, or simply use the Coupon, and be sure to give

1. Your full name;
2. Your occupation;
3. Exact date of your birth.

Every standard form of Life and Endowment insurance is issued by this company, and information as to any of them will be gladly furnished. Your inquiry will receive prompt attention.

POSTAL LIFE INSURANCE CO.

WM. R. MALONE, President 511 Fifth Avenue, Corner 43rd Street, New York



PM-5-30

Postal Life Insurance Company
511 Fifth Avenue, New York

Without obligating me, please send full information on Start-Off Whole Life Policy.

Name.....

Address.....

Occupation.....

Exact date of birth.....

Amount.....



419



Suggesting a Conclave of the Ku Klux Klan; a Battery of Sound-Recording Motion-Picture Cameras, Hooded and Shielded to Keep Out Foreign Noises

Popular Mechanics Magazine

REGISTERED IN U. S. PATENT OFFICE

WRITTEN SO YOU CAN UNDERSTAND IT

Vol. 53

MAY, 1930

No. 5



Artist's Drawing of "Magnafilm," as Presented at the Pantheon Theater in Chicago; the Effect Is Produced by Magnifying Standard Thirty-Five Millimeter Film through Lenses in the Projector

By H. H. DUNN

San Diego, Calif. 4351 Esmeralda St.

LED by new masters into a soundproof world of their own invention, the making of motion pictures has entered upon one of the most radical changes it has experienced since the first "flicker films" were produced more than a quarter of a century ago.

New stages, scenery, cameras, microphones, lighting, new methods of directing, even new forms of acting—all have been devised within the last year to meet the exacting demands of sound and color reproduction, for the days of the "silent" drama are passed and the "rainbow-sound show" is upon us with giants filling the screen.

From the noisiest place on earth, the studios of Hollywood have become "cities of silent sound." The coatless director, waving his megaphone, is reduced to a speechless manikin, obeying the telephoned instructions of a young man in a soundproof glass cage up among the shadows of the studio roof. This young man—and there are scores of him moving unostentatiously around Hollywood—is the most astounding factor in the new making of motion pictures. Usually, he knows nothing about the stage, but he does know sound.

These young sound engineers sit in soundproof rooms, known as "iceboxes."

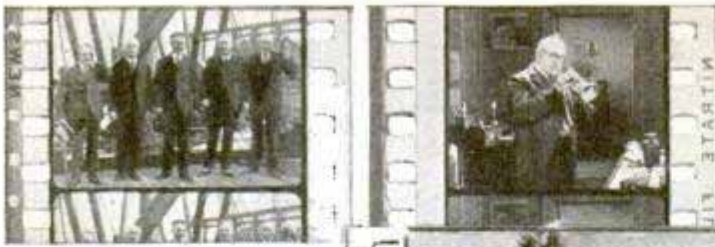

They look down on the stage, or on the open-air scene, if the company is on location, through a large window of triple plate glass. In front of this new master of the movies is the "mixing table," with a dozen small switches, by which he may modulate the voices, speed up the timing, eliminate anything he does not want in the completed sound track, or stop all sound from entering the recording instruments. On his head are delicate ear-phones, through which he hears, possibly a fraction of a second ahead of the microphone, all the sounds on stage or open lot. Before him is the mouthpiece of a telephone, direct-connected to headphones on the director's ears.

Nearly all the equipment which was considered newest and most perfect in the making of sound pictures a year ago has been discarded. Sound stages, larger than most theaters, virtually have replaced outdoor locations, except for the filming of aerial pictures. Built with padded floors,

dead walls, scenery which runs on ball bearings, these stages will hold an entire automobile race or give room for as much of a battle as can be shown on a film. Well ventilated, brilliantly illuminated so as to be independent of the sun, rain, darkness, wind or fog, scenes from the desert, mountains, ocean or the depths of the



Top to Bottom, Strips of Thirty-Five-Millimeter Film, with and without Sound Track, of Spoor Brothers' "Mammoth" Film and Fox "Grandeur"

earth are staged on them. They are the laboratories in which sound is wrought from silence.

But the greatest change has been wrought in the cameras. Six months ago, they were housed in portable soundproof boxes, with plate-glass fronts, through which the cameraman and his lens peered like a diver in a diving bell. Now, at costs ranging from \$4,000 to \$6,000 each, the studios are rebuilding their cameras into sound-insulated steel boxes operated by electric motors. The focusing gear, and the "bloop" button, whereby the cameraman marks off the places where the sound track should begin and end, also work in absolute silence.

It should be understood that the camera with which the picture film is made, does not make the sound film, better known as the "sound track." But on the picture film, at one side of the "frames" or images which go to make up the completed picture, is left a space, about one-eighth

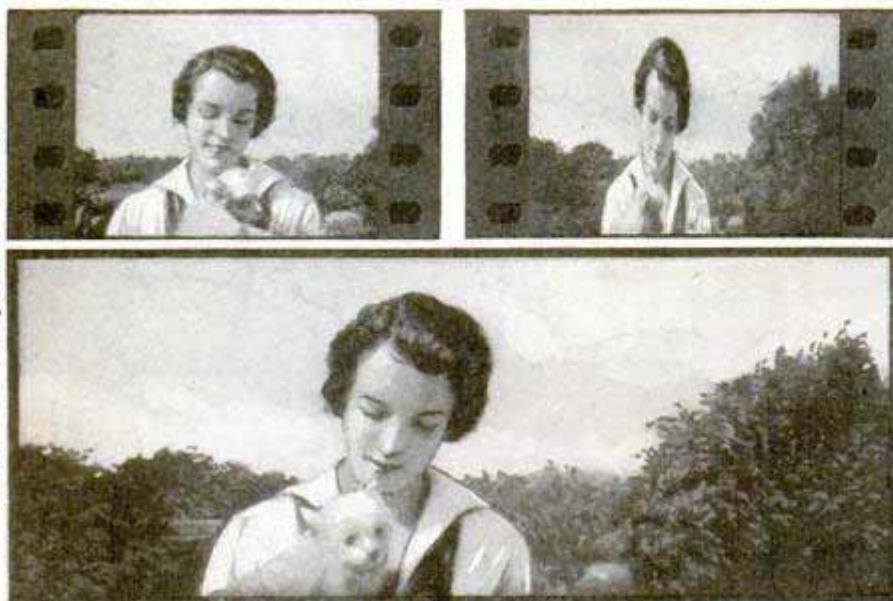

Above, Ordinary Film and Same Scene as Taken by "Panorama" Lens Showing Distortion; Below, the Distorted View "Ironed Out" in Projection

Mrs. Lewis J. Douglas, 375 Montgomery St. 278 Post St.
 San Francisco, Calif.

419

THE LATEST SOUND CAMERA

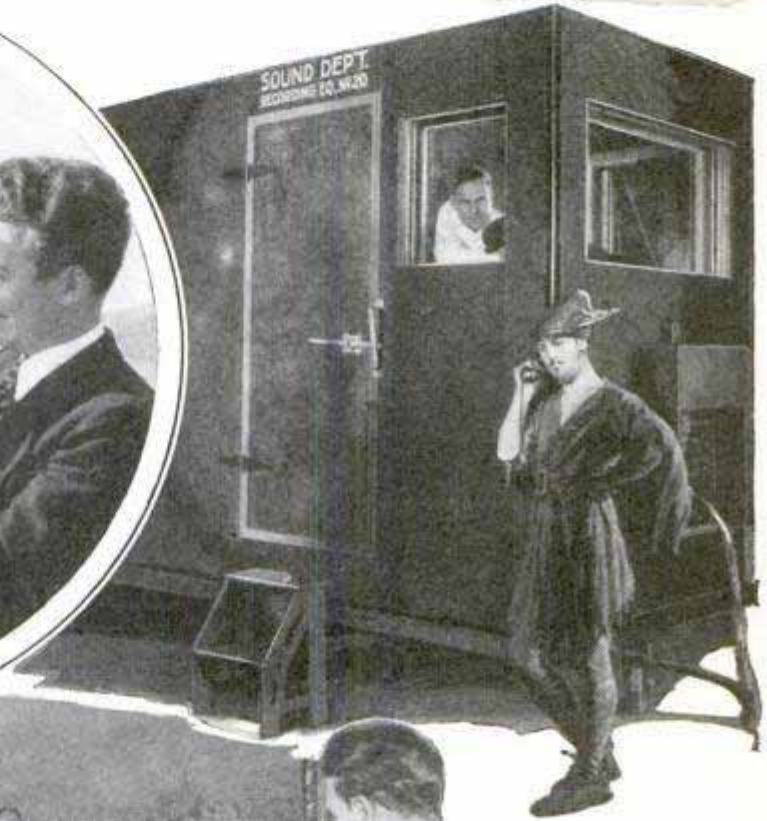

Above, How Camera Styles Have Changed to Keep Up with the March of Progress in Sound and Size; Inset, Placing the "Mike" in Its Insulated Jacket to Keep Out Extraneous Noises; Center, at Right, Portable "Mixing Table" Where Sounds Are Correlated and Co-Ordinated during Filming of a Sound Picture, and, Bottom, in the Mixing Room; the Operator, Whose Salary Approaches That of a Star, Is the Monarch of the Sound Studio; While Watching the Action through a Plate-Glass Panel, He Modulates, Puts in Emphasis and Otherwise "Edits" the Sound as It Is Produced

of an inch wide, into which is to be printed the sound track. This is made from sound picked up by the microphone and made up as "sound lines" on a separate film, in the same manner as sound is recorded on a disk for use in phonographs. For every sound track so made, a disk-phonograph record also is made for use by the film editor in checking the completed picture.

After the sound track has been made, and before it is printed into the final film, it and the action film are turned over to the film editor. From 100,000 to 500,000 feet of film are made on every large picture. It is the job of the sound editor to cut this film to the final 2,000 to 10,000 feet which will be shown in the theater.

Before the sound track and the action film reach him, however, the monitor has synchronized sound and action, presenting to the film editor the sound film rearranged to fit in where it should on the action film.

Placing the action film in an instrument known as a "moviola," and putting the sound record into a reproduction machine synchronized to the same speed as the moviola, the film editor sees the action and hears the dialogue or other sounds in their entirety. With scissors and cement pot, he cuts and patches, eliminates and condenses, just as a magazine editor would handle a manuscript, with the exception that he cannot add anything to the film; he must use what he has, but, due to his work, the final picture is given continuity, and what is known around the studios as "sense." Then the sound-track record is printed in on the action film.

With the perfection of the talkies, the engineers of every studio are hard at work to devise a method whereby sound and color may be reproduced on the same film. So far, the use of color has

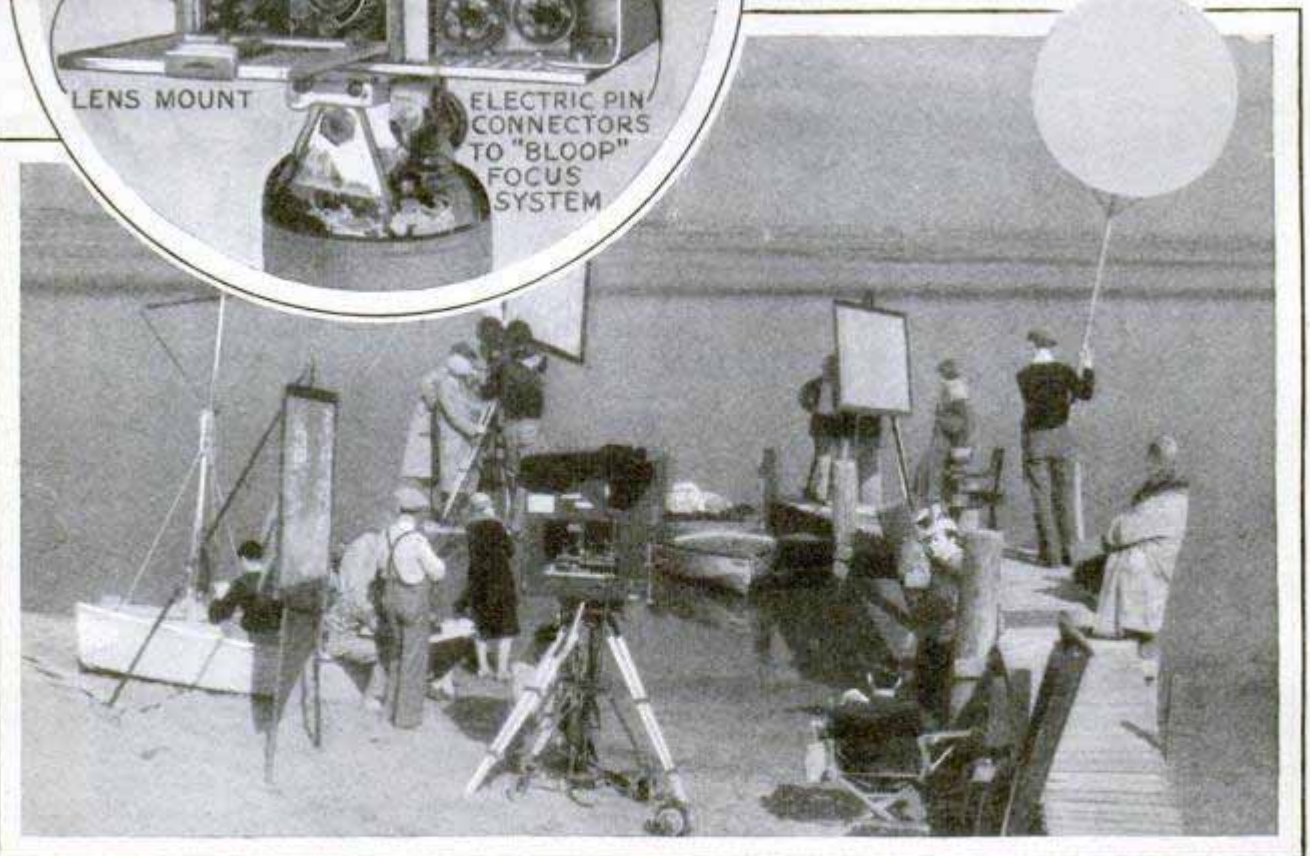
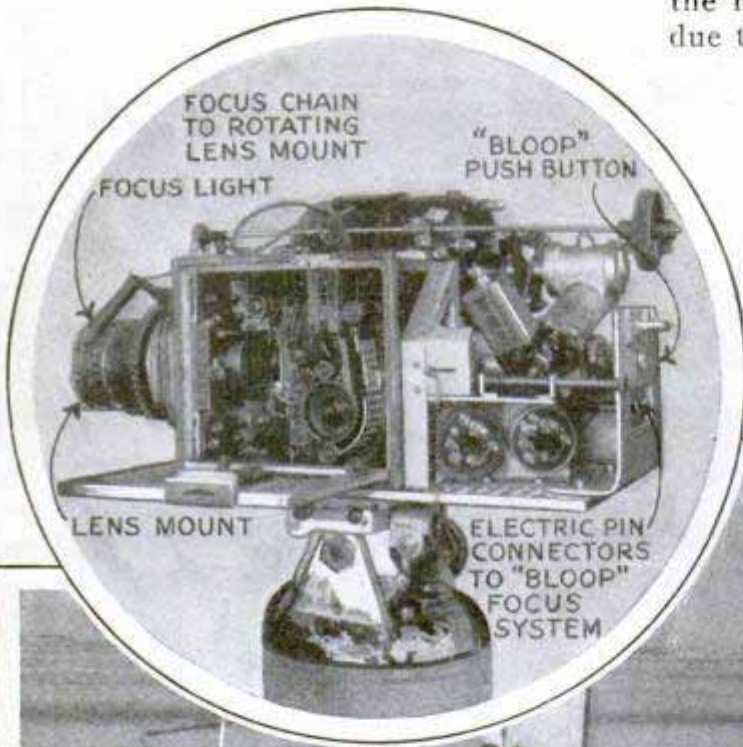

Inset Shows Interior of One of the Latest Cameras Developed for Producing Sound Pictures; Below, Using White Shields to Help Direct the Sunlight during the Filming of an Outdoor Picture

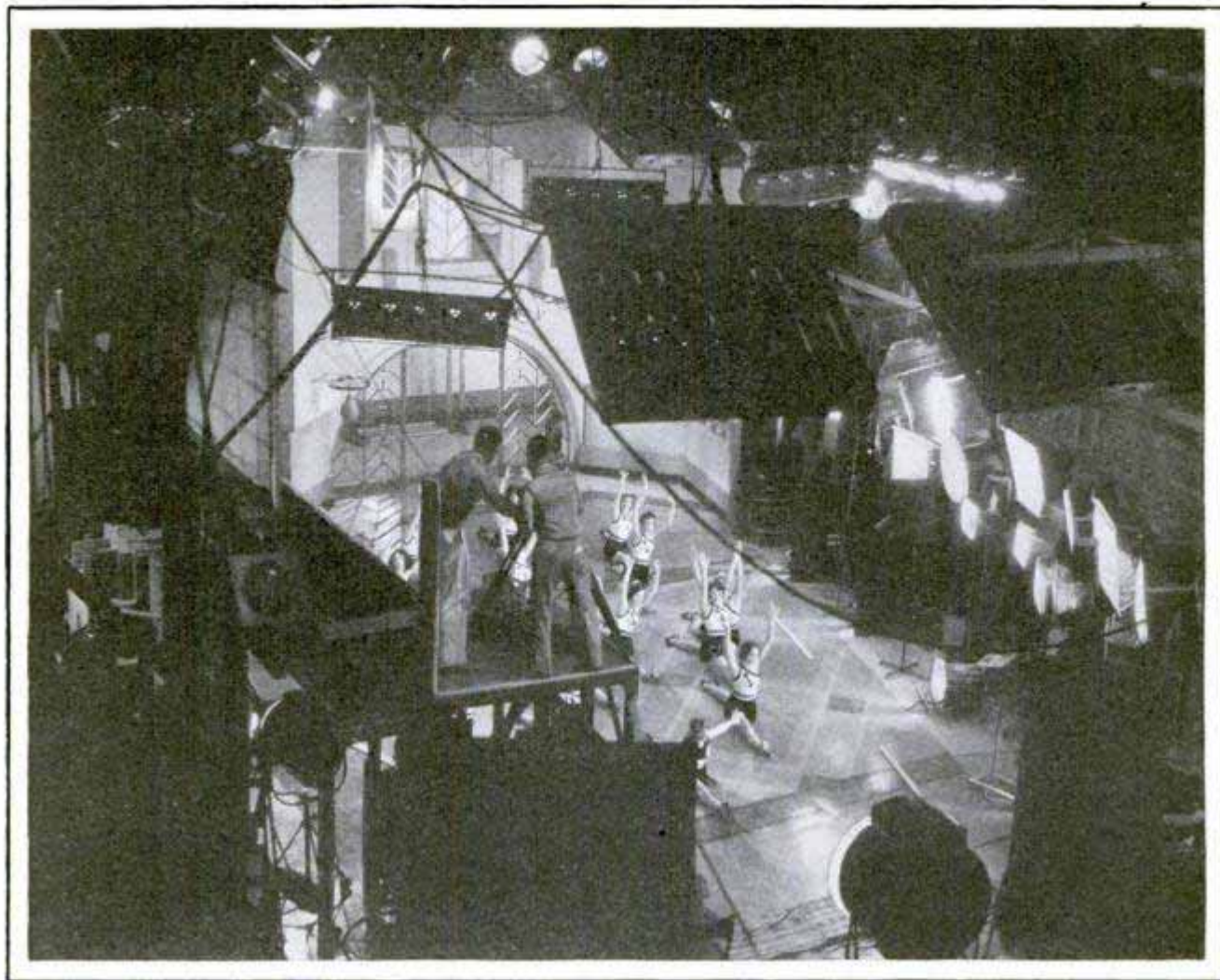

Where the Microphones Are Swinging above the Great Arc Lights; Taking Sound Picture in Modern Studio; Return to Arc Lights Has Been Made Possible by a Device That Eliminates Their Noise

been to some extent limited by the fact that, in the photography of colors at high speeds, varying apertures and rates of shutter operation are essential, or the colors will not appear with equal clearness on the completed film. This makes difficult the synchronization of sound record and action film. Hence the importance of the "color cops," as these dictators are called in studio slang.

In the size of the projected pictures another silent revolution has taken place with the result that the familiar standard thirty-five-millimeter films are being replaced by larger ones. Just the other day, there appeared at a few theaters, the long-awaited Spoor "Mammoth" film, taken by the natural-vision process. Figures stood out and moved lifelike in three dimensions. This film is the result of some fourteen years of experimenting by George K. Spoor and his associates.

Mr. Spoor explains that, contrary to popular conception, the film is not stereo-

scopic nor was it intended to be, but that by means of special cameras and special lenses, a totally different printing process and a new type of projector, he preserves and reproduces all but about ten per cent of the natural depth of the scenes.

The film is sixty-three millimeters wide instead of thirty-five and is the same thickness as standard-size film. The actual picture area is twice as wide and half again as high as that of the usual film. Each frame of the film stays on the screen four times as long as in the usual movie. This longer "moment of rest" gives the eye time to see the picture more accurately.

Another wide film that has already made its appearance is the Fox "Grandeur" size. This is seventy millimeters wide, giving a much larger screen image and a wider and longer sound track per frame. Then there is the "Magnafilm." This is produced from standard-size reels but the pictures appear in gigantic proportion, due to the use of magnifying lenses in the projectors.

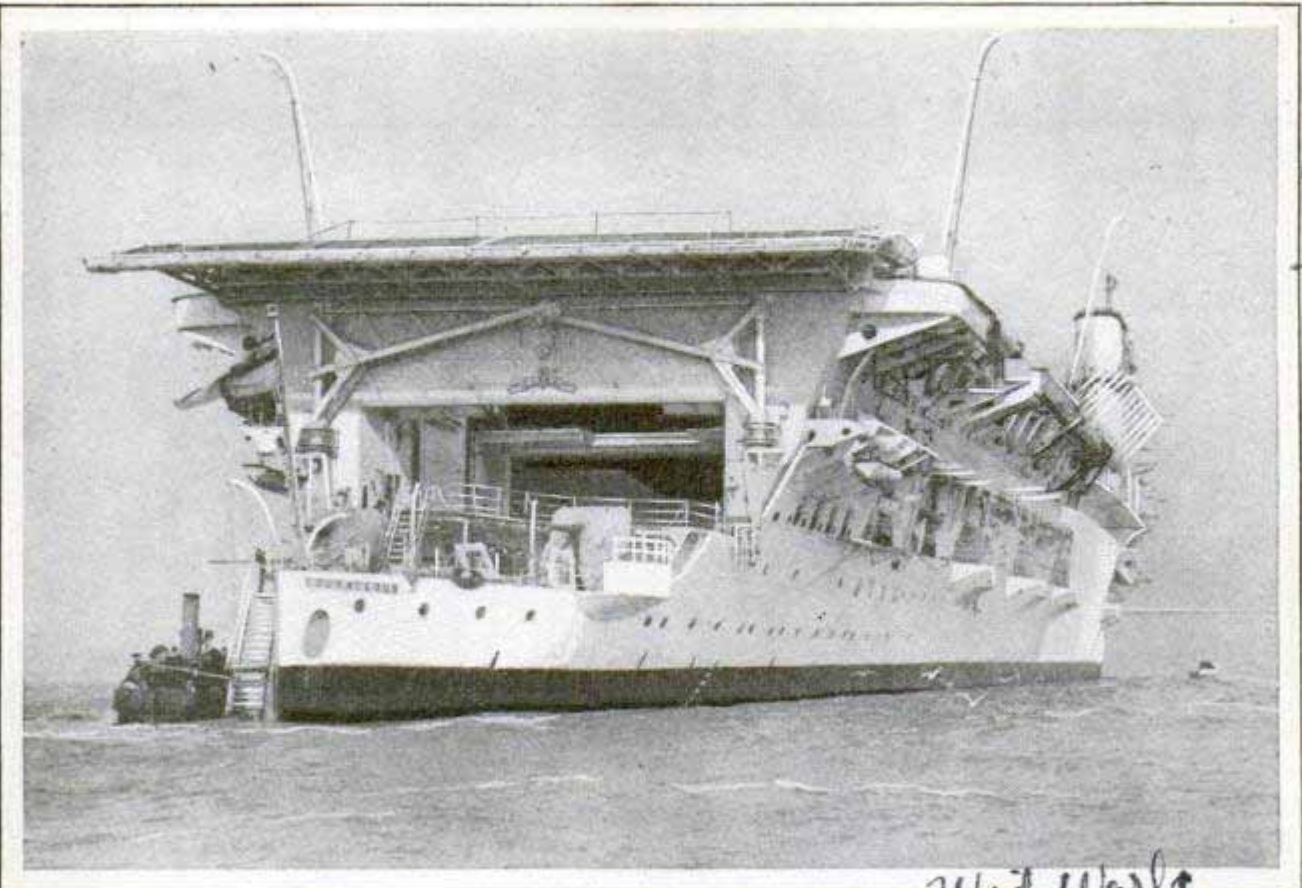

One of the Most Striking Vessels Afloat Is This Airdrome, the British Aircraft Carrier "Courageous"; It Is Mother Ship for Dozens of Seaplanes Attached to the Fleet.

Wide World

BRITISH FLOATING AIRDROME RESEMBLES HOUSEBOAT

Somewhat resembling a huge river houseboat, the British aircraft carrier "Courageous" is one of the most striking vessels afloat. It is equipped to carry dozens of airplanes which may be launched from or landed on its upper deck. The carrier returned recently after maneuvers in the Mediterranean.

COST OF RUNNING AUTOMOBILE SHOWN ON DASH REGISTER

Enabling the motorist to keep accurate record of his gasoline and oil costs, a dash register now is on the market. Gallons of gas and quarts of oil are recorded by turning calibrated knobs, and a small celluloid tab is supplied on which may be recorded mileage, date, oil change and bat-



191
Motor Register

tery-inspection periods. The tab pulls down from the bottom of the register on a roller, thus releasing the knobs, and when it is back in position, the knobs are locked so that they cannot be moved accidentally.

SPARK-PLUG TERMINAL CLIPS KEEP WIRES INTACT

To keep ignition wires from working loose from the spark plugs in an airplane engine, terminal clips, somewhat resembling ordinary paper clips, have been made. Two strong phosphor bronze jaws grip the spark-plug ball nut, and a hinged spring bale swings over the end of the terminal when it is in place, snapping firmly into position and greatly increasing the gripping power of the contact jaws. The terminal may also be used on auto engines.



320
Connecticut Telephone
Electric Corp.
Meriden

338
Hoover Lamp & Stamping Corp.
Evansville, Ind.
534

Dr. Phonyard & Co. Berlin
 15, Mittelstr. 14, Berlin

NEW PHONOGRAPH DISK HAS LONG LIFE 4/4

From a by-product of the coal-tar industry, Germany has produced a phonograph-record disk that is flexible, unbreakable, and fire and waterproof. It is very thin and light, six disks weighing no more than one of the ordinary kind and wearing much better. In tests, one disk was played 200 times, and was virtually as good as new afterward. The lasting quality is ascribed to the elasticity of the material, which allows the grooves to resume their shape after the needle runs through them.

AIRPLANE SILHOUETTE ON CLOTH FLOWN BY A REAL SHIP 250

Equally adaptable for war or peace-time purposes, a camouflage airplane is the invention of a German flyer. It consists simply of a full-size plane painted in black on a huge white cloth. The cloth is suspended by weights from a real ship, thus giving the impression that two planes are flying together where actually there is but one. It is being used for advertising purposes, but might be employed in war time to give a false impression of airplane strength.

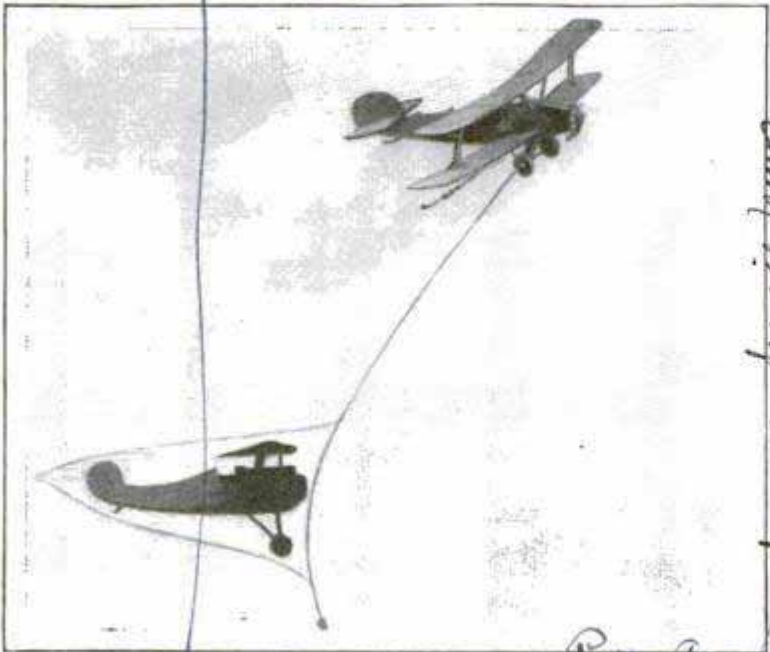

Camouflage Plane Painted on Cloth and Flown from a Real Ship. It Is Being Used for Advertising Purposes

Ernest H. Adet

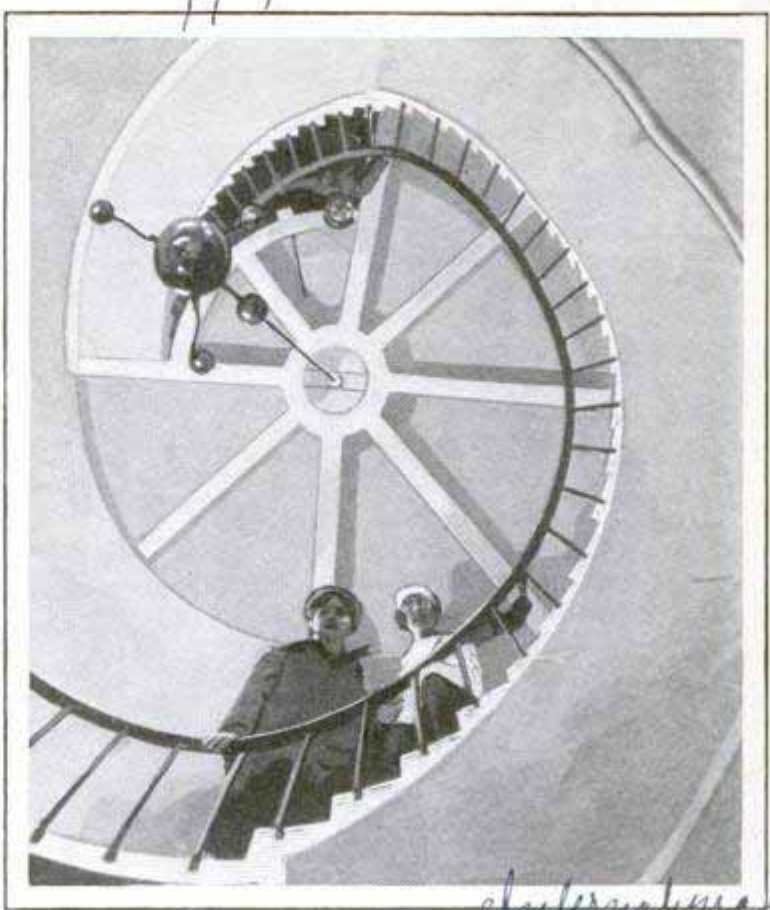

Spiral Staircase in an English Home That Formerly Was a Lighthouse, the Stair Leading to the Light Room

LIGHTHOUSE WITH SPIRAL STAIR TURNED INTO RESIDENCE

One of the most curious staircases in any residence probably is contained in a home at Winterton, England, which has a spiral stair leading to one of its two rooms. The house formerly was a lighthouse and the winding steps were used to ascend to the light room, which now has been turned into sleeping quarters.

SUNNED YEAST IS FED TO CHICKENS 401

Yeast that has been exposed to the ultraviolet rays of sunlight has proved effective at the University of Wisconsin in keeping young chickens free from leg weakness, which in reality is a form of rickets. In the past, the ailment has been combated by feeding codliver oil, but the irradiated yeast has been found cheaper and easier to administer, and is less likely to leave undesirable flavors in the flesh.

Science Service News

Experiments at University of Wisconsin by H. G. ...

Dr. J. S. Halpin and Dr. G. S. Holmes

316 QUEER FACTS ABOUT "MYSTERY GUNS" REVEALED

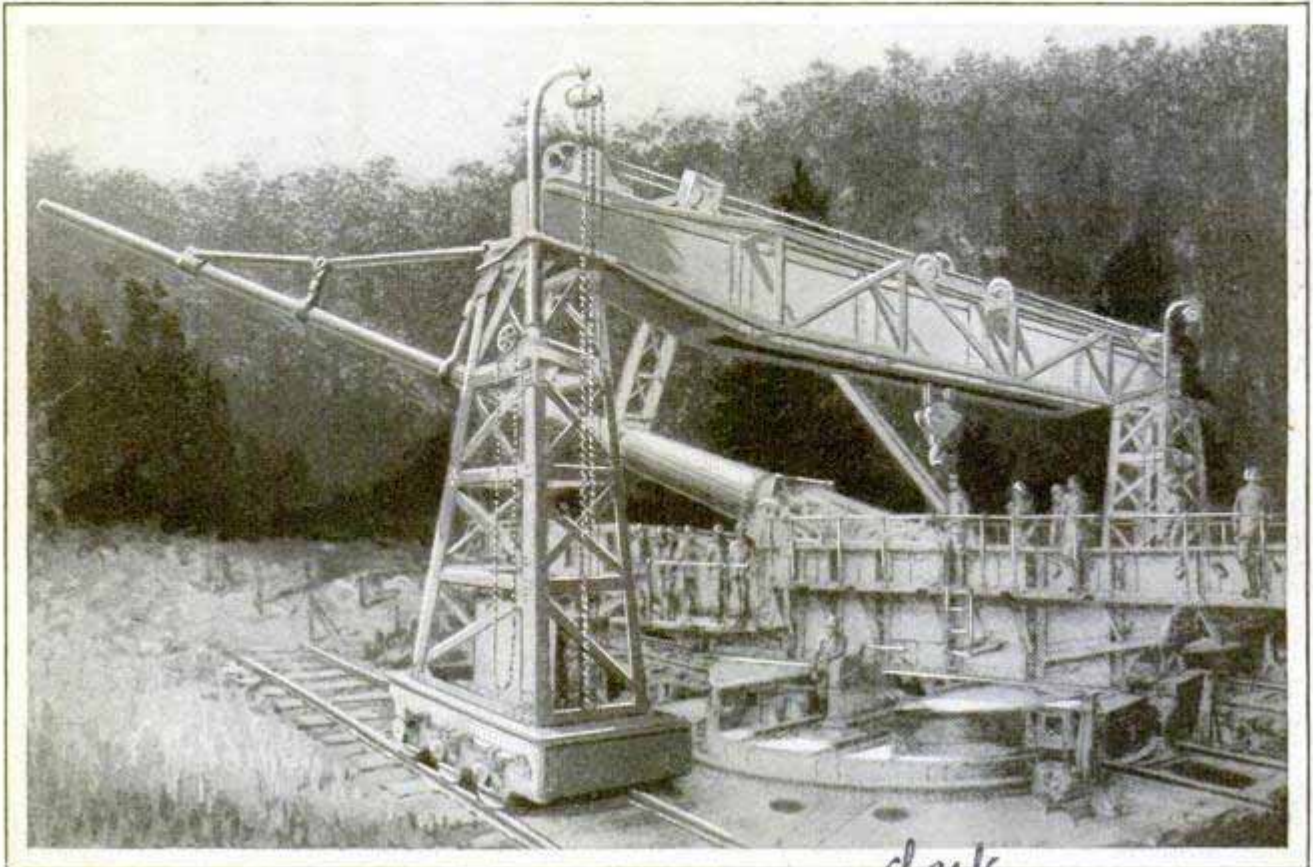

Drawing of One of the German "Big Berthas" That Fired on Paris from a Distance of Seventy-Five Miles; Note the Long, Slender Barrel and the Many Railroad Tracks Required for Mounting

Additional details of the long-range super-guns that dropped shells on Paris from a distance of seventy-five miles, have been revealed by Col. H. W. Miller, of the U. S. army. The Krupp works made the weapons, which were as tall as a ten-story building and required enormous emplacements. The gun itself tipped the scales at 200 tons. Its shell, however, was relatively small, weighing only 264 pounds, and the bore was smooth as it turned itself. Its trajectory was twenty-four miles high. The guns, despite their size, were remarkably accurate. Each had a pressure chamber, and after the gun was fired, the ballistics officer read the pressure in the barrel and from it was able to compute, within a relatively few yards, exactly where the shell had struck. Each shell fired had a new position in the gun, and each position required a new calculation. There were three powder charges, a variable charge in a silk bag, a standard charge in a silk bag, and a large cartridge charge for firing. Each shot required a different charge in the first bag, and calculations had to be made of the tempera-

ture of the powder and the gun. Even the curvature of the earth was carefully figured. Seven guns of this kind in all were made or rebored, and one exploded prematurely. From March to August, 367 shots were fired at Paris and the French city was kept in a state of anxiety, although French artillery forced the long-range guns to change locations repeatedly, an enormous task in itself.

395 PATENTS ON PLANTS AND TREES
SAME AS FOR MACHINERY

Those developing new varieties of fruit trees or plants would receive the same protection by a patent as the inventor of a machine under an amendment to the patent statutes introduced in the senate. The amendment is aimed to afford plant breeders some legal claims to the profits accruing from varieties of fruit trees and plants on which they sometimes spend several years in experiments.

1 An old clipper ship at Sydney, Australia, has been converted into flats.

N.Y. Times 2/20/30

Author of book - The Paris Gun

PARACHUTE OPENS INSTANTLY AS IT CLEARS PLANE 38

Operating safely at an altitude of only 150 feet, a type of parachute that opens instantly was tested recently at Roosevelt field, Long Island. It lowered a dummy thrown from the plane so gently that flyers said a pilot making a similar jump would not have been injured. Flyers made jumps with the parachute at 2,000 and 800 feet and intended to try a 150-foot jump after the parachute had opened each time the instant it was clear of the plane, but the authorities objected to the low leap.



Preparing the Bricks in Experimental Furnace; Samples of the Product Are Seen in Center Foreground

BUMPER PROTECTS LIGHT POST FROM AUTO ASSAULT 15

Guard rails to protect light standards from automobiles have been erected in Los Angeles on some of the streets with steep grades. Cars out of control on the hills often crashed into the poles, sometimes in an effort to stop and sometimes unintentionally. Occasionally the light posts were snapped off and crushed the top of a car. The braced bumper saves the post and possibly the motorist.



TWENTY-FOOT HOUSE BRICKS TO SERVE AS STEEL 36

Huge bricks that can be rolled out like steel instead of being molded to size, and that may be used to replace the metal and concrete in various buildings, are predicted as the result of a process developed by experts in the department of ceramics at Pennsylvania State College. Prof.

Joseph B. Shaw explains that the bricks may be impressed upon one another, annealed to form a single structure, or shaped to resemble steel and concrete units. Steel may be used to reinforce the bricks by placing it in the clay just before it is shaped and pressed at a high temperature and while in a plastic state. Much research remains to be done before the process may be regarded as wholly successful, Professor Shaw says, but he believes that sea walls, piling, heavy beams, foundations and building walls can be manufactured more economically by this system. Clay unsuitable for ordinary brick can be utilized and light or heavy units produced. Bricks about half the weight of the usual kind already have been made.

RATCHET SCREWDRIVER LEVER GIVES ADDED POWER 33

Affording greatly increased power, a ratchet screwdriver set with a lever attachment now is on the market. The lever, which slips over the ratchet frame, makes possible the setting of screws as deeply as desired. Several blades are provided.



Ans. Prof. Joseph B. Shaw

Hemis Engineering Co. Grand Rapids Mich

Cont. H. Luscumb, 3214 Farwell Ave. Los Angeles, Calif.

maker unknown

*Capt. U.S. Jackson,
Coast Artillery
corpse*

MOVIES HELP AERIAL GUNNERS TO FIND CORRECT RANGE

Motion pictures of shells bursting about an aerial target are used in a spotting apparatus recently tested to enable anti-aircraft gunners to find the range of their objective. The spotter employs two movie cameras, one at the battery position and another a measured distance away on a flank. The cameras are synchronized by an electric timing arrangement and replace the human observers who have great difficulty in locating all bursts, due to the speed of modern anti-aircraft fire, which reaches 100 shots per minute for a battery of four guns.

*39
U.S. Army 2/24/30*

HEADLIGHT SHUTTER FOR AUTOMOBILES PREVENTS DAZZLE

To prevent automobile headlights from blinding approaching drivers, an English woman has invented an anti-dazzle light shutter operated by an electric button on the steering wheel. It consists of leaves of celluloid which, when not in use, nestle about the rim of the light. Pressing the button causes them to spread like a fan over the headlight, reducing the beam of light



Anti-Glare Auto-Light Shutter in Open and Closed Positions; It Operates from Steering Wheel

about two-thirds, so that it does not affect the eyes.

*Mrs. Lois Imriell
Thobson New Cross*

30



Paris Traffic Tower Equipped with Gas Heater beneath the Floor, to Keep the Traffic Officer's Feet Warm

GAS HEATER FOR TRAFFIC COP KEEPS FEET WARM

Paris traffic officers no longer will suffer with cold feet as floor heaters are being installed in the raised stands or towers from which they direct travel. The foot warmer is a gas-operated heater placed beneath the platform on which the officer is stationed.

ANCIENT CITY IS REVEALED BY PUMPING OUT WATER

Modern hydraulic-engineering methods have been applied in excavation work at Kish, where the Field Museum-Oxford University expedition to Mesopotamia has found many valuable relics. A motor-driven pump, connected with extensive pipe lines installed over a large area of the ancient city site, has been put into operation to clear away the huge volume of subterranean water encountered about fifty feet below the present-day water level, and enable the scientist to reach depths heretofore unattained by explorers.

*Reported by L. C. Watelin,
Field Director*

402

354

Spotting Smugglers from the Air



Smuggler Scouting from the Air; a Loening Amphibian of the Coast-Guard Fleet Flying with Two of the Government's Speedy Chasers; Note the Guns on the Vessels' Decks

By K. M. PAINTER

The Chastleton Hotel, Washington, D.C.

FLYING for the coast guard in peacetime furnishes thrills for the most hardened pilot, though there is the compensation of scouting prizes.

Consider the exciting flight of Lieutenant Melka when he was flying from the Fort Lauderdale station. He was over James creek, when he sighted a cabin-cruiser power boat. Though he could make out no signs of contraband, the boat appeared to be riding unnecessarily low in the water. He flew close and waved his hand, signaling the boat to stop. The signal was ignored, and immediately his suspicions were strengthened.

The observer in the plane trained a machine gun ahead of the boat and several shots were fired across her bow. When the crew realized that the airmen really meant business, they stopped. Lieutenant Melka then brought his plane down and taxied to within twenty feet of the ship. The rubber lifeboat—part of every patrol plane's equipment—was inflated and served to carry the pilot and observer to the suspected vessel, while the radio-

man stayed behind in the plane's cockpit. More than a hundred and fifty sacks of assorted liquors and beer were discovered hidden under tarpaulins on the deck and inside of the cabin.

Of course the boat had no manifests, so the two men aboard were placed under arrest, and left in charge of the coast guardsman, while Lieutenant Melka took off in his plane to see if any patrol boats were in that vicinity. Seeing none at hand, he radioed details of the capture to the coast-guard base, and soon a picket boat was heading for the scene of action. Awaiting its arrival, the pilot stood by the captured boat.

After the necessary formalities had been disposed of, Lieutenant Melka and his crew of observer and radioman took off and headed southward along the Keys to Barnes sound; then, following the main shore line of Biscayne bay, headed north. Just off Snapper creek, the observer sighted what appeared to be sacks of liquor. The plane was landed and taxied to an advantageous position. The observer and radioman dove overboard and

359



Crew of One of the Air-Patrol Planes, and, at Right, a Captured Boat in Tow

City canal, about four miles north of the suspected position. One of these boats corresponded to the description of the



found a cache of twenty-one sacks of liquor and six sacks of beer, which were reported by radio and subsequently picked up. Both the above experiences occurred within the short period of four hours, between the hours of five and nine in the morning, after a flight of only 280 miles—yet an area of 3,800 square miles had been searched.

Another early-morning search made by Lieutenant Anderson of the coast guard brought in a rich harvest of contraband. At 6:20 in the morning, when he was flying abreast of Cutler's beach, he sighted a motorboat pulling away from a large skiff moored about four miles south. The observer trained the machine gun, and the plane swooped down near the skiff and motorboat. The skiff was loaded with sacks resembling those in which rum is usually carried, so the pilot circled the motorboat and signaled it to stop. But it continued on its way southward. The pilot flew alongside, displayed the coast-guard ensign, and gave the order to "heave to." The observer boarded the motorboat which Lieutenant Anderson kept under cover with the machine gun, and sixty-eight sacks of liquor were discovered.

One day information was received that a speed boat, sighted by custom officials while discharging a cargo of contraband, had eluded capture and was supposed to be hiding in a creek somewhere south of her escape. A plane was dispatched and soon three boats were located, hidden in a small creek branching off the Florida

fugitive, so Lieutenant Melka, who was piloting the coast-guard plane, anchored in the canal. The rubber life raft was inflated, and pilot and observer rowed along the winding creek to the hidden boats which, because of underbrush and trees, could not be seen from the road along the canal. The crews of the three boats must have been warned, for there was not a sound, nor was there a man to be found.

³⁰⁰
FISH LURE IMITATES MINNOW BY FLUTTERING MOTION

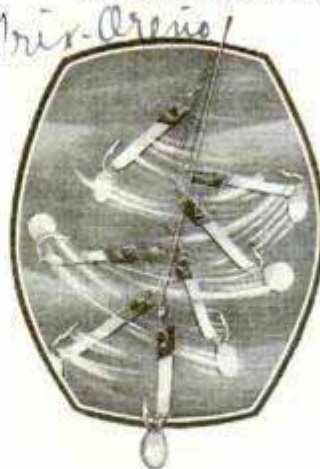

For the fly-rod fisherman, a lure now is on the market that closely imitates the motions of a bug or minnow without manipulation by the angler. When cast in a running stream and allowed to sink, the lure, with its at-

attention-arresting bangle, bobs about much like a bug, but when retrieved, it flutters and darts like a swimming minnow, due to the angle at which the line is fastened, and the action of a rubber "pork" ring attached to the tip of the hook.

South Bend Bait Co,
South Bend, Ind

Hubbard, Spencer, Bartlett & Co. Chicago.

substituting for Sir Douglas Mawson,
POPULAR MECHANICS
as professor of geology at Adelaide

717
308

MYSTERY LAKE OF SOLID SALT AT END OF FIVE RIVERS

Lake Eyre in Australia, about which superstitious bushmen for many years have told tales of mystery and evil, has been found by a party of visiting scientists to consist of a vast expanse of solid salt, more than 100 miles long and over fifty miles wide, and so thick that a heavy truck can be driven over the surface. It is estimated that one section of the lake alone contains three billion tons of salt ranging in depth from six to seventeen inches, but its commercial value is negligible because both the salt and the gypsum found are available much nearer civilization. Five rivers empty into the salt lake, but their flow is intermittent, and the intense heat causes rapid evaporation of the water, leaving only the salt deposits they bring. Bushmen had told stories of a vast quaking morass that engulfed horses and cattle venturing onto the surface of the lake, but it was found to be entirely safe, having much the appearance of a frozen sea in an unnatural tropical setting.



Using Electric Eye as Fire Extinguisher; the Sensitive Photoelectric Cell Detects the Smoke

ELECTRIC EYE PUTS OUT FIRES BY DETECTING SMOKE

Watching for smoke with an electric eye, the light-sensitive photoelectric cell has been used successfully in tests as an automatic fire extinguisher. A ray of light is focused on the cell. If fire breaks out, the cell operates a chemical fire extinguisher as soon as smoke lowers the intensity of the light ray to an appreciable extent.

*Westinghouse Lamp Co
East Pittsburgh, Pa*

CONVERTIBLE TOP FOR PLANE IS TRANSPARENT

Col. Charles A. Lindbergh's new monoplane has been fitted with a convertible top which transforms the open cockpit into a closed cabin. The transparent sliding hatch over front and rear compartments not only offers weather protection without affecting visibility, but has been found to add to the speed of the craft by cutting down suction from the cockpit.

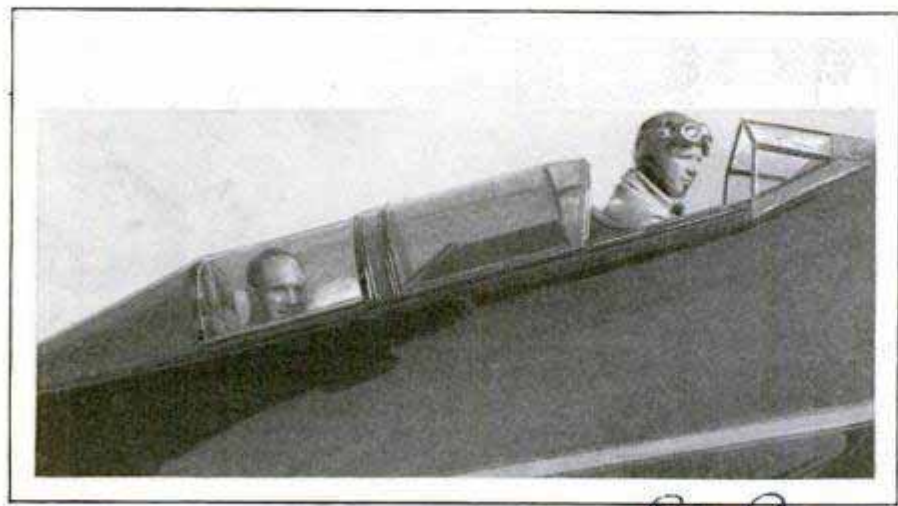

Colonel Lindbergh in His Monoplane with a Convertible and Transparent Top, Giving Protection from Weather and Affording Visibility

Lockheed

RADIUM IN GEORGIA MOUNTAIN

In the granite of Stone mountain in Georgia lies locked an unknown quantity of radium, according to tests made by Prof. James A. Hootman, physicist of Emory University. Extended investigations were conducted of nine springs originating in the mountain, and tests showed the spring waters contain almost twice as much radioactive properties as the famous Joachimsthal spring of Germany. No estimate is made of the amount of radium in the mountain, nor was there any guess as to its availability. Investigators have been unable to trace the source.

*398.
Atlanta
Ga*

*N. J. Jones
2/24/30*

NEW MOTOR TO END FIRE HAZARD IN AVIATION

Killed April 24th on flight with this engine.



Capt. L. M. Woolson, Designer, at the Right, and Walter Lees, Test Pilot, with First Packard Diesel Aircraft Engine and Test Plane; Motors of This Type Promise Interesting Results in Aviation and in Automobiling, Due to Economy of Fuel and Elimination of the Usual Ignition System

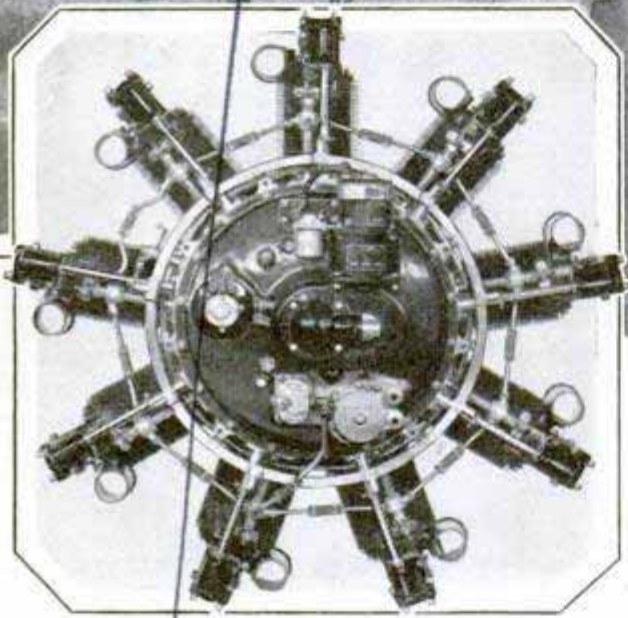

The Engine Is of the Radial Air-Cooled Type with Nine Cylinders; It Develops 225 Horsepower at 1,900 Revolutions



The Engine Weighs Only 510 Pounds or 2.26 Pounds per Horsepower, Exceptionally Light for Diesels; Each Cylinder Weighs Eleven and Three-Fourths Pounds

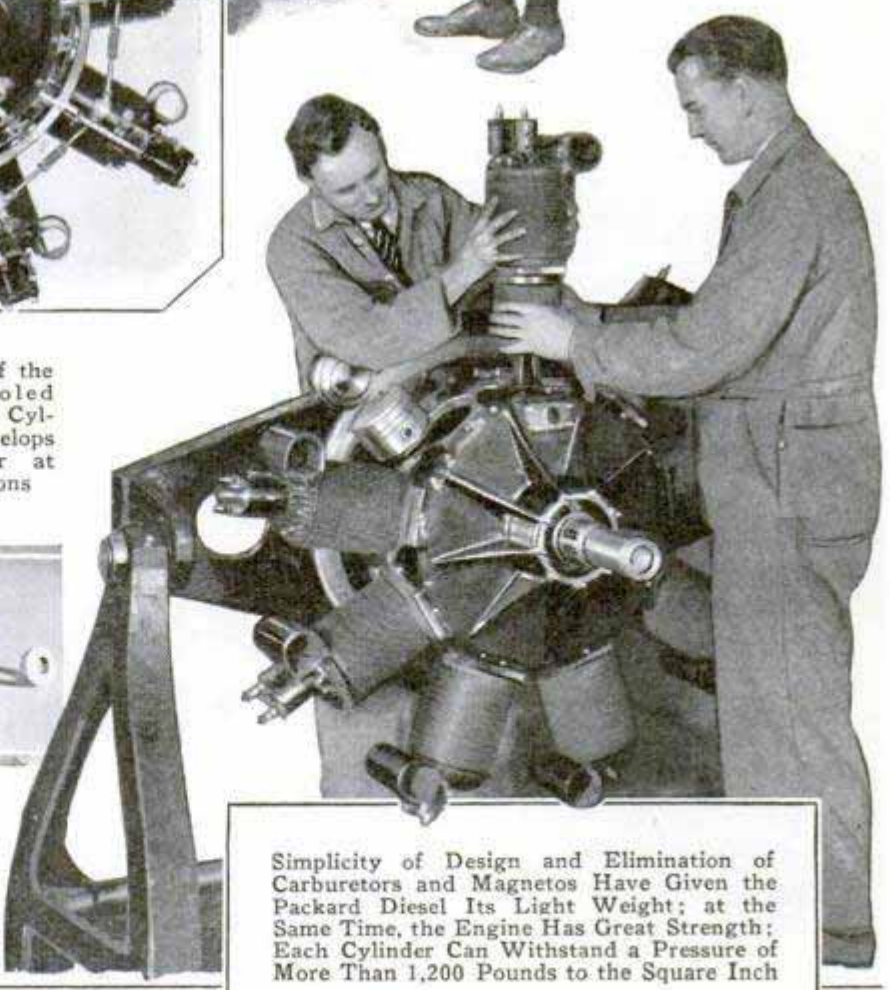

Simplicity of Design and Elimination of Carburetors and Magnetos Have Given the Packard Diesel Its Light Weight; at the Same Time, the Engine Has Great Strength; Each Cylinder Can Withstand a Pressure of More Than 1,200 Pounds to the Square Inch

Edward Macanley, Sales Mgr

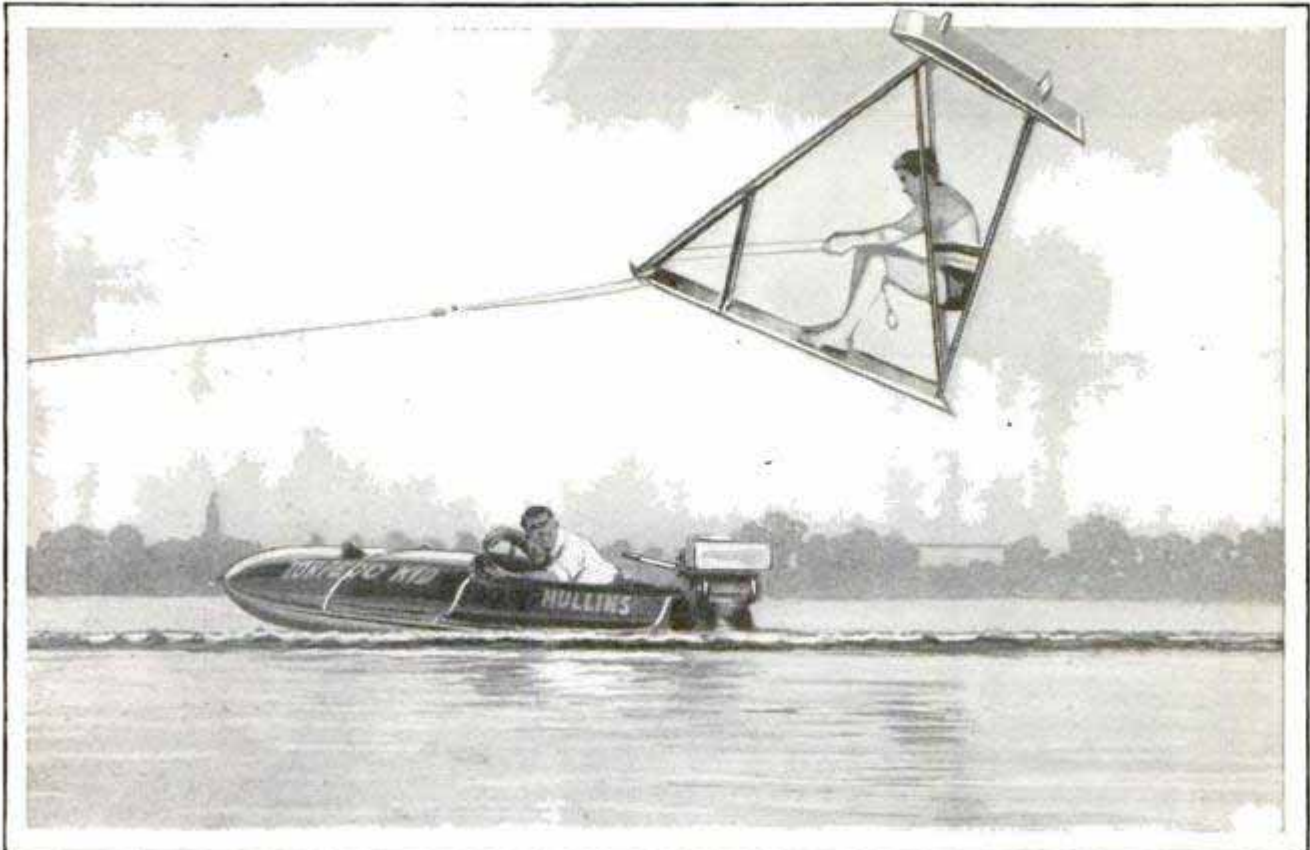

Dick Pope at the Controls of His "Aqua Glider," in a Test Flight at Winter Haven, Fla.; the Wing Is Like That of an Airplane

WATER GLIDER WITH WINGS TESTS RIDER'S SKILL

Aquaplanes with airplane wings that shoot the rider into the air after a short fast skim across the water behind a motorboat, have appeared in Florida. Balancing is accomplished by pulling on ropes attached to the lower wing of the glider and by the movements of the occupant, who sits on the braces that support the wings. If the rider does not wish an aerial trip, the craft serves as a safe and easily maneuvered water glider.

PIANO NOTES ARE PROLONGED BY ELECTROMAGNETS

399

For sustaining and intensifying the tones of a piano by prolonging the notes, a Brooklyn scientist has invented an electric apparatus called the "crea-tone." It prolongs the vibrations of the piano strings through electromagnets run by current from an ordinary radio battery. The magnets, operated by a switch over the keyboard, are set in action by the vibrations of the strings struck, and recommunicate these vibrations to the strings. Intensification or diminution of the tone

*And Simon Cooper,
2066 Hamilton Ave*

is accomplished through the pedals, the sound continuing as long as the keys are pressed. Thus the instrument is not only capable of prolonging the sound of a desired tone, but of varying its intensity. It is expected to prove particularly useful to music students.

AIR-CIRCULATING FIREPLACE MAINTAINS EVEN HEAT

228

Maintaining a constant and even temperature throughout the house, an air-circulating fireplace has proved successful for heating large residences. The plant heats the air brought to it through transoms under the floor, and sends the hot air out through the ceiling, thus maintaining an even temperature from floor to ceiling and keeping the farthest room at the same heat as that in which it is installed. In summer, the fireplace may serve for cooling.

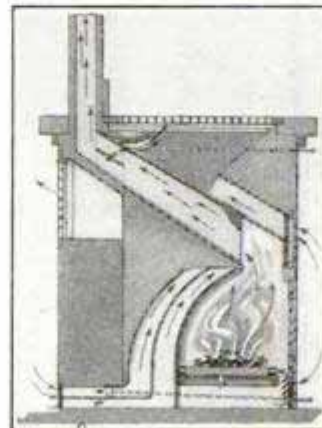

*And Mr. E. O. Miles,
Hobart Okla*

Westinghouse Electric Co. nyc
East Pittsburgh Pa
INVISIBLE-RAY BURGLAR ALARM
KEEPS WATCH OVER SAFE

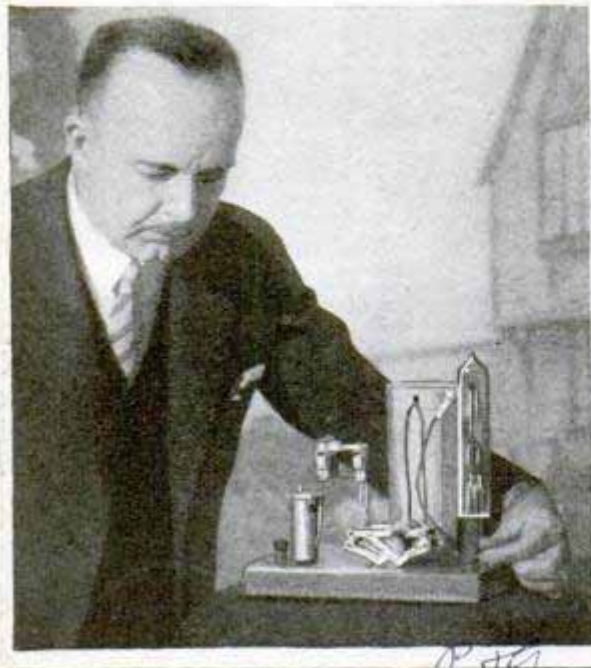

Model of Ultraviolet-Ray Burglar Alarm; Interruption of the Invisible Rays Rings an Alarm

Ultraviolet rays, invisible day or night, have been used successfully in tests as the basis for a burglar alarm. The rays, turned on a safe or even on exposed valuables, constitute an efficient guard because as soon as an intruder passes between the invisible-ray source and a photoelectric cell on the safe or valuable, the cell operates to sound the alarm. In like manner, the rays may be used to set off tear bombs or to give silent alarms, particularly if directed from several angles in the room which they guard.

FOOD FROZEN IN CONTAINERS PRESERVED INDEFINITELY

Eliminating cold storage as it is now practiced, a method of rapid freezing of perishable meats, fruits and vegetables in their fresh state is being attempted with the expectation of delivering the solid frozen foods to the consumer with all the fresh flavor conserved. The system is expected to lower shipping costs and to make possible year-round marketing of perishable foods at mid-season prices. The process is based on the relation of the size of ice crystals to the rapidity with which they are frozen. The usual cold-storage process freezes large crystals

slowly and they destroy the walls of the cells in the food, thus drawing out flavor and freshness. By accomplishing the rapid freezing of food inside and outside almost simultaneously, small crystals are formed and the original state is preserved. The foods thus treated will be frozen in containers and kept in temperatures ranging from ten degrees below zero to ten above until placed on the market. The thawing begins almost as soon as the food is shipped and continues slowly, but with ordinary care the frozen products may be handled much like dry foods. When the consumer takes them home, they are placed in the ice box, where they are kept for several days, the refrigerator temperature slowing up the thawing process. Cooking methods for the frozen food are the same as for ordinary products. With this method, it will be possible to buy a week's supply of fresh foods at one time.

AUTO GREASE PIT ILLUMINATED BY INDIRECT LIGHTING

Indirect lighting for the automobile grease pit is obtained by a system of prismatic lenses arranged about the sides of the pit in such manner that the rays are bent upward to illuminate the bottom of the chassis from several directions. The lenses are recessed in the side of the pit for protection and the light, coming from several sources, throws no shadows.

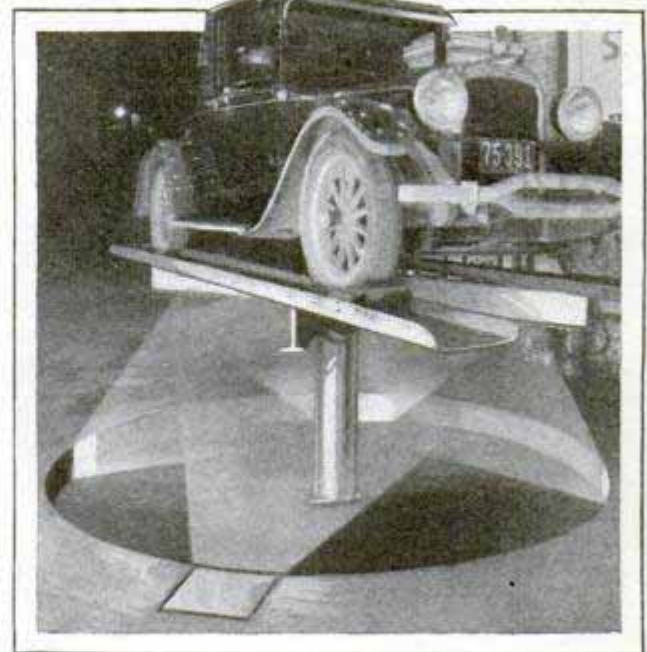

Indirect Lighting for Auto Grease Pit; Lenses in the Sides Give Light from Various Angles

Developed by Clarence Biddison, Lancaster

Holophane Co, Inc. 342 Madison, Pitt



Night Scene at Monte Carlo, Famous European Resort, Showing How the Casino, and Even the Trees, Fountains and Flower Plots Have Been Used in the Exterior Lighting Scheme

NIGHT SCENE AT MONTE CARLO SHOWS BEAUTY IN LIGHTS

Monte Carlo, the playground of Europe, has been transformed into a fairyland of lights at night by an elaborate system of exterior illumination. The famous casino after dark is bathed in white lights and the broad avenues leading to it also are illuminated, trees, fountains and even the flower plots being decorated with concealed lighting effects.

PLANT BUILDS NEW TERRITORY BY FILLING MARSHES 365

Rice grass, long considered a worthless nuisance, is now being utilized to add yearly to the inhabitable and tillable area of Holland. The plant, by its ability to take root in mud and spread quickly, is rapidly converting Dutch marshes into meadows. The seeds take root in the marshes and mud banks, the grass continuing to spread until, after fifteen or twenty years, the grass, with the silt it has collected, has transformed the mud flats into solid ground. By planting the rice grass in lanes, the meadowing operation can be speeded up so that land is reclaimed in about five years, and this is

what Holland has done. The reclamation of the Zuyder Zee is being carried forward by a different method. This inlet is being cut off from the sea by dams, and is now being pumped dry to be used for farming.

SUPPORTING RACK ON GOLF BAG DOES WORK OF CADDY 132

Doing some of the work of the caddy, a convenient supporting rack has been invented for the golf bag. The nickelplated holder attaches to the bag rim and maintains it at a convenient angle for the player to reach any club, thus preventing stooping and at the same time saving the bag. When the bag is carried, the holder, which is light in weight, automatically folds against it.

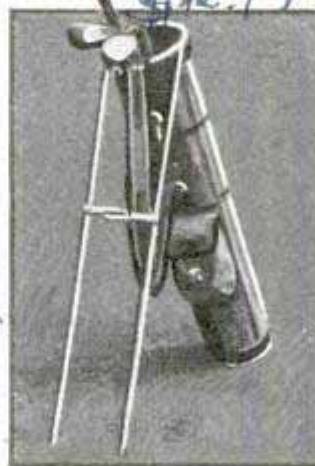

Development of a L-head radial aviation engine has been announced.

Wide World

Illustrations London News

*The Clatchie Partridge, Clatchie, Calif
d no. Warren Mc Clatchie, Comp. Co.*

Spartina Tansendii

Caddy. Ette Co. Box 215, Newark, N.J.

Trailing Animal



been developing. under the biological survey, a sort of Yankee Scotland Yard for animals, composed of men with keen insight into the ways and habits of wild creatures, seeking at all times to develop new and improved methods of destruction to supplement those already in use: shooting, trapping, poisoning and den hunting.

Time and again these supersleuths have found it necessary to spend weeks, months, and even years, to trail to death an individual coyote or gray wolf. That this procedure is well worth while may be realized from the fact that a single wolf has been



L. E. Lutz, Trapper Who Aided the Lion Party, and, Below, Wolf Caught in Government Trap

Washington, D.C.
By JAMES N. MILLER
236 Park Central Hotel

A VAST animal underworld, hardly less formidable than the illegal dens of crime that are supposed to prevail in certain of our large cities, actually exists in the United States. It has definite boundaries, regular strongholds and a membership of notorious renegades.

This haven of four-footed criminals stretches through twelve of our great western range states. The "racket" is dominated by giant wolves and cunning coyotes, and includes lesser rogues like mountain lions and bobcats, who all together take an annual toll in live stock and game to the tune of about \$30,000,000.

Of course Uncle Sam does not stand idly by and indifferently permit such wholesale destruction. Since 1916, he has

known to kill twenty-three calves during a week's raids, while a pair of renegades were able to destroy between forty and fifty per cent of the calves in one group of Colorado ranches.

Coyotes are at least equally destructive to live stock, and it has been found that in California they have done tremendous damage to melon and grape crops. Wild game also suffers substantially from the work of coyotes, and it was discovered recently that the stomach of forty-eight

Gangsters

coyotes, taken during a single month, all contained deer flesh.

Probably the most famous of all coyotes known to government hunters was "Old Three Toes," caught several years ago. For six years he spread destruction among the herds and flocks in an eighteen-mile area in Caddo county, Oklahoma, outwitting pack upon pack of expensive dogs that killed off his weaker and slower relatives. After much effort, he was finally caught in a trap.

More spectacular was the capture of the notorious "Custer" wolf, who had created a virtual reign of terror for herders and ranchers of Custer, S. Dak., for nine years. He was caught only after seven months' persistent effort on the part of a single federal hunter, and had taken a toll of more than \$25,000 in cattle and escaped the combined efforts of numerous bounty hunters.

Prior to the time the government hunter, H. P. Williams, was dispatched to the scene of action, these facts were presented to him: First, that the renegade could ravage a range and then, as early as the following night, commit depredations in another section 100 miles away; second, that he seemed not only to bear a charmed life, but also to be possessed of remarkable cunning to the extent that he steadfastly refused to touch any kind of poison.

Realizing fully that he had no ordinary hunting job on his hands, Williams spent long hours planning his methods of attack. First of all, he placed many traps along trails known to be frequented by the wolf, and then he put wolf scent on the soles of his shoes, a trick known only to the veteran hunter. This was in the month of April, and not until October did success come.

"Custer" had a strange habit, previously believed to be possessed only by certain types of bears, of following a certain trail and then retracing his steps backward, later

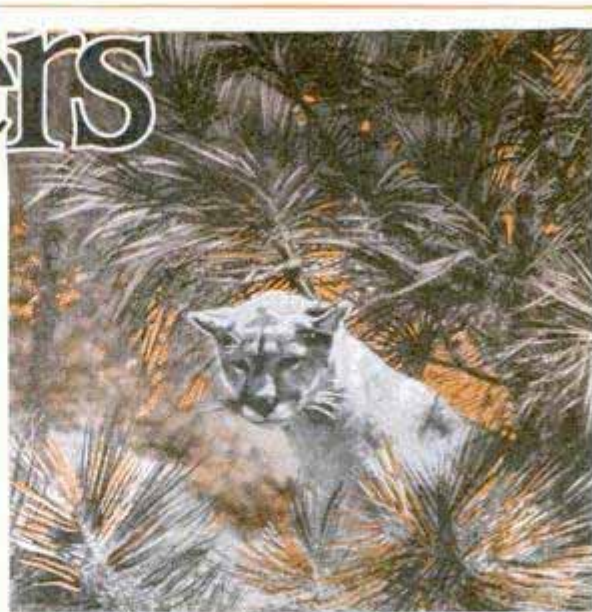

Interesting Studies of Mountain Lion Trapped in Tree; These Animals Are Skillful Climbers in an Emergency and Show Fight Chiefly When Cornered

*M. U. Schoopf
Gunch,
Switzerland*

131

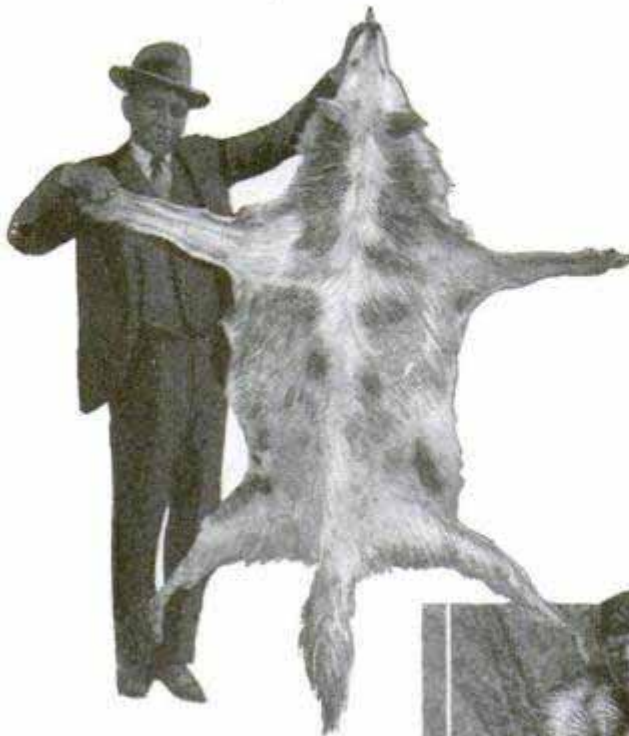

watching his pursuer from a hidden vantage point. Three times the wolf stepped into traps but escaped. Then, in October, he was caught again and dispatched with a bullet.

There was great rejoicing, not so long ago, among the cattlemen and rangers of the west when the news leaked out that "Lobo," king-wolf of the Arizona cow-killers, was dead. After a long and successful career as a cattle bandit on the Arizona plains, he finally bit the dust at the command of a government hunter. And at that, the rifle had the rear sight missing.

For three years, according to the report received by the biological survey, "Lobo" took a terrific toll of pure-bred Hereford stock, eluding all hunters and apparently leading a charmed life. Once every two weeks the old bandit of the plains paced his regular trail. On one ranch alone, some fifty white-faced yearlings had fallen victims to his skill and cunning, while many other ranches told similar stories of his depredations.

Perhaps it was the old wolf's belief that

his luck would last for ever, perhaps he was getting a trifle slow on his feet. Anyway, he seemed to become careless. Wary of men, the big fellow felt reasonably safe at the near approach of an automobile containing a government hunter. Hardly had he ran fifty yards when he fell at the first crack of the rifle.

366 BANK NOTES COATED WITH TIN WILL NOT TEAR OR BURN

Bank notes which will not tear, burn or wear out can now be made by a process evolved by a Swiss scientist. It consists in coating the paper pulp to be used with tin. The metal is fused at a suitable temperature, then applied to the pulp with an atomizer. Previous efforts to metallize paper have injured the fiber, but this process is said not to harm the pulp. Other metals, such as aluminum and copper, may be applied in similar fashion. The process also would make it difficult to counterfeit bank notes, it is claimed, and the metallized paper may find other uses in the radio industry.



Skin of Huge Wolf, Tracking Animals in Winter and Preparing Bait for Wolves

U. S. ENTERS RACE FOR BLUE RIBBON OF ATLANTIC

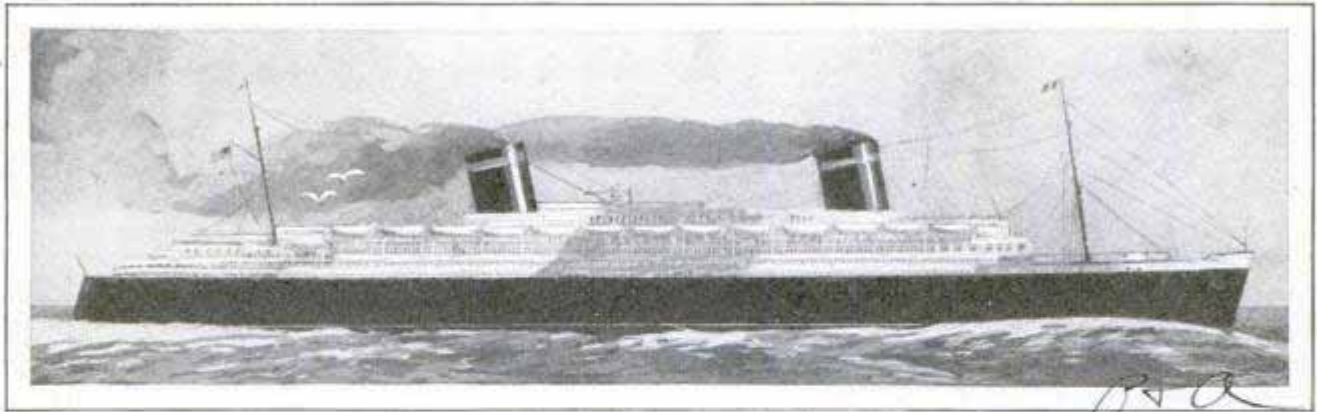

Drawing of One of Two Giant Liners Which United States Lines Will Build in Struggle for Transatlantic Trade; It Will Be Faster Than the "Bremen" and Longer Than the "Leviathan"

Plans have been prepared by the United States lines for one of two giant liners representing America's entries in the contest for transatlantic trade. The vessel, in excess of 50,000 gross tons, will be longer than the "Leviathan" and is expected to develop greater speed than the German liner "Bremen." The great bulk will be of streamline design to add to speed, and the ship will be equipped with every modern nautical appliance, including a catapult to launch airplanes.

376

DESERT MAY FURNISH DRY ICE

Torrid desert sands may furnish the ice of the future, and it will be twice as cold as any ice made from water. The commercial possibilities of "dry ice" from carbon-dioxide wells lying beneath the arid stretches of western Colorado and eastern Utah are being stressed by the department of the interior. The dry ice manufactured from this gas has a refrigerating efficiency twice that of water ice, and transforms more slowly than the latter, thus being superior for long shipments of perishables. It is particularly adapted to fish, fresh meats and ice cream, which are best preserved when frozen, but is less satisfactory for vegetables because of its extremely low temperature. If its frigid-ity can be lessened without impairing its efficiency, the dry ice may be used as a general refrigerant. It usually is produced by burning coke and capturing and compressing the carbon dioxide. The problem in using the natural gas rests on the ability to convert it to ice form and transport it to market. In some wells the car-

bon dioxide occurs with inflammable gas, and these can be separated, the one being used to produce the power to compress the other.

MUSIC PRINTER FOR THE NOVICE REQUIRES NO ENGRAVING 182

Easily operated by a musician with little practice, a machine for printing music, known as the "scriptograph," has been placed on the market. It consists of two separate units, one that takes the specially ruled music paper and gives precision for position of musical and other characters, and a case which holds other characters required in music but not included in the mechanical unit. It does away with the tedious process of engraving plates for publication, as excellent lithographic copies may be made from the original at small cost.

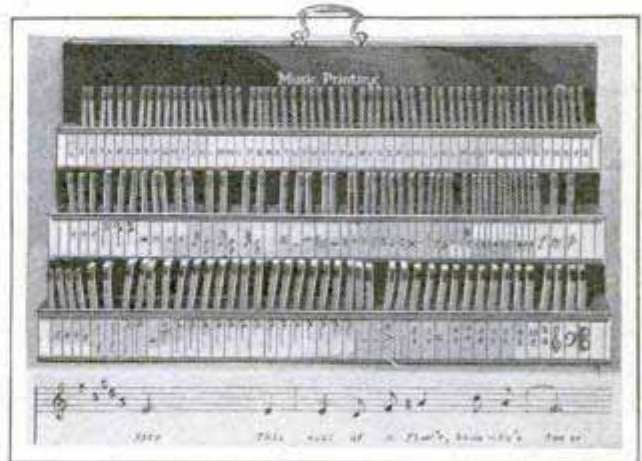

Machine for Printing Music Which Is Simple in Operation and Intended for the Novice

The moon's actual color is brown, astronomers believe.

Kansas City Star
2/33/22

I M Newbaker,
294 Crossborough Ave

OIL POURED ON WAVES STEADIES NAVY'S BIG GUNS

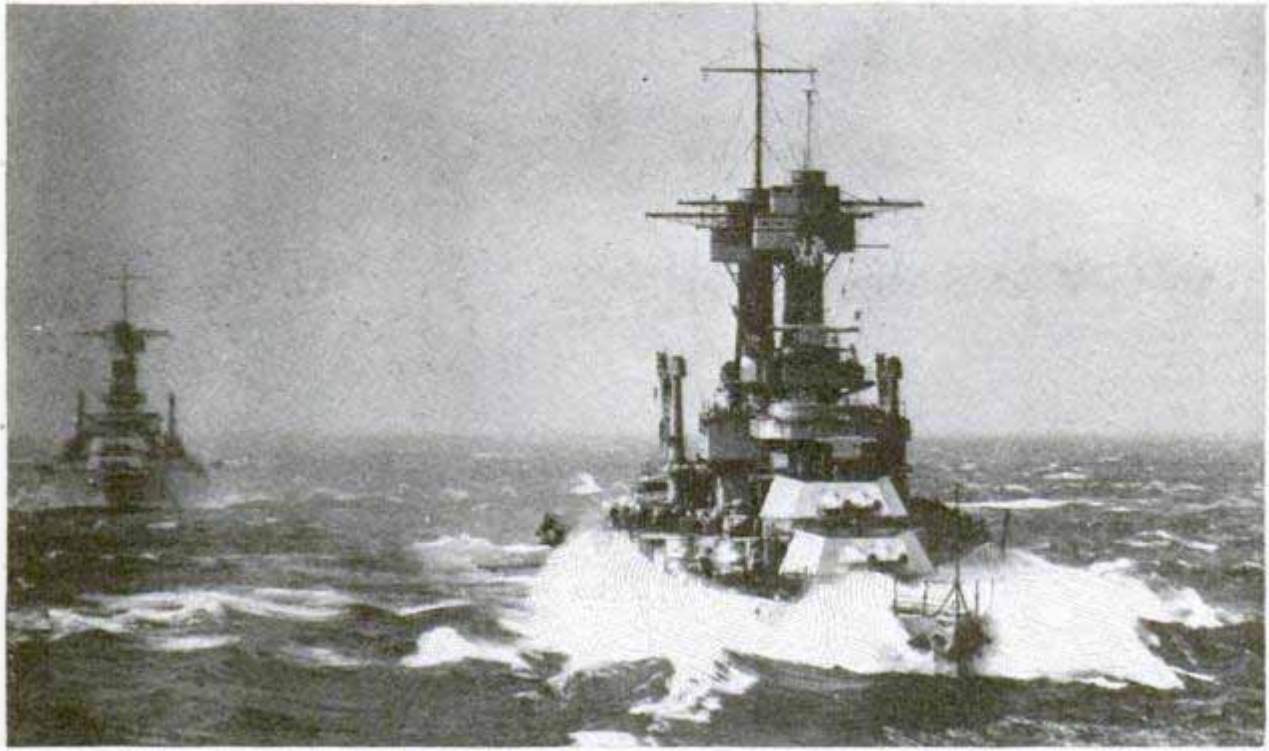

In the Foreground, the U. S. S. "Colorado" during a Storm; in Such Cases the Battleships Pour Oil on the Waters to Steady the Guns for Firing, or to Allow Seaplanes to Land

While the use of oil for flattening turbulent seas has been known for almost a century, now it has been elevated to one of the cardinal points of seamanship, and the navy has just completed a long series of actual experiences with it on a large scale. The most recent utilization of the oil flat at sea was its application a few weeks ago by the battle fleet. Ships preceding others would leave oil behind for those following to use in steadying themselves while firing their great guns. In other instances, where the battleships were executing intricate patterns, the oil was laid by destroyers. In any case, the use of oil considerably steadied the gun platforms, resulting in increased accuracy. When it is desired to bring aircraft in for landing, destroyers steam slowly ahead on parallel paths, ejecting oil, and the planes come in safely on the oiled flat. When an aircraft has alighted in distress on a dangerous seaway, the rescuing ships steam to windward laying oil. The plane then rigs a sea anchor, and the oil drifts down about it, creating a small area of comparative safety. Submarines, too, carry oil for ejection in heavy weather. It is rather well known that when a sub-

mersible dives, it encounters smooth seas at a depth of about thirty feet and lower. But when breaking surface again—and United States submarines of the V-type are designed for high-sea work with the fighting fleet—they may be badly rolled and even damaged by violent seas. A submarine about to break surface and emerge from a dive in such conditions uses its oil film from below. The oil immediately rises to the surface and breaks the waves, then establishes an area in which only a gentle roll is perceived. Into this area the submarine rises.

CRADLES FOR INFANT OYSTERS AID ARTIFICIAL CULTURE

Paper cradles are being employed with success in the artificial culture of oysters. The cradles are cardboard lattices, like those used to partition egg crates, in which the baby oysters are kept. The system has been found to develop even-sized oysters, while eliminating the loss due to crowding and producing greater quantities of seed oysters from a given area than by the ordinary method of shell-planting. Commercial practice has been

Harly News 2/20/30

324

Brycherch, U. S. Bureau of Fisheries, Washington, D. C. in each dept. of Club through *Solarium* 727

to scatter shells from shucking houses in the spawning grounds, the minute fry attaching themselves to the shells. More than 1,000 have often been found to one square inch of shell, but the majority are crowded out during development. The cradle also has been dipped in sand, cement and lime to produce an artificial shell-like substance to which the seed oysters attached themselves. From either type, the mollusks may be transferred easily to growing grounds and broken off to mature singly. Paper cradles are intended for use in northern oyster grounds, ordinary brush being employed for the same purpose in the south.

And W. H. Stage Commercial Paper

UMBRELLA AND CASE FOR AUTO FIT BACK OF SEAT

155

For the motorist who must leave his car during an unexpected shower, an umbrella for the automobile now is available that fits in a neat case which may be installed in an out-of-the-way corner above the windshield, over the rear window or back of the driver's seat. The umbrella is of standard size, while the rack, operated on flexible steel springs, brings it out ready for use at a slight pull, or snaps it back into the case when it is pushed.

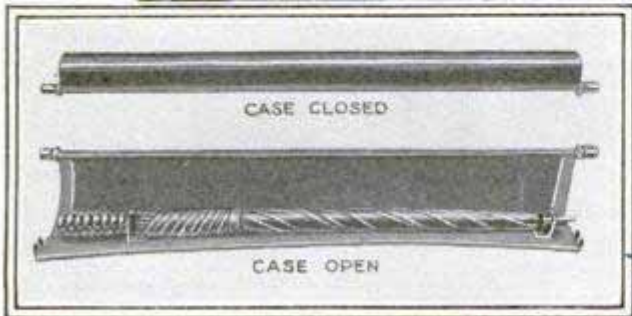

Umbrella with Roll Case for Auto Driver's Seat Where It Is Out of Way but Always Handy

Wm. Beehler, 222 W. Baltimore Md



262. Dr. James G. Stoddard manager, hair and scalp Dept. Penn Athletic Club Phila

Apparatus Which Stimulates Growth of Hair with Ultraviolet Rays and Cooling-Fan System

GROWTH OF HAIR STIMULATED BY FAN AND LIGHT RAYS

Growing hair by machinery now is being attempted by members of a Philadelphia athletic club, which has installed an apparatus to stimulate the crop of hair. The machine, under which the patient sits, treats the scalp with ultraviolet rays, and a cooling-fan system.

RADIO STATIC TO BE FORECAST LIKE THE WEATHER

33 4

Predictions, like those for the weather, which would tell radio listeners of coming static and what kind of reception to expect within a certain period, now are planned. A proposal that reports of daily magnetic disturbances be transmitted on short waves along with the weather forecast and seismic activities is to be made at a Stockholm meeting of a section of the International Geodetic and Geophysical society. These magnetic storms rage as fiercely as windstorms, but do not make their presence known physically. Research workers have decided that fairly accurate forecasts can be made of such storms, accompanied by predictions of the kind of radio reception to be expected.

Science number 1/12

Announced by Dr. H. S. Hazard asst. chief, div. of terrestrial magnetism and seismology, U.S. Geologic Survey

246 NOISELESS SHOES AND JEWELS FOR THE TALKIES



Microphones that record the sound for talking movies pick up and often magnify or distort the most insignificant noise, and as a result every article of furniture and every piece of clothing or jewelry must be carefully inspected before use in the production. Beads worn by actresses in the talkies must be arranged so that they do not strike together and rustle or click, soles and heels of shoes must be covered with felt, and the squeaks must even be taken out of noisy chairs or other furniture used on the sets.



Above, Placing Felt Pads on Shoes to Be Worn in Talkies to Make Them Noiseless; in Circle, Taking the "Click" Out of Beads; at Right, Eliminating Squeaks from a Talkie Chair

358 DIAMOND DIGGERS IN FOOTRACE TO MARK CLAIMS

Fleetness of foot is one of the primary requirements of successful diamond diggers in South Africa, for a footrace in which thousands often participate is the first formality in opening a new area. If finds during prospecting operations have been good, diggers by the hundreds load their donkey wagons with tools and a flimsy shack, and flock to the alluvial fields in their quest for riches. The ground to be claimed is marked in sections, and

prior to the rush, the diggers explore every foot of it, judging by surface soil where diamonds are likely to be found. On a fixed day the commissioner of mines comes to proclaim the area for digging, and just before the actual rush, every person is driven from the grounds, and the diggers, often kept in order by hundreds of officers, are lined up to await a signal. Sometimes the race starts eight miles from the claim, and often the line of diggers extends for two or three miles. At the signal, the dash for the favored claims is on, each digger carrying four iron pegs

with his name attached, and on arrival at the coveted spot, he quickly stakes his claim, about fifteen yards square. Here the police often are called on to settle hundreds of disputed or overlapping claims. Claimants are of all ages, and even young women have staked claims after running for miles with the men. Once a claim is settled, the digger erects his shack and starts operation immediately, sifting and washing the gravel, stones and dirt until finally the small gravel and any diamonds are separated. Lucky finds are few and far between, and most of the diggers come back penniless, or move on to other fields in the hope that the next claim will hold stones that spell riches. The hardships suffered by the diggers are manifold, because they operate in areas usually remote from comforts of civilization, and they are forever on the move to new fields.

**WINDMILL OVER CENTURY OLD
 CONVERTED INTO MUSEUM** 260



Picturesque German Windmill, over a Century Old, Which Has Been Converted into a Museum

Uelken
 On the lower Rhine in Germany, a picturesque old windmill, relic of the machine age of a century ago, has been converted into a museum containing antiques of the same age and neighborhood. The windmill was built in 1807 and was in operation for nearly a century.

**BRIDGE SCORE ON TABLE EDGE
 IS OUT OF THE WAY** 305

Bridge-score pads that are out of the way of the players at all times now are on the market. A metal holder equipped with score card and pencil is made for attachment to the side of the card table so that it is always within easy reach of the scorer, yet is not on the table itself where it might be in the way. The paper is held in a roll beneath the pad.

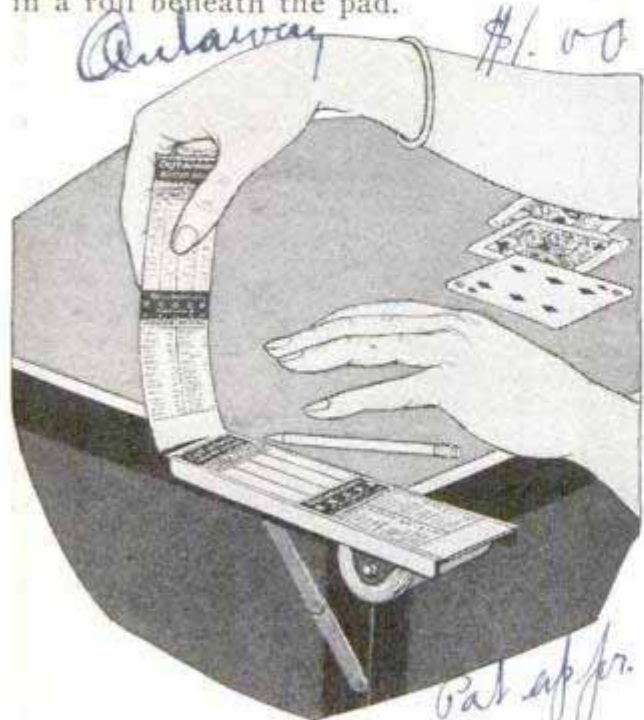

Metal Bridge-Score Pad Holder Which Attaches to the Side of the Card Table Out of the Way

**ARTIFICIAL LIGHT FOR WHEAT
 MATURES CROP EARLIER** 342

Plant breeders of the Canadian government experimental farms are using batteries of electric lights in greenhouses in the evenings to mature two crops of wheat in a year and save time in the development of promising new varieties. Time is important because usually it takes eight years to produce enough seed of a new variety to test it for yield in field trials. By maturing a second crop in greenhouses during the winter, the period until field testing is shortened. Without the batteries of 300-watt lamps, the indoor crop would lack vigor and would not mature in time to effect any saving. Several hardy varieties have been developed at the government farms.

Con. John H. Spicer, 1948. 4th Ave. East, Denver, Col.

Albert H. Siple Co., at Allaw

The Tricks of Fancy

By "PETE" DESJARDINS

(Olympic Diving Champion, as told to H. H. Dunn)

4351 George St. San Diego Cal.
MOST people regard diving as a mere falling, or leaping, from a wall or springboard, and hitting the water head first or feet first, as chance may direct. As a matter of fact, however, diving is the most highly specialized, and the most intricate, of all water sports.

Though diving is by no means merely "falling into the water," the beginner should learn first to fall forward off the springboard, or the wall, into the pool, until he overcomes all fear of entering the water head first. Then he should learn to spring away and up from the take-off at the instant that he throws his arms forward. Contrary to the usual picturing of diving positions, the arms never should be held high over the head; they should be held at right angles to the body, extended parallel to and over the water.

My greatest difficulty, when I began to dive in 1921, was the overcoming of fear. I believe that is the greatest obstacle to diving, even on the part of experienced swimmers, who, once in the water, know just what to do and how to do it to keep afloat indefinitely.

Hundreds of times, as a lad, I stood on the rim of the pool at Miami, Fla., and dropped feet first into the water. I never will forget the first time I went in head foremost. Then, I had to learn to open my eyes and keep them open throughout the execution of the dive. No beginner ever worked harder than I did; no one ever had greater fear of that first plunge into the water. But by 1924, at the age of seventeen, I had so far mastered fear that I won second place in the Olympic Games at Paris. Four years later, I had the good fortune to take the springboard, and the plain and fancy high-diving titles. I mention this merely to show how a determined diver can overcome fear.

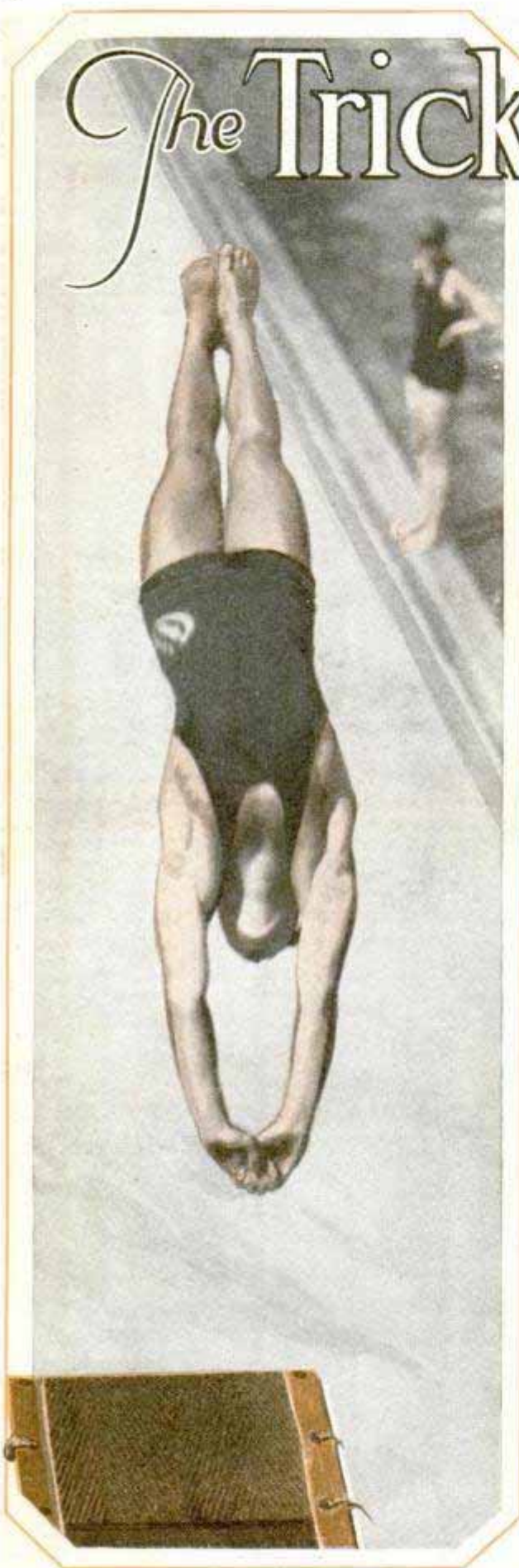

Take-Off in a Backward Dive from Position with Both Hands at Extreme End of Springboard; a Good Start Insures Better Form in the Air

Diving

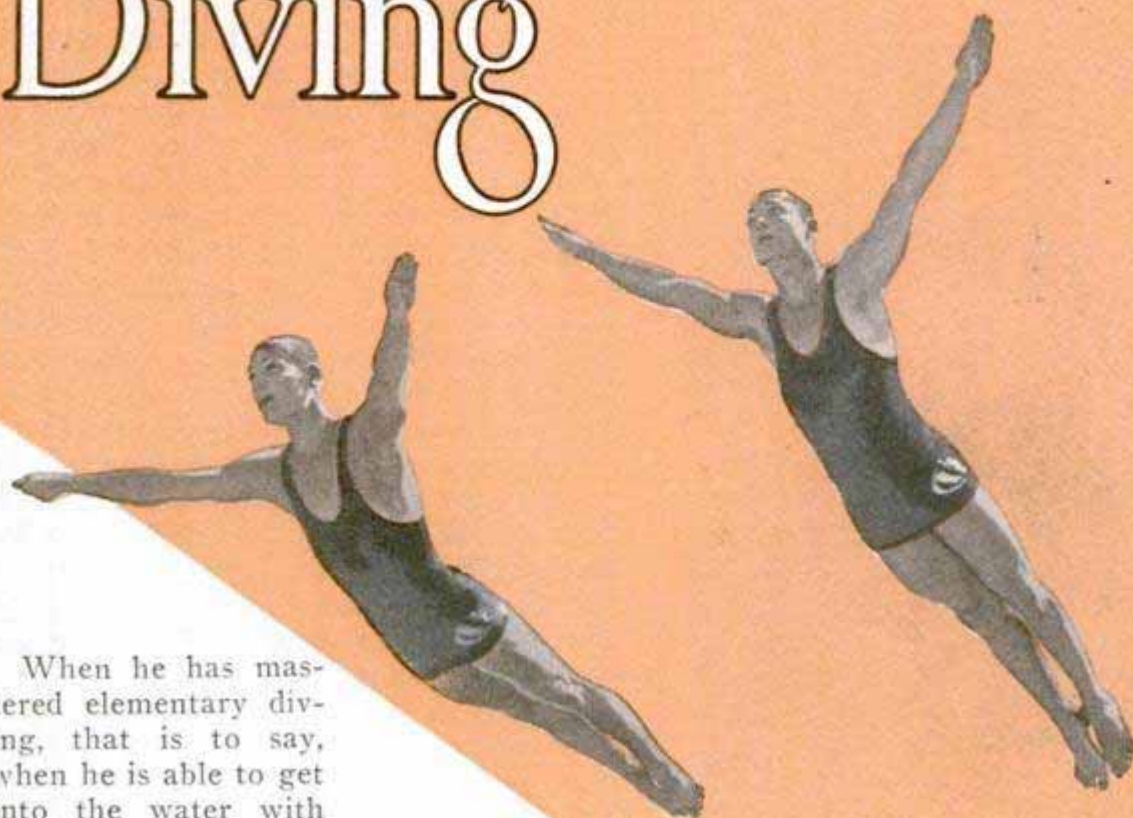

When he has mastered elementary diving, that is to say, when he is able to get into the water with the minimum of effort and the maximum of grace and force, the beginner will want to continue into fancy diving. Here, he (or she) will find five elementary principles which must be learned in theory and applied in practice. The object of fancy diving is to lift the body, apparently without effort, from the springboard; hold it suspended, literally by its own internal forces, in the air for a few seconds; turn it at will in the air, and, finally, make it disappear, smoothly and almost silently, beneath the surface, to rise at will, either immediately or after some time under the water.

The first thing is position at the start. The correct diver stands straight, at the extreme end of the board, either face or back straight to the water, and hands extended at a right angle over the surface of the pool. In running dives, the approach is the second principle. The run should include at least three steps, with the arms at the sides of the body until the final step to the end of the board, when they are swung in a fashion most suitable to the individual—that which will enable him to obtain the maximum height. Or, if the diver finds this more suitable, they may be swung along the sides of the body, as



Two Experts in Double Swan Dive, Timing Their Movements to Synchronize Almost Perfectly; This Is Beautiful but Not So Difficult as Others

in natural walking. The swing of the arms at the take-off, however, should end in a forward and upward movement which simplifies the action of the dive. The arms never should be behind the body in the take-off.

The take-off, which is closely involved with the approach, is the third essential element in diving of any kind. This is made from both feet, with the spring up-

103

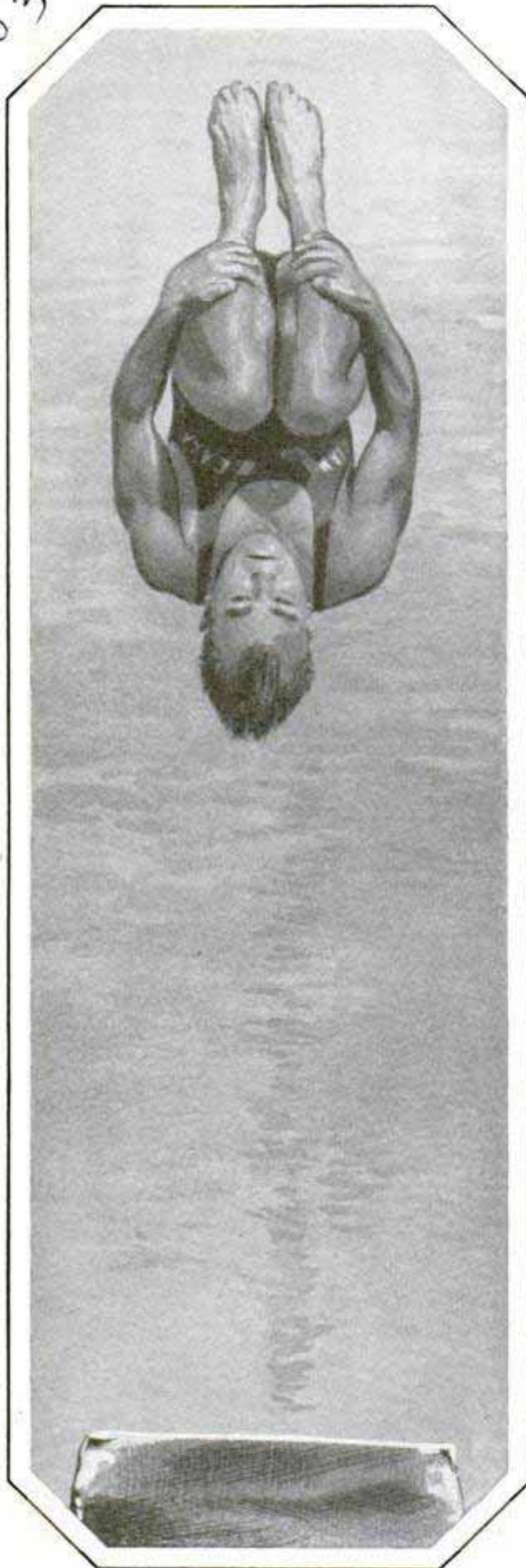

The Diving Face of "Pete" Desjardins; Here He Is Doing a Double Somersault

ward, rather than outward. One of the most common errors in fancy diving is that of leaping, almost straight outward over the water, from the springboard. There is nothing in all athletic competition more beautiful than a properly executed dive; and nothing more discordant than a badly handled body, either in the air or in the water. The take-off includes a spring from both feet, at the end of the board, co-ordinated with a shoulder lift and an arm swing, so that the greatest height consistent with the particular dive being made may be obtained.

Then comes the most important factor of all, especially for the man or woman who is diving in competition. This is form in the air. On its excellence or inferiority depends the rating in points of the competing individual, and it is the most difficult to acquire of all the departments of fancy diving. First of all, especially in the lay-out, or swan, forms of dives, as the diver leaves the board, the back should be arched gently, the head held back and the toes pointed, as illustrated in the photos with this article.

In a number of the many fancy dives, the starting position will be held only for so brief a time as to be hardly perceptible, yet it is absolutely essential to all forms of diving. The position, the take-off, and the handling of the body in the air so melt into each other in very quick time that they seem to be one continuous motion, but the result is accomplished through close attention to three quite separate actions. The beginner must learn all three until he can pass from one to the other seemingly without effort, and without any break in the continuous action which culminates in a smooth passage into the pool.

The fifth and last principle of diving is the manner in which the diver gets his body into the water. Once in the air, passing through the various somersaults, the jackknife or other tricky turnings of the body, the diver must straighten himself at exactly the right moment, arch the back slightly, bring the arms above the head, with the hands close together in line with the body, and the heels joining, with the toes pointed—all in the fraction of a second just before the swiftly falling trunk enters the water. At the instant

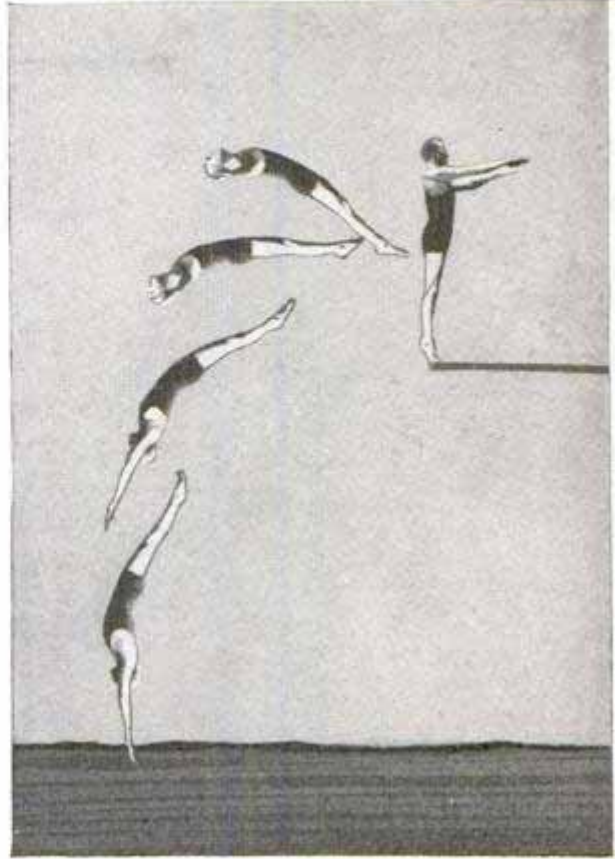

At Left, Various Poses in the Backward One and One-Half Somersault Dive; This Diagram, by Fred A. Spongberg, Swimming Coach of the Detroit Yacht Club, Was Made from Slow-Motion Movies; at Right, Principal Positions during a Back Dive; Note Particularly the Take-Off

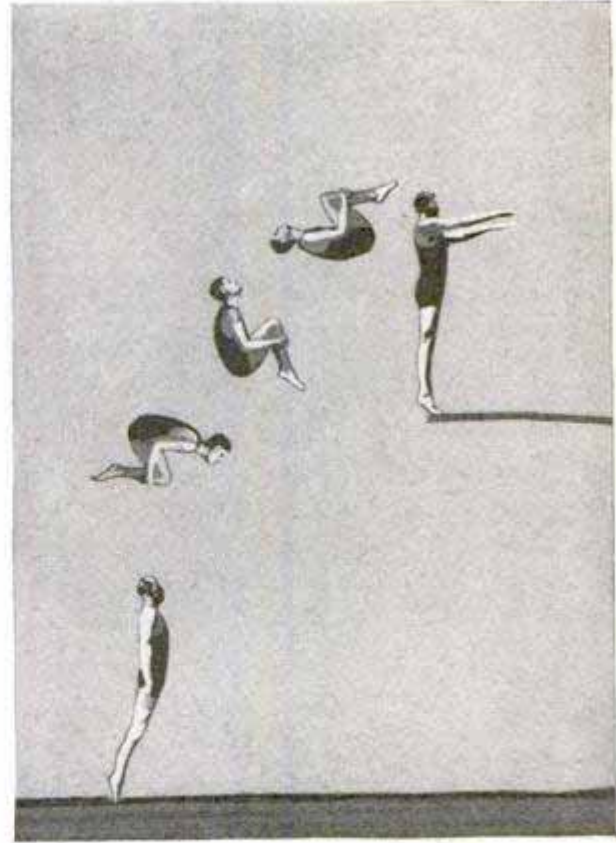
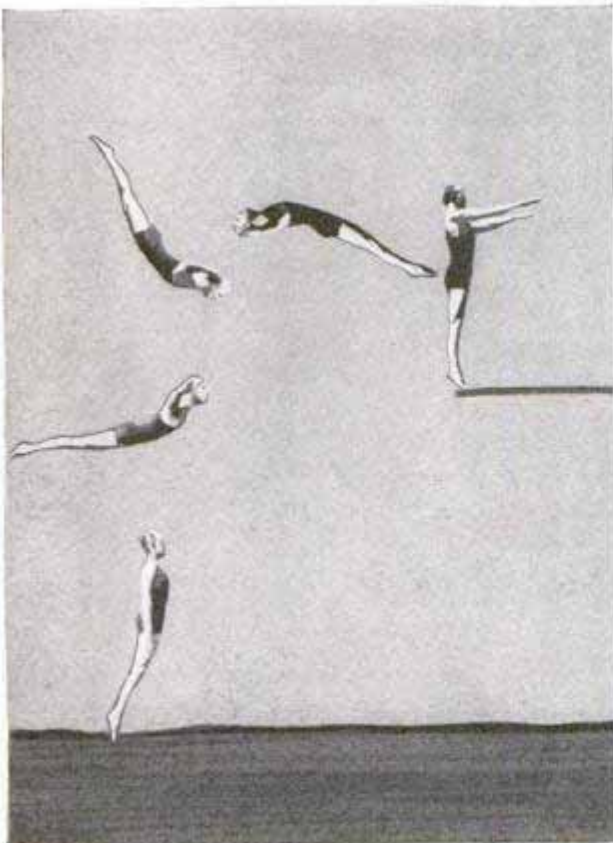

At Left, Back Somersault in Which the Body Is Made to Turn on Its Shortest Axis in Mid-Air and Enter the Water Feet First; at Right, the Double Backward Somersault

103

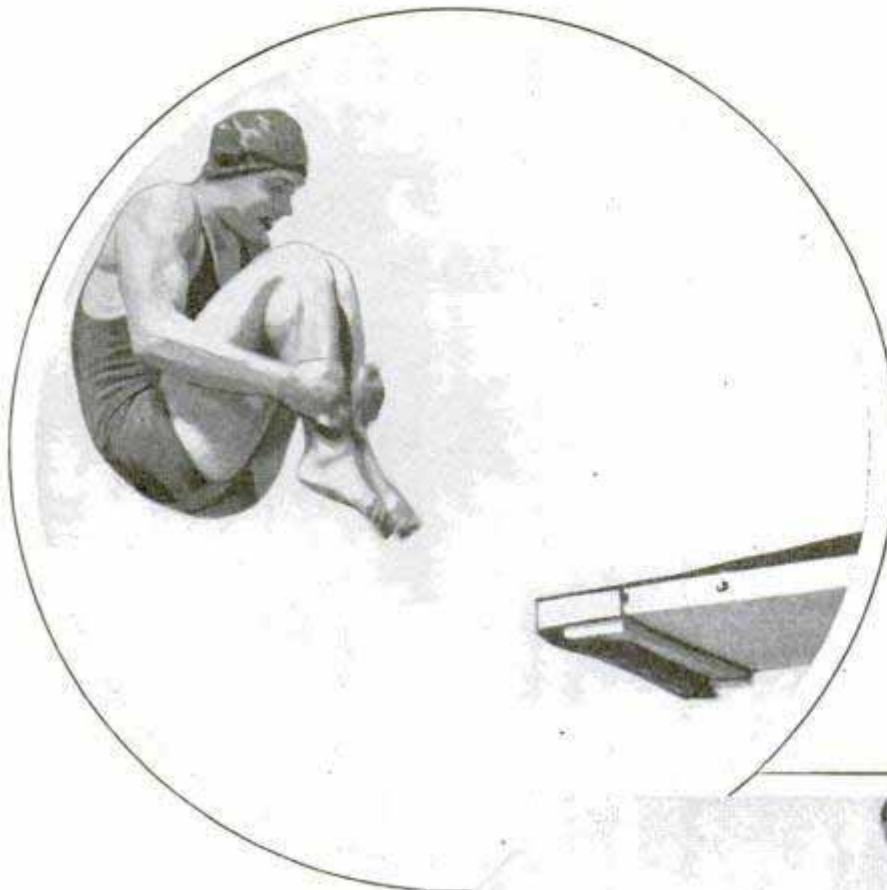

but I was desperately afraid to plunge into the water; more than this, I was not even of the average strength of boys of my age. Today, twelve years later, while I have not added to my stature, I have won excellent health, increased my weight, added to my strength, and found a sport in which a puny boy may train himself to excellence and health.

Swimmers, divers and coaches helped me at first, "because," as they freely admitted, "they never saw a boy with so many ungraceful ways of

the hands break the surface, the body should be practically perpendicular to the water. More than this, it must remain in this up-and-down position until the tips of the toes disappear.

The casual spectator at a diving exhibition probably would consider the position of the hands more essential than that of any other part of the body; yet it is the position of the head which is of the utmost importance, both to diver and to judges. If the head is held too far back, the dive seems strained; if held too far forward, it will tend to throw the legs over and to turn the diver on his back.

I say that anyone can learn to dive who can swim. I know from hard experience. In 1917, a boy of ten, I could swim,

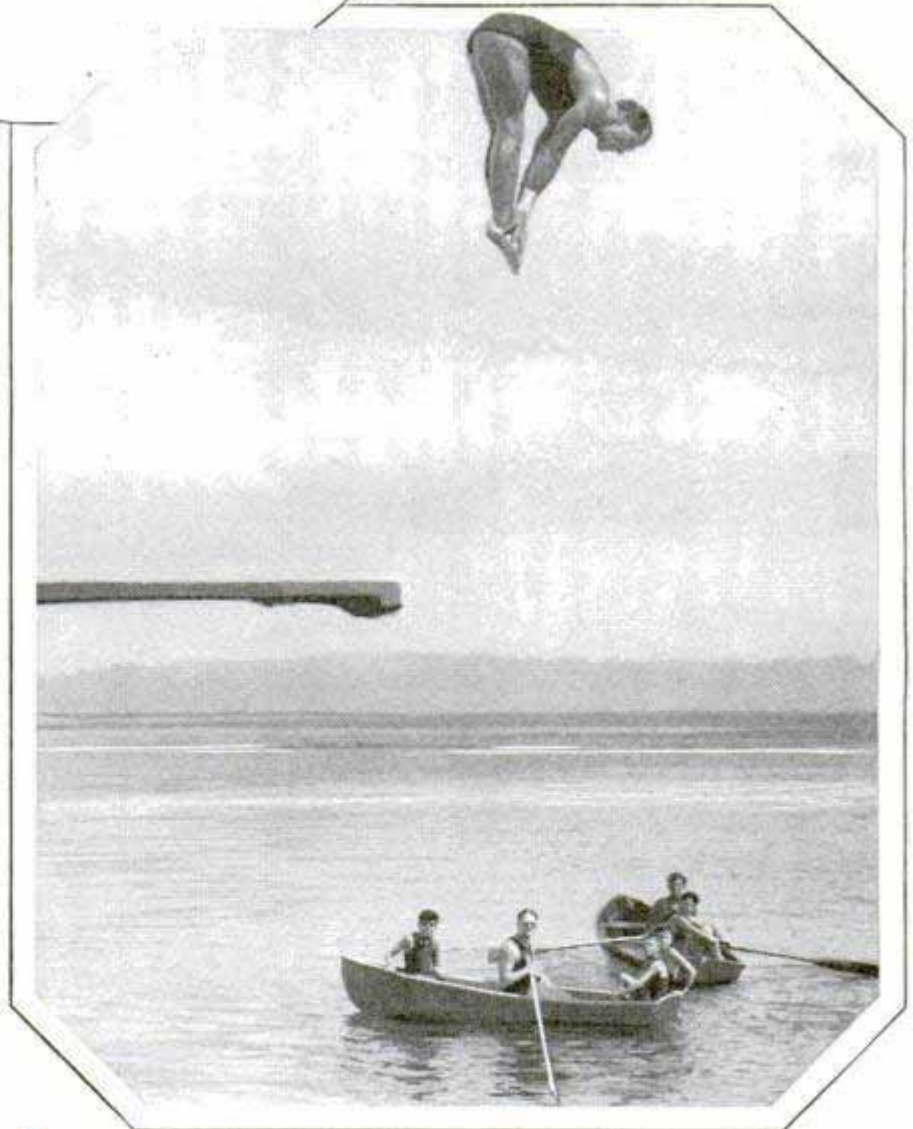

"Sitting on the Air," Midway through a Double Somersault, and, Below, Desjardins Doing a Jackknife in Perfect Form and Rhythm

getting into the water." They felt sorry for me. Unlike boys in fiction, I never displayed any sudden and startling ability; I did not become a champion overnight; but I did what every other boy can do—I worked all the time to learn how to do one thing, and that thing was how to dive. As in education, there is no royal road to diving success.

One of the most popular dives, done by one person alone, or by two or more acting in unison, is the "swan." This starts with a running take-off from both feet, with the spring mainly upward and slightly outward. As the body lifts from the springboard, the hands are held outstretched at the sides of, and at right angles to, the body. The head is brought back, and the back

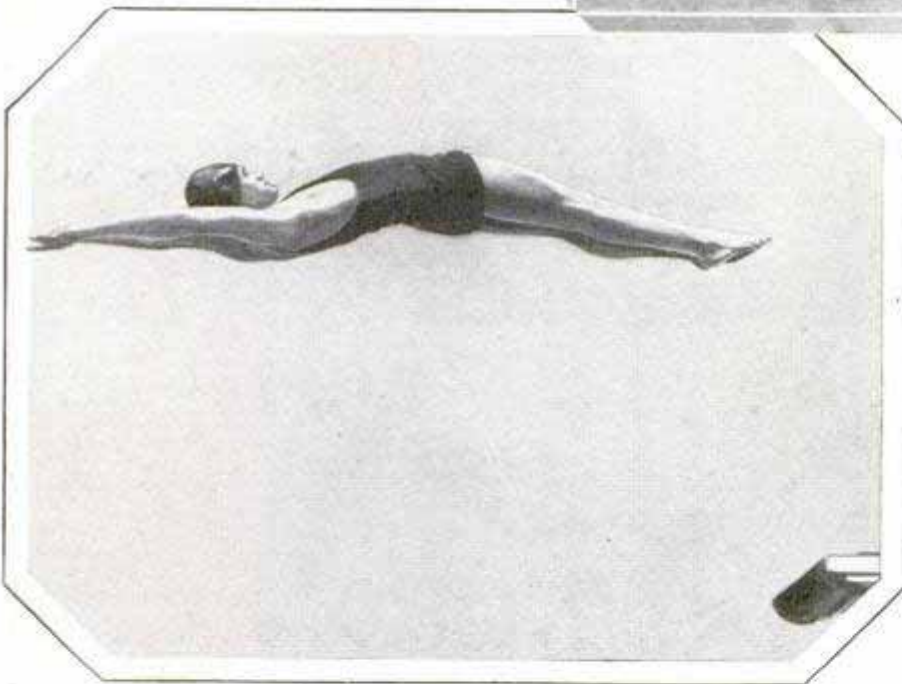

Coming Up through the Pool in Good Form after a Fancy Dive, and, Below, a Graceful and Correct Position in the Air

arched just enough to give the body a beautiful curve. The hands and arms remain, like the spread wings of a bird, until exactly the right second, when they are brought together, extended at full length beyond the head, preparatory to entering the water. As they break the surface, the hands should be together, body arched slightly, legs straightened, heels together, and toes pointed, the head coming back

into a position in line with the body, so that there is a slight, continuous and graceful curve made by the entire outstretched body, between the tips of the fingers and the ends of the toes. The body then enters the water almost perpendicularly to the surface.

Another spectacular dive, with three variations, is the "jack-knife." In this, the take-off is the same as I have described in the swan, but the lift, or hoist, of the body is mainly from

the hips, instead of from the feet, as in the swan. The position from which this dive takes its name is entered at the extreme height of the passage through the air, with the body bent at the hips, the hands touching, but not grasping, the legs below the knees, the toes pointed, and the head held slightly back. From this position, above the springboard, the body describes a long, graceful bow into

103

the water, entry being the same as that for the swan dive.

The somersault dives, of which there are half a dozen or more, always are popular. Leaving the springboard with an outward and upward leap, legs either straight or bent, with hands at right angles or on the legs below the knees, or tucked tightly holding each other below the knees, the diver whirls like a pinwheel, on his own axis, in mid-air. Then, suddenly, and exactly at the right point, he straightens his body, and drops, either head or feet foremost, into the water. As he drops, his arms are rigid at his sides, head held straight on the long line of the body, legs straight and toes pointed, so that he sinks gracefully from sight.

By using the principles and methods described in this article, I have won ten national diving championships, competed in two Olympic games, and am the only American to win two Olympic championships at the 1928 games by taking both the springboard and the combined plain and fancy diving titles. Much of my diving ability was gained in tumbling, jumping and somersaulting over kneeling

companions on the sea beaches in Florida and California. As in flying, confidence in one's ability to spin through the air, literally standing, sitting and lying on nothing, can be gained only by going into the air, with the certainty that, no matter in what form one comes down, the water will catch the diver, sooner or later.

Let me add that anyone who can swim, and who has perseverance and courage enough to overcome fear of that first plunge into the water, can learn fancy diving. First of all, complete confidence must be built up; then knowledge and practice of the rules acquired, and, lastly, abundant work, kept up all the time.

CHURCH OF GLASS AND STEEL IS ALL WINDOWS

72

Consisting of a glass envelope on a steel frame, a church that is composed entirely of windows has been modeled by a German architect. As yet no plans for building it have materialized. The model in shape somewhat resembles half an egg, constructed of steel and with glass panels set in the meshlike openings, even in the

Der Loosend, Essen, Germany

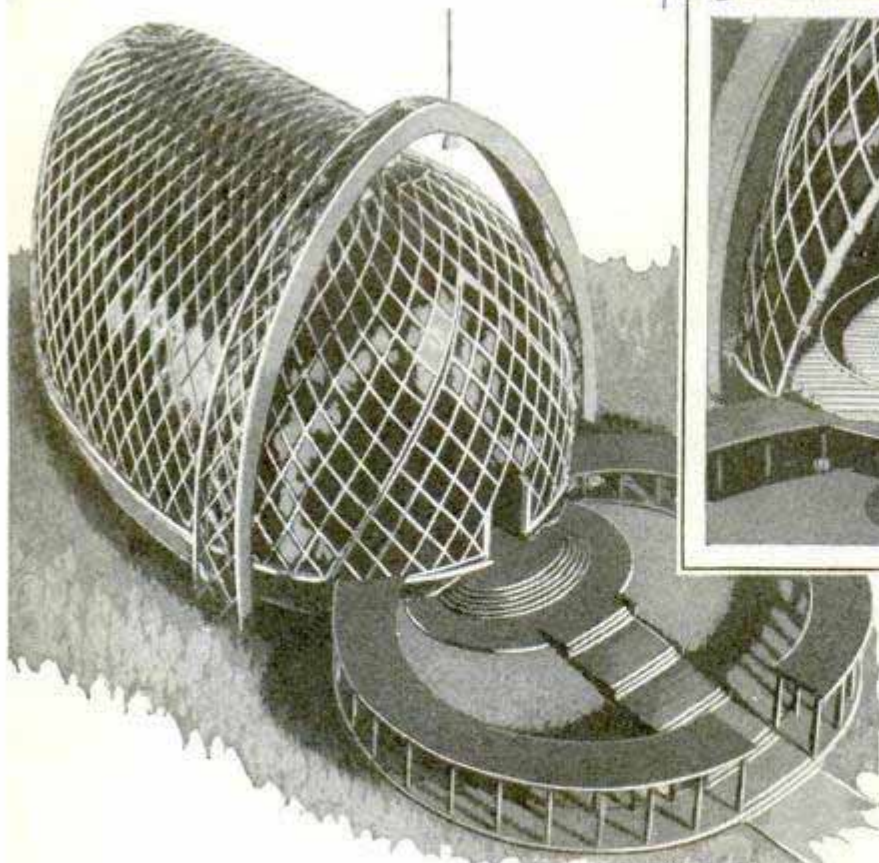

Courtesy The Illustrated London News
Architect's Model of Church of Glass on a Frame of Meshed Steel, and View of Interior, Showing Seats Arranged in Tiers

roof. The seats are arranged in tiers so that the interior somewhat resembles a theater, while in front of the edifice provision is made for a circular covered promenade. Cross and bells are placed upon an arc at the entrance.

*P-1125
12/28/29*

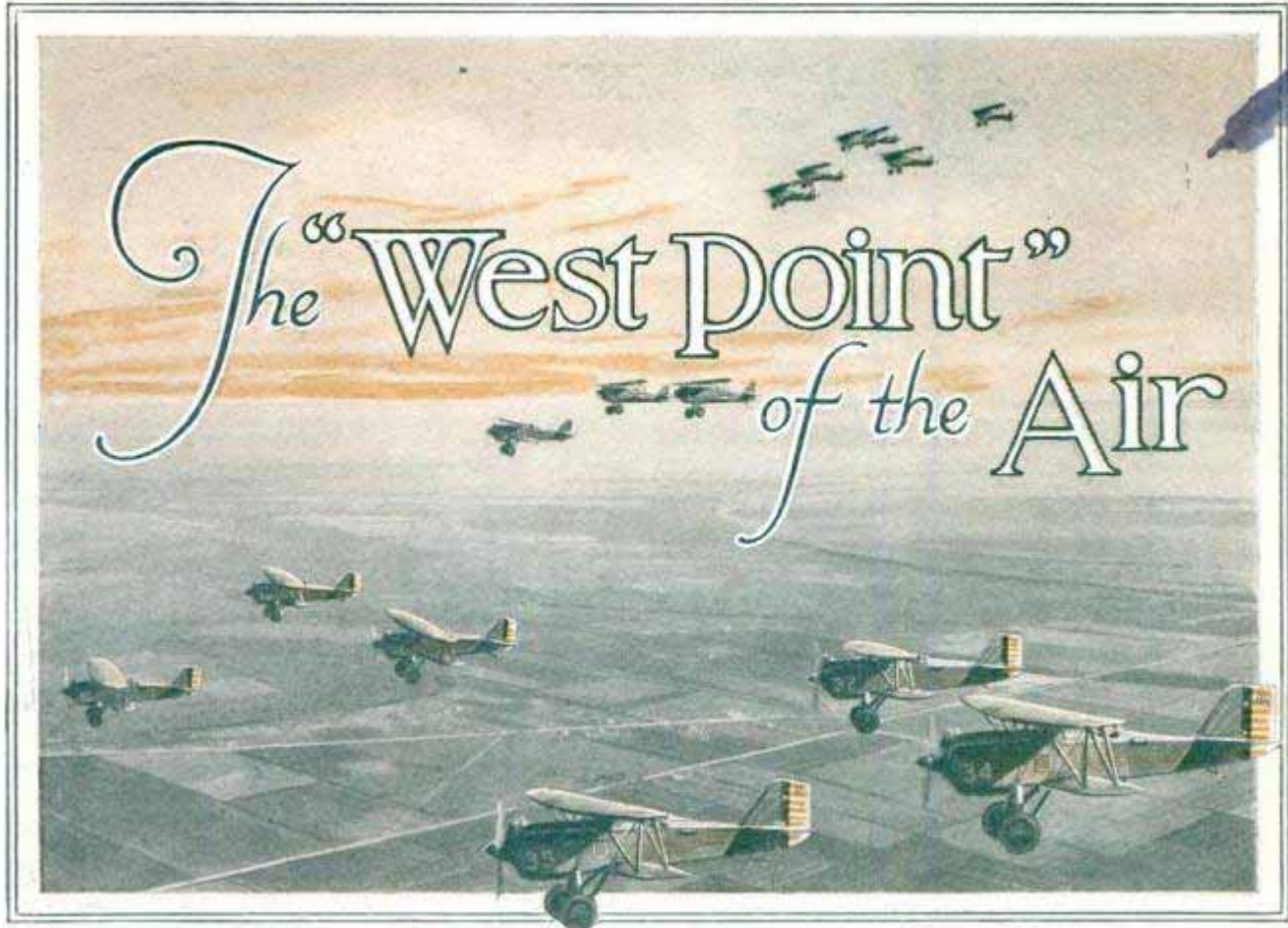

Army Pursuit Planes in Attack Formation, One of the Many Maneuvers in Which Flying Cadets Become Expert, Just as Soldiers Master Drills on Land

MANY men can learn to fly in a few hours, but the army considers a year of intensive training none too long to make a pilot out of a flying cadet. Starting in the primary schools at Brooks or March fields, the candidate for wings is advanced through a constantly progressing and increasingly difficult course until, if he is not "washed out" somewhere down the line, he reaches Kelly field, at San Antonio, Tex., for his finishing work and graduation.

During the busy year, the cadet will have spent approximately 250 hours in the air, under rigid observation and constant instruction. Upon the completion of the course, he is commissioned, without further examination, a second lieutenant in the air-corps reserve but if he desires and there is an opening, he may be sworn into active duty and called at once for service at one of the army posts. Many men elect to go at once into civil life, where they step into good positions, as pilots or in some other capacity, with aviation transport or other commercial firms.

An interesting development is under way at San Antonio in the construction of Randolph field, which is planned to combine Brooks, March and Kelly fields into one centralized unit where the primary and advanced schools will be closer together.

While not more than fifty per cent of the men who are admitted to the air-corps flying schools are graduated, mere admission as a candidate for wings is a desired distinction, for it means that the man has passed severe physical and other tests. One of the most important of all the examinations is that relating to the applicant's type of mind. Army experts are convinced that great flyers are born not made. On that basis, they proceed to weed out, at the start, large numbers of men who, by their reactions to a series of scientific tests, seem to be doubtful material for further instruction. Experience has proved that the tests permit the analysis of a candidate and the determination of his potential value as a military pilot with only a negligible degree of error. It is always important to remember that the air corps is interested in turning out military pilots and not merely men who know how to fly.

(To Be Continued)

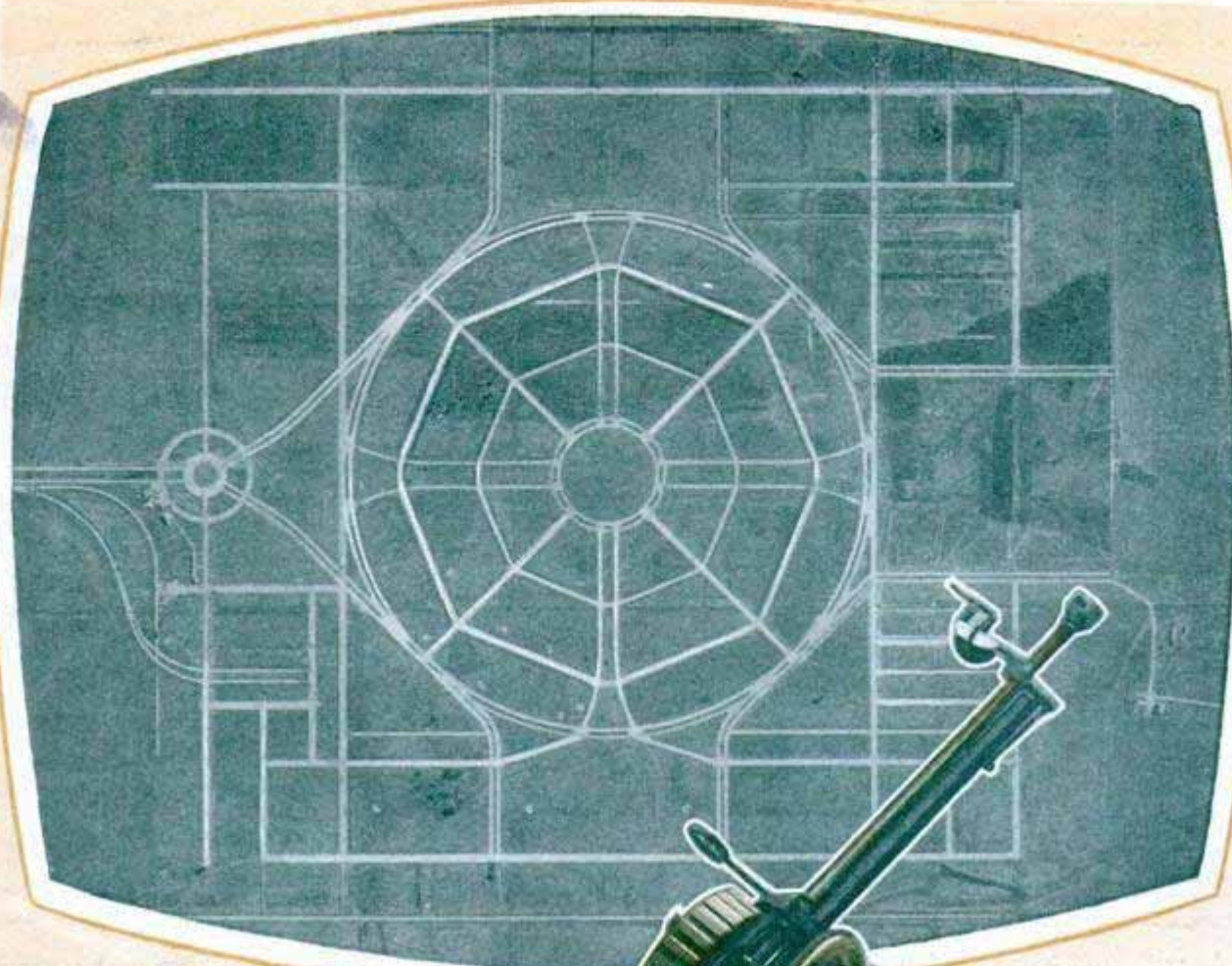

At the Top Is an Airplane View of the Roads Already Constructed at Randolph Field, Site of the New Training School Where Kelly, Brooks and March Fields Will Be Centralized; This Illustration Was Made from What Is Known as a Pin-Point Negative, Taken from an Altitude of 10,000 Feet; Below, a Cadet at Machine-Gun Practice in His Fast Plane; Note How the Chin Is Resting on Hand and Gun Handle to Increase the Steadiness of Aim

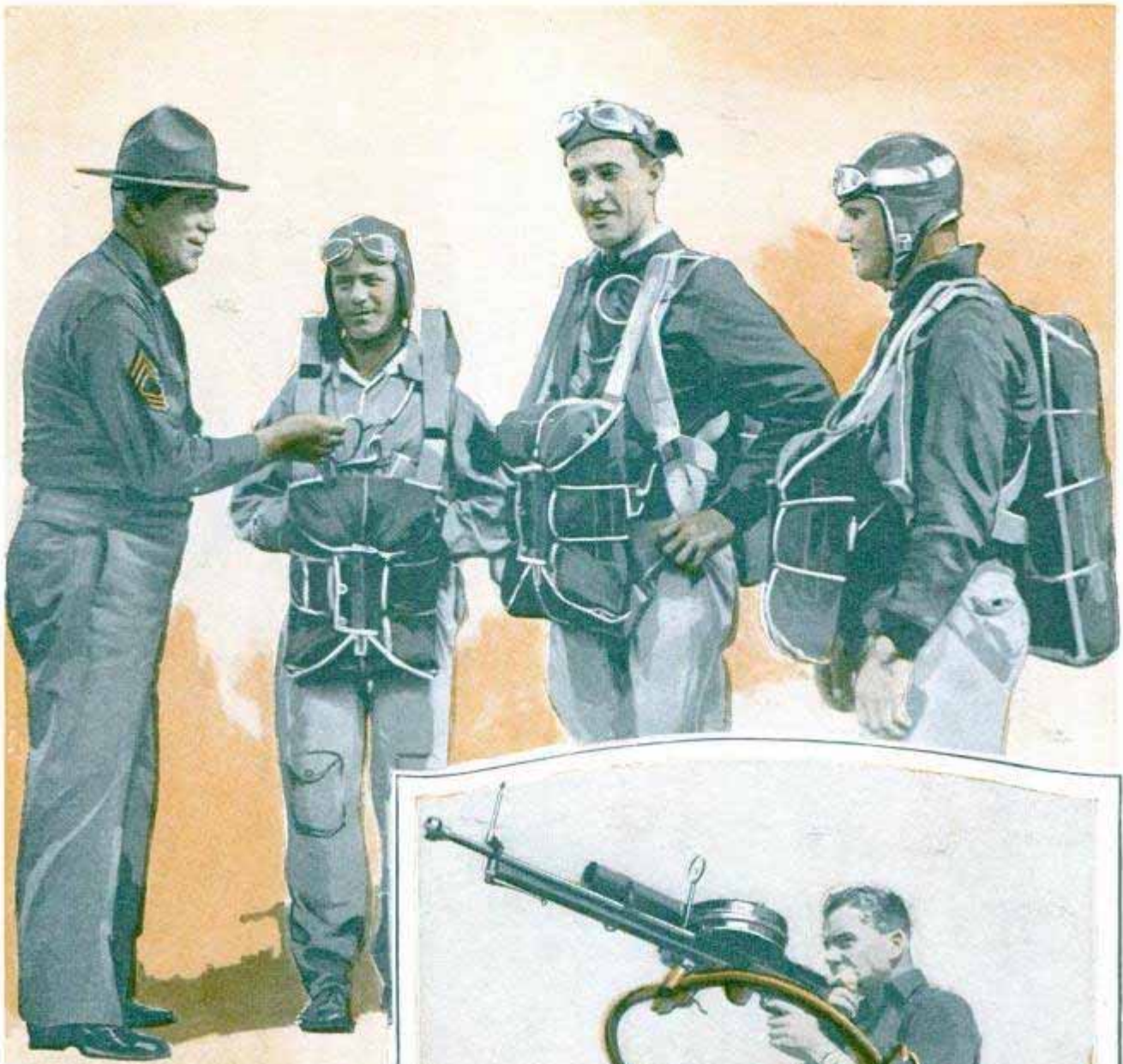

Students in the Primary School at Brooks Field, Listening to an Explanation of Some of the Fine Points of Parachute Jumping from the Master Sergeant Instructor; at Right, "Shooting" at a Plane with the Camera Gun, Which Registers the Results as Shown in the Circles Below; the Instrument Is Handled in Much the Same Manner as a Machine Gun but Uses Film Instead of Bullets.

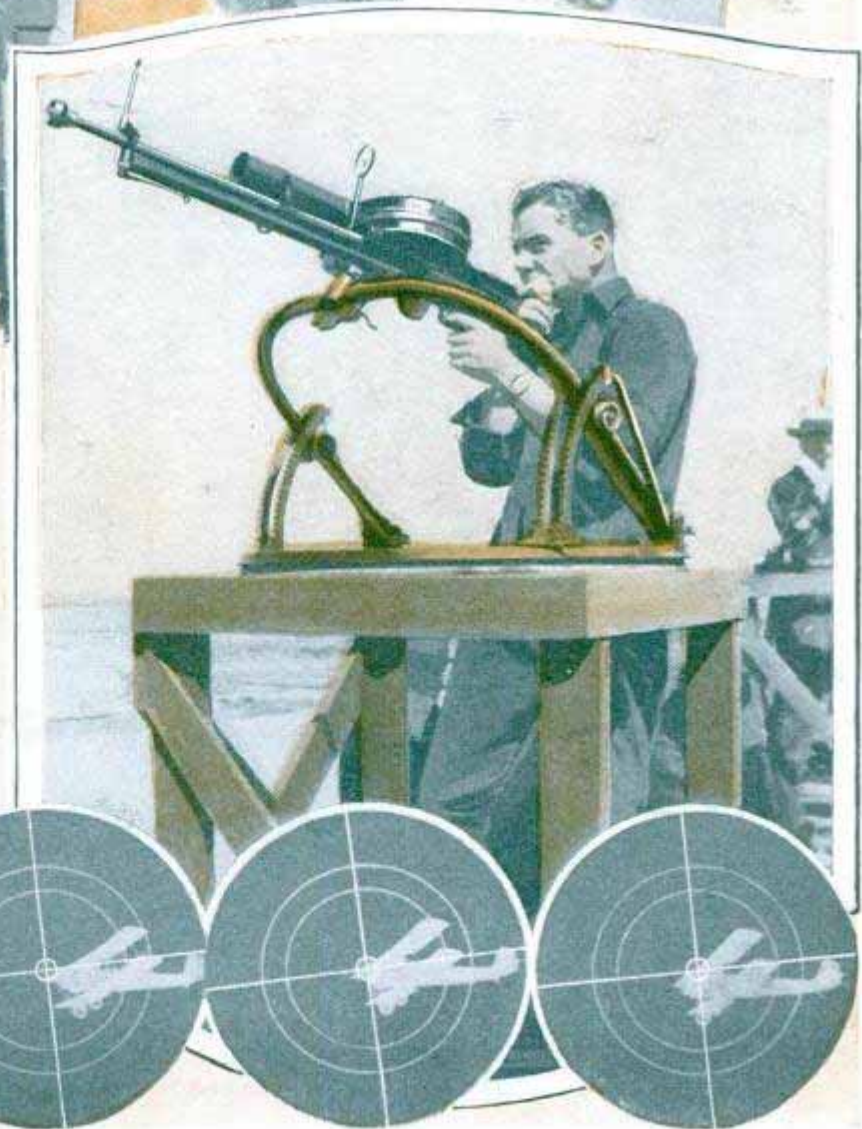

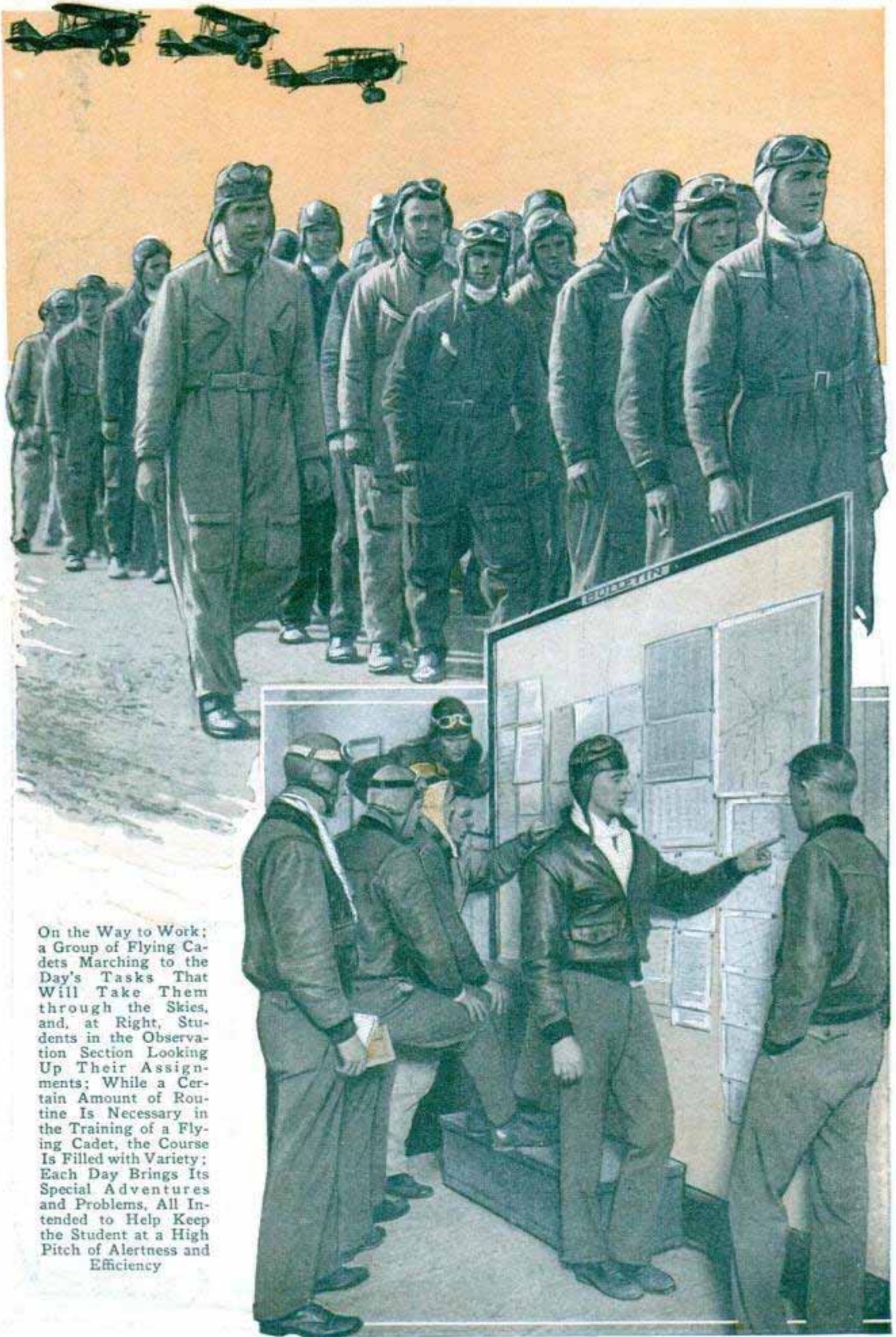

On the Way to Work; a Group of Flying Cadets Marching to the Day's Tasks That Will Take Them through the Skies, and, at Right, Students in the Observation Section Looking Up Their Assignments; While a Certain Amount of Routine Is Necessary in the Training of a Flying Cadet, the Course Is Filled with Variety; Each Day Brings Its Special Adventures and Problems, All Intended to Help Keep the Student at a High Pitch of Alertness and Efficiency

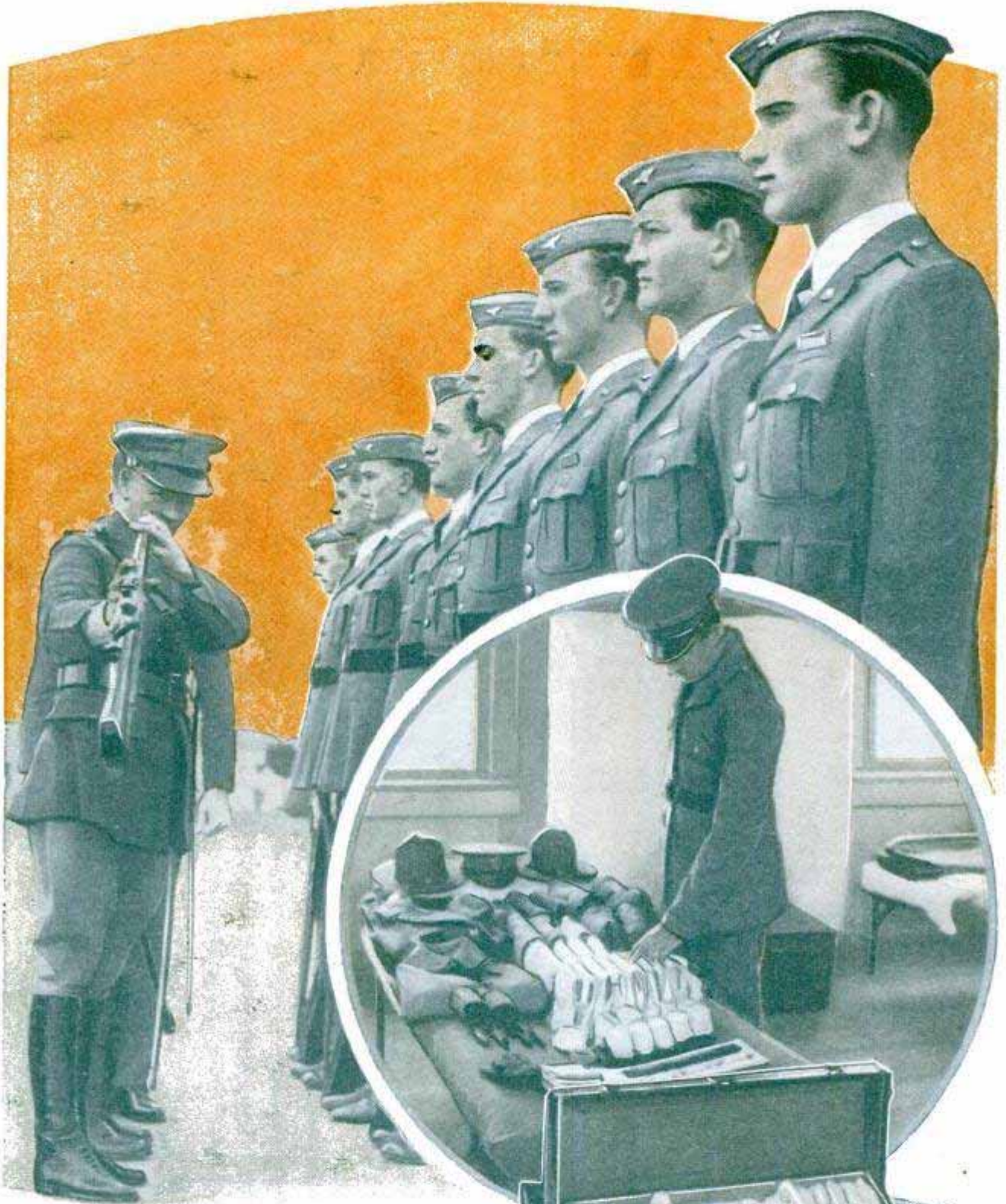

Inspection Day at Brooks Field; Inset Shows Bunk and Chest with Equipment Properly Packed and Displayed for the Inevitable Inspection; as Will Be Noticed, Flying Cadets Wear Special Uniforms, and, Although the Army Rifles Are of the Familiar Kind, the Men Have Other Special Equipment Not Allotted Regular Army Men; While in Training, the Cadets Are Quartered in Special Barracks and Have Somewhat the Same General Status as West Pointers or Students at Annapolis; This Is Consistent with the Fact That They Receive \$75 a Month Base Pay and Are Also Given a Ration Allowance of \$1 per Day; Uniforms and Equipment Are Furnished without Cost

196

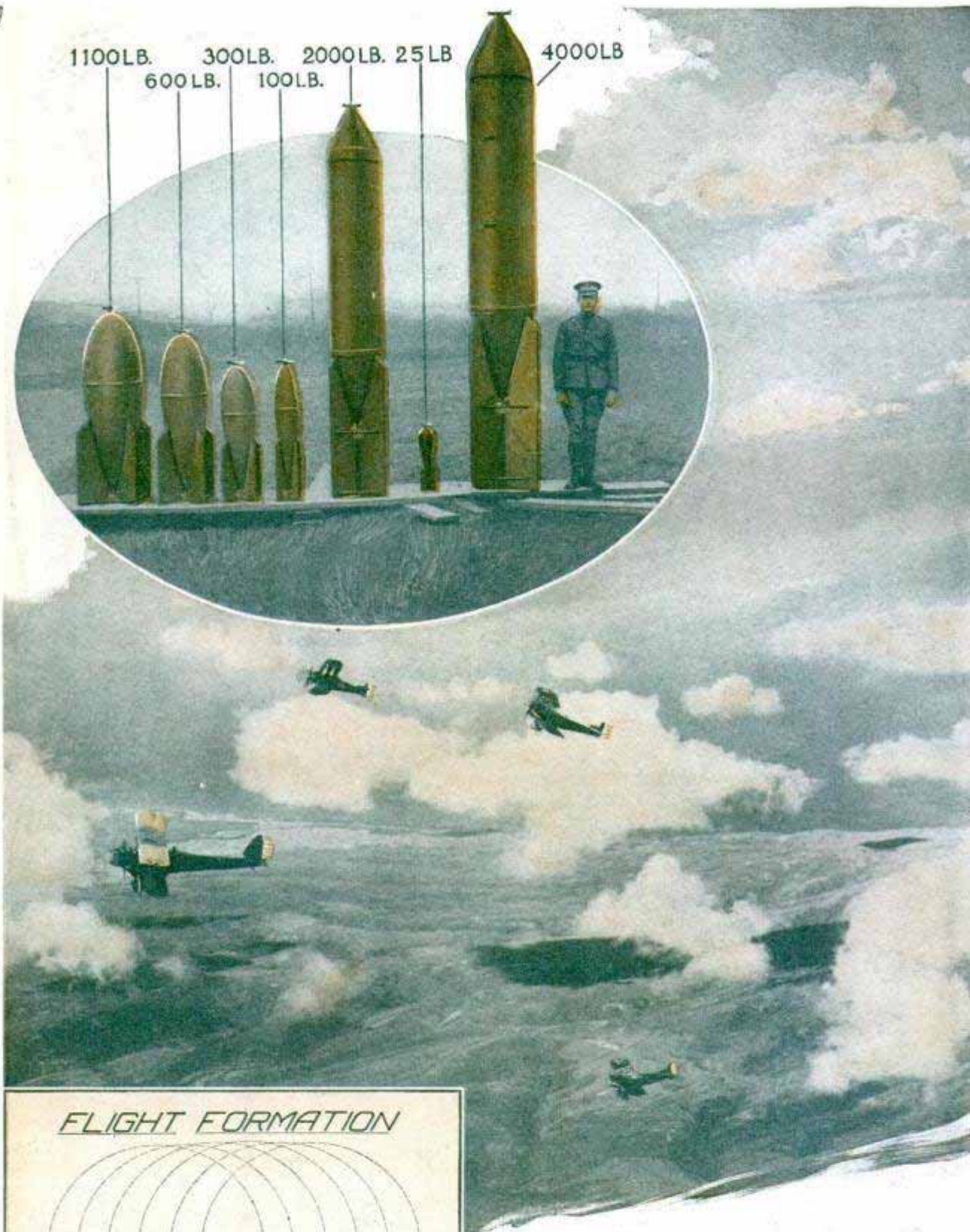

FLIGHT FORMATION

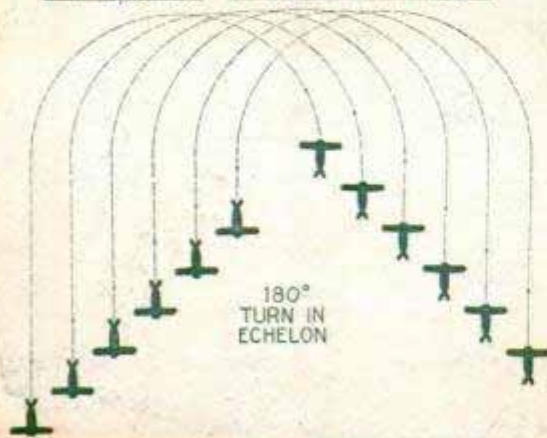

Some of the Bombs, Big and Little, a Flying Cadet Comes to Know Rather Well Before He Finishes Training; Center View Shows Pursuit Planes "Attacking" a Big Bomber at the Left, and Inset Illustrates a Method of Executing a 180-Degree Turn in Echelon; Note How Planes Change Their Relative Inner and Outer Positions as Well as Direction to Equalize the Distance Each Has to Fly; the Inside Plane Does Not "Hold That Pivot" as Is Done in Marching Tactics

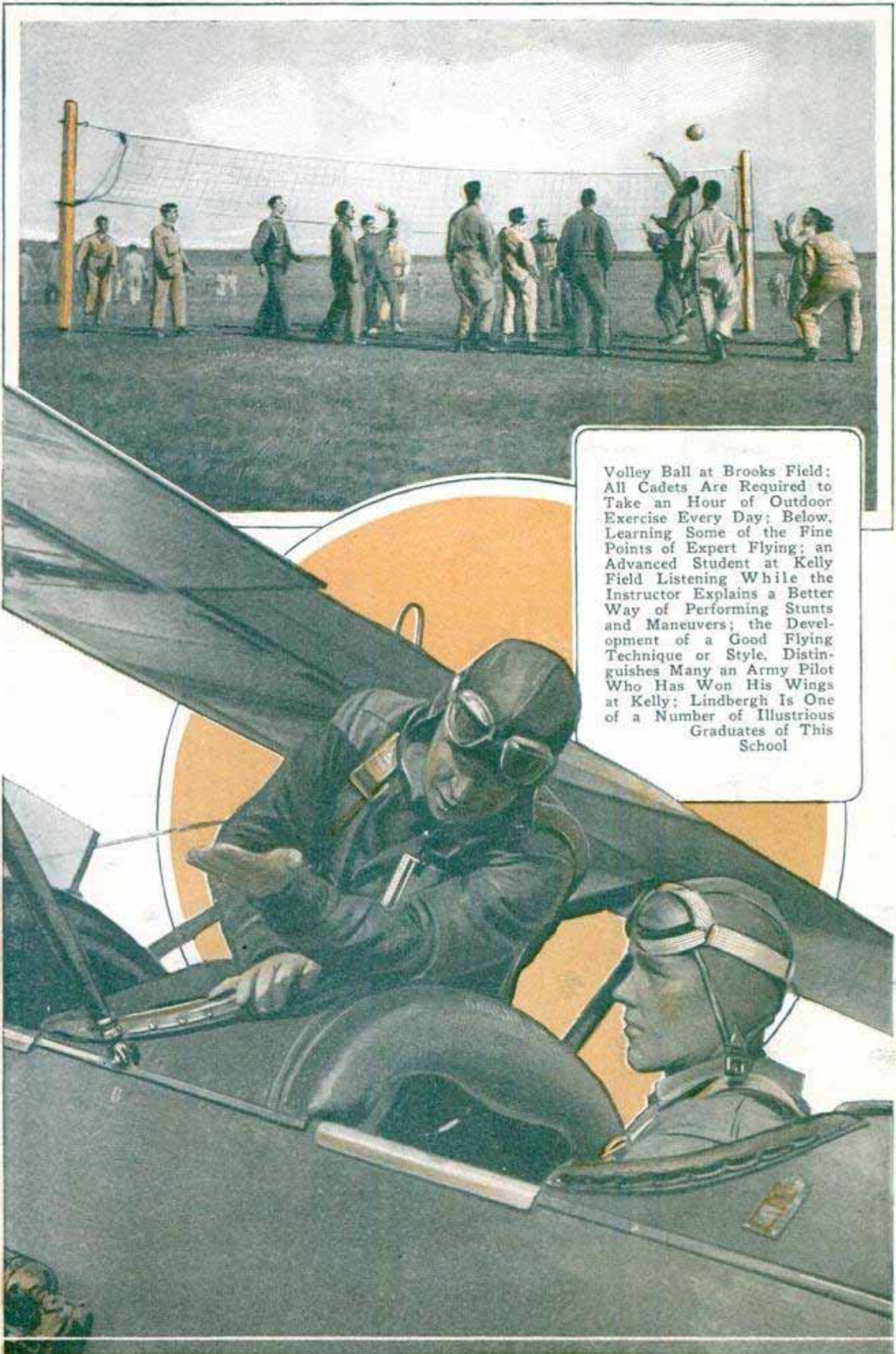

Volley Ball at Brooks Field; All Cadets Are Required to Take an Hour of Outdoor Exercise Every Day; Below, Learning Some of the Fine Points of Expert Flying; an Advanced Student at Kelly Field Listening While the Instructor Explains a Better Way of Performing Stunts and Maneuvers; the Development of a Good Flying Technique or Style, Distinguishes Many an Army Pilot Who Has Won His Wings at Kelly; Lindbergh Is One of a Number of Illustrious Graduates of This School

196

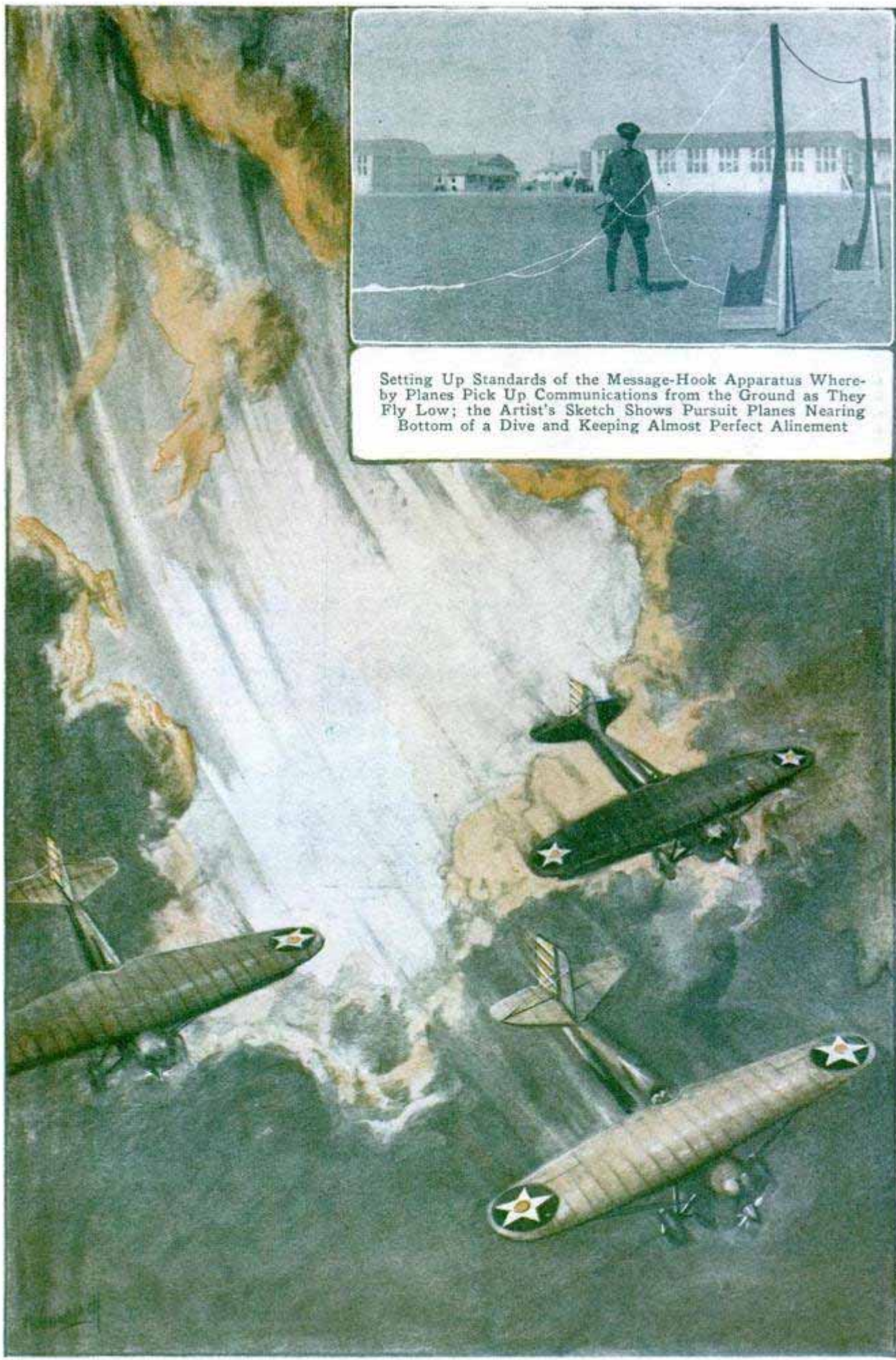

Setting Up Standards of the Message-Hook Apparatus Whereby Planes Pick Up Communications from the Ground as They Fly Low; the Artist's Sketch Shows Pursuit Planes Nearing Bottom of a Dive and Keeping Almost Perfect Alinement

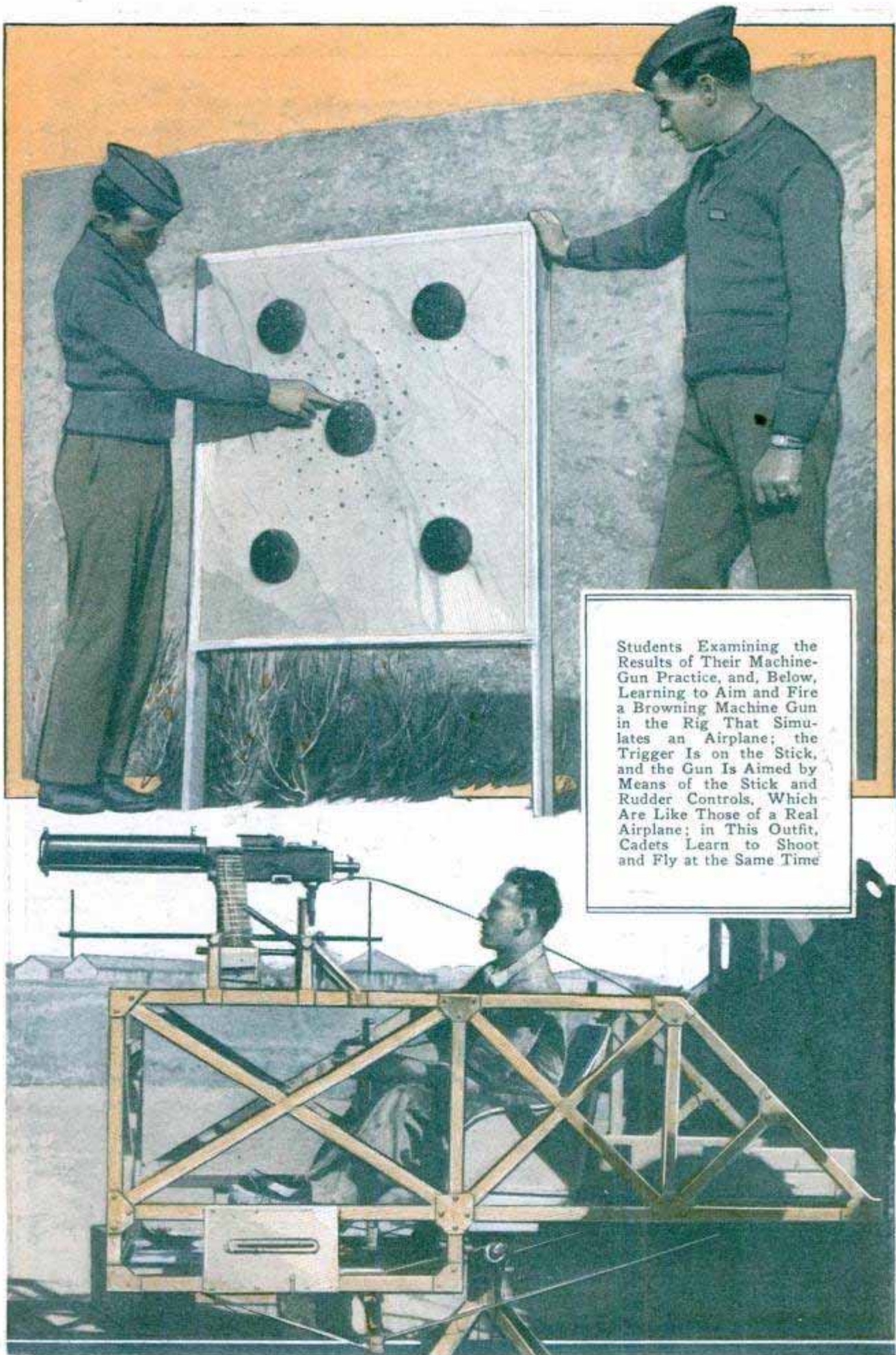

Students Examining the Results of Their Machine-Gun Practice, and, Below, Learning to Aim and Fire a Browning Machine Gun in the Rig That Simulates an Airplane; the Trigger Is on the Stick, and the Gun Is Aimed by Means of the Stick and Rudder Controls, Which Are Like Those of a Real Airplane; in This Outfit, Cadets Learn to Shoot and Fly at the Same Time

196

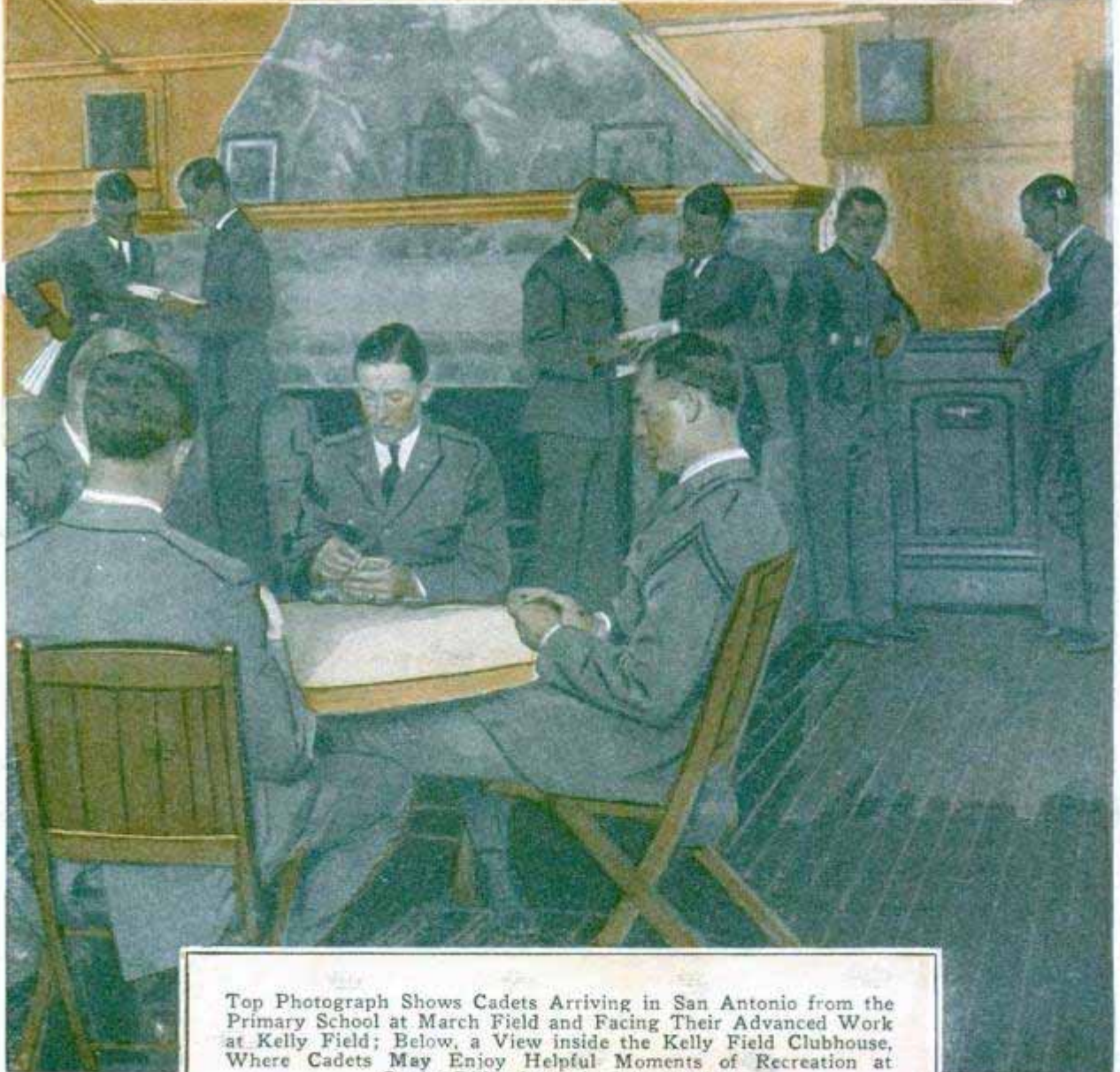

Top Photograph Shows Cadets Arriving in San Antonio from the Primary School at March Field and Facing Their Advanced Work at Kelly Field; Below, a View inside the Kelly Field Clubhouse, Where Cadets May Enjoy Helpful Moments of Recreation at Cards, Billiards, or in Just Loafing

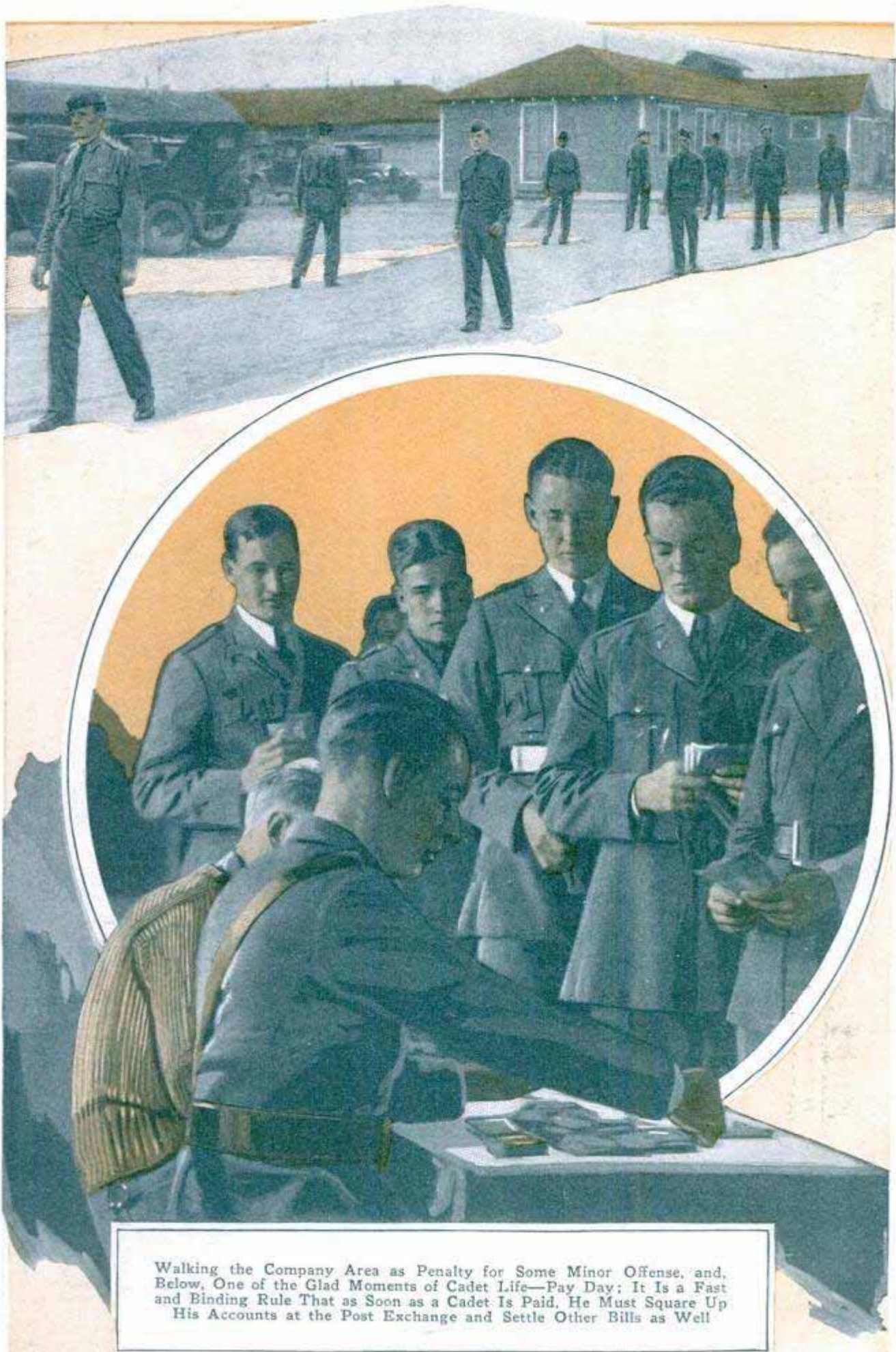

Walking the Company Area as Penalty for Some Minor Offense, and, Below, One of the Glad Moments of Cadet Life—Pay Day; It Is a Fast and Binding Rule That as Soon as a Cadet Is Paid, He Must Square Up His Accounts at the Post Exchange and Settle Other Bills as Well

196

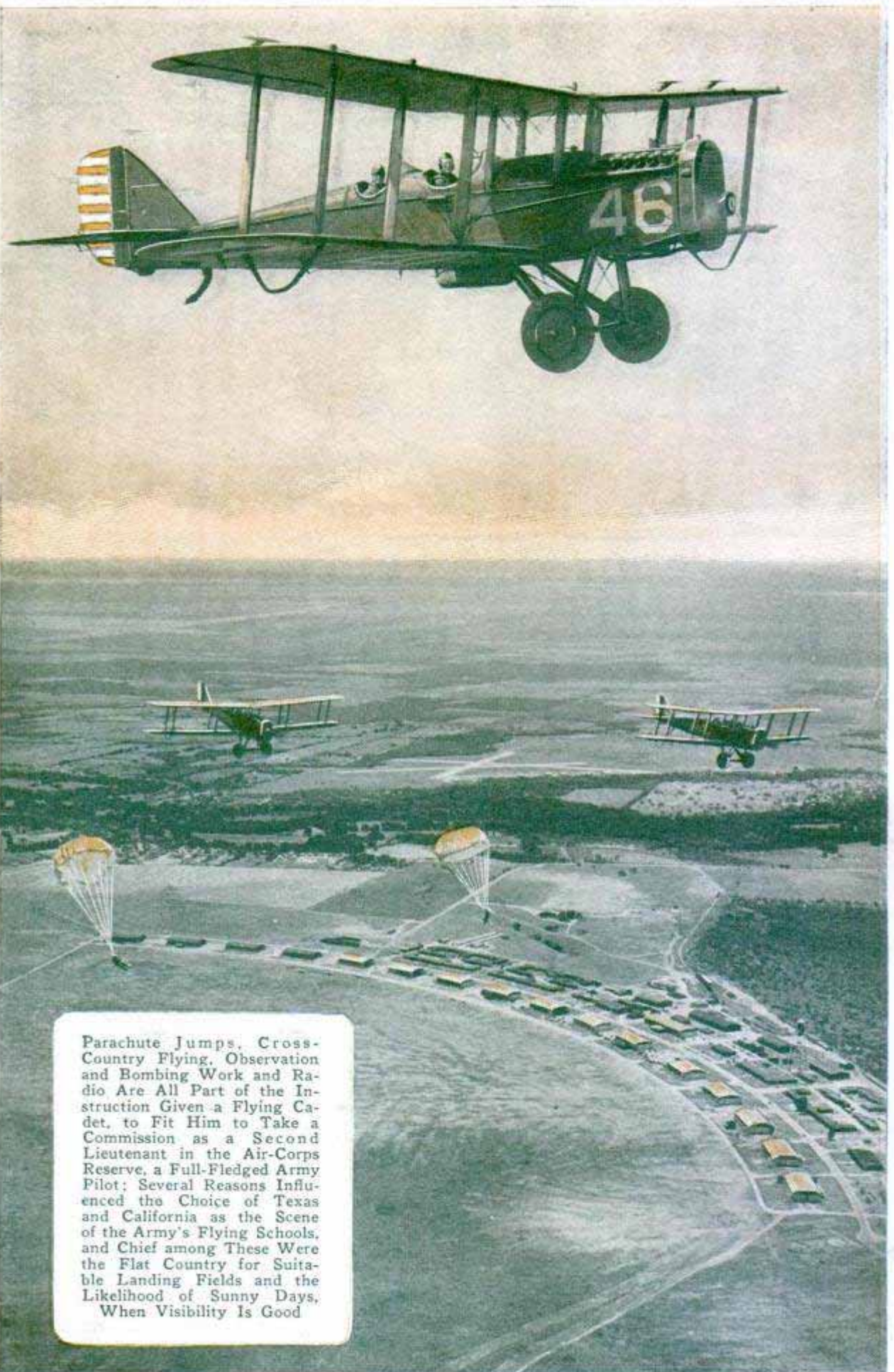

Parachute Jumps, Cross-Country Flying, Observation and Bombing Work and Radio Are All Part of the Instruction Given a Flying Cadet, to Fit Him to Take a Commission as a Second Lieutenant in the Air-Corps Reserve, a Full-Fledged Army Pilot; Several Reasons Influenced the Choice of Texas and California as the Scene of the Army's Flying Schools, and Chief among These Were the Flat Country for Suitable Landing Fields and the Likelihood of Sunny Days, When Visibility Is Good

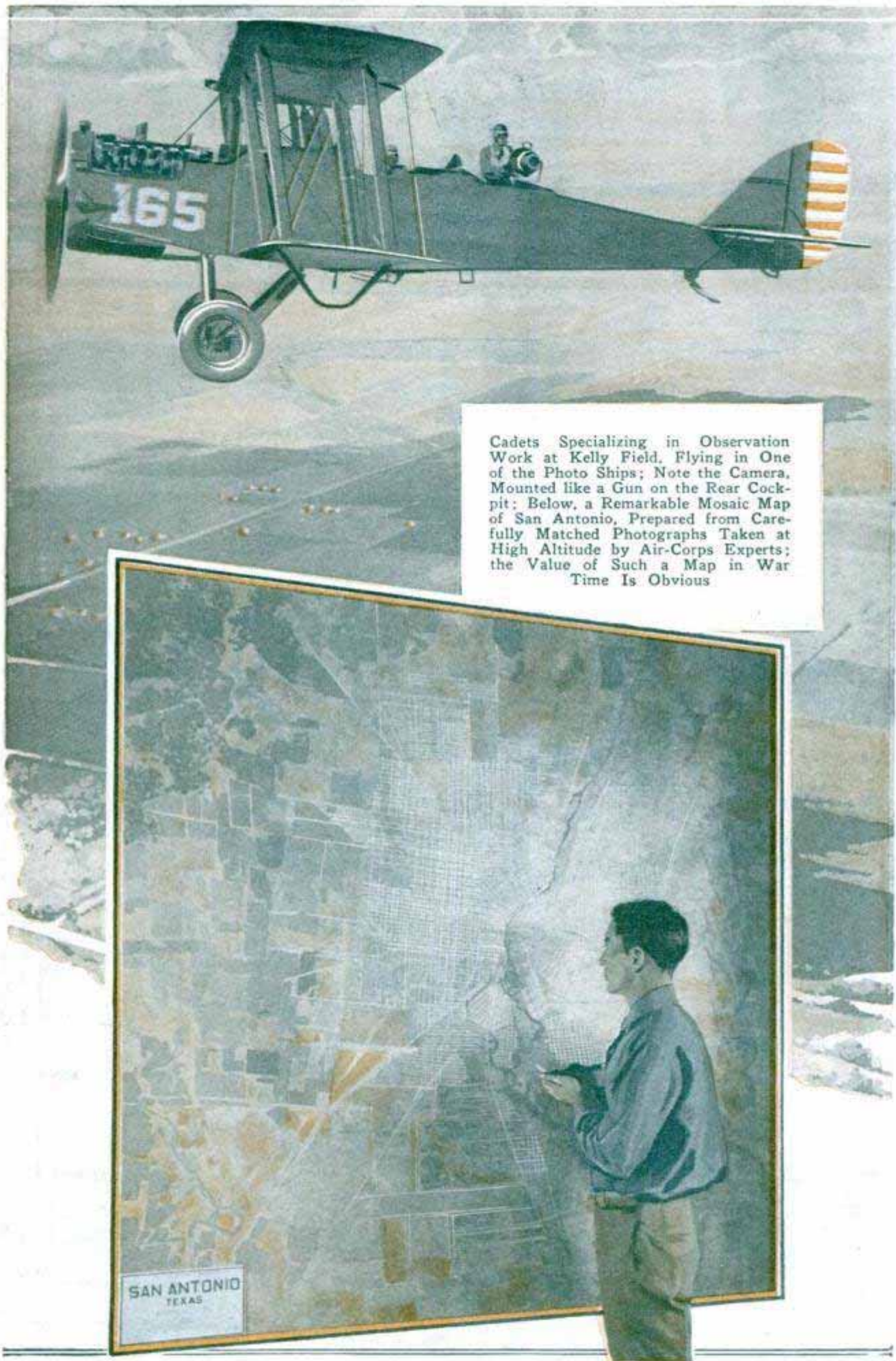

Cadets Specializing in Observation Work at Kelly Field, Flying in One of the Photo Ships; Note the Camera, Mounted like a Gun on the Rear Cockpit; Below, a Remarkable Mosaic Map of San Antonio, Prepared from Carefully Matched Photographs Taken at High Altitude by Air-Corps Experts; the Value of Such a Map in War Time Is Obvious

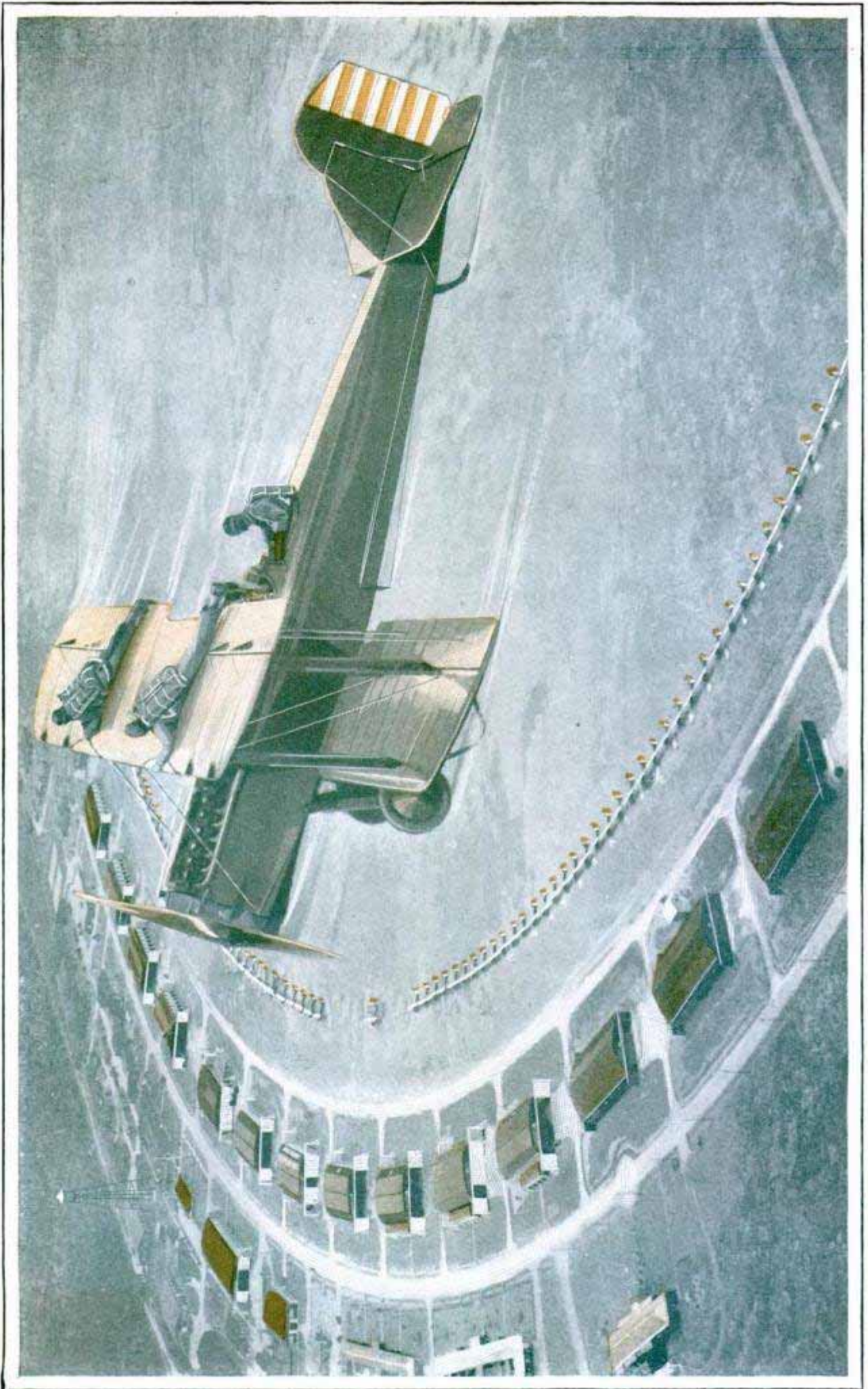

Students on Wings of Plane Ready to Make a Parachute Jump; This Was Taken at the Beginning of Parachute Training at Brooks Field; All Cadets Are Eligible to Parachute Work, but Are Not Compelled to Make Jumps, as This Is Voluntary; the Instruction Has Helped Save Lives on Several Occasions

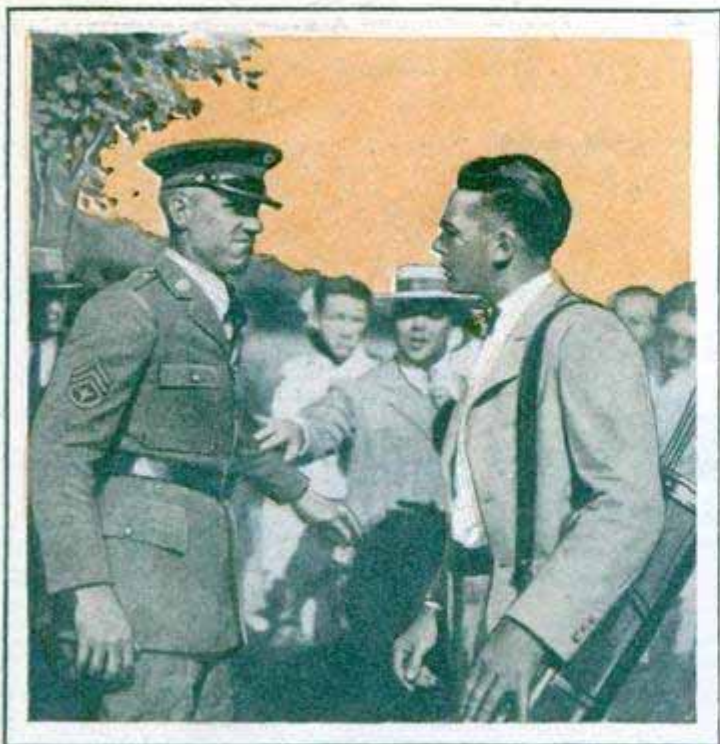

A Word with the Sergeant as a Cadet Begins His Training, and, Below, a Seven-Ship Formation of "D-H's"; Cadets in Advanced Primary School, the Second Four Months at Brooks or March Field, Are Given This Type of Ship with Which to Train; in Advanced School at Kelly, They Receive More Modern Curtiss and Douglas Planes



Just before a Flight in a Keystone Bomber, a Change-Off between Periods; One of the Important Phases of Bombing Flight Is the Target Practice Cadets Receive; by Radio Signals from the Plane and by Photographic Charts on the Ground, a Record of Hypothetical Bomb Hits and Misses Is Made as the Bomber Flies Overhead

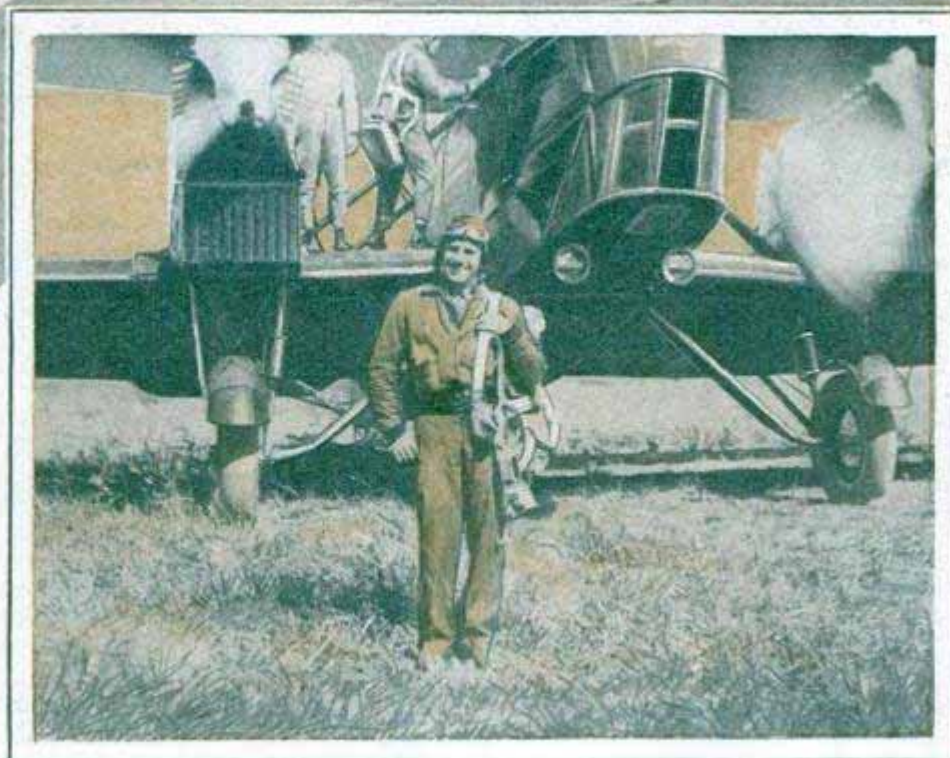

196

Pursuit Ships over Kelly Field, Alma Mater of Many Skilled Pilots, and, in Inset, Demonstrating a Problem in Radio Installation and Operation in Skeleton Plane to Kelly Field Class; More Attention Is Being Paid to Radio Instruction in View of the Increasing Importance of Wireless to Successful Aviation in Peace as Well as in War



POPULAR MECHANICS
 SLIP-FLOAT FOR MOTORBOAT CONTAINS BUNGALOW

*Fidelity Bldg, Livingston Ave 753 9th
 New York City*

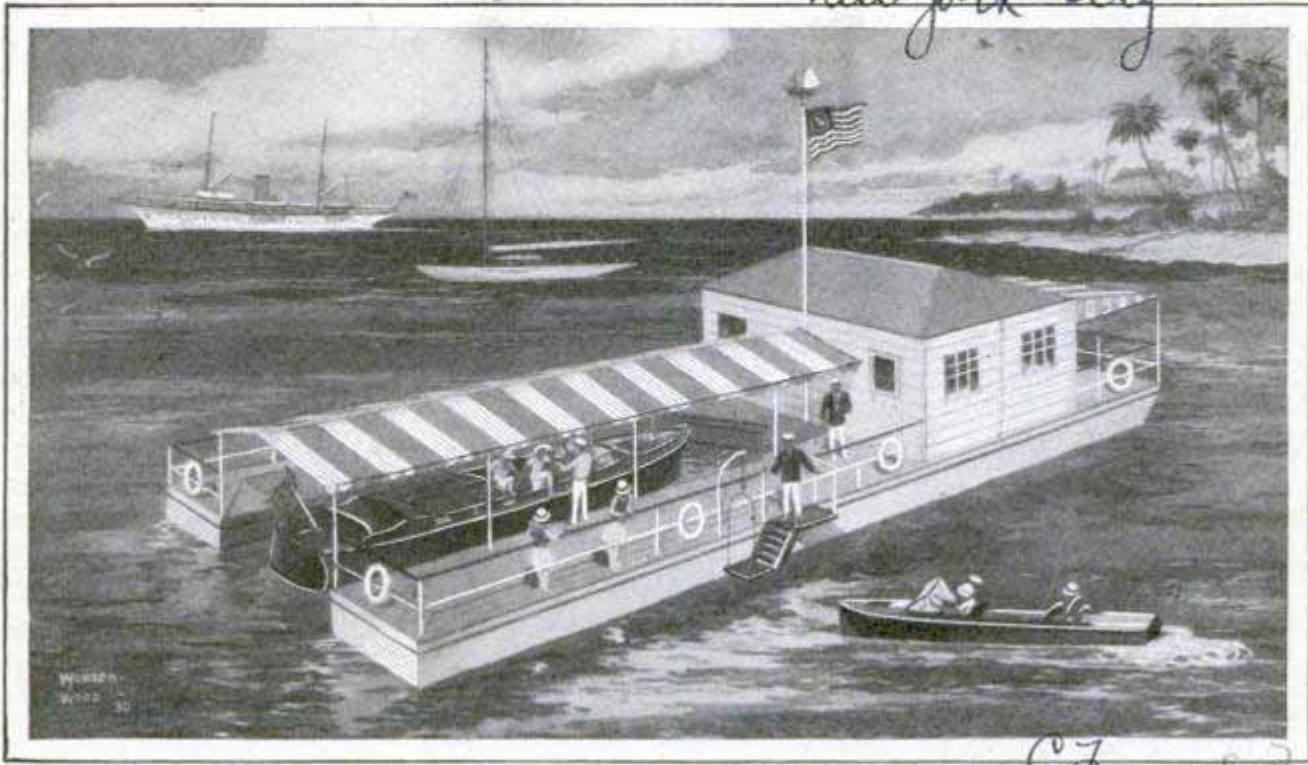

Slip-Float for Motorboat Which Also Contains a Bungalow; the Float, Which Is Assembled in Sections, May Be Moved Easily, and Is Also Available as a Landing Dock or Bath House

Protecting the motorboat from damage and providing a commodious floating bungalow that can be anchored in deep water, a U-shaped slip-float now may be obtained, already assembled in four separate units that are easily attached or taken apart, thus facilitating hauling out and launching. The boat lying in the slip cannot chafe and, if desired, the craft can be raised on davits and placed on cradle bars in a few minutes. Awnings over the slip are equipped with side curtains for better protection, and deck houses vary in size from a small shop at the end of the slip to a six-room bungalow with electric lights and refrigeration, running water and a hot-water heating plant.

shield that communication was possible with the home station at all times without any extraneous noises. The value of this antenna lies in the facts that it eliminates the elaborate shielding required with the wire hanging in the ordinary manner and also makes possible the use of simple sets powered by portable batteries, thus permitting continued communication even if the ship is on the ground and disabled.

AIRCRAFT ANTENNA SHIELDED BY FIRE PARTITION 311

Affording complete protection from motor interference, a type of airplane radio antenna which uses the fire partition between the motor and the pilot as a shield has been successfully tested. The antenna wire streams horizontally from the tail of the plane, being held in position by a wind-driven cone, and the fire partition was found to furnish such an excellent

FOUNTAIN-PEN HOLDER IN CANE FOR THE BUSINESS MAN 283



making it easily accessible and also eliminating danger of staining clothing if the pen develops a leak.

For the business man, a walking stick with a receptacle for a fountain pen is being sold in London. The pen fits into an opening just below the crook, a metal lid snapping over it when it is inserted in the cane, thus

Journal British Industries Fair

*Dr. W. C. Francis Jenkins
 1519 Connecticut Ave*

*Messrs. Henry Howell,
 180 Old St. S. C.*

W. M. Weigel
Elysees
Paris, France

Missouri Pacific
A. R. Mineral Technol
just

382

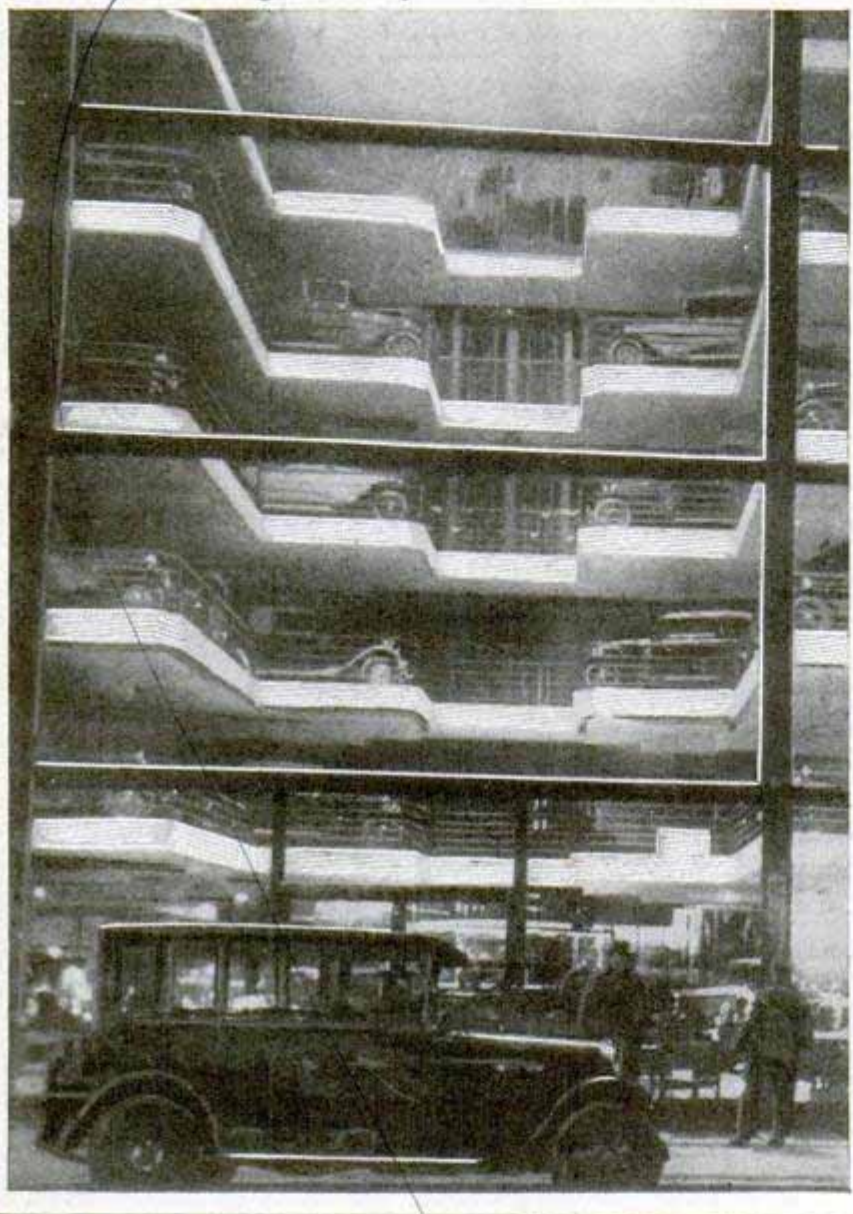

Paris Auto Sales Room Whose Six Floors Are Glassed in So Prospective Customers May View Nearly All the Cars from the Street

AUTO GARAGE BUILT OF GLASS HELPS SELL CARS

In Paris is an automobile firm whose display room is in reality a huge show window, for the six floors of the building have glass sides so that persons can look through them and see practically all the cars. Some architects believe that it is only a question of time until glass will be widely used in this manner for building material.

Popular Mechanics Magazine does not publish the name of the maker or seller of any device described in its pages, but this information is kept on file and will be furnished free upon application to our Bureau of Information.

WIRE USED TO CUT MARBLE SLABS

Marble slabs are being sawed from a hillside in the Ozarks with a quarter-inch three-stranded steel wire, 1,400 feet long, driven by an old automobile engine. Wire sawing previously had proved its value in slate quarrying. Sand, hand-fed into the artificial crevice made by the wire, does the actual cutting. The wire travels twenty feet per second and cuts a complete section from the hill without wearing out or breaking, the entire operation being carried on by one man.

DELIVERY TRUCK HAS THREE WHEELS

For light delivery purposes, a three-wheeled motor truck now is on the market that somewhat resembles a motorcycle in front and an automobile at the rear. It is steered similarly to a motorcycle, but space is provided between the two rear wheels for a small truck body to be set on a light frame. It is particularly suitable for parcel deliveries, for a garage service car or first-aid work.

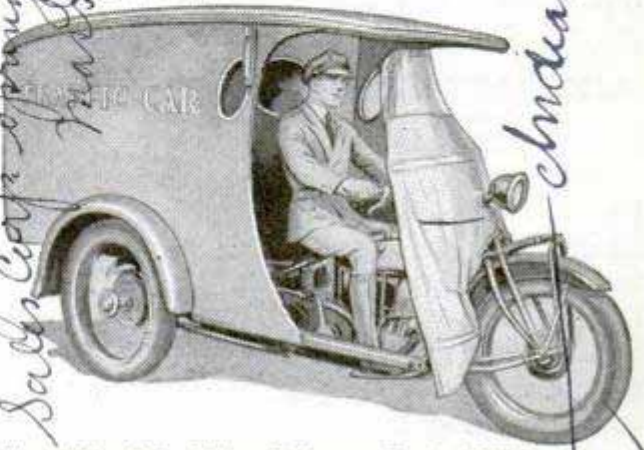

Three-Wheeled Light Delivery Truck Which Seems a Cross between Automobile and Motorcycle

Refer inquiries to Indian Sales Dept. of Chicago
Stigum Bros Motorcycles
Chgo 1790 First Ave

200 Corn Mr. Dearholme
359 Edmonton St. Winnipeg

Money from Farm Waste

Manitoba
Canada

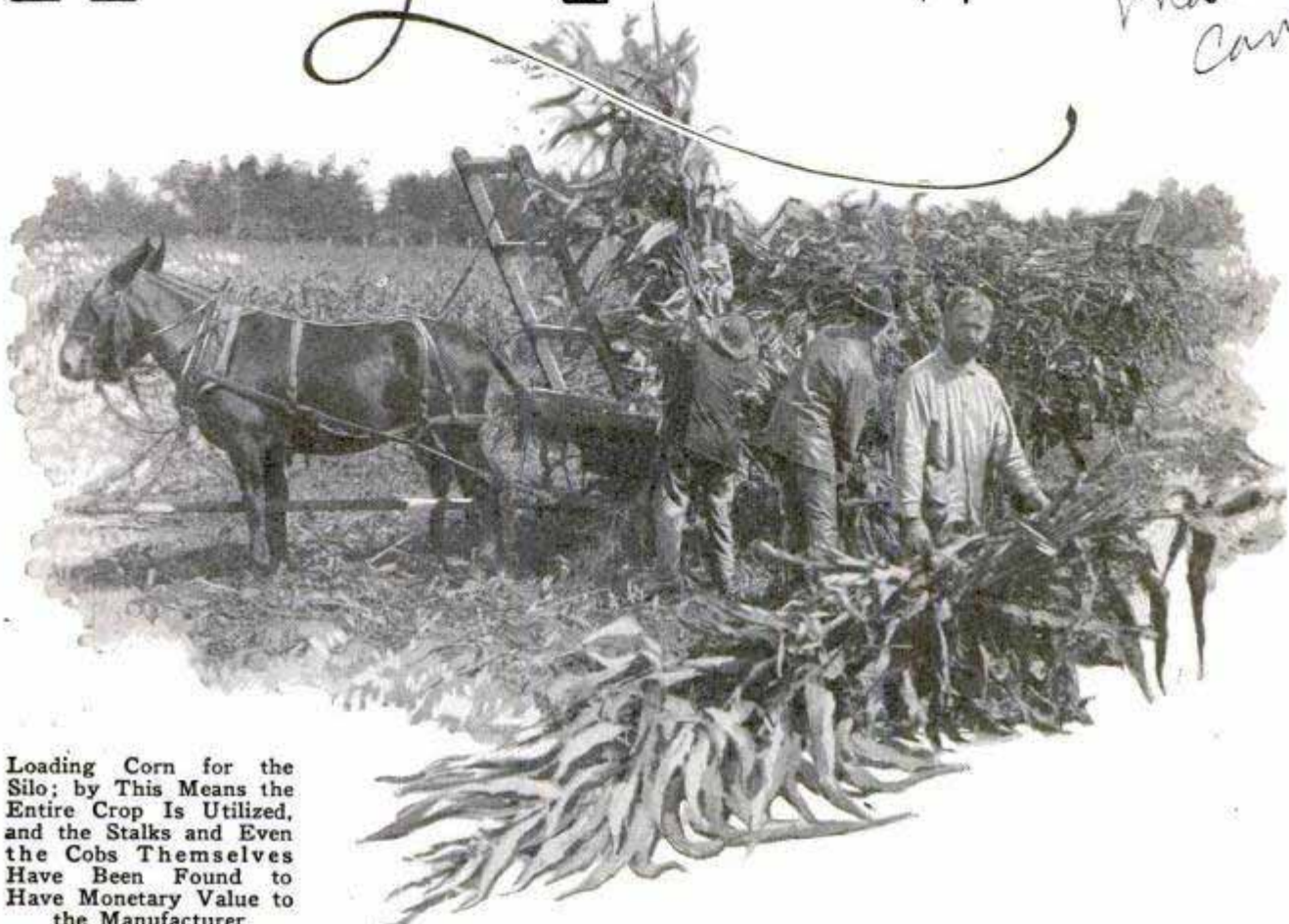

Loading Corn for the Silo; by This Means the Entire Crop Is Utilized, and the Stalks and Even the Cobs Themselves Have Been Found to Have Monetary Value to the Manufacturer

By PATRICK DUFFY

"IT PLEAS^ES me to see ordinary wheat straw, many a stack of which I have burned, turned into a commercial product of value to the building industry," said Secretary of Agriculture Arthur M. Hyde recently when he inspected a large mill at St. Joseph, Mo., which turns out 125,000 feet of lumber every day from wheat straw. No longer need it be put to the torch. The farmer can sell it for \$6 or more per ton to mills which transform it into fireproof, soundproof lumber that saves the householder from twenty-five to forty per cent in fuel bills.

At the present time more than 30,000,000 tons of this straw are burnt in North America. Straw burnt in the open air yields less than forty pounds of ash per ton. In the hands of a chemist, a single ton will yield 12,600 cubic feet of gas, 640 pounds of carbon for the making of elastic paints, fifteen gallons of phenol oil for the manufacture of antiseptics, 400

pounds of fireproof roofing, and a substantial quantity of acetic acid; to say nothing of dyes, flysprays, explosives and a host of other and valuable things. A ton of straw, once despised and put to the torch, is now the raw material for articles valued at \$250.

This is just a sample of the magic coming from the test tubes of chemists working in the cloistered calm of their laboratories. The world has come, almost unaware, into a new industrial period which men of science have dubbed "The Age of Cellulose." Within a decade, great new industries have sprung into existence which require cellulose as their base.

Three great industries—pulp and paper, cotton and lumber—representing a total investment of \$7,000,000,000 of capital, make use of this substance in its natural state. Rayon is already an industrial giant while artificial leather is now produced in greater volume than animal leather can

see article Jan. 1919
Stewart & McRoberts Co
St. Joseph, Mo



Samples of By-Products Made from Corncobs, Including Insulating Material, Furfural, Lignin, Ethyl, Alcohol, Cellulose and Oxylose

be grown—and both have a cellulose base. The chemical conversion of this complicated compound is the basis of such lusty infant industries as insulating material, airplane dope, non-shatterable glass, new solvents and lacquers as well as old-established industries such as explosives, films and celluloid.

From the point of view of the practical application of cellulose, one of the outstanding problems of the immediate future seems to be the source from which these industries can secure their raw material. American paper consumption, for instance, has doubled in the last decade while forest depletion proceeds at a rate four times as fast as replacement. Several of the newer cellulose-consuming industries are increasing their output by hundreds of per cent each year. The constant and heavy depletion of our forests makes it imperative, therefore, that new supplies of cellulose be developed without delay.

Fortunately plants manufacture this precious substance cheaply and in abundance. Cotton is almost pure cellulose. Cornstalks, cotton stalks, sugar-cane bagasse, cereal straws and other plant fibers are from forty to fifty per cent cellulose. A recent survey brought to light the fact that 600,000,000 tons of these materials go

to waste annually—an enormous loss of potential industrial raw materials that brings no profit to farmers. The most practical and profitable method of ending this waste is in the utilization of the cellulose these products contain.

Science admits that it is relatively ignorant of cellulose. It is one of the most complicated compounds known to chemistry, the structure of the cellulose molecule being still unknown. But Dr. Charles Herty, one-time president of the American chemical society, predicts a wonderful future for cellulose. "See what happened when once the

structure of the benzene molecule became known," he recently stated. "All the wonderful developments in the coal-tar field, dyes, medicinals, photographic chemicals, synthetic aromatics, tanning materials followed the revelation of the ring structure of benzene." And he predicts a similar industrial revolution when science solves the riddle of cellulose.

Even weeds may contribute to the income of the farms of the future. Recently Messrs. K. S. Markley and W. T. Schriber, of the bureau of standards, have investigated the possibilities of a weed with the outlandish name of *Helianthus argophyllus*, but better known as Texas sunflower. It grows wild in the drier districts of Texas and neighboring states, and has hitherto been considered worthless. But these chemists have found the weed exceedingly rich in both cellulose and furfural, so that there is the possibility of weeds doing something toward swelling the farm income.

Dr. Warren E. Emley, of the same institution, has discovered a new use for peanut shells. He makes an excellent lemonade from them. At the present time the new beverage labors under the awful handicap of the name "Xylotrihydroglutaric"; but what's in a name if it covers the utilization of farm waste?

JAPANESE GARDENS BUILT IN WESTERN SETTING

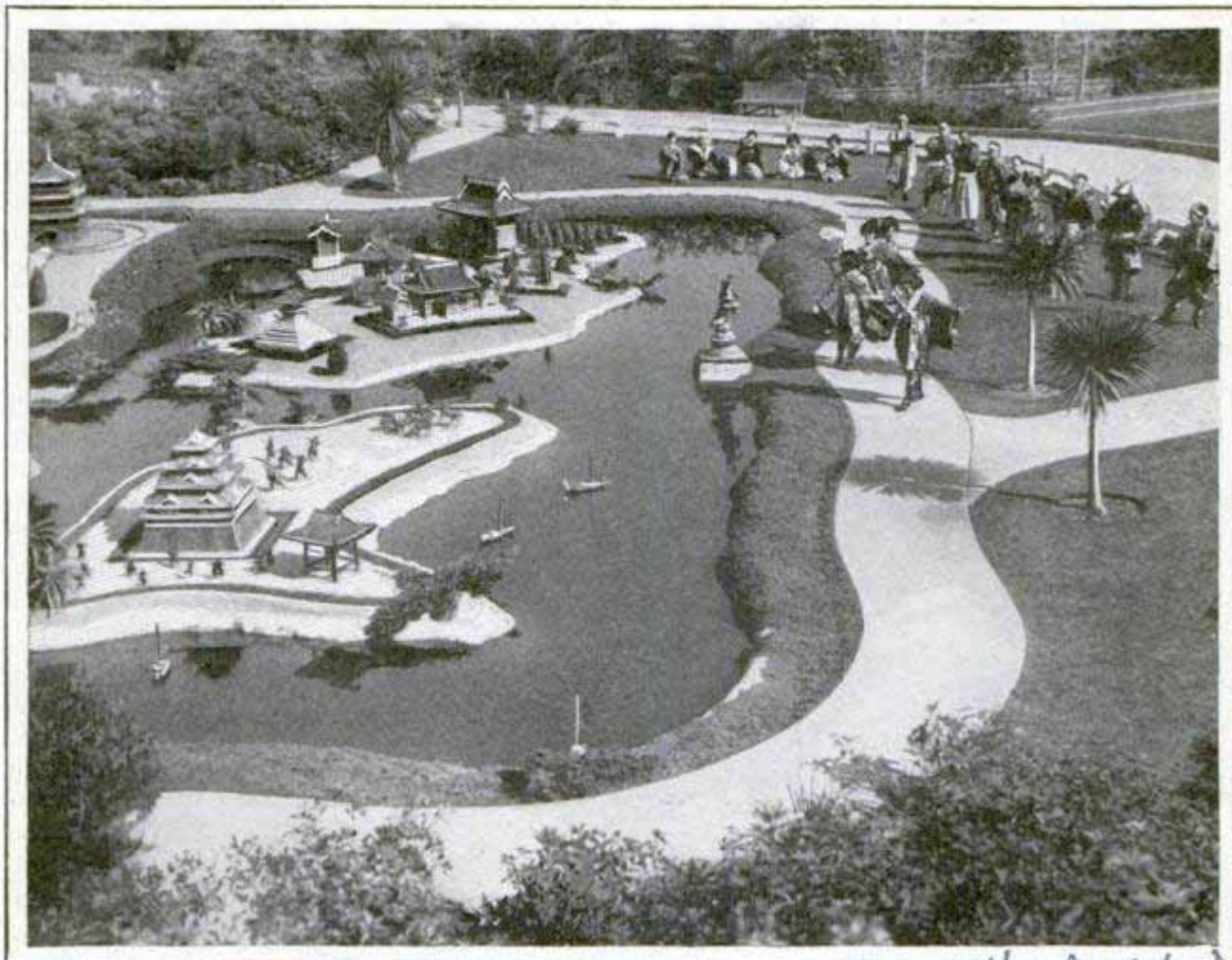

Like a Bit of Oriental Splendor Brought from Across the Sea Are These Japanese Gardens on a California Estate; a Japanese Theatrical Troupe Is Rehearsing in This Perfect Setting

Oriental splendor in an occidental setting is provided by the magnificent Japanese gardens on the beautiful Bernheimer estate in Los Angeles. Quaint vistas of flowers, water and architecture are revealed to the visitors. Here recently a Japanese troupe staged an outdoor rehearsal.

clamp automatically adjust themselves to any shape or thickness, up to three inches, and do not mar or scratch the surface.

SPRING CLAMP FOR LIGHT BULB FASTENS ANYWHERE 97

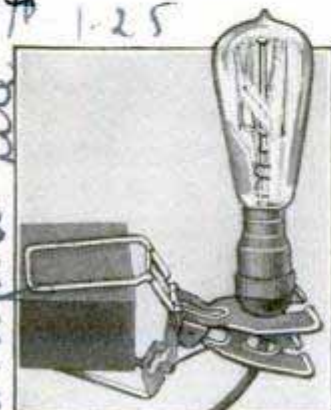

Fastening easily to any projecting surface, a spring clamp for the electric-light bulb now is on the market, by means of which a convenient portable lamp is made out of an ordinary bulb and socket. The jaws of the

ELECTRICALLY HEATED BOTTLE TO SUPPLANT FURNACE 333

Homes of the future will be heated by electricity "bottled" up in a reservoir in the house at night when the electric company's facilities are not busy, and used the next day, in the opinion of Chester I. Hall, an electrical engineer. The "bottle," containing water, would be heated during the night by electrodes which would raise the water temperature above boiling. By reason of insulation, the reservoir would retain its heat during the day. It would be equipped with thermostatic controls. Such a heating plant would be economical, it was estimated, if the power company could store the heat during the idle hours of night.

Clamp. G. Lite. # 1-25

Webb Electric Mfg. Co.
2498 Kingston Road.

before American Institute of Electrical Engineers.

Hallmark Electric Heating Co 17 27 Walnut St Phila
see catalog file

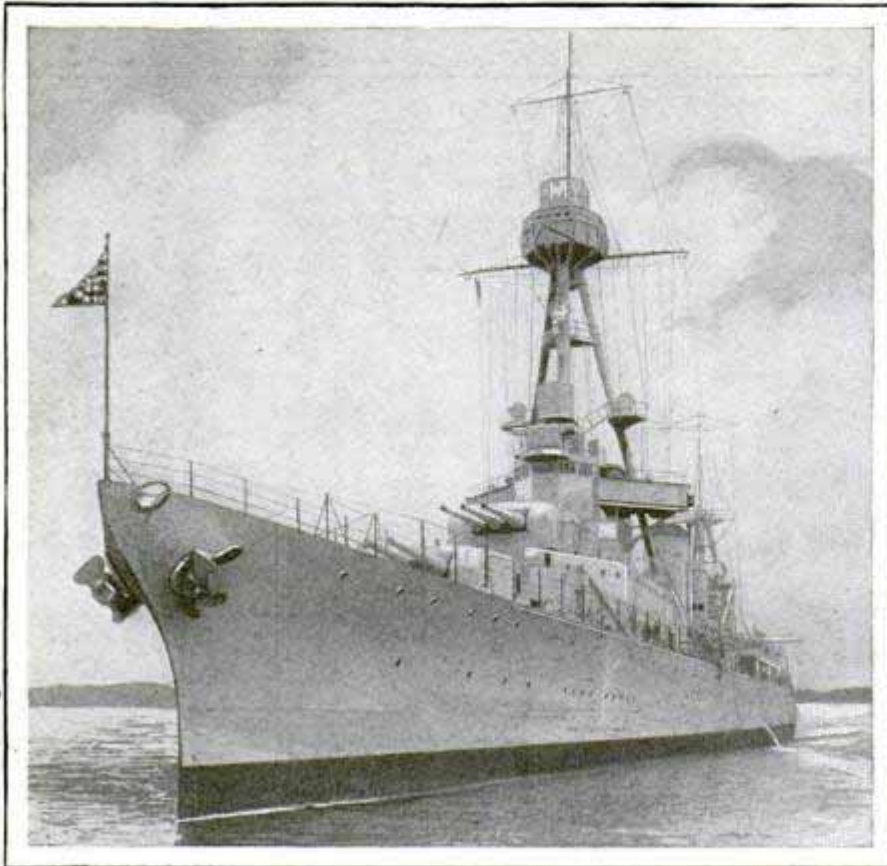

The "Pensacola," First of the United States' Fleet of 10,000-Ton Cruisers
Built under an Agreement with Other Naval Powers

tions. The arched roof construction provides space at each side of the doors for shops, offices and storage facilities, and the absence of beams and girders makes more space for ships. Such a hangar was exposed, without damage, to a pressure equivalent to that of a ninety-mile gale and a roof snow load of thirty pounds per square foot. It readily adapts itself to any form of covering or insulating material and can be moved easily.

ECONOMICAL SPEED FOR AIRPLANES IS HUNDRED MILES

310 Commercial airplanes with present power plants can be operated most economically at a speed

FIRST OF "TREATY CRUISERS" PLACED IN SERVICE

Built to specifications agreed upon between naval powers, the first of the 10,000-ton "treaty cruisers" constructed by the United States recently was launched at the Brooklyn navy yard. The craft has the lines of a larger man-of-war and has been named the "Pensacola."

CONTINUOUS-ARCH HANGAR HAS NO BEAMS OR GIRDERS

Containing no inside beams or girders, a type of airplane hangar topped by a continuous wooden arch now is in use. It is constructed of standardized factory-built sectional units, the sectional panels being bolted together through arched ribs so that the size of the hangar can be increased at any time simply by adding sec-

of 100 miles per hour, according to tests of the aeronautics branch of the department of commerce. Planes built to fly at higher speeds are so constructed at the cost of efficiency, it was found. The engineers said planes have been speeded up by increasing engine power and making the loading of wings heavier, along with a sacrifice of landing speed and a reduction of pay load. The speedy planes also have been responsible for decreasing the size of cabins with resulting discomfort for passengers. Transport lines demand planes operating at a speed of up to 130 miles an hour, while five years ago a cruising speed of ninety miles an hour was

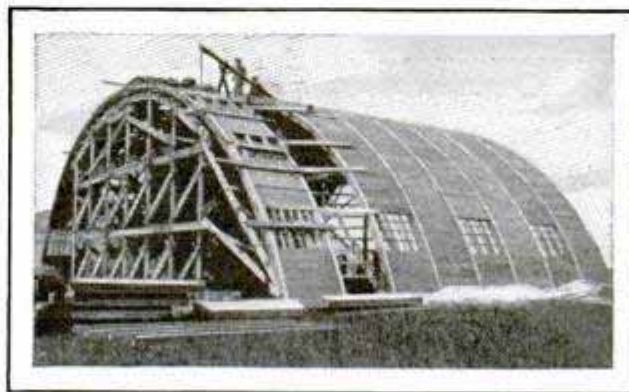

Sections of a Continuous Arch Hangar Which Is Constructed without Either Beams or Girders

considered sufficient. Although the engineers do not dispute predictions that transport planes eventually will fly at 300 miles an hour, they do not think it likely that this high speed will be realized commercially for many years.

erected for Great Lakes Aircraft Corp. 16800 McClain Cleveland Ohio

2/16/33 Herald Tribune

Notrus Hangar Corp, Esperson Bldg, Houston Texas

22
Kenneth O. Donaldson
Sturgeon, Mich.

How Eyes Tell Lies

By KEN. MURRAY

FREQUENTLY you hear people say, "It sounds weird, I know, but it is the truth because I saw it with my own eyes." But are your eyes, and your ears and your taste always to be depended on?

Lacking the power of forming illusions—if our eyes showed us everything exactly as it is—life would be a nightmare. In motion pictures the illusion of continuous action would be lost in a series of jerky single pictures that would appear

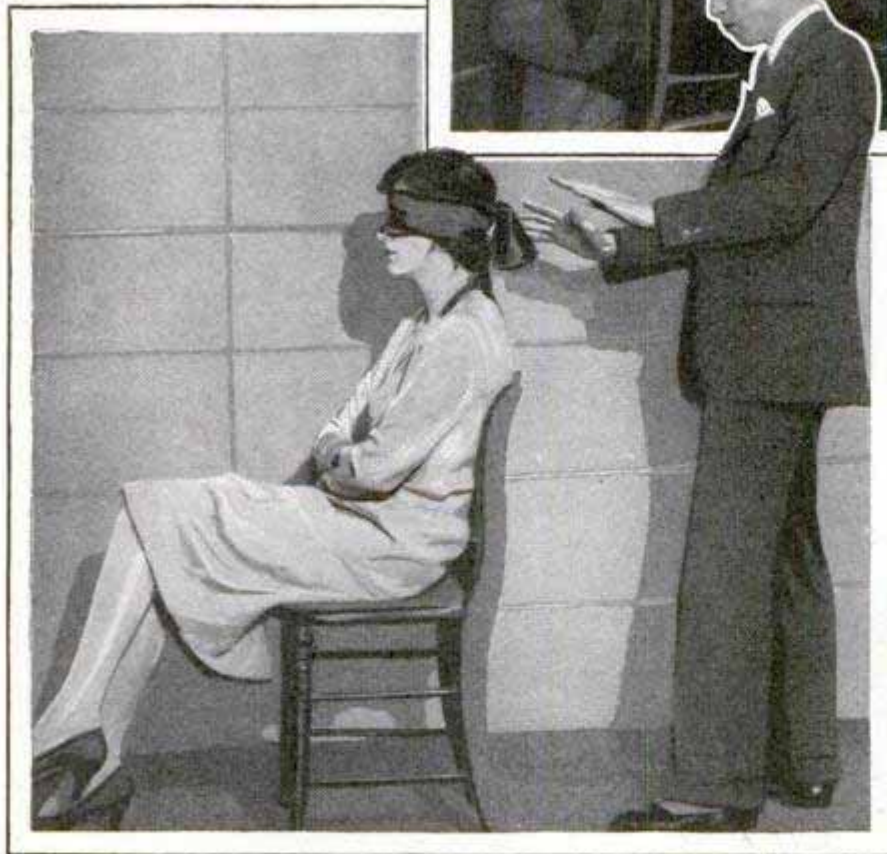
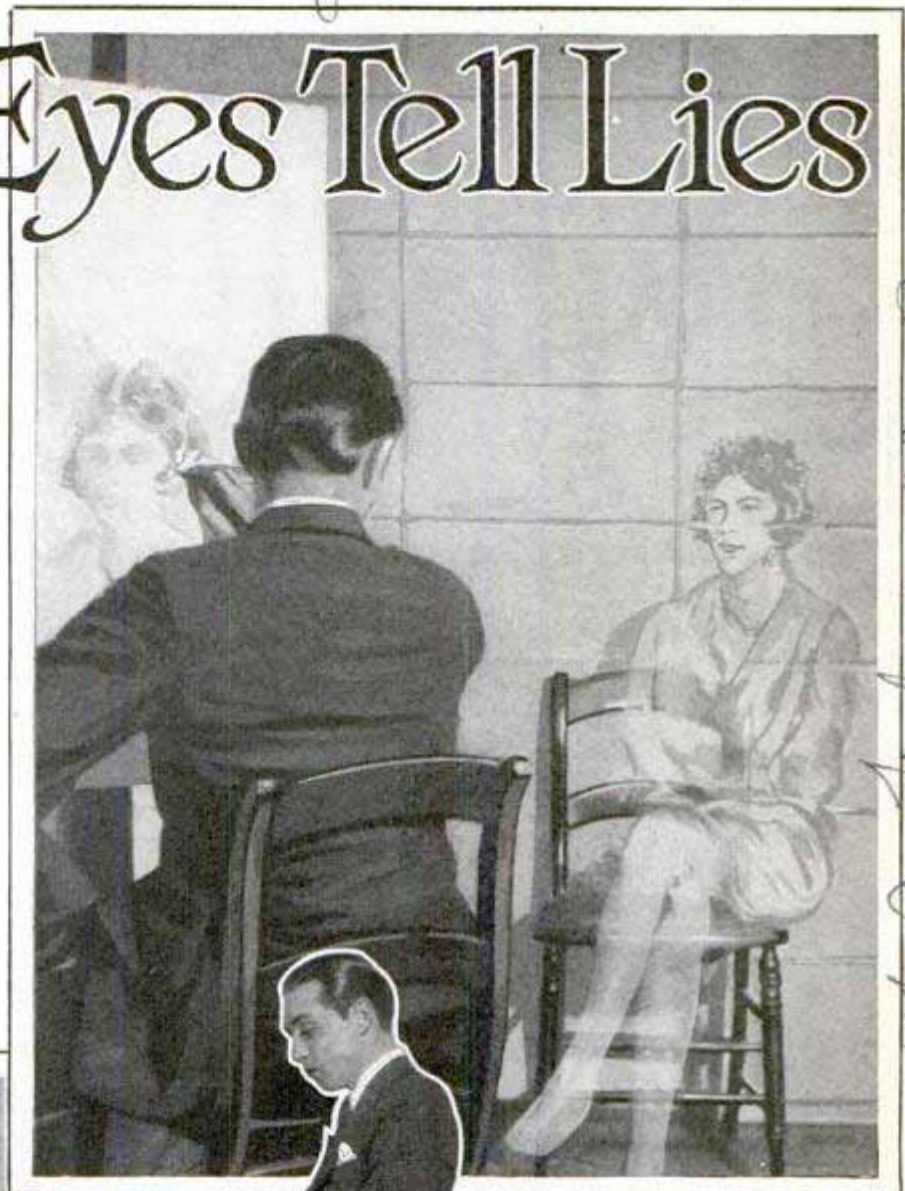

like thousands of stereopticon slides thrown on the screen in rapid succession.

According to ancient folklore, a peasant was once sitting by his cottage door when he chanced to notice a white horse with rider dressed in black passing along a distant road. The peasant watched the rider and horse for some minutes until they passed behind a small group of trees. When they emerged into view again, he was startled to see a black horse and the rider dressed in white. To the peasant it was a spiritual token;

Artist Sketching Portrait from Mental Image of Person, and, Below, an Intuition Test; Can the Subject Guess When Someone Is behind Her Chair?

U.S.A. Salmo, 1530 Broadway
New York

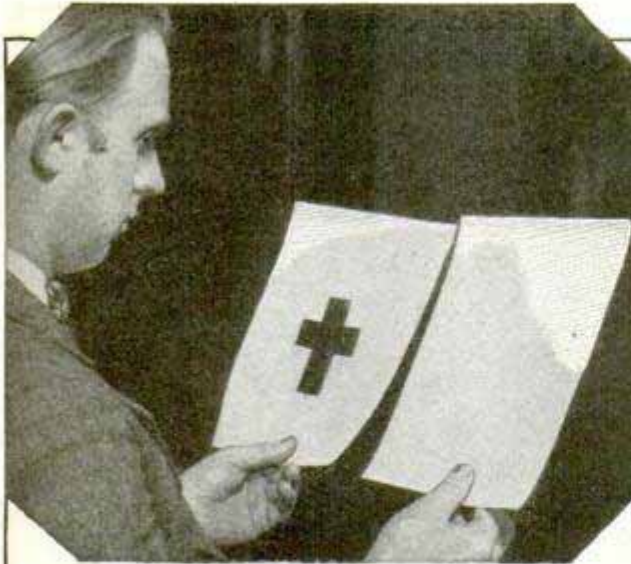

The Black Cross on White Sheet Will Appear White on Black When Gaze Is Suddenly Switched to Blank



Both Borders in This Sketch Are Parallel, but They Appear to Diverge, Due to Effect on Eye of Small Diagonal Lines

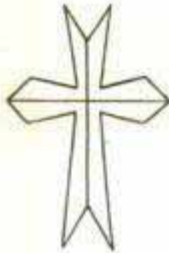

Line Illusion of Modified Cross, and, at Right, Really Parallel Diagonal Lines Appear at Angles Due to the Cross Marks

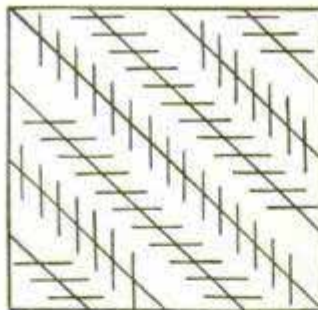

All Cross Lines in Sketch at the Left Are Parallel in Spite of Effect of Squares

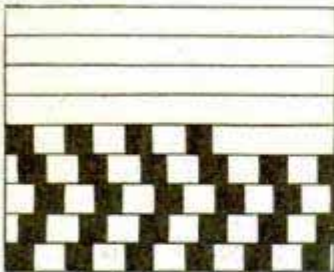

Which Is the Larger of the Two Center Dots, the One Below or the One Above? As a Matter of Fact, They Are Exactly the Same Size

Courtesy UFA Films



1530 Broadway nyc

the black horse foretold famine, the white rider represented the angel of death.

Unfortunately for the superstitious, the incident is readily explained as a mere hallucination which might be seen by anyone gifted with imagination and under similar conditions. You can perform a test yourself with the following simple experiment, in which a black cross represents the rider and white paper represents his horse.

Cut a cross from black paper and paste it in the center of a sheet of white paper. Hold this in your left hand, a sheet of plain white paper in the right. Gaze at the black cross steadily for a minute or two, then immediately switch your gaze to the blank white paper. At once it will appear to be black with a white cross in the center. It is a simple hallucination or illusion such as the peasant saw when the white horse and black rider apparently exchanged colors.

For hundreds of years people have had premonitions of the death of friends and relatives. Due to the law of coincidence, these predictions are sometimes true and therefore startling. Some persons especially gifted with strong imaginations, which tend to occasional hallucinations, wake in the middle of the night to see the ghost of some relative or friend standing near. These illusions always disappear in a moment, but if, perchance, the person represented by the ghost has recently passed away, the case is given wide publicity as an example of premonition. Of the thousands of cases where the premonition proves unfounded, however, nothing is ever heard.

Illusions and hallucinations depend largely on mind concentration. There is a case of a famous European portrait painter which illustrates how an imaginative mind may be, under certain conditions, subject to harassing illusions. The artist first became famous through his ability to make a portrait with but a half hour sitting by the subject necessary. He explained to friends that so adept had he become that in half an hour he could impress every detail of the sitter's features on his mind, completing the portrait at a later time when he was alone. For a number of years he became more and more successful, and then disappeared, and it was learned that his power to visualize had overcome him. Whenever he

*266 Mrs. Parlan
Scraper College,
Claremont
Calif*

saw a chair, his imagination quickly formed a person sitting in it, and these hallucinations became so frequent that he was continually seeing people who were not present.

Are you a believer in intuition? Scientists affirm that intuition is nothing more or less than an illusion. Find a person who will confess a belief that he has intuition—your search will not be long—and you can conduct an interesting experiment to decide the question in your own mind. This should take place in a large room with a heavy rug on the floor to deaden the sound and jar of footsteps. Seat the subject on a chair in one corner with his back to the room. If necessary his eyes may be bandaged and his ears stopped with cotton. Then, in stocking feet, the others in the room take turns walking slowly and quietly up to the back of the subject and as quietly returning.

If the subject really possesses that quality popularly known as intuition, he will be able to tell when there are people standing behind his chair. It is important that allowance be made for the law of coincidence or the law of chance guesses; so the subject must have at least fifty per cent of his guesses correct to show any slight degree of intuition.

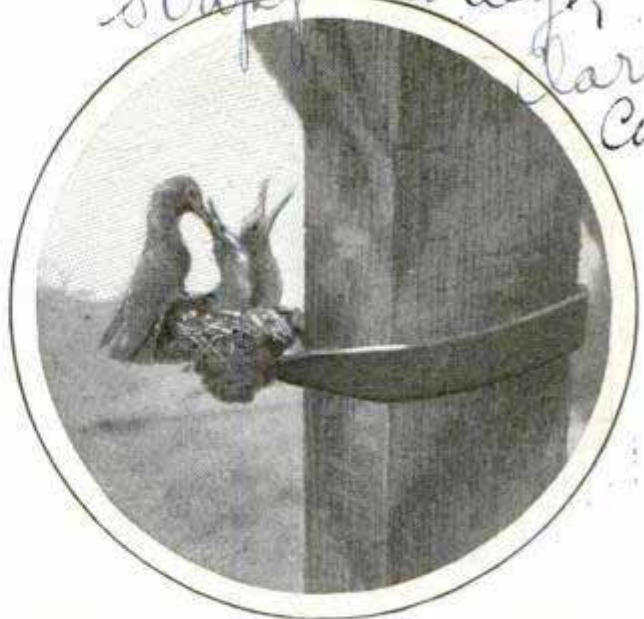

Hummingbird Feeding Its Young in Nest Built on a Scaffold on Which Men Were Working

HUMMINGBIRDS BUILD A NEST ON SCAFFOLD

Hummingbirds probably have less fear of harm from man than any songsters, and sometimes become so trusting that they will flutter down to eat out of the hand. Three pairs of these birds built a nest on protected places of construction scaffolds on which men worked daily, and successfully reared three families while the men labored above, around and under the nests. A woman induced a hummingbird to eat honey from her hand, and it vanished only to reappear after a several months' absence, settling at once on the hand of its benefactress for a meal.

BIG BURNERS SPEED UP HEATING OF KEROSENE STOVES *167*

Chicago, 346 W. Kenzie



Speeding up the heating efficiency of a kerosene stove until it cooks with the rapidity of a gas flame is the purpose of an enlarged burner with which some such stoves now are being equipped. The increased heating area removes one of the principal

drawbacks of the kerosene heater—the slowness of operation. In the new burner, the flame originates at the sides of the perforated inner chamber of the burner, spreading quickly across the top in an intensely hot flame.

*National Enameling & Stamping Co.
H. B. L. Insulubee*

LIGHT CLAMPS ON DIAL PHONE ILLUMINATING NUMBERS *100*

Clipping under the base of the desk telephone, an electric light now is available to illuminate the numbers of the dial phone, simplifying the calling of numbers by the manual system. The light is portable and is also suitable for closets or other dark corners where wall lights are not installed.



*Padroni Electric Supply Corp.
20 Bond St. New York*

BRAIN TESTER REVEALS TIME REQUIRED TO THINK

*29
5
Cnd. Robert L. Moscholder,
1129 Plum St. Lincoln, Neb.*



Apparatus Which Measures Time Required to Think; It Is Being Used to Test a Student's Mental Reactions

To measure how fast the brain works, and record the time necessary for mental and emotional reactions, Dr. Charles For-dyce, of the University of Nebraska, has developed a mind-testing machine, named the "Richards chronoscope" in honor of its inventor, J. C. Norman Richards. The apparatus differentiates between six types of persons, the very quick and accurate, the very quick but inaccurate, the medium and accurate, the medium but inaccurate, the slow but accurate, and the slow and in-accurate. Because certain work requires certain mental abilities, the brain tester may be useful in enabling persons to select vocations to which they are mentally adapted. The chronoscope, inclosed in a neat cabinet, on the operator's side has a dial graduated to hundredths of a second, and a hand which travels around the dial in one second, along with switches controlling colored electric lights and other testing devices. On the stu-dent's side is a flat board on which are

placed two tickers, one for the right and the other for the left hand, which are connected by electric wires to the hand on the dial. The controller pushes a spring which starts the dial ro-tating when a test begins, and the student, when seeing or hearing his signal for action, presses the ticker which stops the dial, thus measuring in hundredths of a sec-ond the time he required for re-action. One of the simplest tests consists in instructing the student to press the ticker when he sees a red light in a series of colored lights passing behind a glass opening in the cabinet. Every person, it has been found, reacts more quickly to an audible signal, such as a buzzer, than to a visi-ble one, such as a light, the differ-

ence being from four to six-hundredths of a second. The instrument also tests by the use of words, the student being given a word and instructed to press the ticker as soon as a word of opposite mean-ing appears. Ability to make decisions, concentration faculties, will power and emotional reaction, all may be tested by the simple apparatus which gives a line on the time required for co-ordination be-tween the mind and the muscles.

REVERSIBLE CASEMENT WINDOW IS EASILY CLEANED

2P1 Permitting excellent ventilation and at the same time easily accessible on both sides for cleaning, a reversible casement window is coming into use in London. The window oper-ates on a support for the sash, which is hinged both to the latter and to the frame.



Reversible Casement Window Which Is Easily Cleaned

☐ Potatoes were in-troduced into New England from Ire-land.

Cnd. W. H. Shipman

207 Ave. of the Americas, 10th Floor,
Park Central Hotel,
Washington, D.C.

When the Mountain Moves

MYSTIFIED by the strange fact that entire California mountains have shown a habit of working loose from their moorings and have moved in different directions during the past twenty-five years, government scientists have been conducting experiments to test the theory that certain geographical features tend to float away from their old positions as the deep layers of the earth's crust change.

Uncle Sam's recently completed check-up on the itinerant landscapes of California shows that Point Reyes has moved more than ten feet northward; Mt. Santa Ana has moved seven feet southeast; Mt. Diablo about two feet southeast, and Mt. Somaprieta about six feet in the same direction. Other vagabond mountains and landmarks of lesser importance likewise have been discovered.

Land lighthouses, consisting of adjustable steel towers, 150 feet high, are being used in various parts of the country for making rapid surveys. The men who construct and transport them for observation

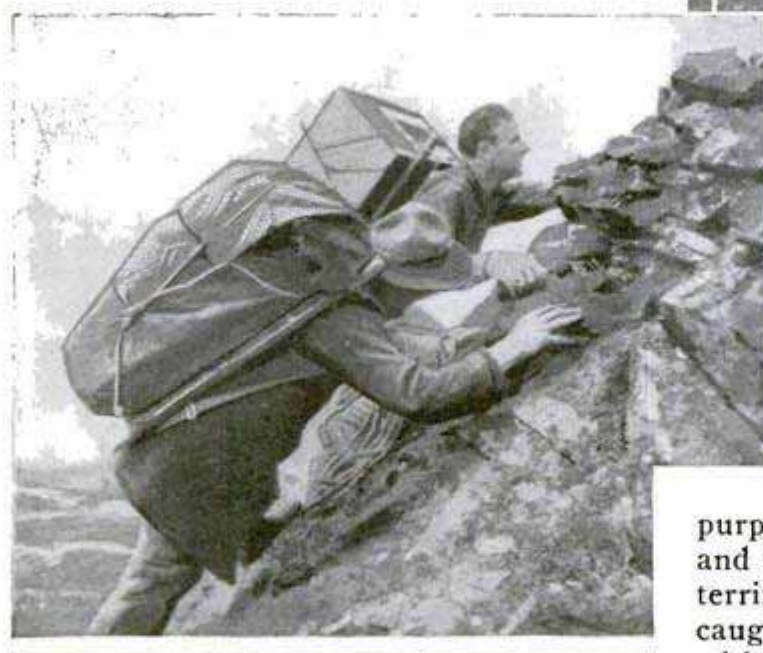

Taking Observations from Peak, and Climbing Steep Slope with Outfit for Measuring Mountain Movements; the Work Is Filled with Adventure

purposes lead adventurous lives. Time and again they have been in the path of terrific bolts of lightning; have been caught in quicksands; while encumbered with heavy packs, they have had to climb high mountains covered with ice formations, and have battled blinding blizzards.

Coast and Isodetic Survey

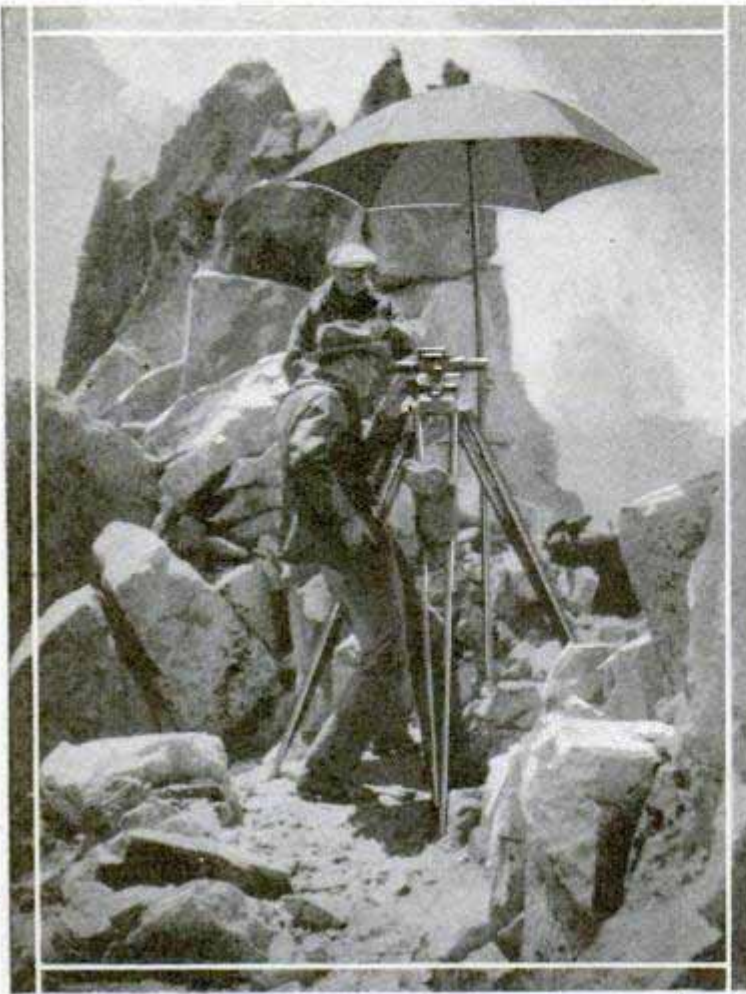

How the new lighthouses came to be invented is told by Capt. R. S. Patton, director of the coast and geodetic survey:

"Since the earth is a sphere, its curvature must of course be taken into account in all of our surveys. Rolling terrain, trees and buildings, all obstruct the line of vision between two points whose latitude and longitude must be determined, so that when high hills are absent our experts have found it necessary to build towers on which to make their important observations.

"Probably the most outstanding work of the new lighthouses was accomplished last summer when a quick and thorough survey was made of the Mississippi river region between Cairo, Ill., and New Orleans. The construction work was done in the daytime and the observations made at night with the help of signals that were flashed from tower to tower by means of controlled lights. When the work in one region was completed, the tower was dismantled and transported by heavy truck to another strategic point."

In many sections of the country, filled

with rough timber that reaches unusual heights, land lighthouses cannot be constructed. This is because no adequate roadways are available for transporting the sections of a steel tower. In such cases, the field men have to improvise towers in the tops of great trees, whose base often is over nine feet in diameter.

The skill required in this sort of construction work calls for the facility of the expert lumberman plus the climbing art of the telephone lineman. Their first problem is how to climb the trees. Years of experience has shown that, while cleated shoes and safety belts are satisfactory for the smaller trees, they fail to suffice for those over 200 feet. In such cases, a steel spike, similar to those used on telephone poles, is employed. It is about fourteen inches long, sharply pointed at

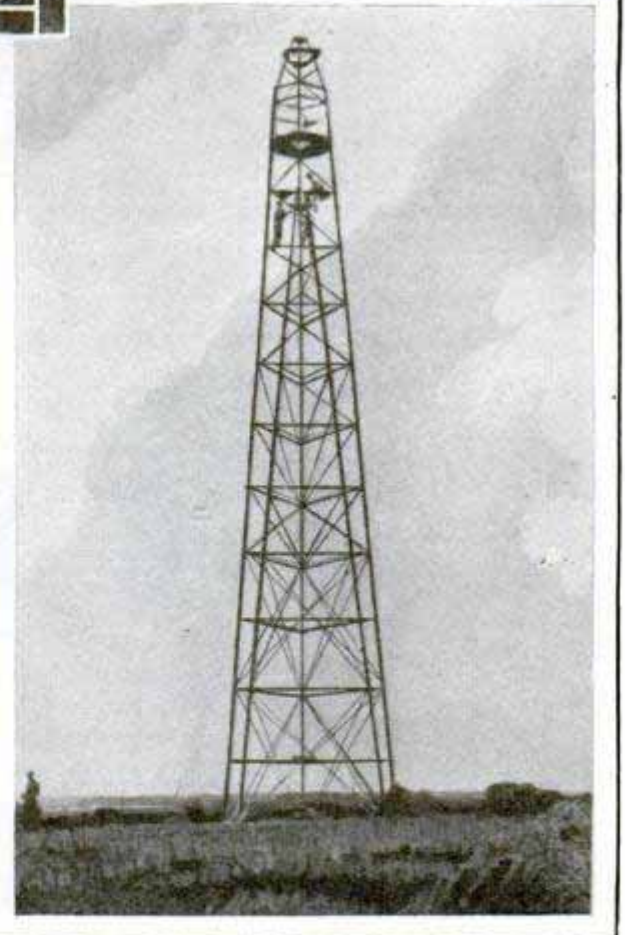

Taking Readings from Lofty Mt. Whitney, and a "Land Lighthouse" for Mountain Studies; Repeated Observations Give a Measure of Land Movements

one end, and turned up for about an inch and a half at the other extremity. It takes a man of some nerve to drive the spikes, as he has to stand on one, hook his safety belt over the next one above, and drive the third peg on a level with his head.

A good many years ago, long before the advent of the land lighthouse, a survey man had occasion to climb a crude observation pole. After considerable thought, he hit upon a unique way of climbing it quickly. First he hired a horse, attached a block and tackle to it and instructed a boy to keep a sharp eye on the beast while he was perched aloft, some 150 feet above the ground.

All went well for perhaps an hour. Whereupon the horse decided to make a quick get-away. There was a tremendous tug on the rope and the pole swerved perilously. Certainly it would have snapped and the engineer would have received a broken leg or worse, had not the boy caught the animal in the nick of time.



Rope-Stretcher Sled Which Has Demonstrated Its Usefulness in Carrying or Pulling the Victims of Mine Disasters to the Surface

ROPE STRETCHER AIDS RESCUE WORK IN MINES

As an aid in mine-rescue work, a rope-stretcher sled has been developed by the mine-rescue department of Birmingham university in England. It consists of a length of tough wear-resisting rope netting, around the edge of which are ropes and straps for fastening the patient on the stretcher and carrying him or pulling him to the surface by means of other ropes. The safety device has undergone successful tests.

IVORY DREDGED FROM THE SEA

Ivory covered with barnacles recently was dredged from the bottom of the North sea fishing grounds by a trawler. Scientists believe the ivory represents the tusks of prehistoric animals that once roamed over country that now is under the sea.

Whenever you find that you wish to know more about any article in this magazine, write our Bureau of Information.

ALARM CLOCK TURNS ON LIGHT TO DISPEL SLUMBER

Sleepers not easily aroused by the ringing of an alarm clock now may also use a light to get themselves up. A German clock manufacturer has devised an alarm clock with electric-light bulb attached, so arranged that when the alarm rings, the light is switched on automatically. The light is on an extension cord and may be placed so it shines in the slumberer's face.

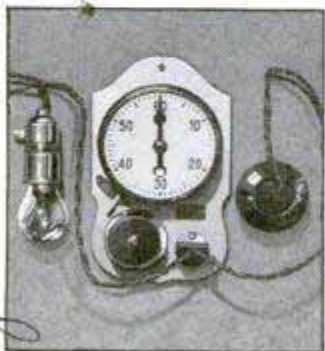

Hamburg-Amerikanische Utherei-Fabrik & Schwebmengen-Schwarzwaldbahn
 267
 249
 Brought into harbor at Esrumby, England 355
 English
 The Black Forest Co.

284

DOT-AND-DASH PATH GUIDES PLANES IN LANDING

Artist's Drawing of Earl C. Hanson's Radio-Wave System for Guiding Airplanes to a Landing Field through Fog; the Sketch Shows the Four Underground Cable Loops, Two on Each Side of the Field, but with Only One in Operation, the One at the Side Permitting the Plane to Land into the Wind; a Dot on One Side and a Dash on the Other Audibly Guide the Pilot into the Lane

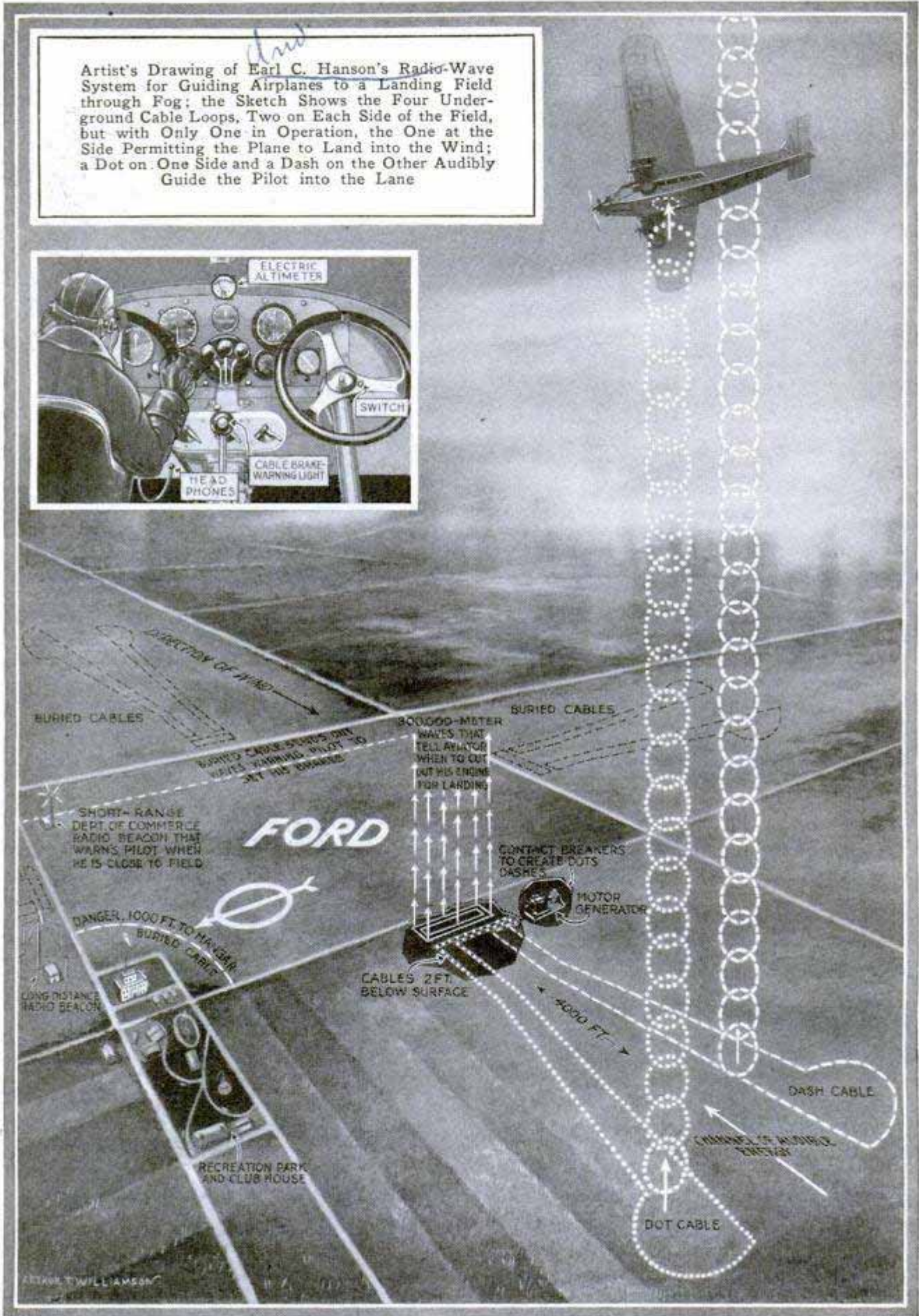
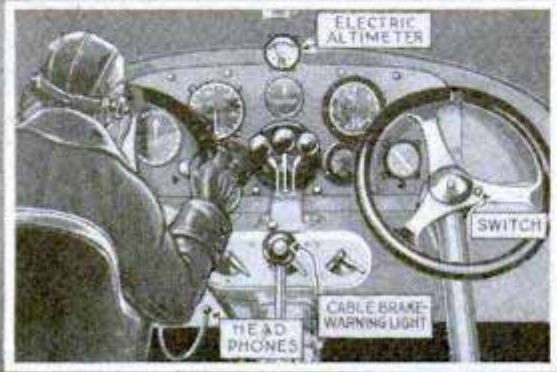

ARTIST T. WILLIAMS

Engaged by Univ. of California

in charge of vineyards at Oularad

LARGER GRAPES ARE PRODUCED BY GIRDLING VINES 328

Girdling the stalks of grape vines in California is now being practiced to produce larger and earlier fruit. This operation involves removal of a ring of bark down to the growing layer of the woody part of the trunk. A double incision is made in the bark around the stalk, the lines being about one-quarter of an inch apart, and the intervening bark is removed with as little injury as possible to the surrounding growth. The first girdling is done when the blossoms are beginning to form to make them remain on the vine and insure a good setting, and the second girdling, when the grapes are about one-fourth of an inch in diameter, is for the purpose of producing large symmetrical bunches and earlier fruitage by from two to five weeks. A girdle usually lasts for several years. The practice prevents early sap from returning to the roots to be absorbed for further growth of the woody structure.



Dummy Gunman Used to Demonstrate to Student Policemen How Criminals Conceal Their Weapons

Edward Butler Crime Museum

TRICKS OF GANGSTERS SHOWN BY DUMMY GUNMAN

Outfitted with all the impedimenta of the modern crook or gangster, a dummy gunman is used in the New York police college to show embryo officers the tricks of the criminal. The dummy is a veritable arsenal of weapons, pistols, knives, saws and blackjacks hidden about the clothing in every place the ingenious crook might choose, to demonstrate to students that a cursory "frisking" is not always safe. The dummy also wears a bullet-proof vest.

Dreht.

TELESCOPING GAUGE MEASURES INSIDE DIMENSIONS 79

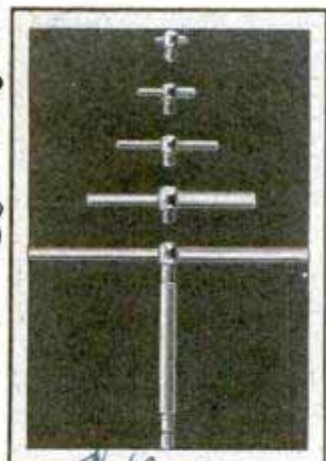

Determining internal measurements, formerly difficult to obtain, is simplified with a set of telescoping gauges for use with a micrometer. The set consists of five heads interchangeable on one handle. The telescoping head is inserted

into the hole or slot to be measured, where it expands to the size of the hole and is locked in that position by turning a knurled screw in the handle. The gauge then is removed and measured with the micrometer. Measuring surfaces of the heads are ground on a radius, adapting the tool for use on curved surfaces.

\$12.00

Brown & Sharpe Mfg. Co.

Coded telegraph messages now can be flashed across the Atlantic at a speed of 2,500 letters per minute.

Providence, R.I.

LUGGAGE RACK ON SPARE TIRE FOLDS WHEN NOT IN USE 76

Designed for attachment to the spare tire at the rear of the auto, a handy luggage carrier recently has been placed on the market. A lever arrangement provides a simple and easy method of attaching or removing the rack, which is large enough to hold three or four bags. It is locked on the tire by pushing down a center-clamp lever and folds back out of the way when not in use.

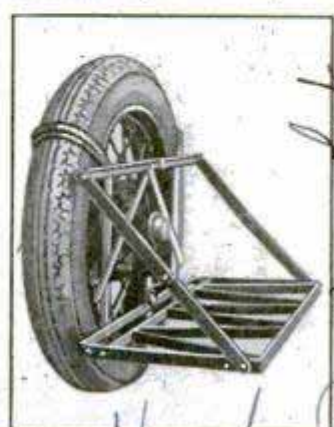

Wes. Lat.

Welker Hoops Mfg. Co. Midvale, Utah

Chicago - 628 W. Washington

Cont. H. J. Wilkens, 27 Dean Road,

Colombene, Desley Heath, London, Eng.
FOUR THOUSAND HORSEPOWER SEEKS RECORD

185 Capable of developing 4,000 horsepower, a racing car which uses the body surface as a radiator has been built for
between two layers of thin metal composing the body. Its flat bottom is expected to enable it to scoot over the surface of the

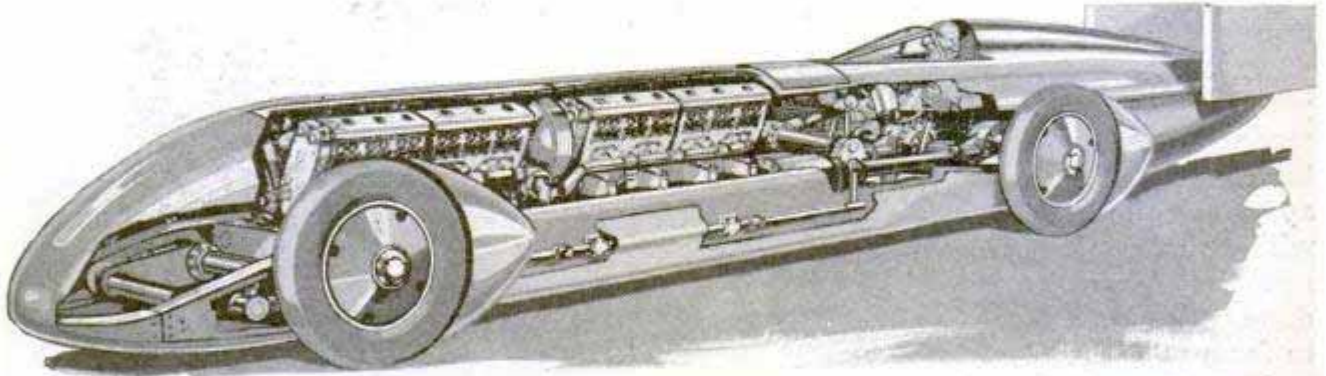

Courtesy The Autocar

Cross-Sectional Drawing of 4,000-Horsepower Racer in Which Kaye Don, British Driver, Hopes to Establish New World's Speed Record; It Utilizes Body Surface as Radiator

Kaye Don, British driver, who will attempt to better the speed record of more than 231 miles an hour now held by Sir Henry Seagrave. Water circulates be-

water or along the ground, if it should enter the sea or a wheel give way during the speed attempts. The car weighs two and one-half tons.

TEST MEAT CUTS BY TASTING TWO THOUSAND SAMPLES

299 To find out why one cut of meat is palatable while another, that looks just as promising, turns out to be a disappointment, five scientists of the U. S. bureau of home economics have sampled, by tasting, 1,700 legs of lamb, 600 rib roasts of beef and 200 cuts of pork. Each piece of meat cooked was accompanied by its career and pedigree including the age and sex of the animal, its breeding record, how it was fed, how much exercise it had, and other facts that might affect meat quality. Each cut sampled was cooked exactly the same way, taken out of the stove at the same stage, and the same section cut for the judging. The judges each ate off a numbered plate the same relative slice from every single cut of the meat. They rated the sample for juiciness, tenderness, aroma, the flavor of lean and the flavor of fat, scoring each

piece on a range of seven degrees of perfection. Out of all this tasting, it is expected, will come better methods that stock growers can use in raising meat to increase its palatability.

LONG HANDLE ON GRASS SHEARS 183 MAKES WORK EASY

Long-handled grass shears that permit clipping out-of-the-way corners of the lawn without stooping now are on the market. The clipper, weighing less than two pounds, is entirely automatic, being equipped with a pendulum-action foot which operates the shears when a slight pressure is exerted on the handle. The moving foot operates a toggle-action stud which brings the cutting edge of the lower blade up, and that of the upper blade down, as the shears close. The blades are self-sharpening and self-adjusting. This makes it possible to cut thin or heavy grass.



Long-Handled Grass Shears for Clipping Difficult Corners of the Lawn without Stooping

Service, Service News Bulletin no. 464.C. 2/12/30

Alvanice Hyslop
Akron, Ohio

302 *maine kept great northern*
POPULAR MECHANICS
Paper Co Bangor, Maine

**BOAT THAT JUMPS OVER LOGS
 HELPS LUMBERMEN**

Pulp and paper companies in northern Maine use a type of motorboat called a "boom-jumper" for errands and light work in placing the four-foot lengths of pulpwood in the booms. The craft, as its name indicates, actually is able to cross or jump the long logs chained together to hold the pulpwood in place. When it is necessary for a boat to enter a boom, it is headed directly for it, the motor opened wide, thus sucking down the stern and lifting the bow. The craft hits the boom with a splash, rises smoothly at the bow and slides easily over the big log. The stem post of the boat is rounded from water line to keel so it rides the log instead of smashing into it, while the main keel is supported by two other keels on either side of the flat bottom, projecting under the stern and making a box to protect the propeller blades. Some of the boats have glass-inclosed cabins and are powered with Diesel engines.

Boat in company photo

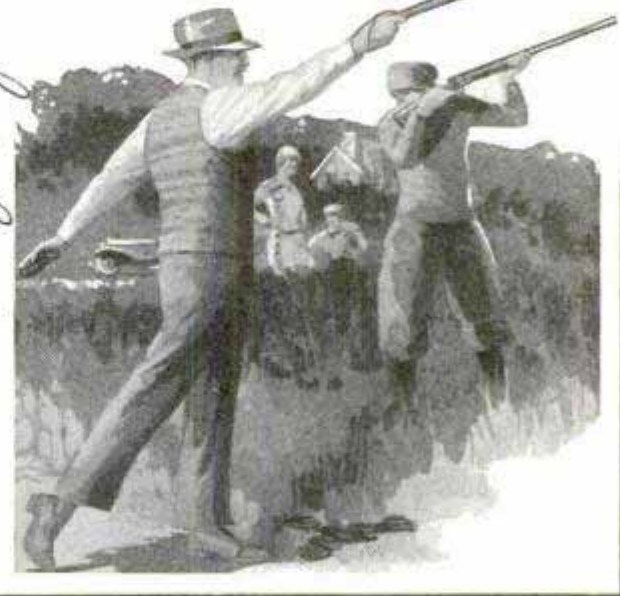

Hand-Operated Trap for Shotgun Practice; It Throws Clay Targets Like an Automatic Trap

HAND TRAP THROWS TARGETS FOR SHOTGUN PRACTICE

For target shooting with a shotgun, a hand-operated trap now is on the market. The trap has a thong fitting around the wrist and a slot in which the clay target is placed before it is flung. It gives perfect control of the target, allowing easy or difficult shots, and imparts to the clay disk the same spinning motion given by the automatic trap. It weighs only eleven ounces and is convenient to carry.

SPARK-PLUG CLEANER REMOVES CARBON QUICKLY

Spark plugs may be cleaned easily and quickly without taking them apart with a spring-steel cleaner so constructed that it can be inserted into the part of the plug where carbon is formed. The handle of the cleaner contains a circular gauge for setting the spark gap to the proper width. The cleaner is so shaped that it reaches every part of interior surface.

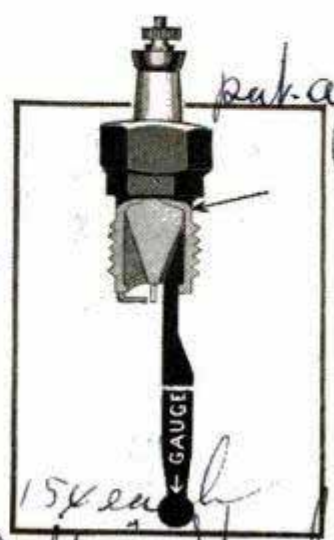

GRADUATED-ROD DEPTH GAUGE FOR HOLE MEASUREMENTS

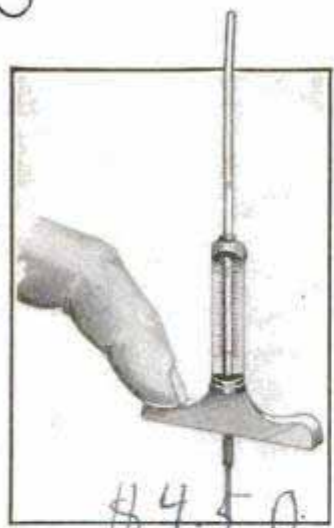

Measuring the depth of large or small holes by reading from a gauge graduated to sixty-fourths of an inch is accomplished with a rod depth gauge now on the market. Its wide base makes it possible to measure large or small holes, the bottom of the measuring

rod being one-sixteenth of an inch in diameter, and the upper part one-eighth of an inch. There also is available a combined depth and drill-point gauge, used for measuring holes and also to check the angles of drill points when grinding them to determine whether the point is central. It is furnished also in metric measure.

☐ The largest nugget of gold ever found weighed 190 pounds.

#2.00 job
 East Alton 245
 769

*Western Cartridge Co.
 East Alton, Ill*

Chicago - 628 W. Washington

*Brown & Sharpe
 Mfg. Co. Providence R.I.*

*"Jiffy" Spark Plug
 Cleaner Co. 3023-*

Washington, D.C.

83

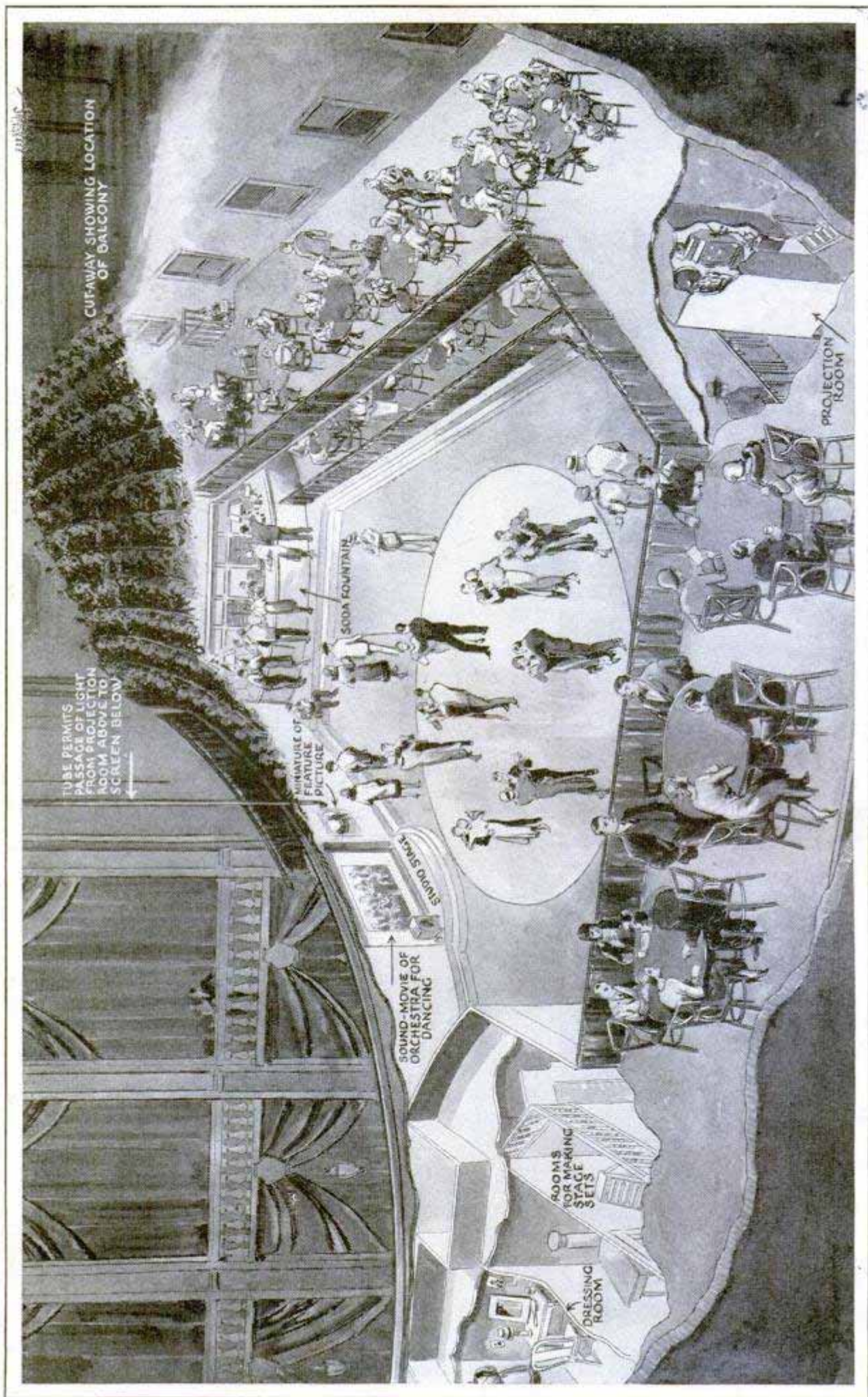

Artist's Drawing of Albert L. Godoy's "Duplex" Theater, Showing How He Utilizes the Triangular Space between the Horizontal Base and Seat Tiers in the Balcony. There Is Room for a Dance Floor, Refreshment Tables and Other Things; the Walls Would Be Soundproofed, and a Special Ventilating System Installed

108

A Ten Cent Store Edison

By DON GLASSMAN, 151 W. 80th St. New York

FIFTY patents are credited to Albert L. Godoy, whose inventions sell in lots of a million. They range from a chemical formula for a beverage to a system of rapid underground transportation.

Visiting his laboratory on Long Island, my eyes fell on a large sphere hanging from a chandelier, and I first asked him about that.

"It is an unbreakable electric bulb," he said, turning on the current and illuminating the room. "You see, it is not totally transparent like glass, but that is no defect, since frosted globes are the vogue now."

Then, taking out another globe, about fifteen inches in diameter, he pressed its walls with his thumbs, making several depressions in the surface, but it did not collapse. The globe is made of composition substance somewhat like rubber, but not very flexible or elastic.

Robot talking pictures are another recent invention credited to Godoy. Essentially, he has devised a means of creating the human voice, or any other sound, to order. Heretofore, he says, all speaking inventions merely reproduced sounds; his invention creates a sound; for instance, a disk record merely repeats what some speaker has spoken into a recording apparatus. Godoy says: "Tell me whether you want a man, woman, or child to sing a certain song, and I will create such a voice solely by mechanical means."

No sooner were sound films produced, than Godoy noted the definite patterns or arrangements of the shaded lines in the sound track. A certain pattern denoted the tolling of a bell; another be-

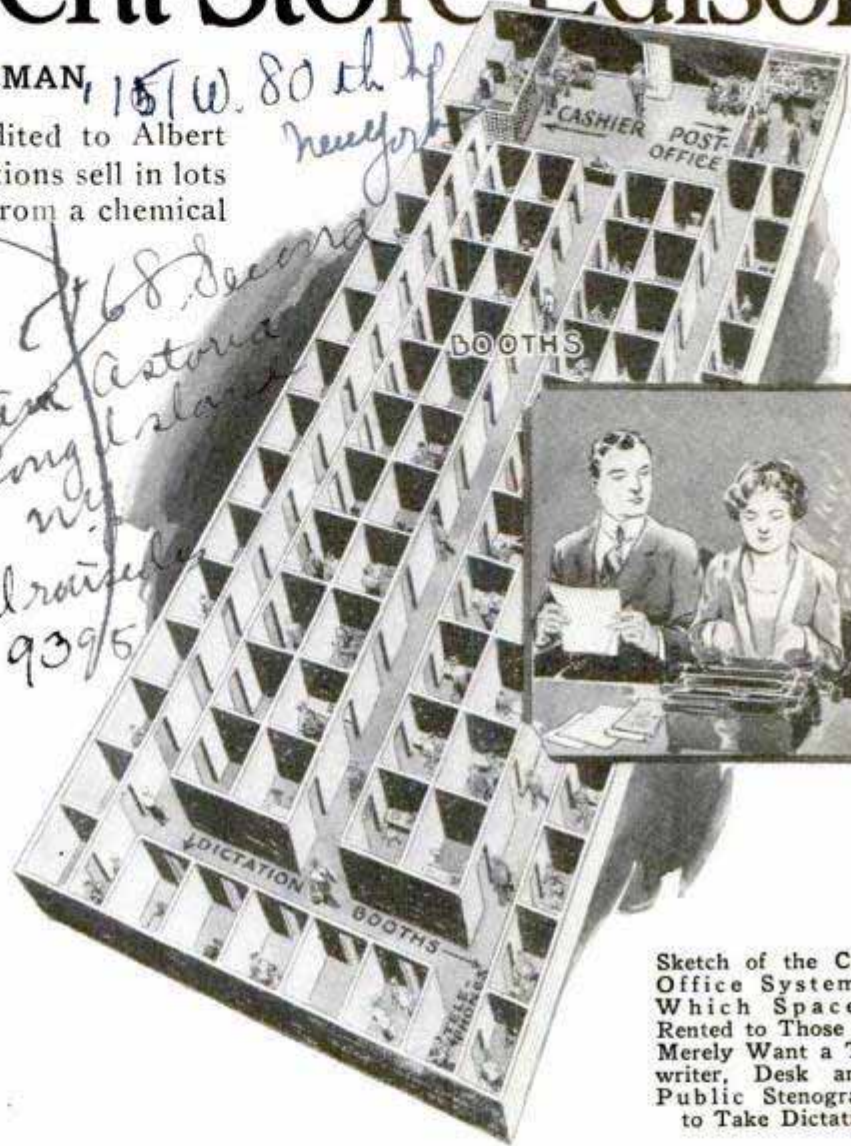

Sketch of the Chain-Office System, in Which Space Is Rented to Those Who Merely Want a Typewriter, Desk and a Public Stenographer to Take Dictation

trayed the voice chords of a child; another showed the sound-wave vibrations of a baritone voice. Applied study of these patterns convinced him that he could identify music and voices just as the musical conductor does, that is, by reading the notes. When he grasped the secret of reading sound tracks, he learned the sound-recording camera's vocabulary, on the film margin.

"I discovered," he said, "that each minute design or wavelength represented a particular sound; that the 'peaks' had a fixed sound value of infinite variety, and that by combining 'peaks,' 'wavelengths' or 'designs,' you could produce any intonation of the voice and make it say whatever is desired without employing human vocal chords.

"Likewise, by widening these peaks, or

Albert L. Godoy, 168 Second Ave. Astoria, N.Y.

Letter
replied
3/8/35
c/o St. Louis Picture Productions
Merriam City, Mo.

158 772



The Sketches on This Page Show the Godoy Arrangement for Combining Studio Action with Distant Scenic Backgrounds; Above, Is a Positive Print of Action on Thin Film, and, at Right, Above, the Negative of the Scenery; the Center Sketch Shows the Positive Action Film Being Superimposed over the Negative of the Background; When This Is Done, a Print Is Made from the Combination, Producing a White Silhouette of Action as Shown Below



To Arrive at the Final Result, the Negative of the First View at Upper Left Is Printed into the Outline, as Shown Below, at Left, with the Finished Exposure Attained as Illustrated Just Beneath; This Modification of the Double-Exposure Method Is Intended to Reduce the Cost of Producing Motion-Picture Film and Make More Successful the Employment of Miniature Sets of Scenes; the Cost Would Be Only a Fraction That of a Full-Size Set



Below, at Left, Photographing the Original Action in Studio, within a Special Compartment Painted White and with Rounded Walls to Reduce Accidental Shadows; the Original White Background Permits Recording a Silhouette Effect of the Figures; the Inventor Estimates that a Show That Ordinarily Requires Three Weeks Could Be Made in Three Days by Employing the Miniature Scenic-Background System of Film Production

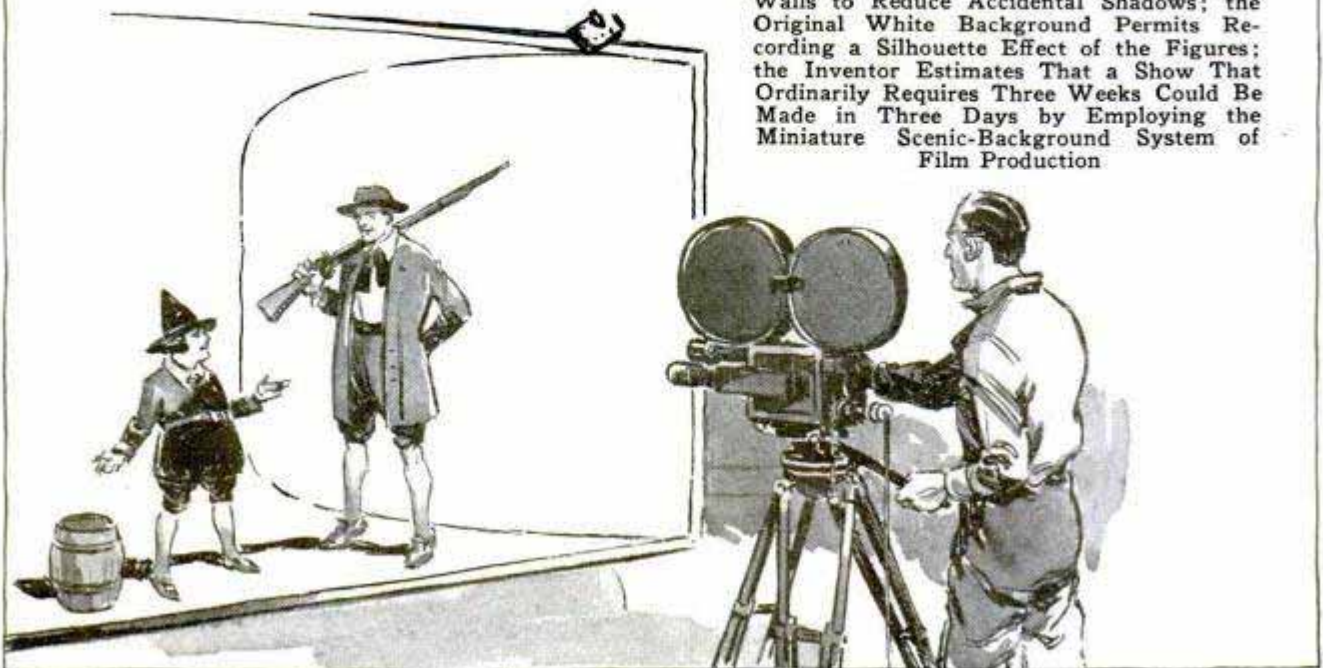

thinning them, you can modify the voice, adding either masculine or feminine qualities. Furthermore, by applying a certain light or dark shading, you can create a bass

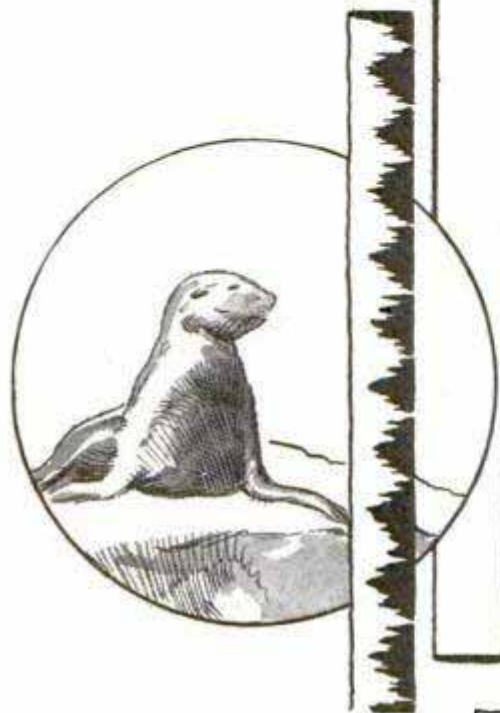

or tenor voice in man; a contralto, mezzosoprano, or soprano, in woman; a boy's or a girl's voice, and even a baby's voice that would be distinctly recognized.

"Eventually, I hope to make it possible for every moving-picture studio to have a library of sounds. When a director requires a tolling bell, or a steamboat whistle, or a telephone ring, or a child's 'Da-da,' he will only have to order the proper cards or film from the studio librarian."

Godoy's favorite invention is his "duplex" theater, prototypes of which are now operating successfully in Mexico City. By this invention, it is possible to have "a theater within a theater." Two performances can be given simultaneously. The public is also benefited, says Godoy, in that two different shows may be seen for the price of one.

In Godoy's duplex theater, he utilizes the triangular space between the horizontal base and seat tiers in a theater balcony.

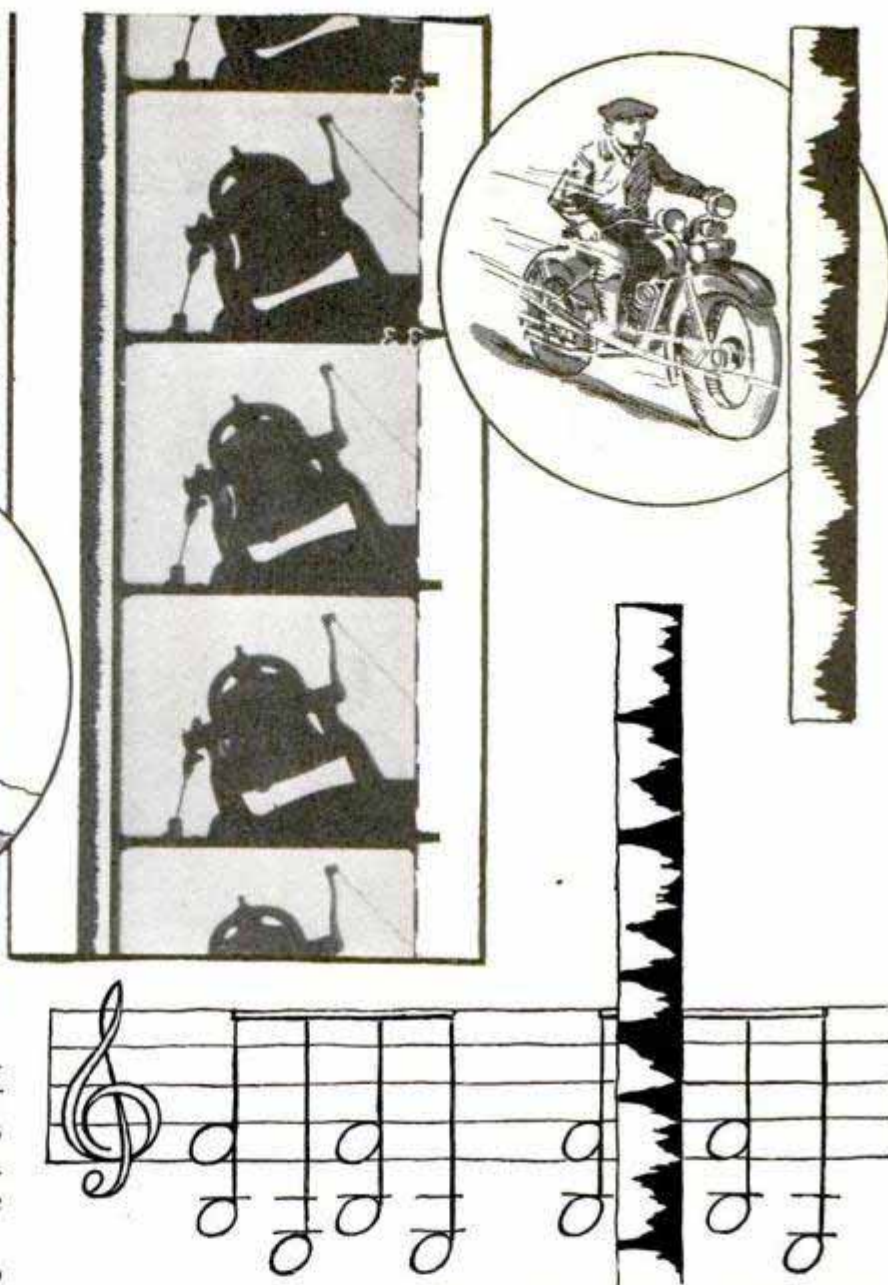

Sounds of Sea Lion, Motorcycle Bell and Piano Chord, Identified by the Curious Jagged Pattern of "Peaks and Valleys" Each Produces

In a theater seating 5,000 or 6,000 people, this amounts to an appreciable area and volume. The interior walls of this waste space can be soundproofed and a system of forced ventilation provided. A large dance floor or a vaudeville stage can be installed; or a restaurant or refreshment parlor. From 500 to 1,000 people could be entertained in this space at one time. The first duplex in this country will be constructed soon in New York.

A process to eliminate sets and backgrounds in the making of moving pictures is what Godoy calls his greatest invention.

"No pattern-made scenery will be required," the inventor said. "That is, no life-size sets will be necessary. In the

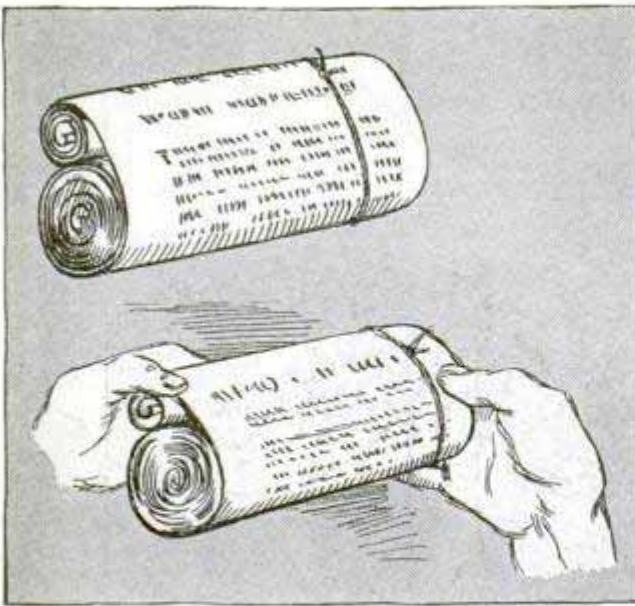

Godoy's "Reel-a-Book"; 35,000 Words Can Be Printed on Both Sides of Seventeen Feet of Narrow Paper

prevailing system, actors move among expensive manufactured sets which fit particular scenes. But I have made it possible to do all set building in miniature.

"Six inventions are involved in my process of eliminating full-size moving-picture scenery. The principles I apply are entirely new. They make possible the recording of speech in any room, preferably one whose back wall is white and concave. A silent-film camera may record a street background in Africa or China. I can easily combine these two films and make it appear that the people actually were speaking in China or Africa when the scene was 'shot.'

"Any sort of action may be recorded without resorting to double exposure. It helps to eliminate a great deal of waste in movie producing. A show that ordinarily requires three weeks can be made in three days; life-size sets that cost \$100,000 can be made either in miniature or on separate film for one-tenth that amount. It saves the salaries of actors, directors and mechanics who ordinarily are paid merely to wait. I predict that it will cut the cost of certain movie productions as much as ninety per cent."

Godoy has invented a chain-office system which will be put into practice shortly. For an established price of one cent per minute, anyone may rent a typewriter and desk; he will have access to a public stenographer whose services will cost one cent a minute also; he will have a tele-

phone handy; mimeographing, mail and message service. The chain system will rent its office as a mailing address for a price of five cents for each letter delivered. In other words, it will give every comfort that one's private office is intended to provide.

Most of Godoy's inventions are sold for five and ten cents in chain stores specializing in such merchandise. Since they are very popular and sell by the millions, he has been given the title of the "Ten Cent Store Edison." One of his small inventions is a three-point pencil. Another is a pencil that writes in three colors. His "Octo Game" is a collection of octagon-shaped cards with which a boy may play baseball, football, basket ball or tennis; besides, he can make trips around the world and learn many things about geography; 240 combinations are possible.

To date, Godoy's "Movielets" have sold to the number of 50,000,000; hardly a child in the country has not found some pleasure in them. About 1,000,000 "Moviescopes" have been sold. A moviescope projects a movielet on a tiny screen inside a cylinder. Although a toy, it is used by most film cutters in the country.

A "reel booklet" is a 35,000-word booklet wound on a continuous reel. The reader does not have to turn pages. The reading is continuous. It can be printed to retail for five cents. Also, he has invented an unbreakable mirror—which cannot bring bad luck, of course. Another mirror portrays your face with a thousand different grimaces. He has petrified fruits; made candy from peels of oranges and lemons and devised simple photographic printers, a telephone-locking device, a photographic paper which develops in fresh water, and a system for decreasing subway congestion.

ELECTRIC SPARK IS BRIGHTER AND HOTTER THAN SUN

217 During its brief life, a 20,000-volt spark of electricity is fifty per cent hotter than the sun and 100 times as bright. These conclusions have been reached through an analysis of the electric spark at the University of California with a camera whose shutter operates in one-billionth of a second. Using this electro-optical cam-

462 J 2/1/30

Wm. W. Morse, 111 N. MacLay San Bernardino, Calif

era, experimenters were able to take what amounted to slow-motion pictures of the life of a spark at intervals of four one-millionths of a second, and to show the changes it undergoes. The camera is not a mechanical device, but makes use of the physical properties of light, the spark literally taking its own picture.

TROLLEY POLE FLASH IS BASIS OF FOG-SIGNAL TESTS 215

Col. Charles A. Lindbergh unwittingly furnished the idea for experiments with a fog-signal light for aviators based on arcking. He observed that even though dense fog obscures other lights above a city, flyers always are able to see the flashings of the poles of trolley cars. The trolley-pole flashings are due to arcking, and experiments now are under way to develop a fog signal based on this fact.

QUIET MOTOR FOR AIRPLANES SAVES GASOLINE 152

Quietness, freedom from vibration and economy are claimed for an air-cooled airplane motor that differs considerably from the usual type in its cylinder arrangement and other features. It is of the opposed-piston variety of radial engine, that is, each cylinder contains two pistons, one above the other and with the explosion chamber between them. They are pushed apart by the same explosion, the bottom one pushing down on the crankshaft and the



upper one, pushing against a yoke and drive-rod arrangement in such a way that an upward pull is exerted on the crankshaft. A five-cylinder motor of this type, running in a test block and turning a propeller at 1,000 revolutions per minute, operated for seven continuous hours on but ten gallons of gasoline. When run at the highest speed, the motor produced only a thin, high-pitched whistle, according to reports, a noise that easily could be kept from the cabin of an airplane.

GANG-PLOW HOE CULTIVATES AND WEEDS AT SAME TIME 213

With its tines constructed like the shares of a gang plow, a hoe that decreases



Gang-Plow Hoe for the Truck Garden, Which Cultivates and Weeds in the Same Operation

the hand labor of caring for garden or field now is on the market. The gang-plow hoe cultivates and weeds in one operation, cutting labor and time in half, and is an implement particularly adapted for truck farming.

AUTO CRANKCASE VENTILATOR ELIMINATES ODORS 127

Removing unpleasant odors and preventing oil from splashing over the engine, a crankcase ventilator for the new Ford cars is on

the market. The ventilator, which is easily installed, also provides a handy self-closing oil-filler cap and keeps oil from coming in contact with the rubber parts and disintegrating them.



Will put on market. J. W. Morse, 111 N. MacLay Ave, San Bernardino, Calif

Mr. Lyon Motors, Ltd 940 Exchange St., Hollywood, Calif

Lee Bowman, 952 Gardner

Apex Mossberg Corp. Pittsboro, Mass

Chicago. 222 W. Adams



Richardson Engineering Co.
1627 W. Pershing
Chicago, Ill.

Courtesy General Electric Co.
Seven Thousand Electric Lights, Controlled by One Person at the Console of a Color Organ, Provide the Only Decoration for This Ballroom, the Walls of Which Are Solid White

CHANGING MAGIC OF COLOR TRANSFORMS BALLROOM

Seven thousand electric lights are blended by a giant organ controlled by one person into a magnificent symphony of color in the decorative lighting scheme of the ballroom of the St. George hotel in Brooklyn. Blending the lights has given a third dimension of flexibility and fluidity to color which heretofore was either fixed or confined to repeating single patterns, such as flames or clouds. The ballroom, with a floor area of 11,000 square feet, a thirty-one-foot ceiling and two balconies, was finished throughout in flat white without any decorations whatever except for the lights. A remote-control system serves the 7,000 lamps of red, green, blue and clear, the control board being in effect a mechanical console on which the color organist interprets his soundless symphony by molding, interweaving and changing the lights. The lamps are placed in a system of coves and flutes, four separate and parallel coves about the walls and, for the ceiling, a series

of five troughs, ten feet wide and sixty feet long, placed symmetrically on twenty-foot centers. The troughs have sawtooth openings along the sides through which colors and shadows are formed. All effects are produced by varying the current to the different colored lamps. The lamps are equipped with color caps of red, green and blue, and from these primary colors shades of gray, orange, yellow, purple and cerise, together with many pastel shades are produced. One man alone can govern every effect at the thirty-foot control board with its 500 buttons.

WALL-REGISTER ELECTRIC FAN SPEEDS UP HEATING

Speeding up the heating of a room from a wall or floor register, a portable electric fan for attachment to the register now is on the market. A light metal casing gives protection around fan and motor and also forms



Chicago. 1500 Delaware Place in U.S.

Chicago. 413 N. Dearborn
International Heater Co.
Chicago. 1935 W. Wentworth.
Richardson Engineering Co.
Chicago. 1627 W. Pershing

A. H. Robinson Co.,
Manufacturers

1803
Howell
Larchmont Ave.
777
Chicago

a base for setting it in an upright position. It may be suspended from a wall register by a hook at the back, or laid on its back over the floor register to accelerate circulation of warm air which it sucks from the furnace and forces up into the room. In summer it may be used as an ordinary fan to cool a room that it helps warm in the winter.

MOTORBOAT HAS STERN DRIVE AND REVERSE GEAR, 22

Giving the comfort, control and safety of a costly motorboat, a stern drive and reverse gear now are available for the small boat. The stern drive makes possible a unit power plant at the rear out of the way of passengers, with operation of starter, lights, throttle, spark, forward and reverse from the driver's seat, thus making the running as simple as driving a car. The aluminum gear housing is water-cooled and spiral bevel gear and ball bearings are used. The reverse gear allows driving backward at the same

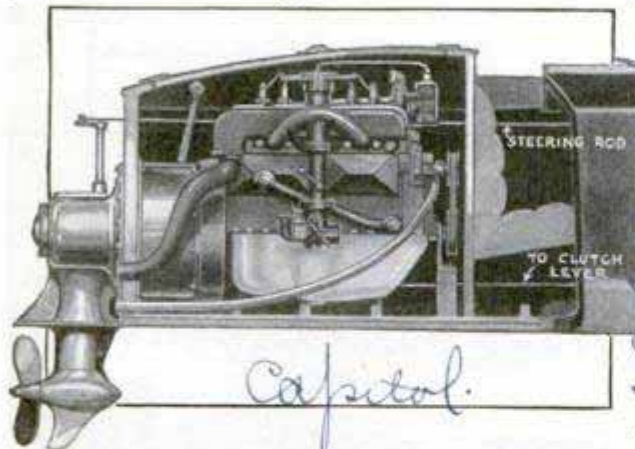

Stern Drive and Reverse Gear Arrangement for the Small Motorboat

speed as forward, giving all the control of four-wheel brakes on the car and making it possible to stop within a boat length. It is constructed for use particularly with the new Ford engines.

D. W. Anari & Sons
43 Royalston Ave.

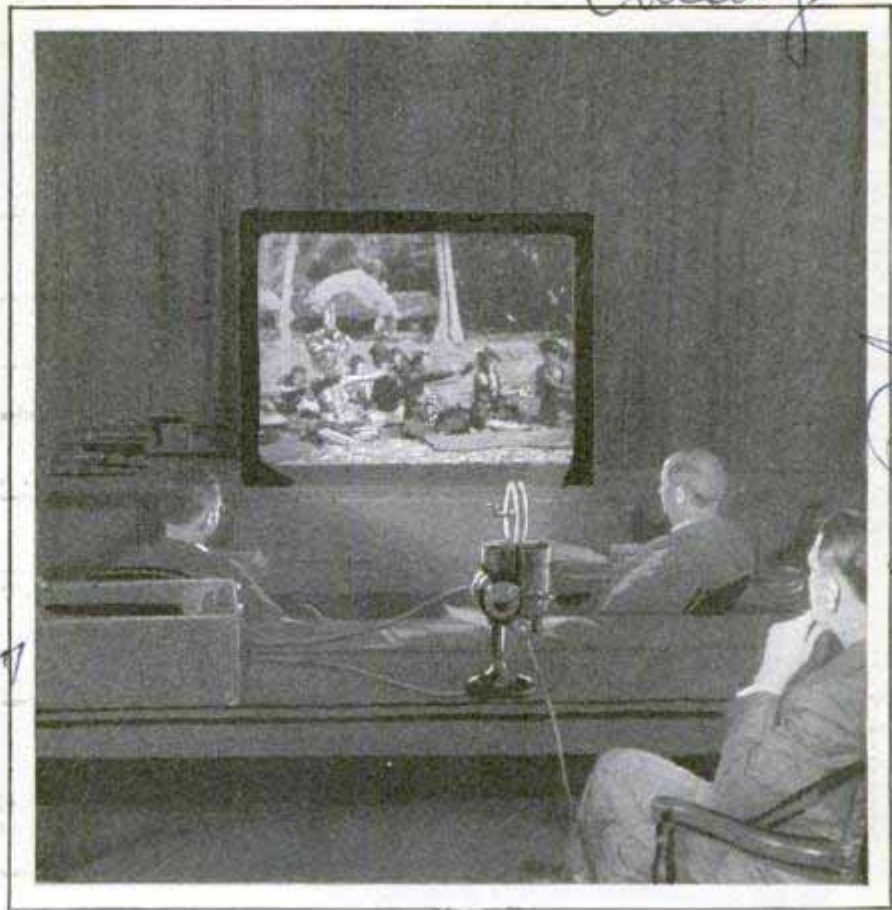

Portable Sound-Movie Outfit for School and Business Purposes; Standard Phonograph Records Produce the Sound Effects

PORTABLE SOUND-MOVIE OUTFIT FOR SCHOOL OR BUSINESS

Standard sixteen-inch phonograph records have been utilized in the making of a portable sound-movie machine, called the "project-o-phone," now on the market, intended particularly for business and educational fields, and consisting essentially of a projector, player unit and dynamic speaker, each contained in a separate case. Projector and playing unit are driven by separate motors, but the two are coupled with a flexible shaft to insure synchronization. The playing unit consists of a power pack, amplifier, turntable, electrical pick-up and tonearm, a rectifier and three amplifier tubes being used. The machine is designed to operate on alternating current but a converter is furnished for direct current, if needed. The projector runs at a constant speed of twenty-four pictures per second, the standard for all sound movies, and may be operated independently of the sound unit.

☐ The chinchilla is a squirrel-like rat of the Andes.

Projecto O-Phone

*Compagnie des Marchés
Schlumberger
Paris*

4 082

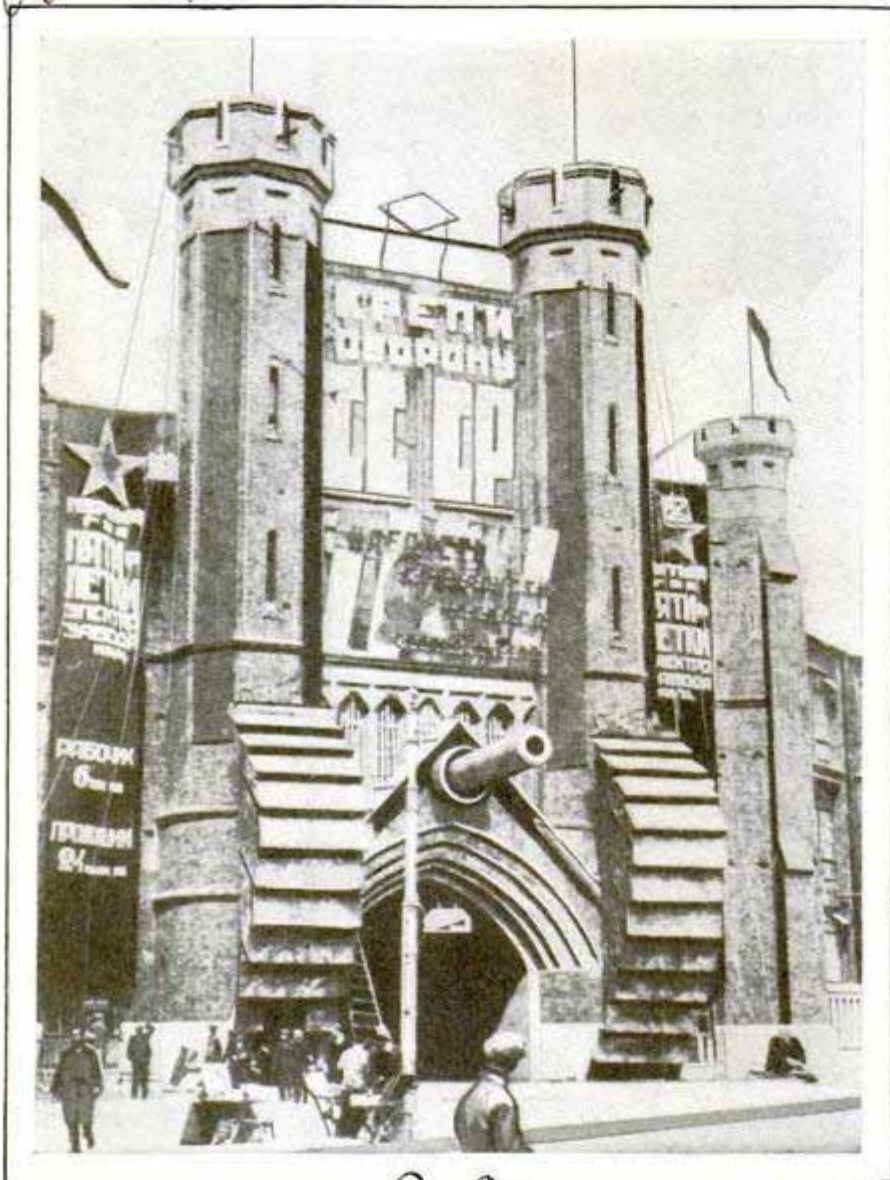

Russian Building Constructed to Resemble a Huge Army Tank, Realistic Even to Its Protruding Gun; It Houses an Electrical Company

BUILDING LIKE WAR-TIME TANK HOUSES RUSSIAN FACTORY

Russia has struck a martial note in its latest architecture, one of the best examples being a building constructed to resemble a war-time tank. At each side of the entrance are columns representing the endless track of an army tank and over the archway a cannon is mounted, giving the structure a realistic effect. It houses an electrical company.

INTERIOR OF EARTH EXPLORED WITH ELECTRICITY 309

Exploration of the interior of the earth thirty-one miles below the surface, by measurement of an artificial electrical current passing through the ground, has been

*described at American
Institute of Mining and*

successfully accomplished by two French scientists. While it is as yet impossible to predict the formations at such a depth, the work of the Frenchmen is the first step in applying to such great depths a method which has proved of value to geologists in locating mineral deposits much nearer the earth's surface. The scientists used a current of about two amperes which was passed through the ground and careful readings of voltage and current taken.

PHOTO PROJECTOR AIDS IN CATCHING OF FUGITIVES

As an aid to the police in recognizing fugitives, the Los Angeles department has installed a projector which throws on a small screen an enlarged picture of suspects wanted. The projector throws the visage of a person sought on a screen about four feet square,

police officials declaring that such a method leaves an indelible impression on the mind of the officers.

Vis-a-Film

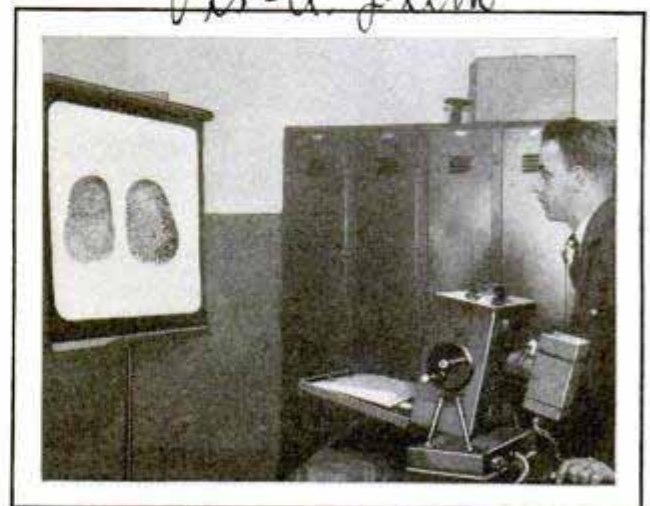
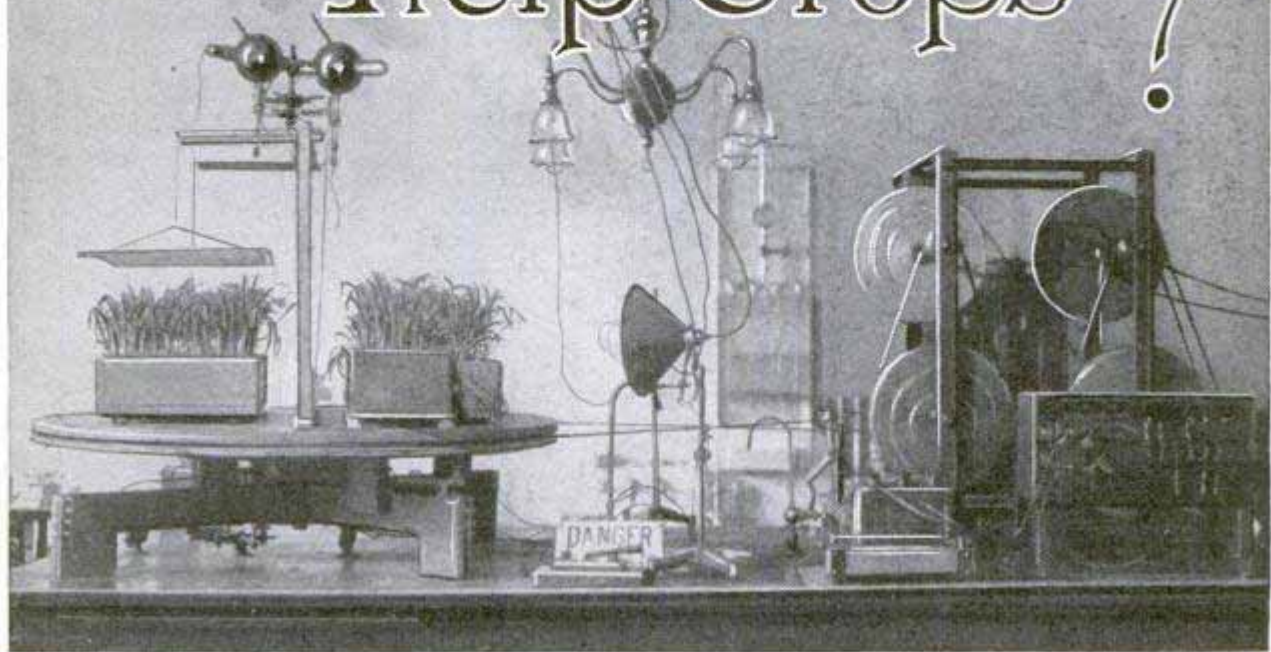

Photo Projector Which Enlarges Pictures of Fugitives or Fingerprints as Aid to the Police

in Brittany

Does Electricity Help Crops?



Test Plants Being Rotated on Revolving Stand to Increase the Exposure to Electric Light and Insure a More Even Distribution of the Illumination during Growth Tests

By G. H. DACY *46 39 Montgomery Ave
Berkeley Calif.*

WITH our world population increasing out of all proportion to normal food production, science has resorted to "shooting" electricity into old Mother Earth in an effort to augment her annual crops of bread, beans, butter, beef and bacon.

The means, measures and methods employed in reviving tired soils by shots of electrified energy have been many. Networks of charged wires, supported on insulators, fed with electrical energy from high-tension lines, have been placed at varying distances above experimental acres. Other attempts have featured the burial of large copper and zinc plates in the soil, the plates being linked together above the ground to form a galvanic cell.

Platinum and carbon electrodes were used in tests at the Harvard botanical gardens on the influence of soil-conducted currents on plant life. These experiments divulged that germinating seeds near the anode were killed by a current of very small amperage if continued for twenty hours.

S. Lemstrom, in Finland, subjected garden vegetables, fruits and small grains to electrified-soil treatments and reports average crop increases of fifty per cent. He claims that soil electrification should never be attempted when the sunlight is bright, as such a condition will injure the vegetables. The best time to electrify the soil is at night, he says.

An Englishman, J. H. Priestley, used externally applied electromotive force, one terminal of which was grounded and the other connected to wires suspended over experimental gardens and also to wires in special glass houses. All these electrified wires were suspended sixteen inches above the growing plants and were fitted with discharge points uniformly spaced. Increased yields of from fifteen to eighty per cent were reported where such food crops as beans, strawberries, cabbage and cucumbers were grown.

V. H. Blackman, of the British ministry of agriculture, has carried on field trials, pot cultures and laboratory tests over a

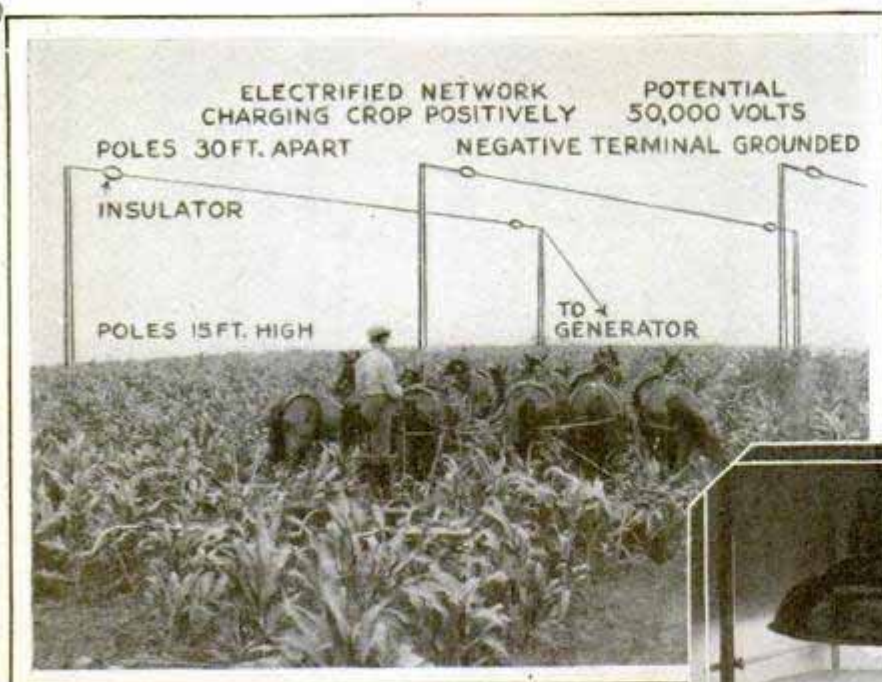

Diagram Showing Wiring High above Plants to Permit Cultivation, and Apparatus for Growth Experiments with Electric Lamps

series of years, all of which demonstrated favorable growth response to the applications of electricity. This scientist said he had increased wheat crops as much as fifty per cent over a term of years by charging the atmosphere above the plants with electric energy or by circulating electric currents through the soil.

Your Uncle Sam, at our national plant-proving grounds at Arlington Farm, Virginia, has fostered electrocultural investigations over a period of eight years. The average potential of the electrified network suspended over the test field was 50,000 volts, producing an electrified air-to-earth current. The network in most of the field experiments was suspended high enough to allow horse-drawn implements to be used in cultivating the electrified crops. In additional tests, the electrified network was placed directly above the plants at a distance of sixteen inches above the ground.

A scientific study of the electrical condition of the atmosphere existing over an open field on a clear day reveals a force tending to move a positively charged body downward; in other words, the electrical field of force is identical with that which would occur if the earth were charged negatively.

Although this air-earth current per unit of ground area is small, it is sufficient when applied to the whole of the earth's

surface to reduce the negative charge of our world to one-half its initial value in approximately ten minutes. The accurate explanation of the maintenance of our earth's negative charge under such extraordinary conditions is one of the riddles which thus far has



defied solution. In the original government research, an electrostatic machine was used as the source of the high potential. Its positive pole was connected to an open wire network strung on glass insulators, while the negative pole was grounded. Large poles encircling the test acres supported the network of wires. The network was usually charged throughout the night, the various test gardens being subjected to electrical treatments lasting from 500 to 800 hours.

Uncle Sam's electrocultural experiments have produced no measurable increases in the yield of the cereals, including rye and wheat, which have been electrified. During one lengthy test, a slight increase in wheat production occurred where the bread grain was grown under a positively charged electrical network, but that recorded gain was well within the experimental error of ordinary field trials. Plant-house tests were also made on the influences of an electric charge on the transpiration rate and water requirements of test plants. No outstanding results were obtained which demonstrated that electrification was beneficial to plant growth. Uncle Sam hence has turned "thumbs down" on the potentialities of electricity as an efficient aid to food production.

On the other hand, the British ministry of agriculture is continuing its experiments with high-potential discharges by networks placed above the growing crops. English scientists are persistent in their claims that the electrification of the soil or crop will increase the yield markedly.

The preponderance of scientific evidence so far supports the American theory that electricity is a failure as a source of increased food yields per acre from soils charged by overhead networks.

**"PENTODE" TUBE
GIVES MORE
POWER** 163

Three times as powerful as the ordinary screen-grid tube, a five-element radio tube has been developed that makes unnecessary the multi-tube receiver and enables utilization of the tube at its full efficiency. This "pentode" tube is expected to lower the manufacturing cost of sets and to decrease maintenance. The tube has a double screen grid, one around the plate and another between the control grid and cathode, the second permitting increased amplification.

Chicago 1012 of Michigan

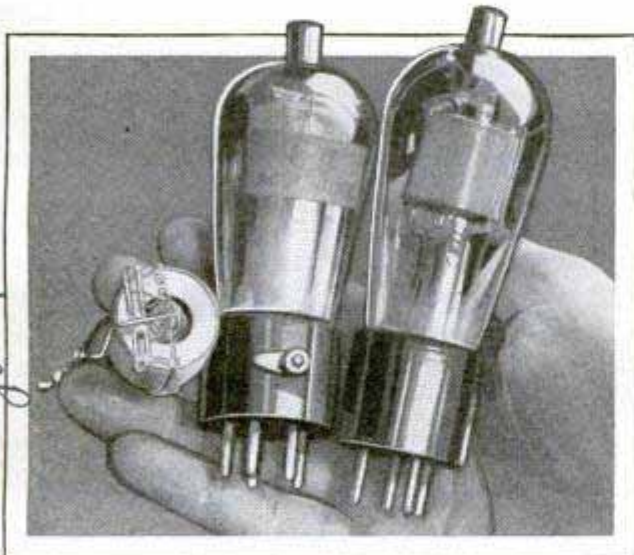

Right, Old Type Screen-Grid Tube; Center, New Five-Element Tube; Left, Tube with Glass Removed

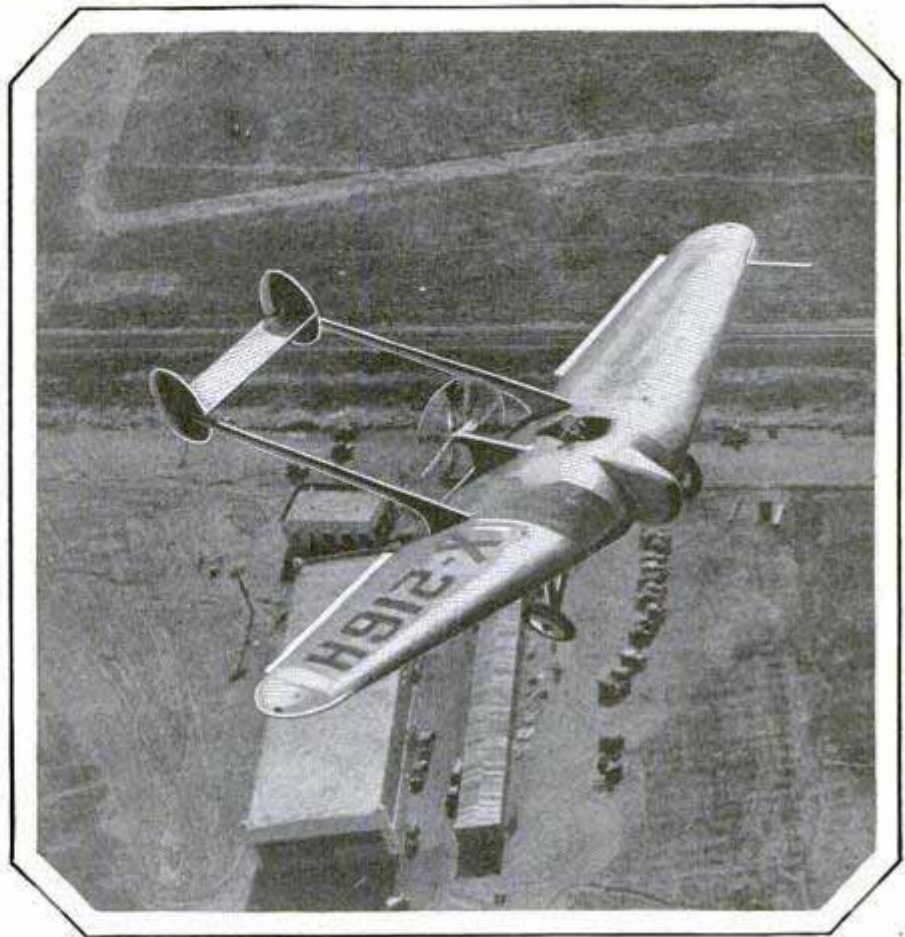

"Flying Wing" Airplane Which Is Virtually All Wing and without Fuselage; Cockpit and Landing Gear Are Fitted in the Big Wings

**FLYING WING IS SUCCESSFUL
IN FIRST TESTS**

Successful tests of an all-metal "flying wing" airplane, a ship that is virtually all wings, recently were conducted in California. The test model is a two-seater with a wing span of thirty feet, its sixty horsepower engine giving it a speed of more than 100 miles per hour. The tail surfaces are attached to two metal outriggers, and a pusher propeller is installed between these supports practically flush with the trailing edge back of the pilot and affixed to a shaft extending back from the engine. Motor, cockpit and landing gear are all fitted into the wings when in flight, the landing wheels being retractable. The landing gear consists of three wheels instead of two, the rear wheel being steerable, providing maneuverability on the ground. Fuselage and other appendages creating wind resistance are virtually eliminated, passengers and cargo being carried in the wings. Makers of the ship claim it affords greater speed for given horsepower.

Ceco Mfg Co
Northrop Aircraft Corp.
Eddy Providence United Airport

TINY MONSTER HAS A MILLION-DOLLAR APPETITE

94 In a few seconds, a little yellowish speck, not much larger than the

The weevil starts its existence as a tiny egg laid deep in a cranberry bud, but

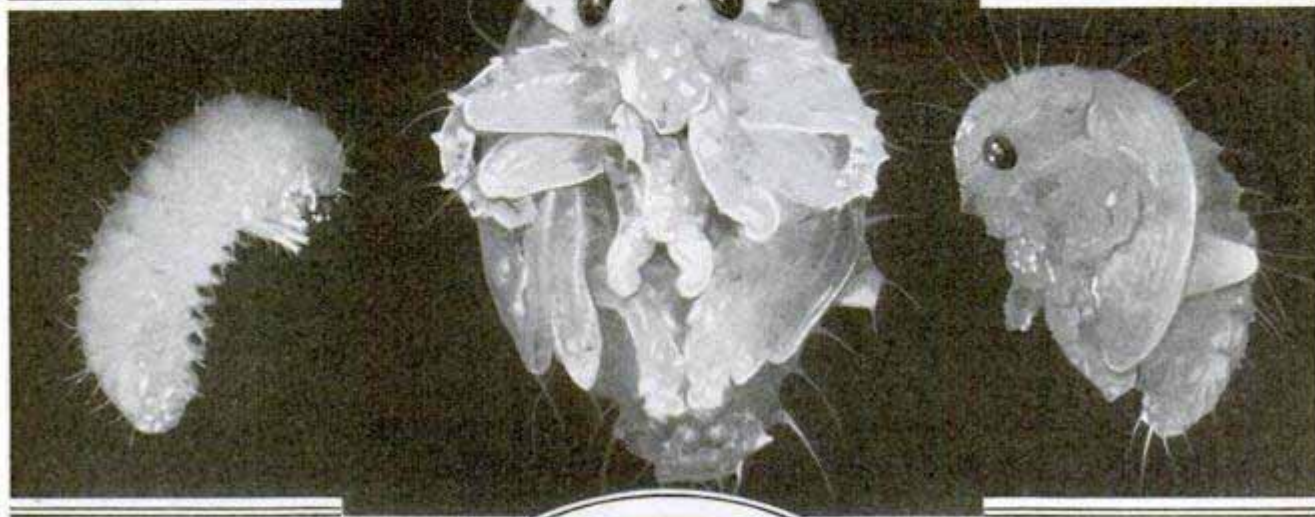

head of a pin, becomes a grotesque, goggle-eyed monstrosity; a mite of an insect, scarce a sixteenth of an inch over all, grows into a massive beetle with long, lumbering legs and an elephantine proboscis. And in the accomplishment of this quick-change act, under the lens of the photomicrograph camera, all mankind reaps a real dollars-and-cents benefit. For this camera that makes magnified photographs, has become the latest aid to the men who are fighting the insect pests that annually take a toll of many million dollars from the food crops of the United States alone. Consider the cranberry weevil. It's only about a sixteenth of an inch long and a third of this length is in its elongated snout, like an elephant's trunk. Just a mite of an insect, but one member of a horde that each year consumes over a million dollars' worth of that crop, on the Cape Cod bogs alone—one-fifth of Massachusetts' only export crop.

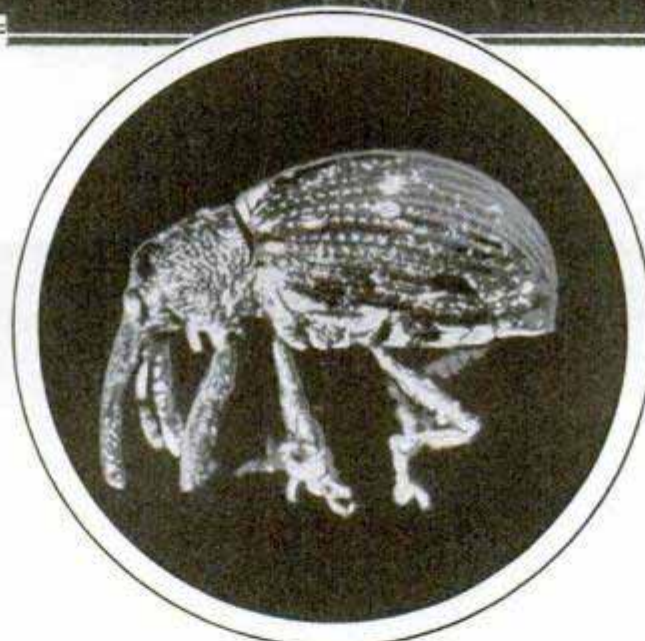

Photomicrographs by Wilbur F. Turner
Magnified Photographs of Cranberry Weevil during Its
Various Stages of Development

soon hatches out into a grub. Then it starts to gorge on the fruit bud and becomes a pupa. Six days later, the pupa changes into the weevil itself. For years the grower, examining the grub or pupa, could only make a long guess what it would grow up to be. But before the cranberry-growing season of 1930 starts, he may supply himself with definite informa-

tion, in the shape of reproductions of photomicrographs of the weevil in all stages of development. The taking of these magnified photographs was an inspired idea, but it was accomplished only after the solution of several problems, the most baffling being how to keep the subject quiet long enough to make its picture. At first, it was thought that the grub would retain its natural form if killed by the fumes of potassium cyanide. But, immediately the spark of life departed, it shriveled up. Sticking the subject on a glass plate proved no more satisfactory for it messed

615 W. A. R. Ave.

Ward Morgan, Cal.

itself up with the glue and lost all semblance to its prior shapes. Chilling them on a cake of ice was barren of desired results as the grubs refused to stay extended. "Why not try giving them a little ether?" suggested the photographer. That solved the problem, the merest whiff killed the subjects, but before they died there was an interval of a few seconds when they stayed quiet and kept their living form. Then the pictures were taken.

SOIL USED FOR INSULATING

29 paid

Soil used in making insulating materials for heat and sound resistance has been found in abundance along a two-mile stretch of the Smoky Hill river in Wallace county, Kansas. The deposit is six feet deep, lies more than 100 feet above the river and is of a higher grade than many other deposits. Because of the white color, the region had been known as the Chalk Hills. Due to the fact that the soil once was composed of the shells of fishes and snails, it has a large content of calcium carbonate.

SUCTION-GRIP CLOTHES HANGER ATTACHES ANYWHERE

122

Instantly attached without marring to any smooth surface, a coat hanger with vacuum grip now is on the market. The rubber suction fastener enables placing such a hanger on walls, doors or in the car without screws or nails, and when detached, no disfiguring marks or holes are left.



25 cent match the surface to which they are to be fastened.

Masterlite Mfg Co,

110 E 23rd St

RIBBED SCREWDRIVER BLADE PREVENTS SLIPPING

101

Preventing accidents and saving time, a screwdriver now is on the market with a

ribbed blade which will not slip out of the slot. Because the ribs grip the screws, these are driven without pushing and straining, the tool being particularly useful for overhead work, where applying great strength is more or less difficult.



Bridgeport Adve Mfg Co

100 Seaside Park

HAT WITH TRANSPARENT BRIM FOR SPORTS WEAR



Crusher Hat of Cloth with Transparent Brim for the Golfer and for General Outdoor Sports Wear

For general sports wear and for motoring, a crusher hat with a transparent brim now is on the market. The brim gives all the protection of a cap of similar material. The hat is made of fine-texture cloth in various colors and may be rolled up for carrying in pocket or golf bag. As the brim is in one piece, it quickly resumes its shape when unrolled. The head-piece is made of such material that it may be washed and ironed.

Superior Hat Co. 2301 Madison St. S.W. Mo

244 Ex. Day

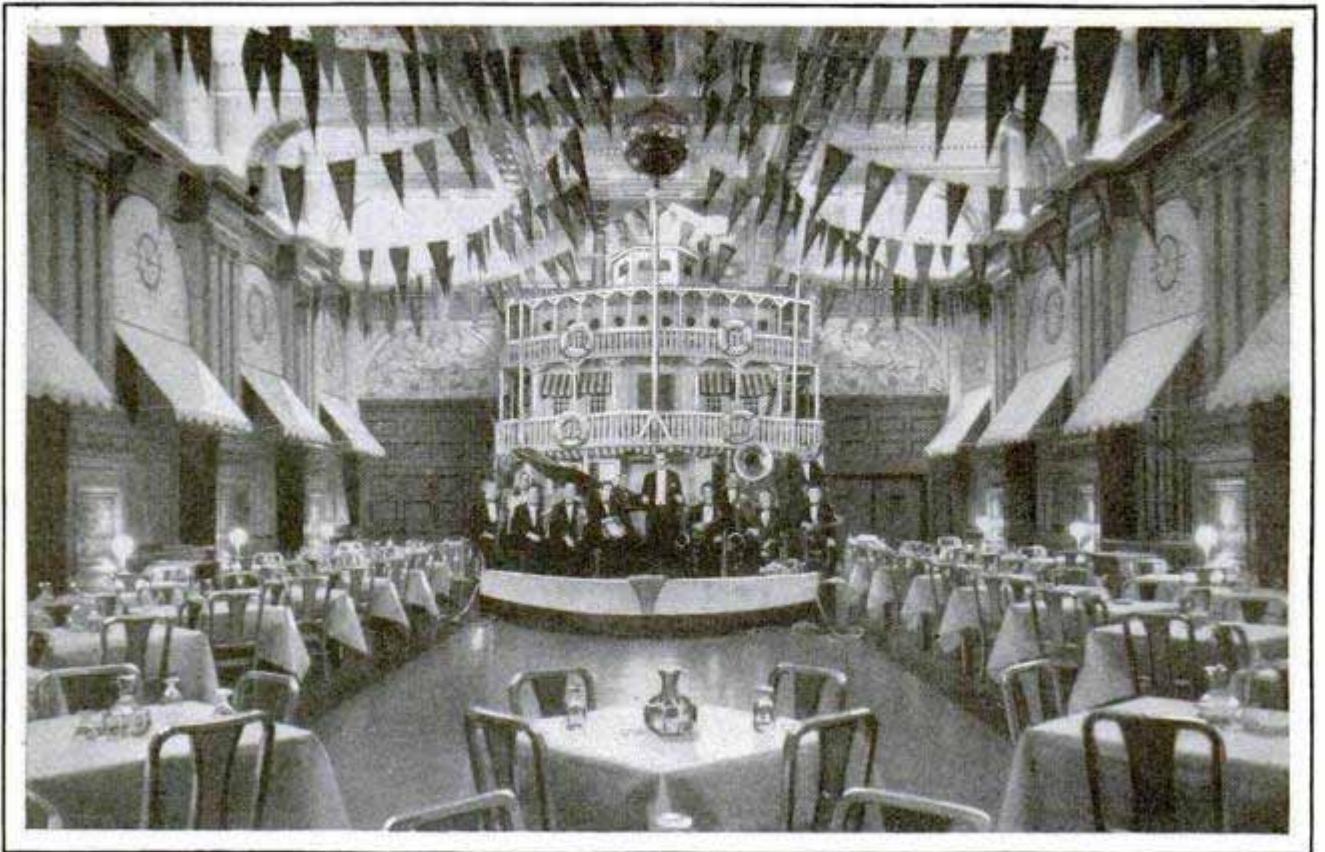

Full-Size Model of the Forward End of a Mississippi River "Show Boat," Which Appears to Be Steaming over the Polished Ballroom Floor; It Serves as a Platform for the Orchestra

RIVER STEAMER IN BALLROOM IS ORCHESTRA PLATFORM

In the ballroom of a *Hollenden* Cleveland hotel stands a full-size model of the forward end of a Mississippi river "show boat," the lower deck serving as the platform for the orchestra. Every detail of the steamer is faithfully reproduced, including captain's quarters, bridge, lights, cabins and smokestacks. The boat appears to be steaming up a narrow inlet suggested by the polished floor, and an intricate system of colored lights adds to the illusion.

stencil, and a handle on a frame which fastens to the ends of the cylinder. It faithfully reproduces typewritten or handwritten material or drawings, and rapid work is possible because it is unnecessary to feed paper into the machine, but merely to remove the copies as the duplicator rolls over the sheets.

TWO-PLATE ELECTRIC GRILL CONTAINS DRAWER OVEN

Combining many of the features of a real stove in a small cooking apparatus, a two-plate electric grill that cooks in and over a complete oven now is on the market. The oven, of the drawer type, slides in or out beneath the plates. High-speed heating units on top and a separate unit for the oven provide a compact and convenient arrangement for cooking full meals in small space and time. The miniature electric range fries, boils, bakes, roasts and grills as perfectly as a larger stove, yet is smaller than a suitcase, easily portable and plugs in any wall outlet.



HAND-OPERATED DUPLICATOR MAKES STENCIL COPIES

Capable of making copies of letters from a stencil at the rate of 1,500 an hour, a hand-operated duplicating machine has been placed on the market that is extremely simple in construction and operation. It contains

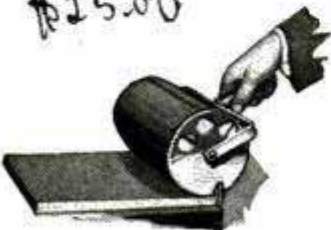

no cranks or gears, consisting essentially of a cylinder for holding the ink and

Rapidograph

*General Stamping Works
238 E 64th St.*

*National Enamelers
& Stamping Co.
1101 11th St. N.W.*

*Bab. Olesell
about \$23.50*

265

Chicago

AIRPLANE FLOWN BACKWARD AND UPSIDE DOWN 384

Flying an airplane backward and upside down simultaneously was the feat recently accomplished by Martin Jensen, solo endurance-flight record holder. The remarkable feat was performed in a 100-horsepower biplane equipped with unusual safety devices. The aviator first flipped his ship upside down and flew with a southwesterly wind at his tail. Then he righted it, headed into the wind, turned it over and throttled the engine to stalling speed. The forty-mile head wind then carried him backward at about ten miles an hour and he flew for about a mile in this manner.

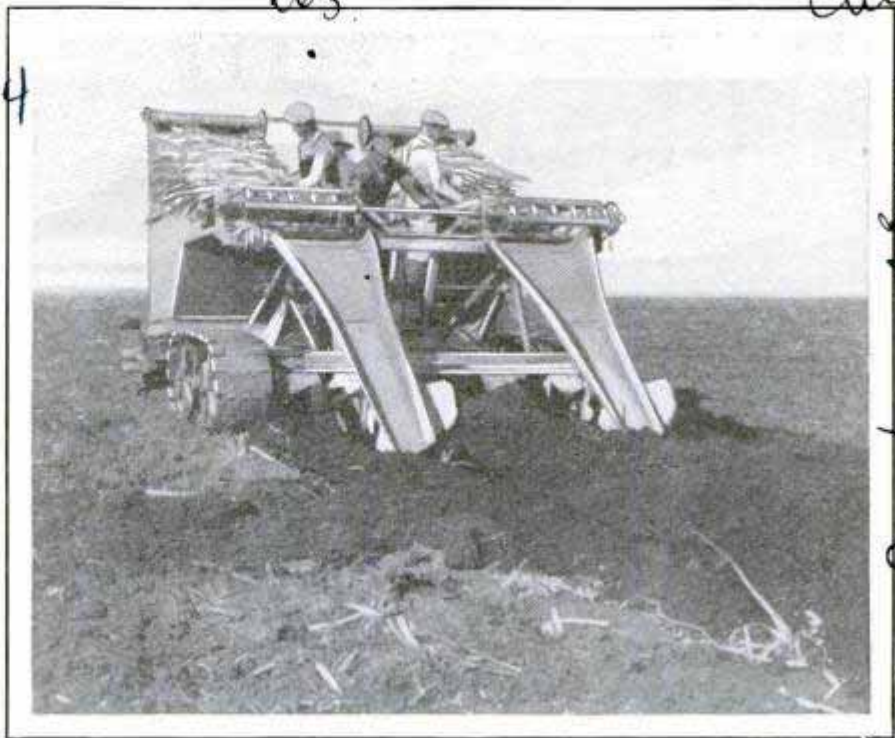

Sugar-Cane Planter Which Plows and Sets Two Furrows of Seed Stalks Simultaneously, Work That Formerly Required Twenty Men

SUGAR-CANE PLANTER TRAVELS FIFTEEN MILES AN HOUR

Traveling over a field at a fifteen-mile-an-hour clip, a sugar-cane planter now does the work of twenty men by setting the seed stalks in the ground in the Florida Everglades. The machine, mounted on a tractor frame, plows and sets the cane stalks into two furrows simultaneously, planting twenty acres per day. It is equipped with two bins, one for each furrow, carrying a supply of stalks sufficient for two acres of planting. An elevator system, driven by the tractor, lifts the cane from the bins to conveyors which carry it back to two chutes down which it slides into the furrow.

TRAVELING ELECTRICAL SHOW MOUNTED ON A TRUCK 325

Mounted on a motor truck which has exposed sides to provide display space, an electrical exhibit is being hauled through Germany's rural communities to educate the residents in the many uses of electricity. The traveling display contains a dozen exhibits of various uses for electric power, and also shows moving pictures and sound films. The exhibit section may be detached.



Traveling Electrical-Appliance Display Mounted on a Motor Truck with Exposed Side Sections

PLANE LOCATES GAS-LINE LEAK 388

Finding a leak in a gas main from an airplane was successfully accomplished a few months ago near Ponca City, Okla. When a leak somewhere in a fifteen-mile main was reported, an aviator flew over the route the line followed, and within fifteen minutes located the leak by noting the spot where snow and earth had been mixed on the surface by the force of the erupting gas. Repairmen were thus able to stop the leak very quickly.

Mark. Electrical Works
Berlin, Germany

Detroit Aircraft Corp.
3300 Airport Bldg
Detroit, Mich.

Mr. Storey, Mechanical Engineer
Sugar Cane Industries
Sugar Cane Division, D.H.
Clemson, S.C.

Iderada Tribune

at Field, L.C.

3983

Capt. John ...
151 W. 80th St. New York

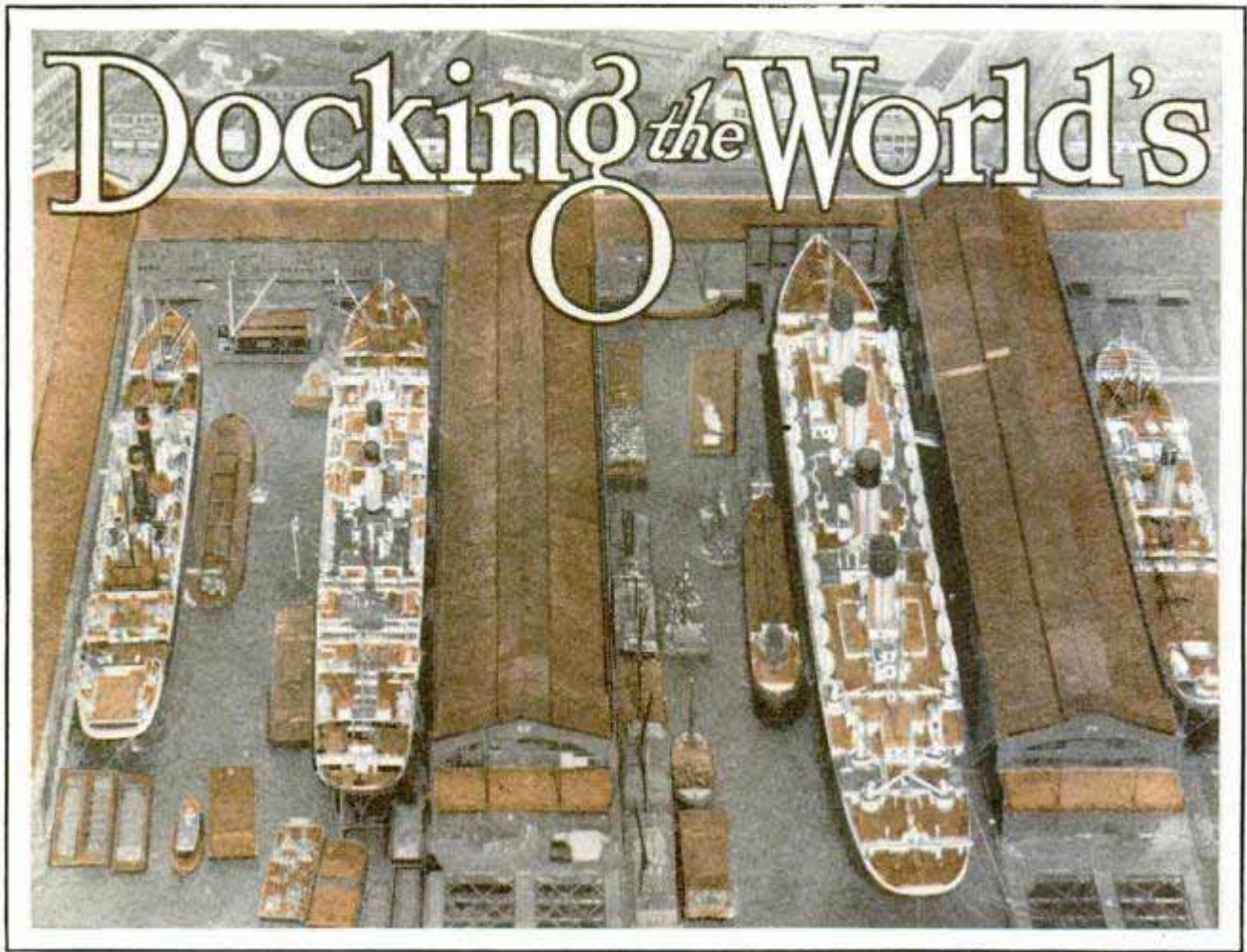

Looking Down on Four Atlantic Steamers, Tied Up at Their American Berths; the Piers Are at Right Angles to the Shore Line

AT THE END of her 3,000-mile dash across the Atlantic, the greatest liner afloat—56,551 gross tons and 956 feet long—rushes into the lower harbor and drops anchor at quarantine. The telegraph operator watches from his shore observation tower, and immediately clicks a message to his office. The ship-to-shore radio informs the steamship company that owns her. Within five minutes, the marine ticker in hundreds of buildings speaks in a staccato voice. "S. S. 'Majestic' arrived Quarantine 5:33."

A United States cutter comes alongside with immigration, health and custom inspectors. The mail steamer ties up to the starboard beam and the great greyhound, panting from her recent exertion, begins to disgorge thousands of mail sacks. After the mail is transferred and inspections have been completed, the vessel heads for Ambrose channel under reduced speed, escorted by several tugs.

She is now in the world's wonder harbor, where ships from the earth's ends

meet. Scores of them anchor off the roadstead, because there is insufficient room at the docks. The "Majestic" passes them with proud bearing, for she is bound for a berth, as befits the longest ship on the seven seas.

It is grim winter. Ice floats down the North river, and a whipping wind drives across the wharves. I stood at the head of a Chelsea pier beside Capt. James Thompson, port captain of the International Mercantile Marine, who supervises the docking of a colossal fleet of greyhounds.

We forget the lashing wind and bitter cold. Our eyes look anxiously down the river, wondering whether the marine ticker was wrong when it broadcast the arrival of the "Majestic."

"How's the tide?" Captain Thompson asks a tugboat pilot.

"Just a little ebb, sir. Too weak to bother much."

"Good," ejaculates the captain.

When he says "good," he is considering

Greatest Liner

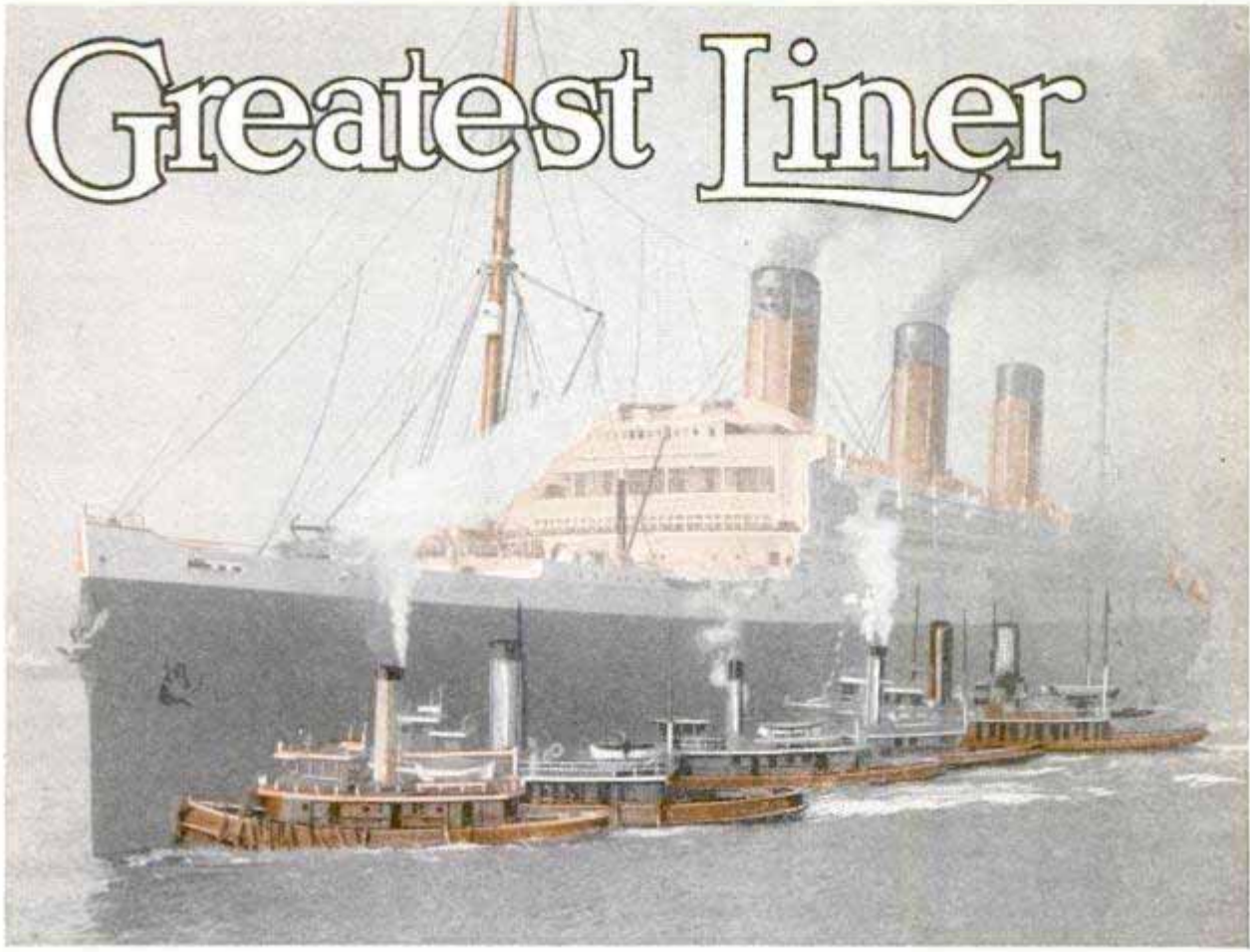

A Group of Powerful Tugs Escorting the S. S. "Majestic" into Harbor; Fewer Could Do the Actual Pulling but Numbers Aid in Tight Places

the interests of the "Majestic," for the running of a stiff tide may cost an hour's delay. In the life of one person, an hour means little, but in the career of this ship an hour means thousands of dollars. From fifteen to twenty tugboat crews must be paid overtime; about 500 longshoremen, baggage carriers, elevator operators, watchmen and gatemen will collect extra wages. And, of course, the custom inspectors are paid for waiting if the ship is delayed in warping into her slip. The great saving in overhead charges realized by docking promptly may mean the difference between profit and loss to the operators. To sail and arrive on a fixed schedule is the aim of the captain, and the continuation of his services will depend upon his success in that important phase of ship operation. The "Majestic's" owners have millions of capital invested and maintain more than 1,000 men in her crew. If her manpower is allowed to idle, the ship will deteriorate. And when she is moored to a

dock, the overhead is simply stupendous. A ship must be kept in motion if she is to pay for herself.

Captain Thompson, meanwhile, squints through the glasses, and suddenly remarks, suspense in his voice, "Here she comes," with the joy of one who has never witnessed the sight before. Coming up the North river at night, the "Majestic" always holds fresh thrills for spectators. She was rising as a skyscraper out of the sea. Tiny tugs, lighters and ferries darted hither and yon, to be clear of her massive bow. On such occasions, the harbor police see that all regulations are obeyed, for it is difficult to maneuver a floating skyscraper in a river. Craft must not cross the bow of this ship for, even at a slow pace, it travels with the might of 100,000 horses.

Now, were the river free from traffic, the "Majestic" might steam up to her private dock at twenty knots with no risk to herself. But such a speed would bring the gravest danger to all other shipping.

The result might resemble that caused by a miniature submarine earthquake or volcanic eruption. Her bow would plow up a ripple that would roll shoreward like a tidal wave. And that is not all. She equals the weight of 56,000 tons of water, and the sudden displacement of this vast volume would cause enough suction to sink small craft and strain the moorings of docked steamers so that the strongest cables would snap like threads.

Along her beam, several tugs kept close, while, from the stern, several more tagged along like children hanging on to their mother. Her three funnels slanted back as if pressed by the wind. Countless portholes, no larger than pin points, stretch along her side, like strands of jewels.

Half a dozen tugs stood by at the pier head and waited for the liner to come abreast. Another half dozen began to push rope-padded noses against the towering stern to keep her from drifting with the tide. One tug turned her spotlight on the pier so the "Majestic's" captain on the bridge might see his clearance.

"Here's where we need co-operation," said Captain Thompson. "Co-operation makes docking possible. The 'Majestic's' commander has control of 100,000 horsepower in that ship, and the least error in

judgment may send her against the pier."

So saying, he placed a whistle to his mouth and blew it through a three-foot megaphone. The tugs began pushing against the starboard stern. Then he swung his searchlight through several wide arcs.

It would require an army of tugs to turn the liner on a short pivot, so the "Majestic" assists in this maneuver with her own engines. If at any stage of her close-quarter maneuvering the ship finds herself in need of assistance, she has but to give a warning blast of her whistle demanding the services of extra tugs, and they respond to her summons as a taxicab driver answers the call of a customer.

Three tugs came forward on signal, like troopers moving into a fighting position. On Captain Thompson's summons, they nosed against the starboard bow. It was like butting against a stone wall. Fortunately, a tug's bulwarks are stanch, else they would crumble under such an impact.

The "Majestic's" master ordered the engines stopped.

Sailors on the high decks tossed several one-inch manila ropes to the stevedores, who caught their ends, and waited for the ship to come closer.

Now the job of fitting the floating sky-

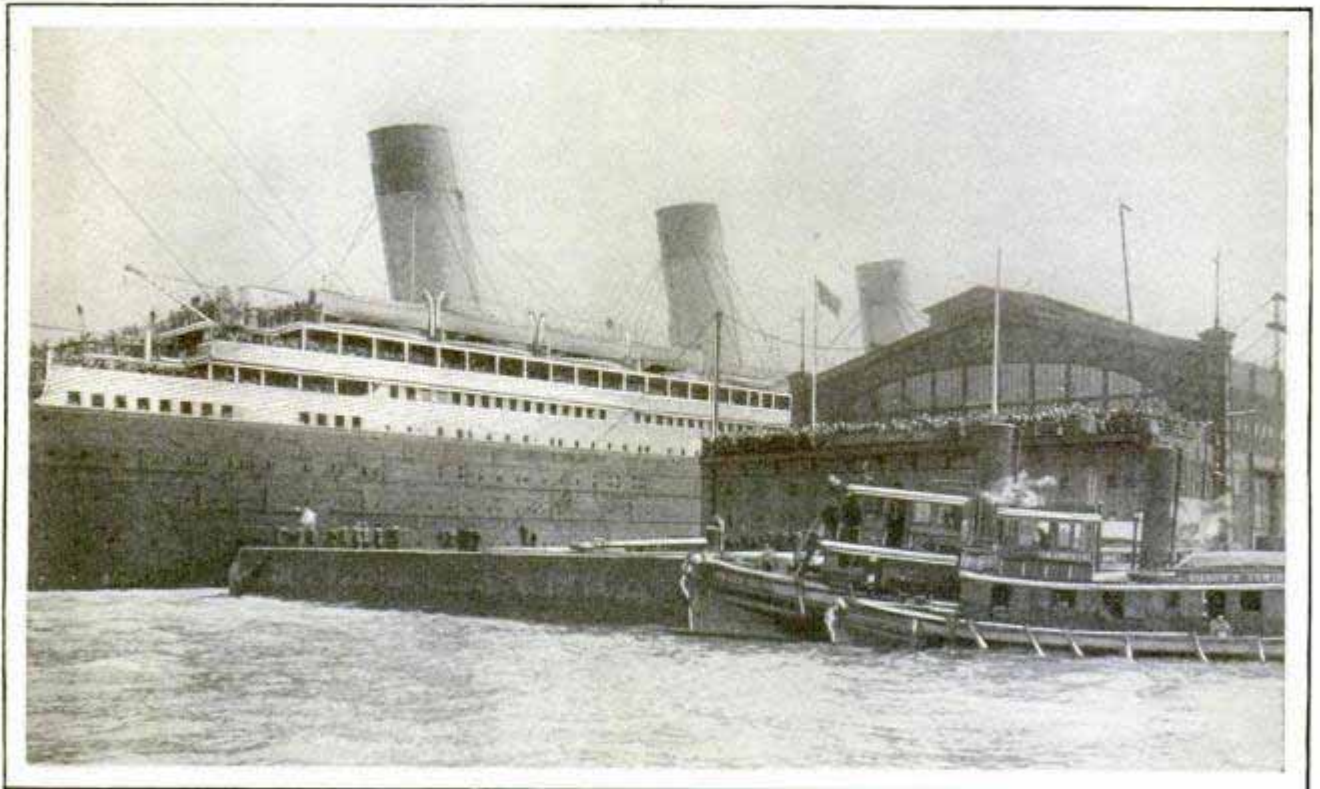

Courtesy the White Star Line

Backing Out of the Slip; the S. S. "Olympic" Starting on a Voyage While Passengers and Friends Wave Gay Farewells and Tugs Wait to Take Charge of the Liner

scraper into her slip depends upon the tugs. Land fixtures are too close for any further maneuvering from the ship's engines. The tugs may push her from almost any position save from the rear, for to injure or nick one of the propellers means that she will have to take leave of the transatlantic service and steam, in a crippled condition, to the nearest dry-dock, which happens to be at Boston.

The next objective of the tugs was to turn the liner so that she would be at right angles to the river current, but parallel to the pier, which juts from the shore. While one battery of tugs prevented her from crushing the pier head, the others set up a wild screaming and puffing as they scrambled against the starboard stern. Their propellers churned the water into white foam. But the "Majestic" moved slowly, by inches, almost in contempt of these gnats struggling to move her against the ebb tide. In still greater rage, the tugs trembled and snorted. They fought for every foot, and their funnels belched black clouds in vertical columns. At last, they had their way; bowing to these persistent tuggers, the "Majestic" gradually swung upstream, her starboard beam resting against the pier head and acting as a pivoting point.

At this stage, she lay across the slip diagonally, fitting into the space so snugly that her bow was mere inches from the opposite pier. One wrong move would have crushed the pier and damaged the sharp prow by springing the steel plates in her hull. Tenderly, gracefully, the bow was swung into the slip as the stern crossed the river current at right angles.

Her present dock on the North river is too small for the "Majestic." Her after

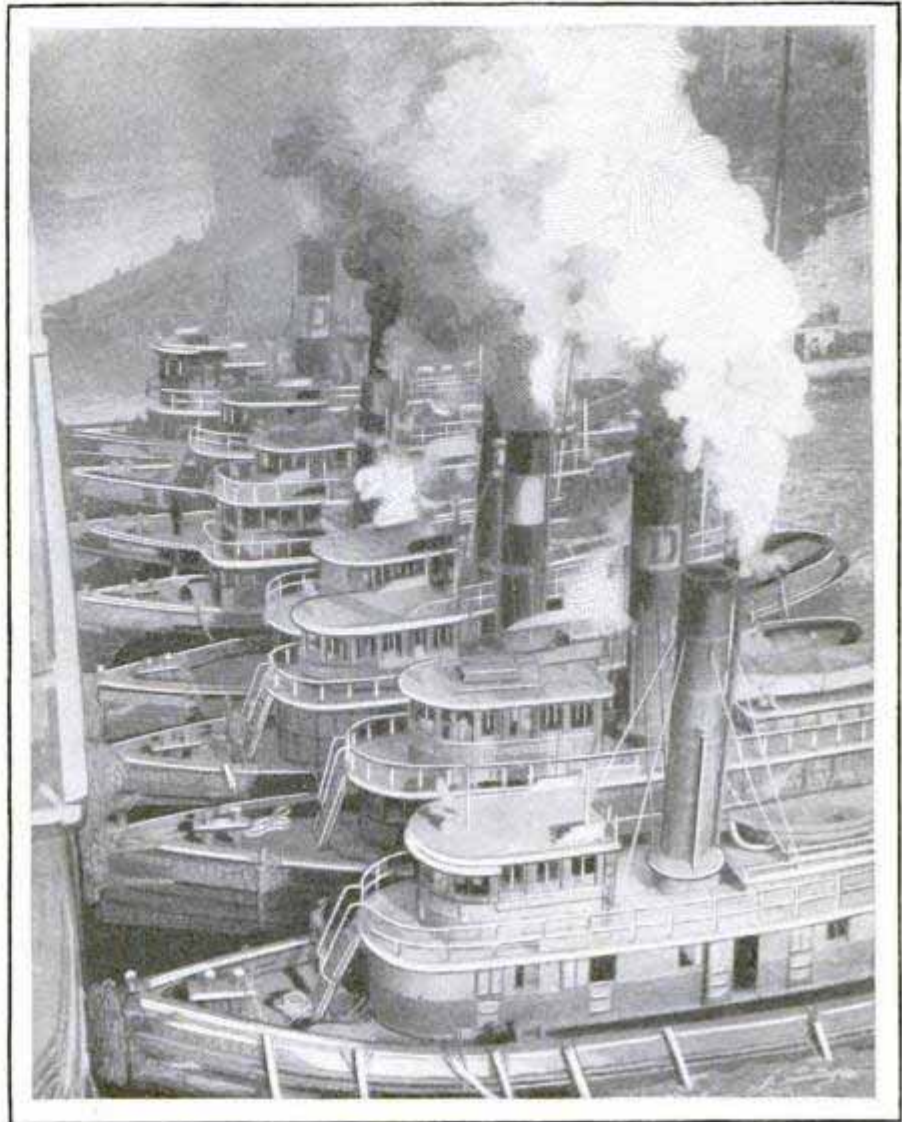

Eight Tugboats, All Working as One, Maneuver the S. S. "Majestic" into Close Quarters at the Docks

deck and propellers jut into the open channel. In a harbor where craft are very thick she is always in danger of injury to her propellers. In order to avoid this, her guardians protect her delicate driving apparatus by mooring two barges to the stern to act as fenders.

Under ideal conditions, the "Majestic's" actual docking requires about thirty minutes; but the strength of tides and currents, and the inclemencies of weather may delay the operations for one or two hours.

Just how short a time the "Majestic" requires to complete its shore duties may be seen from a typical "turn round." Thus, if the vessel docks at 7:00 p. m. on Tuesday, she will have hundreds of tons of cargo, provisions and fuel, thousands of mail sacks and about 4,100 passengers on board in time for a midnight sailing on Friday.

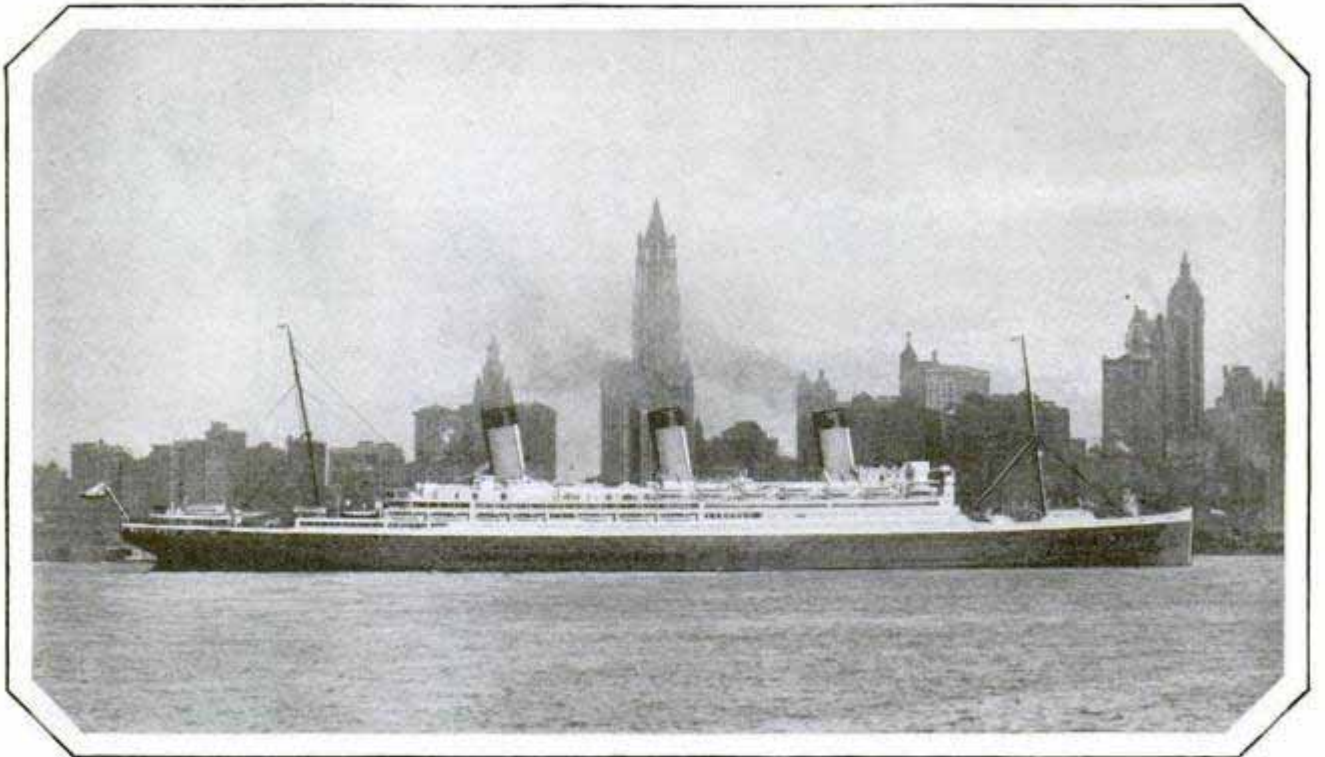

Where Land and Sea Reveal the Mighty Works of Man; the S. S. "Majestic," One of the World's Greatest Liners, in New York Harbor

In embarking, she runs on a schedule, hardly less exacting than train time. If she is advertised to sail at midnight, the gangways slide back and she slips out of her berth on the instant the ship's chronometer says it is midnight. An express liner cannot wait.

SHOCK RECORDER FOR AIRPLANE MEASURES LANDING STRAIN

Guesswork in determining stresses on landing gear, tail group or other parts of



Shock Recorder Attached to Airplane Landing Gear

an airplane during landings and take-offs is eliminated by a shock recorder known as an accelerometer. The instrument is contained in a small metal box that can be attached to any part of a ship. A heavy piston held normally in a fixed position inside an electric solenoid is the heart of the device. When the instrument is subjected to a sudden shock, as in landing, the relative movement of piston and solenoid causes a pair of electric contacts to close, this action being recorded on a dial. It can be set to record a shock of any magnitude by varying the battery current that energizes the solenoid. It is an adaptation of a similar instrument used for measuring shocks to which automobile and truck tires are subjected, and is expected to decrease the number of landing-gear mishaps and failures.

UNKNOWN ELEMENT IS FOUND IN TWO MINERALS

By a method so delicate as to detect the presence of a chemical compound when dissolved in ten billion times its own weight in water, two physicists of Alabama Polytechnic Institute have located the unknown element "eighty-seven" in two well-known minerals. Lepidolite, a form of mica, and pollucite, a mineral

Developed by these Engineers

Hrestone Turgo & Co

Mr Fred Allison

Autburn, Ala

915 Broadway
 Menomonee, Wis

Metropolis Bldg
 POPULAR MECHANICS 791
 R. 1113-1115 Union Square
 FRESH LIQUID FRUITS BOTTLED
 WITHOUT FERMENTATION
 142. New York City

consisting chiefly of three elements, including aluminum, were the substances studied. The properties of the unknown element are known in a general way, although it has not been discovered, and studies of the substances in four different chemical combinations all showed the effects to be expected from the unknown element, affording evidence of considerable weight for its presence in the samples under test. The next step will be to extract the element from the minerals, when it may truly be said that it has been discovered. Then there will be left but one unknown element, number eighty-five, out of a total of ninety-two.

FLOOR DRAIN MADE ACCESSIBLE FOR EASY CLEANING 223

Easily accessible for cleaning, a floor drain containing a flanged tube which forms the water seal now is on the market. In exterior appearance the drain is similar to others, but inside all partitions have been removed, and, in place of the usual elbow, the flanged tube is lowered into the base to make the trap. The tube is held in place by non-corrosive metal



screws, and packing makes it water and gas-tight. Bolted to it is a rubber seat for the seamless copper ball shutting off the back water pressure. Removal of the tube permits insertion of cleaning tools, or

the hand, directly into the drain outlet. It is made in various sizes.

SUN AFFECTS BRIDGE CABLES 222

In order to avoid the sun's rays, workmen on the vehicular bridge over the Hudson river at Highland, N. Y., begin the task of spinning the wire cables at three o'clock in the morning. In this way, they can adjust the wires for the cables before the sun rises, as engineers found that an increase of ten degrees in temperature elongates the strands one inch. Each of the wires is 4,000 feet long.

Comd. Alfred Aabelti
 c/o The News, 25 Park



Bottling Machine Which Fills Containers with Fresh Liquid Fruits for Future Consumption

By a special process, recently developed, fresh fruits are being converted into liquids in Germany without fermentation and bottled for future use. The product preserves all the fresh-fruit flavors until such time as the container is opened, the bottling being accomplished by a machine resembling a large wheel with the bottles as the spokes.

Deutz Werke, m. b. H., in
 C. 7, Kreuznach, Rheinland, Germany

MEMO ROLL FOR DESK PHONE IS HANDY REMINDER 139

Providing a pad that is always in readiness for taking notes, a memorandum roll for the desk telephone now is on the market. It consists of a roll of paper which threads through a writing shelf attached to the phone stand. As notes are taken, the paper is pulled through the shelf and a fresh sheet unrolls from the spool. Memoranda thus may be of any length and torn off when completed. The pad and roll do not interfere with the use of the phone.

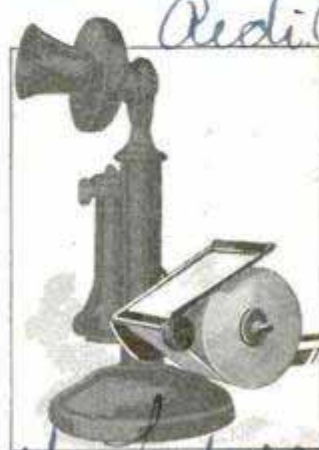

Redi Roll
 \$1.00 and roll

The Colyth Laboratories
 565 W Washington

Interview with Lieut. Commander
W. M. Thompson,
POPULAR MECHANICS
Navy Submarine Expert

792

236

TELEPHONING MEN TRAPPED IN SUNKEN SUBS

*Cont. J. N. Muller
326 Park Central Hotel
Washington, D. C.*

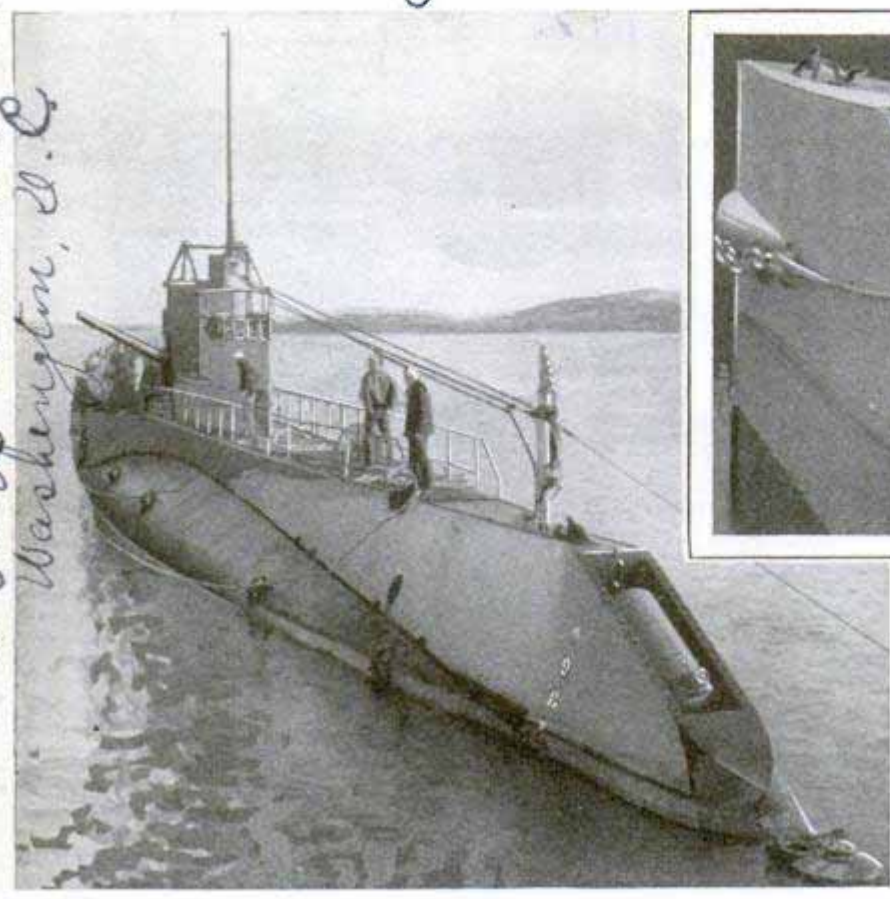

Above, Testing Undersea Telephone on a Submarine; at Right, Front View of Sub, Showing How the Telephone Buoy Is Housed

Buoys containing telephone apparatus which float to the surface after being released from disabled submarines offer the latest method of locating and communicating with such craft. The navy recently tested the apparatus consisting of two buoys housed near the top of the submarine at opposite ends of the vessel and connected by rubber-covered cables with two compartments in the craft. In case of an enforced stay at the bottom, a crew member throws a lever in either compartment, depending on which is undamaged, releasing one of the buoys which floats to the surface to attract the attention of the tender ship or rescue vessel. Members of the surface crew open a trapdoor in the buoy which contains a telephone circuit and light, operated by a line from the submarine's batteries. At night, the buoy automatically flashes a light. If the power plant of the undersea craft has been damaged, the surface ship can plug in on the buoy, thereby permitting light and heat to be maintained for the undersea crew, and liquid food and air can be passed through

salvage air connections which are separate for each compartment in the submarine. Another communication instrument, known as the "undersea speaker" also has been successfully tested. It is intended to displace the tapping system by which a diver tries to communicate with the crew by sig-

nals in code tapped out on the side of the boat. The speaker, carried on the surface ship, can be lowered to the disabled craft without divers' assistance. By means of an electromagnet it adheres to the hull of the submarine, through which words spoken into the mouthpiece on the surface are clearly audible underseas. A turn of the switch on the surface ship makes the transmitter a receiver by which conversations below the water may be heard on the rescue boat. It may be used with radio or with wires, and, in principle, is somewhat similar to amplification systems in large auditoriums. To be used with the two methods of communication, three varieties of diving bells are being tested, two of the open type with a capacity of fourteen persons, and one of the closed kind, holding about ten persons. The closed bell is expected to be useful in rescuing submarine crews from great depths.

CA digger, operated behind a tractor plow, has been made for sugar beets that are frozen in the ground.

Made by Great Western Sugar Co

Reported by *asst. Trade Commissioner*
POPULAR MECHANICS
A. Douglas Cook at Berlin.
LOAD AND DISCHARGE FREIGHT FROM MOVING PLANES 375

Successful tests have been made in Germany of an apparatus for loading and discharging freight from airplanes in flight. The freight to be discharged is attached to a cable and lowered by means of a windlass through an opening in the floor just before the ship flies over a double-gallows structure. On the ends of the crossbeams, which nearly touch, a slotted disk is placed, to which the freight to be picked up is attached with rubber ropes. When the cable touches the cross-beam, it is led to the slit in the disk, where two clamps automatically close around it. The disk then falls down the cable, striking a trip attachment to release the load. At the same time the freight attached to the disk is picked up from the ground. Mail, express and bulky freight, all can be picked up or discharged with the apparatus.

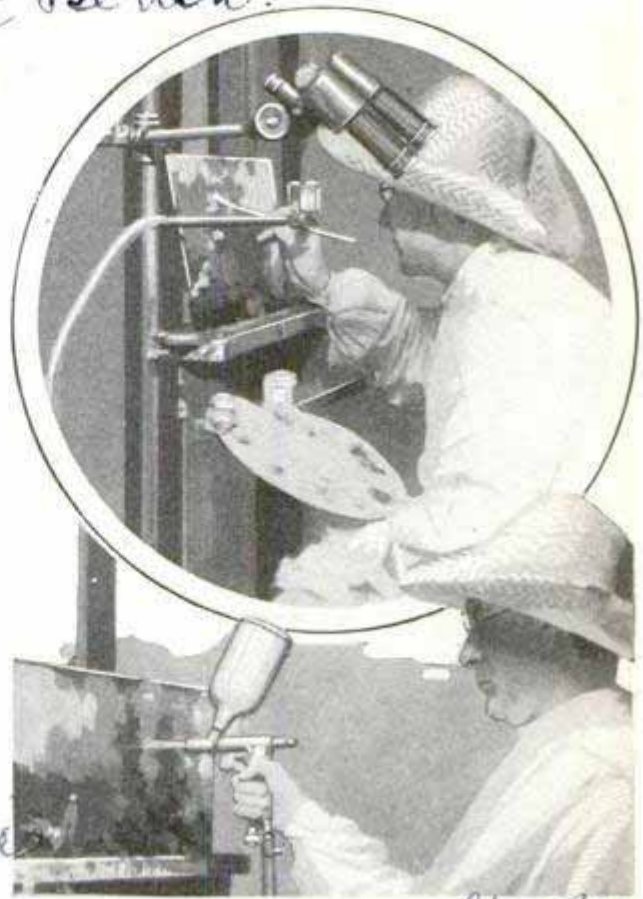

Above, Retouching Old Painting with Aid of Microscope; Below, Applying Final Coat of Varnish

475 Brainerd St. San Francisco

The Paraffine Company

ROOFING THAT RESEMBLES TILE HAS SLATE SURFACE 171

Resembling clay-tile units of the so-called Spanish type in appearance, slate-surfaced roofing in various colors recently has been placed on the market. The tile substitute is molded over a base of small-mesh chicken wire, or hardware cloth, with a layer of asphalt felt imbedded on the underside. The units are less costly than clay tile and are applied with nails much more quickly than can be done with tile.



\$15.00 per square

RARE PAINTINGS ARE RESTORED WITH AID OF MICROSCOPE

Restoring rare paintings is a fine art in itself and often requires almost as much skill as was necessary to produce the original work. After the painting has been cleaned, the artist retouches the spots that time has damaged or destroyed, employing a microscope to obtain exactly the

in Berlin

right blending of colors. When the painting has been retouched, a coat of varnish is applied to preserve the work. The expert wears an African hunting helmet for this work to protect him from the heat of the 1,000-watt bulbs which he needs to provide the necessary illumination for his delicate task.

SHOCK ABSORBERS FOR RADIO END VIBRATION 301

For use under the legs of the radio cabinet, phonograph or other piece of furniture in which vibration is objectionable, sponge-rubber shock absorbers now are on the market. The plastic pads are placed under each leg of the radio cabinet, cups being provided for the leg tips. The elasticity of the rubber absorbs jars and vibrations that might otherwise unbalance the set.

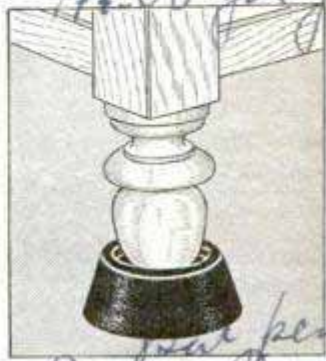

\$11.00 for four

Quality Mfg. Co.

174

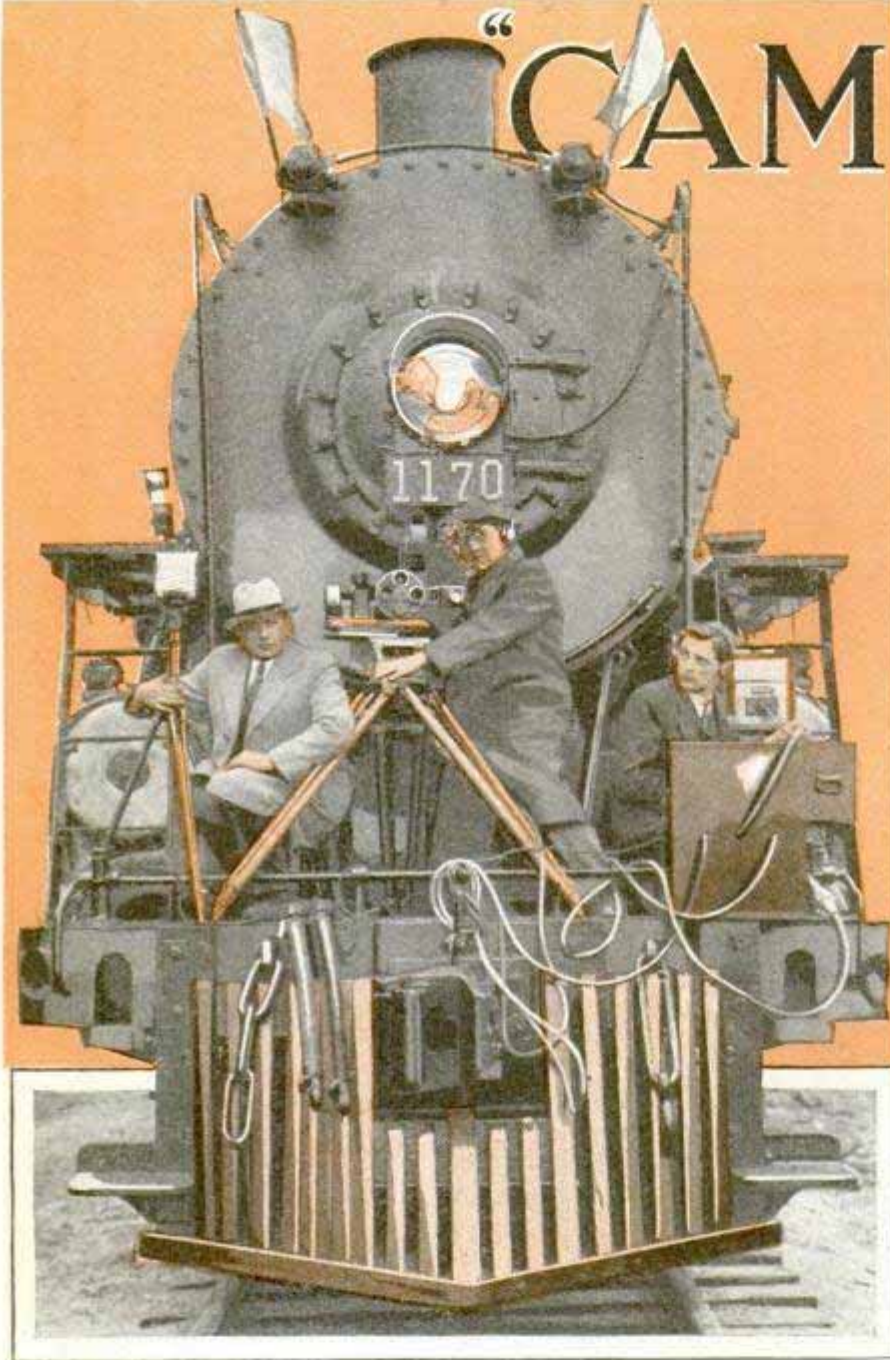

“CAMERA!”

another year to shoot the scene. Yet, when completed, it will appear on the screen for no more than a minute.

Another newsreel organization spent more than five months recently in filming two cats on a fence engaged in a battle royal—with sound, of course, and plenty of it. Only a cat specialist, described as a “catologist,” who knew why cats quarrel, was able to stage the fracas. And then a national audience of seventy million viewed it for but ninety seconds!

During the past two years almost every photographer on the staff of still another newsreel company has, at one time or another, worked on “the baby stunt.” Although to date 27,000 feet of “cute-baby-film” has been shot and even the boss’ offspring has consented to pose, only one-half of the story has been completed.

Anything to get the picture—with sound, preferably—says the newsreel editor of today. It’s getting to be a big business. New rivals in the field each year are making competition for original and exclusive pictures keener than ever, despite the complications and difficulties resulting from the introduction of sound. And the newsreel will soon emerge as a daily institution similar to the newspaper. In one year, predict newsreel officials, there will be a newsreel theater in every large city in the country to which people will come to see and hear the news of the day just as they turn to their morning newspaper.

Shooting a Scene from the Pilot of a Locomotive, Just One of the Many Hazards Faced Daily by the Newsreel Cameraman

By THEODORE D. IRWIN

FOR the past eighteen months two young and indomitable salamanders have been obliged to chase each other around a circular track in a New York motion-picture studio. While cameras grind, they wonder, no doubt, what the shooting’s all about. A newsreel company, it seems, is trying to get an X-ray movie of the spectacle; that is, a picture of the two amphibian skeletons, each in pursuit of the other. Thousands of feet have been taken of which none can be used, thousands of dollars have been expended, and it is expected that it will take

Feeding *the* News Reels

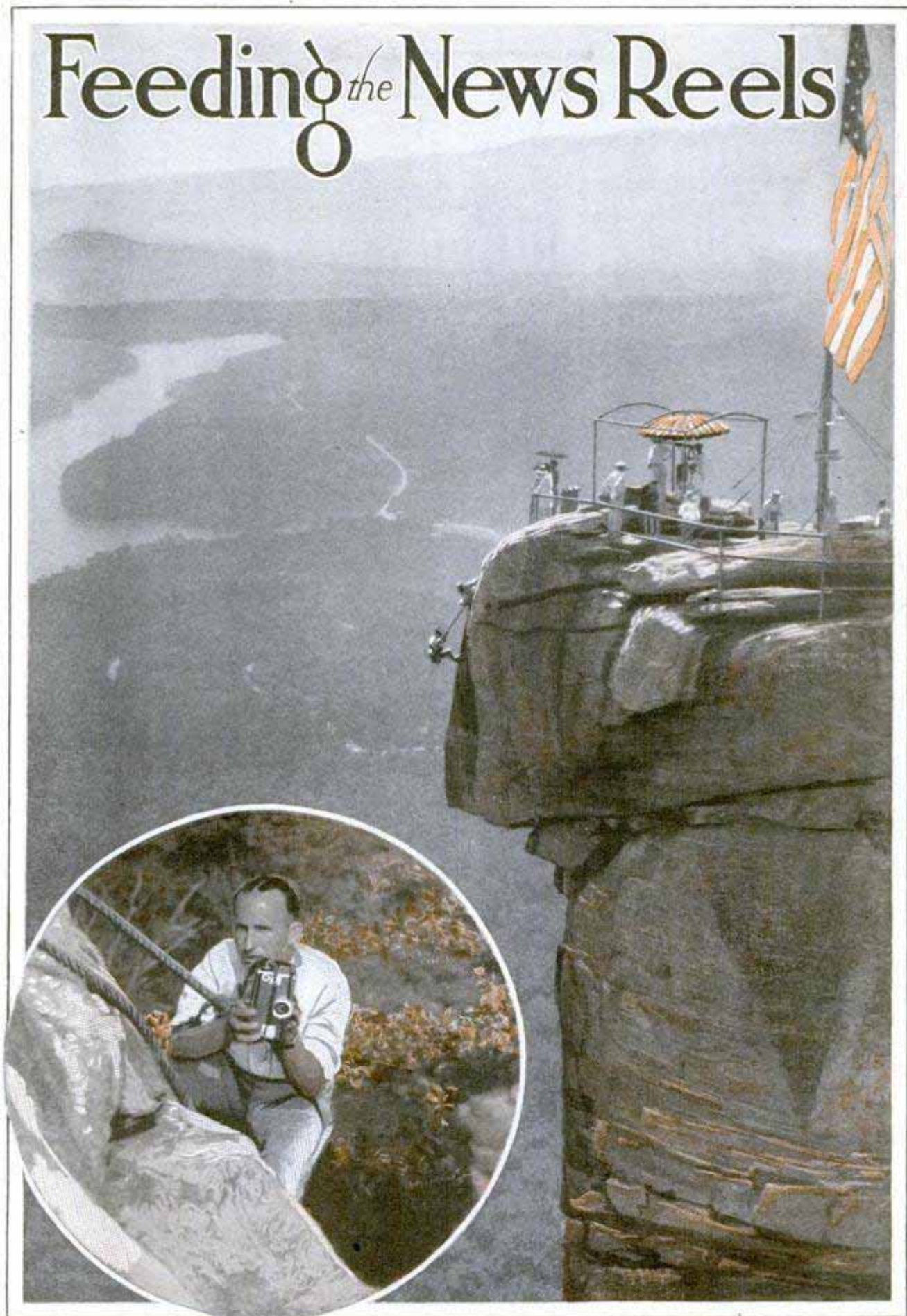

One Dare-Devil Cameraman Wanted a Shot from the Side of Chimney Rock, ^{North} South Carolina, and, Above, He Is Shown Going after It; in Circle, Close-Up Showing How Camera Was Supported

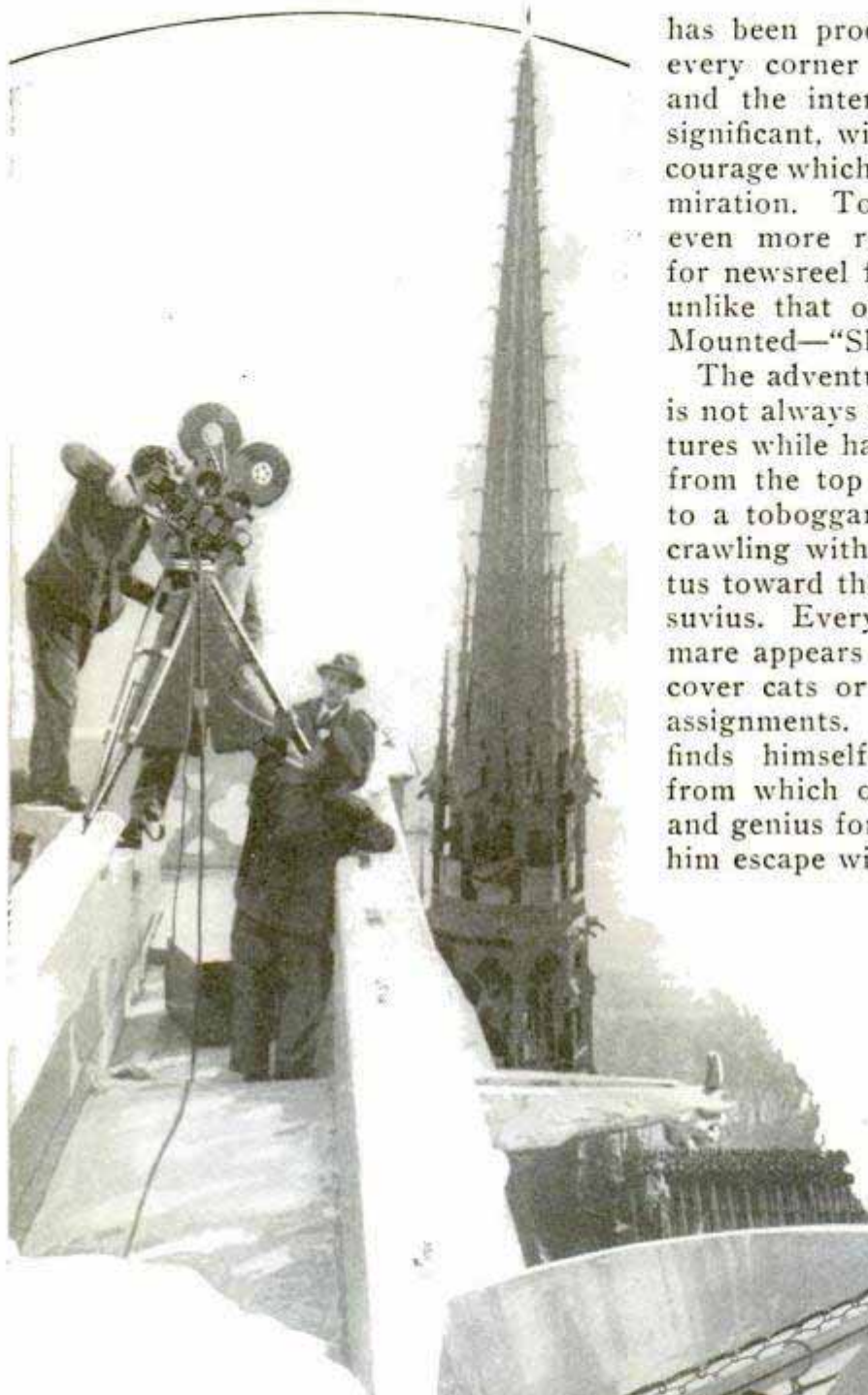

All these "screen newspapers" will be alike in every respect, so that a visitor to a strange city will not be confused by an unfamiliar newspaper; he need only step into the theater and see and hear his "home-town daily."

Feeding these newsreels daily will not be as formidable a task as one might suppose. For a race of supercameramen

has been produced that is able to comb every corner of the globe for the new and the interesting, the occult and the significant, with an ingenuity, agility and courage which have excited widespread admiration. Today they are being sent to even more remote and stranger places for newsreel fare, their blanket order not unlike that of the celebrated Northwest Mounted—"Shoot your man!"

The adventurous cameraman, to be sure, is not always engaged in shooting his pictures while hanging on to a slender cable from the top of the Eiffel tower, lashed to a toboggan at breath-taking speed or crawling with camera and sound apparatus toward the mouth of an erupting Vesuvius. Every so often the dreaded nightmare appears in the form of an order to cover cats or babies or other such hard assignments. And just as frequently he finds himself in peculiar predicaments from which only his customary audacity and genius for quick thinking have helped him escape with his life.

During a Chinese revolution, Merl La Voy, well-known American cameraman, found himself filming one of the bloodiest battles, where thousands of men had been killed, when he was suddenly rushed by a

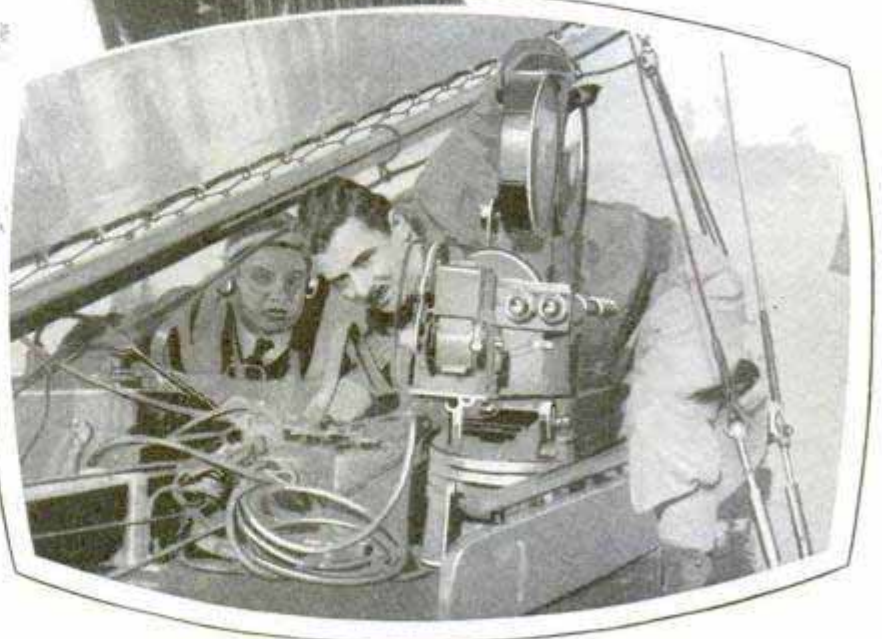

Above, Recording Repairs to Spire of Notre Dame Cathedral; Below, Taking Pictures from an Ice Boat Traveling Fifty Miles an Hour; Special Adjustments Give the Camera Remarkable Steadiness

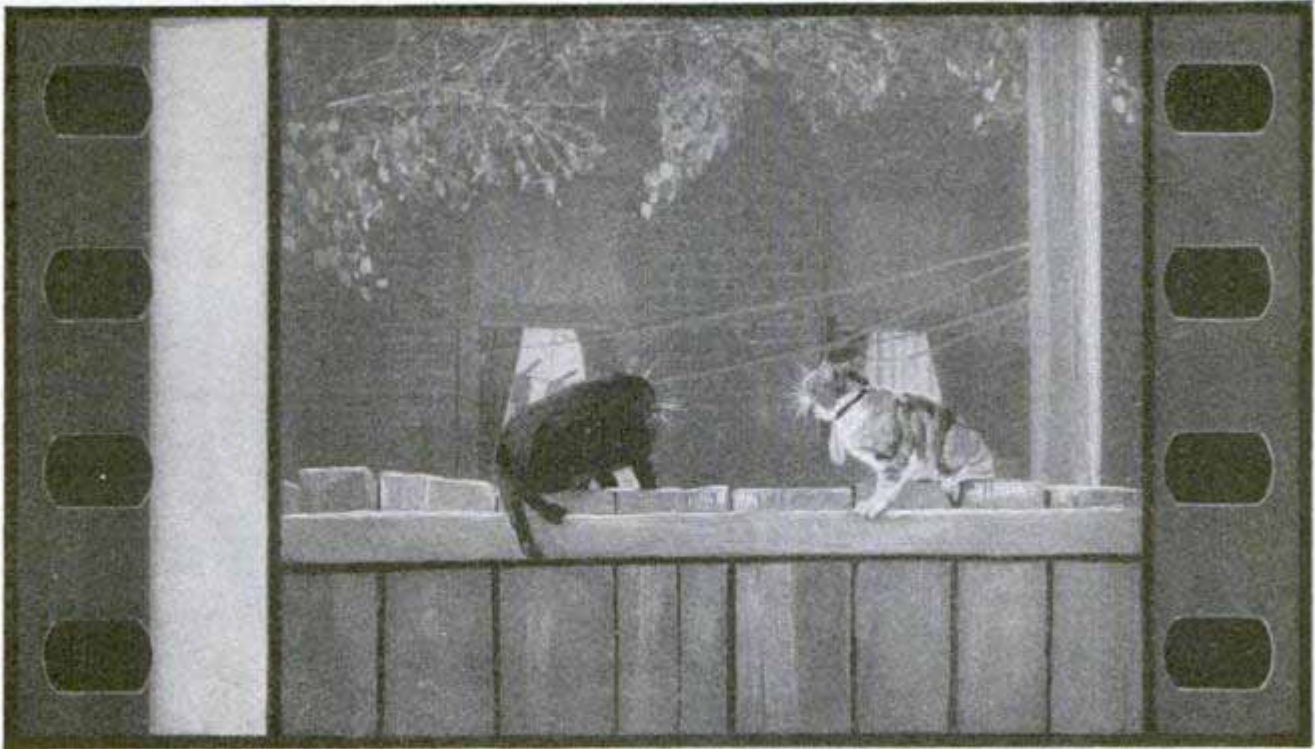

Just a Nocturnal Cat Fight, but It Took Five Months and the Services of a "Catologist," Who Knew Why Cats Quarrel, Before the Indefatigable Cameraman Finally Got His Picture

squad of soldiers and dragged to an earthen mound. Apparently he was being mistaken for a White Russian, many of whom were fighting in the hostile army. His safe-conduct papers proved useless, for none of the soldiers could read, and La Voy's knowledge of the Chinese language was limited to but two words. As the preparations for the execution proceeded, he was suddenly struck with an inspiration. Holding up his right hand, he broke into a wide grin.

"Mah Jong!" he exclaimed.

The soldiers stared at the American, then went into a fit of laughter. A few moments later, the firing squad released their captive and shuffled off, no doubt much to La Voy's relief.

Shooting an execution is another matter. Karl Fasold, whose specialty ordinarily is photographing presidents and kings, is probably the only man alive who ever had an execution held up merely to suit his convenience. Sent to Mexico to cover one of its recent uprisings, he learned one day of a proposed execution of several prisoners at sunrise. Now a sunrise may be all right for people who like that sort of thing, but to a cameraman it is as useless as a cocktail shaker without the cocktail. There's not enough light in which to take a picture. Forthwith, then, went the unabashed Fasold to

the commanding officer. "General," said he, "I'd like to have you postpone that execution a couple of hours tomorrow. I've got to have enough light to shoot the shooting." So the prisoners were dispatched at noon.

Proper lighting effects is but one of the many handicaps the cameraman works under, but generally he overcomes it by some ruse or other. In another Mexican rebellion, several years ago, a cameraman found to his consternation that most of the battles were being fought at night. Thereupon he arranged a contract between his company and the revolutionary general whereby he was to fight all his battles in the daylight! This courtesy netted the general several thousand dollars. Still the cameraman was not satisfied. The battles lacked sufficient action, the screen pictures showed, so he had the general stage sham fights instead.

In getting the news of significance from the scene to the screen and thereby grinding out history, the newsreels today are breaking all existing records in movie news gathering. At the inauguration of President Hoover, one company had no less than twenty-three cameramen assigned to the event. And that very same day people all over the country were viewing the ceremonies in their favorite theaters. Four hours after two flyers crashed



cameraman, begged for the assignment. The chances of his reaching the prison in time appeared extremely slim and, with the prevailing weather, the trip decidedly hazardous.

"If you want to take a chance, Russel," said the news editor, "I guess I can."

In a tri-motored Ford, Muth at once hopped off for Auburn. After a few hours of silence, a report came in from Syracuse. It had proved impossible to fly through the Mohawk valley. Muth had been forced to detour to avoid a storm. But he succeeded in getting some good air shots of the prison. Landing in a field near Syracuse, he transferred his apparatus to a truck and hastened to Auburn. After several pictures of the prison interior and an

interview with the warden, the film was rushed in the fastest train back to New York, where it arrived with the dawn. At the first performance of the newsreel theater that morning at ten o'clock, the story of the Auburn outbreak was on the screen.

Frequently a cameraman will take all sorts of hazards in order to get an unusual picture and

into a building in mid-Manhattan a short time ago, the lone survivor entered the newsreel theater on Broadway and beheld on the screen the scene of the crash and heard himself tell how it happened.

The newsreel editor has developed a horror of being "scooped," and speed and resourcefulness have become the paramount qualities required of every cameraman. The story of how motion pictures were taken of the last outbreak in Auburn prison aptly illustrates the manner in which every available facility is commandeered in bringing the news to the screen. When news of the break was flashed to the New York headquarters of the Fox Movietone News, it was decided to cover the story from both air and land. A train, however, could not reach Auburn till early evening. Flying weather was reported extremely unfavorable. Moreover, it would take, ordinarily, at least five hours for a fast plane to make the trip and but four hours of daylight remained. Russel Muth, star



© Paramount News, Associated Press
 Preparing to Shoot a Submarine Scene; Working the Sound and Sight Apparatus; Snapping Eiffel Tower



This Picture Determined a Court Case; the Two Women Claimed the Child, and Secret Movies of Them Were Made; the Judge Viewed the Reel and Found for the Agitated Woman

then learn that the film was never used. It is these occasions that literally break the heart of the star cameraman, for he is usually as temperamental and as difficult to handle as the movie star. But if the film arrives too late to make the "deadline" in the laboratory, it often goes "cold" before the next edition. Or it may be the sort of picture which cannot be shown on the screen at all. Jack Lieb, of International News, had some wonderful shots of a battlefield with the sky black with fattened vultures, but they were never used. Pictures for which the cameraman may have risked his life several times may be shown for but a few seconds on the screen and, out of 100,000 feet of film

secured by the newsreel company each week, only 800 feet can be used.

"Get the picture at any cost!" is the newsreel photographers' slogan. Always, he sticks to his post, no matter how dangerous it may be.

ROLL MAP FOR AIRPLANE PILOT ATTACHES TO WHEEL 188

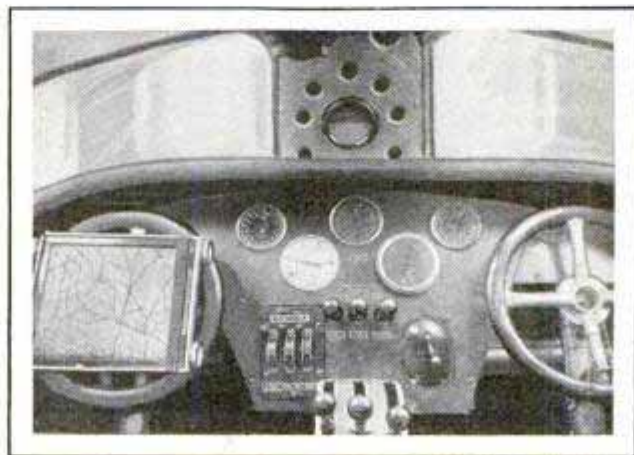

The Roll Is Attached to Control Wheel of Airplane

Conveniently attached to the control wheel of the airplane where it is in plain sight of the pilot, a roll map has been placed on the market in Germany. The map is on a substantial frame and may be rolled back and forth to keep the craft's route before the flyer's eyes.

Left Hansa use it on the control wheel

The Regina Carpen

Chm. Du Wayne L. Clark,

Stationed at Johannesburg

800

Rahway, N.J.

POPULAR MECHANICS

258 ELECTRIC SCRUBBER FOR FLOOR ALSO WAXES AND POLISHES

Electric Floor Machine Which Contains Various Brushes for Scrubbing, Waxing or Polishing

\$89.50



Reported & Dept. of Commerce

with a culture medium, the typhoid germs and one or two other kinds can grow on it, but the typhoid culture is of a distinctive color as compared with the other organisms. The scientist therefore is able to pick out the typhoid germ.

FLICKERLESS MOTION PICTURES USE MULTIPLE LENSES

Flickerless motion pictures have been produced by a South African inventor through the use of several lenses for the projection of the film. A series of lenses is arranged in a channel shaped like the letter "D," and these move with the film, so that an image of each picture is formed through a separate lens. Two or three lenses are in use simultaneously, casting their images on a large lens, which, in turn, combines them on the screen. The result is that each picture fades imperceptibly into the next. Other methods have been evolved for accomplishing the purpose, one using a number of lenses moving with the film around the edge of a disk.

MARKERS SET IN FLOOR GUIDE PASSENGERS TO TRAINS

Passengers who had difficulty in locating some of the numbered tracks in a Philadelphia railroad station to board the right trains now need only follow a line. Small white blocks have been set in the platform from the train gates to the coaches, the lines of blocks being marked with the numbers of the various tracks to which they lead.

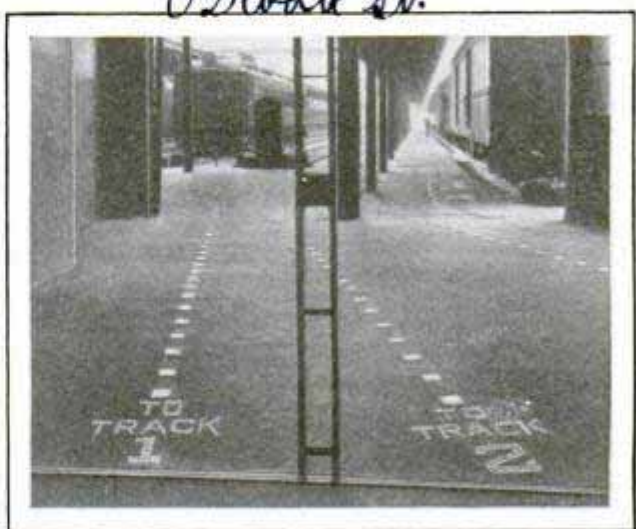

Markers Set in Floor Guide Passengers to Various Tracks of Philadelphia Railroad Station

Operated much like a vacuum cleaner, an electric floor machine now is on the market that not only scrubs, but also waxes, polishes, scours or sands all kinds of floors. It weighs sixteen pounds and is equipped with various brushes and other units for the different operations. It may be used on linoleum, tile or marble as well as on hardwood floors and even on steps. It is operated as simply as a vacuum cleaner.

DYES FOR DETECTION OF GERMS TO BE STANDARDIZED

Standardization of the brightly colored dyes with which scientists stain dangerous disease germs to make them visible, now is being attempted by a special commission. The reliability of the tests for identifying the germs often depends on the quality of the aniline dyes. For instance, typhoid bacilli look almost exactly like certain other germs having no relation to the disease, and telling them apart was difficult until a certain red dye was used. If this dye is of proper quality, and is used

From Science Service News Bulletin 465-7 2/21/30

Commission on Standardization of Biological Stains

BOX SEATS IN PRISON SCHOOL HELP KEEP ORDER

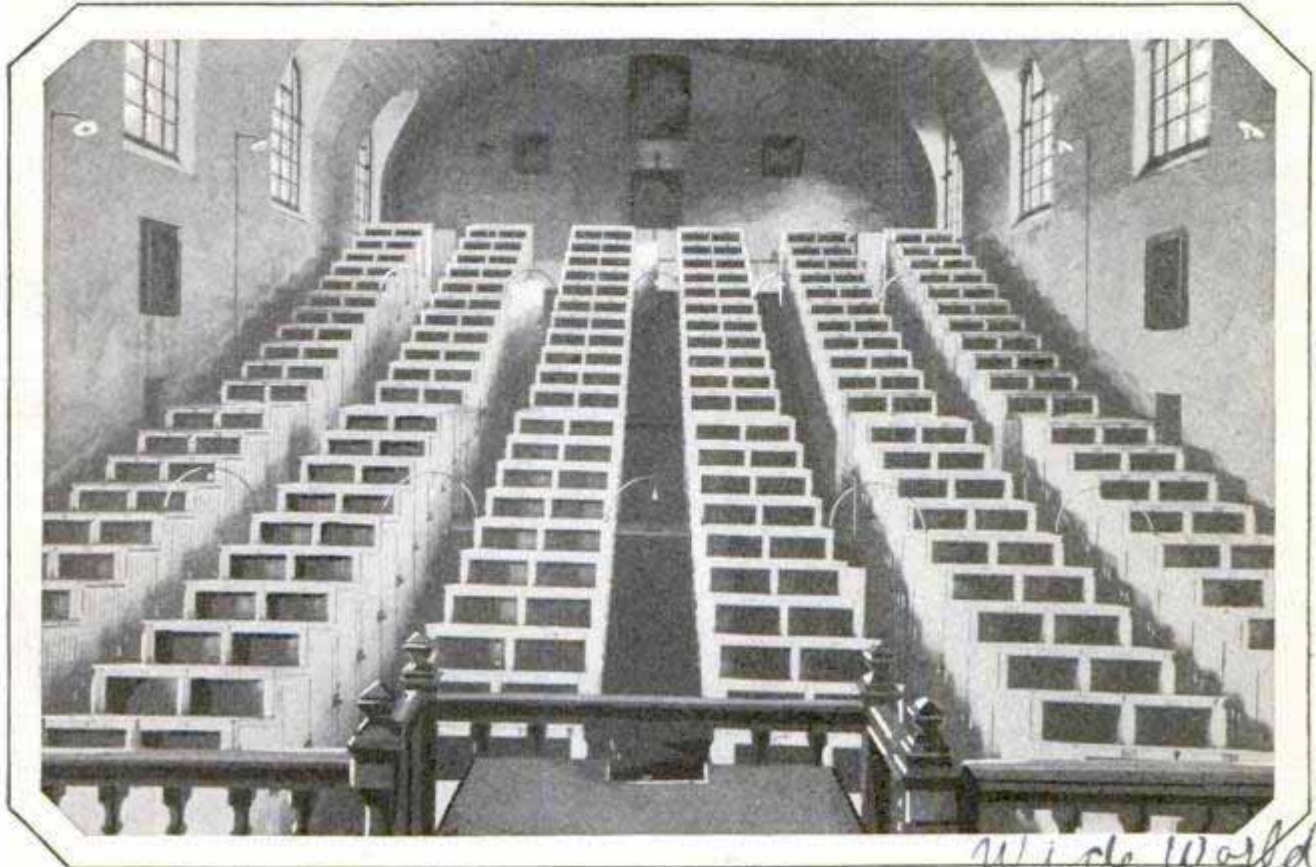

Wide World

Prisoners' Seats in Chapel School of Model French Penitentiary at Fresnes, near Paris; Occupants Cannot See Each Other and Enter and Leave Boxes from Below

To help maintain discipline and prevent conspiracies among prisoners in the model French penitentiary at Fresnes, near Paris, the seats in the chapel school are constructed as a series of boxes, holding only one man each. They are arranged on a steep incline so that the view is unobstructed even from the back of the room, but communication is impossible between the men even though they occupy adjoining boxes. Each seat is numbered and entrance and exit are from beneath. Since many riots occur when the inmates are assembled for meals or other purposes, this method has proved successful.

LIQUID WOOD IS FIREPROOF AND COMES IN COLORS 123

In plastic form and applied like putty, a synthetic wood that becomes fireproof when it hardens now is on the market. It is used for repairing all kinds of wood and for veneering, molding and filling in cracks. When hard, it may be shellacked, rubbed and treated like the natural wood, and is made in mahogany, walnut and

Fireproof Wood by G. L. Petersen
 242 B road St.

oak. A form of fireproof liquid wood also is available that can be used not only on wood but on plaster or metal as well. It comes in many colors.

AUTO LICENSE-PLATE HOLDER
109 **ADJUSTABLE IN SIZE**

Adjustable in size to the plate to be fastened to it, an auto-license holder that is quickly attached to the car now is on the market. It consists of two plates of sheet

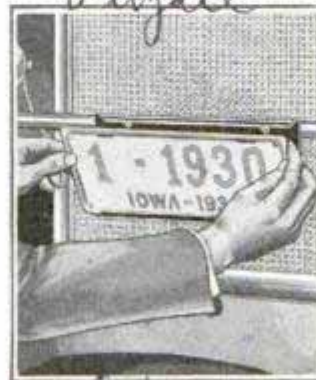

Hitzgall
 steel crimped at the top and bottom edges and fastened together with tension springs. The holder is attached to the car with bolts and the license is inserted between the grooved edges, springs causing the grooves to grip the plate firmly. The device is finished in black lacquer.

\$1.00 pair
 The J.C. Petersen Mfg. Co.
 Spencer, Iowa

55 The main place
New York

Dr. Morley Stone
802 of Bacteriology
St. Vincent College, New York

TYPEWRITER BUILT INTO PIANO

TRANSPPOSES MUSIC

234

Capable of both recording and transposing compositions on the piano, a



Superimposed Keyboard for Transposing Music, and a Music Writer for Recording Improvisations

music writer has been developed by a New York college professor. The recording device consists of a typewriter attachment which can be built into any piano, and operates in such a manner that the touch of the fingers on the piano keys is transmitted through a system of pulleys to corresponding small levers which print on a revolving roll of paper, bearing enlarged reproductions of the musical staves, marks proportionate to the time-value of the notes. Each note played is recorded by a series of dashes, and from the position of these marks between the scale lines, each note is identified easily, thus making possible the recording of a difficult improvisation of any composition.

LEAKS IN PIPE LINES LOCATED WITH WAR INSTRUMENTS 270

Geophones, instruments developed during the World War to detect enemy sappers undermining trenches to blow them up, are finding a peace-time use in locating leaks in pipe lines. They also have been used in tests to locate men in mines, with a view to employing them in rescue work. Small leaks in pipe lines, especially those carrying water under pressure, have

Dr. P. B. Wagoni Prof. of Physics, University of

been a serious problem since they often run under paved streets, and digging is a tedious and expensive task. The geophone, which finds the leak, is constructed along the principles of the stethoscope with two distinct receivers, each connected separately to an ear attachment. The receivers are placed on the ground near the suspected leak, and the escape of the water can be heard through receiver and earpiece. When the sounds coming to both ears are of equal strength, the leak is located on a line perpendicularly bisecting that between the two geophone receivers, and this line is drawn on the pavement. The detectors then are moved about until another point is found where the sounds are the same. A second perpendicular is drawn, and the point where these lines cross is above the leak.

HOBBLE LIMITS SPEED OF AUTO WHILE BEING DELIVERED

To prevent new cars from being driven at excessive speed while being delivered from factory to dealer, one automobile company has devised a "hobble" which limits the rate of speed. The device, known also as an orifice governor, is a thin steel plate placed between carburetor and intake manifold. It contains a small opening that permits only a twenty-five-mile-per-hour supply of gas mixture to reach the cylinders, and is secured by a steel wire similar to those used on freight-car doors, with a seal on the ends.

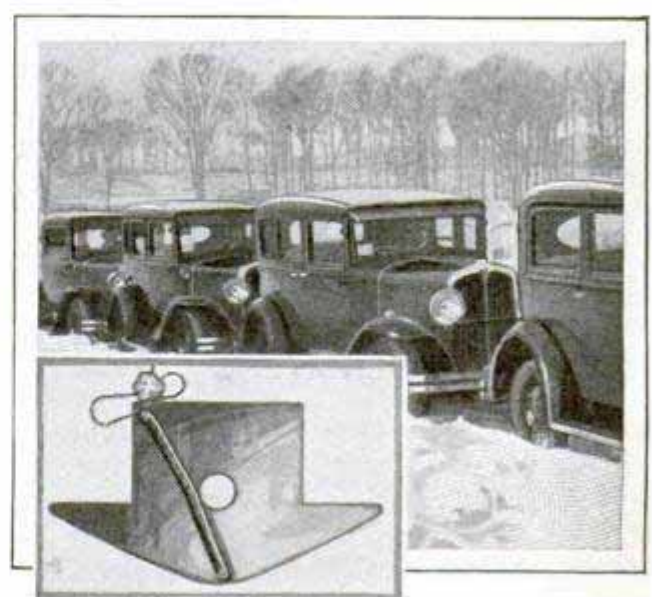

Autos En Route from Factory to Dealer Are Equipped with This "Hobble," Limiting Their Speed

Oakland Motor Car Co. Portae Mich

Feb 1923-192
see
Dec 1924-1923

297

The WORLD'S MOST FAMOUS PLAY

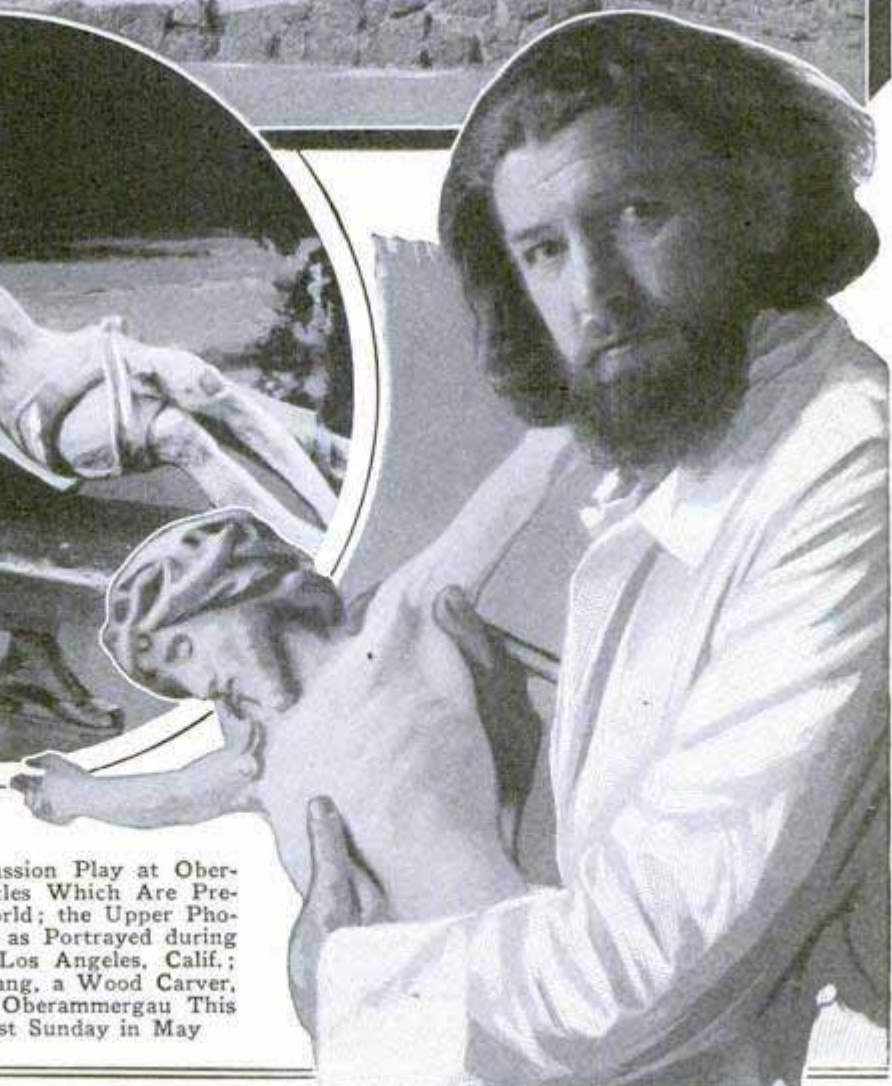
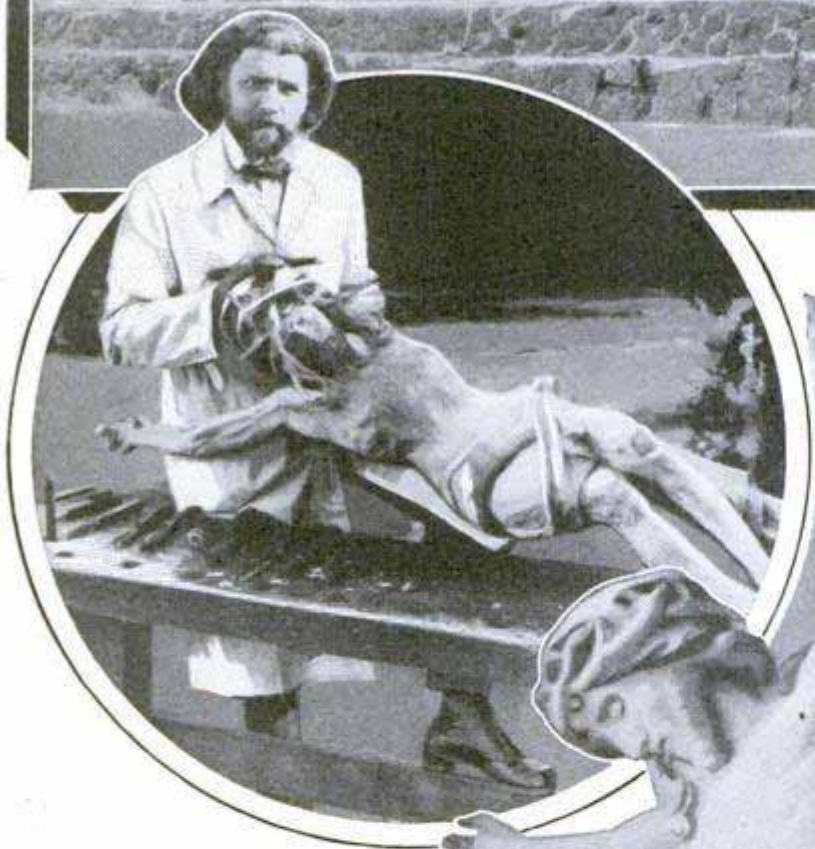
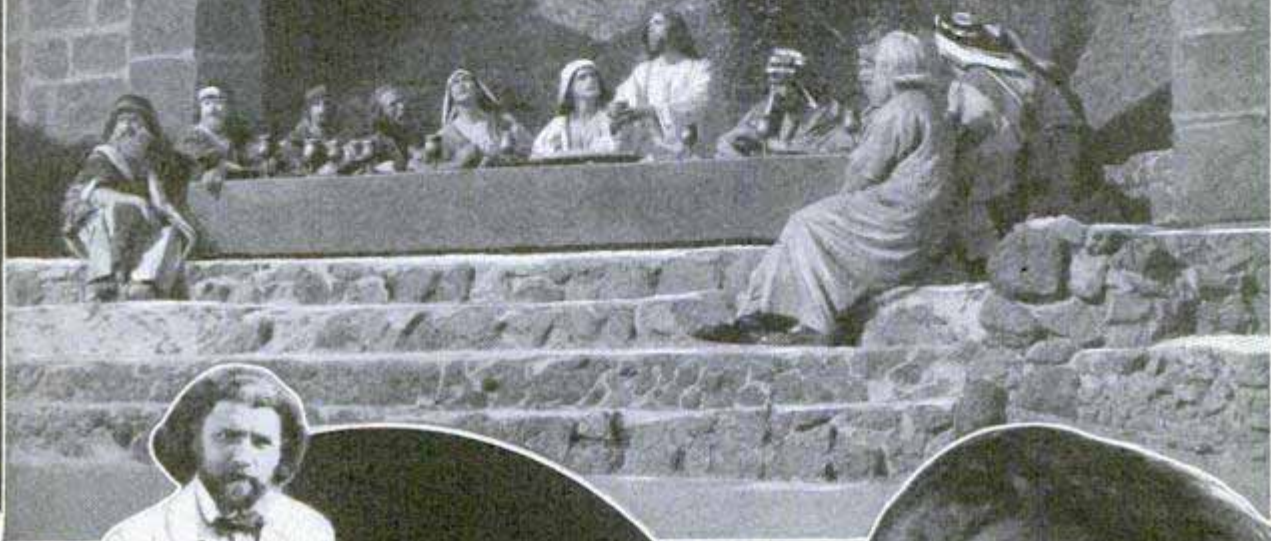

This Year's Production of the Passion Play at Oberammergau Recalls Similar Spectacles Which Are Presented in Various Parts of the World; the Upper Photograph Shows the "Last Supper" as Portrayed during the Famous Pilgrimage Play in Los Angeles, Calif.; the Lower Photos Are of Alois Lang, a Wood Carver, Who Is to Play the Christ at Oberammergau This Season, Beginning with the First Sunday in May



The Village of Oberammergau in Bavaria, Where Rehearsals for the Passion Play Have Been in Progress Since Christmas; at Right, Guido Mayr Who Played the Part of Judas, Teaching His Daughter How to Carve; Most of the Passion Players Are Expert Craftsmen

At Left, Peter Rendl, Who Takes the Part of Peter, Working at His Wood-Carving Bench; the Passion Plays Have Been Presented Nearly Every Ten Years Since 1634



A Class in Wood Carving; Looking down the Main Street of Oberammergau, and, Below, the Passion Play Theater against Its Background of Mountains; the Idea of Presenting the Play Every Ten Years Started Shortly after 1533, When the Village Was Swept by a Plague; the Few Survivors Resolved to Present the Drama of Christ's Life as a Token of Their Gratitude for Being Delivered from the Pestilence; the Players Are Taught from Early Youth to Emulate the Lives of Biblical Characters; during the Years between the Presentations, Many of Them Make Their Living as Wood Carvers or Potters; They Receive No Dramatic Training outside That Given by Their Own Direction

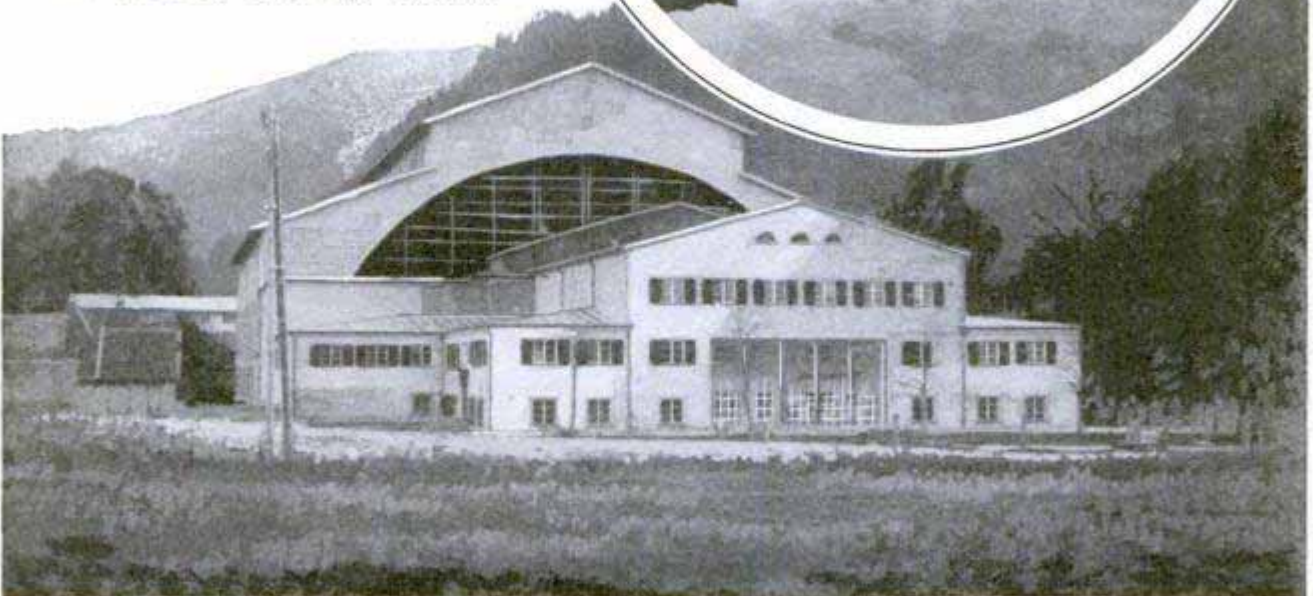
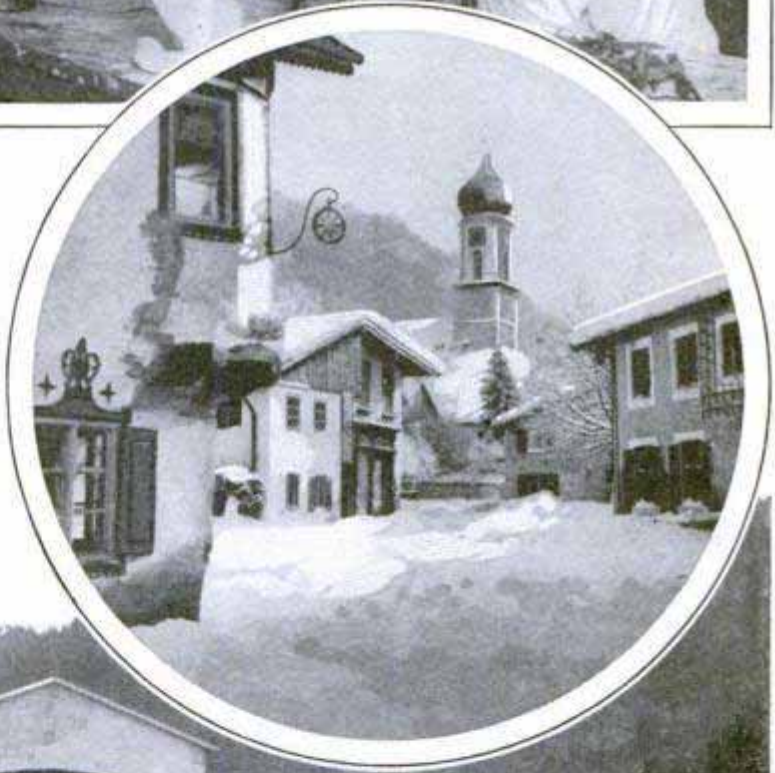

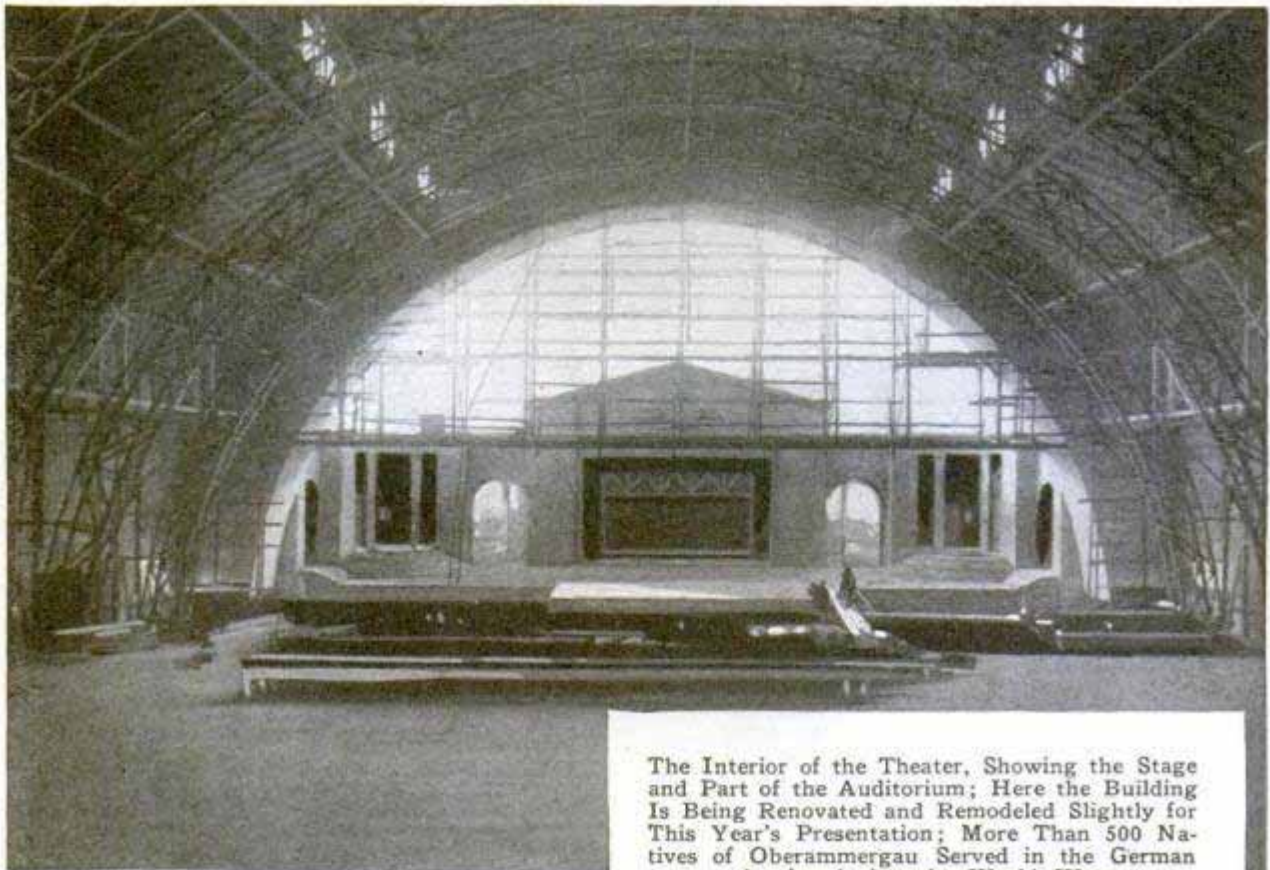

The Interior of the Theater, Showing the Stage and Part of the Auditorium; Here the Building Is Being Renovated and Remodeled Slightly for This Year's Presentation; More Than 500 Natives of Oberammergau Served in the German Armies during the World War



A Bit of Wood Carving by Andreas Lang, One of the Players

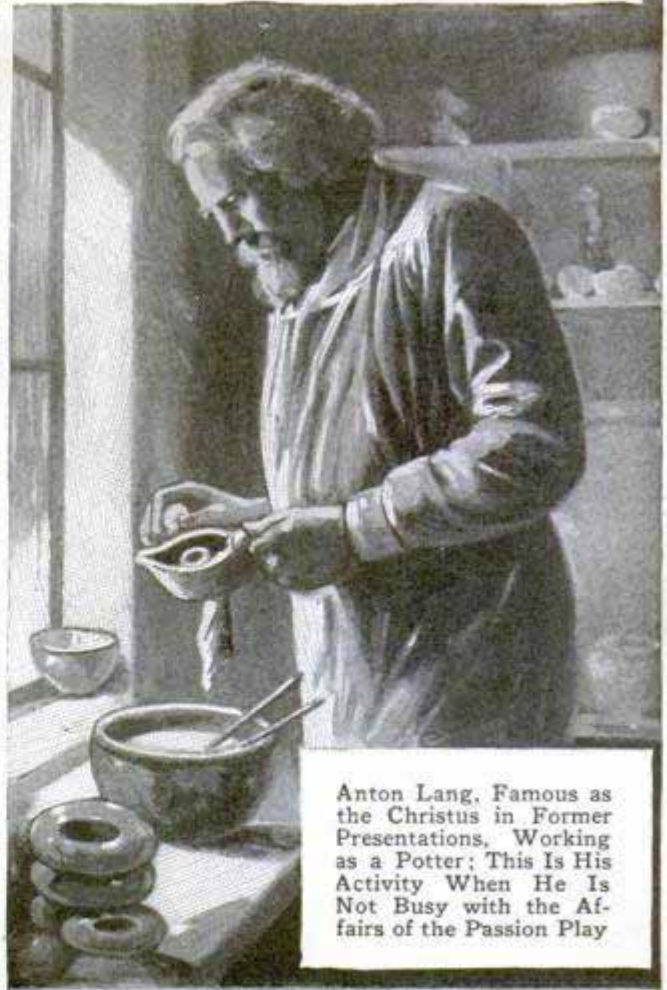

Anton Lang, Famous as the Christus in Former Presentations, Working as a Potter; This Is His Activity When He Is Not Busy with the Affairs of the Passion Play

Capt. John D. Loggswell, 16 Edgemoor Road,

808

POPULAR MECHANICS

Belmont, Mass

THERE IS MONEY IN THE FARMING OF BROOK TROUT



went forth to whip the pond waters. Soon the owner put in his own trout hatchery and rearing pools. Now he raises nearly a quarter million adult trout every season. A great many of them are transferred to the ponds to be caught by the club members, others are sold at a fine



Rearing Pools of Running Water on a Trout Farm, Where Millions of Baby Fish Get a Start in Life; in Circle, Salvaging Predatory Fish from a Lake before Stocking with Brook Trout

Some ten or twelve years ago, a man, living about fifty miles from a large eastern city, had a gone-to-seed farm and a deep conviction that sportsmen would pay big money for good trout fishing within easy travel of town. On the farm was a chain of small spring-fed ponds connected by brooks. So he tinkered up the old dwelling and called it a clubhouse, put wire screens at inlet and outlet of one pond and bought a few rowboats. From a trout farm, he ordered \$600 worth of adult brook trout. Soon the news got abroad that there was good trout fishing to be had for a price within a couple of hours' drive of the city. Enthusiastic anglers arrived by the score, paid their membership fees in the new fishing club and

profit to hotels, restaurants and private fishing clubs, while the sale of trout eggs to small hatcheries is an additional source of income, and so artificial propagation of brook trout—commonly known as trout farming—is coming close to the big business class. In Massachusetts alone, the annual production is over \$750,000. The other New England states bring the yearly total for that district to nearly \$2,000,000. New York, New Jersey and Pennsylvania, together, come close to doubling that figure. An expert estimates that the entire country, through the medium of national, state and privately owned rearing stations, produces well over \$10,000,000 worth of brook trout annually, and the department of commerce estimates that

before a subscription of
Chemical Engineers
in London

4008

the supply is far short of the demand. The man who would breed trout for the market can begin at any stage of the cycle from eggs to the full-grown fish. Eggs cost about \$1.25 per thousand, fish, three to four inches long, about \$60, and yearlings, six inches or over, \$160 per thousand. In small quantities the price runs somewhat higher. This investment brings no income until the trout are nearly two years old, when the first eggs are available for the market.

SILK FROM THE AIR 251

Unlimited supplies of cellulose, the raw material of paper, artificial silk and explosives, will before long be obtained from the air by synthetic methods, in the opinion of Dr. Herbert Leivstein, president of the British Society of Chemical Industry. Research has shown that sugar and cellulose come from the same fundamental chemical units, and sugar already has been prepared synthetically from the carbon-dioxide existing in a small amount in the air and the water vapor everywhere present, so it is not unreasonable to expect cellulose products from the same source. The carbon-dioxide content of air is small, but billions of tons of air are available from which to extract it, and the supply is being constantly renewed so that it offers a virtually inexhaustible source of raw material.

TIRE-REPAIR GUM SEALS CUTS IN TREADS QUICKLY 148

Using tread-cut-repair gum as ammunition, a tire gun now is on the market

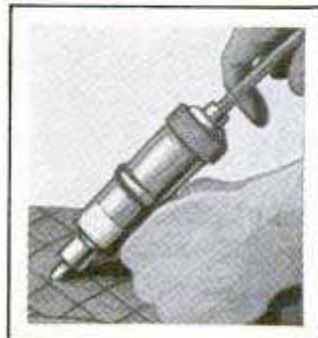

which quickly seals cuts in automobile treads. The gum is forced into the cut by a screw plunger, emerging through a pointed nozzle. The sealing compound prevents the entrance of sand and

moisture that usually result in separation of the tread from the tire body. Repairs can be made with the gun without removing the tire from the wheel.

Goodyear Tire & Rubber Co. Akron, Ohio

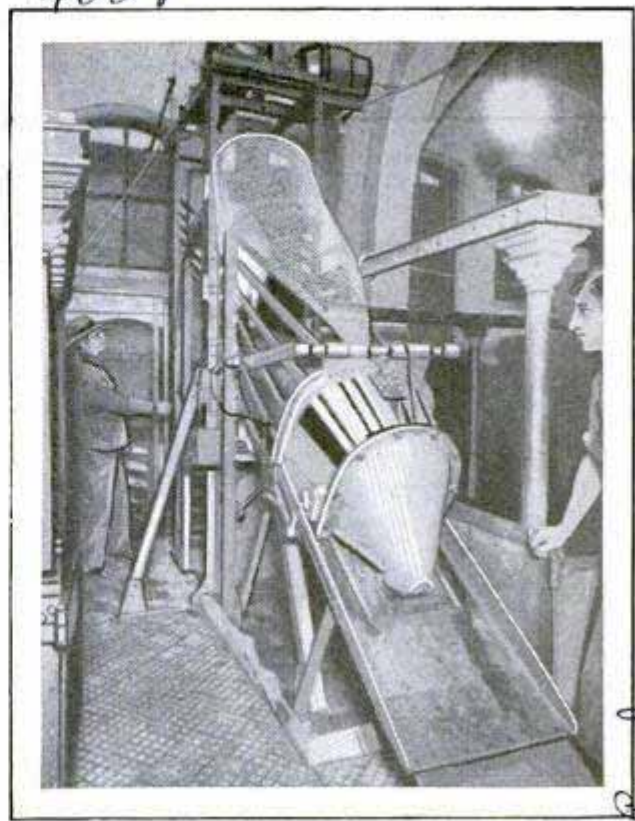

Paul

Apparatus in a German Packing Plant Which Electrocutes Hogs at the Rate of 200 an Hour

HOGS KILLED BY ELECTRICITY IN GERMAN PACKING PLANT

As a speedier and more humane method of slaughtering hogs, a packing plant at Munich, Germany, has installed an electrocuting apparatus. From an elevated cage the animal is discharged into a trap where it is instantly electrocuted, the carcass being slid from the electrocution chamber to the cleaning boards. By this method one man, who controls the current and the mechanism, disposes of about 200 hogs an hour.

HOME GOLF-PRACTICE TARGET MAY BE USED ANYWHERE 233

For home golf practice, either indoors or outside, a canvas target now is available which also stops the balls and retains them as they strike it. It is a heavy canvas backstop on which a circular white target is painted. Wings extend from the sides and a sod cloth retains the balls.



Anchor Supply Co., Evansville Ind

"HOT FEET" WHILE YOU WAIT IS PART OF THE

Harrison 5581

Machinery imported from Stockholm, Sweden

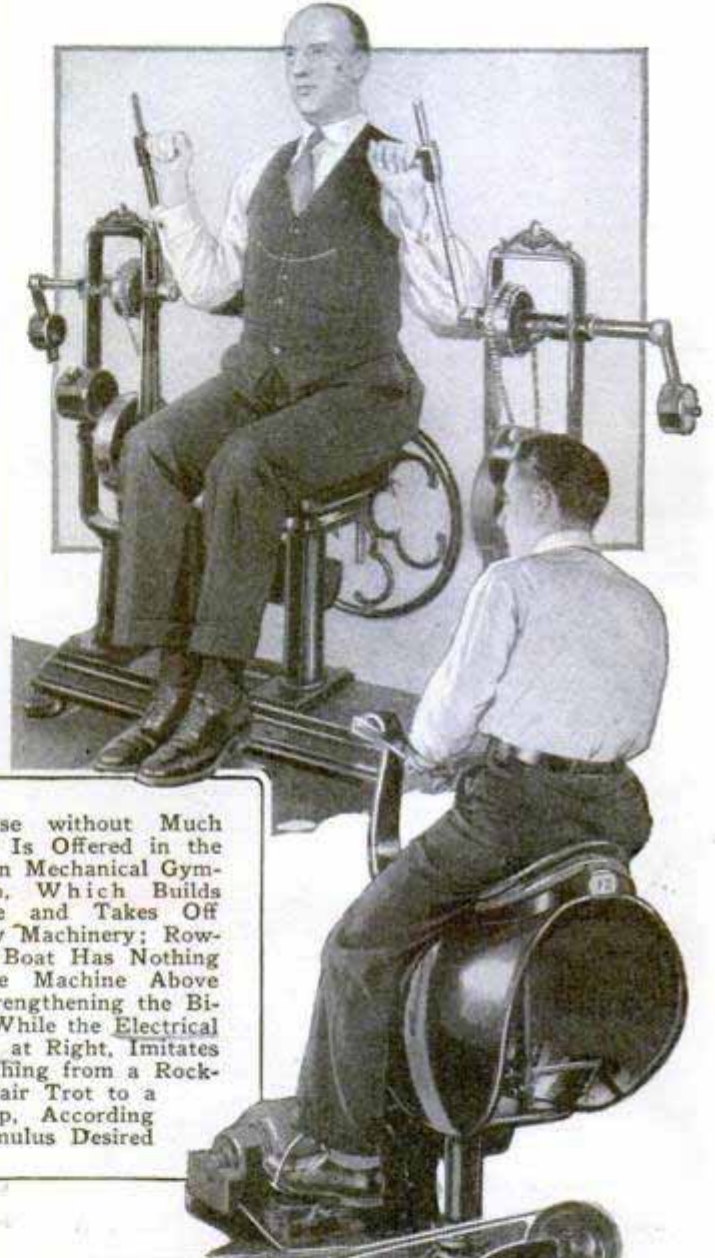
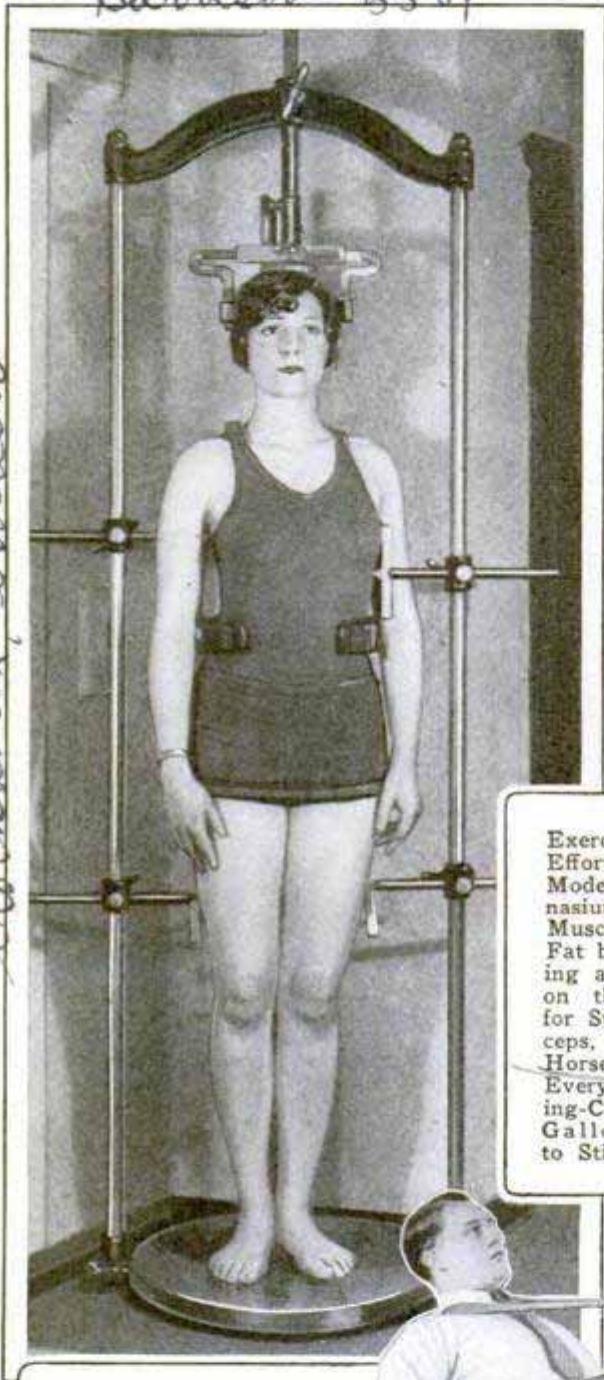

Exercise without Much Effort Is Offered in the Modern Mechanical Gymnasium, Which Builds Muscle and Takes Off Fat by Machinery; Rowing a Boat Has Nothing on the Machine Above for Strengthening the Biceps, While the Electrical Horse, at Right, Imitates Everything from a Rocking-Chair Trot to a Gallop, According to Stimulus Desired

Above, Apparatus for Taking Complete Body Measurements Which Makes It Possible to Keep a Correct Record of Muscular and Weight Changes from Using the Mechanical Exercisers; Right, Apparatus Which Gives the Effect of Heavy Lifting or Strenuous Effort without the Hard Work; Weights Are Attached to the Belts around Waist and Shoulders, and the Subject, with Legs Extended, Pulls the Weights Up and Down

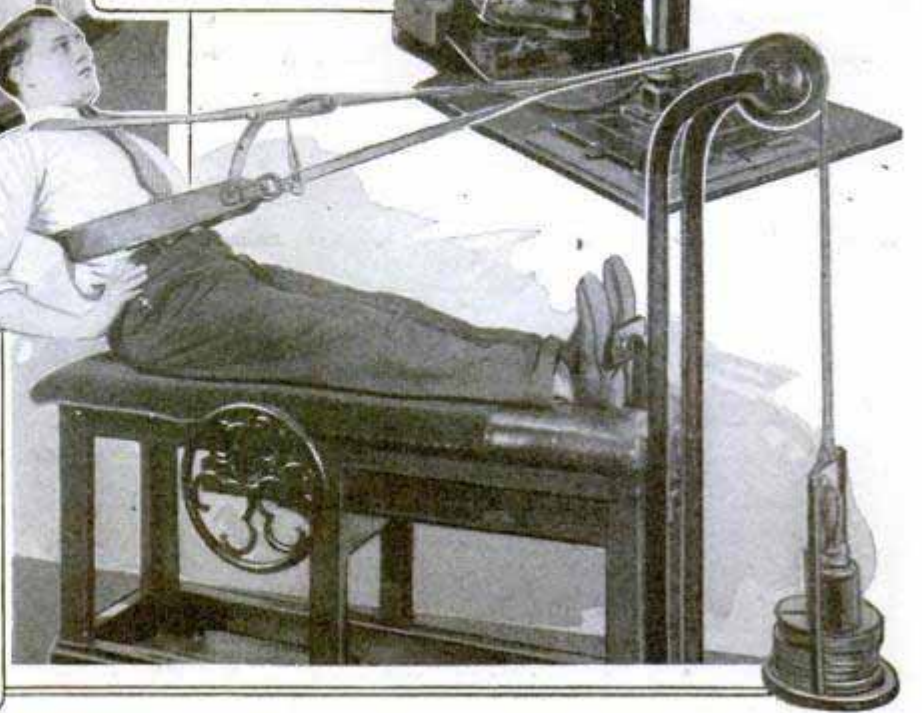

TREATMENT IN THIS ELECTRIFIED GYMNASIUM

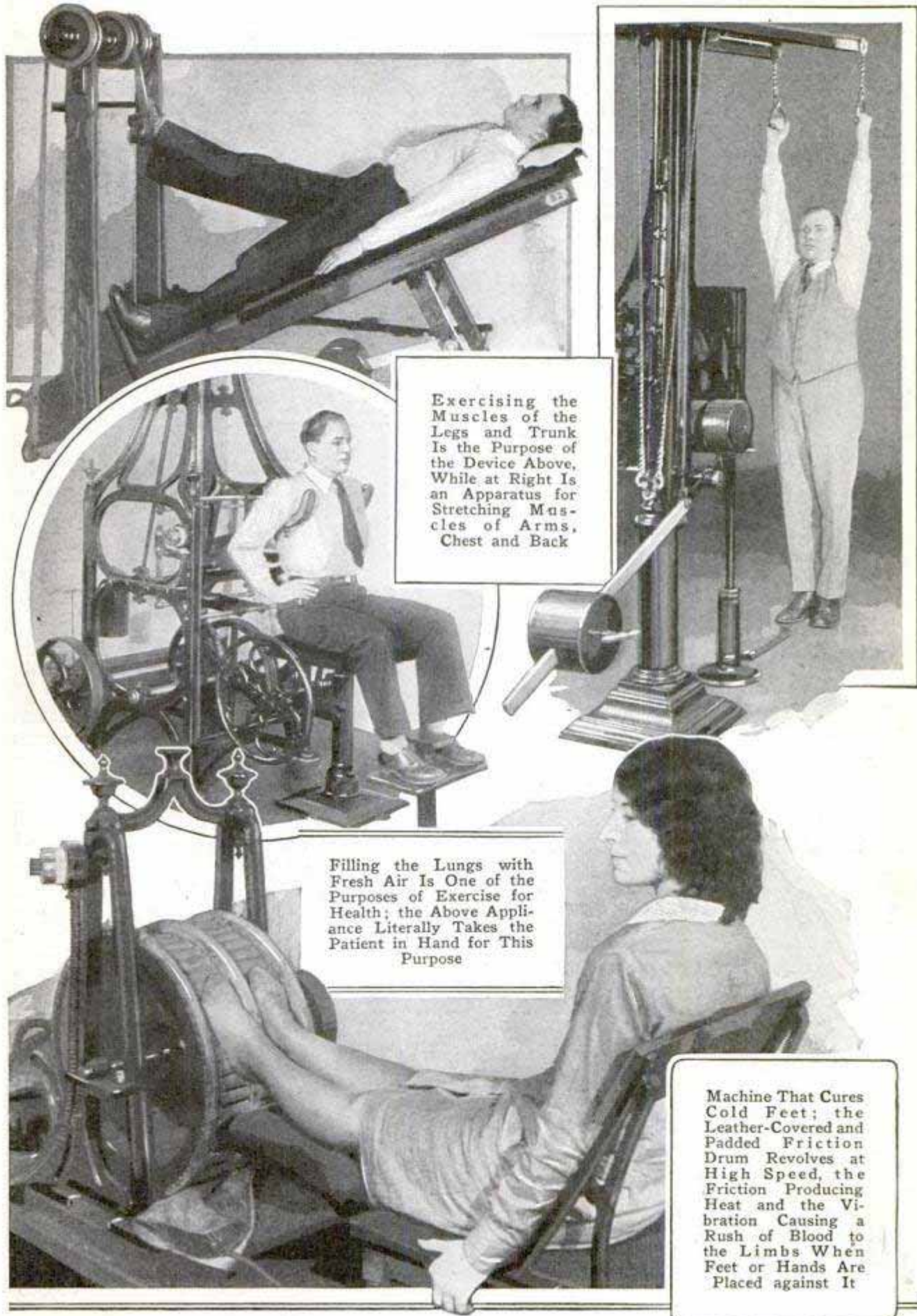

Exercising the Muscles of the Legs and Trunk Is the Purpose of the Device Above, While at Right Is an Apparatus for Stretching Muscles of Arms, Chest and Back

Filling the Lungs with Fresh Air Is One of the Purposes of Exercise for Health; the Above Appliance Literally Takes the Patient in Hand for This Purpose

Machine That Cures Cold Feet; the Leather-Covered and Padded Friction Drum Revolves at High Speed, the Friction Producing Heat and the Vibration Causing a Rush of Blood to the Limbs When Feet or Hands Are Placed against It

*Western Lying. 1950
Spring, Los Angeles Calif*

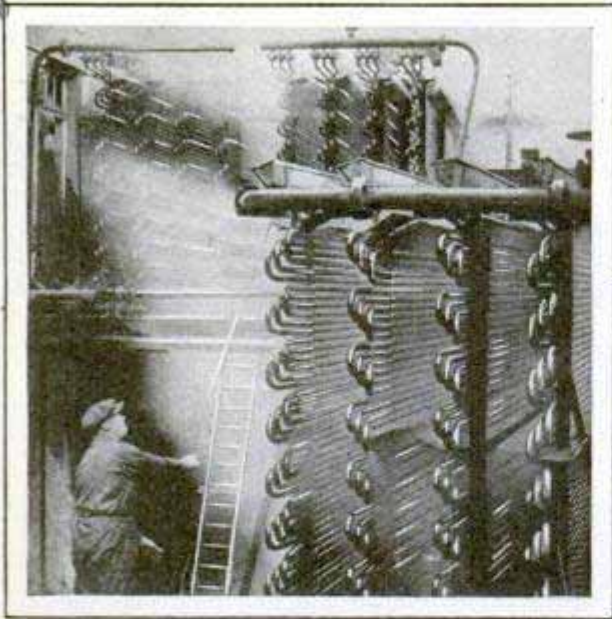

Skating Is Enjoyed throughout the Year in Vienna on This Outdoor Artificial-Ice Rink, Accommodating 8,000 Persons; Above, the Machinery Which Provides the Necessary Ice

ARTIFICIAL ICE-SKATING RINK ACCOMMODATES THOUSANDS

Vienna boasts one of the largest artificial outdoor ice-skating rinks in the world. The sport is enjoyed there throughout the year, the rink accommodating 8,000 persons. The huge machinery which makes the ice is almost as much of a wonder as the rink itself and has served as a model for other similar enterprises.

SEEDING LAND WITH AIRPLANE IS ECONOMICAL METHOD

Sowing grass seed from an airplane has been found to be the most economical method of converting logged-off lands of western Oregon into pastures. The northwest contains 3,000,000 acres of such lands, but heretofore seeding has been too ex-

six months. Furthermore, the hand method uses about eight pounds of seed to the acre, while, with the plane, only four pounds were required. The equipment is simple, consisting of a frame filling the forward cockpit of the plane, with a downspout flared out toward the tail, and a venturi opening which directs the slip stream of the propeller into the seed stream, thus spreading the seed. It makes a spread of 200 feet at an altitude of 500 feet and the seed falls directly, even in a heavy wind, with no gaps or overlapping. An ordinary three-place plane can carry seed to cover 100 acres, which requires about fifteen minutes.

To supply America with lily blooms for Easter, Japan growers shipped to this country during the past winter 50,000 cases of bulbs.

*89
Cmk J. W. Fickle
5021-12th St. N.E.*

Used by Mr. C. Carl Lous

*112 1/2 d 64 d
Grant Partridge*

PAY-AS-YOU-ENTER FOOD SHOP HAS AUTOMATIC SERVICE 275

Pay-as-you-enter restaurants in which the patron pays a flat charge and eats as much as he wants from a variety of food passing the counter on an endless conveyor, recently have been opened. Conveyors extending from kitchen to dining room carry trays of food to the customers, the entire menu passing each customer within easy reach every two minutes. A separate conveyor, concealed beneath the counter, carries out soiled dishes. The conveyors operate electrically and on the bottoms of some of the trays are electric-heating elements to keep food warm, while others are cased so they can be refrigerated, glass covers being provided for all the food. The system not only gives instant service, but eliminates considerable labor and consequent cost.

LIGHTWEIGHT SPONGE RUBBER HAS VARIETY OF USES 206

Representing nearly twenty years of research, a lightweight sponge rubber recently has been made that weighs about one-half as much as the old-style rubber sponge and is expected to have a wide variety of uses. The material has been named "belozel," and, while it does not look different from the other variety, the cell formation is such that all the openings are connected and the filaments between them are thinner. Possible uses of the material include rubber cushions for boats and office chairs and rubber mattresses for railroad sleepers, steamships and hospitals. The old sponge material was too heavy and lacked the necessary liveliness for such purposes. Cushions and mattresses on boats can be increased in water-tight covers and used as life-savers if provided with handles. The material also may find a use in the upholstering of automobile seats. It is an effective insulator against both sound and moderate heat, and therefore may be of value in constructing airplane cabins.



ions and mattresses on boats can be increased in water-tight covers and used as life-savers if provided with handles. The material also may find a use in the upholstering of automobile seats. It is an effective insulator against both sound and moderate heat, and therefore may be of value in constructing airplane cabins.

*I. W. Eplean & Willis
Akron, Ohio*

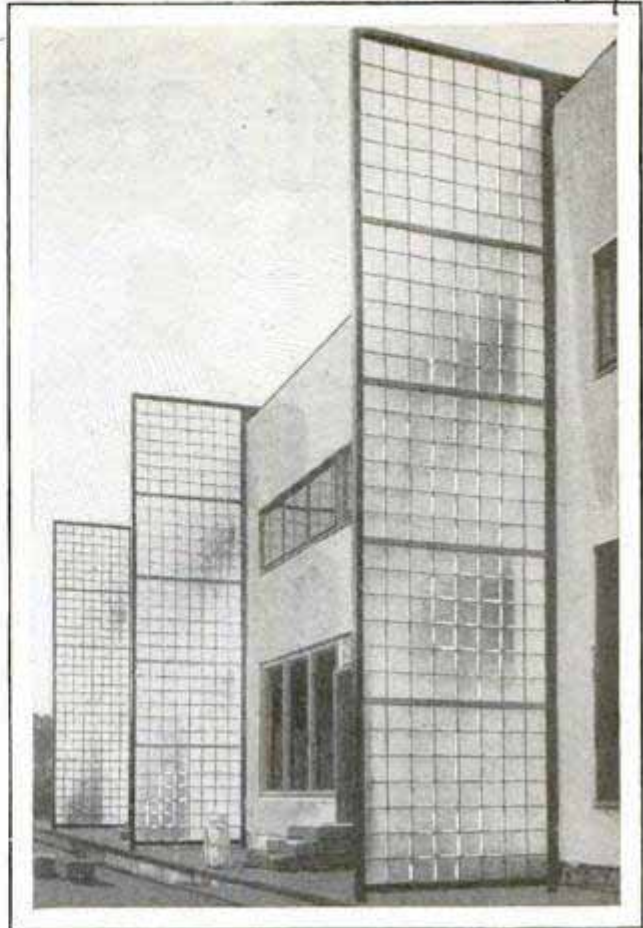

Row of Steel Houses in Germany with Glazed Partitions between Them for Privacy

GLASS WALLS OFFER PRIVACY TO STEEL HOMES

Modern steel houses are being constructed near Berlin, reflecting the modernistic trend of architecture in Germany, but at the same time highly utilitarian because rentals for such structures are moderate. The houses are built in rows and between them are walls of frosted glass to afford greater privacy for occupants.

RUBBER AUTOMOBILE SHACKLES ELIMINATE RATTLING 161

Rubber shackles for the automobile now are on the market, the rubber lining fitting wherever a metal part comes in contact with the shackle. The rubber eliminates the rattling common to the metal kind of shackles and, in addition, does not require any oiling.

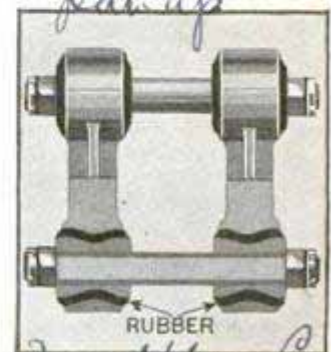

Chicago 2037 S. Wabash

*Powell Muffler Co
Utica, N.Y.*

38 49

Easier Ways



Sandwich Board with Well for Chopping Ingredients Reduces Waste and Saves Time

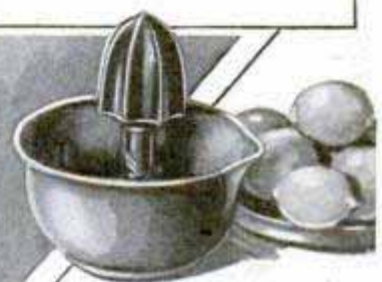

Juice Extractor Rotates at Pressure and Has Bowl to Receive the Liquid



Tray and Table in One; the Legs Drop Down from Underneath and the Top Lifts Off

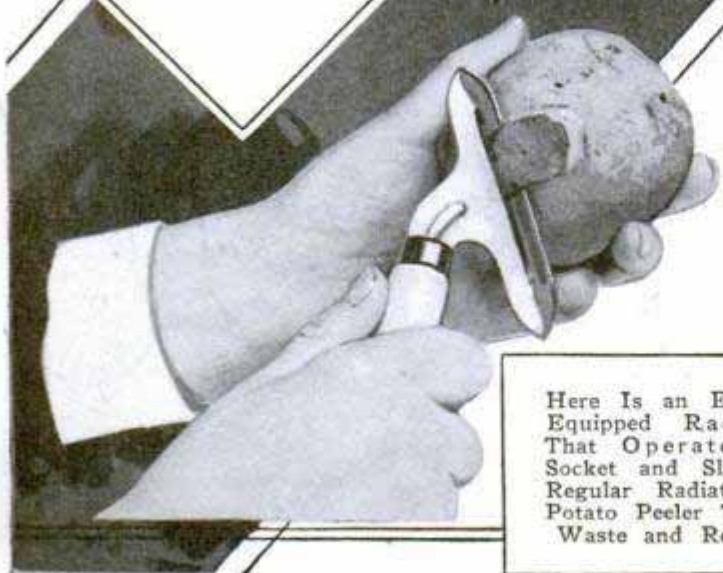

Here Is an Electrically Equipped Radio Cabinet That Operates from the Socket and Slips over the Regular Radiator; Left, a Potato Peeler That Reduces Waste and Removes Eyes



of Doing It

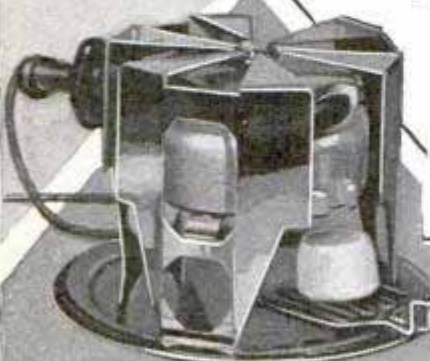

Electric Tea Kettle, at Right, Operates from Light Socket and Is Said to Heat More Rapidly Than a Gas or Ordinary Electric Stove; It Holds Five Pints

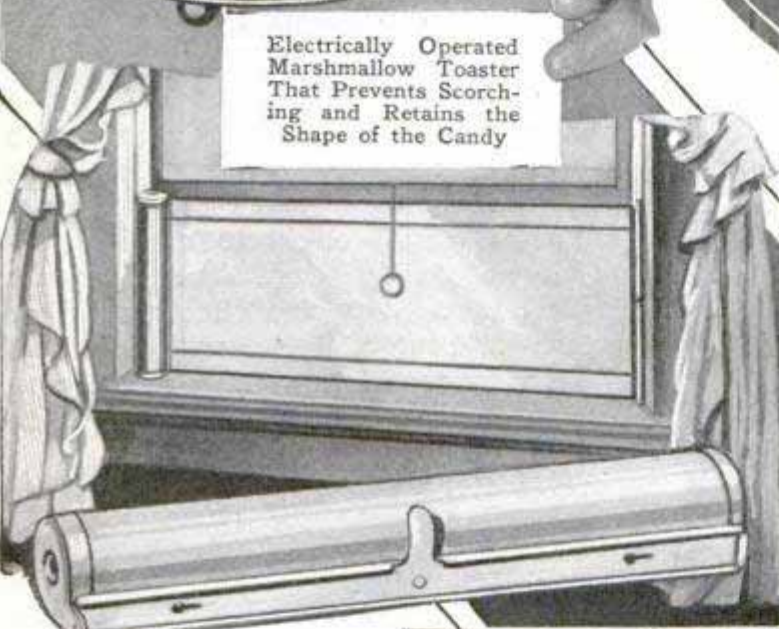

Electrically Operated Marshmallow Toaster That Prevents Scorching and Retains the Shape of the Candy



Above, Ventilator That Rolls Up like a Window Shade and Is Installed at Side, Out of Sight When Not in Use; Below, Improved Dirt Bag for Vacuum Cleaner, More Easily Emptied, or It May Be Burned if You Like



This Reversible Mop Head Fits on Spring Frame like a Glove; Reaches Places Difficult of Access

Sydney Pump & Well Co

816 1310 E. TRAPULAR MECHANICS

Richmond, Va.

200
225. ~~pad~~ ap. for

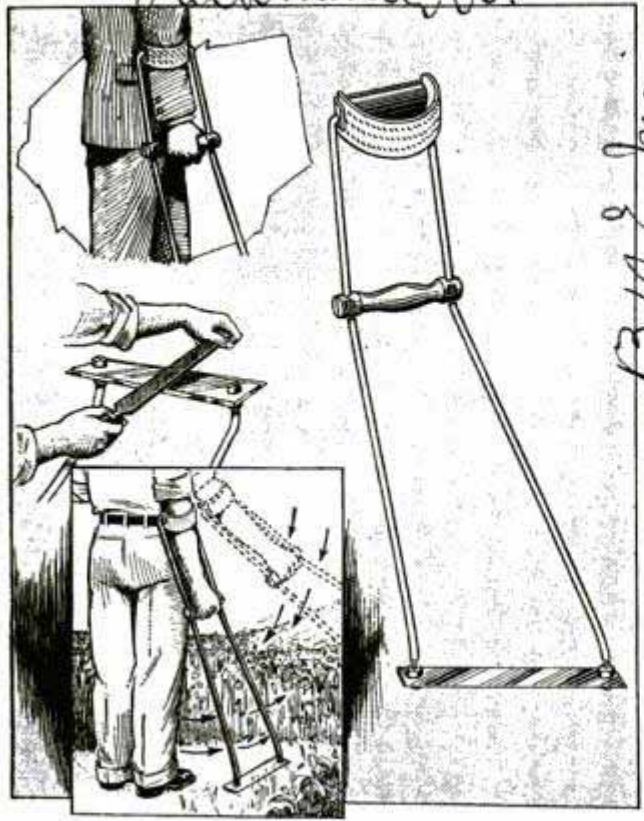

1310 E. Trapular
4069

Long-Handled Weed Cutter with Double-Edged Blade, Which Can Be Operated with One Hand

LONG-HANDLED WEED CUTTER OPERATED WITH ONE HAND

Operated with one hand without stooping, a long-handled weed cutter with a double-edged blade now is on the market. The tool consists of a blade attached to a metal frame which terminates in a reversible arm cuff for right or left arm. Part way down the frame is an adjustable hand grip. The blade itself is detachable and fitted with wooden shoes for transportation. It is light in weight and swings from the shoulder with an ordinary arm motion.

HEAT RADIATED FROM WALLS BY PANEL WARMING

226

Applying a principle used by the Romans 2,000 years ago, many English homes today are being warmed by heat radiated from walls and ceiling. The method, known as panel warming, involves the installation of hot water or electrical units high on the walls or in the ceiling, invisible beneath the plaster. The walls thus are warmed and a room is kept comfortable at a temperature as low as sixty degrees. The panels, which are only slightly warmer than the atmosphere in the room, do not set up drafts as the more

Sold by L. J. Fowler, of Inds., at International Heating and

concentrated and hotter units do, and so do not take heat from the body. The upper air also is kept at about the same temperature as that near the floor. Its continuous use is considered reasonable, but intermittent operation is expensive because of the time required to heat the walls.

MICROSCOPIC WOOD STRUCTURE PROVIDES DRESS DESIGNS

Designers of wallpapers and dress materials are turning to woods to provide unique effects. The department of technology of the New York State College of Forestry, at Syracuse University, recently completed a microscopic examination of the cellular construction of different varieties of tree trunks to facilitate identification of commercial timbers. To the wood technologists, these microscopic photographs are the fingerprints of trees, but to textile experts and wallpaper manufacturers they brought to mind gracefully intricate shapes for silks or the walls of the home. Waterfall effects, rainbow patterns and interesting variations of pin stripes were revealed in many of the coniferous trees and these designs were found to be particularly adaptable to sports materials that are following the modernistic trend. So the dress and

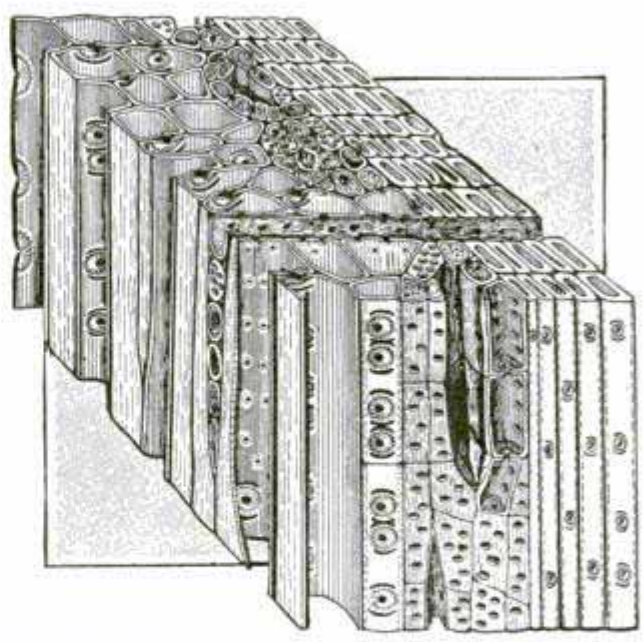

Magnified Photograph of Wood Structure Used as Model by Designer of Dress Materials

wallpaper makers have copied the wood-structure patterns in their fabrics.

Is Our Climate Changing?

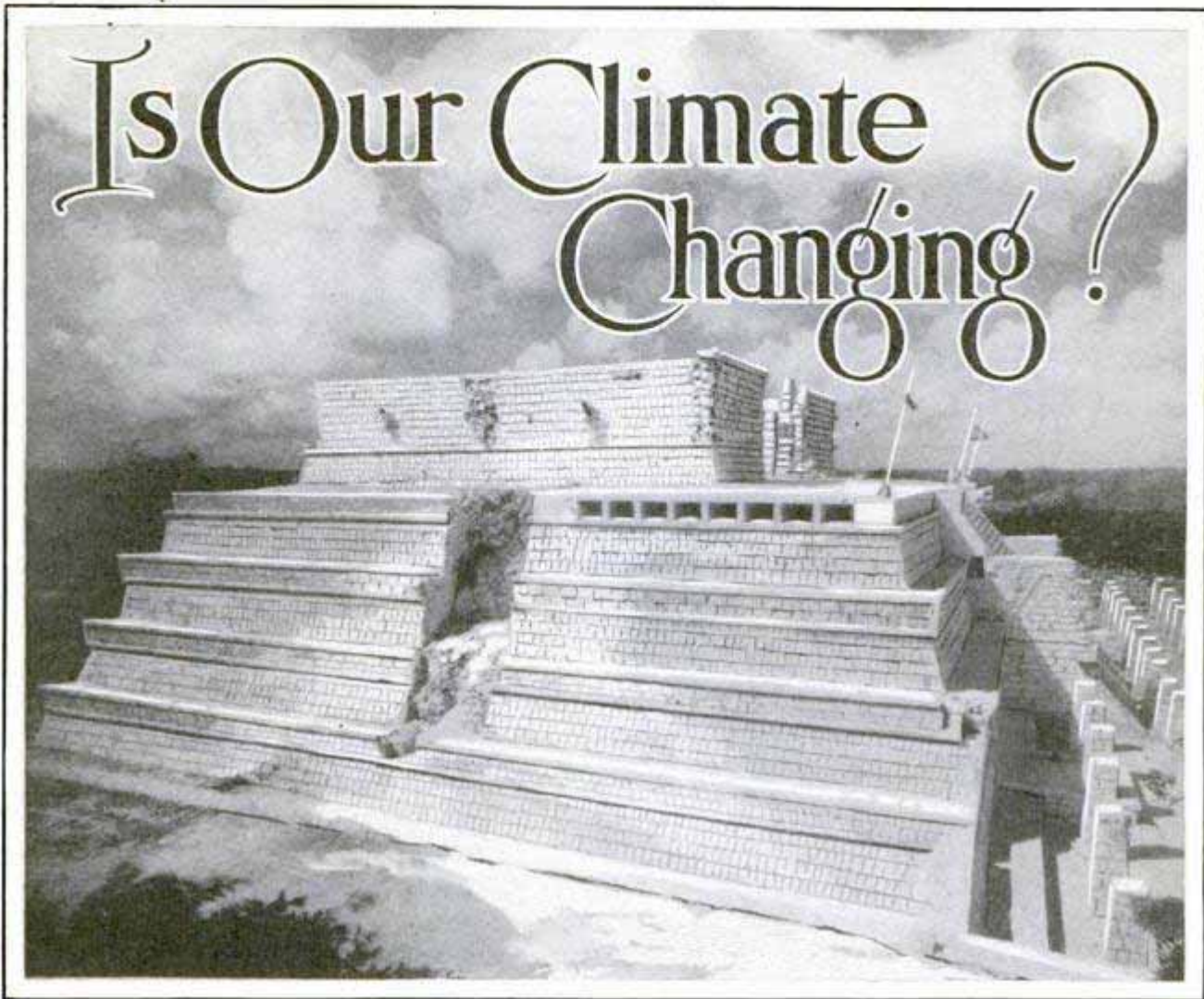

Courtesy The Carnegie Institution

Temple of the Warriors at Chichen-Itza, Yucatan, Excavated and Restored by the Carnegie Institution; It Is Evidence of a Civilization That May Have Perished Because the Climate Became Too Humid

By CHARLES FITZHUGH TALMAN

*of The Pictogram
Co. 2840 Washington
D.C.*

THE OBSERVING and recording of weather has been described as "the biggest scientific job." It is performed at the present time by an army of more than 35,000 men and women, who take observations once, twice or oftener every day. In recent times, individual observations have amounted to upward of 10,000,000 a year, and the total number taken since weather observing began runs far up into the hundreds of millions. The results of these millions of observations are used in a form of long-distance forecasting.

For example, the weather bureau publishes charts showing the average dates of the last "killing" frost in spring and the first in autumn in all parts of the United States. These charts are not based on theoretical considerations but are merely a record of what has happened in past years. They are interesting as historical docu-

ments, but the great cost of compiling and publishing them certainly would not be justified if they did not enable farmers and fruit growers to know approximately when, in any locality, frosts are due in years to come.

The bureau receives quantities of letters from merchants and manufacturers inquiring when, in certain foreign countries, certain kinds of weather are likely to prevail. The exporter of electric fans wants to know when periods of great heat may be expected in different parts of the world. The exporter of umbrellas needs similar information about rainy seasons. The inquirer does not say to the bureau, "please give me a forecast of the weather in such and such a country for the coming year," but he asks for a record of the climate, which amounts to the same thing.

When, toward the close of the last cen-



Two Views from Alaska; Above, Valdez in Winter; Below, Oats Grown near Fairbanks, Where Summer Temperatures Require Straw Hats

ture, Germany acquired territorial possessions in Africa, one of the first steps taken by the colonial authorities was to establish hundreds of stations for observing the weather in these almost unexplored regions. Thus, within a few years, it became possible to publish extensive climatic tables, charts and descriptions for each colony, and these were used to good advantage in planning agricultural and other economic developments.

An epoch-making achievement of Maury, the American hydrographer, was the preparation of charts showing the average winds and currents in all parts of the ocean, as determined from an examination of the records contained in

many thousands of log-books covering long periods of years. These were immediately turned to account by mariners as a means of shortening the time of sailing voyages, and it is said that British shipping alone profited to the extent of \$10,000,000 a year by their use.

Of course long-range weather forecasts based on climatic statistics are less definite and generally less accurate than the predictions for tomorrow that are made from a daily weather map, and they are much less satisfactory for some parts of the world than for others. We can predict with entire confidence from the climatic record that very little rain will fall in California next July, and that there will be no violent cyclones in the West Indies next February. We cannot tell even approximately how low the temperature will fall next winter in London, but we can safely assert that it will not reach zero. Our climatic forecasts have their limitations,

but they are exceedingly valuable as far as they go.

And now we come to a curious contradiction. All these uses of climatic records as a guide to the future imply a general belief on the part of humanity that climates are stable. Indeed, the very conception of climate as distinguished from weather is that it is a thing that remains constant while weather is always changing. And yet there is hardly any part of the world where you do not hear many people assert that they themselves have observed a change in the climate.

No census has ever been taken of the number of persons in the United States, of or beyond middle age, who sincerely

believe that the winters of their youthful days were colder and snowier than those of today, but there must be at least a hundred who cherish this belief to one who does not. Indeed, the notion has prevailed for generations. Back in the eighteenth century Thomas Jefferson, in his "Notes on Virginia," declared that the winters in that state were much less severe than they had previously been, and Samuel Williams wrote in a similar vein about the climate of Vermont, where, he says, "snows are neither so frequent, deep or of so long continuance as they were formerly."

Other supposed changes of climate are frequently heard of in this country. I recently had a letter from a man in Chicago beginning with the words, "It is a well-known fact that there has been a marked decrease in the rainfall of the plains states west of the Mississippi"; and he asked

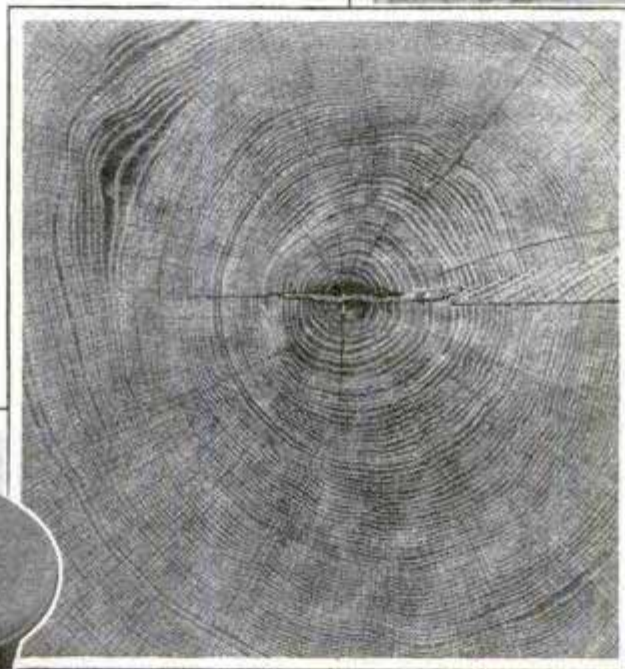
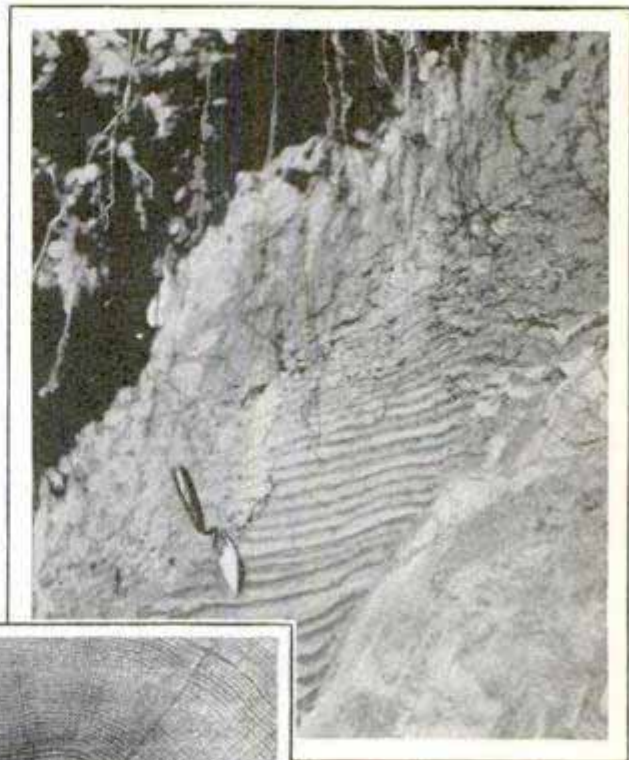

Courtesy Geological Survey of Canada

for an explanation. I gave him one; not of the climatic change, which has not occurred, but of the widespread belief that it has. This particular idea, very prevalent in the middle west, harks back to the nineties of the last century, when a

few abnormally wet years on the plains led to a spectacular land "boom" in western Kansas and Nebraska. When normal climatic conditions returned, the boom collapsed and thousands of settlers were ruined.

The belief that appreciable changes of climate occur within the compass of human memory is at least ninety-nine per cent illusion, explained chiefly by the fact that exceptional weather makes a more lasting impression on people's minds than does ordinary weather, so that after a lapse of years the exceptional seems to have been the usual. The other one per cent of the

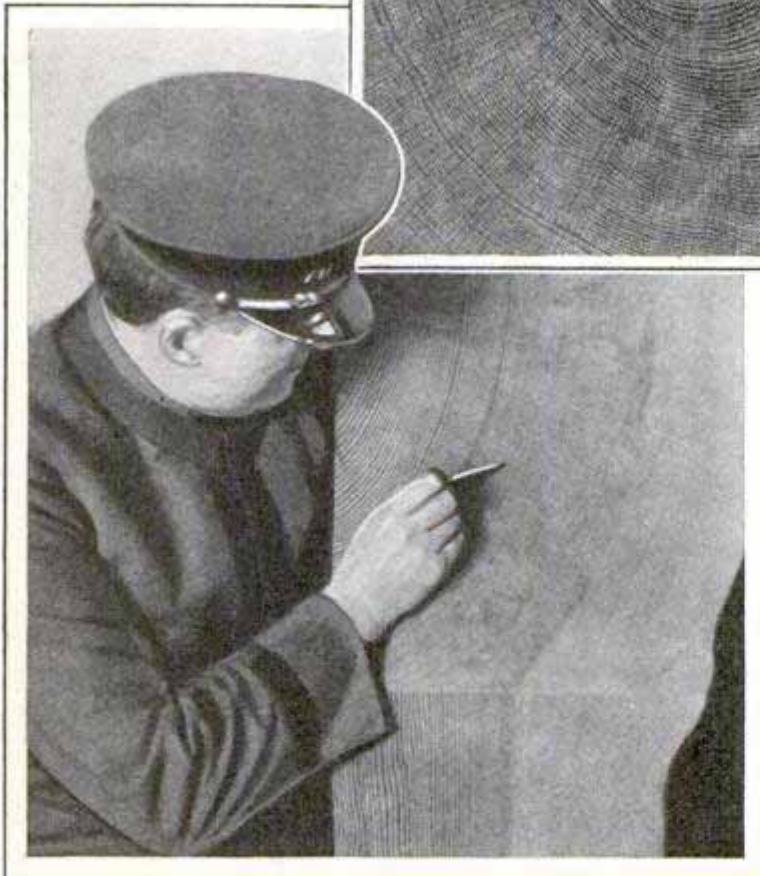

Courtesy Field Museum of Natural History

Markings in Clay Bank That Tell Weather Conditions Ages Ago, and Two Tree-Ring Records Indicating Past Climatic Factors

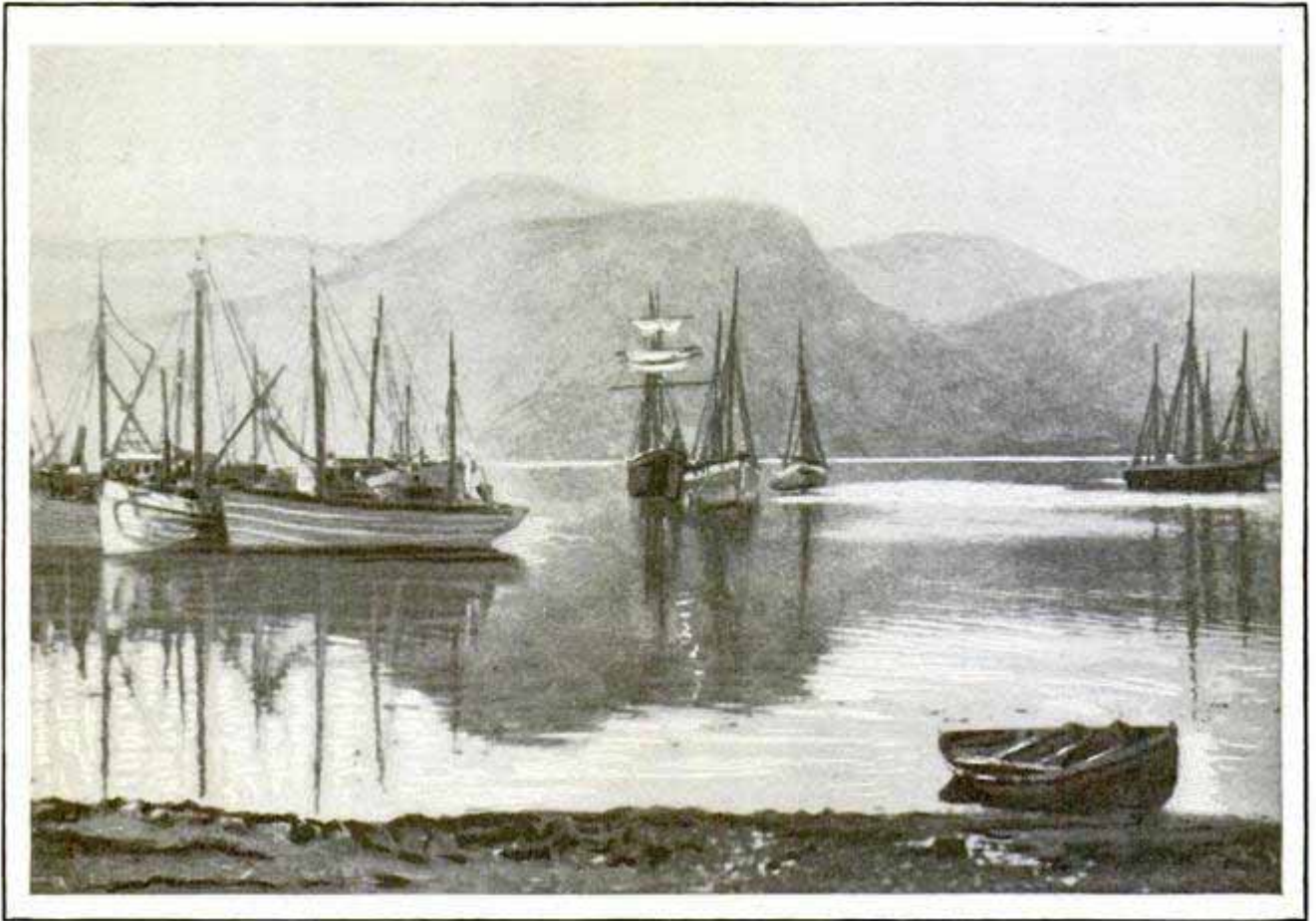

In the Harbor at Reykjavik, Iceland; Water Here Freezes Over Hardly Once in Fifty Years Although the Harbor Is in Approximately the Same Latitude as Hudson Strait

idea may be based on facts, more or less.

Climates do, of course, change radically in the course of long periods of time. The coal seams found by Byrd's geologists in the antarctic are the remains of luxuriant vegetation that flourished in that now frigid region when it had a relatively mild climate. The earth has passed through at least four great ice ages, and we are probably now living in the declining stage of the latest one. The climatic changes implied in such events are, however, exceedingly slow, requiring millions of years for their accomplishment, and have nothing to do with the abrupt changes that so many people claim to have observed within their own lifetimes.

On the other hand, many believe that the weather shows a tendency to run through certain cycles—to be persistently somewhat colder or warmer, drier or wetter than the average during comparatively brief intervals of time—and that some of these cycles may be sufficiently pronounced to attract the attention of the layman and to help foster the popular belief in more extensive changes of climate. These cycles, if they exist, are masked to

a great extent by local and irregular weather changes and must be sought by methods of mathematical analysis. The fascinating task of searching for them has been carried on with so much zeal that more than a hundred different cycles, ranging in their periods from a few years to a few centuries, have been announced by different investigators, but not one of these has been positively proved to exist.

Then again, a great deal of evidence has been brought forward of much more persistent changes, chiefly in rainfall—perhaps long-period cycles—supposed to have occurred in certain parts of the world, where they are said to have helped shape the course of human history, causing civilizations to rise and fall, leading races to migrate from one region to another, and so on. Many books and hundreds of articles have been written to state the evidence pro and con bearing on these alleged climatic changes and their effects. A typical case is that of the Mayas of Central America, whose wonderful civilization may or may not have succumbed to an increase in the dampness of the climate, which broke down the physique of

the people and permitted the jungle to swallow up their works.

Evidence of weather fluctuations is sought from several sources besides the modern records. Some of the most interesting evidence is found in the annual rings of old trees, such as the sequoias of California, some of which give a record extending over 3,000 years. The thickness of the rings is supposed to be governed by the weather conditions, especially the rainfall, of the years in which they were formed. The same method of investigation has been applied to fossil trees that grew hundreds of thousands of years ago. A fossil spruce recently found in British Columbia is said to show sequences of thick and thin rings corresponding to the eleven-year sunspot period.

The most stubborn of all fallacies about climate is the notion that temperature depends almost entirely on latitude—with the hottest weather at the equator and the coldest weather at the poles. This idea is false even in regard to average temperatures for the year, and it is conspicuously false in regard to the extreme temperatures of summer and winter. In the interior of Alaska, the temperature goes well above ninety degrees every summer, and Fort Yukon, just north of the arctic circle, has registered 100 degrees. The highest summer temperatures recorded anywhere on earth occur in deserts of the so-called temperate zone of the northern hemisphere, and the lowest winter temperatures near or just beyond the polar border of that zone in Siberia.

CAST-OFF MOTORBUS SERVES AS A LUNCHROOM *2/10*

At least one use for old motorbuses has been found by a London coffee-stall proprietor who has transformed an abandoned double-deck motor coach into a two-story restaurant. The upper deck serves as a lunchroom and the lower as the kitchen and counter.

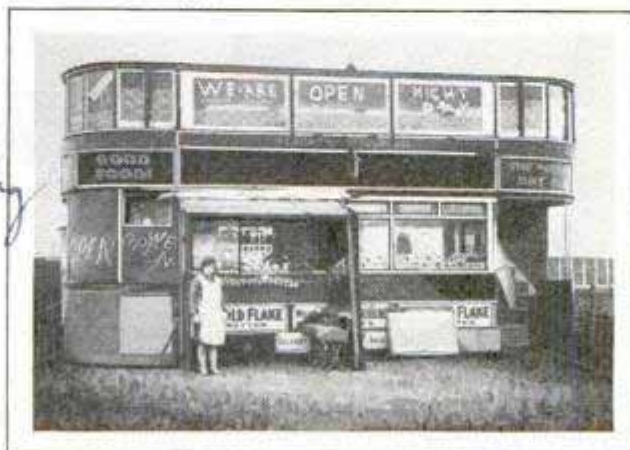

Bus Converted into a Restaurant and Coffee Stand



© U. & U. Detector Which Warns Pilots by a Red Light When Ice Is About to Form on Plane Wings

ICE DETECTOR FOR AIRPLANES FLASHES RED SIGNAL

Airplane pilots are warned when ice is about to form on their ships by an ice detector invented by an employe of the bureau of standards. When the temperature reaches the freezing point, the contacts in a weatherproof case, mounted on a strut, close automatically, lighting a red bulb on the instrument panel.

WIND PENETRATES BRICK WALL *26*

A thirteen-inch brick wall in the face of a thirty-mile gale will allow 14.75 cubic feet of air to pass through it every hour, according to a report to the International Heating and Ventilating exposition. Proper plastering was found to stop ninety-six per cent of the leakage, and less air

will pass through a wall properly constructed with all spaces between the bricks filled with mortar. Houses are hard to heat in windy weather, not only because cold air is blown through the cracks, but also because the heat leaves building material faster when a wind blows.

Dr. T. Larson to W. Nelson and Birnata at Univ.

David Minnesota
Elgren & Blochshaw
Fi. O. B. Rayley, D. B.

Builder, Wed. 1929

14 /

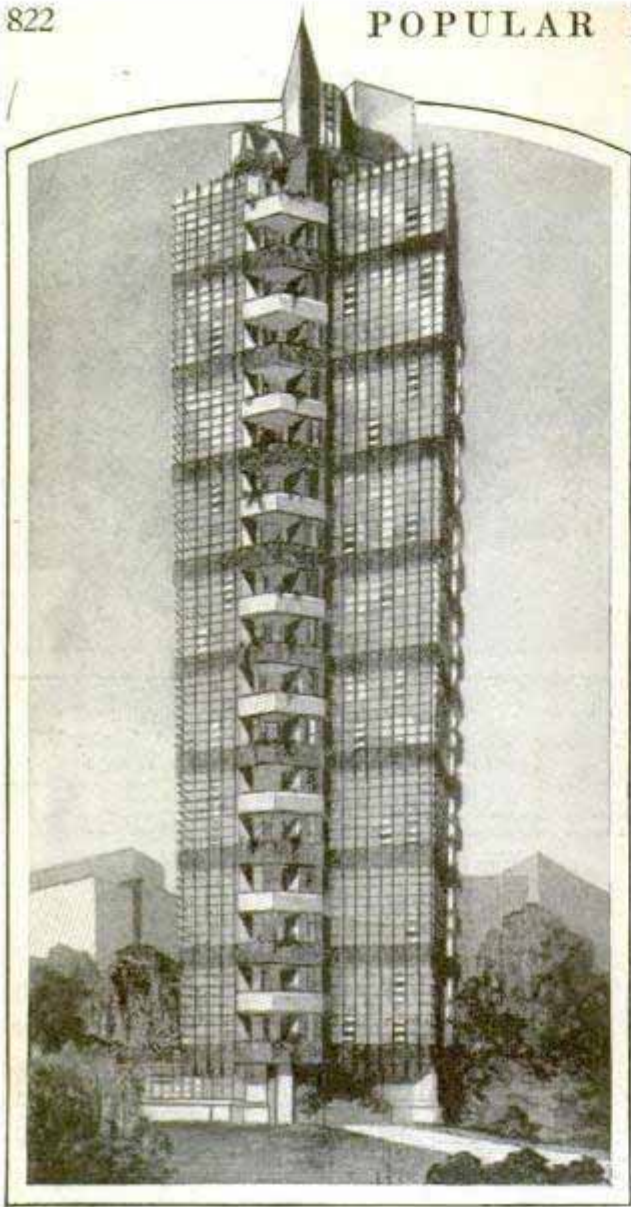

Courtesy Architectural Record

Architect's Drawing of Eighteen-Story Glass Apartment Building Planned for New York

EIGHTEEN-STORY GLASS HOUSE WITH CONCRETE FRAME

Drawings have been made of a proposed eighteen-story glass apartment building which Frank Lloyd Wright, internationally known architect, plans to erect in New York. The walls will be of clear, heavy plate glass with concrete floors and balconies or parapets of copper, and a two-story penthouse on the roof. It will contain no structural steel.

PULVERIZED COAL IS BURNED IN MOTOR CYLINDERS

221 At the end of the last century, Doctor Diesel, inventor of the engine bearing his name, conceived the idea of burning coal directly in the cylinder of an engine to furnish power. Finding this impossible with the equipment for pulverizing coal

then available, he dropped the idea and turned to the oil engine. In 1916, however, another inventor converted an eighty-horsepower Diesel engine to burn pulverized coal, and this engine has run for 8,000 working hours with very little wear on the cylinder walls. The greatest difficulty was to prevent dust and ashes from getting between the piston rings, and the carbonization of the rings. This was solved by supplying the space between the rings with compressed air at a pressure sufficient to prevent the entrance of dust and ashes. This air also increases the supply of oxygen to the coal.

WHY USED NEEDLES DAMAGE 216 PHONOGRAPH RECORDS

Reasons why worn or unsuitable needles damage phonograph records were shown recently at the exhibition of the Physical Society in London, where models of needle points magnified 400 times were displayed. Enlarged models of record grooves also were shown and used to study the behavior of different types of needles at various stages of wear. A new needle, under the microscope, was shown to have a blunt, bullet-nosed point. After commencing a record, the rounded point was somewhat worn off, leaving sharp edges which increased by the time a record was finished, and when a needle was used repeatedly, ridges formed on its sides which cut into the walls of the grooves in the record much after the manner of a sharp knife. Experiments showed that use of the right needle is almost as important as to avoid using worn needles.

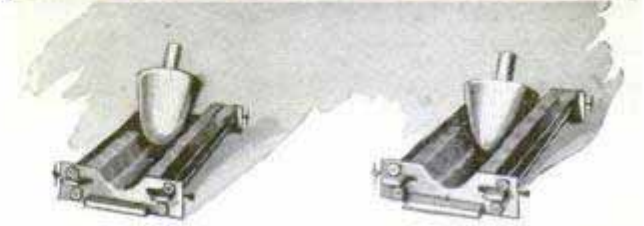
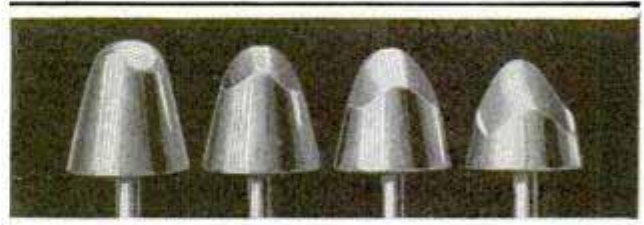

Courtesy The Sphere
Enlarged Point of Phonograph Needle at Various Stages of Wear and Model of Record Groove

11/18/30

Abstract. U.S. Naval Institute Proceedings

192

Used by Arizona Bellmore

MOTOR HOTEL BRINGS LUXURY TO ADVENTURERS

Storage machines rebuilt with chassis extended about one foot

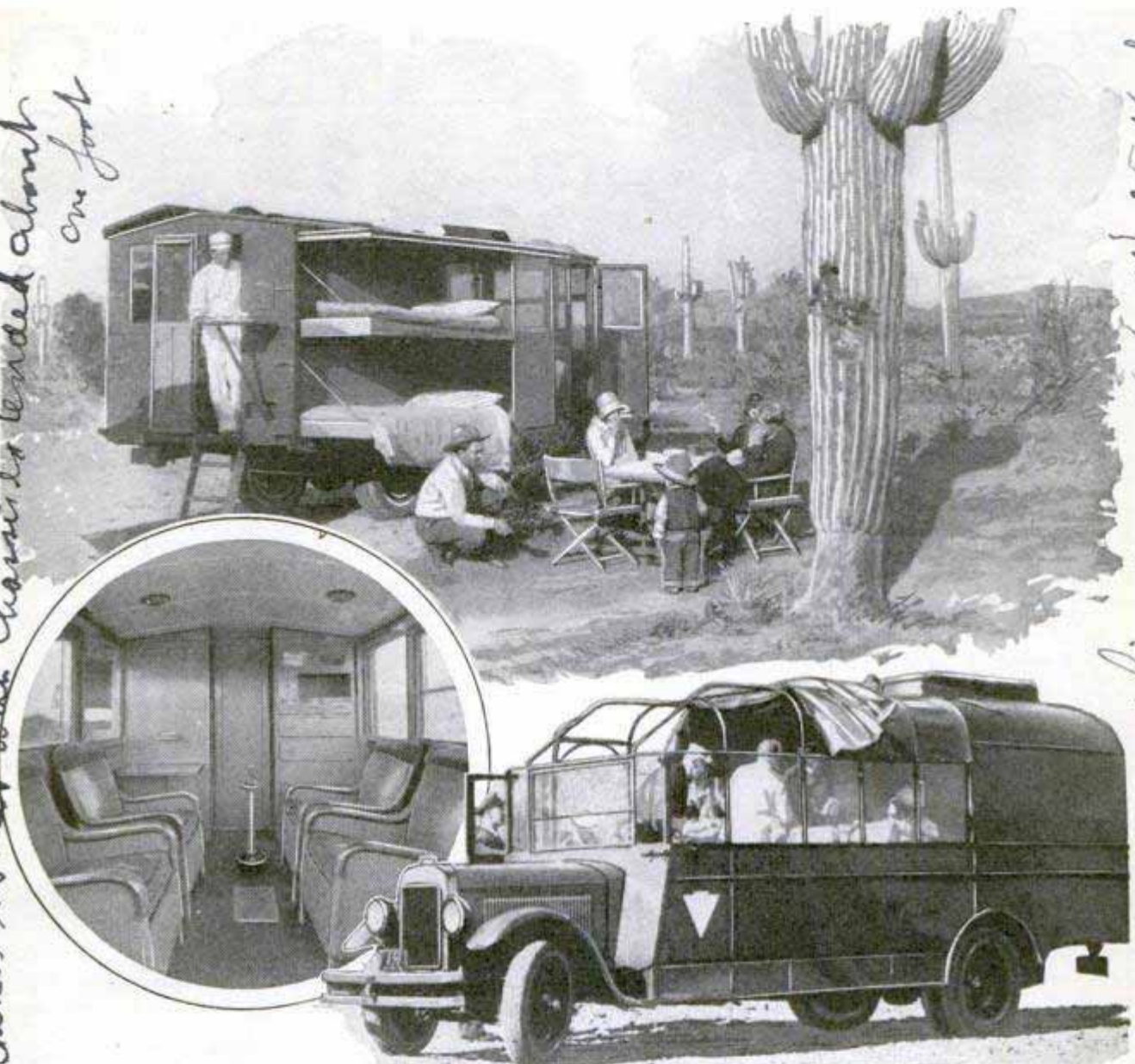

Cand. C. M. Lignuday, 1616 W. 25th St. Los Angeles, Calif.

Traveling Hotel for Roughing It in Luxury; the Bus Contains a Living Room Shown Above, Combination Sleeper and Diner, Bathroom with Shower, Kitchen, Ice Plant, Radio and Electric Lights

Lewis and Clark, no doubt, accepted the discomforts of exploring the west as unavoidable, but now the adventure seeker may take his hotel with him. An Arizona hotel has worked out a plan whereby the guest can rough it in a deluxe manner. There are two eight-passenger "wonderbusses" and one four-passenger "wonderbus," not to mention a trailer traveling under its own power. The four-passenger bus is a combination Pullman sleeper and diner, including a spacious living room, driver's compartment and four comfortable beds. There are electric lights and fan, ventilators, radio, writing desk and copper-screened windows. The electric power plant is under

the floor. Then there is a bathroom, with shower and running hot and cold water. Behind the living room is a fully equipped kitchen, with stove, sink, tables that fold into the walls, cupboards and large automatic ice plant, making it possible to carry plenty of fresh meats, vegetables, cream, eggs and fruit. Four commodious berths fold into the outside of the car. The companion supply car, or trailer, has an equipment of dining and sleeping tents that may be taken when large parties are under way. Tours are arranged for any length of time, and a cook is sent out from the hotel, as well as a bellboy in uniform to perform errands, wait on table and make up beds at night.

Work done by McArthur Bros agents
1928
Paul G. Huseman

Correction of diagram in
 Dec. 1930 October 1930
 P. 651

It's Easy to

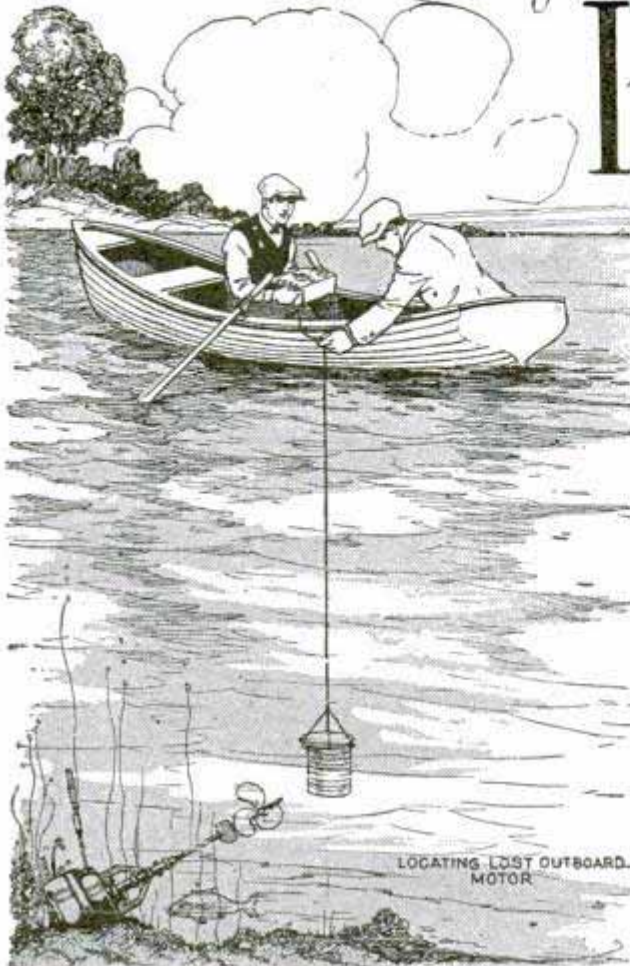

an outboard motor lost during a fishing trip on Orange lake in Florida, but it is applicable to many other uses.

One of the members of the party straightened up quickly and in doing so caught his rod in the handle of the motor, lifting it off and dropping it into the lake. The incident occurred near the middle of the lake so that it was difficult to mark the exact spot at which the motor went down.

Although the lake was only about 10 ft. deep in this vicinity, locating the motor proved to be a difficult job because of the dense growth of vegetation at the bottom of the lake. After probing, dragging and even the use of an underwater periscope failed to locate the lost motor, the radio exploring device was used, and the motor was located after about two hours of

prospecting. This particular device is, of course, most sensitive to iron, for which it was designed, but many interesting applications are possible. For other metals, a more sensitive device is necessary to give the same instrument deflection, but the presence of these metals within the range of the device will register, although the effect will depend somewhat on the mass of the hidden metal. There are several highly sensitive radio circuits that may be employed to increase the range and sensitivity of

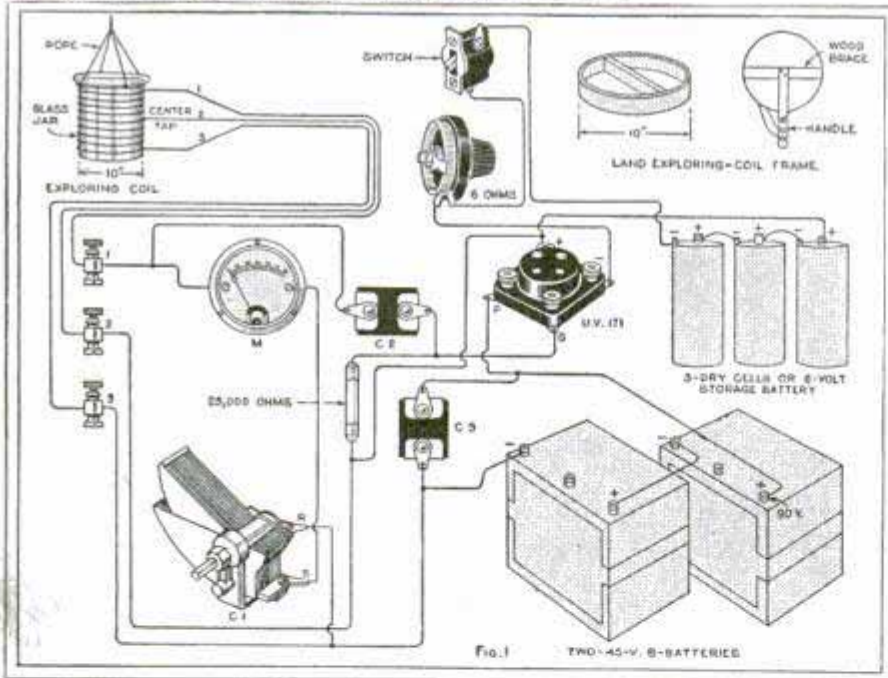

TREASURE hunting has lost very little of its appeal even in this matter-of-fact age, and modern methods employed to solve simple everyday problems often suggest possible ways and means of locating buried and submerged metals. The radio exploring device described in this article, for example, is a simple instrument designed for the purpose of locating

this device, but the simple circuit shown has a number of interesting possibilities which are illustrated in the various sketches—locating pipes hidden in walls quickly, without the usual tapping and guessing; locating ore, battlefield relics and possibly that old iron kettle in which grandfather buried his valuables during the Civil war and passed on without leaving in-

Parts - Newark Electric Co.
 226 W. Madison
 Chicago

Locate Hidden Metals

formation for its recovery to his lawful heirs.

The electrical circuit is an adaptation of a radio-frequency oscillator in which the main inductance is replaced by an "exploring coil." When the filament of the tube is lighted, the circuit oscillates and there is a radio-frequency field about the coil. If a piece of iron or other metal comes within this field, the electrical losses in the metal will reduce the current through the condenser C1 (Figs. 1 and 2) and a decrease in the reading of meter M will result.

The marine exploring coil is made by winding nine turns of No. 18 wire, with a tap at the fifth turn, around a glass jar or carboy, 10 in. in diameter. The wire must,

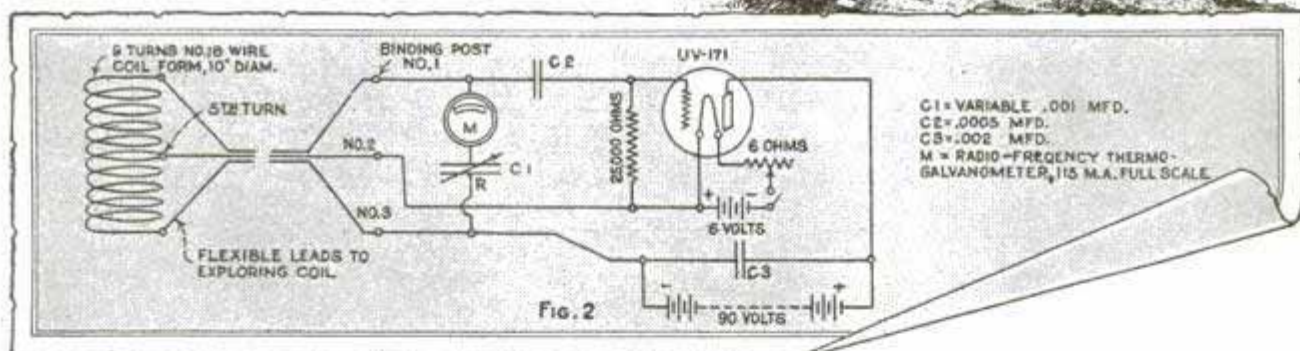
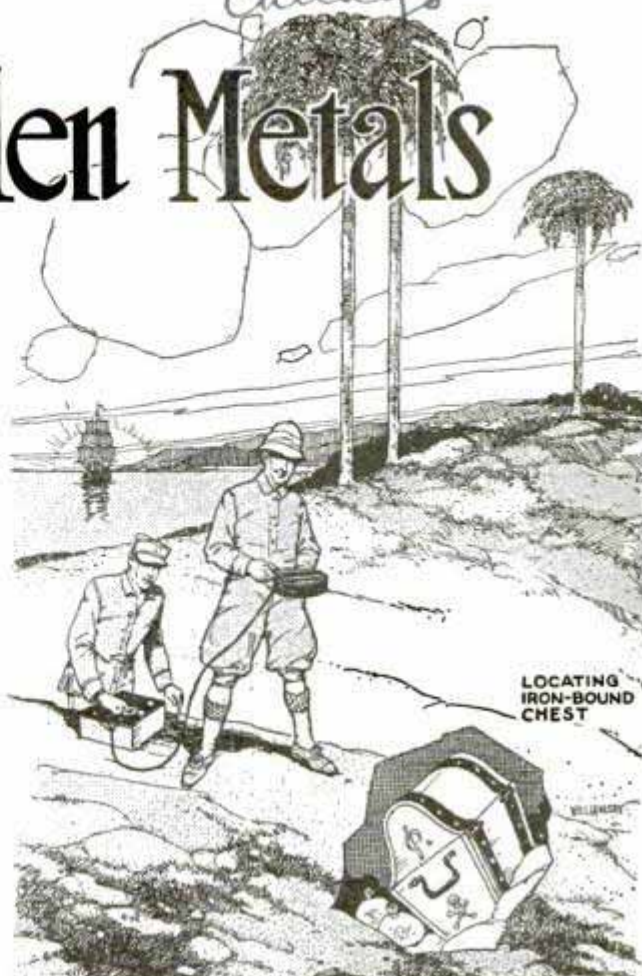

of course, be covered with waterproof insulation and all joints carefully insulated and waterproofed. The three connecting wires are of a flexible rubber-covered seven-strand type, of equal diameter, and should all be in one cable, if possible. If the wires are simply twisted together, the meter reading may change slightly when the coil is lowered into the water. This slight change, however, will not affect the sensitivity of the device.

The middle tap of the coil is connected to binding post No. 2, Fig. 1, and the other coil leads to posts Nos. 1 and 3. The constants of the circuit are given in the schematic diagram, and none of these are very critical. Fig. 1 shows the simplified layout and wiring together with the details of the marine exploring coil and wooden

frame for the land coil. Schematic diagram Fig. 2 is given for those who prefer it to the simplified type. The completed instrument is shown in Fig. 3, together with the dimensions for the case, which is large enough to contain the necessary dry batteries, if small types are employed.

To test the completed instrument, with all currents on, adjust the variable condenser C1 until the meter reading is about two-thirds full scale, then, when a piece of iron a few cubic inches in size is brought within about 4 ft. of the coil, a pronounced dip in the reading of the meter will be observed. A large piece of iron, big enough to cover the face of the coil, will reduce the current in the meter to zero as the iron is brought up to the coil along its axis. Other metals will pro-

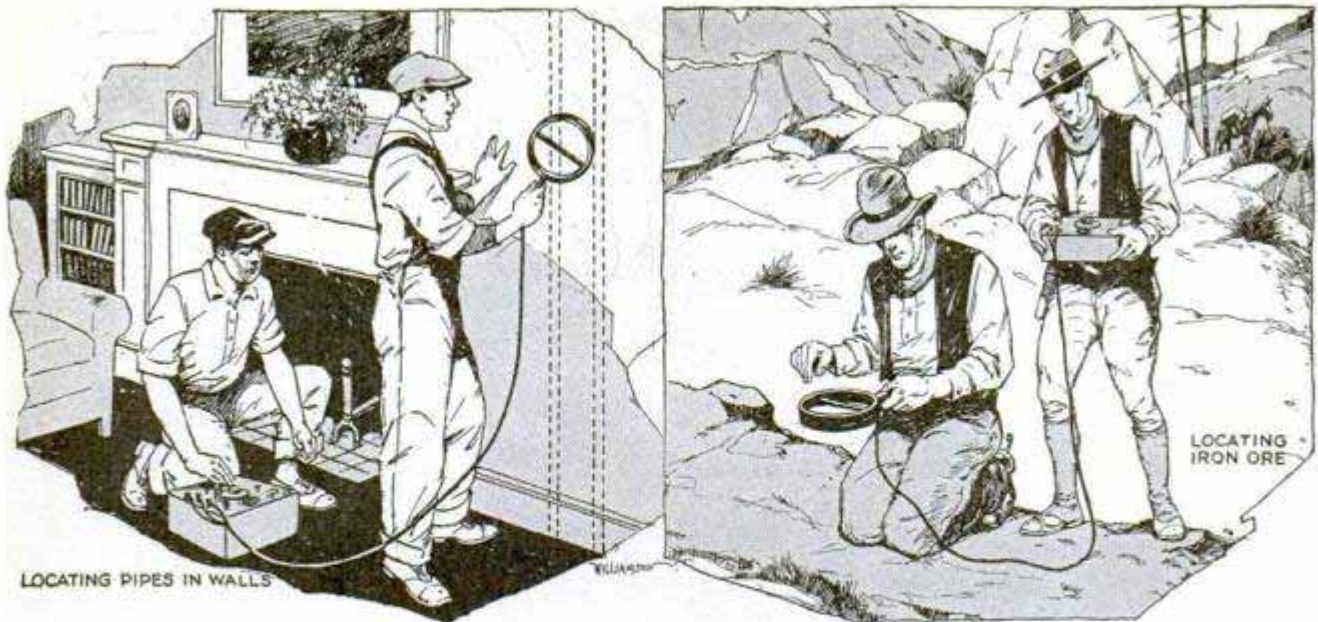

duce effects according to their size and character.

To use the outfit for locating sunken objects, the coil is suspended by a cord with its axis vertical, and, with the adjustment of the condenser made as above, the coil is carried over the suspected area, raised just high enough so that it does not drag on the bottom. When a dip is noticed in the meter reading, the immediate area is thoroughly explored until the meter will give a minimum or zero reading. At this point the coil is directly over the object sought. The land coil is used in exactly the same manner, except that, as it must be carried in the hand, the frame for the coil is made of light wood and provided with a handle, as shown in Fig. 1.

This exploring coil does not, of course, require the careful insulating and waterproofing attention given to the marine coil. The wire is wound around the circular frame, and the three leads are brought out to three binding posts mounted on the handle. It is necessary to keep this coil parallel to the surface to be explored in order to bring the axis of the coil directly

over the metallic body if possible. When using the marine coil it will be necessary to support the weight of the glass jar with rope to which the cable may be loosely tied.

Protecting Unmounted Transformers

Unmounted audio transformers consisting of a bare core and windings with flexible leads are now widely used for replacements in modern sets. They are equal in quality to the table-type instruments, but are supplied in this form to reduce the cost of repairs. The delicate windings and small leads in such units may be protected by mounting the instrument in the case removed from the defective transformer. The case is usually clamped on with nuts and bolts, but if rivets have been used, machine screws and nuts will do. Cover the leads with spaghetti tubing and solder them to the binding posts on the case. A good strong case on the transformer holds the core lamina-

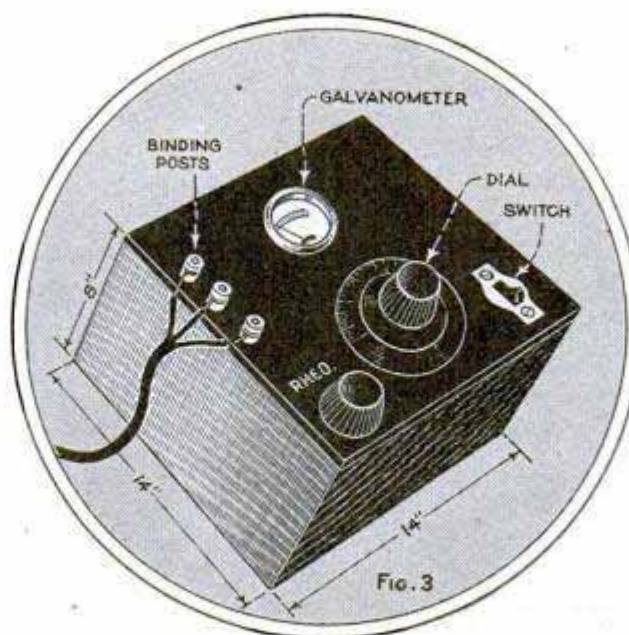

tions firmly together and prevents distortion caused by a loose, vibrating core.—
John C. Heberger, Rochester, N. Y.

Homemade Power-line Filters

by
Gordon I. Henry

OWNERS of a.c. receivers may not realize that under average conditions the electrically operated set will frequently pick up broadcast signals from the power line, as well as disturbances caused by sparking contacts, battery chargers, poorly grounded motors, generators, elevators and leaky insulators in the neighborhood. The disturbance may be anything from an ordinary a.c. hum to hissing or crackling, depending on the piece of faulty equipment causing it. Sometimes it is possible to tune the interference in and out at will with the tuning condensers, but, more often, this is not the case, since the majority of such disturbances cause the detector tube to be microphonic, sensitive to body capacity and unusually sensitive to the speaker cord or power-line lead to the set. Such disturbances should, of course, be taken care of at their source, but since this is usually beyond the power of the set owner, there is an easier way out of the difficulty which will frequently work just as well. One side of the line should always be properly grounded, if an a.c. set is to work well.

A simple homemade r.f. power-line filter is a device that anyone can make, and the cost is quite low. It consists of two filter condensers of either 2 or 4-mfd. capacity, rated for from 200 to 400 volts, connected in series across the power line



with their center point grounded, with two air-core choke coils, one in each leg of the power line feeding the receiver. The size of the choke coils may be anything from 50 turns on a 2-in. spool up, and they are mounted as shown in Fig. 1 and photo above.

It is important that the receiver be con-

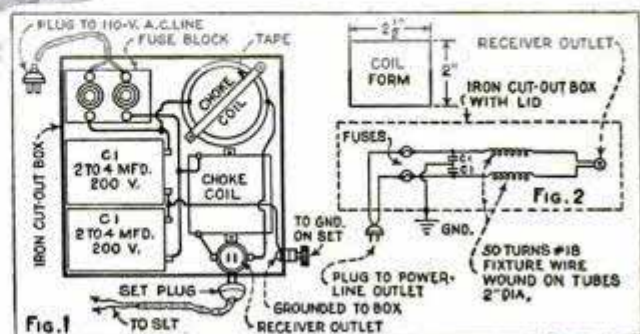
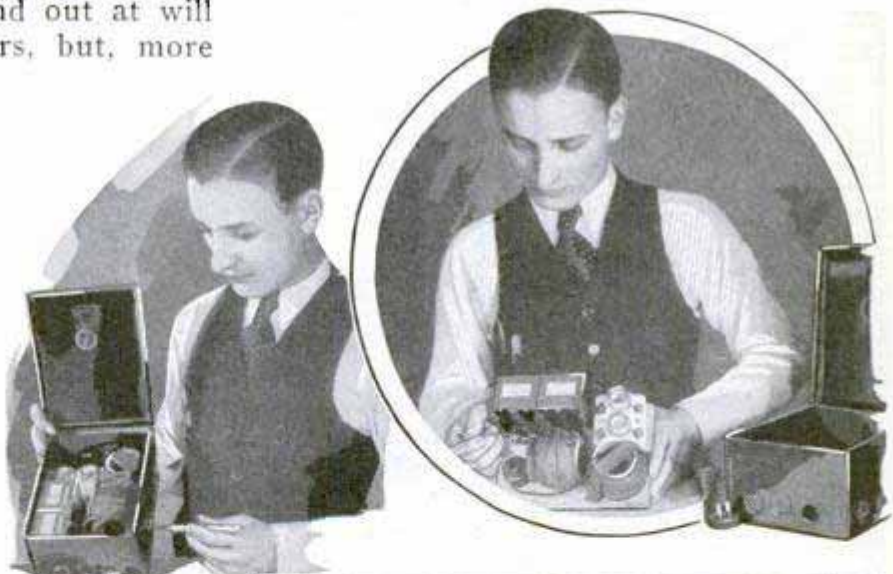

Above, Left, Binding Post Grounded to Case and Center Point between the Condensers; Right, Completed Power-Line Filter as Detailed in Fig. 1

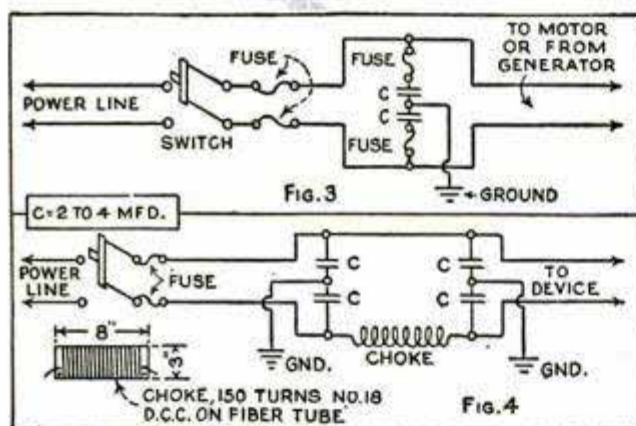

Top, Mounting Porcelain Fuse Block for the Filter Shown in Fig. 3

connected to the side of the choke coils away from the bridging condensers, as shown in Fig. 2. The filter units are mounted on a wooden baseboard, and a length of lamp-cord leads from the fuse block to the line outlet. The coils may be wound on cardboard mailing tube, 2 in. in diameter, and fastened to the baseboard by means of strips of friction tape tacked to the board; they are also wound with a covering of tape to hold the winding in place. A lead from each coil is then connected directly to the outlet socket, which may either be screwed directly to the baseboard or mounted on the case.

The container is a common steel cut-out box with a hinged cover, which may be obtained from any electrical-supply house for less than a dollar. The box used in this case is 4 by 6 by 8 in.; a hole

is drilled in one side to take a binding post for the lead from between the condensers, which grounds the center point to the case. When installed in the line between the set and the power supply, a lead from this binding post is taken directly to the receiver ground post, the usual ground lead from the set being retained.

A simpler type of filter, which may be used where it is possible to locate and get at a motor or generator that is causing interference, consists of the two condensers and the fuse block, mounted as before and connected between the power switch and motor or on the output side of the generator, as close to the device as possible. The connections are shown in Fig. 3, and the center point is grounded to the frame of the apparatus.

A more complicated filter, of the type shown in Fig. 4, is required at oil burners employing constantly operating igniter plugs. The diagram is self-explanatory, and the detail of the one choke employed is given at the lower left. When installing this device, carefully ground the motor frame and furnace casting. This type of filter necessitates the use of a larger metal container, but as the device is located in the basement this is not objectionable. The smaller case employed to house the power-line filter at the set may be neatly enameled and is small enough to be placed inside the modern console. It is best, however, to keep it on the floor away from the power units of the set, as shown in the photo at the head of the article.

Detecting Radio Interference with a Street Car

Defective street-car rails are a source of radio interference rather difficult to locate by ordinary practices. A San Antonio, Tex., public-service company has worked

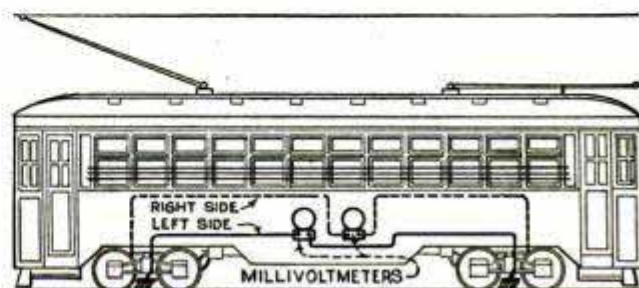

Street Car Equipped with Meters and Brushes Detects Radio Interference Caused by Track Breaks

out a way to locate such rails, which will be of interest to other localities having similar trouble, by equipping a street car with break-detecting meters, as shown in the sketch. The apparatus consists of a millivoltmeter for each rail, connected to small metal brushes which are let down on the rails. The car is started out into regular traffic and a map is used, so that, as the car runs over a break and the meter fluctuates, the operator can mark the location on the map. Since double trucks turn with the track when making a curve, a brush is mounted between the two wheels of each truck. This method has been successful in eliminating all interference of this type.—Joseph B. McShane, San Antonio, Tex.

Transformer Winding Kink

The handiest coil winder for experimenters the writer has ever seen applies the wire directly on the laminated core. The usual method of building transformers is to wind the coil on a form first and then insert the core laminations later, which always leaves a chance of vibration caused by loose laminations. The size of the fixture, or coil and core holder, may be made adjustable so as to take any ordinary transformer core. Most of the material for this fixture is available around the bench or can be obtained for a few cents. The turn counter is the only costly part; this may be bought for about \$2 and should be of the type built with a reciprocating lever. The bar iron forming the base is $\frac{1}{4}$ by 2 by 12 in., the two angles that support the fixture are 2 in. high, 2 in. long and 1 in. wide at the base. These angles are drilled and tapped for the centering screws and locknuts at either end of the core-holding fixture, and for capscrews to hold the angles to the base. The base plate may be slotted so that these screws can be loosened and the end brack-

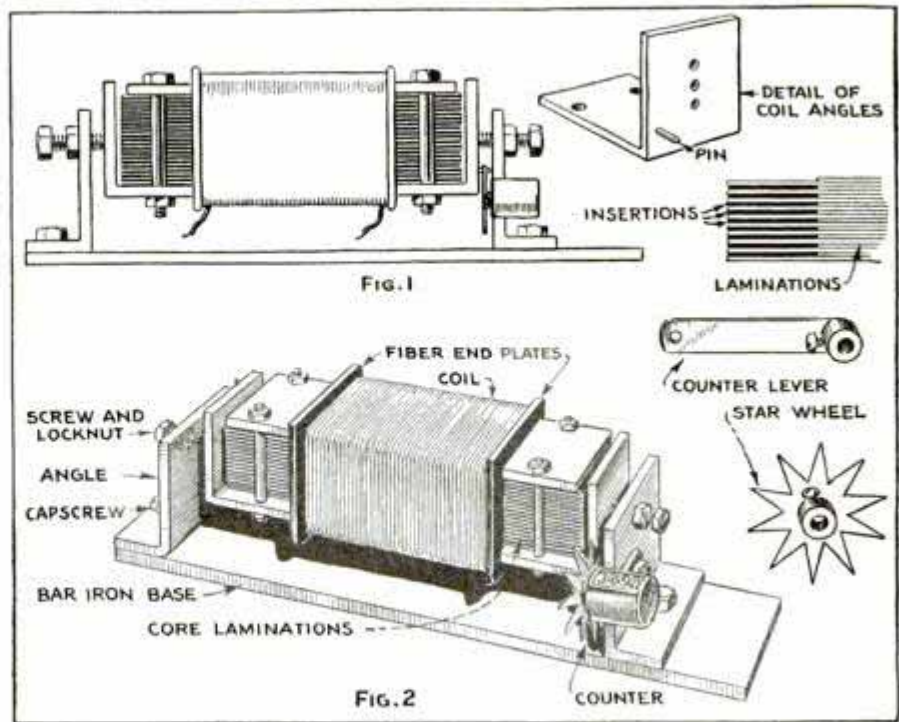

ets slid in or out to accommodate various core lengths. The coil-holding angles shown at the upper right are $1\frac{1}{2}$ by $1\frac{1}{2}$ by $1\frac{3}{4}$ in. long. The center holes are countersunk according to the height of the lamination centers, so that the coil will revolve true on its axis when held by the pointed centering screws in the end angles. Two straight bars and four long bolts are required for clamping the laminations to the coil-holding angles, as shown in Fig. 1. The length of these bars and bolts, as well as the spacing of the holes for them on either side of the centering points, will depend entirely on the size of the cores on which the coils are to be wound. The striking pin for turning the counter at each revolution of the coil is located on the coil angle after making and setting the star wheel shown in the sketch. Short pieces of laminating material are inserted in each end of the core laminations to be wound, as shown at the upper right, to provide a solid end for clamping. These pieces may protrude slightly beyond the end of the core so as to be easily pulled out after the coil has been wound. The clamping angles and plates which hold the core together are adjusted to fit snugly against the fiber end plates so as to keep the coil within its prescribed limits. When completed, the winding is covered with a layer of friction tape and the clamping plates may be removed.—Theo. H. Hansen, Clinton, Iowa.

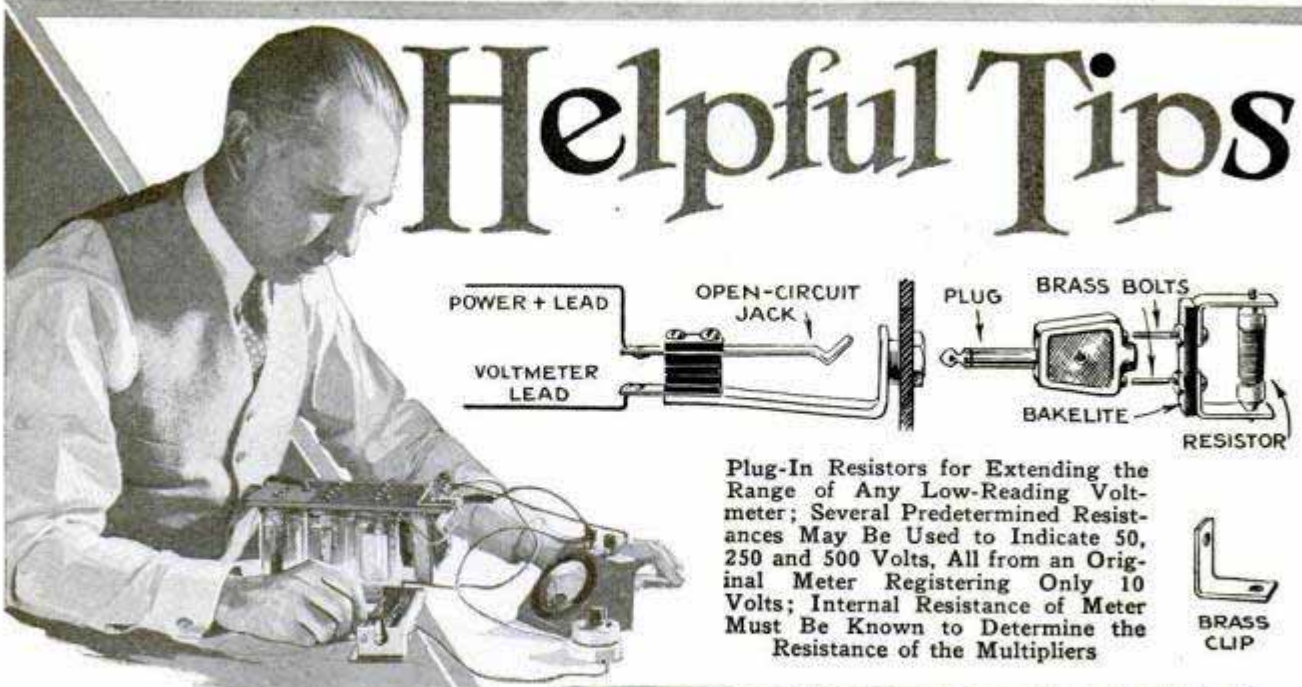

Helpful Tips

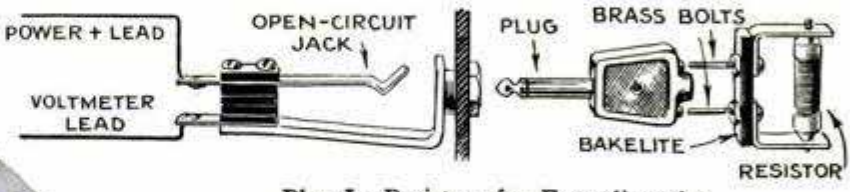

Plug-In Resistors for Extending the Range of Any Low-Reading Voltmeter; Several Predetermined Resistances May Be Used to Indicate 50, 250 and 500 Volts, All from an Original Meter Registering Only 10 Volts; Internal Resistance of Meter Must Be Known to Determine the Resistance of the Multipliers

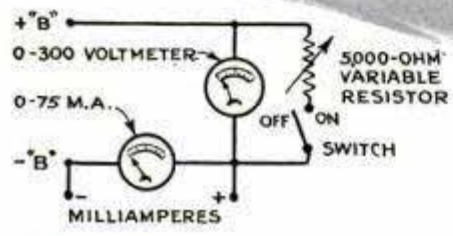

Testing Power Units under Load; Check Voltage with High-Resistance Voltmeter, Then Cut In Resistor and Vary Resistance to Determine Current Supplied

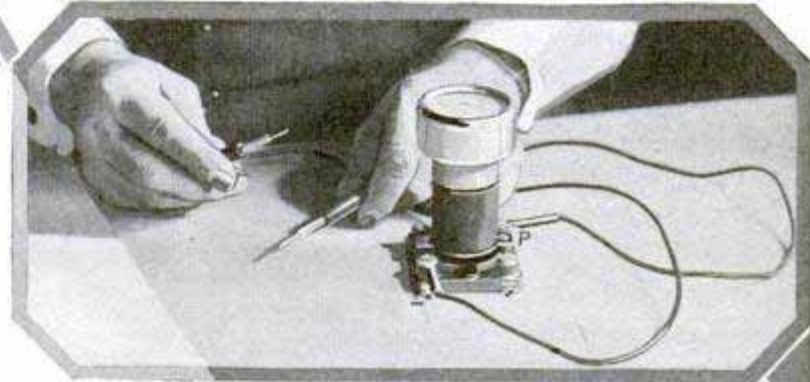

Above, Right, Socket Meters, Designed for Plugging into the Tube Sockets of a Receiver in Operation, May Be Used Externally by Inserting Them in a Separate Socket and Connecting Test Leads as Shown; Left, Prolonging Life of B-Batteries with Two Bell-Ringing Transformers and a 201-A Tube as Rectifier; Ford Spark-Coil Supplies Condensers, and Choke Is Made by Winding 500 Turns No. 28 S.C.E. Wire on the Core; Right, Mounting C-Batteries on Baseboard by Means of Busbar Wire, Bent and Looped as Shown

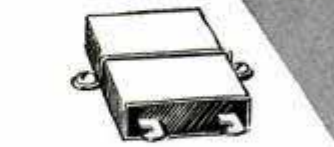
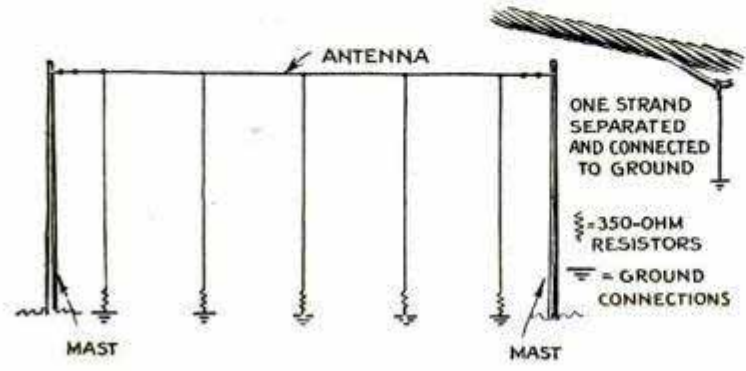
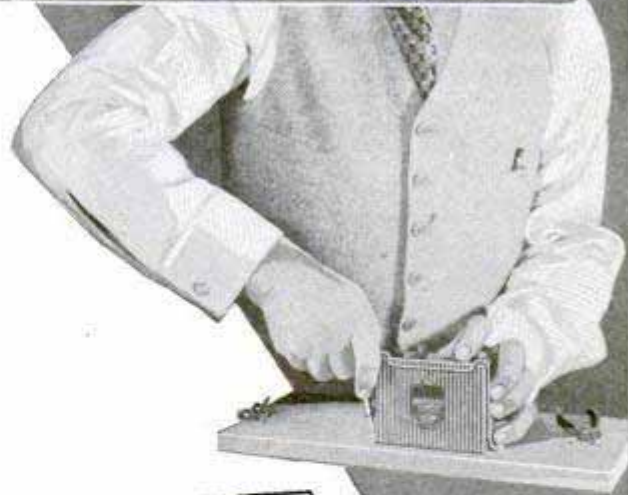
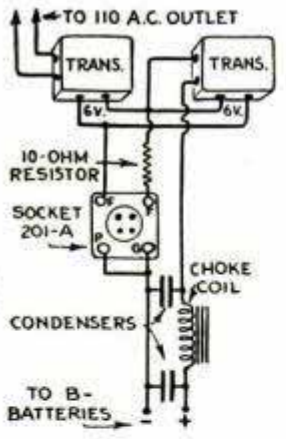

Left, Reducing Interference from High-Tension Lines; Increase Antenna Length to 200 Feet and Ground at Intervals through Resistors; a Simpler Method Is to Ground One Strand and Insert a Variable Condenser in Series with Ground, as in Detail at Top

from the Radio Lab.

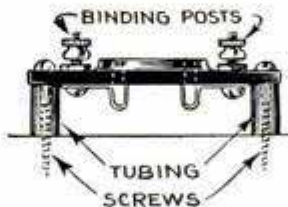
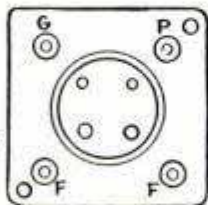

Extra Sockets for the Experimenter May Be Cut from Discarded Subpanels and Drilled to Take Short Machine Screws and Nuts from Dry Cells to Provide the Necessary Binding Posts; Short Pieces of Metal Tubing Are Used for Mounts; Right, Aluminum Baking Pans Make Ideal Mounting Bases for Power Units of All Types and Provide Ample Room Below for Mounting Resistors and By-Pass Condensers; the Wiring Is Hidden, Giving the Unit a Better Appearance

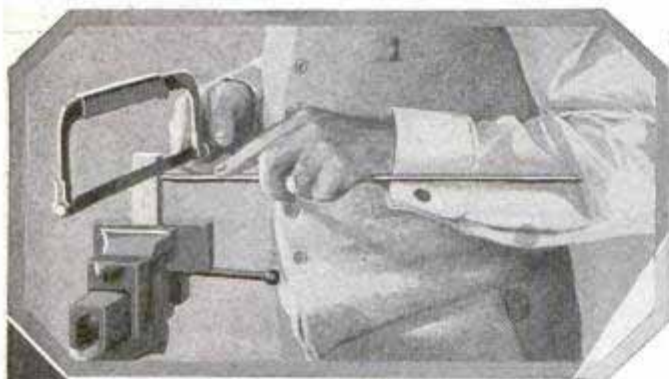
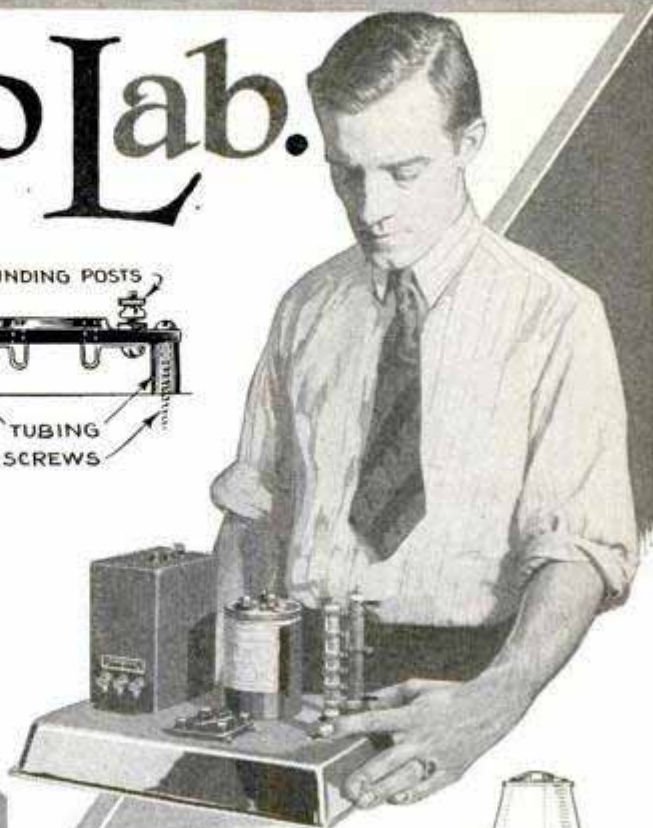

Left, Jig for Cutting Several Pieces of Metal Tubing of the Same Length; the Width of the Wood Block Is Equal to the Length Desired and Is Drilled to Take the Stock; Right, to Determine if Speaker Units Are Connected Correctly after Repair, Arrange as Shown, Then Switch the Current from Dry Cells through Windings; If Light Image on Diaphragm Becomes Larger, Diaphragm Is Drawn toward Poles and Connection Is Correct; if It Becomes Smaller, the Coil Connections Should Be Reversed; Left, Removing Corrosion from Switch Points with Strip of Sandpaper

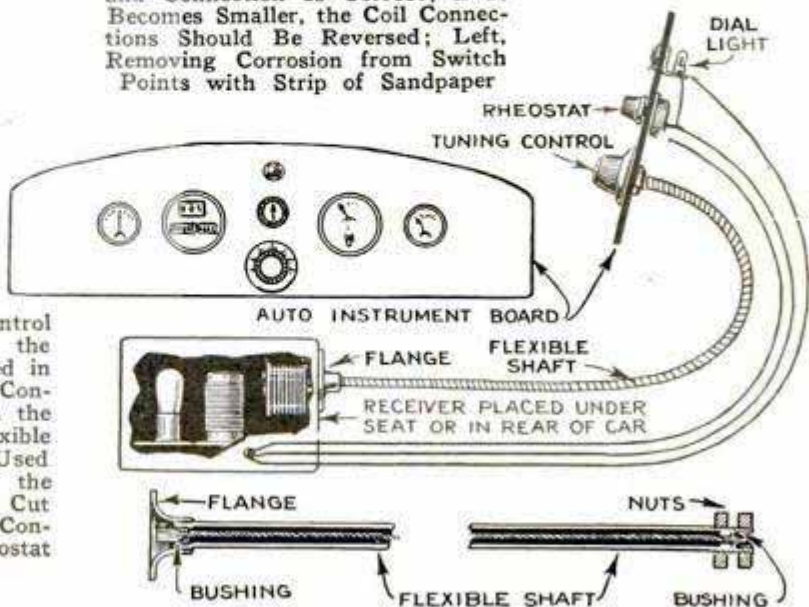
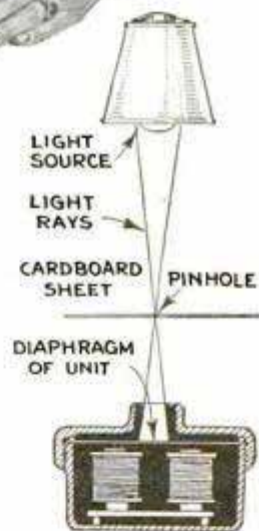

Right, Remote Control for Auto Receiver; the Set May Be Installed in Rear of Car and Controlled Directly from the Dashboard; the Flexible Cable Is of the Type Used on Motorcycles; the Rheostat on Set Is Cut Out of Circuit and Connected to Switch Rheostat on Dash

Separating Interfering Stations

Trapping out of undesired stations is not a new idea, but the average experimenter, who has tried numerous wave-trap circuits with indifferent success, may

is 7 by 12 in. and may be of either wood or bakelite. A wood baseboard, $\frac{3}{4}$ by 10 by 11 in., may be used, but the exact dimensions of the panel and baseboard will, of course, depend on the size of the cabinet the builder happens to have. The

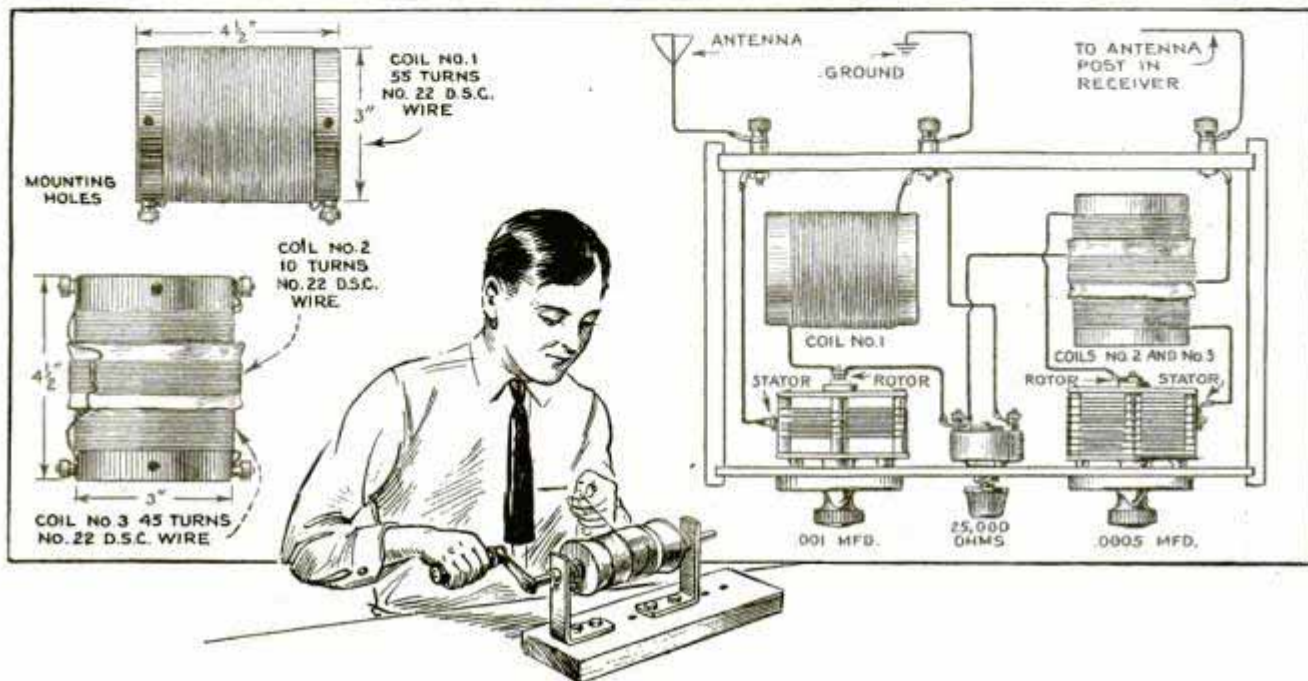

have decided that it is a rather difficult task to accomplish. It can be done, however, by carrying the construction a little further than that usually found in the ordinary wave trap. The absorption type of trap shown here employs the principle of a well-known Cockaday circuit. Advanced experimenters are now of the opinion that this is the easiest and most efficient remedy within the reach of the average owner of a set that tunes too broadly in congested localities. In this trap the incoming signal passes through coils Nos. 1 and 3 and is tuned to the frequency of the undesired station by means of the .001-mfd. condenser. The condenser at the right, which controls the absorption circuit proper through coils 2 and 3, is then turned until the signal of this station is heard at its minimum strength. When properly tuned, most of the energy of the undesired station will be absorbed and the signals from the other stations permitted to pass through without interference. The 0 to 25,000-ohm variable resistance across coil No. 1 has been found useful by the writer, as it can be adjusted so as to reduce static disturbance. The construction of the wave trap is very simple, and inexpensive parts may be used. The panel

building posts at the rear should be mounted on a strip of bakelite. The parts required are all specified in the drawings, and a $\frac{1}{4}$ -lb. spool of No. 22 d.s.c. wire will be more than sufficient for the coils. The tubing for the coils may be of either cardboard or fiber, the terminals being short 6-32 brass machine screws and nuts from discarded dry cells. Short brackets, made from $\frac{1}{2}$ -in. brass strip, are used to raise the coils above the baseboard. The connections to the antenna post, ground and antenna lead-in are all clearly shown.—Henry Laraby, New Haven, Conn.

Using Ground as Temporary Antenna

A good ground will often serve as a temporary antenna with surprisingly good results. Merely connect the antenna binding post to the ground, omitting any connection to the ground post on the set. A good ground for this purpose is the city water pipe on the street side of the water meter, if there is one.—G. Curtis Engle, Ridgewood, N. J.

☞ For further information on any radio construction article write to the radio department; this service is free.



Attractive Hampers Easily Made

By DICK COLE

MANY useful and serviceable articles can be made from discarded corrugated-board cartons, which most merchants are glad to give away, since it saves the trouble of burning them. For many purposes, corrugated board serves just as well as ply or plasterboard.

The hamper shown in the drawings

each side as in Fig. 2. Each side is lightly scored on the inside, along the center lines, and the carton formed to the octagonal shape shown in Fig. 3. A bottom is then cut from another piece of corrugated board to fit inside the box, and fastened with gummed-paper strips. Your grocer, no doubt, will give you the few yards of tape necessary when you get the carton from him. A top is cut of the same shape as the bottom, but allowing for 2-in. flaps, as shown above Fig. 3, which are bent down to form the flange of the top; these flaps are held rigid by means of a wrap-

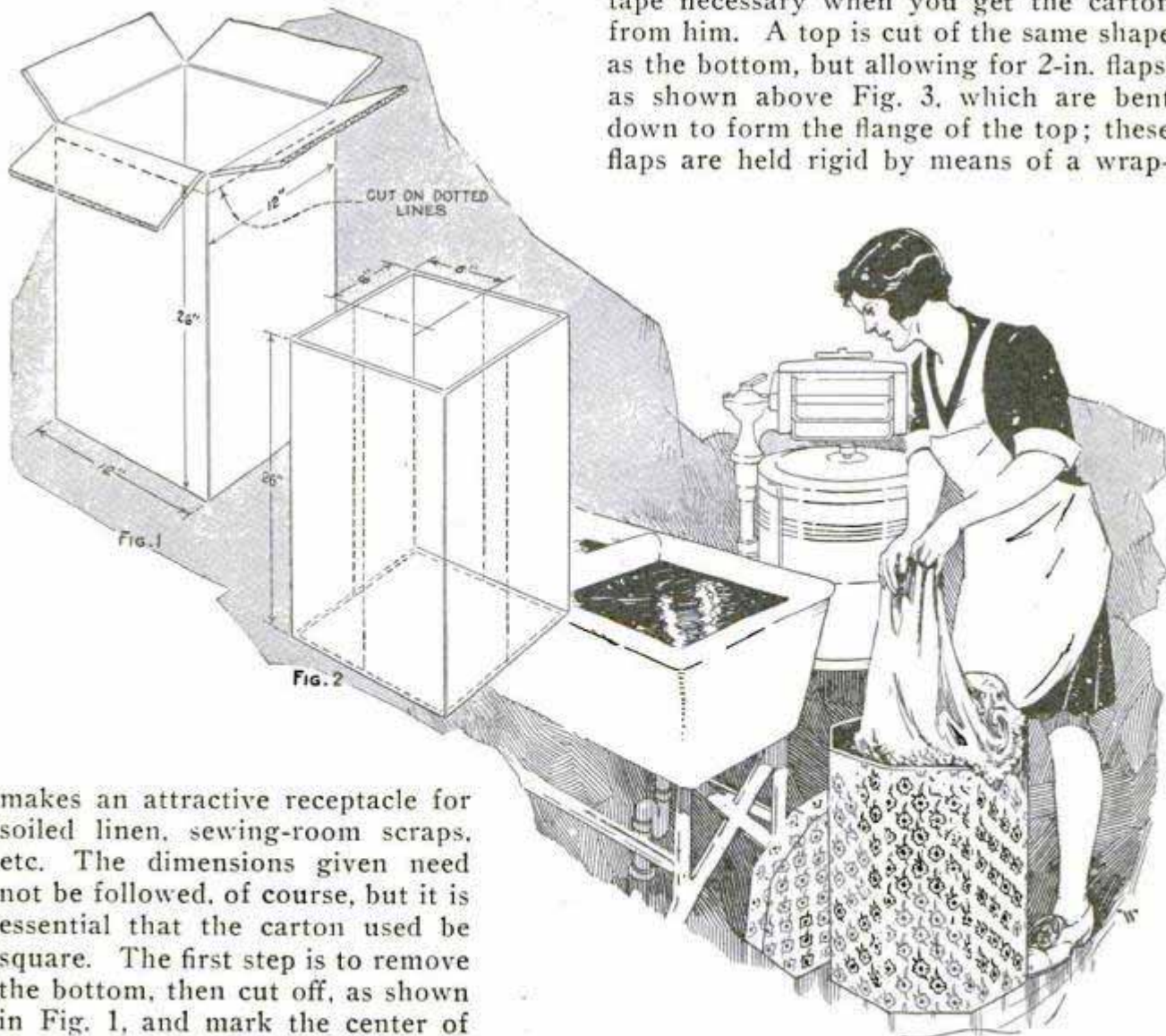

makes an attractive receptacle for soiled linen, sewing-room scraps, etc. The dimensions given need not be followed, of course, but it is essential that the carton used be square. The first step is to remove the bottom, then cut off, as shown in Fig. 1, and mark the center of

ping or two of the gummed paper, whereupon the hamper is ready for covering.

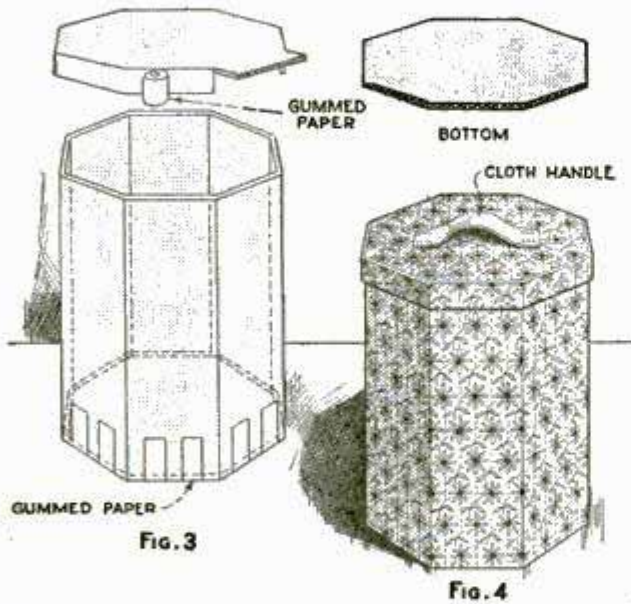

Either cheap cretonne or wallpaper can be used for this purpose. If the former is selected, use varnish, shellac, liquid glue or rubber cement as the adhesive, and allow the cement to become tacky before applying the cretonne, so that it will not penetrate the fabric and make a messy job. Ordinary flour paste can be used as an adhesive if wallpaper is to be used for the covering.

If used as a container for soiled linen, it is well to give the inside a coat of paraffin to make it damp-proof. This is easily done if the hamper is inverted over a gas burner, turned low, and the inside thoroughly warmed before applying the melted paraffin. An even coat can then be put on with a brush. Powdered camphor, sprinkled down the corrugations, will help eliminate the odor of perspiration. A cloth handle, sewed to the top with strong thread, completes the hamper.

Many variations of this idea will suggest themselves, such as decorative hat boxes, wastebaskets, etc., and small cartons, cut down to the proper size and covered with cretonne or suitable wallpaper, make unusual glove and trinket boxes.

Backlash Stop for Fly-Casting Reel

Fishermen who are troubled with tangled lines when casting, owing to the reel continuing to turn after the fly has struck water, will appreciate the anti-backlash stop shown in the drawing. To make it

for a level-winding reel, use a piece of $\frac{1}{32}$ -in. wire and bend it to a U-shape, the ends of the legs being formed into eyes which fit loosely around the crossbar of the reel as indicated. One leg is a trifle longer than the other and is bent to extend against the flange of the drum, a wrapping of thread on the end of the wire serving to increase the friction of this improvised brake. Cut a piece of light brass rod, about $\frac{3}{16}$ in. in diameter and slightly longer than the distance between the legs of the U-shaped piece, so that after a groove has been made in each end of the rod, it can be slipped between the legs and soldered in place. Allow about $\frac{3}{8}$ in. clearance between the rod and the sides of the reel. To mount the device on the reel, it may be necessary to take the latter apart. A soldering lug, bent at right angles and retained by means of the screw holding the side disk and the crossbar together, serves as a stop so that the weight will not swing too far when the rod is thrown back. The details of fitting, of course, will vary with different reels, but the principle is the same in all. Generally,

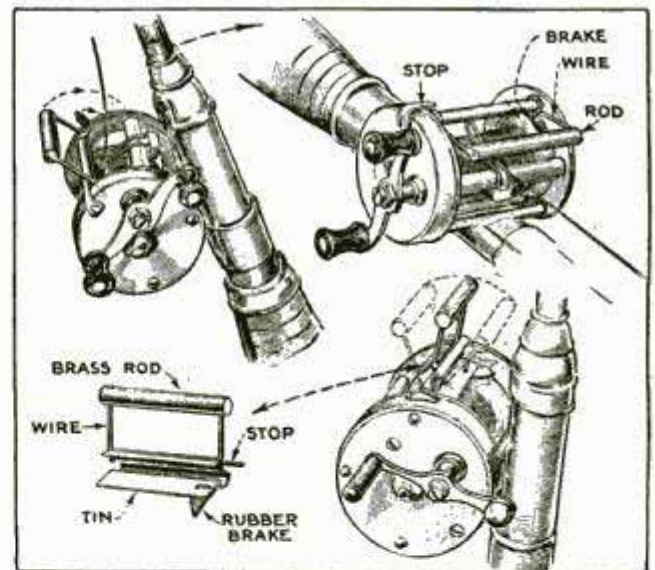

Two Variations of a Reel Backlash Stop to Prevent Tangled Lines When Fly Casting

the line is run over the fixed bar on the reel and under the bar of the anti-backlash attachment. The weight of the bait causes the latter bar to rise, releasing the brake on the spool of the reel. As soon as any slack occurs in the line between reel and bait, the bar of the attachment drops, swinging the brake against the spool, thus preventing overrunning with its consequent entanglement. The lower detail

shows a variation of the same idea, applied to a plain reel, in which a small piece of sheet metal is bent to form a sleeve around the crossarm of the reel, this piece being extended and fitted with a small piece of rubber, which acts as a brake when it comes in contact with one of the flanges of the revolving drum.—Arthur Burkman, Milwaukee, Wisconsin.

How to Preserve the Edge of Razor Blades

One reason why safety-razor blades become dull after being used a few times, is the formation of rust on the edge, which can readily be seen through a powerful magnifying glass or microscope. To overcome this trouble, immerse the blades in a small glass jar of light oil. It is not even necessary to remove the blade from the razor if the jar is large enough to hold both, such, for instance, as a cold-cream jar. Any light vegetable or mineral oil is satisfactory, and it can be removed before shaving by the simple process of holding the razor under the hot-water faucet for a few moments.—H. Rossiter Snyder, Guilford, Conn.

Windshield Screen for the Car Prevents Entrance of Insects

Mosquito netting, glued to the bottom of the windshield and to the edge of the cowl, has been found highly effective in keeping insects out of the car while driving with the windshield open. When

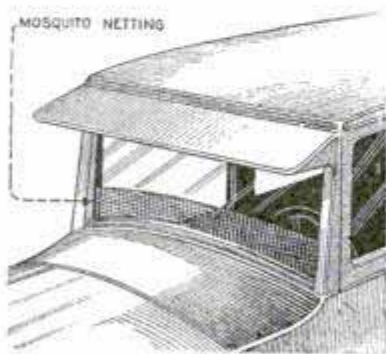

the latter is closed, the netting folds underneath and is entirely out of sight.

One strip of netting will last all summer. Waterproof glue or collodion should be used as an adhesive for the purpose.—Jack Van Coevering, Grand Rapids, Mich.

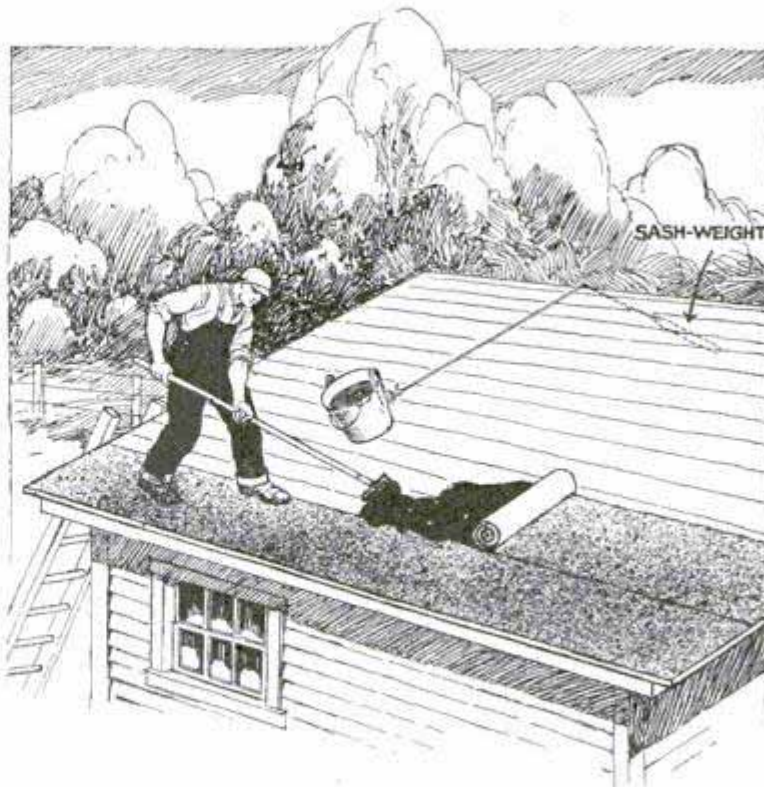

Sash Weight Counterbalances Tar Bucket to Prevent Its Slipping on Sloping Roof

Holding Tar Bucket on Roof

When tarring the surface of a sloping roof, preparatory to applying roofing paper, and difficulty is encountered in keeping the bucket from slipping down the roof, try the method indicated in the illustration. Get a short length of heavy galvanized-iron wire and bend it to form a clip to fit over the side of the pail as indicated, with an eye at one end. A suitable length of rope, with a sash weight attached to one end, is tied to the eye of the clip. In use, the rope is brought over the ridge of the roof with the pail on one side and the sash weight on the other, the latter serving as a counterweight for the former. With this arrangement the pail will remain wherever it is placed without slipping.—G. M. Beerbower, Hollywood, Fla.

Accompaniment for the Player Piano Marked on Music Roll

In order to be able to accompany a player piano with another instrument, I put my part of the music on the edge of the roll. Instead of drawing a staff for every few notes, I had a rubber stamp made for this purpose, so that all I had to do was to write in the notes.—Paul B. Desch, Casper, Wyo.

These Attractive Statuettes



PHOTOGRAPHIC statuettes are by no means new, but the many uses to which these novel cut-out pictures can be put go to make a highly interesting and remunerative art which should appeal to all camera enthusiasts.

The procedure is extremely simple. We will imagine that you already have, or have taken for the purpose, a picture of a girl, side view, full length, with her arms outstretched. This picture has been enlarged so that it is a full 10 in. high. To convert this photographic print into a novel ash tray is a matter of but two or three easy steps. You start by cutting out the picture of the girl. Then, you trace the outline of the figure on a piece of thin wood (any of the composition fiberboards now on the market are excellent for this purpose) and proceed to saw it out with a coping saw. After cutting the wood pattern, the actual picture of the girl is then mounted, with good glue, onto the wood, as in Fig. 1. A $\frac{1}{2}$ -in. length of wood is left projecting below the girl's feet so that the figure can be inserted into a mortise cut in a wood block which serves as a base, as shown in Fig. 2.



The final step in the converting of the photograph into an ash tray consists in screwing to the arm of the girl a composition or metal ash tray, as pictured in



are Easy to Make

by Lela M. Brown

Fig. 3. Then, of course, you can lean back, have a smoke, and survey your work. Naturally enough, the job can be made much more artistic if you give the base and the back of the figure a coat of paint, and more useful if a block is added, as in Fig. 4, to carry a box of matches. Red and black make the best combination for such work; the base of the figure would be red, the edge of the figure would be red, and the back would be painted black. Some very neat effects can be obtained, too, by tinting the photograph.

The method of cutting the photograph and the wood block separately is only a suggestion. If your saw is sharp and your skill great, the figure may be mounted onto the board and the whole thing cut out in one operation. This method gives a very neat job if done properly, but often the teeth of the saw will tear the picture. By using the other method, this will not occur, although a file and a pair of scissors may have to be used in order to make the two outlines coincide exactly.

Working on the



same order, you can easily make up a set of very attractive photographic book ends, as pictured in Fig. 5. The cut-out is nailed to a wood block in order to give it stability. You should paint the wood and tint the photograph if you would have a really artistic creation.

Photographic dolls are a real novelty. Instead of letting your



daughter, or the little girl next door, or Aunt Sadie's little girl from the country play with paper dolls cut from some mag-

trinket holders, door stops and bedroom lamps—the list is almost endless. And there is real money in these attractive statuettes if you care to turn merchant.



azine, why not give her her own picture to dress as she pleases?

The picture of the little girl is first taken, in "undies," as paper dolls are usually dressed, and with her arms held out stiffly on either side, as paper dollies are wont to stand. The figure is then enlarged to about 11 in. high and mounted on a wood block, as in Fig. 6. The rest is "just kids." They can spend hour after hour, perfectly content, cutting out dresses, coats and hats, and fitting them over their own picture. Fig. 7 will give you the idea. A small block of wood nailed to the bottom of the figure will hold it erect.

Figs. 9, 10 and 11 will give you the idea for a novel tie rack. The picture should be posed with the girl's lips puckered, so that a hole, as in Fig. 9, may be bored at the place where the lips are parted. A short piece of dowel stick is then glued into the hole. The stick should be painted white, and the whole thing carried out with the idea in mind of a girl smoking.

Many other novel items can be fashioned in the same manner. Vases, tops for laundry bags,

Preventing Infection from Chemicals in Swimming Pools

Owing to the use of strong chemicals, especially copper compounds, for purifying the water of most indoor swimming pools, users are frequently troubled with an infection of the delicate membrane lining the ear. An instructor in the physical-education department of a western school, requires that his students, who are so troubled, insert a small wad of vaseline-coated absorbent cotton in their ears before entering the water, which prevents the water from coming in contact with the membrane. The students are also warned not to close the nose if it is filled with water, as this tends to force the water through the tubes leading from the mouth to the inner ear.—Cecil Metzger, Lincoln, Nebr.

Breather-Pipe Oil Fumes Can Be Used to Advantage

Oil fumes coming out of the breather pipe on many cars often deposit an oily film over the surface of the motor and inside of the hood. An effective cure consists in soldering a

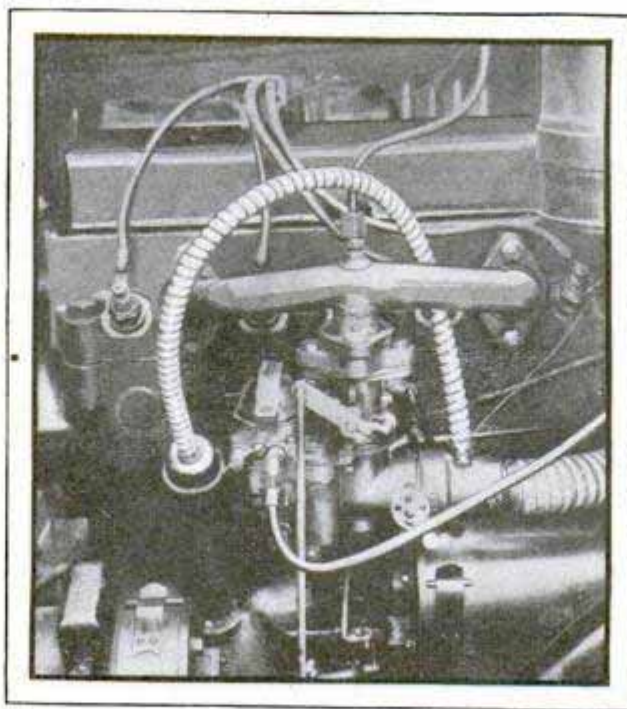

Metal Tubing from Breather-Pipe Cap to Carburetor Intake Conducts Oil Fumes into Motor

length of flexible metal tubing into a hole in the breather-pipe cap, and inserting the other end into the auxiliary intake of the carburetor. The oil fume is then drawn up through this tube into the carburetor and into the combustion chambers of the motor, where it helps to lubricate the top piston rings and valve stems, besides which it also preheats the gasoline vapor.

*Cont. Thos. J. McElvough
Luna, N. J.*

SAND MOTOR RUNS THIS DANCING MONKEY

By Bob Harvey

THIS novel toy can be made from a cigar box, a spool, some wire, pasteboard and a sheet of celluloid. It runs continuously for nearly a minute and is "rewound" simply by giving the box a complete turn. This returns the sand to the hopper and it starts all over again. The celluloid back permits a view of the machinery in operation, and on the front side the grinning organist grinds away while the monkey hops around in a lively manner.

Remove the cover from a standard cigar box, about $8\frac{1}{2}$ by 6 by $2\frac{1}{2}$ in.,

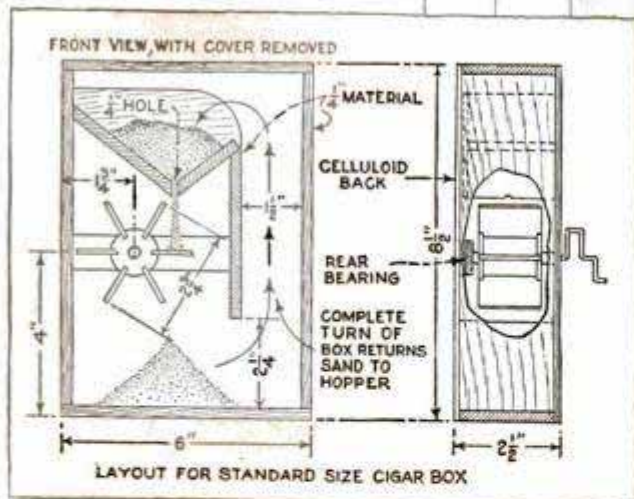
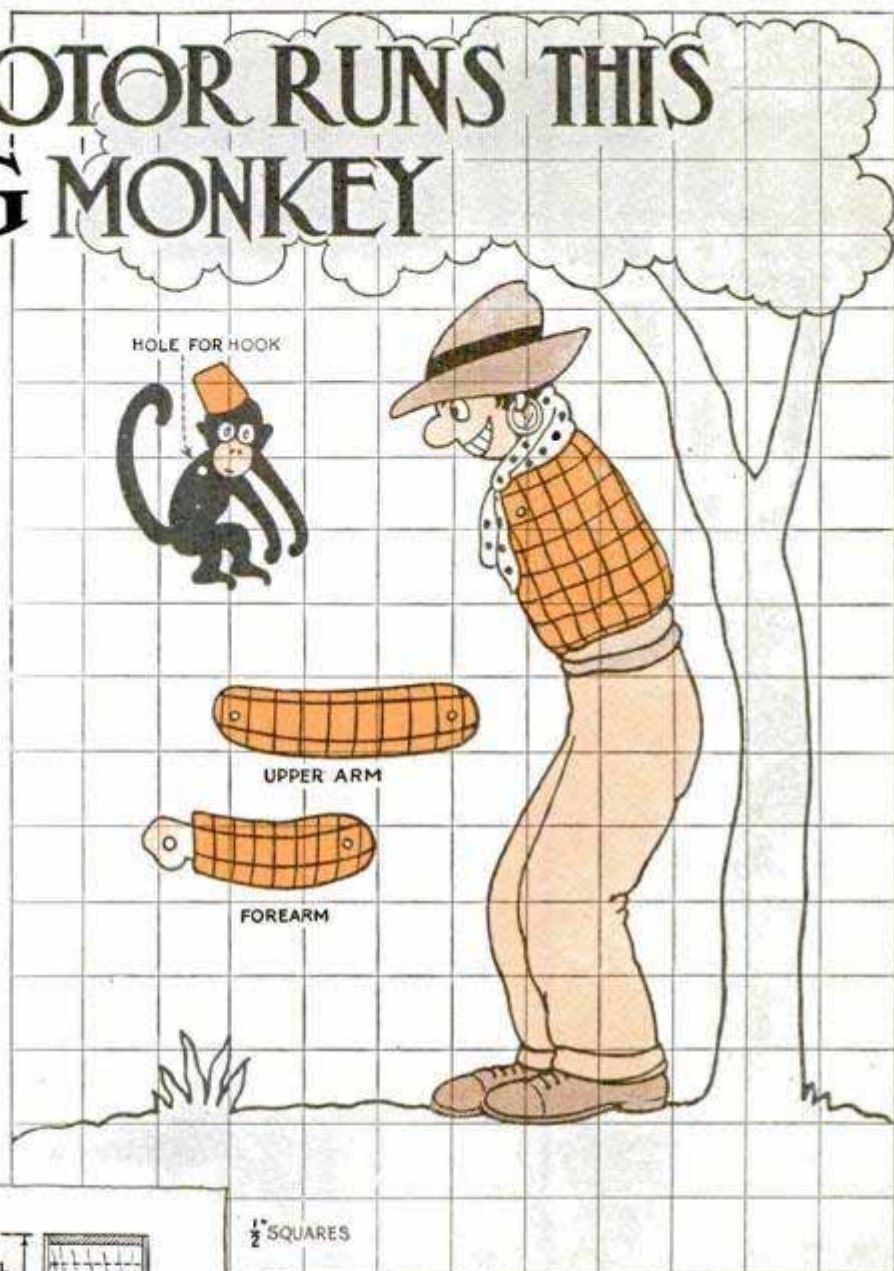

and scrape or soak off as much of the paper as possible. In soaking, do not leave the box too long in warm water as the veneer will peel off certain kinds.

First locate the small hole for the wire crankshaft and then make the paddle wheel. This is a very simple device; merely an ordinary spool, notched as

shown, for six pasteboard paddle blades, which are held in place with pins and glue. The axle, or long hub, is a section of round lead pencil which has been split and the lead removed. Drive it into the hole in the spool and insert the wire shaft temporarily, so that the hopper can be properly located for the sand to fall on the middle of the blades. A $\frac{1}{4}$ -in. hole is about the right size in the hopper.

With the hopper and return chute installed, glue on the wood crosspiece which serves as the rear bearing for the crankshaft. Now bend the two crank arms for the monkey shaft and grinder's arm respectively, and, after filling the hole in the split pencil with glue or, better still, with ambroid, insert the shaft in the paddle wheel, letting the glue harden for at

least half an hour. In bending the crank arms use square-nosed pliers and make the bends as nearly sharp right angles as possible. Two small washers soldered or ambroid to the sides of the monkey-

the organ-grinder crank on the outside. Bear in mind that the entire mechanism should run very freely, and adjustments must be made to obtain this effect by bending the wires or moving the crankshaft wire in or out.

Glue three $\frac{3}{4}$ -in. wood strips to the face of the box, as indicated, so the figure of the organ grinder and tree will stand out to give perspective. The figures are easily drawn by laying out the outlines on a chart marked in half-inch squares like the illustration. Use a smooth grade of fairly heavy pasteboard, and paint in the colors before gluing to the wood strips. Oil paints are most satisfactory, as they will dry brighter and do not fade. For the

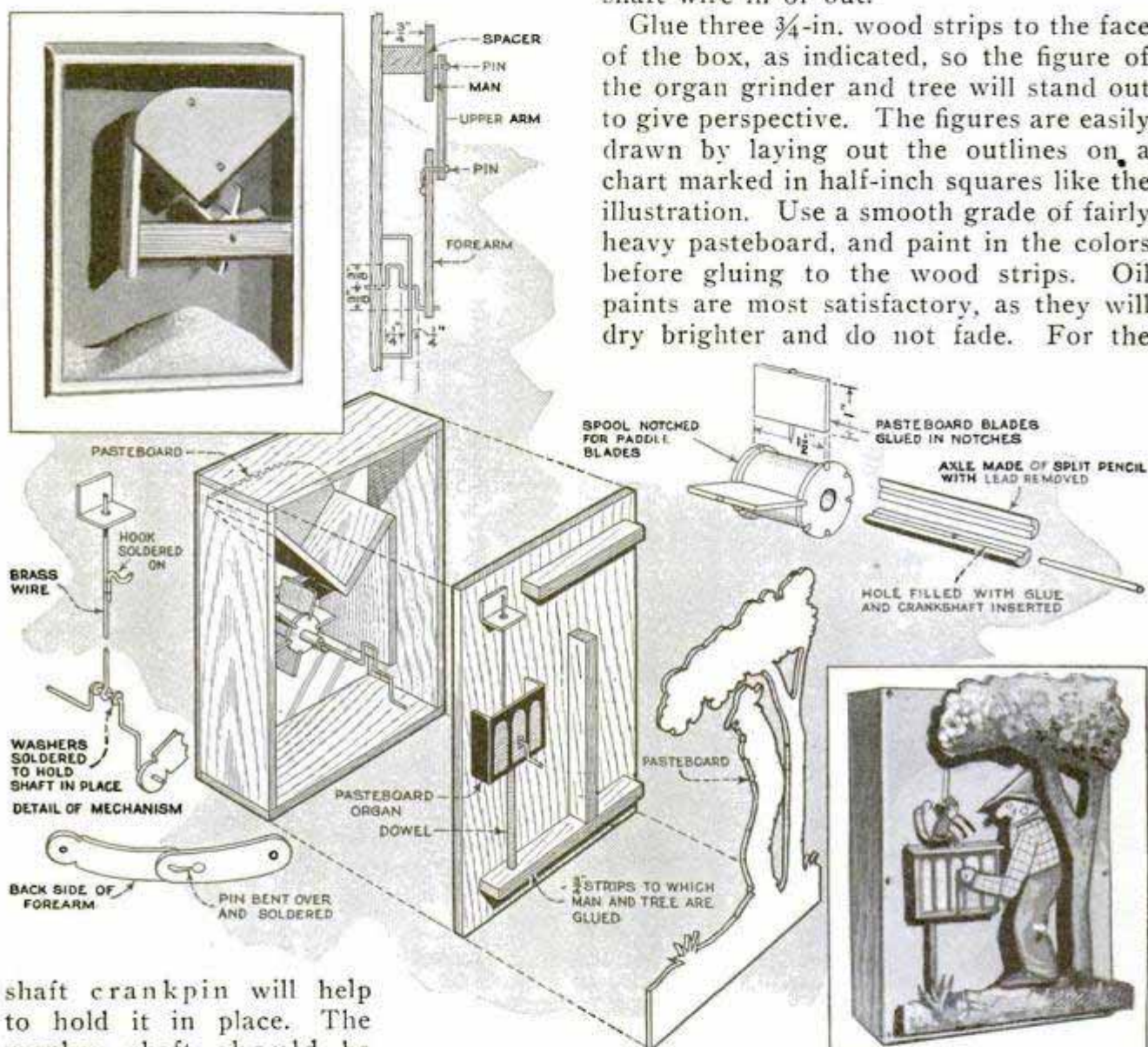

shaft crankpin will help to hold it in place. The monkey shaft should be made of very light wire.

Copper is satisfactory, as the hook from which "Jocko" is suspended can then be soldered on. The upper end of the shaft slides in a pasteboard guide glued to the front of the cigar box. At this point, the mechanism can be tested, but be sure the sand is absolutely dry and sifted through a fine screen, as small bits of paper or shavings will clog the hopper hole.

Next cut out and fold the grind organ from pasteboard, so that it will stand out about $\frac{1}{2}$ in. from the face of the box. A $\frac{1}{8}$ -in. slot is cut halfway up the middle to straddle the crankshaft. Thus the monkey-shaft crank is inside the organ, and

man's face and hands a white enamel, tinted with red, gives a good flesh color, the features being marked in black with a fine brush or pen. Make the arm in two parts, joined with a pin bent over on the back side and glued or ambroid in place. Ambroid, the excellent cement sold for model airplane builders, is better than glue for work of this kind; in fact, it can even be used in the place of solder. It dries to a glass hardness and is very tenacious.

See that all holes are large enough to move freely on the pins at the joints. Cut the monkey from a good grade of bristol

board. Pasteboard is not satisfactory for this, and, besides, is too heavy. It will be well to paint the monkey before cutting it out.

Give the machinery a final test before gluing the celluloid sheet on the back, and see that just the proper amount of sand is put in. Too much will retard the action. There should be just enough to fill the hopper without spilling over.

Glue or shellac all cracks so that the fine sand will not be dribbling out every time the box is moved. It is not a bad idea to give the sides of the box a coat of bright paint after the shellac at the joints is dry.

When completed, you have an amusing toy that will last indefinitely. In fact, the original of this model has been knocking around the house for three years and still operates as well as the day it was made.

Cleaning Electric Auto Connections

An authority on automotive lighting claims that a voltage drop of 10 per cent will result in a loss of one-third of the candlepower. This, I have found, is absolutely true. The electric connections of my car all appeared perfectly tight and clean, but, after going over each with sandpaper, I found that the charging rate was 2 amp. higher, and that the lights burned much more brightly than before.—E. T. Gunderson, Jr., Humboldt, Iowa.

Soap Holder for Cleaning Small Parts

When, in overhauling any piece of machinery, it is necessary to clean small parts, get a soap holder as shown in the illustration, insert the parts to be cleaned and rinse in kerosene or gasoline. After the dirt has been washed away, shake the surplus liquid off and dump the parts on a piece of clean newspaper to dry.—C. E. Packer, Chicago, Illinois.



Substitute for Focusing Cloth

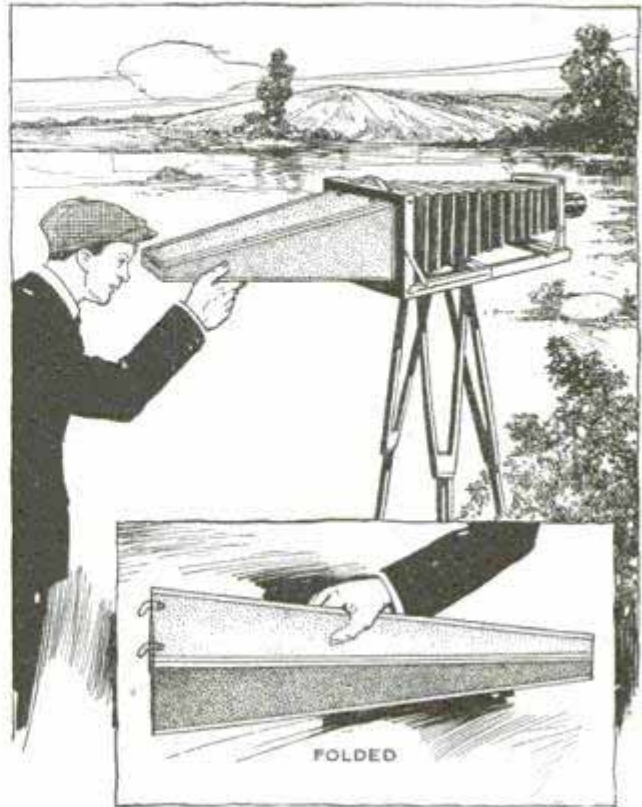

Folding Cardboard Box Has Many Advantages over the Customary Focusing Cloth

Photographers who have much outdoor work to do will find that the folding focusing box, shown in the drawing, has many advantages over the focusing cloth, as it cannot blow off, whip about or pull the cap off. It is made of cardboard and is of pyramid design, the large end fitting over the ground glass and being equipped with small hooks made from paper clips to engage with the springs of the plate holder, thus providing a suitable support for the box. The small end is just large enough to permit the user to look through. The edges of adjacent sides are joined with adhesive tape, and, if desired, the whole box may be covered with light imitation leather or other suitable fabric to improve its appearance and increase its strength. When folded flat, the box takes very little space in the camera case.

How to Soften Plastic Wood

After plastic wood has been kept for a long time it will usually harden, even though the cover seems to fit tightly. To soften it again, add a little acetone and then replace the cover.—Douglas Leechman, Ottawa, Can.

"The Fo'c'sle"-A

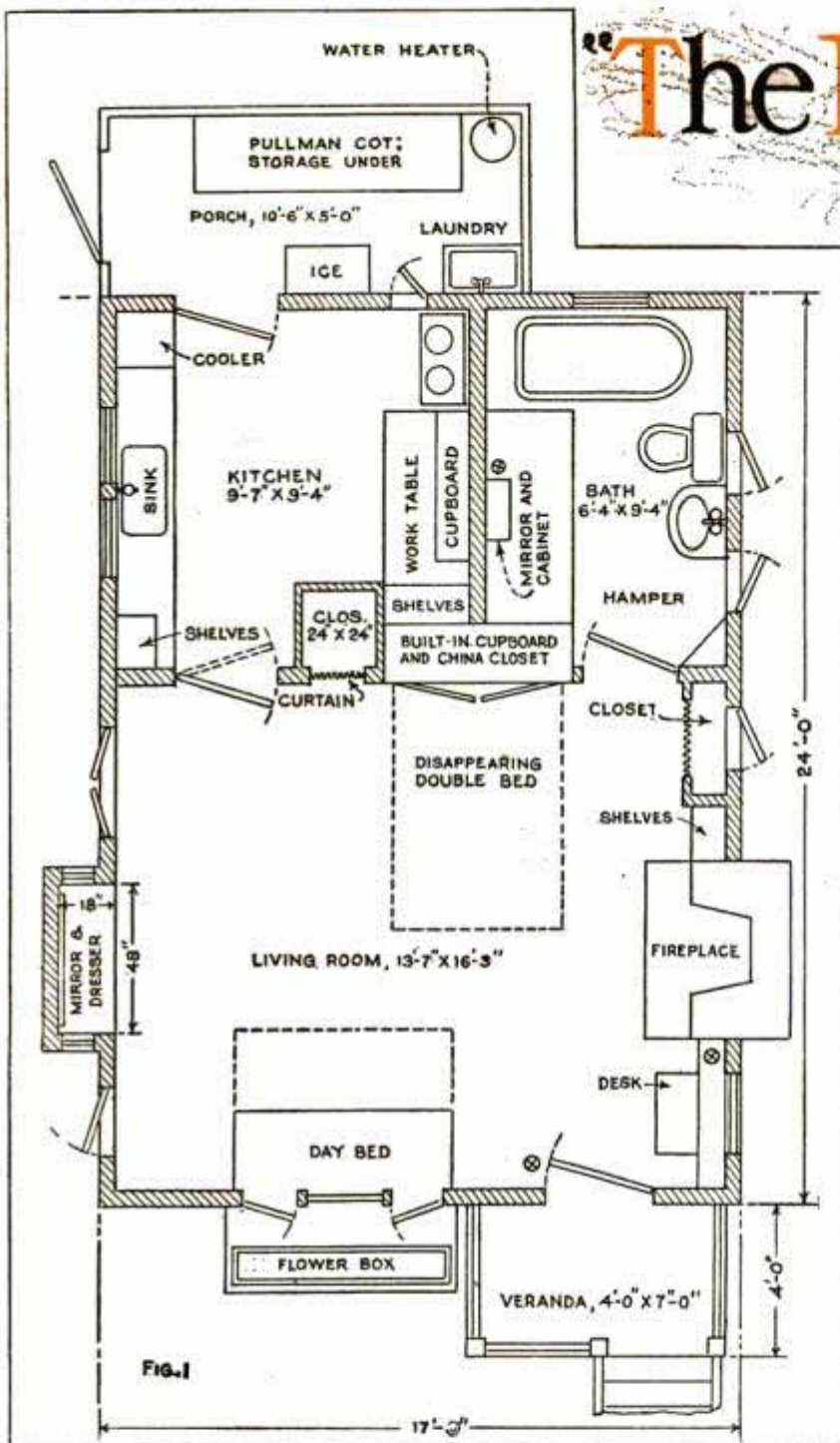

are included three rooms with sleeping accommodations for four adults. A folding Pullman cot on the screened porch takes care of an extra guest, and an unexpected visitor finds very comfortable quarters in the little attic.

Both beds are double, 6 ft. 6 in. by 4 ft. 8 in. One of these disappears entirely when not in use, sliding into the wall under the china closet and benches in kitchen and bathroom, as shown in Figs. 4 and 11. No sacrifice of necessary space is made in either of the latter rooms. The other bed slides halfway into a sort of cubicle extending from the front wall of the house, Fig. 1, and serves as a couch in the daytime.

At one side of the living room an alcove (Fig. 1) serves as a dresser, having a mirror and drawers beneath. The lid of the built-in desk on the opposite side, Fig. 3, folds up against the wall. Space on either side is devoted to shelves and cupboards for books, etc., as may be seen in Fig. 4.

There are two closets of fair size; drawers under the china closet for linen and silver; drawers and cabinets in the bathroom for towels (see Fig. 14), and a built-in hamper behind the door for soiled laundry.

Housewives will find the

LAST summer we occupied a beach cottage that was a model of ingenuity. The designer, in his youth, had sailed before the mast, and experience in the restricted space of a fo'c'sle had enabled him to work out a plan that included all conveniences in a surprisingly small area.

With a number of modifications, we have embodied many of the sailor's ideas in this trim little cottage. In a floor plan only 17 by 24 ft.

neath. The lid of the built-in desk on the opposite side, Fig. 3, folds up against the wall. Space on either side is devoted to shelves and cupboards for books, etc., as

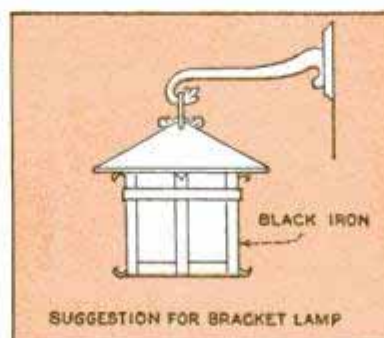

Shipshape Summer Cottage

by Hi Sibley

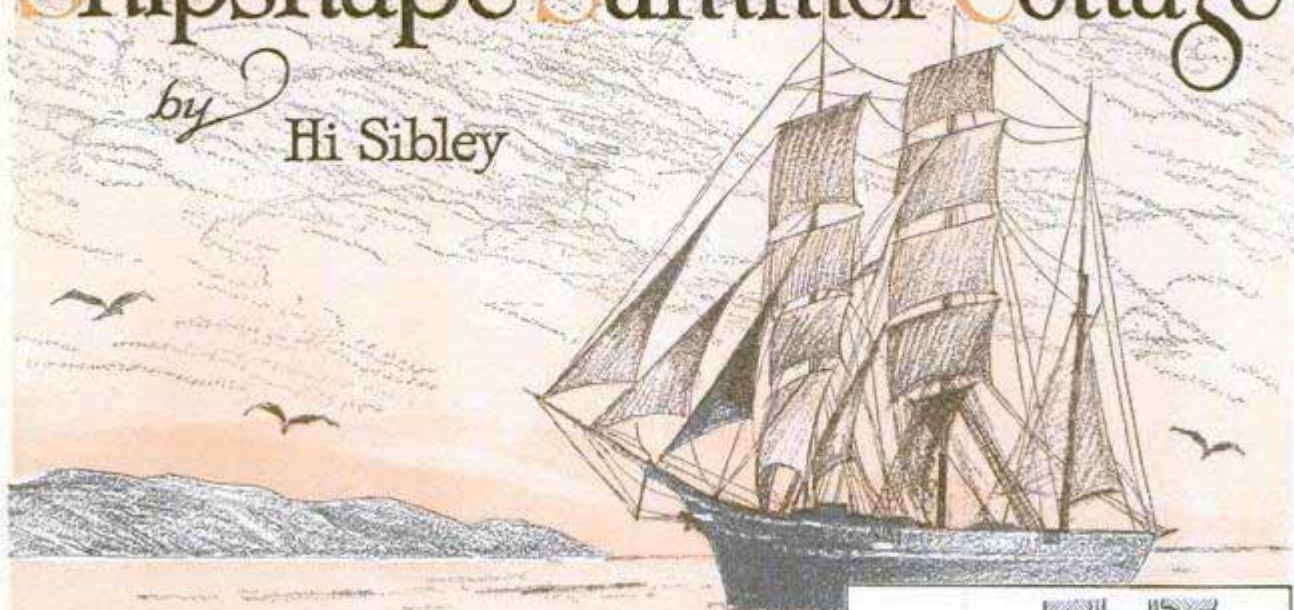

kitchen, arranged as shown in Fig. 12, a very convenient size, with abundant light and ventilation. On the screen porch are laundry tub, water heater (if gas is available) and ice box. Under the folding cot is space for storage of boxes and trunk. See Fig. 7.

If the site selected slopes toward a lake or stream, the forward section is excavated to make storage room for boats and other summer equipment. This is quite important, as many cottagers who own boats well know.

Access to the attic is gained through a closet and hatch by means of a port-

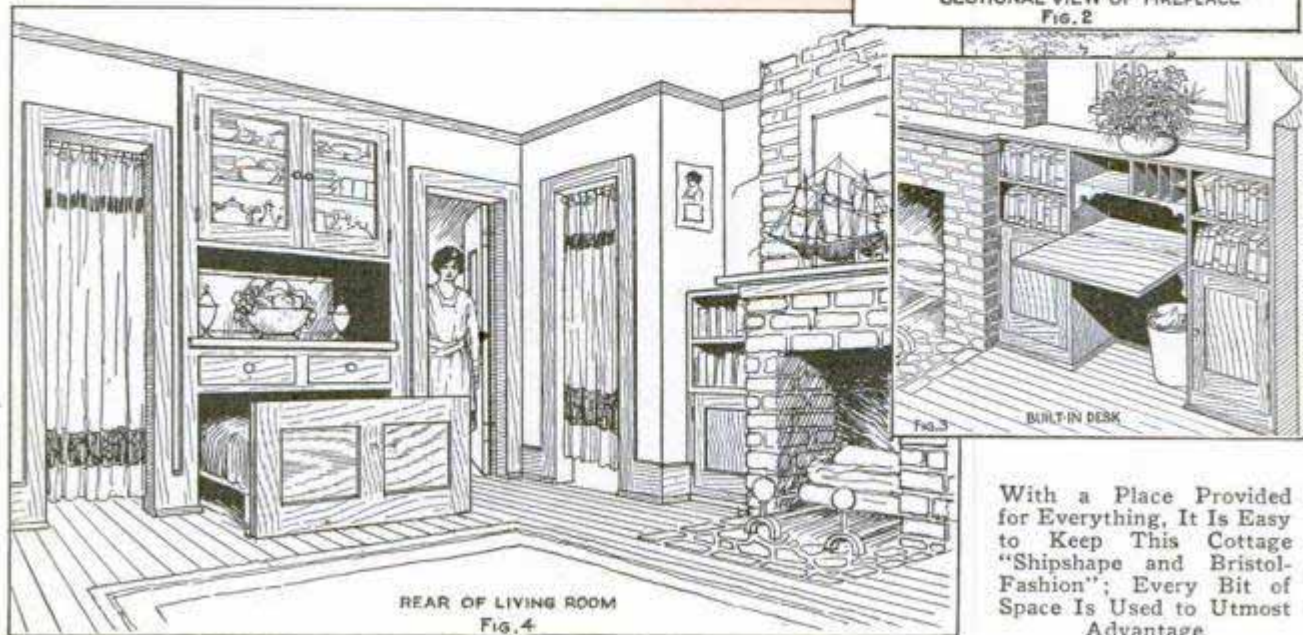
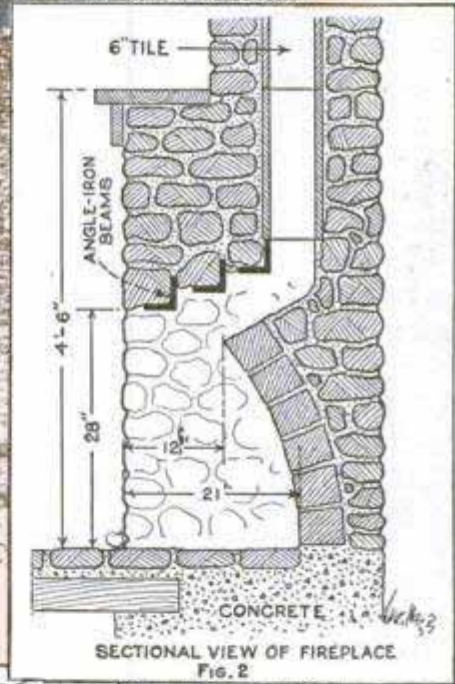

With a Place Provided for Everything, It Is Easy to Keep This Cottage "Shipshape and Bristol-Fashion"; Every Bit of Space Is Used to Utmost Advantage

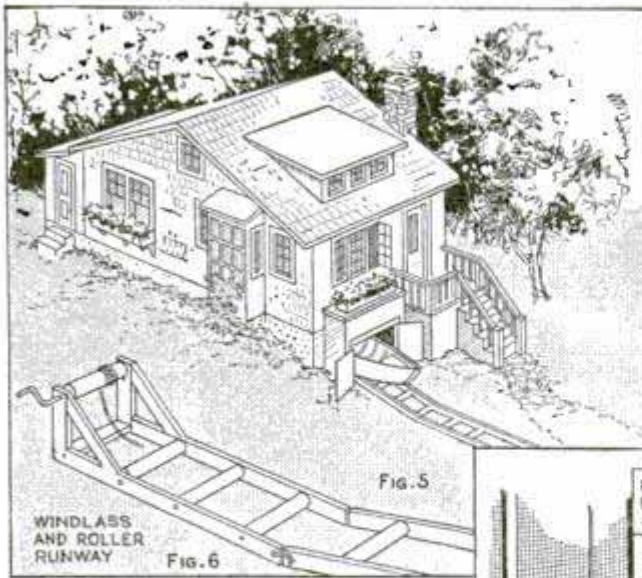

able ladder, as shown in Fig. 10. Windows and dormer in the attic provide good ventilation.

Any man who has had some experience in carpentry and a working knowledge of simple cabinetwork can put up this house himself, with the exception, perhaps, of the plumbing and gas fitting. In case the cottage is built in a remote section without gas or water, independent units can be purchased which give splendid service, at least for water and electricity. An oil stove would be used in this case.

In localities where more or less severe winds occur, it is well to set the structure on concrete footings, securing the sills with anchor bolts. Note in the diagram, Fig. 9, that standard construction is used, with 2 by 8-in.

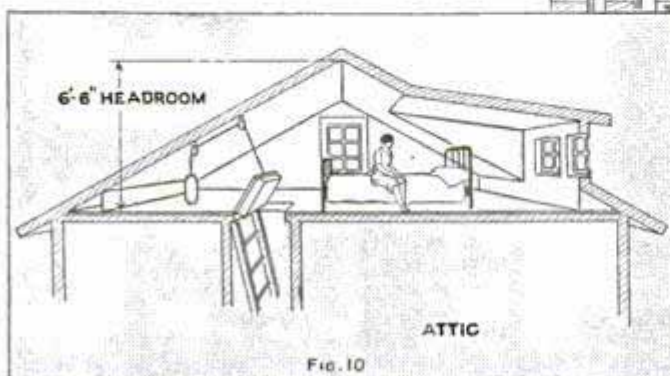

sills, 2 by 6-in. floor joists, and 2 by 4-in. studs, set 16 in. on centers. The subfloor should be laid diagonally, and corners of the frames well braced, as shown. An exterior of shingles or shakes is desirable, particularly on the sea coast, for this assumes a soft weathered effect in keeping with the environment. Painted structures suffer in salty winds and fogs.

By all means spare no pains with the fireplace, Fig. 2. This should have ample width to accommodate backlogs and heavier pieces of driftwood. If flat stones are available in the vicinity, use them in place of brick. It is an economy and more attractive, in this instance, than manufactured material. No ash pit is shown in the drawing, but this convenience can be added with little extra expense and labor.

Casement windows are recommended for the best ventilation. These should swing out, with hinged screens inside, but substan-

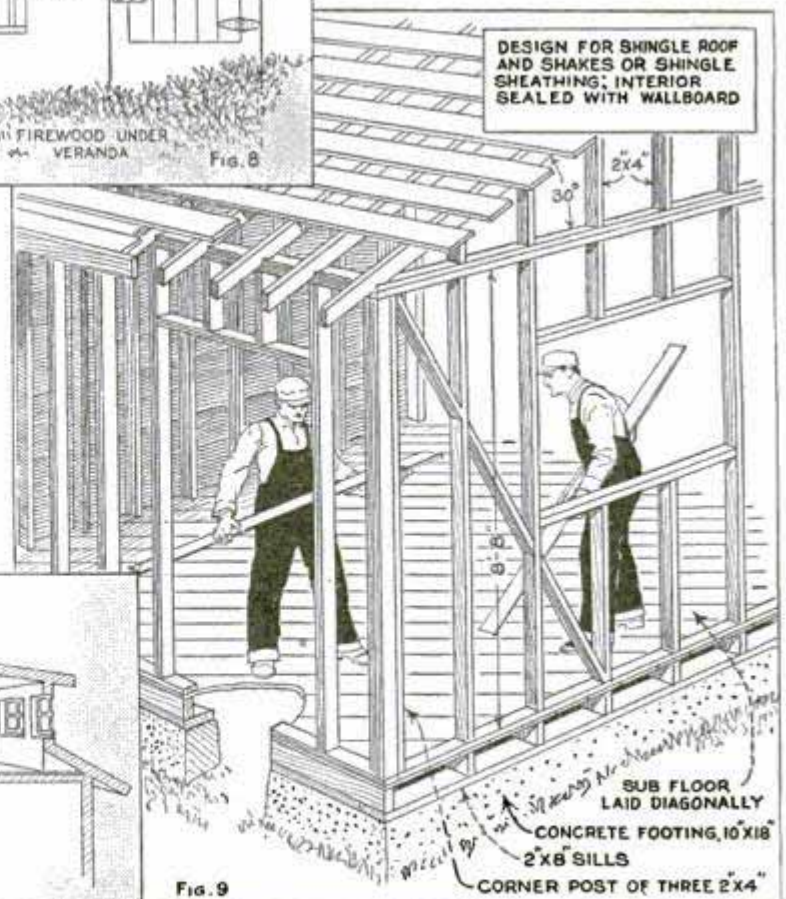
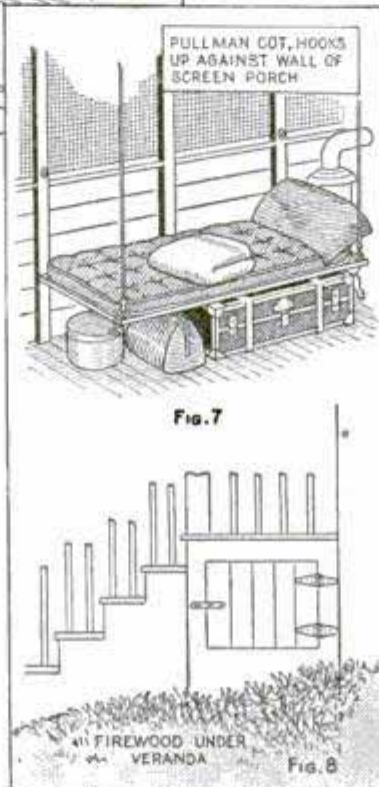
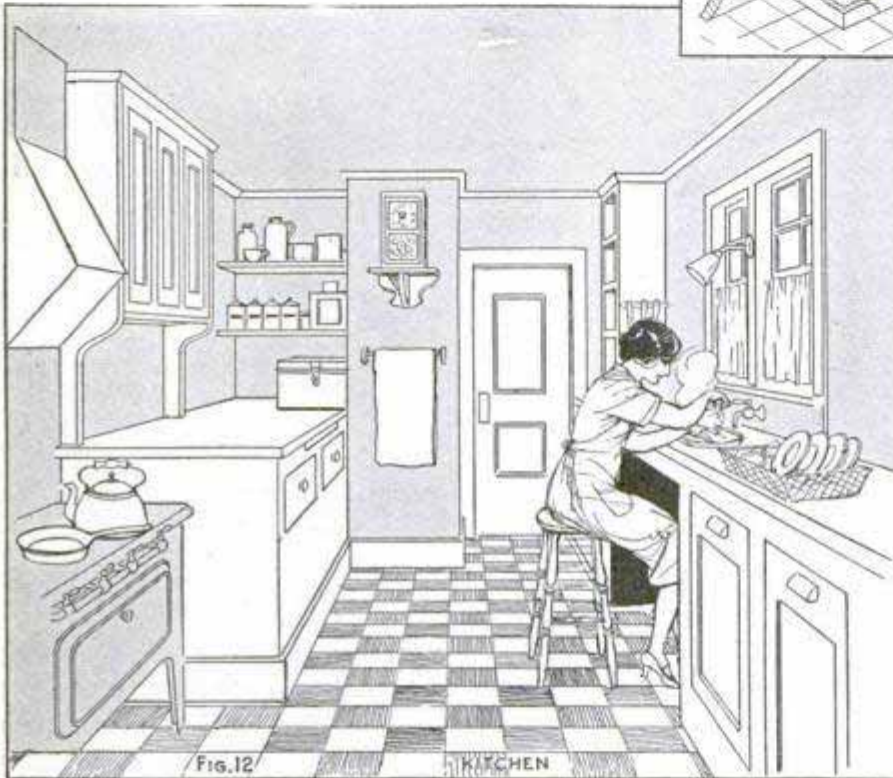
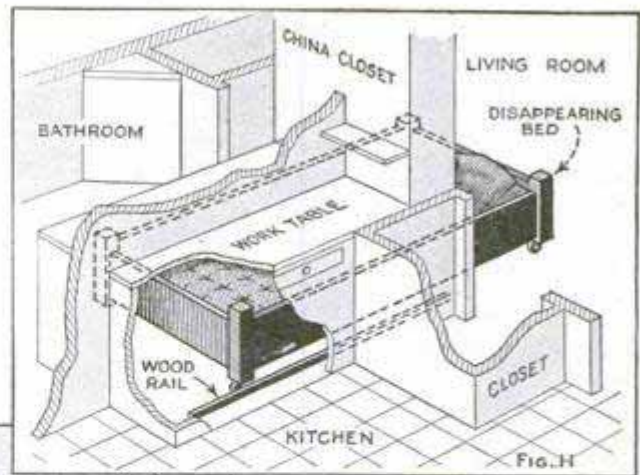

Fig. 9

Fig. 10

tial fasteners should be installed to hold them open. Nothing is more annoying than windows that creak and bang in high winds.

On fairly large bodies of water without bays or inlets, a valuable boat will get considerable rough treatment if left tied to a pier, or if too heavy to haul up on the beach. A roller runway, Fig. 6, is a great convenience in this case. Make it in about 12-ft. sections, which can be unhooked



a 3-in. roller having lag-screw axles.

Under the front veranda is space to keep firewood dry and at the same time within easy reach of the fireplace.

There is one advantage in a cottage of this small size. In many beach resorts lots are very narrow, averaging about 25 ft. in southern California. This house, with its over-all width of only 19 ft. allows plenty of room on either side. For plans, turn to page 880.

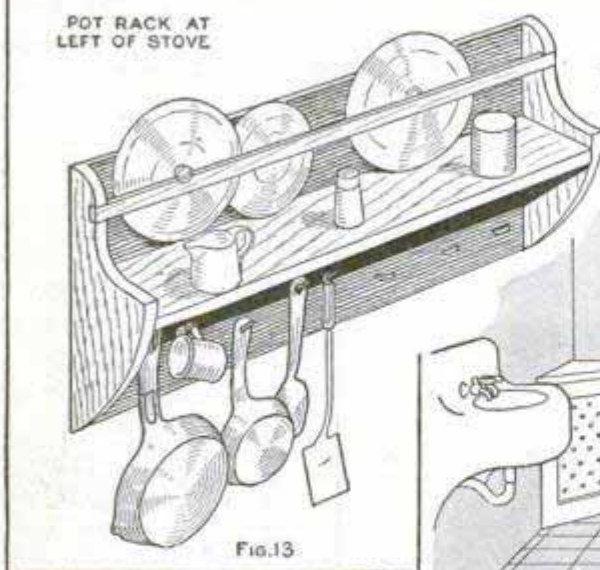

for storing away. Side members are of 2 by 4 or 2 by 6-in. pieces, depending upon the "tonnage" of the vessel, with about



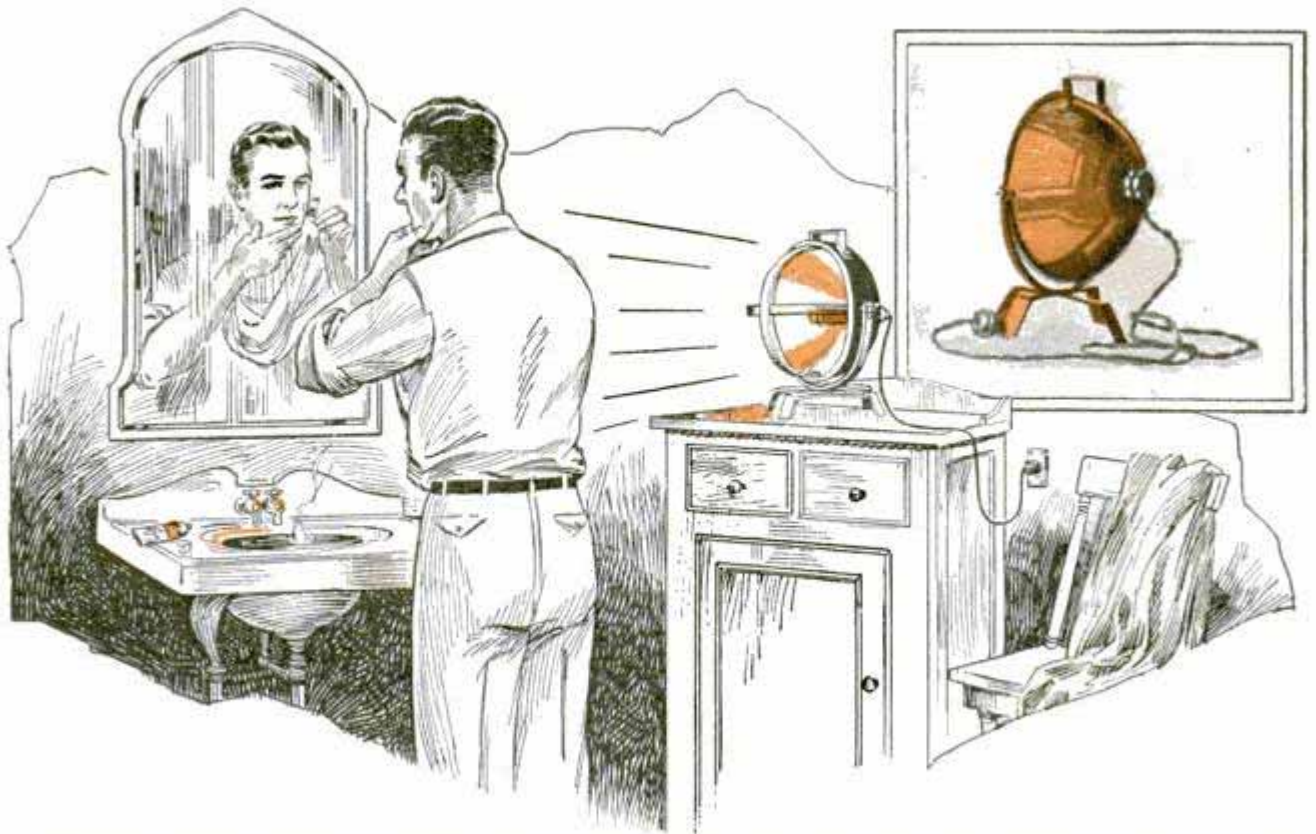

Costing Little over a Dollar to Make, This Electric Heater Can Be Built by Any Home Mechanic and Is Very Efficient; the Heating Element Is Quickly Replaceable, an Advantage over Ordinary Cheap Heaters

You Can Make This Electric Heater

By E. A. RERUCHA

AN EFFICIENT electric heater may be easily made in the home workshop. The materials required are readily obtainable, and the total cost of the device is not much over a dollar. Although the appearance of the heater, perhaps, does not measure up to that of the commercial article, the performance and lasting qualities compare favorably with those of the cheaper type of heaters on the market. A good grade of standard replaceable cone-type nichrome-wire heating element is used. These elements last for a comparatively long time and are easily replaced when worn out, which is not always convenient with the cheaper type of heaters, in which the element is wound on a special form, that is not al-

ways standardized and is in many cases permanently fastened to the device so that replacement is difficult. An aluminum mixing bowl is used for the reflector, a porcelain screw-ring receptacle to hold the element, and the stand is made out of band iron. The mixing bowl may be purchased in most variety stores for 25 cents.

To make the stand, proceed as follows: Find the center of the piece of $\frac{3}{8}$ -in. band iron and drill two holes $\frac{5}{32}$ in. in diameter, one on each side of the center and $\frac{5}{16}$ in. from the center mark. Round off the ends and drill a hole about $\frac{3}{8}$ in. from each end, large enough to admit the No. 8 machine screws. Now bend the piece in the shape of a semicircle. Cut the two legs from the 1-in. band iron and

MATERIAL LIST

- 1 aluminum mixing bowl about 9½ in. in diameter.
- 1 porcelain screw-ring receptacle with covered terminals.
- 1 standard cone-type nichrome-wire heating element.
- 2 No. 8 round-head machine screws, 1 in. long.
- 2 thumbnuts to fit above screws.
- 2 hexagon nuts to fit the No. 8 screws.
- 4 washers to fit the No. 8 screws.
- 2 rivets, $\frac{1}{8}$ in. in diameter and $\frac{1}{2}$ in. long.
- 6 machine screws with nuts, about 4-32 and $\frac{3}{8}$ -in. long, for guards and handle.
- 1 detachable plug.
- 6 ft. No. 14 asbestos-covered heater cord.
- 22 in. band iron, $\frac{3}{8}$ by 1 in., for stand.
- 24 in. band iron, $\frac{1}{16}$ by $\frac{1}{4}$ in., for guards.
- 8 in. band iron, $\frac{1}{16}$ by $\frac{1}{2}$ in., for handle.
- 17 in. band iron, $\frac{1}{8}$ by $\frac{5}{8}$ in., for stand.

bend to shape as shown in the drawing. One of these should be $\frac{1}{4}$ in. shorter than the other so that the bottoms of all four legs are on the same level when the stand is completed. Find the centers and drill holes for the $\frac{1}{8}$ -in. rivets shown in the drawing. These holes should match the holes in the semicircular piece so that the rivets pass through all the holes. Assemble and rivet together. For decoration, any colored lacquer may be used. However, the iron should first be washed with soap and hot water to remove all grease, and then rinsed in clear water to remove all traces of the soap. Allow to dry thoroughly before applying the lacquer. Black stovepipe enamel may be used instead of the lacquer, which makes a fine-appearing job with the aluminum reflector. The thumbnuts and the screws should also be finished in the same color as the stand, as well as the guards and the handle.

The handle may be made next by bending the piece of $\frac{1}{16}$ by $\frac{1}{2}$ -in. iron as shown in the drawing. Round off the ends and drill a hole in each to admit a 4-32 screw.

The guards are prepared by cutting two pieces 12 in. long from the $\frac{1}{16}$ by $\frac{1}{4}$ -in. iron and soldering them together at right angles at the center. Round off the ends and drill a hole to admit the 4-32 screws about $\frac{5}{16}$ in. from each end. Bend in a semicircular shape as shown in the drawing, with the ends fitting inside the reflector.

To prepare the mixing bowl for the reflector, locate the center of the bottom, and cut a hole in it large enough so that the nipple of the screw-ring receptacle just passes through it. Also locate the holes for the 4-32 screws for the guards and the handle, and for the No. 8 screws by which the reflector is attached to the stand. Drill the holes and attach the guards and handle. Place a washer on each of the No. 8 screws, then put them through the holes prepared for them in the reflector, and screw on a nut tightly, so that the screws will not turn when adjustments are made for inclination. Place the reflector on the stand, put a washer over each screw and screw on the thumbnuts. The stand and the reflector are now complete.

Attach the plug to one end of the heater cord and the receptacle to the other

end. Place the nipple of the receptacle through the hole in the center of the re-

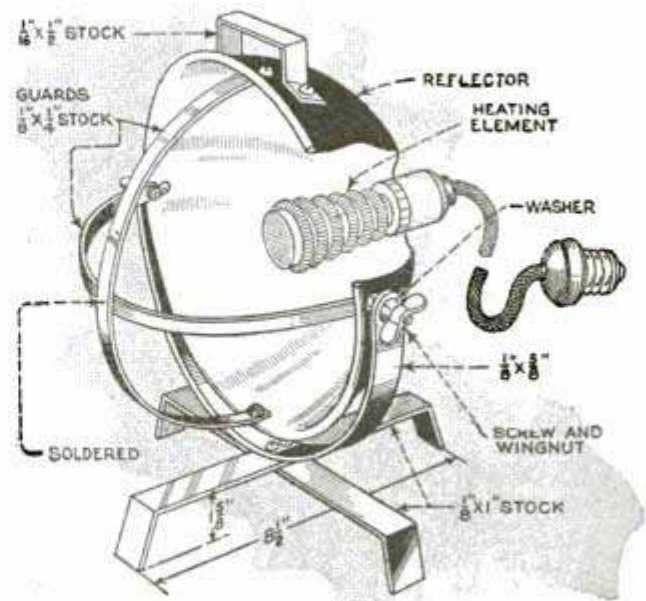

flector from the rear and screw on the ring from the inside of the reflector. Screw in the heating element, and the heater is completed. The reflector should be left in its natural finish.

Holder for Ringing Hogs

Holding a hog's snout still when ringing it is an easy matter with the holder shown in the drawing. It consists of a length of pipe, a handle made of iron rod and a length of wire, one end of which is fastened to the end of the handle and the other to the end of the pipe, holes being drilled through the pieces to receive the wire. In use, the handle is pushed down so that the wire forms a loop to catch the snout, after which the handle is drawn up. Invariably the hog will start to pull backward but will hold its snout steady enough to permit ringing without trouble.—J. R. Koontz, Bremen, Indiana.

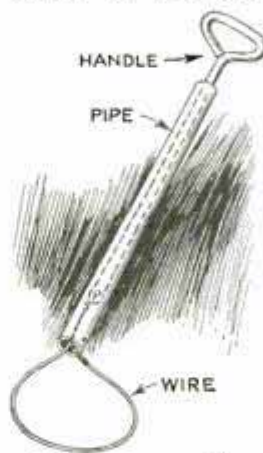

☛ A small, sharp spade, with a folding handle is a convenient tool to carry on a touring trip.

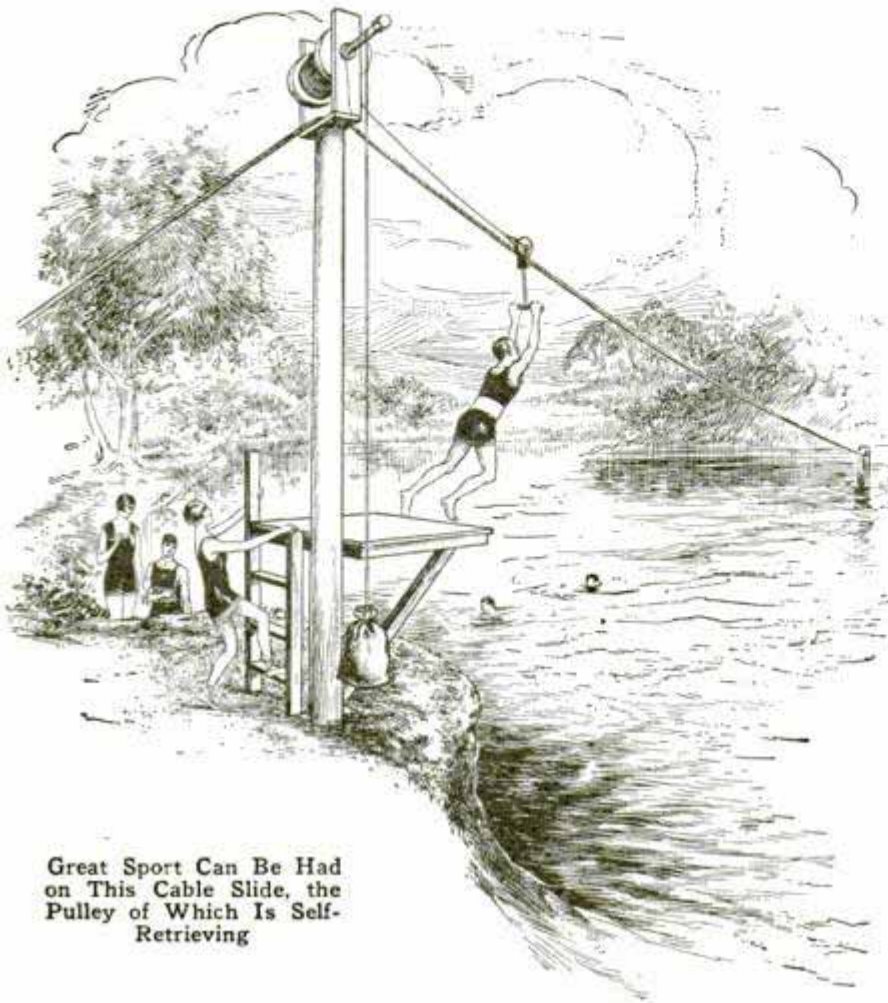

Great Sport Can Be Had on This Cable Slide, the Pulley of Which Is Self-Retrieving

Self-Retrieving Cable Slide for Bathers

In a middle-western summer resort, which is equipped with elaborate and expensive apparatus, the most popular feature is a self-retrieving cable slide. A telephone pole was set up on a bank so that its upper end was about 35 ft. above the surface of the water. A 250-ft. steel cable, of the kind used for guying poles, was run from a stake driven firmly into the ground at some distance behind the pole, over it and to a post in the water as shown. A pulley, fitted with a suitable handhold, rides on the cable, and is returned to the pole from the far end by means of a rope wound on a drum, which is revolved by the weight of a 75-lb. bag of sand. The drum is mounted in a wooden frame using a 2½-in. pipe for a shaft and ball bearings from a discarded rear auto axle. The pipe was driven through the drum with the end extending a short distance at one side, upon which another rope holding the sand bag is wound up when a rider goes down the slide. Owing to the difference in circumference of the drum and

the shaft, the rope attached to the pulley travels a much greater distance than the one holding the sandbag. A convenient platform, enabling the bathers to get at the handhold on the pulley is also provided. The end of the cable should be close to the surface of the water so that it will check the speed of the rider in case he does not jump off soon enough, and will thus prevent him from hitting the post with possible injury.—R. F. Starzl, LeMars, Iowa.

Box 347

Why Auto Tires Lose Pressure

In trying to determine causes of air leaking out of auto tires slowly, it has been found that the valve is usually to blame.

The nut on the base of the valve stem, which locks the latter to the tube, often becomes loosened and allows air to escape and therefore it should be turned down tightly just before an inner tube is inserted in the casing. The valve inside may also be faulty. The small rubber gasket in the core frequently becomes fouled with bits of dirt, which prevent it from seating properly, providing a passage for air. To prevent the entrance of dirt, keep an air-tight cap on the valve, the cap being driven on as tightly as possible with the fingers. Many motorists claim that new tires are not so easily kept up to the recommended pressure as old ones. This is due to the fact that, during the first 1,000 miles or so, the tire to a certain degree "grows" by stretching slightly in all directions and becoming larger, which accounts for the loss of pressure. Tire manufacturers have also found that air seeps through the rubber to a slight extent. The air in a tire used a long time on one filling will show a greater content of nitrogen than fresh air, indicating that some of its oxygen content has either

seeped through the tube walls, or has united with the rubber in the tube. Seepage also takes place through minute holes in the inner tube. When inflated inside of a casing, a tube is nearly always stretched, which makes a small hole larger. The tube may leave the factory without a single microscopic hole, but it soon deteriorates through the action of grit and rust particles. Another factor that many motorists fail to consider is temperature changes. If a tire is filled at noon, during the summer season, the pressure will be much lower at night, when it is cooler, and the reverse is also true. This change is not great enough to be detrimental to passenger-car tires, but sometimes is important in the case of truck tires. A truck tire has been known to vary in pressure within a range of as much as 70 lb., due to temperature change alone.—Walter E. Burton, Akron, Ohio.

Stone and Cement Cleaner

For cleaning stone and cement, the following solution has been found effective: Acetate of soda, 9 oz.; powdered alum, 4 oz.; oxalic acid in crystalline form, 2 oz., and water, 1 gal. Dissolve the chemicals in the water and scrub the surface with the solution, after which it is washed off with clean water.

Graduated Post-Hole Auger Tells Depth of Hole

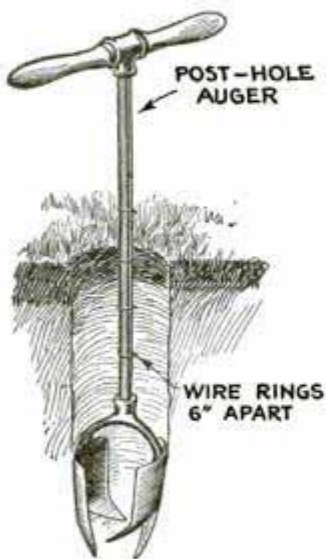

marks should be spaced every 6 in. and, if desired, rings, made by twisting some wire around the handle in the grooves, can be provided. This idea saves much time.—A. C. Schofield, Craven, Can.

To graduate a post-hole auger so that you can tell just how deep the hole is, file or cut a number of grooves around the handle as indicated in the illustration. The marks should be spaced every 6 in.

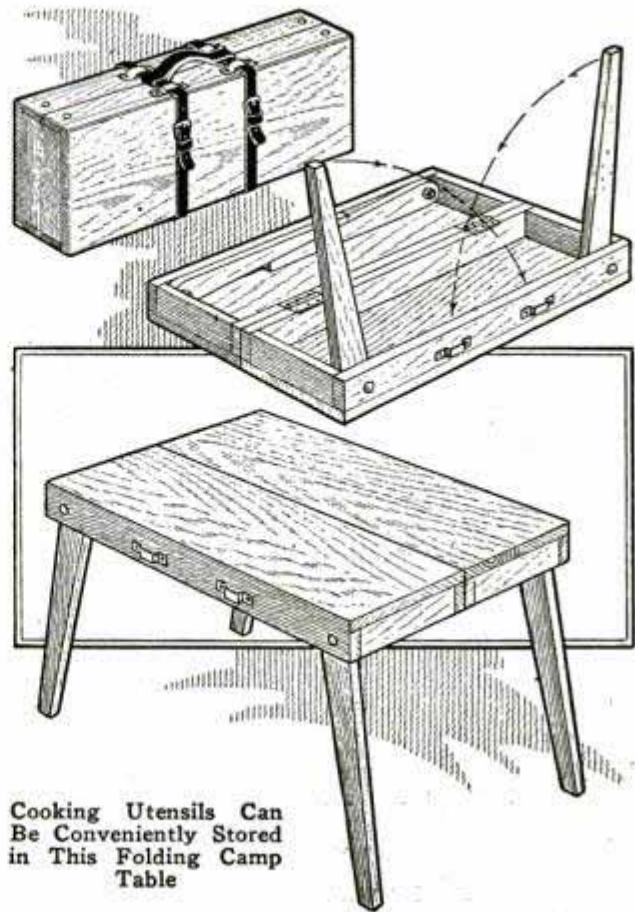

Folding Camp Table for Holding Cooking Utensils

Almost anyone who is at all handy with tools can make the illustrated camp table in a short time. Its convenience lies in the fact that it can be folded and will then hold a large number of cooking utensils. Two shallow boxes, hinged together, form the top, and the legs are bolted at the four corners as indicated, so that they can be folded within the top. Suitable straps or hooks and screweyes hold the two boxes together when closed. It is best to make the sides and ends of the boxes of 1-in. stock, about 2½ or 3 in. wide. The bottom is made of ¾-in. plywood or other thin lumber suitable for the purpose. The legs should be made of 1-in. material, preferably hardwood, 28 in. long. They should be tapered from a width of 3 in. at the top to 1 in. at the bottom. The top end of the legs must be rounded to prevent binding when they are folded inside of the top. When bolting the legs in place, do not set them tight up in the corners; they should be set back about ¼ in. from the corners, so that when the table is set up they will project outward at the bottom.—J. K. Elliott, Ft. Lupton, Colo.

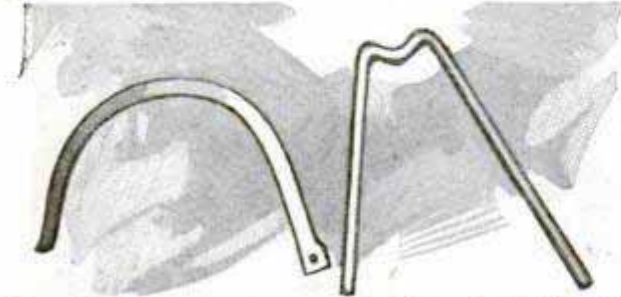
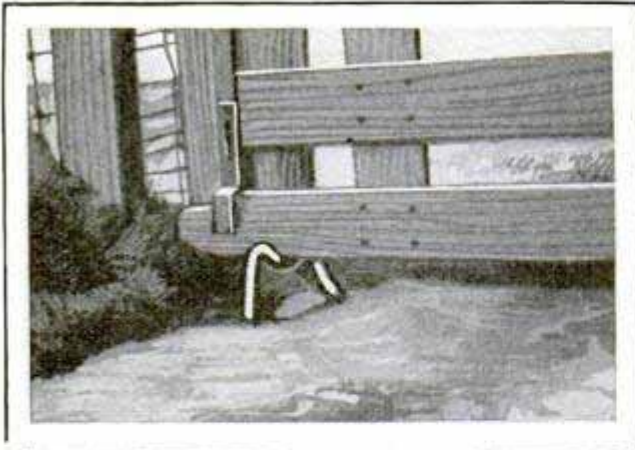

Gates Will Be Kept in Good Condition Indefinitely by Providing These Flat-Iron Supports

Simple Support Will Prolong Life of Farm Gates

Many good farm gates are ruined each year by tearing them out of frozen mud when it is necessary to open them. This trouble can be prevented by providing a support under the gate, as shown in the photo, to keep it off the ground. There is plenty of iron around the farm to make a large number of these supports. The iron is bent to the shape shown at the left, the legs being made long enough to be driven into the earth next to the gate posts, where they will be out of the way. A notch formed at the top of the support, as shown above and at the right, prevents the gate from slipping off, and is especially useful when the support is used for a swinging gate.—J. R. Koontz, Bremen, Indiana.

Sight for Small-Bore Rifles Is Improved by Reversing

In the average .22-caliber rifle, with its small stock and fore end, the rear sight comes so close to the shooter's eye that a good aim is impossible. More peep-sights have been installed on cheap rifles because of the incorrect installation of open sights than for any other reason. One of the best methods of adjusting a

leaf sight is to remove it and turn it around, which will move it about 4 in. ahead of its old position. Rifle sights fitted in grooves in the barrel are inserted from the right and driven out from the left. To remove or insert a sight, use either one of the copper hammers sold for this purpose, or an ordinary tack hammer. Protect the barrel and the sight with a layer or two of thick cloth in case a tack hammer is used. Tap lightly and sharply. When replacing a sight, hold the gun in a clamp such as a vise, the jaws being wrapped with cloth, and alternately sight through the barrel and over the sights until they seem to be in line. Take a box of cartridges and a sheet of graph paper with a bull's-eye marked in the center. Use this target at 50 yd. or more, adjusting the sights until the group centers on the vertical line of the bull's-eye. Even if you are a poor shot, the average will show you where to line the sights. It might seem, with the wedge of the sight base reversed, that the sight would be wobbly, but this is not the case.—John L. Story, Oklahoma City, Okla.

Novel Sign Post for Home Owners

One of the most attractive sign posts to be found in a western suburb is shown in the photo. Besides bearing the street name and house number, it holds a sheet-metal silhouette of the family before whose



home this marker stands. The silhouette was made by gluing a photograph to a piece of sheet metal and then cutting out the figures with metal shears as indicated.—Nancy Smith, Hollywood, Calif.

☞ To prevent burning the hand with steam while filling a hot teakettle, run the water from the faucet through the spout.

Safety Measures for Sewer-Gas Traps

When a house is left for any length of time without heat during the winter, the water traps which prevent sewer gas from entering the house, may be frozen so badly that the trap bursts, necessitating replacement. For this reason the water is often removed, but this has the disadvantage of admitting the gas into the house, which is also very objectionable. A method of preventing both troubles is to remove the water from the trap and then replace it with kerosene. This will neither freeze nor allow the entrance of sewer gas. Also, when the house is left for some time during the summer, the water in the trap will evaporate, and sewer gas will enter. The same remedy is effective in this case, but it is only necessary to cover the water in the trap with a layer of oil to prevent its evaporation.—James E. Noble, Toronto, Can.

Rake Attached to Lawn Mower Saves Time and Work

When cutting large lawns much time can be saved by combining the cutting and raking operations, as shown in the drawing. File or cut out a semicircular notch to fit the rake handle at the end of the mower shaft, and then make a strap of metal or wood to hold it in position, the strap being screwed onto the mower handle as indicated. As the latter is movable, the worker can put just the right amount of pressure on the rake while pushing the mower along. When enough grass has been gathered in the rake, it is dumped by simply raising the mower handle without stopping. If the grass is dumped in regular rows it can easily be raked into piles at suitable intervals. — Harry Moore, Hamilton, Canada.

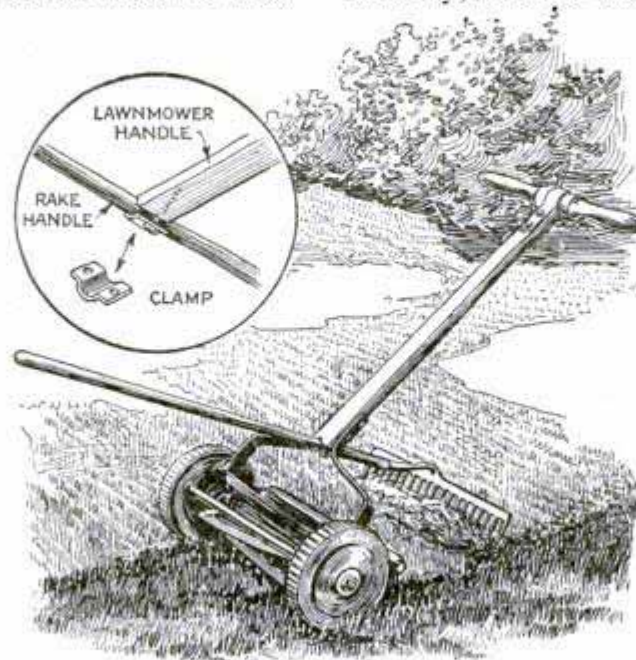

Rake Attached to Lawn Mower Picks Up the Grass While Mowing

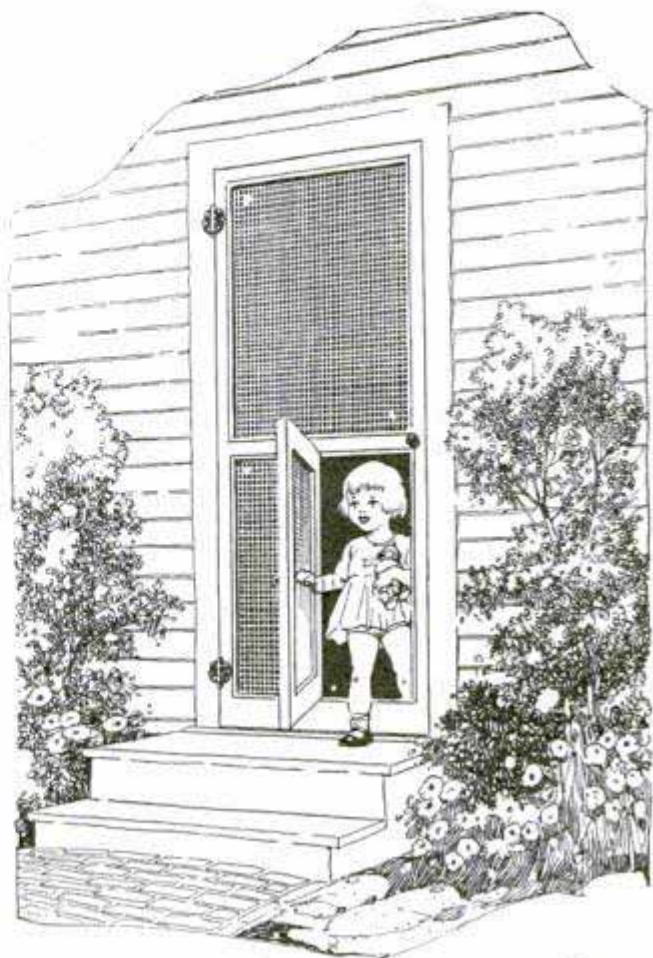

Small Door Gives Passage to Children but Hinders Entrance of Flies

Separate Exit for Children in Screen Door

In a home where there were a number of children who constantly went in and out of the door, it was found impossible to keep the house free from flies. As a remedy, a small door was arranged in the bottom panel of the screen door as shown in the drawing. Spring hinges, of course, were used on the small door so that it would close. The screen door was kept locked with a hook on the inside.—Mrs. F. F. Pickens, Jr., Weaver-ville, N. C.

¶ If dry cells run down quickly, examine the wiring system for a short circuit.

Chimes movements
1659 Ruffner, Phila.
orders U.S. Canada, Mexico only

GRANDFATHER YOU CAN

BY R. O. BUCK
 and L. DAY PERRY

PART II

AN ENTIRELY different procedure is employed in the construction of the clock case described in this part. It consists of four units which are built separately, the assembly being made only when they are all completed, and you are ready to add the moldings. Fig. 14 shows a front and

fastened with both glue and screws, but only screws are used in the assembly.

Fig. 15 gives complete details and dimensions for constructing the waist of the case. The construction is very simple and involves nothing more difficult than housed butt joints. After finishing the stock for the sidepieces, lay out, at the top and bottom of the back edge, a notch, 2 in. long and $\frac{3}{4}$ in. wide, to house the back cross rails. The front rails are not housed, but simply screwed to the edge as shown, so that they will bring the face out flush with the face of the door, as will be seen later.

Sides and back rails are both rabbeted to receive the $\frac{3}{8}$ -in. plywood backing. The top and bottom ends of the waist unit are open to permit the weights and pendulum to hang through. Screws should be used with glue to assemble the parts of the unit. Be very careful in the assembly that all faces are square and true.

The door, dimensions for which are given on Figs. 14 and 15, should be made with mortise-and-tenon joints, the lower rail tenons being $\frac{1}{4}$ by $1\frac{1}{2}$ in., while the upper ones should be made only $\frac{1}{4}$ by 1 in. A $\frac{3}{8}$ -in. rabbet all around is made to take the glass, which is to be fastened with strips as in the previous design. The glass, of course, is not to be put in until the final finishing coat has been applied. Notice that the top of the glass is not cut to the shape of the door curve but has a square top, as indicated by the dotted lines, Fig. 14. It will be necessary to leave a lip on the inside shoulders of each tenon to fill in the rabbet on the stiles. After all joints have been made and the door set up, it should be glued and clamped. Care must be taken to have the door perfectly flat and square in the clamps, or it will not fit flush against the edges as intended. The

Chamberlain's
Century
door

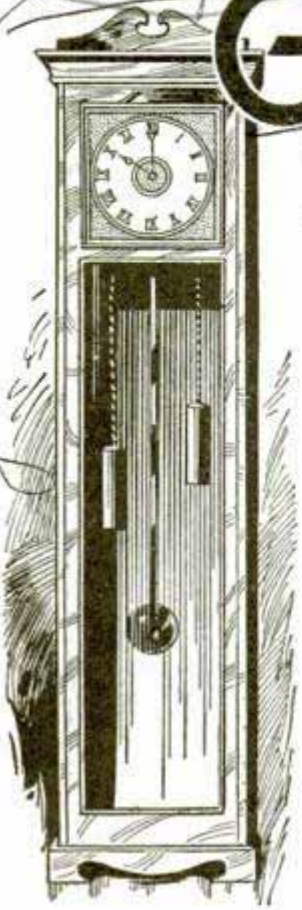

side view of the clock case assembled, and the names of the different units. In general, the various parts of the units are

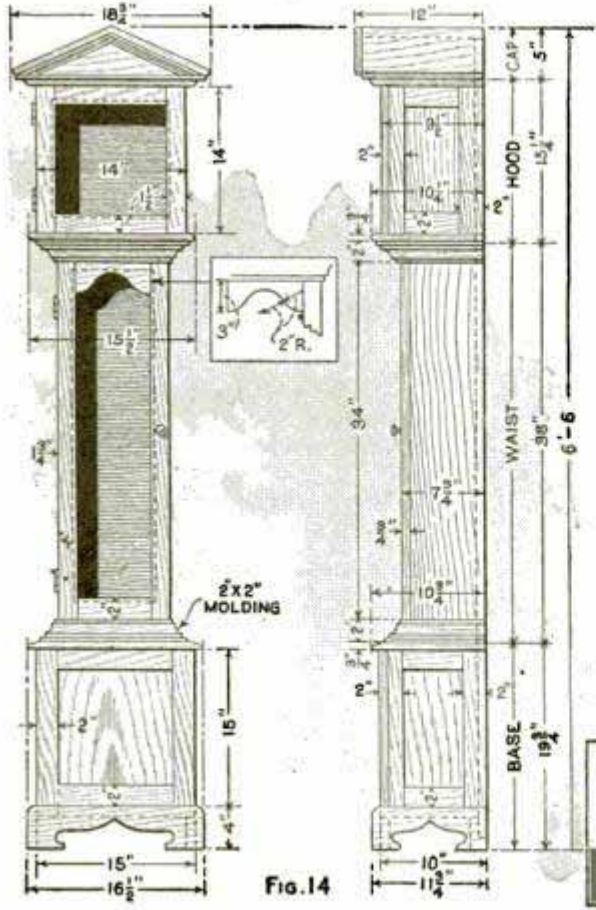

of the base, Fig. 18, is practically the same as the hood, with the exception that instead of a door in front a solid panel is used. The three panels should be made up first, after which they may be squared up and joined just as if they were solid boards. The top end is open, but the bottom is closed and is made of any $\frac{1}{2}$ -in. soft wood, glued and nailed to triangular cleats as shown. Set the bottom up about $1\frac{1}{4}$ in. Notice that the bottom rails on all panels are 3 in. wide but that only 2 in. of this width is exposed, the remaining 1 in. being used as a ground on which the base pieces are fastened. To further reinforce the bottom structure, base blocks are glued inside the base molding, as shown in Fig. 20.

The paneled front is made to fit flush just as the doors do so that the arrangement will be uniform all the way up. Sections of all of the pieces in the base unit make it easy to get out all the stock to size before starting to glue up the panels.

The 4-in. top molding, which will have to be made with a plane, is screwed and glued to the top edges of the panel, and the back is set in a rabbet as usual, with top and bottom rails of any convenient size. The molding will cover the screw heads, so the screws may be put in from the top.

Fig. 19 is a pattern for the formed base moldings. The figure shows half of each pattern and is divided into $\frac{1}{2}$ -in. squares. Make full-size cardboard patterns from which the curves may be traced on the stock. Nails and glue fasten the pieces in place.

The assembly of the units is a comparatively simple matter as the offset edges

of the hood and base sections suggest a convenient method for screwing the units together. Care must be taken to center the parts so that the clock case stands plumb and true. The final step in the assembly is the fastening of the 2 by 2-in. molding connecting the waist with the base and hood units. A stock molding of a design similar to the one shown is suggested for this purpose. A plain pattern is commonly used for this purpose, but some of the conventional embossed or carved moldings give a very pleasing effect also. All holes that are not covered by the moldings should be carefully puttied, with water putty preferably, after which the entire case should be scraped and sanded.

The type of finish to use for your grandfather clock is largely a matter of choice. Lacquers were used extensively in the early cases, and, of course, a case that is to be lacquered does not require as fine a grade of lumber as one that is to be varnished. This method, therefore, has much to recommend it. For a lacquer finish proceed as follows: First use a lacquer undercoating all over the case, followed by two coats of the color lacquer. Decorations in the form of decalcomanias or transfers may be applied and the clock finished with striping of old gold. The inside is generally finished in solid color without decoration or shading.

A very effective gold-and-lacquer treatment for the case may be made by the use of an atomizer and some dry old-gold powder. With an atomizer, spray a coating of thin shellac on a small portion of the surface, followed immediately with a coating of gold powder blown from a piece of cardboard onto the wet shellac.

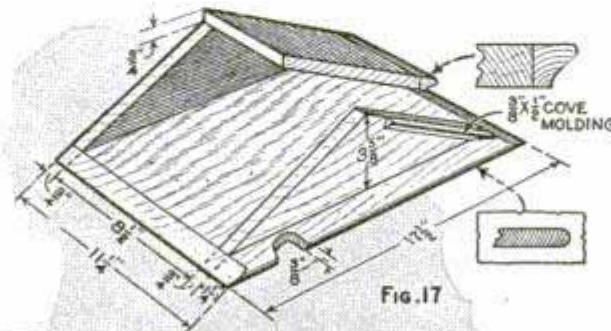

Fig. 17

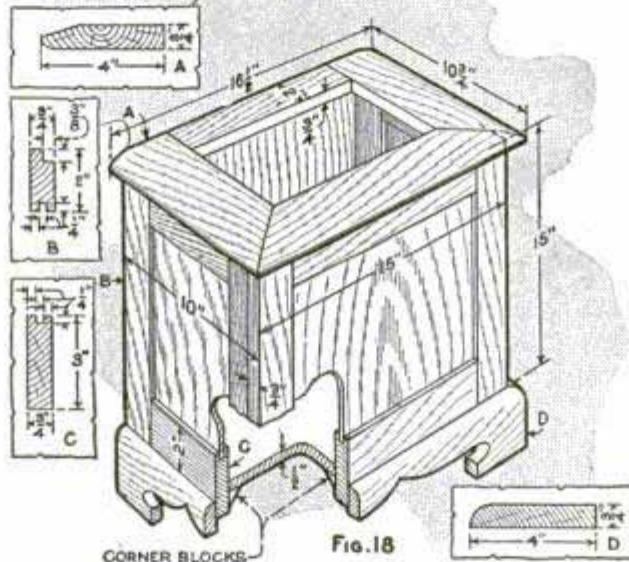

Fig. 18

It is easy to get a blended and very pleasing effect in this way.

If a crackled effect is desired, all that is necessary is to go over the gold previously applied, as described above, with another coat of the shellac but somewhat thinner than before. This will cut the former finish and thus cause the gold to run in such a manner that a very beautiful effect is obtained. It is rather difficult to describe this process, but a little experimenting will make it clear. In case you are dissatisfied with a first attempt, you can wipe the gold off with a cloth soaked in turpentine, and start over.

For real richness and beauty, the natural grain of carefully selected wood excels by far any decorative effect you may secure with the aid of opaque finishes. An oil-rubbed or varnish finish is always handsome and durable, and is always in good taste. If your cabinetwork is well done, a varnish finish is the most satisfactory. The process of wood finishing has been described and discussed so many times in the pages of this magazine that we will not repeat it here.

After the finishing is completed, the glass may be put in the doors, using a clear piece

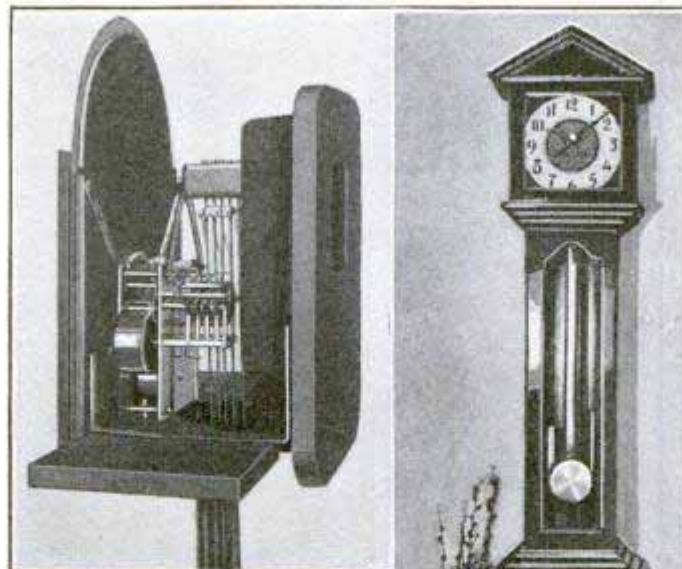
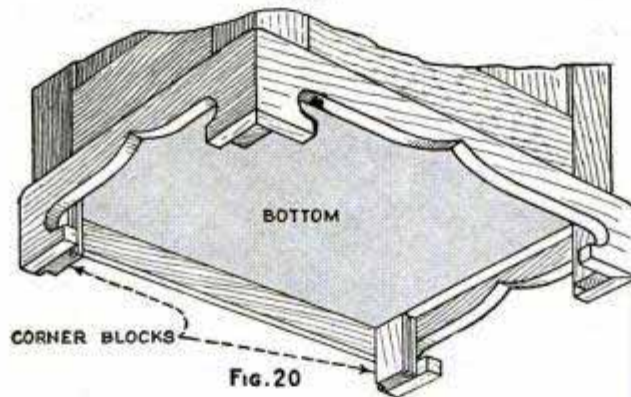
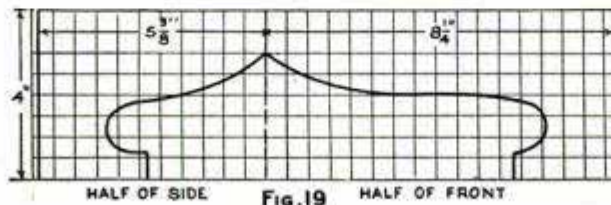
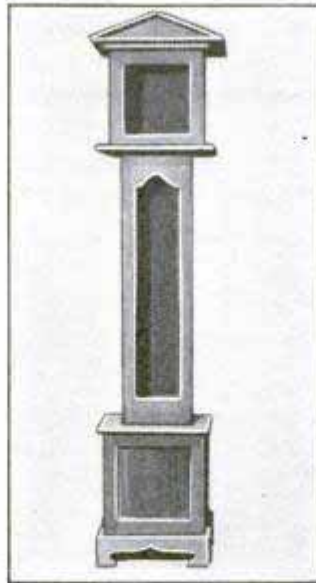

Above, Grandfather-Clock Movement Fitted with Westminster Chimes, Ready for Installation; Right, the Finished Clock, Made as Described in This Article

of single-strength glass for each door. The glass is fastened in place with strips and brads, or small screws, as previously described.

In the bottom of the legs, four $\frac{1}{4}$ -in. lag screws should be set. Drill holes as large as the root diameter of the screw threads to prevent splitting the legs, then drive in the lag screws their entire length. Be careful to stop when the end of the thread is reached, however, as it is quite easy to cut away the wood threads the

screw has formed. The screws should have a smooth head, so that they will not mar the floor when they are turned. The purpose of the lag screws is to enable you to level the clock on the floor. Of course, the movement must be so mounted that it also can be adjusted to a balance. If a thin-end wrench is used, the adjustment can be made without tipping up the clock. If the location of the clock is changed at any time, it is necessary to readjust these screws, to compensate for irregularities in the floor.

Clock movements may be obtained in a variety of designs and prices, and there are one or two manufacturers who specialize in the sale of them.

Cleats should be screwed to the inside of the hood on which to mount the movement. Various manufacturers have different ways of mounting their movements, but the usual practice is to hang them from some sort of a sliding cross support which in turn rests on the cleats. Directions or drawings are usually included with a movement showing how to mount the movement and also the dial. The dial usually is mounted on cleats set back $\frac{3}{8}$ in. from the front to give clearance for the hands and hand post.

Lamp Pull Made of Wallpaper

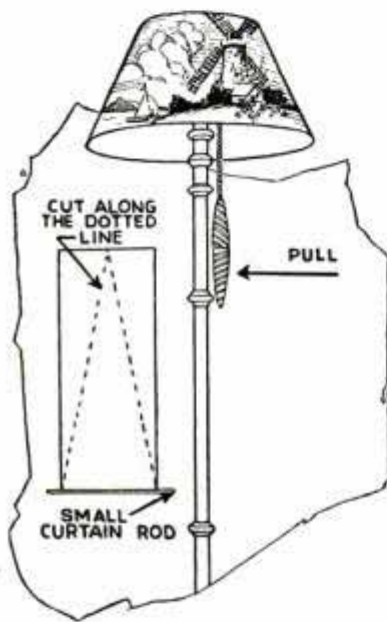

For bridge, floor or junior lamps, an attractive pull can be made from a piece of colored wallpaper, 18 in. wide, 12 ft. long, cut to a triangular shape as shown. Starting at the wide end, the piece is rolled up tightly on a $\frac{1}{4}$ -in. metal

curtain rod, so that, when finished, the point of the paper comes midway of the roll. A drop of glue is rubbed on the underside to hold the roll tight, and after the glue has dried the curtain rod is pulled out. Apply one or more coats of white shellac and, after this has dried, slip a length of chenille lamp cord through the pull, tying a knot at one end and attaching the other end of the cord to the brass chain of the lamp socket.—Sandra La Plante, Washington, Ill.

Rubber and Rosin Make Compound for Many Uses

By melting bits of rubber, cut from an old inner tube, and adding an equal amount of rosin, a useful compound can be made. Pouring it into a worn-out spot on the shoe sole and pressing sand on the surface before cooling, will produce a dur-

able, waterproof patch. When spread thinly on a piece of cloth and allowed to cool, the compound makes an effective mending tissue, which is used without heat, the cloth being simply pressed on. In the same way, it makes an excellent glue for fastening paper and cloth to metal or glass, and as it does not harden and get brittle, it will adhere tenaciously. Besides being waterproof, this material is a good electrical insulator. Adhesive tape can be made by coating a strip of cotton tape with the compound, and a protective salve for cuts and burns can be made by slightly warming a lump of the mixture. It has also been found effective as a cement for holding tool tangs securely in the handles. To make the cement more brittle, the amount of rosin should be increased. Kerosene is used to remove it from the hands.

Lighted Lanterns Protect Sheep

Sheep raisers in a western state have found that the use of lighted lanterns, hung at intervals around the pens at night, will keep roving bands of dogs and wolves at bay. The sheep will also feed better at night when the pens are lighted. Before the use of lanterns was introduced, thousands of head were lost every year, and it is now planned to install electric lights.—F. S. Reynolds, Ft. Morgan, Colo.

Tool Rack in Auto Trunk

Fitting snugly against the side of the auto trunk, the illustrated rack makes the tools accessible to the motorist without scrambling through the compartment under the rear seat.

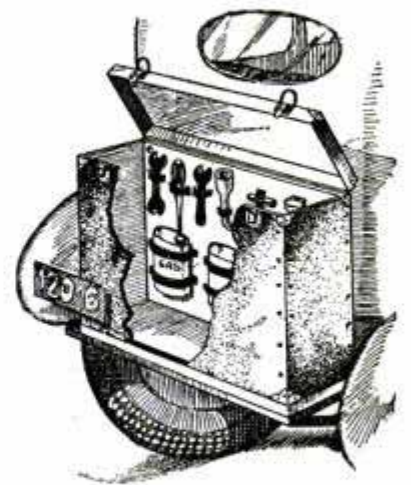

The rack is merely a wallboard or wooden panel fastened to the inside of the trunk by means of two wood screws, which can easily be removed when necessary. Each tool has its place, all being held by suit-

able straps made from old inner tubes. For heavy tools wire straps may be better. Besides the convenience of this arrangement, rattling is entirely eliminated.

Tourists' Stove Heated by Exhaust Gas

Cooking food while driving will appeal to many motorists even though they do not eat the meal until they reach the camping place. Utilizing the exhaust gas of the car, the cookstove shown in the drawing makes this possible. It was built directly over the exhaust pipe under the floorboards, as close to the motor as possible. Part of the front floorboard was cut out directly over the stove, and a wooden box with a hinged lid built over the hole. The inside was lined with asbestos and the outside covered with imitation leather to match that of the car. At the forward end of the stove, which is made of $\frac{1}{16}$ -in. sheet iron and measures $4\frac{1}{2}$ in. deep, 7 in. wide and 20 in. long, a cutout valve was installed so that the exhaust gas could be diverted into the stove or kept out of it, as desired. Before making the stove, three 3-qt. milk cans were purchased. The bottom of these pails was carefully measured and sheet-metal cups were made, which were later sunk in holes of corresponding size cut in the top of the stove and welded in place. The seams of the stove were also welded. The method used for cutting the holes in the top was to lay the flat metal on a piece of 2-in. wood and proceed with a cold chisel and hammer, after scribing the size on the surface. Although three pails were used in this case, two are sufficient to prepare a meal for half a dozen persons. The time required to boil water is about the same as with gas. After the food has been cooked, the valve is thrown over and the heat from the exhaust pipe will be sufficient to keep the food warm.

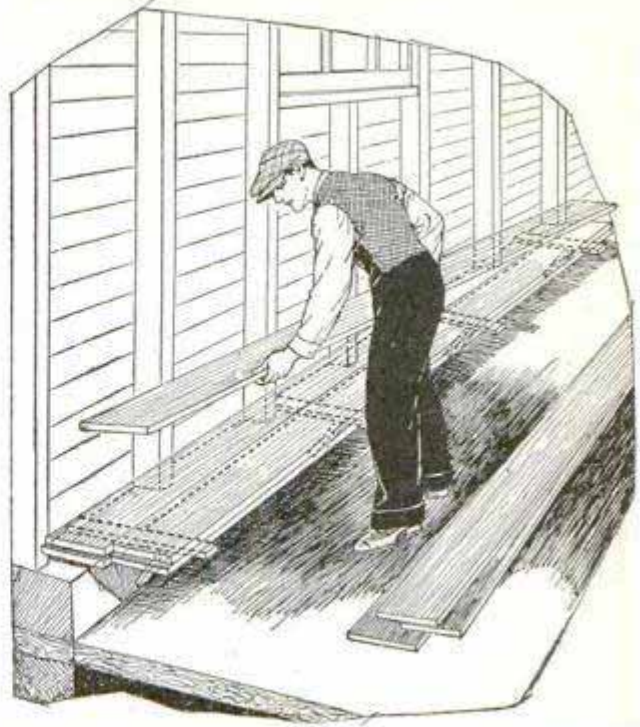

Wooden Brackets on Garage Wall Provide Place for Storing Lumber Flat

Lumber Should Be Stored Flat

Often the home owner is at a loss to find a suitable place for storing long pieces of lumber flat, which should be done in order to prevent it from warping. Leaving it in the weather on the open back porch, if this is large enough, or setting it slanting against the wall in the garage, is poor practice. It is much better to provide a number of wooden brackets, spaced not over 4 ft. apart, above the sill in the garage. By making them extend from the wall 12 in., they will support a considerable quantity of lumber. There

is usually enough extra room in a garage to permit using such a narrow space for storage, and the humidity conditions in a garage, being similar to that in lumber dealers' sheds, are well suited to the purpose. This method is much easier than arranging overhead slings to hold the lumber. —H. R. Snyder, Guilford, Conn.

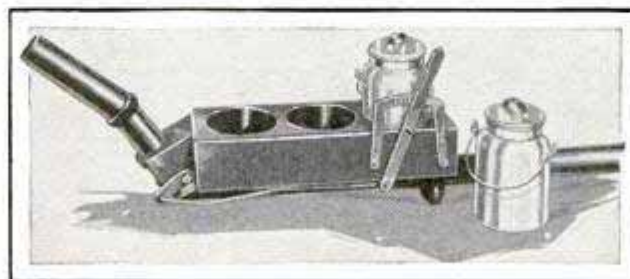
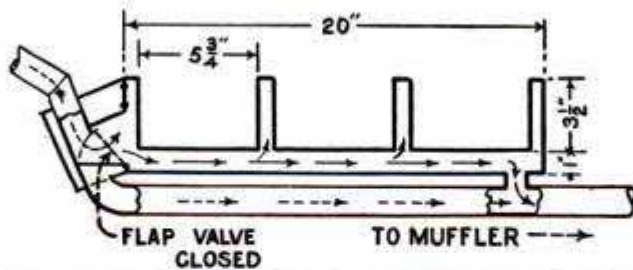

Sheet-Metal Stove Uses Exhaust Gas for Heating Motorists' Food While Driving

Homemade Modern Lamp

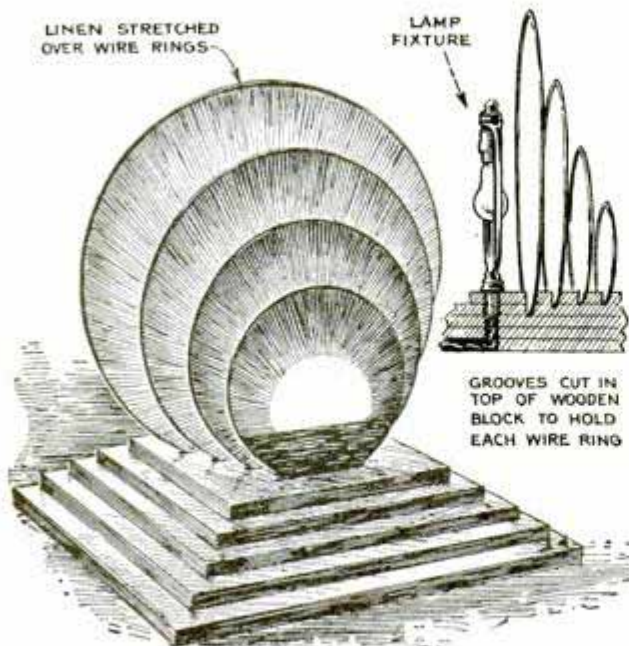

Attractive Lamp with Linen Shades and Pyramid-Design Base Has Pleasing Lighting Effect

Novelty in design is the feature of the illustrated lamp. The base is made up of five blocks of wood of graduated sizes, glued together as shown. The largest one is 16 in. square and each successive one is 2 in. smaller. Grooves are cut in the upper piece to receive fabric-covered rings of heavy galvanized-iron wire. The fabric used was white linen of fine texture and the rings were formed by bending them around bowls. Four disks of graduated sizes are used and are glued in the grooves, which must be spaced an equal distance apart, allowing enough space on one side for a lamp socket. The lamp should not be closer than 3 in. to the largest disk. Glue or collodion may be used as an adhesive for holding the linen to the rings, the edges of the cloth being neatly wrapped around the wire. Each disk is tinted a different color by using stick wax dissolved in denatured alcohol, the color being shaded heavier near the edges. On the smallest disk a sun can be outlined and the spreading rays can

be brought out with lines of metal powder. This gives the lamp a beautiful appearance both when lighted and unlighted. A suitable lamp socket is provided, the lampcord being brought through a hole drilled in the base and through a groove run to the edge. A frosted lamp is used.—Jayne Rider, Washington, Ill.

Rubber Bands Help to Loosen Threaded Parts

When delicate threaded parts, such as fountain pens, flashlights, etc., are screwed together so tightly that they cannot be readily unscrewed, wrap a rubber band tightly around the parts so that slipping of the fingers is avoided, and a firm grip can be maintained. It is, of course, poor practice to hold such parts in a vise or with any tool which may mar or break them. I have tried the rubber-band method a number of times and have always found it effective.—J. I. Hommel, East Pittsburgh, Pa.

Remedy for Rattling Car Windows

Keeping closed-car windows quiet when they are shut is not difficult, as it is only necessary to make them fit snugly in the side channels. To do this, lower the windows, remove the channels and insert cardboard strips behind them. Apply glue to both sides of the strips to make them adhere to the door and to make the felt stick to the strips. Then close the windows until the glue has dried thoroughly. When they are open it is more

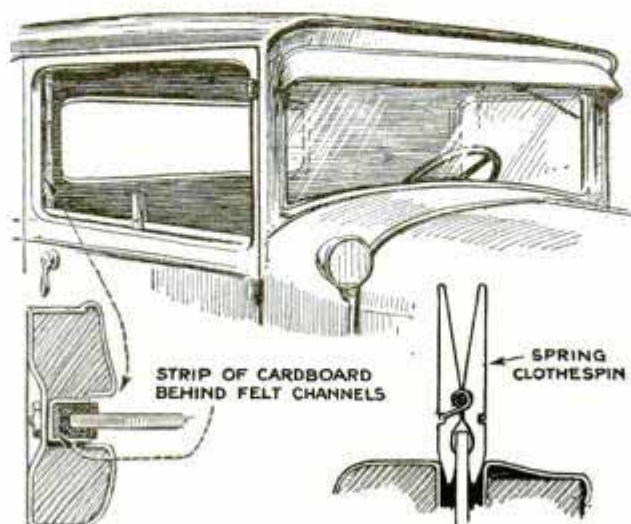

Simple Methods Are Effective for Stopping Car Windows from Rattling

difficult to prevent the rattling, but it can be done by the simple method indicated in the illustration. Take a spring clothespin and slip it over the edge of each window, near the center. The taper on the outside of the clothespin jaws can be increased by whittling the inside or outside of the jaws.

Preventing Fence Posts from Rotting

Copper anti-fouling paint, which is extensively used for covering submerged parts of boat hulls to prevent marine worms from boring into the wood, has also been found highly effective for preserving fence posts, according to tests covering a ten-year period. The point where the posts rot through first is immediately below the surface of the ground, and therefore a 12-in. section of the post, 9 in. below and 3 in. above the surface, is given an application of the paint. This paint is especially beneficial for garden posts, as it is not poisonous to vegetation. Plants grow with unusual vigor in the vicinity of copper-painted posts, probably because the copper is a powerful fungicide and has a deterrent action on all harmful soil bacteria. Most gardeners know the remarkable effectiveness of "Bordeaux mixture," in which copper is the active ingredient, for controlling a large number of plant diseases.—John G. Hanna, Dunedin, Fla.

Safe Holder for Long Garden Tools

Long-handled garden tools can be hung up safely by following the illustrated method. Cut a rubber band from an old inner tube and tie it firmly to the end of the handle, letting a loop project to slip over a nail driven into the wall. Tools held in this way will not cause much damage if accidentally dislodged, but there is more or less risk of injury to children if they are hung with the working end up.—Frank W. Bentley, Jr., Missouri Valley, Iowa.



Locking Oars in a Rowboat

Theft of oars left in a rowboat at the beach or dock can be prevented by locking them to the boat as shown in the drawing. A heavy chain is fitted at one end with two rings, large enough to be

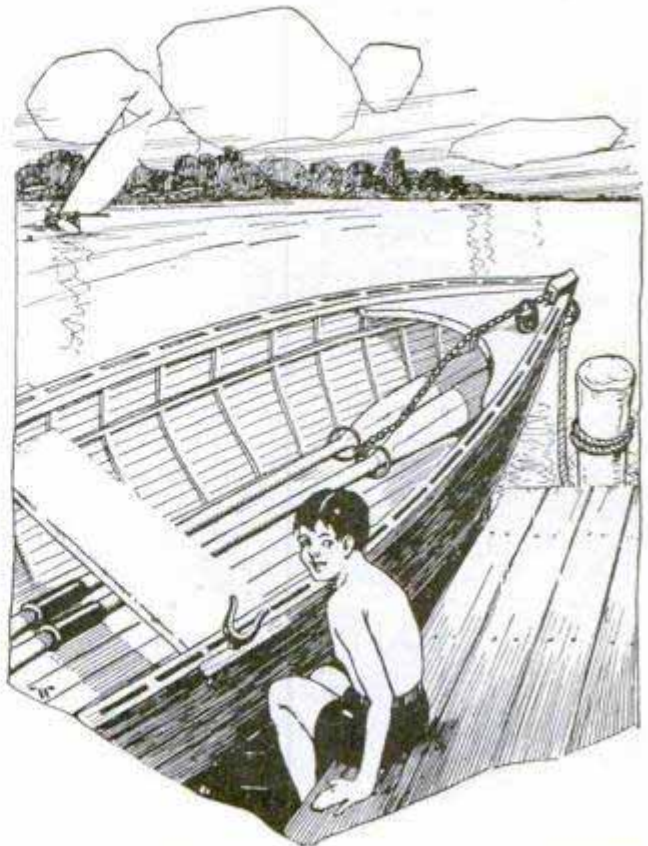

Effective Method of Locking Rowboat Oars under Bow Seat and Middle Thwart

slipped over the round section of the oars, but not over the blades. With the handles under the middle thwart and the blades pushed under the bow seat, the rings are drawn against the blades as indicated. The chain is then pulled taut through the painter ring and padlocked in this position. It is obvious that the oars cannot be removed without unlocking or cutting the chain.—W. F. Quackenbush, New York City

Remedy for Grease Leakage at Gear-Shift Lever

Grease leakage around the pivot of a gear-shift lever can be prevented by slipping half of an old tennis ball over the lever as shown, a small hole being cut in the ball to fit snugly on the lever. This simple precaution is a wise one if one wishes to keep light-colored shoes clean, and will be appreciated by women drivers.—G. A. Luers, Washington, D. C.

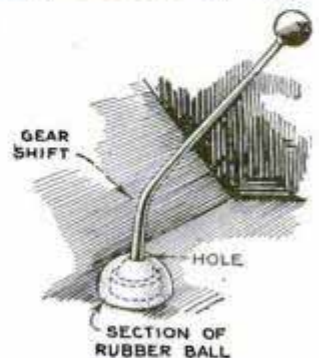

Alcohol Removes Carbon in Auto Motors

Although not generally known, denatured alcohol has been found effective for

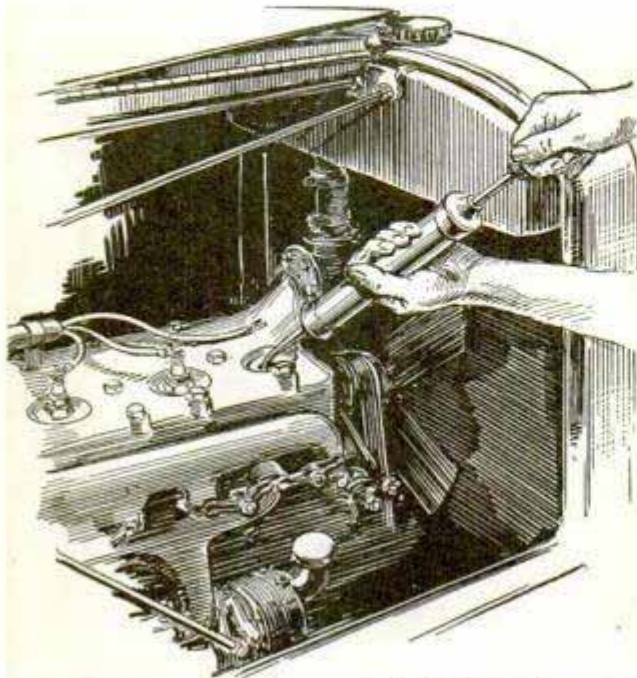

Using Oil Gun and Denatured Alcohol for Removing Carbon in Auto Motors

removing auto motors of carbon. Remove the spark plug from the cylinder when the motor is not too hot. Bring the piston to the top of the cylinder with the valves closed as in the firing position. About $\frac{1}{2}$ gill of alcohol then is sprayed into it by means of an oil gun and a small quantity is poured inside the spark plug, which is then replaced. Let the motor stand about half an hour, to give the alcohol time to loosen the carbon. When the motor is started, the loose particles are blown out. If you make it a practice to decarbonize one cylinder each week in this way, your motor will be kept clean.—G. A. Luers, Washington, D. C.

Collapsible Ridgepole for the Tent

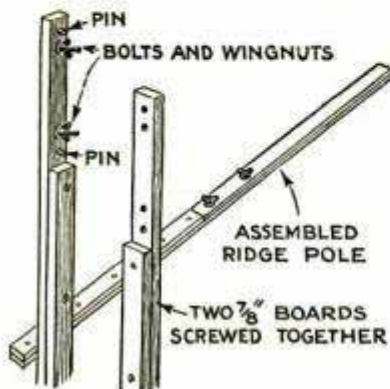

To make a strong ridgepole for the tent, which is collapsible into a small bundle and can be readily assembled, take two pieces of $\frac{3}{8}$ -in. lumber of

suitable width for its length, and make a 12-in. lap on one end of each length. Use screws and wingnuts to hold the pieces together firmly.—M. D. Cole, Romeo, Michigan.

Removing Scratches from Glass

When it is necessary to remove a few scratches from the surface of a piece of glass, start by grinding with a medium-grade emery or carborundum powder, mixed with water and applied with a block of hardwood having a perfectly flat surface, until the scratches have disappeared. Then the glass, roughened by this process, must be repolished by using fine-grade emery or carborundum rubbed on with a piece of coarse cloth folded over the surface of the block or tacked to its sides. After the minute scratches left by the first grinding have been removed, a third and still finer abrasive, such as powdered rouge, is applied, the rouge being moistened with water and rubbed on with a block covered with fresh cloth. The finishing touches are given with dry powdered rouge applied with chamois skin.

Airplane Bird House

This airplane bird house is $5\frac{1}{2}$ ft. long and has a wingspread of $4\frac{1}{2}$ ft. The fuselage is divided into three compartments or nests; two more are built on the wings, and another underneath the fuselage between the landing gear. It is pivoted on a pole 20 ft. high and is fitted with a propeller which turns in the wind. Besides serving as a bird house, it is also a weathervane. During the summer months there never is a vacant compartment in this house.

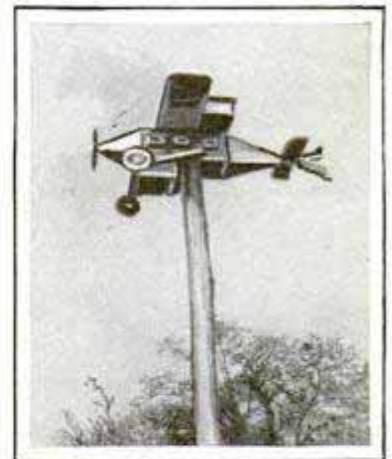

When tin gets dull, its luster can be restored by polishing with white flour, applied with a wad of wrapping paper.

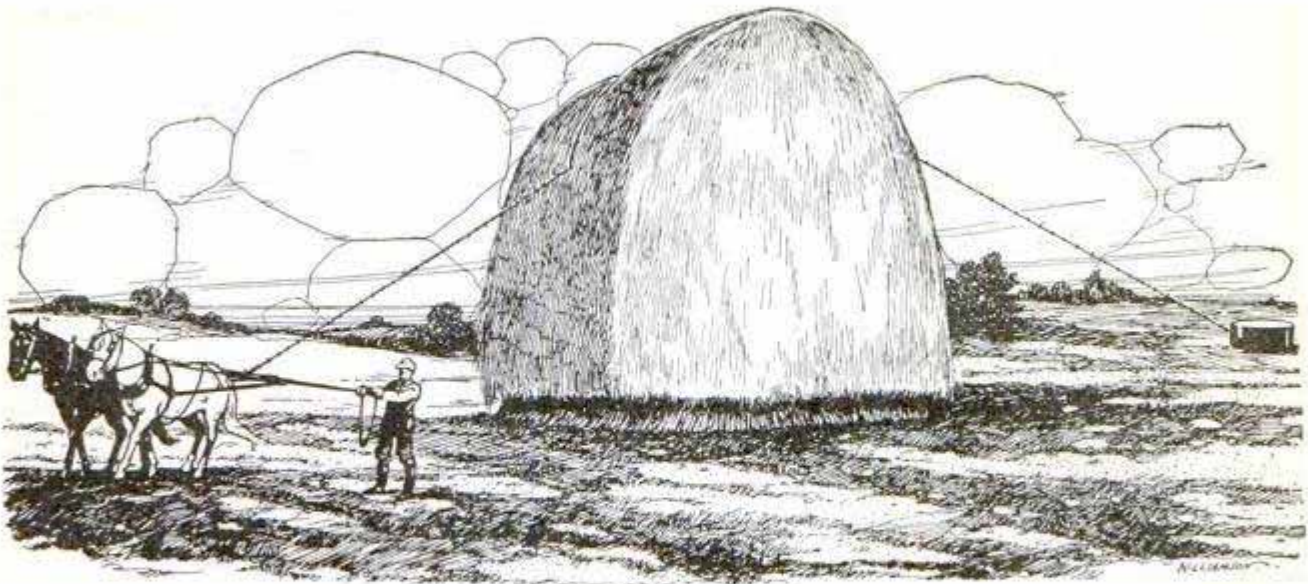

Length of Barbed Wire, Anchored at One End to a Weight, and a Team of Horses Are Used to Cut This Haystack in Two

Easy Method of Cutting a Haystack

Large haystacks can be cut in two, with a straight, clean cut, by using the method shown in the drawing. About 1,000 ft. of barbed wire, a 500-lb. weight and a team of horses, hitched to a doubletree, are used for the purpose. The weight is attached to one end of the wire and the team to the other. Driving the team forward will cause the wire to saw straight down through the stack. If one cut is not enough, the positions of the weight and the team are reversed, and the process is repeated.

Increasing the Chimney Draft

It is almost impossible at times to get a good draft in a chimney having a square or rectangular hole. The smoke and burned gases pass up in a circular form and a down pull is created in the corners, and it takes a large fire to make an upward draft for the entire area. To remedy this faulty condition, obtain a number of common stovepipes of a size sufficient to carry the gases from them up, introduce them into the chimney and connect the lower end to the smoke pipe leading from the stove or furnace. There will then be a circular opening inside of the chimney, out of sight and safe from risk of fire, which will give a better draft than before. It is not difficult to make the connection. For a similar connection to a grate, it would be necessary to have a funnel-like

piece to fit into the chimney just above the fireplace. The opening in the top of this must be circular and of a size to receive the stovepipe. Dampers or other means of control are easy to arrange. This method, of course, is not suitable for all cases, but has worked where other methods failed.—Geo. W. Weaver, Standpoint, Idaho.

How to Make Candles Remain Straight in Holders

A good method of setting ordinary wax or paraffin candles straight in candlesticks is to hold the lower end over a flame to

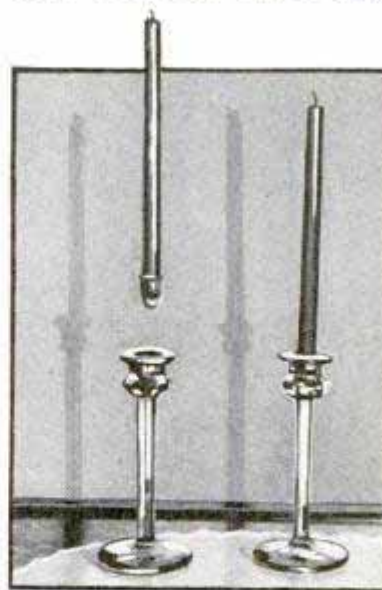

soften the wax without melting it, then press it firmly into the candlestick, taking care to get it straight. After the wax has hardened the candle will remain in this position, fitting the holder perfectly. The usual method of shaving off the end of the

candle to make it fit the holder does not provide a good fit.—C. E. Packer, Chicago, Illinois.

Hookless Fastener Co., Meadville, Pa.



Hookless Fasteners Taken from Old Shirts Can Be Used for Closing the Tent

Hookless Fastener for the Tent

Fasteners of the hookless type, which have become quite popular for a great number of purposes, are very convenient for holding tent flaps together. These fasteners can be obtained separately, mounted on tapes ready for sewing onto the flaps. They keep out wind and rain.

Quick Cleaner for Piston-Ring Grooves

Removing carbon deposits from piston-ring grooves can be done quickly by means of the tool shown, which consists of a short piece of square iron stock, bent as shown and having the scraping edges ground sharp. This piece is slipped into the groove and a piston-ring compressor is placed around the piston to hold the

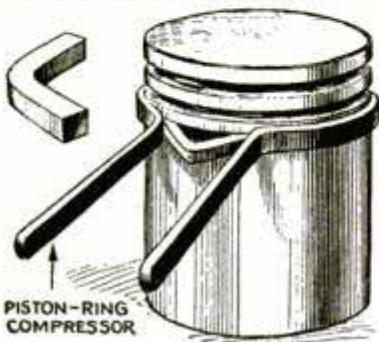

PISTON-RING COMPRESSOR

scraper. Drawing the handles together pushes the scraper into the carbon and swinging the tool around once or twice removes it from the groove.

Dull Prints Made on Glossy Paper

Finding that it was more or less inconvenient to carry two stocks of paper, dull and glossy, an amateur photographer uses the following method of making dull prints on glossy paper: He sandpapered a few of his ferrotype tins on one side, using a fine grade of sandpaper, and then sprayed them with two coats of eggshell-finish lacquer. One coat is not enough and three are too much. The prints are applied to the lacquered surface in the usual way, and the result is a soft finish. Prints to be finished dull or glossy can be washed and dried together in the same batch.

Motometer Installed on Tractor

I have found the installation of a motometer on a tractor just as handy as it is on an automobile, serving as a constant indicator of the engine temperature. It is installed on the regular cap in the usual way. The normal temperature of a kerosene-driven tractor is a little higher than that of an automobile, so that the mercury should rise to the center of the small circle.—Howard J. Eigsti, Buda, Ill.

Sections of Inner Tube Protect Auto Bumper

Deep scratches in the front bumper, which cannot be removed, are often evidence of beginner's luck at driving. A good precaution against such damage, is illustrated in the drawing. A section of old inner tube, about 1 ft. long, is slipped over each end, where damage is most likely to occur. Of course, it is advisable to use an inner tube which must be slightly stretched to fit over the bumper.—Charles Denesha, Fulton, N. Y.

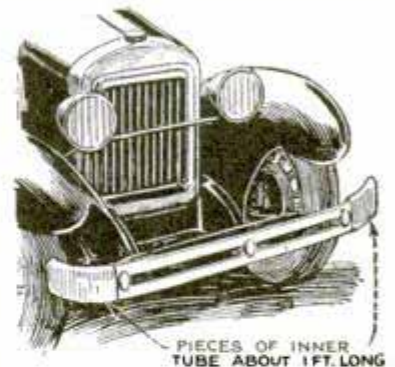

PIECES OF INNER TUBE ABOUT 1 FT. LONG

Equal parts of raw linseed oil and vinegar, thoroughly mixed, make a good restorer for linoleum.

SHOP NOTES

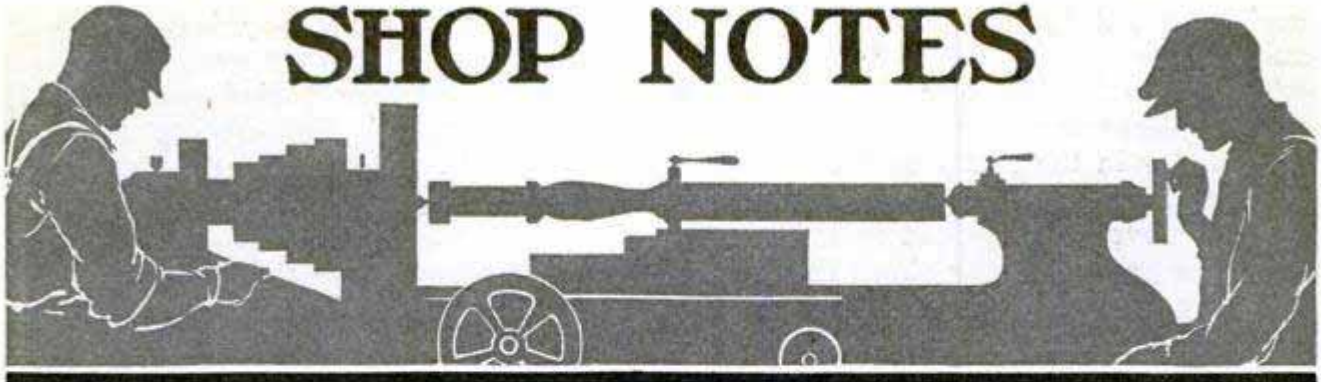

Simple Inlays Will Improve Your Work

By D. R. VAN HORN

IF YOU are fortunate in the possession of a combination shop that comprises saws and lathe, sooner or later you will want to try your hand at inlays. Most of us at first believe that any inlay is difficult, and it is true that some types not only task the worker's skill and ingenuity, but are

with wood of another color consists first in cutting a groove, and, second, cutting a strip of contrasting wood to fit it. Then follow the mechanical processes of gluing this strip into the groove, cutting it down flush with the scraper chisel, and finishing. The tray shown herewith, for instance, required but one hour and twenty minutes from the time the rough block was cut until it had been unscrewed from the faceplate. That's fast work, and even better results will be obtained if an hour or more is allowed for the glue to dry, and more than one finish coat is added, to accentuate the luster of the completed job. The bracelet shown was

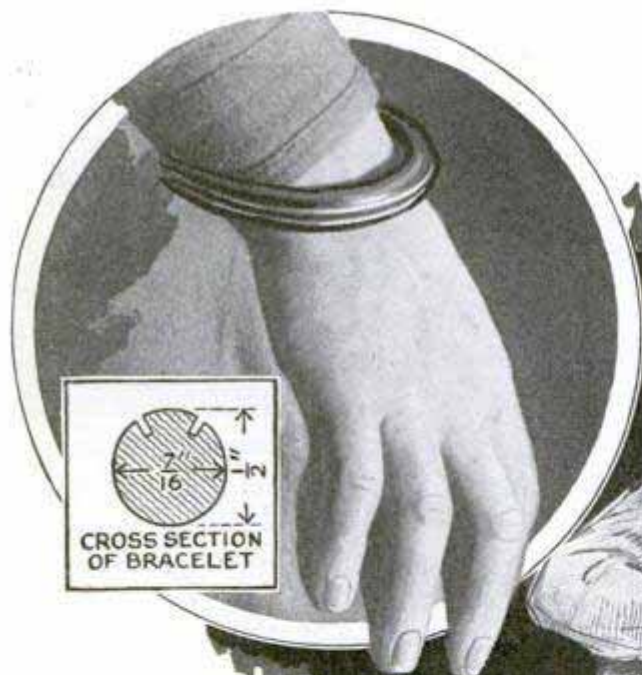

CROSS SECTION OF BRACELET

Simple Inlays That Will Appeal to the Home Lathe Worker; the Bracelet Shown Above Was Made in Forty-Five Minutes

exceedingly time-consuming. There is, however, some simple inlay work that is both easily and quickly accomplished, and which adds greatly to the appearance of the finished article.

Reduced to its simplest form, the inlaying of wood of one color

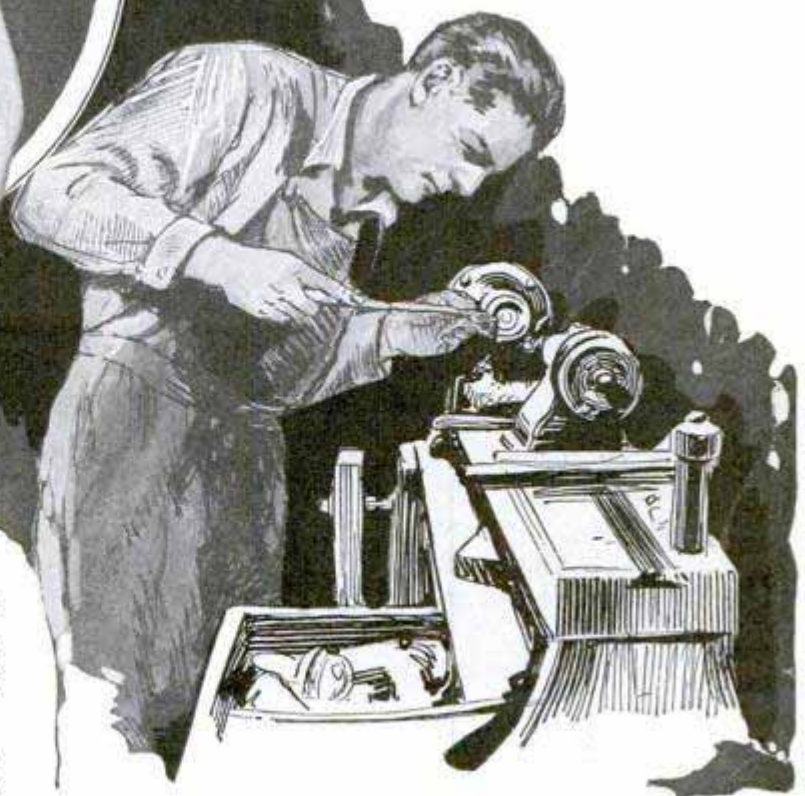

made and put into use within forty-five minutes.

These two simple inlay projects are typical, and differ from more complicated inlaying only in the fact that more time is required for the latter. Accurate cutting of the grooves is facilitated on lathe work when the grooves occur about the center. The tray has two grooves on top of the

cut on the power saw to slightly over $\frac{1}{16}$ in. in thickness. Then they were drawn back and forth between folded sandpaper to smooth them. A good-quality glue was placed in the grooves and the strips were tapped home with a mallet. On small diameters you will have some trouble with breakage of the strips, and moistening them will help. The strips should be

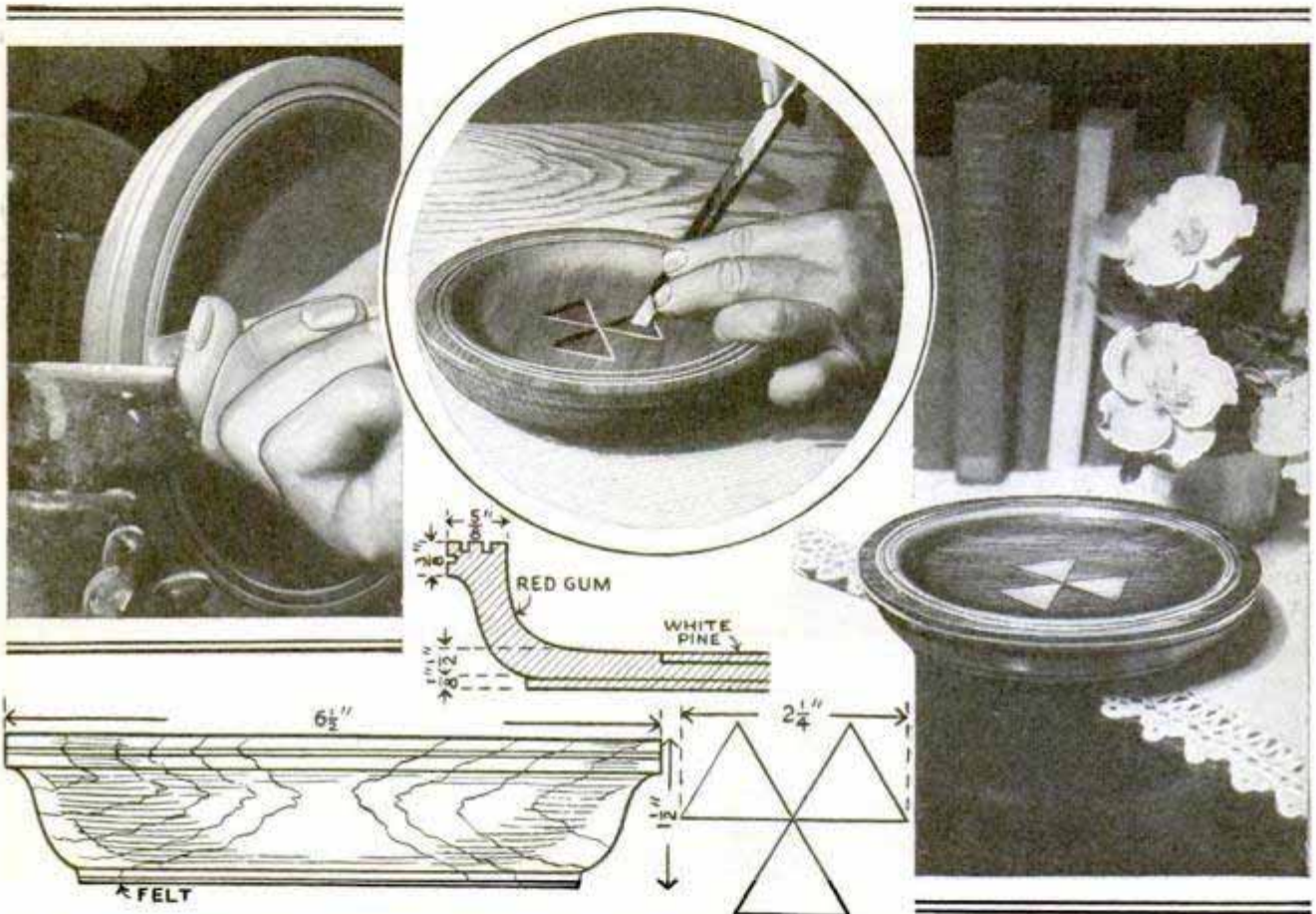

Left, Cutting the Grooves for the Line Inlays; Center, Cutting Out for Triangle Inlays; Right, the Completed Tray; Below, Sketch and Section of Tray, Showing How Grooves Are Cut

edge and one on the side. These were cut with the edge of a small file, approximately $\frac{1}{16}$ in. thick, simply because no other tool was handy. The grooves were made about $\frac{1}{8}$ in. deep, all three being cut merely by shifting the tool rest. The tray was made from a piece of red gum, originally $1\frac{1}{2}$ in. thick and 7 in. square, cut down to $6\frac{1}{2}$ -in. diameter and then shaped out into dish form.

After sanding, the tray was rubbed with a rag slightly oiled with linseed oil, then the grooves were cut, and, after this, the wood was treated to a coat of walnut stain. This coat was intended to heighten the contrast between the woods and may be omitted if desired.

The white-pine strips for the inlay were

cut wide enough to stand well above the surface when they have been driven home. In only a few minutes, the glue will have set sufficiently to permit turning down, although it is better to let the work stand overnight, if possible.

Cutting down must be done carefully, especially if the main work has been stained, as otherwise the cutting tool might get below the stain and lessen the contrast. Sanding with two or three grades of sandpaper follows, and a final rubbing with a varnish-soaked rag will put on a nice luster. Or the tray can be well varnished and allowed to dry for twenty-four hours, after which it can be again rubbed with fine steel wool held lightly against the surface. If this is done,

the final polish can be made with an oily rag.

The three-triangle inlay will also add to the novelty of the tray. Describe a circle in the exact center lightly with the dividers immediately after the piece has been turned. Make six points upon this circle, evenly spaced, and mark the outline of the three triangles. Then carefully cut along the three sides of each with a wood chisel, taking care that the blade is held vertically and each cut is made in line. Then cut out the three spaces to an average depth of $\frac{1}{8}$ in.

Three pieces of white pine are cut to fit these, somewhat thicker than the depth of the depressions. The holes and sides are now coated with glue and the triangles tapped to a tight fit. When the glue has set, the projecting surfaces are turned down flush with the tray bottom, turning down the line inlays at the same time. Sanding, rag-rubbing and finishing then follow.

The bracelet is even simpler. Turn down a wooden disk on a small faceplate and round the edge slightly. Then cut the grooves, coat them with glue and cut strips to fit. When dry, round carefully, then start the cut-off inside. Before the final cut-off, however, finish the outside and top and bottom of the bracelet as far as the cut-off grooves permit. The final cut-off is made with a sharpened file tang, or with a regular parting tool, and any rough surfaces are smoothed over with sandpaper. Rub this last cut surface with stain, varnish or polish.

There are dozens of interesting novelties possible, even when all grooves are cut on the lathe. For instance, you can turn boxes with lids, the tops and sides of which are ornamented with wide or narrow strips of contrasting wood. Wide bands of inlay can also be accomplished by turning the inlays as rings on the lathe. And they usually can be made from scrap.

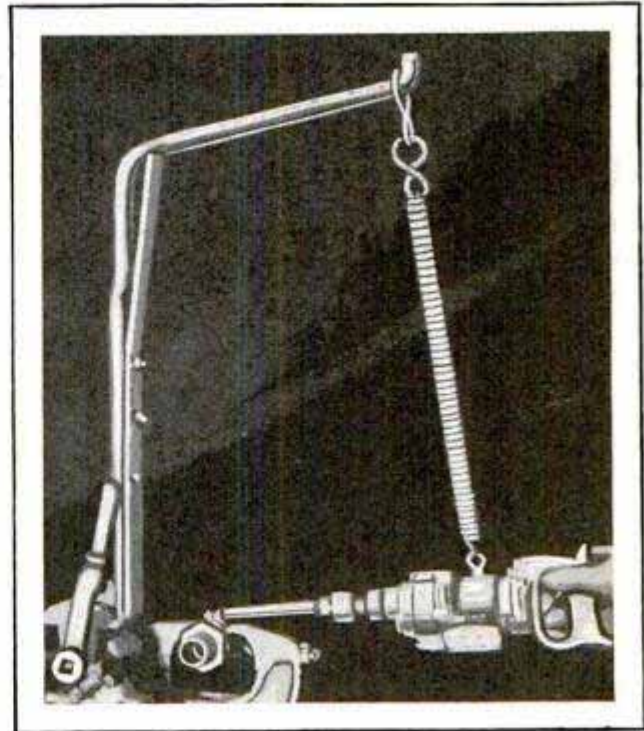

Holder for Air Tools, Made of Steel Rod and Coil Spring, Relieves Worker of Strain

Spring Hanger Used on Air Tools

When using air motors, the worker will often find a coil-spring holder highly effective in reducing the strain of handling the tool. Besides the spring itself, the holder consists of a rigid support made of steel rod and, to prevent bending, braced by means of a flat strip of steel riveted to the vertical and horizontal parts as shown.—Ken H. Arott, Pittsburgh, Pa.

Old Tire Prevents Belt from Slipping off Gas-Engine Flywheel

By slipping an old tractor tire on the flywheel of his gasoline engine, a western farmer found that the trouble previously encountered by the belt constantly slipping off, was entirely eliminated. The tire must, of course, fit snugly on the flywheel. The convex surface of the latter will cause the belt to run on its center.—Cecil Metzger, Lincoln, Nebraska.

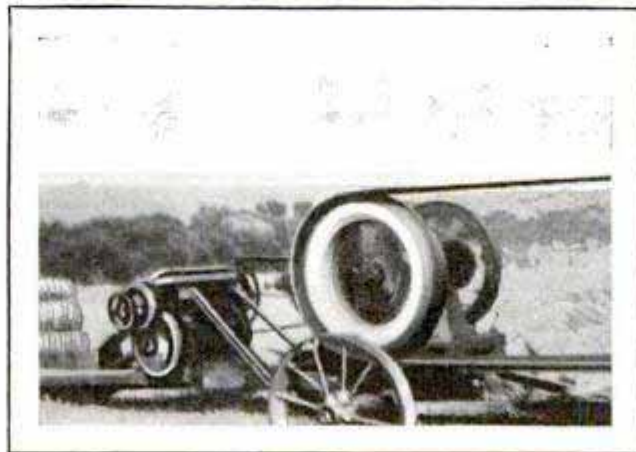

Old Tractor Tire Slipped on Flywheel of Gasoline Engine Prevents Belt from Coming Off

Belt and Pocket for Holding
Welding Rods Has Been
Found Handy in Practice

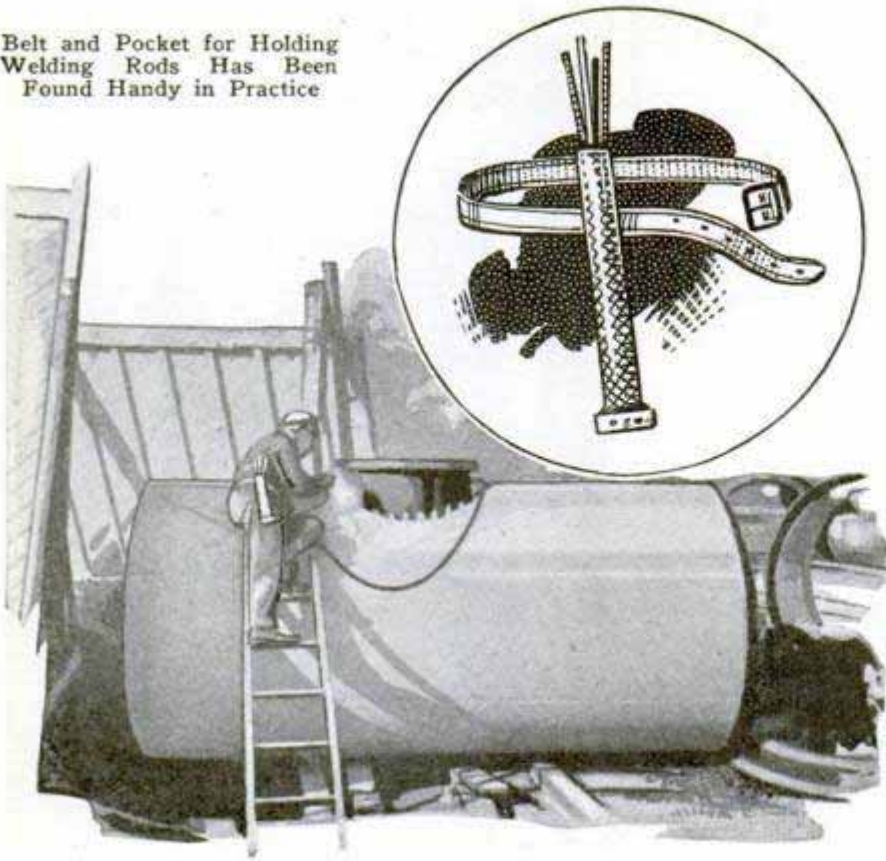

Handy Welding-Rod Carrier

For the welder whose work consists of many small jobs at different points about a plant, the welding-rod carrier shown in the photo will be handy. It is made from a 16-in. section of a 3-in. cotton air hose, the bottom end of which is closed with a sheet-metal band fastened by means of two rivets passed through both the band and the cloth. The carrier is swung from the workman's belt, where it is always accessible without interfering in any way with his movements in climbing ladders and on other occasions.

Taper-Shank Drills Used in Chuck

In the machine shop of a felt mill, only straight-shank drills were used, as they were easily obtained in the small town near which the mill was situated. One day the errand boy brought back six taper-shank drills, and some of them had to be used immediately. The only lathe in the shop was a small one with a solid tailstock, and we had no way of boring a taper hole, but as there was no time to send the drills back for exchange, we solved the difficulty in the following manner: The drill shank was rubbed with

black lead, and a layer of copper wire was wrapped around it. The ends were firmly tied to hold it in place, and the whole wire was then given an application of soldering flux. A straight hole was drilled through a block of wood, the wrapped drill shank placed centrally in the hole, tang down, and the lower end packed with clay, whereupon melted hard solder was poured in around the drill shank. When cool, the shank and its copper-and-solder socket were removed from the mold by splitting the wood. A hole was drilled through the side of the socket and partly into the drill

shank, to make a good countersink, and the hole was threaded. A setscrew was used in the hole to clamp the drill in the socket. The whole collet was then turned down in the lathe. As it was not practical to drive the drills by means of the shanks, they were driven by the setscrew.—J. B. Murphy, Plainfield, N. J.

Safety Razor Makes Convenient Tool for Skinning Wallpaper Seams

For skinning wallpaper seams, a handy tool can be made from an old double-edged safety razor. The teeth on the guard are all filed away except those at the extreme end and the edges are beveled to clear the paper. It takes only a

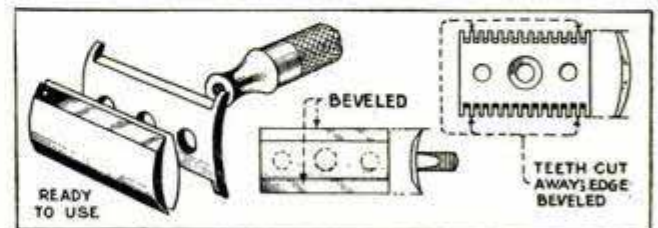

Double-Edged Safety Razor Modified to Serve as Wallpaper Seam Skinner

short time to do the filing, and the tool will be found entirely satisfactory for the purpose.—Julius Fast, Denver, Colo.

Surface Grinding on a Drill Press

By W. CLYDE LAMMEY

ONLY recently the writer was confronted with a job, that, with the ordinary run of tools in the individual shop, appeared to be more than ordinarily difficult. Three small pieces of $\frac{1}{2}$ -in. flat iron had to be surface-ground absolutely smooth and true and to uniform thickness. A number of shifts were tried, all of which involved much uninteresting labor and failed to produce the desired result.

Figs. 1 and 2 show how the job was finally done, making use of a small drill press and an 8-in. sand disk such as that furnished with home-workshop machines. First a piece of medium emery cloth was trimmed to size and glued to the face of the disk, using as a clamping caul a flat, stout piece of hardwood stock held with

same as the diameter of the table. All pieces were squared to uniform thickness so that the work was square on the table.

With minor alterations, a similar set-up might be used for a considerable variety of light surfacing. In this particular in-

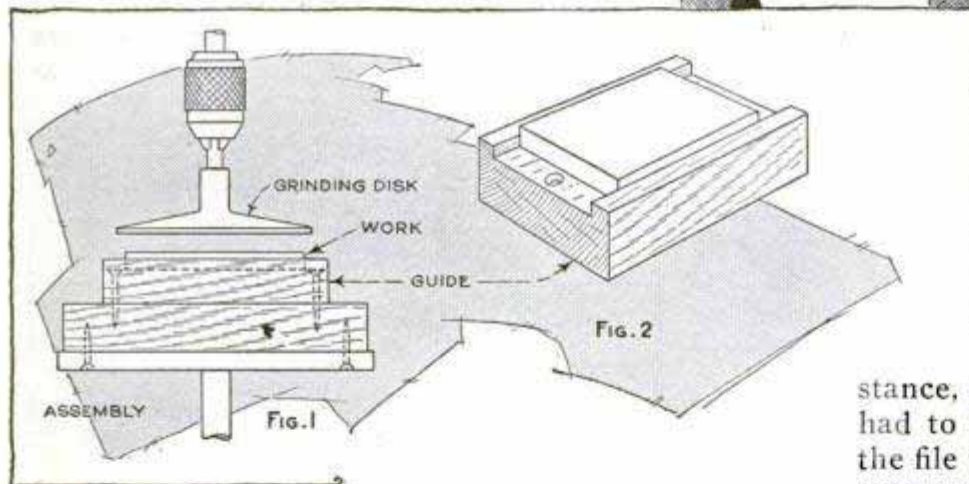
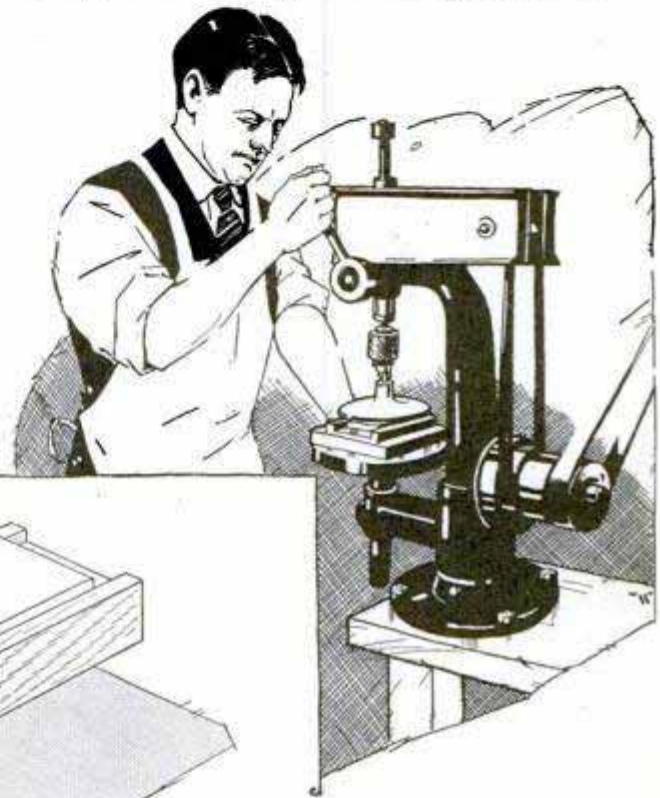

a number of C-clamps. A spindle, $2\frac{1}{2}$ in. long, was cut from a piece of $\frac{1}{2}$ -in. steel shafting and a $1\frac{1}{4}$ -in. flat keyway filed back from one end, making the keyway about $\frac{1}{16}$ in. deep. The disk was slipped on this end of the spindle and tightened with the setscrews provided. The assembly was then gripped in the chuck and carefully tested for running truth. This assured, the work was blocked up as shown and the assembly clamped to the drill-press table with C-clamps. The work was set in a wide groove, cut $\frac{3}{8}$ in. deep on the flat face of a length of 2 by 4-in. oak. This piece was cut longer than the work, to leave room for a screw at each end by which it was fastened to a second block, the length of the latter being the

stance, the edges of the bars had to be dressed square with the file to a light fit in the wide groove of the supporting block.

The flat surfaces were also cleaned off with the file and washed with gasoline, to remove dirt and oil and prevent clogging of the grinding cloth.

Only light pressure is necessary on the press as the emery cuts very fast. When all indentations were removed from the surface with the roughing cut and the thickness was within less than $\frac{1}{64}$ in., the medium emery was replaced with a fine grade. The surfaces were then lightly finish-ground to exact size. The arrangement did a perfect job.

☐Oxygen and acetylene tanks should never be gripped or handled roughly nor be stood on end, unless fastened so as to prevent falling over.

Oil Container for Tempering

When thick oil is used for tempering, it can be handled economically by adopting the style of tank shown in the drawing.



Oil-tempered work should be left immersed until it is properly cooled and this means that considerable oil is usually wasted in recovering the pieces and in wiping them clean. This tank is made

so that it can be tipped up to allow the oil to run from one compartment to the other, through a sieve, which holds the work, allowing it to drain off before removal. Thus the tank is always available for use. While one compartment is draining, the other may be filled. Two tin boxes, fitted into each other as shown and soldered together at the edges to make them oil-tight, and a perforated piece of sheet metal, bent at right angles and also soldered in place, make up the tank. To recover and drain off any pieces dropped in the bottom, tip the tank so that the oil runs into the other section.—Harry Moore, Hamilton, Can.

Emergency Pipe Coupling

While doing work in the oil fields, I found it difficult to keep a sufficient quantity of pipe couplings on hand and, in their absence, I have made quite a few of these fittings in the following manner: The threads of the pipe ends were thoroughly cleaned and given a coat of blacklead. A piece of brass tube was obtained, having an inside diameter $\frac{1}{8}$ in., or more, larger than the outside pipe size. A hole was bored in a piece of hardwood to receive the brass shell, which was cleaned and dipped into soldering fluid, then, while hot, driven into the hole bored in the wood. The tube with the wood was slipped on one pipe, past the threads, and

the pipe ends were then brought together. A piece of copper wire of a size to let it halfway into the threads was obtained and dipped in the soldering fluid. The wire was wrapped in the threads, beginning on one pipe and finishing on the other. Then the brass tube was moved centrally over the pipe threads, the ends were stopped up with clay, allowing a vent at one end and a gate at the other, and bab-bitt was poured in. This made a good serviceable coupling and the wire made a steam-tight thread.—J. B. Murphy, Plainfield, N. J.

Inner Tube Prevents Vise Marks

Woodworkers who wish to avoid marring their work while it is held in the vise, can easily prevent this by slipping sections of inner tube between the work and the vise jaws. Rubber is better for this purpose than either cloth or paper, because the friction of the rubber combines with the pressure applied in the vise to strengthen its grip.—H. Rossiter Snyder, Guilford, Conn.

Clamp for Holding Sheet Metal Against a Wall

Sheet metal is often set on edge against a wall of the shop in order to save space, and cleats or metal straps, attached to the wall, are usually used to hold the pile. This method, however, makes it necessary for the worker to lift the sheets over the retaining strap when they are removed, which is rather difficult in the case of large, heavy sheets.

A better device is a pivoted clamp forced tightly against the sheets by means of two small coil springs, as shown in the drawing. It is made of flat iron in two sections, the stationary part being bolted

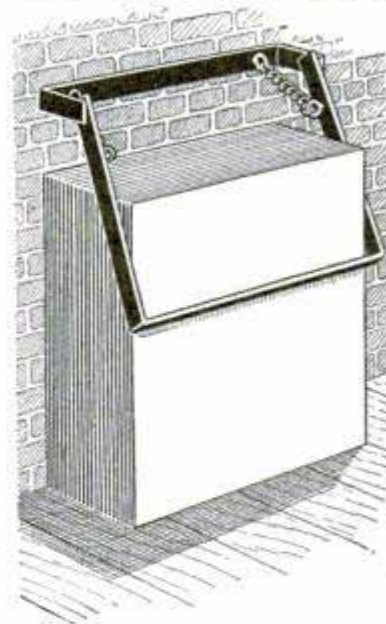

to the wall. In use, the worker raises the other part and removes a sheet without lifting it off the floor.

Lubricant for Closed-Car Window Frames

Many of the older models of closed cars have the door windows mounted in metal frames, which are covered with cloth. When the frame holding the glass is raised or lowered by means of a strap, it slides in grooves in the sides of the door frame. If the frames are too tight to allow easy movement of the window, apply some powdered graphite, which is not oily, but reduces friction to a minimum. Apply the graphite when the windows are entirely down, then slide up and down until the graphite is well worked in. Excess graphite can be blown away with compressed air.

Handy Clamp for Welding Fenders

When welding fenders, the clamp illustrated will be found useful for holding the broken edges together. It consists of three 10-in. lengths of $\frac{1}{2}$ by $1\frac{1}{4}$ -in. bar stock. One piece, the central one in the detail, has a crosspiece welded on at right angles near one end. It projects about 1 in. on one side and 2 in. on the other, and bolts are used to hinge the side members to the crosspiece on the center member. One of the side members is slightly longer than the other, and the end is bent over sharply at right angles. A clamp screw also passes through this and the middle member about 3 in. from the hooked end. In use the clamp is placed on the fender as indicated, and the wing-nut is tightened to hold the beads together until welded. The other member, which is hinged, is set against the underside of the fender to prevent it from turning inward as the screw is tightened.—Jos. Coyle, Denver, Colo.

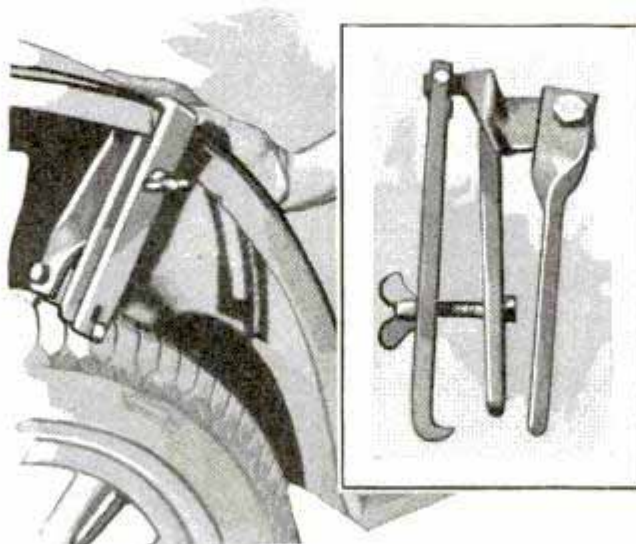

Simple Clamp Made of Bar Stock Holds Broken Fender in Position for Welding

Steel Balls for Flaring Ends of Tubing

In shops where it is necessary to flare the ends of tubing, the method of using

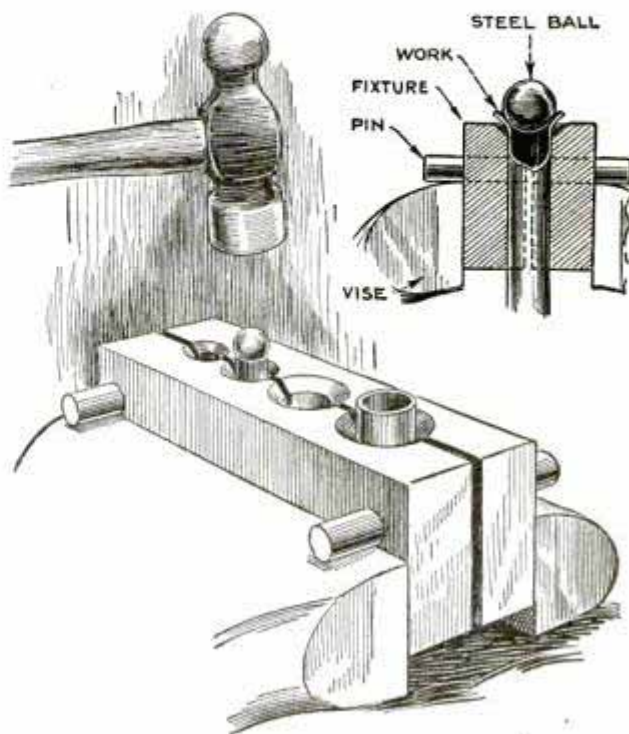

Fixture Holds Tubing While Flaring Out End with a Steel Ball

steel balls as shown in the drawing will be found convenient. The tubing is held in a fixture consisting of two steel jaws, held together by means of pins as indicated. Holes of various sizes are drilled and countersunk to receive the tubing, half of each hole being drilled in each jaw, which is an easy thing to do while they are clamped tightly together. The holes should be slightly smaller than the tubing

they are designed to accommodate, so that the tubing will be held without slipping while a steel ball is tapped into the top end to flare it.—G. A. Luers, Washington, D. C.

☐ A scale filed on a bit, beginning at the cutter end, will save the trouble of pulling out the bit every few turns to see if the hole is deep enough.

P. M. Shaper Makes Good Miller

By F. G. WALTER, *1041 Atlantic Ave Long Beach Calif*

A VERY useful tool in the small shop is a milling machine. A good one can be constructed very easily if you have built the shaper described in the November, 1928, issue of Popular Mechanics. Once the parts are fitted, the change from shaper to miller can be made in less than five minutes.

You have a very sturdy frame in this machine and two movements of the work table, horizontal and vertical. One more movement is essential—a traverse. This is obtained by fitting a vise on a slide base, the movement being about 4 in.

Obtain a piece of cold-rolled steel, $1\frac{3}{4}$ in. in diameter, with a $\frac{3}{4}$ -in. hole, about 14 in. long, and machine it to $1\frac{1}{4}$ in. for the front bearing and 1 in. for the rear, leaving a $\frac{1}{8}$ -in. flange on the front end; then thread the front end for a length of $\frac{7}{16}$ in., 13 threads per inch, and taper the hole at this end to fit No. 9 B. & S. arbors and collets. Fit the shaper with bronze bearings, one 2-in. outside diameter and $1\frac{1}{4}$ -in. inside with $\frac{1}{8}$ -in. flanges, for the

front, and one 2-in. outside diameter by 1-in. inside with the same size flanges, for the rear. See that the spindle is a fairly tight running fit, to prevent chatter. You will have to split the bearings on the shaper to fit the bronze bearings. Have two extra cone pulleys cast, the same size as on the original shaper.

The slide vise is a gray-iron casting with a circular base, and is held on the table with clamps and T-bolts, to allow it to be set at any angle. The base may either be cast integral with the vise, or made separate and bolted to it, whichever is easier to machine. I made a separate casting and machined it in the lathe, then planed the bottom of the slide and bolted the two together. The rest of the work was then done with one set-up.

In order to do smooth work on the shaper, the feed should be uniform, which is a very hard thing to get by hand. However, you can fit an automatic feed to this shaper with very little work.

Make the 1-in. shaft, which carries the

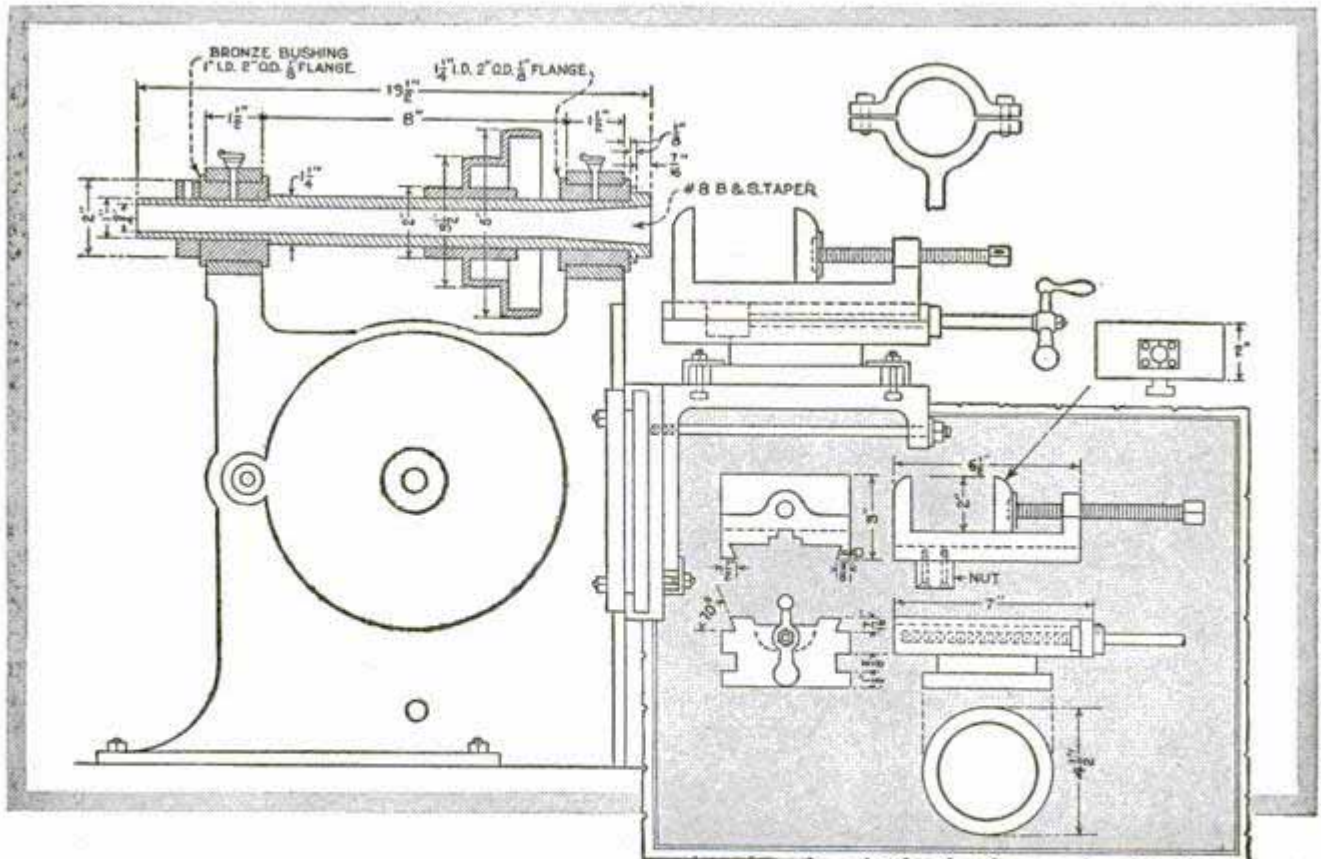

Adapted from the Sturdy Shaper Designed for Popular Mechanics by J. V. Romig, This Milling Machine Has Proved Very Useful in a Small Shop; the Change from Shaper to Miller Is Made in a Few Minutes

80-tooth gear, extend about 1 in. beyond the collar. Also make the horizontal feed shaft long enough to extend $1\frac{1}{2}$ in. beyond the horizontal slide plate, and fit a bearing on both ends of this plate. Turn two ratchet wheels of brass, $1\frac{1}{4}$ in. in diameter, with hubs. Lay off the circumference into 16 or 20 equal parts, and file ratchet teeth, making one wheel right and the other left. Mount the ratchets on the extension of the feed shaft, with a crank between them carrying a pawl on each side, and with a pivot bolt for a connecting rod. This rod is made from $\frac{1}{8}$ by $\frac{3}{4}$ -in. flat iron and in two pieces, one with a slot to take a bolt and wingnut to adjust the length for various positions of the work table. Make the pawls large enough so that you can throw them in and out with your finger, to change the direction of the feed.

The feed crank on the 1-in. shaft may be a machined casting or built up of flat cold-rolled steel—one piece $\frac{1}{4}$ by $1\frac{1}{2}$ by 4 in., with a $1\frac{1}{2}$ by $\frac{3}{4}$ -in. collar bolted to the exact center of the back. This is drilled to fit the 1-in. shaft and is fastened to it with a $\frac{1}{4}$ by $\frac{1}{2}$ -in. setscrew. The face side is fitted with a T-slot made up of two pieces of cold-rolled steel, $\frac{1}{4}$ by $\frac{1}{2}$ by 4 in., and two pieces, $\frac{1}{8}$ by $\frac{9}{16}$ by 4 in., fastened by three No. 8 by $\frac{5}{8}$ -in. flat-head machine screws on each side. The T-slot takes a $\frac{3}{8}$ -in. bolt head. Use a $\frac{3}{8}$ by $\frac{1}{2}$ -in. bolt and a $\frac{1}{2}$ by $\frac{9}{64}$ -in. bushing with a $\frac{3}{8}$ -in. hole. Tighten with a thumbnut and washer. The bolt head may have to be ground or turned thinner to slide freely in the crank slot. By adjusting this bolt, and with it the connecting rod, you can vary the feed from one to four teeth.

Boiler-Lid Lifter and Holder

Copper wash boilers are frequently used in the shop for tinning and cleaning operations. The lids of the boilers are hard to remove when they are hot, and in one shop an attempt to jerk the lid off nearly resulted in an accident. Another minor inconvenience is the lack of a suitable place to put the lid while filling or emptying the boiler. Both of these objections can be overcome by using a lifter and holder made of flat iron and fastened to the side handles of the boiler by means



Rod Attached to Wash Boiler Helps to Remove Lid and Serves as a Holder for It

of screws and nuts, as shown, so that the lifter passes directly over the handle of the lid. A tight-fitting lid can be safely removed by merely squeezing the lifter and lid handle together. Then the lifter is swung around to serve as a holder for the lid.

Side Hold on Screwdriver Increases Leverage

Any screwdriver having a heavy shank can be provided with a side hold as shown in the drawing. Flatten a section of the shank, drill and tap it to receive the threaded end of a short steel rod. After threading the end of the rod it should be tempered. The greater leverage gained by the addition of the rod will be found valuable, especially for the removal of tight screws.—Jas. E. Noble, Toronto, Can.



Twist-Turning with a Portable Router

By JOHN E. HYLER

SOME heavy double-twist turnings of 6 by 6-in. fir, for use as ornaments on window frames, presented quite a prob-

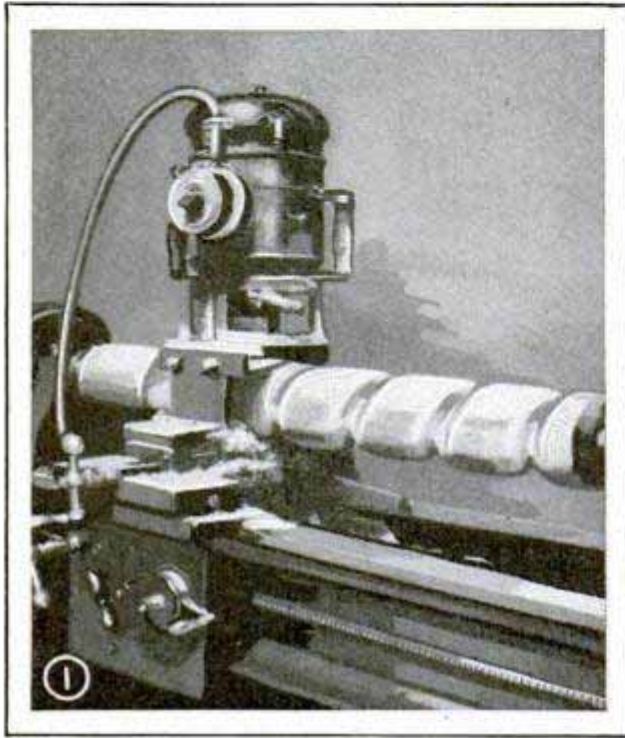

Cutting Spirals of Considerable Pitch by Using a Portable Router on a Machine-Shop Lathe

lem in one shop, until a method making use of a portable router in conjunction with a machine-shop lathe, was devised. Since the pitch of the twists was much greater than could be cut by the regular lead-screw gearing, this was disconnected and a small pulley was mounted on the end of the lead screw. The pulley was belted to a countershaft, as shown in Fig. 2, the size of the driver pulley being selected for the proper speed ratio between lead screw and work (36 to 1 in this case) in order to obtain the required pitch.

The most interesting feature of the setup was the unusual application of a portable router fitted with a regular router cutter of the "rounding-over" type. The cutter came down to a point at its center, as that was the kind of cut required. On the tool carriage of the lathe, a support for the router, made up of angle iron and bridged with a steel plate, was attached. A hole was drilled through the center of the plate, directly over the axis of the work, to allow the router bit to extend through

to the work. At the back of the support, a depth screw was arranged so that the cutter could be accurately set for depth.

The carriage was run back to the tail-stock end of the work, the router bit lowered and the lathe started just as in cutting a thread. Fig. 1 shows how the router was mounted on the carriage and also the appearance of the work after the first cut was made. A very slight amount of tearing was experienced, but this was to be expected on fir. After the first cut was completed, the router was backed through the cut to its starting point. The lead screw was then disengaged from the carriage, and a chalk mark made on the lead-screw pulley. To make the second cut, it was necessary to turn the work exactly halfway around. As the ratio of the lead screw to the work was 36 to 1, the screw was turned 18 complete revolutions, which located the work at the correct point where the second cut was to be made. The lead screw was then again engaged with the carriage, and the router and lathe set in motion as before. Fig. 2 shows the appearance of the work after the second cut was made. Coarse sandpaper was used to finish the job.

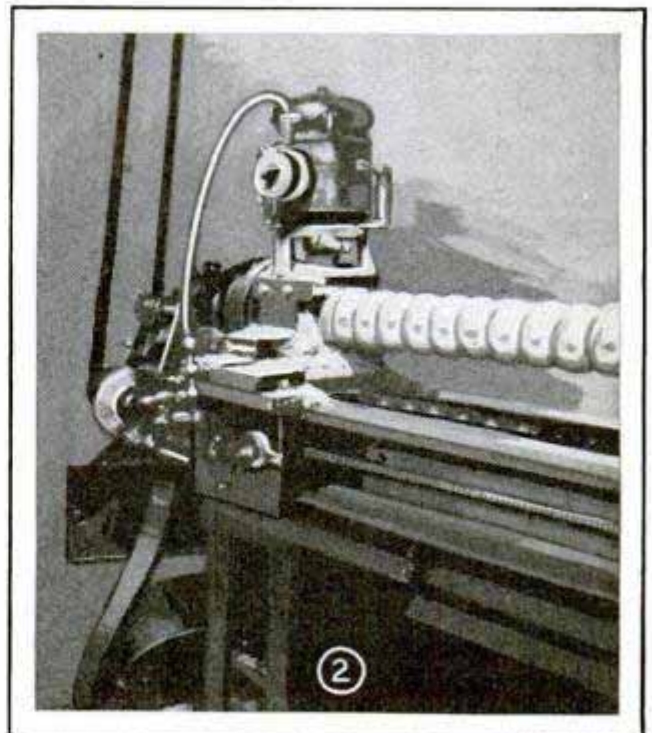

Completely Finished Spiral after Making Two Cuts with the Router

Similar turnings were required for use in a corner, and on this a cut on only part of the surface was necessary. Therefore, instead of making the work full size and then dressing it down to the specified dimensions, the center of the work was set out of alinement with the lathe centers, so that only part of the surface came in contact with the cutting tool, and it was found that 5 by 5-in. stock could be used instead of 6 by 6-in. stock, which made quite a saving in material. Even though the work was out of balance, it was revolving so slowly that this did not affect the set-up.

Burlap Sacking Protects Seeded Terrace from Washout

To prevent rain from washing out a steep terrace after it has been seeded, cover the terrace with burlap sacking, thoroughly soaked so that it will lie smooth. The grass will grow through the burlap and the latter is not removed but allowed to rot. After the grass has taken root well, the resulting sod will protect the terrace from washing out.—Frank Sargent, Holton, Kans.

Detachable Plate Holds Latch Open

In stores and shops, a detachable plate may be used to hold the door latch open during the day. It can be made of any suitable sheet metal, cut and bent as shown in the drawing, L-shaped slots being filed in the edges to fit over screws driven into the door. The thickness of the metal to be used depends to some extent on the space between the door and the jamb. Fitted with such a plate, the door can be pushed open with very little effort, which is something to be desired in busy stores.—John Anson Ford, Los Angeles, Calif.

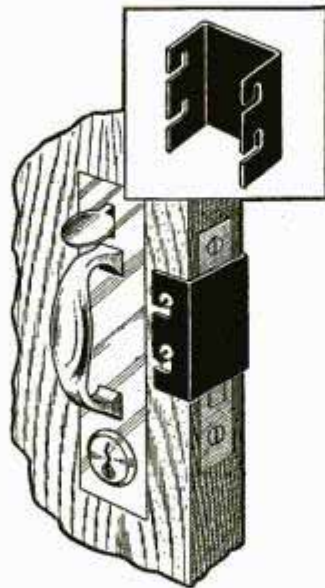

Holder for Repair of Auto Bearings

When scraping bearings, it is bad practice to clamp them in a vise, although this procedure seems to be general practice in many auto-repair shops. The vise compresses the bearing slightly, making it impossible to do the work accurately. A better method is indicated in the drawing, which shows an old connecting rod being used as a holder.

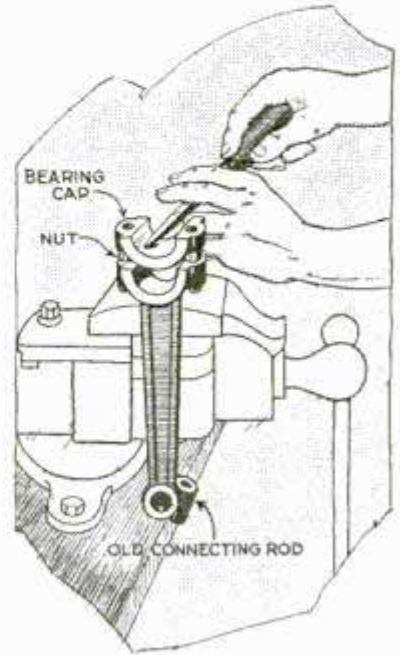

Of course, it is necessary to have the same size of connecting rod as that on which the work is being done, so that the cap screws, which are fitted to the connecting rod, will project through the holes in the bearing, holding it in place securely but without strain. The connecting rod is clamped in the vise.

Temporary Repair for Broken Battery Cable

If the cable on your automobile battery breaks while out on the road and it is impossible to run the motor due to the lack of ignition current, you can make a temporary repair in the following manner: Get a piece of wire (anything that is available although copper wire is best) and wrap it tightly around the wire of the cable and the battery terminal. Then crank the motor by hand, as the wire is not heavy enough to stand up under the amperage passed by the starting motor. After the motor is running, you will be able to get to a garage, where a permanent repair can be made. Corrosion of battery terminals and cables can be prevented by keeping the connections clean, which is done by monthly washing with a soda solution.—R. W. Fowler, West Lafayette, Indiana.

Difficulty of Holding Seams Together While Soldering Remedied by Using Small Clips

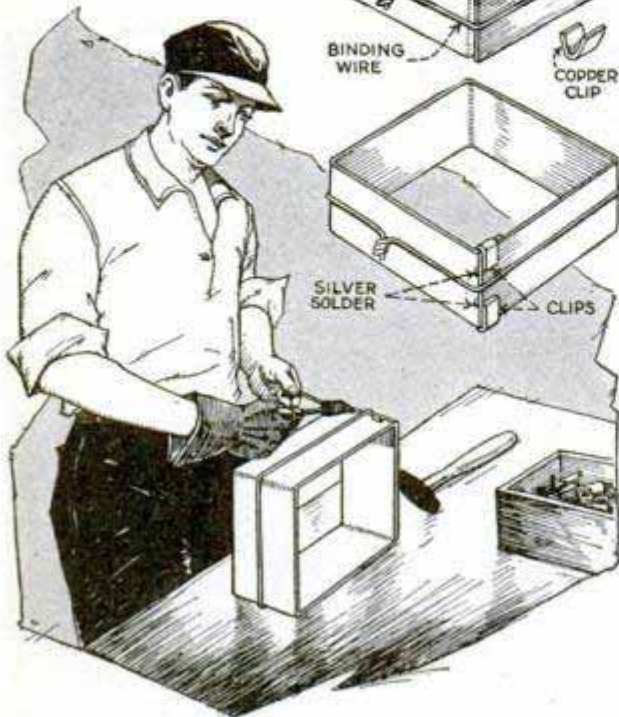

Clips Hold Seams While Soldering

When making a number of copper boxes, the seams of which had to be sweated together with hard silver solder, I had considerable difficulty in holding them tight. Each box was made from a strip bent at right angles at four points. A length of iron binding wire was used to hold the edges of the seam together, but when heat was applied the sides invariably warped and allowed the seam to spring apart. The trouble was quickly corrected by making a few small clips, which, when slipped over the seam, held it together securely.—L. L. Llewellyn, Piedmont, Calif.

Removing Rusty Screws from Wood

In trying to remove a rusty screw, which held two pieces of oak together, I was unable to do so with the ordinary screwdriver. Some soldering work being pressing, I turned to it, and after finishing the job, looked around for a place to lay the soldering iron. As the pieces with the rusty screw in them happened to be handy, I set the point of the soldering iron on the head of the screw and leaned the handle against the wall. I did this simply to avoid

burning anything with the iron. A short time afterward the iron was taken back to the stove. When I returned to the bench, I thought I would have just one more try at the screw, and found that it came out quite easily. For a moment I was puzzled, but upon picking the screw up by my fingers I discovered it was hot. Then I remembered having set the soldering iron on it. The next time I had a rusty screw to remove I applied heat to it, and the screw was easily removed.—W. S. Lockwood, Chicago.

Drop Bottom of Cash Register Baffles Holdups

After his cash register had been rifled by holdup men three times, a gas-filling-station attendant devised the drop bottom shown in the drawing. The bottom of the bill compartment was hinged at the front end and a spring catch provided to hold it in place. An inconspicuous trip, extending $\frac{1}{8}$ in. in front of the drawer, upon being pressed, caused the bottom to drop down, dumping the bills into a box on which the register is set. Of course, felt-covered stops were provided to deaden the noise caused by the dropping bottom. The silver, of course, could be taken, but the bills were saved. The key which opens the register was labeled as one fitting some other lock, so that the bandit, unfamiliar with the register, cannot open it but must force the attendant to do so. This gives the latter the opportunity to push the releasing trip and dump the bills as he fumbles with the keys.

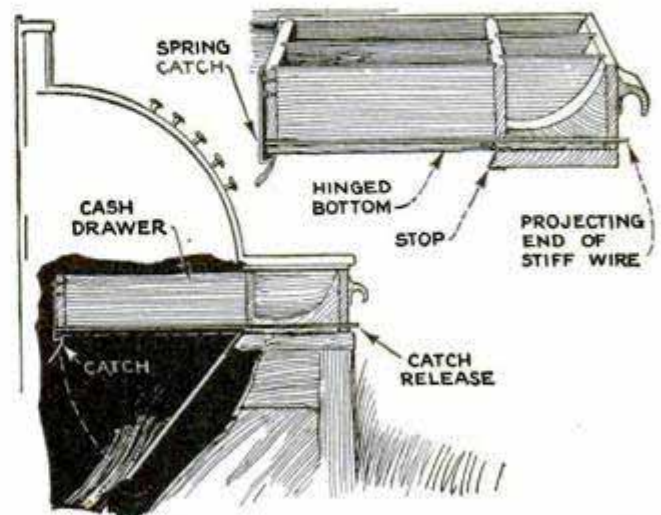

Bills in Cash Register Dumped into Lower Box Foils Holdup Attempts

Water Heater for Sunny Climes

By ERNEST E. OERTEL

WHEREVER the sun shines strong and long, the heater shown in the illustrations will supply warm water, and

The gas heater is not needed for bath water in this home. For washing clothes and dishes, where very hot water is re-

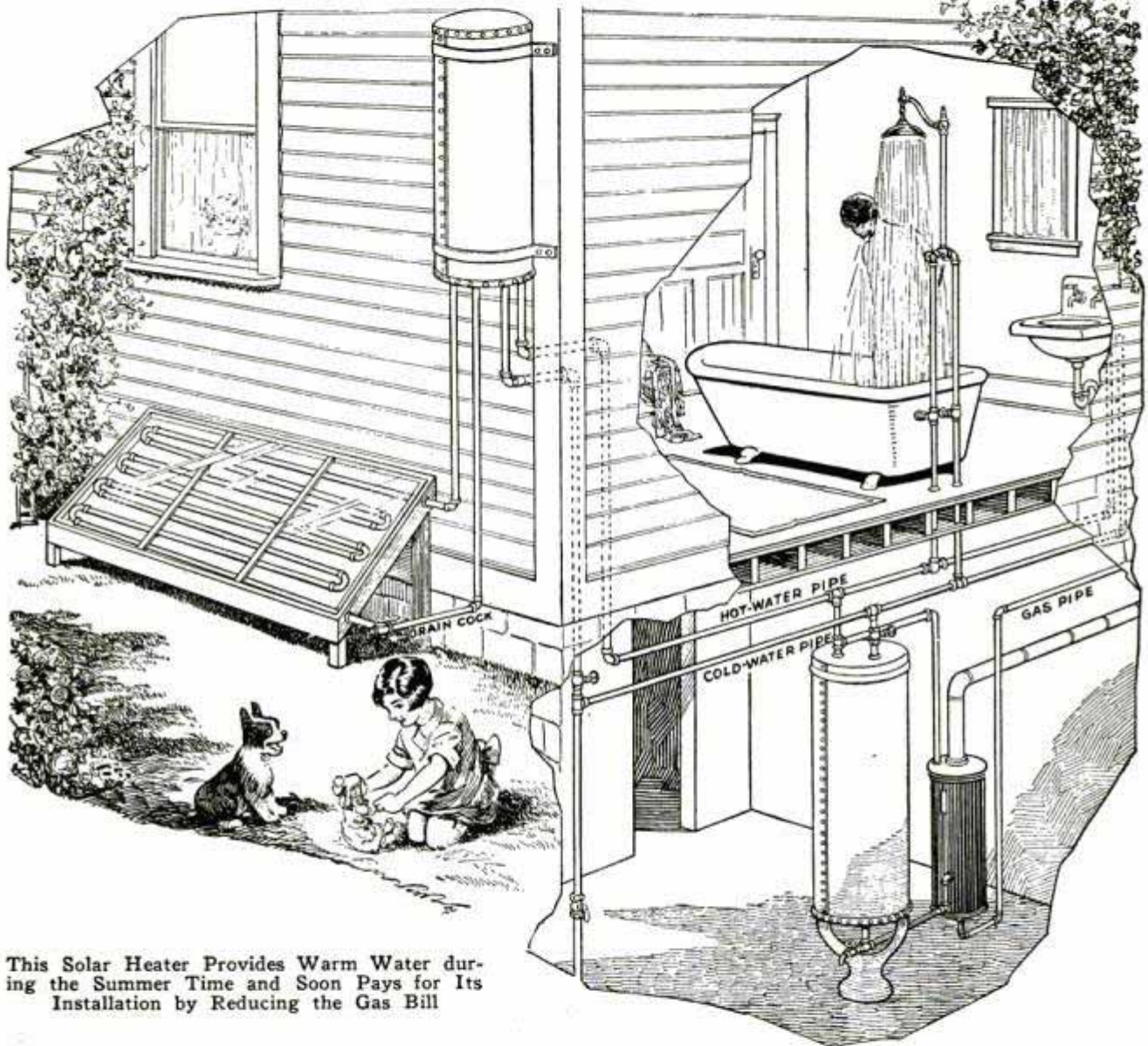

This Solar Heater Provides Warm Water during the Summer Time and Soon Pays for Its Installation by Reducing the Gas Bill

form a good substitute for a gas heater if it is not necessary to heat the water to a temperature higher than 115° F. Another feature is that water can be heated in this way at no expense except the installation cost, which in one particular case amounted to \$32. A coil made up of 3/4-in. iron pipe, in which the water is heated, is connected to a well-insulated 18-gal. galvanized-iron water boiler. In California summer weather, a total of 36 gal. of water at an average temperature of 115° can be drawn daily, according to the owner.

quired, the gas heater is used as an auxiliary. As the installation is made outdoors, the temperature inside of the house is not raised.

The heater is located on the south side of the house, where the coil is exposed to the sun for the greater part of the day. Cold water from the tank enters the coil at its lower extremity, and as the temperature of the water rises due to the heat of the sun, it passes up through the coil to the top of the storage tank, while the cooler water at the bottom of the tank

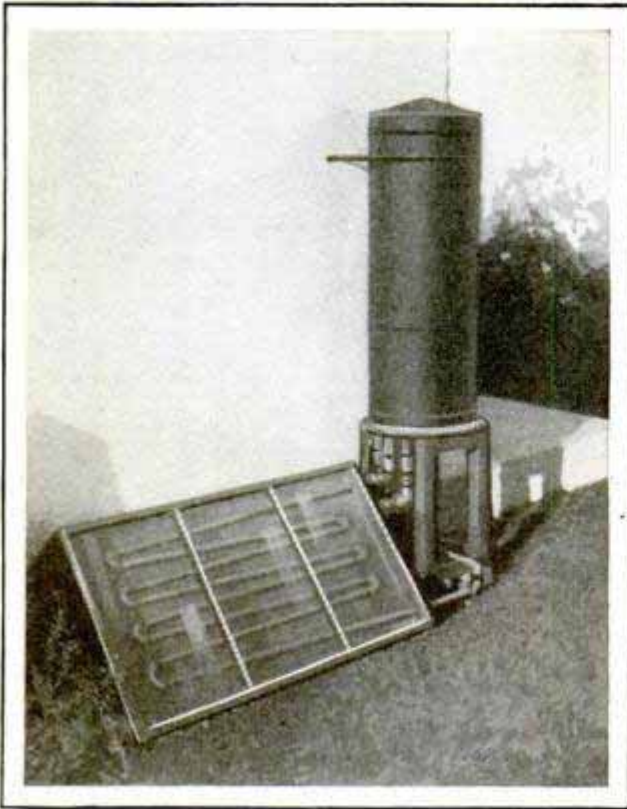

Actual Installation of Solar Heater Which Has Given Satisfactory Results

runs to the coil; this thermo-siphon action continues as long as the water in the coil is at a higher temperature than that in the tank. The size of the coil and tank may vary from the dimensions given in the drawing, in order to meet local conditions. A solar heater having three heating coils, each 12 ft. long and connected to a 200-gal. tank, has been used successfully to furnish water for showers in a high school.

The coil is installed in a well-made wooden box, which has a top of double-thickness glass, the box being similar in construction to the gardeners' cold frame. The coil must be set at an angle so that the sun's rays will strike the surface of the box as nearly perpendicular as possible throughout the entire day. Since white objects reflect light and heat rays, while black objects absorb them, and as it is essential to get the coil as hot as possible, the coil and interior of the box are painted a dull black. To prevent loss of heat from the latter, the cover should fit tightly and the box should be lined with wallboard, painted dead

black. The coil is strapped to the floor of the box, and only $1\frac{1}{2}$ in. should be left between coil and glass. These are highly important points, and the efficiency of the heater depends on their close observance. A suitable frame to support the coil box, can be made of 4 by 4 or 2 by 4-in. wood, and the glass top may be protected against breakage by wire mesh.

The storage tank must be set at a higher level than the heating coil, as shown in the drawings. The tank can be attached to the side of the house or it can be set on a small stand built for the purpose. Carefully follow the pipe connections as indicated, the cold-water pipe extending down into the tank nearly to the bottom, just as in the regular house-range boiler. Let all the pipes extend about 1 ft. below the bottom and then apply a thick layer of ground asbestos, covering all the pipes well in this layer. For reasons of economy, the pipes should be laid as close to the side of the tank as possible. The asbestos is thoroughly mixed with water to form a thick paste, which is then smeared on, after which the surface can be worked smooth. A cheesecloth covering is placed over the wet asbestos to prevent the latter from breaking off after it has dried. A galvanized-iron covering is later provided to protect the asbestos from the weather. After the tank has been permanently located, connections are made to the coil.

At the lowest point of the heating system, which is the level of the bottom pipe of the heating coil, a drain cock is fitted, so that all the water can be drawn from both tank and coil, this being necessary in temperate zones, where the heater is used only

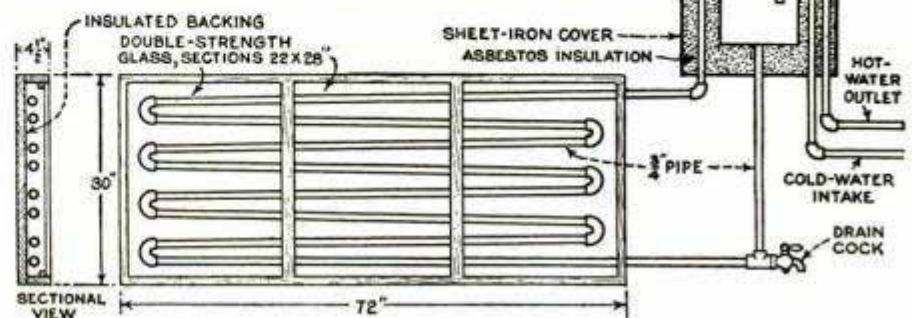

Storage Tank and Heating Coil of the Solar Heater, Showing Arrangement of Piping and Dimensions

during the summer time and is subject to freezing during the winter. The cold-water intake pipe is connected directly to the cold-water supply pipe in the house, while the hot-water outlet pipe is connected to the hot-water tank in the basement, at the point indicated, where the gas heater delivers its supply of hot water to the tank. In the absence of a hot-water tank in the basement, run the piping directly to the points where warm water is desired. As will be noticed, two extra valves are provided in the water system, one to cut off the cold-water supply to the solar heater during winter, and the second to cut off the cold-water supply to the basement tank. The two tanks can then be used separately, by opening the valve to the tank in use and closing the other.

If the builder installs his own tank, including the cold-water pipe running down nearly to the bottom of the tank, there is one important precaution to be observed. Three inches below the top of the tank, drill a $\frac{1}{8}$ -in. hole in this pipe, inside the tank. If this hole is omitted, under certain conditions the entire contents of the boiler may be siphoned out. This is not as dangerous in the case of the solar heater as in the gas heater, since the water temperature does not become so high, but it is annoying. The drilling of the small hole will break the siphon, should this condition develop.

Spring Clips Hold Lens-Board Screws

Cameras equipped with adjustable lens boards often give trouble by the screw working loose and falling out. To prevent this, take two lengths of clock spring, remove the temper and file a slot partly through them lengthwise as shown. They are drilled, retempered and then riveted to the upright lens-board supports. The clips straddle the base shoulders of the thumbnuts and do not hinder adjustments.

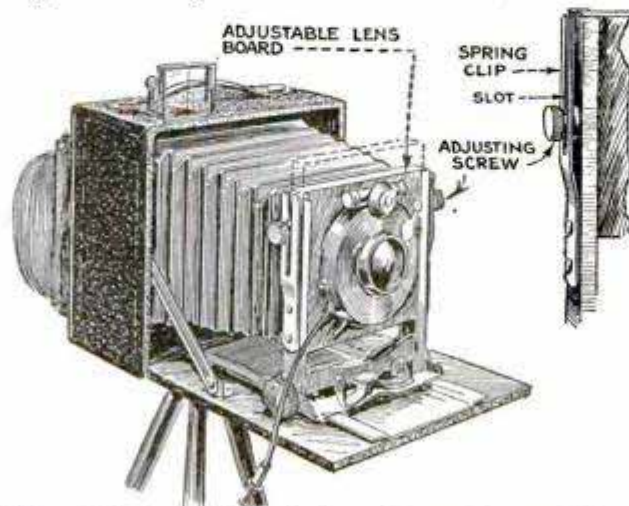

Clips Made from Clock Springs Prevent Loss of Lens-Board Thumb screws

Handy Rear-End Rack for Garage

Any garage man will appreciate the utility of a rack for holding auto rear ends.

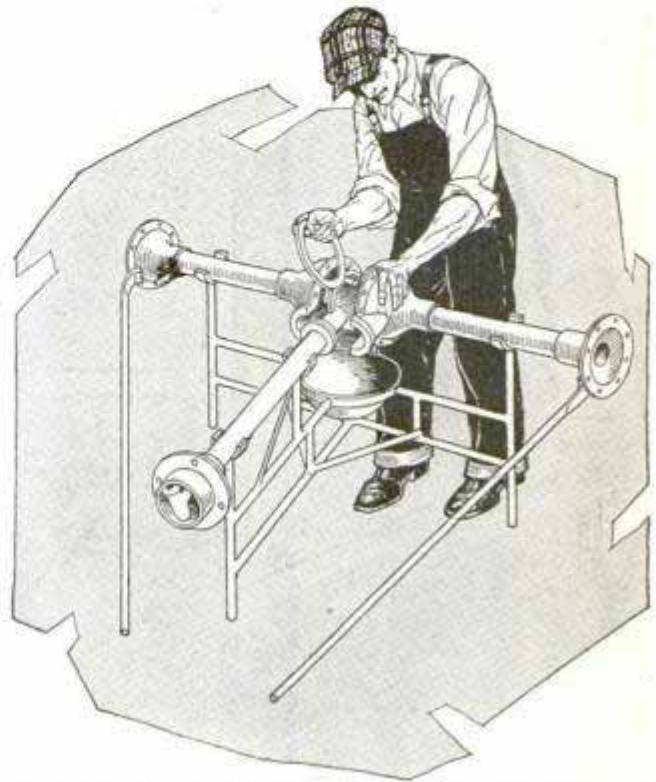

Rack for Overhauling Rear Ends Can Be Made of Half-Inch Pipe, Welded at the Joints

The one shown is built up of $\frac{1}{2}$ -in. iron pipe and a removable differential-housing cover, used as a grease pan. The three legs are split at their upper end and bent to form forks as indicated, the two forks on the support for the driveshaft housing permitting the latter to be held up separately when it is disconnected from the differential. All the joints are welded together, instead of using pipe fittings. On this rack, a rear end can be dismantled, overhauled and reassembled, making the work not only easier, but cleaner.—Mrs. Margaret Coffman, Cleburne, Tex.

☞ A knob formed of friction tape on the end of straight tool handles will aid in guiding the tool as well as prevent it from slipping in the hand.

Concrete Potting Benches for Greenhouse

In a greenhouse at York, Pa., the potting benches are made of concrete slabs,

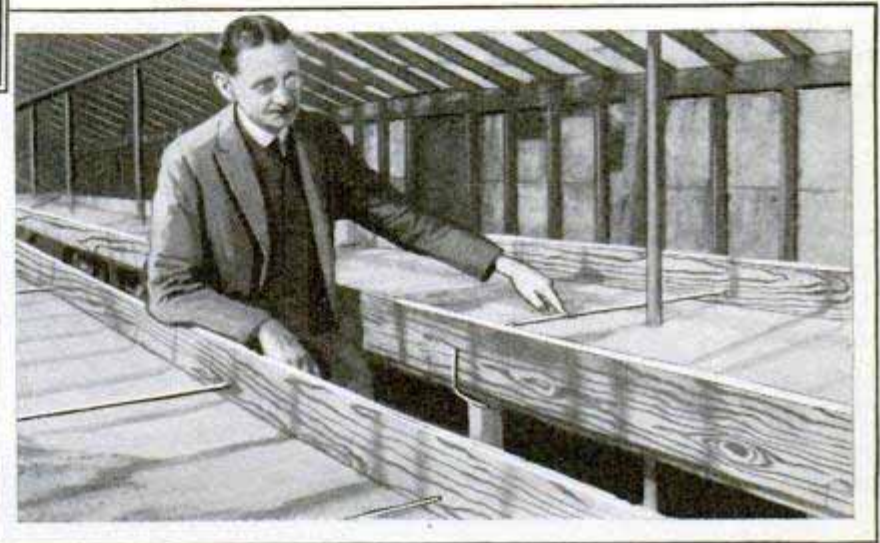
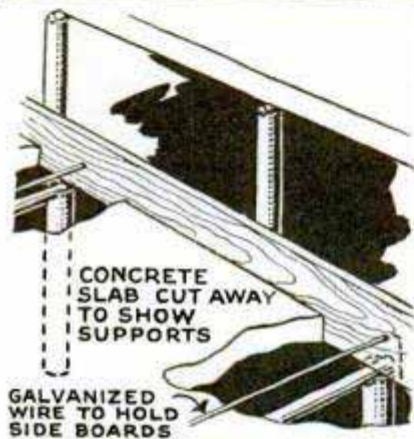

Concrete Potting Benches Supported by Pipe Uprights; the Side Boards Are Held in Place by Means of Heavy Tie Wires

which rest on iron-pipe supports. Formerly the side boards were held against the concrete slabs by nailing them to strips of wood laid across the tops of the slabs at regular intervals, but this plan proved unsatisfactory as the strips warped and usually the nails holding the boards rusted through in a single season. Heavy galvanized tie wires are now used instead

of the wood strips, being spaced about 4 ft. apart. Each length of wire is passed through holes directly opposite each other in the side boards, and the ends are then twisted together underneath the bench. The tie wires last longer than the wood strips, are easily repaired or replaced and do not take up as much space as the strips. The iron pipe used for supports was obtained from a junk dealer. Large-size pipe was used for the posts, which were set in concrete blocks in the greenhouse floor, and smaller pipe for the crosspieces upon which the concrete slabs rest. In-

stead of elbows for fastening the crosspieces to the posts, notches were formed in their tops. This was done by holding a round iron bar across the top and driving down on it with a sledge until a suitable depression was made, as shown in the upper photo and detail. The crosspieces will not roll out of the notches.—Alice Crowell Hoffman, York, Pa.

Repairing a Felt Roof

During the winter months snow and ice on the roofs present some unusual problems. One factory roof, with none too much pitch, was covered with a felt-composition roofing. Usually the snow was removed with shovels, but conditions after one snowfall of about 1 ft. were such that this was not cleared off, and a few days later a troublesome leak developed on the lower side. The warmth from within

heated the roof so that part of the snow melted and the water ran slowly down and froze near the eaves, thus forming a dam. To chop off this ice meant to cut some holes in the roofing, and it appeared as if the only thing to do would be to let it leak until the entire lot had melted and run away. One of the carpenters, however, took some cement to the roof and found a spot where a lot of water was standing, somewhat higher than the point of the leak. Enough cement was de-

posited in the hole to close it in two hours, and the leak was entirely stopped in a short time afterward.—Phil Wood, Rochester, N. Y.

How to Improve Blueprints and Photostats

When drying blueprints and photostats in a rotary-curtain drier, it is usually quite difficult to prevent getting steam pockets on the prints or mottled blotches on the photostats, which, of course, greatly detract from their appearance, or even spoil the prints. The steam pockets are formed by moisture being pressed out of the paper, and the mottled effect in photostats is caused by the texture of the canvas curtain being impressed on the paper. A good method of avoiding these troubles is to place each print or photostat between two pieces of brown cardboard of the kind used in filing cabinets. This paper will absorb the water from the prints while these are passing through the drier, and its use will effect quite a saving of material.

Arrangement for Regulating Temperature of Chemical Tanks

Photographers and others using tanks of chemicals that have to be kept at a more or less constant temperature will find the regulating conductor, or radiator, shown in the drawing, a convenience. It

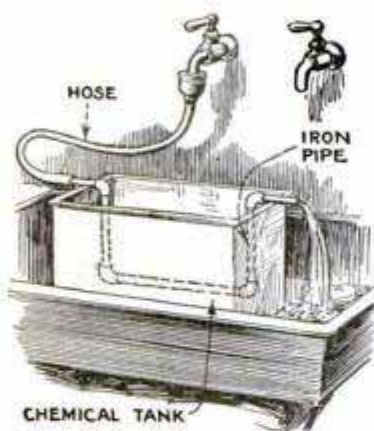

consists of a pipe run through the liquid and a length of rubber hose with a faucet connection, so that either hot or cold water can be passed through the pipe in order to raise or lower the temperature of the liquid as may be necessary. The pipe is built up in a U-shape so that it will not be in the way, and the upper ends project over the edges of the tank. Ordinary long nipples and elbows are used in its construction.

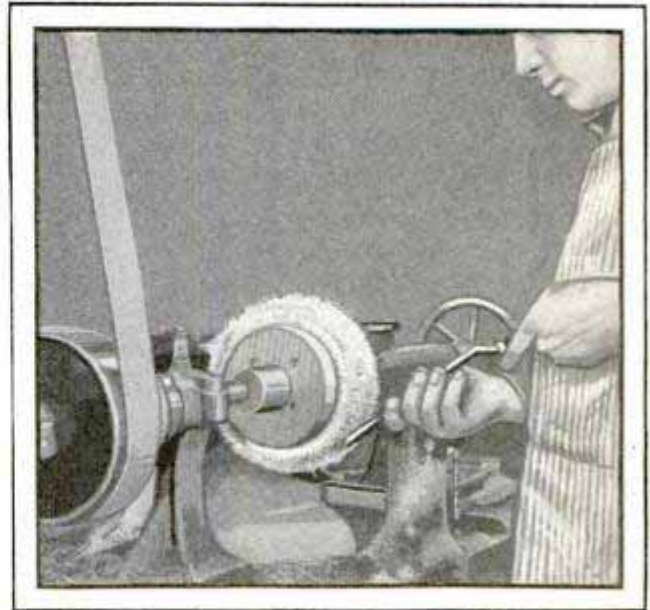

Buffer Made of Canvas Disks Puts a Keen Edge on Woodworking Tools

Canvas Buffer Puts Edge on Tools

The buffing wheel shown in the photo was made up of a number of canvas disks, 10 in. in diameter, and has been found highly effective in putting a keen edge on woodworking tools at a Denver shop. The disks were stitched together with stout cord, using an upholstery needle, and the finished wheel was made about 2 in. thick. Circular blocks of wood hold it firmly together.—Jos. C. Coyle, Denver, Colorado.

Cement Drip Block Saves Lawn Hydrant

Water dripping from the wall hydrant soon digs a small, unsightly hole in the lawn and the mud usually found here sticks to the bottom of a bucket set under the hydrant when filling it. If inadvertently set on a clean floor, the bucket will

leave some of the mud there. The provision of a cement drip-block under the hydrant will prevent this trouble as indicated in the photo.—Frank W. Bentley, Jr., Missouri Valley, Iowa.

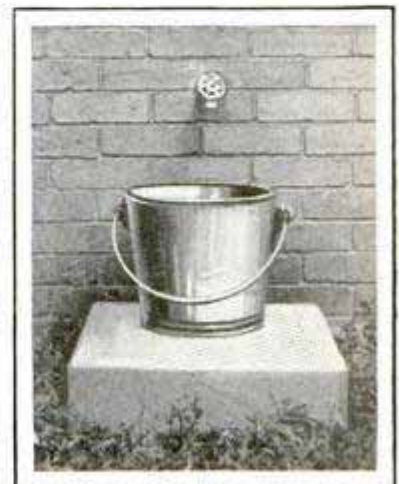

150

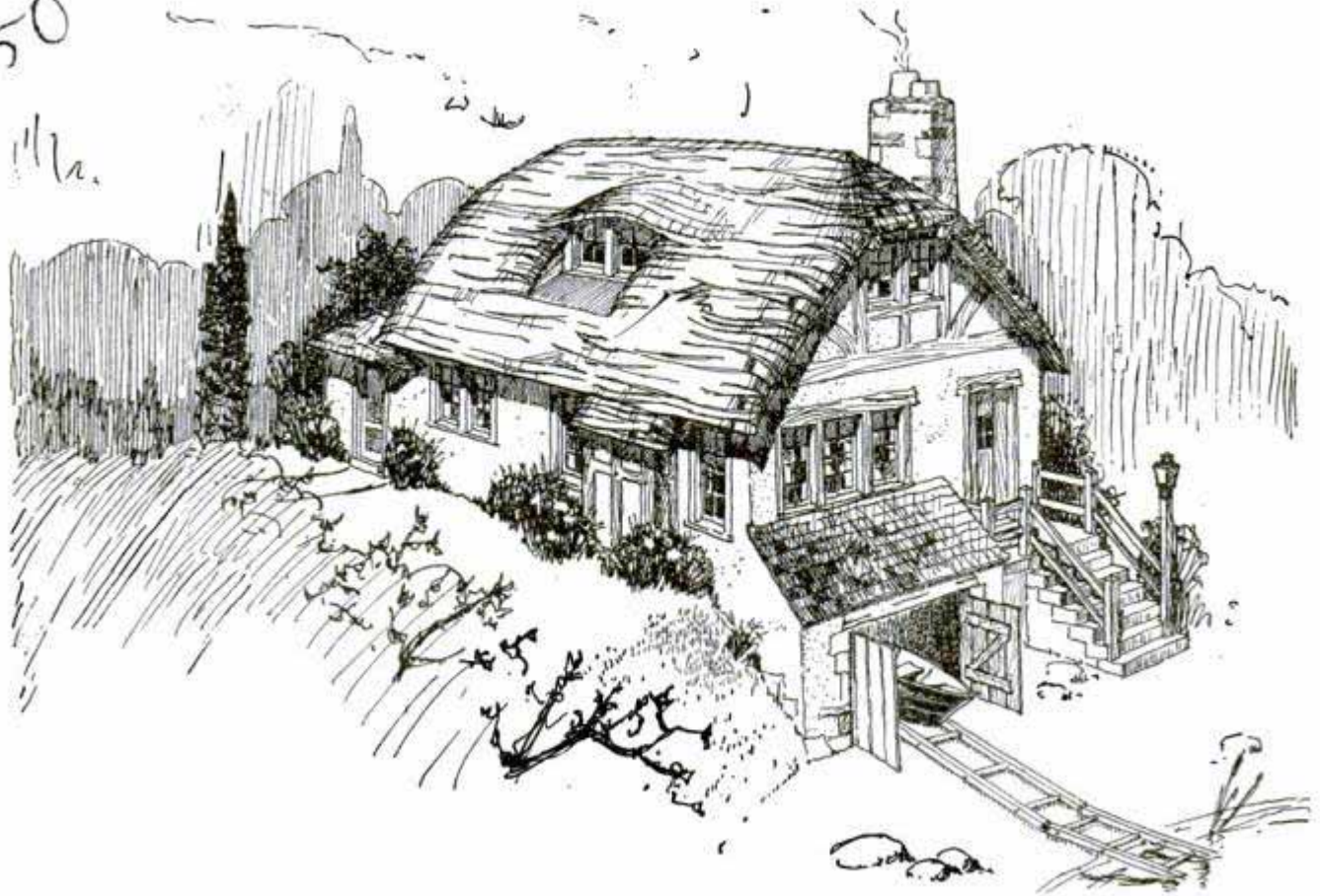

© POPULAR MECHANICS MAGAZINE

PLAN 3-5-37

A Sailor-Made Home

SHIP ahoy! An old-time sailor designed this summer house for himself. He planned it after the compact, space-saving ideas in a ship's fo'c'sle. The house is small, nineteen by twenty-four feet. There are no bedrooms. Even so, five adults can sleep with comfort on the first floor. A ship's ladder with hatchway ascends to the second floor where there is space for storage and additional sleeping quarters.

Notice how cleverly a roller bed slides, like a drawer, underneath the kitchen worktable and bathroom counter. Above the bed in the living room is a bookcase. A "fold-up" cot takes care of two more in the living room. A Pullman cot on the screened rear porch accommodates an overnight guest. Turn to page 842, this issue of Popular Mechanics, for a more complete story and illustrations of the fascinating fo'c'sle equipment and how to build it.

If built on a hillside, space beneath

the cottage can be used for boat storage or garage. A man handy with saw, hammer and some knowledge of cabinet work should be able to do most of this job himself. The plan is so practical in many ways, that, with a few minor changes, it may be used for more or less permanent service in town or suburb.

What about construction? It's a frame house with exterior finish of siding, shingles, shakes or stucco. The roof may be a plain pitch affair or roll-thatch effect as shown.



FIRST FLOOR PLAN

Popular Mechanics Magazine will supply readers a one-sheet blueprint of any house appearing in the magazine for \$1, and a new bungalow book will be sent for ten cents.

"...you've wished for a 3rd. hand"

ALONG comes a job (they're innumerable) that "ties up" one of your hands—to hold in place angle-iron, hinge, lock, lamp-fixture, shelf-bracket, chair-leg, moulding, or whatnot—forcing you to manipulate your screw-driver alone with the other hand!

And how you have wished for a third hand!

"Yankee" Ratchet Screw-driver is the answer to your wish!

Grasp handle. Hold your first good grip. Turn to and fro. Handle, working on ratchet, turns back with your hand. No letting go and grip

again. No relax of pressure on bit in screwhead. No friction—no turning screw back. One hand does the trick! And not a moment or motion lost.

Where many screws are driven, the "Yankee" Ratchet saves a fourth to half of a man's time. Such is "Yankee" ingenuity!

Unless a tool is ingenious, designed to do faster, better, more accurate work, or to operate in ways and places impossible with other tools of like purpose, it cannot bear the name "Yankee."

There is no substitute for "Yankee" efficiency, durability and economy!

Tiny screw started by turning blade with thumb and forefinger.



"Yankee" Ratchet Screw-drivers

No. 15—"Thumb-turn" on blade starts the wobbly screw. Ratchet movement drives it home. Blade $\frac{3}{4}$ " diameter. Six lengths: 2", 70c; 3", 75c; 4", 80c; 5", 85c; 6", 90c; 8", 95c.

No. 10—For husky screws. Eight blade lengths: 2", 65c; 3", 80c; 4", 85c; 5", 95c; 6", \$1.05; 8", \$1.20; 10", \$1.45; 12", \$1.60. Ratchet Shifter moves lengthwise.

No. 11—Same as No. 10, except Ratchet Shifter moves across tool.

Working on ratchet, the handle moves to and fro with your hand. Finger-touch gives right or left ratchet, for driving or drawing screws; or makes it a rigid driver.

Able to ratchet screw home with one hand.

"YANKEE" TOOLS

—TO HELP YOU MAKE THINGS—

North Bros. Mfg. Co., Lehigh Avenue, Philadelphia, U. S. A.

I want to know about time-saving modern tools: Send me "Yankee" Tool Book showing Adjustable-tension Push Drills, Bit Braces with famous "Yankee" Ratchet, Quick-Return Spiral Screw-drivers, New Two-speed Hand Drills (11-inch), Ratchet Tap Wrenches, Automatic-feed Bench and Chain Drills, Ratchet Hand and Breast Drills, Vises, Etc.



Name..... Address..... (p m)



“Select the car you like . . . *then try it out for 5 days!*”

“*That should give me time enough to make sure I like the car.*”

“*Yes sir. And every used car backed by the famous Studebaker Pledge carries the same privilege of five days' driving trial!*”

THE privilege of trial by the jury of your family — and *five days* to reach a verdict! That's what the famous Studebaker Pledge permits when you choose a used car under its protection!

You drive it — your wife can drive it — you can test it in any reasonable manner for five days. Then, if you're not satisfied, you may return it and apply your payment on *any* car in your Studebaker dealer's stock — *new or used!*

The Studebaker Pledge also provides a 30-day guarantee on all Certified cars, as well as the assured protection of plainly marked prices — one price for every buyer!

More than 150,000 thrifty motorists bought Pledge-backed used cars last year. They knew that a good used car is a better buy than a cheap car bought new.

PLEDGE
to the Public on
USED CAR SALES

1. 5 days' driving trial.
2. 30-day guarantee on certified cars.
3. Plainly marked prices.

STUDEBAKER

Builder of Champions

INVEST 2c
you may save \$200

Spend 2c now for your copy of this interesting and instructive booklet, "How to Judge a Used Car"—it may save you as much as \$200 on the used car you buy. Mail the coupon—*now!*



THE STUDEBAKER CORPORATION OF AMERICA
Div. 155, South Bend, Indiana

Please send me copy of "How to Judge a Used Car"

Name

Street

City State

Amazing New Hack Saw Blade of Disston High-Speed Steel

*Cuts Hard Metals that defy ordinary blades
Lasts 6 times as long; cuts easier, faster, better*

NOW Disston brings you hack saw blades, for use in your hand frame, made of the same steel, with the same cutting stamina, as the Disston High-Speed Steel Machine Hack Saw Blades which, in actual tests, have outlasted fifty or more alloy-steel blades, cutting twice as fast, and cutting, with ease, steel that no other blades could touch!

Every man who ever uses a hand hack saw will

want these faster, harder, tougher blades of Disston High-Speed Steel: money savers, labor savers. To make it easy for you to try them, we will mail you a Disston High-Speed Steel Blade, 10-inch length, 18 teeth to inch (standard for all-around use) for 30 cents; and, with it, the new Disston Hack Saw Chart. Just send the coupon below, and later buy at your dealer's. Cut it with Disston Steel, in saws, tools and files!



Use the Right Hack Saw Frame

The Disston No. 36 1/2, illustrated, is extra strong; to hold blade firmly. Takes 8" to 12" blades. Handle, of hand saw type, gives user perfect control of saw. Frame nickel plated, with riveted sockets and reversible stretchers. \$2.10.



Files for the Metal Worker

Every kind, size and style, all made of Disston steel. Accurately cut, dependable. A Disston 8-inch Mill File, bastard cut, is fine for sharpening axes, lawn mowers, etc., and for general work. 25 cts.

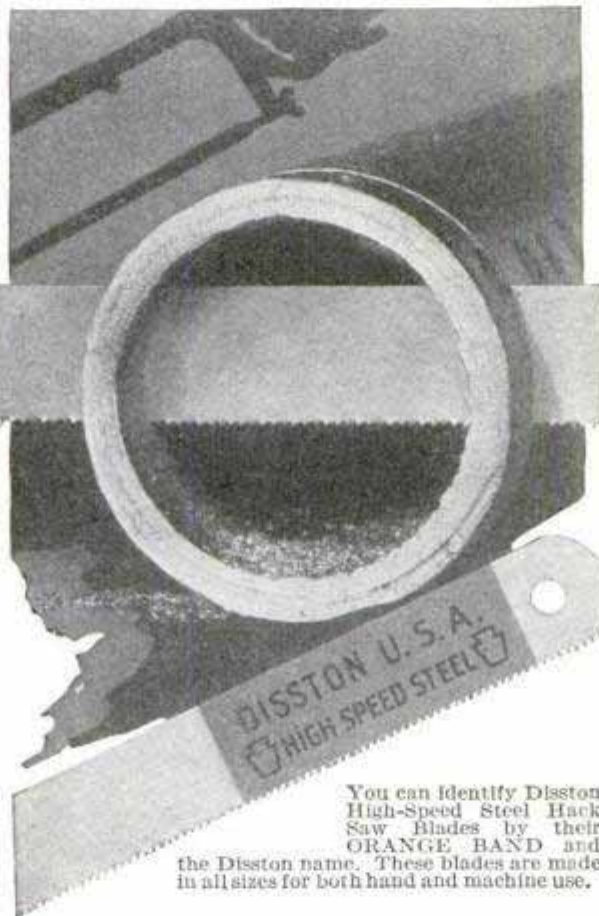

You can identify Disston High-Speed Steel Hack Saw Blades by their ORANGE BAND and the Disston name. These blades are made in all sizes for both hand and machine use.



"The Saw Most Carpenters Use"

The two handiest saws for the home workshop are the 26-inch 8-point for cross-cutting, and the 26-inch 5 1/2-point for ripping. You will need these on almost every job. The popular "D-S" Lightweights cost \$3.45.

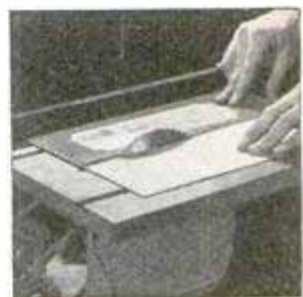

For Cutting Soft Metals

You can use a Disston Metal-Slitting Saw on your power outfit. Cuts sheet brass, zinc, copper, etc. Disston makes the most efficient metal-cutting circular saws of all types. Write for information.

IN using a Disston High-Speed Steel Hack Saw Blade in a hand frame, see that material to be cut is held firmly. Stretch blade tightly in frame, with teeth pointing forward. Start cut easily with a light forward stroke, as in filing, and lift blade slightly on return stroke, to prevent teeth from rubbing in the cut.

Put pressure on each forward stroke by moving body back and forth in line with the stroke instead of moving hands only. Make each stroke do its work. Forty to 60 strokes per minute, with pressure,

will cut faster, more accurately, and easier than faster strokes without sufficient pressure.

"The Disston Hack Saw Chart" is a new and valuable guide to tool users, amateur and professional. It tells and shows how to choose and use hack saws for every purpose. A copy of this helpful chart will be included, without charge, with your order for one Disston 10-inch High-Speed Steel Hack Saw Blade for 30 cents. The coupon below is for your convenience. Use it now, before you forget!

DISSTON

Makers of "THE SAW MOST CARPENTERS USE"



For only 30 cents, in coin or stamps, (40c in Canada), Disston will send you, promptly, post-paid, the amazing new Disston High-Speed Steel Hand Hack Saw Blade, in the 10-inch size, 18 teeth to the inch, and with it "The Disston Hack Saw Chart," which embodies latest information on use of hack saws. Mail coupon, and buy later from your dealer.

Disston Hack Saw Chart



Henry Disston & Sons, Inc., Philadelphia, U.S.A. (In Canada, Henry Disston & Sons, Ltd., Toronto)

For 30 cents, enclosed, (in Canada, 40c), send Disston High-Speed Steel Hack Saw Blade and "The Disston Hack Saw Chart" to

Name and Address.....

New Type Electrically Started Motor Craft Open Even Shallowest Waters to Motor Boating

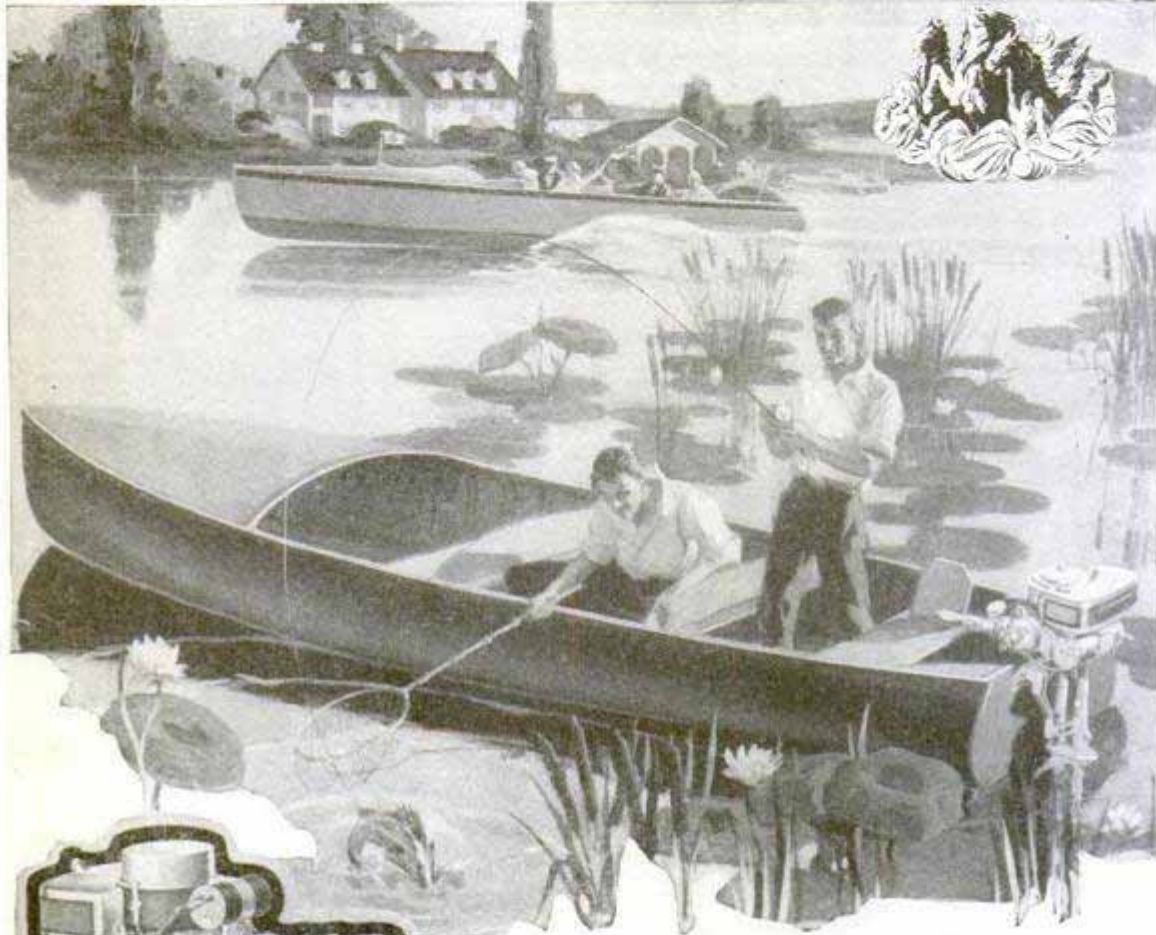

Once turned on electric starter runs until turned off; hence motor cannot stall. Starter also charges battery. Requires no engaging clutch or gears.



Sea-Horse propellers tilt automatically on striking obstructions and pass over them.

Fishing from the 15-ft. Utility B, the boat \$275. In the background the 20-ft. Aquaflyer, Philippine mahogany, price with electric-starting Sea-Horse "32," \$1065.



Sea-Horse "24"

SEA-HORSE PRICES

"Single," \$125;
"3," \$150; "4,"
\$160; "10," \$185;
"12," \$195; "16,"
\$250; "24," \$280;
"32," \$325.

Electric-starting
Motors
"16," \$315; "24,"
\$350; "32," \$395.

All prices f. o. b.
factory. Partial
payment terms.

Complete outboard motor boats, powered by swift, silent Sea-Horse motors—both electrically started with auxiliary rope-starter, or rope-started only, fulfill every desire for trim, fast, comfortable runabouts at a fraction of the cost of motor boats hitherto.

Cruise, fish, explore or race, regardless of obstructions. They make deep waters safer and also navigate shallow waters where inboard motor boats cannot go. For propellers automatically tilt over obstructions that disable stationary propellers.

Heading these Matched Units are the Aquaflyer Runabouts, luxuriously upholstered, electrically

started, and steered by an auto-type wheel. Their Sea-Horse Motors are neatly concealed in a hatch-covered recess in the stern, making the usable space 30% greater than in inboard motor boats.

Seamless Sealite hull construction offered in 17½ ft. Aquaflyers and in three other Johnson boats, is impervious to water, 35% stronger than small boat wood construction, and yet weighs only half as much in water service, and is decidedly faster.

Write for Color-illustrated Catalog De Luxe

All dealers carry first-aid service parts. Stations for complete service in all parts of the country.

JOHNSON MOTOR CO., 2489 Pershing Rd., Waukegan, Ill. In Canada: Canadian Johnson Motor Co., Ltd., Peterboro, Ont.



OUTBOARD RACING

Skim the water at express speed. Even flying cannot offer you such thrills. Sea-Horses hold 14 out of 24 official 1930 records including the fastest time ever made—49.34 m. p. h. Sea-Horses won over 450 victories in races and regattas last year alone. For speed that wins, drive a Johnson Sea-Horse. Send for catalog.

JOHNSON MATCHED UNITS SEA-HORSES & BOATS

Largest Manufacturer of Outboard Motors and Matched Units

TELLING THE WORLD

The Linotype tells the world what the world is doing. It forms the metal lines-of-type that print your daily paper, most books, this magazine.

The Linotype is a fine-meshed thicket of deft steel arms and hands and fingers. Synchronized to a split second, they do precisely the right thing, at precisely the right moment. Because they are accurate.

Accurate, in hundreds of cases, to one ten-thousandth of an inch. Accurate with the surpassing accuracy of skilled hands and precision tools—tools like Starretts.

Do you work with your hands? If you do, let us urge you to use the same precision tools that make possible machines like the Linotype. With Starrett Tools, you'll do your work with nicer precision, with greater pride and pleasure.

Let us send you our new Starrett Catalog No. 25 "AP."

THE L. S. STARRETT CO.
World's Greatest Toolmakers
Manufacturers of Hacksaws Unexcelled
Steel Tapes—Standard for Accuracy
ATHOL, MASS., U. S. A.

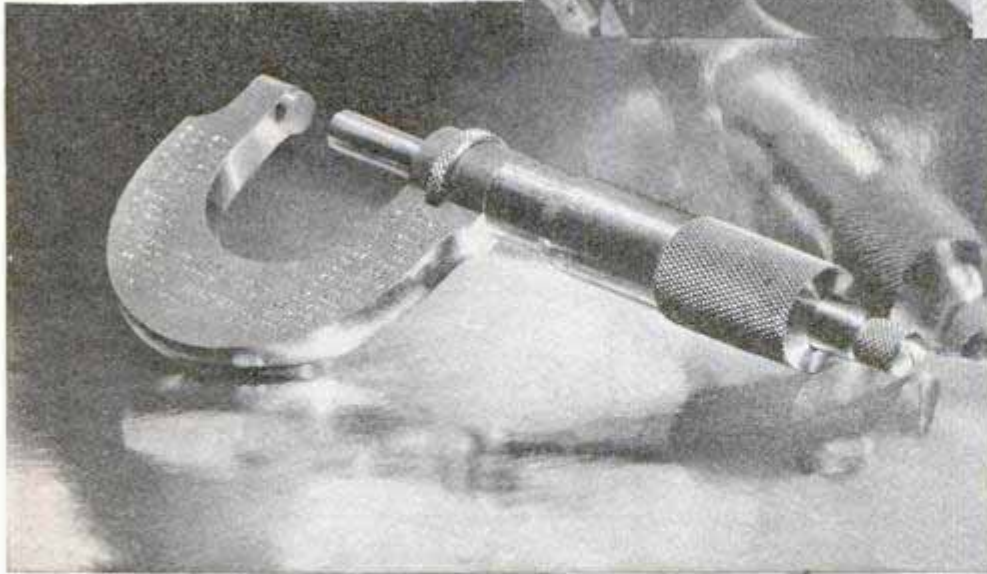

This photograph, taken through the courtesy of the Mergenthaler Linotype Company, shows the keyboard and matrix-assembling sections of the machine. Left: Starrett Micrometer No. 230, typical of the precision tools that most skilled machinists, professional and amateur, prefer. With 2500 other Starrett Tools, it is fully described and illustrated in the new Starrett Catalog No. 25 "AP." Send for it.

50th Anniversary of
Starrett Tools
1880—1930



Use Starrett Tools

WHY FAMOUS MEN OF THE DAY USE BARBASOL

"Barbasol makes every shave a masterpiece"



Courtesy of National Broadcasting Company

VINCENT LOPEZ, society's favorite musical conductor, a distinguished pianist and radio celebrity, creator of harmonious dance rhythm, enjoyed by millions, whose masterful performances have made his name world-famous.

BARBASOL friends practically write the Barbasol advertisements. Mr. H. J., out in Nebraska says, "Barbasol does the business so pleasantly and smoothly that one marvels—it cuts the time in two." From Ohio, W. D. G., an ex-barber, says, "I must admit after two years' refusal to give Barbasol even a trial, that it is just wonderful." From Texas, J. W. B. writes, "Barbasol is far superior—not the slightest irritation, smarting or burning after shaving." (Yes, we'll supply these names on request.)

Follow these directions and you'll follow the crowd

Try Barbasol tomorrow morning and learn why it's the fastest growing shaving cream in the world. Give up all your old ideas about shaving. Start fresh. Don't touch a brush; don't look for a lather. Barbasol is different; new; modern.

1 Wet your face. Better yet, wash it in soap and water and *leave it wet*. **2** Spread on Barbasol. *Don't rub it in*. **3** Wet your razor and—*shave!*

*"Barbasol makes close harmony between the blade and the beard. There's a sort of magic in the way it softens the hairs and makes them come off close and clean and easy—all in quick tempo, too. Barbasol has made all the old-fashioned juzzing around with brush and rub and lather completely out of date. It's modern. That's why I use it every day."

*Barbasol testimonials are not paid for.

Vincent Lopez
(VINCENT LOPEZ)



That's all! You'll hardly believe it when you feel the crisp, clean way the blade slides along. Man, what comfort! How quick and easy. And how soft and refreshed your face feels. No lotions needed here. And blades last longer, too.

Treat yourself to Barbasol *now*. Generous tubes, 35¢ and 65¢. All drug stores have it, of course. Get set for a trial tomorrow and—the shaving surprise of your life! The Barbasol Co., Indianapolis, Ind.



BARBASOL SKIN FRESHENER

A great facial pick-up for men. Douse it on face and neck when you need a bracer—morning, noon or night. It tingles, rejuvenates. Try it!

Barbasol

For Modern Shaving

No brushing—No lathering—No rubbing

The *proof* that Ethyl develops more power

Right: This is the instrument board of a "knock" demonstration machine. The wattmeter (at the left) registers power. The tachometer (at the right) records engine revolutions per minute. When this picture was made, the engine was running on ordinary fuel.



Left: When the lower picture was taken, Ethyl had been fed into the carburetor. The wattmeter shows that the power has risen to the maximum; the tachometer shows a corresponding increase in revolutions per minute.

"SEEING is believing." These pictures of a "knock" demonstration machine let you *see* how Ethyl Gasoline will knock out that "knock" and increase the power of your motor.

A simple valve switches the fuel from ordinary gasoline to Ethyl and back again. When Ethyl goes in, "knock" goes out, R.P.M.'s (engine revolutions per minute) increase, power goes up. That is how Ethyl improves

motor car performance. It is the Ethyl anti-knock compound in Ethyl Gasoline that makes the difference. This remarkable fluid was developed by General Motors Research Laboratories to find an ingredient which, when added to gasoline, would make it a better fuel.

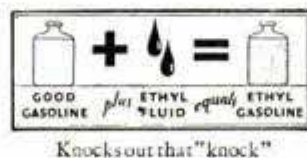

Have you seen this convincing demonstration? Ethyl Gasoline Corporation, New York City.

ETHYL GASOLINE

The active ingredient now used in Ethyl fluid is tetraethyl lead.

© E. G. C. 1930

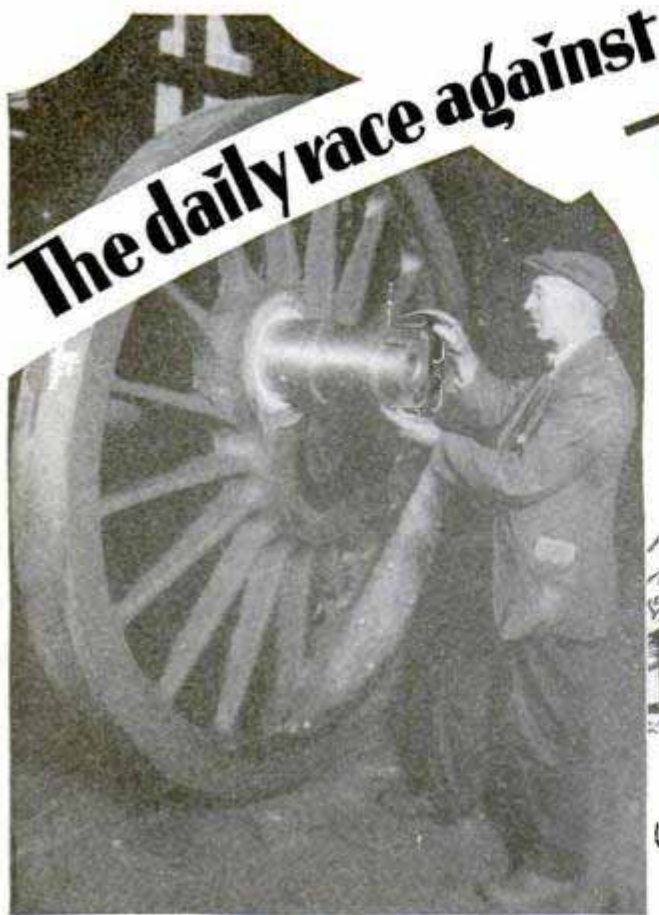

TIME DEPENDS UPON ACCURACY

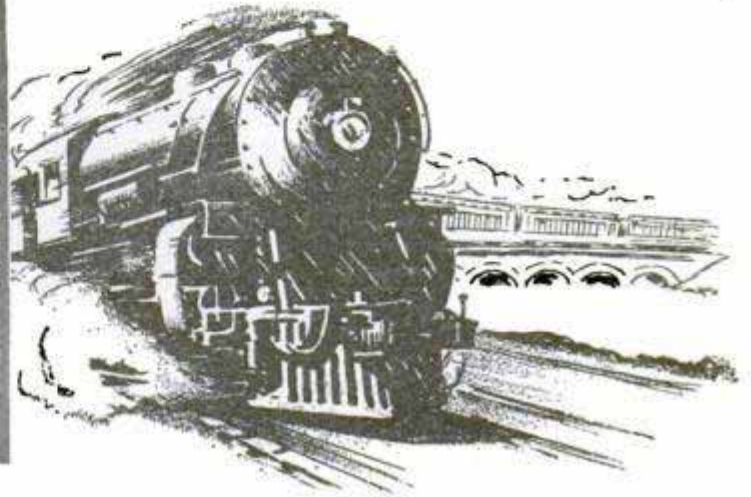

AS we sit in the comfortable seats of today's fast trains we give little thought to the giant up ahead whose power permits us to check off the miles by the minutes on our watch.

Cylinders, pistons, driving rods, bearings, pins—all moving parts of this efficient monster must be accurately fitted to withstand the strain of exacting schedules. Both in the manufacture and subsequent upkeep, skilled

mechanics are constantly checking to insure accuracy. It is in this tremendously important mechanical work that Brown & Sharpe Tools—micrometers, gauges, rules, calipers, squares—are universally used in checking sizes and clearances.

In every industry where performance depends upon mechanical accuracy you will find Brown & Sharpe Tools are the choice for important measurements.

Our Small Tool Catalog No. 31 describing over 2300 useful tools will be sent upon request. Dept. P. M., Brown & Sharpe Mfg. Co., Providence, R. I., U. S. A.



Brown & Sharpe Tools

"WORLD'S STANDARD OF ACCURACY"



Micrometer
Caliper
No. 11 R S



Planer and Shaper
Gauge No. 625



Combination
Square No. 408



Inside
Micrometer
No. 264

PRESWOOD SIGNS

point the way to
Greater Production
Economies

Thousands of dollars saved in the elimination of a single process... freedom from rusting and denting, ease of working, and beauty and permanence of painting. These advantages have made Masonite Presdwood the ideal sign material. And in industry after industry the same exceptional qualities of this grainless wood board have dictated its use for everything from toys to motor truck bodies.

Roadside signs of Presdwood are outlasting those of other materials. This grainless wood is highly resistive to moisture and warping. It requires no preliminary acid wash, has a broad, smooth surface which takes paint perfectly. Scorching heat and bitter cold have practically no effect on finish applied to Presdwood, for the minutely fibrous surface bonds firmly with the paint and there is almost no expansion or contraction to make the paint peel or crack.

In reducing factory costs and improving products, these same qualities of Presdwood make it almost invaluable. It does not crack or splinter, can be nailed near the edge without splitting, and is readily worked on punch press or band saw.

Helps keep eggs—or hatch 'em

Presdwood makes iceboxes and incubators, bee hives and bird houses, shipping containers and breakfast nooks, table tops and bookcases, kitchen cabinets and speed boat decks. It lines concrete forms for stately buildings, provides permanently beautiful paneling for the finest homes.

Manufacturers, sign makers, builders and home mechanics should read the Presdwood booklet and examine a sample of Presdwood. Both the booklet and sample are sent to you, Free, without obligation. Just clip out the coupon and mail it in NOW.

MASONITE CORPORATION

111 West Washington Street
 Chicago, Illinois



Cut-out signs of this grainless wood are not weakened by cross grain



For motor truck body paneling



On the farm



For chick signs



For cut-out signs



For painted bulletins

Masonite
PRESWOOD
Made by the makers of
MASONITE STRUCTURAL INSULATION

MASONITE CORPORATION
 Dept. L5, 111 West Washington Street, Chicago
 Please send me, Free, a sample of Masonite Presdwood and the Presdwood booklet.

Name

Address

City..... State.....



7 Shaves Free to dissatisfied shavers

A FREE trial test is the method we've employed to introduce Palmolive Shaving Cream. For if it is all we claim, we win new users to it. 86% of the men who have tried Palmolive Shaving Cream abandon all other methods for it.

For 67 years we have been making "leaders" in the soap field. Thus it is natural that our laboratories would not rest content until our shaving cream was worthy to join that group.

129 times they rejected their own formulas. The 130th time they were successful. Their idea was to make a shaving cream in which olive oil would play a prominent part in easing the action of the blade. Five great advantages result.

1. Multiplies itself in lather 250 times.
2. Softens the beard in one minute.
3. Maintains its creamy fullness for 10 minutes on the face.
4. Strong bubbles hold the hairs erect for shaving.
5. Fine after-effects due to palm and olive oil content.

Are they what you are seeking?
Then won't you make our test?



5260

PLEASE MAIL THE COUPON - WE TAKE THE RISK

7 SHAVES FREE and a can of Palmolive After Shaving Talc

Simply insert your name and address and mail to Palmolive, Dept. M-837, P. O. Box 375, Grand Central Post Office, New York City.

.....
.....
.....

(Please print your name and address)

soothing to eyes

Swimming, motoring and other outdoor activities often cause even the strongest eyes to burn and become bloodshot. When this occurs, apply a few drops of soothing, cooling *Murine*. Almost instantly the burning sensation will disappear, and before long your eyes will be clear and bright again.

Millions of bottles of *Murine* are used each year to soothe and beautify eyes. Many persons make a practice of cleansing their eyes with it daily. A month's supply costs but 60c. Learn its benefits!

MURINE FOR YOUR EYES



ELECTRIC LAWN MOWER

Don't tire yourself out with an old style mower when you can get an electric at a price you can afford to pay. 110 volt A. C. or 32 volt farm plant. Write for particulars. Agent wanted.

Raun Lawn Mower Co.

Box 533

El Campo, Texas

The Woodworking Equipment You Need Above All Others—H & A SAW TABLE

The Tool of Many Uses



Use it for ripping, cross-cutting, mitering, grooving, rabbeting or dadoing. A sturdy, powerful, large capacity machine that will handle wide material. Accurate, speedy, reasonably priced. Equipped with tilting fence for bevel sawing; 1/4 or 1/2 H.P. motor; ball bearing spindle. Write for catalog of woodworking tools.

HESTON & ANDERSON, 605 Kirkwood Ave., Fairfield, Iowa



FISHING-

WHAT TACKLE AND WHEN"

Write for your copy of this interesting book. **Sent Free!** Ozark Ripley, Cal Johnson, Sheridan Jones and other angler-writers tell how to catch fish of every species. Contains practical fishing hints. Shows complete variety of South Bend tackle.

100
PAGE
BOOK

Illustrated and written for old timers as well as beginners. **Write today.**

**SENT!
FREE!**

SOUTH BEND BAIT CO., 560 High St., South Bend, Ind.

SOUTH BEND

Fishing Tackle of all kinds... Rods-Reels-Lines-Baits

**"45" Twin**

One of the great
1930 models.
Harley-Davidson
prices range from
\$260, f. o. b. factory.

MORE FUN *than an* AMUSEMENT PARK

ALL yours with your Harley-Davidson Motorcycle — the dip and zoom of the "Roller Coaster", the thrilling whirl of the "Airships", the zip and speed of the "Whip"!

All yours to enjoy—every time you ride your Harley-Davidson — for motorcycling combines the thrills of a dozen sports in one. You never tire of it.

What wonderful vacation and outing trips you'll take with the jolly bunch of Harley-Davidson riders! And the cost is so low—a Harley-Davidson is easy to buy, and its upkeep is only a penny or two per mile.

Let your nearest Harley-Davidson Dealer show you the 1930 models, and explain his Pay-As-You-Ride Plan.

Mail the coupon to us for literature.

MAIL THE COUPON

HARLEY-DAVIDSON MOTOR CO.,
Dept. P., Milwaukee, Wis.

Interested in your motorcycles.
Send literature.

Name.....

Address.....

My age is 16-19 years, 20-30
years, 31 years and up, under
16 years. Check your age group.

Ride a **HARLEY-
DAVIDSON**

\$ 5 0 0 0 0 REWARD

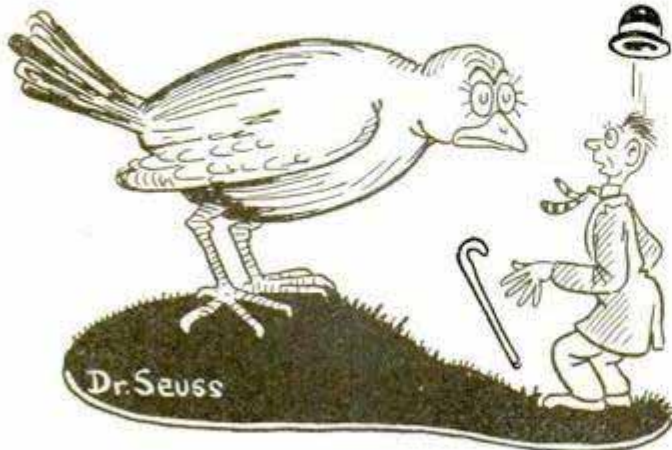

WANTED John Sparrow

(alias "Nuisance," alias "English")

John Sparrow—one of the most brazen of outlaws—is sought on two major offenses.

He roosts on housetops, defaces gables, ledges, windows and awnings, and nests in drain pipes.

This culprit's open hostility drives away welcome songbirds, replacing their musical notes with his "cheep, cheep, cheep."

John Sparrow should be tarred as well as feathered. Or, better still, he should be shot with a CROSMAN SILENT .22—the most amazing gun ever invented for shooting targets and killing small game, furred or feathered. Hence the

\$500 REWARD

for making such criminals, now at large, as silent as the Crosman Silent .22 itself, the rifle that has six features found in no .22 firearm. For full information on the Crosman Rogues' Gallery and the valuable rewards for the capture of the outlaws, write us now or see your Crosman dealer.

CROSMAN ARMS CO.

403 St. Paul Street,
Rochester, N. Y.

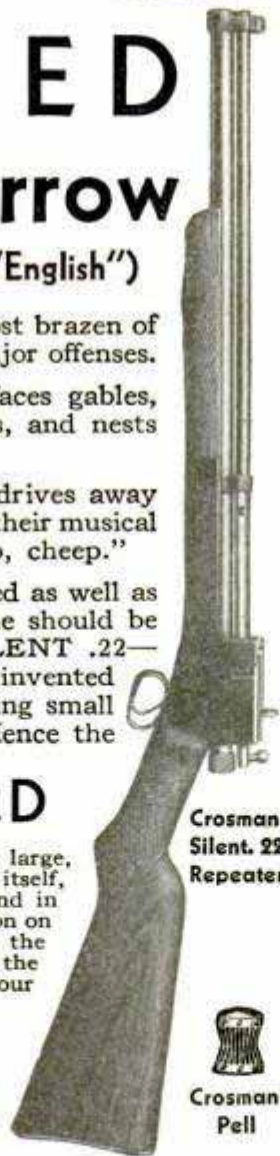

Crosman
Silent .22
Repeater

Crosman
Pell

CROSMAN RIFLES
SILENT .22

"POWER WITHOUT POWDER"

Be Independent!

Do you want to have your own cash business? Here's your chance to do it and make big money, too. Morse earned \$1520 in five months. Many others are making big profits. Start in spare time—there are hundreds of lawn mowers right in your own neighborhood that need resharp-
ening.

**\$10
Brings
It to You**

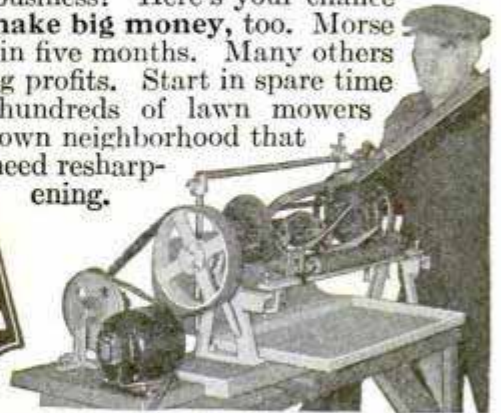

Foley Electrakeen Lawn Mower Sharpener

Sharpens all kinds of lawn mowers the factory way in from 15 to 20 minutes. Easy and simple to operate. 99c out of every dollar is PROFIT. Woodmancy made \$25 to \$30 a day. Others are making good money in part or full time. YOU can too. Write for complete information and FREE PLAN now.

Foley Manufacturing Co.

1437 Foley Bldg.

11 Main Street, N. E. Minneapolis, Minn.

FLY THIS COMBAT MONOPLANE!



This realistic copy of a military monoplane is an unusually graceful flyer. Wing-spread 18 in. Weight only 7/8 oz. Will take off by own power and fly over 80 ft. Markings in red and blue. Can be built in 2 hrs. without tools. Construction set includes 6-in. aluminum propeller with shaft, 4 in. disc wheels, wood struts, rubber band motor and all other parts, with clear directions. Complete set, packed in unbreakable container, only \$1.00, postpaid in U. S. and Canada. Order today. Satisfaction or money refunded.

The MIDLAND MODEL WORKS, Chillicothe, Ohio
(We cannot make C.O.D. shipments. No retail catalogue issued.)

AGENTS! SELLS LIKE WILDFIRE



New improved window washer eliminates all muss and fuss wherever there is glass to be cleaned. Approved by Good House-keeping Institute. Restricted territory to producers. Write today

CARTER PRODUCTS CORP.

935 Front Street

Cleveland, Ohio

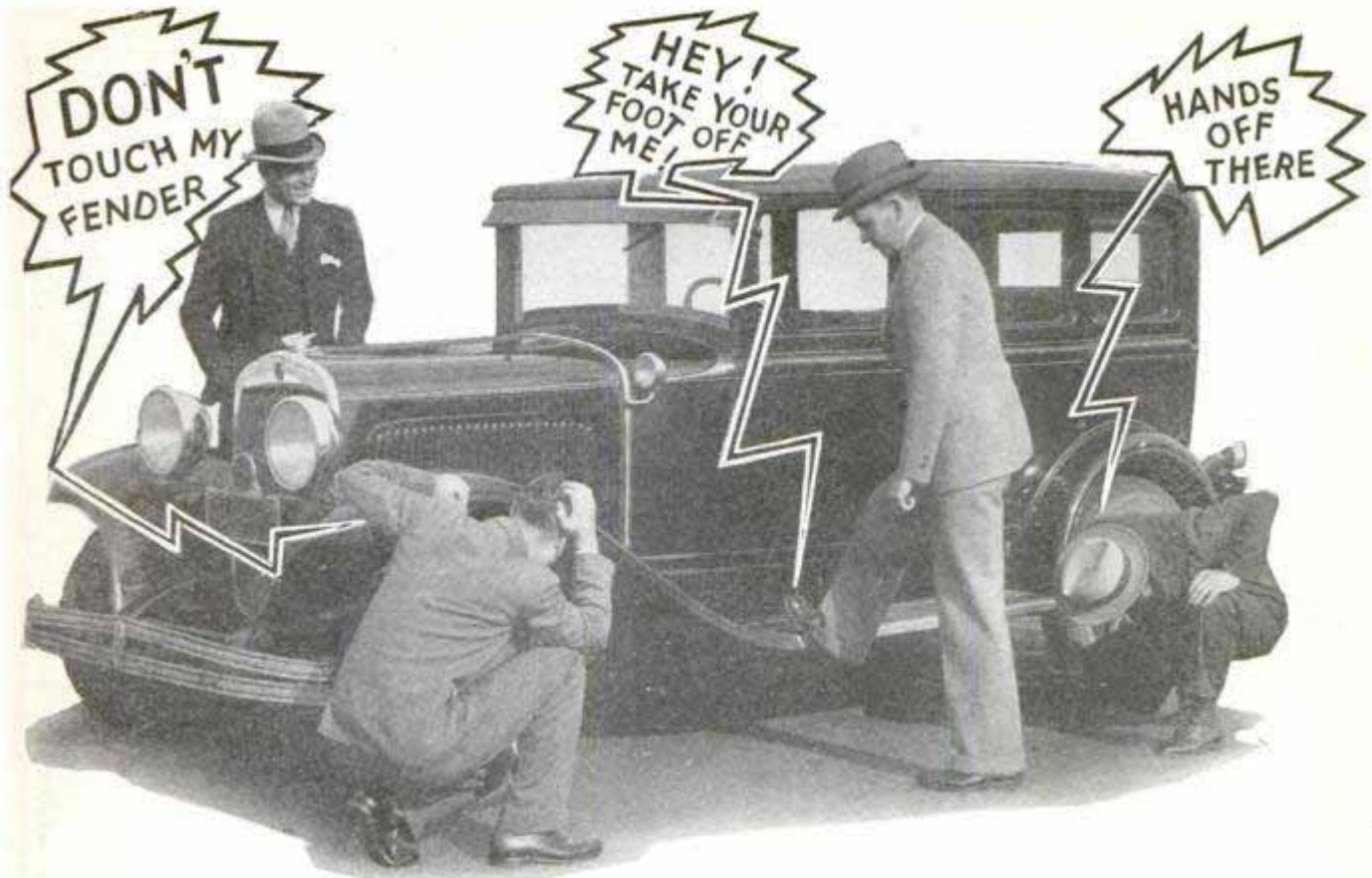

Uncanny Invention Startles Motorists Protects Your Car From Thieves, Puzzles Your Friends!

Here is something incredibly new and revolutionary. More mysterious than anything since the first discoveries of radio! As uncanny as electricity itself! Actually more

useful and valuable than the self-starter on your car! As easily controlled as your headlights! Inexpensive! No wonder it has turned the motor world topsy-turvy overnight!

Pays Agent Record Earnings Of \$138 In A Day!

IMAGINE having a car that no sneak thief can tamper with! No joy-rider can steal! No friend can touch without being warned to keep away! Then think of offering this uncanny electrical device to other motorists at a price scarcely greater than the cost of a new radio tube!

In the above few words you have the reason why G. Oliver of Illinois set a profit record of \$138 in a single day. James Harper of London, England, cables, "Devil-Dogs received, ship immediately three hundred, cable best terms for sales concession, Great Britain." A. Karratti of Hawaii writes, "Have equipped my car with Devil-Dog and am creating a sensation." Earnest Flom, No. Dakota, states, "The Police force praise it highly." Richard Jacques, Canada, writes, "Have sold one for Police armoured car and am getting letters from Chief of Police and Detective Departments." What these men say is just an indication of what motorists everywhere are saying. No wonder our agents are making money hand over fist, both spare time and full time.



can be installed by anyone in ten minutes or less. There is no cost for operation. No extra batteries to buy. An introductory offer now lets you examine the most spectacular invention since the radio first came in, on 5-day test. Profit possibilities as our agent are almost unlimited. Mail the coupon for 5-day offer and complete territory details. No obligation whatever, but do it now!

**AUTOMATIC
DEVIL DOG**

**NORTHWEST ELECTRIC CORP.
Dept. E-10, Pukwana, S. Dakota**

Northwest Electric Corp., Dept. E-10, Pukwana, S. Dak.
Rush me your 5-day test offer and distributor's territory details.

Name.....
Address.....
Town.....State.....

Send Quick For 5 Day Test

This astounding invention fits any car from a Ford to a Rolls-Royce without adjustment or fussing. It



NEVER MIND! Savogran Crack Filler will fix it!

HOLES in the plaster, cracks in wood, corners knocked off furniture, castors loose . . . they are all quickly fixed with Savogran Crack Filler—the *permanent* repair material. Just mix a little Savogran Crack Filler with water—press it into place, smooth when dry, and paint or stain it, and the damage has disappeared for good.

Householders, painters, carpenters, industrial users, are turning to Savogran Crack Filler because *it will not shrink*. It's easy to use, permanent, and inexpensive. At hardware and paint stores everywhere!

Made by the makers of Painters' Savogran, which has saved painters and housewives hard work for over 35 years. Painters' Savogran cleans dirt and grease like magic, renews hard paint brushes, removes paint and varnish. Saves your time and money—try it.

BIG ONE-POUND CAN

30c

Large users buy Savogran Crack Filler in 35-lb. all-metal pail—\$7.70. The 5-lb. can costs \$1.25, 1-lb. can 30c. Low price—no waste—no hardening in the can—here's the biggest value on the market.

SAVOGRAN COMPANY
India Wharf, Boston, Mass.



SAVOGRAN CRACK FILLER

REG. U.S. PAT. OFF.

PAT. APP. FOR

WILL NOT SHRINK!

5 Room ALADDIN

\$552



All Materials Read-Cut; Freight Paid



Summer Cottages and up \$179

Many sizes and designs. Save money, time and annoyance by ordering all materials from one source, shipped to your destination in a single car.

Buy direct from the big Aladdin Mills at wholesale prices. Pay cash—save 20% to 40%. Shipment is made in sealed box car—**freight prepaid**. Safe arrival guaranteed.

Save \$200 to \$1000

Aladdin Homes are cut-to-fit at the Mill on huge labor-saving machines, instead of on the job, where labor and lumber waste costs dearly. You save the difference and get the finest home your money can buy.



Garages \$92 up

All sizes—attractive designs. Prices are astonishingly low. Build one yourself in a day or two, save labor costs—really enjoy the easy work!

FILLING STATION

Practical design \$369 with roofed driveway, positions for 2 pumps, and stove space. Quickly erected—starts paying for itself out of first week's profits.

What You Get

Prices include all lumber read-cut, millwork, windows, doors, interior woodwork, hardware, roofing, glass, nails, paints, varnish, and stains.

Catalog FREE

Profusely illustrated. Overflowing with interest. Address nearest office **today** for your FREE copy. No obligation. Send **now**. Ask for Catalog No. 946.

The ALADDIN CO.
Bay City, Mich., Portland, Ore.
Wilmington, N. C.

Lighter and Pencil Combined

"It Lights and It Writes"

PENCILITE SETS BIG PROFITS QUICK!

It's irresistible! No. 5 Bullet Style PENCILITE—a serviceable pencil and sure-fire cigar lighter. Sells on attractive display cards to all stores, soda fountains, cigar stands, etc. Big repeater. Write for Salesmen's extra big profits plan. Get sample. Protect territory now. Sample 50c Prepaid. **CHECO MFG. COMPANY** 2715-17 S. Mich. Ave., Dept. 805-G, Chicago

Uses any lighter fluid. Does work of \$5 lighter or pencil. Sells on sight! Write for special offer—Now.

Ford Owner Stop that ruinous chatter on your car. **MAKETHISTEST**—take out your floor boards, pull your emergency brake back and forth. If you notice play at the ball joint, you need Bredar's Ball Shim. Price \$5.00. Ask your Dealer or order direct. Demand Bredar's Shim.

NIC BREDAR'S SON MFG. CO., Rock Island, Ill.

Get This—True "Santa Maria" Ship Model

Made in knocked down form with all parts carefully cut to fit, each part carefully numbered so as to make assembling easy from drawing and instruction sheet furnished with each kit. Sails and flags with colored designs at no extra cost. Very educational and interesting pastime; when completed you have a handsome ornament for your radio cabinet or mantel.

SIZE
23½" Long, 22" High
10" Wide

\$5.48 Plus Mailed C. O. D. anywhere in U. S. A. Postage Foreign orders must be accompanied with U. S. money order or check.

COLARK CO., INC.
2213 E. Susquehanna Ave., Phila., Pa.

New Model SOUTH BEND LATHES

BACK GEARED SCREW CUTTING LATHES

45,000 Lathes in Use in U. S. and 78 Foreign Countries

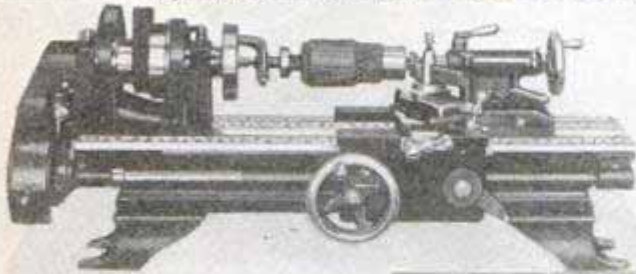

9" x 3' New Model South Bend Jr. Back Geared Screw Cutting Lathe (Weight 375 lbs.) Complete with Countershaft and \$169 Equipment shown only

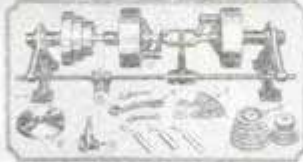

FOR THE

Manufacturing Plant	Service Station Maintenance
Tool Room	Airport
General Repair Shop	Electrical Shop
Machine Shop	Engineering Shop and Laboratory

USED BY MANUFACTURERS OF

Automobiles	and
Electrical Parts	Government Departments
Machinery	National and State
Aircraft	
Textile Machines	

Prices of 9-in. Junior Bench Lathes Including Lathe Equipment

Size of Lathe	Shipping Weight	Countershaft Drive	Horizontal Motor Drive
9" x 2 1/2'	350 lbs.	\$163.00	\$248.00
9" x 3'	375 lbs.	169.00	254.00
9" x 3 1/2'	400 lbs.	175.00	260.00
9" x 4'	425 lbs.	182.00	267.00

New FREE Catalog

Shows 96 Sizes from 9-in. to 18-in.

Write or send coupon today for the New South Bend Lathe Catalog. This complete book illustrates and describes 96 sizes and types of Countershaft Driven Lathes, Motor Driven Lathes, Quick Change Gear Lathes, Standard Change Gear Lathes, Tool Room Lathes, Gap Bed Lathes, Brake Drum Lathes and Bench Lathes. Investigate the New Model Lathe as it has all the latest improvements.

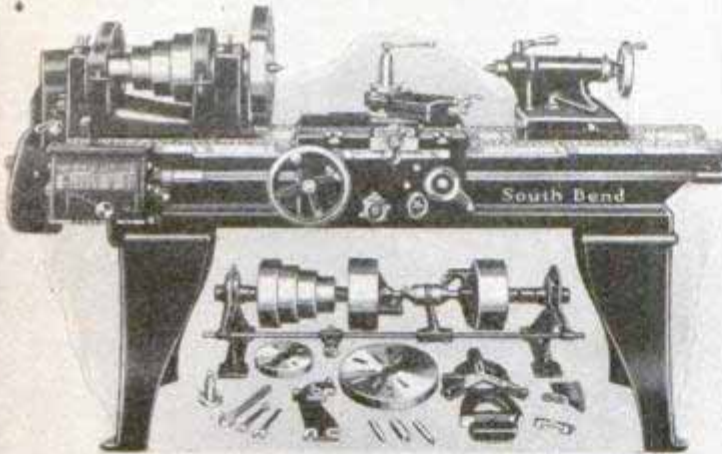

16" x 6' Quick Change Gear New Model South Bend Lathe - - - \$598

Prices of Popular Sizes of Quick Change Gear Lathes with Lathe Equipment

Size of Lathe	Shipping Weight	Countershaft Drive	Silent Chain Motor Drive
9" x 3'	490 lbs.	\$294.00	\$398.00
11" x 4'	725 lbs.	359.00	498.00
13" x 5'	1110 lbs.	443.00	602.00
15" x 6'	1550 lbs.	543.00	720.00
16" x 8'	2035 lbs.	638.00	817.00

Easy Payments

We ship any South Bend Lathe immediately upon receipt of only 20 percent of Catalog Price. Balance in 12 equal monthly payments. Write for Time Payment Catalog.

South Bend LATHES
Catalog No 90-A
SOUTH BEND LATHES
South Bend

SOUTH BEND LATHES WORKS
621 Madison St., South Bend, Ind., U.S.A.
() Time Payment Catalog. () New Lathe Catalog No. 99-A

Name.....
Address.....
City.....
State.....

SOUTH BEND LATHES WORKS

621 E. Madison St., South Bend, Ind., U.S.A.

Lathe Builders for 23 Years

3-in-One

3 Oils in 1

This well known oil is exactly what its famous name implies—three oils in one—*animal, mineral and vegetable*. By blending these three fine oils, of different characteristics, the quick penetration and excellent lubrication of 3-in-One is obtained.

3-in-One immediately penetrates the tightest bearings of fine tools and all other kinds of light mechanisms—small motors, lathes, etc. Here it dissolves the gummy grease, with its accumulation of grit and bits of worn metal, and works this harmful mass right out of the bearing.

And combined with all this is 3-in-One's great characteristic of "staying put" and providing wear resisting lubrication of the highest order.

Rust prevention is another 3-in-One property that is of immense value to tool users. Keeps tools new looking.

Sold everywhere by good hardware, drug, grocery and general stores. Two size Handy Oil Cans and three size bottles.

Manufactured since 1894
Three-In-One Oil Co.
130 William St., N. Y.

FREE SAMPLE
Also Dictionary of Uses.
A postal request will bring both.

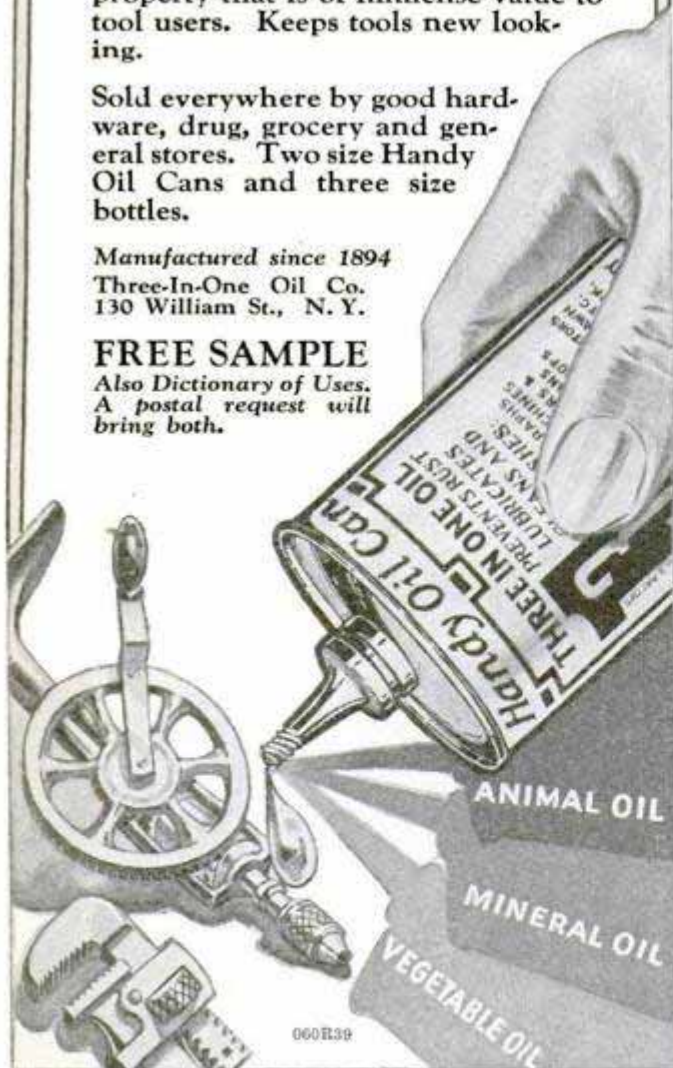

060E39



Mackinac Island . . .

Niagara Falls

America's two famous summer haunts whose very names mean pleasure!

A fast, trim D & C fleet cruising the Great Lakes links Buffalo (55 minutes from the Falls) and Mackinac Island with Chicago, Detroit and Cleveland.

Plan your vacation *now!* . . . to visit one or both of these noted places . . . to enjoy a luxurious D & C voyage. You'll spend long - remembered days.

DAILY SERVICE	1 WAY	R. T.
Detroit-Buffalo	\$5	\$10
Detroit-Cleveland	\$3	\$5.50

3 SAILINGS WEEKLY

Fares include meals and berth

Detroit-Chicago	\$31	\$52.50
Detroit to Mackinac Is.	\$15	\$26.50
Chicago to Mackinac Is.	\$16	\$27.50

☞ Tickets, reservations from any authorized tourist agency. ☞ Liberal Stop-over Privileges. Autos Carried. Send today for illustrated "Vacation Days". Address E. H. McCracken, P. T. M., 11 Wayne St., Detroit, Mich.

DETROIT & CLEVELAND NAVIGATION COMPANY



Thompson BEATS the World on BOATS CATALOG FREE!

The Best that skill and experience can produce—at real money-saving prices. Prompt shipment from factories to you.

Outboard Motor Boats
\$60.00 and up

A complete line of real fast, safe and sea-worthy boats for family use. Also fastest racing models.

Rowboats
\$48.00 and up

Improved models. Safe and seaworthy. Strong and durable. Easy to row and handle with oars.

Canoes
\$50.00 and up

Three models and four lengths to choose from. Including non-sinkable sponson canoes.

Motor Boats
Six passenger

20 ft. long; speed 30 to 35 miles an hour.

CATALOG FREE—SAVE MONEY—ORDER BY MAIL
Please state the kind of boat you are interested in (34)

→ TWO LARGE FACTORIES ←

THOMPSON BROS. BOAT MFG. CO.

213 Ann St.
PESHIGO
WISCONSIN

(Write to
Either Place)

113 Elm St.
CORTLAND
NEW YORK

Make Your FORD Into The "ACE"

GET READY FOR SPRING—BUILD YOUR ACE NOW—
\$599 Red-i-Kut life size patterns Class—Snap



38-inch Easy Riding Seat

Famous sure-fit RED-I-KUT life-size patterns and picture instructions show how you can easily convert your Ford into this **Fast, Saucy, Sport-Car** as thousands have done with easily obtained materials. No need to lay up the car. Makes wonderful 4-passenger car. Send 10c coin for actual photo of sport car and size manual of distinctive sport car patterns from \$4.80 up—“RKO” Steel “Spring-Lo” irons, Tops, Windshields and many other necessities. **ORDER RIGHT NOW** and get a real thrill.

KUEMPEL COMPANY, 120 Kuempel Bldg., GUTTENBERG, IOWA

Every Coo-Coo \$1.75 for You!

A “knock-out” instant selling hit! The Coo-Coo Auto Horn (Patents pending) sells itself at \$4. Costs you \$2.25. Going like wildfire in Hollywood and Los Angeles. 1 dealer sold 3,000 in short time. Agents making as high as \$25 an hour. 1 horn sells 5 others. No house to house stuff—just stand around garages and service stations—coo-coo and clean up. Installed by anyone in 3 minutes. Not an exhaust or motor horn. Certain in action—never fails to create a musical note that cleverly sings “Hello.”



Send \$2.25 for sample horn or write for further information.

PACIFIC COAST PRODUCTS CO., LTD., 1616 Cahuenga Blvd., Dept. 5, Hollywood, Cal.

25 POWER \$1 GERMAN POCKET MICROSCOPE

A marvelous German 25 power microscope, size of pencil. Enlarges diameter 25 times, area 625 times. Fine lenses give extra large field and great light. Only 4 3/8 inches x 3 1/2 inches; weighs but one-half ounce. Used in schools and colleges throughout the country. Fine for biology, geology, botany, nature study, examining stamps, finger prints, insects, cloth, metals, photographs and thousands of other things. Equipped with handy fountain pen clip. 40-50-60X, 1 1/2 oz., \$4.00. \$1 Prepaid. Money back guarantee. Discount for 6 or more.

BINOCULARS Over 200 Glasses All Makes \$1-\$110

Everything in binoculars, field glasses, telescopes and optical instruments. The finest and largest assortment in America. Catalog gives all information how to choose the best for your individual needs at the **LOWEST PRICE.**

Try America's Leading Binocular House First

DuMAURIER CO. Dept. 205 ELMIRA, N. Y.



He uses
PLASTIC WOOD

REG. U. S. PAT. OFF.

When the top leaks or cracks, when joints loosen, when door bumpers are worn, and for repairing dents in body and fenders, the best auto repair shops use Plastic Wood. It handles like putty and hardens into wood, and sticks fast to wood, metal, or other material—but scrape away all paint or dirt before applying. It can be sanded to a hair edge, and takes paint, varnish, or lacquer perfectly. Any automobile owner can use it for many jobs on his own car, as well as for repairs around the home. To soften or thin Plastic Wood and clean the hands or tools after working, use Plastic Wood Solvent.

Plastic Wood in Colors

In addition to the natural wood color in which Plastic Wood is regularly supplied, it is now carried by many dealers in mahogany, oak, walnut and other wood colors in handy tubes. Industrial users can obtain Plastic Wood in any colors desired. Bulk prices furnished on request.

Handles Like Putty



Hardens Into Wood

Tube 25c.—1/4 lb. can 35c.—1 lb. can \$1.00

At Hardware and Paint Stores

Send for Circular on Automobile Repairs
ADDISON-LESLIE CO., 427 Bolivar St., Canton, Mass.

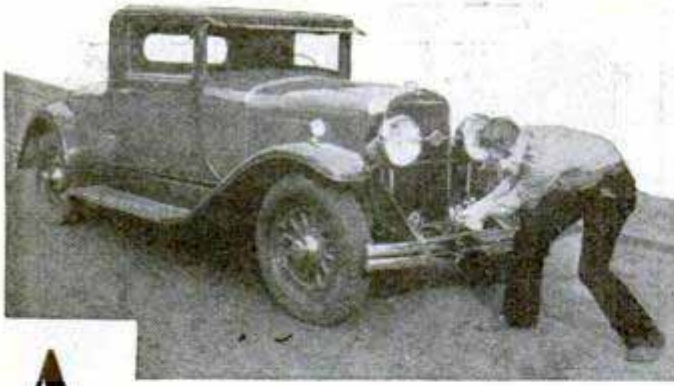

AMAZING STUNT proves Gripping Power of **NON-SKID** TRADE MARK Screw Driver

The
RIBBED BLADE
Prevents Slipping

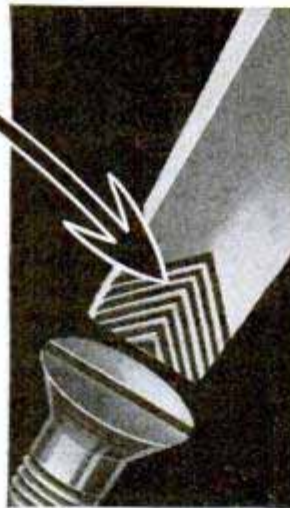

Pat. U. S. A., Dec. 3, 1929

A BRIDGEPORT Non-Skid Screw Driver was inserted in the slot of one of the screws holding the license plate, and, with a firm turning pressure to bind the blade in the slot, the car was actually pulled!

The Non-Skid Screw Driver grips the screw like a non-skid tire grips the road. Drives screws *easier, quicker, safer*. No pushing—you need only *turn* the Non-Skid. Grips *battered* and *rusted* screws as though they were new. Grips *greasy* screws that smooth blades merely "skate" off. And the point *lasts longer* because it doesn't slip.

Ask your dealer today to show you the new Bridgeport Non-Skid! If he is not yet supplied, order direct: No. 1 (blade clear through handle)—4", 50c; 6", 60c. No. 2 (blade, handle and ferrule securely riveted together)—4", 35c; 6", 45c. No. 3 (shock-proof to 18,000 volts)—4½", 45c; 6½", 55c.

THE BRIDGEPORT HDWE. MFG. CORP.
Bridgeport, Connecticut
The World's Largest Makers of Screw Drivers

Bridgeport

TRADE MARK

THE CHOICE of MEN WHO KNOW TOOLS

HERE'S THE TOOL

for cutting sheet metal, gaskets, wire, leather, linoleum, canvas, etc. An indispensable tool in every household and workshop.

This Crescent Snip is entirely drop-forged of special analysis steel. It has many new features and carries an unconditional guarantee. Ask your hardware dealer for Crescent Snip No. S47.

For Catalog write

Crescent Tool Company
210 Harrison Street
JAMESTOWN, N. Y.

75¢
7 inch

8 sizes 7 to 14
inches proportionally priced.



CRESCENT and Smith & Hemenway TOOLS

BURN YOUR NAME ON TOOLS

WITH THE
ARKOGRAF

PROTECT YOUR TOOLS FROM THEFT
Write with electricity any name or design on the hardest and finest tools and instruments, or any metal, like writing on paper with pen or pencil. Complete Outfit \$3.50—Prepaid Anywhere Interesting illustrated circular free. Write today. Agents wanted.
ARKOGRAF PEN CO., 1171 E. Stark St., Portland, Oregon



OTTAWA LOG SAW



only \$39

GREATEST OFFER
EVER MADE

PUTS THIS
OTTAWA
TO WORK FOR YOU

Make Money! Wood is valuable. Saw 15 to 20 cords a day. Does more than 10 men. Ottawa easily operated by man or boy. Falls trees—saws limbs. Use 4-hp. engine for other work. 30 DAYS TRIAL. Write today for FREE book. Shipped from factory or nearest of 4 branch houses.

OTTAWA MFG. CO., 1741 -W Wood Street, Ottawa, Kansas

This Modern Woodworker \$45.00

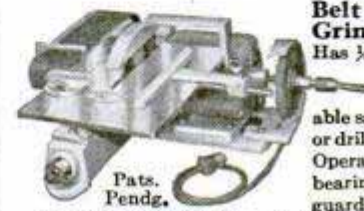

Belt Sander—Saw—Grinder—Drill

Has ¼ H. P. GE Motor, switch, cord and plug. 3x24 in. sander for strips any length. 6-in. adjustable saw. 5x½ in. grinder for any tool or drill. Chuck takes up to ¼-in. drills. Operates many other tools. Bronze bearings, endless belt, polished table, guards and trimmings lacquered. Size

20x20. Weight 60 lbs. Lowest price known for high grade tool. Satisfactory or money back. Order now or write for circular P.

Steiner-Fulton Products Corporation
5751 Easton Ave. St. Louis, Mo.



That's the Rule I want
The FARRAND RAPID RULE

The Original Rigid—Flexible—Concave Rule

The most remarkable practical invention in years. Six or eight foot steel rules coiled in a vest-pocket size holder.

Ask Your Dealer to Demonstrate or Write to Factory for 6-inch Sample

Manufactured by

HIRAM A. FARRAND, Inc., BERLIN, N. H.



FREE CATALOG!
GERSTNER Better Made TOOL CHESTS
 are the Choice of Toolmakers and Machinists.

Write to-day for catalog.

Gerstner & Sons

477 Columbia Street, Dayton, Ohio



For ONLY \$6.00

You can secure a Soldering and Brazing Outfit using acetylene only.

For \$30.78 to \$69.20

You can buy a Welding, Carbon Burning, Lead Burning and Radiator Outfit combined.

Write for particulars and catalog.

THE SUPERIOR OXY-ACETYLENE MACHINE CO., Box 285, HAMILTON, OHIO.

KINKADE GARDEN TRACTOR and Power Lawnmower

A Practical, Proven Power cultivator for Gardeners, Suburbanites, Truckers, Florists, Nurserymen, Fruit Growers.

New Low Prices—Easy Terms
 AMERICAN FARM MACHINE COMPANY
 1058, 33rd Av. SE. Minneapolis, Minn.



\$10⁰⁰ DOWN

Brings this Lathe to You

Lathes \$6.00 to \$75.00. Largest line of small lathes in America. Send ten cents for 32 page catalog of lathes, bench saws, jig saws, band saws, etc.
SYFHER MANUFACTURING COMPANY
 Dept. D-15 Toledo, Ohio

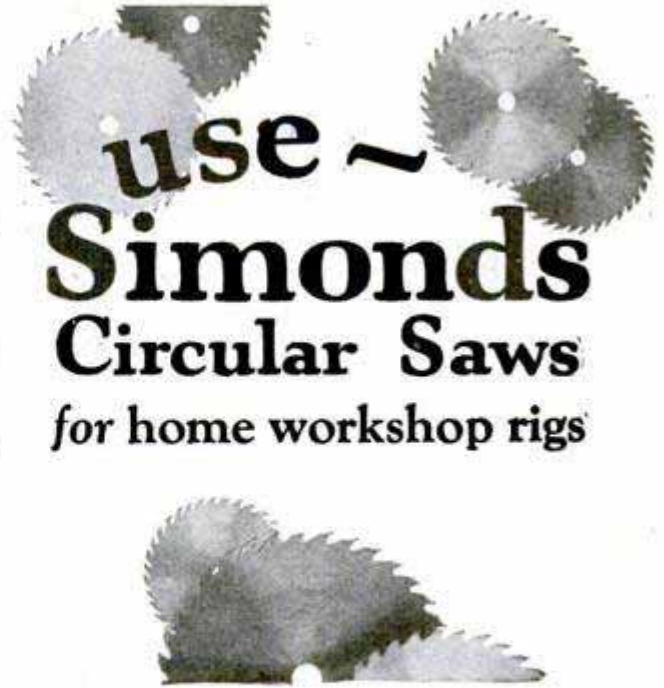

use ~
Simonds
Circular Saws
 for home workshop rigs

NO matter what make sawing outfit you use in your workshop, a Simonds Circular Saw will stand lots of grueling service and give you results that exceed your expectations.

Simonds Saws are made from the toughest steel known—heat-treated steel, specially tempered to hold cutting edges. They stay sharp; they are fast cutting and accurate. Every Simonds Saw is an excellent specimen of fine workmanship.

Leading manufacturers of portable rigs and home electric outfits will supply you with Simonds Circular Saws. Look for the name Simonds. Free booklet on woodworking saws sent on request. Write for it.

SIMONDS SAW AND STEEL CO.

"The Saw Makers" Established 1832
 Fitchburg, Mass.

BRANCH OFFICES AND SERVICE SHOPS IN PRINCIPAL CITIES

SIMONDS
 Circular Saws
 fit all types
 of portable
 rigs

SIMONDS
SAWS FILES
 KNIVES
 STEEL

To acquaint **YOU** with
GOODELL-PRATT
 quality we make this
REMARKABLE OFFER
SEND 1.00
 for **HANDY POCKET
 SCREW DRIVER SET**



To introduce a sample of Goodell-Pratt quality to every tool lover in America, we are offering at the special, low price of \$1.00, this handy tool. Ideal for repair work on radios, fire-arms, clocks, household appliances, etc. Contains three screw driver blades and reamer. When not in use, the chuck and blades are inside as shown. Nickel plated handle. Satisfaction unconditionally guaranteed. Pin dollar bill to this coupon and send in today.

GOODELL-PRATT CO., Greenfield, Mass.
 Attached is one dollar for Pocket Screw Driver Set.

Name.....
 Street.....
 City.....State.....
 My hardware dealer is.....

Have You Ever Used a CORNWELL Tool?



THEY are the strongest tools made. Mechanics always choose them for their personal kits. They are famous everywhere for standing up against tests that ruin or break other tools.

Finest Mechanics Tools Made
 Made of Swedish Chrome Molybdenum Steel—hardened and heat treated by special Cornwell process. There is absolutely no substitute for a Cornwell Tool.

Every Tool Hand Forged
 Every Cornwell tool is hand made and is specially designed for its particular duty. Mechanics have found them the most efficient tools ever put in their hands.

Money-Back Guarantee
 Just send for this catalogue showing dozens of guaranteed Cornwell Tools. Your money always back if any one fails to do what we claim.

**CORNWELL
 QUALITY TOOLS CO.**

- Socket Wrenches
- Punches
- Chisels
- Screw Drivers
- Open end Wrenches
- Valve Lifters
- Special Tools for Model "A" Ford and Chevrolet 6.



Send for this Catalog

The Cornwell Quality Tools Co., Dept. X, Mogadore, Ohio. (Formerly at Cuyahoga Falls, O.)
 Send me new illustrated catalog with prices on full line of CORNWELL Handmade Tools.

.....Where Employed

Name.....
 Address.....
 City.....State.....

Popular!

YOU will be doubly welcome everywhere when you learn to play a Conn. Chances to join a band or orchestra, to travel, to make extra money. Conns are the choice of Sousa and the world's greatest artists. Easiest to play. Recommended to beginners for quicker progress.

FREE TRIAL, EASY PAYMENTS on any Conn. No matter which band or orchestra instrument interests you most, Conn will send you a special booklet on that instrument giving valuable facts.

C. G. CONN, Ltd., 531 Conn Bldg. Elkhart, Ind.

CONN

World's Largest Manufacturers of BAND INSTRUMENTS

Write for FREE BOOK
 >> Mention Instrument <<

SALESMEN WANTED!

SELL COX HOLDFAST SCREW DRIVERS

Sells on sight to mechanics for Auto, Radio and Electrical Work. Self Holding, Self Releasing.

Send 50c for sample and ask how to get Salesman's Outfit Free.
S. J. COX Dept. F, FRANKLIN, PA.

Makes Old Ford a Tractor

Now you can convert that old Ford car into a useful farm tractor without altering any Ford parts. We furnish the traction wheels, drive gears and auxiliary axle and mountings, ready to clamp on to the Ford frame. Pulls 16" plow.

We supply a Belt Pulley also

Write for Free Particulars.
Shaw Mfg. Co., Dept. PM5, Galesburg, Kan.

THE WELDON JUNIOR

sharpens shears, scissors and knives; is electrically driven and equipped with two rests, switch, cord and plug.

WELLS MANUFACTURING COMPANY
 Box 613, Greenfield, Massachusetts, U.S.A.

CRESCENT 20" Band Saw

A high grade, moderately priced band saw for light work; affords all the accuracy, convenience and efficiency of large band saws. Ball bearing. Self contained motor operates from light socket; or may be driven from line shaft. Machine finished table, with graduated scale tilts any angle to 45 degrees. Quick locking device. Saw, with spring tension, is fully guarded. We make wide line of light machines for cabinet makers, schools, and amateurs, also heavy machines for factories.

THE CRESCENT MACHINE CO.
 93 Columbia St. Leetonia, Ohio

Send for FREE BULLETINS

DIAMONDS WATCHES

CASH OR CREDIT



No. 918
One blue white sparkling Diamond in center; 2 smaller blue white Diamonds on sides of solid 18-k white gold ring. \$37.50. \$1.00 a week

No. 27
Fiery blue white Diamond, solid 18-k white gold ring, exquisitely designed. \$60. \$1.25 a week

BUY NOW



No. 910
Magnificent blue white Diamond in square prong top ring of solid 18-k white gold. \$100. \$2.50 a week

Elite Wedding Ring, solid platinum, only \$19.50. In solid 18-K white gold, \$5.00, or with 3 Diamonds, \$18.75.

Lady's Bulova Wrist Watch

No. 926—"Baroness"
14-k gold filled; 15 Jewels. Dust-proof case, \$29.75. \$2.97 down; \$2.97 a month.

Our References: Any Bank or Banker in U.S.A.

The Old Reliable Credit Jewelers

LOFTIS Dept. N-894
BROS. & CO. 108 N. State St. Chicago, Ill.

Genuine Diamonds Guaranteed!

Buy of Loftis—"Jewelers to the Sweethearts of America for Three Generations."

SEND FOR CATALOG

Big free book of 2000 illustrations and descriptions. Catalog explains everything.

Satisfaction guaranteed or money back. Credit terms: Pay one-tenth down; balance weekly, semi-monthly, or monthly at your convenience. ALL GOODS DELIVERED ON FIRST PAYMENT. ORDER NOW!

Elgin "Legionnaire" for men No. 927—latest style, embossed dial, \$16. \$1.90 down and \$1.90 a month.



Beautiful HOUSES \$900 and BUNGALOWS CAN BE BUILT FOR And Up

Sixty-nine up-to-date designs in the most complete and comprehensive book of medium cost English and American homes published, 8 x 11 inches, nearly 250 photos and floor plans, contains a description of each design and approximate cost to build. It is the last word on home building and may save you several hundred dollars in the cost of your home. Sent Postpaid \$1.



FREDERICK H. GOWING, Architect, 101 Tremont St., Boston, Mass.

STRANGE INVENTION! PAYS YOU IMMENSE PROFITS NEW FIELD for AGENTS



Sell only device in the world that prevents kinking, snarling and tangling of telephone and electric iron cords.

Housewives and business men buy 1 to 50.

NEW KIND OF CORD SET FREE

Every Neverknot Salesman is given FREE the complete Neverknot Switch Plug Cord Set pictured. This new kind of ironing cord automatically coils itself out of the way and a new kind of switch plug prevents scorching and saves electric bills. This set is a "gold mine" for house-to-house workers. It's different and it's yours free if you work for us. Don't delay! Send now for free offer.

NEVERKNOT CO. 4503 Ravenswood, Chicago



The Plug That Saves Electric Bills.

FREE TO BOYS SEND NOW!

"BB Magic" tells the wonderful story of round shot; its importance and place in boy training. Points way to leadership, self-expression, poise and concentration. Makes crack shots. Belongs in every boy's pocket, every parent's desk. Your copy FREE. Write at once.



NEW BENJAMIN 25 SHOT AUTOMATIC "THE MYSTERY RIFLE"



OUTSHOOT ALL OTHERS
Now the wonderful Benjamin principle of compressed air action that made the Benjamin Single Shot famous for hard, safe, accurate shooting, has been applied to 25 shot automatic rapid firing—the only gun of its kind in the world. Learn about both. **BENJAMIN AIR RIFLE CO., 605 North Broadway, St. Louis, Mo.**

WORLD'S GREATEST SELLERS



Laymon's 5c & 10c Merchandise Counter Display Cards of Medical & Confection Products

Here's the Line that's in widespread demand. Big Repeats. Advertised nationally and by radio. **SALESMEN COLLECT 100% PROFIT DAILY IN ADVANCE. 8 years of successful merchandising. No cash needed! Write quick for FREE complete outfit. World's Largest Producers of 5c Aspirin**
WORLD'S PRODUCTS CO. 613 Main St. Spencer, Ind.

San Francisco representative made \$90 first 3 days.

30 Days' Free Trial on all MEAD Bicycles

New RANGER Models now ready for delivery direct from our factory. Astonishing new prices and terms. Do not buy until you get them. **RIDER AGENTS WANTED** to ride and exhibit sample. Save big money. Many models, styles.



wheels, lamps, horns, equipment at half usual prices. Easy Payments. Write for our marvelous prices and terms.

Mead CYCLE COMPANY DEPT. C110 CHICAGO

Write us today for free catalog

EARN TO PAINT SIGNS and SHOW CARDS

We quickly teach you by mail, or at school, in spare time. Big demand, big future, interesting work. Oldest, foremost school. **EARN \$50 TO \$200 WEEKLY**

Otto Wiegand, Md., home-study graduate, made \$12,000 from his business in one year. John Vassos, N. Y., gets \$25 for a show card. Crawford, B. C., writes: "Earned \$200 while taking course." Write for complete information.

DETROIT SCHOOL OF LETTERING 150 Stimson Ave. Est. 1899 DETROIT, MICH.

FREE "Book of Facts"

Write For It

BUILD SHIP MODELS

Easy to build and sell. Plans and instructions: Santa Maria, \$1.00—Clipper Ship, 80c—Viking Galley, 40c—or all three for \$2.00. Catalog 6c.

RICHTER'S, 3217 A. Walnut Street, MILWAUKEE, WIS.

Only 8 Sales a Day Nets You \$116 a Week

Profits on larger size run higher. Unusual earning opportunity for ambitious men. No experience necessary; we teach. Part or full time.

FUGO World's Simplest Fire Extinguisher

Automatic and instantaneous action. Within reach of every home, shop, store, theatre, garage, car owner, etc. Even smallest place needs two or more. Exclusive territory to producers. You get your pay every day. Write for full details.

The National Formetal Co. 6535 Metta Ave. Cleveland, O.

Amazing New Fly Killer

offers **\$15 a Day**

Here's a wonderful opportunity to make \$8 to \$15 in a day—\$1 to \$2 an hour in spare time—taking orders for our amazing new liquid called FLY DOPE. Instantly kills flies, mosquitoes, ants, roaches, and other insect pests. Makes a wonderful demonstration. Sells like hot cakes. Harmless to humans. Stainless. Pleasant odor. Every home, store, restaurant, etc., a prospect.

FORD TUDOR SEDAN FREE
No capital or experience needed. We supply everything. Ford Tudor Sedan offered FREE to producers as extra reward. Don't miss this chance. Write today for full particulars FREE.

AMERICAN PRODUCTS CO.
5667 Monmouth Ave. Cincinnati, Ohio



PRINT YOUR OWN

Cards, stationery, circulars, tags, labels, advertising, menus, etc. Save money and time, cut cost.

Print for Others BIG PROFITS

Easy rules supplied with every outfit. Opportunity to turn your spare time into cash, or develop full time business of your own. Popular raised printing like engraving done with any of our presses. Junior Press \$5.90, Job presses \$11, \$23, Rotary \$149. Write for catalog No. 037 showing presses, outfits and all details. **The KELSEY Co., Meriden, Conn.**



DEAFNESS IS MISERY

Multitudes of persons with defective hearing and Head Noises enjoy conversation, go to Theatre and Church because they Use Leonard Invisible Ear Drums which resemble Tiny Megaphones fitting in the Ear entirely out of sight. No wires, batteries or head piece. They are inexpensive. Write for booklet and sworn statement of the inventor who was himself deaf.

A. O. LEONARD, Inc., Suite 699, 70 5th Ave., New York

SELF CONFIDENCE DEVELOPED!

Self-Consciousness in the presence of others easily overcome. *Social Poise* and *Confident Personality* developed. *Charm, ease, commanding manner* can be yours. *Authoritative training* by mail. Send **25 CENTS** for my book.

MR. RICHARD BLACKSTONE
BA-475 Flatiron Bldg. New York City

CAN YOU USE \$100 A WEEK AND UP

An opportunity to make \$100 a week selling fine made-to-measure all-wool suits at \$23.50—\$29.50 and \$36.50 retail, direct to wearer. Biggest values—positively sell on sight. Biggest commissions paid in advance. **CHANCE TO EARN OWN CLOTHES FREE.** We attend to delivery and collections. New style outfit of large cloth samples, 100 styles—furnished Free. Write at once.

SPENCER MEAD COMPANY Dept. S-816
Harrison & Throop Streets CHICAGO, ILL.

\$23.50 ALL WOOL SUITS



Hands Up!

If you're one of those fellows who think that work-stained hands can't be cleaned, I'll bet you've never tried Lava Soap.

For more than 30 years men with jobs like yours have been using Lava Soap . . . because it gets the grimeiest, greasiest hands clean in 58 seconds, without hurting the skin . . . because it makes a lather rich as cream in the hardest water.

Here's the secret of Lava's speed, thoroughness and gentleness. In addition to pure vegetable oils, Lava contains pulverized Italian pumice. That's what makes dirt and grease disappear so quickly, without harm to the skin.

Get a cake or two tonight and see if I'm not right.

George, the Lava Soap Man

Lava costs a dime (or 6c for the medium size cake) at any drug or grocery store. But if you want to try it at our expense, mail this coupon.

Procter & Gamble, Dept. W-530
Cincinnati, Ohio

George: I want a free sample cake of your Lava Soap.

Name.....
Street.....
City..... State.....

NEW VEST POCKET ADDING MACHINE

ADDS, SUBTRACTS, MULTIPLIES, DIVIDES
Does work of \$300 machine. Guaranteed 5 years NOT A TOY.
Made of steel and indestructible. Million dollar capacity. Fits in pocket. Will not make mistakes. So simple child can operate it. Instructions furnished. Everybody should carry one for figuring.

FREE TRIAL \$2.50 Total Cost

SEND NO MONEY—Just name and address. We will ship Calculator immediately. On delivery pay postman \$2.50 (Plus few cents postage). (If outside U. S. send cash.) 30 additional in Leatherette Case. If not satisfied after 10 days trial you get your money back. **THOUSANDS OF SATISFIED USERS.**

This is lowest priced practical calculator made. "Why pay more for inferior imitations?" Order from this ad.

Guaranteed

Mail Coupon Today

BABY CALCULATOR MACHINE CO., (MANUFACTURERS)
Dept. 41, P. O. Box 1118, CHICAGO, ILL., U. S. A.

I am enclosing \$2.50—send adding machine prepaid.
 Send Adding Machine C. O. D. \$2.50 plus 18c postage. (10c additional in Leatherette Case)

Name.....
Address.....
City..... State.....

AGENTS Write for big commission and territory proposition.



“... the end of that ugly hole!”

You can easily make cracked walls and ceilings good as new with Rutland Patching Plaster—the quick, money-saving mender. Just mix with a little water, then fill crack or hole. If you want a perfect, lasting job, be sure to ask for Rutland Patching Plaster—made by the secret Rutland formula that insures absolute whiteness and permanence. At paint, wallpaper and hardware stores. Rutland Fire Clay Co., Rutland, Vermont.

RUTLAND PATCHING PLASTER

PROTECT YOUR CAR EVEREADY PRESTONE National Carbon Company, Inc. General Offices: New York, N. Y. Branches: Chicago, Kansas City, New York, San Francisco. Unit of Union Carbide and **UCC** Carbon Corporation

Build a CLOCK for Pleasure or PROFIT!
FREE BOOK of Clock Making, Money Making ideas. Gives details, prices of movements, parts. Write NOW for copy!
Shows How YOU Can Make Fine Clocks Right at Home—for yourself, or to sell at Big Profits. We furnish instructions, parts. Works \$1.65 up; others with chimes, all prices. Make case or assemble parts. Cash-in on demand for Mantel, Banjo, Grandfather's Clocks. Write for Special Blue Print Offer, FREE Catalog.
AMERICAN CHIME CLOCK COMPANY
 1670-X Ruffner St. Philadelphia, Pa.



Selling Kit Furnished

“A great idea!”

Something different—an original idea—never before seen on the market. Every man and boy a prospect. Hook-Fast Belt and Buckle made to individual order—no two alike. Every buckle with personal initials and emblems—according to individual taste. Splendid profits made easily—**HANDSOME SELLING OUTFIT FURNISHED**—contains actual samples. Become the official representative of Hook-Fast Belt and Buckle in your locality—Make big money—Sells itself. Belt made of genuine English cowhide—never wears out—Buckle made of attractive plati-croyd—lasts a life time, bright and untarnished—Specially patented Hook-Fast catch never slips. **Red-Hot selling proposition. Get in on it now! Write for free particulars.**

NATIONAL CRAFTS COMPANY
 20 West 27th Street, Dept. B-56 New York City

MOTORCYCLES



Price \$10 and up purchased through our Co-Operative Plan for as low as \$1.00 down and \$1.00 per week Indians Harley-Davidsons Ace Henderson and Clevelands. Send ten cents for Bulletin A. Motorcycles shipped to all parts of the world.

WALKER-INDIAN CO., 1309 Boylston St., BOSTON, MASS.

MOVIES AT HOME LET US SEND OUR INTERESTING AND FREE CATALOGUE OF MOVIE MACHINES—AS LOW AS \$3.75 POSTPAID—USE STANDARD OR 16mm SIZE—COMPLETE LINE OF FILM SUBJECTS AVAILABLE WITH EXCHANGE SERVICE—LOWEST PRICES—DON'T DELAY—WRITE FOR FREE CATALOGUE
PARAMOUNT MFG. CO. NOW! RUN SHOWS EARN EXTRA MONEY!
 BOSTON DEPT. G-27 MASS.

ELECTRIC LIGHTS ANYWHERE

Complete 110-volt Electric Light Plant. Ideal for Farms, Camps and Summer Homes. **\$139.00**

Runs household appliances, Install it yourself, Wiring, Fixtures and Lamps for 7 rooms, \$17.50. Also larger models D. C. or A. C. Write for circular—D. W. ONAN & SONS, 32 Royalston Ave., Minneapolis, Minn.



Rotary Stencil Duplicator \$39

Print Bulletins, Circulars, Programs, Letters, with the Amazing “EXCELLOGRAPH”

Simple and easy. Just write, typewrite, draw or trace on dry stencil; place in position and print up to 1,000 copies per hour. All supplies and instructions furnished. Guaranteed 10 years. Prints any size from postcards to sheets 9x14. Does beautiful work.

SAVE MONEY—MAKE MONEY

Saves and makes money for Merchants, Ministers, Teachers, Offices, etc. Use it to build your business. Do work for others at big profits.

Write for Free Book—TODAY

Shipped at our risk. Positive MONEY-BACK GUARANTEE. Amazing value. Thousands in use. Get free book describing all details and easy payment plan.



Easy Terms

PITTSBURGH TYPEWRITER & SUPPLY COMPANY
 Dept. M-7 339 Fifth Ave. Pittsburgh, Pa.

It's a BULOVA—Sent with a Mesh Band! For \$1.00

TAKE 12 MONTHS TO PAY

Send \$1.00 with order and tell us a little about yourself: (A) How long at present address, (B) Age, (C) Married or Single, (D) Name of Employer, (E) Position, (F) How long employed. All information held **strictly confidential**. We make no direct inquiries of anyone—not even from your employer.

10 Days Free Trial—Satisfaction Guaranteed
This genuine Bulova watch comes to you postage paid—no C.O.D. to pay on arrival. You take no risk—satisfaction guaranteed or money back.

Estab. 1895



\$2975
DG5-
15 jewel BULOVA gent's wrist watch. White Gold filled case; "dust-tite" protector; radium dial and hands; latest woven mesh wristband. Guaranteed, \$1 now, \$2.33 a mo. *Nationally advertised cash price, no extra charge for credit.*

Catalog FREE New catalog of genuine diamonds, standard nationally advertised watches, fine to Adults jewelry. Write for it now.

ROYAL DIAMOND & WATCH CO.
ADDRESS DEPT. 11-E 170 BROADWAY, N.Y.

AGENTS 500% PROFIT
GENUINE GOLD LEAF LETTERS

S guaranteed to never tarnish. Anyone can put them on stores and office windows. Enormous demand, large profits. Paul Clark says: Smallest day \$28.70. R. L. Reel made \$920 in two months. Write today for free sample and liberal offer to general agents.
METALLIC LETTER CO. 433-B N. Clark St., CHICAGO

ELECTRIC OR BATTERY

TRY IT 30 DAYS FREE BEFORE YOU BUY

1 yr. guaranteed
9 TUBE
TRIPLE Screen Grid Steel Chassis
\$49.88 Lighted 1 dial **MIRACO**

Radio's most amazing bargain direct from big, old, reliable maker. Don't buy unless 30 days use proves entire outfit unbeatable at 2 to 3 times the price, for tone, selectivity, distance, volume.

Free Catalog and **BIG SPECIAL OFFER**
MIDWEST RADIO CORPORATION
10th Successful Year
407-GM Miraco Bldg., Cincinnati, O.

Factory to you. Save 50% on latest AC Electric or Battery Radio. Get "Send No Money" Offer

Big choice of cabinets



TRICKS MAGIC JOKES

SCIENTIFIC NOVELTY CO.
88-2 PARK PLACE, N.Y.C.

FREE CATALOG POSTAL BRINGS IT

SOLDERALL
METAL IN PASTE FORM

The only convenient metal solder

Every Electrical Connection needs Solderall for perfect reception

25¢

The SOLDERALL CO., NEWARK, N.J.



Send for this free booklet



SIR WALTER RALEIGH had a hunch that pipe lovers would welcome some practical hints on how to take care of a pipe. It was a good hunch. Thousands of pipe smokers have sent for this free booklet.

It tells you how to break in a new pipe—how to make a good pipe smoke smoother and sweeter—the proper way to clean a pipe—and many worth-while hints on pipe hygiene.

If you haven't sent for this booklet, write for a copy today and find out what pipe makers and pipe lovers suggest doing to keep your pipe sweet and mellow. Just drop a line—the Brown & Williamson Tobacco Corporation, Louisville, Kentucky, Dept. 80.

SIR WALTER RALEIGH

Smoking Tobacco
It's 15c and It's milder



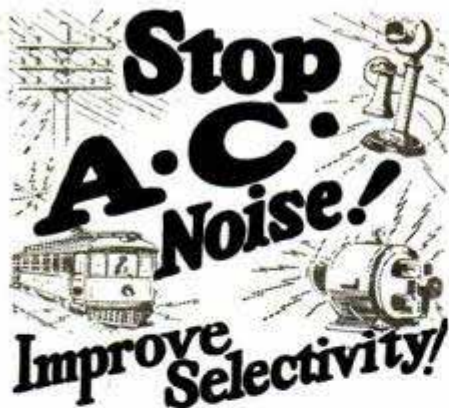

RADIO reception may be made much more enjoyable by plugging in a Falck Claroceptor between the light socket and your set. By blocking out the line interference noises, this wonderful device also helps selectivity and distance. Tested, proved. Thousands now in successful use all over America. No change required in your set. Only equipment of the kind. Compact size: 3 1/2" x 5 1/2" x 2 1/2". Made by pioneer radio manufacturer. At radio parts dealers, or write us for new free folder.

Falck \$7.50
(With Cord and Plug)
CLAROCEPTOR

Manufactured by ADVANCE ELECTRIC CO.
Dept. P M—1260 W. Second St., Los Angeles, Calif.
JOBBER AND DEALERS, GET OUR PROPOSITION

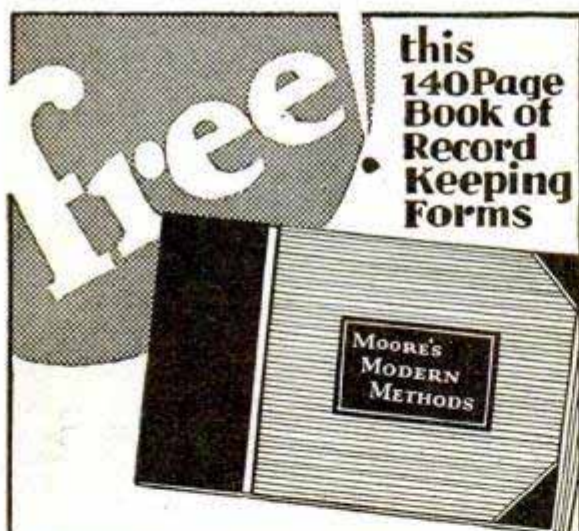

HERE'S a book that will help you with your record-keeping problems. Contains wide variety of life-size Bookkeeping forms, completely filled in, illustrating uses. For office or factory—business or profession—it shows you simplest and most efficient methods of accounting now being used by 300,000 leading firms. Book sent FREE when requested on business stationery. No obligation!

JOHN C. MOORE CORP., Est. 1839
6070 Stone Street, Rochester, N. Y.

Merely Fill in Coupon and 140-page Book Will be Sent you FREE

Name _____
Business _____
City _____ State _____

FREE!
RADIO BARGAIN CATALOG

ALSO FREE RADIO GIFT

Send now for this new free radio catalog which saves you many dollars on radio outfits, kits, parts, tubes and accessories! Also TIME CONVERSION CHART FREE. Tells you instantly what time it is in any part of the world! Given free if your request for catalog reaches us this month.

20TH CENTURY MAIL ORDER CORP.
238 So. Wells St. Chicago, Ill.

Genuine **PILOT** Products

FREE RADIO BARGAIN CATALOG
WHOLESALE PRICES!

Send today for this big money saver.
A postal brings it.
Buy from Radio's Oldest Mail Order House.
Radio Specialty Co.
98E PARK PLACE
NEW YORK CITY

LOFTIN-WHITE
Direct-Coupled
AMPLIFIER
with Approved ELECTRAD KIT
175 Varick St., New York, N.Y.
ELECTRAD
INC.

Build Your
Write Dept. PM5



CLASS PINS 35¢
FREE CATALOG SHOWING 200 DESIGNS
PIN SHOWN, SILVER PLATE 35¢ EA., 12 OR MORE, \$3.50
DOZ.; STERLING SILVER OR GOLD PLATE, 70¢ EA.
12 OR MORE \$6.50 DOZ. 1 OR 2 COLORS ENAMEL;
3 OR 4 LETTERS; DATES 1930-31-32-33.

BASTIAN BROS. CO. 925 BASTIAN BLDG., ROCHESTER, N. Y.

OUTFLEW ALL OTHERS!

Model No. 3
Dual Control Rudder

In 193 recent test flights out of 200 the Kingsbury Silver Arrow Flying Plane outflew all others, regardless of price. Most sensational plane in years. Not a construction toy but fully built. A moment to assemble and it's ready to fly. Made of Balsa wood and aluminum; aluminum propeller; adjustable wings and dual control rudder; strong elastic motor. Model No. 3, Racing Type, wing spread, 33 in., \$3. (West of Miss., \$3.30.) Other models, Racing and Cabin Types, at \$1 to \$3.50. If your dealer cannot supply you, send your order to us. Kingsbury Mfg. Co., 83 E. Myrtle St., Keene, N. H.

Join the Silver Arrow Flying Club and become a Master Pilot.

KINGSBURY MOTOR DRIVEN TOYS

FREE! Novelty Moviescope; shows motion picture of Silver Arrow flight. Also complete toy catalog.

Send 10c for Kingsbury Disc Wheel, Balloon Tire Eraser, Set of 4, 35c.



**CAST OFF IN THIS BOAT,
AND UNROLL A WIDE,
WHITE WAKE**

HERE'S a stout boat—this "Old Town." She rides the water like a sea-gull—cuts along like a shark. Never shivers or vibrates—she's built extra-rigid. The heavy, non-leak canvas has no seams to open up, and therefore won't ever need caulking. Ideal for heavy loads, but wonderfully light and well-balanced.

Free catalog shows big, fast, seaworthy, all-wood, outboard family boats; canvas-covered, square-stern boats with sponsons; rowboats; dinghies; speedy step-planes; and all types of canoes. Write, Old Town Canoe Co., 1145 Middle Street, Old Town, Maine.

"Old Town Boats"



**FREE
CATALOG**

Just off the press. Fully illustrated—showing Wading Boots, Clothing, Tents, etc., for fishermen and motor campers.

L. L. BEAN
65 Main Street
Freeport, Maine

BUCHSTEIN'S FIBRE LIMB
is soothing to your stump—strong, cool, neat, light. Easy payments. Braces for all deformities.
D. BUCHSTEIN CO.
610 3rd Ave., So. MINNEAPOLIS, MINN.

Send for Catalog Today

SHIP MODELERS!
This pin vise (steel) is handy tool, only 50c. Holds Nos. 55, 60, 70 drills, 10c each. Mooring Bitt, 1/4" high, brass, \$1.00. Old sailing binnacle, 1/2" high, \$1.50, polished brass. Send dime for full catalog of hard-to-get fittings.

ROY HANCOCK
323 Douglas Ave., Portsmouth, Va.

Pin Vise—2 3/8" long
Mooring Bitt
50's Binnacle

MOTORCYCLES

Direct to you at wholesale prices. Send 10c today for the latest Illustrated Bulletin and Confidential Price List of Guaranteed Indians Harleys Hendersons SuperX etc. (Small Weekly Payments Now—Spring Delivery at Winter Prices)

CRANDALL CYCLE CO. 826-28 State St. Springfield, Mass. Shipments to all parts of the world
Motorcycles Since 1905

**Have you a
Wet Cellar?**

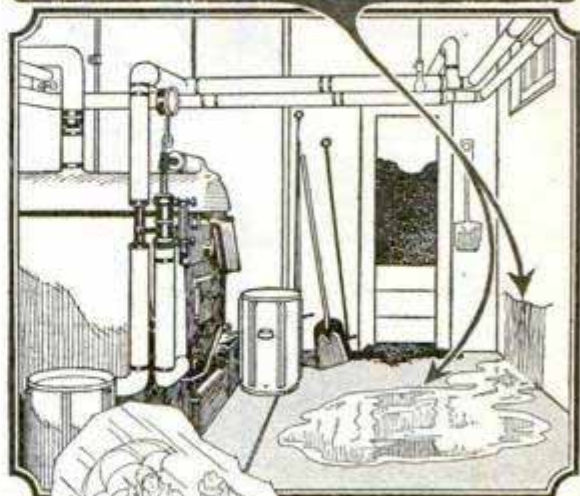

Dampness and flooding from ground water getting in is easily stopped by filling the cracks and painting over the porous spots in concrete or brick walls and floor with

SMOOTH-ON NO. 7

—the only effective waterproofing material that can be applied from inside and to wet or dry surface.

Excellent also for waterproofing boiler pits, cisterns, tanks, ponds, wash-room, garage and stable floors, etc. About 25 lbs. required for each 100 sq. ft. of surface.

You should also know
SMOOTH-ON NO. 1

—The good old standby for stopping leaks in pressure joints, mending cracks, making loose handles, screws, etc., tight, stopping leaks in automobile radiators and hose connections, keeping lubricators, hub caps and nuts from loosening, etc.

The Free Smooth-On Repair Book

will show you how, and by doing the work yourself you make big savings. Mail the coupon for free copy.

Get Smooth-On No. 7 in 1 or 5-lb can, or 25 or 100-lb. keg and Smooth-On No. 1 in 7-oz. or 1 or 5-lb. can. At any hardware store, or from us direct.



Do it with **SMOOTH-ON**

SMOOTH-ON MFG. CO., Dept. 37,
574 Communipaw Ave., Jersey City, N. J.
Please send the free Smooth-On Repair Book.

Name.....

Address.....
5-30

PATENT

Protect Your Ideas

Take the First Step Today

If you have a useful, practical, novel idea for any new article or for an improvement on an old one, you should communicate with a competent Registered Patent Attorney AT ONCE. Every year thousands of applications for patents are filed in the U. S. Patent Office. Frequently two or more applications are made for the same or substantially the same idea (even though the inventors may live in different sections of the country and be entirely unknown to one another). In such a case, the burden of proof rests upon the last application filed. Delays of even a few days in filing the application sometimes mean the loss of a patent. So lose no time. Get in touch with me at once by mailing the coupon on the opposite page.

Prompt, Careful, Efficient Service

This large, experienced organization devotes its entire time and attention to patent and trade mark cases. Our offices are directly across the street from the U. S. Patent Office. We understand the technicalities of patent law. We know the rules and requirements of the Patent Office. We can proceed in the quickest, safest and best ways in preparing an application for a patent covering your idea. Our success has been built on the strength of careful, efficient, satisfactory service to inventors and trademark owners located in every state in the Union.

NO CHARGE for Information On How to Proceed

The booklet shown here contains valuable information relating to patent procedure that every inventor should have. And with it I will also send you my "Record of Invention" form on which you can sketch your idea and establish its date before a witness. Such evidence may later prove valuable to you. Simply mail the coupon and I will send you the booklet, and the "Record of Invention" form, together with detailed information on how to proceed and the costs involved. Do this NOW. No need to lose a minute's time. The coupon will bring you complete information entirely without charge or obligation.

My Offices
Just Across
Street From
U.S. Pat. Office



Above is a view of my drafting and specification offices where a large staff of experienced experts are in my constant employ. All drawings and specifications are prepared in my offices.

NEWS

Inventors
Write for these

**Free
Books**

Strict Secrecy Preserved

All communications, sketches, drawings, etc., are held in strictest confidence in strong, steel, fireproof files, which are accessible only to authorized members of my staff. Feel free to write me fully and frankly. It is probable that I can help you. Highest references. But **FIRST**—clip the coupon and get my free book. Do **THAT** right now.

Clarence A. O'Brien

Registered Patent Attorney

Member of Bar of: Supreme Court of the United States; Court of Appeals, District of Columbia; Supreme Court, District of Columbia; United States Court of Claims.

Practice confined exclusively to Patents, Trademarks and Copyrights

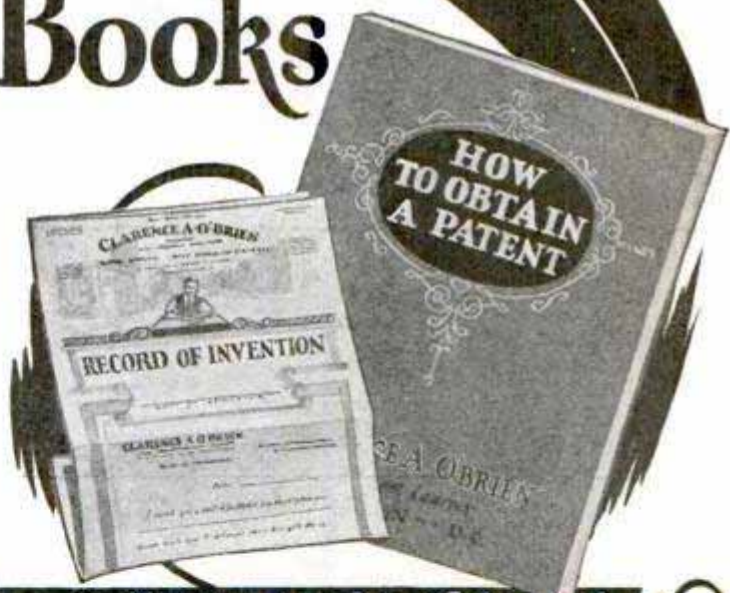

Clip this Coupon and Mail it Now!

CLARENCE A. O'BRIEN, Registered Patent Attorney
704 Security Savings and Commercial Bank Bldg.
Washington, D. C.

(Or, Suite 1106 Woolworth Bldg., New York City)

Please send me your free book, "How to Obtain a Patent," and your "Record of Invention" form without any cost or obligation on my part.

Name.....

Address.....

(Important—Write or print name plainly and address office nearest you)

PATENTS TRADE MARKS COPYRIGHTS

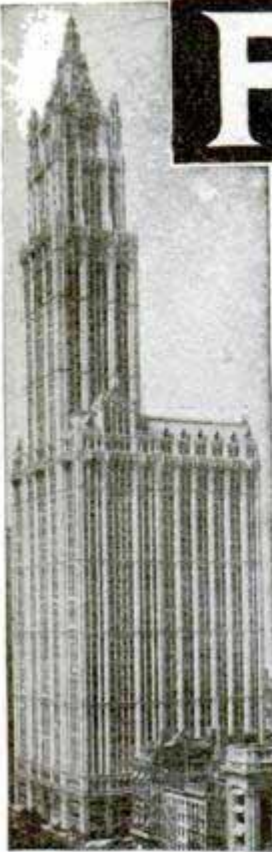

Our New York Office
Suite 1007 Woolworth Bldg.



Our Philadelphia Office
828 Fidelity Phila. Trust Bldg.



VICTOR BUILDING
Our New Building Nearly Opposite U. S. Patent
Office Specialty Erected by Us for Our Own Use



Have You An Idea?

Our Offer: FOR THE PROTECTION OF YOUR INVENTION

YOUR FIRST STEP—The Inventor should write for our blank form "RECORD OF INVENTION." A sketch and description should be made on this Blank, signed, witnessed, then returned to us. We also give our opinion as to whether the invention comes within the Patent Office definition of a patentable invention. This "Record of Invention" will serve as "proof of conception." *There is no charge or obligation for this service.*

Our Five Books Mailed Free to Inventors
Our Illustrated Guide BOOK

How to Obtain a Patent
Contains full instructions regarding U. S. Patents. Our Methods, Terms, and 100 Mechanical Movements illustrated and described.

Our Trade Mark Book
Shows value and necessity of Trade Mark Protection. Information regarding *Trade Marks and unfair competition in trade.*

Our Foreign Book
We have Direct Agencies in Foreign Countries, and secure Foreign Patents in shortest time and lowest cost.

Progress of Invention
Description of World's Most Pressing Problems by Leading Scientists and Inventors.

Payment of Fees in Installments
It is not necessary that the total cost for the preparation and prosecution of a patent be paid in one payment. Our custom is to permit our clients to pay for their applications in three installments as the preparation of the application progresses in our office. This plan makes the payments easy for the inventor.

We Regard a Satisfied Client as our best advertisement, and furnish anyone, upon request, lists of clients in any state for whom we have secured patents.

*Highest References—Prompt Service
—Reasonable Terms*

VICTOR J. EVANS & CO.

Patent Attorneys, Established in 1898
Main Offices: 789 9th St., N. W., Washington, D. C.
Nearly Opposite U. S. Patent Office

DELAYS ARE DANGEROUS IN PATENT MATTERS

IMPORTANT! To Avoid Delay!

YOU SHOULD HAVE YOUR CASE MADE SPECIAL IN OUR OFFICE to save correspondence, secure protection and early filing date in the Patent Office. To secure **special preparation** of your case send \$25.00 on account with model or sketch and description of invention. If the invention is not patentable we will return fee less cost of search.

We Assist our Clients to Sell their Inventions.



Our Chicago Office
Suite 1640-42 Conway Bldg.

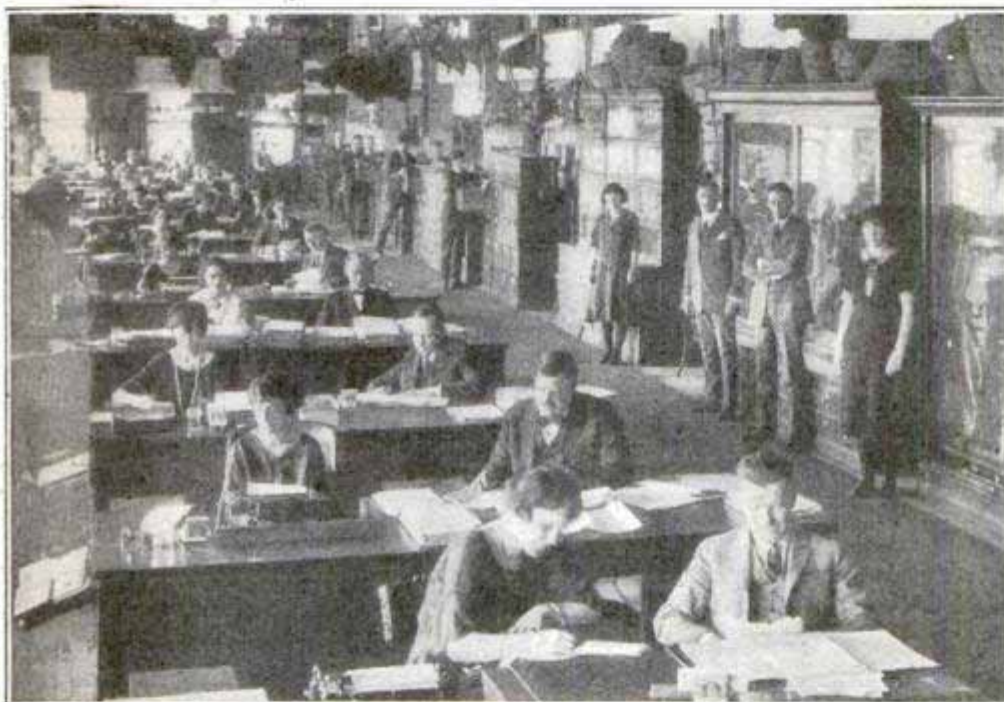

MAIN OFFICE, VICTOR J. EVANS & CO.—VICTOR BUILDING, WASHINGTON, D. C.

Our Large, Comprehensive Organization has been established for 30 years and offers Prompt, Efficient and **Personal Service** by experienced Patent Lawyers and Draftsmen. Every case is in charge of a Specialist who has been selected for his knowledge and experience in certain lines of invention. Our Lawyers practice in all U. S. Courts and defend clients in suits involving Patents, Trademarks and Copyrights. All Communications, Sketches, Drawings, etc., preserved in fireproof Files, strictly **Secret and Confidential**. We shall be glad to have you consult us or to answer any questions in regard to Patents, Trademarks or Copyrights without charge or obligation.



Our Pittsburgh Office
Suite 514 Empire Building



Our San Francisco Office
Suite 1010 Hobart Building

**FREE
COUPON**

VICTOR J. EVANS & CO.
PATENT ATTORNEYS *Established in 1898*

NEW YORK OFFICES
1007 Woolworth Bldg.

CHICAGO OFFICES
Suite 1640-42 Conway Bldg.

PHILADELPHIA OFFICES
828 Fidelity Phila. Trust Bldg.

PITTSBURGH OFFICES
514 Empire Bldg.

SAN FRANCISCO OFFICES
1010 Hobart Bldg.

MAIN OFFICES: 789-9th Street, N. W., WASHINGTON, D. C.

Gentlemen: Please send me *Free of Charge* your books as described on preceding page.

Name

Address

PATENTS

Booklet Free Highest References
Promptness Assured Best Results

Send drawing or model for preliminary examination and advice.

ALL BUSINESS GIVEN PROMPT AND PROPER ATTENTION

Listed Patent Lawyer in the latest editions of the Rand-McNally Directory of Bankers and Bonded Attorneys, published by Rand-McNally & Co., Chicago, Ill.; The Baggott & Ryall Directory of Guaranteed Attorneys, published by Legal Directory Corporation, Boston, Mass.; Flugel's Law List, published by Legal Directory Publishing Co., St. Louis, Mo.; American Lawyers Annual, published in Cleveland, Ohio; Bankers Service Legal Directory, published by Bankers Service Co., Boston, Mass.; Eyre's Law List, 9 Park Place, New York City; Walters Legal Directory, Omaha, Nebraska, and the National Directory of Attorneys, Baltimore, Maryland.

WATSON E. COLEMAN,
REGISTERED PATENT LAWYER

Victor Building, 724 Ninth Street, N. W.
WASHINGTON, D. C.

PATENTS

To the Man with an Idea

PATENTS Procured. Trade Marks Registered. —A comprehensive, experienced, prompt service for the protection and development of your ideas. Preliminary advice gladly furnished without charge. Booklet of information and form for disclosing idea free on request.

IRVING L. McCATHRAN, Patent Lawyer
Formerly with and successor to RICHARD B. OWEN
704 International Bldg., Washington, D. C.
41-E Park Row, New York City

TRADE-MARKS
REGISTERED

DO YOU

WANT a new business profession of your own, with all the trade you can attend to? Then become a foot correctionist, and in a few weeks earn big income in service fees,—not medical nor chiropody—easy terms for home training, no further capital needed, no goods to buy, no agency. Address

Stephenson Laboratory, 1 Back Bay, Boston, Mass.

INVENTORS

who derive largest profits know and heed certain simple but vital facts before applying for Patents. Our book *Patent-Sense* gives those facts; sent free. Write **LACEY & LACEY,** 646 F St., Washington, D. C. Established 1889.

PATENTS

PROTECT YOUR IDEAS

Write today for FREE INSTRUCTIONS—or send Drawing or Model of your Invention for Examination.

Promptness Assured with Best Results

CARL MILLER
REGISTERED PATENT ATTORNEY

Former Member Examining Corps U. S. Patent Office
255 McGill Building Washington, D. C.

PATENTS

Trade Marks, Copyrights, Patent Litigation Handbook with illustrations, 100 mechanical movements. Sent free on request.

ALBERT E. DIETERICH

formerly member Examining Corps U. S. Patent Office

REGISTERED

PATENT LAWYER and SOLICITOR

621-A, Ouray Bldg.

30 Years' Experience Washington, D. C.



PATENTS

Send us sketch or model for advice and exact cost of patent. Our book "How to Obtain a Patent" sent free. It tells how to apply for Patents, Trade Marks, Foreign Patents, Copyrights, etc.; gives information on Patent Procedure; tells what every inventor should know. Thousands of Inventors, who are our clients, are our reference.

CHANDLEE & CHANDLEE, 25 Years' Experience
912 F Street Washington, D. C.

PATENTS SECURED TRADE-MARKS REGISTERED

High-class professional service for Inventors and Trade-Mark Users is necessary for PROPER PROTECTION. We Offer you our facilities on Reasonable Terms. If you have an invention send us a model or sketch and description and we will give you our OPINION whether your invention comes within the provisions of the Patent Laws. Our book, "HOW TO GET YOUR PATENT" and Record of Invention Certificate sent on request. DELAYS are DANGEROUS in Patent Matters.

Terms Reasonable.

Best References.

WRITE TODAY

RANDOLPH & COMPANY, Patent Attorneys

301 VICTOR BUILDING, WASHINGTON, D. C.

Name

Address

This Needed Invention Paid \$135,000

a year. Beverage manufacturers immediately adopted this simple crimped tin cap. This invention would have made you independently wealthy. Fortunes await inventors working along right lines. Concentrate on things that are **NEEDED**. Get Raymond Yates's new book **"1000 NEEDED INVENTIONS"**

Costs only \$1.50 and may lead to a big idea. Find out what industry needs and the public wants. That's where the money is! Mr. Yates's book tells you what these things are. This revised 1929 edition contains valuable chapters on Aviation and Television. Send no money. Just write postal. Pay mail man \$1.50 plus postage when book arrives. Your money back if you want it. This offer limited. Write now and get on the right track. (Outside U. S. \$1.70 cash with order.)

Bureau of Inventive Science, 35 Wisner Bldg., Rochester, N. Y.



PATENTS TRADE-MARKS
Don't Lose Your Rights To Patent Protection
 Before disclosing your invention to anyone send for blank form "EVIDENCE OF CONCEPTION" to be signed and witnessed.
LANCASTER, ALLWINE & ROMMEL
 480 Ouray Bldg. WASHINGTON, D. C.
 Originators of forms "Evidence of Conception."



PATENTS TRADEMARKS-COPYRIGHTS
 Before showing your idea to anyone, send for new—"DUPLICATING INVENTION RECORD"—you keep a copy for evidence and send me a copy for advice and exact cost of patent. Prompt Personal Service. Advice and Record free on Request.
JOHN J. LYNCH, Registered Patent Attorney
 41-H Park Row, 704-H International Building, New York City Washington, D. C.

PATENT YOUR INVENTIONS
EDWARD GOTTLIEB
 Attorney in Patent Causes
 5 Beekman Street New York
 Inventions Developed—Representatives for
BLAIR TOOL AND MACHINE CORP.

Cal. 30-40 Six Shot  **Price \$9.75**
KRAG CARBINE
 All the qualities of a high price rifle. In fine used condition, all working parts guaranteed for one year. Send today for our Free 60-page illustrated catalog of money saving values: Guns, Ammunition, Cutlery, Sports and Gov't goods. Deposit required on all orders. Money refunded if not satisfactory.
W. Stokes Kirk, Dept. P. M. 8, 1627 N. 10th St., Phila., Pa.



PANTS MATCHED!
 Why Throw Away That Coat and Vest? Save \$25 or more! Let us match your coat and vest with new trousers and save the price of a new suit. Each pair tailored to your measure. (Average price \$8.50). Over 100,000 patterns. Mail sample of suit, or your vest which will be returned together with **FREE Sample for your approval.**
MATCH PANTS CO., Dept. 210
 20 W. Jackson Blvd. CHICAGO

Make Your VEST POCKET BRING YOU \$400. A MONTH

Brand New
 An article that arouses instant curiosity. Quickly demonstrated and conveniently carried in vest pocket. Protection for everybody against robbers, criminals, morons, vicious dogs, etc. yet it is not classed as a weapon, because absolutely harmless.

"Sold 17 First Day Out"

writes Hansen of Northern Illinois. Hayes of Minn. wires "Sold my first dozen in five hours. Sold 3 Doz. C. O. D. at once." Agents make \$2.55 on each sale. Big extra profits on quantity. Prospects everywhere—men, women, banks, theatres, merchants, etc. You should close at least 40%.

Looks Like A Fountain Pen



INSTANT TEAR GAS PROTECTION WITHOUT INJURY TO ANYONE

Two Tear Gas Cartridges Free
 with every gun. You make 20 cents each on every extra cartridge sold.

Exclusive Territory
 still open. Especially attractive proposition to men controlling force of salesmen. Send Coupon for details regarding How to get Free Demonstrator, etc.

Women are not afraid to use the Atlas Gun. Great protection for women ever invented. 500 Atlases recently ordered by banks in one territory alone.

ATLAS TEAR GAS FOUNTAIN PEN GUN

Atlas Tear Gas Co., Chicago, Ill. Ogden Park Station, Dept. 105
 Gentlemen: Please send me particulars regarding your Fountain Pen Tear Gas Gun agency. Also tell me how I can get a Demonstrator and two cartridges Free.
 Name.....
 Town.....
 St. or R. F. D.....State.....

Information on any book free. Write Popular Mechanics Press, Chicago, Ill.

SILVER ACE
 Mail this Coupon
AERO MODEL COMPANY
 Dept. M25
 111 N. Wacker Dr. CHICAGO
 I enclose 5 cents for your new 1930 catalog, describing \$1.50, 1 1/2 ounce, Flamingo construction set, quality supplies, 24 famous SILVER ACE ships and a History of Flight.
 Name.....
 Address.....

Stage Money



New Bills To Conform With Small Size Currency

With these bills it is easy for a person of limited means to appear prosperous by flashing a roll of them at the proper time. By peeling off a genuine bill or two from the outside of the roll, the effect created will be all that can be desired. Prices, postpaid: 50 bills 25c; 140 for 50c, or \$3.00 thousand postpaid.

Nose Blower



Concealed in the handkerchief. Proceed to blow your nose and your friends

will think they heard a steam engine or something. You can blame the whole noise on a very bad cold and keep up the fun as long as you like. Price 10 cents; 3 for 25c, or 75c doz. postpaid.

OAKS' CARD MIRACLES



Complete box of our most popular card tricks. Easily performed with instructions for each trick. Box contains Disappearing Spots, Hindoo Cards, Phantom Cards, Pick It Out Cards, Satan Card Tricks, Educated Car Dice Trick, Knock-out Cards, Diminishing Card Trick and Wonderful Ace Trick. If purchased separately would cost \$1.00. Special complete, only 50c.

Serpent's Eggs



When lit with a match each egg hatches itself into a snake several feet long, curling and twisting in like manner. Box of 12, 10c postpaid; 3 for 25c.

Fire-Eater

A great trick by which you appear to breathe fire from mouth. Quite harmless. All necessary apparatus sent complete for only 30c, postpaid.



Black Art

This book tells of the sciences of Magic, Witchcraft, Alchemy, Necromancy, Mesmerism, etc. It tells how to make persons think of you, how to charm those you love, etc. The book contains 122 pages. Price 30c prepaid.



SIBERIAN TRANSPORT CHAIN



Strong chain is thoroughly examined, after which performer's wrists are chained together and locked with a padlock. Under the very eyes of the spectators, the performer makes his escape. Creates a sensation in the parlor or on the stage and is highly recommended. Very easy to perform. Price 75 cents.

Exploding Cigarettes

JUST LIKE ORDINARY CIGARETTES, BUT SUCH REAL STARTLERS! The box contains ten genuine cigarettes of excellent quality. They appear so real, but when each cigarette is about one-third smoked, the victim gets a very great surprise as it goes off with a loud BANG! A great mirth provoker yet entirely harmless. Price 25c box.



Buddha's Money Mystery

With this contrivance it is apparently possible to change a blank piece of paper into a bill of any denomination. Can be performed easily by anyone. Price only 25c.



Magic Nose Flute

A unique and novel musical instrument played with nose and mouth combined. Just a little knack required to enable you to produce sweet music that resembles a flute. No fingering. Effect is charming when played as an accompaniment to piano or other musical instrument. Price 10c postpaid.

MAGIC CARD CASE



A well made case to hold a pack of cards. The cards are removed and all parts of the case freely shown. The performer now causes a handkerchief to disappear, when, upon opening the case, it is found that the cards have vanished, the missing handkerchief having taken their place. The cards are placed in the case right in front of the audience and immediately upon opening the case, candy, rings, coins, and other articles will be found in same and the cards gone. Useful in many combinations. Easy and a fine effect. We can highly recommend it. Price 40 cents.

BIG FREE OFFER

Our large die box trick is sent to you when you have orders amounting to only \$25 within one year. You have twelve full months from the date we receive your first order to make your purchases totaling \$25. We are the largest dealers in tricks of all kinds in the world. Order from this advertisement or send for our big catalog immediately. Above are only a few of more than six hundred and eighty new tricks, puzzles, illusion and novelties. Deal with us and get satisfaction.

OAKS' MASTER BOX OF TRICKS

Mystery and entertainment for every day in the year. Whole evening's entertainment complete for \$1.00. Without practice or experience, anyone can give a complete entertainment with these mechanical and self-working tricks so simple that a child can perform. Contains apparatus for 7 complete tricks. The Magic Ball and Vase Trick. Wooden ball is placed inside, and upon replacing the lid has disappeared and is found in someone else's pocket; Disappearing Spots. This trick consists of changing four Kings to four Aces, and then to blank cards; Magnetic Wand. Magician's Wand clings to fingers and floats about as if magnetized, yet falls when anyone else tries; Ribbon Factory from the Mouth Trick. A seemingly endless supply of colored paper ribbon comes out of the mouth; Disappearing Handkerchief. Handkerchief held in the mouth mysteriously vanishes; Enchanted Bottle. No one but yourself is able to make it lie down; Great Hat and Dice Trick. Large dice is placed on top of hat, disappears, and is found underneath, yet no one has touched the hat. Only \$1.00 for all.



MAGIC CARD BOX



This mysterious box is useful in performing many card tricks. You ask two persons to each select a card from any ordinary pack of cards. One of the cards is now placed in this box and a second later when the box is opened the card has mysteriously disappeared. The other card is now placed in the box and when it is again opened the first card appears and the other one is gone. You can make several cards disappear and at command they all appear at once. You can tear a card up and place it in the box and when you open the box again it will be found whole. All easy to perform after reading our simple directions. Price 25 cents. Better grade, made of highly finished wood, \$1.25.



Seebackroscope

With this instrument to your eye you can see what is going on behind your back. Many times things occur when no one thinks you are looking. Just like having eyes at the back of your head. Price 25c postpaid.

CARD TO MATCH BOX

This is a new and original trick; just invented and we can safely say that it is one of our very best tricks. With sleeves rolled up and hands examined, the performer shows a card—suddenly it changes into a match box which is exhibited on all sides and a match is then taken out of it and lit. No sleeve work, pulls, etc., but worked on a new principle—just out. The trick can be performed under the very eyes of your friends and it is easily done and defies detection. Price complete 15 cents.



WANDERING DICE THROUGH HAT

A solid dice after being inspected by the company, is placed on the crown of a borrowed hat which the conjurer holds by the rim. An examined cover is now put over the dice, and upon command, passed through the hat and falls upon the floor. This is easy to do, and so clever that no one can possibly discover the secret. Price complete 35c. Best made.

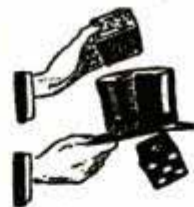

MULTIPLYING BILLIARD BALLS



Magically producing a solid billiard ball, the conjurer simply moving his hand thru the air, causes a second ball of the same size to appear beside it. Everyone watching closely, a third appears in like manner. Then to the amazement of all, a fourth appears. Make them vanish singly until hand is empty. Per set, 35c. Larger sizes, \$1 and \$1.25.

ALKAY CALENDAR

On what day of the week were you born? What day was September 8th, 1852? Tells a birth, death, marriage or any important event from 46 B. C. to 2500 A. D. Past, present or future. On what day of the week was Lincoln and Washington born? Would you like to know? Useful for students, lawyers, ministers, mindreaders, palmists, etc. A most wonderful calendar chart and we guarantee it to be absolutely accurate. The marvel of the Twentieth Century. Price only 15 cents.



OAKS' CARD TEARING FEAT



A favorite with the late Alexander Herrmann and other magicians of note. For this seemingly impossibility, we offer five methods of working so that the merest neophyte may perform the trick with ease. Neat typed instructions giving five complete methods. Price 25c.

202 ILLUSTRATED PAGES OF THE LATEST ILLUSIONS, TRICKS, NOVELTIES, PUZZLES AND SENSATIONAL ESCAPES. Send only ten cents (United States stamp or coin) for this interesting catalog fully describing over six hundred eighty articles. Each one pictured. Write for it today or make a note of it and include with your order of any of the tricks described above.

Get Into Business this Easy Way

7

Machines in One!



Ball Bearing Throughout

Weight 520 Lbs.

A YEAR TO PAY!

Small deposit brings it to you for FREE TRIAL

The Electric Carpenter

Runs from Any Light Socket

Make money on screens, trellises, furniture, toys, etc. 8" Circular Saw; 14" Band Saw; 36" Lathe; 10" Swing; 6" Jointer; Reversible Shaper; 1/2" Hollow Chisel Mortiser; Sander. Does 35 woodworking operations. NOT a Toy!

Write Today for Illustrated Folder

THE WOODWORKING MACHINERY CO., INC.

Eleventh and Vine Sts., Philadelphia Pa.

We Also Build a Complete Line of Single-Purpose Machines



12-INCH SCALE MODEL

of Lindbergh's Spirit of St. Louis. Scientifically designed and very realistic. Rises from ground by own power and flies 40 ft. or more. Only flying scale model sold at this price. Easily built in 2 or 3 hours. No tools needed. Construction



set, with all parts and full directions, postpaid in U. S. and Canada, only 50c (no stamps). Satisfaction or money back. Send today and print your address plainly.
MANN & BENTON
Box D, Chillicothe, Ohio

Electrify Your Radio for

With Townsend "B" Power Unit. Over 150,000 in use. Hooked up in a few moments. Use same tubes—no changes. Better reception—distance. Write for details, Proof and Free Trial Offer.

TOWNSEND LABORATORIES

715 Townsend St., Chicago, Ill.

\$6.85 COMPLETE

REAL ESTATE EDUCATOR

A most comprehensive yet concise arrangement of useful facts about buying, selling, leasing and sub-letting of Real Estate, contracting, for erection or repairs, mortgaging, transferring, insuring, etc.

New revised edition. 288 pp. Price \$2.00, postpaid.
POPULAR MECHANICS PRESS, 200 E. Ontario St., CHICAGO



WOMEN

BIG DAILY EARNINGS

SELLING NEW IMPORTED LINE

"DAINTY-MAID" PRODUCTS are so superior for Feminine Hygiene that to show them usually means a sale. Two sales per day nets you \$51 weekly. No experience necessary. We train you, furnish every aid to success in this dignified, well-paid saleswork. You can devote full or spare time. Name and address on margin.

Mary Coleman Importing Co. brings you **FREE SAMPLE OFFER**
Dept. PM-518 Meriden, Conn.



Earn \$10 to \$35 A Week EXTRA

FREE PLAN Helps You Start

Hundreds of men have started their own profitable business right at home in their spare time with the Foley Automatic Saw Filer. Everett Myers, shown above, writes, "... I banked \$161.66 in one month which was accomplished in spare time ..."

Start a Permanent Business of Your Own in Spare Time

Many men who started in business for themselves in spare time have had to give up their other job and devote all their time to their saw filing business because they got so much business they could not handle it all in spare time. Brunick Serdinsky writes, "... I started business in my spare time and now have the best saw filing business in this community and have earned \$3000 in the past year. ..."

The Foley Model F-5 "3-Way" Automatic Saw Filer

This one machine files all kinds of hand saws, band saws and circular saws better than the most expert hand filer. Work done on the Foley is always satisfactory to your customers. Very simple and easy to operate. No eye-strain. Boys of 14 and men of 70 are making money with the Foley.

\$10 Brings It to You

Start Now—Make Big Profits

Have a steady, cash business the year 'round. No Canvassing—Repeat Customers. Costs less than 3c to file a saw and you get 50c or more for each job. Others are making good money. YOU can too.

Mail Coupon for FREE PLAN

Foley Manufacturing Co.

201 Foley Bldg., 11 Main St., N. E., Minneapolis, Minn.

Please send me FREE PLAN and tell me how I can make extra money in my spare time with the Foley Filer.

Name

Address



Here's an Amazing New Business THAT PAYS UP TO \$1,000 A MONTH

MEN, here is a real, red hot money-making opportunity! It's a chance to jump into business for yourself and make more money every week than the average man makes in a month.

Surprising as it may sound, we actually put you in a business, with the first day's profits often running from \$18 to \$55. \$350 to \$600 the first month is not unusual for ambitious men.

Cut in on the Big Money

All you need is the ambition to make real money. We supply you with complete equipment to make and sell that famous new food specialty—Brown Bobby—a greaseless doughnut baked by electricity!

It's a crispy, flaky, delicious new kind of doughnut cooked without one drop of oil or grease. Easily digested by everyone. More appetizing than old-style doughnuts ever were. Costs less to make. Sells four times as fast. No baker's skill required. Just add water to our prepared "Mix." You can open a shop; rent cheap floor space in a grocery, delicatessen, lunch counter, drug store, etc. Or start at home—and make up to \$250 your very first week.



"I made \$3,000 in 3 months in my greaseless doughnut business!" — T. Chas. Minch, Fla.

Start at Once ANYWHERE!

Men and women everywhere are starting in this business daily! YOU cannot afford to delay! Details will gladly be sent without obligations of any sort. Such an amazing money maker may never come your way again. So fill in and send the coupon at once! TODAY—

FOOD DISPLAY MACHINE CORP.
Dept. 35 500-510 N. Dearborn St., Chicago, Ill.

Food Display Machine Corp.,
Dept. 35, 500-510 N. Dearborn St., Chicago, Ill.

Gentlemen: Please send me the plan by which I can cash in on Brown Bobby, the Greaseless doughnut. It is understood that this obligates me in no way whatever.

Name.....

Address.....

City.....State.....

Complete WOODWORKING SHOP FOR INCOME OR HOBBY



FIVE FOOT WORKSHOP INCLUDES:
Planer, Circular Saw, Lathe, Disc Sander, Buffer, Grinder, Drill Chuck, Motor, V Belt Pulleys, Sub Base, Cable with Plug. Under the magic of Workace Electric Woodworker raw lumber is easily converted into useful and valuable articles. Man or boy will enjoy Workace. Simply plug into electric light socket. \$9.00 down will bring it. Send now for offer.

J. D. WALLACE & CO.

Adams St. at California's, Chicago
11 W. 42nd St., New York
268 Market Street,
San Francisco



WORKACE Electric WOODWORKER

Build a Ship Model at Home



It is a wonderful fascination and a beautiful decoration for your mantel, radio cabinet or it may be used in any part of the home.

We have parts for the following models: **SANTA MARIA \$4.98; LA PINTA \$4.98; MAY-FLOWER \$4.98; CONSTITUTION \$6.98; FLYING CLOUD \$6.98.** All F. O. B. Sellersville plus a few cents postage.

These models are sold in knock down form. All parts are cut to fit and ready to assemble. They will be sent anywhere in U. S. C. O. D. Money order or check must accompany all foreign orders.

New Stage Coach Models . . . Assembly Kits now ready. . . Attractive addition to our line. . . Descriptive pamphlet.

Write for free illustrated catalog

MINIATURE SHIP MODELS, Inc. Dept. Sellersville, RT-5 Pennsylvania

Auto Seat Covers \$2.95



Special Price Offer

AGENTS Make \$20 a Day

WRITE NOW! Write orders fast for this excellent Quality line Auto Seat Covers. Amazing value—quick sales. Cash daily. We deliver. Write for handsome Free Leatherette Sample Outfit. Quality Sales, Dept. 16, 1834-36 North Ave., Chicago

NEW PRACTICAL

DIESEL ENGINE BOOK

The importance of the Diesel engine in its various applications to Marine, Locomotive, and Stationary operation can scarcely be overestimated. Every progressive engineer and student of mechanical engineering will realize the necessity of extending his knowledge into this field.

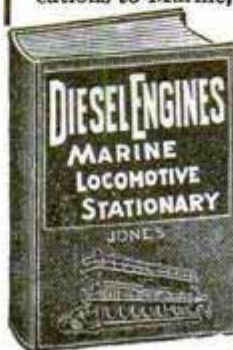

This up-to-the-minute book by D. L. Jones, Chief Machinist, U. S. Navy, is extremely practical, complete and in simplified language. Deals thoroughly with installation, operation and maintenance.

500 pages (6x9)—280 Illustrations. Pay postman \$5.00 on delivery.

Popular Mechanics Press
200 E. Ontario St. CHICAGO

The Model A Ford Car

is treated in a special supplement to the latest edition, the 15th, of

Dyke's Auto Encyclopedia

For 15 years "Dyke's" has been the one recognized and undisputed authority on the Automobile. Each succeeding edition has surpassed the last one. Now comes the greatest book of all—the wonderful 15th Edition—A. L. Dyke's crowning triumph—the super auto book of all times.

Some "High Spots" of the New Book!

- 1,249 pages covering every known auto fact.
- 4,200 Pictures, Plans, Diagrams and Charts.
- 15,000 lines of Index by which you can instantly locate any subject you want.
- A new section of "Trouble Shooting" Charts in Colors to enable you to quickly locate any major or minor trouble on any car.
- Special instructions on testing and adjusting every part of the automobile.
- Specifications of Gasoline Passenger Cars, Trucks and Tractors.

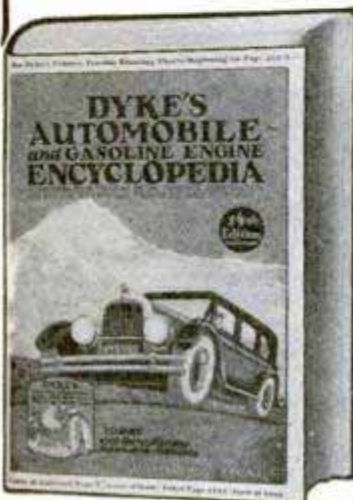

Specifications for Replacements, Accessories, Interchangeable Parts and Equipment.

Large colored Combination Chart which shows the working principles of the Automobile.

Large Charts showing the working principles of Trucks and Tractors.

Cloth \$6.00; Limp American Morocco \$7.50

Sent postpaid upon receipt of price.

Will be sent C. O. D. if preferred to any address in the U. S.

POPULAR MECHANICS PRESS
Room P-5
200 E. Ontario St.,
Chicago

Popularity! Fame! Fortune!



Yours with a BUESCHER!

Be popular socially. Make friends. Step ahead in business. Earn money on the side. Have fun. Win fame and fortune, as did Rudy Vallee. You can do it with a Buescher Sax.

BUESCHER True-Tone BAND INSTRUMENTS

are the choice of both celebrities and beginners, because unrivalled in easy playing and in purity and sweetness of tone. Easy to own, too. Just a little down. Then pay as you play. Tell us which of the 88 Buescher Band Instruments you want to play; and whether in band, orchestra or at home; also what instrument you now play, if any; and your age. We'll send the proper catalog folder and full details. Write. (567)

Buescher Band Instrument Co., 3046 Buescher Bldg., Elkhart, Ind.

Make Furniture At Home



—either for your own pleasure or to sell. It is easy when you have the instructions supplied in Popular Mechanics Home Furniture Making Library. This library consists of the

following cloth-bound, profusely illustrated books of which many thousand have been sold to satisfied customers everywhere:

1. Mission Furniture—Part 1
2. Mission Furniture—Part 2
3. Mission Furniture—Part 3

These three practical, money-saving books contain full directions and drawings for the making of all sorts of furniture, including tables, chairs, stools, davenports, electric table lamps, and many other useful and beautiful articles of furniture. Crystal clear instructions in 3 handy books; 360 pages—186 illustrations. Just follow directions and you'll be amazed at your good results. Use the furniture in your own home or sell it. One man writes he

sold over \$1,000 worth of furniture made from these books. You can do the same.

Send No Money! Just write a postal asking that Popular Mechanics Home Furniture Making Library be sent you C. O. D. When the postman delivers the books, simply hand him \$2.98 plus the few cents postage. Money refunded if not delighted.

POPULAR MECHANICS PRESS
Popular Mechanics Bldg., Room 702, Chicago, Ill.

USE A REASONATOR for

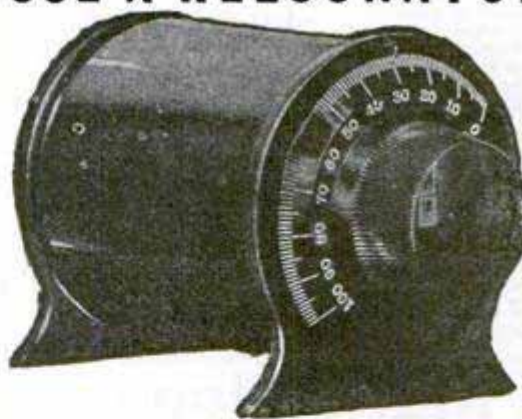

Sharp
Tuning,
Distance
and
Power

\$4⁷⁵

Complete

Over 40,000 Satisfied Users

Bring your set up to date! For all sets using an untuned floating or antenna tube, such as Atwater Kent Models 30-32-35-37-38, Victor, Silver, Knight, Temple, Crosley Bandbox, Radiola Models, 16-17-18-51-33-333, Dayfan, Apex '28 Models, and many others. Attaches across aerial and ground leads without tools in less than a minute.

It will enable you to tune sharper and play with dance volume, stations which are barely audible or sometimes entirely inaudible without it. Requires tuning only when additional selectivity or power is required. Attractively constructed from hard rubber and bakelite in a highly polished rich mahogany color. Guaranteed against defects in material and workmanship for a period of six months. Get a Reasonator from your dealer today, or order direct. We guarantee satisfaction. Try one for three days at our risk. If not thoroughly satisfied your money will be cheerfully refunded.

Dealers!
Over Sixty
Leading
Jobbers
Carry This
Item.
Ref.:
 Fargo Nat'l
 Bank, Dun's
 or
 Bradstreet's

F. & H. RADIO LABORATORIES
Dept. 109
 Fargo, N. Dak.

- I enclose check or money order for \$4.75 for which send Reasonator postpaid.
- Send Reasonator C. O. D.
- Send Dealer's Proposition.
- Please send literature.

Name.....

Address..... State.....

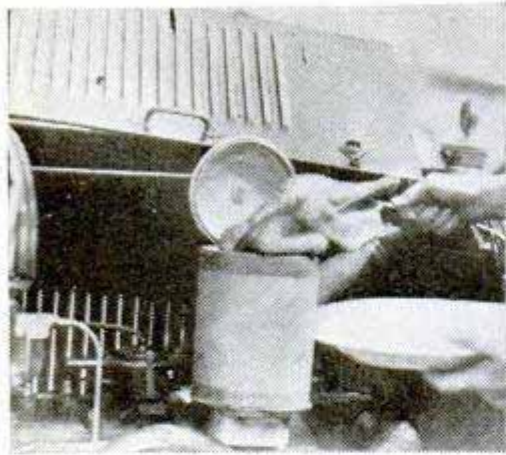

The CONKLIN AUTOMOBILE COOKER COOKS WHILE YOU RIDE

This interesting invention enables the motorist to have delicious, home cooked food with no loss of time from his trip as all food is cooked while riding without any attention until mealtime.

The CONKLIN COOKER roasts, steams or boils all meats, vegetables or desserts while touring the country or out on a day's trip. Enjoy a fine roast or savory stew with well cooked fresh vegetables every day at much less cost than at restaurants. Protect the health of your family while travelling. Buy one of these COOKERS now and enjoy it on week end trips. It will help greatly in planning your vacation. Price \$7.00, state make and model of car.

CONKLIN MFG. CO., Box 475, Palm Beach, Fla.

AGENTS Some Seller at
Looks Like \$5.00 Worth **\$ 2.00**
Gives You \$1.00 Profit!



You should see our Lucky 11 Package. Our representatives introduce our products with a first sale of beautiful combination sets of Toilet Articles, Soaps, etc. with valuable premium with each sale at half store prices. No fancy talk—they sell on sight. Make twenty to thirty sales a day with \$1.00 profit on each.

Easy to Average \$100 a Week

Could you ask more while introducing line establishing a permanent business for yourself? 200 Quality Products—100% Profit. Write today for illustrated circulars explaining our unique plans. **Act NOW.**

E. M. DAVIS CO., Dept. 5605, CHICAGO

MORE FLYING—LESS COST

That's why HEATH PARASOLS are America's Most Popular Sport Planes.

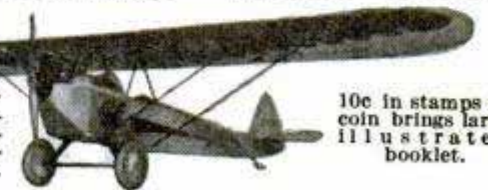

10c in stamps or coin brings large illustrated booklet.

HEATH AIRCRAFT CORP., Dept. P-5 1721 Sedgwich Street, CHICAGO



MONEY FOR YOU IN ELECTRIC ARC WELDING

Auto mechanics, garages, welding shops can easily get into profitable arc welding business with the latest equipment that's sure to earn tremendous profits—with far lower costs than other types. HB Constant Arc Welder with exclusive Unitrol Panel starts you on road to success with practically no expense. Previous experience not required, the HB panel simplifies operation.

COSTS ONLY \$40 MONTHLY Liberal trial on money back guarantee to prove its worth. Write today to **HOBART BROTHERS, Box M-502, TROY, OHIO**

Catch Fish!



Eels, Mink, Muskrats with our new folding galvanized **STEEL WIRE TRAP.** Write for our **FREE TRAP OFFER** and Bargain Catalog. \$1 Box of our famous Fish Bait **FREE** to introduce our traps. **WALTON SUPPLY CO., 3502 JUNIATA AVE., ST. LOUIS, MO.**

Build This Tri-Motor Ford Model



Send for description of this accurate scale model of the Ford 17 passenger, all-metal air transport.

AIRPLANE MODEL & TOY CO.

203A. Eustis Bldg. Minneapolis, Minn.

A New Money Maker for Agents!

Sell new kind of automatic window washer. Carries own water supply. Stores, housewives, autoists buy on sight. Write for money-making proposition and free sample offer.

NATIONAL INDUSTRIES, 67 E. Lake St., Dept. 155, Chicago, Ill.

SAMPLES OF 33 RARE WOODS

20 cabinet woods \$1.00. Sets **ONLY 25c** labeled and postpaid. Send 5c stamp for 16 page illustrated catalog showing 16 different things to make. Catalog lists blue prints, all kinds of lumber, panels, veneers and inlay woods.

CRAFTSMAN WOOD SERVICE CO.
PM-166 West 74th St., Chicago, Ill.

Make Money in Spare Moments



Universal Jig Saw without motor,

\$12

Now's the time. Season just opening. Make screens, garden furniture, window boxes, tourists' novelties, etc. Sell them and reap financial harvest. Turn idle moments into extra money. Make pleasant pastime profitable. Get ready—

Buy Boice-Crane and Build Better

The purring motor—the whirring dado—the singing saw—fairly eat work. Marvelous how easily and quickly you make money. We help you. Advise what to make. Explain how to make. Tell you how to sell it. It's interesting and profitable.

This sturdy, rigid, Universal Handi-saw, without motor,

\$30



Send 10c for complete 80-page catalog showing and describing a full line of Circular Saws, Band Saws, Jig Saws, Jointers, Lathes and Accessories. Address

Made High as \$25.00 Day

Our files crammed with enthusiastic letters. W. H. Duer, Mich., writes: "Basement Boice-Crane Shop earning high as \$25 day." Mingle pleasure with profit. Investigate our proposition.

A few evenings' fascinating occupation with clean, fragrant lumber quickly pays for BOICE-CRANE equipment with the extra money you earn. BOICE-CRANE machines are sturdy, staunch and true—capable of any reasonable woodworking task.

W. B. & J. E. BOICE, Dept. P.M.5-F., TOLEDO, OHIO

8" Band Saw \$13.95 Only

Here It Is. An Ace of An Up-To-Date Band Saw. Just What You Have Been Looking For!

A Band Saw that is guaranteed to give the same results as the larger and more expensive machines now on the market.

Has hardened and ground shafts—saw guides made of tool steel— $\frac{1}{4}$ " Atkins Silver Steel Saw Blade—will cut wood up to 2 $\frac{1}{2}$ " thick and light metal. A real machine made to last a life time, and carries a guarantee of satisfaction or money refunded. With Endless "V" Belt and Motor Pulley \$15.00.

Up-To-Date Machine Works
Dept. 50 2915 South Wabash Ave.
CHICAGO, ILL.

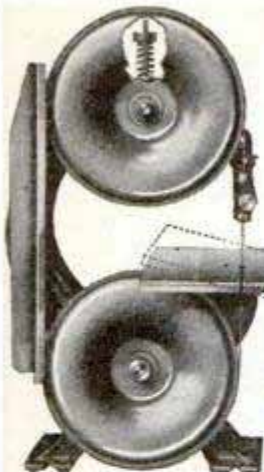

Build your own outboard hydroplane motor or sail boat. Use our plans or knock-down frames and machined parts. Many models to select from. Write for new catalogue.

J. B. WELCH, Dept. B, 724-31st St., Milwaukee, Wis

BOYS! MAKE BIG MONEY Build Bird Houses



Here's a real money-maker. With my simple instructions **any boy** can build and erect Grandpa Bird House. They sell at \$2 to \$97.50 each. \$2000 worth sold in Oak Park, Ill., in a year. Send \$1 for my big collection of work shop plans for boys who want to have fun and make money building my famous bird houses. Valuable information about song birds and tips and advice on making sales included **Free**.

GEO. J. BREIDERT, 1040 N. Elmwood Ave., OAK PARK, ILL.

FOR THE RADIO BUILDER

The blueprints below include the best of Popular Mechanics tested circuits. When ordering, simply quote the numbers of blueprints desired and inclose proper amount addressed to Popular Mechanics Magazine, Radio Dept., 200 E. Ontario St., Chicago, Ill. Magazines containing full descriptions of the circuits can be obtained. Send 25 cents for each magazine desired, giving date of publication.

- No. 111, Homemade Tube Tester..... July 1926.. 25c
- No. 116, Three-Tube Loop Set..... Dec. 1926.. 25c
- No. 123, Economy-Nine Super-heterodyne..... Nov. 1927.. 50c
- No. 134, Edison Type B-Battery..... July 1928.. 25c
- No. 138, Screen-Grid Perfect-Tone Six Receiver..... Nov. 1928.. 25c
- No. 139, Simple Television Receiver.. Dec. 1928.. 25c
- No. 140, Power Amplifier and B-Supply for Television..... Jan. 1929.. 25c
- No. 142, Two-Tube Screen-Grid Short-Wave Adapter..... Mar. 1929.. 25c
- No. 143, Four-Tube Screen-Grid Receiver..... May 1929.. 25c
- No. 144, Three-Tube Self-Contained A.C. Receiver..... Oct. 1929.. 25c
- No. 145, One-Tube S-G Set for Beginners..... Nov. 1929.. 25c
- No. 146, Adjustable B-Eliminator... Nov. 1929.. 25c
- No. 147, A-Eliminator for Set and Dynamic Speaker..... Dec. 1929.. 25c
- No. 148, Adding Audio Stages to S.G. Receiver..... Dec. 1929.. 25c

WURLITZER

Trade Mark Reg.
THE WORLD'S LARGEST MUSIC HOUSE

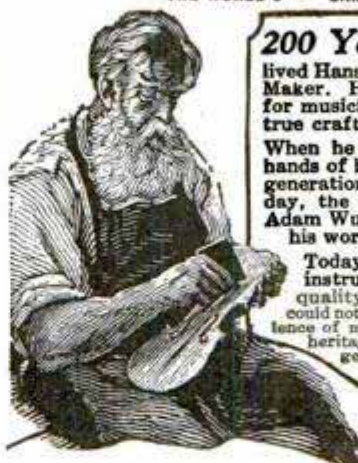

200 Years Ago in the little Saxon town of Schoeneck lived Hans Adam Wurlitzer, Master Violin Maker. His shop was a gathering place for musicians of the time, for he was a true craftsman.

When he died his shop passed into the hands of his eldest son, and for seven generations, down to the present day, the descendants of Hans Adam Wurlitzer have carried on his work.

Today in every Wurlitzer instrument you will find a quality, a character, that could not come from mere excellence of manufacture. It is the heritage of these seven generations of music craftsmanship.



Try

any Wurlitzer Instrument
in your
Own Home

YOU may now have any Wurlitzer instrument for a generous free trial in your own home. Examine the instrument, show it to your friends, play it as much as you wish. No obligation to buy—no expense for the trial. We make this liberal offer because we want you to try for yourself these wonderful instruments, the result of 200 years' experience in musical instrument Building. Easy payments are arranged to suit your convenience. This is your opportunity to try a famous Wurlitzer instrument in your own home.



Send for New Catalog

The greatest musical catalog ever published. Over 3,000 articles—every known instrument described and illustrated; many of them shown in full colors. Gives you lowest prices and all details of Free Trial, Easy Payment plan. All sent **FREE**—no obligation.

Send this Coupon

THE RUDOLPH WURLITZER CO.
135 E. 4th St., Cincinnati, Ohio

Send me absolutely free, your new illustrated catalog, with prices and description of every known musical instrument. Also tell me how I may try any instrument in my own home and pay for it in small monthly sums. No obligation.

Name.....
Address.....
City..... State.....
Instrument.....
(State instrument in which you are interested)



Add This to Your Collection

If you're a carpenter or mechanic, professional or amateur; if you're a fellow who likes to tinker around, who can do things with your hands—you need several Remington knives. Knives that Remington has designed especially for men like you.

The blades in all these knives are of high-carbon steel, forged, hardened, and tempered to take and hold a biting edge. All are sharp—hand-honed at the factory. All are sturdily built and well designed, and beautifully finished.

R3843, pictured here, is an all-round, useful knife. If you're a one-knife man, you can't make a better choice. If you need several good knives, you'd better add this to your collection.

Remington knives are sold where good cutlery is sold. If your dealer hasn't R3843 in stock, send his name with \$4.00 and the knife will be mailed to you promptly. Address: Remington Cutlery Works, Bridgeport, Conn.



Knife R3843
Price \$4.00

REMINGTON ARMS COMPANY, Inc.
Originators of Kleanbore Ammunition

Remington

BOYS! Here's Fun Galore



Zip! Here they come! Around a turn and down the home stretch to cross the finish line with a last furious burst of speed!

You want things that will "GO"—things you can race with—scooters, pushmobiles, small autos with motorcycle engines, wind wagons, etc.—Whether on spinning wheels or glistening runners—fast ice yachts, skis, toboggans, bobsleds, motor driven sleds and snow speedsters.

You air-minded boys enjoy gliders and model airplanes. Turn your back yard into a regular amusement park with all these thrillers—ferris wheels, roller coasters, merry-go-round swings, etc.

How fascinating to imitate the big engineers and make small water wheels, pile drivers, aerial cableways and other things that "work."

When at camp or on the water you need plenty of ideas for new ways of having fun. Here are dozens such as water bicycles, push boats, water coasting toboggans, water games, etc.

On rainy days and other times when working in your home shop you have the hardest time finding interesting things to make. Here are any number such as electric locomotives, motion picture cameras, wood turning lathes, etc.

All in this great

Boy Mechanic Library

YES—ACTUALLY

4000 Worth While Things to Make and Do

Don't envy the other boys on account of the things they have. Be the boy in your neighborhood to make the others wonder where you get all your ideas.

Get the thrill of having "Made It Yourself." Everything is pictured out and made easy. Don't try to get along without these books. Send for them right away.

The complete library of 4 volumes, each book 7x10x1½ inches and with 460 Pages.

Price \$7.00

or single volumes at \$2 each. Each volume complete in itself.

Books are numbered: 1, 2, 3 and 4. State the ones you want when ordering. Sent postpaid when remittance is sent with your order, or will be sent C. O. D. anywhere in the U. S. Pay postman price plus extra postage for this service.

POPULAR MECHANICS PRESS
200 E. Ontario St. Room P.5 Chicago, Ill.

Books on 32 Subjects

Popular Mechanics Press specializes in supplying books on any subject. Look over this list. Check the books you want, and mail this advertisement as your order blank. Catalog with lists on 2,000 subjects free.

AIRCRAFT (Modern) Complete. Up-to-date... \$5.00	FURNITURE REPAIRING Finishing and Decoration... \$5.00
ARTIST (Commercial) Money-Making Art... \$5.00	HYPNOTISM A Reliable Treatise... \$2.50
ATLAS (of World) Modern. New Boundaries... \$3.00	INVENTIONS How to Make Pay... \$2.50
AUTOMOBILE (Modern) Gasoline. New Edition... \$5.00	MAGIC World's Best Book of... \$2.00
BOOKKEEPING Practical Handbook... \$1.00	MODEL ENGINEERING Very Interesting... \$4.00
BRICKLAYING Plain and Fancy... \$1.50	PLASTERING Best Instruction Manual... \$1.25
CARBURETORS (All Makes) Only Book Covering... \$2.00	RADIO ENCYCLOPEDIA Very Complete... \$6.00
CHALK TALK and Crayon Presentation... \$1.25	REAL ESTATE Educator... \$2.00
DRAWING Freehand and Perspective... \$1.50	SHOW CARDS Artistic... \$3.50
DRY CLEANING (Practical) and Dyer... \$3.00	SIGNS (Artistic) How to Make... \$3.50
ELECTRICAL SYSTEMS Automobile... \$3.50	Steam Engineer's License How to Obtain... \$2.00
FLOWER RAISING 1001 Questions Answered... \$2.00	STEEL SQUARE How to Use... \$1.00
FLYING A B C of... \$1.50	TELESCOPE (Amateur's) How to Make... \$3.00
FUNNY PICTURES How to Draw (by Zim)... \$3.00	TOOLS (Using) Tinkering with Tools... \$2.00
FUR RAISING For Profit... \$4.00	TRICKS (200) For the Amateur... \$1.00
	WOOD FINISHING Plain and Decorative... \$2.00
	WOODWORKING (New) Most Complete Book for Amateurs... \$2.00

SEND NO MONEY

Just check the books you want, and mail the whole advertisement. It is your order blank. When postman hands you books, pay him the price and the postal charges. If outside the U. S. remit when ordering and include 10 cents per book extra for postage.

POPULAR MECHANICS PRESS, Room P5, 200 East Ontario St., Chicago, Ill.

366 SHORT CUTS FOR

CARPENTRY WORK

Popular Mechanics Carpenter's Handbook is filled with illustrated short cuts and improved methods for doing all sorts of carpentry work and odd jobs. Each idea was discovered by a practical man in the course of his work. Each idea is practical, a time-saver, a money-saver. The **229 Pictures** are so clear that in many cases, the picture itself explains the short cut. This new book is a book for professional carpenters, for amateurs, and for boys. It is destined to be just as popular as the many other handbooks published in recent months. This new book is beautifully bound in golden brown cloth, is a handy size, and sells for the remarkably low price of \$1.50.

Send No Money Simply write a postal saying that you want Popular Mechanics Carpenter's Handbook. It will be sent C. O. D. and you may pay the postman the price of the book and the few cents postage when he delivers the book to you. If you live outside the U. S. or if you are not at home when the postman delivers your mail, send \$1.50 with your order.

POPULAR MECHANICS PRESS

Room 705, Popular Mechanics Bldg., 200 E. Ontario Street, Chicago, Ill.

Mathematics Made Easy by

ROPP'S CALCULATOR

AND SHORT-CUT ARITHMETIC

Shows the Answer as Quickly as a Watch shows the Time to all Problems likely to occur in the Office, Store, Shop, Bank, Farm, or Factory.

Over 2,000,000 Sold

Explains and simplifies every principle in Arithmetic, Mechanics, and Mensuration.

PRICES POSTPAID

Desk Size, Flexible Keratol Binding... \$2.00
Pocket Size, Art Leather Binding... \$1.00
Pocket Size, Cloth Binding... \$0.50

POPULAR MECHANICS PRESS

Room P5 200 E. Ontario St. Chicago

ELECTRIC STARTING

ON
EVINRUDE
Elto
LOCKWOOD

OUTBOARD MOTORS

Now you simply touch a switch. Instantly your motor whirls... ten times faster than strongest human hands could spin it. Starting is immediate, positive—precisely what you expect from finest motor cars. Start and stop as often as you wish, for the powerful 12 volt battery is automatically recharged. Have spot and running lights, for there's current a plenty.

Write today for new, interesting catalog on your favorite outboard—Elto, Evinrude or Lockwood—all divisions of Outboard Motors Corporation.

OUTBOARD MOTORS CORPORATION
Ole Evinrude, Pres.
5560-27th St. Milwaukee, Wis.

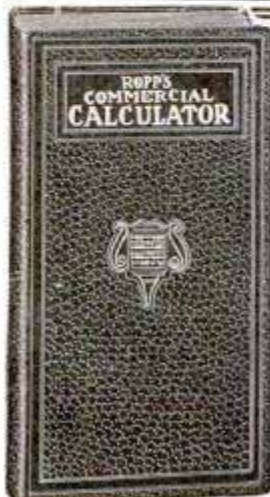

Send for
Watch
Catalogue

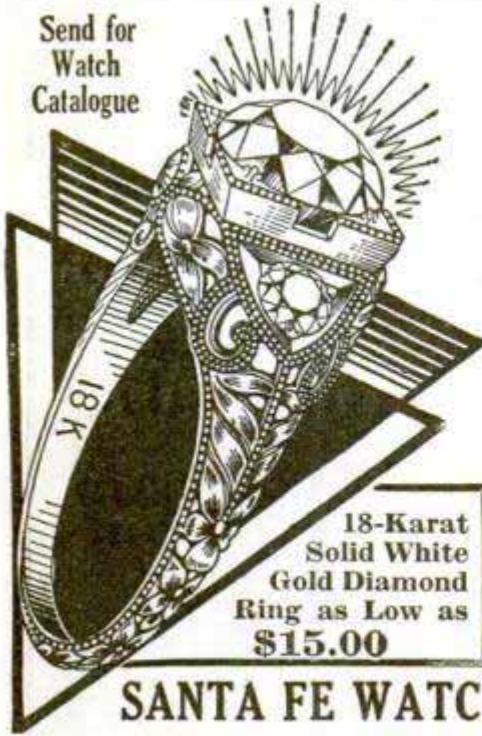

18-Karat
Solid White
Gold Diamond
Ring as Low as
\$15.00

DIAMONDS

SOLD DIRECT—CASH OR CREDIT

At One-Half Regular Retail Price

RING SENT FOR EXAMINATION FREE

Look prosperous—nothing succeeds like success. Diamonds are symbolic of success and prosperity. You can easily wear one of these sparkling blue white diamonds set in artistically designed rings of 18-karat solid white gold. Diamond ring sent on Free Examination. Compare with that of any other jeweler's. Wear the ring 10 days FREE. If not satisfied return at our expense.

SEND FOR FREE CATALOG OF BARGAINS

Every diamond ring is beautifully illustrated and accurately described and priced at ONE-HALF REGULAR RETAIL PRICE. You don't risk a penny. Write today! We are authorized distributors for the famous Rings 'O Romance. Marvelous designs in both Ladies' and Men's Rings. Catalog sent FREE.

CREDIT TERMS—A small down payment, the balance monthly.

SANTA FE WATCH CO., 563 Thomas Bldg., Topeka, Kansas

\$1000.00 REWARD

For Men and Women With Thinning Hair

Realize your hopes for luxuriant hair! Instead of paying hair specialists large fees you can now get the same results by the Pilocarpine System, employing the same ingredients and methods—at one-tenth the cost! For only \$2 you can now obtain the full Pilocarpine treatment and our secret system for growing hair. New hair is seen in 2 weeks in many cases, unless the roots are dead. Dandruff stopped, germs killed, new vigor infused in the dying roots, new life and lustre in dull, stringy hair!

HARMLESSNESS AND PURITY GUARANTEED

On proof to the contrary we will pay a cash reward of \$1,000.00 to any man or woman who has used our system properly without any result.

SPECIAL! 8,000 Pilocarpine Sets to be offered at the \$2 price in the U. S. to introduce in every town. Send check, M. O. or stamps, or pay \$2.15 on delivery. Absolute guarantee of satisfaction.

MAISON JEUNESSE, Parisian Hair Culture, 25 West Broadway, New York, Dept. A-24



Win a Buick Sedan or \$2,900.00 in Cash

SOMEONE WHO ANSWERS THIS AD will receive a fully equipped 7-passenger BUICK SEDAN or its full value in cash (\$2,000.00) and \$900.00 in cash for promptness. We are also giving away 6 Three Window Fordor FORD SEDANS, an Eastman Home Moving Picture Outfit, a Shetland Pony, a Radio, Gold Watches, Silverware and many other valuable prizes—besides Hundreds of Dollars in Cash to people who solve our puzzle and win our prizes. Already we have given away more than \$200,000.00 in cash and prizes to advertise our business. Miss Jewell Casey won \$3,720.00, Mr. I. Nystrom won \$3,375.00, Miss Anna Linke won \$2,320.00, Mr. M. D. Reidman won \$3,920.00, Mrs. Robt. Ellington won \$1,750.00 and Mr. E. N. Garrett won \$2,320.00. More than \$7,500.00 in prizes will be awarded in this offer, which is guaranteed by an old reliable company with a reputation of many years of honest dealings and is open to anyone living in the United States outside of Chicago.



Solve This Puzzle

There are many objects in the picture of the barnyard to the left, such as dog, girl, fence, automobile, rooster, boy, tent, etc. If you can find 5 starting with the letter "C," write them on a piece of paper together with your name and address and send it to me at once.

\$900.00 Given for Promptness

In addition to the 7-passenger Buick Sedan, 6 Ford Sedans and the many other valuable prizes—besides Hundreds of Dollars in Cash—I am also going to give an extra added Cash Prize of \$900.00 for Promptness to the winner of the Buick Sedan, making a total of \$2,900.00 you may win. In case of ties the Buick Sedan, making a total of \$2,900.00 you may win. In case of ties duplicate prizes will be awarded, and any winner may have cash instead of the prize won if so preferred. Get busy right away. Find 5 objects starting with the letter "C," write them on a piece of paper together with your name and address and send it to me just as soon as possible to qualify for an opportunity to share in the \$7,500.00 total grand prizes. EVERYBODY PROFITS. Who knows but that you may be the Lucky First Prize Winner? It pays to act promptly.

ROBERT HARRISON, Mgr., Dept. 1775

315 South Peoria Street, Chicago, Ill.



WADE AMATEUR MECHANICS, REPAIR SHOPS, INVENTORS, STUDENTS

BENCH LATHE

A real machine tool for the home work bench—capacity 4" dia. x 12' length. For Metal—Wood—Composition materials. Turning—Facing—Boring—Drilling—Winding—Thread Cutting. Accurate—Strong—Quiet—Compact. Slide-rest has travel entire length of bed. Leadscrew inside bed. No. 1 Lathe, plain headstock, \$40.00. No. 2 Lathe, back-geared headstock, \$68.00. Extra for lathes with 18 inches between centers, \$7.00. Complete line of accessories at equally low prices. Write for free catalog. THE GEROLD CO. Dept. P-63 120 Liberty St. New York

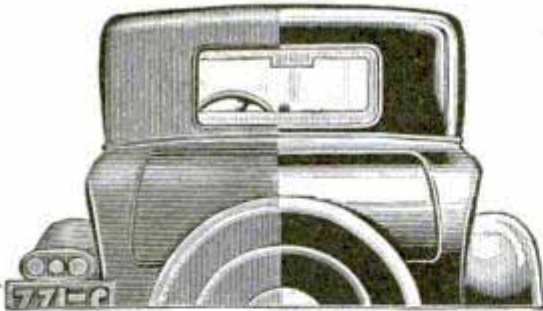

New Fluid Restores Finish of Old Autos

Unquestionably this is one of the greatest discoveries in the automobile field. Think of it! A marvelous liquid called NUREX, almost magical in its effect, does away entirely with all polishes and waxes.

WITH A SWEEP OF THE HAND

NUREX requires no rubbing, painting, cleaning nor waxing. Just a sweep of the hand and the drab, dull surface vanishes before your eyes and the hidden color gleams forth with wonderful lustre. Your car then looks like it just came from a paint shop and the beautiful new finish will last indefinitely.

PAYS BIG MONEY TO AGENTS

By merely showing NUREX you will make big money. Every car owner to whom you demonstrate will buy. Sales rapidly multiply. Every sale brings you enormous repeat business. In your spare time you can easily make up to \$5.00 or \$10 an hour with little effort.

REFINISH YOUR OWN CAR FREE

We are now appointing men in various localities to take care of the big demand. Just write us and say, "Send me your FREE sample and big money making offer and tell me how I can refinish my own car free."

Nurex Products Co., Sta. C, Dept. 225, Milwaukee, Wis.

BUILD MODEL SHIPS OF THE BETTER KIND



We can supply construction sets and all sorts of parts such as semi-finished hulls, blocks, deadeyes, special flags, anchors, steering wheels, capstans, figureheads, blue prints, books, etc., for building real fine scale models of the Flying Cloud, Constitution, Spanish Galleon, Mississippi River Steamboat, Sovereign of the Seas, Bluenose, Mayflower and many others. Also special construction sets for racing sail boats, power boats, model steam engines, propellers, etc., and fine tools for the model maker. Our large 48-page photographically illustrated booklet contains valuable information and hints for building ship models in addition to prices and full description of the above articles. Many people only slightly interested in models have become greatly enthused upon receiving this booklet. A copy will be sent postpaid upon receipt of 15 cts. (coin preferred).

MODEL SHIP SUPPLY CO., Dept. E, Mineola, N. Y.

New Complete "Wonder" Workshop



Outfit saves you \$15.00

Now you can have this new, amazing 8-in. Combination Saw (18 tools in one) shipped on 15 days' approval, at manufacturer's risk. A complete ideal machine shop for factory, workshop or home; will rip, cross cut, bevel, miter, mortise, drill, groove, tenon, grind, rabbet, buff and polish, 1/3 H. P.-A. C. motor included with all attachments. If your dealer cannot supply you, write us, giving dealer's name.

S & B MFG. CO.

Dealers Wanted P. M. 5, 4611 W. 20th St. CHICAGO, ILL.

ADD TO ANY INCOME



Costs Next to Nothing. No Personal Selling Required. Make immediate, immense and endless profits. Become a Vacuum Cleaner Builder and Service Expert. New evergrowing field.

Readily mastered under our expert advice and full instructions which are entirely free. Valuable secrets revealed for first time. We can supply all needs. Using spare-time, start a home, branch factory all your own. End uncertainty forever. Be your own boss. Pay your own salary. Undersell all. Lead all. Literature tells how and why. Join us, the originators.

URON ASSOCIATED INDUSTRIES, 1302 Engineers Building, CLEVELAND, OHIO, U. S. A.

QUIT TOBACCO

Don't try to banish unaided the hold tobacco has upon you. Thousands of inveterate tobacco users have, with the aid of the Keeley Treatment, found it easy to quit.

KEELEY TREATMENT FOR TOBACCO HABIT Quickly banishes craving for tobacco. Successful for over 50 years. Write today for FREE BOOK and particulars of our MONEY-BACK GUARANTEE.

THE KEELEY INSTITUTE, Dept. A-933, Dwight, Ill. Home of the famous Keeley Treatment for Liquor and Drugs. Booklet Sent on Request. Correspondence Strictly Confidential.



Will You Pull this Little Lever for \$100 a Week?



Now Step Into a Flourishing Business

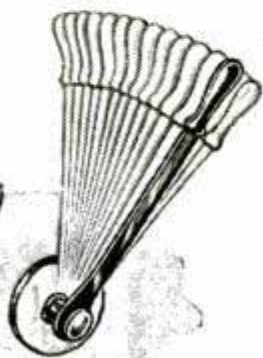

An Ohio man has now invented a clever machine that "pops" out "money" by just pulling a little lever. Already many have made even up to \$100 in a single day. Now this big company wants more men everywhere to look after its local interests on a new plan that requires no selling.

Without big capital or sales ability this machine puts you right into a "ready-made" business of your own with big money right from the start. For now this big company, originators of the most popular confections in the world, will actually let local men and women share in the tremendous nation-wide demand for this delicious confection. It is none other than famous Crispettes—nationally known—nationally advertised. Already eaten by millions of people everywhere. Honest men and women in every city, town and village are now wanted to make Crispettes fresh daily—and make deliveries to regular dealers on a new profit sharing plan. You can do it at home—in spare or full time. No big investment needed to start making big money. Profits are enormous.

No Selling To Do

No house to house canvassing. You do business with stores. New dealer profit-sharing plan gets Crispettes into nearly every store without necessity of taking orders. Repeat sales are fast on our clever "Taste It First" offer. This opening means more to you than big money quick. Get a big, steady profit day after day from nearly every store in your district. Build a permanent, prosperous business. Grocers, druggists, confectioners, bakeries, cigar stores—all push Crispettes for you. We show you just what to do to make money quick. Anyone can follow our easy, proved plan. If you don't want to call on stores yourself we show you how to get others to do it for you on our profit-sharing plan.

\$11,265 In 3 Months

Already big money records almost beyond belief are pouring in to us. Look at these examples: Ira Shook, \$365 in a single day. Marine of California, \$11,265 in sales in only 3 months. Gordon, \$4,000 profits in 2 months. Nazer, \$3,000 for 3 months. Big earnings reported by hundreds of others.

Rush Application

This liberal offer is so unusual, so generous, so different from agent and canvassing jobs that thousands will apply quick. So we urge you not to delay. Rush the application below for opening in your territory on new profit-sharing plan that makes big money without selling anything. No obligation on your part. H. W. Eakins, President, Long-Eakins Co., 528 High St., Springfield, Ohio.

H. W. Eakins, President, Long-Eakins Co., 528 High St., Springfield, Ohio.

Consider me an applicant for opening to operate Crispette business on your liberal profit-sharing plan that gets me big money without doing any "selling." I want \$25 a day. How can I get it?

Name.....
 Address.....
 City.....State.....



LUMINOUS PAINT

Make Your Watches, Clocks, Etc., Visible by Night

The very latest discovery in the scientific world, Hitterto, practically unobtainable, succeeded in producing this remarkable LUMINOUS PAINT, which, applied to the surface of any article, emits rays of white light, rendering it perfectly visible in the dark. **THE DARKER THE NIGHT, THE MORE BRILLIANT IT SHINES.** Quite simple to use. Anyone—you can do it. A little applied to the dial of your watch or clock will enable you to tell the time by night. You can coat the push buttons or switch plates of your electric lights, match boxes, and innumerable other articles; make your own Luminous Crucifixes, Luminous Rosaries, etc. Small bottle, price 25c. Larger sizes, 50c and \$1 postpaid. **JOHNSON SMITH & CO., Dept. 801 RACINE, WIS.**



Cigarette Maker

Roll your own and save money. Better and quicker; saves more than half. Use your favorite brand of tobacco. Nat. useful, handy. Pocket size, weighs 1/2 oz. Made entirely of metal, nickel plated. 25c, 3 for 65c.



GOOD LUCK RING

Very striking, quaint and uncommon. Silver finish; skull and crossbones design, two brilliant, flashing gems sparkle out of the eyes. Said to bring good luck. Only 25c ppd.



Exploding Cigarettes

Box contains ten genuine cigarettes of excellent quality. They appear so real, but when each cigarette is about one-third smoked, the victim gets a very great surprise as it goes off with a loud BANG! A great mirth provoker yet entirely harmless. Price 25c box.



U. S. BABY TANK

25 Cents



It goes with real Yankee Pep—by its own power. Most remarkable toy ever invented. By drawing the Tank backward, either with the hand or over the floor or table and then placing it down, it will crawl along, overcoming all obstacles, in the same life-like manner as the larger Tank that proved so deadly in the great war. What makes it go is somewhat of a mystery, for there is no mechanism to wind up as is usually understood with mechanical toys, yet this tank will keep plodding along ten times longer than the ordinary run of toys. It will perform dozens of the most wonderful stunts; 2 1/2 inches long. Price only 25c prepaid.

NOVELTY BADGES



Kissing Permit 10c. Garter Inspector 10c. Two very novel metal badges, nickel plated, that you can wear, giving you fun out of all proportion to their trifling cost. 10c, each badge, 3 for 25c, or 75c per doz. postpaid anywhere.

MIDGET BIBLE



GREAT CURIOSITY Smallest Bible in the World. Size of a postage stamp. 200 Pages. Said to bring good luck to the owner. A genuine work of art. Must be seen to be appreciated. Make good money selling them to friends, church acquaintances, etc. PRICE 15c each, 3 for 40c, 12 for \$1.35, 100 for \$7.50. Also obtainable in Leather Binding, with gold edges. Price 50c each, 3 for \$1.25, \$4.50 per doz. Magnifying Glass for use with Midget Bible 15c.

STAGE MONEY



With a bunch of these bills, it is easy for each person of limited means to appear prosperous by flashing a roll of these bills at the proper time and peeling off a genuine bill or two from the outside of the roll, the effect created will be found to be all that can be desired. Prices, postpaid: 40 Bills 20c, 120 for 50c, or \$3.50 thousand postpaid.



Wonderful X-Ray Tube

A wonderful little instrument producing optical illusions both surprising and startling. With it you can see what is apparently the bones of your fingers, the lead in a lead pencil, the interior opening in a pipe stem, and many other similar illusions. Price 10c, 3 for 25c.

SURPRISE MATCHES

More fun than fighting with your wife. Look just like ordinary matches. As the victim tries to light one he gets quite a surprise. Price 10c per box, 3 boxes for 25c, 12 for 75 cents.



Lots of harmless fun and amusement wearing these rings. Made in platinum finish (to resemble platinum), with wording on enameloid, as illustrated. Price only 25c Postpaid.

BLANK CARTRIDGE PISTOL



Well made and effective, modelled on latest type of Revolver; appearance alone is enough to scare a burglar. When loaded it may be as effective as a real revolver without danger to life. It takes standard .22 Cal. Blank Cartridge—obtainable everywhere. Special cast with order offer: 1 Superior quality Blank Cartridge Pistol, 100 Blank Cartridges, and our new 550 page De Luxe Catalog of latest novelties; all for ONLY \$1.50. Shipped by Express only. Cannot go by parcel post. Extra Blank Cartridges 50c per 100. Special Holster (Cowboy Type) for pistol 50c. No C. O. D. shipments.

LOOK 35c LOOK Instrument.



Everybody delighted with it. Odd, Curious and interesting. Lots of pleasure as well as very useful. It is a double Microscope for examining the wonders of nature. It is also an Opera Glass, a Stereoscope, a Burning Lens, a Reading Glass, a Telescope, a Compass, a pocket Mirror, and a Laryngoscope—for examining eye, ear, nose and throat. It is worth all the cost to locate even one painful cinder in the eye. Folds flat and fits the pocket. Something great—you need one. Don't miss it. Sent by mail. Only 35c or 3 for \$1.00

THROW YOUR VOICE

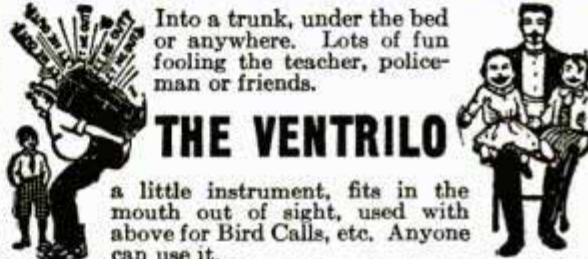

Into a trunk, under the bed or anywhere. Lots of fun fooling the teacher, policeman or friends. **THE VENTRILIST** a little instrument, fits in the mouth out of sight, used with above for Bird Calls, etc. Anyone can use it.

Never Fails. A 16-page course on ventriloquism, the Ventrilo. ALL FOR 10 CENTS

PISTOL CIGARETTE CASE



It looks like a deadly weapon, but it is merely a novel Cigarette Case. This clever contrivance has proved itself better than the real thing in many an awkward encounter. Great fun "sticking up" your friends. They squirm and protest it might be loaded. Pull the trigger and the slide flies open disclosing the cigarettes. Well made, light and compact. Weight only 2 ounces. PRICE POSTPAID 25c

MAGICIAN'S BOX OF TRICKS



Apparatus and Directions for a Number of Mysterious Tricks. Enough for an Entire Evening's \$100 Entertainment.... **Anyone Can Do Them** It is great fun mystifying your friends. Get this Conjuror's Cabinet, and you will be the cleverest fellow in your district. It contains the apparatus for ten first-class tricks, including The MAGIC BALL AND VASE TRICK (a wooden ball is placed inside, and upon replacing the lid has disappeared and is found in someone else's pocket); The HINDOO TRICK CARDS (can be made to change completely no less than five times); DISAPPEARING COIN BOX (a coin, placed in the wooden box, vanishes entirely or changes into a coin of another denomination); The GLASS GOBLET TRICK (a coin is dropped into a glass of water and when the water is poured out the coin has vanished and is found somewhere else); The RIBBON FACTORY FROM THE MOUTH TRICK (a seemingly endless supply of colored paper ribbons comes out of your mouth); the DISAPPEARING HANDKERCHIEF (a handkerchief held in the hand mysteriously vanishes); the WIZARD'S RING COIN TRICK; the ENCHANTED BOTTLE (no one but yourself is able to make it lay down); the GREAT HAT AND DICE TRICK (a large die is placed on top of a hat, disappears, and is found underneath yet no one has touched the hat), and last, but not least, the GREAT PHANTOM CARD TRICK, or two from five leaves nothing. Full instructions are sent for performing each trick. In addition to the above, a number of other feats and illusions are fully explained for which you can easily make or procure the necessary apparatus. Price complete \$1.00 postpaid.

JOHNSON SMITH & CO., Dept. 801, RACINE, WIS.



JOHNSON SMITH & CO.

Dept. 801 RACINE, WIS. A De Luxe Edition of our new CATALOG mailed on receipt of 25c. Handsome binding. Bigger and better than ever. Only book of its kind in existence. Nearly 700 pages of all the latest tricks in magic, the newest novelties, puzzles, games, sporting goods, rubber stamps, unusual and interesting books, curiosities in seeds and plants, etc., unobtainable elsewhere. Remit by Coin, Money Order, Check or unused U. S., Canadian and Foreign Stamps for all articles listed above.



THIS MAN IS MAKING \$4⁰⁰ to \$6⁰⁰ an hour!

SHARPENING LAWNMOWERS in Spare Time With the "IDEAL" LAWNMOWER SHARPENER Man, Why Don't You Do That?

You've got the chance—the same chance as W. T. Moore, Twin Falls, Idaho, who made \$1200 net profits in 90 days—the same chance as Walter Wever, Middletown, N. Y., who made \$1000 in 4 months—the same chance as hundreds of others who have reaped rich rewards with this amazingly efficient lawnmower sharpener.

Use Your Spare Time. If you work at a trade, put an Ideal in your basement and earn \$4 to \$6 an hour evenings and Saturday afternoons. E. W. McCormick, Saginaw, Mich., writes: "Five years ago I bought an Ideal Sharpener on which I have ground over 5,000 lawnmowers. In the last few weeks I worked at my trade, machinist, full time 9 hours a day. I also ground 97 mowers which netted me \$114.10 clear gain."

Pays for itself and makes big profits: C. S. Coburn, Little Rock, Ark., writes that his "Ideal" Sharpener earned enough in 18 months to pay for itself and \$1857.00 worth of additional machinery.

Our Free Book Tells You How—these men and many others have made themselves independent—built substantial, permanent, BIG PAYING businesses with this Ideal Sharpener. Send for this book today—It's Free.

FREE BOOK TELLS HOW OTHERS DO IT!

THE "IDEAL" LAWNMOWER SHARPENER is a wonderfully simple machine that sharpens all makes of mowers perfectly, scientifically, without taking the mowers apart. Just pick up the mower, set it in the "Ideal," make a few simple adjustments and proceed to sharpen. In 15 minutes the mower is ready for the lawn, and you have made \$1.50 to \$2.00—depending upon the charge you fix. No training required, and machine set up in a few minutes. Plug into light socket and start to sharpen. Hundreds of dull mowers in your locality are waiting to be sharpened. Owners are looking for a place to get them sharpened. Sharpens skates—all kinds—perfectly.



SIGN THIS AND MAIL TODAY

THE FATE-ROOT-HEATH CO.
918-944 Bell St., Plymouth, Ohio.

Send me the book that tells me how I can make my spare time worth \$4 to \$6.00 per hour.

Name.....

Address.....

AGENTS AND SIGN MEN

Earn up to \$100 Weekly, and over, Putting up OUR GENUINE GOLD LEAF SIGN LETTERS

R—on store and office windows, board signs, trucks and glass signs. We also make to order script signs and business emblems singly or by the thousands. A permanent business. No capital or experience required. Big demand in every City. Samples and Literature Free.

CONSOLIDATED SIGN LETTER CO. 71-X W. Van Buren St., Chicago, Illinois

MASTER INTERLOX SLIDE RULE

MASTER RULE MFG. CO., Inc., 821 E. 136th Street, NEW YORK CITY

EXACT INSIDE MEASURE

Ask the Dealer or send 20c each lineal foot

Every kind of Inside Measurement. Just slide out the MASTER till it reaches from stop to stop. No guessing. Quick results. Locks rigid in use. Without equal for Outside measure, too. Dealers and Agents Wanted

The WILBAR 12" BANDSAW \$57.50

Complete as illustrated ready to operate from any light socket with 1/4 H. P., 110 V., 60 C., A. C. Motor and Extra Bandsaw Blade. Table Top will tilt from 0 to 45 degrees with Ball Bearing Guides. Shipping weight 155 lbs. \$47.50 without Motor, F.O.B. Phila.

8" COMBINATION SAW OUTFIT \$45

Complete F. O. B. PHILA. with Ball Bearings, 1/4 H. P. Double Shaft Motor. Base 28" long by 8" wide. Table Top 18" by 12". Will Rip, Crosscut, Bevel, Grind, Mitre, Groove, Sand, Mortise, Tenon and Polish. Everything complete ready to plug in any light socket. Same specifications without Ball Bearings, with 18" by 12" Table Top—\$35.00. Saw Table only with Combination Blade and 1/4 H. P. Motor \$30.00. Order direct or through your Hardware Dealer.

Catalog Free in which these outfits are clearly pictured. Also contains Bench Lathes, Complete Workshop and Hardware Specialties Dept. A-5

CARLISLE MOULD WORKS, Inc., M'ILLVILLE, NEW JERSEY

CAILLE REDHEADS

Newest Thing in Outboard Motoring!



Electric Starting . . . Multi-Flexible Control

Simply touch a button and your motor starts! The same dependable starting you enjoy in your automobile, combined with three speeds forward, neutral and slow reverse. Load your boat with motor running . . . back away from the dock by a simple move of a hand on the control lever . . . go forward at trolling speed or shift into high in a jiffy, with all the ease and maneuverability of a modern motor car. This is brought to you in the 1930 Caille REDHEADS. Get the complete story.

CAILLE MOTOR COMPANY
6455 Second Blvd. Detroit, Michigan

Mail Coupon at once for New Caille Catalog



Please mail complete information on the New 1930 Caille Redheads.

Name.....
Address.....
City..... State.....



Earn
\$150
to \$300
MONTHLY

COSTS ONLY
\$16 MONTHLY
30 DAY TRIAL

START A MONEY MAKING BUSINESS OF YOUR OWN

Mechanics, Filling Stations, Repair Shops, Garages and Battery Stations are all making **BIG MONEY** with **HB 8 Hour Battery Service**. Recommended by the leading car and battery makers. Constant Potential lets you give a better charge than the other fellow in one-third the time, and at a saving of 30% to 50% on current. Anyone can operate. Check coupon below for full information on how to get started in this money making work. **Shouldn't Cost You a Cent. Pays for Itself—Brings a Big Profit Besides.**



CAR WASHER

20-Minute Car Washing

The best paying work in automotive field today is 20 minute car washing. Puts you above competition—eliminates all drudgery! Users report \$100 weekly profits. Liberal trial, easy terms. Savings in labor and material over other methods will easily pay for it.

Earn 5 Men's Wages

Portable Paint Spray does the work of five brush painters. You get four men's wages as profit. Paints Cars, Houses, Garages, Barns, Furniture. No experience necessary to operate. Check coupon for trial offer and terms.



Paint Spray

Air Service

Profitable Air Service

Free Air Service costs you only \$10 monthly for a few months. Fully Automatic day and night service will draw customers to your shop as well as operate your air tools. Check coupon for full details without obligation.



HOBART BROS., Box M50, Troy, Ohio

—Tear off and Mail Today—
Hobart Brothers, Box M 50, Troy, Ohio. Send me complete information on the items I've checked—your thirty-day trial offer—easy payment terms—information on how HB equipment will increase my earnings.
 HB 8 HOUR BATTERY CHARGER
 HB TEST BENCH HB PAINT SPRAY
 HB AIR SERVICE HB 20-MINUTE CAR WASHER

Name.....Address.....

SPORS GUARANTEED No. 1 FOUNTAIN PEN

SELLS FOR \$1.25
SEND ONLY

39c
Sent Post-Paid

"Writes Like a \$7 Pen."

Use 60 Days
Money Back If Not Pleased



AGENTS! CHANCE TO MAKE \$10 TO \$20 A DAY.

Write for Free Wholesale Catalog Showing Over 400 Articles.

F. SPORS & CO., 330 Main Street, LESUEUR CENTER, MINN.

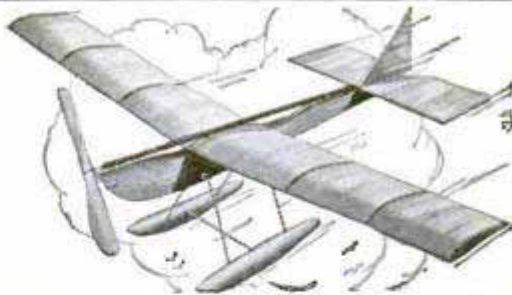

Build and Fly this New Ideal "CONDOR"

Plans for Model Airplanes 25c each

- Floyd Bennett Monoplane
- Fokker Monoplane
- New York-Paris Plane
- Curtiss BiPlane
- DeHaviland BiPlane
- NC-4 Naval Seaplane
- Bleriot, Nieuport or Monoplanes
- Cecil Peoli Racer

The latest idea in Featherweight Models; 22 in. size and weighs only 1/4 oz. Simplified, advanced design; all Balsawood construction; adjustable wings; adequate power for long flights; interchangeable landing gear; easy, quick construction. Get the **CONDOR—Construction Set . . . \$1.**

Ask your Dealer, or Order Direct. (Postage 15 cents extra)
Catalog of Parts, Fittings, Supplies **5 cents** for Model Builders.....

IDEAL AEROPLANE & SUPPLY CO., Inc.
26 West 19th Street New York

THE MAGIC AERIAL and STATIC FILTER

The Greatest Discovery in Years

Heralding a New Age in radio reception, **THE MAGIC AERIAL and STATIC FILTER** banishes costly, hazardous aerial wires and provides **perfect radio reception, safety and ultra convenience.**

Smaller than a tube, fits **inside** set and replaces **outside** of inside aerial wires. Eliminates electrical hazards, produces **even** volume, easier tuning.



Minimizes static, reduces interference.

Fully Efficient on Electric or Battery Sets

DEALERS—WRITE.

Capacity equals 60 Ft.—75 Ft. of aerial wire. Non-directional, non-corrosive. Will not wear out.

Only \$2.00 complete, at your dealer's.

VEE-CEE MFG. CO.

101 So. Wells St. Dept. PM5 Chicago, Ill.

\$12.75

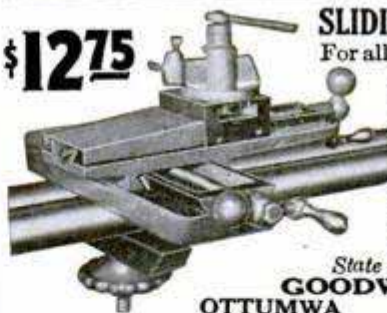

SLIDING TOOL RESTS: \$12.75

For all lathes from 6" to 13" swing. Ways are milled and gibbed for take-up. Has 8" cross feed and 8" longitudinal feed. Shield lifts off for turning large diameters at extreme left. 7 1/2" to 13" swing has tool holder and H. S. bit, as shown. 6" to 7 1/2" has 1/8" straight H.S. bit.

State swing with order

GOODWIN MFG. CO.

OTTUMWA

IOWA

IF YOU WANT TO FLY

read Alexander Klemin's great book. This brilliant engineer is the first to succeed in marvelous fashion to make the whole subject of flying intelligible to a child and at the same time of absorbing interest and information to every grown-up.

256 Pages—75 Illus.—Cloth.—Price \$2.50 Postpaid

Popular Mechanics Press—200 East Ontario St., Chicago

Enjoy the Thrill of Making Things Quickly and Easily with the NEW 1930 Delta ELECTRIC Handi-Shop



Make the things you have always wanted to make, with this sturdy, full-sized equipment. Save money on repair work—earn money in spare time. It is so easy—so quick with the "Delta." Complete Handi-shop includes all necessary equipment for Circular Sawing, Wood Turning, Scroll Sawing, Sanding, Drilling, Grinding and Buffing. Full instructions and complete set of working blue-prints furnished.

Many Exclusive Delta Features

You will be delighted with the sturdy construction, splendid efficiency, and moderate cost of this Delta equipment. You will appreciate keenly in the "Handi-Shop" such exclusive constructional features as the Patented Tilting Tables, Automatically-Oiled Bronze Bearings, Heavy U-Shaped Lathe Bed, and Circular Saw Raising Lever. Send coupon for complete description of this remarkable workshop.

New Woodworking Units

The introduction of the Delta Jointer and Circular Saw Units marks a new era in moderately priced wood-working equipment. Now, for the first time, are available sturdy, practical machines in compact, convenient form at price levels astonishingly low. The individual units are built ruggedly to give years of heavy service. Both incorporate many special features of great value. The combination unit affords a compact, convenient arrangement which permits sawing and planing in one quick operation. Either Jointer or Saw can be operated separately or both together. Welded steel stand of convenient height. All three units are furnished with or without motor, as desired.

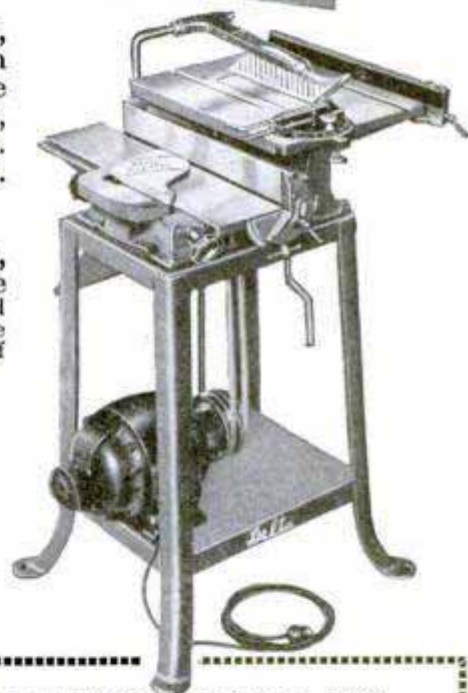

10 Day Trial — Easy Terms

For complete details and full description of the new 1930 Delta line, send coupon for FREE illustrated literature. Shows many items of interest to those who work with wood. You will learn, also, how you can try any Delta equipment for 10 days under actual working conditions **at our risk**. Choice of three convenient payment plans. Mail coupon TODAY!

DELTA SPECIALTY CO.

Division of "Delta Manufacturing Co."

1661-67 Holton St., Dept. A. 530, Milwaukee, Wis.

DELTA SPECIALTY COMPANY, Dept. A. 530
Division of "Delta Manufacturing Co."
1661-67 Holton St., Milwaukee, Wis.

Please send me FREE, illustrated literature describing 1930 model "Delta" Woodworking Units. Also details of 10-Day Trial Offer and Easy Payment Plans. (Check special information desired.)

- Handi-Shop Moulding Cutter
 4" Jointer Units 8" Circular Saw Unit
 Combination 4" Jointer and 8" Circular Saw
 New Delta Band Saw.

I am interested for home use for shop use

Name.....
Address.....

Get Into A Business of Your Own — EARN \$150 to \$300 Monthly

8 HOUR
BATTERY
CHARGING



Start a BIG PROFIT-MAKING BUSINESS of your own—"8 Hour Battery Charging." Requires SMALL SPACE AND PRACTICALLY NO INVESTMENT. Anyone can successfully operate. Charges batteries in $\frac{1}{4}$ the time at $\frac{1}{4}$ the cost. EVERY CAR OWNER A CUSTOMER. 20 minute Car Washing, Electrical Service, Spray Painting and Arc Welding offer same opportunity. HB shouldn't cost you a cent—it will pay for itself on EASY MONTHLY PAYMENT PLAN, with practically no expense and with a handsome profit for you. WRITE NOW for details stating what you're interested in to Hobart Brothers, Box M501, Troy, Ohio.

30 DAYS TRIAL—Pay Out of Income Terms

FREE!



This Beautiful Silvered Holton Clarinet!

With it a complete Home Instruction Book for Clarinet. You will play popular airs in five days — it's so easy. Be popular immediately in every social gathering. Join band and orchestra first month. Make money. Constant demand for clarinet players at good pay.

Send No Money

This offer is **FREE**. You keep this beautiful new Holton Silvered Clarinet and Popular Home Instruction Book 10 days. Return at our expense, or keep and pay only \$6.00 a month. Similar **FREE** loan offer on Holton Saxophone, Trumpet, or any band instrument. No obligation to buy. Just

Send This Coupon

FRANK HOLTON & COMPANY
528 Church St., Elkhorn Wisconsin
Send on 10 days **FREE** Loan new Holton Clarinet with Instruction Book, or
.....
(any other instrument)

Name.....
Address.....
City..... State.....

Free Instruction Book



BRINGS SALESMEN UP TO \$125- WEEKLY

Ash-Pak, amazing cigarette holder, completely encloses cigarette, presents ashes from falling, sparks from flying! Smokers snap it up—auto drivers buy on sight. Safe! Sanitary! Sells for \$1.00. You make big cash profit on every sale.

GET YOUR ASH-PAK FREE

New, sensational selling plan offers you your Ash-Pak **FREE**. Your sample will sell dozens in every block. No experience necessary—merely show and sell. An amazing money-maker—every smoker wants one. Made of bakelite in assorted colors. Rapid-fire seller brings you steady year-round profits. Write immediately for details of **FREE** Ash-Pak offer.

ASH-PAK SAFETY Cigarette Holder

Ashes cannot fall—sparks cannot fly—makes cigarette smoking safe, cooler and sweeter. Pays you big cash profits.

THE NORLIPP COMPANY
Dept. C-5, 568 W. Congress Street
CHICAGO, ILL.

SAVE 1/2 ON PLUMBING HEATING

Any handy man can install his own plumbing or heating by our new easy cut-to-fit method. Low wholesale prices on highest quality Grade A goods enable you to save one-half!

WE SHOW YOU HOW—BOOK FREE

Send for our new wholesale catalog. Save waste material and high labor costs. This book has saved money for home owners and builders for over 50 years.



Free Estimate—Send for Sketch Blank

OUR BONDED GUARANTEE PROTECTS YOU

HARDIN-LAVIN CO. EST. 1876
122-32A West Pershing Road, Chicago, Ill.

MORE MONEY DAILY FOR YOU SHIRTS UNDERWEAR TIES!

Men and Women—Industry's leader offers you direct-to-wearer agency. Pays big. Happy work. Thousands successful. Sample outfit free. Start at once. Write today.

DEPT. 593-K
79 Fifth Ave., New York, N. Y.



A.C. ELECTRIC LIGHT PLANTS

60 cycle, 110-volt. 1000 and 2000 watt capacity. Operate at constant voltage and cycle. Suitable for Homes, Farms, Camps, and Stand-by Emergency Equipment. Operating any Electric Tool, etc., in places where electric service is not available. D. C. Plants as low as \$139.

WRITE FOR PARTICULARS—
D. W. ONAN & SONS, 33 Royalston Ave., MINNEAPOLIS, MINN.



Now! Do Your Own Electric Nickel Plating

Introductory Offer

ONLY \$6.50 Plus Postage



For Plating Nickel, Brass, Copper, Silver, Gold, etc.

A REAL MONEY-MAKING OPPORTUNITY

NO EXPERIENCE REQUIRED. Do YOUR OWN Electro Plating in Your Home; Garage, Office, or Place of Business. Electrically Deposit Metal—Nickel, Brass, Copper, Silver, or Gold. You can Successfully do all the plating on your Automobile, Electric Fixtures, Faucets, Spoons, Forks, Chandeliers, Tools, Coffee Urns, Surgical and Dental Instruments, Utensils, large or small, Iron Stoves, Music Instruments; recondition worn plating or plate New Work; do it instantly without interrupting the Service or without removing the parts to be plated with the

ALADDIN PORTABLE ELECTRO-PLATER

Simple and Economical to operate. Not a toy, but a practical Plating Outfit with which Perfect and Durable Work can be done. Positively Guaranteed to do as we claim. **BE YOUR OWN BOSS!** Build up a Profitable Aladdin Electro-Plating Business of your Own. This offers wonderful **ECONOMY** to users and **BIG MONEY-MAKING** possibilities to **AGENTS**. Thousands in Service since 1924. Write for **FREE BOOKLET** and Testimonials and **30 DAY TRIAL OFFER** Today.

P. J. F. BATENBURG CO. Dept. 184 RACINE, WISCONSIN

—AGENTS— WANTED EVERYWHERE

True Stories of Stars who were not "born" but "made." No. 3

This coach

cuts 60 men from the squad
before they've seen the ball field

THIS happens every year at one of the biggest and oldest colleges in the country: Before they've had any real practice, while they're still working out indoors in the cage, before they've even seen the diamond, the coach often cuts as many as 60 men from the freshman baseball squad of 100.

The reason for it is this; college and prep school coaches can tell a lot about you just by watching you. They know a player, or a man who will *make* a player, by the way he handles himself.

The impression you make on the coach counts more than your past record. If you "look good" to him, he gives you a "break." If you don't, you'll have a hard time proving you *are* good.

Do you know what makes most people look clumsy? Their feet. They're slow-footed, stumbling; they fall all over themselves. Watch a star in almost any sport. His feet move like lightning, yet they never get in his way.

Learn to handle your feet. College stars train themselves in footwork. Go into a gym and what do you find—a hefty guard boxing—a stroke oar handballing—a shortstop skipping rope—usually in Keds—the Shoe of Champions.

Keds are the most scientifically built athletic shoe in the world. They have "Feltex" insoles

that keep your feet cool and comfortable. Keds' canvas tops are light, but strong. They give sure support to your ankles. And Keds have specially compounded safety soles that get a firm grip on the ground and prevent slipping and sliding.

You'll "look good" with Keds on, because Keds *help* your footwork.

There are many different styles of Keds. Choose the one that's best suited to you. You can get Keds from the best shoe dealers in town at prices from \$1.00 to \$4.00, according to the type and style you want.

FOOTWORK BUILDS STARS

Keds

REG. U. S. PAT. OFF.

THE SHOE OF CHAMPIONS

United States



Rubber Company

Keds "Conquest"

Made with the popular crepe sole, famous for wear. A special toe cap reinforcement that gives extra protection at point of hardest service. "Feltex" insole.



Free! 50 pedigreed dogs

50 pedigreed wire-haired fox terriers and 480 pairs of Keds are prizes in Keds Essay Contest for boys and girls not over 15. Get entry blank and contest details from nearest Keds dealer or write Keds Contest Editor, United States Rubber Company, 1790 Broadway, New York.



Keds "Holdfast"

This light Keds model gives excellent service for the price. Holdfasts come with white or brown uppers and have black trimmings and black corrugated soles. A sturdy low priced shoe.

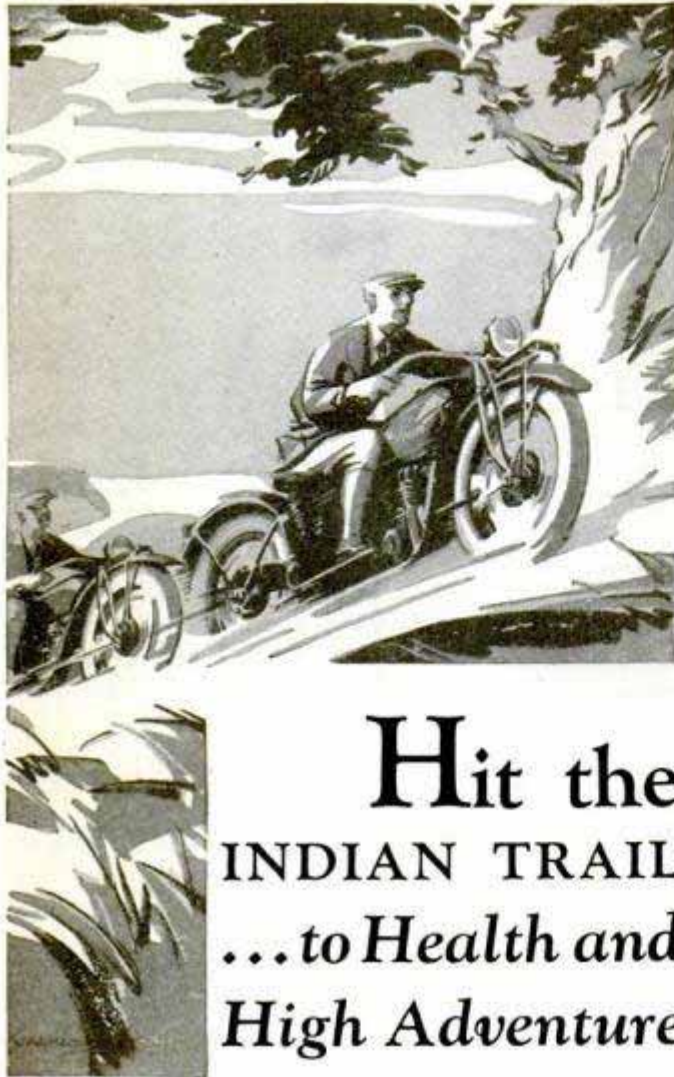

Hit the INDIAN TRAIL ...to Health and High Adventure

An Indian Motorcycle is the outdoor man's choice—it snaps away like a ball off Babe Ruth's bat . . . it slips through traffic like a clever quarter-back . . . it takes the steepest hills with the smoothness and grace of a pole vaulter . . . it skims the open road with the flash of a sprinter or throttles down to the smooth, steady pace of a cross-country runner.

If you've never driven an Indian, go to a dealer for a demonstration . . . "kick" the motor over, settle down in the comfortable, springy saddle . . . feel the thrill of power that throbs out of its big motor. Try it on the road . . . put it on the steepest hill you know . . . test it in traffic for snappy get-away—for quick, sure stopping. Then you will know why an Indian Motorcycle is "The Sportsman's Steed."

For the boating enthusiast—the new INDIAN SILVER ARROW Outboard Motor. On display by INDIAN dealers. INDIAN MOTORCYCLE CO., DEPT. C6, SPRINGFIELD, MASS.

Indian MOTORCYCLES

INDIAN MOTORCYCLE CO., DEPT. C6, SPRINGFIELD, MASS.

Send me booklets checked:

Indian Motorcycles NAME.....
 Indian Outboard Motor ADDRESS.....

Cabinet Shop Special Complete with Motor \$290 **Cash In on Your Spare Time—with a PARKS!**

Instead of sitting around wishing for extra money, go after it in earnest with a Parks equipped shop. Think of the fun and the money there is in making odd and unusual pieces of furniture and doing small repair jobs right in your own shop during spare hours. The Cabinet Shop Special, especially designed and moderately priced for the small woodworking shop, does practically everything that larger machines will do and does it just as accurately.

Send this coupon for complete catalog.

THE PARKS WOODWORKING MACHINE CO.
 Dept. P-5, 1530 Knowlton St., Cincinnati, Ohio.
 Canadian Factory: 338 Notre Dame, East, Montreal

Name.....
 Address.....

PARKS

WOODWORKING MACHINES

Every Parks Guaranteed 10 years.

QUICK MONEY FOR ACTIVE AGENTS

New method of applying monograms, initials (solid gold or any color embossed) on automobiles, trunks, golf bags, suit cases, etc. Takes five minutes—no experience. An easy process (not transfers) \$3 profit—costs 2 cts. Write now for free samples while offer is open.

BAKON MONOGRAM CO.
 Dept. 15, 4028 Greenview Av., CHICAGO

In Six Weeks—

\$45

You can be living in this snug, cozy Liberty Home

Home-building goes like clock-work with our mill-cut lumber and easy construction plans. Mrs. A. A. Bishop moved into her home one month after starting. Hundreds of other home builders saved \$288 to \$1000 and more building the Liberty way. Beautiful life-time homes from \$329 to \$1558. Price includes all highest quality lumber cut-to-fit, doors, windows, stairs, high-grade interior woodwork, lath, shingles, hardware, glass, paints, nails, etc., complete. Porch included. Time payments if desired. Materials fully guaranteed.

Write for big Catalog—FREE

LIBERTY HOMES
 Lewis Mfg. Co. Dept. 12-E Bay City, Mich.

WE PAY FREIGHT

Get Going! ON A REAL FUTURE!

YES! You can make a real future as a Clarke Flor-Kraftsman. It's easy—no trade to learn—no books to buy—no office—you start earning big profits the first day. There's no magic—no bunk about it. It's an honorable, highly respected, big profit-paying business of your own—the business of surfacing floors in new buildings and resurfacing those in old buildings right in your own community. The work is done

by the light weight, high speed, powerful, fast-cutting *Clarke Vacuum Portable Sander*—the most marvelous wood surfacing machine ever built. With little effort you just guide it and on old floors resurface 300 to 1000 sq. feet in a day and this work pays from 7c to 15c a sq. foot and on new work 900 to 2200 sq. ft. at 3c to 5c a sq. foot. Figure out the profit. There is need for several thousand FlorKraftsmen today. About \$100.00 will start you in this profitable business. Act now. Lick the low pay long hour no-future job. Get the things you want in life without the eternal fight against mounting bills. Flor-Kraft will do this for you. Mail the Coupon. Get the facts. There is no charge, no obligation. Act now!

CLARKE SANDING MACHINE CO.
Dept. T-35—3831 Cortland St., Chicago, Ill.
Originals and for 15 years manufacturers of Portable Sanding Machines.

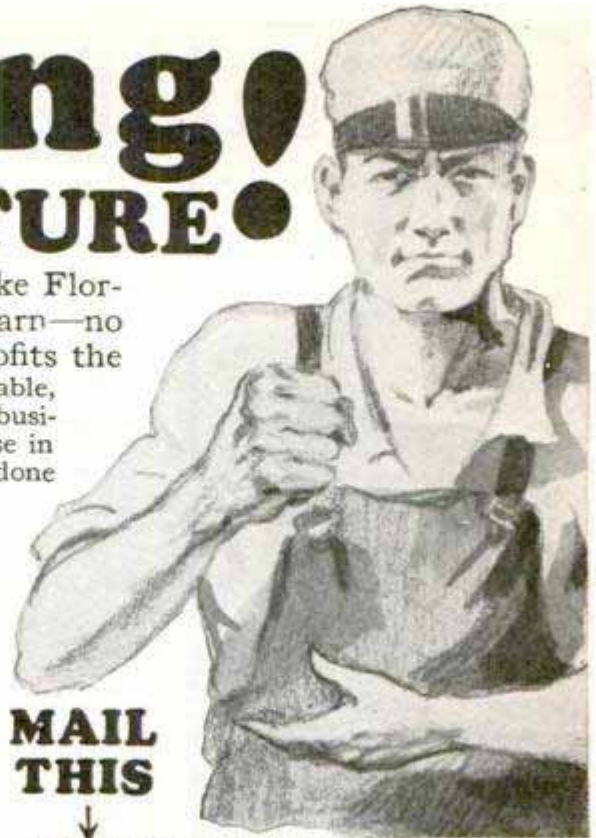

MAIL THIS

CLARKE SANDING MACHINE CO.,
Dept. T-35—3831 Cortland St., Chicago, Ill.
Gentlemen: Please send me, without obligation, full details on the Clarke Sander, and the money-making possibilities of FlorKraftsmanship.

Name.....
Address.....
City..... State.....



SEMI-BUILT \$265.00
Assemble yourself stamps for Catalog
TRUSCOTT BOAT COMPANY, ST. JOSEPH, MICH.

ITALIAN ACCORDIONS
Best in the world. 10-year guarantee, lowest prices. FREE instruction, ask for FREE catalog. RUATTA, SERENELLI & CO., 1014 Blue Island Ave. Dept P, Chicago, Ill.

The man who studies gets ahead. Popular Mechanics Press will advise you what books to read to advance in your trade. 200 East Ontario Street, Chicago, Illinois.

Mechanical Toys Ship Models, Colonial Bric-a-Brac, Leather and Celluloid articles and hundreds of other useful things are described in our new book, *Make It Yourself*. 460 Pages. Illustrated. Price \$3 Postpaid.
POPULAR MECHANICS PRESS, 200 E. Ontario St., Chicago

**\$2,840 Taken
By Clynic in His
First Two
Months**

4 to 6 Jobs a Day—One Man—Powerful—Light

Big Profits—and Your Own Boss

Furnace cleaning with a **Super Suction Cleaner** is an all-year money maker, and you can own this new, highly profitable business on easy terms.

In his first 2 months Clynic had 178 cleanings at \$1,424; 74 repair jobs and 15 complete overhauls bringing \$1,416. Total, gross: \$2,840. And he sold nine new furnaces besides.

You need not be an expert furnace man to get big profits. Our free **Plan Book** tells how to make money from the start. Send coupon for it today.

The National Super Service Co.
1958 N. 13th St., Toledo, Ohio.
Please send Plan Book and easy terms.

Name.....
Street.....
City..... State.....

6 Vital Improvements

... what a difference they make in your shave

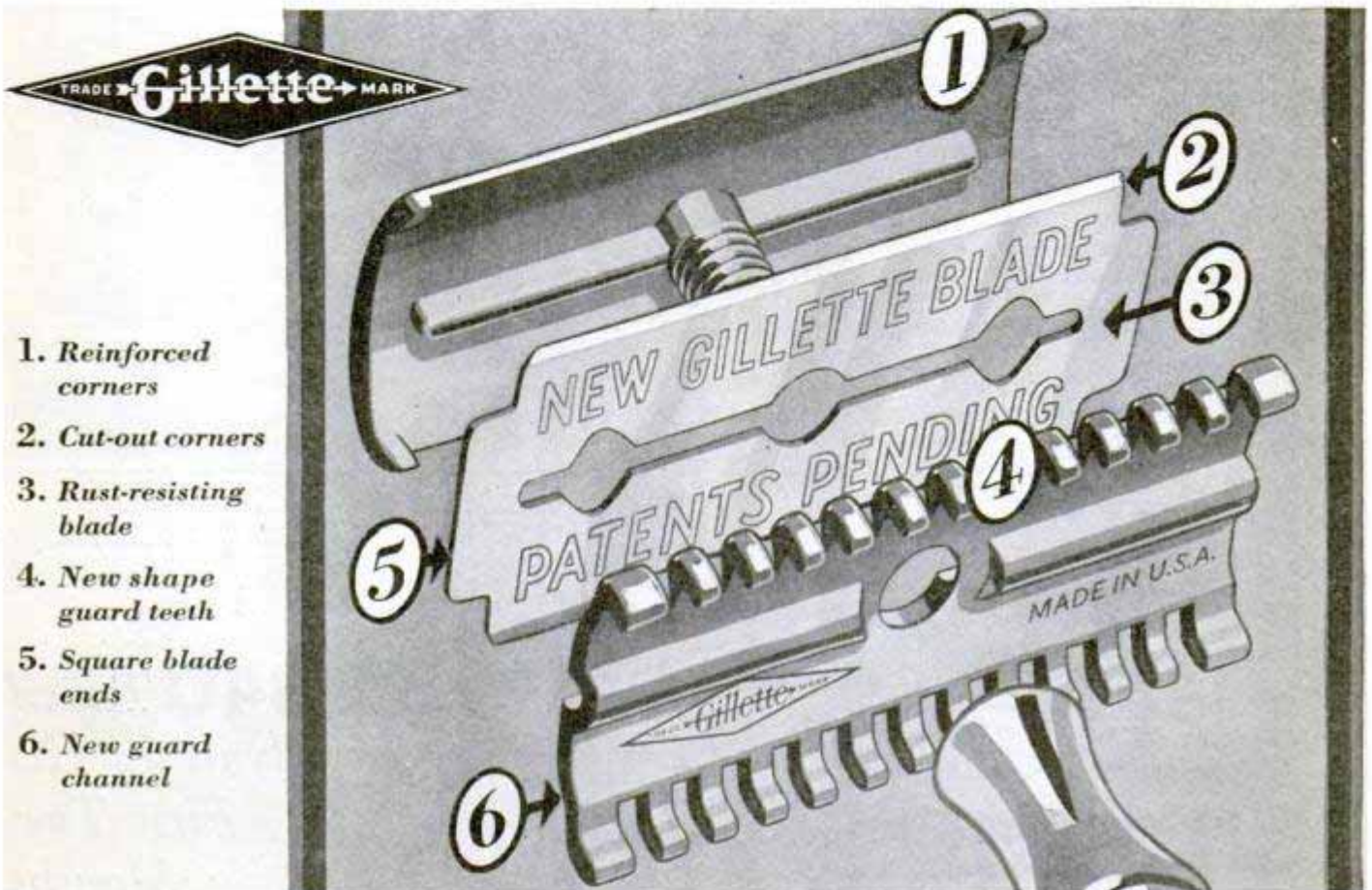

1. Reinforced corners
2. Cut-out corners
3. Rust-resisting blade
4. New shape guard teeth
5. Square blade ends
6. New guard channel

NO WONDER millions of men have thrown away their old razors for this New Gillette. Its reinforced razor cap and cut-out blade corners, in combination with the new shape guard teeth, abolish "razor pull." Its specially processed new blade resists rust. You merely shake it dry—no more tedious wiping—no more cut towels.

Then there are the new guard channel and the square blade ends—six reasons in all why the New Gillette gives you the fastest, smoothest, most comfortable shave you've ever had.

Here is your chance to have the greatest bargain in shaving comfort and convenience that \$1.00 has ever bought: The New Gillette Razor, 24K. gold-plated, in a handsome case, and one New Gillette Blade. Additional new blades are priced the same as the old, one dollar for ten, fifty cents for five. Your dealer has both waiting for your call.



\$1.00 for ten and
50c for five.
The New Gillette
Blades in the new
green packet

The New Gillette Razor, 24K. gold \$ **1.00**
plated, in a beautiful case, complete
with New Gillette Blade . . . Price
Other De Luxe Models at \$5.00 to \$75.00

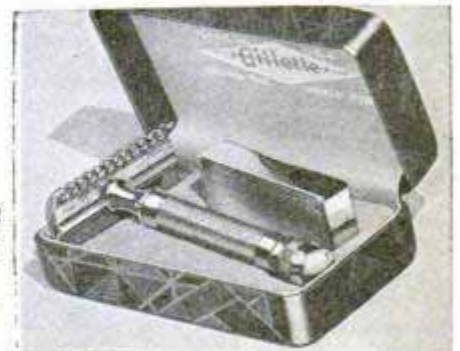

GILLETTE SAFETY RAZOR CO., BOSTON, U. S. A.

The New Gillette Shave

CHIEF LONG LANCE tells about speed in the Sign Language



RUN . . .

Bring both hands in front of chest, index fingers extended, right index finger nearer to body and parallel with left index finger; then with wrist action, cross right index finger over left and left over right several times in quick succession, reversing position in circular motion.

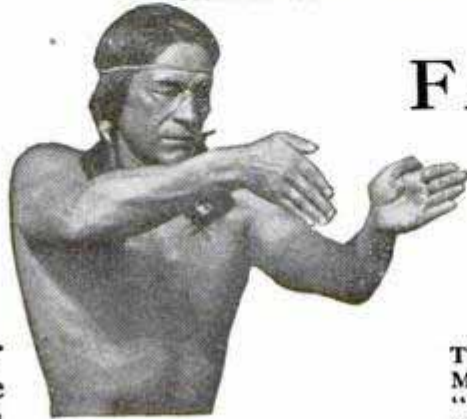

FAST

Bring left hand in front of chest, pointing forward, palm facing right. Bring right hand between left hand and right shoulder, fingers pointing downward. With quick movement carry right hand downward and upward, ending movement with right hand in front of left.

“CANVAS rubber-soled shoes give free play to the feet and leg muscles. They are most like Indian moccasins in strength building of any modern shoe.”

So writes Chief Long Lance, and in the pictures shown here, using the language he learned before ever he heard English spoken, he describes the athletes who observe this strength-building principle.

Chief Long Lance designed the remarkable new sport shoe which bears his name. It is illustrated below.

The full story of how he discovered the “barefoot tread,” and what it means to every athlete, is told in his booklet on the Indian Sign Language.

THE CHIEF'S OWN Moccasin showing the “barefoot tread.” Compare it with the sole of the Chief Long Lance Shoe. The flexible shank allows the long “lift” in every step—that builds power and speed. The “barefoot tread” supports your foot as nature intended.

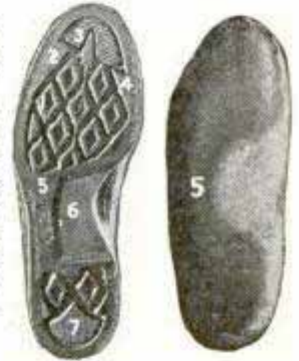

TEN FEATURES: 1. Indian Design. 2. Dodging Pivot. 3. Brake. 4. Whirling Pivot. 5. Barefoot Tread. 6. Flexible Shank. 7. Non-Skid Heel. 8. Instep Grip. 9. Cushion Inner Heel. 10. Form-Fit Tongue.



CHIEF LONG LANCE explains the sign language with over 80 illustrations in a big 32-page booklet. The story is told, too, of how he discovered the principle of his shoe. Send for this valuable booklet now.

Goodrich

Sport Shoes



The B. F. Goodrich Rubber Co. 3M Akron, Ohio

Enclosed find 10c in coins or stamps. Please send me “How to Talk in the Indian Sign Language” by Chief Buffalo Child Long Lance.

Name.....

Address.....



Col. Edw. V. Rickenbacker and a 30-passenger Fokker

This
Spring
get into

AVIATION!

EDDIE RICKENBACKER had the right ideal. Twenty-five years ago he was just a boy working in a garage. He took the International Correspondence Schools Automobile Course — studied in spare time and learned the fundamentals of gasoline engines. That was the groundwork of his famous career — first as an automotive engineer and race driver — then as America's foremost ace in France — now as Vice-president of the great Fokker Aircraft Corporation.

Aviation holds the greatest future of any career a young man can choose. Get into it *now*, by the shortest, most practical route—from the ground, as a mechanic. *Study engines!*

The new I. C. S. Course in Aviation Engines offers you a marvelous opportunity. You don't have to have experience or a large amount of capital. You don't have to give up your present job. At home, in spare time, you can gain the knowledge of aviation motors that will qualify you as a mechanic.

The course is thoroughly modern and complete. It gives you a working knowledge of every up-to-date type of aviation engine — principles, construction, operation, maintenance and repair. Prepared by such experts as Lieutenant Commander D. M. Carpenter, U. S. N., formerly in charge of ground training at the Pensacola Naval Air Station, and others.

Find out today, without cost or obligation, just how this course will prepare you for a career. Mail the coupon *now!*

INTERNATIONAL CORRESPONDENCE SCHOOLS

"The Universal University"

Box 5681-F, Scranton, Penna.

Without cost or obligation on my part, tell me how I can qualify for the position or in the subject before which I have marked an X:

AVIATION ENGINES

- | | |
|---|--|
| <input type="checkbox"/> Complete Automobile Course | <input type="checkbox"/> Complete Gas Engine Course |
| <input type="checkbox"/> Automobile Electric Equipment | <input type="checkbox"/> Architect |
| <input type="checkbox"/> Electrical Engineering | <input type="checkbox"/> Architects' Blueprints |
| <input type="checkbox"/> Electric Lighting | <input type="checkbox"/> Contractor and Builder |
| <input type="checkbox"/> Mechanical Engineer | <input type="checkbox"/> Architectural Draftsman |
| <input type="checkbox"/> Mechanical Draftsman | <input type="checkbox"/> Concrete Builder |
| <input type="checkbox"/> Machine Shop Practice | <input type="checkbox"/> Structural Engineer |
| <input type="checkbox"/> Railroad Positions | <input type="checkbox"/> Pharmacy <input type="checkbox"/> Chemistry |
| <input type="checkbox"/> Civil Engineer <input type="checkbox"/> Mining | <input type="checkbox"/> Agriculture |
| <input type="checkbox"/> Surveying and Mapping | <input type="checkbox"/> Navigation |
| <input type="checkbox"/> Plumbing and Heating | <input type="checkbox"/> Mathematics |
| <input type="checkbox"/> Steam Engineering | <input type="checkbox"/> Radio |
| <input type="checkbox"/> Gas Engine Operating | |

BUSINESS TRAINING COURSES

- | | |
|---|---|
| <input type="checkbox"/> Business Management | <input type="checkbox"/> Show Card and Sign Lettering |
| <input type="checkbox"/> Industrial Management | <input type="checkbox"/> Stenography and Typing |
| <input type="checkbox"/> Personnel Management | <input type="checkbox"/> English |
| <input type="checkbox"/> Traffic Management | <input type="checkbox"/> Civil Service |
| <input type="checkbox"/> Accounting and C.P.A. Coaching | <input type="checkbox"/> Railway Mail Clerk |
| <input type="checkbox"/> Cost Accounting <input type="checkbox"/> Bookkeeping | <input type="checkbox"/> Grade School Subjects |
| <input type="checkbox"/> Secretarial Work <input type="checkbox"/> Salesmanship | <input type="checkbox"/> High School Subjects |
| <input type="checkbox"/> Spanish <input type="checkbox"/> French | <input type="checkbox"/> Illustrating |
| <input type="checkbox"/> Advertising | <input type="checkbox"/> Cartooning |
| <input type="checkbox"/> Business Correspondence | |

Name.....
Street Address.....
City..... State.....
Occupation.....

If you reside in Canada, send this coupon to the International Correspondence Schools Canadian, Ltd., Montreal

Beginner Makes \$1500 in 4 months



By Amazing NEW CHAIN SELLING SYSTEM

Here is W. H. Schoen of Ohio—who made \$1,500 in 4 months last summer—as much as he earned the entire year before! Now Schoen is averaging \$90 a week in 1930—he says that's easy with the **Progress line** backed by wonderful new CHAIN SELLING SYSTEM.

PAINT—Direct from Million-Dollar Factory

Why not go after "big game" while you're at it? Roofing pays you \$24 a barrel—average paint order commission \$16—cash in advance. Just as easy to sell on our credit terms as things paying a dollar or two. You can sell every home owner, factory, dairy, store, farmer by CHAIN SELLING method.

DOUBLE PAY for your "over-time" — Write today!

Hurry—big season just starting—big earnings for you right off the bat. Clever "demonstrator" free—weighs only a few ounces—write immediately for Chain Selling Plan, stating territory, etc.

THE PROGRESS PAINT CO., Dept. 137, Cleveland, Ohio

World's Finest SHORT WAVE Receiver

A. C. or D. C. in kit form or completely constructed. Write Us for Full Information.

1930 Catalog Free SET BUILDERS! Write for your Short-Wave Supplies, Standard Parts and Accessories.

CHICAGO RADIO APPARATUS CO., Dept. PM 415 S. Dearborn St., Chicago, Ill.

You Can Build This \$25 Electric Clock for



We furnish instructions for making case and base and supply guaranteed electric clock chassis—you make your own clock and save half or more. Offers big money-making business opportunity. Write for complete particulars today—FREE.

6 in. x 7 in. with 8 in. Base Guaranteed Observatory Time Always

MIDLAND APPLIANCE CORPORATION 225 No. Michigan Ave. Dept. 1710 CHICAGO, ILL.

861 PRACTICAL IDEAS for REDUCING FARM LABOR and INCREASING INCOME

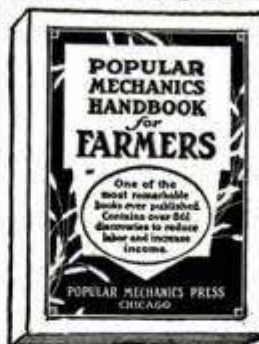

One farmer writes: "I would not take \$100 for my copy if I could not secure another."

The Handbook for Farmers contains: 138 ideas for the farm shop, 35 on fencing, 98 on auto, truck and tractor, 61 on farm buildings, 36 on field machines, 48 on concrete work, 22 on orchard work, 23 on painting, 15 on live stock, 34 on poultry, 54 on garden work, 25 on electrical work, 22 on farm tools, 16 on hunting, fishing and trapping, 140 household helps.

394 HELPFUL KINKS to LIGHTEN the LABOR of the FARMER'S WIFE

The Handbook for Women contains: 83 kitchen and dining room helps, 17 on garden and flowers, 19 on sewing and mending, 37 on furniture, pictures and fixtures, 38 on laundry and cleaning, 32 on house cleaning, 12 on music, 14 on sleeping rooms, 11 on care of children, 16 on lights, 9 on photography, 14 on clothing and shoes, 23 on house temperatures, 12 on water and drains, 10 on insect pests, and 47 miscellaneous.

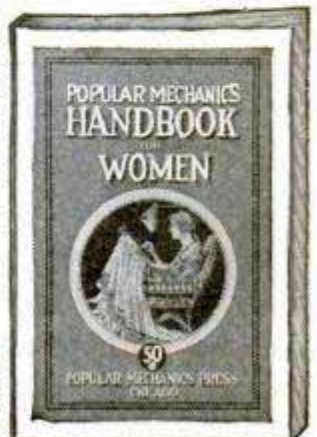

SPECIAL OFFER BOTH for \$1

(Regular \$1.50 Value) For a limited time you are offered both books for \$1 plus the postage. Pay postman when he delivers package. If outside U. S. send remittance and include 15 cents extra for postage.

POPULAR MECHANICS PRESS Room 5, 200 E. Ontario St., Chicago

Auto Owners Now Save Millions of Gallons of Gas

A new invention called the Whirlwind is actually saving millions of gallons of gasoline for automobile owners. Those who have installed this amazing device on their cars report almost unbelievable gasoline savings. They also report more speed and power, quicker starting and disappearance of carbon.

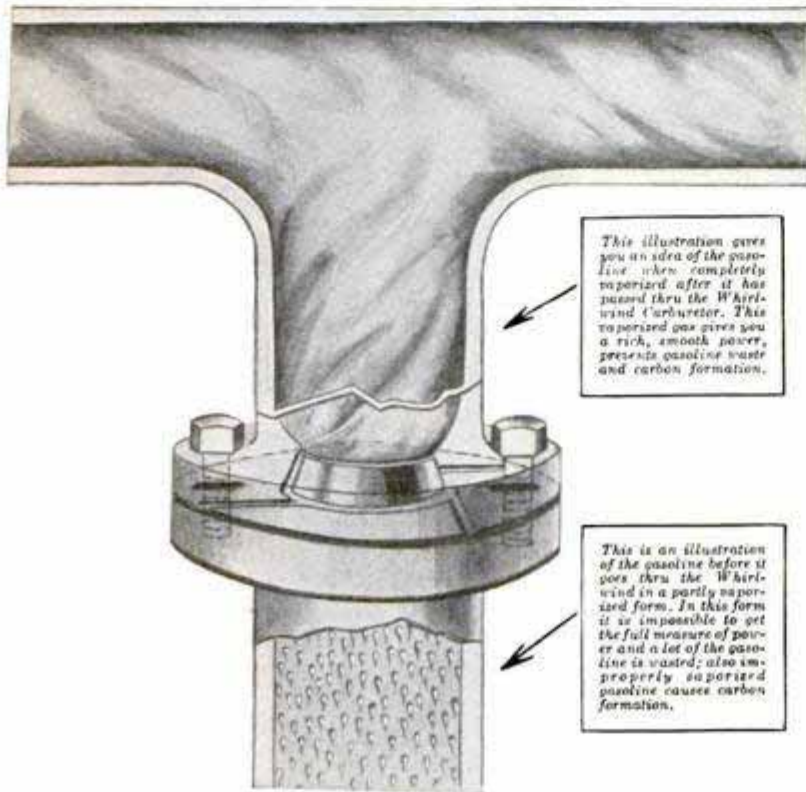

This illustration gives you an idea of the gasoline when completely vaporized after it has passed thru the Whirlwind carburetor. This vaporized gas gives you a rich, smooth power, prevents gasoline waste and carbon formation.

This is an illustration of the gasoline before it goes thru the Whirlwind in a partly vaporized form. In this form it is impossible to get the full measure of power and a lot of the gasoline is wasted; also improperly vaporized gasoline causes carbon formation.

The marvelous thing about this Whirlwind is that it works as well on all makes of cars. Reports are received from owners of practically every known make of automobile from Fords to Lincolns and they are all equally enthusiastic in their praise.

FITS ALL CARS

In just a few minutes the Whirlwind can be installed on any make of car, truck or tractor. It's actually less work than changing your oil or putting water in the battery. No drilling, tapping or changes of any kind necessary. It is guaranteed to work perfectly on any make of car, truck or tractor, large or small, new model or old model. The more you drive the more you will save.

SALESMEN AND DISTRIBUTORS WANTED

FREE SAMPLE AND \$100.00 A WEEK OFFER

Whirlwind men are making big profits supplying this fast selling device that car owners cannot afford to be without.

Good territory still open. Free sample offer and full particulars sent on request. Just check the coupon.

GUARANTEE

No matter what kind of a car you have—no matter how big a gas eater it is—the Whirlwind will save you money. We absolutely guarantee that the Whirlwind will more than save its cost in gasoline alone within 30 days, or the trial will cost you nothing. We invite you to test it at our risk and expense. You are to be the sole judge.

WHIRLWIND MFG. CO.
 DEPT. 999-265-A THIRD ST.
MILWAUKEE, WISCONSIN

Free Trial Coupon

**Whirlwind Mfg. Co.,
 999-265-A Third St., Milwaukee, Wis.**

Gentlemen: You may send me full particulars of your Whirlwind Carbureting device and free trial offer. This does not obligate me in any way whatever.

NAME.....

ADDRESS.....

CITY.....

COUNTY..... STATE.....

Check here if you are interested in full or part time salesman position.

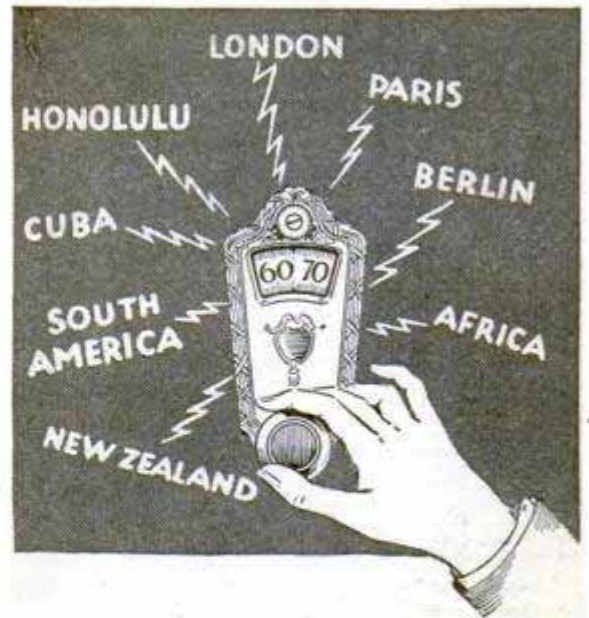

Parade of International Radio DIRECT from Foreign Stations

**Without Dependence On
Local Re-Broadcasting!**

PILOT SUPER-WASP
Short Wave and Broadcast Receiver

RANGE 14 TO 500 METERS

In Kit Form for A. C. or Battery Operation

Widen Your Circle of Entertainment!

Your broadcast receiver is useless below 200 meters, but the Super-Wasp, swooping down to 14 meters, and up to 500, unlocks a new world of trans-oceanic radio you never heard before! And you get it directly from the foreign station and not from a local rebroadcast. Enthusiasts report European, African, South American and Australian stations. Music amazingly new! Welcome variety for listeners "fed up" with domestic radio programs! To assure consistently satisfactory operation, Pilot engineers developed the Pilotron P-227, which naturally makes it a splendid tube for broadcast receivers.

*See Nearest Dealer or
Write Direct for Details*

Kit K-115: The A. C. Super Wasp. Use your own ABC pack or Pilot K-111 at \$16.50, specially designed for the Super-Wasp. Power Pack and Tubes Extra

\$34⁵⁰

Kit K-110: The battery-operated Super-Wasp. Batteries and Tubes extra

\$29⁵⁰



PILOT RADIO & TUBE CORP.

323 BERRY STREET
BROOKLYN
N. Y.



Chicago Office: 234 South Wells Street
San Francisco Office: 1278 Mission Street

JOINING THE RADIO INTERNATIONAL GUILD

Costs only 50c and includes lapel pin, certificate and "Radio Design" Construction Quarterly Magazine, the Guild's Official Organ. Enclose 50c coin or stamps to Radio International Guild, 103 Broadway, Brooklyn, N. Y.

F

Name

Address

City State



Test This Amazing Money Making Invention **FREE**



Men, here's the most remarkable money maker of the age! A little automatic machine that makes old-style can openers obsolete! Now, just a twist of the wrist makes the dollars hum for you! So mail the coupon today for liberal **FREE TEST OFFER**.

UP TO \$6 and \$8 IN AN HOUR Just Offering This \$1,000,000 Can Opening Machine

NO more awkward stabbing and hacking with old-style can openers! No more danger of blood poisoning from gashed and lacerated fingers! For now a remarkable new invention banishes every old-style can opener to the scrap heap. Now a simple twist of the wrist opens any can in a couple of seconds. No wonder they all simply go wild over it! No wonder salesmen have sold to every house in the block and have made up to \$8 in an hour!

Works Like a Charm

This queer little device doesn't just chop a ragged hole in the top of the can. It cuts the entire top completely out, not off, clean as a whistle! The machine takes hold of the can—opens it—flips up the lid so you can grab it—and gives it back without any sharp edges to snag your fingers. You just put the can in the machine

—turn the handle—and almost instantly the job is done!

Sells Itself in Seconds

Everyone knows how women detest the dangerous old-style can opener. Imagine, then, how they welcome this startling new method—this automatic way of doing their most distasteful kitchen task. Men, honestly I'm not exaggerating one bit when I tell you that not ten words are necessary to sell many of them! All you do is hand your demonstrator to your prospect and let her try it! She often sells herself in seconds—and you pocket a nice, fat profit! Yes really, it's just that simple and easy! That's why salesmen have made \$75 to \$150 a week.



Opens Any Can in a Jiffy

You just slip the can in the holder and turn the handle. Nothing complicated, nothing to get out of order. Opens any can, square, round or oval, in a few seconds. And, men, **IT'S TRIPLE PATENTED**, so there is no competition.

Act Quick for FREE Test Offer

I don't care whether you're an "old-timer" or just breaking in, some of the quickest, easiest money of your life is waiting for you now, right here! That's a mighty strong statement. But all I ask is a chance to prove it at my risk. I know this proposition will coin money for you with such speed that it will make your head swim! Territories are closing fast. The Free Test costs you nothing. Just mail me the coupon and I'll shoot you the most sensational dollar making plan you ever heard of. Mail it today! Right now!

CENTRAL STATES MFG. CO.
Dept. E-703
4500 Mary Ave. ST. LOUIS, MO.

OH BOY!

How the Dollars Roll In!
\$208 In 24 Hours



"Speedo products do everything that is claimed for them. I went to a small railroad town and sold 24 Speedo products in about 3 hours. In another instance I sold 30 Speedos on one street in 1½ hours. In 24 hours of selling I have made exactly \$208." John Neighbors, O.

1,000 Sales In 90 Days

"I have now made 1,000 Speedo sales in 90 days, which is pretty good to start. The other day I sold 31 Speedos in less than 5 hours. Anyone can work up a nice business with Speedo; my earnings are now almost \$1,000." R. W. Graffe, Ind.



Revolutionary New Sharpener

Works like magic. Puts a razor edge on any knife or tool in a few seconds. Anyone can use it. Sharpens scissors, too. The coupon brings full details.

Central States Manufacturing Co.,
Dept. E-703, 4500 Mary Ave.,
St. Louis, Mo.

Rush me your Free Test offer.

Name.....

Address.....

Town..... State.....

() Check here if interested only in one for your own home.

“It’s the Camel blend!”

The mild and fragrant blend
of choice tobaccos makes
the smoking of every Camel
Cigarette a pure delight.



Camel

the better cigarette