

APRIL

N.S.E.
25 CENTS

POPULAR MECHANICS

MAGAZINE

WRITTEN SO YOU CAN UNDERSTAND

REG'D. TRADE MARK, GREAT BRITAIN, NO. 410426

REG. U.S. PAT. OFF.

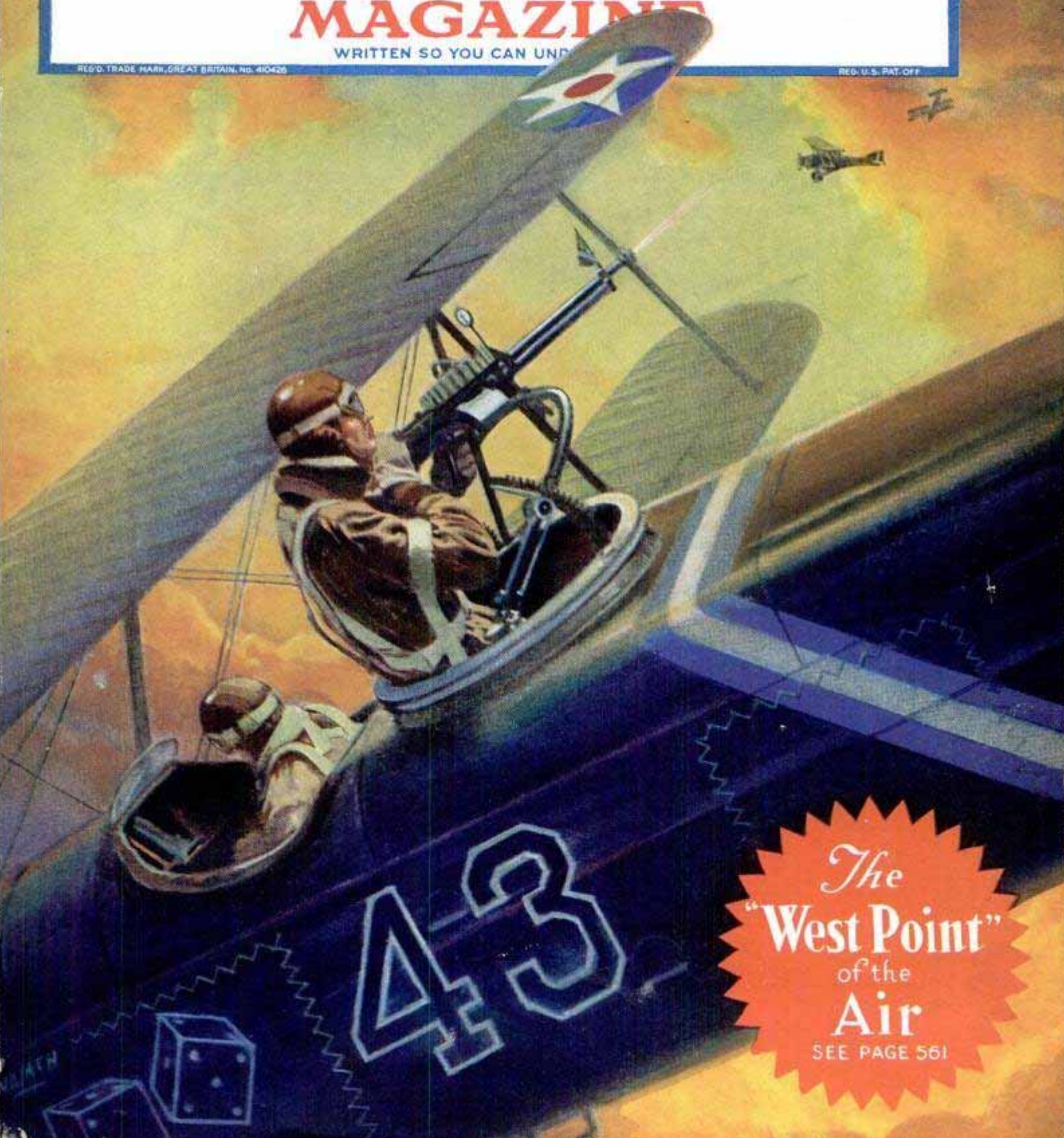

43

The
"West Point"
of the
Air
SEE PAGE 561

Think of it! Genuine UNDERWOOD

**Yours for
10 Days
FREE**

Yes—this world-famous Underwood is yours free for full 10 days. See for yourself the *real bargain* it is. See how beautiful and new it looks—compare its neat, perfect work—without obligation.



Buy Direct at Below 1/2 Mfg's Regular Price

Now **\$1 DOWN**
Only



My unchallenged direct sale price and easy terms on this genuine Underwood No. 4 is the lowest ever offered. While they last—less than half (1/2) the manufacturer's regular price—and easy terms besides. Do not confuse this genuine late model Underwood with inferior or frail machines worth only one-half as much. This is the full sized standard Underwood with 4-row keyboard and late improvements, manufactured to sell originally for \$100. **Fully Guaranteed** in writing.

on Easy Terms

Easy Terms—Only 10c a Day

Think of it—a genuine late model Underwood reduced to \$39.90 (Cash). A saving of over \$60 by acting now. Send only \$1. deposit for a 10-day Free Trial. Then only 10c a day on my easy year-to-pay plan. And you use and enjoy your typewriter all the time. This Underwood all rebuilt and refinished like new is without question the greatest value ever offered at this rock-bottom price. (See column to right for its many outstanding features and improvements.)



Limited Quantity—Send at Once!

This exceptional bargain offer is for a very limited time only. Remember, every typewriter is sent on 10-days' Free Trial and Fully Guaranteed.

International Typewriter Exchange,
231 West Monroe St., Chicago, Ill., Dept. 494.

Please send the Underwood No. 4 at the special reduced price for 10-day Free Trial. I am enclosing \$1.00 deposit with the understanding that if I am not perfectly satisfied I can return it Express Collect and get my deposit back. If I keep it I will pay \$3 a month until I have paid \$44.90 (term price) in full.

Name.....Age.....
Address.....
Town.....State.....

FREE Complete
9-Piece
Office Supply Set and
Typewriting Course

We teach you speed typewriting Free. Complete Home Study Course of the Famous Van Sant Speed Typewriting System, fully illustrated, easily learned. We also give complete office supply set free during this sensational sale.

**12 REASONS
WHY
this is the
Greatest Value
Ever Offered**

1. **Genuine Underwood**
2. **Standard 4-row Keyboard**
3. **2-color Ribbon**
4. **Back Spacer**
5. **Ribbon Reverse**
6. **Tabulator**
7. **Automatic Release**
8. **Shift Lock**
9. **Lowest Price**
10. **Easiest Terms**
11. **10-Day Free Trial**
12. **Fully Guaranteed**

The combined tonnage of Admiral Dewey's fleet at Manila Bay was 19,000 tons—less than the tonnage of any one of the electrically driven ships of the Panama Pacific Line.

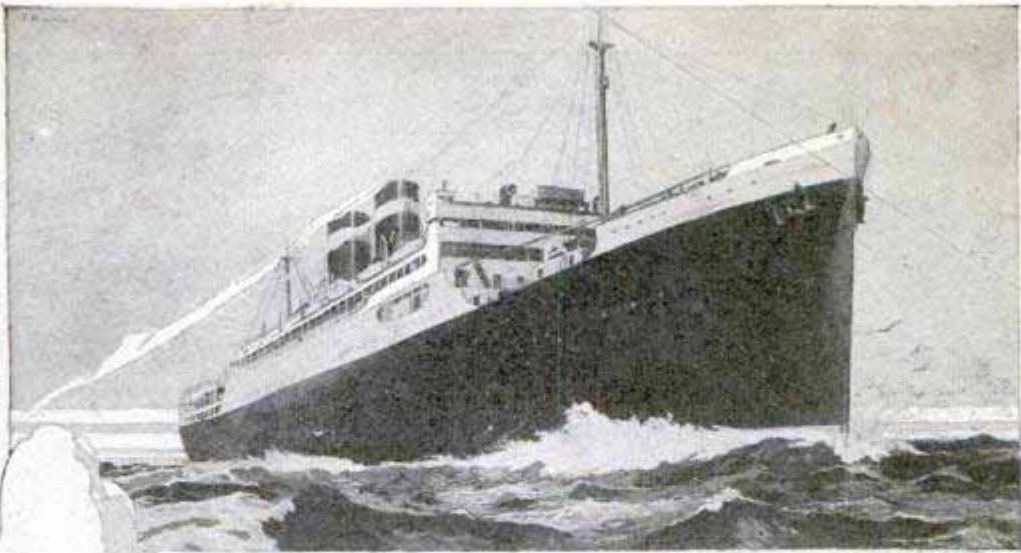

BIGGER than

Dewey's whole fleet

BUILT not for war but for peace, the 35,000-ton *S. S. Pennsylvania* is not only bigger than all the ships of Dewey's heroic squadron put together, but far more efficient than any of them. Her 17,000-hp. motors have enabled the *Pennsylvania* and her sister ships, *California* and *Virginia*, to cut the coast-to-coast schedule of the Panama Pacific line to thirteen days, and have set a new standard of noiseless, vibrationless ocean travel.

General Electric, which engineered and built the electric equipment for these magnificent new ships, is doing equally important pioneer work in the design of electric products for domestic and industrial use. Among these are G-E refrigerators, wiring systems, vacuum cleaners, and Sunlamps; and electric locomotive and street-car equipment, motors, generating and distributing apparatus, and street-lighting systems.

JOIN US IN THE GENERAL ELECTRIC HOUR, BROADCAST EVERY SATURDAY
AT 9 P.M., E.S.T. ON A NATION-WIDE N.B.C. NETWORK

95-722C

GENERAL ELECTRIC

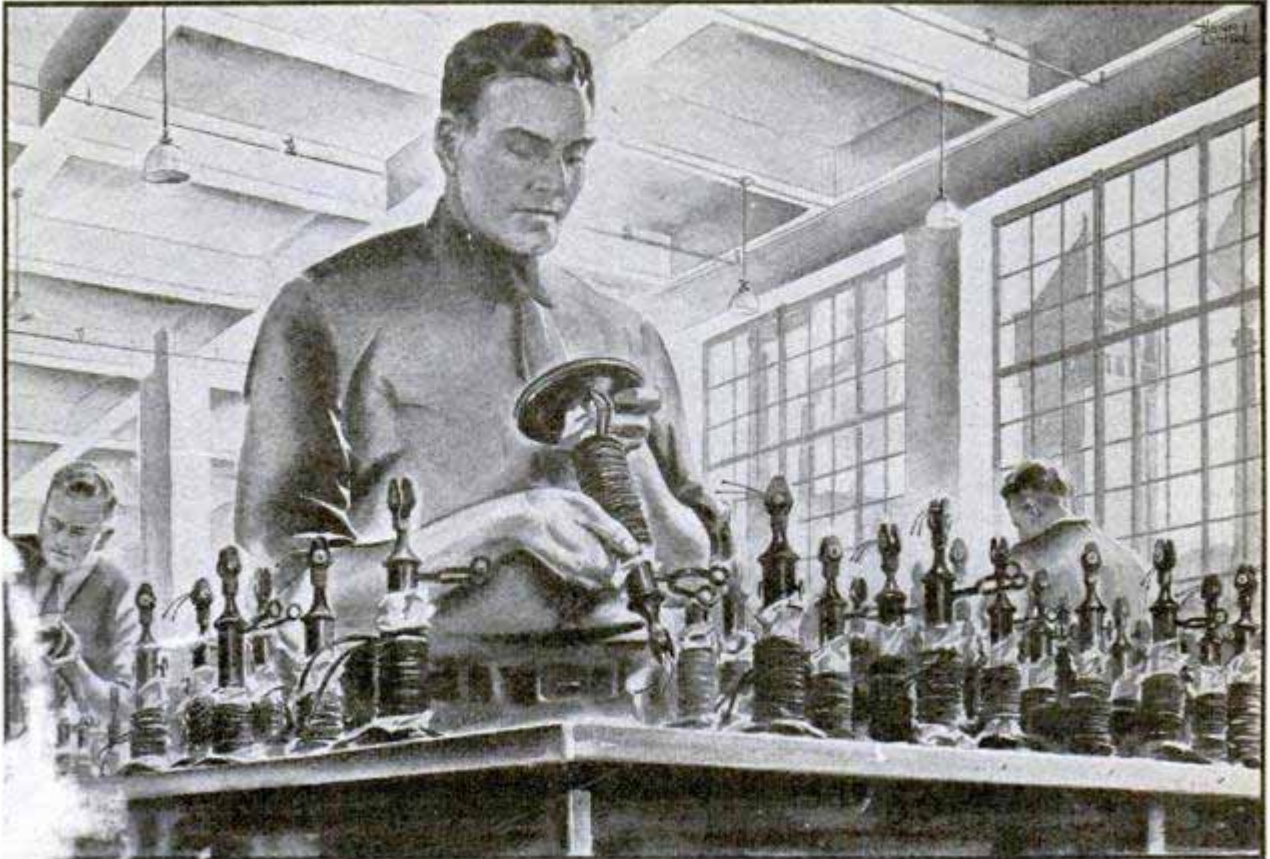

WESTERN ELECTRIC COMPANY SEARCHES THE WORLD FOR MATERIALS, AND FASHIONS THEM INTO THE EQUIPMENT OF A NATION-WIDE TELEPHONE SYSTEM

That time and distance may be subject to your voice

An Advertisement of the American Telephone and Telegraph Company

THE Telephone System shapes the structure of the earth to your communication needs. It delves into the forces and methods that enable you to project your voice where you wish. It searches the world for the materials needed to put its discoveries at your command, and fashions them into the connected parts of a nation-wide system.

It has dotted the nation with exchanges, and joined them and the connecting companies with the wires and cables which enable you to talk with anyone, anywhere.

Each of the 24 operating companies of the Bell System is attuned to the needs of its area. Each is local to the people it serves and backed by national resources in

research, methods and manufacture. Each has the services of the staff of the American Telephone and Telegraph Company, which is continually developing improvements in telephone operation. Each has the advantage of a centralized production of the Western Electric Company. This production policy achieves the results achieved by the staff of the Bell Telephone Laboratories, one of the great industrial research institutions of the world.

Your telephone company is in a position to offer you the service which you have today because the Bell System is organized to meet your growing communication needs with increasing satisfaction and economy.



Popular Mechanics Magazine

200 E. Ontario Street, Chicago, U. S. A.

H. H. WINDSOR, Founder

H. H. WINDSOR, Jr., Editor and Publisher

London: Hachette & Cie.,
3 La Belle Sausage, Ludgate Hill, W. C. 2

Paris: Hachette & Cie.,
111 Rue Reaumur

Melbourne: Gordon & Gotch
509-513 Little Collins St.

ISSUED MONTHLY

SUBSCRIPTION:

SINGLE COPY, 25 CENTS

In United States and its possessions, Canada, Cuba, Mexico, and all } countries in the Pan-American Postal Union, per year, postpaid } \$2.50

To all other countries in the Postal Union 3.00

All subscriptions are discontinued at expiration. Please examine the date printed on your wrapper.

Entered as Second Class Matter Sept. 15, 1908, at the Post Office at Chicago, Illinois, under Act of March 3rd, 1879.

Entered as Second Class Matter at the Post Office Department, Canada.

Published monthly by POPULAR MECHANICS CO.

Copyright, 1930, by Popular Mechanics Co.

Copyright in Australia. Copyright in France

Vol. 53

Contents for April, 1930

No. 4

Special Features

Adventures of Treasure Hunters	546
Tornadoes on the Sun	554
The "West Point" of the Air	561
The "Brain Wave" Room	578
Who Owns the South Pole?	588
The Secrets of Your Voice	594
A Hunt for Future Champions	603
You Can't Get Away With It	610
When the Ocean Floor Quakes	618
If We Had the Sense of Insects	626
A Drug Store from the Sea	641
Calendar—holds milk tickets	598
Cannon—why double-barreled failed to work	644
Children—safety thumb guard for baby	637
Clock—combined with aerial for radio set	559
Drilling	
offset drill attachment reaches odd places	625
"silent" road drills	644
Electricity—city's electric brain in power control room	645
Factory—a floating	592
Fish and Fishing	
automatic fish-hook setter	582
creel keeps contents fresh	607
Furnace—Cadorus, cannon cast for Revolution	545
Gardening—hand tractor plows and mows lawn	601
Gas—plants find plumbing leaks	599
Geese—flying wedge adds to speed of wild	631
Germs—electronic bullets destroy	599
Goats—ultraviolet rays for, improve milk quality	583
Golf—aerial score cards	583
Guns	
pistol bullet spins cocoon in sheepskin coat	630
shotgun has one barrel on top of other	615
Hair—makes chemical important in diet	645
Heater—hot-water, electric	617
Homes—of concrete and glass built for health	636
Household Devices	638
House Plan	704
Insects—ant eggs as game-bird feed	545
Knife—containing ten tools	545
Lamp, Health—gives sun bath harmless to eyes	608
Lifeboat—safe launching assured by skids	615
Life Saving—self-filling vest keeps wearer afloat	602
Manna—of the Bible is found to be desert shrub	600
Metals—magnetism hardens	647
Acid—queer quacks of	593
Agricultural Implements—rotary grader levels land	623
Agriculture—talc helps kill grain pest	617
Air/Mail—plane in flight picks mail from truck	640
Airplanes	
limit to the size of is set by weight	552
portable service platform for	585
Airship—observation car is hung below	608
Aquarium—boat turned into	593
Astronomy—riddle of the stars sought in depth of earth	584
Automobiles—Accessories	
carrying nets in top of auto	640
hidden lock for tire mirror	637
tail light for "bumperette"	577
Automobiles—Tires	
smaller tire is safer but wears out sooner	636
solid tires have blowouts	624
Automobiles—Trailer—expands into sleeping car	587
Aviation	
electrically heated masks for pilots	624
robot that never sleeps guides landings	635
student flyers fly blind	623
wireless aids student in solo flight	647
Baby Carriage—rear-view mirror for	630
Bathing Beach—metal nets protect bathers from sharks	637
Bells—tin in, softens tone	623
Boats and Boating	
aero speed boat with wings	634
"alligator" ships climb hills and haul lumber	609
craft with wings driven by outboard motor	607
Bowling—with a billiard cue	599
Brain—"wheels" of, are heard as thoughts formulate	592
Bridges—"nutcracker" tests metal for columns	602
Cable—pressure on electric cable serves as switch	607

Centrifuge 633

Japomizer 534

Red adjustable

[Continued on Page 4]

580

flash gun for camera shutter 600

[Contents—Continued]

Milk Bottle—metal band for, shows age of contents . . . 635

Moving Pictures
 ancient China had talkies . . . 609
 lions are filmed in their native haunts . . . 632

Occupations—queer listed by census officials . . . 614

Office Supplies
 finger moistener fits hand . . . 645
 fountain moistener for desk . . . 559

Oil
 art of ceramics latest aid to search for . . . 647
 electroplates surface which it lubricates . . . 558
 from sand . . . 633

Oil Wells—rubber doughnuts solve oil-field problem . . . 600

Oysters—"noisy" heard by ships . . . 559

Paints and Painting—electric spray saves time and paint . . . 623

Paper—weighing with light . . . 634

Photography
 flash gun operates camera shutter release . . . 601
 how the camera man got his masterpieces . . . 646

Pipes—stopped up, cleaned by shaft on drill . . . 647

Plants—wonders of unseen world revealed by lens . . . 631

Plow—rotary tosses snow from roadway . . . 560

Power Line—upright pole tied to truck bridges . . . 630

Prohibition—"hides" for liquor test skill of detectives . . . 616

Radio—helpful tips from the radio laboratory . . . 654

Radio—Aerials
 steam-heated . . . 587
 using phoné line as . . . 653

Radio—Apparatus—wavemeter for short-wave sets . . . 656

Radio—Loud Speakers—improving tone of your dynamic . . . 649

Radio—Receivers
 an efficient crystal set . . . 656
 converter for operating a.c. sets from farm lighting plant . . . 657
 reducing hum in a.c. . . 651
 simple instrument brings your set to top-notch efficiency . . . 652

Radio—Tubes
 removable filament reduces cost . . . 599
 screen-grid unit . . . 658

Radium—tracks of invisible rays seen in magic glass . . . 601

Railroads
 beam of light stops train . . . 553
 concrete car made on steel frame . . . 634

Rain-Making—machine makes thunder and lightning . . . 586

Refrigeration—truck keeps its contents cool as it travels . . . 644

Roads—sand spreader for icy . . . 634

Rubber—material X-ray proof . . . 592

Russia—warning for lazy workmen atop factory . . . 592

Salt—mine beneath Detroit, Mich . . . 577

Saws and Sawing—portable electric rip saw . . . 593

Scaffold—has automatic safety locks . . . 553

Science—how tricks of upset many common ideas . . . 602

Ships and Shipping
 Atlantic blue ribbon sought by Canada . . . 625
 automatic course marker for . . . 587

Signs—cage ladder for worker insures safety . . . 625

Skating—on skyscraper roof . . . 552

Sports, Water—greased-pole contest . . . 577

Street Cars
 lubricant for trolley wires . . . 583
 open shelters at car stops . . . 585

Surfboard—riders puncture balloons in water game . . . 559

Thumbtack—removed easily by twisting head . . . 623

Traffic—jars do little harm to buildings . . . 640

Umbrella—without a frame folds like envelope . . . 617

Voice—ability of singer is tested by wave recorder . . . 587

Volcano—steam from to heat Hawaii hotel . . . 637

Waves—facts regarding giant . . . 545

Weather—balloons send out reports by radio . . . 560

Useful sounds reveal secrets.

AMATEUR MECHANICS

Airplane—baby commercial model . . . 666

Automobiles—arranging bed in two-door sedan . . . 674

Automobiles—Accessories
 combined screens and curtain for windows . . . 665
 watch holder for the auto . . . 680

Automobiles—Engine—don't neglect your generator . . . 662

Automobiles—Repairing
 cylinder-lapping tool attached to power drill . . . 669
 waterproofing old-model Ford cars . . . 672

Balsa Wood—tool for cutting strips . . . 675

Barn—old, makes a cozy clubroom . . . 684

Belt—emblem, attractive for small boys . . . 681

Brush—for cleaning bolt-holes in bearing caps . . . 684

Camera
 movie, cord holds steady . . . 686
 support on auto fender . . . 683

Ceiling—how to get a beamed-ceiling effect . . . 662

Chimney—to make a low chimney draw . . . 682

Clocks—grandfather, you can build . . . 676

Closet-Door—hinged screen on provides dressing room . . . 681

Crack Filler—flexible and durable . . . 680

Fireplace—novel screen for . . . 669

Fish and Fishing—lead sinker salvages snagged fishing tackle . . . 682

Flagstones—stone path adds beauty to lawn . . . 683

Flashlight—holder, for the motorist . . . 685

Flowers—wire holders for long-stemmed . . . 662

Furniture—garden, gnarled tree roots for . . . 675

Garden Pool—of heart shape is easy to make . . . 685

Gasoline—theft from autos prevented by locking cap . . . 682

Gloves—damp, how to dry out . . . 686

Heaters, Gas—preventing condensation in . . . 672

Hotbeds—putty for glazing frames . . . 682

Lamps—making an old fashioned . . . 670

Lamps, Health—a simple sunshine lamp . . . 663

Matches—shellac for waterproofing . . . 685

Mortar—for brick walks . . . 675

Paints and Painting
 cover spout for pouring paint from small cans . . . 680
 durability of white paint . . . 674
 how to repaint Venetian blinds . . . 684
 plaster walls require special care in painting . . . 668

Pewter—methods of cleaning . . . 686

Photography
 homemade trays for . . . 685
 lens shade for beach . . . 673

Plants—how to destroy insects on house plants . . . 680

Rifle—emergency repair for broken sight . . . 681

Roads—making speed on muddy . . . 669

Roof Brush—improvised . . . 681

Screws—template for fillister-head . . . 673

Smoking Stand—of real utility . . . 659

Stove—hard coal converting into a soft-coal burner . . . 675

Table—handle for extension . . . 674

Trap—mirror makes effective rat trap . . . 683

Wardrobe—attached to closet door . . . 673

Wicker Work—staining . . . 683

Shaver, Angle plate 694

SHOP NOTES

Agricultural Implements—effective weed hook . . . 695

Angle Plate—for planer or shaper . . . 694

Automobiles—Accessories—combination bench and tool box . . . 703

Automobiles—Lubrication—springs lubricated with blowtorch . . . 691

Automobiles—Repairing
 generator wrench for model-T Fords . . . 700
 guide for grinding model-A Ford valves . . . 693
 powdered soapstone on gaskets prolongs their life . . . 699
 testing auto valves for leaks . . . 695

Automobiles—Trucks—semi-streamlining bodies . . . 702

Cesspool—ejector for draining . . . 700

Cotter Keys—removing small . . . 702

Drilling
 holes in wood with nails . . . 696
 improvised force-feed drill press . . . 703
 magnetic chip remover . . . 702

Fence—portable requires no posts . . . 696

Garage—rotating holder for light cords . . . 696

Glass—simple way of cutting disks for pressure gauges . . . 695

Gold—reclaiming old, for sale to mint . . . 701

Greenhouse—two useful ideas . . . 691

Heater—for garage or workshop . . . 692

Incubator—cigar box protects adjustment of thermostat . . . 690

Line Current—test for distinguishing a.c. and d.c. currents . . . 700

Manuscripts—restoring writing on old . . . 695

Nuts—tool for starting . . . 700

Paints and Painting
 nails for mixing paints . . . 702
 rig for spray-painting of oil drums . . . 701

Saws and Sawing—hardening hacksaw blade to cut tool steel . . . 690

Screen Holder—roller skates for . . . 701

Screw—bright finish on threads . . . 703

Shaper—you can make . . . 687

Shop—two space and time savers for the . . . 697

Sidewalk—attached to logging train . . . 694

1859 by [unclear] 689
Spark plug by 689
Handyman's 689

Greatest ENCYCLOPAEDIA VALUE

ever offered the
American People

.. Completely New

Encyclopaedia Britannica



\$45 BOOKCASE INCLUDED
This handsome bookcase table, made of genuine Mahogany, is included with every set of the new Britannica.

EVERY FAMILY, every wide-awake man or woman, can now own this newest, finest Encyclopaedia Britannica! Mass production on a scale never before possible brings you this superb 14th Edition at a *new low price*—the lowest at which any completely new Britannica has been offered in more than 60 years!

Never before has such an opportunity been given American readers.

More for your Money A \$2,000,000 Work

When you buy the *new* Encyclopaedia Britannica you buy sound built-in value that is little short of amazing.

You get the equivalent of 500 ordinary books in text matter alone—and at one-tenth their cost. Here is literally the sum total of human knowledge in 24 compact readable volumes!

You get the varied richness of 15,000 illustrations—paintings, photographs, maps and drawings, a unique gallery of art, science and mechanics, worth many times the cost of the books.

You get the writings of 3,500 authorities—of men

and women whose services only the world-wide prestige of the Britannica could command. Here is authority, accuracy, fresh interpretation direct from the best minds of the century.

You get up-to-date knowledge—the time-proven learning of the past, the latest discoveries of today, the promised progress of tomorrow. New facts, clearly interpreted.

You get a wealth of practical information for every member of the family. It answers every "what," "who," "why," and "when." But it also answers ten thousand "hows." It is the finest guide to *doing things* ever published.

You get, in short, what critics have called "the finest encyclopaedia in English."

SPECIAL \$5 DOWN OFFER—only \$5

Large scale production makes possible the present amazingly low price. \$5 brings the 24 volumes and table to your home. Balance may be paid in convenient monthly payments.

Send for Free Booklet

Send for the handsome new 56-page booklet containing numerous color plates, maps, etc., from the new edition and giving full information about it, with details of bindings, low prices and easy payment plan.

You needn't risk a cent. The booklet is yours FREE, without the slightest obligation.

Now—while you have this page at hand—tear out the coupon and send it in.

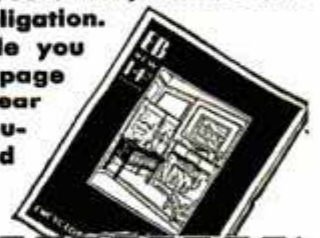

ENCYCLOPAEDIA BRITANNICA, Inc.
342 Madison Avenue, New York, N. Y. P.M. 3-E2

Please send me by return mail, without any obligation on my part, your 56-page illustrated booklet describing the new Britannica together with low price offer, etc.

Name.....
Address.....
City.....State.....

SEND FOR FREE BOOKLET TODAY

To the man whose ship never quite comes in

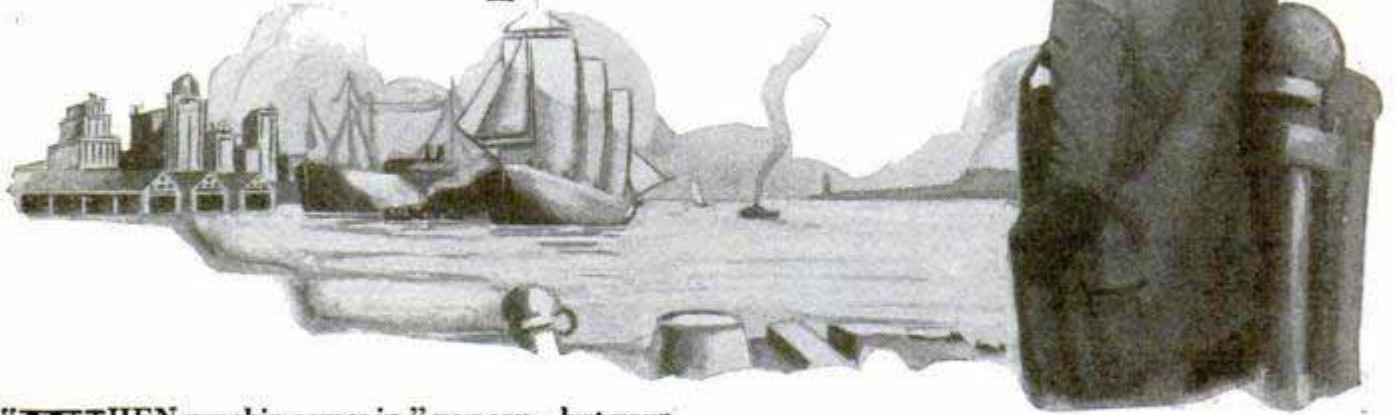

"WHEN my ship comes in," you say—but your smile cannot hide the worry gnawing at your heart—

A fine sea-going vessel you thought that ship of yours when you launched it on the business ocean—

Yet the days and months and years slip by—and though others see their ships ride triumphantly to harbor, still you scan the horizon anxiously for a ship that never quite makes port.

No one's fault, perhaps—but what a misfortune that so many business ships should founder on a hidden reef or a treacherous shoal, when the channels to Success are plainly charted and a chart for every channel is available to every thinking man!

How the "Right" Chart Increased E. T. Orcutt's Income 500%

Certainly my ship-of-fortune seems far off its course, said E. T. Orcutt, in effect, when as railroad clerk at \$20 a week he enrolled with LaSalle for home-study training in Traffic Management.

Before he had completed the training, however, came an opportunity with Hitchings & Co., Elizabeth, N. J., one of the largest manufacturers of greenhouses in the world.

Training had set his "ship" on the right course.

Later, as sales manager and still later as head of his own firm, he continued training with LaSalle—in Business Management.

Since taking his first course, his income has increased more than 500 per cent.

How G. W. Clason Placed His "Ship" on the Right Course

No bands were playing when G. W. Clason launched his "ship" upon the business ocean.

Clason had left school at 14, and at 19 his job was to take care of all the horses in the barn of a laundry.

"Never mind," said G. W. Clason, "I'll make my opportunity right where I am!"

So he learned the laundry business, and at 28 was operating his own plant. When fire wiped his business out, he started again. Unable to finance properly—*thru lack of business understanding*, as he testifies—he sold out and became superintendent of the Ideal Laundry Company, Spokane, Washington.

Right then he made up his mind to remedy his lack—and enrolled with LaSalle for training in Business Management.

Today, at 48, he is vice-president and a director of this successful company, and commands an income several times as large as when he started with LaSalle six years ago.

"I'll give all credit to my LaSalle training," writes Mr. Clason. "It has proved by far the most profitable investment I ever made."

No More Drifting! Send for These Free Books—Today

Are you letting your ship-of-fortune drift where it will—or are you charting its course to the Harbor of Success?

There's a route that will take it straight to its destination. LaSalle can help you find it.

Without cost or obligation the coupon will bring you your free copy of a 64-page booklet fully describing the opportunities in the business field that most appeal to you, and showing you how you can turn those opportunities into cash.

Are you going to keep on waiting on the shore of life when others have long since brought their ships to harbor? Fill in, clip and mail the coupon NOW!

----- Find Yourself Through LaSalle! -----

LaSalle Extension University

The World's Largest Business Training Institution

Dept. 464-R Chicago

I would welcome an outline of the LaSalle plan, together with a copy of "Ten Years' Promotion in One," all without obligation.

- Business Management
- Modern Salesmanship
- Higher Accountancy
- Traffic Management
- Law: Degree of LL. B.
- Commercial Law
- Modern Business Correspondence
- Credit and Collection Correspondence
- Railway Station Management
- Telegraphy
- Railway Accounting
- Stenotypy—Stenography

- Banking and Finance
- Modern Foremanship
- Personnel Management
- Industrial Management
- Expert Bookkeeping
- Business English
- Commercial Spanish
- Effective Speaking
- C. P. A. Coaching
- Paper Salesman's Training



Name

Present Position

Address

POCKET EDUCATORS

For all BUILDERS AND MECHANICS



Read Audels Pocket Educators for advancement and profit in your work. Every mechanic in the building trades should have this inside trade information at his fingers' ends. Learn the scope and possibilities of your profession. Any job can be done better if you are well informed. To earn more, learn more.



AUDELS CARPENTERS AND BUILDERS GUIDES—4 VOLS. \$6

Inside Information for Carpenters, Builders, Joiners, Building Mechanics—all Wood-workers. **1600 pages; 3700 diagrams; flexible; pocket size.** Short-cut instructions, new methods, ideas, solutions, plans, systems—money saving suggestions. An easy progressive course for the apprentice. A practical daily helper and Quick Reference for the master worker. A Helping Hand to Easier and Better Work and Better Pay. To get this aid for yourself, simply fill in and mail the FREE COUPON below.

INSIDE TRADE INFORMATION ON:
 How to use steel square; How to file and set saws; How to build furniture; How to use mitre box; How to use chalk line; How to use rules; How to make joints; Carpenters' arithmetic; Mensuration problems; Estimating strength of timbers; How to set girders and sills; How to frame houses and roofs; How to estimate costs; How to build houses, barns, garages, bungalows, etc.; How to read and draw plans; Drawing up specifications; How to excavate; How to use settings 12, 13 and 17 on the steel square; How to build hoists and scaffolds—skylights; How to build stairs; How to put on interior trim; How to hang doors; How to lath—lay floors; How to paint.

"Audels Guides worth four times their price—handy too as I carry them in pocket for reference." **W. J. Bates, Knoxville, Pa.**



AUDELS PLUMBERS AND STEAMFITTERS GUIDES—4 VOLS. \$6

A new set—just out! A practical, illustrated, Reference Library and Study-Course for Master Plumbers, Journeymen and Apprentice Steamfitters, Gas Fitters and Helpers, Sheet Metal Workers, Draughtsmen, Master Builders, Engineers and all Building Trade Students. **1670 pages; 3642 diagrams; flexible; pocket size.** Guides explain all the principles, advances and short cuts of the Plumbing and Heating trade. Contains instructions on how to figure and estimate jobs. Use FREE COUPON below to examine, without obligation, this valuable work.

INSIDE TRADE INFORMATION ON:
 Soldering; tinning. Joint wiping, bending, beating. Pipe—iron—steel, threading. Mathematics, tables, physics. Materials—iron, steel, copper, brass, lead, tin, antimony. Sheet metal—galvanized—plate. Sanitation, syphonage, tanks. Drainage, sewage, purification. Fixtures—bath—kitchen. Pipe fittings, soil pipe, tools. Laying out work. Roughing. Screwed fittings, flanges, joints. Pipe bending, examples. Elbows, Heating, ventilation, refrigeration. Water supply, mains, wells, tanks. Gas-fittings. Underwriters. Sheet metal work, problems, methods, brazing, heating, lead burning. Welding, various welds, methods. Blacksmithing, forges, tools.

"Audels Guides are practical, easy to understand, reliable. Cover the field in plain language." **W. F. Armingor, Annapolis, Md.**



AUDELS MASONS AND BUILDERS GUIDES—4 VOLS. \$6

A new, complete, illustrated trade reference library, for Bricklayers, Cement Workers; Plasterers, Tile Setters and Stone Masons, including a practical outline of Steel Construction. **1100 pages; 2067 diagrams; flexible; pocket size.** A practical Trade Assistant explaining modern methods of masonry construction. Easy to understand and apply. A reliable and authentic reference work and study-course for Master Journeyman and Young Mechanic. Use FREE COUPON below and find out for yourself, without obligation, whether this set will benefit you.

INSIDE TRADE INFORMATION ON:
 Bricklaying, tools, materials; Brick designs, patterns, bonds; Setting frames and foundations; Mortars, scaffolds, estimating; Mortars and mortar mixing; Tile setting, mosaic, hollow tile; Straight edge test, troweling; How to figure brick work; Safe loads, piers, chimneys; Boiler settings, anchors, fire stops; Labor tables; Concrete, forms; How to figure concrete work; Stucco—on old and new buildings; Plastering—wood lath—metal; Plasterers agreement; Plastering on various surfaces; Stonemasonry; Cutting, finishing, estimating stone; Derricks, rigging; Steel construction; Fire proof; How to read blue prints.

"Audels Masons Guides are the best books on the subject. Have laid brick 12 years and am able to judge." **H. A. Senneft, Corlies, Pa.**



PRACTICAL ELECTRICITY — 1 VOL. \$4

Audels Handy Book of Practical Electricity is a simplified Ready Reference and Study Course in one pocket size, leather bound volume—for Engineers, Professional Electricians and Students. **1040 pages; 2600 diagrams; flexible red leather bound.** A reliable authority and handy helper for every electrical worker. Contains important and valuable wiring diagrams, calculations, machine sketches, helps on maintenance and repair. Use this FREE COUPON today and find out, without obligation, how this handy book will help you in your daily work.



INSIDE TRADE INFORMATION ON:

Electro-Therapeutics, X-Rays, Shocks, Welding, Brazing, Radio Hook-ups, Motion Pictures, Telephone, Telegraph, Cranes, Bells, Elevators, Pumps, Tools, Ship Drive, Railways, Vehicles, Automobile Electric Systems, Ignition, Generation, Lighting, Plant Management, Power Plans, Armature Winding, Repairing, A. C. Motors and Apparatus, D. C. Motors and Apparatus, Alternator Construction, Dynamos, Wiring Diagrams, Sign Flashers, Cable Splicing, Power Wiring, Outside Wiring, Switches, Lighting, Rectifiers, Converters, Transformers, Fuses, Circuit Breakers, Rheostats, Electro Plating, Electrolysis, Storage Batteries, Magnetism, Electrical Energy, Conductors, Insulators, Static, Dynamic, Radio Electricity, Applications, Ready Reference and Index Covering the entire field of Modern Electricity.

Learn More and You Will Earn More!

Know your job and you'll never be without one. The skilled man is always in demand. Knowledge is power. Learn your trade thoroughly by easy reading. This coupon is your opportunity for advancement and better pay. You risk nothing in sending for Audels Guides for free examination. Send it NOW!

This One



2ANT-PP4-TUTW

GUIDES \$6 | GUIDES \$6

4 MASONS GUIDES \$6 | 1 ELECTRICIANS HANDY BOOK \$4

NAME

ADDRESS

OCCUPATION

EMPLOYED BY..... AT30

4 of the 40 Easy Ways to Make \$3⁰⁰ an Hour

In Your Spare Time in RADIO

THE four plans shown are but a sample of the many ways in which our members are making \$3.00 an hour upwards, spare time and full time, *from the day they join the Association.* If you want to get into Radio, have a business of your own, make \$50 to \$75 weekly in your spare time, investigate the opportunities offered the inexperienced, ambitious man by the Association.

Our Members Earning Thousands of Dollars Weekly

The Association was formed to help men cash in on Radio. It makes past experience unnecessary. As a member of the Association you are trained in a quick, easy, practical way to install, service, repair, build and rebuild sets—given sure-fire money-making plans developed by us—helped to secure a position by our Employment Department. You earn while you learn, while you prepare yourself for a big-pay Radio position.

The Association will enable you to buy parts at wholesale, start in business without capital, help you get your share of the \$600,000,000 spent annually for Radio. As a result of the Association, men all over the country are opening stores, increasing their pay, passing licensed operator examinations, landing big-pay positions with Radio makers.



Mail Coupon for the FREE HANDBOOK

It is not only chock-full of absorbing information about Radio, but it shows you how easily you can increase your income in your spare time. Mailing the coupon can mean \$50 to \$75 a week more for you.

Radio Training Association of America
4513 Ravenswood Avenue Dept. PM-4 Chicago, Illinois

Below are a few reports from those cashing in on the "easy ways"

Clears \$3,000.00 Frank J. Deutch, Pa.—"Since joining the Association I have cleared nearly \$3,000.00. It is almost impossible for a young fellow to fail, no matter how little education he has, if he will follow your **easy ways** of making money."

\$1,100.00 in 6 Weeks J. R. Allen, Calif.—"Have done over \$1,100.00 worth of business in the last 6 weeks. Next month I am going to open up a store of my own. I never knew that money could come so fast and easy."

\$25.00 a Week Spare Time N. J. Friedrich, N. Y.—"I have averaged \$25.00 a week for the last 7 months even though I am not a graduate but just learning."

Training Lands Him Job R. C. Kirk, N. C.—"Your training has been very valuable to me. I landed a job with the big department store out here a few weeks ago because I had my membership card with me. There were a large bunch of applications ahead of me."

ACT NOW If You Wish NO-COST Membership

For a limited time we will give to the ambitious man a No-Cost Membership which need not—should not—cost you a cent. For the sake of making more money now, and having a better position in the future, mail coupon below *now*.

Radio Training Association of America
Dept. PM-4 4513 Ravenswood Ave., Chicago
Gentlemen: Please send me by return mail full details of your Special No-Cost Membership Plan, and also a copy of your Radio Handbook.

Name _____

Address _____

City _____ State _____





Salary increased from \$112 to \$400 a month

"MY I. C. S. course in Cost Accounting was of great practical help in enabling me to install a cost system in a plant having somewhat unusual problems. It also helped me to get my B. C. S. degree from a resident commercial school and in preparing for the C. P. A. examination. My salary was \$112 a month when I enrolled. It is now \$400 a month, with a generous allowance for traveling expenses."

That's a true story of what spare-time study has done for just one man. There are thousands of others. Why don't you take up a home-study course with the International Correspondence Schools and prepare yourself to earn more money? You can do it if you really try.

It doesn't cost you a penny or obligate you in any way to mark and mail the coupon, but that one simple step will bring you information that will help you to get out of the rut and make good in a big way.

Mark and Mail the Coupon Today

INTERNATIONAL CORRESPONDENCE SCHOOLS, Box 5676-F, Scranton, Penna.
"The Universal University"

Without cost or obligation on my part, please send me a copy of your 48-page booklet, "Who Wins and Why," and tell me how I can qualify for the position, or in the subject, before which I have marked an X:

BUSINESS TRAINING COURSES

- | | | | |
|---|--|---|---|
| <input type="checkbox"/> Business Management | <input type="checkbox"/> Cost Accounting | <input type="checkbox"/> Business Correspondence | <input type="checkbox"/> Mail Carrier |
| <input type="checkbox"/> Industrial Management | <input type="checkbox"/> Bookkeeping | <input type="checkbox"/> Show Card and Sign Lettering | <input type="checkbox"/> Railway Mail Clerk |
| <input type="checkbox"/> Personnel Management | <input type="checkbox"/> Secretarial Work | <input type="checkbox"/> Stenography and Typing | <input type="checkbox"/> High School Subjects |
| <input type="checkbox"/> Traffic Management | <input type="checkbox"/> Spanish <input type="checkbox"/> French | <input type="checkbox"/> English | <input type="checkbox"/> Grade School Subjects |
| <input type="checkbox"/> Accounting and C. P. A. Coaching | <input type="checkbox"/> Salesmanship | <input type="checkbox"/> Civil Service | <input type="checkbox"/> Illustrating <input type="checkbox"/> Cartooning |
| | <input type="checkbox"/> Advertising | | <input type="checkbox"/> Lumber Dealer |

TECHNICAL AND INDUSTRIAL COURSES

- | | | | |
|--|--|---|--|
| <input type="checkbox"/> Architect | <input type="checkbox"/> Telegraph Engineer | <input type="checkbox"/> Aviation Engines | <input type="checkbox"/> Pharmacy |
| <input type="checkbox"/> Architectural Draftsman | <input type="checkbox"/> Telephone Work | <input type="checkbox"/> Plumber and Steam Fitter | <input type="checkbox"/> Coal Mining Engineer |
| <input type="checkbox"/> Building Foreman | <input type="checkbox"/> Mechanical Engineer | <input type="checkbox"/> Plumbing Inspector | <input type="checkbox"/> Navigation <input type="checkbox"/> Assayer |
| <input type="checkbox"/> Concrete Builder | <input type="checkbox"/> Mechanical Draftsman | <input type="checkbox"/> Foreman Plumber | <input type="checkbox"/> Iron and Steel Worker |
| <input type="checkbox"/> Contractor and Builder | <input type="checkbox"/> Machine Shop Practice | <input type="checkbox"/> Heating and Ventilation | <input type="checkbox"/> Textile Overseer or Supt. |
| <input type="checkbox"/> Structural Draftsman | <input type="checkbox"/> Toolmaker | <input type="checkbox"/> Sheet-Metal Worker | <input type="checkbox"/> Cotton Manufacturing |
| <input type="checkbox"/> Structural Engineer | <input type="checkbox"/> Patternmaker | <input type="checkbox"/> Steam Engineer | <input type="checkbox"/> Agriculture |
| <input type="checkbox"/> Electrical Engineer | <input type="checkbox"/> Civil Engineer | <input type="checkbox"/> Marine Engineer | <input type="checkbox"/> Woolen Manufacturing |
| <input type="checkbox"/> Electrical Contractor | <input type="checkbox"/> Surveying and Mapping | <input type="checkbox"/> Refrigeration Engineer | <input type="checkbox"/> Fruit Growing |
| <input type="checkbox"/> Electric Wiring | <input type="checkbox"/> Bridge Engineer | <input type="checkbox"/> R. R. Positions | <input type="checkbox"/> Poultry Farming |
| <input type="checkbox"/> Electric Lighting | <input type="checkbox"/> Gas Engine Operating | <input type="checkbox"/> Highway Engineer | <input type="checkbox"/> Mathematics |
| <input type="checkbox"/> Electric Car Running | <input type="checkbox"/> Automobile Work | <input type="checkbox"/> Chemistry | <input type="checkbox"/> Radio |

Name..... Street Address.....

City..... State..... Occupation.....

If you reside in Canada, send this coupon to the International Correspondence Schools Canadian, Limited, Montreal, Canada

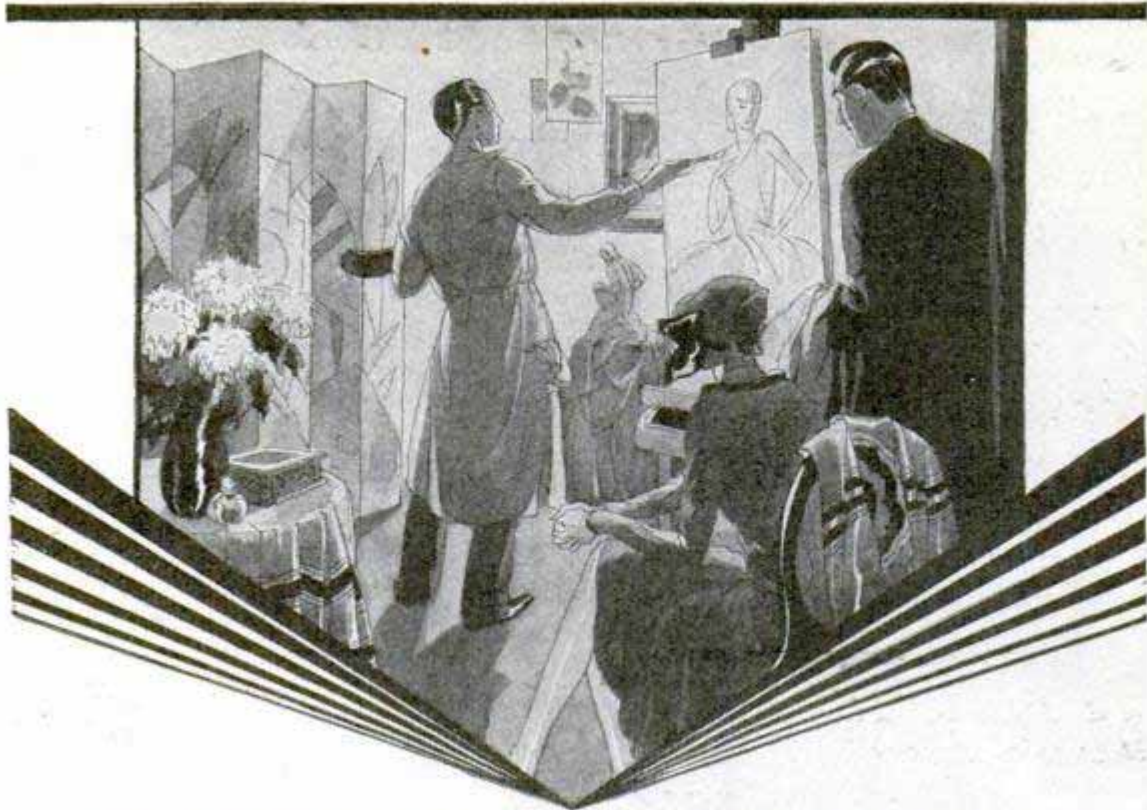

ENJOY YOUR WORK be an artist!

IF I could only be in some line of work that gripped me, I know I would succeed." How often you have said this to yourself! And you are right. When you love your work, you can throw your whole soul into it — success comes faster.

Many successful artists worked in commonplace jobs before they found themselves. One internationally famous cartoonist and art editor was clerk and bookkeeper in a general store. Another great illustrator was a taxidermist. You may have hidden artistic talent—wasted in your present work—which will help you succeed with training.

Through the Federal Course in Illustrating more than fifty famous artists give you the benefit of their experience in Illustrating, Cartooning, Lettering, Poster Designing, Window Card Illustrating, etc. The methods of these highly paid artists as explained through the

Federal Course help you to become a professional.

If you have artistic talent, you will be happier and will learn quickly and easily when you commence the Federal Course. You can learn at home during your spare time — continue your present work while fitting yourself for art. Art is a vital part of today's business. Publishers spend millions of dollars each year for illustrations.

FIND YOURSELF—READ THIS FREE BOOK

"A Road to Bigger Things" gives fascinating details about how famous artists of today started their careers—tells how you can learn to earn in art and shows examples of our students' drawings. Many successful Federal Students are earning from \$2500 to \$6000 a year—some even more. Write your name, age and address on the coupon and we will send a copy of this encouraging book together with Vocational Art Test—both without charge.

FEDERAL SCHOOL of ILLUSTRATING

4130 Federal Schools Building

Minneapolis, Minnesota

Federal School of Illustrating,
4130 Federal Schools Building,
Minneapolis, Minnesota.

Please send me free book, "A Road to Bigger Things," and Vocational Art Test.

Name _____ Age _____

Occupation _____ Address _____



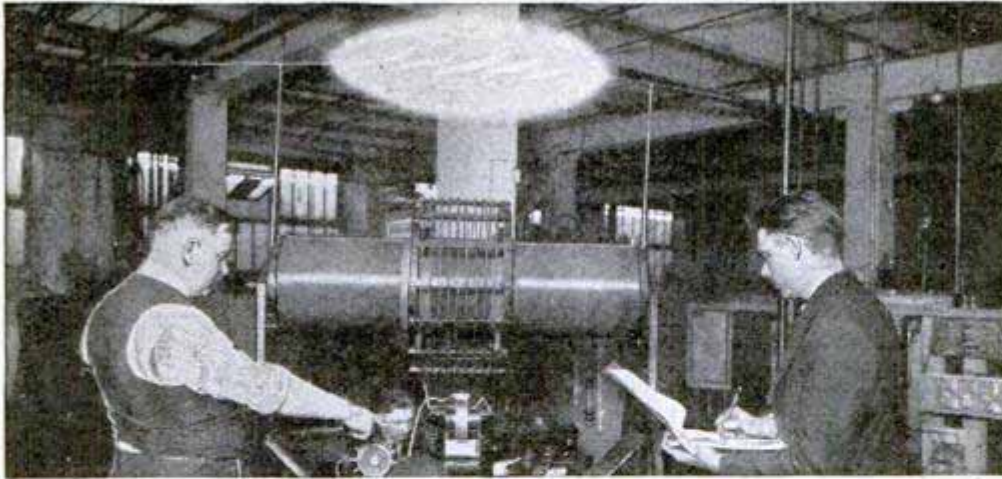

500,000 VOLTS

"Artificial lightning" being developed in COYNE School. Spark of 500,000 volts is shown jumping 30 inches. This gigantic Tesla coil is the same as that used by Steinmetz, absolutely harmless, because of high frequency.

LEARN ELECTRICITY Without Books or Lessons in 12 Weeks

By Actual Work - In the GREAT SHOPS of COYNE



Anyone who can see and understand the English language can master Electricity in 90 days. I teach you with the most complete outlay of electrical apparatus ever assembled in any school—30-foot control board—2-story transmitting stations—skeleton houses, huge motors of all kinds—dynamoes—sub-stations—auto-

mobiles—switchboards. In one department we generate enough electricity to supply a small city!

No Books—No Lessons—No Classes

ENTER ANYTIME. Experts teach you without books or classes. They guide you every step of the way with individual attention. You do the actual work on real full-size machinery in full operation. Take motors for instance. Instead of learning from books and charts—you actually build motors. You can't help but know all about them. Anyone can learn this fascinating way.

No Experience Necessary

That's how my methods make men master electricity in 12 wonderful weeks. You don't need experience—Coyne training starts from the very beginning. You don't need advanced education—you learn by doing. Age is no handicap—Coyne students range from 16 to 40.

Triple Your Earning Power

I don't need to tell you about the opportunities in Electricity. They are too many and too amazing to mention. Ordinary jobs run from \$50—\$75—\$150 a week. And Coyne training leads to the biggest positions.

COYNE ELECTRICAL SCHOOL

H. C. LEWIS, President — ESTABLISHED 1899
500 S. Paulina St., Dept. 40-72, Chicago

Many Coyne men are making up to \$600 a month. Demand for Coyne men often exceeds the supply. Our Employment Bureau secures dozens of positions weekly.

EARN WHILE YOU LEARN

We help many students to secure part-time jobs to earn a good part of living expenses while learning.

RAILROAD FARE to Chicago Allowed

Right now I am including railroad fare to Chicago and complete courses in Radio, Aviation, and Automotive Electricity without extra charge.

All Details Sent Free

This school is 30 years old—Coyne training is tested—proven beyond all doubt—endorsed by electrical industry. You can find out everything absolutely free. Simply mail the coupon and let me send you the big, free Coyne book of 150 photographs—facts—jobs—salaries—opportunities. See what Coyne training can do for you in just 90 days! This does not obligate you. So act at once. Just mail coupon.

Get this Free Book



H. C. LEWIS, President

COYNE ELECTRICAL SCHOOL, Dept. 40-72
500 S. Paulina St., Chicago, Ill.

Dear Mr. Lewis:

Without obligation send me your big free catalog and all details of Railroad Fare to Chicago, Free Employment Service, Radio Aviation and Automotive Electrical Courses you are including and how many "earn while learning."

Name

Address

City State

"Must have had a Big Raise, eh, Bill?"



NO WONDER ED, the Receiving Teller down at the National Bank, was curious. This was the fifth Monday in succession I had made a big EXTRA deposit. By "big" I mean \$20 to \$25 more than I usually banked each week. And Ed noticed that I was dressed better, too!

He wondered where I was getting all the Extra Money

"You bet I had a big raise," I answered. "In fact I gave myself one!" "What do you mean," asked Ed, still puzzled. "Just this, Ed, I'm a professional TENOR BANJOIST three nights a week—playing in Harry Smith's Dance Orchestra, at \$10 a night! Believe me, it's the easiest money I ever earned, too." "You, a paid musician!" exclaimed Ed. "Why, I didn't know you ever touched a string!"



Six Months ago I was Lonely— Six Months ago I was Poor!

"Well," I said, "one night I was sitting at home feeling lonely and blue — wishing for more good times and more money to spend. Picking up a magazine I just happened upon an ad about a new way of learning the TENOR BANJO at home. It said anyone who could read English could learn to play. I had no idea I could — always thought those things were just for a few 'talented' folks. But I was sick and tired of being 'on the outside,' so I said to myself, 'I'll

send for their Free Book, anyway.' Guess you can tell from my face and my bank book that I'm mighty glad I did, Ed! That Course sure taught me quick. Then Harry Smith heard me playing one night at a party. It was only two months after I started, but right away he offered me a spare-time job with his Orchestra. And he'll soon be able to use me steady, six nights a week—at \$70 a week. That's twice what I'm making down at the Freight Office. I can't really call playing the TENOR BANJO 'work.' It's FUN!—every minute of it. And it's better than having a rich uncle."

Big Tenor Banjo and Outfit comes with 1st Lesson

The Same Opportunity is Yours - Right Now!

Never mind if you've never played a note in your life. This new method can make you a popular, high-paid Tenor Banjoist in a few short weeks. The Coupon below brings your Free copy of my book, "The Play-Way to Popularity and Big Pay." It tells how thousands of others have succeeded, just as Bill did—just as YOU CAN! Send for it right NOW—today!

Clip-Sign-Send

A. F. BLOCH, President, New York Academy of Music, Studio 1040, 100 Fifth Avenue, New York City.

Send me the book that started Bill. No obligation on my part, of course.

Name.....Age.....

Address.....

City.....State.....

Now Comes the New Shorthand

Written in A B C's

AT LAST! The answer to the urgent need of modern business for a really scientific shorthand. Speedwriting, the new easy shorthand, sets new standards for speed and accuracy.

So simple anyone can learn its principles in one evening. We guarantee you can learn it, at home, in 72 hours — thousands have learned it in less time. Busy executives are using it themselves, so are professional men, engineers, lawyers, students, etc.



Good, competent, men stenographers are preferred by business men—more are needed every day. This is a quick way to step out of the crowds and earn more money.

FREE Book Tells All

Write tonight for this free book. In it you get all the facts about this fascinating new system that can be learned in spare time.



SPEEDWRITING, Inc.
Dept. 244 200 Madison Ave.
New York City

the SCARLET FLASH

AMAZING MODEL PLANE

'Rises off Ground' wonderful CABIN plane you may have it

FREE!

FREE

Here's the SCARLET FLASH model airplane construction set with a record of 90 seconds in air. Sworn statements available. Rises off ground. Will not nose-dive, stall or spin. Has flown 350 ft. Altitude record 50 ft. A wonderful model plane and you can have it FREE.

GIVEN FREE

THE OPEN ROAD FOR BOYS Magazine is a 50 page monthly magazine, crammed with thrilling stories of aviation, high adventure, mystery and suspense. Over 200,000 readers. Regular price \$1.00 a year. Send me \$1.00 and I'll send you THE OPEN ROAD FOR BOYS Magazine for 12 months and give you this airplane set FREE. Order at once.

Pilot Rumford
THE OPEN ROAD FOR BOYS
130 Newbury Street, Boston, Mass.

Name.....
Street.....
City.....State.....



We have placed machinists, carpenters, masons, plumbers, railroad men, office clerks, farmers and even laborers in fine Drafting Jobs under this plan. Mail coupon for details of our remarkable offer.



Men Who Work With Their Hands Make the Best DRAFTSMEN



—and we'll back them with this EMPLOYMENT CONTRACT

We are looking for more ambitious young fellows with factory, building-trade or any other kind of mechanical experience to prepare for and help place in well-paid Drafting positions. Such men, we find, are unusually successful as Draftsmen, because they know how things are done, and that's a priceless asset to the man who makes the blueprint plans. Get in touch with me and I'll tell you how you can cash in on your entire past mechanical experience.

Drafting Is Logically Your Next Move!

Of course you realize the biggest handicap to mechanical work is that you're limited in earning capacity to the output of your two hands, as long as you live. Even the skilled mechanic earning \$50 to \$60 a week has reached his limit. He can never earn more and when he gets old he will earn less. So I don't blame any man for wanting to get away from this futureless outlook. For wanting to get into something where he can use his head as well as his hands—where he will be paid for what he knows, instead of only for what he does . . . You know enough about blueprints to understand that PLANS govern every move in factory and construction job. The Draftsman who makes them is several jumps ahead of the workman who follows them. And so I want you to know that DRAFTING is a logical, natural PROMOTION from mechanical and building work—better-paid, more interesting—just the kind of work you'd enjoy doing.

Get Our NO-RISK PLAN

The way to a fine Drafting job for you—is easier than you think. It takes no "artistic talent" or advanced education. Thousands of men no smarter than you, with no more education or ability, have learned it quickly and you can, too. With the co-operation of some of the biggest employers and engineers in the U. S., we have worked out a plan to prepare you for Drafting work in your spare time at home—then to help you get a fine position at increased pay. Mail the coupon and we'll be glad to tell you all about this lifetime chance to get into Drafting.

THE AMERICAN SCHOOL

Dept. D-447, Drexel Ave. and 58th St., Chicago, Ill.



36-Page Drafting Book—FREE

Tells how easy Drafting is to learn—how interesting the work is—what remarkable opportunities are open for Draftsmen right now. Mail coupon for a copy—without cost or obligation.

AMERICAN SCHOOL, Dept. D-447, Drexel Ave. & 58th St., Chicago, Ill.

Please tell me, without cost or obligation, about your training and employment service in line marked X below.

DRAFTING

- Architecture Civil Engineering
 Building Auto Engineering
 Electrical Engineering
 Business Management
 Accounting
 Mechanical Engineering
 Shop Superintendent
 Foremanship
 High School in 2 years
 Structural Steel

Name _____

St. No. _____

City _____ State _____

Age _____ Occupation _____



"I have landed a job with the Pacific Tel. and Tel. Co. in Seattle, and I must say that I am greatly indebted to the American School for my success. You have done all that you promised in helping me obtain employment."

T. C. White
Seattle, Wash.



"I have obtained a position as a junior draftsman with the Muncie Oil Engine Co., and so far I like the work real well. I appreciate your aid in obtaining this position very much."

M. N. Bareham
Muncie, Ind.



WANT A GOVERNMENT JOB?

**RAILWAY
POSTAL CLERKS**

\$158 to \$225 a Month

Mail Coupon Before You Lose It

FRANKLIN INSTITUTE, Dept. H187, ROCHESTER, N. Y.

Sirs: Rush to me, without charge, copy of 32-page book "How to get U. S. Government Jobs," list of positions obtainable and full particulars telling how to get them.

Name.....

Address.....

**STEADY WORK—NO LAYOFFS—PAID VACATIONS—CITY
MAIL CARRIERS—POST OFFICE CLERKS—CENSUS CLERKS**
Over 20,000 Government Jobs Open Yearly
Common Education Usually Sufficient

CARTOON & COMIC STRIP COURSE FOR \$2.98 ONLY COMPLETE

The Ace of Cartoon Courses



For fun and profit learn to draw cartoons and comic strips. Amazingly simple system developed by CARL ANDERSON, famous contributor to SATURDAY EVENING POST, COLLIER'S, LIFE, JUDGE, NEW YORK JOURNAL, NEW YORK WORLD and other leading publications, gives complete instructions in DRAWING, CARTOONING, COMIC STRIP AND ILLUSTRATION. These easy lessons make drawing as easy as writing. Spend only a few hours a week practicing and you will be able to draw and draw well in a very short time. 48 lessons, hundreds of illustrations, cost but \$2.98, the greatest bargain ever offered in a guaranteed drawing course. We

SEND NO MONEY
Just order course and pay postman \$2.98 plus postage on delivery.

positively **GUARANTEE MONEY BACK** if the course is not everything we claim. Order today—Address

THE CARL ANDERSON SCHOOL, MADISON, WIS.

Send \$3.28 cash with orders from outside U. S. A.

TELEGRAPHY

(Morse and Wireless) and RAILWAY ACCOUNTING, taught thoroughly. Big salaries. Tremendous demand. Oldest, largest school. Endorsed by Telegraph, Railway, Radio, and Government officials. Expense low—opportunities to earn large portion. Catalog free. DODGE INSTITUTE, Jones St., Valparaiso, Ind.

LAW

STUDY AT HOME
Become a lawyer. Legally trained men win high positions and big success in business and public life. Be independent. Greater opportunities now than ever before. Big corporations are headed by men with legal training. Earn **\$5,000 to \$10,000 Annually**. We guide you step by step. You can train at home during spare time. Degree of LL.B. conferred. LaSalle students found among practicing attorneys of every state. We furnish all text material, including fourteen-volume Law Library. Low cost, easy terms. Get our valuable 64-page "Law Guide" and "Evidence" books FREE. Send for them NOW. **LaSalle Extension University, Dept. 464-L, Chicago**
The World's Largest Business Training Institution

ELECTRICITY WELDING AUTOMOBILES

PRACTICAL TRAINING ON MASSIVE LAY-OUT OF ELECTRICAL EQUIPMENT

Aircraft Oxy-Acetylene and Electric Welding, Armature Winding; Power Plants, Switchboards, Transformers, Motors, Generators, Batteries, Radio and Automobiles. Write now for Free Catalog.

Coleman Electrical School, 1628 Main St., Kansas City, Mo.

Learn Watchwork, Jewelrywork and Engraving

A fine trade commanding a good salary, and your services always in demand. Address **Herological, Dept. P, Bradley Institute, PEORIA, ILLINOIS**, for our latest catalog.

Do YOU want a good Job?

Broadcasting Stations are continually needing engineers, operators, managers and pay \$1,800 to \$5,000 a year. Radio Manufacturers continually need testers, inspectors, foremen, engineers, service men, buyers and managers for jobs paying up to \$15,000 a year. Shipping Companies use hundreds of Radio operators, give them world wide travel with practically no expense, and pay \$85 to \$200 a month besides. Radio Dealers and Jobbers (there are over 35,000) are continually on the lookout for good service men, salesmen, buyers, managers and pay \$30 to \$100 a week. Talking Movies pay as high as \$75 to \$200 a week to the right men with Radio training.

Extra Money In Spare Time Too

There is an opportunity in almost every community for one or more good service men—men who really know how to put all makes of sets in perfect working order—to make \$10 to \$30 a week in their spare time. There are hundreds of opportunities for you to have a spare time or full time Radio business of your own—to be your own boss. Many start one with money earned while learning my course. The day you start I'll show you ten jobs common in most every neighborhood that you can do for extra money. My book gives you many examples of men who made \$200 to \$1,000 extra while learning.

**Radio
needs more
spare time
and
full time
Men**

Here are a few examples of what I've done for others. J. A. Vaughn, 3715 S. Kingshighway, St. Louis, Mo., jumped from \$35 to \$100 a week. E. E. Winborne, 1414 W. 48th St., Norfolk, Va., seldom makes under \$100 a week now. Erle Chambers, 228 W. 7th St., Cincinnati, Ohio, made well over \$5,000 last year. The coupon below will bring my book in which you can read their letters—see the proof that I am doubling and tripling the salaries of many.

I'll Give You This And More Too

Over 50 Lesson Texts covering the fundamental principles of Radio, Transmitting and Receiving Sets, Radio's use in Talking Movies, Wired Radio, Radio's use in Aviation, Television and home Television Experiments and many other subjects. Over 40 Service Sheets giving authentic information on servicing different makes and models of sets. Eight Outfits of Radio Parts for a Home Experimental Laboratory; help in finding you a job upon graduation and I'll give you many other services and considerably more material. Furthermore, I've made my course easy to learn. I'll agree to refund your money if, upon completion, you are not satisfied with my Lessons and Instruction Service. Send the coupon. After you have read my book you can decide one way or the other.

Get the facts—Mail this Coupon



J. E. SMITH, President,
National Radio Institute, Dept. ODPP
Washington, D. C.

Dear Mr. Smith:—Send me "Rich Rewards in Radio." I understand this request does not obligate me in the least and that no representative will call.

Name.....

Address.....

City..... State.....

**Lifetime Employment
Service to all Graduates**

NATIONAL RADIO INSTITUTE
EST. 1914
WASHINGTON, D. C.

Muscles 5¢ apiece!

WOULDNT it be great if we could buy muscles by the bag—take them home and paste them on our shoulders? Then our rich friends with money to buy them, sure would be socking us all over the lots. But they don't come that easy, fellows. If you want muscle you have to work for it. That's the reason why the lazy fellow never can hope to be strong. So if you're lazy and don't want to work—you had better quit right here. This talk was never meant for you.

I Want Live Ones

I've been making big men out of little ones for over fifteen years. I've made pretty near as many strong men as Heinz has made pickles. My system never fails. That's why I **guarantee** my works to do the trick. That's why they gave me the name of "The Muscle Builder."

I have the surest bet that you ever heard of. Eugen Sandow himself said that my system is the shortest and surest that America ever had to offer.

Follow me closely now and I'll tell you a few things I'm going to do for you.

Here's What I Guarantee

In just 30 days I'm going to increase your arm one full inch. Yes, and add two inches to your chest in the same length of time. But that's nothing. I've only started; get this—I'm going to put knobs of muscles on your shoulders like baseballs. I'm going to deepen your chest so that you will double your lung capacity. Each breath you take will flood every crevice of your pulmonary cavity with oxygen. This will load your blood with red corpuscles, shooting life and vitality throughout your entire system. I'm going to give you arms and legs like pillars. I'm going to work on every inner muscle as well, toning up your liver, your heart, etc. You'll have a snap to your step and a flash to your eye. You'll feel the real pep shooting up and down your old backbone. You'll stretch out your big brawny arms and crave for a chance to crush everything before you. You'll just bubble over with vim and animation.

Sounds pretty good, what? You can bet your old ukulele it's good. It's wonderful. And don't forget, fellow—I'm not just promising all this—I **guarantee** it. Well, let's get busy, I want action—So do you.

SEND FOR
MY NEW
64-PAGE BOOK

"Muscular Development"

IT IS
FREE

It contains forty-eight full-page photographs of myself and some of the many prize-winning pupils I have trained. Some of these came to me as pitiful weaklings, imploring me to help them. Look them over now and you will marvel at their present physiques. This book will prove an impetus and a real inspiration to you. It will thrill you through and through. This will not obligate you at all, but for the sake of your future health and happiness do not put it off. Send today—right now before you turn this page.

EARLE LIEDERMAN
Dept. 2004, 305 Broadway, New York City

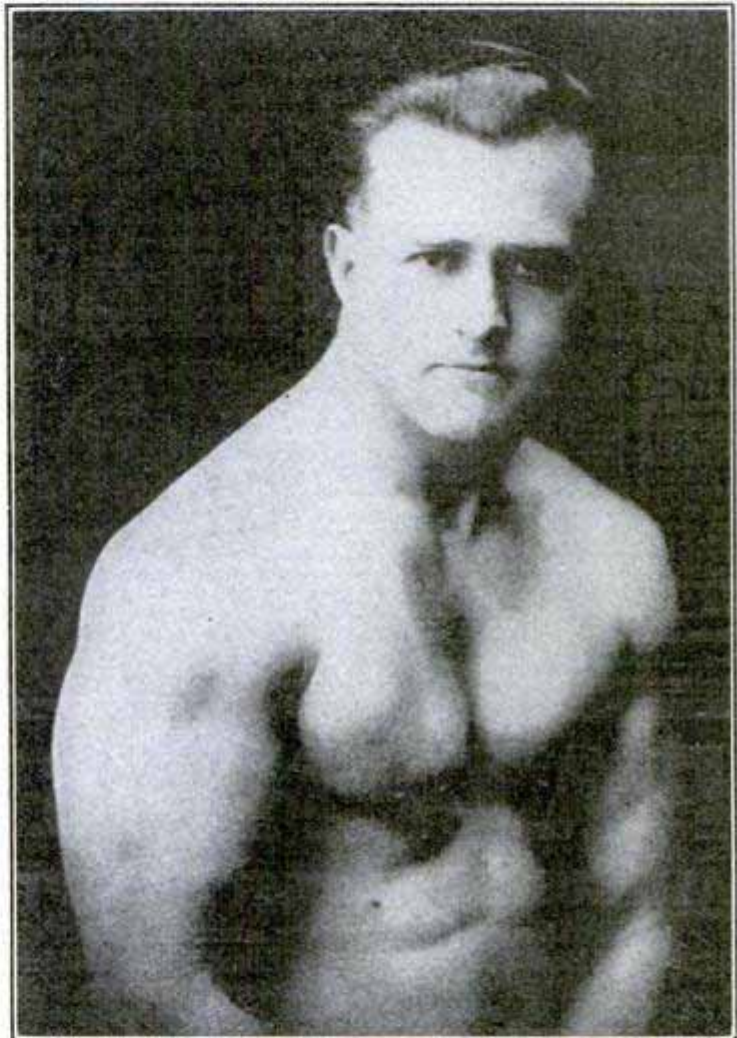

EARLE LIEDERMAN, The Muscle Builder

Author of "Muscle Building," "Science of Wrestling and Jiu Jitsu," "Secrets of Strength," "Here's Health," "Endurance," Etc.

EARLE LIEDERMAN
Dept. 2004, 305 Broadway, New York City

Dear Sir:—Please send me without any obligation on my part whatever, a copy of your latest book "Muscular Development." (Please write or print plainly.)

Name.....Age.....

Street.....

City.....State.....

ELECTRICITY

PAYS BIG!



LEARN IN 90 DAYS ON ACTUAL EQUIPMENT — NO BOOKS

Don't let the world bluff you. Get into electricity—earn \$50.00 to \$150.00 a week—and hold your head as high as the next man. Do it easily, by coming to my famous electrical school. In 12 short weeks you'll pack in many years of practical knowledge. You learn on real Electrical Equipment, with real Tools. My special School Shops are fitted with Switchboards, Generators, Motors, etc. You get first hand knowledge of A. C. and D. C. Armature Winding, House Wiring, Splicing, in fact everything you need to

No Education or Experience Needed

No books to read. No dry lectures to listen to. You learn by doing. I don't care if you can't tell a motor from a horse-and-bug-gy now. When you graduate I guarantee that you'll know electricity from "A" to "Z."

know to fit you for an Electrical job. Also complete instruction on Automobile, Aviation and Radio Electrical Systems and Batteries.

Satisfaction Guaranteed!

I guarantee satisfaction! I guarantee to continue giving you my practical training until you are able to hold a first class electrical job.

Big Illustrated Book Sent FREE

Today, right now, take the first step out of that low pay rut. Mail the coupon to me for big, illustrated book on ELECTRICITY. Act today. Get my special Remarkable Tuition offer.

JUST MAIL COUPON!



IT'S EASY THIS WAY

Fascinating, practical shop work in my big school fits you. Not a correspondence course.

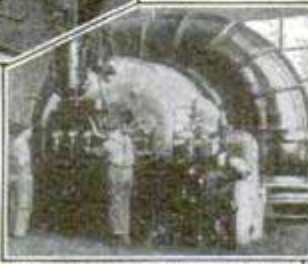

COMPLETE RADIO COURSE



McSWEENEY ELECTRICAL SCHOOLS

Dept. E-11-W, 1815 E. 24th Street, Cleveland, Ohio, or Dept. E-11-W, 263 Madison Street, Memphis, Tenn.

J. H. McSweeney, Pres., McSweeney Elec. Schools, Dept. E-11-W, 1815 E. 24th St., Cleveland, O., or Dept. E-11-W, 263 Madison St., Memphis, Tenn. Dear Mac: Without obligation send me a copy of your big free book on ELECTRICITY; also details of remarkable tuition offer and complete radio course.

Name.....
Address.....
Town.....State.....

PATENTS

Booklet Free Highest References
Promptness Assured Best Results

Send drawing or model for preliminary examination and advice.

ALL BUSINESS GIVEN PROMPT AND PROPER ATTENTION

Listed Patent Lawyer in the latest editions of the Rand-McNally Directory of Bankers and Bonded Attorneys, published by Rand-McNally & Co., Chicago, Ill.; The Baggott & Ryall Directory of Guaranteed Attorneys, published by Legal Directory Corporation, Boston, Mass.; Flugel's Law List, published by Legal Directory Publishing Co., St. Louis, Mo.; American Lawyers Annual, published in Cleveland, Ohio; Bankers Service Legal Directory, published by Bankers Service Co., Boston, Mass.; Eyre's Law List, 9 Park Place, New York City; Walters Legal Directory, Omaha, Nebraska, and the National Directory of Attorneys, Baltimore, Maryland.

WATSON E. COLEMAN,
REGISTERED PATENT LAWYER

Victor Building, 724 Ninth Street, N. W.
WASHINGTON, D. C.

TRAVEL - for 'UNCLE SAM'

RAILWAY POSTAL CLERKS

MAIL CARRIERS—POSTOFFICE CLERKS
GENERAL CLERKS—CUSTOMS INSPECTORS
\$1700 to \$3400 a Year for Life

No "lay-offs" because of strikes, poor business, etc.—sure pay—rapid advancement. Many other U. S. Government Jobs. City and country residents stand same chance. Common sense education usually sufficient.

STEADY WORK

Cut coupon and mail it before turning the page.

MEN—BOYS 18 to 45

Use Coupon Before You Lose It

COUPON

FRANKLIN INSTITUTE, Dept. H173, Rochester, N. Y. Rush to me, free of charge, (1) A full description of the position checked below; (2) 32-page book, with list of positions obtainable; (3) Tell me how to get the position checked.

- Railway Postal Clerk (\$1900 to \$2700)
- General Clerk (\$1260 to \$2100)
- Postoffice Clerk (\$1700 to \$2300)
- Customs Inspector (\$2100 up)
- City Mail Carrier (\$1700 to \$2100)
- Rural Mail Carrier (\$2100 to \$3300)

Name.....
Address.....



They Told Him Salesmen Were "Born" But Now He Makes \$10,000 a Year ...Thanks to This Little Book

IT was just a little free book that made the difference between Ed Pinkham and the rest of the men in our shop. Nobody ever imagined that Ed would land, even in the \$5,000-a-year class, let alone be making \$10,000 before he was thirty. Ed didn't know himself the abilities he had in him as a money-maker.

But one day, a strange occurrence changed his whole life. During his lunch hour Ed started to read a little book he had brought to work with him.

"It's a book called 'The Key To Master Salesmanship,' Bill," he told me. "It's the most amazing thing I ever read. I never dreamed there was so much in salesmanship. You ought to send for a copy yourself. It's free."

"Huh!" said Luke Jones. "Does that book tell you how to become a salesman?"

"It sure does," replied Ed, enthusiastically.

"Don't waste your time," advised Luke. "You can't learn how to be a salesman. A fellow has to be 'born' that way to be a good salesman."

Ed just smiled at that, but he said nothing. Soon afterward he quit the shop, and we forgot about him. And then last night, I met Ed again—driving a snappy new sedan and dressed like a million dollars.

"For Pete's sake," I said. "What are you doing nowadays, Ed?" He smiled. "City Sales Manager for the Steel Castings Company," he told me. "What are you doing?"

"Still at the shop," I replied. "But what I want to know is, how do you come to be Sales Manager for Steel Castings? They're one of the biggest firms in the business."

Ed smiled again. "Remember that book on Salesmanship that Luke Jones was kidding me about one day? Well, when I finished my Salesmanship training the Association I took it from gave me a choice of twenty-two jobs through their Free Employment Department, and I took a position as salesman for Steel Castings Company. They made me City Sales Manager three months ago at ten thousand dollars a year."

"Good night!" I said. "And Luke and I are still punching the old time clock!"

Ed looked at me seriously. "See here, Bill," he said. "Are you sport enough to risk two cents that you can do as well as I did? Then spend the two cents to write to the National Salesmen's Training Association tonight and get

their free book. Then take their course. When you have your diploma, their Free Employment Department will help you get a good sales job—every year they have calls for over 50,000 salesmen. Not only will they help you get the job, but they give you an iron-clad money-back guarantee that you must be satisfied with the training received—or they refund your tuition!"

FREE—TO EVERY MAN

A book—but what a book! Just seven ounces of paper and printers' ink—but it reveals facts and secrets that help hundreds of men to success beyond their fondest expectations! See for yourself—FREE—why "The Key To Master Salesmanship" has increased the earning capacities of thousands, as a direct result of their reading it! You'll know, then, how J. H. Huppert of Michigan learned from its pages the secrets that enabled him to make \$525 in one week. You can understand how it helped A. A. Fidler of Alabama to raise his pay 700%. Learn for yourself the REAL TRUTH about salesmanship. You do not risk one penny or incur the slightest obligation. And since it may prove the turning point in your career it is certainly worth your while to fill out and mail the coupon below. Do it now!

NATIONAL SALESMEN'S TRAINING ASSOCIATION

Dept. D-102, N. S. T. A. Bldg., Chicago, Ill.

NOW SENT FREE



NATIONAL SALESMEN'S TRAINING ASSOCIATION,

Dept. D-102, N. S. T. A. Bldg., Chicago, Ill.

Without cost or obligation please send me my free copy of "The Key To Master Salesmanship," including details of your FREE EMPLOYMENT Service.

Name.....
Address.....
City.....State.....
Age.....Occupation.....



A giant plane dips and soars across the sky, leaving against the brilliant blue the one word
ELECTRICITY.....

Men stop and gaze at the huge letters written so gracefully thousands of feet above the earth. Somewhere an electrical expert has groomed the giant plane for its flawless flight . . . every wire tested . . . every electrical device in perfect running order.

Today industry is as dependent upon the expert electrician as the powerful plane tracing the magic name over countless cities and towns. To him come the profits of industry and commerce. You, too, can be an electrical expert. Write today for the 48-page booklet.

NEW YORK ELECTRICAL SCHOOL

44 West 17th St., NEW YORK

MAIL TODAY

THE NEW YORK ELECTRICAL SCHOOL
44 WEST 17TH STREET, NEW YORK

Please send me **FREE** your 48-page booklet. It is understood that this request puts me under no obligation.

Name

Address

Increase Your Earning Power

Apply time and labor-saving kinks to your work. Your efficiency will soon be recognized and you will be in line for advancement.

If you do machine shop work of any kind, sheet-metal work, painting, carpentry, auto repairing, farming, concrete work, plumbing, electrical work, welding, building, glass work, general repairing, tool-making, poultry raising, masonry or home repair work, get this

LIBRARY OF 6000 TIME AND LABOR SAVING IDEAS FOR SHOPMEN AND HANDYMEN

JUST PUBLISHED

SHOP NOTES for 1930

192 Pages
415 Articles
377 Illustrations

See partial list of contents below

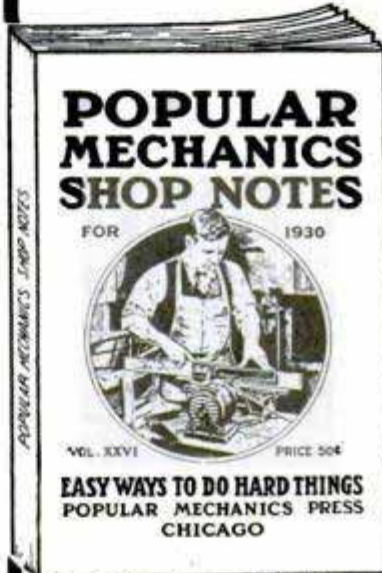

Including the new 1930 issue illustrated above, there are now 14 volumes in the Shop Notes Library of 6,000 easily understood short cuts to every-day jobs. Here are just a few of the subjects taken from the 415 articles in the latest issue.

- | | | |
|--|-------------------------------------|---|
| Animal Traps, Care of | Concrete Fountain Water, Cooler for | Sanding on the Lathe |
| Barrel Method of Slings | Furniture, Refinishing Old | Saw Mounts for Home Shop |
| Bench Light, Convenient | Furniture, Restoring Damaged | Saws, Keeping Fit |
| Bench Saw, Getting Most Out of | Hacksaw, Power, for Small Shops | Scrollsaw, Ball-Bearing |
| Boatswain's Chair Rigging | Heats, Light and Strong | Speedboats, Automatic Switch for |
| Bookcase, Modern | Household Shortcuts | Stainless Steel, Soldering "Sugi" Finish, How to Apply |
| Brass Fixtures, Cleaning Builders' and Contractors' Kinks | Ice Cutter, Engine-Driven | Summer House, Japanese Templates, Making Accurate |
| Cams Jig for Layout of Conveyor, Portable | Outboard Motor, Super-charger for | Tinners, Paint Scraper for |
| Speeds Loading | Package Sealer, Homemade | Toolrest, Sliding, for Emery Wheel |
| Dadoing on Small Power Saws | Pipe Holder, Hammered-Copper | Tools for Home Mechanics |
| Decorating with Pastry Gun | Power Saw Made from Buffing Head | Towed Car Steered by Tow Bar |
| Disk Sander Making Ellipse, How to Lay Out "Exerciser", Electric | Power Shears Made in Small Shop | Wood, Plastic Filler for Workshop, Homemade Combination |
| Farmers, Labor-Saving Kinks for | Sand Disk for Small Lathe | |
| "Flagstones", Making | | |

Each volume contains approximately 500 articles and 400 illustrations and has 224 Pages. At the regular price of 50 cents per single volume this library costs \$7.00, but for a limited period we will supply the 14 vols. when ordered at one time at the special reduced price of only \$4.25.

SPECIAL OFFER COUPON

POPULAR MECHANICS PRESS, 200 E. Ontario St., Room P4, Chicago, Ill.

Send me, as per your special offer, the following books. I will pay for books C.O.D. when they arrive. My money will be refunded if I am not satisfied. (Check what you want.)

- 1930 Shop Notes and Lathe Handbook, both for 98c.
 Complete Shop Notes Library (14 vols.) \$4.25.

Name

Street and No.

City State

“LOOK..... he’s imitating a pianist!”

.....someone shouted
Then a queer thing happened

JACK had just strummed some “Blues” and Nan had done a burlesque on the “Kinkajou”. We were all set for dancing when—the radio refused to work!

No amount of jiggling brought it to life, either. All we could get from it were desolate howls. Someone suggested bridge. But Tom had a better plan. Pulling Joe to his feet—good old “sit-in-the-corner” Joe—he cried in a loud voice:

“The party is saved! Joe, here, has kindly offered to enliven the proceedings with a piano solo . . .”

Loud cheering drowned out the rest. This promised to be good—for, as we all knew, Joe couldn’t play a note. Naturally we expected him to clown . . .

Just as he sat down to the piano, Tom called out:

“Play ‘The Varsity Drag’—that’s a hot dance number!”

I couldn’t help smiling at the thought of Joe—who had always taken a back seat at our parties—playing “hot” music. Excited whispers came from all parts of the room. “Wonder what he’s going to do!”—“He doesn’t know one note from another!” Suddenly someone shouted:

“Get this! Look — he’s imitating a pianist!”

A Queer Thing Happens

Raising his hand melodramatically, Joe waited a moment to command silence.



Then, without any more preliminaries, and to the complete amazement of us all, he struck the first bars of—“The Varsity Drag!”

And how! With all the verve and expression of a professional! No wonder Tom’s eyes almost popped out of his head! This wasn’t the clowning he had expected Joe to do!

Unable to resist the tantalizing music, couple after couple glided around the floor. When Joe stopped playing, the applause could have been heard around the block—only to be instantly followed by requests for more numbers.

All evening they kept Joe busy at the piano—playing jazz, popular songs, sentimental ballads, even classical stuff—everything the crowd asked for, and they asked for plenty!

How that lad could play! I was dumbfounded. Why, it was incredible! Joe had always seemed to be a “born wallflower”—he had never displayed any talent for entertaining—yet now . . . I determined to solve the puzzle. On the way home that night I drew Joe aside and demanded:

“How on earth did you do it?”

He laughed. “Why, it was very easy! I simply took that home-study course in music your cousin told us about . . .”

“You don’t mean that course that was supposed to show you how to play without a teacher, do you?” I interrupted.

“That’s it! Say, it’s a great course, all right!” he enthused. “There wasn’t any expensive private teacher to pay—and since the lessons came by mail, I didn’t have to set aside valuable hours for study. In fact, I practiced only in my spare time, a few minutes a day. And the course is thorough! Why, almost before I knew it, I was playing simple pieces by note, and . . .”

“I guess you don’t have to tell me how thorough it is,” I broke in. “Your performance tonight was a knockout! And you used to say you had no ‘talent!’”

“I haven’t,” he insisted. “Anybody can learn to play the U. S. School of Music way!”



This story is typical. You, too, can learn to play your favorite instrument by this **e a s y** ‘‘at home’’ method that has taught over half a million people. It’s so simple you don’t have to know the slightest thing about music. Your progress is amazingly rapid because every step is clear and easy to understand. Just pick out the instrument you want to play. The U. S. School of Music does the rest, and the cost averages just a few cents a day!

Pick Your Instrument

Piano	Violin
Organ	Clarinet
Ukulele	Flute
Cornet	Saxophone
Trombone	Harp
Piccolo	Mandolin
Guitar	Cello
Hawaiian Steel Guitar	Sight Singing
	Voice and Speech Culture
	Drums and Traps
	Automatic Finger Control
	Banjo (Plectrum, 5-String or Tenor)
	Piano Accordion
	Italian and German Accordion

Free Book and Demonstration Lesson

Our Illustrated Free Book and Free Demonstration Lesson explain all about this remarkable method. If you really want to learn to play—take this opportunity to make your dreams come true. Sign the coupon below. Instruments supplied when needed, cash or credit. U. S. School of Music, 74 Brunswick Bldg., New York.

U. S. School of Music,
74 Brunswick Bldg., New York City.

Please send me your free book “Music Lessons in Your Own Home” with introduction by Dr. Frank Crane, Free Demonstration Lesson and particulars of your easy payment plan. I am interested in the following course:

Have you
.....instr?

Name.....

Address.....

City.....State.....



"I'm making real money now"

"REMEMBER the day you urged me to send that coupon to Scranton? It was the best thing I ever did.

"Mr. Carter called me in today. Said he'd been watching my work for some time—ever since he learned I was studying with the International Correspondence Schools.

"Then he asked me if I could take over Bill Stevens' job. I told him I was sure that I could—that I had had that goal in view ever since I started my I. C. S. course.

"I start tomorrow, Mary, at an increase of \$60 a month. It's wonderful how spare-time study helps a man to get ahead."

For thirty-seven years, the I. C. S. has been helping men to win promotion, to earn more money, to get ahead in business and in life.

You, too, can have the position you want in the work you like best. Yes, you can. All we ask is the chance to prove it. Without cost, without obligation, just mark and mail this coupon.

INTERNATIONAL CORRESPONDENCE SCHOOLS
Box 5678-F, Scranton, Penna.

Without cost or obligation, please send me a copy of your booklet, "Who Wins and Why," and full particulars about the course before which I have marked X in the list below:

TECHNICAL AND INDUSTRIAL COURSES

- | | |
|--|---|
| <input type="checkbox"/> Architect | <input type="checkbox"/> Automobile Mechanic |
| <input type="checkbox"/> Architectural Draftsman | <input type="checkbox"/> Aviation Engines |
| <input type="checkbox"/> Building Foreman | <input type="checkbox"/> Plumber and Steam Fitter |
| <input type="checkbox"/> Concrete Builder | <input type="checkbox"/> Plumbing Inspector |
| <input type="checkbox"/> Contractor and Builder | <input type="checkbox"/> Foreman Plumber |
| <input type="checkbox"/> Structural Draftsman | <input type="checkbox"/> Heating and Ventilation |
| <input type="checkbox"/> Structural Engineer | <input type="checkbox"/> Sheet-Metal Worker |
| <input type="checkbox"/> Electrical Engineer | <input type="checkbox"/> Steam Engineer |
| <input type="checkbox"/> Electrical Contractor | <input type="checkbox"/> Marine Engineer |
| <input type="checkbox"/> Electric Wiring | <input type="checkbox"/> Refrigeration Engineer |
| <input type="checkbox"/> Electric Lighting | <input type="checkbox"/> R. R. Positions |
| <input type="checkbox"/> Reading Shop Blueprints | <input type="checkbox"/> Highway Engineer |
| <input type="checkbox"/> Telegraph Engineer | <input type="checkbox"/> Chemistry |
| <input type="checkbox"/> Telephone Work | <input type="checkbox"/> Pharmacy |
| <input type="checkbox"/> Mechanical Engineer | <input type="checkbox"/> Coal Mining Engineer |
| <input type="checkbox"/> Mechanical Draftsman | <input type="checkbox"/> Navigation <input type="checkbox"/> Assayer |
| <input type="checkbox"/> Machine Shop Practice | <input type="checkbox"/> Iron and Steel Worker |
| <input type="checkbox"/> Toolmaker | <input type="checkbox"/> Textile Overseer or Supt. |
| <input type="checkbox"/> Patternmaker | <input type="checkbox"/> Cotton Manufacturing |
| <input type="checkbox"/> Civil Engineer | <input type="checkbox"/> Woolen Manufacturing |
| <input type="checkbox"/> Surveying and Mapping | <input type="checkbox"/> Agriculture <input type="checkbox"/> Fruit Growing |
| <input type="checkbox"/> Bridge Engineer | <input type="checkbox"/> Poultry Farming |
| <input type="checkbox"/> Gas Engine Operating | <input type="checkbox"/> Mathematics <input type="checkbox"/> Radio |

BUSINESS TRAINING COURSES

- | | |
|--|---|
| <input type="checkbox"/> Business Management | <input type="checkbox"/> Business Correspondence |
| <input type="checkbox"/> Industrial Management | <input type="checkbox"/> Show Card and Sign Lettering |
| <input type="checkbox"/> Personnel Management | <input type="checkbox"/> Stenography and Typing |
| <input type="checkbox"/> Traffic Management | <input type="checkbox"/> English |
| <input type="checkbox"/> Accounting and C. P. A. Coaching | <input type="checkbox"/> Civil Service |
| <input type="checkbox"/> Cost Accounting | <input type="checkbox"/> Railway Mail Clerk |
| <input type="checkbox"/> Bookkeeping | <input type="checkbox"/> Mail Carrier |
| <input type="checkbox"/> Secretarial Work | <input type="checkbox"/> Grade School Subjects |
| <input type="checkbox"/> Spanish <input type="checkbox"/> French | <input type="checkbox"/> High School Subjects |
| <input type="checkbox"/> Salesmanship | <input type="checkbox"/> Cartooning |
| <input type="checkbox"/> Advertising | <input type="checkbox"/> Illustrating |
| | <input type="checkbox"/> Lumber Dealer |

Name.....
Address.....
City.....State.....
Occupation.....

If you reside in Canada, send this coupon to the International Correspondence Schools Canadian, Limited, Montreal, Canada

Learn to Write

I Teach by Mail

I can make a good penman of you at your home during spare time, no matter where you live or how poorly you now write. My simplified system has shown thousands of others the way to good penmanship during the past thirty-five years—it can and WILL do the same for YOU!

Thos. C. Swope
My signature above and below show the wonderful improvement I've made in less than six months after beginning your course.
THOS. C. SWOPE, Rt. 2 Gillespieville, O.
Thos. Swope

Beautifully Illustrated Book
"HOW TO BECOME A GOOD PENMAN" FREE!

It contains information, testimonials and beautiful specimens of penmanship, showing what others have accomplished by the Tamblin System. (Your name elegantly written on a card if you enclose stamp.) Write today. Address:

F. W. TAMBLIN
418 Ridge Bldg., Kansas City, Mo., U. S. A.

F. W. Tamblin

IF YOU STAMMER

Write for my free book "Millard's Advanced Natural Corrective Course" and a free copy of my speech magazine. 10,000 cases successfully treated. Est. 24 years. Largest school for stammerers in world. Millard Inst. of Normal Speech, 2317 Millard Bldg., Milwaukee, Wis.

SENT ON REQUEST

Helpful discussion of this important problem and of fastest growing of Mechanical Trades—Mechanical Dentistry. Easily learned. Of interest to men of all ages. Send for Bulletin 2.

BODEE INSTITUTE
1755 Broadway, New York
1305 N. Broad St., Philadelphia
85 Court St., Brooklyn

PLAY BANJO

Gibson

LET the sweet-voiced, easy-playing Gibson banjo help you make your dreams come true. Gibson banjoists play everywhere—on the records, over the radio, on the stage, for dances and parties. The Gibson is easy to learn. Francis Henry, at left, with Guy Lombardo, plays a Gibson banjo. You learn to play a Gibson easily, quickly.

FREE Trial, Easy Payments
Send the coupon for information and free book, "The Road to Happiness." Check the instrument desired.

GIBSON, INC., 403, Parsons Street, Kalamazoo, Michigan.
Gentlemen: Please send free book and complete information about

BANJO GUITAR MANDOLIN

Name.....
St.....
City.....



FREE BLUE PRINTS

AND FREE BOOK "HOW TO READ BLUE PRINTS"

SHOW YOU THE WAY TO 9 BIG PAY JOBS

- | | |
|---|--|
| 1 Building Superintendent—\$5,000 to \$12,000 | 6 Building Estimator—\$6,000 to \$10,000 |
| 2 Building Inspector—\$4,800 to \$8,000 | 7 Real Estate Expert—\$5,500 to \$12,000 |
| 3 Appraiser—\$6,000 to \$10,000 | 8 Construction Foreman—\$4,500 to \$8,500 |
| 4 Material Buyer—\$5,000 to \$7,500 | 9 CONTRACTOR AND BUILDER IN A BUSINESS OF YOUR OWN—\$5,000 to \$12,000 |
| 5 Material Salesman—\$5,000 to \$12,000 | |

FIND OUT HOW

Easy it is to Make
Up to \$12,000 in a Year

Learn to read Blue Prints this amazing new way! Get into the world's richest industry—Building! See how quickly and easily you can train to make up to \$12,000 in a year! My FREE Book "How to Read Blue Prints" discloses all the so-called "mysteries" of Blue Print Reading—also gives some startling facts about the nine best jobs in America. Don't send one penny—just mail the coupon!

NO longer need you spend years trying to pick up the "mysteries" of Blue Print Plan Reading. For now a quick, sure, practical method has been perfected that has made thousands of men Blue Print Experts in a surprisingly short time.

This is no ordinary "school course." It is practical from start to finish. It is based on many sets of real Blue Prints—plans that would cost thousands of dollars if purchased from architects. Twenty famous experts in all lines of construction work talk over these Blue Prints with you in plain, simple language. Show you every detail. Explain every short cut. Tell you the "secrets" of quick, accurate estimating. Explain Superintending. Give you for the first time many inside facts and money-making methods used by the "Giants" of the Building Industry.

This is the kind of training that quickly puts men into the high salaried jobs—or into profitable contracting businesses of their own. Yet now you get it right at home in only 2 or 3 months. It requires no extensive education. If you can read and understand what is written here you can easily master it. See what this training has done for others: Bartholomew, Calif., became a contractor at an increase of over 300% his first year; Blair, Okla.,

stepped up to Superintendent at 100% increase; Dickerson, R. I., increased his salary 700% in 12 months; Marchand, La., says: "My income has increased 200% and I now have more contracting work than I can do."

Billions of dollars will be spent this year in new construction! No wonder such tremendous opportunities are open to you when you have this "head-work" training in Blue Prints.

If you want more money—real big money!—then choose a "Blue Print" job in Building. For here is the one field where there are unlimited opportunities for advancement. So accept my FREE gift of a complete set of real working Blue Prints, and my fascinating Book "How to Read Blue Prints" that tells all the interesting and instructive facts about Blue Print Plans. Don't send one penny—pay no C. O. D.—It's all FREE. Just fill out and mail the coupon today—NOW!

TWO BOOKS also FREE



IF YOU LIVE NEARBY

Visit our big day or evening school attended by over 1000 Builders. You can get the same training at home by mail—same plans, lessons and instructors. Your spare time is enough.

Chicago Technical School for Builders—Dept. D-143, Chicago Tech. Building, 118 East 26th Street, Chicago, Ill.

Please send me your free book, "How to Read Blue Prints," and complete set of real Blue Prints. I understand these are mine to keep without obligation. It is also understood that no salesman will call on me.

Name.....

Address.....

City..... State.....

Age..... Occupation.....

Chicago Technical
SCHOOL for BUILDERS

Dept. D-143, 118 East 26th St., Chicago, Ill.



Easy home method quickly teaches HAWAIIAN GUITAR



Play all the latest hits just as the Hawaiians do! Have good times aplenty!

Win fame—friends—fortune! Play the Hawaiian Guitar!

Native Hawaiian expert directs you

You get expert instruction directed by a world-famous player and teacher, Prof. Walter Kolomoku. He quickly reveals to you the secrets of this fascinating instrument.

Learn at home—in spare time

Study in spare time at home. Even if you don't know a note our method is so simple, plain and easy, you begin a piece your first lesson. In half an hour you can play it!

Only 4 Motions to learn. Then you can play any music—popular songs, classical, old-time melodies, native Hawaiian airs—or real jazz. You'll never be lonesome after you learn the Hawaiian Guitar.

Complete Course 52 lessons. Nothing omitted. Pictures explain every move. You are sure to learn—what we can do for others we can do for you. Over 50,000 successful students.

Payasyouplay We make it easy for you. Start with small first payment—then pay while learning. Costs only few cents per lesson. You only pay the cost of instruction—we furnish everything.

Sweet Toned HAWAIIAN GUITAR

GIVEN when you enroll

—with genuine seal grain Fabrikoid Cover and complete playing outfit. Reliable retailers ask \$18 to \$20 for a similar instrument and outfit without the fine Fabrikoid Case, which alone is valued at \$3.50.

TENOR BANJO and other courses

The same thorough instruction on the Tenor Banjo, Violin, Tiple, Tenor Guitar, Ukulele, Banjo Ukulele—well known instructors. Write for full information.

FIRST HAWAIIAN CONSERVATORY OF MUSIC, Inc.
9th Floor, Woolworth bldg., Dept. 748, New York

Approved as a Correspondence School Under the Laws of the State of New York
Member National Home Study Council



Send This Coupon for Liberal Offer!

FIRST HAWAIIAN CONSERVATORY OF MUSIC, Inc.
9th Floor, Woolworth Bldg., Dept. 748, New York, N.Y.
Please mail full information about your 52-lesson Hawaiian Guitar Course. I am not obliged to enroll unless I want to.

Name _____
Address _____
City _____ State _____

Learn SIGN and SHOW-CARD WRITING

In spare time few hours weekly

FREE
"Book of Facts"
—
Write For It

Fascinating profession. Big opportunity in this fast-growing trade. Earn while you learn the sign arts. No talent or experience required. Be your own boss or obtain a good position. Learn show cards, posters, bulletins, signs, advertising layouts and allied subjects. We teach by mail or at our school. Quick results—easy to learn.

EARN \$50 TO \$200 WEEKLY

Otto C. Wiegand, Md., home-study graduate, made \$12,000 from his business in one year. Many successful graduates. Oldest and foremost school. Don't delay. Write for complete information.

DETROIT SCHOOL OF LETTERING

193 Stimson Ave. Est. 1899 DETROIT, MICH.

COLLEGE COURSES

AT HOME



Carry on your education. Develop power to initiate and achieve. Earn credit toward a Bachelor degree or Teaching Certificate by correspondence. Select from 450 courses in 45 subjects, including English, Mathematics, History, Education, Psychology, Economics, the Languages, etc. Write for catalog.

The University of Chicago

427 ELLIS HALL CHICAGO, ILL.

WELDING—The Busy Big-Pay Trade

We teach ambitious men by actual welding practice.

—OXY-ACETYLENE and ELECTRIC ARC—
Pipe-line, Sheet Steel, Structural Steel, Aircraft, Cast-Iron, Aluminum and Commercial Welding. Cutting, Brazing and Plating. Splendidly Equipped to Teach You Right Rapidly and at Reasonable Rates

A Free Booklet for You—Write for it Now.

COLEMAN ELECTRICAL SCHOOL, 1628-X Main Street KANSAS CITY, MO.

Learn Watchwork, Jewelrywork and Engraving

A fine trade commanding a good salary, and your services always in demand. Address **Horological**, Dept. P, Bradley Institute, PEORIA, ILLINOIS, for our latest catalog.

Learn Photography at HOME

Make money taking pictures. Prepare quickly during spare time. Also earn while you learn. No experience necessary. New easy method. Nothing else like it. Send at once for free book, OPPORTUNITIES IN MODERN PHOTOGRAPHY and full particulars

AMERICAN SCHOOL OF PHOTOGRAPHY
Dept. 1354 3601 Michigan Ave. Chicago, U. S. A.

GOV'T. POSITIONS

\$35 TO \$75 WEEKLY

- | | |
|-----------------------|-------------------------|
| () Ry. Mail Clerk | () Steno-Typist |
| () Prohibition Agent | () Immigrant Inspector |
| () R. F. D. Carrier | () Seamstress |
| () Special Agent | () Auditor |
| () Customs Inspector | () Steno-Secretary |
| () City Mail Carrier | () U. S. Border Patrol |
| () Meat Inspector | () Chauffeur-Carrier |
| () P. O. Clerk | () Watchman |
| () File Clerk | () Skilled Laborer |
| () General Clerk | () Postmaster |
| () Matron | () Typist |

OSZMENT INSTRUCTION BUREAU, 111 Arcade Bldg., St. Louis, Mo. Send me FREE particulars how to qualify for positions marked "X". Salaries, locations, opportunities, etc. ALL SENT FREE.

NAME.....
ADDRESS.....

MEN-WOMEN

AGE 18 to 55

now! take your place in AVIATION



LET THIS WORLD-WAR FLYER TRAIN YOU AT HOME

Major Robert L. Rockwell stands high in the Aviation history of the World War. He is now devoting himself to helping men get the right start in Aviation. Let him train you for this great new industry and your future in Aviation is assured.

No Special Education or Experience Necessary

You don't need to have a high school or college education to master my course. You do not even need to know anything about airplanes, motors or mechanics. My home course is thorough and complete. Everything is so clearly explained, with easy-to-understand text and pictures, that in a few short months you will be able to grasp every fundamental principle of Aviation ground work, and you will be well on the road to qualify for any important aviation job paying \$300 to \$400 a month. My Home Study Course will give you all the knowledge necessary to pass the government's written examinations for mechanics' or pilots' licenses.



Soloed in 7 Hours

Dear Major: Your excellent advice prevented me from

taking up Aviation the wrong way when I wanted to learn flying first. After I had completed your ground course, which thoroughly prepared me in the principles of flight, I was able to solo in 7 hours. I always will be glad to tell anyone that I am a Rockwell trained man. Sincerely, Wm. C. Rickels.

Now Manager of Big Co.

Dear Major: The main thing about your individual method of instruction is that you not only gave me a thorough knowledge of Aviation, but you also showed me how to capitalize on what I learned. I am now General Manager for International Air Surveys and making three times what I ever earned before. I will always be a booster for your method of training. Floyd Prothero.



LEARN AT HOME
"EASY TO START"
"FLY YOURSELF"

Major R. L. Rockwell Will Train You Until You Have an Aviation Job Paying \$300 to \$400 a Month

I make this amazing offer, for a short time and to a limited number, to supply the crying need for trained men. Here is your opportunity to get into this uncrowded, fascinating field with a definite certainty of your future.

In 12 Weeks

Just devote about an hour a day to my Home Study Course, and in 12 weeks you can be mastering the principles of Ground

Training, which are necessary before you take your place in any branch of Aviation. In a few short months I will give you practical aviation training and prepare you for one of the big pay, thrilling jobs open only to men thoroughly trained in Aviation.

You Learn Principles of Aviation at Home Then Choose Any One of 40 Ground Jobs.

—If You Want Actual Flying, My Home Study Course

teaches you the principles of flight. When you have completed the ground training I will arrange for you to take your flying instruction at any licensed airport near your home at special reduced rates. Or, if you want, you can come here to Dayton and get training at one of the finest and best equipped airports in America. No matter where you learn to fly you can qualify for a pilot's license and a high pay flying job in passenger lines, mail service, and other important branches of flying.

Satisfaction or Money Back

I am so sure that you can learn Aviation every penny of your tuition. Act now while with my help, and step into a big aviation my special offer lasts. Rush this coupon to job, that if you are not satisfied when you me for a copy of my have finished my course, I agree to return famous free book.

Get My No-Risk Plan My Big Book Explains ALL I'll send it FREE



Major Rob't L. Rockwell
 The Dayton School of Aviation
 Desk D-1, Dayton, Ohio.

Dear Major:—Please send me FREE and without obligation a copy of your famous book on Aviation; also your special tuition and position offer.

Name.....
 Address.....
 Town..... State..... Age.....

MAJOR ROB'T L. ROCKWELL
THE DAYTON SCHOOL OF AVIATION
 Desk D-1 DAYTON, OHIO



Become an Expert Accountant

The Profession That Pays

The demand for skilled accountants—men who really know their business—is unceasing. Big corporations are in constant need of expert counsel in matters relating to Auditing, Cost Accounting, Business Law, Organization, Management, Finance. Men who prove their qualifications in this important branch of business are rapidly promoted to responsible executive positions—given an opportunity to earn real salaries. The range is from \$3,000 to \$15,000 a year—even to higher income-figures.

**Send for Free Book—
"Accountancy, the Profession that Pays"**

Why let the other fellow walk away with the better job, when right in your own home you can equip yourself for a splendid future in this profitable profession?

Preliminary knowledge of bookkeeping is unnecessary. Our free book on accountancy fully explains how we train you from the ground up, according to your individual needs. Low cost; easy terms.

The facts about LaSalle training in Accountancy and the opportunities in this highly profitable field are clearly outlined in a 64-page book which LaSalle will send you free.

The man in earnest to get ahead will find this coupon a most profitable aid to progress. If you have the urge and the will to increase your income, clip and mail the coupon NOW.

— Find Yourself Through LaSalle! —

LaSalle Extension University

The World's Largest Business Training Institution

Dept. 464-HR Chicago

I would welcome details of your salary-increasing plan, together with copy of "Accountancy, the Profession that Pays," also a copy of "Ten Years' Promotion in One," all without obligation.

Higher Accountancy

Training for position as Auditor, Comptroller, Certified Public Accountant.

Other LaSalle Opportunities:

LaSalle opens the way to success in every important field of business. If interested in one of the fields below, check and mail.

- | | |
|--|---|
| <input type="checkbox"/> Business Management | <input type="checkbox"/> Law—Degree of LL.B. |
| <input type="checkbox"/> Modern Salesmanship | <input type="checkbox"/> Modern Business Correspondence |
| <input type="checkbox"/> Traffic Management | <input type="checkbox"/> Stenography—Stenotypy |
| <input type="checkbox"/> Railway Station Mgmt | <input type="checkbox"/> Expert Bookkeeping |
| <input type="checkbox"/> Railway Accounting | <input type="checkbox"/> C. P. A. Coaching |
| <input type="checkbox"/> Banking and Finance | <input type="checkbox"/> Business English |
| <input type="checkbox"/> Commercial Law | <input type="checkbox"/> Business Spanish |
| <input type="checkbox"/> Industrial Management | <input type="checkbox"/> Effective Speaking |
| <input type="checkbox"/> Modern Foremanship | <input type="checkbox"/> Telegraphy |
| <input type="checkbox"/> Personnel Management | <input type="checkbox"/> Credit and Collection Correspondence |
| <input type="checkbox"/> Paper Salesman's Training | |

Name.....

Present Position.....

Address.....



TAMBURITZA

FUN—POPULARITY Easy To Play

Good times—Extra money from spare time—popularity—entertain or play in orchestras—Thrill at playing your favorite music. For solos or instrumental combinations, none surpass the beautiful Tamburitza in richness of tone or volume.



FILLS EVERY NEED—Not a novelty—but a high-class, moderately-priced, string instrument you will play for years. Comes complete with easy-playing instructions. Write today about any of these *Tamburitza's*: Tenor-Soprano-Cello-Bass-Alto.

IRA M. PETERSIME & SON, Gettysburg, Ohio

BEDFORD YMCA TRADE SCHOOL

Aviation Mechanic
Airplane Welding
Airplane Drafting
Auto Mechanic
Starting, Lighting, Ignition
Machine Shop. Electric Welding
Oxy-Acetylene Welding
Radio Mechanic. Battery Repair
Mechanical, Architectural Drawing
Blue Print Reading
Building Estimating
Sign Painting. Show Card Writing
Window Dressing
Commercial Art. Fine Art
DAY AND EVENING SESSIONS
Write for Catalog 50
Brooklyn Engineering Institute
(Operated by Bedford Y. M. C. A.)
1125 Bedford Avenue, Brooklyn
New York City

Learn PIANO TUNING At Home

Our TEMPERAMETER makes it easy. Earn \$10 to \$20 a day. Unusual opportunities for making extra money.



CAPITALIZE YOUR ABILITY

Reide of New York City says: "The section on Player-Piano in your excellent course is a veritable Encyclopedia."

Write for FREE book "Winning Independence"

BRYANT SCHOOL 16 BRYANT BLOCK
AUGUSTA, MICH., U.S.A.



Wonderful, new device, guides your hand; corrects your writing in a few days. Big improvement in three hours. No failures. Complete outline FREE. Write C. J. Ozment, Dept. 34, St. Louis, Mo.

You can be quickly cured, if you

STAMMER

Send 10 cents for 288-page book on Stammering and Stuttering. "Its Cause and Cure." It tells how I cured myself after stammering 20 yrs. B. N. Bogue, 11128 Bogue Bldg., 1147 N. Illinois St., Indianapolis.

Anyone CAN LEARN

No talent or experience necessary. Fascinating work. Pays Big Money. Complete instruction book tells about: Alphabets, Colors, How to Mix Paints, Show Cards, Window Bards and Wall Signs. Ready made letters, Gilding, Tricks of the Trade, also gives 100 Alphabets and Designs. Book bound in flexible int. leather-gold edges, and four ball bearing Show Card Pens. Sent postpaid \$3.00. (C.O.D.) 10c ex. Ogilvie Pub. Co., 57 Ross St., Dept. 20, N.Y. City

**EARN MONEY IMMEDIATELY—
WE FURNISH EQUIPMENT TO START !!**

How to Paint
SIGNS
and
Show Cards
\$3

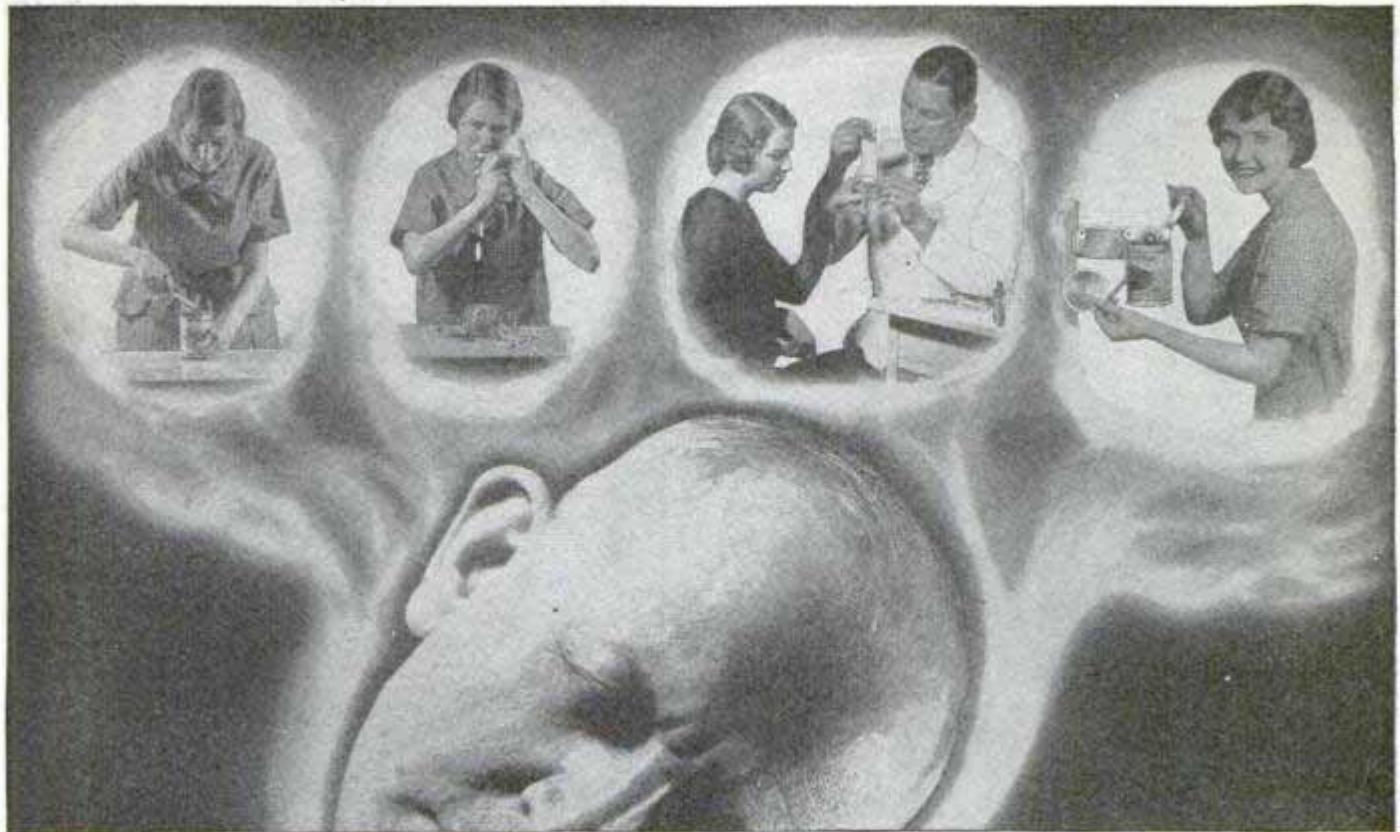

INVENTOR'S DREAM COMES TRUE!

Dangerous Old-Style Can Openers Are Banished Forever!

The Million-Dollar Can Opener IS a Reality! At One Sweep, An Astonishing Little Invention Now Banishes EVERY Old-Style Can Opener To The Scrap-Heap! No More Stabbing and Hacking! No Cut Hands, No Pain, No Danger, No Blood-Poison! Just Read Below The Limited, Introductory, "Risk-No-Money" Offer Being Made This Month. Then Use The Coupon Promptly.

And Agent Makes \$117 in Just 1 1/2 Days!

ONE man takes a lever, a tiny steel wheel, and some other queer gadgets and Presto! out of his dream comes one of the most magical, yet astonishingly simple invention of all time. It's a little, automatic can opening machine that ends mess, muss and danger forever. It's THE invention waited for by women everywhere! No wonder the experts of direct selling are astonished! Next a St. Louis manufacturing genius takes this invention and works out production methods to bring the cost down so almost anyone can afford it . . . yet sales people make even bigger profits on every sale. And THEN the whole selling world literally goes crazy!

single day! The next question is "Who will beat his record first?" By acting promptly you can make your own profit test without risking one single penny.

No Cost or Obligation

This automatic can opening invention for the home is called "Speedo." A well-known 20-year-old company makes you this timely offer. Prompt action gives you an option on exclusive territory. Everything is furnished. This invention is sold only through agents, not through any stores. Complete sales training manual, big expensive selling outfit are supplied. Mail the coupon at once and you can make your own "Free Profit Test" right away. Remember, you do not risk one penny. So act quick!

Every Profit Record Broken

Why have so many "Star" salesmen tripled incomes? What is the secret of inexperienced beginners cleaning up more in a single day than they ever made in a whole week before? The answer is quickly and convincingly found in the invention itself. For imagine a queer little machine that opens cans at the mere twist of your wrist. This almost human invention grips the can—holds it for you—cuts out the top inside the rim—flips up the lid so you can lift it out—then hands back the can without a drop spilled and without any sharp edges to snag your fingers. You just slip the can in the machine—turn the handle—and almost instantly the job is done, slick, smooth and clean. No wonder 9 out of 10 women are ready to buy on sight! And no wonder one man whose record is shown elsewhere on this page actually cleaned up \$86 in cash in a

CENTRAL STATES MFG. CO.
4500 Mary Ave., Dept. D-703, St. Louis, Mo.

Central States Mfg. Co., Dept. D-703
4500 Mary Ave., St. Louis, Mo.

Rush me your FREE Test Offer.

Name.....

Address.....

Town..... State.....



Works Like Magic

Every woman hates the dangerous old-style can opener. Just one slip she's cut her finger! And she knows what too often follows—infection—blood-poison—amputations—even death may result. Now these dangers are banished forever, at a mere twist-of-the-wrist. No wonder sales people make so much money.



Full Time

E. T. Barclay, N. Y., cleaned up \$117 in a day and half. O. H. Dickinson, Idaho, made his first \$1,000 in just 27 1/2 selling days. Mrs. Spain, Kas., made \$11 her first afternoon. Dee Miller, California, averaged over \$200 a week. Where else in any kind of selling do ordinary people make money like this?



Part Time

O. C. Gregg, Wyo., made \$20 in 3 hours. After his regular day's work P. K. Rowley, Mich., started and made \$15.50 before 9 o'clock. In half a day in a little Minnesota town, D. C. Harris cleaned up \$26.00. G. W. Grosvener says, "My record so far is \$18.50 for just one hour's work!" Neighbors, Ohio, says he made \$10 in just 28 minutes. C. F. Durbin, Sr., a Kentucky Train Dispatcher made \$28 in 5 1/2 hours spare time. What is to prevent any man from tripling his earnings the same easy way?



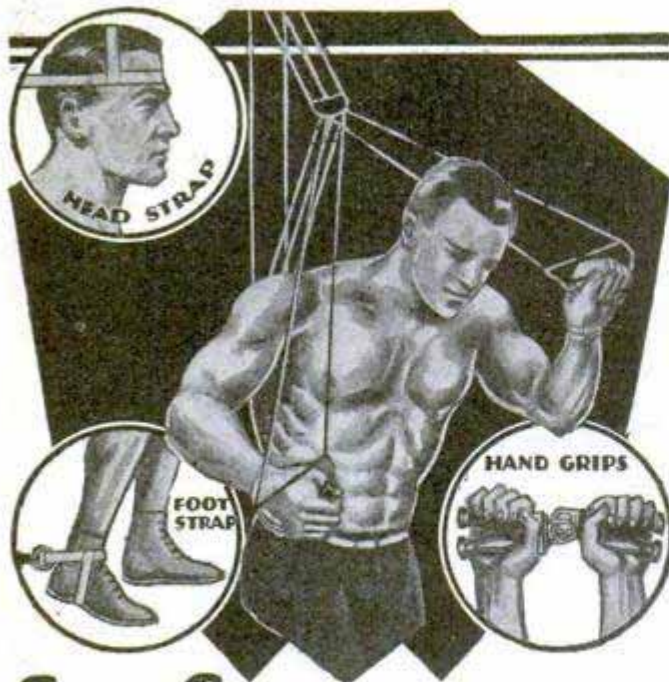

GET STRONG with these 6 improved Muscle Builders..All for \$5.00

Realize your ambition and develop muscles of a super-man. **Get strong!** Easily master feats which now seem difficult—or if you want physical culture for your health's sake, this equipment is what you need. With this special offer you **save at least half.** We furnish 10 cable chest expander adjustable to 200 lbs. resistance. Made of new live extra strength, springy rubber so as to give resistance you need for real muscle development. You also get a pair of patented hand grips for developing powerful grip and forearms. We include wall exercising parts which permit you to develop your back, arms and legs—a real muscle necessity. The head strap permits you to exercise muscles of your neck. Develop leg muscles with foot strap furnished. This gives speed, endurance. In addition you get specially written course containing pictures and diagrams showing how to develop any part of your body.

Act now! Send No Money

Sign name and address to coupon and rush to us. We send everything by return mail. Pay postman \$3.00 plus postage. (If you desire, send money order now and we pay postage.)



CRUSADER APPARATUS CO., Dept. 104, 44 Parker Ave., Maplewood, N. J.

I accept your offer. Send me everything described in your advertisement by return mail. I will pay postman \$5.00 plus postage on arrival. It is understood if I am not entirely satisfied after examination I can return the goods and you will refund my money.

Note:—No C. O. D. Orders to Foreign Countries or Canada.

Name.....
 Street.....
 City..... State.....

Magic



Learn at Home, By Mail! Easily! Quickly!

New! Different! Dr. Harlan Tarbell, Famous Magic Wizard, teaches you Big Tricks, Illusions, Stage Stunts, "Patter" and the Principles of Magic. You learn easily and quickly at home by mail. Earn \$250 to \$1,000 a month. Write today for free literature. Please tell us your age.

Tarbell System, Inc. 1926 Sunnyside Ave., Studio 13-54 Chicago, Ill.

ENGINEERING ELECTRICAL MECHANICAL STRUCTURAL and ARCHITECTURE

Intensive, Practical, Technical Courses. Degree in 2 years. Diploma in 1 year. Special short courses in Electricity, Radio, Power Plant, Drafting, Welding. Low Tuition. Expert Instructors. Extensively equipped laboratories. Free employment service for graduates. Part-time work secured during training. Write for new free illustrated catalog giving all facts.



FINLAY ENGINEERING COLLEGE, 1001-A Indiana Ave., KANSAS CITY, MO.

HOT PIANO Ultra-modern Piano

Jazz taught by mail. Note or ear. Easy rapid lessons for adult beginners. Also Self-instruction system for advanced pianists. Learn 358 Bass Styles, 976 Jazz Breaks, hundreds of Trick Endings, Hot Rhythms, Sock, Stomp and Dirt Effects; Symphonic and Wicked Harmony in latest Radio and Record Style. Write for Free Booklet.

WATERMAN PIANO SCHOOL, 1826 W. Adams St., Los Angeles, Calif.

Learn to PAINT SIGNS and SHOW CARDS

We quickly teach you by mail, or at school, in spare time. Enormous demand. Big future. Interesting work. Oldest and foremost school. **EARN \$50 TO \$200 WEEKLY**
 Otto Wiegand, Md., home-study graduate, made \$12,000 from his business in one year. John Vasso, N.Y., gets \$25 for a show card. Crawford, B.C., writes: "Earned \$200 while taking course." Write for complete information.



DETROIT SCHOOL OF LETTERING 154 Stimson Ave. Est. 1899 Detroit, Mich.

BASHFUL?

"Shame on you!" Are you nervous, embarrassed in company of the other sex? Stop being shy of strangers. Conquer the terrible fear of your superiors. Be cheerful and confident of your future! Your faults easily overcome so you can enjoy life to the fullest. Send 25c for this amazing book, **RICHARD BLACKSTONE, B-474 Flatiron Bldg., N. Y.**

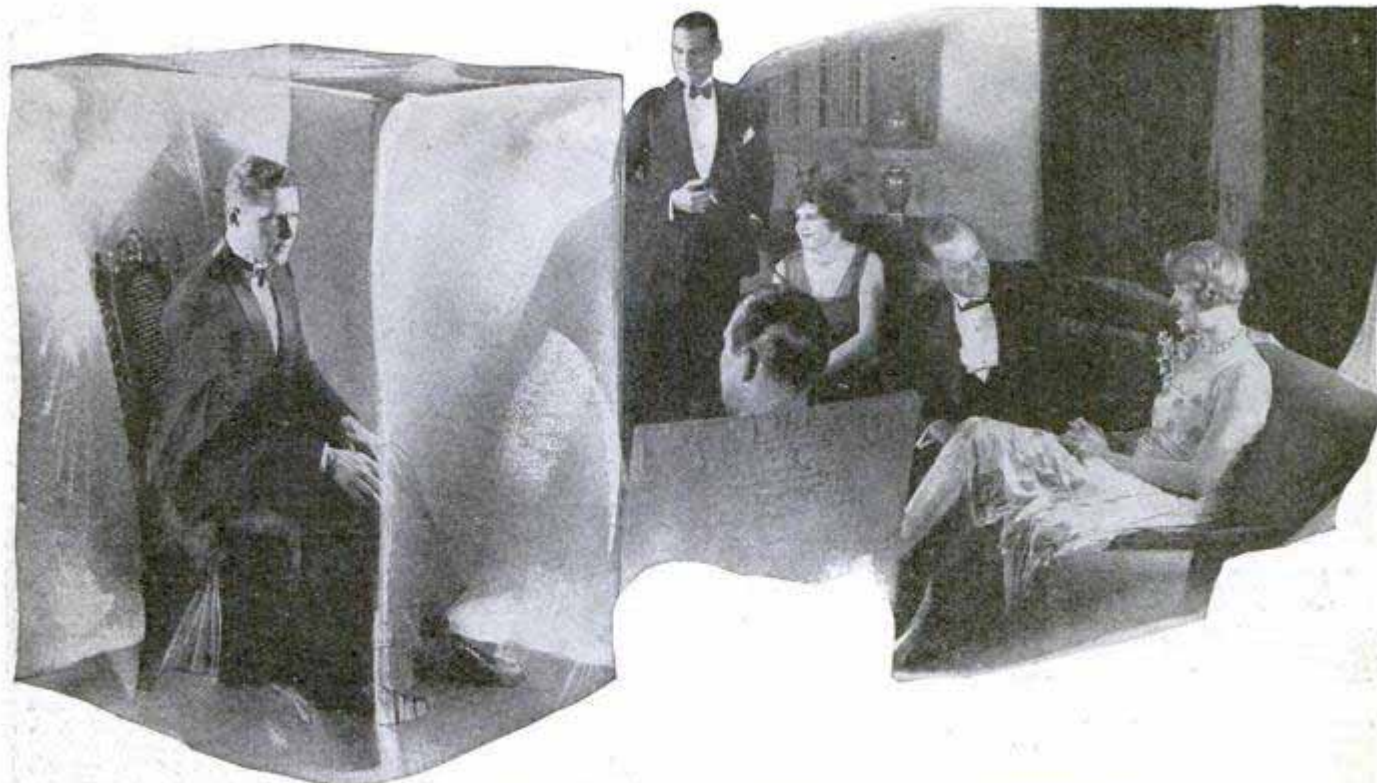

I Turned To Ice When I Tried To Talk

- But Now I Can Sway An Audience of Thousands!

I HAD always been painfully bashful. When trying to carry on even the most commonplace conversation my voice would sound unnatural and my hands and knees would tremble. Often I would listen to an argument among a group and become so keenly interested that I would want to voice my own opinion—yet timidity would keep me silent. I never had the courage to stand up for what I knew to be my rights—I was always afraid of "what people would say," of ridicule. Since my childhood I had had a secret desire to appear in public—to be active in politics—but my shyness was so great that I turned to ice when I tried to talk—in even the smallest gathering!

My inability to talk was also affecting my business success. I dreaded going in and asking for a raise—I was afraid of any situation that meant using my voice—having to express myself. I didn't know how to present the ideas which I was sure the firm could use. I was just a plodder—a truck horse, capable of doing a lot of heavy work but of no use where brilliant performance was required. Often I would see men who were not half so thorough nor so hard working as I, promoted to positions where they made a brilliant showing—not through hard work, but through their ability to talk cleverly and convincingly—to give the appearance of being efficient and skillful.

local candidate—I who a short time before had turned to ice when I tried to carry on an ordinary conversation!

Soon I had won salary increases, promotion, popularity, power. Today I always have a ready flow of speech at my command. I am able to rise to any occasion, to meet any emergency with just the right words, to approach all types of people with ease and fearlessness. And I accomplished all this by developing the natural power of speech possessed by everyone, but cultivated by so few—by simply spending 20 minutes a day in my own home on this most fascinating subject.

Send for This Amazing Book

This new method of training is fully described in a very interesting and informative booklet which is now being sent to everyone mailing the coupon below. This book is called, *How To Work Wonders With Words*. In it you are shown how to conquer stage fright, self-consciousness, timidity, bashfulness and fear—those things that keep you silent while men of lesser ability get what they want by the sheer power of convincing speech. Not only men who have made millions, but thousands have sent for this book—and are unstinting in their praise of it. You are told how to bring out and develop your priceless "hidden knack"—the natural gift within you—which will win for you advancement in position and salary, popularity, social standing, power and real success. You can obtain your copy absolutely free by sending the coupon.

Now Sent
FREE



**NORTH AMERICAN
INSTITUTE**

3601 Michigan Ave. Dept. 1354
CHICAGO, ILLINOIS

What 20 Minutes a Day Will Show You

How to talk before your club or lodge
How to propose and respond to toasts
How to address board meetings
How to tell entertaining stories
How to make a political speech
How to make after-dinner speeches
How to converse interestingly
How to write letters
How to sell more goods
How to train your memory
How to enlarge your vocabulary
How to develop self-confidence
How to acquire a winning personality
How to strengthen your will-power and ambition
How to become a clear, accurate talker
How to develop your power of concentration
How to become master of any situation

In Twenty Minutes a Day

And then suddenly I discovered a new easy method which made me a forceful speaker almost over night. I learned how to dominate one man or an audience of thousands. —how to say just the right words at the right time, how to win and hold the attention of those around me, how to express my thoughts simply and clearly, yet in a pleasing, interesting and amusing way. In just a few months I was able to make campaign speeches for a

North American Institute,
3601 Michigan Ave., Dept. 1354, Chicago, Illinois.

Please send me FREE and without obligation my copy of your inspiring booklet, *How To Work Wonders With Words*, and full information regarding your Course in Effective Speaking.

Name.....

Address.....

City..... State.....

An ELECTRICAL Job

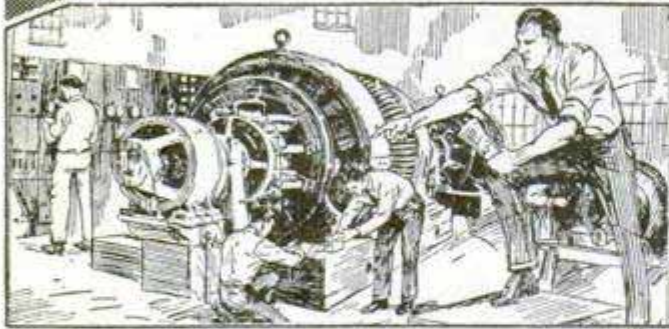

when you're only Half Way Through!



Gentlemen:
Thanks to the consistent effort of the American School I have found an entirely satisfactory job doing Electrical construction and maintenance work.
(Signed)
W. B. McClellan,
Mason City, Iowa



"I have accepted employment with the Iowa Railway and Light Corporation starting at \$125.00 per month, who wrote me a letter suggesting an interview.
Thanking you very much for your splendid cooperation, I remain, Yours truly,
(Signed)
Glen Vandelaar,
Leighton, Iowa

During the past few months we have placed HUNDREDS of our graduates and also students when only half through the course—in well-paid Electrical positions. These men are now on the high road to a real future in the world's greatest business—some in power plants—some in Electrical factories—others in the business or drafting or selling or radio end.

Go After the Big Money

The big Electrical Utility magnates have just laid down a TWO-BILLION DOLLAR program of new projects before President Hoover. Remember, that's in addition to the billions already invested and the millions of men already employed in Electricity.

Just think—how light, power, railroads, radio, telephone, telegraph, all manufacturing, automatic devices, home appliances—now depend on Electricity. That's a wonderful line to get into—because it has no "hard times" or unemployment.

And now it's easy to break into Electricity. In your spare time, right at home, you can now quickly master WIRING, MOTORS, GENERATORS, POWER PLANT EQUIPMENT and other fascinating branches of the work—and almost before you realize it, we'll be recommending you for your first Electrical position.

WHO ELSE Wants a Good Electrical Job?

The letters shown at the left are just typical of HUNDREDS we'd like to show you. We want to tell you more about the wonderful chances waiting for you in Electricity—our fastest growing industry. Mail coupon for an interesting proposition we are making right now to ambitious men.

American School Dept. E-447, Drexel Ave. and 58th St., CHICAGO

AMERICAN SCHOOL, Dept. E-447, Drexel Ave. and 58th St., Chicago, Ill.

Please send me without cost or obligation your Electrical bulletin, and tell me about your combined training and employment service in line marked X below.

- | | | |
|--|---|---|
| <input type="checkbox"/> Drafting | <input type="checkbox"/> ELECTRICAL ENGINEERING | <input type="checkbox"/> Business Management |
| <input type="checkbox"/> Architecture | <input type="checkbox"/> Building | <input type="checkbox"/> Accounting |
| <input type="checkbox"/> Building | <input type="checkbox"/> Structural Steel | <input type="checkbox"/> Mechanical Engineering |
| <input type="checkbox"/> Civil Engineering | <input type="checkbox"/> Auto Engineering | <input type="checkbox"/> Shop Superintendent |
| | | <input type="checkbox"/> Foremanship |
| | | <input type="checkbox"/> High School in 2 years |

Name.....
St. No.....
City..... State.....
Age..... Occupation.....

ALWAYS A DEMAND for Skilled Tree Experts

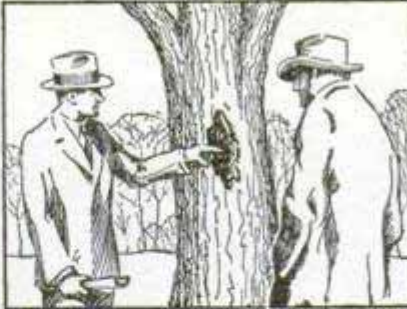

The only method that restores Tree Health NATURE'S WAY

Big money—opportunities both in America and abroad. Anyone can learn. Little spare time home study. City park departments, private estates, forestry companies, telephone companies, fruit growers, tree surgery companies need trained tree experts at all times. Profitable healthy work. Write.

VAN YAHRES TREE SURGERY SCHOOL
Dept. P., Westbury, New York

A Card Case Any MASON Would Be Proud To Own



Protects your lodge cards, \$1 auto license, passes, etc. under isinglass windows, 1 ready to be seen at a glance. A genuine leather, 5-window sturdy card case, extra pocket—snap button—gold corners, for only \$1. Stamped with Masonic Emblem in heavy gold FREE—Same price without emblem. Name and other stamping 35c a line extra. Larger cases, 9 windows \$1.50, 13 windows \$2. Send for Catalogue.

- Masonic Books, Monitors, Jewelry.
 Lodge Supplies. [Check Choice]

REDDING MASONIC SUPPLY CO.
200 Fifth Ave., Dept. P.M., New York

LEARN WATCH REPAIRING



You can learn by our modern and original system of instruction every part of the Watch Repairing Trade at home as good or better than at a shop. You can earn money while learning and secure a well paying position or start in business after completing our course of instruction. Good watch repairers are always in demand and earn from \$50 to \$75 per week. For particulars apply to the Wisconsin School of Watch Repairing 166 Mason St., MILWAUKEE, WIS.

"BECOME A LIGHTNING TRICK CARTOONIST"

Send \$1.00 for Laugh Producing Program of 28 Trick Drawings with instructions. Catalog of Chalk Talk Supplies Free. BALDA ART SERVICE, Dept. 1, Oshkosh, Wis.

PUBLIC SPEAKING SIMPLIFIED

Just published—an amazing new, practical and fascinating easy way to learn Public Speaking. With this Course you will gain immediate self-confidence, and start making talks or speeches. SEND NO MONEY. Pay Postman only \$5 plus few pennies postage. 5-day examination privilege. Also "How To Get Vocabulary You Want" \$1. You'll astonish your friends.

NIAGARA SCHOOL, Inc., Dept. P., B. L. E. Bldg., CLEVELAND, O.

WHY NOT spend spring, summer and fall gathering butterflies; insects? Simple and intensely interesting outdoor work with my instructions, illustrations, price list. I buy hundreds of species for collections. Some worth \$1 to \$7 each. Before sending any butterflies, send 10c (not stamps) for my Illustrated Prospectus. It certainly would be wise to send for it right away before you turn this page, or you may forget. So—send right away.



MR. SINCLAIR, DEALER IN INSECTS,
Dept. 6, Box 1424, San Diego, Calif.

SONG WRITERS!



SUBSTANTIAL ADVANCE ROYALTIES are paid on work found acceptable for publication. Anyone wishing to write either the words or music for songs may submit work for free examination and advice. Past experience unnecessary. New demand created by "Talking Pictures" fully described in our free book. Write for it Today. NEWCOMER ASSOCIATES

759 Earle Building, New York, N. Y.

-takes only 8 weeks to get a big job



George Smith owns an agency and repair shop in West Alexandria, Ohio. He makes \$200 a week.



C. E. Gillespie has charge of a fleet of trucks and tractors for the State Highway Commission, due to McSweeney training.

and Earn \$75 to \$125 a Week as Auto or Aviation Expert

Learn the auto and tractor business by the McSweeney method, then step out and get a good job at \$75 to \$125 a week or open your own repair shop and make up to \$10,000 a year. Trained men are needed everywhere. Opportunities galore! Eight weeks' training fits you to open repair shop or to go on with one of the big firms waiting for trained men. Read what George Smith and C. E. Gillespie have done. Hundreds of other McSweeney trained men can tell as interesting facts. Every month McSweeney men who complete their training are taking the place of half-trained and incompletely self-trained men.

Satisfaction Guaranteed!

I guarantee satisfaction. I guarantee to continue giving you my practical training until you are able to hold a first-class automotive or electrical job.

AVIATION Course

AVIATION is paying tremendous incomes to trained men! Coupon brings complete details about complete course in AVIATION. Learn on real airplane engines under experienced instructors. Ask about special course in FLYING. Don't miss this remarkable opportunity. Save by enrolling at once. The sooner you start the sooner you will be ready to earn big pay or get into business for yourself.

(Write to Nearest School)

McSWEENEY Auto, Tractor SCHOOLS

Dept. A-11-W, 1615 E. 24th St., Cleveland, Ohio, Dept. A-11-W, 263 Madison St., Memphis, Tenn.



Learn in Only 8 Weeks

Simple, thorough, practical shop methods. You learn the "why" of everything you do, then learn to do it right. You do real work with real tools and real equipment. No book studying. Very little schooling necessary. Any man from 16 to 60 can learn. Write today for Big Special Limited Time Tuition Offer. No facilities for colored students. Write for Big, Illustrated Book FREE!

MAIL COUPON FOR FREE BOOK

McSWEENEY AUTO, TRACTOR AND AVIATION SCHOOL, Dept. A-11-W, Chester at 30th St., Cleveland, O., or 263 Madison St., Memphis, Tenn. Without cost or obligation, send me your big FREE book on Autos and Aviation, also full details of your special tuition offer.

Name.....
Street.....
Town..... State.....



Step INTO A BIG-PAY HOTEL JOB

Earn \$2,500 to \$10,000 a Year

In America's 3rd Largest Industry comprised of Hotels, Apartment Hotels, Clubs, Restaurants, Institutions, Schools, Colleges, Hospitals, etc. Daily calls for Lewis Trained Men. Over 70,000 high-class positions as Manager, Assistant Manager, Steward, Engineer, Room Clerk, Publicity Director, Purchasing Agent, Bookkeeper, and scores of other executive positions paying \$2,500 to \$10,000 a year open annually in hotels alone. Salaries up to \$3,500 to start.

We Put You in Touch with Positions

Without cost let us show you how big pay, fascinating work, quick advancement can be yours in the great hotel industry. Age is no obstacle—young and old alike have equal chance for success. A common school education is all you need with the amazing Lewis System of Sparetime Training in Hotel Operation.

Previous Experience Unnecessary

Hundreds of Lewis Students are winning success. Totally unacquainted with hotel work before taking the Lewis Course, N. Frank Hills is now Assistant Manager of a \$250,000 Apartment House. Elwood V. Matlack rose from Elevator Boy to Manager of a big hotel, in less than two years, due to training he received from Lewis Schools. YOU can do as well. Low cost—easy terms—money back agreement. Write today for Free Book, "Your Big Opportunity" and complete details, mailed without obligation.

LEWIS HOTEL TRAINING SCHOOLS
Room CE-339 Washington, D. C.
The Original and Only School of Its Kind in the World

OPPORTUNITY COUPON

SEND FOR FREE BOOK



Lewis Hotel Training Schools, Room CE-339, Washington, D. C. Send me the Free Book, "Your Big Opportunity," without obligation.

Name.....
Address.....
City..... State.....

These Lewis Students "Made Good"

O. F. Stuart—"I accepted the position of Manager. I know my course is going to bring me thru with colors flying."

C. A. Jones—"I was chosen Manager of this Hotel. My success is due to the Lewis Schools."

R. J. Gross—"I have been appointed Assistant Manager of this 400-room Apartment Hotel. I can never thank the Lewis Schools enough for their assistance."

Henry R. Thompson—"I will have charge of the Auditing Department in this new hotel, at 100% increase in salary."

MEN

EARN \$100

While LEARNING BARBERING



The Simplest Work in the World to Learn
SHORT—PRACTICAL COURSE
Protecting Laws Make It the Best Profession
in the Universe

ART STEFFEN paid his way through a two year course of Aviation by Barbering. He came to Moler's from an Automobile Job.

RALPH KUHLMAN has a Barber job on the Santa Fe running from Chicago to Los Angeles paying as high as \$60 a single trip. A short while ago he was a farm hand.

ARTHUR BAKER runs a shop in the exclusive great money district of Wall Street. He has accumulated a fortune. He learned at Moler's.

60,000 have done as well as these boys. It is better than the average man does and it is so easy.

GOODNESS !!! GRACIOUS !!!

anybody can barber and it's put within your easy reach. There is a school near you. Write to the nearest one and see.

Standardized Branches

Moler System of Colleges

139 E. 23rd St., New York City.
 512 N. State St., Chicago, Ill.
 810 N. 6th St., St. Louis, Mo.
 801 Main St., Kansas City, Mo.
 206 E. 4th St., Cincinnati, Ohio.
 215 Huron Road, Cleveland, Ohio.
 559 Michigan Ave., Detroit, Mich.

109 S. 15th St., Omaha, Nebr.
 501 E. Water St., Milwaukee, Wis.
 81 Forsyth St., N. W., Atlanta, Ga.
 81 S. Second St., Memphis, Tenn.
 912 Main St., Dallas, Texas.

Address Nearest Branch

Please send me without obligation on my part your Booklet B telling how I may earn \$100 and my meals while learning barbering.

Name.....

Address.....

City.....State.....

\$80 to \$150 A WEEK

MOTION PICTURE OPERATORS EARN THIS and MORE

Big Pay—Easy Work—Short Hours

YOU can quickly qualify for one of these well-paying positions. Big demand now for motion picture projectionists—in theatres, schools, industrial motion pictures or for spare-time entertainments!

Our complete home study course teaches you everything—qualifies you in short time for big pay and fascinating work. Earn two to five times your present salary in this growing, uncrowded profession.

FREE BOOK shows you how you can easily and quickly qualify as an Expert Motion Picture Operator—tells about the ever-growing field of photography—motion picture projection and photography, still photography and photo-finishing. Send for it TODAY—NOW!

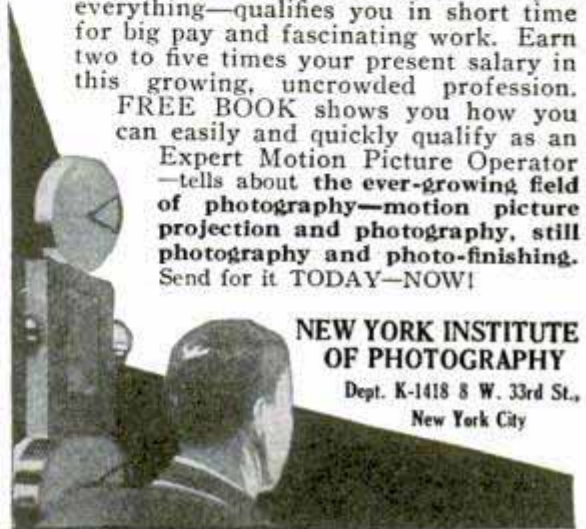

NEW YORK INSTITUTE
 OF PHOTOGRAPHY
 Dept. K-1418 8 W. 33rd St.,
 New York City

TRI-STATE COLLEGE



B. S. degree in 2 years in Aeronautical, Civil, Electrical, Mechanical, Chemical, Administrative Engineering. Students who left H. S. can make up work. Tuition low. *Catalog.*

440 College Street

Angola, Indiana

MUSIC LESSONS IN YOUR HOME

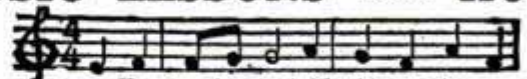

You can play music like this quickly

Write today for our FREE BOOKLET. It tells how to learn to play Piano, Organ, Violin, Mandolin, Guitar, Banjo, etc. Beginners or advanced players. You pay as you learn. Costs only a few cents a day. Thousands of satisfied students.

AMERICAN SCHOOL of MUSIC,

51 Manhattan Bldg., CHICAGO

AVIATION FREE Information

Send us your name and address for full information regarding the Aviation and Airplane business. Find out about the many great opportunities now open and how we prepare you at home, during spare time, to qualify. Our new book "Opportunities in the Airplane Industry" also sent free if you answer at once.

AMERICAN SCHOOL OF AVIATION

3601 Michigan Ave.

Dept. 1354

CHICAGO

LEARN TO Mount Birds

We teach you At Home by Mail to mount Birds, Animals, Heads, Tax Furs and Make Eggs. Be a taxidermy artist. Easily, quickly learned by men, women and boys. Tremendously interesting and fascinating. Decorate home and den with beautiful art. *Make Big Profits from Spare Time Selling Specimens and Mounting for Others.*

Free Book—Beautiful book telling all about how to learn taxidermy sent Free if you state your AGE. Send Today. You will be delighted.

Northwestern School of Taxidermy 3374 Elwood Bldg., OMAHA, NEB.



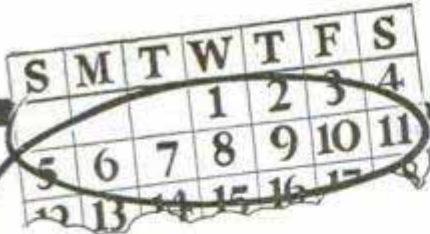

You get **PROOF** in
the first 7 days—

I can make a new man

of YOU—Add weight, increase
measurements, develop powerful muscles
... get new vitality and tireless energy
—my quick **Dynamic-Tension** way!

By **CHARLES ATLAS**

"The World's Most Perfectly Developed Man"

I'VE helped thousands of men—young and old—underweight and overweight—weaklings and even "strong men" and other physical directors who wanted *my kind of Muscle Power*. Now I'll show YOU my quick, sure way to build yourself a new body and make "a new man" of yourself.

It's easy my way—my secret of *Dynamic-Tension does the work!* You get the **PROOF** in your first seven days—in one week you begin to **SEE** and **FEEL** the difference in your bodily condition and physical appearance. Spending just a few minutes a day, doing what I tell you, without tricky apparatus, starving or gorging—using only my natural methods of *Dynamic-Tension*—you build up or tone-down to reach the fighting trim that I am always in myself.

And besides getting this new muscle power and the strength and energy of an "Atlas Champion," my *Dynamic-Tension* method digs down into your system, banishing such ailments as constipation, pimples, skin blotches and the others that do you out of the good things and good times of life. Your new health, pep and vigor show even in your eyes, your hair, and the way you carry yourself. If you're timid and bashful, you lose all that—you have a new more forceful personality—you become a **NEW MAN!**

Gamble a 2c Stamp

It's a shame if you are being held back by a below-par body—now that you can so easily and quickly make this new man of yourself. Do what my thousands of other pupils did—send for a free copy of my 48-page book "*Everlasting Health and Strength*." You'll get the stories of scores of other fellows and learn how I built myself up from a weak, no-muscle, always-tired "runt" to the powerful, evenly-balanced figure that you see in my new photos and that won for me my title "*The World's Most Perfectly Developed Man*."

Where shall I send **YOUR FREE COPY?** Don't put off. Tear out my coupon, put it in an envelope and gamble a 2c stamp for the biggest prize that anyone can win—a handsome, healthy, husky body. I'm waiting to help you. Address **CHARLES ATLAS (Dept. 84), 171 Madison Ave., New York City.**



*There's a He-Man's strength and vitality in a back like this. I'll show you how to add the muscles where they're needed, and what to do to increase the breadth of your shoulders. These two photos of me show that I don't go in for muscle-bound, top-sided development—my secret of *Dynamic-Tension* gives even, **BALANCED** development, and muscles and strength where they are needed.*



Photo taken
Oct. 15, 1929

FREE

The coupon below entitles you to a free copy of my 48-page book, full of photos of myself and pupils. Supply is limited—mail coupon at once.

**CHARLES ATLAS (Dept. 84),
171 Madison Ave., N. Y. C.**

I want the proof that your system of *Dynamic-Tension* will make a **New Man** of me—give me a healthy, husky body and big muscle development. Send me your free book, "*Everlasting Health and Strength*."

Name.....

Address.....

City.....State.....

(Please print or write plainly)



The Boss—Could You Handle his Job?

SUPPOSE the Boss should leave tomorrow—who would they put in his place? Could you handle his job?

It's worth thinking about because such things happen—every day. Would you have the background—the technical knowledge to carry on his work?

In an hour a day of your spare time, right in your own home, the International Correspondence Schools can give you exactly the training you need. And when you are ready, the opportunity will surely come.

Choose now the job that you would like to hold a year—two years—five years from now. Then prepare yourself for that job through I. C. S. study. Thousands of men—starting where you are today—have advanced to better positions and bigger pay in just this way.

You can do it too. There is no cost or obligation in finding out how. Just mark and mail the coupon and we will gladly send you full details at once.

INTERNATIONAL CORRESPONDENCE SCHOOLS
Box 5679-F, Scranton, Penna.

Without cost or obligation, please send me a copy of your booklet, "Who Wins and Why," and full particulars about the course before which I have marked X in the list below:

TECHNICAL AND INDUSTRIAL COURSES

- | | |
|--|---|
| <input type="checkbox"/> Architect | <input type="checkbox"/> Automobile Mechanic |
| <input type="checkbox"/> Architectural Draftsman | <input type="checkbox"/> Aviation Engines |
| <input type="checkbox"/> Building Foreman | <input type="checkbox"/> Plumber and Steam Fitter |
| <input type="checkbox"/> Concrete Builder | <input type="checkbox"/> Plumbing Inspector |
| <input type="checkbox"/> Contractor and Builder | <input type="checkbox"/> Foreman Plumber |
| <input type="checkbox"/> Structural Draftsman | <input type="checkbox"/> Heating and Ventilation |
| <input type="checkbox"/> Structural Engineer | <input type="checkbox"/> Sheet-Metal Worker |
| <input type="checkbox"/> Electrical Engineer | <input type="checkbox"/> Steam Engineer |
| <input type="checkbox"/> Electrical Contractor | <input type="checkbox"/> Marine Engineer |
| <input type="checkbox"/> Electric Wiring | <input type="checkbox"/> Refrigeration Engineer |
| <input type="checkbox"/> Electric Lighting | <input type="checkbox"/> R. R. Positions |
| <input type="checkbox"/> Reading Shop Blueprints | <input type="checkbox"/> Highway Engineer |
| <input type="checkbox"/> Telegraph Engineer | <input type="checkbox"/> Chemistry |
| <input type="checkbox"/> Telephone Work | <input type="checkbox"/> Pharmacy |
| <input type="checkbox"/> Mechanical Engineer | <input type="checkbox"/> Coal Mining Engineer |
| <input type="checkbox"/> Mechanical Draftsman | <input type="checkbox"/> Navigation <input type="checkbox"/> Assayer |
| <input type="checkbox"/> Machine Shop Practice | <input type="checkbox"/> Iron and Steel Worker |
| <input type="checkbox"/> Toolmaker | <input type="checkbox"/> Textile Overseer or Supt. |
| <input type="checkbox"/> Patternmaker | <input type="checkbox"/> Cotton Manufacturing |
| <input type="checkbox"/> Civil Engineer | <input type="checkbox"/> Woolen Manufacturing |
| <input type="checkbox"/> Surveying and Mapping | <input type="checkbox"/> Agriculture <input type="checkbox"/> Fruit Growing |
| <input type="checkbox"/> Bridge Engineer | <input type="checkbox"/> Poultry Farming |
| <input type="checkbox"/> Gas Engine Operating | <input type="checkbox"/> Mathematics <input type="checkbox"/> Radio |

BUSINESS TRAINING COURSES

- | | |
|--|---|
| <input type="checkbox"/> Business Management | <input type="checkbox"/> Business Correspondence |
| <input type="checkbox"/> Industrial Management | <input type="checkbox"/> Show Card and Sign Lettering |
| <input type="checkbox"/> Personnel Management | <input type="checkbox"/> Stenography and Typing |
| <input type="checkbox"/> Traffic Management | <input type="checkbox"/> English |
| <input type="checkbox"/> Accounting and C. P. A. Coaching | <input type="checkbox"/> Civil Service |
| <input type="checkbox"/> Cost Accounting | <input type="checkbox"/> Railway Mail Clerk |
| <input type="checkbox"/> Bookkeeping | <input type="checkbox"/> Mail Carrier |
| <input type="checkbox"/> Secretarial Work | <input type="checkbox"/> Grade School Subjects |
| <input type="checkbox"/> Spanish <input type="checkbox"/> French | <input type="checkbox"/> High School Subjects |
| <input type="checkbox"/> Salesmanship | <input type="checkbox"/> Cartooning |
| <input type="checkbox"/> Advertising | <input type="checkbox"/> Illustrating |
| | <input type="checkbox"/> Lumber Dealer |

Name.....
Address.....
City..... State.....
Occupation.....

If you reside in Canada, send this coupon to the International Correspondence Schools Canadian, Limited, Montreal, Canada

Books on 65 Practical Subjects

Popular Mechanics Press specializes in supplying the outstanding best books on many subjects. As new books of merit appear, we will revise the list accordingly.

- | | |
|---|--|
| AIR NAVIGATION AND METEOROLOGY
Every flyer needs.....\$3.00 | JOINT WIPING
(New Edition).....\$1.00 |
| AIRCRAFT ENGINES
Dyke's New Instructor
Best Engine Book.....\$5.00 | KITES THAT FLY
How to make.....\$1.25 |
| ARCHITECTURAL
Drafting.....\$2.00 | LANDSCAPING
Practical.....\$2.50 |
| ARITHMETIC
Rapid.....\$1.50 | LATHE WORK (METAL)
and Drilling and Thread
Cutting.....\$1.00 |
| ARMATURE WINDING
Excellent new book.....\$2.00 | LETTER WRITING
Social and Business
Only.....\$1.00 |
| AUTO ENCYCLOPEDIA
Dyke's. (Covers New
Model A Ford).....\$6.00 | MACHINIST
419 Kinks for.....\$1.50 |
| AVIATION
Practical new book on flight
training.....\$5.00 | MAGIC
200 New Tricks for Am-
ateurs.....\$1.00 |
| BIRD HOUSES
How to Make.....\$1.00 | MAKING THINGS
YOURSELF
900 Different Articles..\$3.00 |
| BLUE PRINTS
How to Read.....\$2.00 | MASONS AND BUILDERS
Guides (4 vols.).....\$6.00 |
| BOAT BUILDING
35 Craft, Popular Outboard
Engined Type.....\$3.00 | MATHEMATICS
Made Easy for the Prac-
tical Man.....\$1.50 |
| BOY MECHANIC
Famous 4 Vol. Library,
4000 Things to Make..\$7.00 | MECHANICAL DRAWING
Practical Course in...\$1.00 |
| BUILT-IN FURNITURE
Complete Instructions..\$2.50 | MODEL AIRCRAFT
Building and Flying...\$2.25 |
| CARBURETORS
Excellent book on all
makes.....\$2.00 | MOVIE MAKING
for Amateurs.....\$3.00 |
| CARPENTRY
Hand book of 336 Kinks..\$1.50 | OUTDOOR OPPOR-
TUNITIES
for Making a Living...\$2.00 |
| CHEMISTRY
For Old and Young Be-
ginners.....\$2.50 | OUTDOOR SPORTS
for All Year 'Round...\$1.50 |
| COLOR SIMPLIFIED
Practical new Book (for
Color Users).....\$3.50 | PAINTING
House (Best Methods)..\$2.00 |
| CONCRETE
173 Ways of Using
New Edition (Cloth)..\$1.00 | PLUMBING
500 Plain Facts for
Every Homeowner...\$1.50 |
| CONTRACTOR
Building Cost Estimator..\$2.00 | POULTRY RAISING
for Profit.....\$2.00 |
| DIESEL ENGINES
(New Work). Best Au-
thority.....\$5.00 | POWER WIRING (D. C.)
Electrical (Just Out)...\$3.50 |
| DOGS
Care and Raising.....\$2.00 | PUZZLES
Amusing Mathematical..\$1.50 |
| ELECTRICITY
Practical Lessons In...\$2.50 | RADIO
Trouble Shooting. Covers
All-Electric Sets and
Television.....\$3.00 |
| ELECTROPLATING
Practical Results Easily
Obtained.....\$1.00 | ROPE SPINNING
Only Book on Subject..\$1.50 |
| ENGLISH
Self-Improvement In...\$2.50 | SHIP MODEL
Making.....\$2.50 |
| ETIQUETTE
New 560-Page Book.
Only.....\$1.00 | SHOP NOTES
14 Vols. of 6000 Valu-
able Kinks.....\$4.25 |
| FARMER'S BOOK
of 861 Kinks and Book
for Farmers' Wives..\$1.00 | STEEL SQUARE
Pocket Book, Practical..\$1.00 |
| FLYING
Simplified.....\$1.00 | TELEVISION
See what you hear....\$2.75 |
| FORMULAS
10,000 Money Making..\$4.00 | TENNIS
By Helen Wills.....\$2.00 |
| FURNITURE (Mission)
Homemade (3 vols.)...\$3.00 | TOY MAKING
Complete Instructions..\$1.50 |
| HOME REPAIRS
Practical Book of.....\$2.50 | TREASURES
Hunting Hidden.....\$2.50 |
| INTERIOR DECORATING
Best book of new
methods.....\$4.00 | WIRING
House (New Book)...\$2.50 |
| INVENTIONS (American)
Popular History of
2 vols. Reduced to...\$5.00 | WOOD TURNING (LATHE)
Practical Course in...\$1.50 |
| INVESTMENT
Policies that pay
By Ray Vance.....\$4.00 | WOODCRAFT
Famous 590 Page Book
by Ernest Thompson
Seton; Only.....\$1.00 |

Books sent C. O. D. anywhere in U.S.

Just check the books you want, write your name and address below, and mail the advertisement. It is your order blank. When postman hands you books, pay him the price and the postal charges. If outside the U. S. remit when ordering and include 10 cents per book extra for postage. We have many other books on these and 2,000 other subjects. Catalog free.

Name.....
City..... State.....
Address.....

Mail to Popular Mechanics Press,
Room P4—200 East Ontario St., Chicago, Ill.

"How can I get into Aviation?"



Read this Answer from A World Famous Trans-Atlantic Pilot

AVIATION is waiting for no one! Too many millions of capital are already invested—the demand for air service of *every* kind is increasing too fast. Aviation demands men who KNOW. Men who can DO. Men who can step into the real jobs and command the real salaries. Landing fields, municipal airports, plane and equipment factories, air mail and passenger lines, service and sales organizations—all are leaping ahead in the fastest, most amazing development that any industry has ever known. In such racing, feverish activity, where is there any room for a man who has nothing to offer? An empty pocketbook is no drawback—but Aviation has no place, no patience, no time for empty hands or empty heads! Aviation is taking off for the greatest non-stop flight in history—and the men who will go along and climb to the top are the men with a foundation of FACTS under them.

Walter Hinton

Walter Hinton was pilot of the famous NC-4, first plane to fly the Atlantic; he piloted the first plane from North to South America; he was first to fly to the headwaters of the Amazon. During the War he was a crack flying instructor for the Navy. Today—with a course that experts agree is the most complete and practical ever produced—Hinton is training keen-sighted men for the Big Pay jobs in Aviation.

You Don't Have to Fly; 40 Different Jobs on the Ground PAY BIG TOO!

To succeed in Aviation—make BIG MONEY—you need not necessarily be a pilot. There must be many thousands of pilots, certainly. But for every plane that flies there's an immediate need for trained men in more than forty different important jobs on the ground. Construction, motor and instrument experts—airport managers, service foremen, salesmen—all make real money. But every last one of them must have the FACTS. Today's problem—YOUR problem—is to LEARN Aviation quick. And right there is where Walter Hinton is achieving the biggest success of his career.

Get Your Ground Work NOW Right at Home—Hinton Is Ready to Train You

YOU can train at home in spare-time for the best paid jobs in the industry. Hinton's proved course starts you at the beginning, trains you fast. You get *all* the facts about construction, rigging, motors, repairs, instruments, theory of flight, navigation, commercial Aviation—facts that *every* man must have to intelligently and profitably fill ANY job in the industry. With this Institute's training you'll have your foundation, your *start*, for real accomplishment. Serious-minded—*air-minded*—men are reading and *acting* on the Free Book shown below. YOU should have a copy too. Send the coupon NOW.

Get his FREE Book

You Must be 16

To take an active part in Aviation you must be at least 16 years of age. If you are under 16, please do not ask for Lieut. Hinton's Book.

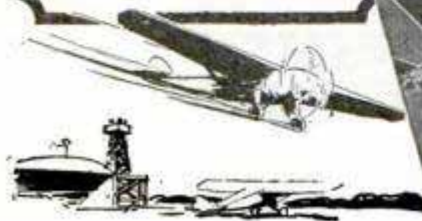

Aviation Institute of U. S. A.

Walter Hinton, President

1115 Connecticut Ave., Washington, D. C.

Rush back to Washington Quick!

Walter Hinton, Pres. 301-F
Aviation Institute of U. S. A.
1115 Connecticut Ave., Washington, D. C.

Please send me at once your FREE Book "Wings of Opportunity" showing how I can get into this tremendous field.

Name.....

Street..... Age.....
(Must be over 16)

City..... State.....

\$25,000 worth of 1929 cars for you to work on!

Students at work on 1929 Packard Str. 8. Other 1929 Models include Buick, Study, Marmon, Auburn, Nash, Geo, Essex, De Soto, Chev., Ford, Oakland—and 11 more chassis.



Learn Autos IN LOS ANGELES

and LEARN IT RIGHT!

1. NATIONAL—America's Best Equipped Auto School

NATIONAL is a Million Dollar institution—established in Los Angeles in 1905—recognized throughout the automotive industry as one of America's foremost trade schools. NATIONAL offers practical, intensive training in all automotive branches. No age limit. No previous experience necessary. You learn by "Actual-Shop" Methods. Life Scholarship privileges. Start any time of the year.

2. NATIONAL Qualifies YOU to Make Good

NATIONAL properly trains you in the Auto Trades in the short time of 4 to 6 months. Upon completing this Condensed Course you are fully qualified as a Practical, Competent Automobile man, and you have not risked your chances of employment because of inferior, incomplete instruction.

3. NATIONAL Guarantees YOU Efficient Employment Service

NATIONAL GUARANTEES to give unlimited and efficient Employment Service to students wishing to earn living expenses while learning; and to graduates getting started in the automobile field. This is the most any reputable school can be expected to do.

4. NATIONAL'S Training in Every Man's Reach

NATIONAL offers YOU the very best technical-practical training that money can buy at a cost within every man's reach. It does not offer to pay your railroad fare, room and board or other personal expenses, preferring to limit its activities to the PROPER TRAINING OF MEN FOR SUCCESS.

5. Come to LOS ANGELES—the Playground of America!

LOS ANGELES is the heart of the country's most prosperous automobile section—as well as the world's most ideal city in which to live and prepare for success in the auto game.

WRITE for FREE BOOK NOW!

National Automotive School

NATIONAL AUTOMOTIVE, Dept. 733, 4006 Figueroa St., Los Angeles, Calif.

Send me, absolutely free, your big illustrated catalog of Automotive Opportunities.

Name.....
Address.....
Age.....City.....State.....

Your Future assured!

National Automotive School
LOS ANGELES

"Pick YOUR Government Job"



I'll show you the quickest way to get on Uncle Sam's payroll. Send for free book—HOW TO SECURE A GOVERNMENT POSITION.

Work for Uncle Sam. Get good pay, regular increases, vacations and sick leave with pay, steady advancement, pension. Send for my free book—tells about all jobs, near home or traveling, the money, what you need to know and how to get posted. Forget "job hunting."

IMPORTANT NOTICE
—Railway Postal Clerk examination coming. Yearly pay, with allowances, averages \$2759.00. Prepare yourself NOW. Write for my big, free 32-page book TODAY. Address Arthur Patterson, Civil Service Expert, PATTERSON SCHOOL, 84 Wisner Bldg., Rochester, N. Y.

LEARN TO PLAY



VIOLIN, TENOR BANJO, HAWAIIAN GUITAR, BANJO CORNET, UKULELE, BANJO UKULELE, GUITAR, BANJO MANDOLIN, BANJO GUITAR, MANDOLIN, SNARE DRUM, FIELD DRUM, PIANO or ORGAN at home this new and "easy to learn" way. No teacher or talent required. Entirely different from any "chart" or "diagram" system. Lessons are so simplified most pupils play by note after only 10 lessons. Thousands of men, women, boys and girls have learned to play quickly by our Home Study method. Your opportunity to become popular and play for profit or pleasure. A few cents a day pays for lessons. Pay while you learn. Write to-day for full particulars. No obligation. Instruments except Piano and Organ furnished at cost if desired.

CHICAGO CORRESPONDENCE SCHOOL OF MUSIC, INC.
1632 No. Halsted St., Dept. 68 Chicago, Ill.

Learn **MECHANICAL DENTISTRY** in 10 Months!



Men and Women can do this at home in their spare time. As much as \$100 weekly and even more is made by trained mechanical dentists. Steady work. Earn big money in a profession. Write for FREE particulars about our easy but complete Home Study Course.

AMERICAN SCHOOL OF MECHANICAL DENTISTRY
Dept. A-J 150 E. South Temple St., SALT LAKE CITY, UTAH

LEARN WATCHMAKING

and become independent. We help you secure a position. Easy to learn. Send for FREE CATALOG.

ST. LOUIS WATCHMAKING SCHOOL Dept. 5, ST. LOUIS, MO.

TRAVEL for "Uncle Sam"



New Bandit Proof Railway Mail Car

U.S. GOVERNMENT JOBS \$1260 TO \$3400 YEAR

Men—Boys, 18 Up

Steady Work
Paid Vacations
Common Education
Usually Sufficient
Mail Coupon
—Today SURE

FRANKLIN INSTITUTE
Dept. H175, Rochester, N. Y.

Gentlemen: Rush to me without charge 32-page book with list of U. S. Government big paid positions obtainable. Advise me regarding the salaries, hours, duties, vacations and full particulars. Tell me how to get a job.

COUPON

Name.....
Address.....



MEN!

Get Your Copy of **My New Book**

It shows you

How to get a good job in the Radio Industry

Hundreds of Jobs paying \$50, \$60, \$75, \$100 a week are opening in Radio every year.

J. E. SMITH, Pres
NATIONAL RADIO INSTITUTE

I showed these men how to get **Big Pay** like these



Seldom under \$100 a Week

"My earnings in Radio are many times bigger than I ever expected they would be when I enrolled. In November I made \$577, December \$645, January \$465. My earnings seldom fall under \$100 a week. I merely mention this to give you some idea of what a Radio man can do who has the training."

E. E. WINBORNE,
1414 W. 48th St., Norfolk, Va.



\$3000 a Year in Own Business

"I cannot give N. R. I. too much credit for what I have been able to do in Radio. I can safely say that I averaged \$3000 a year for the past three years. I am in the Radio business here. Any man who really wants to advance cannot go wrong in Radio. There is certainly a lack of trained men."

FRED A. NICHOLS,
P. O. Box 207, Eaton, Colo.

If you are earning a penny less than \$50 a week, send for my book of information on opportunities in Radio. It is free. Radio's amazing growth is making hundreds of fine jobs every year. My book shows you where these jobs are, what they pay, how I can train you at home in your spare time to be a Radio Expert.

You have many jobs to choose from

Broadcasting stations use engineers, operators, station managers and pay \$1,800 to \$5,000 a year. Manufacturers continually need testers, inspectors, foremen, engineers, service men, buyers for jobs paying up to \$15,000 a year. Shipping companies use hundreds of operators, give them world-wide travel with practically no expense and \$85 to \$200 a month besides. Dealers and jobbers are always on the lookout for good service men, salesmen, buyers, managers and pay \$30 to \$100 a week for good men. Talking Movies pay as much as \$75 to \$200 a week to men with Radio training. There are openings almost everywhere to have a spare time or full time Radio business of your own—to be your own boss. Radio offers many other opportunities. My book tells you about them.

New 8 Outfits give you Extensive Practical Radio Experience

With me you not only get the theory of Radio—you also get practical Radio experience while learning. You can build over 100 circuits—build and experiment with the circuits used in Atwater-Kent, Majestic, Crosley, Eveready, Stewart-Warner, Philco, and many other sets. These experiments include A. C. and screen grid sets, push pull amplification and other late features. When you finish my course you won't need to take "any old job" just to get experience—you will be trained and experienced ready to take your place alongside men who have been in the field for years.

Back view of 5-tube A. C. screen grid tuned Radio frequency set—only one of many circuits you can build with the parts I give without extra charge.



I Will Train You at Home in your Spare Time

Hold your job until you are ready for another. No need to leave home. All I ask is part of your spare time. I have doubled and tripled the salaries of hundreds through my practical home-study training. You don't have to be a high school or college graduate. My course is written in easy, simple terms that most anyone can understand.

My Course Includes Talking Movies, Wired Radio, Television
My course is up-to-date with Radio's latest uses and improvements. It includes Radio's application to Talking Movies, Television and home Television experiments, Wired Radio, Radio's use in Aviation, in addition to fitting you for many other lines.

Money Back If Not Satisfied
I will agree in writing to refund every penny of your tuition if you are not satisfied with my Lesson Texts and Instruction Service when you have finished my course. This agreement is backed by the Pioneer and World's Largest organization devoted entirely to training men and young men by mail, for good jobs in the Radio industry.

Find out what Radio offers you Get My Book

This book gives the facts on Radio's opportunities and the many features and services of N.R.I. training. It gives 100 letters from students who have proved that my methods are successful. Get your copy today. There is no obligation.

J. E. SMITH, President, National Radio Institute
Dept. ODP, Washington, D. C.

THIS COUPON IS GOOD FOR ONE FREE COPY OF MY NEW BOOK *mail it NOW*

J. E. SMITH, President,
National Radio Institute, Dept. ODP
Washington, D. C.

DEAR MR. SMITH:—Send me your book. I want to see what Radio offers and what you offer in Radio training. This request does not obligate me in any way.

Name.....

Address.....

City..... State.....

Lifetime Employment Service to all Graduates

VOICE

NOW! you can have the VOICE you want!



100% Improvement Guaranteed!

No matter how hopeless your case may seem—send for free Voice Book. New SILENT Method of Voice Training. Increases Range. Improves quality. Banish huskiness—hoarseness. 100 per cent improvement *guaranteed*—or money back. Mail coupon *at once* for free booklet—the greatest voice booklet ever written—sent FREE with no obligation!

Perfect Voice Institute, Dept. 13-54
1922 Sunnyside Ave., Chicago

Mail Coupon for Free Voice Book

Perfect Voice Institute, Dept. 13-54
1922 Sunnyside Ave., Chicago

Please send me FREE and without obligation, Prof. Feuchtinger's new book, "Physical Voice Culture." I have checked subject in which I am most interested.

Weak Voice Singing Stammering Speaking

Name

Address

City State

FREE BOOKS of BUSINESS HELPS

We publish over 200 Home Study Books, each a complete treatise of its subject. We have one or more for you. Books on

- | | |
|--|---|
| <input type="checkbox"/> Commercial Art | <input type="checkbox"/> Decoration |
| <input type="checkbox"/> Lettering | <input type="checkbox"/> Automobiles |
| <input type="checkbox"/> Advertising | <input type="checkbox"/> Battery Work |
| <input type="checkbox"/> Sign Making | <input type="checkbox"/> Electricity |
| <input type="checkbox"/> Radio | <input type="checkbox"/> Carpentry |
| <input type="checkbox"/> Aviation | <input type="checkbox"/> Building |
| <input type="checkbox"/> Painting | <input type="checkbox"/> Contracting |
| <input type="checkbox"/> Silk Screen Process | <input type="checkbox"/> Sheet Metal Work |

and many other subjects. All fully described in our FREE CATALOG. Check the subjects in which you are interested and write today.

FREDERICK J. DRAKE & CO., Publishers
Room 508—179 No. Michigan Blvd., Chicago
Drake books are for sale in all book stores.

LEARN AUTOS



At home! Stop working long hard hours for low pay. My "Job-Way" Training is the short cut to a Real Job paying up to \$75 a week. Get my FREE Book. See how I train you in spare time, then help you get a good job or go into business. Read about wonderful opportunities in World's Biggest Business. Write me today.

B. W. Cooke, *Directing Engineer*
Motor Institute of America, Dept. 3164
Motor Institute Bldg. Evanston, Ill.

Government Positions

Census Clerks, Clerk Carriers, Rural Carriers, Railway Mail Clerks, Postmasters, Department Clerks, and many others. Splendid salaries, easy work, vacation with pay. Only common school education required. Examinations often. 37,976 appointed last year. Send for our Civil Service Catalog No. 6. **COLUMBIAN CORRESPONDENCE COLLEGE, Washington, D. C.**

BIG Demand for Skilled Mechanics!

The entire country is calling for skilled mechanics! Good pay—steady work—good opportunities for advancement! Master this fascinating trade with the aid of the

AMERICAN MACHINISTS' LIBRARY
6 volumes—2,000 pages—2,500 illustrations

(A combined home-study course and reference library)

This library of machine shop practice was written for practical men. It gives you the best methods for every kind of machine shop work. It explains machine tools and their operation, tool work, gears and grinding, jigs and fixtures, automatic screw machines, their tools, punches, dies, etc. Plainly written—completely illustrated—the best kind of help to the machine-shop man who wants to advance himself.

Free TRIAL

No money down—only 7c a day

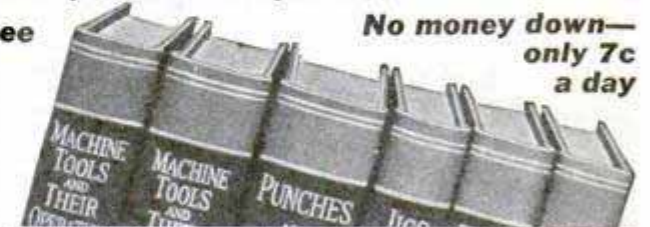

FREE EXAMINATION COUPON

McGRAW-HILL BOOK CO., Inc., 370 Seventh Ave., New York
Send me for 10 days' free examination the AMERICAN MACHINISTS' LIBRARY. If satisfactory, I will send \$1.50 in 10 days and \$2 monthly until the special price of \$17.50 is paid. If not wanted, I will return the books at your expense.

Signed

Address

City and State

Position

Company

Step into **BIG PAY** this New Way through **DRAFTING**

COME on you fellows who are sick and tired of lay-offs, job hunting and poor pay work. Say goodbye forever to hard times and starvation wages. Become an Engineering Draftsman and land a fine paying, year 'round job through the now famous L. L. COOKE "See it - Do it" Method - the amazingly simple quick-action Training that's getting sensational results for men like you everywhere. It's new, it's thorough, it's complete - said to be the first real improvement in Drafting instruction in 30 years - and you don't have to be a High School graduate nor a master of figures to learn it and learn it right.



Only Spare Time At Home Needed - Complete Drawing Outfit Furnished

Just give a little of your spare time to this wonderful training and you'll be surprised how rapidly you make progress. With this amazing "See it - Do it" Method and the Big Complete Drawing Outfit that comes with it you start at once to do Drafting just as it's done in the great Drafting Rooms everywhere - you begin immediately to get the knowledge and the skill that employers demand and pay Big Money for - your advancement is fast and steady - and almost before you realize it you're ready for a fine job in work that pays \$50 to \$100 a week and more.



SIMPLE THOROUGH PRACTICAL

It's just as easy as it looks in these pictures. You learn by DOING. Actual pictures of your instructor's hands guide you. You SEE IT done - and

you DO IT yourself. The pictures show you HOW and the text tells you WHY. And you learn about mechanics, shop practice and everything a Draftsman must know. It's just like actually working in a Drafting Room with an expert instructor at your elbow every minute showing you what to do and how to do it. No wonder it's so intensely interesting, so thorough, so quick!



Step by Step YOU SEE IT

The pictures in this ad show you how easy it now is to learn Drafting. But these are only 5 of the 37 fine drawings and pictures in Job No. 13. And the whole Training is worked out so expertly and clearly that you make real progress right from the start and advance rapidly.



Step by Step YOU DO IT

Make up your mind to get into Drafting. It's your Big Opportunity for Big Pay. But don't sign up for any Course until you've learned all about this highly-simplified "See it - Do it" Method. Mail coupon for Big FREE Book. Read all about this wonderful Training and what it has done for other men like you. See the Big Outfit of Draftsman's Tools and Complete Drawing outfit given without extra charge. Read about the Earn-while-Learning Plan, the Nationwide Job Service and the great Money Back Agreement. Mail the coupon right now.

K. M. BOYD



Act today to increase your pay

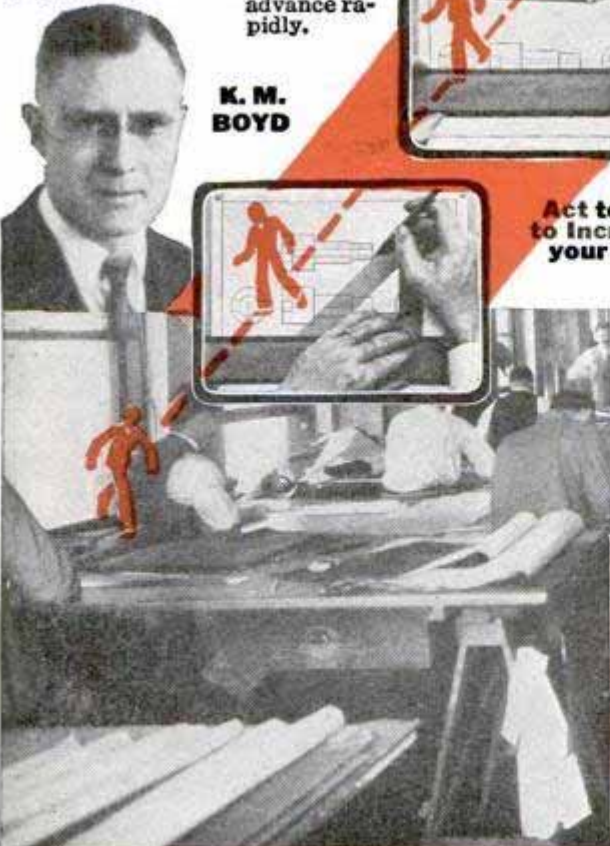

**K. M. Boyd, Chief Drafting Engineer
L. L. COOKE SCHOOL OF DRAFTING
Dept. 14, 2132 Lawrence Avenue, Chicago, Illinois**

Send me your book "Draw Big Pay in Drafting" and tell me more about your "See It - Do It" Method. This does not obligate me in any way.

Name

Address

City.....State..... Age.....



High School Course in Two Years!

You Want to Earn Big Money!

And you will not be satisfied unless you earn steady promotion. But are you prepared for the job ahead of you? Do you measure up to the standard that insures success? For a more responsible position a fairly good education is necessary. To write a sensible business letter, to prepare estimates, to figure cost and to compute interest, you must have a certain amount of preparation. All this you must be able to do before you will earn promotion. Many business houses hire no men whose general knowledge is not equal to a high school course. Why? Because big business refuses to burden itself with men who are barred from promotion by the lack of elementary education.

Can You Qualify for a Better Position

We have a plan whereby you can. We can give you a complete but simplified high school course in two years, giving you all the essentials that form the foundation of practical business. It will prepare you to hold your own where competition is keen and exacting. Do not doubt your ability, but make up your mind to it and you will soon have the requirements that will bring you success and big money. **YOU CAN DO IT.**

Let us show you how to get on the road to success. It will not cost you a single working hour. Write today. It costs you nothing but a stamp.

American School

Dept. H-47 Drexel Ave. and 58th St., Chicago

American School

Dept. H-47 Drexel Ave. and 58th St., Chicago

Send me full information on the subject checked and how you will help me win success.

- | | |
|-----------------------------|---------------------------|
|Architect |Business Law |
|Building Contractor |Lawyer |
|Automobile Engineer |Machine Shop Practice |
|Automobile Repairman |Mechanical Engineer |
|Civil Engineer |Shop Superintendent |
|Structural Engineer |Employment Manager |
|Business Manager |Steam Engineer |
|Cert. Public Accountant |Foremanship |
|Accountant and Auditor |Sanitary Engineer |
|Bookkeeper |Surveyor (& Mapping) |
|Draftsman and Designer |Telephone Engineer |
|Electrical Engineer |Telegraph Engineer |
|Electric Light & Power |High School Graduate |
|General Education |Wireless Radio |
|Vocational Guidance |Undecided |

Name.....
Address

BE A RAILWAY TRAFFIC INSPECTOR

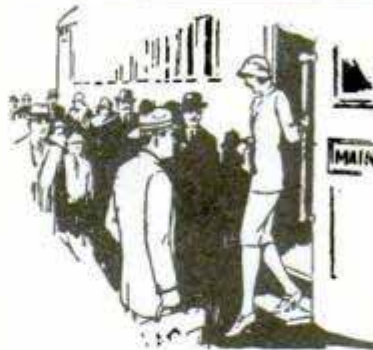

Earn up to \$250 per month plus expenses

Earning \$192 per Month—and Likes His Work

I am earning \$192.00 per month and I have the knowledge and satisfaction that my work is highly satisfactory to my superiors. I am far more than satisfied and received far more than I expected when I first subscribed for your course. Considering you the greatest benefactor that has come into my life, I am

(Signed) JOE ETTLE

Many men are needed to fill existing vacancies in this fascinating railway work. Pays \$120 to \$150 monthly to start. Rapid advances to \$175, \$200, \$250. Travel, or remain near home.

For eleven years this school has trained men for Traffic Inspection and assisted them to positions upon completion of training. Railways look to us for men. We'll train you in a few weeks' spare time home instruction, and upon completion assist you to a position at \$120 to \$150 or refund your tuition. You take no risk.

SEND FOR FREE BOOKLET

Learn complete details of this great uncrowded profession today. Our free booklet explains all about it—how we have obtained positions for our graduates, and what we can do for you. Write today.

Standard Business Training Inst. Div. 2, BUFFALO, NEW YORK

QUIT TOBACCO

Don't try to banish unaided the hold tobacco has upon you. Thousands of inveterate tobacco users have, with the aid of the Keeley Treatment, found it easy to quit.

KEELEY TREATMENT FOR TOBACCO HABIT

Quickly banishes craving for tobacco. Successful for over 50 years. Write today for FREE BOOK and particulars of our MONEY-BACK GUARANTEE.

THE KEELEY INSTITUTE, Dept. A-932, Dwight, Ill. Home of the famous Keeley Treatment for Liquor and Drugs. Booklet Sent on Request. Correspondence Strictly Confidential.



ZIP-ZIP SHOOTER

THOUSANDS of boys are made happy with this wonderful Zip-Zip shooter, scientifically and practically made. If you like hunting and outdoor sports, get a Zip-Zipshooter with plenty of pep and force. If your dealer happens not to have them, order from us. Zip-Zip shooter 35c or three for \$1.00; send stamps, coin or money order.

Automatic Rubber Co., Columbia, S. C.



Get Rid of COAL NOW-OIL HEAT at Amazing Low Cost



Now—OIL HEAT is no longer a luxury for the rich. A wonderful invention—the LACO AUTOMATIC BURNER, burns AIR and OIL, and smashes fuel costs. Sold on EASY TERMS at a price so amazingly low, any home can easily afford it. Laco's patented indestructible mineral wick does it. Automatic temperature control. FITS ANY KIND OF FURNACE INSTANTLY.

Complies with all ordinances. Safer than the ordinary kitchen gas range. Guaranteed. Built to last a lifetime. Write now for full information. Also, ask about the Laco Power Burner for coal cook stoves; and the Laco, Jr., for room heaters, Arcolas, water heaters, etc. DEALERS WANTED. Write for details. LACO OIL BURNER CO., 130 Union St., GRISWOLD, IOWA

3 BIG PAY FIELDS

Learn ELECTRICITY A BIG PAY JOB

Electricity and Radio now pays hundreds of trained men \$60, \$75, \$100, up to \$200 a week. The world's Greatest businesses, Billions—not millions—but billions of dollars are spent in them yearly. Now is the time to get away from low pay!

Learn in Only 3 Months in Great Greer Shops on Real Equipment

Mine is not a correspondence course. You start any day or any evening. It is practical, easy, quick, fascinating training. You learn on great, running live equipment in tremendous Greer Shops. Electricity is the fastest growing industry in the world—Radio a close second, and yet in its infancy, is a billion dollar industry. Trained men by scores needed for positions up to \$250 a week. Find out now about my great shops training.

You Get Real Help to Big Jobs

My big Employment Department gets jobs for Greer men. You get this help before and after graduation. Don't let money hold you back. Get my free book. Learn how I get you ready so Employers gladly pay you what you are worth.

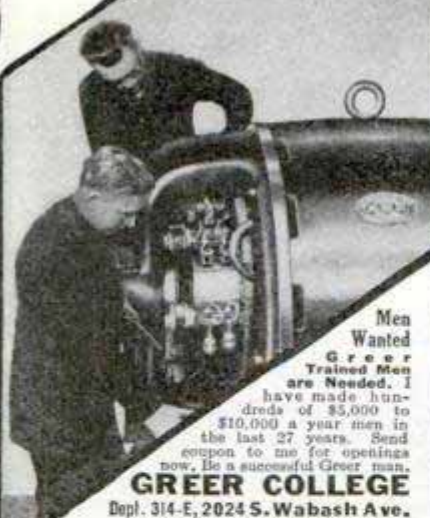

Men Wanted
Greer Trained Men are Needed. I have made hundreds of \$5,000 to \$10,000 a year men in the last 27 years. Send coupon to me for openings now. Be a successful Greer man.

GREER COLLEGE
Dept. 314-E, 2024 S. Wabash Ave., CHICAGO, ILLINOIS

Big Money in AUTOS OWN YOUR OWN BUSINESS

Be your own boss. Learn it all. Big men draw big money because they know the whole business. You can't make big money by just doing one single little thing. Factories pay a very ordinary salary to "Jones" who screws on nut number 39, because they can quickly teach someone else to do it just as well.

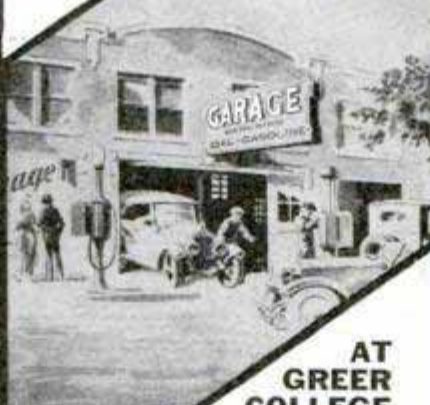

AT GREER COLLEGE

you learn how to boss the job.

Quickest, Easiest of Ways to Become Expert

I'll allow your fare here free of extra cost, then help you to a job while learning. Then I not only fit you to get a big pay job, but I'll help you hold it. Young and old, educated and uneducated, experienced and inexperienced, have found Greer Shops training easy, fascinating and valuable. You learn on big, actual full size equipment like you will work on out on the big pay job. Coupon below brings details. Don't delay! Get my free book now!

GREER COLLEGE
Dept. 314-A, 2024 S. Wabash Ave., CHICAGO, ILLINOIS

Get into AVIATION

You know the vast opportunities. Greer offers the way to get them. Now is the time.



You Learn to Fly by Flying

The 27 years' growth of Greer College, thru genuine service, speaks for itself. From 1902, to the present tremendous plant including three modern buildings and three airports in the Chicago area. Real endorsement by satisfied students and graduates have made this possible. Aviation enthusiasts come to marvel at the tremendous outlay of motors, planes, instruments, wood and metal working equipment, welding and ignition shops. Many more have come to consult our Chief Aviation Engineer, C. L. Laird, regarding airplane design and construction.

Get My Free Book "Winning Your Wings"

Learn how my students prepare for amazing opportunities in this most fascinating and alluring profession—Aviation. Learn about my great shop and field training. Rates are reasonably low because of our large enrollment. Mail the coupon below for full details of my free employment offer and the many ways I help you to pilot's and mechanic's license.

Now All Can Learn to Fly
My shop training plan equips you for any branch of Aviation. Get the details today.

GREER COLLEGE
Dept. 314, 2024 S. Wabash Ave., CHICAGO, ILLINOIS

FREE Electrical Book

Erwin Greer, President, Dept. 314-E, 2024 So. Wabash Ave., Chicago, Illinois.

Send Free Book and details of Special offer, without obligation to me.

Name.....
Address.....
State..... Age.....

FREE Auto Book

Erwin Greer, President, Dept. 314-A, 2024 So. Wabash Ave., Chicago, Illinois.

Send Free Book and details of Special offer, without obligation to me.

Name.....
Address.....
State..... Age.....

FREE Aviation Book

Erwin Greer, President, Dept. 314, 2024 So. Wabash Ave., Chicago, Illinois.

Send Free Book and details of Special offer, without obligation to me.

Name.....
Address.....
State..... Age.....

Send for this Gripping Secret Service BOOK

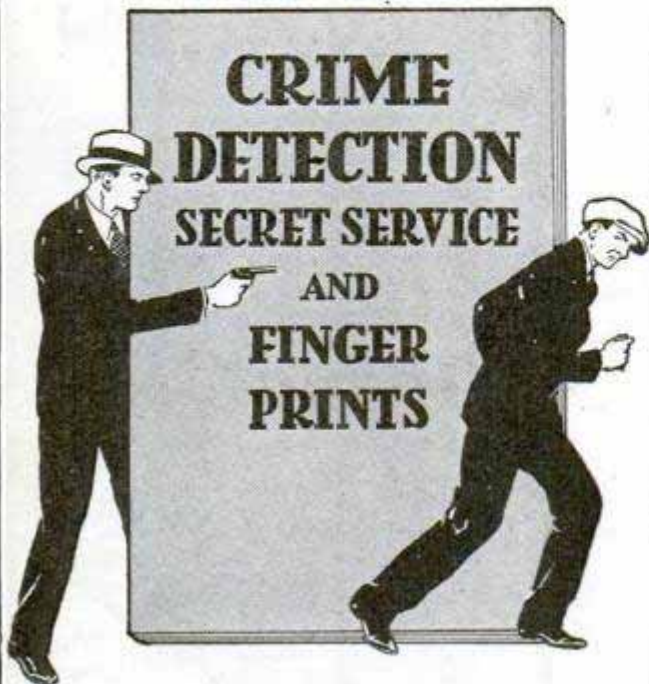

30 Days FREE Reading No Money Down

Here is one of the greatest books that has ever been written on Crime Detection, Secret Service and Finger Print Identification Work. Written by a well-known authority. Scores of gripping mystery cases. Actual crime cases — not fiction. You follow the operator straight through as he unravels some of the most baffling crime cases that have ever confronted officials. Nothing like it ever before.

Send for this unusual book TODAY. All you have to do now is merely mail the coupon below. Send no money. The book comes to you postpaid — for 30 Days Free Reading. Then, if you decide to keep it, you send me only \$1.00. If not—return it. That's all. You are not obligated to buy anything. Fill in, mail coupon now—before present limited supply is exhausted.

T. G. COOKE, Book Dept. 13-54
1920 Sunnyside Ave. Chicago, Illinois

T. G. COOKE, Book Dept. 13-54
1920 Sunnyside Ave., Chicago, Ill.

Send me at once—for 30 days free reading—with no obligation to buy, your "Crime Detection—Secret Service—Finger Print" Book. If after the free reading period I desire to keep the book I am to send you \$1.00. Otherwise I have the liberty to return it with no further obligation.

Name _____
Address _____ Age _____
City _____ State _____

Electrical Engineering

Training for men of ambition and limited time. Concise, comprehensive course in Theoretical and Practical Electrical Engineering including the closely related subjects of Mathematics and Mechanical Drawing. Students construct motors, install wiring,

test electrical machinery. Course designed to be completed in one college year by eliminating non-essentials. **THIRTY-SEVEN YEARS'** successful experience assures you maximum training in minimum time.



Send for free catalog

Bliss Electrical School

134 TAKOMA AVE., WASHINGTON, D. C.

New Way to Improve YOUR ENGLISH



A command of effective English gives you added advantages and better opportunities. Poor English handicaps you more than you now realize. You can improve your English through Sherwin Cody's 100% self-correcting invention. If you are ever embarrassed by mistakes in grammar, spelling, punctuation, or pronunciation, this new free book "How You Can Master Good English—in Fifteen Minutes a Day" will prove a revelation to you. Send for it now. It is free. Address **SHERWIN CODY SCHOOL OF ENGLISH** 54 Searle Building Rochester, N. Y.

LAW HIGH-GRADE INSTRUCTION BY CORRESPONDENCE

College, Post Grad. and Bar Ex. Rev. Courses. Law has attracted more keen, brainy men than any other calling. Send today for catalog. Low cost, easy terms. Standard texts. Degrees. **Chicago School of Law** Dept. 801, Reaper Block CHICAGO, ILL.



Minstrels

Unique First Parts for complete show with special songs and choruses. Make-up. Catalog Free.

T. S. Denison & Co., 623 S. Wabash, Dept. 19 Chicago



Wrestling Book FREE



Learn wrestling at home from former world's champions Farmer Burns and Frank Gotch. Free book tells how. Secret holds, blocks, tricks revealed. Be strong, healthy. Handle big men easily. Write for free book. State age. **Farmer Burns School, 3374 Railway Bldg., Omaha, Neb.**

The Marshall Flying School Offers Complete Training at Sensible Prices



Here, at the original "College of the Air" you receive the complete, thorough training that assures skill in the air. Every instructor is chosen for his proficiency in his particular line and every student, upon graduation, is fully equipped to take his place in aviation. And our prices are cut to fit the purse of all. Fill in the coupon and let us send details and prices of all courses. You will be amazed to see how quickly and economically you can become an expert pilot.

MARSHALL FLYING SCHOOL

190 English Street Marshall, Mo.

Please send without obligation your new descriptive booklet "Win Your Wings."

Name _____
Address _____
City and State _____

You Can Be Raised to the Heights of Glorious Manhood—



LIONEL STRONGFORT

Dr. Sargent, of Harvard University, U. S. A., declared Lionel Strongfort to be unquestionably the finest specimen of physical development he had ever seen.

Send For My FREE BOOK

Send for your copy of my extraordinary book and you will learn facts that will astonish you and help you out of your sorry plight. The experience and research of a lifetime are contained in this wonderfully instructive book, "Life's Energy Through Strongfortism". Just check the subjects on the consultation coupon on which you want special confidential information and send to me. Send for my FREE book right now—TODAY.

STRONGFORT INSTITUTE

LIONEL STRONGFORT, DIRECTOR.

Physical and Health Specialist for over 27 years.

Dept. 42, NEWARK, NEW JERSEY, U. S. A.

IF you want to succeed in life—if you want to get recognition in business, in industry, in sports, in social life—you must have health and energy. You won't get anywhere without it. Thousands fail miserably because of physical weakness and mental cowardice. If you would win life's prizes, brace up. **BE A MAN!**

Build up your body—if you are weakened from excesses, neglect, stimulants or disease. Get rid of annoying ailments that disgust everybody with you—Catarrh, Constipation, Chronic Colds, Indigestion, Rheumatism, Rupture, Weak Heart, Bad Blood, Nervousness, Timidity, Sleeplessness, etc., etc.

Do You Want These Things?

Restful, peaceful sleep; eagerness for work; sustaining energy throughout the day; better earning power, desire for pleasure and athletics; a springy step; bright eyes; a hearty hand clasp; a more cheerful outlook on life; optimism; hopefulness; happiness?

These come with health—all of them, just as sure as sunrise. If you have a healthy body—full powered, muscular, energetic, manly—you will make good—in your work, in business, in society and in athletics. You will be happy. You will attain complete success.

Don't Be Discouraged

You need not be discouraged and down with the blues because of your weakened physical condition, your ailments, your lack of manliness. **STRONGFORTISM** put thousands on their feet after they had been dragged down so deep they thought they could never be real men again. It gave them stamina, pep, vigor, energy, ambition. It built them up inch by inch—internally and externally—by my original methods until they became outstanding men, full of snap and "go" and steam. And tens of thousands of letters in my office tell of their restoration to health, the rejuvenation of their whole muscular system, the awakening of their mentality and the joy and happiness and success that came through all these.

STRONGFORTISM Will Make a He-Man of You

Don't stand by and see your body tottering and growing weaker and flabbier day by day, unfitting you for every physical function, making a sorry spectacle of you in everything you undertake. Don't do it—if you want to be a man—a real he-man—a man who will be noticed in a crowd by both men and women. Don't be a weakling when you can be a healthy, powerful, muscular fellow with a grip like iron, a chest that denotes strength, and a face that pictures buoyant health and happiness.

Send this Coupon

Free Confidential Consultation

Mr. Lionel Strongfort, Strongfort Institute, Dept. 42, Newark, N. J.—Please send me absolutely free my copy of your book, "LIFE'S ENERGY THROUGH STRONGFORTISM." I have marked (x) before the subjects in which I am most interested.

- | | | |
|-------------|-----------------|----------------------|
| .. Catarrh | .. Constipation | .. Lung Troubles |
| .. Colds | .. Rheumatism | .. Round Shoulders |
| .. Asthma | .. Nervousness | .. Stomach Disorders |
| .. Headache | .. Overweight | .. Increased Height |
| .. Rupture | .. Weak Back | .. Muscular |
| .. Thinness | .. Weak Eyes | .. Development |
| .. Pimples | .. Short Breath | .. Great Strength |
| .. Insomnia | .. Weak Heart | |

Other Ailments.....

Name.....

Age..... Occupation.....

Street.....

City..... State.....

Open this **FREE BOOK** and you open the door to **SUCCESS** IN **RADIO**

YOU, too, can be trained for a big-time radio job... Clip this coupon now and send for this **FREE BOOK**... Read it page by page... see for yourself why thousands of fellows just like you are now making from \$50 to \$100 a week... why many others earn as high as \$10,000 to \$15,000 a year and even more. This free book gives you 40 fascinating pages of pictures and text, all about RCA Institutes, the only school that is endorsed by the Radio Corporation of America... The school that actually sends you radio instruction direct from RCA... the very source of radio achievement!



EASY TO LEARN RADIO AT HOME IN YOUR SPARE TIME

Let the RCA Institutes Home Laboratory Training Course give you the real inside facts of radio... quickly and easily. Use your spare time to train for success with the remarkable outlay of screen-grid apparatus given to every student of this course. You learn how to solve every radio problem such as installing, repairing and servicing fine sets. This is the training that will help you to make money in radio!

RCA GRADUATES IN BIG DEMAND

For more than 20 years, there has been a well-paid position in Radio waiting for practically every graduate of RCA Institutes. This is a record unequalled by any other school. Only the vast resources of RCA could give you this practical training...

SEND FOR THIS FREE RCA BOOK

"RADIO... THE FIELD OF UNLIMITED OPPORTUNITY"

Start today on the road to Success in Radio... Send for this **FREE BOOK**. Every page is packed with pictures and text telling you all you want to know about RCA Institutes, the oldest radio training organization in the world. Radio can easily be your road to success... That's why you should

Clip this Coupon NOW!

RCA INSTITUTES, Inc.

Formerly
Radio
Institute of
America

SPONSORED BY



RCA INSTITUTES, Inc.
Dept. PM-4, 76 Varick Street, New York.

Gentlemen: Please send me your **FREE** 40-page book which illustrates the brilliant opportunities in Radio and describes your laboratory-method of instruction at home!

Name.....

Address.....

Why Good Dancers Are Popular

Every one wants to dance with the person who knows the smart new steps!

Through my new method you can learn the latest, most popular steps in *one evening*—right in your own home, without music, partner, teacher. Simple as taking one step after another.

Thorough—takes you from the very beginning to this season's newest dances and all their variations.

Regular **Now Only \$1.98**
\$5.00 Course

5 Day Trial—Free Would cost you \$24.00 if taken at a Studio. Practice in your spare time—surprise your friends—with your new-found popularity.

400,000 have already become accomplished, versatile dancers this easy way. Your success is guaranteed! To prove it I will send you my dancing course without one penny in advance! Just send your name and address and when the package arrives give postman only \$1.98 plus delivery charges, and this famous course is yours. Try for 5 days—money back if not delighted! Don't delay—act now and be a good dancer soon.

ARTHUR MURRAY Studio 990, 7 East 43rd Street
NEW YORK, N. Y.



ACCOUNTING LESSON **FREE**

Don't wonder about
Accounting Courses

Find out about this
one by trying it free

Send for our 84-page book
"How to Learn Accounting"
and the first lesson free of charge.

INTERNATIONAL ACCOUNTANTS SOCIETY, INC.

A Division of the
ALEXANDER HAMILTON INSTITUTE

Dept. 125, 3411 So. Michigan Ave., Chicago

Learn Advertising at HOME

Send your name and address for free booklet giving interesting information and vital facts about Advertising. Find out how we prepare you at home, in your spare time, for the opportunities open in this fascinating business. Practical work. No text books. Old established school. Successful graduates everywhere. Just the plan you have always wanted. Write today. No obligation.

PAGE-DAVIS SCHOOL OF ADVERTISING
Dept. 1354 3601 Michigan Ave. Chicago, U. S. A.

"The TRUTH about VOICE"

SENT FREE No Obligation to Buy

If you act quick!—we will send you postpaid—for 30 days free reading—new Voice Book disclosing startling FACTS that may save hundreds of dollars to every man or woman seeking a strong, rich voice for either singing or speaking. 30 days free reading—then send \$1. Otherwise, return it.

Prof. E. Feuchtinger, 1810 Wilson Ave., Suite 29,
Dept. 13-54 Chicago, Ill.



BE AN OIL EXPERT!

Trained geologists, drillers, refiners, salesmen are at a premium! New, easy, practical way to learn at home in spare time!

Write Today! **FREE Book!**
PETROLEUM ENGINEERING UNIVERSITY, Dept. 224, FORT WAYNE, IND.

SHORTHAND IN 30 DAYS

Boyd, the wonderful easy system. 150 words a minute guaranteed. Send today for Catalog and sample lesson.

CHICAGO HOME STUDY SCHOOLS
801 Reaper Block Chicago, Ill.

PAINT SHOW CARDS

and SIGNS. LEARN AT HOME IN SPARE TIME. WE TEACH YOU QUICKLY—FASCINATING WORK. \$75 WEEKLY. SEND 5c IN STAMPS FOR CIRCULAR.
Universal School of Lettering NEW HAVEN, CONN.



FREE!

If You Copy This sketch



If you are ambitious—want to earn big money as a draftsman—copy this sketch and mail to me. If I think you show talent I will send you, direct from my drafting room, a handsome Airplane blue print in three views with all main parts named and explained. Also FREE my two books, "My Pay Raising Plan," and "Successful Draftsmanship." Learn about this fascinating profession and my working method by which I train you right in your own home. Clip the coupon and learn what I can do for you.

These

Money Making Tools

AVIATION

Drafting and Designing **COURSE** Included—No Extra Charge!

To meet the demand for designers, I have prepared a complete course on aeroplane drafting which I will include free of any extra charge.



Sent to You At Once With My Training

—No Extra Charge!

Draftsmen Needed In:

Auto Work
The automobile industry is one of the greatest in America. Thousands of draftsmen needed. I'll train you for the work.

Electricity
Electricity is the coming motive force of the world. Draftsmen are needed in every department of this fascinating work. I'll train you at home. Get a job here.

Aviation
Aviation is just in its infancy. It is bound to expand to enormous proportions. Draftsmen are essential to it. I'll train you quick at home for drafting position.

Motor Bus Work
Motor bus building and motor bus transportation have become leading world industries. Hundreds of draftsmen engaged in this work. I'll show you the way.

Building Work
There will always be building. No structure can be erected without plans drawn by draftsmen. I'll make you an architectural draftsman.



I train you at home. Engineer Dobe

If You Earn Less than \$70 a Week — Write Me!

Mail coupon with copy of Airplane sketch. Get "My Pay-Raising Plan" and "Successful Draftsmanship". Both of them sent Free. You owe it to yourself to find out what big opportunities there are in practically all industries, for Draftsmen. They come to you postpaid. Mail Coupon TODAY!

My "Pay-Raising Plan" Sent Free

Write today for this book which has started hundreds of men—many with but little education and no experience. Learn about the other features of my training. Write today.

I Train You At Home for a Big-Pay Drafting Job!

No need to leave home or quit your job. Not only do I give you complete practical drafting room training at home—but I show you how to earn while you are learning—in a few short weeks after you start. I have trained men who are making \$3,500 to \$9,000 a year. Get started today. Copy sketch and mail with coupon.

Employment Service

After training you I help you to get a job without charging you a cent for this service. Employers know that Dobe Trained Men make good. They know they are not taking chances with men trained by me.

Age or Lack of Education No Drawback

Previous experience is not necessary for success. You do not need to be a college man or even high school graduate. If you have gone to grade school and can read and understand plain, every day English—that's all you need.

Mail Coupon for Free Blue Print Now!

ENGINEER DOBE, 1951 Lawrence Ave. Div. 13-54 Chicago

FREE Blue Print Coupon

Engineer Dobe, Div. 13-54 1951 Lawrence Avenue, Chicago

I am attaching sketch of Airplane and am interested in getting a Big-Pay Draftsman's job. Send me the three-view blue print, as offered. Also your two books—all free to me.

Name _____ Age _____

Address _____

Town _____ State _____

Learn Electricity IN LOS ANGELES

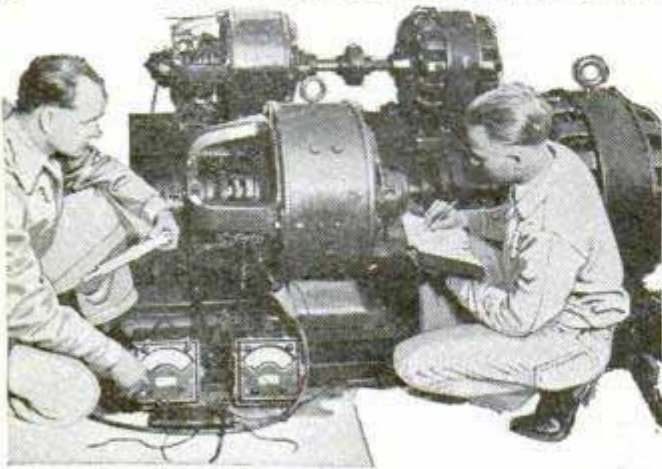

and LEARN IT RIGHT!

1. What Kind of a School Is NATIONAL?

NATIONAL is a Million Dollar institution—established in 1905—recognized throughout the electrical industry as one of America's foremost trade schools. NATIONAL offers practical, intensive training in all electrical branches. All technical essentials included. No age limit. No previous experience necessary. Life Scholarship privileges. Start any time of the year.

2. How Long to Learn Electricity?

NATIONAL properly trains you in the short time of 6 to 9 months. Upon completing this Condensed Course you are fully qualified as a Practical, Competent Electrician, and you have not risked your chances of employment because of inferior, incomplete instruction.

3. What Employment Service Does NATIONAL Guarantee?

NATIONAL GUARANTEES to give unlimited and efficient Employment Service to students wishing to earn living expenses while learning; and to graduates getting started in the electrical field. This is the most any reputable school can be expected to do.

4. What Inducements Does NATIONAL Offer?

NATIONAL offers YOU the very best technical-practical training that money can buy at a cost within every man's reach. It does not offer to pay your railroad fare, room and board or other personal expenses, preferring to limit its activities to the PROPER TRAINING OF MEN FOR SUCCESS.

5. Why You Should Come to LOS ANGELES!

LOS ANGELES is the heart of the country's most rapid electrical development—as well as the world's most ideal city in which to live and prepare for success in electricity.

WRITE for FREE BOOK NOW!

NATIONAL Electrical School

Dept. 542, 4006 Figueroa St., Los Angeles, California.

Send me your big free illustrated catalog of Electrical Opportunities showing how I can learn quickly and get a Big-Pay Electrical Job.

Name.....

Address.....

Age..... City..... State.....

Electricity
YOUR LIFE
MELTTON
NATIONAL
ELECTRICAL
SCHOOL

LEARN the BANJO at Home under HARRY RESER the World's Greatest Banjoist



The Famous Leader of the Widely Broadcasted **CLICQUOT CLUB ESKIMOS**

offers an amazingly simple Banjo Course by mail which anyone, even without musical talent, can master at home in a few spare hours. Positions, fingering and chords thoroughly illustrated and explained. Students and Professionals heartily endorse this Simplified Home Method. Costs only few cents a day. Special Banjos for Students.

BE POPULAR—MAKE MONEY

At home, parties, or week-end gatherings, the banjo player has many friends. Also, the banjo is vitally essential in the dance orchestra of today. Banjoists make big money. Learn more about this inexpensive course.

Send for my FREE ILLUSTRATED BOOKLET

HARRY RESER, Banjo Studio No. 23
148 West 46th Street, New York, N. Y.

Harry Reser famous radio entertainer, phonograph recording artist, teacher of Tenor Banjo, orchestra leader and composer of banjo music, guarantees your success or money back.

A GENUINE 240 POWER MICROSCOPE! Sent for Only \$100 DOWN



An educational and entertaining instrument that enables all to see and know life invisible to the naked eye. Thrills and fun galore! See tiny bugs grow to proportions of great elephants. See plant and mineral life reveal amazing wonders in form and color. Made just like microscopes used by physicians, scientists etc. Now only \$3.98. Could easily sell for \$10 and \$20 more. Adjustable lens of 240 power! Pay balance (\$2.98 plus postage) when postman delivers. If not satisfied, return in 5 days, and money will be refunded.

IDEAL FOR STUDENTS!

A wonderful help in studying science, botany, etc. Never before has such a wonderful instrument been offered at such an amazingly low price of \$3.98.

DEALERS AND TEACHERS WRITE FOR OUR PROPOSITION!

R. B. SPECIALTY COMPANY
Dept. D-336, 220 E. 3rd St., Cincinnati, Ohio

SELF CONFIDENCE DEVELOPED!

Self-Consciousness in the presence of others easily overcome. Social Poise and Confident Personality developed. Charm, ease, commanding manner can be yours. Authoritative training by mail. Send 25 CENTS for my book.

MR. RICHARD BLACKSTONE

BA-474 Flatiron Bldg. New York City

10c NEW SCIENTIFIC WONDER



SILVER ONLY

BOYS You apparently see thru Clothes, Wood, Stone, any object. See Bones in Flesh. FREE—PKG. RADIO PICTURE FILMS. Takes pictures without camera. "You'll like 'em." 1 pkg. with each 25c order.

MARVEL MFG. CO. Dept. 31 NEW HAVEN, CONN.

ALWAYS Ask for DENISON'S—54 Years of Hits

Comedy - Dramas, Farces, Musical Comedies, Revues, Musical Readings, Street, Blackface Skits, Make-up Goods. Catalog FREE. T. S. DENISON & CO. 623 S. Wabash, Dept. 9 CHICAGO

Save Your Feet

When all else fails end your suffering with the flexible "no metal"

Heefner ARCH SUPPORT

WRITE FOR FREE BOOKLET



HEEFNER ARCH SUPPORT CO. 674 M. E. TAYLOR BUILDING LOUISVILLE KY.

R. T. I. R. T. I. QUALIFIES YOU TO MAKE MONEY AND ITS SERVICE KEEPS YOU UP-TO-THE-MINUTE ON THE NEWEST DEVELOPMENTS IN RADIO TELEVISION AND TALKING PICTURES **R. T. I.**

RADIO TELEVISION TALKING PICTURES CALLS FOR MORE TRAINED MEN

Big Money quick—the chance to more than double your salary—is offered to you now. RADIO has leaped from the experimental stage to a gigantic industry, employing many, many thousands and loudly calling for MORE TRAINED MEN to fill the Big-Pay jobs. TALKING PICTURES have taken the larger cities by storm and will sweep the entire country, opening up many new good jobs everywhere. TELEVISION now comes with even greater promise of a large number of good paying jobs and big profits for those who are prepared.

BIG MONEY NOW! MORE TO COME

Here is an entirely new field of profitable employment—Big-Money Jobs—\$2500—\$3500—\$5000 and up, right now—lots of money easily made in spare time—increasing pay for you and more and more money as this new industry grows bigger and bigger.

ANSWER THE CALL—GET INTO THIS MONEY-MAKING INDUSTRY NOW!

The "R.T.I." famous "3 in 1" Home Training in Radio, Television and Talking Pictures makes it easy for men, young men and boys to get into this new field quickly. R. T. I. home training is practical and easy to understand. It trains your head and hands at the same time. Your opportunities for money-making are unlimited. Your age, amount of education, or experience make no difference. If you are interested and ambitious you can succeed. Are you willing to use a little spare time at home? That is all you need to quickly start making money with R.T.I. material and home training. You will be ready for a good job or profitable business of your own, even before you finish the training. Remember—you learn at home in your spare time on actual equipment included in fine, big outfits sent you. R.T.I. with all its connections in the industry, keeps you up-to-date and pushing forward all the time.

R. T. I. Wonderful Free Book Nothing Like It Ever Published

No one can fully realize the amazing size and future growth of the Radio, Television, and the Talking Picture industries unless they know all the facts revealed in this R.T.I. book. It will open your eyes to the vast number of new money-making jobs—enormous spare-time profits—all within easy reach of ambitious men.

Big R.T.I. Book Free—While They Last

LET F. H. SCHNELL AND THE R. T. I. ADVISORY BOARD HELP YOU.

20 years' Radio Experience. First to establish 2-way amateur communication with Europe. Former traffic Mgr. of Am. Radio Relay League. Lieut. Com. U. S. N. R. Inventor and Designer. Cons. Radio Engineer.

Assisting him is the R. T. I. Advisory Board, composed of men prominent in the Radio Industry—manufacturing, broadcasting, engineering and servicing. All these men know Radio and will help you succeed in their field.

RADIO & TELEVISION INSTITUTE
Dept. 14, 4806 St. Anthony Ct., Chicago

RADIO & TELEVISION INSTITUTE
Dept. 14, 4806 St. Anthony Court, Chicago

Send me Free and prepaid your BIG BOOK "Tune In On Big Pay" and full details of your three-in-one Home Training (without obligating me in any way.)

Name

Address

City State

Hasn't Finished the Course \$500 in 2 Months
Your radio course enabled me to earn over \$500 in two months' spare time work.—J. Noffsinger, R. I. Box 37, Greenville, Ky.

I am earning \$80 a Week—Through R. T. I. Training spare time Radio Work. Your Course was the best investment I ever made.—W. W. Mead, 915 W. 25th St., Indianapolis, Ind.

STEP UP QUICK TO A BIG-MONEY JOB THROUGH R.T.I. training in Broadcasting, Sales, Service, Manufacturing, Repairing, Ship and Station Operating, Installing, and business for yourself.

R. T. I. R. T. I. TRAINS YOU AT HOME FOR A GOOD JOB OR A PROFITABLE PART TIME OR FULL TIME BUSINESS OF YOUR OWN

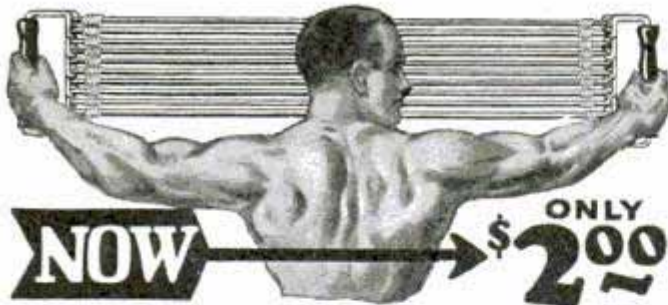

NOW → **ONLY \$2.00**

Giant Chest Expander

and Progressive Exerciser

Be a muscular marvel. Have the muscles of a superman. Become strong for your health's sake or to astound your friends with extraordinary feats which only men of giant strength can do. In a few short weeks you will easily do stunts which now seem difficult—then real muscles and strength will be yours—and yours to keep. If you want exercise to just keep in good shape you can reduce the strength of the Progressive Exerciser by eliminating as many cables as you wish. If you want great resistance so as to build up big solid muscles then use the full strength.

Send No Money Use This Money Saving Coupon

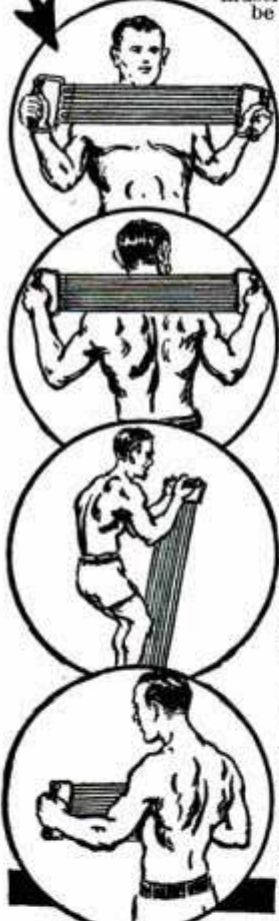

How the Giant Chest Expander and Progressive Exerciser is Made

The Giant Chest Expander and Progressive Exerciser is made with new live, springy rubber so as to give it long wearing and great resisting qualities. Do not pay more for an exerciser that has forty or less rubber strands to each cable. Get the best and most durable. The Giant Progressive Exerciser has **50 strands** of the finest rubber procurable to each cable.

Free Instructions

We do not think it enough to send you an exerciser worth double what we ask, so for a limited time, we will also include instructions absolutely free. These instructions are interesting and simple to follow—they show you the short cut to health and strength. Order today before this wonderful offer is withdrawn.

Your Guarantee

The Giant Chest Expander is sold with a guarantee that you will say it is the finest you ever saw or your money back.

5 Cables or double 10 Cables for strength for \$2 The double strength exerciser has resistance of over 200 lbs. **\$4**

How to Order—Send No Money

Sign your name and address to coupon below and get your Giant Exerciser at the present low introductory price by return mail. The price is made low because we want everyone to enjoy muscles and strength at the lowest possible cost. Don't pay more—order from us—get the most for your money. Use coupon now.

PROGRESSIVE EXERCISER CO.,
4004 Langdon Bldg.,
Broadway and Duane Street, New York

Please send Your 10 cable Progressive.
 Your 5 cable Exerciser.

Check the Exerciser you want, and it will be sent you by return mail. Pay postman introductory price, plus few cents postage on arrival. It is understood that if you are not entirely satisfied with your exerciser you may return it within 5 days and get your money back.

Name.....

Street.....

City..... State.....

If you live outside the United States, send cash with order.

Learn AVIATION

WHERE LINDBERGH STARTED!

GET TRAINING THAT ASSURES SUCCESS!

Learn where "Lindy" learned—at Lincoln! Get **complete, thorough** Aviation training. Attend the Lincoln Airplane and Flying School. One of the largest, finest equipped civilian aviation schools in U. S. Complete courses in flying, airplane building and mechanics. Planes and pilot instructors carry the Dept. of Commerce license. Write for **FREE** Literature, stating age!

Lincoln Airplane & Flying School
209 Aircraft Bldg. LINCOLN, NEBR.

BOYS—A Pistol Sling Shot!

NOTHING LIKE IT BEFORE!
Cocks and shoots like a real pistol. Special aiming sights and extra heavy pure gum rubbers enable you to shoot with power and accuracy of the best air guns. Ideal for indoor and outdoor target practice. Shoots stones, marbles, lead balls, etc. Sample shot **FREE**. Scientifically and practically made to last a life time. Pin a dollar bill or money order to this advertisement and mail today. If not satisfied, return within five days and your money will be promptly refunded.

Pat. Pend.
Only \$1.00

R. B. SPECIALTY CO.
Dept. D-345, 220 E. 3rd Street, CINCINNATI, OHIO

NERVES?

Are You Always Excited? Fatigued? Worried? Gloomy? Pessimistic? Constipation, indigestion, cold sweats, dizzy spells and bashfulness are caused by **NERVE EXHAUSTION**. Drugs, tonics and medicines cannot help weak, sick nerves! Learn how to regain Vigor, Calmness and Self Confidence. Send 25c for this amazing book, **RICHARD BLACKSTONE, N-474** FLATIRON BUILDING, N. Y.

RAILWAY MAIL CLERK, GOVERNMENT CLERK, MAIL CARRIER, POSTOFFICE CLERK

WANT A STEADY GOVERNMENT JOB?

\$1260 to \$3400 YEAR
Men—Boys—18 Up
STEADY WORK

Paid Vacations
Common education usually sufficient
Mail coupon today—**SURE**

FRANKLIN INSTITUTE,
Dept. H180, Rochester, N.Y.

Gentlemen: Rush to me, **FREE** of charge, list of U. S. Government big pay positions now obtainable. Send me **FREE** 32-page book describing salaries, hours, work, vacation and giving full particulars on how to get a position.

Name.....

Address.....



Actual size of Magic Dot. The new system weighs only 4 ounces, yet holds rupture more securely than pounds of steel springs, and hard, gouging cushions.

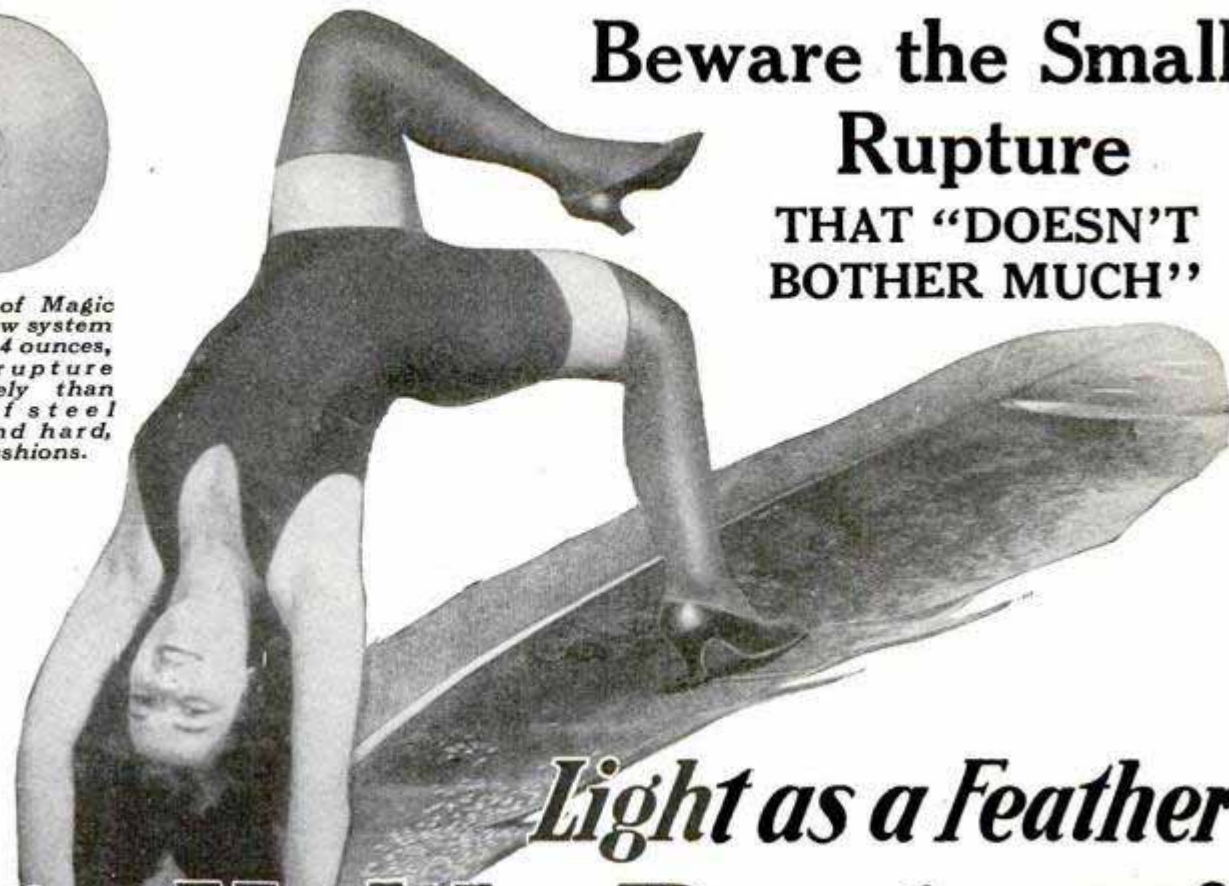

Beware the Small Rupture

THAT "DOESN'T BOTHER MUCH"

Light as a Feather
Yet... Holds Rupture!

Now—An Ohio Scientist Is Helping Nature Rescue Thousands Of Rupture Victims From The Eternal Horror Of Many Dangerous Cumbersome Trusses And Other Torturous, Harness-Like Contraptions. He Has Perfected A Tiny, Feather-Weight Magic Dot That Frequently Brings About Joyous Relief And New Comfort From The First Day. Countless Former Victims Everlastingly Thank This Interesting Discovery For Their New Happiness. Just Mail The Coupon For Free Material Sample If You, Too, Want New Freedom.



SCIENCE has at last developed a tiny, interesting device weighing less than 1/25 of an ounce, which has helped to free and amazed thousands of rupture sufferers and won the admiration of many doctors and scientists.

The New Science System makes utterly obsolete all painful trusses, gouging knobs, steel springs and unsanitary, cumbersome leg straps.

It "Breathes" Air

Magic Dot anchors a flesh-soft padlet composed of a newly perfected substance named Airtex. This is honey-combed with microscopic air cells that tend to "breathe" air with each movement of your body. It expands and contracts as easily as your own flesh. When you walk, run, bend or exercise it tends to squeeze itself—not the part of the body it rests against.

The appliance is so light—so comfortable—the wearer as a rule hardly knows he has it on. It does not produce that "hot spot" feeling. Sanitation is now more sure—because the padlet can be washed clean and sweet in a jiffy.

Immediate relief and new comfort are not the only things the New Science System should accomplish. Of far greater importance is the comfort you have dreamed of—the possibility of ultimate FREEDOM! This should be possible because this amazing new method gives nature a chance to heal the rupture automatically. This is not possible with gouging trusses that prevent free circulation.

Test Sample Free

Send no money. Just mail the coupon for Free Sample of remarkable Airtex. With it we send, without charge, latest copy of a very new and informative book on Rupture and Hernia that should open your eyes.

NEW SCIENCE INSTITUTE

2171 Clay Street

Steubenville, Ohio

New Science Institute,
2171 Clay St., Steubenville, Ohio.

Without obligation send me a no-cost Airtex sample with new book about rupture and hernia relief.

Name.....

Address.....

City..... State.....

Print address and be sure of reply.

"SURE! I get \$100 a week in ELECTRICITY-



and I Learned At Home - the L.L. Cooke Way"

WOULDN'T you like to be able to say truthfully what Ralph Crousore of Greencastle, Indiana, says? "Sure, I get \$100 a week in Electricity!" Wouldn't you like to be sitting on top of the world with a fine Big Money Job, a brilliant future, and all the good things of life within your grasp? Of course you would! Well, then, why don't you do like Crousore and thousands of other fellows no smarter than you have done -

Previous experience or higher education not needed to learn Electricity the L. L. COOKE Way. You can read, you can write - that's enough. This great Training is simple, clear and easily mastered. It trains you roughly to go into this great field and do the things for which the Big Money is paid.

Why Don't You, Too, Get Into Electricity?



\$75 A Week
 "Was working for \$18 a week when I enrolled with you. Now I average \$75 a week."
 J. Wollaston, 104 Robin St., Dunkirk, N. Y.

Learn at home in your spare time with the famous L. L. COOKE "Work Sheet and Job Ticket" Method - the old-established but up-to-the-minute Electrical Training that has placed hundreds of men on Easy Street for life. There's nothing like it anywhere.

Hundreds of "Cooke Trained Men" earn \$60 to \$100 a week - some even more. Get started toward a job like one of these. Act today to increase your pay.

GET STARTED - MAIL COUPON
 Get Big FREE Book that tells you how to start and shows how easy it is to get into this Big Pay field the L. L. COOKE Way. See the Big Outfit that's furnished, and read the famous Money Back Agreement. Get this great Pay-Raising Book. Mail coupon today sure!



\$30 A Day
 "Your Training has increased my earnings from \$25 a week to over \$30 a day."
 G. W. Schnupp, 315 E. New, Lancaster, Pa.

LIKE REAL SHOP TRAINING
 It's simple, it's thorough, it's practical. Just like actual shop training. But it's all done in spare time in your own home with the Big Complete Outfit of Tools and Apparatus given to you without extra charge.

L.L. COOKE SCHOOL OF ELECTRICITY
 CHICAGO, ILLINOIS

DEPT. 14
 2150 LAWRENCE AVENUE
MAIL COUPON FOR FREE BOOK

L. L. COOKE
SCHOOL OF ELECTRICITY

Dept. 14, 2150 Lawrence Ave., Chicago

You may send me, entirely Free and fully prepaid, your book, "Secrets of Success in Electricity," together with facts about your Home Study Course in Electricity.

Name _____
 Address _____
 City _____ State _____ Age _____

Classified Advertisements

WORLD'S BEST WANT AD MEDIUM

Advertisements in this section, 35 cents per word, each insertion, minimum 10 words, payable in advance. To be printed under proper classification in May issue, copy should be in our office March 18th.

ADVERTISING AGENCIES

THE Big Idea. What may be an idea now may be the germ of a nation-wide business later. Get our views and suggestions for developing your business. In our 45 years in advertising, we have helped to build numerous small advertisers into widely known success. Guenther-Bradford & Co., Newspaper-Magazine Advertising, 15 E. Huron St., Chicago, Ill. Our Advertisers' Pocket Guide sent on request.

GET Into advertising. Learn quickly at home. Experience unnecessary. New easy plan. No text books used. Practical work. Old established school. Send name and address for interesting free booklet. Page-Davis School of Advertising, Dept. 3434, 3601 Michigan, Chicago.

ADVERTISE—24 Leading Sunday newspapers, 24 words \$15.00. Excellent for obtaining help, salesmen, or business opportunities. Information 1,000 best paying dailies, mail-order weeklies, monthlies, mailing lists, everything. Free. Wade Agency, Great Northern Bldg., Chicago.

ADVERTISING: 24 Words 20 newspapers \$9; free list; magazines, farm. LeGrand Agency, 34 West 33rd St., New York.

BEFORE Advertising get our catalog. No charge. 25 years in business. The largest classified agency in the world. Ankrum Advertising Agency, 100 No. LaSalle St., Chicago, Ill.

IF Advertising, or about to advertise, write Doughty Advg. Agency, Counsellors for Advertisers for over 40 years. Costs nothing. Will save you time, money, grief. 31 Pickering Bldg., Cincinnati, Ohio.

FREE—New 1930 Advertisers Rate Guide, 44 pages. Includes everything. Lowest rates. E. H. Brown Advertising Agency, 140 S. Dearborn, Chicago.

OBTAIN Canvassers, distributors through publication advertising. Martin, 276B West 42d, New York.

ADVERTISE In rural weeklies. Lists free. Meyer Agency, 4112 Hartford, St. Louis, Mo.

INCH Display advertisement 50 magazines year \$24. Wood's Popular Services, Atlantic City, N. J.

TIME Counts in applying for patents. See pages 138 and 139. Clarence A. O'Brien, Registered Patent Attorney, Washington, D. C.

FOR ADVERTISERS

24 WORDS—87 Southeast weeklies, \$3.72. S. Stout, Warm Springs, Ga.

ADVERTISE In country papers. Lists free. Low rates. Keator, Hartford Bldg., Chicago.

SALES PROMOTION

STOCK-SELLING Campaigns written for legitimate enterprises seeking capital. Twenty-five years experience. My new publication, "Ideas on Capital Raising," free if you submit full details regarding your plans. Ernest F. Gardner Service, 219-B Balcony Bldg., Kansas City, Mo.

MAILING LISTS

LATE Names, men and women from original orders. Printed on perforated gum paper, \$3.50 thousand. Chas. Blanford, Terre Haute, Ind.

50,000 NEW York business addresses, 1929, \$7.00; 2,000 chemical manufacturers address, 1929, \$6.00. E. Perry, Gig Harbor, Wash.

SEND \$1.00 For names of 1,000 rural buyers. Ill. Commercial Office, 5327 Cornell Ave., Box 301, Chicago, Ill.

AUTOMOBILES

TIME Counts in applying for patents. See pages 138 and 139. Clarence A. O'Brien, Registered Patent Attorney, Washington, D. C.

AUTOMOBILE SUPPLIES

AUTO Carburetor attachment greatly increasing power, speed, mileage. Chrysler car test over 38 miles per gallon. Mailed COD \$2. Give make, year. Whirlgas Co., 816 Ford Bldg., Detroit.

GENERATORS—Starters exchanged for all cars. Completely rebuilt and guaranteed same as new. Orders shipped same day we receive your old unit. Magneto repairing a specialty. Attractive dealers discount on bakelite, condensers, genuine tungsten points, etc. Complete stock. Rhoads Electric Co., 4142 Olive St., St. Louis, Mo.

AUTO Parts new and used. Lowest prices. Bankrupt supplies: motors, wheels, radiators, gears, generators, carburetors, brake lining 50%. Brightman, 2065 Main St., Hartford, Conn.

LIQUID Silver plating compound, replates auto headlights, trimmings, brass, copper, tableware, etc.; works like magic; send \$1.00 for bottle. Beck, 370 Riverside Drive, New York.

SET Eight spiral expansion reamers, \$12.45. Catalog. W. Barnitz, 203 Briggs, Harrisburg, Pa.

SPECIAL Automotive tools for mechanics and car owners. Representatives wanted. Greene, Dover, Mass.

SAVE Money on auto and truck repairs. Gears, axles, bearings, motor and transmission parts at 50 to 75% off factory list prices. Satisfactory parts guaranteed. Prompt service. Price lists free. Century Parts Co., 1712 Lafayette Ave., St. Louis, Mo.

YOU Can make \$300 to \$500 a week by securing our exclusive sales franchise in chosen territory. Motor Saver Corporation, 5095 Euclid Ave., Cleveland, Ohio.

LESS Than half price. Write for prices on parts needed to make your car run. Auto Wrecking Co., Ninth and Picher, Joplin, Mo.

USED Air compressors, automatic. Reconditioned, guaranteed like new. Shipped trial easy payments. Also used testers, car washers, chargers, sprayers. Write "Connor Supplies," Box M-402, Troy, Ohio.

SPECIAL Introductory offer on socket wrenches, also reduced prices on other time-saving tools. Wrench, Dept. M-4, 2640 Greenview, Chicago.

"SPRINGS of silence."—Universal anti-rattler. For the noisy 4 wheel brake rods all cars. Ask your dealer. Universal Spring Co., Grand Rapids, Mich.

SIMPLE Inexpensive method for removing carbon, \$1.00. Wm. Eckstein, 10101 Nelson, Cleveland, Ohio.

DYKE'S Famous Automobile Encyclopedia—Latest edition. Fully revised to cover all latest facts regarding newest developments in automobile field, including new Model A Ford. Information given on repairing and adjusting every part of all motor cars. How to find trouble and fix it. 1,250 pages. 4,200 illus. Price, cloth, \$6. Flexible Morocco \$7.50. Pay postman price and postage when he delivers book. Popular Mechanics Press, Room 801, 200 E. Ontario St., Chicago.

AUTO SERVIC EQUIPMENT

SAVE Money—Garage equipment reconditioned guaranteed like new. Bargains test stands, chargers, compressors, car washers. Shipped trial easy terms. Write "Byrum's Electric," Box M-403, Troy, Ohio.

PROFITS In 8-hour battery charging or 20 minute car washing. Install equipment practically no investment. Bargains in reconditioned buffers, grinders, compressors, sprays, are welders. Write Ken's Service, Box M-404, Troy, Ohio.

REAL Money maker. Special automotive starting motor and generator service tool. Four jobs pay for it. Ewing Mfg. Co., Middleport, Ohio.

SEND For "A Billion Ideas"—our latest catalog of books just issued. Thousands of good books listed on almost every subject. Free upon request. Popular Mechanics Press, 200 E. Ontario St., Chicago.

FOR FORD OWNERS

AURORA Underlung parts and 3.1 racing gears. Speedster bodies, headlights, hi compression head. See Sport Factories ad page 132.

MOTORCYCLES, BICYCLES AND SUPPLIES

HARLEY Davidson bargains at a tremendous sacrifice. All models and prices. Guaranteed. Send 4 cents in stamps for our catalog. "Money Saving Motorcycle Bargains." The Knuth Co., 2525 Fond du Lac Ave., Milwaukee, Wis.

MOTORCYCLE Bargains, lowest prices, bargain sheets for stamp, special aviators supplies, motorcycle accessories largest line in America, lowest prices. Largest motorcycle mail order house in the United States. Rochester Harley Davidson Corporation, 129 West Main St., Rochester, N. Y.

USED Motorcycles \$32.50 up. Largest stock used machines in middle west. Send 15c for latest catalog. Indian Motorcycle Sales, Kansas City, Mo.

USED Motorcycle parts half price or less. New parts, accessories, repairing. New and rebuilt Indians, Harleys, others. J. B. Dahl, 3661 Archer Ave., Chicago, Ill.

MOTORCYCLE Parts, new and used. Lists free. Tower Cycle Co., Pine Lawn, Mo.

HENDERSON, Excelsior, Indian, Harley used parts and engines cheap. Ballak & Co., 100 N. 12th, St. Louis, Mo.

AVIATION

CRAWFORD'S Powered gliders. Plans complete for home building, \$5.00. we sell parts and supplies America's first successful motorcycle motored gliders. America's first glider school of flying we soled our first ten students. First come in less than one hour average time, each so he could go two hundred feet high and do his figure eights. Last word and safest thing in aviation. Boys get your plans and get going for this summer. Crawford Motor and Airplane Mfr., Seal Beach, Calif.

IF You buy blueprints of a sport plane be sure you are buying prints of a plane that has been built and flown. Demand a photo. Heath planes have 23 years experience behind them. They have been thoroughly tried out by Heath engineers and pilots. Large detailed shop prints of the Heath Parasol represent 6 years refinement of this wonderful little sport plane at \$5.00 per set. 10c in stamps or coin for large illustrated booklet. Heath Aircraft Corporation, Chicago, Ill.

SUPERIOR Model airplane supplies and construction sets are the best obtainable. Catalog 32 pages 10c. construction sets Ford, Lockheed Vega, Lockheed low wing, supermarine and many others. 100 feet assorted sizes of Balsa wood \$1.00. Get our catalog at once. Fully complete construction set \$2.50. Lowest prices on market. Dealers wanted. Superior Model Aircraft Company, Largest Dealers in the Field, Box 15, Station Y, Brooklyn, N. Y.

THREE Solar Detroit model fliers club plans (Biplane, tractor, pusher) instructions, all material for making all three. Send money order (85c); no stamps. Collins Plow Co., Dept. 215, Quincy, Ill.

GLIDERS, Crawford powered gliders using motorcycle engine will carry 200 lb. pilot. Blue prints detailed \$5.00 complete set. Price list of parts, materials, etc., on request. Crawford Motor and Airplane, Seal Beach, Calif.

PROPELLERS, 4', \$6.00; 5', \$10.00; 6', \$14.00. For powered gliders, boats, sleds, road speedsters, hydroplanes and airplanes. Let our free engineering staff care for your particular air propulsion problem. Crawford Motor and Airplane, Seal Beach, Calif.

AIRPLANES, Monoplanes, biplanes; all types, lowest prices. Motors, 30 to 300 hp., new and used; at big discounts. Send for list. State your needs. Aviation Service, 925 Broadway, New York.

2c POSTAGE Stamp will bring you complete model airplane supplies price list. A. A. C. Model Aircrafters, 4719 Third Ave., New York.

GET Motors, and propellers that will make your plane perform. Henderson and Harley motors. Ten cents in stamps or dime brings you the catalog. Sensenich Bros., Littitz, Pa.

HEATH Henderson aircraft motors are designed to give hundreds of hours of flying with the least attention. Developed for America's oldest aeronautical engineers they consume 50% less fuel than any aircraft motor in this country. 10c in stamps or coin brings large illustrated booklet. Heath Aircraft Corporation, Chicago, Ill.

TURNBUCKLES 15c, 20c, 25c. Blueprints German glider \$3.00. Aeroplane hub complete fits auto engines \$1.00. Aeroplane seats \$1.00. 2 pair aviator's goggles \$1.00. Wheels \$3.50. All types sportplane motors. Fuselage with tail unit \$35.00. Booklet 5c. Hopkins Aeroplane Co., Box 124, Hopkins, Minn.

FOR Sale: Aeromarine Klemm 2-place sport (60 hours, engine 20 hours); Sikorsky Jenny like new, 2 hours; Completely overhauled OXN6, Millerized, new mags.; Eagle-rock fuselage, like new, newly covered (tail); D. K. Steele, 372 Walnut Ave., Roanoke, Va.

ORNAMENTAL Propellers about 24" long \$1.00. Karl Ort, York, Pa.

AVIATION Books—Complete 24-page illustrated catalog covering every phase of subject, sent free upon request. Popular Mechanics Press, 200 E. Ontario St., Chicago, Ill.

HEATH Propellers represent the last word in aerial propulsion. Made to measure by aeronautical engineers of long experience, you obtain performance that will surprise, 4c in stamps or coin brings large illustrated booklet. Heath Aircraft Corporation, Chicago, Ill.

BALSA Wood, 40c board foot. Model catalog, 5c. Marx Aircraft, 320 South Fourth East, Salt Lake, Utah.

CLERGET 130Hp., \$75; Gnome 50 or 100hp., \$98; Lawrence 28hp with propeller, \$98; Lehone, 80hp., \$80. Pennsylvania Aero Service, 155 1/2 Dennick, Youngstown, Ohio.

ENTER New era of model aircraft engineering. Send dime for catalog. Cleveland Models, 1866P West 57th St., Cleveland, Ohio.

SAILPLANES, Wonderful performance, \$425. Full scale plans \$2.50. Primary gliders; good trainers, \$225. Plans \$1. Literature 10c. Aeroglidlers, Rochester, Ind.

MODEL Airplane builders, 32 page catalog 5c. Many models, all supplies. National Model Aircraft & Supply Co., 29P North Ave., New Rochelle, N. Y.

INSTRUCTION Book, Five hundred aviation questions correctly answered, postpaid \$1.00. Agents wanted. George Tuck, 73 South Shirley Ave., Pontiac, Mich.

THE Age of the Air Is Here. For reliable information on both airplane building and flying we recommend "Aeroplane Construction and Operation," by Rathbun, a book used in government schools. All features of construction treated. Send no money. Pay postman \$2.50 and postage. Popular Mechanics Press, Room 801, 200 E. Ontario St., Chicago, Ill.

FINEST Propellers, 4", \$8.75; 5", \$13.25; 6", \$16.50; special Henderson propeller, \$15.00; "Aerodrive" sled or boat prints 50c each. Everything aeronautical. Ostergaard Aircraft, 4503 North Narragansett, Chicago.

\$175 WILL Build our beautiful steel fuselage one place monoplane. Plans \$1. Sail planes performance guaranteed \$350. Plans \$1. Literature 10c. Barney Snyder, Rochester, Ind.

TIME Counts in applying for patents. See pages 138 and 139. Clarence A. O'Brien, Registered Patent Attorney, Washington, D. C.

BOYS: Get a pursuit tractor kit complete 25c. No stamps. Send 5c for price list. W. & J. Aeroplane Shop, 200 Maple St., Wyandotte, Mich.

GET The latest sportplane constructor book. Full of blueprints, photographs, drawings, detail instructions, etc. Postpaid \$1.00. May save you hundreds. Circular free. Russell Aero, Box 455, Toledo, Ohio.

BOYS—Model airplanes supplies 2ft. Curtiss Hawk Flying Model Construction Set containing all necessary parts. \$2.50. Baby R. O. G. Kit, 50c. Send 5c for booklet. Hawthorne Model Aero Co., Hawthorne, N. J.

BIGGEST, Best catalog model airplanes; parts, supplies; 5c postpaid. Ideal Company, 19 West 18th St., New York.

AIR Navigation and meteorology—A practical book for every flyer. Capt. B. Duncan, the author, has presented the subject in a simple, non-technical way. 243 pages, illustrated. Delivered to your door C. O. D. Simply pay postman \$3 and postage. Popular Mechanics Press, Room 801, 200 E. Ontario St., Chicago.

BOOKS AND PERIODICALS

EVERYONE Needs aviation book. Before you fly, ride or learn, read "Flying Fish." Save time, money, perhaps your neck. Exposes tricks, false advertising, hooking suckers, dangers, bunk, dreams that can't come true. Truths you'll never learn elsewhere. By veteran war and civilian pilot, 2,500 hours. Excerpts by Lieut. Ben Ellison, world famous arctic flyer. Only 50c postpaid. Worth weight in gold. "Aeronautics," Waupun, Wis.

4TH EDITION, revised "Radio Theory and Operating," by Mary Texanna Loomis. The standard radio text and reference book of America. 992 pages, 800 illustrations, flexible binding. Price \$3.50 postage paid. For sale by hundreds of book dealers throughout America and many foreign countries. Or may be purchased direct from the publishers. Send check or money order to Loomis Publishing Company, Dept. 18, Washington, D. C.

INDUSTRIAL Alcohol. Complete directions for making. Fully illustrated, \$2.50. Spon & Chamberlain, 120 Liberty St., New York.

MASTER Books on secret service. Circular free. International Service, D100, Bandon, Ore.

HYPNOTISM Easily learned. Lessons guaranteed. Postpaid \$1.10. Smith Pub. Co., Dept. 3, Springfield, Mass.

KNOWLEDGE Is power; employ your spare time profitably; send for free catalog; lists instructions on radio, electricity, aviation, chemistry; manufacture of household, auto products. Get your copy today. Manhattan Co., 333 W. Manhattan Blvd., Toledo, Ohio.

YOUNG Idealists who still believe in democracy—25c gets four months' trial subscription to Democratic Youth, published at West Liberty, Ky., especially for you.

ARE You going to read Friscoe Pete. The story poem that can't be beat. Three dimes. Address Paul, 722 Mace, Greensburg, Pa.

MILLION Books cent each. "Proverbs," San Jose, Calif. Solomon's Uncommon Sense.

YOU Need a better grip on mathematics? Ask us to send you a copy of "Mathematics for the Practical Man," only \$1.50. By common sense methods it removes the mystery and difficulties to algebra and calculus are made simple. Assuming your knowledge is limited to arithmetic you quickly and easily gain a working knowledge of algebra, geometry, trigonometry and calculus. Simply pay postman when he hands you the package. Address Popular Mechanics Press, Room 802, 200 E. Ontario St., Chicago, Ill.

PICTURES AND POSTCARDS

IMPORTED French lovers photos. Love scenes of fellows and girls, taken from life poses. 15 for \$1.00 Carrano Novelty Co., (P.M.-A) West Haven, Conn.

TEN Imported lovers photos with illustrated novelty catalog \$1.00. Money refunded if dissatisfied. Photo Sales Co., Box 744-R, Chicago, Ill.

ART Pictures—220 all different, 100 samples \$1.00. Particulars 10c. Howard Sales Co., Dept. 15, Box 529, San Francisco, Calif.

BIRTHDAY Cards, 50c value, 5 for 25c. Elsassier, Ames Station, Omaha, Nebr.

ART Beauties: 350 different, 45c. Samples 10c. Smiths, M8541 Lowe Ave., Chicago.

GAMES, ENTERTAINMENTS AND PLAYS

PLAYS, Musical comedies and revues, minstrels, comedy and talking songs, black-face skits, vaudeville acts, monologs, dialogues, recitations, entertainments juvenile plays and songs, musical readings, make-up goods. Catalog free. T. S. Denison & Co., 623 So. Wabash, Dept. 11, Chicago.

BASEBALL: How to play it with deck of regular playing cards, nothing mechanical. Let your own "headwork" and baseball skill produce the winning runs. Send 25c for complete directions, including playing diamond. Pastime Games Co., Box 795, Chicago.

PUPPET Theatre. Easy to make, fun to use. 24 beautiful stage settings, proscenium 19x32 inches, to mount and cut out, with plans, \$3. Miniature Theatre Guild, Box 311, Gary, Ind.

MAGIC TRICKS, BOOKS AND JOKER NOVELTIES

ELECTRIC Fun! Seventy stunts, 110 volts, \$1. Chemical fun, magic, hundred effects, \$1. Kutting Sons, Campbell, Calif.

THE Wonderful dime and penny trick. This is the most clever, most mystifying, most entertaining of all coin tricks. This trick is entirely mechanical. No knowledge of sleight-of-hand, nor practice, is at all necessary. Price, complete (with mechanical coin), \$1.50. H. C. Myers & Co., 141 Regent St., Salt Lake City, Utah.

HINDU Money mystery—A marvel of East India. Can be performed by anyone without previous practice. Price, postpaid, 50c. H. C. Myers & Co., 141 Regent St., Salt Lake City, Utah.

ACE Of match tricks. Hold an ordinary match head down over small nicked tube. Drop it—it comes out head up! Amazing! Easy! Complete, \$1.00. Watson Bros., 24 N. May St., Chicago, Ill.

INSTANT Popularity. Learn magic. Travel. Stage. 12 master, easy, real magicians' tricks with apparatus \$2.00. Regular price \$4.65. Palming art included. Free gift also. Circular free. Teycer Magician, Box 1275P, Chicago.

YOU Can become a handcuff king. Enormous salaries are paid in vaudeville. Interesting, mystifying. Full instructions 50c. Particulars free. L. Ricker, 2458 South St. Louis Ave., Chicago, Ill.

MAGIC Catalog 20c. Lynn, 195 Beach, Dept. 3, Jersey City, N. J.

FUNNY Stage money: Million dollar Wad. 10c. Smith, M8541 Lowe Ave., Chicago.

TRICKS With cards. Easy to do. Produce any card called for. Name any card drawn from pack. 6 tricks for 25 cents, including large catalog listing over 600 tricks. Wizard Magic Co., Dept. 15-L, Box 1055, Station "C," Los Angeles, Calif.

MAGIC Tricks, cards, books, illusions, etc. Catalog free. Geo. Fenner, Louisville, Ky.

"THE Book of 1,000 Wonders" explains many mystifying tricks with coins, cards, handkerchiefs, etc. Also contains complete catalog magic tricks, jokes, puzzles, books, and imported novelties. Largest assortment, lowest prices. Amaze and mystify your friends. Send 10c today. Lyle Douglas, Station A-5, Dallas, Tex.

SEVEN Optimagical delusions. Five magi catalogs, 25c. Gilmagico, Morgan Park, Chicago.

MAGIC—Tricks, Books and Supplies. For amateurs as well as the great professionals. Anyone can learn through our instructions. Feature Acts in Mind-Reading, Spiritualism, Rope Ties, etc. Large illustrated professional catalog, 20c. Chicago Magic Co., 140 So. Dearborn St., Dept. B, Chicago, Ill.

READ Sealed Messages in Dark; messages retained by audience; burned message appears on black slate; spirit message appears on slate in sitter's presence; spirit rappings; spirits appear in the dark; answer questions written on folded papers while blindfolded. All this you can do with directions in "Behind the Scenes with The Mediums," 69 best secrets of mediums fully exposed. The best because most baffling, yet all easy to do. Send no money. Just write a postal. Pay postman \$1.50 and postal charges. Popular Mechanics Press, Room 801, 200 E. Ontario St., Chicago, Ill.

CHALK TALKS

ENTERTAIN Lodges, clubs, schools with magical chalk talks, crayon, clay, sand, smoke pictures. Learn one evening. G. E. Hendrickson, Argyle, Wis.

LAUGH Producing program, \$1.00. Catalog free. Balda, The Cartoonist, Oshkosh, Wis.

CHALK-TALK Your way to popularity. Audiences at your feet if you learn how to entertain with a few simple pictures. Little artistic ability needed. "How to Chalk Talk" tells what to say and what to draw. Profusely illustrated. Make money giving chalk talks. Just order on a postal. Pay postman \$1.00 and postage when delivered. Popular Mechanics Press, Room 801, 200 E. Ontario St., Chicago, Ill.

RADIO SETS AND SUPPLIES

\$5 RADIOS All makes Atwater-Kent, Majestic, R. C. A., and others. Hundreds—world's best makes. Used, new and rebuilt. Going at \$5 to \$65. Many formerly priced at \$150 to \$300. Amazing bargains. Backed by responsible guarantee and 30 years' experience. Write for big free list today. Brown's Radio Exch., Dept. E, 3018 East 91st St., Chicago.

NEW 300-Mile "pocket" radio, \$3.85. Complete with special loud receiver. No tubes or batteries required. Order direct. Spencer Laboratories, 116 Atlas, Akron, Ohio.

MICROPHONES—Amateur, public address, broadcast, kits and parts. Free catalog. Universal Microphone Co., Ltd., Inglewood, Calif.

RADIOS At lowest wholesale prices. Free list. American Phonograph Co., 3602 Wesley, Berwyn, Ill.

TIME Counts in applying for patents. See pages 138 and 139. Clarence A. O'Brien, Registered Patent Attorney, Washington, D. C.

STAMP COLLECTING

WRITE For our free illustrated price list. The illustrated Scott price list is the most complete offering of sets, packets, junior album packets, airmail and special packets, catalogs, albums, stock books and accessories ever made available to the stamp collector. It is beautifully illustrated throughout, and contains a wonderful range of offerings from 10c to hundreds of dollars. Free for the asking. Now on sale, Scott's Specialized United States catalog, 1930 edition. Pocket size \$2.00. Scott's Airmail catalog. A complete catalog of all airmail and semi-postal airmail stamps 15c. Scott Stamp and Coin Co., 1 West 47th St., New York, N. Y.

MYSTIC "Queer Country" Packet! Contains scarce stamps from the following strange lands: San Marino, Antioquia, Congo, Cyprus, Fiji Islands, Gwalior Hyderabad, Iceland, Jhind, Kenya, Uganda, Lebanon, Monaco, North Borneo, Nyassa, St. Thomas Prince, Eastern Roumelia, Siam, Sierra Leone, Tanganyika, Trinidad Tobago, Ubangi, Upper Volta, Wallis Futuna, Alaouites. Get this wonderful packet of "freak countries" and make your friends envious! Price only 10c to approval applicants! Write today. Mystic Stamp Company (Dept. 8), Camden, N. Y.

5 SENSATIONAL Offers, 10 cents! 1. packet U. S., airmail, triangle stamps, etc.; 2. packet British colonies; 3. packet French colonies; 4. packet hinges; 5. beautifully illustrated new booklet, 64 pages, brimfull of bargains and things you shouldn't miss! Packets include pictorials galore from Barbados, Congo, Gabon, Guedeloupe, Guinea, Jamaica, Nyassa, Niger, Philippines, Somali, Senegal, Tasmania, Ubangi and other exotic mandates; beauties! Entire combination only 10 cents; approval applicants. Vogue Stamp Co., P Port Chester, N. Y.

THRILLING War scenes. A packet of all different stamps showing exciting scenes and records of nations at war. Includes siege guns; firing squad; mounted troops; prisoners of war; fire-pot hurlers; hand-to-hand bayonet struggle; bloody battle scenes; troop transport; red cross stamp; dying soldier; victory stamps, etc. Send for this thrilling "Big Parade" packet at once—limited supply. Only 10c to approval applicants. W. A. Rowell, 58 Cornhill, Boston, Mass.

500 DIFFERENT Stamps for 25c. Big collection from Bosnia, Crete, Epirus, Honduras, Iceland, Kenya, Liberia, Malta, Nyassa, Quelimane, Siam, Zambesia and other "hard" countries. Catalog value \$10. Price 25c to approval applicants! Bargains, 1,000 different 79c; 15 triangles 49c; 100 British colonies 39c; 100 French colonies 35c; 100 Portuguese colonies 50c. Five packets for \$2.00! Illustrated lists free. Loma Stamp Co., 4231 42d St., San Diego, Calif.

ANCHERS \$\$\$ Outfit—only 12c! Fine triangle stamp; set German stamps with (pre-war) value forty million dollars (interesting!); perforation gauge, mm scale; airmail set; scarce stamp from smallest republic on earth; newspaper set; packet good stamps and Travancore, Malay, Dutch Indies, etc. Entire outfit for 12c to approval applicants! (Nice pocket stock book, value 25c, with every order!) Ancher Stamp Co., Box 126, Rutherford, N. J.

ROMULUS & Remus, \$2.00 for 10c! Set of 6 unused Flume (1922 issue, cat. 89c) picturing Romulus & Remus with wolf-mother; and ancient Roman slave ship. Also 57 other interesting stamps from Alaouites, Costa Rica (pirate ship); France (Joan of Arc); Tacna-Arica, Uruguay (teru-teru bird); commemorative, airmail, triangle, "too-late" stamp, etc. Cat. value over \$2.00. All for 10c to approval applicants. Robert G. Howard, 245 Waverley Ave., Newton, Mass.

ABSOLUTELY Different—We will send the Sizzle Bug packet, free, to introduce our famous approvals. This swell packet includes airmail, triangle and animal stamps positively free, with big price lists, to approval applicants enclosing 4c postage. Write today, and see what the Sizzle Bug packet is. Inland Stamp, Inc., 1021 Main, Kansas City, Mo.

300 DIFFERENT Foreign stamps, 10c to approval applicants. Fulmen, Columbia, Mo.

FREE! Largest stamp in the world! Fine packet 65 different stamps from Cape Verde, Jamaica, Mozambique, Syria, etc., including dying soldier, beautiful women, ships, maps, savages, airplane, scenes, bird and animal stamps, for only 5c to approval applicants. Largest Stamp in the World (Rare China Wild Goose Special Delivery) given absolutely free with each order. Supply limited! Send your 5c today! Western Philatelists, 6021 Harper Ave., Mt. Chicago.

BIG 10c Bargain: Pair stamp tongs; water-mark detector; set scarce Greece Red Cross; fine packet 55 different British and French colonies, including Egypt, Newfoundland, birds, scenery, animals, map stamps, etc. All for 10c to approval applicants. Highland Stamp Co., 62 Woodcliffe Road, Newton Highlands, Mass.

51 DIFFERENT Iceland, Hamburg, etc., 2c. 15 Confederate essays, 10c. Tatham Stamp Co., Mittineague, Mass.

300 DIFFERENT Stamps, 20 cents; 600, 50 cents; 1,100, \$1.00; 2,000, \$3. Fred Onken, 630 79th St., Brooklyn, N. Y.

BIG Combination, including nice packet Liberia, scarce Turkistan, Sudan, Famine Stamp, Azerbaijan, packet others and fine pocket wallet. All for 10c to approval applicants. Rogers, 1136 Woodland Ave., Houston, Tex.

ONLY 25c For six months' subscription. One hundred different stamps sent each subscriber. Satisfaction guaranteed. Stamp Collector, Dept. D, 515 Sedgwick Drive, Syracuse, N. Y.

STAMP Bulletin. Published monthly. Fine stamp offerings. Profusely illustrated. Authoritative information. Sent free to advanced collectors. Reimers Co., 30 N. La Salle St., Chicago.

ILLUSTRATED Descriptive U. S. list, price 50c, large complete U. S. price list 1930 free; U. S. library, 4 volumes, \$2.50. Stanley Gibbons, 38P Park Row, New York City.

TRY My penny approvals. S. Oare, 992 Michigan, Columbus, Ohio.

100 DIFFERENT Stamps, mounted on approval sheets, cat. \$10, post free \$1. F. Lambert, Fort William, Ontario, Can.

OPPORTUNITY To earn 500,000 stamps. Information free. John Czerwiec, 101-M Beech St., Holyoke, Mass.

CANADA Airmail stamp free if you ask for approvals and send 15c for 25 diff. airmails or 30 diff. Canada and Newfoundland; both packets only 25c. We list 329 countries in our dime packets. Lists free. Special bargains—500 diff. 25c; 1,000 diff. 75c; 2,000 diff. \$2.50. Victoria Stamp Co., London, 4, Canada.

200 DIFFERENT 8c. Lists free. Midwest Stamp Co., Kemper Bldg., Kansas City, Mo.

APPROVALS, 1/2c And up. Carl Schulz, 314 So. Olive, Los Angeles, Calif.

HUNDRED Different and three \$1.00 U. S., 10c. Approvals. Vaclav Bilek, 644 Cass, Chicago.

STAMP Collectors Magazine. Finest monthly stamp paper. Write for free sample copy. Philatelic Publishing Co., Inc., 15 John St., New York, N. Y.

FREE—French cover 1859—to applicants for sets at 60% discount. Charles (Cleveland, 806 North Humphrey Ave., Oak Park, Ill.

ZANZIBAR! Packet Queer freakish stamps from Zanzibar, Helkar, Antioquia, Congo, Hyderabad, Goldcoast, Newfoundland, British colonials, Souamericans. Don't delay! Don't wait! This whopping packet free for 5c postage. Gray Stampeo, Toronto, Can.

UNITED States, 25, 10c; 50, 25c; 100, \$1, with approvals. Evanston Stamp Shop, 2412 Noyes, Evanston, Ill.

MAGNIFICENT! Nine Nyassa triangles, 10 airmails 25c. 50% approvals. Webster Stamp, Box 11, Tremont Sta., New York.

STAMPS—The qualified kind. Send for approvals. Boston Stamps, 1013 Hawthorne St., St. Paul, Minn.

WE Are giving set of Trinidad and Tobago (large stamps), to all sending 10 cents (coin) and 2c postage for illustrated album, packet of stamps (cat. value \$1.00), hinges, perforation gauge, etc. Argonaut Stamp Company, Dept. 37, New Canaan, Conn.

ABYSSINIA, 210 Different stamps, etc., 10c. George Rosenschein, Lake Placid, N. Y.

50 BRITISH Colonies 10c; 100, 25c; 200, 75c. Hollister, 3523 N. Seeley, Chicago, Ill.

FREE Surprise packet with unpicked mixture 500 United States, 35c. Drexel Stamp Shop, 5726 Drexel, Chicago.

A SNAP—300 Different foreign and 60 different U. S. stamps, including \$1 and \$2 revenues, all for only 25c. Free, with each order, our pamphlet which tells "How to Make a Stamp Collection Properly," together with our price lists of albums, supplies and hundreds of bargains in sets, packets, etc. Queen City Stamp & Coin Co., Room 36, 604 Race St., Cincinnati, Ohio.

ATTRACTIVE Approvals reasonably priced for advanced collectors. Dominion, Box 222, Toronto, Can.

UNITED States, biggest stock, lowest prices, large list free. Reliant Stamps, 65 Nassau, New York.

BUY Stamps in sets. One set given to applicants. Pickwick Stamp Co., Rahway, N. J.

FREE—Ceylon with approvals. Reference. Applebaum, 1258 Brook, New York.

SPECIAL—500 Different stamps 25c to approval applicants. Ohio Stamp Co., Box 249, Cleveland, Ohio.

FREE—Send 25 cents for first flight airmail cover. Receive another airmail cover free. M. Bowyer, Retreat, Pa.

TRY My 1/4 to 1 cent approvals. Send dime for packet. Mooney's Stamps, 1026 N. Kedzie, Chicago.

CELBECO'S Surprise packet contains many queer stamps. Only 10c to approval applicants. Celbeco, 1800 Commonwealth Suite 8, Boston.

NEWFOUNDLAND Catalog, with air mail section. Free. Rev. Butler, St. Georges, Newfoundland.

FREE! Bargain lists and scarce set Azerbaijan, 2c postage. Penna. Stamp Co., Greensburgh, Pa.

MAMMOTH Free packet! Sent to approval applicants enclosing 2c postage. Eagle Stamp Company, Box 366, St. Paul, Minn.

FREE—25 Foreign with approvals. Al. Van Dahl, Salem, Ore.

300-300-300! ALL Different stamps (catalog over \$6.00). 300 hinges; 5 approval sheets; duplicate stamp album; perforation gauge; millimeter scale and ruler, to approval applicants only for 20c. Edgewood Stamp Co., Dept. PM, Milford, Conn.

FREE—200 Different stamps, if approvals requested. Postage 4c. Berkeley Stamp Co., South Berkeley, Calif.

100 DIFFERENT Stamps free to applicants for our popular approvals. Send 2c for return postage. E. B. Gunter, 2820 Main St., Davenport, Iowa.

FREE—Packet 200 different. Postage 2c. Approvals. R. Sherman, 3618 Heath Ave., New York City.

DANDY Approvals. Beautiful set free. William Monjar, 1551 Knox, Cincinnati, Ohio.

25 CENTRAL America unused, 25c; 25 diff. Latvia, 20c. William Kolberg, Beverly, N. J.

4,000 U. S., CANADA, Etc., \$1.00; 1,000 mixed, 25c; 1,000 finely mixed, \$1.00; 100 Canada, 12c; 100 U. S., 12c. Burton, Madison, N. Y.

100 DIFF. United States, 40c; 1,000 mixed, 25c. 70% approvals. Burton, Madison, N. Y.

ESTABLISHED 30 Years. Best line of approvals. Premium. Hub Stamp Co., 45 Bromfield, Boston, Mass.

FREE: 55 Different stamps, including rare Mauritius revenue, gold coast, Sudan, Trinidad, Tobago, Travancore, Orange River Colony, etc. Absolutely free to approval applicants enclosing 4c for mailing. Viking Stamp Co., Sheepshead Bay Station, Brooklyn, N. Y.

GET Good stamps! Fine set Jugoslavia (cataloged \$1.81) 5c with choice approvals. Rosedale Stamp Company, Box 1733, Winnipeg, Canada.

ATTRACTIVE Approvals at 50% discount and 25% discount. Noemus Stamp Co., 312 East 23rd St., New York.

40 DIFFERENT United States 12c. 60% approvals. Seidenberg, Baroda, Mich.

ATTRACTIVE Assortment, Central American with additional interesting unusual stamps, 2c postage only. Midland Stamp Company, Toronto, Can.

16 DIFFERENT Triangle stamps, all uncanceled, including Austria, Estonia, Latvia, scarce Liberia, Nyassa, etc. Catalog value nearly \$2.00—regular price \$1.00. Special for limited time, only 35c. High-grade approval sheets. Price list free. E. Newton Searles, PM, Pomfret Center, Conn.

U. S. STAMPS Only on approval; give reference. Stamp House, 39 Torry, Dorchester, Mass.

BIGGEST Bargain ever offered: 10 high grade stamps including one 75 year old classic, total catalog value over five dollars for only 10 cents to approval applicants. We make this sensational offer to prove: "That it pays to deal with Globus." We are one of the largest approval houses in America with millions of stamps in stock and serve thousands of satisfied collectors. From Globus you always get what you want and for less money too. Send your dime for \$5.00 catalog value today and be ready for a pleasant surprise. Globus Stamp Co., 214 Third Ave., New York City.

1/2c APPROVALS. Including Liberia, Nyassa, etc. Also 14,000 averaging 1 1/2c. References. Philatelic Exch., Huntington, W. Va.

BEST One cent approvals in America. F. Hand, 1117 60th St., Philadelphia, Pa.

FREE—Packet French colonials to approval buyers. Lincoln Stamp Company, Shelbyville, Ill.

FREE—Packet of stamps, China, Chile, etc. Send postage. H. C. Buchholz, Norwood, Ohio.

100 FOREIGN Stamps 3 cents. Lufbery Stamp Co., Branford, Conn.

212 DIFFERENT Stamps including U. S. \$2, Dominica, Syria, etc. Catalog \$4.90, only 15c. Robert Haynes, Point Place, Toledo, Ohio.

CONGO. Free, five fine to approval applicants. Bernard Karch, Bengies, Md.

105 CHINA. Etc., 2c. Album (500 illustrations) 3c. Bullard, 446 Tremont, Boston.

CANADIAN Commemorative, a complete set of 9 var. air mail, 5 beautiful picture stamps and 100 other stamps, all for 5c to collectors who ask for our approval sheets. Prices on approvals, 1/4, 1/2, 3/4 1c, etc. Lowest prices and best quality. Kelgwin Stamp Co., P. M., Fernandina, Fla.

ONLY 5c. 33 Different stamps including scarce Latvian triangular airmail stamps, 10 airmail, 12 United States (early issues, commemoratives, etc.) and 10 Canada. Approvals and illustrated price list sent with each order. Curhan Stamp Company, Gloucester, Mass.

FREE! Loose leaf postage stamp album at rate of 8 pages each month given with subscription to monthly journal. Send 2c stamp for prospectus. United Stamp Co., Marquette Bldg., Chicago, Ill.

FREE, 6 Different Luxemburg to approval applicants. E. D. Stamp Co., 3905 Forest Park Ave., Baltimore, Md.

55 DIFFERENT Including scarce country to approval applicants 4c. Richard Lamrecht, Valparaiso, Ind.

STAMPS—100 Varieties, Africa, Brazil, Peru, Cuba, Mexico, etc., 10c; 25 different U. S. 25c; 1,000 mixed, 40c; 1,000 binges, 15c. C. Stegman, 5941 Cote Brillante, St. Louis, Mo.

FREE Stamps with approvals. 2c postage. Harvey Teepie, Decatur, Ind.

STAMPS Sent on approval at 70% discount. Reference required. Emory Renoll, Hanover, Pa.

COVERTCO Packet, 200 different stamps 10 cents, with 60% discount approvals. Covert Stamp, 39 State, Rochester, N. Y.

FREE—31 Different stamps to applicants for Royal approvals. 2c return postage. Royal Stamp Company, Bristol, Pa.

FREE—\$1.00 U. S. postage old issue free. If you write for our 56 page price-list of U. S. and foreign stamps, 2,000 illustrations. Also fine but cheap stamps on approval. Hussman Stamp Co., 620-3 Olive St., St. Louis, Mo.

FREE—Canada (15 Var.) for new applicant of my 1c, 2c and 3c approval, and also my 50% discount. Chas. W. Schmidt, P. O. Box No. 4832, Frankford Sta., Phila, Penna.

110 DIFFERENT Stamps, many unused, high values, free to collectors requesting our net approvals. Postage 2 cents. Christensen, Milwaukee, Wis.

PENNY Approvals that Satisfy. Neil Gronberg, Box 5441, Philadelphia, Pa.

FREE! 115 Different stamps to approval applicants, 2c postage. Paige Stamp Co., Oak Park, Ill.

110 NEW Europe All Different, a wonderful collection cataloguing several dollars, free to collectors requesting our Net Approvals. Postage 2 cents. Badger Stamp Co., Milwaukee, Wis.

FREE! Triangles, airmail, Iceland and 50 others to approval applicants including 3c postage. Hawkeye Stamp Co., Cedar Rapids, 39, Iowa.

118 STAMPS Free with approvals. L. W. Hudson, Plainfield, N. J.

STAMPS, 100 all different. Postage 2c. Lists free. P. M. Quaker Stamp Co., Toledo, Ohio.

24 VARIETIES Cuban stamps, 10 cents. List of 6,000 low-priced stamps free. Address Chambers Stamp Co., 111P, Nassau St., New York City, N. Y.

FREE—20 Different Argentine. Approvals. List. Send 4c today for postage, etc. Renter, Santa Ana, Calif.

RARE COINS

COMMEMORATIVE Half dollars uncirculated; Lincoln, \$1.19; Maine, \$1.27; Pilgrim, 89c; Grant, \$1.19; Monroe, 89c; Lexington, 89c; Oregon, \$1.29; Bennington, \$1.19; special bargains, trade dollars, \$1.19; 10 large cents, 79c; 10 firing eagle cents, 73c; 10 2c bronze coins, 19c; 10 3c nickels, 89c; lettered edge half dollar, 79c; 2 broken bank bills, 25c; old coin and bargain price list, 10c. Arcey, Box 483, Muskogee, Okla.

NORTH Or South American or foreign 5c silver, one copper coin one large crisp bank note and catalog 10c. Geo. Best, Cedar Rapids, Iowa.

OLD Money wanted. Will pay \$100.00 for 1894 dime, S. Mint, \$50.00 for 1913 Liberty head nickel (not buffalo). Big premiums paid for all rare coins. Send 4c for large coin folder. May mean much profit to you. Numismatic Co., Dept. H, Ft. Worth, Tex.

LARGE Priced U. S. coin encyclopaedia, valuable, useful, 25c postpaid. Maitland Milliken, University Bldg., Denver, Colo.

UNITED States silver half dollars, 1821 to 1839, 90 cents each. Trade dollars, \$1.15 each. Selling price list free. G. T. Davis, Box 1791, Huntington, W. Va.

WHILE They last—35 dates large cents, \$1.00; 150 different foreign coins, \$1.00; 500 coin envelopes, 75c. Romanocoinshop, Springfield, Mass.

10,000,000 MARK And list 10c. Fred Greenleaf, Box 2551, Denver, Colo.

15 DIFFERENT Coins, 25c; 60 different coins, \$1.00. Oddehon, Box 681, Kansas City, Mo.

CALIFORNIA Gold quarter 25c, half 50c. Chester Brooks, Cuero, Tex.

25 DIFF. Fine foreign coins 50c, 12 diff. 25c. Willbert Bishoff, Ottawa, Kans.

UNITED States. Large cent, two-cent bronze, three-cent nickel and bargain list, 25c. Thirteen dates large cents, \$1.00. George Coffin, Greenwood Mountain, Me.

\$2 to \$500 Each paid for hundreds of old coins. Keep all old money, it may be very valuable. Send 10 cents for illustrated coin value book, 4x6. Prices guaranteed. Get posted. We buy and sell. Clarke's Coin Office, Box 5, Le Roy, N. Y.

RARE United States, foreign coins, war medals, Chinese coin and catalog 10c. Alexis Mengelle, Colorado Springs, Colo.

CALIFORNIA Gold—quarter size, 27c; 3/4 size, 53c; 3c piece and catalog, 10c. Norman Shultz, Box 746, Salt Lake, Utah.

GET Profit and pleasure in collecting old coins. Send 10c for large illustrated coin catalog. You'll be delighted with it. Send for it right now. B. Max Mehl, Numismatist, Mehl Bldg., Dept. P, Fort Worth, Tex. Largest Rare Coin Firm in the U. S.

OLD Coins, large fall selling catalog of coins for sale free to collectors only. Catalog quoting prices paid for coins, ten cents. William Hesslein, 101A Tremont St., Boston, Mass.

CAMERAS AND PHOTO SUPPLIES

BARGAINS. A sample few taken from our latest bargain book, 2 1/2 x 4 1/4 roll film Voigtlander Arus Camera with f:4.5 lens Compur shutter \$23.75, 3 1/4 x 4 1/4 Ser. B Graflex Camera, Kodak f:4.5 lens \$52.75, 3 1/4 x 5 1/4 -3A Autogr. Kodak Special with Iib Tessar f:6.3 lens \$54.75. Secure your copy now, it is free. Everything guaranteed fully. Money returned if not satisfied in ten days. Central Camera Co., 230 South Wabash Ave., Dept. PM-4d, Chicago, Ill.

SAVE Money. Movie cameras, \$25; projectors, \$35; Pathex camera, \$20; stereopticon, \$25; printing machine, \$75; 35mm negative stock, 2 cents foot; 100 foot Eastman 16mm negative, \$4.50; Kodak, \$5. Typewriter \$18. Cameras and films bought and exchanged. Ray, 266 W. 40th, New York.

GERMAN Cameras, lenses, Barltro, 237 1/2 S. Spring St., Los Angeles, Calif.

TRIAL Enlargement 10c. Send 10m. Roll developed Glosso prints, 20c. Gloss Studio, Cherryvale, Kans.

LEARN "Transography" photograph without films. Sample and particulars, 10c. Koch's Studio, Collbran, Colo.

SAMPLE Enlargement—dime, and negative (returned). Trial roll, glossy prints, 25c silver. Brown, Warsaw, N. C.

YOUR Favorite kodak picture enlarged, size 5x7, 10c. Three for quarter, coin. Send best negative (film) today. Address Darmer Photo. Lab., 221 Securities Bldg., Des Moines, Iowa.

HAVE You a Camera? Write for Free sample of our big magazine, showing how to make better pictures and earn money. American Photography, 116 Camera House, Boston, 17, Mass.

TIME Counts in applying for patents. See pages 138 and 139. Clarence A. O'Brien, Registered Patent Attorney, Washington, D. C.

FILMS Developed. Special Trial Offer. Any Size Kodak film developed 5c, prints 3c each. Trial 6x10 Enlargement in handsome folder 40c. Overnight Service. Roanoke Photo Finishing Co., 209 Bell Ave., Roanoke, Va.

MAKE Money in photography. Learn quickly at home. Spare or full time. New plan. Nothing like it. Experience unnecessary. American School of Photography, Dept. 3431, 3601 Michigan Ave., Chicago.

KODAK Films developed 5c roll. Prints 3c each. Trial offer. 8x10 enlargement 25c. Young Photo Service, 405 Bertha St., Albany, N. Y.

MOTION PICTURES

\$1,250 FOR Original photoplay story. Our sales department sold unknown author's first story for above amount. We revise, copyright and submit to studios stories for both silent and talking pictures. Being located in the heart of motion picture industry we know production requirements. Established 1917. Free booklet. Universal Scenario Company, 206 Western and Santa Monica Bldg., Hollywood, Calif.

BARGAINS—A sample few, 16mm., 3-T Turret-Front Victor Cine Camera, Cooke f:3.5 lens at \$122.50, 35mm., Institute Motion Picture Camera with f:5 lens \$84.75, Motion Picture Panoramic Top Tripod \$13.75. Many others listed in our bargain book offered free. Get your copy now. Central Camera Co., 230 South Wabash Ave., Dept. PM-4d, Chicago, Ill.

\$1.00 POSTPAID For new book Motion Pictures with the Baby Cine. Also free literature on this new Pathe Automatic Motion Picture Camera and Projector. Send \$1.00 today to Motion Picture Headquarters, Bass Camera Company, 179 West Madison St., Chicago, Ill.

NEW 35mm Films on spools, comedies, westerns, 200 ft. \$1.50; no lists. DeVry 16mm projectors \$85. R. Jones, 309 E. Sunbury St., Shamokin, Penna.

125 FEET 50c. New list free. Bargains. Clifford Hoffman, Albany, N. Y.

BUSINESS Is fine today. Scholefeld, Jr., Chicago Film Dealer, 6801-63 S. Carpenter St., Chicago, Ill.

LEARN Motion picture theatre management as a business or profession. Big opportunities. Theatre Managers Institute, Elmira, N. Y.

MOVIE Cameras, projectors \$10.00 each. Booklets, samples 10c. Beacon, 239 8th Ave., Paterson, N. J.

FILMS For toy machines. Largest selection obtainable; new low prices. Big discount on all makes of new machines; latest models. Send for catalog. Interstate Films, 732 S. Wabash, Chicago, Ill.

WESTERNS, \$3.00 Reel. Rebuilt projectors bargains. Marshall Films, Rome, Ga.

FILMS Dirt cheap. List. Enterprise Films, 828 Chestnut St., Hagerstown, Md.

PATHE Home movies. Own the entire outfit at lowest cost. Write for catalog. The Wambaugh Co., Goshen, Ind.

300 FEET Good film, 90 cents. Star Films, Allentown, Penna.

FILMS (New) natural color 50 ft. sent \$1.00. Worth \$12.50. Westerns, Indians, no lists. Hemenway Film Co., 37 Church St., Boston, Mass.

CHOOSE Subjects—225 feet 75c. Film cement free! H. Schaefer, Keansburg, N. J.

WE Buy, sell, trade motion picture cameras, projectors, lens, accessories. List for stamp. F. W. Buchanan, Johnstown, Pa.

FILMS, Odd reels \$2.00. Features \$10; comedies, \$2.50; talking films 1/2c per foot. Savarese, Box 15, Union City, N. J.

RE A movie exhibitor. Big opportunity only moderate capital required. Conoleto equipment at remarkably low prices. Write Atlas Moving Picture Co., 825 So. Wabash, Chicago, Ill.

TIME Counts in applying for patents. See pages 138 and 139. Clarence A. O'Brien, Registered Patent Attorney, Washington, D. C.

GOOD Film—300 feet \$1.00. Reels \$2.45. Samples, lists, particulars for stamp. Eastin Feature Films, Gatesburg, Ill.

MOVIE Films, 1,000 ft. reels, \$2.50 each; shipped anywhere on receipt of remittance. Particulars on request. Independent Films, 177 Golden Gate Ave., San Francisco, Calif.

FILMS, Machines. Stamp for list. Box 255, Hickman Mills, Mo.

FILMS, 300 Ft. \$1.00, reels \$1.95. List. Edgeworth Sales, Box 155, Blue Island, Ill.

TRADE AND TECHNICAL SCHOOLS

HILES Watchmaking and engraving school. The largest and best equipped school in the west. 5330 Mission St., San Francisco, Calif.

OUR Extension course covers entire subject of radio. Graduates allowed three months finishing course free at the college. Tuition charge moderate. Have always placed graduates at pay ranging \$150 to \$300 monthly from the start. Write for catalog. Loomis Radio College, Dept. 7-A, Washington, D. C.

DRAFTSMEN! Be an expert. Our method trains you quickly. Books and tools furnished. Write for illustrated catalog. Columbia School, 2048 Drexel Bldg., Philadelphia.

BE a blue print reader. Men in your trade have succeeded. Write for facts. What's your trade? Carroll Rumsay, Drexel Bldg., Philadelphia.

LEARN Morse and wireless telegraphy. Big salaries. Tremendous demand. Expenses low, can earn part. Catalog free. Dodge's Institute, Fern St., Valparaiso, Ind.

BUSINESS OPPORTUNITIES

WITHOUT Exception most profitable opportunity ever offered. Unlimited possibilities—plan unique—unbelievable results; small investment for advertising matter only; no stock to carry; permanent income; no effort required; tremendous number buyers developed automatically. We warehouse and deliver for you. Anyone can succeed with this most profitable of all sales plans. For full particulars write The Finance Corporation, Desk K, 522 McKnight Bldg., Minneapolis, Minn.

PRIVATE Stationery. 100 printed letterheads 6x7 inches and 100 envelopes. Attractive. Send name and address with \$1.00. Conrad Schader, 60 Broad St., Mount Vernon, N. Y.

WE Start you in business, furnishing everything. Men and women, earn \$40 to \$100 weekly operating our original "New System Specialty Candy Factories." Begin home spare time. Unlimited opportunity. Valuable booklet free. W. Hillyer Baggdale, Drawer 4, East Orange, N. J.

"BE Your own boss"; manufacture solvent for spots and stains, formula one dollar. B. Cooper, 409 Tebo St., Windsor, Mo.

CHEMICAL Expert furnishes manufacturing formulas and processes with complete working directions. Reliable individual service only. No lists. Charges reasonable. Correspondence invited. Dr. Arthur VanHeeden, 7051 Bennett, Chicago.

"MAIL Order Selling" magazine. Contains new ideas each month. 3 months' subscription 25c. One year \$1.00. Mail Order Selling, Brookfield, Ill.

START Magazine 25 copies \$1.00. 28 page book mail order business formulas free. Circular mailing, \$2.50, 1,000. 30 years experience. Advertising special. 35 words, 3 months, \$2.00. Paying Imprint Circulars, copy 10c. Dolsen Herald, 36 Liberty St., Brooklyn, N. Y.

"SCHEMER," Alliance, Ohio, subscribers surely succeed. One reports \$25,000 from three schemes; another \$10,000 from one formula. Try your luck! Three copies, 96pp, 25c.

SMALL Capital starts profitable route peanut and gum vending machines. Particulars free. Robbins Corp., Dodworth St., Brooklyn, N. Y.

MIRRORS Resilvered at home. Cost near 5 cents per square foot; you charge 75 cents. Profitable business plating like new, brass, worn-off autoparts, reflectors, tableware, stoves, etc. Outfits furnished. Details free. Sprinkle, Plater, 127, Marion, Ind.

NEW Mail order publication! "Kurford's Outlet." Opportunities galore. Sample 5c. Kurford Company, Box 1545-M, Philadelphia, Pa.

"PROFITABLE New Home Work Ideas," 10c. Greene, Box 53, Los Angeles, Calif.

3,000 MONEY Making plans. Secrets, valuable business formulas, postpaid \$1.00. Agrah Company, 479 Ralph Ave., Brooklyn, N. Y.

SCREW-HOLDING Screw driver! Amazing new invention! Holds, removes, inserts screws instantly inaccessible places. Factories, garages, electricians, radio owners buy on sight! Sells \$1.50. Exclusive territory. Free trial order. Jiffy, 1538 Winthrop Bldg., Boston.

BUILD Business of your own at home. Free literature describes over fifty plans. Co-Operative Co., 409 A Ansonia, Conn.

MANUFACTURE Indefinite liquid stencil ink. Profits large. Instructions one dollar. Particulars for stamp. Francis & Co., 245 First St., Jersey City, N. J.

EXCEPTIONAL offer for anyone who understands garden tools. Greene, Dover, Mass.

IMPROVED Auto polish formula. Not cheap but a money maker. Price \$5.00. Try it before you buy it. Sample postpaid 60c. Voco Chemical Co., 3342 N. Whipple St., Chicago, Ill.

START Mail order business. Learn how. Write for details. Mail Order News, 11 West 42d St., New York.

FINANCING. Expert information how to raise capital; any business. Send \$1 only. Cole, Tower Bldg., Syracuse, N. Y.

MAKE Money manufacturing building materials, marble, granite, fireproof paint, flooring, roofing. No machinery. Cheap. Big profits. For formulas and latest methods, write Wm. Lang, 443 Washington, Portland, Ore.

HAT Blocks, flanges, equipment. Dry Cleaner, 408 Grand St., Buffalo, N. Y.

STRUCTURAL Steel designer wants home work. Reasonable. Morris Dillow, 342 Vincennes St., New Albany, Ind.

DRY Cleaning business of your own. Cleaning hats, clothing, dyeing, pressing. Particulars free. Dry Cleaner, 408 Grand St., Buffalo, N. Y.

DISTRIBUTOR For auto specialty that is a necessity. More power, less gas, sells \$2.00. Large profits. Smith Specialty Co., 1842 S. Highland Ave., Berwyn, Ill.

"LIBERTY Bell," big mail, 10c. Box 136, Murfreesboro, Tenn.

FOR Money-making ideas read Nagel's Mail Order Review. Sample copy, 10c. Nagel, 1329 Olive, Indianapolis, Ind.

I MADE \$30 a week home. French breadmaking. 15 years' experience; free booklet tells. Ashbrook 67, Marengo, Ohio.

FREE Particulars—Business plans. Mail order. Trade secrets. Commercial educators. Desk A, 311 West 13th, Kansas City, Mo.

SOOT Destroyer—Effective, easily made. Big profits. Formula, directions, label copy, everything \$1.00. Westport Laboratories, Box 5945, Kansas City, Mo.

FINISHED And raw stock, high class auto accessory, bargain price. M. Erwin, Room 621 Finance Bldg., Kansas City, Mo.

BIG Profits on our exclusive, unique products for homes and offices. Send \$1.00 for liberal samples worth \$3.00 retail. Cardinell Products, Montclair, N. J.

MAKE Bigger business having New York address. Mail forwarded daily. \$2 monthly. Valles, 77E 110th, New York.

BUSINESS Profession of your own and earn income in service fees. See Stephenson Laboratories, display ad page 142.

UNUSUAL—Uncommon specialties always sell best. Make these yourself from Miller's guaranteed formulas. Why work for others when others can be working for you? Latest eye-opening literature brings you many specialty propositions for you an independent business. Miller, Chemist, 706-K Chemical Bldg., Tampa, Fla.

FIFTY Successful mailorder products, sales plans. K. Home, 3949 Metropolitan, Chicago.

MAKE Your own products. Employ agents yourself. Toilet articles, soap, extracts. We furnish everything. Valuable book free. National Scientific Laboratories, 1935W Broad, Richmond, Va.

SUCCEED With your own products. Make them yourself. Formulas, processes, trade secrets, all lines. Catalog free. B. Thaxly Co., Washington, D. C.

MAKE And sell your own goods. Formulas by expert chemist. 30 years in business. Thousands of satisfied clients. Catalog for stamp. B. Mystic Company, Stamford, Conn.

THE "Naden News" contains tips! Plans! Schemes! Formulas! Sample copy, 10c; \$1.00 per year. Naden, 2001 Burlingame, Detroit, Mich.

MAN Or woman. Tested business. Has made more than \$1,000 monthly profits. Legitimate, dignified, pleasing. Experience unnecessary. We supply everything. Long-Eakins, 2060 High St., Springfield, Ohio.

MAIL Order business your opportunity. Brenner's famous hand books by expert 23 years' experience show how to start selling articles you make or buy—all or part time—small capital. Fascinating, profitable. Set eleven books, \$3.25. Brenner Company, 1607 P. Sansom, Philadelphia. Sample book, 25c, pay \$3 for other ten if satisfied.

"ODD-THINGS" Schemes! Plans! Tips! Formulas! Money making ideas! Opportunities galore! New! Different! Three months' trial subscription 25c. Year \$1.00. "Odd-Things Magazine," 720 Advance Bldg., Cleveland, Ohio.

LEARN Marbleizing. The greatest discovery in cement composition. With our processes it can be brushed on like paint. Resembles polished marble, veined perfectly, flintlike hardness, veneers over any concrete products, wallboard, lumber. Inexpensive, anyone can do. 200% profits; wonderful opportunity. Address Cowell Institute, Grayling, Mich.

\$20.00 PER 100 Stamping keytags. Sample and instructions 25c. Ruth Tag Co., Wheelersburg, Ohio.

ARTIFICIAL Marble sanitary flooring. Instructions covering wood or cement flooring ½ inch thick, fireproof, all colors, low cost. Ornamental casting, concrete, plaster, papier-mache decorations, garden furniture, statuary, flexible molds, particulars and illustrations free. Chris. Mahler, Huntington, N. Y.

CONCRETE Building block manufacturing, is your home town opportunity. Particulars free. Concrete Machine Co., 5 Main St., St. Louis, Mo.

DON'T Sell for others—Employ agents yourself. Make your own products. Toilet articles, household specialties, etc. 500% profit. Valuable book free. National Scientific Laboratories, 1935W Broad, Richmond, Va.

UNPATENTED Ideas can be sold. I tell you how and help you make the sale. Free particulars (copyrighted). Write W. T. Greene, 910 Barrister Bldg., Washington, D. C.

MAKE Big profits with a fur farm in your backyard. Chinchilla rabbits, muskrat, mink. Write for facts. 252 Conrad's Ranch, Denver, Colo.

BIG Money awaits you here. 250 signs and pictures an hour without press, type or machinery. Samples and particulars 10c. Straco, 1013 Mulberry, Springfield, Ohio.

RESPONSIBLE Manufacturer wants competent men open office, manage salesmen; \$200 to \$1,000 necessary. Will pay expenses to Baltimore if you qualify. Address Manager, 603 N. Eantaw St., Baltimore, Md.

AMATEUR Cartoonists: Sell your work. Write Smith's Service, PK1194, Wenatchee, Wash.

THAXLY Formulas produce perfect products. All lines. Catalog free. B. Thaxly Co., Washington, D. C.

SIGNS And showcards easily painted. If you use Letter Patterns. Write for free samples. John Rahn, B2120 Neva Ave., Chicago.

CHEMICAL Expert will furnish formulas and trade secrets. All lines. Lists free. W. L. Cummings, Ph. D., 228 Gordon Ave., Syracuse, N. Y.

SELL By mail! Books, novelties, bargain! Large profits! Particulars Free! B-Elfeo, 525 South Dearborn, Chicago.

FREE Book. Start your own little business anywhere, selling novelties by mail. My beginner's outfit contains everything required, novelties, circulars, instructions, etc. Descriptive book free. Hadwil, 3A-74 Cortlandt St., New York.

LEARN The collection business. Good income, quick results. Interesting booklet, "Skillful Collecting" free. National Collectors Assn., Long St., Newark, Ohio.

A BUSINESS Of your own making—Sparkling Glass Name and Number plates, Checkerboards, signs. Big book and sample free. E. Palmer, 540, Wooster, Ohio.

10,000 MONEY-MAKING Formulas. Tells you how to make and sell almost everything under the sun; cosmetics, mucilage, anti-freeze solutions, battery solutions, beverages, cheese, chewing gum, cleaning preparations, extracts, hair preparations, inks, bluing, leather polish, mirrors, perfumes, polishes, typewriter ribbons, carbon paper, washing powders, liquid soap, and hundreds of other profitable articles. Send no money. Just write a postal for "Henley's 20th Century Book of Formulas." Pay postman postage and \$1. Popular Mechanics Press, 200 E. Ontario St., Room 802, Chicago.

MAN In each town to plate auto parts, reflectors, bathroom fixtures, refinish beds, mirrors, chandeliers; by new method. No capital or experience required. Simple plan of manufacturing at home starts you in big money-making business. Outfit furnished. Free particulars and proofs. Gun Metal Co., Ave. H, Decatur, Ill.

DELAWARE Charters; fees small; free forms. Chas. G. Guyer, Wilmington, Del.

FREE Booklet describes 67 plans for making \$20-\$100 weekly in home or office business of your own. Elite Co., 84 Elizabeth St., New York.

MECHANICS, Painters, carpenters, start furniture refinishing, painting, handyman shop on nearly nothing; winning plan brings customers quickly. John Braceland, 1439 So. Ninth, Philadelphia, Pa.

TIME Counts in applying for patents. See pages 138 and 139. Clarence A. O'Brien, Registered Patent Attorney, Washington, D. C.

TELEGRAPHY

LEARN Morse and wireless telegraphy. Big salaries. Tremendous demand. Expenses low, can earn part. Catalog free. Dodge's Institute, H St., Valparaiso, Ind.

CHEMISTRY

"HANDBOOK For Chemical Experimenters." Hundreds of interesting experiments; illustrated, 50c. Booklet of experiments, 15c. Pricelist, 5c. General Chemical Company, Box 397, Reading, Penna.

ANALYSIS, Chemical consultation. Manufacturing ideas developed. Formulas. Write Associated Chemists, Indianapolis, Ind.

CATALOG Listing 2,500 illustrations chemists' supplies, 5,000 chemicals, 1,000 scientific books sent for 50c. Laboratory Materials Company, 643 E. 71st St., Chicago, Ill.

YOUR Chemical problems solved and formula or process furnished for \$5.00. Write me. W. Stedman Richard, Industrial Chemist, Box 2402, Boston, Mass.

FORMULAS AND TRADE SECRETS

"RUNONO" Seals broken threads, stops runs in silk hosiery, stainless tablecloth, imitation marble, liquid leather, transparent auto refinish, silverplating polish, and 20 other latest formulas, all \$2.00. G. W. Donahoe, Hondo, Calif.

FIFTEEN Selected formulas, manufacturing processes and money-making secrets sent for 25c. R. A. Bertrand, 255 S. Schuyler, Kankakee, Ill.

MAKE Honey without bees; a wonderful imitation easy to make in your own kitchen, costs only four cents a pound. Formula one dollar. H. Frame, Rockland, Ohio.

MANUFACTURING Processes that will give your product distinction and build up your business. Either you are in need of a new product to add to your present line or to start a new business on. It will pay you to write us stating your requirements. Complete analytic service. Nielco Laboratories, Inc., 5401 Cicotte, Detroit, Mich.

LIQUID Silver plating compound, replates auto parts, brass, copper, silverware; works like magic. Easy to make. Formula \$2.00. Beck, 370 Riverside Drive, New York.

BEAUTY Formulas—Ten for \$1.00. Frank R. Fitz, Consulting Chemist, 17 Harugari St., Fitchburg, Mass.

FREE Formula catalog. Latest money makers. Western Chemical, Salem, Oreg.

NEWEST Tested formulas. Particulars, catalog free. Grinstead Laboratories, Oswego, Kans.

25 MONEY Making formulas, premium, \$1. Arthur Lutz, York, Penna.

FREE Formulas—Free materials making \$32.00 worth of guaranteed highest class specialty-necessities. Thirty-third unequalled anniversary offer explains all. Miller, Chemist, 1707-G Jetton, Tampa, Fla.

SUCCEED With your own products. Make them yourself. Formulas, processes, trade secrets, all lines. Catalog free. B. Thaxly Co., Washington, D. C.

DON'T Sell for others—Employ agents yourself. Make your own products. Toilet articles, household specialties, etc. 500% profit. Valuable book free. National Scientific Laboratories, 1935W Broad, Richmond, Va.

500 FORMULAS And big illustrated catalog 25c. Ideal Book Shop, Park Ridge, Ill.

FORMULAS: Guaranteed, catalog free. Restorall Laboratories, 6720 Oconto Ave., Chicago.

FORMULAS All kinds. Catalog free. Clover Laboratories (P), Park Ridge, Ill.

MAKE Your own products. Employ agents yourself. Toilet articles, soap, extracts. We furnish everything. Valuable book free. National Scientific Laboratories, 1935W Broad, Richmond, Va.

AGENTS WANTED

WANTED At once: More good men to introduce and retail Rawleigh's Good Health Products. Town and country. Wonderful opportunity. Get into business with backing of largest manufacturer its kind. Capital over 15 million dollars. Quick freight, express, parcels post service from 10 great factories and branches—one near you. Nothing new—no experimenting. No experience required. You simply follow the same old time-tested Rawleigh Methods which secure the most business everywhere and have given consumers best values and satisfaction for 40 years. 170 necessities frequently needed every home. Enormous demand. Annual sales nearly 40 million products. Big free trial inducements. Quick easy sales. Repeat every 30-60 days. Enormous profits—\$100-\$400 month and more profits. Steady year around; no lay-off. No boss—you become sole owner and manager. Practically no capital required. We supply everything—stocks, outfit, sales and service methods. Big pay every day. Profits increase every month. "First come first served." For full particulars write W. T. Rawleigh Co., Dept. 4-PPM, Freeport, Ill.

AGENCIES Now open for the sensational Tear Gas Fountain Pen Gun. Startling demonstrator. Fits vest pocket like fountain pen. Official police model. Biggest seller of century. Extra big profits. Only safe substitute for revolver. 100% protection without danger. A wonderful ground floor opportunity. Get details quick. Send for new circular. The Atlas Co., Dept. 55, Ogden Park Station, Chicago, Ill.

AGENTS: Big chance to earn \$15 to \$25 daily, introducing new, patented, automatic safety ventilating window lock, for houses, stores, banks, garages, offices, 3 to 12 needed every house. Recommended by police, insurance people everywhere. No competition. Nothing like it on earth. Be first in your locality. Sample easily carried in pocket. Elmwood Mfg. Company, 1204 Elmwood Place, Cincinnati, Ohio.

EASY To sell groceries, paints, auto oils to consumers. Steady, profitable work. Experience unnecessary. Credit given. Valuable outfit free. Loverin & Browne, 1602V So. State, Chicago.

UNUSUAL Income. Every community. Sell homes, shops, theatres, stores, banks, schools, etc., the new Fugo, world's simplest fire protection. No sales experience necessary; we teach you. Part or full time. Act quick! The National Formetal Co., 6547 Metta Ave., Cleveland.

AGENTS—Up to \$9 daily. Introducing hosiery guaranteed 6 months or replaced. 126 styles, colors, for men, women, children. Lowest prices. Auto and hose offered producers. Outfit free. Wilkint Hosiery Co., Dent, C-9031, Greenfield, Ohio.

AMAZING New invention. Electric water heater. Sells for \$2.75. Heats water almost instantly. Make big money. Write today. Lux-Visel Company, Elkhart, Ind.

MAKE Your own products. Employ agents yourself. Toilet articles, soap, extracts. We furnish everything. Valuable book free. National Scientific Laboratories, 1935W Broad, Richmond, Va.

GENUINE Gold Leaf Letters anyone can put on store windows. Guaranteed to never tarnish. Large profits. Enormous demand. Free samples. Write today. Metallic Letter Co., 438-D North Clark, Chicago.

STRANGE New ironing cord! Prevents scorching. Saves electricity. Cannot kink or snarl. For telephones also. Up to \$25 daily. Samples furnished. Neverknot, Dept. 4-A, 4503 Ravenswood, Chicago.

NEW! Different! Milady's novelty clothes buy b. Rainbow colors create instant sales. Wadlein made \$24 first day. Free sample. L. Jensen Co., 304 So. Dearborn, Chicago.

MIRRORS Resilvered at home. Costs near 5 cents per square foot; you charge 75 cents. Profitable business plating autoparts, reflectors, tableware, stores, refinishing metalware, etc. Outfits furnished. Details free. Write Sprinkle, Plater, 128, Marion, Ind.

SELL Household brushes. 100% profit. Free gift brushes. Send for sample case offer. National Fibre Broom Co., St. Louis, Mo.

SELL Changeable signs to stores. Size 14x24. Six lines. Cost 35c, sells \$1.50. Two signs postpaid \$1.00. Particulars free. National Sign System, St. Louis, Mo.

I START Men in a grocery business a new easy way. You use my money. Don't need to put up a penny of your own cash for stock. Expansion program now opens up many desirable opportunities also established trade. Hustlers make good money from the start, increasing rapidly as they learn the business. Not "chain" proposition but your own business. Buy on credit. Give credit if you wish. If honest and need more money write at once for application and details to McConnon & Company, Room-L 6604, Winona, Minn.

NEW! Rubber soles—Cement on instantly. Never loosen. Outwears leather. Waterproof. Sells fast. Big repeater. Test at my expense. Bestever Co., 195 Irving Park Sta., Chicago.

NEW Invention, easiest thing ever sold. Inexpensive washer for autos. Car owners eager to buy on demonstration. No competition. Big profits. Plomo Specialty Mfg. Co., Dept. C, Cleveland, Ohio.

PHOTO Medallion men and women, the largest line of photo novelties in the world. Lowest prices, quickest service. Send for catalog showing over 200 money makers. Gibson Photo Jewelry Co., Inc., 833-837 Gravesend Ave., Brooklyn, N. Y.

AGENTS—Men, earn up to \$12 daily wearing fine felt hats and selling friends. Smartest styles. Latest shades. \$2 to \$5 saving on every hat. Samples free. Taylor Hat and Cap Mfrs., Dept. DC-135, Cincinnati, Ohio.

AGENTS—Here's a chance to get your groceries at wholesale and make \$15 profit a day besides. Wonderful new proposition. Immediate earnings. Albert Mills, 5190 Monmouth, Cincinnati, Ohio.

MEN Or women sell made-to-order house-dresses. One dollar profit per sale—two sales per hour. Merrie Marie, Salt Lake, Utah.

AGENTS—Mosco Corn and Callous Remover will build you a steady repeat business. Send today for pocket-size trial outfit. The Moss Company, 504 Searle Bldg., Rochester, N. Y.

AN Opportunity to make \$100 weekly selling all wool, union made-to-measure suits and topcoats at \$23.50 and up. Build big repeat business. Big pay daily—monthly bonus extra. Large swatch samples free. W. Z. Gibson, Inc., 500S Throop St., Dept. R-517, Chicago.

NEW Kind of automatic window washer. Sensational seller. Agents make \$1.40 profit on single sale. 15 to 25 sales per day easy. Write National Industries, 67 E. Lake St., Dept. 154, Chicago.

FREE "Booklet of money making opportunities," new ideas, original plans, money making secrets and other valuable information. None require peddling or outfits. Elite Co., 84 Elizabeth St., New York.

AMAZING Liquid instantly waterproofs, preserves, polishes leather shoes—last indefinitely; test bottle 10c. Permoshine Co., 1110A Hartford Bldg., Chicago.

AGENTS—Make big money selling high quality prepared waxes, polishes and other products that are necessities in every home. Protected territory means a profitable business of your own. Write to Gold Medal Products Company, North Chicago, Ill.

DON'T Sell for others—Employ agents yourself. Make your own products. Toilet articles, household specialties, etc. 500% profit. Valuable book free. National Scientific Laboratories, 1935W Broad, Richmond, Va.

ARE You old at forty? See our advertisement on page 150 of this issue. The Electro Thermal Company, 2128 Morris Ave., Steubenville, Ohio.

AGENTS' Attention: Nifty auto accessory. 100% profit and F. O. B. Cataract Auto-Washer Co., Topeka, Kans.

MEN Wanted—to demonstrate and take orders direct from motorists. Amazing magnetic trouble light. Sticks on metallic surfaces. Our men earn as high as \$75.00 weekly. Write for demonstrator. Magno, Beacon Bldg., Dept. 164, Boston, Mass.

MEN Wanted immediately by giant international industry; over 7,000 already started; some doing annual business \$13,000; no experience or capital required; everything supplied; realize success, independence Rawleigh's way; retail food products, soap, toilet preparations, stock, poultry supplies; your own business supported by big American, Canadian, Australian industries; resources over \$17,000,000; established 40 years; get our proposition; all say it's great! Rawleigh Company, Dept. D-J-PPM, Freeport, Ill.

BROOMOP—Fits ordinary house broom. For polished floors, sidewalls and ceilings. Dustermat—Slips on like a glove. Fits either hand. Cleans and polishes. Every car owner, housewife, store and office wants one. Sample outfit 50c. Fred Henderson, Creston, Iowa.

AGENTS—Make a dollar an hour. Sell new kind of sharpeners. Sharpens all knives and tools quickly. Demonstrating sample 10c. Premier Mfg. Co., Dept. 102, Detroit, Mich.

NATIONAL Manufacturer of guaranteed quality shoes for entire family, established 25 years, wants representatives. New territories now open. Big profits. Sales outfit, catalog, and valuable book sent free. Write Mason Shoe Mfg. Co., Dept. 42, Chippewa Falls, Wis.

AGENTS—Fast selling pile remedy. Pile-O-Chase Chem. Co., Foxburg, Pa.

MEN! Women! Earn big money. Establish permanent business as our exclusive representative your county. Get particulars quick. Indianapolis Soap Co., Dept. 51, Indianapolis, Ind.

AGENTS And Distributors—Amazing new home invention for extracting orange and lemon juices. No competition. Large cash profits. Protected territories for producers. Get demonstrator at once. Will earn \$100 weekly. Kwikway Products, 1415 Pine St., Dept. D-120, St. Louis, Mo.

BUILD Your own business. Sell shirts and ties. No investment needed. Big self-selling sales outfit free. Liberal commissions. Write Public Service Mills, 521CF 30th St., West New York, N. J.

BIG Money daily selling shirts of all kinds, neckwear, underwear, Sox, pajamas, sweaters, raincoats, coveralls, pants, children's play suits. Experience unnecessary. Outfit free! Nimrod Co., Desk 8, 4922-28 Lincoln Ave., Chicago.

\$20 A DAY Easy, all or part time selling greatest line of shirts, underwear, hosiery, neckwear. Lowest prices. Big commissions. Write today for big free outfit. Carter Welch, Mgr., 227 W. Van Buren, Dept. 512, Chicago.

NEW Imported changeable price tickets, instant seller, every store needs them. Liberal commissions. Tiara, 160 Fifth Ave., New York.

NEW Electro-magnetic auto lamp. Sticks anywhere on car. An everlasting flashlight. Big money making opportunity; agent's demonstrator \$2. (on approval). Will sell itself on sight or return it. Exclusive territory for steady producers. Write today. National Electric Corporation, 230 High St., Newark, N. J.

DISTRICT Managers! Crew managers! General agents! Two sales daily will pay your saleswomen \$51 weekly and net you \$55 monthly overwriting. What have you? Write Daintymaid, J-708, Meriden, Conn.

AGENTS—Magic hot pads, fairy damask tablecovers, sponge rubber mats, and 50 other fast sellers. Write B. & G. Rubber Co., Dept. 437, Pittsburgh, Pa.

DON'T Sell for others—Employ agents yourself. Make your own products. Toilet articles, household specialties, etc. 500% profit. Valuable book free. National Scientific Laboratories, 1935W Broad, Richmond, Va.

AGENTS: Make \$25.00-\$100.00 weekly selling Comet Sprayers and Autowashers to farmers and autoists. All brass; throws continuous stream. Established 40 years. Particulars free. Busler Co., Box C-11, Johnstown, Ohio.

ASTONISHING. Write for hundreds money making plans. Home, office. Men, women wanted immediately. Leredu Co., 17 Parkrow, New York.

OVER 200,000 Articles at low wholesale price. Directory 10c. Popmorris, 2140 N. Carlisle, Philadelphia.

AGENTS: Up to \$16 day and new Bulk auto offered. Sell groceries. Over 400 items for every home. Steady job. Your groceries about half price. Send for new free plan. Harley Company, Dept. D-2016, Cleveland, Ohio.

"WHOOPEE Horns." "The Wonder Auto Novelty." Sells \$2. Sample \$1. Rico, 166 W. 72d St., New York.

NEW Scientific automobile specialties. Self selling. Automotive Research Company, Kingston, N. Y.

FREE Trousers offer. Free outfit. \$15.00 daily writing orders for guaranteed tailored-to-fit trousers. World's greatest value at \$3.95. Big commissions. Wonderful sideline. Dunlap Pants Co., Dept. 122, Cincinnati, Ohio.

AGENTS—Sign men. Collect up to \$4.00 an hour! Speediest selling line; snappy clever display signs for retailers. Free samples. Ever-Ready, 52-P East Ninth, New York.

MEN Making \$78 to \$119 weekly showing home owners beautiful 4-color illustrations of our dependable guaranteed trees, shrubbery, etc.; pay weekly; everything furnished free; experience unnecessary; full-part time; permanent. Perry Nurseries, R-4, Rochester, N. Y.

EARN Your way through college selling waxes and polishes internationally known in homes, institutions, factories, etc. Send 50c for assortment that retails for \$2.30. Reserve your territory now. Gold Medal Products Co., North Chicago, Ill.

250,000 ARTICLES At low wholesale prices. Directory 10c. W-Patterson, Publishers, 4111 University, Des Moines, Iowa.

AGENTS—No peddling necessary to make \$20 to \$100 weekly in home or office. Send for free booklet describing 67 money making opportunities. Elite Co., 84 Elizabeth St., New York.

DON'T Sell for others—Employ agents yourself. Make your own products. Toilet articles, household specialties, etc. 500% profit. Valuable book free. National Scientific Laboratories, 1935W Broad, Richmond, Va.

STOP Punching door bells! Make big money every week placing Glitknife countercards on store counters everywhere. Glit Company, G 5419 Chicago Ave., Chicago.

GENUINE Alligator and cocoonant electric lamps. Joseph Fleischman, Tampa, Fla.

400% PROFIT Selling perfumes. Melrose Works, Box 731, Chicago, Ill.

GET The dollars that are waiting for you. Sell the world beating Eli Washing Mystic. Write today for our liberal offer. Berberich Company, Kirkwood, Mo.

A NEW Product prevents runs in silk stockings. Hailed with delight by women. Sample 35c. Act now. Baldwin Sales Co., Dept. 1-509 Fifth Ave., New York, N. Y.

JUST Out—New electric flashing sign, beautiful colors, unbreakable, guaranteed. Sells to every merchant on sight. Retail price \$13.50, your profit 100%. We guarantee your sales. Write at once for protected territory. Preston Mfg. Co., Dept. S-18, St. Louis, Mo.

AGENTS: Big money selling Lincoln portrait from original negative. Large field. L. H. Roberts, 736 Quebec St., N. W., Washington, D. C.

HAN-DEE Cloth quickly polishes all metals. One minute's demonstration convinces. Men everywhere snapping up this rapid money maker. Retail 25c. Sample free. Buskin Company, 1501 Euclid, Cleveland.

FREE "Unheard of Booklet" describes daily problems. Increases income 300%. Hirshfield's, Kossuth Ave., New York.

AGENTS \$15 Daily selling fancy launderless table cloths. Samples free. Empire, 2260 Kirkland, Chicago.

MOTORISTS, Attention: Enjoy a hot meal when you stop. The Conklin Exhaust Cooker roasts, steams or boils as you ride. Fuel costs nothing. No time lost. Have healthful, better tasting food without waiting when your mealtime comes. Cooks breakfast, dinner and supper. Quickly installed by anyone. Send \$5.00. Agents wanted. Conklin Mfg. Co., Box 475, Palm Beach, Fla.

FREE "Unheard of Booklet" describes daily problems. Increases income 300%. Hirshfield's, Kossuth Ave., New York.

AGENTS 150% Profit. Dri-Kleanit cleans any car like new. Removes mud, grease, road oil, all one operation. No soap or water used. Cleans car for about 10c. Wonderful seller. Send three 2c stamps for sample. American Accessories Co., Desk 6231, Cincinnati, Ohio.

EVERLAST No-Pin clothes line—needed in every home, snappy demonstration, sure sale; large commission. John Dunn, Olive Blvd., South Hempstead, N. Y.

"QUICK Trick." The automobile dry wash and polishing cloth washes and polishes finest automobile and furniture finishes in one simple operation. Also keeps chromium metal trim in perfect condition. Exceptional sales and profits. Sample free. Walter S. Doe & Co., Dept. 80, Kent, Ohio.

SELL "Prevents Runs" Guaranteed to prevent runs in silk hosiery. Large profits. Particulars. Specialty Mfg., 127P S. Broadway, Los Angeles, Calif.

ENGRAVED Name plates, signs, numbers, desk plates, store window signs, etc.; profits large. Brett Bros., Winthrop, Mass.

SUPER Stropper—new direct selling sensation! Make six easy sales daily, earn \$10.80! Produces ultra-keen sharpness. Fascinating appearance, convenient shape, ten year guarantee. Write today or forward \$3.95, stating type blade used. Wright Specialty Company, 1040-M South Broadway, Los Angeles, Calif.

MAKE Ice from heat for 2c daily. New type refrigerator Crosley Icyball non-electric. Preserves foods, drinks in hottest weather. One half cost of other mechanical refrigerators. Guaranteed. Agents wanted. \$25 profit every sale. Crosley Icyball Division C-824 Arlington St., Cincinnati, Ohio.

AGENTS Buy direct at lowest mill prices. Men's latest fancy hose, doz. \$1.45-\$2.10; ladies' Pointex silk hose, doz., \$4.25-\$7.00. Catalog free. Superior Knitting Company, Dept. 34, New Haven, Conn.

SELL Stores 5c carded breathlets, etc. Lorrac Products, Albany, N. Y.

AGENTS—Men, women, big money selling needle threaders to housewives. For particulars and prices write L. Miller, Box 3, Tremont Station, New York City.

ENGRAVED Nameplates, signs, numbers, initial, desk, city nameplates. Big profits. Hilton Specialty, 90 Stewart, Providence, R. I.

DISTRIBUTORS. Prefer men or women, house to house experience. Avalon Specialty Co., 8320 South Chicago Ave., Chicago.

WANTED—Book and magazine agents. Men and women. New line. No competition. Sells on sight. Big demand everywhere. Box 367, Price, Utah.

AGENTS Make \$100 weekly with the only perfect reducing remedy, externally. Money back guarantee. Closed territory. Columbia Laboratories, 102 Murray St., Newark, N. J.

MANUFACTURE Glass name and number plates, mirrors, signs. Investigate! Radiant Signs, 15905 Alden, Detroit, Mich.

SPEED-E. 3 In 1 vegetable shredder; unique combination. Three distinct sizes all in one piece. Greatest of all household necessities. Nothing like it. Thirty million ready buyers. Amazing demonstration. Agents, distributors, crew-managers reaping financial harvests. 50 to 150 dollars weekly profits. Write for details. (Be convinced. Sample postpaid 50 cents). Speed E Company, 7021 Arthur St., Oakland, Calif.

BIG Profits selling only guaranteed electric waffle iron for \$2.75. Everybody buys. Supreme Products E, 8 So. Dearborn, Chicago.

AGENTS Up to \$10 daily introducing guaranteed hosiery. 126 colors, styles. Men, women, children. Undersell stores. Auto and your own hose furnished to producers. Demonstrator free. Send no money. Betterknit Hosiery, Desk BC-4631, Columbus, Ohio.

FREE Trousers offer. Free outfit. \$15.00 daily writing orders for guaranteed tailored-to-measure trousers. World's greatest pants value. Big commissions. Wonderful pocket sideline. Hutchins Pants Co., Dept. 424 A, Cincinnati, Ohio.

SELL New signs, embossed price tickets and changeable signs, big profits. Wonderful selection, all storekeepers buy. 25c brings \$1.00 worth of samples. Information free. P. Franklin Co., 3322 3rd Ave., New York.

WANTED: District manager to appoint agents. Unlimited opportunity. No canvassing. Mother Hubbard Products, 534U Congress, Chicago.

MYSTERIOUS Pocket novelty. Sample 10c. John Leibowitz, 23 Jefferson St., Paterson, N. J.

150% PROFIT! Demonstrating rubber goods line. Items everybody needs. Experience unnecessary. Free outfit. Easetex Manufacturers, 431-AP North Clark, Chicago.

CHEMIST—Inventor wants representatives to take orders for new 25c household necessity. Every home uses \$3.00 worth netting \$2.04 profit! Wonderful repeater. Absolutely new demand every 4 months. Over 1,000,000 sold last year. Experience unnecessary. Write immediately. Zoro, 129-P N. Halsted, Chicago.

MAKE Your own products. Employ agents yourself. Toilet articles, soap, extracts. We furnish everything. Valuable book free. National Scientific Laboratories, 1935W Broad, Richmond, Va.

QUICK Easy sales. Small simple cleaning device. Average profit \$1.00. 15 to 20 sales per day. Experience unnecessary. Free sample offer. Old reliable organization. MacLeod Co., Dept. PM-4, 2640 Greenview, Chicago.

NEW Article which appeals to every house-wife, costs you 6c, retail for 25c. 200 easily carried in pocket. 4 samples for 25c sent on request. Bingo Mfg. Co., 1149 So. San Pedro St., Los Angeles, Calif.

AGENTS 40 To 50% profit. Sell complete new line guaranteed hosiery. All colors, styles. Work all or part time. Free hose for own use with your outfit. Write today. Fashion Silk Hosiery Co., Desk 631, Cincinnati, Ohio.

BIG Money demonstrating famous Dupont Launderless Tablecloth. Also \$2.98 trench coats, and full line waterproof necessities. Sample free. American, 724-AB Roosevelt, Chicago.

CASH Paid for Butterflies, Insects. See Sinclair Display Advertisement on page 28.

MAGICLOTH. The world's best metal polish; on market twenty years. Everybody buys. Unusual profits. Magic Mfg. Co., 3317 Summit, Kansas City, Mo.

AGENTS—Make two dollars an hour selling name and business cards and stationery. Samples free. Broomhall Card Shop, 21 A South 2nd St., Harrisburg, Pa.

WHERE To buy thousands of articles wholesale. New directory. Agents wanted. Pruitt, Brookfield, Ill.

AMAZING Nulustre cloth, great money maker; cleans, polishes all metals. Big profits; quick sales. Exclusive territory. All or part time. Samples free. Irving Shef, 20 Shef Bldg., Weehawken, N. J.

SANITARY Rubber goods, etc. New items. Samples free. Dependable, 716 Madison, Chicago.

NEW, Profitable—Sell auto step mats. Quality rubber with owner's name molded white. Details free. Ebonite Products, Dept. D-80, 895 Main, Akron, Ohio.

BIG Money easy, simply showing new Polly wrench. 10 wrenches in one. Guaranteed! Fast seller. Sample furnished. Gellman Mfg., Dept. 6-R, Rock Island, Ill.

NO Excuse to be out of a job. Hundreds of firms need representatives in every community in the U. S. Send for sample copy of Opportunity Magazine, D750 N. Michigan Ave., Chicago. Your whole future may lie between the covers of this magazine.

WHIRLWIND Seller. Mystery silverware polishing cloth in tin cans. Sample free. Mohler, Onamia, Minn.

FINEST Needle case, self threading needles, needle threaders. \$50 to \$100 weekly. Samples 25c, particulars free. Empire, 2260 Kirkland, Chicago.

FREE "Unheard of Booklet" describes daily problems. Increases income 300%. Art-Craft Co., Kossuth Ave., New York.

OH Hello! Why didn't I see this before? Christy's Iron Rust and Stain Remover sells like blazes. Write for free sample. Christy, Inc., 5067 Broadway, Newark, N. Y.

\$20.00 DAILY Selling lifelong underground airdials. Sample \$2.95 prepaid. Free information. Expert Radio Shop, 14236 Indiana, Detroit, Mich.

MAKE Your own products. Employ agents yourself. Toilet articles, soap, extracts. We furnish everything. Valuable book free. National Scientific Laboratories, 1935W Broad, Richmond, Va.

A REAL Surprise await you! Get details of our premium deals, which make sales easy! Foods, toiletries, remedies, all guaranteed. Togstad Corp., 32 Punion St., Kokomo, Ind.

BIG Profits, quick repeats, placing Aspirin, Notartar, Flints, Silktone, other self-selling counter cards with dealers. Over 100% profit. Sterling Co., HT, Baltimore, Md.

CHEXARUN: Latest invisible fluid, stops silk hosiery runs. Make this yourself also many unusual, biggest-selling specialties using Miller's guaranteed formulas. Investment small. Profits immense. Miller, Chemist, 706-L Chemical Bldg., Tampa, Fla.

LOIDLAC Forever ends automobile polishing and repainting; instantly restores colors. Guaranteed, sun-water-weather proof. Make this yourself; also other high-class automobile specialties from my unequalled guaranteed formulas. Miller, Chemist, 1706, Tampa, Fla.

AGENTS: Stamping names on pocket-key protectors. Sample check with your name and address, 25c. Stamping outfits, Emblem checks, check-fobs, name plates. Hart Mfg. Co., Desk 2, 303 Degraw St., Brooklyn, N. Y.

SUCCEED With your own products. Make them yourself. Formulas, processes, trade secrets, all lines. Catalog free. B. Thaxly Co., Washington, D. C.

80c PROFIT On \$1.00 sales. Wonderful cleaner for automobiles, furniture, metal and glass. Fast repeater. Your name on labels. Exclusive territory. Free sample. Minute Kleen Laboratories, Dept. E, Evansville, Ind.

PORTRAIT Men you can make money anywhere selling our guaranteed portraits. Send for free frame catalog. Portrait Agents' Supply Co., Dept. F, LaPorte, Ind.

MAN Wanted, well acquainted, reliable, energetic. No investment. No experience—just your time. Big earnings. Free outfit. Beard Paint Co., Dept. 4, Kansas City, Mo.

"INSTANT Weld" welds rubber instantly without heat, gasoline or tools. Make big money all year 'round. No experience required. Write for territory. Tourists Pride Mfg. Co., Desk M-3, Minneapolis, Minn.

FLAVORING Extracts—Bottle yourself! Concentrated. Labels furnished. 600% profits! Whirlwind moneymakers! Free offer! Thomas Manufacturing Company, Indianapolis, Ind.

"HOW To Secure Agents," a specially prepared booklet, tells of one of the most inexpensive methods in which to secure good live producing agents. It is free; write for your copy today! M. L. Rund, Mgr. Classified Advertising, Popular Mechanics Magazine, 200 E. Ontario St., Chicago, Ill.

SENSATIONAL New invention makes shaving a pleasure. Nothing like it! Pays \$2.75 profit on \$5 sale. You should make \$25 daily. Every man you meet wants one. Territories still open for state managers. Pacific Metal Industries, Dept. E, San Diego, Calif.

400% PROFIT—Build a permanent business with giant temporary transfers and permanent window letters in colors and gold. Sell every store and office. Exclusive territory. Sample free. Print-A-Sign, Akron, Ohio.

WANT Distributing agent for Hanslick powdered handsoap; removes anything from the hands without injury to skin; everybody a customer; great opportunity for hustler to get in business; sample free. Solar Products Co., 32144 So. Troy, Chicago.

AGENTS—\$75.00 Weekly. New Sunbeam changeable letter electric sign selling fast. Every store buys. Excellent, profitable territory open. Write today for particulars. Sunbeam Sign Co., 5509 West Division St., Chicago, Ill.

OLIVER Cleared \$700 in 30 days with our line of books and Bibles. Outfit free! Exclusive territory! Nichols Co., Dept. B5, Naperville, Ill.

GET Our free sample case. Toilet articles, flavorings and specialties. Wonderfully profitable. LaDerma Co., Dept. A, St. Louis, Mo.

\$60-200 A WEEK. Genuine gold letters for store windows. Easily applied. Free samples. Liberal offer to general agents. Metallic Letter Co., 438-B North Clark, Chicago.

CHICAGO Expert valued \$3 stone at \$900. The diamond's only guaranteed rival! Greatest spare time side-line article ever known! Amazing profits. \$5 pocket sample case free. Write quick! Mexican Gem Company, Dept. PM, Monterey, Calif.

GREATEST Opportunity; newest proposition. Build continually paying business in your own name. Household, industrial, brushes, brooms, mops, dusters, fully guaranteed. New catalog, all net prices, no discounts to bother with. Make as high as 300 per cent and over. Write today. Wire Grip Sanitary Brush Corp., 41 East 11th St., New York.

TIME Counts in applying for patents. See pages 138 and 139. Clarence A. O'Brien, Registered Patent Attorney, Washington, D. C.

AGENTS: Free catalog 200 household specialties, toilet preparations, food products, remedies, portraits, frames, photo pillows, medallions, religious goods, pictures, damask tablecloths. Credit. James C. Bailey Co., Station C1, Chicago.

SELL Koehler's blue signs. Cost 3/4c, sells for 20c. Koehler, 717 N. Fourth, St. Louis, Mo.

BIGGEST Surprise offer ever made. Be sure to answer this ad. My line of soaps, coffee, tea, spices, toilet articles, household specialties, pays you bigger profits. M. G. Roth, President, 2833 Dodder, St. Louis, Mo.

MAKE Your own products. Employ agents yourself. Toilet articles, soap, extracts. We furnish everything. Valuable book free. National Scientific Laboratories, 1935W Broad, Richmond, Va.

\$50.000 PICTURE Man Friedman made canvassing. Beginners can make \$100.00 weekly with my sales talk. Experienced men make more. Free book "Profits in Portraits" explains. Sample free. Picture Man Friedman, Dept. 8, 109 West Austin, Chicago.

CALIFORNIA Perfumed beads selling like hot cakes. Agents coining money. Big profits. Catalog free. Mission Factory P, 2328 W. Pico, Los Angeles, Calif.

WE Start you without a dollar. Soaps, extracts, perfumes, toilet goods. Experience unnecessary. Carnation Co., 641, St. Louis, Mo.

BIG Money and fast sales. Every owner buys gold initials for his auto. You charge \$1.50; make \$1.34. Ten orders daily easy. Write for particulars and free samples. American Monogram Co., Dept. 40, East Orange, N. J.

MAKE—Sell your own goods. We tell you how. Formula catalog free. Clover Laboratories (PM) Park Ridge, Ill.

SELL Housewives something they want. A necessity. Reduces gas bills 25%. New in your territory. No competition with this guaranteed gas saving device. Exclusive sales rights. 400% profit. Box 18E, East San Diego, Calif.

AUTOMOBILE Specialties. Guaranteed formulas for all latest money makers. Lowest prices. Write for free lists. Murphy, Chemist, Tujunga, Calif.

NO Dull times selling food. People must eat. Federal distributors make big money; many over \$3,000 yearly. No capital or experience needed; guaranteed sales; unsold goods may be returned. We furnish you with license, sample case and free samples for customers. Repeat orders sure; exclusive territory. Ask now! Federal Pure Food Co., A2307 Archer, Chicago.

BIG Money applying gold initials on automobiles. Easiest thing today. No experience needed. \$1.45 profit every \$1.50 job. Free samples. "Ralco," X-1043 Washington, Boston, Mass.

SELL Men's neckwear—wonderful proposition. Astor-M, 39 East 28th, New York.

REMNANT Store, Bethel, Ohio. Greatest Dry Goods Bargains on Earth. Agents and Dealers.

AGENTS—Make a dollar an hour. Sell Mendets, a patented patch for instantly mending leaks in all utensils. Sample package free. Collette Mfg. Co., Dept. 404, Amsterdam, N. Y.

GOLD-LEAF Window letters and script signs; no experience; 500% profit; samples free. Consolidated, 69-T West Van Buren, Chicago.

POLMET Polishing Cloth removes tarnish from metals without the use of liquid, paste or powder. Our agents say it sells like "hot cakes." Retail 25c; sample free. Gale & Co., Inc., 15 Edinboro St., Boston, Mass.

AGENTS—New shirt proposition. No capital or experience needed. Commissions in advance. Samples free. Madison Company, 566 Broadway, New York.

THAXLY Formulas produce perfect products. All lines. Catalog free. B. Thaxly Co., Washington, D. C.

AGENTS Wanted—On a fast selling 25c item for the kitchen, costs you 8 1/2c. Sample sent parcel post prepaid for 10 cents. P. Seed Filfer Mfg. Co., Inc., 353 Broadway, New York.

MAN in each town to plate auto parts, reflectors, bathroom fixtures, refinish beds, mirrors, chandeliers; by new method. No capital or experience required. Simple plan of manufacturing at home starts you in big money-making business. Outfit furnished. Free particulars and proofs. Gun Metal Co., Ave. H, Decatur, Ill.

A BUSINESS of your own—Making sparkling glass name and number plates, check-boards signs. Big book and sample free. E. Palmer, 512, Wooster, Ohio.

AMAZING Profits showing new table cloth. Looks like linen. Wash like oilcloth. No laundering. You just take orders. We deliver. Pay daily. Sample free. Bestever, 231 Irving Park Station, Chicago.

AGENTS—Clever Invention! Inkspoon makes every pen a fountain pen. Fast office seller; big profit, demand increasing everywhere. Exclusive territory offered. Sample free. H. Maru Company, Tribune Bldg., New York, N. Y.

BIG Profits! Fast sales! \$9.75 automatic washing machine. Guaranteed. Write Storm Royalty Co., 3601 Enright, St. Louis, Mo.

REPLATE Brass worn-off automobile parts, reflectors, bath room fixtures, worn spoons, forks, etc., with pure silver. Looks like new. Use U-Kan-Plate Polish. Postively no mercury; \$1.00 half pints. Postpaid. Satisfaction guaranteed. Agents wanted. Dept. A, U-Kan-Plate Co., Philadelphia.

SELL Razor blades, sideline. Big profits. Agrab Co., 479 Ralph Ave., Brooklyn, N. Y.

HIGH-GRADE SALESMEN WANTED

\$60.00 FIRST Day for Guggenbuehl Amazing new Sunshine lamp at only \$14.75 is taking the country by storm. Gives either genuine ultra-violet or infra-red rays at turn of switch. Guaranteed to equal in final health results the highest priced hospital lamps. Absolutely safe for home use. Free 100 lessons with each lamp covering treatment of over 80 diseases. Course alone worth \$15.00. An absolute knock out for the money. If you want to clean up big, wire or write for my wonderful proposition today. Wm. F. Richardson, Aerial Electric Co., 815 Monroe St., La Porte, Ind.

BONUS Check for you. Adellite, the sure-fire seller. A new, spectacular electric window display; ever-changing colors, knock-out set of business and holiday posters; patented changeable letter system defying imitation. Fat commissions in your pocket every night. Bonus check on Saturday. Dignified work calling on merchants and better business houses. Special model for banks. Repeat orders credited. Special thirty day trial demonstrator offer. Display Products Co., 409-A East 31st St., Kansas City, Mo.

FINANCIAL Independence and income for life without extra work. Enjoyed by our distributors because they have stopped selling slow or non-repeating articles, joining our organization marketing a product which sells on sight and repeats indefinitely. Needed by all business and professional men. 240% initial profit. Repeat commissions without call-backs. Only high class salesmen wanted. No house to house peddling. Brand new. Unusual. Copyrighted. The Commonwealth Co., 508 So. Dearborn, Chicago.

SALESMEN—Brush salesmen. A real opportunity for an experienced brush salesman (house-to-house). Commission straight 50 per cent. Handy brushes free. Liberal territory. Donald Brush Co., established 1923 now nationally known. Donald brushes are of highest quality, reasonably priced, approved by Good Housekeeping Institute. Also opening for field managers. Donald Brush Co., Inc., Camden, N. J.

SELL Nothing, earn up to \$170 weekly, empty handed. No samples to tote. Oldest and largest punchboard firm, established 20 years, rated \$500,000, announces amazing new plan. Salesmen cleaning up. No one invests a penny. We even pay express charges. Unsalable merchandise returnable. Big season now here. Full commission repeat business. Grab this quick. K&S Sales Co., 4333 Ravenswood, Chicago.

NEW And plenty different. Fast selling 5c-10c merchandise on attractive counter cards. 100% commission for you and dealers. Advertised by radio. No capital required. Catalog free. World's Products (Estab. 1921), 39 Central, Spencer, Ind.

ADVERTISING Pencils sell fast to every line of business. New line. Quick cash commission plan. Main or sideline. Free pocket outfit to real salesmen. Chicago Graphite Co., 130 So. Clinton, Chicago.

SALESMEN: Our varied line enables us to offer you a sideline for almost any class of trade. State territory and class of trade called on, also references. Bradford & Co., Inc., St. Joseph, Mich.

SALESMEN Make \$5.00 an order selling high-grade suits, topcoats \$19.85. Fine materials, union made. Big repeat business. Free giant outfits. Write Metro Tailors, 879-L Broadway, New York.

\$18 To \$25 Daily; biggest selling line of men's suits, \$11.95, \$14.50, \$16.95, \$19.95. Amazing values. Pure virgin wool overcoats \$18.95. Also raincoats, slickers, top coats and boys' suits. Biggest commissions paid in advance. Liberal bonus. Free outfit. "Jim" Foster, Inc., Dept. 24, 2250 S. Spaulding Ave., Chicago, Ill.

300% PROFIT Selling Mystery Gas Lighter. Retail 25c. Costs you \$1.00 doz. Sample free. Square Deal Mfg., Desk PM6, Bradford, Pa.

ARE You old at forty? See our advertisement on page 150 of this issue. The Electro Thermal Company, 2128 Morris Ave., Steubenville, Ohio.

\$200.00 MONTHLY Salary, \$10,000 yearly commissions. Easy, sure. Sell "Royal Policy." Death benefit \$5,000. Disability \$100 monthly. Sickness \$50.00 monthly. All for \$3.65 yearly. Everybody 16 to 70 buys. No medical examination. American Peoples Life, Dept. 1512D, 134 N. LaSalle, Chicago.

SALESMEN, Calling on manufacturers, department stores, institutions, schools, etc. Sell the building superintendent a giant pump, guaranteed product, removes stoppages in plumbing pipes. \$5.00 commission on each sale. Fernald Mfg. Co., North East, Penna.

CLOTH Advertising specialties. New items never shown before. Snappy numbers for every line of business. Big commissions. Get them while they're hot. Fred Henderson, Creston, Iowa.

SALESMEN—Calling on hardware, sporting goods, notions, toys, drug and department stores. New, fast selling outdoors plaything for boys and girls. Liberal commission. Tora Warner Co., 1601 Pleasant St., Cincinnati, Ohio.

WONDERFUL Invention. Seals fifty envelopes minute. Sells on sight at \$2.25. Attractive trial offer. Square deal. Bank references. Kendall Sealer Co., 440 Sansome, San Francisco, Dept. C-17.

FREE Trousers offer. Free outfit. \$15.00 daily writing orders for guaranteed tailored-to-measure trousers. World's greatest pants value. Big commissions. Wonderful pocket sideline. Hutchins Pants Co., Dept. 4248, Cincinnati, Ohio.

BIG Money showing \$2.98 trench coats and DuPont's Launderless tablecloths. Samples free. American, 724-AE Roosevelt, Chicago.

BRAND New union label printing line. Largest assortment cuts and specialty items in country at half price. 72-hour delivery. Big commissions advanced. Sensational bonus offer. Experience unnecessary. Outfit free. Northwestern, 625-G Jackson, Chicago.

DAILY Cash! \$25.00 sale. \$15.00 is yours. Merchants amazed at wonderful results! Big repeat commission income. Free kit. Sales Stimulators, Inc., 339 W. Madison, Chicago.

YOU Can sell business printing. Our big complete selling outfit makes it easy. Our quality and price positively beats competition. Thousands of prospective buyers. Free illustrations, big commissions daily—full repeats. Full time or part time. Write for details now. All-Trades Printing Service, 191 N. Second St., Rockford, Ill.

DON'T Sell for others—employ agents yourself. Make your own products. Toilet articles, household specialties, etc. 500% profit. Valuable book free. National Scientific Laboratories, 1935W Broad, Richmond, Va.

BIG Money daily, selling shirts of all kinds. Neckwear, underwear, Sox, pajamas, sweaters, raincoats, coveralls, pants, children's play suits. Experience unnecessary. Outfit free! Nimrod Co., Dept. 65, 4922-28 Lincoln Ave., Chicago.

SALESMEN Wonderful sideline. 40% commission paid daily. Sells all merchants. Pocket outfit free. David Lionel Press, 312 S. Hamilton, Dept. 142, Chicago.

PROFITABLE Sideline. Automotive Research Company, Kingston, N. Y.

FREE Trousers offer. Free outfit. \$15.00 daily writing orders for guaranteed tailored-to-fit trousers. World's greatest value at \$3.95. Big commissions. Wonderful sideline. Dunlap Pants Co., Dept. 122, Cincinnati, Ohio.

YOUR Pockets will bulge with commissions earned selling Red-I-Lite Electric Match for autos to garages and accessory jobs. Also advertising tire covers and other specialties. Full or part time. Dura-Products Manufacturing Company, Canton, Ohio.

COMMISSIONS Up to 55%! Experience unnecessary. Nationally known printing stationery line. Over 1,000 absolute necessities for every business. Lowest prices. Guaranteed quality. Thousands free cuts. 1930 outfit now ready. Kae-ser & Blair, Inc., Dept. 211, Cincinnati, Ohio.

EXPERIENCED Magazine salesmen take on fastest selling contract ever offered. Irresistible premium appeals instantly to everyone, everywhere. Nothing else like it. Big commission. Write quick. Geographical Publishing Co., 621 Plymouth Court, Chicago.

OUR Aspirin and candy laxatives. 6 for 5c on cards sell like fire. (Established 1921). Burton Laboratories, 1551 Donaldson, Cincinnati, Ohio.

THE Best seller and offer ever made salesmen. A real opportunity to build a business of your own. 100% profit to salesmen. Saves users 40 to 60% of their present costs. Steady income from repeat orders. See testimonials. The Economic Company, 203 North Second St., Richmond, Va.

SELL Dishwashers, \$6.50 to \$30. Electrics. Good proposition. Baum's Metal Specialists, Kansas City.

AGENTS Wanted. Sell new liquid discovery that restores show room lustre and color to old cars. Specialty Products Co., 402 Harewood Road, Nanaimo, B. C.

COMMISSIONS Daily. Sell classy printing and personal "N-Grav-O" stationery. Commissions on customers' repeat business. Bonuses. Interested? Write United Specialty Printing Co., PM424 So. 2nd, Minneapolis, Minn.

POOL Shooter, new fascinating vending machine. Merchants everywhere buy! Splendid sideline. Big profit maker! Free pocket outfit! Specialty Mfg. Co., W617 W. Division, Chicago.

BIG Commission daily selling office building directories and new changeable letter display signs to hotels, banks, merchants. American Signotype Co., 544 Washington, Chicago.

A PAYING Position open to representative of character. Take orders shoes-hosiery direct to wearer. Good income. Permanent. Write now for free book, "Getting Ahead." Tanners Shoe Co., 2004 C St., Boston, Mass.

TAILORING Salesmen; strictly made to measure pants at low cost of \$4.95 per pair. Collect \$1.00 commission at sale. Write for free outfit. Gold Seal Pants Co., Box 2, Mt. Healthy, Cincinnati, Ohio.

RELIABLE Men and cars. Liberal proposition. Establish independent business. Sell socket wrenches and other time-saving tools. Write for amazing introductory offer. York Co., 2640 Greenview, Dept. PM-24, Chicago.

PUNCHBOARD Salesmen. Up to \$10,000 yearly. New line. All fast sellers. Lowest prices. Full commission on repeat business. Catalog free. Puritan Novelty, 1409 Jackson, Chicago.

COVERALL Salesmen—Lettered garments, \$3.25. Commission 75c. Write for sample. Blue Bar Sales, 844 Dorr, Toledo, Ohio.

SALESMEN—Make \$5.00 an order, selling high-grade suits, topcoats, \$19.85. Fine materials; union made. Big repeat business. Free giant outfit. Write Metro Tailors, 879-K Broadway, New York.

NEW Specialty—Sells every business and professional man. Used by Bell Telephone Co., National Radio, etc. Four \$15 sales daily pay \$288 weekly. Walker made \$165 first day. F. E. Armstrong, Dept. PM, Mobile, Ala.

SELL 3A Garage door holders, simple, automatic, quickly installed. Interests garage owners, builders, everybody. Exclusive territory proposition. Knowlson-Stevenson Co., Ann Arbor, Mich.

80c PROFIT On \$1.00 sales. Wonderful cleaner for automobiles, furniture, metal and glass. Fast repeater. Your name on labels. Exclusive territory. Free sample. Minute Kleen Laboratories, Dept. E, Evansville, Ind.

PUNCHBOARD Salesman—Most gigantic line ever featured. Vending machines, all kinds. Make high as \$28.00 on single order. Repeat commissions. Beautiful colored catalog free. Lion Mfg., Dept. 8, 308 W. Erie, Chicago.

FREE Booklet describes 67 plans for making \$20-\$100 weekly in home or office business of your own. Elite Co., 84 Elizabeth St., New York.

SELL Goodyear raincoats; \$2.95 up. Goodyear Rainwear, 682 Sixth Ave., New York.

PUNCHBOARD Salesmen make big commissions, selling punchboards and vending machines. Reliable concern, established 20 years. Largest most complete catalog in colors, free. Best season now. Write today! Lincoln Sales, 116 S. Wells, Chicago. Dept. D.

SALESMEN: Reliable line disinfectants and paints, for merchants, schools, hospitals. Commercial Chemical Co., Marion, Ind.

EARN \$100.00 Weekly selling our \$1,500 accident and registration policy for \$1.00 per year. E. W. Shaw Company, Insurance Bldg., Denver, Colo.

MAKE Your own products. Employ agents yourself. Toilet articles, soap, extracts. We furnish everything. Valuable book free. National Scientific Laboratories, 1935W Broad, Richmond, Va.

WANTED District managers—Capable men to represent us in prosperous territories with direct home office contract. Our organization is the oldest of its kind in the health and accident business and offer exceptionally remunerative compensation. Write today for information. Dept. 18, Inter-State Business Men's Accident Association, Brown Bldg., Des Moines, Iowa.

PUNCHBOARDS—Hottest, largest money-making line ever offered. Season starting. Best commissions. Nothing to carry. Catalog free. Act! M&L Sales, 301 W. Adams, Chicago.

ELECTRICAL Tool line selling to garages, mechanics and auto owners, wonderful demonstrators, big commissions. Salesmen, write Barker Specialties, Girard, Penna.

MAIN Or sideline. Sell auto tires and auto accessories to tire stores, garages, etc. Protected territory, liberal commission. Economy Rubber Products Co., 604 Burkhardt Ave., Dayton, Ohio.

SALESMEN—Four \$15.00 sales to merchants net you \$40.00 daily. Sayers Systems, 2813 Sheffield, Chicago, Ill.

SALESMEN—Become independent. Own your business; experience unnecessary. Selling our \$10,000 Accidental Death; \$50 Accident; \$25 Sick Weekly Benefits—\$10.00 yearly. Other amounts proportionate. Guaranteed steady income from renewals. \$250,000 deposited Insurance Department, Universal Policy Dept. A, 40 Clinton St., Newark, N. J.

GOLD-LEAF Window letters and script signs; no experience; 500% profit; samples free. Consolidated, 69-V West Van Buren, Chicago.

\$60-\$200 A WEEK. Genuine gold letters for store windows. Easily applied. Free samples. Liberal offer to general agents. Metallic Letter Co., 438-A North Clark, Chicago.

HELP WANTED

AGENTS—Big chance to earn \$15 to \$25 daily, introducing new, patented, safety, automatic burglar proof ventilating window lock for homes, stores, offices, banks, all buildings. Sensational seller. Anyone, even without experience, should make 3 to 10 sales in single call. Nothing else like it. No competition. Write quick for terms—territory. Elmwood Mfg. Co., 1514 Elmwood Place, Cincinnati, Ohio.

WOMEN: To introduce new, fast selling imported sanitary necessity. Two sales daily nets you \$51.00 weekly. No deliveries; no collections; no experience or capital required. Write Mary Coleman, P-331, Meriden, Conn.

YOU Are wanted to resilver mirrors at home. Profitable business, plating auto-parts, tableware, etc. Write Sprinkle, Plater, 77, Marion, Ind.

IMPORTED Mexican diamonds guaranteed life time; get prices. Salesmen wanted. National Sales Company, Marfa, Tex.

MAN With car for permanent work in your own locality. Full or spare time. Unusual opportunity to make \$10 a day and expenses. Albert Mills, 5191 Monmouth, Cincinnati, Ohio.

HELP Wanted—Women demonstrators for Porfrey Face Clay and Odorless Hair Remover. Indorsed, guaranteed and demanded. Norman Products, Box 178, San Francisco, Calif.

CASH Paid for Butterflies, Insects. See Sinclair Display Advertisement on page 28.

AGENTS. Salesmen, our new quality designed rubber rugs sell on sight. Big profits. Write at once for territory and terms. Modern Rug Co., Akron, Ohio.

MAKE Big profits silvering mirrors. Easily learned patented process. Plans free. Wear Mirror Works, Excelsior Springs, Mo.

MANUFACTURER Wants distributor for 300-mile \$2.00 "Pocket" Radio. "Sells itself with music." Pays 100%. Spencer Radio, Dept. 10, Akron, Ohio.

EDUCATIONAL AND INSTRUCTION

FIREMEN. Brakemen, baggagemen (white or colored), sleeping car, train porters (colored), \$150-\$250 monthly. Experience unnecessary. 810 Railway Bureau, East St. Louis, Ill.

MEN—Women, 18 up. Want a government job? \$105.00 to \$280.00 month. Steady work. Short hours. Paid summer vacation. Common education usually sufficient. Experience usually unnecessary. We coach you without leaving home. 32 page book with full particulars and sample coaching free. Write immediately—today. Franklin Institute, Dept. H3, Rochester, N. Y.

DON'T Work for others all your life. Start "on your own." Operate a sample and circular distributing bureau. My instructions teach you this business from A to Z. Particulars, Wagner, Box 457-a, Palo Alto, Calif.

ART Students: I have sets of study plates showing more than 350 hands in every conceivable position. Send 10c (coin) for sample plates. Herbert Wuest, 7 Durant St., Lawrence, Mass.

PRIVATE School for boys and girls. Wilson Schools, Dayton, Ohio.

INTERIOR Wall decoration in a valuable new book covering all the modern methods of artistic wall treatments. Practical working instructions for both plain and decorative finishes are given. 451 pages, illustrated. Delivered to your door C. O. D. Simply pay postman \$4 and postage. Popular Mechanics Press, Room 801, 200 E. Ontario St., Chicago.

KEEP Your accounts straight. Use "Kopp's Account Book and Reckoner." Full particulars free. L. Ricker, 2458 South St. Louis Ave., Chicago.

LEARN Music shorthand. Box 193, Pismo Beach, Calif. Copy 25c. Stamps not accepted.

MEN 18-35. Railway postal clerks, \$158-\$225 month. Steady. Spring examinations likely. Common education sufficient. Particulars free. Write immediately. Franklin Institute, Dept. H14, Rochester, N. Y.

HYPNOTISM—Instantaneous method. Send for this amazing new method. Guaranteed. \$2.00. Dr. Q., Hypnotist, 37 Wick St., Buffalo, N. Y.

AIRPLANE Welding—Just out. Only book on new subject vital to all mechanics. Big demand for men thoroughly familiar with the work. Get into this big, new, unlimited field. Complete, illustrated book will be delivered to your door C. O. D. Simply pay postman \$3.50 plus postage. Popular Mechanics Press, Room 801, 200 E. Ontario St., Chicago.

BECOME A landscape architect. Uncrowded profession; wonderful opportunity for money-making. Easily mastered by mail. Earn while you learn. Est. 1916. Write for details. American Landscape School, 29 Plymouth Bldg., Des Moines, Iowa.

U. S. GOVERNMENT Wants men, \$1,700-\$1,900 and up at start. Railway mail clerk examination coming. Let our expert (former government examiner) prepare you for this and also rural carrier, post office, customs, internal revenue, and other branches. Write today for free booklet. Dept. 8, Patterson School, Rochester, N. Y.

WANTED Immediately, men-women, 18-35, qualify for permanent government positions, \$105-\$250 month; no government experience required. Paid vacations. Common education. Many needed soon. Write Ozment Inst., 101, St. Louis, Mo.

PHOTOPLAY Talking picture and magazine stories wanted for revision, development and copyright. Sell on commission. Established 1917. Booklet free. Universal Scenario Company, 406 Western and Santa Monica Bldg., Hollywood, Calif.

LEARN Rapid figuring by studying "Higher Arithmetic." Send 2 dollars for book or write for prospectus. F. A. Smith, 608 S. Dearborn St., Chicago.

SHORTHAND—Memoriscip, most rapid, readable system, easily learned at home. English, bookkeeping and typewriting courses. Cook Shorthand College, Roanoke, Va.

DOUBLE Entry bookkeeping 60 hours with 8 keys; guaranteed. (Diplomas.) International Bookkeeping Inst., 8 Springfield, Mo.

BOY Mechanic, Book One, new, revised edition—just out. 230 pages containing 489 articles of new material never before published in book form. Filled with interesting things to make and do. Owners of the old edition will want this new book. Delivered to your door C. O. D. Simply pay postman \$2 and postage. Popular Mechanics Press, Room 801, 200 E. Ontario St., Chicago.

TYPEWRITERS AND SUPPLIES

TYPEWRITERS—All makes, guaranteed, \$6 to \$33. Catalog free. Dee Typewriter Exchange, Ada, Okla.

TYPEWRITERS. Motorcycles, radios \$5; best \$35. Send cash. Agents wanted. Knights, 1512 Locust, St. Louis, Mo.

ADDING MACHINES

NEW \$3.50 Automatic adding machine. Adds, subtracts, multiplies, absolutely accurate. Capacity 999,999.99. Fully guaranteed. 75,000 pleased users. Makes adding easy, positive, quick. Eliminates mistakes. Saves time. Postpaid \$3.50. Bassett Co., 1458-F, Hollywood Ave., Chicago.

"MARVELOUS" 999,999,999 Calculator eliminates mistakes automatically. Postpaid \$2.75. Calculator Company, 721-GXPM Magoffin St., Lexington, Ky.

PRINTING, ENGRAVING AND MULTIGRAPHING

500 ENVELOPES \$1.25; 500 Letterheads \$1.00. Eppley, Queen, York, Pa.

PRINTING—Lowest prices. Samples free. The Bauer Print, Unionville, Conn.

PRINTING—Low prices, fine work. Stationery, circulars, folders, catalogs, etc. Modern plant, small town, low operating costs. Price list and samples free. Shenandoah Publishing House, Strasburg, Va.

PRINTING—General, done right. Low prices. Owen Press, Westmont, Ill.

YOUR Personal monogrammed stationery 50c per box. Applebaum, 1258 Brook, New York.

"NEARGRAVURE" Secret processes professional. Business stationery; facsimile copperplate; lithography; embossing. Samples—state business. Solldays, Knox, Ind.

5,000 BOND Letterheads, 8½x11, \$9.00. 5,000 circulars, 5½x8½, \$9.00. We save you money. Hilton Printery, 137 Front St., Worcester, Mass.

GENUINE Leather case with 150 vellum business cards, \$1.00 cash. Postpaid Baumgartner, 1570 Freeman, Cincinnati, Ohio.

250 WHITE Bond letterheads and 250 envelopes, \$2.49; 500 each \$4.00. Webster's Press, Farmland, Ind.

5,000 ENVELOPES (Printed) \$7.75; letterheads, \$2.19 thousand; statements, \$1.79 thousand. Lawrence Company, 700 South Kedzie, Chicago.

PUBLICATIONS, Catalogs, stationery. Prices reasonable. Annville Printing Company, Annville, Penna.

ONLY 69c For 250 business cards. Expert work guaranteed. Samples free. Hanzers, 10398 Cleveland, Phila., Pa.

200 LETTERHEADS, 100 Envelopes, printed \$1.00. Abbott Printery, Oswego, Kans.

1,000 BUSINESS Cards, \$2.75 postpaid. Samples free. John Miller, Montgomery Ave., Narberth, Pa.

PRINT Anything. Lowest prices. Highest quality. Catalog free. National Printing, Goshen, Ind.

LETTERHEADS, Envelopes, 500, \$1.10; 1,000, \$2.00; 5,000, \$8.00, plus postage. Samples, Coyle & Kimballs, Newport, N. Y.

1,000 LETTERHEADS Or envelopes \$2.50. Patton Company, 534 Paxton Block, Omaha, Nebr.

OUR Standardized plan makes it possible to print house organs and magazines at one-third ordinary prices. We print more than 1,100 different publications. Samples and particulars free. National Publishers Press, Grand Rapids, Mich.

200 LETTERHEADS And 100 envelopes \$1.00. 200 letterheads, 8½x11, 150 envelopes \$2.00. 250 cards \$1.00. Hoosier Print Shop, Portland, Ind.

WE Print stationery, booklets, catalogs, circulars. Samples. Commercial Press, Batavia, Ohio.

QUALITY Printing! Reasonable Prices! Send for Free Standardized samples and prices. Folders, Circulars, Catalogs our specialty. Earnest Fantus, 525 South Dearborn, Chicago.

250 BOND Letterheads, Envelopes, Billheads, Cards, \$1.35 each. Economic Press, Leonia, N. J.

PRINTING OUTFITS AND SUPPLIES

PRINT Your own cards, stationery, circulars, advertising, etc. Junior press \$5.90; job presses, \$11; rotary, \$149. Print for others; big profit. Easy rules furnished. Write for catalog presses, type, paper, etc. Kelsey Company, Q-11, Meriden, Conn.

PRINTING Outfits—Presses, type supplies, type novelties. Send stamp for catalog. Model Press, York, Penna.

RUBBER STAMPS

MUSIC Stamps, metal badges, numbering machines. Wait, Karstaedt, Dayton, Ohio.

COMPLETE Rubber stamping outfit \$1.00 postpaid. J. B. Hamilton, 1064 S. 32nd St., Birmingham, Ala.

RUBBER Stamps. 15c per line. Supplies. Newman & Son, Auburn, Nebr.

INFORMATION, SERVICE, COUNSEL

SAGINAW, E. S., Michigan. What do you want to know? Information on any subject. Where to buy—where to sell. Expert advice given special problems bothering you. Mail \$1 bill. Satisfaction guaranteed or money refunded. Specialty Expert, Box 273.

GUMMED LABELS

1,000 PRINTED: Name, business, address
50c. JBS Company, Box 93, Holyoke, Mass.

DUPLICATORS AND DEVICES

YOU can make 50 to 100 copies of a letter, notice, etc., at a cost of three cents on a Heyer Quality Duplicator. Write for free trial offer. The Heyer Duplicator Co., 909 Jackson Blvd., Chicago, Ill.

"EXCELLOGRAPH" Portable rotary stencil printing duplicators \$39. Terms. Description, testimonials, printed samples, free. Pittsburgh Typewriter Supply Co., Dept. 531, Pittsburgh, Pa.

"RAPIDOGRAPH" Rotary Stencil Duplicator, duplicates typewriting, handwriting, drawings. Complete \$25.00. Samples free. General Stamping Works, 238 E. 24th St., New York.

STENCIL Duplicator—Anyone can make. Practical! Different! Particulars, specimens free. Grinstead Laboratories, Oswego, Kans.

FOR THE HOME

NEED Extra money? Home weaving pays. Free book. Union Looms, Boonville, N. Y.

CEDAR Chests only \$11.65—"Red-i-Kut" complete with rich copper trim—you assemble and save half—send for pictures. Kuempel Furniture Company, Guttenberg, Iowa.

LATEST And best House Wiring book—just published—This new book of over 250 pages and 600 illustrations represents 15 years of work in perfecting the material for the best House Wiring manual it is possible to produce. The work of two men high up in the fields of mechanical arts and electricity. Price \$2.50 postpaid. Sent C. O. D. anywhere in the U. S. or possessions. Popular Mechanics Press, Room 802, 200 E. Ontario St., Chicago, Ill.

EASTER EGG DYES

"KAUFFMAN'S" Easter Egg Dyes. Beautiful, harmless, cheap. Easiest used. Sells at sight. Demonstrate neighbors, friends, societies, churches, schools. Sample set. Particulars 50c. Martin Laboratories, Gap, Penna.

FOR MECHANICS

ATTENTION—Home mechanics: We sell unusual cabinet hardware, chest trimmings, tea wagon wheels and casters, big line small hinges, locks, etc. Upholstering supplies, electrical hardware, knocked down cedar chests, etc. Send ten cents stamps for catalog. Thurston Manual Training Supply Company, Jobbers and Manufacturers, Anoka, Minn.

AN Automobile electrician of long practical experience gives his secrets and methods of quickly and thoroughly locating and repairing automobile electrical and ignition trouble. 25 practical questions and answers on baffling electrical problems thoroughly explained so you can understand them. Booklet invaluable to auto mechanics and electricians. Order on a postal. Pay postman \$1.00 and postage. Woodbury Products Co., 1624 Bonita Ave., Berkeley, Calif.

YOUR Initials cut onto your tools, traps, dog collar, key ring tag and other private possessions identify you as the owner; will settle disputes, will locate lost articles. Send only eighty-three cents for regular \$1.50 value—three 1/2" steel marker stamps. Stamps accepted. Adams-Barr, Columbus, Ohio.

BEST Opportunity for profit in 8-hour battery charging. Practically no investment, easy terms. Bargains in reconditioned car washers, paint sprays, compressors. Write today. Galbreaths Automotive, Box M-405, Troy, Ohio.

PATTERNS Of all shapes for the sheet metal mechanics for Blower systems and factory farm and home requirements. J. C. Harrington, West Medway, Mass.

IN Your home shop use our remarkable book called "Make It Yourself." Contains a great variety of 900 worth while things to make, all fully illustrated and explained. For the home mechanic, whether young or old. Delivered to your door C. O. D. Simply pay postman \$3 and postage. Popular Mechanics Press, Room 801, 200 E. Ontario St., Chicago.

FOR SMOKERS

GOLD Leaf tobacco. Mild, mellow; like rare old wine. Smoking, 4 pounds \$1; chewing, 4, \$1.25, postpaid. Belmont Farms, Box A, Chatham, Va.

2c STAMP Brings 50 hand made long filler 4 inch cigars factory direct. Pay postman \$1.75, smoke 8, double value or money back. Carney-Graham, Box J, Paducah, Ky.

SMOKE On me free—I'll send you free big generous sample Old Green River pipe tobacco. Enjoy the mild mellow tasty natural tobacco flavor. See how smooth and satisfying. No obligation. Send today. Pete Moberly, Box 775, Owensboro, Ky.

RAZORS AND BLADES

GILLETTE Razor blades honed and stropped, 1c each. Petter Wetterquist, Rockford, Ill.

ANTIQUES, WAR RELICS AND INDIAN GOODS

OLD Homemade lathe, stamp for particulars. Everett Kelly, Farmington, Iowa.

SEA Shells—Collection of twenty-five varieties of sea shells, postpaid \$1.00. Satisfaction guaranteed. H. Schoenlegh, 109 Post, Petaluma, Calif.

MILITARY Medals for your collection. Illustrated catalog 10c. Craig Dare, 67 E. 42d, Brooklyn, N. Y.

GENUINE Navajos: How they are made by the Navajo squaw. Illustrated booklet, 15c. Beads, curios, Moab Navajo Co., 141 Recent St., Salt Lake City, Utah.

SEND 5c For fine new list Indian relics, antique firearms. F. E. Ellis, Webster Groves, Mo.

BOATS AND LAUNCHES

FITTING Out number March of The Rudder, price 50c. The world's oldest boating publication. Handsomely illustrated throughout—old time ships, Diesel yachts, express cruisers, sailing craft. Also complete illustrated list "Boats for Sale"—all types. The Rudder, 15 Murray St., New York.

BUILD Your own outboard hydroplane motor or sail boat. Use our plans or knock-down frames and machined parts. Many models to select from. Write for new catalog. J. B. Welch, Dept. E, 724 31st St., Milwaukee, Wis.

HUBBELL Marine Coolers convert Ford engine into marine motors. Booklet free. Ford speedboat easily built, large blueprint and directions one dollar. C. C. Hubbell, Perry Ave., Norwalk, Conn.

16' CANVAS Canoe. Easily made. Blueprint, 30c. Weesho-Uco, 31st Office, Detroit, Mich.

MAKE 12' Rowboat. Blueprint 30c. Weesho-Uco, 31st Office, Detroit, Mich.

PROPELLERS. Pumps, stuffing boxes, bearings, etc. Wm. H. Baker, Pond St., Quincy, Mass.

TWENTY Foot V bottom cruiser. Complete plans (price 70c) in January and February Rudder, the oldest boating paper in the world. Catalog of boat plans free. Rudder, 15 Murray St., New York.

MAKE 16' Rowboat. Blueprint, 30c. Weesho-Uco, 31st Office, Detroit, Mich.

ARCHERY

MAKE Your own archery equipment. We furnish highest grade materials and instructions for assembly. Build highest quality outfit for fourth cost of complete outfits. Letter brings catalog and prices. Sidney Archery Co., Box M-43, Sidney, Ohio.

FIELD GLASSES, MICROSCOPES AND TELESCOPES

\$5.00 GOVERNMENT Field glasses with leather case. Send free list binoculars, field glasses, cameras, lenses and musical instruments. Weill's Curiosity Shop, 20 South Second St., Philadelphia, Pa.

MINERALS, SEMI-PRECIOUS STONES

WE Are dealers in mineral specimens and polished semi-precious gems for educational and cabinet display purposes. Price lists, table of birth stones and list of gem minerals free with order for PM Specials. Six assorted rough and polished minerals \$1, or four genuine, polished gem stones \$1 postpaid, labeled; satisfaction guaranteed. The Gem Shop, Box 373, Wolf Creek, Mont.

MUSIC AND MUSICAL INSTRUMENTS

TRY One of Lynn's patent unbreakable metal clarinet and saxophone reeds. The only playable metal clarinet and saxophone reed on the market. Finished in medium stiff, medium, medium soft and soft. Price each, E and B clarinet, \$1.75; soprano saxophone, \$1.80; E alto saxophone, \$2.00; C melody saxophone, \$2.25; B tenor saxophone, \$2.25. Sold only for cash or C. O. D. Lynn's Patent Metal Reed, 1810 Fifth Ave., Beaver Falls, Pa.

SONGS Professionally arranged for publication. Expert service. Submit poems. Brennen, 11660 Broadway, New York.

"BANJOS" Should interest all musicians on account of the popularity of the banjo, as it easily increases a player's income. Illus. catalog of 48 pages free. The Bacon Banjo Co., Inc., Groton, Conn., U. S. A.

THE Truth about song poems 25c. Frank Littig, Nipomo, Calif.

SWEETHEARTS In Dreamland, 1,000 copies and copyright; yours for \$140. Beasley, 3229 1/2 Ross, Dallas.

SONG Poems wanted! We publish, arrange, compose. Write today. Ace Music Publishers, 1547 Broadway, New York City.

VENTRILOQUIST Figures. Piano, accordions, bargains. Jack Holland, Box 405, Plainfield, Conn.

BETTER Composing \$12 complete. Lon Healy, Liberty Theatre, Colorado Springs, Colo.

GUARANTEED Results. Write Sequoia Songwriters Service, Sherman Branch, Los Angeles, Calif.

FREE! Song Writers Guide. Beaver, 1257 Elm, Green Bay, Wis.

COMPOSERS—Verse or music. Brilliant opportunity. Write VanDuren, 1964 McClurg Bldg., Chicago.

SONGWRITERS: Submit your song-poem or complete song! Will return it immediately if not acceptable! Chester A. Escher, Music Publisher, 125 West 45th St., New York City.

PLAY Piano by ear. A sound system. Particulars free. Boucher's Harmony Studio, Ottawa, Can.

SONGWRITERS—Arranging, composing. Free booklet. Tucker, 330 Wadsworth, New York.

SONGWRITERS: Substantial advance royalties are paid on publisher's acceptance. New booklet, "Song Requirements of Talking Pictures," sent free. Newcomer Associates, 790 Earl Bldg., New York.

SONG Poem writers, "Real" proposition. Hübeler, D1, 2104 N. Keystone, Chicago.

POEMS Wanted. Work guaranteed. We publish. Great Eastern Song Bureau, Dept. 27, Thomaston, Me.

SEND Song poems, 50-50 plan. Indiana Song Bureau, (Brookside), Salem, Ind.

VIOLINS, Deep, mellow, soulful—on credit. Easy terms for wonderful instrument. Get details today. Gustav F. Henning, 302 University Building, Seattle, Wash.

CORNETISTS—Trumpetists—Saxophonists—Clarinetists. Get "Free Pointers." Name instrument. Virtuosi School, Buffalo, N. Y.

"MUSIC Composed" to words. Bauer Bros. (formerly of Sousa's Band), Oshkosh, Wis.

SONG Writers. Send for our "Publishing Agreement." McKinley Music Printers, 1501 E. 55th St., Chicago.

WRITE Songs. Big money and reputation. Write for information. J. Gordon Pub. Co., 201 N. Hoyne Ave., Chicago.

SONG Poems solicited. A different proposition. Richard Broughton, Sioux Falls, S. D.

PATENT ATTORNEYS

LACEY'S Patent Sense. Valuable book free. See ad page 142.

PATENTS Procured. Prompt, careful efficient service. Highest references. Moderate fees. Send sketch or model for actual search and advice. George P. Kimmel, Master of Patent Law, 54-D Legal Bldg., Washington, D. C.

TIME Counts in applying for patents. See pages 138 and 139. Clarence A. O'Brien, Registered Patent Attorney, Washington, D. C.

CASH From your invention—patented or unpatented. Booklet free to inventors. Chartered Institute of American Inventors, Barrister Bldg., Washington, D. C.

UNPATENTED Ideas can be sold. I tell you how and help you make the sale. Free particulars (copyrighted). Write W. T. Greene, 906 Barrister Bldg., Washington, D. C.

LANCASTER, Allwine & Rommel, 221 Ouray Bldg., Washington, D. C. "Originators of the Form Evidence of Conception." Before disclosing your invention to anyone send for blank form to be signed and witnessed. Form and patent information bulletin free.

SELL Your invention before patenting. Write for free particulars. W. T. Greene, 901 Barrister Bldg., Washington, D. C.

INVENTOR'S Adviser with mechanical movements sent free. Lablner, 15 Parkrow, New York.

EDWARD C. Sasnett, attorney at law, formerly a principal examiner U. S. patent office. I offer to inventors and manufacturers a strictly personal service based on twenty years experience in patent work. 516 McGill Bldg., Washington, D. C.

PATENTS—Write for our free book, "How to Obtain a Patent" and Record of Invention Blank. Send model or sketch of invention for inspection and instructions free. Terms reasonable. See advertisements on pages 140 and 141. Victor J. Evans & Co., 934 Ninth, Washington, D. C.

INVENTORS Service Bureau will send booklet and give you free advice concerning the proper procedure for obtaining patents on easy payment plan and at least expense. Dept. B, Union Trust Bldg., Washington, D. C.

REGISTERED Patent attorney-engineer. Expert in chemical and mechanical patent matters. Former patent examiner. Correspondence invited. A. Ponack, 401 Homer Bldg., Washington, D. C.

INVENTIONS Patented; confidential advice; inventions developed—representative for Blair Tool and Machine Corp.; trademarks registered. Edward Gottlieb, Patent Attorney, 5 Beekman St., New York.

PATENTS Procured; trade marks registered—preliminary advice furnished without charge. Booklet and form for disclosing idea free. Irving L. McCathran, 704 International Building, Washington, D. C.

PATENTS, Trade-Marks, Designs. This firm has 27 years' experience and gives expert personal service at reasonable rates. We properly protect your invention. Write for free information and exact cost of procuring patent before proceeding. John B. Thomas & Co., 902 F St., N. W., Washington, D. C.

INVENTORS: Send for booklet telling how to patent and sell your inventions at lowest cost. Ralph Burch, Patent Lawyer, 900 F St., Washington, D. C.

ESTABLISHED 1864. Milo B. Stevens Company. Free booklet. Patents. Trade marks. Copyrights. Offices, Monadnock Block, Chicago; Barrister Building, Washington, D. C.

INVENTORS—Write for our Guide Book, "How to Get Your Patent," and Evidence of Invention Blank. Send model or sketch of your invention for our prompt examination and instructions free. Randolph & Co., Dept. 430, Washington, D. C.

PATENTS. Prompt personal service. Write for information. Albert E. Dieterich, Registered Patent Lawyer, 621½ Ouray Bldg., Washington, D. C.

PATENTS. Send sketch or model for advice. Free book: "How to Obtain a Patent." Established thirty years. Highest references. Prompt service. Reasonable charges. Chandler & Chandler, 910 F St., Washington, D. C.

PATENTS. Booklet free. Highest references. Best results. Promptness assured. Send model or drawing for preliminary examination. Watson E. Coleman, Patent Lawyer, 724 Ninth St., Washington, D. C.

"**INVENTOR'S** Guide," valuable information, free. Frank Ledermann, Registered Attorney-Engineer, 1712 Woolworth Bldg., New York.

PATENTS—Write for free instructions. Send drawing or model for examination. Carl Miller, Registered Patent Attorney (former Patent Office examiner), 259 McGill Bldg., Washington, D. C.

PERCY S. WEBSTER, 203 Saving and Loan Building, Stockton, Calif. Patent booklet free.

FOR INVENTORS

INVENTORS Notice. Your invention or improvement can be protected from theft, until its commercial value has been determined, without the expense of first securing a patent, by using our new inexpensive copyrighted Inventors Protection System. Write for full particulars. Inventors Protection Bureau, Dept. F, 2032 Estes Ave., Chicago, Ill.

PATENT Rights wanted on articles in woodworking or in machine shop line. Exclusive royalty or outright purchase. Room 111, % Popular Mechanics Magazine, 200 E. Ontario St., Chicago, Ill.

I SELL Patents. Established in 1900. A nationally-known service. Experienced, respected. Why take chances Charles A. Scott, 773PM Garson Ave., Rochester, N. Y.

IF You have a good commercial patent or pending patent to sell, write us immediately. American Patents Corporation, Barrister Bldg., Washington, D. C.

INVENTIONS Sold, patents obtained, advice free. Crompton, 700-P Washington, Buffalo, N. Y.

INVENTIONS Wanted. We have large plant. Can make any article from metal stampings, or metal and wood combined. Will manufacture on royalty basis—take over invention and assist in developing, or market it ourselves. M. Rogers, Highland Body Company, Desk 1, Station P, Cincinnati, Ohio.

GUARANTEE Invention before manufacturer or refund. \$5 complete. Chado Commercial Products, 204 Home Savings Bldg., Albany, N. Y.

PATENTS Placed with responsible manufacturers. Fantus, 139 North Clark, Chicago.

INVENTORS. Share benefits of national mutual aid society. For information write American Society of Inventors, Crosby Bldg., Buffalo.

FOR Inventors—Have floor space for small manufacturer of patented article. Will finance if interested. Write in detail what you have to offer. Oliver J. Sorg, Massillon, Ohio.

PATENT And mechanical drawings made from your description, sketch or model; confidential service; guaranteed satisfaction. Post Office Box 175, Three Rivers, Mich.

INVENTORS—Ideas developed and working models built. Electrical problems solved. Lowest charges and confidential service. Indusro Electric Tools Co., Petersburg, Va.

WE Sell patents by presenting them personally to manufacturers. Largest firm in U. S. Send description of patent or invention for examination. Harry G. Green & Company, 180 West Washington St., Chicago.

INVENTORS—Investigate before investing in a patent. Complete advisory, developing and manufacturing service for the Man with an Idea. (Whether idea is patented or unpatented.) Jas. S. Douglass, Jr., Licensed Professional Engineer, Canandaigua, N. Y. New York State License.

LACEY'S Patent Sense. Valuable book free. See ad page 142.

UNPATENTED Ideas can be sold. I tell you how and help you make the sale. Free particulars (copyrighted). Write W. T. Greene, 907 Barrister Bldg., Washington, D. C.

SELL Your invention before patenting. Write for free particulars. W. T. Greene, 907 Barrister Bldg., Washington, D. C.

BIG Money made with good inventions. Get yours into action by sending full details to manufacturer with two large plants. G. W. MacDow, 200 Dartmouth St., Boston, Mass.

TIME Counts in applying for patents. See pages 138 and 139. Clarence A. O'Brien, Registered Patent Attorney, Washington, D. C.

INVENTIONS—Write for our free book "How to Obtain a Patent" and Record of Invention Blank. Send model or sketch of invention for inspection and instructions free. Terms reasonable. See advertisements on pages 140 and 141. Victor J. Evans & Co., 157 Ninth, Washington, D. C.

INVENTIONS Wanted—Patented, unpatented. If you have an idea for sale write Hartley, Box 928, Bangor, Me.

LOW Cost manufacturing. Large plant completely equipped for blanking, drawing, stamping and wire forming in any finish. Can save you money on your product. Our figures will convince. Eastern States Products, Box 721, New Haven, Conn.

GET Your own patents. Legal blanks, complete instructions \$1. Cutting Sons, Campbell, Calif.

INVENTORS Universal - Educator - contains 900 mechanical movements; 50 perpetual motions. Tells how to obtain and sell patents. Suggests new ideas. Explains how to select your attorney and avoid patent sharks. Price (revised edition) \$1.00 postpaid. Albert E. Dieterich, 621 Ouray Bldg., Washington, D. C.

INVENTORS—Cash in on your invention now! Don't delay the sale any longer! Send for a free copy of our specially prepared booklet, "Turn Your Patent Into Money," today! It contains helpful information for all inventors. M. L. Rund, Mgr. Classified Advertising, Popular Mechanics Magazine, 200 E. Ontario St., Chicago, Ill.

PATENTS FOR SALE

WANT Partner to finance invention, power development, until ready for market. Great possibilities. Box 250, Princeton, British Columbia.

ANTI-GLARE Shield, patent allowed. Cheap and easily manufactured. Panos Lamis, 44 Bull St., Savannah, Ga.

PATENT Pending in U. S. and new issues in Canada for sale or on royalty basis. "Life Saving Boat," which is speedy, non-sinkable and cannot be capsized. M. Faroux, 99 1st Ave., Lackline, Can.

PATENT 1,616,300. Screwdriver counts for 12. Outright or royalty. Three other inventions. Frank Bido, 92 Charles St., Jersey City, N. J.

CLASP Opposite pull. Use on anything. American and Canadian patents. Trade-mark applied for. Cash or royalty. Address Grace E. McNamara, 4511 S. Welton Place, Los Angeles, Calif.

HAND Garden cultivator; pays for itself every day used over common hoe. Write Box 35, San Marcos, Calif.

PATENT Pending. Bearing boring cutting of toolholder with steady rest. Address Anton Gasser, 2406 Trussitt Ave., Youngstown, Ohio.

OUTRIGHT Or royalty. Chain boiler and furnace cleaner. New principle. Manufactured cheap; easily operated. Manufacturers investigate. Ralph McCarthy, 302 Percy St., Elgin, Ill.

FOR Sale outright. Combination battery pliers and terminal puller. Makes battery changing easy. H. R. Schultz, 633 Hayman St., Youngstown, Ohio.

PATENTED—Rotary flexible shaft. Address Peter M. Hetland, Radcliffe, Iowa.

"**PARACHUTE** Kite"—Patented November 1929. Number 1,735,309. Charles Albrecht, 306 Waltham St., Calumet City, Ill.

PATENT On safety plug for electric irons. Adams, 3830 Linden, Seattle, Wash.

NON-REMOVABLE Screw cap for collapsible tubes; patent applied for. Adams, 3830 Linden Ave., Seattle, Wash.

FOR Sale—Patent on invention pertaining to railroad trucks. This is a valuable invention. For full particulars, address Mrs. E. W. Pritchard, 1719 S. Lamar St., Dallas, Tex.

NEW Invention will revolutionize industrial world. Big profit. Rendering patented plastering machine. Royalty and cash. Pages, 51 Willow Place, Brooklyn, N. Y.

FOR Sale—New automatic gas saving device automobiles; 8 cylinder cars get 16 miles per gallon. Patent pending. James U. Lytle, Box 241, Station "C," San Diego, Calif.

CASH And royalty. Patented hardwood floor nail driver. Box 153, Pleasant Ridge, Cincinnati, Ohio.

OUTRIGHT—New action toy, wood or metal, original. Patent 1,701,243. John Payne, 252 West 143rd St., New York City.

WATER Faucet, double closing feature; closes tightly, no effort required in closing. Outright sale or royalty. C. Weir, 2335 Grand River, Detroit, Mich.

JUST Out patent 1,739,354, home laundry boiler, saves 45 to 50% of fuel and time. N. D. Goff, Clinton, Iowa.

PIPE Coupling for antennas, flagstays, power line poles, made of cast steel, malleable iron or drop forgings, no machine work. Alexander Cruickshanks, 3911 13th St. N. W., Washington, D. C.

CASH—Toy merry-go-round, electric light and drive. Patent pending. Fred Pohle, 425 19th St., Milwaukee, Wis.

EXTENSION Brush handle. "Superior to anything of its kind." Alice W. Swayne, Swarthmore, Penna.

FOR Sale: City director time control. T. Johnson, Etowah, Tenn.

OUTRIGHT Or royalty. Shoe lace clasp. Would sell through any sporting goods or shoestore. Address Chas. Herman, Box 368, Las Vegas, Nev.

UNITED States patent No. 1,641,574; Great Britain patent, 292,377. "Car speed boat," new type of automobile, adapted to travel on land and water. Outright or royalty. Felipe Chavez, Box 937, Station C, Los Angeles, Calif.

CANADIAN Incubator patent, 279,041, outright. Reasonable. C. W. Fleet, Listowel, Ontario, Can.

PATENT For sale—Dual pointless spark plug. Georgias, 192 Fourth St., So. Boston, Mass.

AUTO Inner-tube tester. Test tubes under pressure; outright \$5,000.00. Geo. E. Mancos, Westhampton Sta., Richmond, Va.

COMBINATION Motor truck, concrete and mortar mixer; establishing a new mixing principle and will prove a big money maker to manufacturer. Chas. Payne, 27 Fulton Ave., Waukegan, Ill., U. S. A.

FOR Sale one-third interest in patent No. 1,637,266. Price \$300.00. F. L. Perkins, Boise City, Okla.

TIME Counts in applying for patents. See pages 138 and 139. Clarence A. O'Brien, Registered Patent Attorney, Washington, D. C.

INVENTORS—Cash in on your invention now! Don't delay the sale any longer! Send for a free copy of our specially prepared booklet, "Turn Your Patent Into Money," today! It contains helpful information for all inventors. M. L. Rund, Mgr. Classified Advertising, Popular Mechanics Magazine, 200 E. Ontario St., Chicago, Ill.

MODELS AND MODEL SUPPLIES

SCALE Model railroad supplies—not toys. For hobbies or railroad exhibition work. The first and only complete model railroad catalog in the country—35c with credit slip. Well illustrated, parts for five gauges. American Model Railway Company, New Rochelle, N. Y.

THE Shipmodeler, Magazine of the ship model maker's club. Sample copy 20 cents. 55 A. Middagh St., Brooklyn, N. Y.

MODEL Steam engines and boilers for miniature power boats. Boat and boiler fittings. New catalog 15c. Model Machine Shop, 212 Price St., Rahway, N. J.

BLOCKS, Deadeyes, belaying pins, steering wheels, scale fittings. 11 W. 48th, New York City.

PRODUCERS of results. Mechanical and consulting engineers. Our specialty models in metal. Designing, developing, building special machinery, manufacturing, experimental work, patterns, castings and model supplies. Reasonable rates. Inventors see or write us. 25 years in this work. The Johns Engineering Co., 1382 E. 17th St., Cleveland, Ohio, Dept. F.

THE Modelmaker: An illustrated magazine devoted to practical model making. Sample 10c. Modelmaker, 123 Liberty St., New York.

TIME Counts in applying for patents. See pages 138 and 139. Clarence A. O'Brien, Registered Patent Attorney, Washington, D. C.

SHIP Model fittings. Send dime for illustrated catalog No. 6. A. J. Fisher, 1002 Etowah Ave., Royal Oak, Mich.

LET Our experience be your guide. Models that are models; tools and equipment for economic manufg. Patterns of all types; manufacturing in all branches. Satisfaction guaranteed. United Machinery Company, Cincinnati, U. S. A.

WE Make working models for inventors and do experimental work and carry a complete stock of brass gears and model supplies. Send for catalog. The Pierce Model Works, Tinley Park, Ill.

SEND For free 24-page illustrated catalog of all latest and best books on aviation. Special lists classified by subjects and recommended by well-known aviation authorities are a helpful feature of this catalog. Popular Mechanics Press, 200 E. Ontario St., Chicago.

DRAWING INSTRUMENTS AND DRAFTING SUPPLIES

DRAFTSMEN, Swedish Ruling Pens, best in the world, at big savings. Catalog free. Liden, 1034 Elmwood, Evanston, Ill.

MANUFACTURING

METAL Goods manufacturer desires meritorious articles to manufacture, royalty or contract basis. Has own stamping, chrome plating and die casting plant. National reputation for excellence. Low operating costs. World-wide selling organization. Write us. W. H. Manufacturing Company, Middletown, Conn.

SPECIALTY Manufacturing, Stampings, wire products, patents developed and marketed. Safety Globe & Mfg. Co., Columbus, Ohio.

LOW Cost manufacturing. Large plant completely equipped for blanking, drawing, stamping and wire forming in any finish. Can save you money on your product. Our figures will convince. Eastern States Products, Box 721, New Haven, Conn.

SPECIAL Machinery or parts, dies, tools, metal specialties, models, special gears, stock gears and model supplies. Send for Catalogue. The Pierce Model Works, Tinley Park, Ill.

WIRE Goods made to order. Cooley Mfg. Co., 530 N. Western Ave., Chicago.

MANUFACTURING Models, dies, stampings, brass work, one or thousands. Circular free. Baum's Metal Specialties, Kansas City, Mo.

MACHINERY, TOOLS AND SUPPLIES

SMALL Lathe, 12 castings. Make your own lathe. Stuart Keneipp, Mt. Carmel, Ill.

16"x6" VON WYCK Lathe, \$175.00; No. 1 1/2 Valley City plain milling machine, \$350.00; No. 60 Hand grinder, \$275.00; 21" Handy shaper, \$250.00; 15" Smith & Mills crank shaper, \$225.00; 36"x18" Field lathe, \$750.00; 20" silver upright drill press, \$60.00; Quincy air compressor with tank, \$65.00; 10" bench drill press, new, \$23.00. Terms to suit. Write for catalog. Cincinnati Machinery & Supply Co., 27 West Second St., Cincinnati, Ohio.

4 1/2"x4 1/2" CURTIS Compressor, 2 gun size, 4 gal. pressure container with regulators and gauges. Binks 105 paint gun, 1/4 container, 14x48 air tank, air cleaner. All new. Will sell separate or together. John W. Neal, Clarksdale, Ill.

PUNCH Presses: Small power bench type, \$85.00. Circular. Allen Industries, Independence, Mo.

LATHES, \$25 And up, also drills, millers, shapers and grinders. Klauber Machinery Co., 320 South Third St., St. Louis, Mo.

START Business of your own, small investment required, doing nickel, copper and silver plating. This work in big demand. Information free. Electro Platers Supply Co., 28 W. Second St., Cincinnati, Ohio.

CONCRETE Building block machines and molds. Easy payments. Catalog free. Concrete Machine Co., 5 North Main St., St. Louis, Mo.

SAVE Money—Automatic air compressors, constant potential battery chargers, reconditioned, guaranteed like new. Real value—shipped on trial easy terms. If can use, write Baker Company, Box M-408, Troy, Ohio.

ENGINES, MOTORS AND DYNAMOS

NEW General Electric 1/2 hp. series compensated universal motor 110v., dc. or ac 25 to 80 cycle. Speed 6,500 r.p.m. Armature mounted on Norma ball bearings. Dimensions: diameter 5 1/2", length 9 1/2", including shaft extension of 1"; shaft diameter 1/2". Note small size in comparison with standard 1/2 hp. motors, 1/3 size and weight. Weight complete 29 lbs. Fully guaranteed. \$25.00 f.o.b. Newburgh, Dumonin Corp., 302 Water St., Newburgh, N. Y.

BRAND New motor bargains. 1/4 hp. a.c., \$7.50; 1/3 hp., \$10.50; 32v. motors, 1/4 hp., \$8.50; 1/3 hp., \$12.00. 32v. motors with emery and buffer, \$6.00. Write for prices on larger sizes, motors and generators. Queen City Electric, 1736 Grand Ave., Chicago.

BIG Catalog—Small steam and gasoline engines, motors, lathes, drills, gears and model makers supplies. Postpaid 20c. Canada 25c. Howard Engine & Mfg. Co., 2417 N. Ashland Ave., Chicago, Ill.

NEW 1/2 Horse gasoline engines, \$18.00; with 32 volt 5 1/2 ampere generator and belt, \$26.00. 1/4 horse alternating, 1750 speed motors, \$7.00; 1/3 horse, \$10.50; 1/2 horse, 3450 speed, \$16.50. Other bargains. Electrical Surplus Company, Dept. 12, 1911 Chicago Ave., Chicago.

USED Arc welders, air compressors, buffers, grinders, reconditioned like new. Shipped on trial and easy terms. If you need good guaranteed equipment, write today to Bob Jones, Box M-408, Troy, Ohio.

FOR Sale: One-sixth and one-quarter hp. used elec. motors—60 cycle, 110 volt—a.c., good running condition, \$4.50 and \$5.00 respectively. Cash with order. Maytag-Chicago Co., 160 E. Illinois St., Chicago, Ill.

ELECTRIC Motor winding models and instructions. Gaines Bros., Gainesville, Tex.

GOVERNORS (Ours) will control any make of auto engine at any speed desired. Easy to install. \$10 C. O. D. Circulars. Candee-Smith Governor Co., 215 North Los Angeles St., Los Angeles.

TIME Counts in applying for patents. See pages 138 and 139. Clarence A. O'Brien, Registered Patent Attorney, Washington, D. C.

EDISON Phonograph motors with speed governor. Universal. \$5.00 plus express 10 lb. Geo. Schulz, Calumet, Mich.

STEAM Engines—One h. p. \$18.00; 1/2, \$12.00. James Chambliss, Bessemer, Ala.

BENDING MACHINES

THE Famous Hossfeld "Wrenchless" Universal Iron Bender is the last word in bending machines. Bends metal, cold or hot, into most any conceivable shape, including Eye Bolts and Automobile Spring Eyes. Bends up to 1" bars or 1 1/2" pipe cold. Thousands in use by all classes of trade, from the smallest shops to the largest railway systems. Write for circular and prices. Hossfeld Mfg. Co., Winona, Minn.

WELDING AND SOLDERING

START in highly profitable arc welding business, practically no expense. Our constant arc welder starts you on road to success. Easy monthly terms, liberal trial on money back guarantee. Write today. Hobart Industries, Box M-407, Troy, Ohio.

SURVEYING INSTRUMENTS

SAVE On transits and levels. Rebuilt and guaranteed. All kinds and makes. Terms if desired. Write today for descriptive list M-44. Warren-Knight Co. (Manufacturers of "Sterling" Transits and Levels), 136 N. 12th St., Philadelphia, Pa.

FARMS AND FARM LANDS

LAND Opening—The Great Northern Railway serves an agricultural empire in Minnesota, North Dakota, Montana, Idaho, Washington and Oregon. These states abound in opportunities for small farmers or large operators to rent or purchase a farm at lowest prices and best terms of many years. Every kind of farming, grain, livestock, dairying, fruit, poultry; large acreage or small suburban tracts, rich cutover or high producing irrigated land. Write for free Zone of Plenty book with detailed information. Low homeseekers' rates. E. C. Leedy, Dept. 457, St. Paul, Minn.

OZARKS—20 Acres, poultry land, \$100, \$5 monthly. Fishing, hunting, trapping. Other bargains. Alvin Zimmerman, 1802 N. Fifth, Kansas City, Kans.

TRUTH About California: Land surveys, soil, land valuations, reclamation, crop returns, crop estimates, business opportunities, natural resources. For \$2.00 we answer any inquiry. Reasonable rates for detailed reports. Engineers, Box 28, Sacramento, Calif.

FOR Sale—20 acres Ozark region; \$5.00 monthly; only \$125. Other bargains. Alfred Fisher, Hannibal, Mo.

SOUTHWEST Missouri lands, 160 acres near Joplin. Sims, Mount Vernon, Mo.

WANTED: Hear from owner having good farm for sale. Cash price, particulars. John Black, Chippewa Falls, Wis.

LAND Sale, \$5 down, \$5 monthly, buys 40 acres Southern Missouri. Price \$200. Send for list. Box 22N, Kirkwood, Mo.

MONEY Made in Mich. potatoes, \$10 down now and easy terms buys land near markets, lakes, streams. Write today. Swiggart & Co., P-601, 32 N. State St. Bldg., Chicago, Ill.

PECAN-Orange-Fig groves "On the Gulf." Monthly payments. Guaranteed care. Big, quick returns. Suburban Orchards, Dept. M, Biloxi, Miss.

SELL Your property quickly for cash, no matter where located. Don't pay big commission. Particulars free. Real Estate Salesmen Co., Desk B, Lincoln, Nebr.

EASTERN Pennsylvania farms near Philadelphia. Write for bulletin giving prices, sizes and descriptions. Wilson George, Quakertown, Pa.

REDUCE Labor on your farm and increase income. One farmer writes he would not part with the information for \$100 if it could not be duplicated. Send today for our valuable "Farmers' Handbook" and get ready to put some of the 861 practical ideas into operation for your own benefit. Pay postman only 98 cents plus postage when delivered. Popular Mechanics Press, Room 808, 200 E. Ontario St., Chicago.

DOGS AND PETS

PEDIGREED German Shepherd pups, eight months old, \$25.00. Chas. Standard, Elkton, Ky.

FANCY Fishes—Aquarium supply catalog free. German's Aquarium, 3823 N. Richmond, Chicago.

WHITE Collies and other colors. Beautiful and useful. Dept. P, Shomont Kennels, Monticello, Iowa.

FOR Sale. Minks, squirrels, raccoons, foxes, ferrets, muskrats, ginseng, rabbits, skunks, wolf pups, opossums. B. Tippman, Caledonia, Minn.

ST. BERNARDS! Rare, beautiful thoroughbred puppies. Photos submitted, delivery guaranteed. Helvetia Kennels, 181-P McKenna Ave., Montreal, Que.

RABBITS

RAISE Fur bearing rabbits. We buy all you raise, paying as high as \$30.00 each. Send for free catalog and contract. Brand Farms, P. O. Box 147, New Orleans, La.

FINE Income from rabbits under our contract. Proposition covers housing, feeding, breeding, marketing. Build your own big business. Free particulars. Aulabaugh Fur Farms, Box 9, Waterloo, Nebr.

RAISE Chinchilla fur rabbits for profit. Our free circulars start you right. Midland Hills Fur Farms, 301 Ridgeway, Little Rock, Ark.

RAISE Fur rabbits. We pay \$4.00 for those raised from our stock. Send 10c for catalog, contract, etc. Goldenrod Fur Farms, Inc., Dept. PM, Lincoln, Nebr.

MAKE Money. Raise rabbits. Write for details on marketing and breeding. National Fur Farms, Kasota Bldg., Minneapolis, Minn.

FOR Sale—Fine pedigreed Chinchilla does. John Weinberger, Springfield, Minn.

RAISE Rabbits for us. Guaranteed market. Beautiful Chinchilla chokers, \$8.50. Breeders, Furrers, Packers. Northlands Fur & Packing Co., Rhinelander, Wis.

STANDARD Rabbit Journal, Winchester, Ohio, 50c year, 2 months 10c.

MAKE Big profits with Chinchilla rabbits. Real money-makers. Write for facts. 872 Conrad's Ranch, Denver, Colo.

MUSKRATS

TRAPPERS—"Eleven Box Traps." Complete blueprints, 30c. Weesho-Uco, 31st Office, Detroit, Mich.

MAKE Money from muskrat fur—Raise muskrats in dry land pens or hutches. Get the facts. 652 Conrad's Ranch, Denver, Colo.

WANTED—MISCELLANEOUS

MAIL Us your discarded jewelry, gold, crowns and bridges, watches, diamonds, silver, platinum. Money promptly mailed. Goods returned if offer refused. United States Smelting Works (The Old Reliable), Dept. 71, Chicago.

HUNDREDS Of people have sent their old gold, silver, platinum jewelry, dental work to me. Why not mail yours today? Highest prices paid. Satisfaction guaranteed or goods returned. F. Polcer, 2408 South Cicero Ave., Cicero, Ill.

WANTED: False teeth. We pay high as \$10 for full sets. Any condition. We buy crowns, bridges, gold, platinum, silver. Jewelry Dept., Western Metal Company, Bloomington, Ill.

FOR SALE—MISCELLANEOUS

25 BEAUTIFUL California scenic postcards \$1.00. Samples, novelty catalog 15c. Letters mailed 10c. Ziese Enterprises, 254-P Abby, Fresno, Calif.

AM Closing out, large list. Radios, kodaks, binoculars, etc. Amazing bargains. Write for list. Fred Lewis, Creighton, S. Dak.

WOODEN Works clock. Price on request. J. Bartlet, Jonestown, Pa.

ADDRESSOGRAPHS. Letter folders, multigraphs, envelope sealers, duplicators, less than half price. Guaranteed. Pruitt Co., Suite 108, 190 N. LaSalle St., Chicago.

WATCHMAKERS Lathe for sale at a bargain. R. Jaegermann, 5815 Easton Ave., St. Louis, Mo.

PERSONAL

LIFE Reading. 1930 forecast; advice on business, occupation, health, love, marriage, etc.; complete \$1. Character outline 25c; send birthdate. M. Kleman, 96 Eaton St., Winnipeg, Man.

TOBACCO—Chemists, botanists and physicians unite in pronouncing tobacco one of the most deadly poisons known. Habit instantly conquered with our assistance. Treatment composed of medicines most needed to overcome tobacco in any form. Price \$2.00 postpaid and guaranteed to cure or money refunded. Tonic tablets, diet and hygienic suggestions included with each treatment. Reliable Remedy Co., P. O. Box 535, Omaha, Nebr.

STAMMERING Stopped quickly, privately; guaranteed. William Heimlich, 210 Werby Bldg., Kansas City, Mo.

EXCHANGE Your old false teeth for new, natural, unbreakable "Hecolite" plates by mail cheaply. Dentists' pyorrhea prescription \$1.00. Dentists Laboratory, Desk B, Box 691, South Bend, Ind.

KNOW True character of your friends, prospective life partners. Send their hand-writings, stating age, profession, with \$1.00 to E. Landis, Graphologist, 1212 East 46th St., Chicago.

FREE! Herbalist almanac. Over 500 herb medicine recipes for home use. Write for details. Botanics, 145 West 112th St., Chicago.

EXERCISES For the eyes that magnetize and strengthen and prevent the wearing of glasses with advancing years. Price complete \$1.00. Paul Jewell, Walker, Minn.

KNOW Thyself—The stars reveal your fate and fortune; trial reading for dime. Psycalite Studio, Dept. 12, Box 2, Brookline, Mass.

KLEAR-SKIN Masters skin diseases. Write Klear-Skin Laboratories, 1930 N. 8th St., Springfield, Ill.

HIGH Blood pressure inexpensively overcome, without drugs. Send address. Franklin Stokes, Mohawk, Fla.

TOBACCO Habit overcome or no pay. 500,000 used Superba to help stop cigarettes, cigars, chewing, pipe, snuff. Treatment sent on trial. Costs \$2.00 if successful. Superba Co., L84, Baltimore, Md.

OCCULT Books, magic perfume. Catalog 10c. Hindu Publishers, Garrick Bldg., Chicago.

ADVICE. Information 25c coin up. Experience. Ref. Fred Klotz, Reading, Pa.

BEST Books for \$1. All formerly sold for \$2.50 to \$5 each. Select from the following list of guaranteed bargains. All brand new books: Woodcraft by Seton. Book of Letter Writing by Crowther. Etiquette by Eichler. Creative Chemistry by Slosson. Lawn Tennis by Tilden, also Revolt in the Desert by Lawrence, Trader Horn, White Shadocks in South Seas by O'Brien, Count Luckner (The Sea Devil) and Outline of History by Wells. Delivered at your door C. O. D. Simply pay postman \$1 each and postage. Popular Mechanics Press, Room 801, 200 E. Ontario St., Chicago.

MISCELLANEOUS

BUILD With your old lumber garages, bungalows, cabins. We furnish material list and patterns to cut all rafters. J. C. Harrington, West Medway, Mass.

MEXICAN Made holsters, lariats, horse-hair articles; rattlesnake belts. Send four cents for illustrated list. Tex-Mex Leather Co., 309 Esperson Bldg., Houston, Tex.

MIRRORS Resilvered at home. Costs near 5 cents per square foot; you charge 75 cents. Profitable business plating autoparts, reflectors, tableware, stoves, refinishing metal-ware, etc. Outfits furnished. Details free. Write Sprinkle, Plater, 288, Marion, Ind.

LUMINOUS Paint, small bottle 25c, medium 50c, large \$1.00; pound can \$3.00; invisible ink 20c. A. Claude Massapequa, Long Island, N. Y.

ELECTRICITY For light and power from the free wind. Plant easy to build. Blueprints, \$5.00. Klingsick Propeller Shop, Optima, Okla.

HOMEOPATHIC And Biochemic preparations sent postpaid to all parts of the world. Manual and booklet free. Halsey Bros. Co., 5547 Ravenswood Ave., Chicago, Ill. Established 1855.

TATTOOING—Learn how with my outfits. Descriptive circulars sent anywhere. Sergt. Bonzery, 367 South Main, Providence, R. I.

LEARN Tattooing. Instruction catalog. dime. Miller, V131 Main, Norfolk, Va.

ARTISTS—"Sell Your Drawings" booklet tells how, where. \$1.00. Seneca Studio, Box 349, Oil City, Pa.

BE A Trick cartoonist. Program 10c; 6 different programs 50c. Seamann, 2104 Liberty, Terre Haute, Ind.

BILLS Collected everywhere! Ace Collection Syndicate, 824 Park Ave., Weehawken, N. J.

BARGAIN Circular No. 10. Wholesale novelties. Send stamp. Kant, 246P Third Ave., Pittsburgh, Pa.

SCRAP Gold and silver refined. Returns made on actual recovery with refining charge only 5%. Colorado Refining and Research Corporation, Box 68, South Denver, Colo.

CASH Paid for Butterflies, Insects. See Sinclair Display Advertisement on page 28.

25 RED Devil cards. Best yet. 10c Samples for red stamp. Topaco, 3130 N. Parkside Ave., Chicago.

TATTOOING Outfits, supplies. Illustrated list free. "Waters," 965 Put-nam, Detroit.

AMATEUR Cartoonists: Sell your work. Write Smith's Service, PW1194, Wenatchee, Wash.

TIME Counts in applying for patents. See pages 138 and 139. Clarence A. O'Brien, Registered Patent Attorney, Washington, D. C.

AMATEUR Cartoonists earn \$25.00 week, spare time, copying or tracing cartoons for advertisers. 12 months contracts. 3-M Syndicate, Argyle, Wis.

CUTS Anybody can make. Simple, cheap process, \$1.25. Specimens, particulars. 2c stamp. M. Day, Windfall, Ind.

TELL An army of 3,000,000 live readers all about your offer! If you have anything to sell, buy or exchange, or if you have any reasonable proposition, tell our readers all about it—they'll respond quickly. Our booklet "How to Create More Business" contains some very interesting, helpful facts. Write today for your copy—it's free. M. L. Rund, Manager Classified Advertising, Popular Mechanics Magazine, 200 E. Ontario St., Chicago, Ill.

LEARN CARTOONING

AT HOME DURING SPARE TIME

with the course that has trained HUNDREDS of beginners successfully. The Landon Picture Chart Method of teaching ORIGINAL drawing by mail makes cartooning easy to learn. This school is a Member of The National Home Study Council. Write today for sample picture chart to TEST YOUR ABILITY and examples of the work of successful students now earning from \$50 to \$200 and more per week. Enclose 6c in stamps and STATE YOUR AGE.

THE LANDON SCHOOL, 2838 National Bldg., Cleveland, Ohio

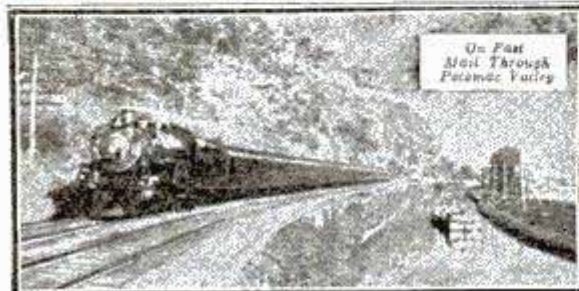

Many Other Government Jobs Obtainable
Steady Work—No Layoffs—Paid Vacations
Common Education Sufficient
MEN—BOYS 18 UP

Travel on "Uncle Sam's" Payroll \$158 TO \$225 MONTH

Mail Coupon Before You Lose It

FRANKLIN INSTITUTE, Dept. H171, Rochester, N.Y.

Sirs: Rush to me, without charge, (1) Full particulars, telling how to become a Railway Postal Clerk; (2) send copy of 32-page book "How to Get U. S. Government Jobs," with list of many positions obtainable.

Name.....

Address.....



How I Made \$100,000 (In Less Than 5 Years)

Learn the secret of my success. Use my money-making system. Get into the biggest business of all—where the most money is. Start right at home, in your spare time. Mail coupon and learn how.

ONE hundred thousand dollars—a comfortable fortune. That's the net profit I made in less than five years in the biggest and best business in the world.

And the hard-to-believe part of it is that I started right at home, in my spare time, with less than \$5 capital and no experience in the business.

Of course, I don't expect you to take my word for this. You don't know me. So I don't blame you for saying, "I'm from Missouri."

But I do expect you—for your own satisfaction—for your own profit—to sign and mail the coupon and receive—without a penny of cost or the slightest obligation—the most convincing proof of the greatest opportunity for business success you ever saw—proof of my own success—proof of the success of hundreds of ambitious men and women—of all ages—who are using my amazingly successful business system—proof of how you—yourself—can use my method of money-making to build up a permanent, profitable business of your own—right at home, in your spare time.

The Best Business

When I say that my kind of a business is the biggest and best business there is, I have at least ten reasons for saying so. Here they are:

1. The business in round figures amounts to about 28 billion dollars yearly.
2. More money is invested in it than in anything else.
3. The increase in land values alone in the U. S. is more than double the output of all the gold and silver mines in the country—the product of all the oil wells—the dividends on all the railroad stock—the capital and surplus of all the national banks.
4. It is the most permanent of all businesses. It cannot be injured by changes in fashion or by any human whims or caprices.
5. The business is growing bigger every day, and nothing can stop it.

FREE Book Tells How

This FREE Book has helped MORE men and women make MORE money in LESS time than any similar book ever published.



You can't afford to turn your back on this remarkable business opportunity.

6. It is a pleasant, healthful, high-class vocation.
7. It does not take years of study to learn like most businesses or professions.
8. It is a business suited to young and old of both sexes.
9. You do not have to keep a stock of goods, invest in machinery, or buy any expensive tools or instruments to get started.
10. You can start in your spare time, right at home, with a few dollars capital, just as I did.

I know of no other business, of any kind, anywhere, that includes all of these important advantages. That is why I say it is the biggest and best business there is. That is why you should investigate this business at once. That is why you

should mail the coupon now and learn about the big, quick money that is being made in this immense and profitable field.

What Others Are Doing

Enthusiastic letters pour in from those who are making money with my successful system. Read these words of praise:

"Your system is wonderful. Without giving up my job as stationary engineer I made \$900 the first three months in my spare time."—M. J. Stokes, Pennsylvania.

"Have been helped a great deal by your system. I have now a new car, two new typewriters, a stenographer, and a dandy office and money in the bank, all through my own efforts and without any capital to start with."—Mrs. A. Moore, Connecticut.

"Made \$14,400 in less than six months with your system. Gladly recommend it."—H. G. Stewart, Maryland.

"Before getting your System was a Ford salesman averaging \$300 a month. Have now increased my earnings 200%. Now own a Chrysler Sedan, up-to-date office equipment and have increased my bank account."—A. J. Bennett, Michigan.

There's no room here for more such letters, but sign and mail the coupon and you will receive a bunch of the most enthusiastic letters of business success you ever read.

A minute's time and a postage stamp brings you full information about your big opportunity to make big money my way—build up a profitable business of your own—right at home—in your spare time—without capital or experience.

Get the Facts at Once

Tear out the coupon now—before you turn the page—and mail it to Pres. AMERICAN BUSINESS BUILDERS, Dept. DD-44, 205 East 42 St., New York. Then you will have the satisfaction of knowing that you did not turn your back upon the biggest and best business opportunity that ever came your way.

In
The
Best
Business
There
Is

Mail This Coupon

Pres. American
Business Builders, Inc.

(Established 1917—Authorized Capital
\$500,000)

Dept. DD-44, 205 E. 42 St., New York

Send me—without cost or obligation—
full particulars of how others are succeeding
—and proof of how I can succeed in the best
business there is.

Name.....

Address.....

FIT YOURSELF AT HOME

A for

BIG-PAY JOB

in ELECTRIC REFRIGERATION

EARN \$50 TO \$125 A WEEK!

Be the first in your locality to get into America's new magic industry—Electric Refrigeration. Trained experts needed in every town and neighborhood. You can easily qualify at home to install, service and repair electric refrigerators. Clean, fascinating work and pays big because trained men are scarce. You will visit the better homes and merchants in your vicinity; drive a car with expenses paid. Perhaps you'll have your own business as the local service station for distant manufacturers. U. E. I. training, a few tools and some business cards get you going. Splendid opportunity for salesmen.

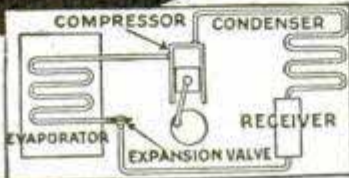

Come into Electric Refrigeration—the fastest growing money-making industry! That's what General Motors, General Electric and other money powers did! They invested millions and now they need men like you with proper training. Here is your chance to get in on the ground floor and escape forever from poor pay, unemployment and limited future.

Now . . . Easy to Learn at Home in Your Spare Time

THIS amazing, new, simplified method of training prepares you quickly at home, in spare time, for big pay positions open only to trained men. Unlike ordinary schooling. No textbooks. No study drudgery. Fascinating lessons—charts, diagrams, pictures and practical problems—teach you every principle and practice. Experts guide you, step by step. Free employment service. Easy terms. Money-back agreement.

Highly praised by General Electric, Servel, Kelvinator, Copeland, Zerzone and others. Hundreds of satisfied students. Coupon below brings full facts and free proof. Mail it today!

UTILITIES ENGINEERING INSTITUTE

Dept. 140, 4403 Sheridan Rd., Chicago, Ill.

FREE You should have our new valuable book of facts about Electric Refrigeration. Sent without cost or obligation—simply mail coupon NOW!

Dealers: We are referring our students to you as fast as they graduate. Please write us your requirements as early as possible for choice selection.

Utilities Engineering Institute,
Dept. 140, 4403 Sheridan Rd.,
Chicago, Ill.

Send me without cost or obligation your big book, Rich Rewards in Electric Refrigeration and details about your home training.

Name.....
Address.....
City..... State.....



"My salary has been increased 15% since I enrolled," writes S. C. Mathias, Penn.



O. Horn, Ill., says: "Altho I am only half thru with my training, I have been called on to make adjustments on refrigerators."



Quit Being Janitor! Get Automatic Oil Heat At Amazing Low Cost

MONEY-MAKING OPPORTUNITY
To reliable men and dealers we offer the chance of a lifetime to make real money with this fastest selling oil burner. Get the facts.



All Advantages of Other Burners Plus Sensational New Features!!

Here's the greatest achievement ever reached in oil heating industry. An amazing new burner priced so low everybody now can enjoy the luxury of oil heat. Quit being janitor to a dirty furnace. Install the new Griswold and forget your heating troubles.

Plugs in Your Light Socket

As simple as a radio to install. Plugs in your light socket. Nothing to adjust. Nothing to get out of order. Guaranteed. Quiet. Complies with all city ordinances. Won't interfere with radio reception. Fully Automatic. No oil pumps, ignition systems, or complicated wiring necessary. Send now for complete information and startling low prices.

Quickly Installed
Fits Any Stove or Furnace

Absolutely Reliable

Go away and leave it all day. Operates perfect just the same. Turn on high and low flame. You can't flood the burner. Merely starts up automatically, because Siphonic Constant Level Valve makes it safe to operate.

Cheapest to Operate

Burns oil and air the new way. Patented indestructible Mineral Wick does it. Perfect combustion. All the oil burns. No smoke, soot, or grease. Dealers, write for our special proposition.



Griswold Oil Burner Co.
306 N. Union St.,
Griswold, Iowa

Write Today

PARACHUTE TRAP



Send parachutes up your kite string. The wind takes the parachute and trap up the string until the trap hits a button near the kite. The parachute unnooks and the trap slides down the string and is ready to be sent up again. 10c each or 3 for 25c. Postpaid. S. R. Petersen, 9152 Chamberlain, Detroit, Mich.



BUSINESS ENGLISH

AND CORRESPONDENCE

It takes colorful, correct speech to put yourself "across" in business or socially. And the ability to write an unusual business letter is often reason enough for promotion. Not wise-cracks, not gift-of-gab—but a cultivated habit of crisp, expressive, errorless English—is in demand today—everywhere!

The first step toward a better position!

Frank A. Vanderlip, famous New York banker who writes the introduction to this rapid, new home-study system says: "Young men and women entering business must be able to express themselves crisply, definitely, correctly, convincingly! Those who can do this, can be trusted to handle important matters. Business letter writing is one of the essential tools of the trade."

Rapid Home Training Very Low Cost

A new method which avoids old-fashioned memorizing—by building correct speech habits through 58 easy exercises. Shows you how to avoid common errors, how to master words and build vocabulary—how to develop an individual "style"—with particular attention to business letters, sales and collection correspondence. Can be completed in 8 to 12 weeks, costs only a trifle, payable on easy terms if desired.

AMERICAN SCHOOL

Dept. EC-447, Drexel Avenue & 58th St., Chicago, Ill.

Please send without cost or obligation, complete information about your inexpensive, rapid home-study course, in Business English and Correspondence.
Name.....
Address.....



ARE YOU

the Popular Boy in Your Crowd?

WOULDN'T you like to be able to play the harmonica so well that you could make your crowd sit up and take notice like Bob and Ann do? Wouldn't you always like to be *in demand* at parties—always "in" on all the good times?

twelve-year-old Bob Lewis from Ohio. "I did not know one musical note from another—but now I play any song, popular, classic or jazz I have ever heard, and my Hohner and I are very popular."

Everyone loves the harmonica, and you can always have it with you, no matter where you go.

WELL, HERE'S YOUR CHANCE!

A QUALITY INSTRUMENT

Without costing you a cent, you can learn to play the harmonica almost like a professional in a short time. Just send the coupon below for the FREE Illustrated Instruction Book, "HOW TO PLAY THE HARMONICA."

Hohner Harmonicas are the choice of professionals everywhere. Musicians recognize them as the "world's best"; real musical instruments true in tone, accurate in pitch, perfect in workmanship. While Hohner Harmonicas are slightly higher in price than inferior instruments, you always have the satisfaction of knowing you own the best—one that enables you to play anything from jazz to opera. Learn to play a Hohner. Fill out coupon now and mail it AT ONCE.

You don't have to know one note from another to begin, for this book tells you just what to do and illustrates each easy step. In a few minutes you can play the scale and the simple melodies shown in the book. And soon you'll be amazing your friends with the way you can reel off popular airs.

You can get Hohner Harmonicas everywhere, in many different styles—at all prices.

"I never had a music lesson in my life," says

FREE

Illustrated
Harmonica
Instruction
Book

Mail Coupon
T O D A Y

How
to Play the
HARMONICA

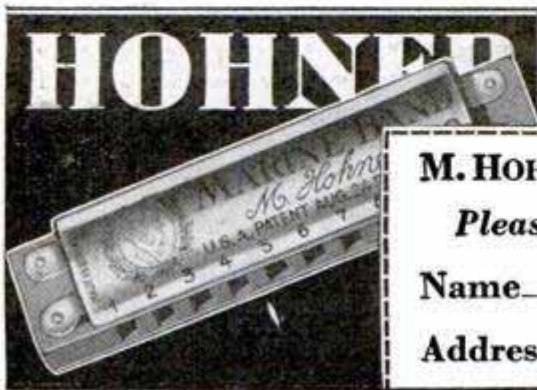

M. HOHNER, Inc., 114 E. 16th St., Dept. 18-D, New York

Please send free Instruction Book.

Name _____

Address _____

We Will Train You in a Few Months



Day and Night Schools in Chicago, Detroit, Cleveland, Boston, Phila.

**No Books—
No Classes—**

Wonderful Future in this Uncrowded Field

Experts Earn Up To \$125 A WEEK

as MECHANICAL DENTISTS

We teach you to make rubber plates, crowns, bridge work, metal base dentures, etc., for dentists. After graduating you are ready for a job or can open your own laboratory. We assist you.

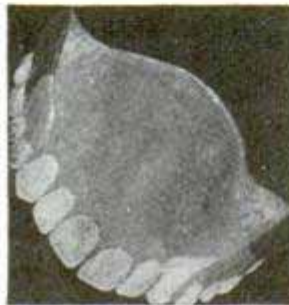

Big Demand for Men!

Mechanical Dentistry is the laboratory bench work which the dentist turns over to the laboratory worker. Master this profession and help meet the demand of 64,000 dentists for laboratory work. Every city and every town where dentists are located offers work to the mechanical dentist. We train you in a few months in day or night school for this uncrowded field—no classes—no books—no mechanical experience necessary. **No Educational Requirements.**

Work Your Way Thru School

We will help you find a job to meet your expenses while taking our training. And we will help you find satisfactory living quarters when you arrive.

Schools located in Chicago, Detroit, Cleveland, Boston, Philadelphia. Day and night schools. We pay railroad fare of students who enroll.

INTERESTING FREE BOOK

Our illustrated free book on Mechanical Dentistry will acquaint you with some surprisingly interesting facts. It tells about the thriving profession of Mechanical Dentistry—the way to swift and certain success. And it tells about the progress of many of our graduates—men who have succeeded beyond their expectations, also full details of our liberal offers. Mail the coupon and find out more about this fascinating opportunity.

**McCarrie School of Mechanical Dentistry
1338 S. Michigan Ave., Dept. 387, Chicago, Ill.**

McCARRIE SCHOOL OF MECHANICAL DENTISTRY
1338 S. Michigan Ave., Dept. 387, Chicago.

Without cost or obligation, send me your illustrated book on Mechanical Dentistry, and complete information as to my opportunities in dental laboratory work.

Name.....

Address.....



RAISE CHINCHILLA AND NEW ZEALAND WHITE FUR RABBITS Make Big Money We Supply Stock and pay you following prices for all you raise: Chinchillas—average \$5. each—New Zealand Whites \$2 each. 32-page illustrated book, catalog and contract, also copy of Fur Farming magazine, tells how to raise rabbits for big profits, all for 10c. Address **OUTDOOR ENTERPRISE CO., Box 1021 Holmes Park, Missouri**



70 BREEDS Chickens, ducks, geese and turkeys. Pure bred hardy, northern raised and most profitable. Fowls, eggs, baby chicks, incubators; low prices. America's great plant. 37th year. Valuable new 100 page Poultry book FREE. **R. F. NEUBERT Co., Box 878, Mankato, Minn.**



MAKE MONEY RAISING SQUABS Highest market ever known. Breeders shipped everywhere Homers, Carneaux, White Kings a specialty. All o'her breeds. Send 10 cts for 32 page catalog and price list. **Allston Squab Co. 61 N. Beacon Street ALLSTON, MASS.**



Raise Rabbits, Make Money Join our Association and receive Free 350 page Year Book. Mail two dollars for membership. **A. Weygandt, Secy. American Rabbit & Cavy Breeders Association 7408 Normal Ave. Chicago, Ill**



RAISE PIGEONS AND RABBITS For Pleasure and Profit OUR FREE BOOKLET TELLS YOU HOW. Over 20 varieties of Pigeons. Also Bantams. **W. V. MOORE, Box A, STERLING, ILL.**



BRASS WAFER THERMOSTATS For temperature control on incubators, Brooders, Fire Alarms; any place a wafer Thermostat can be used. 3, 4, 5 inch sizes. **RELIABLE INCUBATOR & BROODER CO. 2615 Chestnut St. Quincy, Ill.**



SQUAB BOOK FREE Breed PR squabs for rich trade. Sold by millions for more than chickens. Write for free 48-page book telling how to do it and how to profit by new sales method. **PLYMOUTH ROCK SQUAB CO. 634 H Street Melrose Highlands, Mass.**



RAISE RABBITS, GUINEA PIGS, PIGEONS Make big money. We supply stock. Good market. Illustrated list, facts, bulletin all for 10c. **JAS. W. HOUCK & CO., Box 58, TIFFIN, OHIO**

NO JOKE TO BE DEAF
—EVERY DEAF PERSON KNOWS THAT
I make myself hear, after being deaf for 25 years, with these Artificial Ear Drums. I wear them day and night. They stop head noises and ringing ears. They are perfectly comfortable. No one sees them. Write me and I will tell you a true story, how I got deaf and how I make you hear. Address **GEO. P. WAY, Artificial Ear Drum Co. (Inc.) 80 Hoffman Bldg., Detroit, Mich.**



BOW LEGS and KNOCK-KNEES UNSIGHTLY
Those afflicted with BOW LEGS should wear the "PERFECT LEG FORMS" and overcome this deformity. Tr users hang perfectly straight. Made of the highest grade Aluminum. Sanitary, Light and Durable. Easy to put on or off. Send for booklet showing photos of men with and without the "PERFECT LEG FORMS" **PERFECT SALES CO. 140 N. Mayfield Ave. Dept. 5 Chicago, Ill.**



CORRECT Your NOSE!
Improve your appearance with the ANITA NOSE ADJUSTER. Shapes flesh and cartilage—quickly, safely and painlessly, while you sleep. Results are lasting. Doctors praise it. 68,000 users. Write for 30-Day TRIAL OFFER and FREE BOOKLET. **ANITA INSTITUTE, 412, Anita Bldg., Newark, N. J.**

NOW FIX ANY MAKE OF



SIX BIG AUTO BOOKS ALL SHIPPED FREE



on approval; whether you want to qualify as garage owner, auto repair expert or merely wish to know how to keep your own car 100% efficient, look at these books—they are sent to you for free examination. This brand new 1930 edition has been prepared by a large group of America's greatest automotive engineers. Anybody who can read will understand them, for this great automobile encyclopedia is a veritable gold mine of valuable facts. Take advantage of this great opportunity now; send in the coupon for FREE examination. You don't pay us a penny, you don't obligate yourself to pay anything unless you decide to keep the books. Just tell us you want to see them and the full set of 6 great volumes, just off the press, will be sent to you. Read them, look them over and prove to your own satisfaction that one fact alone, which you will find in them, may save you an expensive repair, or help you to a better job.

AVIATION MOTORS

In addition to being a complete encyclopedia of automobile engineering these books contain over 100 pages on Aviation Motors, and as they are just off the press they bring to you the newest and latest information obtainable. This alone makes these books *invaluable* to anyone.

NEW 1930 EDITION EVERY PAGE UP TO DATE

Imagine books which are so new that with the co-operation of the largest automobile manufacturers we have been able to bring every page right up to date—wiring diagrams, construction details, service problems—are all right up to the minute. Nowhere else that we know of can you get as complete and up to date information. Over a million dollars of resources have enabled us to give you the most up to date books on the subject ever published. You will find nearly 20 pages on front wheel drives alone. Everybody interested in automobiles in any way will welcome these books, especially on our

NO MONEY OFFER

This plan brings this valuable information within the reach of everyone. You don't send us a single penny; you don't have to pay us anything; just send your name and address and we will send you the complete set of 6 volumes specially bound in De Luxe Flexo covers. Read them carefully, keep them 10 days, find out anything you want to know and then if you want to keep them send \$2.00 then and \$3.00 per month until the special low price of only \$24.80 is paid. There is no further obligation.

Jiffy Index

You don't have to read the books through, the special Jiffy Index enables you to put your finger on the information wanted in a jiffy.

American Technical Society Membership FREE

If you send now for this brand new 6 volume edition of automobile engineering we will include a consultation membership in this great organization. Our large staff of automobile and aviation experts will be ready to help you at all times—you can write or wire any time for special information—answers will be sent to you promptly WITHOUT COST. This membership is good for one full year.

Learn All About Autos

Get these 6 big new books on this liberal offer and learn all the things you want to know—carburetors, transmissions, springs and spring suspensions, brakes, four-wheel drives, front-wheel drives, lubrication systems as well as over 100 pages on Aviation Motors—all of these subjects are fully covered. These complete and comprehensive auto books are yours, if you want them, on this easy plan. Send for your set now.

SEND NO MONEY

American Technical Society, Dept. A-419, Drexel Ave. at 58th St., Chicago, Illinois

I would like to see the new 6 volume 1930 edition of your automobile books but without any obligation to buy. I will pay the few cents delivery charges only and will examine the books and return them at your expense in 10 days unless I like them, in which case I will send you \$2.00 then and only \$3.00 per month until the special price of only \$24.80 is paid. You are to include free, consulting membership certificate in the American Technical Society. Send brand new 1930 edition.

Name.....
 Street.....
 City..... State.....
 Employer's Name.....
 Employer's Address.....

These books will be sent free immediately upon receipt of coupon with writer's name and address and that of his employer or other business man as a reference.

MOULDING MIGHTY LEGS



The Greatest Yet!
Complete Course on Leg Building
ONLY 25c

Don't be a half built man. Don't let your legs spoil your physique. Get a 24 inch thigh, a 16 inch calf with 16 inch biceps. Your legs can be made props of power. Never again will the world yell "skinny legs" when you walk the beach in a bathing suit. Let your legs proclaim you a fully developed man no matter whether you are on the beach, in the gym or paddling your canoe. No matter what the physical problem of your legs may be this book course will solve it.

Do your knees fold like a weak clasp knife when you carry a load? Have you trembly legs, weak knees or ankles, or cold, aching feet? Blood stagnation or low nerve vibration? This remarkable book course provides numerous new exercises with priceless information on leg building and foot correction that will quickly remedy these conditions. Tells how knock knees and bow legs can be effectively corrected. Vigorous legs make a vigorous heart, increase virility, dynamize the nerve forces and fill the body with vital life.

Let the small investment of 25c get you a pair of powerful, shapely legs. Let the spring in your heel and the swing of your stride proclaim a new existence of health and strength within you. Get this marvelous new book course hot off the press. The most remarkable illustrated course on the legs and leg exercises ever published. Contains thousands of dollars' worth of health, strength and happiness for you. Yours for only 25c.

RUSH THE COUPON TODAY

With each copy will be given **THE THRILL OF BEING STRONG**—a priceless book to the strength fan and muscle builder. Full of pictures of marvelous bodied men who tell you decisively how you can build symmetry and strength the equal of theirs.

REACH OUT---GRASP THIS SPECIAL OFFER

JOWETT INSTITUTE of PHYSICAL CULTURE

422 Poplar Street, Dept. 4D, Scranton, Penna.

Dear Mr. Jowett: I am enclosing 25c. Please send me the course "MOULDING MIGHTY LEGS" and a free copy of "THE THRILL OF BEING STRONG."

Name _____

Address _____

WORLD NEEDS PLUMBERS

Old style plumbers are fading like the horse and buggy. The world demands modern Plumbing and Skilled Trained Mechanics to do it. Unlimited, swift growing field. **Make \$50 to \$100 a week or start own shop. We train you quick.** Learn in 8 to 12 WEEKS to do any job with skill and science. Need no previous experience. Strictly tool using system. Opportunity knocks. Investigate today—amazing offer—low tuition. World's greatest school.

Write—

UNIVERSAL PLUMBING SCHOOL
2130 Troost Ave. Kansas City, Mo.



BE AN ARTIST

WE CAN TEACH YOU DRAWING in your own home during your spare time. Twenty-five years of successful teaching proves our ability. Artists receive large salaries.

Write Today for Art Year Book

SCHOOL OF APPLIED ART
ROOM NO. 2 BATTLE CREEK MICH.

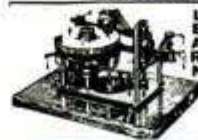

CODE TELEGRAPH Morse or Radio AT HOME WITH THE AUTOMATIC Omnigraph

Leads quickly to big money jobs of Aviation, Ships and Rail roads. Easily and cheaply. U. S. Govt. Schools, etc., use it. The World's Hobby. Models \$17 to \$35. Catalogue P.S. Now Omnigraph Mfg. Co., 810 E. 39th St., Brooklyn, N. Y.

BE A MAGICIAN!

I WILL TEACH YOU, FREE!



Be popular in any crowd. Give exhibitions at clubs, parties and lodges. I can teach you hundreds of entertaining tricks in just a few hours so you can delight your friends and be invited everywhere.

12 MAGIC TRICKS SENT FREE

To prove how quickly you can learn, I will send you 12 amazing magic tricks and teach you how to do them—ABSOLUTELY FREE. Send only 25c to cover postage, packing, etc. Write today to

THEATRICAL ENTERPRISES

431 No. Clark St.

Chicago, Ill.

GOOD PAY JOB or BIG MONEY BUSINESS OF YOUR OWN



I helped Graham, Tullius, Moser, Holtzer and hundreds of other fellows to make up to \$60 and more weekly.

Kaiser, Silverman, Leutz and scores of National trained men are doing a weekly business of \$2,000 and over.

Let me help you to a good-paying steady job as Meat Cutter or give you a start in a Big Money business of your own.

**YOUR FUTURE CERTAIN
—PEOPLE MUST EAT**

371 MILLION Pounds of Meat sold weekly in U. S. America's fastest-growing industry; an everyday necessity; PEOPLE MUST EAT.

Get into the Meat Business quickly as Meat Cutter or in your own shop. I'll show you the way; previous experience not necessary; my instructions easy and simple.

Estimate 12,000 Meat Cutters Needed at Once

I estimate 12,000 Meat Cutters could be used at once in Meat Markets, Clubs, Hotels, Steamships, etc. I need you to help fill this demand.

Mail coupon today. Get full details at once telling how to get one of these splendid jobs. SPECIAL OFFER to men who mean business and want steady, Big Paying Jobs.

THOMAS E. LATTIN, PRES.

NATIONAL SCHOOL OF MEAT CUTTING, Inc., Toledo, Ohio

Thomas E. Lattin, Pres., National School of Meat Cutting, Dept. 96, Toledo, Ohio.

I realize the tremendous possibilities as a Meat Cutter or in a business of my own. Rush SPECIAL OFFER at once, without obligation on my part.

Name _____

Address _____

City _____ State _____

Sell CROSLLEY
ICYBALL Refrigerator Earn
 Makes ICE from HEAT up to...
 No GAS No ELECTRICITY **\$100⁰⁰**
weekly



ICYBALL is an amazing new type mechanical refrigerator that needs neither electricity nor gas and costs only 2c a day to run. Enjoy this modern convenience in your own home. Show to friends and make money.

Costs only 2¢ a day

For Small Towns and Farms
 Brings all the pleasure of mechanical refrigeration to homes where electricity is not available. Saves food from spoiling. Saves lives! No moving parts. Nothing complicated. Nothing to get out of order. Guaranteed. Rush name and address for information on how you can be the distributor in your locality—get your own ICYBALL Refrigerator without cost—and make up to \$100 weekly and over. Write today.

CROSLLEY ICYBALL DIVISION
 824 ARLINGTON ST., CINCINNATI, OHIO

FREE BOOK ON MIND TRAINING

An instructive book which explains an amazing system of mind training already used by more than 700,000 people.

Let us send you a free copy of "Scientific Mind Training." It will show you how and why Pelmanism is the *only* system of teaching for developing all the mental powers at the same time. Endorsed by such distinguished men as Edgar Wallace, Sir Harry Lauder, the late Jerome K. Jerome, Prince Charles of Sweden and hundreds of others. Write TODAY to

THE PELMAN INSTITUTE OF AMERICA
 71 WEST 45th STREET SUITE D-206 New York City

Big Money for You as an Automobile Mechanic

These four practical books, written by five well known teachers of automobile practice, will teach you right in your own home during your leisure time just what you need to know about automobile troubles and repair. They will teach you automobile construction, maintenance and repair as practiced by experts and will help you to earn an expert's pay.

Practical Automobile Library: Four Books—\$1.50 in 10 days and \$2 monthly for 6 months—only \$13.50 in all!

Hundreds of question-answering diagrams—hundreds of clearly-marked illustrations—make the books plain and readily understandable. All the explanations and descriptions are clear, simple, direct. Every chapter is packed with definite, step-by-step, how-to-do-it information. Here is your opportunity to enter a big-pay field.

FREE TRIAL

Send No Money
 Mail the Coupon

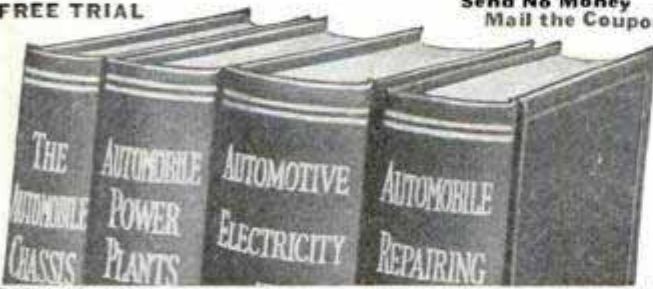

FREE EXAMINATION COUPON

McGraw-Hill Book Co., 370 Seventh Ave., New York

Send me for 10 days' free examination the New Practical Automobile Library. If satisfactory, I will send you \$1.50 in 10 days and \$2.00 monthly until the special price of \$13.50 is paid. If not wanted, I will return the books at your expense.

Signed.....
 Address.....
 City and State.....
 Position.....
 Employer..... P. M. 4-30

There's Quicker, Bigger MONEY for YOU in POULTRY RAISING!



Wherever You Live—Whatever You Do Now—\$2,000 to \$5,000 a Year Can Be Yours!

YOU Can Do What They Have Done

"Your Course on Poultry Raising is the most practical and complete in the country. You have opened up a pleasant and profitable way for me to spin an independent living."—S. Anderson, Burlington, R. I.

J. L. Mosher of Buffalo, N. Y., started at \$35 a week after 10th Lesson. F. O. Anderson of Phoenix, Ariz., writes: "Thanks to N. P. I. I got a job even before I finished your Course!"

Spare Time or Full Time YOU Can Cash-In BIG

The Poultry Industry is growing by leaps and bounds. Eggs and Poultry meat are commanding high prices—prices that mean real profits on every bird you raise—every egg your flock produces. Thousands of my students have turned to Poultry Raising for part-time extra money or full-time big pay. I'll show you how to start in a small way—in your own back yard—and make it pay—make your little investment multiply itself automatically. Or, if you want to work for someone else at a good salary—my FREE Employment Dept. will help place you in one of the thousands of splendid positions open to trained poultrymen. Why wait? I'll PROVE that I can put you among the big money makers QUICK!

My Proved Methods Assure Success Right from START

All the "mystery," all the "secrets," all the guesswork are taken out of Poultry Raising by my sure, tested, proved successful methods. I will teach them all to you. Nothing left out, nothing for you to have to figure yourself. I make it easy for you. It's fascinating, healthful, pleasant, profitable. You'll be your own boss—I'll show you how to make \$1.00 to \$3.00 for every hour of your spare time. What's more, I'll show you the way to a salary of \$5,000 a year AND UP! Start as small as you want; my methods will get the maximum profits out of your flock and make it grow automatically, into a sure source of steady big income for YOU.

FREE BOOK Shows Way to BIG PROFITS

My big new FREE book, "How to Raise Poultry for Profit," will amaze you! It brings evidence—a plenty—absolute proof—of what I have done for thousands of others. My forty years experience as Commercial Poultryman and former Senior Poultryman in the U. S. Dept. of Agriculture is yours for real Success and Independence. The Poultry Business needs you—and you need the profits that the poultry business brings. You need my book. Get in line for QUICKER, BIGGER MONEY. Do it this minute—don't delay a day. Get this coupon into the very next mail!



48 Pages of Money-making FACTS

Get this FREE Book NOW!

Harry M. Lamon, Pres., NATIONAL POULTRY INSTITUTE Dept. 411-G, Washington, D. C.

Dear Mr. Lamon: Send me your FREE Book, "How to Raise Poultry for Profit." I want to know more about MY opportunity to make \$2,000 to \$5,000 a year, spare time or full time.

Name.....
 Address.....
 City..... State.....



Given Up Hope for a College Education?

This advertisement deals with facts—facts on how to realize that dream of a college education. If you've never had such a dream you won't read far. But if you've at some time or other set your heart on a college education—and found lack of money and time blocking your way—then this message spells opportunity for you.

A Degree for You

There is a school in Chicago that rekindles the spark of ambition—a technical school that brings to men of limited means, the great chance to earn a college degree . . . to become really trained . . . in less time . . . and with only half the usual expense. A school for men short on funds but long on ambition.



These 4 Fields Pay Big

The school is Chicago Technical College . . . specializing in degree and diploma courses in Drafting, Engineering, Architecture and Electricity. Training in 4 technical branches of opportunity . . . the 4 fields that make a degree or diploma mean more in dollars and cents than any other profession or branch of learning. High grade training under the supervision of specialists and backed by the experience of this 26 year old institution.

Success for You . . . In Chicago

Here in Chicago there is a world of opportunity for the technical student. Building activities going on all the time . . . the engineering center of the nation . . . part time positions to help pay expenses . . . good reasonably priced living accommodations.

We have a special plan for men who have not finished high school. Send the coupon—it brings all the facts.

Our Free Blue Book Tells All—Send for It Now!

If a college education . . . a degree . . . the training that will bring you success, recognition and happiness, means anything to you . . . then you will want this 80 page Free Blue Book . . . the book that shows you why resident training at this school will put you way out in front. Fill in the coupon and send it now! This may be the opportunity that will change your whole life. You're only gambling with 2c—the cost of a stamp to get the coupon to us. Will you take that chance?

CHICAGO TECHNICAL COLLEGE

Dept. D-78, Chicago Tech. Bldg.
118 East 26th St., CHICAGO, ILL.

CHICAGO TECHNICAL COLLEGE, Dept. D-78, 118 E. 26th Street, Chicago
I want to know how I can get a degree or diploma and be college trained in Drafting, Engineering, Architecture and Electricity in less time and with less cost. Send me your Blue Book, free, without a cent cost to me.

Name..... Age.....
Address.....
City..... State.....
Education.....

TRY THIS TEST!

CHECK YOUR ENGLISH WITH THIS FAMOUS SELF-INSTRUCTOR



In the following list of ten words, half of them have the wrong pronunciation given—can you tell which are wrong and which right?

- | | | |
|------------|---|---------------|
| callope | — | co-L-tee-pe |
| communist | — | com-MU-nist |
| conversant | — | CON-ver-sant |
| dirigible | — | di-REDJ-able |
| exquisite | — | EX-quit-ite |
| grimace | — | grim-ACE |
| lamentable | — | la-MENT-a-ble |
| paprika | — | pap-REE-ka |
| secretive | — | se-KREE-tive |
| vaudeville | — | vau-da-ville |

How embarrassing to discover that you have been pronouncing even the simplest words incorrectly! What impression must you have made at the office, at luncheon, in social and business talks if, for instance, you said "con-VER-sant" when you should have said "CON-ver-sant."

What A Difference Just A Few Words Make

Everyone makes mistakes in English—in pronunciation, grammar, construction, phraseology and spelling. But, the better English you use, the better is the impression that you create.

The least that anyone can do is to spend a few minutes a day to check up and improve his language. Putnam's famous "Pitfalls in English" is a handy instructor—easy to follow and learn from. Thousands of people in all walks of life have read and studied this book to their profit.

SEND NO MONEY

You may TEST yourself with Putnam's famous "Pitfalls in English" in your home. Send this convenient coupon today. Deposit \$1.90 (and postage charges) with postman when the book arrives. Test yourself—check and improve your English—for 30 days. Then if for any reason you are dissatisfied return the book and we will immediately refund purchase price and postage.

G. P. PUTNAM'S SONS, 2 West 45th St., New York, N. Y.

Please mail me your "Pitfalls in English." When the book arrives I will deposit \$1.90 (and postage) with postman; my money and postage to be refunded at any time within 30 days if I return book to you.

Name..... P
Address.....
(Cash with order price \$2—Same guarantee of satisfaction)

ADD TO ANY INCOME

Costs Next to Nothing. No Personal Selling Required. Make immediate, immense and endless profits. Become a Vacuum Cleaner Builder and Service Expert. New evergrowing field. Readily mastered under our expert advice and full instructions which are entirely free. Valuable secrets revealed for first time. We can supply all needs. Using spare-time, start a home, branch factory all your own. End uncertainty forever. Be your own boss. Pay your own salary. Undersell all. Lead all. Literature tells how and why. Join us, the originators. URON ASSOCIATED INDUSTRIES, 1302 Engineers Building, CLEVELAND, OHIO, U. S. A.

MAKE YOUR INVENTIONS PAY

MILLIONS have been made from ideas properly developed and protected by inventor. One of the first steps is the development of a practical working model. Send us rough sketch or model of your idea. We will submit complete report backed by 30 years' experience in model making. Confidential service. Modern equipment. Bank references furnished. FREE booklet "Making Inventions Pay."

CRESCENT TOOL CO., Dept. A, CINCINNATI, OHIO

Sell More With SIGNS

Signs are "silent salesmen." They never loaf, sleep or go out to lunch. Use more signs in your business and sell more merchandise.

Showcarder
Makes high grade professional looking signs. Anyone can use it without experience or practice. Show Cards, Price Tickets, Streamers when you want them at negligible cost. Write today for full information and prices.
AGENTS: Write for proposition—exclusive territory.
SHOWCARDER, Inc.
2302 University Ave. SAINT PAUL, MINN.

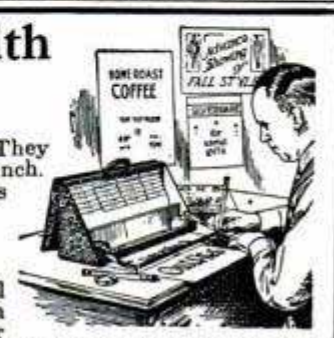

Start Now! HERE IS AN EASY WAY!



Get Instruction at HOME

Learn to Fly at Our School Later
 Let us tell you how you can NOW start at home to prepare yourself for a position in aviation—a position paying \$300 to \$1000 a month in the world's fastest growing industry. The School of Von Hoffmann NOW offers you individual instruction right in your own home from U. S. Licensed instructors.



Lieut. Murel R. Bouse
 Our chief instructor is well qualified to teach aviation and assist you in preparing for a good paying position. He was an instructor for seven years at the U. S. Air Technical School, Chanute Field. Write Lieut. Bouse today for full information on how the School of Von Hoffmann will start you in aviation at home.

Trained Men Are Needed

There is money for you in aviation if you get thorough training NOW! Commercial aviation needs men, and there is an ever increasing demand ONLY for those who have been properly trained. Start now to secure this training at home with our course of instruction—instruction given under the direction of U. S. Licensed Transport Pilots and covering everything about planes, motors, their maintenance and construction.

"The Von Hoffmann Graduate Qualifies"

Our home instruction will give you all the knowledge necessary to pass the government's written examinations for mechanics' and pilots' licenses. Start now at home to prepare yourself for a position as pilot, mechanic, or any of the other great number of positions in aviation.

PAY AS YOU LEARN

You can get this instruction and keep your present position until you have finished our course and are ready to apply for a place in aviation or come to our school and take up actual flying, where you can acquire the necessary instructions needed to secure a pilot's license. You pay as you learn—only a small amount being paid for each lesson as you receive it, and what's more, if you come to our school later, you are credited on a flying course with the full amount you have paid, so that your home instruction costs you nothing. Write TODAY for full information and FREE outline of our Home Instruction.

VON HOFFMANN AIRCRAFT SCHOOL
 128 Lambert-St. Louis Flying Field ST. LOUIS, MO.

EMPLOYMENT SERVICE

Our school maintains an excellent employment service which will be of great value to you when you are ready to take your place in aviation, and will assist you in getting a job without charge.

Lieut. Murel R. Bouse,
VON HOFFMANN AIRCRAFT SCHOOL,
 128 Lambert—St. Louis Flying Field,
 St. Louis, Mo.

Please send me free outline of your course and full information on how I can start in aviation at home.

Name.....
 Address.....
 City.....
 State..... Age.....

YOU CAN OIL PAINT

Amazing new method teaches men or women to earn after first lesson. OIL PAINT photos—portraits, landscapes or art subjects. Earn \$18 to \$50 and more a week. OIL PAINT OUT-LET GIVEN. Send now for free illustrated book. PICTORIAL ART STUDIOS Inc., Dept. MP, 2926 Broadway, Chicago, Ill.

Study LAW AT HOME

Lincoln did it! Also thousands of other great lawyers, politicians and business men. YOU, too, can become a lawyer or law trained businessman through home study guided by the successful practicing lawyers of our faculty. Write today for free book. AMERICAN CORR. SCHOOL OF LAW 3601 Michigan Ave., Dept. 1354, Chicago



BE A MOTION PICTURE OPERATOR LEARN TALKING EQUIPMENT

THRILLING WORK BIG PAY
 Make big money in this easy and pleasant work. Big demand for trained operators. Write Today! MOTION PICTURE OPERATORS SCHOOL 61 Sprent St. Detroit, Mich.



DRAW CARTOONS

TURN YOUR TALENT INTO MONEY

Cartoonists earn from \$50 to \$250 per week—some even more. Remarkable Circle System of Drawing teaches you in half the usual time. Students from all parts of the world are enrolling for this exceptional instruction. Personal criticism service and up-to-the-minute instruction make it easy for National students to attain success. Send for interesting BOOKLET and SAMPLE LESSON PLATE explaining full details of the Course and what National students are accomplishing. No salesman will call.

The National School of Cartooning, 623 Penton Bldg., Cleveland, Ohio



Men! Extra Money Quick

Here's An Easy Way!
 —to bring you a fine cash income! Without taking any time away from your job. Pleasant easy work at home. Decorate beautiful giftwares the Fireside way. You can do it — in spare moments. No previous training required. No special ability needed. No tedious study. No memorizing. With the Three Simple Steps sent you by Monsieur Petit the great artist — Director of Fireside Industries, it is just fun! We want men in every community. Be the first! Fireside Industries, Dept. 66-D, Adrian, Mich.

Begin Right Now!

Thousands are making Fireside decorations—making from hundreds to thousands of dollars and doing their own work besides. We supply you with everything you need. Big Generous Complete Kit WITHOUT EXTRA COST. It's a cinch! We absolutely guarantee your success.

FREE!
 Fill out and mail coupon at once. Without any obligation it brings you wonderful Fireside Book in colors. Explains everything. Act now!



Fireside Industries,
 Dept. 66-D, Adrian, Mich.
 Send me your wonderful Free Book in colors. This does not put me under any obligation.
 Name.....
 Address.....



FREE! Body Chart

If you will mail the coupon below, this Anatomical and Physiological Chart will be mailed to you without one cent of expense. It shows the location of the Organs, Bones of the Body, Muscles of the Body, Head and Vertebra Column and tells you how the nerves radiate from your spinal cord to all organs of the body. This chart should be in every home.

Where Is That PAIN?

It may be in the neck, back, hips, stomach, liver, legs or arms. Wherever it is, the chart will help to show you the location and cause of your ailment. For instance, this chart will help you locate verminiform appendix pains. Hundreds of lives might have been saved if people had known the location and character of the pain and had received proper attention.

Stop that Pain

By Relieving the Cause with

**Violet Ray - Vibration
Ozone - Medical Electricity**

The Four Greatest Curative Powers Generated by This

Great New Invention!



Elco Health Generators at last are ready for you! If you want more health—greater power to enjoy the pleasures and delights about you, or if more beauty is your desire—write! Ask for the book on these inventions which has just been prepared. It will be sent to you without cost. It tells you how Elco Health Generators aid you in leaving the lethargy and hopelessness of bad health and weakness behind forever. Re-vitalize yourself. Bring back energy. Be wholly alive. Write today!

Here's What Elco Users Say—

"Wouldn't take \$1000 for my Elco."
"Has done me more good in 2 weeks than doctors did in three years."



"Cured my Rheumatism." "My Eczema gone." "Cured my stomach trouble." "Cured my weakness." "Now I sleep soundly all night." "Thanks to Elco my strength and vigor are back." "No more pain." "Colds never bother me now." "Chronic Constipation banished."
These great new inventions generate Violet Ray, Vibration, Electricity and Ozone—combined or separate. They operate on the electric light in your home or on their own motive power at less than 50 cents per year. Elco Health Generators are positively the only instruments which can give you in one outfit Electricity, Violet Ray—Vibration and Ozone—the four greatest curative agents. Send the coupon below. Get the Free Book NOW!

Free Trial

MAIL COUPON for FREE BOOK

Do not put this paper down without sending the coupon. Don't go on as you are with pains and with almost no life and energy. You owe it to yourself to be a better man or woman. You were put here to enjoy life—not just to drag through it. So do not rest another day until you have put your name on the coupon here. That will bring the whole story of these great new inventions. Do it today—now.

Lindstrom & Co. [Makers of Therapeutic Apparatus since 1892.]
2322 Indiana Avenue Dept. 1354 Chicago
Please send me your free book, "Health—Power—Beauty" and full information of your 10-day Free Trial Offer.

Health
Power
Beauty

Name.....
Address.....

Learn to Earn

\$50 to \$150 PER WEEK

Big Opportunities Open for Sweeney Trained Men
If you are mechanically inclined, if you prefer to work with tools, you will learn under the "Sweeney System" by actually doing the work. Everything about all kinds of automobiles, welding, vulcanizing, battery, electrical and aviation ground work. No experience or education needed. No books are used. You get to work on complete gas engines, tractors and electrical equipment untripped in any school. You'll get dirty and greasy but you'll learn by the Sweeney System that fits you for big pay jobs at \$50 per week and up that are awaiting Sweeney Trained Men.

FREE BOOK Send name for Auto and Aviation catalog and Special Offer. Actual photos—lists high pay jobs.

LEARN A TRADE Sweeney Automotive Electrical Aviation School 1615 CP GRAND AVE., KANSAS CITY, MO.

WASHES CARS in A JIFFY!

Here's the cleverest invention of the age! GY-RO washes cars CLEAN without *chamots*, soap or spray! Water pressure from garden hose makes it operate. And in the *easiest*, *simplest* manner ever! Whirling brush cuts right through dirt and road film—car becomes spotlessly clean in a jiffy. Saves autoists valuable time and a nasty job. They buy GY-RO on sight. **USEFUL IN EVERY HOME**—Cleans screens, walls, etc., like new.

100% PROFIT FOR AGENTS!

AGENTS WANTED AT ONCE. Valuable territories still open. No experience needed. Exceptionally large profits for hustlers. Car owners, garages, service stations, etc., are prospects. **COSTS NOTHING TO START.** Send name and address for full particulars.

GY-RO BRUSH COMPANY, Dept. D-14, Amers, N. J.



DRAFTING

BOOKS SENT FREE!

For Beginners

Written so you can understand every word, by 18 famous Engineers and Architects. Deluxe, flexible binding. 1750 pages, 1050 blue prints, charts and diagrams. Prepares you for a good Drafting job in mechanical or architectural lines. Sent for 10 days' free use, if you mail coupon immediately.

"Blueprint Reading"
"Architectural Plate"

Only fifteen minutes a day with these WONDER BOOKS will prepare you for a good Drafting job in less than a year! Mechanical and Architectural Drafting from simple straight lines to important, complex plans, a step at a time! Built especially for beginners, for men with only grammar schooling. Drafting room practice plus engineering made easy and clear!

Big Field—Big Demand—Big Pay!

Competent Draftsmen are urgently needed right now in all building and manufacturing lines at \$50 to \$100 a week. That's just the beginning—for draftsmen have the best chances for advancement! Pleasant, fascinating work, easy to learn and do. Learn quick with these books—send coupon for a set FREE, and see for yourself!

[A year's Consulting Membership in the American Technical Society now given free to all readers of this famous Cyclopedic of Drafting. Many say that's worth more than cost of books.]

American Technical Society
Dept. D-419, 58th & Drexel Ave., Chicago

FREE If you send for these great Drafting Books NOW we will include without cost a complete volume "Blueprint Reading" containing 120 pages durability bound in cloth and also a complete portfolio of 58 plates covering the basic orders of architecture. These plates are drawn to scale and are very valuable.

American Technical Society
Dept. D-419, 58th & Drexel Ave., Chicago

Send for 10 days' free use 4-volume set of DRAFTING. In return for mailing this coupon promptly send absolutely FREE "Blueprint Reading" (Building) 120 pages, 69 illustrations, also a complete portfolio of 58 plates. I will pay the few cents delivery charges. If I wish I may return books in 10 days and owe you nothing. But if I prefer to keep them I will send \$1.80 after 10 days, then \$2.00 a month until \$14.80 (special reduced price) is paid.

Name.....
Address.....
Employed by.....
Address.....

"I Never Put On Muscles SO FAST in all my life"

IT'S A GREAT LIFE IF YOU DON'T WEAKEN

By RAFE

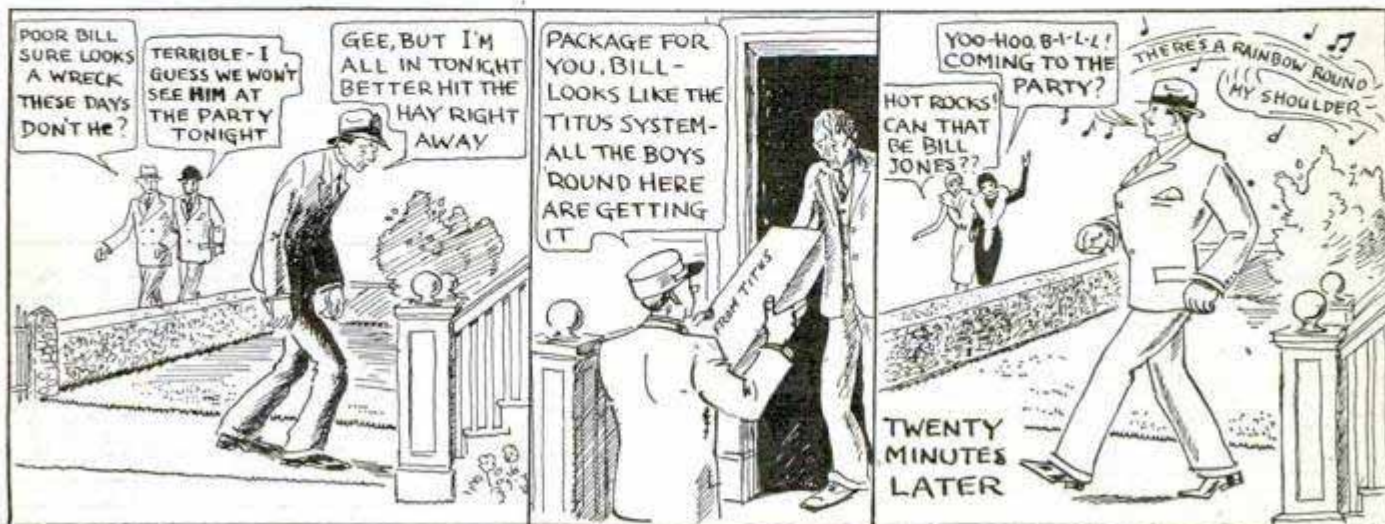

That's what one man writes: "I never put on muscles so fast in all my life!" And his words are echoed by thousands of others all over the world.

MIRACLES WORKED IN MUSCLES! Weak men made strong! Puny, sickly chaps transformed into husky, broad-shouldered athletes! Man, if you've got an ounce of red blood in your veins you're going to find out about this wonderful way to get **STRONG**. All in a few minutes a day at home. My Free Book tells the whole amazing story. Send for it **TODAY**.

A New Body in 20 Minutes a Day!

Find out how you can be *made over!* How you can quickly change into a superb model of muscular **MANHOOD**—how you can develop a powerful athletic build—how you can cover that frame of yours with rippling layers of solid muscle! Man, I'm going to fill you so full of glorious pep and health that you'll be the life of the party wherever you go. Read what I've done for other men and be happy—for boy, you're **NEXT**.

Can You Do These Feats of Strength?

How would you like to amaze your friends by tearing a telephone book or deck of cards in two? Titus Trained men do these feats, and many others, with ease. Anthony Ottavio of Massillon, Ohio, is only 18—but what a **MAN!** He writes: "I can bend a light horseshoe with my hands. I can lift 200 lbs. with my left and right hands. I can lift 150 lbs. with one finger." **ADAM ALTMAN**, of Chicago, Ill., writes: "Before I took your

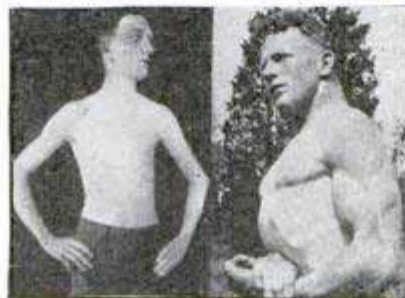

WHICH IS YOU?

Look at these two pictures! Which is **YOU?** A puny run-down weakling, scorned by your fellow-men, avoided by the girls, ashamed to show yourself in a bathing suit? Snap out of it, friend! Take a look at that big boy at the right and cheer up. That's the way **TITUS** builds men.

course I could only chin myself eight times; now I can chin myself twenty-five."

STANLEY THOMPSON, of Multnomah, Ore., writes: "I can tear a pack of cards in half, bend spikes, and do many other things which I could not do before. Titus Built men sure have the speed and power behind every punch."

Let Me Make YOU Over

Just give me 20 minutes a day, that's all — and **WATCH THOSE MUSCLES GROW!** See the amazing change in 30 days. Man, won't you be **PROUD** of those big, rippling muscles! But don't get a swelled head when



SAXON World-Famous Strong Man Says:

"My feats of strength on the stage have brought me hundreds of inquiries asking how I develop such extraordinary strength. I tell them all to write to Titus; he'll show them how to develop physical power that will amaze them. Every red-blooded man should read for that marvelous book, 'MIRACLES IN MUSCLES.'"

you hear the girl friends raving about your handsome, athletic build.

I don't just *promise* you all these good things—I **GUARANTEE** results. I guarantee to put "a solid inch of powerful muscle on your arms, a couple more on your legs—I guarantee to develop every muscle in your body in proportion — to broaden your shoulders and add 5 inches to your chest—to strengthen your internal organs, too—I Guarantee you new pep, new energy, **NEW LIFE**."

TITUS Dept. M-149, 853 Broadway NEW YORK CITY

FREE-MIRACLES IN MUSCLES

Come on, friend, you're next! This book will give you the surprise of your life—read how weaklings have been changed into strong, brawny, **HEMEN**—see actual photos of magnificent models of muscular manhood—discover how **EASY** it is for *you* to get strong. This glorious book is yours **FREE**. Mail that coupon **NOW**.

TITUS, Dept. M-149
853 Broadway, New York City.

Dear Titus: Okay, send me that wonderful new book of yours "Miracles in Muscles." Get it to me by return mail without the slightest cost or obligation on my part.

Name.....

Address.....

Town.....State.....





You Can Learn HYPNOTISM

... or No Cost
Try FREE 5 Days!

DON'T be unpopular, lonesome, or unhappy a minute longer. Now you can make your life what you want it to be—now you can win admiration, success and big money—through the strange power of hypnotism. I'll show you how to use this great force to help you master every situation or *The Five Day Trial is FREE!*

In just a few hours I'll teach you the hidden secrets of Hypnotism—the methods used by the great operators—the amazing things you can accomplish once you understand this mighty power. You can use it to overcome obstacles, achieve your fondest ambitions and become **MASTER** of yourself, friends and acquaintances—either sex. See for yourself how Hypnotism can banish fear, worry and opposition—improve your memory—increase your earnings—and force others to give you the good things in life you deserve!

In his startling **NEW** book, *The Science of Hypnotism*, the world famous hypnotist—Prof. L. E. Young—reveals the most carefully guarded secrets of this fascinating subject. He not only explains the methods of noted hypnotists, step by step—but tells clearly all about the nine stages of hypnotism, the Hypnotic Mirror, Mental Telepathy, how to select your subjects, magnetic healing, methods of hypnotizing, how to waken the subject, how to make money out of hypnotism!

**Try 5 Days FREE—
Send No Money**

So confident are we that Prof. Young and his great book will quickly teach you the science of hypnotism, that we will send you a copy without one cent in advance! Simply clip and mail the coupon below. When the book arrives pay the postman the special low price of \$2.50 plus few cents postage. Then test the powers of Hypnotism 5 days! If not amazed and delighted return the book and money will be refunded at once and the coupon now.

FRANKLIN PUBLISHING CO.
Dept. D-70, 800 N. Clark St., Chicago

Mysteries of Hypnotism Revealed

- How to Hypnotize at a Glance
- Susceptible Subjects
- How to Hypnotize by Telephone
- How to Give an Entertainment
- How to Make Others Obey You
- Overcoming Bad Habits
- How to do Dozens of Hypnotic Feats
- Use of Hypnotism in Operations

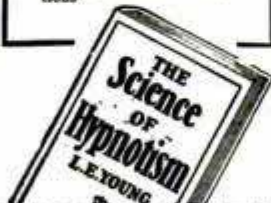

Franklin Publishing Co., Dept. D-70,
800 N. Clark St., Chicago

Please send me your amazing new book—*The Science of Hypnotism*—by Prof. Young. When the book arrives I'll pay the postman only \$2.50 plus postage. If I am not satisfied after 5 days' trial, I may return the book and you are to refund my money.

Name.....
Street and No.....
Town.....State.....

If you are likely to be out when postman calls, send \$2.50 with coupon and we'll pay delivery charges. Customers outside U. S. must send cash with order.

Let this business pay YOU \$50 to \$150 a week

**Work for Yourself or Others;
Learn Quickly Right at Home**

MEN are needed to capitalize the big opportunities for managers and assistants in Restaurants, Tourist Inns, Cafeterias, Coffee Shops. High class work, unlimited future, salaries \$2500 to \$7500 a year. LEWIS graduates *succeed* in this interesting, growing, profitable field. Practical home-study course can fit YOU in few short months; National Employment Bureau *free of extra cost*. Without obligation, write for **FREE** Book that brings complete details. Address:

**Manage a
Restaurant
Coffee Shop
Cafeteria**



Lewis Training Institute **FREE Book**
Dept. 314-CE Washington, D. C. **Shows how**

FREE BOOK CATALOG

Send today, without obligation, for our new 72 page catalog, describing books on more than one hundred and fifty practical and scientific subjects, including books on Aviation, Automobiles, Air Brakes, Alloys, Electricity, Horology, Heating, Hydraulics, Model Making, Metallurgy, Radio, Ship Models, Soaps, Perfumes, Recipes, Plumbing, Inventions, Tanning, Television, etc.
Norman V. Henley Publishing Co., Dept. 44, 2W. 45th St., New York, N.Y.

•BIG BOOM COMING IN• •BUILDING• •CONSTRUCTION•



Night scene of buildings for World's Fair at Chicago



A Good Job When You're Only Half Way Through!

Contractors, Architects, Engineers, Railroads—big industries like Electricity are making plans for new building projects running into **BILLIONS**.

Big salaries, fine positions, real opportunities waiting for every man who learns Building Construction, Drafting and related Engineering subjects.

Permanent Positions

Right now we are making an interesting proposition to men ambitious to break into this worth-while, **prosperous** field—who are willing to devote a part of their spare time to getting ready. Jobs for students **when only half-way through**, a new feature of our service. Mail coupon for interesting offer.

American School

Dept. C-447 Drexel Ave. & 58th St.
Chicago, Ill.

JOHN CREGAN
American School
Dept. C-447, Drexel Ave. & 58th St., Chicago.
Without cost or obligation send your employment and training offer leading to position marked X below.
 Building Contracting Drafting and Design
 Architecture Structural Steel, Concrete
Name.....
Address.....

Broadcasting Station WISN is operated from The School of Engineering; also Amateur Station W9SO.



Established 1903. Chartered by State of Wisconsin.

"NOW I will train YOU for BIG PAY in ELECTRICITY IN YOUR OWN HOME Just as I have trained 25,000 Graduates in my Great Electrical School"

Oscar Werwath, E. E.

Director of the Extension Division, School of Engineering—Pioneer in electrical training for 25 years.

Home Shop-Laboratory Without Extra Cost!



A Full-sized Home Shop-Laboratory (not toys) that you can't duplicate for \$60, included with each course without extra charge.

Exclusive Patented Laboratory Equipment

that cannot be secured elsewhere. Special Unit Board System makes fascinating sport of laboratory experiments. Amazingly easy to use.



Learn By Doing



No mere book on theoretical study—but PRACTICAL training on full-sized motor, switchboard, circuits, and electrical equipment.

Satisfaction Guaranteed

You can take S. of E. Home Shop-Laboratory training without risking a penny. Guarantee Bond protects you.



NOW, through my Extension Division, I will train you for advancement and MORE PAY in Electricity without your leaving your home! You will get the same course, the same methods, the same faculty of skilled engineers that have made The School of Engineering internationally famous.

Behind your training will be an institution specializing in Electricity. Not a mere correspondence school but a fully established college, over 25 years old, recognized by the U. S. Gov't. Thousands of S. of E. graduates now employed in important positions with largest concerns in the country.



Diesel Engines for the Panama Canal, on which S. of E. Students assisted with acceptance tests at the request of U. S. Government.

ELECTRICALLY TRAINED MEN Earn \$3,000 to \$10,000 a Year

In Radio, Television, Aviation, Automotives, Refrigeration, Moving Pictures, Super-Power, Lighting—Electricity is the key. Big manufacturers are pleading for men trained in Practical Electricity. Salaries of \$3,000 to \$10,000 a year now are common. Here is a vast field for you, with unlimited opportunities. Now is the time. Start on the road of Electrical Training that leads to bigger pay—bigger opportunities—and SUCCESS!

EARN AS YOU LEARN

Cash in on your Electrical Training while you're learning. Many students report increased earnings, advancement, even while studying. Train in your spare time at home. Employment Service renders FREE aid for life. Lifetime Consultation Service. Many exclusive features available nowhere else. Mail the coupon today for full particulars. Please mention age.

**EXTENSION DIVISION
SCHOOL OF ENGINEERING
Dept. 37, Milwaukee, Wisconsin**

FREE!

Send Coupon TODAY for FREE illustrated Catalog—"Practical Electricity—the Key to Success"—and full details of Extension Division Training. Please mention age.

MAIL COUPON NOW!

Extension Division, Dept. 37
SCHOOL OF ENGINEERING
Milwaukee, Wisconsin
Please send me, without obligation, FREE illustrated catalog, "Practical Electricity—the Key to Success," and details of Extension Division training.

Name.....

Address.....

.....Age.....

Electricity for Boys

AND OTHER BOOKS

Boys! Here's a complete library of the most interesting sciences in the world. Have fun learning electricity and these other allied subjects. Earn extra money making and fixing hundreds of useful things. Make fascinating experiments. These four books tell how. Practical. Easy to understand. Written specially for Boys.

Electricity — 125 Illustrations. 333 Pages.
COVERS: Home laboratories; galvanometers, batteries, magnets, coils, condensers, dynamos, motors, transformers, telephone and telegraph sets, electric bells, fans, irons, house lighting, ignition, radio, hook-ups, circuits, etc. How to make repairs, etc. Over 51 experiments.

Physics — 101 Illustrations. 305 Pages.
COVERS: Matter, measurements, force, machinery, liquids, gases, wave motions, sound and musical instruments, phenomena of heat, steam and other engines, light and optical instruments, X-rays, radium, future of physics, etc., etc. Over 71 experiments.

Chemistry — 82 Illustrations. 265 Pages.
COVERS: Experimenting with water, gases, acids, bases, salts, metals, alloys, amalgams, practical and home chemistry, brilliant chemical tests, electro-chemical arts, chemistry in photography, soils, warfare, synthetic chemistry, apprentices' tables, charts, etc., etc.

Astronomy — 110 Illustrations. 291 Pages.
COVERS: Movements, measurements, relation, etc., of earth, sun, moon, stars, planets. Gives facts about sun spots, northern lights, magnetism, eclipses, comets, meteors, coronas, etc. How time is told, navigation, mapping, practical astronomy, astronomy for Boy Scouts, etc., etc.

EACH \$2.45 CASH SET \$8.45 CASH

1194 Pages — 418 Illustrations — 121 Experiments.

SEND NO MONEY—MAIL COUPON

E. P. DUTTON & CO., 290 Fourth Ave., N. Y. C.

Gentlemen: Please send me:
 Complete set of DUTTON'S SCIENCE LIBRARY OF 4 BOOKS FOR BOYS (at \$8.45)
 A copy of the BOYS BOOK OF _____ (at \$2.45)
 I will pay postman I enclose full amount \$.....

Name.....
 Address.....
 City..... State.....

NOTE: If not satisfied return in 10 days. Money refunded.



Complete Muscle Building \$1.00 Course including exercisers

I POSITIVELY GUARANTEE to increase your arms one-half inch in size, chest one full inch, strength 25%, health, 100% in one week's time, by following my instructions and using my exerciser 10 minutes mornings and at night. Send \$1 for complete course and exercisers.

Satisfaction guaranteed or \$1 refunded.

PROF. J. A. DRYER
 Box 1850-P CHICAGO, ILL.

34 Lesson

Drawing Course \$2.98

The biggest value you ever saw advertised anywhere



Haven't you often wished that you could draw cartoons, illustrate some idea, sketch some pretty face, etc.? You can do all of these things. One of America's most famous Cartoonists and illustrators has developed a great, simple system for success in all branches of Commercial Art. This system has revolutionized the entire theory of drawing. It means that drawing can be as easy for you as writing — much simpler than learning shorthand, bookkeeping or typewriting. We are now placing this original system for learning Drawing, Art and Cartooning, consisting of 34 lessons with over 500 illustrations, within reach of every one. If you will devote a few hours each week to the Course WE ABSOLUTELY GUARANTEE that you will learn to draw and draw well before you have half finished the Course. If we fail to make this claim good, we will refund every cent paid us. By eliminating a large office force for answering correspondence, expensive catalogs, etc., we are enabled to make a price of \$2.98, the cheapest price ever known for a high-grade, home study course. Learn to draw. It is a big asset, no matter what field you are in.

Send No Money

Just order the course and on arrival \$2.98 pay postman

plus a few cents postage, payment in full for the entire Course and Drawing Outfit. If not entirely satisfied, return within five days and we will refund Money. Address:

LEDERER SCHOOL OF DRAWING, Dept. 500-D, Chattanooga, Tenn. Orders from outside the U. S. A. are payable \$3.28 cash with order.

If you order the course at once, we will include a drawing outfit, consisting of artist's pencils, pens, paper, erasers, thumb tacks, etc., enabling you to go to work without any additional cost.

RUPTURE

Appliances Made To Measure



Want solid comfort? Wear a Brooks Appliance with patented Automatic Air Cushion. Get more comfort and joy out of your favorite sport. No gouging springs or hard pads, but soft, clean, washable air cushion. Aids healing because tissues are gently but firmly

held. Over 3,000,000 Brooks Appliances sold. Wear one on ten days' trial. Try it. Know real comfort. Write for 28-page Rupture Booklet FREE. Sent in plain sealed envelope.

Brooks Appliance Co., 107 C State Street, Marshall, Mich.

Information on any book free. Write Popular Mechanics Press, Chicago, Ill.

Win a Nash Sedan or \$2750.00 in Cash

Someone who answers this ad and qualifies will receive a fully equipped 7-Passenger, Advanced Six Nash Sedan or its full value in cash (\$2,000.00) and \$750.00 in cash for promptness. We are also giving away a Dodge Sedan, a Brunswick Phonograph and many other valuable prizes—besides Hundreds of Dollars in Cash for advertising purposes to men, women and children who solve our puzzle and win our prizes. Over \$100,000 in Cash and Prizes already given! Mrs. Kate L. Needham won \$3,150.00; W. R. Eddington, \$3,050.00; Mrs. M. Iverson, \$2,320.00. This offer is guaranteed by a big reliable company with a reputation of many years of honest dealings, and is open to anyone living in the U. S. A. outside of Chicago.



Find the Twin Babies

There are eight babies in the picture at left. Two, and only two, are alike. These two are the twins. See if you can find them. The rest are different either in their clothes or in their eyes. When you find the twins, mark them with an "X," tear out the picture and send it to me together with your name and address.

\$750.00 Extra for Promptness

In addition to the many valuable prizes and Hundreds of Dollars in Cash we are also giving a Special Added Prize of \$750.00 Cash for Promptness to the winner of the Nash Sedan—making a total of \$2,750.00 in prizes or cash that you can win. In case of ties duplicate prizes will be awarded each one tying. Solve the puzzle and send it to me right away together with your name and address to qualify for an opportunity to share in the \$4,500.00 total Grand Prizes. EVERYBODY PROFITS—you may be the lucky first prize winner. It pays to be prompt.

JOHN T. ADAMS, Manager, Dept. 1774

323 South Peoria Street, Chicago, Illinois

Where the World's Largest System of Air Transportation GETS ITS MEN

IF YOU wonder what aviation can offer you, stop and consider the number of pilots, mechanics, welders, executives, salesmen, radio operators, service men, traffic men, accountants, cashiers, clerks, and others needed to operate a large air transportation system.

Notice the map above which shows the territory over which planes are being operated on regular daily schedule by the American Airways, Inc., the world's largest air transportation system and the organization of which Universal Aviation Schools are a division.

As Employment Manager of Universal Aviation Schools, I am constantly being called upon for men who have aeronautical training to fill positions in aviation.

This service is not limited to graduates of Universal Aviation Schools, but Universal graduates receive first consideration.

An important reason for this is that we have accurate check on their qualifications, including not only their references, previous employment, education, etc., but also first-hand knowledge of their grades, industries, dependability, and character. From experience, other large aviation companies have learned to place confidence in Universal trained men.

Universal Aviation Schools are located in a number of principal cities in the United States. Each school has been inspected, rated and approved by the United

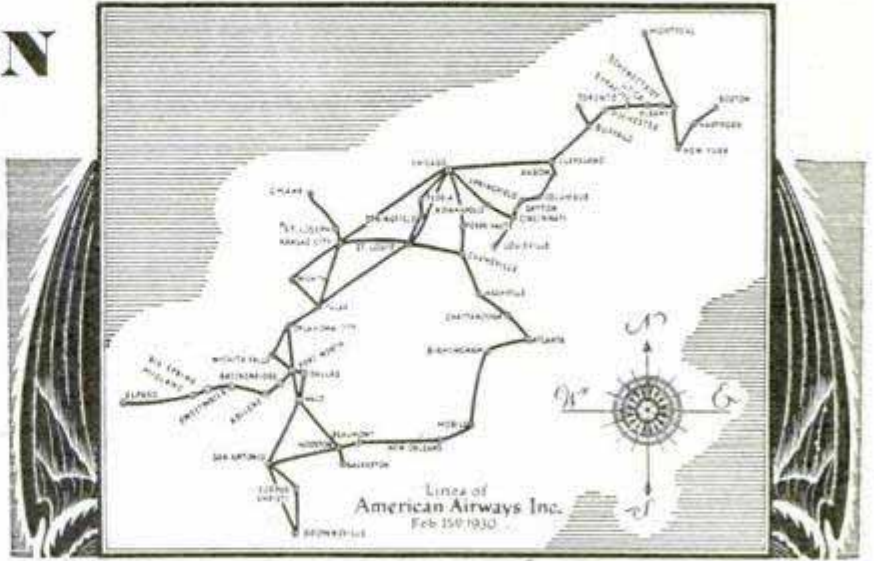

by
Glen Ogle
Employment
Manager of
Universal Aviation
Schools



Transport pilots are given a minimum of 10 hours training on tri-motored planes

States Department of Commerce. This is the highest recommendation any aviation school can have.

What Position Do You Want?

We are training a special group of young men this summer for positions with American Airways, Inc. If you are interested in establishing yourself in this new industry, with us or with others, give us the information asked for in the coupon below.

I will personally look over your past experience and advise you without obligation, just what training you should have and whether your qualifications meet our requirements.

Employment Manager

Universal Aviation Schools

A DIVISION OF AMERICAN AIRWAYS, INC.

Operating Company of The Aviation Corporation

A National System of U. S. Government Approved Schools

INFORMATION BLANK FILL IN AND MAIL

Mr. Glen Ogle, Employment Manager,
UNIVERSAL AVIATION SCHOOLS,
1047-56 Boatmen's Bank Bldg.,
St. Louis, Mo.

Please advise me what training I should take. I prefer position as Pilot.....
Mechanic....., Welder....., Office work.....
Name..... Age.....
Address.....
City..... State.....
Telephone Number.....
My past experience is.....



Which Job do YOU Want

Lawyer



Auto Expert



Civil Engineer



Business Manager

Try for it This way

Men don't just fall into easy jobs of big pay positions—they prepare for the big chance before it comes. Make up your mind today what you want to be, then take the first step at once. You don't have to go to college to get ahead. Other men have gone there for you and have put the things they learned there and through years of practical experience into easily understood books which give you a short cut to a better and a bigger job. We have picked 13 of the best paying professions and have published for your benefit new editions of the most practical, the most valuable books we have ever printed on the subjects covered.

JIFFY INDEX

Our new Jiffy Index makes each book a quick reference work—no time need be wasted in search or study—put your finger on the facts you want instantly.

Special Price List of Pay-Raising Books

Automobile Engineering, 6 volumes, over 2,500 pages, brand new 1930 edition.....	\$24.80
Civil Engineering, 9 volumes, 4,000 pages, 2,000 pictures....	34.80
Practical Business Administration, 12 volumes, 3,400 pages, (Extra volume containing self quiz reading course of 80 lessons included free).....	39.80
Electrical Engineering, 8 volumes, 4,300 pages, 3,200 illustrations.....	34.80
Modern Shop Practice, 7 volumes, 2,600 pages, 2,670 pictures	29.80
American Law and Practice (with reading course), 13 volumes, 6,000 pages, illustrated.....	49.80
Telephony, 925 pages, 682 illustrations.....	6.00
Sanitation, Heating and Ventilating, 4 volumes, 1,436 pages, 1,000 pictures.....	14.80
Drawing, 4 volumes, 1,750 pages, 1,000 pictures, blue prints, etc.....	14.80
Employment Management and Safety Engineering, 7 volumes, 1,800 pages, 450 illustrations, charts and diagrams....	24.80
Architecture, Carpentry and Building, 5 volumes, includes 120 page book "Blueprint Reading" free. Special price—reduced from \$24.80.....	19.80

SHIPPED FREE

Words alone cannot describe the full value these books may be to you, so we ship Free for Examination. Pick the set you want, the price is plainly shown, but **Send No Money**; just your name and address, and the books will be sent promptly. Take fifteen full days to read, test and examine them. You'll realize at once what a tremendous force for a better future they can be. After fifteen days you send only \$2.00; then \$3.00 per month until the balance is paid. **There Are No Interest Charges of Any Kind**; the price shown is the total cost.

MEMBERSHIP FREE

Anyone who takes advantage now of this opportunity to "Raise his Pay" will be given absolutely free, a certificate of membership in the American Technical Society, which entitles him to full consultation privileges with our experts in his chosen field. This is good for a whole year and is of tremendous value in solving special problems.

**American Technical Society, Dept. X-419,
Drexel Ave. at 58th St., Chicago, U. S. A.**

Please send me set of.....

for **Ten Days'** examination. I will examine the books thoroughly and if satisfied, will send \$2.00 within 10 days and \$3.00 each month (\$2.00 on telephony) until I have paid the special price of \$..... If I decide not to keep the books I will return them at your expense at end of 10 days.

Name.....

Address.....

Reference.....

BE A CARTOONIST

\$100 to \$500 A Week Earned by Cartoonists Today.

Like to Draw? Learn Easily..... Billy Hon's Way.

Wonderfully simple system devised by Billy Hon, famous cartoonist, formerly with Hearst Newspapers and other well-known publications. Head of western school of cartooning. Easy to learn course. 30 complete lessons, over 300 cartoons. Full of trade secrets that only one with Billy Hon's many years experience could teach you. \$2 postpaid. \$2.25 outside U. S. A. SATISFACTION GUARANTEED



BILLY HON'S CARTOON STUDIO
P. O. Box 960 P, Hollywood, California

Big Profits Charging Batteries

Starts You. Let me show you how to make big money in the battery charging business. I've prepared a free book explaining all details. My charger is years ahead of ordinary chargers—will handle 50 per cent more batteries. Get into a business of your own with a very small investment. Write for my book today.



C. F. Holmes, Chief Engineer
INDEPENDENT ELECTRIC WORKS
Dept. P. M., 4912 North Clark St., Chicago

Write for **FREE BOOK**



STAMMERING

easily, permanently corrected. Win happiness and success. Ask for full information and special phonograph record. Send dime for postage

12972 Woodward Ave., LEWIS INSTITUTE, Detroit



How to Obtain A Better Looking Nose!

Improve your personal appearance

My new Model 25 Nose Shaper is designed to improve the shape of the nose by remoulding the cartilage and fleshy parts, safely and painlessly. This is accomplished thru the very fine and precise adjustments which only my patented Model 25 possesses. Results are lasting. Can be worn at night, or during the day. Money refunded if not satisfied after thirty days' trial. Write for free booklet to

M. TRILETY, Pioneer Nose Shaping Specialist
Dept. 61 BINGHAMTON, N. Y.

RUPTURE IS NOT A TEAR

Your physician will tell you that hernia (rupture) is a muscular weakness in the abdominal wall.—Do not be satisfied with merely bracing these weakened muscles, with your condition probably growing worse every day!—Strike at the real cause of the trouble, and

WHEN—

The weakened muscles recover their strength and elasticity, and—

The unsightly, unnatural protrusion disappears, and—
You recover your vim, vigor and vitality,—your strength and energy,—and you look and feel better in every way,—and your friends notice the difference,—

THEN—

You'll know your rupture is gone, and
You'll know why for almost a quarter of a century numerous sworn statements report complete recovery and freedom from uncomfortable mechanical supports, without delay from work.

SEND NO MONEY

A Test of the scientific self-treatment mentioned in coupon below is now available to you, whether you are young or old,—man or woman. It costs you nothing to make this test.—For your own good mail the coupon NOW—TODAY.

FREE TEST COUPON

Plapao Laboratories, 455 Stuart Bldg., St. Louis, Mo.

Send me a Free 10 day test supply of the remedial factor Plapao and 48-page illustrated book on Rupture; no charge for this now or later.

Name.....

Address.....

Start to Play Very First Day!



How'd you like to play this instrument? Free easy lessons show you how . . . 5 days' trial in your own home . . . a year to pay!

A LIFETIME of Popularity A LIFETIME of Extra-time Money A LIFETIME of Musical Happiness

TO YOU who have so often remarked, "If only I could be as popular as some fellows," this is an opportunity. To you who a thousand times have said, "If only I could play some musical instrument," we now say, "There is no reason why you shouldn't."

Even if you can't read a note of music right now, you can, by following the free easy lessons furnished with each instrument, play a simple melody on the day you get your Xylorimba! Before you realize it, you will be playing well enough to amaze friends and relatives. Then a new life opens to you. Long, happy evenings of joy; not only invited to parties but the center of attraction—the pride of every girl and the envy of every fellow present. The thrill of having your friends listen to you over the radio! Last but not least, the same chance to earn \$5 to \$25 a night as Ralph Smith, Chicago, who says: "I played twenty minutes at a wedding—received \$20." Or the Hallmann family, Reading, Pa.—"Made \$300 in five weeks, spare time. Had never played instrument before."

We don't ask you to take our word for this. We offer to send you the

Xylorimba of your choice for five days' trial in your own home, so you can judge for yourself. See how easy it is to play. Look over the simple lessons, prepared by experts, which make a teacher unnecessary.

Keep the instrument only if you are satisfied—and then take an entire year to pay!

Was a fairer offer ever made? We make it because we want you to know the joy of creating your own music, the pleasure of being looked up to wherever you go, the profit of big extra money. Remember, this is the most fascinating of all instruments—the same make as used by national stage, radio and phonograph artists. Remember, too, you begin to play at once—no finger or lip exercises; no teacher; no tiresome practice.

Hundreds will take advantage of this chance. Will you be one of them? The coupon will bring, without obligation, our big FREE book which tells more about this amazing offer. Send it in today!

MAIL COUPON TODAY!

J. C. Deagan, Inc., Dept. 1454, 1770 Berteau Ave., Chicago

Send me, without obligation, full details of Free Trial offer and easy payment plan on the Deagan Xylorimba.

Name.....

Address.....



Fame and Money Broadcasting



Center of Attraction at Gatherings



Big Money at Dances

297

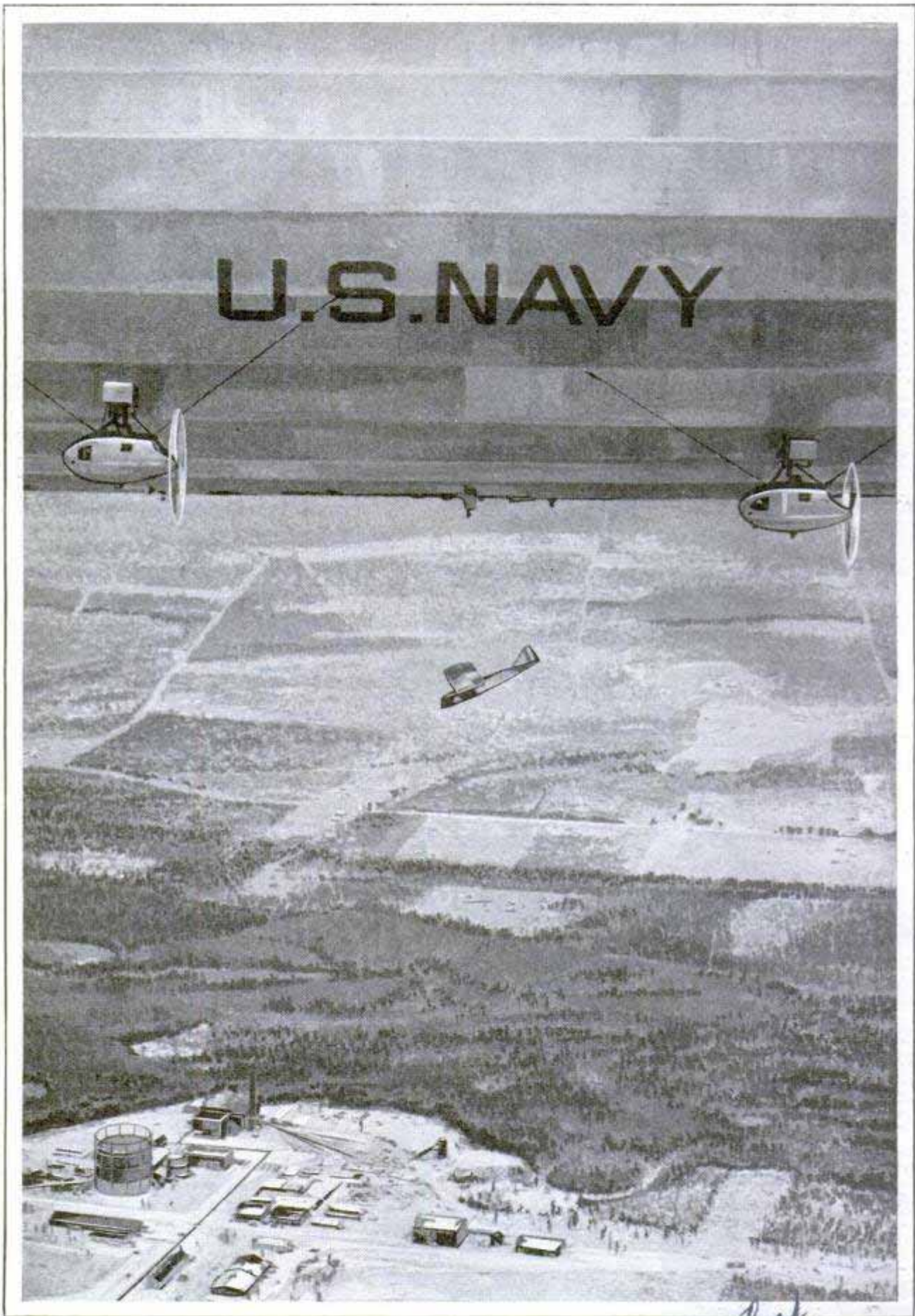

Launching a Glider from the Dirigible "Los Angeles" at a Height of 3,000 Feet over Lakehurst, N. J.; a Naval Officer Kept the Glider under Control, Descending in Eight Minutes

Prints & Barnaby

Popular Mechanics Magazine

REGISTERED IN U. S. PATENT OFFICE

WRITTEN SO YOU CAN UNDERSTAND IT

Vol. 53

APRIL, 1930

No. 4

Lindbergh Learns to Glide

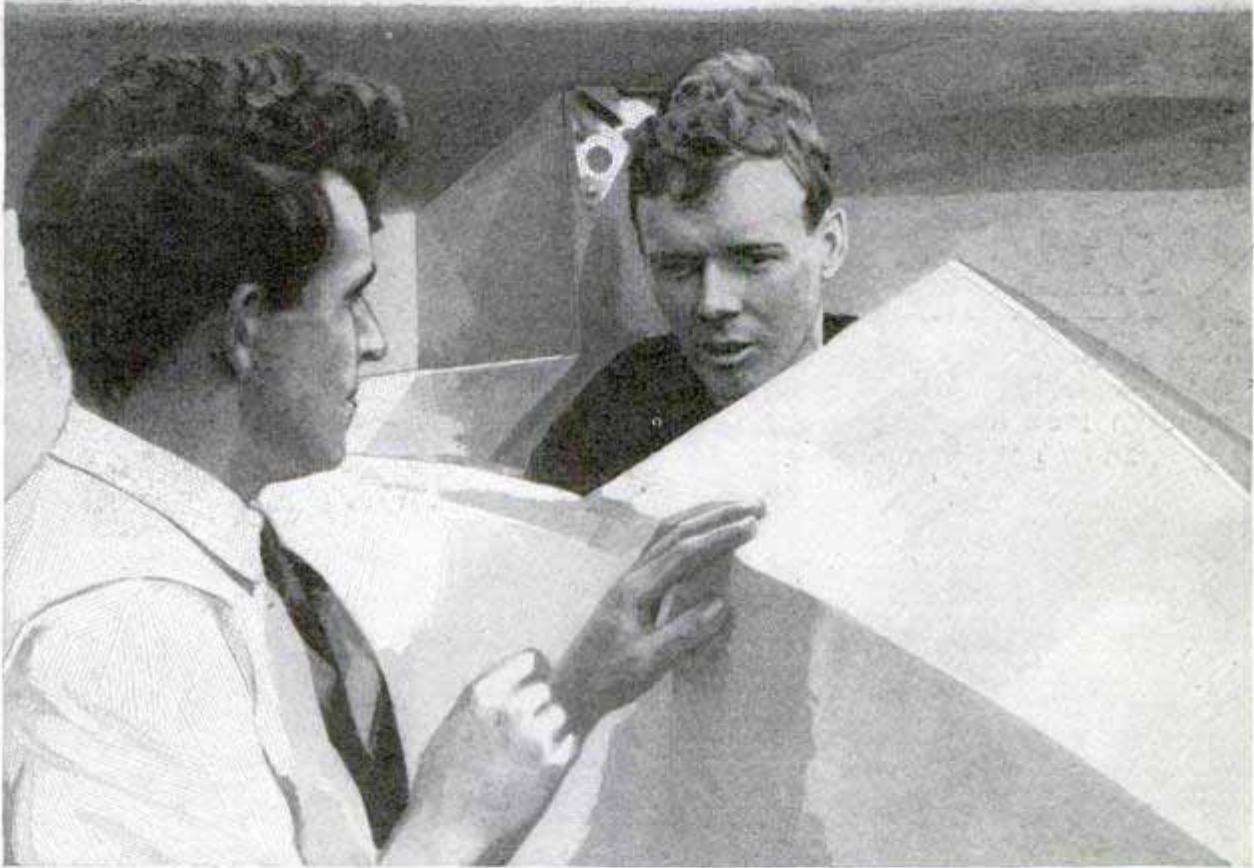

By WILLIAM H. BOWLUS

(Holder of the American Glider Endurance Record)

WE WERE standing on the crest of Point Loma, that narrow tongue of land which separates San Diego bay from the Pacific ocean, looking down the precipitous cliffs that lead into the sea—700 feet, almost straight down!

"You don't fly here, do you?" asked Col. Charles A. Lindbergh, who had come with me to the crest of the Point, where we planned to fly in a sailplane. "Where do you land?"

I explained that it was safe enough to take off into the wind over the Pacific in

a light glider, and that, should necessity arise, a landing could be made in the brush near the cliffs or on the roadway.

The day was ideal for gliding. I was willing to prove that he would encounter no unusual difficulties in being shot into the air from the top of the Point, and to demonstrate the ease with which one may operate a glider, I had the crew manning the shock cords shoot me out over the ocean and for fifteen minutes I sailed about near the point where Colonel Lindbergh watched my maneuvers.

Com. Andrew G. Boone 613 Spreckels 529
Theatre Bldg, San Diego.

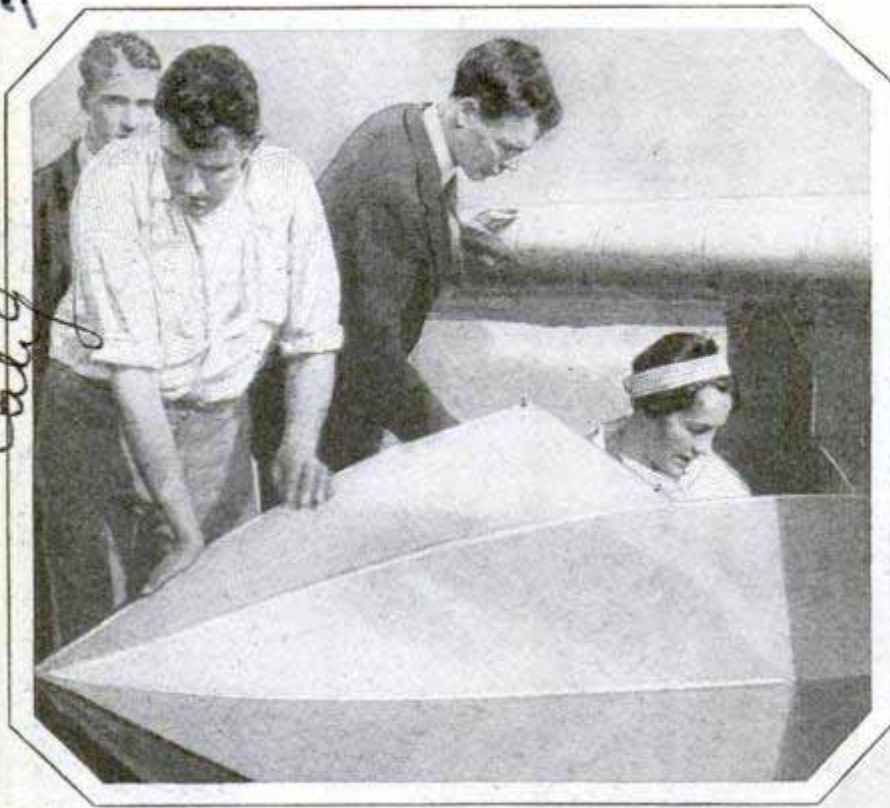

After I had landed, Colonel Lindbergh took his place in the cockpit, and I gave him very few instructions. I told him not to force the glider off the ground after he had started moving, but to let the plane fly itself off after it had attained sufficient speed. I told him not to dive the glider to pick up speed.

He also was to remember always to turn the glider while in an upward current of air and not while flying in a down draft. Usually, in making a turn, the glider loses altitude, and if this is attempted while in a down draft, the pilot suffers a double loss—the normal loss of altitude by the plane itself and the sinking due to the air moving downward.

Since sail flying involves use of energy derived solely from air currents, Colonel Lindbergh's exhibition of remaining in the air thirty-one minutes in this first attempt, and to maneuver it sufficiently, was a considerable tribute to his ability as a pilot. Once he actually climbed 150 feet while making a turn.

During the flight Colonel Lindbergh qualified for a first-class glider pilot's license No. 9, in the United States. He achieved this by remaining above the hori-

zon longer than five minutes and returning to his point of departure.

"It was great sport," he commented as he stepped from the tiny cockpit. "All you need is a hill and some wind. This was my first flight in a sailplane but it certainly was great sport. It also was the first time I have ever carried on a two-way conversation from plane to ground."

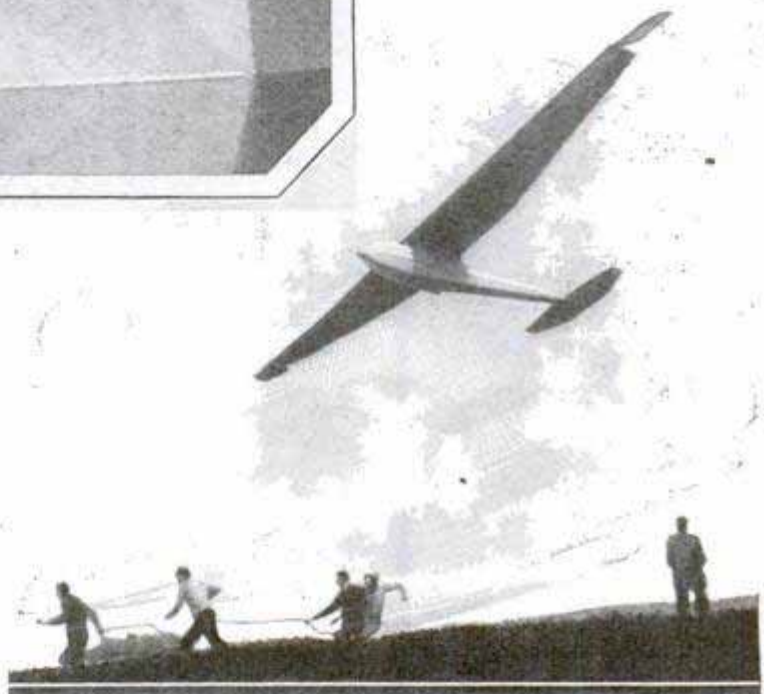

Mrs. Lindbergh in the Cockpit of the Glider While Her Husband Looks On, and, Below, Mrs. Lindbergh Starting Her First Glide

One explanation for Colonel Lindbergh's success in gliding a relatively long distance lies in the fact that the glider, owing to its extremely light weight, can soar three times as far as an airplane before it comes to earth. Should the wind fail while the light craft is slowly descending, the pilot has plenty of time to find an air current that will buoy him up again. These rising breezes are not found by accident. Colonel Lindbergh, being an experienced pilot, knew just where to look for them.

After her husband's flight, Mrs. Lindbergh went up alone and succeeded in staying in the air nine minutes.

VISIBLE SOUNDS REVEAL THE SECRETS OF MUSIC

By means of an electrical device known as the "projection osis," tones produced

for future study. Many world-famous artists are co-

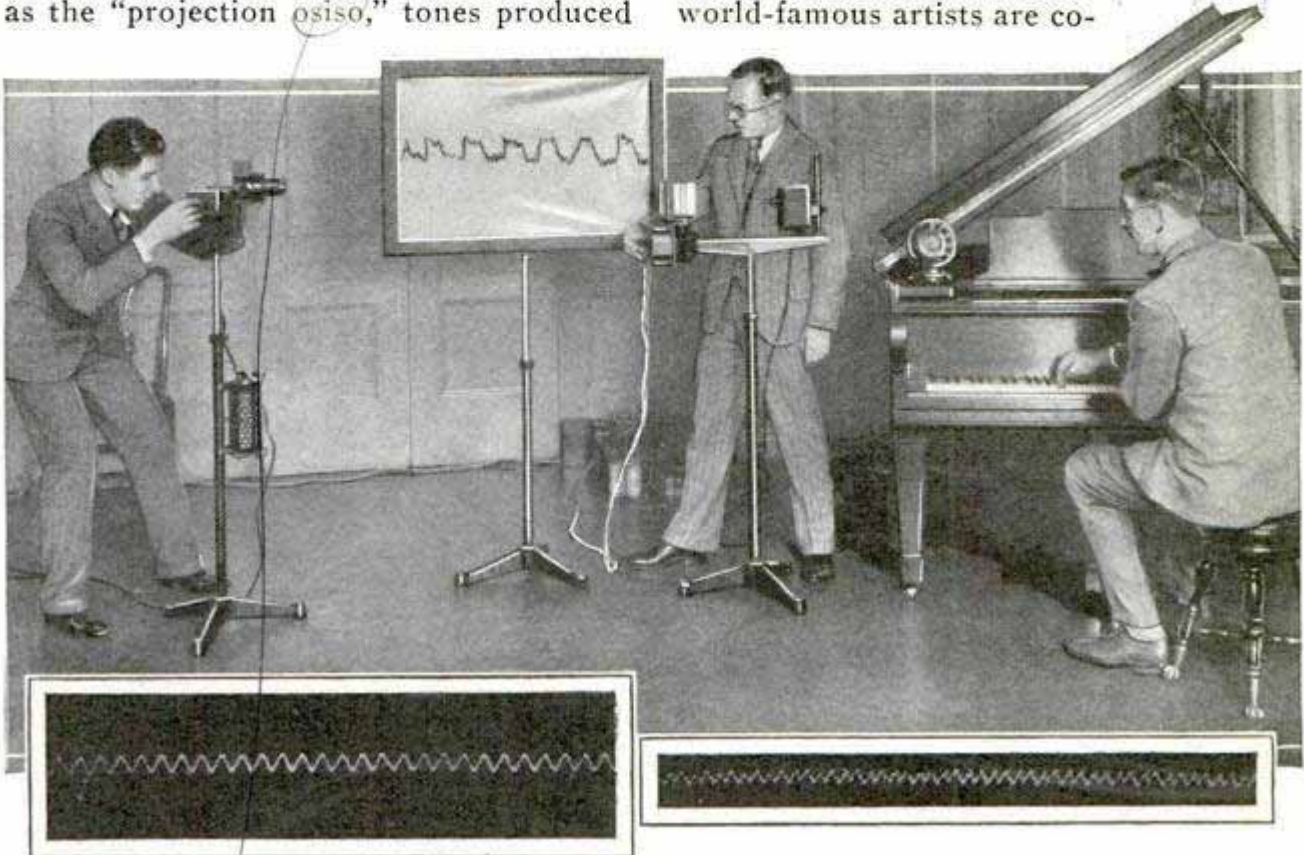

Making a Visible Record of a Piano Note, and, in Insets Below, Two Sound Patterns; at Left, Vibrations from a Tuning Fork, and, at Right, the Same Note as Played by a Violin

by voice or instrument are seen as lines of patterned light moving across a screen. The apparatus was developed primarily to study the "steel heart of music," that is, the sounds made by the strings of pianos and other instruments, but it has a wider application. With it, a singer can see the forms of the sounds his throat is making. Teachers are given a visible means of showing the correct manner of speaking or singing. Each tone is accompanied by its moving pattern, the shape of which reveals the quality of the sound. The width of the pattern indicates the volume. The apparatus consists of a microphone which picks up the sounds and translates them into electrical current. This current, in turn, vibrates a small mirror. The glass reflects a beam of light across another mirror with the result that the original tone reaches the screen as a dancing line of light, varying in pattern and size. Sound photographs of the voices of great singers and of the tones produced by famous pianists and other musicians are being taken by this method and preserved

operating with the acoustic laboratory of the American Steel and Wire company in this work.

VAPOR-GAS SERVICE FOR HOME IS FREE FROM DANGER

Forcing air at controlled pressure into a tank partly filled with liquefied natural gas, a compressor unit now makes possible a vapor-gas service for homes regardless of their distance from gas mains. The tank containing the liquefied gas is buried outside the home, while the compressor is installed in the basement and connected to the tank with pipes. Other pipes carry the vapor gas formed to cookstoves, water heaters or fireplaces. Automatic safety devices are incorporated.

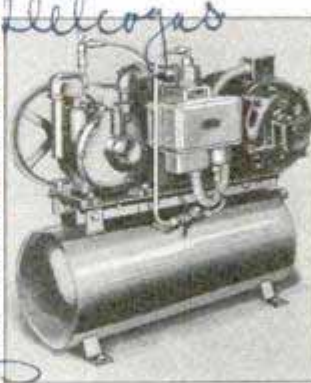

Master Engineering Dept. New York World, Edward H. See Dec. 1929. 512

Chicago - 835 W. Washington

A. B. Hill, Instrument Section Head, Westinghouse
Illco. Light. Co., 425 E 1st St. Dayton, Ohio

Cont. A. J. Wilkins Esq.
 Coloniberie, 29 Beain Road

Mr. Coleman,
 Control operator

400 532 Besley Heath nr
 London, England

POPULAR MECHANICS

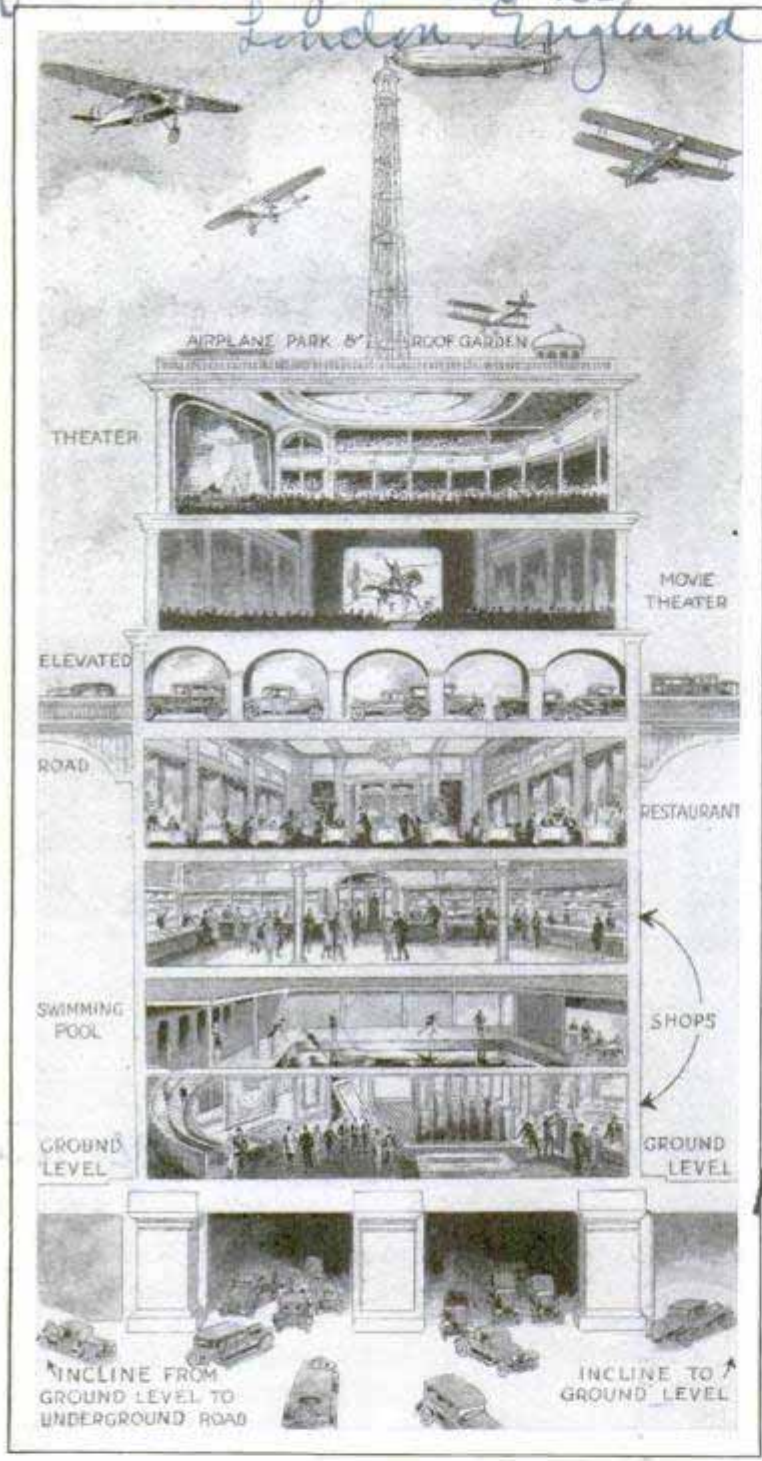

Courtesy The London Daily News
 Plans for London Department Store, Including Mooring Mast on Roof, Theaters, Swimming Pool and Radio Room

MOORING MAST ON STORE ROOF FOR DIRIGIBLES

Plans for a skyscraper London department store include provision for a mooring mast on the roof for small private dirigibles, and a park for private airplanes, as well as elaborate roof gardens. A theater and movie house will occupy the upper floors of the building, while batteries of escalators rising spirally from

the ground floor will lead to swimming pool, dressing rooms, barber and beauty shops, libraries, post offices and television rooms. Moving floors and revolving platforms will convey merchandise and customers, and an elevated roadway will pass through one of the top floors, while beneath the ground will be streets and space for parking automobiles.

201 BIRDS MAKE TROUBLE FOR BROADCASTERS

Birds roosting on the antenna of radio station WFI, Philadelphia, have caused trouble to the control operators. A few birds perched on the wires cause an appreciable change in frequency, and a flock means real trouble. To keep the birds away, the operators hit upon the plan of discharging blank cartridges, and during the sending of evening programs, it often is necessary to station a man on the roof to discharge a gun at regular intervals to force the birds to vacate.

159 ROTATING CLUTCH GRIPS HOSE WITHOUT SCREWS

Gripping an air, steam, gas or water hose so tight that it is leak proof, yet requiring no screws, threads, nuts, springs, wires or washers to install, a rotating-clutch hose fitting now is available. The fitting is adjustable to the varied thickness of hose walls and the parts include an external or internal pipe thread attached to the clutch which opens or closes to grip or release the hose by turning a boss sleeve at the hose end. For connecting broken hose a hose-to-hose unit is provided, consisting of two hose couplings swiveled at the center. Heavy metal hose couplings are unnecessary when the units are employed.



Various Units of a Rotating-Clutch Hose Fitting Which Grips without Screws or Washers

C.P. Fitzgerald
 230-13 Sacramento

4528 Walnut St
 Philadelphia
 Mr. George H. Eckhardt
 16-13th St
 Calif
 Sacramento

COLOR-BLINDNESS CORRECTED BY SPECIAL LENSES

A Berlin scientist has developed a special lens to correct the abnormality of vision resulting from red and green color-blindness. The special glass accomplishes its purpose by the incorporation of two chemicals which filter some of the spectral colors of light passing through glass. The fullest action of these chemicals is seen in the orange-yellow range between the red and green, thus exaggerating the contrast and assisting the color-blind to distinguish between them. Temporary pathological color-blindness—usually for the greens and blues—comes under another category. Relief for such difficulties often can be obtained only by removing the cause, which sometimes is a center of infection.

HAND-DRIVEN VALVE GRINDER WORKS LIKE AUGER

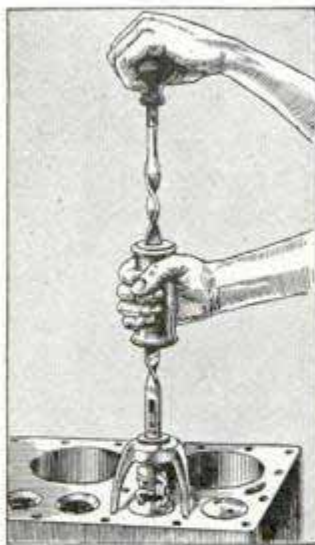

Valve grinding by hand is made easy with a tool which in some respects operates like an auger, except that the grinding motion is accomplished by pushing an inclosing frame up and down over a spiral rod so designed as to give the reaming apparatus a reverse

motion five times for each stroke. Both handle and support are equipped with roller bearings and there is no crank. A sliding arm in the base is adjustable to any-size valve, and a rubber vacuum-cup attachment is provided for Fords.

John's Mechanical Products Co.
3906 S. Weychester Ave.



Self-Operated Lifeline to Escape from Fire, the Person Clinging to the Line Governing the Speed of Descent to the Ground

LIFELINE TO ESCAPE FROM FIRE IS SELF-OPERATED

For the use of tenants in tall buildings, a self-operated lifeline recently underwent successful tests in London. The descent of the person clinging to the line is governed by him through the apparatus to which he clings. The safety device is portable and quickly attached to any substantial object for a rapid descent. Because of the manner in which the line is payed out, the apparatus is called the "spider" lifeline.

REFLECTORS SET IN FISH LURE RESEMBLE RED EYES

Providing a lifelike lure for fish, a spoon in which reflectors have been set now is on the market. As the lure moves about in the water, the reflectors cast rays of light and resemble red eyes set in a living head.



The buffalo has replaced the eagle on the seal of the department of the interior.

Hofschneider Corp
848 Jay St

MODEL RAILWAY PROVIDES INSTRUCTION AND FUN

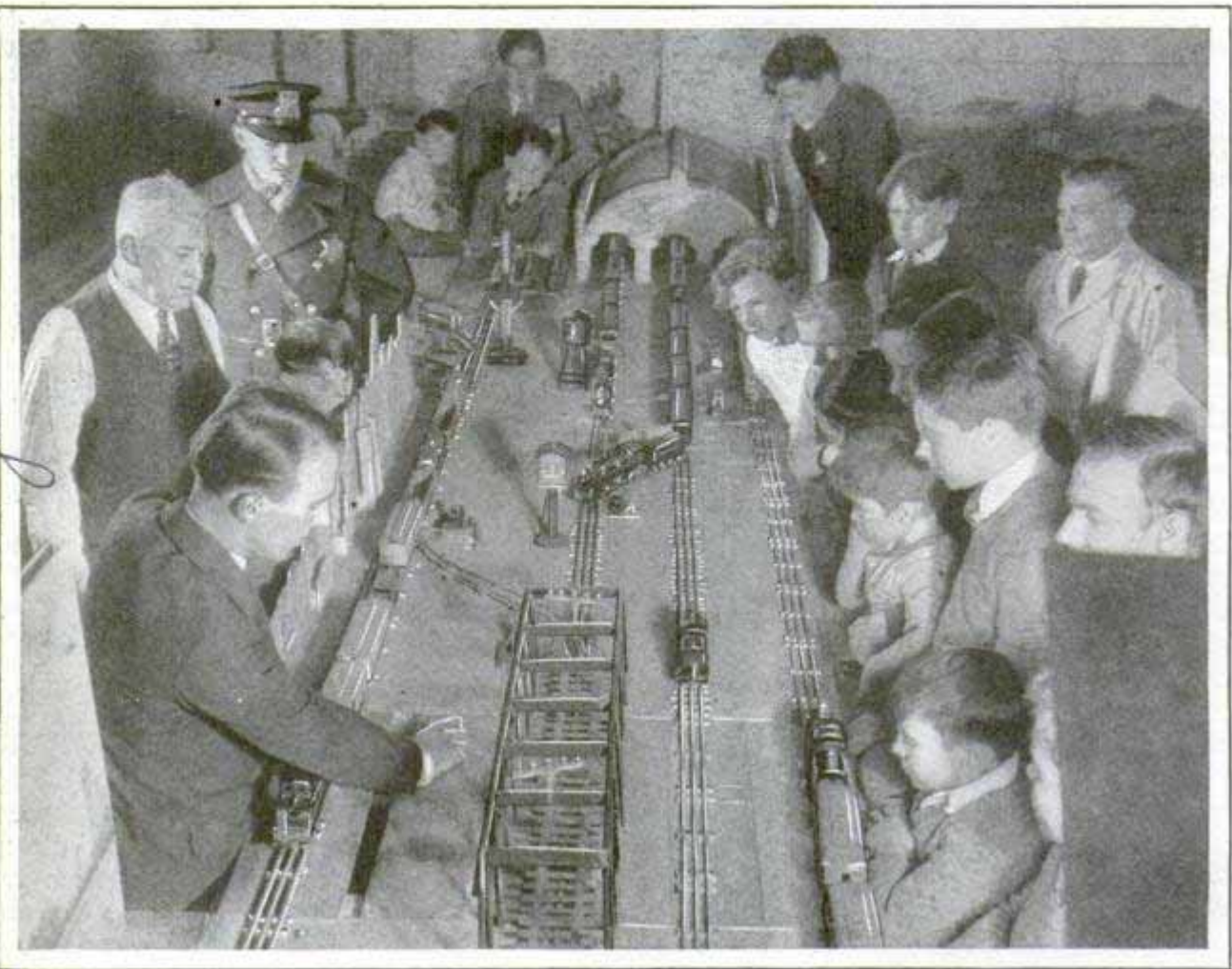

Perry A. Ball, at Left in Foreground, Teaching Class of Boys and Men Some of the Principles of Railroad- ing by Means of Miniature System That Closely Duplicates a Real Railway

A complete railway system, in minia- ture, has been installed in a Chicago of- fice building to teach boys, and men, too, many of the details of railroading. Here, on nearly 1,000 feet of track, representing the distance from Chicago to San Fran- cisco, and with scores of engines, cars, signal towers and switches, all operated by electricity, youngsters and their fathers learn how to route trains, manage ter-

minals, maintain schedules and execute other operations necessary in the running of a real railroad. Work and play are combined as the pupils are taught how to install and repair the units, are instructed in some of the primary principles of elec- tricity and, at the same time, are given valuable information in geography, as the area represented corresponds to that of the western part of the United States.

BOOTLEG LIQUOR RUNS MOTOR WITH FUEL VAPORIZER

Confiscated bootleg liquor has been used successfully as fuel for an army truck, without any engine changes, in tests made by army engineers with a fuel vaporizer, the invention of an English- man. The vaporizer enables the use of cheaper fuel, including alcohol and low- grade gasoline, and at the same time de-

velops more power. The army report said that the efficiency of a truck engine was increased from a peak of fifty-two horsepower to more than sixty-nine horse- power, and at the same time the deadly carbon-monoxide content of the exhaust gases was decreased. The device slows down the fuel on its way to the cylinders in a chamber equal in capacity to one cyl- inder. This chamber is so constructed that the incoming charge is subjected to

Perry A. Ball 1126 Lawrenceville -53
Av. Chicago

Daily Mail 11/18/29
3203

Ernest Howard
Howard Isasgenerator Co
227 Parkway NYC

*Botanical Gardens
Univ. of Pennsylvania*

centrifugal action, the heavier particles being thrown outward, the speed of the gas supplying the necessary force. The unvaporized fuel is spread on a heated surface which varies in temperature from the bottom upward, the lighter fuels being vaporized at once and the heavier ones flowing down until they reach a portion hot enough to turn them to gas. A total heating surface of 2,000 square inches within the chamber vaporizes the mixture of fuel and air entirely before any of it enters the intake manifold, requiring no alteration in compression when different fuel is employed.

MORNING GLORY PETALS FOR ACID TEST

Morning glory petals may be used to detect acidity in the same manner as litmus paper. In the presence of acid, the blue litmus paper turns red, and in an alkaline solution turns blue again. The petals of the blue morning glory react in the same manner. Red cabbage or its juice also may be used for the same purpose.

REFLECTOR GIVES SIGNAL OF CAR'S APPROACH FROM SIDE STREET

Signaling to the motorist the approach of a car from a side street before it reaches the corner, a mechanical policeman in the form of a street-intersection light reflector has been placed on duty at busy corners in San Francisco. The reflector rises a few inches above the pavement and by means of red-glass squares in its base light from each approaching automobile is diverted at right angles and warns motorists coming from either cross direction before any of the cars can reach the intersection.

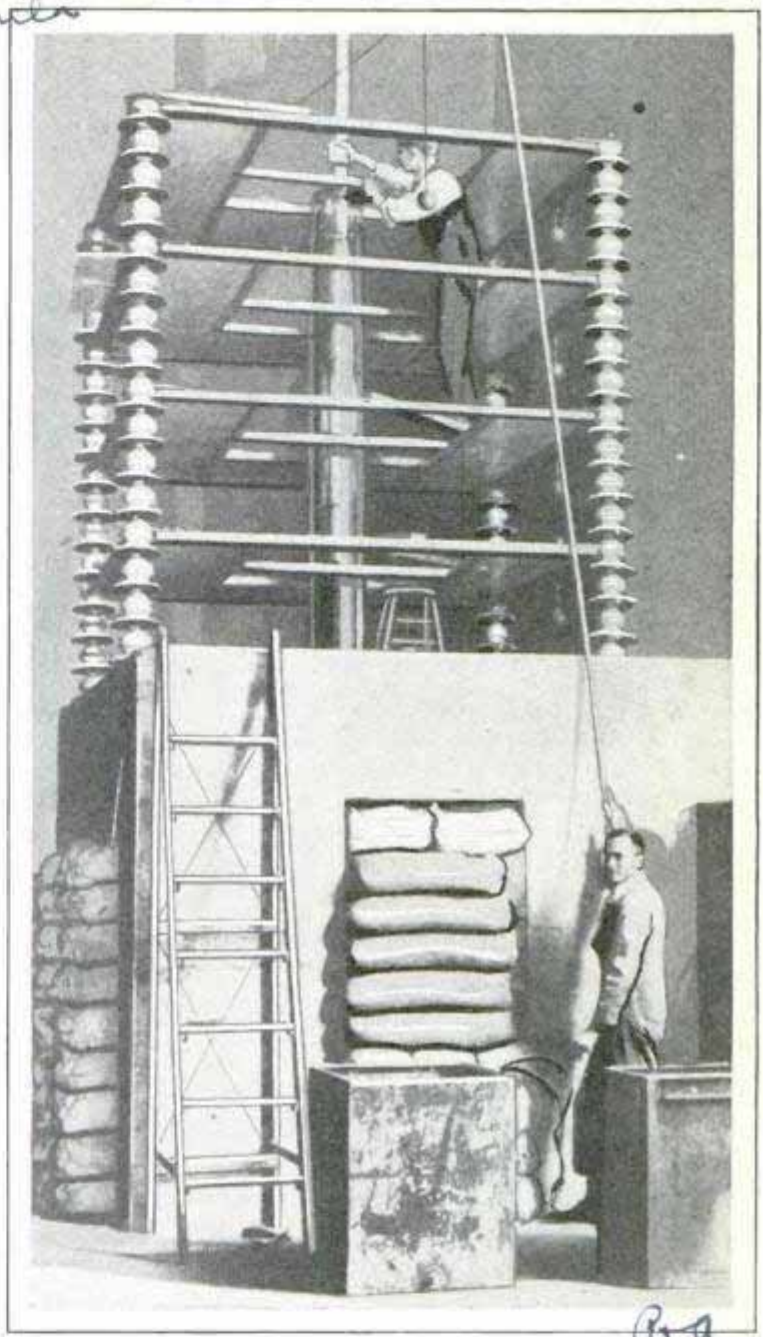
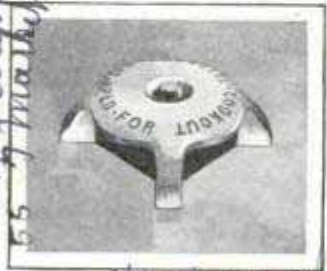

Million-Volt X-Ray Machine, Most Powerful in the World, Which Is Capable of Penetrating an Inch of Lead

MILLION-VOLT X-RAY MACHINE PENETRATES INCH OF LEAD

Capable of penetrating an inch of lead, a million-volt X-ray machine has been installed in the high-tension laboratory of the California Institute of Technology. The machine constitutes the most powerful X-ray apparatus in the world, and stands some twenty feet high.

Popular Mechanics Magazine does not publish the name of the maker or seller of any device described in its pages, but this information will be furnished free on application to our Bureau of Information.

*Business apparatus - Acme Safety Window Co.
55 7/8 Market*

*Wid. word
Chas. Fred Burkhardt,
San Francisco*

by Chas. C. Laurentin

HOW YOU CAN CULTIVATE SUPER-NORMAL SENSES



Exercises for Cultivating Keen Senses; at Top, a Test for Eyes, Mind and Nerves; Below, Counting the Number of Dots on a Card at a Glance; Right, Developing Steady Nerves

Some time ago a business man startled his associates with an unusual feat that at first was ascribed to stage trickery. No wonder, for he demonstrated that he could, at a single glance of two seconds' duration, read and memorize an entire page of printed or typewritten matter. Far from being abnormal, science has made the discovery that such a feat of vision is better termed "super-normal," because anyone can, in a greater or less degree, depending on the training and patience given in acquiring proficiency, duplicate this and other seemingly astounding demonstrations.

As being simply a matter of practice, the feats are comparable to the ability of the expert marksman in scoring a bull's-eye without sighting his revolver, and the ability to do them may be cultivated. Place a number of black dots, five, for instance, on a sheet of white paper, and a person of average ability should be able, at a single glance, to state the number without counting individual dots. Increase the number to six, and it is slightly more difficult; yet, when one has mastered this step, the mind and eyes are

trained to a new ability which is ready to grasp more difficult tests. With ten minutes' practice each day for a week or two, the eye will become accustomed to the routine, and, in a short time, you will be able to count at a glance up to twenty-five and more dots. After this has been accomplished, a more interesting daily training may be undertaken. Select a book containing short printed paragraphs. Cover all but the first line with a sheet of paper and in one glance try to perceive and memorize the entire line. Continue with other lines; when you become proficient, two lines, then an entire paragraph. Daily and patient practice will prove that you can understand printed paragraphs in half the usual time, and that what you read clings more tenaciously in the memory.

Another exercise is quite as simple and promotes mental agility and the power of quick decision. Following is a list of words, each having a certain meaning. As you read each one write down a word of exactly the opposite meaning. This must be done as rapidly as you possibly can, and at a glance, as for example, sweet—sour.

Wear	Angry	Raise	Lose
Burn	Fall	Repair	Learn
Lack	Finish	Write	Mar

The list requires no more than a minute to complete. Select a like number of other words and try to do them in less time. Practiced daily, the procedure soon gives a super-normal quickness to the mental machinery.

How are your nerves? A man of iron nerves can control the muscles of his body so that fidgets is an unknown term to him. Steady nerves are an asset; you can test yours with a two-foot length of string with a pellet suspended from the end. Can you hold the end of the string at arm's length steady enough so that the ball will remain perfectly still? You can secure super-normal nerve control in a short time with this apparatus. When you have mastered the two-foot length, shorten the string an inch at a time until you can hold the lead pellet without moving at the end of three inches or less of string. These practices, if carried out patiently and consistently, give both the eyes, mind and nerves super-normal ability. How about co-ordination between the three? Do they work together efficiently? The track man trains his nerves to respond at the crack of a pistol shot. Could you do the same? Quite easily, with practice.

Cut a twelve-inch disk from a sheet of heavy white cardboard, and through the exact center run a spindle or axle on which it will revolve freely. Along the edge, paint a one-inch black square. Another disk, slightly larger, is placed over the first on the spindle and is to remain stationary. A one-inch square window is cut out along the edge so that the black square can be seen through it. Now give the first disk a spin with the finger; it should make several complete revolutions a second. Each time it goes around the black square will flash momentarily past the little window. Spin the disk again and in the

right hand have ready a pencil posed over the little window opening. As soon as you see the black square, jab at it with the pencil. This will leave a pencil mark on the disk, and its distance from the square shows that your mind, nerves and muscles required quite a large fraction of a second to heed the impulse of the eyes. Try again. In a short time you find that you are becoming more and more proficient in the last as well as in the former tests; soon your eyes, nerves and muscles are found more adept. But do not stop practicing, for you are on the road to possession of unusual, acute senses that are decidedly out of the ordinary—super-normal, in fact.

**DIESEL ENGINE IN AUTOMOBILE
45 FURNISHES CHEAP POWER**

After a journey of 792 miles at a fuel cost of \$1.38, an automobile equipped with a Diesel engine was demonstrated recently in New York. On the trip the machine used thirty gallons of heavy fuel oil instead of gasoline. The motor is a four-cylinder engine mounted on a standard passenger-car chassis, the engine itself being of the standard type used in portable and marine work, and not built particularly for the automobile in which it was used to test the feasibility of employing such power for the propulsion of cars.

see Aug 19 30. 208

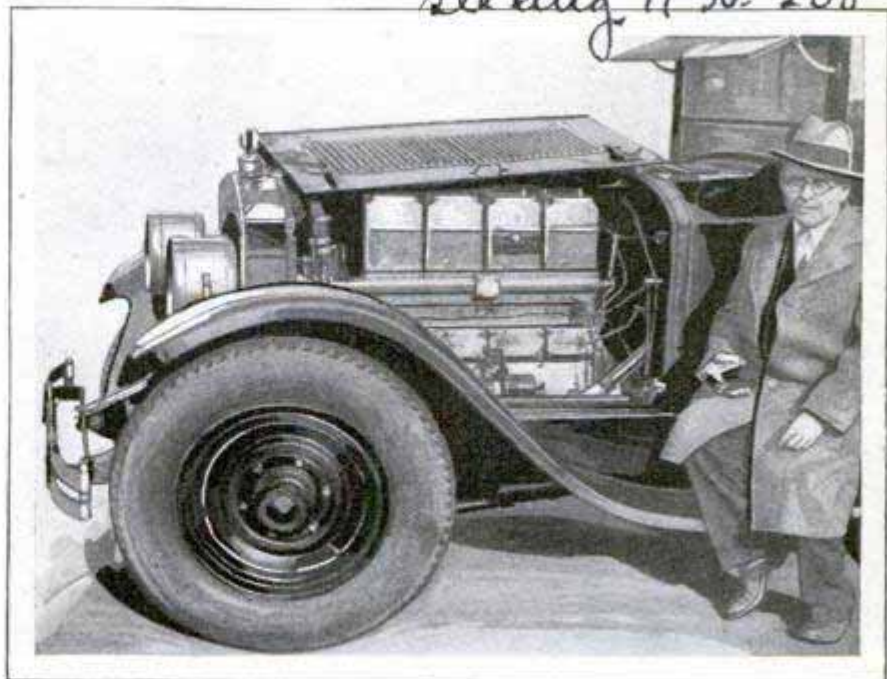

Diesel Engine in Standard Car Chassis; the Auto Traveled 792 Miles with This Motor at a Fuel Cost of \$1.38

*Cummins Engine Co.
Columbus, Ind.*

Photo by Chukhina &

"STUNTS" SHOW WAY IN THE CHOICE OF A CAREER

4025.

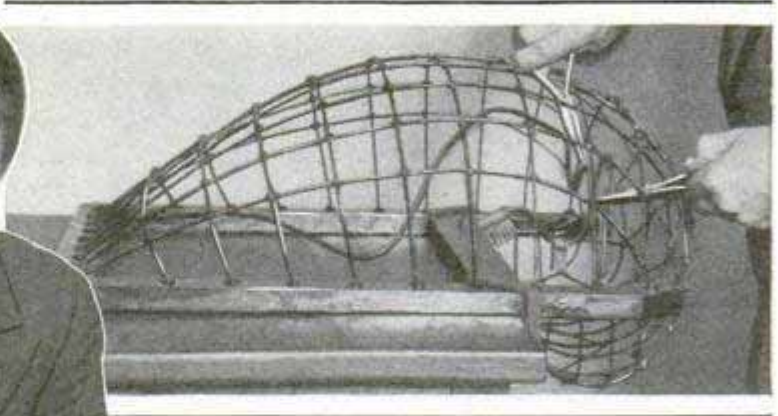

Tests for Boys and Girls of All Ages, to Find Out for Which Career They Are Best Suited, Are Given at the National Institute of Industrial Psychology to Prevent a Wrong Choice

*no steel
advising
remain London
England*

Tests Illustrated on This Page Reveal the Presence or Lack of Mechanical Ability in the Candidates

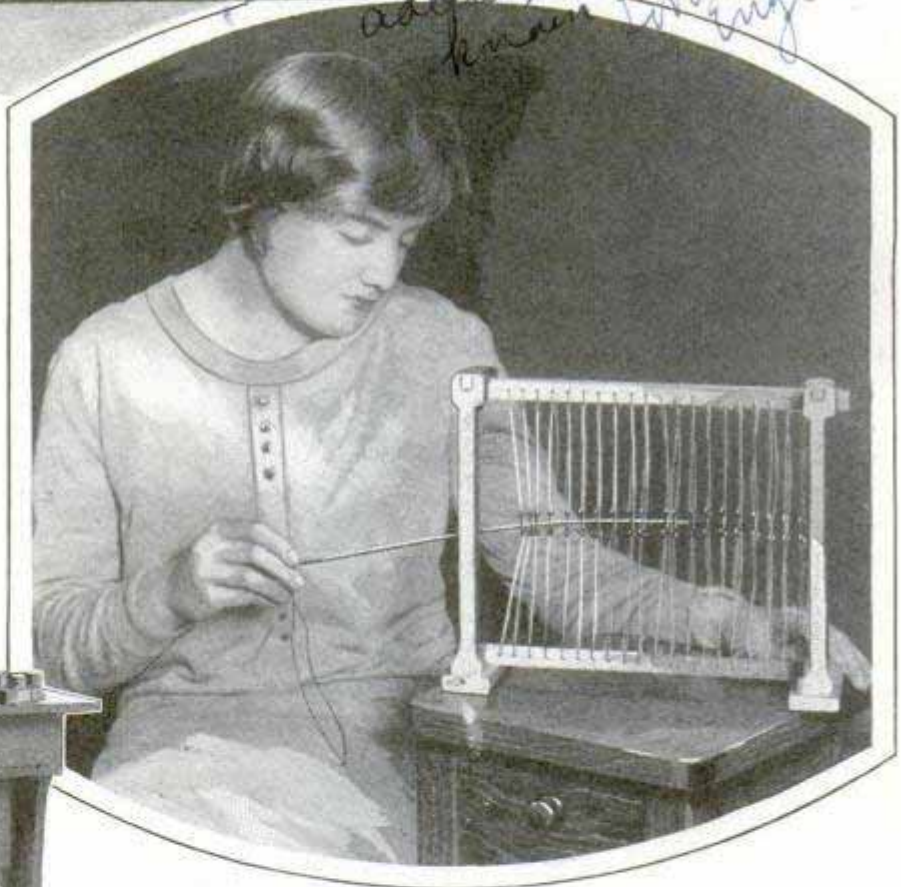

© Keystone View Co.

Examiners Do Not Rely Wholly on the Tests to Analyze Their Subjects, but Study Their Temperaments and Physical Attributes as Well; the "Stunts" Often Show That a Boy or Girl Has a Talent Which Has Not Received Adequate Cultivation and Likewise Reveal That There Are Certain Lines of Work for Which the Youth Is Probably Physically and Mentally Unfit; Ignorant or Unmindful of These Limitations, Many Boys and Girls Embark on Careers in Which They Have Only the Slightest Chance of Succeeding, Simply Because They Are "Square Pegs in Round Holes"

and Peter J. Mulder

105 Chicago Detective Bureau

EXACT COLOR SHADE RECORDED BY ANALYZING APPARATUS

Far more accurate and sensitive than the human eye, a color-analyzing apparatus has been made by two University of Pennsylvania scientists which will record in black and white on a photographic plate a shade of color so that it can be matched exactly by some one hundreds of miles distant. Placing the colored object in the apparatus and turning a crank is all that is necessary for it to analyze the color, but the apparatus itself is not so simple as its operation. The entire mechanism is contained in a box no larger than a radio cabinet and operates from an electric-light socket or bank of batteries. The sample to be tested is placed over a rectangular opening in the top of the box where it is illuminated by a powerful source of light. The light reflected from the sample passes into a spectroscope which separates it into its component colors. A portion of the dispersed light then enters a photo-electric cell attached to amplifying apparatus which records the current passed by the cell as a result of the light excitation, both on a measuring instrument and on a photographic film. By turning the crank, different parts of the spectrum are successively admitted to the photo-electric cell until the entire range has been covered, the film moving through a corresponding distance.

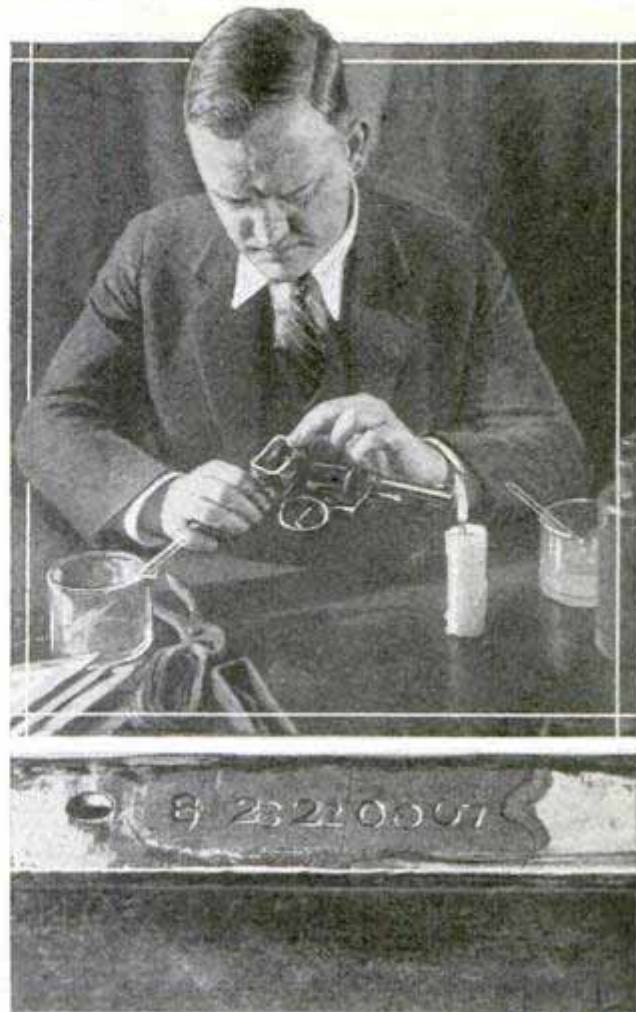

Preparing Wax Form to Hold the Acid against Revolver, and, Below, Restored Numbers on Auto Frame

CHEMICAL TO COMBAT CRIME RESTORES AUTO NUMBERS

Numbers on automobile parts, guns, watches and other metal articles, mutilated or partly obliterated by thieves in an effort to baffle identification, may be restored with a chemical prepared by members of the stolen-automobile detail of Chicago's police department. The chemical, in liquid form, is applied to the part where the original number is believed to be. In five minutes or five hours, perhaps, depending upon the kind of metal and the degree to which the old characters have been worn away or obscured, the faint outlines of the original numbers usually can be seen. Special lights and magnifying glasses are sometimes necessary, but usually the digits are visible to the unaided eye. The restoration is generally not permanent but lasts long enough to permit an accurate tracing of the numbers. More than 100 automobiles, many guns, watches and other articles thus have been identified by the chemical squad.

4014 AUTOMATIC ELECTRIC PRIMER STARTS AUTO IN WINTER

To facilitate starting the automobile in cold weather, an automatic electric primer which operates when the starter is depressed, now is on the market. It contains a heavy-duty filament which heats to 650 degrees, vaporizing the first charge of gas drawn into the cylinders and giving the effect of starting a warm motor. It cuts off when the starter is released. Thus it helps increase life of batteries.



2098 7.05.27

Autoprimer Corp 603 E Washington St.

403
540

Padlock

Machine Shop Practice

Sept. - Dec. 1929



Drawing to Show How the Shadow Dance Is Produced; in the Ballroom, Guests See the Shadow and the Real Dancer as Well

**DANCE ON BALLROOM WALLS
LATEST SHADOW NOVELTY**

Shadows of entertainers are made to dance on the walls of the Bal Tabarin in Chicago's Hotel Sherman, where light is used exclusively for interior decoration. The effect is produced by having the dancers stand before projectors which are installed over the false ceiling above the ballroom floor. Their shadows are thus cast upon the walls. Curious and novel results are obtained by this system when the dancers appear against various backgrounds. For instance, bathing girls can be made to look as though they were plunging into a sea, divers walk under an ocean and other effects are produced. From certain parts of the ballroom, patrons may see the performers on the runway as well as their shadows.

**AUTO HEATER DRAWS PURE AIR
THROUGH WARMING CHAMBER**

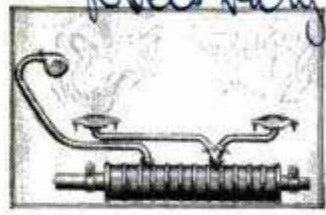

to a heating chamber and then circulates it through the car. It consists of a fan con-

trolled by a two-speed switch which draws fresh air into a chamber around the muffler, where it is heated and then passed into the car through floor registers. In summer, the fan may be used to cool the car.

**HARDEST METAL GOES UP
AS NEW USES FOR IT
194 ARE FOUND**

Tungsten carbide, the hardest compound known to science, is constantly finding new uses, and as a result, it is now worth nearly \$500 a pound. Regarded for many years as little more than a curiosity, this compound of tungsten and carbon, both soft, is used principally for the cutting of metals. Experiments have shown that tungsten-carbide tools for machining operations far outlast the ordinary high-speed steel tools, and it has been used successfully in working with manganese steel, armor plate, bronze and bakelite. The metal, which will even scratch a sapphire, is being produced under various trade names.

**RADIO-SET NOISE IS REDUCED
BY SPECIAL FILTER**

Capable of eliminating radio interference from supply lines or household electrical devices, two types of filter have been placed on the market. The filters may be attached between the electrical device causing interference and the power supply, or between the radio set itself and the power outlet if the source of interference cannot be readily determined. Each is fitted with connecting attachments so they may be changed easily from one appliance to another. The stronger filter is intended for use with household devices operated from alternating or direct-current motors, and the other for appliances commonly connected to power lines by a cord and plug.



Chicago - 2077 S. Wabash

Madison
20
Chicago Electric Co, 226 W. Madison

Powell Muffler Co.
Altica, N.Y.

Jobe Leutschman Corp
Canton, Mass

Lead and zinc mine in Pecos Canyon near Santa Fe, New Mexico

124

TRACTOR RUNS TRAMWAY SPANNING A MOUNTAIN

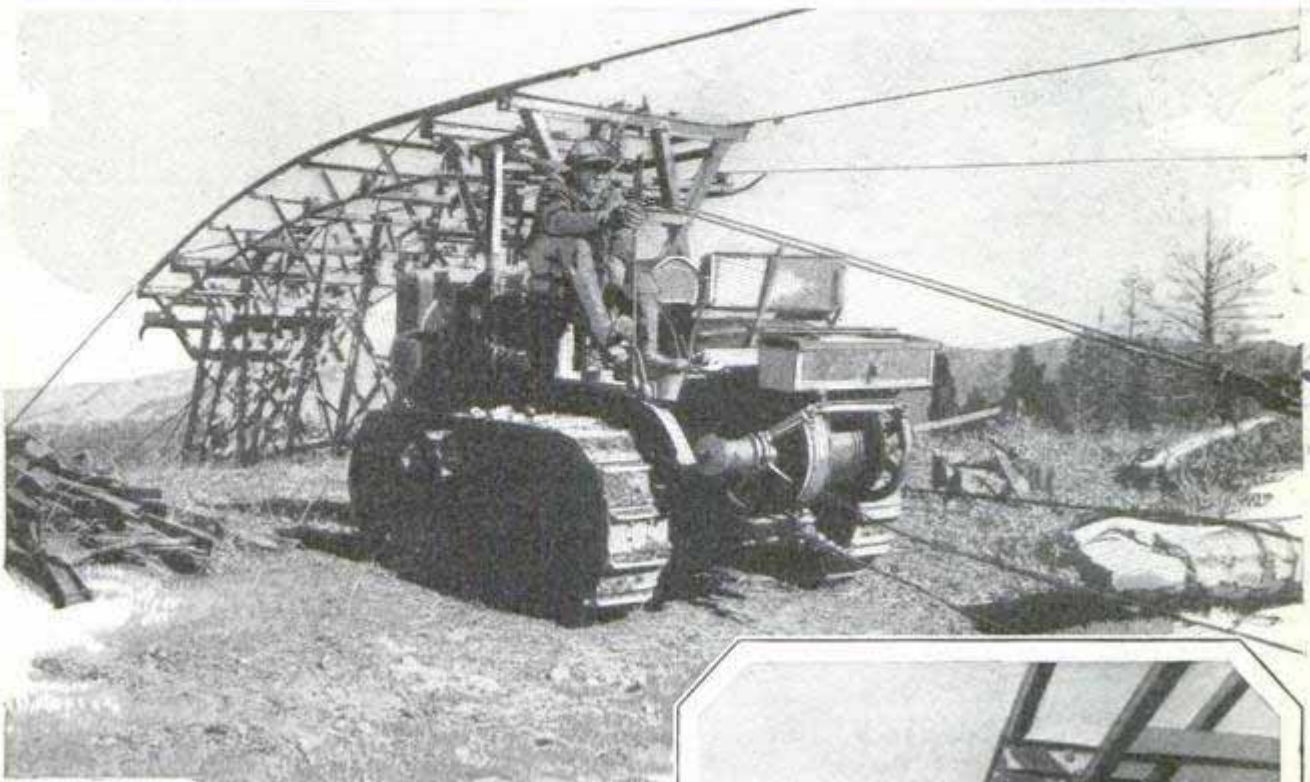

Single-Drum Winch Attached to a Tractor Used to Operate Mining Tramway over a Canyon When the Machinery Failed

When machinery failed on the long mining tramway spanning rough, mountainous country in New Mexico, and lead and zinc ore could not be transported from the mine to the mill across a canyon, a tractor was pressed into service to operate the tram until the machinery could be repaired. A single-drum winch was attached to the tractor which furnished the power to carry fully loaded ore cars up over the 8,500-foot summit of Pecos canyon as empties were dropped down the other side in readiness for loading.

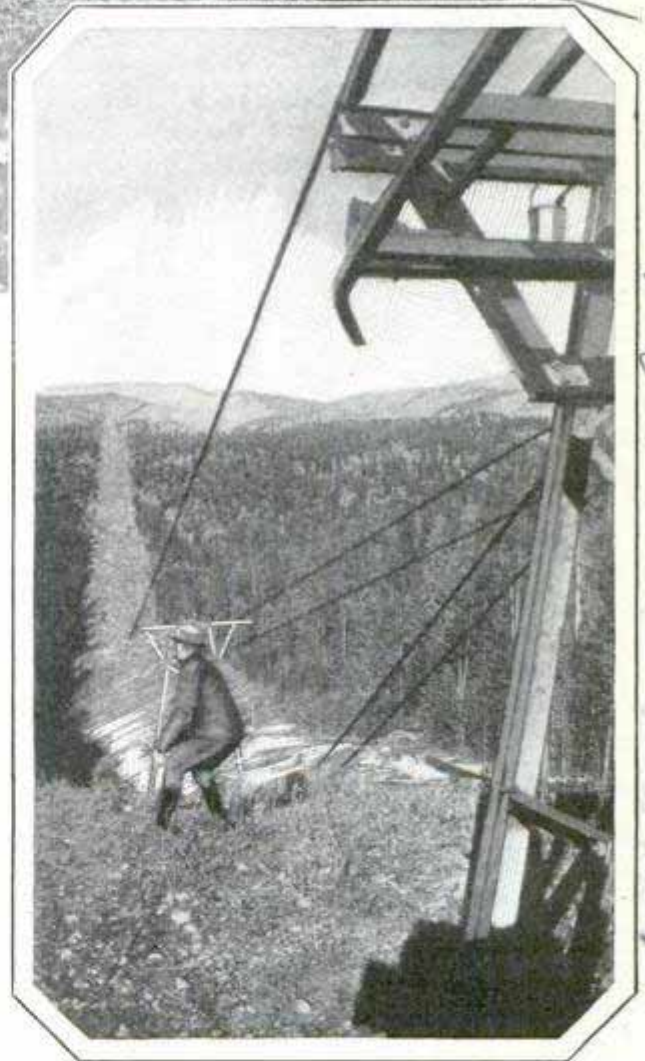

cont. Earle W. Craig - Asheville, N.C.

THIEVES USE OWN BROADCAST TO JAM POLICE SIGNALS 184

Thieves in London are employing their own broadcasting set to frustrate the radio-signal system of Scotland Yard. Recently when the police attempted to broadcast to squad cars the news of a jewelry-store robbery, it was found that the squads could not pick up the signals because some secret station, using the same wavelength, began oscillating and jamming

the police messages. Using an interference locator, repeated efforts have been made to trace the offender, but unsuccessfully because it only operates when the police broadcast information of crimes.

Cont. H. J. Wilkins
Columbie 29 Bean Road Berlin Heights 9

*Multiplex News Corp.
225 W 34th St.*

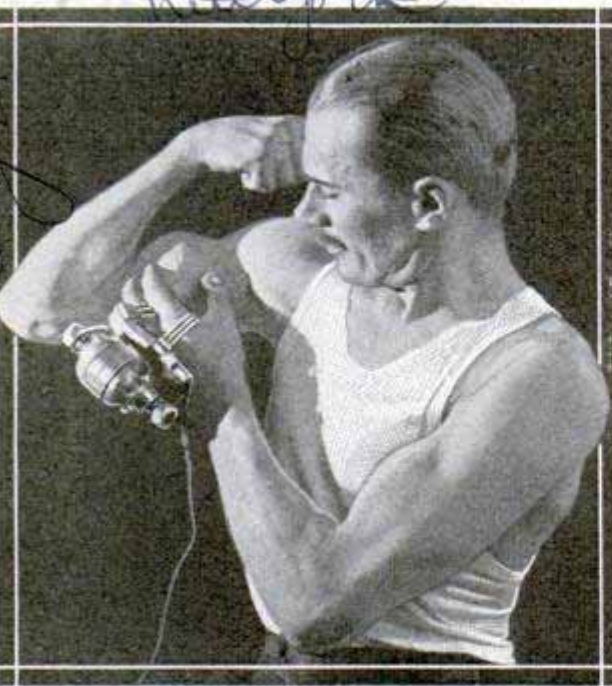

Small Electric Vibrator Which Fits on Hand and Transmits Its Energy through the Fingers

VIBRATOR ON HAND TRANSMITS ENERGY THROUGH FINGERS

Weighing little more than one pound, a midget electric vibrator now is on the market which transmits energy through the fingers. It fits on the back of the hand and the fingers of the same hand are applied to the part to be treated. The small instrument and the finger transmission make possible a concentrated local self-treatment on most parts of the body.

RAIN FALLS INSIDE AIRDROME AS SUN SHINES OUTSIDE

Probably the only building in the world that has its own weather, including rain, fog and clouds, is the big nine-acre airship factory and dirigible dock located at Akron, Ohio. Sudden changes in temperature last winter revealed that it can be raining quite vigorously inside the structure while the sun shines brightly outside, and the presence of fog and clouds has become common to men whose heads often pro-

trude above the clouds while their bodies are obscured as they labor at various heights. When the temperature outside the building is high for a day or two, then suddenly falls, the outer air cools more rapidly than that inside, eventually chilling the steel plates of the roof and sides, and causing the moisture-laden air inside to condense and fall as rain. Rainfall also has resulted from the movement of warm air from around machines and assembly operations upward to the cold sides of the dock. The building's independent weather is giving engineers considerable concern, as rainfall is a serious matter in some of the operations of airship building. In an attempt to control the condition, a strip along the roof was insulated with a one-inch layer of a special compound, and it may be necessary to extend this costly insulation down the sides. One way of stopping the interior rainfall, of course, would be to open the huge doors at the ends of the dock and let air currents drive out the moisture, but this is costly and the rush of air through the structure often is objectionable. The structure contains about 45,000,000 cubic feet of space, and consequently is so large that heating it is entirely out of the question.

ELECTRIC SLEEPING BLANKET FOR WINTER WEATHER

156 Sleeping in comfort with windows open in the coldest weather is made possible with an electric blanket now on the market which is particularly adapted for the use of persons whose health requires much fresh air, even in zero weather. The blanket is full single-bed size and weighs about the same as an ordinary comforter.

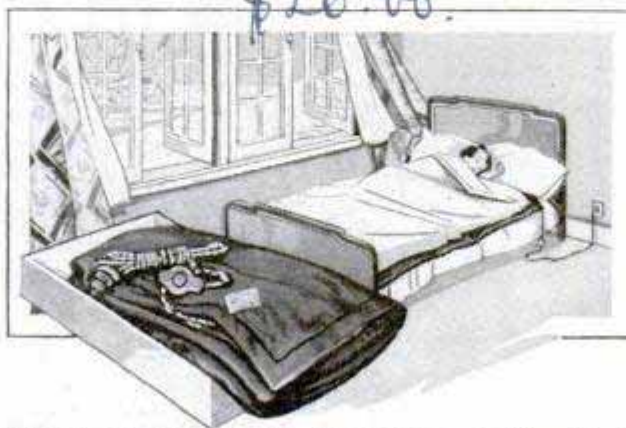

Electric Sleeping Blanket Which Operates like Heating Pad to Keep User Warm

It plugs into a light socket, contains a heat regulator, costs little to operate and is protected from short-circuiting or overheating. The heating apparatus is covered with purple sateen, so that the appearance differs in no way from that of an ordinary quilt.

*Jamson United Corp
Rochester NY*

*Health. Elator, chue
11 W. 42nd St. New York
6/20/33
Goodyear. Jepselin Corp
Akron Ohio 79*

4023

WASHINGTON'S FACE IS CARVED IN MOUNTAIN ROCK

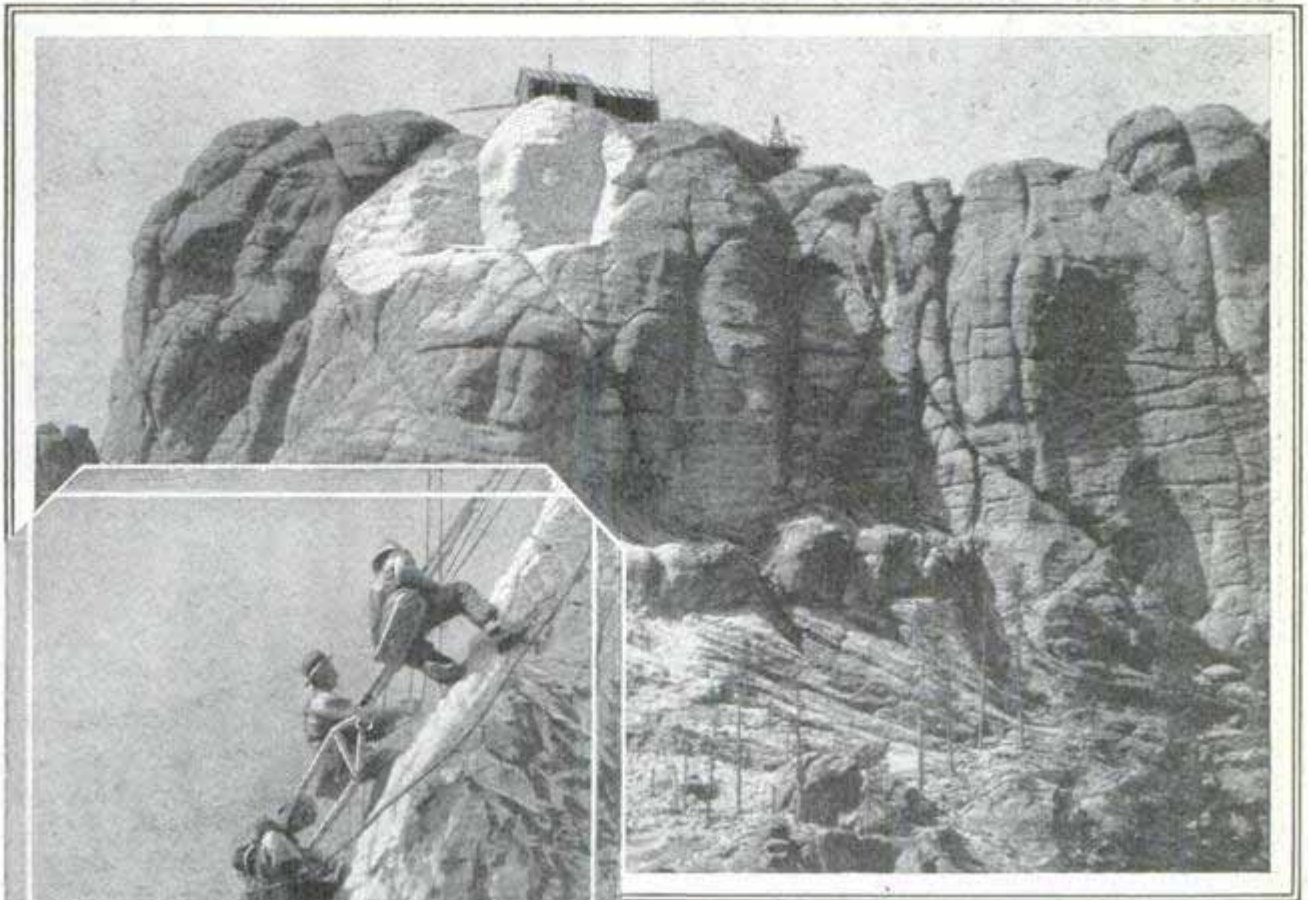

Scene in National Monument Memorial Park, Showing Head of Washington, One of the Four Figures of Presidents of the United States Which Are Being Carved on Mount Rushmore by Gutzon Borglum; at Left, Taking Measurements at the Tip of Washington's Nose

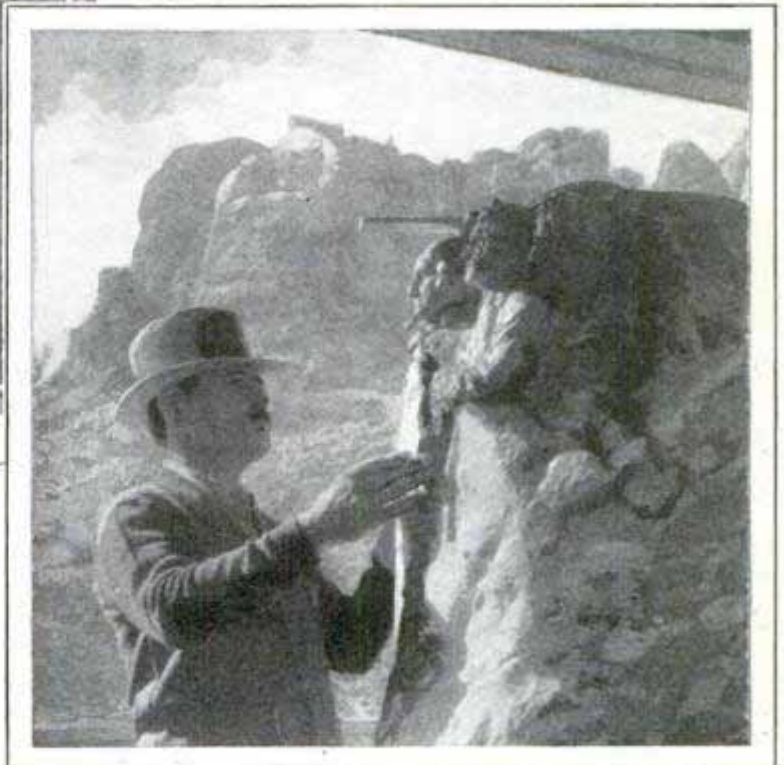

© Publishers' Photo Service
 1050
 40th New York
 Mr. Borglum Working on Model of Mount Rushmore Memorial, Which, When Completed, Will Display the Figures of Four Presidents; in the Distance, through the Plate-Glass Window, Can Be Seen the Real Mount Rushmore and the Partly Completed Face of Washington; the Park Is Located in the Black Hills of South Dakota and Is Expected to Become a Mecca for Thousands of Tourists

149 BIG ANIMALS HELIUM-FILLED FOR STREET PARADE

Macy & Co, Broadway + 24th, New York

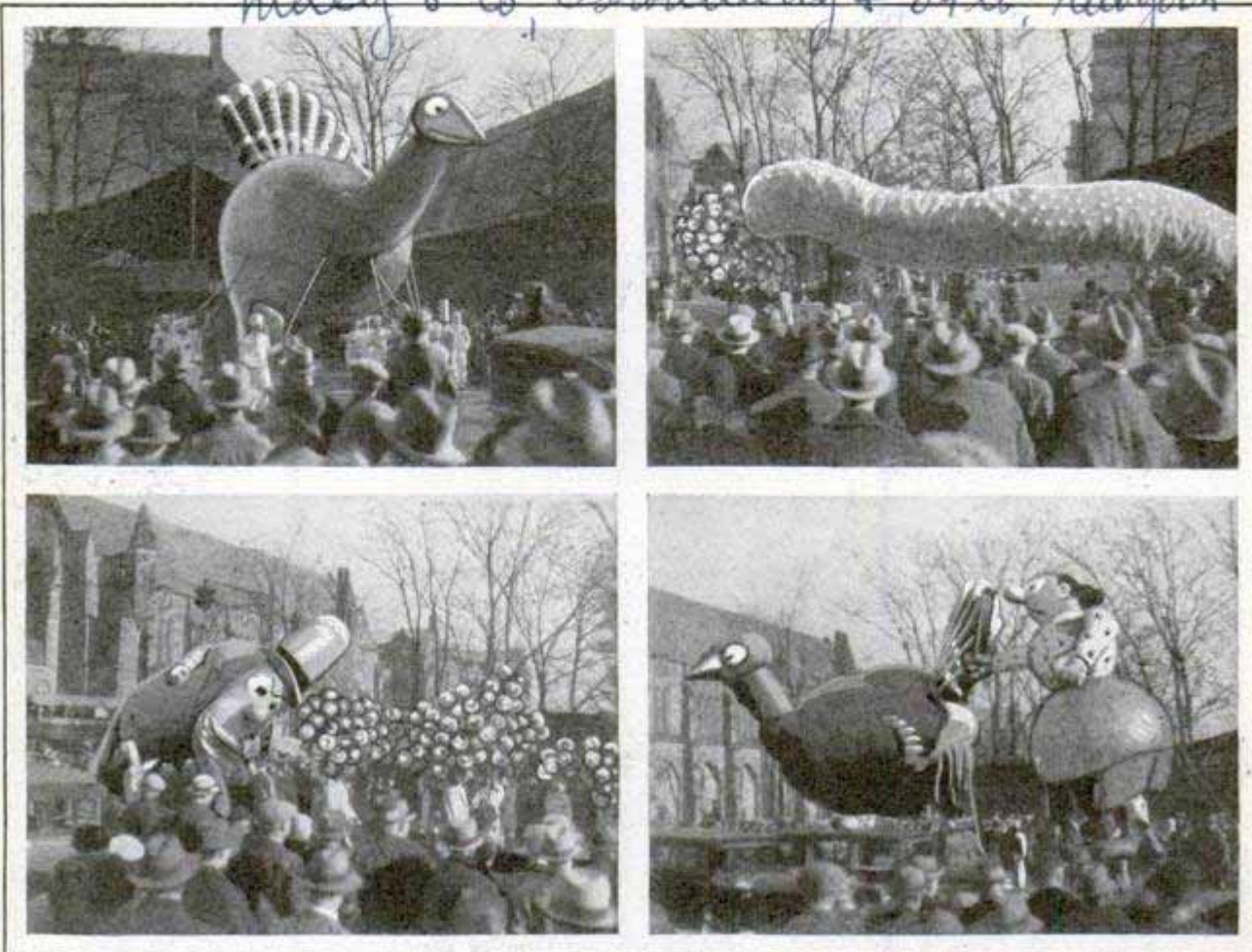

Huge, Grotesque Animals, Which Appeared in a New York Street Parade; They Were Made of Sections of Rubber Inflated with Helium Gas and Were Held Down by Ropes

Huge inflated balloons made to resemble grotesque animals, dragons and comic-strip characters participated in a New York street parade recently. Except for their shape, the balloons were like the ordinary captive type, but were filled with 12,000 cubic feet of helium gas to eliminate danger of fire. A dragon, 177 feet long, was the largest single piece, but there also was a thirty-five-foot dog standing ten feet high, and a turkey of corresponding proportions, as well as a horse, thirty feet high. After the parade, the balloons were released and floated out over the Atlantic, prizes for their return being offered.

and that also resists corrosion due to the hot gases in the engine cylinder, thus maintaining a constant sparking voltage. Tests have shown that, in the ordinary spark plug, the voltage across the gap may vary as much as fifty per cent from one spark to the next, and that there is a loss of electronic emission from the electrode, much the same as in a radio tube, so that a plug, when old, may require as much as 3,500 more volts from the coil than when new, even if the gap is the same. With the new alloy, the voltage required does not vary, provided the gap is kept constant. This results in easier starting in cold weather, and fewer inspections of spark gaps are needed.

SPARK-PLUG ALLOY MAINTAINS CONSTANT VOLTAGE

For spark-plug electrodes recently developed alloy has been found that requires a considerably lower sparking voltage than the commercial electrode wire,

(We want all our readers to write us freely and often whenever they wish additional information on articles published in this magazine. Address Bureau of Information, Popular Mechanics, Chicago.

A.C. Spark Plug Co,
25111 Michigan

180

1795 Broadway

FACTS REGARDING GIANT WAVES

Passengers on ships in storms who often imagine waves breaking over the vessel are from eighty to 100 feet high are mistaken, as the greatest actual height reached by a wave is probably not more than forty feet. Persons on a vessel with a deck sixty feet above the water line, naturally assume, when a wave reaches twenty feet above the deck, that it is eighty feet high. The vessel, however, piles up a large bow wave so that even if it were on an even keel when a thirty-foot wave struck, the wave might break aboard a ship whose deck were much higher. Actually the vessel may not be on an even keel when she encounters a wave and besides is actually burrowing into the mountain of water as it hits so that people on the deck think the wave is of tremendous height. Authorities consider that a wave forty feet from trough to crest is about the largest possible, except in the stretch of water between Capetown and Australia, generally considered the roughest bit of ocean in the world.

KNIFE CONTAINING TEN TOOLS IS HANDY POCKET KIT

Containing ten tools, a knife now on the market constitutes a pocket tool chest in itself. Besides the blade, the instrument comprises an adjustable spanner, screwdriver, punch, corkscrew, file, tin opener, electric-wire scraper, bottle opener and rule.

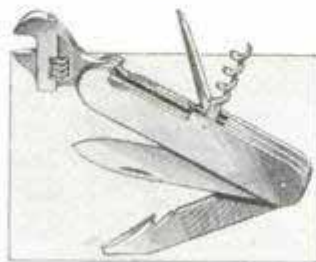

The Continental Hire Agency
80 Brompton Road

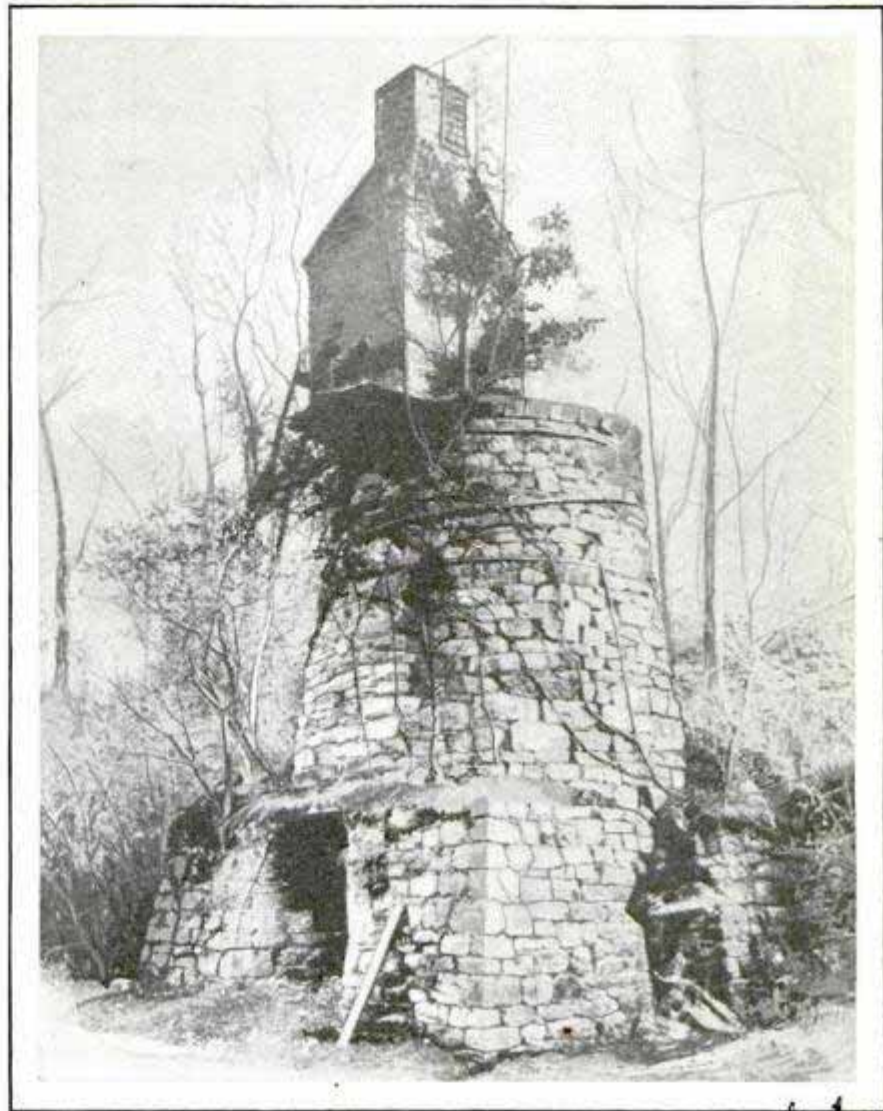

Codorus Furnace, near York, Pa., Which Turned Out Many of the Cannon and Balls for the Revolution, and Still Is Standing

CANNON CAST FOR REVOLUTION IN PLANT STILL STANDING

Codorus furnace, America's most important munitions factory in the Revolutionary war, still is standing near York Pa., although today it is little more than a pile of stones which might represent the smokestack of a modern munitions plant. Despite its size, Codorus furnace turned out many of the cannon and cannon balls for General Washington's continental army, and a movement is now under way to restore the plant.

ANT EGGS AS GAME-BIRD FEED

Ant eggs form the principal diet of newly hatched quail, pheasants and partridges on several game-bird farms in the west. The dried eggs are imported from South America.

Mr. W. Fickle, 5021 1/2 St
North East, Seattle

No. 4. S. Argent known

International

135 W. 42nd St
New York City

90

S. J.

395²

Colomberie, 29 Beazly Road, West by Beach, N. London, England

Adventures of

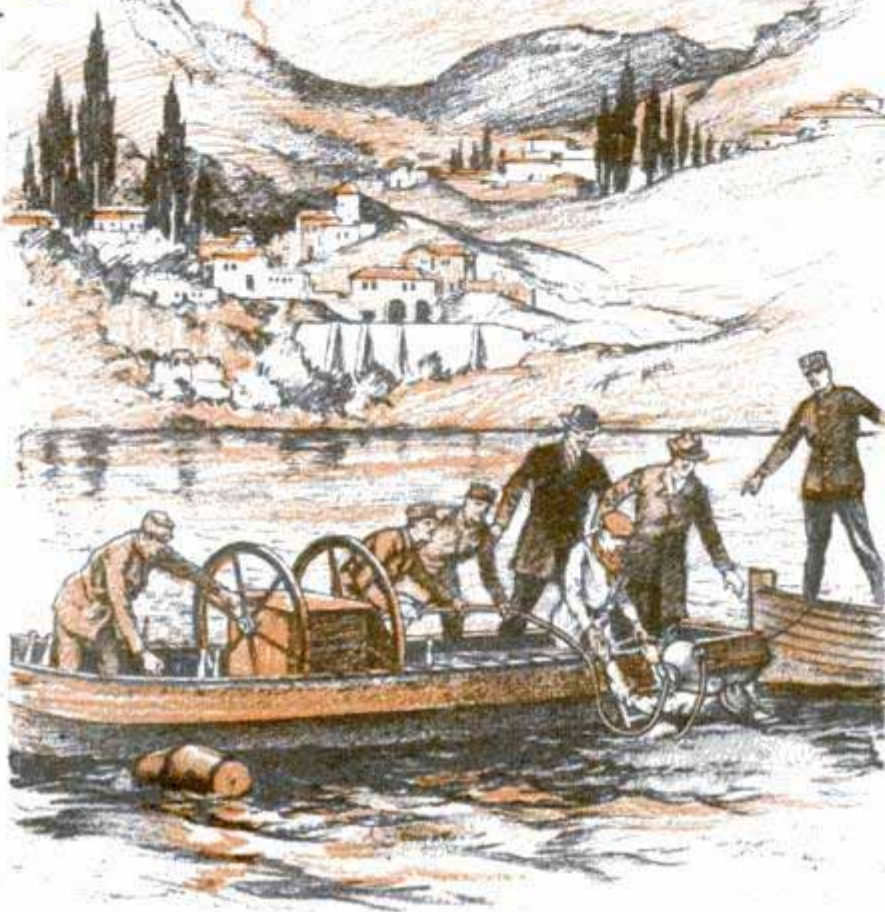

Diver About to Descend to the Bottom of Lake Nemi to Explore the Ancient Sunken Gallies in Search of Treasure

By HAROLD T. WILKINS, Esq.

"I was in Italy, when there came to my hands a treasure chart drawn up by a Mr. Carmichael who, about seventy years ago, was living in Guatemala. A roving band of Indians told him of a lost Aztec treasure temple, buried deep in the jungle. He set out from Te Kow into the bush, and after a long search found the temple but not the treasure. Armed with his chart, I myself set out, in 1927, along with Captain Joyce of the British Museum. We were beaten back by the impassable forest and the lack of water. I am sure the treasure is there, if we can only find it."

Central America holds many romantic treasure caches dating from the days when the old Spanish colonies revolted and piratical craft were raking with their topsails the tall trees and palms

"SUCH great progress has been made in deep-sea diving, where a record of 308 feet for ordinary diving dress has been set, that there is now open a possibility of treasure hunting which must fire the imagination." This was the recent remark of Prof. Leonard Hill, of the Royal Society and president of the National Institute of Medical Research of London.

Hardly had these words been uttered than Dr. Thomas Gann, a famous American explorer, announced to listeners-in over the radio in England that he was anxious to get into touch with young healthy men out for adventure and willing to hunt a treasure cache in the unknown jungles of Honduras.

"Some time ago," said Doctor Gann,

of shining coves and islands, all the way from Cuban mangrove swamps and Haitian shores round the Horn to Valparaiso and the lone bays of southern California. Many attempts have been made by generations of long-dead adventurers to locate these hidden treasures, but often chance rather than the shovels, picks and drills of the treasure hunters has laid bare the doubloons and the buried jewels.

Where, for example, are the treasures of the Mexican hill called the "Lock of the Treasure"? On the jungle-clad slopes of this hill, in southern Mexico, are hidden an immense store of silver ingots. The story is that they were concealed by Spanish miners fleeing from Mexican rebels. Following the example of the

British Museum Archaeological Expedition
to British Consul, Belize Honduras

Treasure Hunters



old-time pirate who is alleged always to have slain a negro cook or sailor "Jonah," and buried the corpse on top of the treasure chest to guard the hoard, these Spanish fugitives slew all the Indian laborers, to keep secret the location of the silver cache. They then drew up a plan of the workings which came into the possession of an aged priest, who sold the chart to two Americans. The Americans surveyed the hill and discovered the foundations of old buildings and the ancient "rastra" in which the ore was washed. All had been accurately marked on the chart, which clearly showed the entrances to the tunnels of the old workings. Cli-

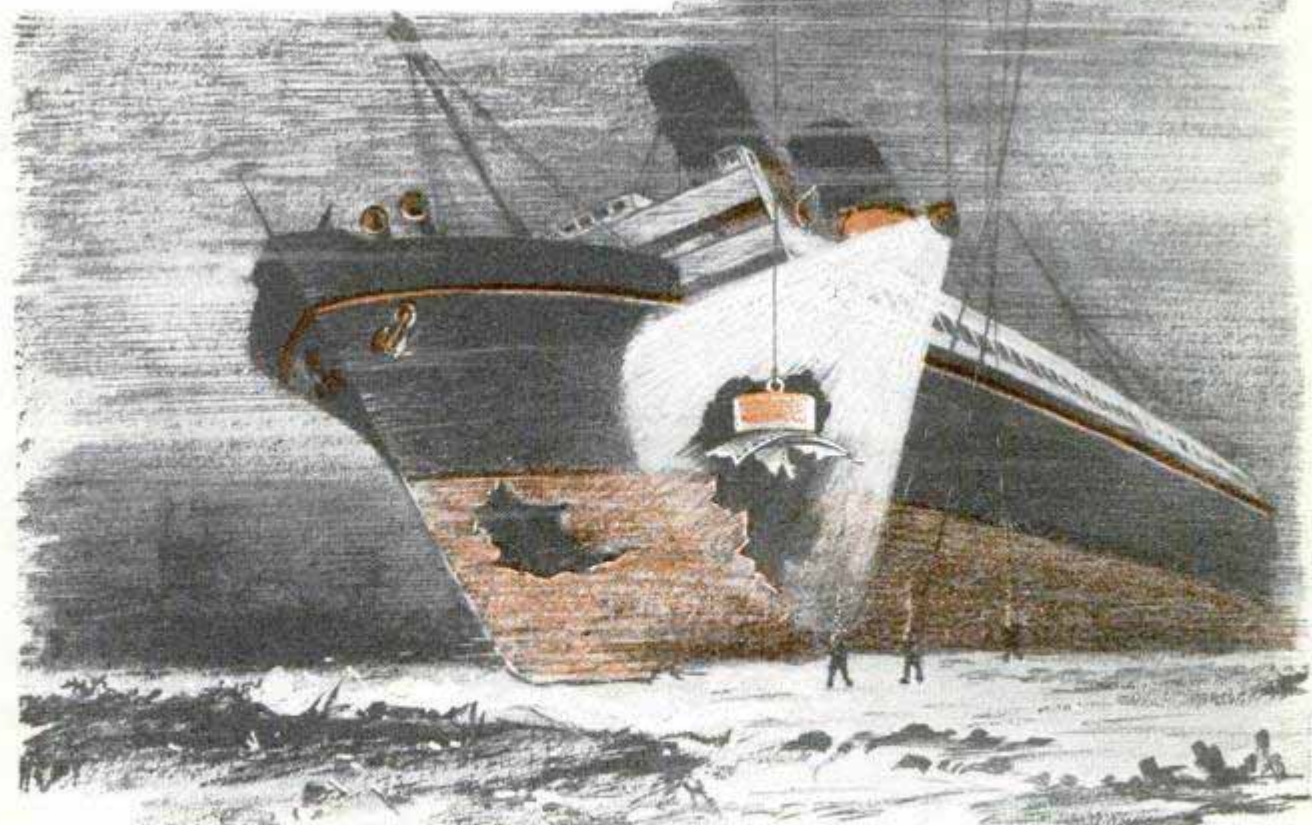

Drawing Showing How Huge Electromagnets Are Being Used in an Attempt to Salvage the Treasure from the S. S. "Egypt," Which Sunk in the Bay of Biscay with a Fortune in Gold Bars

more of all accessible
near to

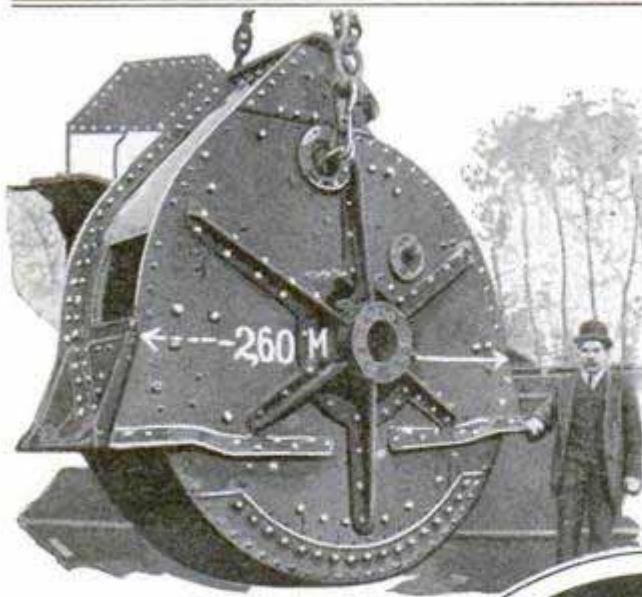

in 1815 and held for five years by a bandit gang under the famous Mexican leader "El Solo," so named because of his daring single-handed robberies. He is known to have buried a large part of his loot. It is likely that the farmer has unearthed one of El Solo's caches.

Lives have been lost and fortunes spent in the attempt to locate the mysterious Inca cache of treasure at Sacambaja, on the eastern slopes of the Andes, near La Paz, Bolivia. One account says that there are hidden in a hill on the banks of this river \$60,000,000 in gold and silver, buried there in 1767, when a Spanish king ordered

the monks who lived there to quit his South American dominions. Another story—probably the truer one—is that the cache was made by Peruvian Indians in the days of the conquistadores Pizarro and Almagro. An Englishman, Cecil Producers, the son of a Wiltshire landowner, secured an old Spanish document which directed him to go to

matic difficulties and fever are said to have stopped the work on the cache.

Davy Jones may slide shoals and sandbanks over the Spanish treasure-galleon wrecks at sea, but ashore, nature just as effectively piles up hills and sets cliffs tumbling onto pirate caches. The famous Cocos island cache, in the Pacific, off Costa Rica, and Trinidad island, the lone cable station in the South Atlantic, are places where landslides have hurtled tons of rock and debris to bury deeper the graves in which old-time pirates have hidden their ill-gotten hoards. In both cases, it seems not unlikely the treasures will remain hidden till doomsday, unless further landslides or earthquakes again expose them.

A few months ago, a farmer, Francis Calderon, was plowing on his land in Oaxaca, Mexico, when the shares turned up buried treasure worth more than \$250,000. The estate, which had belonged to Senor Calderon's family for more than 150 years, was seized



Top, Sand Sucker Which Helps Uncover Treasure Wrecks; Center, Radio Locator Which Detects Buried Metals; Bottom, Underwater, 20,000-Candlepower Lamp Used on Salvage Ships

suggests Westinghouse Lamp
Co. 150 Broadway, N.Y.C.

the hill of the Caballo Cunco, near the river Sacambaja, or Sacambaja. When he dug into the hill he found a faded, yellow parchment on which was written in Spanish: "You who dig here withdraw! The spot is dedicated to the Lord, and who dares enter shall meet with an agonizing death in this world, and eternal punishment in the next. The riches hidden here belong to our Master and are not for men."

All around the walls surrounding the cache, and on the entrances, a compound of strychnine had been spread. The poison is said to be derived from a bean found growing locally in the forests on the slopes of the Andes. Trying to force his way into the hill, Prodiges was poisoned and had to spend a year recuperating in an English watering place. Modern bullion salvors might do well to turn to the other side of Latin America where, off Cape Frio, 100 miles east of Rio de Janeiro, lies the wreck of the British forty-six-gun frigate "Thetis," freighted with \$810,000 in bags of gold and

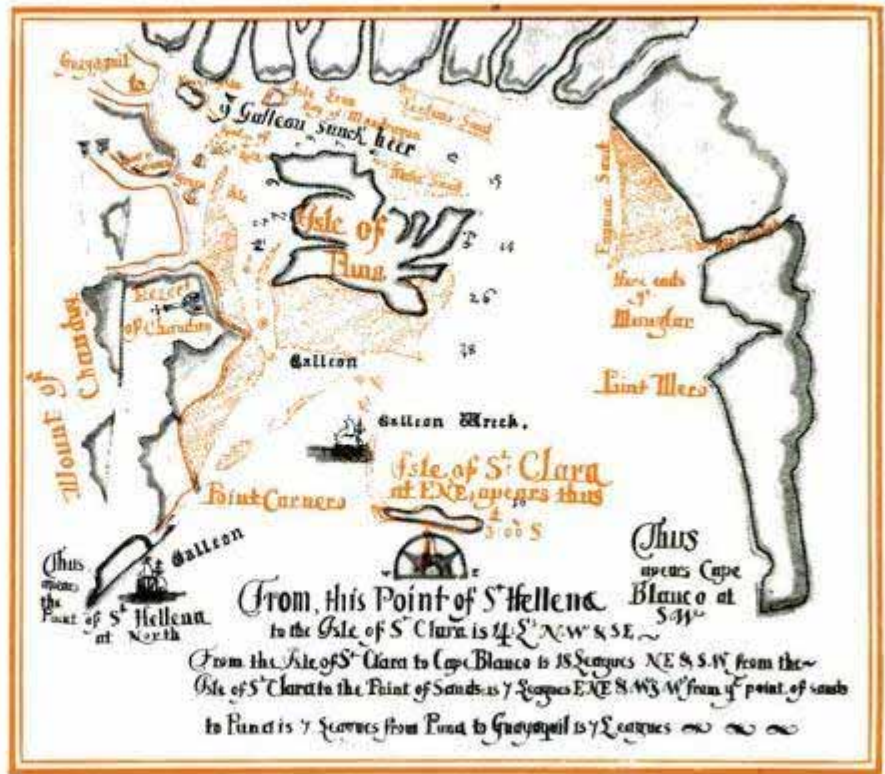

Buccaneer's Map of Sunken Treasure Ships in the Spanish Main Which the Pirate Presented to King Charles II of England

silver, the property of merchants afraid of the numerous and bloodthirsty pirates who swarmed the seas in the year 1830. Treasure to the value of about \$270,000 in bullion and specie still remains to be fished up from this old wreck by some up-to-date deep-sea diver with armored suit, grabs, and underwater lamps.

Among the dangerous coral reefs and cays, or hidden in the dense mangrove thickets on the shores of the West India islands, many treasure caches and galleon wrecks are still waiting for the modern hunters and salvors. In 1597, a Spanish galleon, the "Santa Margherita," crashed against a range of reefs and went to the bottom with some \$6,250,000 worth of silver aboard. Four hundred years later, a famous American diver, Layman, was repairing a cable between Santo Domingo and the Bahamas, when he blundered straight into the rotting hulk with the treasure still intact. Layman marked the spot and later bought a yacht used by Sir Thomas Lipton in the well-known contest for the American cup. He sailed for the treasure, reached the ancient wreck and was then smashed up by one of those three-day hurricanes which are the curse of salvors in these reef-sown waters. His yacht became a derelict. A passing steamer



Electromagnet Able to Raise Many Tons, Employed in the Salvaging of Sunken Treasure Ships

suggest Ohio Electric Controller Co
5902 Maurice Ave Cleveland
Ohio

3952

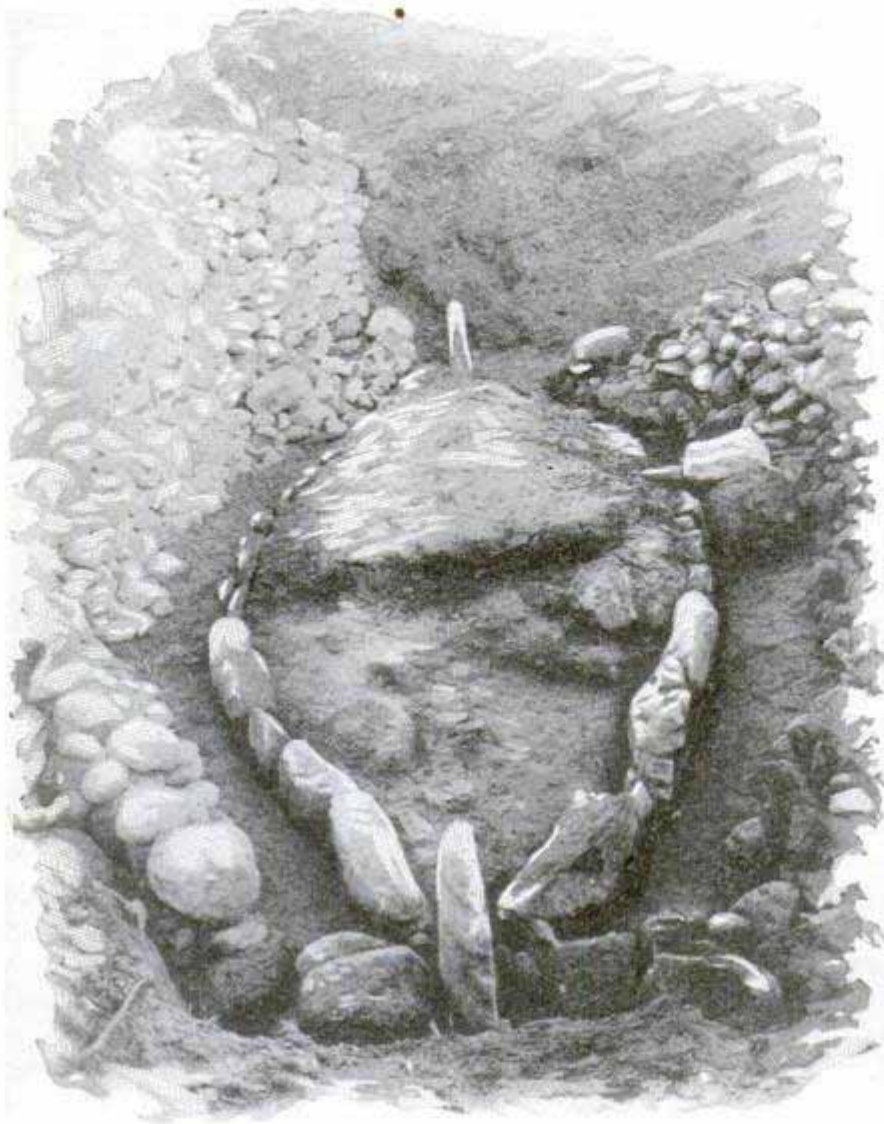

Viking Ship Propelled by Banks of Oars Which Was Found Buried in a Mound on the West Coast of Sweden Recently

rescued Layman who was forced to give up the quest. There are hundreds of such wrecks on the Bahama reefs and around Haiti and Santo Domingo.

Many of the old castles and ruined abbeys of England and Scotland still keep the secrets of old-time treasure hoards never found, though often sought. Peel castle, handed over by King George of England to the people of the Isle of Man, 700 years ago was the fort and dungeon of a Danish pirate chief, named Orry, who is known to have raided and robbed ships and seaside towns. Traditions, handed down for generations in the little Manx town of Peel, say that great hoards were hidden by his pirates in the precincts of the castle. Gold and silver coins have been dug up in and near the ruins of the old haunted castle, which stands on an islet rock, connected with the mainland

by a causeway. A few months ago, the Peel town commissioners read a letter from a Mr. Price, of Australia, describing passages in the ruins in which he said explorers will find hidden treasure. The authorities are now thinking of exploring these ruins and the labyrinth of subterranean passages.

Submarine treasure alleged to lie in the rotting timbers of the galleons in the sound of Tobermory, Scotland, lured two British members of parliament, in 1929, to join the numerous seekers after hidden wealth. The Duke of Argyll owns the rights in the old wreck, which is supposed to have gone to the bottom with treasure worth about \$10,000,000. Although divers have made many descents, they found that silt and mud had been so heaped up by the tides and currents in the sound that it was for the time impossible

to locate the wreck.

The English salvage firm, Siebe, Gorman, of London, has a museum in which is to be seen a Spanish treasure chest recovered from the wreck of the steamship "Alphonse XII." The chest is one of seven which held gold coins worth \$50,000, and one of the coins is set in a glass panel fixed outside the chest. Next to the coffer is exhibited a silver dish, spoon and gold ring raised by divers from the wreck of the British warship "Royal George," which was blown up near Portsmouth, in 1782. Many relics taken from the old Spanish galleon in Tobermory sound are in this museum.

Modern Americans, in 1928, were hunting around lone Mount Nebo, Palestine, to find the solitary hollow cavern where Jeremiah, the prophet, hid the sacerdotal treasures, including the Ark of the Cove-

Suggested A
Schraders Son. Inc. 470 Vanderbilt Ave Brooklyn N.Y.

nant, the golden altar, the wooden chest lined with pure gold and adorned with golden cherubim. Nebuchadnezzar and the hosts of Babylon were advancing on Jerusalem, when the prophet announced in stern tones "that place [the hiding place of treasure] shall not be known until the time that God gather his people together and receive them unto mercy." An adventurer from Los Angeles recently climbed for the first time by automobile up Mount Nebo, the Palestine government having given him permission to explore the mountain for the hidden cave of the golden ark. He returned to America,

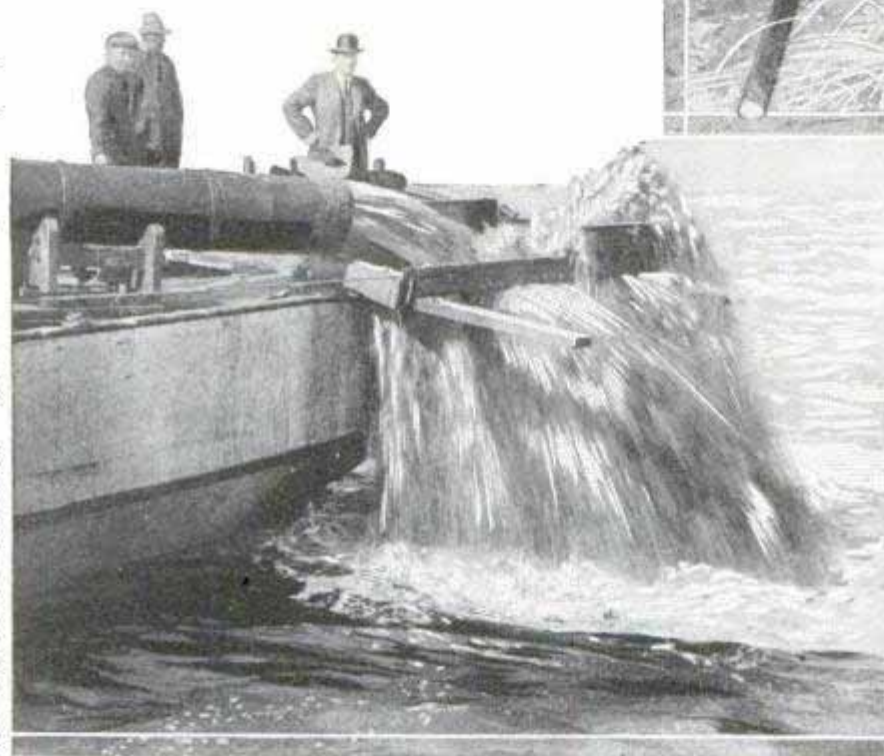

the sunken liner "Laurentic," torpedoed during the European war, believe that, with a new and improved water digger, they will eventually enter the strong rooms of the "Egypt."

Modern treasure-wreck salvors may like to hear that the richest of all treasure wrecks lies unconquered just outside Vigo bay, Spain. Among the logs of British men of war, which the writer has examined at the London Public Record office, is that of the "Monmouth," which

Top, Attacking Bullion Room of Sunken Ship with Oxyhydrogen Blowpipe; Below, Pumping Out a Wreck in the Search for Riches

where he is now said to be arranging for another expedition to make a more exhaustive search around the mountain. Many treasure hunters have sought for these temple hoards, but without success.

All the latest and most scientific deep-sea diving apparatus, ocean lamps, electric grabs and magnets have been unable to break from Davy Jones' locker the ten or twelve million dollars worth of bullion and specie lying in the strong rooms of the sunken British P. and O. liner "Egypt," at the bottom of the sea, off Ushant, France. For six years the search has been going forward. Now, however, divers, who have raised some of the treasure from

captured a Vigo galleon with immense treasure aboard. The galleon ran on a submerged rock pinnacle, and went to the bottom of the sea off the south end of the isle of Bayona, near Vigo. Several modern expeditions, whose projectors have never seen the evidence of these documents, have searched the wrong location. The right place, as Doctor Iberti, a previous salvor and historian, has pointed out, is that marked on modern nautical charts as "Los Castros de Agoeiro," to the northwest of which, about half a mile distant, lies the wreck of this richest of the galleons of the Spanish fleet, bound for Vigo bay.

Suggested
The Hayward Co., 40 Church St
N.Y.C.

Aircraft Development Corp. g.

**SKATING ON SKYSCRAPER ROOF
LATEST WINTER SPORT**

96

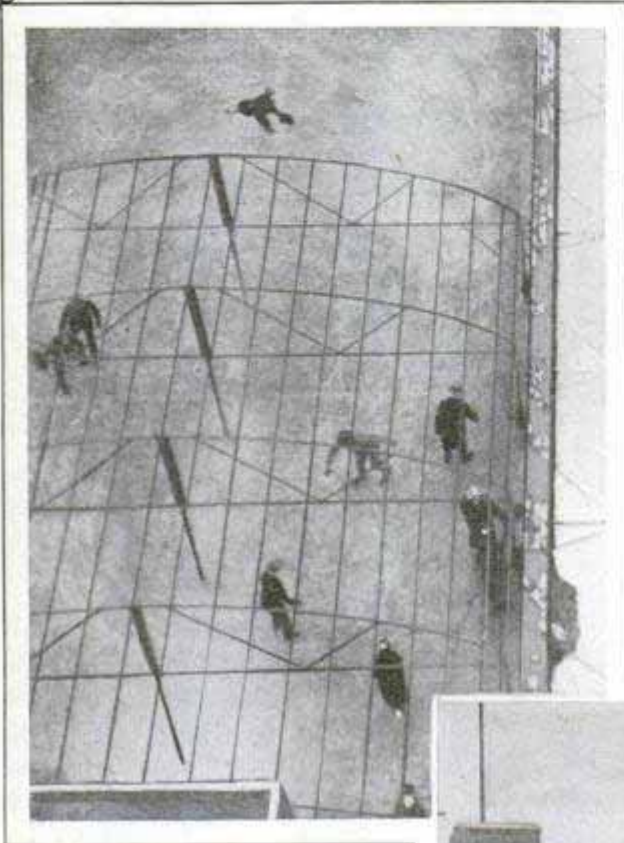

Looking Down on the Skyscraper Skating Rink from a Higher Level, and a Corner of the "Pond," Showing the Lofty Location among Near-By Towers

Skating on the skyline is enjoyed by members of the Tavern club and others who flood a portion of the roof of a Chicago skyscraper in cold weather. The area, used for dining and dancing in the summer, is quickly transformed into a large rink that may be lighted at night and will accommodate a considerable crowd. Tenants of this and adjacent buildings thus are afforded a healthful way to spend part of their noon hour or other leisure time.

**LIMIT TO THE SIZE OF PLANES
IS SET BY WEIGHT**

Whether commercial aviation in the future will depend mainly on airplanes or airships remains to be seen, but for carrying heavy loads at moderate speed the

lighter-than-air craft, considering materials and designs as now known, has decided advantages. The chief factor is that its usefulness as a load carrier increases with increased size, while this is not so true of the airplane. Engineers have declared that eleven pounds per horsepower appears to be the maximum useful load of a flying boat, but a super-airship still shows an increasing efficiency with a useful load of seventy-four pounds per horsepower. Experts of the Detroit Aircraft corporation, who supervised the construction of the all-metal "ZMC-2" for the United States navy, report that "airplanes of a gross lift of twenty to twenty-five tons and flying boats of a gross lift of fifty to sixty tons mark the limit beyond which any increase in size would not be profitable." In an airship, the useful load per horsepower increases rapidly

Detroit Mich.



with volume, but in an airplane, the useful load per horsepower is about constant, showing little increase with size and, in extremely large craft, actually decreasing. For these and other reasons, engineers are looking to the airship to solve the problem of extensive oceanic air traffic.

Whenever you find that you wish to know more about any article that is described in this magazine, write our Bureau of Information.

338 N. Michigan Ave

137

Science & Service News Bulletin 45903
1/17/30

Iserman & Tate U.S.
between Berlin
and Munich

Rolph J. Lachner
35 Luqueer St
Brooklyn, N.Y. 91
553

BEAM OF LIGHT STOPS TRAIN WHEN SIGNAL SHOWS

Using a flashing beam of light, reflected back to a locomotive from mirrors on signal posts, to stop trains automatically, is being tried out in Germany with success. From a small searchlight on the front of the engine the narrow beam of light is thrown upward. Around the searchlight lens is a ring of light-sensitive cells, the mirror on the signal post reflecting the beam back to one of these cells. This starts an electric current which makes a visible signal in the engine cab. If the engineer does not respond promptly to this signal, the train is stopped automatically. Movement of the mirror on the post determines which cell receives the reflected light, each cell giving a definite signal to the engineer. With this system all the complicated apparatus is on the locomotive where it can be adjusted and repaired in the roundhouse instead of along the right of way, as has been the case with other electrical-signal systems for the same purpose.

57

MUSICAL TAXIS FURNISH TUNES TO ORDER OF PASSENGERS

Parisian taxicabs have enabled passengers to play as they ride by installing radio loud speakers in the roofs. When a fare enters a taxi, the first polite query of the driver concerns the type of music preferred, after which the set is tuned to one of the broadcasting stations selected by the passenger.

3899

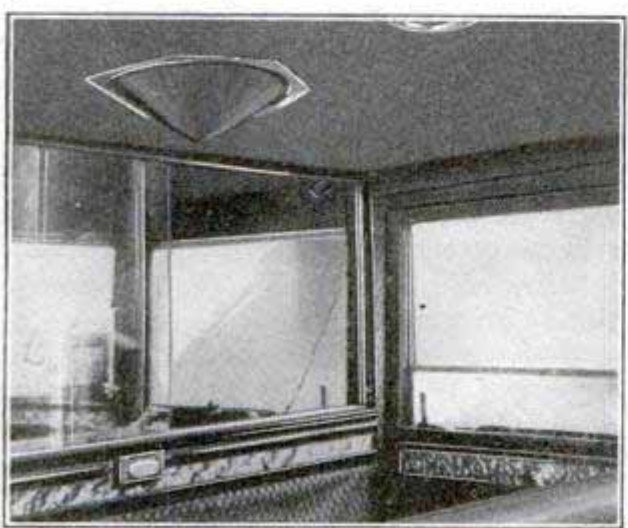

Paris Taxicab, Showing Radio Loud Speaker in Roof Which Furnishes Music for Passengers

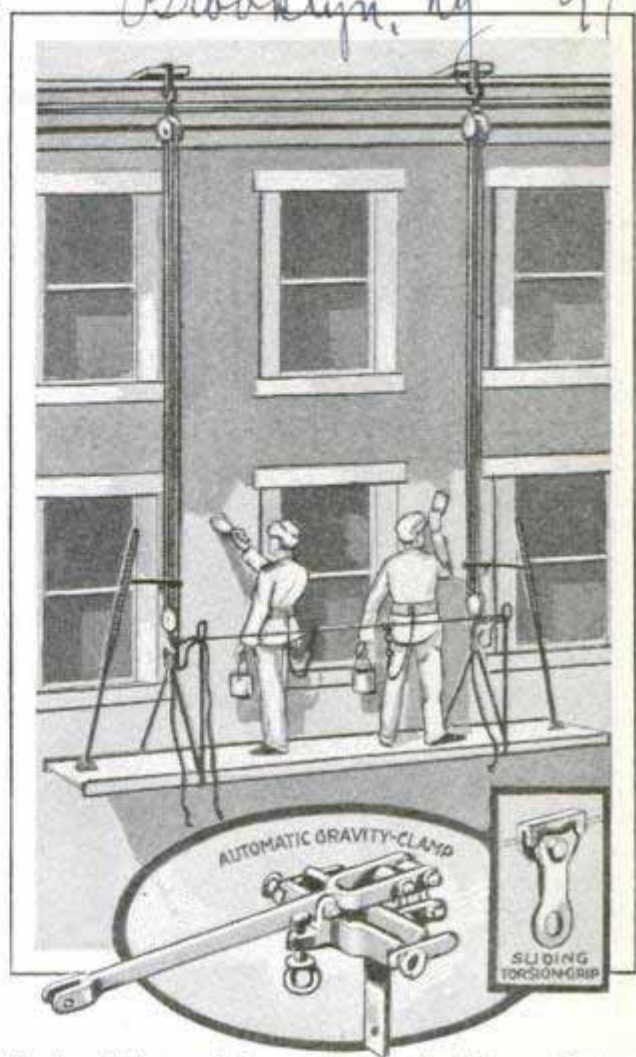

Torsion Grips and Automatic Gravity Clamps Protect Workmen on This Scaffold from Accident

SCAFFOLD HAS SAFETY LOCKS WORKING AUTOMATICALLY

Equipped with three separate safety attachments that operate automatically, a scaffold now is available which is virtually accident-proof. Workmen wear belts by which they are attached by torsion grips to a trolley, suspended between the ropes of the scaffold and secured independently to the building. Thus they can move about freely but are automatically attached to the trolley if the ropes break or they should slip. A gravity clamp permits the ropes to slide through the pulleys but closes on them if one breaks or a knot slips loose, the scaffold locking itself after falling a few feet. A steel anchorage for hanging the scaffold from the roof consists of two steel cables with hook terminals, a chimney-corner clip at one end and a torsion grip at the other.

(Palestine is slightly larger than the state of Vermont.

International

Tornadoes

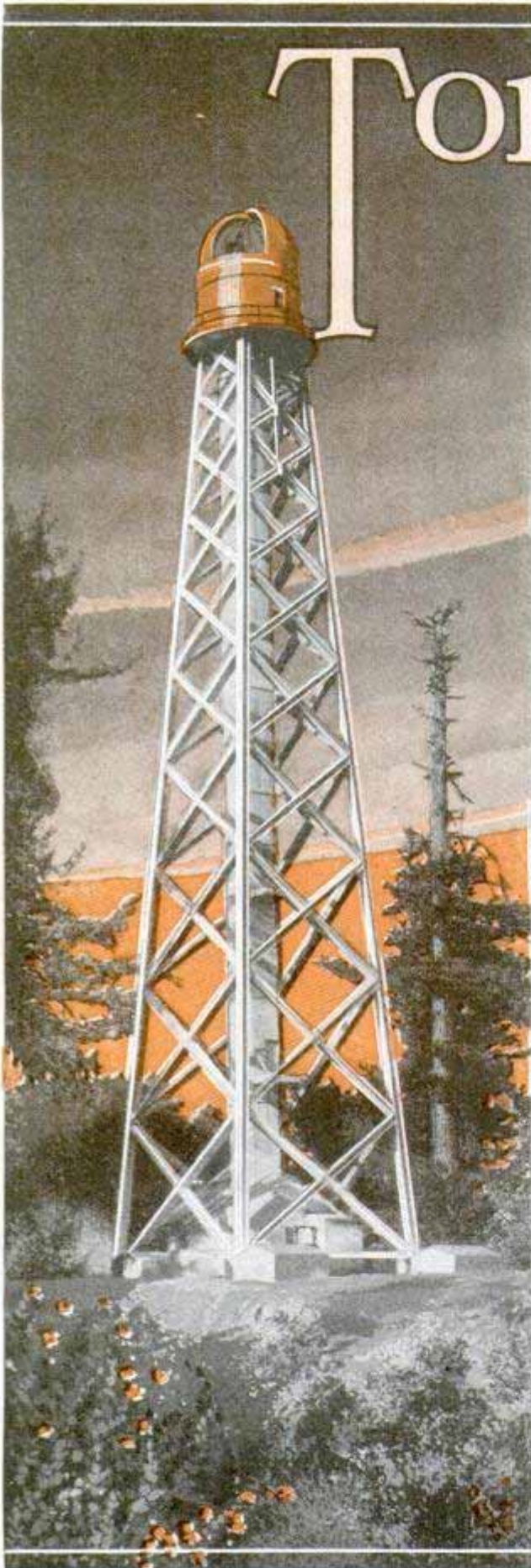

The 150-Foot Tower Telescope at Mount Wilson Observatory, Used Exclusively in Solar Research

By **GEORGE W. GRAY**
Sparkill, N.Y.
 A BLIZZARD was sweeping the continent from the Rockies to the Atlantic one day last fall. The freeze reached as far south as Jacksonville and Dallas. Even Mexico City was touched by the cold wave which rode in there on a hailstorm.

While millions of surprised people all over America shivered through this cold snap, a few men here and there were quietly watching another outburst 93,000,000 miles away—for it chanced that storms were raging on the sun.

The most prodigious of these solar disturbances could be seen clearly through a smoked glass; it looked like a black moth that had alighted squarely on the nose of Old Sol. But a moth of such dimensions could swallow the earth and gulp down the moon as dessert, for the astronomers' measurements showed its diameter to be not less than 40,000 miles—and the earth's broadest diameter is less than 8,000 miles. Though by far the largest, it was but one of a flock of spots that strung along the face of the sun for 700,000 miles.

This sunspot procession is remarkable not only for its size and numbers, but also for the fact that it was predicted. Dr. Harlan True Stetson, then of Harvard, announced in December, 1928, that an unusual outburst of solar activity should be expected in October or November, 1929. Doctor Stetson recently became director of the Perkins observatory at Delaware, Ohio, where he is continuing his studies with the aid of the great sixty-nine-inch reflecting telescope lately erected there.

"How did you arrive at this prediction?" he was asked.

"I have been collaborating with Dr. Greenleaf W. Pickard in an investigation of possible relations between the sun and radio communication," answered the astronomer. "We found that about every fifteen months radio reception became noticeably poorer. In every instance this

on the Sun



A Solar Prominence, 80,000 Miles High, Photographed at the Mount Wilson Observatory; the Huge Flames of Hydrogen Gas Shown Are Associated with Sunspots by Scientists

marked disturbance in the earth's atmosphere was matched by the appearance of spots on the sun.

"It has been known for nearly a century that sunspots wax and wane in cycles. There comes a year when the sun seems to calm down; its face is unmarked for days and weeks on a stretch. Then spots begin to appear, increase in number, and generally in size too. Finally a time is reached when they are within five degrees of the solar equator, and it is usually at this time that the largest spots appear and the greatest number are visible at the same time. When this peak arrives we are at sunspot maximum. Thereafter, spots diminish in size and number until finally they disappear and we are at sunspot minimum. The time from one minimum to the next varies, but on the average it is a little more than eleven years. Now, what Doctor Pickard

and I have observed is that within this well-known eleven-year cycle the sun seems to pulse at intervals of about fifteen months.

"I have looked back in sunspot records for many years, and find again and again recurrence of this period. With such data, it seemed reasonable to expect another solar outburst about fifteen months following that of July, 1928. So I felt complete confidence in predicting one for the fall of 1929.

"We may look for a new outbreak of spottedness around February, 1931," added Doctor Stetson, venturing another forecast, "though I don't expect it to equal the procession of last November. We are surely past sunspot maximum now, and can look forward to a minimum about 1934. When minimum is attained, radio reception should be the best we have had in many years."

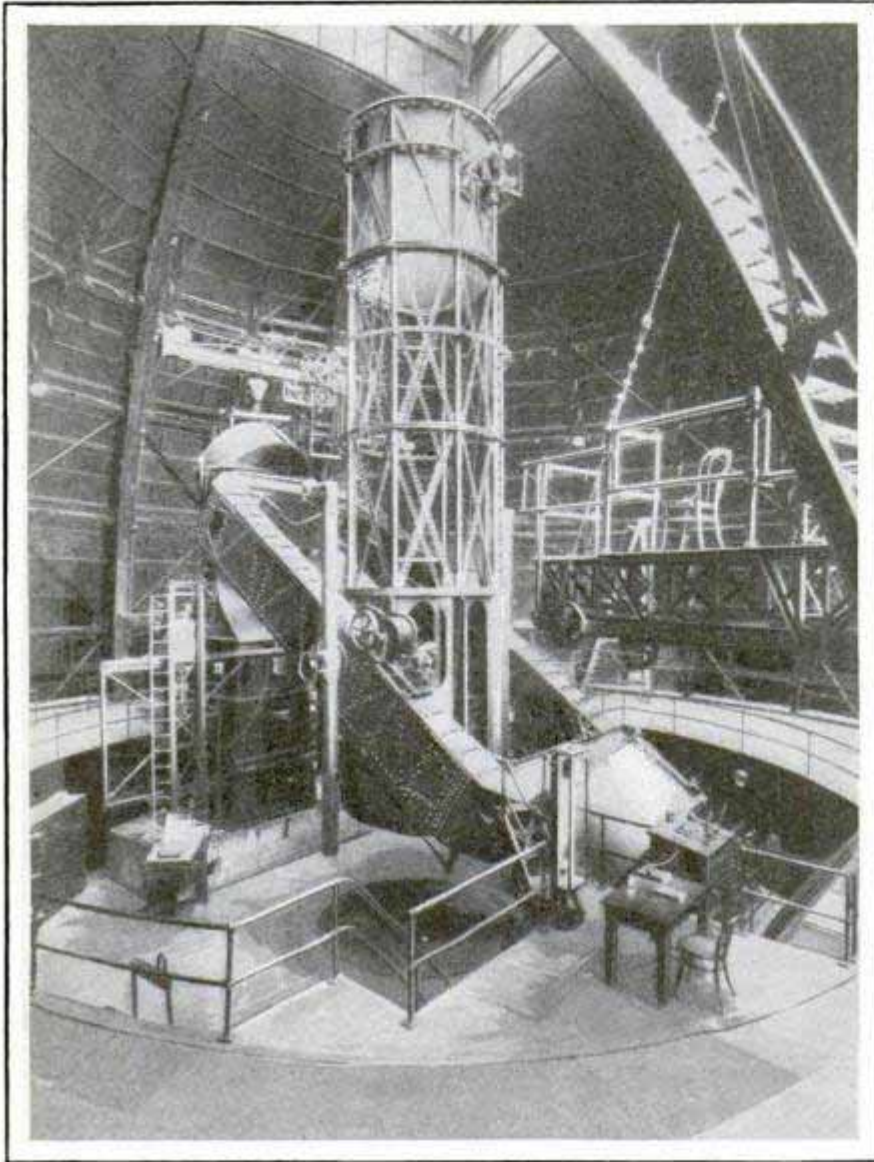

Nebulae, Believed to be 840 Million Million Miles from the Earth, Have Been Seen through This 100-Inch Hooker Telescope

What are these mysterious spots that can reach across 93,000,000 miles of interplanetary space to distress and mock our new-found mastery of the ether?

Tornadoes, say the astronomers—great eruptive whirls of hot glowing gas, each a spiraling funnel moving at incredible velocity, spurting up clouds of hydrogen and calcium and other elements, sucking the fiery vapors back into its capacious crater where atoms are smashed, stripped, excited into intense radiation, and bombarded into space.

Thus each sunspot becomes in effect a gigantic cathode-ray tube shooting a beam of electrons. The collision of these high-speed sun particles with the atoms of our upper air is believed to be responsible for the radio difficulties which recur with increase of sunspots.

Dr. George Ellery Hale, of Mt. Wilson observatory, is largely responsible for our present knowledge of sunspots. He found that the spots are not only tornadoes but are huge magnets. In many cases they occur in pairs, one spot being positively magnetized and the other negatively. Working with more powerful instruments, he discovered unsuspected areas of magnetic activity where no dark markings were visible, and in this way located hidden sunspots.

In addition to atmospheric agitations which trouble radio communication, strange currents of electricity are set up in the earth. These get into grounded telegraph and telephone lines and cause more trouble. Thus in May, 1921, when two large spots approached the sun's equator, a terrific magnetic storm raged over the earth, and wild electrical currents interrupted telephone

and telegraph service over a wide area of the United States. These untamed currents punctured the insulation of cables, burnt out fuses and operated other protective devices, set fire to a telephone switchboard at Philadelphia and to a railroad signal station at Brewster, N. Y., and are charged with responsibility for the fire which destroyed the union railway station in Albany, N. Y., and a telephone exchange in Karlstad, Sweden.

Dr. Charles G. Abbot and his associates, of the Smithsonian Institution, by investigations extending over many years, have found that the sun's temperature rises with increase of spots. Strangely enough, the earth seems to be a little cooler than average when spots are numerous, and slightly warmer when spots are few or absent.

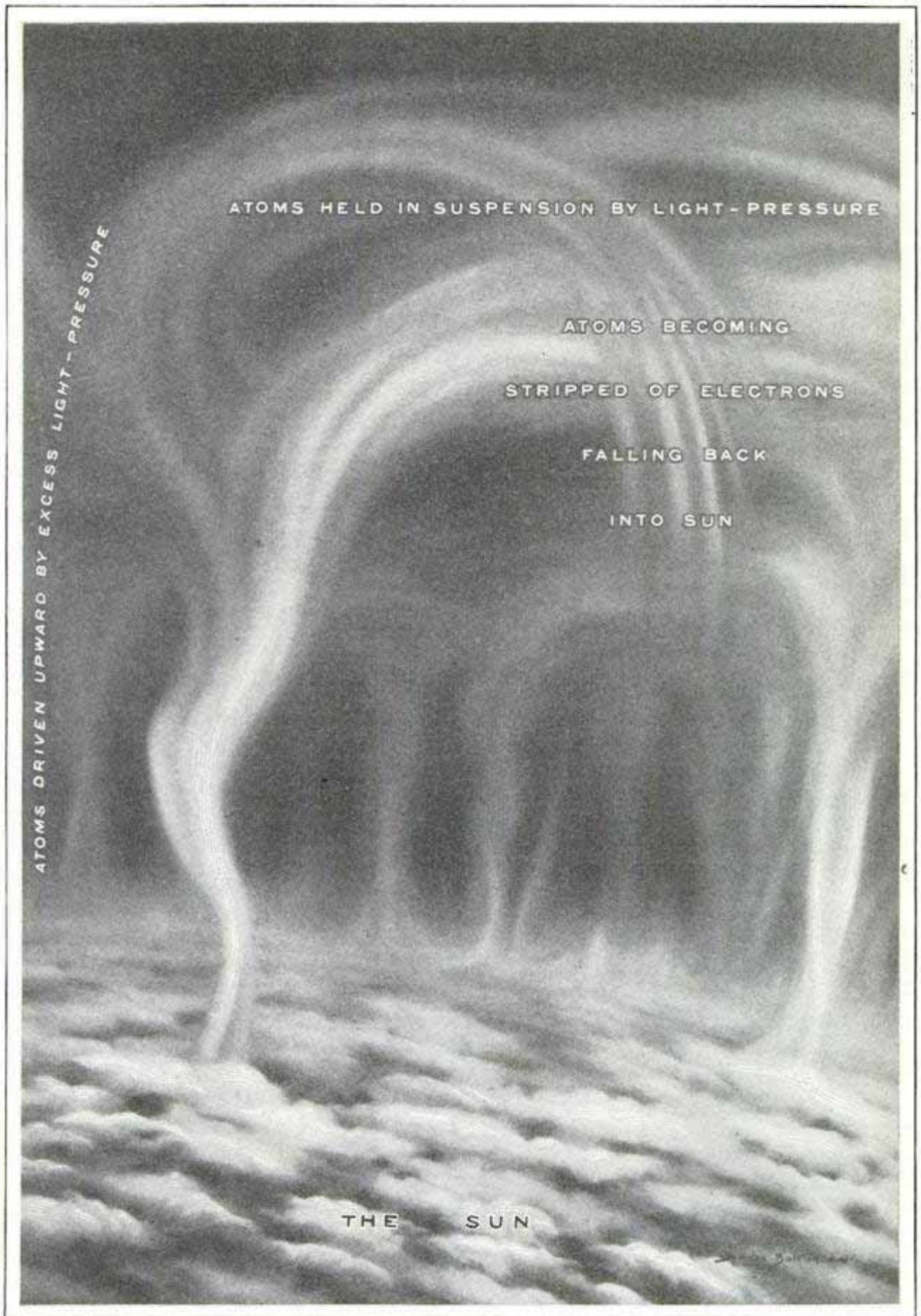

© The Illustrated London News

This Wraithlike Picture of the Sun Shows Clouds of Atoms Kept in Suspension between the "Push" of Light and "Pull" of Gravity, Until They Lose Their Electrons and Fall Back

Mr. J. S. Shackwell
5918 Highland Ave

Mr. J. S. Shackwell
Eslen Eden Hotel
Chicago

St. Louis, Mo

4013

Chicago

"NOISY" OYSTERS HEARD BY SHIPS

145

Noise of oysters, it has been found, is interfering with ships' "ears"—the microphones suspended below the surface as an aid in figuring depths and guiding the vessels. When the oysters open and close their shells, the highly sensitive apparatus picks up the noise and transmits it to the ship. The microphones used on ships are so sensitive that they have broadcast the beat of the human heart and the noise of insects eating in a corn crib, so that a closing oyster shell makes a great racket in comparison. Any decrease in sensitivity, however, would impair the usefulness of the apparatus.



Surfboard Riders Enjoying a "Balloon Busting" Contest; They Attempt to Puncture the Balloons with Pin-Tipped Bamboo Poles

SURFBOARD RIDERS PUNCTURE BALLOONS IN WATER GAME

Not content with the mere thrill of clinging to a swaying surfboard towed by a speeding motorboat, some of the devotees of this exciting sport have organized a game called "balloon busting." The rider is equipped with a pin-tipped bamboo pole, some six feet long. One person drives the boat, another sits in the rear and releases inflated balloons, and the rider attempts to puncture each one released with the lance.

CLOCK COMBINED WITH AERIAL FOR THE RADIO SET

47

Containing an inside radio aerial in its base, a clock now is on the market which serves the dual purpose of timepiece and means of concealing unsightly inside wires. It is equipped with connections for light wires and terminals for hooking up with the radio, and operates on alternating or direct current. The clock itself is not electrically operated, but contains a multi-zone dial, giving the time in each of the twelve zones of the world, thus making it easy to pick up a radio program anywhere without computing difference in time.

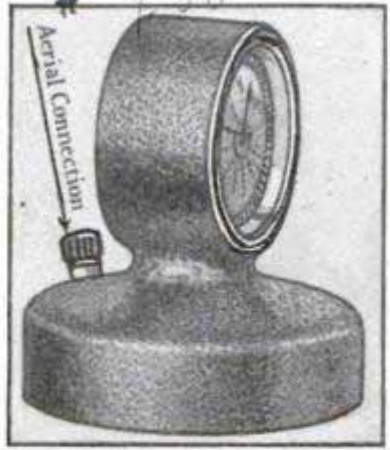

The clock itself is not electrically operated, but contains a multi-zone dial, giving the time in each of the twelve zones of the world, thus making it easy to pick up a radio program anywhere without computing difference in time.

FOUNTAIN MOISTENER FOR DESK REPLACES SPONGE

4017

Replacing the sponge and water-filled dish as a moistener for the desk, a handy fountain implement now is available. It consists of a handle on the end of which is a wide sponge tip. A rubber holder containing water keeps the moistener upright and in condition when not in use, and a valve prevents leakage.



Tungsten carbide is hard enough to scratch sapphire.

Aerial Insulator Co., Inc.
Essex, Mass

Sam Rubber Co.
Barberton Ohio

*of my Mr Morganthall
Rush 378 Golden
state Cal - San Francisco
Calif*

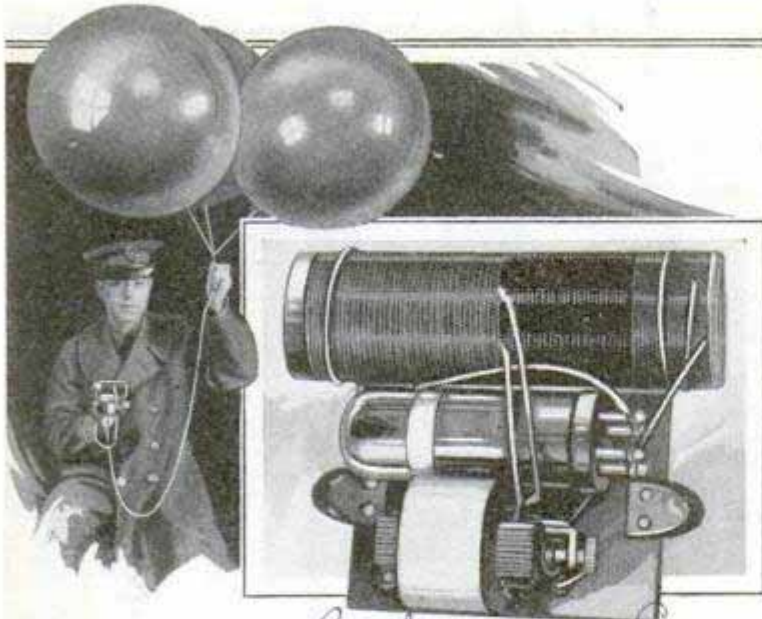

Three Balloons to Which Are Attached Radio Instruments for Recording Weather Conditions, and Recording Apparatus

developed by the U. S. signal corps indicates the speed and direction of the upper winds. A small radio transmitter is sent aloft attached to three hydrogen-filled balloons. At various ground stations the direction from which signals come is determined by apparatus such as is used with the radio compass, and reported to a central point where the movements are worked out and plotted.

PIE PAN THAT DOES NOT SPILL JUICE

Pie pans that do not allow juice to spill over the edges onto the oven floor are equipped with a trough around the outer rim where all the excess liquid is caught during baking. This upper rim also prevents the bubbling juice from dripping back into the pan itself, thus keeping the pies from sticking.

SNOW TOSSED FROM ROADWAY BY ROTARY PLOW

Rotary snowplows that tossed the snow in a cascade from fifty to one-hundred feet from the roadway were employed in keeping Chicago streets and boulevards clean during heavy winter storms. The plows were pushed by trucks and gathered the snow into a conveyor which shot it out at the side like a great waterfall.

WEATHER BALLOONS SEND OUT REPORTS BY RADIO

Radio-equipped balloons that automatically report atmospheric conditions encountered in free flights recently have been used in Russia and France. The Russian instrument carries a light meteorograph with indicating arms for barometric pressure, temperature and relative humidity. The ends of the arms are spaced about a disk, on which is mounted a contact point turned by clockwork once a minute. A battery and spark gap announce the contacts made by this point with the ends of the arms. At the receiving instrument a record of the contacts is traced on a revolving cylinder by apparatus similar to that used for receiving weather maps broadcast by radio. The French device sends out radio signals at regular intervals showing barometric pressure and temperature encountered by the balloon. These are received both as audible signals and by a recording pen. In this instrument a make-and-break device is used to indicate barometer and thermometer readings by the duration of the signals. A radio pilot balloon, de-



Rotary Plow That Eats Up a Snow Bank at Twenty Miles an Hour, Picking Up the Snow and Tossing It Far beyond the Curbing

Klauer Mfg Co Dubuque

inv. P.A. Molchanov

4074.

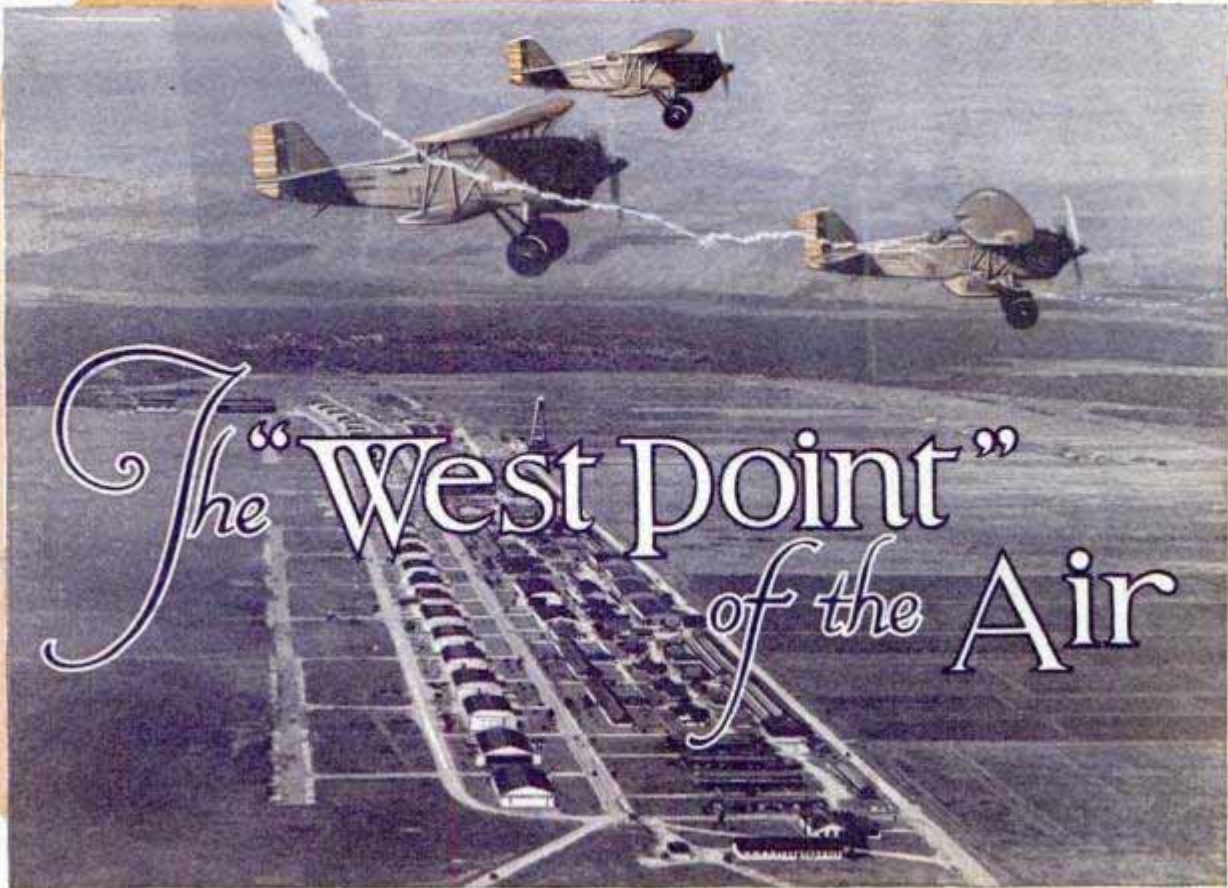

Looking Down on Kelly Field, the Advanced Flying School of the United States Army Air Corps at San Antonio, Tex., Where Flying Cadets Complete Their Year's Course

FLYING instruction, second to none in the world, is offered by the United States Army Air Corps at its three main schools, Kelly and Brooks fields, near San Antonio, Tex., and March field, at Riverside, Calif. The last two are known as the primary schools where the students, flying cadets, receive rigorous training in all maneuvers necessary to pilot an airplane, besides work on airplane engines, navigation, machine guns, radio and other subjects necessary for a military pilot.

For a month at either of the primary schools, the cadet is dubbed a "Dodo," for he is more or less on probation, and the fact that approximately fifty per cent of the men who enter the training schools are eliminated, or "washed out," before they reach the advanced stage of the year of instruction, the last four months at Kelly field, is evidence of the thoroughness of the work and the high standards required to complete it.

After a successful month, the Dodo disappears and in his stead a full-fledged cadet emerges who is rapidly advancing in the intricate tasks of flying with an instructor, solving ground-school problems and absorbing military drill and discipline.

Four months of primary work, and the cadet enters on the second and last stage of his training preliminary to the advanced school at Kelly field. Here he pilots regulation service-type airplanes instead of the training ships, takes part in cross-country flying, receives thorough instruction in aerial gunnery and special work in either pursuit, attack, bombardment or observation aviation. Once admitted to the final stages of training here, the cadet is almost certain to finish unless he is dismissed for some infraction of regulations, and receive the coveted "wings," the insigne of an army pilot.

Air-corps cadets are recruited from the enlisted ranks of the regular army, from members of the national-guard air corps, members or graduates of R. O. T. C. units and from civilian life. Candidates must be unmarried male citizens of the United States between the ages of twenty and twenty-seven, must have had the equivalent of two years of college, must be of excellent character and in sound physical condition.

(To Be Continued Next Month)

Charged to Randolph 561

4074

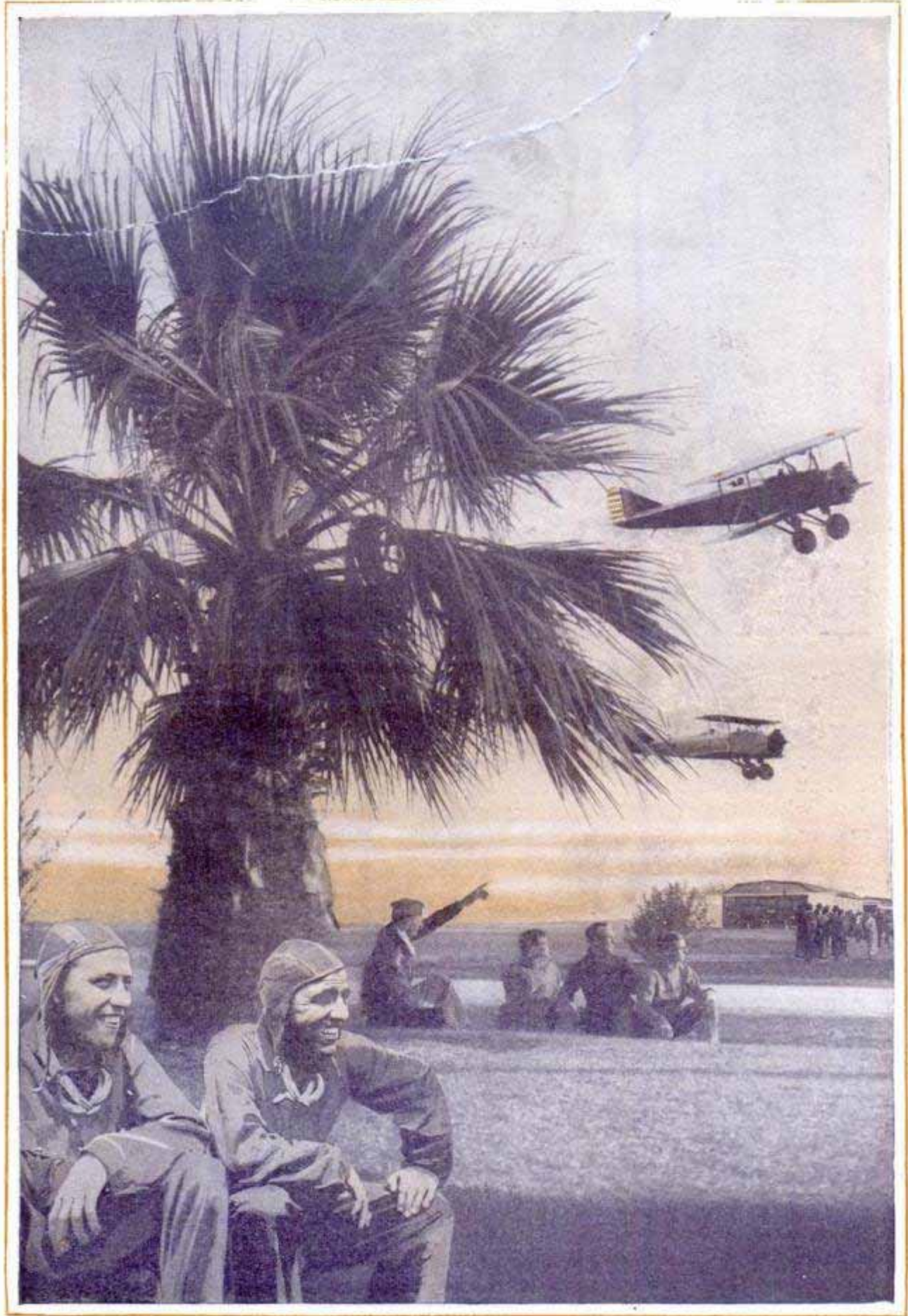

Learning, and Laughing a Bit Too, While Waiting Their Turn in the Air; Students at the Advanced Flying School Receiving Pointers from an Instructor and Watching Their Fellows Fly

4074



A Three-Man Jump at Brooks Field; a Remarkable Photograph Showing Three Stages of the Drop; the Man at Top Has Just Left the Plane; the Next Lower Is Pulling the Cord, and the Chute of the Third Is Unfolding; at Bottom, the Way Parachute Jumping Is Taught at Brooks Field, the Primary Training School; the Jumper Dives Head First, but Before He Leaps, He Must Have His Hand on the Ring

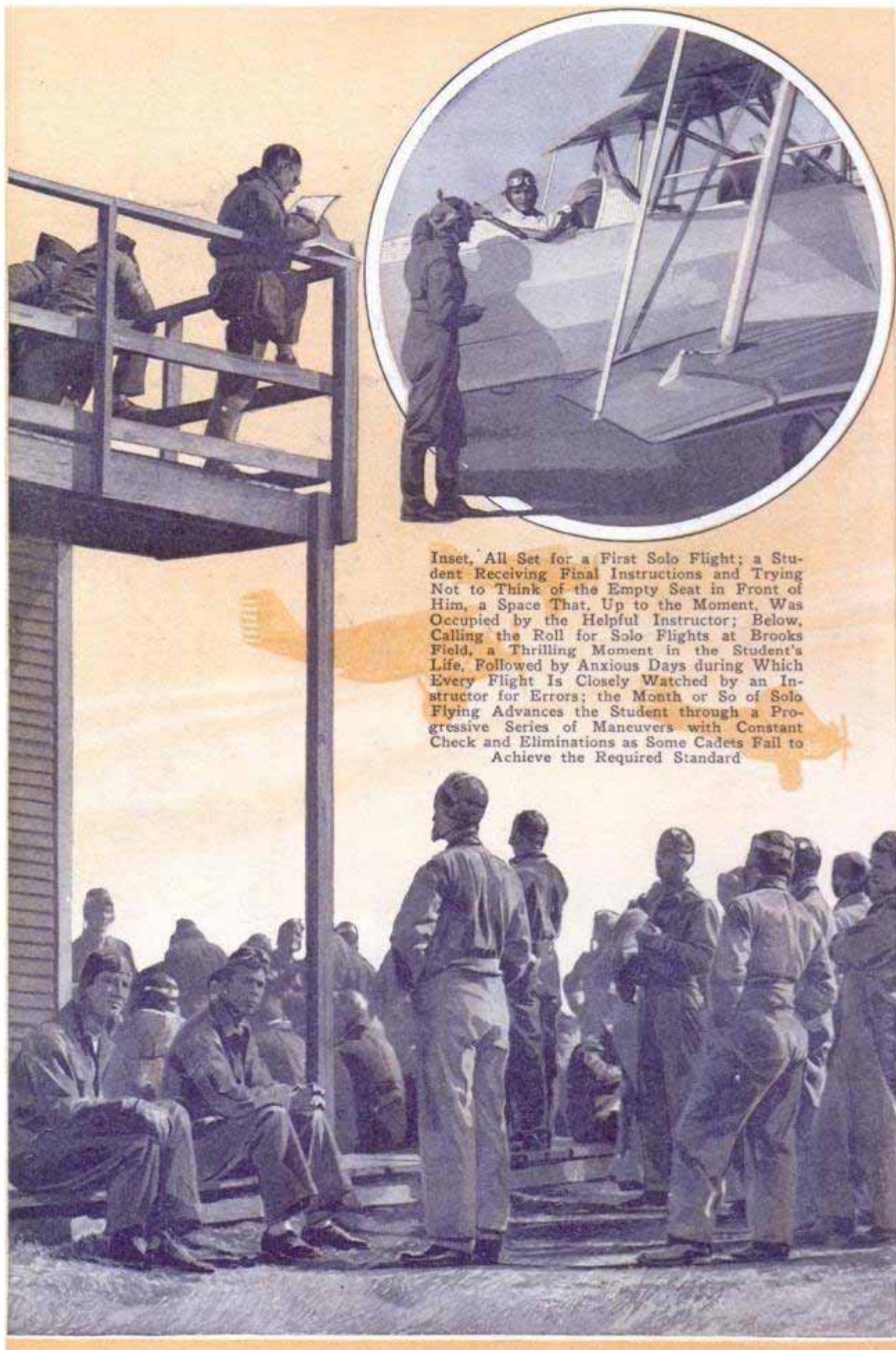

Inset. All Set for a First Solo Flight; a Student Receiving Final Instructions and Trying Not to Think of the Empty Seat in Front of Him, a Space That, Up to the Moment, Was Occupied by the Helpful Instructor; Below, Calling the Roll for Solo Flights at Brooks Field, a Thrilling Moment in the Student's Life, Followed by Anxious Days during Which Every Flight Is Closely Watched by an Instructor for Errors; the Month or So of Solo Flying Advances the Student through a Progressive Series of Maneuvers with Constant Check and Eliminations as Some Cadets Fail to Achieve the Required Standard



Kelly Field Polo Team; Superbly Drilled, Skillful and Always Ready for Battle with Other Army Units; Below, Major General Hines Speaking at Graduation Exercises; upon the Successful Completion of the Course, the Flying Cadet is Discharged from the Service with the Rating of Airplane Pilot and Receives the Coveted "Wings," a Commission as Second Lieutenant in the Reserve, or Accepts Active Duty

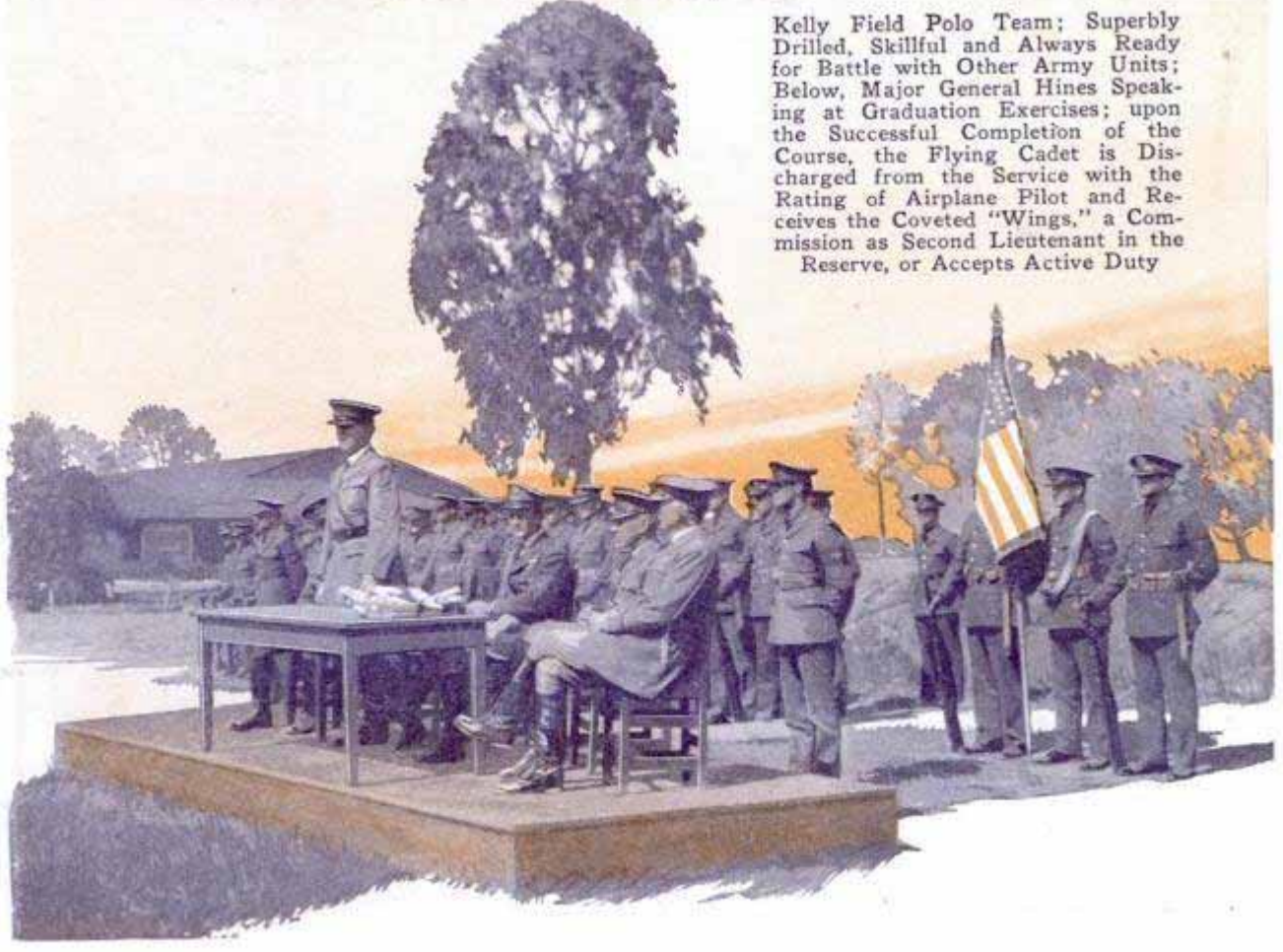

4074

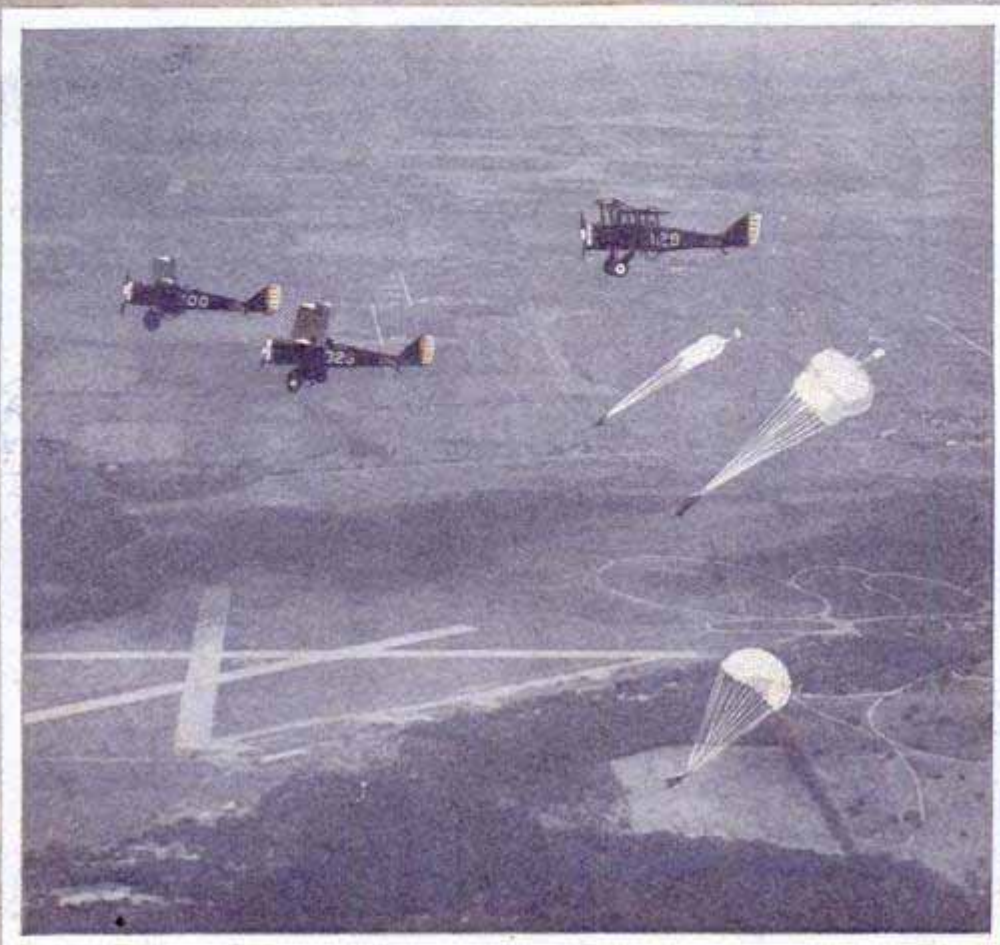

Growing Wings for the Machine-Gun Units; in Upper Photograph, Three Gunners Are Leaving Their Planes; a Ship Following Them Drops the Gun, Attached to a Parachute from an Altitude of About 200 Feet; It Is Inclosed in a Heavy Bag, but Is Quickly Unpacked and Made Ready for Firing as Shown Below; This Maneuver Illustrates How Strategic Positions, Especially behind the Enemy's Lines, Can Be Seized Quickly in Case of Actual Battle



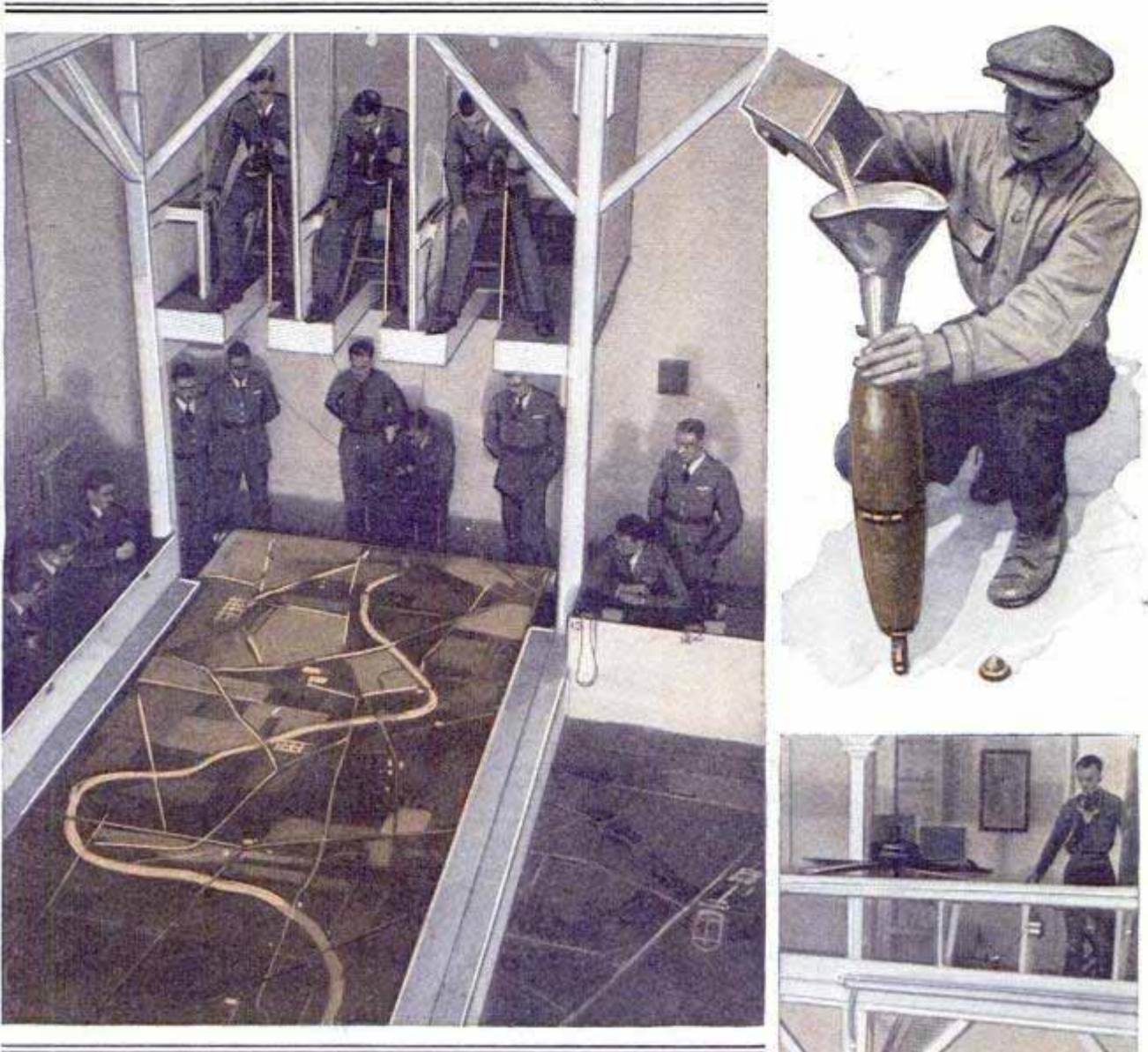

Above, the Traveling Carpet, a Miniature Field of Battle, upon Which Students of Flying Practice Dropping Bombs; the Three Men in the Upper Center Are Stationed at the Bomb Sights and the Instructor and His Men Sit Immediately below Them; at Upper Right, Loading a Practice Bomb; This Shows the Fourth Operation, Pouring in Sand; Below, at Right, the Instructor and His Assistants Are at the Control Board of the Miniature Bombing Range, Regulating the Shell Flashes on the Model Landscape; Instruction Such as This Supplements Pursuit, Attack, Observation and Bombardment Flying, Maneuvers That Duplicate Actual War Requirements and Include Night Missions, Flying Low and Raking an Area with Machine-Gun Fire, Acting as Lookout and Communicating by Radio or Dropping Big and Little Bombs from Huge "NB's" and "Keystones"

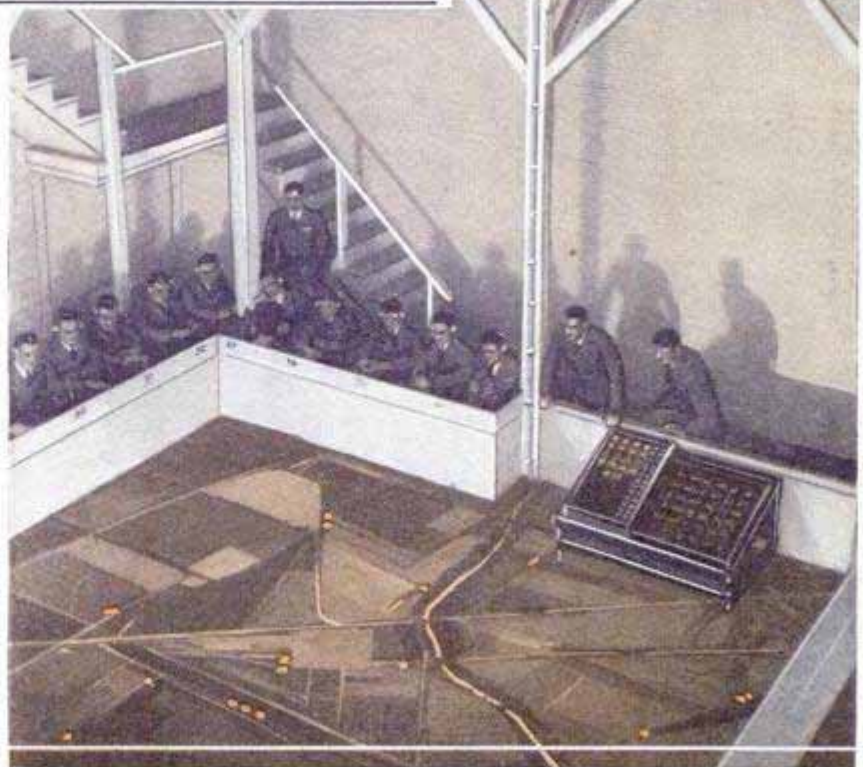

*in B 39 airplane -
Thomas Morse*

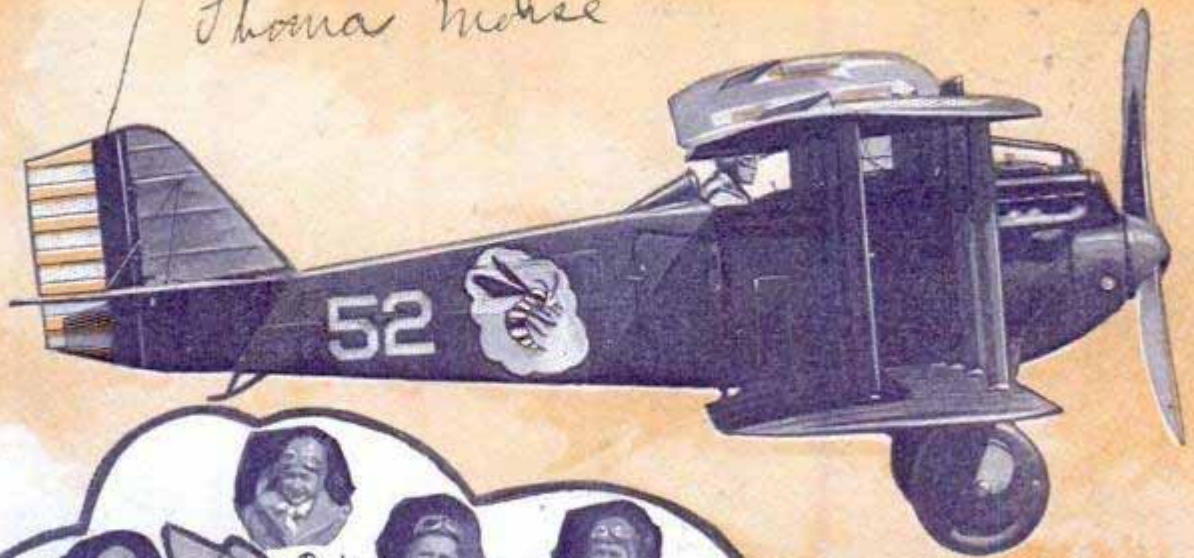

*404 &
H 3 ad School Squadron
Kelly Field Texas*

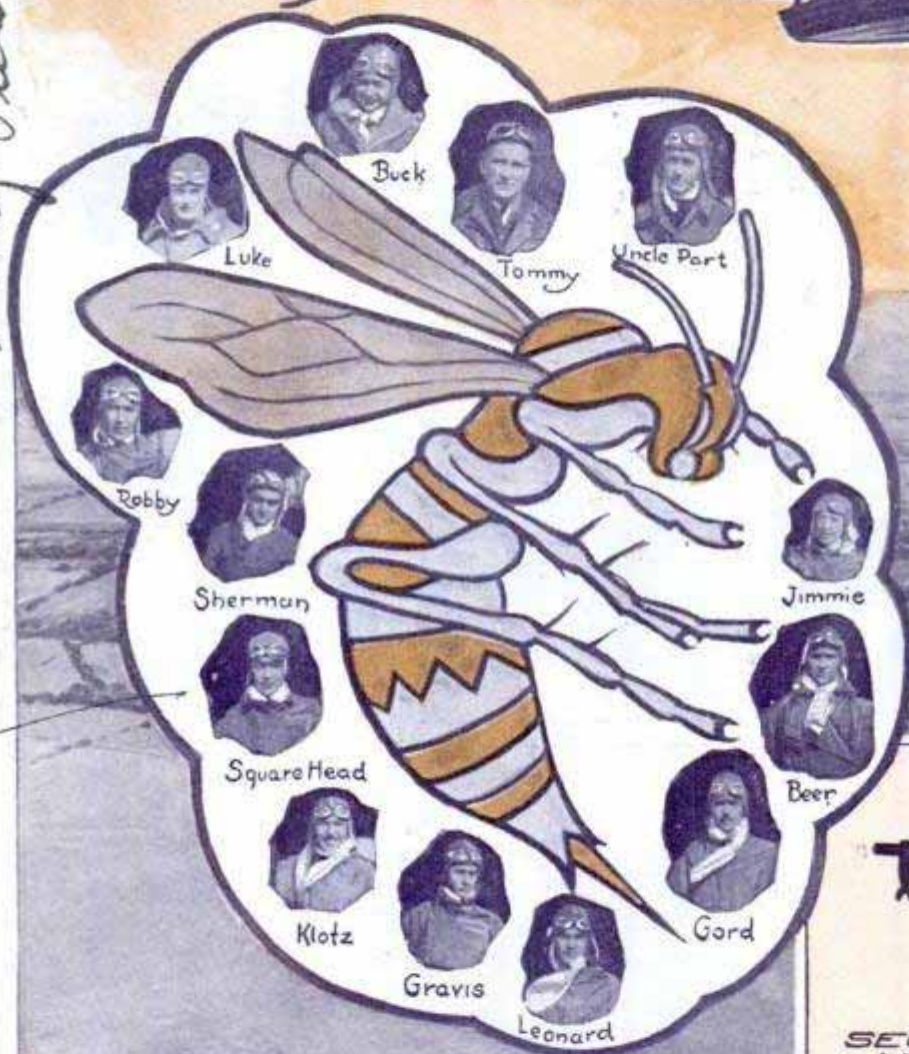

Close View of Advanced Airman in Pursuit Plane, Bearing Insignia Which Indicate to Which Squadron the Flyer Belongs; Center, Enlarged View of the "Attack Clan's" Coat of Arms and Portraits of Its Members; Each Man Cherishes a Copy of This for His Personal Files as These Men Are His Classmates; at Right, Two Views of Six-Ship Formation, Showing Relative Positions of the First and Second Units and the Different Ships in Each



*6 SHIP
FLIGHT FORMATION*

4074

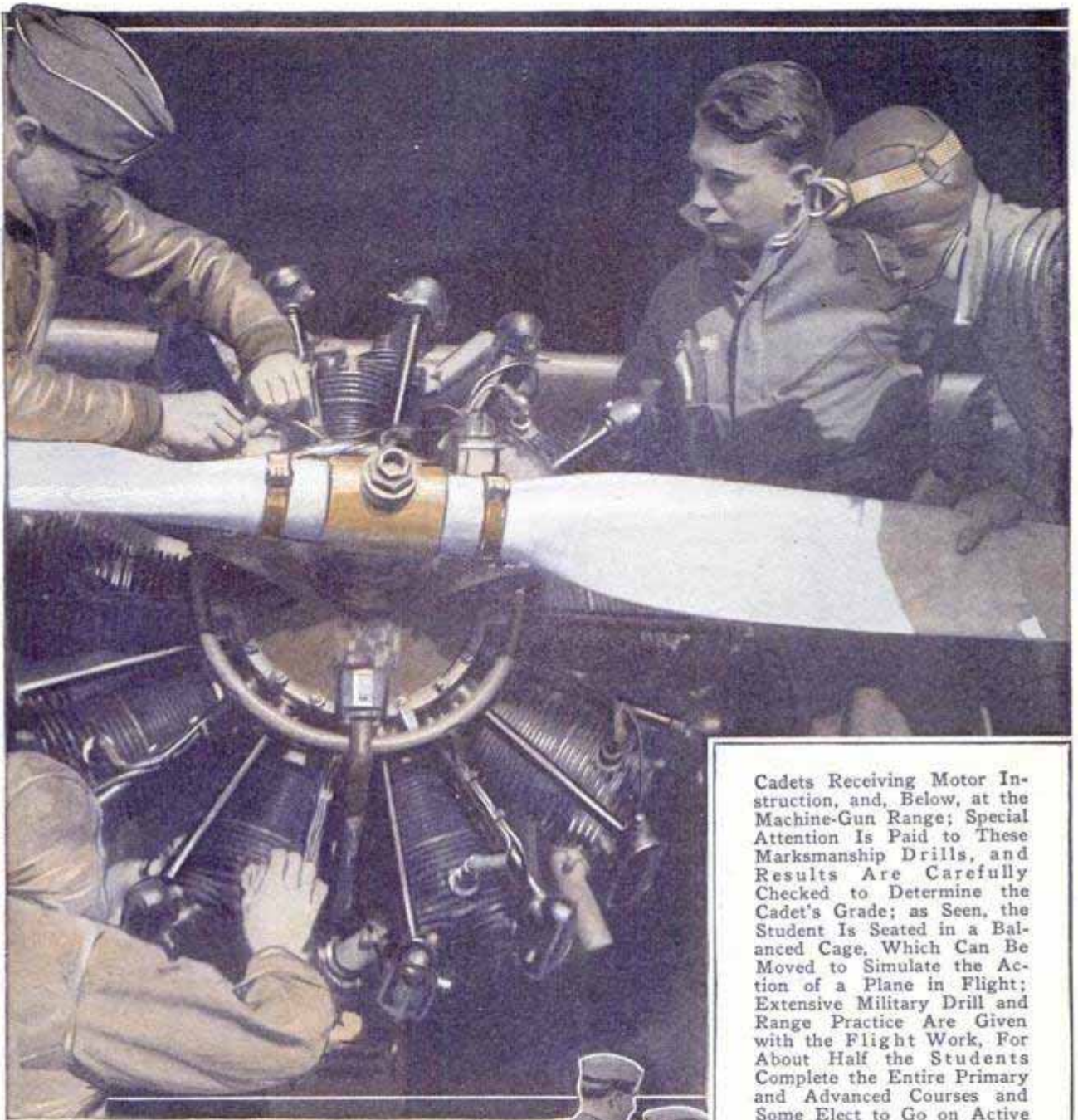

Cadets Receiving Motor Instruction, and, Below, at the Machine-Gun Range; Special Attention Is Paid to These Marksmanship Drills, and Results Are Carefully Checked to Determine the Cadet's Grade; as Seen, the Student Is Seated in a Balanced Cage, Which Can Be Moved to Simulate the Action of a Plane in Flight; Extensive Military Drill and Range Practice Are Given with the Flight Work, For About Half the Students Complete the Entire Primary and Advanced Courses and Some Elect to Go on Active Duty with the Air Corps

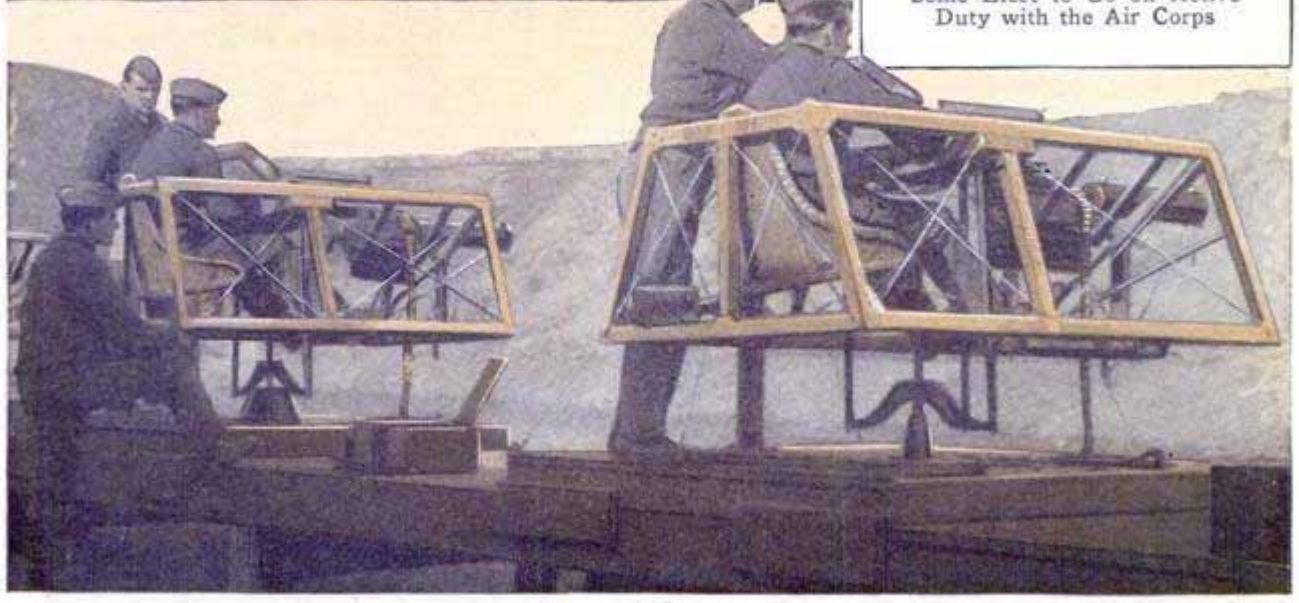



Big Reel for Drying Films Taken to Prepare a Mosaic Map; Extensive Work in Aerial Photography and All Its Stages Is Given Along with the Observation Training of a Flying Cadet



Aerial Camera on a Machine-Gun Mount in an Attack Plane with Part of the Class, and, at Right, Developing Large Negatives; Students Are Taught All the Processes of Photography in the Observation Section, from Taking Pictures While in the Air to Developing the Prints and Preparing Mosaic Maps; Learning to Control the Plane While Air Pictures Are Being Taken Is a Trick in Itself

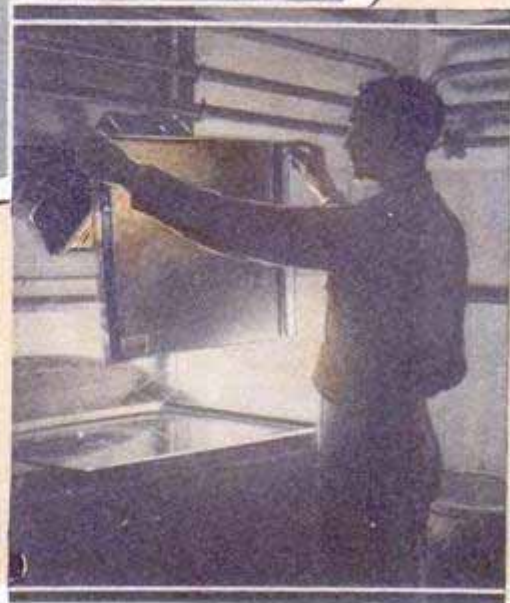

4074

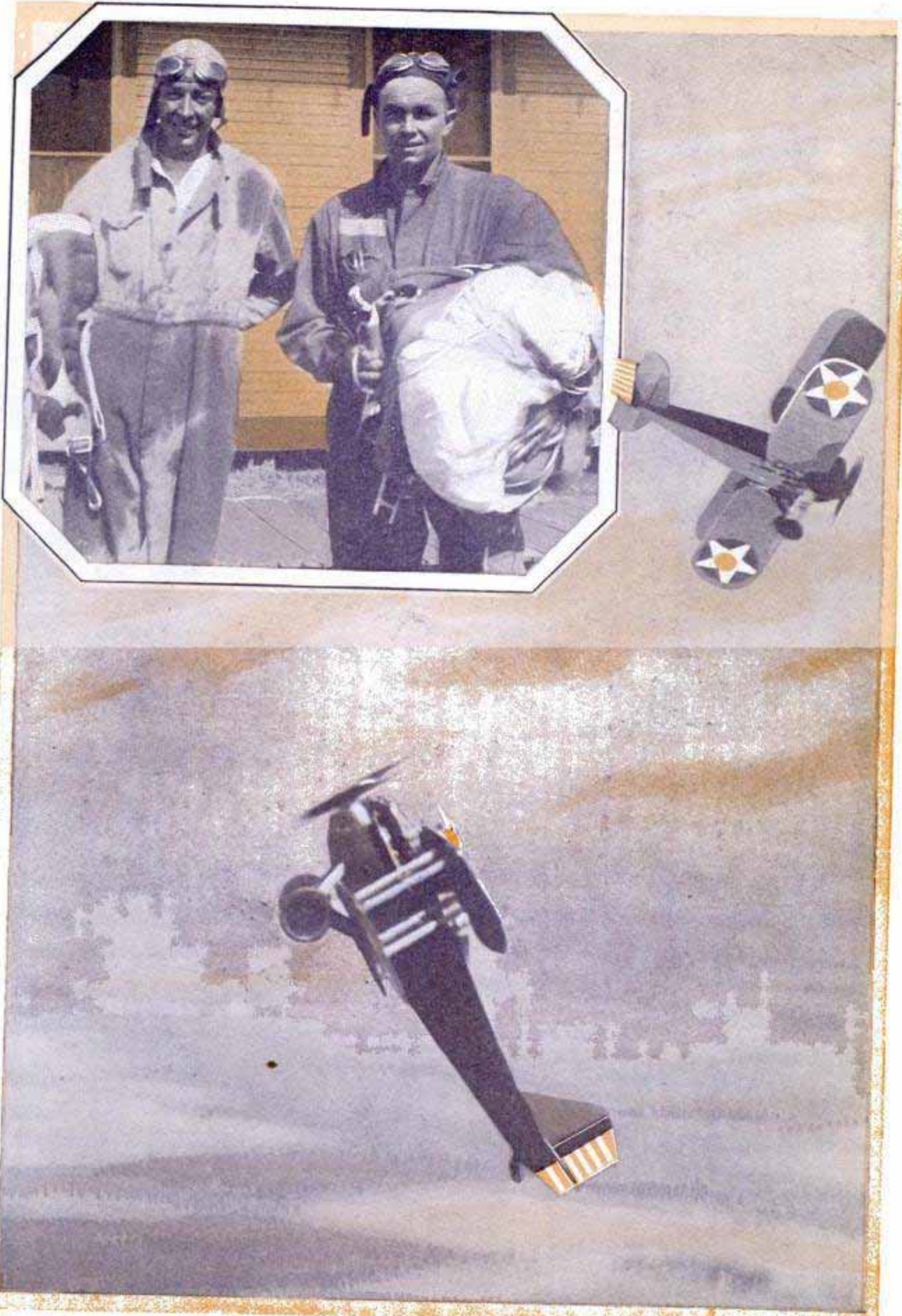

Inset, after an Air Collision; Both of These Men Had Just Jumped Safely, Following a Mishap in Dog-Fighting, an Episode of Which Is Shown in Lower Photo

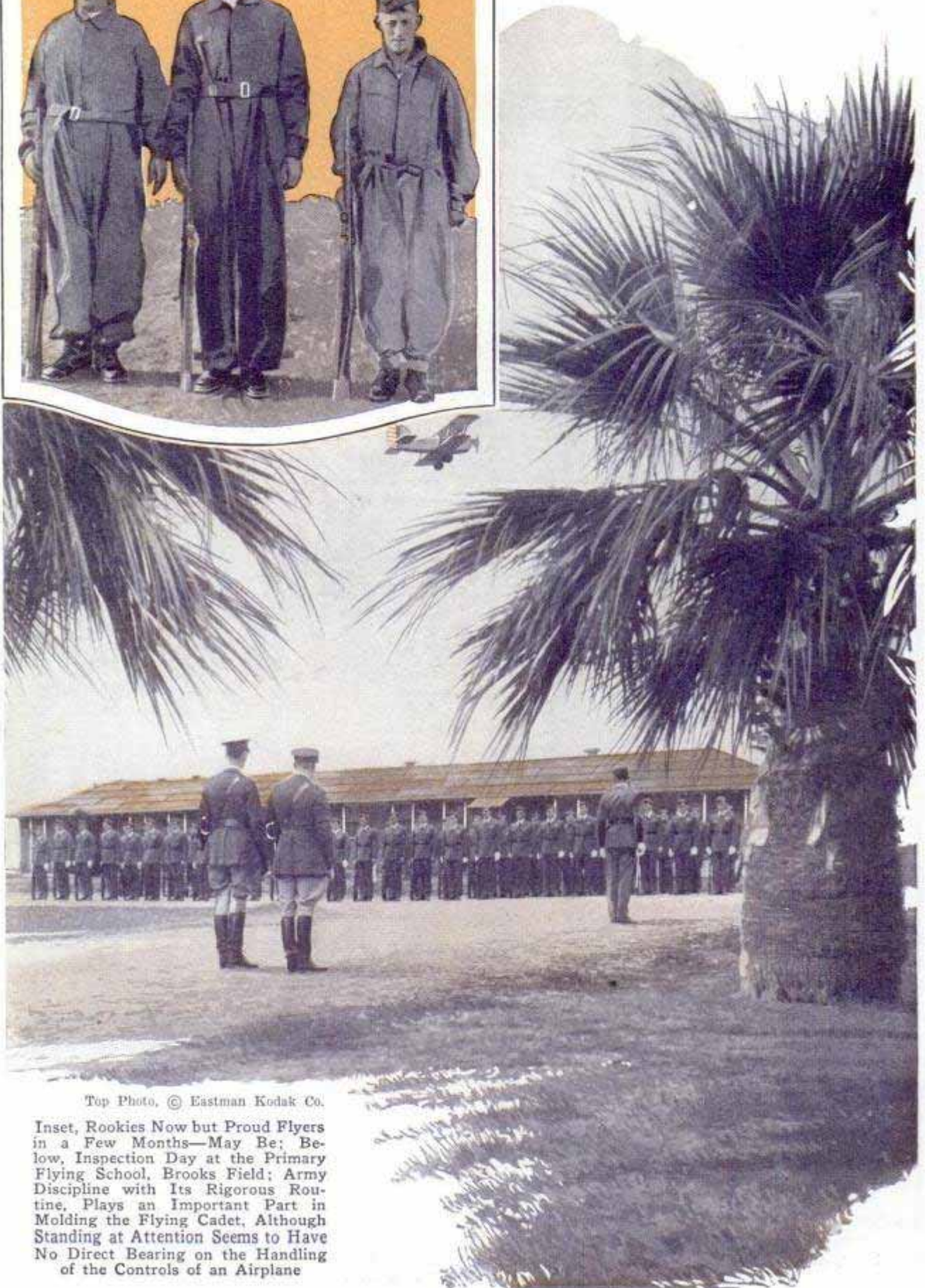
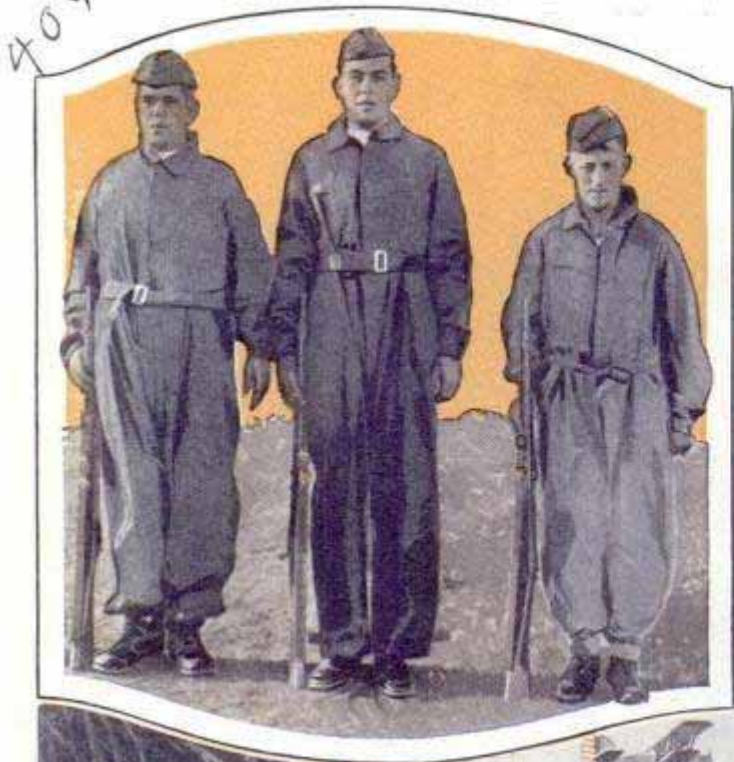

Top Photo, © Eastman Kodak Co.

Inset, Rookies Now but Proud Flyers in a Few Months—May Be; Below, Inspection Day at the Primary Flying School, Brooks Field; Army Discipline with Its Rigorous Routine, Plays an Important Part in Molding the Flying Cadet, Although Standing at Attention Seems to Have No Direct Bearing on the Handling of the Controls of an Airplane

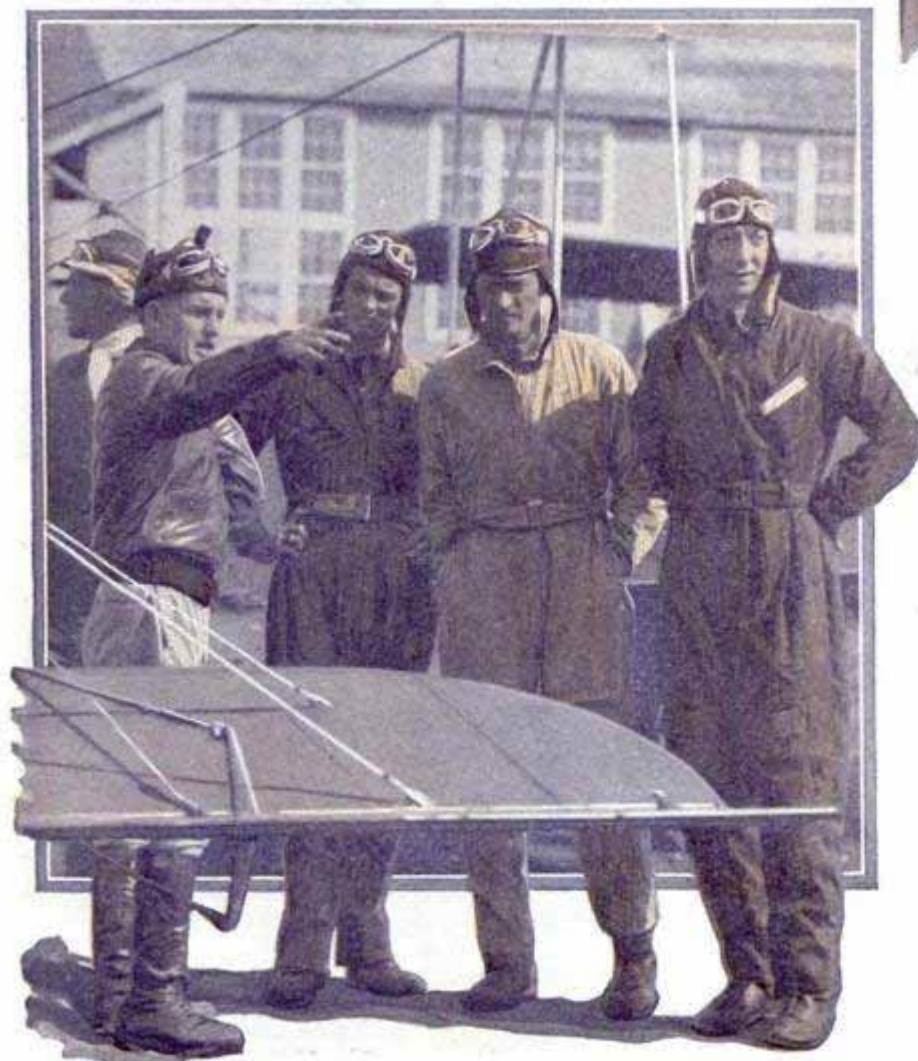

"Dodo" Boys, Primary Student Flyers, Drawing Helmets and Goggles, and, Below, Advanced Primary Students Receiving Instructions before a Flight; during These Early Days of His Course, the Future Pilot, So One Described It, Passes through a Routine Something like This: "Examinations, Drill, Drill, Examinations, Inspections from 6:00 A. M. to 10:00 P. M. One Bell after Another. No Time to Wash. Drill. Squads East and West. Double Time. To the Rear, March! Will You Ever Learn to Fly or Is It Just a Dream? Examinations, Three Times to the Orientator. More Bunk Flying. But Finally the Two Weeks Drag to a Close and You Draw Helmets and Goggles. Flying Starts Monday. Could It Be True and Would the Weather Be Fair?" On Monday the Cadet Meets His Instructor, Adjusts His Parachute and Has the Thrill of a First Ride with Fifteen Minutes of Joy and the Pleasure of the First Attempt at the Stick; the Plane Responds but in a Perplexing Way, So It Seems to the Candidate

4094

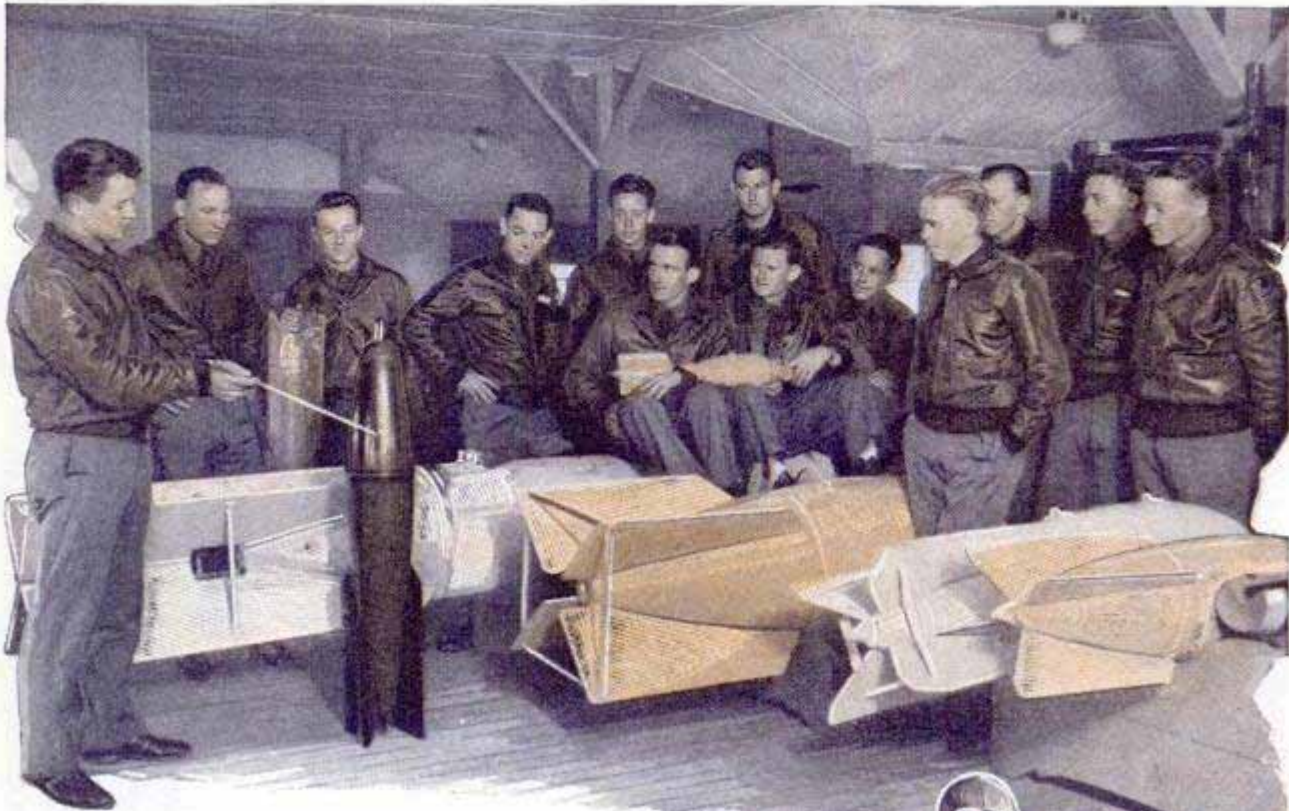

Instruction on Bombs and Bombing; Cadets Learn the Interior Construction of Bombs, How They Are Aimed and Released, and What They Probably Will Do When They Strike; All This Comes in Connection with the Flight Training in Big Bombing Planes and during Warlike Maneuvers



Inspection of Students and Personal Equipment at Advanced Flying School, and, Right, an Instructor at Kelly Field Showing Students of the Observation Class How an Aerial Camera Is to Be Mounted

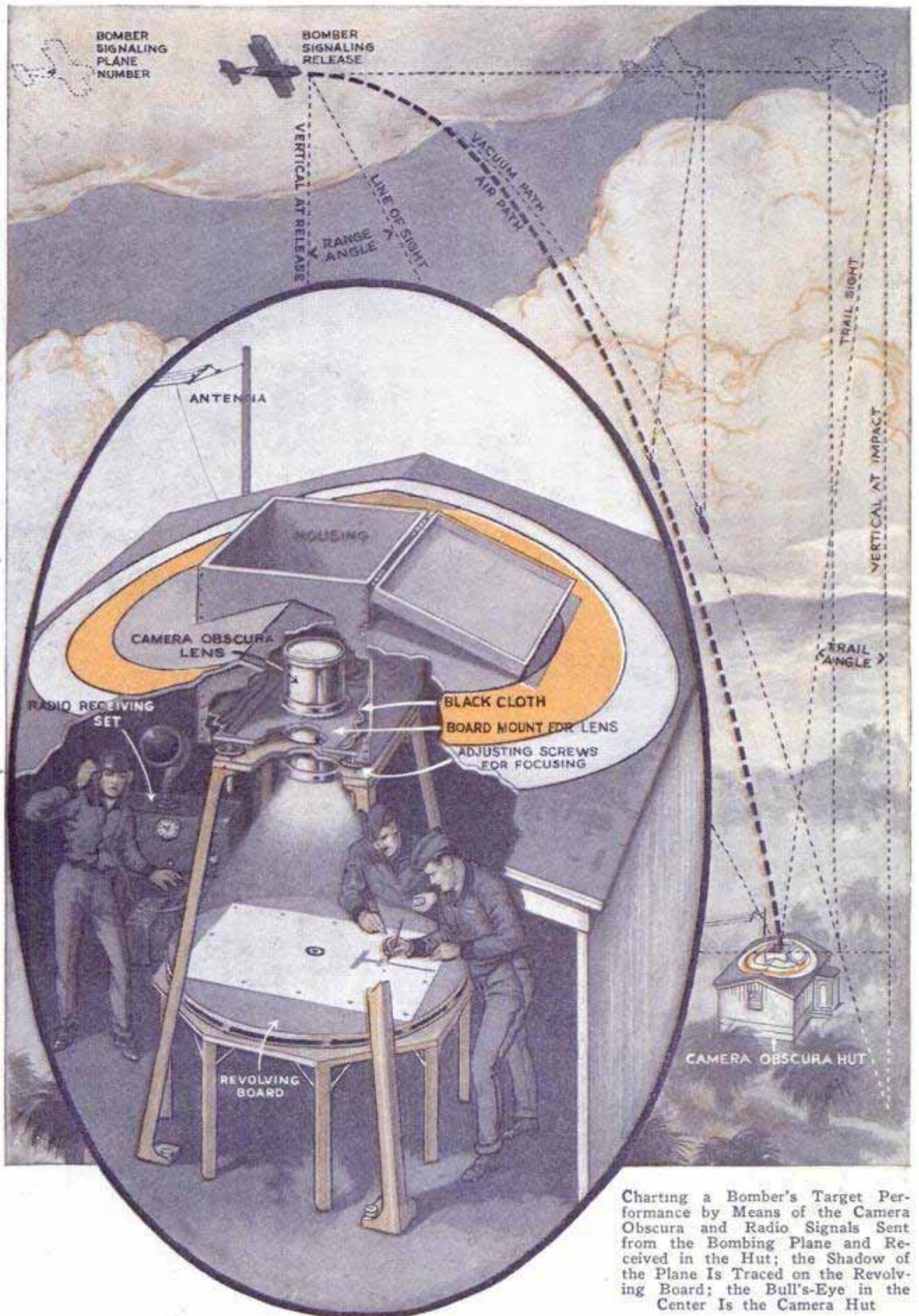

Charting a Bomber's Target Performance by Means of the Camera Obscura and Radio Signals Sent from the Bombing Plane and Received in the Hut; the Shadow of the Plane Is Traced on the Revolving Board; the Bull's-Eye in the Center Is the Camera Hut

As the Bomber Approaches the Target, He Signals His Plane Number Which Is Received by Radio in the Hut; Next He Flashes "Release," and the Man in the Center Notes the Position of the Plane on the Paper; It Is Then Merely a Matter of Computing Altitude, Angles and Wind Conditions to Determine How Close to the Mark the Bomb Would Have Fallen

407 4
576

New Arrivals of Flying Cadets to Start Their "Dodo" Days; the Change from City Clothing and Manners to Flying Togs and Ways Is Swift, Drastic and Effective



The Orientator; Whirls and Spins in This Machine Test the Occupant's Sense of Balance and His Response to Various Movements, and Are Part of the First Two Weeks of Training; the Trials Often Reveal Defects That May Eliminate the Man at the Start; Below, a Lighter Moment Just before "Dodo Recognition Day"; This Comes at the End of the First Month's Training at Brooks Field and Gives the "Dodo" the Right to Speak to an Upper Classman without First Asking Permission and Other Privileges

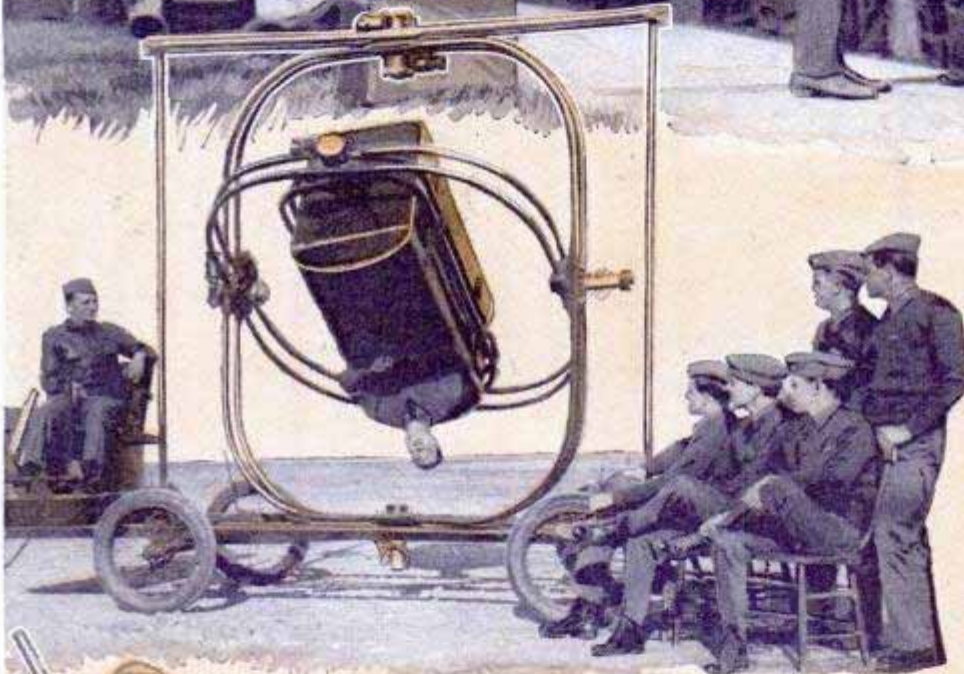

118 *island retreat of Miami Beach Fla.* 577

POPULAR MECHANICS

LATEST WATER SPORT IS FILLED WITH THRILLS

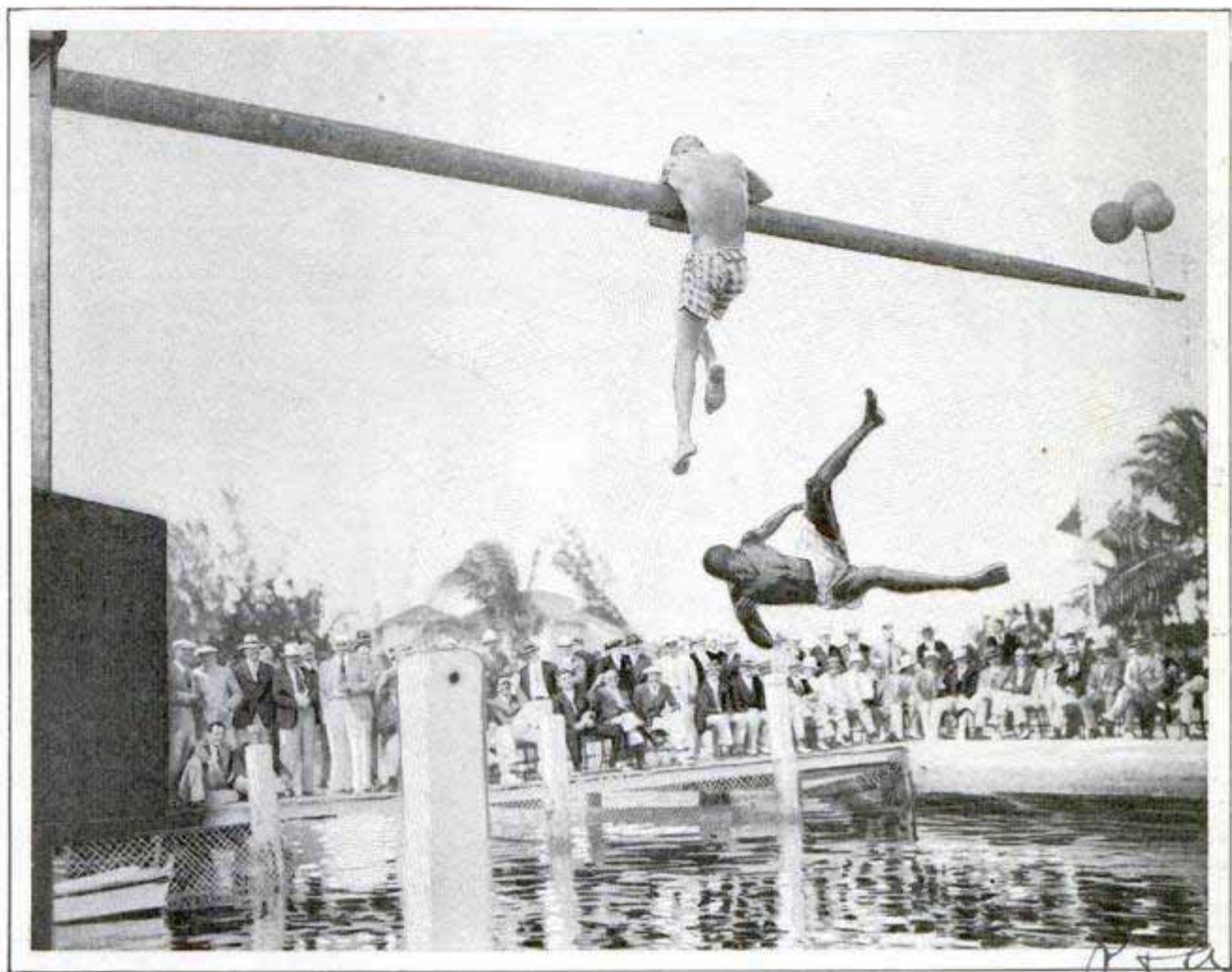

Participants in a Greased-Pole Contest That Proved Popular in Florida during the Winter; the Object Is to Negotiate the Slippery Pole and Get the Balloons without a Ducking

For the amusement of winter colonists in Florida, a variation of the greased-pole contest of bygone days has become popular. Instead of being set upright, the slippery pole is placed in a horizontal position, some distance above the water, with a cluster of balloons at its tip. The object of the contestants is to get the balloons, with a fall and a plunge in the water as the penalty for a slip.

SALT MINE BENEATH DETROIT

One of the largest salt mines in the United States is 1,100 feet beneath an important industrial section of Detroit. Despite a production of more than 1,400 tons a day, it is estimated that the deposits are sufficient to last more than 100 years. The salt is blasted with dynamite and a labyrinth of narrow-gauge tracks are winding through the mines. Electric shovels

dump and load the salt, and all other operations are controlled electrically, while, at the surface, a twenty-foot ventilating fan drives air into the shaft at the rate of 40,000 cubic feet per minute.

TAIL LIGHT FOR "BUMPERETTE" PROTECTED FROM BREAKING

A combination tail and stop light, constructed to interlock in the rear bumper or bumperette of the automobile where it is protected from damage, now is available. No extra bolts or nuts are required for installation, and the light also completely illuminates the rear license plate. The lens comes in various colors and the panel glass is easily removed to replace bulbs.



*Chicago Tech. News
Modern Science Institute*

*Barber Combustion & Top Light Co
Tail and Stop Light
625 Williams St. Lansing, Mich*

3954

The "Brain Wave"



Two Interesting Inventions by Women: A Bolt Which Cannot Be Opened Even if There Is Space between the Door and the Jamb, and, Below, a Baby Carriage Which Can Be Folded to Fit in a Suitcase for Carrying

© The Daily Mirror



© The Planet News

ARE we nearing the age when there will be nothing worth while left to invent?

A few months ago, Sir Alfred Ewing, principal of Edinburgh University, said, "We cannot maintain our astounding pace of discovery and invention. Engineers of the future will not be able to accomplish developments comparable to those of the last hundred years."

No evidence of a decline in inventive ability, however, is to be found in the "Brain Wave" room in London. Here shelves mounting from floor to ceiling are loaded with new inventions—mechanical, electrical and domestic and household—forty thousand of which each year are pouring into the headquarters of the Institute of Patentees.

Among the latest arrivals, in 1929-1930, are a hatpin which need never be taken out of the hat and will always fit into just the same groove in the hair, a non-drip shaving brush with bristles of absorbent sponge, a geyser kettle producing instantaneous and continuous hot water, and a square protective tin, inside which all frying may be done, to prevent splashing of grease on the stove.

A man has invented an ingenious method for papering walls without the splashing of pails of liquid and acres of wall paper, while another has devised a

telephone stand with a writing pad which shoots out automatically into the correct position. It is just these little things which may bring inventors big profits, as in the case of the man who, for some years, drew royalties of \$25,000 a year from his invention of a collar stud with a movable top.

"All sorts of folk invent all sorts of things," said Capt. G. Drury Coleman, secretary of the Institute of Patentees. "A nurse, a traveling salesman, a plumber a government official, a dry-goods man, a hotel attendant and a parson have just invented devices ranging all the way from the latest helicopter to a method of removing ingrowing toenails. Inventors

39. Victoria St. London, S.W. 1. England.

Room



© The Daily Mirror

Inventors and Organizers of the London Institute of Patentees Looking at Some of the New Inventions Assembled in the "Brain Wave" Room of 40,000 Inventions

come to our yearly exposition for new inventions, from all over the world—America, Jugoslavia, Norway, South Africa, Germany, India, etc.”

The woman inventor is forging ahead in devising ingenious appliances and labor savers for the home and outside it. Many of the ideas are of the kind which make people say: “How simple! Wonder nobody ever thought of that before!”

“At one time,” said Captain Coleman, “women inventors failed because, though they had ideas which came to them in the course of their work, they failed to understand some technicality. They did not grasp, for example, that it is no use to patent a new type of saucepan unless it is really exceptional, because no manufacturer making standardized saucepans will scrap his present plant unless he is sure he can sell millions of the new article.

“I remember a wealthy woman in London who some time ago invented a burglar alarm, which, when a crook opened a window, started a phonograph playing

a disk of a dog’s barking. She spent a fortune on her idea, and, of course, never made a penny out of it. True, it was very ingenious, but most people would find a dog cheaper to buy and keep than the invention. Professor Low once said that a cat would cost less than a certain new type of mousetrap, and would not need emptying.

“I have seen dish washers, masterpieces of ingenuity, wash and dry dishes at the rate of twenty-five a minute; but, as it took fifteen minutes to place the dishes in the patent washer, it was actually slower than the old-fashioned way. But women are becoming more practical, and they have the advantage over men of knowing what is wanted in the sphere of domestic inventions. Every housewife is an inventor, because almost every day of her life, she is making something new or devising some gadget.”

At the last international exposition for inventors, the organizers tried out a new notion of asking visitors to drop into a

3954 580

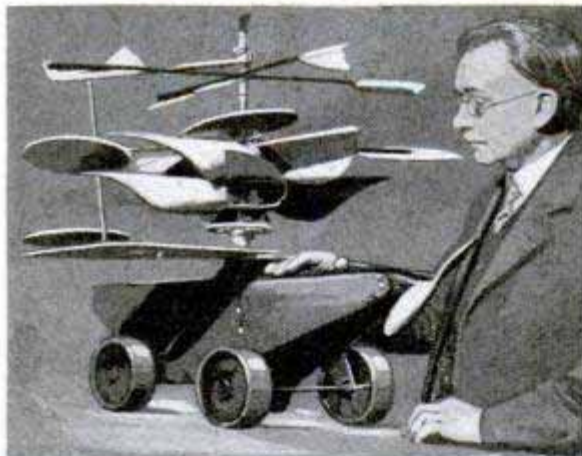

Second Photo, Courtesy The London News Agency
Products of "Brain Waves"; an Amphibious Motorboat at Sea; a New Bat-and-Ball Game Played in Small Space; a Flying Machine That Has Four Horizontal Planes to Elevate the Assembly as They Rotate, and a Bed That Adjusts Itself at the Touch of a Button

box their ideas for a "What's Wanted Competition." Here are some of the

ideas dropped into the suggestion box, and it may pay inventors to set their wits to work on them: Wanted, a boot-polish that will not soil hands; a reliable and inexpensive means of abolishing washing-up of dishes and plates; a blotless ink; a way to slice onions without making the eyes water; a small cleaner to go into a vanity bag to remove mud splashes from stockings; a way to affix buttons to avoid sewing. A man wants a cream to remove a day's growth of beard without injuring the skin, and a Scotchman asks for a sheet of notepaper that can readily be converted into an envelope, thus dispensing with the need of a separate covering.

Prizes were given for special labor-saving devices in the domestic and household sections of the inventors' exposition. A special women's prize went to the daughter of a former British navy-department official, who devised a fixture for funnels by which bottles and other receptacles can be filled without any risk of spilling. A man won a silver medal for an improved picture hanger, insuring that a picture, if tilted, returns to the vertical and cannot slip; other men received prizes for inventions to absorb cooking smells in flats and houses; a device which automatically cooks eggs in three ways, soft, medium or hard, and a special range top for a gas stove, to give more than one gallon of boiling water at no extra cost.

A retired sea captain, who turned up at the exposition, has made much money out of his inventions, and can now afford to maintain a workshop. For five years past, he has made inventing a whole-time job. He showed seventeen patents at the exposition and has disposed of half the rights all over the world. They include an electric iron which, if left lying on its face, automatically switches off the current and prevents a fire; a bottle stopper for patent medicines that incorporates a measure graduated in teaspoonfuls; a fire vase concealing a fire extinguisher, and a non-drip coffee or teapot.

In the electrical section, a man has devised a simple and ingenious invention to show whether any lights have been left in a house after persons have retired for the night. Other inventions prevent gas explosions in street mains and collieries, while a miners' safety lamp shows a red

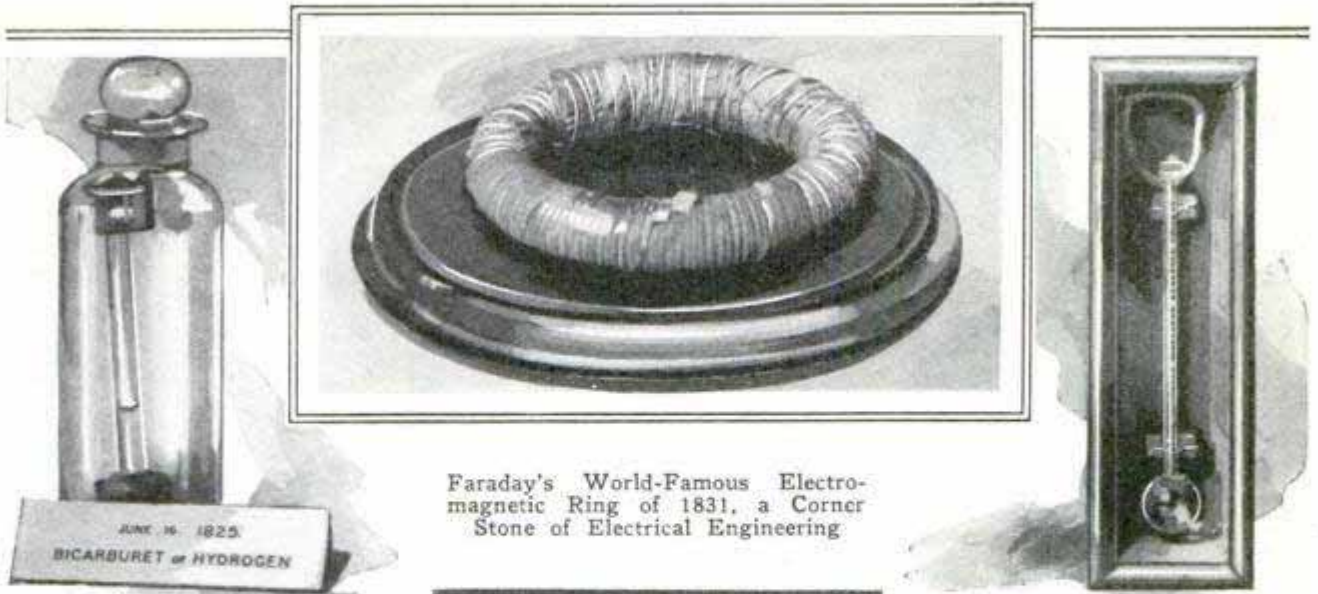

JUNE 16 1825
BICARBURET OF HYDROGEN

Faraday's World-Famous Electro-magnetic Ring of 1831, a Corner Stone of Electrical Engineering

Faraday's Original Sample of Benzine, a Basic Discovery for Dyes, Drugs and Explosives

The Florentine Thermometer of 1665, a Pioneer Weather Gauge of Early Times

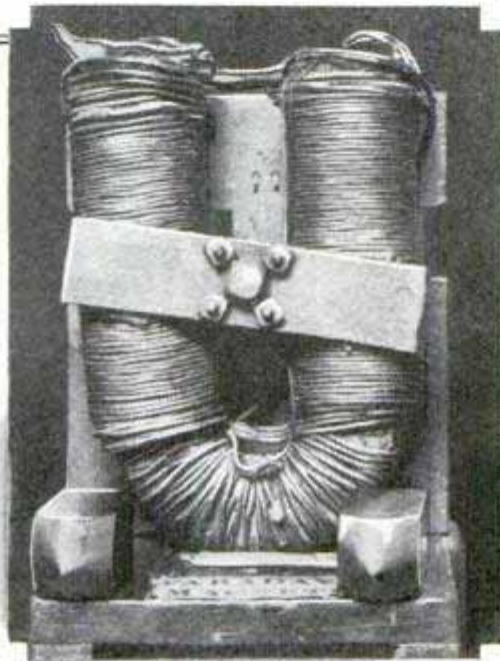
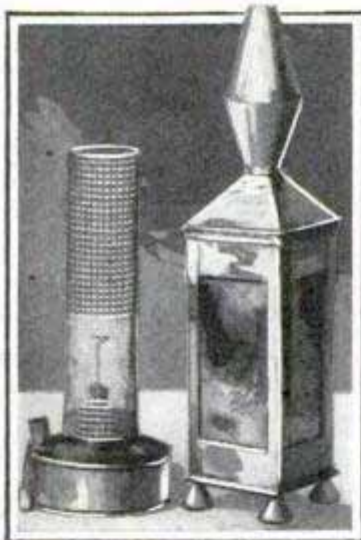

Davy's First Safety Mine Lamp of 1815

Michael Faraday's Original Electromagnet, Made in 1845 and Recognized Today as an Important Step in the Development of Wireless

Bowl in Which Dewar Kept Large Soap Bubbles, Sometimes for Weeks at a Time

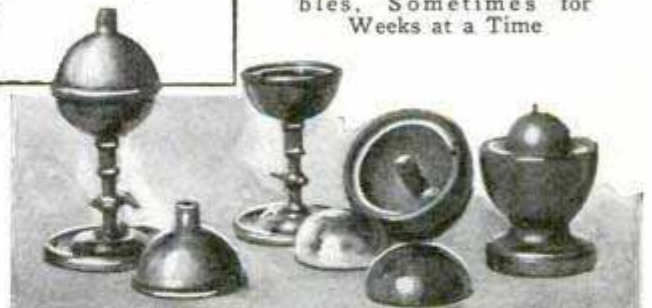

Series of Vessels Which Sir James Dewar Used to Solve the Problem of Maintaining a Vacuum; the Final Unit, at Right

Faraday's Specific Inductive-Capacity Apparatus of 1837, Used in Experiments That Blazed the Way for Important Industries

3954
suggest Jaton Mfg Corp.
23-9-41 St. Paul, N.Y.
American Wading Pool Co.
605 Wabash
Pittsburgh
Pa.



Demonstrating Portable Bathing Pool Invented by Woman; It Is Made of Waterproof Canvas, Holds 600 Gallons and Is Easily Set Up

© Topical Press Agency

light in presence of gas. For use in the bathroom is a toothbrush which can be bent to any shape.

Here are some wants taken from the 1929-30 "What's Wanted Book" of the London institute, which may mean money for inventors: A silent vacuum cleaner; a simple non-leaking tap; a simple device to prevent glass stoppers coming out of bottles when traveling; lining clips to prevent loss of coins from pockets of stooping persons; a device for ridding the air of stale cigar smoke in rooms where, as in winter, the windows cannot be constantly opened; a hard-steel chisel-ended tool for cleaning burnt saucepans quickly; device to lock the last stitch on a sewing machine; a really hole-proof stocking; a substitute for sausage skins; a stove which concentrates the heat on what is being cooked; a wall-papering machine which can be successfully and easily used by an amateur; a quick snow remover from sidewalks; a straw hat not to be discolored by sunlight; a check book that will allow the account to be kept accurately with the minimum of trouble; a non-leak-

ing noiseless valve for steam radiators, and a new road material or new way of road construction which will insure a nearer approach than the present to indestructibility.

AUTOMATIC FISH-HOOK SETTER JERKS LINE AT NIBBLE

41 Snagging bait-stealing fish the minute they strike is the purpose of an automatic

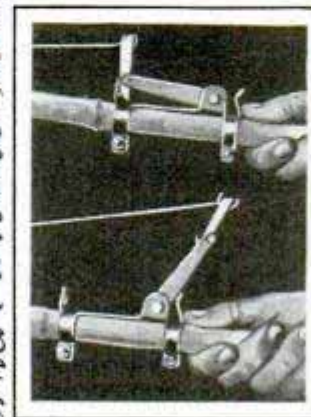

hook setter that may be attached to a pole or reel. The line runs through the hook setter and the least tug on the bait trips a trigger, causing a lever to fly back with sufficient pull to set the hook. The attachment is

entirely automatic, working as well on a pole stuck in the ground as on one held in the hand, and it is claimed that it is

Jimmie S. Leroves
Richardson (Hally Co.)

Does not answer letters

*11-6 Ability New
New England Bee of Pub. Serv*

dupr. 24 Milk St Boston, Mass

Eastern Michigan Railways Co.

quicker and more sensitive than the hand of the fisherman. For reels, the setter is so constructed that, after the first jerk, it snaps back out of the way, giving the angler a free hand to manipulate the line.

Highland Park, Mich

LUBRICANT FOR TROLLEY WIRES FREES THEM OF ICE

Trolley wires may be kept free of ice and sleet in winter by applying grease to them, and a Michigan street-railway company recently developed a device to replace the slow method of hand application. A lubricating paste mixed with water was placed in a tank on a work car, the tank being kept under thirty pounds' pressure from the car compressor. The lubricant is forced through a flexible tube attached to the trolley pole ending in a nozzle which sprays the wire. Excess lubricant drops into a receptacle and drains back to the tank.

Article in Electric Trades

3949

AERIAL GOLF-SCORE CARDS TELL STORY OF GAME

Aerial photographs of golf courses are now being prepared in score-book form so that records of the games may be preserved in a pictorial manner. The photos clearly show the fairways, obstructions and other details of the course, so that the performance of the players may be indicated by lines, tracing the path of the balls between the holes. The cards may be used more than once or preserved as a permanent record. The distance of each shot, wind direction and other data are kept on the cards.

ULTRAVIOLET RAYS FOR GOATS IMPROVE MILK QUALITY

40 62

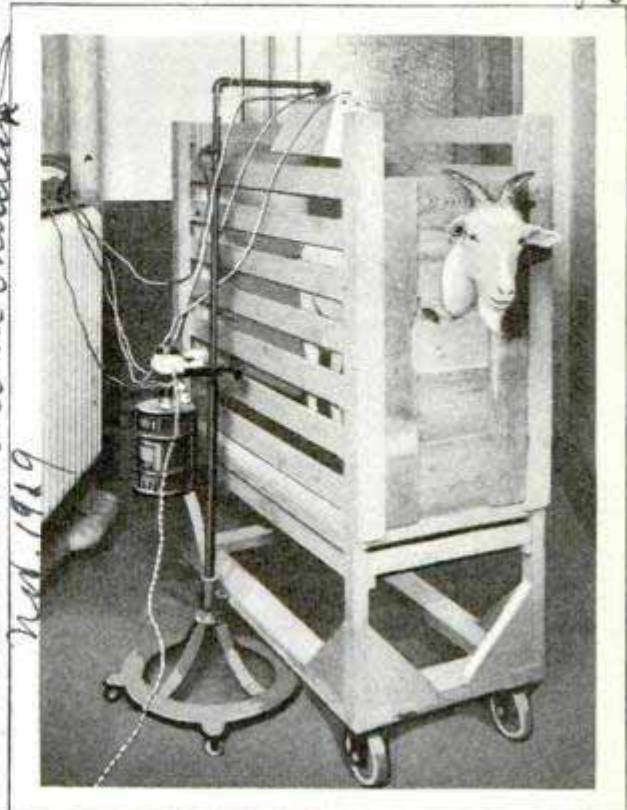

Goat Being Treated with Ultraviolet Rays to Increase Antirachitic Properties of Milk

*Art. by H. Slacy. 4-6-39 Montgomery
Dr. Betts, Md.*

Scientists of the University of Wisconsin have increased the antirachitic properties of goat's milk 2,400 per cent by exposing it to ultraviolet rays. The increase was also effected, although in a less degree, by the direct irradiation of the goats themselves. Marked improvement in the bone-building quality of the milk was shown by but two hours' irradiation of the goats in four days. Ultraviolet rays have no effect whatever on cows or on the milk they produce, and investigators decided that the results obtained with goats was probably due to the difference in body area as compared with the volume of milk produced, and because of secretory functions of the milch goats' skin that are lacking in the dairy cow. Goats irradiated for long periods eventually lose much of the lime stored in their bodies, as does also codliver oil.

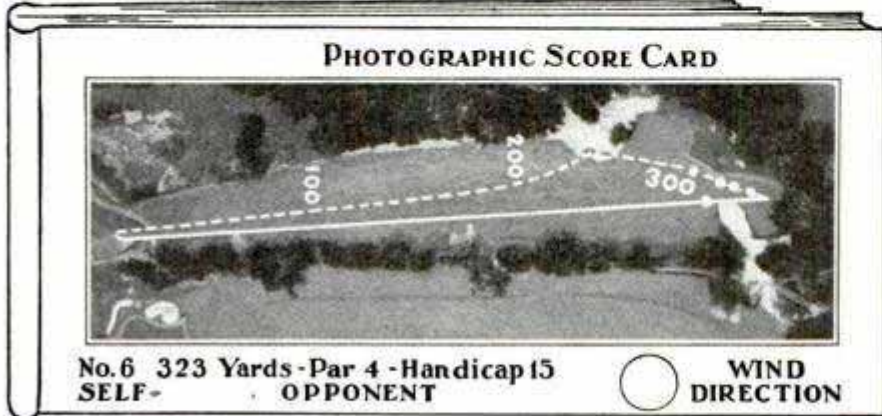

Golf-Score Card Containing Aerial Photo of Course on Which Player's Performance Is Indicated by Lines as Permanent Record

*Curtis - Wright Flying Service
Photo Dev. 350 W. 31st New York City*

Conn. John C. O'Sullivan, 70 Essex Sunday
Post, Boston, Mass.

4104

RIDDLE OF THE STARS SOUGHT IN DEPTH OF EARTH

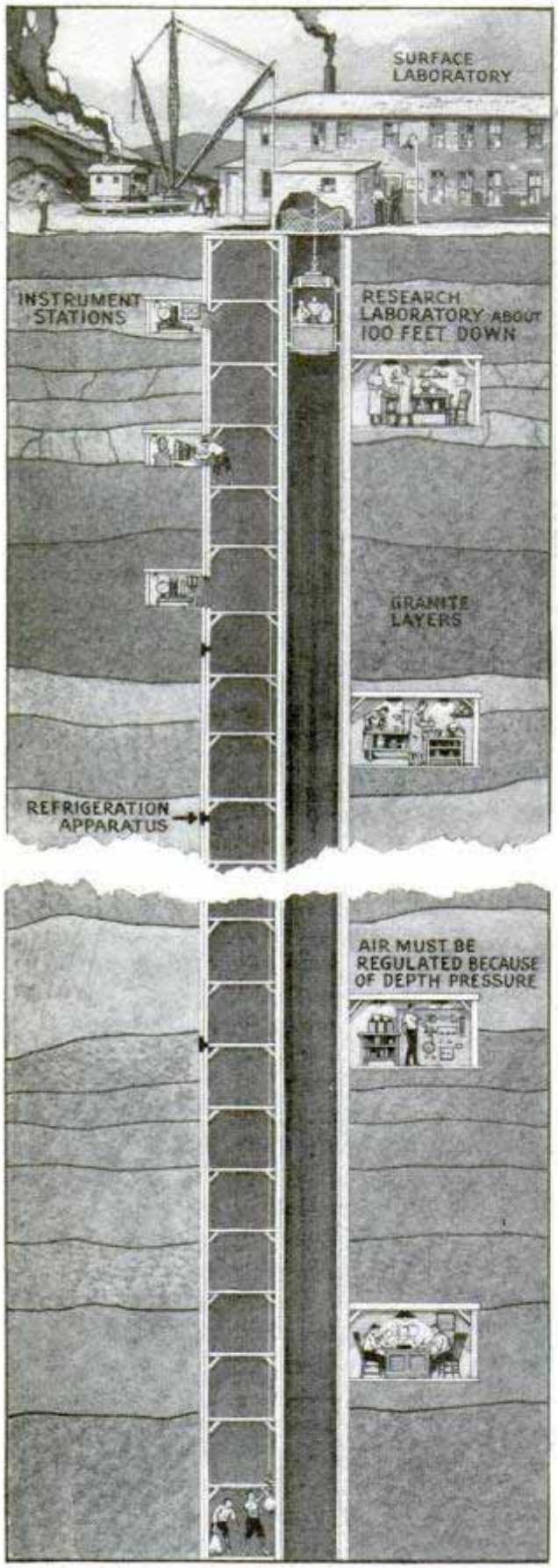

Locked only a couple of miles below the surface are the answers to many of the riddles of the stars and mysteries of the earth which are baffling the world's greatest scientific minds, according to Prof. Harlow Shapley, internationally famous director of Harvard observatory. So, he seriously proposes the sinking of a vertical shaft as deep into the earth as may be found practicable, and the establishment of subterranean laboratories along its sides in which could be tested the theories advanced by leading scientists to explain how and when the earth, the planets and the stars originated; how they are organized and distributed, the controlling factors of their movements, evolution and existence, the stability of matter and energy, and the dimensions of space.

"The carrying out of such projects is not beyond modern engineering skill, and the idea is entirely feasible and worthy of serious consideration by national governments and great organizations interested in the advancement of science," Professor Shapley declares.

A vast amount of money and many valuable lives have been devoted to explorations of the polar regions, but the scientific knowledge and possible material results of such explorations are not to be compared with Doctor Shapley's picture of what civilization has to gain by a great engineering probe of the "innards" of the earth.

You may not have noticed any change in the length of the day, that is, the twenty-four-hour day, but Doctor Shapley tells us that it is lengthening at the rate of one-thousandth of a second a century. That may not impress you as being a circumstance for anybody on earth to be concerned about. But the astronomer considers it a mighty important and mysterious phenomenon indicating the earth is running down, and it naturally suggests the question of whether or not the universe also is running down.

"For some years we have been familiar with the fact that the earth's rotation is slowing down, that the day is getting longer, and that the moon is gradually re-

Artist's Conception of Shaft, Two Miles Deep, with Laboratories at Various Levels, in Which Scientists Would Determine if Universe Is "Running Down"

*Used by Aero Corp. of California
27 Los Angeles Calif*

ceding from the earth about seven feet per century," Doctor Shapley explains. "And our observations tend to show that our universe is running down too. The sun is losing mass at the rate of about 4,000,000 tons a second, and all the other stars are radiating their matter away at rates proportionate to their magnitude. Millikan speculates that the energy of radiation is translated back into matter. But it is only speculation, not evidence."

Linked up with this problem are the perplexing wabbles of the earth which are responsible for latitude variations. The earth's poles wobble and wiggle all over the map, so to speak. Astronomers now cannot predict in advance where the pole will be at any particular time, but ultimately they hope to be able to do so, and the underground laboratories would help to solve this mystery.

"Such laboratories would also be of great value in testing the theory that the American continents are drifting away from the African and Eurasian continents," said Doctor Shapley. "If the Americas split away from Europe and Africa at some time in the dim ages of the past and have drifted since to their present location, there is no reason to suppose they have stopped drifting. Nevertheless the drift is so infinitesimal that it is impossible to determine accurately with our present equipment. But if such a drift is going on it might readily be studied from the bottom of a shaft dug a few miles into the earth."

Doctor Shapley stated that by-products of such scientific boring into the earth would be an investigation of the commercial possibility of tapping and utilizing the earth's internal source of heat, and a better knowledge of its mineral wealth.

"Installation and maintenance of such a tube will be a scientific adventure of great difficulty and expense," he admitted, "but if carried on in connection with work in existing mines and borings, it may mark the coming decade as one of the important epochs in man's attempt to understand the earth."

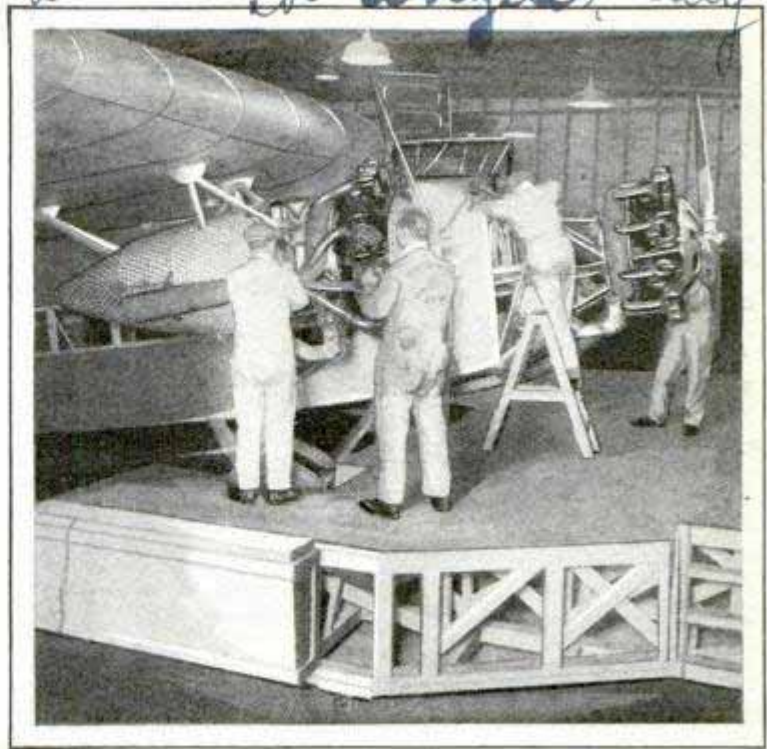

Portable Service Platform for Airplanes Which Gives Mechanics Easy Access to All Parts of the Engine

WORK STAND FOR PLANE ENGINE GIVES EASY ACCESS

Making all parts of an airplane engine easily accessible to mechanics, a service stand has been developed for single-motored and tri-motored planes. It consists of a substantial platform equipped with shelves for tools, vises and other needed equipment. It is built on casters so that it can be moved from plane to plane.

OPEN SHELTERS AT CAR STOPS FOR TROLLEY PATRONS 60

Open shelters for trolley-car patrons have been constructed at regular stops by one mid-western traction company.



The platform structures are bolted to a concrete base, being about four and one-half feet wide and six feet from base to eaves. A partition built at right angles in the center affords protection from wind, and, with the roof and back, offers shelter from rain and snow.

protection from wind, and, with the roof and back, offers shelter from rain and snow.

*Cont. Cecil Metzger
1617 2 St. Lincoln, Nebr.*

RAIN MACHINE MAKES THUNDER AND LIGHTNING

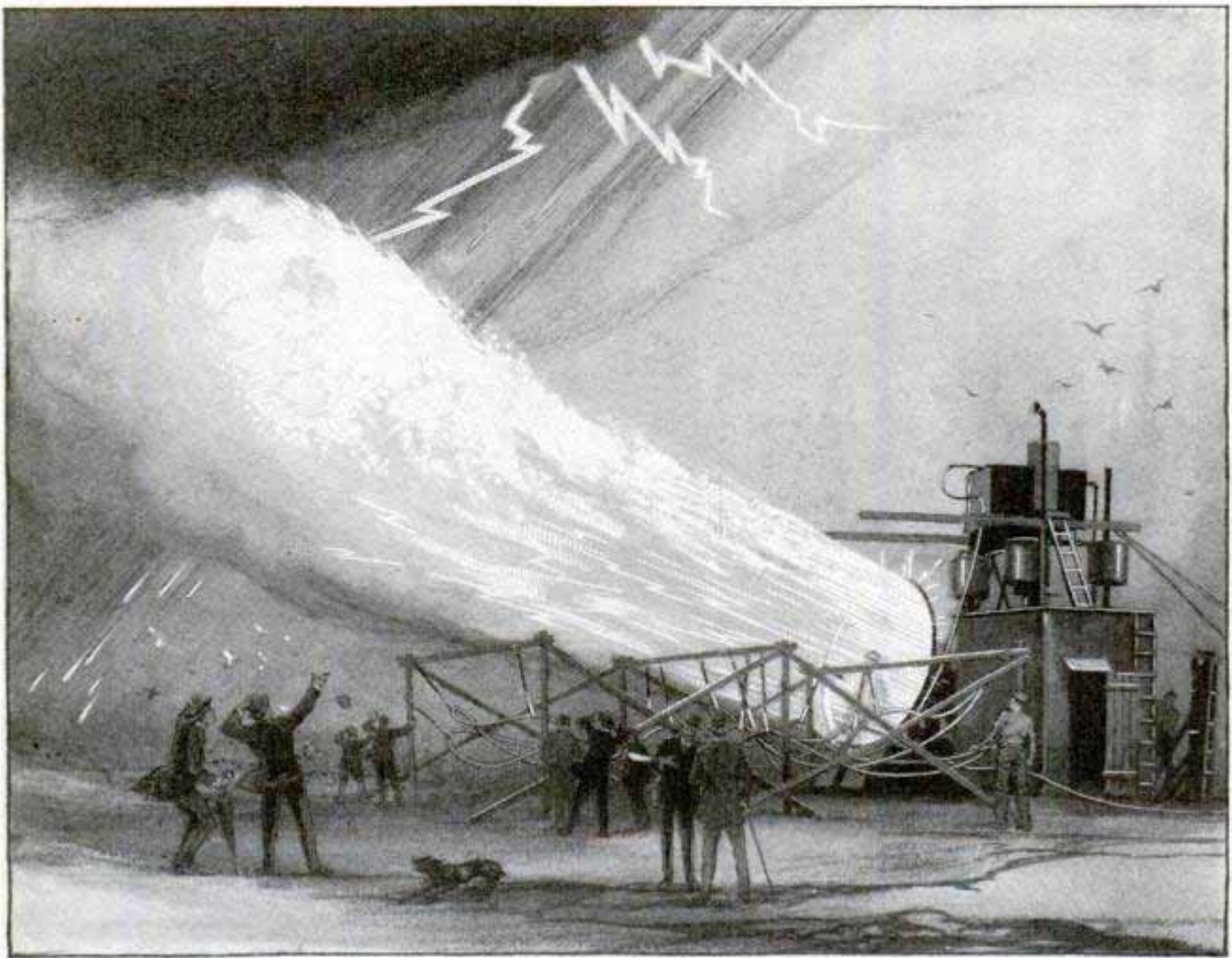

Rain-Making Machine with Artist's Conception of a Manufactured Thunderstorm; Artificial Mist Charged with Electricity Blown into a Humid Atmosphere Causes the Precipitation

Most picturesquely remarkable of recent scientific achievements has been the making of rain—not an imitation of rain, but the real thing, although it is discharged from artificially produced clouds. Means have been found whereby not only clouds can be formed, and rain caused to fall, but actually thunder and lightning are in some instances produced. A machine does it all, but an indispensable requirement is that the atmosphere shall be humid. No such effects could be obtained in the dry air of a desert. The experiments which have yielded such amazing results have been in progress for some months past at Mustin field, Philadelphia, belonging to the navy department. The apparatus consists of water tanks, an airplane engine fitted with a propeller, and a 75,000-volt transformer. In front of the propeller, and connected to the tanks, is a ring of one-inch pipe perforated all

around with tiny holes. The ring acts as an atomizer, seventy-seven gallons of water being blown through its holes each minute, to form an artificial mist. The ring is charged to so high a voltage that sparks six and a half inches long may be drawn from it when the current is turned on. Thus, when the water is blown through it outward, the mist thereby dispersed is heavily charged with electricity. The mist is so fine that it immediately evaporates, leaving a heavy charge of electricity upon the humid air. This electrical charge, in turn, ionizes the particles of moisture in the air, causing them to run together and form drops which fall by gravity to the earth, making rain. The mist is discharged with great force in the direction of the wind, traveling with the latter some hundreds of feet before it evaporates. Presently, as observed again and again, a black cloud forms "down the

wind," dense and threatening. A few minutes later, it is likely to discharge rain, and on more than one occasion, this has been accompanied by thunder and lightning.

COURSE MARKER FOR VESSEL IS AUTOMATIC

134

Automatically marking the true course of a ship on the vessel's chart, an apparatus known as a "dromograph" has been invented by a French naval officer and successfully tested. It indicates the ship's exact geographical position at any time and also its precise course in arriving at the location. A stylus marks not only main changes in the course, but also smaller variations resulting from the helmsman's operation of the rudder.

L'illustration 7/4/30.

ABILITY OF SINGER IS TESTED BY VOICE-WAVE RECORDER

56

Those with operatic ambitions now may test their voices with a machine instead of attempting to obtain an audition before persons competent to judge voice quality. Students and professors of the University of Iowa have developed an instrument called a tonoscope, which registers the waves of the voice.

Iowa City, Iowa



Instrument Which Tests a Singer's Voice by Registering Tone Waves as They Are Produced

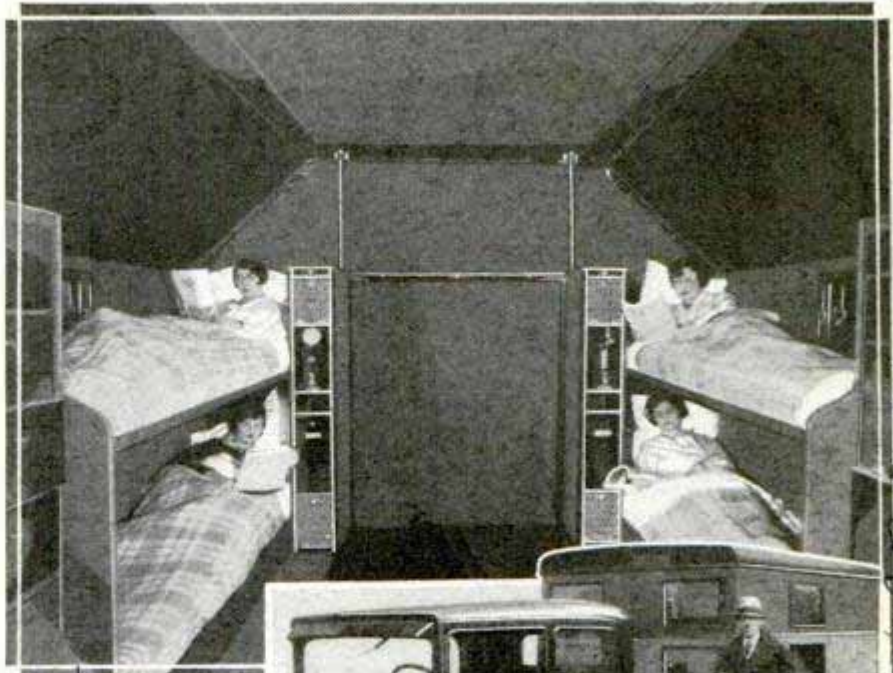

Auto Trailer Which at Night May Be Expanded to Provide Sleeping Quarters for Four Persons

AUTOMOBILE TRAILER EXPANDS INTO SLEEPING CAR

Expanding like an accordion to a width equal to that of a railway coach, an auto trailer no wider on the road than an ordinary car, at night becomes a commodious sleeping compartment for four persons. The car is equipped with two lower and two upper berths, running water, electric lights and special ventilating apparatus. The change from a narrow trailer to a hotel on wheels takes only a few minutes.

STEAM-HEATED RADIO AERIAL //6

Radio station WEBR, of Buffalo, uses a steam-heated radio aerial to prevent the forming of ice and sleet on the antenna and mast during winter storms. Hot steam at high pressure is piped into the interior of the mast, a huge metal pole on the roof of a ten-story warehouse. The mast thus is kept warm enough so that ice cannot form and ground the circuit.

*Arch. Dr. Sigmund Osor
933 Buffalo, N.Y.*

*Standard #875.00
See Index #1, 250-00*

95



Who Owns the

By JAMES W. BOOTH

3903 Walnut, photo
Who Owns Antarctica?

The question has caused much pondering at the state department since Rear Admiral Byrd's first official report of his explorations in south-polar regions was received, and especially since his flight to the pole itself.

More than 50,000 square miles of ice-blanketed lands, glittering under an antarctic sun and streaked with imperious ranges never before seen by man, have been discovered by the Byrd expedition and claimed in the name of the United States.

While Byrd has claimed the land in the name of the United States, the fact remains that some time before he set sail for Antarctica the British government filed with the state department a communication granting permission to the explorer to use territory claimed by it in south-polar regions, but setting forth that it had sovereignty over certain lands there.

It was a harmless enough little note, and the state department did not pay much attention to it. Byrd's discoveries, however, now bring to the fore the ques-

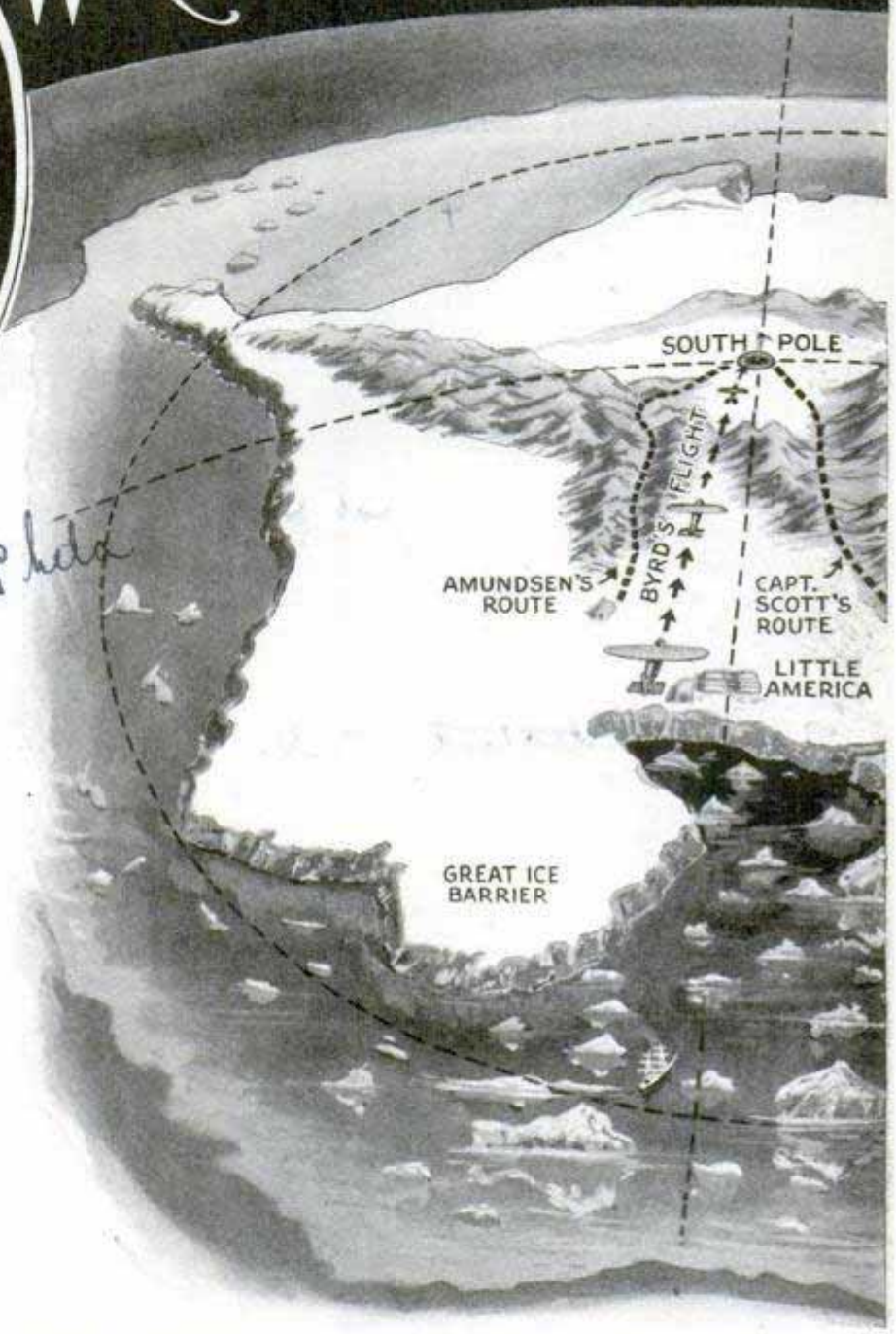

Drawing of Antarctica, a Land Larger Than All Europe, Showing Routes of Two Famous Explorers; Inset, Capt. Roald Amundsen, Who Reached the South Pole Thirty-Two Days before Capt. Robert F. Scott

tion of actual ownership of these more than 50,000 square miles. On the surface, the land is apparently of no great value, but what if it should contain untold mineral wealth, oil, gold, etc.? Then it would be of great value.

Previous to the airplane, the antarctic continent lay silent and alone, its face screened from prying eyes of the world,

South Pole?

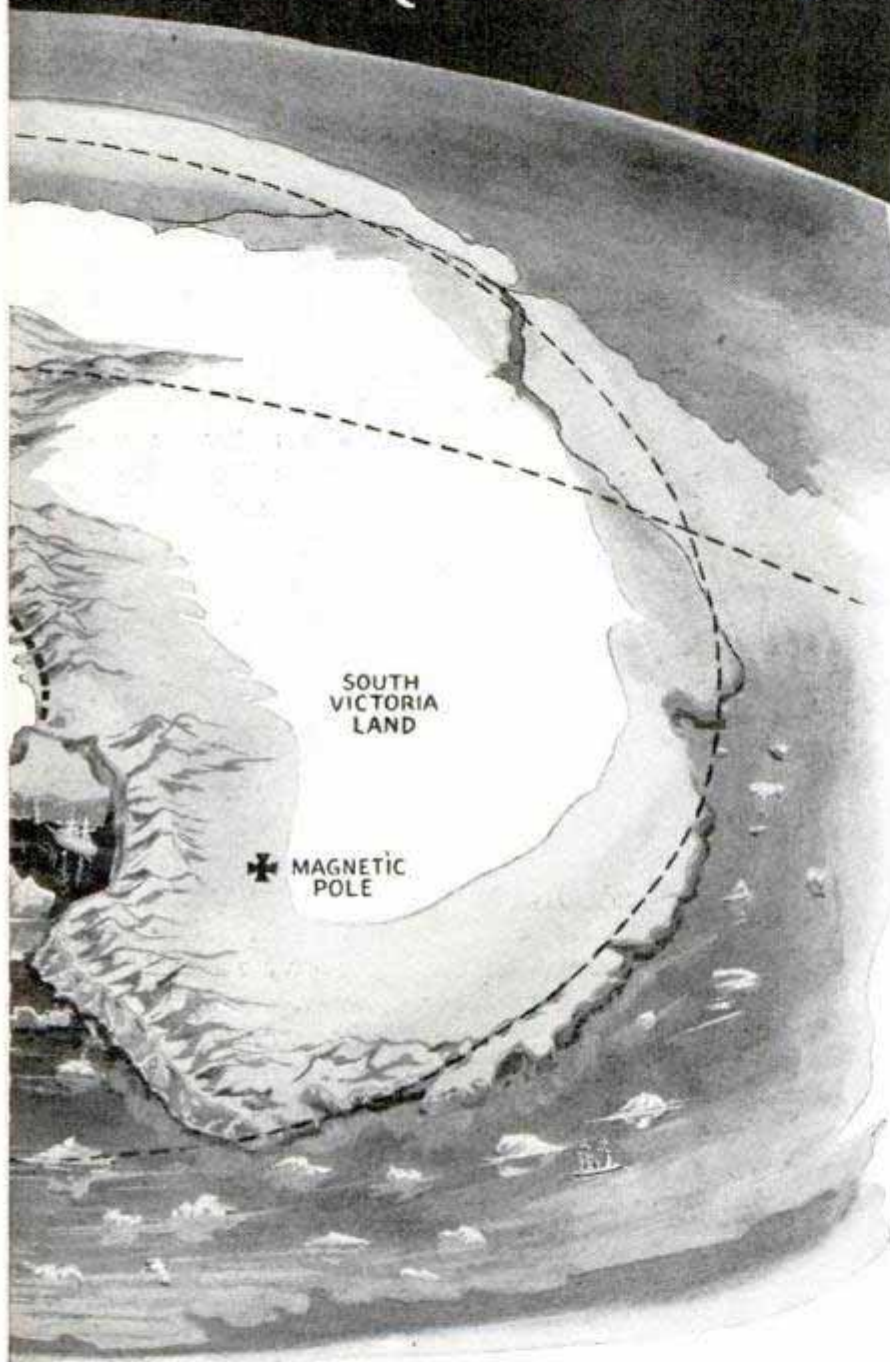

Captain Scott and His Entire Party Perished on Their Attempted Return from the South Pole; Inset, Rear Admiral Richard E. Byrd, Who Flew over the Pole and Returned Safely to His Base

beneath a mask of impenetrable snow and ice and roaring winds. Only the most meager reports of its character have been brought back to the world by the intrepid explorers, Wilkes, Ross, Shackleton, Palmer, Amundsen, and others.

British claims in Antarctica, if allowed, would affect practically all future exploration work there. The claims follow a

proclamation made by the British Imperial Conference in 1926, promulgated at the instance of Australia. It was filed with the state department at Washington and holds that "British title already exists by virtue of discovery to the following islands: The outlying parts of Coats Land, viz, the portion not comprised within the Falkland dependencies; Enderby land; Queen May land; Cates land, and the area which lies west of Adelie land."

The discovery of the antarctic probably belongs as much to the United States as to any other nation, although a continent in this region had been definitely shown on early maps, such as that of the Dutchman Ortelius, in 1575. Early voyages to the south seas, particularly that of Cook in 1775, revealed the fact that

there was no connection between South America, Africa, Australia or New Zealand and any land that might be found near the south pole.

To counteract British claims in Antarctica the United States probably will declare priority discovery. There is the claim of Capt. Nathaniel B. Palmer, a whaler from New London, Conn., who

U.S. Naval Station, Lakehurst, N.J.
Commander M. G. O'Neil

95
cooperating with
Eastman Kodak Co.
Rochester, N.Y.
loaned to Byrd



Sextant Camera That Photographs a Complete Reading of the Sun to Show the Observer's Exact Position; This Instrument Has Been a Great Aid to the Byrd Expedition

acting under mandate of congress, which discovered Wilkes land in January or February, 1840.

Wilkes left Hampton Roads on Aug. 18, 1839, with orders general in character, to do exploration work in the southern Pacific and to make astronomical and other observations and, specifically, "to reach the most southern point reached by Cook in the antarctic and to make observations and collections within the antarctic region south of Van Diemen's land and as far south as Enderby's land." Cook was the first navigator known to have passed the antarctic circle. He reached the latitude 67 degrees 15 minutes in east longitude 39 degrees on Jan. 17, 1773.

attached with his eyes for the United States what the Russian, Bellingshausen, later named Palmer land. That was in 1821, eighteen years before the great voyage of Ross, the English explorer, after whom Ross sea is named, and who in addition, discovered Victoria land, several islands and an active volcano.

Captain Wilkins, in 1928, under the auspices of the American Geographical Society of New York, flew south from near Palmer land and found that the peninsula resolved itself into two large islands, now commonly known as Palmer island and Graham island, separated from the antarctic mainland by an island-dotted strait.

From these discoveries the United States could lay claim to considerable areas in this region, namely, the major part of Palmer island and the southeastern part of Graham island, and islands and coast to the south.

The year following Ross' discoveries, if the "I saw it first" rule is to determine ownership, the United States gained more territory by the expedition of Capt. James Wilkes, of the United States navy,

some dispute as to the correctness of Wilkes' discoveries in the antarctic because of the rather inaccurate habit of record keeping on his part. And Ross, the British explorer, who was in antarctic waters at the time Wilkes was there, declared that Wilkes' report of land was without substantiation of fact. As a result Wilkes' claims were clouded with doubt and, worse still, the American people have been inclined to let them remain so. Wilkes was not a popular figure with the public. Sir Ernest Shackleton, however, has been instrumental in getting for him the recognition which should have been his years ago. Today, as a monument to his work below the Capricorn, exists Wilkes land.

While Great Britain lays claim to the Falkland island dependencies, this claim could easily be challenged on the basis of discovery. It is true that Cook, Ross, Powell, Wendell and Shackleton all did pioneer work in various parts of this region, but so did men of four other nationalities, particularly Bellingshausen, the Russian; D'Urville, the Frenchman;



Rear Admiral Byrd and His Companions at the North Pole; Byrd, Then a Lieutenant Commander, Electrified the World by His Spectacular Airplane Flight across the "Upper Roof" of the World

Larsen, the Norwegian, and Filchner, the German.

As far as the Ross dependency claim is concerned, if discovery amounts to anything, Great Britain seems to have some justification for her claim to the land nearly up to the pole on the west side of the region, because here Shackleton came within ninety-seven miles of the pole before Amundsen; and here Scott actually did reach the pole soon after Amundsen. However, Borchgrevink's exploration near Cape Adare and Amundsen's dash to the pole give Norway a basis for claims in this area.

The United States has so far never claimed land in the antarctic, not even in the case of Wilkes land, discovered by an official expedition. Charles Evans Hughes made the announcement, as late as 1924, that "it is the opinion of the state department that the discovery of lands unknown to civilization, even when coupled with a formal taking of possession, does not support a valid claim for sovereignty unless the discovery is followed by an actual settlement of the discovered country."

Admiral Byrd, while knowing the posi-

tion of the United States on claiming land in the antarctic, evidently wanted to be on the safe side, as Dr. Isaiah Bowman, of the American Geographical Society, recently pointed out: "In order to avoid the consideration of the new discoveries as mere continuation by land from the Ross dependency, it seemed desirable to make an independent tie-up with the coastline in case further consideration of the discoveries makes it wise for the United States government to set up a specific claim."

France is the only country besides Great Britain which now lays definite claim to land in the antarctic. Her claims are based on the voyage of D'Urville in search of the south magnetic pole in 1840. D'Urville was in the region of 140 degrees east visited by Wilkes the same year, and first saw Antarctica less than one day after Wilkes did. He was in ignorance of Wilkes' prior discovery. He landed on a small islet near the coast and called the place Adelie land. The claims of France were published in March, 1924, in the *Journal Officiel*, and were made to reserve the rights of fishing, hunting and mining in the region to Frenchmen.

*with original Copenhagen
"Aloe" Rochester Road
Sea Point, near Cape Town
SA*

it in place and the nails are not always opaque to the rays, but the rubber can be cemented to floor or walls. The compound is essentially a rubber sheet containing finely divided lead.

Designed by Capetown firm
A FLOATING FACTORY

20 Having served its time for a quarter of a century as a cable-repair ship, a vessel on the southwest African coast has been converted into a floating plant dealing in fish products. Instead of hauling the fish to the factory, the vessel proceeds to the raw product, either making the catch itself, or going to coast towns at fixed periods to work up the catch awaiting it. The floating factory makes fish meal and also cans crayfish.

WARNING FOR LAZY WORKMEN ATOP RUSSIAN FACTORY

3906 Lazy Russian workmen are given a visible warning of the fate awaiting their country if they loaf, by a fantastic puppet attached to a crane atop a Moscow textile factory. The grotesque sign, in the modernistic style, predicts ruin of the country unless all join in a program of construction.

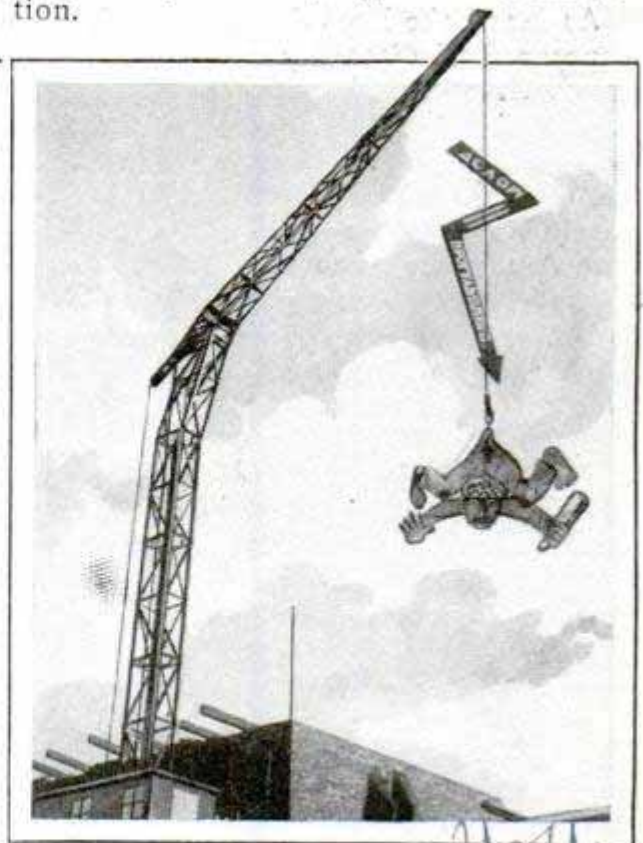

Warning over Moscow Factory Intended to Depict Ruin of Russia if Workmen Are Not Industrious

46

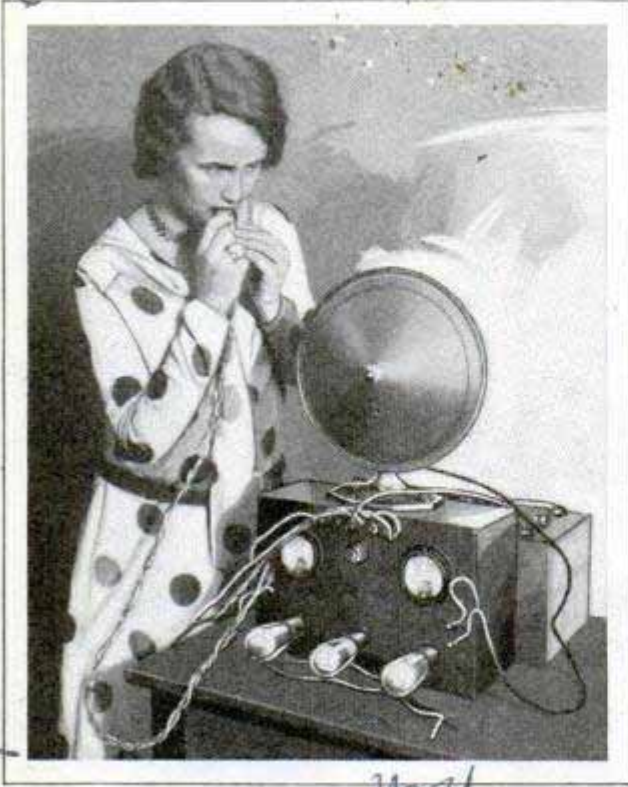

Girl Listening to Herself Think through Electrodes in Mouth Connected by Radio Apparatus

"WHEELS" OF BRAIN ARE HEARD AS THOUGHTS FORMULATE

Literally hearing the "wheels" of your brain go round as you think has been made possible by a combination of radio devices developed by Dr. Milton Metfessel, authority on speech defects, of the University of Southern California. Electrodes held in the mouth pick up tiny disturbances set up in the tongue by nerve impulses from thoughts, these impulses being amplified and made audible by the combination of radio instruments. Thus one can hear his own brain working.

Los Angeles, Calif

RUBBER MATERIAL X-RAY PROOF

As a substitute for sheet lead, a rubber compound has been developed that is an effective shield against X-rays. The material, which can be made thick enough to resist penetration of the most powerful rays, is intended as a lining for rooms where X-rays are used and has been named "ray rubber." It resembles ordinary rubber floor covering and normally is made in sheets one-half inch thick, in which form it is equal in protection to sheet lead one-eighth of an inch in thickness. Sheet lead requires nails to hold

*Used in X-Ray room. H. Manly's Professor
Huntington Hall, Va.
also. New York University Prof*

*Goodyear Tire & Rubber Co
Phon Phon*

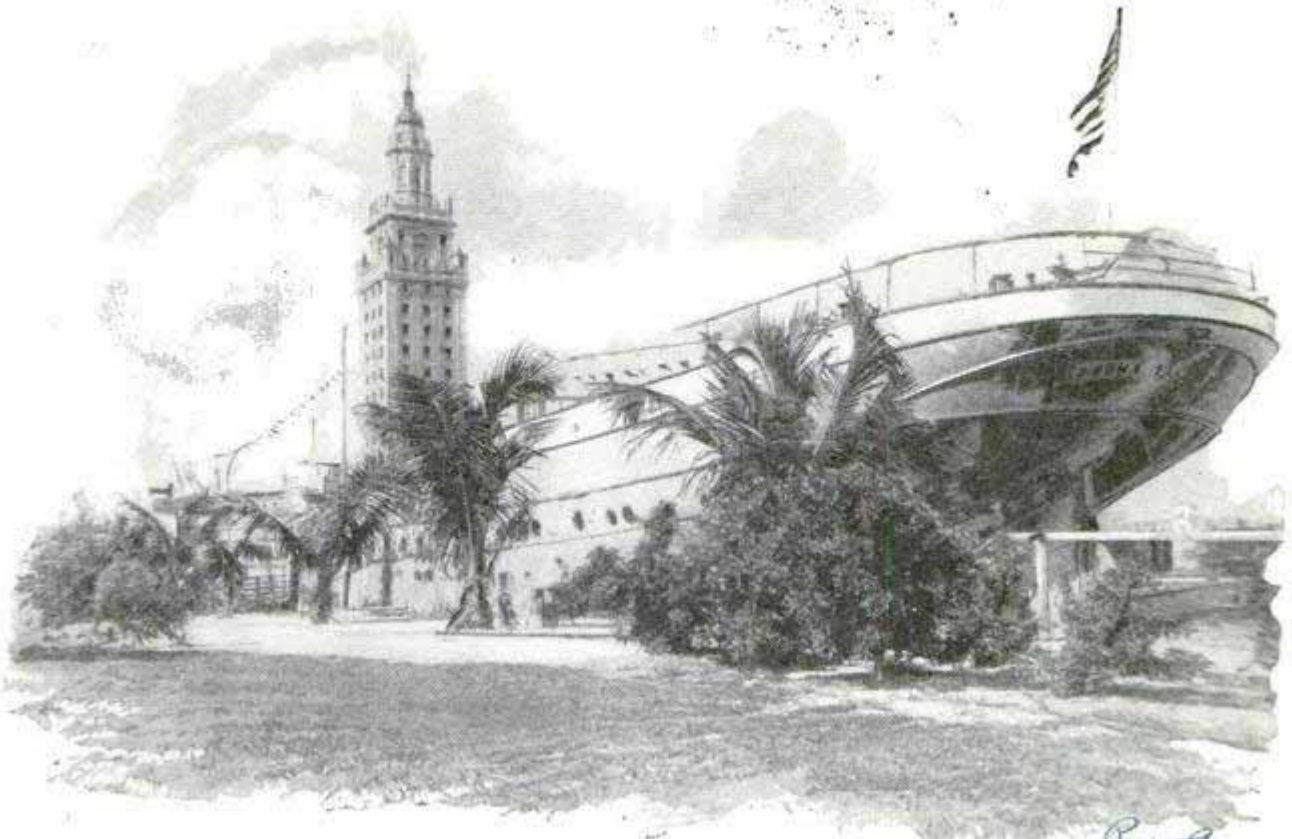

Former German Yacht at Miami, Fla., Which Has Been Transformed into an Aquarium; What Seems to Be the Towering Mast Is Actually the Top of a Building in the Background

**BOAT TURNED INTO AQUARIUM
UNIQUE IN APPEARANCE**

At Miami, Fla., the former German yacht "Prins Valdemar" has been transformed into an aquarium. From a distance the craft, anchored in an inlet of Biscayne bay, appears to be resting on land, while the spire of a stately building in the background seems to be its mast.

QUEER QUIRKS OF ACID 128

Sulphuric acid possesses many queer and apparently contradictory traits. Steel tanks unaffected by 100-per-cent acid are ruined by the same acid after it has been weakened with water below sixty-five per cent. The weaker acid can only be kept in lead, rubber or glass containers. On the other hand, strong sulphuric acid will disintegrate lead and rubber, glass being the only material that will hold all strengths equally well. Seventy-three-per-cent sulphuric acid will remain liquid at twenty degrees below zero and a ninety-three-per-cent solution does not freeze at ten below, but an eighty-three-per-cent solution freezes at forty above zero and

100-per-cent solidifies at ninety above. The same astonishing irregularity of freezing point obtains for all strengths from twenty-per-cent sulphuric up to 120-per-cent fuming acid.

**PORTABLE ELECTRIC RIPSAW
HAS AUTOMATIC GUARD 4101**

Compact and light in weight, a portable electric rip saw now is on the market, operating on either direct or alternating current. The saw may be obtained with either ten or twelve-inch blade, and a swinging guard covering the lower part

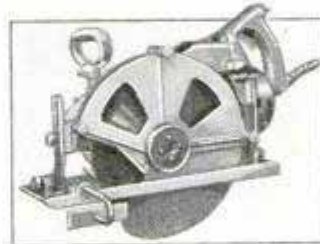

of the saw is automatic in operation, pushing out of the way when cutting pressure is applied and returning to guarding position when the pressure is released. The upper portion also is provided with a removable guard. Ball bearings and spur and bevel gears eliminate wear and heating. A steel carrying case is provided. Either size weighs less than thirty pounds.

*Cont. John L. Cogswell,
16. Edgewood Road,*

*Speedway Mfg Co.
1834 S 52 St. Ave. Ill*

40 38

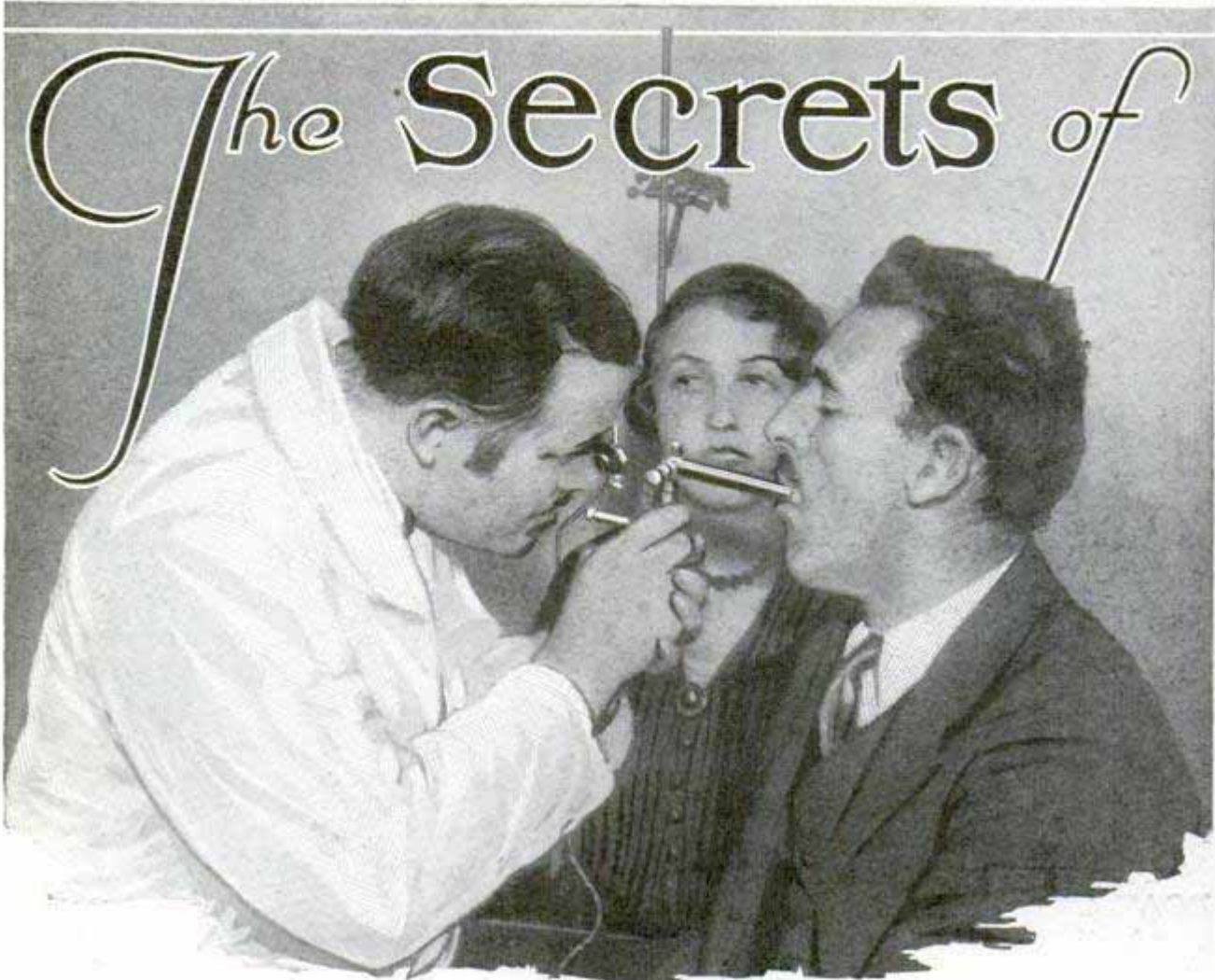

Instrument Which Facilitates a Multiple View of the Human Voice in Action, Making It Possible for from Two to Eight Observers to Watch a Voice at Work Simultaneously

Science Discloses That Traditional Theories about Speech and Voice Quality Are Wrong

By **GEORGE H. DACY** *46 39 Montgomery Ave. Bethesda Md.*

UNRAVELING the age-old mysteries of human speech, voice quality and the singing superiority of the operatic stars is a field of research which has yielded new grains of knowledge recently.

Both X-ray and motion pictures of the human voice in action, synchronized with simultaneously produced phonographic records, have been made. Research has developed miraculous appliances which enable the speaker or singer to watch his vocal cords in action as he talks or sings.

Dr. G. Oscar Russell, director of the phonetics laboratory at Ohio State University—the finest of its kind in the world—was the first to observe and photograph the human voice at work. Doctor Russell is the originator of a marvelous appa-

ratus called the "laryngoperiskop," which makes the organs of speech visible as they operate in ordinary conversation.

This instrument is a glistening metal tube equipped with a series of lenses, prisms and a tiny electric bulb of wonderful brilliancy. This light illuminates the inky darkness of the voice chamber. The picture is reflected so that the observer who gazes into the opposite end of the tube can watch the voice in action.

Science for generations has believed that certain voice characteristics, tone qualities and song notes were dependent upon the size of the mouth cavity, vocal chamber and throat aperture. By means of his unique "throat telescope," Doctor Russell has observed that many of these

Columbus, Ohio

Your Voice

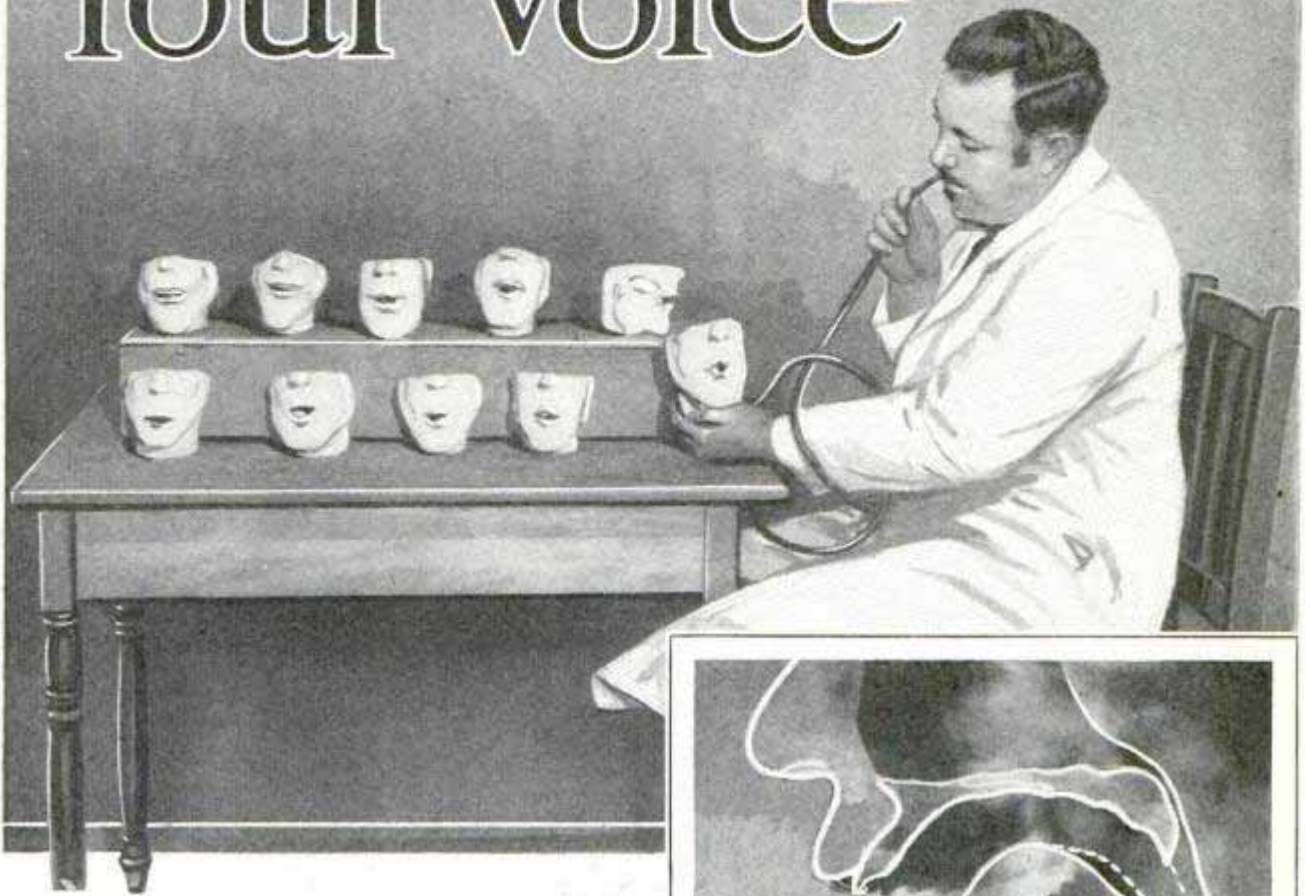

properties of speech and voice are also dependent on the play of infinitely small muscles inside the Adam's apple. The true and false vocal cords, the "trapdoor" to your Sunday throat, and the softness or hardness of the walls against which the tones strike or between which they must pass in issuance from the organs of speech, also influence the voice.

Assisted by F. G. Haskett, the university photographer, Doctor Russell linked a regulation camera to his laryngoperiskop and made the first pictures ever taken of the human voice uttering vowel sounds and singing low and high-pitched notes and booming bass gutturals. Subsequently, Doctor Russell extended his research to the production of clay models made from pictures and measurements of the organs of speech at work. These models are facsimiles of the lower half of human heads. Cross sections of the models represent accurately the changing positions of the organs of speech as various vowels are spoken.

Doctor Russell has attempted to make

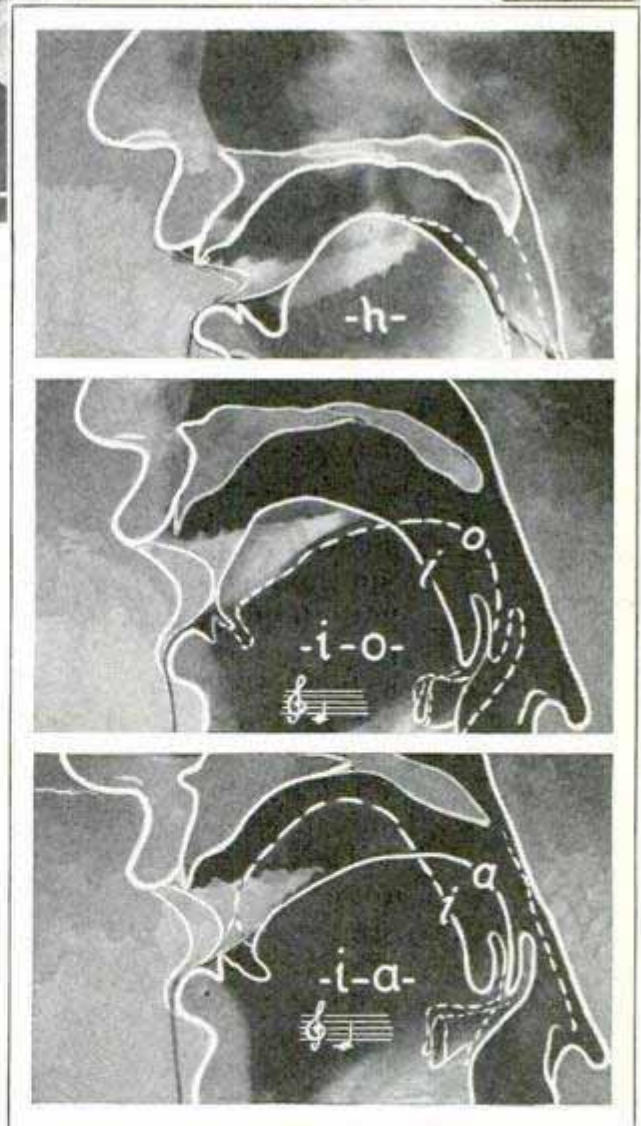

Above, Clay Models of Human Voice Organs Reproducing Sounds; Below, How Voice Looks Making Sounds Representing "H," "IO" and "IA"

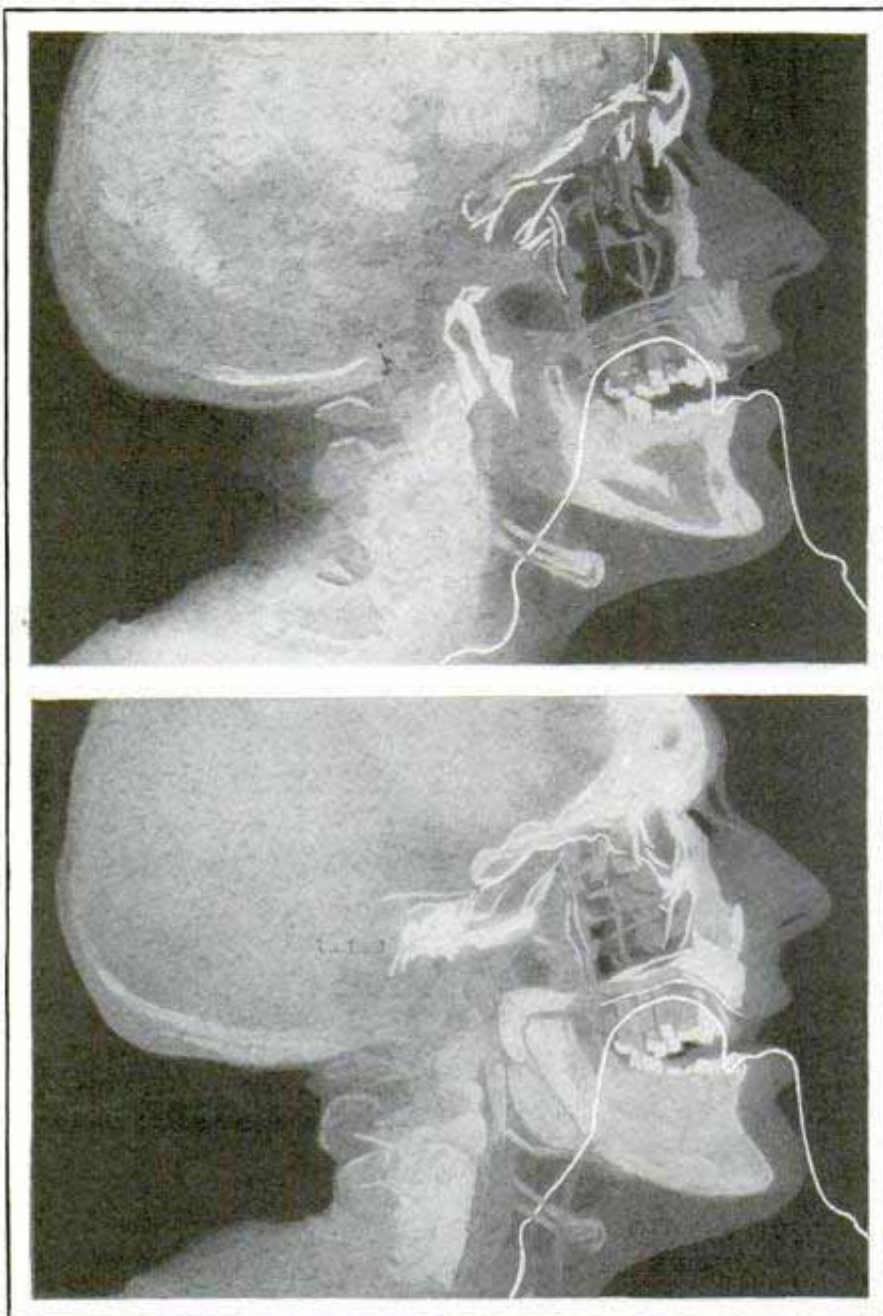

X-Ray Pictures of Person Who Has Swallowed Thread and Is Speaking Vowel Sounds as Exposures for Voice-Study Research Were Made

throat muscles as the voice is engaged in song. One terminal of the electric circuit is attached to the wrist of the subject while the circuit is closed by pressing the other terminal against his throat. The electricity lowers the voice tone of the person thus stimulated and produces a distinct guttural quality in his speech.

Doctor Russell demonstrated that the false membranes—incorrectly called false cords—in the throat play an important role in creating speech and voice quality. They contract and close when one coughs and are the major sources of whatever guttural quality exists in your voice. In the rendition of high notes, these false membranes clash together like cymbals. They become either sharp-edged, rounded-edged or blunt as successive tones and notes are produced by the singing voice.

The X-ray pictures show the changes in cavity dimension and tongue position in uttering different sounds and vocal notes. They disprove without

exception existent theories about how we talk and sing. Actually, the tongue arches all the way back to the soft palate, producing a long neck with a large cavity behind it when man speaks or sings. The tubes really function like irregular or spherical resonators rather than as pipes in producing various vowel sounds.

Our vocal cavity, so the Russell experiments prove, is exclusively a "one-piece" structure from the exit of the sound at the epiglottis on out to the teeth. This refutes all previous theories on the subject—both scientific and empirical. The narrow vocal cavity used in saying "aw" is lined with back throat soft tissues while

his clay models talk. They are as faithful artificial imitations of the human voice as can be made. Notwithstanding, they have been unable to speak as man does. Doctor Russell believes that these artificial voices are unable to simulate man faithfully in speech because certain inharmonics—non-musical factors as well as high-pitched partials—are responsible for peculiar notes in the human voice. It was impossible to reproduce these peculiarities in the clay models.

These voice-study experiments have divulged that speech quality can be stimulated measurably by passing an electric charge into the body through the external

Stimulating the Human Voice with Electricity and Recording the Effects Phonographically. Thus Comparing Tone Variations with Records of a Vibrating Tuning Fork

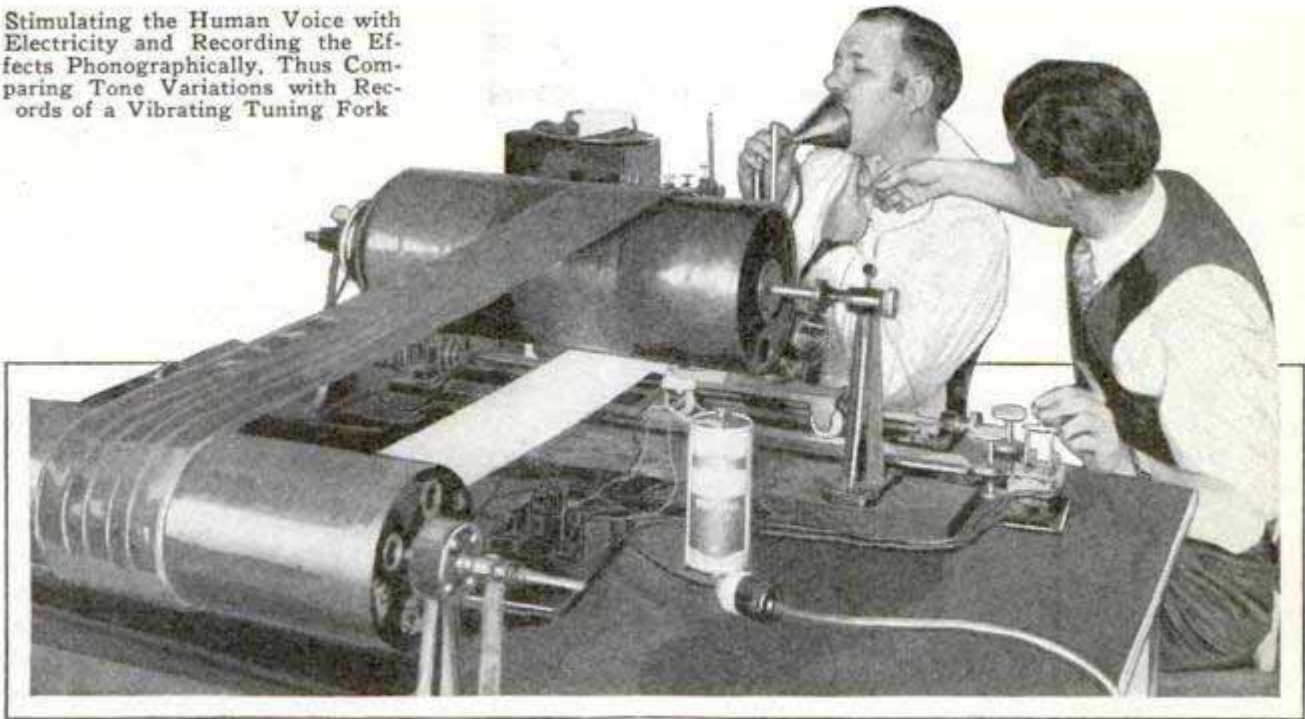

the "ee" cavity is created by arching the tongue against the hard surfaces of the front mouth. Both these cavities in principle resemble the ordinary megaphone.

Musical research has divulged that different surfaces change the quality of flutes. An organ pipe provided with double walls, between which water can be poured, will change its quality from thirty to forty times during such a test despite the fact that the dimensions of the resonance cavity remain constant. Varying surfaces in the vocal chamber similarly create quality differences in the speaking and singing voice. Soft surfaces in the throat, for example, muffle the sound or mellow its quality especially where the tube is narrow in relation to the total area. The same thing occurs if sound is passed through a soft-surface tube. The soft surfaces filter out certain sound frequencies.

Through the co-operative aid of the Carnegie Foundation and at the special request of the American Academy of Music Teachers and Singers, Doctor Russell will continue certain of his voice-research experiments at the College of Physicians and Surgeons, in New York City, in an effort to answer the existent riddles of professional singing. What differences account for the variations in soprano and alto tones when singing the same note? How can this new and revolutionary knowledge about the human voice be

yoked most efficiently for the future training of singers and the development of grand-opera stars? Can a standard practice system be evolved for the molding and seasoning of the million-dollar voices of the operatic tenors, baritones and basses?

Doctor Russell says that the average singing teacher's definition of resonance is entirely wrong. The position of the tongue has little, if any, effect on the quality of the singing voice. In rapid speech, the tongue assumes all kinds of strange postures and positions. The unit of loudness in the singing and speaking voice is difficult for the lay mind to comprehend. Strange to say, the energy used in ordinary conversation is so minute that the voices of 1,000,000 persons speaking in unison would represent only enough energy to light the ordinary incandescent bulb. When the human voice changes from normal speech to song, its energy volume is increased anywhere from 10,000 to 100,000 times.

This renders the scientific reproduction of the human voice very difficult for technical research purposes. Doctor Russell employs a system of networks and filters to eliminate undesirable "blasts" of sound. If you are familiar with the radio broadcasting of song, you probably know that professional singers are required to sing in "light" voice before the microphone for satisfactory reproduction. They can-

Dr. Roanney H. Stone,
Director, Botanic
Gardens, U. of Penna.

104

**PLANTS FIND PLUMBING LEAK
BY REACTION TO GAS**

House plants, particularly carnations, sweet-pea sprouts and castor beans have been used successfully to detect gas leaks where other means have failed because of their extreme sensitivity to ethylene gas, which occurs in coal and illuminating gases. One part of ethylene gas in 400 parts of air is the minimum that can be detected by odor, yet as little as one part in 10,000,000 will have its effect on plant life. The carnation is a more sensitive gas detector than the apparatus of the average chemist, and will "fold up" when one part of ethylene gas is present to 1,000,000 parts of air. Sweet-pea sprouts develop goiterlike growths, and this fact has been used in finding a leak in a home gas line by placing the sprouts at various suspected areas and observing the results. The castor-bean plant's leaves are so extremely sensitive that they will change position when as little as one part of ethylene gas to 10,000,000 parts of air is present.

Can not locate 3/12/30



Radio Tube with Removable Heating Element, Which May Be Replaced When a Tube Fails

**REMOVABLE RADIO FILAMENT
REDUCES TUBE COST**

Radio tubes with a removable heating element have been made by a woman radio engineer in order to reduce the cost of supplying tubes for the set. When a tube burns out, a fresh filament is inserted to renew the tube's usefulness.

Mrs. C. E. Quinn, New York

**ELECTRONIC BULLETS DESTROY
GERMS PRODUCING BOILS**

Electronic bullets, fired with electricity as low as thirty volts, are capable of killing at least one common form of germ, the mildest of the several that produce boils. In a study made at the University of Cincinnati, Dr. D. A. Wells found that the relatively low-speed electrons are deadly to the boil germs, it having been observed previously that high-speed electrons, driven by voltages of several thousand, have definite germ-killing effect. Electrons, according to one theory, are similar to forms of radiation like the ultraviolet rays which also kill germs.

Science Service Bulletin
460-22 1/16/30

**BOWLING WITH A BILLIARD CUE
COMBINES TWO GAMES**

Combining many of the features of both bowling and billiards, the game of "skill ball" recently has made its appearance. The table on which it is played is waist-high, but in other respects resembles a bowling alley with light pins at the end. Billiard balls are shot at the pins, but the scoring is the same as for bowling.

4095

Skill Ball

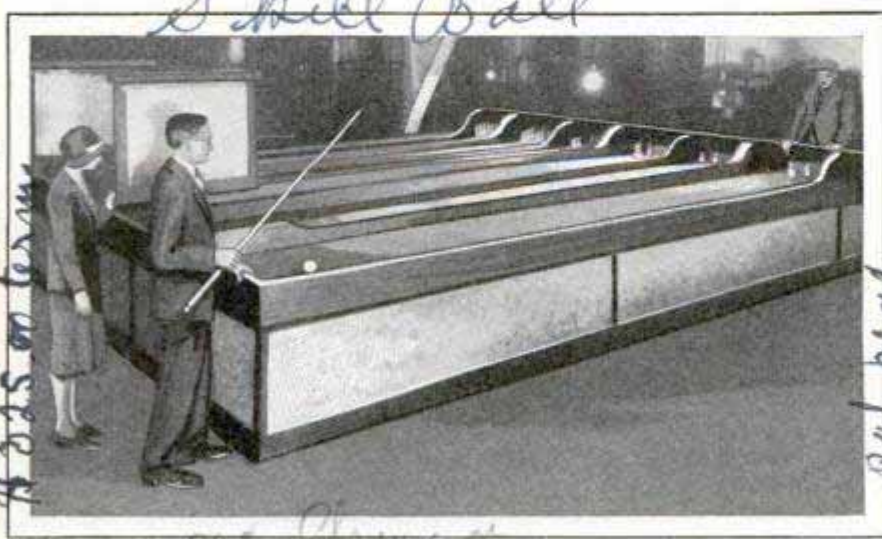

\$300.00 each
\$225.00 term

pat. pend.

Bowling with a Billiard Cue Combines Some of the Thrills of Both Sports in the Game of "Skill Ball," Which Is Illustrated

Washington Bowling Billiard Co
Tower Bldg. Washington, D.C.

RUBBER DOUGHNUTS SOLVE OIL-FIELD PROBLEM

4115

Mr. W. I. Bettes



Rubber "Doughnuts" Which Eliminate Friction between Casing and Tools in Drilling Oil Wells; a Spinning Auto Tire Furnished the Idea

Observation, plus inventive ability and pieces of rubber have solved one of the most stubborn problems of petroleum-exploration drilling procedure. Two years ago, a western inventor set out to learn why wet rubber slipped, and although he failed to some extent in the solution of that problem, he ascertained beyond a doubt that wet rubber does slip and, once convinced of that principle, he adapted it to a use which he knew existed. It was all brought about by watching the rubber-tired driving wheels of a heavily loaded truck as they spun round in a mud hole. Just how many people have watched the driving wheels of a truck lose their traction when they encounter muddy roads there can be no accurate conception, but, as this inventor saw the wheels spinning, he visioned another condition. Petroleum drilling requires that a steel pipe should revolve within another of somewhat larger diameter. The revolving pipe is attached to the drilling tools and the larger pipe serves to keep the earth surrounding the well from closing

up the hole. Furthermore, water and mud are forced down through the revolving pipe and allowed to come up between the larger and smaller pipes, bringing the material loosened by the drilling tools with it. Since this particular process, which is almost universally used today, was first introduced some twenty-eight years ago, the ravages of friction between the revolving or drill-pipe and the larger pipe, known as the casing, have gone on unconquered. As the inventor stood watching the spinning motor-truck tires, he visioned drill pipe as it went around, also in mud. With two friends, he made up a crude sample but met with derision and discouragement

everywhere. Finally, the first "rubber doughnut," as the device was dubbed, went into service at an oil well near Long Beach, Calif. The drilling crew were both skeptical and severe in the test they gave the device, but it worked, and so, by close observation of a most simple natural phenomenon, an inventor solved a problem which had baffled both scientific and engineering genius, yet, unheeded and unnoticed, other natural phenomena go on about us which are equally applicable and may be as productive of reward.

MANNA OF THE BIBLE IS FOUND TO BE DESERT SHRUB

85 Manna which the children of Israel ate during their sojourn in the wilderness came from the sap of a desert shrub, the tamarix, drawn off and predigested by insects and dried to hardness in the desert air, according to the conclusions reached by an expedition sent out by the Hebrew University of Jerusalem to investigate the question. There always has been a dis-

under Mr. F. J. Bodenheimer and Mr. C. Theodor

pute among scholars as to whether manna was an edible lichen, a low form of desert plant life, or was hardened sweet sap of the tamarix shrub. The expedition decided it is the same thing known elsewhere as "honey dew," the sap of the plant drawn off by aphids and exuded from their bodies. It is produced by one or two species of aphids on a single species of tamarix in sufficient quantity to form large drops that harden into sweetish grains of solid matter. Chemical analysis has shown the grains contain three varieties of sugar, as well as other compounds. The honey dew that turns into manna is formed from the downward current of sap that bears the food substances made in the leaves toward the roots of the plant.

Central Science Co. 460 E. Ohio Chicago

4055

**TRACKS OF INVISIBLE RAYS
 SEEN IN MAGIC GLASS**

"Glimpses of the invisible" are seen through a small glass window in a laboratory and classroom unit that brings evidence of the magic world of the radioactive materials, a realm that hitherto has been open to only a few investigators equipped with elaborate apparatus. The article somewhat resembles a microscope but, instead of looking into a lens,



the observer peers into a cylindrical chamber, beneath the glass top of which is a short glass rod tipped with an invisible speck of a radioactive material. By pressing a rubber bulb, the chamber is partly filled with water; then, at the instant the bulb is released and the water recedes, an "explosion" of what appear to be tiny smoke paths shoots across the chamber. The effect is produced by the tiny particles that are constantly bombarded, at the speed of bullets, from the radioactive material. Releasing the water causes the air space in the chamber to expand. This results in a condensation of moisture on the ions produced by the particles as they shoot across the area.

By pressing a rubber bulb, the chamber is partly filled with water; then, at the instant the bulb is released and the water recedes, an "explosion" of what appear to be tiny smoke paths shoots across the chamber. The effect is produced by the tiny particles that are constantly bombarded, at the speed of bullets, from the radioactive material. Releasing the water causes the air space in the chamber to expand. This results in a condensation of moisture on the ions produced by the particles as they shoot across the area.

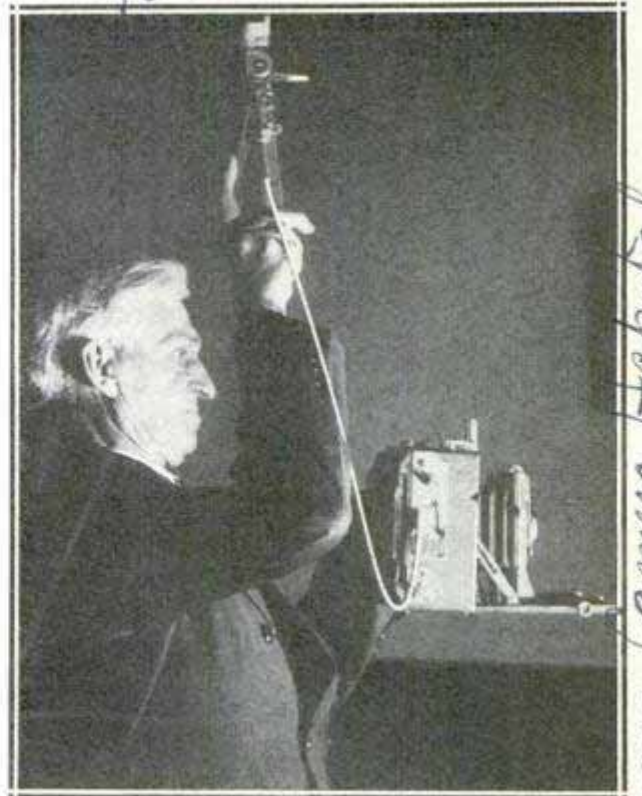

Firing the Flash and Releasing the Camera Shutter at the Same Instant by Improved Flash Gun

**FLASH GUN OPERATES CAMERA
 SHUTTER RELEASE**

Taking flashlight photographs is simplified by using a gun that has a cable release to operate the shutter at the instant the flash is fired. The two are said to be synchronized accurately, and the photographer has both hands free to manipulate the gun if necessary.

**HAND TRACTOR PLOWS GARDEN
 92 AND MOWS THE LAWN**

Equipped with a gasoline engine and tank for motive power, a hand-operated garden tractor is adapted to perform various garden tasks. It contains sprayer equipment for trees and garden, a full set of plows of various sizes and a harrow, and also may be attached to a lawn mower and utilized for other tasks about the home. All the implements are interchangeable, being attached or detached in a few minutes.

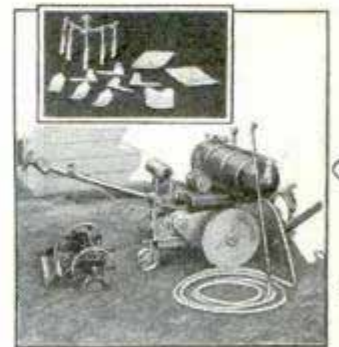

Aug. O. Wheel Plow +
 Tractor Co. Box 768,

Images Camera Hospital 1638 S. St. Louis Ave
 Dehencloody, N.Y.

Bureau of the Census
Washington, D.C.

602
4076

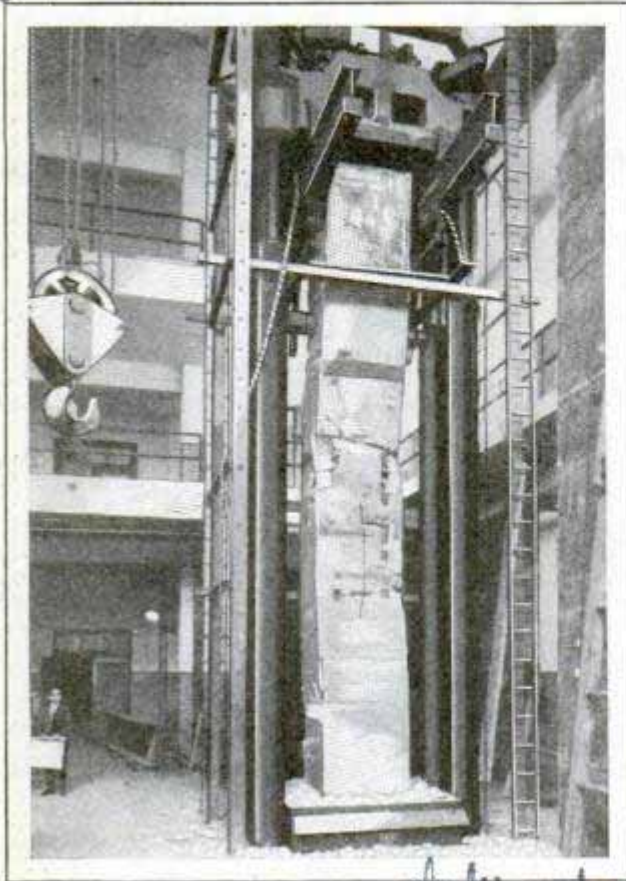

"Nutcracker" Which Tests Bridge Columns, and a Column Which Has Crumpled from Its Impact

"NUTCRACKER" TESTS METAL FOR BRIDGE COLUMNS

Capable of exerting 10,000,000 pounds' compression, a "nutcracker," the largest tester of steel columns in the world, is used by the bureau of standards to determine the strength of huge pieces of steel to be employed for various purposes. Recently the reinforced steel columns that will support the new Hudson river and Kill Van Kull bridges in New York were tested in it. It bent columns half the size of those to be used in the bridges, but it had to be exerted to the limit to affect any of the full-size supports.

HOW TRICKS OF SCIENCE UPSET MANY COMMON IDEAS

The average person might absorb a whole library of scientific works, yet the inborn conception would still remain with him that there would be light from a fire even in an unpeopled waste, and that a boiler factory going full blast would make some sound even in a world of deaf-mutes. Strictly speaking, however, there would be no light from the fire, nor sound from

the boiler factory, for sound waves are silent until they strike an eardrum, and light waves are not light themselves; they are merely invisible vibrations in the atmosphere, conveying not matter, but energy to the eye. Light is merely a sensation within ourselves. Now take an ordinary lump of ice and hold it in your hand for five minutes. You will say that the ice is cold. You will find it hard to believe that there is any heat in the ice, but there is. Ice doesn't seem so cold, after all, when one discovers that it is hot enough to make liquid air boil. There are many mistaken popular notions relating to heat and cold. A woman with a fan has an idea that she is cooling the air. As a matter of fact, her fanning is making the air hotter, because it is being more rapidly passed over the human body, and is, therefore, absorbing more of the heat of the body. But the woman feels cooler because the heat is driven out.

SELF-FILLING LIFE-SAVING VEST KEEPS WEARER AFLOAT

Serving the purposes of a life belt, but without its cumbersomeness, a self-inflating life-saving vest which is worn like the ordinary garment now is on the market. The inside of the vest is of air-tight rubber material and has snap fasteners. Inflation is accomplished by jerking a discharge lever which releases air into the rubber chamber from a charged pressure tube. The garment, for use on boats or for fishing and duck-hunting trips, as well as for those learning to swim, will keep the wearer afloat on his back and does not interfere with swimming.



Life-Saving Vest Which Inflates Itself When the Wearer Pulls a Lever in Emergency

Edward Cave & Co
205 E 43rd St. N.Y.C.

M. J. Markus self inflating

International

4032

4-4 Cont. W. H. Stacy, 4659
Montgomery Ave. Bethesda
Md.

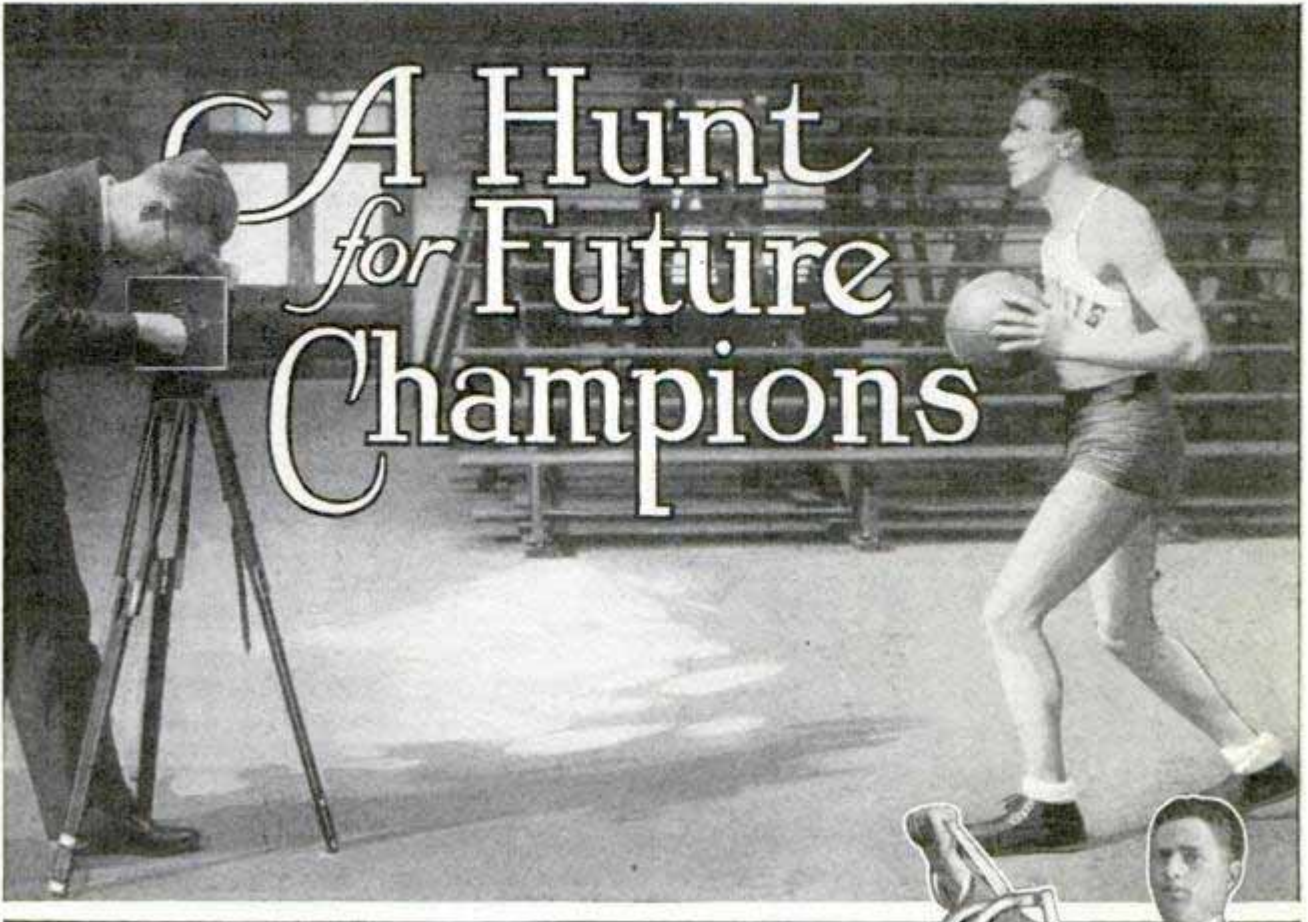

THRILLING acrobatics and polished athletic feats are performed at the University of Illinois, championship sports which are reproduced by the motion-picture camera and subsequently plotted and blueprinted—even as engineers solve railroad curve puzzles—in order that the muscular movements may be studied.

A seasoned gymnast gracefully and rhythmically turns a back somersault while the movie machine reproduces the act on celluloid film. A student, aided by a tumbling belt, then strives to duplicate the feat. After the negative has been developed and printed, the projection machine reproduces the movements of the two athletes on the screen.

Ordinary eyesight identifies the skill of the veteran and the faults of the novice as the slow motion picture is presented. The pictures are run slowly forward and backward time and again while investigators study the successive positions of the athletes. Deficiencies of movement

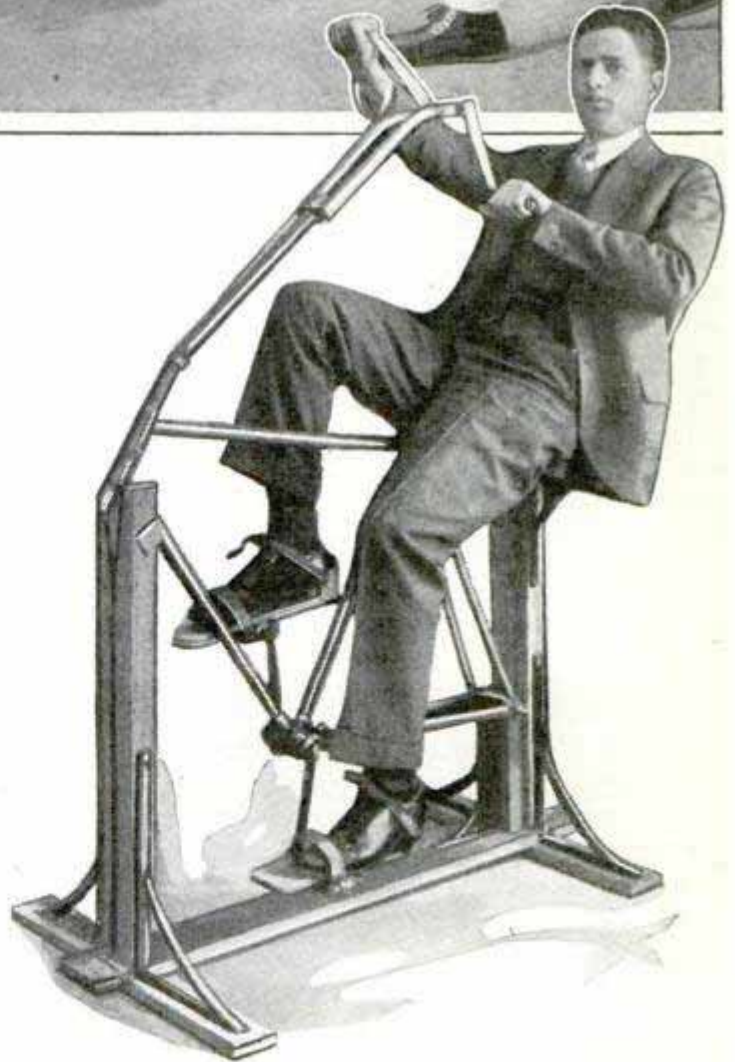

Making Movies of a Basket-Ball Player in Action, and Exercising on Eccentric Stationary Bicycle Used in Testing the Muscular Co-Ordination of Athletes

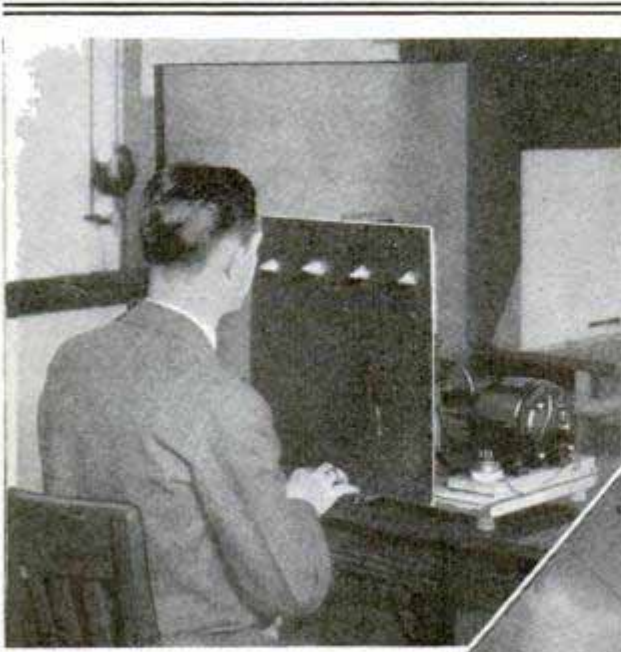

suspended on the wall of Dr. Coleman R. Griffith's laboratory. There are some forty-two plays in organized baseball, so the story goes, and by means of a synchronous motor, similar to that employed in commercial window displays, these various plays can be presented in pantomime on the technical play board. These electrical plays are run at the average speed of major league baseball. The device can be used to test the baseball knowledge of the candidate as well as in training him to think quickly and to solve baseball situations as rapidly as they flash before his view. The player who undergoes this novel test is scored on his success in solving the different field situations flashed before him.

and faults in form are noted and the performer is shown his error and how to overcome it.

The motion-picture camera is an all-revealing eye which never lies. The baseball batter, pitcher, fielder and base runner can now be analyzed as never before. The secrets of the football player's success, the golfer's grooved swing, the diver's daring agility, the gymnast's gyrations, the shot putter's half turn, the hurdler's form and the sprinter's start and finish bare their former bafflements before this new system of photographic reproduction and dissection.

At Illinois, various other mechanical and electrified "sleuths" are being employed in the investigations of the qualifications of candidates for different sports. Not only are these devices used in ferreting out the peculiarities of individual students, but some of them are also yoked as silent teachers to train a man in certain of the finer points of the game in which he seeks to excel.

A case in point is that of an electrified baseball diamond and its midget players,

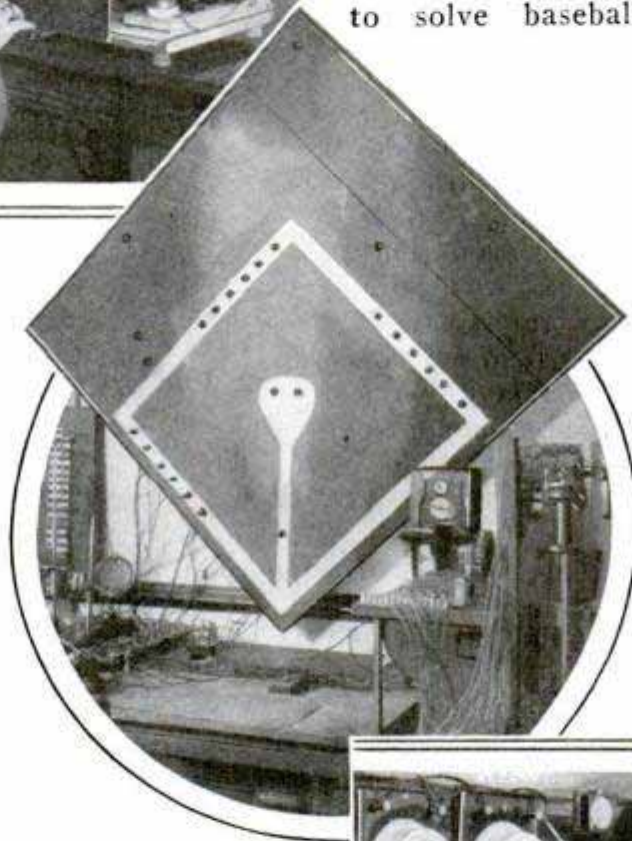

Various other testing devices reveal the mental lag, or reaction time of the students to different emergencies. All these responses to ringing bells, falling weights, flashing lights and



Top, Testing Vision with Lights; Center, Electric Baseball Diamond in Miniature, and, Bottom, Another Co-Ordination Test

out-of-position handles are timed by a delicately adjusted device which registers intervals as short as one one-thousandth of a second. Another interesting equipment keeps track of the athlete's time reactions to sound, light and pressure.

Involuntary muscular tremor naturally will affect the marksmanship of a trap-shooter, rifleman or archer, while it also collects its toll from other sports. Doctor Griffith employs a simple, yet very difficult, test, in detecting evidence of muscular tremor. The subject holds an electric pencil in his hand and stands at arm's length from a block of wood having three copper-lined holes in its surface, slightly larger than the diameter of the pencil. The subject seeks to plug the pencil into these holes in fairly quick sequence without touching the surface of the block or the sides of the apertures. A special recorder keeps

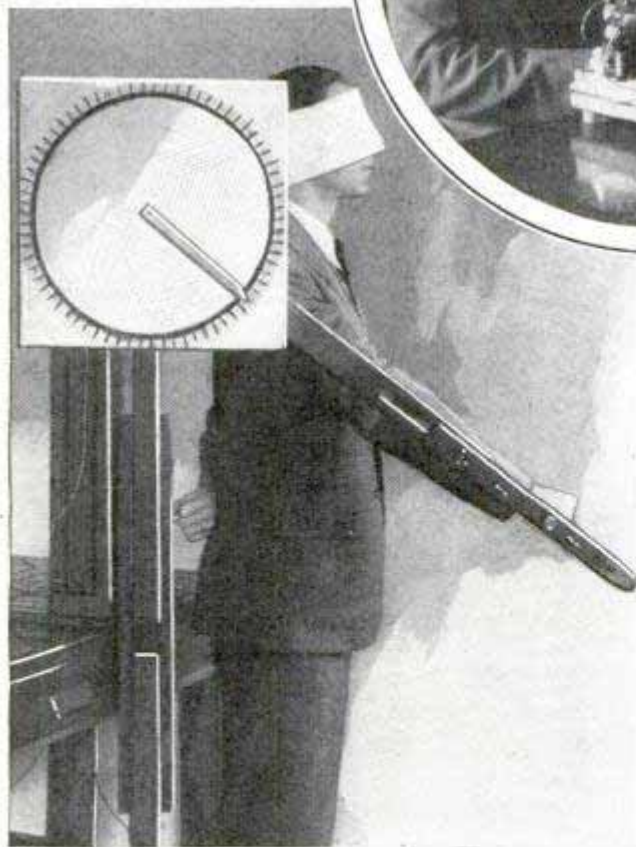
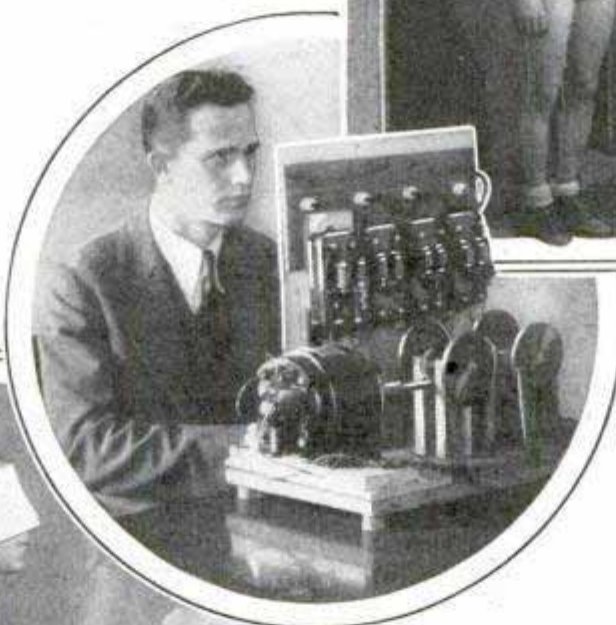
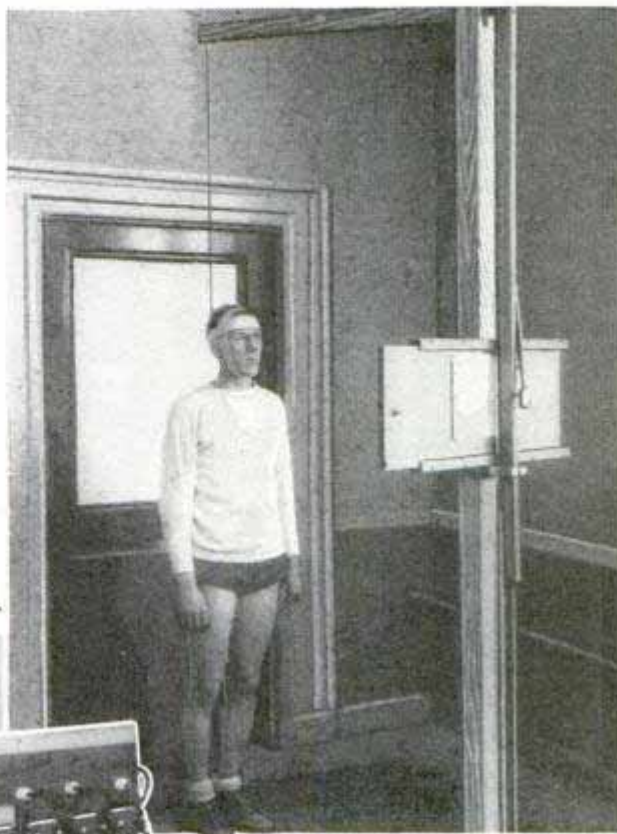

tab on his efforts, while each time he touches the copper and completes the electrical circuit, a bell rings.

Then there is another device used in the presentation

of "flash" or emergency situations. It consists of a large black screen with a small opening at one side. A wooden arm, which can be moved over a circular course, is so equipped that a picture of a football, baseball, basket-ball or hockey play can be attached and flashed through an opening in the black screen in the same interval that it would require on the actual field of play. It tests the ability of the athlete to size up plays and grasp vital situations as they develop on diamond, gridiron or court.

The Griffith eye-hand apparatus is devised to determine co-ordination of vision and manual action. The turntable of a talking machine is inlaid with eight circular spots. This turntable is wound up by means of a spring motor and operates at a normal speed of thirty-two revolu-

Top, Muscular Test; Center, Controls for Flashing-Light Set, and, Bottom, Apparatus for a Muscular Position-Memory Test

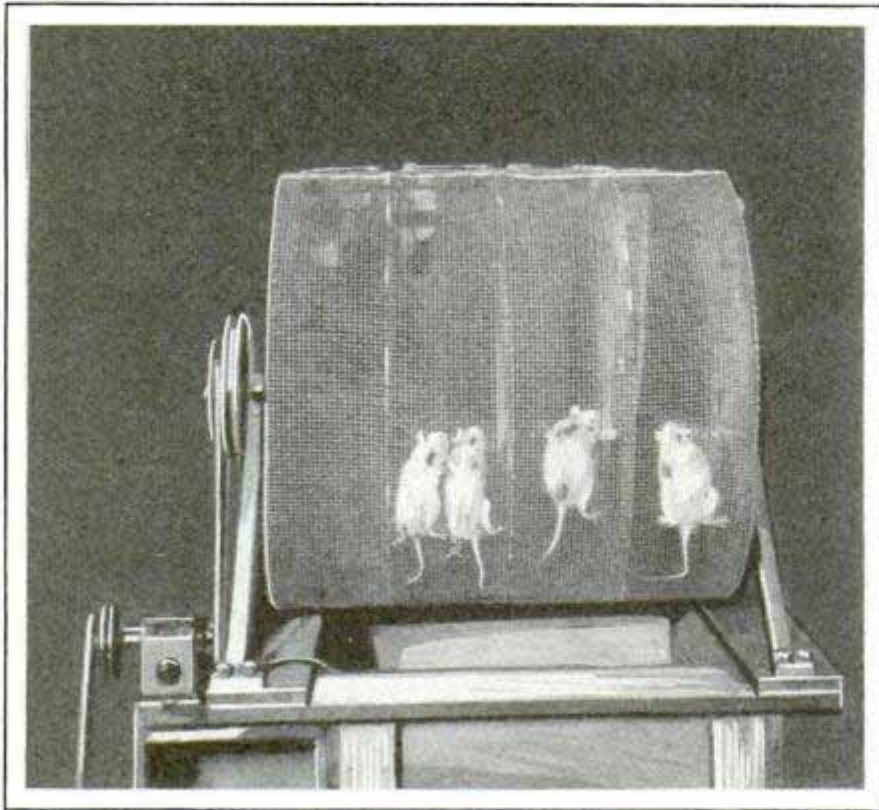

Rats in Rotating Cage, Driven by Electric Motor, to Test Effects of Exercise on the Animals' Ability to Learn

forward simultaneously as both handlebars are being spun backward in unison. And just to prove that athletics develop muscular co-ordination, these tests have demonstrated that varsity athletes soon master the strange eccentricities of this stationary bicycle, while those unskilled in modern sports make poor showing when astride this steed of steel.

One of the most important experiments which Doctor Griffith is directing is a test with white rats to ascertain the effects of violent exercise on learning. The rats were first introduced to a simple problem—how to make their way from one end of a com-

plex maze to another in order to obtain food. A rat, when it is first placed in the maze, will, as a rule, require anywhere from thirty minutes to four hours to negotiate the trip. On its arrival at the opposite outlet, the animal is given a piece of cheese. When the rats gain experience, they travel this maze in ten seconds. All rats run the maze five times daily until they are able to make the trip five times in succession without committing a mistake.

tions per minute when released. The athlete under test stands in front of the turntable. Its surface is covered with celluloid except one small wedge-shaped space. This space is just large enough so that three spots on the revolving disk are exposed simultaneously. The subject attempts to make contact with an electric point with each of these circles as they are exposed. The situation presented is similar to that which confronts the open field runner in a football game. He must watch the closest tacklers out of the corner of his eye and simultaneously must keep track of the players in front whom he must evade in his dash for a touchdown.

These rats are divided into experimental groups, each animal being identified by special ear notches and dye stains. The rats which compose one group are given no exercise, living in wire cages so small that they can barely turn about. Another group exercise as they desire in large cages, while a third group are subjected to one hour of enforced exercise daily in a rotating motor-driven drum. Other groups are exercised, respectively, for three and five-hour periods daily in this electric exerciser.

An unusual bicycle which you can ride indefinitely without accomplishing any forward progress is another novel appliance. The machine is so built that the pedals can be operated either together or separately in either clockwise or counter-clockwise directions. Each terminal of the handlebars may also be turned in any direction. He who is tested for co-ordination on this machine can be ordered to execute an extensive series of movements. For example, the right foot may pedal backward while the left one is working

forward simultaneously as both handlebars are being spun backward in unison. And just to prove that athletics develop muscular co-ordination, these tests have demonstrated that varsity athletes soon master the strange eccentricities of this stationary bicycle, while those unskilled in modern sports make poor showing when astride this steed of steel.

This remarkable research is expected to yield definite data on the effects of exercise on the faculty of learning, a moot question which, heretofore, has defied scientific solution.

BOAT WITH WINGS DRIVEN BY OUTBOARD MOTOR

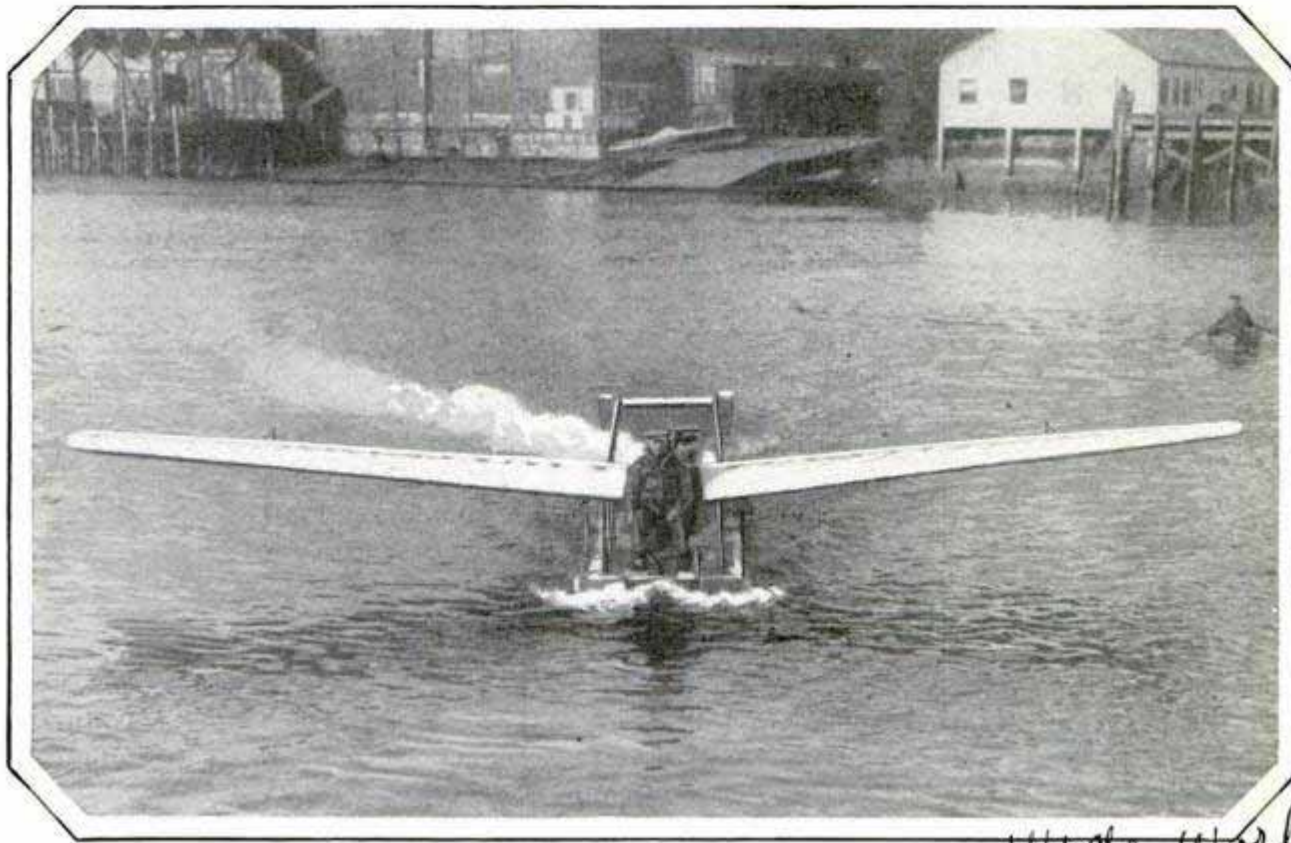

see June 1930-895
 James Robertson 251
 lifeyard
 Alameda Calif

A "Waterplane" Equipped with Wings to Allow It to Skim over the Surface, and Powered with an Ordinary Outboard Motor; It Attains a Speed of Sixty-Five Miles an Hour

Wide World.

Equipped with wings and driven by an outboard motor, a craft called a "waterplane" has been built by two Californians, and in tests attained a speed of sixty-five miles an hour. The boat is powered with an ordinary racing motor, and the long wings help to lift it out of the water without actually carrying it into the air.

PRESSURE ON ELECTRIC CABLE SERVES AS SWITCH

4030

Pinching a cable at any point throughout its length, to make an electric contact to operate any device to which the cable is connected, is possible with a novel electric wire cord now being produced. The apparatus consists of a water, dust

and acid-proof cable the size of a lead pencil. Two conductors, inclosed by the outside insulation, are left bare but separated from each other by a cushion of rubber. Pressure applied to the cord at any point causes the rubber to yield and brings the outer conductor in contact with a wire which is always in contact with the inner conductor, thus closing the circuit as long as the wire is pinched, and making the cable one continuous switch. The contact-control cable may be used to operate electric switches, lights or radios, as a signal of a holdup in banks, in mines as a signal of danger or call for aid, and also in automatic traffic control.

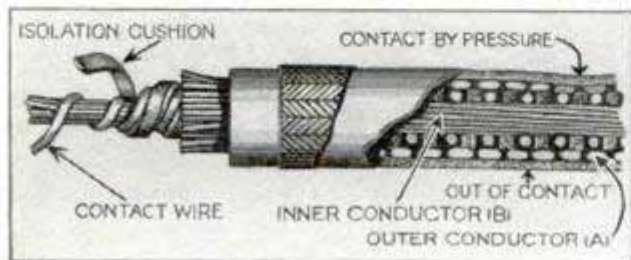

Cross Section of Cable Which Makes an Electric Contact When It Is Pinched at Any Point

CREEL KEEPS CONTENTS FRESH

110

Capable of keeping fish fresh and unspoiled for more than forty hours, a ventilated creel has been invented by a Salt Lake City man. It is made of canvas with a rubberized lining and is reinforced on the outside with leather. In appearance it is like the ordinary creel. The container may be turned inside out for cleaning and drying.

Bishop Wire & Cable Co.
420 25th St N.Y.C.

Amos. Eli J. Marsell
117 McClelland St

*Army Air Corps
at Wright Field
Dayton Ohio*

*Capt. S. R. Winters District
National Band Bldg*

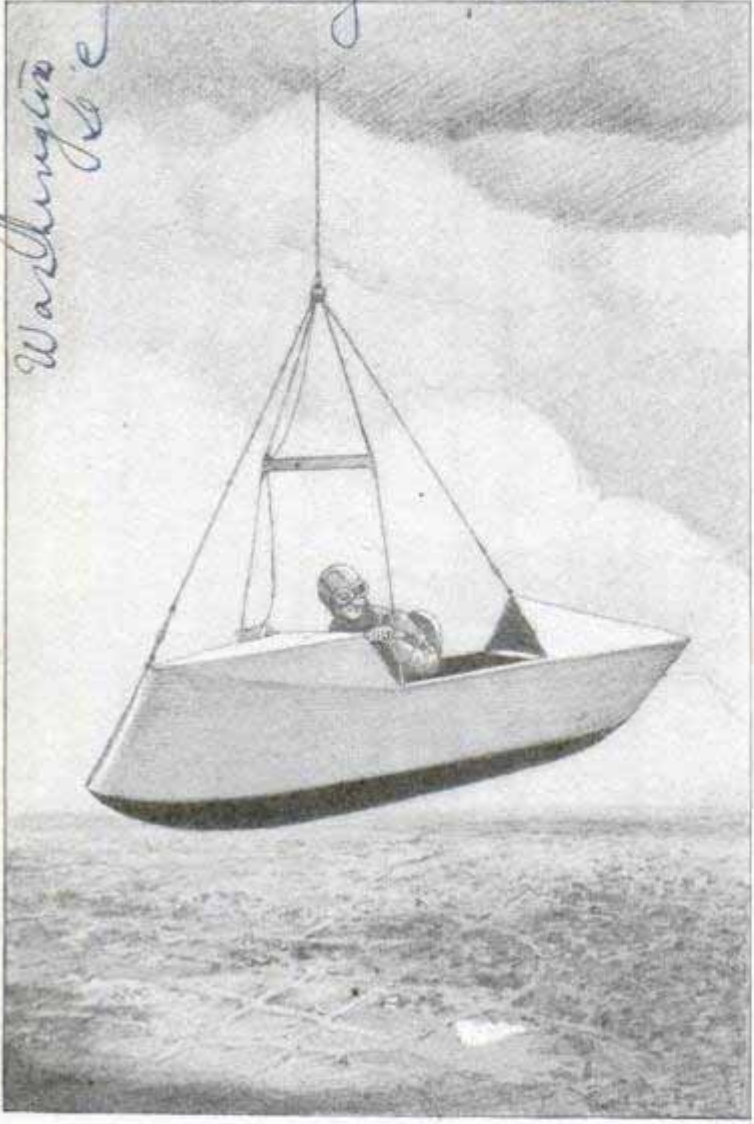

Observation Car Attached to Dirigible from Which Observer May Direct Flight of Craft in Fog above Him

car lends itself particularly to assisting an airship to land in fog, and for special observations, such as air photography. The car is lowered by a cable and windlass and is so designed that the rear end acts as an automatic rudder to keep it from revolving. Possibility is seen that the entire flight could be governed by an observer if the car and ship were radio-equipped, and radio telegraphy or telephony could easily be substituted for the telephone sets used in the tests. Planes already have been flown by radio.

OBSERVATION CAR IS HUNG BELOW AIRSHIP

Remote control and guidance of a dirigible through instructions telephoned the crew by an observer stationed in a car suspended from the airship, have been successfully accomplished in tests by the air corps of the United States army. The compartment in which the observer sits is known as the "sub-cloud observation car" and makes it possible to fly a dirigible through clouds, while the observer, stationed in the car below the clouds, governs the flight by directing the crew above him by the telephone set connecting car and dirigible. The idea dates back to world-war days when such observers often were lowered from attacking blimps, but the air corps hopes to convert the plan to peace-time uses. The observation

supports. The lamp is burned with the base up and requires a current regulator, consumption differing when arc and filament burn separately and together. When used with the proper reflector, the lamp produces light containing both infrared and ultraviolet rays. The extremely short ultraviolet rays likely to affect the eyes, however, are screened out by the bulb material so that no eye protection is needed. The lamp provides a brilliant illumination.

LAMP GIVES SUN BATH HARMLESS TO EYES

98

Giving light of a quality closely approximating sunlight, but requiring no goggles to protect the eyes from the rays, a mercury health lamp now is available. The heart of the lamp is a bulb containing both a filament and mercury-arc generator. When current is passed through it, the filament becomes heated and in turn heats a pool of mercury in the bowl of the bulb. The mercury vapor rises and creates an arc across a tungsten gap whose electrodes project from the filament

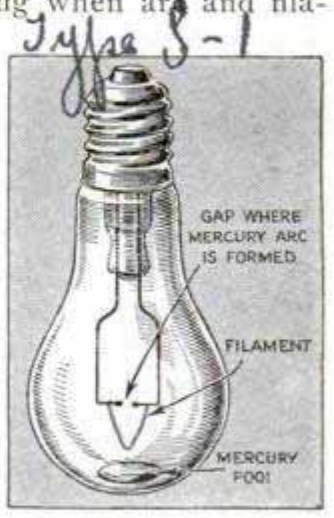

*National Lamp Works
General Electric Co.*

Used by West & Beachy

Junice, Ont.

Canada

ALLIGATOR SHIPS CLIMB HILLS AND HAUL LUMBER 4613

Up in the far northern woods of Ontario, the "alligator" does its busy day's work in starting the logs on the trip downstream to the mills. Like the saurian from which it takes its name, the alligator of the lumberman is thick-skinned and can navigate on land or water. One of them, recently launched, climbed over a hill from the shipyard, plunged into the river, where it paddled along until opposite the railroad siding, where it climbed up the bank and finally hoisted itself aboard the two flat cars that were to bear it away to duty in the northern lumber camps. These tugs are built in various sizes, from thirty-seven to seventy feet in length, in either paddlewheel or twin-propeller type. They draw but thirty inches of water and are shod on the bottom with heavy steel runners. The propeller type is built with a flexible joint in the shaft so the screws will rise when meeting any obstruction, with heavy skegs to guard them from striking logs or rocks, and the rudder is hung on a hinge, so it will lift when going over logs or booms, then drop back to its former position. The boats are equipped with warping gear and double drums carrying a mile of steel cable and are powered with a sixty-horsepower marine steam engine. The fact that the alligator's power plant is small, does not handicap it in towing work, which is done in a unique fashion. Instead of towing the logs outright, the alligator, its cable hitched to a boom and unwinding as the boat moves, proceeds for about a half mile, when the anchor is let go or the boat is made fast to a tree. Then the cable is wound in, and in this manner the alligator is capable of hauling a boom of 60,000 logs at a time. In making a portage overland, logs or skids are placed under the runners, the cable fastened to a tree ahead, the winch



"Alligator" Boat That Navigates Land as Well as Water by a System of Skids and Cables Attached to It

started and the alligator climbs up or down hill, through swamps, bogs or underbrush to the next river or pond, where rollways or skidways may be constructed, the whole procedure effecting a considerable saving in time and men.

ANCIENT CHINA HAD TALKIES 120.

More than 100 years before the Christian era, a form of talking pictures with motion originated in China and has continued popular to the present day. This is the shadow play which gives the illusion of moving pictures, while the "talkie" effect is supplied by persons who read the parts of the drama

St. Joseph News-Press
1/4/31

Ont. W.A. Gordon, Box 485, Port Dover, Ont. Canada

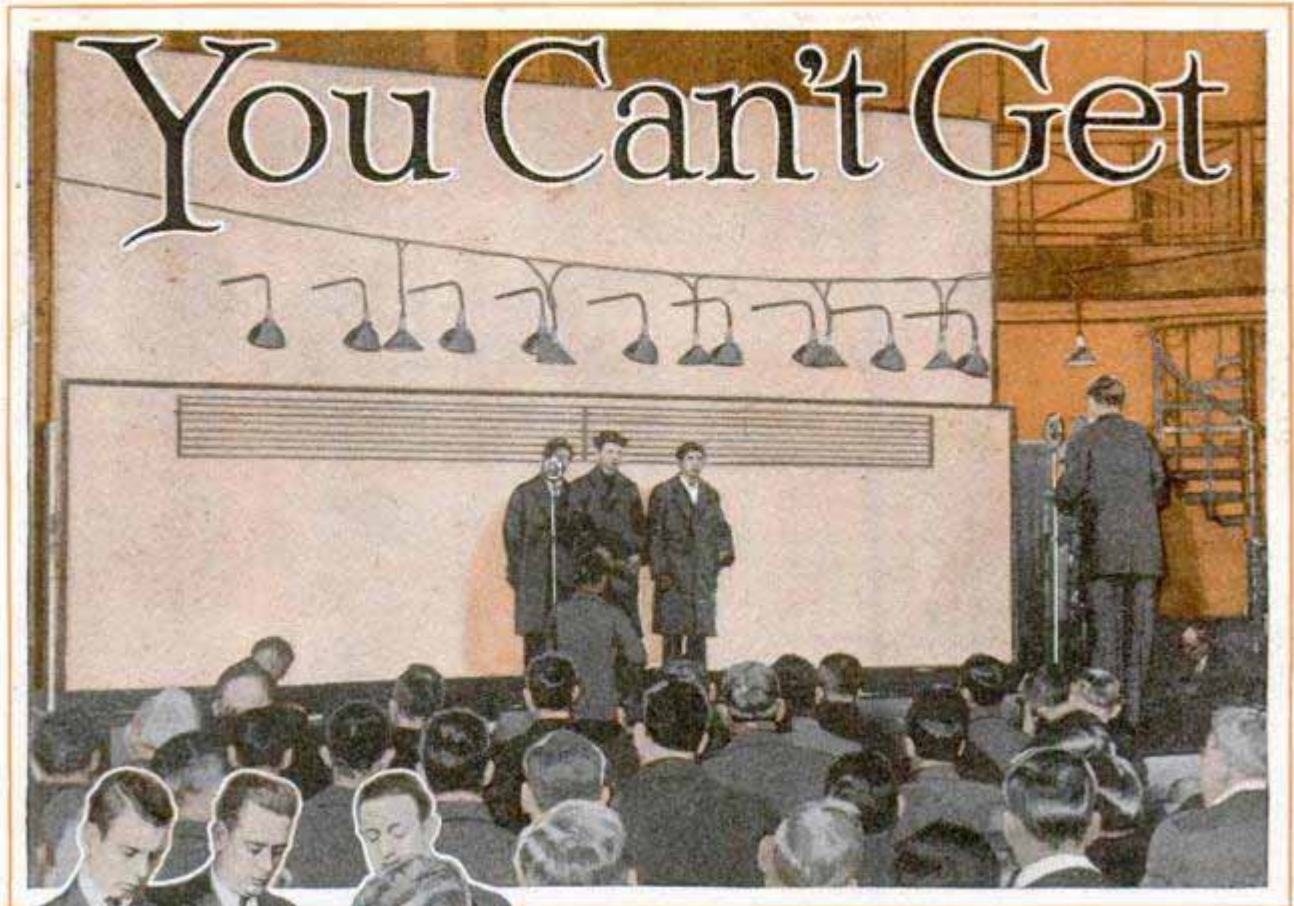

Police Viewing Suspects for Identification, and Coroner Herman N. Bundesen of Chicago Testing Machine-Gun Bullets

tion of crime, is fast becoming a veritable Nemesis to wrongdoers.

The defendant had been a long-term convict in the Massachusetts state prison. He became possessed of a revolver of the same caliber and type as those carried by the prison guards. One Sunday, while the convicts were returning to their cells after chapel exercises, the young prisoner attempted to shoot his way to freedom. Two guards returned his fire. One of them fell mortally wounded. The other winged the convict, who was subsequently subdued and disarmed. Shortly afterward, he was placed on trial for murder. His lawyers maintained that the guard was killed, not by the convict, but by his brother guard. They prepared charts, showing the position of each of the three combatants and demonstrated the possibility of their contention.

Then appeared one Wilbur F. Turner, an expert on guns and their ammunition, knives, handwriting, fingerprints and other details of criminal investigation. He submitted several photomicrographs taken by a camera equipped with a series

By JOHN F. COGGSWELL

16 Edgewood Road, Boston, Mass.

JUST a few weeks ago, an eastern man, convicted of slaying, was executed in the electric chair. Before the trial, he thought he had a defense that would arouse doubt in the mind of any juror, but it collapsed before evidence brought out by the photomicrograph camera, which, as an instrument for the detec-

Away With It

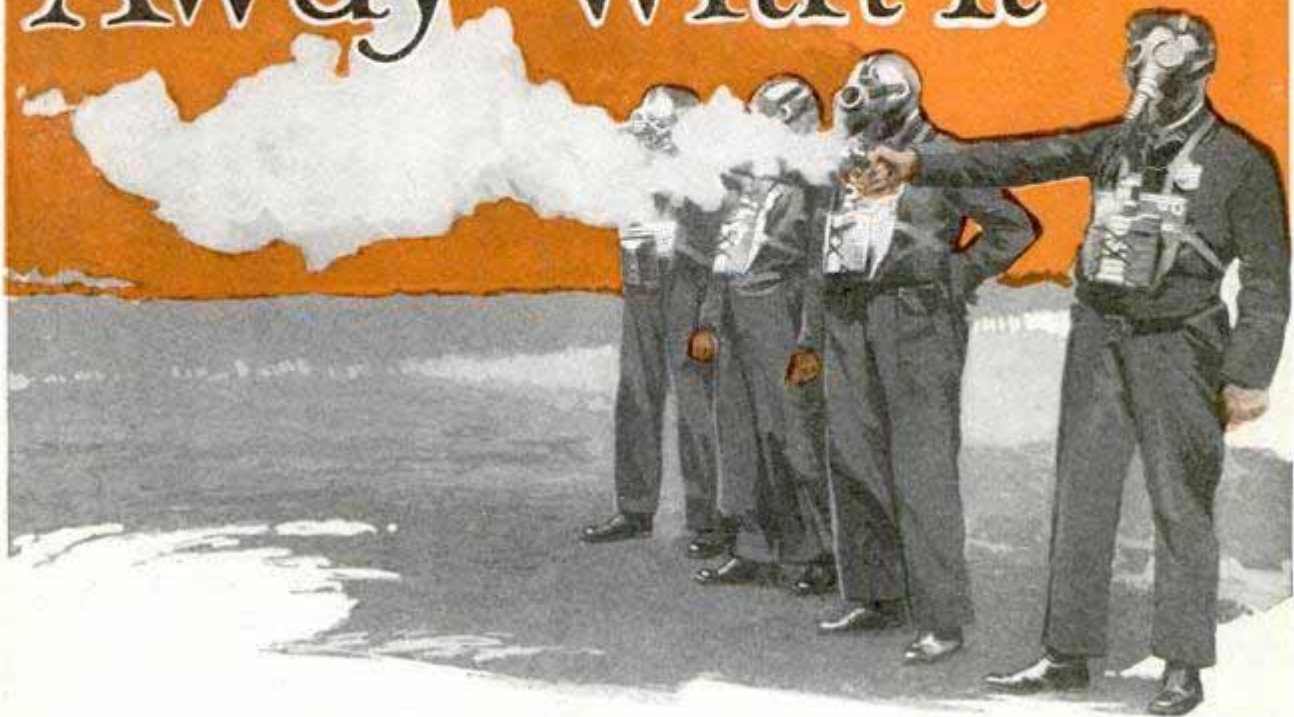

Emergency Squad, Attending Police College, Equipped with Gas Masks, Firing Tear-Gas Pistols Developed to Curb Criminals; the Weapons Are Effective at a Surprising Range

of lenses having the power to make, directly from the subject, pictures magnified anywhere from ten to several hundred diameters.

Turner's photomicrographs showed, side by side, the mortal bullet and missiles from the surviving guard's and the convict's guns, these being test projectiles fired after the crime. In these greatly magnified pictures the revolver bullets appeared nearly as large as those from small cannon.

The reproductions showed that the fatal bullet had been fired from a gun, whose rifling had a right-hand twist. The test projectile from the convict's gun showed this same direction of twist, but the guard's was exactly opposite—a left-hand twist. Furthermore, the test bullets from the convict's gun displayed certain characteristic markings, the beginnings of them also easily discernible on the mortal bullet, even though its nose had mushroomed somewhat. Markings on the test bullets from the guard's gun were entirely different.

In short, the photomicrographs proved conclusively that the fatal shot could not have come from the guard's gun and did

come from the convict's, so the defense crumbled and he went to the chair.

On bullets discharged from them, gun barrels leave markings as individual as are fingerprints. Two or two hundred projectiles fired from the same gun will show the same characteristics. On the other hand, bullets from different firearms—even though guns and ammunition are of the same caliber and make—are always marked differently. Infinitesimal flaws in the steel, variations of one ten-thousandth of an inch in the lands and grooves of the rifling, show up plainly visible in the photomicrographs of the projectile.

On the slope of a hill, close by the Canadian border, was found the body of an aged man, shot through the head. The murderer had covered the body with brush and bushes cut near by. Close to the corpse lay the victim's hat, two bullet holes through the rim. In the road below, stood his automobile.

The slain man and a farmer, upon whose place he held a mortgage soon due, had been seen to enter the car together and start up the road on which the machine was found. The farmer was suspected



of brush that had covered the body and broke off a few of the stubs from which they had been cut. These, with the hat and the bullet, he carried to his laboratory. The discharged shells could not be found.

The victim, he reported a few days later, had been climbing up the hill. A rifleman, some distance down the slope—at a point about sixteen feet lower vertically—had fired two shots at the mounting figure. The first was a miss and penetrated the rim of the hat. The startled man had ducked and turned to see who was shooting at him, when the second shot, fired closely after the first, killed him.

The slayer had used a .32-caliber rifle, likely a .32-40, using smokeless powder.

He was an expert shot in spite of his first miss. He possessed a large clasp knife that had been sharpened with a file. And he was left-handed. Subsequent developments proved the criminologist right in every detail.

Simple reasoning, a keen eye for angles, a set of accurate scales and the photomicrograph

of the crime and was taken into custody. The state's attorney called the expert criminologist into the case. The expert viewed the body, paying particular attention to the wound and a fragment of a bullet that had been probed from it. Then, taking the hat with him, he went to the scene of the crime. Obviously, the man had been slain where the body was found; the blood and the condition of the ferns and bushes proved that.

Imbedded in the bark of a near-by tree, Turner found a soft-nose bullet, part of it missing, its lead nose badly distorted, but a narrow strip of the steel jacket around the base still intact. It gave evidence of having passed through flesh before striking the tree.

After a careful survey of the scene, the expert gathered up some of the pieces

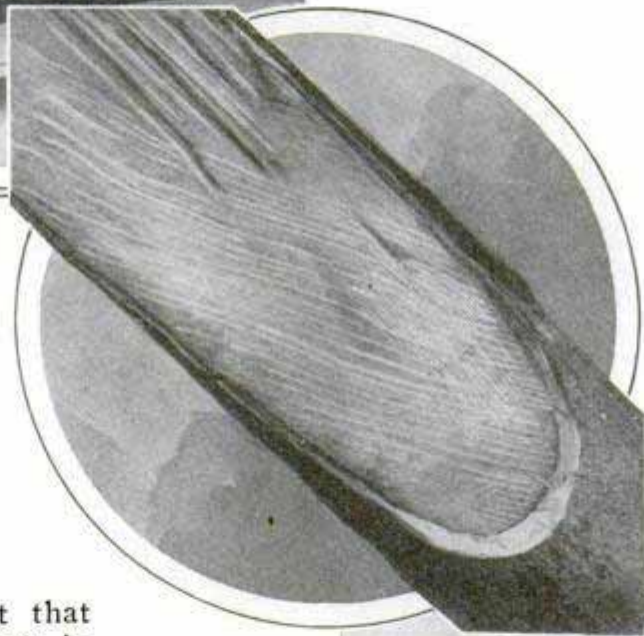

Photomicrographs by, Wilbur F. Turner
Loading Tear-Gas Bombs, and Two Important Photomicrographs; the Center One Shows Ridges in Severed Brush End That Figured in Murder Case, and, Below, the Marked Knife Blade That Made the Ridges

camera had given him the whole story. A Marlin .32-40 rifle, together with two empty shells and a part box of loaded ones, was found in the home of the accused man. A heavy knife, the marks of a file on its blade, was among the possessions taken from him when he was jailed. In addition, he was known to be left-

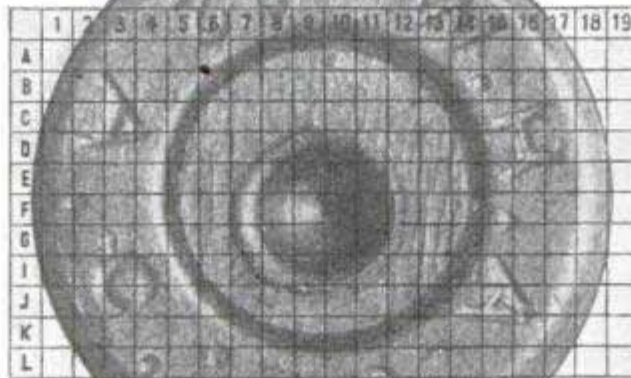
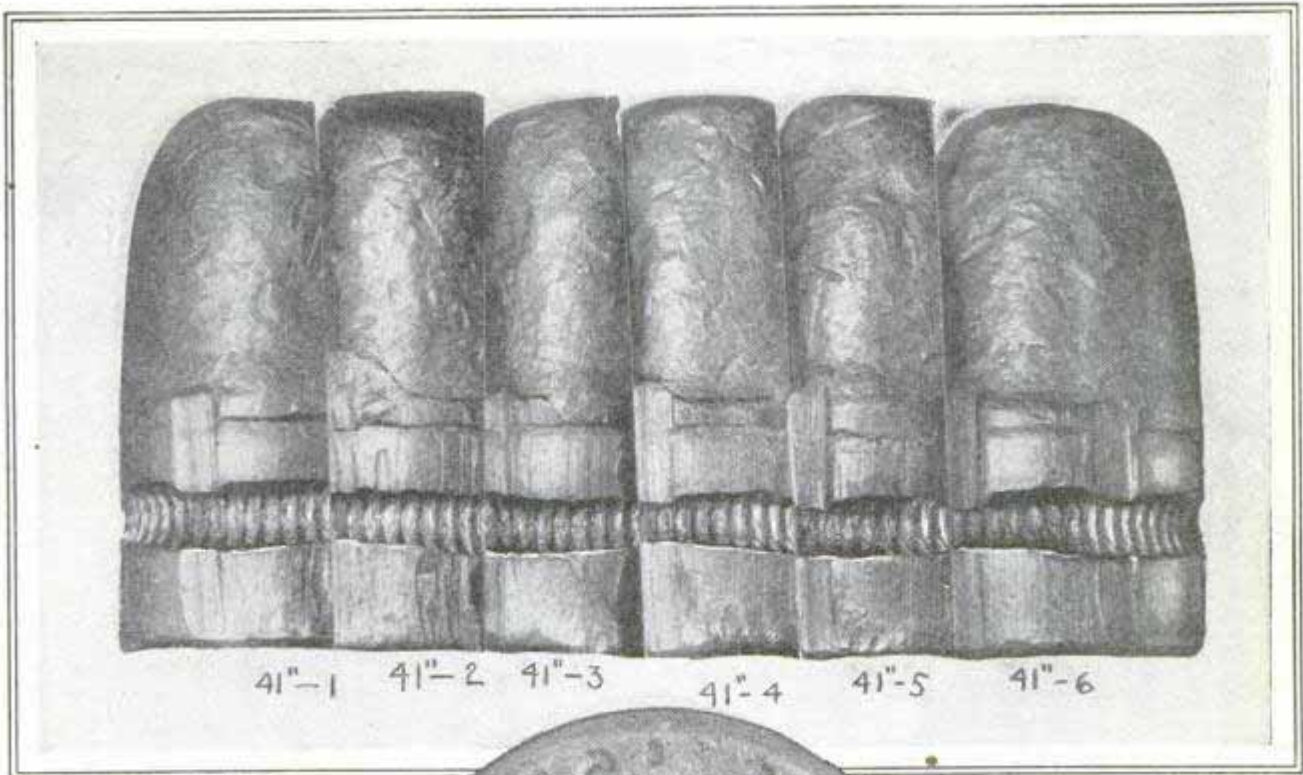

Photomicrographs by Wilbur F. Turner
 Above, Composite Photomicrograph of Six Sections of Entire Circumference of a Bullet; Below, Sectional Method of Studying and Comparing Shells

handed. His prowess as a hunter was legend.

Knife and rifle were forwarded to the expert. Back came his report that the rifle was the one that had fired the bullet found at the scene of the crime, and that the knife submitted was the one which had severed the saplings that covered the body. How could he possibly have arrived at these conclusions?

The murdered man's hat brim had been turned up at the back and front. Photomicrographs of the two holes in the brim showed, by direction of entry and exit, that both had been made by the same bullet. It had entered from the back and left through the front. The angle showed that it had been fired from a point directly behind the victim. The second shot, however, had entered his right eye and emerged through his left ear. Evidently, the man had not turned quickly enough to face the killer before the second shot had crashed home. None but an expert marksman could have ejected the

empty shell, pumped in a load and sped off the fatal bullet in such a short interval. Careful measurements and weighing of the recovered bullet and the fragment from the wound, had disclosed its caliber. Comparative photomicrographs of the rifling markings upon it and those upon a test bullet, fired after receipt

of the gun, linked the farmer's firearm and the mortal projectile.

Photomicrographs of the severed ends of the brushwood showed certain ridges in the wood—common to all—that had been left by minute nicks in the cutting blade. But the knife would have to be keen and heavy to sunder, at one slash, brush of the size cut. Logically, the nicks were not from use but from a sharpening device—hence a heavy knife sharpened by a file.

Anyone possessing a knife with a good-sized nick in the blade, can see for himself how the expert discovered that the slayer was left-handed. The ridge left in the

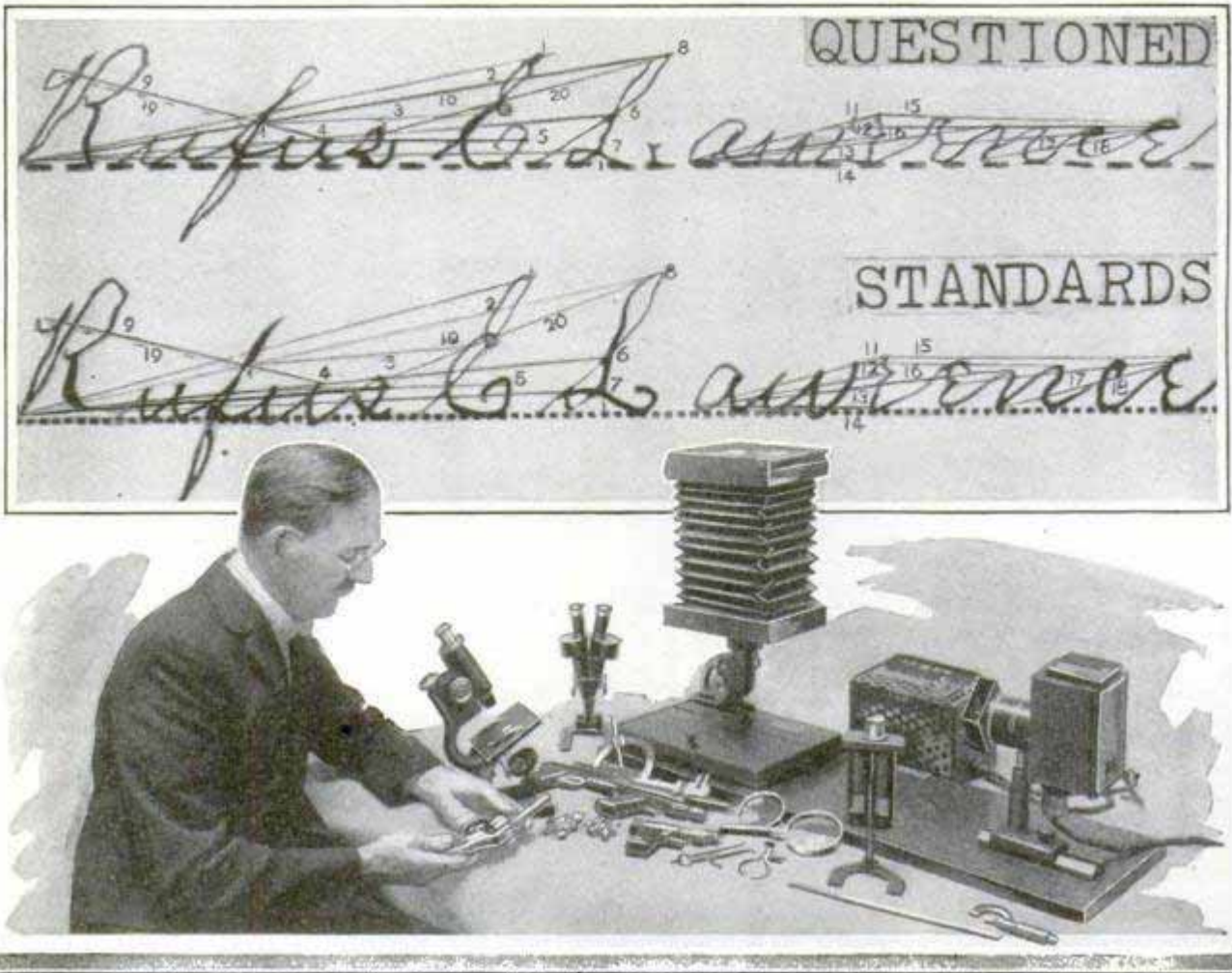

Photomicrograph by Wilbur F. Turner

The Upper Signature Is an Excellent Forgery of the Lower; Note Angles Drawn to Compare the Two; Below, an Investigator with Photomicrograph Camera and Other Aids, Used in Detecting Crime

wood by the nick will slant to the right, when the knife is held in the right hand and to the left if held in the left hand. In the case under consideration, the nicks were too small to produce ridges visible to the naked eye, but the photomicrograph camera made them apparent. Furthermore, when a reproduction of the knife blade—magnified to the same diameter—was placed against the magnified view of the cut ends of the brush, nicks fitted ridges precisely.

In the famous Sacco-Vanzetti case, a photomicrograph of the cap end of a discharged shell, found on the scene of the payroll robbery and murder, showed a flaw in the indentation made where the firing pin had hit the cap. The keen eye of the magnifying lens showed a corresponding nick in the firing pin of a revolver involved in the case—an important link in the evidence.

The most expert forgeries lose their resemblance to the genuine when both are

displayed side by side in their magnified form. Discrepancies in the size and form of letters and the angle of the script become evident.

The work of the best chemical-ink eradicator is exposed when an altered document is placed before the photomicrograph lens. Raised checks and notes, and modified clauses in legal papers, such as wills, are quickly proved fraudulent by the keen eye of the camera.

All of which gives additional weight to the old saying regarding crime: "You can't get away with it."

MONEY IN WALRUS WHISKERS REVEALED BY TAX REPORT

Queer occupations are listed by census officials. Among them is described the odd occupation of "Cinder Ella," an old woman who goes about the Wall street district of New York, earning small fees by removing dust from the eyes of the

brokers. In Virginia, there is a young woman who makes a fine living collecting shells on the beach and coloring and carving them as souvenirs. The occupation of tea taster is no longer unusual, nor is that of the professional ham smeller, who sticks a skewer into a ham in the meat-packing plant and can tell at once whether it has soured around the bone. It was an income-tax report that brought to light the profession of collecting and selling walrus moustaches. The collector, a resident of San Francisco, turns over a profit of \$7,000 a year in this business. When the government officials read his report, they became curious to learn about his market. He explained to them that among the Chinese in America there is a great demand for the bristles, which are made into ornamental toothpicks by Chinese artisans and sold for curiosities, gifts or souvenirs. But the occupation of time selling by an individual is a new one to this country. Americans can buy the correct time in almost any city by calling up the telephone or telegraph company. In London, however, in the industrial section, the correct time is purveyed by an old woman. She has London's quaintest job. Every day she visits the Greenwich observatory and sets her famous old watch, which is more than a century old, and which was once owned by the Duke of Sussex. This watch, it is said, keeps perfect time. When she has had it set she returns to make her rounds.



Photo Topical Press

Traveling Skids on Rollers Attached to Lifeboat Which Prevent the Boat from Overturning While Being Launched as a Ship Lists

diff, South Wales. It has happened in the case of recent wrecks, that the heavy list joined to high seas and rough winds, has overturned the ship's lifeboat, hanging suspended from the davits between wind and water, and has spilled passengers and crew into the raging seas, drowning even the strongest swimmers. By the new device, the lifeboat has two traveling skids, with caster wheels attached to its keel by the bow and aft. When the sinking ship is listing too heavily for the lifeboat to be launched in the ordinary way from the davits, a strong rope and pulley are attached to the davit on the deck of the liner and connected up with the bow of the lifeboat, which is then slid on the traveling skids down the sloping hull.

Ready Jan 1, 1931.
**THIS SHOTGUN HAS ONE BARREL
 195 ON TOP OF OTHER**

Double-barrel shotguns with one barrel on top of the other, instead of beside it, are being placed in production as the result of the invention of a Utah man. The gun with its superimposed barrels has but one trigger which fires one barrel at a time. It is intended primarily for sporting purposes.

*J. M. Browning Utah
 Claden*

**SAFE LAUNCHING OF LIFEBOAT
 ASSURED BY SKIDS 4041**

To save life and avoid the frequent tragedies occurring when a lifeboat is launched down the side of a wrecked liner's hull listing at a dangerous angle, a device was recently demonstrated in the port of Car-

*Com. H. J. Wilkins Esq
 Colombarie 29 Beau Road*

*Browning Arms
 Co. Large Detachable
 Magazine*

"HIDES" FOR LIQUOR TEST SKILL OF DETECTIVES

*Cont. John D. Caggswell
16 Edgewood Road
Cleveland Mass*

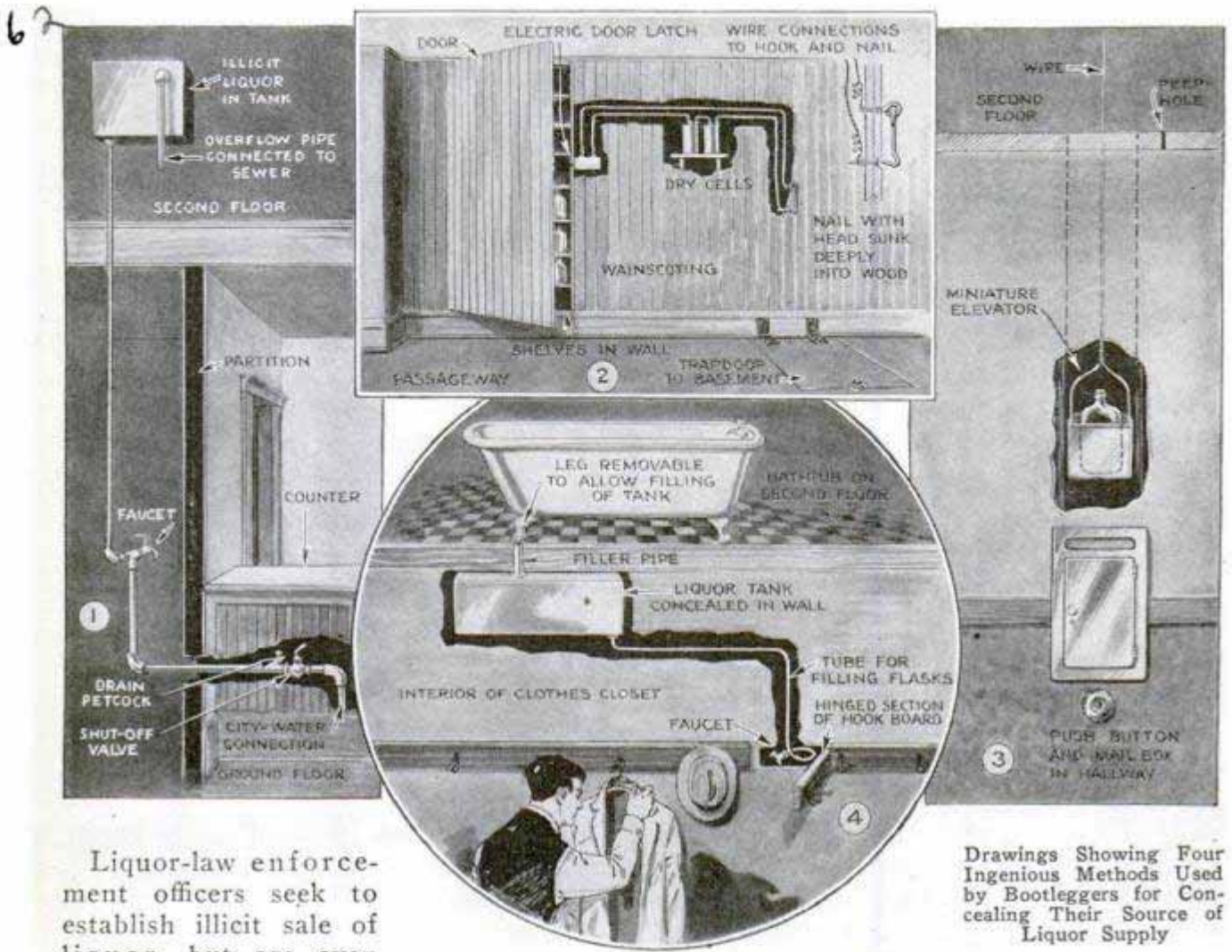

Drawings Showing Four Ingenious Methods Used by Bootleggers for Concealing Their Source of Liquor Supply

Liquor-law enforcement officers seek to establish illicit sale of liquor, but are even more keen to locate the bootlegger's "hide"—the place where he secretes his supplies. Many of these hides indicate real mechanical ingenuity. Illustration No. 1: Enforcement officers call this the most ingenious hide that they have unmasked. It embodied the two prime essentials desired by purveyors of illicit beverages. First, the liquor, although stored at a point remote from the place of sale, was easily accessible to fill orders, and, second, it could be disposed of quickly in case of a raid. When the shut-off valve was closed, the water from the upstairs tank and the connecting pipe flowed off through the drain petcock, which was afterward plugged. Then the tank was filled with liquor, which was drawn off into flasks through the faucet behind the partition. In the event of a raid, the shut-off valve was opened, allowing the city water to rush up through the pipe into the tank, carrying the liquor before it out

through the overflow pipe into the sewer, whereupon the faucet ran clear water instead of liquor.

Illustration No. 2: Raid after raid failed to reveal the hide in a city drug store, where officers were certain illicit liquor sales were being made. Connecting the main store with a stockroom in the rear, was a narrow passageway, both walls wainscoted from baseboard to ceiling. Part way down the passage was a trapdoor, held up, when open, by a steel hook, screwed into the wainscot. A nail had been driven through the boards, its head imbedded deeply in the wood, in such a position that the point of the hook could just touch it. Wires connected the end of the nail and the screw of the hook with a pair of dry batteries and an electric door latch, concealed behind the wainscot. Making contact of the point of the hook and the head of the nail closed the circuit and released the latch, allowing

The Umby Corp.

129

35 W. 19th St

UMBRELLA WITHOUT A FRAME
FOLDS LIKE ENVELOPE

New York City

Umbrellas without frames that fold like an envelope so they may be carried under

a section of the boards to swing out. Behind the section were shelves, stocked with illicit liquor.

Illustration No. 3: A customer of a bootlegger, located on the second floor of an apartment block, signaled the liquor dispenser by pressing the electric bell button in the corridor. If inspection, from a peephole drilled through the floor and ceiling, revealed that all was well, the illicit purveyor lowered a miniature elevator box down a shaft concealed in the wall and connected with the mail box. Opening the door of the box, the customer placed a bill in the elevator, which on its return trip carried down to him a filled flask.

Illustration No. 4: Opening off a small restaurant, was a clothes closet, every hook in which was hung with various pieces of wearing apparel. A small section of the hook board could be swung outward. In a recess, behind the section, was the end of a tube, fitted with a tiny faucet. From it flasks were filled, on order, with liquor stored in a copper tank concealed in the wall. The pipe through which the tank was filled was concealed beneath a removable leg of the bathtub located on the second floor.



Wied. Wolla

The "Umby," an Umbrella without Ribs or Handle, Which Folds Like an Envelope for Carrying

the arm or in the pocket when not in use, are handed out to patrons of a chain of New York theaters on rainy days. The rain protector, known as an "umby," has neither ribs nor handle, is made from a material which turns water, is set on the head and held in place with the hand. It covers head and shoulders and, when in use, somewhat resembles the newspaper frequently employed by persons caught in a sudden shower.

ELECTRIC HOT-WATER HEATER FOR THE FARM HOME 43

Designed particularly for rural and suburban homes, wired for electricity but without modern means of obtaining a supply of hot water, an electrically operated hot-water tank now is on the market. The tanks, of sixty or 120 gallons capacity, are covered with balsam wool, the heating elements being so arranged that they may be removed without disturbing the plumbing. The elements are not affected by hard water, and tests have shown operation of the heater is possible at moderate cost, while the first cost compares favorably with other plants.

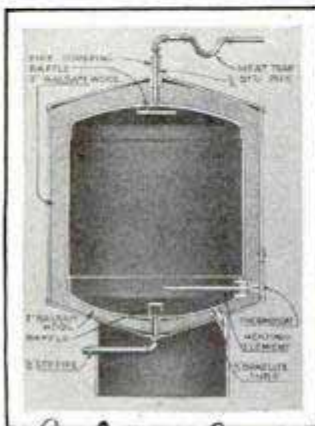

TALC USED FOR FACE POWDER HELPS KILL GRAIN PEST 417

Talc, which is the base of face powders, assumes a new role in the campaign of science against a disease that destroys barley. Iowa state agricultural-experiment station workers are employing it in the manufacture of a dust applied to combat the disease. The talc is the carrier for a poison mixture which is composed of bicarbonate of soda, sodium bisulphite and other chemicals calculated to check the spreading of the pest.

Chas Edison Co, Springfield, Ohio

Mr. C. S. Reddy and Mr. L. C. Burnett

When *the* Ocean

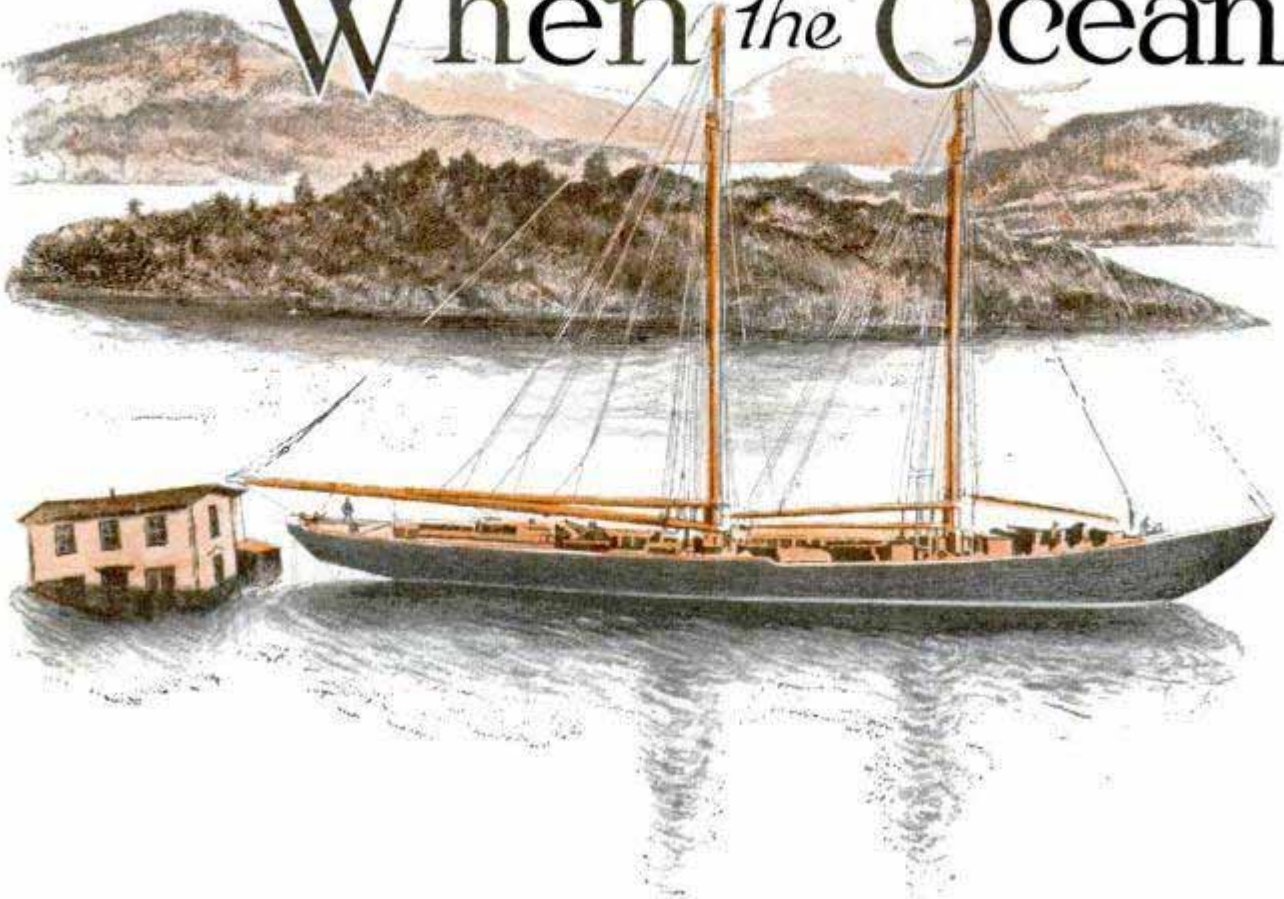

Fishing Schooner Towing into Harbor a Two-Story House Which Had Been Swept Five Miles Out to Sea by the Recent Newfoundland Tidal Wave Which Took a Toll of Many Lives

By CHARLES FITZHUGH TALMAN

The Picogram
Co. Box 840, Washington, D. C.

AN EARTHQUAKE strong enough to cause some alarm, but not to do any immediate damage, shook New York state, New England and eastern Canada late last fall. Records of this quake were obtained by seismographs at points as far distant from one another as Victoria, B. C., Tucson, Ariz., and West Bromwich, England. The reports from these places and others, promptly collected by international arrangements, were examined and the center of the disturbance located under the Atlantic ocean about 120 miles south of Newfoundland.

An interesting sequel of this event remained unknown to the world at large for three days. Owing to a local interruption of telegraph service, it was not until several days later that press dispatches reported the occurrence of a destructive tidal wave along the shore of the Burin peninsula, in southern Newfoundland, causing loss of life and much destruction.

What happened in that region for the

first time in its history has often happened on seacoasts in other parts of the globe. The ocean suddenly invaded the land in a series of great waves, which, crowding into narrow inlets, rose forty to fifty feet above the normal level of the sea. Many ships were wrecked, buildings were lifted from their foundations and some were carried out to sea as the waters receded. A serious blow was dealt to the fishing industry upon which the locality depends for a livelihood, as the waves destroyed boats and tackle and swept away storehouses containing the season's catch.

The scientist will tell you that this disaster was not due to a tidal wave. In a narrow and proper sense of the term, a tidal wave is one of a somewhat complex series of waves that constantly travel around the globe under the gravitational pull of the moon and the sun, causing the waters on our coasts to ebb and flow twice a day. These moderate upliftings of the ocean surface are so gradual in their slope

Floor Quakes

that they bear no resemblance to waves except in the diagrams published in reference books.

For the present purpose, however, we shall follow familiar usage and describe as "tidal waves" the occasional upheavals of the ocean and inundations of the shore that occur without any relation to ordinary tides and are often very disastrous in their effects. They appeal to the imagination of mankind, because, in many cases, they arrive in calm weather and their cause is not obvious to casual observation, but there is no real mystery about them. They are sometimes produced by storms, near or distant; sometimes by earthquakes, and occasionally by volcanic outbreaks under the sea.

It is not a sufficient explanation of the recent tidal wave in Newfoundland to say that it was due to an earthquake. Many severe earthquakes under or near the ocean are followed by no marked disturbance of its waters. It is only when a quake causes a subsidence of the sea bottom over a considerable area that the resulting displacement of a large body of water sets up waves at the surface. The first effect of subsidence is an inrush of water from all sides, which explains the withdrawal from near-by shores that is often observed to precede an earthquake. When the inflowing currents meet over the place of subsidence their impact raises a mound of water that is, so to speak, the parent of the tidal wave. When this mound collapses, waves spread out from it in an ever-widening circle, flowing over neighboring shores. The mound

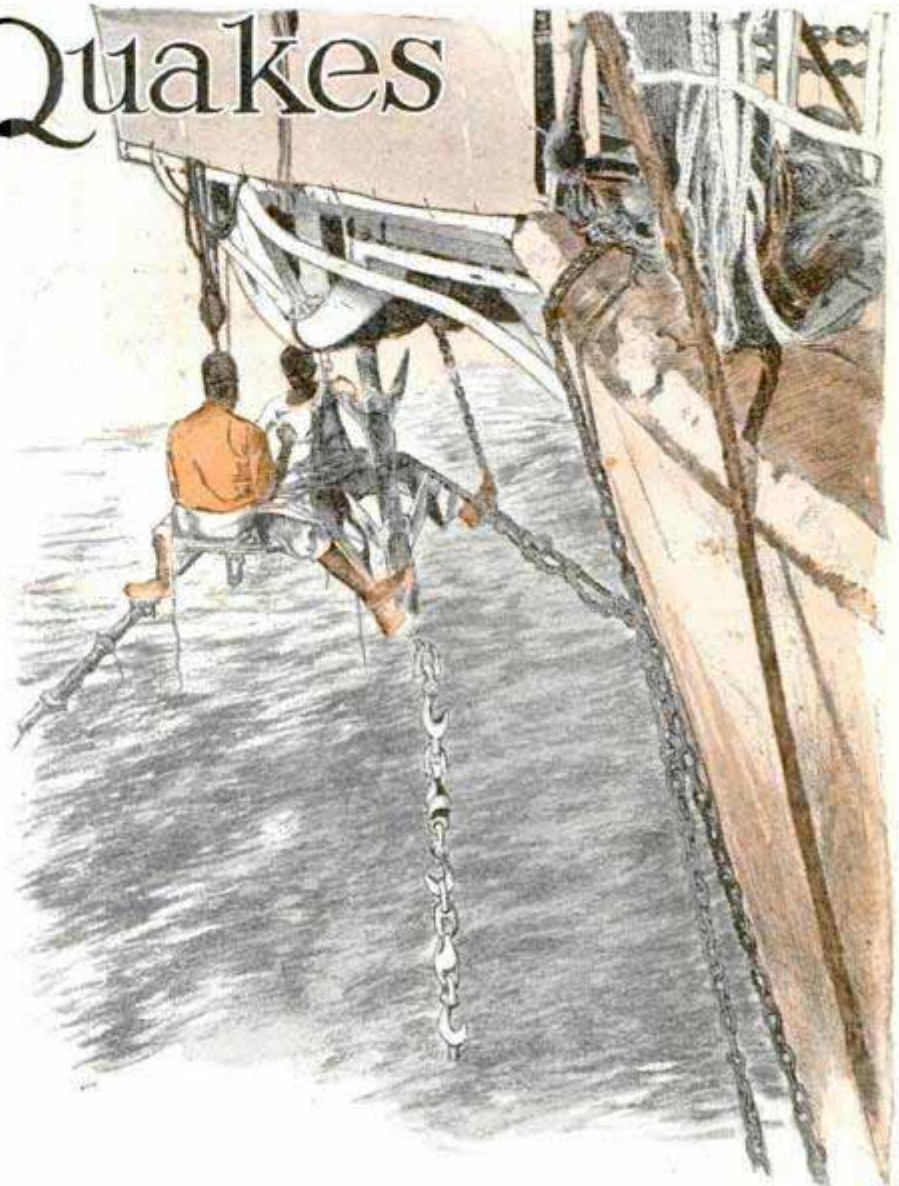

Cutting a Broken Cable with Hacksaws before Heaving the Ends Aboard for Testing; Grappels Are Shown Suspended from the Bow Sheaves

gives place to a depression, the waters flow in again, and the process is repeated until equilibrium is restored.

The sinking of the sea bottom that produces such waves is due in some cases to slipping along a "fault," such as is often observed in earthquakes on dry land, when the ground on one side of a break drops many feet below its previous level. Other subsidences under the sea consist of landslides along the steep faces of gigantic submarine cliffs. Many such cliffs are well known to hydrographers and others are constantly being discovered through the rapid survey of the ocean floor now being carried out by acoustic methods of sounding.

That there was a considerable sinking of the ocean bed in the November earthquake is proved by the fact that the trans-

atlantic cables broke at several points at the time of the shocks. The location of these breaks corresponds in a general way with the western border of the deep channel leading out of Cabot strait. Here the shape of the bottom is favorable to the occurrence of extensive landslides under the shaking of an earthquake, and, pending further investigations, it may plausibly be assumed that such slides caused the tidal wave.

Submarine cables are often broken by earthquakes, and the location of a break can be promptly determined on shore by a process that consists in measuring the electrical resistance of the line up to the point where it has parted. Thus there is little delay in getting a repair ship to the spot and restoring service. This information does not help in locating the earthquake itself, because the subsidence causing the break may occur hundreds of miles

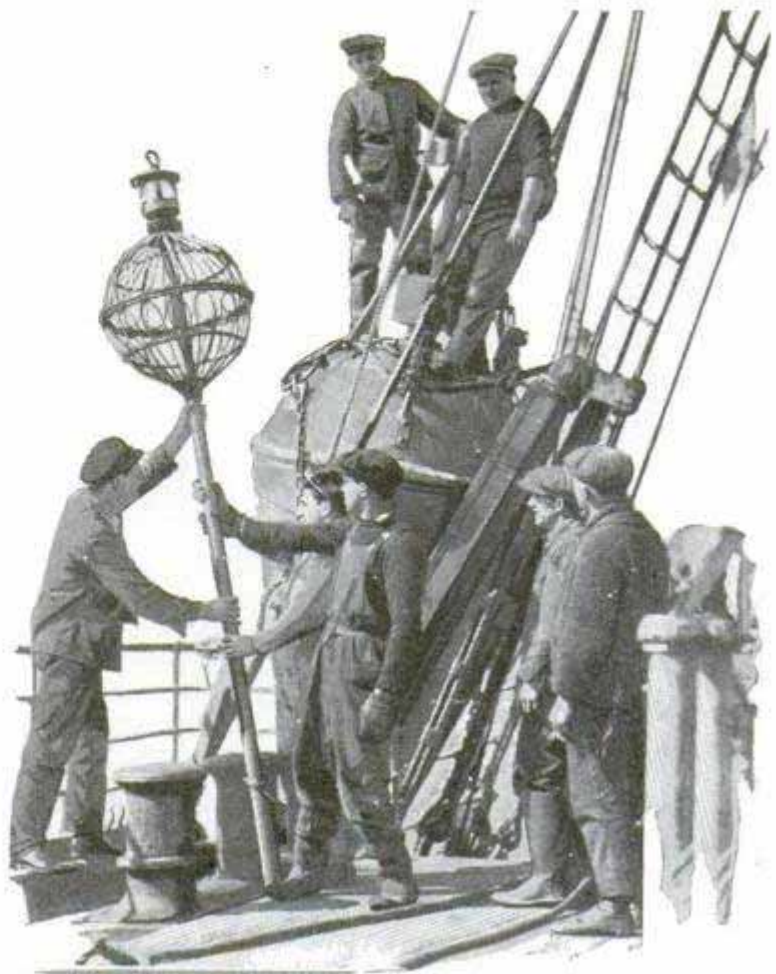

away, but it does indicate the point of origin of the tidal wave, and thus it might, in some cases, make possible the issue of timely warnings to the inhabitants of coasts likely to be engulfed.

The feat of predicting a tidal wave in time to save life and property has already been accomplished. At the Hawaiian Volcano Observatory on the morning of Feb. 3, 1923, the earthquake recorders in the basement told of a quake 2,000 miles away. Doctor Jaggar, the director of the institution, knows the Pacific well and he realized that big waves from the disturbed area would roll across to the Hawaiian shores. Warnings were sent out by tele-

Top, Rigging On a Mark Buoy of One of the Veteran Cable-Repair Ships;
Below, Repairing a Broken Cable After It Has Been Raised

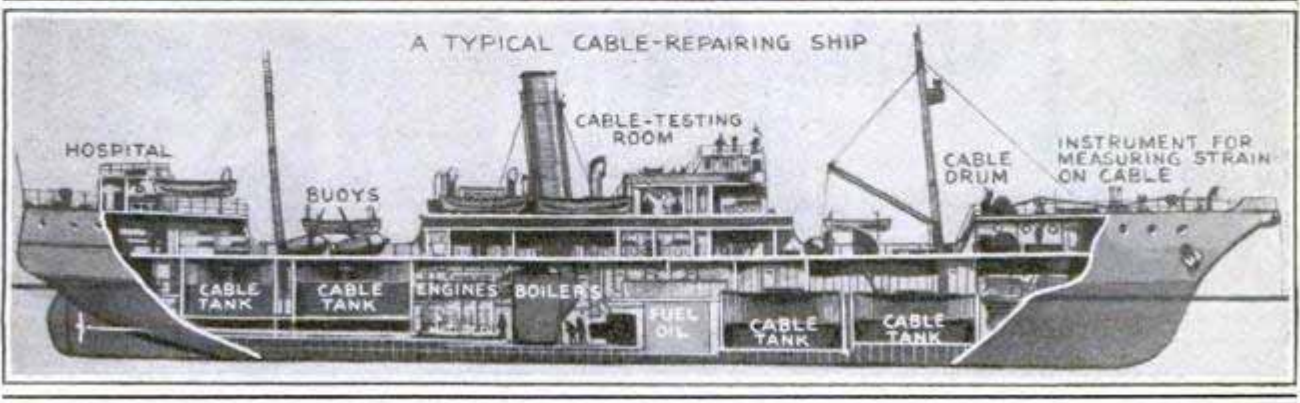
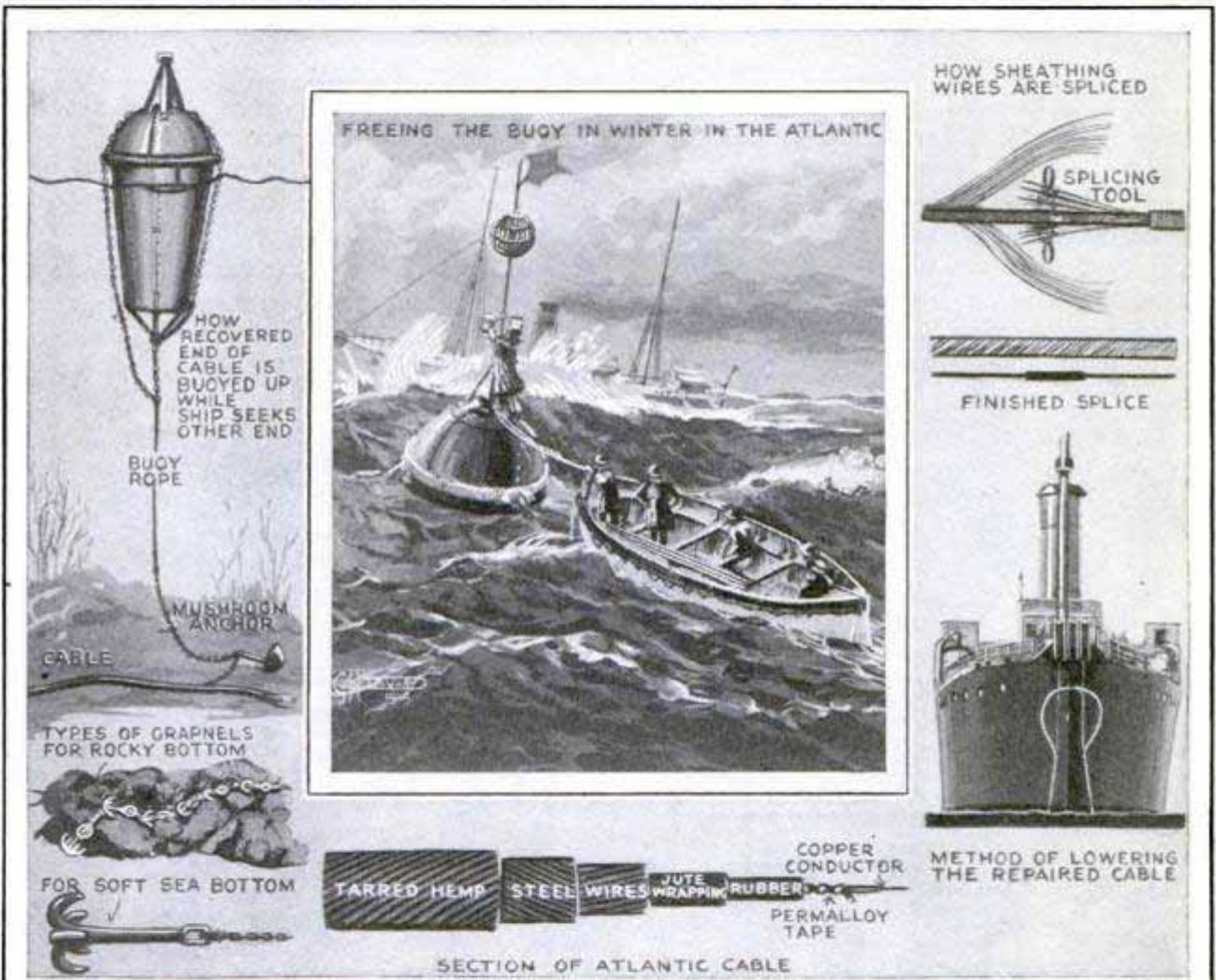
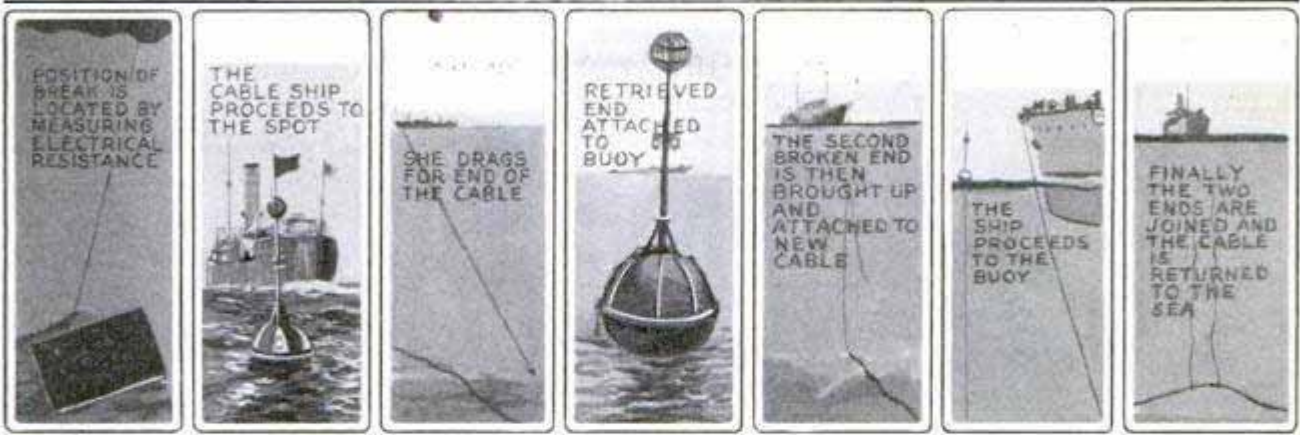

3964
622

phone. In the early afternoon the tidal wave arrived. It washed sampans over the railroad bridge at Hilo, wrecked the latter and killed one man, but the disaster was small compared to what it would have been if no warning had been given.

The Lisbon earthquake, of 1755, was attended by the most celebrated tidal wave in history. The center of the quake was under the Atlantic. The shocks threw down almost the entire city, but a large proportion of the loss of life (variously estimated at from 20,000 to 100,000) was due to sea waves. When the quake began, the water retired from the land to such an extent that the bar at the mouth of the Tagus was left completely bare, but it returned a few minutes later as a series of waves, the first of which was sixty feet in height.

The great earthquake that destroyed the city of Lima, Peru, on Oct. 28, 1724, was accompanied by a huge tidal wave at the neighboring port of Callao, where the water first receded and then returned

as a wave eighty feet high. Nineteen ships were sunk in the harbor.

Volcanic eruptions and uprisings under the sea sometimes cause tidal waves, but, on the other hand, the most gigantic outbreaks from craters above sea level and close to the ocean usually leave the latter undisturbed. The tidal waves that frequently flood low shores during the passage of severe storms are due chiefly to the mere force of the wind, but partly also to the elevation of the ocean surface at the storm center under the diminished pressure of the atmosphere, and partly, in the case of the relatively small cyclones of the tropics, to the heaping up of the water by the convergence of the winds toward the center. As the winds may blow at high speed around the center while the storm as a whole moves slowly, the waves produced by the winds frequently travel far beyond the storm-area. Thus it happens that a rising sea is a usual premonitory sign of an approaching tropical hurricane.

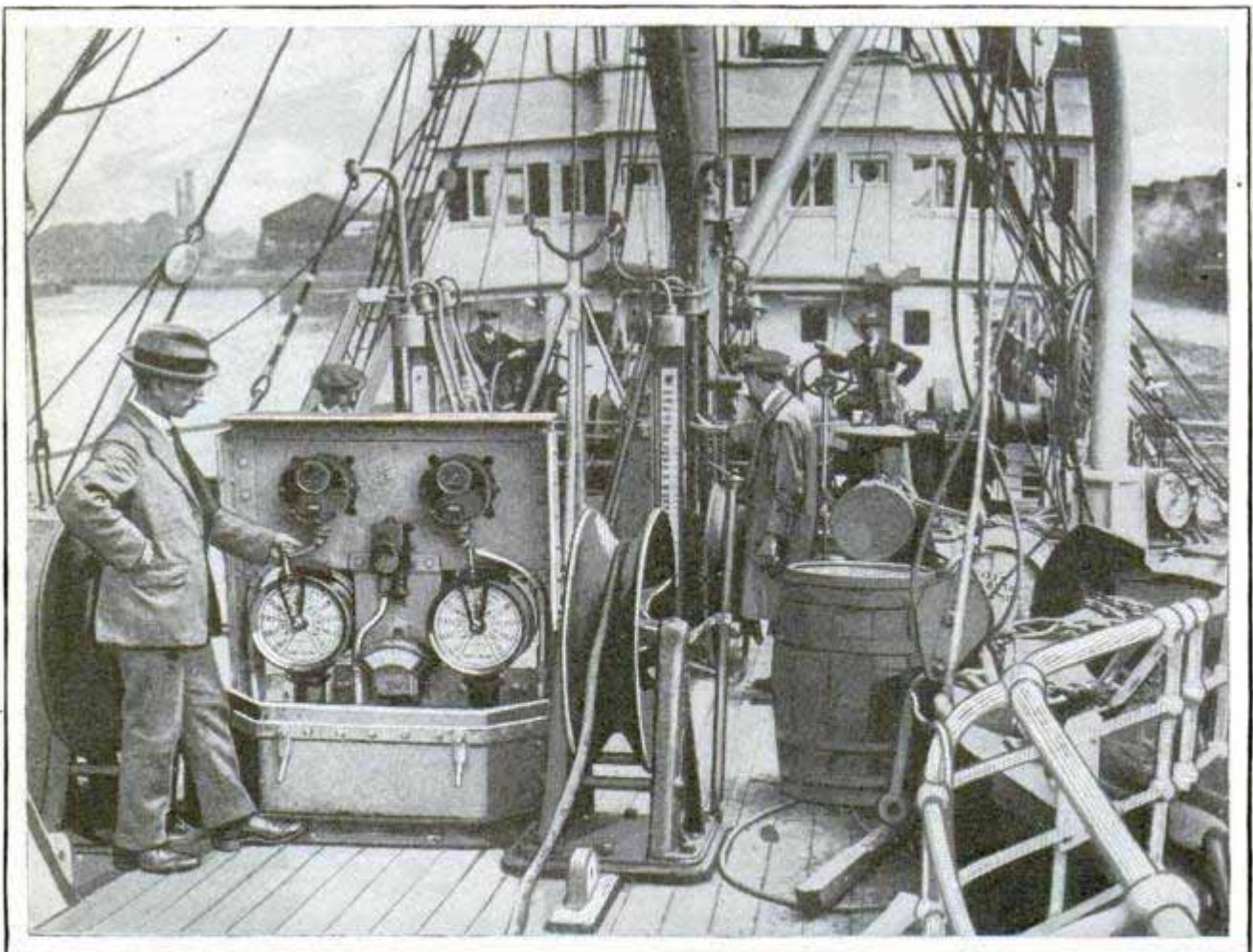

Equipment on the Deck of a Cable-Laying Ship Which Controls the Paying Out of a Cable, a Task Requiring Much Skill and Care

461-03
1/2(130)
Service News Bulletin
Science
Tworstout Thumb Tack & Metalcast

Longer method developed in France

106

STUDENT AVIATORS FLY BLIND 151

Just as typists are taught to write by touch, so students in some French flying schools are learning to fly entirely by the "feel," or sensation obtained from looking at the instrument board. The student flyer's compartment from the beginning is completely hooded, the instructor communicating with him by phone from another cockpit when he makes an error. One student on his ninth flight became hopelessly lost in clouds while flying by personal impression after learning to fly by feel, but quickly overcame his difficulty when he reverted to the instrument method.

THUMB TACK REMOVED EASILY BY TWISTING HEAD 10

Thumbtacks that are pushed into position, but twisted out easily now are on the market. The tack has two slots in the flat head for the nails of the thumb and forefinger to secure a twisting leverage. Removing the ordinary tack often results in damage to valuable drawings as well as loss of time, both these objectionable features being eliminated with the new tack.

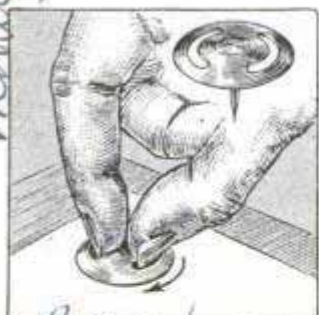

TIN IN BELLS SOFTENS TONE 10

Whistles and bells may be made less disturbing in the noise and din of large cities by using more tin in their manufacture, a British metal expert has found. A fine bronze, containing twenty-five per cent of tin, was found to produce a softer tone less offensive to the ears than sounding apparatus made of brasses or of bronze containing less tin. The tin also gives bells fine ringing notes.

Es. C. Harro, before British Institute of Foundry

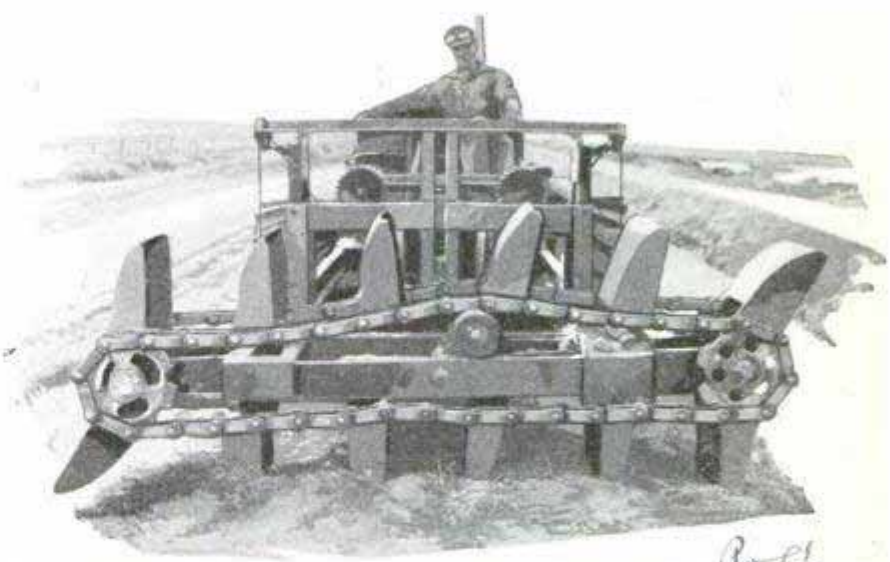

Rotary Grader Used to Reclaim Farm Lands Laid Waste by Floods; the Shovels Move at Right Angles to the Path of the Machine

ROTARY GRADER LEVELS LAND FOR FARMING PURPOSES

As a means of reclaiming valuable farming lands in the west that were laid waste years ago by the Colorado river, a rotary grader has been built and placed in operation in the territory. The shovels of the grader move at right angles to the path of the machine, leveling banks and filling in ditches so that the agricultural implement always travels on smooth ground. It has been found valuable in leveling the damaged territory.

ELECTRIC SPRAY SAVES TIME LABOR AND PAINT 121

Designed for both home and shop work, an electric spraying unit now is on the market that shoots paint, varnish, lacquer, bronze or enamel. The spray gun is attached to an air hose which in turn is fastened to a rotary air compressor. Filling the air gun, attaching the equipment to a light socket and pressing the trigger in the grip handle are the only operations necessary to begin work. It sprays a coat of paint from one to six inches wide and is particularly adapted to refinishing damaged surfaces.



\$ 39.50

Metal & specialties Co, 338 N. Kedzie Ave

from Selfridge Field

84

ELECTRICALLY HEATED FACE MASKS FOR PILOTS

and tri-motored air transports participated in a "fight" over a 3,500-mile battle front extending from Detroit, Mich., to Spokane, Wash. Every modern device for the comfort and safety of the pilots flying in zero temperature was used. Pursuit planes were equipped with skis for landings on

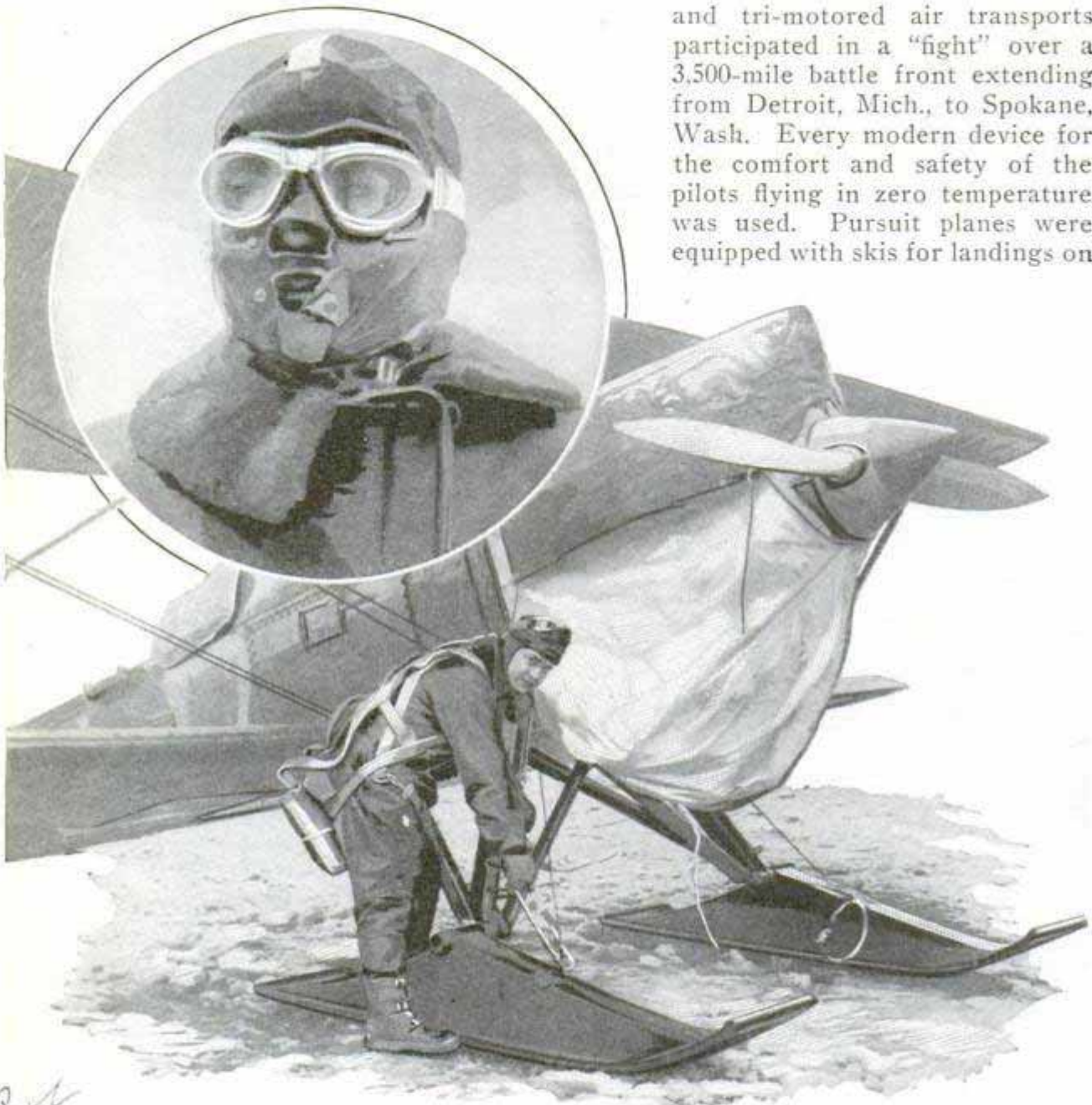

Top, Electrically Heated Face Mask and Goggles for Pilot Flying in Zero Weather; Below, Plane on Skis Equipped with Canvas-Covered Heating Element to Keep the Engine Warm

First attempts of the United States army to engage a large air fleet in mock warfare under subarctic weather conditions were undertaken by the "arctic patrol" in which twenty pursuit planes

ice-coated fields, and a canvas covering about the engine held a chemical heating element to keep the motor warm when inactive. Electrically heated face masks and goggles were worn by the flyers.

SOLID TIRES HAVE BLOWOUTS

Solid truck tires sometimes suffer from blowouts similar to those affecting pneumatic tires. Such blowouts are caused by the collecting of air at a spot where the tire has separated from the steel rim

on which it is built. The air bubble, expanding from heat or as a result of the thinning of the rubber by wear, causes the damage.

☐ Mexican shrimp are being brought to Los Angeles in "refrigerator" planes.

147

Cml. Walter E Burton
1922 Florida at Kenmore

ATLANTIC BLUE RIBBON SOUGHT BY CANADA

The next holder of the blue ribbon of the Atlantic may easily be a Canadian ship, in the opinion of experts, thus introducing a "dark horse" into the race. German, English and Italian builders are agreed that it is not impossible to produce a ship with a service speed of thirty-one to thirty-three knots, which would enable crossing of the Atlantic in four days. Such a ship need not be of more than 30,000 to 35,000 tons' displacement. Experts are not agreed, however, on the type of machinery that would be most economical, although it is implied that none of them greatly favor Diesel drive, since an excessive number of cylinders would be required, and vibration would be a factor. The most practical immediate proposition is the geared turbine, such as is used in the "Bremen." The "Empress of Britain," now being built in England for the Canadian Pacific line and the Canadian entry in the ocean championship, also has this type of drive. Another ship of this line, the "Empress of France," recently accomplished the fastest voyage on record from Hongkong to Liverpool. The distance of 10,000 miles was covered in twenty-two days, steaming 455 miles per day.

24

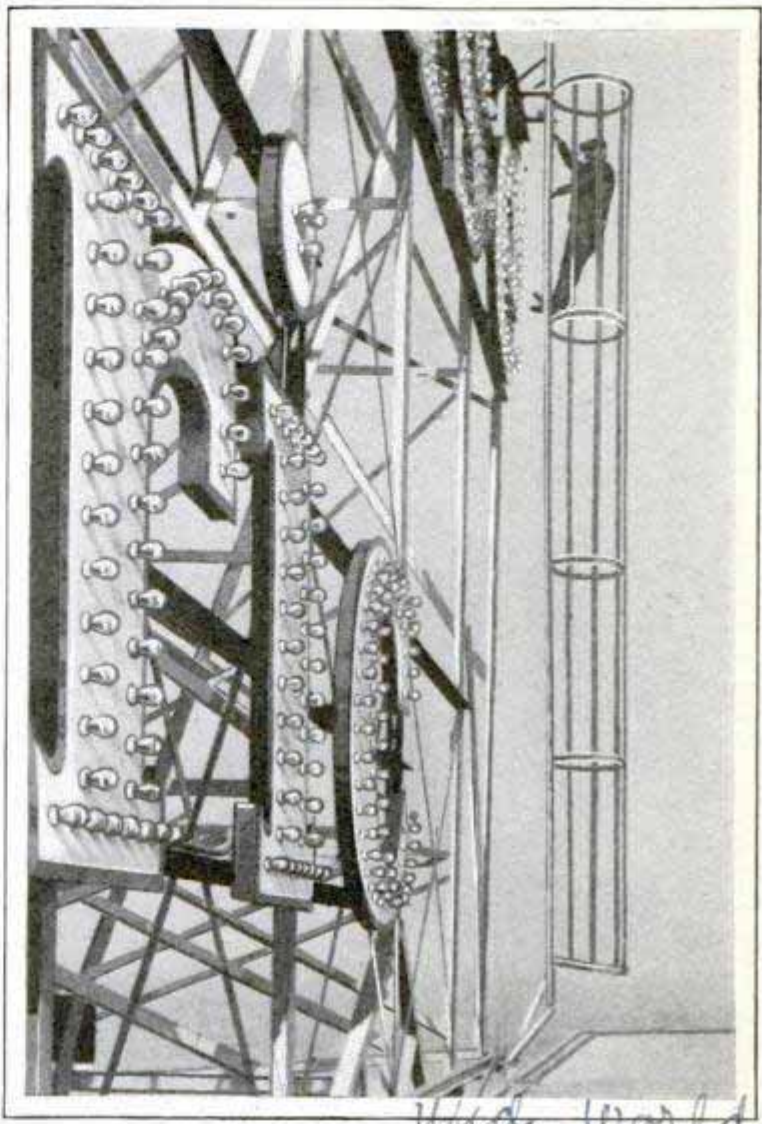

Mid World
Cage Ladder Which Insures Safety of the Men Who Keep the 1,400 Bulbs in This Electric Sign in Operation

CAGE LADDER FOR SIGN WORKER INSURES SAFETY

As a safety measure, a cage ladder has been installed as part of the equipment for the maintenance of a huge electric sign over the Cleveland foundry of the Westinghouse Electric and Manufacturing company. The cage operates along the 100-foot width of the sign, the electrician in charge of maintaining the 1,400 lamps having ready access to any part of the sign when he crawls inside the cage and manipulates the ladder along its face. The sign itself is unusual in that it is entirely arc-welded, not a bolt or nut being used in fabricating the fourteen tons of steel. Electric welding was employed to enable the sign to withstand the strain of gales from Lake Erie, only a few hundred yards distant. The letters themselves are more than twelve feet high.

OFFSET DRILL ATTACHMENT REACHES ODD PLACES

For drilling in small apertures not easily accessible, an offset drill attachment now is available. It consists of an aluminum body with phosphor-bronze head in which the gears are inclosed, and has a thrust bearing on each shaft. The driving gear is of hardened steel and the driven gear of hardened bronze.



The driving gear is of hardened steel and the driven gear of hardened bronze.

Fowler's Garage Equipment Co. Inc. Maine

If We Had *the*

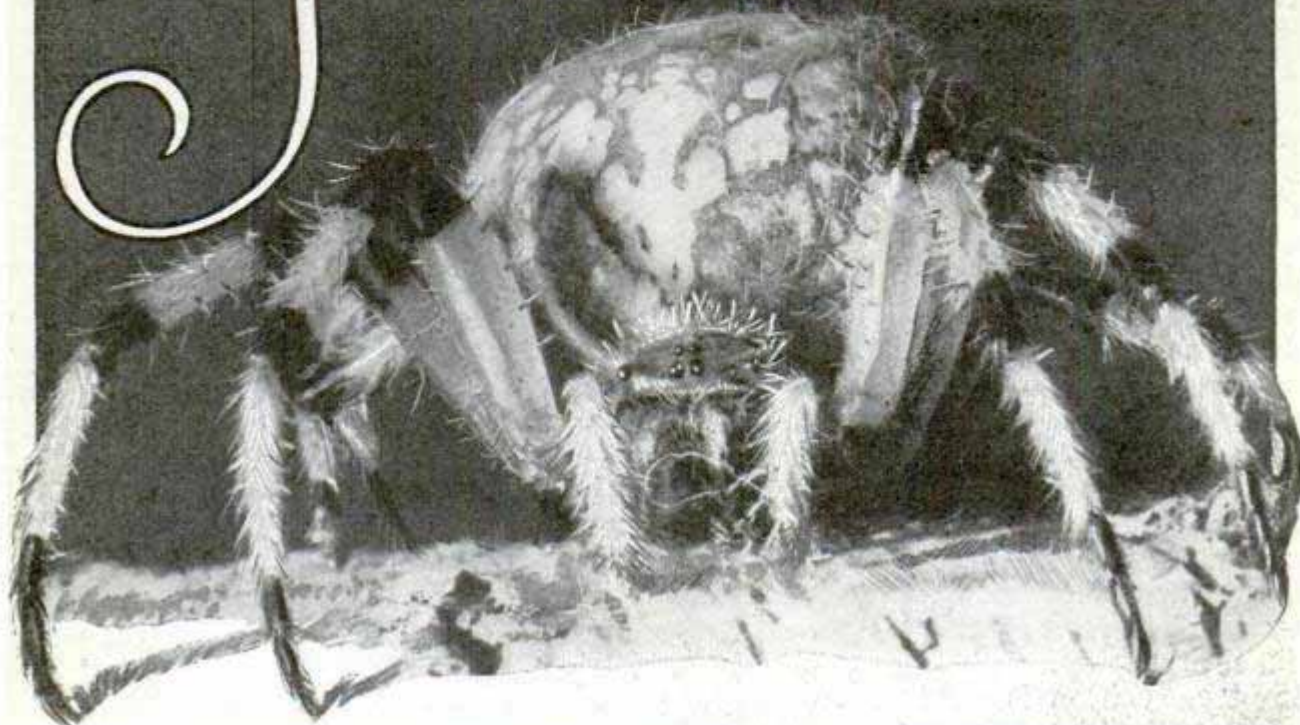

Close-Up of Spider Showing the Cactuslike Legs, Many Hairs of Which Are Connected with Scent Glands with Which, It Is Believed, the Spider Follows the Trail of Its Prey

By VINCENT WILCOX

U.S. Biology Washington D.C. International

CERTAIN insects, it seems, have as good, if not a better way of communicating than human beings.

People make sounds that have produced a language, while bees and ants do their communicating by their sense of smell. Theirs is a refined method. They have a smell language. If people were able to develop their noses to the extent of these insects, they could listen in on their conversation.

Dr. N. E. McIndoo, of the department of agriculture, determined to discover, if possible, just what means of communication was used by bees. He wondered how bees, for example, know one another, how do they convey information when once they have gained it? How do they know friend from foe?

Some have supposed that sight was responsible. Yet it is not reasonable to suppose that each insect in a community of thousands could recognize by sight every other individual in it; hence it was pre-

sumed there must be signs or passwords.

Doctor McIndoo has proved that the signs and passwords are largely a development of the smell language. In fact, experiments, tests and long studies showed that many insects have an amazing ability to distinguish odors. They are able not only to quickly recognize a single odor but a combination of several. Theirs is a complicated knowledge. While one odor might stand for one word, they distinguish a number of smells equal to several sentences or even paragraphs, thus receiving a whole group of ideas. In attempting to discover this strange language, it was found that there are at least six different odors that are fundamental and might be compared to an alphabet of the hive.

There is the individual odor. Every bee has its own odor. The queen bee has her specific odor and the workers have theirs. All offspring of one mother queen have a common inherited odor, in addition to the

Sense of Insects

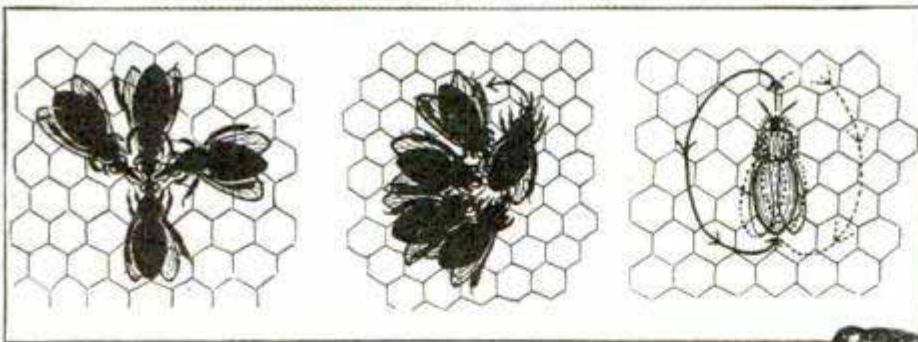

Top, Using Scents and Other Devices in Experimenting with Bees on Government Farms; Below, Figures Formed by "Dancing" Bees When Discovering Food; Right, Harvest Flies Marking Flowers with Their Scent and Gathering the Nectar

individual odors. Then there is the brood, drone, wax, honey and the hive odors.

Carefully developing his own ability to distinguish intricate odors, Doctor McIndoo found that the queen odor seemed to be the predominant one that made for happy bee life. The hive without a queen is not a smooth-running colony. The bees without the pleasant voice of their queen, as expressed in her pervading odor, are irritable and do not work normally. They

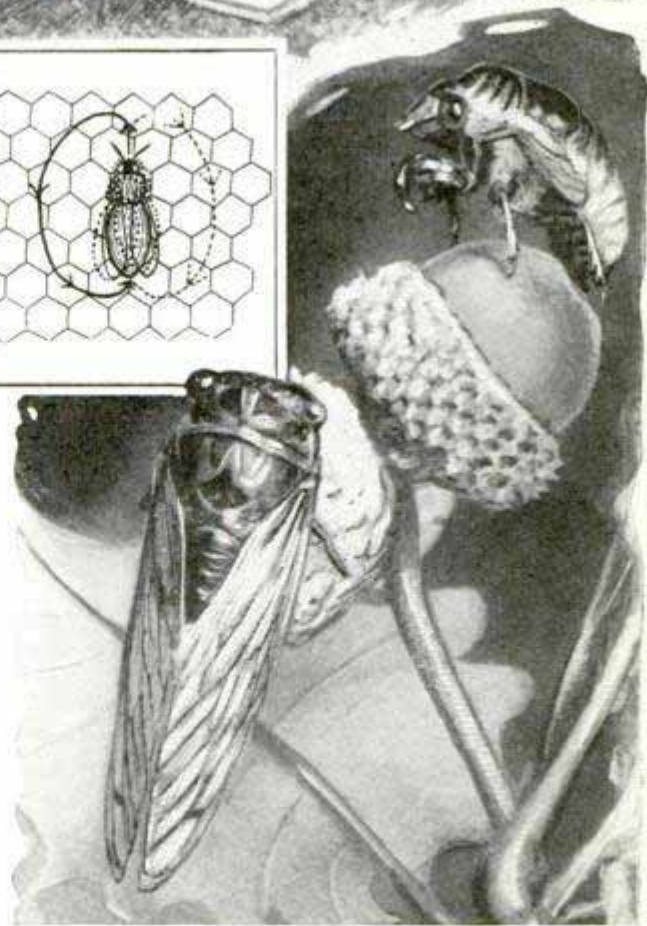

400 X
628

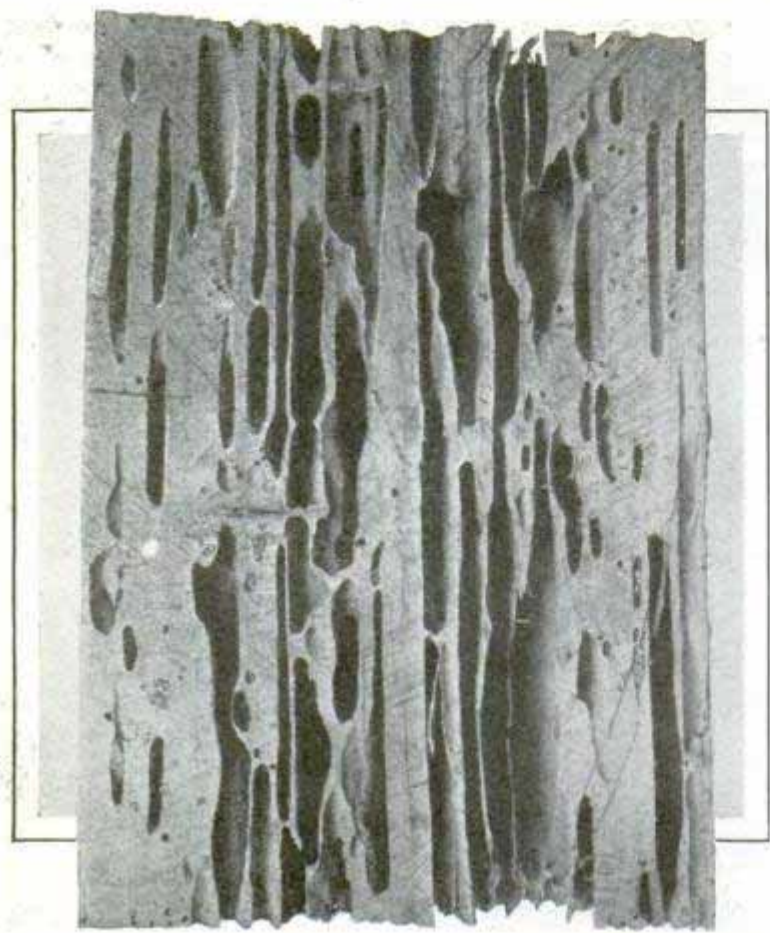

Termites Cut These Intricate Labyrinth Passageways in Wood by the Simple Expedient of Following Their Noses

are unhappy and might be called melancholy.

Worker bees, returning to the hives from the field, pass the guards unmolested because they have the proper smell. This shows the ability of the bee to understand many odors, for these workers may be carrying honey or nectar which has its own odor, yet, underneath somewhere is the individual odor of the bee and the hive odor, and it is recognized and gives unchallenged entry.

A bee, however, is in danger of losing its own password or mark. Doctor McIndoo found that if a bee was kept away from its hive for three days, it lost the odor of the colony. Attempting to return, this poor bee was challenged at the entrance. Possibly it was killed or driven away.

But the wonderful sense of smell is not the only way bees talk. For example, when they are happy they dance. Doctor McIndoo watched their round dance and their tail-wagging dance, each the apparent result of pleasure. Von Frisch, a German professor of zoology, says that dancing among bees is almost as common

as among people. They express their emotions of joy or happiness. As far as is known, the bees do not dance to music.

Doctor McIndoo watched this strange dancing and noticed that, when a bee returned from scouting for food, it began to dance in happiness. This round dance is a lively little rite. It is a kind of waltz. First, the scout bee salutes its friends of the hive with extended antennæ, while gently crossing and recrossing those of the other bees. While it is performing this kind of "handshaking," it is also sharing its nectar with several of the attending bees.

"The attending bees seem to acquire without difficulty the necessary information about the nectar to be sought," says Doctor McIndoo. "We cannot even guess what the dancer tells the attending bees while stroking their antennæ; neither can we imagine what kind of impression

is produced in the 'minds' of the attending bees by the fragrant odor of the flower, carried on the body of the dancer. All we definitely know is that bees become greatly excited by attending the round dance, quickly rush out of the hive and search in all directions for the plants furnishing this particular nectar. This action may help to explain why bees have the habit of collecting nectar or pollen from only one kind of plant on any one trip."

Bees are like people. Their behavior, Doctor McIndoo says, reminds him of people performing a piece of work. "As long as there is an abundance of enthusiasm and work to be done, everything goes well; but as soon as enthusiasm lags and the end of the work is in sight, the organization weakens and quitters become common."

There is a whole language of odors used by bees. For example, Doctor McIndoo noted that sometimes the bees kept their scent organs from being exposed while visiting flowers. And again they would leave this smell-mark on the flower so that after their dance other bees would

not only find that they had been there, but would note that this flower and its nectar or pollen belonged to that particular hive, since the bees' individual odor and that of the hive were both found. Experiments showed that bees did not poach on flowers first visited by other bees.

Doctor McIndoo's studies proved that not only bees but ants talk to each other through odors. Some ants have a smoky odor, others a pungent and ether odor, and still others smell like lemon, geranium, or oil of citronella, and so on. Ants seem to spread their own colony odor by their feet.

The production of individual odors by insects and animals comes from tiny scent glands that lubricate the skin and hair. Dogs have the ability to distinguish many things by the odor. But

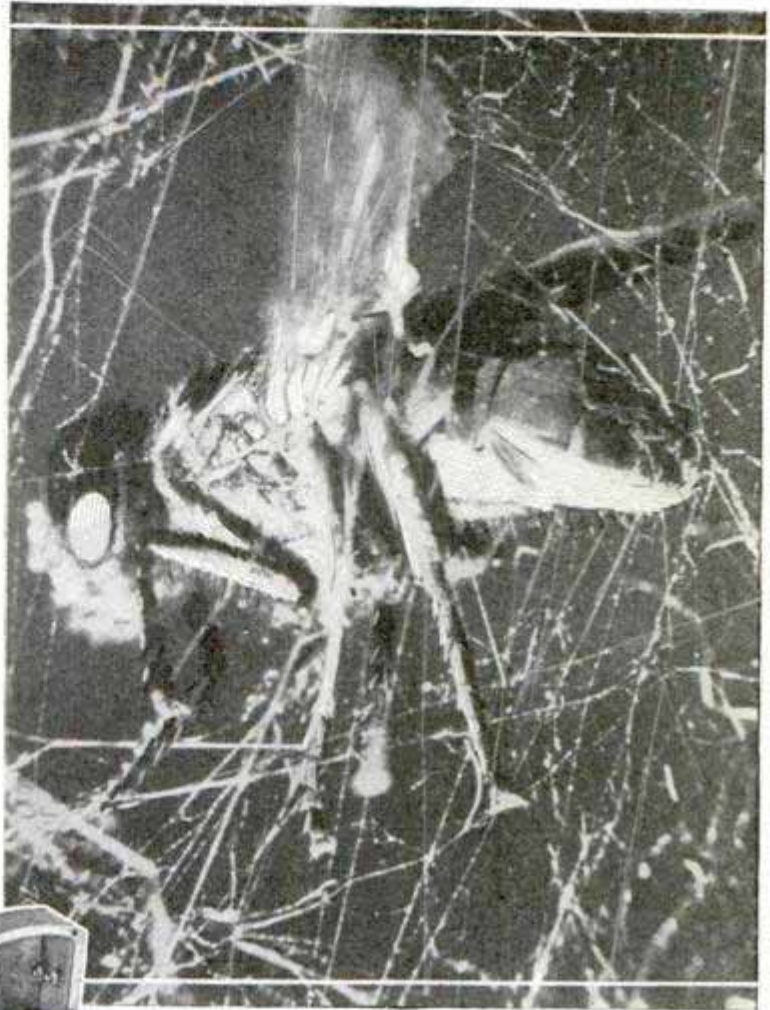

Top, Fly in Web to Which Experimenters Believe It Was Attracted by Spider's Odor; Center, Device for Counting Bees as They Come and Go; Below, Left, Insect's Leg Containing Scent Glands; Right, Dotted Line Is Route of Police Dog in Tracking Boy from B to L, Arrow Showing Wind Direction

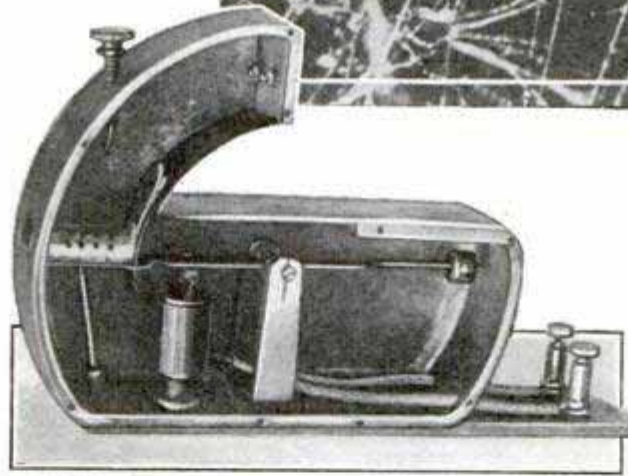

lively interest was taken in the breeding of dogs for the rendering of aid to the wounded. At that time an interesting experiment was made on a level, sandy place in Amsterdam where a boy followed a rec-

tangular route ending at a laboratory. The boy walked in the sand and after the trip the dog was started on the scent. Although there were many obstacles and a strong wind was blowing, street cars and people along the way, the dog made the right turns and finally reached the laboratory.

Police dogs succeeded in distinguishing single pebbles held by certain individuals among hundreds, and, what is more, the

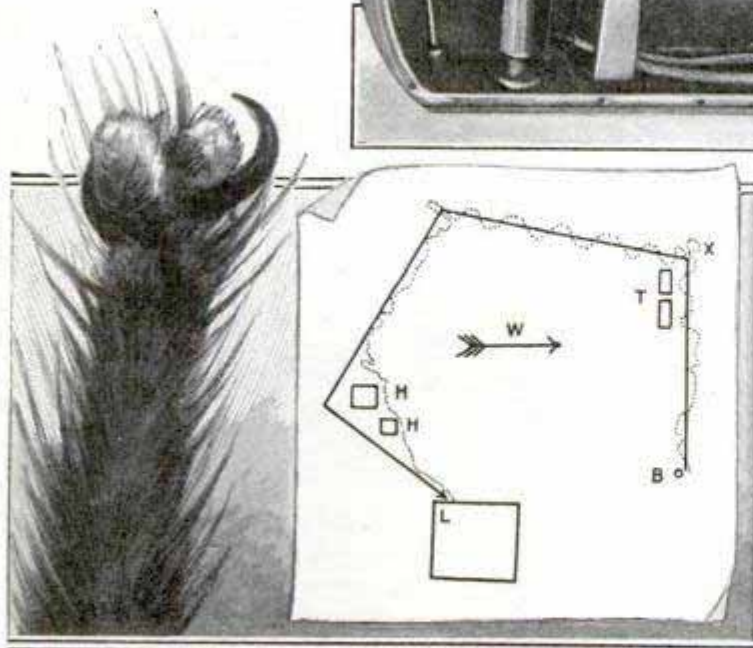

even a dog's nose is not as accurate as many insects. During the World War, a

right pebble would be taken back to the right person.

Keywood, Wakefield Co,
209 Washington

630

4068

Boston Mass

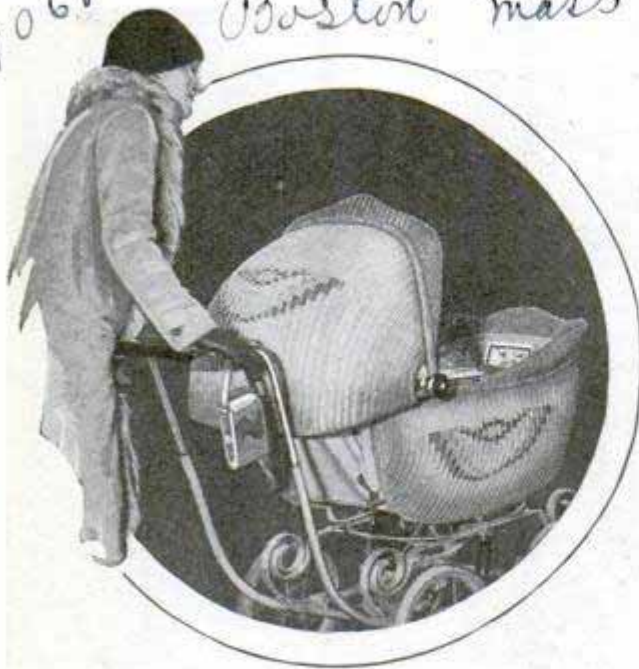

Rear-View Mirror for Baby Carriage, through Which Mother Observes Child's Actions

REAR-VIEW BABY-BUGGY MIRROR KEEPS TAB ON INFANT

To enable the mother or nurse wheeling the baby carriage to observe what the child is doing, a rear-vision mirror for the perambulator, similar to those used in automobiles, now is on the market. The mirror also allows the operator of the carriage to observe what is approaching from the rear when the buggy is to be turned, just as the driver of a car uses the rear-view mirror for the same purpose.

PISTOL BULLET SPINS COCOON IN SHEEPSKIN COAT

Gunshot experts believe that a sheepskin-lined overcoat may be nearly as efficient a bullet-proof armor as any garment that has been produced for the purpose. One night, early last winter, a railroad detective was making the rounds, wearing a sheep-lined coat, when he engaged in a gun battle with some marauders, who escaped. The detective was shot through the hand and was taken to a hospital. When his clothing was removed, there dropped to the floor, an object that looked like a large cocoon, nearly an inch in diameter. Examination showed that the body of the cocoon was composed of sheep wool. Inside, like a core, was a bullet. The rifling on the inside of the gun barrel causes a discharged bullet to

leave the muzzle spinning at a terrific rate. Penetrating the detective's sheep-lined coat, the projectile had twisted the wool around itself until it was about three times its original size and had lost most of its momentum. The experts were not at all surprised at the occurrence. For years, in making test shots, they have fired bullets into cotton batting—a few inches will stop a revolver bullet.

San Joaquin Light Paper

UPRIGHT POLE TIED TO TRUCK BRIDGES POWER LINE

21 Linemen of a California power company, faced with the task of repairing storm damage to a 110,000-volt power line without shutting off power from a 10,000-volt line below it, solved the problem by lashing a fifty-foot pole to a truck at an angle, the top leaning to the tip of the power-line poles when the truck was in position. This enabled the linemen to climb the leaning pole to repair the high-tension line, without passing through the live 10,000-volt line, which could not be disturbed because poultrymen were hatching thousands of chickens at the time with

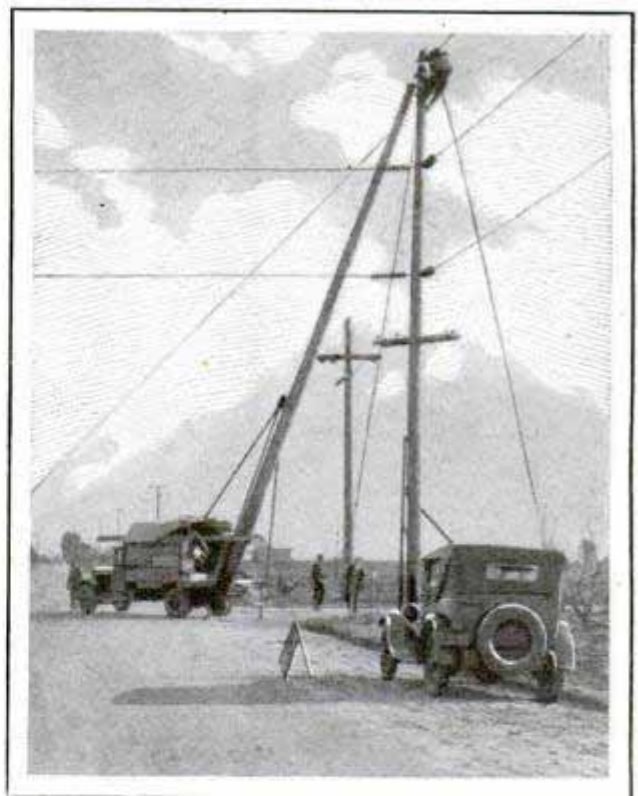

Pole Lashed to Truck, Enabling Repair of Power Line without Shutting Off Power on Other Lines

electrical equipment obtaining power from it.

*Cont. John L. Cogswell,
16 Goldsboro Road*

13 N. S. News, Times Day, New York

WONDERS OF UNSEEN WORLD REVEALED BY LENS

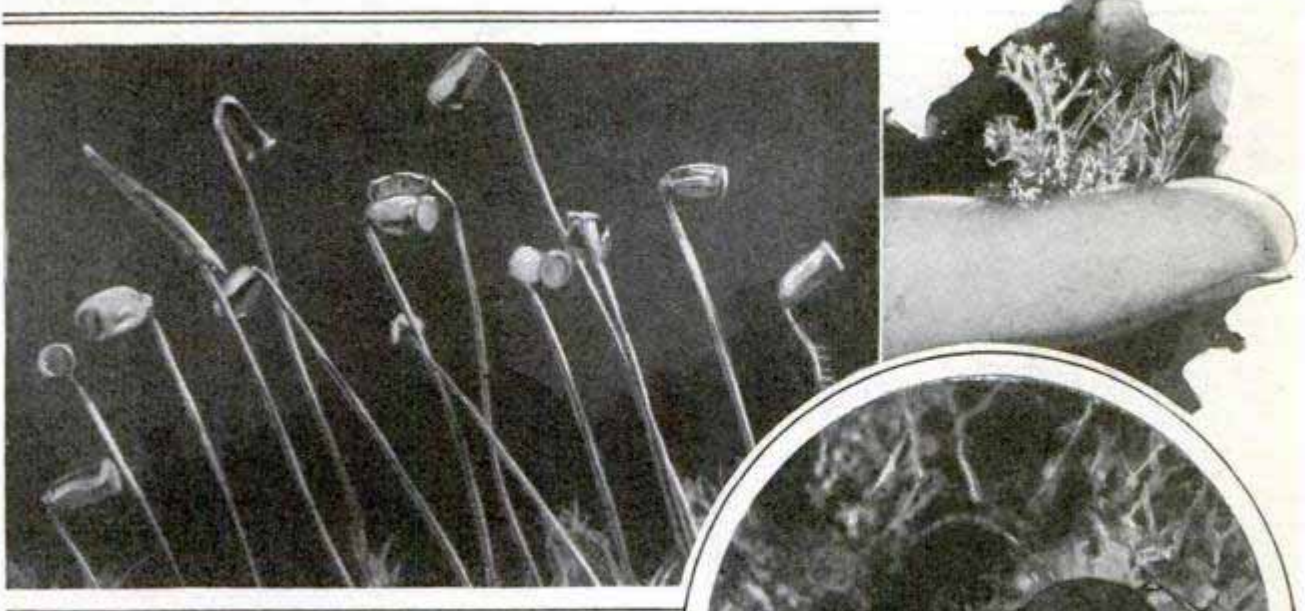

© UFA Kultur

Above, Microscopic View of Seed Pods of Moss Plants; Right, a Tiny Lichen on a Finger Tip; in Circle, a Small Bug in a Microscopic Forest of Lichens

A weird landscape of curious plants and lights justifies the question: Where, would you say, does this forest grow? You would never guess that it is concealed within the world which spreads before your eyes. True, it is so tiny that a vast expanse of it finds room on the tip of your finger. Many a time our feet, walking across country, have stamped out one after another of these minute landscapes. There are growths that might be banks of coral from the bottom of the sea. Others might have served as patterns after which the landscapes of the moon were fashioned. They are so tiny, that a young froglet jumping through the scene, looks like a huge monster jumping over the moon. A bumble bee, coming to drink at a water hole, might be some prehistoric monster. When drouth sets

in, all this microscopic vegetation withers like other plants. In the tiny pools, left standing by evaporating moisture, strange monsters may be observed with the microscope. Creatures, looking like miniature Zeppelins, glide slowly and stiffly about. These are known as Infusoria Silica. In ages gone by they have perished in such numbers that their corpses form layers in the earth yards deep. There would seem to be no connection between the dynamiting of huge factory chimneys and these mites, but there is. These dead bodies form the basic component of dynamite.

FLYING WEDGE ADDS TO SPEED OF WILD GEESE

69

Wild geese, flying through the sky in V-formation, use the wedge shape to increase speed. As the leader forges ahead, he displaces air which is thrown obliquely backward in two diverging surges. Properly spaced behind and to either side the following geese are pushed forward in some degree by these surges which strike

their bodies at an oblique angle. Each goose in turn performs this service for the following bird, so that, being led by the strongest bird and graduating backward according to strength, the flock's speed is equalized. The principle is intensified by the wing beats which compact the air immediately behind the wings, so that, as the following bird makes its downward stroke, its leverage is increased as the wings act against the compressed air.

Ant. Harry A. Farnham
 Harold Hubel Portland

LIONS ARE FILMED IN THEIR NATIVE HAUNTS WITH

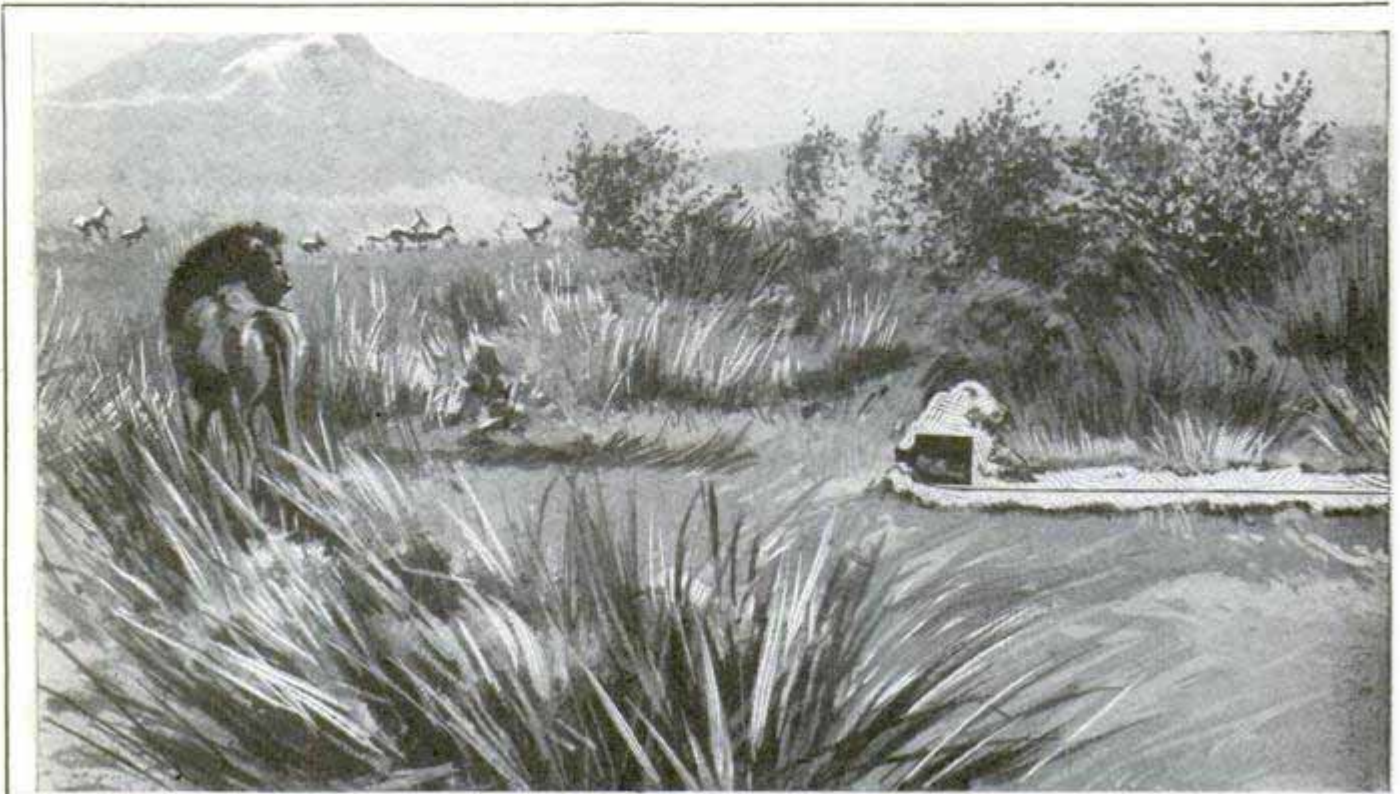

Photos Copyright, The

Drawing Illustrating How Cameraman, Concealed in Man-Made Anthill, Took Movie of Unsuspecting Lion with Distant-Release Camera; Left, Viewfinder in Anthill Shows a Lion



common to that region, were most successful. A hole, four feet deep, was dug 100 feet from a waterhole, and roofed with poles and grass. The grass roof was covered with mud and carefully modeled to resemble an anthill, after which grass and small bushes were planted while the mud was still wet to make it realistic. Four small windows were provided for the cameras, and, on one side, steps were cut and a bundle of grass pulled over the entrance. The hides did not allow human scent to escape, and wild game appeared entirely unsuspecting. One buffalo cropped grass outside such a camera ambush, and another time, some animals tried to browse off the grass on top, before the mud was set, and broke through. Cameras inside the hides were operated with telephoto lenses, but a distant-release camera often was set at the edge of the waterhole and covered with mud, the release cord being run underground to the anthill. In some instances, even the waterholes were made by hand when no suitable natural watering place was found.

MAN-MADE anthills, large enough to conceal three persons, were constructed as places of hiding from which to take moving pictures of wild animal life in the western Sudan by the Court-Treant expedition which spent a year obtaining the animal photographs for the British film "Stampede." Platforms in trees and hollowed-out bushes also were utilized as "hides" for cameras, but the huge anthills,

for British Instructional Films.

CAMERAS HIDDEN IN MUD ON MAN-MADE ANTHILLS



Illustrated London News

p. 969, 90. J

OIL FROM SAND OPENS UP NEW SOURCE OF SUPPLY

Silently, from the four corners of this continent, famous oil authorities slipped into Edmonton during the latter part of last year. They came unheralded and as quietly journeyed out of Edmonton to a small shack some miles outside the city. And in that shack the oil experts who command hundreds of assistants donned overalls and worked as they used to in the early days of their careers. There they witnessed the operation of a centrifuge which extracted pure crude oil from a vast pile of dark-colored sand which had been brought from Alberta. The samples these engineers took home to work on have shown that the oil extracted from the sand can be used as high anti-knock gasoline, when it is refined by the cracking process; that it will make excellent fuel and lubricating oil, can be used as road oil, as paving material, as a pure grade of asphalt for use in shellac, that it approximates a rare product known as gilsonite, and will make first-class roofing asphalt. For many years scientists have looked on the bituminous sands of

northern Alberta as the last resource should the world's oil supply in other regions be exhausted. Fortunes have been spent to find ways and means of opening up these bituminous sands to commercial exploitation. Then came an American engineer of world fame, and a Canadian engineer. Between them they concocted an adaptation of the American's device for extracting certain types of ore from other ores. The centrifuge is a machine for separating and cleaning any combination of materials of differing specific gravity. The new method requires only the centrifuge and a supply of warm water. To heat the water in such large quantities as will be required, it is intended to use discarded natural gas wells which are to be found not far from the tar-sand deposits. The natural gas will be piped to the plant to be erected this summer, when a machine with a capacity of 600 tons a day will be placed in operation.

Those wishing further information on anything described in the editorial pages can obtain it by addressing Bureau of Information, Popular Mechanics Magazine, Chicago.

Hinton, Campbell, Laidlaw
 8 King St. E. Toronto, Canada.

W. P. McLaughlin

32. Fitchburg Mass

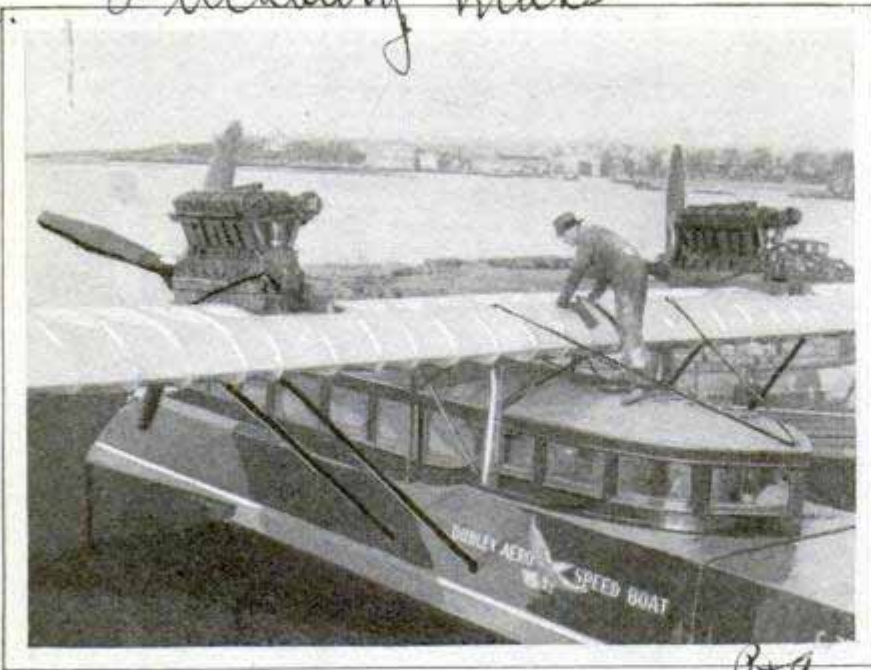

Speed Boat Equipped with Wings, Enabling It to Skim along Surface of Water at a Clip of Ninety-Five Miles an Hour

AERO SPEED BOAT WITH WINGS SKIMS SURFACE OF WATER

Designed to skim along the surface of the water at a ninety-five-mile-an-hour clip, a speed boat with wings has been built by a nineteen-year-old Fitchburg, Mass., youth who is considering an attempt to cross the Atlantic in the craft. The aeromarine boat can carry thirty persons and is powered with three motors. The wings are insufficient to lift the boat from the water, but are large enough to hold the craft at an elevation so that it skims the surface, thus decreasing resistance.

SAND SPREADER FOR ICY ROADS PREVENTS ACCIDENTS

Attached as a trailer to a truck, a sand spreader now is on the market which distributes sand or other material on icy pavements much more rapidly and evenly than is possible by hand. The spreader consists of a revolving roll at the bottom of a hopper, which serves as an agitator to carry the material through a steel wire brush, the tension of which regulates the depth. It spreads an even coat of sand, cinders, rock or salt at any speed, the brush allowing the coarser pieces to pass through easily.

More than 1,000 applications for radio patents were filed last year.

WEIGHING PAPER WITH LIGHT

Weighing with light as the medium now is being accomplished with an instrument called the "opacimeter" which uses the light sensitiveness of the photo-electric cell to measure the degree of transparency of a fabric by registering on a gauge, calibrated in weight units, the fluctuations of the current set up in the cell by the varying intensity of the light penetrating the fabric. So far the instrument has been used only in the paper industry. Formerly paper

was weighed by clipping a part of the dry product into small sheets of certain size, compressing the sheets into a bundle, and weighing it. This method is not only inaccurate, but troublesome and wasteful. With the opacimeter, it is, of course, the thickness of the paper that governs the operation of the photo-electric cell, but the apparatus is wholly automatic.

CONCRETE RAILWAY CAR MADE ON STEEL FRAME

Built on a reinforced-steel framework, a concrete railway car is being tested in England. The sides, floor and roof are of concrete, the car being placed on a standard steel undercarriage. If the car proves

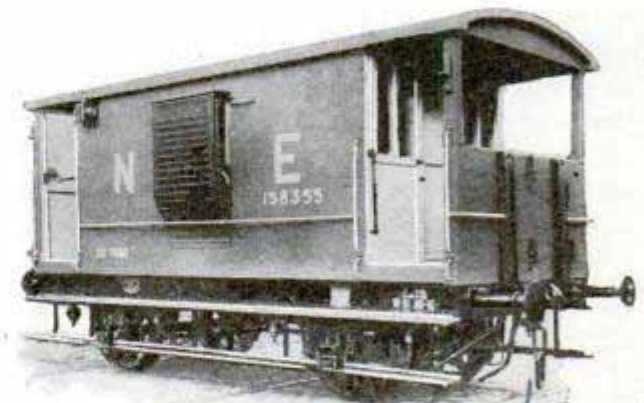

Railway Car of Concrete, Built on a Steel Framework, Which Is Being Tested in England

serviceable, as expected, many of similar design are to be built.

London & North Eastern
R.R.

The Highway Service, Inc. New Bedford, Mass.
11-15 N. 6th St.

38 Airport lighting, a... 10 & 40th St

ROBOT THAT NEVER SLEEPS GUIDES LANDINGS



Landing-Field Lights and Wind Arrow Which Are Illuminated Automatically to Indicate the Runways and Show the Direction of the Wind for the Guidance of Pilots at Night

Greater safety in night airplane landings is the object of an automatic system of field lights which indicate the direction of the wind and the proper runway for the descent. A dotted line of lamps, set flat in the ground where they offer no obstruction, shine without glare and are lighted without the aid of human attendants. One of the most successful installations of the systems is at the Grosse Ile airport, at Detroit. Each of the three runways has a row of lights, each line being flanked at either end by two lights to form a "T." On the roof of a control house near by, a vane points in the direction of the wind and, by its position, causes a corresponding row of lamps to burn. This is done automatically by contacts made through a special control board as the arrow moves. The lamps are strongly constructed so that heavy ships will not shatter them.

weight wood of even texture has thin bands of summer wood and holds paint well, but most heavy woods are uneven with wide bands of summer wood and hence shed the paint. Edge-grain boards expose summer wood in narrower bands and hence hold coatings better than flat-grain cuts from the same log. Aluminum paint as a primer under customary house paints on summer woods has been found to lengthen the life of the coating.

PAINTS STICK BEST TO WOOD GROWN IN SPRING 76

Scientific experiments have shown that the part of wood grown in the spring retains paint better than the summer wood. The summer growth is dense, horny and darker-colored than the spring. Light-

METAL BAND FOR MILK BOTTLE SHOWS AGE OF CONTENTS

To enable the busy housewife to determine, without tasting or guessing, the age of milk contained in partly filled bottles, a set of metal bands for the neck of the bottles now is available. Each band is stamped with a day of the week, and as the milk is received, the proper band is snapped around the bottle neck. A round metal holder is provided to store the markers when not in use.

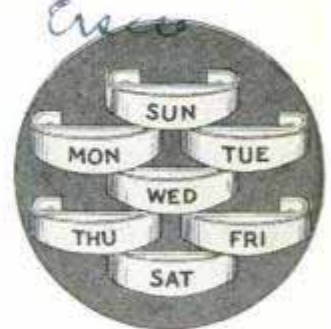

Mr. J. L. Brown... Forestry Products Laboratory... Paper Sales Co. 211 International Bldg. Washington, D.C.

Scene Service 459d-119/20

HOME OF CONCRETE AND GLASS BUILT FOR HEALTH



Home of Concrete, Steel and Glass Designed Entirely from Health and Comfort Standpoints; Note the Provision for Sunlight and the Several Open-Air Sleeping Porches Provided

Architect. Richard J. Neutra, 835
Kemp Road, Hollywood, Calif.

Steel, concrete and huge areas of plate glass have been used in building a modern Hollywood home, architecturally designed from a health standpoint. The house has been made modern in every way to conform to the best standards of good living, but with ample provision for sunlight, open-air sleeping quarters, efficient heating and ventilating systems, labor-saving conveniences, sanitation and adequate recreation facilities. Radio and phonograph outlets are provided on every floor, and all illumination is from indirect lighting. Tennis and handball courts and a swimming pool are among the recreations included. The house is constructed on a central frame with balconies and even parts of rooms are supported on cantilevers. The concrete was applied by the gun method to obtain rigid, long-lasting walls. The structure is fireproof and resistant to earthquakes. Bathrooms have vitreous-paneled walls with all fixtures wall-hung, and the kitchen is provided with such conveniences as water filter, electric dish washer, fruit-juice press and

a hopper to the incinerator. The cost of steel construction was found to be only about five per cent more than wood.

SMALLER AUTO TIRE IS SAFER BUT WEARS OUT SOONER

Smaller automobile tires are being used on many 1930 cars, the cross-sectional diameter being greater while the circumference of the wheel is decreased. This provides a lower center of gravity with resulting greater safety and more pulling power, but there is an increase in the rate of tire wear because the wheels must make more revolutions to the mile, and tests have shown that the rate increases in more than direct proportion to the decrease in tire circumference. Experiments indicate that a tire with nine per cent less circumference shows a decrease of twenty-two per cent in mileage as compared with the larger one. This year a different system of marking is being adopted, the tire's cross-sectional diameter being followed by the diameter of the rim it fits.

General Tire &
Rubber Co., Akron, Ohio

Director, Hawaiian volcanic observatory
**STEAM FROM VOLCANO
 TO HEAT HAWAII
 HOTEL**

Letter to editor returned. 2/19/34

Natural steam heat from Kilauea volcano is planned for a hotel on the island of Hawaii as a result of experiments by a scientist who used the volcano's steam for several years to heat his laboratory. The hotel will utilize the natural low-pressure steam issuing constantly from fissures in the earth. Steam vents will be tapped by holes drilled into the rock and the steam will flow into a boiler, heating water in its pipes. The steam itself cannot be used in pipes, as it contains corrosive acids. The heat supply is considered dependable, as rain falls regularly and seeps down to the hot rocks. Although the island is in the tropics, the volcano is high enough to be in cool weather the year round. Kilauea is unique in that people run toward it instead of away from it when it is in eruption, finding safety on the edge of the crater. Volcanic steam is used for heat also in Japan, New Zealand and Iceland, and generates electric power in California and Italy.

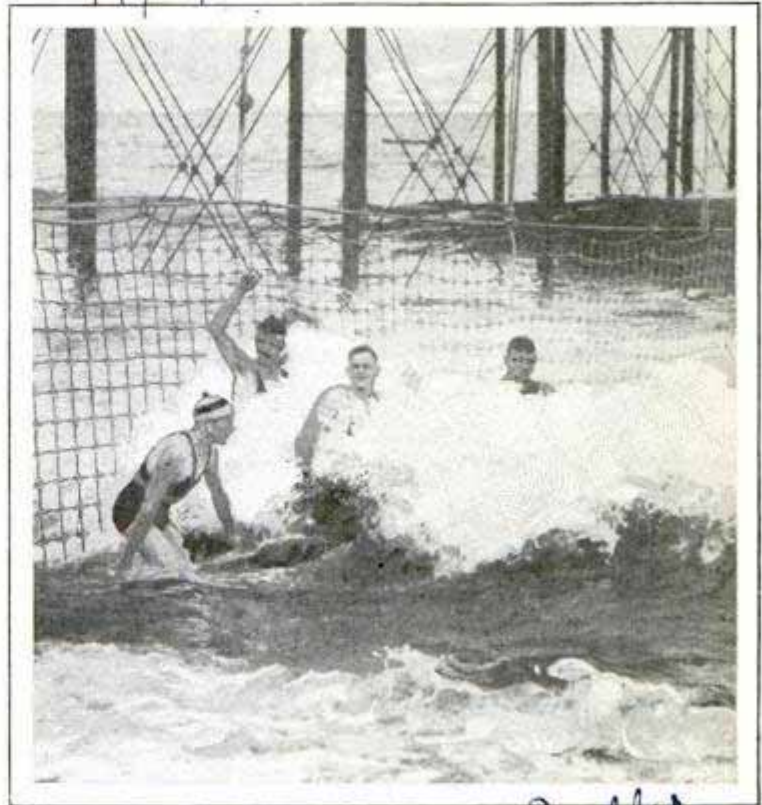

Miller
 Metal Net about Australian Bathing Beach to Protect Swimmers from Man-Eating Sharks

METAL NETS PROTECT BATHERS FROM MAN-EATING SHARKS

at Coogee.
 Swimmers in the ocean near Sydney, Australia, are protected from the man-eating sharks by a strong metal net which keeps the tigers of the sea outside the confines of the bathing beach. The nets, made of wire, are stretched about the place, and weighted at the bottom to hold them down.

SAFETY THUMB GUARD FOR BABY CORRECTS BAD HABIT

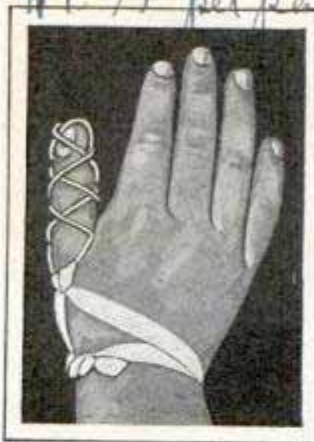

To correct a baby's tendency to suck its thumb, a safety wire guard now is on the market. The diagonal wires break the suction, and the wire itself is in one piece with looped ends to guard against injury. It is tied

on with tape and does not hinder the use of the thumb while in place.

Para rubber trees planted in Florida are making remarkable progress, according to government scientists.

HIDDEN LOCK FOR TIRE MIRROR ELIMINATES CHAINS

4096
 Eliminating chains and padlocks to secure the rear-view tire or fender mirror, this accessory is now provided with a concealed locking device. In the base is a ratchet which winds up the locking band, and it cannot be unwound without inserting the key. The mirror may be turned at any angle.



*Pair - \$22.50
 \$9.50
 \$10.00
 wood or wire - angle
 disc*

*Safety Thumb guard Co
 1030 1249
 Conn.*

*Trico Products Co
 817 Washington*

37 98

New CONVENIENCES



This Sturdy Stool for Many Household Tasks Has a Step That Folds into the Base and Also Serves as a Footrest; the Unit is Constructed of Steel and Will Support Over Half a Ton



Ice Cubes Are Easily Removed from This Container; It is Made of Tough, Flexible Rubber and Can Be Bent

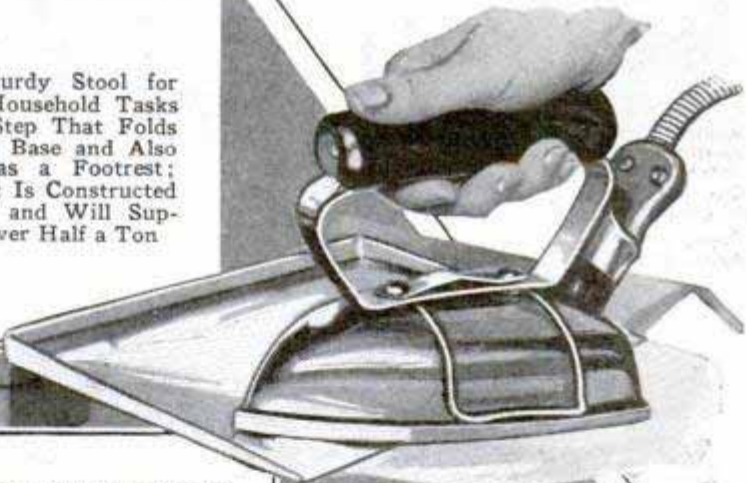

Raised Edges on This Flatiron Rest, Which Fits Any Board, Prevent the Iron from Slipping Off, and the Support Permits Sliding the Iron On Instead of Lifting It



Here is an Adjustable Shoe Rack That Extends to Thirty-Five Inches; It Screws into the Wall and May Be Used Also for Neckties or Towels



Something New in Clothespins; It Has a Wire Belt That Makes the Pin Much Stronger, Eliminating Splitting; the Slot is Smooth and Free from Splinters

for YOUR HOME

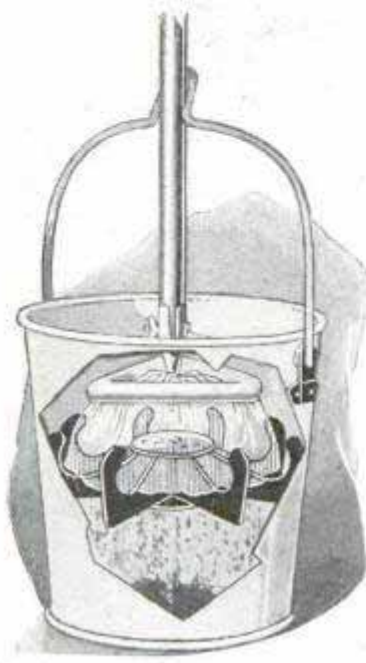

Scraper Blades inside Bucket Clean the Dusting Mop in Little Time; They May Be Used on Dry or Oiled Mops; the Pail Is Emptied by Removing the Blades

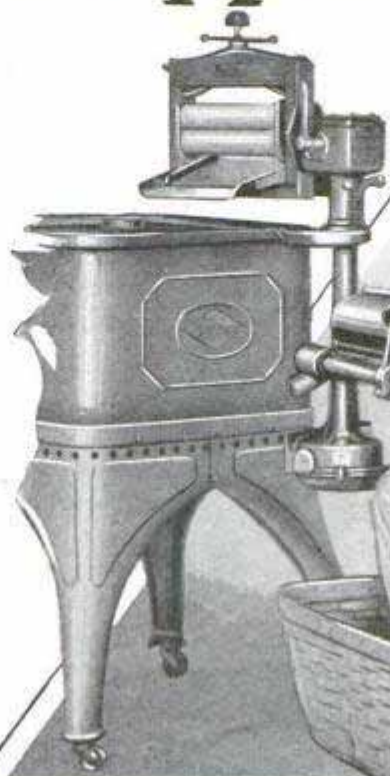

Ironer Attachment Fits on the Wringer Shaft at the Proper Height and Saves Lifting and Extra Adjustments; It May Be Left On at All Times and Swings Out of the Way



For Hanging Garments, Towels or Other Articles; This Simple Catch Does Not Injure the Fabrics and the Articles Are Easy to Remove or Attach



Footrest for Any Type of Chair Allows Healthful Relaxation, Is Portable and Fits at the Side of the Chair When It Is Not in Use

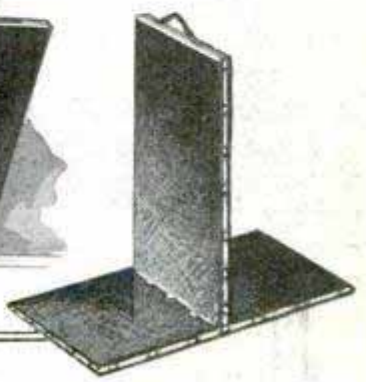

Tested for Post Office Dept. at Curtiss Field

3943



Mail Plane with Hook Attachment, Snatching Mail from Truck by Hooking Line between Upright Posts to Which Bag Is Fastened

PLANE IN FLIGHT PICKS MAIL FROM TRUCK ON GROUND

Air-mail planes now are enabled to snatch a mail bag from a truck on the ground while they are in flight, by means of a hook and wire attachment. The hook is suspended from the plane, and the wire or rope, attached to the mail bag, extends through two parallel uprights above the truck, thereby giving the pilot an opportunity to pick up the bag by flying so that the hook passes between the poles. After the pick-up, the bag is pulled aboard.

TRAFFIC JARS DO LITTLE HARM BUILDING TESTS SHOW

Needless alarm has arisen in many cities as to the effect of traffic, train and machinery vibrations on buildings, according to Prof. C. C. Williams, of the University of Iowa, who believes that such jars usually are exaggerated by the senses. To the average person, a vibration of but one one-thousandth of an inch at a frequency of ten per second would seem a rather violent shaking. The vibrations from most earthquakes have an amplitude of

but a fraction of an inch, Professor Williams declares. Tests have shown that truck, train and machine vibrations do not materially weaken the bearing capacity of piers or masonry walls. Where buildings, particularly brick structures up to four stories in height, are founded on plastic soil, they may be expected to settle somewhat when subjected to vibrations of the magnitude caused by the passing of heavy street traffic or of railroad trains.

NET IN TOP OF CAR CONVENIENT FOR TOURING

39

39 Packages which ordinarily are tossed on the seat or floor of the automobile, now may be stored away in a convenient net which attaches to hooks in the top of the car. The net keeps all packages in plain sight and easily accessible by unfastening the hook nearest the package wanted, but at the same time entirely out of the way. The carrier fits any make of car and is adjustable by changing the position of the loops fitting over the hooks, thus keeping packages in their original position.

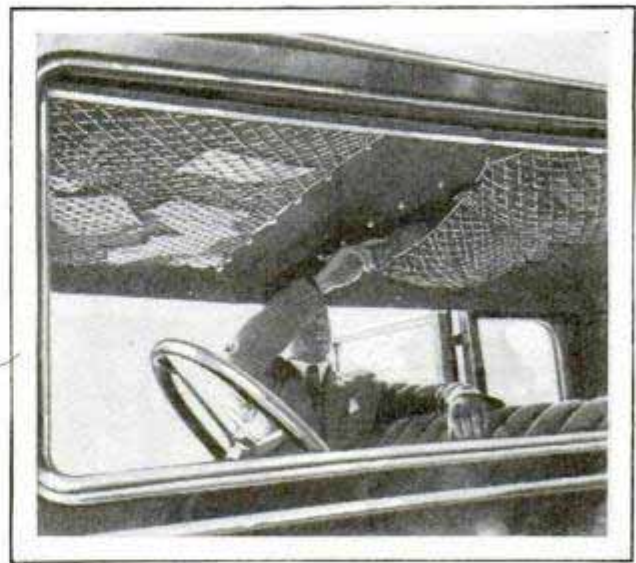

Carrying Nets in Top of Auto Which Provide Convenient Storage Space for Packages

Iowa City, Iowa

The Esrae Co. 706 Esrae Ave. 10th Avenue, Iowa City

A Drug Store from the Sea

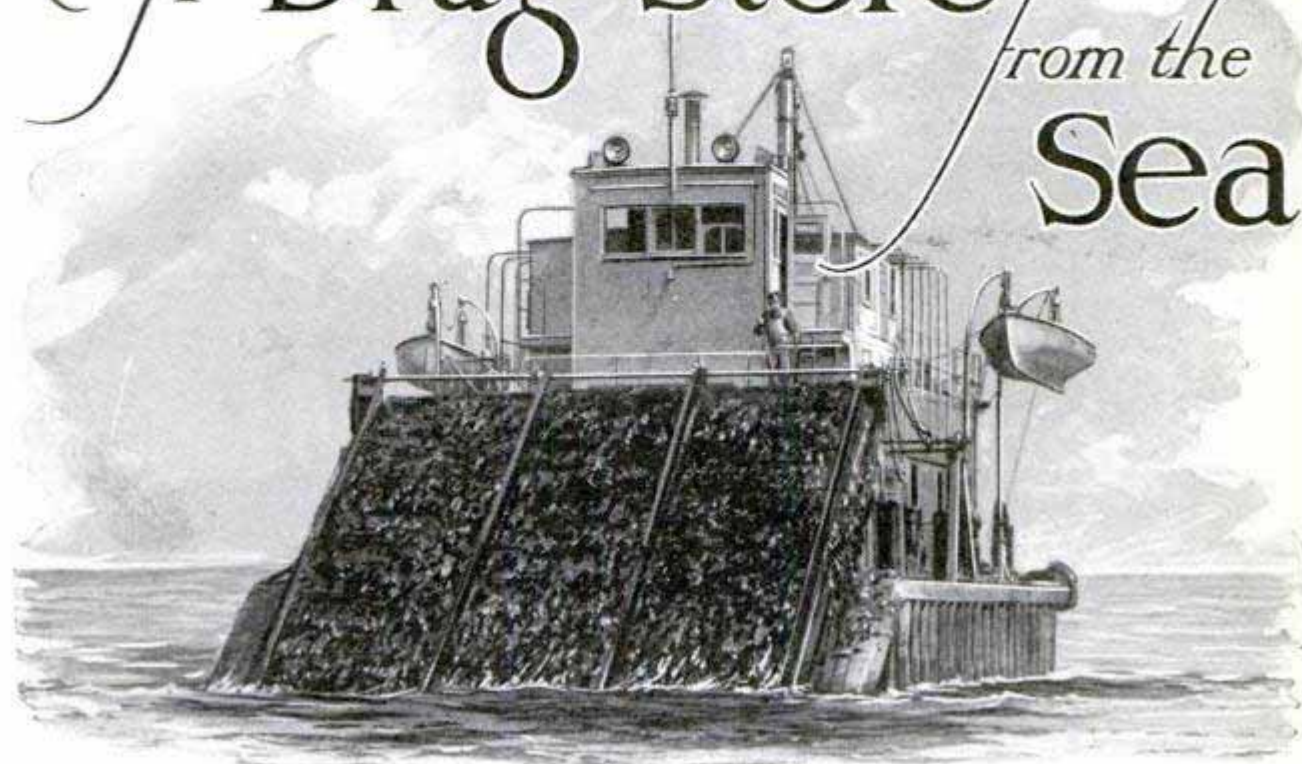

Kelp-Cutting Barge, Which Is Towed about the Kelp Fields, Harvesting a Wide Swath on the Surface of the Sea; It Differs from the Self-Propelled Barge Shown in Another Photo

Wonder Gardens Beneath the Waves Equal or Surpass Those to Be Found on Land

By H. H. DUNN, 4351 Georgia St. San Diego, Calif.

IF THE earth is the mother of all of us and the air our nurse, as the ancient philosophers believed, then the salt waters which cover three-quarters of the surface of the globe are the chemical laboratory of the world. From the present supply of chemicals—animal, vegetable and mineral—held in the seven seas and their salty sisters, enough can be drawn to supply many of man's needs for the next thousand years or more—nearly 100 different, and widely varying drugs, from which approximately 1,000 medicinal products may be made.

The greatest sources of some of our best-known and most useful drugs are in the ocean, held in suspension in their waters, carried hither and yon by their finned wanderers, or borne in the trunks, branches and leaves of their vast plant

life, estimated to equal, if not exceed, all the plant growth of the land. Undoubtedly, there are still other chemicals, probably many of them, whose largest and most valuable sources are the seas, but for which practical commercial methods of separation have not been devised. Some of the world's salt, for example, is taken from the sea; by far the greater part of it is mined and leached from deposits in the earth; yet if all the salt could be taken from the ocean, there would be 4,500,000 cubic miles of it, so great a quantity that all the known salt deposits of the earth could be buried in one small corner of it!

Gold is the least valuable mineral taken from the sea; indeed, it is the least of the products of the sea, though man has put millions of dollars into various futile schemes for extracting the yellow metal

from sea water. Silver and radium also occur in the salt waters of almost all parts of the globe, but no profitable method of extraction has been found. Yet with every 100,000 tons of salt that is taken from the world's oceans, come 2,800 tons of chemicals with a value in excess of \$200,000 at wholesale prices.

The common bath salt, colored and perfumed until even Mother Nature would not know it, comes from several sea-salt evaporation plants. Glauber's and Epsom salts are produced from similar sources. Bromine, chlorine, potassium, sodium, magnesium, iron, strontium, barium, an arsenate or two, and silica sand, are other profitable by-products of the making of salt from sea water. Modern methods of sea-salt production depend on the taking of the salt from the water after some of the other salts have been precipitated, and before others appear as solids. This is a nice scientific and mechanical process, though the equipment used is merely clay-bottomed ponds alongside the bay or ocean. After the salt has been taken out, washed and sent on its way to the refinery, the mother liquor ("bittern") remains. This is saturated with the other chemicals which have been brought by the earth's rivers and brooks to the seas for countless centuries, and from this heavy solution the world's drug stores draw much of their supplies.

From the sands of the sea silica can be produced; from its tremendous beds of shells comes cement in large quantities. Petroleum springs under or at the edge of the water have supplied oil for centuries. The whale—largest animal that lives

on this globe—gives milady ambergris, the basis for her finest perfumes, and at the same time valuable animal oils. In the past, it yielded the stays in which the woman of fashion bound herself, while today this mammal furnishes with its flesh and bone one of the most powerful of fertilizers. In the not distant future, it is probable that adrenalin in considerable quantities, and thyroid extract in greater amount, will be taken from the glands of whales.

Oil from several varieties of fish is on the shelves of every drug store, and men are finding practical uses for the skins of whales, sharks, dolphins, the larger rays and some other fishes. Pearls are being made from fish scales, and the teeth of whales and the larger sharks make a useful substitute for elephant ivory. Approximately 127,000 men were paid \$113,000,000 for 3,000,000,000 pounds of fish they caught in the waters of the United States in 1928, during which year the consumption of frozen and canned fish in this country increased 350 per cent over that of 1926.

But it is from the plant life of the world's oceans that the drug stores draw their largest supplies of chemicals. To most persons, the seas are barren wastes, yet these salt waters cover the most extensive forests, containing the tallest plants on the globe, while their floating content of vegetation is estimated to be equal to, if not greater than, the plant life of the land. The minute, often microscopic "plankton," or floating vegetation of the sea, feeds the smallest fishes, tiny members of the vast and varied herring family, which, in turn, furnish food for man, or feed the

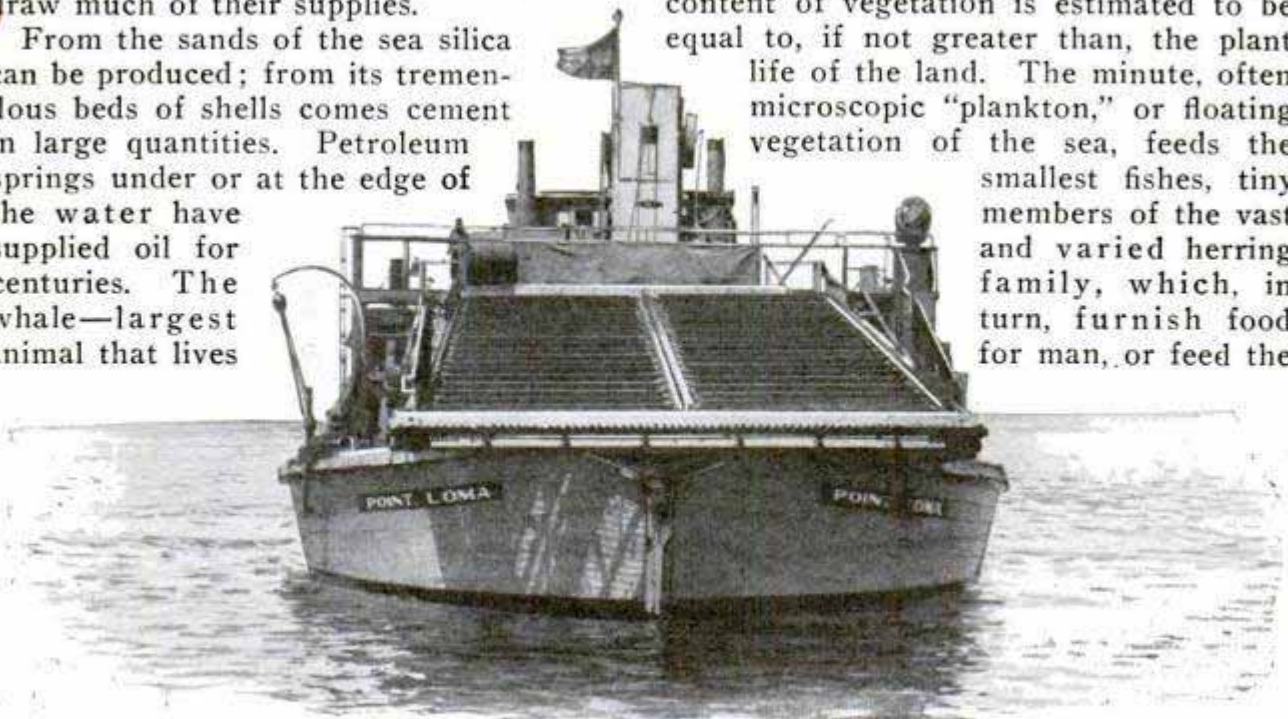

Self-Propelled Kelp Harvester Used on the California Coast; the Huge Machine Is Shown with Cutter and Elevator Drawn Up as the Vessel Is on Its Way to the Kelp Fields

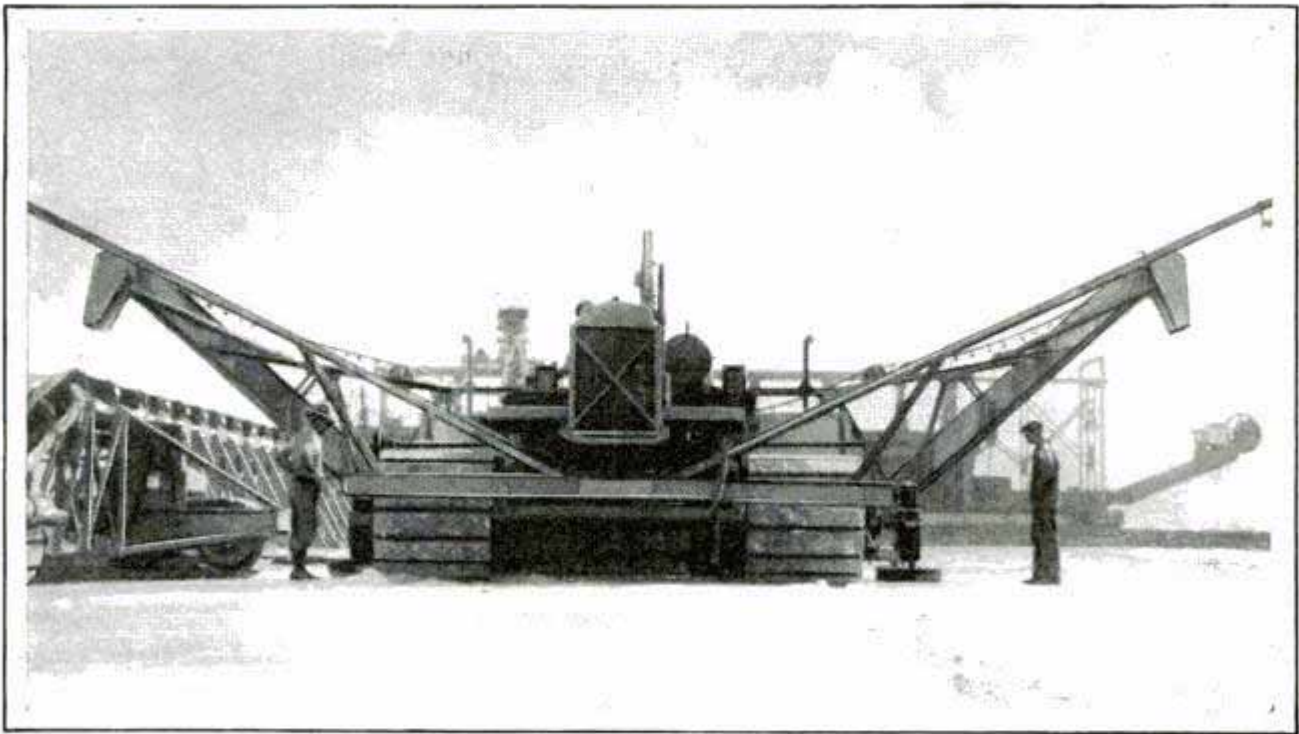

* Tractor with Rotary Digger Used on Salt Farm; the Salt Is Elevated to Conveyors and Carried to a Barge, Another Tractor Towing the Barge by Canal to the Cleaning Plant

larger fishes, on which man feeds. From this ever-moving plankton, plaything of tides and currents, the vegetation of the seas passes upward to giant weeds, fixed on the rocks of the sea bottom, their leatherlike trunks stretching 400 to 500 feet up to the surface.

On the way up this vegetational scale, we pass a hundred or more sea grasses, growing out to such depths that men in diving suits cut these submarine lawns, while mechanical harvesters strip the surface of the sea—both to provide supplies for the drug stores of the shore. For centuries man, primitive and civilized, has eaten seaweed as a food. Somewhere along the way he found that some of these weeds helped him in his fight on certain diseases—the iodine content of the so-called kelp reducing goiter; Irish moss helping bronchial and lung disorders; others keeping the stomach in better condition—to name a few of the simpler and better aids to man among the gardens of the sea. But when scientific investigation and mechanical methods of production were brought together on the seaweed beds, man began to get potash, iodine, bromic acid, ammonia and more than a score of other chemical products. The queerest of these—agar-agar, the “cold-cold” of the Malay seaweed eater—leaped

into demand overnight as a culture medium for bacteria.

Large plants for the production of chemicals from the kelp beds and from the smaller seaweeds have been erected in the United States, notably in California, and similar establishments have been or are being set up in France, Italy and Scotland. Men had been working for some years on methods for the extraction of chemicals from kelp, but it was not until the World War presented a great demand for potash, that it was found that the kelp beds of the Pacific coast of the United States are of sufficient extent to yield more than 60,000 tons of the weed every year, and that this kelp has a larger potash content than any other. Figuring two cuttings a year, these kelp beds, ranging from about the central point of the coast of western Alaska on the north to Cedros island on the south, are estimated to yield more than 2,500,000 tons of potassium chloride annually.

This kelp is harvested by what amounts in principle and practice to a very large hay-mowing machine, mounted so that it cuts the kelp from four to six feet below the surface. As it is cut, the seaweed is passed up an incline on endless chains to the deck of the barge at the bow of which the cutter is attached.

*Kelp gatherer largest in country -
American Agar Co. Harasty + India
auth. H. St. MacLennan mgr.*

Mark Chassis.

3896

Pneumatic Road Drill Equipped with Silencers Which Deaden Much of the Noise of This Tool

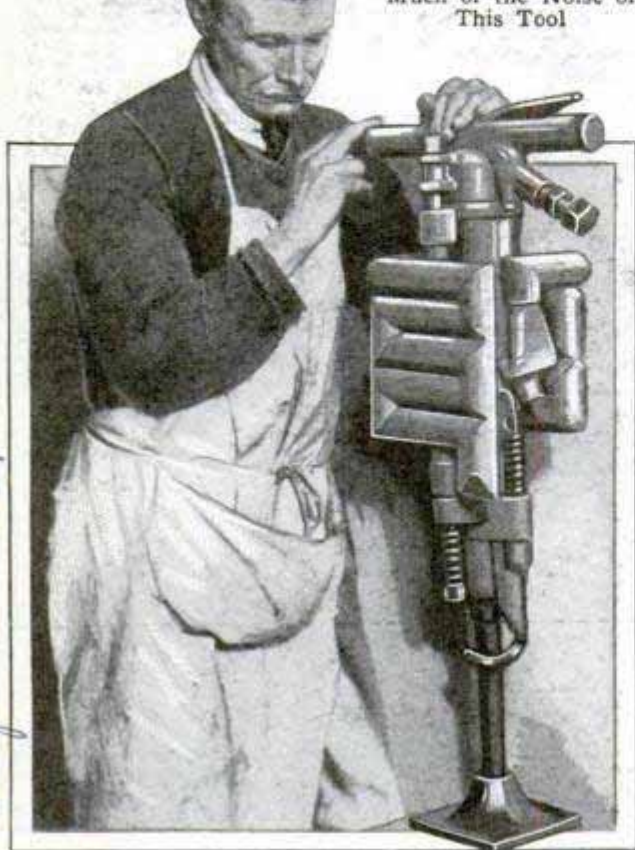

gaged or disengaged by the driver. When operating, less than one horsepower of energy is required, but it is unnecessary to keep it connected throughout a trip, the driver being able to observe the temperature inside the van by glancing at a thermometer behind him. Refrigeration is obtained by passing air through a radiator by means of a fan operated from the truck shaft, and cooling methyl chloride, which, in gas form, is forced into a compressor, then through the rear outlet and into the coils of the van. By making a few changes and bringing hot water from the radiator of the truck motor, the refrigerating unit may be turned into a heating system for the van in winter.

WHY DOUBLE-BARRELED GUN FAILED TO WORK

71 On the public square at Athens, Ga., stands the only double-barreled cannon in existence, a weapon built by an inventor of Confederate sympathies during the Civil War. The inventor made the weapon with the idea of connecting two cannon balls with a long chain and firing them simultaneously. The balls, it was reasoned, would travel in parallel courses and mow down everything in front of them with the connecting chain, inflicting wholesale slaughter. The scheme came to grief when it was found that it was impossible to fire both balls at the same rate of speed. The one going the faster simply dragged the other behind by the chain and the weapon proved no more destructive than the single-barreled kind then in use; so only the one was built.

*Public works, road and transport
by pneumatic.*

"SILENT" ROAD DRILLS REDUCE CONSTRUCTION NOISE

Equipped with a silencer which eliminates more than half the noise and much of the vibration, a pneumatic road drill attracted much attention when exhibited recently in London. It was made for the use of contractors who meet with protests against the noise made by the ordinary drill exhaust. The silencers, clustered around the center of the drill, are designed along the principles of the motorcycle silencer.

TRUCK REFRIGERATES ITS LOAD WHILE IT TRAVELS

Keeping its contents cool as it travels, a truck recently has been placed in service that serves the same purpose in transporting perishables by road as the refrigerating car does by railroad. Tests have shown that temperature in the van may be maintained constantly under forty degrees with an outside reading of 100 or higher. The system is operated from the driveshaft of the truck and may be en-

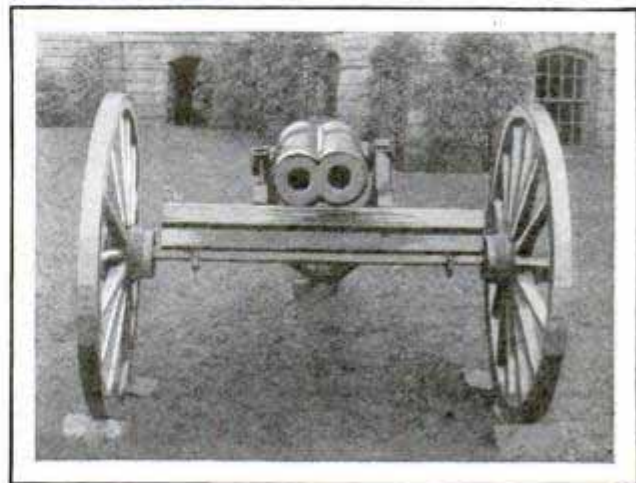

Double-Barreled Cannon Which Was Intended to Fire Two Balls Connected by a Chain

*Washington St.
San Francisco, Calif.
50.*

Robert W. Hatch, Los Angeles

*Capt. Archie Richardson
E. Lake Decatur, Ga.*

CITY'S ELECTRIC BRAIN IN POWER-CONTROL ROOM

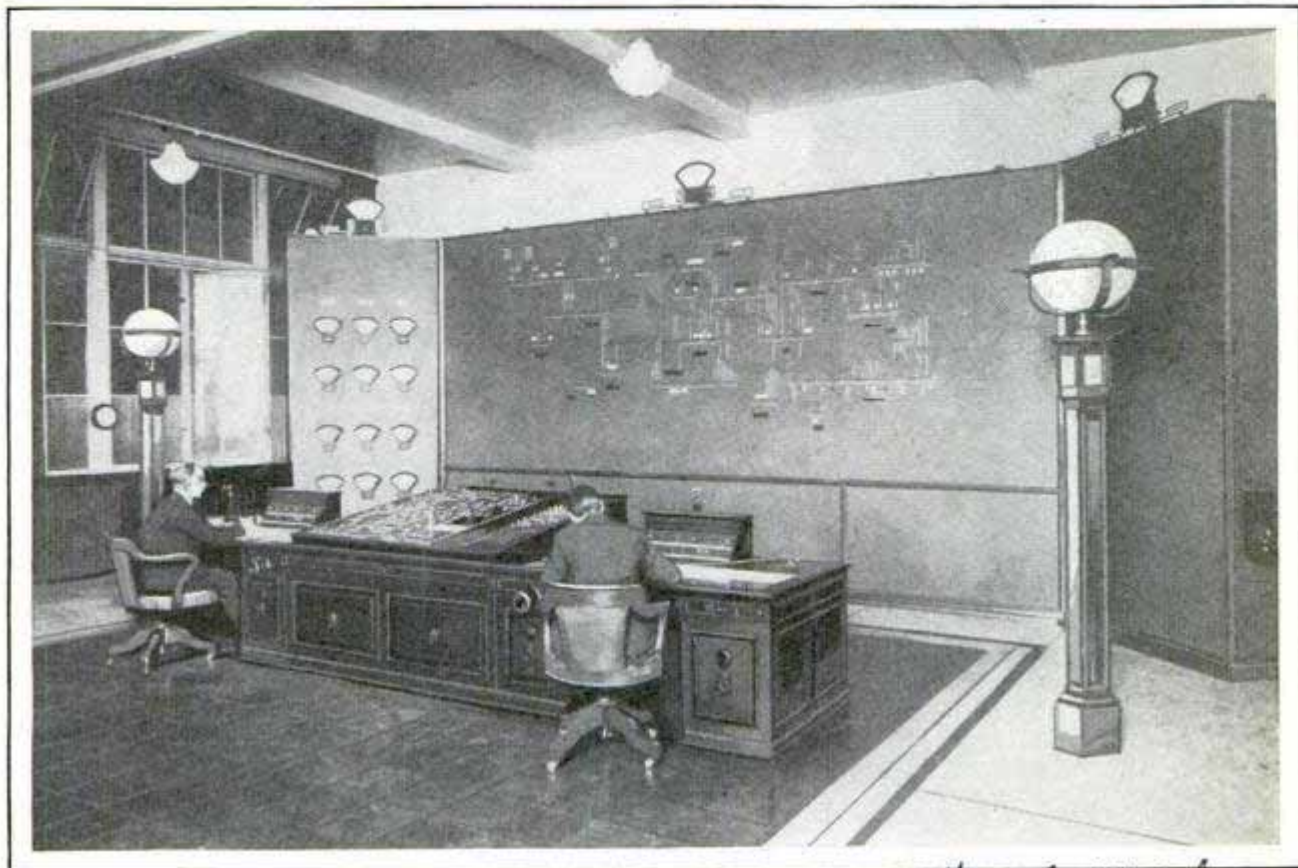

General Control Room of the London Power Company—the Brain of London's Electric Supply System, on the Walls Are Maps Showing the Type and Amount of Power Going to Various Sections

What may properly be termed the brain of London's electrical supply is contained in the recently constructed general control room of the London Power company. Besides housing the apparatus controlling the supply of power to all parts of the British metropolis, the room is equipped with maps of various parts of the city, indicating the type and amount of power going to these sections.

HUMAN HAIR MAKES CHEMICAL IMPORTANT IN DIET

Hair clipped by barbers from the heads of University of Pennsylvania students has been put to a useful purpose in the chemistry laboratory where eighty pounds of it is cleaned and treated monthly, being used as the basis for the manufacture of cystine, an expensive chemical employed in research work. Cystine is an important constituent of the protein diet. The hair as it comes from the barber shop is freed of foreign particles, then treated with hydrochloric acid in which it is digested, whereupon the acid is neutralized and the

cystine precipitate emerges in beautiful white six-sided crystals. During a year more than \$800 worth of the chemical was made by this method.

FINGER MOISTENER FITS HAND LIKE A WRIST WATCH 4/10 2

Fitting the palm of the hand as snugly as a wrist watch might, a finger moistener now is available for the convenience of



those handling paper or money. It consists of a metal band with a felt pad and water reservoir which leaves the fingers free to write or post and saves reaching for a sponge to moisten the fingers.

Shoes, the soles of which are made from cast-off automobile tires, are being sold abroad.

of Physiological Chemistry

Carrier July 8. Northwestern University

HOW THE CAMERA MAN GOT HIS MASTERPIECES

4 003

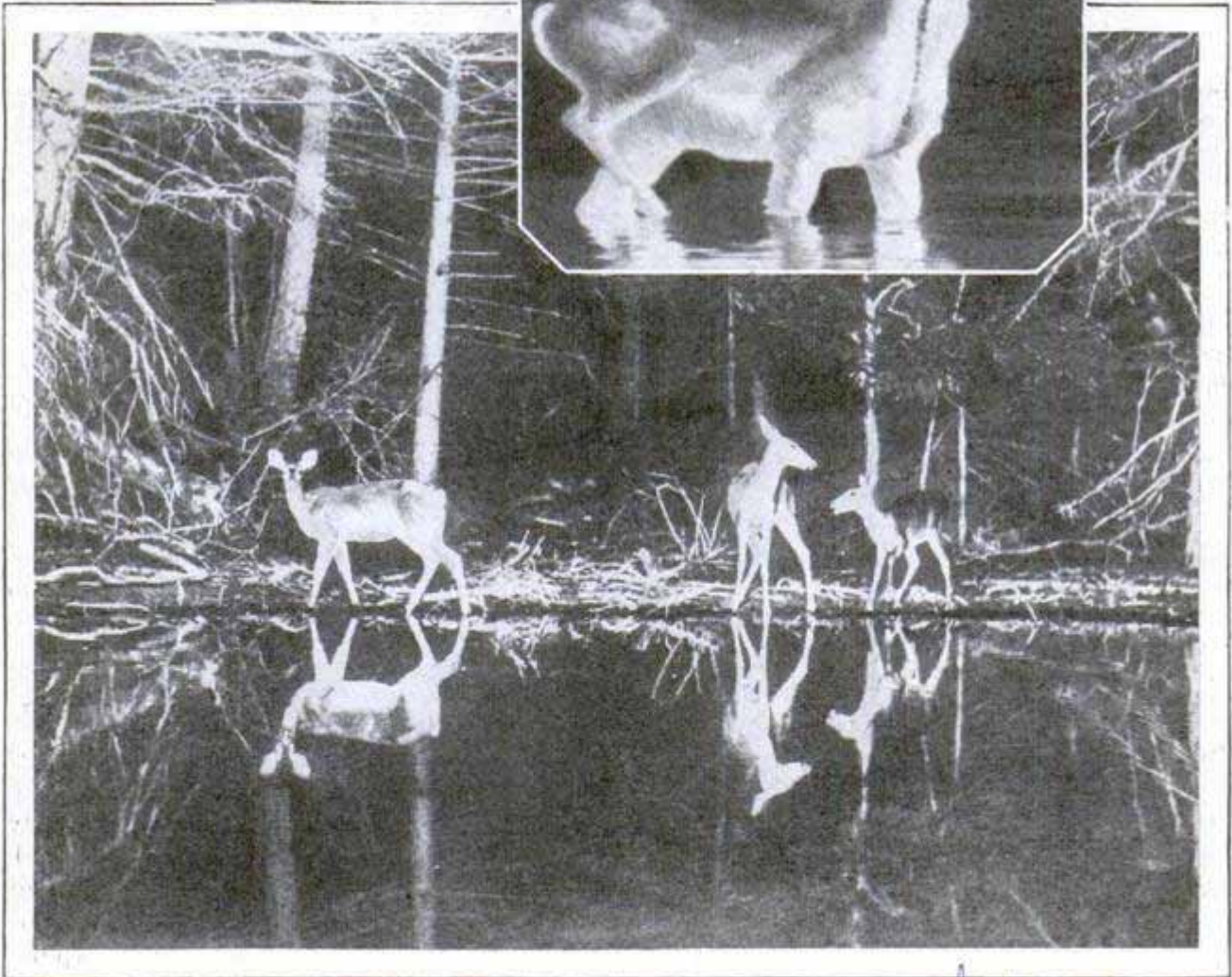

Triumphs in Photography; Hobart V. Roberts, of the New York State College of Forestry, Took These Night Snapshots of Deer by Using a Canoe and Special Lights as Shown in the Photograph at the Top

International

ART OF CERAMICS
LATEST AID TO
SEARCH FOR OIL

Based on the theory that no two clays will burn the same color in the same temperature, a method has been developed for using ceramics to help scientists in their search for oil. This is the latest of some fourteen recognized scientific means now employed to discover oil fields, and is being used when other methods have failed. Soil likely to give a clue as to the presence of oil may be identified by its color after burning. Scientists have discovered, and at the same time they make other chemical tests to determine the nature of the sample. According to Dr. Charles Gould, of Norman, Okla., a recent survey of 170 oil fields showed that thirteen of them had been brought in by accident and 157 by geologists using intelligent methods. In late years, 815 wildcat wells have been drilled in California, but none produced oil.



Ground Station in England from Which Instructions Are Sent by Radio to Student Pilots Making Their First Flights Unattended

WIRELESS AIDS STUDENT PILOT
IN FIRST SOLO FLIGHT

Student flyers making their first flights alone are being aided by wireless messages from the ground at the Heston aerodrome in England. The student's ship is fitted with a receiving instrument and instructors on the ground communicate to them any necessary information for controlling the flights and making safe landings.

STOPPED-UP PIPES CLEANED
BY SHAFT ON DRILL

Opening up a crooked stopped drain or sewer pipe is simplified with a flexible pipe cleaner which is driven by a breast drill.

The apparatus consists of the flexible shaft, on the end of which is a cleaning tip for removing scale and rust. When rotated by the drill, the snakelike shaft advances automatically through a feeding block clamped into place at the outlet opening. The cleaner may be obtained in various sizes and lengths.

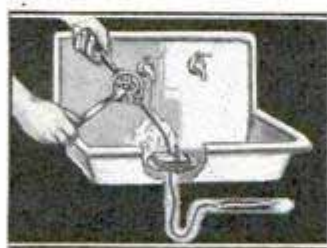

MAGNETISM HARDENS METALS

Metals can be super-hardened by magnetic treatment as well as by heat, the magnetic process consisting in repeatedly changing the polarity of the steel. Whether this treatment is likely to become of commercial value has not been indicated, but it is evident from experiments that both magnetism and heating appear to produce the same atomic arrangement.

Chicago-106 Jefferson

residence \$5.00
Industrial 17.50 4010

Wireless Aids Student Pilot Bulletin 459/10 1/19/20

Barlow Moor Road
Metalurgist 149

Slowly G. Ave
443 State St.

E. Is Herbert, before I row
and steel of institute, Eng

Improving Tone

TO REALIZE the utmost in tone from your dynamic speaker, experts declare that the nearest edge of the baffle should be at least 16 in. from the center of the cone opening, as shown in Fig. 1. With this distance the speaker will reproduce faithfully down to sixty vibrations a second, below which few ears can hear. For greater accuracy, the distance should be made 32 in., which will bring the tone down to the bottom notes of a piano.

When the speaker is mounted in a console, however, the entire cabinet, top, bottom, front and sides, acts as a baffle, and the distance is then figured from the center of the opening to the nearest back edge of the cabinet, as shown in Fig. 2. The back should be open and covered with a large-mesh screen, Fig. 3, or have several fair-sized holes in it, to prevent damping effects on the back of the cone, due to imprisoned air.

The baffle material may be anything that is firm and has a hard surface. Wood is satisfactory, but it should be 1 in. thick so that it will not vibrate excessively. If the baffle is placed in a console, it should be insulated from the cabinet with sponge rubber or felt pads as illustrated in Fig. 4. The pad under the speaker base is not essential, but helps in some cabinets of light construction.

A short horn, added to some dynamics, may improve the reproduction, but is not recommended in most cases, as it has a tendency to cause resonances. Nor, is it practical to use a dynamic with small battery sets, as the cost is prohibitive, or with a high impedance-output tube, such as the UX-201A, because the low tones will be cut off. A magnetic speaker should be used in all such cases. A dynamic speaker gives poor reproduction when worked far below its normal output.

Aside from proper installation, the dynamic itself needs no adjustment. Experience goes to show it is virtually indestructible. In test to see how long a paper cone would last, a laboratory set a dynamic in a loft room and let it run six months day and night on one note. A cone, only 7 in. in diameter, was used, and the note was a low one of sixty vibrations

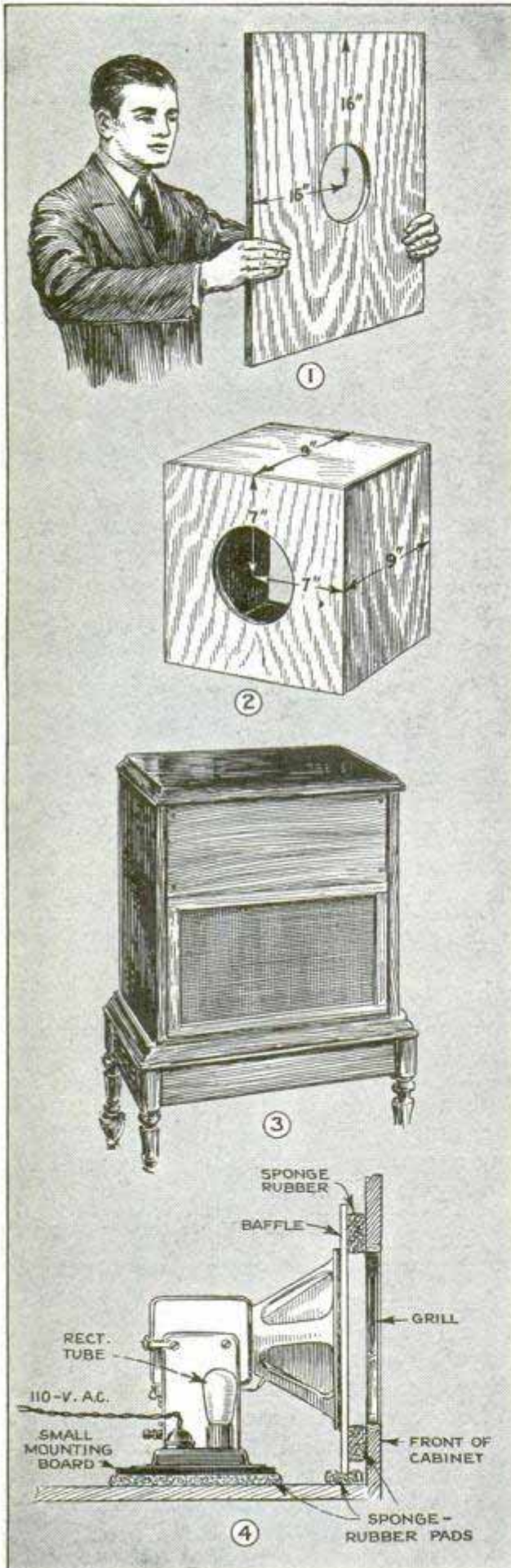

of Your Dynamic

a second in order to give the cone a long jerk of $\frac{1}{4}$ in. on each vibration. The test started April 1, 1929. At the end of September it was discontinued, the cone having run without interruption all that time; it was singing just as loud and clear as at the start, and showed no signs of breakdown.

Sound coming directly from the loud speaker of a set intermingles with that reflected from various surfaces in a room. If there are too many hard surfaces, too much reflection will occur, and the radio will sound unnatural. If you ever have heard a set operating in a room devoid of all furnishings except the radio receiver, you will appreciate this condition. On the other hand, too many soft objects, rugs, draperies, upholstered furniture, and the like, will cause too much sound to be absorbed, and the music will have a "dead" tone. It is because of such absorption and reflection that a set often sounds differently in a store and in the home. Fortunately, the average home has its furniture and other contents so arranged that a happy medium exists, and there is nothing to worry about as far as too much or too little reflection of radio or phonograph music is concerned.

Prof. John Martin, of the Case School of Applied Science, maintains that any good amplifying system can be built to perform as well as another. This does not mean that a set of cheap transformers will turn out as excellent quality as a set which has received careful engineering attention, although the performance of poor transformers can often be improved by shunting resistances or condensers across the primary and secondary windings. A good resistance-coupled amplifier has been found to give excellent all-around results. Its main drawbacks are the low gain per stage and the relatively high voltage required, but with modern equipment these are easily surmounted. Such an amplifier is remarkably free from distortion, because only the tubes do the voltage boosting. By changing resistances and coupling condensers, such an amplifier can be made to cover any tone range and to emphasize certain portions

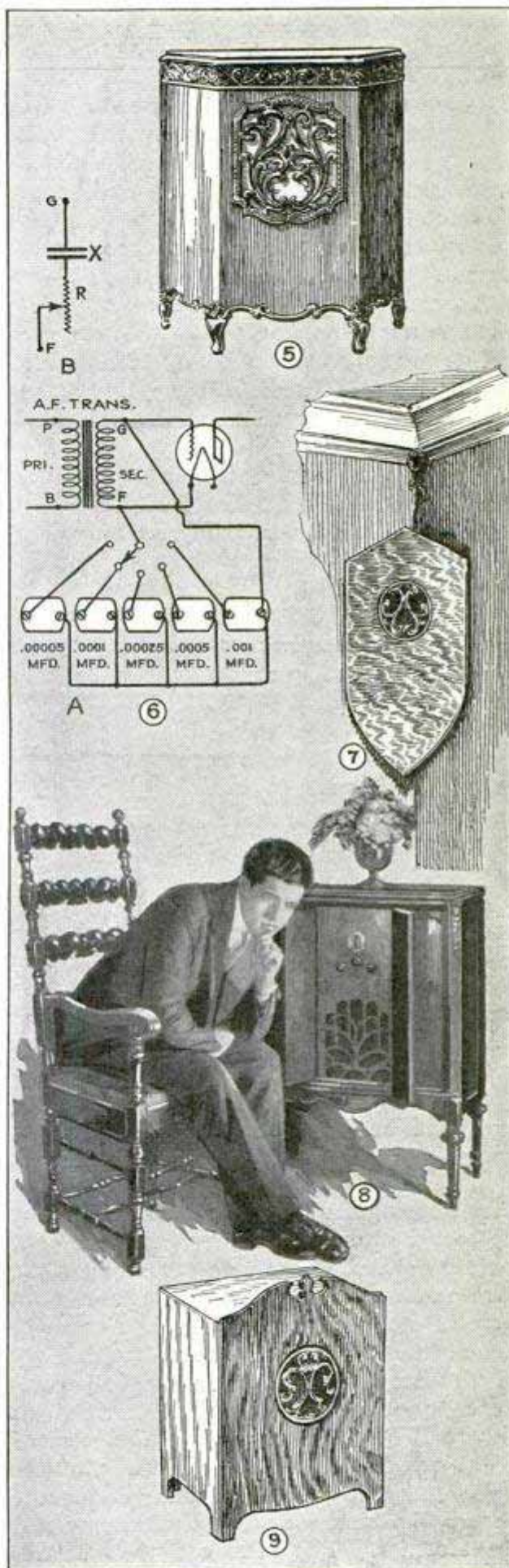

of the musical scale. Large coupling condensers improve low-note rendering and small ones emphasize the higher tones.

Impedance coupling is so similar to resistance that there is not a great deal of choice between them, except, perhaps, the cost of the coupling units. Inefficient transformers can be "doctored" like resistance or other circuits, so that the quality can be regulated to a considerable extent.

According to one authority, there is no need to use two 250-type tubes in order to get good reproduction in any set intended for the home. One 250-tube, if conditions are correct, is more than enough, and, with proper design in the set, two 245-tubes in push-pull are all that is necessary. In fact, the 245-tubes are preferable both from the standpoint of economy and with regard to weight of the complete set.

A radio tube, to operate as a good amplifier, must have its grid potential kept negative. If it goes positive, distortion will result. That is why C-batteries or a negative grid bias are used. So, if your radio develops the tendency to leave out the hissing tones of the voice, or otherwise distorts issuing sound, you should investigate the negative grid voltages.

There is a simple device that you can construct and use for modifying the quality of your speaker, regardless of type. It is connected across the secondary of the second a.f. stage, and is merely a series of condensers of various sizes, arranged so that they can be shunted across one at a time, as shown at A, Fig. 6. The individual units may be of capacities ranging from .00005 to .001 mfd., or up to .01 mfd., and are arranged so that a rotary switch, like those common on the first radio receivers, connects one at a time into the circuit. When the capacity which seems to give the most satisfactory results has been selected, a simple permanent tone control may be provided as shown at B. This consists of the selected capacity, X, in series with a variable 100,000-ohm to $\frac{1}{2}$ -meg. resistor connected across the secondary of the second a.f. transformer. The tone can then be ad-

justed to suit the most critical ear. Some speakers have an output filter built into the speaker unit and some of the older ones have a condenser across the primary of the output transformer. In some cases, these condenser values may be greatly reduced or removed with a corresponding increase in high-note rendering.

Perhaps you can improve the quality of your speaker by changing its location in a room. Large portable loud speakers, of the types shown in Figs. 5 and 7, are best placed in a corner or against a large wall surface which will act as a baffle. This is especially true of cones. The radio set with built-in speaker likewise performs best in a corner, as in Fig. 8, and should not be directly against a flat wall. Whenever possible, the speaker should be at ear level; if you build your speaker into a small cabinet of the type shown in

Fig. 9, therefore, it should be placed on a table or mantel for best results. And remember that the weather often affects speakers, especially cones that absorb moisture; so don't condemn your set too hastily. It may be suffering from a temporary speech affliction.

The home builder is often told that the impedance of

his output tube should match the impedance of his speaker. This, of course, is so much Greek to the uninitiated. The engineer can, and does, when designing a manufactured set, match these impedances, but the amateur cannot match the impedance of a speaker, which he does not know, with the impedance of a tube, which he also may not know. With this in mind, manufacturers are making output transformers with tapped secondaries, as shown in Fig. 10, which make the approximate matching of the impedances a mere matter of trying one or the other of three taps. On such transformers, the leads to the speaker are tried first on one set of taps and then on the other until the best combination is found.

The transformer built into the average dynamic is matched for average power-tube outputs, and gives good results on any homemade set. If the builder wants to experiment, however, he can cut out

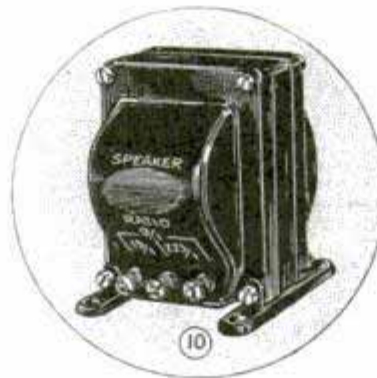

the transformer in the speaker and use one of the new output transformers in his set. To do this, he must find the leads from the secondary of the speaker transformer that go to the voice coil, and clip them, as indicated in Fig. 12. New leads are then taken from the voice coil to the tapped secondary of the new output transformer, which may be made a part of the set assembly, or mounted on the speaker in place of the old transformer. As mentioned above, the combination of taps on the transformer giving the best results is the one used. No other changes are necessary in the speaker. Most large cabinet dynamic speakers of the type illustrated in Fig. 5 have sufficient space below the speaker shelf for the installation of a separate power amplifier, as shown in Fig. 11. This is an excellent idea in cases

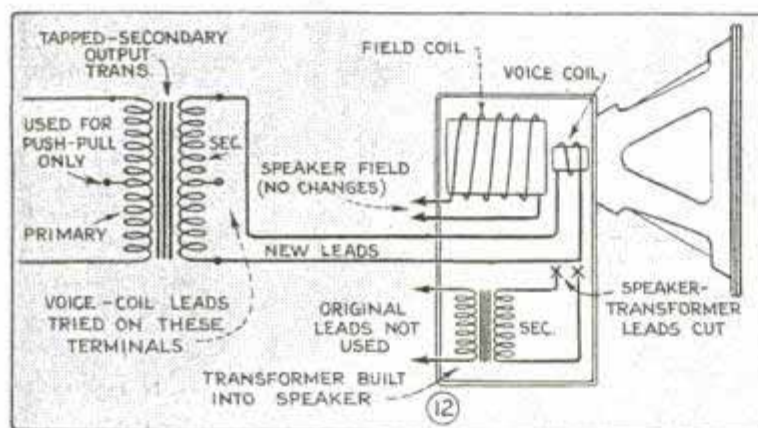
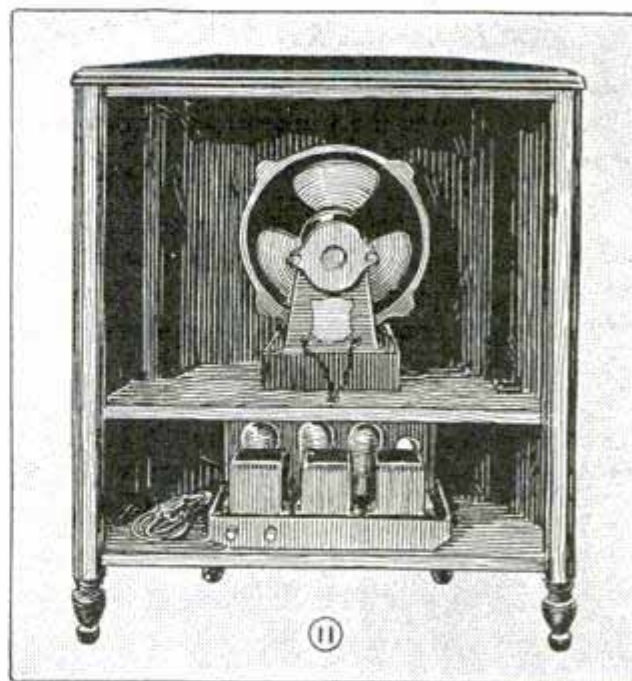

where the audio installation in the receiver is out of date or not up to par, as the detector output of the set is taken directly to the power amplifier, and the fact that the two are separated makes an ideal condition for improving the tone and performance of the dynamic speaker. Troublesome feed-back effects are also avoided by having a separate B-supply for the detector and r.f. stages, independent of the audio amplifier.

Reducing Hum in A.C. Receivers

One of the most troublesome causes of hum in a.c. receivers is found in the coupling in the circuit between the r.f. and detector stages. If the wiring is carefully cabled to avoid inductive coupling, there will be little hum, but, in many cases where space is limited and the parts are crowded together, loops will be formed in the circuit and a hum will result. While the gridleak-and-condenser method of detection is far superior in sensitivity and efficiency, the parts surrounding the gridleak and condenser, due to capacity coupling, often tend to make the receiver critical and unstable. In this case, changing the detector to the grid-bias type will sometimes eliminate the hum. If this does not remedy the trouble, connect a 100,000-ohm fixed resistor from the F-terminal

of the r.f. transformer to the center tap of the filament-heating transformer. This resistor should be shunted by a .1-mfd. condenser. Another method of keeping down the hum is to connect the center tap of the filament winding, supplying the 227-tube, to 45-volt positive-B of the plate supply. This places a bias of from $22\frac{1}{2}$ to 45 volts between the heater filament and the cathode of the tube. If the hum comes from the power stage, connect a 20-ohm center-tapped resistor across the filament supply and run the grid return from the center tap.—D. A. Brown, Marion, Ohio.

Popular Mechanics radio department offers its information service free to all readers of our magazine. We will be glad to help you with your problems, and will promptly answer all inquiries.

Simple Instrument Brings Your Receiver to Top-Notch Efficiency

MOST modern receivers employ ganged condensers, but, unless these are perfectly alined, the set does not perform as it should. While they may be alined by tuning in a station and then adjusting them until the point of greatest volume is reached, this method has limitations, owing to the natural variation in intensity of the music as received. If a signal of constant intensity could be produced for adjusting purposes, the job would be not only easier, but the alinement would be more accurate and, in many cases, it would be found that a remarkable increase in efficiency is apparent in the receiver after it has been adjusted by this method.

It is, in fact, a simple matter to make an inexpensive oscillator to supply constant signals, both

neutralizing receivers as well as for many other tests.

The schematic diagram for this oscillator is shown in Fig. 1 and the instrument layout in Fig. 2. All specifications are given except for the milliammeter, which is an inexpensive 0-to-10-milliamp. instrument, the use of which is optional. All instruments are mounted directly on the underside of the $\frac{3}{16}$ by 8 by

9-in. bakelite panel. The case is 3 in. deep and may be made of $\frac{1}{4}$ -in. stock, glued and nailed together with small brads, after which it can be covered with imitation leather or stained and varnished as the builder may de-

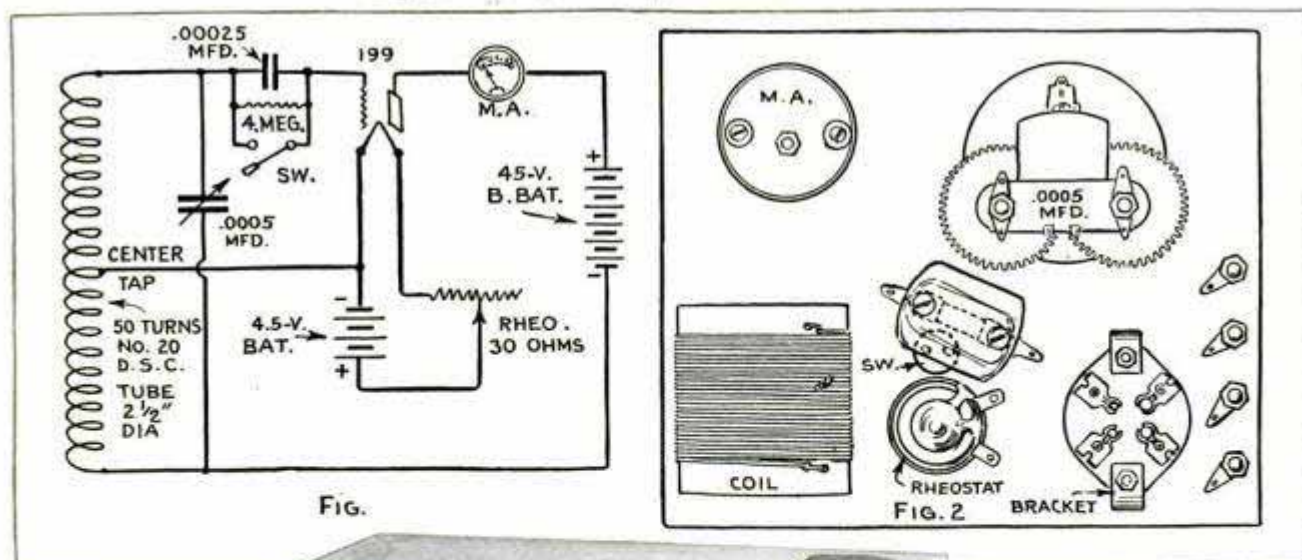

r.f. and a.f., which the custom builder, service man or even the individual fan will find indispensable, since it can be used also for neu-



sire. Inexpensive cases of this type are obtainable at department stores.

The coil consists of 50 turns of No. 20 d.s.c. wire, wound on a $2\frac{1}{2}$ -in. bakelite or

cardboard tube, $2\frac{3}{4}$ in. long. A tap is taken at the 25th turn (the center of the coil), and connected to negative side of tube filament. The coil should be placed at the end of the box so that close coupling to the set under test may be obtained; the .0005-mfd. condenser tunes this coil. A type-199 tube is used. A 4.5-volt C-battery with a 30-ohm rheostat, having an "off" point, in series with it, lights the tube, and the plate is supplied with 45 volts from two small 22.5-volt B-batteries. The four lugs shown at the right in Fig. 2 are for the battery binding posts, if the batteries are used externally, as shown in the photo above. If the builder desires, he may enlarge the case to contain the batteries.

The coil is fastened to the underside of the panel by means of two short machine screws at each end. The switch, a small battery type, is connected across the gridleak and condenser. When this switch is open, the condenser and gridleak will modulate the output of the oscillator to produce a.f. signals; when it is closed, the output is r.f. The tube socket is a subpanel type mounted with two brass brackets, $2\frac{3}{8}$ in. long, made from two strips, $3\frac{3}{8}$ in. long and bent over $\frac{1}{2}$ in. at each end. This allows the socket to be mounted so far below the panel that the top of the tube, which projects through a hole in the panel, clears the top of the lid when it is closed.

This oscillator will cover from 550 to 1,500 kilocycles (545.1 meters to 199.9 meters) very efficiently. To align ganged condensers all that is necessary is to switch on the receiver and remove the antenna lead from the set. The oscillator is then placed close to the antenna-tuning end of the receiver and switched on. The receiver dial is set to a low reading, such as 10 or 20 on a wavelength dial, or at about 1,300 kilocycles if so calibrated. The dial on the oscillator is then rotated until the signal comes through the loud speaker. The locknuts on the gang condenser are now loosened, and the individual condensers, from left to right, varied until the signal comes through with the greatest intensity. If trimmer or balancing condensers are employed across each condenser unit, use a spudger made of a piece of hardwood or bakelite sharp-

ened to a screwdriver edge at one end for varying the adjusting screws, as shown in lower photo on opposite page.

If a visual reading of the receiver output is desired, instead of trusting to the ear, use the simple hookup shown in Fig. 4, consisting of a thermo-galvanometer

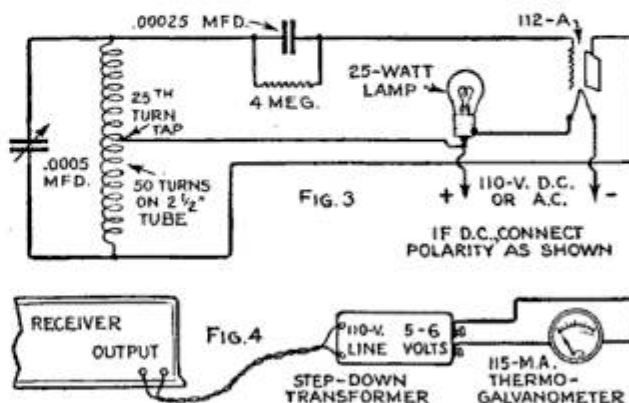

connected across the 6-volt secondary of a bell-ringing transformer. The 110-volt primary leads of the transformer are connected to the output of the set instead of the loud speaker. The instrument deflection will be at maximum when all stages of r.f. are tuned to resonance. The same hookup may also be used as an indicator when neutralizing a neutrodyne receiver, by adjusting the galvanometer deflection to a minimum at each stage.

The oscillator may be calibrated in wavelengths or kilocycles and used as a standard to determine whether a certain receiver will cover the broadcast range sufficiently, and also to determine the degree of selectivity by using a distance of 4 ft. between oscillator and receiver as a standard.

The diagram given in Fig. 3 is for a similar oscillator that is operated directly from a 110-volt a.c. or d.c. source.

Using Phone Line as Antenna

Telephone lines make a good temporary antenna when properly connected to the receiver. A .00025-mfd. fixed condenser of the mica type should be connected between the antenna binding post on the set and one of the telephone wires. Use whichever wire gives the best results. This arrangement allows the radio signals to pass to the set, but will not affect the telephone in any way. As a rule, it will not be necessary to use a ground.—G. Curtis Engle, Ridgewood, N. J.

Helpful Tips from

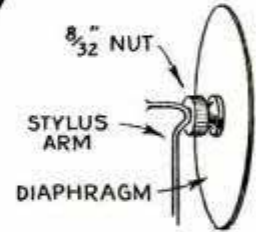
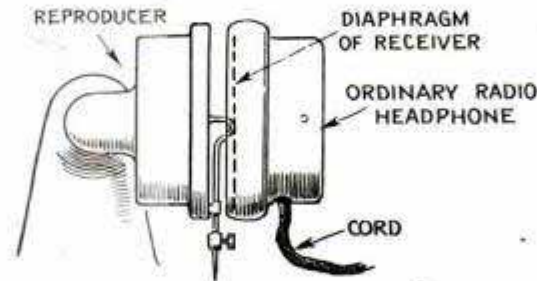

Left, Date Scribed on New Tube Bases for Checking Tube Life Also Prevents Possibility of Mixing Old Tubes with New; Above, Experimental Phonograph Pick-Up Made by Clamping Headphone to Phonograph Reproducer with Rubber Band; If Stylus Arm Does Not Touch Diaphragm, Use Brass Battery Nut as Shown; Phone Cord Goes to Detector Grid and Filament or to Audio-Amplifier Input

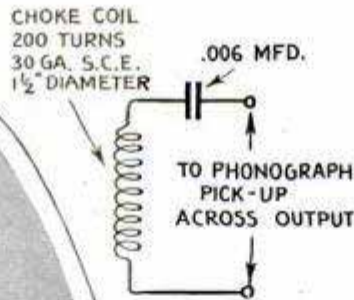
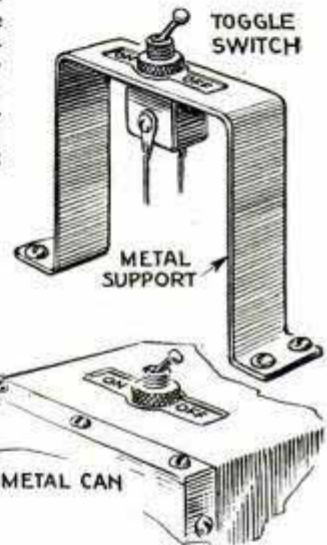

Above, Left, Simple Scratch Filter Removes Troublesome Record Scratch by Absorption; Right, Convenient Method of Mounting Switch in Power-Unit Shields; Can Be Removed without Disturbing Switch Connections; Lever Projects through Hole Cut in Can

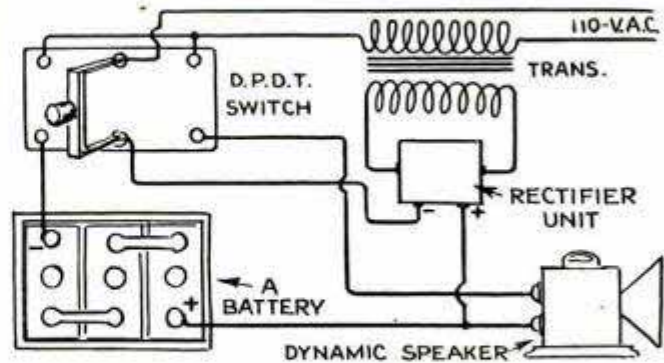
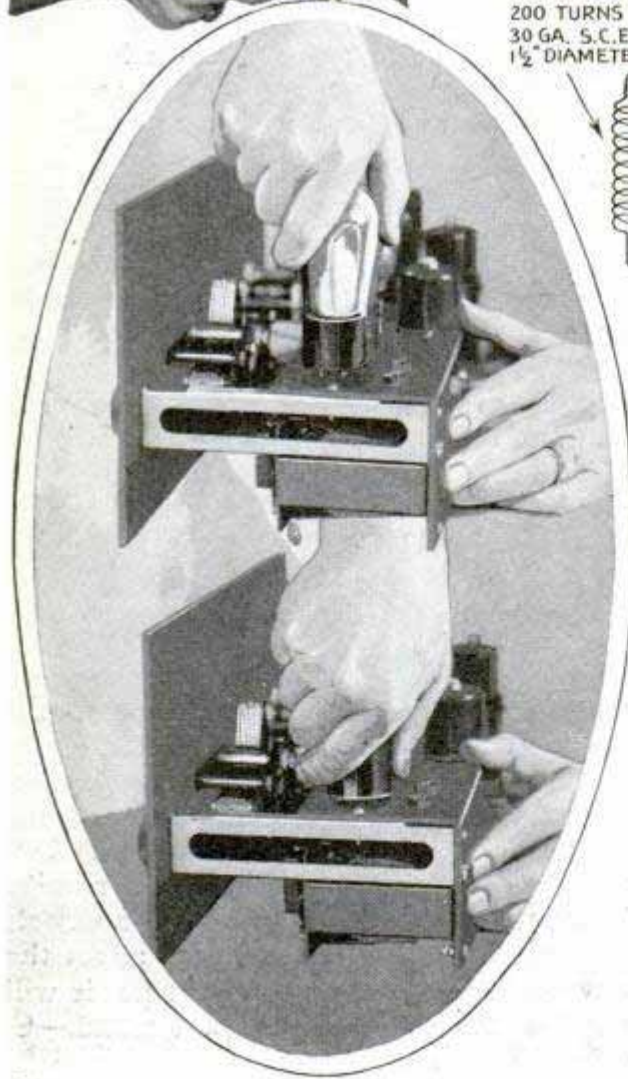

Left, Removing Tube from Socket, by Grasping Glass Bulb as Shown in the Upper Photo, Frequently Results in Broken or Damaged Tubes; Lower Photo Shows Proper Method of Grasping the Tube at the Base; Above, Operating a Six-Volt Dynamic Speaker from Trickle Charger to Save Drain on Storage Battery; Diagram Shows Connections for Switching the Trickle Charger from the Speaker Field Coil Back to the Battery for Charging When the Receiver Is Not in Use

the Radio Lab.

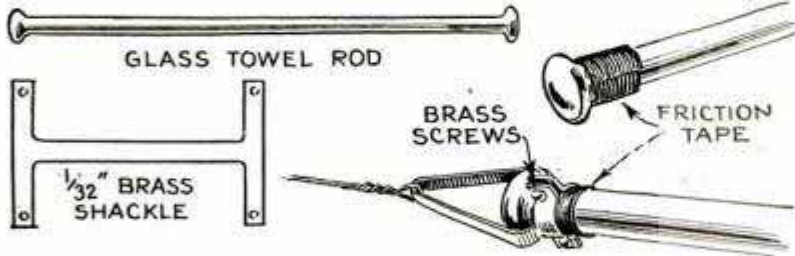

Inexpensive Antenna Insulators Made from Glass Towel Rods; Right, Checking R.F. Transformers by Means of an Adjustable Carborundum Crystal in Series with Headphones; Below, Push-Pull from Ordinary A.F. Transformers; the Output Transformer Is Connected in the Same Way, but Resistor Shunted across Secondary Is Connected to Plates of Tubes with Center Tap to Positive-B; Left, Bakelite Strip, Softened in Hot Water, Forms Lever for Vernier Tuning Dial

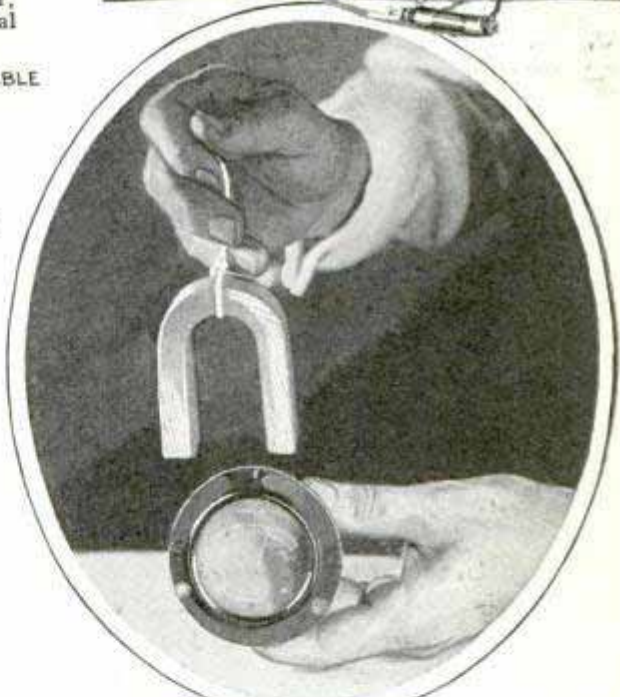
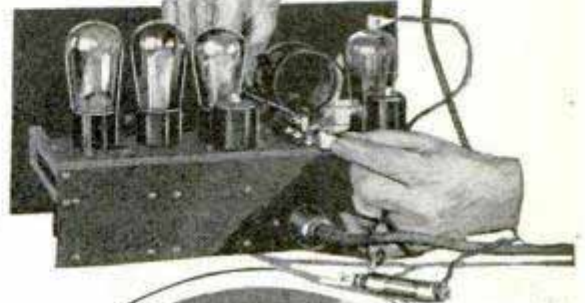
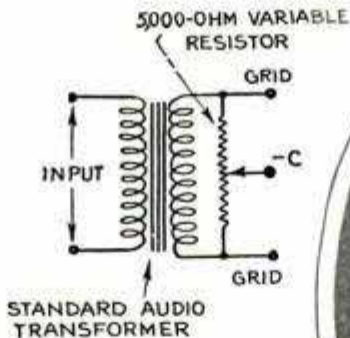
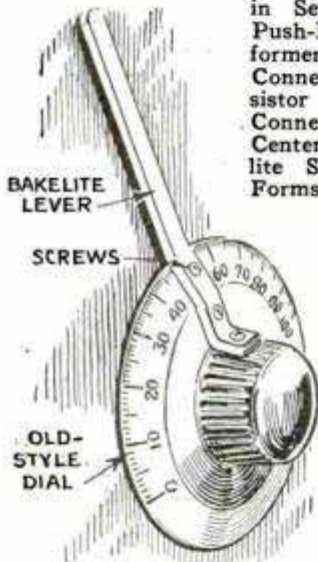

Right, Determining Magnet Polarity; South Pole Will Show Charge on Auto Ammeter When Passed Across behind Meter near Positive Terminal, Changing to Discharge as North Pole Approaches Negative Terminal

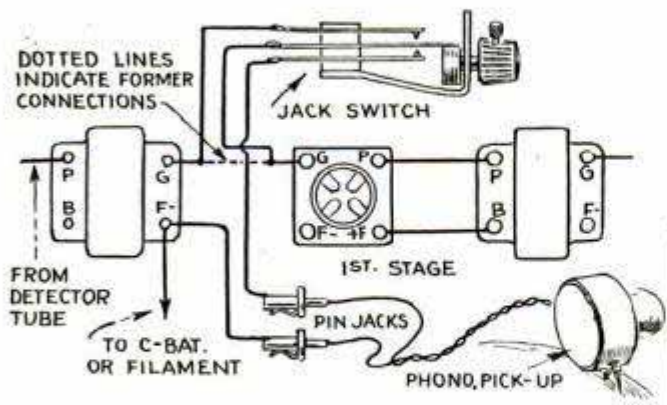

Handy Phonograph Pick-Up Switch Permits Quick Change from Radio to Record without Raising Cabinet Lid or Removing Tube; the Switch May Be Mounted at Any Convenient Position on the Control Panel; Right, Inexpensive Aluminum Baking Pans Make Excellent Bases for Mounting Radio Tuner or Amplifier Units; One Side of the Pan May Be Drilled to Take Binding Posts on a Bakelite Strip as Shown

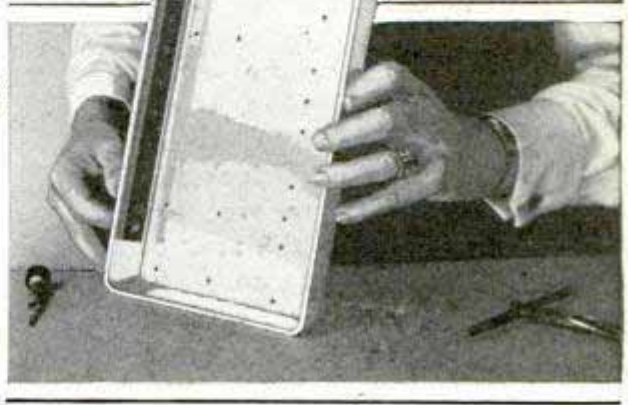

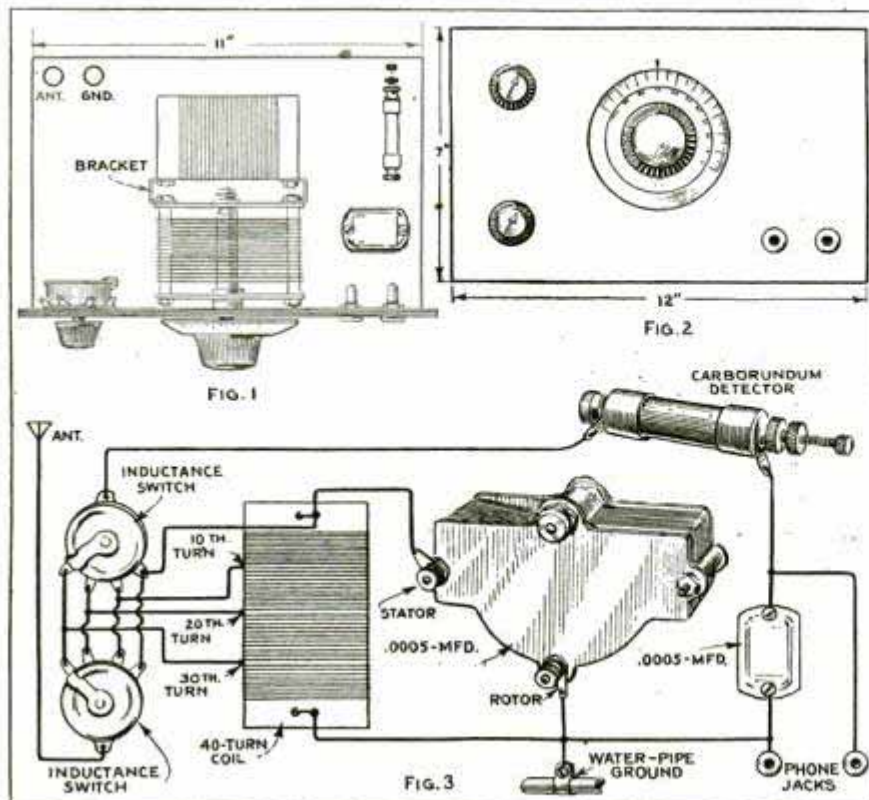

Upper Left, Instrument Assembly Showing Coil Mounted on Variable Condenser; Right, Front Panel Layout; Below, Simplified Wiring Diagram

An Efficient Crystal Set

This crystal receiver will give excellent results at low cost, and the beginner will find it very easy to assemble. The tuning coil consists of 40 turns of No. 22 or 20 d.c.c. magnet wire wound in a single layer on a cardboard tube, 4 in. in diameter and 5 in. long. The coil is tapped at the 10th, 20th and 30th turns, and about 1 ft. of the wire at each end of the coil is left for connections. The ends are anchored by running them in and out through the two small holes shown at the top and bottom of the coil. The taps may be taken off at the points specified by lifting the turn of wire at each point with a match or toothpick. The insulation is then scraped from the wire, and the leads to the four-point inductance switches soldered in place. After completing the coil, assemble the parts on the panel and baseboard as shown in Figs. 1 and 2. The latter may be made from $\frac{5}{8}$ -in. wood, and the instrument panel from either thin wood or bakelite. Two small brass brackets are used at the rear of the condenser to support the coil, as shown in Fig. 1. The two four-point switches are connected in parallel, as shown. The leads from the coil may be of the same wire as

the coil, or of ordinary flexible rubber-covered hookup wire, as used for the remaining circuit connections. The carbondum-crystal detector is quite sensitive to weak signals, and, being adjustable, can be set at the highest point of efficiency. A single-wire antenna, at least 100 ft. long, should be used with this receiver for best results. Tuning is very simple; plug a pair of 2,000-ohm headphones into the phone-tip jacks, and rotate the condenser dial and inductance switches until a station is picked up. The crystal is then adjusted to a sensitive point, and the variable condenser and

switches further manipulated to get maximum volume and clarity. The receiver is fairly selective and will separate stations nicely even in crowded localities, unless located in the immediate vicinity of a powerful local station.

Wavemeter for Short-Wave Sets

Four coils are used in this simple and compact wavemeter for tuning over the three most popular short-wave bands, 20, 40 and 80 meters, which cover everything between 19 and 91 meters. Coils for the 5 and 10-meter bands are also available.

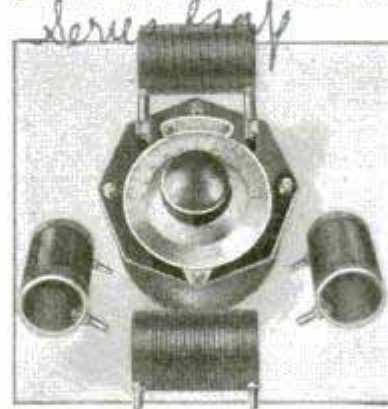

The meter consists of a series of fixed and variable capacities built into a single unit, heavy jacks and plugs providing positive contact and facilitating quick changing from one wave band to another. The dial is of the vernier type, which enables reading to one-tenth of a division.

*Aero Products Inc.
4611 E. Cravenwood*

Converter for Operating A. C. Sets from Farm Lighting Plant

By D. A. BROWN

A ROTARY converter can be made from the average type of 32-volt motor to convert the d.c. supply of the farm plant into a c. current for the operation of practically any standard a.c. receiver. To step up the output of the converter, a heavy-duty bell-ringing transformer, with the windings connected in reverse to usual practice, was used by the author. The device can be made to operate on either 32, 220 or 440-volt direct current as desired, so long as the motor voltage corresponds with the line voltage.

It is preferable to use a four-pole shunt-wound motor, as the driving speed will only have to be 1,800 r.p.m., while a two-pole machine will have to make 3,600 r.p.m. However, there is no objection to the latter if the bearings will allow such speed without overheating. The connections of the armature will be the same in both cases, proceeding as follows: Mark the bars of the commutator on which the brushes rest when the motor is idle; these will serve as guides later. Remove the armature from the frame and drill a $\frac{3}{16}$ -in.

hole down the end of the shaft opposite the commutator end, meeting it with another hole as indicated at A in the drawing. Through this hole the wires are brought from the commutator to the slip rings.

It will be found that wooden or fiber wedges are used in the armature slots to hold the windings in place. Remove the wedges in line with the commutator bars previously marked, solder a small well-insulated wire to each of the marked bars, then run the wire through the slots in the armature from which the wedges were removed, taking them down through the hole in the shaft and out of the end. Replace the wedges and tape the end of the armature winding where the wires are fastened to the commutator, then wrap firmly with heavy cord and cover with black asphaltum insulating varnish. Let this dry thoroughly and then reassemble the motor.

The slip-ring assembly is made by drilling a fiber block to a snug driving fit on the motor shaft. The rings are cut from brass tubing, 1 in. in diameter, and should be $\frac{1}{2}$ in. wide. The motor may now be started and the fiber turned down until it is just a trifle larger than the inside diameter of the brass rings. Heat the rings

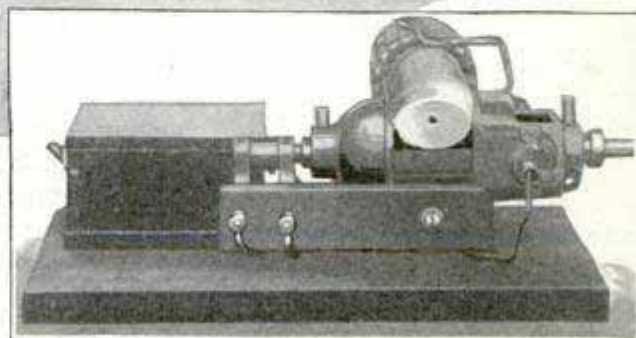
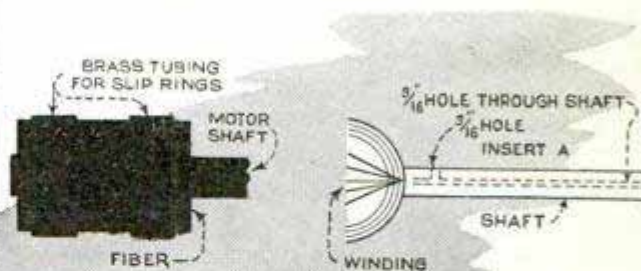
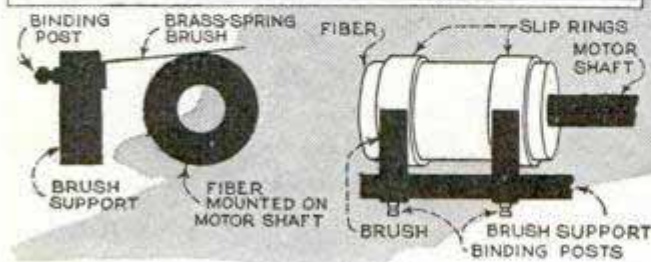
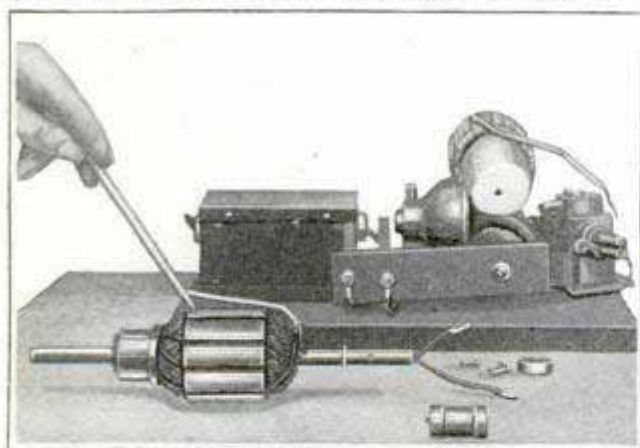

Upper Left, Armature Removed from Frame; Lower Right, Complete Converter-Unit Assembly, Showing the Transformer in Position

and slip them in position on the fiber, where they will fit tightly when cold.

The two wires from the commutator

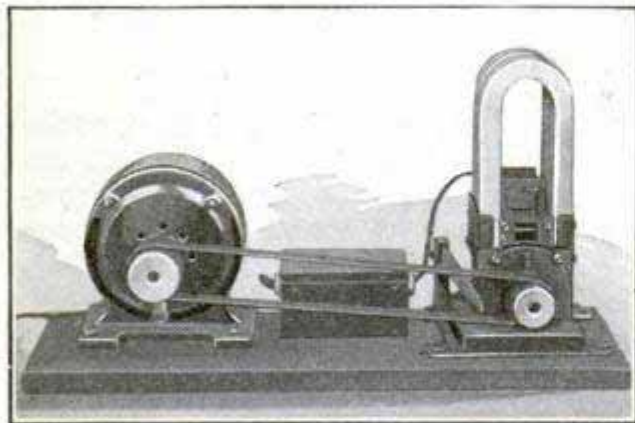

Magneto Driven by Motor Used to Furnish A.C. Source for Step-Up Transformer

are then connected to the rings, one being turned over the end of the motor shaft and connected directly to the ring, while the other is slipped through a small hole drilled in the fiber so that the wire can pass under the ring with plenty of clearance. Two brushes, made of hard spring brass, are then mounted on a fiber block which is attached to the motor frame, so that the brushes will bear against the slip rings, as shown in the sketch at the lower left. The method of mounting the block depends on the type of motor used. The unit is now a converter, and by connecting it to the farm-lighting battery supply, it will supply a.c. current from binding posts fastened to the brushes. The voltage is usually five-sevenths of the input battery voltage, and, in average operation, the output will be between 22 and 28 volts a.c., depending on the condition of the batteries that furnish the driving current.

In the writer's experiments a heavy-duty bell-ringing transformer, with a 110-volt primary and a 24-volt secondary, was used, the current rating being from 150 to 200 watts. The secondary of this transformer is connected to the slip-ring brushes of the converter and a voltage sufficient for the operation of a standard a.c. receiver is obtained from what was originally the primary of the transformer.

The voltage from the transformer should be checked with an a.c. voltmeter, and, if found too high, a suitable resistor should be placed in the receiver supply line. The usual voltage control devices are suitable for this purpose.

Another interesting experiment along the same line for those who have no suitable motor, or who wish a simpler design, employs a heavy-duty magneto, such as used on older types of autos for ignition. While the converter can be built into one compact unit, the magneto type must be driven with a separate motor. The frequency is governed, as in the case of the converter, by the number of poles in the machine, although, as a general rule, the magneto will be of the two-pole construction. The transformer requirements vary with different machines, so the voltage output will have to be determined by means of a meter and a suitable transformer used for the particular voltage desired.

Adapter Makes Screen-Grid Tubes Usable in Any Set

Enabling an owner of any type of receiver to convert the set to use the new screen-grid tubes, an adapter is said to build up stronger signals, give greater DX-reception, quieter operation and better selectivity. It is designed to permit the use of 224-tubes as r.f. amplifiers in place of 201A, 226 or 227-tubes in any receiver where there is room for it. A 110-volt a.c. supply is necessary for the filament transformer, and a plate supply of from 135 to 220 volts. The device consists of a high-impedance coupler for use in the plate circuit, a self-adjusting screen-grid bias unit, complete shielding

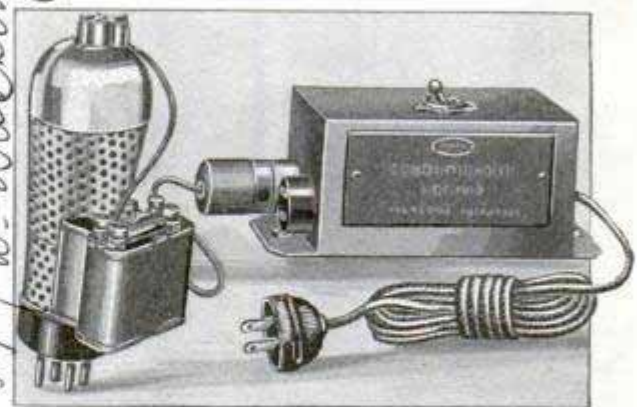

Screen-Grid Unit Ready for Plugging into Power Line

and a two-outlet filament transformer, the latter being unnecessary for sets using 227-tubes. One transformer suffices for two or more r.f. tubes. The adjustable revolving base fits a standard four or five-prong socket.

2456 R
 579 W. Washington
 Meigs.

Invention Corporation of America, 78 Cortlandt



AMATEUR MECHANICS

A Smoking Stand of Real Utility

By FRANK L. WADE

ONE of the commonest projects for the home worker to make is a smoking stand. To the general mind, a smoking stand is good or bad only by virtue of its pleasing (or otherwise) appearance, and it is seldom judged by its utility. In this article we present a stand which is not only very pleasing in design, but is extremely useful. It has two distinct features in its favor. First, should a lighted cigar or cigaret be dropped into it, the smoke will not continue to perfume the room, and, second, if the stand should accidentally be knocked over, the ashes will not scatter on the floor.

Though the main portion of this stand is to be constructed of wood, there are three parts which must be made of sheet metal; these parts, however, are so simple that any handy man can easily construct them.

The stand consists of four turned legs, two handles, two shelves and a drawer, as well as rails, stretchers, etc., of wood. It also has a sheet-metal funnel, cylinder and square pan. Detail drawings of each part are given, and if the dimensions are carefully followed, no difficulty need be experienced.

The design of legs and handles may be altered to suit the workman except for the over-all

length and the square portions where the drawer and the shelves are placed. The sizes given must be followed here.

The hardest part of the job is turning the legs and handles exactly alike. This will be more easily accomplished if a template, or rather, two templates are first made, one for marking and the other for shaping. The templates for the legs are made from $\frac{1}{4}$ by 2-in. pieces of wood, and are 28 in. long; the handle templates

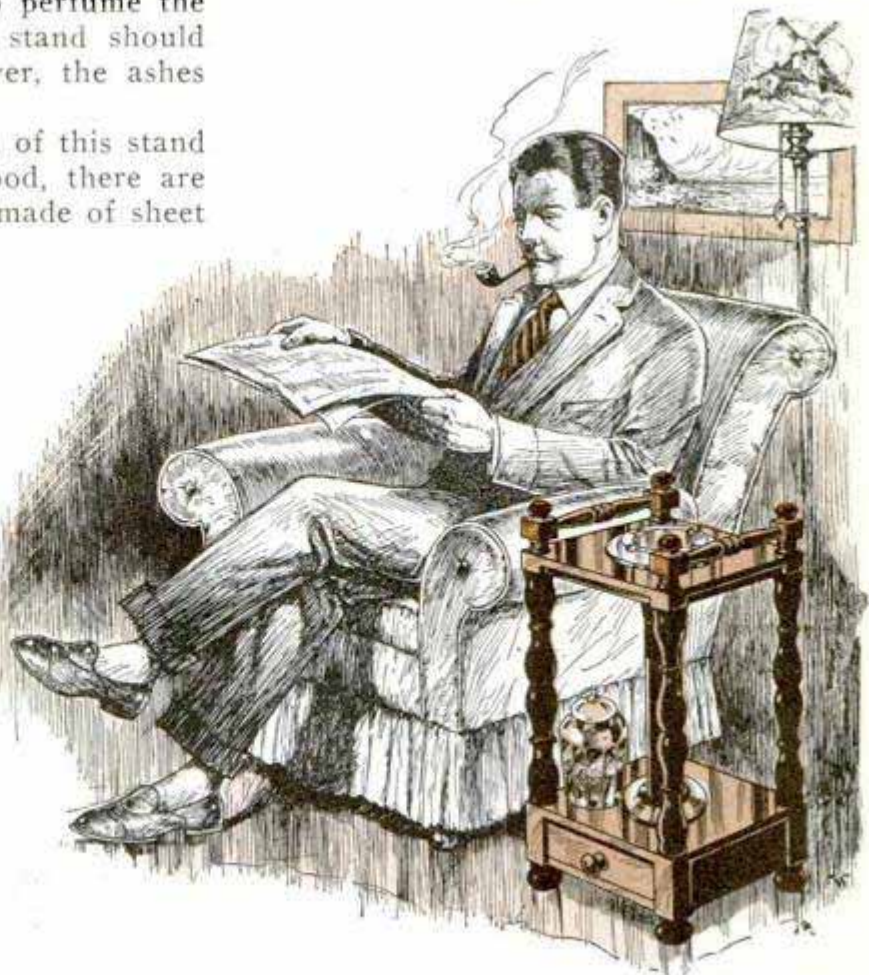

are the same, but $12\frac{1}{2}$ in. long. Detail drawings of the leg templates are given.

The first thing to do is to lay off all the dimensions, starting 1 in. from the end, and at each point square a line across one side and one edge of the template. Then, standing the template on its opposite edge, drive 1-in. brads into the marked edge at each point until they project only $\frac{1}{4}$ in.; the heads are then filed off to a fairly sharp point. This template is used by holding the bradded edge against the stock while it is turning in the lathe, which marks the location of each cut.

The shaping template is merely a pattern of the leg, cut out on the band or jig-saw or even with a coping saw. At the square portions of the leg, allowance must be made in the template for the distance across corners of the stock. This template is held against the stock from time to time while turning it, to determine if the leg fits the pattern. The handle templates are made and used in a similar manner, the design serving as a guide.

The stock for the legs is $1\frac{1}{2}$ in. square, 28 in. long, and four pieces will be required.

After turning, the legs must be bored to fit the handles and mortised to fit the rails and stretchers. In the detail drawings of the legs, the exact size and location of these various holes will be found. Be very accurate in the measuring and cutting, as much depends on the way the pieces fit together. Note that $3\frac{1}{8}$ by $\frac{1}{2}$ -in. mortises are cut on one side of the squares at the bottom of the front legs, for the side rails, while on adjacent sides the tenons are $\frac{3}{8}$ by $\frac{5}{8}$ in., for the front lower stretchers, as shown in the lower sketch of the leg. On the back legs, $3\frac{1}{8}$ -in. mortises are cut in both sides, as the back rail is the same as the side rails. The mortises at the top are all alike.

Two shelves will now be required, each measuring $12\frac{1}{2}$ by $12\frac{1}{2}$ by $\frac{5}{8}$ in. Locate the exact center of each piece and, in one piece, cut a hole, 4 in. in diameter; in the other cut a hole, $2\frac{1}{2}$ in. in diameter. In each corner of each shelf cut a square notch exactly $1\frac{1}{2}$ by $1\frac{1}{2}$ in. Dress all outside edges and surfaces perfectly smooth. Rails and stretchers are then cut according to the details and placed where shown on the assembly drawing.

In constructing the drawer, follow the common practice of drawer construction, using the sizes shown in the drawing. A small knob may be turned if desired, or it can be purchased at any five and ten-cent or variety store.

Two wooden rings are now turned, one to fit around the cylinder, where it enters the lower shelf, and the other to fit around the opening in the upper shelf. Sizes and shapes of these rings are given in the drawings. The upper ring is to have four grooves gouged in it, in which to lay cigars or cigarettes.

If the worker cannot make up the funnel, cylinder and pan, any sheet-metal shop will make them, from the patterns given, for a very small sum.

In assembling the various parts, the pair of legs on each side should be glued and clamped together with their handles, stretchers and rails and allowed to remain in the clamps until the glue has thoroughly set. The two sets of legs thus obtained are to be assembled with the crosswise stretchers and rails and again clamped until the glue has set. The shelves are then put in place and need not be fastened unless it is desired, though it is better to fasten them from the underside to prevent the possibility of warping.

The funnel and cylinder are soldered together, allowing the cylinder to overlap the funnel to the point where the flare begins. This whole unit is then inserted down through the hole in the upper shelf, through the lower ring and into the hole in the lower shelf until the flange of the funnel rests on the upper shelf. The upper wooden ring is then fastened to the upper shelf over and hiding the flange of the funnel. The sheet-metal pan forms a removable lining for the drawer to prevent any danger from fire and must always be used for that purpose.

The stand is now completed and ready for the finishing. It will probably be desirable to finish the stand to match some other piece of furniture, so it will not be necessary to give processes in this article. If such woods as mahogany, maple or walnut are used, the finish will naturally be stain and varnish or shellac. If a lacquer or enamel finish is desired, then cheaper woods can be employed. Gum and birch, in this class, are good for turning.



Beamed-Ceiling Effect, Obtained by Exposing the Joists, Adds to the Attractiveness of the Cottage or Lodge

How to Get a Beamed-Ceiling Effect

To get a beamed-ceiling effect, remove the plaster and laths on the ceiling thereby exposing the joists. They should be smoothed with coarse sandpaper, and all holes must be filled. Wallboard is fitted between the joists and tacked at the edges to the floor or roof boards above. The rows of nails holding the wallboard in place are covered with quarter-round molding. The wallboard is painted any desired light color while the joists are stained with dark-walnut oil stain.

Wire Holders for Long-Stemmed Flowers

When long-stemmed flowers are placed in shallow vases or dishes, or in wide-necked jars, the wire supports shown in the photo will be found handy. One of them consists of a group of hair pins set vertically in a lead base. The lead is melted and poured in a tin-can cover, the pins being inserted before the lead has hardened. As the pins are placed close together, they will hold the flower stems firmly at their base. If an additional support is desired farther up the stem, place a few long, twisted and looped wires in the cluster of hairpins. Other supports of wire and screen are also shown.

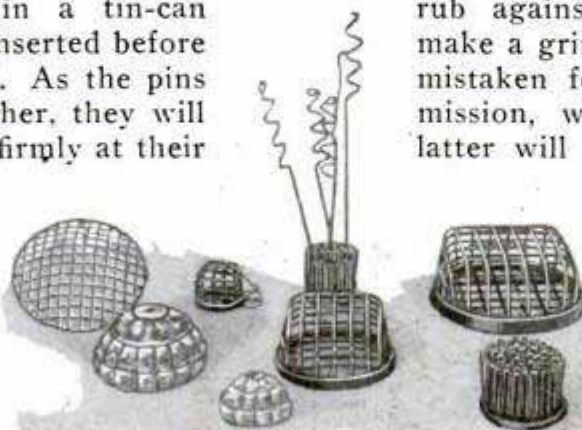

Simple Methods of Supporting Long-Stemmed Flowers in Shallow or Wide-Necked Containers

Don't Neglect Your Generator

One of the most important units of an automobile engine is the generator. If you examine it, you will notice a little oil cup at the rear end. Being small, it is frequently overlooked, but it should be supplied with several drops of light oil once a week, and more often if long drives are made. On a Ford generator this oil cup supplies lubrication to a

ball bearing supporting one end of the armature shaft. Should this bearing run dry, it would soon go to pieces and allow the armature to rub against the inside of the generator housing. This would necessitate an expensive repair and, perhaps, an annoying delay, so that it is well to give this unit the attention it requires and shield it as much as possible from dust and dirt. Sometimes a film of gummy oil will collect on the commutator, preventing the generator from charging as it should. When this occurs, it is necessary to clean the commutator with a fine grade of emery cloth or garnet paper. With the motor running idle, hold a small piece of this against the commutator until the film has been removed. The generator should then charge properly, but if not, take it to the local service station for examination. To neglect the generator is to invite trouble. Sometimes a burned-out ball bearing, which lets the armature

rub against the field pieces, will make a grinding noise that is easily mistaken for a noise in the transmission, with the result that the latter will sometimes be needlessly overhauled. The generator should never have an output of more than 15 amperes, as a high-charging rate is hard on both battery and generator.—Glen F. Stillwell, Collinsville, Ill.

A Simple "Sunshine" Lamp

By WALTER E. BURTON

1032 Florida Ave
Arnon Ohio

FOR the price of a box of good candy you can have a "health" lamp as efficient as one costing many times more. The lamp is a twin-arc type, using two pairs of either "sunshine" or therapeutic "C" carbons, and the cost of operation is low.

The lamp housing is an aluminum bread pan measuring approximately 5½ by 9½ in. at the top, and nearly 3 in. deep, which can be obtained for about 25 cents. The two carbon carriers are of porcelain,

and are bases from single-pole, single-throw knife switches, purchased for 10 cents each. Remove all metal parts, and on one side of one piece mark a center point. Likewise, run a center line from top to bottom of the bread pan, on each end. Place the marked porcelain piece so that its center mark coincides with the line on the pan, and align the screw holes of the base halfway between the top and bottom of the pan end. Mark the position of the holes, and drill through the pan with a ⅜-in. bit. Do this on both ends of the pan. The holes are to receive the two parallel rods upon which the movable carbon holder slides, and on which

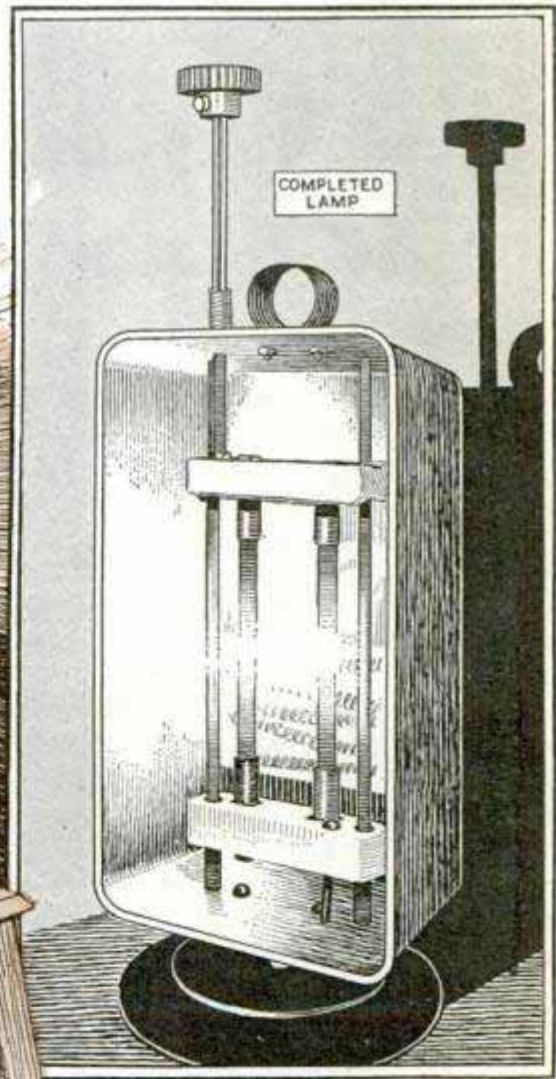

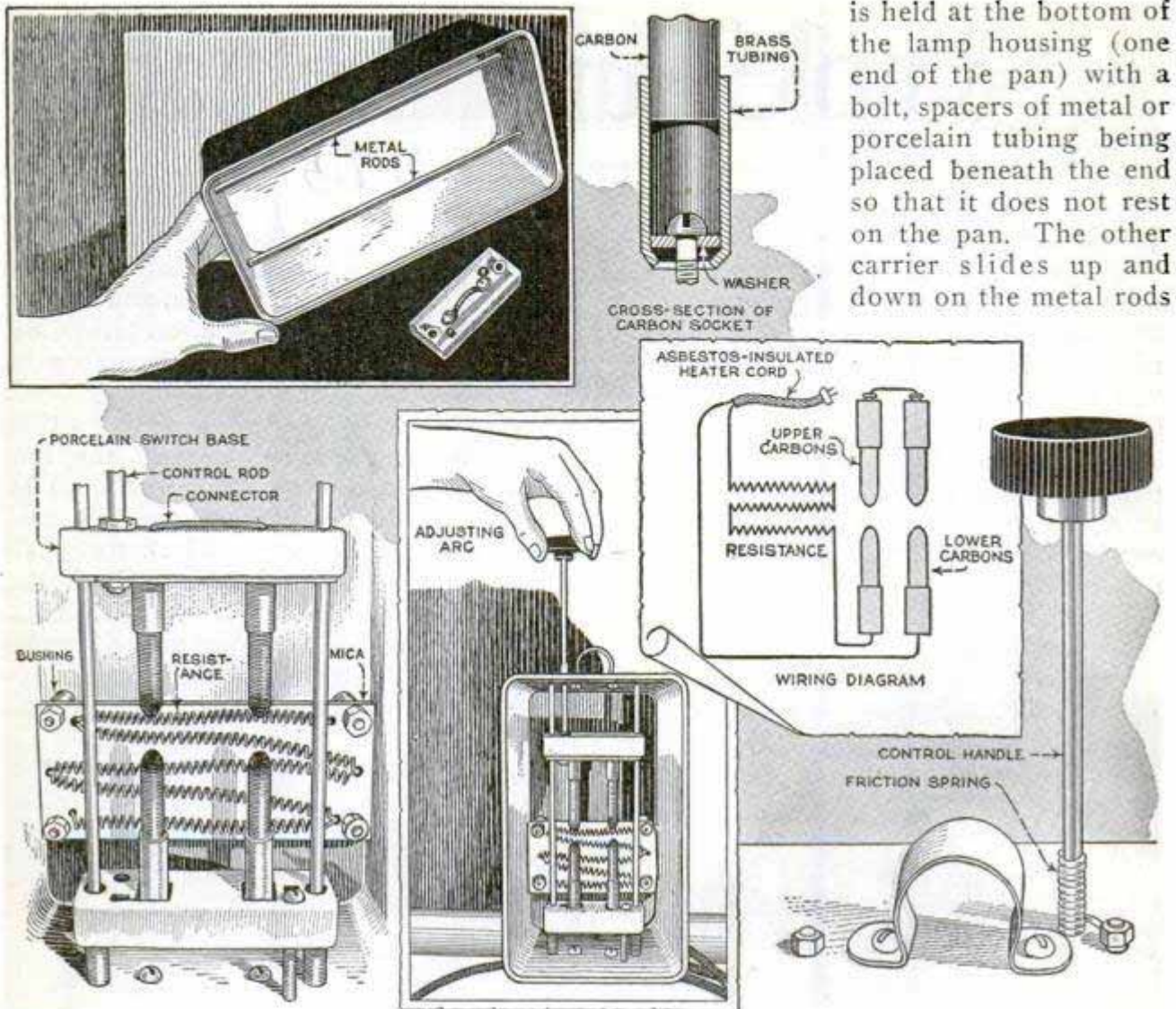

is held at the bottom of the lamp housing (one end of the pan) with a bolt, spacers of metal or porcelain tubing being placed beneath the end so that it does not rest on the pan. The other carrier slides up and down on the metal rods

the other one rests. The rods are made from the solid portion of a sectional curtain rod, cut to size and threaded at each end to receive nuts.

Prepare each of the carbon carriers as follows: Obtain four pieces of metal tubing, about 1 in. long and having an internal diameter nearly the same as the outside diameter of the carbons to be used. Those illustrated are $\frac{5}{16}$ in. If the tubing is too small to receive the carbons, spread one end slightly with a tapered punch. If it is too large, bend the edges in with a hammer or pliers. Then insert a solid-metal rod or other solid object into the tubing so that the end comes within a fraction of an inch of the base end of the piece. With a hammer, burr over this end so that a washer, when slipped inside, will not pass through. This is to make possible bolting of the piece to the porcelain base.

One carbon carrier is stationary, and

running lengthwise of the pan. The two carbon sockets of the sliding piece are connected by a piece of heavy copper wire. There are six holes in each porcelain piece. Two of these hold the carbon sockets and two slide over the parallel rods. Of the remaining two, one is employed for fastening the bottom carrier, and the one in the sliding unit receives the adjusting handle. This is a rod running through a hole in the top of the housing, and is fitted with a radio knob at the upper end. To prevent the sliding carrier from dropping down, a short coil spring, bent sharply so as to have a friction grip when in place, is slipped over the handle, as shown in one of the drawings. One end of the spring is held by the nut on the nearest rod. The spring creates friction on the control rod so that the carrier will remain in any position to which it is set. A small metal handle, also shown, is bolted to the top of the lamp housing.

A resistance is required for the arc. This consists of a length of coiled resistance wire—half of that on a 550-watt heater element is about right—mounted on a rectangular mica sheet, which, in turn, is fastened by means of bolts and spacers near the rear side of the lamp housing, behind the lower carbons. The mica is backed with a sheet of asbestos, although this can be omitted if all wires are arranged so as not to touch the metal. The resistance wire can simply be wound around the mica piece, but it is best to place the wire on the outside surface of the mica, in the manner illustrated. The resistance is held in place by staples made of short pieces of the same wire, clinched through holes in the mica. By mounting the resistance unit inside the housing, two advantages are gained. First, it is out of the way and is protected from damage; second, the heat produced is directed toward the lamp user, a not unwelcome feature on a chilly day.

The lamp may be provided with a base in any of a number of ways. It may be screwed to a square wooden block, suitably finished. The lamp illustrated uses the base from an old radio loop aerial. This happened to have a hole in the center, so a bolt fitting it was fastened to the lower side of the housing. This allows the lamp to be turned easily.

Power wires enter the housing at the back, near the bottom. One wire goes to one side of the resistance and the other to one of the lower carbons, as shown in the wiring diagram. The second bottom carbon is connected to the other resistance terminal by heavy copper wire, either bare or enameled. A piece of mica should be inserted so as to keep some of the heat from the lead wires.

A standard-length carbon is broken in half to form one pair for the lamp. The pieces are inserted into their sockets so that a tight fit is obtained, and the lamp is ready to operate. After connecting it to a 110-volt current supply, the arc is started by bringing the carbons together and then separating them slightly. Be sure that both pairs of carbons touch at the same time.

It is necessary to use goggles with this lamp, in order to protect the eyes from injury. These should have colored glass

mounted in close-fitting leather, so that rays of ultraviolet light cannot reach the eyes from the sides. You usually can obtain them from physicians' supply stores.

First exposures to the lamp should be brief, two or three minutes a day at most. This can be gradually increased in length as the skin becomes tanned, but too long exposures are likely to produce painful sunburn. The lamp will burn five to ten minutes with one setting of the control handle, a feature that prevents overexposure if the user happens to fall asleep.

But before using this or any other kind of health lamp, it is a wise precaution to consult your physician to determine the advisability of such treatment, and to learn the length and frequency of exposures. There are some persons who are harmed rather than benefited by short-wave radiation, and illnesses in which it is dangerous. The "C" carbons are rich in ultraviolet rays and are suggested for use under a doctor's directions. Sunshine carbons are less powerful.

Combined Screens and Curtains for Auto Windows

For those who occasionally sleep in their cars on week-end camping trips, beach parties, etc., the combined screens and curtains shown in the drawing will be found a great convenience. The screen frames are made of light wood to fit the windows and the curtains may be of the spring-roller type, or simply pieces of

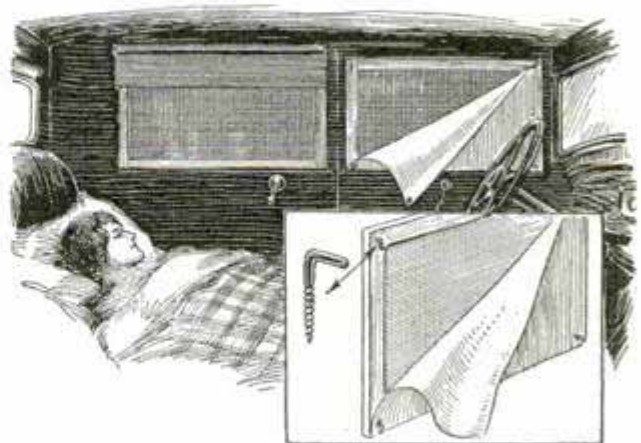

Combined Screens and Curtains for Car Windows Are Found Convenient by Campers

suitable cloth fastened to the screen frames by means of hooks. The curtains are useful as sunshades.

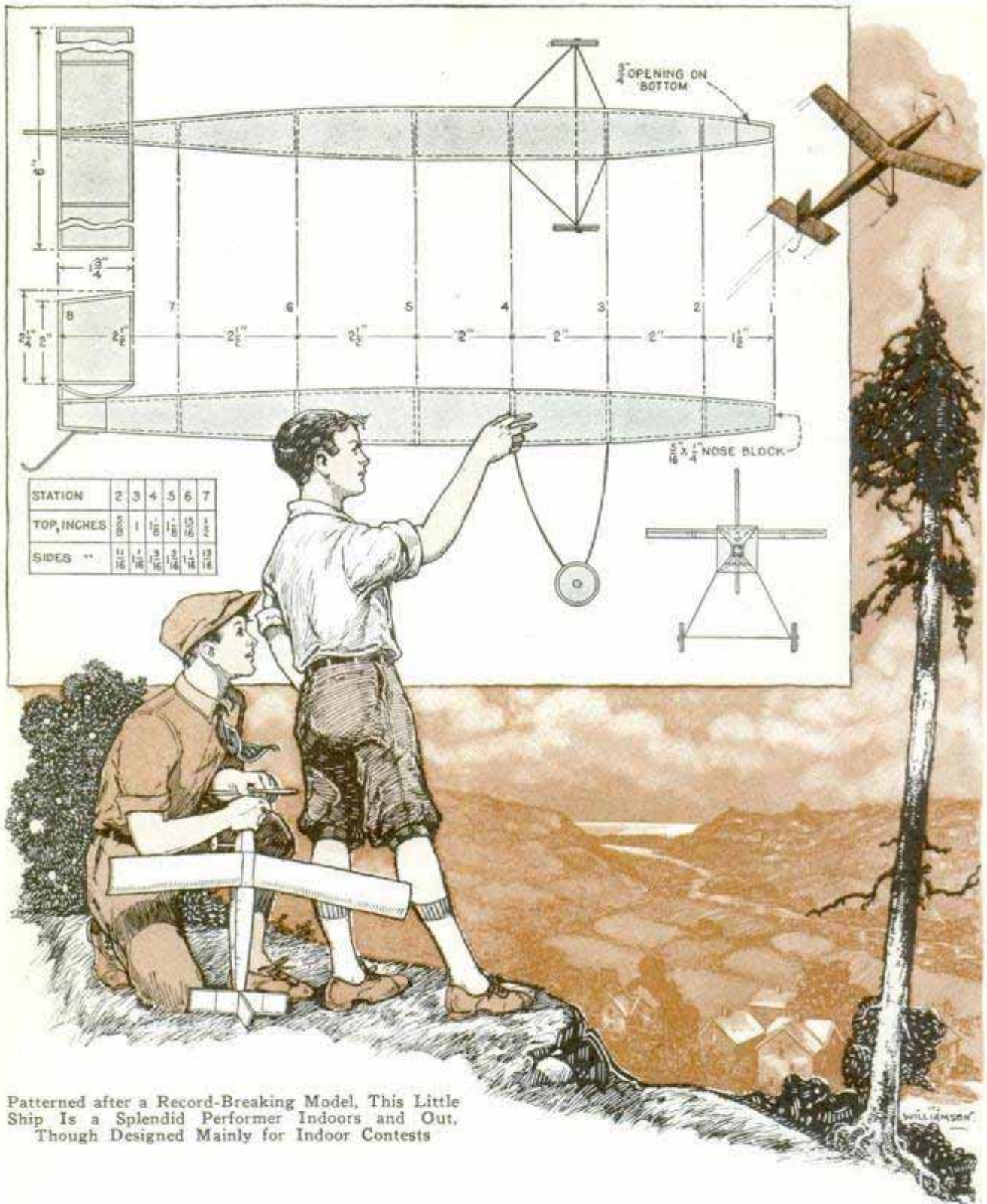

STATION	2	3	4	5	6	7
TOP, INCHES	10.00	1	11- ¹¹ / ₁₆	12- ¹ / ₁₆	13- ¹⁵ / ₁₆	14
SIDES "	11- ¹¹ / ₁₆	12- ¹ / ₁₆	13- ¹⁵ / ₁₆	14	15- ¹ / ₁₆	16

Patterned after a Record-Breaking Model, This Little Ship Is a Splendid Performer Indoors and Out. Though Designed Mainly for Indoor Contests

Baby Commercial Plane Has Features of Prize Winners

By JOHN McLEAN

EVERY model-plane builder who knows of the records of Ernest McCoy and Aram Abgarian knows of the success of the cambered wing with the reverse-camber stabilizer. An excellent baby indoor

commercial model can be constructed around these features. The model described here includes, with slight alterations, those used on Abgarian's record-breaking tractor. The fuselage length of

15 in. is the same as Abgarian's motor stick. The wing is 19 in. long and has a 1-in. center section.

With its motor wound to only three-quarter capacity, one of these planes has risen from the ground and remained in the air for 41 seconds. With a good propeller, it should be able to remain up over one minute.

This ship is a rather difficult job and is recommended only to the builder who has had considerable experience. If properly constructed, it will repay any efforts or money expended. Remember that one should be thoroughly familiar with the drawings and directions before starting the work.

Balsa is the chief material used. For the fuselage you will need three strips, 3 ft. long and $\frac{3}{32}$ in. square, also a propeller block 7 or 8 in. long, $1\frac{1}{4}$ in. wide and $\frac{3}{4}$ in. thick. Two pieces of balsa veneer are needed, one 2 ft. long, 1 in. wide and $\frac{1}{16}$ in. thick; the other 6 in. long, 2 in. wide and $\frac{1}{32}$ in. thick. Only two pieces of bamboo are used, a short sternpost and the tail skid. As considerable piano wire is used, you will need about 2 ft. of .012-in. wire and several inches of a larger size, about .020 in., also a small aluminum washer, two small glass beads and a sheet of superfine silk tissue. The rubber motor is of two strands of $\frac{3}{16}$ by $\frac{1}{32}$ -in. flat rubber, about 29 in. Adhesives used are ambroid and banana oil, or airplane dope.

The most difficult piece of work is the fuselage. Two of the 36-in. strips are cut into 15-in. lengths. The resulting four strips are each sanded down to $\frac{5}{64}$ in. square. The third strip is sanded and cut into struts of the lengths given in the table. Each longeron has a small notch in one end so that, when assembled, they form a small slot for the sternpost. Two longerons and the necessary struts are assembled to form each side of the fuselage. While the cement is drying, make the nose block and the sternpost. The nose block is of balsa, $\frac{5}{16}$ by $\frac{1}{4}$ by $\frac{1}{16}$ in., with notched corners. The sternpost is of bamboo, $\frac{5}{8}$ by $\frac{3}{64}$ by $\frac{1}{32}$ in. The aluminum washer is cemented onto the nose block.

When all cement is dry, complete the frame by joining the two sides and adding nose block and sternpost. Then cover, leaving a $\frac{3}{4}$ -in. opening in the tail at the

bottom, and a 1-in. opening in the tail side. If necessary, dope the paper.

Now construct the landing gear. The tail skid is of bamboo, bent over a candle flame, and cemented on at the junction of the lower longerons. The wheels are two $\frac{5}{8}$ -in. balsa disks, $\frac{1}{32}$ in. thick, cemented together. The landing struts are of .012-in. piano wire, bent with a small loop at the bottom of each pair, to take the $4\frac{1}{2}$ -in. axle. Carefully straighten this piece, slip it through the loops in the struts, put on the wheels, bend a "U" on each end of the wire, force back into the wheels, then cement. When dry, force the ends of the struts into the lower longerons at stations 4 and 5. Adjust the undercarriage and cement the struts in place.

The success of this model is in great part due to the cambered wing, consequently this member should be made carefully. For a contest model, tapered wing spars are recommended, as they not only decrease weight but also resistance.

Split off the two 19-in. spars from the $\frac{1}{16}$ -in. veneer, cutting against a straight-edge. Taper the spars from $\frac{1}{8}$ in. at the middle to $\frac{1}{16}$ in. at the tips. Sandpaper lightly, thinning the spars slightly at the ends. Cut the spars at points 9 in. from each end, and cement together to form 2-in. dihedral angles. To make the ribs, a piece of $\frac{1}{32}$ -in. veneer, about $\frac{3}{4}$ in. wide and $2\frac{3}{4}$ in. long, is bent to about the curve shown. Steaming will be found to be the best way to bend the balsa. If necessary, however, the wood can be soaked, bent to shape and dried in that position.

Split off the eight ribs slightly wider than necessary and sand to $\frac{1}{16}$ in. Trim off the ends to make them $2\frac{5}{8}$ in. long. The ribs are cemented on the spars at 3-in. intervals. When the cement is dry, cover the wing on the top with tissue. When covering, be sure to give the wing "wash," that is, bend one wing tip up and the other one down to compensate for propeller torque.

The stabilizer is not difficult to construct. The spars are split from the $\frac{1}{16}$ -in. veneer and sanded to $\frac{1}{16}$ by $\frac{3}{64}$ in. The reverse-camber ribs are perfect arcs, $\frac{3}{16}$ in. deep. A piece of the $\frac{1}{32}$ -in. veneer is bent and the ribs split off and sanded, then cemented to the spars at $1\frac{1}{2}$ -in. intervals. The stabilizer is covered on the

bottom side. The frame of the fin, which is made of $\frac{1}{32}$ -in. balsa, is covered only on one side, and cemented to the top of the stabilizer. The entire tail unit is then cemented

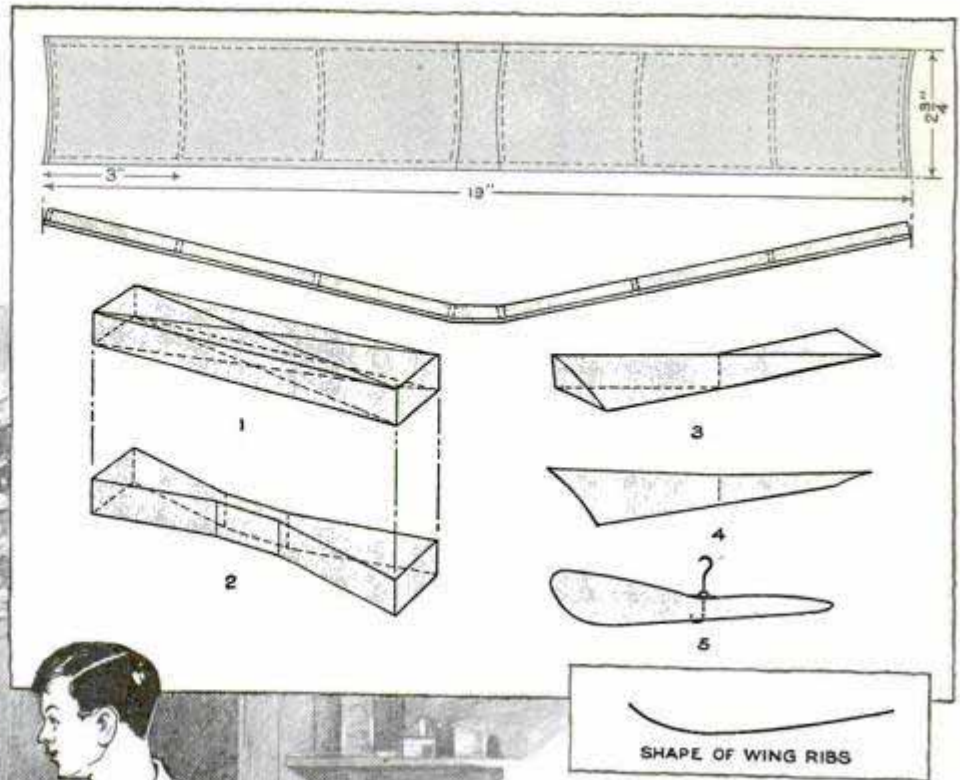
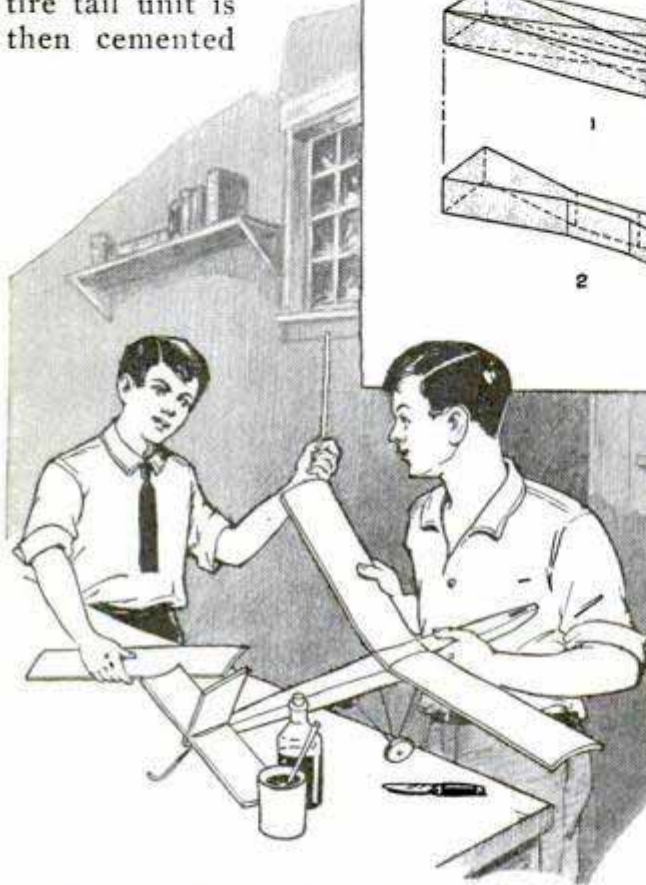

essary, adjust the stabilizer or change the balance to obtain the best performance. When it is adjusted properly, wind the motor to its full capacity. The $\frac{3}{16}$ -in. motor takes 300 turns when hand-wound. With a winder you can give it 625 turns.

Although designed as an indoor ship, this little plane is sufficiently strong to be used outdoors in good weather. If indoor commercials are an event in your next local contest, build one of these little ships and be prepared to take home a ribbon.

to the top of the fuselage with a $\frac{1}{16}$ -in. block under the front spar and a $\frac{5}{16}$ -in. block under the rear spar.

The final job is the propeller. The drawings show the steps in carving a Langley true-pitch prop. A fairly low-pitch propeller will be found most efficient on this model. The length should be 7 or 8 in. The propeller shaft is of .020-in. piano wire. Bend the hook first. Force the shaft through the bearing on the nose block, slip on the beads, run through the propeller, bend over the wire and cement. Make an S-hook of .020-in. wire. Put in the two-strand motor, looping the rubber over the front hook and the S-hook. Leave about $\frac{1}{8}$ -in. slack, and clip off any excess rubber.

Fasten the wing lightly with a rubber band or thread. Glide the ship until you obtain proper balance. For the first flight, wind the motor about 200 turns. If nec-

Painting of Plaster Walls Requires Special Care

More paint is needed to cover a plastered surface than a wood one as the former is more porous. Paint should not be applied to plaster until it is perfectly dry. The first coat should consist of white lead and oil, to which has been added one teaspoonful of japan drier for each pint of paint in order to insure it drying hard. Before applying the first coat, fill all the holes in the wall with plaster of paris, or patching plaster obtainable at paint and hardware stores. All dark-colored, damp or moldy spots on the surface of the walls should be given a coat of shellac before sizing. Next apply a coat of glue size,

which will reduce the absorption of paint. After the size is thoroughly dry apply the first coat of paint and after this the successive coats of the desired finishing shade. Always allow plenty of time for each coat to dry before applying another. Buy ready-mixed paint of the best grade if a durable job is desired. Instructions for mixing the size, etc., can be obtained from any paint dealer. It is rarely necessary to use more than two coats of paint on a wall properly sized. There are many kinds of wall finishes both in gloss and in flat. No matter what color you select for the ceiling of a room, be sure that it is a shade or two lighter than that of the walls. By adhering to this rule you will prevent a top-heavy appearance, which is depressing. If you are not familiar with the right combinations you can get a color chart from the paint dealer. This will also give information concerning colors suitable for rooms of different exposures.—Francis W. Henry, Pottsville, Pennsylvania.

Cylinder-Lapping Tool Attached to Power Drill

Operated by means of a power drill, the improvised lapping tool, shown in the drawing, has been found highly satisfactory. It consists of a piston, cut in half lengthwise. Both halves are pinned to a wristpin, and slots are cut in the latter to receive cotter pins, which allow the halves of the piston to be pushed together or pulled apart a short distance.

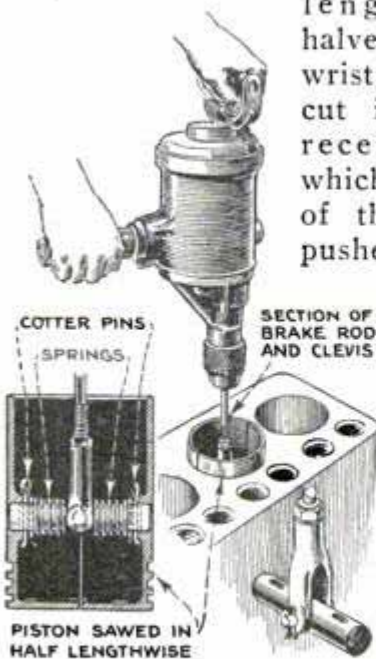

To the center of the wristpin a drive-shaft is pinned at right angles, as shown in the detail. Coil springs are slipped over the wristpin at the points indicated to force the piston tightly against the cylinder wall while lapping.

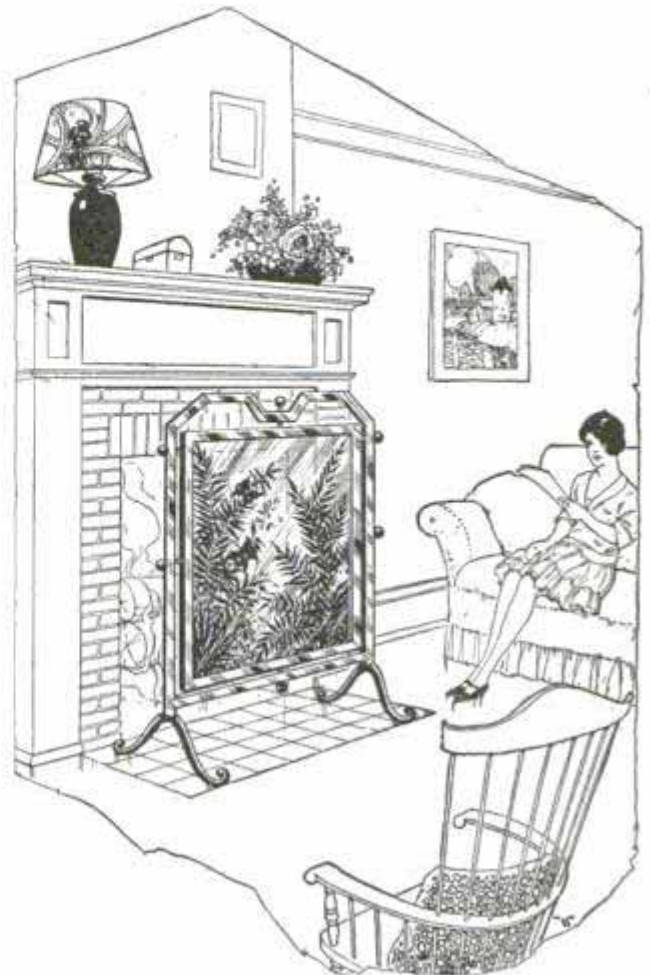

Artistic Fireplace Screen Consisting of a Metal Frame and Glass Panes Holding Ferns

Novel Fireplace Screen

One of the most attractive fireplace screens I have ever seen consists of a metal frame in which two large window panes are mounted. On one of the glasses an artistic arrangement of mountain ferns, autumn leaves, some grasses and a few butterfly wings, were glued, and the glass panes were then cemented together to exclude the air.—Juliette Frazier, Forest Grove, Oreg.

Making Speed on Muddy Roads

An interstate bus driver who works on a schedule and therefore has no time to waste, has hit upon an effective method of getting over slippery, muddy roads in record time. Instead of shifting gears for an hour or so in a vain effort to get out of a bog, he immediately releases about one-half of the air from the two rear tires. This allows the tires to flatten out and provides much more traction than ordinarily. After he has passed the muddy stretch, the tires are again inflated.

An Old-Fashioned Lamp

by D. R. VAN HORN

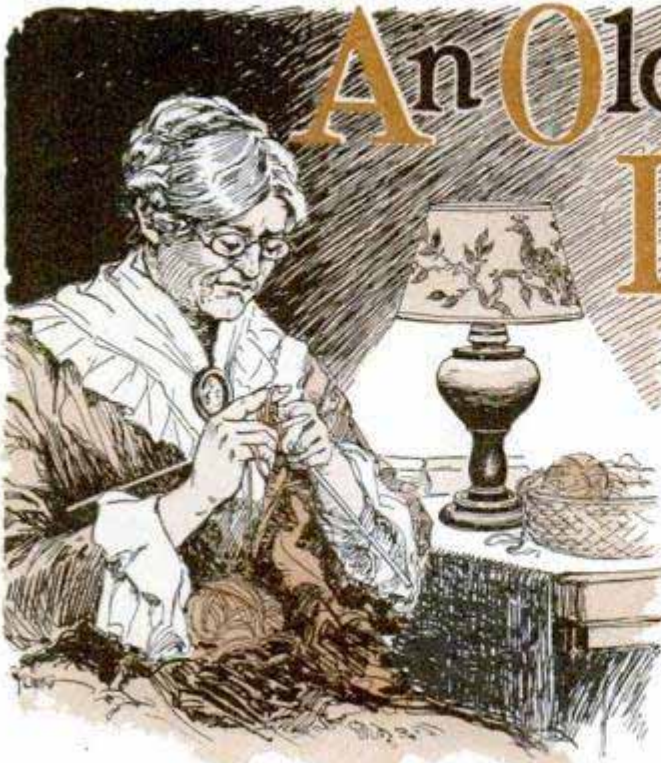

DO YOU remember the old coal-oil lamp that mother kept bright and clean for company? Or the one that stood on the kitchen table? We used to peer up from our books and imagine that we could see the fuel traveling up the wick. Every line and curve and bulge stands out clearly.

Today that lamp and its million coun-

terparts are gone, but not forgotten. You can quickly fashion a duplicate from the pattern in your memory. Not to burn coal oil, of course. It is made from walnut or other choice woods and is wired for a single electric light that rests within a socket on top. With a suitable shade, it is presentable anywhere, as the illustrations show. A lamp like this serves several good purposes. It will bring back a touch of youth; it is a thing of beauty, and it is quite in keeping with the modern trend in home furnishings. Make one, finish it nicely and you will be proud to own it.

For most turnings you would go to a planing mill for the stock, but with this lamp only scrap pieces about the shop are necessary, for the block from which the lamp is turned is made up of a pile of blocks. In fact, if more than one kind of wood is used, so much the better. And the block thicknesses need not be the same. A very good effect can be obtained by making the base and spindle from a dark wood, such as mahogany or walnut, and the bowl from birch, maple, or some other wood that looks well finished "in the white."

Or a couple of thin blocks of contrasting woods can be used in that part of the assembly which forms the bowl, giving the effect, when turned, of inlaid bands. If this is done, the bands are coated with thin shellac before the rest of the lamp is stained, so that the stain will not take on them. The lamp shown was made from walnut blocks of three thicknesses. The thickest,

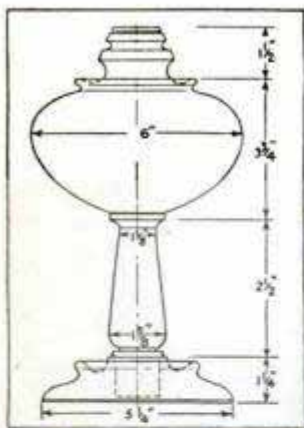

Below, Left, Gluing the Scrap Blocks Together to Form the Lamp Blank; Right, Glued-Up Blank Clamped in the Lathe



used for the base, was not glued up at the start but was turned separately. The re-

used for the base, was not glued up at the start but was turned separately. The re-

maining nine blocks (to give a total length of about 9 in.) were coated with glue on one side and stacked as shown. Then they were set between the centers in the shop lathe, pressed tightly together, and left over night for the glue to set. Notice that the blocks are not stacked regularly. This random assembling will give a result under a clear finish that is distinctive and lovely.

The exact design given need not be strictly followed; you can use any design you have in mind. Turn the piece first of all until every section is round, then proceed to develop the shape. Spend considerable time with coarse, then fine sandpaper until every unevenness and slight blemish is removed. The glue lines will be dark and of hair thinness. Remember that the strength of the piece is not so great when glued up in this way as when the grain runs lengthwise, so turn the small diameters with reasonable care and keep all

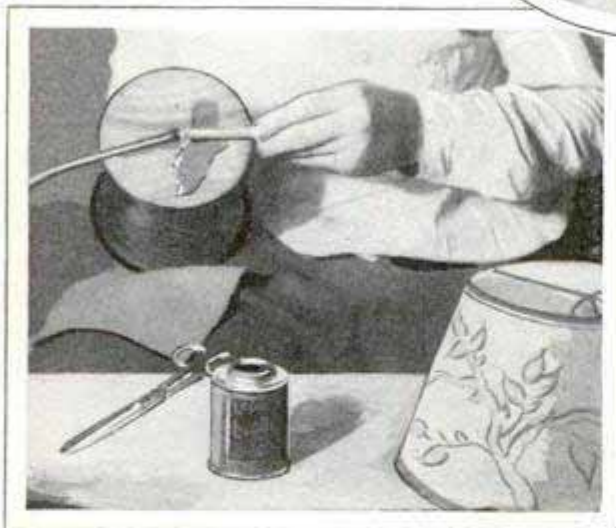

Top, Polishing the Lamp; Center, the Turned Base; Cutting Groove for Cord; Below, Gluing Felt to Base

dimensions above 1 in. Turn a tenon at the bottom, 1 in. long and 1 or $1\frac{1}{4}$ in. in diameter, and be sure the shoulder above it is square. This will insure a snug fit with the base. After the final sand-

ing, go over the piece once more with fine steel wool or garnet paper, and finally with a handful of the shavings. This is really a polishing process. The piece is now ready for the walnut stain (if stain is to be used). After the stain has soaked in for a few moments, start the motor again and wipe the whole piece with a soft rag to remove any surplus stain. When the stain has dried overnight, you can go over the whole exterior with clear varnish. Then remove and hang up to dry by turning a screw-hook into the top.

Twenty-four hours later, again put the piece in the lathe and dress down with finest steel wool. Then add another clear-varnish coat and hang up to dry. This coat will dry in 12 hours or less. A third coat is not necessary, but will improve the finish. After the last finish has dried, again rub very lightly with fine steel wool or with pumice and oil to dull the surface. You may now wax it, if desired.

The base is a 6-in. block, $1\frac{1}{4}$ in. thick. The corners are sawed off, then it is screwed to the faceplate and turned down to the shape shown. The final maximum diameter should be $5\frac{1}{4}$ in. if the upper bowl is 6 in. in diameter. There is sufficient weight to make the lamp quite stable with this small base. Turn a hole nearly through the center for the tenon of the spindle, which should be a snug fit.

Finish the base in the same way as the

upright, using first the stain, then two or three coats of clear varnish, with a final light rubbing to dull the surface. Should you prefer the bright finish, you can omit the use of steel wool or pumice and oil. Another way of producing a fine polish is to rub with rottenstone and oil, on a felt pad, after the finish has been dulled with the pumice. Dip the pad in the oil and then in the rottenstone, and rub the dulled surface until the polish returns. Be sure that the varnish is hard before attempting to rub with anything, as otherwise the job will be ruined. As a rule, it is not safe to rub varnish until at least 48 hours has elapsed from its application; also one should be sure that varnish intended for rubbing is used, such as cabinet-finishing varnish. Varnishing is not essential, as a satisfactory finish can be built up with shellac by the same process. The writer used a buffing wheel on a flexible shaft, as shown in one of the photos, to lessen the labor of rubbing.

When you bore the upright, put a $\frac{3}{8}$ -in. bit or gimlet in the motor chuck and bore through halfway from each end. Be sure to keep the ends between centers to insure a smooth hole.

Get a brass flange with threaded nipple to take a standard socket for the top, and, centering this carefully, fasten with screws on top. Then pass the cord through and wire the socket before screwing it in place. Cut a groove with the power saw or chisel, leading from the center to the edge of the base and large enough to hold the cord and small staples with which it is fastened after the slack has been taken out. Now pour some glue on the bottom, rub out to the edges with your finger, put on a piece of green felt and trim off the edges.

A 50-watt lamp is about right. Get a shade and frame that will rest upon its top, as shown, and your lamp is complete. The shade shown came from the variety store and cost 25 cents.

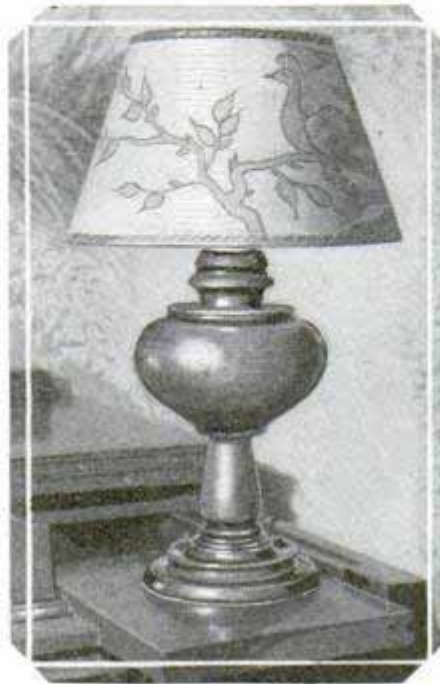

Preventing Condensation in Gas Heaters

During the late fall and early spring months, when the furnace is shut down, many home owners use a radiant gas heater. When the burning is on such a large scale as in these heaters, the moisture resulting from it strikes the cool wall, condenses and sometimes damages the walls so that redecoration may become necessary. This trouble can be minimized by properly ventilating the heater. If the flue in the fireplace in which the heater is kept has been entirely closed to prevent the escape of heat, it should be partly opened and some form of canopy extended over the front of the gas heater about 6 in.

to catch the moisture-laden air and carry it out. A small opening in the flue does not carry away much of the heat. The opening should, of course, not be larger than necessary. Where it is not possible to install the heater in a fireplace, and some of the walls of the room are outside ones which are exposed to the weather and are therefore cooler than the room temperature, a vent should be provided above the heater, such as a partly raised sash or an opening cut in the wall. A little care in this preliminary work will generally save an expensive decorating job later on. Failure to obtain the full amount of heat from such a heater is often due to the use of a rubber hose too small to carry a sufficient amount of gas. As a matter of safety a rubber-hose connection should never be used.

Waterproofing Old-Model Ford Cars

Ford cars of the older models usually have trouble with water getting into the coil box, which makes it impossible to start the car. The point where the water generally enters is between the dash and the metal cowl. The writer found a simple remedy that has proved effective in keeping water out. Loosen the bolts that

clamp the dash and the cowl together several turns and pry them apart. Tamp some oakum strips, with a screwdriver or other suitable tool, entirely around the dash. Insert quite a quantity of oakum, forcing it well into place below the top edge of the dash. Tighten the bolts again, which will compress the oakum still more. Go over the job and tamp down any stray strands and then apply thick shellac liberally with a small brush, letting it run down into the material. If this is done carefully, a permanent waterproof job will result.—Harold P. Strand, Malden, Massachusetts.

Template for Fillister-Head Screws

Tool designers will find the triangle illustrated of considerable utility for marking off fillister-head screws, as it eliminates the use of a scale and a consulting table for measuring and drawing screw heads on drawings. The sizes of various screws in common use are first carefully scribed on the edge of the triangle as shown. Small holes, as indicated in the detail, are then drilled to take the pencil point. The method of using the tool is obvious as well as the saving of

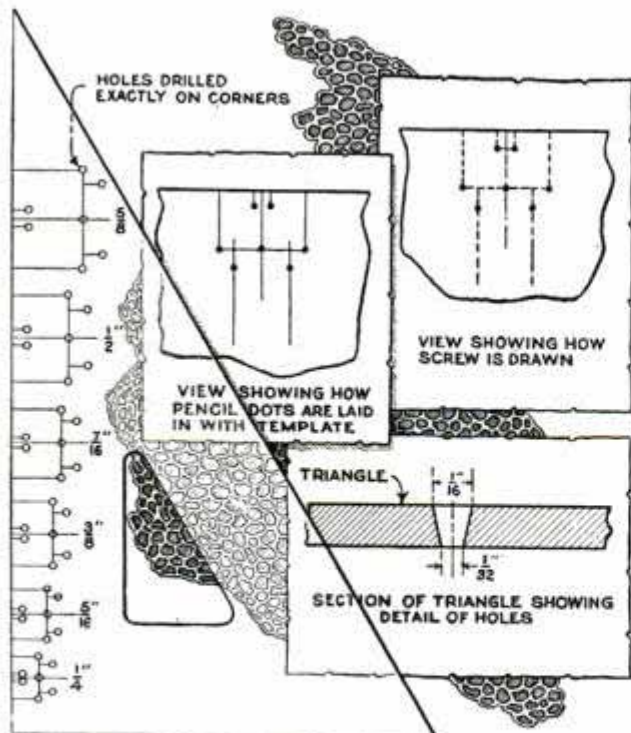

Laying Off Fillister-Screw Heads on Triangle Saves the Draftsman's Time

time that can be effected with it.—Alfred Westrom, South Bend, Ind.

Wardrobe Attached to Closet Door

In apartments and small homes where space is limited, an excellent wardrobe



Wardrobe Attached to the Inside of Closet Doors Provides Additional Space

can be built onto the inside of one or more closet doors as shown in the drawing. It consists of a box of plywood, plaster board or even of corrugated cardboard. Although it may be made the full height of the door, 60 in. has been found a convenient height. The depth should be about 9 in. and the width must be less than that of the door so that the box will not interfere with the opening and closing. The shelf formed by the bottom of the box provides a place for shoes and slippers, and if desired, an extra shelf may be arranged at the top for hats.

Lens Shade for Beach Photography

Many photos, taken at beaches and other places where reflected light is intense, are failures because the photographer neglects the use of a lens shade. Such a shade can be made in a few moments from dull-finish black paper. Cut a narrow strip and make a cylinder to fit over the lens barrel, then pin or glue the overlapping ends together. If a more durable shade is desired, make it from light sheet metal painted dead-black to avoid reflections.—Wm. C. Vestal, Redlands, California.

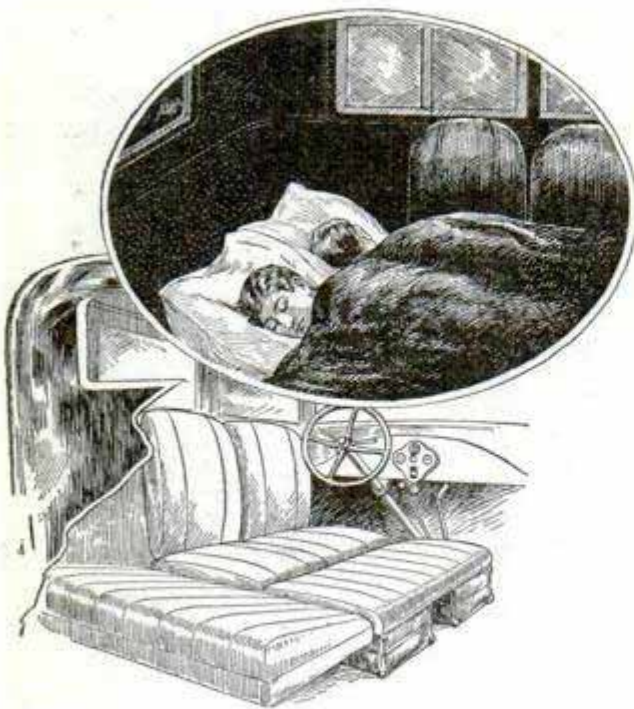

How the Car Cushions Can Be Arranged to Form Comfortable Bed for Emergencies

Arranging Bed in Two-Door Sedan

Owners of a two-door Ford sedan can arrange the cushions and seats to form a comfortable bed. Detach both front seats by slipping off the rings and drawing out the hinge bolts which hold the legs. Raise and slide the back seat forward to unfasten it and remove the bolt and nut which holds the back cushion. Lift this cushion off the hooks that support it and then turn the back seat around so that the highest part of the cushion is in the rear. Place both front seats on one side with their backs against the side of the car. Then fit the back cushion in the remaining space, blocking it up to the level of the other cushions. In this way a bed 40 to 47 in. in width and 60 to 70 in. in length can be improvised. Sliding screens can be obtained to fit the side windows to provide ventilation without letting insects inside.—Dr. Paul W. Goldsburly, Warwick, Massachusetts.

☐ A squeaking door hinge should be lubricated with graphite and a drop of oil.

Durability of White Paint

Some tests of white paints for outdoor use undertaken at the bureau of standards show interesting results. The paints under test are white lead, lead-zinc and lithopone. Thus far, results have been obtained on six weeks of accelerated exposure, taking a set of panels out of the test every week. The white-lead paints fail by chalking off and by fine checking, and the lead and zinc paints by cracking, resulting in flaking or crumbling off of the paint coat; the lithopone paints fail by heavy chalking and checking, and soon disappear from the wood. White lead shows up best, lead-zinc next and lithopone a poor third. Lithopone paints fail in about three weeks, under the accelerated tests, and lead-zinc in about five weeks. The white-lead paints, after six weeks' exposure, have not reached as bad a condition as the lithopone paints have done at the end of three weeks.

Handle for the Extension Table

Usually it takes two persons to open an extension table for inserting the extra leaves, but it can easily be done single-handed by the following method: Screw a crosspiece to the sliding rails at one end of the table and to this a connecting board that reaches to the other end. A handle provided with a thumb hole is attached to the latter. The handle is held with one hand while the nearest end of the table is

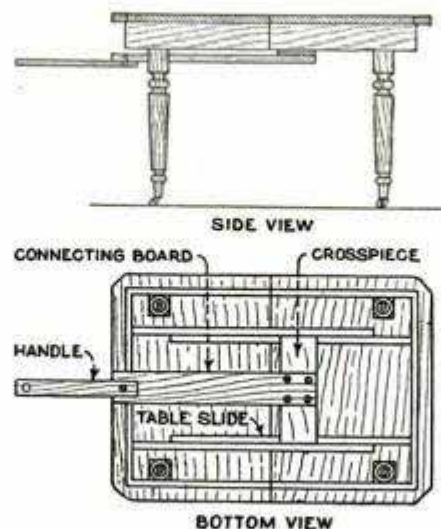

Arm Attached to Extension Table Makes It Possible for One Person to Open or Close It Single-Handed

pulled or pushed, according to whether it is to be opened or closed. When not in use, the handle is swung out of the way beneath the table.—Alice Moore, Hamilton, Can.

Mortar for Brick Walks

Front-entrance walks are often made of bricks for the sake of appearance, but if they are not well laid they will not be durable. The trouble is found mostly in the mortar, which often crumbles away after a winter or two, making repairs necessary. The mortar used for this purpose can be so made that it will not be affected by frost. To $\frac{1}{2}$ bu. of unslaked lime add $1\frac{1}{2}$ bu. of sharp sand, commonly known as "torpedo" sand. Then mix $\frac{1}{2}$ lb. of alum with $\frac{1}{2}$ pt. of linseed oil separately, and add this solution to the mortar. Use the mortar as hot as possible.—L. H. Georger, Buffalo, N. Y.

Gnarled Tree Roots for Garden Furniture

Attractive porch and garden furniture of the rustic type can be made from gnarled tree roots and branches, an example of which is shown in the photo. This odd chair was made of roots. The pieces are, of course, thoroughly cleaned, then cut and fitted with care in order to produce an attractive design. If a finish is desired, the surface may be sanded after the article is completely assembled, and then given a coat of shellac or varnish.—H. Rossiter Snyder, Guilford, Conn.



Tool for Cutting Balsa Strips

Balsa strips as small as $\frac{1}{16}$ in. square can be cut with the tool shown in the illustration. It consists of a number of old razor blades and wooden spacers bolted in a hardwood holder. With this arrangement it is easy to remove the

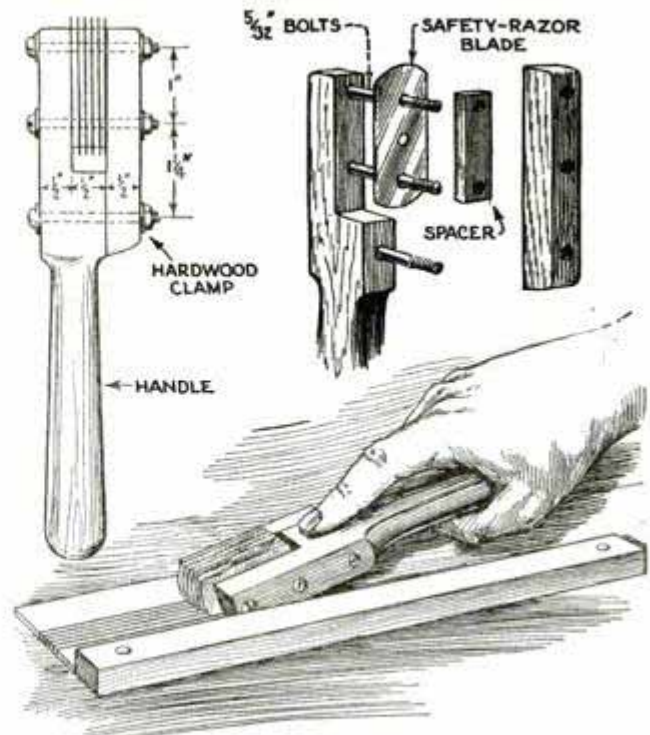

Handy Tool for Cutting Strips of Balsa Wood of Any Desired Width

blades when dull, or to change the spacers for cutting strips of any desired width. If you have attempted to cut a straight strip of balsa by running a knife along the edge of a ruler, the convenience of this tool will be appreciated.

Converting a Hard-Coal Stove into a Soft-Coal Burner

By making a few simple changes in a hard-coal stove, it can easily be converted into a soft-coal burner. Remove the cap, lid and coal magazine. Substitute a lid cut from galvanized sheet iron, using the original lid as a pattern. Cut a hole in the center to receive the end of a stovepipe nipple. After this is inserted, fit onto it an elbow and a second nipple containing a draft damper, connecting this nipple to a tee in the flue. After the pipes have been set and wired, the lid and pipe edges are carefully closed with stove cement.—Lydia MacGregor, Manistee, Michigan.

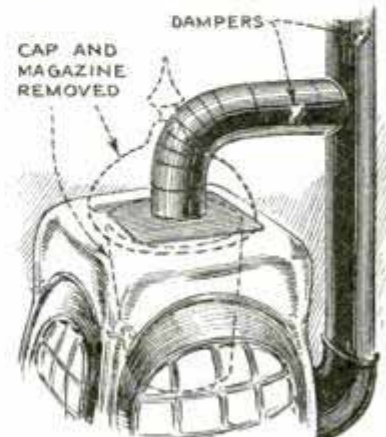

*American Change Clock Co.
1659 Ruffner St. Phila.
Knempfle, Esuttenberg & Co.*

GRANDFATHER YOU CAN

BY R. O. BUCK
and L. DAY PERRY

PART I

THERE is a special appeal to the home craftsman in the construction of a grandfather clock, for it combines utility with beauty to an unusual degree, plus the added advantage that it is never out of style. If a good movement is installed, the grandfather clock you build will serve

your modern household and perhaps your children's for many years just as did the long-case clocks of old.

Grandfather clocks fit well in the decorative scheme of bungalow, house or apartment. They may be designed to fit any room, regardless of ceiling height or size, and to harmonize with the surroundings. Of course, it would be impossible to describe all the types in the limited space allowed in an article; we are presenting, however, two typical designs which we believe are especially suitable for home construction. They are within the ability of anyone who has the patience to do an accurate job of fitting combined with a fair degree of skill with commonly used woodworking tools. The clock case described first is typical of a design much in vogue in the humbler homes in colonial days, while the second is a composite design of many periods. Both of the designs possess grace and beauty of line without ornate decoration.

The colonial case, as we shall call it for convenience, is built much in the form of a long box and most nearly resembles the old long-case clocks. As shown by the drawing Fig. 1, it has solid sides made of 12-in. boards, 1 in. thick. After the boards are planed and sanded they will be the approximate size specified in the drawing. The dimensions given in all the drawings are finished sizes.

In building objects of this type, it is essential that an orderly procedure be followed so that each separate part will fit the assembly. Accurate measuring, and, what is equally important, working to measurement is necessary to secure tight joints and a square, well-made case. The progressive steps in the assembly are shown in Figs. 2 to 5, inclusive.

The first step should be the roughing out of all the principal pieces, that is, cutting them to approximate size. For the sidepieces, select two boards that have a pleasing grain. if a varnished finish is to be used, as the markings will be greatly in evidence. After squaring and planing

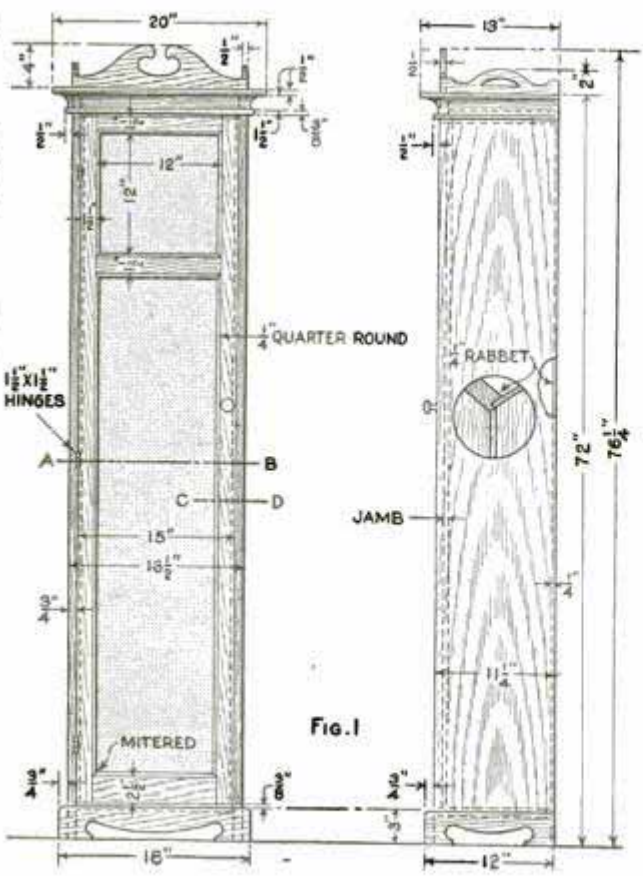

do not fill orders except U. S. Canada. Mexico

*Leahriet of New York
85 Broadway Ave. New York*

CLOCKS BUILD

the sides, measure off the spacing for the top and bottom pieces, and notch out the bottom as shown in Figs. 2 and 3. The purpose of this is to make a clear opening for the ornamental base mold that is fastened to the sides. This method is used in order that the sidepieces may extend to the floor, thus adding rigidity, an essential quality of a clock case. A $\frac{1}{4}$ -in. rabbet to house the backing should also be cut into the back edges of the sidepieces. If you have no rabbeting plane or circular saw for cutting this rabbet, another method may be used for fastening the backing. Tack and glue two triangular strips, about $\frac{3}{8}$ in. thick, on the inner face of each sidepiece, setting them back $\frac{1}{4}$ in. from the back edge. After the top and bottom are in place, similar strips should be fastened to them also. The backing of plywood is to be glued and tacked into place. The method for the first part of the assembly is very simple. The top and bottom pieces are nailed and glued into dados, as shown in Fig. 2, after which the back may be set in and fastened as just described.

The cap piece, which is to be $\frac{1}{2}$ by 13

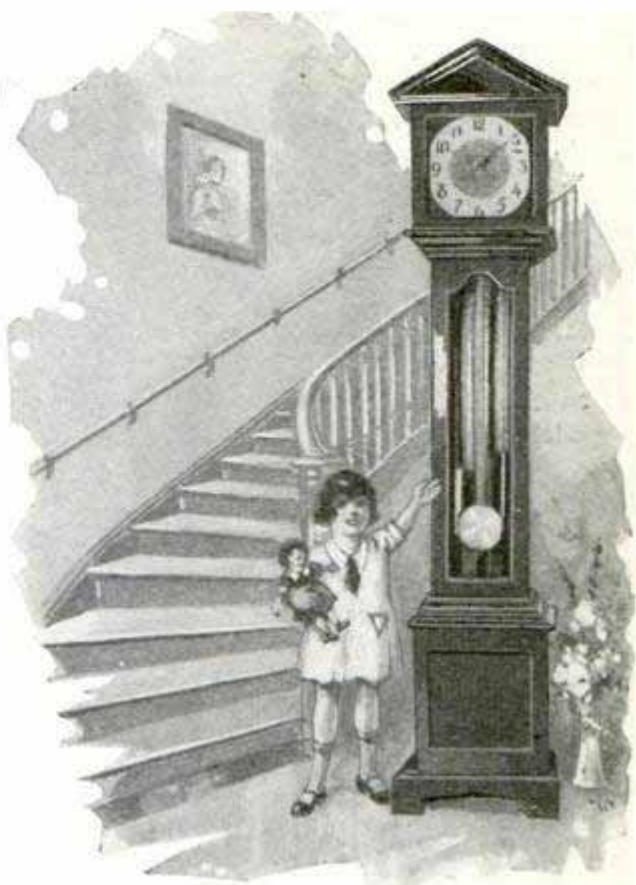

by 20 in., should be glued up in the manner shown in Fig. 3. First glue up or secure a board, $\frac{1}{2}$ by 11 by 16 in., of any soft wood. Be sure that the piece is square and the edges true. To three edges of this, glue strips, as indicated in Fig. 3, of the same kind of stock as is to be used for the outside of the case. They should be $\frac{1}{2}$ in. thick and 2 in. wide. The edges are formed after the strips have been glued, but the corners should be

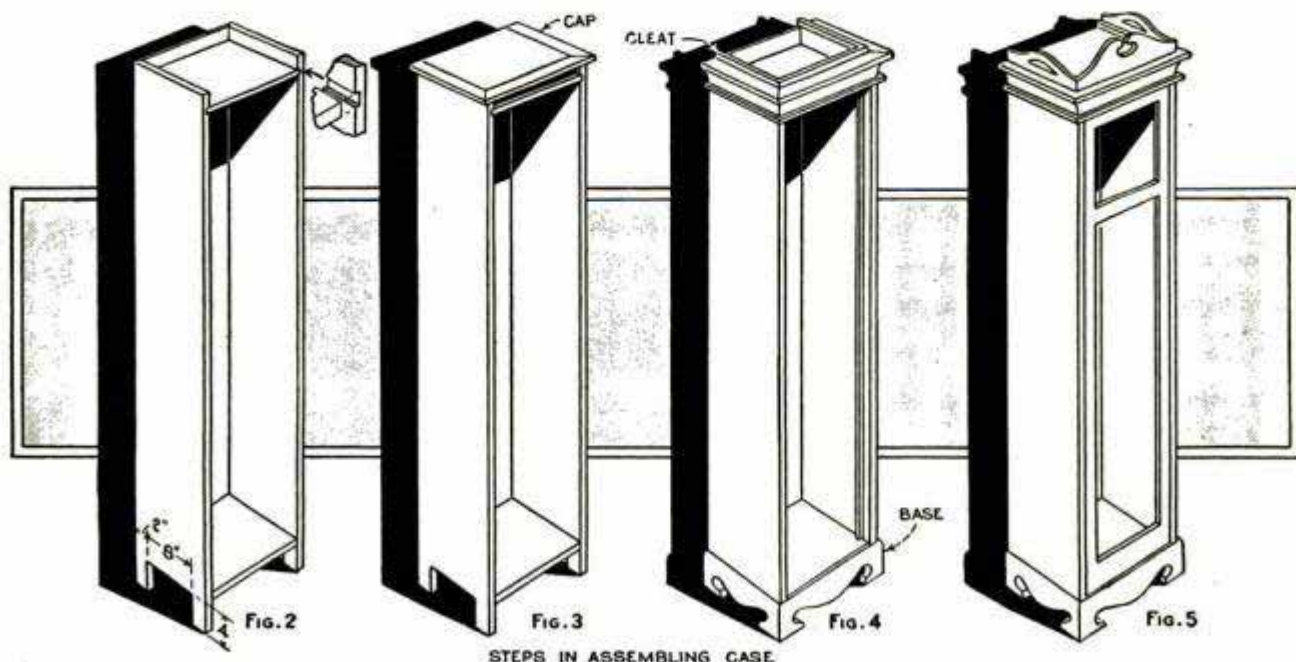

STEPS IN ASSEMBLING CASE

mitered to avoid having end grain show on the finished surfaces. The outer edge of the molding is made half-round as shown in Fig. 7. Nails and glue are used to fasten the cap in place.

Fig. 4 shows the base pieces and fillet fastened in place. The formed base pieces are $\frac{3}{4}$ in. thick, quarter-round on the top edges. Figs. 10 and 12 are patterns for the front and side base pieces, half of each pattern being shown. Each square represents $\frac{1}{2}$ in., so it will not be difficult to make full-size cardboard patterns of these pieces. After tracing the curves on the stock, the sawing is done with a coping or turning saw if a band saw is not available. The corners should be carefully mitered and glued when assembling them on the bottom of the frame. The fillet consists of three strips of the outside stock, $\frac{3}{8}$ in. thick and $\frac{1}{2}$ in. wide, with a half-round edge as shown. The corners are mitered and the pieces fastened with small brads and glue in a position just $1\frac{1}{2}$ in. below the underside of the cap. Between cap and fillet a cove molding is used as shown in Fig. 7. This is a stock molding that can be purchased at most any mill in pine, and perhaps oak or gum, but is rather hard to find in mahogany. If you are unable to purchase the molding in the wood required, it will be necessary to make it with a gouge and sandpaper. This is not very difficult to do with walnut or mahogany.

Cleats, $\frac{3}{4}$ in. square, are glued and screwed to the top of the cap, as shown, so that the crown may be securely fastened in place. Care must be taken to place them accurately, as a slight deviation from center in the spacing of the formed crown pieces would be very noticeable. Fig. 5 shows the crown pieces and door in place, which completes the assembly of the clock except for the movement. The crown pieces are made from

the half patterns given in Figs. 9 and 11, as previously described. The joints are mitered and the whole nailed and glued in place. Fig. 7 is a sectional view of

the upper part of the assembled case.

The construction of the door is perhaps the most difficult part of the whole job, for it must be straight and true and have good solid joints. A simple type of door construction has been chosen in order to avoid any complicated joinery. The door material, consisting of two stiles and three cross rails of the

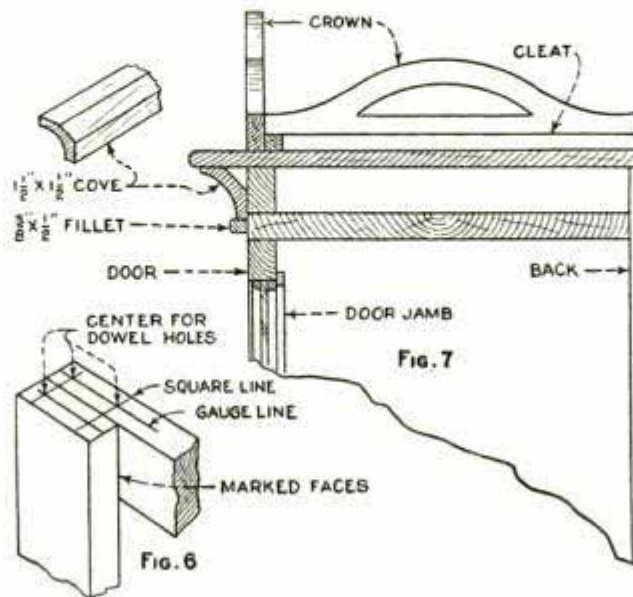

sizes given in the drawing, should first be cut to exact size. Holes for dowel rods are next located on the various pieces as follows: Lay the pieces on your bench in the position they are to occupy in the finished door. Mark the top face of each, also mark each joint with some distinguishing number. Turn the pieces so that the two marked faces are together, as shown by Fig. 6, and mark the positions of your dowel holes with a sharp knife and a try-square. A marking-gauge line, run across these marks, will determine the location of the holes. The dowel holes must be drilled straight and true, and about $1\frac{1}{4}$ in. deep. If you are not sure of your ability to drill these holes true, a jig should be used. This may be one of the metal kind on the market, or a simple one that you can make will serve quite as well. This jig consists of a block of hardwood, the thickness of the door pieces, with cleats nailed on its sides so that it just fits the edge of the stock to be bored. Through this block, bore two straight, true holes of the size required, and spaced as shown in the drawing. This device insures a true set of holes with correct spacing and is well worth the trouble involved in making it. After all holes are bored, the door should be assembled with the dowel rods, to make sure that all joints fit snugly. Fig. 8 shows a detail of

the joints, which are to be clamped and glued. Care must be taken to keep the door flat and true in the clamps. If clamps are not available, a good job of gluing can be done by simply nailing cleats on your bench top and driving wedges between them and the door pieces, in order that necessary pressure may be obtained.

Strips to hold the glass in place are tacked and glued in place after the door is assembled and glued up. By using strips in this way the necessity of rabbeting for the glass is



closed. A wood or brass knob, to harmonize with the hinges, will be satisfactory.

Grandfather clocks appar-

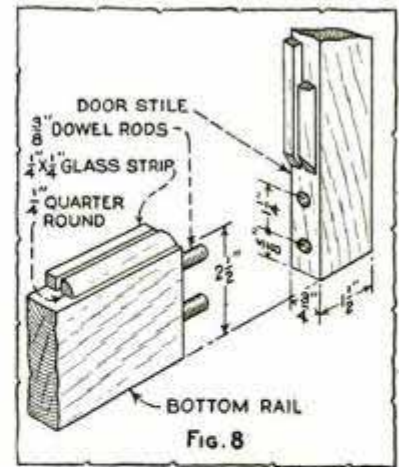

ently were made out of practically all of the cabinet woods, the kind depending largely on the availability of the particular wood and the taste of the cabinet-maker. Mahogany and oak seem to have been the most fa-

vored woods, although walnut, rosewood, teak and ebony were often used, alone or in combinations, in some of the finer and more elaborate cases, where a great deal of carving and other forms of ornamentation were added. Oak seems to have been used for most of the simpler and more rugged types in the early colonial days.

There is no standard height for grandfather clocks even to this day, though the size of the dial and other features have been standardized by several of the larger manufacturers. The size of the dial regulates

to some extent the size of the case, however. The length of the case must also be great enough so that the weights will have the required distance of travel. The

designs given herewith are suitable for rooms of average modern height.

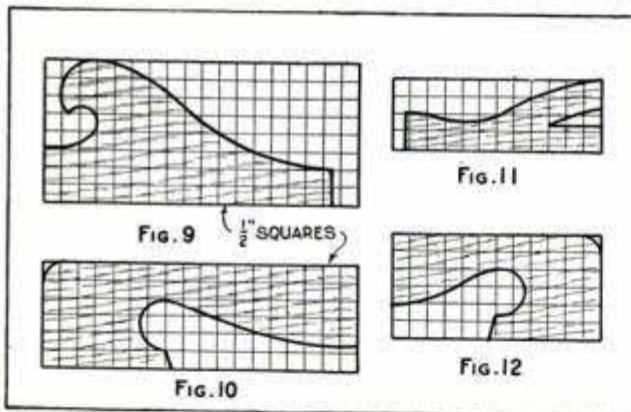
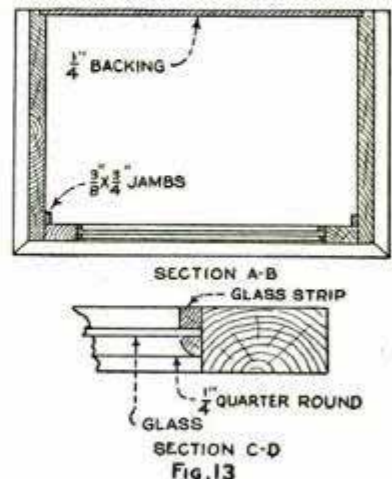

avoided. Figs. 8 and 13 show how these strips are to be fastened and used. The quarter-round is fastened in first, the glass strip being added only after the case is completed and the glass installed. The glass in front of the dial and that in the lower part of the door should be in separate pieces to avoid having too long and narrow a piece. You will have to make the 1/4-in. quarter-round with a plane and sandpaper, as it is not stock material. Jambs for the door are made of 3/8 by 3/4-in. material, and are tacked and glued in place as shown in the section AB, Fig. 13.

Hinges, a knob and bullet catches are all the hardware that is required for this case. Three 1 1/2 by 1 1/2-in. loose-pin butts will be satisfactory, although many cases have four hinges. Bullet catches, also called spring catches, are placed in the top and bottom edges of the door to keep it

(To Be Continued)



Interchangeable Cover Spout for Pouring Paint from Small Cans

Cover Spout for Pouring Paint from Small Cans

In the laboratory of a paint and varnish-manufacturing concern, where it was necessary to pour small portions of paint from numerous small cans, a cover spout was found useful to prevent paint from running over the edge and smearing the cans. The spout was made of light sheet metal, cut and bent to the shape shown in the details, and soldered to a can cover in which a hole was made. A handle is also provided on the cover so that it can be removed without the aid of a tool. All the cans were of the same size, and one cover spout was therefore interchangeable.—E. Perry, Oakland, California.

How to Destroy Insects on House Plants

Growing plants are frequently not desired in the home owing to their tendency of collecting insects. It is a simple matter, however, to get rid of them periodically. Buy some yellow phosphorus and put it on a tin-can cover. Ignite it and place a wash boiler over both plant and burning phosphorus. The fumes will kill the insects in a few minutes.

Flexible and Durable Crack Filler

I experimented with all kinds of commercial crack fillers for closing a weather-exposed opening where the wood was subject to intermittent swelling and shrinking, and found that the filler would always crack and loosen. However, a good substitute for the purpose, which I found entirely satisfactory, is wadding made of paint-saturated rags.—Dexter W. Allis, Everett, Mass.

Watch Holder for the Auto

Fitted in the holder shown in the photo, a cheap watch can be used as an auto clock. It is made of No. 18 gauge sheet copper, cut and bent as indicated for attachment to the steering wheel, which is a convenient location. Portions bent to form a clamp and fitted with a screw and nut hold it in place. It may be polished and lacquered with transparent metal lacquer or painted black. The watch is slipped between the front and back sides,

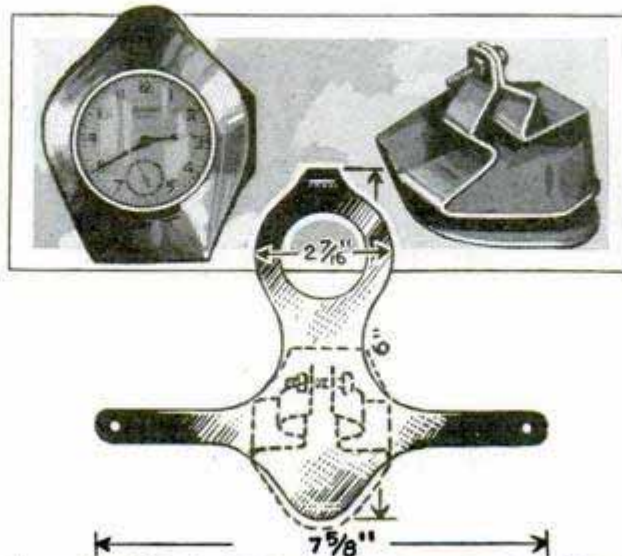

Convenient Watch Holder for the Auto Steering Wheel Is Made of Sheet Copper

which are compressed just sufficiently to hold it firmly in position. The dimensions given in the detail can, of course, be varied. A good feature of this holder is that the watch can be removed and carried in the pocket when the driver leaves the car, so that it cannot be stolen.—Dick Hutchinson, Denver, Colo.

2010 J. Fullinore

Emergency Repair for a Rifle Sight

Just when I needed my rifle most, I found that the bead had broken off the front sight, and not having time to order a new one, I made a bead which has proved satisfactory in every respect. The broken sight was removed and the edge filed smooth. The top was then slotted with a sharp chisel and the sides turned out to form a Y-shaped slit. In the groove thus formed a piece of brass wire, slightly larger in diameter than the required bead, was soldered. The surplus ends of the wire and the solder were removed, and the bead ends polished. To check the height of the sight, fasten the gun securely and set up a target some known distance away. Fire the gun and adjust the rear sight until the sights target properly. The brass bead proved to be better than the one it replaced, as it does not rust and will take a polish.—C. F. Heizer, Falfurrias, Tex.

Hinged Screen on Closet Door Provides Dressing Room

Where sleeping rooms are small and closet space is limited, one may enjoy the convenience of privacy by hinging a screen to the inside of the closet door as shown in the drawing. The screen may be made of a wooden frame, covered with fabric such as burlap, or it may be a piece of plywood or plasterboard. It should, of course, be smaller than the closet door



to prevent interfering with opening and closing. When not in use, it is hooked to the door so that it will not swing out every time the latter is opened. If desired, another hook may be provided to hold the screen in the open position.

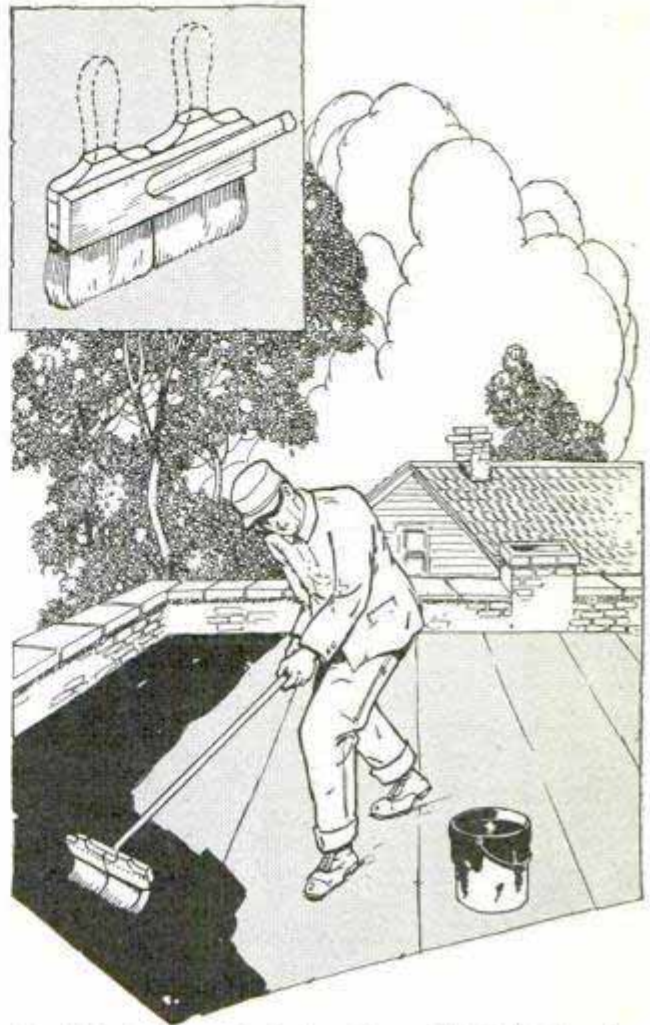

Roof Brush Improved from Two Old Paint Brushes Attached to Suitable Handle

Improved Roof Brush

Two old paint brushes, about 4 in. in width, nailed to a 1 by 2-in. crosspiece to which a handle is attached, make a good roof brush. The brush handles may be cut off as indicated in the upper detail. The hole in the crosspiece for the handle is drilled at an angle so that the free end will be raised about 3 ft. above the surface of the roof when the brushes stand vertically. This will make for easy manipulation.—Jesse L. Blickenstaff, North Manchester, Ind.

Attractive Emblem Belt for Small Boys

A belt in which small boys will take considerable pride can be made by attaching to it emblems taken from old automobile radiators, which can be obtained for a few cents from a junk dealer. To fasten them on securely, drill small holes in each one and rivet them to the belt.—E. T. Gunderson, Jr., Humboldt, Iowa.

To Make a Low Chimney Draw

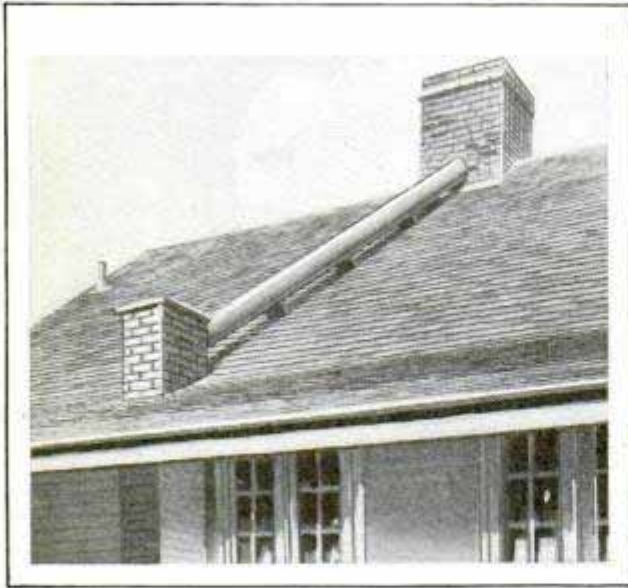

Draft of Low Chimney Can Be Increased by Connecting It to the Main Chimney

Many houses have two chimneys, one extending well above the ridge of the roof but the other far below it, and trouble is frequently encountered in the lower chimney owing to insufficient draft. Adding a portion to this chimney is expensive and usually detracts from the appearance of the house. An effective method of providing more draft in the smaller chimney is to run a 9-in. iron pipe up the slope of the roof to the ridge chimney. The open top of the former is sealed to divert the smoke through the pipe, which is supported by bricks laid on the roof, providing an air space and thus eliminating any fire hazard.

Gasoline Theft from Autos Prevented by Locking Cap



As it is an easy matter to siphon gasoline from auto tanks, many motorists frequently find their tanks empty. To prevent such annoyance the gas-tank cap can be locked

on the filling spout, as shown in the drawing. Get a length of flat iron or steel,

about $\frac{1}{8}$ in. thick and $\frac{1}{2}$ in. wide. A short piece is cut off and bent to fit the cap, to which it is welded, and a hole is drilled through the projecting end. The rest of the strip is bent around the filling spout, just below the top, both ends being allowed to project. A small stovebolt is used to draw the ring up snugly around the spout, after which the nut is welded on so that it cannot be removed without a hacksaw. A hole is drilled in line with the hole on the piece welded to the cap, so that a small padlock can be snapped on as indicated.—G. A. Luers, Washington, District of Columbia.

Lead Sinker Salvages Snagged Fishing Tackle

To aid in salvaging valuable fishing lures, one fisherman uses a heavy lead sinker, which he slips over the line and allows to sink against the tackle, causing the latter to be dislodged. The sinker is made by melting a quantity of lead and pouring it into a plaster-of-paris mold, through the center of which a small coil spring is arranged, the spring being long enough to project about $1\frac{1}{2}$ or 2 in. at each end. The sinker thus can be slipped on the line without removing the latter from the pole. The sinker is then whipped down to the snag where it usually releases the hook, after which the line is reeled in and the sinker removed.—G. E. Hendrickson, Argyle, Wis.



Putty for Glazing Hotbed Frames

Many amateur craftsmen, who pride themselves on the work they do in building hotbeds, wonder why the putty holding the panes does not stay in place. Probably they have used ordinary putty. A special mixture must be made to stand the expansion and contraction, which oc-

curs in a hotbed frame; it must be elastic. Such a putty can be made by adding one part of beef tallow to nine parts of raw linseed oil, with enough white lead to produce a suitable consistency. This mixture will never become hard, but will allow the necessary expansion and contraction without losing its hold.

Mirror Makes Rattrap Effective

In our office, where rats were occasionally seen, an ordinary trap was tried with poor results, no matter what kind of bait we used. The following trick was found effective, however: A small mirror was set against the wall so that a rat near the trap would see its image. Competition between the rat and its image in getting the bait may have been the reason for the success of this method, as rats were caught every day.—Walter J. Stefaniak, Buffalo, N. Y.

Stone Path Adds Beauty to Lawn

The beauty of a flagstone path in a lawn or garden depends largely upon the arrangement of the stones, and this should be carefully studied out before they are permanently set. Place them loosely on the ground so that they can be moved about until a satisfactory effect is obtained. Then dig holes that will take the lower half of each stone, or raise them with gravel if it is desired to make the path higher than the adjacent ground, which is sometimes advisable in order to drain the path properly.—H. Rossiter Snyder, Guilford, Conn.



Flagstones Laid Out on the Lawn to Get Good Arrangement before Setting Them Permanently

Camera Support on Auto Fender



Camera Support Set on Auto Fender for Taking Time Exposures

Taking time exposures on the road requires a level support, which is usually not found on an auto. It is an easy matter to provide one, however. Take a tin saucer, cover it with heavy cloth and tack it to a small square piece of wood, preferably plywood. The inverted saucer is set snugly on the fender so that the board on which the camera is set is level. This enables the tourist to take a picture in any direction with no trouble and a minimum loss of time.—Harold E. Benson, Denver, Colo.

Staining Wicker Work

Wicker work is frequently stained by means of oil or alcohol stains but they are unsatisfactory because the stain wears off after a few months, leaving objectionable light-colored spots. It is much better to use a varnish made from soft gum, such as sandarac, dissolved in methylated spirits. To this may be added any aniline dye in the proportion of three per cent of the varnish.

☐ A cloth used for straining can be held on a pail rim with clothespins.

Old Barn Makes a Cozy Clubroom



Transforming the Old Barn into a Cozy Studio or Clubroom

There are many old barns and outbuildings which can be made into useful shops, studios or clubrooms without going to a great deal of work and expense. Rough-textured wallboard is nailed to the studs of the walls and partitions. The seams are covered with 4-in. battens and these are stained with dark-brown walnut stain to obtain the effect of a half-timbered English cottage. It is an easy matter to rig up an old wagon wheel to serve as a chandelier, as shown in the photo, which may be suspended from a beam by chains. —H. Rossiter Snyder, Guilford, Conn.

How to Repaint Venetian Blinds

Where Venetian blinds are used, it is necessary to understand the method of handling them when they require repainting. The tapes should be removed and the blinds pulled apart. Each slat should be thoroughly cleaned with soap and water, rinsed and dried, after which it is given a coat of paint to harmonize with the color scheme of the room. When all the slats have had two or three coats of paint, and are dry, they should receive a coat of clear spar varnish. If the old paint is rough or blistered, scrape it down

or use paint and varnish remover. The latter must, however, be completely taken off and neutralized before applying paint, which can be done by first washing thoroughly and then using oxalic acid. Use only the best grade of paint. It is a good idea to drive a small brad into the end of each slat so that it can be handled without touching the painted surfaces. Tie a string to the brad to facilitate hanging the slats up to dry. When dry, the brads are removed and the slats restrung. Cord for this purpose can be obtained from a shade and drapery dealer. If you cannot get the desired color of cord, get white cord and dye it with cold-water dye, which can be had at any drug or notion store. Always get the best grade of cord, as a cheap quality will stretch and cause the slats to sag or pull apart.

Safe Cleaner for Delicate Fabrics

A non-inflammable cleaner can be made by mixing kerosene, 10 oz., carbon tetrachloride (commercial), 30 oz., and oil of citronella, 20 drachms. If a strong odor is perceptible in the carbon tetrachloride, shake with some powdered charcoal, and filter. The color should be as clear as water. This mixture will clean very dainty and delicate fabrics; it cleans all kinds of jewelry, removes tarnish and oily deposits from tableware, rust from tools, verdigris from copper, etc.

Brush for Cleaning Bolt Holes in Bearing Caps

When filing bearing caps, use a small round bristle brush, as shown in the illustration, to clean the filings out of the bolt holes. Brushes suitable for this purpose are those designed for cleaning coffee percolators, and cost only a few cents. One push of the brush through the bolt hole of the bearing cap is sufficient to remove the filings.



Shellac for Waterproofing Matches

The method used for waterproofing wood patterns against the effects of damp molding sand suggests a similar treatment for matches, which will be appreciated by many hunters, campers and fishermen. Just dissolve some shellac in denatured alcohol until it becomes of the consistency of thin cream. Dip the matches in it and then let them dry, which will only take a few minutes. Many years of use have proved matches prepared in this way to be entirely satisfactory.

Heart-Shaped Garden Pool

It is almost as easy to make a garden pool of irregular shape as one of the conventional round, square or rectangular design. Lay it out by dusting white powder on the ground and then dig the inclosed area to the desired depth, leaving the banks sloping. The concrete must be stiffer than usual as it is not poured in a form, the consistency of putty being satisfactory for the sides. The bottom may be formed of concrete which has more water in it, and should be about 3 or 4 in. thick. When the concrete begins to set, it can be troweled smooth. The



Garden Pool of Heart Shape Is Out of the Ordinary and Easy to Make

proportions for the concrete should be, for the sides, 1 part of cement and 3 parts of sand, and, for the bottom 1 part of cement, 2 parts of sand and 3 parts of pebbles. The concrete should be thoroughly mixed before any water is added. Laying flagstones along the edge of the pool will add to its attractiveness.

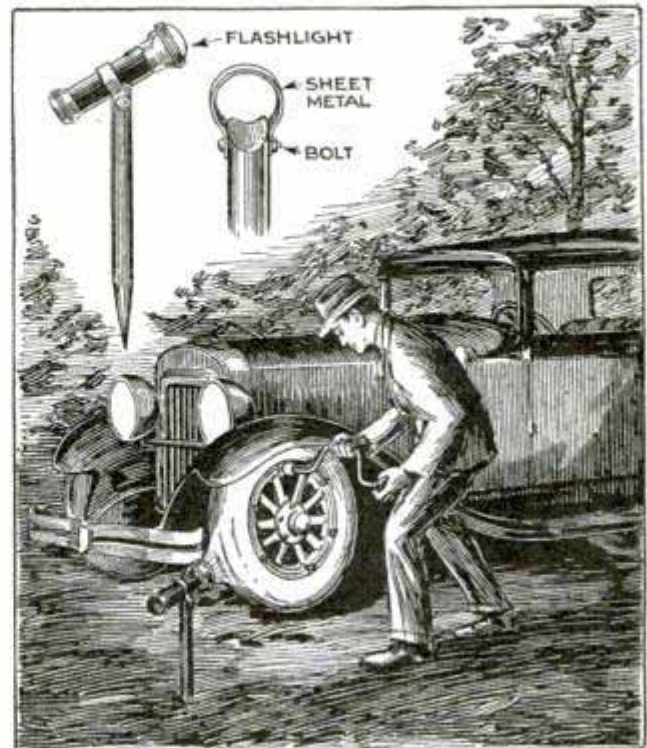

Short Stick and Clamp Make a Handy Holder for the Motorist's Flashlight

Flashlight Holder for Changing Tires

Motorists will find the flashlight holder illustrated convenient for changing tires. Driven into the ground in a suitable position, the light can be adjusted to illuminate any part. It consists of a length of broomstick, pointed at one end and provided with a sheet-metal clamp at the other, the clamp being held with a screw and nut. The clamp must fit the flashlight to hold the barrel firmly without restricting its movement entirely.

Homemade Trays for Photography

Amateur photographers who use large-size trays only occasionally, do not always feel justified in purchasing manufactured trays of enamel ware, glass or hard rubber. Cheap homemade trays can be made as follows: Get a shallow sheet-metal baking pan of the desired size, or make a tray of light wood. Glue ordinary white oilcloth to the inside to make it waterproof, cutting it so that there will be some surplus material to be brought over the edges. After the glue has dried, apply three coats of acid and alkali-resisting bathtub enamel, allowing each coat to dry before applying the next.—Wm. C. Vestal, Redlands, Calif.

Cord Holds Movie Camera Steady

A most important detail in operating a movie camera is to hold it steady. In



Stout Cord Looped around Foot and Camera Helps to Hold It Steady

many cases, however, it is inconvenient to carry a tripod along and, unless a suitable rest can be found when taking the picture, it becomes quite a problem to hold the camera steady. I overcame this trouble by using a very simple method: I got a length of stout cord and looped one end around my foot and the other around the camera as shown. With a slight upward pressure on the camera, I kept the cord taut while taking the picture. You will be surprised to find how steady the camera can be held. A heavy rubber

band tied between the camera and the cord will often add to the smoothness of "follow shots," as it prevents jerky movements.—H. Tappenbeck, Hollywood, Calif.

Methods of Cleaning Pewter

Some fanciers of pewter claim that the best method of cleaning it is by washing in water and pure soap, and then rubbing to a dull finish. Such treatment is all right for pewter that is regularly cared for, but if it is covered with grime and scale, the accumulation may be removed by means of a weak solution of hydrochloric acid, after which the article is immediately washed in pure water, care being taken not to leave the acid solution on long enough to eat holes in the metal. Soaking in kerosene is another method which is followed by rubbing to a finish. Then comes rubbing with a mild abrasive such as brick dust and diluted acid or even with a good metal polish. One collector never allows anything to touch his pewter pieces except castile-soap suds, followed by rinsing, hours of patient polishing by hand and a final rubbing with clean chamois skin. This, he claims, gives that quiet luster which properly belongs to old pewter.

How to Dry Out Damp Gloves

It is poor practice to lay damp gloves on a radiator or other warm metal surface to dry out, as it is likely to harden them. A better method is shown in the drawing. Take an old cardboard shoe box, cut the bottom out and wrap some heavy twine around it as indicated. Lay the damp gloves on the upper grate thus provided and set the box on a radiator or stove. The continual circulation of warm air will dry the gloves without doing them any harm.—Frank W. Bentley, Jr., Missouri Valley, Iowa.

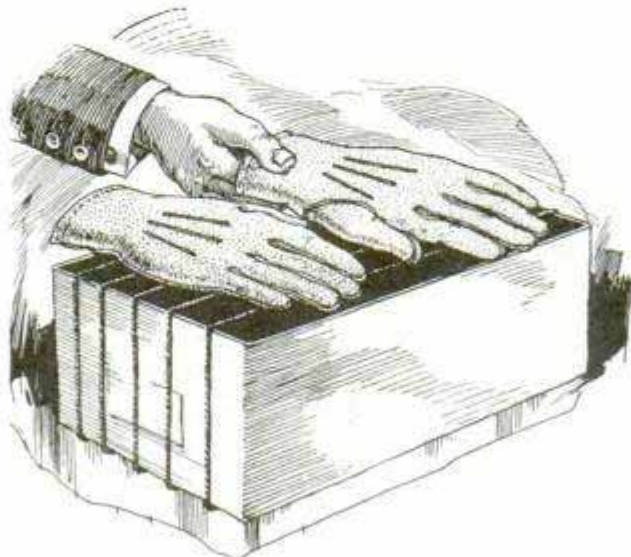

Old Shoe Box Wrapped with Cord Makes Holder for Drying Damp Gloves

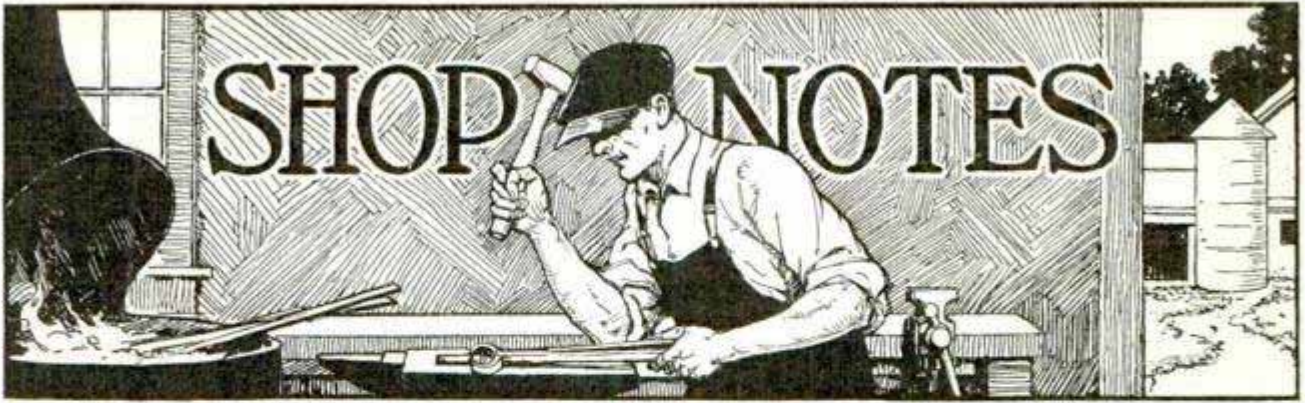

You Can Make This Shaper

By W. CLYDE LAMMEY

1944 Curtis St. Lower Merion, Pa.

MANY individual home workers have been somewhat disappointed in the final results of their effort when making some piece of home furnishing. It is very difficult to get away from a certain amateurish look in the finished work. Its appearance lacks the completeness of the commercial product, even with careful designing. In short, there is one thing lacking—the finishing touch of the shaper. To most home mechanics, however, the

cost of the commercial shaper is prohibitive and, besides, few of these machines are suitable for use in the ordinary individual shop.

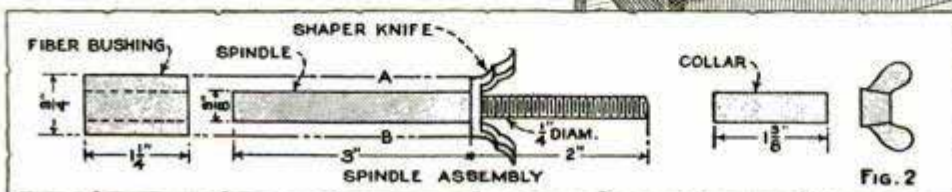
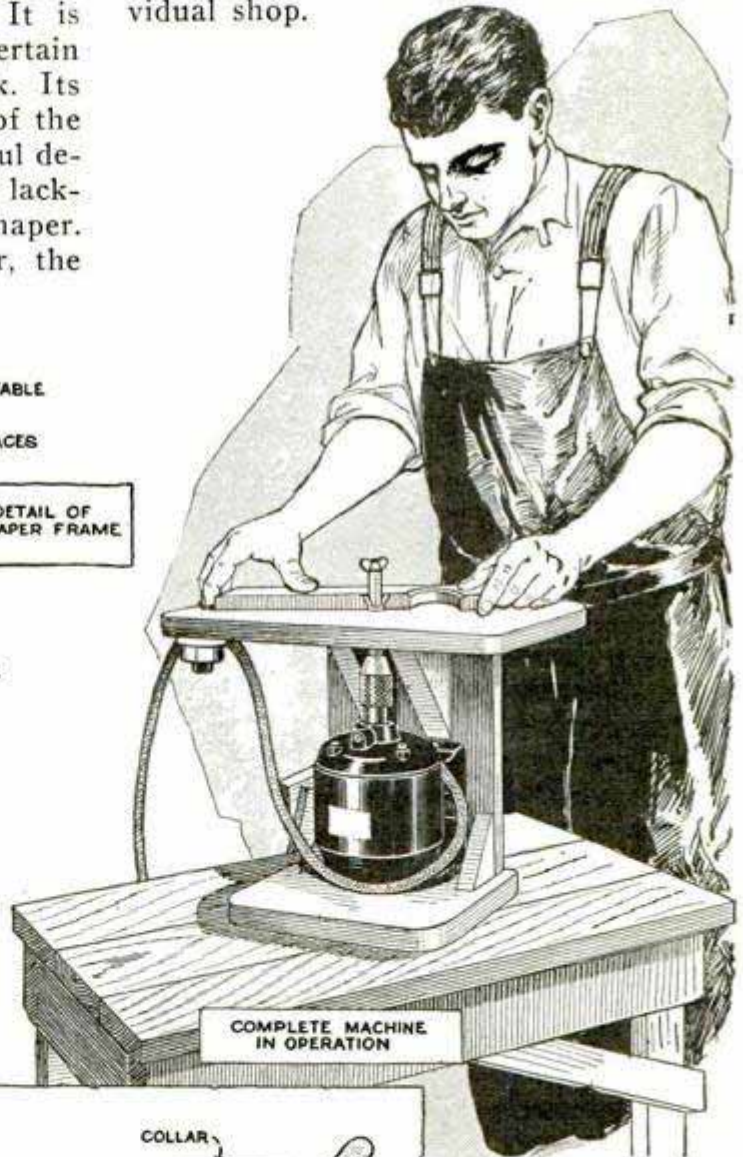
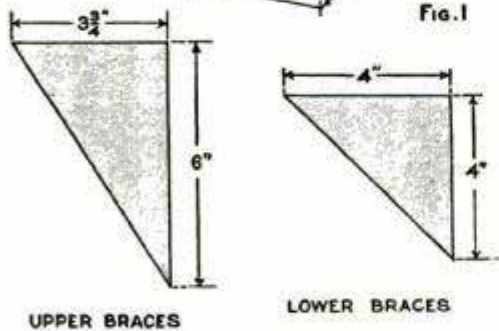
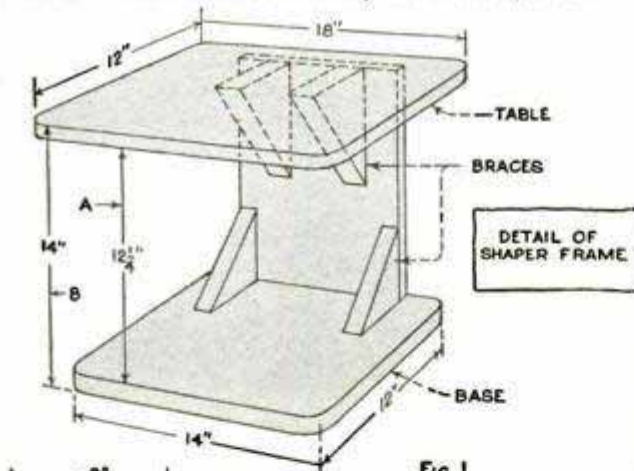

The simple contrivance shown in the illustrations is capable of turning out a variety of first-class shaping on both straight and irregular work. The spindle is adjustable for any thickness of stock from $\frac{3}{8}$ to $1\frac{3}{16}$ in., and even stock $\frac{7}{8}$ in. thick can be molded by careful adjustment of the spindle. This range will cover the average of the work required by the individual user.

For best work, the motor should have a load speed of 3,600 r.p.m., run on ball bearings, and be of at least $\frac{1}{4}$ hp. Most electrical shops can furnish a secondhand motor to these specifications for a nominal sum. The motor must be able to run vertically.

A geared chuck of $\frac{1}{2}$ -in. capacity to fit the motor shaft is the most desirable, but expensive. There are cheaper chucks that will serve the purpose very well for intermittent use. Be sure that the chuck purchased is of $\frac{1}{2}$ -in. capacity and has an effective provision for tightening the jaws.

There are at least two makers of small woodworking machinery who make shaper knives suitable for use on this machine. These may be had in a considerable range of design. Though the single-edged cutter may be used, a knife of what is commonly known as the "wing" type with three or four cutting edges is the best. As the individual will not care to invest in more than two or three knives at the most, one should give some thought beforehand to the shape of the knife and the design of the molding it will cut in order to obtain its greatest range of usefulness. Sizes of wing knives are generally taken as outside diameter, size of the spindle hole and diameter at the lower cutting edge. This last is important and the knife should always be at hand before making the spindle. By this dimension is determined the size of the collar which acts as a guide to the stock being formed. The relation of these two parts will be seen from the two dotted lines A and B in the spindle sketch. The diameter of the spindle collar (in this instance the collar acts also as an upper bearing or bushing) should be only very slightly less than the width across from one cutting edge to the other. This dimension on the knife shown is $1\frac{3}{16}$ in., and the collar measures $\frac{3}{4}$ in., giving a clearance

to the cutting edge of $\frac{1}{32}$ in., which is sufficient.

Make the spindle before constructing the frame. As material, get a $\frac{3}{8}$ by 6-in. bolt, or piece of $\frac{3}{8}$ -in. steel rod, a $\frac{1}{4}$ -in. wingnut, a piece of round fiber rod, 2 in. long and $\frac{3}{4}$ in. diameter, a small piece of $\frac{1}{4}$ -in.-thick flat fiber and a 2-in. length of aluminum tubing with an inside diameter of $\frac{1}{4}$ in. It is advisable also to get a $\frac{3}{8}$ -in. shaft collar with headless setscrew. Cut a $1\frac{1}{4}$ -in. length from the fiber rod, mark the centers on both ends and bore a $\frac{3}{8}$ -in. hole clear through, boring from each end to center the hole. Smooth and square up the ends of the bushing thus made. When assembling in the frame, it may be necessary to cut the bushing shorter to allow the knife to work in the thinnest stock, but at first leave it this length. Turn or grind 2 in. of the bolt or rod down to the diameter of the cutter hole (in this case $\frac{1}{4}$ in.) and be sure to get the shoulder square. Rethread the end to fit the wingnut. The size of this end, of course, depends on the cutter hole, and the same applies to the wingnut and aluminum-tube sizes.

Cut a $1\frac{3}{8}$ -in. collar from the aluminum tubing, true off the ends and try for fit over the upper end of the spindle. It should fit easily. Run the threads down about $1\frac{1}{4}$ in. with a standard die. True off any irregularities on the lower end of the spindle and give a very light grinding all over. Lastly, make a light saw kerf lengthwise of the fiber bushing, to a depth of slightly less than $\frac{1}{8}$ in. Assemble the spindle with the bushing, knife and collar in place, tightening the nut to seat the knife accurately. Set the bushing against the knife and bring up the shaft collar to within $\frac{1}{4}$ in. of the lower end of the bushing. Tighten the shaft collar in place. Slide this assembly in the motor chuck and tighten, with the spindle as far in the chuck as it will go. Measure from the lower end of the motor to the lower edge of the shaper knife. Deduct from this the exact thickness of the stock to be used for the table, plus $\frac{1}{8}$ in., to obtain accurately the dimension A in the frame drawing. The $\frac{1}{4}$ -in. space between shaft collar and bushing allows for the thickness of the fiber plate and at the same time permits the spindle bush-

ing to project $\frac{1}{8}$ in. above the surface of the table to act as a guide on $\frac{3}{8}$ -in. stock. Dimension A is likely to vary, and should be determined for the motor in hand. Vertical adjustment of the spindle is made in the chuck, and for this reason we must be sure of sufficient projection of the spindle below the collar so that the chuck will hold firmly.

Make the table and frame from $1\frac{3}{16}$ -in. sound, straight gumwood stock to approximately the dimensions given. Plane and sand the top of the table to a smooth, true surface and be sure that the ends of the upright are cut square before joining. Saw the four braces to approximately the sizes shown from 2-in. hardwood. The $3\frac{3}{4}$ -in. dimension on the upper braces should be altered if necessary to bring the point of the brace slightly beyond the center of the spindle. Assemble the



frame with screws and glue, for it must be rigid, and must not spring.

Locate the hole for the spindle bushing by bolting the motor to its base, being

careful to get it alined with the frame. Place a small drill in the chuck, then slide the chuck forward on the shaft until the drill touches the wood. Mark this point and remove the motor. Transfer the location of the mark accurately to the table top. Bore the hole for the fiber bushing with a small expansive bit, first testing the setting on a piece of waste until the bushing is a light fit. In boring, be careful that the lower edge of the hole is not splintered. Make a vertical cut with a sharp knife in one side of the hole, making the cut about $\frac{1}{8}$ in. deep and about halfway down from the top. Cut out a very small square of heavy tin, about $\frac{1}{4}$ by $\frac{3}{8}$ -in. in size, and drive this in edgewise into the knife cut. Sink the tin in the wood until less than $\frac{1}{8}$ in. projects out into the hole. Bolt the motor back in place, assemble the spindle with the knife in position and slide the spindle in place through the hole, having the saw kerf on

the fiber bushing engage the piece of tin driven in the knife cut. This piece acts as a key to prevent the bushing turning with the spindle. Tighten the chuck and turn the assembly by

hand to test the running of the spindle. Make sure before bolting the motor tight that the spindle does not bind. It should run easily and without friction.

Remove the spindle and cut the fiber plate to fit between the braces. Bore a $\frac{3}{8}$ -in. hole through the center and two smaller holes at the ends for screws. Place this in position on the underside of the table, slide the spindle through and slip the shaft collar over the end. Slide the spindle into the chuck and tighten. Set the plate so that the spindle turns freely as before and fasten it in place with small screws. Slide the shaft collar against the plate and tighten the setscrew. The shaft collar prevents the spindle from loosening in the chuck and slipping upward. To make a suitable cut on $\frac{3}{8}$ -in. stock it may be necessary to cut off a portion of the fiber bushing. Tap the bushing to the lowest position and measure the length of the projection above the table. As a rule, a projection of $\frac{1}{8}$ in. above the table will make a cut on stock of this thickness. Should the bushing project more than this when in the lowest position, the excess may be cut off and the end trued up.

Set the knife to the desired thickness of stock; tighten chuck and be sure that the motor bolts are tight. Wire a 5-amp. two-pole switch in the

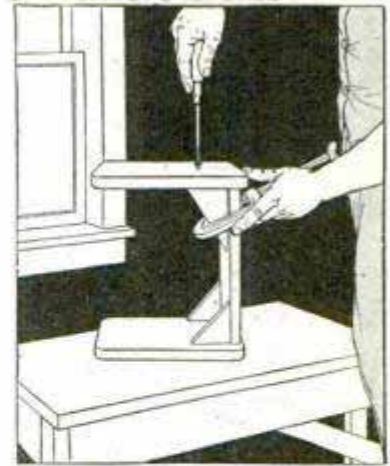

ASSEMBLING FRAME

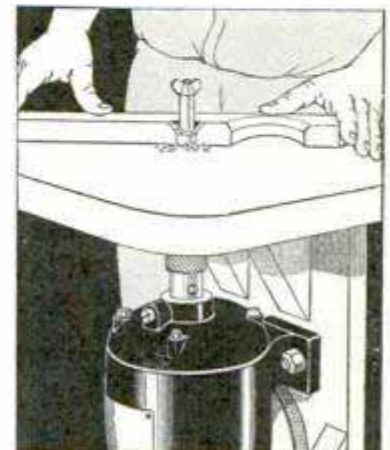

MOULDING EDGE OF BOARD



ALINING SPINDLE

motor line, fastening it to the lower side of the table, and the machine is ready to run.

If the edge is to be molded on a hard close-grained wood such as maple, it is better to make the cut in two separate operations. For the first, set the knife so that one-half of the cutting edge will run in the wood. Run this cut the length of the stock, then lower the knife for the second and finishing cut. This will cause less strain on the spindle assembly and, most important of all, we shall have as a result much smoother and cleaner work. The knife will cut to the full depth in any curve the radius of which is not less than that of the fiber bushing which acts as the guide. Keep the spindle well oiled, but be careful not to get oil in the chuck.

Lastly, it may be well to remind the worker who chances to be unfamiliar with it, that the shaper is a dangerous machine and must always be used as such. One should remember that the cutting edges of the knife are very sharp; that they are running in an exposed position and at a speed of 3,600 r.p.m. A slip might mean a serious accident.

Hardening Hacksaw Blade to Cut Tool Steel

Ordinary hacksaw blades are not intended for very hard steel, and if it is desired to cut such steel, the blade should be hardened. In doing this the blades would warp when brought to a cherry-red, but by experimenting, I find that if a blade is bound on an old flat file and both heated together, the blade will be kept straight and the file will retain the heat while preparing to dip it. The temper of the blade end should be drawn to prevent breaking. For extremely hard temper, heat to a cherry-red and give the blade a mercury bath, but guard against inhaling the fumes, as they are poisonous. Saws or drills hardened in mercury will readily cut glass if moistened with turpentine. In using a hard blade do not press too hard, and run it slowly.—Dr. W. H. Albright, Bellevue, Ohio.

Cigar Box Protects Adjustment of Incubator Thermostat

After losing a quantity of hatching eggs because the adjustment on the incubator thermostat had been dislodged by a rat or mouse, a poultryman used an ordinary cigar box to prevent a repetition of the trouble. A notch was cut in one end of the box to allow the damper arm unrestricted movement, and the box was then placed in an inverted position over the thermostat adjustment and damper arm, as shown, the lid of the cigar box being tacked to the top of the incubator, so that the box could be raised but not dislodged.

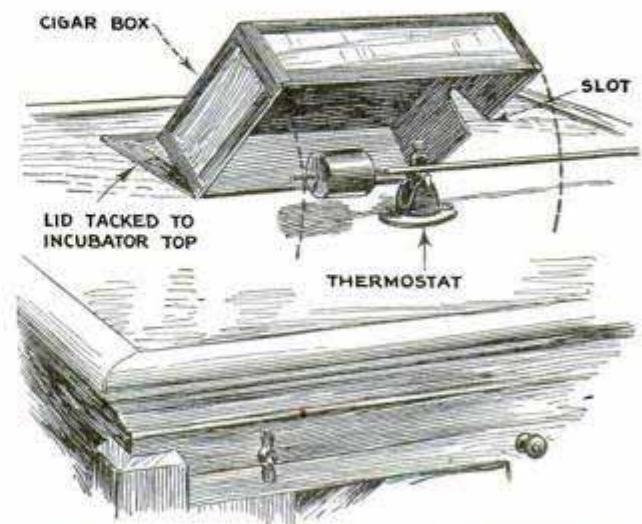

Cigar Box Protects Adjustment of Thermostat and Damper Arm on Incubator

Two Useful Greenhouse Ideas

Two highly useful features that will be appreciated by greenhouse owners are shown in the photos. To shield the greenhouse against the entrance of mice, rats, and insects, such as moths and butterflies, which may cause considerable damage

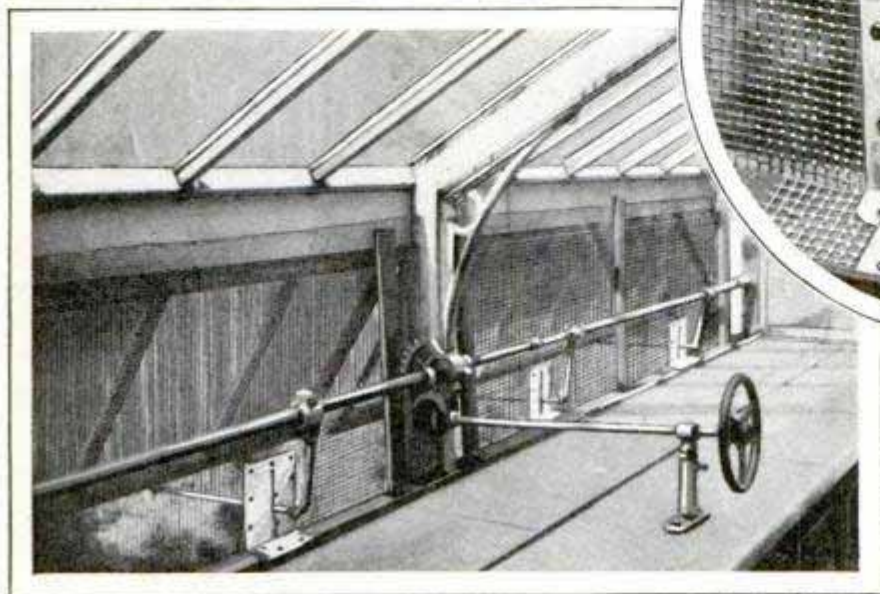

Above, Vermin-Proofing the Greenhouse with Screen without Interfering with the Window-Raising Arms; Below, Non-Slipping Platform for Use When Replacing Window Panes

to plants and flowers under cultivation, the side windows are screened. For this purpose galvanized screen of $\frac{1}{2}$ -in. mesh has been found satisfactory. Ordinarily the task of screening is quite difficult because the window arms are in the way, but the difficulty can be readily overcome by attaching a slotted piece of heavy galvanized sheet iron to both screen and window frame as shown. Small screws, nuts and washers are used for attaching the plate to the screen. Machine screws are similarly used to attach the plate to a metal window frame, the hole in the frame being tapped to receive the screw. Ordinary wood screws are used if the window frame is of wood. The second feature is the roof platform shown in the lower details, which is of use when replacing broken panes. It is made of 2-in. stock, the top piece being 12 in. wide and about 6 ft. long, while the sidepiece, which is spiked onto the underside of the top as indicated, varies in width according to the pitch of the roof. The top must be perfectly horizontal when the platform is set across the rafters. Pieces of an old buck-

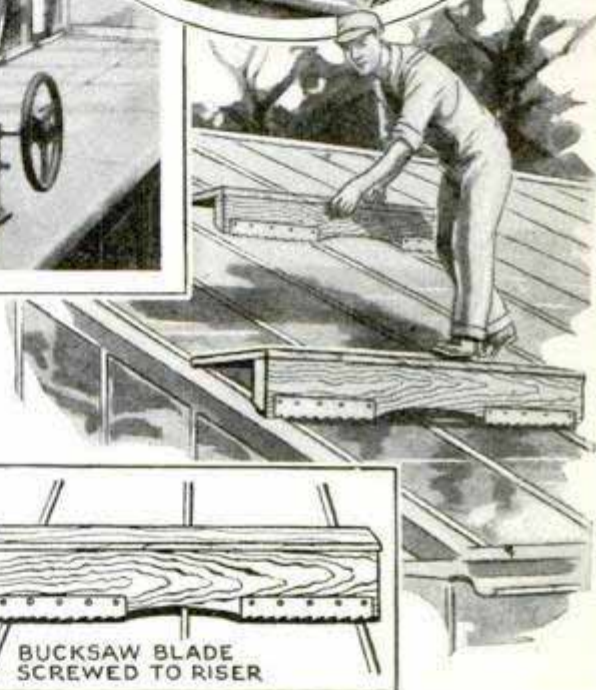
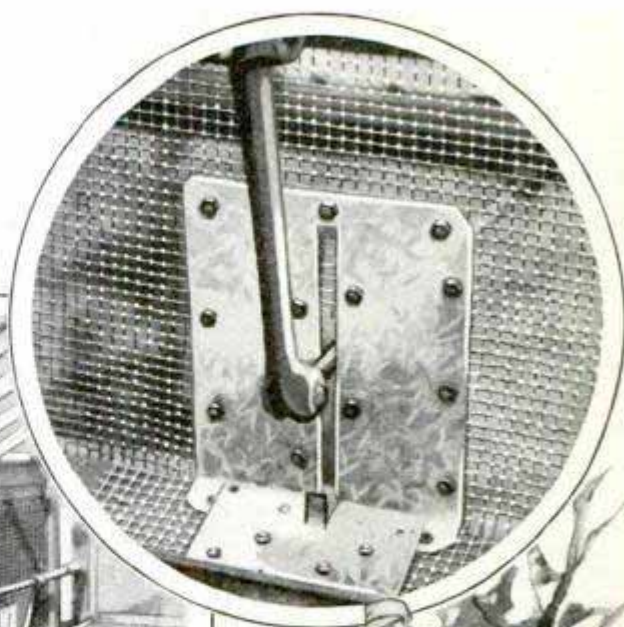

saw blade are drilled and attached with wood screws to the sidepieces so that the teeth project beyond the lower edge and bite into the rafters, thus preventing the platform from slipping.

Automobile Springs Lubricated with Blowtorch

A blowtorch can be used to advantage for oiling parts on the automobile which are ordinarily inaccessible. The torch is filled with penetrating oil or a half-and-half mixture of light oil and kerosene. The stream is directed onto the springs, brake connections, between fenders and the body, etc., and the work can be done without crawling underneath the car.—C. E. Packer, Chicago.

Unit Heater for Garage or Workshop

By KENNETH B. MURRAY

Sturges, Mich

HEAAT, and plenty of it, is wanted when the wind whistles through every crack in your garage or shop. A stove must be tended frequently; other methods are expensive. The heater shown here will operate continuously for \$2 or less a week, day and night; it costs very little to construct, as most of the materials are already at hand or can be picked up for a small sum, and with the flame turned very low, even a large space is warmed hot as toast at a constant temperature day in and day out. The essential materials are: A gas water-heating coil, a gasoline camp stove, an electric fan and an old automobile radiator.

As the pictures show, the gasoline stove is used to heat the water-heating coil. The hot water circulates through the radiator, and an electric fan in the rear forces a continuous blast of hot air into the room. More than that, the air is fresh and provides ventilation, which is important while working on your car in the garage. In the town where the heater was first constructed, it was used to heat a small restaurant with wind exposure on all sides.

So efficient and inexpensive to operate was it, that eleven other outfits were constructed by private parties.

First select a place for the heater, preferably in a corner, then, 5 ft. from the floor, fasten with steel braces a wood shelf that is as large as the radiator is wide. Cut a 3-in. hole in the wall and, on the outside of the room or building, fasten an elbow to serve as a ventilating pipe. A rainwater-pipe elbow answers the purpose, which is to allow air but not rain to enter. In front of the hole, install the electric fan, fastening it with

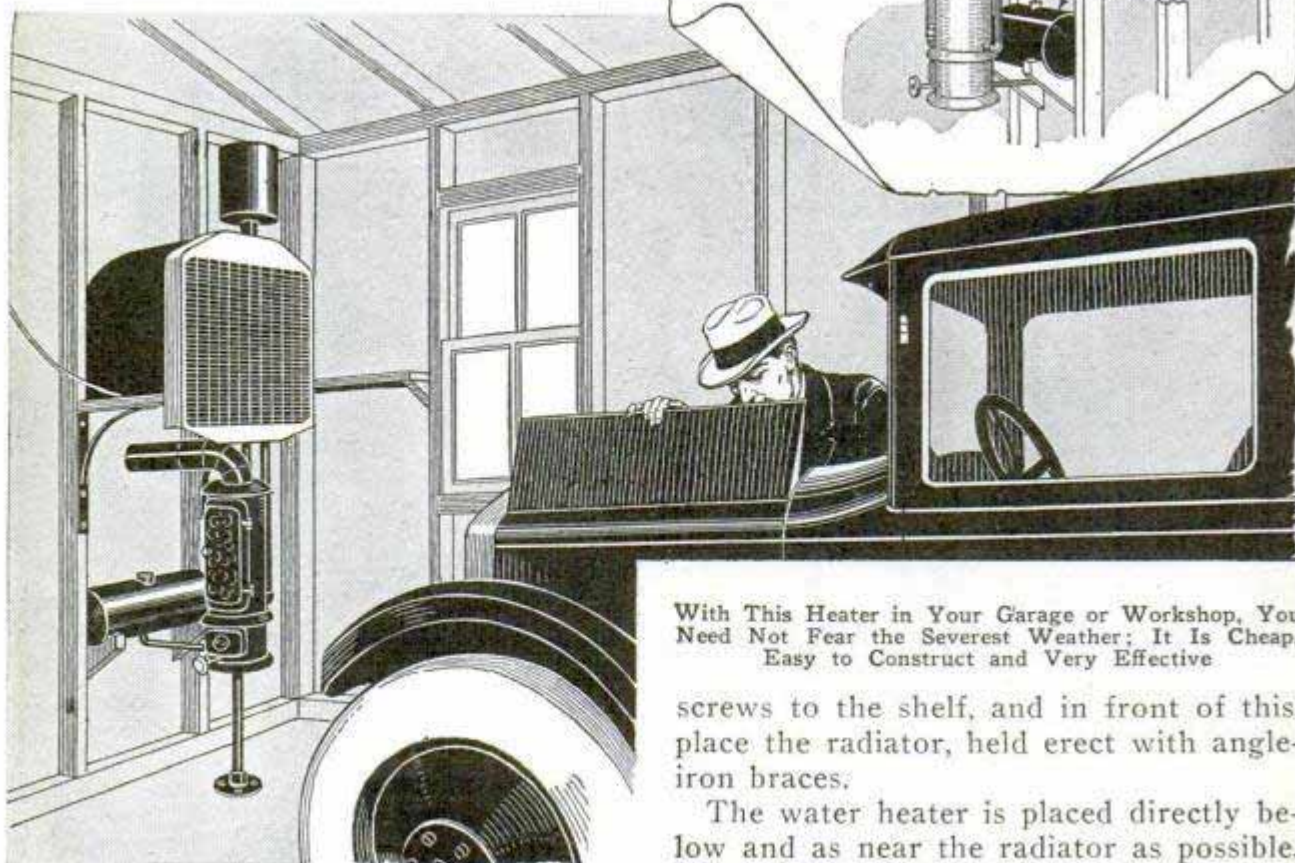
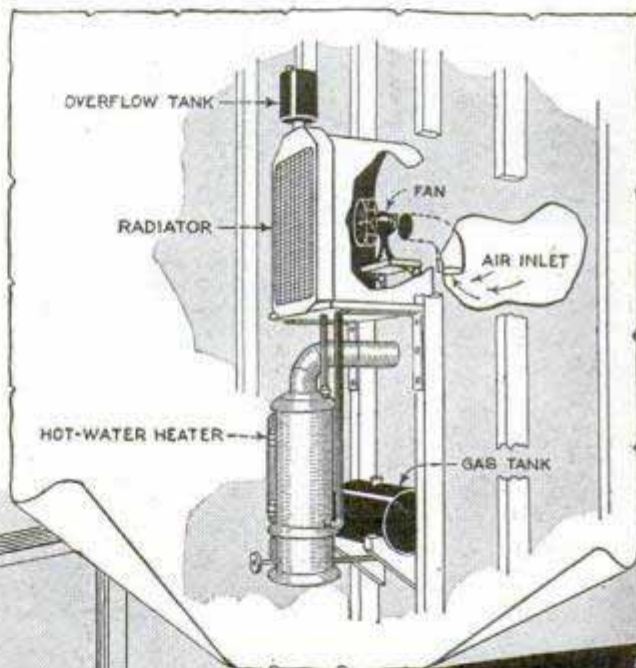

With This Heater in Your Garage or Workshop, You Need Not Fear the Severest Weather; It Is Cheap, Easy to Construct and Very Effective

screws to the shelf, and in front of this, place the radiator, held erect with angle-iron braces.

The water heater is placed directly below and as near the radiator as possible.

Two pipes are run from the heater coil to the inflow and outflow connections of the radiator. The overflow of the latter must be stopped up with a wood plug. Be sure that all connections are water-tight. A regular stovepipe carries off burned gases.

An expansion tank is fastened to the top of the radiator to provide for the condensation of any steam or water vapor, and for the expansion of the water. It should have an opening for filling the radiator with water, the opening being stopped with an ordinary cork, which will blow out should the heater flame be turned too high accidentally and cause steam pressure. In the outfit illustrated an oilcan was used. The system is not filled higher than the top of the radiator.

The water coil is heated with the burner from the gasoline camp stove, placed underneath the coils in the same position as a gas burner. The camp-stove fuel container will be large enough for use of the heater a half or full day at a time. For operation day and night, it is advisable to install a 5-gal. pressure tank fitted with a gauge. An ordinary tire pump can be used for pressure.

The heater is now finished except for inclosing the space around the fan. A sheet of galvanized tin is bent to the shape of an automobile hood, to fit the radiator at one end and reach to the wall at the other. This allows a forced draft of fresh air from the outside. A few ounces of aluminum paint will do wonders to make the entire heater an ornamental affair. The hood and radiator tanks, but not the heating surface of the radiator, should be painted. If any paint is used on the radiator fins, it should be thin and black.

Now fill the heater with water by pouring it into the expansion can. Enough water to reach the bottom of the can is sufficient. Generate the gas in the camp-stove burner in the usual manner and turn it on full blast. The water will be heated quickly, and then the flame can be turned down until it is barely burning. Start the electric fan, and the room will quickly be heated with circulating fresh air from outdoors.

From an economical standpoint it is desirable to keep the gasoline flame low at all times. The heater is so efficient in

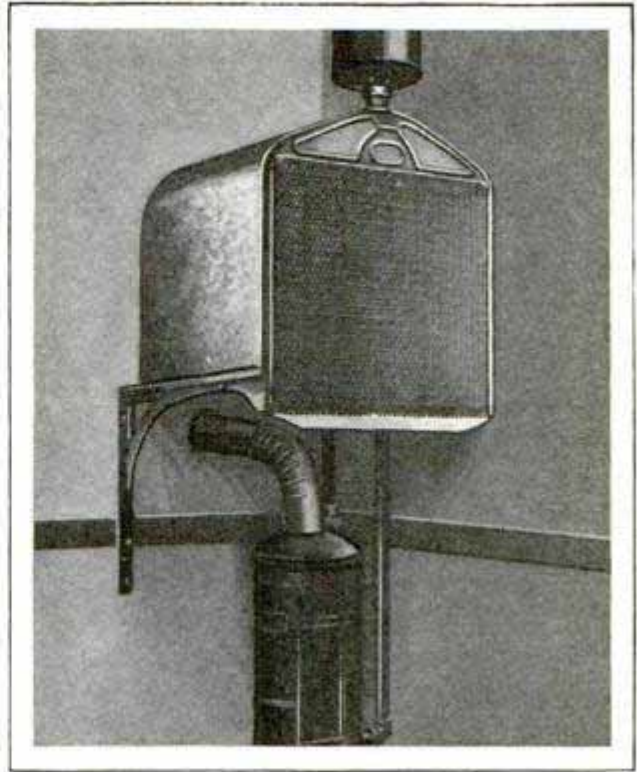

Photo of the Original Heater as Installed in a Restaurant; It Takes Little Room, and Is Economical

utilizing every available bit of heat, that the ease with which the room is kept at even warm temperature will be found surprising. Of course, the gasoline burner is used only where gas is not available. If it is, the gas is much more convenient. Even a kerosene burner, taken from an old stove, will provide sufficient warmth to keep a room at a comfortable temperature.

If the heater is to be installed in a room where inflammable liquids or vapors are likely to be present, it is a wise precaution to inclose the entire heating coil and burner in a screen of fine copper gauze. Ordinary fly-screen wire will serve. The screen should cover the whole unit, and be fitted closely around all connecting pipes. This will make the burner quite safe, on the principle of the miner's lamp.

Guide for Grinding Model-A Ford Valves

A discarded model-A Ford valve guide of the split type, with the sides dressed down slightly to make a loose fit, is useful for grinding the valves. The guide is inserted from the top in an inverted position. This is much better than putting the guides in from the bottom, as they have a tendency to fall out.

Angle Plate for Planer or Shaper

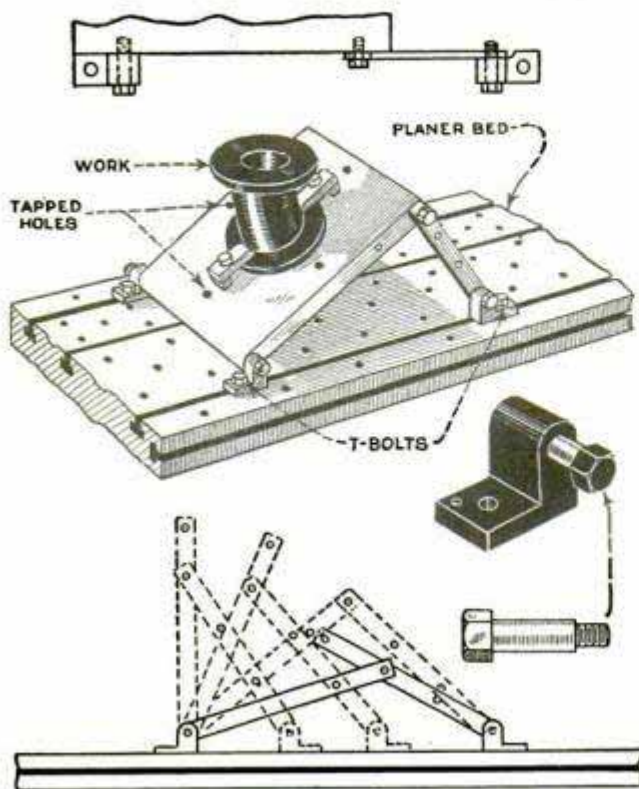

Universal Angle Plate Which Can Be Used on Any Planer or Shaper

The angle plate shown in the drawing can be adapted to any planer or shaper bed and is well worth the time spent in making it. The lower detail is a side elevation, and the dotted lines indicate various angles to which the plate can be set. The two front feet are hinge castings, one of which is shown in the detail. They must be faced off on both sides until their width equals the distance between the shoulders of the hinge studs with which they are fitted. The stud holes should be drilled and reamed to a snug fit. Drill and ream the front feet for dowel pins to fit corresponding holes in the planer or shaper bed so that the fixture always will be parallel to the cross-rail of the ram. The rear feet are somewhat similar to the front ones but narrower, allowing the legs, which are made of suitable bar stock, to be at right angles to the plate to which the work is attached. This is shown in the detail

above the perspective view. No dowels are used in the rear feet, as this end of the fixture must be adjustable to the various angles desired. Capscrews are fitted to the rear feet as indicated, and are also used to fasten the legs of the angle plate. All four feet are held firmly in place on the planer bed by means of T-bolts. After the fixture has been assembled and doweled, a cut is taken across the plate, while flat, and center lines are cut with a tool so that the work can be more easily centered. Two rows of tapped holes in the plate will take care of almost any kind of work. The plate should be at least $1\frac{1}{2}$ in. thick. No specific dimensions are given in the drawing, as the fixture must be made to fit the planer bed on which it is to be used.—Theo. H. Hansen, Clinton, Iowa.

Sidewalk Attached to Logging Train

This logging train has sidewalks attached to the sides by means of large hinges, enabling the walks to be folded against the cars when not in use. It is customary to park the train at one location for several weeks until the crew has finished its work there. Before the train was equipped with these walks, the occupants often had to walk through mud from one car to another, which is now eliminated, as planks are used for bridging the gap between walks on adjacent cars. When the train is moved, the walks are folded snugly against the side and are held in this position by large wooden turn-buttons pivoted slightly off center on heavy bolts so that they will not be turned to a horizontal position by the vibration of the moving train. Suitable folding legs are used to support the outer

edge of the walks when let down, and a stairway is provided to facilitate getting on and off.—Carlton Groat, Portland, Oreg.

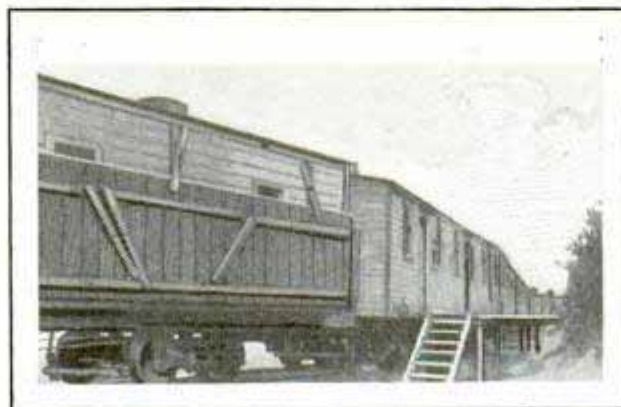

Folding Sidewalk Attached to Side of Bunk and Dining Cars of Logging Train

It is very poor practice to turn a reamer backward in a hole, as this will ruin its cutting edge.

Restoring Writing on Old Manuscripts

To restore faded or effaced ink writing on old manuscripts, moisten the writing with freshly made sulphhydrate of ammonia, and in a few moments the letters will become plainly visible. A fresh solution in water is colorless, but turns yellow quickly when exposed to air. The surplus chemical should be removed by washing with cold water, and the paper is then dried by slight heating or with blotting paper. If the writing again fades after this treatment, a tannin solution should be applied. This process is only useful for restoring ink made with gallic acid.

Effective Weed Hook

When the weed hook of my plow broke, I took two lengths of smooth wire and tied one of them to the front end of the beam and the other at the center, as shown in the upper detail. They were then allowed to drag on one side, being long enough to catch the dirt turned up by the plow, which holds them taut. Weeds are turned under more effectively with this arrangement than with any plow hook I have ever used.—Luther Stro-snyder, Onaga, Kans.

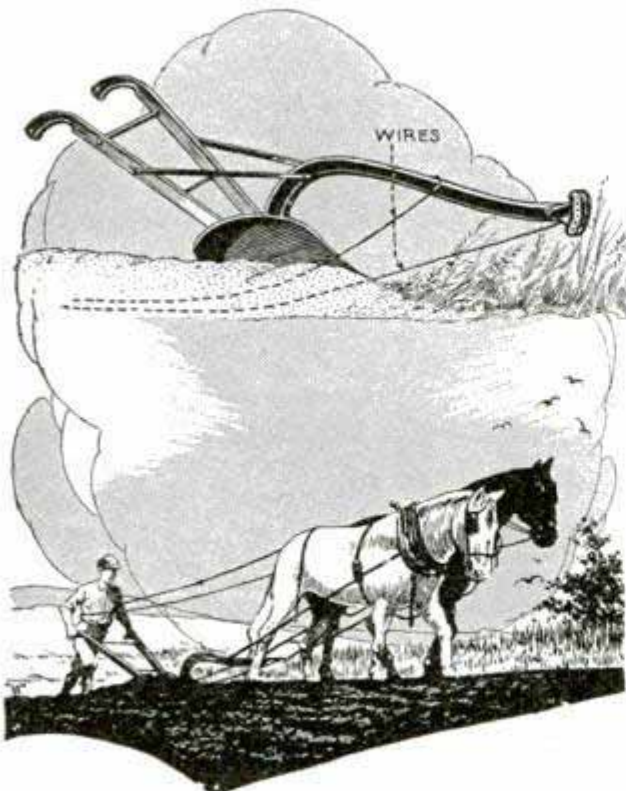

Two Lengths of Smooth Wire Tied to the Plow Beam Are Effective for Turning Weeds



Air Pressure Applied to Valve Port Shows Whether Valves Are Leaky

Testing Auto Valves for Leaks

It is a comparatively easy task to test the valves on your car for leaks by following the method indicated in the drawing. A wooden or rubber plug, with a hole drilled through it to take the end of the pump hose snugly, is fitted into the spark-plug opening. A little lubricating oil is allowed to run around the edge of the valve. Then, with the thumb or finger of one hand pressing firmly down against the valve, give the pump a quick stroke with the other. If the valve leaks, bubbles will appear in the oil.—P. H. Stanley, Sacramento, Calif.

Simple Way of Cutting Glass Disks for Pressure Gauges

The small shop, not equipped with a circular glass cutter, can cut disks for steam and pressure gauges in the following manner: Fasten a wood disk to the faceplate of the lathe, having a diameter larger than the glass disk to be cut. Apply a thin coat of glue to both the surface of the wood and the glass. Place a piece of paper on the glued surface of the glass and then apply both to the glued surface of the wood disk. Rotate the lathe spindle by hand and at the same time hold a glass cutter against the glass at such distance from the center as to make a disk of the proper size. The disk can be removed easily before the glue hardens.—Arthur Hoem, Butte, Mont.

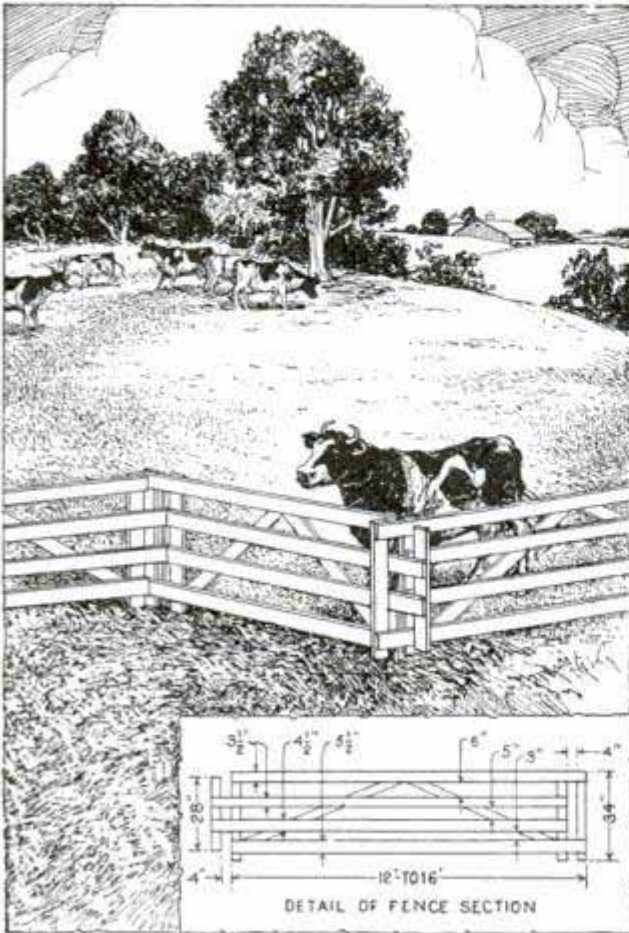

Zigzag Fence Made of One-Inch Stock Useful for Making Temporary Corrals

Portable Fence Requires No Posts

For use in constructing temporary corrals or other inclosures, a portable fence, requiring no posts but nevertheless strong enough for holding cattle, has been designed and used at the Washington state college. It consists of a number of sections which interlock and are light enough to be carried by one man. When set up, the fence somewhat resembles the homestead fence built of rails in zigzag fashion. The construction is simple, and the sections can be made of any desired size. One-inch stock, that may be either 4 or 6 in. wide, can be used for the purpose.—L. W. Pedrose, Seattle, Wash.

Drilling Holes in Wood with Nails

A number of small holes of special size had to be drilled in some thin strips of hardwood, but drills of the proper size were not at hand. Nails were used with good results in the following way: The heads of the nails were cut off; the ends were flattened and pointed slightly as on a flat drill, and the nails were then used in the same manner. They did the work nicely, as the material was not over $\frac{1}{8}$ in. thick, although not so quickly as a drill. At another time, small holes were required in a set of lead-composition letters, to fasten them onto wood patterns. The letters were only $\frac{1}{4}$ in. high, and consequently the body was narrow. Small nails were used to drill these holes as described.

Rotating Holder for Garage Light Cords

Extension cords in garages, usually worn out too soon by letting them lie around on the floor, can be conveniently and safely kept on the rotating holder shown in the drawing. A frame is made of conduit or pipe in the form of an inverted "T," its length depending on the size of the room. The ends of the frame are supported by suitable guy wires as indicated, and the holder is hung from a ceiling joist by means of a swivel joint, which in this case was obtained from a discarded tractor. A flat-iron strip, bent over at right angles, is attached to the joist

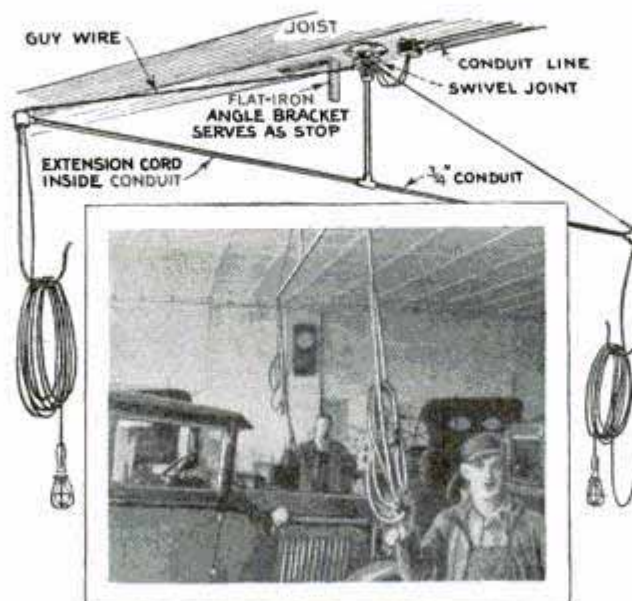

Convenient Holder for the Garage Extension Cord Serves Wide Radius

to serve as a stop to prevent the holder from making more than one revolution, which is not desired, as the wires, which are run through the pipe and around the swivel joint, would then be subject to constant twisting. Heavy wire hooks are provided at the ends of the holder where the extension cord is hung when coiled up.—Geo. R. Harrison, Council Bluffs, Ia.

Two Space and Time Savers for the Shop

By EDWIN M. LOVE

BUILT like a book, with three "leaves" of shelves, this small-parts cabinet holds its glass containers in a compact and orderly array capable of being indexed alphabetically, and cross-indexed with tabs on the edges as well. Casters on the base make it movable to any convenient spot.

The dimensions may be varied to suit the need of the shop or garage. The writer built this case for use in his home workshop to provide containers for the thousand and one odds and ends heaped in boxes, everywhere in the way. Two leaves, 2½ in. deep, with a dozen shelves each, and a third, 3½ in. deep, with six shelves, give over 46 lineal feet of storage space, providing for 1½ gross of 3½-oz. jars, besides several larger glass bottles. Three other cases, hinged from the opposite side, would double the capacity.

Select straight pieces of 1 by 3-in. pine, and cut four lengths to 3 ft. 10½ in.

Mark the best faces to go inside. Taking one piece for a pattern and squaring from the front edges, score lines with a knife point across the inner face, ¾ in. from the upper end, and pairs of lines, ⅜ in. apart, every 3⅜ in. down the length, locating the shelf grooves or dados. Set a gauge for ¼ in. and mark the groove depth on both edges.

Mark the other three, set the gauge for ½ in., and scribe the ends for the corner rabbets, which are to receive the top and bottom pieces. Rip these ends before cutting the shoulders.

Cut the dados by splitting the lines, with the teeth of the saw cutting in the waste wood, and chisel to a uniform depth. A router is excellent for this, as it will insure accuracy of depth; and of course a dado head on a power saw will do the work quickly and well.

Cut twenty-two shelves from ⅜ by 3-in. clear-pine batten strips, which will be

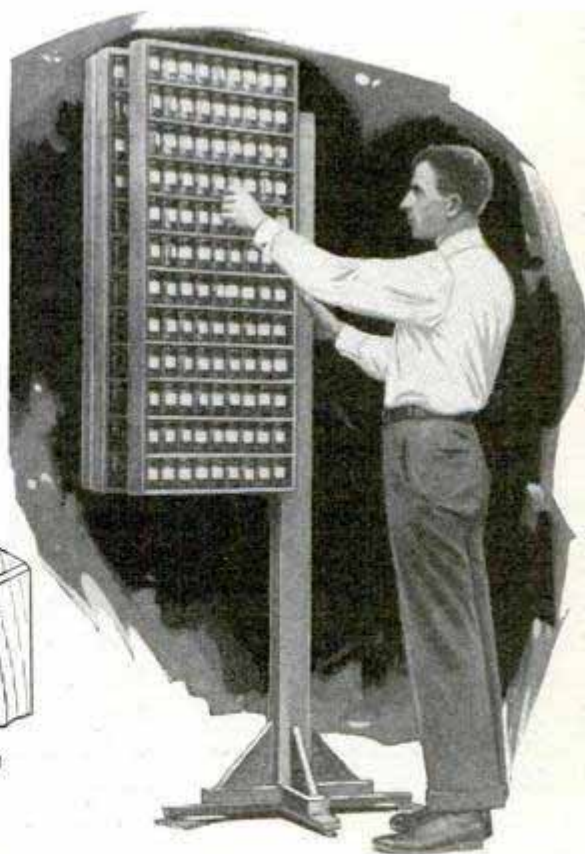
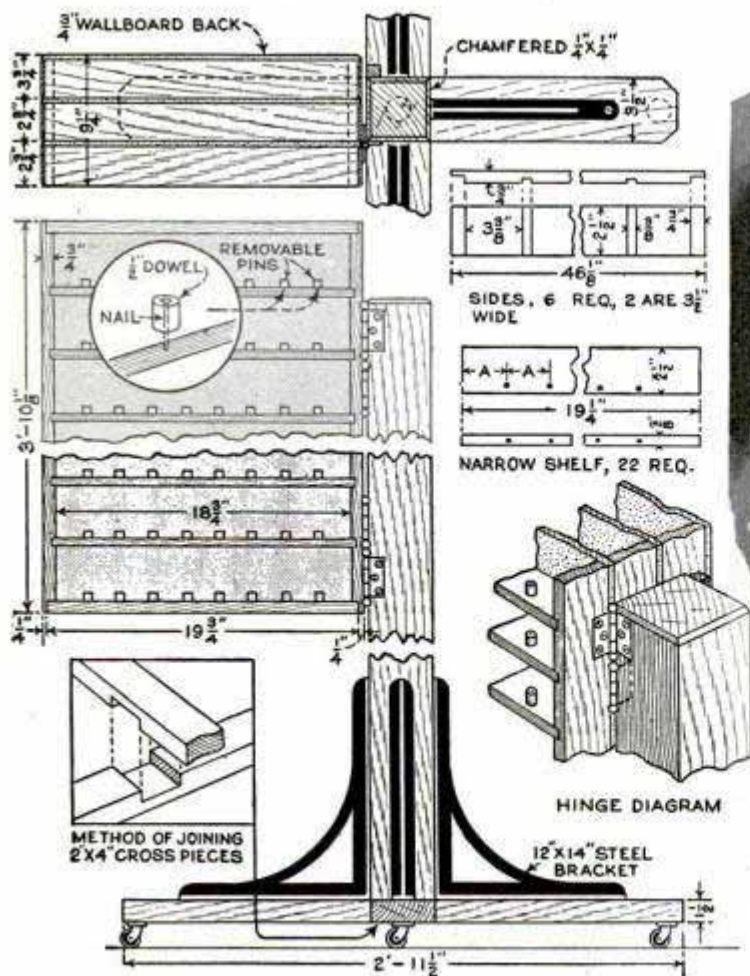

With This Cabinet, All Small Parts Are Easily Found When Wanted and the Cabinet May Be Moved Close to the Job, If Desired

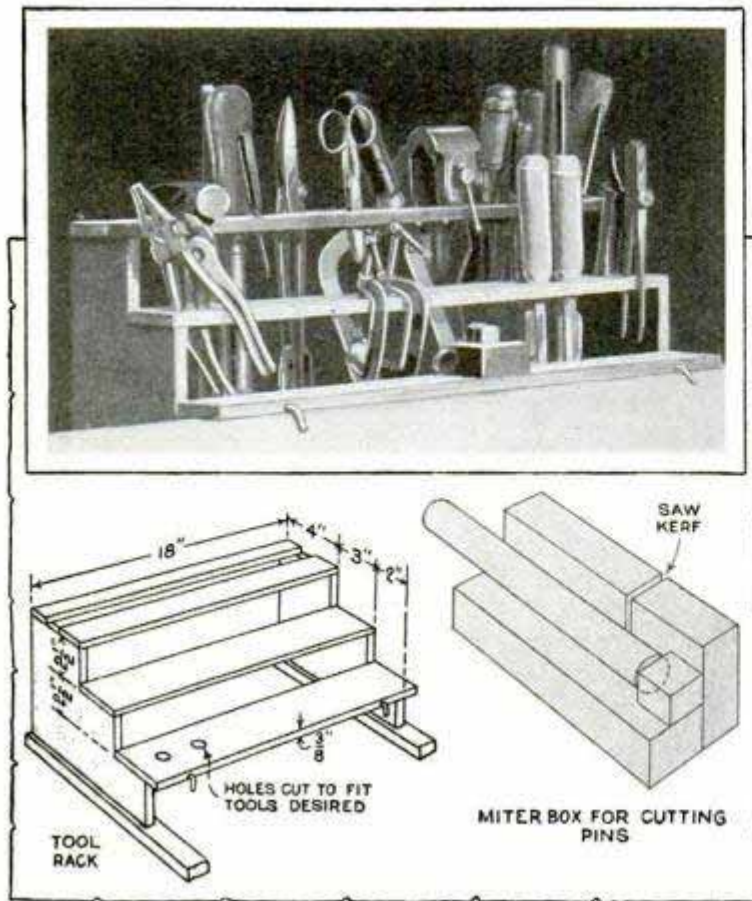

This Convenient Tool Rack Hooks onto the Back of the Bench, Keeping Tools Out of the Way, Yet Instantly Available

the same width as the sides. Be sure to measure all from the same shelf, or the last may be much longer than the first. The ends should fit snugly in their dados, without crushing, but if they bind too much, plane off a shaving or two on the undersides. Gauge a pencil line $\frac{1}{2}$ in. back from the front edge of each; then mark centers for stop-pin holes, $2\frac{2}{3}$ in. from the ends and $2\frac{1}{12}$ in. apart for the rest of the distance.

To assemble, select a pair of sides and lay them on a bench with grooves up. Stand a shelf in each dado of one piece. Then lay the other side on the upper ends of the shelves, enter one or two more shelves and tack with a five-penny finish nail in each. Proceed in this way toward the other end, until all are entered, and then drive two more nails in each. Lay the frame down and lift the other side for nailing. Assemble the other frame in the same way, and add the tops and bottoms, which are of sized 1-in. stock, cut $\frac{1}{2}$ in. longer than the shelves. Nail from the sides, top and bottom. The third case is built in the same way, but with wider stock and spaces between the shelves.

Square the cases by measuring from corner to corner rather than using a framing square from the side. Cover the backs with $\frac{1}{4}$ -in. wallboard, cut to fit and secured with three-penny fine shingle nails driven in the sides and shelves. Do not slight this nailing, as the cases depend on their backs for rigidity. Trim off all outer corners with a chisel and plane and sand to $\frac{1}{4}$ -in. radius.

The stand post is a 4 by 4-in. by 6-ft. pine stick surfaced on four sides to $3\frac{1}{2}$ in. square. Square both ends and chamfer the upper end all around.

The base is made by crossing two pieces of 2 by 4-in. stock, 2 ft. $11\frac{1}{2}$ in. long. Join them by notching in half the thickness, so that they will be flat, and clip the corner of the ends. Spike this cross to the lower end of the post. Brace it with four 12 by 14-in. steel brackets, or use wooden triangles nailed against the post and base. Add casters, preferably with wheels not under $1\frac{1}{2}$ in. in diameter.

To hang the cases, gauge a pencil line on the right face of the post, $2\frac{1}{2}$ in. from the front, and rest the large case on edge behind the line, the lower end at the desired distance from the base. Drive six-penny nails through the side into the post, at various angles, so as to get a dovetail effect. For strength, screw a $\frac{3}{4}$ by $\frac{3}{4}$ -in. strip behind the post against the case.

The $2\frac{1}{2}$ by $2\frac{1}{2}$ -in. loose-pin hinges are sunk full thickness into the post, so that they will rest on the surface of the middle-case side. Place them so that the upper hinge of the front case will be above, and the lower, below the middle-case hinges. Stand the middle case in place, and press the point of a knife crosswise of the joint at the top of the upper-hinge position and the bottom of the lower. Set the case aside, take the pins from the hinges, and mark the hinge lengths with the knife. Gauge for width and depth. Make cross cuts with a wide chisel and trim to depth, then to length and width. Screw the hinge halves in their mortises, and the other halves against the case side, and hang the case.

Now lay the cases flat, put the front case on top, and screw on its hinges, without troubling to mortise in. It may be necessary to relieve the back corners where they touch the hinges of the middle case.

Label the jars and place as desired on the shelves. It is quite easy to pick them out with the fingers, but a bent wire, hung from the post by a string, makes it easier. To prevent the jars from jostling out, cut $\frac{1}{2}$ -in. lengths of $\frac{1}{2}$ -in. hardwood dowel stock, drive a shingle nail through each, lengthwise, and insert in the shelf holes. To remove a jar, remove one pin. The cutting of these pieces is simplified if a miter box is used. This may consist of a 1 by 2-in. block nailed to the edge of another of the same size, with a saw kerf through the first. Nail a stop block $\frac{1}{2}$ in. from the kerf, and push the rod against it for each cut.

The bench-tool rack shown in the photographs is the handiest, easiest built and cheapest that the writer has discovered to date. The construction is evident from the pictures. The ends are of three-ply $\frac{3}{8}$ -in. stock, and the tops are $\frac{3}{8}$ -in. strips. The top step is of two strips, so that hammer handles, etc., can be dropped between them. The lower step projects beyond the endpieces, and carries two screw hooks to clasp the rear rail of the bench-tool tray, while a strip nailed to the bot-

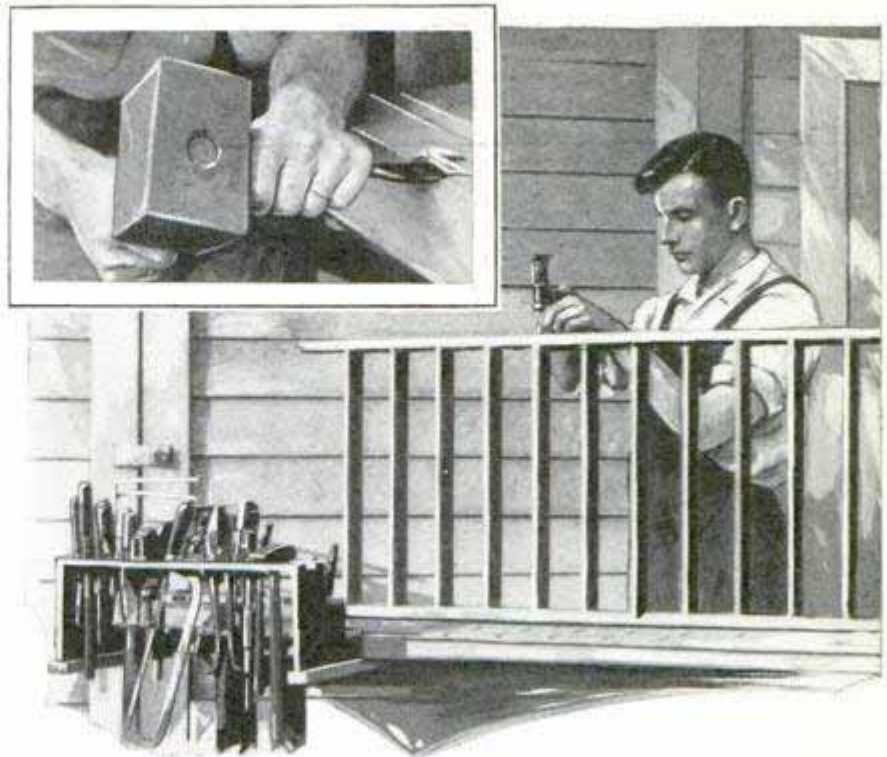

Above, Cutting the Dadoes for the Parts Cabinet; Below, Mr. Love Nailing the Shelves in Place; Note the Tool Rack at the Left

tom of each end slips underneath the tray, providing a secure, yet instantly movable, grip. The tools are grouped according to their tasks, such as driving, shearing, rasping, holding and marking, with holes of such size as to hold their upper ends approximately level on each step, and open spaces are left between groups for future tools.

This rack is within easy reach, and, with a little practice, a tool can be placed there as quickly as it is laid carelessly on the bench top, thus avoiding the annoyance of moving tools to find room for the work, or of searching in the litter for small instruments that are easily misplaced.

Powdered Soapstone on Gaskets Prolongs Their Life

I have found that powdered soapstone makes the best parting I have ever tried on engine gaskets. Rub on the powder with a piece of felt. Parts can be taken off very easily without breaking gaskets when this method is used.—A. Gemmell, Ansonia, Conn.

ⓂA mechanic should never wear jewelry on the hands while working at a machine as it is apt to catch on the work and cause serious injury.

MATERIAL LIST

- 1 piece, 2 by 4 in. by 6 ft., pine, S4S.
- 3 pieces, 1 by 3 in. by 8 ft., pine, S4S, sanded.
- 1 piece, 1 by 4 in. by 12 ft., pine, S4S, sanded.
- 1 piece, 4 by 4 in. by 12 ft., pine, S4S.
- 2 pieces, $\frac{3}{8}$ by 3 in. by 12 ft., pine batts, S4S, sanded.
- 1 piece, $\frac{3}{8}$ by 3 in. by 14 ft., pine batts, S4S, sanded.
- 1 piece, $\frac{3}{8}$ by 4 in. by 9 ft., pine batts, S4S, sanded.
- 1 piece, $\frac{1}{4}$ by 48 in. by 6 ft., fiber wallboard.
- Three-penny fine shingle nails.
- Five-penny finish nails.
- 2 pairs $2\frac{1}{2}$ by $2\frac{1}{2}$ -in. loose-pin butts.

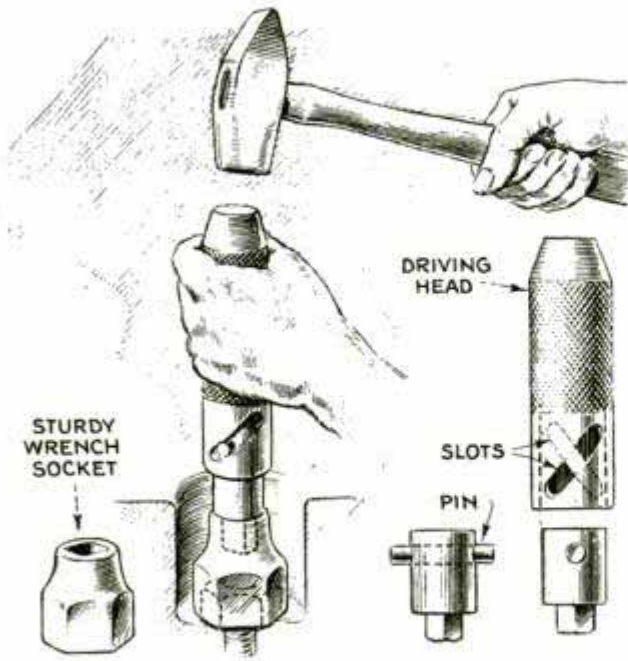

Simple Tool for Starting Nuts and Bolts in Places Difficult of Access

Tool for Starting Nuts

A tool for starting stubborn nuts and bolts in cramped quarters is shown in the illustration. It is made suitable for use with any unit of a full set of sockets and consists of a steel bar drilled for a socket stock. Two diagonal slots are cut for a driving pin through the stock. The top part is knurled for a handgrip, and the other end is squared to fit the sockets. A crosspin engages the slots in the driver. In use, the tool is placed on the nut, the driver raised and held by the left hand, and the top is given a sharp hammer blow.

—G. A. Luers, Washington, D. C.

2855 Ashmead Place, Washington

Generator Wrench for Model-T Fords

Every mechanic who has worked on Ford model-T motors knows how difficult it is to remove the bottom screws on the generator. The wrench shown in the drawing was made especially for this work and was found entirely practical. It consists of an axle-shaft gear, a Ford differential gear, with a

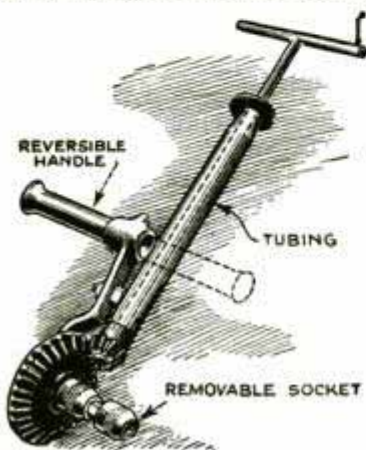

bracket fashioned from a motorcycle connecting rod and a housing from a Chevrolet steering column. The small gear is fastened to a length of 3/8-in. rod with a T-shaped handle at the end. The other gear is fitted with a removable socket on each side and a reversible handle is provided so that both sides of the wrench can be used for different nuts.—M. Coffman, Cleburne, Tex.

Test for Distinguishing A.C. and D.C. Currents

Here is a method I used to determine whether a line current is alternating or direct. I held one pole of a horseshoe magnet, taken from an old magneto, against a lamp of the carbon-filament type. Immediately the filament began to vibrate back and forth, toward and away from the magnet pole, the frequency of vibration being the same as that of the frequency of the line current, which in this case was alternating. The vibrating filament produces an illusion of a wider area of incandescence than that produced when the filament is still. When I tried the same experiment on a carbon lamp in a direct-current line, no fluctuations were noticed.—Neil D. Cameron, Vancouver, British Columbia.

Ejector for Draining Cesspool

For draining a cesspool, or any other similar tank or well, a Y-fitting like that indicated in the illustration, slipped over the nozzle of a hose, will be found useful. The path of the water is through the straight section of the fitting, which causes suction at the other end of the Y. A length of hose attached to this end is lowered into the cesspool or other tank to be emptied.

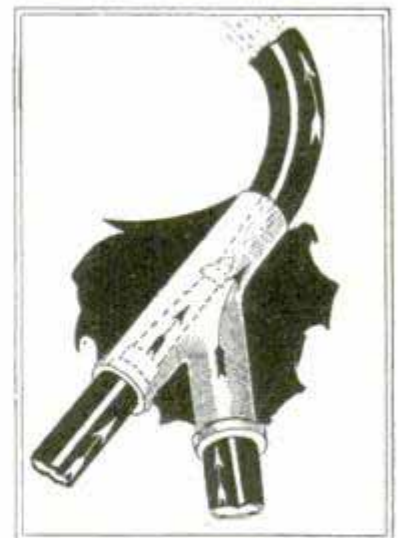

Reclaiming Old Gold for Sale to Mint

To sell scrap gold to the United States mint, it must be reduced to almost pure gold or about 24 carat. Melt the junk and roll it into very thin sheets. Place them in a bowl, so that the pieces will not lie together, and pour chemically pure nitric acid over them. This will separate the gold from the base metal, the latter being dissolved and the gold forming a powder on the bottom of the vessel. After this powder has formed, pour off the acid, put water into the vessel, and shake well, after which allow it to settle, then pour off the water. Repeat this washing several times to free the powder of all the acid. Allow the powder to dry, and put it in a crucible with some flux, pearlash or bicarbonate of soda. Melt it into a lump in the bottom of the crucible. This will be almost fine gold, but not absolutely pure. While melting, be careful not to inhale the fumes, as the remaining acid that cannot be washed out is highly injurious to the lungs.

Roller Skates for Screen Holder

Roller skates, turned upside down and nailed to a counter at one end, make a good holder for a roll of screen in the hardware store. The roll turns easily when mounted in this way and its weight prevents it from being dislodged easily. Obviously, this holder saves considerable work and time, as a roll laid on the counter sometimes becomes unmanageable, and always is more or less difficult to handle.—George R. Harrison, Council Bluffs, Iowa.



Stand Equipped with Electric Motor for Rotating Barrels While Spray-Painting Them

Rig for Spray-Painting of Drums

In a western concern, where considerable time was consumed in painting oil drums, the illustrated device was made to speed up the work, with gratifying results. The base consists of two drums connected with flat-iron braces. A Ford front axle was fastened across the tops of the drums and the spindles turned upward, after which they were locked in position. Old auto wheels set up on the spindles were rotated at slow speed by means of an electric motor mounted between

the barrels, as indicated, a single $\frac{1}{2}$ -in. belt passing over both wheels and over the motor pulley. The drums to be painted are placed on the wheels and rotated while the paint is applied, allowing the man to remain stationary while he works.

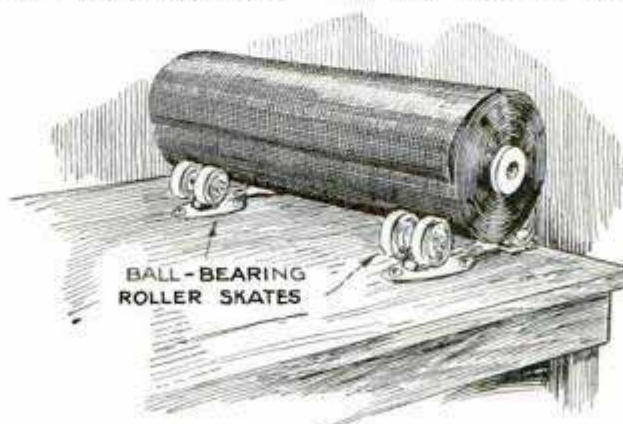

Handy Holder for Rolls of Screen Can Be Made from a Pair of Roller Skates

Semi-Streamlining Truck Bodies

Impressed by the importance of streamlining in airplanes and racing cars, the

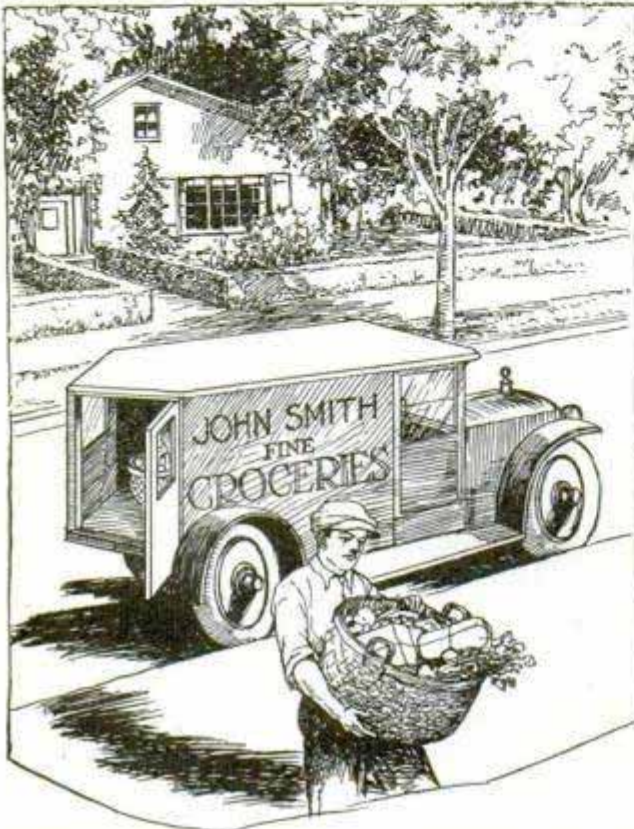

Semi-Streamlining Delivery Trucks Reduces Wind Resistance and Provides More Storage Space

owner of a fleet of light delivery trucks investigated the possibilities of adapting the design to his truck bodies. He found that it would not be practical to streamline them entirely, but that the effect could be approximated at little expense. An experimental model, shown in the drawing, proved to have greatly reduced wind resistance, especially when traveling against the wind at 40 miles per hour. A gasoline saving of five miles per gallon was effected. The additional section built onto the back also provided greater space and made loading and unloading easier. The results completely satisfied the owner so that he altered all his trucks in the same way.—R. F. Starzl, LeMars, Iowa.

Magnetic Chip Remover

When drilling holes in stationary steel or iron, such as machinery, some of the chips are likely to remain in the hole. To remove them, get a magnet and suspend a nail from one pole. Lower the nail into

the hole and you will find that the chips will adhere to it. Any kind of a light horseshoe magnet can be used for this purpose. If a large number of holes of the same size are to be drilled, in production work, a piece of steel of slightly smaller diameter than that of the holes may be split about two-thirds of its length and then magnetized, which will be found to be handier than the use of a separate magnet and nail.

Nails for Mixing Paints

After a can of paint or lacquer has been left on the shelf for some time, the pigment settles to the bottom and it is then rather difficult to mix it thoroughly. One method of hastening the mixing process is to put a small handful of clean nails in the can. Thereafter the paint can be mixed quickly by shaking the can, as the nails beat up the pigment.—Blair L. Gilbert, Chicago.

Removing Small Cotter Keys

Small cotter keys, $\frac{1}{16}$ in. and smaller, are frequently rather difficult to remove, particularly when they are slightly rusted, and the usual snub-nose pliers happen to be the only tool available. Attempting to get the cotters out with the pliers alone often results in crushing the eye or in breaking it off completely. A good method of removing the cotter is to take a short piece of the

tough wire used as a hinge pin of a tobacco can, or similar wire, and bend it to form a small "V," one end of which is inserted through the eye of the cotter.

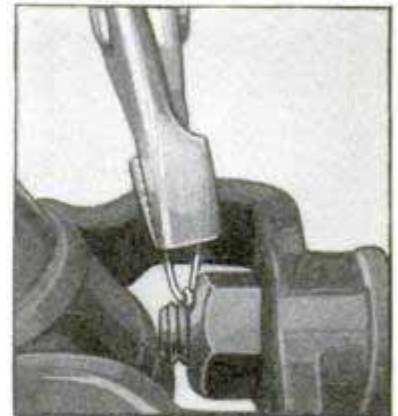

Then grip the ends of the wire as shown in the photo, and the pin can usually be pulled out easily, with the eye remaining in good condition. If the eye does break, one side will invariably snap first, leaving a good bit of the other end or side to grip with the pliers.

Bright Finish on Screw Threads

In working tool steel, it is always difficult to produce a good finish by any other means than grinding, and this cannot be done to screw threads. Where a thread is used in toolmaking, a good, smooth finish is desirable, not only as a matter of appearance, but to maintain the accuracy and lengthen the life of the thread. The best method is to turn the threads to size, then procure a piece of soft wood and hold it against them. Dip it in oil, then in No. 0 or 00 emery, and chase over the threads. It will be impossible to remove over .001 in. of the material in this way, and a fine, ground finish is obtained quickly and in an inexpensive manner. Many things can be lapped in this simple way.—J. B. Murphy, Plainfield, N. J.

Combination Bench and Tool Box on Auto

Service men and others who use a pleasure car for carrying their tools to work will find the combination bench and tool box shown in the illustration practical and convenient. It eliminates the habit of cluttering the floor of the car with tools that may soil and tear the upholstery. The supports for the bench are made of heavy flat iron, bent to the shape indicated, and clamped to the rear bumpers. An additional brace of the same material is bolted to each bench support and to the frame of the car. Use a piece of hardwood, such as oak, maple or hickory, for the bench top and bolt it to the supports. The tool box can be built to fit the dimensions of the bench top, or, if desired, a regular auto trunk can be used for the purpose. Holes are drilled through the bottom of the tool box and bench top, and the two are then firmly fastened together by means of bolts fitted with wingnuts.—M. L. Harmon, South Bend, Ind.

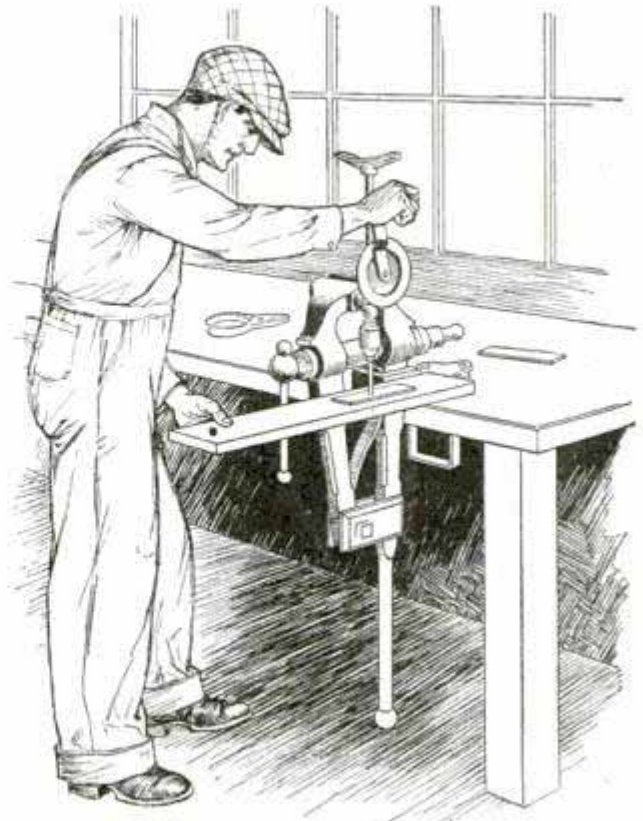

Hand Drill Held in Vise with a Board under Work to Provide Force Feed

Improved Force-Feed Drill Press

Those who have only an ordinary breast drill can easily improvise a drill press as shown in the illustration. Grip the side handle of the drill in a vise, attached to the bench top, so that the drill point is a short distance above the level of the top. Then place, or clamp, the work on a piece of 1-in. stock, set one end on the bench and draw up on the other end with the left hand while turning the crank of the drill with the right. I have found this

method very useful in drilling hard steel, which requires considerable pressure. Besides the feature of having a force feed with little exertion, this method insures drilling to size.—Luther Strosnider, Onaga, Kansas.

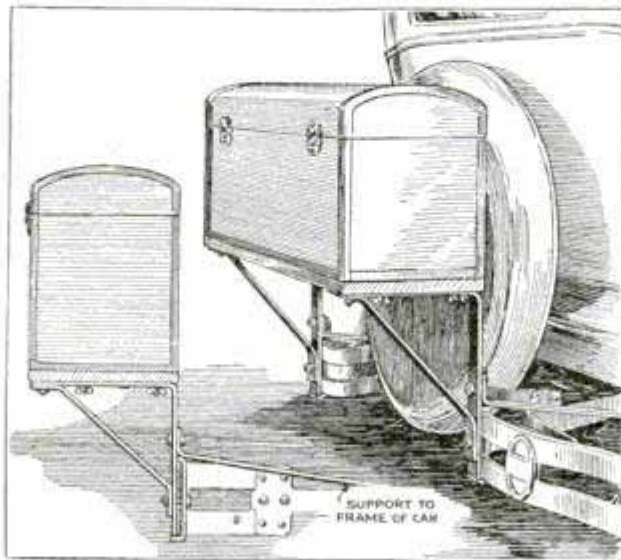

Bench Top and Tool Box Attached to Rear Bumpers

☐ The best ratio of heating to grate surface is about 35 to 1, and grate area to draft area 8 to 1.

3982

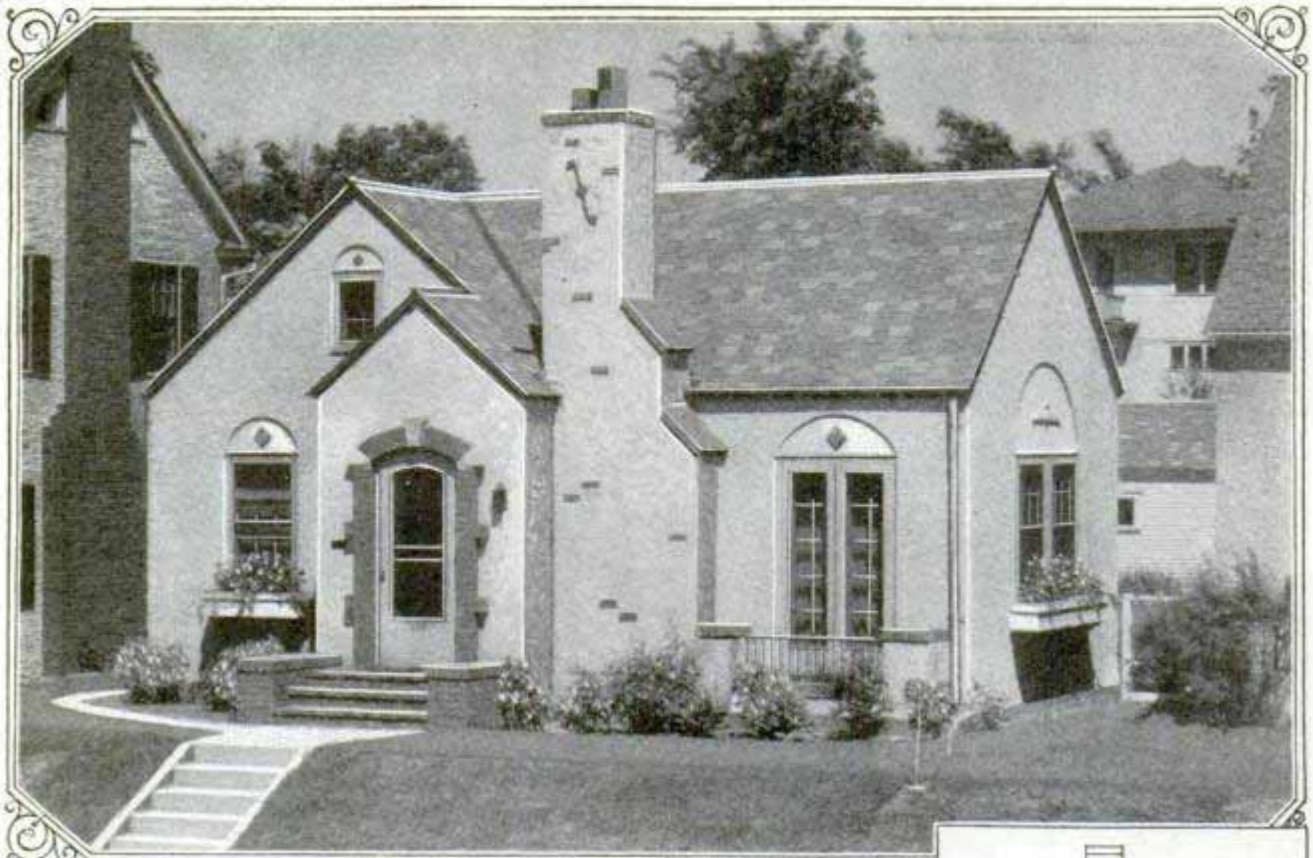

COPYRIGHT POPULAR MECHANICS

PLAN 5-S-30

A Better Investment Than Wall Street Can Offer

YOUR dollars put into a bungalow of this type are not only well invested with more liquid and assured market value than many a high-priced stock, but they buy a house with as large an amount of service, comfort and convenience within small area as it is possible to design.

If your preference runs to living rooms across the front you have one here with exposure on three sides. Furthermore, you have three-bedroom equipment without the expense of a third sleeping room. The carefully placed bed closet in the living room provides extra service when you need it. That's a saving of between \$500 and \$1,000.

Every modern service feature is included in this bungalow; features that give a house ready resale market. What are they? A fireplace, a breakfast alcove; built-in china cabinet; abundance of closet space; a scientifically planned kitchen with dirt and dust-proof cabinets; a colorful modern bathroom and extra space on the second floor for storage and sleeping quarters when required.

Here's a bungalow of the proportions and refinements that would do justice to a much more expensive house.

What about cost? As it stands, the house has been built for as low as \$5,500. Costs, however, will vary, depending upon location and equipment.

Construction is frame with stucco on metal lath. Solid masonry is satisfactory. Common brick whitewashed, brick veneer and skintled brick are all adaptable to this style of dwelling. You'll not find a better plan of more assured investment and resale values. You can't go wrong on this house.



Popular Mechanics Magazine will supply readers a one-sheet blueprint of any house appearing in the magazine for \$1, and a new bungalow book will be sent for ten cents.

Handymen who want a boring and screw-driving tool that will work any place, will buy the "YANKEE" SPIRAL RATCHET SCREW-DRIVER

With These Attachments:

3 Screw-driver Bits, 1 Bit with Screw-holder, 1 Bit with Screw-eye Holder, 1 Chuck (for holding drills), 8 Drill-points, 1 Countersink. And (for jobs calling for small nuts), 1 Hexagon Socket.

HERE is a screw-driver that drills holes, countersinks the holes for the screwheads, and drives in the screws—all simply by pressing on the handle. In same way, it runs up small nuts. And all at express speed! Or it does all these jobs by ratchet movement.



Driving screws at express speed.

It is a Spiral Screw-driver or a Ratchet Screw-driver, either right or left hand, or a Rigid Screw-driver, at will.

With the spiral movement, the drill or bit is revolved by a spiral in the tool, when handle is pressed down.



With ratchet movement, you turn drill or bit by moving the hand forward and back without releasing your grip on handle.

Both spiral and ratchet movements are instantly available. They may be used successively: sending screw in by

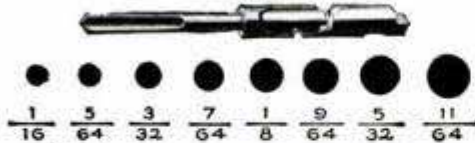

"Yankee" Chuck and Eight Drill-points

spiral and setting it up by ratchet.

A simple adjustment makes it a 13-in. screw-driver, or, for long overhead

reaches, an 18 1/4-inch screw-driver.

With a bit for small screws, another for medium screws, and a third for large screws, it is three different size screw-drivers.

A fourth bit, with the "Yankee" Screw-holder Attachment, places and drives screws one-handed, in hard-to-get-at places.



Screw-holder

A fifth bit holds and drives screw-eyes.

Eight "Yankee" Drill-points, for boring holes 1-16" to 11-64", with special chuck for holding the drills, are supplied for this screw-driver.



Countersink

Countersink is provided, fitting into the tool same as screw-bits.

Sockets for running up nuts are made to fit into this tool.



Simple adjustment makes it 18 1/4 in. driver for long overhead reaches.



Spring in handle makes it the "Quick-Return." Great for working one-handed.



No. 30-A.—Standard Spiral Ratchet Screw-driver used the world over by skilled mechanics. Price, for tool with three screw-driver bits, \$3.00.

Also made Heavy and Light Patterns.

No. 130-A.—Spring in handle makes it the Quick-Return Spiral Ratchet Screw-driver. Price, with three bits, \$3.45. Also Heavy and Light Patterns.

"Yankee" attachments sold separately. Your dealer can supply you.



FREE "YANKEE" TOOL BOOK

To Help You Make Things, we will send book with action pictures showing the ingenuity in use of many "Yankee" Tools. Mail coupon to NORTH BROS. MFG. CO., PHILADELPHIA, U. S. A.

Name.....Address.....(p m)

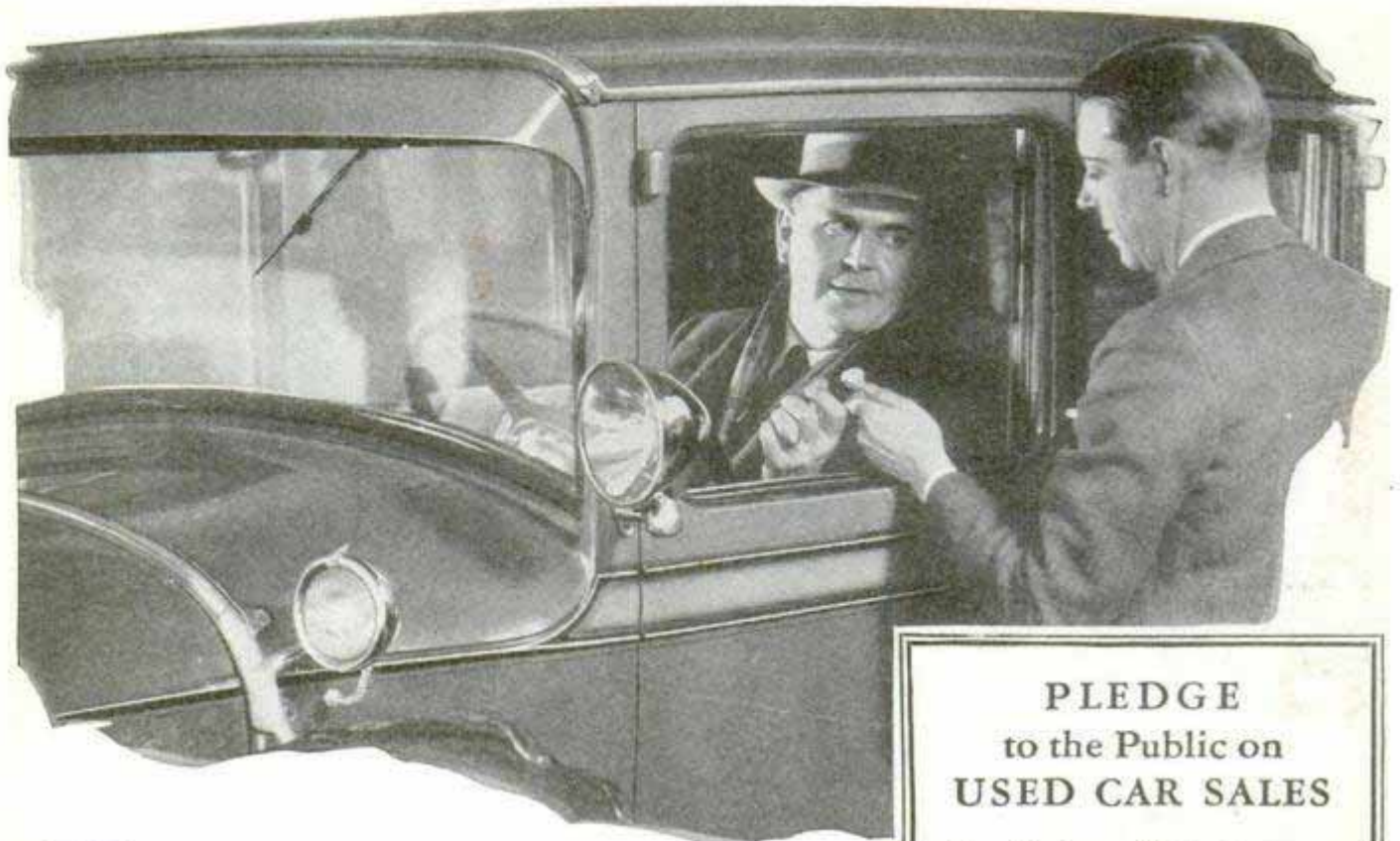

**“Here are the keys . . .
drive it for five days
before you decide!”**

“That’s the kind of demonstration I want!”

“That’s the kind of demonstration everyone gets who buys a used car backed by the Studebaker Pledge!”

Under the terms of the famous Studebaker Pledge, you get five days’ driving trial with the used car of your choice. If it does not satisfy, you may return it within five days and apply your payment on *any* car in your Studebaker dealer’s stock!

The Studebaker Pledge also

provides a 30-day guarantee on all Certified cars and gives you the honest representation of plainly marked prices.

More than 150,000 thrifty motorists last year bought Pledge-backed used cars. They bought because a good used car is a better buy than a cheap car bought new.

When you buy *your* used car, see your Studebaker dealer first. See that you get the protection of the famous Studebaker Pledge.

**PLEDGE
to the Public on
USED CAR SALES**

1. 5 days’ driving trial. _____
2. 30-day guarantee on certified cars. _____
3. Plainly marked prices.

Invest 2c—you may save \$200



Spend 2c now for your copy of this interesting and instructive booklet, “How to Judge a Used Car”—it may save you as much as \$200 on the used car you buy. Mail the coupon—*now!*

THE STUDEBAKER CORPORATION OF AMERICA
Div. 154, South Bend, Indiana

Please send me copy of “How to Judge a Used Car”

Name.....

Street.....

City..... State.....

STUDEBAKER

Builder of Champions

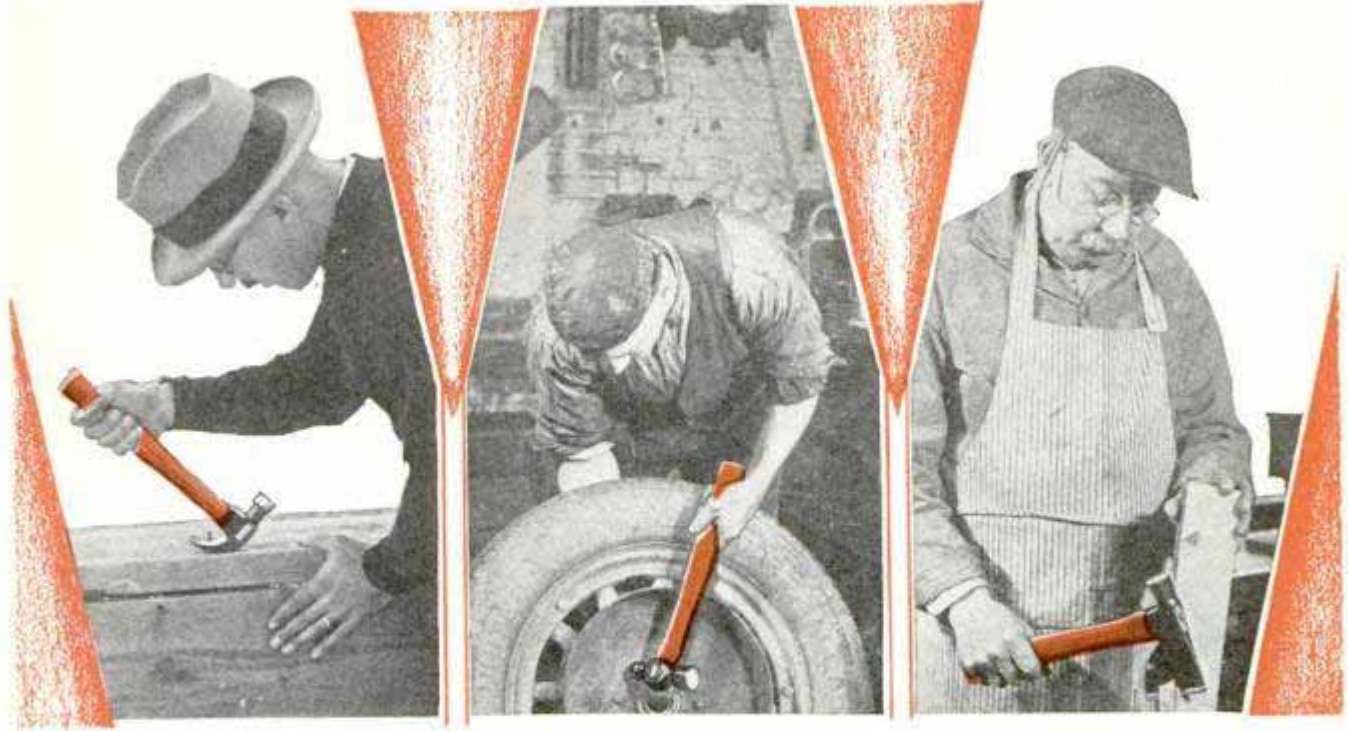

There's economy in buying these "lifetime" **PLUMB TOOLS**

IT'S the service that counts; not the initial cost. When a Plumb Nail Hammer will give you years of faithful service, where's the economy in a cheap tool which, on one job, wastes enough time to pay for a Plumb.

The Plumb is scientifically designed . . . a development of hundreds of tests with carpenters.

It has a full face for accurate nail driving; with the weight centered to give the tool a natural fall; nipper claws that pull even a headless brad; *balance* that makes it work like a part of your arm; a shock-tested, second-growth hickory handle; and that exclusive feature — the Plumb Screw Wedge—which tightens the handle, just by a turn of the screw. A tool you'll be proud to own.

Model HF81
PRICE \$1.50

POWER! Accuracy! And Balance! You get them all in the Plumb Ball Pein. The head is mounted off-center to give more driving force to your blows; the oblong eye takes a sturdy, full-size handle; the cone-shaped pein spreads rivets instead of mashing them; the balance gives precision on fine jobs, and power on big ones.

Equipped with the Take-Up Wedge which tightens the handle (when it finally loosens) just by a turn of the screw. For work-bench or car, own this finest of all ball peins.

Model HF375, 1½ lbs.
PRICE \$1.30



CONFIDENCE in a tool, and especially in a hatchet, is a big asset. With a Plumb you can sink home those long, clean blows that get work done. The edge goes where you aim it. Every line of the head and handle, every ounce of weight in a Plumb is worked out to give that balance that is so vital in an edge tool.

The entire Plumb Hatchet head is one solid piece of steel . . . with the edge tempered through and through to hold a keen edge; with the head toughened for heavy pounding; with a broad eye to reduce handle breakage. And, of course, that unique safety feature . . . the Screw Wedge . . . which enables you to keep the handle tight.

Add this Hatchet to your kit.

Model 2962
PRICE \$1.60

AT GOOD HARDWARE DEALERS' EVERYWHERE

True Stories of Stars who were "made" and not "born." No. 2.



This record-holder *never ran a race* before he went to college

"Ever do any running?" The varsity track coach in a well-known Eastern university singled out a tall freshman from a gym class of fifty.

"No sir, none at all."

"Well, that doesn't make any difference. Report for track at three o'clock tomorrow. I think we can use you."

The boy reported. He became the greatest half-miler his college ever had. Today, after five years he still holds the half-mile record for the college he attended. And yet, *before he came to college he had never run a race.*

This is a true story. And incidents like this are happening all the time. Coaches in every sport are continually on the lookout for men who have the makings of a star.

If you can handle yourself like an athlete, if you "look good," you're going to get a chance these days, no matter what your past record has been.

The great secret of handling yourself well is

footwork. Awkward people are generally those who look "all feet." Watch a star athlete; his feet move like lightning, yet he doesn't stumble or trip. He doesn't seem to know they're there.

Star athletes in any sport *train* themselves in footwork. Visit a college gym. You'll find an all-American tackle skipping rope—in Keds; a pole-vaulter boxing—in Keds; a varsity third baseman wrestling—in Keds; two members of the championship hockey team playing handball—in Keds. Keds are worn by more star players than any other shoe. Keds *help* your footwork. You'll *look good* with Keds on.

Keds are the most scientifically built athletic shoe in the world. They've got "Feltex" inner-soles that hold your feet snug and comfortable. Keds' canvas tops are cool but strong. They give sure support to your ankles. And Keds have a safety sole that gets a firm grip on the ground and prevents slipping and sliding.

There are many different styles of Keds. The best shoe dealers have them at prices from \$1.00 to \$4.00. Look for the name. They are not Keds unless the name "Keds" is on the shoe.



Keds "Big Leaguer"
Keds moulded-sole models, of which "Big Leaguer" is one, range in price from \$2.00 to \$4.00.

FOOTWORK BUILDS STARS

Keds

REG. U. S. PAT. OFF.

The Shoe

of Champions

United States



Rubber Company



' A NEW ' CATALOG

Put the NEW Starrett Catalog in your kit. Old familiar tools, improved tools, new tools—you'll find over 2500 of them in the latest Starrett Catalog, No. 25 "AP" just out. Tear out the coupon Mail it today.

GOLDEN ANNIVERSARY OF STARRETT TOOLS 1880-1930



My occupation is (please check one): Machinist
 Student Executive
 Carpenter Airplane Mechanic Diemaker
 Toolmaker Auto Mechanic

NAME _____ ADDRESS _____



Use Starrett Tools

The L. S. STARRETT CO., Athol, Massachusetts
 Gentlemen: Please send me my copy of Starrett Catalog No. 25 "AP"

SHAVING IS NOW FUN

... so easy, smooth,
quick ... with **Barbasol**

*"Shaving gets a laugh out of me now, instead of a moan. It's all fun. No brush. No lather. No hairs that miss their exit cues—and a face as smooth as a baby's. How? Just Barbasol and a trusty blade, nothing else . . . Shakespeare said, 'There's the rub,' but he wore a beard. You don't have to rub in Barbasol; just another reason it's so quick, clean and comfortable, I guess . . . I'm one of the Barbasol boys and proud of it—every time the spotlight hits me."

Phil Baker

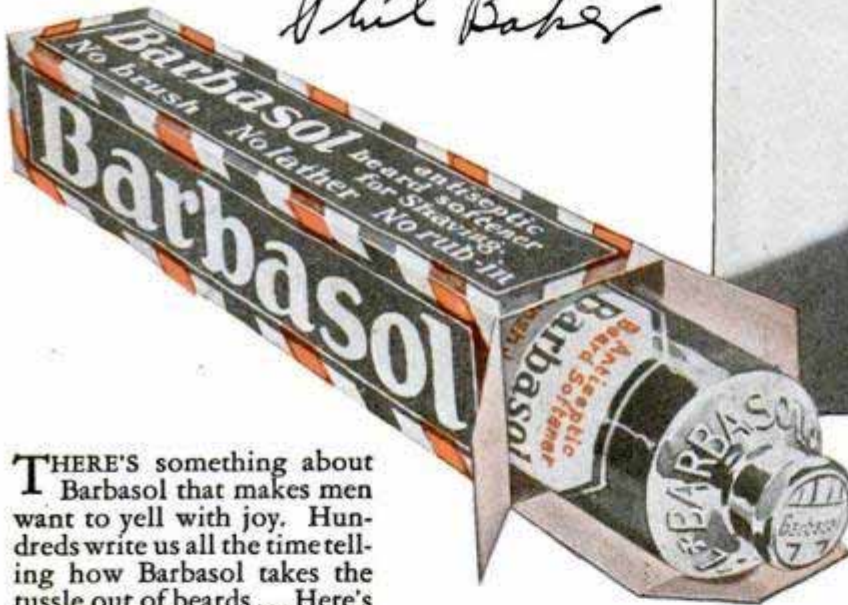

PHIL BAKER, the bright boy who makes his accordion talk, and makes his talk—accordingly. Entertainer and star of more good shows than almost any other songster. He's wise-cracking in "Pleasure Bound" these days and, from all reports, is producing a laugh a minute as usual.

THERE'S something about Barbasol that makes men want to yell with joy. Hundreds write us all the time telling how Barbasol takes the tussle out of beards . . . Here's one: "I never really enjoyed a shave until I used Barbasol—no pull."—W. C., Illinois. And another: "It leaves the skin so wonderfully smooth. I get more shaves per blade."—J. E. S., New York. Again: "Barbasol is a boon to shavers—a revelation."—J. T. B., Pennsylvania. (Yes, names on request if you want.)

Follow these directions and you follow the crowd

Get this straight—Barbasol doesn't make a lather. You don't need it. Barbasol is entirely different . . . **1 Wet your face well. Leave it wet. 2 Spread on Barbasol. Don't rub it in. 3 Hone up, strop up, wet the blade and—shave.**

Who'd believe this quick, simple method could perform such wonders? The beard is soft, but crisp. Blade slides along easily. Whiskers come off clean, close. Face is soft, refreshed. No lotions needed and the blades last longer.

You can only prove this about Barbasol on your own face! Try it tomorrow morning. Generous tubes, 35¢ and 65¢ at all drug stores. Buy it now and give your face a glad surprise! The Barbasol Company, Indianapolis, Indiana.

*Barbasol testimonials are not paid for.



BARBASOL SKIN FRESHENER

Here's a bracer for the face, morning, noon or night. Slap it on face and neck when tired. It tingles; rejuvenates. Makes a new man of you. Try it!

Barbasol

For Modern Shaving

No brushing—No lathering—No rubbing

Has your favorite service station man seen this demonstration?

At the right is the demonstration machine which engineers from the Ethyl Gasoline Corporation take from place to place to prove how Ethyl "knocks out" that "knock" and develops an engine's maximum power.

By turning a valve, ordinary gasoline flows into the combustion chamber. The engine "knocks"; its speed decreases; the power begins to drop.

Then the valve is turned in the opposite direction to feed Ethyl into the chamber. The engine quiets swiftly. "Knock" goes out. R. P. M.'s (engine revolutions per minute) increase. And the engine delivers the power of which it is capable.

That's why thousands of service station men advise you to use Ethyl in your own car. They know that *any* car performs better with Ethyl Gasoline in its tank.

Ethyl Gasoline Corporation, New York City.

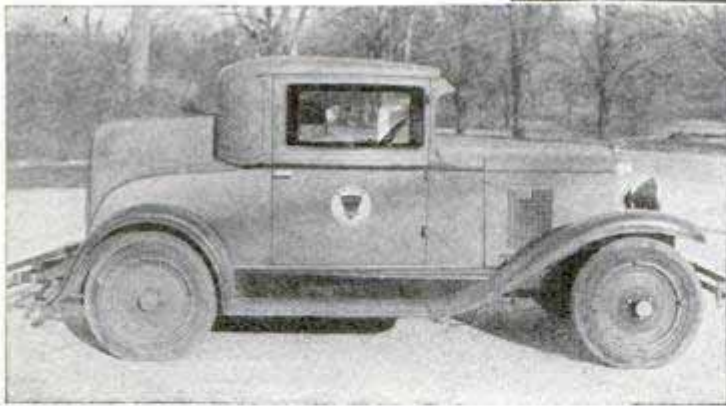
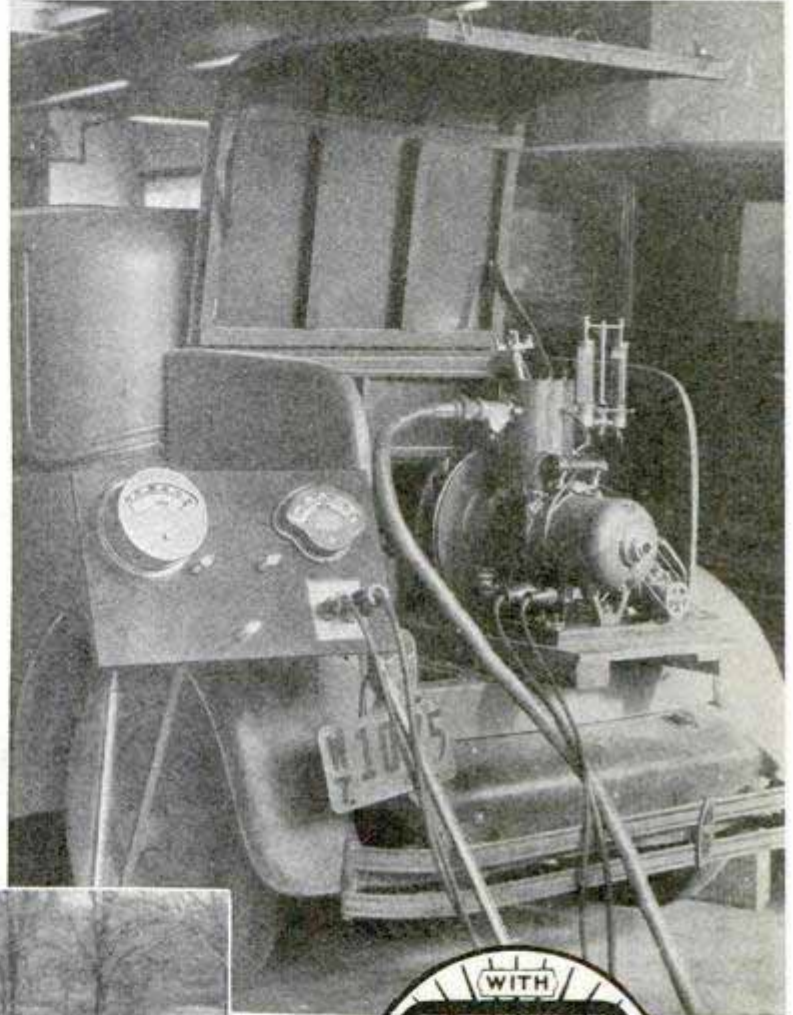

Fitted into the rear of this car is the "knock" demonstration machine. (Above at right) The machine ready for action.

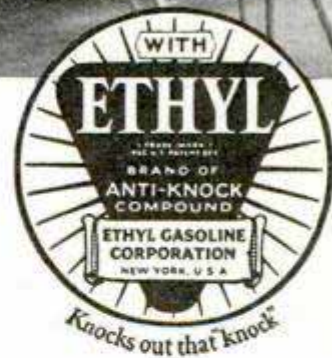

Wherever you drive—whatever the oil company's name or brand associated with it—any pump bearing the Ethyl emblem represents quality gasoline of high anti-knock rating.

ETHYL GASOLINE

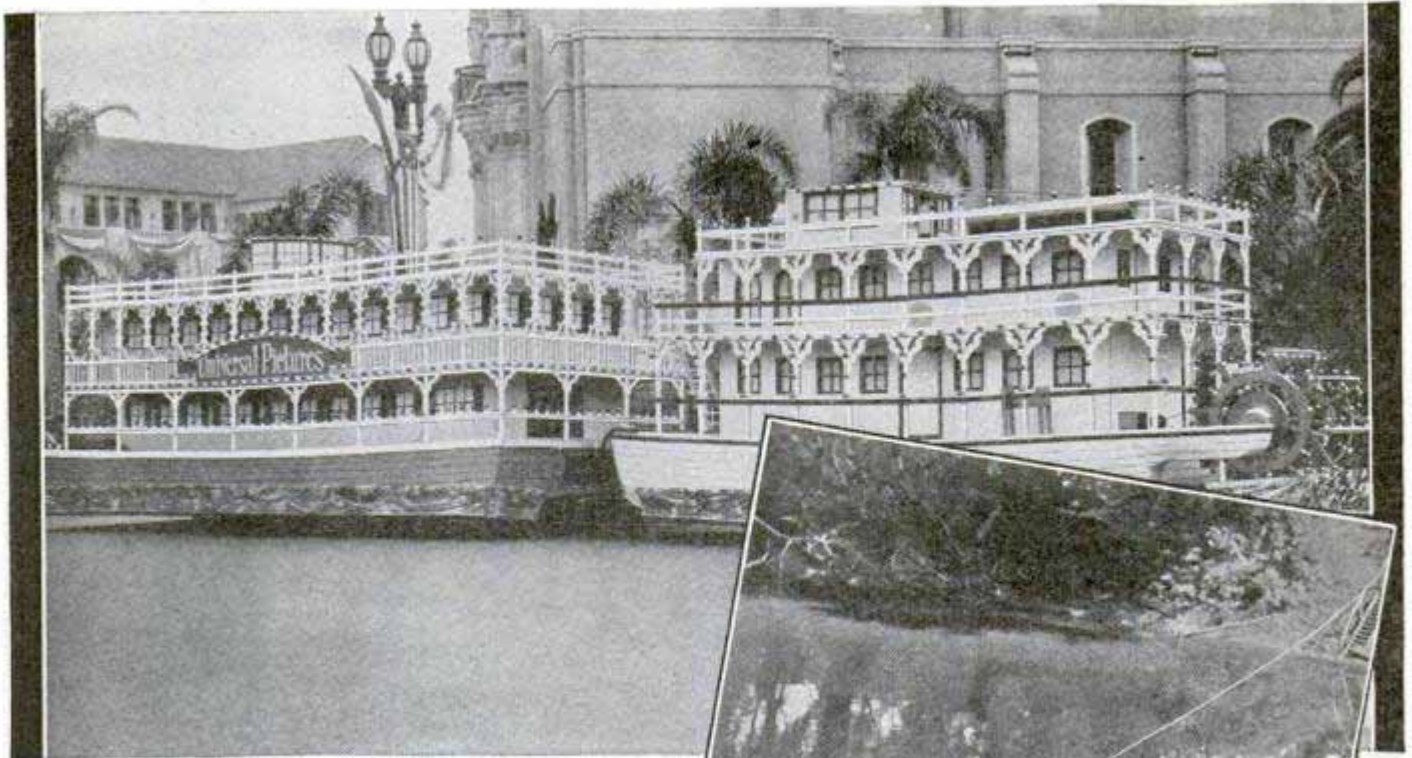

The "Show Boat"—
and work boats, too,
are made of

PRESDWOOD

The romantic period in American history, when show boats carried entertainment to towns along the Mississippi, is faithfully portrayed in the Universal Pictures' production, "Show Boat." But there is just as much romance back of the industry which contributes to the advertising and production of the play itself.

In a thriving Mississippi town, wood is blown apart and pressed together again in a patented process which makes the grainless wood boards called Masonite Presdwood. And it is this readily worked and easily painted material which is so successfully used in reproducing the "Show Boat" pictured above.

Does not crack or splinter

This workability of Presdwood has also led to its extensive use for set construction in Hollywood studios. For Presdwood does not crack or split. It does not splinter. It is dense and smooth, and so tough and strong that the same pieces are used over and over, in set after set.

But Presdwood's "marine" uses are not confined to the "Show Boat," as evidenced by the Presdwood ferry boat built by John H. Parmalee, prominent Nashville architect. He proved, as have many boat builders, the ability of this grainless wood to resist moisture and withstand the hardest usage.

Panels homes—lines concrete forms

Presdwood provides beautiful paneling for homes, smooth lining for concrete forms. It builds incubators and iceboxes, kitchen cabinets and breakfast nooks, aisle runners and dance hall floors. It makes show window backgrounds, motor truck paneling and outdoor signs; makes things better, lowers their cost.

If you manufacture in quantity or make things at home, you should read the Presdwood booklet. It is sent, Free, with a sample of Presdwood, on request.

MASONITE CORPORATION
111 West Washington Street, Chicago, Illinois

MASONITE CORPORATION, Dept. L-4, 111 W. Washington St., Chicago, Ill.
Please send me, Free, a sample of Masonite Presdwood and the Presdwood booklet.

Name.....

Address.....

City..... State.....

© M. C., 1930

Masonite
MPRESDWOOD
Made by the makers of
MASONITE STRUCTURAL INSULATION
REG. U.S. PAT. OFF.

Indian Chief designs new shoe with razor blade . . .

CHIEF Long Lance has long been an enthusiastic user of canvas rubber-soled shoes. One day he noticed that the print of his bare foot had a shape quite different from the print of his old-fashioned sneaker.

He reflected. Off came his shoe! With an old razor blade he whittled away at the soles. When he was through the tread of his shoes resembled his own natural footprints.

Wearing the shoes he had "operated on," he kept his speed-muscles strong and active.

Chief Long Lance came to Akron. There he held conferences with Goodrich designers. The new "Chief Long Lance Shoe" is the result. It is based on his new principle of the "barefoot tread."

At last the muscle-building qualities of a moccasin have been combined with the comfort and protection of a modern sport shoe. A pair of "Chief Long Lance Shoes" will put your feet in training. Ask to see them at your shoe store.



BUFFALO CHILD LONG LANCE, Blackfoot Indian Chief. Born in a tepee. Trick rider for Buffalo Bill. Tackle on famous Carlisle football team. Captain in World War. Wounded, decorated for bravery. Light heavyweight boxing champion of Canadian army. Author of "Long Lance." Active sportsman.



THE TREAD of a normal healthy foot can be seen on this worn moccasin, sent by the Chief from the wilds of Canada to the Goodrich factory. Wear shows that the weight of the body is instinctively thrown where support is felt.

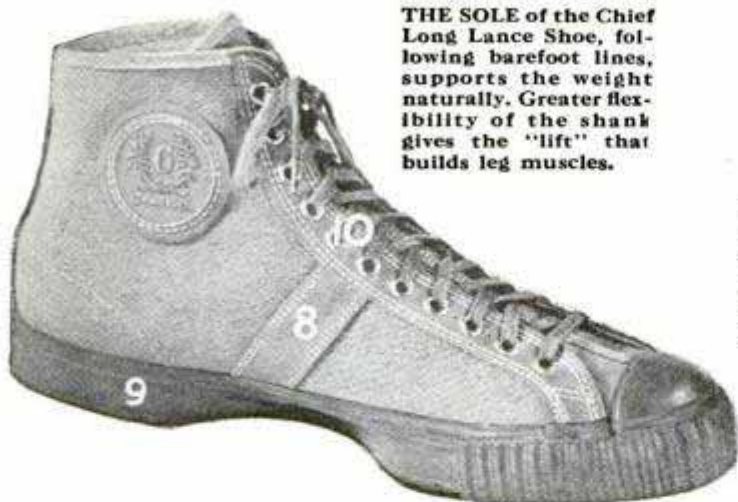

THE SOLE of the Chief Long Lance Shoe, following barefoot lines, supports the weight naturally. Greater flexibility of the shank gives the "lift" that builds leg muscles.

10 Special Features

- | | |
|-------------------------|-------------------------|
| 1. Unique Indian design | 6. Easy-Flexing Shank |
| 2. Dodging Pivot | 7. Non-Skid Heel |
| 3. Emergency Brake | 8. Moccasin-Grip Instep |
| 4. Whirling Pivot | 9. Cushion Inner Heel |
| 5. Barefoot Tread | 10. Form-Fit Tongue |

CHIEF LONG LANCE shows exactly how to speak the famous Indian sign language with over 80 illustrations. Ten cents brings you this big 32-page booklet. Use coupon below.

Goodrich

 *Sport Shoes*



The B. F. Goodrich Rubber Company, 2M Akron, Ohio.

Enclosed is ten cents (coin or stamps). Please send me "How to Talk in the Indian Sign Language," by Chief Long Lance

Name.....
Address.....

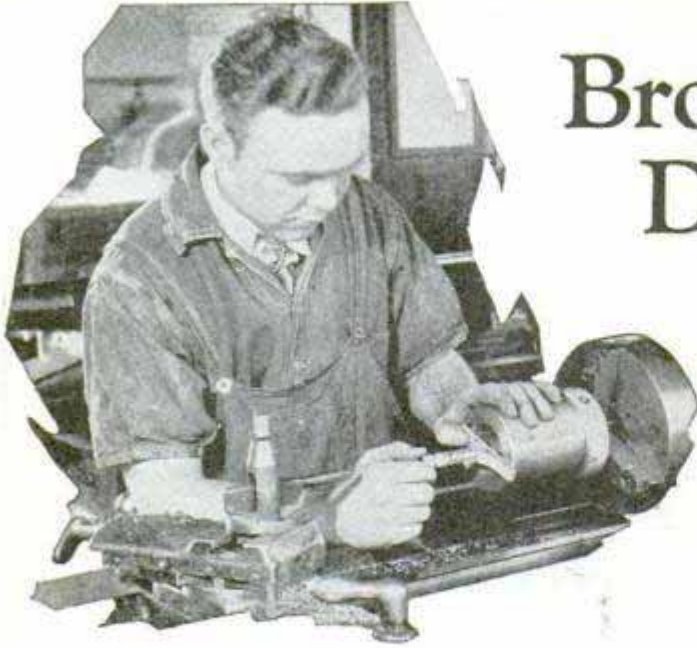

Brown & Sharpe Depth Gauges

*answer accurately
the question
How deep?"*

There is a Brown & Sharpe Depth Gauge to meet every requirement. The variety of designs, all maintaining the rigid Brown & Sharpe standard of accuracy, makes them exceptionally popular with skilled mechanics.

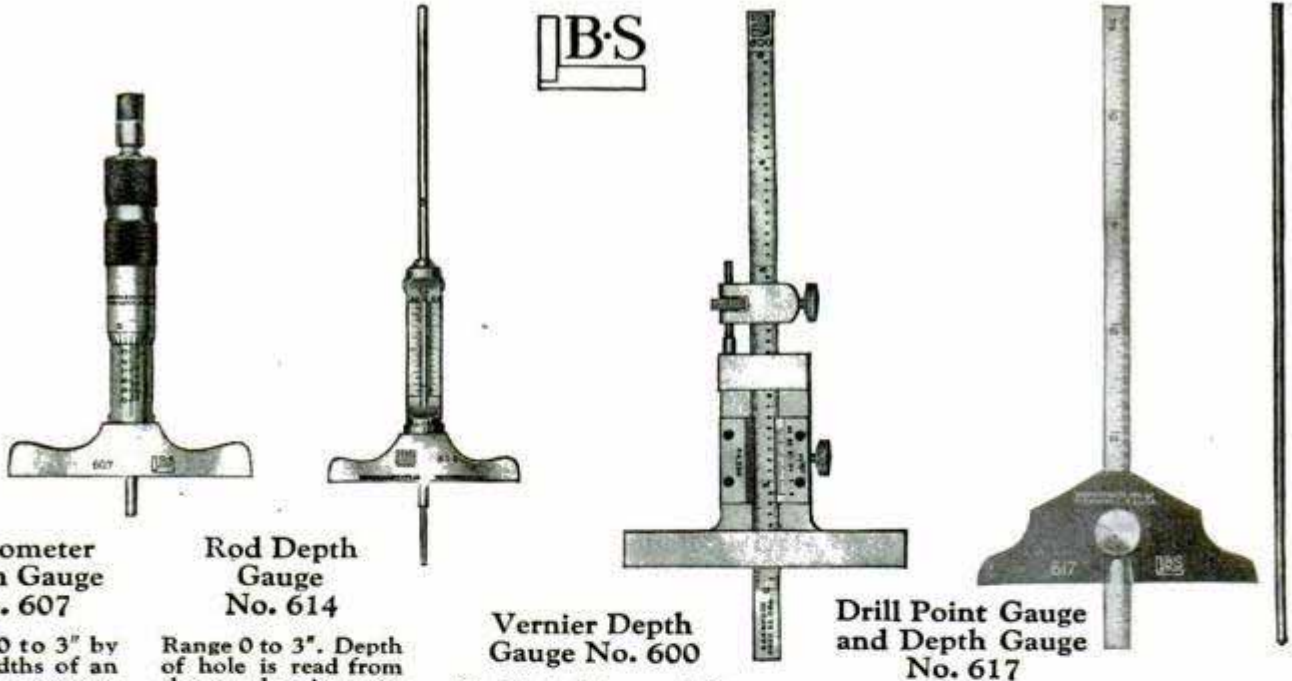

**Micrometer
Depth Gauge
No. 607**

Range 0 to 3" by thousandths of an inch. An accurate tool which is especially handy to use.

**Rod Depth
Gauge
No. 614**

Range 0 to 3". Depth of hole is read from the graduations on the body of the gauge. The small diameter of the rod permits its use in small holes.

**Vernier Depth
Gauge No. 600**

Graduated to read in 64ths on one edge and by means of a Vernier, in thousandths of an inch on the other. Furnished with 6" or 12" blades.

**Drill Point Gauge
and Depth Gauge
No. 617**

Range 0 to 5". No. 617 can be used for checking angles of drill points when grinding them and determines whether the point is central, or it may be used as a depth gauge. Furnished with 6" rule and 6" rod.

The full line of Depth Gauges is described in our Small Tool Catalog No. 31. Send for a copy. Dept. P. M., Brown & Sharpe Mfg. Co., Providence, R. I., U. S. A.

Brown & Sharpe Tools

"WORLD'S STANDARD OF ACCURACY"

New Model SOUTH BEND LATHES

BACK GEARED SCREW CUTTING LATHES

15,000 Lathes in Use in U. S. and 78 Foreign Countries

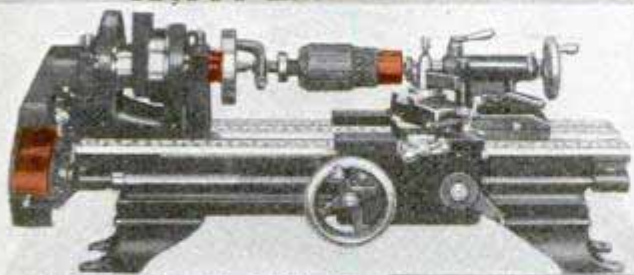

9" x 3' New Model South Bend Jr. Back Geared Screw Cutting Lathe (Weight 375 lbs.) Complete with Countershaft and **\$169**
Equipment shown only

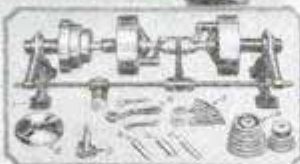

FOR THE

Manufacturing Plant	Service Station Maintenance
Tool Room	Airport
General Repair Shop	Electrical Shop
Machine Shop	Engineering Shop and Laboratory

USED BY MANUFACTURERS OF

Automobiles	and
Electrical Parts	Government Departments
Machinery	National and State
Aircraft	
Textile Machines	

Prices of 9-in. Junior Bench Lathes Including Lathe Equipment

Size of Lathe	Shipping Weight	Countershaft Drive	Horizontal Motor Drive
9" x 2 1/2'	350 lbs.	\$163.00	\$248.00
9" x 3'	375 lbs.	169.00	254.00
9" x 3 1/2'	400 lbs.	175.00	260.00
9" x 4'	425 lbs.	182.00	267.00

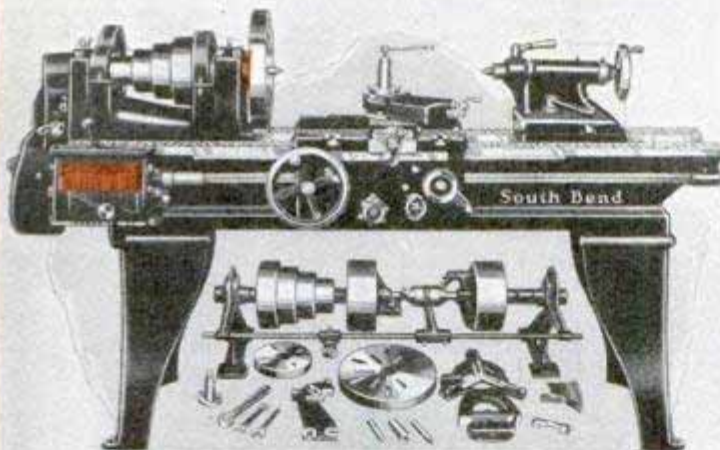

16" x 6' Quick Change Gear New Model South Bend Lathe - - - **\$598**

Prices of Popular Sizes of Quick Change Gear Lathes with Lathe Equipment

Size of Lathe	Shipping Weight	Countershaft Drive	Silent Chain Motor Drive
9" x 3'	490 lbs.	\$294.00	\$398.00
11" x 4'	725 lbs.	359.00	498.00
13" x 5'	1110 lbs.	443.00	602.00
15" x 6'	1550 lbs.	543.00	720.00
16" x 8'	2035 lbs.	638.00	817.00

Easy Payments

We ship any South Bend Lathe immediately upon receipt of only 20 percent of Catalog Price. Balance in 12 equal monthly payments. Write for Time Payment Catalog.

New FREE Catalog

Shows 96 Sizes from 9-in. to 18-in.

Write or send coupon today for the New South Bend Lathe Catalog. This complete book illustrates and describes 96 sizes and types of Countershaft Driven Lathes, Motor Driven Lathes, Quick Change Gear Lathes, Standard Change Gear Lathes, Tool Room Lathes, Gap Bed Lathes, Brake Drum Lathes and Bench Lathes. Investigate the New Model Lathe as it has all the latest improvements.

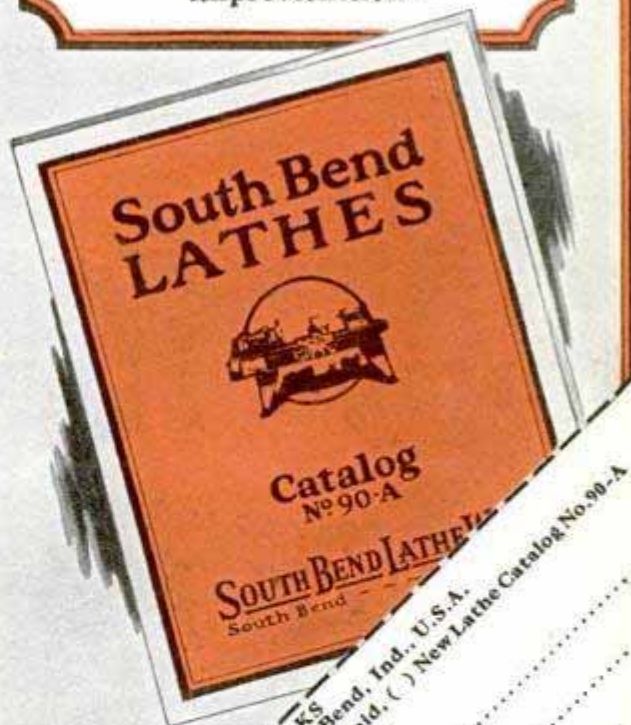

SOUTH BEND LATHE WORKS

620 E. Madison St., South Bend, Ind., U.S.A.

Lathe Builders for 23 Years

SOUTH BEND LATHE WORKS
620 E. Madison St., South Bend, Ind., U.S.A.
() Time Payment Catalog.

Name.....
Address.....
City.....
State.....

“Do I smell a short circuit or your pipe?”



But why smoke a pipe that smells like burning insulation? ...The poor chap probably never heard of Sir Walter Raleigh's favorite smoking mixture. He doesn't know there's a tobacco so mild and fragrant it gets the O. K. of even the fussiest pipe-smoother. He doesn't know that true mildness needn't sacrifice body, flavor and "kick." He doesn't know he can smoke a pipe all day long without getting himself or anybody else all hot and bothered. In other words, he hasn't met Sir Walter Raleigh. Some day he will. Let's hope it's soon.

How to Take Care of Your Pipe (Hint No. 4)

Don't use a sharp knife to clean out the carbon. You may cut through the cake and chip the wood. A lot of little "wood spots" take away from the sweetness of a pipe. Use a dull knife or reamer. Send for our free booklet, "How to Take Care of Your Pipe." Brown & Williamson Tobacco Corporation, Louisville, Kentucky, Dept. 79.



SIR WALTER RALEIGH

Smoking *It's* **Tobacco milder**



It's a BULOVA - Sent with a Mesh Band! For \$1.00

TAKE 12 MONTHS TO PAY

Send \$1.00 with order and tell us a little about yourself: (A) How long at present address, (B) Age, (C) Married or Single, (D) Name of Employer, (E) Position, (F) How long employed. All information held **strictly confidential**. We make no direct inquiries of anyone—not even from your employer.

10 Days Free Trial - Satisfaction Guaranteed
This genuine Bulova watch comes to you postage paid—no C.O.D. to pay on arrival. You take no risk—satisfaction guaranteed or money back.

Estab. 1895

\$2975 DGS-
15 jewel BULOVA gent's wrist watch. White Gold filled case; "dust-tite" protector; radium dial and hands; latest woven mesh wristband. Guaranteed. \$1 now. \$2.39 a mo. *Nationally advertised cash price, no extra charge for credit.*

Catalog FREE to Adults New catalog of genuine diamonds, standard nationally advertised watches, fine jewelry. Write for it now.

ROYAL DIAMOND & WATCH CO.
ADDRESS DEPT. 11-D 170 BROADWAY, N.Y.

A.C. ELECTRIC LIGHT PLANTS

60 cycle, 110-volt. 1000 and 2000 watt capacity. Operate at constant voltage and cycle. Suitable for Homes, Farms, Camps, and Stand-by Emergency Equipment. Operating any Electric Tool, etc., in places where electric service is not available. D. C. Plants as low as \$139.



WRITE FOR PARTICULARS—
D. W. ONAN & SONS, 31 Royalston Ave., MINNEAPOLIS, MINN.

BIG MONEY

easily made sanding floors with the new model "American Handy Sander." Operates from light socket—weighs only 34 lbs.—easily carried with one hand—produces highest quality work. Build up a sanding business all your own—Large capital and experience not required. Write NOW for free information.



The American Floor Surfacing Machine Co.
523 South St. Clair St. Toledo, Ohio

The Tool of a Hundred Uses
H&A Portable Motor-Driven Band Saw

For commercial shop or home workshop—a heavy duty precision tool; portable, motor-driven, reasonably priced. Does speedy and accurate work.

Write for attractive price offer
HESTON & ANDERSON
604 Kirkwood Avenue Fairfield, Iowa

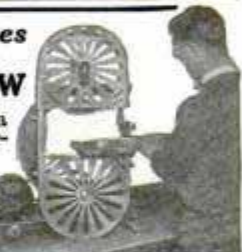

\$10.00 DOWN
Brings this Lathe to You

Lathes \$6.00 to \$75.00. Largest line of small lathes in America. Send ten cents for 32 page catalog of lathes, bench saws, jig saws, band saws, etc.

SYEPHER MANUFACTURING COMPANY
Dept. D-4 Toledo, Ohio



The Non-Skid screw driver was inserted in the slot of one of the screws holding the license plate, and, with a firm turning pressure on the screw driver to bind the blade in the screw slot, the car was actually pulled, just as shown here!



The New **NON-SKID** Screw Driver

TRADE MARK

is such an **AMAZING IMPROVEMENT** that you will never buy another smooth blade

The **RIBBED BLADE** Prevents Slipping

THE new Non-Skid Screw Driver—the most revolutionary improvement ever made in a screw driver blade—is so much better that you'll wonder why it wasn't thought of before!

Take a "chewed-up" screw, securely sunk in hard wood, and just try to turn it with a smooth blade screw driver! It can't be done! Now insert a Bridgeport Non-Skid—see and feel how the ribbed blade grips. No pushing, no straining—you only turn the Non-Skid.

The Non-Skid holds like a gear in mesh. Grips a screw like a non-skid tire grips the road. Drives screws so much easier that you'll never want to see another smooth blade. Turns screws at almost any angle. Turns battered and rusted screws as though they were new. Turns greasy screws which smooth blades merely "skate" off. Saves furniture and flesh—and a tremendous amount of time. Lasts longer, because it doesn't get chipped and worn from jumping and slipping.

And the beauty of it is you can try the Non-Skid before you buy! Dealers everywhere are displaying the new Non-Skid screw driver with a demonstration block and screws, so that you can see for yourself what a whale of a difference a ribbed blade makes! Ask your dealer to show you the new Bridgeport Non-Skid today! If he is not yet supplied, order direct: No. 1—4", 50c; 6", 60c. No. 2—4", 35c; 6", 45c. No. 3—4½", 45c; 6½", 55c.

THE BRIDGEPORT HDWE. MFG. CORP.
Bridgeport, Connecticut
The World's Largest Makers of Screw Drivers

Bridgeport

TRADE MARK

THE CHOICE of MEN WHO KNOW TOOLS

3 STYLES All Sizes

No. 1

Blade runs clear through handle. "The finest screw driver I ever owned," say thousands of mechanics and carpenters.



No. 2

Blade, handle and ferrule are riveted securely together. The best screw driver in its price class.

No. 3

Shock-proof up to 10,000 volts. Designed especially for electrical and cabinet work. Slim blade with magnetized point.



Pat. U. S. A.
Dec. 3, 1929
No. 1738404

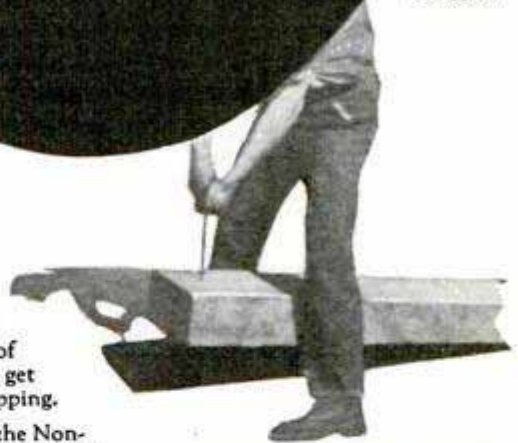

With a firm turning pressure on the screw driver to bind the blade in the screw slot, the 6" x 8" x 6' timber was lifted just as shown.



Yes, and it's FIXED for LIFE!

WHAT a help to the man-about-the-house! Mix up a little Savogran Crack Filler in a dish, take your putty knife, and in no time at all you've got those annoying little "fix-it" and repair jobs out of the way for good.

Savogran Crack Filler *won't shrink!* Repairs are permanent. Easy to work, taking paint perfectly, low in cost (note price), Savogran Crack Filler is the ideal filler for plugging cracks and holes, building up surfaces, making models, inlay work (can be colored when mixed), etc. Send for demonstration can—see for yourself. Use coupon.

Savogran Crack Filler is a product of the Savogran Company, makers of the famous Painters' Savogran used by painters and householders for over 35 years. Painters' Savogran renews hard paint-brushes, cleans dirt and grease like magic, removes paint and varnish, strips off ground-in dirt without scrubbing. It will save you time, money, and hard work.

**SAVOGRAN
CRACK FILLER**

PATENT APPLIED FOR

WON'T SHRINK!

Painters, Industrials, and other large users—note these prices! One lb., 30c.; 5-lb. can, \$1.25; 35-lb. all-metal pail, \$7.70. No hardening in can—no waste.

Big One-Pound Can

**ONLY
30c**



Savogran Company, India Wharf, Boston, Mass., Dept. M4.

I want to give Savogran Crack Filler a work-out. I enclose 10 cents. Send me a 1/4-lb. can by return mail.

Name

Address

SOUSA

*The
World's Greatest
Band Master
Says:*

"COMPLETE equipment with Conn instruments enhances the musical value of any band at least 50%."

Conns are the choice of the world's greatest artists. Especially recommended to beginners for quicker progress and greater musical success. Easiest to play. Many exclusive features. Yet they cost no more.

FREE TRIAL, Easy Payments on any Conn. Write for interesting book. Tells everything you want to know about your favorite instrument. Full color illustrations of most popular models. Write today. C. G. Conn, Ltd. 431 Conn Bldg. Elkhart, Ind.

CONN
World's Largest
Manufacturers of
BAND INSTRUMENTS



**SEND FOR THIS FREE BOOK ON
YOUR FAVORITE INSTRUMENT**

**ELECTRIC
LIGHTS
ANYWHERE**

**Complete 110-volt Electric
Light Plant. Ideal for Farms,
Camps and Summer Homes.**

\$139.00

Runs household appliances, Install it yourself, Wiring, Fixtures and Lamps for 7 rooms, \$17.50. Also larger models D. C. or A. C. Write for circular—D. W. ONAN & SONS, 30 Royalston Ave., Minneapolis, Minn.



**SHIP
MODELERS!**

Get fittings that make you proud of your finished model. Hancock parts include figureheads, bells, anchors, etc. Also historic and modern sets. Mail 10c for new colored booklet.

Easy-to-Build 20' Flying Cloud

Perfect lines. Sanded hull fitted with stem, keel, rudder, deckhouses, rails, \$13.00. Free model stand. Ready to rig. Special.

323 Douglas Ave. **ROY HANCOCK** Portsmouth, Va.

Only 8 Sales a Day Nets You \$116 a Week

Profits on larger size run higher. Unusual earning opportunity for ambitious men. No experience necessary; we teach. Part or full time.

FUGO *World's Simplest
Fire Extinguisher*

Automatic and instantaneous action. Within reach of every home, shop, store, theatre, garage, car owner, etc. Even smallest place needs two or more. Exclusive territory to producers. You get your pay every day. Write for full details.

The National Formetal Co.
6535 Metta Ave. Cleveland, O.





"45" Twin

One of the great 1930 models.
Harley-Davidson prices range
from \$235, f. o. b. factory.

Come on and Ride!"

SWING astride your Harley-Davidson and come on out with the "Jolly Riders".

Tours, picnics, week-end jaunts to lake and stream-side—wonderful vacations! Plenty of pals to ride with, for Harley-Davidson riders are good-fellows all, and there's a group of them in every town.

Motorcycling is the Greatest Sport on Wheels — and it costs so little! A Harley-Davidson is easy to buy and costs only a penny or two per mile to run.

Let your nearest Harley-Davidson Dealer show you the wonderful 1930 models — the Single, Twins, and Sidecars.

Ask about his Pay-As-You-Ride Plan.

Ride
a

HARLEY-DAVIDSON

MAIL
THE
COUPON
FOR
ILLUSTRATED
LITERATURE

Interested in your
motorcycles. Send
literature.

HARLEY-DAVIDSON MOTOR CO., Dept. P., Milwaukee, Wis.

Name.....

Address.....

My age is 16-19 years, 20-30 years, 31 years
and up, under 16 years. Check your age group.

ONLY \$6⁵⁰ down

for this *Guaranteed*
factory overhauled

**BURROUGHS
ADDING
MACHINE**

Balance
In Easy
Payments



MAIL TODAY

This standard Burroughs Adding Machine has been completely overhauled and the worn parts replaced at the Burroughs factory. It carries the same guarantee as a new machine. It can be put to work in your office or store for an initial payment of \$6.50; balance in easy payments. Total cash price, \$65. Mail the coupon now, today, while you are thinking about it.

Other machines of different style or larger capacity at slight increase in prices.

Burroughs Adding Machine Co.
6514 Second Blvd., Detroit, Mich.

Please send me full information about your special factory-overhauled Burroughs Adding Machine.

Name _____

Address _____

Catch Fish!

Eels, Mink, Muskrats with our new folding galvanized **STEEL WIRE TRAP**. Write for our **FREE TRAP OFFER** and Bargain Catalog. **\$1 Box** of our famous Fish Bait **FREE** to introduce our traps. **WALTON SUPPLY CO., 3502 JUNIATA AVE., ST. LOUIS, MO.**



Build Model Airplanes
the **IDEAL** way!

- Plans for Model Airplanes 25c each
- Floyd Bennett Monoplane
- FOKKER MONOPLANE
- New York-Paris Plane
- Curtiss Biplane
- DeHavilland Biplane
- NC 4 Naval Seaplane
- Bleriot or Nieuport Monoplanes
- Cecil Peoli Racer

Build the **IDEAL** "American Eagle"; the new, low-wing Model. 26 in. wing span, weight 3 1/4 oz. A marvelous flyer and easy to build. Construction Set, with Instructions . . . \$2.50
Assembled Model . . . \$5.00

Ask your Dealer, or Order Direct
Catalog of Parts, Supplies for Builders 5c

IDEAL AEROPLANE & SUPPLY CO.
26 West 19th St., New York

FREE!
RADIO BARGAIN
CATALOG



ALSO FREE RADIO GIFT

Send now for this new free radio catalog which saves you many dollars on radio outfits, kits, parts, tubes and accessories! Also **TIME CONVERSION CHART FREE**. Tells you instantly what time it is in any part of the world! Given free if your request for catalog reaches us this month.

20th CENTURY MAIL ORDER CORP.

238 So. Wells St.

Chicago, Ill.

Genuine **PILOT** Products

AUTOMOBILE RADIO

We have new information for you. Write us today mentioning Popular Mechanics Magazine

NATIONAL COMPANY INC.
ENGINEERS AND MANUFACTURERS
61 SHERMAN ST., MALDEN, MASS.

Established 1914 W. A. Ready, Pres.

ELECTRIC OR BATTERY

TRY IT 30 DAYS FREE BEFORE YOU BUY

1 yr. guarantee
9 TUBE

TRIPLE Screen Grid Steel Chassis
\$49⁸⁸



Factory to you. Save 50% on latest AC Electric or Battery Radio. Get 'Send No Money' Offer

Big choice of cabinets

Lighted **MIRACO**
1 dial



Radio's most amazing bargains direct from big, old, reliable maker. Don't buy unless 30 days use proves entire outfit unbeatable at 2 to 3 times the price, for tone, selectivity, distance, volume.

Free Catalog and **BIG SPECIAL OFFER**
MIDWEST RADIO CORPORATION
10th Successful Year
407-GA Miraco Bldg., Cincinnati, O.



Gears and Model Supplies

Gears and parts to make your own remote control radio receiver, either short wave or broadcast. Also gears to operate your Moving Picture Machine and Phonograph at correct time. For the Inventor and Experimenter we carry a complete stock of brass gears and supplies—also special brass gears and parts made in quantities.

Send for Catalog.
THE PIERCE MODEL WORKS
TINLEY PARK, ILL.

MOTORCYCLES



Price \$10 and up purchased through our Co-Operative Plan for as low as \$1.00 down and \$1.00 per week
Indians Harley-Davidsons Ace Henderson and Clevelands
Send ten cents for Bulletin A.

Motorcycles shipped to all parts of the world
WALKER-INDIAN CO., 1309 Boylston St., BOSTON, MASS.

Send for **FREE BULLETINS**

CRESCENT WOOD WORKING MACHINES



Crescent Wood Working Machines make money for you by turning out work accurately, fast and easily. Portable machines operate from any light socket. Big line of heavy machines for factories, all quality made; moderately priced.

Send for Free Bulletin

The Crescent Machine Co., 93 Columbia St., Leetonia, O.

Making Real Money!

\$4.00 to \$6.00 an hour

You can do it too
with the **IDEAL**
Lawnmower Sharpener



A days pay ~
for
2 hours work!

And That's What You Can Do!

Herman Barber, 1505 E. Carter Ave., Ashland, Ky., writes: "I have sharpened to date 459 mowers, receiving \$988.30. These were sharpened in evenings and in spare time. I have seen other machines, but this is the most perfect one I have seen yet."—And hundreds of others are cashing in with this efficient machine. **OUR FREE BOOK TELLS YOU HOW**—It tells how others have made themselves a business of their own—built permanent businesses on spare time work which has helped to buy the extras for the home, etc., that everyone wants. Send for this book—It's Free.

Use Your Spare Time If you work at a trade, put an Ideal in your basement and earn \$4.00 to \$6.00 an hour evenings and Saturday afternoons. E. W. McCormick, Saginaw, Mich., writes: "Five years ago I bought an Ideal Sharpener on which I have ground over 5,000 mowers. In the last few weeks I worked at my trade, machinist, full time 9 hours a day. I also ground 97 mowers which netted me \$114.10 clear gain."

A Nice All Year Business S.E. Raup, 1312 N. Cameron St., Harrisburg, Pa., writes: "I have been using two Ideal and one Peerless grinders for four years with fine success and have been able to build up a nice all-year business. At present I am employing one man and a boy to help me."

Same Customers Each Year—D. N. Wood, Winchester, Ky., writes: "This is the third year I have been using your machine and I have built up a nice repeat trade. Evidently the work is satisfactory or I would not get the same customers each year; also each one generally sends a new one."

Profits Year After Year C.S. Coburn, Little Rock, Ark., writes that his "Ideal" Sharpener earned enough in 18 months to pay for itself and \$1857 worth of additional machinery.

Zeno Brandon, Middletown, Ohio, writes: "I have made \$820.70 in 55 days with my 'Ideal.' Have made as high as \$38.70 in one day."

W.F. Kendt, Buffalo, writes: "I have sharpened 994 lawnmowers last season and the receipts were nearly \$2100—not bad for a side line."

Hundreds of Dull Mowers Waiting For You

to sharpen them right in your locality—and no town is too small. William G. Mercier, 178 E. Mohawk St., Oswego, N. Y., writes: "We have our shop on a truck and we travel all over the county." W. W. Dresser, Sanford, Florida, writes: "I live five miles out of town so have no rent to pay. Collect and deliver mowers. Get \$2.00 or better. Buy up old mowers and repair same and therefore make from \$4.00 to \$10.00 on same, which counts up in a season. Am well pleased with the machine."

Here Is Your Chance

Send for the book, "Let George Say It"—It's the proof of what we advertise. We also show you the best ways to get the mowers to sharpen.

THE FATE-ROOT-HEATH CO.
Dept. M, 918-944 Bell Street, Plymouth, Ohio, U. S. A.

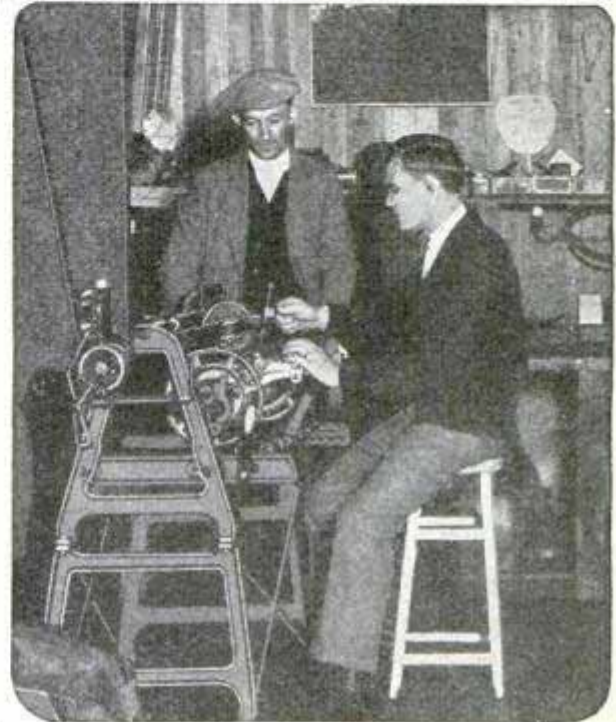

Sharpens Lawnmowers to Razor Edge

The Ideal Lawnmower Sharpener is a wonderful, but simple, machine that sharpens lawnmowers perfectly, scientifically, without dismantling the mower. Sharpens them as emery dust, files and obsolete methods never could.

Sharpens Any Mower in 20 Minutes

Just pick up any mower, set it in the Ideal, make a few simple adjustments and proceed to sharpen. In 15 to 20 minutes after you pick up the mower it is ready for the lawn, and you have made \$1.50 to \$2.00, depending on the charge you fix.

No Training Required

You don't have to be a mechanic to use the Ideal. Its operation is simple and practically automatic once you start to grind.

Set Up Ready to Grind in a Few Minutes

Shipped practically completely assembled. Uncrate it, place in position, plug into a light socket and it is ready to start earning for you.

Special Grinding Wheel Attachment

For sharpening grass shears, hedge shears, sickles, scythes, axes, etc., etc. Will add many dollars to your income.

Skate Sharpener Attachment Included

Sharpens all makes of skates—including hockey with shoe attached. The "Ideal" earns money all the year round.

Uses Little Power

Operated by 1/4-H.P. Motor attached to light socket or can be run direct from line shaft.

Here's what you'll want to read
Send for it NOW!

Sign and Mail This Today

The Fate-Root-Heath Co.,
Dept. M, Plymouth, Ohio.

You'll have to prove that I can make real money with the "Ideal" Sharpener. Send me your FREE BOOK.

Name.....

Address.....

City..... State.....



Ceiling cracks
quickly
vanish

YOU can easily make cracked walls and ceilings good as new with Rutland Patching Plaster—the quick, money-saving mender. Just mix with a little water, then fill crack or hole. If you want a perfect, lasting job, be sure to ask for Rutland Patching Plaster—made by the secret Rutland formula that insures absolute whiteness and permanence. At paint, wall-paper and hardware stores. Rutland Fire Clay Co., Rutland, Vermont.

**RUTLAND
PATCHING
PLASTER**

**Photos
ENLARGED**

Size 16x20 inches
Same price for full length or bust form groups, landscapes, or pet animals, etc., enlargements of any part of group picture. Safe return of your own original photo guaranteed.
98¢
Just mail photo or snapshot (any size) and within a week you will receive your beautiful life-like enlargement size 16x20 in. guaranteed fadeless. Pay postman 98¢ plus postage or send \$1.00 with order and we pay postage. **SPECIAL** With each enlargement we will send FREE a hand-tinted miniature. **FREE OFFER** reproduction of photo sent. Take advantage now of this amazing offer—send your photo today!
UNITED PORTRAIT COMPANY
900 West Lake St. Dept. D-360 Chicago, Ill.



**WHEN YOUR LINE'S
RUNNING OUT**

FOUR POUNDS of fish-power on a hook require all the attention you've got. And it gets it too—when you're in an "Old Town." For the man in the stern can put an "Old Town" wherever a fish wants to go. That's how easy they are to handle! Light—beautifully balanced—responsive to the blade's slightest dip.

No wonder most fishermen choose "Old Town"! Send for free catalog today. It shows and prices many models—all fashioned after Indian birch-barks, as low as \$67. Also shows rowboats; dinghies; big, fast, seaworthy, all-wood, outboard family boats, and speedy step-planes. Old Town Canoe Co., 1144 Middle St., Old Town, Maine.

"Old Town Canoes"

FLY THIS COMBAT MONOPLANE!



This realistic copy of a military monoplane is an unusually graceful flyer. Wing-spread 18 in. Weight only 7/8 oz. Will take off by own power and fly over 80 ft. Markings in red and blue. Can be built in 2 hrs. without tools. Construction set includes 6-in. aluminum propeller with shaft, 1/4 in. disc wheels, wood struts, rubber band motor and all other parts—with clear directions. Complete set, packed in un-

breakable container, only \$1.00, postpaid in U. S. and Canada. Order today. Satisfaction or money refunded.

The MIDLAND MODEL WORKS, Chillicothe, Ohio
(We cannot make C.O.D. shipments. No retail catalogue issued.)

Make Your FORD Into The "ACE"

GET READY FOR SPRING—BUILD YOUR ACE NOW—
\$599 Red-I-Kut life size patterns Famous sure-fit **RED-I-KUT** life-size patterns and picture instructions show how you can easily convert your Ford into this **Fast, Snappy, Sport-Car** as thousands have done with easily obtained materials. No need to lay up the car. Makes wonderful 4-passenger car. Send 10¢ coin for actual photo of sport car and new manual of distinctive sport car patterns from \$5.80 up—**"RKO" Steel "Swing-Lo" Irons, Tops, Windshields** and many speed necessities. **ORDER RIGHT NOW** and get a real thrill!

KUEMPEL COMPANY, 119 Kuempel Bldg., GUTTENBERG, IOWA

**PROTECT YOUR CAR
EVEREADY
PRESTONE** National Carbon Company, Inc
General Offices: New York, N. Y.
Branches: Chicago, Kansas City,
New York, San Francisco
Unit of Union Carbide and **UCC** Carbon Corporation
for preparation of the perfect anti-freeze.

Build a CLOCK for Pleasure or PROFIT!

FREE BOOK of Clock Making, Money Making ideas. Gives details, prices of movements, parts. Write NOW for one!

Shows How YOU Can Make Fine Clocks Right at Home
—for yourself, or to sell at Big Profits. We furnish instructions, parts. Works \$1.95 up; others with chimes, all prices. Make case or assemble parts. Cash-in on demand for Mantel, Banjo, Grandfather's Clocks. Write for Special Blue Print Offer, FREE Catalog.

AMERICAN CHIME CLOCK COMPANY
1670-V Ruffner St. Philadelphia, Pa.

5 Ft. Workshop
 INCLUDES
 4" Planer, 8" Circular Saw, 6" x 36" Lathe, 8" Disc Sander, 6" Buffer, 5" Grinder, 3/4" Drill Chuck, 3/4 H. P. G. E. Motor, 110 V., A. C., 60 Cycle. Endless V Belt, Two 2-step 4" and 2 1/2" Pulleys, Cast Iron Sub Base, 10 ft. Cable with separable Plug. Planer and Saw may be purchased separately—\$25.00 each.

>> HERE'S A Real Man's HOBBY

J. D. WALLACE & COMPANY,
 Adams St. at California Ave., Chicago, Ill.
 Please send me full information about the Workace Electric Woodworker and also the Workace Machines checked below.

Workace Jig Saw Workace Band Saw
 Workace Shaper Workace Planer Workace Radial Saw

Name.....
 Address.....
 City..... State.....

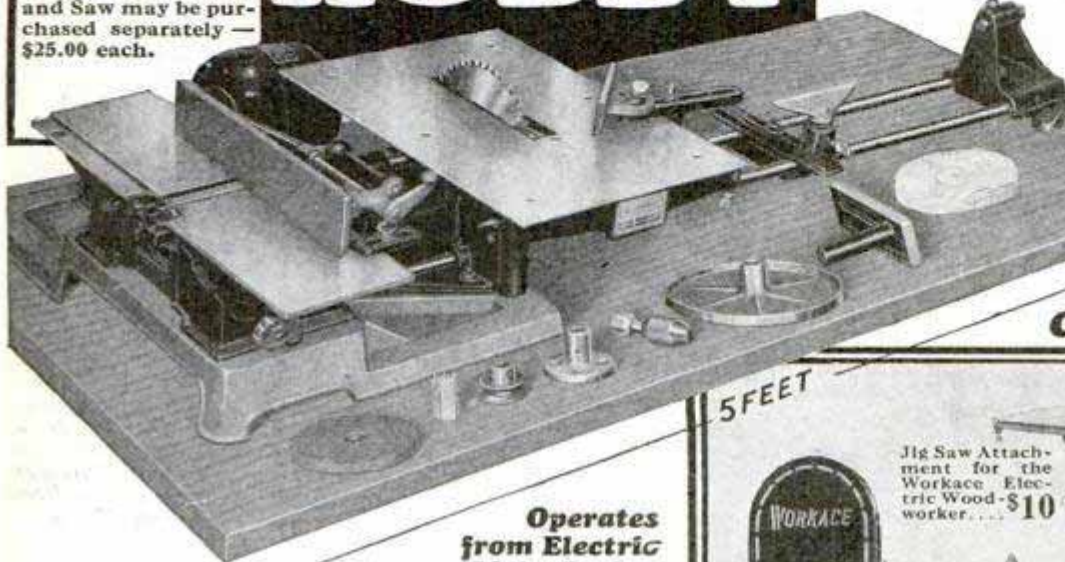

\$9.00 DOWN
\$89.00 COMPLETE

Mail Coupon Above

Operates from Electric Light Socket

WORKACE Electric WOODWORKER

HERE'S A HOBBY that offers relaxation from everyday cares—bringing pleasure and profit. Thousands of men have adopted the Workace hobby. Make hundreds of things with the Workace Electric Woodworker. Under the magic of the whirling saw, planer, lathe, sander, drill, grinder and buffing wheel (all included in the Workace Woodworker) raw lumber is easily converted into furniture, household necessities and countless other articles. Work out your ideas with your own complete electric workshop.

There's no better gift for the growing boy than Workace. It provides a wholesome man-building outlet for his energy and enthusiasm. Man or boy will appreciate Workace. \$9.00 down will bring it. Send coupon now for details.

J. D. WALLACE & COMPANY
 Adams Street at California Avenue, CHICAGO
 11 W. 42nd St., New York 268 Market St., San Francisco
 Consult telephone directory for branch addresses in other cities

5 FEET

Jig Saw Attachment for the Workace Electric Woodworker... \$10

Workace Electric Shaper—high speed, direct drive, portable... \$95

14 in. Workace Band Saw, fast, accurate, economical... \$75

Workace Radial Saw. Saws at any angle... \$140
 Cast Iron Table \$10 Extra
 Cast Iron Legs \$15 Extra

Workace Portable 4 in. Planer... \$25
 Complete with motor \$60

MOTORCYCLES

Direct to you at wholesale prices Send 10c today for the latest Illustrated Bulletin and Confidential Price List
 Guaranteed Indians Harleys Hendersons SuperX etc.
(Small Weekly Payments Now—Spring Delivery at Winter Prices)
CRANDALL CYCLE CO. 826-28 State St. Shipments to all parts of the world
Motorcycles Since 1905 Springfield, Mass.

Beautiful HOUSES \$900 and BUNGALOWS CAN BE BUILT FOR And Up

Sixty-nine up-to-date designs in the most complete and comprehensive book of medium cost English and American homes published, 8 x 11 inches, nearly 250 photos and floor plans, contains a description of each design and approximate cost to build. It is the last word on home building and may save you several hundred dollars in the cost of your home. **Send Postpaid \$1.**

FREDERICK H. GOWING, Architect, 101 Tremont St., Boston, Mass.

FREE TO BOYS SEND NOW!

"BB Magic" tells the wonderful story of round shot; its importance and place in boy training. **Points way to leadership, self-expression, poise and concentration. Makes crack shots.** Belongs in every boy's pocket, every parent's desk. Your copy **FREE.** Write at once.

NEW BENJAMIN 25 SHOT AUTOMATIC "THE MYSTERY RIFLE"
 OUTSHOTS ALL OTHERS

Now the wonderful Benjamin principle of compressed air action that made the Benjamin Single Shot famous for hard, safe, accurate shooting, has been applied to 25 shot automatic rapid firing—the only gun of its kind in the world. Learn about both.

BENJAMIN AIR RIFLE CO., 605 North Broadway, St. Louis, Mo.

WET CELLARS MADE DRY from the Inside!

DAMP musty cellars are unsanitary, a danger to health and a poor place to store valuable material.

Where water or moisture seeps in through cracks or porous spots in the floor or walls, you can make and keep your cellar dry and sweet—a fit place to work, free from odor, mold and rust—by filling the cracks and coating the moist surface with Smooth-On No. 7.

This is the one practical waterproofing that you can apply yourself, easily, from the inside, to wet or dry surface and with every assurance of thorough watertightness, even in the wettest seasons.

Excellent also for patching concrete floors, waterproofing garage, stable and washroom floors, brick walls, cisterns, septic tanks, water troughs, fountains, fish ponds, swimming pools, manure pits, etc.



Write for **FREE BOOK**

About 25 pounds of Smooth-On No. 7 are required for each 100 square feet of surface covered, and no experience is necessary. Complete instructions on the package.

Sold in 5-pound cans and 25 and 100-pound kegs.

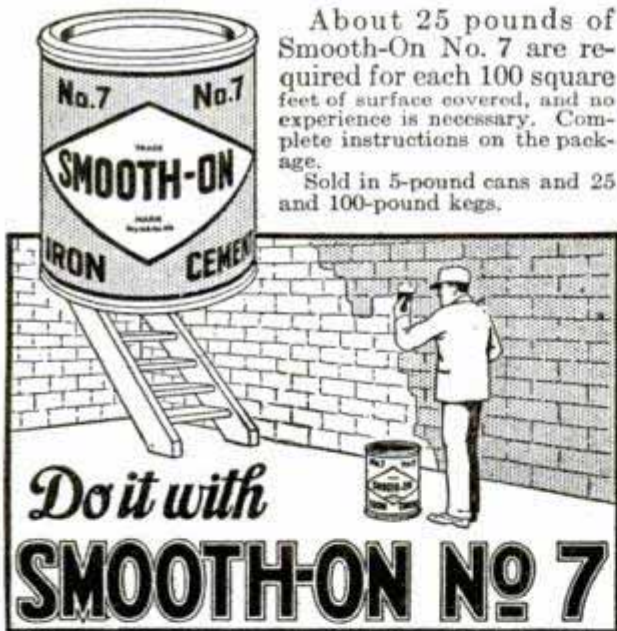

Do it with
SMOOTH-ON No. 7

SMOOTH-ON MFG. CO., Dept. 37,
574 Communipaw Ave., Jersey City, N. J.
Please send the free Smooth-On Repair Book.

Name.....

Address.....

**Return this coupon for
FREE copy of Booklet**

4-30

30 DAYS' FREE TRIAL



We Ship On Approval

and 30 days' trial direct from our factory. Select from 44 styles, colors and sizes.

Save \$10.00 to \$25.00 No extravagant selling expenses enter into the cost and selling prices of these bicycles. Factory-to-Rider saves you big money and assures you service.

EASY PAYMENTS if desired. Only \$5 down. We allow 30 days for trial and test. If it does not suit—return at our expense. Do business direct with makers of Ranger—Pathfinder—Crusader bicycles.

TIRES, Lamps, Wheels, Equipment and Sundries at half usual prices.

RADIO—Musical Instruments. Complete line—exceptional prices and terms. Please mention which catalog you wish.

Write today for catalog and marvelous new price offers and terms.
Mead Cycle Co., Dept. F110 Chicago

\$2.00

INKOGRAPH

PENCIL POINTED FOUNTAIN PEN

FREE 10 DAYS TRIAL

Writes with ink smooth as a lead pencil on cheapest or finest paper, without miss, skip or blur. Won't blot, scratch or leak.

Makes 3 carbon copies at one time with original in ink. Any one can use your Inkograph—hard pressure cannot spread or injure its 14 Kt. gold point. Patent automatic feed prevents point from clogging. No complicated mechanism. Best material and workmanship. Fully Guaranteed.

Send No Money. Pay postman \$2.00 plus postage. Sent prepaid if remittance accompanies order. Money back if not satisfied within 10 days.

INKOGRAPH CO., Inc., 161-80 Centre St., New York City

AGENTS Send for Inkograph or FREE sales plan booklet. Sells on sight, no investment, immediate commissions.

the New Mobiloil

Sport Bodies for Fords At Factory Prices



This Model in Grey Prime **\$38.50**

Send 10c for catalog showing all models of bodies and other equipment for Ford and Chevrolet. Hi-compression heads, underslung parts, 3:1 gears, headlights, fenders. Cut shows body on Model A Ford. Also made for Model T Ford.

Make Your Ford Into Classy Car
Sport Factories, Dept. A-5 Aurora, Illinois

Thompson BEATS the World on BOATS

THOMPSON
BOATS

CATALOG FREE!



OUTBOARD MOTOR BOATS—For Every Purpose and Every Purse—The very fastest and most seaworthy V Type, V Bottom and Sled Type Boats for family use, and a strictly up-to-date line of Step Plane Racing Models to choose from.

Rowboats
\$48.00
and up—

The most complete line ever offered, at real money-saving prices.

Canoes
\$50.00
and up—

Some all wood, others canvas covered. Light, swift, safe, strong and durable. Choice of many distinctive color combinations.

**20 ft.
Motor
Boats**

With or without Engine. Fast, handsome six passenger craft at money-saving prices.

CATALOG FREE — SAVE MONEY — ORDER BY MAIL
Please state the kind of boat you are interested in (35)

TWO LARGE FACTORIES

THOMPSON BROS. BOAT MFG. CO.

213 Ann St.
PESHTIGO
WISCONSIN

(Write to
Either Place)

113 Elm St.
CORTLAND
NEW YORK

Learn to **PAINT SIGNS and SHOW CARDS**

We quickly teach you by mail, or at school, in spare time. Big demand, big future, interesting work. Oldest, foremost school. **EARN \$50 TO \$200 WEEKLY**

Otto Wisegrad, Md., home-study graduate, made \$12,000 from his business in one year. John Vason, N. Y., gets \$25 for a show card. Crawford, B. C., writes: "Earned \$200 while taking course." Write for complete information.

DETROIT SCHOOL OF LETTERING
150 Stinson Ave. Est. 1899 DETROIT, MICH.

AGENTS AND SIGN MEN

Now Making \$50.00 to \$100.00 and Up Per Week Selling Our **GOLD LEAF SIGN LETTERS**

R

For store and office windows, board signs, trucks and glass signs. We also make to order script signs and business emblems singly or by the thousands. A permanent business. No capital or experience required. Big demand in every city. Samples and Literature Free.

CONSOLIDATED SIGN LETTER CO. 71-X W. Van Buren CHICAGO, ILL.

OLD MONEY and stamps WANTED



POST YOURSELF! It pays! I paid J. D. Martin, Virginia, \$200 for a single copper cent. Mr. Manning, New York, \$2,500 for one silver dollar. Mrs. G. F. Adams \$740 for a few old coins. I want all kinds of old coins, medals, bills and stamps. I pay big cash premiums.

WILL PAY \$100 FOR DIME
1894 S. Mint; \$50 for 1913 Liberty Head Nickel (not buffalo) and hundreds of other amazing prices for coins. Get in touch with me. Send 4c for Large Illustrated Coin Folder. It may mean much profit to you. Write today to

NUMISMATIC COMPANY OF TEXAS
Dept. 370 FORT WORTH, TEXAS

[Largest Rare Coin Establishment in U. S.]



It's
New

Only
\$1

BIG YANK

Work Shirt with Patented Cigarette Pocket

Made so you can push a single cigarette up without unbuttoning flap.

The 12 BIG YANK Features

1. Sweat Resisting Cigarette Pocket with button flap.
2. Big Utility Pocket, with pencil section, holds can of tobacco when buttoned.
3. All Strain Points Thread Riveted.
4. Double Thick Ventilated Arm Pits.
5. Conforming Ventilated Yoke.
6. Triple Stitched Seams.
7. Over-size for Comfort.
8. Fashioned Collar.
9. Indestructible Buttons.
10. Special, Extra Strong Fabrics.
11. Form-Fitting Shoulder.
12. Every Garment Guaranteed to Give Satisfaction.

Every Big Yank is triple-stitched, thread-riveted; guaranteed not to rip. Most good dealers everywhere can show you this new Big Yank. Ask to see this sensational shirt value. If by chance he can't supply you, send \$2.00 and we'll send you two shirts, postpaid.

RELIANCE MANUFACTURING COMPANY
212 WEST MONROE STREET
CHICAGO, ILLINOIS

Free this 140 Page Book of Record Keeping Forms

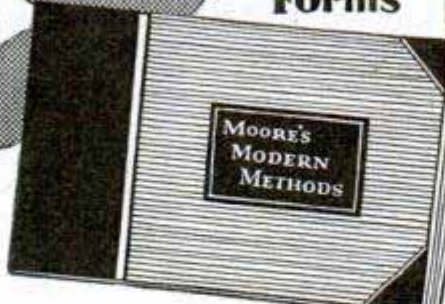

HERE'S a book that will help you with your record-keeping problems. Contains wide variety of life-size Bookkeeping forms, completely filled in, illustrating uses. For office or factory—business or profession—it shows you simplest and most efficient methods of accounting now being used by 300,000 leading firms. Book sent FREE when requested on business stationery. No obligation!

JOHN C. MOORE CORP., Est. 1839
6064 Stone Street, Rochester, N. Y.

Merely Fill in Coupon and 140-page Book Will be Sent you FREE

Name _____
Business _____
City _____ State _____

This CORNWELL Expert Mechanics KIT



Only \$8.60

Amazing Tests Prove Quality

Catalog describes remarkable tests by which the phenomenal strength and guaranteed quality of CORNWELL tools may be tested. Your money back for any tool that fails to do what we claim.

HERE is a convenient kit of CORNWELL chisels and punches that are forged from the very highest grade Chrome Molybdenum steel. They are hardened, heat treated and specially tempered by our exclusive CORNWELL process. They will withstand the hardest usage, and will accomplish results that no other similar tools will do. While costing slightly more than ordinary tools, figured in man-hours of performance and the resultant satisfaction from their use they are the cheapest in the end. CORNWELL tools will enable you to do better work in considerably less time.

There Is No Substitute for Cornwell Quality

Mechanics are proud of their CORNWELL tools because they know there are none others like them. They meet the most exacting requirements for hard usage. They withstand the most severe tests to which any tools can be put.

Money Back Guarantee

You are fully protected by our guarantee that covers every CORNWELL tool. You take no risk. If tools are not all we claim for them send them back and your money will be immediately refunded.



This Catalog-FREE

The Cornwell Quality Tools Co.
Dept. W, Mogadore, Ohio
(Formerly at Cuyahoga Falls, Ohio.)

Send me new illustrated catalog with prices on full line of Cornwell Hand-Made Tools.

..... Where employed
Name
Address
City State

Rotary Stencil Duplicator #39

Print Bulletins, Circulars, Programs, Letters, with the Amazing "EXCELLOGRAPH"

Simple and easy. Just write, typewrite, draw or trace on dry stencil; place in position and print up to 1,000 copies per hour. All supplies and instructions furnished. Guaranteed 10 years. Prints any size from postcards to sheets 9x14. Does beautiful work.

SAVE MONEY—MAKE MONEY
Saves and makes money for Merchants, Ministers, Teachers, Offices, etc. Use it to build your business. Do work for others at big profits.

Write for Free Book—TODAY
Shipped at our risk. Positive MONEY-BACK GUARANTEE. Amazing value. Thousands in use. Get free book describing all details and easy payment plan.

Easy Terms



PITTSBURGH TYPEWRITER & SUPPLY COMPANY
Dept. M-6 339 Fifth Ave. Pittsburgh, Pa.

Andy Sannella Talks to Reed Players. Get this Free Book!

On the air tonight, and every night, Andy Sannella is earning a fabulous salary with his Selmer Sax. In his book of "Advice to Saxophone Players," he gives more valuable information than in ten private lessons. This book also contains Talks to Clarinetists by Alexandre Selmer. Send for free copy.

If you will mention the instrument you play, we will send also, free samples of our Alexandre Reeds. They Play!

Selmer

266 SELMER BUILDING, ELKHART, INDIANA
27 (In Canada: 10 Shuter St., Toronto)



12-INCH SCALE MODEL

of Lindbergh's Spirit of St. Louis. Scientifically designed and very realistic. Rises from ground by own power and flies 40 ft. or more. Only 50c scale model sold at this price. Easily built in 2 or 3 hours. No tools needed. Construction set, with all parts and full directions, postpaid in U. S. and Canada, only 50c (no stamps). Satisfaction or money back. Send today and print your address plainly.

MANN & BENTON
Box D, Chillicothe, Ohio



AGENTS 500% PROFIT

GENUINE GOLD LEAF LETTERS

guaranteed to never tarnish. Anyone can put them on stores and office windows. Enormous demand, large profits. Paul Clark says: Smallest day \$28.70. R. L. Reel made \$920 in two months. Write today for free sample and liberal offer to general agents.

METALLIC LETTER CO. 433-B N. Clark St., CHICAGO

Do Your PRINTING

Cards, stationery, circulars, tags, labels, advertising, etc. Save money. Print for Others, Big Profits. Junior Press, \$5.90. Job Presses \$11 up, Rotary \$149. Will do popular Raised Printing like Engraving. Easy rules sent. Send for catalog outfits. **THE KELSEY CO., S-37, Meriden, Conn.**



WE START YOU IN BUSINESS

Eakins Co., 428 High St., Springfield, O.

Mail at once your free catalog about how to make big profits in the Crispette business with little capital.

Name _____
Address _____

\$1000 a Month Profits Possible



Easy Money! ... with a Parks

Make your spare hours at home pleasant as well as profitable with a Parks Cabinet Shop Special. This compact little woodworker—a complete small shop in itself—is earning spare time money for hundreds of Parks users who are turning out odd and unusual pieces of furniture and contracting for small repair work in their communities. Send the coupon today for the complete Parks catalog.



PARKS CABINET SHOP SPECIAL \$290

Complete with motor

THE PARKS WOODWORKING MACHINE CO.

Manufacturers of good woodworking machines since 1887
Dept. P-4 1530 Knowlton St. Cincinnati, O.

Name.....

Address.....

Business.....



Every Parks guaranteed 10 years

OTTAWA LOG SAW



GREATEST OFFER
EVER MADE

only \$39

PUTS THIS
OTTAWA
TO WORK FOR YOU

Make Money! Wood is valuable. Saw 15 to 20 cords a day. Does more than 10 men. Ottawa easily operated by man or boy. Falls trees—saws limbs. Use 4-hp. engine for other work. **30 DAYS TRIAL.** Write today for **FREE** book. Shipped from factory or nearest of 4 branch houses.

OTTAWA MFG. CO., 1741-W Wood Street, Ottawa, Kansas

MOTORCYCLES

WE WILL TRUST YOU
Pay As Low As \$2.00 per Week
Hendersons, Harley-Davidsons, Indians
Slightly used and rebuilt. Hundreds to select from.
Send 10c for list today.

MYEROW BROS. CO., 15 Berkeley St., Boston, Mass., U. S. A

Walsh Garden Tractor

and Power Mower
For Gardeners, Florists, Fruitmen, Suburbanites
Plows, Seeds, Cultivates, Mows Lawns & Hay
Single and Twin Engine-Belt Jobs-Walk and Ride
SPECIAL FACTORY PRICE
New Improved Models—CATALOG FREE
WALSH TRACTOR CO. Minneapolis, Minn.
3328 Talmage Av. SE

CLASS PINS 35¢

FREE CATALOG SHOWING 200 DESIGNS
PIN SHOWN, SILVER PLATE 35¢ EA., 12 OR MORE, \$3.50
DOZ.; STERLING SILVER OR GOLD PLATE, 70¢ EA.
12 OR MORE \$6.50 DOZ. 1 OR 2 COLORS ENAMEL;
3 OR 4 LETTERS; DATES 1930-31-32-33.
45825
BASTIAN BROS. CO. 925 BASTIAN BLDG., ROCHESTER, N. Y.

Why So Many Home-Shop Owners Use ATKINS Circular and Band SAWS



In his home workshop, Mr. W. C. Miller, San Bernardino, Cal., uses ATKINS Circular, Band and Hand Saws.

ATKINS SILVER-STEEL SAWS

BECAUSE "Silver Steel," used exclusively by ATKINS, makes these saws cut faster, easier, hold their keen tooth-edge longer, and outlast two or three ordinary saws!

That's why thousands of home-craftsmen use the small sizes of ATKINS Circular Saws and Band Saws—just as great mills and factories everywhere use the larger sizes.

For your electrically-driven bench or hand machine, there is an ATKINS Silver Steel Circular Saw to do your work quicker, smoother and better.

For your band saw machine, you can get an ATKINS Saw to do faster, finer cutting.

And you get this same world-famous "Silver Steel" in scores of other ATKINS Saws for your shop. Hand Saws in widest variety—Hack Saw Frames with the New Silver Steel Blades that cut any metal speedier and easier—Back Saws—Compass Saws—Coping Saws—Files and Saw Sets—Scraper Blades—Machine Knives for planers, jointers, etc., and many other fine cutting tools.

See the ATKINS Saws you want at your Hardware Store. Write us for the four helpful saw booklets offered FREE below.



Finest hand saw made. Silver Steel blade. Perfection handle.



Rip or Cross-cut Saws for fast, accurate work on any machine. Made of Silver Steel. All sizes.



Silver Steel Narrow Band Saws for small machines. All lengths.



For fine, smooth cabinet work. It planes as it saws. Silver Steel.



Adjustable frame. Non-Breakable or Silver Steel Blue-End Blades.



The simple, easy way to cut smooth grooves as 1/8" to 1/4" in width.

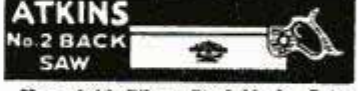

Has rigid Silver Steel blade, 8 to 18-inch. Applewood handle.

GET THESE SAW BOOKS FREE

CIRCULAR SAWS DADO HEADS
SAWS IN THE HOME
SAW SENSE

E. C. ATKINS & CO.
Est. 1857 426 S. Illinois St.
Indianapolis, Ind.

Send me the free booklets "Saws in the Home," "Circular Saws," "Dado Heads," and "Saw Sense."

Name.....
Address.....
My Dealer is

To acquaint **YOU** with
GOODELL-PRATT
 quality we make this
 REMARKABLE OFFER
SEND 1.00
 for **HANDY POCKET
 SCREW DRIVER SET**



To introduce a sample of Goodell-Pratt quality to every tool lover in America, we are offering at the special, low price of \$1.00, this handy tool. Ideal for repair work on radios, fire-arms, clocks, household appliances, etc. Contains three screw driver blades and reamer. When not in use, the chuck and blades are inside as shown. Nickel plated handle. Satisfaction unconditionally guaranteed. Pin dollar bill to this coupon and send in today.

GOODELL-PRATT CO., Greenfield, Mass.
 Attached is one dollar for Pocket Screw Driver Set.

Name.....

Street.....

City..... State.....

My hardware dealer is.....



"Here's the Rule You Need"
The FARRAND RAPID RULE

The Original Rigid—Flexible—Concave Rule

On the job, in the office, or in the home workshop, you will find the FARRAND rule one of the most practical inventions in years. It modernizes old methods of measuring, since it combines the better features of the wooden rule and steel tape without their many limitations.

Ask Your Dealer to Demonstrate

or write to factory for 6-inch sample of rule strip.

Manufactured by

HIRAM A. FARRAND, Inc., Berlin, N. H.

This Modern Woodworker \$45.00



Belt Sander—Saw—Grinder—Drill

Has 1/4 H. P. GE Motor, switch, cord and plug. 3x24 in. sander for strips any length. 6-in. adjustable saw. 5x1/4 in. grinder for any tool or drill. Chuck takes up to 1/4-in. drills. Operates many other tools. Bronze bearings, endless belt, polished table, guards and trimmings lacquered. Size

20x20. Weight 60 lbs. Lowest price known for high grade tool. Satisfactory or money back. Order now or write for circular P.

Steiner-Fulton Products Corporation

5751 Easton Ave. St. Louis, Mo.

BURN YOUR NAME ON TOOLS

WITH THE ARKOGRAF

PROTECT YOUR TOOLS FROM THEFT

Write with electricity any name or design on the hardest and finest tools and instruments, or any metal, like writing on paper with pen or pencil. Complete Outfit \$3.50—Prepaid Anywhere. Interesting illustrated circular free. Write today. Agents wanted. ARKOGRAF PEN CO., 1171 E. Stark St., Portland, Oregon



Makes Old Ford a Tractor

Now you can convert that old Ford car into a useful farm tractor without altering any Ford parts. We furnish the traction wheels, drive gears and auxiliary axle and mountings, ready to clamp on to the Ford frame. Pulls 16' plow.

We supply a Belt Pulley also



Write for Free Particulars. Shaw Mfg. Co., Dept. PM4, Galesburg, Kan.

LE PAGE'S GLUE

HOW TO MAKE YOUR OWN ATTRACTIVE FURNITURE
 Send 10 cents for LePage's New Third Home Work Shop Book, containing complete directions for making 20 different projects. LePage's Craft League, 728 Essex Ave., Gloucester, Mass.

Now! Do Your Own Electric Nickel Plating

Introductory Offer

ONLY \$6.50 Plus Postage



For Plating Nickel, Brass, Copper, Silver, Gold, etc.

A REAL MONEY-MAKING OPPORTUNITY

NO EXPERIENCE REQUIRED. Do YOUR OWN Electro Plating in Your Home, Garage, Office, or Place of Business. Electrically Deposit Metal—Nickel, Brass, Copper, Silver, or Gold. You can Successfully do all the plating on your Automobile, Electric Fixtures, Faucets, Spoons, Forks, Chandeliers, Tools, Coffee Urns, Surgical and Dental Instruments, Utensils, large or small, Iron Stoves, Music Instruments; recondition worn plating or plate New Work; do it Instantly without interrupting the Service or without removing the parts to be plated with the

ALADDIN PORTABLE ELECTRO-PLATER

Simple and Economical to operate. Not a toy, but a practical Plating Outfit with which Perfect and Durable Work can be done. Positively Guaranteed to do as we claim. **BE YOUR OWN BOSS!** Build up a Profitable Aladdin Electro-Plating Business of your Own. This offers wonderful **ECONOMY** to users and **BIG MONEY-MAKING** possibilities to **AGENTS**. Thousands in Service since 1924. Write for **FREE BOOKLET** and Testimonials and **30 DAY TRIAL OFFER** Today.

P. J. F. BATENBURG CO. Dept. 183 RACINE, WISCONSIN

—AGENTS— WANTED EVERYWHERE

ALL STEEL HACKSAW

An all steel, unbreakable hacksaw with perfect balance. The newly designed pistol grip fits the hand comfortably. A rugged fast cutting tool handsomely finished in heavy nickel plate. Sold with a money-back guarantee by hardware dealers.

Crescent Tool Co.
Jamestown,
N. Y.



Other saws, with wood, steel and composition handles. 60c to \$1.25.

CRESCENT and Smith & Hemenway **TOOLS**

Write for Catalog

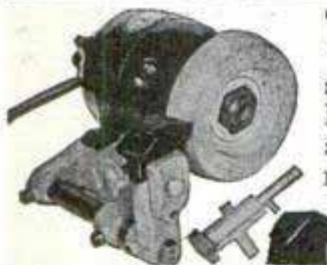

THE WELDON JUNIOR

sharpens shears, scissors and knives; is electrically driven and equipped with two rests, switch, cord and plug.

WELLS MANUFACTURING COMPANY
Box 613, Greenfield, Massachusetts, U.S.A.



GERSTNER Tool Chests

are made in the best possible manner, and are finished very attractively. They are splendid values and are the choice of Machinists and Toolmakers everywhere. Free Catalog.

Gerstner & Sons

476 Columbia Street, Dayton, Ohio

KINKADE GARDEN TRACTOR and Power Lawnmower

A Practical, Proven Power cultivator for Gardeners, Suburbanites, Truckers, Florists, Nurserymen, Fruit Growers.

New Low Prices-Easy Terms
AMERICAN FARM MACHINE COMPANY
1058, 33rd Av. SE. Minneapolis, Minn.



Catalog Free

SALESMEN WANTED!

SELL COX HOLDFAST SCREW DRIVERS

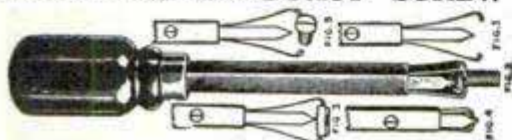

Sells on sight to mechanics for Auto, Radio and Electrical Work. Self Holding, Self Releasing.

Send 50c for sample and ask how to get Salesman's Outfit Free.
S. J. COX Dept. F, FRANKLIN, PA.



Keen edged Files

... with a lasting bite

WHEN you want files that keep their sharp-cutting teeth, no matter how tough the job, choose Simonds. Rugged, durable, specially hardened Simonds Files never quit under fire of hard service. Their perfectly shaped teeth are evenly spaced to give you sure, accurate cutting and long wear. All Simonds Files are made in Simonds plants with the skill developed by years of experience in making the finest quality cutting tools.



SIMONDS SAW AND STEEL COMPANY
FITCHBURG, MASS.

"The Saw Makers" Established 1832
Branch Offices and Service Shops in Principal Cities

SAWS FILES KNIVES STEEL
SIMONDS

PATENT

Protect Your Ideas

Take the First Step Today

If you have a useful, practical, novel idea for any new article or for an improvement on an old one, you should communicate with a competent Registered Patent Attorney AT ONCE. Every year thousands of applications for patents are filed in the U. S. Patent Office. Frequently two or more applications are made for the same or substantially the same idea (even though the inventors may live in different sections of the country and be entirely unknown to one another). In such a case, the burden of proof rests upon the last application filed. Delays of even a few days in filing the application sometimes mean the loss of a patent. So lose no time. Get in touch with me at once by mailing the coupon on the opposite page.

Prompt, Careful, Efficient Service

This large, experienced organization devotes its entire time and attention to patent and trade mark cases. Our offices are directly across the street from the U. S. Patent Office. We understand the technicalities of patent law. We know the rules and requirements of the Patent Office. We can proceed in the quickest, safest and best ways in preparing an application for a patent covering your idea. Our success has been built on the strength of careful, efficient, satisfactory service to inventors and trademark owners located in every state in the Union.

NO CHARGE for Information On How to Proceed

The booklet shown here contains valuable information relating to patent procedure that every inventor should have. And with it I will also send you my "Record of Invention" form on which you can sketch your idea and establish its date before a witness. Such evidence may later prove valuable to you. Simply mail the coupon and I will send you the booklet, and the "Record of Invention" form, together with detailed information on how to proceed and the costs involved. Do this NOW. No need to lose a minute's time. The coupon will bring you complete information entirely without charge or obligation.

My Offices
Just Across
Street From
U.S. Pat. Office



Above is a view of my drafting and specification offices where a large staff of experienced experts are in my constant employ. All drawings and specifications are prepared in my offices.

NEWS

Inventors
Write for these **Free**
Books

Strict Secrecy Preserved

All communications, sketches, drawings, etc., are held in strictest confidence in strong, steel, fireproof files, which are accessible only to authorized members of my staff. Feel free to write me fully and frankly. It is probable that I can help you. Highest references. But **FIRST**—clip the coupon and get my free book. Do **THAT** right now.

Clarence A. O'Brien

Registered Patent Attorney

Member of Bar of: Supreme Court of the United States; Court of Appeals, District of Columbia; Supreme Court, District of Columbia; United States Court of Claims.

Practice confined exclusively to Patents, Trademarks and Copyrights

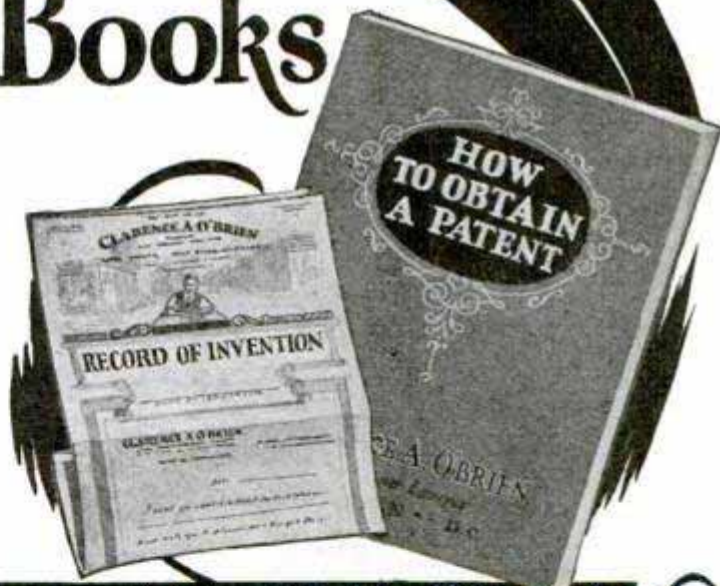

Clip this Coupon and Mail it Now!

CLARENCE A. O'BRIEN, Registered Patent Attorney
703 Security Savings and Commercial Bank Bldg.
Washington, D. C.

(Or, Suite 1106 Woolworth Bldg., New York City)

Please send me your free book, "How to Obtain a Patent," and your "Record of Invention" form without any cost or obligation on my part.

Name.....

Address.....

(Important—Write or print name plainly and address office nearest you)

PATENTS TRADE MARKS COPYRIGHTS



Our New York Office
Suite 1007 Woolworth Bldg.



Our Philadelphia Office
828 Fidelity Phila. Trust Bldg.



VICTOR BUILDING
Our New Building Nearly Opposite U. S. Patent
Office Specially Erected by Us for Our Own Use



Have You An Idea?

Our Offer: FOR THE PROTECTION OF YOUR INVENTION

YOUR FIRST STEP—The Inventor should write for our blank form "RECORD OF INVENTION." A sketch and description should be made on this Blank, signed, witnessed, then returned to us. We also give our opinion as to whether the invention comes within the Patent Office definition of a patentable invention. This "Record of Invention" will serve as "proof of conception." *There is no charge or obligation for this service.*

Our Five Books Mailed Free to Inventors
Our Illustrated Guide BOOK

How to Obtain a Patent
Contains full instructions regarding U. S. Patents. Our Methods, Terms, and 100 Mechanical Movements illustrated and described.

Our Trade Mark Book
Shows value and necessity of Trade Mark Protection. Information regarding *Trade Marks and unfair competition in trade.*

Our Foreign Book
We have Direct Agencies in Foreign Countries, and secure Foreign Patents in shortest time and lowest cost.

Progress of Invention
Description of World's Most Pressing Problems by Leading Scientists and Inventors.

Payment of Fees in Installments
It is not necessary that the total cost for the preparation and prosecution of a patent be paid in one payment. Our custom is to permit our clients to pay for their applications in three installments as the preparation of the application progresses in our office. This plan makes the payments easy for the inventor.

We Regard a Satisfied Client as our best advertisement, and furnish anyone, upon request, lists of clients in any state for whom we have secured patents.

**Highest References—Prompt Service
—Reasonable Terms**

VICTOR J. EVANS & CO.

Patent Attorneys, Established in 1898
Main Offices: 789 9th St., N. W., Washington, D. C.
Nearly Opposite U. S. Patent Office

DELAYS ARE DANGEROUS IN PATENT MATTERS

IMPORTANT! To Avoid Delay!

YOU SHOULD HAVE YOUR CASE MADE SPECIAL IN OUR OFFICE to save correspondence, secure protection and early filing date in the Patent Office. To secure **special preparation** of your case send \$25.00 on account with model or sketch and description of invention. If the invention is not patentable we will return fee less cost of search.

We Assist our Clients to Sell their Inventions.



Our Chicago Office
Suite 1640-42 Conway Bldg.



Our Pittsburgh Office
Suite 514 Empire Building

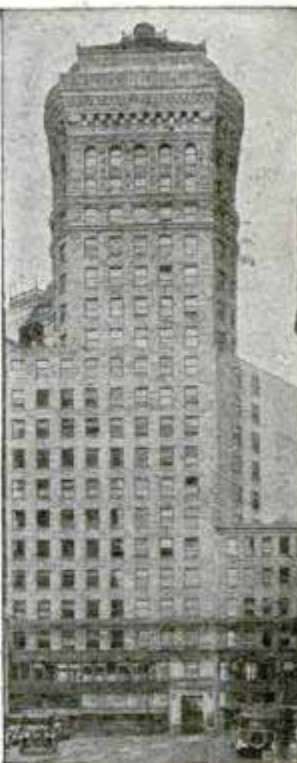

Our San Francisco Office
Suite 1010 Hobart Building

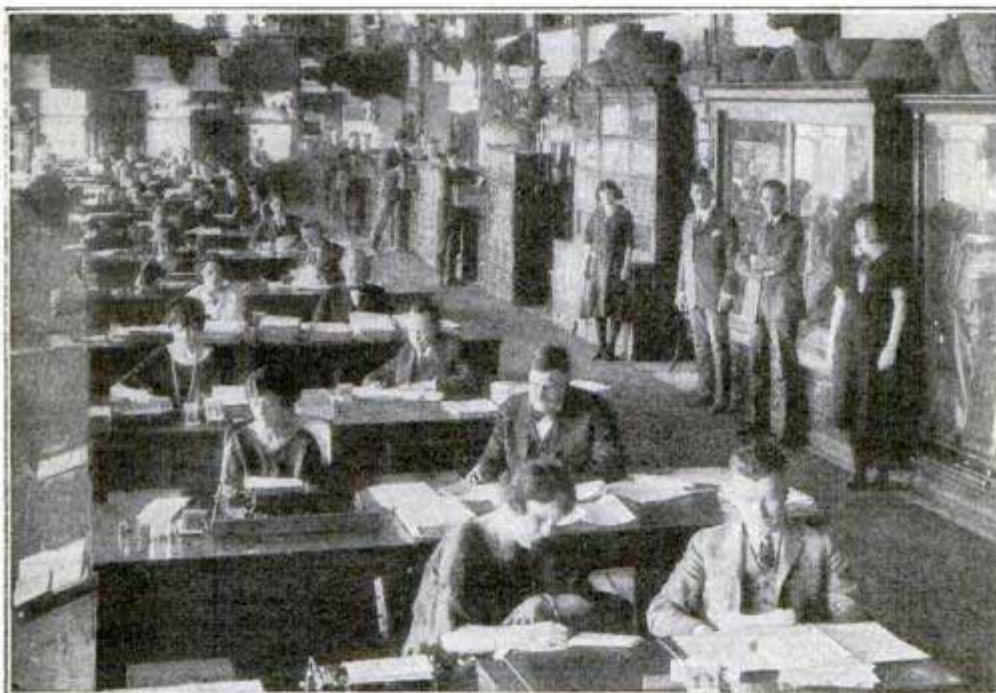

MAIN OFFICE, VICTOR J. EVANS & CO.—VICTOR BUILDING, WASHINGTON, D. C.

Our Large, Comprehensive Organization has been established for 30 years and offers Prompt, Efficient and **Personal Service** by experienced Patent Lawyers and Draftsmen. Every case is in charge of a Specialist who has been selected for his knowledge and experience in certain lines of invention. Our Lawyers practice in all U. S. Courts and defend clients in suits involving Patents, Trademarks and Copyrights. All Communications, Sketches, Drawings, etc., preserved in fireproof Files, strictly **Secret and Confidential**. We shall be glad to have you consult us or to answer any questions in regard to Patents, Trademarks or Copyrights without charge or obligation.

**FREE
COUPON**

VICTOR J. EVANS & CO.
PATENT ATTORNEYS *Established in 1898*

NEW YORK OFFICES
1907 Woolworth Bldg.

CHICAGO OFFICES
Suite 1640-42 Conway Bldg.

PHILADELPHIA OFFICES
828 Fidelity Phila. Trust Bldg.

PITTSBURGH OFFICES
514 Empire Bldg.

SAN FRANCISCO OFFICES
1010 Hobart Bldg.

MAIN OFFICES: 789-9th Street, N. W., WASHINGTON, D. C.

Gentlemen: Please send me *Free of Charge* your books as described on preceding page.

Name

Address

PATENTS

Booklet Free Highest References
Promptness Assured Best Results

Send drawing or model for preliminary examination and advice.

ALL BUSINESS GIVEN PROMPT AND PROPER ATTENTION

Listed Patent Lawyer in the latest editions of the Rand-McNally Directory of Bankers and Bonded Attorneys, published by Rand-McNally & Co., Chicago, Ill.; The Baggott & Ryall Directory of Guaranteed Attorneys, published by Legal Directory Corporation, Boston, Mass.; Flugel's Law List, published by Legal Directory Publishing Co., St. Louis, Mo.; American Lawyers Annual, published in Cleveland, Ohio; Bankers Service Legal Directory, published by Bankers Service Co., Boston, Mass.; Eyre's Law List, 9 Park Place, New York City; Walters Legal Directory, Omaha, Nebraska, and the National Directory of Attorneys, Baltimore, Maryland.

WATSON E. COLEMAN,
REGISTERED PATENT LAWYER

Victor Building, 724 Ninth Street, N. W.
WASHINGTON, D. C.

PATENTS

To the Man with an Idea

PATENTS Procured. Trade Marks Registered. —A comprehensive, experienced, prompt service for the protection and development of your ideas. Preliminary advice gladly furnished without charge. Booklet of information and form for disclosing idea free on request.

IRVING L. McCATHRAN, Patent Lawyer
Formerly with and successor to RICHARDE. OWEN
704 International Bldg., Washington, D. C.
41-E Park Row, New York City

TRADE-MARKS
REGISTERED

DO YOU

WANT a new business profession of your own, with all the trade you can attend to? Then become a foot correctionist, and in a few weeks earn big income in service fees,—not medical nor chiropody—easy terms for home training, no further capital needed, no goods to buy, no agency. Address

Stephenson Laboratory, 1 Back Bay, Boston, Mass.

PATENTS

As one of the oldest patent firms in America we give inventors at lowest consistent charge, a service noted for results, evidenced by many well-known Patents of extraordinary value. Book, Patent-Sense, free. Lacey & Lacey, 646 F St., Washington, D. C. Estab. 1869

PATENTS

PROTECT YOUR IDEAS

Write today for FREE INSTRUCTIONS—or send Drawing or Model of your Invention for Examination.

Promptness Assured with Best Results

CARL MILLER
REGISTERED PATENT ATTORNEY

Former Member Examining Corps U. S. Patent Office
255 McGill Building Washington, D. C.

PATENTS

Trade Marks, Copyrights, Patent Litigation Handbook with illustrations, 100 mechanical movements. Sent free on request.

ALBERT E. DIETERICH

formerly member Examining Corps U. S. Patent Office

REGISTERED

PATENT LAWYER and SOLICITOR

621-A, Ouray Bldg.

30 Years' Experience Washington, D. C.

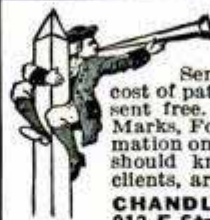

PATENTS

Send us sketch or model for advice and exact cost of patent. Our book "How to Obtain a Patent" sent free. It tells how to apply for Patents, Trade Marks, Foreign Patents, Copyrights, etc.; gives information on Patent Procedure; tells what every inventor should know. Thousands of Inventors, who are our clients, are our reference.

CHANDLEE & CHANDLEE, 25 Years' Experience
912 F Street Washington, D. C.

PATENTS SECURED TRADE-MARKS REGISTERED

High-class professional service for Inventors and Trade-Mark Users is necessary for PROPER PROTECTION. We Offer you our facilities on Reasonable Terms. If you have an invention send us a model or sketch and description and we will give you our OPINION whether your invention comes within the provisions of the Patent Laws. Our book, "HOW TO GET YOUR PATENT" and Record of Invention Certificate sent on request. DELAYS are DANGEROUS in Patent Matters.

Terms Reasonable.

Best References.

WRITE TODAY

RANDOLPH & COMPANY, Patent Attorneys

301 VICTOR BUILDING, WASHINGTON, D. C.

Name.....

Address.....

\$165,000 REWARD for an IDEA

That sum was paid to the inventor of "Kiddie Kars". Here is a remarkable book which tells you what inventions are NEEDED in every field. Don't waste your ideas. Send today for **1,000 NEEDED INVENTIONS**

Prepared by Raymond F. Yates, famous inventor, former managing editor of Popular Science Monthly, who knows what manufacturers want. New, revised 1930 edition contains valuable chapters on Aviation and Television. This book may start you toward a fortune. Send no money. Just write a postcard. Pay mail man only \$1.50 plus postage when book arrives. Money back after ten days if desired. Limited offer. Write now. Get started in right direction. (Outside U. S. \$1.70 cash with order.)

Bureau of Inventive Science 34 Wisner Building
ROCHESTER, N. Y.



PATENTS TRADE-MARKS

**Don't Lose Your Rights
To Patent Protection**

Before disclosing your invention to anyone send for blank form "EVIDENCE OF CONCEPTION" to be signed and witnessed.

LANCASTER, ALLWINE & ROMMEL
480 Ouray Bldg. WASHINGTON, D. C.
Originators of forms "Evidence of Conception."

PATENT YOUR INVENTIONS

EDWARD GOTTLIEB
Attorney in Patent Causes
5 Beekman Street New York
Inventions Developed—Representatives for
BLAIR TOOL AND MACHINE CORP.



GEARS IN STOCK— immediate delivery

Gears, speed reducers, sprockets, thrust bearings, flexible couplings, pulleys, etc. A complete line is carried in our Chicago stock. Can also quote on special gears of any kind. Send us your blue-prints and inquiries. *Write for catalog No. 10.*

Chicago Gear Works
769-773 W. Jackson Blvd., Chicago, Ill.

**\$10.00 PER MONTH BUYS
Fibre-Life Limbs**



NEXT TO NATURE. BRACES MADE TO ORDER. AGENTS WANTED. FREE FIBRE SAMPLE **WORMAN CO.** 252-P HENNEPIN AVE. MINNEAPOLIS, MINN.



NOSE *Beautiful*

NO OPERATION—
••30 DAY HOME TRIAL••
Dr. Josephs Nose Corrector can make your nose beautiful by moulding flesh and cartilage to desired shape. Worn night or day in absolute comfort. Amazing and lasting results in shortest time. **FREE BOOKLET tells all.** Write today.
DR. JOSEPHS, Inc.
Dept. D-18 Irvington, N. J.



*I'll hand it
to you!*

I'll hand it to you for doing your darnedest to get your hands clean with ordinary soap. But, man, you can't do it with ordinary soap. I've tried, and I know. The only soap I've found which can do it is Lava Soap. Ask Jim, or Ed or Bill—fellows who have work like yours—they know Lava, too. They'll tell you it's the best hand-friend they've got. It gets the grime and grease, but leaves the skin behind. Gets work-stained hands clean in 58 seconds, because it's made from pure vegetable oils and pulverized Italian pumice that's almost as fine as flour. Makes a rich, creamy lather in the hardest water.

George, the Lava Soap Man

Lava costs a dime (or 6c for the medium size cake) at any drug or grocery store. But if you want to try it at our expense, mail this coupon.

Procter & Gamble, Dept. W-430
Cincinnati, Ohio

George: I want a free sample cake of your Lava Soap.
Name.....
Street.....
City.....State.....



BOW LEGS?

THIS GARTER (Pat'd)
Makes Trousers Hang Straight
If Legs Bend In or Out
Free Booklet—Plain Sealed Envelope
THE T. GARTER CO., Dept. E
South Bend, Ind.

MEN OUT OF WORK

WONDERFUL CHANCE TO MAKE
\$15 a Day

Join this old, established, million-dollar manufacturing company. Wonderful openings in every locality with chance to make \$12 to \$15 a day handling orders for fast-selling ZANOL Food Products, Toilet Preparations and Household Necessities. 350 high-quality products at low prices. Fast sellers. Big orders in every home. Repeat business. No capital or experience needed. Big profits.

Ford Tudor Sedan Free
We offer you a Ford Tudor Sedan free on our plan of giving a car to producers as an extra reward or bonus—in addition to large cash profits. Start at once. Full particulars free.

American Products Co.
5632 Monmouth Ave. Cincinnati, Ohio





Where's the can of PLASTIC WOOD?

(Reg. U. S. Pat. Off.)

Cracks around a built-in tub. Water slopping through. Seal up the cracks with Plastic Wood, or Plastic Wood White Waterproof Tile Cement (which dries to a hard flat white).

Not only for bathroom cracks, but for gouged or broken furniture, loose handles, rotted wood, mouse holes and other household repairs or depreciation, Plastic Wood is invaluable. It is an inexpensive, practical, household repair product that often saves many dollars and anyone can use. It handles like putty, hardens into wood, is waterproof and grease-proof, and takes paint, lacquer or varnish perfectly.

Plastic Wood Solvent

When working with Plastic Wood, keep a can of Plastic Wood Solvent on hand to soften it if it hardens too rapidly, thin it if necessary, and clean the hands and tools after using. At dealers, in 25 and 50 cent cans.

Handles
Like
Putty



Hardens
Into
Wood

Tube 25c.— $\frac{1}{4}$ lb. can 35c.—1 lb. can \$1.00

At Hardware and Paint Stores

ADDISON-LESLIE CO., 426 Bolivar St., Canton, Mass.

"Your Eye Sees It—

250



Times Larger"

MADE IN
U. S. A.

WOLLENSAK MICROSCOPE \$ 16.50

SOLVE the mysteries of insect, plant and mineral life with the Wollensak Microscope. Reveal to yourself the beauties of nature hidden from the unaided eye. One of these fine microscopes should belong to every student, dentist, physician, or scientist and should be part of the equipment of home, office, school, or laboratory. It gives a range of magnifications from 100 to 250 diameters in steps of 25. Elaborately finished tilting stand, nickel trim, plush lined case, prepared slide, complete instructions. Ask your dealer, or we will send you one postpaid. *Money back guarantee.* Lower powered Wollensak models \$2.50 to \$8.50. Catalog free.

WOLLENSAK OPTICAL COMPANY
867 Hudson Avenue Rochester, N. Y.



BOYS! Make Big Money

BUILD BIRD HOUSES

Here's a real money maker. With my simple instructions any boy can build and erect Grandpa Bird Houses. They sell at \$2 to \$97.50 each. \$2000 worth sold in Oak Park, Ill., in a year. Send \$1 for my big collection of work shop plans for boys who want to have fun and make money building my famous bird houses. Valuable information about song birds and tips and advice on making sales included *Free*.

GEO. J. BREIDERT, 1040 N. Elmwood Ave., Oak Park, Ill.

SOLDERALL

METAL IN PASTE FORM



The
Only
Convenient
metal
solder

Every Electrical
Connection needs
Solderall for perfect reception

25¢

The SOLDERALL CO., NEWARK, N. J.

231

miles an hour!



Kingsbury

"Golden Arrow" 21 in. long. \$3

Most sensational toy in years! Exact copy of the fastest car in the world—Major Segrave's "Golden Arrow." Lifelike in every detail. Beautiful golden-bronze finish like original. Hidden wheels. Real Dunlop rubber tires. Built all of steel. Equipped with racing speed clock-steel motor. Fastest toy on wheels. 21 in. long. \$3. (West of Miss. \$3.30.) Also Sunbeam and Blue Bird Racers, \$3 each. If your dealer cannot supply you, send your order to us.

KINGSBURY MFG. CO., 83D Myrtle St., Keene, N. H.

Send 10c for a Kingsbury Disc Wheel,

Balloon Tire Eraser. Set of 4, 35c.

KINGSBURY MOTOR TOYS

FREE

Wonderful novelty—moniscope. Twist the leaves in your hands and it un-reels a motion picture of a thrilling airplane flight. Also shows all kinds of the most lifelike toys you ever saw. Send today.



WHOLESALE
Mills-to-You
SAVINGS



5 Rooms, Bath
Modern Throughout
\$992



6 Rooms, Bath
Modern Throughout
\$1495

BE YOUR OWN CONTRACTOR!

Build your own permanent home and save \$2000. Any work you do counts as cash. Earn as high as \$1.75 an hour building your own home! Get the facts: Our easy-to-follow instructions and correct plans simplify building. That's why 80% of our customers do all or part of the work themselves. 20% employ contractors. Since 1865 we have made it possible for 225,000 families to build safely and profitably.

You get everything from our own building material factories, lumber mills, huge warehouses and distributing yards. We furnish machine-sawed materials for a complete house; ready for exact fitting; saves 30% hand labor and 18% lumber waste.

Modern designs, beautiful interiors, built-in convenience features. Finest lumber, millwork and insulation. Frame, brick or stucco. Satisfaction guaranteed. Write—

Gordon-Van Tine

World's Largest Specialists in Home Building Since 1865

1484 Case St.,

DAVENPORT, IOWA

100 Home Plans FREE

Send me free () Book of Homes; () Book of Garages; () Book of Poultry Houses; () Book of Building Material.



Name.....

Address.....

LITTLE SAXO
Auto Clothes Hanger

A Practical, Valuable little "Wonder." Slip it on window in a half second, then hang hats, coats, purses, maps, ANYTHING conveniently out of your way. Most useful article for all motorists and tourists. Causes no interference. Sample 25c. Box of 50, \$4.00. Salesmen write quick for money making plan.

Frank Saxton, Mfgs., Dent. P.M.-4 Blissfield, Mich.

EXACT INSIDE MEASURE

MASTER INTERLOX SLIDE RULE

Every kind of Inside Measurement. Just slide out the MASTER till it reaches from stop to stop. No guessing. Quick results. Locks rigid in use. Without equal for Outside measure, too.

Dealers and Agents Wanted
MASTER RULE MFG. CO., Inc., 821 E. 136th Street, NEW YORK CITY

BUY OR BUILD A HEATH PARASOL

\$975 READY TO FLY
America's Popular Sport Plane is the shortest way to aviation. 10c in stamps or coin brings large illustrated booklet.

HEATH AIRCRAFT CORPORATION, Dept. P-4, 1721 Sedgwick St., Chicago, Ill.

SELL PIONEER All Wool Tailoring
Full or Part Time

4.50 to \$7.00 PROFIT Per SUIT (WITH BONUS)

An opportunity to make \$12 a day from the start, selling famous Pioneer tailored-to-measure, all-wool suits at \$25. Commissions paid in advance. Chance for own clothes at no cost. Striking Big Outfit of over 100 large swatches furnished free—other equally remarkable values at \$30 and \$35. We train the inexperienced. Men willing to work for success will write for this big money-making opportunity, today.

Cash Paid Daily

PIONEER TAILORING CO.
Congress and Throop Sts., Dept. R-1116, Chicago

A Perfect Shave Every Day for Life

THE best shave you've ever had—every morning for the rest of your life. Think of it! No more agonizing face scrapes, no more fussing with "stoppers," no more blades to buy. The Bello Hollow Grinder will give you two newly ground concave edges on your Gillette blades for every shave—edges that slide through the toughest beard and leave your face cool and comfortable. Bello is guaranteed a lifetime—there's nothing to wear out. It makes stoppers as out of date as the old fashioned shaving mug. Its first cost is its last!

FREE 10-DAY TRIAL!
Start today to get the best shaves you've known. Try Bello ten days at our expense. Mail or copy the coupon and we'll send you the razor cloth that saves the family towel—FREE.

BELLO HOLLOW GRINDER

Bello Corp., Dept. M4, Gardner, Mass.
Let me try Bello for 10 days and send me my free razor cloth.

Name.....
Address..... St. Check here for agent proposition.
City..... State.....
My bank is

JAPANESE ROSE BUSHES

The Wonder of the World

Japanese Rose Bushes bloom all the year round. Just think of it. Six weeks after planting the seed, the plants will be in full bloom. It may not seem possible, but we positively guarantee it to be so. They will bloom every ten weeks, Summer or Winter, and when three years old the bush will be a mass of roses, bearing from five hundred to a thousand roses on each bush. The flowers are in three shades—white, pink, and crimson. The plants will do well both in and out doors. We guarantee at least three bushes to grow from each packet of seed. Price, 10c packet, 3 pkts. for 25c postpaid.

10 Cts.

Chinese Fragrant Tree Fern

Just introduced; noted for its rapid growth. An exceptionally pretty ornamental plant. Foliage is rich dark green. Forms grand pyramidal bushes about 5 feet high. Branches very desirable for decorative purposes, wreaths, etc. Seeds 15c pkt., 3 for 40c.

Weather Plant

NATURE'S WEATHER PROPHECY By mysterious changes that take place, this remarkable plant accurately forecasts the weather many hours in advance. Will grow anywhere all the year around. An interesting house plant. Bears large, fragrant, pink, butterfly shape flowers. Seeds, 15c packet, 3 for 40c, postpaid

THE REMARKABLE FIREFLY PLANT A Vine that Blooms at Night



Fills the Atmosphere with Fragrant Aroma One of the most rapid growing vines known. Under favorable conditions this vine has been known to grow OVER 25 FEET IN A SINGLE WEEK. In a very short space of time indeed the Vine has climbed to a great height, and is covered with IMMENSE FLOWERS, from 5 to 7 inches in diameter. It is, indeed, a great novelty, for, unlike other plants, the flowers OPEN IN THE EVENING, and remain open until about noon the following day. In dull weather they will remain open all day. It is a most INTERESTING SIGHT to watch the opening and closing of the flowers as the clouds appear and disperse. As the flowers open they give forth the most DELIGHTFUL AROMA and the whole atmosphere around is full of scented fragrance. It is always the object of favorable comment, and much curiosity is aroused by people passing at night time as to the cause of the charming aroma, frequently stopping in an endeavor to satisfy their curiosity. PRICE, 19 CENTS packet, two packets for 35 CENTS, POSTPAID. JUNIOR SMITH & CO.

GROUND ALMONDS

Amazingly Prolific—Easily Grown From Seed The Ground Almond has a flavor that is MOST EXCELLENT, resembling the coconut. The meat is snow white, covered with a shell or skin of brown color. It grows close to the surface and anything from 200 to 300 Almonds may be expected from a single nut. There is no trouble whatever in growing anywhere and in any kind of soil. May be planted any time, and in eight or ten weeks from time of planting you will have an ENORMOUS CROP of the MOST DELICIOUS ALMONDS YOU EVER TASTED. Seeds 15c Pkt.



The Great Wonderberry

A luscious berry that may be grown and ripened from seed in any soil or climate in 3 months. The flavor is fine and unsurpassed for eating raw, cooked, canned or preserved in any form. The fruit is black in color, and tastes like a luscious, rich blueberry. One bush will produce an enormous amount of fruit, yielding great masses of rich fruit all Summer and Fall. Packet, 10c, 3 pkts. for 25c, postpaid.

Bush Musk Melon

A vineless Musk Melon, grows in bushes, and thus can be cultivated in the smallest garden. The fruit is of the popular "Jenny Lind" type, but larger, averaging 6 inches in diameter. The flesh is very deep, edible almost to the rind and is colored light green, flushed with a taint toward the center. The quality is superb, lusciously sweet and juicy. Packet of seeds, with full directions for culture, 15 cents, 3 packets for 40 cents, p.pd.

Perfume Plant

Blooms only at night, giving forth the most delightful scented fragrance for quite a distance. Causes much comment. For house or garden. Also valuable because of rare perfume made from it. SEEDS, 10c pkt., 3 for 25c.

SENSITIVE PLANT

Marvel of the Philippines. Leaves curl, fronds droop when touched. Apparently resents interference. A handsome shrub for house or garden; very curious and interesting. Seeds, 15c pkt., 3 for 40c.

The Great Umbrella Palm A Graceful House or Conservatory Plant

Easily Grown From Seed Winter or Summer The Japanese Umbrella Palm is a semi-aquatic plant. It is easily grown from seed either in a bowl of water or in very damp soil. Probably the most usual, as well as the most interesting method, is to cultivate the plant in a bowl or jardiniere filled with water, with two or three inches of good garden soil at the bottom. The seeds soon commence to germinate, and the plant shoots up stems two to three feet high and rapidly assumes a most pretty palm-like appearance, as shown in the engraving. The tops of the stems are surmounted by a whorl of umbrella-shaped leaves, of a waxy appearance. We will send a package of this seed, with full instructions for culture, for only 15c or three packets for 40c postpaid.



Calabash or Pipe Gourds

A luxuriant and rapid growing climber; thrives anywhere. Produces the ornamental gourds from which the famous African calabash pipes are made. Grow this interesting vine and make your own. Seeds, with instructions, 15c pkt., 3 for 40c.

Japanese Nest Egg Gourd

Very curious. Produces fruit same size and color of nest eggs. Matured fruit does not crack. Will serve for years as a nest egg, stocking darrer, ornamental purposes, etc. Seeds 15c pkt., 3 pkts. for 40c. J.S. & CO.

Butterfly's Own Bush

This plant is a veritable refuge or haven for butterflies, and it attracts all the most beautiful types of butterflies to the neighborhood. Bears, too, a very good crop of it. It is a pretty plant bearing perfectly double flowers, ranging from white to rich crimson, deep red and pink, lilac and other delicate shades. Packet 10 cents, 3 for 25 cents postpaid.

FAMOUS MEXICAN FIREFLY PLANT

Beautiful hedge plant, grows 2 to 2 1/2 feet high and resembling a closely clipped ornamental evergreen. The globe-shaped or pyramidal bushes are close and compact, and of a pleasing light green color. May be grown singly or in the form of a hedge or background. In early autumn the whole bush becomes carmine or blood red, hence the name of Mexican Fire Plant, or "Burning Bush," as it is sometimes called. Selected Seeds, 10c

Mammoth Peanuts

Peanuts can be easily cultivated. Their culture is very simple and exceedingly interesting. Mammoth Peanuts grow to an astonishing size. It is a good producer, very prolific, and the giant nuts have a thick, heavily ribbed protecting shell. The plant is very attractive, the leaves being of odd shape and a handsome green shade, tinted through the center with white. You will derive much pleasure cultivating this interesting species. Seeds 15c pkt., 3 pkts. for 40c.

Musk Plant

A universally admired favorite for house, flower garden or greenhouse. A very fine house plant, leaves for 24 hours of the sweet scented variety, giving forth much fragrance. Also valuable on account of the perfume that can be made from it. Seeds 15c pkt., 3 for 40c.

Japanese Climbing Cucumber

Unusually strong and vigorous growing vine. Attains twice the size of ordinary varieties. Grows readily on fences, poles, trellises, etc. One hill will keep an entire family supplied all summer. Seeds 15c packet, 3 for 40c, postpaid.

CROWN OF THORNS

A very curious clover-like plant, can be cultivated indoors or outdoors, the three red blotches on the leaves representing the three wounds of Christ. Has curious thorny seed ball; if loosened at tip the hull is found to consist of a long prickly seed, and giving the plant its name. Seeds 15c packet, 3 for 40c.

Asparagus Sprengeri

The best plant for hanging baskets. Masses of rich, gleaming foliage droop in a very graceful manner. The foliage when cut for decorative purposes will last for weeks in water. The seed pods are very pretty red berries adding to its beauty. Packet, 25c, 3 pkts. for 65c postpaid

GIGANTIC NEW GUINEA BUTTER BEANS

THE NEW EDIBLE VEGETABLE WONDER Grows to an astonishing size, the Beans measuring from 3 to 8 feet long, and weighing anything from 10 to 16 lbs., and even more. One Bean is sufficient for a family for several meals. Very gainable and rich in nutritious materials. The delicate Buttery Flavor is much appreciated. The Vines are easily grown, very prolific, and a most welcome and valuable adjunct to your garden. Try them; you will find them the most delicious vegetable you have ever tasted. Imported direct. Unobtainable elsewhere. Sample package of Seeds with full directions for cultivating and cooking. 25c, postpaid.

Yard Long Bean

Produces enormous crop of long, slender, round pods, of excellent quality for snap beans. Pods grow from 2 to 5 feet in length. Very tender and fine flavor. The vines are rampant growers; an interesting curiosity. Seeds, 15c pkt., 3 for 40c

"Wong-Bok" Chinese Cabbage

Novelty from China and should be grown in every garden. Seems to be a cross between Celery and Cos Lettuce. Flavor is more mild than any other cabbage. Can be served on the table and eaten raw or cooked like cabbage, spinach or lettuce or made into salad. Grows very rapidly, easy to cultivate. You can create quite a sensation by cultivating this remarkable novelty. Seeds, 15c packet, 3 pkts. for 40c.

TREE OF HEAVEN

This splendid ornamental tree is a native of China, and is called the Tree of Heaven, on account of its great beauty. Very hardy, thrives in any soil, no matter how poor, and grows from 6 to 10 feet high from seed the first summer. The leaves are from 5 to 6 feet in any length, giving it a grand appearance. Nothing outside the tropics can rival it for lawn decoration. Large panicles of bloom, followed in season by great clusters of colored seed pods, make the tree a continual thing of beauty. Packet, 15c; 3 packets 40c

Kudzu Vine

Most rapid growing vine known. Will grow 20 feet in one week. Luxuriant foliage, lovely purple flowers, very fragrant. Nothing to equal it for shade purposes and quick growth. Seeds 15c packet, 3 for 40c.

Yard Long Bean

Produces enormous crop of long, slender, round pods, of excellent quality for snap beans. Pods grow from 2 to 5 feet in length. Very tender and fine flavor. The vines are rampant growers; an interesting curiosity. Seeds, 15c pkt., 3 for 40c

SURPRISE FLOWER GARDEN Over Hundred Varieties of Mixed Flower Seeds

MANY RARE AND CURIOUS NOVELTIES An Abundance of Flowers Assured Throughout the Season A mixture of easily grown annuals that bloom very soon after sowing the seed; others vary in their time of blooming. Those who cannot give the constant care necessary for finely arranged flower beds will be delighted with the Surprise Wild Flower Garden. Will prove a continual surprise and pleasure, as new varieties and the old garden favorites flower successively throughout the season. There are over a hundred varieties of seeds. Many of the plants may be taken inside as house plants and will bloom during the winter. Fine for children, also teachers for school gardens. Packet, 15 cents, three packets for 40 cents, Postpaid. J. S. & CO.

A PERFECT PAINT GUN

The Electric Paint Brush

DIRECT FROM FACTORY

1/2 Price

\$39.50



3 EXTRA COLOR CANS FREE

ALL STEEL PRODUCTS CO.

DEPT. A-4
1245 Michigan Theater Building
DETROIT, MICH.

SURE SPRAY

Guaranteed to work perfectly with any kind of paint including heavy lacquer. Does work equal to or better than large outfits costing hundreds of dollars. Clogging made impossible by patented invention developed by leading engineers after a decade of research. Perfect work on smallest articles, machines, automobiles, or on big surfaces, buildings, etc. Made to sell at \$80.00. Half Price factory-to-you offer for 30 days. Order Now.

FREE
Send your name for large illustrated broadside telling all about it.

FOR ONLY \$30.78

You can secure a welding—carbon removing, lead burning and radiator outfit combined.

FOR ONLY \$6.00

You can secure a Soldering and Brazing Outfit, using acetylene only.

Write for particulars and catalog. The Superior Oxy-Acetylene Machine Co., Box 285 . Hamilton, Ohio.



Build your own outboard hydroplane motor or sail boat. Use our plans or knock-down frames and machined parts. Many models to select from. Write for new catalogue.

J. B. WELCH, Dept. B, 724-31st St., Milwaukee, Wis

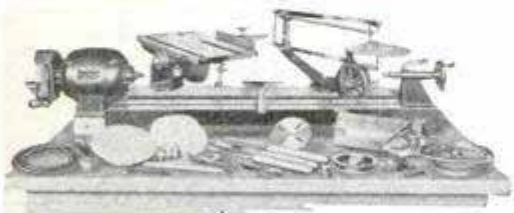

The KING of Them All

AR-CON UTILITOO

is the master-workman's idea of what a home work-shop should be. Sturdy, powerful, accurate. 1/2 HP repulsion-induction motor; no radio interference. Send 4¢ in stamps for complete data and terms.

THE AR-CON TOOL COMPANY
500 Fassett Street Toledo, Ohio

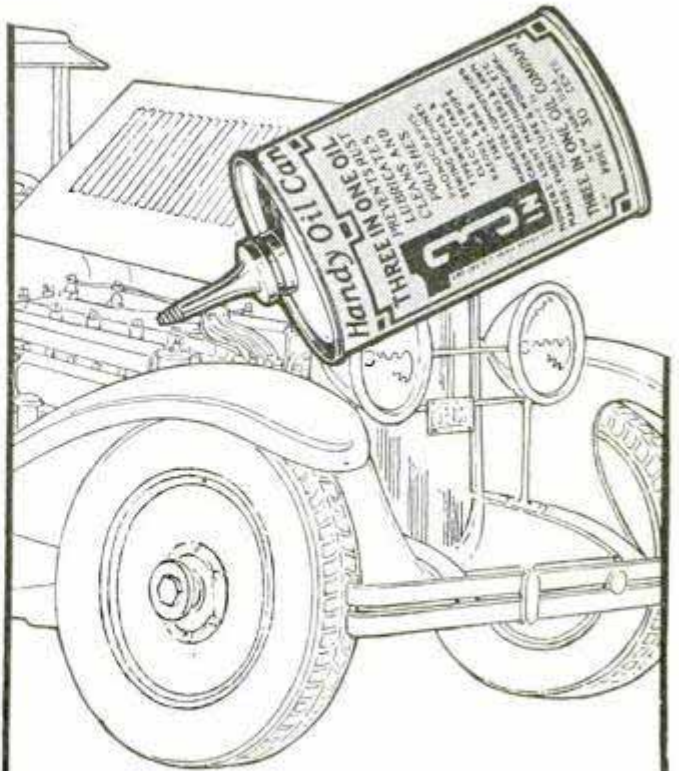

As Necessary as a Tool

Keep a Handy Can of 3-in-One in your car and you will use it more often than most any tool. "It's the little thing that does big things." Here's where many Auto Dealers and Repairmen use

3-in-One

Prevents Rust-OILS-Cleans & Polishes

- ✓ Starter
- ✓ Generator
- ✓ Horn
- ✓ Distributor
- ✓ Model T Ford Timer
- ✓ Windshield Wiper
- ✓ Hinges
- ✓ Latches
- ✓ Locks
- ✓ Hood Hooks
- ✓ Body Squeaks
- ✓ Spring Squeaks
- ✓ Cleaning Glass
- ✓ Polishing Body
- ✓ Polishing nickel and protecting it from water spots, rust and tarnish

The vital properties of several highest quality oils are scientifically blended in 3-in-One. That's why it costs a trifle more than ordinary oils but does so very much more.

Sold everywhere by auto accessory, hardware, grocery, drug and general stores.

Manufactured Since 1894
THREE-IN-ONE OIL CO.
130 William St., New York

FREE SAMPLE

Generous sample and Dictionary of Uses. Request both on a postal.



DIAMONDS CASH WATCHES
or **CREDIT**

Send for Our Big Free Catalog
2,000 Illustrations. Catalog explains everything.

How to Order

Send first payment—state article desired—name of employer—kind of work you do—how long in position—age—married—where live—how long there. **EVERYTHING IS CONFIDENTIAL.** Send first payment, OR goods sent Prepaid for your **FREE Examination** on request.

No. 949—Dinner ring, set with three fiery blue white Diamonds; ring of solid 18-K white gold. **\$60. \$1.50 a Week.**

No. 918—Blue white center Diamond; two smaller blue white Diamonds on sides of solid 18-K white gold ring. **\$37.50. \$1.00 a Week.**

No. 944—Sparkling blue white Diamond set in square top ring of solid 18-K white gold. **\$48.50. \$1.25 a Week.**

CREDIT TERMS:
One-tenth down; balance weekly, semi-monthly or monthly at your convenience.
Buy Now

No. 950—Bracelet Watch, solid 14-K white gold, 15 Jewels. \$5 Kreisler mesh bracelet included, **\$25. \$2.50 Down; \$2.50 a Month.**

No. 927—Elgin "Legionnaire" **\$19. \$1.90 Down; \$1.90 a Month.**

LOFTIS NATIONAL JEWELERS
BROS. & CO. ESTD. 1858
Dept. M-894, 108 No. State St., Chicago, Ill.
Stores in Leading Cities

THIS "STERLING" HOME for \$1194

Big Special Discount for Cash!



Here's a modern 7-room home that you can build yourself and save money. We ship you the lumber cut-to-fit, freight paid to your station. Our simple plans and new system of cutting make it easy for anyone to build a Sterling home. No skilled labor necessary. Our customers claim average savings of 47% over local builders' prices.

Rock-Bottom Prices!



Our large volume of sales enables us to quote rock-bottom prices and sell on time-payments without high interest or financing charges. Terms as low as \$8.10 per month. Send 25c today for beautiful Color Book of NEW Sterling Home Plans and learn how you can buy a home with your rent money.

International Mill & Timber Co.
344 S. Wenona Ave. Bay City, Mich.

Cal. 30-40 Six Shot



KRAG CARBINE

All the qualities of a high price rifle. In fine used condition, all working parts guaranteed for one year. Send today for our Free 60-page illustrated catalog of money saving values; Guns, Ammunition, Cutlery, Sports and Gov't goods. Deposit required on all orders. Money refunded if not satisfactory.

Price \$9.75

W. Stokes Kirk, Dept. P. M. 4, 1627 N. 10th St., Phila., Pa.

MOVIES AT HOME

LET US SEND OUR INTERESTING AND FREE CATALOGUE OF MOVIE MACHINES—AS LOW AS \$3.75 POSTPAID—USE STANDARD OR 16mm. SIZE—COMPLETE LINE OF FILM SUBJECTS AVAILABLE WITH EXCHANGE SERVICE—LOWEST PRICES—DON'T DELAY—WRITE FOR FREE CATALOGUE

PARAMOUNT MFG. CO.

BOSTON DEPT. G-26 MASS.

ROUNDS SHOWS EARN EXTRA MONEY!

NEW VEST POCKET ADDING MACHINE

BABY CALCULATOR
CHICAGO U.S. A. PATENT APPLIED FOR

ADDS, SUBTRACTS, MULTIPLIES, DIVIDES
Does work of \$300 machine. Guaranteed 5 years. NOT A TOY.
Made of steel and indestructible. Million dollar capacity. Fits in pocket. Will not make mistakes. So simple child can operate it. Instructions furnished. Everybody should carry one for figuring.

FREE TRIAL \$2.50 Total Cost

SEND NO MONEY—Just name and address. We will ship Calculator immediately. On delivery pay postman \$2.50 (Plus few cents Postage). (If outside U. S. send cash.) 10c additional in Leatherette Case. If not satisfied after 10 days trial you get your money back. **THOUSANDS OF SATISFIED USERS.**

This is lowest priced practical calculator made. "Why pay more for inferior imitations?" Order from this ad.

Guaranteed

Mail Coupon Today

BABY CALCULATOR MACHINE CO., (MANUFACTURERS)
Dept. 41, P. O. Box 1118, CHICAGO, ILL., U. S. A.

I am enclosing \$2.50—send adding machine prepaid.
 Send Adding Machine C. O. D. \$2.50 plus 18c postage. (10c additional in Leatherette Case)

Name.....
Address.....
City..... State.....

AGENTS Write for big commission and territory proposition.

PANTS MATCHED!

Why Throw Away That Coat and Vest? Save \$25 or more! Let us match your coat and vest with new trousers and save the price of a new suit. Each pair tailored to your measure. (Average price \$8.50). Over 100,000 patterns. Mail sample of suit, or your vest which will be returned together with FREE Sample for your approval.

MATCH PANTS CO., Dept. 302
20 W. Jackson Blvd. CHICAGO

Originators and Largest Pants Matchers

CAMPBELL'S

RELIEVES PAIN QUICKLY

INFRA-RED RAY LAMP

Have You a Troublesome Ailment?

Infra-Red Rays Relieve Aches and Pains in the Body
These rays penetrate deeply into the tissues. As they penetrate they create an active circulation of the blood. Relieve Bronchial trouble, Neuralgia, Neuritis, Sinus trouble, Catarrh, Asthma, Rheumatism, Tonsillitis, Lumbago and many other ailments with soothing Infra-Red Rays. 30 days' FREE TRIAL. Sent on approval. Easy payments. Agents wanted.

Write for FREE BOOK giving full information
WM. CAMPBELL CO., Dept. 1040, ALLIANCE, OHIO

Men Wanted by 17 Million Dollar Industry



**Good Pay Every Day
Independence for Life
Stop Working for Others
Own Your Business**

Help yourself to a better income the well known Rawleigh way. 7500 already started—thousands still needed to extend Rawleigh's International Service. Starting without experience many now doing \$10,000 annual business; others \$8,000; many \$3,000 to \$6,000; leaders \$15,000 to \$17,000. With their profits many have purchased homes, farms, automobiles. You too can own a Rawleigh business. Experience unnecessary—

but little capital. We supply everything needed in Stocks and Equipment to start and succeed. Use our resources—over \$17,000,000—our 17 great Factories, Branches, Plantations, U. S., Canada, Australia. Established over 40 years. Annual sales over 40,000,000. World's greatest market, the home. Nearly 200 home necessities, Medicines, Food Products, Soaps, Toilet Preparations, Stock, Poultry Supplies. Best values, quality, quantity, price. Best sales and service methods. Big repeaters on merit. Lifetime business. By all means send us your name. Demand proof. Our offer will surprise you. It's free and convincing.

**THE W. T. RAWLEIGH COMPANY
DEPT. D-31 PPM FREEPORT, ILL.**

DEAFNESS IS MISERY



Multitudes of persons with defective hearing and Head Noises enjoy conversation, go to Theatre and Church because they Use Leonard Invisible Ear Drums which resemble Tiny Megaphones fitting in the Ear entirely out of sight. No wires, batteries or head piece. They are inexpensive. Write for booklet and sworn statement of the inventor who was himself deaf.



A. O. LEONARD, Inc., Suite 699, 70 5th Ave., New York



SUNLIGHT FOR HEALTH, NEW LIFE AND VIGOR

Special low price on Mann CARBON ARC Ultra Violet Lamp—complete with carbons, etc., only \$8.50. Produce genuine Ultra-Violet Ray in your home! Aids and maintains health, relieves pain, builds up vitality! Has automatic device and uses big 8mm carbons. Efficient, powerful and easy to use. Built extra strong and durable. 12 1/2 in. high. **SEND NO MONEY!** Pay postman \$8.50 on arrival, plus postage. Try it! If not more than delighted with results, return it and your money will be promptly refunded. Descriptive literature free on request.

Ultra Mfg. Co., (Lamp Dept.) 121 N. Francisco Ave. CHICAGO

WORLD'S GREATEST SELLERS



Laymon's 5c and 10c Merchandise Counter Display Cards of Medical and Confection Products Here's the Line that's in wide-spread demand. Big Repeats. Advertised nationally and by radio. **Pays Salesmen 100% profit daily in advance**

8 years of successful merchandising. No cash needed! Write quick for FREE complete outfit. **WORLD'S LARGEST PRODUCERS OF 5c ASPIRIN**
WORLD'S PRODUCTS CO.
612 Main St. Spencer, Ind.

San Francisco representative made \$90 first three days.



Here's an Amazing New Business ^{THAT PAYS UP TO} **\$1,000 A MONTH**

MEN, here is a real, red hot money-making opportunity! It's a chance to jump into business for yourself and make more money every week than the average man makes in a month.

Surprising as it may sound, we actually put you in a business, with the first day's profits often running from \$18 to \$55. \$350 to \$600 the first month is not unusual for ambitious men.

Cut in on the Big Money

All you need is the ambition to make real money. We supply you with complete equipment to make and sell that famous new food specialty—Brown Bobby—a greaseless doughnut baked by electricity!

It's a crispy, flaky, delicious new kind of doughnut cooked without one drop of oil or grease. Easily digested by everyone. More appetizing than old-style doughnuts ever were. Costs less to make. Sells four times as fast. No baker's skill required. Just add water to our prepared "Mix." You can open a shop; rent cheap floor space in a grocery, delicatessen, lunch counter, drug store, etc. Or start at home—and make up to \$250 your very first week.



"I made \$3,000 in 3 months from my greaseless doughnut business!" — T. Chas. Mineh, Fla.

Start at Once ANYWHERE!

Men and women everywhere are starting in this business daily! YOU cannot afford to delay! Details will gladly be sent without obligations of any sort. Such an amazing money maker may never come your way again. So fill in and send the coupon at once! **TODAY—**

FOOD DISPLAY MACHINE CORP.
Dept. 34, 500-510 N. Dearborn St., Chicago, Ill.

Food Display Machine Corp.,
Dept. 34, 500-510 N. Dearborn St., Chicago, Ill.

Gentlemen: Please send me the plan by which I can cash in on Brown Bobby, the Greaseless doughnut. It is understood that this obligates me in no way whatever.

Name.....

Address.....

City.....State.....

SAWS FILED
FOLEY FILER SERVICE

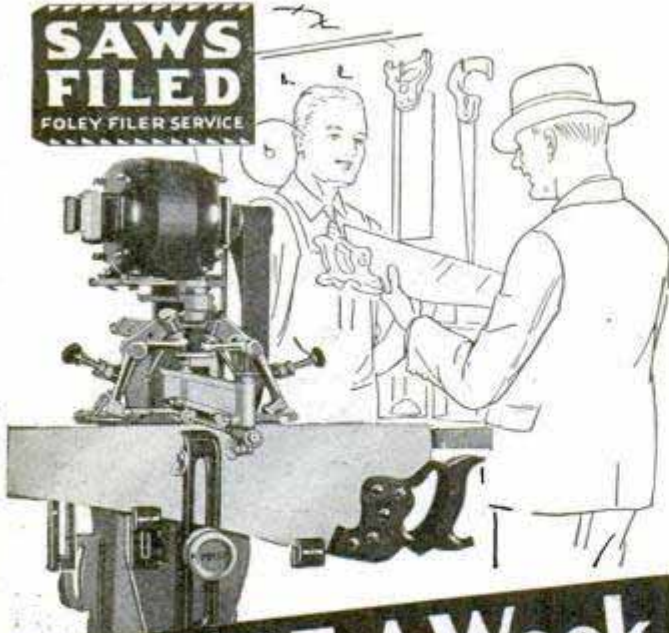

**Add \$25 A Week
To Your Present Earnings**

**Free Plan
Helps You Start!**

Many men are earning \$10 to \$25 a week extra money in their spare time—some even more—filing saws on the Foley **Automatic** Saw Filer. Walter S. Thompson writes, "In 6 months I made an average of \$26 per week in spare time." You can quickly develop a fine paying, cash business of your own too, by starting in spare time at home.

**The Foley Model F-5
"3-Way" Auto-matic Saw Filer**

One machine automatically files all hand saws, band saws and circular saws with such mechanical precision that they cut better and stay sharp longer. Easy and simple to operate—no experience necessary.

**\$10
Brings
It to You**

Steady, Cash Business

No Canvassing. Saw users want their saws filed the Foley way because they are so much better than hand filed saws. **Free Plan** shows you how to get the business, and the excellent work you can do on the Foley makes steady, repeat customers. Don't delay—investigate now.

Mail Coupon for FREE PLAN

Foley Manufacturing Co.

200 Foley Bldg., 11 Main St. N. E., Minneapolis, Minn.
Please send me Free Plan and tell me how I can make extra money in my own business with the Foley.

Name.....
Address.....
City & State.....



PATENTS

TRADEMARKS—COPYRIGHTS

Before showing your idea to anyone, send for new—"DUPLICATING INVENTION RECORD"—you keep a copy for evidence and send me a copy for advice and exact cost of patent. Prompt Personal Service. Advice and Record free on Request.

JOHN J. LYNCH, Registered Patent Attorney
41-E. Park Row, 704 International Building,
New York City, Washington, D. C.



SEMI-BUILT

any type or size, assemble yourself, save half. Stamps for catalog.

TRUSCOTT BOAT CO., Dept. E, ST. JOSEPH, MICHIGAN



**At 48..A Wreck!
At 50..A MAN!**

'A WRECK—a derelict—a has-been when I should have been in the prime of life! That was my situation at 48. Tormented by ceaseless pain in my back and legs; sleepless because I had to get up as often as ten times in one night; subject to "blues" and mental depression! I had reached, I think, the lowest ebb of my powers, mentally as well as physically.

"I stood it for six months—stood the ravages of prostate gland disorder. Specialists did me no good. Finally they said I'd have to have an operation.

"Yet today—at 50—I look and feel ten years younger than I am. One little book—plus an amazing scientific treatment—brought back the health and the strength that was my right. I can do twice as much work as I could two years ago—and it tires me less."

Thousands of men past 40—men who are in or near the later years of life have stories to tell like this one, which is based on the actual experience of a Chicago man. In two thirds of men past middle age the tiny prostate gland—painless of itself—causes symptoms like those named above. Thousands of men who think they suffer from "bladder troubles" and "premature old age" pains are actually victims of the prostate gland.

Today two hundred thousand men have learned the real truth about this common gland weakness from an extraordinary book, "The Destroyer of Male Health." They have learned, too, how science has found an amazingly easy quick way to combat the ravages of this weakening gland disease. Send today and get this book for yourself—free and without obligation. Learn these vital facts about gland health. The coupon's for your convenience.

THE ELECTRO THERMAL COMPANY
2128 Morris Ave. Steubenville, Ohio

If you live west of the Rockies, mail your inquiry to The Electro Thermal Co., 303 Van Nuys Building, Dept. 21-E, LOS ANGELES, CALIFORNIA



The Electro Thermal Company
2128 Morris Ave., Steubenville, O.

Without obligation to me, please send me your sensational free book, "The Destroyer of Male Health," and full details of the new treatment.

Name.....
Address.....
City.....State.....

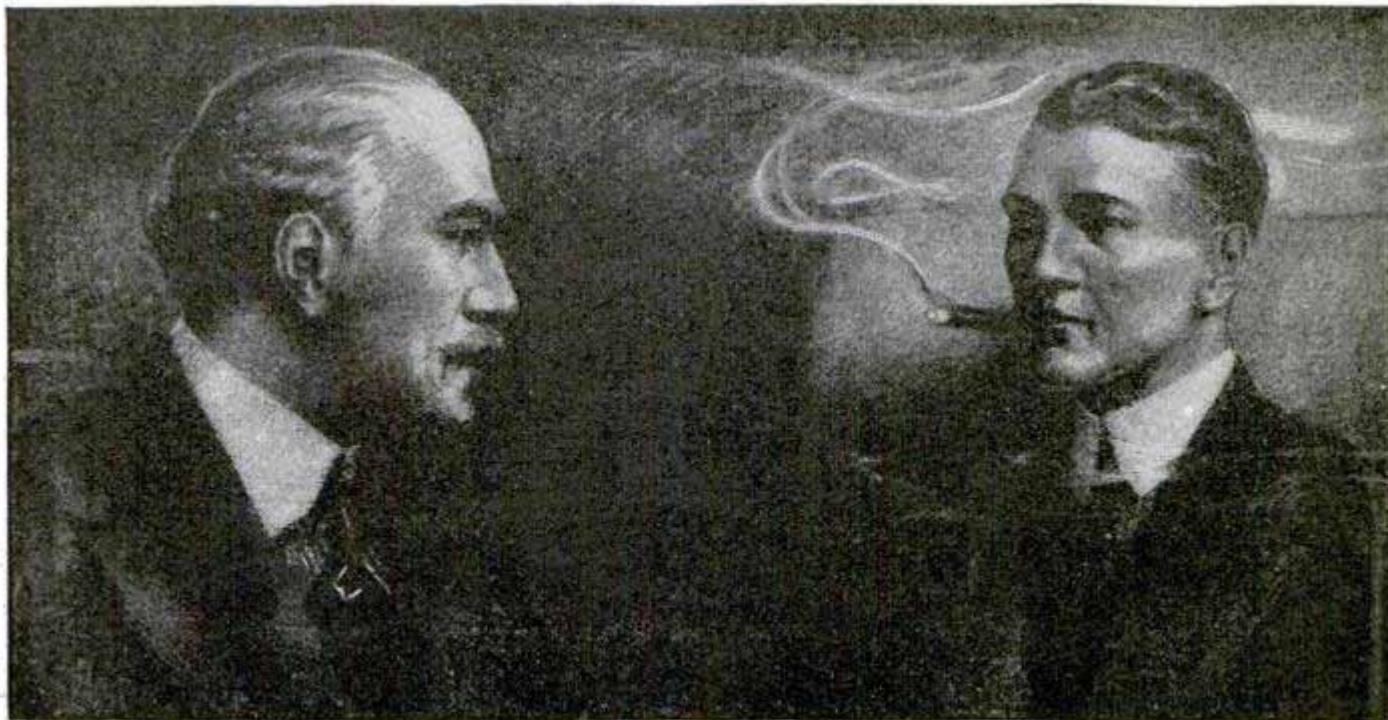

Is Tobacco Hurting You?

Look the facts square in the face, Mr. Tobacco User. You may think tobacco is not hurting you.

That is because you haven't as yet, perhaps, felt the effects of the nicotine poison in YOUR system. For you know that nicotine, as absorbed into the system through smoking and chewing tobacco, is a slow working poison. Slow, yes—but sure.

Tobacco lowers efficiency. It slows a man down. Makes it harder to concentrate the mind on work. Tobacco users seldom have the amount of "pep" and energy of those who do not use the weed. There's many a man older than you in years who is younger in energy, simply because he lets tobacco alone.

Some day, probably, you will realize to what an alarming extent tobacco does undermine the system.

When your hands begin to tremble—
and your appetite begins to fail—
and your heart seems to "skip a beat" now and then—
and slight exertion makes you short of breath—
then you have a right to suspect that
TOBACCO is getting the upper hand.

Any well-informed doctor will tell you that these are only a few of many symptoms of tobacco poisoning.

And YOU know that the use of tobacco in any form is an expensive, utterly useless habit. You know you ought to quit.

Tobacco Habit Banished In Many Cases—Let Us Help You

It doesn't make a particle of difference whether tobacco has been used for a single month or fifty years, or how much, or in what form—whether cigars, cigarettes, pipe, plug, fine cut, or snuff. In most cases, Tobacco Redeemer removes all craving for tobacco in any form in a very few days. Not the slightest shock to the nervous system. The tobacco craving will usually begin to decrease after the very first dose—there is no long waiting for results.

Tobacco Redeemer contains no habit-forming drugs of any kind and is quick, safe, pleasant and thoroughly reliable.

It is in no sense a substitute for tobacco. After finishing the treatment, there is usually no desire to use tobacco again or to continue the use of the remedy. It helps to quiet the nerves and makes one feel better in every way.

Our Guarantee

A single trial will convince you. Our legal, binding, money-back guarantee goes with each full treatment. We will refund every cent you pay for the treatment if, after taking it according to the easy-to-follow directions, it should fail to banish the tobacco habit completely.

SEND Coupon for Free Proof

Let us send you our free booklet on the injurious effects of tobacco, together with testimonial letters from men all over the country telling how they have been absolutely freed from the tobacco habit by this simple home treatment. You could not ask for stronger proof that Tobacco Redeemer usually does do the work than the evidence we will gladly send on request. Just mail the coupon—or a postal will do.

NEWELL PHARMACAL CO.

Dept. 300 Clayton Station St. Louis, Mo.



Free Book Coupon

NEWELL PHARMACAL CO.

Dept. 300 Clayton Station St. Louis, Mo.

Please send, without obligating me in any way, your free booklet regarding the tobacco habit and proof that Tobacco Redeemer does positively relieve the tobacco habit in most cases. If it fails your money will be refunded.

Name.....

Street and No.....

Town..... State.....

Earn BIG MONEY with this Making Money Equipment



30 DAYS TRIAL

Pay out of Income Terms

No Expense to You

Start a Money Making Business of your own. Mechanics, Filling Stations, Repair Shops, Garages and Battery Stations are all making BIG MONEY with HB 8 Hour Battery Service. Recommended by the leading car and battery makers. Constant Potential lets you give a better charge than the other fellow in one-third the time, and at a saving of 30% to 50% on current. Anyone can operate. Check coupon below for full information on how to get started in this money making work. **Shouldn't Cost You a Cent. Pays for Itself—Brings a Big Profit Besides.**

Only \$16 Monthly



20-Minute Car Washing

The best paying work in automotive field today is 20 minute car washing. Puts you above competition—eliminates all drudgery! Users report \$100 weekly profits. Liberal trial, easy terms. Savings in labor and material over other methods will easily pay for it.

Earn 5 Men's Wages

Portable Paint Spray does the work of five brush painters. You get four men's wages as profit. Paints Cars, Houses, Garages, Barns, Furniture. No experience necessary to operate. Check coupon for trial offer and terms.



Paint Spray



Air Service

Profitable Air Service

Free Air Service costs you only \$10 monthly for a few months. Fully Automatic day and night service will draw customers to your shop as well as operate your air tools. Check coupon for full details without obligation.

HOBART BROS., Box M40, Troy, Ohio

---Tear off and Mail Today---

Hobart Brothers, Box M 40, Troy, Ohio.

Send me complete information on the items I've checked—your thirty-day trial offer—easy payment terms—information on how HB equipment will increase my earnings.

HB 8 HOUR BATTERY CHARGER
 HB TEST BENCH HB PAINT SPRAY
 HB AIR SERVICE HB 20-MINUTE CAR WASHER

Name.....Address.....

Stage Money



New Bills To Conform With Small Size Currency

With these bills it is easy for a person of limited means to appear prosperous by flashing a roll of them at the proper time. By peeling off a genuine bill or two from the outside of the roll, the effect created will be all that can be desired. Prices, postpaid: 50 bills 20c; 140 for 50c, or \$3.00 thousand postpaid.

Fire-Eater

A great trick by which you appear to breathe fire from mouth. Quite harmless. All necessary apparatus sent complete for only 30c, postpaid.



Black Art

This book tells of the sciences of Magic, Witchcraft, Alehemy, Necromancy, Mesmerism, etc. It tells how to make persons think of you, how to charm those you love, etc. The book contains 122 pages. Price 30c prepaid.



OAKS' MASTER BOX OF TRICKS

Mystery and entertainment for every day in the year. Whole evening's entertainment complete for \$1.00. Without practice or experience, anyone can give a complete entertainment with these mechanical and self-working tricks so simple that a child can perform. Contains apparatus for 7 complete tricks. The Magic Ball and Vase Trick. Wooden ball is placed inside, and upon replacing the lid has disappeared and is found in someone else's pocket; Disappearing Spots. This trick consists of changing four Kings to four Aces, and then to blank cards; Magnetic Wand. Magician's Wand clings to fingers and floats about as if magnetized, yet falls when anyone else tries; Ribbon Factory from the Mouth Trick. A seemingly endless supply of colored paper ribbon comes out of the mouth; Disappearing Handkerchief. Handkerchief held in the mouth mysteriously vanishes; Enchanted Bottle. No one but yourself is able to make it lie down; Great Hat and Dice Trick. Large dice is placed on top of hat, disappears, and is found underneath, yet no one has touched the hat. Only \$1.00 for all.



OAKS' CARD MIRACLES



Complete box of our most popular card tricks. Easily performed with instructions for each trick. Box contains Disappearing Spots, Hindoo Cards, Phantom Cards, Pick It Out Cards, Satan Card Trick, Educated Card Dice Trick, Knockout Cards, Diminishing Card Trick and Wonderful Ace Trick. If purchased separately would cost \$1.00. Special complete, only 50c.

MULTIPLYING BILLIARD BALLS



Magically producing a solid billiard ball, the conjurer simply moving his hand thru the air, causes a second ball of the same size to appear beside it. Everyone watching closely, a third appears in like manner. Then to the amazement of all, a fourth appears. Make them vanish singly until hand is empty. Per set, 35c. Larger sizes, \$1 and \$1.25.

Buddha's Money Mystery



With this contrivance it is apparently possible to change a blank piece of paper into a bill of any denomination. Can be performed easily by anyone. Only 25c.

Serpent's Eggs



When lit with a match each egg hatches itself into a snake several feet long, curling and twisting in life-like manner. Box of 12, 10c postpaid; 3 for 25c.

Send 10c in stamps or coin and our 1930 catalogue, DeLuxe Edition, containing 202 pages of all the latest tricks and novelties, will be sent to you. We are the largest dealers in tricks of all kinds in the world. Order from this advertisement or send for our catalogue today. **FREE—Our large die box trick when you have sent in orders amounting to \$25 within one year.**

OAKS MAGICAL COMPANY
Dept. 812 . . Oshkosh, Wisconsin

TRICKS MAGIC JOKES

FREE

SCIENTIFIC NOVELTY CO.
PARK PLACE, N.Y.C. CATALOG POSTAL BRINGS IT

ATTRACTIVE NEW BINDERS

For POPULAR MECHANICS MAGAZINE

Your choice of colors: blue, green, brown, red or black in beautiful and durable art binders at \$1.25 postpaid. Your name in gold on front cover for 25 cents extra. Address **POPULAR MECHANICS CO., 200 E. Ontario St., CHICAGO**

Amazing new kind of RUBBER

Makes Any Auto Tire PUNCTURE-PROOF

for a Few Cents

"SILVER STAR" is an emulsified compound of Pure Rubber Latex. Stops Punctures Instantly and Automatically. Not a filler. You ride on air. Applied in a minute without taking tire off wheel or rim. Seals slow leaks and porous tubes. Don't confuse with anything else you have ever heard about. "Silver Star" is absolutely New—different and scientifically correct. Compounded from Pure Rubber by a newly perfected process the result of five years of intense chemical research. The cost per tire is very low—often less than the price of fixing one puncture.



At Our Risk—Make This Test

Hammer as many nails into a tire as you wish, pull them out or leave them in—just as you please—no air will escape—no pressure will be lost. We welcome you to subject "Silver Star" to the severest tests you can devise. Results will amaze you. Get convincing facts today.

AGENTS Big enthusiastic crowds gather whenever "Silver Star" is demonstrated. We want live, energetic distributors everywhere. No talking—just hammer nails in an old tire and make the most powerful, attention compelling, self-selling demonstration ever devised. If you are earning less than \$100 per week, you can make this the most profitable proposition in the direct selling field today—bar none. Exclusive Territory Rights—Honest Money Back Guarantee—Low Selling Price—Liberal Profit. Write or wire NOW for complete information. Territory going fast—don't delay—Send Today.



VILO MFG. CO. 159 N. Michigan Ave., Dept. 22, CHICAGO
CANADIAN PLANT—GALT, ONT.

FREE RADIO BARGAIN CATALOG
WHOLESALE PRICES!
Send today for this big money saver.
A postal brings it.
Buy from Radio's Oldest Mail Order House.
Radio Specialty Co.
98E PARK PLACE
NEW YORK CITY



Get This—True "Santa Maria" Ship Model

Made in knocked down form with all parts carefully cut to fit, each part carefully numbered so as to make assembling easy from drawing and instruction sheet furnished with each kit. Sails and flags with colored designs at no extra cost. Very educational and interesting pastime; when completed you have a handsome ornament for your radio cabinet or mantel.

SIZE
23 1/2" Long, 22" High
10" Wide

\$5.48 Plus Postage
Mailed C. O. D. anywhere in U. S. A.
Foreign orders must be accompanied with U. S. money order or check.

COLARK CO., INC.
2213 E. Susquehanna Ave., Phila., Pa.

This CATALOG tells how to Select the Right OUTBOARD For Your BOAT

Answer all your outboard questions from the pages of this handsome new Caille Catalog. Here is the information you need to make the right selection of power for your boat—full data on hulls, engines, speeds, etc.

CAILLE RED-HEADS have electric starting plus **MULTI-FLEXIBLE CONTROL**. Your boat will handle like an automobile when it's powered with a Caille Red Head. Here is the only outboard motor in the world that gives you electric starting, plus Multi-Flexible Control. Start it in neutral, back out of the slip, shift to slow, trolling, or high speed at the touch of a hand! Full ball bearing construction throughout gives smooth operation, long life and low oil consumption. New big free catalog, handsomely illustrated, tells how to get more fun out of boating. **WRITE FOR IT!**



CAILLE MOTOR COMPANY
6454 Second Blvd. Detroit, Mich.

Mail coupon for your copy

Gentlemen: I want real automobile control for my boat. Please send me the Caille Catalog that tells how to get it.

Name _____
Address _____

Hi 30 The World's Premier Custom-Built RADIO



Band-Filter Tuning
Screen-Grid Amplifier
Six Tuned Circuits
World-Wide Range

NO radio produced in large quantities can even approach the skilled perfection of the new Custom-Built "HiQ-30." Here is the most efficient model ever presented by Hammarlund—the climax of five years of unequalled custom designing and famed throughout the world for power, selectivity and tone. Assemble it yourself with factory-built units or we'll recommend a local custom-builder to do it for you. Choice of magnificent cabinets and speakers, \$139.50 to \$1,175 complete, less tubes.

Mail coupon for 48-page "HiQ-30" Manual

Hammarlund-Roberts, Inc.
424-38 W. 33rd St., N. Y.
Enclose 25c (stamps or coin) for "HiQ-30" Manual. PM 4
Name _____
Address _____

LOOK!



We'll
Loan
You
This
"SAX"
FOR FREE!

With it a complete Home Instruction Book for beginners. It's so easy you will play "America" in 30 minutes, and all popular airs in a short time. In a few weeks you can join band or orchestra or play solos and duets at home. Be popular. This offer is FREE. Send no money. It's a beautiful new

Holton.

factory guaranteed instrument. You keep saxophone and Easy Instruction Method 10 days. Return at our expense, or keep and pay only \$8 on easy payment plan. Same remarkable FREE LOAN offer on any Holton trumpet, trombone, clarinet or other band instrument. Send no money. No obligation to buy. Just

Send This Coupon

FRANK HOLTON COMPANY,
428 Church St., Elkhorn, Wisconsin
Send on 10 days FREE loan a Holton Saxophone with Complete Easy Method book, or.....(Other Instrument)

Name.....
Address.....
City..... State.....

FREE INSTRUCTION BOOK



A New Money Maker for Agents!

Sell new kind of automatic window washer. Carries own water supply. Stores, housewives, autoists buy on sight. Write for money-making proposition and free sample offer.
NATIONAL INDUSTRIES, 67 E. Lake St., Dept. 154, Chicago, Ill.

ARTISTIC ENLARGEMENTS

Size 16x20 inches

Surely you have a photo of some dear one, mother, dad, baby, or friend that would enlarge beautifully and bring out the lifelike features perhaps better than in the small picture. The usual price of this work is \$5.00, but our price is only 98c.

98c

SEND NO MONEY

Just mail photo or snap—about any size, full figure, bust or group. Within a week you will have your enlargement, size 16 x 20, or smaller, if desired. Guaranteed indecible. Pay postman 98c plus postage, or send \$1.00, and we pay postage. Money back, if not delighted.

FREE With each enlargement we send Free a hand tinted miniature reproduction of photograph. Take advantage of this amazing offer now. Send photo today.

ALTON ART STUDIO, 5654 West Lake St., Dept. 80 Chicago, Ill. Please send.....enlargements from enclosed photo. I will pay postman 98c plus postage for each enlargement. (If \$1.00 cash for each enlargement is enclosed with this order, we pay postage.)

Name.....
Address.....
Town..... State.....

Check Size Wanted
 16x20 in.
 10x16 in.
 11x14 in.
 8x10 in.

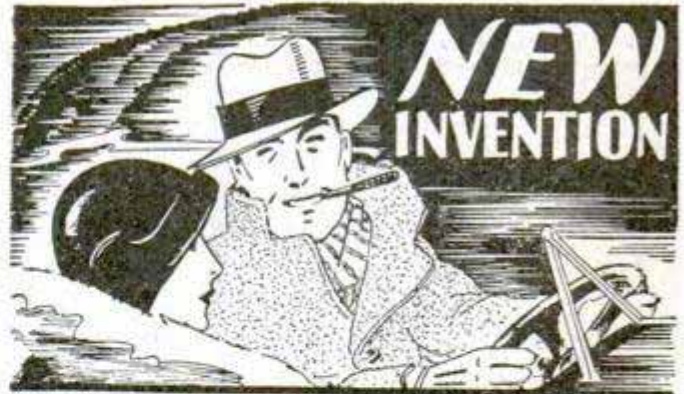

BRINGS SALESMEN UP TO \$125.00 WEEKLY
Ash-Pak, amazing cigarette holder, completely encloses cigarette, prevents ashes from falling, sparks from flying! Smokers snap it up—auto drivers buy on sight. Safe! Sanitary! Sells for \$1.00. You make big cash profit on every sale.

GET YOUR ASH-PAK FREE

New, sensational selling plan offers you your Ash-Pak FREE. Your role will sell dozens in every block. No experience necessary—merely show and sell. An amazing money-maker—every smoker wants one. Made of bakelite in assorted colors. Rapid-fire seller brings you steady year-round profits. Write immediately for details of FREE Ash-Pak offer.

ASH-PAK Safety Cigarette Holder

Ashes cannot fall—sparks cannot fly—makes cigarette smoking safe, cooler and sweeter. Pays you big cash profits.

THE NORLIPP COMPANY
Dept. C-4, 569 W. Congress Street
CHICAGO, ILL.

Build a Ship Model at Home

For Pastime and Pleasure



It is a wonderful fascination and a beautiful decoration for your mantel, radio cabinet or it may be used in any part of the home.

Santa Maria—Size—25" high, 10" wide, 27" long\$4.98
La Pinta—Size—26" high, 11" wide, 27" long\$4.98

Mayflower—Size—26" high, 10" wide, 30" long\$4.98
Constitution—Size—25" high, 8" wide, 29" long\$6.98
Flying Cloud—Size—27" high, 9" wide, 36" long\$6.98
These prices are f. o. b. Philadelphia, plus a few cents postage.

These models are sold in knock-down form. All parts are cut to fit and ready to assemble. They will be sent anywhere in United States C. O. D.

Money order or check must accompany all foreign orders.

Write for free illustrated catalog

MINIATURE SHIP MODELS, Inc.

Dept. RT-4, 3216 BARING ST., PHILADELPHIA, PA.

SUPER OIL BURNER

10 LBS 100 GALLONS OR MORE IN LESS THAN HOUR

TERRIFIC HEAT

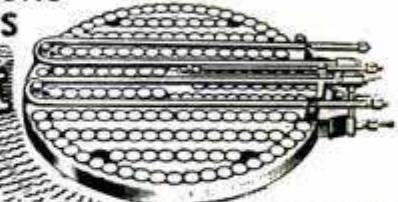

MOST REMARKABLE GIANT BLUE FLAME BURNER BUILT.

Ideal for gas fired boilers, heating large vats and tanks for factory, farm, agricultural and many other uses. (Burns outdoors as well as indoors.) Develops heat for 20 Horsepower gas fired boiler. Easy to install and operate.

NO SOOT NOISE SMELL SMOKE

DOUBLE HEAT AT HALF COST

Improved generators, convert ordinary kerosene oil into rarefied superheated gas, producing intensely hot blue flame capable of boiling from 100 to 500 gallons of water or other liquid. Double generators assure continuous performance without shut downs. 150 lava flame discs intensifies heat. Equipped with all accessories. Nothing to buy.

QUICK STARTING — PERFECT FLAME CONTROL

Equipped with pilot light for quick starting. Improved valve control, regulates heat to any degree desired same as city or natural gas. For heavy or light duty this super-pressure oil burner gives entire satisfaction. Write for Catalog of Giant Thermo-o-gas Burners, also smaller general utility burners for cook stoves, heaters, pressing machines, etc.

HOME MFG. CO., Dept. 4213, 20 E. Kinzie St., Chicago, Ill.



Boys win a BICYCLE

Hi, Buddy! Get a swift new bike like these fellows have! You can quickly do it in your spare time. Besides, you can win any of three hundred other dandy prizes—and make big cash commissions!

Join the Crowell Club and deliver The American Magazine, Woman's Home Companion and Collier's, The National Weekly, to regular customers. No experience is necessary. You can start immediately. Mail the coupon today!

These boys mailed a coupon like this. It starts you on the happy road to money and prizes. Mail it NOW!

Mr. Jim Thayer, Dept. 143,
The Crowell Publishing Co.,
Springfield, Ohio.

Dear Jim: I want to begin earning money and prizes at once. Start me off as a salesman.

My Name is.....
Address.....
City..... State.....

QUIT TOBACCO

Don't try to banish unsaid the hold tobacco has upon you. Thousands of inveterate tobacco users have, with the aid of the Keeley Treatment, found it easy to quit.

KEELEY TREATMENT FOR TOBACCO HABIT Quickly banishes craving for tobacco. Successful for over 50 years. Write today for FREE BOOK and particulars of our MONEY-BACK GUARANTEE.

THE KEELEY INSTITUTE, Dept. A-932, Dwight, Ill.
Home of the famous Keeley Treatment for Liquor and Drugs. Booklet Sent on Request. Correspondence Strictly Confidential.



LOFTIN-WHITE

Direct-Coupled

AMPLIFIER

with Approved ELECTRAD KIT

175 Varick St., New York, N.Y.

ELECTRAD

Build Your
Write
Dept. PM4

Books on all subjects are sold by Popular Mechanics Press, 200 East Ontario Street, Chicago, Illinois.

SPARE TIME WORTH \$1.00 PER HOUR

Others do it. So can you. A modest equipment of Boice-Crane machines installed in basement or garage workshop will make your spare hours worth money. Mr. M. W. Cushing, Fitchburg, Mass., even

claims an average of \$2.00 per hour for his spare

time. Mr. W. L. Muir, Olympia, Wash., makes \$1.00 per hour in his time at home. Mr. Frank Whitaker, paying his way at college, sold 23rd ship model for \$125.00, his 24th will sell for \$75.00. W. H. Duer, Marquette, Mich., though in poor health, supports a family of four in basement shop, earning as high as \$25.00 per day.

Earnings from spare time easily meet monthly payments.

Buy Now Pay Later

4" Hand-Jointer
Tables 20 in.
Planes 1/4x4 in.
Fence tilts 45 deg.
both ways. Bronze bearings.

Improved rabbit
earm.
Safety
guard
\$3, \$25,
6 in. Hand-
Jointer \$75.

Hand-saw
Universal.
Table 15x
17 in. tilt
45 deg. 8
in. s.w.

cuts 2
in. Elevates
for dnding
Attachments for
sawing
jointing
disc, drum
and
borin
plane, grinding. \$37

12" Band Saw

Table 10x12
in. tilts 45
deg. Cuts
4 1/2 in. deep.
Bronze bearings.
Sturdy.
Guards \$8.
Without
motor or
guards,
\$35

A variety
of Lathes,

Priced,
\$13.50 up.

Send 10c for 80 page catalog describing Boice-Crane Circular Saws, Jig Saws, Lathes, 4 in. and 6 in. Jointers. Let us tell you how to turn spare hours into money.

W. B. & J. E. Boice
Dept. P. M. 4-F Toledo, Ohio

Jig Saw

Table 8 in.
dia. Tilts
45 degrees.
Stroke 1 1/2
in. Capac-

ity 10 in.
to frame.
600 R. P.
M. 6 sizes
of blades.
\$12.

ANNOUNCING SPORS No. 1 Guaranteed Pen

*Embodying All
of the Latest Features*

Rubber sponge keeps point ever moist, thus pen writes the instant it touches the paper. The point is glass, which is one of the hardest substances known,—will not spread and can be held in any position. An excellent ruling pen. The eight grooves in point permit an even flow of ink. Ideal for business men, express agents, book-keepers, students, stenographers, in fact any person using a pen.

New Colors and Attractive Band Make Our Pens Look Like a \$7.00 Pen

We Give a Two Year Guarantee With Each Pen

Retails for \$1.25

SEND ONLY

39¢

(Postpaid)



**BIG
PROFIT
FOR
AGENTS
\$8.40
PROFIT
in 10 Minutes**

was made by Tracy Krenz of Nebraska. M. F. McDowell, Ind., sold 22 pens in one day during his spare time, netting a profit of \$16.50.

John Summerfield, W. Va., sold 3 doz. pens in 2 days, making \$27 in these two days.

We Guarantee All Goods and Pens—Money Refunded if Not Pleased

F. Spors & Co.,
230 Main St.,
Lesueur Center, Minn.

Please send me pen as marked below. I agree to pay agent's price. (plus postage) as indicated below, with the understanding that my money will be refunded if I don't think it is the best pen I ever wrote with and if returned within 60 days from date of purchase.

- 35c enclosed plus 4c for postage for 1 pen.
- Send 1 pen C. O. D. 35c plus C. O. D. charges, 19c.
- Send 12 pens C. O. D., \$2.75, plus C. O. D. charges.
- Send me your FREE wholesale catalog.

Name.....

Address.....

AIR PAINTING

*With Haywood Payntgun
Gives Factory Finish Job*

Anyone can now easily refinish cars, furniture, etc., and achieve a smooth, brilliant coat. Painting time cut in half with new exclusive payntgun features. Built for service.

FREE Folder on Perfect Painting. Write for your copy now.

HAYWOOD EQUIPMENT CO.
2345-E Ogden Ave. Chicago



Why Be Bald?



No need, when science makes the impossible of yesterday *the reality of today.* New discovery shows amazing results in correcting falling hair, dandruff, dry itching scalp, bald spots and promoting new growth shortly after commencing treatment. Results show in 30 days!

GUARANTEE OFFER!

DON'T SEND A PENNY. Get our guarantee offer, facts and actual evidence of our simple home treatment which requires only a few moments each day.

Famous Doctor's Discovery

Several years ago a noted doctor seeking to restore his hair, applied all his scientific knowledge to this problem, and finally found the cause and methods for stopping falling hair.

Treatment Reaches Roots

In nine out of ten cases of so-called baldness, the roots ARE NOT DEAD, ONLY DORMANT. When you try to reach them with hair tonics and oils, etc., you are obviously wasting your time and money, for you merely treat the surface of skin, never reaching the roots.

Send No Money

Don't wait longer. Mail coupon at once for *guarantee offer* and wonderful facts. **DO IT TODAY!**

AMERICAN HAIR & SCALP INST.
4326 Elston Avenue Dept. P. 4, Chicago, Illinois

COUPON

AMERICAN HAIR & SCALP INSTITUTE,
4326 Elston Ave., Dept. P. 4., Chicago, Illinois

Send me without obligation, particulars of our wonderful Hair & Scalp Treatment, and *Guarantee Offer.*

PRINT Name.....
PRINT Address.....
PRINT City..... PRINT State.....

Your BRAINS and this machine can make anything

Why waste your time and money on toy machines when you can get this real rig at such a low price?

The SAFETY-SAW MODEL N

- RIPS...MITERS...
- CROSS-CUTS...
- BEVELS...DADOES...
- PLOUGHS...
- GROOVES...
- RABBETS...
- SANDS...
- BORES...
- GRINDS...
- POLISHES...ETC.

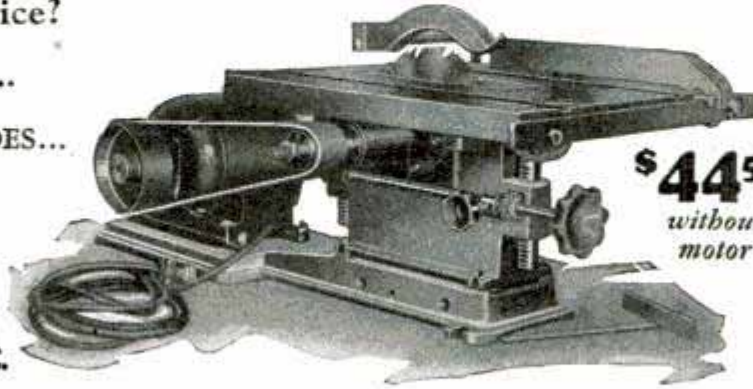

\$44⁵⁰
without motor

Easy to operate
Easy to own
BALL BEARING
Table Top 18" x 14"
Raises and lowers on a level.
Saw Arbor 3/4" Dia.
Cuts 2 1/2" Thick
Rips 12" Wide
Cross-cuts any width
Bevel Rips to 45°

Send Coupon Now for Details, Illustrations and EASY TERMS

TRY THIS Safety-Saw AT OUR EXPENSE

Put this machine on your work bench . . . give it a thorough test . . . compare it with others . . . and then if you're not more than satisfied with it in every way . . . send it back and we'll return every cent of your down payment and pay the transportation charges both ways. You can't lose a nickel, but you can gain a lot. Don't buy any machine until you've read our FREE descriptive folder . . . It shows Bench Saws . . . Band Saws . . . Lathes . . . Jointers . . . and all equipment.

SAFE TOOL MFG. CO. • BRIDGEPORT, PA.

SAFE TOOL MFG. CO., Bridgeport, Pa.

Please send me full information about your woodworking machines.

Name.....

Address.....

GET DETAILS NOW!

The man who studies gets ahead. Popular Mechanics Press will advise you what books to read to advance in your trade. 200 East Ontario Street, Chicago, Illinois.

22 Cal. Blank Automatic

NO PERMIT REQUIRED You can own this 6-shot Automatic (for Blanks only) without a license. Get one for fun or real protection, to frighten off traps and thieves and scare dogs away. Identical in construction and appearance to genuine Automatic Pistol. Load report. Full blue steel finish, rubberstock. Send no money. Pay expressman \$4.89, plus express charges. 3 for only \$11.89. Address WINEHOLT MAIL ORDER, Box 8-25, Woodbine, Pa.



Win Nash and \$500 or \$1,845 Cash

Seven Brand New 6-Cylinder Cars Given

For advertising purposes I am going to give a brand new six-cylinder "Special Six" Nash four-door Sedan, an Oldsmobile two-door Sedan, a De Soto two-door Sedan, a Pontiac two-door Sedan, an Essex two-door Sedan, a Whippet two-door Sedan, and a Chevrolet two-door Sedan, all six-cylinder latest model Sedans; also 4 splendid new console type radios, a Victor Orthophonic Victrola and other valuable prizes. Any person living in the United States outside of Chicago may enter an answer to this puzzle except employees of the

Solve This Traffic Puzzle

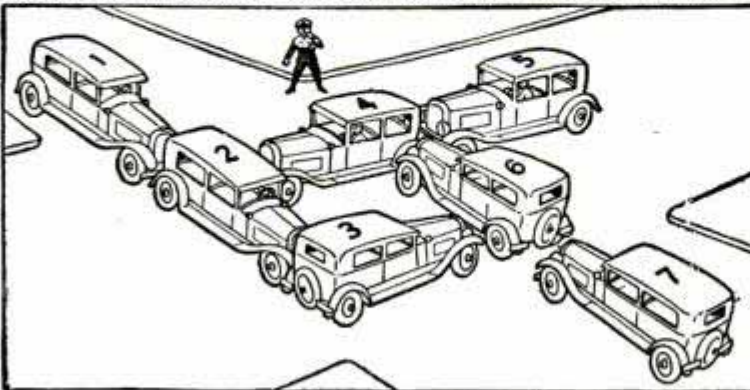

W. D. Boyce Company or members of their families, or winners of automobiles or first prizes in any of our previous offers, or members of their families.

In the picture there are 7 cars in a bad traffic jam. None of them can move forward, for each car is blocked by the one in front of it. One of these cars will have to be backed out. Which one? The traffic policeman seems to be stumped. Can you straighten up this tangle for him? Only one car may be moved backward and if you pick out the right one, you will see that it is not necessary to back up any of the others. Send the number of the car which when backed out will relieve this traffic tie-up, and if your answer is correct you will be qualified for this opportunity.

\$500.00 for Promptness We are not only giving the Sedans, radios and so forth in our big prize list amounting to over \$6,800.00, but are also giving an additional \$500.00 in cash for promptness to the winner of first prize if he or she has been prompt. Thus, the first prize winner will receive the Nash Sedan and \$500.00 in cash, or \$1,845.00. Find the car which when backed out will relieve this traffic tangle and send the number of it in a letter or on a post-card, or you can mark the car on the picture and send it to me. Be sure to write or print your name and address plainly. All who answer correctly will be told how they can share in the prizes or cash. Duplicate prizes paid in case of ties. **ANSWER TODAY.** ARTHUR MESKE, Dept. 31, 510 N. Dearborn St., Chicago, Ill.



This 3 pound DRILL is only $9\frac{3}{8}$ inches OVERALL

3000 R.P.M. packed in only $9\frac{3}{8}$ inches, power a-plenty contained in only about three pounds—no wonder the new $\frac{3}{16}$ " Millers Falls Electric Drill marks a new step forward in the development of electric tools.

You can handle this new power tool as easily as you would a rat tail file—reach in and out of inaccessible spots—ten inches of space is all you need.

Carefully built, strongly made, the Millers Falls $\frac{3}{16}$ " Drill is only \$36.00. Price includes auxiliary handle. The housing is made of "Racolite," a non-conductor of heat and electricity. Write for a full description of this new Millers Falls Tool. MILLERS FALLS COMPANY, Millers Falls, Mass.; New York: 28 Warren Street; Chicago: 9 So. Clinton Street; Cable Address: MILLERFALL NEW YORK.

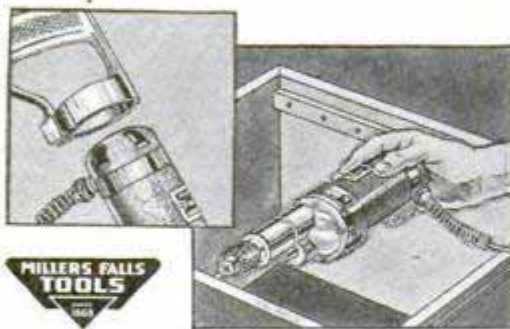

MILLERS FALLS ELECTRIC TOOLS

MILLERS FALLS Co., Millers Falls, Mass.

Send complete description of this new drill.

Write name and address in margin below.

SPRAYIT *Electrically* Only \$14.50



Less Than
 $\frac{1}{2}$ Factory
Price!

Regular
Price \$34.50

Nationally
Advertised

Wonderful
Bargain

Purchased entire factory surplus. For spraying paint, lacquers, enamel, shellac and insecticide. Complete with nozzles, cord and plug.

Also

Westinghouse Exhaust Fans. 12 in. 6 blades, 110 volt, 60 cycle, A. C. With adjustable panel. Finished in Duco Ivory. Regular price \$39.50. Our price \$14.50.

All new merchandise. Guaranteed. In original factory cartons. Send check or money order.

National Jobbing & Export Co.
Dept. 24, 192 N. Clark Street, Chicago, Ill.

SAVE $\frac{1}{2}$ ON PLUMBING HEATING

Any handy man can install his own plumbing or heating by our new easy cut-to-fit method. Low wholesale prices on highest quality Grade A goods enable you to save one-half!

WE SHOW YOU HOW—BOOK FREE
Send for our new wholesale catalog. Save waste material and high labor costs. This book has saved money for home owners and builders for over 50 years.

Free Estimate—Send for Sketch Blank

OUR BONDED GUARANTEE PROTECTS YOU

OVER 50 YEARS **HARDIN-LAVIN Co.** EST. 1876
122-32A West Pershing Road, Chicago, Ill.

Mechanical Toys Ship Models, Colonial Brle-a-Brac, Leather and Celluloid articles and hundreds of other useful things are described in our new book, Make It Yourself. 460 Pages. Illustrated. Price \$3 Postpaid.
POPULAR MECHANICS PRESS, 200 E. Ontario St., Chicago

Auto Seat Covers \$2.95
Special Price Offer
AGENTS Make \$20 a Day
WRITE NOW!
Write orders for this excellent Quality Line Auto Seat Covers. Amazing values—quick sales. Cash daily. We deliver. Write for handsome Free Leatherette Sample Outfit.
Quality Sales, Dept. 16, 1834-36 North Ave., Chicago

Thank you for making it possible for me to own a **21 Jewel~ Santa Fe Special**

Writes Thousands of Our Customers

The Nationally Popular Santa Fe Special sent to you for your approval. Send No Money with Order ~ Wear 30 Days FREE!



Write for Watch Book and Diamond Book Buy Direct

Buy and Pay the Santa Fe Way

You must be pleased when you buy a "Santa Fe Special" Watch. That is why I will send for your approval one of these Standard Watches, guaranteed for a lifetime of satisfactory service, not only by the Santa Fe Watch Company, but by the Great Illinois Watch Factory. They are found in the pockets of men in the service on every railroad in this country. Senators, Congressmen, and Governors keep their official appointments by "Santa Fe Special" time, Army Officers and Privates carried them all through the Greatest War in history—thousands of these splendid watches are in use all over the World. If you want one on my liberal Buy and Pay the Santa Fe Way Plan—you had better write for my Free Watch Book today and make your selection. I will even let you wear the watch 30 days FREE, then sell it to you on a binding money back guarantee, and on easy monthly payments.

JUST OUT!—New "Santa Fe" Watch Book

Send coupon for our New Watch Book—just off the press. All the newest watch case designs in white or green gold, fancy shapes and thin models are shown. Read our easy payment offer. Wear the watch 30 days FREE. Nothing to risk. See the watch before you buy. Write for New Book Today—It's FREE. Select Your Watch NOW.

FREE A limited offer! With every Santa Fe Special, a beautiful gold chain or strand of exquisite pearls. Write today.

SANTA FE WATCH COMPANY
Dept. 46, Thomas Bldg., Topeka, Kansas

Send No Money 11 1/2 cents a day—pays for any of these Watches, wear 30 days free!

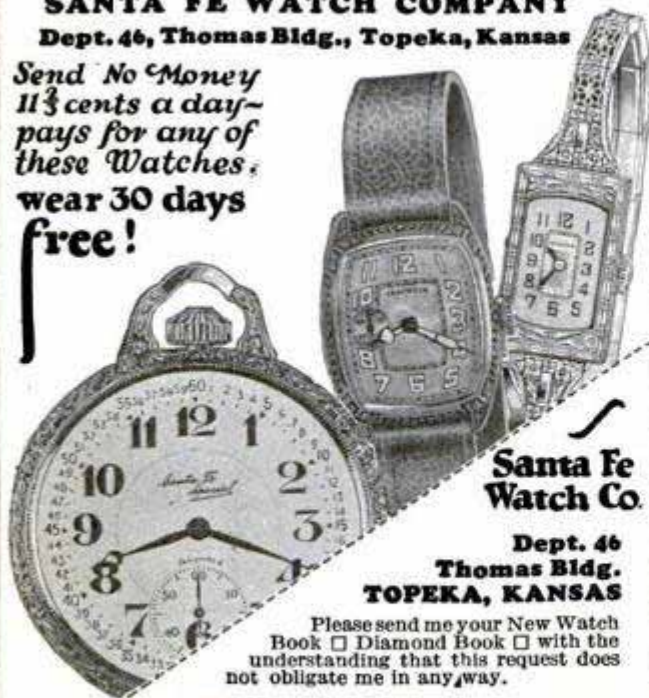

Santa Fe Watch Co.

Dept. 46
Thomas Bldg.
TOPEKA, KANSAS

Please send me your New Watch Book Diamond Book with the understanding that this request does not obligate me in any way.

Name.....
Address..... State.....

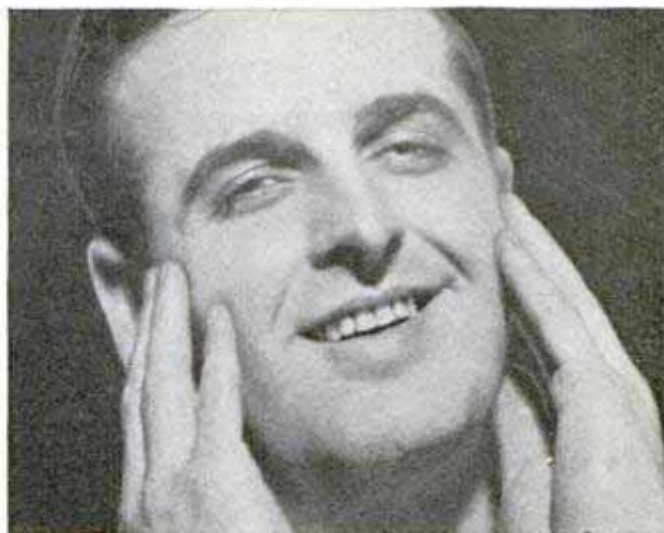

A coupon that Wins Friends

Millions of men have accepted these seven free shaves. Will you?

GENTLEMEN: We know that 86% of the men who make this test are convinced by it—become regular users of Palmolive Shaving Cream. Surely our chances are good of pleasing you.

A few years ago men told us—1,000 of them—where other shaving preparations failed. They set a high goal for us, and our great laboratories responded. Behind them stood 68 years' experience in soap-making. But it was not easy.

The first 129 formulas were rejected . . . finally success came, in a shaving cream based on the olive oil principle.

Now we ask the courtesy of a test. We offer to convince you at our own expense. All you risk is a stamp—and a few days' shaves will do the rest. Will you mail the coupon now, please?



7 SHAVES FREE

and a can of Palmolive After Shaving Talc

Simply insert your name and address and mail to Palmolive, Dept. M-836, P. O. Box 375, Grand Central Post Office, New York City.

.....
.....
.....
.....

(Please print your name and address)



41 muscles that may get sore

EVER stop to think of it? There are 41 muscles in each arm and hand. 41 muscles . . . any one of which may get stiff and lame from overstrain or overwork. And how that stiffness can hurt! You don't feel like work; you don't feel like play; you just feel "all in".

YET no one needs to suffer from stiff, sore muscles. Hard work . . . strenuous exercise . . . one simple method relieves aches and pains. Apply Sloan's Liniment when muscles feel sore. *Sloan's healthy heat warms the body like sunshine.* Repeat application of Sloan's every hour until pain is gone. Used in 13 million homes. Get a *fresh* bottle from your druggist today. 35c.

SLOAN'S Liniment

**Stop
A.C.
Noise!**
**Improve
Selectivity!**

RADIO reception may be made much more enjoyable by plugging in a Falck Claroceptor between the light socket and your set. By blocking out the line interference noises, this wonderful device also helps selectivity and distance. Tested, proved. Thousands now in successful use all over America. No change required in your set. Only equipment of the kind. Compact size: 3½" x 5½" x 2½". Made by pioneer radio manufacturer. At radio parts dealers, or write us for new free folder.

Falck \$7.50
(With Cord and Plug)
CLAROCEPTOR

Manufactured by ADVANCE ELECTRIC CO.
Dept. P M—1260 W. Second St., Los Angeles, Calif.
JOBBER AND DEALERS, GET OUR PROPOSITION

Rudy VALLEE'S favorite SAX



Fun... Fame... Fortune...

Win them with a Buescher!

See Rudy Vallee in his latest playing-talking pictures. Hear him on the big radio programs. Listen to him play his Buescher, as only Rudy knows how to play it. Then you'll want to own the sax that helped Rudy Vallee in his rapid climb to fame and fortune.

BUESCHER True-Tone Band
Instruments

are chosen by both professionals and beginners because they are supreme in tone, beauty and ease of playing. Bueschers are also easy to own. Just a little down. Then pay as you play. Tell us which of the 88 Buescher Band Instruments you want to play; and whether in band, orchestra or at home; also what instrument you now play, if any; and your age. We'll send the correct Buescher Catalog-Folder, and full details. Write. [564]
Buescher Band Instrument Co., 3045 Buescher Block, Elkhart, Ind.

Enjoy the Thrill of Making Things Quickly and Easily with the NEW 1930 Delta ELECTRIC Handi-Shop

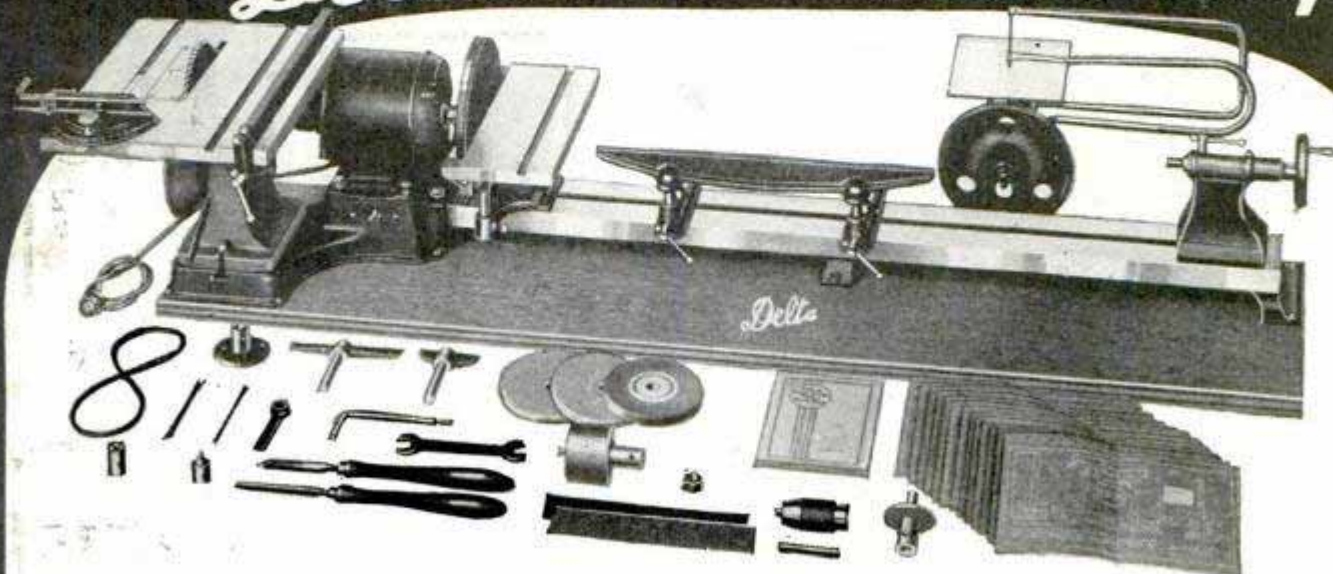

Make the things you have always wanted to make, with this sturdy, full-sized equipment. Save money on repair work—earn money in spare time. It is so easy—so quick with the "Delta." Complete Handi-shop includes all necessary equipment for Circular Sawing, Wood Turning, Scroll Sawing, Sanding, Drilling, Grinding and Buffing. Full instructions and complete set of working blue-prints furnished.

Many Exclusive Delta Features

You will be delighted with the sturdy construction, splendid efficiency, and moderate cost of this Delta equipment. You will appreciate keenly in the "Handi-Shop" such exclusive constructional features as the Patented Tilting Tables, Automatically-Oiled Bronze Bearings, Heavy U-Shaped Lathe Bed, and Circular Saw Raising Lever. Send coupon for complete description of this remarkable workshop.

New Woodworking Units

The introduction of the Delta Jointer and Circular Saw Units marks a new era in moderately priced wood-working equipment. Now, for the first time, are available sturdy, practical machines in compact, convenient form at price levels astonishingly low. The individual units are built ruggedly to give years of heavy service. Both incorporate many special features of great value. The combination unit affords a compact, convenient arrangement which permits sawing and planing in one quick operation. Either Jointer or Saw can be operated separately or both together. Welded steel stand of convenient height. All three units are furnished with or without motor, as desired.

10 Day Trial—Easy Terms

For complete details and full description of the new 1930 Delta line, send coupon for FREE illustrated literature. Shows many items of interest to those who work with wood. You will learn, also, how you can try any Delta equipment for 10 days under actual working conditions at our risk. Choice of three convenient payment plans. Mail coupon TODAY!

DELTA SPECIALTY CO.

Division of "Delta Manufacturing Co."

1661-67 Holton St., Dept. A. 430, Milwaukee, Wis.

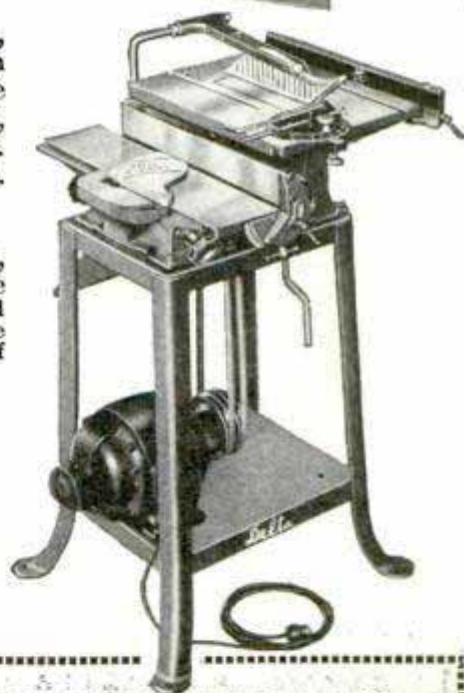

DELTA SPECIALTY COMPANY, Dept. A. 430
Division of "Delta Manufacturing Co."
1661-67 Holton St., Milwaukee, Wis.

Please send me FREE, illustrated literature describing 1930 model "Delta" Woodworking Units. Also details of 10-Day Trial Offer and Easy Payment Plans. (Check special information desired.)

- Handi-Shop Moulding Cutter
 4" Jointer Units 8" Circular Saw Unit
 Combination 4" Jointer and 8" Circular Saw
 I am interested particularly for home use
 I am interested for shop and professional use

Name

Address

Get Into A Business of Your Own—EARN \$150 to \$300 Monthly

8 HOUR
BATTERY
CHARGING



Start a BIG PROFIT-MAKING BUSINESS of your own—"8 Hour Battery Charging." Requires SMALL SPACE AND PRACTICALLY NO INVESTMENT. Anyone can successfully operate. Charges batteries in 1/2 the time at 1/2 the cost. EVERY CAR OWNER a CUSTOMER. 20 minute Car Washing, Electrical Service, Spray Painting and Arc Welding offer same opportunity. HB shouldn't cost you a cent—it will pay for itself on EASY MONTHLY PAYMENT PLAN, with practically no expense and with a handsome profit for you. WRITE NOW for details stating what you're interested in to Hobart Brothers, Box M401, Troy, Ohio.

30 DAYS TRIAL—Pay Out of Income Terms

Name This House

**We Will Pay \$500.00 Cash
For the Most Suitable
Name For This Beautiful
Six-Room House**

**\$500.00
GIVEN!**

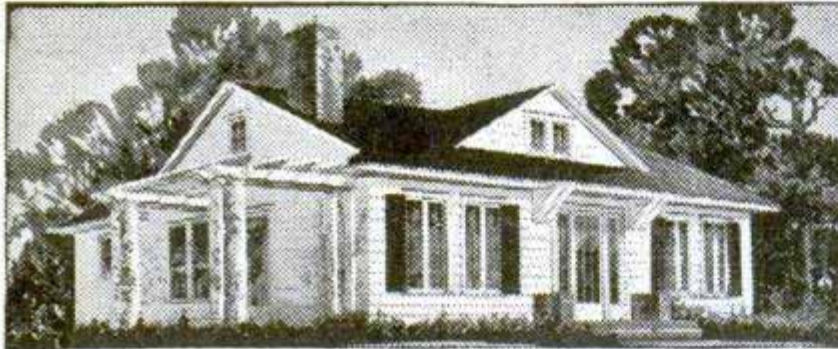

**ANY NAME
MAY WIN!
Offer open to
everybody. Nothing
to buy or sell. No
Obligation.**

**WHOEVER SENDS THE MOST SUITABLE NAME WILL
WIN \$500.00—NOTHING ELSE TO DO!**

This is a new Colonial Bungalow---cozy, convenient---yet a roomy house. It is meeting with such popularity that we are desirous of obtaining a suitable name for it for use in connection with our building program, and will pay \$500.00 cash for the most suitable name suggested. There are no strings tied to this offer. Sending us a name for this house does not obligate you in any way. Nothing to buy or sell. We merely want a suitable name and are willing to pay \$500.00 in cash for the best one

sent in. Surely you can think of an appropriate name for such a beautiful home. Do not use more than two words. Any word or words may be used or any combination of words, such as Ridgelawn, Shadynook, Hearthome or names like Sunshine Inn, Journey's End, etc. No matter how simple your suggestion is, you cannot afford to neglect sending it in at once. Any name may win. Possibly you may have the most suitable name right on the end of your tongue this minute. If you have, send it in at once, and \$500.00 in cash is yours.

\$100.00 EXTRA FOR PROMPTNESS

We want the name for this house quickly, and will pay the winner an extra \$100.00 cash just for promptness---or a total of \$600.00 in all. Send your suggestion today! The very first name you think of may be worth \$600.00 cash to you.

FREE! In appreciation of your suggesting a name for this house real quickly, we will send you FREE and POSTPAID, the floor plans and blue print of this beautiful house. Understand, this does not obligate you in any way. Rush us a name for this house TODAY---QUICK. A postal card will do.

FOLLOW THESE RULES

This offer is open to everyone, excepting members of this firm, its employees and relatives. Each participant may send only one name. Sending two or more names will cause all names submitted by that person to be thrown out. Contest closes June 28th, 1930. Should two or more persons submit an equally suitable name for this house, the full amount of the prize offered will be paid to each one so tying. To win the \$100.00 CASH PROMPTNESS PRIZE, the winning name must be mailed within three (3) days after this announcement is read. This \$100.00 CASH PROMPTNESS PRIZE will be added to the \$500.00 prize and paid to each one submitting the winning name, provided suggestion is mailed within (3) days after this announcement is read. Rush name today.

HOME BUILDERS' SOCIETY, Box 3374, BATAVIA, ILLINOIS

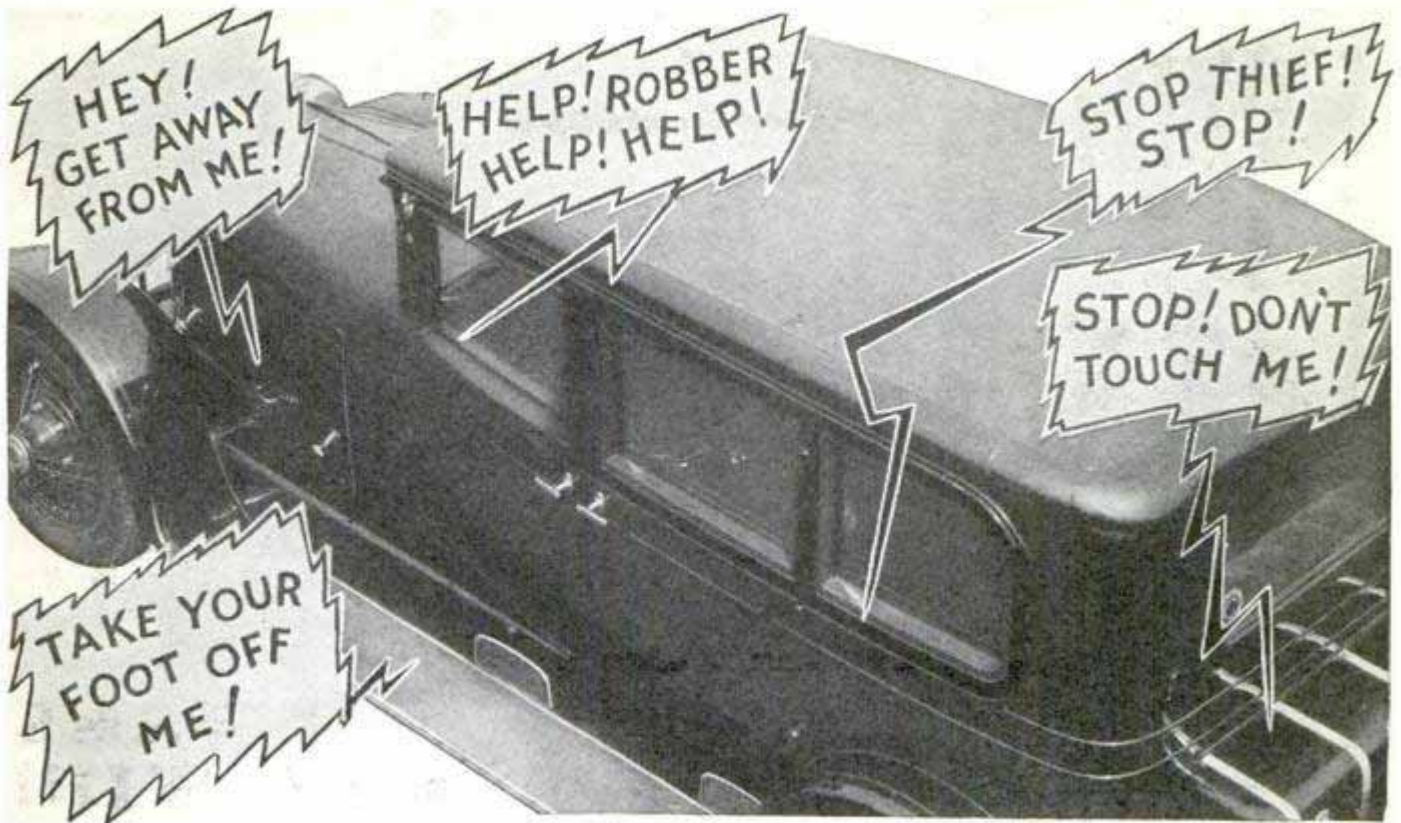

Astonishing Electrical Invention Protects Your Car from Thieves *...Automatically!*

This unquestionably is the queerest, most incredible invention since the first discoveries of radio! A magical, shouting, automatic watchman that actually is far more than human! Never sleeps, rests or gets

tired! Stands guard over your entire car from spare tire to headlights and steering wheel! Endorsed by police! Approved by Motor Associations! Now offered on generous 5-day test basis! The coupon brings full details.

A Startling, Uncanny Money Maker For Agents

"WHAT makes it work?" "Where on earth did you get it?" "Bet you five dollars he's got some one hiding in there!" "It simply can't be true." A running fire of comment like this breaks out whenever and wherever this new invention is exhibited. And why not? When no one ever heard of such a startling, uncanny device before! In fact few people would even dare to dream there could be such a thing! So this, men, is something really NEW, something to grip the imagination of everyone, something that sells to every autoist on sheer novelty alone. Distributors, "star" salesmen, every man who wants to double and triple his present income should note carefully the following facts.

The Secret Of A Theft-Proof Car

Now in this amazing new way, every car can be protected from theft for 24 full hours a day. In the garage or parked on the street, if any thief so much as pulls at your spare tire or touches his foot to your running board—ZOWIE! A riot of noise starts instantly! And your car never shuts up till the thief leaves. And listen to this. Even if the thief is wise to what's up, you alone place the secret control button anywhere you want it around the car. The thief can't possibly find it. If he wastes time looking for it—Bingo! He's caught and on his way to jail! This astonishing invention guards your spare-tire, head-lights and spot-lights as well as the car itself.

Installed In 10 Minutes—Costs Nothing To Operate

The inventor has asked the U. S. Government to protect his patent rights in this revolutionary discovery. Because of its uncanny powers and to distinguish it from everything else on earth this queer discovery is now

called "Devil Dog." Among its amazing features is the fact that it can be installed by anyone in 10 minutes or less. There is absolutely no cost for operation. It will last as long as the car. Fits any car from Ford to Rolls Royce without adjustment or fussing.

For introductory purposes a special 5-day test offer is now being made. If you are interested in learning about the most astonishing invention since the radio first came in, use the coupon at once. If your present income is less than \$50 a week, the profit possibilities as our agent may astonish you. The coupon brings details of all offers. Mail it now.



Note the tiny size of this amazing invention in the above picture. The switch, wire and sealed tube containing the "activator" is all there is to it. The entire cost is scarcely more than an ordinary radio tube! Test it. Mail the coupon today.

NORTHWEST ELECTRIC CORP.,

Dept. D-10,
Pukwana, So. Dakota

DEVIL  DOG

Northwest Electric Corp.,
Dept. D-10,
Pukwana, So. Dakota.
Rush details of your big 5-day test offer and big profits for agents.

Name.....
Address.....
Town..... State.....
 Check here if interested only in one for your own car and not in agents' money-making offer.

Trade Mark Reg.
WURLITZER
THE WORLD'S LARGEST MUSIC HOUSE

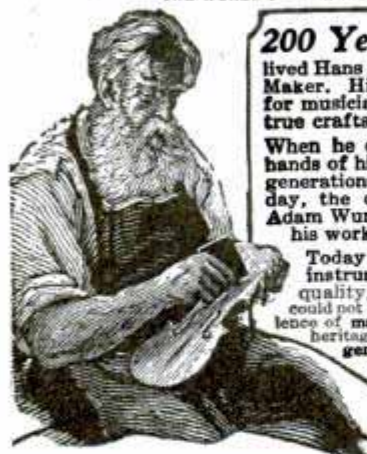

200 Years Ago in the little town of Schoeneck lived Hans Adam Wurlitzer, Master Violin Maker. His shop was a gathering place for musicians of the time, for he was a true craftsman.

When he died his shop passed into the hands of his eldest son, and for seven generations, down to the present day, the descendants of Hans Adam Wurlitzer have carried on his work.

Today in every Wurlitzer instrument you will find a quality, a character, that could not come from mere excellence of manufacture. It is the heritage of these seven generations of music craftsmanship.



Try
any Wurlitzer Instrument
in your Own Home

YOU may now have any Wurlitzer instrument for a generous free trial in your own home. Examine the instrument, show it to your friends, play it as much as you wish. No obligation to buy—no expense for the trial. We make this liberal offer because we want you to try for yourself these wonderful instruments, the result of 200 years' experience in musical instrument Building. Easy payments are arranged to suit your convenience. This is your opportunity to try a famous Wurlitzer instrument in your own home.



Send for New Catalog

The greatest musical catalog ever published. Over 3,000 articles—every known instrument described and illustrated; many of them shown in full colors. Gives you lowest prices and all details of Free Trial, Easy Payment plan. All sent FREE—no obligation.

Send this Coupon

THE RUDOLPH WURLITZER CO.
134 E. 4th St., Cincinnati, Ohio

Send me absolutely free, your new illustrated catalog, with prices and description of every known musical instrument. Also tell me how I may try any instrument in my own home and pay for it in small monthly sums. No obligation.

Name.....
Address.....
City.....State.....
Instrument.....
(State instrument in which you are interested)

\$57 in 30 minutes - Reid
\$31³⁰ in 30 minutes - Murphy
\$116⁶⁶ in 25 minutes - Hart of Maryland
\$117 in one Day - Wienecke of Detroit
PROCESS "SnowBall" Plan

PAYS BEGINNERS A DOLLAR A MINUTE!

Men with no selling experience—are setting records for dollar-a-minute earnings from the first day, rolling up \$40 to \$90 a week commissions, and preparing for life-time positions with us—ALL through the wonderful "Snow-Ball" Plan! They use this "never-fail" plan on Process nationally known YEAR-ROUND lines—Raised-letter Personal and Business Stationery, Pictorolls, and other things which everybody, everywhere needs! Big commissions paid daily, big bonus, cash prizes. Get the amazing FACTS NOW!

Easy to Make \$3,000 before Xmas

- CHECK!**
- Personalized Stationery
 - Bridge Pads
 - Xmas Greeting Cards
 - Pictorolls
 - Business Stationery

with these ALL YEAR LINES

Write me today for "Snow-Ball" Plan and free sample outfit.—We teach you the business and supply everything free. State territory wanted, experience if any, references, and whether spare or full time wanted.

The Process Corporation
Dept. 940-A, Troy at 21st St., CHICAGO

New Complete "Wonder" Workshop

Outfit saves you \$15.00



Now you can have this new, amazing 8-in. Combination Saw (18 tools in one) shipped on 15 days' approval, at manufacturer's risk. A complete ideal machine shop for factory, workshop or home; will rip, cross cut, bevel, miter, mortise, drill, groove, tenon, grind, rabbet, buff and polish. 1/3 H. P.-A. C. motor included with all attachments. If your dealer cannot supply you, write us, giving dealer's name.

S & B MFG. CO.

Dealers Wanted P. M. 4, 4611 W. 28th St. CHICAGO, ILL.

BREAKFAST NOOK and 26 other splendid articles of Built-In Furniture in our new book on this subject. 198 pages. Illustrated. Price \$2.50 Postpaid.

POPULAR MECHANICS PRESS, 200 E. Ontario St., Chicago

AUTO SEAT COVERS
Direct from Factory

Protect and beautify your car with "Supreme" Auto Seat Covers at new low "direct-from-factory" prices. Complete sets as low as \$6.95. Tailored to cover entire upholstery, including seats, back of front seat, doors, side panels and arm rests. Perfect Fit Guaranteed! Attached in a jiffy with patented glove fasteners (no pins). Made of durable materials in 18 attractive patterns. Supreme Auto Seat Covers protect upholstery from dirt and damage. Cool, comfortable and sanitary. Add to car appearance and trade-in value.

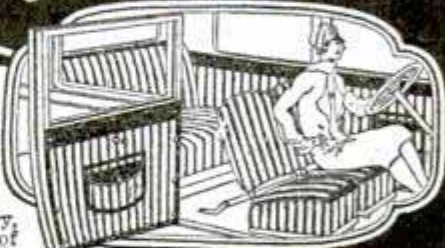

Big Discounts For Agents

AGENTS wanted to meet tremendous demand from millions of car owners. Big discounts and liberal commissions. Write Today for Free Sales Kit, material swatches, prices and details of money-making plan. No obligations.

Supreme Auto Seat Cover Co.
2229 Ogden Avenue,
Dept. 174 Chicago

This man is no smarter than You - BUT he makes \$25⁰⁰ to \$75⁰⁰ a Day in FLORKRAFT



YOU CAN DO IT TOO! Here is a business that requires no schooling, no long period of study, no hard work. It's the chance of a lifetime for the average man who has nothing but a daily grind to look forward to, low wages, and dependence upon others in his old age.

CAN YOU AFFORD to pass up the golden opportunity for providing RIGHT NOW the luxuries of good living that you see some others enjoy? Can you bear the thought of refusing better education to your children than you had and can you shut your eyes to a comfortable, independent income as your own boss?

DO AS THOUSANDS of others have done. Read this carefully and then ACT. Grasp this opportunity to make \$25 to \$75 a day. Become a Clarke FlorKraftsman, a well paid business man. Make big money steadily all year round. Clarke FlorKraftmanship is pleasant indoor work. There is an immense amount of this work to be done and that means steady employment. It consists of surfacing floors, benches, table tops, woodwork of all kinds in preparation for varnishing or waxing. Ordinarily this work is tedious and back-breaking—that's why the rate per square foot is so high. If you are a Clarke FlorKraftsman most of this money is profit—and here's why—

IT IS ALL DONE by machine, the light-weight, high-speed Clarke Vacuum Portable Sander. The product of an inventive brain—the last word in ingenuity and precision engineering, this 31 lb. machine places an easy and princely living right in your hand. It surfaces floors with amazing speed and perfection—faultlessly. Half a day's practice and you are ready to go. This work pays from 3¢ to 15¢ a square foot depending on condition and whether new or old floors. You can surface from 300 to 2200 square feet a day. Figure it out.

TOO MANY LITTLE THINGS interfere and make us forget the big things we know we should do for our own good—so *don't put it off!* You can be the FlorKraftsman, the floor surfacing specialist in your own community. Send in the Coupon NOW. About \$100 starts you off *right* for life. Get on the road to Prosperity, a big earning business and Independence TODAY.

CLARKE SANDING MACHINE CO.
DEPT. T-34
3831 Cortland Street CHICAGO, ILLINOIS
Originators and, for 13 years, Manufacturers of
Portable Sanding Machines

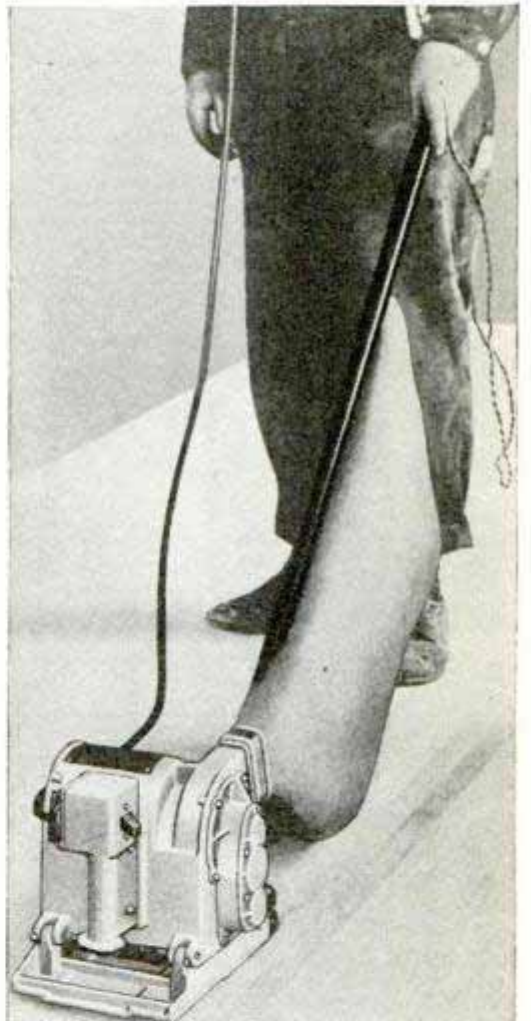

POWERFUL FLOOR SURFACING
CLARKE
VACUUM PORTABLE SANDER

CLARKE SANDING MACHINE CO.,
Dept. T-34, 3831 Cortland St., Chicago, Ill.

Gentlemen: Please send me, without obligation, full details on the Clarke Sander, and the money-making possibilities of Flor-Kraft.

Name.....
Address.....
City..... State.....

BUICK 4-DOOR SEDAN **CARS GIVEN!**

Ever win a prize? Here is your chance! Every year we spend over \$150,000.00 on prize offers to advertise our business. In this new offer 150 grand prizes totaling \$6555.00 will be given to the fortunate ones who solve our puzzle correctly and win.

Here it is—**FIND THE "DIFFERENT" AUTO!**

The 16 cars in the circle all look alike. 15 of them are exactly alike—but one is different from all the rest. That's the trick for you. Find this "different" car if you can—and mark it. The difference may be in the fenders, bumper, name plate, radiator, or top. Be careful now—because winner must solve puzzle correctly in order to qualify for this opportunity to

WIN BUICK SEDAN OR \$2035.00 CASH

Winner has choice of new 1930 Buick 4-door Sedan or cash if preferred. Also four other fine new Sedans, radios, victrolas, etc., in big prize list. Duplicate prizes awarded in case of ties. All actively interested who have answered correctly and qualify will receive prizes or cash compensations.

\$705.00 FOR PROMPTNESS

Don't delay—act this minute! Solve the puzzle correctly and receive at once Certificate good for \$705.00 if you are prompt and win first prize, making total first prize worth \$2035.00. This is the only puzzle to solve. Any man, woman, boy, or girl in the U. S. A., outside of Chicago, may submit an answer. 150 of the people who take up this offer are going to win these splendid prizes. Be one of them. Send the number of the "different" auto in a letter or postcard today. Nothing to buy, so send no money. But act promptly!

★ **B. A. BLACK, Room 230, 504 N. Dearborn St., Chicago, Ill.**

SEND NO MONEY! REPLY TODAY! **\$705.00 PROMPTNESS!**

STRANGE INVENTION!
PAYS YOU IMMENSE PROFITS
NEW FIELD for AGENTS

Sell only device in the world that prevents kinking, snarling and tangling of telephone and electric iron cords.

Housewives and business men buy 1 to 50.

NEW KIND OF CORD SET FREE

Every Neverknot Salesman is given FREE the complete Neverknot Switch Plug Cord Set pictured. This new kind of ironing cord automatically coils itself out of the way and a new kind of switch plug prevents scorching and saves electric bills. This set is a "gold mine" for house-to-house workers. It's different and it's yours free if you work for us. Don't delay! Send now for free offer.

NEVERKNOT CO. Dept. 4-V 4503 Ravenswood, Chicago

The Plug That Saves Electric Bills.

ELECTRIFY YOUR RADIO FOR ONLY \$6.85 COMPLETE

Why discard your present good set when you can electrify it for only \$6.85, and banish the annoyance and expense of buying new "B" batteries?

Over 150,000 Townsend "B" POWER UNITS IN USE

Hooked up in a few minutes. Delivers 90 V. on any set. Use same tubes—no changes. You'll be amazed at the improvement in reception and distance getting. Send name and address today for full details, proof and Free Trial Offer.

TOWNSEND LABORATORIES, 715 Townsend St., Chicago, Ill.

NEW SUPER-WASP AC & DC SHORT-WAVE RECEIVER
In Kit Form or Completely Constructed

1930 Catalog Free Set Builders! Write for your Copy. Complete line of Short-Wave Supplies, standard parts and Accessories.

CHICAGO RADIO APPARATUS CO., Dept. PM 415 S. Dearborn St. Chicago, Ill.

WADE AMATEUR MECHANICS, REPAIR SHOPS, INVENTORS, STUDENTS

BENCH LATHE

A real machine tool for the home work bench—capacity 4" dia. x 12' length For Metal-Wood-Composition materials. Turning—Facing—Boring—Drilling—Winding—Thread Cutting. Accurate—Strong—Quiet—Compact. Slide-rest has travel entire length of bed. Leadscrew inside bed. No. 1 Lathe, plain headstock, \$40.00. No. 2 Lathe, back-geared headstock, \$68.00. Extra for lathes with 18 inches between centers, \$7.00. Complete line of accessories at equally low prices. Write for free catalog.

THE GEROLD CO. Dept. P-62 120 Liberty St. New York

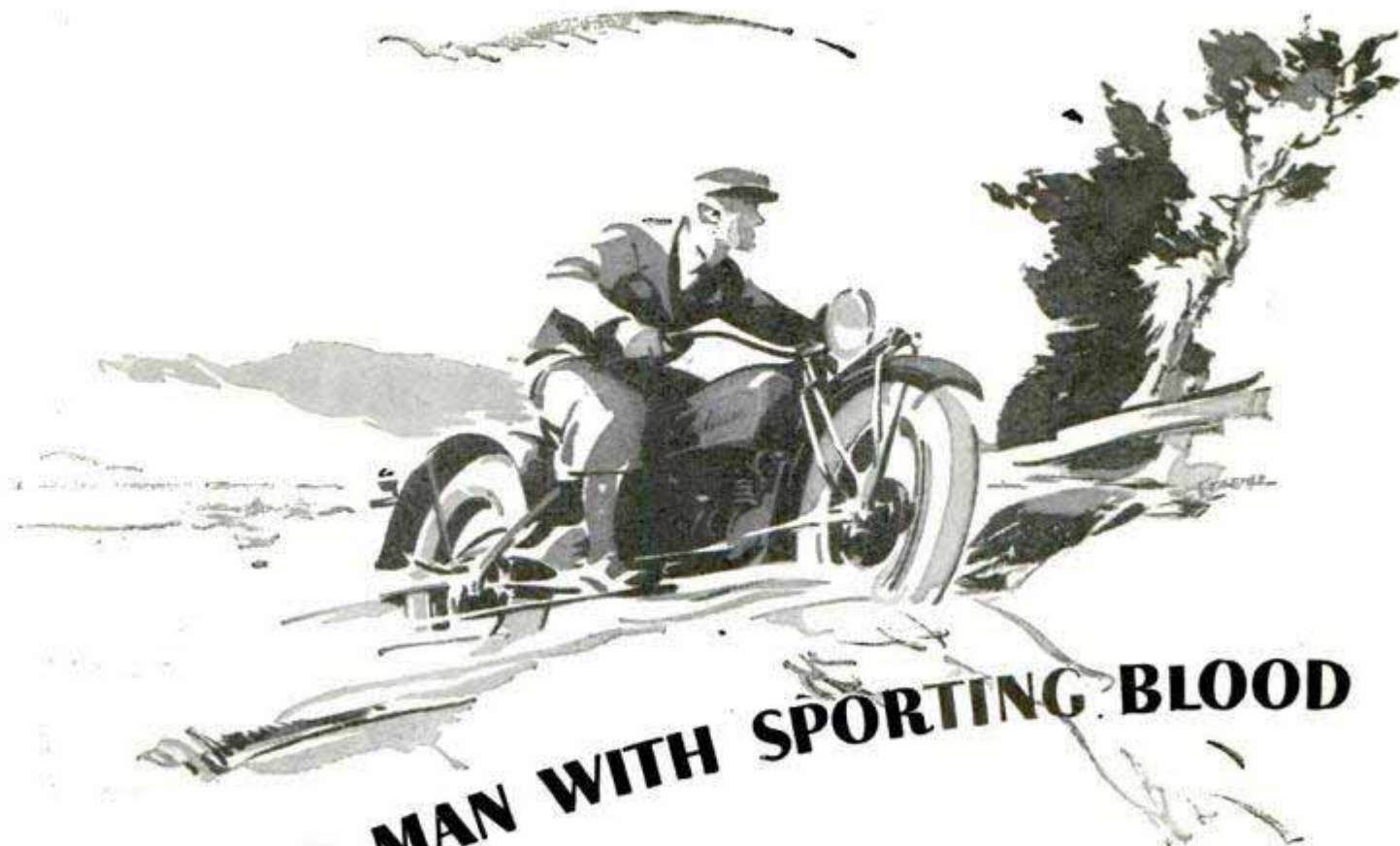

FOR A MAN WITH SPORTING BLOOD

... for him who revels in the rush of the wind, the warmth of the sun ... an Indian ... the sportsman's steed ... a lithe, live companion of the highway. It's the outdoors man's way to go places ... swiftly, smoothly, *safely*. No waiting in traffic delays ... no crawling up hills behind "Sunday drivers."

Get astride an Indian ... feel the thrill of the surging power between your knees ... feel your blood tingle as you slip through traffic like a cat—out to the open highway, with the breeze in your hair!

An Indian is Safe

And remember—Indian has a reserve of power to pull you quickly out of danger, yet it is light enough to stop in half the space a car needs. Indian's a tough machine, too—a stock model holds the world's record of 497 hours continuous running, beating the famous "St. Louis Robin" plane endurance record. That's stamina—one of the things twenty-seven years successful motorcycle making puts into every Indian. That's why New York City's great motorcycle squad, and those of many other cities, are *exclusively* Indian equipped. Thousands of merchants, too, use Indians for quick, economical delivery service.

Visit your local Indian dealer ... Inspect these *Improved Indians*—the CHIEF 74, the SCOUT, and the FOUR, and the New Indian Silver Arrow Out-board Motor. Or write for folders.



INDIAN goes nautical, too!

Now you can enjoy on the waterways famous, dependable *Indian* power in the new



A Class B outboard, embodying all the experience Indian has gained in 27 years of building small power plants. Power, speed, stamina—all you look for in an outboard, plus an ease of starting hitherto unknown.

Indian

MOTOCYCLES

INDIAN MOTORCYCLE CO., DEPT. C6, SPRINGFIELD, MASS.

Devastating AERIAL WEAPON for next WAR!

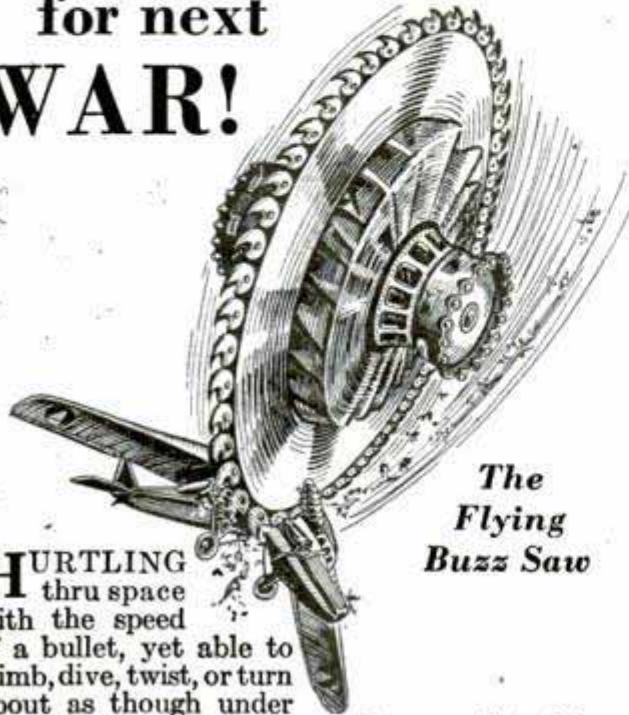

The
Flying
Buzz Saw

HURTLING thru space with the speed of a bullet, yet able to climb, dive, twist, or turn about as though under direct control of the brain of its human pilot, this new instrument of aerial defense literally saws enemy planes and dirigibles in two as a buzz saw severs a match. "The Flying Buzz Saw" by Harold McKay is one of the most amazing narrative revelations of advanced science ever set into type. Every paragraph—every page of the enthralling treatise on aerial warfare of the future will enthrall you to the very end. Read it in April "Air Wonder Stories."

"HOW HIGH CAN MAN FLY?"

by Lieutenant Apollo Soucek, recently the holder of the world's altitude record, is another wonder story in the April issue. The author gives us the facts that will limit and determine the ultimate altitude man can reach with the present type airplanes.

"Evans of the Earth Guard"

by Edmond Hamilton, is a story in which we learn some of the problems that man will face if communication is ever established with the moon, and commerce with lunar cities is ever started. He shows how, in the future, we will have to have an "earth guard" to protect commerce and transportation between the earth and its satellites.

In "Through the Meteors"

by Lowell Howard Morrow, we learn in a very dramatic story how man can overcome one of the present obstacles of interplanetary flight—the menace of meteors. The table of contents also includes: "The Flying Legion," by George Allan England; "The Heat Ray," by O. Beekwith, and other super stories of gripping interest—all based on newly developed scientific fact—and all in the April issue!

Next 4 Months for Only 50c

"Air Wonder Stories," a fully illustrated 9 x 12 inch magazine of 100 pages, is 25c per copy or \$2.50 a year on regular subscription. For a limited time only we will accept your 4 month subscription for only 50c and the coupon from this announcement. Clip—mail coupon today—and save half.

AIR WONDER STORIES, 96 Park Place, Dept. P4, New York, N. Y.

Air Wonder Stories, 96 Park Place, Dept. P4, New York 50c enclosed. Send me Air Wonder Stories for the next 4 months.

Name.....

Street.....

Town..... State.....

When your eyes BURN!

Does exposure to sun, wind and dust make your eyes bloodshot and cause a burning sensation? Then you should use *Murine!* A few drops of this harmless lotion speedily ends the burning feeling and soon clears up the bloodshot condition.

Always apply *Murine* after motor-ing or outdoor sports to soothe and refresh your eyes. And also after reading or working to relieve eye strain. Write the Murine Co., 9 E. Ohio St., Chicago, for valuable free book on the care of the eyes.

MURINE

FOR YOUR
EYES



Ford Owner Stop that ruinous chatter on your car. **MAKE THIS TEST**—take out your floor boards, pull your emergency brake back and forth. If you notice play at the ball joint, you need Bredar's Ball Shim. Price \$1.50. Ask your Dealer or order direct. Demand Bredar's Shim.
NIC BREDAR'S SON MFG. CO., Rock Island, Ill.

Mac You Can Make It **24 PLANS 25¢**

Only 25c brings you this portfolio of valuable plans. 24 separate sheets, with complete particulars covering each operation. Collection includes Grandfather's Clock, Ship Model, Book Case, Table and many other useful and practical furniture objects, novelties and toys.

Join the thousands of men who find joy and pleasure in making their own furniture. Experience the thrill of building something that will last a lifetime. Don't miss this opportunity to get these valuable plans. Easily worth \$2.50—but while this special offer lasts—only 25c. **Send now.**

Midland Appliance Corporation
225 N. Michigan Ave.,
Dept. 1610 Chicago, Ill.

FREE Send for literature describing Mac - The Popular Mechanic Workshop - electrically operated, and details of our Free Trial offer. Enables you to do all wood-working operations in one-tenth the time.
WRITE TODAY

SILVER ACE

1930 Catalogue



SEND 5 cents for the new 32 page booklet describing this sensational new indoor "Humming Bird" (which you can build for 50 cents), two new, flying, scale models, and the complete new low price list of SILVER ACE MODELS and Supplies.

AERO MODEL COMPANY
Dept. M 24, 111 No. Wacker Drive, CHICAGO, ILL.

Make a Clean-up This Summer



Start to earn big profits immediately sharpening lawn mowers by the Foley Electrakeen System. This is the same system used by the leading lawn mower manufacturers to put such a fine cutting edge on new mowers. It does a perfect job easily and quickly.

\$10 to \$25 a Day in Your Own Cash Business

Hundreds of men made plenty of money with the Foley last year, and hundreds more are going to make big money this year. Are YOU going to be one of them? It is easy if you try. Woodmancy made \$25 to \$30 a day—Lemont sharpened nearly 600 mowers and got from \$1.50 to \$2.00 apiece. You get cash for your work—and 99 cents out of every dollar you take in is your profit!

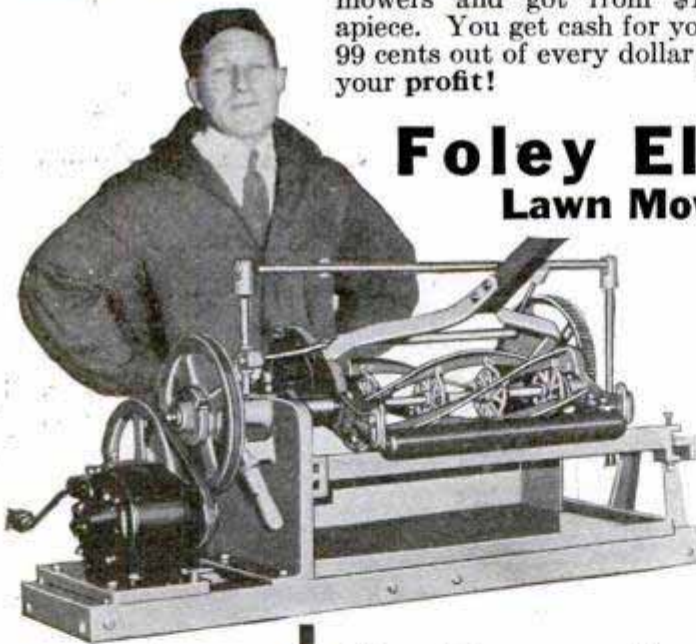

Foley Electrakeen Lawn Mower Sharpener

\$10
Brings It to You

Sharpens all kinds of lawn mowers the factory way in from 15 to 20 minutes and does a perfect job. Customers come back and recommend you to friends because no other method does such a good job. There are hundreds of lawn mowers right in your own neighborhood that need sharpening NOW. Steady repeat business year after year.

Morse Earned \$1520

He writes, "I started in spare time and found I was making from \$5 to \$6 an evening, so decided to make it a full time proposition." Others are doing it too, and so can YOU.

No Experience Necessary—Mail Coupon NOW!

Foley Mfg. Co.

Investigate at once! The Foley is easy and simple to operate. You can learn to turn out perfect work in a short time. Don't miss this wonderful opportunity to get into your own fine paying cash business. YOU can get these easy profits. Send coupon for complete information.

1436 Foley Bldg.,
11 Main St. N. E.,
Minneapolis, Minn.

Please send me complete information about the Foley Electrakeen Lawn Mower Sharpener and tell me how I can start my own cash business.

Name.....

Address.....

City & State.....

LUMINOUS PAINT

Make Your Watches, Clocks, Etc., Visible by Night

The very latest discovery in the scientific world, Hitherto practically unobtainable except at an exorbitant price, we have at last succeeded in producing this remarkable LUMINOUS PAINT, which, applied to the surface of any article, emits rays of white light, rendering it perfectly visible in the dark. THE DARKER THE NIGHT, THE MORE BRILLIANT IT SHINES. Quite simple to use. Any one can do it. A little applied to the dial of your watch or clock will enable you to tell the time by night. You can coat the push buttons or switch plates of your electric lights, match boxes, and innumerable other articles; make your own Luminous Cigarettes, Luminous Flowers, etc. Sent by express, price per 100, 10c per doz. 80c and \$1 postpaid. JOHNSON SMITH & CO., Dept. 800 RACINE, WIS.



CIGARETTE MAKER

Roll your own and save money. Better and quicker; saves more than half. Use your favorite brand of tobacco. Neat, useful, handy. Pocket size, weighs 1/2 oz. Made entirely of metal, nickel plated. 25c, 3 for 65c postpaid anywhere.



GOOD LUCK RING

Very striking, quaint and uncommon. Silver finish; skull and crossbones design, two brilliant, flashing gems sparkle out of the eyes. Said to bring good luck. Only 25c ppd.



Exploding Cigarettes

Box contains ten genuine cigarettes of excellent quality. They appear so real, but when each cigarette is about one-third smoked, the victim gets a very great surprise as it goes off with a loud BANG! A great mirth provoker yet entirely harmless. Price 25c box.

NOVELTY BADGES



Kissing Permit 10c Garter Inspector 10c Two very novel metal badges, nickel plated, that you can wear, giving you fun out of all proportion to their trifling cost. 10c, each badge, 3 for 25c, or 75c per doz. postpaid anywhere.

MIDGET BIBLE



GREAT CURIOSITY Smallest Bible in the World. Size of a postage stamp. 200 Pages. Said to bring good luck to the owner. A genuine work of art. Must be seen to be appreciated. Make good money selling them to friends, church acquaintances, etc. PRICE 15c each, 3 for 40c, 12 for \$1.35, 100 for \$7.50. Also obtainable in Leather Binding with gold edges. Price 50c each, 3 for \$1.25, \$4.50 per doz. Magnifying Glass for use with Midget Bible 15c.

STAGE MONEY



With a bunch of these bills, it is easy for each person of limited means to appear prosperous by flashing a roll of these bills at the proper time and peeling off a genuine bill or two from the outside of the roll, the effect created will be found to be all that can be desired. Prices, postpaid: 40 Bills 20c, 120 for 50c, or \$3.50 thousand postpaid.

NOSE FLUTE

The Magic Nose Flute, or Humaton, is a unique and novel musical instrument that is played with nose and mouth combined. There is just a little knack in playing it which, when once acquired after a little practice, will enable you to produce very sweet music that somewhat resembles a flute. There is no fingering, and once you have mastered it you can play all kinds of music with facility and ease. When played as an accompaniment to a piano or any other musical instrument, the effect is as charming as it is surprising.



JOHNSON SMITH & CO.

Dept. 800 RACINE, WIS. A De Luxe Edition of our new CATALOG mailed on receipt of 25c. Handsome binding. Bigger and better than ever. Only book of its kind in existence. Nearly 700 pages of all the latest tricks in magic, the newest novelties, puzzles, games, sporting goods, rubber stamps, unusual and interesting books, curiosities in seeds and plants, etc., unprocureable elsewhere. Remit by Coin, Money Order, Check or unused U. S., Canadian and Foreign Stamps for all articles listed above. See next page also.

BLANK CARTRIDGE PISTOL



Protection against Burglars, Tramps, & Dogs Special Offer 1 Blank Cartridge Pistol 100 Blank Cartridges 1 600-poise Novelty Catalog ONLY \$1.50 The Lot Shipped by Express Only Cash With Order Only Well made and effective, modelled on latest type of Revolver; appearance alone is enough to scare a burglar. When loaded it may be as effective as a real revolver without danger to life. It takes standard .22 Cal. Blank Cartridge—obtainable everywhere. Special cash with order of 100! Superior quality Blank Cartridge Pistol, 100 Blank Cartridges, and our new 550 page De Luxe Catalog of latest novelties; all for ONLY \$1.50. Shipped by Express only. Cannot go by parcel post. Extra Blank Cartridges 50c per 100. Special Holster (Cowboy Type) for pistol 50c. No C. O. D. shipments.

LOOK 35¢ LOOK Wonderful Instrument.



Greatest thing yet. Nine separate articles in one. Everybody delighted with it. Odd, Curious and Interesting. Lots of pleasure as well as very useful. It is a double Microscope for examining the wonders of nature. It is also an Opera Glass, a Stereoscope, a Burning Lens, a Reading Glass, a Telescope, a Compass, a pocket Mirror, and a Laryngoscope—for examining eye, ear, nose and throat. It is worth all the cost to locate even one painful clinder in the eye. Folds flat and fits the pocket. Something great—you need one. Don't miss it. Sent by mail. Only 35c or 3 for \$1.00.

Watch Charm Pistol \$1.00



Exact reproduction of a real pistol; actually fires REAL BLANK CARTRIDGES of miniature size. Illustration is actual size, 1 1/4 inches long, with ring at end for attaching to watch chain. Loads like a regular pistol. Pull the trigger and it goes off with a loud bang. Pistol is break open type; illustration shows position for loading. Made entirely of high grade steel, nickel plated, octagon barrel, handoperated handles, complete in box with cleaning rod. PRICE \$1.00. BLANK CARTRIDGES, 50c per box of 25 (shipped by Express)

PISTOL CIGARETTE CASE



It looks like a deadly weapon, but it is merely a novel Cigarette Case. This clever contrivance has proved itself better than the real thing in many an awkward encounter. Great fun "sticking up" your friends. They squirm and protest it might be loaded. Pull the trigger and the slide flies open disclosing the cigarettes. Well made, light and compact. Weight only 2 ounces. PRICE POSTPAID 25c

MICROPHONE TRANSMITTER BUTTON



AS A TRANSMITTER ON PICTURE MICROPHONE MUSIC AT A DISTANCE TALKING THROUGH CUPBY

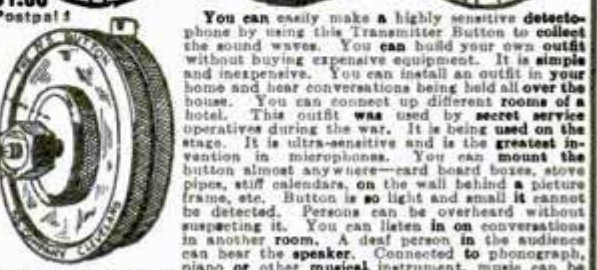

You can easily make a highly sensitive telephone by using this Transmitter Button to collect the sound waves. You can build your own outfit without buying expensive equipment. It is simple and inexpensive. You can install an outfit in your home and hear conversations being held all over the house. You can connect up different rooms of a hotel. This outfit was used by secret service operatives during the war. It is being used on the stage. It is ultra-sensitive and is the greatest invention in microphones. You can mount the button almost anywhere—card board boxes, stove pipes, stiff ceilings, on the wall behind a picture frame, etc. Button is so light and small it cannot be detected. Persons can be overheard without suspecting it. You can listen in on conversations in another room. A deaf person in the audience can hear the speaker. Connected to phonograph, piano or other musical instrument, music can be heard hundreds of feet away. Button may be used to renew telephone transmitters; often makes an old line "talk up" when nothing else will. The ideal microphone for radio use; carries heavy current and is extremely sensitive. Amplifies radio signals. Countless other similar uses will suggest themselves. Experimenters find the button useful for hundreds of experiments along the lines of telephones, amplifiers, loud speakers, etc. Many fascinating stunts may be devised, such as holding the button against the throat or chest to reproduce speech without sound waves. PRICE \$1.00.

JOHNSON SMITH & CO., Dept. 800, RACINE, WIS.



BOYS! BOYS! BOYS! Throw Your Voice

Into a trunk, under the bed, under a table, back of the door, into a desk at school, or anywhere. You get lots of fun fooling the teacher, policemen, peddlers, and surprise and fool all your friends besides.

THE VENTRILO

is a little instrument that fits in the mouth out of sight. Cannot be detected. It is used in connection with the above, and with the aid of this wonderful DOUBLE

THROAT, or VENTRILO, you can imitate many kinds of birds, animals, etc. Remember you get everything for ONLY TEN CENTS—a booklet giving you full instructions how to become a ventriloquist and throw your voice, the Double Throat, or Ventrilo, and our big 600 page catalog of novelties, tricks, puzzles, masks, books, etc., ALL SENT POSTPAID TO ANY ADDRESS FOR ONLY 10 cents



INVISIBLE INK Rubber Chewing Gum

The most confidential messages can be written with this ink, for the writing makes no mark. Cannot be seen unless you know the secret. Invaluable for many reasons. Keep your posts and other private memoranda away from prying eyes. Great fun for playing practical jokes. Only 15c a Bottle; 3 for 40c.



It is just like a regular package of chewing gum and looks so real that it fools everybody. Of course no one suspects it is not genuine until they start to chew it. There's a world of fun in this rubber chewing gum — 5 sticks to the package. Price, 10c Pkg.; 3 for 25c; 12 for 75c postpaid.

Rubber Tacks. Box 10c
Rubber Cigs, Price Ea. 10c
Rubber Cigarettes, Price per Box, 20c
Rubber Matches, Price per Pkg. 10c



MAGICIAN'S BOX OF TRICKS

Apparatus and Directions for a Number of Mysterious Tricks, Enough for an Entire Evening's Entertainment. \$1.00

ANYONE CAN DO THEM

It is great fun mystifying your friends. Get this Conjuror's Cabinet, and you will be the cleverest fellow in your district. It contains the apparatus for ten first-class tricks, including THE MAGIC BALL AND VASE TRICK (a wooden ball is placed inside, and upon replacing the lid has disappeared and is found in someone else's pocket); THE HINDOO TRICK CARDS (can be made to change completely no less than five times); DISAPPEARING COIN BOX (a coin, placed in the wooden box, vanishes entirely or changes into a coin of another denomination); THE GLASS GOBLET TRICK (a coin is dropped into a glass of water and when the water is poured out the coin has vanished and is found somewhere else); THE RIBBON FACTORY FROM THE MOUTH TRICK (a seemingly endless supply of colored paper ribbons comes out of your mouth); the DISAPPEARING HANDKERCHIEF (a handkerchief held in the hand mysteriously vanishes); the WIZARD'S RING COIN TRICK; the ENCHANTED BOTTLE (no one but yourself is able to make it lay down); the GREAT HAT AND DICE TRICK (a large dice is placed on top of a hat, disappears, and is found underneath yet no one has touched the hat), and last, but not least, the GREAT PHANTOM CARD TRICK, or two from five leaves nothing. Full instructions are sent for performing each trick. In addition to the above, a number of other feats and illusions are fully explained for which you can easily make or procure the necessary apparatus. Price complete \$1.00 postpaid. JOHNSON SMITH & CO.



U. S. BABY TANK

25 Cents



It goes with real Yankee Pep—by its own power

Most remarkable toy ever invented. By drawing the Tank backward, either with the hand or over the floor or table and then placing it down, it will crawl along, overcoming all obstacles, in the same life-like manner as the larger Tank that proved so deadly in the great war. What makes it go is somewhat of a mystery, for there is no mechanism to wind up as is usually understood, with mechanical toys, yet this tank will keep plodding along ten times longer than the ordinary run of toys. It will perform dozens of the most wonderful stunts! 2 1/2 inches long. Price only 25c prepaid. Stamps accepted. JOHNSON SMITH & CO.

toys, yet this tank will keep plodding along ten times longer than the ordinary run of toys. It will perform dozens of the most wonderful stunts! 2 1/2 inches long. Price only 25c prepaid. Stamps accepted.

RESURRECTION PLANT

Great curiosity. Place in water, plant opens up and starts to grow in few minutes. Taken out it dries up and goes to sleep until put in water again. PRICE 10c, 3 for 25c. 75c dozen postpaid.



EXPO WATCH CAMERA



The most wonderful and ingenious Camera made

It is but little larger than a watch, which it closely resembles. You can carry the Expo about in your pocket and take pictures without any one being the wiser.

Less Than 2 Cents a Picture

The Expo loads in daylight with 10 or 20 Exposure Films, costing 25c and 35c respectively, and thus the picture taking part of a whole day's outing may be had for a very nominal sum—Little more than one cent a picture.

Easy to Manipulate

It is simplicity itself to operate. Takes pictures through the stem, where the Rapid Fire Lens is located. The photos (5-8x7-8) may be enlarged to any size. Time and instantaneous shutters; weighs but 3 ounces; nickel plated. Endorsed by amateurs and professionals the world over. Thoroughly practical—printing and developing of films just the same as ordinary cameras—in daily use by the police, newspaper reporters, detectives, and the general public. Important hints have been secured with the Watch Camera by enterprising reporters. Produces clear, sharp negatives indoors or outdoors equal to any camera on the market, size or price notwithstanding. Sold Under a Positive Guarantee.

Expo Watch Camera \$3.85 FILMS, 10 Exposures 25c, 20 Exposures 35c
Price Post Paid Leather Pocket Carrying Case, 35c



MAGIC MADE EASY 250 MAGIC TRICKS 10c

An excellent little book containing 250 Parlor Tricks, tricks with cards, coins, handkerchiefs, pecker rings, glasses, etc. So simple that a child can perform them. Profusely illus. Sent postpaid to any address for only 10c, 3 copies for 25c.



Comical Motto Rings

Lots of harmless fun and amusement wearing these rings. Made in platinum finish (to resemble platinum), with wording on enameloid, as illustrated. Price only 25c Postpaid.

The "Little Giant" Typewriter

A First Class Writing Machine For \$1.50

A perfect little typewriter for \$1.50. There are thousands of persons who would like to use a typewriter but whose needs and business do not warrant the expense attached to the purchase and use of a fifty or seventy-five dollar machine. To such persons we cordially recommend our Little Giant. It is strongly made, but simple in construction, so that anyone can quickly learn to operate it, and write as rapidly as they would with pen and ink. The letters of the alphabet most frequently used are so grouped as to enable one to write rapidly, the numerals 1 to 10, and the punctuation marks being together. With this machine you can send your best girl typewritten love letters, address envelopes, make out bills, and do almost any kind of work not requiring a large, expensive machine. With each typewriter we send a tube of ink and full printed instructions for using the machine. Price complete \$1.50 by mail postpaid to any address in the world. Stamps accepted.



Send remittance (Postage Stamps accepted) for all articles listed above, also in our other ad on previous page

JOHNSON SMITH & CO. Dept. 800 Racine, Wis.



There's the Man Who's Holding You Down

Yes, sir! There's the man! You see him every time you look in the mirror. His name isn't Brown or Smith or Jones but Y-O-U. He's your real boss. He's the man who decides whether your salary will be \$35 a week or \$100 or \$150.

If you want to get ahead there's just one sure way to do it—train yourself to do the day's work better than any other man in the office. Ability is bound to count. Your employer will be glad to pay you more money if you show him you *deserve* it.

A home-study course with the International Correspondence Schools will prepare YOU for the position you want in the work you like best. All it takes is an hour a day of the spare time that now goes to waste.

At least find out how by marking and mailing the coupon that has meant the difference between Failure and Success to so many other men. It doesn't obligate you in any way to fill in this coupon, yet it may be the means of changing your entire life. *Do—it—now!*

Write for Free Booklet

INTERNATIONAL CORRESPONDENCE SCHOOLS Box 5677-F Scranton, Penna.

Without cost or obligation, please send me a copy of your booklet, "Who Wins and Why," and full particulars about the course before which I have marked X in the list below:

TECHNICAL AND INDUSTRIAL COURSES

- | | |
|--|---|
| <input type="checkbox"/> Architect | <input type="checkbox"/> Automobile Mechanic |
| <input type="checkbox"/> Architectural Draftsman | <input type="checkbox"/> Aviation Engines |
| <input type="checkbox"/> Building Foreman | <input type="checkbox"/> Plumber and Steam Fitter |
| <input type="checkbox"/> Concrete Builder | <input type="checkbox"/> Plumbing Inspector |
| <input type="checkbox"/> Contractor and Builder | <input type="checkbox"/> Foreman Plumber |
| <input type="checkbox"/> Structural Draftsman | <input type="checkbox"/> Heating and Ventilation |
| <input type="checkbox"/> Structural Engineer | <input type="checkbox"/> Sheet-Metal Worker |
| <input type="checkbox"/> Electrical Engineer | <input type="checkbox"/> Steam Engineer |
| <input type="checkbox"/> Electrical Contractor | <input type="checkbox"/> Marine Engineer |
| <input type="checkbox"/> Electric Wiring | <input type="checkbox"/> Refrigeration Engineer |
| <input type="checkbox"/> Electric Lighting | <input type="checkbox"/> R. R. Positions |
| <input type="checkbox"/> Reading Shop Blueprints | <input type="checkbox"/> Highway Engineer |
| <input type="checkbox"/> Telegraph Engineer | <input type="checkbox"/> Chemistry |
| <input type="checkbox"/> Telephone Work | <input type="checkbox"/> Pharmacy |
| <input type="checkbox"/> Mechanical Engineer | <input type="checkbox"/> Coal Mining Engineer |
| <input type="checkbox"/> Mechanical Draftsman | <input type="checkbox"/> Navigation <input type="checkbox"/> Assayer |
| <input type="checkbox"/> Machine Shop Practice | <input type="checkbox"/> Iron and Steel Worker |
| <input type="checkbox"/> Toolmaker | <input type="checkbox"/> Textile Overseer or Supt. |
| <input type="checkbox"/> Patternmaker | <input type="checkbox"/> Cotton Manufacturing |
| <input type="checkbox"/> Civil Engineer | <input type="checkbox"/> Woolen Manufacturing |
| <input type="checkbox"/> Surveying and Mapping | <input type="checkbox"/> Agriculture <input type="checkbox"/> Fruit Growing |
| <input type="checkbox"/> Bridge Engineer | <input type="checkbox"/> Poultry Farming |
| <input type="checkbox"/> Gas Engine Operating | <input type="checkbox"/> Mathematics <input type="checkbox"/> Radio |

BUSINESS TRAINING COURSES

- | | |
|--|---|
| <input type="checkbox"/> Business Management | <input type="checkbox"/> Business Correspondence |
| <input type="checkbox"/> Industrial Management | <input type="checkbox"/> Show Card and Sign Lettering |
| <input type="checkbox"/> Personnel Management | <input type="checkbox"/> Stenography and Typing |
| <input type="checkbox"/> Traffic Management | <input type="checkbox"/> English |
| <input type="checkbox"/> Accounting and | <input type="checkbox"/> Civil Service |
| <input type="checkbox"/> C. P. A. Coaching | <input type="checkbox"/> Railway Mail Clerk |
| <input type="checkbox"/> Cost Accounting | <input type="checkbox"/> Mail Carrier |
| <input type="checkbox"/> Bookkeeping | <input type="checkbox"/> Grade School Subjects |
| <input type="checkbox"/> Secretarial Work | <input type="checkbox"/> High School Subjects |
| <input type="checkbox"/> Spanish <input type="checkbox"/> French | <input type="checkbox"/> Cartooning |
| <input type="checkbox"/> Salesmanship | <input type="checkbox"/> Illustrating |
| <input type="checkbox"/> Advertising | <input type="checkbox"/> Lumber Dealer |

Name.....

Address.....

City.....State.....

Occupation.....

If you reside in Canada, send this coupon to the International Correspondence Schools Canadian, Limited, Montreal, Canada

Get Into Business this Easy Way

7

Machines in One!



Ball Bearing Throughout

Weight 520 Lbs.

A YEAR TO PAY!

Small deposit brings it to you for FREE TRIAL

The Electric Carpenter

Runs from Any Light Socket

Make money on screens, trellises, furniture, toys, etc. 8" Circular Saw; 14" Band Saw; 36" Lathe; 10" Swing; 6" Jointer; Reversible Shaper; 1/2" Hollow Chisel Mortiser; Sander. Does 35 woodworking operations. NOT a toy!

Write Today for Illustrated Folder

THE WOODWORKING MACHINERY CO., INC.
Eleventh and Vine Sts., Philadelphia, Pa.

We Also Build a Complete Line of Single-Purpose Machines

MAKES A COMPLETE MACHINE SHOP

\$1.75 UNITOOL ELECTRIC MOTOR ATTACHMENT

without chuck
\$1.25
with
chuck



Fastens directly on motor shaft, no pulleys or belts necessary. Holds grindstones, buffs, saws, wire scratch brushes, drills, etc. Serves as pulley. Made to fit 3-8, 1-2 and 5-8 in. shafts. State size. Postage prepaid if remittance accompanies order.



United Electric Motor Co., 178 Centre St., Dept. C-4, New York



ITALIAN ACCORDIONS

Best in the world. 10-year guarantee, lowest prices. FREE instruction, ask for FREE catalog. RUATTA, SERENELLI & CO., 1014 Blue Island Ave. Dept P, Chicago, Ill.

BUCHSTEIN'S FIBRE LIMB



is soothing to your stump—strong, cool, neat, light. Easy payments. Braces for all deformities. D. BUCHSTEIN CO. 610 3rd Ave., So. MINNEAPOLIS, MINN.

Send for Catalog Today

MODEL SHIPS



We can supply construction sets and all sorts of parts such as semi-finished hulls, blocks, dead-eyes, special flags, anchors, steering wheels, capstans, figureheads, blue prints, books, etc., for building real fine scale models of the Flying Cloud, Constitution, Spanish Galleon, Mississippi River Steamboat, Sovereign of the Sea, Mayflower and many others. Also special construction sets for racing sail boats, power boats, model steam engines, propellers, etc., and fine tools for the model maker. Our large 48-page photographically illustrated booklet contains valuable information and hints for building ship models in addition to prices and full description of the above articles. Many people only slightly interested in models have become greatly enthused upon receiving this booklet. A copy will be sent postpaid upon receipt of 15 cts. (coin preferred).

Model Ship Supply Co., Dept. D, Mineola, N. Y.

Auto Owners Now Save Millions of Gallons of Gas

A new invention called the Whirlwind is actually saving millions of gallons of gasoline for automobile owners. Those who have installed this amazing device on their cars report almost unbelievable gasoline savings. They also report more speed and power, quicker starting and disappearance of carbon.

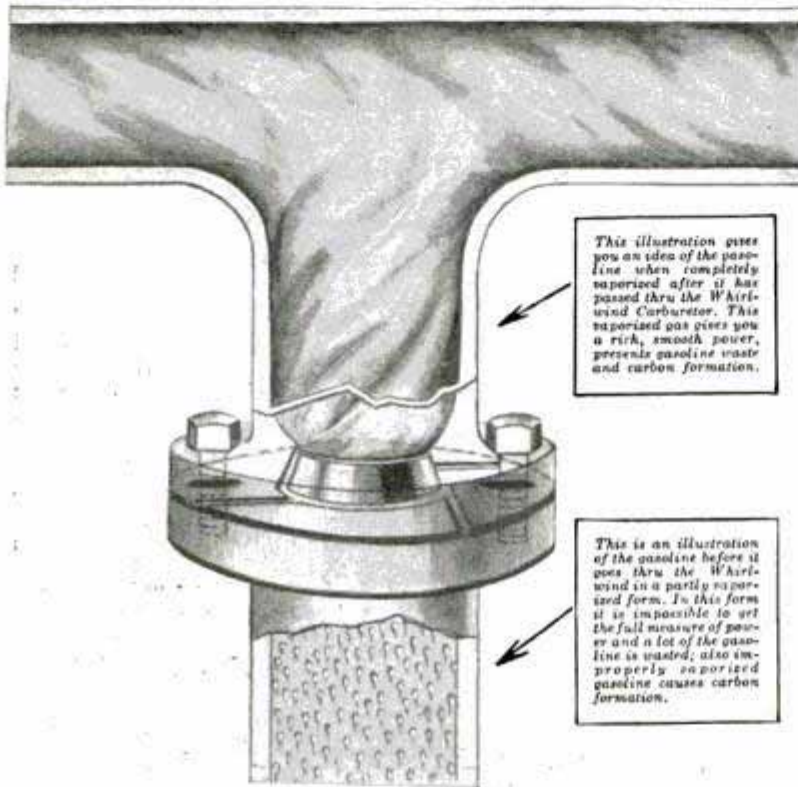

This illustration gives you an idea of the gasoline when completely vaporized after it has passed thru the Whirlwind Carburetor. This vaporized gas gives you a rich, smooth power, prevents gasoline waste and carbon formation.

This is an illustration of the gasoline before it goes thru the Whirlwind in a partly vaporized form. In this form it is impossible to get the full measure of power and a lot of the gasoline is wasted; also improperly vaporized gasoline causes carbon formation.

The marvelous thing about this Whirlwind is that it works as well on all makes of cars. Reports are received from owners of practically every known make of automobile from Fords to Lincolns and they are all equally enthusiastic in their praise.

FITS ALL CARS

In just a few minutes the Whirlwind can be installed on any make of car, truck or tractor. It's actually less work than changing your oil or putting water in the battery. No drilling, tapping or changes of any kind necessary. It is guaranteed to work perfectly on any make of car, truck or tractor, large or small, new model or old model. The more you drive the more you will save.

SALESMEN AND DISTRIBUTORS WANTED

FREE SAMPLE AND \$100.00 A WEEK OFFER

Whirlwind men are making big profits supplying this fast selling device that car owners cannot afford to be without.

Good territory still open. Free sample offer and full particulars sent on request. Just check the coupon.

GUARANTEE

No matter what kind of a car you have—no matter how big a gas eater it is—the Whirlwind will save you money. We absolutely guarantee that the Whirlwind will more than save its cost in gasoline alone within 30 days, or the trial will cost you nothing. We invite you to test it at our risk and expense. You are to be the sole judge.

WHIRLWIND MFG. CO.

DEPT. 999-223-A THIRD ST.

MILWAUKEE, WISCONSIN

Free Trial Coupon

Whirlwind Mfg. Co.,
999-223-A Third St., Milwaukee, Wis.

Gentlemen: You may send me full particulars of your Whirlwind Carbureting device and free trial offer. This does not obligate me in any way whatever.

NAME.....

ADDRESS.....

CITY.....

COUNTY..... STATE.....

Check here if you are interested in full or part time salesman position.

Simplex Screw Jacks

For the Home, Workshop, or Manual Training

WITH this 500 lb. capacity Simplex Jack, you can straighten window or door frames and avoid planing or re-setting locks—level radiators, plumbing, drain pipes, ice box—straighten or clamp glued work, radio cabinets, etc. This little—

“Jack in the Box” is for the man who uses tools, or the boys interested in manual training or mechanical toys. It has hundreds of uses. Sturdily built, beautifully finished, and unconditionally guaranteed. Its purpose is to demonstrate and advertise the exclusive safety feature of the visible screw and power of the larger Simplex Jacks, and will be sent you prepaid for 35 cents—Canada 45 cents. Money refunded without question and instantly if not satisfied.

Templeton, Kenly & Co. 35¢
 ESTABLISHED 1899
 1020 So. Central Av. Chicago Ill. U.S.A. 140

Gentlemen: Please send me postpaid 1 Simplex Miniature Jack at 35 cents and at 35 cents each for my friends. A total of \$..... is enclosed.

Name.....
 Street.....
 City..... State.....
 Mark color desired: Red, Blue, Green.

Ask Your Hardware Dealer for the Larger **SIMPLEX** Jacks

AGENTS! SELLS LIKE WILDFIRE

New improved window washer eliminates all muss and fuss wherever there is glass to be cleaned. Approved by Good House-keeping Institute. Restricted territory to producers. Write today

CARTER PRODUCTS CORP.
 935 Front Street
 Cleveland, Ohio

DISTRIBUTING AGENTS

MAKE \$100 A WEEK

Make 85c on a \$1.50 Sale

Sell the finest steel tow cables. Every car owner needs one. \$10 to \$25 a day profit easy.

SEND trial order for full length 65¢ Postpaid cable

Positively the greatest value on the market.

MICHIGAN METAL PRODUCTS COMPANY
 44 Gardner Street
 Battle Creek, Michigan

SENT FREE **ON THIS COUPON MAIL NOW**

This E-F ANGLE SCREWDRIVER—of tempered crucible Spring steel—7 powerful edges for large and small screws. Works under obstructions where others won't—101 uses. Carries like pen-knife—often more valuable.

(PRINT*)
 Name.....
 Route.....
 No., St.....
 P. O.....
 City, St't.....
 Interested in Plier-Rench Representative Prop's't'n!
 In User Literature! **THE FLASH SALES CORP**
 PMD 4809 N. Ashland Ave., CHICAGO, ILL.

Also FREE—Amazing 125-Picture Story of **The “Pocket Machine Shop”**
 Its GEAR gives Your Hands the 1-TON grip of 20 hands, that outgrips a 40-Lb. Vise!

An Automatic Lock-Grip Ratchet Wrench
 Speed VISE
 Parallel PLIERS Plus

No. 1, Universal—for All Pliers, Nut Wrench, Vise & Clamp, Spring-making Work, etc.
 No. 2—for all Pipe work, “chewed” nuts in tight places, etc.
 No. 3—For all Wire chain, spring-making, fencework, etc.

EIFEL-FLASH PLIERENCH KIT
 (Say “Eye-tel-Flash”) “The T.N.T. of Tools”
 A 1-Second change of Gear-Jaws gives you 1, 2 and 3, in this 24 oz. Master KIT—for the Price of 1 tool. They DO the Work of 60 Lbs. of Other Tools costing \$50, and things no other tools can do!

A GREAT ALL-YEAR MONEY-MAKER for Plier-Rench Representatives—Full or Part time. \$75.00 to \$200.00 Weekly!

NEW LOW PRICES—Mail Coupon!

QUICK MONEY FOR ACTIVE AGENTS

New method of applying monograms, initials (solid gold or any color embossed) on automobiles, trunks, golf bags, suit cases, etc. Takes five minutes—no experience. An easy process (not transfers) \$3 profit—costs 2 cts. Write now for free samples while offer is open.

BAKON MONOGRAM CO.
 Dept. 14, 4028 Greenview Av., CHICAGO

SAMPLES OF 33 RARE WOODS

ALSO, 20 cabinet and 20 inlay, \$1.75 ONLY 29¢
 —or your choice \$1.00. Sets labeled and postpaid. We carry WOODS of all kinds, including panels, veneers and inlay woods. Write for FREE Price list.

CRAFTSMAN WOOD SERVICE CO.
 PM-188 West 74th St., Chicago, Ill.

WHY BALD? At 40?

Lucky Tiger Corrects
 Scalp Ailments and stops falling hair, like Whyte-Fox No. 2 knocks head colds, skin and rectal irritations. Used by millions. Money-Back Guarantee. A toilet necessity. A valuable booklet free on request.

At Barbers, Druggists, Beauty Parlors
 Kansas City, Mo. **LUCKY TIGER REM. CO.**

Gain Success Fame-Money in Aviation . .

AT THE SCHOOL OF * PERSONAL INSTRUCTION

**Classes are purposely limited at the Training Division of Weeks Aircraft Corporation. Students in our school must receive personal attention from the school heads not just assistants.*

One hundred factories are now turning out airplanes—and every plane sold means another pilot needed — more men for ground attention and tuning up. No wonder America is crying for trained airplane experts.

EARN UP TO \$500 A MONTH

Hundreds of young men just like you—have said "I can" and are making \$400, \$500, \$1000 a month —every moment of their work is fascinating — the future is rich —no rut for them.

COMPLETE FLYING SCHOOL —FULL GROUND COURSE

You repair engines, and planes, make real ribs and struts—students are now building experimental planes in the Weeks Training Division—all under the PERSONAL instruction of a former head of U. S. Naval Aviation School. You learn to fly in latest planes with U. S. Licensed Transport Pilots at U. S. Air Mail Field.

YOU HOLD SUCCESS IN YOUR HAND Now!

Take a pencil in your hand — that pencil is your key to success—print your name and address on the coupon —don't spend your future in regret — join America's fastest growing industry — the richest field open to young men—profit from Aviation—Act NOW!

The coupon brings
this aviation book
FREE



TRAINING
DIVISION
WEEKS AIRCRAFT CORPORATION
376-4-11th Street, Milwaukee, Wis.

Yes!
I want to profit from Aviation. Without obligation send me full information on your personal instruction aviation course which I have checked.
 Airplane Pilot Aviation Mechanic
Name.....
Street.....City.....
Age.....Occupation.....



Be
an
Aviator



His first solo flight.



Hauling a \$200.00 load.



Repair and
Build Planes



Building experimental plane.



Personalized
flight in-
struction.

Hear - Foreign Radio Stations DIRECT!



**Without Dependence On
Local Re-Broadcasting!**

PILOT SUPER-WASP

Short Wave and Broadcast Receiver
RANGE 14 TO 500 METERS

In Kit Form for A. C. or Battery Operation

See Nearest Dealer or
Write Direct for Details

Kit K-115: The A. C. Super Wasp. Use your own ABC pack or Pilot K-111 at \$16.50, specially designed for the Super-Wasp. Power Pack and Tubes Extra

\$34⁵⁰

Kit K-110. The battery-operated Super-Wasp. Batteries and Tubes extra

\$29⁵⁰

Widen Your Circle of Entertainment!

Your broadcast receiver is useless below 200 meters, but the Super-Wasp, swooping down to 14 meters, and up to 500, unlocks a new world of trans-oceanic radio you never heard before! And you get it *directly from the foreign station* and not from a local rebroadcast. Enthusiasts report European, African, South American and Australian stations. Music amazingly new! Welcome variety for listeners "fed up" with domestic radio programs! To assure consistently satisfactory operation, Pilot engineers developed the Pilotron P-227, which naturally makes it a splendid tube for broadcast receivers.



PILOT RADIO & TUBE CORP.

323 BERRY STREET
BROOKLYN
N. Y.



Chicago Office: 234 South Wells Street
San Francisco Office: 1278 Mission Street

JOINING THE RADIO INTERNATIONAL GUILD

Costs only 50c and includes lapel pin, certificate and "Radio Design" Construction Quarterly Magazine, the Guild's Official Organ. Enclose 50c coin or stamps to Radio International Guild, 103 Broadway, Brooklyn, N. Y.



Name.....
Address.....
City..... State.....

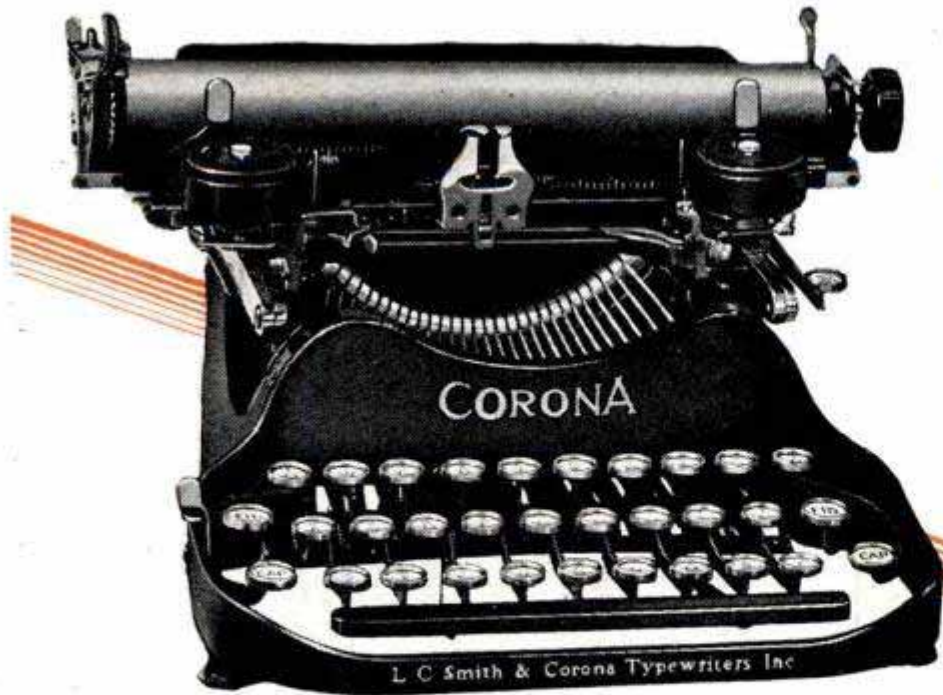

BRAND NEW

CORONA GENUINE Model #3

Lowest Price — Easiest Terms



HERE'S your chance to own that *brand new* Genuine Model 3 Corona you've wanted—on the easiest terms ever offered—at **LOWEST PRICE** ever offered. Complete in every detail; back spacer, etc. *Manufacturer's Guarantee*. Recognized the world over as the finest, strongest, sturdiest portable built.

S. Joveton writes: "It truly is a wonderful machine. I am very pleased with it and find it very simple to work although it is the first typewriter I have ever used."

F. J. Barsuglia, Jr., writes: "I am very well pleased with your little Corona and I must say I do not know what I would really do without it. It works like a charm and has every convenience of a larger machine."

Don P. Fina, composer and pianist says: "Corona has helped me put my songs over and is still doing it. I find it just the thing for writing words to songs and for all correspondence to the profession."

Mrs. G. Bernstein says: "Allow me to thank you for prompt delivery of the Corona. I am delighted with it and know I shall derive great pleasure from its possession."

Yours for 10 DAYS FREE

Only a limited number of these splendid machines available. To get one, you must act now! Experience the joy this personal writing portable typewriter can give you! Use it ten days free! See how easy it is to run and the splendidly typed letters it turns out. Ideal for the office desk, home, traveling. Small, compact, light, convenient. Don't send out letters, manuscripts, reports, bills in poor handwriting when you can have this Corona at such a low price on such easy terms. Remember these are *brand new* machines right out of the Corona factory.

Carrying Case FREE
If You Act Now!

Leatheroid carrying case, oiler, instructions free on this offer. Send no money—just the coupon. Without delay or red tape we will send you the Corona. Try it 10 days. If you decide to keep it, send us only \$2—then \$3 a month until our special price of \$39.90 is paid. Now is the time to buy. This offer may never be repeated.



Save Money—Use this Coupon

Smith Typewriter Sales Corp., (Corona Division)
469 E. Ohio St., Chicago, Ill. Dept. 34

Ship me the Corona, F. O. B. Chicago. On arrival I'll deposit \$2 with express agent. If I keep the machine, I'll send you \$3 a month until the \$37.90 balance of \$39.90 price is paid; the title to remain with you until then. I am to have 10 days to try the typewriter. If I decide not to keep it, I will repack and return to express agent, who will return my \$2. You are to give your standard guarantee.

Name _____

Address _____

Employed by _____



How I Started Making \$5300 A Year

With a Borrowed Kriss Kross Stropper

By B. G. LOUGHREN



\$200 the first week! \$1000 in a single month! And over \$5300 cash profits in a year!

When I sit down and look at those figures in my bank book, I can't help marveling at the strangeness of fate. It was Chance—and Chance alone—that thrust this money-making opportunity into my path at the very moment I needed it most! I had been in the real estate business in Florida, when suddenly the "boom" collapsed. The immediate future looked gloomy, until one day when I dropped in to talk things over with a friend.

When I went into his office, he was at the wash bowl just finishing shaving, so I sat down at his desk where my eye fell on a little nickel-plated contrivance about half the size of my hand. There was something about it that aroused my curiosity.

NEW, REVOLUTIONARY INVENTION

"What's this thing?" I asked.
 "That's one of those KRISS KROSS razor stropers," said Jimmy. "You've read about it in the magazines. I've only been using it a month but I'm getting the keenest shaves of my life, all from the same blade. Look here, I'll show you how it works."

Well, it certainly was a mechanical marvel. I hadn't seen anything as ingenious in years!

"I wish I could invent something like that," I said. "I'll bet the company that puts it out is coining money hand over fist."

"They are," said Jimmy. "Furthermore, they only sell through agents and demonstrators,—and those agents are making plenty too! I sent for their proposition the other day just out of curiosity."

He handed me a letter with some sample order blanks attached. I read it through and then read it all over again.

"Jimmy," I said at last, "this thing sure will SELL,—and they certainly give their men a generous split! Let me borrow your stropper this afternoon and see how many orders I can take!"

ASTONISHING PROFITS

That afternoon I got the surprise of my life. The first man I walked up to had read all about KRISS KROSS in the Saturday Evening Post and said "Send me one" before I got half-way through my demonstration. By 4:30 I had 9 orders—and the next morning I got 11 more!

That sure convinced me—and I wrote the company that although they were not aware I was working for them, the only way they could stop me was by wire! . . . They wrote back—"Good work. Go to it." . . . Needless to say, I "went to it" in earnest and the end of the week found me with exactly \$200 cash profit in my pocket!

A \$15,000 BUSINESS ALMOST OVERNIGHT

The money I made that first week came easily enough—but after I got well started it became easier and easier. And then, before I knew it, I found that I was actually clearing as high as \$1000 in the single month!

Today I figure that I did a \$15,000 gross business that first year—with profit of over \$5000. And it all came from getting started with the right kind of a proposition. Success comes from giving the public what it wants and they surely have shown that they WANT KRISS KROSS! Personally, I believe that it is the greatest direct-selling item of all time!

Mr. Loughren's experience is typical of the surprising success of KRISS KROSS representatives in all parts of the country. Practically every man finds himself making money faster and easier than he ever dreamed possible. Right now, due to our heavy advertising program in Liberty, The Saturday Evening Post, Collier's, etc., there is room for more KRISS KROSS representatives—to earn \$30 a day and up. Find out about this opportunity today. No obligation. Just clip the coupon and mail it at once!

KRISS KROSS CORP.

1418 Pendleton Ave., Dept. D-3714, St. Louis, Mo.

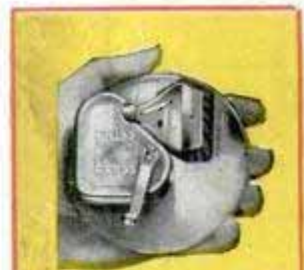

Why KRISS KROSS Pays Agents Such Astonishing Profits

KRISS KROSS actually reproduces with mechanical precision the intricate diagonal stropping stroke of a master barber. Strops any make blade (except Durham Duplex), giving the keenest cutting edge that steel can take! Just insert blade and turn the crank for 11 seconds.

How can anyone help but be interested in such an amazing device, especially since it means cool, smooth shaves forever with no more blades to buy!

KRISS KROSS CORP., Dept. D-3714
 1418 Pendleton Ave., St. Louis, Mo.

Please send me details of KRISS KROSS Stropper with generous commission proposition you offer to representatives and agents, working full or spare time.

Name.....

Address.....

Town.....State.....

Check here if interested only in a Stropper for your own use.