

DECEMBER

25 CENTS

POPULAR MECHANICS

MAGAZINE

WHAT YOU CAN UNDERSTAND IT

REG. U.S. PAT. OFF.



SEE PAGE 881



We asked:

“What do you notice first about the New Mobiloil?”

Motorists answered:

“It lasts longer”

When the New Mobiloil had been in use several months, we sent investigators to call on motorists in different parts of the United States and Canada. We wanted their unbiased opinion of this new oil.

Our investigators asked: “What do you notice first about the New Mobiloil?” Motorists everywhere answered: “*Mobiloil lasts longer.*”

What is the significance of these three words “Mobiloil lasts longer”? Perhaps they sound unimportant at first glance. But as a matter of fact, they are the most significant words in the science of lubrication. For, in comparing oils of similar “body,” engineers have proved that the oil which lasts longest, also lubricates best.

Of course, we already knew the New Mobiloil was the longest-lasting oil on the market. We had given it every scientific and practical test we could devise. Through all hours of steady speedway driving at an average speed of nearly 70 miles an hour, we conclusively proved that the New Mobiloil stands up better and lasts longer under every speed and condition of driving.

This is why we can say to you: “The New Mobiloil will keep the first-year feel in your engine, lubricate your engine better—it lasts longer.”

VACUUM OIL COMPANY

Makers of high quality lubricants for
all types of machinery

the New



Mobiloil

Keeps the first-year feel in your engine

WHAT MAKES IT TICK?



*The boy takes his birthday watch apart to see what makes it tick. The man listens to the tick of the uranium electrons discharged into space—he actually **hears** the atoms of the metal disintegrate.*

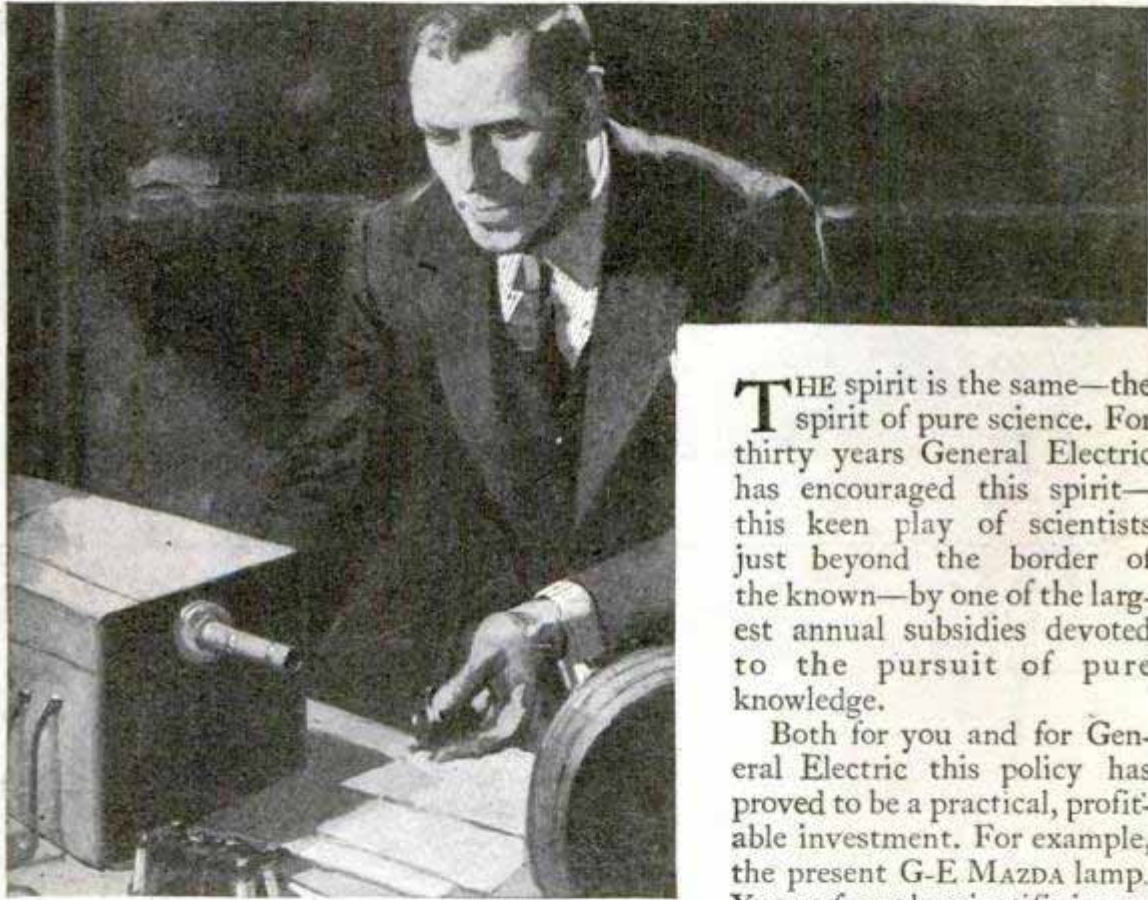

THE spirit is the same—the spirit of pure science. For thirty years General Electric has encouraged this spirit—this keen play of scientists just beyond the border of the known—by one of the largest annual subsidies devoted to the pursuit of pure knowledge.

Both for you and for General Electric this policy has proved to be a practical, profitable investment. For example, the present G-E MAZDA lamp. Years of purely scientific investigation

preceded this invention. And to-day, it saves the American people about a billion dollars a year in lighting bills.

The history of General Electric research is, in fact, crowded with such practical contributions to the comfort, health, and prosperity of us all, yet most of them owe their origin to the purely scientific curiosity which is the real dynamo of General Electric accomplishment. Because General Electric has pioneered this policy, and maintains it on a steadily increasing scale, the G-E monogram on any electric product—whether it is the little motor that runs your sewing machine or the turbines that drive the newest liners out to sea—is your assurance of electrical correctness and dependability.



JOIN US IN THE GENERAL ELECTRIC HOUR, BROADCAST EVERY SATURDAY AT 9 P.M.,
E.S.T. ON A NATION-WIDE N.B.C. NETWORK

GENERAL ELECTRIC

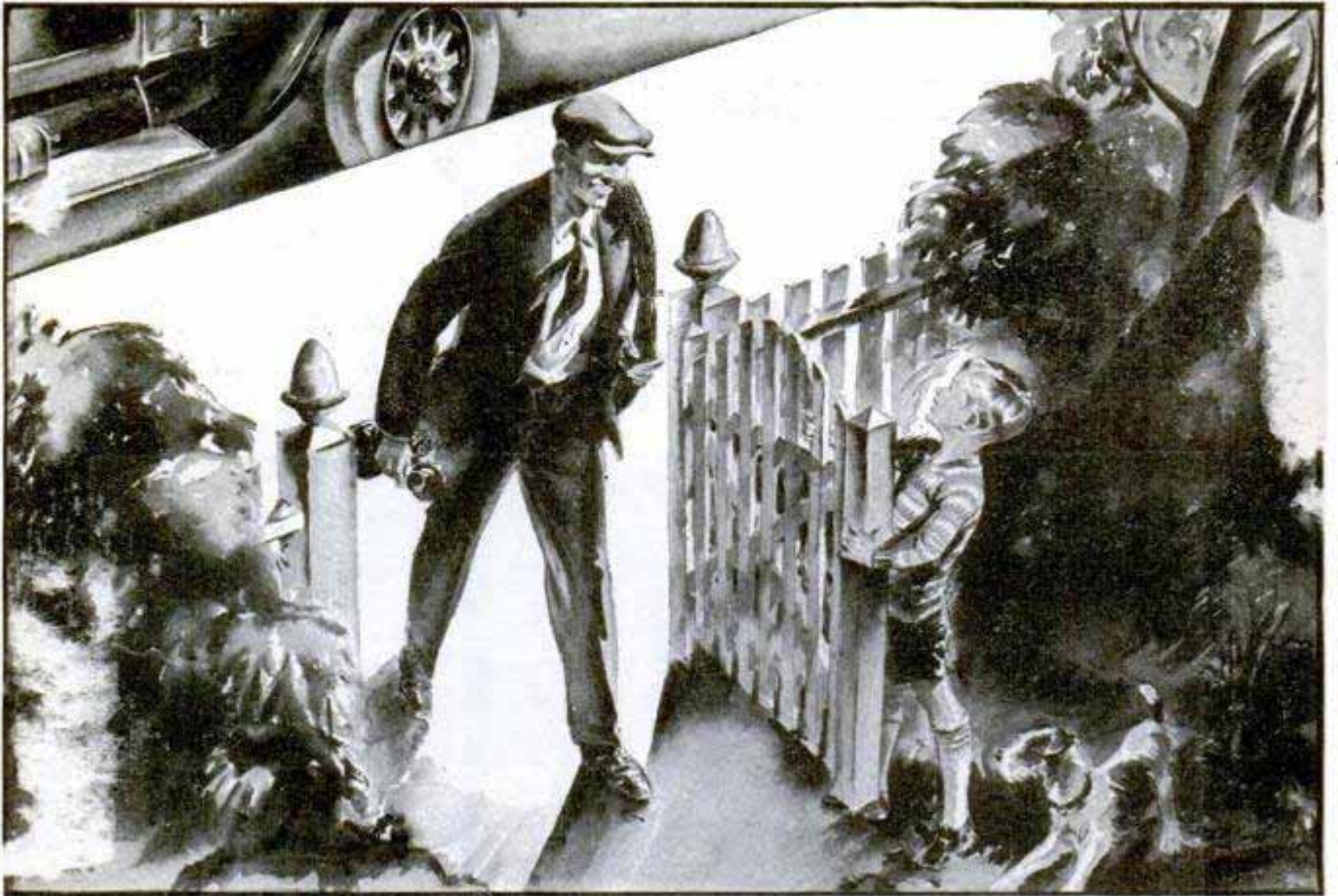

800,000 ADDITIONAL TELEPHONES ARE GOING INTO USE THIS YEAR

△ million and a half dollars a day

*An Advertisement of the
American Telephone and Telegraph Company*

More than 200 new Bell telephone buildings are going up every year in the United States, 100,000 additional telephones are going into use and new switchboards are for 3,000,000 additional calls a day. Thousands of miles of new cable, millions of miles of wire, new carrier systems, vacuum tubes and loading

These are a few of the things in the big construction and improvement program of the Bell System which will cost more than 550 million dollars—a million and a half a day.

Telephone growth is essential to the new American civilization of better opportunity for the average man. The



Bell System employs more than 400,000 workers, is owned by 450,000 stockholders, and serves the people of the nation.

Every day the Bell System is extending its lines to more people, increasing the speed and accuracy of its service, giving greater comfort and convenience in telephone use. All of this is done that each individual may get the most from this means of all inclusive and instantaneous communication and that the nation may be one neighborhood. This is part of the telephone ideal that anyone, anywhere, shall be able to talk quickly and at reasonable cost with anyone, anywhere else. There is no standing still in the Bell System.

Popular Mechanics Magazine

200 E. Ontario Street, Chicago, U. S. A.

H. H. WINDSOR, Founder

H. H. WINDSOR, Jr., Editor and Publisher

London: Hachette & Cie.,
16-17 King William Street, Charing Cross, W. C. 2

Paris: Hachette & Cie.,
111 Rue Reaumur

Melbourne: Gordon & Gotch
509-513 Little Collins St.

ISSUED MONTHLY

SUBSCRIPTION:

SINGLE COPY, 25 CENTS

In United States and its possessions, also Canada, Cuba, and Mexico, per year, postpaid - \$2.50

To all other countries in the Postal Union - 3.00

All subscriptions are discontinued at expiration. Please examine the date printed on your wrapper.

Entered as Second Class Matter Sept. 15, 1903, at the Post Office at Chicago, Illinois, under Act of March 3rd, 1879.

Entered as Second Class Matter at the Post Office Department, Canada.

Published monthly by POPULAR MECHANICS CO.

Copyright, 1929, by Popular Mechanics Co.

Copyright in Australia. Copyright in France

Vol. 52

Contents for December, 1929

No. 6

Special Features

<u>My Twin-Cylinder Flight around the World</u>	898
<u>Canada's Flying Gold Rush</u>	914
<u>The Detective of the Future</u>	930
<u>Strange Adventures in Davy Jones' Graveyard</u>	938
<u>In Step with the Stars</u>	946
<u>Hurdles to Jump for Inventors</u>	954
<u>Toys Make the Man</u>	962
<u>With the Snow Fighters</u>	978
<u>Shooting at the Moon</u>	985
<u>How the Plane Is Built</u>	994

<i>Schneider Cup Race</i> Airplanes		
chair on top of wing for jumper	960	
engine built like a barrel	984	
filling station for, at London aerodrome	929	
larger planes promise lower flying fares	951	
one landing-wheel plane accepted by army	968	
throat phones to eliminate roar of motor	905	
traps blackmailer by trailing pigeon	912	
Aluminum—white finish for	951	
Anesthetic—takes away fear of surgeon's knife	945	
Art—jointed model for artists	953	
Automobiles		
camouflage makes autos crow like roosters	902	
convertible coupe provided with a metal top	983	
test machine finds defects in front end of car	911	
Automobiles, Accessories		
rubber boot for shift lever	912	
table that attaches to front seat	923	
Automobiles, Truck—rubber tail light for	984	
Aviation		
airway lights in U. S. cover ten thousand miles	923	
electric parachute flare	987	
highway signs guide pilots	961	
lights turned on by siren on speeding plane	937	
pilots fly spiral courses when blindfolded	992	
sky harbors of the future	970	
skyrocket blazes way across sky	926	
Boats and Boating		
caterpillar boats on river pull box car barges	988	
speedboat leaps onto bank	977	
water shoes make sailboat	897	
Bottle Opener—on pencil tip fits in vest pocket	953	
Buildings—sixty-three-story is most economical	976	
Camera—revolves to "shoot" from any position	989	
Cathedral—shave windows of	960	
Chemistry—to outlaw war	984	
Coal		
substitutes for, tested	969	
truck fills containers	984	
Dog—wheel chair for injured	983	
Dredge—turns water of lake into land	952	
Electricity—cost of making	950	
Electric Light—first model of station in Ford museum	902	
Feet—impression on inked pad reveals ills	932	
Fish and Fishing		
Chinese fish walks on land	944	
crooked hook helps land fighting fish	960	
paddle water to keep fish alive while shipped	904	
rare "stone" fish found hiding in coral	911	
Fly Paper—luminous, catches insects at night	960	
Fowl—tissues of, kept alive for seventeen years	993	
Fuel—harness winter sun for heat to cut costs	902	
Golf—balls dotted in colors easier to find	967	
Health—judged by eyelashes	961	
Heating and Ventilating—humidifier and air cleaner		
one unit	999	
Horses—auto truck hauls six horses each in own stall	945	
House—of future is seen in glass building	958	
Household Devices	990	
House Plan	1055	
Ice Well—is good refrigerator for dairy	937	
Impersonation—art of make-up taught in strange school	903	

[Continued on Page 4]

*Cornucopia, compound
made from sweater* 995

Daily Serialized with Hearst
 Grant 1903
 903
 893
 894

unusual achievement - Unbreakable sea
 in sasophone and clarinet [4] 894

[Contents—Continued]

mining Canada's Flying Gold Bird 914

Insects—the war of the ages	906
Inventions—dance of whispering sands challenges inventors	904
Jewelry—revolving stand keeps tools in order	977
Ladder—is kept from slipping by adjustable rods	945
Lake—beavers stop seepage	977
Leaves—alcohol makes red	905
Life Preserver—flexible life raft holds twelve	904
Life-Saving—catapult to shoot life line resembles cannon	967
Light—artificial daylight is best for color matching	982
Lighting—symphonies in colored light	897
Metals	
platinum substitute found in "konel"	988
tungsten carbide penetrates the hardest	989
Monument—Washington, over nine million visitors to	989
Moon—the new moon at sunset in all climes	897
Motorcycle—runs candy cart	961
Moving Pictures—for home, cabinet holds projector and screen	967
Music—transformed to light	912
Needle—cushion fits on spool	902
Oil Tank—of spheroid shape gives added strength	944
Oysters—pink, are wholesome	999
Parachute	
and seat combined for air safety	950
dummy leaps from airplane to test	944
tri-colored reduces landing shocks	935
Plants	
food doubles growth	976
garden tool prepares hole for setting out	969
Pneumatic Tubes—do the work of 300 boys	936
Radiator—shelf bracket for	937
Radio—soldering iron works like fountain pen	1004
Radio—Aerial—light-socket antenna kink	1004
Radio—Apparatus—making a midget multimeter	1008
Radio—Application—radio compass for small craft	1003
Radio—Broadcasting—queer radio sound effects made to order	929
Radio—Coils—plug-in coils wound on tube bases	1013
Radio—Condenser—handling charged filter	1009
Radio—Construction—good connections important	1004
Radio—Eliminator—humless A-eliminator	1005
Radio—Receiver	
adding audio stages to beginner's screen-grid	1000
employs five screen-grid tubes	1012
set in octagon table top	1009
Radio—Reception	
bringing out the bass notes	1012
regaining lost sensitivity	1014
Radio—Repairing—cleaning tip of soldering iron	1012
Radio—Television	
broadcasting in England	1010
new scanner employs shutter	1014
Radio—Tubes—emergency clips for screen-grid	1014
Railroads	
dumper overturns coal car	905
giant locomotives squeeze through tunnels	993
schools on, help to train workers	961
train is cooled by iced air	911
windows for upper berths	989
Rats—prove acquired traits inherited	998
Rowing—machine is portable	968
Serving Tray—revolving for dining table	976
Ships and Shipping—river beggars collect alms with baskets	999
Stove, Oil—fills itself from big tank	905
Street Car—foot-controlled operated like auto	976
Submarine—gun that patches, also aids in rescues	935
Telephones—U. S. has the world's longest direct circuit	983
Tin Cans—profit in	936
Toaster—heats inside of bun	992
Traffic—speedway for autos over railroad	944
Tunnel—under Detroit river for motor cars	929
Water—tiny electric heater carried in pocket	960

Automobiles—Accessories	
handy spark-plug carrier	1034
rubber tube keeps spark plugs dry	1037
Automobiles—Driving—postage stamps prevent headlight glare	1033
Automobiles—Repairing	
anti-rattler for front fender	1019
cable replaces noisy brake rods	1025
Basement—extra shelves in	1035
Bed—cover for child's	1037
Birds—a heated cafe for	1036
Boats and Boating—automatic shut-off for the outboard motor	1034
Breakfast Nook—shelf for the	1025
Brick—imitation for the Christmas tree	1034
Canvas—floor covering for the kitchen	1032
Check—fingerprint as protection	1019
Christmas Tree—dressing up the	1020
Curtain—lace used for stencils	1025
Dividers—washer makes a good hermaphrodite attachment for	1038
Extension Cord—insulating an electric	1018
Eyeglasses—cement for celluloid rims	1024
Fish and Fishing—old bathtub makes fish pond	1019
Flowers—arranging in shallow dish	1033
Fruits—winter protection for bush	1025
Glass—black ink for writing on	1035
Glue—spreading liquid quickly	1033
Guns—auxiliary magazine for shotgun	1032
Lawn—green, without grass	1018
Photography—photographing moving objects	1038
Pictures—brads steady small	1019
Plants—potting house	1038
Poison Ivy—eradicating	1018
Saws and Sawing—improving the crosscut guide	1035
Tractor—used as locomotive	1018
Tricks—easy chemical	1015
Veneer—regluing on curved surfaces	1033

SHOP NOTES

Advertising—substitute for stickers in	1052
Armature—repairing a short-circuited	1044
Automobiles—Fuel—test shows filter reduces oil changes	1043
Automobiles—Repairing	
correct method of repairing chassis	1042
how to hold a fender bow	1045
overheating of motor caused by water pump	1049
running truck with broken axle	1049
Boxes—pasteboard, tool for cutting open	1054
Bulletin Board—handy shop	1042
Clamps—angle-iron corner fixture for	1044
Decorating—with a pastry gun	1039
Filing Cabinet—new type takes little space	1043
Garage—removing monoxide gas from	1050
Hammer—prolonging the life of handle	1045
Lathe—tool tray for	1052
Machinery—oiled at close of the day starts easily in cold	1050
Milk—automatic cooler	1044
Paints and Painting—painting imitation brick joints	1049
Pipes, Smoker's—making a hammered-copper holder for	1051
Planer—brush holder for the	1052
Putty—durable homemade	1053
Reflector—work lighted by	1043
Refrigerator—auxiliary lid for	1053
Saws and Sawing	
power saw cuts disks quickly	1050
using a hacksaw in confined places	1043
Setscrew—T-handle bolt as substitute for	1053
Sheet Metal—punching holes in	1052
Steam Shovel—lifts heavy truck	1045
Steel	
ladle of frozen, cut in two with oxygen lance	1054
soldering stainless	1053
Threads—device for checking	1049
Thumbtack—puller	1053
Valve Spring—device for testing	1042
Vise—holding small objects in	1042
Workshop—a practical homemade combination	1046

AMATEUR MECHANICS

Airplanes	
a scale-model plane is easy to build	1026
novel wood trolley	1034
rubber band for model	1024

Reed, unbreakable
 in sasophone and clarinet 894

DRAKE'S PRACTICAL MECHANICAL BOOKS

THEY WILL RAISE YOUR PAY —

ORDER ON 5-DAY TRIAL

The books listed below will perfect you in your chosen trade—pave the way to the big positions. Written in non-technical language—easy to read and understand. Every book covers its subject completely. An entire course of instruction condensed into one volume. Your choice sent postpaid—profit 5 days—money refunded in full if not entirely satisfactory. Order direct.

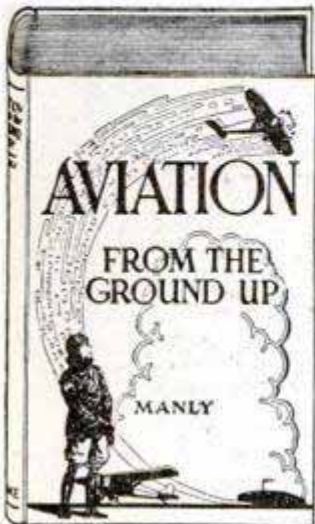

Aviation and Auto Books

- Aviation From the Ground Up... \$3.50
- Automobile Starting, Lighting and Ignition, by Manly... 700 pp. \$3.00
- Brookes' Automobile Handbook... \$2.00
- Ford Motor Car, Truck and Tractor, by Manly... Cloth \$1.50
- Auto and Radio Battery, Care and Repair, by Manly... Leatherette \$2.00
- Motorcycle Handbook, by Manly... \$1.50



Shop Practice Books

- Practical Heating Systems, Trouble Jobs and Ventilation... \$4.00
- Sheet Metal Workers' Manual... \$2.00
- Oxy-Acetylene Welding and Cutting... Cloth \$1.25
- Slide Rule and Logarithmic Tables... \$2.00
- Handbook for Millwrights... Cloth \$2.00
- Machine Shop Practice... Cloth \$2.00
- Mechanical Drawing and Machine Design... Cloth \$2.00

ORDER DIRECT FROM THIS PAGE — ON OUR MONEY-BACK PLAN

The books listed above are only a few of the many in our catalogue, which you will receive promptly after filling out and mailing us the attached coupon. For quick action order direct from this page—cross name of each book wanted and send in with price quoted. We prepay postage and send the books on our money-back plan.

FREDERICK J. DRAKE & CO.

Publishers

R508—179 No. Michigan Ave. CHICAGO

Drake Books Are For Sale at All Book Stores

Mail Coupon For Free Catalogue
Your Guide to Home Study

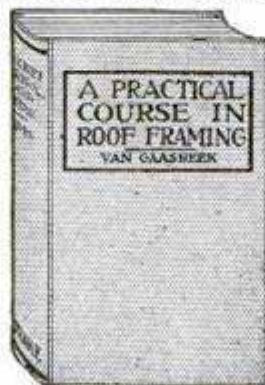

Carpentry Books

Cloth Binding

- Modern Carpentry, 2 vols... \$3.00
- The Steel Square, 2 vols... \$3.00
- Modern Estimator... \$1.50
- Timber Framing... \$2.00
- Builders' Architectural Drawing... \$2.00
- Concretes... \$1.50
- Practical Bungalows... \$1.00
- Roof Framing, by Van Gaaabeek... \$1.50

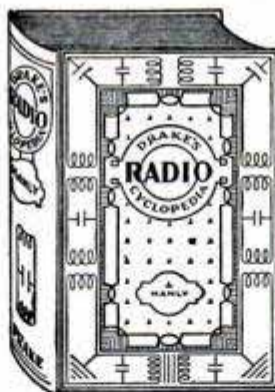

Drake's Radio Cyclopedic

By H. P. Manly

920 Pages, 1025 Illustrations, 1700 Subjects, arranged alphabetically. For Service and Repair Men, Dealers, Salesmen, Experimenters and Designers. Bound in Art Buckram. Price... \$6.00

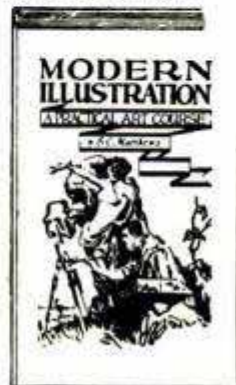

Painting and Decorating

- Modern Illustration... \$3.50
- The Lacquer System of Sign Painting... Cloth \$3.00
- Practical Estimating for Painters and Decorators... Cloth \$2.00
- How to Draw Funny Pictures—a Complete Course in Cartooning... Cloth \$3.00
- Layouts for Advertising... Lea. \$3.00
- Furniture, Furniture Finishing, Decoration and Patching... \$5.00
- Ross Crane Book of Home Furnishing and Decoration... Cloth \$3.00
- House Painting Methods... Cloth \$2.00
- Interior Wall Decoration, by Vanderwalker... Leatherette \$4.00
- The Mixing of Colors and Paints, by Vanderwalker... Cloth \$2.00
- Studio Handbook—Letter and Design... \$3.00
- A Show at Sho' Cards... Cloth \$4.00
- Sign Painting, by Atkinson... Cloth \$4.00
- Strong's Book of Designs, Leatherette \$4.00
- Modern Painters' Cyclopedic... Cloth \$2.00
- Automobile Painting... Cloth \$1.50
- Wood Finishing, Plain and Decorative... Cloth \$2.00

Steam Engineering

- Swingle's Handbook for Steam Engineers and Electricians... Leatherette \$4.00
- Examination Questions and Answers for Marine and Stationary Engineers... Leatherette \$2.00
- Steam Boilers... Leatherette \$2.00
- Swingle's Catechism of Steam, Gas and Electrical Engineering... Leatherette \$1.50

Modern Languages

- By Prof. P. S. Allen, U. of Chicago
- French without a Teacher... Cloth \$1.25
- Spanish without a Teacher... Cloth \$1.25
- German without a Teacher... Cloth \$1.25
- Everyday French... \$1.25
- Everyday Spanish... \$1.25

FREDERICK J. DRAKE & CO.
R508—179 No. Michigan Avenue
Chicago, Ill.

GENTLEMEN:—Please send me free, postage paid, your illustrated catalogue which lists and describes 200 Practical Mechanical Books for Home Study.

My name is

This One

and my address



NUJP-HBL-KA94



To the man whose ship never quite comes in

"WHEN my ship comes in," you say—but your smile cannot hide the worry gnawing at your heart—

A fine sea-going vessel you had thought that ship of yours when you launched it on the business ocean—

Yet the days and months and years slip by—and though others see their ships ride triumphantly to harbor, still you scan the horizon anxiously for a ship that never quite makes port.

No one's fault, perhaps—but what a misfortune that so many business ships should founder on a hidden reef or a treacherous shoal, when the channels to Success are plainly charted and a chart for every channel is available to every thinking man!

How the Right "Chart" Increased E. T. Orcutt's Income 500%

Certainly *my* ship-of-fortune seems far off its course, said E. T. Orcutt, in effect, when as railroad clerk at \$20 a week he enrolled with LaSalle for home-study training in Traffic Management.

Before he had completed the training, however, came an opportunity with Hitchings & Co., Elizabeth, N. J., one of the largest manufacturers of greenhouses in the world.

Training had set his "ship" on the right course.

Later, as sales manager, he kept on training with LaSalle—in Business Management.

Since taking his first course, his salary has increased more than 500 per cent.

Recently he has organized his own company, capitalized at \$100,000, of which he is president.

How G. W. Clason Placed His "Ship" on the Right Course

No bands were playing when G. W. Clason launched his "ship" on the business ocean.

Clason had left school at 14, and at 19 his job was to take care of the horses in the barn of a laundry.

"Never mind," said G. W. Clason, "I'll make my opportunity right where I am!"

So he learned the laundry business, and at 23 was operating his own plant. When fire wiped his business out, he started again. Unable to finance properly—through lack of business understanding, as he testifies—he sold out and became superintendent of the Ideal Laundry Company, Spokane.

Right then he made up his mind to remedy his lack—and enrolled with LaSalle for training in Business Management.

Today, at 47, he is vice-president and a director of this successful company, and commands an income several times as large as when he started with LaSalle five years ago.

"I give all credit to my LaSalle training," writes Mr. Clason. "It has proved by far the most profitable investment I ever made."

No More Drifting!

Send for These Free Books—Today

Are you letting your ship-of-fortune drift where it will—or are you charting its course to the Harbor of Success?

There's a route that will take it straight to its destination. LaSalle can help you find it.

Without cost or obligation, the coupon will bring you a special 64-page booklet fully describing the opportunities in the business field that most appeals to you, and showing you how you can fit yourself to grasp them.

As you value your future—fill in, clip and mail the coupon NOW!

— — — — Find Yourself Through LaSalle! — — — —

LaSalle Extension University

The World's Largest Business Training Institution

Dept. 1264-R Chicago

I would welcome an outline of the LaSalle plan, together with a copy of "Ten Years' Promotion in One," all without obligation.

- Business Management
- Modern Salesmanship
- Higher Accountancy
- Traffic Management
- Railway Station Management
- Law: Degree of LL. B.
- Commercial Law
- Industrial Management
- Modern Business Correspondence
- Credit and Collection Correspondence
- Telegraphy

- Banking and Finance
- Modern Foremanship
- Personnel Management
- Expert Bookkeeping
- Business English
- Commercial Spanish
- Effective Speaking
- C. P. A. Coaching
- Stenotypy—Stenography



Name.....

Present Position.....

Address.....

What Every ELECTRICIAN Wants to Know

JUST OUT!—Latest Exact Information from A to Z!



We take pleasure in announcing: **"AUDELS NEW ELECTRIC LIBRARY"**

New and More Uses for Electricity that come up daily offer great opportunities to men who can handle this power correctly and accurately. Modern electrification of industry calls for trained men who know how to handle electricity.

Simple as A. B. C.—"Audels New Electric Library" gives latest, exact information from foundations of electrical practice to latest modern applications. This is a NEW practical and theoretical course in electricity for home study and ready reference.

Here are the answers to your questions, giving you the real dope that every electrician must know. They chart your knowledge, taking away the uncertainty of guess work.

NEW!

Beautiful, timely books for service—pocket size; completely illustrated with diagrams and charts; simplified, easy to read and understand. No electrical man can afford to pass up this opportunity. Extremely low price; buy on your own terms.

NEW!

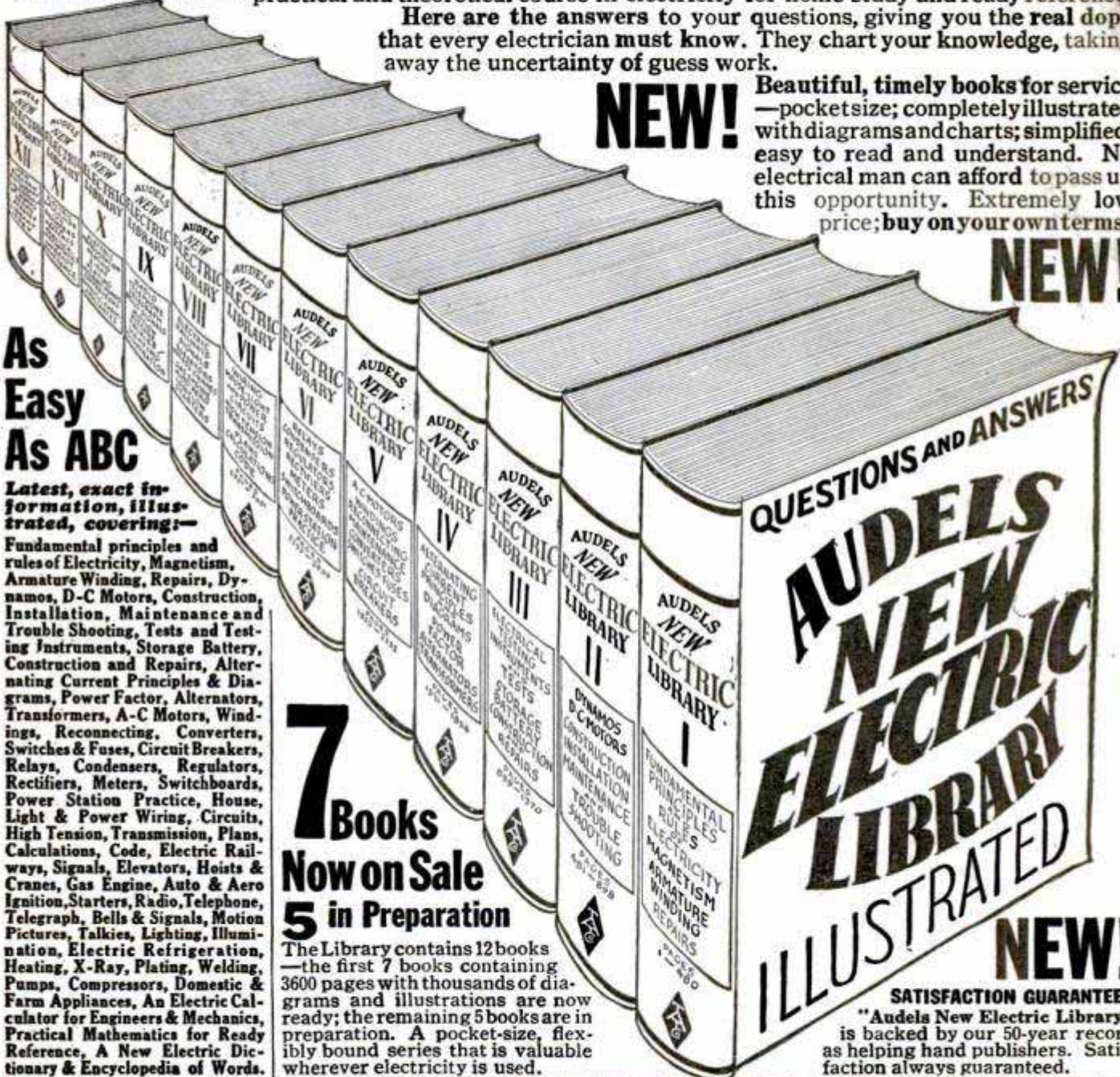

As Easy As ABC

Latest, exact information, illustrated, covering:—

Fundamental principles and rules of Electricity, Magnetism, Armature Winding, Repairs, Dynamos, D-C Motors, Construction, Installation, Maintenance and Trouble Shooting, Tests and Testing Instruments, Storage Battery, Construction and Repairs, Alternating Current Principles & Diagrams, Power Factor, Alternators, Transformers, A-C Motors, Windings, Reconnecting, Converters, Switches & Fuses, Circuit Breakers, Relays, Condensers, Regulators, Rectifiers, Meters, Switchboards, Power Station Practice, House, Light & Power Wiring, Circuits, High Tension, Transmission, Plans, Calculations, Code, Electric Railways, Signals, Elevators, Hoists & Cranes, Gas Engine, Auto & Aero Ignition, Starters, Radio, Telephone, Telegraph, Bells & Signals, Motion Pictures, Talkies, Lighting, Illumination, Electric Refrigeration, Heating, X-Ray, Plating, Welding, Pumps, Compressors, Domestic & Farm Appliances, An Electric Calculator for Engineers & Mechanics, Practical Mathematics for Ready Reference, A New Electric Dictionary & Encyclopedia of Words.

7 Books Now on Sale 5 in Preparation

The Library contains 12 books—the first 7 books containing 3600 pages with thousands of diagrams and illustrations are now ready; the remaining 5 books are in preparation. A pocket-size, flexibly bound series that is valuable wherever electricity is used.

QUESTIONS AND ANSWERS
AUDELS NEW ELECTRIC LIBRARY
ILLUSTRATED

NEW!

SATISFACTION GUARANTEED
"Audels New Electric Library" is backed by our 50-year record as helping hand publishers. Satisfaction always guaranteed.

BUY ON YOUR OWN TERMS

PLAN 1—ONE BOOK A MONTH
Please enter my subscription to "Audels New Electric Library" to consist of twelve volumes, price \$1.50 a volume (\$10.50 for the seven volumes now ready). Mail one volume each month and as they are received, I will mail you \$1.50 promptly.

PLAN 2—PAY 50c OR MORE A WEEK
Please ship me for one week's free trial the first seven volumes of "Audels New Electric Library," \$1.50 each (\$10.50 for the seven volumes now ready). The remaining five volumes to be mailed as issued at \$1.50 a volume. If satisfied, I will mail you 50c or more each week as payment for the first seven books and I will pay for the last five numbers as I receive them at \$1.50 each.

PLAN 3—CASH PRICE \$9.98
Please ship me postpaid "Audels New Electric Library" for which I enclose remittance \$9.98 in full payment for the seven volumes now ready. You are to ship me on one week's trial the remaining five volumes as they are issued for which I will either pay \$1.50 each as received or

THEO. AUDEL & CO.,
65 West 23rd St., New York, N. Y.

Please ship me the NEW "Audels Electric Library" on the plan marked (X).

NAME

ADDRESS

OCCUPATION

EMPLOYED BY

LEARN AUTO

New Easy Way to

AT HOME

EARN
UP TO
\$100 a Week

Say good-bye to low pay. Get into the Auto Business, where big pay—extra money—raises come quick! A brilliant future awaits you in the World's Biggest Business. If you're earning a cent less than \$60 a week, clip that coupon. Learn how \$50—\$75—even \$100 a week is possible for you now! Find out about this training which boosted Yancy of Perla, Ark., from \$30 a week up to \$90!

Open Your Own AUTO SHOP

My Free Book tells how men make extra money while training, and then go into business with no further Capital. It's the Training that counts, and it is complete training that I give you.

Common Schooling all you need

Men between 15 and 60, with very little education, are becoming Garage owners, Superintendents, Foremen. Whether you have had years of Auto Experience, or never touched a car before, send for this FREE Book Now. I'll show you the quick way to get in line for real success in the Auto Business.



B. W. Cooke
Directing
Engineer



Send coupon for Free Auto Book. See how I train you right at home, in every branch of Auto work—Learn how I prepare you, quickly and easily, for the **Big Jobs**, paying up to \$100 a week and more. "Job-Way" Training includes all Mechanical and Electrical work—Starting, Lighting, Ignition—also Welding, Brazing, Vulcanizing—everything you need to get in line for a big pay Job as an Electrical and Mechanical Auto Expert.

**Aviation
Course &
3 Working
Outfits ~
FREE
of extra
cost!**



I'll Help You Get a Good Job

My Employment Department will help you get a good Job whenever you want one. You don't have to wait until you have graduated to use this service. No sir, as soon as you have shown that you know enough about Autos to hold the Job I'll give you this help whenever you ask for it! What is more, you can use it as long as you live!

Get All The Facts!

Send for my new Free Book now! See what "Job-Way" has done for hundreds. See what it can do for you. Learn all about my legal money-back agreement—and the many added features. Clip coupon now!

B. W. COOKE

DIRECTING ENGINEER
Dept. 2169

Motor Institute of America

[Formerly Chicago Motor Training Corp.]

Motor Institute Bldg.
EVANSTON - - - ILLINOIS

MAIL THIS COUPON

B. W. COOKE, Directing Engineer
MOTOR INSTITUTE OF AMERICA **FREE!**
Dept. 2169 Motor Institute Bldg.
Evanston, Illinois Auto Book

Send me your Book, "Auto Facts," Free of charge. Also full particulars of "JOB-WAY" Training and of your working outfits and Aviation Course offer. This obligates me in no way whatever.

Name.....

Address.....

Town.....State.....

Age.....Occupation.....

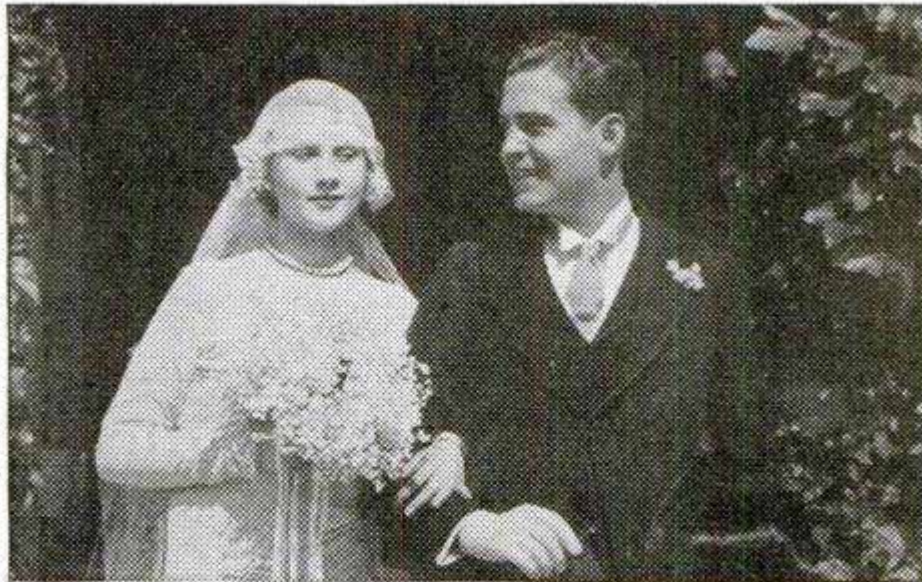

"The Happiest Day of My Life!"

"OUR WEDDING DAY! A year ago it seemed like a dream that would never come true, for my salary then was barely enough for *one* to live on. I faced the facts. Unless I could make more money I had no right to keep Ruth waiting. I must find out how to make myself *worth more*.

"It was Ruth herself who showed me the way. She clipped a coupon out of a magazine and we sent it to the International Correspondence Schools for information about their courses. Within a week I had enrolled. The training I got from studying at home showed up almost at once in my office work. They gave me more responsibilities. Inside of six months I was

promoted, with a substantial raise. Now I'm getting double what I was a year ago—*and we're married!*"

Employers everywhere are on the watch for men who want to get ahead, and are willing to prove it by training themselves to do some one thing well. I. C. S. Courses have given thousands the special knowledge they need to win better jobs and bigger pay. *Why not you?*

One hour of spare time a day, spent in I. C. S. study, will prepare you for the position you want, in the work you like best. Find out how. It won't obligate you in the least to ask for full particulars. Do it now —for HER!

Mail the Coupon for Free Booklet

INTERNATIONAL CORRESPONDENCE SCHOOLS, Box 5652-F, Scranton, Penna.
 "The Universal University"

Without cost or obligation on my part, please send me a copy of your 48-page booklet, "Who Wins and Why," and tell me how I can qualify for the position, or in the subject, before which I have marked an X:

BUSINESS TRAINING COURSES

- | | | | |
|---|--|---|---|
| <input type="checkbox"/> Business Management | <input type="checkbox"/> Cost Accounting | <input type="checkbox"/> Business Correspondence | <input type="checkbox"/> Railway Mail Clerk |
| <input type="checkbox"/> Industrial Management | <input type="checkbox"/> Bookkeeping | <input type="checkbox"/> Show Card and Sign Lettering | <input type="checkbox"/> Mail Carrier |
| <input type="checkbox"/> Personnel Management | <input type="checkbox"/> Secretarial Work | <input type="checkbox"/> Stenography and Typing | <input type="checkbox"/> Grade School Subjects |
| <input type="checkbox"/> Traffic Management | <input type="checkbox"/> Spanish <input type="checkbox"/> French | <input type="checkbox"/> English | <input type="checkbox"/> High School Subjects |
| <input type="checkbox"/> Accounting and C.P.A. Coaching | <input type="checkbox"/> Salesmanship | <input type="checkbox"/> Civil Service | <input type="checkbox"/> Illustrating <input type="checkbox"/> Cartooning |
| | <input type="checkbox"/> Advertising | | <input type="checkbox"/> Lumber Dealer |

TECHNICAL AND INDUSTRIAL COURSES

- | | | | |
|--|--|---|--|
| <input type="checkbox"/> Architect | <input type="checkbox"/> Telegraph Engineer | <input type="checkbox"/> Aviation Engines | <input type="checkbox"/> Pharmacy |
| <input type="checkbox"/> Architectural Draftsman | <input type="checkbox"/> Telephone Work | <input type="checkbox"/> Plumber and Steam Fitter | <input type="checkbox"/> Mining Engineer |
| <input type="checkbox"/> Building Foreman | <input type="checkbox"/> Mechanical Engineer | <input type="checkbox"/> Plumbing Inspector | <input type="checkbox"/> Navigation <input type="checkbox"/> Assayer |
| <input type="checkbox"/> Concrete Builder | <input type="checkbox"/> Mechanical Draftsman | <input type="checkbox"/> Foreman Plumber | <input type="checkbox"/> Iron and Steel Worker |
| <input type="checkbox"/> Contractor and Builder | <input type="checkbox"/> Machine Shop Practice | <input type="checkbox"/> Heating and Ventilation | <input type="checkbox"/> Textile Overseer or Supt. |
| <input type="checkbox"/> Structural Draftsman | <input type="checkbox"/> Toolmaker | <input type="checkbox"/> Sheet-Metal Worker | <input type="checkbox"/> Cotton Manufacturing |
| <input type="checkbox"/> Structural Engineer | <input type="checkbox"/> Patternmaker | <input type="checkbox"/> Steam Engineer | <input type="checkbox"/> Woolen Manufacturing |
| <input type="checkbox"/> Electrical Engineer | <input type="checkbox"/> Civil Engineer | <input type="checkbox"/> Marine Engineer | <input type="checkbox"/> Agriculture |
| <input type="checkbox"/> Electrical Contractor | <input type="checkbox"/> Surveying and Mapping | <input type="checkbox"/> Refrigeration Engineer | <input type="checkbox"/> Fruit Growing |
| <input type="checkbox"/> Electric Wiring | <input type="checkbox"/> Bridge Engineer | <input type="checkbox"/> R. R. Positions | <input type="checkbox"/> Poultry Farming |
| <input type="checkbox"/> Electric Lighting | <input type="checkbox"/> Gas Engine Operating | <input type="checkbox"/> Highway Engineer | <input type="checkbox"/> Mathematics |
| <input type="checkbox"/> Electric Car Running | <input type="checkbox"/> Automobile Work | <input type="checkbox"/> Chemistry | <input type="checkbox"/> Radio |

Name..... Street Address.....

City..... State..... Occupation.....

If you reside in Canada, send this coupon to the International Correspondence Schools Canadian, Limited, Montreal, Canada

4 of the 40 Easy Ways to Make \$3⁰⁰ an Hour

THE four plans shown are but a sample of the many ways in which our members are making \$3.00 an hour upwards, spare time and full time, from the day they join the Association. If you want to get into Radio, have a business of your own, make \$50 to \$75 weekly in your spare time, investigate the opportunities offered the inexperienced, ambitious man by the Association.

Our Members Earning Thousands of Dollars Weekly

The Association was formed to help men cash in on Radio. It makes past experience unnecessary. As a member of the Association you are trained in a quick, easy, practical way to install, service, repair, build and rebuild sets—given sure-fire money-making plans developed by us—helped to secure a position by our Employment Department. You earn while you learn, while you prepare yourself for a big-pay Radioposition.

The Association will enable you to buy parts at wholesale, start in business without capital, help you get your share of the \$600,000,000 spent annually for Radio. As a result of the Association, men all over the country are opening stores, increasing their pay, passing licensed operator examinations, landing big-pay positions with Radio makers.



Mail Coupon for the FREE HANDBOOK

It is not only chock-full of absorbing information about Radio, but it shows you how easily you can increase your income in your spare time. Mailing the coupon can mean \$50 to \$75 a week more for you.

Radio Training Association of America
4513 Ravenswood Avenue Dept. PM-12 Chicago, Illinois

In Your Spare Time
in **RADIO**

Below are a few reports from those cashing in on the "easy ways"

Clears \$3,000.00 Frank J. Deutch, Pa.—"Since joining the Association I have cleared nearly \$3,000.00. It is almost impossible for a young fellow to fail, no matter how little education he has, if he will follow your easy ways of making money."

\$1,100.00 in 6 Weeks J. R. Allen, Calif.—"Have done over \$1,100.00 worth of business in the last 6 weeks. Next month I am going to open up a store of my own. I never knew that money could come so fast and easy."

\$25.00 a Week Spare Time N. J. Friedrich, N. Y.—"I have averaged \$25.00 a week for the last 7 months even though I am not a graduate but just learning."

Training Lands Him Job R. C. Kirk, N. C.—"Your training has been very valuable to me. I landed a job with the big department store out here a few weeks ago because I had my membership card with me. There were a large bunch of applications ahead of me."

ACT NOW If You Wish NO-COST Membership

For a limited time we will give to the ambitious man a No-Cost Membership which need not—should not—cost you a cent. For the sake of making more money now, and having a better position in the future, mail coupon below *now*.

Radio Training Association of America
Dept. PM-12 4513 Ravenswood Ave., Chicago
Gentlemen: Please send me by return mail full details of your Special No-Cost Membership Plan, and also a copy of your Radio Handbook.

Name _____

Address _____

City _____

State _____



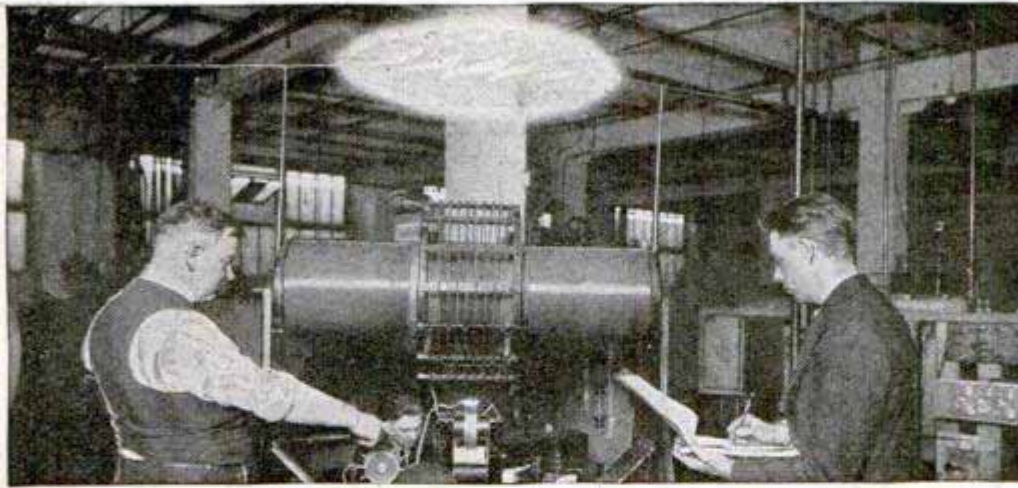

500,000 VOLTS

"Artificial lightning" being developed in COYNE School. Spark of 500,000 volts is shown jumping 30 inches. This gigantic Tesla coil is the same as that used by Steinmetz, absolutely harmless, because of high frequency.

LEARN ELECTRICITY Without Books or Lessons in 12 Weeks

By Actual Work - In the GREAT SHOPS of COYNE



Anyone who can see and understand the English language can learn Electricity in 90 days. I teach you with as complete an outlay of electrical apparatus as was ever assembled in any school—30 foot control board—2-story transmitting stations—skeleton houses, huge motors of all kinds—dynamos—sub-stations—auto-

mobiles—switchboards. In one department we generate enough electricity to supply a small city!

No Books—No Lessons—No Classes

ENTER ANYTIME. Experts teach you without books or classes. They guide you every step of the way with individual attention. You do the actual work on real full-size machinery in full operation. Take motors for instance. Instead of learning from books and charts—you actually build motors. You can't help but know all about them. Anyone can learn this fascinating way.

No Experience Necessary

That's how my methods make men learn electricity in 12 wonderful weeks. You don't need experience—Coyne training starts from the very beginning. You don't need advanced education—you learn by doing. Age is no handicap—Coyne students range from 16 to 40.

Triple Your Earning Power

I don't need to tell you about the opportunities in Electricity. They are too many and too amazing to mention. Ordinary jobs run from \$50—\$75—\$150 a week. And Coyne training leads to the biggest positions.

COYNE ELECTRICAL SCHOOL

H. C. LEWIS, President — ESTABLISHED 1899
500 S. Paulina St., Dept. 99-72, Chicago

Many Coyne men are making up to \$600 a month. Demand for Coyne men often exceeds the supply. Our Employment Bureau helps you secure position.

EARN WHILE YOU LEARN

We help many students to secure part-time jobs to earn a good part of living expenses while learning.

RAILROAD FARE to Chicago Allowed

Right now I am including railroad fare to Chicago and complete courses in Radio, Aviation, and Automotive Electricity without extra charge.

All Details Sent Free

This school is 30 years old—Coyne training is tested

—proven beyond all doubt—endorsed by electrical industry. You can find out everything absolutely free. Simply mail the coupon and let me send you the big, free Coyne book of 150 photographs—facts—jobs—salaries—opportunities. See what Coyne training can do for you in just 90 days! This does not obligate you. So act at once. Just mail coupon.

Get this Free Book



H. C. LEWIS, President
COYNE ELECTRICAL SCHOOL, Dept. 99-72
500 S. Paulina St., Chicago, Ill.

Dear Mr. Lewis:

Without obligation send me your big free catalog and all details of Railroad Fare to Chicago, Free Employment Service, Radio Aviation and Automotive Electrical Courses you are including and how many "earn while learning."

Name

Address

City.....State.....

How Fred Fisher Makes \$30 a Week in Spare Time with his **TENOR BANJO**

**Found Course Easy Right from Start;
Now Enjoys More Friends, More Parties**

"Had no idea it was so easy! Nobody could go wrong with your clear, sure method. I now have more friends and never miss any parties. I have been earning \$30 a week in spare-time. There's always a job for a Tenor Banjoist."—Fred Fisher, 123 Ridge Street, Steelton, Pa.

**YOU Can Learn Quick Right
at Home to Make**

Big Spare-Time Money

Why "wish" for friends, fun and ready cash when you can have them—quick! Our tested, easy system will teach you—in 1 to 3 months—to make \$5 to \$15 an evening spare-time playing; \$65 to \$100 a week or even more playing in orchestras, etc. Be popular, have all the extra money you want. Find out NOW about "The Tenor Banjo Play-Way to Popularity and Big Pay."

C. E. Samwell
20 Devonshire Ave., Brantford, Ont. (shown above) writes: "Was only quarter-way through Course when playing in one of the best orchestras here. The Tenor Banjo is the sure, easy way to Big Money. My playing now paying for \$550 Banjo. Owe success to you."

FREE BOOK tells how

This inspiring book—that has shown countless others the short-cut to SUCCESS—will show you how to get the friends, popularity and money you want—QUICK! No obligation. Get the facts about the fascinating method that taught Fisher and Samwell and other prosperous Tenor Banjoists. No knowledge of music or notes necessary. No extras to buy. We teach everything—furnish—everything—you need. Clip and mail coupon at once.

**Big Tenor Banjo
Records and Outfit
FREE
When You Enroll**

with First Lesson

The same day we receive your enrollment for Course you are shipped a handsome, full-tone, professional-size Tenor Banjo worth \$20—lessons, Complete Outfit—and correct, fool-proof demonstration Phonograph Records of every selection in the Course!



Mail Coupon Now

A. F. Bloch, President,
New York Academy of Music,
Studio 1129,
100 Fifth Ave., New York City.

Dear Mr. Bloch: Please rush me your FREE Book telling how I too can make a Quick Success and Big Money with the Tenor Banjo.

Name.....

Address.....

THE CHICAGO DAILY NEWS School and College Bureau

Offers You Its Specialized Services in Choosing a School

Last year the School and College Bureau of The Chicago Daily News saved many busy parents and questioning boys and girls both time and worry by sending them prompt, reliable information about just the kind of school they wanted—personal requirements as to location and tuition charges being considered in each individual case.

Again this year many young people will be perplexed by the problem of finding the right school. Why not let us help you?

The Chicago Daily News maintains this service absolutely free of charge to you. No need to hurriedly select a school on mere hearsay when expert advice can be obtained by telephoning Dearborn 1111, writing or calling for a personal interview at

THE CHICAGO DAILY NEWS School and College Bureau

Dept. K, Daily News Plaza, 400 W. Madison St., Chicago, Ill.

Electrical Engineering

Course for men of ambition and limited time. Over 5000 men trained. Condensed course in Theoretical and Practical Electrical Engineering including the closely related subjects of Mathematics and Mechanical Drawing.

Students construct motors, install wiring, test electrical machinery. Course designed to be completed in one college year. Prepare for your profession in the most interesting city in the world. Est. 1893. Catalog on request.



Bliss Electrical School

122 Takoma Ave., Washington, D. C.

Learn Watchwork, Jewelrywork and Engraving

A fine trade commanding a good salary, and your services always in demand. Address **Horological**, Dept. P, Bradley Institute, PEORIA, ILLINOIS, for our latest catalog.

Travel On "Uncle Sam's" Pay Roll



\$1900 to \$2700 A YEAR Men—18 to 35

Railway Postal Clerks

Franklin Institute, Dept. D 180, Rochester, N. Y. Sirs: Rush to me without charge, (1) 32 page book describing Government jobs, (2) List of many U. S. Government jobs now obtainable. (Tell me how to get a position.)

Name.....

Address.....

Mail Coupon Today Sure

COUPON

Fix

that

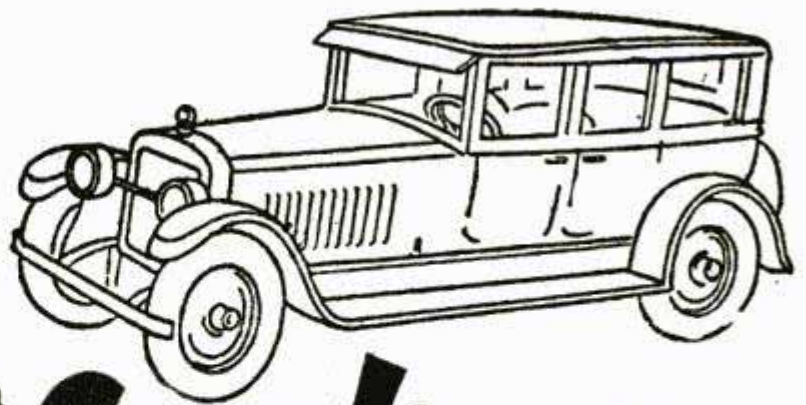

Car! Learn How-Easily

JIFFY INDEX in These Five New Big Auto Books Makes All Facts Instantly Available. Find Anything You Want To Know in a Moment in This Latest Edition

All Shipped Free

Don't miss a word of our free shipment offer. You don't have to pay us a cent—we ship without receiving one penny.

Repair any auto fault, learn how now. You can do it easily in this new simple way. These five big automobile books are the most interesting, the most practical books we have ever published on automobile construction, operation and repairs. Brimful of facts, photographs and explanations so easy to understand that anyone can learn how to repair auto faults in almost no time. Over 2,000 pages full of diagrams, data sheets and everything else needed to make anyone an authority on automobiles. Whether you want to qualify as garage owner, auto repair expert or merely wish to know how to keep your own car 100% efficient, you will recognize the amazing value of these five big books, especially on our

No Money Offer

A very liberal plan of distribution brings these books to you for examination without one cent of payment to us. We don't ask a cent of you, but ship the books free. Look them over, read them as much as you want to, note the splendid photographs and drawings, and then if you decide you want them, send only \$2.00 and then \$3.00 a month until only \$24.80 is paid. That is all. Nothing more to pay us. There is no further obligation.

REPAIR ANY AUTO FAULT

With these books you don't have to worry about autotroubles. Illustrations are so clear and explanations are so simple that anyone can understand them. All phases of automobile engineering fully covered. Engines, chassis, carburetors, ignition systems, transmissions, differentials—in fact every part of a modern automobile explained from the standpoint of theory and practice.

Learn All About Autos

Get these five big books on this liberal offer and learn all the things you want to know about autos—carburetors, engines, springs and spring suspension, brakes, 4-wheel drive, lubricating system—all are fully covered. These complete and comprehensive books are yours if you want them on this easy plan. Send for a set now. Fill in the coupon.

FIND FACTS QUICKLY

One of the best things about these money making books is the Jiffy Index, which puts vital facts at your finger tips. You don't have to read the books through; you don't have to spend long hours over them. This Index enables you to put your finger on the information wanted in a jiffy.

DON'T HESITATE

There are no strings to this offer—it means just what it says. Send name and address on the coupon and all of the five big books—the complete set—will be sent you for examination. Remember, one fact alone which you can find in these books may save you an expensive repair, or help you to a better job.

FOR FREE OFFER USE COUPON

American Technical Society, Dept. A919
Drexel Ave. at 58th St., Chicago, Ill.

I would like to look at the five big auto books—send them on your free offer. I will pay the few cents delivery charges. If I like them, I will send you \$2.00 when I have had the books fifteen days, and then \$3.00 a month until the special price of only \$24.80 is paid. Otherwise I will return the books at your expense. You are to include, without charge, free consulting membership certificate in the American Technical Society.

Name.....
Address.....
Employer's Name.....
Employer's Address.....

American Technical Society Membership Free

Yes, we include a certificate of membership in the American Technical Society, which entitles you to free consultation on any subject relating to automobile engineering. We have over a million dollars of resources enabling us to get co-operation of the largest automobile manufacturers and dealers who have furnished us plans and photographs. This membership, which you get for an entire year free, entitles you to consultation with 18 automobile experts, any of whom will be ready to help you at all times. You can write or wire any time for special information. Answers will be sent promptly without cost.

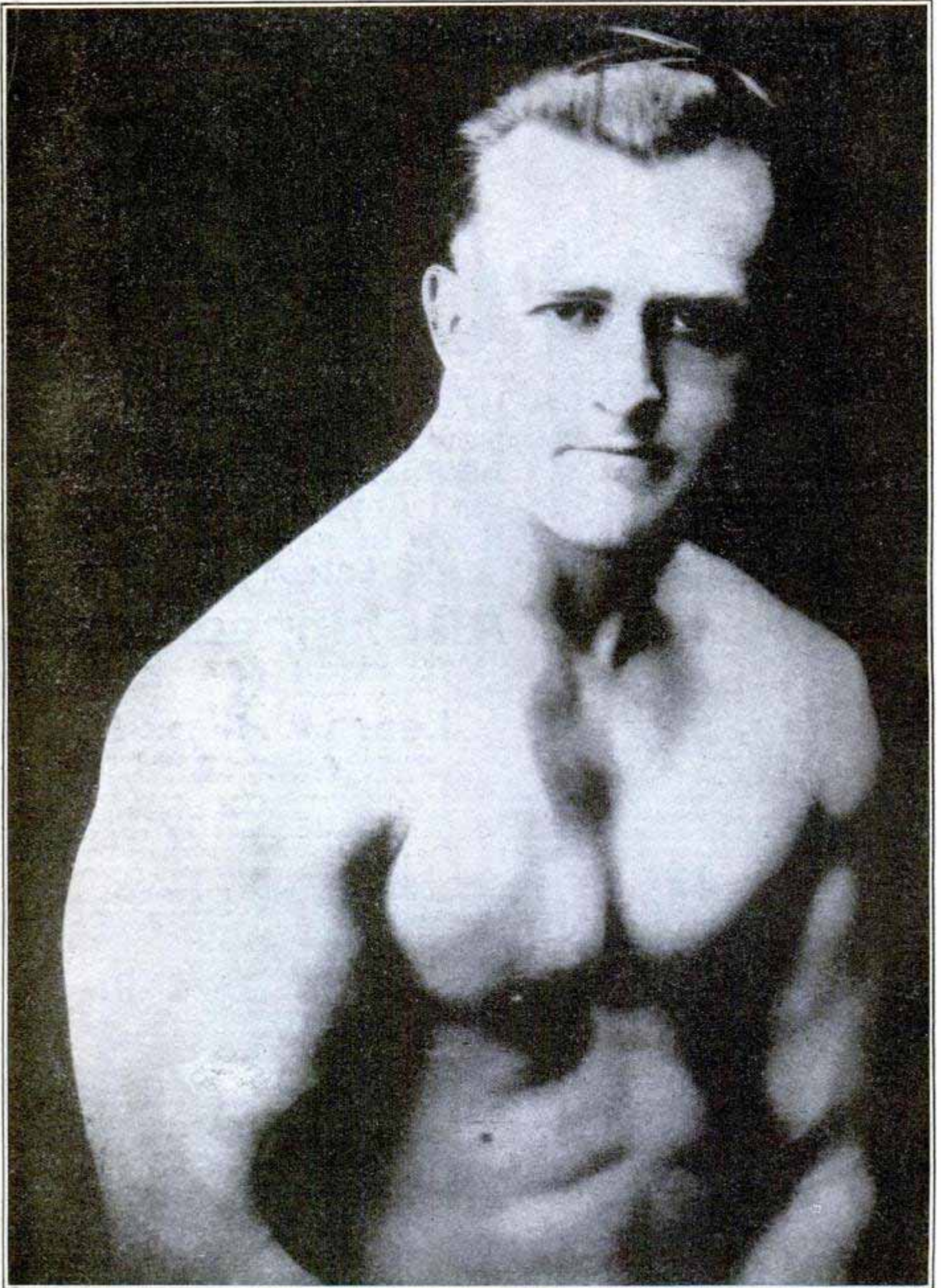

EARLE LIEDERMAN, *The Muscle Builder*

Author of "Science of Wrestling," "Muscle Building," "Secrets of Strength," "Here's Health," "Endurance," etc.

1 inch to your biceps 2 inches to your chest

in **7½** hours

A marvelous system of muscular education that transforms weaklings into strong men almost overnight . . .

This is *not* a fish story. It's a fact! When I say I can add one whole inch of real live muscle to each of your arms and two whole inches of the same wonderful strength across your chest, in just 7½ hours, I mean just that.

But I don't stop there. I do things with your body that even you never dreamed of. My business is to build muscle, and the health and strength that always come with muscle. In the past 19 years I've taken over 200,000 puny little underdeveloped bodies—coaxed them along—worked on them—filled them with new life—new hope—new terrifying strength that forced their owners to be powerful, fighting, proud he-men. And how simple it all is under my instruction!

Here's How I Do It!

All I ask of you is 7½ hours of your spare time, divided into 15 minute periods for 30 consecutive days. In those 15 minute periods you are to do exactly as I advise, using the apparatus I send you. At the end of the 7½ hours step before your mirror, and marvel at the transformation.

Could that great, handsome figure be yours? Those huge broad shoulders—that immense barrel-like chest with its powerful lungs—those tremendous arms and wrists, ready to crush everything before them—could it be possible?

Yours it can be—and quickly, too. But first send for my new 64-page book. Let me show you how such a body can be yours without risking a single penny. How my ironclad guarantee absolutely protects every single pupil. Send for it today. Get going to new health—new happiness—new joys now!

Send For My New
64 Page Book

"Muscular Development"
IT IS FREE

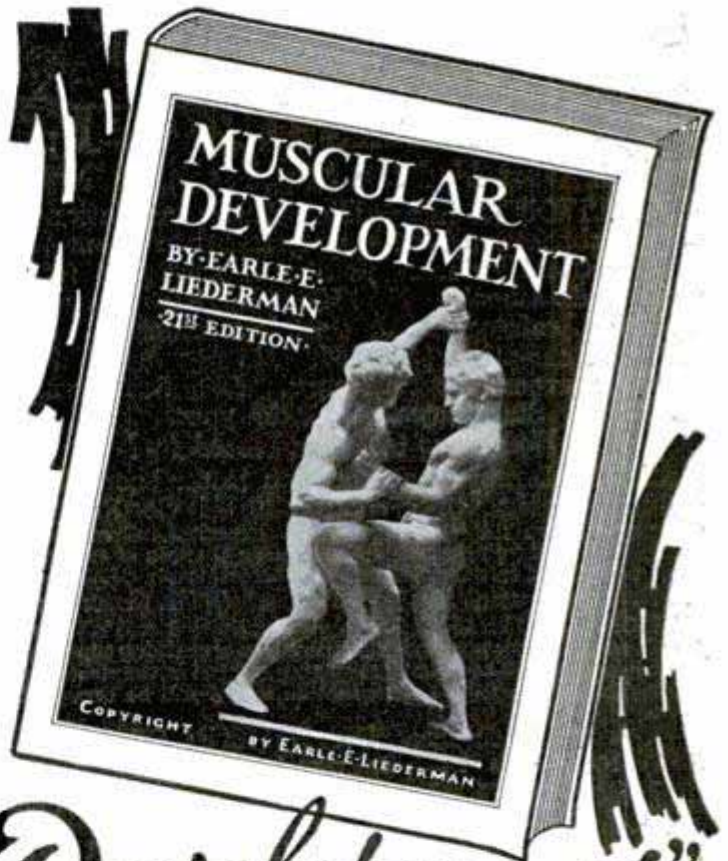

Do you get that? It's free. I don't ask a cent. It's yours with my compliments. Take it and read it. It's the peppiest piece of literature you ever flashed your eyes on. And 48 full-page photos of myself and some of my numerous prize-winning pupils. This is the finest collection of strong men ever assembled into one book—look them over—doctors, lawyers, merchants, mechanics and every line of trade you can think of. I swear you'll never let this book get out of your hands again. And just think—you're getting it for nothing. Don't hesitate—no strings attached to it. Grab it.

Take your pen or pencil and fill out the coupon, or even your name and address on a postal will do—do it now before you turn this page.

Earle Liederman

Dept. 2012, 305 Broadway, New York City

EARLE LIEDERMAN
Dept. 2012, 305 Broadway, New York City

Dear Sir:—Please send me absolutely free and without any obligation on my part whatsoever, a copy of your latest book, "Muscular Development." (Please write or print plainly.)

Name.....Age.....

Street.....

City.....State.....

Learn Electricity IN LOS ANGELES

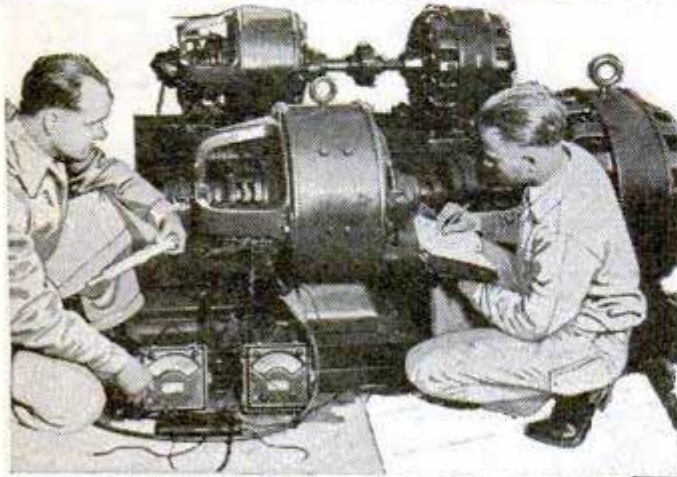

and LEARN IT RIGHT!

1. What Kind of a School Is NATIONAL?

NATIONAL is a Million Dollar institution—established in 1905—recognized throughout the electrical industry as one of America's foremost trade schools. NATIONAL offers practical, intensive training in all electrical branches. All technical essentials included. No age limit. No previous experience necessary. Life Scholarship privileges. Start any time of the year.

2. How Long to Learn Electricity?

NATIONAL properly trains you in the short time of 6 to 9 months. Upon completing this Condensed Course you are fully qualified as a Practical, Competent Electrician, and you have not risked your chances of employment because of inferior, incomplete instruction.

3. What Employment Service Does NATIONAL Guarantee?

NATIONAL GUARANTEES to give unlimited and efficient Employment Service to students wishing to earn living expenses while learning; and to graduates getting started in the electrical field. This is the most any reputable school can be expected to do.

4. What Inducements Does NATIONAL Offer?

NATIONAL offers YOU the very best technical-practical training that money can buy at a cost within every man's reach. It does not offer to pay your railroad fare, room and board or other personal expenses, preferring to limit its activities to the PROPER TRAINING OF MEN FOR SUCCESS.

5. Why You Should Come to LOS ANGELES!

LOS ANGELES is the heart of the country's most rapid electrical development—as well as the world's most ideal city in which to live and prepare for success in electricity

WRITE for FREE BOOK NOW!

NATIONAL Electrical School

Dept. 538, 4006 Figueroa St., Los Angeles, California.

Send me your big free illustrated catalog of Electrical Opportunities showing how I can learn quickly and get a Big-Pay Electrical Job.

Name.....

Address.....

Age..... City..... State.....



"MY BANJO MADE ME POPULAR OVERNIGHT!"

"NO mixer—that's what everyone in town had me down for. They were right, I couldn't sing, couldn't play, whenever there was a party I was at it—but not in it! Then I learned to play the banjo. Studied home at night—it was so easy, so simple, so much fun, that almost in no time I could play the most difficult pieces.

"One night I played at a small gathering. Everyone was amazed. People noticed me now who never before knew I existed. And to cap the climax, Mr. one of our leading merchants, made me a fine business proposition—said he only wanted live wires in his organization. Take it from me, it was the turning point in my life the day I sent for details about learning to play the banjo at home." If you want to win quick popularity, or earn easy, extra money, then write for particulars NOW!

TENOR BANJO STUDIOS

Dept. C-103 9th Floor Woolworth Bldg. New York City

LEARN WATCH REPAIRING



You can learn by our modern and original system of instruction every part of the Watch Repairing Trade at home as good or better than at a shop. You can earn money while learning and secure a well paying position or start in business after completing our course of instruction. Good watch repairers are always in demand and earn from \$50 to \$75 per week. For particulars apply to the Wisconsin School of Watch Repairing 166 Mason St., MILWAUKEE, WIS.

AIRPLANE DRAFTING

THOUSANDS OF MEN

will make fortunes in Aviation. Airplane Drafting and Designing are the biggest jobs ahead in this fastest growing industry. A new field of opportunity for you is opened in our improved method of training.

EASY TO LEARN. STUDY AT HOME. PAY AS YOU GO. EMPLOYMENT SERVICE.

Write for booklet outlining courses in Airplane Drafting and other aviation subjects, including the famous Weem's System of Navigation—endorsed by Col. Lindbergh, Commander Byrd, Lincoln Ellsworth, Admiral Moffett, etc.

Name.....

Address.....

City..... State.....

- AIRPLANE DRAFTING
- AIRPLANE MOTORS
- AIRPLANE MECHANICS

PACIFIC TECHNICAL UNIVERSITY SAN DIEGO CALIFORNIA

LOW PAY.. LONG HOURS.. ROUTINE.. NO FUTURE



Always worrying over money. Always skimping and economizing—going without the comforts and luxuries that every man **DESERVES** for his family and himself.



The Time Clock—a badge of hawk-like supervision and The Rut. A constant reminder that one is "just another name on the pay-roll."



Human cogs in a great machine. No chance to meet people, travel or have interesting experiences. A long, slow, tiresome road that leads nowhere.



Always wondering what would happen in case of a "lay-off" or loss of job. No chance to express ideas and ability—no chance to get ahead. **COULD** there be a way out?

I Said "Good-bye" to It All After Reading This Amazing Book— Raised My Pay 700%!

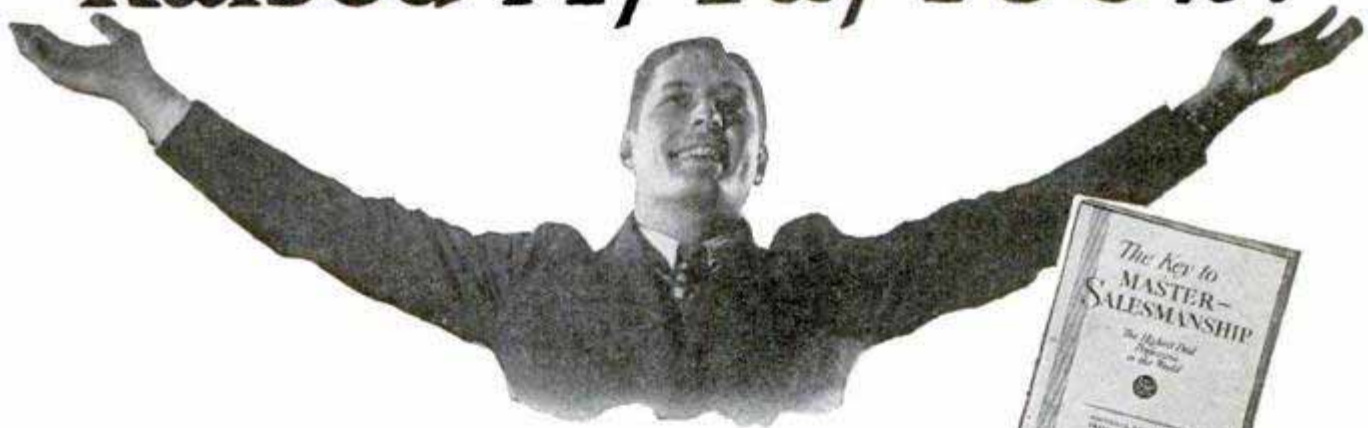

Where Shall We Send Your Copy—FREE?

WHEN a man who has been struggling along at a low-pay job suddenly steps out and commences to earn real money—\$5,000, \$7,500 or \$10,000 a year—he usually gives his friends quite a shock. It's hard for them to believe he is the same man they used to know—but such things happen much more frequently than most people realize. Not only one, but **HUNDREDS** have altered the whole course of their lives after reading the amazing book illustrated at the right.

True, it is only a book—just seven ounces of paper and printers' ink—but it contains the most vivid and inspiring message that any ambitious man can read! It reveals facts and secrets that will open almost any man's eyes to things he has never even dreamed of!

Remarkable Salary Increases

For example, R. B. Hansen, of Akron, Ohio, is just one case. Not long ago he was a foreman in the rubber-curing room of a big factory at a salary of \$160 a month. One day this remarkable volume, "The Key to Master Salesmanship", fell into his hands. And from that day on, Mr. Hansen clearly saw the way to say "good-bye" forever to low pay, long hours, and tiresome routine! Today he has reaped the rewards that this little volume placed within his reach. His salary runs well into

the 5-figure class—actually exceeding \$10,000 a year!

Another man, Wm. Shore of Lake Hughes, California, was a cowboy when he sent for "The Key to Master Salesmanship." Now he is a star salesman making as high as \$525 in a single week. L. H. Lundstedt, Chicago, read this free book—and raised himself from a stenographer to the head of a business with 600% increase in earnings. C. V. Champion of Danville, Illinois, raised his salary to over \$10,000 a year and became President of his company in the bargain!

A Few Weeks—Then Bigger Pay

There was nothing "different" about any of these men when they started. None of them had any special advantages—although all of them realized that **SALESMANSHIP** offers bigger rewards than any other profession under the sun. But, like many other men, they subscribed to the foolish belief that successful salesmen are born with some sort of "magic gift." "The Key to Master Salesmanship" showed them that nothing could be farther from the truth! Salesmanship is just like any other profession. It has certain fundamental rules and laws—laws that you can master as easily as you learned the alphabet.

City and traveling sales positions are open in every line all over the country. For years, thousands of leading firms have called on the N. S. T. A. to supply them with salesmen. Employment service is free to both

employers and members, and thousands have secured positions this way.

Free to Every Man

See for yourself WHY "The Key to Master Salesmanship" has been the deciding factor in the careers of so many men who are now making \$10,000 a year. Learn for yourself the **REAL TRUTH** about the art of selling! You do not risk one penny nor incur the slightest obligation. And since it may mean the turning point of your whole career, it certainly is worth your time to fill out and clip the blank below. Send it now!

National Salesmen's Training Association

Dept. W-102, N. S. T. A. Bldg. Chicago, Ill.

National Salesmen's Training Assn.,
Dept. W-102, N. S. T. A. Bldg.,
Chicago, Ill.

Without cost or obligation you may send me your free book, "The Key to Master Salesmanship."

Name.....

Address.....

City..... State.....

Age..... Occupation.....



He Found the Key to \$10,000 a Year!

"Just a bookkeeper"—that's how J. A. Hogg, now Public Accountant at Logan, W. Va., would have classified himself six years ago when he first enrolled with LaSalle for home-study training in Higher Accountancy.

Little he dreamed that within two years—thanks to his specialized training—his yearly income would be \$5,000, and that two years later he would be making better than \$10,000 a year! But read what he writes, under recent date—

"It isn't often that an investment brings money profit of more than 7500 per cent in only six years, yet that's exactly what my enrollment in two LaSalle courses—Higher Accountancy and Law—has meant to me. I estimate it worth more than \$30,000 in cash returns, besides additional returns in personal and business prestige, in self-confidence and all-round larger success.

"Whereas when I first became a LaSalle member I was earning about \$100 a month, today I have my own successful public accounting firm, and have been mayor and police judge of my home town for the past five years, and LaSalle has made all this possible.

"I have enjoyed very much my LaSalle work. Your Problem Method has been a revelation—so much easier and more efficient than the classroom methods of my school days."

His Opportunity Is Yours— Send for Free Book

Are you ambitious to make a real success in business—to fit yourself for positions paying \$3,000, \$5,000, \$10,000 a year, and even better?

Here, then, is your chance—the same chance that faced J. A. Hogg when he clipped a LaSalle coupon.

Below is the coupon, and it will bring you—free—LaSalle's 64-page book, "Accountancy, the Profession that Pays." You will find it of the greatest help and inspiration.

If you mean what you say when you say that you want to get ahead—fill in, clip and mail the coupon NOW.

— Find Yourself Through LaSalle! —

LaSalle Extension University

The World's Largest Business Training Institution

Dept. 1264-HR Chicago

I should be glad to have details of your salary-increasing plan as applied to my advancement in the business field checked below. Also a copy of "Ten Years' Promotion in One," all without obligation.

- Higher Accountancy
- Business Management
- Modern Salesmanship
- Traffic Management
- Railway Station Mgmt
- Railway Accounting
- Law—Degree of LL.B.
- Commercial Law
- Industrial Management
- Banking and Finance
- Personnel Management
- Credit and Collection Correspondence
- Modern Business Correspondence
- Modern Foremanship
- Expert Bookkeeping
- C. P. A. Coaching
- Business English
- Commercial Spanish
- Effective Speaking
- Stenotypy—Stenography
- Telegraphy



Name.....
 Present Position.....
 Address.....

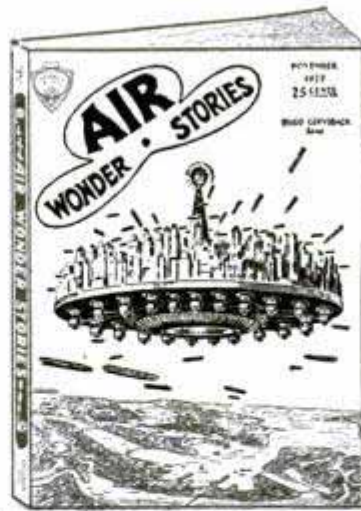

Aviation Stories of the Future

Air Wonder Stories

is a revelation in Science Fiction Stories of the Air. Many monthly contributions by noted science fiction writers.

Thrilling: Daring: Visionary

Read one issue and you will be impatient for the next.

On Sale at all newsstands—25c the copy. Special subscription offer—one dollar, eight months.

Stellar Publishing Company

98 West Park Place, New York City

MUSIC LESSONS IN YOUR HOME

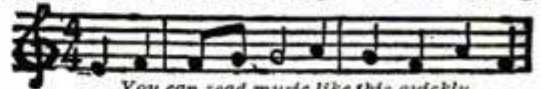

You can read music like this quickly

Write today for our FREE BOOKLET. It tells how to learn to play Piano, Organ, Violin, Mandolin, Guitar, Banjo, etc. Beginners or advanced players. You pay as you learn. Costs only a few cents a day. Thousands of satisfied students.

AMERICAN SCHOOL of MUSIC, 51 Manhattan Bldg., CHICAGO



Start with

WIRING

—the first step toward a good job in ELECTRICITY

The sensible way to "break into" Electricity is to learn WIRING. Then the doors of opportunity in the world's most prosperous industry are open to you—

The new idea is to first learn how to wire bells, annunciators, alarms—how to wire homes and stores and factories for light and power—how to estimate the cost—

—then cash in on the training, before tackling the next branch. You will be surprised how quickly you can learn WIRING, at home in your spare time, by our JOB-ticket method of practical experience—

—takes only a few months—costs only a very few dollars. (Now, there is no longer any need to take a "Complete Course" costing hundreds of dollars, requiring years of time.)

Start with WIRING but don't stop when you're an Electrician. From time to time you can learn motors and generators, electrical drafting, power station equipment, radio, or other advanced subjects. Plan to learn one thing at a time and to advance one step at a time, until you're at the top of this money-making business.

If you are interested in getting into Electricity—right, send for Free "Unit Plan" book.

Unit Plan Book FREE



American School

Dept. E-947—Drexel Ave. at 58th St., Chicago

AMERICAN SCHOOL, Dept. E-947, Drexel Ave. at 58th St., Chicago

Please send free Unit Plan Book, and tell me all about WIRING and other low-cost, quick Electrical Units of home training.

Name.....
 Address.....

The Outstanding Gift of 1929

This handsome bookcase table, made of genuine Brown Mahogany, is included with every set of the new Britannica.



This completely NEW Encyclopaedia Britannica

"The Essential Book
for Every
American Home"

THIS is the year of all years to give the Britannica for Christmas! For today you can give a completely new Encyclopaedia Britannica—the superb *Fourteenth Edition*, that has just come from the presses.

A gift that brings lasting appreciation

ALL the family is included when you give this new Britannica for Christmas!

Here is a Britannica made new from cover to cover. A Britannica so different from any other encyclopaedia that there is literally no comparison.

Everyone in the home will be thrilled with such a gift. Think of the eager excited interest at Christmas! These twenty-four handsome volumes, in the graceful bookcase table which is included with each set, will attract all eyes.

There will be no gift more exciting beneath the Christmas-tree this year; no gift, certainly, which will give such lasting pleasure.

For young and old alike—the child in school, the woman who wants practical help with her home or family, the student engaged in research, the busy man of affairs whose reading time is limited—for every-

one this superb new Britannica is the gift of gifts.

Wherever the finest things of life are appreciated, men and women are proud to own the new Britannica. The handsome bindings, the profusion of rich and colorful plates, indeed the superb craftsmanship shown in every detail, set this book apart as a gift of rare distinction.

This new Britannica, prepared at a cost of more than \$2,000,000, is a library in itself—written by 3,500 leading authorities from fifty different countries.

**Extremely
Low Price**

Yet this incomparable encyclopaedia comes to you at a tremendous saving! Never has any encyclopaedia offered such manifold riches as

this one does. And not in two generations has a completely new Britannica been offered at so low a figure! Mass production has made it possible to place the greatest of all encyclopaedias within the means of all.

Send for Free Booklet

Make this Christmas a Britannica Christmas!

You have the opportunity now to learn why this new Britannica is the finest gift you could select. But the time is short, and you should act promptly.

The coupon below will bring you our special **FREE** booklet telling the full story of the Britannica and describing the various bindings and the bookcase table now included with every set. Mail the coupon now! (This obligates you in no way whatsoever.)

ENCYCLOPAEDIA BRITANNICA, INC.

342 Madison Avenue, New York City

PM9-C3

Please send me by return mail, without any obligation on my part, your 56-page illustrated booklet describing the new Britannica together with low price offer, etc.

Name _____

Address _____

City _____

State _____

MAIL THIS COUPON TODAY

We Will Train You in a Few Months

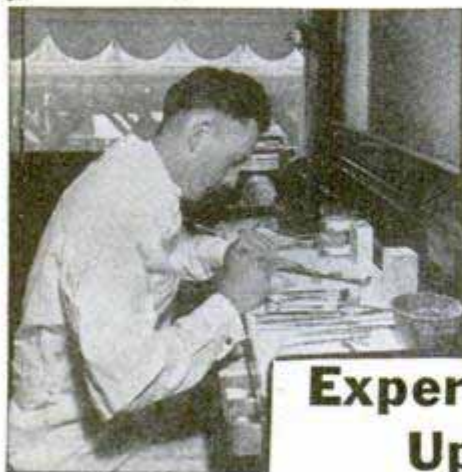

Day and Night Schools in Chicago, Detroit, Cleveland, Boston, Phila.

No Books—No Classes—

Wonderful Future in this Uncrowded Field

Experts Earn Up To

\$125 A WEEK

as MECHANICAL DENTISTS

We teach you to make rubber plates, crowns, bridge work, metal base dentures, etc., for dentists. After graduating you are ready for a job or can open your own laboratory. We assist you.



Big Demand for Men!

Mechanical Dentistry is the laboratory bench work which the dentist turns over to the laboratory worker. Master this profession and help meet the demand of 64,000 dentists for laboratory work. Every city and every town where dentists are located offers work to the mechanical dentist. We train you in a few months in day or night school for this uncrowded field—no classes—no books—no mechanical experience necessary. **No Educational Requirements.**

Work Your Way Thru School

We will help you find a job to meet your expenses while taking our training. And we will help you find satisfactory living quarters when you arrive.

Schools located in Chicago, Detroit, Cleveland, Boston, Philadelphia. Day and night schools.

We pay railroad fare of students who enroll.

INTERESTING FREE BOOK

Our illustrated free book on Mechanical Dentistry will acquaint you with some surprisingly interesting facts. It tells about the thriving profession of Mechanical Dentistry—the way to swift and certain success. And it tells about the progress of many of our graduates—men who have succeeded beyond their expectations, also full details of our liberal offers. Mail the coupon and find out more about this fascinating opportunity.

**McCarrie School of Mechanical Dentistry
1338 S. Michigan Ave., Dept. 359, Chicago, Ill.**

McCARRIE SCHOOL OF MECHANICAL DENTISTRY
1338 S. Michigan Ave., Dept. 359, Chicago.

Without cost or obligation, send me your illustrated book on Mechanical Dentistry, and complete information as to my opportunities in dental laboratory work.

Name.....

Address.....

BEDFORD YMCA TRADE SCHOOL

Auto Mechanic
Aviation Mechanic
Starting, Lighting, Ignition
Electric Welding, Airplane Welding
Oxy-Acetylene Welding
Wheel Alignment. Brake Testing
Machine Shop. Battery Repair
Electrical Course. Radio Mechanic
Mechanical, Architectural Drawing
Airplane Drafting
Blue Print Reading
Building Estimating
Sign Painting. Show Card Writing
Window Dressing
Commercial Art. Fine Art

Write for Catalog 50

Brooklyn Engineering Institute
(Operated by Bedford Y. M. C. A.)
1125 Bedford Avenue, Brooklyn
New York City

COLLEGE COURSES at Home

Carry on your education. Develop power to initiate and achieve. Earn credit toward a Bachelor degree or Teaching Certificate *by correspondence*. Select from 450 courses in 45 subjects, including English, Mathematics, History, Education, Psychology, Economics, the Languages, etc. Write for catalog.

The University of Chicago

427 ELLIS HALL CHICAGO, ILL.

STAMMERING

easily, permanently corrected. Win happiness and success. Ask for full information and special phonograph record. Send dime for postage

12972 Woodward Ave., LEWIS INSTITUTE, Detroit

DRAFTING

BOOKS SENT FREE!

Only fifteen minutes a day with these WONDER BOOKS will prepare you for a good Drafting job in less than a year! Mechanical and Architectural Drafting from simple straight lines to important, complex plans, a step at a time! Built especially for beginners, for men with only grammar schooling. Drafting room practice *plus engineering* made easy and clear!

Big Field—Big Demand—Big Pay!
Competent Draftsmen are urgently needed right now in all building and manufacturing lines at \$50 to \$100 a week. That's just the beginning—for draftsmen have the best chance for advancement! Pleasant, fascinating work, easy to learn and do. Learn quick with these books—send coupon for a set FREE, and see for yourself!

A year's Consulting Membership in the American Technical Society now given free to all readers of this famous *Cyclopedia of Drafting*. Many say that's worth more than cost of books.

American Technical Society
Dept. D919, 58th & Drexel Ave., Chicago

Modern American Homes FREE!

American Technical Society
Dept. D919, 58th & Drexel Ave., Chicago

Send for 15 days' free use 4-volume set of *DRAFTING*. In return for mailing this coupon promptly send absolutely FREE "Modern American Homes," 112 plates, exteriors, interiors and plans. I will pay the few cents delivery charges. If I wish I may return books in 15 days and owe you nothing. But if I prefer to keep them I will send \$1.80 after 15 days, then \$2.00 a month until \$14.80 (special reduced price) is paid.

Name.....
Address.....
Employed by.....
Address.....

\$16 the first night for playing!

MOST of the world works for a living—works hard, too. But that doesn't mean you have to. Why not play for a living? Do something you like to do, and make it pay you big money. Plenty of men and women who had a hard time to get along six months ago—are now making from \$50 to \$100 a week—playing their Hawaiian Guitars. And they didn't know how to read a single note of music when they came to me.

America's Most Popular Music

The haunting, soft, melodious strumming of the Hawaiian Guitar is America's most popular music. Everywhere orchestras are looking for men and women who can play the Hawaiian Guitar. Everywhere those who have mastered the Hawaiian Guitar are getting paid more and more money. Roy Reibane writes in, "I have made \$200 extra money in 6 weeks playing my Hawaiian Guitar." Carelton E. Scarbro recently wrote me, "I have made \$1000 since I took your course." Granville Smith writes, "I make \$8 a night and play only 4 hours."



One of the Dozens of Photo helps sent with each Course

Dozens of such letters have come in. But let me tell you about my short-cut to good times and big pay—my simplified method of learning to play the Hawaiian Guitar at home in a few weeks. A new method—so easy to understand—so much fun to learn—that even a child can pick it up. (We have successfully taught children only 8 years of age.)

Pictures Instead of Words, Teach You

All I ask is that you like music. I don't care if you have never read a note in your life, or even know what a Hawaiian Guitar looks like. My methods are so clear and easy to understand that you will actually play a real melody after the very first lesson. Sounds uncanny, doesn't it? Here's how I do it.

With your lessons I send dozens of photographs showing just how to place your fingers, how to strum the strings. My Know-All Chart teaches you to read notes almost automatically. It's as simple as learning your A B C's over again. Some of our students become finished musicians the first month, others take a little longer, but they all learn with surprising speed.

Lonesome? It's a Sure Cure!

Once you have mastered the Hawaiian Guitar, the world lies waiting at your feet. You can travel anywhere, meet the best people, live in real style and comfort, and gain a host of friends. All this is yours, waiting for you, if you are willing to spend a few minutes a day with me for a few short weeks.



We Send You Regular Phonograph Records of Every Piece in the Course

And we don't miss a single bet. To make sure that you can't go wrong, we send you a whole set of regular phonograph records, on which are recorded every melody you learn to play while taking the course. These aid you to correct minor mistakes, and make you sure that your technique is perfect. With these records to guide you—the tiniest error in your playing is quickly corrected. These records come absolutely free with the course, and are an excellent addition to your home music as well.



This is what Prutzman Did

"A friend asked me if I could play the Hawaiian Guitar. I told him I'd only been playing for a few weeks, but he said, 'Come along anyway, and play at the dance.' I made out very well, and was paid \$16 for my first night's work. And I see more opportunities ahead." — RALPH PRUTZMAN, Lehigh-ton, Pa.

We Give You this genuine HAWAIIAN GUITAR WORTH \$20



Send for FREE BOOK IT SHOWS YOU HOW

Everything is explained. Every last bit of proof is given you. It shows you just how you can master the Hawaiian Guitar at home in double-quick time. How you risk absolutely nothing to learn. How I send everything you need. Get on the road to Big Pay and Pleasure Today. Write Now!

A. F. Bloch, President,
Hawaiian Studios, 52129 of
New York Academy of Music,
100 Fifth Avenue, New York City.

Without obligation, send me FREE Book "How to Learn Hawaiian Guitar" with facts on how I can make BIG MONEY, spare-time or full-time.

Name.....

Address.....



A giant plane dips and soars across the sky, leaving against the brilliant blue the one word **ELECTRICITY**

Men stop and gaze at the huge letters written so gracefully thousands of feet above the earth. Somewhere an electrical expert has groomed the giant plane for its flawless flight . . . every wire tested . . . every electrical device in perfect running order.

Today industry is as dependent upon the expert electrician as the powerful plane tracing the magic name over countless cities and towns. To him come the profits of industry and commerce. You, too, can be an electrical expert. Write today for the 48-page booklet.

NEW YORK ELECTRICAL SCHOOL

44 West 17th St., NEW YORK

MAIL TODAY

THE NEW YORK ELECTRICAL SCHOOL
44 N. Y. E. S. BLDG., 17TH STREET, NEW YORK

Please send me **FREE** your 48-page booklet. It is understood that this request puts me under no obligation.

Name

Address

Books on 65 Practical Subjects

Popular Mechanics Press specializes in supplying the outstanding best books on many subjects. As new books of merit appear, we will revise the list accordingly.

- AIR NAVIGATION AND METEOROLOGY**
Every flyer needs . . . \$3.00
- AIRCRAFT ENGINES**
Dyke's New Instructor
Best Engine Book . . . \$5.00
- ARCHITECTURAL**
Drawing and Lettering . \$2.00
- ARMATURE WINDING**
Excellent new book . . . \$2.00
- AUTO ENCYCLOPEDIA**
Dyke's. (Covers New Model A Ford) . . . \$6.00
- AVIGATION**
By Dead Reckoning . . . \$2.00
- BIRD HOUSES**
How to Make \$1.00
- BLUE PRINTS**
How to Read \$2.00
- BOAT BUILDING**
35 Craft, Popular Outboard Engine Type \$3.00
- BOY MECHANIC**
Famous 4 Vol. Library, 4000 Things to Make. \$7.00
- BUILT-IN FURNITURE**
Complete Instructions. \$2.50
- CARBURETORS**
Excellent book on all makes \$2.00
- CARPENTRY**
Hand book of 336 Kinks. \$1.50
- CHEMISTRY**
For Old and Young Beginners \$2.50
- CIVIL SERVICE**
How to Prepare for . . . \$3.00
- COLOR SIMPLIFIED**
Practical new Book (for Color Users) \$3.50
- CONCRETE**
173 Ways of Using New Edition (Cloth) . \$1.00
- CONTRACTOR**
Building Cost Estimator. \$2.00
- DIESEL ENGINES**
(New Work). Best Authority \$5.00
- DOGS**
Care and Raising \$2.00
- ELECTRICIAN**
214 Practical Kinks . . . \$1.50
- ELECTROPLATING**
Practical Results Easily Obtained \$1.00
- ENGLISH**
Self-Improvement in . . \$2.50
- ETIQUETTE**
New 560-Page Book. Only \$1.00
- FARMER'S BOOK**
of 861 Kinks and Book for Farmers' Wives. \$1.00
- FLIGHT TRAINING**
Practical, new book, best on subject \$5.00
- FORD (HENRY)**
His Philosophy of Industry . . . \$1.50
- FORMULAS**
10,000 Money Making. \$4.00
- FURNITURE**
Homemade (3 vols.) . . \$3.00
- HOME REPAIRS**
Practical Book of \$2.50
- INTERIOR DECORATING**
Best book of new methods \$4.00
- INVENTIONS (American)**
Popular History of 2 vols. Reduced to . . \$5.00
- INVESTMENT**
Policies that pay
By Ray Vance \$4.00
- JOINT WIPING**
(New Edition) \$1.00
- KITES THAT FLY**
How to make \$1.25
- LANDSCAPING**
Practical \$2.50
- LATHE WORK (METAL)**
and Drilling and Thread Cutting \$1.00
- LETTER WRITING**
Social and Business Only \$1.00
- MACHINIST**
419 Kinks for \$1.50
- MAGIC**
200 New Tricks for Amateurs \$1.00
- MAKING THINGS YOURSELF**
900 Different Articles . . \$3.00
- MATHEMATICS**
Made Easy for the Practical Man \$1.50
- MECHANICAL DRAWING**
Practical Course in . . \$1.00
- MODEL AIRCRAFT**
Building and Flying . . \$2.25
- MOVIE MAKING**
for Amateurs \$3.00
- OUTDOOR OPPORTUNITIES**
for Making a Living . . \$2.00
- OUTDOOR SPORTS**
for All Year 'Round . . \$1.50
- PAINTING**
House (Best Methods) . \$2.00
- PETS**
For Pleasure and Profit. \$2.00
- PLUMBING**
500 Plain Facts for Every Homeowner . . \$1.50
- POULTRY RAISING**
for Profit \$2.00
- POWER WIRING (D. C.)**
Electrical (Just Out) . . \$3.50
- PUZZLES**
Amusing Mathematical. \$1.50
- RADIO**
Trouble Shooting. Covers All-Electric Sets and Television \$3.00
- ROPE SPINNING**
Only Book on Subject. . \$1.50
- SHIP MODEL**
Making \$2.50
- SHOP NOTES**
15 Vols. of 6000 Valuable Kinks \$4.50
- STEEL SQUARE**
Pocket Book, Practical. \$1.00
- TAXIDERMISTRY**
Best Book of Methods. . \$3.50
- TENNIS**
By Helen Wills \$2.00
- TOY MAKING**
Complete instructions. . \$1.50
- WELDING**
ENCYCLOPEDIA
All Methods \$5.00
- WIRING**
House (New Book) . . . \$2.50
- WOOD TURNING (LATHE)**
Practical Course in . . \$1.50
- WOODCRAFT**
Famous 590 Page Book by Ernest Thompson Seton; Only \$1.00

Books sent C. O. D. anywhere in U.S.

Just check the books you want, write your name and address below, and mail the advertisement. It is your order blank. When postman hands you books, pay him the price and the postal charges. If outside the U. S. remit when ordering and include 10 cents per book extra for postage. We have many other books on these and 2,000 other subjects. Catalog free.

Name

City

State

Address

Mail to Popular Mechanics Press,
Room P12—200 East Ontario St., Chicago, Ill.



Get into

AVIATION

Major R. L. Rockwell Says:

"I'll Train You at Home

**Major Rockwell
World War Flyer
Who Will Teach You**

Major Rockwell is a famous world war flyer, decorated with the Legion of Honor and the War Cross. He is now devoting himself to teaching Aviation, and he will train you for a position in this great new industry as only a Veteran World War Flyer can train you. Under Major Rockwell's guidance your future in Aviation is assured.

—and in 12 Weeks You Can Master Every Principle of Ground Training Which Is Necessary Before You Are Ready to Take Your Place in Any Branch of Aviation"

Of course you want to get into Aviation quickly! Every man, young and old, is eager to take his place and insure his future in this fastest growing industry which is paying big incomes to trained men. **Aviation is the only field in which manufacturers and airports are literally raid-**

ing each other for men with proper training! Now is the time for you to start! And my Home Study Course is the easiest, quickest, least expensive way for you to make the start. Mail coupon for my fascinating book which gives all details.

**You Learn Aviation Ground Work at Home
—Then Choose Any of the 40 Ground Jobs**

Right in your own home, devoting about an hour a day, I teach you the essential Aviation fundamentals covering every phase of ground work, as well as the principles of flying and navigation. This is the same instruction that you would receive if you went away to a ground school. It makes no difference whether you intend to fly or to make your mark in Aviation as a designer, rigger, motor expert, repairer, inspector, builder or in any of the 40 big-pay ground jobs, **you must have this**

highly important ground work instruction to land any real good job in this new fast-growing industry. I will help you find your proper place in Aviation and start you on the right road to sure success. Manufacturers, Transport Companies and Airports prefer Rockwell trained men. Then if you want to go farther and take up actual flying, you can come here to Dayton where I'll see that you get your flying instructions at one of America's finest airports—**at my special reduced prices.**

40 Ground Jobs for Every Airplane

Every airplane in service means 40 men on the ground, all highly paid.

- Riggers**
- Designers**
- Electricians**
- Metal Workers**
- Draftsmen**
- Piano Mechanics**
- Motor Inspectors**
- Air Port Managers**
- Welders**
- Transport Managers**
- Etc., etc.**

No Advance Education or Experience Needed

You don't need to have any previous education to master my course. You do not even need to know anything about airplanes or mechanics. My home study course is thorough and complete. Everything is clearly explained with easy-to-understand text and pictures. In a few short months you will have grasped every

fundamental principle of aviation ground work and you will be well on the road to qualify for any important aviation job paying \$300 to \$400 a month. My Home Study Course will also give you all the knowledge necessary to pass the Government's written examinations for mechanics' or pilots' licenses.

My Students Make Good

Floyd Prothero Writes:

"The main thing about your individual method of instruction to me was you not only gave me a thorough knowledge of Aviation, but gave me valuable pointers on how to capitalize on what I had learned, so I am now General Manager and Field Director, for the National Air Surveys, Inc., and I am making more than three times what I ever earned before. I cannot say too much about your individual method of training men in Aviation."



Money Back Guarantee

I am so certain of your success in Aviation that if you are not satisfied after completing my course, I will refund every cent of your tuition.

Employment Service

After you graduate I help you get a job without cost. There's a great demand for men with Rockwell training!

Aviation Begging for Trained Men

Only TRAINED men can command the high salaries. Employers are glad to pay big money for men who know Aviation—builders, mechanics, service and maintenance men, and flyers. Let me prepare you for one of the many high salaried Aviation jobs open to the trained man. I will prepare you at home to take your place in the most fascinating, fastest growing industry in the world. Rush this coupon to me for a copy of my famous free book.

**MAJOR ROB'T L. ROCKWELL
THE DAYTON SCHOOL OF AVIATION
Desk S-1 DAYTON, OHIO**

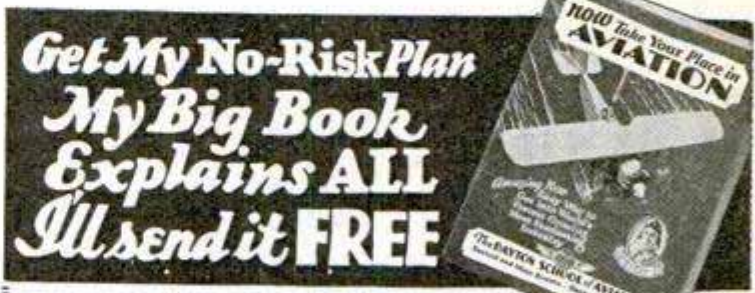

**Get My No-Risk Plan
My Big Book
Explains ALL
I'll send it FREE**

Major Rob't L. Rockwell
The Dayton School of Aviation
Desk S-1, Dayton, Ohio.
Dear Major:—Please send me FREE and without obligation a copy of your famous book on Aviation; also your special tuition and position offer.

Name.....
Address.....
Town..... State..... Age.....

Easy home method quickly teaches HAWAIIAN GUITAR



Play all the latest hits just as the Hawaiians do! Have good times aplenty!

Win fame—friends—fortune! Play the Hawaiian Guitar!

Native Hawaiian expert directs you

You get expert instruction directed by a world-famous player and teacher, Prof. Walter Kolomoku. He quickly reveals to you the secrets of this fascinating instrument.

Only 4 Motions to learn. Then you can play any music—popular songs, classical, old-time melodies, native Hawaiian airs—or real jazz. You'll never be lonesome after you learn the Hawaiian Guitar.

Complete Course

52 lessons. Nothing omitted. Pictures explain every move. You are sure to learn—what we can do for others we can do for you. Over 50,000 successful students.

Learn at home in spare time

Study in spare time at home. Even if you don't know a note our method is so simple, plain and easy, you begin a piece your first lesson. In half an hour you can play it!

Payasyouplay

We make it easy for you. Start with small first payment—then pay while learning. Costs only few cents per lesson. You only pay the cost of instruction—we furnish everything.

GIVEN when you enroll

—with genuine seal grain Fabrikoid Cover and complete playing outfit—this beautiful sweet-toned

HAWAIIAN GUITAR

Reliable retailers ask \$18 to \$20 for a similar instrument and outfit without the fine Fabrikoid Case, which alone is worth \$3.50.

Instrument and outfit valued at **\$18 to \$20**

Other Courses {Banjo, Violin, Tiple, Tenor Ukulele—well-known instructors.

FIRST HAWAIIAN CONSERVATORY OF MUSIC, Inc.
9th Floor, Woolworth Bldg., Dept. 648, New York

Approved as a Correspondence School Under the Laws of the State of New York
Member National Home Study Council

Send This Coupon for Liberal Offer!

FIRST HAWAIIAN CONSERVATORY OF MUSIC, Inc.
9th Floor, Woolworth Bldg., Dept. 648, New York, N.Y.
Please mail full information about your 52-lesson Hawaiian Guitar Course. I am not obliged to enroll unless I want to.

Name _____
Address _____
City _____ State _____



Young men needed by Davey Tree Expert Co.

Interesting, vigorous outdoor work in a growing organization where merit wins advancement. Good starting wages. Permanent positions and a real future for men who make good. Expansion to meet increasing need for this unique service creates additional openings. So we are selecting now, to enter our employ, a number of sturdy, clean young men, thorough Americans, single, between 20 and 30 years old, free to travel, industrious, with good practical education, and able to give good references. Write for qualification blank to serve in place of personal interview. The Davey Tree Expert Co., Inc., 311 Federal Bldg., Kent, Ohio.

Anyone CAN LEARN

No talent or experience necessary. Fascinating work. Pays Big Money. Complete instruction book tells about: Alphabets, Colors, How to Mix Paints, Show Cards, Window Board and Wall Signs. Ready made letters, Gilding, Tricks of the Trade, also gives 100 Alphabets and Designs. Book bound in flexible imt. leather-gold edges, and four ball hearing Show Card Pens. Sent postpaid \$3.00. (C.O.D.) 10c ex. Ogilvie Pub. Co., 57 Rose St., Dept. 20, N.Y. City

EARN MONEY IMMEDIATELY— WE FURNISH EQUIPMENT TO START !!

Make Much Money

Making and Selling Your Own Goods. Formulas by experts. Manufacturing Processes. Trade-Secrets. All Kinds. All Lines. Send for interesting catalog, special circulars, free.

B. THAXLY CO., WASHINGTON, D. C.

IF YOU STAMMER

Write for my free book "Millard's Advanced Natural Corrective Course" and a free copy of my speech magazine. 10,000 cases successfully treated. Est. 24 years. Largest school for stammerers in world. Millard Inst. of Normal Speech, 2317 Millard Bldg., Milwaukee, Wis.

LEARN WATCHMAKING AND ENGRAVING

BY OUR PROFIT-SHARING PLAN OUR GRADUATES SUCCEED

One of our Iowa students started in a very small way—now doing over \$30,000 a year. Another in Wisconsin, over \$10,000 the first year. Day or night classes. Call or write for FREE BOOK.

Chicago School of Watchmaking, Dept. 5901, 549 W. Randolph St., CHICAGO

FREE BLUE PRINTS

AND FREE BOOK "HOW TO READ BLUE PRINTS"

SHOW YOU THE WAY TO

9 BIG PAY JOBS

- | | |
|---|--|
| 1 Building Superintendent — \$5,000 to \$12,000 | 6 Building Estimator — \$6,000 to \$10,000 |
| 2 Building Inspector—\$4,800 to \$8,000 | 7 Real Estate Expert—\$5,500 to \$12,000 |
| 3 Appraiser — \$6,000 to \$10,000 | 8 Construction Foreman — \$4,500 to \$8,500 |
| 4 Material Buyer—\$5,000 to \$7,500 | 9 CONTRACTOR AND BUILDER IN A BUSINESS OF YOUR OWN—\$5,000 to \$12,000 |
| 5 Material Salesman—\$5,000 to \$12,000 | |

**FIND
OUT HOW
Easy it is to Make
Up to \$12,000 in a Year**

Learn to read Blue Prints this amazing new way! Get into the world's richest industry—Building! See how quickly and easily you can train to make up to \$12,000 in a year! My FREE Book "How to Read Blue Prints" discloses all the so-called "mysteries" of Blue Print Reading—also gives some startling facts about the nine best jobs in America. Don't send one penny—just mail the coupon!

NO longer need you spend years trying to pick up the "mysteries" of Blue Print Plan Reading. For now a quick, sure practical method has been perfected that has made thousands of men Blue Print Experts in a surprisingly short time.

This is no ordinary "school course." It is practical from start to finish. It is based on many sets of real Blue Prints—plans that would cost thousands of dollars if purchased from architects. Twenty famous experts in all lines of construction work talk over these Blue Prints with you in plain simple language. Show you every detail. Explain every short cut. Tell you the "secrets" of quick, accurate estimating. Explain Superintending. Give you for the first time many inside facts and money-making methods used by the "Giants" of the Building Industry.

This is the kind of training that quickly puts men into the high salaried jobs—or into profitable contracting businesses of their own. Yet now you get it right at home in only 2 or 3 months. It requires no extensive education. If you can read and understand what is written here you can easily master it.

See what this training has done for others: Bartolomew, Calif., became a contractor at an in-

crease of over 300% his first year; Blair, Okla., stepped up to Superintendent at 100% increase; Dickerson, R. I., increased his salary 700% in 12 months; Marchand, La., says: "My income has increased 200% and I now have more contracting work than I can do."

Over seven billion dollars will be spent this year in new construction! No wonder then, such tremendous opportunities are open to you when you have this "head-work" training in Blue Prints.

If you want more money—real big money! Then choose a "Blue Print" job in Building, Clerk or Salesman, Carpenter or Bricklayer, here is the one field where there are limited opportunities for advancement.

So accept my FREE gift of a complete set of real working Blue Prints, and my fascinating Book "How to Read Blue Prints" that tells all the interesting and instructive facts about Blue Print Plans. Don't send one penny—pay no C. O. D.—it's all FREE. Just fill out and mail the coupon today—NOW!

**TWO
BOOKS
also**

FREE

Chicago Technical College



IF YOU LIVE NEARBY

Visit our big day or evening school attended by over 1000 Builders. You can get the same training at home by mail—same plans, lessons and instructors. Your spare time is enough.

Chicago Technical School for Builders—Dept. R-142, Chicago Tech. Building, 118 East 26th Street, Chicago, Ill.

Please send me your 'free book,' "How To Read Blue Prints," and complete set of real Blue Prints. I understand these are mine to keep without obligation. It is also understood that no salesman will call on me.

Name.....

Address.....

City..... State.....

Age..... Occupation.....

**Chicago Technical
SCHOOL for BUILDERS**



Dept. R-142, 118 East 26th St., Chicago, Ill.



High School Course in Two Years!

You Want to Earn Big Money!

And you will not be satisfied unless you earn steady promotion. But are you prepared for the job ahead of you? Do you measure up to the standard that insures success? For a more responsible position a fairly good education is necessary. To write a sensible business letter, to prepare estimates, to figure cost and to compute interest, you must have a certain amount of preparation. All this you must be able to do before you will earn promotion. Many business houses hire no men whose general knowledge is not equal to a high school course. Why? Because big business refuses to burden itself with men who are barred from promotion by the lack of elementary education.

Can You Qualify for a Better Position

We have a plan whereby you can. We can give you a complete but simplified high school course in two years, giving you all the essentials that form the foundation of practical business. It will prepare you to hold your own where competition is keen and exacting. Do not doubt your ability, but make up your mind to it and you will soon have the requirements that will bring you success and big money. YOU CAN DO IT.

Let us show you how to get on the road to success. It will not cost you a single working hour. Write today. It costs you nothing but a stamp.

American School

Dept. H-947 Drexel Ave. and 58th St., Chicago

American School

Dept. H-947 Drexel Ave. and 58th St., Chicago

Send me full information on the subject checked and how you will help me win success.

- | | |
|-----------------------------|---------------------------|
|Architect |Business Law |
|Building Contractor |Lawyer |
|Automobile Engineer |Machine Shop Practice |
|Automobile Repairman |Mechanical Engineer |
|Civil Engineer |Shop Superintendent |
|Structural Engineer |Employment Manager |
|Business Manager |Steam Engineer |
|Cert. Public Accountant |Foremanship |
|Accountant and Auditor |Sanitary Engineer |
|Bookkeeper |Surveyor (& Mapping) |
|Draftsman and Designer |Telephone Engineer |
|Electrical Engineer |Telegraph Engineer |
|Electric Light & Power |High School Graduate |
|General Education |Wireless Radio |
|Vocational Guidance |Undecided |

Name.....

Address

I Teach by Mail

I CAN make a good penman of you at your home during spare time, no matter where you live or how poorly you now write. My simplified system has shown thousands of others the way to good penmanship during the past twenty years — it can and will do the same for YOU!

Beautifully Illustrated Book
“How to Become a Good Penman”
 It contains general information, with testimonials and beautiful specimens of penmanship showing what others have accomplished by the Tambllyn System. **FREE!**
(Your name elegantly written on a card if you enclose stamp for postage.) WRITE TODAY. Address
F. W. TAMBLYN
 418 Ridge Bldg., Kansas City, Mo., U. S. A.

WORLD NEEDS PLUMBERS

Old style plumbers are fading like the horse and buggy. The world demands modern Plumbing and Skilled Trained Mechanics to do it. Unlimited, swift growing field. Make \$50 to \$100 a week or start own shop. We train you quick. Learn in 8 to 12 WEEKS to do any job with skill and science. Need no previous experience. Strictly tool using system. Opportunity knocks. Investigate today — amazing offer — low tuition. World's greatest school.

Write—
UNIVERSAL PLUMBING SCHOOL
 2130 Troost Ave. Kansas City, Mo.

WHY NOT spend Spring, Summer and Fall gathering butterflies, insects? I buy hundreds of kinds for collections. Some worth \$1 to \$7 each. Simple outdoor work with my instructions, pictures, price-list. Send 10 cents (not stamps) for my illustrated Prospectus before sending butterflies.
MR. SINCLAIR, DEALER IN INSECTS.
 Dept. 6. Box 1424. San Diego, Calif.

HOT PIANO

Ultra-modern Piano
 Jazz taught by mail. Note or ear. Easy rapid lessons for adult beginners. Also Self-instruction system for advanced pianists. Learn 358 Bass Styles, 976 Jazz Breaks, hundreds of Trick Endings, Hot Rhythms, Sock, Stomp and Dirt Effects; Symphonic and Wicked Harmony in latest Radio and Record Style. Write for Free Booklet.
WATERMAN PIANO SCHOOL, 1826 W. Adams St., Los Angeles, Calif.

Learn Photography at HOME

Make money taking pictures. Prepare quickly during spare time. Also earn while you learn. No experience necessary. New easy method. Nothing else like it. Send at once for free book, OPPORTUNITIES IN MODERN PHOTOGRAPHY and full particulars

AMERICAN SCHOOL OF PHOTOGRAPHY
 Dept. 1359 3601 Michigan Ave. Chicago, U. S. A.

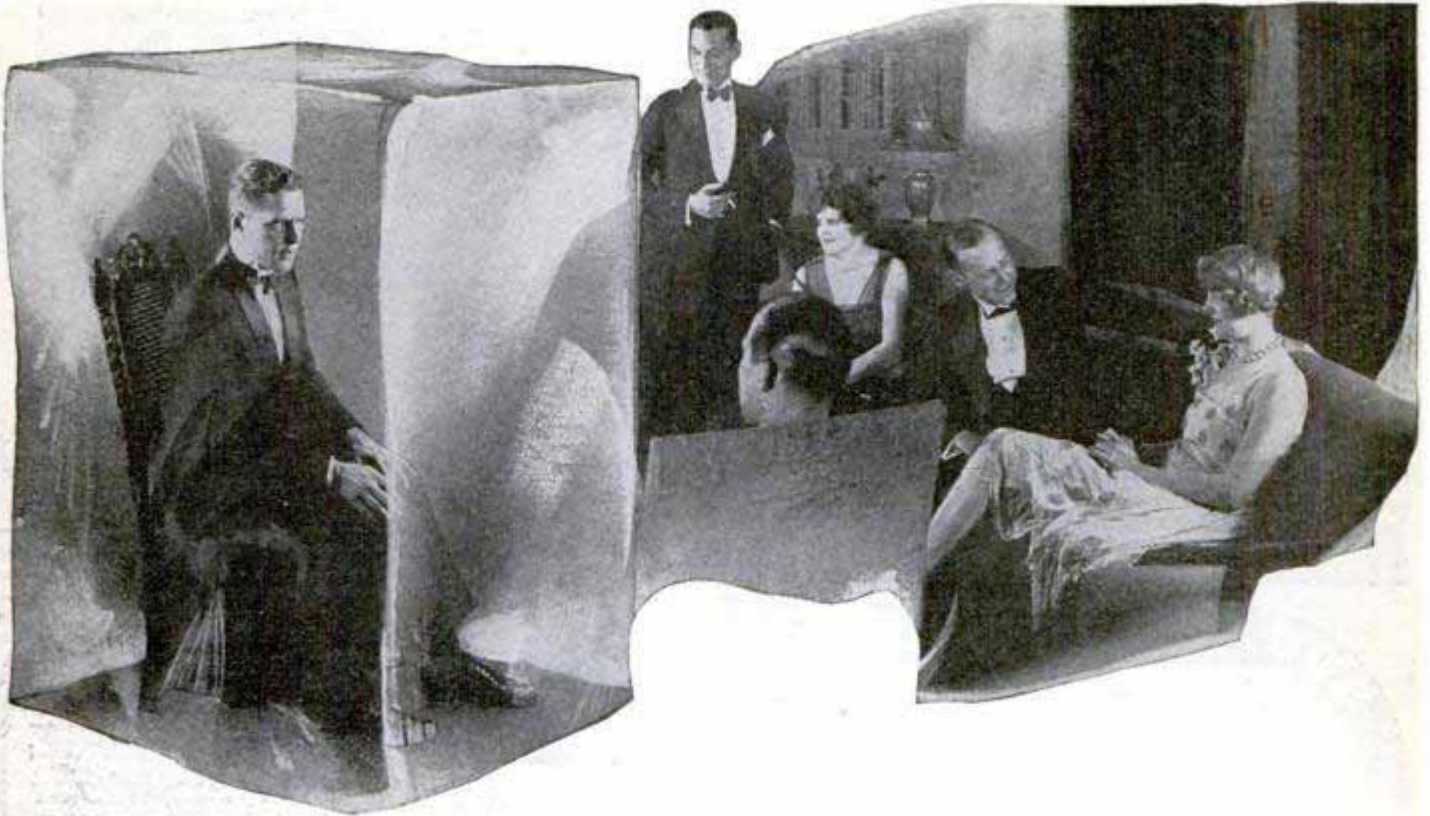

I Turned To Ice When I Tried To Talk

-But Now I Can Sway An Audience of Thousands!

I HAD always been painfully bashful. When trying to carry on even the most commonplace conversation my voice would sound unnatural and my hands and knees would tremble. Often I would listen to an argument among a group and become so keenly interested that I would want to voice my own opinion—yet timidity would keep me silent. I never had the courage to stand up for what I knew to be my rights—I was always afraid of "what people would say," of ridicule. Since my childhood I had had a secret desire to appear in public—to be active in politics—but my shyness was so great that I turned to ice when I tried to talk—in even the smallest gathering!

My inability to talk was also affecting my business success. I dreaded going in and asking for a raise—I was afraid of any situation that meant using my voice—having to express myself. I didn't know how to present the ideas which I was sure the firm could use. I was just a plodder—a truck horse, capable of doing a lot of heavy work but of no use where brilliant performance was required. Often I would see men who were not half so thorough nor so hard working as I, promoted to positions where they made a brilliant showing—not through hard work, but through their ability to talk cleverly and convincingly—to give the appearance of being efficient and skillful.

local candidate—I who a short time before had turned to ice when I tried to carry on an ordinary conversation!

Soon I had won salary increases, promotion, popularity, power. Today I always have a ready flow of speech at my command. I am able to rise to any occasion, to meet any emergency with just the right words, to approach all types of people with ease and fearlessness. And I accomplished all this by developing the natural power of speech possessed by everyone, but cultivated by so few—by simply spending 20 minutes a day in my own home on this most fascinating subject.

Send for This Amazing Book

This new method of training is fully described in a very interesting and informative booklet which is now being sent to everyone mailing the coupon below. This book is called, *How To Work Wonders With Words*. In it you are shown how to conquer stage fright, self-consciousness, timidity, bashfulness and fear—those things that keep you silent while men of lesser ability get what they want by the sheer power of convincing speech. Not only men who have made millions, but thousands have sent for this book—and are unstinting in their praise of it. You are told how to bring out and develop your priceless "hidden knack"—the natural gift within you—which will win for you advancement in position and salary, popularity, social standing, power and real success. You can obtain your copy absolutely free by sending the coupon.

Now Sent
FREE



**NORTH AMERICAN
INSTITUTE**
3601 Michigan Ave. Dept. 1359
CHICAGO, ILLINOIS

What 20 Minutes a Day Will Show You

How to talk before your club or lodge
How to propose and respond to toasts
How to address board meetings
How to tell entertaining stories
How to make a political speech
How to make after-dinner speeches
How to converse interestingly
How to write letters
How to sell more goods
How to train your memory
How to enlarge your vocabulary
How to develop self-confidence
How to acquire a winning personality
How to strengthen your will-power and ambition
How to become a clear, accurate thinker
How to develop your power of concentration
How to become master of any situation

In Twenty Minutes a Day

And then suddenly I discovered a new easy method which made me a forceful speaker almost over night. I learned how to dominate one man or an audience of thousands—how to say just the right words at the right time, how to win and hold the attention of those around me, how to express my thoughts simply and clearly, yet in a pleasing, interesting and amusing way. In just a few months I was able to make campaign speeches for a

North American Institute,
3601 Michigan Ave., Dept. 1359, Chicago, Illinois.

Please send me FREE and without obligation my copy of your inspiring booklet, *How To Work Wonders With Words*, and full information regarding your Course in Effective Speaking.

Name.....
Address.....
City..... State.....

Students at work on 1929 Packard Str. 8. Other 1929 Models include: Buick, Study, Marmon, Auburn, Nash, Rev, Essex, De Soto, Chev., Ford, Oakland—and 11 more chassis.

\$25,000 worth of 1929 cars for you to work on!

Learn Autos IN LOS ANGELES

and LEARN IT RIGHT!

1. NATIONAL—America's Best Equipped Auto School

NATIONAL is a Million Dollar institution—established in Los Angeles in 1905—recognized throughout the automotive industry as one of America's foremost trade schools. NATIONAL offers practical, intensive training in all automotive branches. No age limit. No previous experience necessary. You learn by "Actual-Shop" Methods. Life Scholarship privileges. Start any time of the year.

2. NATIONAL Qualifies YOU to Make Good

NATIONAL properly trains you in the Auto Trades in the short time of 4 to 6 months. Upon completing this Condensed Course you are fully qualified as a Practical, Competent Automobile man, and you have not risked your chances of employment because of inferior, incomplete instruction.

3. NATIONAL Guarantees YOU Efficient Employment Service

NATIONAL GUARANTEES to give unlimited and efficient Employment Service to students wishing to earn living expenses while learning; and to graduates getting started in the automobile field. This is the most any reputable school can be expected to do.

4. NATIONAL'S Training in Every Man's Reach

NATIONAL offers YOU the very best technical-practical training that money can buy at a cost within every man's reach. It does not offer to pay your railroad fare, room and board or other personal expenses, preferring to limit its activities to the PROPER TRAINING OF MEN FOR SUCCESS.

5. Come to LOS ANGELES—the Playground of America!

LOS ANGELES is the heart of the country's most prosperous automobile section—as well as the world's most ideal city in which to live and prepare for success in the auto game.

WRITE for FREE BOOK now!

National Automotive School

NATIONAL AUTOMOTIVE, Dept. 729, 4006 Figueroa St., Los Angeles, Calif.

Send me, absolutely free, your big illustrated catalog of Automotive Opportunities.

Name.....
Address.....
Age.....City.....State.....

Your Future assured!
National Automotive
LOS ANGELES

LEARN TO FLY—

WHERE LINDBERGH LEARNED!

GET the same complete, thorough, foundational training that Lindbergh received. Get it now—under greatly improved facilities—at the Lincoln Airplane School. Much better than when Lindbergh learned here. Get the best training now available. Here competent, experienced instructors teach you practical Flying and Ground Work. You go right up into the sky in our famous Lincoln Page Government Licensed Planes—with transport pilots. Learn on actual planes and motors supplied by the Lincoln Aircraft Factory. Write for full information today!

LINCOLN AIRPLANE SCHOOL
205 Aircraft Bldg., LINCOLN, NEBR.

Learn How to WRESTLE

In Your Own Home By Mail

Yes, learn to become an expert wrestler right in your own home, by mail, from the greatest wrestlers the world has ever known. Be an athlete, be strong, be healthy. Learn how to throw and handle big men with ease. Learn to defend yourself. All taught in our course of lessons, and illustrated with hundreds of charts and actual photographs by

Farmer Burns and Frank Gotch

Farmer Burns, "the grand old man of the mat," taught Frank Gotch, the World's Champion, all he knew about wrestling, so Gotch said. He will now teach you Scientific Wrestling—Physical Culture—Jiu-Jitsu—Self Defense. Every man and boy in America, no difference what age, needs this wonderful course of lessons. Write today—your name, age and address on a postcard or letter brings you our fine book absolutely free—no obligation of any kind. A splendid book on wrestling and physical culture. Write today stating your age.

Farmer Burns School of Wrestling 3379 Range Bldg., Omaha

This Wrestling Book FREE

Learn Advertising at HOME

Send your name and address for free booklet giving interesting information and vital facts about Advertising. Find out how we prepare you at home, in your spare time, for the opportunities open in this fascinating business. Practical work. No text books. Old established school. Successful graduates everywhere. Just the plan you have always wanted. Write today. No obligation.

PAGE-DAVIS SCHOOL OF ADVERTISING
Dept. 1359 3601 Michigan Ave. Chicago, U. S. A.

Send for my Book

STRONG ARMS and BROAD SHOULDERS

for 25c coin or 30c stamps

Illustrated with 20 full-page half-tone cuts, showing exercises that will quickly develop, beautify and gain great strength in your shoulders, arms and hands, with-out any apparatus.

Equal to a \$20.00 Course

Prof. ANTHONY BARKER
1235 6th Avenue Studio F New York City

AVIATION Information FREE

Send us your name and address for full information regarding the Aviation and Airplane business. Find out about the many great opportunities now open and how we prepare you at home, during spare time, to qualify. Our new book "Opportunities in the Airplane Industry" also sent free if you answer at once.

AMERICAN SCHOOL OF AVIATION
3601 Michigan Ave. Dept. 1359 CHICAGO

BIG PAY THRILLING WORK

BE A \$ \$ MOVIE OPERATOR

Make big money in this easy and pleasant work. Big demand for trained operators. We help you earn while learning. Complete course in 5-10 weeks. Don't Wait. Write to-day.

MOVIE OPERATORS SCHOOL
61 Sprout St. Detroit, Mich.

They Thought I Was Trying to be Funny —

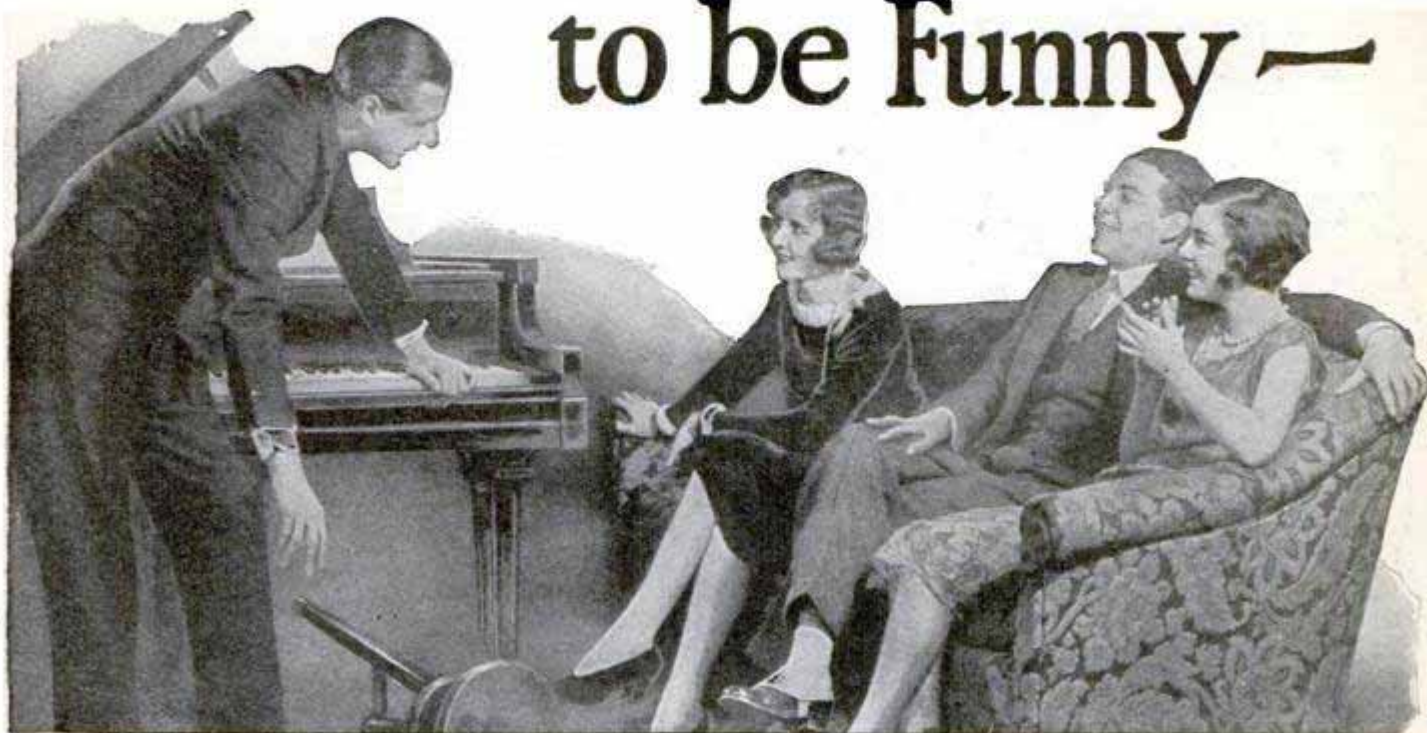

Until I Started to Play — Then I Gave Them the Surprise of Their Lives

THE crowd sat spellbound. Harry had just played the violin—beautifully. With mock dignity, I arose.

"With your kind permission," I announced, "I shall now charm you with a piano recital."

Everyone snickered. They were sure I couldn't play a note. "Does he really play?" one girl asked. "Yes," Phil laughed, "he plays the Victrola—beautifully!"

With studied clumsiness, I fell over the piano stool. Then I proceeded to pick out "Chop Sticks" with one finger! The crowd laughed. This was the dramatic moment for my surprise. Dropping the mask of the clown, I struck the first sweet chords of Wagner's lovely "The Evening Star" from "Tannhauser."

The laughter died on their lips. The magic of my music cast a spell over everyone. As I played on with complete confidence, I forgot the room—the people—everything. I was alone—lost in the sheer beauty of the immortal master's tender melodies.

The Thrill of My Life

When the last notes had faded away, there was a roar of applause. Then came questions and congratulations from my dumbfounded friends—"How long have you been playing?"—"Who was your teacher?"—"Where did you learn?"

"I know it is hard to believe," I replied, "but I learned at home—and without a teacher!"

Then I told them the whole story.

"I have always wanted to play the piano. But I never had a chance to take lessons. Then one day I saw an interesting ad. It told about a new, easy way of learning music—right at home—without a teacher. I sent for the Free Demonstration Lesson and Free Booklet.

"When they arrived, I was amazed to see how easy playing the piano really was. I decided that I would send for the course and practice secretly. Then I could surprise you all.

Just a Few Minutes a Day

"The course was as fascinating as a new game. I enjoyed every minute of it. I was playing real tunes from the start, *by note*. Reading music was as easy as A-B-C! No weary scales, no monotonous exercises, no tiresome hours of practicing. Soon I could play jazz, ballads, classical music—all with equal ease."

"You, too, can learn to play your favorite instrument by this easy "at home" method that has taught over half a million people. It's just a common sense practical method—so simple you don't have to know the slightest thing about music. You find your progress amazingly rapid because every step is clear and easy to understand. Just pick out the instrument you want to play. The U. S. School of Music does the rest. And its cost averages just a few cents a day!"

Free Book and Demonstration Lesson

Our illustrated Free Book and Free Demonstration lesson explain all about this remarkable method. They prove how anyone can learn to play his favorite instrument in almost no time.

If you really want to learn to play, take this opportunity to make your dreams come true. Sign the coupon below. Instruments supplied when needed, cash or credit. U. S. School of Music, 712 Brunswick Bldg., New York.

U. S. SCHOOL OF MUSIC,
712 Brunswick Bldg., New York City

Please send me your free book, "Music Lessons in Your Own Home," with introduction by Dr. Frank Crane, Free Demonstration Lesson and particulars of your easy payment plan. I am interested in the following course:

Have You

.....Instr. ?

Name.....

Address.....

City.....State.....

Pick Your Instrument

Piano	'Cello
Organ	Sight Singing
Violin	Ukulele
Drums & Traps	Hawaiian Steel
Guitar	Guitar
Mandolin	Clarinet
Harp	Flute
Cornet	Saxophone
Piccolo	Trombone
Voice and Speech Culture	
Harmony and Composition	
Automatic Finger Control	
Piano Accordion	
Italian and German	
Accordion	
Banjo (Plectrum, 5-String or Tenor)	



"I'm making real money now"

"REMEMBER the day you urged me to send that coupon to Scranton? It was the best thing I ever did.

"Mr. Carter called me in today. Said he'd been watching my work for some time—ever since he learned I was studying with the International Correspondence Schools.

"Then he asked me if I could take over Bill Stevens' job. I told him I was sure that I could—that I had had that goal in view ever since I started my I. C. S. course.

"I start tomorrow, Mary, at an increase of \$60 a month. It's wonderful how spare-time study helps a man to get ahead."

For thirty-seven years, the I. C. S. has been helping men to win promotion, to earn more money, to get ahead in business and in life.

You, too, can have the position you want in the work you like best. Yes, you can. All we ask is the chance to prove it. Without cost, without obligation, just mark and mail this coupon.

INTERNATIONAL CORRESPONDENCE SCHOOLS
Box 5637-F, Scranton, Penna.

Without cost or obligation, please send me a copy of your booklet, "Who Wins and Why," and full particulars about the course before which I have marked X in the list below:

TECHNICAL AND INDUSTRIAL COURSES

- | | |
|--|---|
| <input type="checkbox"/> Architect | <input type="checkbox"/> Automobile Mechanic |
| <input type="checkbox"/> Architectural Draftsman | <input type="checkbox"/> Aviation Engines |
| <input type="checkbox"/> Building Foreman | <input type="checkbox"/> Plumber and Steam Fitter |
| <input type="checkbox"/> Concrete Builder | <input type="checkbox"/> Plumbing Inspector |
| <input type="checkbox"/> Contractor and Builder | <input type="checkbox"/> Foreman Plumber |
| <input type="checkbox"/> Structural Draftsman | <input type="checkbox"/> Heating and Ventilation |
| <input type="checkbox"/> Structural Engineer | <input type="checkbox"/> Sheet-Metal Worker |
| <input type="checkbox"/> Electrical Engineer | <input type="checkbox"/> Steam Engineer |
| <input type="checkbox"/> Electrical Contractor | <input type="checkbox"/> Marine Engineer |
| <input type="checkbox"/> Electric Wiring | <input type="checkbox"/> Refrigeration Engineer |
| <input type="checkbox"/> Electric Lighting | <input type="checkbox"/> R. R. Positions |
| <input type="checkbox"/> Reading Shop Blueprints | <input type="checkbox"/> Highway Engineer |
| <input type="checkbox"/> Telegraph Engineer | <input type="checkbox"/> Chemistry |
| <input type="checkbox"/> Telephone Work | <input type="checkbox"/> Pharmacy |
| <input type="checkbox"/> Mechanical Engineer | <input type="checkbox"/> Coal Mining Engineer |
| <input type="checkbox"/> Mechanical Draftsman | <input type="checkbox"/> Navigation <input type="checkbox"/> Assayer |
| <input type="checkbox"/> Machine Shop Practice | <input type="checkbox"/> Iron and Steel Worker |
| <input type="checkbox"/> Toolmaker | <input type="checkbox"/> Textile Overseer or Supt. |
| <input type="checkbox"/> Patternmaker | <input type="checkbox"/> Cotton Manufacturing |
| <input type="checkbox"/> Civil Engineer | <input type="checkbox"/> Woolen Manufacturing |
| <input type="checkbox"/> Surveying and Mapping | <input type="checkbox"/> Agriculture <input type="checkbox"/> Fruit Growing |
| <input type="checkbox"/> Bridge Engineer | <input type="checkbox"/> Poultry Farming |
| <input type="checkbox"/> Gas Engine Operating | <input type="checkbox"/> Mathematics <input type="checkbox"/> Radio |

BUSINESS TRAINING COURSES

- | | |
|--|---|
| <input type="checkbox"/> Business Management | <input type="checkbox"/> Business Correspondence |
| <input type="checkbox"/> Industrial Management | <input type="checkbox"/> Show Card and Sign Lettering |
| <input type="checkbox"/> Personnel Management | <input type="checkbox"/> Stenography and Typing |
| <input type="checkbox"/> Traffic Management | <input type="checkbox"/> English |
| <input type="checkbox"/> Accounting and C. P. A. Coaching | <input type="checkbox"/> Civil Service |
| <input type="checkbox"/> Cost Accounting | <input type="checkbox"/> Railway Mail Clerk |
| <input type="checkbox"/> Bookkeeping | <input type="checkbox"/> Mail Carrier |
| <input type="checkbox"/> Secretarial Work | <input type="checkbox"/> Grade School Subjects |
| <input type="checkbox"/> Spanish <input type="checkbox"/> French | <input type="checkbox"/> High School Subjects |
| <input type="checkbox"/> Salesmanship | <input type="checkbox"/> Cartooning |
| <input type="checkbox"/> Advertising | <input type="checkbox"/> Illustrating |
| | <input type="checkbox"/> Lumber Dealer |

Name.....
Address.....
City..... State.....
Occupation.....

If you reside in Canada, send this coupon to the International Correspondence Schools Canadian, Limited, Montreal, Canada

Increase Your Earning Power

Apply time and labor-saving kinks to your work. Your efficiency will soon be recognized and you will be in line for advancement.

If you do machine shop work of any kind, sheet-metal work, painting, carpentry, auto repairing, farming, concrete work, plumbing, electrical work, welding, building, glass work, general repairing, tool-making, poultry raising, masonry or home repair work, get this

LIBRARY OF 6000 TIME AND LABOR SAVING IDEAS FOR SHOPMEN AND HANDYMEN

JUST PUBLISHED

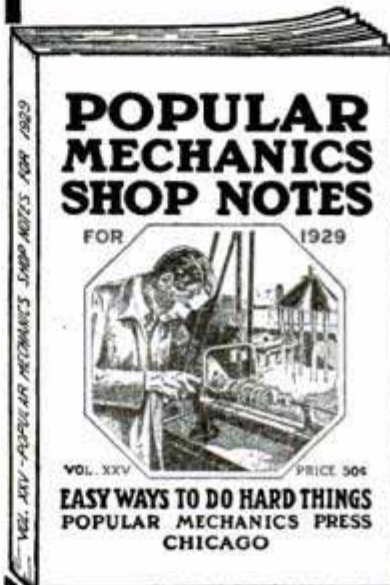

SHOP NOTES for 1929

224 Pages
347 Articles
400 Illustrations

See partial list of contents below

Including the new 1929 issue illustrated above, there are now 15 volumes in the Shop Notes Library of 6,000 easily understood short cuts to every-day jobs. Here are just a few of the subjects taken from the 347 articles in the latest issue.

- | | | |
|-------------------------|---------------------------|---------------------------|
| Aluminum Mending | Drilling Kinks | Practical Mimeograph |
| Artistic Doorplates | Dumb Waiter | Reamer Holder |
| Artistic Plaques | Electric Crucible | Removing Roller Bearings |
| Attractive Lampshades | Furniture Designing | Renewing Old Pumps |
| Bird Bath in Concrete | Handy Workshop | Renovating Gaskets |
| Blowtorch Making | Homemade Jack | Repairing Laundry Tubs |
| Brass Pipe Handling | Homemade Silo | Rush or Fibre Seats |
| Build Your Own Garage | Insulating Hot Water Tank | Safe Folding Ladder |
| Burning Coke | Lathe Kinks | Six-Inch Bench Shaper |
| Burning Out Carbon | Long Narrow Photographs | Softening Leather Belting |
| Camera Exposure Meter | Machine for Making Rope | Tables in Art Moderne |
| Candlestick Making | Paint Removing | Tin Can Mechanics |
| Chute for Parcels | Piston Ring Compressor | Tractor for Light Work |
| Colonial Spinning Wheel | Pneumatic Soldering Plant | |
| Crane for Small Garage | | |
| Double Vice Press | | |
| Draft Regulator | | |

Each volume contains approximately 500 articles and 400 illustrations and has 224 Pages. At the regular price of 50 cents per single volume this library costs \$7.50, but for a limited period we will supply the 15 vols. when ordered at one time at the special reduced price of only \$4.50.

SPECIAL OFFER COUPON

POPULAR MECHANICS PRESS, 200 E. Ontario St., Room P12, Chicago, Ill.

Send me, as per your special offer, the following books. I will pay for books C. O. D. when they arrive. My money will be refunded if I am not satisfied. (Check what you want.)

- 1929 Shop Notes and Lathe Handbook, both for 98c.
 Complete Shop Notes Library (15 vols.) \$4.50.

Name.....
Street and No.....
City..... State.....

POCKET EDUCATORS

For all BUILDERS AND MECHANICS



Read Audels Pocket Educators for advancement and profit in your work. Every mechanic in the building trades should have this inside trade information at his fingers' ends. Learn the scope and possibilities of your profession. Any job can be done better if you are well informed. To earn more, learn more.



AUDELS CARPENTERS AND BUILDERS GUIDES—4 VOLS. \$6



\$1 PER MO.

Inside Information for Carpenters, Builders, Joiners, Building Mechanics—all Woodworkers. **1600 pages; 3700 diagrams; flexible; pocket size.** Short-cut instructions, new methods, ideas, solutions, plans, systems—money saving suggestions. An easy progressive course for the apprentice. A practical daily helper and Quick Reference for the master worker. A Helping Hand to Easier and Better Work and Better Pay. To get this aid for yourself, simply fill in and mail the FREE COUPON below.

INSIDE TRADE INFORMATION ON:

How to use steel square; How to file and set saws; How to build furniture; How to use mitre box; How to use chalk line; How to use rules; How to make joints; Carpenters' arithmetic; Mensuration problems; Estimating strength of timbers; How to set girders and sills; How to frame houses and roofs; How to estimate costs; How to build houses, barns, garages, bungalows, etc.; How to read and draw plans; Drawing up specifications; How to excavate; How to use settings 12, 13 and 17 on the steel square; How to build hoists and scaffolds—skylights; How to build stairs; How to put on interior trim; How to hang doors; How to lath—lay floors; How to paint.

"Audels Guides worth four times their price—handy too as I carry them in pocket for reference." W. J. Bates, Knoxville, Pa.



\$1 PER MO.

AUDELS PLUMBERS AND STEAMFITTERS GUIDES—4 VOLS. \$6

A new set—just out! A practical, illustrated, Reference Library and Study-Course for Master Plumbers, Journeymen and Apprentice Steamfitters, Gas Fitters and Helpers, Sheet Metal Workers, Draughtsmen, Master Builders, Engineers and all Building Trade Students. **1670 pages; 3642 diagrams; flexible; pocket size.** Guides explain all the principles, advances and short cuts of the Plumbing and Heating trade. Contains instructions on how to figure and estimate jobs. Use FREE COUPON below to examine, without obligation, this valuable work.

INSIDE TRADE INFORMATION ON:

Soldering, tinning. Joint wiping, bending, beating. Pipe—iron—steel, threading. Mathematics, tables, physics. Materials—iron, steel, copper, brass, lead, tin, antimony. Sheet metal—galvanized—plate. Sanitation, syphonage, tanks. Drainage, sewage, purification. Fixtures—bath—kitchen. Pipe fittings, soil pipe, tools. Laying out work. Roughing. Screwed fittings, flanges, joints. Pipe bending, examples. Elbows. Heating, ventilation, refrigeration. Water supply, mains, wells, tanks. Gas-fittings. Underwriters. Sheet metal work, problems, methods, brazing, heating, lead burning. Welding, various welds, methods. Blacksmithing, forges, tools.

"Audels Guides are practical, easy to understand, reliable. Cover the field in plain language." W. F. Arminger, Annapolis, Md.



\$1 PER MO.

AUDELS MASONS AND BUILDERS GUIDES—4 VOLS. \$6

A new, complete, illustrated trade reference library, for Bricklayers, Cement Workers, Plasterers, Tile Setters and Stone Masons, including a practical outline of Steel Construction. **1100 pages; 2067 diagrams; flexible; pocket size.** A practical Trade Assistant explaining modern methods of masonry construction. Easy to understand and apply. A reliable and authentic reference work and study-course for Master Journeyman and Young Mechanic. Use FREE COUPON below and find out for yourself, without obligation, whether this set will benefit you.

INSIDE TRADE INFORMATION ON:

Bricklaying, tools, materials; Brick designs, patterns, bonds; Setting frames and foundations; Mortars, scaffolds, estimating; Mortars and mortar mixing; Tile setting, mosaic, hollow tile; Straight edge test, troweling; How to figure brick work; Safe loads, piers, chimneys; Boiler settings, anchors, fire stops; Labor tables; Concrete, forms; How to figure concrete work; Stucco—on old and new buildings; Plastering—wood lath—metal; Plasterers agreement; Plastering on various surfaces; Stonemasonry; Cutting, finishing, estimating stone; Derricks, rigging; Steel construction; Fire proof; How to read blue prints.

"Audels Masons Guides are the best books on the subject. Have laid brick 12 years and am able to judge." H. A. Sonnett, Corliss, Pa.



PRACTICAL ELECTRICITY — 1 VOL. \$4

Audels Handy Book of Practical Electricity is a simplified Ready Reference and Study Course in one pocket size, leather bound volume—for Engineers, Professional Electricians and Students. **1040 pages; 2600 diagrams; flexible red leather bound.** A reliable authority and handy helper for every electrical worker. Contains important and valuable wiring diagrams, calculations, machine sketches, helps on maintenance and repair. Use this FREE COUPON today and find out, without obligation, how this handy book will help you in your daily work.

Complete in one handy, red leather bound volume

INSIDE TRADE INFORMATION ON:

Electro-Therapeutics, X-Rays, Shocks, Welding, Brazing, Radio Hook-ups, Motion Pictures, Telephone, Telegraph, Cranes, Bells, Elevators, Pumps, Tools, Ship Drive, Railways, Vehicles, Automobile Electric Systems, Ignition, Generation, Lighting, Plant Management, Power

Plans, Armature Winding, Repairing, A. C. Motors and Apparatus, D. C. Motors and Apparatus, Alternator Construction, Dynamos, Wiring Diagrams, Sign Flashers, Cable Splicing, Power Wiring, Outside Wiring, Switches, Lighting, Rectifiers, Converters, Transformers, Fuses, Circuit Breakers, Rheostats, Electro Plating, Electrolysis, Storage Batteries, Magnetism, Electrical Energy, Conductors, Insulators, Static, Dynamic, Radio Electricity, Applications, Ready Reference and Index Covering the entire field of Modern Electricity.



Learn More and You Will Earn More!

Know your job and you'll never be without one. The skilled man is always in demand. Knowledge is power. Learn your trade thoroughly by easy reading. This coupon is your opportunity for advancement and better pay. You risk nothing in sending for Audels Guides for free examination. Send it NOW!

FREE EXAMINATION COUPON

THEO. AUDEL & CO.,

65 W. 23 ST., NEW YORK CITY

Please mail me for free examination the books marked (x) below. If I find them satisfactory, I agree to mail \$1 in 7 days, on each set ordered, and to further mail \$1 monthly on each set until I have paid the purchase price.

- 4 CARPENTERS GUIDES \$6 4 PLUMBERS GUIDES \$6
- 4 MASONS GUIDES \$6 1 ELECTRICIANS HANDY BOOK \$4

NAME

ADDRESS

OCCUPATION

EMPLOYED BY

Earn \$75 to \$100 a Week as AUTO MECHANIC —

In 8 Weeks You Can Have a Big-Pay Job as an Auto, Airplane or Tractor Mechanic

Eight short weeks of pleasant, fascinating, practical Auto, Airplane or Tractor work in my big shops—and then a real job paying \$75 to \$100 a week! You can step right out of low pay, long hours, and no future into the job of a high-salaried trained mechanic. Everywhere jobs are waiting for men trained as I train them. Change the whole course of your life in 8 weeks!

Learn on Real Machines—No Books

Come to my shops. I will make you a mechanic able to handle the hardest mechanic's job easily and quickly. I'll teach you to know Autos, Airplanes and Tractors inside out. You don't need education. You don't need previous experience. All you need is ambition. You learn by doing—by working on actual machines with real tools. This is not a correspondence course. (No facilities for colored students.)

Short Cut to Big Pay Learn how easy it is to get a steady, big pay job in the great Auto, Tractor and Aviation fields. Learn what other fellows like you have done with McSweeney training. Get special low tuition offer.

Special Aviation Course

AVIATION is paying tremendous incomes to trained men! Learn on real airplane engines under experienced instructors. Ask about special course in FLYING. Don't miss this remarkable opportunity.



Mail Coupon for Book

Money Back Guarantee

If, after completing my training, you are not satisfied, if you are not qualified to accept a big-pay job, your tuition will be refunded.

McSweeney Auto, Tractor and Aviation Schools, Dept. A-18-M, Chester at 30th St., Cleveland, O., or 263 Madison St., Memphis, Tenn.

Without cost or obligation, send me your big FREE Book on Autos, Tractors and Aviation, also full details of your special tuition offer.

Name.....

Street.....

Town.....State.....

McSWEENEY

Auto, Tractor and Aviation SCHOOLS

Chester at 30th St., Cleveland, O. or 263 Madison St., Memphis, Tenn.

Aircraft Drafting Now taught at home!

The demand for trained Aeronautical Draftsmen is so great that the famous old Columbia School of Drafting now offers a special Aeronautical Course. Under the new home study plan, non-resident students get the same instruction as those who come to Washington, and all receive the free services of Columbia's active employment service. The coupon will bring you our message to wide-awake men, "Drafting and Its Opportunities." Send for it today!

Columbia School of Drafting & Engineering
All Branches of Drafting
13th and E. Sts., N. W., Washington, D. C.

P. M.-12

Please send me my copy of your Free Book, showing how I can learn Aeronautical Drafting right at home.

Name.....

Address.....

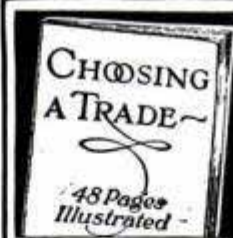

SENT ON REQUEST

Helpful discussion of this important problem and of fastest growing of Mechanical Trades—Mechanical Dentistry. Easily learned. Of interest to men of all ages. Send for Bulletin 2.

BODEE INSTITUTE

1755 Broadway, New York
1305 N. Broad St., Philadelphia
85 Court St., Brooklyn

"STAMMERING

Its Cause and Cure"

You can be quickly cured if you stammer. Send 10 cents coin, or stamps, for 288 page cloth bound book on Stammering and Stuttering. It tells how I cured myself after Stammering and Stuttering for 20 years. BENJAMIN N. BOGUE
11124 Bogue Building, 1147 N. Ill. St. Indianapolis

TRAVEL - for 'UNCLE SAM'

RAILWAY POSTAL CLERKS

MAIL CARRIERS—POSTOFFICE CLERKS
GENERAL CLERKS—CUSTOMS INSPECTORS

\$1700 to \$3400 a Year for Life

No "lay-offs" because of strikes, poor business, etc.—sure pay—rapid advancement. Many other U. S. Government Jobs. City and country residents stand same chance. Common sense education usually sufficient.

STEADY WORK

Cut coupon and mail it before turning the page.

MEN—BOYS 18 to 45

Use Coupon Before You Lose It

COUPON

FRANKLIN INSTITUTE, Dept. D173, Rochester, N. Y.

Rush to me, free of charge, (1) A full description of the position checked below; (2) 32-page book, with list of positions obtainable; (3) Tell me how to get the position checked.

- Railway Postal Clerk (\$1900 to \$2700)
- General Clerk (\$1260 to \$2100)
- Postoffice Clerk (\$1700 to \$2300)
- Customs Inspector (\$2100 up)
- City Mail Carrier (\$1700 to \$2100)
- Rural Mail Carrier (\$2100 to \$3300)

Name.....

Address.....



The Man with the "Grasshopper Mind"

YOU know this man as well as you know YOURSELF. His mind nibbles at EVERYTHING and masters NOTHING. At home in the evening he tunes in the radio—gets tired of it—then glances through a MAGAZINE—can't get interested. Finally, unable to CONCENTRATE on anything, he either goes to the MOVIES or FALLS ASLEEP in his chair

At the OFFICE he always takes up the EASIEST thing first, puts it down when it gets HARD, and starts something else. JUMPS from ONE THING TO ANOTHER all the time!

There are thousands of these PEOPLE WITH GRASSHOPPER MINDS in the world. In fact they are the very people who do the world's MOST TIRESOME TASKS—and get but a PITTANCE for their work.

They do the world's CLERICAL WORK, and routine drudgery. Day after day, week after week, month after month, year after year—ENDLESSLY—they HANG ON to the jobs that are smallest-salaried, longest-houred, least interesting, and poorest-future!

If YOU have a "grasshopper mind" you know that this is TRUE. And you know WHY it is true. Even the BLAZING SUN can't burn a hole in a little piece of TISSUE PAPER unless its rays are focussed and concentrated ON ONE SPOT!

A BRAIN THAT BALKS at sticking to ONE THING FOR MORE THAN A FEW MINUTES surely cannot be depended upon to get you anywhere in your YEARS of life!

The TRAGEDY of it all is this: you know that RIGHT NOW you are merely jumping HERE AND THERE. Yet you also know that you have WITHIN YOU the intelligence, the earnestness, and the ability that can take you right to the high place you want to reach in life!

What is WRONG? WHAT'S holding you back?

Just one fact—one SCIENTIFIC fact. That is all. And when you know what it IS, then you can easily learn how to apply it; make it carry you STEADILY, POSITIVELY, AND DIRECTLY to prosperity and independence.

That fact is one which has been PROVEN and stated by the world's foremost scientists and psychologists. You are only ONE-TENTH as successful as you COULD be! Why? BECAUSE, as Science says, you are using only ONE-TENTH of your real BRAIN-POWER!

TEN per cent of his brain is all the AVERAGE person uses. He is paid for ONE-TENTH of what he really possesses because that is all he actually USES. The remainder lies dormant. The longer it is unused, the harder it becomes to use it. For the mind is like a muscle. It grows in power through exercise and use. It weakens and deteriorates with idleness.

What can you DO about it? That is the question you are asking yourself. Here is a suggestion.

Spend 2c for a postage stamp. Send in the coupon below for a copy of "Scientific Mind Training." There is no further obligation whatever. You need not spend another penny.

This little book will tell you the secret of self-confidence, of a strong will, of a powerful memory, of unflagging concentration. It tells you how to acquire directive powers, how to train your imagination (the greatest force in the world), how to make quick, accurate decisions, how to reason logically—in short, how to make



your brain an instrument of all-around POWER. It tells you how to banish the negative qualities like forgetfulness, brain fog, inertia, indecision, self-consciousness, lack of ideas, mind wandering, lack of system, procrastination, timidity.

Men like Judge Ben B. Lindsey, Sir Harry Lauder, Prince Charles of Sweden, Jerome K. Jerome, the famous novelist; Frank P. Walsh, Chairman of the National War Labor Board, and hundreds of others equally famous, praise the simple method of increasing brain power and thought power described in this free book. OVER 650,000 OTHERS PRAISE IT.

You have only TWO CENTS to lose by writing for your copy. You may GAIN thousands of dollars, peace of mind, happiness, independence!

Thousands who read this announcement will DO NOTHING about it. The effort and the will needed to send for this book—which is FREE—may be lacking. How can these people EVER gain what they hope for, crave for? They are the skeptics, the doubters, the "show me" wiseacres.

Other thousands will say, "I can lose only TWO CENTS. I may GAIN a great deal by reading 'Scientific Mind Training.' I will send for it NOW. It promises too much for me to RISK MISSING."

The thousands who are open minded—who are willing to learn something to their advantage—will ACT on their impulse to send the coupon. They will be better, stronger minded for having TAKEN SOME ACTION about their lives, even if they do nothing more than to READ a booklet about the inner workings of the mind. For your own sake—and for the sake of your loved ones, don't continue to GAMBLE that your future will be bright whether or not you DO anything about it! Mail the coupon today—NOW.

THE PELMAN INSTITUTE OF AMERICA

Suite 612. 71 West 45th Street, New York City

Offices in London, Paris, Stockholm, Delhi,
Durban and Melbourne

The Pelman Institute of America
Suite 612. 71 West 45th Street,
New York City

Please send me without obligation your free booklet, "Scientific Mind Training." This does not place me under any obligation and no salesman is to call on me.

Name _____

Address _____

City _____ State _____

Step INTO A BIG-PAY HOTEL JOB



Earn \$2,500 to \$10,000 a Year

IN America's 3rd Largest Industry. Hotels, Clubs, Restaurants, Institutions, Schools, Hospitals, etc., are daily calling for Lewis Graduates. Over 70,000 high-class positions paying \$2,500 to \$10,000 a year open annually in hotels alone. Salaries up to \$3,500 to start. C. W. Ryder says:—"Shortly after completing your course I was appointed Purchasing Agent of a chain of hotels at a 100% increase in salary."

We Put You in Touch with Positions

Without cost let us show you how big pay, fascinating work, quick advancement can be yours in the great hotel industry. Age is no obstacle—young and old alike have equal chance for success. O. O. Miller, 55, qualified for a well-paid position thru the Lewis course. A common school education is all you need with the amazing Lewis System of Sparetime Training in Hotel Operation.

Previous Experience Unnecessary

Hundreds of Lewis students are winning success. Totally unacquainted with hotel work before taking the Lewis Course, N. Frank Hills is now Assistant Manager of a \$250,000 Apartment House. YOU can do as well. Low cost—easy terms—money back agreement. Write today for Free Book, "Your Big Opportunity," and complete details, mailed without obligation.

1000 HOTEL POSITIONS OPEN

**Lewis Hotel Training Schools
Room BU-339
Washington
D. C.**



These Lewis Students "Made Good"

Charles A. Jones:—"I was chosen for the position of Manager. My success is due to Lewis Training."

Frank H. Jenkins:—"Mr. Jarow has just made me Steward and, as the business grows, he expects to give me full charge of the house. Just think, I haven't been in the work a year and yet I fully understand what will be required of me, thanks to Lewis Training."

LeRoy L. Saunders:—"October 1st, our organization moves into the new \$8,000,000 club house. I am assisted to become Assistant to the General Manager. Thank you for your cooperation."

Morris S. Johnston:—"I am Manager of the finest hotel of its kind in this city. Your course is essential to hotel work."

**LEWIS HOTEL TRAINING SCHOOLS,
Room BU-339, Washington, D. C.**

Send me the Free Book, "Your Big Opportunity," without obligation.

Name.....
Address.....
City..... State.....

OPPORTUNITY COUPON

\$80 to \$150 A WEEK

MOTION PICTURE OPERATORS EARN THIS - and MORE

Big Pay — Easy Work — Short Hours

YOU can quickly qualify for one of these well-paying positions. Big demand now for motion picture projectionists—in theatres, schools, industrial motion pictures or for spare-time entertainments!

Our complete home study course teaches you everything—qualifies you in short time for big pay and fascinating work. Earn two to five times your present salary in this growing, uncrowded profession.

FREE BOOK shows you how you can easily and quickly qualify as an Expert Motion Picture Operator. Send for it **TODAY—NOW!**

NEW YORK INSTITUTE OF PHOTOGRAPHY

Dept. D-1418
8 West 33rd Street
NEW YORK CITY

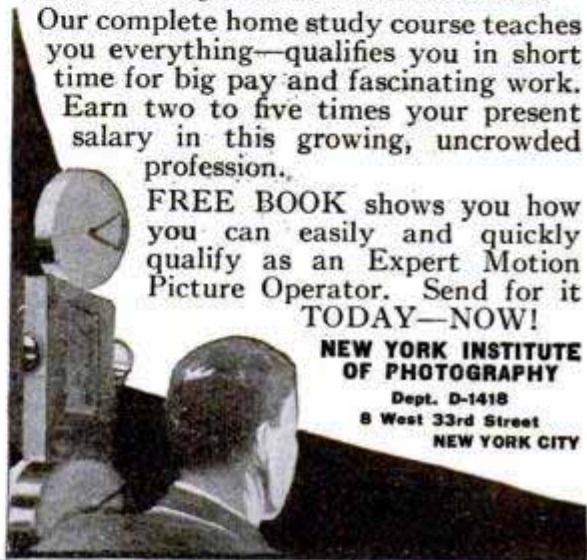

Big Money for You as an Automobile Mechanic

These four practical books, written by five well known teachers of automobile practice, will teach you right in your own home during your leisure time just what you need to know about automobile troubles and repair. They will teach you automobile construction, maintenance and repair as practiced by experts and will help you to earn an expert's pay.

Practical Automobile Library: Four Books—\$1.50 in 10 days and \$2 monthly for 6 months—only \$13.50 in all!

Hundreds of question-answering diagrams—hundreds of clearly-marked illustrations—make the books plain and readily understandable. All the explanations and descriptions are clear, simple, direct. Every chapter is packed with definite, step-by-step, how-to-do-it information. Here is your opportunity to enter a big-pay field.

FREE TRIAL

**Send No Money
Mail the Coupon**



FREE EXAMINATION COUPON

McGraw-Hill Book Co., 370 Seventh Ave., New York

Send me for 10 days' free examination the New Practical Automobile Library. If satisfactory, I will send you \$1.50 in 10 days and \$2.00 monthly until the special price of \$13.50 is paid. If not wanted, I will return the books at your expense.

Signed.....

Address.....

City and State.....

Position.....

Employer..... PM-12-29

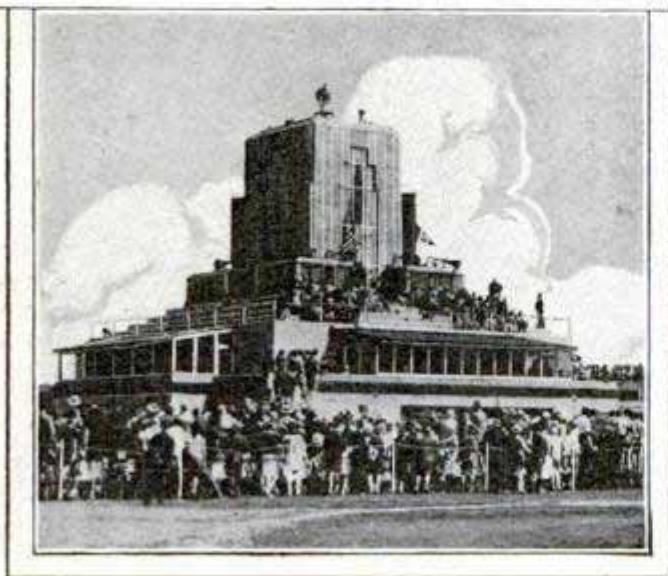
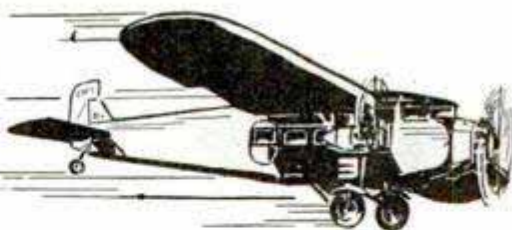

*Club House, Office and Air Depot,
Sky Harbor, Chicago*

FLY AT SKY HARBOR



Steel and Concrete Hangar, Sky Harbor, Chicago

NOW is the time to get into aviation—learn to fly at Sky Harbor the finest flying field in the Middle West. Training on latest type training planes with air cooled motors similar to those used in the Army. Advanced training on Fokker and Tri-motored Ford. We fly at Sky Harbor all winter.

Complete mechanic's courses covering every phase of aerodynamics taught at our big down town building—six floors of equipment—everything needed for finest instruction. Training given on latest types of motors, including Whirlwind and other air cooled radials. Welding, navigation, meteorology, construction, and motors are included. Mail the coupon today for complete information. Be sure to investigate Sky Harbor before you pick your flying school.



Sky Harbor Flying School—Six Floors of Equipment

SKY HARBOR FLYING SCHOOL DEPT. M

1801 S. MICHIGAN AVENUE CHICAGO, ILL.

SKY HARBOR, DEPT. M
1801 S. MICHIGAN AVE., CHICAGO, ILL.

Please send me complete information on the course checked below:

<input type="checkbox"/> Private Pilot's Course.	<input type="checkbox"/> Complete Airplane Mechanic's Course.
<input type="checkbox"/> Transport Pilot's Course.	<input type="checkbox"/> Welding Course.
<input type="checkbox"/> Limited Commercial Pilot's Course.	

NAME

ADDRESS

TOWN..... STATE.....



I'll Teach You To Dance

—at home without music or a partner or the Trial is Free

YES—I'll teach you in a few hours—at home—in private—how to learn all the modern dances—Charleston, Black Bottom, Valencia, Canter, French Tango, St. Louis Hop, Latest Waltzes, Fox Trots, etc., or the trial costs you nothing. I'll train you to be an easy, confident dancer by a system so clear, so simple, so complete that you will soon start dancing gracefully—even though you've never danced before.

Dancing Made Simple as A-B-C

You will be surprised to see how easily you can learn to dance by our simple chart system. Every dance is explained step by step with charts and diagrams. You can't possibly go wrong. The directions are so easy to follow, and the pictures are so clear, that you'll be dancing before you know it.

It isn't necessary that you understand music or even have a piano, phonograph or radio. Our remarkable system teaches you a very simple system of timing yourself. It tells how to know by the music what kind of a dance is next, how to start on the right beat, how to follow the music, how to be graceful and feel at ease, how to get rhythm, how to lead or follow, how to stand correctly, how to gain confidence, how to become popular. In fact, in a short time this remarkable course should make you one of the best dancers in your set.

If you want to become a perfect dancer—if you want to be popular—learn to dance at home this new, easy way.

Think of the Good Times You Are Missing

Every time you turn down an invitation to a dance, you are missing hours of fun, enjoyment and pleasure. Dancing is the best of the social accomplishments. If you are a good dancer, you will be the most popular person in your set and get invitations to all the parties. Why not learn to dance and share the splendid times others are enjoying?

Try for 5 Days FREE

Just send your name and address and we'll send the complete course—323 pages, 49 illustrations, by return mail. When the postman hands you the book, pay him only \$1.98, plus the delivery charges. Try the course for 5 days. Then if not satisfied, return it and your money will be refunded. Mail your order now!

Franklin Publishing Co., Dept. 9423,
800 N. Clark St., Chicago

Please send me your complete course—"Dancing Made Easy"—323 pages, 49 illustrations. When the book arrives I'll pay the postman only \$1.98, plus delivery charges. If I am not satisfied after 5 days' trial, I may return the book and you are to refund my money.

Name.....

Street and No.....

Town..... State.....

If you are likely to be out when postman calls, send \$2.00 with coupon and we'll pay delivery charges. Customers outside U. S. must send cash with order.

PIN A DOLLAR BILL TO THIS

Get this genuine leather 5 window card case, with gold corners, Masonic emblem stamped in heavy gold. Your name or other stamping 35c extra, per line. Money back guarantee.



9 windows \$1.50.
13 windows \$2.00.

A Novel Charm

A most mysterious watch charm of heavy plated gold. Shows the Square and Compass when revolved. Something different. Packed in an attractive box. \$1.00 Catalogue suggests many other gifts.....



SOLID GOLD PIN

Just the right size. Latest style. A lasting remembrance and an appreciated present.



- No. 10, Books, Monitors, Jewelry
 - No. 11, Lodge Supplies
- Established 1859

ent. Large variety—Masonic, Chapter, 32nd Degree, Shrine, Grotto, O. E. S., DeMolay. \$1.00.....

Redding Masonic Supply Co.
200 Fifth Ave. Dept. P. M., New York

"Everything Masonic"

Be a Civil Engineer!

Learn at Home!



Cyclopedia of Civil Engineering

9 great volumes.
4000 pages.
3000 illustrations.
New edition just off the press, by twelve of America's greatest engineers. Includes: Surveying, bridges, railroads, steel structures, municipal engineering, water supply, road building, etc.

Earn \$5000

a Year—and Up!

"CIVIL ENGINEERING"—in plain English written so you can understand it, even if you have only a limited education. Prepares you for a well paid railroad structural or public works position. Covers every branch of Civil Engineering practice. At once a reading course for the ambitious student and an authoritative reference work for the experienced engineer. Borrow a set—free. Look over the test questions which help you master each subject quickly. Mail the coupon without obligation today!

American Technical Society
Dept. C-919 Chicago

American Technical Society,
Dept. C-919, Chicago

I want to BORROW the CIVIL ENGINEERING Cyclopedia for 15 days FREE. I will gladly pay the few cents express, but I am to pay nothing for the loan of the 9 big volumes if I return them within 15 days. If I wish to keep them I will send you \$2 after the 15 days, then \$3 a month until special advertising price, \$34.80, is paid.

Name.....

Address.....

(Attach letter stating age, occupation, employer's and references' names and addresses.)

Loaned Free!

To prove you can learn Civil Engineering at home in your spare time. And because no description here could do it justice, to let you see for yourself the scope and simplicity, the authority and quality of this great home reading course. Cost and terms are within your reach. Send no money—just mail the coupon.



Radio Inspectors \$2000 to \$4500 a Year.



Radio Operators \$90 to \$200 a month (board free).



Broadcast Operators \$1800 to \$4800 a Year.



Radio Repair Mechanics \$1800 to \$4000 a Year.

Fill one of these BIG MONEY RADIO

PICK yourself a big-money job in Radio! Hundreds of men just like you earn from \$2,000 to \$25,000 a year in this giant world-wide industry . . . The liveliest money-making business of today! The whole world is calling for trained radio men.

Broadcasting stations and manufacturers are eagerly seeking trained men. Thousands of opportunities are waiting for you.

Easy to Learn at Home With This Magnificent Laboratory Outfit

The Radio Corporation of America sponsors this marvelous, simplified home-training course . . . by means of which you can prepare for success in Radio. Learn by actual experience with the remarkable outlay of apparatus given with this course . . . You, too, can easily have the confidence and ability to hold a big-money Radio job.

Only Course Backed by Radio Corporation of America

The progress of Radio is measured by the accomplishments of the great engineers in the Radio Corporation of America. This gigantic organization sets the standards for the entire industry . . . and sponsors every lesson in the course. That's why graduates of this school are always posted in newest up-to-the-minute developments in Radio and are always in big demand.

Money Back if Not Satisfied

This marvelous home-laboratory training practically insures your success by preparing you

RADIO INSTITUTE of AMERICA

SPONSORED BY



JOBS *many do it in 9 months!*

FREE BOOK SHOWS HOW!

thoroughly in every phase of Radio manufacturing, servicing, broadcasting, photoradiograms, television and airplane radio equipment. As a student you will receive an agreement signed by the president of this school assuring you of complete satisfaction upon completion of your training—or your money will be instantly refunded.

Read This Free Book

The young men in Radio today will be the industrial leaders of tomorrow . . . that's what happened in the automobile business . . . in aviation . . . and in every other essential industry . . . Get in on the ground floor and climb with this tremendous industry!

Free . . . everything you want to know about Radio . . . 50 fascinating pages . . . each one packed with pictures and descriptions about the brilliant opportunities in this fast-growing profession. See for yourself why R. I. A. training has placed thousands of men in well paid positions—usually from 3 to 10 days after graduation. Mail this coupon now and receive your Free Book.



RADIO INSTITUTE
of AMERICA
Dept. P.M. 12, 326 Broadway,
New York, N. Y.

Gentlemen: Please send me your FREE 50-page book which illustrates the brilliant opportunities in Radio and describes your laboratory-method of instruction at home!

Name

Address

BARBERING

Now One of the Highest Paid Professions! \$ **90** to \$ **150** Every Week!



Easy to Learn—Quick to Earn!

That's BARBERING for YOU! And the best part of it all is this—scientific barbering, as taught the modern MOLER way, makes YOU a Master Barber in a short course of intensive training, at small expense! You soon step out as your own Boss, if you wish, in your own Shop, which we will gladly help you equip.

MOLER Graduates are Always Busy!

MOLER trained Men are always given the preference, for they alone possess the valuable, thorough MOLER training in the application of all the latest scientific Barbering methods, including the Electric hair cutter, the mechanical massage, and the latest vogues in ladies' hair bobbing. MOLER also gives special training in ladies' marcelling and an easy practical course in the treatment of skin diseases.

EARN WHILE LEARNING!

"Where there's a Will there's a Way" to earn BIG pay! Write to the nearest MOLER College, there is one near you, and learn how you can earn while you learn the barber trade. Ask for the new FREE MOLER Barbering Booklet B. Find out HOW MOLER helps you help yourself AFTER you graduate, as well as BEFORE! Find out why MOLER Men are making DOUBLE the money others made last year, before Ladies' Shingle Bobbing became so popular. You're NEXT in line for big pay—the MOLER way. Send Coupon TODAY!

Standardized Branches

Moler System of Colleges

- | | |
|-----------------------------------|------------------------------------|
| 139 E. 23rd St., New York City. | 109 S. 15th St., Omaha, Nebr. |
| 512 N. State St., Chicago, Ill. | 501 E. Water St., Milwaukee, Wis. |
| 810 N. 6th St., St. Louis, Mo. | 81 Forsyth St., N.W., Atlanta, Ga. |
| 801 Main St., Kansas City, Mo. | 81 S. Second St., Memphis, Tenn. |
| 206 E. 4th St., Cincinnati, Ohio. | 912 Main St., Dallas, Texas. |
| 215 Huron Road, Cleveland, Ohio. | |
| 559 Michigan Ave., Detroit, Mich. | |

Address Nearest Branch

Please send me without obligation on my part your Booklet B.

Name.....

Address.....

City..... State.....

CHICAGO TECH

FOUNDED 1903

ENGINEERING-ELECTRICITY ARCHITECTURE-DRAFTING

4 Fields of real opportunity. Big pay—a permanent position or a business of your own. 7 Billion dollars spent last year in one of these fields alone. Train here in Chicago, America's industrial center. 1, 2 and 3 year courses. Diplomas and B. S. Degrees. Special 4 months' practical course in Drafting. Other short courses. Earn while you learn. Enter any time. Day and evening classes. No time wasted. Free Employment Bureau. Low tuition—easy terms. Athletics. Successful graduates everywhere. Free 80-page "Blue Book." Address the President, Chicago Technical College, Dept. R-77, 118 East 26th Street, Chicago, Ill.

ELECTRICITY WELDING AUTOMOBILES

PRACTICAL TRAINING ON MASSIVE LAY-OUT OF ELECTRICAL EQUIPMENT Aircraft Oxy-Acetylene and Electric Welding, Armature Winding, Power Plants, Switchboards, Transformers, Motors, Generators, Batteries, Radio and Automobiles. Write now for Free Catalog. Coleman Electrical School, 1628 Main St., Kansas City, Mo.

LAW

STUDY AT HOME

Become a lawyer. Legally trained men win high positions and big success in business and public life. Be independent. Greater opportunities now than ever before. Big corporations are headed by men with legal training. Earn \$5,000 to \$10,000 Annually

We guide you step by step. You can train at home during spare time. Degree of LL.B. conferred. LaSalle students found among practicing attorneys of every state. We furnish all text material, including fourteen-volume Law Library. Low cost, easy terms. Get our valuable 64-page "Law Guide" and "Evidence" books FREE. Send for them NOW. LaSalle Extension University, Dept. 1264-S, Chicago. The World's Largest Business Training Institution

"The TRUTH about VOICE"

SENT FREE No Obligation to Buy

If you act quick!—we will send you postpaid—for 30 days free reading—new Voice Book disclosing startling FACTS that may save hundreds of dollars to every man or woman seeking a strong, rich voice for either singing or speaking. 30 days free reading—then send \$1. Otherwise, return it. Prof. E. Feuchtinger, 1810 Wilson Ave., Suite 29, Chicago, Ill. Dept. 13-59 Chicago, Ill.

Government Positions

Census Clerks, Clerk Carriers, Rural Carriers, Railway Mail Clerks, Postmasters, Department Clerks, and many others. Splendid salaries, easy work, vacation with pay. Only common school education required. Examinations often 37,976 appointed last year. Send for our Civil Service Catalog No. 6. COLUMBIAN CORRESPONDENCE COLLEGE, Washington, D. C.

GOV'T. POSITIONS

\$35 TO \$75 WEEKLY

MEN - WOMEN

Ry. Mail Clerk	Steno-Typist
Prohibition Agent	Immigrant Inspector
R. F. D. Carrier	Seamstress
Special Agent (Investigator)	Auditor
City Mail Carrier	Steno-Secretary
Meat Inspector	U. S. Border Patrol
P. O. Clerk	Chauffeur-Carrier
File Clerk	Watchman
General Clerk	Skilled Laborer
Matron	Postmaster
	Typist

MENTOR INSTRUCTION BUREAU, 111 Arcade Bldg., St. Louis, Mo. Send me FREE particulars How To Qualify for positions marked "X". Salaries, locations, opportunities, etc. ALL SENT FREE.

NAME.....

ADDRESS.....

AGE 18 to 55



BE AN ARTIST!

— and be your own boss

If you like to draw, why drudge when success and a good income may be yours through art training? Publishers pay millions of dollars yearly for illustrations. Many successful Federal Students are earning from \$2500 to \$6000 a year — some even more.

If you hold yourself down to a routine job you may always do uncongenial work. But if you like to draw and are willing to train your talent, your art ability may help you to success in life.

Through the Federal Course in Illustrating more than fifty famous artists give you the benefit of their methods of Illustrating, Cartooning, Lettering, Poster Designing, Window Card Illustrating. You may learn through the experience of these successful artists how to bring your own drawings to a professional standard. They understand the methods that make art pay well.

You can keep your present position while gaining your art training. Through the Federal Course you learn

FEDERAL SCHOOL OF ILLUSTRATING

12139 Federal Schools Building
Minneapolis :: Minnesota

at home in your spare time. Hundreds of Federal Students have already proved by their professional success the value of this home study instruction.

Vocational Art Test—Free

Find out about your drawing ability by sending in the Free Vocational Art Test we offer. Just write your name, age and address on the coupon and we will send this Test together with a copy of the book "A Road To Bigger Things" without charge or obligation. Why drudge at uncongenial work when the chance to plan your own work and be your own boss may be yours through Art Training? It is important that you take your first step out of the rut by mailing the coupon now.

Federal School of Illustrating,
12139 Federal Schools Building,
Minneapolis, Minnesota.

Please send me free book, "A Road To Bigger Things," and Standard Art Test.

Name _____

Age _____ Occupation _____

Address _____





400,000 miles of flight are behind the training Hinton gives You



WALTER HINTON

WHAT'S more, Hinton's hundreds of thousands of miles in the air is only one side of his remarkable experience. The things that so many other star performers lack—the thing that makes Hinton what he is today, a real Maker of Men—is his ability to share his knowledge with others in a clear, simple, interesting manner. As proof of that, consider Hinton's record during the war. He was one of the crack pilots singled out by the U. S. Navy to instruct recruits. Under his capable, seasoned eye, hundreds of newcomers learned their P's and Q's of Aviation; made their first excursions into the clouds.

Now's the Ideal Time to Get Into Aviation

The business world has taken to the air in earnest. Mail and passengers fly from coast to coast. Forty-five operating companies are now flying 70,000 miles a day on regular schedule! The development in the last three years has been amazing, astounding—and yet, an official publication says, "There is every reason to believe that the immediate future will bring forth even greater accomplishments." So now is the time to get started—NOW is the time to get your training—NOW while Aviation is young—NOW while the demand for trained men is at its greatest.

Get Your Ground Work Where You Are—At HOME

Hinton will train you right at home in your spare time. His famous course takes you over a plane inch by inch; shows you all about construction, rigging, motors, instruments, theory of flight, air navigation—EVERYTHING. When you graduate his nation-wide employment service helps you to get the kind of job you want; or, if you want to fly, he arranges special rates for you at accredited flying schools. Send for his book today, and learn the FACTS.

First to fly the Atlantic, first to fly from North to South America, first to use the Airplane in Exploration, first world-famous flyer to train men at home for big jobs in Aviation. The facts about this remarkable course and this real result-producing employment service are yours for the asking in his

FREE BOOK

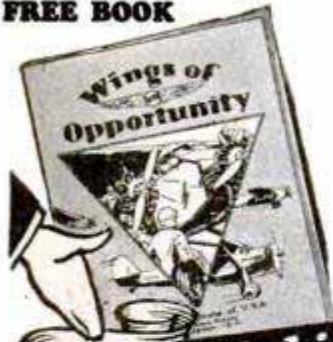

Send to Washington—Quick

Walter Hinton, President, Aviation Institute of U.S.A., 1115 Connecticut Ave., Washington, D. C. 301-B

Please send me your Free Book, "Wings of Opportunity," showing how I can get my Ground Training right at home and qualify for Aviation.

Name..... Age.....
(Must be over 18).

Street.....

City..... State.....

Poor English!

How much is it costing you in wasted opportunity?

Every day your associates are judging you — by what you say and how you say it! Hazy ideas, ill-chosen words, halting sentences, crude, slovenly speech—these mark a man as loose in thinking. Thoughts clear-cut, words that give true shape and color, sentences aflame with power and originality—these are the things that proclaim ability, that win for their users swift advancement. Stop apologizing for poor English—it's inexcusable! In the quiet of your home—with LaSalle's help—you can learn to speak and write with real distinction, learn to make the words you utter and the letters you compose stamp you as educated, cultured, a power to reckon with in the business world. Complete details in an attractive 32-page book, "Effective Business English," sent you free upon request. Ask for it TODAY, LaSalle Extension University, Dept. 1264-BE, Chicago

Learn to PAINT SIGNS and SHOW CARDS

We quickly teach you by mail, or at school, in spare time. Big demand. Big future. Interesting work. Oldest, foremost school.

EARN \$50 TO \$200 WEEKLY

Otto Wiegand, Md., home-study graduate, made \$12,000 from his business in one year. John Vassos, N. Y., gets \$25 for a show card. Crawford, B. C., writes: "Earned \$290 while taking course." Write for complete information.

DETROIT SCHOOL OF LETTERING
150 Stimson Ave. Est. 1899 DETROIT, MICH.



MAKE YOUR VIOLIN

YOU CAN DO IT!

Famous Violin Maker sells genuine "Strad" Patterns, Instruction Book, Fine Woods, etc. Simple! Wonderful.

C. C. FRASER, Box 14, Sta. C, Grand Rapids, Mich.

FOREMEN!

FACTORY WORKERS AND ALL MECHANICS



\$1.98

(Worth \$25)
Lecture Course Complete in 1 Volume

SEND NO MONEY

Every foreman, factory worker, manager and ambitious mechanic will find a gold mine of inside information in "The Modern Foreman" by Robt. Grimshaw. The 28 chapters of this great work are shop talks pointing the way to success, efficiency, better pay and the job higher up. A complete study course in leadership; a handy, daily reference and guide.

SUBJECTS COVERED INCLUDE:—The Magic Wand of Efficiency, The New Type of Foreman, Teamwork, The Kicker, The Agitator, Bonus Plans, Self-Improvement, How to Handle Men, Hiring and Firing, Assigning Men to Jobs, How to Keep Records, How to Cut Out Waste of Time and Materials, New Inventions, Modern Methods, The Inspector, Health and Character Requirements, What the Foreman Should Know, Mathematics, Business Law, The Foreman as "Top Sergeant," Factors of Success, Leadership, What is "Labor"? Time and Idleness, Knowledge is Power, "Morale," The Value of Mistakes.

"The Modern Foreman" has 297 pages, quick reference index, many tables, diagrams, illustrations and forms; big type, easy to read and understand; rich binding, gold stamped. Size 6 x 9 x 1 1/4. Reg. price \$2.50. Our special sale price \$1.98. Send no money. Satisfaction guaranteed. Mail this coupon TODAY!

GREGG PUBLISHING CO., 20 W. 47 St., New York, N. Y.

Send me "The Modern Foreman." I will pay postman \$1.98 and postage on arrival. My money is to be refunded if I am not satisfied.

Name.....

Address..... 335

LAW TRAINING=SUCCESS

This complete 25-volume standard size law library is provided to all students at the time of enrollment.

The Aristocrat of Training Programs



LESSON GUIDES

Lesson guides are mailed at regular intervals to direct and outline the study of the Course.



LECTURES

The Course contains a series of printed lectures written by outstanding national authorities on subjects not ordinarily found in law text books.



LAW BULLETINS

A Law Bulletin is distributed each month containing the latest Supreme Court decisions on matters of special business interest—an exclusive Blackstone feature.

THIS message is directed to the man who is contemplating the study of law— And where is the man who has not at some time yearned for law training and the certainty of success it brings?

The Aristocrat of Studies

Law is the aristocrat among training courses. Law students are stamped as men of discernment and dignity. They are looked upon with respect.

A knowledge of law enhances earning power and helps to win advancement. The demand for men trained in the law is growing constantly.

For years the Blackstone Institute, through its professional home-study law course, has been meeting and satisfying this demand. Today the Institute can point to more than 50,000 substantial men and women who have received financial, personal or business benefits from this training. Hundreds of successful attorneys are among our graduates.

The Outstanding Course

The Institute delivers prepaid to every student immediately upon enrollment the nationally known 25-volume *Modern American Law* library, cited as "M. A. L." by the courts of last resort. (See illustration in miniature above.)

This set of text and case books forms the basis of the Course and in addition serves as a valuable reference work upon the entire field of modern day law. Many students have said that this library alone is worth the modest tuition fee asked for the entire Course.

Elaborate Lesson Material

Elaborate lesson material is mailed at regular intervals to the student as he progresses through the Course. These lesson units (illustrated in miniature at the left) direct the study efforts carefully and call attention to the money-making pos-

sibilities of using the principles of law in daily business affairs. Graduates of the Course are awarded the LL. B. degree.

The authors of the Course are outstanding authorities in the field of law. Included in the group are two Justices of the United States Supreme Court, the deans of eight university law schools, and sixty university law professors and attorneys. These men know law and how it should be taught.

No Exaggerated Claims

The Institute makes no claim that the study of its Course will bring a startling increase in income to every student. Yet many students have reported increases, some as high as 200% before completing the Course.

Neither does the Institute claim that a law training will enable you to earn from \$10,000.00 to \$35,000.00 a year, yet a great many law-trained men earn in excess of that.

The Institute does claim that a law training is the best foundation for a successful business or professional career, and that its Course is without a peer in the field of non-resident law instruction today.

Get the Facts Today

Complete evidence of the merits and money-making possibilities of Blackstone training is contained in an attractive booklet, "The Law-Trained Man," which will be sent free upon request. Ask for your copy today while the present edition is still available for free distribution.

Use the convenient coupon below or address a letter or post card to the Blackstone Institute, Department 59: 307 N. Michigan Avenue, Chicago, Illinois.



BLACKSTONE INSTITUTE

Dept. 59, 307 N. Michigan Ave., Chicago

Please send me by mail, and without obligation, a copy of your 128-page book, "The Law-Trained Man," and details of your law course and service.

Name _____

Business Position _____

Business Address _____

City _____ State _____





The only man who could talk to the Superintendent

"Soon after I began studying," a student wrote to us the other day, "we had a change in management at our plant. I certainly was glad then that I had decided to study in my spare time. For, thanks to my I. C. S. course, I was the only man in the organization who could talk to the Superintendent in his own language. As a result, I was promoted over men who had been here from ten to twenty years. My salary has been increased 90% in the last ten months."

That's a true story of what just one I. C. S. student has done. There are thousands of others. Every mail brings letters from men and women telling of promotions and increases in salary due directly to spare-time study.

One hour a day, spent with the I. C. S. in the quiet of your own home, will prepare you for success in the work you like best. Yes, it will! Put it up to us to prove it.

Mail this Coupon for Free Booklet

INTERNATIONAL CORRESPONDENCE SCHOOLS
Box 5654-F, Scranton, Penna.

Without cost or obligation, please send me a copy of your booklet, "Who Wins and Why," and full particulars about the course before which I have marked X in the list below:

TECHNICAL AND INDUSTRIAL COURSES

- | | |
|--|---|
| <input type="checkbox"/> Architect | <input type="checkbox"/> Automobile Mechanic |
| <input type="checkbox"/> Architectural Draftsman | <input type="checkbox"/> Aviation Engines |
| <input type="checkbox"/> Building Foreman | <input type="checkbox"/> Plumber and Steam Fitter |
| <input type="checkbox"/> Concrete Builder | <input type="checkbox"/> Plumbing Inspector |
| <input type="checkbox"/> Contractor and Builder | <input type="checkbox"/> Foreman Plumber |
| <input type="checkbox"/> Structural Draftsman | <input type="checkbox"/> Heating and Ventilation |
| <input type="checkbox"/> Structural Engineer | <input type="checkbox"/> Sheet-Metal Worker |
| <input type="checkbox"/> Electrical Engineer | <input type="checkbox"/> Steam Engineer |
| <input type="checkbox"/> Electrical Contractor | <input type="checkbox"/> Marine Engineer |
| <input type="checkbox"/> Electric Wiring | <input type="checkbox"/> Refrigeration Engineer |
| <input type="checkbox"/> Electric Lighting | <input type="checkbox"/> R. R. Positions |
| <input type="checkbox"/> Reading Shop Blueprints | <input type="checkbox"/> Highway Engineer |
| <input type="checkbox"/> Telegraph Engineer | <input type="checkbox"/> Chemistry |
| <input type="checkbox"/> Telephone Work | <input type="checkbox"/> Pharmacy |
| <input type="checkbox"/> Mechanical Engineer | <input type="checkbox"/> Coal Mining Engineer |
| <input type="checkbox"/> Mechanical Draftsman | <input type="checkbox"/> Navigation <input type="checkbox"/> Assayer |
| <input type="checkbox"/> Machine Shop Practice | <input type="checkbox"/> Iron and Steel Worker |
| <input type="checkbox"/> Toolmaker | <input type="checkbox"/> Textile Overseer or Supt. |
| <input type="checkbox"/> Patternmaker | <input type="checkbox"/> Cotton Manufacturing |
| <input type="checkbox"/> Civil Engineer | <input type="checkbox"/> Woolen Manufacturing |
| <input type="checkbox"/> Surveying and Mapping | <input type="checkbox"/> Agriculture <input type="checkbox"/> Fruit Growing |
| <input type="checkbox"/> Bridge Engineer | <input type="checkbox"/> Poultry Farming |
| <input type="checkbox"/> Gas Engine Operating | <input type="checkbox"/> Mathematics <input type="checkbox"/> Radio |

BUSINESS TRAINING COURSES

- | | |
|--|---|
| <input type="checkbox"/> Business Management | <input type="checkbox"/> Business Correspondence |
| <input type="checkbox"/> Industrial Management | <input type="checkbox"/> Show Card and Sign Lettering |
| <input type="checkbox"/> Personnel Management | <input type="checkbox"/> Stenography and Typing |
| <input type="checkbox"/> Traffic Management | <input type="checkbox"/> English |
| <input type="checkbox"/> Accounting and | <input type="checkbox"/> Civil Service |
| C. P. A. Coaching | <input type="checkbox"/> Railway Mail Clerk |
| <input type="checkbox"/> Cost Accounting | <input type="checkbox"/> Mail Carrier |
| <input type="checkbox"/> Bookkeeping | <input type="checkbox"/> Grade School Subjects |
| <input type="checkbox"/> Secretarial Work | <input type="checkbox"/> High School Subjects |
| <input type="checkbox"/> Spanish <input type="checkbox"/> French | <input type="checkbox"/> Cartooning |
| <input type="checkbox"/> Salesmanship | <input type="checkbox"/> Illustrating |
| <input type="checkbox"/> Advertising | <input type="checkbox"/> Lumber Dealer |

Name.....

Address.....

City..... State.....

Occupation.....

If you reside in Canada, send this coupon to the International Correspondence Schools Canadian, Limited, Montreal, Canada

ELECTRICAL ENGINEERING

Intensive, practical—technical courses. Engineering degree in 2 years. Diploma in 1 year. Also Special Short Courses in Practical Electricity—Power Plant Operation—Armature Winding—Radio—Electric Refrigeration—Aviation Electricity—Electric Welding. LOW TUITION RATES. Faculty of recognized experts. Extensive Laboratories. Free employment service for graduates. We help secure part-time work during training, 28th year. Write for catalog.

FINLAY ENGINEERING COLLEGE 1001-A Indiana Ave. Kansas City, Mo.



Learn the Code with Teleplex!

Be an expert Morse or Continental code operator! BIG PAY—TRAVEL—FUN—ADVENTURE. After a few short weeks of practical study with Teleplex you will be an expert operator. This amazing instrument teaches you right in your own home. Works like a phonograph. No knowledge needed—beginners learn at once! Not a school. Free 10 days' trial. Write for free booklet G-10, TELEPLEX COMPANY, 72 CORTLANDT ST., NEW YORK CITY



SONG WRITERS!



SUBSTANTIAL ADVANCE ROYALTIES are paid on work found acceptable for publication. Anyone wishing to write either the words or music for songs may submit work for free examination and advice. Past experience unnecessary. New demand created by "Talking Pictures" fully described in our free book. Write for it Today. NEWCOMER ASSOCIATES

759 Earle Building, New York, N. Y.

LEARN WATCHMAKING

and become independent. We help you secure a position. Easy to learn. Send for FREE CATALOG.

ST. LOUIS WATCHMAKING SCHOOL Dept. 5, ST. LOUIS, MO.

SHORTHAND IN 30 DAYS

Boyd, the wonderful easy system; 150 words a minute guaranteed. Send today for Catalog and sample lesson.

CHICAGO HOME STUDY SCHOOLS
801 Reaper Block Chicago, Ill.

BIG Demand for Skilled Mechanics!

The entire country is calling for skilled mechanics! Good pay—steady work—good opportunities for advancement! Master this fascinating trade with the aid of the

AMERICAN MACHINISTS' LIBRARY

6 volumes—2,000 pages—2,500 illustrations

(A combined home-study course and reference library)

This library of machine shop practice was written for practical men. It gives you the best methods for every kind of machine shop work. It explains machine tools and their operation, tool work, gears and grinding, jigs and fixtures, automatic screw machines, their tools, punches, dies, etc. Plainly written—completely illustrated—the best kind of help to the machine-shop man who wants to advance himself.

Free

TRIAL

No money down—
only 7c
a day

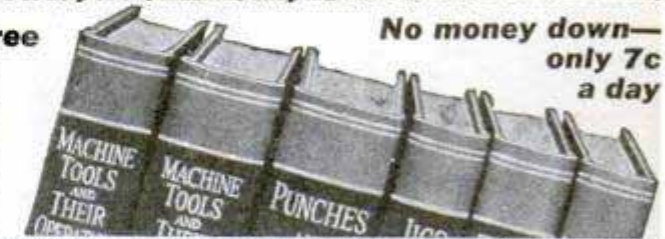

FREE EXAMINATION COUPON

McGRAW-HILL BOOK CO., Inc., 370 Seventh Ave., New York

Send me for 10 days' free examination the AMERICAN MACHINISTS' LIBRARY. If satisfactory, I will send \$1.50 in 10 days and \$2 monthly until the special price of \$17.50 is paid. If not wanted, I will return the books at your expense.

Signed.....

Address.....

City and State.....

Position.....

Company..... P. M. 12-29

At Last! Real College Instruction in Drafting At One-Third the Cost!

Right at Home!

Unquestionably, hundreds of the readers of this magazine have waited and hoped to run across just such a message as this. For an old-established and recognized engineering school now makes an important announcement about Drafting. At last, you can get real college training right at home, inexpensively, in this big-pay profession. The trial lesson and other material offered below bear convincing proof and may now be obtained without cost simply by mailing the coupon.

LOOK here, men. It is true that this message is addressed to men who would like to have the very highest type of college training in drafting. But let's understand one another right at the start. Just because some of the most successful business and professional men in America are Chicago Tech graduates is no sign that anybody is going to try to get "high-brow." And because students come to Chicago from all over the world—often spending many hundreds of dollars—doesn't mean that you have to pay a lot of money for this practical, simplified, easily mastered training. Far from it! For now as part of the Chicago Tech new plan you may obtain complete home training in Drafting at a mere fraction of the usual cost of a college course.

Experience Is the Best Teacher

Nearly everyone has heard of Chicago Technical College. Over 1,000 men each year attend this well-known school. Here they quickly learn engineering and architecture, including Drafting. Not out of dry, hard-to-master text books. Not by a lot of tedious "study." But by the wonderful "practice" system developed by Chicago Tech. By this method everything is far easier to learn because it is more interesting. In fact man after man will tell you that learning any subject the Chicago Tech way is more like playing a fascinating new game than anything else. It is almost as different from the drudgery that you will find in ordinary "schooling" as night is from day. And now this easily mastered, pay-raising training is yours quickly, right at home, in spare time, at nominal cost.

Earn Up to \$100 in a Week

This is the type of training that really leads to the big-pay positions in Drafting, where many earn from \$5,000 to \$7,500 a year and up. The largest employers of skilled draftsmen recognize the value of College-Training-in-Drafting, and con-



stantly apply to Chicago Tech for Draftsmen. Hundreds of Chicago Tech graduates who are now in top-notch positions of authority or in business for themselves do the same. The Chicago Tech employment department makes no charge either to students or employer if you accept one of these jobs. The entire success of this College-Training-in-Drafting has been proved so thoroughly that the "at-home" training is covered by a binding money-back agreement. With the Chicago Tech course you are supplied a full set of high-grade drawing instruments in pocket case. A special drawing table for home use. And a valuable drawing outfit. These are the same as used in the College. You get them without any extra cost whatever.

Learn the Facts—Now!

Where else on earth can you get real college training in Drafting like this? Yet now it is offered to you as part of the new Chicago Tech Home-Study plan on amazingly liberal terms. So if you want to learn Drafting the successful, approved and easy way—get the Free Trial Lesson and other valuable information. Simply mail the coupon without obligation.

**Get Free
Proof**



CHICAGO TECHNICAL COLLEGE

Dept. R-202, Home Study Division,
Chicago Tech. Building, 118 E. 26th St., Chicago, Ill.
"College-Training-At-Home"

COLLEGE-TRAINING-AT-HOME COUPON
Chicago Technical College, Dept. R-202, Home Study
Division
118 E. 26th Street, Chicago, Ill.

Please send me the facts about your new system that enables men to master professional Drafting at home just as you teach it at the college in Chicago. Include your FREE TRIAL LESSON. This does not obligate me in any way.

Name.....

Address.....

Town..... State.....

() Check here only in case you prefer coming to Chicago to take our short course in Drafting at Chicago Tech.

- takes only 8 weeks to get a big job



George Smith owns an agency and repair shop in West Alexandria, Ohio. He makes \$200 a week.

and Earn \$75 to \$125 a Week as Auto or Aviation Expert

Learn the auto and tractor business by the McSweeney method, then step out and get a good job at \$75 to \$125 a week or open your own repair shop and make up to \$10,000 a year. Trained men are needed everywhere. Opportunities galore! Eight weeks' training fits you to open repair shop or to go on with one of the big firms waiting for trained men. Read what George Smith and C. E. Gillespie have done. Hundreds of other McSweeney trained men can tell as interesting facts. Every month McSweeney men who complete their training are taking the place of half-trained and incompletely self-trained men.

Money Back Guarantee
If, after completing my training, you are not satisfied, if you are not qualified to accept a big-pay job, your tuition will be refunded.

AVIATION Course

AVIATION is paying tremendous incomes to trained men! Coupon brings complete details about complete course in Aviation. Learn on real airplane engines under experienced instructors. Ask about special course in FLYING. Don't miss this remarkable opportunity. Save by enrolling at once. The sooner you start the sooner you will be ready to earn big pay or set into business for yourself.

Learn in Only 8 Weeks

Simple, thorough, practical shop methods. You learn the "why" of everything you do, then learn to do it right. You do real work with real tools and real equipment. No book studying. Very little schooling necessary. Any man from 16 to 60 can learn. Write today for Big Special Limited Time Tuition Offer. No facilities for colored students. Write for Big, Illustrated Book FREE!



MAIL COUPON FOR FREE BOOK

McSweeney Auto, Tractor and Aviation School, Dept. A-11-M, Chester at 30th St., Cleveland, O., or 263 Madison St., Memphis, Tenn.

Without cost or obligation, send me your big FREE book on Autos and Aviation, also full details of your special tuition offer.

Name.....
Street.....
Town..... State.....



McSWEENEY

Auto, Tractor and Aviation SCHOOLS

Dept. A-11-M
Chester at 30th St., Cleveland, O. or 263 Madison St., Memphis, Tenn.

TELEGRAPHY

(Morse and Wireless) and RAILWAY ACCOUNTING, taught thoroughly. Big salaries. Tremendous demand. Oldest, largest school. Endorsed by Telegraph, Railway, Radio, and Government officials. Expenses low—opportunities to earn large portion. Catalog free. DODGE INSTITUTE, Jones St., Valparaiso, Ind.

Learn Watchwork, Jewelrywork and Engraving

A fine trade commanding a good salary, and your services always in demand. Address Horological, Dept. P, Bradley Institute, PEORIA, ILLINOIS, for our latest catalog.

WHICH COURSE WILL YOU LEARN?

- Drafting—Architectural, Machine—Heating & Ventilating Engineering—Plumbing & Sanitary Engineering—Sheet Metal Designing & Drafting—Boiler Maker Laying Out & Inspection—Steel Ship Laying Off & Plan Reading—Contracting & Estimating—Mathematics & Slide Rule Reading—Aeronautical Drafting & Engineering.

CHECK AND MAIL TODAY!



HAVE YOU THE COURAGE TO RAISE YOUR OWN SALARY?

Don't be afraid! You can learn any of the courses we teach. Pick out the one you want to learn and write me today.

Technical training is the way to bigger pay envelopes, to being your own boss. You can do it!

Let me show you how quickly and thoroughly my home instruction methods

train you for the job ahead. Tell me which course you want, and I'll send a big free catalog outlining everything. Then you will know how much I can help you. Finding out costs you nothing, puts you under no obligation. Check your course and write today.

Address O. W. KOTHE, Dir.

ST. LOUIS TECHNICAL INSTITUTE
4545 Clayton Avenue ST. LOUIS, MO.



Travel On "Uncle Sam's" Pay Roll

STEADY WORK—NO LAYOFFS—PAID VACATIONS
RAILWAY POSTAL CLERKS—MAIL CARRIERS—CLERKS
Common Education Sufficient

\$1900 Year to Commence SEE YOUR COUNTRY

Mail Coupon Before You Lose It

FRANKLIN INSTITUTE, Dept., D193, Rochester, N. Y.
Sirs: Rush to me without charge—copy of 32-page book, "How to Get U. S. Government Jobs" with list of positions now obtainable and full particulars telling how to get them.

Name.....
Address.....



Follow this Man!

Secret Service Operator 38 Is on the Job

Follow him through all the excitement of his chase of the counterfeit gang. See how a crafty operator works. Telltale finger prints on the lamp stand in the murdered girl's room! The detective's cigarette case is handled by the unsuspecting gangster, and a great mystery is solved. Better than fiction. It's true, every word of it. No obligation. Just send the coupon.

FREE The Confidential Reports No. 38 Made to His Chief

And the best part of it all is this. It may open your eyes to the great future for YOU as a highly paid Finger Print Expert. More men are needed right now. This school has taken men just like you and trained them for high official positions. This is the kind of work you would like. Days full of excitement. Big salaries. Rewards.

Earn \$2500 to \$10000 a Year *You study at home in spare time*

No advance education is needed. Any man who can read and write, and think can make good. A wonderful book tells all about what others have done. Shows pictures of real crimes and the men who solved them. We'll send you a FREE copy with the free reports. Get our low prices and easy terms. Mail the coupon.

INSTITUTE OF APPLIED SCIENCE
1920 Sunnyside Ave., Dept. 13-59 Chicago, Illinois

INSTITUTE OF APPLIED SCIENCE

1920 Sunnyside Ave., Dept. 13-59 Chicago, Illinois

Gentlemen:—Without any obligation whatever, send me your new, fully illustrated Free book on Finger Prints, also FREE copy of operator No. 38's confidential report. Tell me about your low prices and easy terms.

Name.....

Address

.....Age.....



**DR. HARLAN TARBELL
MASTER OF MAGIC**



**I'll Teach
YOU
Real Professional
MAGIC**

at Home ~ BY MAIL



**Big Stage Illusions
Secrets of the Orient**
Master Illusions from Europe, India, China, Japan. Guarded secrets of the Orient—over 250 tricks from small effects to Big Stage Illusions, with nearly 3000 illustrations, that and more is what you get in the Tarbell Course in Magic!

Read This Great Endorsement

Dr. A. M. Wilson, Editor of the Sphinx, Official Organ of The Society of American Magicians, pays the Tarbell Course this tribute:

"The greatest work on Magic ever attempted and will mark an epoch in Magic greater than the revelations of Robert Houdini, Father of Modern Magic, 60 years ago."

**Money-Back Guarantee
Protects YOU**

The Tarbell course in Magic protects you with an Iron Clad Guarantee to refund your money if you are not satisfied. You can't lose. You have everything to gain.

**Get Started on the
Road to Big Money**

You need not give up your job. You can make nice money entertaining on-the-side as a semi-professional, or if you want to, you can become a big Magician, make big money, enjoy fame and glory.

Tarbell System, Inc.

1926 Sunnyside Avenue, Studio 13-59, Chicago, Ill.

The first
and only
**Course in
Magic**
ever offered to the
public teaching
real professional
Magic!

Mail This Coupon NOW!

Tarbell System, Inc.
1926 Sunnyside Ave., Studio 13-59, Chicago
Tell me about Dr. Tarbell's new and simple system by which I can learn the secrets of MAGIC. Also tell me about your Low Price and Easy Terms Offer. No obligation on my part.

Name.....
Address.....
Age.....

**Don't Miss Half the
Fun In Life!**

BE POPULAR — Learn to dance well! Arthur Murray, America's greatest dancing teacher, has invented a remarkable new easy method which enables anyone to learn all the newest dances at home—in a few hours — without music, partner, teacher! *Success positively guaranteed!* 400,000 learned dancing this easy way.



Regular \$5.00 Course **Now Only \$1.98**

To prove how quickly and easily you can become an accomplished, versatile dancer I will send you my regular \$5.00 dancing course *without one penny in advance*. Just send your name and address and when the package arrives give the postman *only \$1.98* (plus few cents postage) and this famous course is yours. Try it for 5 days—*money back if not delighted*. Don't delay—act NOW and be a good dancer SOON.

Arthur Murray, Studio 965, 7 East 43rd Street, NEW YORK, N. Y.

**Photos
ENLARGED**

Size 16x20 inches
Same price for full length or bust form groups, landscapes, or pet animals, etc., enlargements of any part of group picture. Safe return of your own original photo guaranteed.

98c

SEND NO MONEY Just mail photo or snapshot (any size) and within a week you will receive your beautiful life-like enlargement size 16x20 in. guaranteed fadeless. Pay postman 98c plus postage or send \$1.00 with order and we pay postage. **SPECIAL** With each enlargement we will send FREE a hand-tinted miniature reproduction of photo sent. Take advantage now of this amazing offer — send your photo today!

UNITED PORTRAIT COMPANY
1652 Ogden Ave. Dept. W-369 Chicago, Ill.



Wonderful, new device, guides your hand; corrects your writing in a few days. Big improvement in three hours. No failures. **Complete outline FREE.** Write C. J. Ozment, Dept. 34, St. Louis, Mo.

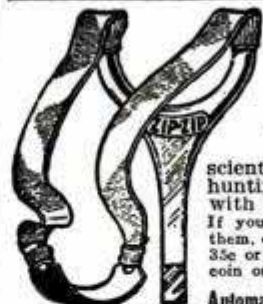

**ZIP-ZIP
SHOOTER**

THOUSANDS of boys are made happy with this wonderful Zip-Zip shooter, scientifically and practically made. If you like hunting and outdoor sports, get a Zip-Zip shooter with plenty of pep and force. If your dealer happens not to have them, order from us. Zip-Zip shooter 35c or three for \$1.00; send stamps, coin or money order.



Automatic Rubber Co., Columbia, S. C.

30 Days' Free Trial

New Models now ready for delivery direct from our factory. **ASTONISHING LOW PRICES** and terms. Do not buy until you get them. **RIDER AGENTS WANTED** to ride and exhibit sample. Make big money. Many models \$21.50 up. Guaranteed \$1.50 each. wheels, lamps, horns, equipment at half usual prices. **Send No Money.** Write for our marvelous prices and terms on RANGER Bicycles.



Mead CYCLE CO. Dent B110 CHICAGO

**10c NEW SCIENTIFIC WONDER
3 for 25c "X-RAY" CURIO**

SILVER ONLY
BOYS You apparently see thru Clothes, Wood, Stone, any object. See Bones in Flash. **FREE—PKG. RADIO BIG FUN PICTURE FILMS.** Takes pictures without camera. "You'll like 'em!" 1 pkg. with each 25c order.
MARVEL MFG. CO. Dept. 31 NEW HAVEN, CONN.



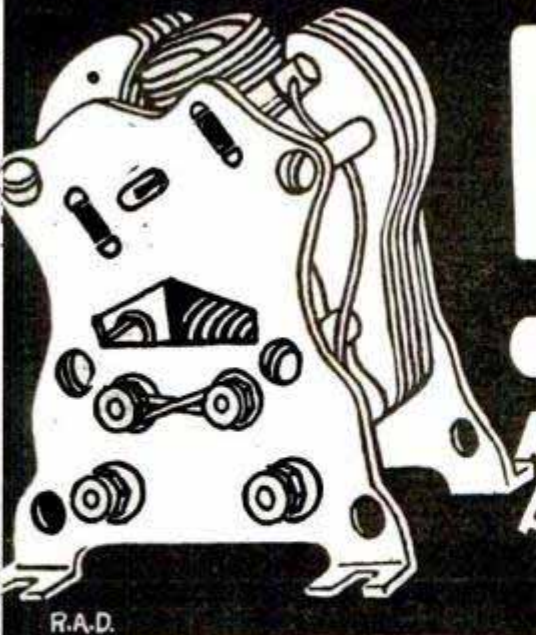

R.A.D.

BOYS

GET THIS ELECTRIC MOTOR ALMOST GIVEN AWAY

Genuine ERECTOR Motor

Here's a genuine ERECTOR motor. Comes equipped with driving pulley, runs all mechanical toys like Erector, Meccano, etc. Binding posts connect with dry battery or transformer.

This is a strongly built little wonder motor, one of the finest we have ever seen. The name Erector is your guarantee of quality. This is just the motor you have been waiting for. With it you can do all kinds of electrical experiments and learn many of the principles of electricity.

We are very fortunate to be able to make this wonderful subscription offer this year and we urge every reader of Popular Mechanics to take advantage of this.

We guarantee your satisfaction 100%. Get your motor at once.

The Magazine Packed With Thrills

The Open Road for Boys Magazine has 50 pages every month crammed with thrilling, breath-taking stories that will hold any boy spell-bound. Tense stories of high adventure on land, on sea and in the air. He-man stories, the kind you have looked for everywhere. Deep mystery, suspense, sport, action, thrills. Big "Boy Mechanic Department" every month. Articles on model planes, aviation, sports, etc. Wonderful departments with contests galore and prizes for all.

The Open Road for Boys Magazine is one magazine you can't do without. You will be wild about it!

"The Street of Dreadful Silence"

Now starting is a new serial "The Street of Dreadful Silence," the most thrilling, breath-taking mystery serial smash in ten years, a story with a punch in every sentence, a tale that will stand your hair on end. Don't you dare miss it! Start getting your magazine today. The regular subscription price to the Open Road for Boys is \$1 a year. Special Offer. For only \$1.25 we will send you this wonderful Erector electric motor, a 32 page book of experiments, and a year's subscription to The Open Road for Boys Magazine. Think of it! All for \$1.25. Wow! what a bargain! Hurry!

12 FAT ISSUES

32 PAGE EXPERIMENTS BOOK FREE

With this very special offer we are giving with every motor a 32 page book of interesting electrical stunts and experiments. This book tells all about motors. Tells you how to take them apart and put them together and teaches you the principles of electricity. Tells how to make a galvanoscope, how to make a magnet from iron nail, how the armature is made, and water rheostat. Scores of electrical tricks. Mystifying. The book is full of illustrations and very valuable. Free with this offer.

BOTH \$1.25 TOGETHER

USE COUPON TODAY!

Open Road for Boys Magazine,
Department 656,
130 Newbury Street,
Boston, Mass.

Canadian Postage 25c extra
Foreign Postage 50c extra

You bet I'll grab that bargain. Enclosed is \$1.25. Rush me the electric motor and the 32 page Experiments Book and put me down for a year's subscription to The Open Road for Boys Magazine. I want to read "The Street of Dreadful Silence."

Name.....

Address.....

City or Town..... State.....

THIS OFFER MAKES A GREAT XMAS GIFT!



Which Job do YOU Want

Lawyer



Auto Expert

Try for it This

Men don't just fall into easy jobs of big pay positions—they prepare for the big chance before it comes.

Make up your mind today what you want to be, then take the first step at once. You don't have to go to college to get ahead. Other men have gone there for you and have put the things they learned there and through years of practical experience into easily understood books which give you a short cut to a better and a bigger job.

We have picked 13 of the best paying professions and have published for your benefit new editions of the most practical, the most valuable books we have ever printed on the subjects covered.

JIFFY INDEX

Our new Jiffy Index makes each book a quick reference work—no time need be wasted in search or study—put your finger on the facts you want instantly.

Special Price List of Pay-Raising Books

- Automobile Engineering, 5 volumes, over 2,000 pages. \$24.80
- Civil Engineering, 9 volumes, 3,900 pages, 3,000 pictures. . . 34.80
- Practical Business Administration, 12 volumes, 3,400 pages, (Extra volume containing self quiz reading course of 80 lessons included free) 39.80
- Electrical Engineering, 8 volumes, 4,300 pages, 3,200 illustrations. 34.80
- Modern Shop Practice, 7 volumes, 7,250 pages, 3,000 pictures. . . 29.80
- American Law and Practice (with reading course), 13 volumes, 6,000 pages, illustrated. 49.80
- Telephony and Telegraphy, 4 volumes, 1,728 pages, 2,000 pictures. 14.80
- Sanitation, Heating and Ventilating, 4 volumes, 1,454 pages, 1,400 pictures. 14.80
- Drawing, 4 volumes, 1,578 pages, 1,000 pictures, blue prints, etc. 14.80
- Employment Management and Safety Engineering, 7 volumes, 1,800 pages, 540 illustrations, charts and diagrams. . . 24.80
- Architecture, Carpentry and Building, 5 volumes, includes 58 beautiful architectural plates free. 24.80

SHIPPED FREE

Words alone cannot describe the full value these books may be to you, so we ship Free for Examination. Pick the set you want, the price is plainly shown, but **Send No Money**; just your name and address, and the books will be sent promptly. Take fifteen full days to read, test and examine them. You'll realize at once what a tremendous force for a better future they can be. After fifteen days you send only \$2.00; then \$3.00 per month until the balance is paid. **There Are No Interest Charges of Any Kind**; the price shown is the total cost.

MEMBERSHIP FREE

Anyone who takes advantage now of this opportunity to "Raise his Pay" will be given absolutely free, a certificate of membership in the American Technical Society, which entitles him to full consultation privileges with our experts in his chosen field. This is good for a whole year and is of tremendous value in solving special problems.

American Technical Society, Dept. X919, Drexel Ave. at 58th St., Chicago, U. S. A.

Please send me set of

for **Fifteen Days'** examination. I will examine the books thoroughly and if satisfied, will send \$2.00 within 15 days and \$3.00 each month until I have paid the special price

of \$ If I decide not to keep the books I will return them at your expense at end of 15 days.

Name

Address

Reference



Civil Engineer



Business Manager way

STATEMENT OF THE OWNERSHIP, MANAGEMENT, CIRCULATION, ETC., REQUIRED BY THE ACT OF CONGRESS OF AUGUST 24, 1912, of Popular Mechanics Magazine, published monthly at Chicago, Ill., for October, 1929.

State of Illinois, County of Cook, ss.
Before me, a notary public in and for the state and county aforesaid, personally appeared H. H. Windsor, Jr., who, having been duly sworn according to law, deposes and says that he is the editor and business manager of the Popular Mechanics Magazine and that the following is, to the best of his knowledge and belief, a true statement of the ownership, management, etc., of the aforesaid publication for the date shown in the above caption, required by the Act of August 24, 1912, embodied in section 411, Postal Laws and Regulations, printed on the reverse of this form, to wit: First. That the name and address of the publisher, editor, managing editor, and business manager are: Publisher, Popular Mechanics Co., 200 East Ontario St., Chicago, Ill., Editor, H. H. Windsor, Jr., 200 East Ontario St., Chicago, Ill., Managing Editor, L. K. Weber, 200 East Ontario St., Chicago, Ill., Business Manager, H. H. Windsor, Jr., 200 East Ontario St., Chicago, Ill. Second. That the owner is: (If owned by a corporation, its name and address must be stated and also immediately thereunder the names and addresses of stockholders owning or holding one per cent or more of total amount of stock. If not owned by a corporation, the names and addresses of the individual owners must be given. If owned by a firm, company, or other unincorporated concern, its name and address, as well as those of each individual member, must be given.) L. B. Windsor, 200 East Ontario St., Chicago, Ill.; H. H. Windsor, Jr., 200 East Ontario St., Chicago, Ill. Third. That the known bondholders, mortgagees, and other security holders owning or holding 1 per cent or more of total amount of bonds, mortgages, or other securities are: (If there are none, so state.) None. Fourth. That the two paragraphs next above, giving the names of the owners, stockholders, and security holders, if any, contain not only the list of stockholders and security holders as they appear upon the books of the company but also, in cases where the stockholder or security holder appears upon the books of the company as trustee or in any other fiduciary relation, the name of the person or corporation for whom such trustee is acting, is given; also that the said two paragraphs contain statements embracing affiant's full knowledge and belief as to the circumstances and conditions under which stockholders and security holders who do not appear upon the books of the company as trustees, hold stock and securities in a capacity other than that of bona fide owner; and this affiant has no reason to believe that any other person, association, or corporation has any interest direct or indirect in the said stock, bonds, or other securities than as so stated by him. H. H. WINDSOR, Jr., Editor and Publisher. Sworn to and subscribed before me this 28th day of September, 1929. J. GRAHAM, Notary Public. (My commission expires June 16, 1932.)

LAW HIGH-GRADE INSTRUCTION BY CORRESPONDENCE

College, Post Grad. and Bar Ex. Rev. Courses. Law has attracted more keen, brainy men than any other calling. Send today for catalog. Low cost, easy terms. Standard texts. Degrees.
Chicago School of Law Dept. 801, Reaper Block CHICAGO, ILL.

WAKE UP!

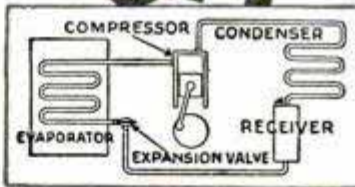

Amazing Opportunities in ELECTRIC REFRIGERATION

WHY look for big pay in crowded industries? Get into the newest and fastest growing industry in America—Electric Refrigeration. Millions of dollars being invested by Wall Street in factories and advertising. Urgent need for scientifically trained men in manufacture, installation, sales and service. Jobs pay \$200 to \$1,000 a month. And now a new easy method trains you at home to fill a big pay job. Learning Electric Refrigeration simplified amazingly. This course sponsored by Kelvinator, Copeland, and praised by General Electric, Servel, Zerozone and other leading manufacturers. Our Employment Dept. helps you find big jobs, FREE.

BIG BOOK FREE

Mail coupon now for big book free "Rich Rewards in Electric Refrigeration." See how easy it is to quickly become a highly paid refrigeration expert. No obligation. Utilities Engineering Institute, Dept. 1129, 4403 Sheridan Road, Chicago, Ill.

"Your Institute should be of great interest to young men wishing to get into the service and sales end of this business. It will be a pleasure to co-operate with you." Col. F. E. Smith, President, Servel, Inc.

Utilities Engineering Institute, Dept. 1129, 4403 Sheridan Road, Chicago, Ill. Without obligating me, send free book "Rich Rewards in Electric Refrigeration."

Name

Address

City State

Movies teach You ELECTRICITY

Amazing New Method Paves the Way To BIGGER PAY

NOW there's an *easier* way to learn ELECTRICITY. Right in your own home you can *quickly* prepare yourself for a BIG PAY JOB. This new way takes away the drudgery. MOVING PICTURES train you, that's the *secret*. Every principle demonstrated before your eyes.

You *see* the currents flow. You *see* generators, dynamos, switchboards and all standard electrical apparatus in action. Fascinating as a news reel. Movie machine furnished *at no extra cost*. Hook it up to any electric connection. See the movies on your own screen. Repeat them as often as you wish. Thousands of feet of film furnished. The best colleges use MOTION PICTURE training. Now you can get it at home. Gives you advantage of home study training *plus* residence school experience. All at *much lower cost*.

Endorsed by Engineers and Educators

With the help of such practical engineers and educators as Bruce A. Rogers, M. S., Western Electric Co., J. A. Shimek, M. E., E. E., Engineer DeVry Corporation; A. P. Hollis, formerly Director Visual Education University of North Dakota; F. S. Wythe, Director Neighborhood Motion Picture School Film Service, and W. N. Littlewood, formerly instructor University of Wisconsin, *who will have personal charge of your training*, you will soon be ready for big pay jobs in Aviation Electricity, Radio, Switchboard Work, Sub-Station and Power Plant Operation, Automotive Electricity, Wiring, Contracting, Merchandising, Etc.

This Money-Back Pledge Protects You

You take *no chances* when you learn electricity this modern way. We are so sure of your success that we pledge *in writing* to give you training and employment service necessary to get you a *better* job at *bigger* pay or refund every cent.

This pledge protects you. It is your assurance that our MOTION PICTURE training will *increase your pay check*. \$60.00 to \$150.00 a week is common in ELECTRICITY. Many make much more. Thousands of men are needed. Work is easy and steady. Here's your chance to say good-bye to long hours and low pay. Prove it to your own satisfaction **TODAY**.

Write Now for Get the money making facts.
Big FREE Book Our big book, "*The Film Way to Bigger Pay*," explains the marvelous opportunities now open in Electricity. The coupon will bring it FREE. There's no obligation. Write **NOW** while special introductory offer lasts.

**Mail
Coupon**

The NATIONAL SCHOOL of VISUAL EDUCATION

537 S. Dearborn St., Chicago, U. S. A. Dept. 12-H

Send book, "*The Film Way to Bigger Pay*," with facts about this new, easier way to master electricity.

Name.....Age.....

St. or R. F. D.....

City.....

State.....

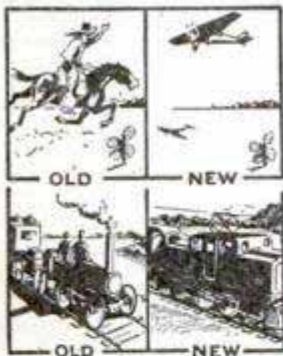

ENGINEER SAYS NEW WAY
IS BEST

Charles L. Fitz, M.E., E.E., a practicing engineer, formerly associated with Steinmetz of General Electric, says: "I am amazed at how clearly and simply you explain the facts about electricity and electrical work. You show the principles in these motion pictures and animated diagrams better than we can even in the laboratory. Your whole course seems to me by far the best method of getting thorough preparation for practical electrical work."

The NATIONAL SCHOOL of
VISUAL EDUCATION

"The Film Way to Bigger Pay"

More Money

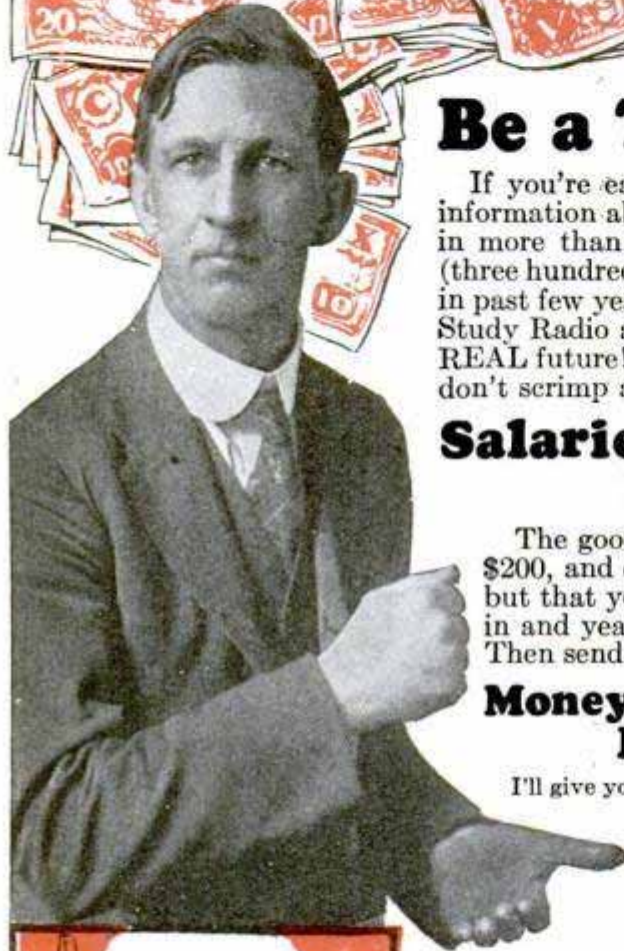

Be a Trained Radio Expert

If you're earning a penny less than \$50 a week, get my free book of information about the Radio business. Trained Radio Experts are needed in more than twenty different lines of this new and growing profession (three hundred thousand new openings created by the swift growth of Radio in past few years). Why go along at \$25 or \$35 or \$45 a week all your life? Study Radio and after only a short time land yourself a REAL job with a REAL future! Be a man who has money in his pocket and in the bank—don't scrimp and scrape for the rest of your days.

Salaries of \$50 Up to \$250 a Week Not Unusual in Radio

The good positions in Radio pay all the way from \$50 on up to \$150, \$200, and even \$250 a week. Suppose you don't climb to the very top but that you do advance to a position that pays you \$125 a week, year in and year out. Any chance to make that much where you are now? Then send for my free book, and learn about a field where there's some

Money Back If You Aren't Fully Satisfied

I'll give you all the training you need to get into any line of the Radio business. And I back up this training by a signed agreement to refund every penny you pay me if upon completion of my course you are not satisfied with the lessons and instruction service I give you.

real opportunity. Where good men, if they have the right training, can work their way into really big salaried jobs!

Get Book!

Find out for yourself about the bigger pay waiting for you in Radio! From \$2,000,000 in 1920 to \$1,000,000,000 in 1929—that's the record of the Radio industry! Plenty of big Radio jobs are waiting for the man who KNOWS. John Fetzer sent for my free book—now he's Chief Engineer at WEMC and designs and builds broadcast stations. T. M. Wilcox sent for the book—now he's in his own Radio business and reports profits as high as \$70 in one day! All information will be sent you free, without obligation—just mail coupon on opposite page.

Six Big Practical Outfits Given You To Help You Learn

I teach you both the "why" and the "how" of Radio. You learn to DO a thing, and you learn WHY it's done. I send you, WITHOUT EXTRA COST with your course, six big practical outfits of material to experiment and work with. These outfits are the real thing—not toys. The parts they contain will build approximately one hundred different Radio circuits. With all this material you do practical work from start to finish of your training. You get your hand in, and you get confidence in yourself. Then when you run into a Radio problem, later on the job, you KNOW you can do it because you've already done it with these six outfits of practical material. With me you don't learn to be a "paper Radio Expert"—you learn to be the kind of expert that shows his worth on the payroll. Full details in my big book—sent free.

Send For Free Book of Information



Broadcasting and commercial Radio land station work appeal to a lot of men—it's a big, growing field and fascinating work. My course prepares you thoroughly to get into this field and make good.

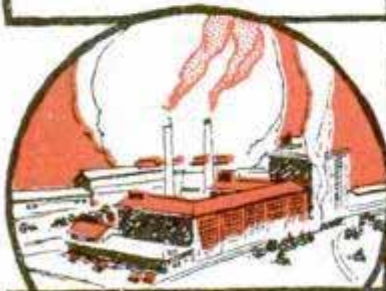

Radio manufacturing has grown faster in the last six years than any other big business ever did. It's two hundred and fifty times as big as it was. That means lots of good chances for the trained Radio Expert.

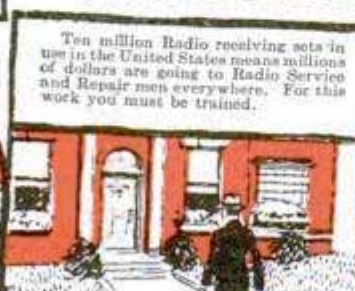

Ten million Radio receiving sets in use in the United States means millions of dollars are going to Radio Service and Repair men everywhere. For this work you must be trained.

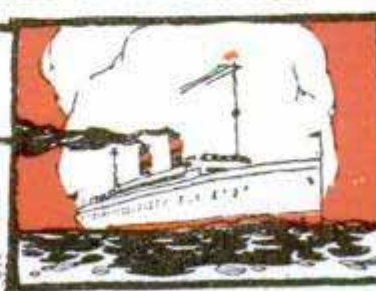

Radio operators on board ship go everywhere—see everything. You sail the world over, all your expenses paid, and draw a good salary besides. It's the life of Reilly.

see
coupon
next
page



for you in Radio

Learn Quickly, Easily Train at Home In Spare Minutes

Stay home! Hold your job! I'll bring your Radio training to you, and you can learn in your spare time after work. No need to go to a strange city and live for months on expense when you learn my way. You study in the quiet of your own home. As for this training—it's written just as I would talk—in straightforward, every day, understandable language. You'll get it, and you'll get it quickly—in a few months' spare time—because I've made it so clear and interesting! No particular education needed—lots of my successful students didn't finish the grades.

Many Earn \$10, \$20, \$25 Weekly Right Away "On the Side"

Deloss Brown, South St., Foxboro, Mass., made \$1,000 from spare-time Radio jobs before he even finished my course. H. W. Coblenz, Washington, averaged \$45 a week; Leo Auchampaugh, 6432 Lakewood Ave., Chicago, made \$500 before graduation; Frank Toomey, Jr., Piermont, N. Y., made \$833 while taking the course. All this done IN SPARE TIME away from the regular job, while these fellows were still studying the course—and they're only a few of hundreds. As soon as you start this training I begin teaching you practical Radio work. Then a few weeks later, I show you how to make use of it in spare time, so you can be making \$10, \$20, \$25 a week "on the side," all the while you're learning.

64-Page Book Sent Free for the Asking

My big book of Radio Information won't cost you a penny, and you won't be under any obligation by asking for it. It's put hundreds of fellows on the way to big pay and brighter futures. Sending for it has been the turning-point where many a man has made his start toward real Success. Get it. See what it's going to mean to you. Send coupon TODAY!

Address: **J. E. SMITH, President**
National Radio Institute

Dept. 9ZP

Washington, D. C.

Send No Money

J. E. Smith, President,
National Radio Institute,
Dept. 9ZP, Washington, D. C.

Dear Mr. Smith: Kindly send me your big free book, "Rich Rewards in Radio," giving all information about the big-money opportunities in Radio and how you will train me to take advantage of them. I understand this places me under no obligation, and that no salesman will call on me.

Name.....

Address.....

Town.....State.....

Hundreds of fine jobs opening in Radio every year

Radio needs more trained men to take care of its rapid growth. Every year there are many fine jobs for men with the right training in broadcasting stations, commercial land stations, Radio factories, with Radio dealers and jobbers, with shipping companies which offer world-wide travel and good pay. Besides there are countless opportunities to have a spare time or full time business of your own.

Talking movies, Television and many other new and recent developments in and uses for Radio are increasing the need for trained men continually. This is best proved by the fact that the Employment Department of the National Radio Institute is getting three times as many calls for our graduates this year as it did last.

Radio's \$5000 and \$10,000 year men of the future will be picked from those who get in now

Just as the men who got into the automobile business, the motion picture industry and others at the right time now have the key jobs, so those who get into Radio now, while it is growing fast, will have the first chance at the big jobs. The opportunities that make men rich in other fields are developing right before your eyes in Radio. I will give you the training you need to break in and have a firm foundation on which to build for a successful future.

Find out about my methods that have increased the earnings of so many others. Mail the coupon today



RICH REWARDS in RADIO



This big 64-page book, printed in two colors, crammed with interesting facts and photos about money-making opportunities in Radio, sent free to everyone who clips the coupon. No obligation by sending for the book—it's absolutely free. One of the most valuable books about Radio ever written.



**6
big
outfits
given**



Salary Increased from \$112 to \$400 a Month

"My I. C. S. course in Cost Accounting was of great practical help in enabling me to install a cost system in a plant having somewhat unusual problems. It also helped me to get my B.C.S. degree from a resident commercial school and in preparing for the C.P.A. examination. My salary was \$112 a month when I enrolled. It is now \$400 a month, with a generous allowance for traveling expenses."

That's a true story of what spare-time study has done for just one man. There are thousands of others. Why don't you take up a home-study course with the International Correspondence Schools and prepare yourself to earn more money? You can do it if you really try.

It doesn't cost you a penny or obligate you in any way to mark and mail the coupon, but that one simple step will bring you information that will help you to get out of the rut and make good in a big way.

Write Today for Free Booklet

INTERNATIONAL CORRESPONDENCE SCHOOLS Box 5655-F, Scranton, Penna.

Without cost or obligation, please send me a copy of your booklet, "Who Wins and Why," and full particulars about the course before which I have marked X in the list below:

TECHNICAL AND INDUSTRIAL COURSES

- | | |
|--|---|
| <input type="checkbox"/> Architect | <input type="checkbox"/> Automobile Mechanic |
| <input type="checkbox"/> Architectural Draftsman | <input type="checkbox"/> Aviation Engines |
| <input type="checkbox"/> Building Foreman | <input type="checkbox"/> Plumber and Steam Fitter |
| <input type="checkbox"/> Concrete Builder | <input type="checkbox"/> Plumbing Inspector |
| <input type="checkbox"/> Contractor and Builder | <input type="checkbox"/> Foreman Plumber |
| <input type="checkbox"/> Structural Draftsman | <input type="checkbox"/> Heating and Ventilation |
| <input type="checkbox"/> Structural Engineer | <input type="checkbox"/> Sheet-Metal Worker |
| <input type="checkbox"/> Electrical Engineer | <input type="checkbox"/> Steam Engineer |
| <input type="checkbox"/> Electrical Contractor | <input type="checkbox"/> Marine Engineer |
| <input type="checkbox"/> Electric Wiring | <input type="checkbox"/> Refrigeration Engineer |
| <input type="checkbox"/> Electric Lighting | <input type="checkbox"/> R. R. Positions |
| <input type="checkbox"/> Reading Shop Blueprints | <input type="checkbox"/> Highway Engineer |
| <input type="checkbox"/> Telegraph Engineer | <input type="checkbox"/> Chemistry |
| <input type="checkbox"/> Telephone Work | <input type="checkbox"/> Pharmacy |
| <input type="checkbox"/> Mechanical Engineer | <input type="checkbox"/> Coal Mining Engineer |
| <input type="checkbox"/> Mechanical Draftsman | <input type="checkbox"/> Navigation <input type="checkbox"/> Assayer |
| <input type="checkbox"/> Machine Shop Practice | <input type="checkbox"/> Iron and Steel Worker |
| <input type="checkbox"/> Toolmaker | <input type="checkbox"/> Textile Overseer or Supt. |
| <input type="checkbox"/> Patternmaker | <input type="checkbox"/> Cotton Manufacturing |
| <input type="checkbox"/> Civil Engineer | <input type="checkbox"/> Woolen Manufacturing |
| <input type="checkbox"/> Surveying and Mapping | <input type="checkbox"/> Agriculture <input type="checkbox"/> Fruit Growing |
| <input type="checkbox"/> Bridge Engineer | <input type="checkbox"/> Poultry Farming |
| <input type="checkbox"/> Gas Engine Operating | <input type="checkbox"/> Mathematics <input type="checkbox"/> Radio |

BUSINESS TRAINING COURSES

- | | |
|--|---|
| <input type="checkbox"/> Business Management | <input type="checkbox"/> Business Correspondence |
| <input type="checkbox"/> Industrial Management | <input type="checkbox"/> Show Card and Sign Lettering |
| <input type="checkbox"/> Personnel Management | <input type="checkbox"/> Stenography and Typing |
| <input type="checkbox"/> Traffic Management | <input type="checkbox"/> English |
| <input type="checkbox"/> Accounting and C. P. A. Coaching | <input type="checkbox"/> Civil Service |
| <input type="checkbox"/> Cost Accounting | <input type="checkbox"/> Railway Mail Clerk |
| <input type="checkbox"/> Bookkeeping | <input type="checkbox"/> Mail Carrier |
| <input type="checkbox"/> Secretarial Work | <input type="checkbox"/> Grade School Subjects |
| <input type="checkbox"/> Spanish <input type="checkbox"/> French | <input type="checkbox"/> High School Subjects |
| <input type="checkbox"/> Salesmanship | <input type="checkbox"/> Cartooning |
| <input type="checkbox"/> Advertising | <input type="checkbox"/> Illustrating |
| | <input type="checkbox"/> Lumber Dealer |

Name.....

Address.....

City..... State.....

Occupation.....

If you reside in Canada, send this coupon to the International Correspondence Schools Canadian, Limited, Montreal, Canada

Wouldn't You Like to Get into Amateur Radio?

Imagine the thrill of building and operating your own private short-wave transmitter and receiver, and talking with other amateurs all over the world!

Talk with the Byrd Expedition at the South Pole! Chat with other expeditions in the far corners of the earth! Gossip with Frenchmen, South Africans, Chinese, Australians, or fellow-Americans thousands of miles away. Or, if you wish, listen in on concerts direct from London, Holland and Australia! You can do it for less than the price of your broadcast receiver and

Here Is a Book That Tells You How!

THE RADIO AMATEUR'S HANDBOOK

It explains everything about amateur radio and short-wave work from A to Z. Tells you how to build short-wave receivers from the simplest to the most complicated, that will bring you signals from all over the world; how to learn the code; how to get your licenses; how to build simple transmitters; how to build better transmitters; how to adjust and operate your set.

232 pages 6½ x 9½ 188 illustrations

Over 60,000 copies in use

Sent postpaid anywhere in the world for

\$1

American Radio Relay League

Hartford, Connecticut, U. S. A.

ACCOUNTING



The uncrowded, highly paid profession of Accountancy offers marvelous opportunities to ambitious men and women. Send for our 80-page book, "How to Learn Accounting," and the first easy lesson. Both will be sent free.

INTERNATIONAL ACCOUNTANTS SOCIETY, Inc.
A Division of the
Alexander Hamilton Institute

Dept. 102, 3411 South Michigan Ave., Chicago, Ill.

Learn to PAINT SIGNS and SHOW CARDS

We quickly teach you by mail, or at school, in spare time. Enormous demand. Big future. Interesting work. Oldest and foremost school.

EARN \$50 TO \$200 WEEKLY
Otto Wiegand, Md., home-study graduate, made \$12,000 from his business in one year. John Varco, N.Y., gets \$25 for a show card. Crawford, B. C., writes: "Earned \$200 while taking course." Write for complete information.

DETROIT SCHOOL OF LETTERING
154 Stimson Ave. Est. 1899 Detroit, Mich.



Learn How to BOX

\$2.98 brings you the famous boxing course by mail of Jimmy DeForest, World's Greatest Trainer and Maker of Champions, the system that trained Dempsey and great champions. Covers everything in scientific boxing from fundamentals to ring generalship. Twenty weeks makes you a finished DeForest trained boxer. Hundreds of DeForest trained men are making good in the ring today. Complete course sent you one mailing. Send \$2.98 or C. O. D. order paying postman \$2.98 plus actual postage.

JIMMY DEFOREST BOXING COURSE
347 Madison Ave., Box 137-B, NEW YORK CITY





BRAND NEW

CORONA GENUINE Model #3

*Lowest Price — Easiest Terms
Ever Offered*

HERE'S your chance to own that *brand new* Genuine Model 3 Corona you've wanted — on the easiest terms ever offered — at **LOWEST PRICE** ever offered. Complete in every detail; back spacer, etc., *Manufacturer's Guarantee*. Recognized the world over as the finest, strongest, sturdiest portable built.

Yours for **10 DAYS FREE**

Only a limited number of these splendid machines available. To get one, you must act now! Experience the joy this personal writing portable typewriter can give you! Use it ten days free! See how easy it is to run and the splendidly typed letters it turns out. Ideal for the office desk, home, traveling. Small, compact, light, convenient. Don't

send out letters, manuscripts, reports, bills in poor handwriting when you can have this Corona at such a low price on such easy terms. Remember these are *brand new* machines right out of the Corona factory.

Carrying Case FREE
If You Act Now!

Leatheroid carrying case, oiler, instructions free on this offer. Send no money—just the

coupon. Without delay or red tape we will send you the Corona. Try it 10 days. If you decide to keep it, send us only \$2—then \$3 a month until our special price of \$39.90 is paid. Now is the time to buy. Special Xmas Package if you act now!

Save Money—Use this Coupon

Smith Typewriter Sales Corp., (Corona Division)
469 E. Ohio St., Chicago, Ill. Dept. C3

Ship me the Corona, F.O.B. Chicago. On arrival I'll deposit \$2 with express agent. If I keep the machine, I'll send you \$3 a month until the \$37.90 balance of \$39.90 price is paid; the title to remain with you until then. I am to have 10 days to try the typewriter. If I decide not to keep it, I will repack and return to express agent, who will return my \$2. You are to give your standard guarantee.

Name _____
Address _____
Employed by _____



OIL HEAT

NOW AT A FRACTION OF PRESENT COSTS

Now — it simply does not pay to use coal when you can have oil heat at such astonishing low cost. Think of the convenience—no more getting up cold mornings, no more chopping, no more shoveling — THEN THINK OF THE ACTUAL MONEY SAVING which is the outstanding advantage of the exclusively patented LACO!

OIL HEAT FOR COAL RANGES



The New LACO
Cook Stove Burner

Now you can have convenience and clean heat for your cook stove, equal to city gas, but at a FRACTION of the cost! The new Laco Cook Stove Burner does away with the drudgery of coal and wood fires. No longer need the housewife be a slave to the coal bucket and the woodpile. The Laco Cook Stove Burner fits easily into any coal stove or range. Has two burners. Gives you CLEAN HEAT, as FAST as city gas, but safer, as you can go away and leave it on all night, or you can leave it unlighted, and nothing will happen. Sold on easy terms at a SENSATIONALLY LOW PRICE. Write for information. State whether you have electricity. Also ask about the New Laco for heating stoves.

Installed Quickly Without Loss of Heating Time

The Laco fits right into your furnace—any kind of furnace—hot air, hot water, steam or vapor heat, etc. Most customers install it themselves—any mechanic can do it in little time, following our A-B-C directions.

EASY TERMS

Just pay down the small amount required, and the new LACO will be shipped to you. The smallest down payment, and the easiest terms. No need now to wait, when you can afford Oil Heat immediately.

you can afford Oil Heat immediately.

Write for Information

Tell type of heating system you now have (hot-air or hot water, or steam) and mention whether you have electricity. Special offer if you act now.

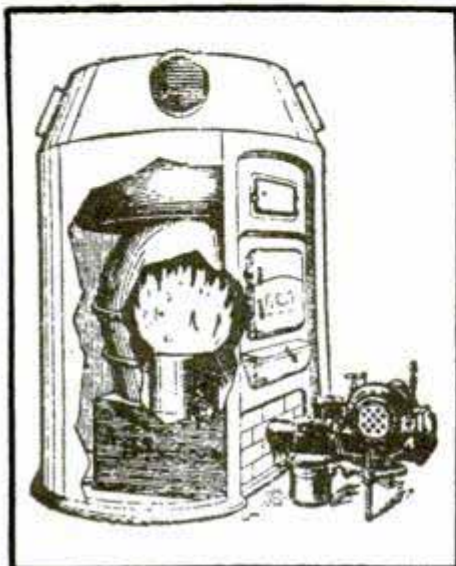

An EXTRA Room for Your Home

With a Laco in your basement, it is no longer a dirty, grimy place barred to the children, unfit for anything but the coal pile. You add a clean, airy room to your home—suitable as a recreation room for the children, a workshop or den for you, a clean place to hang the laundry in winter, etc.



Simply Set The Thermostat — Then Forget Heating Troubles

The Laco thermostat provides just the amount of heat you want, WHEN you want it. Operates quietly. Does not interfere with the Radio. Simple. Nothing to adjust. Designed to last a lifetime. Guaranteed. Complies with all ordinances. Actually safer than the ordinary kitchen gas range.

No More Chopping, Shoveling



Now — resolve to end drudgery, carrying dirty, heavy coal, ashes, smoke, chopping, shoveling. Install a LACO and forget your furnace.

Wonderful Invention Burns Oil New Way

Fits Any Furnace

Other power burners, by means of air pressure, convert the liquid oil into a spray and burn oil in spray form. The surplus air pressure thus required blows a large part of the spray upwards, out of the smokestack, wasting heat, increasing fuel expense. Contrast this with the LACO, which by means of the indestructible MINERAL WICK, converts the oil into hydro-carbon GAS, the most perfect medium for creating heat known to man—because ALL of it burns and WASTE IS ELIMINATED! A given amount of oil, burned in the LACO, lasts longer and saves you money!

Fuel Costs Smashed Smoke, Soot and Grease Eliminated

The spray form method of burning oil means waste oil, and that means smoke, soot, grease. The LACO does away with all this! The LACO, by burning ALL of the oil in GAS form eliminates waste, thus providing clean heat, free from dirt or grease. This is an exclusive feature of the LACO—fully covered by U. S. patents—the LACO is the ONLY burner so equipped and the ONLY burner of its kind on the market!

DEALERS WANTED

We want rated men, preferably—but also the man who will invest a small amount in demonstrators — then get out and SELL. If this description fits you, we will offer you an opportunity BIG ENOUGH FOR ANY MAN!

LACO OIL BURNER COMPANY

126 Union St.,

Griswold, Iowa

R. T. I. R. T. I. QUALIFIES YOU TO MAKE MONEY AND ITS SERVICE KEEPS YOU UP-TO-THE-MINUTE ON THE **R. T. I.** NEWEST DEVELOPMENTS IN RADIO, TELEVISION AND TALKING PICTURES

Easy to Get into
this **BIG**
Money Making
Work

\$60 to \$125⁰⁰
A WEEK
Radio
Operator

\$8 to \$15⁰⁰
A DAY
Servicing and
Repairing Radio Sets

\$5000⁰⁰ A YEAR
AND UP
Radio Engineer
for Broadcasting Station

\$85⁰⁰ A WEEK
Installing and
Repairing Talking
Picture Equipment

**GOOD
JOBS**

Right at Your Finger Tips

WHEN YOU ARE R.T.I. TRAINED IN

RADIO-TELEVISION - Talking Pictures

BIG PAY JOBS! SPARE TIME PROFITS! A FINE BUSINESS OF YOUR OWN! They're all open to you and other live wire men who answer the call of RADIO. The fastest growing industry in the world needs more trained men. And now come Television and Talking Movies—the magic sisters of Radio. Will you answer this call? Will you get ready for a big pay job Now and step into a BIGGER ONE later on? You can do it EASILY now.

R. T. I. Home Training Puts You in This Big Money Field

Radio alone, pays over 200 MILLION DOLLARS a year in wages in Broadcasting, Manufacturing, Sales, Service, Commercial Stations and on Board the big sea going ships and many more men are needed. Television and Talking Movies open up other vast fields of money-making opportunities for ambitious men. Get into this great business that is live, new and up-to-date, where thousands of trained men easily earn \$60 to \$100 a week—where \$10,000 a year jobs are plentiful for men with training plus experience.

Easy To Learn At Home—In Spare Time

Learning Radio the R. T. I. way with F. H. Schnell, the "Ace of Radio" behind you is EASY, INTERESTING, really FUN. Only a few spare hours are needed and lack of education or experience won't bother you a bit. We furnish all necessary testing and working apparatus and start you off on practical work you'll enjoy—you learn to do the jobs that pay real money and which are going begging now for want of competent men to fill them.



FRED H. SCHNELL
Chief of R. T. I. Staff
Twenty years of Radio Experience. First to establish two-way amateur communication with Europe. Former Traffic Manager of American Radio Relay League, Lieut. Commander U. S. N. R. Inventor and Designer Radio Apparatus, Consultant Radio Engineer. Now in charge of R. T. I. Radio Training—and you will like his friendly manner of helping you realize your ambition.

Amazingly Quick Results

You want to earn BIG MONEY, and you want some of it QUICK. R. T. I. "Three in One" Home Training—Radio-Television-Talking Movies—will give it to you, because it's easy, practical, and is kept right up-to-date with last minute information. In a few weeks you can be doing actual Radio work, making enough EXTRA MONEY to more than pay for your training. In a few short months you can be all through—ready to step into a good paying job or start a business of your own. A BIG JOB—BIG MONEY—A BIG FUTURE. There is no other business in the world like it.

Investigate—Send For R. T. I. Book Now

Don't waste a minute. Find out what the great Radio industry, which has grown faster than the Automobile and Motion Picture business, has to

offer you. Find out what other men are earning. SEE HOW EASILY YOU CAN GET STARTED. Get the facts about Radio, Television and the Talking Pictures, firsthand, in the big R. T. I. FREE BOOK. Learn what this R. T. I. "Three in One" Home Training can do for you. Mail the coupon for FREE BOOK NOW.
RADIO & TELEVISION INSTITUTE
Dept. 19
4806 St. Anthony Court, Chicago



RADIO & TELEVISION INSTITUTE
Dept. 19 4806 St. Anthony Court, Chicago

Send me Free and prepaid your BIG BOOK "Tune In On Big Pay" and full details of your three-in-one Home Training (without obligating me in any way).

Name.....
Address.....
City..... State.....

R.T.I. Training Brings Big Jobs Like These!



\$500 EXTRA MONEY IN 2 MONTHS

Your radio course has enabled me to earn over \$500 in two months. This is all spare time work, as I have a permanent position with my father in our store. I give you all the credit for the above.
—J. NOFFENGER,
R. 1, Box 37, Greenville, Ky.



MAKES \$25 A DAY

I make as high as \$25.00 per day and have made \$200.00 in 2 months from Radio work. That's not so bad when I'm only 19 and in a small town. You did all you said you would and much more.—FLOYD KNESELY
Box 91, St. Joe, Ind.



SALARY RAISED 33 1-3%

I am now Radio Service Manager for the H. N. Knight Supply Co., distributors for Eveready Radio Receivers in Oklahoma, and Texas Panhandle, with an increase in salary of about 33 1-3% since I enrolled with your school.
—EARL P. GORDON, 618 E. 6th St., Oklahoma City, Okla.

R. T. I. R. T. I. TRAINS YOU AT HOME FOR A GOOD JOB OR A PROFITABLE PART TIME OR FULL TIME BUSINESS OF YOUR OWN

ELECTRICITY

PAYS BIG!



LEARN IN 90 DAYS ON ACTUAL MACHINERY—NO BOOKS

Don't let the world bluff you. Get into electricity—earn \$50.00 to \$150.00 a week—and hold your head as high as the next man. You can do it easily by coming to my famous electrical school. In 12 short weeks you'll pack in many years of practical knowledge. You work shoulder to shoulder with expert instructors on full-sized moving, whirling motors, generators, batteries, switchboards, tele-



IT'S EASY THIS WAY

Fascinating, practical shop work in my big school fits you. Not a correspondence course.

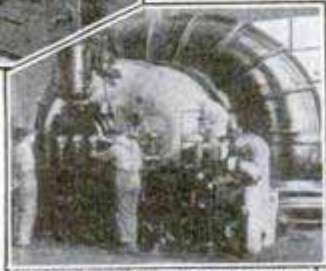

No Education or Experience Needed
No books to read. No dry lectures to listen to. You learn by doing. I don't care if you can't tell a motor from a horse-and-

buggy now. When you graduate I guarantee that you'll know electricity from "A" to "Z". If you're not fitted to fill a big-pay job I'll refund every penny of your tuition.
phone and telegraph systems, etc., etc. McSweeney trained men get the biggest paying jobs. Every day I receive requests for graduates.

Satisfaction Guaranteed!

You are the sole judge of McSweeney training. Your tuition will be instantly refunded if, upon graduation, you are not completely satisfied. No facilities for colored students.

Big Illustrated Book Sent FREE

Today, right now, take the first step out of that low pay rut. Mail the coupon to me for big, illustrated book on ELECTRICITY and remarkable Tuition Offer.

JUST MAIL COUPON!

J. H. McSweeney, Pres., McSweeney Elec. Schools, Dept. E-10-M, Chester at 30th St., Cleveland, O., or 263 Madison St., Memphis, Tenn.

Dear Mac: Without obligation send me a copy of your big free book on ELECTRICITY, also details of remarkable tuition offer and complete radio course.

Name.....
Address.....
Town..... State.....

COMPLETE RADIO COURSE



McSWEENEY ELECTRICAL SCHOOLS

Dept. E-10-M, Chester at Thirtieth Street, Cleveland, Ohio, or 263 Madison Street, Memphis, Tenn.

Write and Speak **MASTERLY ENGLISH**



Learn correct English with Sherwin Cody's new invention. No rules to memorize. Like a fascinating game. Spare-time study, 15 minutes each day, quickly gives you command of English. Send for free booklet "How to Speak and Write Masterly English." Write today, Sherwin Cody School of English, 512 Searle Bldg., Rochester, N. Y.



"BECOME A LIGHTNING TRICK CARTOONIST"

Send \$1.00 for Laugh Producing Program of 23 Trick Drawings with Instructions. Catalog of Chalk Talk Supplies Free. BALDA ART SERVICE, Dept. 1, Oshkosh, Wis.

Learn Watchwork, Jewelrywork and Engraving A fine trade commanding a good salary, and your services always in demand. Address **HOROLOGICAL**, Dept. P, Bradley Institute, PEORIA, ILLINOIS, for our latest catalog.

HIGH SCHOOL Education at Home

Here in 15 wonderful texts is your complete High School Education. Every subject taught by fascinating "Question and Answer" method. Now used in 12,000 high schools. Certificate awarded. It's fun to learn this easy inexpensive spare-time way. Greatest bargain in brain power.

Send for Free Book Find out how YOU can quickly prepare for bigger pay and social culture. Send this ad with name and address for FREE booklet, "What a High School Education Can Do for Me."
High School Home Study Bureau, 31 Union Square, Dept. 3379 New York, N.Y.

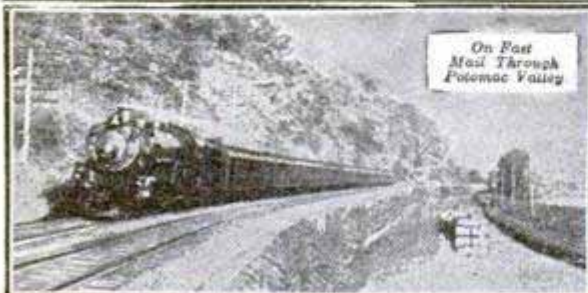

Travel on "Uncle Sam's" Payroll \$158 TO \$225 MONTH

Mail Coupon Before You Lose It
FRANKLIN INSTITUTE, Dept. D171, Rochester, N.Y.

Sirs: Rush to me, without charge, (1) Full particulars, telling how to become a Railway Postal Clerk; (2) send copy of 32-page book "How to Get U. S. Government Jobs," with list of many positions obtainable.

Many Other Government Jobs Obtainable
Steady Work—No Layoffs—Paid Vacations
Common Education Sufficient
MEN—BOYS 18 UP

Name.....
Address.....

Here's an Easy Way to MORE PAY

It's
FREE!

My
Pay-Raising
Plan
Engineer Dobe

Mail
Coupon
For This
FREE Book

"You'll get
your raise."
—Engineer
Dobe

My Plan Success-
fully Used For Over
30 Years

More
Pay-Making
Tools For
You!

Why work all your life for small pay and with little chance for a raise or promotion? Let me train you for *Higher Class Work and Better Pay*. Get my *Pay-Raising Plan*—NOW. I'll send it to you FREE. It will convince you and show you a way to build a big future for big pay, on clean work leading to salaries of \$60-\$70, and up to \$100 a week salary.

I Train You at Home

My practical working method makes every step in learning drafting as clear as a moving picture. That's why I train you so fast to be a draftsman.

Money Back If Not Satisfied

I train you under a positive Money-Back Agreement. If my training does not satisfy you after you have finished you get every penny back.

**Mail This Coupon
If You Earn Less
Than \$70 a Week**

Mail this coupon now, and I will send you "My Pay-Raising Plan", Drafting Book and Draftsman's Pocket Rule—postpaid and free.

**Engineer Dobe, Div. 13-59
1951 Lawrence Av., Chicago**



Draftsmen Needed In:

Auto Work

The automobile industry is one of the greatest in America. Thousands of draftsmen needed. I'll train you for the work.

Electricity

Electricity is the coming motive force of the world. Draftsmen are needed in every department of this fascinating work. I'll train you at home. Get a job here.

Aviation

Aviation is just in its infancy. It is bound to expand to enormous proportions. Draftsmen are essential to it. I'll train you quick at home for drafting position.

Motor Bus Work

Motor bus building and motor bus transportation have become leading world industries. Hundreds of draftsmen engaged in this work. I'll show you the way.

Building Work

There will always be building. No structure can be erected without plans drawn by draftsmen. I'll make you an architectural draftsman.

Earn

While You Learn

You can start earning money a few weeks after beginning my training. I give you special work and tell you how to make money.

Money-Making Tools Furnished

You get these fine quality, genuine, imported draftsman's tools, just as soon as you become my student. No finer tools made for practical drafting work.

Employment Service

After training you I help you to get a job without charging you a cent for this service. Employers of draftsmen come to me for men because they know that men I train make good.

"FREE" Pay-Raising Plan

**ENGINEER DOBE, Div. 13-59
1951 Lawrence Ave., Chicago**

Please send me, free of all cost, "My Pay-Raising Plan", also FREE Drafting Book and Draftsman's Pocket Rule. ALL FREE.

Name

Age

Address

Post Office

State



Wouldn't You Trade Jobs With Him?

A transport pilot flying tri-motor planes—working six pleasant hours a day—earning from \$5,000 to \$8,000 a year. Wouldn't you trade your job for his? You can if you only try. With proper training and experience you, too, can become a high salaried transport pilot.

Learn Aviation by Flying

Whether you intend to become a line pilot or plan to enter any of the dozens of other branches of aviation, you should know how to fly. Men who are doing big things in aviation today are flyers. So it will be in the future. Take a course in a Universal school—a school operated by the largest operating system in the world—and get the kind of training and experience that really counts.



Other Courses in Aviation Offered

In addition to flying courses Universal Aviation Schools offer courses in Aviation Mechanics, Aviation Business, and for those who plan to enter aviation later, an Extension Home Study Course in aviation groundwork. Send for outline of training.

Take This Step Now!

Get into aviation while the field is still open. The time to start is NOW. Investigate what Universal Aviation Schools offer you. Check the coupon below, fill it in and mail.

Universal Aviation Schools

A Division of The Aviation Corporation

Universal Flying School	St. Louis, Mo.
Universal Flying School	Minneapolis, Minn.
Universal Flying School	Marion, Ill.
Universal Flying School	Oklahoma City, Okla.
Universal Flying School	Rochester, Minn.
Universal Flying School	St. Paul, Minn.
Universal Flying School	Memphis, Tenn.
Universal Flying School	Cleveland, Ohio
Universal Flying School	Wichita, Kansas
Porterfield Flying School	Kansas City, Kansas

CLIP COUPON HERE

UNIVERSAL AVIATION SCHOOLS
Suite 1047-56, Boatmen's Bank Bldg.,
St. Louis



Please send me at once your free book, "Aviation—What It Means To You." I am interested in:

- Flying Course Aviation Mechanic's Course
 Business Course Extension Home Study Course

Name..... Age.....

Address.....

City..... State.....



N332R101

BE A RAILWAY TRAFFIC INSPECTOR

There's a position and a future in Railway Traffic Inspection for active men 19 - 55 years old. It's healthful, outdoor work with regular hours, paying up to \$250 per month plus expenses. Unlimited opportunities—meet high railway officials—promotions rapid.

Big demand for trained men.

For 11 years we have been training men for this profitable, permanent profession. Railways look to us for men. We'll train you in a few weeks'

EARN UP TO \$250 per mo.

spare time home instruction, and upon completion, assist you to a position paying \$120 to \$135 per month, plus expenses to start, or refund your tuition. Rapid salary advances with experience to \$175, \$200, \$250 per month plus expenses.

Send for free booklet today.

It tells all about Traffic Inspection—how we started hundreds of men to big pay jobs—what it can do for you—how we can assist you to a salaried position with rapid advancement. Send for it now. Don't delay!



STANDARD BUSINESS TRAINING INST.

Div. 2 Buffalo, N. Y.

Amazing Offer!

PHOTOS ENLARGED

Size 8x10 or 11x14 in.

Only **49c** each



At last your chance to get a life-like Bromide photo-enlargement at a small fraction of the regular price reproduced from any clear photograph, tintype or snapshot you mail us. No photo too large nor any snapshot too small. We guarantee return of your original photograph in the same condition as received. You run no risk. Send as many photos as you wish at the bargain price of 49c each.

Send No Money

Simply mail us the photo, with your name and address, and in about a week you will receive a beautiful enlargement that will never fade. We will also send with the enlargement an illustrated circular describing several of our most popular frames. From this circular you can choose the frame which we are giving FREE with every enlargement ordered in colors. On arrival of picture pay postman only 49c plus a few pennies postage or send 50c with order and we will prepay postage. If not delighted we will refund your money.

FREE BEAUTIFULLY CARVED FRAME—As a special inducement to acquaint you with the high quality of our work, we'll frame every enlargement done in Pastel Water Colors—ABSOLUTELY FREE—during this sale only. DON'T PUT IT OFF! MAIL YOUR PHOTO NOW!

ARTWAY STUDIOS, Room 28 Cragin Bank, Chicago, Ill.		Check Size Wanted <input type="checkbox"/> 11 x 14 in. <input type="checkbox"/> 8 x 10 in.
Please send.....enlargements from enclosed photo. I will pay postman 49c plus postage for each enlargement. (If 50c cash for each enlargement is enclosed with this order, we pay postage.)		
Name.....		
Address.....		
Town.....		State.....

You Can Be a "Registered" Radio Technician in 90 Days!

Tremendous Opportunities For Trained Men in This Fast Growing Industry

The School of Engineering of Milwaukee, home of broadcasting station WISN and amateur station W9SO, now offers a complete practical 90 days' course in radio to ambitious men. This great electrical school is helping to supply the great shortage of trained radio technicians by giving the most practical training ever before attempted in the radio industry.

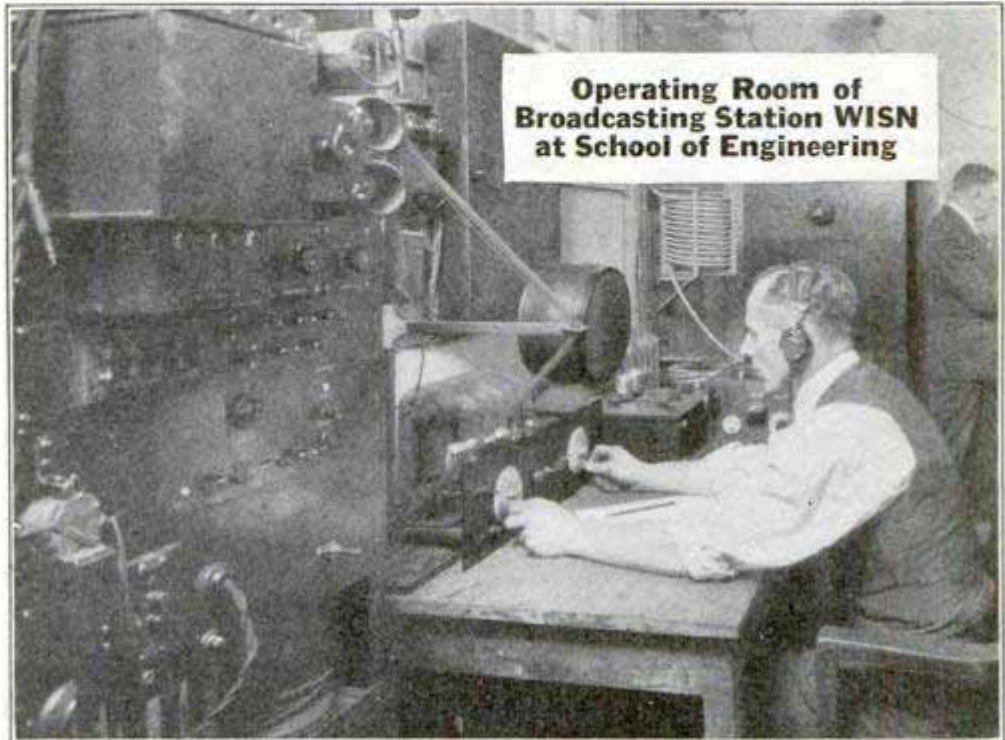

Federated Radio Trade Association Endorses S. of E. Radio Graduates



Read this letter from Michael Ert, Past Pres. of Wis. Radio Trade Ass'n, and now Pres. of the Federated Radio Trade Ass'n:

"We have investigated your Radio and Broadcast Course now being given at the School of Engineering of Milwaukee, and are acquainted with the high quality of educational work you have been doing for years.

Therefore, the Wisconsin Radio Trades Association hereby authorizes you to prepare men to receive Radio Serviceman's Registration Cards, classes A, B or C, of the Wisconsin Radio Trades Association."

The Wisconsin Radio Trades Ass'n now compels every radio service man to pass severe examinations and become registered. Dealers are tired of untrained, incompetent help. Radio trade associations the country over are planning to follow Wisconsin's example. The School of Engineering is the only institution in the country whose course is approved by a radio trade association. Graduates of the S. of E. are "registered."—14 S. of E. men successfully employed by Radio Corp. of America Phonophone, Inc.

Most Thorough, Practical Radio Course in America

Here in this big splendidly equipped electrical school (from which Station WISN is operated) you can secure in three months the most thorough, the most compact, practical radio training offered anywhere. Covers entire field of radio! Complete course includes Radio Laboratory Practice, Radio Telephony Theory, Radio Transmission, Code Instruction, Electrical Mathematics, Service and Installation, Radio Sales and Merchandising. Daily broadcasting from WISN. All training is 100% practical. You learn in three short months!

Part-Time Job While You Learn

If you can finance your tuition we will assist you in getting part-time work to help pay living expenses while at school.



Towers of Broadcasting Station WISN on School of Engineering building. This station now being operated by School of Engineering.

Television Included

Complete Radio Course also includes study of fundamentals of Television and latest developments in that gigantic new field. Enables anyone to keep up with progress of this new industry.

FREE BOOK Mail coupon today for copy of catalog describing the S. of E. 90 days' Radio Course and our Earn-While-You-Learn plan. Write now! Classes Now Organizing.

SCHOOL of ENGINEERING
of Milwaukee

Founded 1903

Dept. P. M. 1229, Milwaukee, Wis.

School of Engineering, Milwaukee, Wis.,
Dept. P. M. 1229.

I am interested in your 90 days' Radio-technician Course. Send me, without obligation, FREE BOOK describing course in detail, also particulars about "Earn While Learning" plan.

Name Age

Address

City State

Let Slamming Doors Pay You \$15 a Day

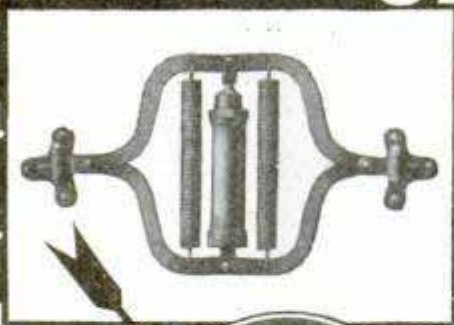

Amazing invention that ends all trouble, annoyance and expense of slamming doors, and brings fortunes to agents. Just one look at this clever device and the sale is made. Can be installed in a few minutes with just a screw driver. Saves nerves, besides enormous loss through broken glass and wasted fuel. Every office, factory, store, institution, or public building needs one for every noisy door.

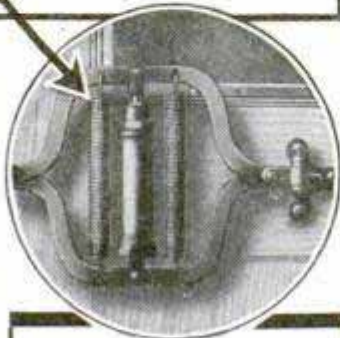

Clever Demonstrator Offered FREE!

LOOK! A FULL SIZED SAMPLE ON MINIATURE DOOR—FURNISHED EVERY ACTIVE AGENT! Can I offer you more than that? An actual working sample mounted on an easy-to-carry, light weight miniature door. With this clever demonstrator you can't fail. Sales pour in, and in just a few minutes time. Demonstrate this clever device—tell how it saves thousands of dollars each year in fuel and broken glass, and you're bound to make good. Mail the coupon for AMAZING FREE OFFER.

Entirely New Principle—Works in Oil

Kant-Slam is different from any other door control. It's not pneumatic, but is built on new oil principle, that controls door like human hand. Gives lifetime service without adjustments. Always efficient in any weather.

Amazingly Low in Price!

Kant-Slam is neat, compact, light in weight and is lowest priced control ever offered with a factory guarantee. Pays big commission that makes agents \$15 a day and more, easily, just showing it. Simple demonstrator does all the work. Just take orders and collect the big commissions in ADVANCE!



Mail Coupon for FREE OFFER

NOW—TODAY! Is the time to mail the coupon for TREMENDOUS FREE OFFER. Get in on the ground floor and clean up the profits being distributed among my representatives. Just open and shut your demonstrator 5 or 6 times a day and you'll be making \$30, \$40, and \$50 a week just as easy as singing a song. You can't afford to wait, because territories are being taken as fast as we can hand them out—mail your name and address on coupon below, and I'll reserve your territory for you.

Kant-Slam Door Check Co.
Dept. T-7 BLOOMFIELD, IND.

KANT-SLAM DOOR CHECK CO., DEPT. T-7, BLOOMFIELD, IND.

GENTLEMEN: Please reserve my territory, and send me full details of your AMAZING FREE OFFER. I am not obligated.

Name.....

Address.....

Town..... State.....

STRAIGHT LINE

30 DAYS TO TRY FREE Mead Ranger RADIO

—10 Months to Pay
SAVE \$25 TO \$100

All Electric With Dynamic Speaker Screen Grid Tubes

The Ranger Radio is a result of 17 years' development. It is to-day fast becoming the most favorably known radio—now leading the field, as its predecessor, the Ranger Bicycle, has for 30 years. The Screen-Grid Tube Ranger Neutrodyne (with 9 tubes) with 2 No. 245 tubes in "Push-Pull" is licensed by R. C. A. Ranger assures you of selective reception from near and distant stations. You may now own one of these distinctive Rangers with Dynamic Speaker in a DeLuxe Console by paying as low as \$10.00 down and balance in 10 months. Table models as low as \$40.00. Rangers come all ready to use—simply insert tubes and plug into your electric light socket—no more trouble than to connect an electric floor lamp.



Write today for big catalog

CYCLE CO.
Mead

MEAD has been known for Ranger Precision Products for 30 Years. Write for marvelous new introductory offer—easy terms DEPT. F173 CHICAGO

2 YEARS TO ENGINEERING DEGREE!

Be a Civil, Electrical, Mechanical Administrative or Chemical ENGINEER in 96 weeks. No entrance examinations or high school diploma required. Low tuition expenses. Degrees conferred by State authority. Catalog FREE. TRI-STATE COLLEGE Box E-9113 Angola, Ind.

ALWAYS Ask for DENISON'S—54 Years of Hits

Comedy - Dramas, Farces, Musical Comedies, Revues, Musical Readings, Comedies, Vaudeville Acts, Monologs, Dialogs, Entertainments, T. S. DENISON & CO. 623 S. Wabash, Dept. 9 CHICAGO

AirMinded Men!



Heed the Call to...

Aviation.

Quickly Train at Home for BIG PAY

If you are seeking a big pay job, get into Aviation! Now—a complete, practical, EASY-TO-GRASP Course in Aviation fundamentals offered at a low price. We teach you—by Home Study—in the quickest possible time the necessary preliminary steps to qualify for position as Pilot, Mechanic, Designer, Motor Expert, Inspector, etc. You are taught every branch of Aviation: Motors, Wings, Assembly, Construction, Design, Nomenclature, Flight Principles, Air Rules, Meteorology, Navigation, How to Handle Ship in Air and on ground and 100 other fascinating subjects. Profusely illustrated with all necessary BLUE PRINTS, diagrams, charts, etc. Endorsed by Aviation experts. Accredited Diploma on graduation. All over America manufacturing, transport, airport service and sales organizations are springing up—with valuable openings for trained men. FREE Employment Service. Write today for your FREE copy of new book, "Aviation."



FREE BOOK

FREE Book Coupon

National Aviation Training, Dept. 120, 1031 So. Broadway, Los Angeles, Calif.

Send me, without obligation, the Free Book "Aviation" and details of your Home Study Course in Aviation.

Name..... Age.....

Address.....

City..... State.....

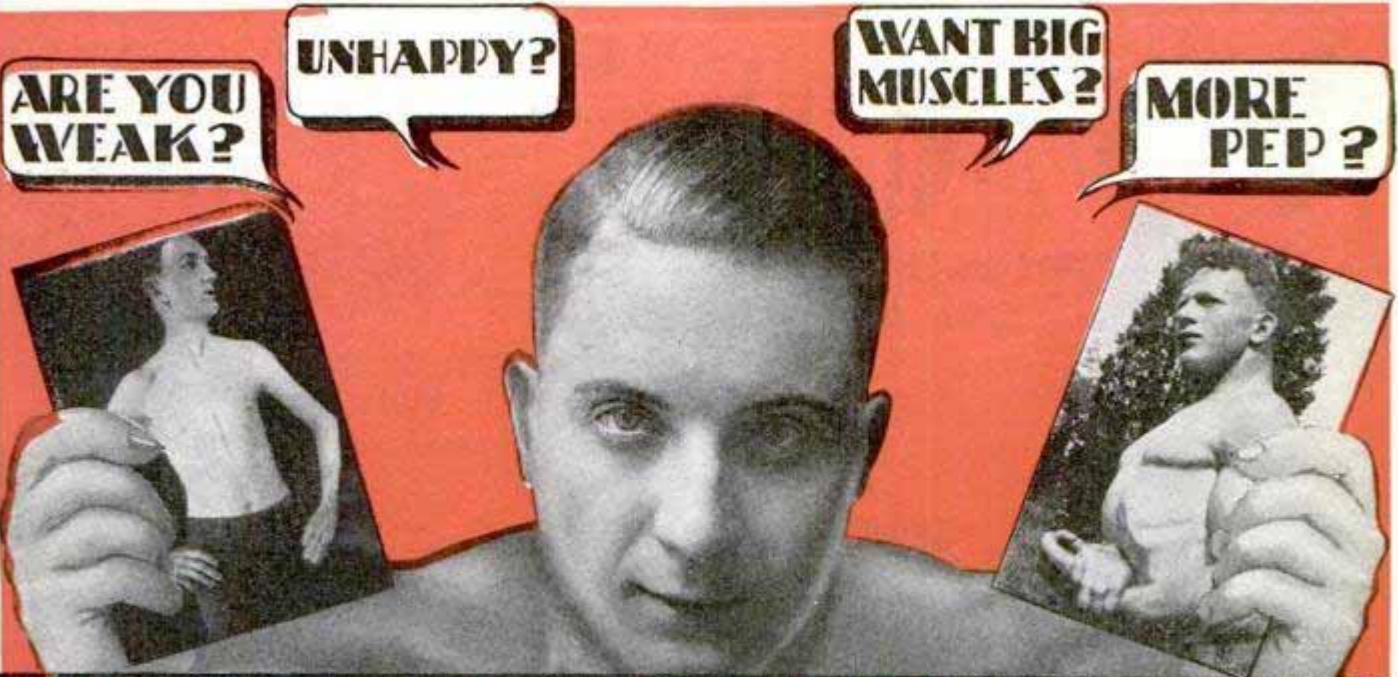

Let Me Show YOU How to Be "BORN OVER AGAIN!"

PICTURE yourself as THE MAN YOU'D LIKE TO BE.

Picture yourself with the strong, handsome body of an athlete, broad across the shoulders, deep-chested, slim and trim at the waist-line—and covered, from head to foot, with powerful bands of brawny muscle!

Would you like to be reborn into THAT MAN?

"The age of miracles is past," you say. Is it? Send for my wonderful FREE BOOK and see! Read that letter at the right. Then read this letter from Franklin Keyfauber, of Keedysville, Md.

"I feel as if I were born all over again. I no longer remain in the back rows of athletics as I did before writing to you. I am very grateful to you for the muscles I now have and thank you many times."

And read THIS:

"It is impossible to express my gratitude for such a miraculous change in so short a time and to put it mildly, I am just amazed." (Signed) Cederic Dawe, Toronto, Can. And THIS:

"Everyone asks me what I have been doing to myself lately and I just tell them it was Titus who made me over from a weakling to what I am today." (Signed) Duncan Robertson, Convert, N. J.

I could go on for page after page giving you instances like these. I could tell you about men of practically all kinds and conditions, young and old, who testify to the amazing change I have made in them—who tell how they have been freed from their weaknesses. I could show you pictures of men transformed from puny weaklings into powerful, muscular PANTHER-MEN.

But I don't want you to take my word for anything. I WANT YOU TO SEE WITH YOUR OWN EYES WHAT I CAN DO FOR YOU.

Make This 30 Day Test

TRY Titus Training for the next 30 days. See whether YOU feel as if you had been "born over again."

Watch Yourself CHANGE in the Next 30 Days

READ THIS!

John Kohler, Jr., of Windber, Pa., writes: "Gee, I feel great this P. M. I feel as though I could clean up on a herd of elephants, not only wild-cats. I'm born all over again, and the credit goes to you and your apparatus. Worked real hard this month but I don't feel tired as I did at one time. Those days are past. My friends notice my sudden change."

One man writes me that he wouldn't trade the set of muscles I gave him FOR A MILLION DOLLARS. Would YOU? Wait and see!

A Few Minutes a Day and Watch those Muscles GROW

Man, here's a proposition you CAN'T refuse. You've heard about my MIRACLES IN MUSCLES—now see one of them worked on your own body. It will just take a few minutes a day—in the privacy of your own room. Follow my simple, easy instructions. No hard work—just a few minutes a day of FUN. My free book tells all about it—mail the coupon.

Let me show you how I develop every muscle in the human body—how I work on your internal organs, too, to tone and strengthen them—how I charge your whole system with surging energy and vitality.

Get the Facts FREE

Don't send a cent. Without cost or obligation I'm going to send you a book that will open your eyes. You'll be amazed at the wonderful possibilities of scientific body-building, at the speed with which you get RESULTS.

Send for your copy of MIRACLES IN MUSCLES now. It's yours absolutely FREE—and no salesman will bother you. Mail the postcard or write—but, brother, do it NOW.

TITUS 853 BROADWAY, NEW YORK, N. Y.

TITUS, Dept. M-145
853 Broadway, New York, N. Y.

Dear Titus: Okay, send that wonderful, big illustrated book of yours, "MIRACLES IN MUSCLES." Get it to me by return mail, without the slightest cost or obligation on my part.

FREE
Mail This
Coupon
NOW



Name.....

Address.....

Town..... State.....

VOICE

NOW! you can have the VOICE you want!



100% Improvement Guaranteed!

No matter how hopeless your case may seem—send for free Voice Book. New SILENT Method of Voice Training. Increases Range. Improves quality. Banish huskiness—hoarseness. 100 per cent improvement *guaranteed*—or money back. Mail coupon *at once* for free booklet—the greatest voice booklet ever written—sent FREE with no obligation!

**Perfect Voice Institute, Dept. 13-59
1922 Sunnyside Ave., Chicago**

Mail Coupon for Free Voice Book

**Perfect Voice Institute, Dept. 13-59
1922 Sunnyside Ave., Chicago**

Please send me FREE and without obligation, Prof. Feuchtinger's new book, "Physical Voice Culture." I have checked subject in which I am most interested.

Weak Voice Singing Stammering Speaking

Name

Address

City State

BOYS A real sensation. The newest development in AVIATION

**"The Eaglet"
Only \$1.00**



A Genuine Duration Scale Model

Very Light and Very Strong

Specifications: Built up model—wood frame. 20 inch wing spread. Fuselage 14 inches. **WEIGHS ONLY SEVEN-EIGHTHS OF AN OUNCE.** This remarkable light weight has never before been achieved in any commercially built scale model of this size. Practically **CRASH PROOF** and has flying qualities galore. The record to date is **92 SECONDS.**

You will get new thrills with this newest and finest type model plane. Wonderful results indoors as well as outdoors. Such a light weight, long flying, *real scale* model will be a revelation to you.

"Win Five Dollars in Gold"

We are offering semi-monthly prizes of five dollars in gold to the one who sends in the best flight record obtained with this model. Full instructions and prize entry blanks are included with every eaglet model. Get yours now. The price is low—order your model now and compete for the prize awards. **CONSTRUCTION SET**—Complete with all parts, plans, instructions and prize entry blanks. Postage free. \$1.00.

Eagle Model Airplane Co., North Haven, Conn.
I have received your "Eaglet" kit and assembled it in one day. Hand-launched and hand-wound it never goes less than 150 ft. at about 30 ft. altitude. Yours truly, LEROY BROWN

Send cash, check or money order. No stamps or C. O. D.



EAGLE MODEL AIRPLANE CO.

DEPT. P12 NORTH-HAVEN-CONN.

Learn Without Study



Amazing Opportunities now open in Electricity

Electricity is the power behind radio, telephoning and telegraphing; it furnishes power for vast industrial plants; and is probably the most important subject in the world today. This new edition of Electrical Engineering is full of important money making information so arranged that you can at once understand how to do many electrical jobs. Fit yourself for advanced electrical work by referring to these facts, through the **JIFFY INDEX** which makes them instantly available. No long hours of study; no tedious grind; put your finger on the facts you want to know and do it **QUICKLY.**

READ Your Way to a Better JOB

Electrical Engineering Revised Edition

8 Volumes, 4300 Pages.
3200 Illustrations.
Gold Stamped Flexible Binding.

Jiffy Index—Vital facts instantly available. Electrical subjects fully covered, including **A. C. radio practice.** Note: If you send now we will include FREE a consulting membership in the American Technical Society.

Eight Big Books Shipped FREE

Yes, just your name and address brings ALL of these books to you

at once. Pay only the few cents delivery charges, look them over, read them, test the Jiffy Index, find out anything you want to know before you decide to keep them.

**The American Technical Society, Dept. E919,
Drexel at 58th St., Chicago, Ill.**

Send me the 8 big books on electrical engineering for free examination. I will pay the few cents delivery charges and if satisfied that these books will raise my pay I will send you \$3.00 and after that \$3.00 a month until a total of only \$34.80 has been paid. Otherwise I will return the books collect in fifteen days and will owe you nothing. I am sending now, in order to get the membership in the American Technical Society FREE.

Name

Address

Employer's Name

Bald Men Look!

FREE



One Full Ampoule of my amazing Hairerbs fluid which I discovered myself and which grew hair on my head.

Here is How I Used to Look

I was just as bald as this picture. It is a true photograph without any tampering or retouching. It is exactly like I used to look. Then look at the full head of hair I have in the picture on the left!

As I have stated so often, I don't know whether I am the first man who discovered this great secret, but I do know I have it, that I grew my own hair and that I am growing hair on the heads of other men.



This Ampoule is absolutely free. Don't send any money. There is no C. O. D. No charge whatsoever. All I want is an opportunity to show you the fluid with which I grew hair on my own and on other men's heads. Merely mail the coupon below for Free Ampoule.

Bald Men

It's No Joke to Be Bald!

I grew my own hair just as it shows here.

When the free Ampoule arrives you will see how different this new treatment is.



These are exact untouched photographs of Miss Augustine Raimondo, 2350 East 25th Street, Cleveland, who was almost entirely bald and who had to wear a net covering in the school room. She was a very unhappy young lady. Physicians, hospitals and clinics told her that she would be bald for life. She saw one of our advertisements, became interested and began taking treatments with Hairerbs. The growth of hair was surprisingly fast. A hairy fuzz began to appear after twelve treatments. More hair came steadily until today Miss Raimondo has a full head of hair which is daily becoming more luxuriant. This case is open to investigation by anyone.



What I accomplished on my own head and on other heads I believe I can do for you, provided you are under 45 years of age and loss of hair was not brought about by burns or scars or other causes leading to absolutely dead hair roots. Anyhow, I must succeed or your money is refunded in strict accordance with my guarantee. No apparatus. My home treatment is simple, and easily applied.

Mail this FREE-Coupon

Mail the coupon today—Right Now—I will send you, immediately, one full Ampoule of my marvelous Hairerbs fluid which I discovered, of which I hold the secret and which grew my own hair on my own bald head. Besides the Free Ampoule of Fluid, I will send photographs, names and addresses of men and women who successfully used my Hairerbs Fluid for dandruff, falling and loss of hair.

FREE COUPON
VREELAND 1359 Euclid - Windsor Bldg. CLEVELAND, O.
 Please send me, entirely free, one full Ampoule of the same Wonderful Hairerbs Fluid which grew your hair.
 My Name _____
 My Address _____
 State _____

VREELAND 1359 Euclid - Windsor Bldg. CLEVELAND, OHIO

\$100 A WEEK NOW



*How did I do it?
Ask L.L. Cooke-He'll show you how*



Own Shop Pays Big Money
"You taught me all I know about Electricity. Last month I made \$675 in my new shop." J.E. Ritch, Rt. No. 3, High Point, N. C.



Now Makes \$12 A Day
"A short time ago when I enrolled, I was a laborer at small pay. Now I make \$12 a day. Sure am well satisfied with Cook Training." Robert Korn, 203 S. Maple, Newkirk, Oklahoma.

That's the answer of Fred Girard, Paris, Ark., when friends ask what put him on Easy Street

GIRARD was just like you — just like thousands of other fellows struggling along on small pay—working long, hard hours with no chance for promotion and no hope of big money. Then he got mad at his lack of progress and asked this great Electrical School to help him. Now look at him. He's got a fine job in Electricity—he's making \$100 a week and more—he's on Easy Street with a future that offers him all the good things of life.

Why Don't You Get Into Electricity, Too?

You want quick success — you want Big Pay. Then why don't **you** get into Electricity. Learn like Girard and hundreds of successful Big Pay Men learned — with the famous tried and proven L. L. COOKE "Work Sheet and Job Ticket" Method. It's simple, easy, practical — just like actual shop experience, with the big complete outfit of apparatus given you without extra cost. Yet it's all done in your spare time, in your own home.

If Making Less Than \$60 A Week — Investigate

Why earn only \$20 or \$30 a week when hundreds of "Cooke Trained Men" are making \$60 to \$100 a week in Electricity. Investigate. Find out for yourself all about this wonderful Training that has made "Cooke Trained Men the Big Pay Men" everywhere. Mail coupon for Big Free Book that tells all about Cooke Training, about the famous Money Back Agreement, and about the brilliant opportunities in Electricity. Get this Big Pay-Raising Book. Mail the coupon at once.

L. L. COOKE SCHOOL OF ELECTRICITY

Dept. 19 2150 LAWRENCE AVENUE CHICAGO, ILL.

L. L. COOKE SCHOOL OF ELECTRICITY
Dept. 19, 2150 Lawrence Avenue, Chicago, Illinois

You may send me, FREE and fully prepaid, your book "Secrets of Success in Electricity," with all particulars about your Home Study Course in Electricity.

Name _____
Address _____
City _____ State _____

THE COOKE TRAINED MAN IS THE BIG PAY MAN EVERYWHERE

Classified Advertisements

WORLD'S BEST WANT AD MEDIUM

Advertisements in this section, 35 cents per word, each insertion, minimum 10 words, payable in advance
To be printed under proper classification in January issue, copy should be in our office November 18th

ADVERTISING AGENCIES

ADVERTISERS. Our 32 years mail order experience at your disposal. 68 page self-help guide, with United States map in colors, giving complete information best paying daily, weekly and monthly publications sent free. Frank W. Lenhoff Advertising Agency, 66 East Lake St., Chicago.

GET into advertising. Learn quickly at home. Experience unnecessary. New easy plan. No text books used. Practical work. Old established school. Send name and address for interesting free booklet. Page-Davis School of Advertising, Dept. 3437, 3601 Michigan, Chicago.

ADVERTISE—24 Big Sunday newspapers, 24 words only \$15.00. Excellent for securing agents, salesmen or business opportunities. Catalog listing 1,000 dailies, weeklies, monthlies, mail-order publications, everything. Free. Wade Agency, Great Northern Bldg., Chicago.

INCH Display advertisement 50 magazines year \$24. Wood's Popular Services, Atlantic City, N. J.

ADVERTISE 50 Magazines 3c word; \$3.00 inch; 5,000 country weeklies 1c line per paper; lists free. Evans King Co., 672P, Wilmington, Del.

ADVERTISING: 24 Words 8 newspapers \$5; free list; magazines, farm, trade. Le-Grand Agency, 34 West 33rd St., New York.

BEFORE Advertising get our catalog. No charge. 25 years in business. The largest classified agency in the world. Ankrum Advertising Agency, 100 No. LaSalle St., Chicago, Ill.

FREE—New 1929 Advertisers Rate Guide, 44 pages. Includes everything. Lowest rates. E. H. Brown Advertising Agency, 140 S. Dearborn, Chicago.

ADVERTISE in rural weeklies. Lists free. Meyer Agency, 4112 Hartford, St. Louis, Mo.

TIME Counts in applying for patents. See pages 156 and 157. Clarence A. O'Brien, Registered Patent Attorney, Washington, D. C.

FOR ADVERTISERS

ADVERTISE—28 Words in 62 different country town newspapers, \$3.40. Lists free. Miller, Box 14-M, Elmwood Station, Syracuse, N. Y.

"THE Master Letter Writer," including 500 successful letters, by Ad-Man Davison, world-famous letter expert; 704 pages, \$3. Circular sent. Opportunity Press, Westport, Conn.

SALES PROMOTION

\$50 TO \$50,000 Daily sales secured for our clients. Though physically handicapped this client launched his present business 12 years ago with \$20 borrowed capital. Today his sales are nation-wide. He is a recognized leader in his field. For several years our copy, counsel, plans have served to further increase his sales. 35 years salesmanship-in-print experience back of our campaigns. Submit sales problems for free diagnosis. 10 years Sales Promotion Manager Larkin Co., James C. Johnson, 118A Woodbridge Ave., Buffalo.

LETTERS Worded to sell anything worth buying. Request evidence, naming your business. Jed Scarboro, South Orange, N. J.

I SPECIALIZE Writing sales letters. Satisfaction guaranteed. R. M. Thompson, 504 W. Glenaven, Youngstown, Ohio.

MAILING LISTS

BIG Free rate list describes 300,000 classified names. Many kinds; guaranteed correct; priced right. De Muth, 88-15 82nd Ave., Glendale, N. Y.

SEND \$1.00 For \$1,000 rural women buyers names. Sheasgreen, PM1427 North Penn, Minneapolis, Minn.

LETTER SPECIALISTS

BUSINESS-BUILDING Mailorder letters—circulards—folders—campaigns. Investigate! Finkel Advertising, 131P Glenwood, Jersey City, N. J.

AUTOMOBILES

TIME Counts in applying for patents. See pages 156 and 157. Clarence A. O'Brien, Registered Patent Attorney, Washington, D. C.

AUTOMOBILE SUPPLIES

USED Air compressor, fully automatic, upright space saving type, beltless. Reconditioned and guaranteed like new. Shipped on trial and easy terms. Also a few test stands, car washers, battery chargers and paint sprays. E. M. Connor, Box M-1292, Troy, Ohio.

GARAGE. Service stations: Make money with harmless, odorless, non-freezing radiator liquid. Costs 25c gallon. 300% profit. Particulars \$1.00. Froproof, 509 Fifth Ave., New York City.

"SPRINGS Of silence."—Universal anti-rattler. For the noisy 4 wheel brake rods all cars. Ask your dealer. Universal Spring Co., Grand Rapids, Mich.

SPEED Specialties, carburetors, motor and ignition parts, automobile ornaments, radio supplies, wholesale prices. Wireless cigar lighter 90c. Catalog and bargain list 10c. Green Engineering Co., Dayton.

OIL Gauge wiper. Cleans gauge rods instantly. Readily installed. Only 10c. George Koch Sons, 2112 Pennsylvania St., Evansville, Ind.

IS Your motor sluggish? Carbon removed and power restored overnight by simple method anyone can follow. Send 25c per cylinder. Money back if not satisfied. Motor Tonic, Box 521, Dayton, Ohio.

YOU Are wanted to resilver mirrors at home. Immense profits plating autoparts, tableware, etc. Write Sprinkle, Plater, 77, Marion, Ind.

OIL Pumping stopped. Spark plugs clean, same rings in most cars. Simple idea for shop and owner. Detailed directions for \$1.00. Ring extractor free. Motor Specialties, Hinsdale, Ill.

AUTO Carburetor attachment adds "pep" and speed; immediate start anytime; saves gas; no carbon. \$1.25. Whirigas, 816 Ford Bldg., Detroit.

CARBEX, Automatic carbon remover. Always a clean engine. Special price now \$5.00. Regular price \$7.80. The Carburetor Man, 4437 Madison St., Chicago, Ill.

WANT More mileage? Wonderful new humidifier (moisture) gas saver. All autos. One sent for test. Vix, RL-805, Wheaton, Ill.

AUTO Parts new and used. Lowest prices. Bankrupt supplies, motors, wheels, radiators, transmissions, generators, gears, carburetors, touring tops complete \$15. Bracketing 50% off. Brightman, 2065 Main St., Hartford, Conn.

RADIATORS At wholesale prices. All standard makes. Satisfaction guaranteed. Send for prices, stating make and model. Independent Radiator Co., 1119 S. Wabash Ave., Chicago.

AUTO SERVICE EQUIPMENT

SAVE Money—Garage equipment reconditioned and guaranteed like new. Unusual bargains in test stands, car washers, battery chargers, air compressors, etc. Shipped on trial, easy terms. What do you need to complete your equipment? E. C. Galbreath, Box M-1294, Troy, Ohio.

GARAGE Men, tiremen, service stations. The quick way to remove pneumatic truck tires from their rim without injury to either. Applies to all solid circle side mounted rims. Can be removed in from one to five minutes. \$10.00 for complete simple illustrated information. No machine. No further expense. Reference Ladd & Bush Bank. Address J. E. Richardson, Lock Box 302, Salem, Ore.

WANTED—Garages, mechanics, battery stations to nickel-silver plate auto parts. Big money sideline. Write promptly. Lincoln Engineering Company, 855-D South 37th, Lincoln, Nebr.

AUTO Service station building plans. Write for plan booklet. Beeman, 656 Brentwood, Detroit.

BIG Opportunity in 8-hour battery charging. Let me tell you how you can install equipment with practically no investment. Earn \$150 to \$300 monthly from it. Bargains in used outfits. Write today. Also have a few reconditioned car washers, paint sprays, automatic air compressors. I. C. Helmick, Box M-1293, Troy, Ohio.

BATTERY Chargers for service stations. Several makes. New and used bargains. Get price sheet. Adams-Barr, Columbus, Ohio.

FOR FORD OWNERS

WANT More mileage? Wonderful new humidifier (moisture) gas saver. All autos. One sent for test. Vix, RM-805, Wheaton, Ill.

AURORA Underslung parts and 3.1 racing gears. Speedster bodies, headlights, hi compression head. See Sport Factories ad page 142.

SPECIAL Model A Ford heater. Low price. Write Broquist, Mfr., Chisago, City, Minnesota.

MOTORCYCLES, BICYCLES AND SUPPLIES

MOTORCYCLES \$25 To \$50. Easy terms. Tires \$2.50, frames \$3, forks \$3, tanks \$5, wheels \$4, chains \$2, saddles \$5, handle bars \$5, engines \$15, side cars \$25, transmissions \$12, belts \$6, airplane engines \$15, airplane wheels \$5, bicycle tires \$1.25, velocipedes \$7.50, bicycles \$9.50, new auto tires \$3, used auto tires \$2.50. Send 50c for catalogs. Price Cutter Deninger, Rochester, N. Y.

DO You like motorcycles? Then get into business for yourself. Ride a shiny brand new Indian and own an Indian motorcycle shop for yourself. Write us and we will tell you how to get started on the road to success in work you will like. Indian Motorcycle Company, Springfield, Mass. Dept. TAH.

MOTORCYCLE Bargains, lowest prices, bargain sheets for stamp, special aviators supplies, motorcycle accessories largest line in America, lowest prices. Largest motorcycle mail order house in the United States. Rochester Harley Davidson Corporation, 129 West Main St., Rochester, N. Y.

HARLEY-DAVIDSON Bargains at a tremendous sacrifice. All models and prices. Guaranteed. Send for our catalog. "Money Saving Motorcycle Bargains." Knuth's Harley-Davidson Agency, 2525 Fond du Lac Ave., Milwaukee, Wis.

BARGAINS Used motorcycle parts for all makes. Goodyear balloon tires, \$8.25. J. B. Dahl, 3661-63 Archer Ave., Chicago, Ill.

SEND 15c For latest used motorcycle catalog. All makes. Indian Motorcycle Sales, Kansas City, Mo.

MOTORCYCLE Parts, new and used. Lists free. Tower Cycle Co., Pine Lawn, Mo.

AVIATION

LATEST, Best and up-to-date aviation books. Modern Aircraft, 900 pages, 500 engravings. Price \$5.00. Everybody's Aviation Guide, 256 pages, 140 illustrations. Price \$2.00. ABC of Aviation, 160 pages, 150 illustrations. Price \$1.00. Modern Aviation Engines, 2,000 pages, more than 1,000 engravings in two large volumes. Price \$9.00 for the set. All these books are written by Major Victor W. Page. Also the latest book on the subject of "Aerial Navigation and Meteorology," by Capt. Lewis A. Yancey, who made the famous flight from Old Orchard, Maine, to Rome, Italy; 350 pages, 102 illustrations. Price \$4.00. You make no mistake in ordering any of these books as they are all standard works, and some are used in 150 schools for instruction purposes. Any of these books sent prepaid on receipt of price, or just send us a card ordering book desired, and you can pay postman the price of book and postal charges when book is delivered. We publish books on more than 150 different subjects, and will send catalog on request. Norman W. Henley Publishing Company, 2 West 45th St., New York.

AIRPLANES Motors and propellers bargains. Smith, Box 1343, Houston, Tex.

PROPELLERS 4', \$6.00; 5', \$10.00; 6', \$14.00. Propellers for snow and ice sleds, boats, road speedsters, canoes, hydroplanes and airplanes. Special propellers built to order for all types of craft. We carry the largest stock of small propellers in the United States. Twenty years of propeller building plus mass production means better propellers for less money. We ship the same day. Write for our free price list. The Crawford Motor and Airplane Manufacturing, Inc., Seal Beach, Calif.

HEATH Henderson motors are aircraft motors built by aircraft engineers. During 6 years of intensive flying we have refined this motor to the point of perfection. For aerial drive of sleds, boats, sea planes or airplanes they have no equal. Remanufactured motors may be had as low as \$190 or brand new for \$325. Send 10c in stamps or coin for large illustrated booklet. Heath Airplane Co., Chicago, Ill.

FOR Sale—Airplanes, flying boats, airplane motors and supplies. Sheeplined leather helmets, \$5.50; furlined, \$8.50; special leather jackets woollined, \$16.00; leather coats woollined, \$18.00; sheeplined, \$23.50; polarbear jackets, \$18.00; leather breeches, \$12.00; nonshatterable goggles (oval) \$2.50; wide-vision, \$3.50. Logan Aviation, 716 W. Superior, Cleveland.

INSTRUCTION Book. Five hundred aviation questions correctly answered. Postpaid \$1.00. Geo. Tuck, 73 South Shirley Ave., Pontiac, Mich.

LIGHTPLANE Wheels, 25x380, pair \$12.00, with tires tubes \$30.00; Russel sport wings, new, \$100.00; Empenages, \$12.00; Clark Y ribs, \$0.75; Lightplane glider supplies, circulars 20c. Kamm Aircraft Co., 524 12th St., Oshkosh, Wis.

AEROPLANE Models and 6 cyl. air motors, the finest to be had. Send 10c coin, new catalog motor driven models, 5 foot, rubber driven, 2 foot. Miniature Aircraft Corp., 83 Low Terrace, New Brighton, N. Y.

HEATH Propellers for the aerial propulsion of sleds, boats or airplanes always gives the best results. They are made to fit the particular condition involved, accurately figured by engineers of 21 years' experience specialized in air propulsion. 4c in stamps brings our propeller catalog. Heath Airplane Co., Chicago, Ill.

NEW And used sport plane motors, water cooled. Bergholt Aircraft Co., 143 East Lake St., Minneapolis, Minn.

DURALUMINUM Construction set, pursuit type single seater, Straightaway and stunt flyer \$1.25 postpaid. Send five cents for manual; teaches building and flying this plane. Foster's Model Airplanes, 5303 Hudson Boulevard, North Bergen, N. J.

GET The latest sportplane constructor book. Full of blueprints, photographs, drawings, detail instructions, etc. Postpaid \$1.00. May save you hundreds. Circular free. Russell Aero, Box 455, Toledo, Ohio.

MODEL Airplane supplies. Send 5c for large catalog. National Model Aircraft & Supply Co., 29 P. North Ave., New Rochelle, N. Y.

LATEST Automatic tilting aeroplane model free with examination course on aerodynamics \$10.00. Navigation without instruments \$5.00; design \$5.00; operation \$5.00; meteorology \$5.00, by correspondence instruction. Model without course \$2.00. Kasmar Rollepter, 1070 Milwaukee Ave., Chicago.

TEN Cents brings our new bargain list of light planes, motors, propellers, hubs and blueprints. Storms Aviation Co., Spartanburg, S. C.

SPECIAL Sale on slightly used converted Harley motors and others, some as low as \$25.00 complete with propeller. Send dime for bargain list and catalog. Sensenich Brothers, Lititz, Pa.

2c POSTAGE Stamp will bring you complete model airplane supplies price list. Lowest in the country for its high quality. A. A. C. Model Aircrafts, 340 East 188th St., New York.

THE American School of Aviation announces a new correspondence course in mechanics of aviation. A thorough training in practical aeronautics. American School of Aviation, Dept. 1872, 3601 Michigan Ave., Chicago, Ill.

WACO Tens—0x5 motors recently overhauled. Several late model planes, first class condition. Priced from \$1,200.00 up. These ships are bargains. Washington Air Terminals, National Press Bldg., Washington, D. C.

BOYS—Model airplanes supplies 2ft. Curtiss Hawk Flying Model Construction Set containing all necessary parts. \$2.50. Baby R. O. G. Kit, 50c. Send 5c for booklet. Hawthorne Model Aero Co., Hawthorne, N. J.

WRITE For new free book, "Aviation." Tells you quickest way to get into aviation, money earned, etc. Also describes new method of home-study training that is preparing hundreds of men for big pay jobs. Address National Aviation Training, Dept. 121, 1031 South Broadway, Los Angeles.

PONTOONS, Pontoon-kits and blue prints are now available for the Heath Super Parasol, America's most popular sport plane. See our ad page 162 this issue. 10c in stamps or coin brings large illustrated booklet. Heath Airplane Co., Chicago, Ill.

TIME Counts in applying for patents. See pages 156 and 157. Clarence A. O'Brien, Registered Patent Attorney, Washington, D. C.

DRIVE Your ice-sled with your auto or motorcycle motor. Send 10c for price list of conversion parts. Heine Motor Works, Orwigsburg, Pa.

SEVENTEEN Inch Balsaplane, guaranteed flier, 50c. Catalog 5c. Marx Aircraft, 320 South Fourth East, Salt Lake, Utah.

PLANS For constructing sport monoplane. Use Ford or Chevrolet motor. Bergholt Aircraft Co., 143 East Lake St., Minneapolis, Minn.

ZEPPELINS! Boys! They're easy to build with our plans. Blue prints 3-foot models Los Angeles, Graf, Italia 50c a-piece. List free. Southern Aero Model Co., 1421 No. Washington Ave., Dallas, Tex.

PROPELLERS For model aeroplanes. Semi carved, 6", 8", 10", 12" 10c each. Any size. Aero Shop, 3050 Huribut Ave., Detroit, Mich.

AIR Plane 150 h.p. Sisso motor for sale. \$600.00. A. J. Simpson, Box 583, Wewoka, Okla.

\$100 FLYING Course. Six hours, including solo. Only \$10 an hour for additional solo time. Allison Airplane Co., Lawrence, Kans.

SPORTPLANE—\$25 Payments. Buy the Also Junior coupe monoplane. We deliver the knockdown parts to you express prepaid in eight convenient groups. Blueprints sold separately, \$2.50 per set of four big sheets. Allison Airplane Co., Lawrence, Kans.

BIGGEST, Best catalog model airplanes; parts, supplies; 5c postpaid. Ideal Company, 19 West 18th St., New York.

VARIOUS Sizes wood, reeds, bamboo, rubber band, wheels, propeller, onion skin covering and other supplies. Big bundle for 25c, five for \$1.00. No stamps. Will also send circular on free three foot model. Aero Shop, 3050 Huribut Ave., Detroit, Mich.

PROPELLERS—4', \$8.75; 5', \$13.25; 6', \$16.50; Special Henderson propeller, \$15.00; Aerodrive boat or sled blueprints, 50c each. Helmets, \$3.00; goggles, \$3.00, both only \$5.00. Engines, fuselages, Ostergaard Aircraft, 4303 North Narragansett, Chicago.

BOYS: Get a pursuit tractor kit complete 35c. No stamps. Send 5c for price list. W. & J. Aeroplane Shop, 200 Maple St., Wyandotte, Mich.

BOOKS AND PERIODICALS

4TH EDITION, revised "Radio Theory and Operating," by Mary Texanora Loomis. The standard radio text and reference book of America. 992 pages, 800 illustrations, flexible binding. Price \$3.50 postage paid. For sale by hundreds of book dealers throughout America and many foreign countries. Or may be purchased direct from the publishers. Send check or money order to Loomis Publishing Company, Dept. 18, Washington, D. C.

INDUSTRIAL Alcohol. Wright's book. Full directions for making, fully illustrated. \$2.50. Spon & Chamberlain, 120 P.M. Liberty Street, New York, N. Y.

HILARIOUSLY Funny book, "The Specialist." Generally known but seldom mentioned subject. \$1.00 postpaid. Smith's Place, 153 Tenth Ave., Charleston, W. Va.

"MASTER Key," 400 pages psychology—Inspiration—Success. Handsome binding, \$2.75. Phipps, 1014 Belmont, Chicago.

PICTURES AND POSTCARDS

FRENCH Lovers photos. Love scenes of French girls and fellows. Taken from five poses. Imported direct from France. 12 for \$1.00. All different poses. Carrano Novelty Co., Dept. PM-D, West Haven, Conn.

MOVIE Stars pictures 5x7, 3 for 25c, 7 for 50c, 15 for \$1.00; 8x10 25c each your choice postpaid. VanWart, 4816 Fountain, Hollywood.

BULLFIGHTING Scenes. Ten photographic postcards \$1. Something original for Xmas greetings. Brown, Box 7062, Mexico City.

ART Pictures—220 all different. 160 samples \$1.00. Particulars 10c. Howard Sales Co., Dept. 15, Box 529, San Francisco, Calif.

NOVELTIES, CURIOS, ETC.

NOVELTIES. My big bargain envelope 25c. Frank L. Chase, Burlington, N. J.

MEXICAN Jumping beans. World's greatest curiosity. Samples with Mexican game card 35c. Hundred with five cards, \$1.00. Stamps or cash. Midwest Novelty Company, 1508 Main St., Kansas City, Mo.

GAMES, ENTERTAINMENTS AND PLAYS

PLAYS, Musical comedies and revues, minstrels, comedy and talking songs, black-face skits, vaudeville acts, monologs, dialogues, recitations, entertainments juvenile plays and songs, musical readings, make-up goods. Catalog free. T. S. Denton & Co., 623 So. Washburn, Dept. 11, Chicago.

VENTRILOQUISM—Complete course, 50c Premier, 1980 Dorchester Ave., Dorchester, Mass.

VENTRILOQUISM By mail—small cost, 2c stamp brings particulars. Geo. W. Smith, Room S-373, 125 N. Jefferson St., Peoria, Ill.

MAGIC TRICKS, BOOKS AND JOKER NOVELTIES

"THE Book of 1,000 Wonders" explains many mystifying tricks with coins, cards, handkerchiefs, etc. Also contains complete catalog of magic tricks, jokes, puzzles, books, escapes, mind-reading acts, spiritualistic effects, illusion plans, curios and imported novelties. Largest assortment, lowest prices. Amaze and mystify your friends! Send 10c today. Lyle Douglas, Station A-5, Dallas, Tex.

MAGIC—Tricks, Books and Supplies. For amateurs as well as the great professionals. Anyone can learn through our instructions. Feature Acts in Mind-Reading, Spiritualism, Rope Ties, etc. Large illustrated professional catalog, 20c. Chicago Magic Co., 140 So. Dearborn St., Dept. B, Chicago, Ill.

TRICKS With cards. Easy to do. Produce any card called for. Name any card drawn from pack. 6 tricks for 25 cents, including large catalog listing over 600 tricks. Wizard Magic Co., Dept. 15G, Box 1055, Station "C", Los Angeles, Calif.

MINDREADERS—1930 Planetary forecasts. 22-paged manuscript 40c. Birthdate. Matthew, 5202 Avalon, Los Angeles, Calif.

EIGHTEEN Magician's tricks, \$1.00, including 29 pieces equipment, balls, dice, magiccards, etc., and wonderful performing secrets. Weber, 647—E4—62nd, Chicago.

NEW Magic and joke catalog free. Eagle Magic, Minneapolis, Minn.

BOOK Of 153 magic tricks and big magic catalog, all for 20c stamps. Midwest Novelty Store, 1312 Main St., Kansas City, Mo.

BARGAINS! Cigaret through handkerchief 25c. "Cortini's" newspaper trick, 25c. Catalogs, 10c. "Stringer", 3020-A, Sheffield, Chicago.

MAGIC Catalog 20c. Lynn's, 105 Beach, Dept. 3, Jersey City, N. J.

BOOKS, Magic imported herbs, incenses, perfumes, gifts, novelties. 100-page catalog, sample 10c. Marelle Company, 160 N. LaSalle, Chicago.

MAGIC Tricks and novelties. Send 15c for illustrated catalog. E. Kay Magic Shop, 8832 Commercial Ave., Chicago, Ill.

SEVEN Magical Delusions and catalogs—25c. Gilmagico, Morgan Park, Ill.

ELECTRIC Fun! Seventy stunts, 110 volts, \$1. Kutting Sons, Campbell, Calif.

CHALK TALKS

LAUGH Producing program, \$1.00. Catalog free. Balda, The Cartoonist, Oshkosh, Wis.

MAKE 'Em laugh with magical cartoons. No talent needed. Entertain lodges, clubs and parties. G. E. Hendrickson, Argyle, Wis.

STAMP COLLECTING

FREE: Stamps from Bolivia, Roumania, Spain, Australia, to those sending 10c (coin) and 2c stamp for album with spaces for hundreds of stamps, free perforation gauge and packet of 80 different stamps. 150 diff. stamps 10c. 4 Vatican stamps 10c, 10 Persia 10c, 20 Turkey 10c, 12 Cape Verde 10c. Argonaut Stamp Company, Dept. 15, New Canaan, Conn.

MAGNIFICAROUS Packet free—Realities from distant lands, many richly colored, unusual designs. 2c postage. Empire Stamp Co., Toronto, Can.

NOW On sale. 1930 edition Scott's standard postage stamp catalog. Cloth bound, \$2.00; with thumb index, \$2.50; forwarding extra, 3 lbs. For sale at all dealers. On sale in December, 1930 edition specialized United States postage stamp catalog, pocket size illustrated, \$2.00. Post free. Start your subscription with the October issue. Start the stamp year right by sending \$1.00 for a year's subscription to Scott's Monthly Journal. It contains a monthly supplement to the catalog, giving new issues and price changes, and it lists many exclusive bargains that will many times repay you the price of your subscription. Sample copy free. Scott's Stamp and Coin Co., 1 West 47th St., New York, N. Y.

MYSTIC "Queer Country" Packet! Contains scarce stamps from the following strange lands: San Marino, Antioquia, Congo, Cyprus, Fiji Islands, Gwalior Hyderabad, Iceland, Jhond, Kenya, Uganda, Lebanon, Monaco, North Borneo, Nyassa, St. Thomas Prince, Eastern Roumelia, Siam, Sierra Leone, Tanganyika, Trinidad Tobago, Ubangi, Upper Volta, Wallis Futuna, Alaouites. Get this wonderful packet of "freak countries" and make your friends envious! Price only 10c to approval applicants! Write today. Mystic Stamp Company (Dept. 8), Camden, N. Y.

500 DIFFERENT Stamps for 25c. Big collection from Bosnia, Crete, Epirus, Honduras, Iceland, Kenya, Liberia, Malta, Nyassa, Quellmane, Siam, Zambesia and other "hard" countries. Catalog value \$10. Price 25c to approval applicants! Bargains. 1,000 different 79c; 15 triangles 49c; 100 Africa 45c; 100 Asia 50c; 100 Balkans 35c; 100 British Colonies 30c; 100 French Colonies 35c; 100 Portuguese Colonies 50c. Eight packets for \$3.00! Illustrated lists free. Lema Stamp Co., 4231 42nd St., San Diego, Calif.

ANCHERS \$\$\$ Outfit—only 12c! Fine triangle stamp; set German stamps with (pre-war) value forty million dollars (interesting!); perforation gauge, mm scale; airmail set; scarce stamp from smallest republic on earth; newspaper set; packet good stamps and Travancore, Malay, Dutch Indies, etc. Entire outfit for 12c to approval applicants! (Nice pocket stock book, value 25c, with every order!) Ancher Stamp Co., Box 126, Rutherford, N. J.

A SNAP—300 Different foreign and 60 different U. S. stamps, including \$1 and \$2 revenues, all for only 25c. Free, with each order, our pamphlet which tells "How to Make a Stamp Collection Properly," together with our price lists of albums, supplies and hundreds of bargains in sets, packets, etc. Queen City Stamp & Coin Co., Room 36, 604 Race St., Cincinnati, Ohio.

UNDERSTAND Your U. S. stamps. Just what you need. Our U. S. library (illustrated) gives full descriptions of all U. S. issues. Volume 1, issues 1847-1869, 50c; volume 2, issues 1870-1893, 50c; volume 3, issues 1894-1900, 50c; volume 4, issues 1901-1929, \$1. Illustrated descriptive price list of U. S. and B. N. A., 50c. Our 32 page list of U. S. and B. N. A. free on request. Stanley Gibbons, Inc., 38P Park Row, New York City, N. Y.

DANDY Colonial set free with approvals. Wm. Monjar, 1551 Knox, Cincinnati, Ohio.

THRILLING War scenes. A packet of all different stamps showing exciting scenes and records of nations at war. Includes siege guns; firing squad; mounted troops; prisoners of war; fire-pot hurlers; hand-to-hand bayonet struggle; bloody battle scenes; troop transport; red cross stamp; dying soldier; victory stamps, etc. Send for this thrilling "Big Parade" packet at once—limited supply. Only 10c to approval applicants. W. A. Rowell, 58 Cornhill, Boston, Mass.

125 FOREIGN Stamps 30c. No duplicates. Allegheny Stamp, 101 Chestnut, Natrona, Pa.

U. S. 5 DIFF. Comms. 6c. 50% approvals. H. E. Sandstrom, 2412 Noyes St., Evanston, Ill.

FREE, Necessary article and packet odd stamps for 8c, mailing costs. Kenley, 432 Chestnut St., Westfield, N. J.

UNITED States, Canada, Newfoundland price list free. Reliant Stamps, 65 Nassau, New York.

5 ICELAND Free to approval applicants. Edward Hammond, Auburndale, Mass.

FREE Canadian packet to approval applicants. Postage 2c. Dominion, Box 222, Toronto, Can.

RARE Congo airmail and 5 other airmails in our packet. 61 different from Antioquia, Hyderabad Morocco, Oceania, etc., 5c. Approvals and free lists. Monumental

FREE! Largest stamp in the world! Fine packet 65 different stamps from Cape Verde, Jamaica, Mozambique, Syria, etc., including dying soldier, beautiful women, ships, maps, savages, airplane, scenes, bird and animal stamps, for only 5c to approval applicants. Largest Stamp in the World (Rare China Wild Goose Special Delivery) given absolutely free with each order. Supply limited! Send your 5c today! Western Philatelist, 6021 Harper Ave., M12, Chicago.

VIKING'S "Extraordinary" outfit! Contains choice stamps from Iraq, Sudan, Johore, Gold Coast, Cyprus, Travancore, Orange River Colony, Malta, etc.; scarce Mauritius revenue; largest stamp in world; packet French and Portuguese colonies; beautiful bi-colored charity set; and valuable premium. This de luxe outfit only 10c to approval applicants. Bargain 1,000 different stamps 75c. Viking Stamp Co., P. O. Box 63, Sheepshead Bay Station, Brooklyn, N. Y.

UNUSED United States stamps at face value. Your government has nearly 100 different stamps to sell to collectors at face value. Pamphlet describing Government Philatelic Agency, list of stamps it has for sale, and sample copy of "Washington Stamp News," all for 10c. A. N. Nickles, 213 Seaton, Washington, D. C.

UNITED States \$2 present issue (catalogs 50c) for ten cents to approval buyers. State size of collection. Leduc, Redlion, Penna.

WRITE For free samples South American stamp weekly. Semanario Filatelico, Peru 309, Buenos Aires, Argentine.

500 MIXED 15c. 100 Var. U. S., 23c. 100 var. precancels, 17c. Charles Peugh, Elma, Wash.

WRAP Dime, receiver over 100 airmail, triangles, old U. S., foreign. Bargain box, \$1.00. 100 nice U. S., 35c. Philatelic Mission, 533 Santa Rosa, Calif.

MOUNTED Stamps, \$10.00, for \$1.00 Richards, W 44th, Shadyside, Ohio.

SALVADOR Triangle free with 100 diff. Greece, India, Japan, etc., 5 cents; approvals. Frank Allen, 19 North Park, Auburn, N. Y.

STAMPS At 1c each; 125 vars., \$1.00; superlative value. 300 vars., cheap but good, 35c. C. Ritchie, Watertown, S. Dak.

CANADIAN Commemorative, a complete set of 9 var. air mail, 5 beautiful picture stamps and 100 other stamps, all for 5c to collectors who ask for our approval sheets. Prices on approvals, $\frac{1}{4}$, $\frac{1}{2}$, $\frac{3}{4}$ a 1c, etc. Lowest prices and best quality. Kelgwin Stamp Co., P. M., Fernandina, Fla.

FREE—1,000 Mixed U. S. stamps. Particulars 2c. Weatherby, Willoughby, Ohio.

ICELAND Pictorials, Cat. 75c; 15c with approvals. Bob Soderborg, 915 1st Ave., Salt Lake City, Utah.

KEDAH 5 Diff. 10c. Bargain lists free. Henry George, 985 Seventh St., Milwaukee, Wis.

25 DIFFERENT Egypt catalogs 90c for 15c; 25 airmail 10c. Ray Bovard, Fort Benton, Mont.

FREE! One thousand dollars—Free! 100 varieties from Prussia, Alsace, Romyana, Bergedorf, Hanover, etc., cataloging thousand dollars free to all who send \$1.00 for life subscription to our weekly bargain list. Maison Eugen Le Blanc, Ltd., 1754 Prytania, New Orleans, La.

25 DIFFERENT Portugal colonies 5c, 25 different French colonies, 5c. Approvals. Holjub, Deland, Fla.

FELLOWS—Valuable United States envelope collection free. Supply limited. 2c postage. J. G. Ferguson, 1919 W. 41st St., Los Angeles, Calif.

PANAMA Lindbergh packet; 55 different super quality, includes Lindbergh Panama, Canalzone, Central American, others. L. Lord, Pedromiguel, Canalzone.

MY SPICE Islands, 29 different better grade stamps several from Kedar Johore, Malay states, North Borneo, Philippines Straits, etc., for 12c to approval applicants. Elder, 114 Pine, Wollaston, Mass.

FREE Set Ukrania unused to approval applicants enclosing stamp. Monroe, Point Pleasant, W. Va.

33 1-3c COMMISSION. Sell our stamps, sheet catalog value, \$4. Our price, \$2.00. Unsold stamps returnable. No investment required. References necessary. Lux Stamp Co., 805-C Fairmont Place, Bronx, New York.

300 DIFFERENT Stamps 15c. Approvals. Michael, 942 So. 23rd, Bellwood, Ill.

333 DIFFERENT Stamps 25c; 111, 10c; 11c, approvals. Robert Mosher, 323 New,

SPECIAL. Watermark detector, instructions for use, stamps to watermark, etc., all for fifteen cents. Lake Stamp Co., Toledo, Ohio.

3 BEAUTIFUL Sets of Congo, Nyassa, Persia. All for 10 cents. Lufberry Stamp, Branford, Conn.

50 UNUSED Stamps 10c. Bell Co., Box 455, Washington, D. C.

ROUMANIA, Young king Michel, 5 va. only 10c. Bargain list free. Rheume, 7748 Henri Julien, Montreal, Can.

100 VARIETIES, Foreign stamps 10c to honest collectors. C. Taylor, Cross St., Newport, R. I.

BIG Combination, including nice packet Liberia, scarce Turkestan, Sudan, Famline Stamp, Azerbaijan, packet others and fine pocket wallet. All for 10c to approval applicants. Rogers, 1136 Woodland Ave., Houston, Tex.

FREE Bargain list. Stamps from Hawaii, Mayotte, Cyprus, Gold Coast, Kena, North Borneo. 100 diff. and 2 old coins all for 20c. H. Rissmiller, 620 N. 12th St., Reading, Pa.

100 DIFF. Stamps and three months' subscription 10c. Philatelist, 56 Times Square Station, New York.

FREE—25 Beautiful French colonies to approval applicants. Reference required. Adams, South Brownsville, Pa.

200 DIFFERENT World 10c; 50 different Portugal colonies 10c. Louis Morrison, Sharon Hill, Pa.

FREE: 100 Diff. and price list to app. appl. against ref. 1,000 diff. 95c; 500 diff., 40c; 10 White Russia, 10c. Cherokee Stamp Co., 275 Hill Crest Ave., Macon, Ga.

NETHERLANDS, 451-3 Free to approval applicants sending references. Beebe, 1253 Chestnut, San Francisco.

BEGINNERS Surprise packet free to approval applicants. Reference please. 3c postage. Superior Stamps, Midland, Ontario, Can.

BETTER Grade stamps, 100 different, listing over \$6.00. Price \$1.00. (No free junk included). Real investment. Bargain circulars free. Tropical Stamp Exchange, Pinnellas Park, Fla.

25 AIRMAIL Stamps free with 3 mos. subscription to livest stamp paper published for 25c. Stamp News, 1476 Broadway, New York City.

100 DIFFERENT U. S. stamps, 75 cents. Jungkind, Box 144-P, Little Rock, Ark.

SAMOA, Siam, 3 each, 12c. Approvals. Simmons Stamp Company, Horton, Mich.

GOOD Stamps on approval. Premium. G. Bluedel, Box 84, Hamlet, Ind.

CONFEDERATE Essay set free with 200 different stamps for 12c. 1,000 fine mixed stamps 35c. Webers Stamp Shoppe, 1377 Park, Plainfield, N. J.

FREE Packet to approval applicants. Suttus, 10234 Traverse, Detroit, Mich.

MINT Blocks, 100 different 50c. Lowe, Box 1387, Spokane, Wash.

WHOLESALE: 100 Airmail 20c; 100 French colonies 20c. Alvin Johnson, Storm Lake, Iowa.

STAMPS—50 Different foreign stamps; illustrated album; stamp hinges; perforation gauge; big illustrated catalog. Send 10c for complete outfit. W. Betts, Clearfield, Penna.

STAMP Tongs free to purchasers of one 10c packet of 50 different from 50 different countries. Paul Revere Stamp Co., Box 40, Astor Station, Boston.

FREE 25 U. S. with approvals only. Postage 3c. Ref. please. F. E. Gaerte, 4707 N. Hermitage Ave., Chicago.

100 DIFF. United States 25c. 1,000 mixed 25c. 70% approvals. Burton, Madison, N. Y.

118 STAMPS Free with approvals. L. W. Hudson, Plainfield, N. J.

U. S. MISSION 35c A pound. 5 new Hebrides 10c. 4 Flume 5c. Lists free. Mech Stamps, 4512 No. Racine, Chicago.

STAMP Collectors Magazine. Finest monthly stamp paper. Write for free sample copy. Philatelic Publishing Co., Inc., 15 John St., New York, N. Y.

REVENUES—Telegraphs—Every country. Pretty—Intriguing—Cheap. Mint \$5.00 revenue free to applicants with references. Vanderhoof, 1114 Logan, Denver, Colo.

FREE—7 Different Newfoundland stamps. Atlantic Stamp Co., 68 Garden St., Springfield, Mass.

FREE! Airmail packet with approvals. Aladdin, 1350 Carol, St. Paul, Minn.

105 CHINA, Etc., 2c. Album (500 illus-

FAR-A-WAY Land's packet, including Zanzibar, San Marino, Orange River Colony, Union South Africa, Southern Rhodesia, Hong Kong, Transvaal, Malay tiger, Triangles, Air Mails, etc. Only 10c to approval applicants. McEwen, 755 Wilson, Columbus, Ohio.

FREE. 5 Scarce African, 2c postage. Stamp Importers, Rosebush, Mich.

5 **CONGO** Free to approval applicants. Edward Hammond, Auburndale, Mass.

STAMPS—100 Varieties, Africa, Brazil, Peru, Cuba, Mexico, etc., 10c; 25 different U. S. 25c; 1,000 mixed, 40c; 1,000 hinges, 15c. C. Stegman, 5941 Cote Brillante, St. Louis, Mo.

THOUSANDS of stamps at 1c each—catalog values disregarded. Arrow Stamp Co., Winthrop Terrace, Meriden, Conn.

FREE Outfit! 52 stamps, hinges, pocket wallet. Postage 4c. Approvals, Milton Angle, South Berkeley, Calif.

FREE—Scarce two dollar postage stamp to purchasers of our superior British Colonial packet, only 10c to approval applicants. Globus Stamp Co., Dept. B, 214 Third Ave., New York.

CONGO, Free, five fine to approval applicants. Bernard Karch, Bengies, Md.

SOUTH Central America, 40 different, 10 cents. Approvals. Croston, Box 25, Haverhill, Mass.

PACKETS, Sets, hinges, albums, etc. U. S., British and French colonies. Lists free. Carl Young, 1208 Chestnut St., Phila., Pa.

ATTRACTIVE Assortment, Central American with additional interesting unusual stamps, 2c postage only. Midland Stamp Company, Toronto, Can.

STAMPS Free. 12 large showy picture stamps, also 12 diff. British colonies for a request for my popular approvals at 50% discount. None better. Good supply of U. S. postage, 2c. P. F. Quinn, 1113 W. Nevada St., Philadelphia, Pa.

FREE Stamps with approvals. 2c postage. Harvey Teepie, Decatur, Ind.

75% **APPROVALS** 3c; 1,000 Stamps 20c; 4,000 75c; well mixed. Geo. Best, Cedar Rapids, Iowa.

WATERMARK Detector free! Approvals. Tatham Stamp Company, 49 Van-horn, West Springfield, Mass.

ONLY 5c! 10 Airmail stamps, including scarce Latvian triangle stamp, Portuguese Red Cross set and 8 different Latvian Occupation stamps. Approvals and free lists with each order. Curhan Stamp Company, Gloucester, Mass.

COVERT'O Packet, 200 different stamps 10 cents, with 60% discount approvals. Covert Stamp, 39 State, Rochester, N. Y.

STAMPS Sent on approval at 70% discount. Reference required. Emory Renoll, Hanover, Pa.

FREE—31 Different stamps to applicants for Royal approvals. 2c return postage. Royal Stamp Company, Bristol, Pa.

40 **DIFFERENT** United States with latest pricelist 12c. Approvals at 60% discount. Seidenberg, Baroda, Mich.

"**NEWFOUNDLAND**" Means "Rev. Butler." Collectors need my catalog (free). Rev. Butler, St. Georges, Newfoundland.

UNITED States stamps on approval. Reference essential. Stamp House, 38 Torrey, Dorchester, Mass.

BULGARIA—25 For 10c to approval applicants. Cleveland Stamp Co., Caxton Bldg., Cleveland.

SPECIAL 500 Different from all parts of the world, 25c to approval applicants. Ohio Stamp Co., Box 249, Cleveland.

SURPRISE Packet—Borneo, Congo, Malay, United States Commemoratives, Illustrated list, etc., to approval applicants 8c. Moseley, 4521 Parkview, St. Louis, Mo.

150 **GOOD** Mixed foreign stamps 3 cents. Stanton, Niantic, Conn.

FREE—\$1.00 U. S. postage old issue free. If you write for our 56 page price-list of U. S. and foreign stamps. 2,000 illustrations. Also fine but cheap stamps on approval. Hussman Stamp Co., 620-3 Olive St., St. Louis, Mo.

FREE—Canada (15 Var.) for new applicant of my 1c, 2c and 3c approval, and also my 50% discount. Chas. W. Schmidt, P. O. Box No. 4832, Frankford Sta., Phila, Penna.

1% **APPROVALS**. Including Liberia, Nyassa, etc. Also 14,000 averaging 1½c. References. Philatelic Exch., Huntington, W. Va.

110 **DIFFERENT** Stamps, many unused, high values, free to collectors requesting our net approvals. Postage 2 cents. Christensen, Milwaukee, Wis.

ONLY 25c For a five months' subscription to The Stamp Collector, America's finest stamp magazine. 100 all different stamps given free to each subscriber. Money refunded if you are not more than pleased. The Stamp Collector, Dept. P. M., 515 Sedgwick Drive, Syracuse, N. Y.

25 **SCANDINAVIAN** 10c. M. Gustafson, 766 East, New Britain, Conn.

ATTRACTIVE Approvals at 50% discount and 25% discount. Noemus Stamp Co., 312 East 23rd St., New York.

PENNY Approvals that Satisfy. Neil Gronberg, Box 5441, Philadelphia, Pa.

FREE! 115 Different stamps to approval applicants, 2c postage. Paige Stamp Co., Oak Park, Ill.

110 **NEW** Europe All Different, a wonderful collection cataloguing several dollars, free to collectors requesting our Net Approvals. Postage 2 cents. Badger Stamp Co., Milwaukee, Wis.

COMPLETE Sets on approval. References necessary. Kenneth White, Rockville, Conn.

FREE! Triangles, airmail, Iceland and 50 others to approval applicants inclosing 3c postage. Hawkeye Stamp Co., Cedar Rapids, Ia.

UNITED States—Send on approval. Send me your want list. Ref. please. M. Hanna, New Kensington, Pa.

200 **DIFFERENT** stamps 10c; 1,000 hinges 10c. R. H. Carlton, 380 W. So. Temple, Salt Lake, Utah.

STAMPS, 100 all different. Postage 2c. Lists free. P. M. Quaker Stamp Co., Toledo, Ohio.

24 **VARIETIES** Cuban stamps, 10 cents. List of 6,000 low-priced stamps free. Address Chambers Stamp Co., 111P, Nassau St., New York City, N. Y.

FREE 50 British Colonials, if approvals requested. Postage 4c. Berkeley Stamp Co., South Berkeley, Calif.

BEST One cent approvals in America. F. P. Hand, 1117 So. 60th St., Philadelphia, Pa.

101 **STAMPS** Free with approvals. Postage 2c. Johnson Stamp Co., (PM) Jamestown, N. Y.

111 **DIFFERENT**, Arabia, Azerbaijan, Zanzibar, etc., 10c to approval applicants. Floyd Marsh, 524 Hamilton Ave., Indianapolis, Ind.

BARREL Of foreign stamps while they last. 25c-1,000 or pound \$1.00 (over 4,000). Approvals sent. Hinges 3,000-25c. Elmer, 61 Court St., Boston.

FREE—20 Different Argentine. Approvals. List. Send 4c today for postage, etc. Reuter, Santa Ana, Calif.

RARE COINS

RARE Coin book, 700 illustrations, 65 cents. Exhibition of United States and colonial coins, 130 pages, 40 plates. Price \$2.00. History and Issues of Private Gold Coinage of California, 1849-1855. Price \$7.50. Latin-American Coinage, 500 pages, 2,000 illustrations, 6,000 coins. Price \$7.50; postage. Foreign \$10 plus postage. Money returned if not satisfactory. Wanted, old paper money (no Confederate or Foreign). Guttig Bros., 95 Broad St., New York.

UNITED States commemorative half dollars. Pilgrim 89c, Monroe 89c, Stone Mountain 79c, Lexington 89c, Lincoln \$1.19, Norse American \$1.19, California \$1.09, Huguenot \$1.69, Bennington \$1.29, Oregon \$1.29, Grant \$1.39, Trade Dollars \$1.19; 10 large cents 79c; 10 two cent pieces 79c; 10 three cent pieces 89c; old coin and bargain price list 10c. Arcy, Box 483, Muskogee, Okla.

40 **OLD** Coins all different, \$1.00; 100 different coins, \$3.00; 100 different Germany war-coins, \$2.00; 5 different porcelain coins, 50c; 50 different Germany banknotes, 50c; 10 different Mexico bills, 50c. Claud Denney, Box 315, Dallas, Tex.

50 **DIFFERENT** Coins 50c; 15 different coins 25c. Oddehon, Box 681, Kansas City, Mo.

OLD Money wanted. Do you know that coin collectors pay up to \$100.00 for certain U. S. cents? And high premiums for all rare coins? We buy all kinds. Send 4c for large coin folder. May mean much profit to you. Numismatic Co., Dent, Ft. Worth, Tex.

10,000,000 **MARK** And list 10c. Greenclay, Box 2551, Denver, Colo.

ONE Million dollars in foreign money, 50c. Craig, 670 E. 42d, Brooklyn, N. Y.

CALIFORNIA Gold quarter 27c; half, 52c; \$3 Georgia 1856, 20c; Connecticut 1787 cent, 60c; farthing, 5c. A. Wylie, 365 Wheaton, Ill.

BUYING List old coins, stamps free. Harry Kelso, Pittsburg, Kans.

CALIFORNIA Gold 8½-50c. Twenty coins 60c. Chester Brooks, Cuero, Tex.

COMMEMORATIVE Half dollars uncirculated; 1920 and 1921 Pilgrim, 90 cents each; Lexington, Bennington, \$1 each. Lincoln, Grant, Oregon, \$1.25 each. G. T. Davis, Box 1791, Huntington, W. Va.

ROMAN And Chinese coins 25c. Durso, 25 Mulberry, New York City.

10 **CIVIL** War cents, 50c; 10 handsome foreign bills, 35c; 10 Confederate bills, 50c; 10 historical medals, 50c; 10 Indian arrowheads, 60c; 10 large copper cents, \$1.00. Catalog free. Nagy, 8 P. South 18th, Philadelphia.

BARGAINS Scarce coins; 12 dates large cents, \$1.00; 3 2c pieces 25c; 5 3c pieces 50c, 20c piece, 50c; 100 different foreign \$2.00; 50, \$1.00; 25, 50c. Romanocolonshop, Springfield, Mass.

25 **DIFF.** Fine foreign coins, 55c, 12 diff. fine coins 25c. Willbert Bishoff, Ottawa, Kans.

FINANCIAL War relics. Collectors derive lasting satisfaction from our free list. Preatorius, 1629 Meyer Court, Chicago.

\$2 To \$500 Each paid for hundreds of old coins. Keep all old money, it may be very valuable. Send 10 cents for illustrated coin value book, 4x6. Prices guaranteed. Get posted. We buy and sell. Clarke's Coin Office, Box 5, Le Roy, N. Y.

RARE United States, foreign coins, war medals, Chinese coin and catalog 10c. Alexis Mengelle, Colorado Springs, Colo.

AMERICAN Coins, bought, sold. Coin value booklet, 12c. Frank Saco, 735 45th St., Brooklyn, N. Y.

CALIFORNIA Gold—Quarter size, 27c; ½ size, 53c; 3c piece and catalog, 10c. Norman Shultz, Box 746, Salt Lake, Utah.

GET Profit and pleasure in collecting old coins. Send 10c for large illustrated coin catalog. You'll be delighted with it. Send for it right now. B. Max Mehl, Numismatist, Mehl Bldg., Dept. P, Fort Worth, Tex. Largest Rare Coin Firm in the U. S.

OLD Coins, large fall selling catalog of coins for sale free to collectors only. Catalog quoting prices paid for coins, ten cents. William Hesselein, 101A Tremont St., Boston, Mass.

3 **DIFFERENT** Fine bronze or nickel coin, 2 large crisp bank notes and catalog 10c. George Best, Cedar Rapids, Iowa.

UNITED States, Large cent, two-cent bronze, three-cent nickel and bargain list, 25c. Thirteen dates large cents, \$1.00. George Coffin, Greenwood Mountain, Me.

FOR BOYS

EARN Christmas money. Order 50 sets Christmas seals. Sell for 10c set. When sold return \$3.00, you keeping \$2.00. No work—just fun. St. Nicholas Seal Co., Dept. 43PM, Brooklyn, N. Y.

BOYS! Subscribe for the "Trailer." 50c year. Valuable premiums free! The Trailer, 1539 Kominsky, Chicago.

CAMERAS AND PHOTO SUPPLIES

BARGAINS: A few practically new items taken from our bargain book issued free: 2½x4¼ Eastman 1A pocket kodak, with f: 6.3 Anastigmat lens kodex shutter, \$14.25, 10x15cm., Ica Trix Camera with Carl Zeiss 1c Tessar f:4.5 lens Compur shutter, 3 plate holders and adapter \$63.75, and many others. Get your copy now. Ten days' trial allowed. Central Camera Co., 230 S. Wabash Ave., Dept. PM-12c, Chicago, Ill.

EXPO Watch Camera. Every tick a picture. Complete \$5 outfit postpaid \$3.98. "Fits the Christmas stocking." G. Genert, Inc., 24 E. 13th St., New York, N. Y.

TRIAL Roll developed and 6 newstyle border prints 25c (silver). Klunker Film Service, Dyersville, Iowa.

TIME Counts in applying for patents. See pages 156 and 157. Clarence A. O'Brien, Registered Patent Attorney, Washington, D. C.

KODAK Films developed 5c roll. Prints 3c each. Trial offer. 8x10 enlargement 25c. Sample holiday greeting card from your own negative 10c. Young Photo Service, 495 Bertha St., Albany, N. Y.

EARN Big money with your camera in your spare time, using Hallderson Home Portrait Lamp. Write for booklet "Home Portrait Photography" and catalog—both free. The Hallderson Company, 4748 N. Western Ave., Chicago.

MAKE Money in photography. Learn quickly at home. Spare or full time. New plan. Nothing like it. Experience unnecessary. American School of Photography, Dent, 3432, 3601 Michigan Ave., Chicago.

SAMPLE Enlargement—dime, and negative (returned). Trial roll, glossy prints, 25c silver. Brown, Warsaw, N. C.

HAVE You a Camera? Write for Free sample of our big magazine, showing how to make better pictures and earn money. American Photography, 116 Camera House, Boston, 17, Mass.

FILMS Developed. Special Trial Offer. Any Size Kodak film developed 5c, prints 3c each. Trial 6x10 Enlargement in handsome folder 40c. Overnight Service. Roanoke Photo Finishing Co., 209 Bell Ave., Roanoke, Va.

GERMAN Cameras. Lenses. Barttro, 129 W 3rd St., Los Angeles, Calif.

MOTION PICTURES

SOUND Motion Pictures! The great and only authoritative text book on this subject by James Cameron, world's foremost authority. 400 pages complete information on all systems—Vitaphone, Movietone, Phototone. Methods of recording, maintenance of equipment. Complete information for projectionists and all interested. Thousands sold. Send for your copy, \$5.00 postpaid. Bass Camera Company, Motion Picture Headquarters, 179 W. Madison St., Chicago, Ill.

\$1.250 FOR Original photoplay story. Our sales department sold unknown author's first story for above amount. We revise, copyright and market stories for both silent and talking pictures. Located in the heart of motion-picture industry. We know the demand. Established 1917. Free booklet. Universal Scenario Company, 206 Western and Santa Monica Bldg., Hollywood, Calif.

325 FEET \$1.10. New lists. Hoffman Film Service, 57 Broad, Albany, N. Y.

BARGAINS: Just a sample few, practically new, 35mm., Sept camera, for motion or still pictures, large spring model, six magazines and case, \$23.50. 35mm., Klix motion picture camera with B & L Tessar f:3.5 lens, 100 foot capacity, \$47.50, second hand, 35mm., Hall projector, hand driven, electric illumination, \$39.75. For other bargains see our bargain list issued free. Everything is fully guaranteed and ten days' trial allowed. Central Camera Co., 230 S. Wabash Ave., Dept. PM-12c, Chicago, Ill.

MOVIE Bargains. Felix-Gump-Mutt and Jeff cartoons, \$10 each. Complete features, \$15.00; single and 2 reel comedies, \$5.00. S. Remington, Box 524, Cincinnati, Ohio.

BARGAINS—Excellent films, talking equipment, projectors. Marshall Films, Rome, Ga.

FILMS Bought, sold, exchanged. No-Wat-Ka, 195 Broadway, Paterson, N. J.

MOVIE Cameras \$16.50. 250 ft. film, 99c. Movie titles, 5c ft. No-Wat-Ka, 195 Broadway, Paterson, N. J.

FILMS, Machines. Stamp for list. Box 255, Hickman Mills, Mo.

MOVIE—Films \$2.45 per 1,000 feet, postpaid. Comedies, etc.; odd reels drama, features, \$1.95 per reel. A bottle of genuine film cement free. List free. Scholefield, Jr., 6801 So. Carpenter St., Chicago, Ill.

350 FEET New film \$1.25. Searles, 130 Fisk St., Providence, R. I.

BARGAINS: Machines, films, supplies, stereopticons. National Equipment Company, Duluth, Minn.

MOVIE Films. Standard size, 250 feet Western or Comedy, \$1.00 postpaid. Home Movies, Box 744, Minneapolis, Minn.

TIME Counts in applying for patents. See pages 156 and 157. Clarence A. O'Brien, Registered Patent Attorney, Washington, D. C.

FILMS \$2.25 Per reel; three motographs reasonable. Rector Film Service, Champaign, Ill.

FILMS \$2.00 Reel, 250 feet \$1.00; 5-reel feature \$10.00. Werner-Leslie, 4442 South Broadway, St. Louis, Mo.

FILMS—250 Feet 80c, 1,000 ft. \$2.50. 5 late news reels \$9.00. Savarese, 149 Palisade, Union City, N. J.

SPRING Motor 35m movie camera \$25; movie projector, \$35. Negative stock 2 cents foot. Pathex camera and projector, \$33. Bargains in 16m cameras, kodaks, typewriters. Ray, 266 W. 46th St., New York.

WANTED Young men—To train as theater managers and theater advertising managers. Big opportunities. Theater Managers Institute, Elmira, N. Y.

1,000 FEET Of film \$2.00. No lists. Sunset Film Exchange, 298 Turk St., San Francisco, Calif.

FILMS, 200 Feet \$1.00. Reels \$2.50. List. Edgeworth Sales, Box 155, Blue Island, Ill.

FILM Bargain (new) theatre size, natural color, Indians, cowboys, scenes, big stars, 3 1/2 foot; sample 10c; no lists. Horizon Film Co., 37 Church St., Boston, Mass.

THE Bass Bargaingram No. 198 hot off the press, culminating twenty years of success with a tremendous offering of bargains in rebuilt standard and amateur Motion Picture Cameras, Projectors, Accessories, Text Books. The great bargaingram will be sent to you for 4c in stamps. Send for your copy today. Bass Camera Company, Motion Picture Headquarters, 179 West Madison St., Chicago, Ill.

GOOD Film—300 feet \$1.00. Reels \$2.45. Samples, lists, particulars for stamp. Eastin Feature Films, Galesburg, Ill.

NEW And rebuilt projectors for theaters, schools, churches, traveling shows. Supplies and complete theater equipments. Bargain prices. Free catalog. Monarch Theatre Supply Co., Memphis, Tenn.

MOVIE Films, 1,000 ft. reels, \$2.50 each; shipped anywhere on receipt of remittance. Particulars on request. Independent Films, 177 Golden Gate Ave., San Francisco, Calif.

RADIO SETS AND SUPPLIES

\$5 RADIOS All makes Atwater-Kent, Majestic, R. C. A., and others. Hundreds—world's best makes. Used, new and rebuilt. Going at \$5 to \$65. Many formerly priced at \$150 to \$300. Amazing bargains. Backed by responsible guarantee and 30 years' experience. Write for big free list today. Brown's Radio Exch., Dept. E, 3018 East 91st St., Chicago.

NEW 300-Mile "pocket" radio, \$3.50. Complete with special loud receiver. No tubes or batteries required. Order direct. Spencer Laboratories, 116 Atlas, Akron, Ohio.

RADIOS \$6.65 And up. Free bargain list. Bright Bros., Radio, 5608 Milwaukee Ave., Chicago, Ill.

RADIOLA III (RCA), \$29.00 cash, guaranteed. Peak, B77, Boulder, Colo.

LIFELONG Underground aerial, less static, better reception. No lightning danger, guaranteed for life. Only \$4.00 prepaid. Expert Radio Shop, 14236 Indiana, Detroit, Mich.

TIME Counts in applying for patents. See pages 156 and 157. Clarence A. O'Brien, Registered Patent Attorney, Washington, D. C.

AMAZING! New! Phantom aerial eliminates outside aerial, enables you to hear new distant stations never before heard, small, compact. Instantly attached any set. Only \$2.75 postpaid. Monarch Radio Corp., 8328 West Vernor, Detroit, Mich.

RADIO World, only national illustrated weekly. Latest radio developments. News-dealers, 15c. \$6 yearly. Special: \$1 trial subscription 8 weeks, free "A" battery tester. Radio World, 145 West 45th St., New York.

TRADE AND TECHNICAL SCHOOLS

OUR Extension course covers entire subject of radio. Graduates allowed three months finishing course free at the college. Tuition charge moderate. Have always placed graduates at pay ranging \$150 to \$300 monthly from the start. Write for catalog. Loomis Radio College, Dept. 7-A, Washington, D. C.

START A business of your own. Big profits and no competition. Make harder and better granite than any from a quarry—beautiful, polished marble for 10c ft.—onyx, turquoise, agate, etc., at one tenth cost of natural stone—fireproof paint, 16c gal.—roofing, flooring, wallboard, terrazzo of all kinds. We teach formulas and methods. Write International School of Cement Arts, 443E Washington St., Portland, Oreg.

BE A blue print reader. Write for facts. See how men in your trade got to the top. What's your trade? Carroll Ramsey, Drexel Bldg., Philadelphia.

HILES Watchmaking and engraving school. The largest and best equipped school in the west. 5330 Mission St., San Francisco, Calif.

DRAFTSMEN! Be an expert. By our method we train you quickly. Books and tools furnished. Write for illustrated catalog. Columbia School, 204P Drexel Bldg., Philadelphia.

LEARN Morse and wireless telegraphy. Big salaries. Tremendous demand. Expenses low, can earn part. Catalog free. Dodge's Institute, Fern St., Valparaiso, Ind.

BUSINESS OPPORTUNITIES

MAIL Order business your opportunity. Breniser's famous hand books by expert 28 years' experience show how to start selling articles you make or buy—all or part time—small capital. Fascinating, profitable. Set eleven books, \$3.25. Breniser Company, 1607 P. Sansom, Philadelphia. Sample book 25c, pay \$3 for other ten if satisfied.

BIG Free printing line brings easy quick profits. Union label. Bigger commissions—up to 55%! Experience unnecessary. Now write orders with America's most profitable printing stationery line. Thousands of free cuts. Over 150 standard items covering every business need: letterheads, noteheads, envelopes, billheads, business cards, statements, garage forms—shipping, battery, dry cleaning, tire, storage, parking and hat-cleaning tags; repair forms; blotters, gummed shipping, drug, advertising stickers, etc. Lowest prices. Steady repeat orders. Ship everywhere. New free outfit just off press. Write quick. Dept. 177, Box 498, Cincinnati, Ohio.

READ The Mail Order News—America's pioneer mail trade journal. Quarter century old. Approximately 600 pages yearly of valuable information for beginners and established mail-order houses. Analyzes mail-order business, its opportunities. Practical mail-order ideas, legitimate money-making schemes, instructive articles. Tells how to start, what to sell. Published monthly. Subscription \$3.00 yearly. Send 25c for sample copy. None free. Mail Order News, 500 Fifth Ave., New York.

WITHOUT Exception most profitable opportunity ever offered. Unlimited possibilities—plan unique—unbelievable results; small investment for advertising matter only; no stock to carry; permanent income; no effort required; tremendous number buyers developed automatically. We warehouse and deliver for you. Anyone can succeed with this most profitable of all sales plans. For full particulars write The Finance Corporation, Desk K, 522 McKnight Bldg., Minneapolis, Minn.

LOIDLAC. Chemist's amazing new discovery. Forever ending automobile polishing and repainting! Instantly restores all colors, producing hard, brilliant lustre-finish. Guaranteed water, sun and weather-proof. You make Loidlac from my guaranteed exclusive copyright-protected formula for \$1.40 gallon, sell at \$14.00 a gallon profit! Write for exceptional offer. Miller, Chemist, 707 Jetton, Tampa, Fla.

ARTIFICIAL Marble sanitary flooring instructions, covering wood or cement flooring 1/2 inch thick, fireproof, waterproof, all colors, low cost. Ornamental casting, concrete, plaster, papier-mache decorations, garden furniture, statuary, flexible molds. 18 years instructing the public; particulars and illustrations free. Chris. Mahler, Huntington, N. Y.

HERE'S A chance to get into a permanent and profitable business with your earnings keeping pace with your ability. We teach you. You earn from the start. Begin in your own locality. You join a \$12,000,000 company. A big, national advertiser. We have a place for a few more reliable men. Write Dept. "T," The Fuller Brush Company, 3580 Main St., Hartford, Conn., for full particulars.

SUCCEED With—food—automobile—household—toilet or medicinal specialties of your own. Successful manufacturer and advertiser—will teach a limited number of ambitious people—how to manufacture—sell and rapidly build up—a real—highly profitable—successful business. Little capital required. An exceptional opportunity. Detailed information free. C. Ruskin and Company, 1501 Euclid Avenue, Cleveland.

LEARN Marbleizing concrete products all kind. Wood or metal with vitreous cement, our new industry. It resembles polished marble, onyx, granite, etc., flintlike hardness. For garden furniture, veneering concrete slabs, table tops, wallboard, everything, put on like paint gives glassy face finish. Membership inexpensive. Dime brings samples and literature. Cowell Institute, Grayling, Mich.

START Business of your own, making investigations, securing evidence for firms and individuals, with the Ace Secret-Phone. Instructions free. Ace Electric Co., 410 Edgewood, Dayton, Ohio.

GIANT Mail, plans, opportunities, samples, etc., 15c. Frank L. Chase, Burlington, N. J.

MANUFACTURE Clever new toys, novelties, foods, preparations, mail order and agents' specialties. Free list reliable plans, patterns, processes, commercial information. Manufacturer's Bureau, R20, 3937 Tracy, Kansas City, Mo.

STAMP Business for sale. Itemized list, 10 cents. Lhernault, 1802 Amsterdam Ave., New York.

BIG Money awaits you here. 250 signs and pictures an hour without press, type or machinery. Samples and particulars 10c. Street 1013 Mulberry Springsfield, Ohio.

LEARN To make molds and mold statuary, lamps, toys, vases and other easily sold specialties from imitation marble-lead-rubber-wax and 25 compositions. Commercial methods. Easily learned. Simple, practical, profitable. Free literature. Manufacturer's Bureau, R16, 3937 Tracy, Kansas City, Mo.

MAKE Your own electric vibrators, reducers and exercisers. We furnish all parts at wholesale prices—wheels, bases, pulleys, stands and vibrating belts. Send for circular. University Floor Machine Co., P. O. Box 68, Cambridge A, Mass.

MAKE Your own products. Employ agents yourself. Toilet articles, soap, extracts. We furnish everything. Valuable book free. National Scientific Laboratories, 1935 Broad, Richmond, Va.

MIRRORS Resilvered at home. Costs near 5 cents per square foot; you charge 75 cents. Immense profits plating like new brass, worn-off autoparts, reflectors, tableware, stoves, etc. Outfits furnished. Details free. Sprinkle, Plater, 127, Marion, Ind.

YOUR Magazine subscriptions—Bargain prices savings up to \$3. Porters Publications, 9416a, 115th St., Richmond Hill, N. Y.

10c WILL Bring Porter's Postal Success ½ year (for dealers and beginners). Helps you succeed. Porter's Publications, 9416a, 115 St., Richmond Hill, N. Y.

400% PROFIT Selling imported and American novelties. A \$5.00 investment will earn \$180.00. Valuable and useful samples. Complete information 25c (no stamps). Northwestern Novelty Co., 543-M North Ashland, Chicago.

ARE You old at forty? See our advertisement on page 162 of this issue. The Electro Thermal Company, 2124 Morris Ave., Steubenville, Ohio.

TAKE Money out of machines. Easy profits operating vending, musical, merchandising and amusement machines. Send 10 cents for sample copy. Automatic Age, 2239 S. Michigan, Chicago.

SMALL Capital starts profitable route peanut and gum vending machines. Particulars free. Robbins Corp., Dodworth St., Brooklyn, N. Y.

PAYING Home business making Floragraph, paintless, brown, black, white signs and floral prints 1st day. No lettering ability. Printing through one makes another, reversing colors. Contrasting samples, 50c. New, organdy screen, shoard process worth \$3.00 free with outfit. Laird's Floragraphs, 5925 Egleston, Chicago.

OPPORTUNITIES Galore! Your address in The Eagle Opportunity Directory will bring you many money-making offers. 10c inserts your address one month; 25c three months; one year, \$1.00. Marden, Box 25, Astor Station, Boston, Mass.

CONCRETE Building block manufacturing, is your home town opportunity. Particulars free. Concrete Machine Co., 5 Main St., St. Louis, Mo.

START Business of your own. Blue book of spare time opportunities, just out. 100 money-making inspirational plans and suggestions. \$1.00 postpaid or write for circular. Standard Supplies Company, 313 Catherine St., Syracuse, N. Y.

PROSPEROUS Business, full or spare time; big money in reconditioned lawnmowers. New device sets and sharpens in one operation. Start now, be ready for spring business, no experience necessary; we show you how. Complete outfit \$7.50. Ace Sharpener Co., 2022 So. Twelfth Ave., Maywood, Ill.

MONEY-MAKING Propositions for home workers and agents. Stamp appreciated. Jackson, 716 W. Exchange, Owosso, Mich.

FREE Listing in Agent's Directory. H. Wolf, 6618 Quimby, Cleveland, Ohio.

FREE Booklet describes 67 plans for making \$20-\$100 weekly in home or office business of your own. Elite Co., 84 Elizabeth St., New York.

AMAZING Screw-holding screw driver! Factories, garages, workers buy on sight! Profit 75c each. Exclusive territory. Free trial offer. Jiffy, 1273-A Winthrop Bldg., Boston.

KING System mail order, co-operative idea. It's different! Honest! Big profits! Details free. Evans P. King Co., Wilmington, Del.

MANUFACTURER Wants responsible men to run permanent branch offices. Some money needed. Millions profits. Safetum Signal Company, Washburn, N. Dak.

TIME Counts in applying for patents. See pages 156 and 157. Clarence A. O'Brien, Registered Patent Attorney, Washington,

DISSATISFIED Working for somebody else? Want your own business. Want to be your own boss? Start a distributing bureau. Easy. Profitable. No experience. No selling. Start immediately. Opportunities everywhere. Complete instructions one dollar. Particulars free. Wagner, Box 457a, Palo Alto, Calif.

CAPITAL—For copy, the "Promoters' Hand Book," a leaflet on financing; an eye opener for capital seekers. Send \$1.00 to Amster Leonard, East Orange, N. J.

EXCEPTIONAL Bargain, latest improvements, homes in Washington and Virginia. Owner, 2551 17th St. N. W., Washington, D. C.

WANTED—Man in each town to do electro-plating. Easy to learn. Write promptly. Lincoln Engineering Company, 855-C South 37th, Lincoln, Nebr.

"MAIL Order Selling," 48 page magazine. New ideas each month. Three months' trial subscription 25c. One year with valuable premium \$1.00. Mail Order Selling, Brookfield, Ill.

DON'T Sell for others—Employ agents yourself. Make your own products. Toilet articles, household specialties, etc. 500% profit. Valuable book free. National Scientific Laboratories, 1935 Broad, Richmond, Va.

PROTECTION Information (mail rackets) 10c. Challenge, P3802 Broadway, New York.

START Own business from home or office. 50 ways to make money published in blue book of opportunities \$1.00 prepaid. Descriptive booklet free. Reliance Company, Prospect-Fourth Bldg., Cleveland.

MONEYSAVERS! Lists, particulars, etc., for red stamp. Write now! Box 881, Glen Cove, N. J.

GUARANTEED Honest, workable money making propositions. Many lines. Little or no capital required. City or country. Send 10c for bulletin. Nebraska Technical Society, 801 Omaha National Bank Bldg., Omaha, Nebr.

BUSINESS Profession of your own and earn income in service fees. See Stephenson Laboratories, display ad page 154.

BUILD A Business of your own. Subscribe to The Income Increaser, the only magazine edited by Edward C. Barroll, the well known advertising man and mail order writer. This 40 page magazine filled with the latest ideas, plans, schemes, pointers and suggestions comes to you monthly for only one dollar per year. Sample copy 10c. Income Increaser, 88 Pearl St., Boston, Mass.

"ODD-THINGS"—Money making ideas! Schemes! Plans! Tips! Opportunities galore! New—different! Special three months' subscription, 10c postage. "Odd Things," 1516 Prospect, Cleveland, Ohio.

EARN Money decorating Christmas cards; new easy method. Send 10c for samples and full particulars. Walter Sharp, 5255 So. Broadway, Los Angeles, Calif.

FOR Sale, copyrights to two books. Reasonable. Good mail order. Strong appeal to homeowners. Opportunity for somebody. Write Geo. L. Brockman, Laporte, Ind.

MECHANICS, Painters, carpenters, start furniture refinishing, painting, handyman shop on nearly nothing; winning plan brings customers quickly. John Braceland, 1439 So. Ninth, Philadelphia, Pa.

ASSOCIATED Chemists, Indianapolis, Ind. Write for formula lists latest household toilet, automobile and medical specialties. Long profits easily made. Analysis.

RESPONSIBLE Manufacturer wants competent men open office, manage salesmen; \$200 to \$1,000 necessary. Will pay expenses to Baltimore if you qualify. Address Manager, 603 N. Eautaw St., Baltimore, Md.

THAXLY Formulas produce perfect products. All lines. Catalog free. B. Thaxly Co., Washington, D. C.

UNPATENTED Ideas can be sold. I tell you how and help you make the sale. Free particulars (Copyrighted). Write W. T. Greene, 910 Barrister Bldg., Washington, D. C.

SIGNS And showcards easily painted. If you use Letter Patterns. Write for free samples. John Rahn, B2120 Neva Ave., Chicago.

SUCCEED With your own products. Make them yourself. Formulas, processes, trade-secrets. All lines. Catalog, circulars free. B. Thaxly Co., Washington, D. C.

CHEMICAL Expert will furnish formulas and trade secrets. All lines. Lists free. W. L. Cummings, Ph. D., 228 Gordon Ave., Syracuse, N. Y.

SELL By mail! Books, novelties, bargains! Large profits! Particulars Free! B-Elfco, 525 South Dearborn, Chicago.

DELAWARE Charters; fees small; free forms. Chas. G. Guyer, Wilmington, Del.

MAKE Big profits with a fur farm in your backyard. Chinchilla rabbits, muskrat, mink. Write for facts, 252 Conrad's Ranch, Denver, Colo.

I MADE \$30 a week home. French bread-making. 15 years' experience; free booklet tells. Ashbrook 67, Marengo, Ohio.

AMATEUR Cartoonists: Sell your cartoons. New plan. Smith's Service, PA-1194, Wenatchee, Wash.

"SCHEMER" Subscribers surely succeed. One reports \$50,000 from one tip; another \$25,000 from three Schemes; another \$10,000 from one formula. Try your luck! Year, \$1.00; three months, 30c. Patterson, Publisher, Alliance, Ohio.

FREE Book. Start your own little business anywhere, selling novelties by mail. My beginner's outfit contains everything required, novelties, circulars, instructions, etc. Descriptive book free. Hadwil, 3A-74 Cortlandt St., New York.

LEARN The collection business. Good income, quick results. Interesting booklet, "Skillful Collecting" free. National Collectors Assn., Long St., Newark, Ohio.

A BUSINESS Of your own making—Sparkling Glass Name and Number plates. Checkboards, signs. Big book and sample free. E. Palmer, 540, Wooster, Ohio.

CHARTERS: Delaware; best, cheapest; free forms. Colonial Charter Co., Wilmington, Del.

COMPOSITION Floor making earns industrious men \$12 and more daily if used as trade. Or make business of it with profits up to \$10,000 yearly. Openings everywhere. Semi-Tile, Box 43, Hollis, N. Y.

MAN in each town to plate auto parts, reflectors, bathroom fixtures, refinish beds, mirrors, chandeliers; by new method. No capital or experience required. Simple plan of manufacturing at home starts you in big money-making business. Outfit furnished. Free particulars and proofs. Gun Metal Co., Ave. H, Decatur, Ill.

AGENTS, Opportunity seekers. Make amazing profits. Write, Empire, Shawano, Wis.

TELEGRAPHY

LEARN Morse and wireless telegraphy. Big salaries. Tremendous demand. Expenses low, can earn part. Catalog free. Dodge's Institute, H. St., Valparaiso, Ind.

CHEMISTRY

YOUR Chemical problems solved and formula or process furnished for \$5.00. Write me. W. Stedman Richard, Industrial Chemist, Box 2402, Boston, Mass.

BOOKLET Of experiments and chemical catalog 15c. General Chemical Company, Box 397, Reading, Penna.

CHEMICAL Analysis, processes, technical information. Robert Henderson, Laboratory, Madison, Me.

CATALOG Listing 2,500 illustrations chemists' supplies, 5,000 chemicals, 1,000 scientific books sent for 50c. Laboratory Materials Company, 643 E. 71st St., Chicago, Ill.

CHEMICAL Fun! Hundred home experiments \$1. Cutting Sons, Campbell, Calif.

FORMULAS AND TRADE SECRETS

INDUSTRIAL Chemist furnishes formulas, processes; all lines. Moderate charges. Individual service. All inquiries answered personally. L. Clore, Industrial Chemist, Crawfordsville, Ind.

NEWEST Tested formulas. Particulars. Catalog free. Grinstead Laboratories, Oswego, Kans.

FREE Formula catalog. Latest money makers. Western Chemical, Salem, Ore.

STAINLESS Damask tablecloth. Looks like linen, washes like oilcloth. Formula, instructions, \$1.00. Donahoo, Box 693, Hondo, Calif.

WHOLE Tomatoes kept without canning. Secret 25c. "Erie," Waukegan, Ill.

WORKING Formulas, \$1.00. Henderson, College Station, Box 51, New York.

MAKE Your own products. Employ agents yourself. Toilet articles, soap, extracts. We furnish everything. Valuable book free. National Scientific Laboratories, 1935 Broad, Richmond, Va.

FOR Sale very valuable formula for product, chemical seed treatment \$12 per acre. Joseph Modrzejewski, 873 Garden St., Milwaukee, Wis.

FORMULAS All kinds. Catalog free. Clover Laboratories (P), Park Ridge, Ill.

BROKEN Dishes, glassware mended. Formula \$1.00. Guaranteed. Quality Products, 216 Cass St., Corinth, Miss.

3,000 VALUABLE Formulas prepaid \$1.00. National Service, 3937 Marburg, Cincinnati, Ohio.

RELIABLE Formulas for newest fast sellers. All lines. Sources for fine labels-containers. Start right. Free literature. Manufacturer's Bureau, R17, 3937 Tracy, Kansas City, Mo.

500 FORMULAS And big illustrated catalog 25c. Ideal Book Shop, Park Ridge, Ill.

MOST Sensational formula bargain ever offered. Latest, best sellers. List free. Specialty Mfg. Service, 801 So. Farragut, Bay City, Mich.

GUARANTEED Formulas, best science can produce for making popular, biggest-selling specialties all lines. Don't buy formulas till you've received valuable eye-opening literature. Miller, Chemist, 706-F Jetton, Tampa, Fla.

DON'T Sell for others—Employ agents yourself. Make your own products. Toilet articles, household specialties, etc. 500% profit. Valuable book free. National Scientific Laboratories, 1935 Broad, Richmond, Va.

FORMULAS: Guaranteed, catalog free. Bestovall Laboratories, 6720 Oconto Ave., Chicago.

SUCCEED With your own products. Make them yourself. Formulas, processes, trade-secrets. All lines. Catalog, circulars free. B. Thaxly Co., Washington, D. C.

AGENTS WANTED

AGENTS! You can buy 200 necessities direct from manufacturer for less than you can make them yourself in quantities you buy! Four big lines big-selling repeaters sold all over United States, Canada, and Australia: Good Health Products, Stock and Poultry Raisers' Supplies, Soaps and Toilet Articles, Food Products, Insecticides, Cleaners; needed daily every home. All guaranteed exactly as represented by largest company of its kind in the world with four great factories—22 acres floor space, 10 branches—one near you. Cash or credit. Quick, easy sales. Good pay over day. Steady repeat business. First come, first served. Write for particulars. W. T. Rawleigh Co., Dept. G-12 PPM, Freeport, Ill.

SALES Representation now being arranged for 1930 all districts. "My Golf Record" sells to golfers, stationery, book stores and business concerns. Good seller; low price; big profits possible. Real business opportunity. Pleasant, lucrative employment. Sample and complete information \$1.00. Houston Advertising-Service Company, 3312 Sunset Blvd., Los Angeles, Calif.

SIXTY Meritorious big-profit mailorder products, trade secrets, sales plans. Success assured. K. Home, 3949 Metropolitan, Chicago.

AGENTS Earn \$240 month. New patented hot bag. Use 3 spoonfuls cold water. Stays hot ten hours. Kraft sold 36 first day. Demand enormous. No competition. Big commission. Write quick. American Accessories Co., Room 1031, Cincinnati, Ohio.

PERMANENT. Highly profitable opportunity. Start your own business in your locality, distributing nationwide patented well-advertised health machine. Quick sales. Big profits. Address "Opportunity," Room 201, 2061 Broadway, New York City.

AGENTS—Absolutely new! Our hand colored popular priced photo statuettes going big! Everyone wants them! Agents making \$10-\$25 daily! Samples furnished! Craver Mfg. Co., MS2456 Jackson, Chicago.

SAMPLE Copy opportunity magazine sent free to those wanting to represent leading manufacturers in their own community. Be independent—earn big money in unlimited field. No experience required. Address Opportunity Magazine, 750AA No. Michigan, Chicago.

BE Independent, make, sell your own goods, immense profits. Catalog dependable formulas, special selected agents' best sellers free. R. Lustru, 4211 Cottage Grove, Chicago.

NO Investment necessary to coin money with sensational "Gits Line" to stores. Your pay daily. No deliveries. Free outfit. Gits Co., F-5419 W. Chicago Ave., Chicago.

SELL Christmas cards. Boxed assortments or personal cards. Unusual value. Large profits. Easy to sell. Howard P. Ellis, 15 Wildwood Ave., Pitman, N. J.

SELL Surety powdered hand soap—A product in great demand; no sales resistance; constant repeat business; immense profits daily. Surety Company, 224 West Huron, Chicago.

MOST Unusual chemical development. New product for all autoists. Prevents steam, rain and snow from blurring windshield. Exceptional opportunity for distributors and salesmen. Exclusive territories open. Retailers 50c. Send 25c for full size product and details. Walter S. Doe Co., Manufacturing Chemists, Dept. 25, Kent, Ohio.

FAST-SELLING Specialties: Make them yourself! Best formulas, processes; guaranteed. Gerard Research Laboratories, Wheeling, W. Va.

SALES Persons wanted for new foot comfort appliance. Big commission, easy sales. Free sample offer. Ventopedics, 120 High St., Boston.

AGENTS—To sell electric water heater for \$2.75. New invention. Heats water almost instantly. Real moneymaker. Write Lux-Viel Company, Dept. N, Elkhart, Ind.

BIG Money and fast sales. Every owner buys gold initials for his auto. You charge \$1.50; make \$1.34. Ten orders daily easy. Write for particulars and free samples. American Monogram Co., Dept. 40, East Orange, N. J.

MEN And women. I have two of the biggest money making propositions ever put on the market. \$60 to \$150 week. Write for particulars. Manager, 443 E. 61st St., Chicago.

AGENTS To sell our metal polishing cloth, powdered hand soap, furniture and Duco polish. Sales Mgr., 1307 East Walnut, Des Moines, Iowa.

AGENTS Cleaning up on pearls and jewelry. Every woman a customer. Write Oriental Pearl, 246 Fifth Ave., New York.

GENUINE Gold Leaf Letters anyone can put on store windows. Guaranteed to never tarnish. Large profits. Enormous demand. Free samples. Write today. Metallic Letter Co., 438-D North Clark, Chicago.

MAKE Your own products. Employ agents yourself. Toilet articles, soap, extracts. We furnish everything. Valuable book free. National Scientific Laboratories, 1935 Broad, Richmond, Va.

PORTRAIT Men: Why not Pasco portraits? We refund your money for all you cannot deliver. Frame catalog free. Portrait Agent's Supply Co., Dept. F, LaPorte, Ind.

WRITING Ink concentrates. Bottle yourself! Green, blue, red, purple, black. Makes five quarts. Huge profit. Five assorted \$1.00. Texply Color Co., Somerville, N. J.

AGENTS Earn \$6 day. Bonus besides. Auto given to producers when earned. Introduce new guaranteed hosiery. All styles, colors. Finest silks. Credit given. Write for sales plan. Wilknit Hosiery Co., Dept. 8231, Greenfield, Ohio.

MAKE \$20 Daily selling merchant's changeable letter show-window signs. Experience unnecessary. Send for free sample offer. Maze Company, 542 W. Washington, Chicago.

STRANGE New electric iron cord! Prevents scorching. Saves electricity. Cannot kink or snarl. Used on telephones also. \$25 daily. Samples free. Neverknot, Dept. 12-A, 4503 Ravenwood, Chicago.

AGENTS Earn \$7 day. Sell finest line guaranteed hosiery. All new styles, big sellers. Big commission. Earn silk hose for your own use. Write quick. Silkknit Hosiery Co., Dept. 1631, Dayton, Ohio.

\$15 DAILY Easily made; great opportunity men and women; experience unnecessary; 95c profit on every dollar. A whirlwind seller. Write quick. Particulars free. E. M. Nelson & Co., West Jackson, Box 324, Jackson, Miss.

SELL Koehler's blue signs. Cost 3/4c, sells for 20c. Koehler, 717 N. Fourth, St. Louis, Mo.

EXPENSIVE Silk dresses: Slightly handled showroom samples sold cheap for cash. Peddlers, storekeepers, write Mme. Isabelle, P-65 Times Square, New York.

"WORLD'S Greatest auto novelty." Jazz-bird whoopee horn. "A Riot." Sells for \$3. Sample postpaid \$1 or C. O. D. Rico Sales, 166 W. 72d St., New York.

BIG Season on! Winter line ready. Overcoats, sheep-lined coats, leather vests, flannel shirts; men's women's underwear, sweaters, hosiery. Outfit free. May Co., Panceo Bldg., Chicago.

"WHERE To buy thousands of articles wholesale." New directory. Agents wanted. Pruitt, Brookfield, Ill.

300% PROFIT Selling Mystery Gas Lighter. Retailers 25c. Costs you \$1.00 doz. Sample free. Square Deal Mfg., Desk PM2, Bradford, Pa.

CHICAGO Expert valued \$3 stone at \$900. The diamond's only guaranteed rival! Greatest spare time, side-line article ever known! Amazing profits. \$5 pocket sample case free. Write quick! Mexican Gem Company, Dept. PM, Monterey, Calif.

BIG Profits selling our brilliantly colored temporary window transfers to merchants for advertising sales and special events. Complete line arrows, symbols and giant letters. Permanent repeat business. Quick returns. Print-A-Sign, Akron, Ohio.

FOOT-JOY Remedies, appliances. Formula by foot specialist. Proven sellers, repeat business. Bellaire Drug Company, Dept. 39, Grand Rapids, Mich.

WELLS Cleared \$820.00 in one month with Business Guide and free legal service. Write for free outfit. Prof. Nichols, Dept. 65, Naperville, Ill.

\$3 TO \$10 Hourly demonstrating amazing door check. Finger-touch shuts all doors silently. No slamming. No broken glass. Keeps doors open when wanted open. Low priced. Big commission. No competition. Quick demonstration sells several to almost every home, office, factory, public institution. Write! Kant-Siam, Dept. TC-7, Bloomfield, Ind.

AGENTS—Men, you can earn \$12 daily wearing felt hats and showing friends. Smartest styles. Latest shades. \$2 to \$5 saving on every hat. Samples free. Taylor Hat and Cap Mfrs., Dept. TC-135, Cincinnati, Ohio.

JUST Out—New kind of electric lamp. 101 lamps in one. So beautiful women can't resist. So useful men buy instantly. Wonderful spare time or full time proposition. Sell C. O. D. or deliver as you sell. Big profits daily. Write for money-making plan. Falcon Mfg. Co., Dept. S-251, 2350 Sullivan, St. Louis, Mo.

TIME Counts in applying for patents. See pages 156 and 157. Clarence A. O'Brien, Registered Patent Attorney, Washington, D. C.

AGENTS—Make a dollar an hour. Sell new kind of sharpeners. Sharpens all knives and tools quickly. Demonstrating sample 10c. Premier Mfg. Co., Dept. 98, Detroit, Mich.

AGENTS: Sell nursery stock. Free landscape service. Wonderful possibilities. Pay check weekly. Write for particulars. Perry Nurseries, R-12, Rochester, N. Y.

MEN Wanted—to demonstrate and take orders direct from motorists. Amazing magnetic trouble light. Sticks on metallic surfaces. Our men earn as high as \$75.00 weekly. Write for demonstrator. Magno, Beacon Bldg., Dept. 169, Boston, Mass.

SALESMEN—Earn \$100 weekly taking orders for dazzler and rainbow glow electric signs. Big commission. Exclusive territory. High grade proposition. Write Chicago Sign Sales Co., Dept. 83, Charlotte, N. C.

AGENTS: Free catalog 200 household specialties, toilet preparations, food products, portraits, frames, photo pillows, medallions, religious goods, pictures. Credit. James C. Bailey Co., Station C-12, Chicago.

CASH Paid for Butterflies, Insects. See Sinclair Display Advertisement on page 26.

MAKE Your own products. Employ agents yourself. Toilet articles, soap, extracts. We furnish everything. Valuable book free. National Scientific Laboratories, 1935 Broad, Richmond, Va.

MIRRORS Resilvered at home. Costs near 5 cents per square foot; you charge 75 cents. Immense profits plating autoparts, reflectors, tableware, stoves, refinishing metalware, etc. Outfits furnished. Details free. Write Sprinkle, Plater, 128, Marion, Ind.

MANUFACTURE Auto Specialties; Radiator Seal, Hand Soap, Puncture Plugger, Silk Life, Glass Cleaner. Get my free list. John Mickman, Chemist, St. Paul, Minn.

MAKE Big money every day. Sell finest work pants and breeches. Every man buys 1 pair at \$1.95, 3 pair for \$5.50, your commission \$1.00. Customer's satisfaction guaranteed. Largest, finest sales outfit free. Write today. Dept. 123, Longwear, 489 Broome St., New York.

\$2.45—RAINCOATS. All colors. Trenchcoats, tweeds, alligators, leatherettes. Sample coat and bonus to workers. Beautiful outfit free. Bradley, Dept. AB-12, 230 S. Wells, Chicago.

REPEAT Orders assured, distributing "Lerdec" rubber specialties; generous profits, needed everywhere; excellent mail order proposition. Particulars free. Leredu Co., Park Row Bldg., New York City.

400% PROFIT Selling perfumes. Melrose Works, Box 731, Chicago, Ill.

SELL Rhinestone initial belt buckles, etc. Fastest Xmas sellers. Big commission daily. We deliver. Pocket outfit free. Chaton, 606 Blue Island, Chicago.

MAKE More money selling most complete line raincoats, sportcoats, sheeplined coats, leather jackets and tablecloths. Latest styles. Lowest prices. Biggest commissions. 7x5 Swatch line free. Jeffrey, 716 Madison, Chicago.

CHURCH'S New lacquered steel drip caps stop rain coming under doors. Dozen complete \$3.50 postpaid. Sample 50c. Sells \$1.50 each. E. L. Church Co., Whitman, Mass.

AGENTS—Men and women with or without experience can sell our superior line of toilet and household specialties, combination bath sets, etc. Big profits. Full particulars on request. Dept. 22, W. C. Johnson Co., Atlantic Highlands, N. J.

MAKE \$20 To \$35 a day selling Imprint Book Matches, spare or full time. Big repeat business—no investment—every merchant a prospect. Send 50c for selling outfit which includes complete samples. Imprint Book Match, Dept. 119, 877 Meigs St., Rochester, N. Y.

\$6.00 TO \$15.00 Daily. Represent leading manufacturers. 1,000 immediate openings all territories. Salesmanager, 18 E. 12th, Dept. E, Cincinnati, Ohio.

WANT More mileage? Wonderful new humidifier (moisture) gas saver. All autos. One sent for test. Vix, RO-805, Wheaton, Ill.

FREE Booklet describes 67 plans for making \$20-\$100 weekly in home or office business of your own. Elite Co., 84 Elizabeth St., New York.

FREE Booklet describes 67 plans for making \$20-\$100 weekly in home or office business of your own. Elite Co., 84 Elizabeth St., New York.

AMAZING Screw-holding screw driver! Factories, garages, workers buy on sight! Profit 75c each. Exclusive territory. Free trial offer. Jiffy, 1273-B Winthrop Bldg., Boston.

100% PROFIT Selling watches. Agents, make over \$15 daily selling men's watches. Write how to get sample watch free. Guaranty Watch Co., 119-P Nassau St., New York.

MAKE—Sell your own goods. We tell you how. Formula catalog free. Clover Laboratories (PM) Park Ridge, Ill.

AGENTS Buy hosiery direct at lowest mill prices. Men's heavy silk and Rayon hose, doz. \$2.25-\$3.50; men's latest fancy hose, doz. \$1.45-\$2.10; ladies' Pointex silk hosiery, doz. \$4.25-\$7.00. Satisfaction guaranteed. Act today. Superior Knitting Company, Dept. 31, New Haven, Conn.

ABSOLUTELY Unequaled window attraction, used by thousands of merchants, offers exclusive permanent opportunity. Big commissions, dignified selling, unlimited prospects. Splendid sales materials free. The Illustranew, 511 Chapel St., New Haven, Conn.

AGENTS—New style tablecloth. No laundering, hemstitched, flannel back, several colors. Sells itself. Samples free. Puritan Mills, 43 Tremont St., Boston, Mass.

AGENTS Earn \$8 day. Sell finest line silk hosiery you ever saw. We furnish auto when earned. Earn silk hosiery for your own use. Write today for sales plan. Betterknit Hosiery Co., Desk 5431, Columbus, Ohio.

CHRISTMAS Cards. Box, 21 cards, 21 fancy-lined envelopes. Sells \$1. Large profit. J. Springer, Room 665, 1440 Broadway, New York.

INSTANT Hot water from light socket. Specialty salesmen, crew-men, agents say: "It sells itself—It's an Oil Well." Also fieldmen organizing. Salesmen and women demonstrators wanted everywhere. All or spare time. Work at home or travel. Experience not necessary. Good pay. Send stamp for particulars. Dad's Factories, Indianapolis, Ind.

PHONOGRAPH Needle plays 50,000 records. \$2.50, profit \$1.25. Excellent side-line. Smit, 3605-D, Kingsbridge Ave., New York.

\$100 TO \$200 Weekly selling new useful article wanted by every home and business. K. K. King, Michigan City, Ind.

LET Us send you free folder explaining 67 money making plans, home office. Raphael Co., 122 West 94th, New York.

AGENTS: Shoe soles for ten cents. Spreads on with knife like butter. Waterproof, pliable and wears like leather. Write for big money making proposition and no cost sample. Universal Laboratories, Inc., Dept. 502, Des Moines, Iowa.

80c PROFIT On \$1.00 sale! Splendid cleaner for automobiles, furniture, metal and glass. Your name on label assures you all repeat business. Appoint your own agents and dealers. Earn \$25.00 daily. Exclusive territory. Free sample. Minute Kleen Laboratories, Dept. E, Evansville, Ind.

HOP Scaler till Christmas! Beautiful toilet goods assortment at \$1.50 with 25 inch pearl necklace free to your customers, 100% profit. E. M. Davis, 238 North Ave., Dept. 530, Chicago.

\$8.00 DAILY Selling lingerie. Exclusive designs. Fashioned at Naomi Shoppe, 1415 U St. N. W., Washington, D. C.

PORTRAIT Agents! Handle "Viking Brand" portraits. They deliver and satisfy. Beautifully finished. Likeness guaranteed. Lowest prices. Viking Portrait Co., 20 West Jackson Blvd., Chicago.

SELL Housewives something they want. A necessity. Reduces gas bills 25%. New in your territory. No competition with this guaranteed gas saving device. Exclusive sales rights! 400% profit. Box 18E, East San Diego, Calif.

\$20 DAILY. Showing \$2.98 trench coats, also Dupont's launderless tablecloths; garment bags. Samples free. American, 726-MH Roosevelt, Chicago.

\$5.00 HOURLY. Mercerized damask scalloped table cloths. Size 58x78". 75c! Tremendous demand. Other bargains. Big sample line free. American Braiding, AM-418 S. Wells, Chicago.

WONDER Hotpad invention paying \$18.00 daily. Banishes water bottle and electric pads. Sales helps. Experience unnecessary. Free sample offer. Applicator Corporation, 3357 Cottage Grove, Chicago.

EARN More. Valuable book teaches. Literature free. Brookins, Warren, Ark.

VENDING Machine men—Grab this! \$12.50 commission every call! New, different, low priced, whirlwind seller. Act quick. Postal Confection Mfg. Co., 2033 W. Charleston, Chicago.

STIK-TITE Sticks rubber, leather, soles, heels on shoes, boots, rubbers. Use old inner tubes, tires. Outwear leather, cost nothing. No cement. No nails. Waterproof. Guaranteed outfit 35c. Distributors. Agents. Exclusive territory. Wonder Products Co., 3617 Cimarron, Los Angeles, Calif.

CAN Opener. Made for service; easily operated; does neat job; long life. Good seller. Write for price to agents. Western Wrench Co., 8427 South Chicago Ave., Chicago, Ill.

MAKE \$2.00 Every hour. Sell every home wonderful preparation; mends hosiery, clothing without sewing. Invisible. Results guaranteed. Send for free sample of work. Queen City Lab., Dept. PM-12, Cincinnati, Ohio.

GO in business for yourself and sell our home motion picture equipments on commission. Write National All-Movie-Sales Co., 333 N. Michigan, Chicago.

DON'T Sell for others—Employ agents yourself. Make your own products. Toilet articles, household specialties, etc. 500% profit. Valuable book free. National Scientific Laboratories, 1935 Broad, Richmond, Va.

AUTOMATIC Hand power nut cracker. Fast, accurate. Two models, \$8.50-\$6.00. Agents can clean up. Clark Nut Cracker, Harrisburg, Pa.

STOP: 400 Fast selling specialties from many parts of world. Write for free wholesale catalog. See ad page 187. Spors Co., Lesueur Center, Minn.

ARTICLES of merit. Repeat sellers. Big profits. For information write Lightning Products Co., 616 W. Kinzie St., Chicago.

SELL Holiday Greeting Checks. Something different. 200% profit. Sample free. 3330 Telegraph, Oakland, Calif.

EMBOSSED Signs. Something new. Going big. Ten cents for two samples. Signs, 3328A Telegraph, Oakland, Calif.

AGENTS—Speed filter. Guaranteed filter beverages crystal clear, one gallon minute; new invention. Sparkler Mfg. Co., 448 West Grand, Chicago.

DON'T Sell for others—Employ agents yourself. Make your own products. Toilet articles household specialties, etc. 500% profit. Valuable book free. National Scientific Laboratories, 1935 Broad, Richmond, Va.

BIG Money weekly year round appointing agents. No canvassing, delivering or investment. Mother Hubbard Foods, 554U Congress, Chicago.

A REAL Money-maker. Sells everywhere. Metal polish in tubes. Trial tube free. P. M. Reid, 1619 Clark, St. Louis, Mo.

GET Into aviation! Earn \$35 to \$100 weekly. World's fastest growing industry. Factories and airports need trained men. Unlimited future. Learn in spare time. Amazing home study method qualifies you in few short weeks. Personal, Practical help of veteran world-war flyer. Employment help free. You must be over 18. Rush name, address for special tuition offer and illustrated book free. Write Major Rockwell, Dayton School of Aviation, Desk SC-1, Dayton, Ohio.

\$10-\$25 DAILY Simply showing new Polly wrench. 10 wrenches in one. Guaranteed seller. Sample free. Gellman Mfg. Co., Dept. 6K, Rock Island, Ill.

AGENTS Wanted—Practical and most used necessity of the present day. Sold on a money back guarantee. The Es-Ton Company, La Salle, Ill.

GREATEST Opportunity; newest proposition. Build continually paying business in your own name. Household, industrial, brushes, brooms, mops, dusters, fully guaranteed. New catalog, all net prices, no discounts to bother with. Make as high as 300 per cent and over. Write today. Wire Grip Sanitary Brush Corp., 41 East 11th Street, New York.

AGENTS "Strike a gold mine" selling Nulustre cloths at 25c; cleans, polishes all metals; the duller the metal, brighter it shines. One agent sells 102 boxes in 116 calls. Write for free samples, particulars. Shef Mfg. Co., 20 Shef Bldg., Weehawken, N. J.

AGENTS—Sterling's "Anti-Freeze" keeps frost off windshield. Sample 50c. Sterling Laboratories, Cedar Rapids, Iowa.

FAST Seller—Big profits. Every housewife, automobile owner, etc., will buy "Kwick Kleen" for windows, mirrors, furniture, store fixtures. Sample 35c. Sales plan free. Sterling Laboratories, Cedar Rapids, Iowa.

NO Dull times selling food. People must eat. Federal distributors make big money; many over \$3,000 yearly. No capital or experience needed; guaranteed sales; unsold goods may be returned. We furnish you with license, sample case and free samples for customers. Repeat orders sure; exclusive territory. Ask now! Federal Pure Food Co., A2307 Archer, Chicago.

ENGRAVED Name plates, signs, numbers, desk plates, store window signs, etc.; profits large. Brett Bros., Winthrop, Mass.

SELL Stores 5c candy specialties. 100% profit. Lorrac Products, Albany, N. Y.

WANT Distributing agent for Hanslick, powdered handsoap; removes anything from the hands without injury to skin; everybody a customer; great opportunity for hustler to get in business; sample free. Solar Products Co., 32144 So. Troy, Chicago.

BIG List of Christmas sellers! Greeting cards, combination toilet sets, perfumes. More than 400 items. Details free. Write! Togstad Co., 30 Pundion St., Kokomo, Ind.

SELL Complete line household brushes. Send for free catalog and sample case offer. National Brushes, St. Louis, Mo.

PHOTO Medallion men and women, the largest line of photo novelties in the world. Lowest prices, quickest service. Send for catalog showing over 200 money makers, photo medallions, photo medallion clocks, photo mirrors, photo fountain pens, photo powder compacts, photo jewelry and photo buttons. Gibson Photo Jewelry Co., 608-614 Gravesend Ave., Brooklyn, N. Y.

AGENTS—Mosco Corn and Callous Remover will build you a steady repeat business. Send today for pocket-size trial outfit. The Moss Company, 442 Searle Bldg., Rochester, N. Y.

BIG Money applying gold initials on automobiles. Easiest thing today. No experience needed. \$1.45 profit every \$1.50 job. Free samples. "Ralco," X-1043 Washington, Boston, Mass.

BIGGEST Surprise offer ever made. Be sure to answer this ad. My line of soaps, coffee, tea, spices, toilet articles, household specialties, pays you bigger profits. M. G. Roth, President, 2716 Dodler, St. Louis, Mo.

SUCCEED With your own products. Make them yourself. Formulas, processes, trade-secrets. All lines. Catalog, circulars free. B. Thaxly Co., Washington, D. C.

SELL Men's neckwear—wonderful proposition. Astor-M, 39 East 28th, New York.

REMNANT Store, Bethel, Ohio. Greatest Dry Goods Bargains on Earth. Agents and Dealers.

MONOGRAM Automobiles, \$1.35 Profit ten minutes' work; every owner wants them; millions without; particulars free. Motorists Accessories Co., Mansfield, Ohio.

START An honest-to-goodness, successful-paying business that's yours. Making world's greatest sellers! Investment small. Profits great. Start anywhere. Get my valuable "eye-opening" literature about specialty manufacturing—How you can easily make guaranteed exclusive automobile specialties, including wonderful LoidLac, finest household cleaners, best soaps, high-grade toilet preparations, modern insecticides, delicious food and beverage lines fastest-selling carded specialties. 32 years unequalled reliable service. Miller, Chemist, 706-J Chemical Building, Tampa, Fla.

"HOW To Secure Agents," a specially prepared booklet, tells of one of the most inexpensive methods in which to secure good live producing agents. It is free; write for your copy today! M. L. Rund, Mgr. Classified Advertising, Popular Mechanics Magazine, 200 E. Ontario St., Chicago, Ill.

DON'T Sell for others—Employ agents yourself. Make your own products. Toilet articles, household specialties, etc. 500% profit. Valuable book free. National Scientific Laboratories, 1935 Broad, Richmond, Va.

SELL "Prevents Runs," Guaranteed to prevent runs in silk hosiery. Large profits. Particulars. Specialty Mfg., 307A West First, Los Angeles, Calif.

AGENTS—Make a dollar an hour. Sell Mendets, a patented patch for instantly mending leaks in all utensils. Sample package free. Collette Mfg. Co., Dept. 404, Amsterdam, N. Y.

GOLD-LEAF Window letters and script signs; no experience; 500% profit; samples free. Consolidated, 69-T West Van Buren, Chicago.

GET Our free sample case—Toilet articles, flavoring and specialties. Wonderfully profitable. LaDerma Co., Dept. A, St. Louis, Mo.

AGENTS: Stamping names on pocket-key protectors. Sample check with your name and address, 25c. Stamping outfits. Emblem checks, check-fobs, name plates. Hart Mfg. Co., Desk 2, 303 Degraw St., Brooklyn, N. Y.

MAKE Your own products. Employ agents yourself. Toilet articles, soap, extracts. We furnish everything. Valuable book free. National Scientific Laboratories, 1935 Broad, Richmond, Va.

THAXLY Formulas produce perfect products. All lines. Catalog free. B. Thaxly Co., Washington, D. C.

POLMET Polishing Cloth removes tarnish from metals without the use of liquid, paste or powder. Our agents say it sells like "hot cakes." Retail 25c; sample free. Gale & Co., Inc., 15 Edinboro St., Boston, Mass.

32 SECONDS Complete tire change by Detmer, Ohio, with Morey Quick Action Rim Tool. Sold, singly, 49 three days cleared \$100. Anderson, Mont., sold 1,400 in 14 weeks. Get details for good territory. Harvest time now. M. Morey Rim Tool, Buffalo, N. Y.

NO Matter what you are selling postal addressed to Excello Sales Co., Shreveport, La., will bring best money making offer you ever received.

AGENTS—New shirt proposition. No capital or experience needed. Commissions in advance. Samples free. Madison Company, 566 Broadway, New York.

AGENTS Wanted—On a fast selling 25c item for the kitchen, costs you 8 1-3c. Sample sent parcel post prepaid for 10 cents. P. Seed Filter Mfg. Co., Inc., 353 Broadway, New York.

AUTOMOBILE Specialties. Guaranteed formulas for all latest money makers. Lowest prices. Write for free lists. Murphy, Chemist, Tulunga, Calif.

FLAVORING Extracts—Bottle yourself! Concentrated. Free labels. 600% profit! Whirlwind moneymaking proposition! Write Thomas Manufacturing Company, Indianapolis, Ind.

MAN in each town to plate auto parts, reflectors, bathroom fixtures, refinish beds, mirrors, chandeliers; by new method. No capital or experience required. Simple plan of manufacturing at home starts you in big money-making business. Outfit furnished. Free particulars and proofs. Gun Metal Co., Ave. H, Decatur, Ill.

REPLATE Brass worn-off automobile parts, reflectors, bath room fixtures, worn spoons, forks, etc., with pure silver. Looks like new. Use U-Kan-Plate Polish. Positively no mercury. \$1.00 half pints. Post paid. Satisfaction guaranteed. Agents wanted. Dept. A, U-Kan-Plate Co., Philadelphia.

A BUSINESS of your own—Making sparkling glass name and number plates, check-boards signs. Big book and sample free.

BRANDNEW 50c Specialty, 150% profit. Quick demonstration sells every housewife. Pocket sample. Deliver on spot. Great sideline. Agents, distributors cleaning up \$65 to \$124 weekly. Territory going fast. Write today sure. Harker Specialties, Battlecreek, Mich.

\$12.00 DAILY Showing new table cloth. Looks like linen. Wash like oilcloth. No laundering. You just take orders. We deliver. Pay daily. Sample free. Bestever, 152 Irving Park Station, Chicago.

\$75 WEEKLY Up placing Aspirin, Notar-tar, Lighter Fillets, Silk-Tone and other self-selling counter display cards with merchants, soda fountains, cigar stores, etc. Over 100% profit. Steady repeats. Sterling Company, F. Baltimore, Md.

AGENTS—Clever Invention! Inkspoon makes every pen a fountain pen. Fast office seller; big profit, demand increasing everywhere. Exclusive territory offered. Sample free. H. Marui Company, Tribune Bldg., New York, N. Y.

TWO Money makers for agents. "Francis" Pocket Adding Machine retails \$4.85. To you \$1.00. "Excellograph" Rotary Stencil Duplicator \$37.50 retail. Write Typewriter Supply, 102 Hersch Bldg., Pittsburgh, Pa.

WE Start you without a dollar. Soaps, extracts, perfumes, toilet goods. Experience unnecessary. Carnation Co., 641, St. Louis, Mo.

MAKE Your own products. Employ agents yourself. Toilet articles, soap, extracts. We furnish everything. Valuable book free. National Scientific Laboratories, 1935 Broad, Richmond, Va.

CALIFORNIA Perfumed beads selling like hot cakes. Agents coinng money. Big profits. Catalog free. Mission Factory P. 2328 W. Pico, Los Angeles, Calif.

BIG Profits! Fast sales! \$9.75 automatic washing machine. Guaranteed. Write Storm Royalty Co., 3601 Enright, St. Louis, Mo.

\$60-200 A WEEK. Genuine gold letters for store windows. Easily applied. Free samples. Liberal offer to general agents. Metallic Letter Co., 438-B North Clark, Chicago.

HIGH GRADE SALESMEN WANTED

BIG Free printing line brings easy quick profits. Union label. Bigger commissions—up to 55%! Experience unnecessary. Now write orders with America's most profitable printing stationery line. Thousands of free cuts. Over 150 standard items covering every business need: letterheads, noteheads, envelopes, billheads, business cards, statements, garage forms—shipping, battery, dry cleaning, tire, storage, parking and hat-cleaning tags; repair forms, blotters, gummed shipping, drug, advertising stickers, etc. Lowest prices. Steady repeat orders. Ship everywhere. New free outfit just off press. Write quick. Dept. 176, Box 498, Cincinnati, Ohio.

OUR Men actually earn \$300 to \$500 selling our lines. Adelite, the newcomer in electric window salesmen, is making a big hit. More for the money. Business posters for every line. Changeable letter system too. Permanent business for you working with us. Territory protected and repeats credited. Fat commissions. Full details prove very interesting. Display Products, Ltd., 409-A East 31st St., Kansas City, Mo.

REPRESENT Leading manufacturers in your community. Big earnings. No experience required. Get the facts about this unlimited field. Write for free copy of Opportunity Magazine, Address 750SA No. Michigan, Chicago.

A SIDELINE That pays 40% advanced commissions. Biggest line illustrated printing for all businesses. No experience needed. Selling outfit free. Hillside, 1217 Van Buren, Dept. 30, Chicago.

EARN \$20 A day. Establish Income for life selling for \$1 a year, \$1,500 accident policy. Write W. C. Stone, 11 So. LaSalle, Chicago.

POOL Shooter, new fascinating vending machine. Merchants everywhere buy! Splendid sideline. Big profit maker! Free pocket outfit! Specialty Mfg. Co., W617 W. Division, Chicago.

GALLOPING Ivories: New game that's thrilling all America. Absolutely legal. Every cigar counter waiting for you. \$125-\$200 weekly. Hurry. K&S, 4308 Ravenswood, Chicago.

\$282.80 COMMISSION On a \$10.50 original sale. Every merchant a prospect. Absolutely new and different. Exclusive territory. Sales Stimulators, 339 W. Madison, Chicago.

SIDELINE To merchants, drug stores, garages. Repeat business. Corona, Box One Sixty, Norfolk, Va.

TAKING Country by storm. Odorless deodorant. Personal uses, Halitosis to foot odors. Household uses, refrigerators to toilets. Powder concentrate hundred times cheaper than any ready-mixed competitor. Amazing repeater. Save time. Send dollar for postpaid dollar bottle and dollar can. Satisfaction guaranteed. Exclusive territory, long discounts, big volume profits. Central Products, 2029A Bellevue, St. Louis, Mo.

SALESMAN—Traveling, to sell new Danite electric celluloid changeable letter signs. Men earning \$125.00 per week. Write at once for interesting proposition. Elwell Sign Co., 201 W. Carroll St., Macomb, Ill.

STEADY Income to mechanically inclined salesman with car, selling guaranteed line socket wrenches and other time saving tools. Every mechanic live prospect. Liberal offer. York Co., Dept. PM212, 2640 Greenview, Chicago.

SUCCESS Is no accident! You will fully understand this slogan when you examine our automatic credit and collection plan. Copy-righted, brand new, unusual. 250% on original sale. Half cash on repeats without callbacks. Commonwealth Publishing, 508 So. Dearborn, Chicago.

BUSINESS Stationery—Largest line, highest quality, quickest delivery. Biggest commissions; liberal bonuses. Free copy-righted cuts every business. Experience unnecessary. Instructions and outfit free. David Lionel Press, 312 S. Hamilton, Dept. 114, Chicago.

HOW About this winter? Does your present connection offer you the money you want to earn this winter? We can show you how to earn \$50 to \$100.00 weekly. Are you interested? Write Geographical Pub. Co., 621 Plymouth Court, Chicago.

DON'T Sell for others—Employ agents yourself. Make your own products. Toilet articles, household specialties, etc. 500% profit. Valuable book free. National Scientific Laboratories, 1935 Broad, Richmond, Va.

MAKE Your own products. Employ agents yourself. Toilet articles, soap, extracts. We furnish everything. Valuable book free. National Scientific Laboratories, 1935 Broad, Richmond, Va.

PAYING Position open. I'll put you in the shoe and hosiery business. Permanent income, protected territory, full commission on repeats. Experience not necessary. Handsome sample outfit, literature—everything you need to become a successful shoe merchant. Send for free booklet "Getting Ahead." Wm. J. Mishel, Tanners Shoe Mfg. Co., M. 20012 C St., Boston, Mass.

OUR proposition is interesting. What and where have you been selling. Neverbreak Tools, Box 304, North Canton, Ohio.

TOOL Salesmen—Now selling auto mechanics, garages and service stations, to sell modern brake tester recommended by leading automobile manufacturers. Give experience, lines now selling, territory covered, etc. The Kelley & Stewart Co., So. Brownsville, Pa.

SELL "Union Label" business stationery. Lowest prices. 72-hour delivery. Big commissions advanced. Amazing bonus. Cuts furnished for every business. Experience unnecessary. Outfit free. Northwestern, 2002 Division, Chicago.

SALESMEN—Don't miss this one: sell "Suredge," the only low-priced guaranteed automatic razor blade sharpener, honing and stropping all blades in ten seconds. 100% commission. Wonderful demonstrator. Real fast seller. Suredge, 15 East 40th St., Dept. G, New York.

\$2.95 AUTO Seat covers; pay daily; sales outfit free. Standard, 1938 Godfrey, Philadelphia.

KLEEN-FOOT Balm cleans the feet of minor troubles everyone has. Free trial. If it cures, sell! 807 Mather Bldg., Washington, D. C.

PUNCHBOARD Salesmen. \$10,000 yearly. New line. All fast sellers. Lowest prices. Full commission on repeat business. Catalog free. Hurry! Puritan Novelty Co., 1409 Jackson, Chicago.

AMAZING Screw-holding screw driver! Factories, garages, workers buy on sight! Profit 75c each. Exclusive territory. Free trial offer. Jiffy, 1273 Winthrop Bldg., Boston.

PUNCHBOARD Salesman. New deal. \$25 daily profit. Great assortment. No selling. Repeats. Free outfit. Manager, 4330 G. Harrison, Chicago.

BUSINESS Stationery—Largest line, commission paid daily. Sells all merchants. Pocket outfit free. Willens Co., Dept. 269, 9130 Gladys Ave., Chicago.

SEVERAL, Active, honest, clean-cut salesmen wanted at once. Well known Detroit manufacturer of the nationally known Stover's Athletic Oil, used and endorsed by Howard Ehnke, world series hero; Sammy Mandell, world's lightweight champ, and most all other major league athletes and champs, has special and alluring proposition to make to men calling on retail trade. Your territory may be open. Write today. Stovers, Inc., 7523 Fenkell, Detroit.

PUNCHBOARD Salesman—Most gigantic line ever featured. Vending machines, all kinds. Make high as \$28.00 on single order. Repeat commissions. Beautiful colored catalog free. Lion Mfg., Dept. 8, 308 W. Erie, Chicago.

\$18 TO \$25 Daily; biggest selling line of 2-piece suits, \$9.95 and \$12.50; 3-piece wool suit, \$17.95 (regular \$28.00 value). All-wool overcoats \$18.50. Splendid raincoats, slickers and boys' suits. Biggest commission. Free outfits. "Jim" Foster, Inc., Dept. 212, 2250 S. Spaulding Ave., Chicago, Ill.

WHILE Others talk, our salesmen actually clean up. \$8.50 commission on ten-minute sale at \$18.50. Original Electric Hot Dog Machine. Write for available territory. Leonard E. Dickerson, Manufacturer, Dept. E-19, Springfield, Mo.

FREE Booklet describes 67 plans for making \$20-\$100 weekly in home or office business of your own. Elite Co., 84 Elizabeth St., New York.

BECOME Your home town leading business man. Sell full line of groceries, motor oils, paints. Everybody a customer. No capital or experience necessary. Selling outfit free. Write Lovelin & Browne, 1602M So. State, Chicago.

FURNACE Carburetor for any heating furnace or boiler. Eliminate 80 per cent of smoke and soot. Reduces coal bill one fourth. Easily installed and operated. We offer you a permanent business with a big profit. Give sales experience, reference and territory covered, when answering. National Engineering Company, Lancaster, Pa.

PUNCHBOARD Salesmen—\$200 weekly. New deal. Biggest commissions. Repeats, liberal cash bonus besides. New catalog. Write Superfine Sales KF-531 So. Franklin, Chicago.

ZINGOIL. The new petroleum oil hand-cleanser, outsells two to one any other cleanser on the market; replacing ordinary hand soaps wherever shown; if you can't build up a business worth \$100 weekly with Zingoil, quit calling yourself a salesman. B. C. Carter Co., 6647 Foothill Blvd., Oakland, Calif.

BRUSH Salesmen attention! We pay highest commission, furnish your gift brushes free, give larger (restricted) territory, promote you quickly. Prices reasonable, quality line more complete, nationally known, tested, approved Good Housekeeping. Act now, company expanding. Donald Brush Co., Camden, N. J.

SPARE Time work for young men selling the super automatic oil heater (for residences) to the trade. Generous commissions on all wholesale sales. Write the Super Oil Heater Sales Company, 275 Connecticut Boulevard, Hartford, Conn.

COVERALL Salesmen—Make \$20 daily selling new \$3.50 improved coveralls, also service coats with customers name embroidered on back. Unusual construction. Commission 75%! Wonderful advertising value. Lowest price; highest commission. Free outfit. Am. B. Co., AS-418 S. Wells, Chicago.

AMAZING Auto oil gauge wiper. Sell garages by the gross as well as car owners. Particulars with sample 10c, refunded. George Koch Sons, 2112 Pennsylvania St., Evansville, Ind.

BURGLAR Locks—For residence windows and doors. Locks them closed or partly open for ventilation. District sales manager of salesman for each city. 66% commission should run \$4,000 to \$18,000 per year. Turney Mfg. Co., Sales Dept., McGee St., Kansas City, Mo.

\$1.50 **POLICY** For \$1.00 a year. Big profits. Easiest, fastest selling proposition ever offered. United States Registry, Desk 10, Townsend and Superior Sts., Chicago.

SALESMEN, Dealers, service men investigate this new radio device. First time advertised. Doubles volume and distance. Can demonstrate coast to coast in summer. Brings in stations never heard on set before. Territories to producers. Write W. H. Lafferty, Sales Mgr., 279 Roughton Ave., Detroit, Mich.

SELL Goodyear raincoats; \$2.95 up. Goodyear Rainwear, 682 Sixth Ave., New York.

PUNCHBOARDS—Hottest, largest money-making line ever offered. Season starting. Best commissions. Nothing to carry. Catalog free. Act! M&L Sales, 301 W. Adams, Chicago.

WONDERFUL Invention. Seals fifty envelopes minute. Sells on sight at \$2.25. Attractive trial offer. Square deal. Bank references. Kendall Sealer Co., 440 Sansome St., San Francisco, Dept. 14.

\$250 TO \$400 Monthly for salesmen. Our goods sell quickly to factories, hotels, garages, public institutions, etc. Large profits. Year around repeat business. Exclusive territory. Free samples. Vasco Products, Elmira, N. Y.

\$50,000 **PICTURE** Man Friedman made canvassing. Beginners can make \$100.00 weekly with my sales talk. Experienced men make more. Free book "Profits in Portraits" explains. Sample free. Picture Man Friedman, Dept. 8, 109 West Austin, Chicago.

ELECTRICAL Tool line selling to garages, mechanics and auto owners, wonderful demonstrators, big commissions. Salesmen, write Barker Specialties, Girard, Penna.

SALESMEN—America's leading collection service wants you to help doctors, merchants collect their bad accounts. You list them; we collect. Hustlers actually make \$75-\$100 weekly. Pleasant work, increasing profits. Get the facts. Arrow Service, 29 Jay St., Schenectady, N. Y.

SALESMEN—Become independent. Own your business; experience unnecessary. Selling our \$10,000 Accidental Death; \$50 Accident; \$25 Sick Weekly Benefits—\$10.00 yearly. Other amounts proportionate. Guaranteed steady income from renewals. \$250,000 deposited Insurance Department, Universal Policy Dept. A, 40 Clinton St., Newark, N. J.

MAIN Or sideline. Sell auto tires and auto accessories to tire stores, garages, etc. Protected territory. Liberal commission. Economy Rubber Products Co., 604 Burkhardt Ave., Dayton, Ohio.

NEW Invention—Sell every business. Four \$15 sales daily pay \$288 weekly. Walker made \$165 first day. Exclusive territory. Adjustment Service, Dept. PM, Mobile, Ala.

WANTED District managers—Capable men to represent us in prosperous territories with direct home office contract. Our organization is the oldest of its kind in the health and accident business and offer exceptionally remunerative compensation. Write today for information. Dept. 18, Inter-State Business Men's Accident Association, Brown Bldg., Des Moines, Iowa.

GOLD-LEAF Window letters and script signs; no experience; 500% profit; samples free. Consolidated, 69-V West Van Buren, Chicago.

SALESMEN—Four \$15.00 sales to merchants net you \$40.00 daily. Sayers Systems, 2813 Sheffield, Chicago, Ill.

TO Market SA garage door holders, simple automatic action, quickly installed, instantly attracts garage owners, builders, dealers. Write for exclusive territory proposition. Knowlson-Stevenson Co., 1118 Packard, Ann Arbor, Mich.

PUNCHBOARD Salesmen make \$200.00 weekly selling punchboards and vending machines. Big repeat commissions. Beautiful 3-color catalog free. Best season now. Write today. Old reliable company, established 20 years. Lincoln Sales, 116 S. Wells, Chicago, Dept. D.

\$60-\$200 A **WEEK**. Genuine gold letters for store windows. Easily applied. Free samples. Liberal offer to general agents. Metallic Letter Co., 438-A North Clark, Chicago.

HELP WANTED

NO Dull times selling food. People must eat. Federal distributors make big money; many over \$3,000 yearly. No capital or experience needed; guaranteed sales; unsold goods may be returned. We furnish you with license, sample case and free samples for customers. Repeat orders sure; exclusive territory. Ask now! Federal Pure Food Co., C2307 Archer, Chicago.

YOU Are wanted to resilver mirrors at home. Immense profits plating autoparts, tableware, etc. Write Sprinkle, Piater, 287, Marion, Ind.

IF You need \$100, \$500 or \$1,000 to pay your bills, buy new clothes, furniture, etc., I'll show you a new, easy way to make it as my local representative. No experience or capital required. Albert Mills, 3948 Monmouth, Cincinnati, Ohio.

OBTAIN Employment desired, quickly, anywhere. Learn how. Write Box 39-203, Station K New York.

MANUFACTURER Wants distributor for 300-mile \$2.00 "Pocket" radio. "Sells itself with music." Pays 100%. Spencer Radio, Dept. 10, Akron, Ohio.

CASH Paid for Butterflies, Insects. See Sinclair Display Advertisement on page 26.

BOYS, Girls, make some extra spending money during your spare time. No experience necessary. Albert E. Pickett & Co., 3019 Diversey Ave., Chicago, Ill.

BIG Wages in Canada, construction work, all trades! Write for list of positions, stamp appreciated. A. Allard, 4724 Des Erables, Montreal, Can.

EDUCATIONAL AND INSTRUCTION

LEARN To figure twice as fast by studying Smith's "Higher Arithmetic" at home. Write for prospectus to F. A. Smith, 608 S. Dearborn St., Chicago.

MAKE Money—Raise canaries for us year round, we buy all. Free: Outfit, birds course. Send 10c for particulars. Schneisser's: Canary & Pet Plant, Dept. 21, 5 East North, Buffalo, N. Y.

GOVERNMENT Jobs. Become railway postal clerks. \$1,900 to \$2,700. City carriers, postoffice clerks. (\$1,700 to \$2,300). General clerks, file clerks (\$1,250 to \$2,500). Men-women, 18 up. Steady work. Life positions. Paid vacation. Common education sufficient. 25 coached free. Particulars free. Write today sure. Franklin Institute, Dept. D3, Rochester, N. Y.

COMMERCIAL Art pays good, new \$1.00 lesson plan leads to success. Write. Integral School of Commercial Art, Melrose Park, Ill.

MEN 18-35. Railway postal clerks, \$158.00-\$225.00 month. Steady. Examinations coming. Common education sufficient. Particulars free. Write immediately. Franklin Institute, Dept. D14, Rochester, N. Y.

FIREMEN, Brakemen, baggagemen (white or colored, sleeping car, train porters (colored), \$150-\$250 monthly. Experience unnecessary. \$10 Railway Bureau, East St. Louis, Ill.

STUDY A scientific profession. Microbiology. Bacteriology. Sanitation. Extension-residential course. Diplomas, degrees granted. Urinalysis outfit-prospectus free. College of Microbiology, 23 State, Hammond, Ind.

AMATEUR Cartoonists: Sell your cartoons. New market. Smith's Service, PR-1194, Wenatchee, Wash.

PRIVATE School for boys and girls. Wilson Schools, Dayton, Ohio.

DOUBLE Entry bookkeeping 60 hours with 8 keys; guaranteed. (Diplomas.) International Bookkeeping Inst., 8 Springfield, Mo.

DON'T Prepare for any civil service examination without seeing our catalog. Free. Columbian Correspondence College, Washington, D. C.

BIG Demand for photoplay talking picture and magazine stories. We revise, develop and copyright. Sell on commission. Established 1917. Booklet free. Universal Scenario Company, 406 Western and Santa Monica Bldg., Hollywood, Calif.

LEARN Aircraft welding, auto mechanics, electricity. Magnetos, radio. Big pay. Big demand. Low rates. Free catalog. Stevinson School, 2008A Main, Kansas City, Mo.

WANTED Immediately, men-women, 18-55, qualify for permanent government positions. \$105-\$250 month; no gov't experience required; paid vacations; common education; many needed soon. Write Ozment Inst., 101, St. Louis, Mo.

BECOME A landscape architect. Uncrowded profession; wonderful opportunity for money-making. Easily mastered by mail. Earn while you learn. Est. 1916. Write for details. American Landscape School, 29 Plymouth Bldg., Des Moines, Iowa.

U. S. GOVERNMENT Wants men, \$1,700-\$1,900 and up at start. Railway mail clerk examination coming. Let our expert (former government examiner) prepare you for this and also rural carrier, post office, customs, internal revenue, and other branches. Write today for free booklet. Dept. 8, Patterson School, Rochester, N. Y.

VALUABLE Kinks for Machinists. 419 time-saving ideas on various phases of machine shop work. Intensely practical. 287 illustrations. Just write for "Machinists' Kinks" and pay postman \$1.50 plus postage when he delivers the book. Popular Mechanics Press, Room 808, 200 E. Ontario St., Chicago.

TYPEWRITERS AND SUPPLIES

SIMPLEX Typewriters \$3-\$8; Remingtons \$12.00; catalog 5c. Demo, 114 Ford St., Breardena, R. I.

TYPEWRITERS—Factory rebuilt Royals, Remingtons, Underwoods. New Royal, Remington and Corona portables. New "Excelligraph" Rotary Stencil Duplicator \$37.50. Catalog free. Pittsburgh Typewriter Supply, Dept. 945, Pittsburgh, Penna.

TYPEWRITERS, All standard makes. \$10 up. Fully guaranteed. Free trial. Write for complete illustrated lists. Northwestern Typewriter Exchange, 121 N. Francisco Ave., Chicago.

TYPEWRITERS—All makes, fully guaranteed. \$15.00 and up. Write for catalog. M. & M. Typewriter Co., 180 W. Washington St., Chicago.

TYPEWRITERS, Radios, motorcycles, \$4.98-\$24.98. Knights, 1524 Locust, St. Louis, Mo.

TYPEWRITERS—All makes, \$6 to \$29. Fully guaranteed. Dee Typewriter Exchange, Ada, Okla.

ADDING MACHINES

NEW \$3.50 Automatic adding machine. Adds, subtracts, multiplies, absolutely accurate. Capacity \$999,999.99. Fully guaranteed. 75,000 pleased users. Makes adding easy, positive, quick. Eliminates mistakes. Saves time. Postpaid \$3.50. Bassett Co., 1458-D, Hollywood Ave., Chicago.

PRINTING, ENGRAVING AND MULTIGRAPHING

BIG Free printing line brings easy quick profits. Union label. Bigger commissions—up to 55%! Experience unnecessary. Now write orders with America's most profitable printing stationery line. Thousands of free cuts. Over 150 standard items covering every business need: letterheads, noteheads, envelopes, billheads, business cards, statements, garage forms—shipping, battery, dry cleaning, tire, storage, parking and hat-cleaning tags; repair forms; blotters, gummed shipping, drug, advertising stickers, etc. Lowest prices. Steady repeat orders. Ship everywhere. New free outfit just off press. Write quick. Dept. 178, Box 498, Cincinnati, Ohio.

PRINTING—Low prices, fine work. New price list and samples. Stationery, circulars, folders, booklets, catalogs, ruled forms. Sell direct, large or small orders. Large modern plant in small town, low operating cost. Shenandoah Publishing House, Inc., Box 1140, Strasburg, Virginia.

WE Print stationery, booklets, catalogs, circulars. Samples. Commercial Press, Batavia, Ohio.

200 LETTERHEADS And 100 envelopes \$1.00. 200 letterheads, 8 1/2 x 11, 150 envelopes \$2.00. 250 cards \$1.00. Hoosier Print Shop, Portland, Ind.

PRINTED Stationery for personal or business use. 200 note heads and 100 envelopes only \$1.75 postpaid. Satisfaction or money refunded. Redfield Co., 515 Sedgwick Drive, Syracuse, N. Y.

PRUITT Pays postage on all printing orders. Satisfied customers in every state. Free samples. Pruitt, Brookfield, Ill.

5,000 3 1/2 x 6 TINTED Enamel folders, \$13.75; 5,000 elegant envelope slips, \$5.00. All printing low prices. Samples. Goodprint, Harrisonburg, Va.

STATIONERY—1,000, \$2.75; 5,000, \$10. Samples. Vincent Mosher, 323 New, Newark, N. J.

1,000 BUSINESS Cards \$2.75 postpaid. Samples free. John Miller, Montgomery Ave., Narberth, Pa.

500 BUSINESS Cards \$1.10, 500 letterheads, envelopes \$1.98, 2,000 6x9 circulars \$3.50 postpaid. Wm. Sirdevan, Ravenna, Ohio.

500 BUSINESS Cards, \$1.25 postpaid. Other printing reasonable. Attractive samples free. Hanzer's, 1039 S. Cleveland, Phila., Pa.

200 NOTE Sheets and 100 envelopes \$1. Brown, Warsaw, N. C.

PARTICULAR? "Neagravure"—Special 500 8 1/2 x 11 letterheads, 250 envelopes, \$4.44 postpaid. Samples. Solldays, Knox, Ind.

QUALITY Printing on quality paper. Prices and samples. Burket Printing Company, Roaring Spring, Pa.

SPECIAL High grade business statements \$1.95 thousand. Many bargains. Battlefield Press, Gettysburg, Penna. Free battlefield souvenir.

1,000 6 1/2 ENVELOPES Printed \$1.85. Free samples. Sports Printery, Lesueur Center, Minn.

500 HAMMERMILL Letterheads or envelopes \$2.00. Patton Company, 534 Paxton, Block, Omaha, Neb.

200 8 1/2 x 11 HAMMERMILL Bond letterheads, envelopes or business cards \$1.00 postpaid. Race Printing Company, Hudson, N. Y.

CIRCULARS, 5,000—5 1/2 x 8 1/2—\$11; 3 1/2 x 6—4-Page folders \$14. Big plant, little prices. Garrison Press, Harrisonburg, Va.

1,000 Hammermill Letterheads or envelopes \$3.25. Cards, statements, billheads, 5 1/2 x 8 1/2 letterheads, \$2.50 cash delivered. The B. & M. Press, "Printers Extraordinary," Dawson, Okla.

MULTIGRAPHING—High grade business letters. Two dollars fifty cents thousand. Commercial Printing Company, 7054 N. Clark St., Chicago.

SAMPLES Raised letter printing with special prices free. LaClyde Service, Westfield, Mass.

\$2.00 1,000, LETTERHEADS, Noteheads, envelopes, cards, billheads, tags, postcards. Samples free. Coyle & Kimballs, Newport, N. Y.

MULTIGRAPHING Business correspondence two dollars thousand. Hammermill letterheads, four dollars; inexpensive quality, three dollars. Miscellaneous printing. Mayera Corporation, Monmouth, Ill.

QUALITY Printing! Reasonable Prices! Send for Free Standardized samples and prices. Folders, Circulars, Catalogs our specialty. Earnest Fantus, 525 South Dearborn, Chicago.

250 BOND Letterheads, Envelopes, Billheads, Cards, \$1.35 each. Economic Press, Leonia, N. J.

GOOD Printing, reasonable prices, distinctive ideas. Stationery, circulars, blotters. Samples free. J. Wilford Price, Harleysville, Pa.

PRINTING OUTFITS AND SUPPLIES

PRINT Your own cards, stationery, circulars, advertising, etc. Junior press \$5.90; job presses, \$11; rotary, \$149. Print for others; big profit. Easy rules furnished. Write for catalog presses, type, paper, etc. Kelsey Company, Q-11, Meriden, Conn.

PRINTING Outfits—Presses, type supplies, type novelties. Send stamp for catalog. Model Press, York, Penna.

MAKE Your own printing device. It's practical—different! Particulars, specimens free. Grinstead Laboratories, Oswego, Kans.

PREUSED Printing presses and supplies. Lists 2c stamp. Popular Bargains, Richland, Pa.

GUMMED LABELS

1,000 PRINTED: Name, business, address 50c. JBS Company, Box 93, Holyoke, Mass.

RUBBER STAMPS

RUBBER Stamps! Name, address, two lines 25c; three lines 35c. DeLuxe Stamp Works, B572M, Auburn, Nebr.

DUPLICATORS AND DEVICES

YOU Can make 50 to 100 copies of a letter, notice, etc., at a cost of three cents on a Heyer Quality Duplicator. Write for free trial offer. The Heyer Duplicator Co., 909 Jackson Blvd., Chicago, Ill.

"EXCELLOGRAPH" Portable rotary stencil printing duplicators \$39. Terms. Description, testimonials, printed samples, free. Pittsburgh Typewriter Supply Co., Dept. 531, Pittsburgh, Pa.

FOR THE HOME

HEAT Regulator. Make one for your own furnace. Simple, effective. No batteries. Handy man can make for few dollars. Send \$1.00 for blue prints. Gryce System, 2416 E. 43rd St., Minneapolis, Minn.

EGG-TIMER With bell; makes soft, medium, hard-boiled eggs certain, \$1. Lellep, P. O. Box 388, San Francisco.

CEDAR Chests only \$11.65—"Red-i-Kut" complete with rich copper trim—you assemble and save half—send for pictures. Kuempel Furniture Company, Guttenberg, Iowa.

SEWING Machine stock. New and used. Lowest prices on parts and accessories. Paul Steckel, Glendora, Calif.

FOR MECHANICS

ATTENTION—Home mechanics: We sell unusual cabinet hardware, chest trimmings, tea wagon wheels and casters, big line small hinges, locks, etc. Upholstering supplies electrical hardware, knocked down cedar chests, etc. Send ten cents stamps for catalog. Thurston Manual Training Supply Company, Jobbers and Manufacturers, Anoka, Minn.

A BIG Opportunity in 8-hour battery charging or 20 minute car washing. Let me tell you how you can install equipment with practically no investment. Earn \$150 to \$300 monthly. Bargains in used outfits. Also a few reconditioned buffers, grinders, air compressors, paint sprays, arc welders. Write today. Ken Byrum, Box M-1295, Troy, Ohio.

FOR SMOKERS

SMOKE Tampa cigars. \$4.50 a hundred, prepaid. Hand made. Ideal Xmas gift. Try them once, smoke them always. Cunningham, Box 374, Tampa, Fla.

AUTOMATIC Cigarette making machines. Rolls, glues 50 for 10 cents; illustrated folder. Postpaid \$2.50. For home use. Automatic Cigarette Machine Works, 6247-51 Broadway, Chicago.

RAZORS AND BLADES

NEW Automatic safety blade sharpener selling like wildfire. Makes old blades better than new. Improves new blades 100%. Prolongs the life of any blade indefinitely. Quickly pays for itself. Every shaver wants one. Sharpens all blades including Gillette, Durham Duplex, curved blades, etc. Simple, compact, easily operated, guaranteed. Agents get free goods bonus proposition. Sample post paid \$1.00, all countries. Viking Blade Company, 1706 Sunset, Los Angeles, Calif.

SHARPEN Razor blades. Build a business for yourself. Make a dollar per hour with our machines. Easy, light work. Ideal proposition for elderly men. Fully equipped machines \$175.00. Velvet Edger Mfg. Co., 725 West 59th Place, Los Angeles, Calif.

NEW Gillette type razor blades. 30 for \$1.00. Every blade guaranteed. Superior Blade Co., Box 1516 Cincinnati, Ohio.

36 GILLETTE Style razor blades, 1 dollar prepaid. World's best. Genuine Swedish steel. Handelskomp, Reilance, Landskrona, Sweden.

GILLETTE Razor blades resharpened 100% keen, 1c each. Petter Wetterquist, Rockford, Ill.

RAZOR Blades sharpened; two-edge blades 3c, single blades 2c. J. Newman, 6402 Ellis Ave., Chicago, Ill.

GUNS, FISHING TACKLE AND SPORTING GOODS

SHOTGUNS: Single barrel \$9.00; double, hammerless, \$21.75. American manufacture; money-back guarantee. Free catalog. Franklin Sporting Goods, Box 10, Amper, N. J.

HUNTERS And trappers: See and try the "Screw-Bug," a mechanical ferret for routing rabbits, skunk and other burrowing animals. Sold by mail, allowing five days' trial with an absolute money-back guarantee. Price \$4.00 each, with order prepaid, or C. O. D. plus postage. Free circulars and testimonials. The Grabow Co., Dept. A, Franklin Square, L. I., New York.

FIELD GLASSES

USED Fieldglasses: \$2 to \$75. J. Alden Loring, Dept. J, O-we-go, N. Y.

ARCHERY

MAKE Your own archery equipment. We furnish complete line highest grade materials and complete instructions for assembly. Can easily build highest quality outfit for fourth cost of complete outfits. Letter brings complete catalog and prices. Sidney Archery Co., Box M119, Sidney, Ohio.

CIRCULAR Free—Yew bows and bowstaves. Arrows—Highest quality, tackle, reasonable prices. Harry Hobson, Lyons, Ore.

ANTIQUES, WAR RELICS AND INDIAN GOODS

GERMAN Iron cross \$1.00; Bohemian medal of honor, 90c. List of medals 10c. Dare, 670 E. 42d, Brooklyn, N. Y.

ANTIQUES, Firearms, swords, relics, daggers, curios. Catalog free. Nagy, 8 South 18th, Philadelphia.

FINANCIAL War relics. Collectors find rich material for den or office in our free list. Pretorius, 1629 Meyer Court, Chicago.

FOR Sale, mounted heads, birds, antiques. Lee Henderson, Stanley, Wis.

SEND 5c For fine new list Indian relics, antique firearms. F. E. Ellis, Webster Groves, Mo.

INDIAN Stone relics. 32-page catalog 5c. Grutzmacher, Mukwonago, Wis.

MINERALS, PRECIOUS AND SEMI-PRECIOUS STONES

TOPAZ. Finest quality, colorless or smoky. The birthstone for November. Buy your stones direct and save money. Some stones low as \$10.00. Can supply any size wanted up to twenty carat. R. A. Garner, Box 188, Lancaster, Pa.

AGATE Jewelry, polished stones. Cabinet specimens. Opals, zircons others. Indian arrow points. Cutting mounting. E. W. Birch, The Stone Man, Box 34, Salem, Ore.

WE Are dealers in rough and polished minerals and polished semi-precious gems for scientific, educational, cabinet display or jewelry craft purposes. List of gem minerals and their varieties, table of birthstones and pricelists free with an order for any of the following. PM Special—Six assorted rough and polished minerals for \$1. Four genuine mined, fully polished gem stones \$1. Two interesting Montana mineral specimens 35c. Any of these postpaid, correctly labeled and with satisfaction guaranteed. The Gem Shop, Box 373, Wolf Creek, Mont.

BOATS AND LAUNCHES

BUILD Your own boat. Commence building now and be ready for next season. Use our ready cut semi assembled materials. 55 designs outboard speedsters, runabouts, cruisers, sail, etc. Send 10c for catalog. Brooks Boat Co., Box S. S., Saginaw West Side, Mich.

MAKE Rowboats, houseboats, canoes. Interesting literature free. Weesho-Uco, 31st Office, Detroit, Mich.

16' CANVAS Canoe. Easily made. Blueprint 30c. Weesho-Uco, 31st Office, Detroit, Mich.

TWENTY Mile outboard racer. Complete plans 25 cents. Free boatbuilding catalog. The Rudder, 15 Murray St., New York.

MAKE 16' Rowboat. Blueprint 30c. Weesho-Uco, 31st Office, Detroit, Mich.

PHONOGRAPHS AND RECORDS

REPRODUCES Voice. Make your own phonographic singing, talking records. \$25. A. Leliep, Box 388, San Francisco.

BUILD Your own phonograph. Parts catalog with instruction mailed for 10c. American Phonograph Co., 3602 Wesley, Berwyn, Ill.

MUSIC AND MUSICAL INSTRUMENTS

COMPOSERS—Verse or music. Brilliant opportunity. Write Van Buren, 1906 McClurg Bldg., Chicago.

EASY To be a drummer. We show you how. Complete trap drum outfit \$40 and up. Easy payments. Free trial. Ludwig, 1611 North Lincoln St., Chicago, Ill.

SONG Poems arranged for publication. Submit poems for examination. Brennen, 11652 1/2 B'way, New York.

SONG-POETS—"Your Best Bet." Healy, Liberty Theater, Colorado Springs, Colo.

\$15.00 UP For a musical instrument. Catalog and complete details on request. Mention what instrument you are interested in. Carl Fischer, Inc., 58 Cooper Square, New York.

SONGWRITERS: Substantial advance royalties are paid on publisher's acceptance. New booklet, "Song Requirements of Talking Pictures," sent free. Newcomer Associates, 790 Earl Bldg., New York.

HOW To market your song. Send for free information. Song Writers Press, 3647 Bloomington Ave., Minneapolis, Minn.

SONG Poem writers, "Real" proposition. Hibbeler, DI, 2104 N. Keystone, Chicago.

VIOLINS—Hand-made masterpieces. John Lehto, 935 14th San Pedro, Calif.

POEMS Wanted. Work guaranteed. We publish. Great Eastern Song Bureau, Dept. 27, Thomaston, Me.

SEND Song poems, 50-50 plan. Indiana Song Bureau, (Brookside), Salem, Ind.

SONG Poem writers. Write Sequoia Songwriters' Service, Sherman Branch, Los Angeles, Calif.

VIOLINS, Deep, mellow, soulful—on credit. Easy terms for wonderful instrument. Get details today. Gustav F. Henning, 302 University Building, Seattle, Wash.

CORNETISTS—Trombonists—Saxophonists—Clarinetists. Get "Free Pointers." Name instrument. Virtuosi School, Buffalo, N. Y.

PLAY Piano by ear. A sound system. Booklet free. Boucher's Harmony Studio, Ottawa, Can.

"MUSIC Composed" to words. Bauer Bros. (formerly of Sousa's Band), Oshkosh, Wis.

SONG Writers. Send for our "Publishing Agreement." McKinley Music Printers, 1501 E. 55th St., Chicago.

WRITE Songs. Big money and reputation. Write for information. J. Gordon Pub. Co., 201 N. Hoyne Ave., Chicago.

SONG Poems solicited. A different proposition. Richard Broughton, Sioux Falls, S. Dak.

PATENT ATTORNEYS

INVENTIONS Patented; confidential advice; inventions developed—representative for Blair Tool and Machine Corp.; trademarks registered. Edward Gottlieb, Patent Attorney, 5 Beekman St., New York.

JOHN PATTEN DUFFIE, Registered patent attorney, Victor Bldg., Washington, D. C. Reasonable rates. Advice free. Booklet. Prompt personal service.

IF You have a good patent or pending patent for sale, write promptly, American Patents Corporation, Barrister Bldg., Washington, D. C.

TIME Counts in applying for patents. See pages 156 and 157. Clarence A. O'Brien, Registered Patent Attorney, Washington, D. C.

PATENTS—Write for our free book, "How to Obtain a Patent" and Record of Invention Blank. Send model or sketch of invention for inspection and instructions free. Terms reasonable. See advertisements on pages 158 and 159. Victor J. Evans & Co., 934 Ninth, Washington, D. C.

LACEY'S Patent Sense. Valuable book free. See ad page 161.

PATENTS Procured. Prompt, careful and efficient service. Highest references. Moderate fees. Send sketch or model for actual search and advice. George P. Kimmel, Master of Patent Law, 54-L, Legal Bldg., Washington, D. C.

REGISTERED Patent attorney-engineer. Expert in chemical and mechanical patent matters. Former patent examiner. Correspondence invited. A. Pomack, 401 Homer Bldg., Washington, D. C.

INVENTORS—Why pay more? H. M. Plaisted, registered patent attorney; 30 years' experience; patents and trade marks. 4413 Page, St. Louis, Mo.

PATENTS—Easy terms. M. S. Cayne (Former Patent Office Examiner), 105 W. Adams, Chicago.

PATENT Information bureau. Free advice regarding procedure. Booklet upon request. Established for the convenience of inventors. Inventors' Service Bureau, Union Trust Bldg., Washington, D. C.

EDWARD C. SANNETT, 518 McGill Bldg., Washington, D. C. Ex-principal examiner United States patent office, attorney at law, registered patent attorney. I offer to inventors and manufacturers a strictly personal service.

PATENTS Procured; trade marks registered—preliminary advice furnished without charge. Booklet and form for disclosing idea free. Irving L. McCathran, 704 International Building, Washington, D. C.

UNPATENTED Ideas can be sold. I tell you how and help you make the sale. Free particulars (Copyrighted). Write W. T. Greene, 906 Barrister Bldg., Washington, D. C.

SELL Your invention before patenting. Write for free particulars. W. T. Greene, 901 Barrister Bldg., Washington, D. C.

PATENTS, Trade-Marks, Designs. This firm has 27 years' experience and gives expert personal service at reasonable rates. We properly protect your invention. Write for free information and exact cost of procuring patent before proceeding. John B. Thomas & Co., 902 F St., N. W., Washington, D. C.

MONROE E. MILLER, Ouray Bldg., Washington, D. C., Patent Lawyer; Mechanical, Electrical Expert. Booklet and Priority Record blank gratis.

INVENTORS: Send for booklet telling how to patent and sell your inventions at lowest cost. Ralph Burch, Patent Lawyer, 900 F St., Washington, D. C.

ESTABLISHED 1864. Milo B. Stevens Company. Free booklet. Patents. Trade marks. Copyrights. Offices, Monadnock Block, Chicago; Barrister Building, Washington, D. C.

INVENTORS—Write for our Guide Book, "How to Get Your Patent," and Evidence of Invention Blank. Send model or sketch of your invention for our prompt examination and instructions free. Randolph & Co., Dept. 430, Washington, D. C.

PATENTS. Prompt personal service. Write for information. Albert E. Dieterich, Registered Patent Lawyer, 621 1/2 Ouray Bldg., Washington, D. C.

LANCASTER and Allwine, 221 Ouray Bldg., Washington, D. C. "Originators of the Form Evidence of Conception." Before disclosing your invention to anyone send for blank form to be signed and witnessed. Form and patent information bulletin free.

PATENTS. Send sketch or model for advice. Free book: "How to Obtain a Patent." Established thirty years. Highest references. Prompt service. Reasonable charges. Chandler & Chandler, 310 F St., Washington, D. C.

INVENTOR'S Adviser with mechanical movements sent free. Labiner, Three Park-row, New York.

PATENTS. Booklet free. Highest references. Best results. Promptness assured. Send model or drawing for preliminary examination. Watson E. Coleman, Patent Lawyer, 724 Ninth St., Washington, D. C.

"INVENTOR'S Guide," valuable information, free. Frank Ledermann, Registered Attorney-Engineer, 1712 Woolworth Bldg., New York.

PATENTS—Write for free instructions. Send drawing or model for examination. Carl Miller, Registered Patent Attorney (former Patent Office examiner), 259 McGill Bldg., Washington, D. C.

PERCY S. WEBSTER, 203 Saving and Loan Building, Stockton, Calif. Patent booklet free.

FOR INVENTORS

PATENTS. If you have an invention which you wish to patent you can write fully and freely to Munn & Co., for advice in regard to the best way of obtaining protection. Please send sketches, or a model of your invention and a description of the device, explaining its operation. All communications are strictly confidential. Our Hand-Book on Patents is sent free on request. This explains our methods, terms, etc., in regard to patents, trade marks, foreign patents, etc. "Scientific American" contains patent office notes, decisions of interest to inventors and particulars of recently patented inventions. Munn & Company, Solicitors of Patents, 524 Scientific American Bldg., Washington, D. C.; 1523 Scientific American Bldg., 24 W. 40th St., New York City; 1313 Tower Bldg., Chicago, Ill.; 666 Hobart Bldg., San Francisco, Calif.; 521 Van Nuys Bldg., Los Angeles, Calif.

UNPATENTED Ideas can be sold. I tell you how and help you make the sale. Free particulars. (Copyrighted). Write W. T. Greene, 907 Barrister Bldg., Washington, D. C.

LOW Cost manufacturing. Large plant completely equipped for blanking, drawing, stamping and wire forming in any finish. Can save you money on your product. Our figures will convince. Eastern States Products, Box 721, New Haven, Conn.

INVENTORS—Ideas developed and working models built. Electrical problems solved. Lowest charges and confidential service. Industro Electric Tools Co., Petersburg, Va.

IF You have a good patent or pending patent for sale, write promptly, American Patents Corporation, Barrister Bldg., Washington, D. C.

SELL Your invention before patenting. Write for free particulars. W. T. Greene, 902 Barrister Bldg., Washington, D. C.

INVENTORS—Cash in on your invention now! Don't delay the sale any longer! Send for a free copy of our specially prepared booklet, "Turn Your Patent Into Money," today! It contains helpful information for all inventors. M. L. Rund, Mgr. Classified Advertising, Popular Mechanics Magazine, 200 E. Ontario St., Chicago, Ill.

INVENTORS, Manufacturers. If you have a specialty of real merit suitable for national distribution write The Plomo Specialty Mfg. Co., Cleveland, Ohio.

WANTED—Article to manufacture and sell. All or some part of which must be consumed and thus be a repeater. Give full particulars and price. Address G. L. P., Room 514, 1240 South Main Street, Los Angeles.

INVENTIONS Wanted—Patented, unpatented. If you have an idea for sale, write Hartley, Box 928, Bangor, Me.

GET Your own patents. Legal blanks, complete instructions \$1. Cutting Sons, Campbell, Calif.

INVENTORS Universal - Educator — contains 900 mechanical movements; 50 perpetual motions. Tells how to obtain and sell patents. Suggests new ideas. Explains how to select your attorney and avoid patent sharks. Price (revised edition) \$1.00 postpaid. Albert E. Dieterich, 621 Ouray Bldg., Washington, D. C.

MAKE Your ideas a reality; consult the Thomas Engineering Laboratories, 1900 Vine St., Cincinnati, Ohio.

PATENT Application blanks, 25 cents. Everything for inventors. Correspondence invited. American Inventors Directory and Inventors Institute, Benning, Washington, D. C. Alfred E. Glascock, Director.

WANTED—An opportunity to back engineers with new ideas for the improvement of airplanes. If we feel your inventions are practical we will help you develop them. Alexander Aircraft Co., Dept. 6, Colorado Springs, Colo.

INVENTIONS—Write for our free book "How to Obtain a Patent" and Record of Invention Blank. Send model or sketch of invention for inspection and instructions free. Terms reasonable. See advertisements on pages 158 and 159. Victor J. Evans & Co., 157 Ninth, Washington, D. C.

INVENTORS—Read marvelous history of American inventions—most impressive record in annals of human achievement. Beautiful 2 vol. set, over 1,034 pages and 500 illustrations. Original price \$10.00—a few sets left will be sold at \$5.00. Pay postman when delivered or, if outside U. S., remit when ordering. Popular Mechanics Press, Room 809, 200 E. Ontario St., Chicago.

INVENTORS' Notice—Your invention or improvement can be sold, or its commercial value can be determined, without the expense of first getting a patent, by using our new copyrighted Inventors' Protection System. Write for full free particulars. Inventors Protection Bureau, A2032 Estes Ave., Chicago, Ill.

WANTED, All lines—household, automobile accessories, farmer requirements, novel lines. Particulars. Patent Supplies, Box 6437, Johannesburg, Africa.

I SELL Patents. Established in 1900. A nationally-known service. Experienced, respected. Why take chances? Charles A. Scott, 773PM Garson Ave., Rochester, N. Y.

PATENT Wanted—To buy outright patent on articles using hard wood as principal stock, maple, birch, beech, etc. Articles must be made from six foot stock. Chas. E. Audinwood, Derby Line, Vt.

PATENTS Sold, models built, sales campaigns prepared. Prospects furnished. Write Leroy Brown, 2519 Barclay, Baltimore, Md.

TIME Counts in applying for patents. See pages 156 and 157. Clarence A. O'Brien, Registered Patent Attorney, Washington, D. C.

LACEY'S Patent Sense. Valuable book free. See ad page 161.

PATENTS FOR SALE

OUTRIGHT—Electric flat tire indicator. Patent pending. Write G. Frederick, 6557 14th N. W., Seattle, Wash.

FOR Sale—Patent pending. Outright, royalty, adjustable sweep stock plow heel; adjust in one minute. Farmers wild. Simple. Benj. P. Best, Ogeechee, Ga.

SCRAPER, 1,728,036; Sept. 10, 1929. Trolley, 1,729,924, Oct. 1, 1929. John Bozowich, 1404 Eddy St., San Francisco, Calif.

OUTRIGHT Or royalty, night bird-cage enclosure. Closes automatically. Phil. J. Adamowicz, 2140 W. 21st Place, Chicago.

KITE String reel—Wire, low cost, flat. Patent pending. Root, 476 Dartmouth, Buffalo, N. Y.

UNITED States and Canadian patent on new loud speaker. L. A. Smith, 2821 Clara St., New Orleans, La.

ADVERTISING Improved reflector sign, shines days by sunlight, nights by electric light, at low cost. Outright or royalty. J. Schauder, 9324 Farragut Rd., Brooklyn, N. Y.

REAR Glare eliminator—For automobiles, for any make automobile (mechanism concealed). Controlled by driver by single movement of finger (action instantaneous). Ornamental and truly a safety device for night driving. Will sell or consider royalty. B. P. Wood, Winchester, N. H.

FOR Sale—A figure toy of quadruped type with traction movement. Patent pending. Joseph Heleniak, 661 Oklahoma Ave., Milwaukee, Wis.

OUTRIGHT Or royalty. Patented brake drum cooling for automobile. Guarantee keep brakes from overheating; every automobile needs it. Peter Lasco, Forest City, Penna.

ROYALTY Or cash, patent pending; adaptor fits all radio tubes; dozens uses, unlimited possibilities. Have others. Cash or royalty. H. Paek, Box 1183, San Francisco.

FOR Sale—Mechanical base-ball game with candy-vending machine. Manufacturers write and give me estimates for manufacturing same. R. J. Thomas, 2209 W. Main St., Kalamazoo, Mich.

"ELLIGRAMS"—Protected ideas for going concerns. Copywritten, health residence (sectional); patent pending. Perfected self-contained fool-proof, stabilizing, banking; control all flying machines. Motor-compelling, lifelike movements, any extinct animal, or toy. All on royalty basis. Be able to put it over completely or don't write. J. B. Ellinger, 645 Henry Bldg., Seattle, Wash.

WILL Sell patent. Something new for hotels, restaurants and homes. Inexpensive. George Uhlig, Rochester, Mich.

PATENTED Clinker tongs. Cash or royalty. Gust Carlson, 331 McPherson, Ottumwa, Iowa.

PATENT On small stamping good or clock. Entirely new, cheap to manufacture. Good market. Guyot, 443 S. Virgil Ave., Los Angeles, Calif.

INVENTIONS To order. Submit problem for estimate. Dudley Bunn, Savanna, Okla.

PARTNER Or purchaser—Patentable steam shovel, gas saver, refrigeration, tire, boiler and others. Garlic, Lock Box 722, New Orleans, La.

SINGLE Sleeve valve motor. Simple construction (no camshaft) 50% greater valve opening than other motors. Less weight per horsepower. Cash, royalties. F. Dauenhauer, Dutton Ave., Santa Rosa, Calif.

OUTRIGHT Good will and trade mark "Vital" registered, a fortune word or brand for some manufacturer. Dr. Keller, Wiaux, Mont.

PATENT For sale. Something new. Cartridge and magazine holder. For sporting and military purpose. Stamp sheet metal, cheap to manufacture. Chas. J. Cook, 3908 Michigan Ave., Detroit, Mich.

OUTRIGHT. New improvement for airplanes. S. Wiechacz, 3520 Trombly St., Detroit, Mich.

FOR Sale or royalty money making patent on fountain pen. Chrystal McCue, Goodell, Mich.

OUTRIGHT Or royalty. Latest grocery fixtures. Patented. Nelson T. Sharo, 32 S. Bellevue, Memphis, Tenn.

FOR Sale—New style weather strip, for bottom of fire door, garage or house door, swinging or sliding. Can be put on without removing doors. A. Lundeen, Lynbrook, N. Y.

NEW Sensation. Kickless scooter. Patent pending. Jos. B. Iams, 929 So. Grant, Tacoma, Wash.

OUTRIGHT—Simple mechanical dandelion remover, destroys plant permanently with one pull. Louis Mauch, 846 Corona St., Denver, Colo.

WIND-STORM Hat retainer. Every man a prospect. Louis Pichler, 670 E. 102d, Cleveland, Ohio.

OUTRIGHT Or royalty. U. S. patent 1,724,767, granted August, 1929; automatic dental water heater. R. A. Mercer, 6605 N. 13th St., Philadelphia, Pa.

INVENTION For sale. Sanitary, self-cleaning cuspidor. Useful on boats, street cars, railroad buildings, etc. Blue prints on request. Frank Seder, Box 1171, Jerome, Ariz.

U. S. PATENT For sale outright in clineing dives for cream separator. Far superior to any now in use. Carl Molstad, Newfolden, Minn.

ROYALTY Cap and jar for preserves, jelly, jam, etc.; very practical and economical. Patent pending. S. Thompson, St. James, Minn.

OUTRIGHT New improvement in ice cream cone filler. Wayne Like, Plainwell, Mich.

OUTRIGHT Or royalty—Butter dispensing device for homes, restaurants, hotels, etc. Serves butter direct to guest's plate. Offers wide distribution for responsible organization. Thomas Kaskouras, 8244 Paxton Ave., Chicago, Ill.

RECENTLY Patented automatic flushing valve, also have a combination water and air machines. Fred Benske, 1422 Stebbins Ave., New York.

TIME Counts in applying for patents. See pages 156 and 157. Clarence A. O'Brien, Registered Patent Attorney, Washington, D. C.

COMBINATION Motor truck, concrete and mortar mixer; establishing a new mixing principle and will prove a big money maker to manufacturer. Chas. Payne, 27 Fulton Ave., Waukegan, Ill., U. S. A.

OUTRIGHT Or royalty—Patented keyless automatic door lock. Jay Westcott, 163 Wilmore Pl., Syracuse, N. Y.

INVENTORS—Cash in on your invention now! Don't delay the sale any longer! Send for a free copy of our specially prepared booklet, "Turn Your Patent Into Money," today! It contains helpful information for all inventors. M. L. Rund, Mgr. Classified Advertising, Popular Mechanics Magazine, 200 E. Ontario St., Chicago, Ill.

ELECTRICAL

FILTER Condensers, test voltage, Imfd, 750 \$1.50; 2,000 \$2.50; 2,500 \$3.25; 4,000 \$8.00. 2mfd, 1,000 \$2.50; 2,000 \$4.00; 4,000 \$15.00. Aluminum, square-foot 85c. Lead 85c. "Ham-List" 4c. Curtis Sales Company, 1109 Eighth Ave., Fort Worth, Tex.

HANDY Electrical kinks on all phases of practical electricity. 47 ideas on wiring, 45 on making electrical devices, 19 on lighting, 5 on transformers, 5 on motors, 8 on generators, 11 on switches, 22 on testing, 12 on repairing, 11 on battery manufacture and repair, 5 on telephones, and 9 on electricians' tools. 214 articles, 162 pictures. Send no money. Just write postal for "Electrical Kinks." Pay postman \$1.50 and postage. Popular Mechanics Press, Room 808, 200 E. Ontario St., Chicago, Ill.

MODELS AND MODEL SUPPLIES

PRODUCERS Of results. Mechanical and consulting engineers. Our specialty models in metal designing, developing, building special machinery, manufacturing, experimental work, patterns, castings and model supplies. Reasonable rates. Inventors see or write us. 25 years in this work. Dept. F. The Johns Engineering Co., 1380 E. 17th St., Cleveland, Ohio.

SCALE Model railroad supplies—not toys. For hobbies or railroad exhibition work. The first and only complete model railroad catalog in the country—35c with credit slip. Well illustrated, parts for five gauges. American Model Railway Company, New Rochelle, N. Y.

TIME Counts in applying for patents. See pages 156 and 157. Clarence A. O'Brien, Registered Patent Attorney, Washington, D. C.

POWER Models for modelmakers. Steam and gasoline engines, boilers. Ship, railway and steam fittings. Modelmakers supplies, metals. Catalog 20c. Chas. Cole, 1355 Church St., Ventura, Calif.

SHIP Model Fittings: Send Dime for booklet. A. J. Fisher, 1002 Etowah Ave., Royal Oak, Mich.

LET Our experience be your guide. Models that are models; tools and equipment for economic manfg. Patterns of all types; manufacturing in all branches. Satisfaction guaranteed. United Machinery Company, Cincinnati, U. S. A.

MODEL Steam locomotives, castings, materials. Catalog 15c. Birch, 131 Eliza Avenue, Hazel Park, Mich.

WORK With master machinist; 15 years experimental experience, well equipped shop. Albert Weiss, 161 W. 21st St., New York City.

THE Modelmaker, a magazine for all interested in making working models, boats, etc. Sample 10c. Modelmaker, 122 Liberty St., New York.

WE Make working models for inventors and do experimental work and carry a complete stock of brass gears and model supplies. Send for catalog. The Pierce Model Works, Tinley Park, Ill.

SPECIAL Machine builders, tool and die makers. Inventors' models production work of all kinds. Dept. L. Quality Hardware & Machine Corporation, Ravenswood and Thorndale Aves., Chicago, Ill.

MODEL Steam engines and boilers for miniature power boats. Boat and boiler fittings. New catalog 15c. Model Machine Shop, 212 Price St., Rahway, N. J.

MANUFACTURING

LARGE Factory exceptionally well equipped to manufacture your product complete, warehouse it and ship to your instructions. Dies, stampings, casting, screw machine, wire products, plating, enameling, assembling, cartons and printing. Quantity production. Estimates promptly furnished. A reliable and efficient organization. Majestic Products Mfg. Company, Box 877, Chicago.

LOW Cost manufacturing. Large plant completely equipped for blanking, drawing, stamping and wire forming in any finish. Can save you money on your product. Our figures will convince. Eastern States Products, Box 721, New Haven, Conn.

MANUFACTURING Models, dies, stampings, brass work, one or thousands. Circular free. Baum's Metal Specialties, Kansas City, Mo.

SPECIAL Machinery or parts, dies, tools, metal specialties, models, special gears, stock gears and model supplies. Send for Catalogue. The Pierce Model Works, Tinley Park, Ill.

WIRE Goods made to order. Cooley Mfg. Co., 530 N. Western Ave., Chicago.

SPECIALTY Manufacturing. Stampings, wire products, patents developed and marketed. Safety Globe & Mfg. Co., Columbus, Ohio.

DIES, Stampings. A. Frye, Box 12, Station A, Elizabeth, N. J.

LIGHT Manufacturing. Stampings, springs, iron, aluminum, brass, die castings. Pattern and die making. Allen Industries, Independence, Mo.

DIES, Stampings, machine work. B. L. Nortwed, Mitchell, S. Dak.

FOR MANUFACTURERS

MANUFACTURERS' Job lots bought for cash. What have you? Edward Ross Co., Westerly, R. I.

HOME WORK SHOP

GOOD Used hand-saws, jig-saws, wood craftsman's lathes, drills at special low prices. Waco Tool Works, 5212 West Kinzie St., Chicago.

MACHINERY, TOOLS AND SUPPLIES

PUNCH Presses: Small power bench type, \$65.00. Circular. Allen Industries, Independence, Mo.

USED Arc welders, air compressors, buffers, grinders, reconditioned and guaranteed like new. Shipped on trial and easy terms. If you're in need of good guaranteed equipment, write today to Bob Jones, Box M-1296, Troy, Ohio.

NO. 3 CINCINNATI Universal Milling Machine with dividing heads, \$550.00; 14 in. x 6 ft. Von Wyck lathe, \$140.00; No. 60 Hand Grinder, \$275.00; 20 in. Hendy Shaper, \$225.00; 24 in. Steptoe Back Geared Crank Shaper \$550.00, 36 in. x 18 ft. Niles Lathe, \$775.00; 20 in. Barnes Drill Press, complete, \$65.00; Quincy Air Compressor with tank and hose, \$65.00; 10 in. Bench Drill Press, \$23.00. Terms to suit. Write for catalog. Cincinnati Machinery & Supply Co., 27 West Second St., Cincinnati, Ohio.

BENCHLATHES. Real working miniature precision machines. 2 inch swing, 6 inch between centers and above. Set of detailed blueprints and directions 50 cents, complete castings \$3. Dzabay, 609 Avery St., Pittsburgh, Pa.

CONCRETE Building block machines and molds. Easy payments. Catalog free. Concrete Machine Co., 5 North Main St., St. Louis, Mo.

START Business of your own, small investment required, doing nickel, copper and silver plating. This work in big demand. Information free. Electro Platers Supply Co., 28 W. Second St., Cincinnati, Ohio.

NEW And used machinery and equipment. One of the largest stocks in the country. Lowest prices. Botwinik Brothers, Inc., 67 Water St., New Haven, Conn.

ENGINES, MOTORS AND DYNAMOS

BARGAINS—Elec. drills, \$11.95; bench saw outfit \$7.35; elec. bench grinders \$13.20; combination lathe, \$8.15; scroll saw, \$5.60; motors, generators, farm plant equipment; flexible shafts; 100 other bargains. Send for special bargain bulletin. Acme Tool Co., 627 W. Washington, Chicago.

FOR Sale: One-sixth hp. elec. motors, 60 cycle, 110 volt, a.c. slightly used, first class running condition. \$4.50 each. Cash with order. Also some 1/2 hp. gasoline engines with magneto fly wheel at \$12.00 each and some electric motors not running at \$1.50 each. Maytag-Chicago Co., 160 E. Illinois St., Chicago, Ill.

NEW 10v. 5 Ampere battery charging generators \$6.50; a.c. 110v. 1/4 hp. motors, \$7.50; 1/2 hp., \$16.50; 32v. motors, 1/2 hp., \$19.50; 1/3 hp., \$12.50; 1/4 hp., \$8.50; 32v. motors with emery, buffer, drill chuck, \$8.00. Large stock motors and generators. Queen City Electric, 1736 Grand Ave., Chicago.

EDISON Phonograph motors with speed governor. Westinghouse dictaphone motors, both universal. \$5.00 plus express 10 lb. Geo. Schulz, Calumet, Mich.

WHILE 100 Last: 1/4 horse alternating double shaft grinding and buffing motors with emery wheel, buff, cord and switch, \$9.75. 1/4 horse motors, \$7.00. 1-3 horse, \$19.50. Also generator bargains. Electrical Surplus Company, Dept. 5, 1911 Chicago Ave., Chicago.

OUR Governors will control any make of auto engine at any speed desired. Easy to install. \$10 C. O. D. Candee-Smith Governor Co., 215 North Los Angeles St., Los Angeles.

COMPRESSORS, Twin cylinder, for small tire shops. Duco spraying. J. Trockman & Sons, Inc., 310-312 Lincoln Ave., Evansville, Ind.

SAVE Money—Automatic air compressors, constant potential battery chargers, reconditioned and guaranteed like new. Unusual value—shipped on trial and easy terms. If you can use, better write today to D. W. Baker, Box M-1297, Troy, Ohio.

TIME Counts in applying for patents. See pages 156 and 157. Clarence A. O'Brien, Registered Patent Attorney, Washington, D. C.

REBUILT 5 Horsepower gasoline engine, price right. W. J. Hildreth, New Kensington, Pa.

STEAM Engines—One h. p. \$18.00; 1/2, \$12.00. James Chambliss, Bessemer, Ala.

NAVY Surplus, 800 new radio generators d.c. and 500 cycles. Unusual prices. List. Henry Kiengle, 501 East 84th St., New York.

WELDING AND SOLDERING

START In highly profitable arc welding business with practically no expense. Our constant arc welder starts you on road to success. Easy monthly terms, liberal trial on money back guarantee. Write today. Hobart Industries, Box M-1298, Troy, Ohio.

BENDING MACHINES

THE Famous Hossfeld "Wrenchless" Universal Iron Bender is the last word in bending machines. Bends metal, cold or hot, into most any conceivable shape, including Eye Bolts and Automobile Spring Eyes. Bends up to 1" bars or 1 1/2" pipe cold. Thousands in use by all classes of trade, from the smallest shops to the largest railway system. Write for circular and prices. Hossfeld Mfg. Co., Winona, Minn.

SURVEYING INSTRUMENTS

GUARANTEED Rebuilt transits and levels. All makes. Sold on approval. Bargain prices. Cash or easy terms. Write today for descriptive list M-312. Warren-Knight Company (Makers of "Sterling" Transits and Levels), 136 N. 12th St., Philadelphia, Pa.

COMPLETS Farm level outfit \$25.00. Combination transit \$45.00. Sent prepaid for cash. Money back guaranteed. Wissler, 639 No. Broadway, St. Louis, Mo.

LUMBER

KNOW Your wood. 33 samples rare woods \$2.00, 20 cabinet and 20 inlay \$1.75, choice \$1.00. Sets postpaid and labeled. Send for catalog. Craftsman Wood Service, L-717 East 62nd St., Chicago.

FARM LANDS

LAND Opening—The Great Northern Railway serves an agricultural empire in Minnesota, North Dakota, Montana, Idaho, Washington and Oregon. These states abound in opportunities for small farmers or large operators to rent or purchase a farm at lowest prices and best terms of many years. Every kind of farming, grain, livestock, dairying, fruit, poultry; large acreage or small suburban tracts, rich cutover or high producing irrigated land. Write for free Zone of Plenty book with detailed information. Low homeseekers' rates. E. C. Leedy, Dept. 457, St. Paul, Minn.

\$900 GETS 78 Acres on asphalt, edge depot village; trout brook; 7 homelike rooms, 15-cow barn, silo, \$2,900 with horses, 8 cattle, poultry, machinery, all crops; \$900 down. Pg 47 big new catalog. Free. Strout Agency, 255-P Fourth Ave, New York City.

WINTER Home in Florida. Lots \$1 down \$1 a week. On Dixie Highway, close to Tampa, Fla. Ask for prospectus. Box 374, Tampa, Fla.

FLORIDA Real estate appraisers. 34 years' experience. Know the real value of your land. Reasonable fees. Cunningham Investment Co., Inc., Box 374, Tampa, Fla.

TO Sell, trade or buy property anywhere located. Write Fisher Realty Co., Hannibal, Mo.

OZARKS—40 Acres, Missouri; \$5 month; own a home. Jarrell, Mt. Vernon, Ill.

WANTED: Hear from owner having good farm for sale. Cash price, particulars. John Black, Chippewa Falls, Wis.

FLORIDA—20 Acre tracts at De Funiak Springs, N. W. Florida. Biggest opportunity of year. Where the sun shines the year around. Fine for poultry, grapes, fruits, garden or truck farms. On good roads. Good soil. Health-giving water. Perfect climate. Near schools and churches. Co-op. market plan assures comfortable steady income. Full price only \$500. Pay \$200 down. You get clear title deed at once, balance \$18 a year; no interest. Specially arranged round trips by auto from Chicago. Great opportunity. Send for free copy Chamber Commerce booklet today. McCaskill Estates, 7 S. Dearborn, Chicago.

EIGHTY Acres oil mineral land, five dollars acre. Terms. Also irrigated grapefruit and vegetable land. Business opportunities. Wonderful subtropical Rio Grande Valley. Phillos, San Benito, Tex.

LAND Sale, \$5 down, \$5 monthly, buys 40 acres Southern Missouri. Price \$200. Send for list. Box 22N, Kirkwood, Mo.

PECAN-Orange-Fig groves "On the Gulf." Monthly payments. Guaranteed care. Big, quick returns. Suburban Orchards, Dept. M., Biloxi, Miss.

SELL Your property quickly for cash, no matter where located. Don't pay big commission. Particulars free. Real Estate Salesmen Co., Desk B, Lincoln, Nebr.

OZARKS—10 Acres near White river and proposed power dam, \$100, \$5 monthly. Alvin Zimmerman, 1802 N. 5th, Kansas City, Kan.

REDUCE Labor on your farm and increase income. One farmer writes he would not part with the information for \$100 if it could not be duplicated. Send today for our valuable "Farmers' Handbook" and get ready to put some of the 861 practical ideas into operation for your own benefit. Pay postman only 98 cents plus postage when delivered. Popular Mechanics Press, Room 808, 200 E. Ontario St., Chicago.

MONEY Made in Mich. potatoes, \$10 down now and easy terms buys land near markets, lakes, streams. Write today. Swiggart & Co., P-601, 32 N. State St. Bldg., Chicago, Ill.

EASTERN Pennsylvania farms near Philadelphia. Write for bulletin giving prices, sizes and descriptions. Wilson George, Quakertown, Pa.

DOGS AND PETS

HUNDRED Hunting hounds cheap; trial; literature free. Dixie, A14, Herrick, Ill.

FOR Sale, my trained coon hound, \$30 buys him on 20 days' trial. D49, D. D. Scott, Calhoun, Ga.

SCOTTISH Terriers for Xmas. Good ones ready for delivery Nov. 1st. S. Guss, Point Reyes, Calif.

ST. BERNARD For Christmas gift! Rare, beautiful thoroughbred puppies. Photos submitted, delivery guaranteed. Helvetia Kennels, 181-P McKenna Ave., Montreal, Que.

FANCY Rats and mice, 30 varieties. Sunshine Mousery, Palmetto, Fla.

FOR Sale. Minks, squirrels, raccoons, foxes, ferrets, muskrats, ginseng, rabbits, skunks, wolf pups, opossums. B. Tippman, Caledonia, Minn.

SHEPHERDS, Collies, fox terriers shipped on approval. Ricketts Farm, Kincaid, Kans.

WHITE Collies and other colors. Beautiful and useful. Dept. P, Shomont Kennels, Monticello, Iowa.

DOG Lovers—Every fact regarding every phase of dog training (all breeds) including psychology, obedience, guarding, swimming, rescue work, hunting, herding flocks, teaching tricks, finding lost articles, racing, war service, police dogs, sled dogs, etc., will be found in "Training the Dog," by Will Judy. Price only \$1.50. Pay postman when delivered or, if outside U. S., remit when ordering. Popular Mechanics Press, Room 809, 200 E. Ontario St., Chicago.

RABBITS

RAISE Fur rabbits. We pay \$4.00 for those raised from our stock. Send 10c for catalog, contract, etc. Goldenrod Fur Farms, Inc., Lincoln, Nebr.

MAKE Big profits with Chinchilla rabbits. Real money-makers. Write for facts. 832 Conrad's Ranch, Denver, Colo.

MAKE Big profits—Chinchilla rabbits. New bonus plan assures big profits. Get facts. T. Mueller, U. S. Nat'l Bank Bldg., Denver, Colo.

RAISE LaSalle fur rabbits. Build big paying business. LaSalle Fur Co., Mt. Clemens, Mich.

MUSKRATS

TRAPPERS—"Eleven Box Traps," Complete blueprints, 30c. Weesho-Uco, 31st Office, Detroit, Mich.

MUSKRAT Farming—The greatest book on one of the greatest opportunities today. Tells of the opportunity in this business and how to do everything in connection with the raising and marketing of muskrats. Pay postman only \$2.25 and postage when delivered or, outside U. S., remit when ordering. Popular Mechanics Press, Room 809, 200 E. Ontario St., Chicago.

WANTED—MISCELLANEOUS

MAIL Us your discarded jewelry, gold, crowns and bridges, watches, diamonds, silver, platinum. Money promptly mailed. Goods returned if offer refused. United States Smelting Works (The Old Reliable), Dept. 71, Chicago.

WE Buy gold teeth. Southwest Gold & Silver Co., Box 63, Ft. Worth, Tex.

WANTED—March 1928 copies of Popular Mechanics Magazine. We will pay 25c each for all copies of this number delivered to us in good condition. Send to Popular Mechanics Magazine, Room, 408, 200 East Ontario St., Chicago.

HUNDREDS of people have sent their old gold, silver, platinum jewelry, dental work to me. Why not mail yours today? Highest prices paid. Satisfaction guaranteed or goods returned. F. Polcer, 2408 South Cicero Ave., Cicero, Ill.

FOR SALE—MISCELLANEOUS

FOR SALE—Remaining stock of Nuway soap cup saver, manufactured by the Hillwood Specialty Co., to retail at fifty cents. About 500 cups and mailing containers on hand. Write for free sample, then make offer on lot. Chas. E. Audinwood, Derby Line, Vt.

ADDRESSOGRAPHS, Letter folders, multigraphs, envelope sealers, duplicators, less than half price. Guaranteed. Pruitt Co., 117 No. Wacker Drive, Chicago.

WATCHMAKERS Lathe for sale at a bargain. R. Jaegermann, 5815 Easton Ave., St. Louis, Mo.

ROOTS AND HERBS

HERBS, Roots, barks, seeds. All kinds, 25c box. Lists free. Botanics, 145 West 112th St., Chicago.

PERSONAL

LEARN To hypnotize. Instructive book on hypnotism, 10c. Geo. Fenner, 2401 Jefferson, Louisville, Ky.

TOBACCO Or cigarette habit cured in seven days. Guaranteed. Costs two dollars. Marcin Helle, 4152 Gladwin, Detroit, Mich.

FOOT-PAINS! Ended with famous "Arch-belt." 15c postpaid. Relief guaranteed. Send shoe size. Box 4, 178 Columbia Road, Dorchester, Mass.

FOOL Your friends! Make them think you are in New York. Send 25c for 10 New York postcards. I will mail them to your friends from here. Send any letter you want mailed from here, with 10c for service. Marvelous fun for practical jokers! Wolgreen, Box 59, Whitestone, N. Y.

YOUR Photo, 20¢. \$1.00. Confidential. Send photo. Pop-Gpo, Box 471, New York.

CHILBLAINS, Ingrowing nails or bunions, safe, natural, painless correction. Write your ailment for free information. Eugene Eaton, D105, Bandon, Oreg.

LETTERS Mailed from here for 10c silver. Foster Mailing Service, 1443 W. 82nd, Chicago, Ill.

IOSALINE. What is it? Send for free sample. A soothing, comforting external application for simple head colds, muscular soreness from exposure and fatigue. Simple headache, neuralgia. For tired aching feet and all pains and aches. It is clean and greaseless. The Iosaline Co., 630 M St. N. W., Washington, D. C.

ARE You old at forty? See our advertisement on page 162 of this issue. The Electro Thermal Company, 2124 Morris Ave., Steubenville, Ohio.

TOBACCO Or snuff habit cured or no pay. \$1.50 if cured. Remedy sent on trial. Suerba Co., N3, Baltimore, Md.

ADVICE, Information, any subject, 25c coin. References. Fred Klotz Reading, Pa.

STOP Fingernail biting habit. Guaranteed cure \$2.00. M. W. McIntire, Wilmington, N. C.

MISCELLANEOUS

HOMEOPATHIC And Biochemic preparations sent postpaid to all parts of the world. Manual and booklet free. Halsey Bros. Co., 5547 Ravenswood Ave., Chicago, Ill. Established 1875.

MIRRORS Resilvered at home. Costs near 5 cents per square foot; you charge 75 cents. Immense profits plating autoparts, reflectors, tableware, stoves, refinishing metalware, etc. Outfits furnished. Details free. Write Sprinkle, Plater, 288, Marion, Ind.

COMMERCIAL Drawing. Work done reasonable. E. Hildreth, 2136 Clinton Ave., New York City.

TIME Counts in applying for patents. See pages 156 and 157. Clarence A. O'Brien, Registered Patent Attorney, Washington, D. C.

OIL-PAINTING—Anyone can learn. Start studio, teach, demonstrate. Inexpensive instruction. Particulars free. Hughes, Box 1264, Los Angeles, Calif.

NINE Foxes in one day is the record of one man that used my methods. One set takes fox, coon or skunk. Write for proof. E. A. Estabrook, Pittsfield, Vt.

"IT'S YOU!" Sensational song 25c per copy. Over 60 waiters, fox-trots, etc. Extraordinary low prices to jobbers, dealers, agents, music teachers, etc. Chester Escher, Music Publisher, 125 West 45th St., New York City.

TATTOOING—Learn how with my outfits. Descriptive circulars sent anywhere. Sergt. Bonzey, 367 So. Main, Providence, R. I.

WATERTIGHT Wrist purse for swimmers. Keep your valuables with you, 50c. Lellep, Box 388, San Francisco.

FASCINATING Christmas gift. Brought from Holy Land. Christians thrilled. Special offer now. Write League, 815 Longacre Bldg., New York City.

CASH Paid for Butterflies, Insects. See Sinclair Display Advertisement on page 26.

MAKE Money with magical cartoons. Learned in one evening. Entertain lodges, clubs and parties. Hendrickson's Chalk Talks, Arcyle, Wis.

MEXICAN Made holsters, lariats, horse-hair articles; rattlesnake belts. Send four cents for illustrated list. Tex-Mex Leather Co., 309 Esperson Bldg., Houston, Tex.

INDIAN Methods—World's greatest trapping secrets exposed for first time. Best "weatherproof" Fox—Coyote—Mink sets on earth. Methods \$1.00—worth hundreds. Cecil Atkinson, 446-T, Mandan, N. Dak.

CUTS Anybody can make. Simple, cheap process, \$1.25. Specimens, particulars, 2c stamp. M. Day, Windfall, Ind.

CARTOONISTS. Sell your drawings. Proven plan. Castle Studios, Independence, Missouri.

TELL An army of 3,000,000 live readers all about your offer! If you have anything to sell, buy or exchange, or if you have any reasonable proposition, tell our readers all about it—they'll respond quickly. Our booklet "How to Create More Business" contains some very interesting, helpful facts. Write today for your copy—it's free. M. L. Rund, Manager Classified Advertising, Popular Mechanics Magazine, 200 E. Ontario St., Chicago, Ill.

Now... You Can Weatherstrip Your Own Home at 1/3 the Cost!



MADE OF REAL S-P-R-I-N-G BRONZE

AGENTS BIG MONEY!

This great new development gives you an amazing chance to get into a business of your own. Up to \$200 in a week is possible even in small cities. Even Spare Time may pay from \$3 to \$6 in an hour. Sales outfit furnished. Mail coupon for territory.

This short message contains facts of almost startling significance to both home owners and renters. Read them and then use the coupon below for detailed proof including generous free sample.

INVENTOR'S DISCOVERY BANISHES ALL OLD-STYLE EXPENSIVE METHODS

NO more costly "make-shifts"! No more inefficient zinc, rubber, felt or composition "strips"! Now a new-type material used to weather-proof the great city skyscrapers is available to householders in a new form. The mechanical wizardry of a St. Louis genius brings this super-insulating material to you ready to use right in your home. If you can handle a yardstick and a pair of scissors you can now weatherstrip every door and window in your home in just a few minutes.

Cuts Fuel Bills in Half . . . Ends Drafts

This new weatherstrip is guaranteed to pay for itself in fuel savings alone in less

Red D Ply

RED-D-PLY MANUFACTURING CO., Dept. W-10, 1531 Washington Avenue, St. Louis, Mo.

than two years . . . otherwise it doesn't cost you one penny. It banishes drafts . . . ends "colds" and doctor bills. Keeps out all the soot, dust and dirt that now sifts in around doors and windows. Curtains, rugs, drapes, clothing stay clean twice as long.

For advertising purposes a sample of this revolutionary new weatherstrip is being sent to interested people. With it are included the many astonishing details that there is naturally not room to print in this limited space. Get the facts along with our low-cost introductory offer. Mail the coupon at once.

FREE SAMPLE!

Red-D-Ply Mfg. Co., Dept. W-10, 1531 Washington Ave., St. Louis, Mo.

Without obligation to me, rush sample of weatherstrip invention, also low-cost introductory offer.

Name

Address

Town State

Put check mark here if you want to make money as our agent.

20 Years of Shirt Sleeve Practice In ELECTRICITY

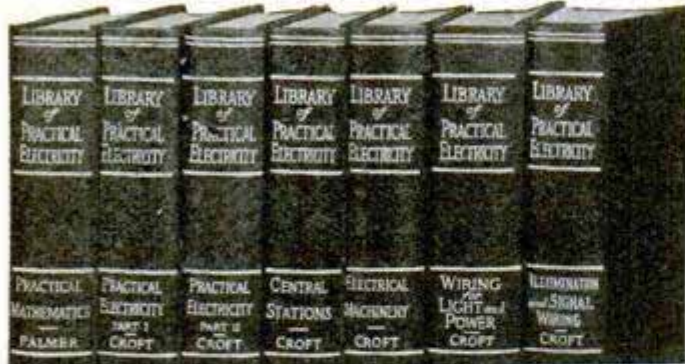

The Croft Library of Practical Electricity

JUST OUT!
Newly Re-vised Edition

THIS is the electrical age, with unlimited opportunities for the man who has educated himself in the finer points of electrical practice. Fit yourself for a big-pay job by knowing electrical practice complete, including inside and outside work, central stations, and the whole subject. With the aid of the Croft books you can know electricity as experts know it and put yourself in line for an expert's pay.

Standard Electrical Training

The Croft Library is a complete electrical educator. It is founded on practice—on work as it is actually done. It is jammed from cover to cover with the kind of hard-headed facts you want. Written so that the beginner can easily understand it, yet so sound, so thorough, that it is the daily guide of 59,000 highly paid electrical workers and engineers. Croft tells you the things you need to know about motors, generators, armatures, commutators, transformers, circuits, switchboards, distribution systems—electrical machinery of every type—wiring for light and power—wiring of finished buildings—underwriters and municipal requirements—illumination in its every phase—the latest and most improved methods of lighting—lamps and lighting effects, etc.—how to do a complete job, from estimating it, to completion. Make no mistake about it—there are big jobs in electricity ready for you when you're ready for them. Thousands of men who have the Croft Library know that to be a fact. The Library itself, on a FREE TRIAL BASIS, will prove it to your own absolute satisfaction.

3000 Pages, 2100 Illustrations

In these volumes Croft teaches you electrical practice complete. He takes you in quick, easy steps from the simplest principles to the complete and economical operation of a great central station. He tells you all that he has learned in twenty years of shirt-sleeve practice. With these books at his elbow a man can learn as much about electricity in six months—good practical "bread and butter" stuff—as he would ordinarily learn in a lifetime of practice.

10 Days FREE TRIAL
Just Mail the Coupon!

NO MONEY DOWN SMALL MONTHLY PAYMENTS

Fill in and mail the coupon attached and we will send you the entire set of eight volumes for ten days' Free Examination. We take all the risk—pay all charges. You assume no obligation—you pay nothing unless you decide to keep the books. Then \$1.50 in ten days and the balance at the rate of \$2.00 a month. Send the coupon NOW and see the books for yourself.

FREE EXAMINATION COUPON

McGraw-Hill Book Co., Inc., 370 Seventh Ave., New York

Send me for 10 days' free examination the Croft Library of Practical Electricity. If satisfactory I will send you \$1.50 in 10 days and \$2.00 monthly until the special price of \$19.50 is paid. If not wanted, I will return the books at your expense. (To insure prompt shipment write plainly and fill in all lines.)

Name.....
Address.....
City and State.....
Position.....
Company..... P. M. 12-29



Get Strong WITH These Improved Muscle Builders All for \$5.00



Why pay an extravagant price for strength—here's an opportunity to get all the equipment you require along with an excellent course of instructions for only \$5.00. Realize your ambition and develop muscles of a super-man. Get strong and amaze your friends. We show you how to easily master feats which now seem difficult—or if you just want physical culture for your health's sake, this equipment is just what you need. With this special offer you save at least \$20.00. We furnish a ten cable chest expander which is adjustable to give resistance up to 200 lbs. It is made of new live extra strength, springy rubber so as to assure long wear and give the resistance you need for real muscle development. You also get a pair of patented hand grips for developing powerful grip and forearms.

We include wall exercising parts which permits you to develop your back, arms and legs—a real muscle necessity. You know that business men and athletes, too, first show their age in their legs. Develop your leg muscles with the foot strap which we furnish. This will give you speed and endurance—but that isn't all that you get. In addition we include a specially written course which contains pictures and diagrams showing you how to develop any part of your body so that you will quickly get on with these exercises and gain the greatest advantage from their use. Act now while you can get in on this special offer. It might be withdrawn, so rush the coupon.

SEND NO MONEY

All of the items pictured on this page are included in this big special reduction offer. Sign your name and address to the coupon below and rush it to us. We will send you ten cable chest expander, the wall parts, a pair of hand grips, foot strap and the course by return mail. Pay the postman only \$5.00, plus the few cents postage on arrival. (If you desire to send check or money order in advance, we pay postage.)

GUARANTEE

All Crusader products are guaranteed to give entire satisfaction or money back.



Crusader Apparatus Co., Dept. 112, 44 Parker Ave., Maplewood, N. J.

I accept your offer. Send me everything described in your advertisement by return mail. I will pay postman \$5.00 plus postage on arrival. It is understood if I am not entirely satisfied after examination I can return the goods and you will refund my money.

Note:—No C.O.D. Orders to Foreign Countries or Canada

Name.....
Street.....
City..... State.....

How I Made \$100,000

(In Less Than 5 Years)

Learn the secret of my success. Use my money-making system. Get into the biggest business of all—where the most money is. Start right at home, in your spare time. Mail coupon and learn how.

ONE hundred thousand dollars—a comfortable fortune. That's the net profit I made in less than five years in the biggest and best business in the world.

And the hard-to-believe part of it is that I started right at home, in my spare time, with less than \$5 capital and no experience in the business.

Of course, I don't expect you to take my word for this. You don't know me. So I don't blame you for saying, "I'm from Missouri."

But I do expect you—for your own satisfaction—for your own profit—to sign and mail the coupon and receive—without a penny of cost or the slightest obligation—the most convincing proof of the greatest opportunity for business success you ever saw—proof of my own success—proof of the success of hundreds of ambitious men and women—from 21 to 65—who are using my amazingly successful business system—proof of how you—yourself—can use my method of money-making to build up a permanent, profitable business of your own—right at home, in your spare time.

The Best Business

When I say that my kind of a business is the biggest and best business there is, I have at least ten reasons for saying so. Here they are:

1. The business in round figures amounts to about 28 billion dollars yearly.
2. More money is invested in it than in anything else.
3. The money made in the business exceeds the output of all the gold and silver mines in the country—the product of all the oil wells—the dividends on all the railroad stock—the capital and surplus of all the national banks.
4. It is the most permanent of all businesses. It cannot be injured by changes in fashion or by any human whims or caprices.
5. The business is growing bigger every day, and nothing can stop it.
6. It is a pleasant, healthful, high-class vocation.
7. It does not take years of study to learn like most businesses or professions.
8. It is a business suited to young and old of both sexes.
9. You do not have to keep a stock of goods, invest in machinery, or buy any expensive tools or instruments to get started.
10. You can start in your spare time, right at home, with a few dollars capital, just as I did.



You can't afford to turn your back on this remarkable business opportunity

I know of no other business, of any kind, anywhere, that includes all of these important advantages. That is why I say it is the biggest and best business there is. That is why you should investigate this business at once. That is why you should mail the coupon now and learn about the big, quick money that is being made in this immense and profitable field.

What Others Are Doing

Enthusiastic letters pour in from those who are making money with my successful system. Read these words of praise:

"Your system is wonderful. Without giving up my job as stationary engineer I made \$900 the first three months in my spare time."—M. J. Stokes, Pennsylvania.

"Have been helped a great deal by your system. I have now a new car, two new typewriters, a stenographer, and a dandy office and money in the bank, all through my own efforts and without any capital to start with."—Mrs. A. Moore, Connecticut.

"Increased my income \$8,000 in three months with your system."—A. W. Fongreen, New York.

"Made \$14,400 in less than six months with your system. Gladly recommend it."—H. G. Stewart, Maryland.

"Before getting your System was a Ford salesman averaging \$300 a month. Have now increased my earnings 200%. Now own a Chrysler Sedan, up-to-date office equipment and have increased my bank account."—A. J. Bennett, Michigan.

There's no room here for more such letters, but sign and mail the coupon and you will receive a bunch of the most enthusiastic letters of business success, you ever read.

A minute's time and a postage stamp brings you full information about your big opportunity to make big money my way—build up a profitable business of your own—right at home—in your spare time—without capital or experience.

Get the Facts at Once

Tear out the coupon now—before you turn the page—and mail it to Pres. AMERICAN BUSINESS BUILDERS, Dept. M-44, 205 East 42d St., New York. Then you will have the satisfaction of knowing that you did not turn your back upon the biggest and best business opportunity that ever came your way.

In
the
Best
Business
There
Is

FREE Book Tells How

This FREE Book has helped MORE men and women make MORE money in LESS time than any similar book ever published.

Mail This Coupon

Pres. American Business Builders, Inc.
Established 1917—(Capital \$500,000)
Dept. M-44, 205 E. 42d St., New York

Send me—without cost or obligation—full particulars of how others are succeeding—and proof of how I can succeed in the best business there is.

Name.....

Address.....

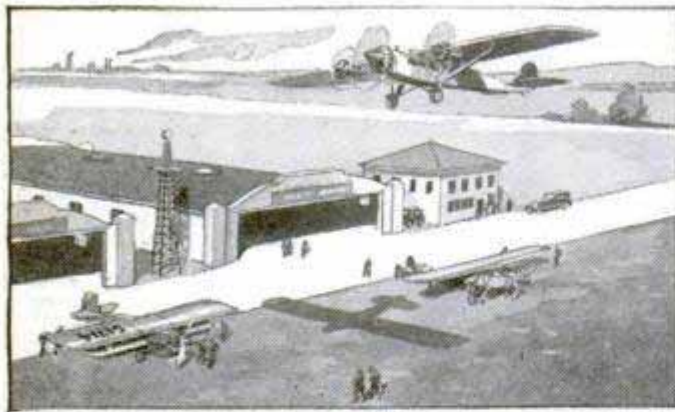

Get into the Air from the Ground!

AVIATION holds the greatest future of any vocation a young man can choose today. Get into it *now*, by the shortest, most practical route—from the ground, as a mechanic.

With the new course in Aviation Engines offered by the International Correspondence Schools, you can quickly gain the knowledge that will qualify you as an expert aviation mechanic. The lessons were written by such experts as Lieut. Commander D. M. Carpenter, U.S.N., formerly in charge of ground training at the Pensacola Naval Air Station.

The course includes a study of the necessary Mathematics, Mechanical Principles, Heat and Its Effects, Combustion and Fuels, Principles of Gas Engines, including the newer Diesel-type engines, Construction of all present-day Aviation Motors, Carburetion, Ignition, Lubrication and Cooling, Pumps, Propellers and other accessories, Aviation Engine Management, Repair and Maintenance.

You can start at *once*. No need to give up your present job. You can study at *home* in spare time.

It costs nothing to find out all about this splendid new course in Aviation Engines, or any other I. C. S. course that interests you. Mark and mail the coupon *today!*

INTERNATIONAL CORRESPONDENCE SCHOOLS

"The Universal University"

Box 5653-F, Scranton, Penna.

Without cost or obligation on my part, tell me how I can qualify for the position or in the subject *before* which I have marked an X.

AVIATION ENGINES

- | | |
|---|--|
| <input type="checkbox"/> Complete Automobile Course | <input type="checkbox"/> Gas Engine Operating |
| <input type="checkbox"/> Automobile Electric Equipment | <input type="checkbox"/> Complete Gas Engine Course |
| <input type="checkbox"/> Electrical Engineering | <input type="checkbox"/> Architect |
| <input type="checkbox"/> Electric Lighting | <input type="checkbox"/> Architects' Blueprints |
| <input type="checkbox"/> Mechanical Engineer | <input type="checkbox"/> Contractor and Builder |
| <input type="checkbox"/> Mechanical Draftsman | <input type="checkbox"/> Architectural Draftsman |
| <input type="checkbox"/> Machine Shop Practice | <input type="checkbox"/> Concrete Builder |
| <input type="checkbox"/> Railroad Positions | <input type="checkbox"/> Structural Engineer |
| <input type="checkbox"/> Civil Engineer <input type="checkbox"/> Mining | <input type="checkbox"/> Chemistry <input type="checkbox"/> Pharmacy |
| <input type="checkbox"/> Surveying and Mapping | <input type="checkbox"/> Agriculture |
| <input type="checkbox"/> Plumbing and Heating | <input type="checkbox"/> Navigation |
| <input type="checkbox"/> Steam Engineering | <input type="checkbox"/> Mathematics <input type="checkbox"/> Radio |

BUSINESS TRAINING COURSES

- | | |
|---|---|
| <input type="checkbox"/> Business Management | <input type="checkbox"/> Salesmanship |
| <input type="checkbox"/> Industrial Management | <input type="checkbox"/> Advertising |
| <input type="checkbox"/> Personnel Management | <input type="checkbox"/> Business Correspondence |
| <input type="checkbox"/> Traffic Management | <input type="checkbox"/> Show Card and Sign Lettering |
| <input type="checkbox"/> Accounting and C.P.A. Coaching | <input type="checkbox"/> Stenography and Typing |
| <input type="checkbox"/> Cost Accounting | <input type="checkbox"/> English <input type="checkbox"/> Civil Service |
| <input type="checkbox"/> Bookkeeping | <input type="checkbox"/> Railway Mail Clerk |
| <input type="checkbox"/> Secretarial Work | <input type="checkbox"/> Common School Subjects |
| <input type="checkbox"/> Spanish | <input type="checkbox"/> High School Subjects |
| <input type="checkbox"/> French | <input type="checkbox"/> Illustrating |
| | <input type="checkbox"/> Cartooning |

Name.....

Street Address.....

City..... State.....

Occupation.....

If you reside in Canada, send this coupon to the International Correspondence Schools Canadian, Limited, Montreal.

Learn to PAINT SIGNS and SHOW CARDS

Get into this interesting, profitable and fascinating business where the field is not crowded. Thousands of cards used weekly. Department stores, clothiers, movie shows, etc., pay big prices—work done quickly and easily—profits large—hundreds of jobs all around you. Our students can more than pay for course doing jobs in spare time while studying. Increase your salary, get a better job or go into business for yourself.

Earn \$50.00 to \$200.00 a Week—Easily

We will train you either at home or here in our big resident school to fill a big-salaried job. Thirty years successful teaching. Thousands of successful graduates all over the world. No town too small. No job too big for our graduates. Get our training. Start now.

Big Money in Card, Sign and Bulletin Business

No other profession pays such profits—work comes to you in abundance—no job will stump you—our students learn all.

FREE OUTFIT
Write now for special literature and prices. Terms, student's samples and free outfit offer. ALL FREE. Don't delay. Act quickly.

POSITIONS
We have placed competent students in profitable positions that pay good money everywhere. The demand for trained, competent men is far greater than the supply.



Get Started Now.

Detroit School of Lettering, DEPT. 9, Detroit, Mich.

MEN for RAILROADS



Nearest their homes—everywhere—to train for Firemen, Brakemen; Average wages \$150-\$200 monthly. Promoted to Conductor or Engineer—highest wages on railroads. Also clerks.

RAILWAY EDUCATIONAL ASSOCIATION, Dept. D-1, Brooklyn, N. Y.

YOU CAN OIL PAINT

Amazing new method teaches men or women to earn after first lesson. OIL PAINT photos—portraits, landscapes or art subjects. Earn \$18 to \$50 and more a week. OIL PAINT OUTFIT GIVEN. Send now for free illustrated book. PICTORIAL ART STUDIOS Inc. Dept. MP. 2926 Broadway, Chicago, Ill.

MORE FUN

Extra Money



**The Joy of Popularity!
The Thrill of Extra-Time Money! Five Days' Trial—Easy Lessons and a Year to Pay!**

DULL days are a thing of the past, monotonous evenings gone forever, when you learn to play the drums. The tamest party becomes a gala affair. In every orchestra and band a drummer is needed. Good drummers get \$3 to \$20 for a night of "play!" . . . And it is so easy to play the drums! Simple lessons, furnished without extra cost, show you how. Even if you can't read a note of music now you begin "right off the reel" to accompany famous orchestras on your radio or phonograph. Soon you thrill friends and family. Before you realize it, you are ready to make a "bid" for an orchestra, band or drum corps. . . . If you want to turn dull, profitless hours into JOYOUS EVENINGS OF PROFIT, ask today for *free literature* telling all about the famous Ludwig line, easy payments, free lessons and 5-day trial offer. No obligation. Simply fill in and mail the coupon.

LUDWIG & LUDWIG, Dept. A-12, 1611 N. Lincoln St., Chicago
Send me without obligation, full information on Ludwig Drums.

Name.....

Address.....

City..... State.....

A Big Pay Job

Up to \$15,000 a year for Greer Graduates. Electricity and Radio now pays hundreds of trained men up to \$200 a week. Here are the world's Greatest businesses. Billions—not millions—but billions of dollars are spent in them every year. Now is the time to get away from the low pay job!

Learn in Only 3 Months in Great Greer Shops on Real Equipment

Mine is not a correspondence course. You can start any day or any evening. It is practical, easy, quick, fascinating training. You learn on great, running live equipment in tremendous Greer Shops. Electricity is the fastest growing industry in the world—Radio a close second, and yet in its infancy, is a billion dollar industry. Choose one of these wonderful professions today. Trained men by scores needed for positions up to \$250 a week and up. Find out now about my great shops training.

You Get Real Help to Big Jobs

Five people are in my big Employment Department, getting jobs for Greer men. You get their help before and after graduation. Don't let money hold you back. Get my free book. Learn how I get you ready so Employers gladly pay you what you are worth.

Learn ELECTRICITY



Men Wanted

Greer Trained Men are Needed. I have made hundreds of \$10,000 a year men. 90,000 in the last 27 years have come to Greer. Thousands more in the future will likely come here. Be one of them. Send coupon to me for openings.

GREER COLLEGE

Dept. #1201E, 2024 S. Wabash Ave., CHICAGO, ILLINOIS

FREE Electrical Book

Erwin Greer, President, Dept. #1201E, 2024 So. Wabash Avenue, Chicago, Illinois.

Send Free Book and details of Special offer, without obligation to me.

Name.....

Address.....

State..... Age.....

Own Your Own Business

Be your own boss. Learn it all. Big men draw big money because they know the whole business. You can't make big money by just doing one single little thing. Factories pay a very ordinary salary to "Jones" who screws on nut number 39, because they can quickly teach someone else to do it

Learn AUTOS



just as well. At Greer College you learn how to boss the job.

Quickest, Easiest of Ways to Become Expert

I'll allow your fare here free of extra cost, then help you to a job while learning. Then I not only fit you to get a big pay job, but I'll help you hold it. Young and old, educated and uneducated, experienced and inexperienced, have found Greer Shops training easy, fascinating and valuable. You learn on big, actual, full size equipment like you will work on out on the big pay job. Coupon below brings details.

DON'T DELAY! GET MY FREE BOOK NOW!

GREER COLLEGE

Dept. #1201A, 2024 S. Wabash Ave., CHICAGO, ILLINOIS

FREE Auto Book

Erwin Greer, President, Dept. #1201A, 2024 So. Wabash Avenue, Chicago, Illinois.

Send Free Book and details of Special offer, without obligation to me.

Name.....

Address.....

State..... Age.....

FLY Learn AVIATION



You Learn to Fly by Flying

The steady 27 years' growth of Greer College, thru genuine service, speaks for itself. From a small beginning in 1902, to the present tremendous plant including three modern buildings and three airports in the Chicago area. Real endorsement by satisfied students and graduates have made this possible. Aviation enthusiasts the country over have come to marvel at the tremendous outlay of motors, planes, instruments, wood and metal working equipment, welding and ignition shops. Many more have come to consult our Chief Aviation Engineer, C. L. Laird, regarding airplane design and construction.

Get My Free Book "Winning Your Wings"

Learn how my students are now preparing for amazing opportunities in this most fascinating and alluring profession—Aviation. Find out about my great shop and field training. Our rates are reasonably low because of our large enrollment. Mail the coupon below for full details of my free employment offer and of the many ways in which I help you to pilot's and mechanic's license.

Now All Can Learn to Fly

My shop training plan equips you for any branch of Aviation. Get the details today.

GREER COLLEGE

Dept. #1201, 2024 S. Wabash Ave., CHICAGO, ILLINOIS

FREE Aviation Book

Erwin Greer, President, Dept. #1201, 2024 So. Wabash Ave., Chicago, Illinois.

Send Free Book and details of Special offer, without obligation to me.

Name.....

Address.....

State..... Age.....

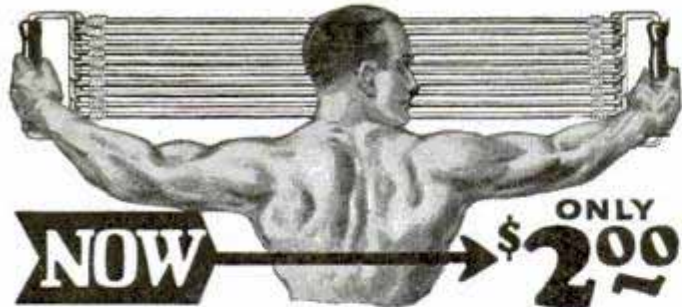

NOW → **ONLY \$2.00**

Giant Chest Expander and Progressive Exerciser

Be a muscular marvel. Have the muscles of a superman. Become strong for your health's sake or to astound your friends with extraordinary feats which only men of giant strength can do. In a few short weeks you will easily do stunts which now seem difficult—then real muscles and strength will be yours—and yours to keep.

Send No Money Use This Money Saving Coupon

If you want exercise to just keep in good shape you can reduce the strength of the Progressive Exerciser by eliminating as many cables as you wish. If you want great resistance so as to build up big solid muscles then use the full strength.

How the Giant Chest Expander and Progressive Exerciser is Made

The Giant Chest Expander and Progressive Exerciser is made with new, springy rubber so as to give it long wearing and great resisting qualities. Do not pay more for an exerciser that has forty or less rubber strands to each cable. Get the best and most durable. The Giant Progressive Exerciser has 50 strands of the finest rubber procurable to each cable.

Free Instructions

We do not think it enough to send you an exerciser worth double what we ask, so for a limited time, we will also include instructions absolutely free. These instructions are interesting and simple to follow—they show you the short cut to health and strength. Order today before this wonderful offer is withdrawn.

Your Guarantee

The Giant Chest Expander is sold with a guarantee that you will any it is the finest you ever saw or your money back.

5 Cables or double 10 Cables for strength for \$2

The double strength exerciser has resistance of over 200 lbs. \$4

How to Order—Send No Money

Sign your name and address to coupon below and get your Giant Exerciser at the present low introductory price by return mail. The price is made low because we want everyone to enjoy muscles and strength at the lowest possible cost. Don't pay more—order from us—get the most for your money. Use coupon now.

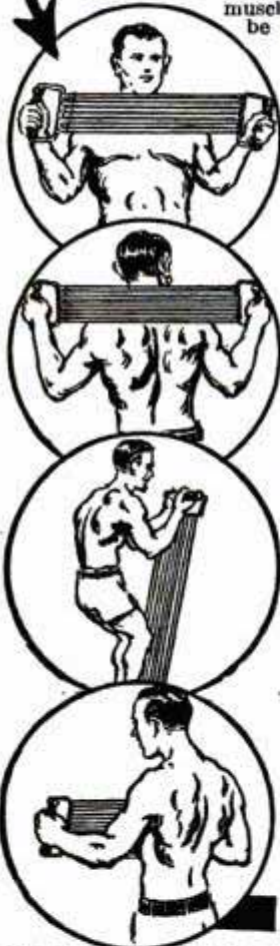

PROGRESSIVE EXERCISER CO.,
4012 Langdon Bldg.,
Broadway and Duane Street, New York

Please send Your 10 cable Progressive.
 Your 5 cable Exerciser.

Check the Exerciser you want, and it will be sent you by return mail. Pay postman introductory price, plus few cents postage on arrival. It is understood that if you are not entirely satisfied with your exerciser you may return it within 5 days and get your money back.

Name.....
Street.....
City..... State.....

If you live outside the United States, send cash with order.



LEARN TO PLAY
VIOLIN, TENOR BANJO,
HAWAIIAN GUITAR, BANJO, CORNET,
UKULELE, BANJO UKULELE, GUITAR, BANJO
MANDOLIN, BANJO GUITAR, MANDOLIN,
SNARE DRUM, FIELD DRUM, PIANO OR ORGAN

at home, this new and "easy to learn" way. No teacher or talent required. Entirely different from any "chart" or "diagram" system. Lessons are so simplified and so easily mastered most pupils play by note after only 10 lessons. Thousands of men, women, boys and girls have learned to play quickly and proficiently by our Home Study method. Your opportunity to become popular and play for profit or pleasure. A few cents a day pays for lessons. Pay while you learn. Write to-day for full particulars and free trial. No obligation. Instruments except Piano and Organ furnished at cost if desired. **CHICAGO CORRESPONDENCE SCHOOL OF MUSIC, INC.,** 1632 No. Halsted St., Dept. 17, Chicago, Ill.



\$100 to \$500 A Week Is Earned by Cartoonists Today
DO YOU LIKE TO DRAW?

Billy Hon's Famous Cartoon Book Will Teach You
Develop your talent, learn this interesting and profitable profession. Billy Hon, the celebrated Cartoonist, has devised a simple, up-to-date course in Cartooning consisting of 30 lessons with over 300 original drawings, which you can easily learn in your spare time. Sent postpaid for **\$1.00**, outside of U. S., **\$1.25**. Satisfaction guaranteed.

Wasley Publishing Co., 210-P West 14th St., Los Angeles, Cal.

WELDING—The Busy Big-Pay Trade

We teach ambitious men by actual welding practice. —**OXY-ACETYLENE and ELECTRIC ARC**— Pipe-line, Sheet Steel, Structural Steel, Aircraft, Cast-Iron, Aluminum and Commercial Welding. Cutting, Brazing and Plating. Splendidly Equipped to Teach You Right Rapidly and at Reasonable Rates

A Free Booklet for You—Write for it Now.

COLEMAN ELECTRICAL SCHOOL, 1628-X Main Street KANSAS CITY, MO.



CODE TELEGRAPH Morse or Radio AT HOME WITH THE AUTOMATIC Omnigraph

Leads quickly to big money jobs. The easy and cheap way. U. S. Gov't., Schools, etc., use it. THE WORLD'S Hobby. Mention Age. Catalog. Omnigraph Mfg. Co., P2-810 E. 39th St., Brooklyn, N. Y.



Minstrels



Unique First Parts for complete show with special songs and choruses. Make-up. Catalog Free.

T. S. Denison & Co., 623 S. Wabash, Dept. 19 Chicago



PAINT SHOW CARDS

and SIGNS. LEARN AT HOME IN SPARE TIME. WE TEACH YOU QUICKLY—FASCINATING WORK. \$75 WEEKLY. SEND 6c IN STAMPS FOR CIRCULAR.

Universal School of Lettering NEW HAVEN, CONN.

BASHFUL?

"Shame on you!" Are you nervous, embarrassed in company of the other sex? Stop being shy of strangers. Conquer the terrible fear of your superiors. Be cheerful and confident of your future! Your faults easily overcome so you can enjoy life to the fullest. Send 25c for this amazing book, **RICHARD BLACKSTONE, 8-4712 FLATIRON BLDG., NEW YORK**

Learn MECHANICAL DENTISTRY

EARN BIG MONEY—Steady Work

WHY spend the best years of your life at uncertain jobs at small pay? You can **EARN WHILE LEARNING** this modern money making business and become independent. **BIG DEMAND.** You **LEARN BY DOING PRACTICAL** work. **DAY AND NIGHT SCHOOL.** **INDIVIDUAL** instructions. Easy terms. **Railroad Fare Allowed—No Extra Cost.** Address **SECRETARY, N. Y. SCHOOL OF MECHANICAL DENTISTRY, 147 W. 33rd Street, NEW YORK, N. Y.**

SEND FOR FREE BOOK



Write or Mail Coupon.

Name.....
Street.....
City..... State.....

FREE

Get two wonderful books by mailing coupon below.

You get these Genuine High Quality, Imported Drawing Instruments, 14 Other Tools and a Drafting Table—all included in my Home Training Course.



These Two Books—
Mail Coupon!

Yes, Absolutely

FREE

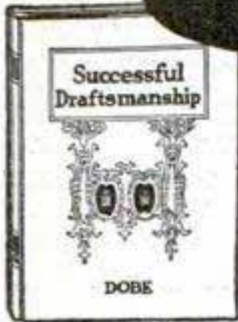

2
Books
FREE

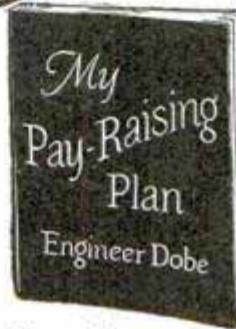

Money-Back Agreement

I train you at home under a positive Money-Back Agreement. If my training does not satisfy you after you have finished, you get every penny back.

Age or Lack of Education, No Drawback

Previous experience is not necessary. You do not need to be a college man or high school graduate.

Help As Long As You Need It

As my student you can write to me any time you want to and as often as you like and I will give you help on any subject pertaining to draftsmanship. I will advise you about jobs, extra work, fees and how to make extra money.

Just Send the Coupon Below!

Jobs for Draftsmen in Great Industries—Learn At Home

Automobiles—Electricity—Motor Busses—Aviation—Building Construction.

There are jobs for Draftsmen in all of these industries and in hundreds of others.

Aviation is expanding to enormous proportions. Electricity is getting bigger every day.

Motor Bus building is becoming a leading world industry.

Building of stores, homes, factories and office buildings is going on all the time.

No structure can be erected without plans drawn by a draftsman. No machinery can be built without plans drawn by a draftsman.

I train you at home, in Drafting. Keep the job you have now while learning drafting.

I will train you in drafting right where you are in your spare time. I have trained men

who are making from \$3,500.00 to \$9,000.00 a year. There is a big future for draftsmen because you plan and supervise the work of others, or you go into business for yourself. Get started now toward a better position, paying a good, straight salary, the year around. Comfortable surroundings. Inside work.

Earn As You Learn

I tell you how to start earning extra money a few weeks after beginning my training.

Employment Service

After training you I help you to get a job without charging you a cent for this service. Employers of Draftsmen come to me for men because they know that Dobe Trained Men make good as they have learned drafting by actually doing the work themselves, in a practical way. Employers know they are not taking chances on men trained by me.

If You Earn Less Than \$70.00 a Week Ask for My 2 FREE Books



Mail this coupon, at once. Get "My Pay Raising Plan" and "Successful Draftsmanship". Both of them point the way to Success. You owe it to yourself to find out what a big opportunity there is in practically all industries, for Draftsmen. These two books are Free. They come to you post paid. Mail the Coupon for them TODAY.

ENGINEER DOBE

1951 Lawrence Ave., Div. 93-59 Chicago

FREE BOOK COUPON

ENGINEER DOBE

1951 Lawrence Ave., Div. 93-59 Chicago

Send me free of all cost your book, "Successful Draftsmanship", also plan to earn money while learning and proof of big money paying positions. Also your new book "My Pay-Raising Plan."

Name.....Age.....

Address.....

Post Office.....State.....

"I'll train you at home"—
Engineer Dobe

ENJOY THE FINEST AVIATION TRAINING

with
The School of VON HOFFMANN
One of America's
Leading Schools
of **AVIATION**

United States Government APPROVED SCHOOL for Transport-Limited Commercial Private Pilot & Ground Course

There is money for you in aviation if you get thorough training now! Our courses will give you this training—they are taught under the direction of U. S. licensed transport pilots and mechanics and cover everything about planes, motors, their maintenance and construction. The training which the student receives at the School of Von Hoffmann is the exact training which he must have to qualify for immediate positions on the ground or in the air. Our equipment is new and of modern design, subject to daily U. S. Gov't inspection—the cost is low considering actual flying and the thoroughness of ground instruction on latest modern type planes, Wright Whirlwind and other standard motors. No student bond required.



WORLD'S FAMOUS PILOTS TRAINED HERE

Our field is identified in the world of Aviation as an outstanding place to enjoy the best training—a place where conditions are ideal—from here was started the 'cross the Atlantic Flight that convinced the world what could be done and more recently the world endurance flight record was established here.

EASY MONTHLY PAYMENTS

It is easy to pay the Von Hoffmann way because small monthly payments are extended. Let us show you how you can start now and pay later, even after you have finished the course of training.

VON HOFFMANN AIRCRAFT SCHOOL
124 Lambert-St. Louis Flying Field
ST. LOUIS, MO.

VON HOFFMANN AIRCRAFT SCHOOL
124 Lambert-St. Louis Flying Field
St. Louis, Mo. MAIL TODAY

Please mail FREE information at once.

Name.....

Address.....

City.....State.....

Age.....I am interested in
FLYING COURSE GROUND COURSE

Drawing Course \$2.98

The biggest value you ever saw advertised anywhere



Haven't you often wished that you could draw cartoons, illustrate some idea, sketch some pretty face, etc.? You can do all of these things. One of America's most famous Cartoonists and illustrators has developed a great, simple system for success in all branches of Commercial Art. This system has revolutionized the entire theory of drawing. It means that drawing can be as easy for you as writing—much simpler than learning shorthand, bookkeeping or typewriting. We are now placing this original system for learning Drawing, Art and Cartooning, consisting of 34 lessons with over 500 illustrations, within reach of every one. If you will devote a few hours each week to the Course WE ABSOLUTELY GUARANTEE that you will learn to draw and draw well before you have half finished the Course. If we fail to make this claim good, we will refund every cent paid us. By eliminating a large office force for answering correspondence, expensive catalogs, etc., we are enabled to make a price of \$2.98, the cheapest price ever known for a high-grade, home study course. Learn to draw. It is a big asset, no matter what field you are in.

Send No Money

Just order the course and on arrival \$2.98 pay postman plus a few cents postage. payment in full for the entire Course and Drawing Outfit. If not entirely satisfied, return within five days and we will Refund Money. Address: **LEDERER SCHOOL of DRAWING, Dept. 224-J, Chattanooga, Tenn.** Orders from outside the U. S. A. are payable \$3.28 cash with order.

If you order the course at once, we will include a drawing outfit, consisting of artist's pencils, pens, paper, erasers, thumb tacks, etc., enabling you to go to work without any additional cost.



6 Ft. LONG GIVEN!
Boys! Here's the great Navy model Airship. Large 6-foot air bag with inflators, parachute with automatic release and complete instructions for flying. Will fly for miles at height of 1000 feet. Great chance to study aerial navigation. Send name and we'll send 6 of our new art pictures to dispose of on special 25c offer. Send the \$1.50 you collect and as a reward for this service we will send this wonderful Airship with full instructions free.

C. M. Thomas, 337 W. Madison St., 12-K-91, Chicago

MAKE \$36 A DAY!

Showing This SELF-LIGHTING Pocket Lighter to Smokers

The world's only windproof automatic cigar lighter. Lights instantly without flint or friction. Guaranteed for ten years. Everyone wonders what makes it light? Sell on a flash demonstration to smokers and dealers. Retail 50c, you make 100%. Send 50c for sample or \$3.00 for dozen in display box packed with fluid ready for use. Our sure fire selling plans included. Masterlite Mfg. Co., Dept. L-19, 110 E. 23rd St., N. Y. C.

NERVES?

Are You Always Excited? Fatigued? Worried? Gloomy? Pessimistic? Constipation, indigestion, cold sweats, dizzy spells and bashfulness are caused by NERVE EXHAUSTION. Drugs, tonics and medicines cannot help weak, sick, nervous! Learn how to regain Vigor, Calmness and Self-Confidence. Send 25c for this amazing book. RICHARD BLACKSTONE, N-4712 FLATIRON BUILDING, N. Y.

Complete Course in BOXING Jiu-Jitsu & Wrestling

Complete Course \$2.97 Plus Postage

Complete course in Boxing, for only \$2.97. Our scientific methods cut time of learning in half. Teaches the blows used by professionals—Dempsey's Triple, Fitzsimmons Shift, etc. Every blow illustrated. Also Wrestling, Jiu-Jitsu and History of Boxers. Six big books—hundreds of pages. Send no money—see coupon.

Marshall Stillman Association, Dept. 12-M, 247 Park Avenue, New York. Send on 10 day approval complete Self-Defense course. I will deposit \$2.97 plus postage, with postman. I will return course in 10 days if not satisfactory and money will be refunded. (Outside U. S. A.—Cash with order.)

Name.....

Street and City.....

Most Amazing INVENTION in 25 Years "Cleans Up" for Agents

**\$90 Weekly
in Spare Time**

Men, here is a wonder—the most sensational invention of the age! If you are looking for a rapid fire seller—an item that nets you 100 per cent profit—an item that sells itself to seven out of ten men on demonstration—I've got it in Ve-Po-Ad, the amazing new vest pocket adding machine!

**Sells for \$2.95
You Make \$1.65**

This most remarkable invention does all the work of a \$300 adding machine, yet fits the vest pocket and sells for only \$2.95! It sells on sight to storekeepers, business men, and everyone who uses figures—and makes you over 100 per cent profit on every sale!

Ve-Po-Ad does any kind of figuring in a jiffy, yet weighs but 4 ounces. Counts up to a billion. Shows total visible at all times. Perfectly accurate, lightning fast. Never makes a mistake or gets out of order. There are over 100,000 in daily use!



**FREE
MACHINE
FOR
AGENTS**

**Get Your
Machine
FREE!**

Live wire salesmen are dropping everything else and flocking to Ve-Po-Ad. Ve-Po-Ad brings them quick money and lots of it. Shapiro out in California made \$475 in one week! You can "clean up" too! Only 10 sales a day in spare time will bring YOU over \$95.00 a week! You need no previous sales experience—Ve-Po-Ad sells itself! If you are really interested in earning a steady, substantial income, write at once for full details of my MONEY-MAKING PLAN and FREE VE-PO-AD given to new Agents. Do it NOW—TODAY!

C. M. CLEARY, 303 W. Monroe St., Dept. 44, Chicago, Ill.

You Can Learn ELECTRIC REFRIGERATION

in 3
Months

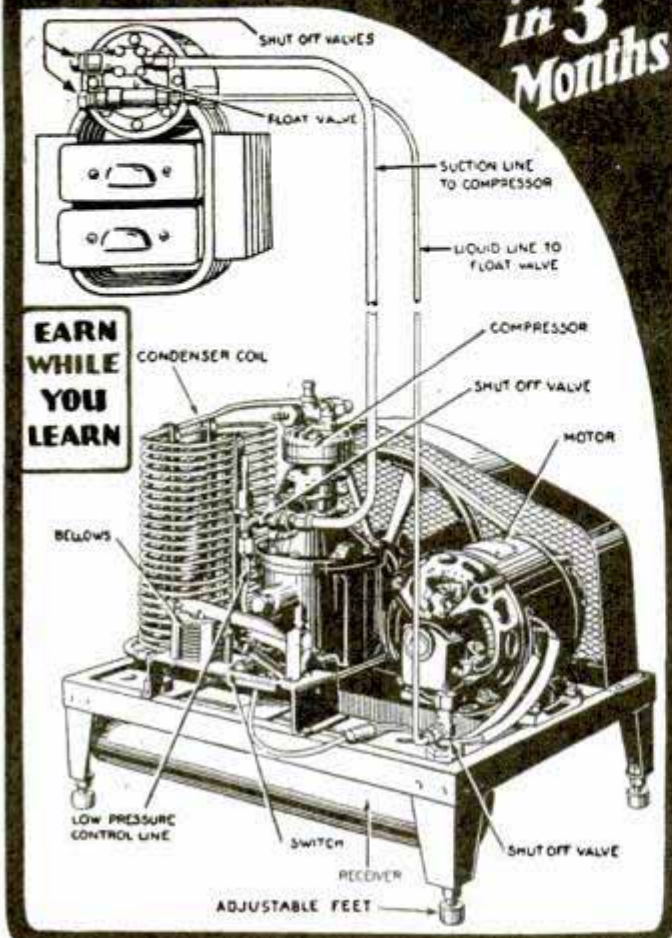

EARN
WHILE
YOU
LEARN

Men in Big Demand!

Hundreds of thousands of Electric refrigerators in use. Thousands being installed day after day. Trained service and installation men are in urgent need in this new, fast growing industry. Big money awaits men who master the principles of Electric Refrigeration in the School of Engineering of Milwaukee—America's greatest Electrical school.

COMPLETE PRACTICAL 90 DAYS COURSE

Includes Electric Refrigeration, Applied Electricity, Merchandising, and Practical Mathematics. Some of the topics are: Physics and Chemistry of Refrigeration, Heat and Heat Transfer, General Theory of Refrigeration, Systems of Refrigeration, Household Compression Systems, Refrigerants, Household Absorption Machines, Refrigeration Cabinets, Installation and Repair, Maintenance, Troubles and Their Cures, Sales and Merchandising. All instruction is thoroughly practical. Splendid equipment and laboratories.

WRITE FOR FREE BOOK TODAY

"Your Future in Electric Refrigeration," a fascinating book describing the School of Engineering course in Electric Refrigeration will be mailed free. Also contains details of "Earn While you Learn" plan, and facts about our employment service after you graduate. Unlimited money making opportunities are open in Electric Refrigeration. Write today!

New Class Organizing Now—Mail Coupon

SCHOOL of ENGINEERING
of Milwaukee
Founded 1903

163 East Wells Street P.M. 1229B MILWAUKEE, WIS.

School of Engineering of Milwaukee,
P. M. 1229B, 163 East Wells St., Milwaukee, Wisconsin.
Send me FREE, with no obligations, a copy of "YOUR FUTURE
IN ELECTRIC REFRIGERATION."

Name.....Age.....

Address.....

City.....State.....

Education.....

MOULDING A MIGHTY BACK



EXTRAORDINARY Complete Course on Back Building ONLY 25c

Does your back back up your physical dreams? Have you the shoulders of a Guardsman and a spine as straight as a die? If not, don't waste time craving them but GET THEM. The back is actually the easiest part of the body to develop—provided you follow the right exercise principles. No man need be narrow or round shouldered. You can build huge, powerful muscles from neck to hips in an incredibly short time by following this wonderful book. "MOULDING A MIGHTY BACK" is a complete treatise on back development packed full of splendid, illustrated muscle-building exercises and other information wonderful for developing every muscle in the back.

Make Your Spine a Column of Might

Arthur Saxon became the strongest man in the world's history through the massive Herculean muscles that surrounded his spine. The author gives you Saxon's favorite exercises—and many others, besides fascinating instruction on how to use your back muscles to perform great feats of strength. It is one of the most interesting books he has ever written. Deals conclusively with the Broad of the Back. More complete than any other course at the price. Will repay you a thousand fold in strength and muscle. With this wonderful book will be given a copy of "The Thrill of Being Strong." The sort of book you have always longed for. Right now, 25c and this coupon means your positive success in back building. Get it now while the offer holds good. Worth \$1.00 of any man's money but yours for 25c if you act today.

REACH OUT---GRASP THIS SPECIAL OFFER

JOWETT INSTITUTE of PHYSICAL CULTURE

422 Poplar Street, Dept. 4Z, Scranton, Penna.

Dear Mr. Jowett: I am enclosing 25c. Please send me the course "MOLDING A MIGHTY BACK" and a free copy of "THE THRILL OF BEING STRONG."

Name.....

Address.....

New Million Dollar Can Opening Machine

BRAND NEW INVENTION BRINGS FORTUNES TO AGENTS!

Here's Something Brand New! An Amazingly Simple Invention—Yet, Absolutely Revolutionary! For Now, At One Sweep, Millions Of Old Style Can Openers Are Doomed To The Scrap Heap! Think Of It, Men! A Tremendous New Opportunity For Quick Profits In Every Home In America! No Wonder Agents Are Making Astonishing, Almost Incredible Sums—\$75, \$100, \$150 In A Week Easily Right Along. So Mail The Coupon For All The Facts And Full Details Of My Remarkable FREE TEST OFFER!

ABOUT once in a "blue moon" some genius pops up with a new invention that everyone has been waiting for. Then, presto! Almost like magic, agents' profits go soaring overnight to tremendous heights! And now the cold, hard-boiled facts about this amazing new can opener bear convincing proof!

More Than a Can Opener

This queer new device doesn't just cut a ragged hole around the edge of the can. It lifts the entire top completely out, clean as a whistle! The machine holds the can—opens it—flips up the lid so you can grab it—and gives you back the can without a drop spilled, without any jagged edges to hack your fingers—all in a couple of seconds! You just put the can in the machine—turn the handle—and almost instantly the job is done! Built to do the job better than anything ever devised! Will last a lifetime! It's far more than just a can opener, it's a real can-opening machine!

The Secret of Big Money

Women hate the old style can opener—and with good reason, too. It's the last relic of barbarism in the modern kitchen. Yet every day millions of women have to open cans the dangerous, laborious old-fashioned way. Food is spilled and wasted. Fingers are cut and torn—often followed by infections and blood poisoning that result in expensive doctor bills. Opening cans the old way is a job nasty enough to make most any man swear—this amazing new way—it's so easy a ten year old child can do it with perfect safety! No wonder women—and men, too—simply go wild over it!



AGENTS!
FULL TIME—
\$265
in a week

"Here is my record for first 30 days with Speedo:—June 13, 60 Speedos; June 20, 84 Speedos; June 30, 192 Speedos; July 6, 288 Speedos. Speedo sells to 9 out of 10 prospects."

M. Orloff, Va.

SPARE TIME—
\$9 first half day

"The first afternoon I received my Speedo outfit I made \$9."

Mrs. R. Spain, Kans.
PART TIME—
\$20 in 3 hours

"I worked about three hours and took 25 orders. This is certainly a money-maker."

O. C. Gregg, Wyo.

A Spectacular New Sales Plan

I want you to see this surprising new invention with your own eyes. I want you to know why everyone, man or woman, falls for it the instant they see it. Whether you are an experienced salesman, or never sold a penny's worth of anything in your life—I want to tell you about a remarkable new sales plan that wins you a profit on every call you make. This plan is made possible by another spectacular money maker in the Speedo line and guarantees you a steady income of up to \$150 in a week!



Free Trial— Act Quickly!

If you are ambitious—if a new, but tested and proved opportunity to make \$75 to \$150 in a week interests you—act at once before some other live wire beats you to this lifetime opportunity. Without obligation, learn about these amazing new patented inventions, and get my FREE TRIAL OFFER. Just mail the coupon today—NOW!

CENTRAL STATES MFG. CO.
4500 Mary Ave. Dept. W-703 St. Louis, Mo.

SPEEDO

CENTRAL STATES MFG. CO.,
4500 Mary Ave., Dept. W-703,
St. Louis, Mo.

Yes, rush me the facts and details of your FREE TEST OFFER.

Name.....

Address.....

City..... State.....

Check here if interested only in one for your home.



FREE!

Body Chart

If you will mail the coupon below, this Anatomical and Physiological Chart will be mailed to you without one cent of expense. It shows the location of the Organs, Bones of the Body, Muscles of the Body, Head and Vertebra Column and tells you how the nerves radiate from your spinal cord to all organs of the body. This chart should be in every home.

Where Is That PAIN?

It may be in the neck, back, hips, stomach, liver, legs or arms. Wherever it is, the chart will help to show you the location and cause of your ailment. For instance, this chart will help you locate vermiform appendix pains. Hundreds of lives might have been saved if people had known the location and character of the pain and had received proper attention.

Stop that Pain

By Relieving the Cause with
**Violet Ray - Vibration
 Ozone - Medical Electricity**
 The Four Greatest Curative Powers Generated by This
Great New Invention!

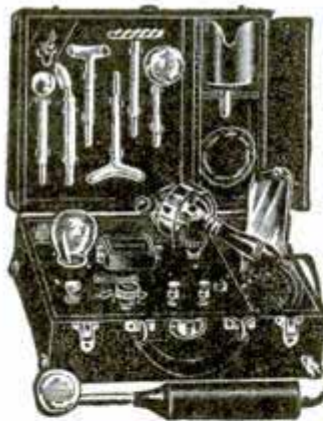

Elco Health Generators at last are ready for you! If you want more health—greater power to enjoy the pleasures and delights about you, or if more beauty is your desire—write! Ask for the book on these inventions which has just been prepared. It will be sent to you without cost. It tells you how Elco Health Generators aid you in leaving the lethargy and hopelessness of bad health and weakness behind forever. Re-vitalize yourself. Bring back energy. Be wholly alive. Write today!

Here's What Elco Users Say—

"Wouldn't take \$1000 for my Elco."
 "Has done me more good in 2 weeks than doctors did in three years."
 "Cured my Rheumatism."
 "Cured my weakness."
 "Now I sleep soundly all night."
 "Thanks to Elco my strength and vigor are back."
 "No more pain."
 "Colds never bother me now."
 "Chronic Constipation banished."



These great new inventions generate Violet Ray, Vibration, Electricity and Ozone—combined or separate. They operate on the electric light in your home or on their own motive power at less than 50 cents per year. Elco Health Generators are positively the only instruments which can give you in one outfit Electricity, Violet Ray—Vibration and Ozone—the four greatest curative agents. Send the coupon below. Get the Free Book NOW!

MAIL COUPON for FREE BOOK

Do not put this paper down without sending the coupon. Don't go on as you are with pains and with almost no life and energy. You owe it to yourself to be a better man or woman. You were put here to enjoy life—not just to drag through it. So do not rest another day until you have put your name on the coupon here. That will bring the whole story of these great new inventions. Do it today—now.



..... **Lindstrom & Co.** [Makers of Therapeutic Apparatus since 1892]

2322 Indiana Avenue Dept. 13-53 Chicago

Please send me your free book, "Health—Power—Beauty" and full information of your 10-day Free Trial Offer.

Name.....

Address.....

Don't Be Afraid To Tackle That Concrete Job!

With the instructions found in the new, revised edition of Popular Mechanics Concrete Handbook you can make any of the following useful articles:



Garden Seats—Fountain and Basin—Flower Boxes and Vases—Pedestals and Bird Baths—Ornamental Pools—Sanitary Drinking Fountain—Gateposts—Auto Driveway—Sidewalks—Boat Landings and Docks—Entrance and Garden Walks—Sidewalk Flagging—Narrow Curb Walks—Curbs and Gutters—Wall Coping—Steps—Garage Floor—Basement Floor—Fence Posts—Lawn Roller—Cistern—Chimney Cap—Refuse Burner—Culvert—Benches for Greenhouses—Tile—Retaining Walls—Foundation Supports—Engine Foundations—Septic Tank—Toy Blocks—Forge—Fireproof Safe—Ice House—Watering Troughs—Milk House—Smokehouse—Silo—Horse Stalls—Hitching Post—Rural Mail Box Post—Cyclone Cellar.

Build With Ease for Permanence and Beauty

This is a book of practical plans for using concrete about the home, farm or shop. For amateurs as well as contractors. In addition to making all the articles mentioned above the making of good concrete mixtures for various classes of construction is given; mechanical mixers and homemade tools are dealt with. All necessary form and mold making are covered as well as many other valuable pointers too numerous to mention here.

Simply write and ask us to send you this book. When postman hands you the package pay him \$1.00 plus the postage. If outside U. S. remit when ordering and include 15 cents extra for mailing.

POPULAR MECHANICS PRESS
 Room P12 200 E. Ontario Street CHICAGO

FOR YOUR HOME WORKSHOP

If you like to make things, you will enjoy this new book just published by Popular Mechanics entitled



Make It Yourself

The home mechanic, whether young or old, amateur or professional, will take pride and delight in making many of the things described therein.

Both father and son will find fascination and an association of interest in making useful and ornamental articles for mother to admire upon their completion.

900 Articles All Different

There are attractive ship models, a great variety of toys that operate themselves by means of an ingenious application of mechanical principles, novel amusement devices for indoors and outdoors, for both water and land, unique designs in furniture for children, scores of useful appliances for the home, things of beauty and utility for lawn and garden, etc.

Special articles instruct the amateur mechanic in the care and use of tools, special tools for special purposes, how to read and use plans, how to solder, the making of a handy work bench, cuts, joints and methods in woodworking, automobile repairing, installing radio equipment, house wiring, fixture hanging, working in glass, leather, metal, celluloid, lathe work, utilizing parts of old machines to make equipment that would be expensive to buy, etc.

480 Pages—823 Illustrations. Size 7x10x1 1/2 in. Cloth Binding **Price \$3.00**

Mailed Postpaid upon receipt of price anywhere in the world. If you reside in U. S., Hawaii, Porto Rico, Alaska or Mexico, we will send the book by mail C. O. D. if you prefer.

POPULAR MECHANICS PRESS (ROOM P-112)
 200 East Ontario St. Chicago, Ill.



Actual size of Magic Dot. The new system weighs only 4 ounces, yet holds rupture more securely than pounds of steel springs, and hard, gouging cushions.



Beware the Small Rupture

THAT "DOESN'T BOTHER MUCH"

Light as a Feather

Yet... Holds Rupture!



Now—An Ohio Scientist Is Helping Nature Rescue Thousands Of Rupture Victims From The Eternal Horror Of Many Dangerous Cumbersome Trusses And Other Torturous, Harness-Like Contraptions. He Has Perfected A Tiny, Feather-Weight Magic Dot That Frequently Brings About Joyous Relief And New Comfort From The First Day. Countless Former Victims Everlastingly Thank This Interesting Discovery For Their New Happiness. Just Mail The Coupon For Free Material Sample If You, Too, Want New Freedom.

SCIENCE has at last developed a tiny, interesting device weighing less than 1/25 of an ounce, which has helped to free and amazed thousands of rupture sufferers and won the admiration of many doctors and scientists.

The New Science System makes utterly obsolete all painful trusses, gouging knobs, steel springs and unsanitary, cumbersome leg straps.

It "Breathes" Air

Magic Dot anchors a flesh-soft padlet composed of a newly perfected substance named Airtex. This is honey-combed with microscopic air cells that tend to "breathe" air with each movement of your body. It expands and contracts as easily as your own flesh. When you walk, run, bend or exercise it tends to squeeze itself—not the part of the body it rests against.

The appliance is so light—so comfortable—the wearer as a rule hardly knows he has it on. It does not produce that "hot spot" feeling. Sanitation is now more sure—because the padlet can be washed clean and sweet in a jiffy.

Immediate relief and new comfort are not the only things the New Science System should accomplish. Of far greater importance is the comfort you have dreamed of—the possibility of ultimate FREEDOM! This should be possible because this amazing new method gives nature a chance to heal the rupture automatically. This is not possible with gouging trusses that prevent free circulation.

Test Sample Free

Send no money. Just mail the coupon for Free Sample of remarkable Airtex. With it we send, without charge, latest copy of a very new and informative book on Rupture and Hernia that should open your eyes.

NEW SCIENCE INSTITUTE
2167 Clay Street Steubenville, Ohio

New Science Institute,
2167 Clay St., Steubenville, Ohio.

Without obligation send me a no-cost Airtex sample with new book about rupture and hernia relief.

Name.....

Address.....

City.....State.....

Genuine
UNDERWOOD
Below 1/2 Price



Famous Model No. 4

NOW ONLY \$1 DOWN

Standard 4-Row Keyboard

Think of it! Only \$1.00 brings the World's most famous Underwood Typewriter for 10 days' free trial. Lowest price and easiest terms ever offered. Pay only 10c a day on easy monthly payment plan. This is the full size standard Underwood 4-row keyboard typewriter, manufactured to sell for \$100.00.

Do not confuse this 4-row standard office model Underwood with other frail machines originally costing only one-half as much.



FREE — Course in Touch Typewriting

We teach you free. Complete Home Study Course of the famous Van Sant Speed Typewriting System, fully illustrated, easily learned, used in schools, business offices, everywhere.

10-Day Free Trial

This late model Underwood, specially priced at \$39.90 cash, is the lowest price ever quoted; has modern improvements including 4-row keyboard, two-color ribbon, back spacer, ribbon reverse, tabulator, release, shift lock and many other improvements. Beautifully refinished and renewed. Looks and operates like brand new.

Other Bargains!

- No. 10 Remington \$100 Model, Cash, Now Only \$39.90
- No. 8 L. C. Smith \$100 Model, Cash, Now Only \$39.90
- No. 5 Woodstock \$100 Model, Cash, Now Only \$39.90

International Typewriter Exch., Dept. 1294
 231 W. Monroe St., Chicago.

Underwood No. 4. L. C. Smith No. 8.
 Remington No. 10. Woodstock No. 5.

Send typewriter checked above for 10 days, Free Trial. I am enclosing \$1 deposit with understanding that it will be returned if the typewriter is not satisfactory. If I keep it I will pay \$3 a month until \$44.90 (term price) is paid.

Name..... Age.....
 Address.....
 Town..... State.....

CARTOON & COMIC STRIP COURSE FOR \$2.98 ONLY COMPLETE



Easy to Learn this New Way

For fun and profit learn to draw cartoons and comic strips. Amazingly simple system developed by CARL ANDERSON, famous contributor to SATURDAY EVENING POST, COLLIER'S, LIFE, JUDGE, NEW YORK JOURNAL, NEW YORK WORLD and other leading publications, gives complete instructions in DRAWING, CARTOONING, COMIC STRIP AND ILLUSTRATION. These easy lessons make drawing as easy as writing. Spend only a few hours a week practicing and you will be able to draw and draw well in a very short time. 48 lessons, hundreds of illustrations, cost but \$2.98, the greatest bargain ever offered in a

SEND NO MONEY

guaranteed drawing course. SEND NO MONEY. Pay the postman \$2.98 plus postage on delivery. We positively GUARANTEE MONEY BACK if the course is not everything we claim. Order today—Address

THE CARL ANDERSON SCHOOL OF ART
MADISON, WISCONSIN

Send \$5.00 cash with order from outside U.S.A.

No Better Christmas Present for \$2.50

than a year's subscription to

Popular Mechanics Magazine

Containing 3600 Pictures and 3600 Articles

Much of it Interests Everybody

Most of it Interests Anybody

All of it Interests Somebody

Order through your Newsdealer or address the Publisher

POPULAR MECHANICS COMPANY

200 East Ontario Street, CHICAGO, ILL.

Here's Your Chance to

Get an Education

The quickest, surest, easiest way

Here is the knowledge that gives real education—all organized in a single volume.

It is really SIX books in ONE offering in simple, clear, fascinating style the understanding you need of

History, Science, Literature, Art, Philosophy, Religion



—the six great branches of knowledge, an understanding of which will give you the education that brings SUCCESS and LEADERSHIP. Here is the easiest, the most practical, the most interesting method of self-education—

The Outline of Man's Knowledge

The Pittsburgh Sun-Telegraph calls it "A University in itself." Here is the whole scope of modern education in one thrilling narrative of 700 sparkling pages—the cream of the world's knowledge for quick and easy self-improvement.

Read It FREE

Use This Coupon



Lewis Copeland Company, Dept. 566,
 119 West 57th Street, New York City.

Kindly send me THE OUTLINE OF MAN'S KNOWLEDGE, by Clement Wood, 700 pages, illustrated, handsomely bound. Within 7 days, I will either return the book or remit \$1.50 as first payment, and then \$2.00 per month for two months, a total of \$5.50. (Ten percent discount for cash with order, same return privilege.)

Same return privilege.

Name.....

Address.....

City..... State.....

If outside continental U. S. send \$5.50 with order.



Learn at Home
in Spare
Time

DRAFTING and TOOL DESIGNING

\$100 A Week and More

Get into the big-paying field. Prepare yourself through our practical, fascinating instruction. Draftsmen and tool designers are always in demand. The highest paid men today in any industry are the production and tool engineers.

Best Equipped, Largest and Oldest School

in Michigan specializing in mechanical drafting and tool designing. Text books written in this school endorsed by leading universities. Our methods are simplified and easy. Lessons given personal attention by chief tool designers and chief draftsmen from Detroit's largest automobile plants.

Learn quickly by mail, or come to Detroit, the center of the automotive and airplane industry, and attend our resident classes.

OUR GRADUATES EMPLOYED IN EVERY DESIGNING ROOM IN DETROIT

Leading manufacturing plants recognize our school. We have more calls for graduates than we can fill. We help you in securing a position. In every city there is a demand for well-trained draftsmen and tool designers.

Detroit School of Applied Science, Inc.
8203-8213 Woodward Ave. Detroit, Michigan

Detroit School of Applied Science, Inc.,
8203-8213 Woodward Ave., Detroit, Michigan.

Please send complete information regarding your instruction in

DRAFTING TOOL DESIGNING

Name.....

Address.....

Age..... Occupation.....

SPORTSMEN

Read This Offer!

Send the COUPON and receive a magnificent Sportsmen's Book telling you how to learn to MOUNT GAME-HEADS, BIRDS and ANIMALS. You can NOW be your own Taxidermist. Our school has over 100,000 graduates throughout the world. You can now learn AT HOME in SPARE TIME.

Mount Your Own Trophies!

Hunting and Fishing have entered a new era. All true sportsmen now kill fewer specimens, but DOUBLE their interest by mounting their trophies. The secrets of Taxidermy (mounting birds and animals) are now revealed. YOU CAN NOW LEARN TAXIDERMY FOR YOURSELF. Be a Taxidermy artist. Mount birds, animals, game-heads, fishes, tan skins and make beautiful rugs and robes. Easily and quickly learned in your own home. Adorn your home and den with nature's finest ART. If you enjoy hunting—you will enjoy Taxidermy MORE.

Big Profits Do you want to MAKE MORE MONEY? Then give your SPARE TIME to Taxidermy. Make \$50 to \$250 a month by mounting for others or selling your mounted specimens, or go into business—open a Taxidermy shop of your own, and earn \$3,000 to \$6,000 a year.

This Book FREE

Every Sportsman should have this marvelous book. You can right now, while this edition lasts, get a copy Free and prepaid by mailing the coupon NOW. Only limited number free—Send Today. Nothing like it. Just off the press. Contains 48 large pages and cover in brilliant colors. More than 100 photos of splendid game specimens and masterpieces of the National Museum at Washington. Brim full of interest to every sportsman. And think of it, this valuable unique and artistic book can be had now, by Sportsmen for the asking.

Mail the Coupon!

If you want to preserve your trophies; if you desire to make money from your spare time, if you are a nature lover—send the coupon and receive your copy by return mail.

N.W. School of Taxidermy, 3379 Elwood Bldg., Omaha, Neb.



N. W. School of Taxidermy

3379 Elwood Bldg., Omaha, Neb.

Send me your free illustrated book "Sportsmen and Their Trophies." Also tell me how I may learn this fascinating art easily and quickly by mail. No obligation.

Name.....

Address.....

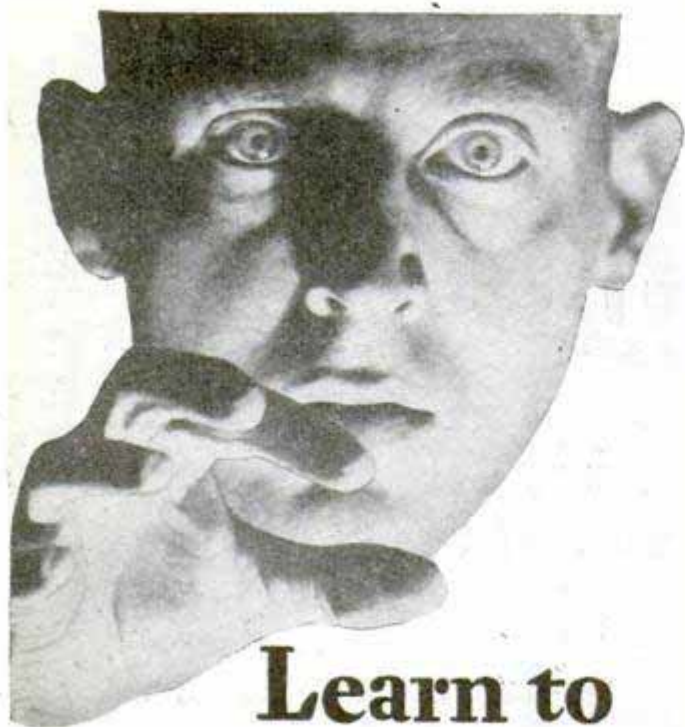

Learn to HYPNOTIZE

**5 DAY TRIAL - NO COST
IF NOT SATISFIED**

Gain New Power!

QUIT being just one of the crowd! Stand out—dominate—make others admire and obey you! Learn how to bend people to your will; how to develop a winning, magnetic personality; how to gain popularity, success, big money—by the USE OF HYPNOTISM.

In just a few hours, I'll show you the inner secrets of this mysterious force or the Five Days' TRIAL IS FREE! I'll show you how to develop the hidden germ of this magic power within yourself. Once you know how, you can use it in overcoming obstacles, achieving your fondest ambitions and becoming MASTER of yourself, friends and acquaintances—either sex. See for yourself how Hypnotism can banish fear, worry and opposition—improve your memory—increase your earnings—and force others to give you the good things in life that you desire!

In this startling NEW book "The Science of Hypnotism," the world famous Hypnotist—Prof. L. E. Young—reveals the most carefully guarded secrets of this fascinating subject and TELLS ALL! He not only explains the methods of noted hypnotists, step by step—but tells clearly all about the nine stages of hypnotism. The Hypnotic Mirror, Mental Telepathy, how to select your subjects, magnetic healing, methods of hypnotizing, how to waken subject, how to make money out of hypnotism!

Try 5 Days Free—Send No Money

So confident are we that Prof. Young and his great book will quickly teach you the science of hypnotism, that we will send you a copy without one cent in advance! Simply clip and mail the coupon below. When the book arrives, pay the postman the special low price of \$2.50 plus few cents postage. Then test the powers of Hypnotism 5 days! If not amazed and delighted, return the book and money will be refunded at once! Mail the coupon now.

Franklin Pub. Co., Dept. W-70
800 N. Clark St. Chicago, Ill.

- Mysteries of Hypnotism Revealed**
- How to Hypnotize at a glance
 - How to Hypnotize By Telephone
 - How to Give an Entertainment
 - How to Make Others Obey You
 - How to Do Dozens of Hypnotic Feats

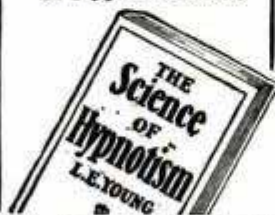

Franklin Pub. Co., Dept. W-70
800 N. Clark St., Chicago, Ill.

Please send me your amazing new book—"The Science of Hypnotism"—by Prof. Young. When the book arrives, I'll pay the postman only \$2.50 plus postage. If I am not satisfied after 5 days' trial, I may return the book and you are to refund my money.

Name.....
Street and No.....

Town..... State.....
If you are likely to be out when postman calls, send \$2.50 with coupon and we'll pay delivery charges. Customers outside U. S. must send cash with order.

I GUARANTEE An Inch of Solid Muscle All Over Your Body In 30 Days!

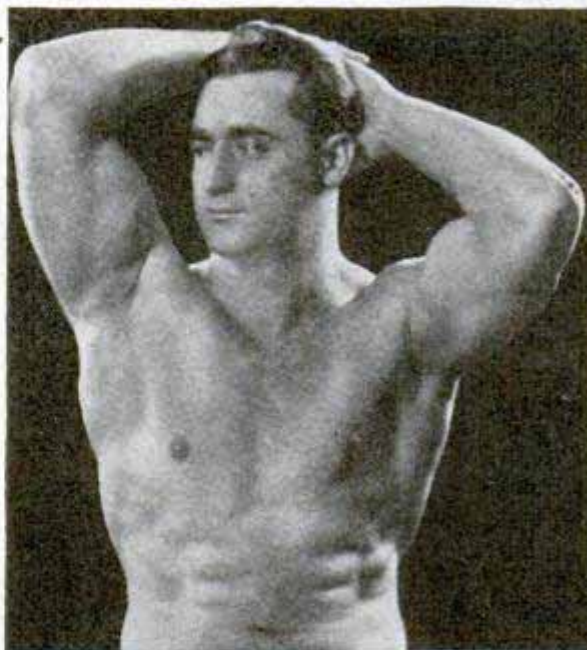

CHARLES ATLAS—Winner of two \$1000 FIRST PRIZES as the World's Most Perfectly Developed Man, at Madison Square Garden, New York City. **No other living man can claim this title!**

Are You Ashamed of Your Figure?

My system "Dynamic Tension" is what you need. Inside of 30 days I'm going to add at least an inch or more of solid muscle all over your body if you'll give me a chance to prove it.

I'll Make You a Muscular Giant in 90 Days

LOOK AT THESE PUPILS



Anthony Sansone



El Marquis de Guadalupe
Mexico City

LOOK AT THESE PUPILS—Here's convincing proof my pupils become tremendous, virile Herculean Giants, more muscular than many other physical instructors are. Regardless of your age I GUARANTEE to give you marvelous quick-fighting muscles in record smashing time, and develop your nerve, courage, confidence and strength, too.

READ THIS!

Look at the picture of El Marquis de Guadalupe. He's 53 years young! He attributes his perfect development to the Charles Atlas Course. What I have done for the Marquis and thousands of others let me prove I can do for you! I'm waiting to give you New Health, Great Strength and a Perfect Physique. So come on, fellows, let's go!

EVERY PUPIL RECEIVES MY PERSONAL ATTENTION

The lessons are prepared to suit the particular condition of each pupil.

FREE! "EVERLASTING HEALTH AND STRENGTH"

Write for this amazing Free Book full of pictures of men I have trained and all information how to have health and strength. Mail the coupon TODAY—NOW!

CHARLES ATLAS

"World's Foremost Muscular Scientist"

Dept. 812, 171 Madison Ave., New York City

Dear Sir: Please send me your Big FREE Book "EVERLASTING HEALTH AND STRENGTH" by return mail, without cost or obligation.

Name.....

Address.....

City..... State.....

When Thomas Edison groped in the dark

IN 1859 Edison was a newsboy on the trains in and out of Detroit. He spent every hour he could spare in the public library "grappling bravely with a certain section, and trying to read it through consecutively, shelf by shelf, regardless of subject."

Admirable determination! Edison was destined to be well read, just as he was destined to become the greatest inventor of all time. But his early desire for fine reading was a blind groping in the dark. The books in a modern public library would take fifty lifetimes to read!

Now—Everyone Can Be Well Read

Just as America's great inventor brought light into the world through the great medium, electricity — America's great educator brought light to everyone through the medium of good reading. Dr. Charles W. Eliot, from his lifetime of study, selected the pure gold from the world's literature. Into a single set he assembled the essentials of a liberal education, the books that everyone must know to be well read. In the Five-Foot Shelf are the carefully selected writings of 302 immortal authors.

Dr. Eliot's Plan of Reading FREE

The Five-Foot Shelf is not a "rich man's library." By the famous Collier plan these wonderful books are brought within easy reach of everyone. Do not put off finding out more about this invaluable set.

DR. ELIOT'S FIVE-FOOT SHELF OF BOOKS

(The Harvard Classics)

Carlyle once said, "If time is precious, no book that will not improve by repeated readings deserves to be read at all." Time nowadays is more precious than ever before. We cannot, like the young Edison, attack the countless shelves of public libraries. Probably none of us possesses the persistency and patience which guided his early reading. We must have only

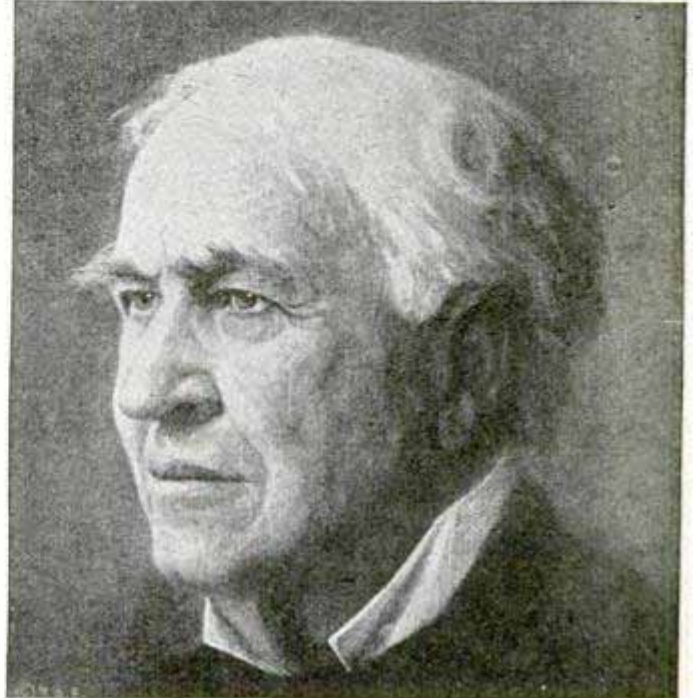

the really great literature, the books that make us think straight, talk clearly and increase both our power to succeed and our enjoyment of life.

The Harvard Classics answer these requirements to the last detail. Already they are read and cherished in thousands of cultured homes. They are constantly bringing keen enjoyment and deeper understanding into busy lives. "Reading," as Edison himself says, "will never take the place of doing, but it enables us to travel twice as far with half the effort."

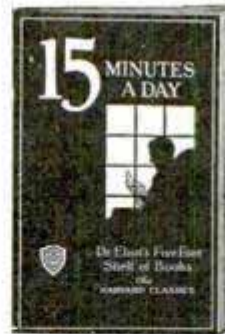

**Mail the Coupon
TODAY!**

P. F. COLLIER & SON CO.
250 Park Ave., New York City

By mail, free, send me the booklet that tells all about the most famous library in the world, describing Dr. Eliot's Five-Foot Shelf of Books (The Harvard Classics) and containing the plan of reading recommended by Dr. Eliot. Also please advise how I may secure the books by small monthly payments.

Name } Mr. _____
Mrs. _____
Miss _____

Address _____

MEN of ACTION!



U. S. Gov't asks S. of E. to test this huge Elec. generating Unit, built for Panama Canal.

Learn Electrical Engineering

Electricity seeks men of action! Jobs up to \$10,000 a year are open to men who have received special training such as is given in the School of Engineering of Milwaukee—one of the foremost and best equipped Electrical schools in America. If you have 14 high school credits or equivalent, you can become an electrical engineer with Bachelor of Science degree. Lacking credits can be made up in our short special course.



B. S. DEGREE IN 3 YEARS

Complete, Practical Electrical Education

Learn by the thorough, approved scientific methods which our 26 years of specializing enable us to give you. In addition to Electrical Engineering, the following complete courses are given: **A. C. and D. C. Armature Winding—Wiring and Testing—Commercial Electrical Engineering—Automotive Electricity—Radio Sales Service and Broadcasting—Electrical Refrigeration.**

EARN WHILE YOU LEARN

Cooperation with large Milwaukee Electrical industries enables us to help place students in part time jobs to help their way while learning. Low tuition. Board and room reasonable. Daily broadcasting. School orchestra. Fraternities.

Send Coupon for Free Catalog
NEW TERM BEGINS NOW

SCHOOL of ENGINEERING of Milwaukee

SCHOOL OF ENGINEERING OF MILWAUKEE
Dept. P. M. 1229A E. Wells & Jackson, Milwaukee, Wis.

Without obligating me in any way please mail free illustrated book "Rise to Success Through Electricity," and particulars regarding the course I have marked with an X.

RESIDENT COURSES

- Electrical Engineering, B. S. Degree. (3 Years)
- Commercial Elec. Engineering. (H. S. Graduates 1 yr.—others 1½ yrs.)
- Armature Winding.
- Light Motor Wiring and Testing.
- Electrical Refrigeration.
- Master Electrician.
- Radio Sales Service and Broadcasting.
- Home Laboratory Service. (Home Study Course.)
- I am interested in your "Earn While You Learn" plan.
- Day..... Evening Classes.

Name..... Age.....
Address.....
City..... State.....
Education.....

Play Piano BY EAR

—IN 90 DAYS!



Play anything—jazz to classical! Even if you know nothing about piano music—I'll have your fingers dancing over the keyboard with confidence in 90 days. If you can hum or whistle a tune you can play it! My students are broadcasting—making money. **MAKE ME PROVE IT!** Without puzzling notes! Without practicing tedious scales! I've found the way to bring out your musical instinct. New and original system does away with years of work. **YOU WANT THE PROOF!** I'll send it. Write me now.
D. M. SUTTLE, Director
ILLINOIS SCHOOL OF MUSIC
1801 Byron, Dept. 1115, Chicago, Ill.

Send NOW for PROOF!

Be a MEAT CUTTER



Harry Holtzer stepped into \$50 a week job as Meat Cutter through NATIONAL training. You, too, can do the same. Previous experience not necessary. We teach you through our Home-Instruction Course. Don't get by—get ahead. Write today. **FREE** book, "Big Pay the NATIONAL Way."
National School of Meat Cutting, Inc.
Dept. D Toledo, Ohio

BART'S NEW CHALK TALK BOOK

"Their Best Stunts" from 25 chalk talk experienced artists. \$1.25 prepaid, 5-day trial. Also catalog "A." Art Supplies, or "S." Show Card Supplies.

BART SUPPLIES, 525 Eustis Bldg., Minneapolis, Minn.

BREAKFAST NOOK and 26 other

splendid articles of Built-In Furniture in our new book on this subject. 198 pages. Illustrated. **Price \$2.50 Postpaid.**

POPULAR MECHANICS PRESS, 200 E. Ontario St., Chicago

Are You Interested in Flying?

No matter what you want to know about this subject, send for our free catalog of aviation books. It is the latest and most complete published. A post card brings it.

Popular Mechanics Press, 200 E. Ontario St. Chicago

Oh, You Skinny!



Don't be laughed at for your lack of flesh and muscle. Don't be an object of ridicule wherever you go, at the dances, in the swimming pool or on the field of sport—don't let them call you "Skinny." Don't suffer this humiliation. You can turn it to admiration by the simple method of letting Lionel Strongfort, the world's foremost physical instructor, take hold of you and build you up through Strongfortism, into a real he-man—with a body to be proud of. Away with weakness. In less time than you think you will rid yourself of vitality sapping ailments and be admired and respected for your fine physique and robust physical powers. Come on—be a manly man. Just write for my illustrated book giving priceless secrets about the human body. Send the coupon today.

STRONGFORT INSTITUTE
LIONEL STRONGFORT, DIRECTOR.
PHYSICAL AND HEALTH SPECIALIST.
DEPT. 964, NEWARK, NEW JERSEY, U.S.A.

STRONGFORT INSTITUTE Dept. 964 Newark, New Jersey, U. S. A.

Please send me, without obligation, my copy of your book, "LIFE'S ENERGY THROUGH STRONGFORTISM," for which I enclose 10c (one dime).
Name.....
Street.....
City..... State.....

Learn AUTOS

I Train You
At HOME

up to **EARN \$5000**
A YEAR



Start to Make Money Quick Like Morrision

M. J. Morrision, Parkersburg, W. Va. (photo at right), never had a day's experience on cars before starting my training. Read what he says when less than half-way through his "JOB-WAY" course. "What I have already learned is worth over \$500 to me. I have gone into business and I'm making over \$50 a week clear, with wonderful prospects." And what Mr. Morrision and hundreds of others have done I will help you to do!



M. J. MORRISON, Parkersburg, W. Va.

Clip this Coupon Now for my Big **FREE AUTO BOOK**

3 repair & testing **OUTFITS INCLUDED**

The World's biggest, most fascinating business needs you!

You needn't slave away at small wages another minute—mail coupon and I'll tell you how I train you at home in your spare time for positions paying up to \$150 a week. Unlimited opportunities for trained Electrical and Mechanical Auto Experts. Let me show you how my "JOB-WAY" training has prepared hundreds of men "just like yourself for a quick, brilliant success in the Auto business.

Earn Up to \$150 a Week!

Don't sell your time for low pay! You don't need to when you have my "JOB-WAY" training. As Directing Engineer of this Institution I know what training you need to succeed. AND I GIVE YOU THAT TRAINING right in your own home. MASTER every branch of Auto, Truck and Tractor work. I train you with JOBS—not books. I bring the original "JOB-WAY" training TO YOUR HOME!

Read My Agreement!
Ten agreements in my big free Auto Book. No. 1 is "I will refund every cent of your money if after receiving my training you are not absolutely satisfied." This and nine other wonderful agreements make my "JOB-WAY" course the training for you! Be sure to get my book and read all ten agreements.

Experience, Education Not Needed!
I don't care how little schooling you have. I will train you to become an Auto Mechanic or refund your money! Boys and men of all ages have become Garage owners and managers, Superintendents, Foremen, Auto Experts, BIG PAY executives, after completing Cooke "JOB-WAY" training. I prove to you that I will prepare you to take advantage of the many wonderful opportunities of the great auto business!

Get My Big Book Quick!
I will send it to you without one penny of cost. Read all the facts, find out about the demand for trained Auto Experts. Let me tell you how easily and quickly you, too, may become an Auto Expert. Splendid offer right now to ambitious men. Coupon brings complete information. Mail it today!

AVIATION Training FREE of extra cost
Coupon brings full details of complete Aviation Training. I am offering FREE of extra charge. Send it now.

Address Me Personally **B. W. COOKE** DIRECTING ENGINEER
MOTOR INSTITUTE OF AMERICA
Formerly Chicago Motor Training Corporation

Motor Institute Bldg., Dept. 9169, Evanston, Ill.

MAIL THIS COUPON NOW!

Free Auto Book

B. W. COOKE, Directing Engineer, Motor Institute of America Formerly Chicago Motor Training Corporation Motor Institute Bldg., Dept. 9169, Evanston, Ill. Send me FREE your Big Auto Book "Auto Facts" and proof that you will train me in spare time at home. Also reserve Complete Aviation Course and 3 Testing and Repair Outfits without obligating me.

Name.....
Address.....
City.....State.....
Age.....Occupation.....

**Start
With**



Mechanical Drawing

... the First Step Toward a Good Job in Drafting ... Building ... Architecture

The fine positions open and big salaries paid in Drafting, Building Construction and Architectural lines, are leading many men to ask how they can "break in."

The sensible way is to learn *Mechanical Drawing*, which every man must know before he can become a Draftsman, or take charge of construction jobs.

You can easily learn Mechanical Drawing at home in spare time—then you can get a job with some Contractor or Architect and *cash in on it*, while gaining valuable practical experience.

Later on you can tackle building superintendence, or architectural drafting, or contracts, estimates and specifications or some one other branch of the work. The new idea is to learn one "unit" of the work at a time, as you need it for promotion, and then make that training pay for itself before you take another.

We'd like to tell you more about this new "one-step-at-a-time" method of training for a better job and a raise, lower in cost and quicker in time than "complete courses." Just mail coupon for free unit plan book.

AMERICAN SCHOOL

Dept. D-947, Drexel Ave. & 58th St., Chicago

American School, Dept. D-947, Drexel Ave. & 58th St., Chicago

I am interested in the new quick way to get into Drafting, Contracting, Architecture, etc., by starting with mechanical drawing. Please send Free Unit Plan Book and complete information.

Name.....

Address.....



DRAW CARTOONS

TURN YOUR TALENT INTO MONEY

Cartoonists earn from \$50 to \$250 per week—some even more. Remarkable *Circle System of Drawing* teaches you in half the usual time. Students from all parts of the world are enrolling for this exceptional instruction. *Personal criticism* service and up-to-the-minute instruction make it easy for National students to attain success. Send for interesting **BOOKLET** and **SAMPLE LESSON PLATE** explaining full details of the Course and what National students are accomplishing. No salesman will call.

The National School of Cartooning, 623 Penton Bldg., Cleveland, Ohio



WANT \$1900 — \$2700 A YEAR?



**Mail Carriers—Postoffice Clerks
No Layoffs—Vacations—Common Education Sufficient**

Would YOU Like To Get Into AVIATION?

Send today for full details about opportunities in Aviation and how, under direction of Art Goebel, World-Famous Flyer, you can **Learn At Home** in spare time, the basic principles of Aviation and qualify to pass all theoretical and written examinations required by Department of Commerce for rating as Pilot or Mechanic. Rapid extension of air-lines, aerial taxi and privately owned planes creates big demand for trained men.



COLONEL ART GOEBEL
Winner of Dole Race (California to Hawaii) and countless flying honors.

Send for FREE BOOK



about the amazing opportunities in the **Fastest Growing, Most Fascinating and Best Paying** industry of all time and how to attain success in Aviation—write for it today.

**THE HOME STUDY PREPARATORY COURSE
THE ART GOEBEL SCHOOL OF FLYING**
Dept. 107 Municipal Air Port, Kansas City, Mo.

How To Secure A Government Position

Why worry about strikes, layoffs, hard times? Get a Government job! Increased salaries, steady work, travel, good pay. I'll help you become a Custom House Clerk, Railway Postal Clerk, Post Office Clerk, City Mail Carrier, Rural Carrier—or any other Government job you want. I was a Secretary-Examiner of Civil Service Commission for 8 years. Have helped thousands.



Now FREE

My 32-page book tells about the jobs open—and how I can help you get one. Write TODAY. **ARTHUR R. PATTERSON**, Civil Service Expert, PATTERSON SCHOOL, 812 Winner Building, Rochester, N. Y.

FREE BOOK CATALOG

Send today, without obligation, for our new 72 page catalog, describing books on more than one hundred and fifty practical and scientific subjects, including books on Aviation, Automobiles, Air Brakes, Alloys, Electricity, Horology, Heating, Hydraulics, Model Making, Metallurgy, Radio, Ship Models, Soaps, Perfumes, Recipes, Plumbing, Inventions, Tanning, Television, etc.

Norman V. Henley Publishing Co., 2 West 45th St., New York, N. Y.

The man who studies gets ahead. Popular Mechanics Press will advise you what books to read to advance in your trade. 200 East Ontario Street, Chicago, Illinois.

Mail Coupon Before You Lose It

FRANKLIN INSTITUTE, Dept. D175
Rochester, N. Y.

Sirs: Rush to me without charge—copy of 32-page book "How to get U. S. Government Jobs," with list of positions obtainable and full particulars telling how to get them.

Name.....

Address.....

**TRAIN
at
HOME**

for

Electricity

THE NEW Shop-Laboratory Way



**Big Shop
Laboratory
Worth \$60.00
without Extra
Cost**

Aviation, Talking Movies, Radio, Super-Power, Television, Refrigeration, Lighting

Need Electrically Trained Men

These new Electrical industries are sweeping the world. This is the Electrical Age! Big manufacturers are pleading for Electrically-trained men. Salaries of \$3,000 to \$7,500 a year are common! Wonderful opportunities for advancement. Here is the field for you. Now is the time to start on the road that leads to increased pay and SUCCESS!

Train the Practical Way

Theory or books alone can never make you a Practical Electro-technician. Our new Home Shop-Laboratory Method, with the patented Unit Board System brings the School right to your home. You learn by doing—by working on full-sized equipment that is yours without extra cost. Behind your training is a fully established college—not a mere correspondence school. Recognized by the U.S. Government. Established 26 years. Over 25,000 graduates holding important Electrical positions all over the world

Earn as You Learn

Cash in on your Electrical Training while you're learning. Many students report increased earnings, advancement, even while studying. Train in your spare time at home. Employment Service renders FREE aid for life. Lifetime Consultation Service. Many exclusive features available nowhere else. Mail the coupon today for full particulars.

EXTENSION DIVISION
SCHOOL of ENGINEERING
MILWAUKEE, WISCONSIN

**FREE
48-Page
Book**

Send Coupon TODAY for illustrated 48-Page Book "Practical Electricity—the Key to Success"—and full details of Extension Division Training.

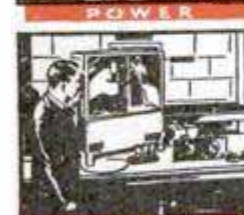

Exclusive Patented Laboratory Equipment

that cannot be secured elsewhere. Special Unit Board System makes fascinating sport of laboratory experiments. Amazingly easy to use.



Learn By Doing



No mere book on theoretical study—but PRACTICAL training on full-sized motor, switchboard, circuits, and electrical equipment.

Satisfaction Guaranteed

You can take S. of E. Home Shop-Laboratory training without risking a penny. Guarantee Bond protects you.



Extension Division, Dept. 33
SCHOOL OF ENGINEERING
Milwaukee, Wisconsin

Please send me, without obligation, FREE illustrated 48-Page Book, "Practical Electricity—the Key to Success," and details of Extension Division training.

Name

Address



There's Quicker, Bigger MONEY for YOU—in POULTRY

Earn \$2,000 to \$5,000 a Year or Have a Business of Your Own!

Whether you want a job at good pay or a highly profitable business of your own—the Poultry Industry offers you more than any other. There's a shortage of poultry meat and eggs—a shortage of trained poultrymen. I'll train you quickly at home—to fill a good job in Poultry—and our FREE Students' Employment Dept. will help you get out!

Spare Time or Full Time YOU Can Cash-in BIG

No matter where you live—city, town or country—or what you do now, my proved methods will assure your success right from the start. I'll help you make from \$2,000 to \$5,000 a year and UP! And, if you choose to start your own business, I'll show you how to make your tiny investment multiply itself automatically. What I've done for thousands of others—I can do for you.

FREE Book Shows Way to Big Pay and BIG Profits

Mail coupon below TODAY—for my Big NEW FREE Book, "How to Raise Poultry for Profit." My forty years of experience are yours. The Poultry Industry needs YOU. You need my book. Get it—and get in line for the BIG Money that's waiting for you in POULTRY.



Mail NOW for FREE Book

NATIONAL POULTRY INSTITUTE, Dept. 411-D
Washington, D. C., Attn: Harry M. Lamon, Pres.

Dear Mr. Lamon: Send me your FREE Book, "How to Raise Poultry for Profit." I want to know more about my opportunity to make \$2000 to \$5000 a year, spare or full time.

Name.....

Address.....

The AMERICAN RED RACER

Only \$1.00

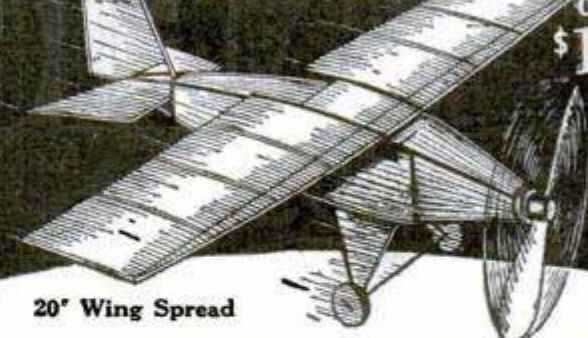

20' Wing Spread

BOYS Here is a brand new development in a model plane for you—an endurance model. It has many novel features which give it endurance and flying qualities that you have never before experienced. It will stay in the air for a minute—a minute-and-a-half or more. It is very light—weighs less than an ounce—and practically crash-proof. You can fly it again and again.

The American Red Racer is easy to construct—the outfit being complete in every detail, having all plans, parts, covering paper, motor, propeller and dope. You can complete it quickly and marvel at the flights it will make for you. Records of 150 to 400 feet have been made. With a heavier motor you can get great speed and distance.

The wing spread is 20" and the fuselage is built up—measuring 14". A very powerful, flexible, long-running, smooth motor, as well as special bearing for propeller. This plane will fly wonderfully hand launched or will R. O. G. rise and make perfect 3-point landing.

The price is low—remarkably low—for such a perfectly designed plane that has so many flying qualities. You will want lots of these American Racers for yourself and your friends. It makes a wonderful gift.

Order yours right now—don't let a day pass without getting the fun and instruction that is in store for you.

Price postpaid complete only \$1.00 or we will send 6 postpaid for \$5.00.

Complete catalog showing other construction sets and ready to fly models from \$1.00 to \$5.00 given with your order, or sent for 10c with free glider.

AMERICAN MODEL AIRCRAFT COMPANY
Desk P12 NEW HAVEN, CONN.

LEARN CARTOONING

AT HOME DURING SPARE TIME

with the course that has trained HUNDREDS of beginners successfully. The Landon Picture Chart Method of teaching ORIGINAL drawing by mail makes cartooning easy to learn. This school is a Member of The National Home Study Council. Write today for sample picture chart to TEST YOUR ABILITY and examples of the work of successful students now earning from \$50 to \$200 and more per week.

Enclose 6c in stamps and STATE YOUR AGE.

THE LANDON SCHOOL, 2838 National Bldg., Cleveland, Ohio



US PATENT DRAFTING

AT LAST! You can now learn to make PATENT DRAWINGS by HOME STUDY. New course trains you to make drawings of inventions such as shown in Popular Mechanics and qualifies you for big paying jobs with Patent Attorneys—U. S. Patent Office, etc. Free drawing outfit included. Not like mechanical drawing. No mathematics. Send for booklets. U.S. School of Patent Drafting, 303 N. Parkside Ave., Chicago

Census Clerks-File Clerks

The taking of the 1930 Census means the appointment of many Government Census Clerks and File Clerks. Now is the time to get ready. Men—women 18 to 50. \$1440 to \$2500 year. Full particulars and list Government Jobs—FREE. Write today sure. Immediate action is necessary.

Franklin Institute, Dep't D705, Rochester, N. Y.



Men! Extra Money Quick

Here's An Easy Way!

—to bring you a fine cash income! Without taking any time away from your job. Pleasant easy work at home. Decorate beautiful giftwares the Fireside way. You can do it — in spare moments. No previous training required. No special ability needed. No tedious study. No memorizing. With the Three Simple Steps sent you by Monsieur Petit the great artist — Director of Fireside Industries, it is just fun! We want men in every community. Be the first! Fireside Industries, Dept. 66-W, Adrian, Mich.

Begin Right Now!

Thousands are making Fireside decorations—making from hundreds to thousands of dollars and doing their own work besides. We supply you with everything you need. Big Generous Complete Kit WITHOUT EXTRA COST. It's a cinch! We absolutely guarantee your success

FREE!

Fill out and mail coupon at once. Without any obligation it brings you wonderful Fireside Book in colors. Explains everything. Act now!



Fireside Industries, Dept. 66-W, Adrian, Mich.

Send me your wonderful Free Book in colors. This does not put me under any obligation.

Name.....

Address.....

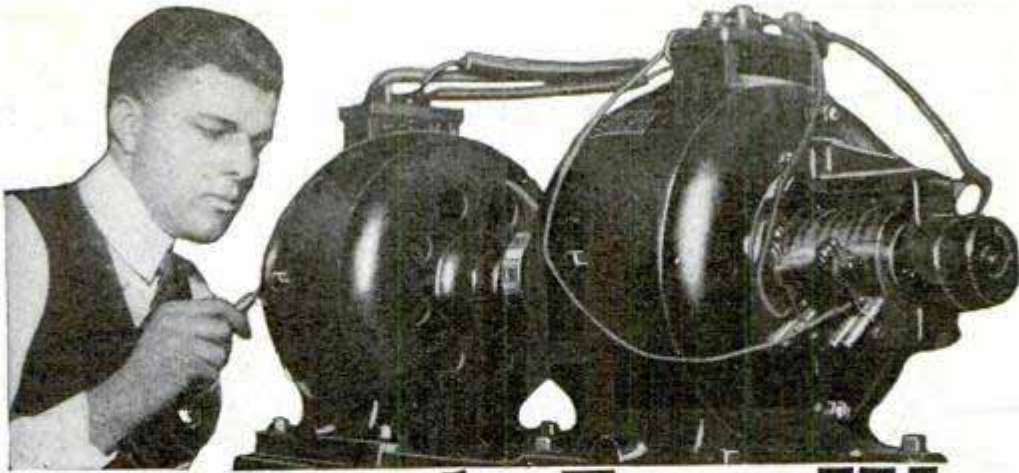

Amazingly Easy Way to get into ELECTRICITY

Don't spend your life waiting for \$5 raises, in a dull, hopeless job. Now . . . and forever . . . say good-bye to 25 and 35 dollars a week. Let me show you how to qualify for jobs leading to salaries of \$50, \$60 and up, a week, in Electricity—NOT by correspondence, but by an amazing way to teach, **RIGHT HERE IN THE GREAT COYNE SHOPS.** You become a practical Electrician in 90 days! Getting into Electricity is far easier than you imagine!

Learn Without Lessons in 90 DAYS

Lack of experience—age, or advanced education bars no one. I don't care if you don't know an armature from an air brake—I don't expect you to! I don't care if you're 16 years old or 48—it makes no difference! Don't let lack of money stop you. Most of the men at Coyne have no more money than you have.

Railroad Fare Allowed

I will allow your railroad fare to Chicago, and if you should need part-time work I'll assist you to it. Then, in 12 brief weeks in the great roaring shops of Coyne, I train you as you never dreamed you could be trained . . . on the greatest outlay of electrical apparatus ever assembled . . . costing hundreds of thousands of dollars . . . real dynamos, engines, power plants, autos, switchboards, transmitting stations . . . everything from doorbells to farm power and lighting . . . full-sized . . . in full operation every day!

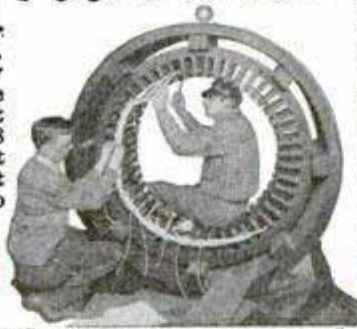

Prepare for Jobs Like These

Here are a few of hundreds of positions open to Coyne-trained men. Our free employment bureau gives you lifetime employment service.

Armature Expert	up to \$100 a Week
Substation Operator	\$60 a Week and up
Auto Electrician	\$110 a Week
Inventor	Unlimited
Maintenance Engineer	up to \$150 a Week
Service Station Owner	up to \$200 a Week
Radio Expert	up to \$100 a Week

etc., etc. That's a glimpse of how we make you a practical electrician in 90 days, teaching you far more than the average ordinary electrician ever knows and fitting you to step into jobs leading to big pay immediately after graduation. Here, in this world-famous *Parent school*—and nowhere else in the world—can you get such training!

Jobs, Pay, Future

Don't worry about a job, Coyne training settles the job question for life. Demand for Coyne men often exceeds the supply. Our employment bureau gives you a lifetime service. Two weeks after graduation Clyde F. Hart got a position as electrician for the Great Western Railroad at over \$100 a week. That's not unusual. We can point to Coyne men making up to \$600 a month. \$60 a week is only the beginning of your opportunity. You can go into radio, battery, or automotive electrical business for yourself and make up to \$15,000 a year.

Get the Facts

Coyne is your one great chance to get into electricity. Every obstacle is removed. This school is 30 years old—Coyne training is tested—proven beyond all doubt—endorsed by many large electrical concerns. You can find out everything absolutely free. Simply mail the coupon and let me send you the big, free Coyne book of 150 photographs . . . facts . . . jobs . . . salaries . . . opportunities. Tells you how many earn expenses while training and how we assist our graduates in the field. This does not obligate you. So act at once. Just mail coupon.

Get This Free Book



NOW IN OUR NEW HOME

This is our new fireproof, modern home wherein is installed thousands of dollars worth of the newest and most modern Electrical equipment of all kinds. We now have the largest amount of floor space devoted to the exclusive teaching of practical electricity in the world. Every comfort and convenience has been arranged to make you happy and contented during your training.



NO BOOKS
No Printed Lessons
No books, no baffling charts . . . all real actual work . . . right here in the great Coyne school . . . building real batteries . . . winding real armatures, operating real motors, dynamos and generators, wiring houses

COYNE ELECTRICAL SCHOOL
H. C. LEWIS, President
500 S. Paulina Street, Dept. 99-72C, Chicago, Ill.

Mr. H. C. LEWIS, President
Coyne Electrical School, Dept. 99-72C
500 S. Paulina Street, Chicago, Illinois

Dear Mr. Lewis:
Without obligation send me your big free catalog and all details of Railroad Fare to Chicago, Free Employment Service, Radio, Aviation Electricity, and Automotive Courses, and how I can "earn while learning."

Name
Address
City State

STEAM ENGINE FREE!

Here's our special "Little Hercules" Steam Engine. Made by "Weeden," world's leading maker. Fine quality and high finish. Has heavy fly-wheel, pulley-wheel, easy acting piston, and heavy cylinder. Strong boiler and fittings. Has fire box. Runs by alcohol or canned heat. Will run mechanical toys like Erector, Meccano. A big, high quality steam engine—powerful—just what you have been waiting for and you can have it FREE.

The Magazine of Thrills
The Open Road for Boys magazine has fifty pages crammed with thrilling, breath-taking stories that will hold you spell-bound. Tense stories of high adventure on land, on sea and in the air. Deep mystery. Suspense. "The Street of Dreadful Silence," the most thrilling mystery serial smash in ten years, now starting. Regular subscription price alone \$1.00 a year. We'll send you The Open Road for Boys



Magazine for a whole year for \$1.00 and this dandy steam engine FREE! Wow! What a bargain.

BOTH TOGETHER \$1

MAIL COUPON TO-DAY

Canadian postage 25c extra. Foreign 50c extra.

The Open Road for Boys
Department W-86
130 Newbury Street
Boston, Mass.

You bet I'll grab that bargain. Here's my \$1.00. Rush the Steam Engine right out to me and put me down for a year's subscription to The Open Road for Boys Magazine.

Name.....

Street.....

City..... State.....

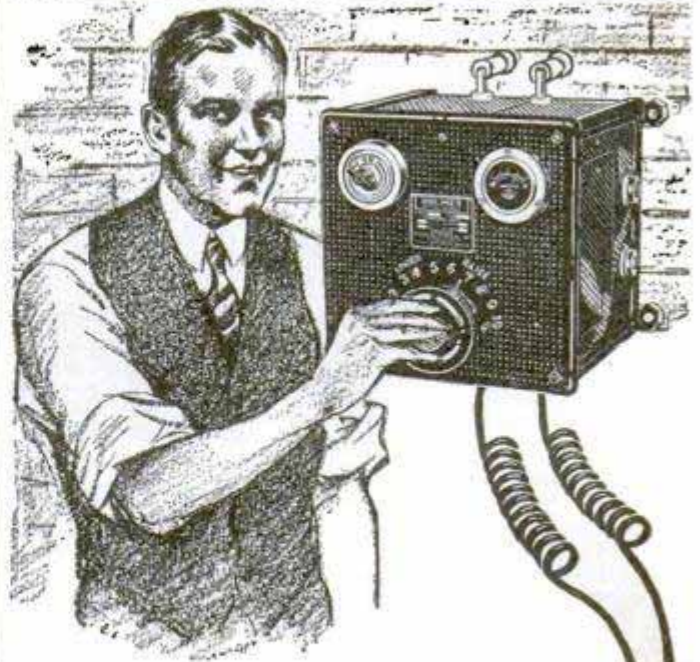

TURN THIS DIAL and make \$20.00 OVERNIGHT RIGHT IN YOUR OWN HOME!

You simply turn the switch with a full set of batteries on the table, and make \$20 to \$40 overnight. Ralph Haron Miranda makes \$125.00 a week charging batteries. Proesel makes \$150 a week, after starting in a small way. You can, too, under my plan.

Pocket 90c Clear Profit on Every Battery

I have invented a new Service Station Charger which saves 40% to 60% in electric current, yet handles 50% to 70% more batteries than similar outfits. Millions and millions of batteries in daily use by auto owners everywhere. Amazing new principle of my Service Station Charger simply scoops up all the business in town for you.

\$5.00 Starts! No Special Experience You or Education Required

You start making money as soon as charger is uncrated, using either full or spare time. Charger is automatic and requires no attention during operation. Profits go into your pocket without effort on your part. A few dollars starts you. We ship complete outfit on receipt of \$5.00.



\$85 a Week for McDermott

Tools, and Extra Equipment Included Without Charge

As an owner of my charger you get the benefit of my advertising. When you open up, business comes right to your door. No soliciting—no plugging for business. Customers are glad to give you their trade.

"You are the best company I ever dealt with. My own station is now bringing me in plenty of money, with practically no effort."

FREE Book Tells How to Start! Full or Spare Time



Clip coupon and get your Free copy of my book, "Big Profits." Read how hundreds of other fellows like yourself have established themselves in their own business. See the description of my amazing Service Station Charger. Find out about my plan for establishing you in this Big Pay field. Clip the coupon now!

Address Me Personally

C. F. HOLMES, Chief Eng.
Independent Electric Works
Dept. H
4912 N. Clark St., Chicago, Ill.

C. F. Holmes, 4912 N. Clark St., Dept. H, Chicago, Ill.
Rush me by return mail a copy of your Free Book "Big Profits."

Name.....

Address.....

Town..... State.....

Everything You Need to Know to Improve Your Speech

in social life, business, and public speaking, is now explained in this great new handbook—a complete guide to the fullest development of your powers of expression—

How to Talk

A Manual of Effective Speech

By John Mantle Clapp and Edwin A. Kane

is a treasury of ideas and methods for IMMEDIATE USE in Business Meetings, Interviews, Selling, Committee Work, Club Meetings, After-Dinner Talks, Public Speeches, and every other situation of personal or business life.

Thousands of men and women have already eagerly demanded this new handbook of speech because it deals with problems of expression for the first time in an intensely practical way. It tells clearly just what you want to know, shows just how to use the priceless information it offers, covers completely every situation and explains fully how to master that situation. The following partial contents indicate the wide range of the subjects treated in this remarkable book:

OVERCOMING YOUR PERSONAL DIFFICULTIES

Analyzing Your Own Case. Practical methods you can apply at once to obtain an immediate improvement in your ability to talk effectively in any situation.

Improving Your Vocabulary. A simple method for testing your knowledge of words. How to develop accuracy in use of words.

Enunciation and Pronunciation. Simple methods for training yourself to speak plainly and correctly.

Developing Your Voice. Easy ways by which you can improve your voice.

Self-Training in Language. How to adjust expression to audience, occasion, and purpose.

Self-Training in Your Delivery. Nervousness and the remedy. Gestures.

PUBLIC SPEAKING

Getting Ready to Speak. How great speakers prepare. Assembling and organizing your material.

Facing Your Audience. Main points you need to keep in mind. Noting room. Gauging audience. Getting started. Finding the right voice tones. Handling emergencies. Impromptu additions to prepared speeches. Resting your audience. Taking your bearings.

Informal Addresses. How to make an immediate improvement in your ability as an informal speaker.

Formal Speeches. How to introduce speakers. Official courtesies. Responses.

Festive Occasions. How to speak at public dinners. Good form. How long to talk. Toastmaster and his functions.

The Plea for a Cause. Persuasion. Getting favorable action.

YOUR BUSINESS SPEECH

Speech in Your Business Life. How to make your conversation businesslike without being abrupt.

Your Conversations with Your Employer. Reports and suggestions.

Your Conversations with Your Employees. Avoiding misunderstandings. How to give orders: wrong and right methods.

Business Conferences. Cutting down waste time. Reconciling differing points of view. Getting results.

Service Conversation in Business. Complaints. Adjustments.

Trading Conversation Involving Buying or Selling. Lessons you can learn from the method of the skilled salesman. Fundamentals of good buying technique.

YOUR ACTIVITIES IN CLUBS AND PROFESSIONAL ORGANIZATIONS

Committee Work. Organization. Committee Chairman.

Meetings—Parliamentary Practice. Duties of chairman and individual members. Motions. Safeguards and management of discussions.

YOUR HOME AND SOCIAL LIFE

Your Family Circle. The art of companionship. Conversation within the family.

Social Conversation. Conversation with strangers, with casual acquaintances, family and intimates.

No Advance Payment

Fill in and mail the coupon. The book will be sent you, delivery charges prepaid. Keep "How to Talk" for five days. Read a few pages here and there. Then decide whether it gives you the help you need. If you don't feel that it will prove one of the best investments you ever made in your life—just send it back and that ends the matter. Otherwise send \$5.00 in full payment.

Use this coupon →

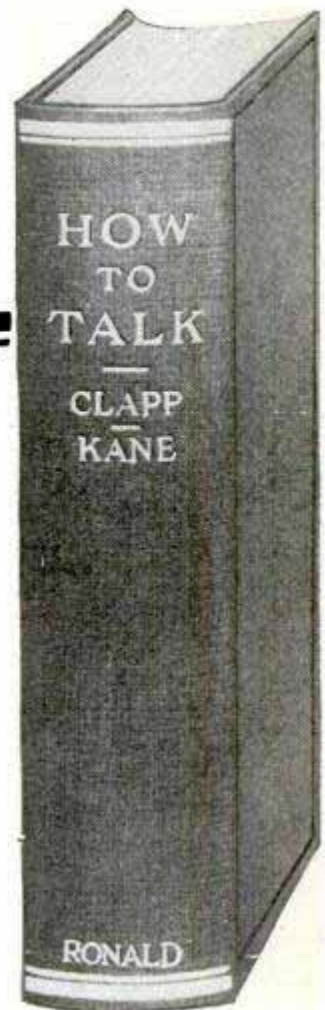

647 pages, 35 chapters

"... It is a veritable speech-encyclopedia... above all practical... recognizes and meets actual speech problems that confront us in our ordinary relationships... drawn from the experience of business men, professional men, and the man of the street... presented so simply and so directly and with such a wealth of illustrative material that it is self-teaching."

M. M. Hoover, Asst. to the Director University Extension, Columbia University.

(Fill in, tear out and mail)

Sent for 5 Days' Free Examination

The Ronald Press Company
Dept. M230, 15 East 26th St., N. Y.

You may send me postpaid a copy of "How to Talk," by John Mantle Clapp and Edwin A. Kane. Within five days after its receipt I will either send you \$5.00 in full payment or return the book.

Name.....
(Please Print)

Address.....

City.....State*.....

*Outside continental U. S. and Canada, \$5.00 cash, plus 25 cents for shipping.

2184

KITES TO HELP RESCUE OF STRANDED AVIATORS

*Dr. O. C. Silverthorn, de Turin
Springs, Florida*

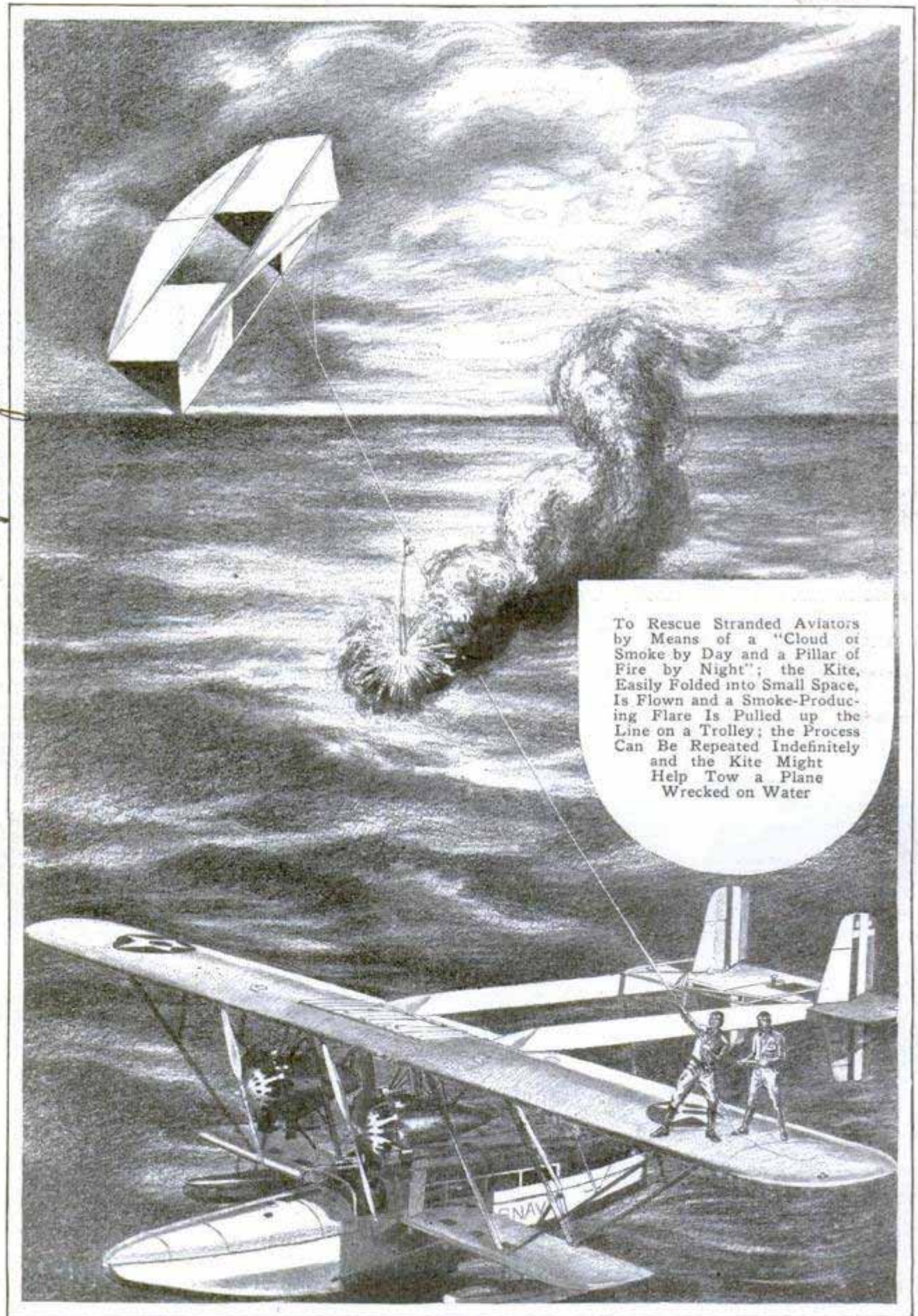

To Rescue Stranded Aviators by Means of a "Cloud of Smoke by Day and a Pillar of Fire by Night"; the Kite, Easily Folded into Small Space, Is Flown and a Smoke-Producing Flare Is Pulled up the Line on a Trolley; the Process Can Be Repeated Indefinitely and the Kite Might Help Tow a Plane Wrecked on Water

Popular Mechanics Magazine

REGISTERED IN U. S. PATENT OFFICE

WRITTEN SO YOU CAN UNDERSTAND IT

Vol. 52

DECEMBER, 1929

No. 6

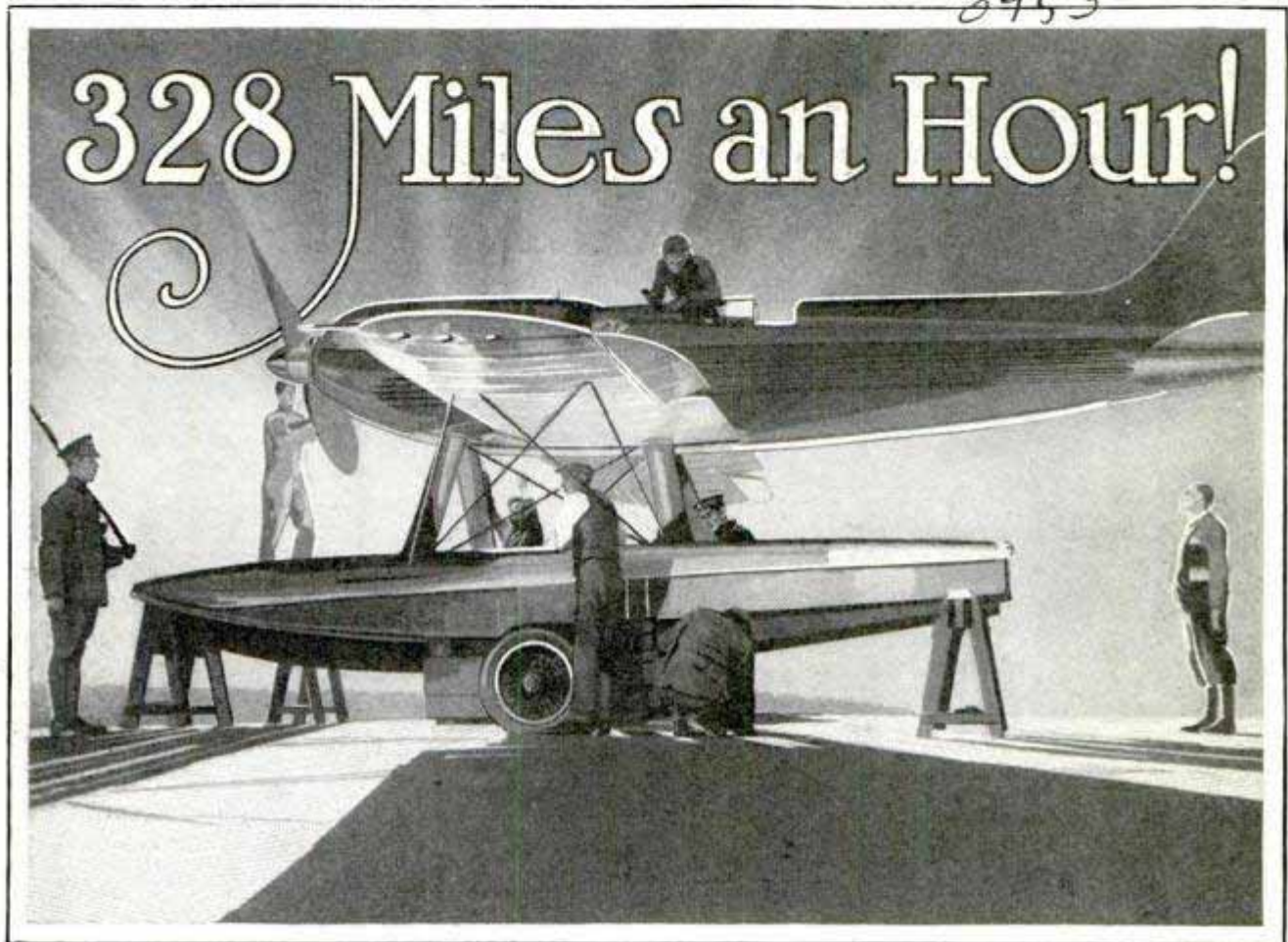

News Was Received at Night That Italy Had Not Withdrawn from the Schneider Cup Races, So Work Proceeded on the Second Supermarine Rolls-Royce at Calshot with the Aid of Searchlights

PA.

By CHRISTOPHER SPRIGG

A TINY blue and white monoplane, its pontoons, each almost as big as its fuselage, glinting silver in the sun! Inside, cramped, masked and goggled, the pilot moves at a speed man has never touched before—and lives! Filling the heavens with sound, the deafening boom of his engine, its supercharger gulping fuel at the rate of two gallons a minute!

Behind it a still smaller, blood-red monoplane, missing death by hair's-breadths as it strives in vain to catch the silver seaplane, skimming the water so that the un-supercharged engine might suck a mixture one iota denser than that of its rival. The pilot, fighting against unconsciousness while the cockpit fills with air tainted by the exhaust gases! Below blue water,

above blue sky, and around, on the golden sands of the coastline, more than a million people, their eyes riveted on the spectacle.

So was history made in the Schneider cup race this year, held in England and christened the greatest event in mechanical sport. For two years the most brilliant aeronautical brains of four countries had worked to produce aircraft that would be triumphs of modern mechanics. Day in and out motors roared on test benches, and engineers peered into wind tunnels, testing, verifying, experimenting. Italy expended \$5,000,000 for development. England spent \$1,000,000 on one engine. France allocated \$1,800,000 for her racing aircraft.

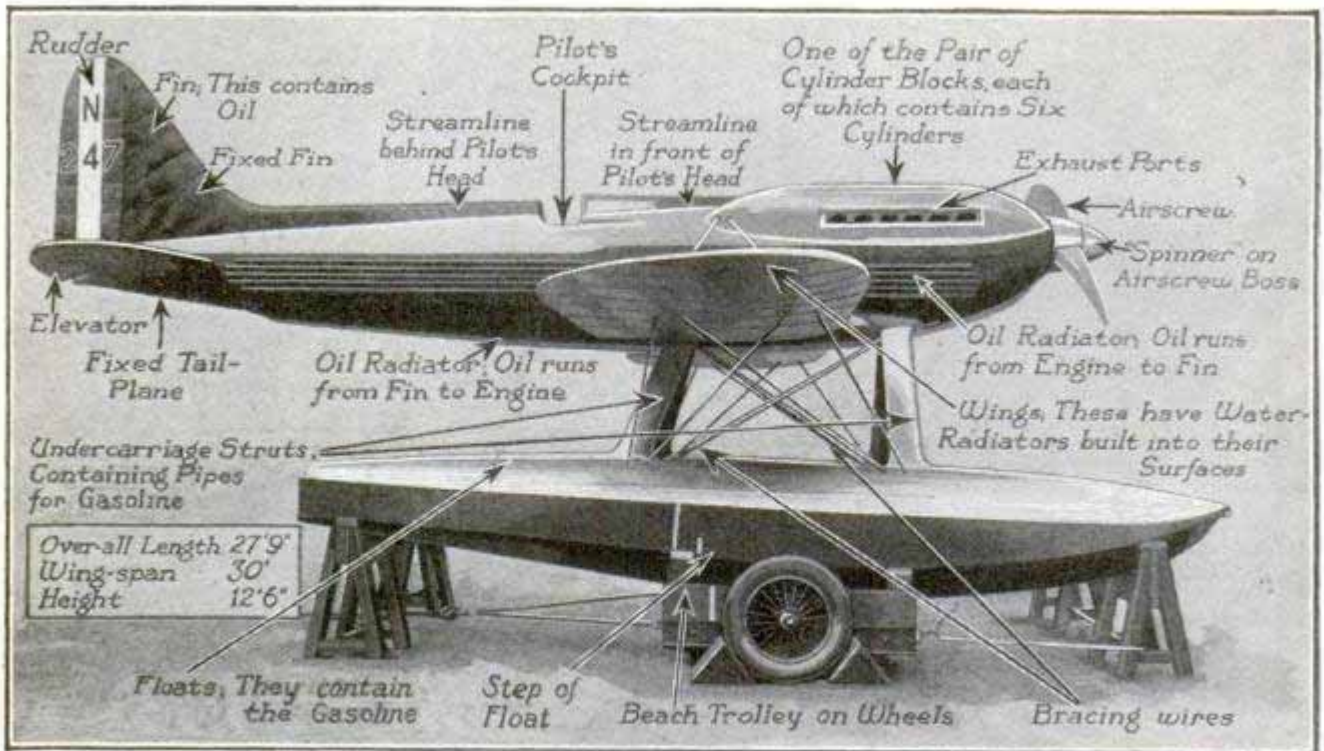

Unusual Features of the Racer as Shown by Diagram; the Floats That Carried Gasoline, Water Radiators in the Wings and an Oil Chamber in the Fin

On the day of the race gathered the skilled pilots who were to stake all, in one breathless hour, on the brains and skill of their engineers and mechanics. Some had already confessed defeat. France avowed that her machines had not developed the expected speed, and withdrew. Italy sought a postponement, but it was decided that the rules forbade. Lieut. Alford Williams, famous American ace, playing a lone hand, was unable to get his Mercury racer ready in time, and so England was given no chance to meet again the rival who had twice defeated her.

The Italian entries were two Macchi 67's. These were low-winged monoplanes, with sixteen-cylinder motors arranged in three banks. More than 1,200 horsepower, it was rumored, was crammed into each of these engines. Nestling beside them was the Fiat, the trickiest aircraft ever built. Only Sergeant Agello, the undersized Italian pilot, could climb into it, and it fitted him like a glove. Already this type had killed one pilot and injured another, for its controls were as light as a feather and it landed at 125 miles per hour. Its motor had two banks of six cylinders each. And its wings were mere stubs. Near by was the most extraordinary speed craft ever built, the Savoia-Marchetti racer. It had no fuselage or tail, for two 1,000-horsepower engines were placed

back to back and between them the pilot sat, with a propeller in front and another aft. Two booms from the side stretched behind each side of this propeller, and carried the control surfaces which would in a normal aircraft have formed the tail.

Then there was the British supermarine "S-6," a craft with a mystery motor. This was the new Rolls-Royce, never flown in a race before, with two banks of six cylinders each, supercharged, and with a geared-down air screw, which, it turned out, developed some 1,600 horsepower, making it the most powerful gasoline motor ever built. Wings as well as fuselage and pontoons were of metal, and the gas was carried in the pontoons. Cooling water from the motor ran between two skins of duralumin forming the outer skin of the wings. Oil, to be cooled, passed along the fuselage to the hollow tail fin and back to the engine. Contrary to Italian practice, both machines had the whole fin above the fuselage, claiming it gave better stability at high speeds.

After winning the race in his supermarine at a speed of 328.63 miles an hour, Flying Officer Waghorn was asked how it felt to fly at six miles or more a minute.

"Well," he answered, "I wasn't dizzy at the turns. The only unpleasantness came from the heat fumes and oil splashes from the engines in the cockpit. My impression

of speed was from the shipping flashing past underneath. I hadn't time to think of anything but the controls."

Sitting almost on the floor incased in a cockpit of duralumin, Waghorn had just about shoulder room and no more. The vertical control stick, the nerve center of the craft, was gripped between his knees. So delicately balanced are these high-speed machines that if one float is damaged when the plane hits the water at the 100-mile-an-hour landing speed, death may easily overtake the pilot.

"A new ventilator, fitted to the seaplane the night before the race," said Waghorn, "did a lot to free the cockpit of the stifling exhaust fumes which smother the pilot and blacken his windscreen. Down below in the float I carried 100 gallons of gasoline, a weight of 700 pounds, which would be all used up in an hour or less."

On a level with Waghorn's eyes was a long funnel-shaped window, giving him a sight along the engine cowling. A few minutes before the starting gun boomed, Waghorn, his ears stuffed with thick wadding to keep out the roar of the engines and propellers, squeezed into his cockpit. Mechanics fastened and bolted the window above his head, making him a prisoner in what might have been a steel coffin had anything broken under the terrific strain.

Another young pilot of the British team describing his sensations said: "If you turn very rapidly you may experience a 'black-out.' You may become blind because the blood has been taken from the retina of the eye owing to the centrifugal force. This only lasts for a moment, and when the turn is over you can see again perfectly well." After the victory, one of the British planes bettered its record by making 365.1 miles per hour.

What is the use of this great sporting

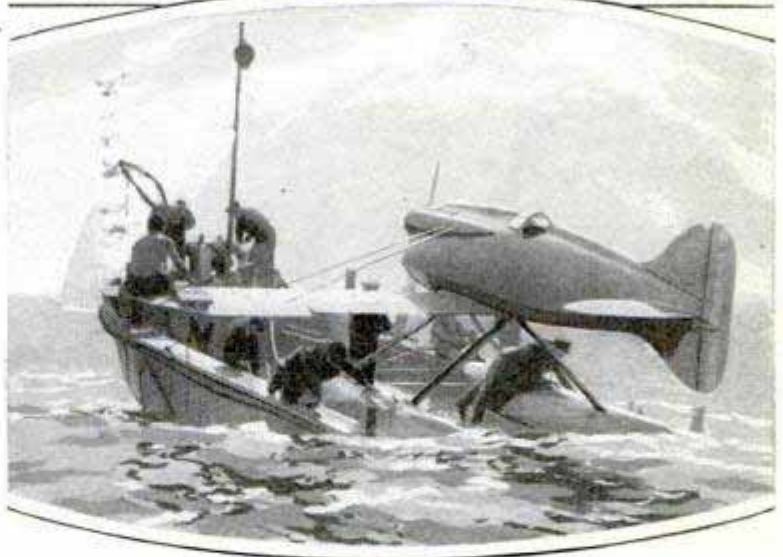
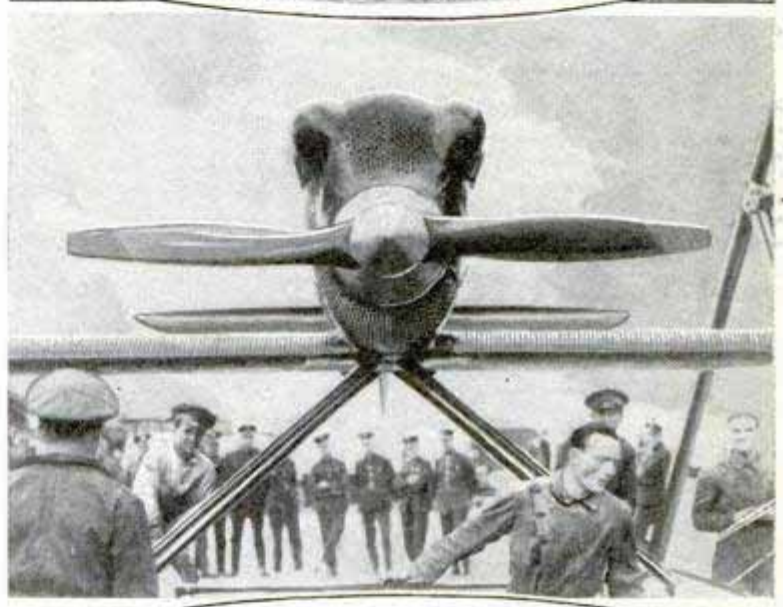

Top to Bottom, Squadron Leader A. H. Orlebar in Supermarine Rolls-Royce "S-6"; Front View of Italian Entry, and Lieut. Dal Molin, Who Was Forced Down

event in the world of aviation and its future? Traveling at Waghorn's speed one could reach New York from London in nine hours.

see April 1931
884 607

metalbauer,
Drechsler
Bismarck

359
Elio H. Stima
Pigeon House, Mass

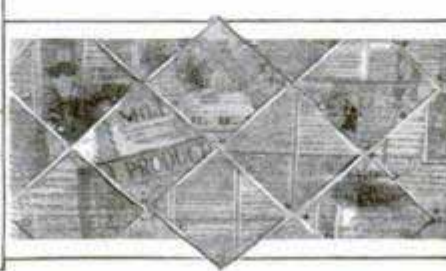
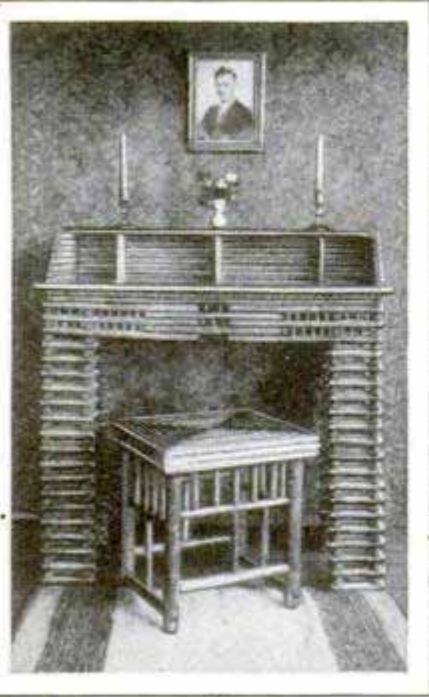

This House Is Made of Newspapers as Are the Desk and Chair; Lower Right, a Wall Section

HOUSE BUILT OF NEWSPAPERS PROVES SUBSTANTIAL

To demonstrate a novel use for old newspapers, a Massachusetts man with the aid of his family has constructed a cottage of newspapers and stocked it with furniture of the same material after eight years of patient labor. Some 65,000 daily papers went into the house besides several thousand rotogravure sections which form a colored border around the tops of the rooms. The walls are made of 215 thicknesses of newspapers, pasted and folded, and subjected to a pressure of about two tons, the surface being strengthened with three coats of varnish. Roof shingles also are of paper, but floors, rafters and window and door sills are of wood. The furniture is made of papers in cylindrical form, having the appearance of bamboo. Among the pieces are a settee, an octagonal table, a floor lamp, chairs, bookcase and radio. One desk is made entirely of dailies containing accounts of Colonel Lindbergh's Atlantic flight.

AIR SHOTGUN SHOTS SHELLS INSTEAD OF SINGLE SLUGS

Actuated by air pressure, a shotgun is on the market which shoots shells instead of single shots. The gun requires neither oiling nor cleaning and shoots with suf-

William Paul

ficient force to kill rats, rabbits, squirrels or other small game at a distance of seventy yards. The new gun is compressed much like the ordinary air rifle, one compression being sufficient for from one to five shots. The weapon is a single-shell gun, firing shells loaded with slugs from "BB" to 10 size. The slugs scatter much as the charge of a shotgun does.

FLYING YACHT HAS OPEN DECKS FOR PASSENGERS

A four-engined twenty-four passenger flying yacht has been ordered in Germany by Gar Wood, the famous speedboat builder. The most novel feature of the craft will be two open decks for the use of the passengers when the flying boat is at anchor or taxiing on the surface. The after deck will be eighteen feet long and the forward deck ten feet, and both will be eight feet wide, which gives some idea of the enormous size of the hull. Each of the four motors will develop 600 horsepower. Doctor Dornier, constructor of the giant flying boat "D-X," is the designer and builder. Mr. Wood learned to fly more than a year ago, and, in addition to his collection of racing boats and cars, has a seaplane hangar built into his home at Detroit.

CAMERA PICTURES EYE BALL AS IT FUNCTIONS



Eyes, the best cameras in the world, themselves now are made the objects of photography with a camera made by a German which pictures the ball of the eye as it functions. The eye camera requires only one-twentieth of a second for exposure.

Carl Juss.
485 5th Ave

d. m. Mr. Norden

485 5th Ave

EFFECT OF OCEAN CURRENTS ON CLIMATE SHOWN

Contrary to the warm Gulf stream, which renders northern Europe mild even in winter, the Humboldt or Peruvian current is blamed for the barren and arid seacoast of Peru. There ordinarily is no rainfall and the climate is temperate, in spite of the tropical location. This is due to the current flowing northward from the icy Antarctic. About once in a generation, however, there is a conflict between this current and a warm equatorial current called El Nino. In 1925, the latter was victorious, rain fell and the Peruvian coast desert turned green and crops were abundant. Ever since, however, the Peruvian current has ruled.

3596

MOTOR BUS CHANGES ENGINES LIKE A RAILROAD TRAIN

Detachable engines are being used in the motor coaches of a western bus line, this feature enabling a change of motors at division points. The engine may be demounted, taken from its hood, and another installed in twenty minutes. Hood and bumpers are removed, after which the motor bolts are loosened. The engine is moved from the coach with a winch. Gas,

3611



Motor Coach with Detachable Engine, the Motor Being Changed at Division Headquarters

battery and water lines are disconnected and the motor is taken to the shops to be repaired or adjusted. Adjusted motors are kept at major stops, so that in case of a breakdown, one may be sent to a stalled coach and put in at the roadside.

Pacifica Stage Lines.



A Shopping Bag Which, When Empty, May Be Used by the Marketing Housewife as a Cushion

MARKET BAG BECOMES CUSHION WHEN IT IS EMPTY

Serving the double purpose of market bag and seat cushion, a padded container is proving popular with the housewife who desires to go to a ball game or movie before she does her shopping. The sides are padded and the covering is of waterproof material. When empty, it makes a comfortable cushion, and when filled it becomes a light water-tight container.

LOCUSTS STOP PLANE MOTOR

Locusts, against which airplanes have been waging war in India and Egypt, have succeeded in instituting retaliatory, although accidental, maneuvers. One pilot in India who went up to scatter a swarm of the insects was forced down and found one of them had been drawn into the air-intake pipe. Other flyers have been forced to descend after the locusts filled the radiators and the engines started overheating.

Three hundred times as sweet as sugar is a new compound made from corncobs, according to claims.

Wiegelt Bros. The Dallas, Tex

daily mail 9/12/29

San Diego Los Angeles San Francisco, Calif

3512

TWIN MOTOR LINER'S CABIN HEATED WITH STEAM

Curtiss Flying Service, 27 W. 57th St. New York

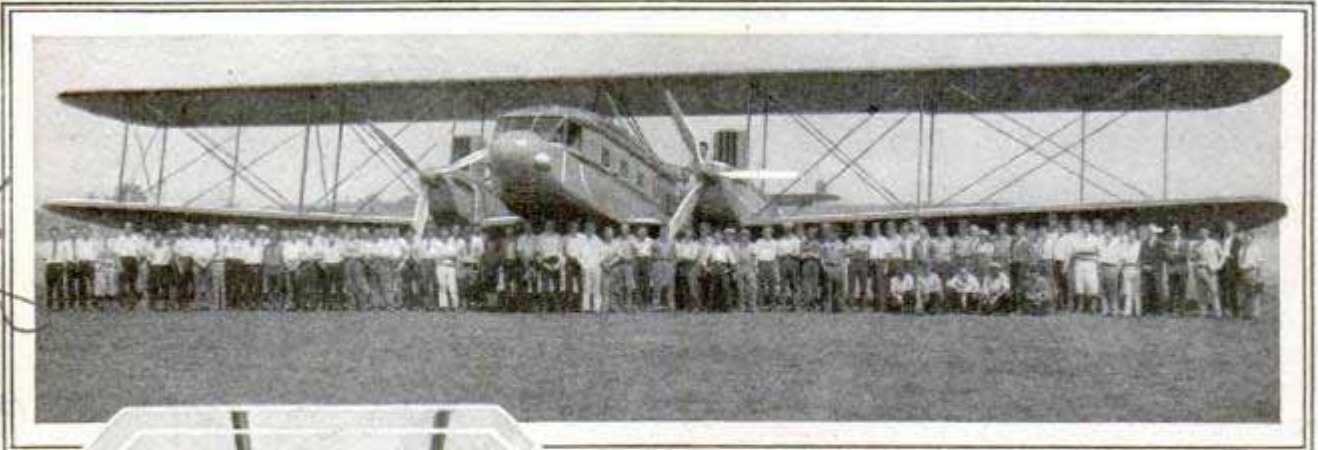

The Enormous Size of the Eighteen-Passenger Curtiss "Condor" Transport Plane Is Well Illustrated by the Photograph Above; the Ship Has a Wingspread of Ninety-One Feet Eight Inches and Is Powered with Two Instead of the Usual Three Motors; It Carries a Useful Load of Over Three Tons and Has a Cruising Speed of 116 Miles an Hour

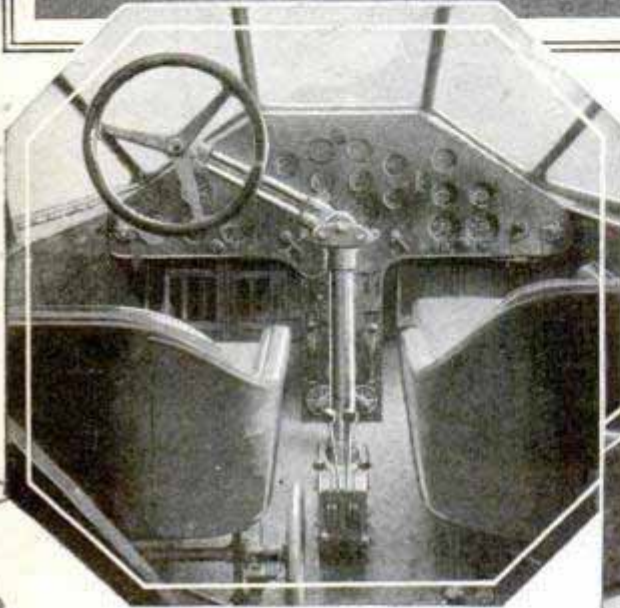

Pilots' Cockpit Showing Hinged Control Wheel; View of Cabin Which Has Steam-Heated Radiators, and, Below, the Mighty Condor in Flight; It Can Climb and Maintain an Altitude of More Than 5,000 Feet on Only One Motor and with a Load of 17,378 Pounds

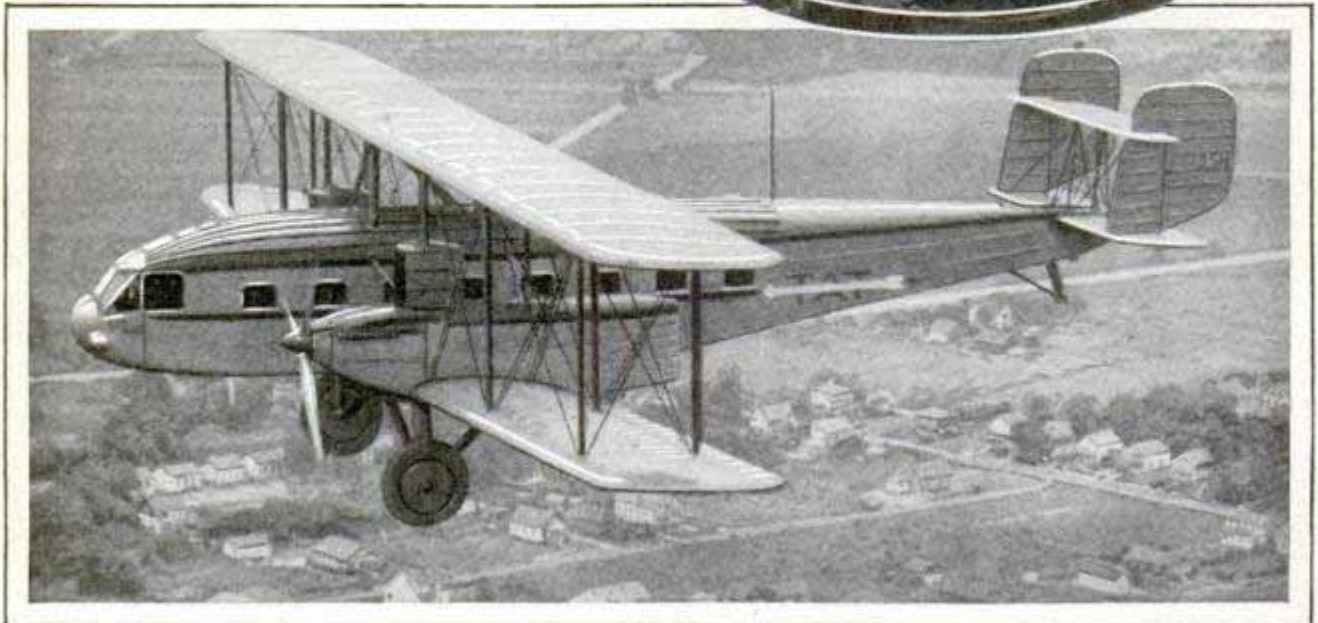
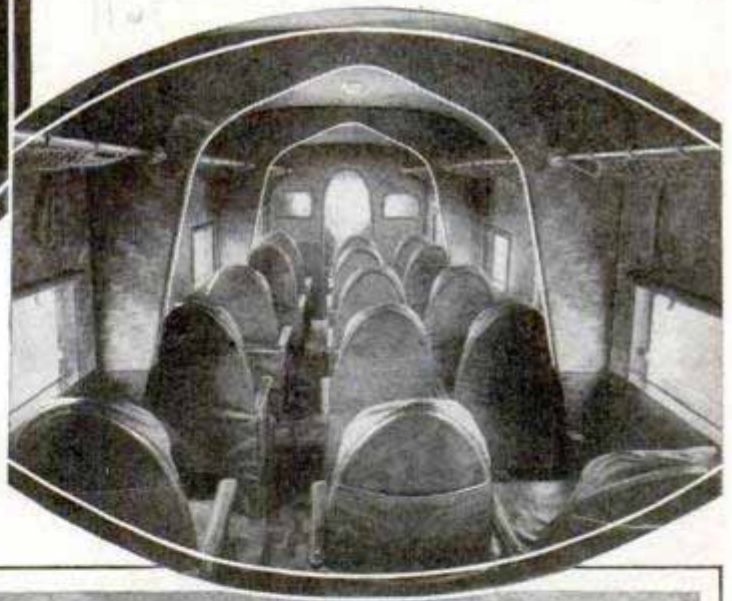

**ALL PARACHUTES MUST PASS
 UNCLE SAM'S TESTS** 3586

Manufacture and use of parachutes for airplane passengers and pilots are soon to come under governmental regulation. Makers will be required to submit samples for test, and none without approval certificates may be sold. To pass the tests, the parachute must open fully and function properly when dropped from a 150-foot altitude, carrying a 200-pound dummy. Then it must be dropped ten times from 500 feet, with the same weight and with three twists purposely put in the shroud lines. It must untwist and open fully before reaching the ground. Next, the same parachute is to be dropped five times from any convenient altitude carrying an 800-pound lead weight, more than four times the weight of an average passenger. If it gets through all these tests without damage, three "live jumps" must be made from 2,000 feet, with a rate of descent not to exceed eighteen feet a second, and a landing without discomfort to the jumper. The parachute must be fitted with a quick release by which the user can step out of the harness as soon as he lands, a provision required to take care of landings in water, where the jumper must be able to free himself instantly.

Apparatus for gas indicator



This Apparatus Detects the Amount of Combustible Gases in the Air of Mines and Factories

Carbide Co
 230 N. Michigan
 Chicago

**DANGER OF EXPLOSION SHOWN
 BY GAS DETECTOR**

Quick, accurate and safe detection of combustible gases and vapors in oil refineries, mines or factories is afforded by a simple gas indicator designed after the instrument for finding fire damp in coal mines, but capable of wider application. The indicator consists of a detector head, a meter and a storage battery. Its working principle is the effect of combustion of inflammable gas and air mixtures on the surface of a glowing filament, the combustion increasing the temperature, and consequently the electrical resistance, of the filament. This causes the meter needle to move over a scale from which readings are taken and referred to a chart which shows gas conditions. The detector head may be lowered into a suspected chamber alone, or the apparatus may be worn by an observer who descends into the chamber to make the test.

**RIGHT OR LEFT TURN INDICATED
 BY AUTO SAFETY SIGNAL** 3568

Combining a right and left-turn signal, stoplight, spotlight, parking-light and rear-view mirror in one auto accessory is accomplished in a safety signal now on the market. The signal is installed at the left corner post of the car, and extends the width of the running board. On the inside, next the wheel, is the switch box and control handle. The stoplight is connected with the brake, the others being operated by pressing a button on the switch box. All signals are visible from the front as well as the rear of the car, giving warning of driver's intentions, while the spotlight is adjustable to any angle, which can be done from the inside of the car.

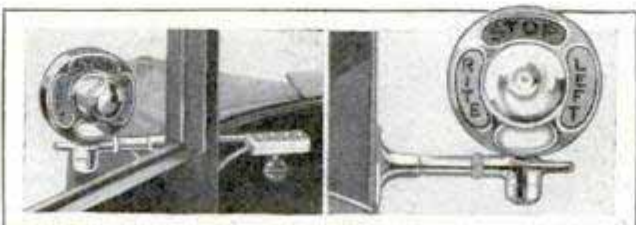

An Auto Accessory Combining Right and Left-Turn Signals, Stoplight, Spotlight and Mirror

Bolton Safety Signal Co.

3602

Plus Hollywood Calif

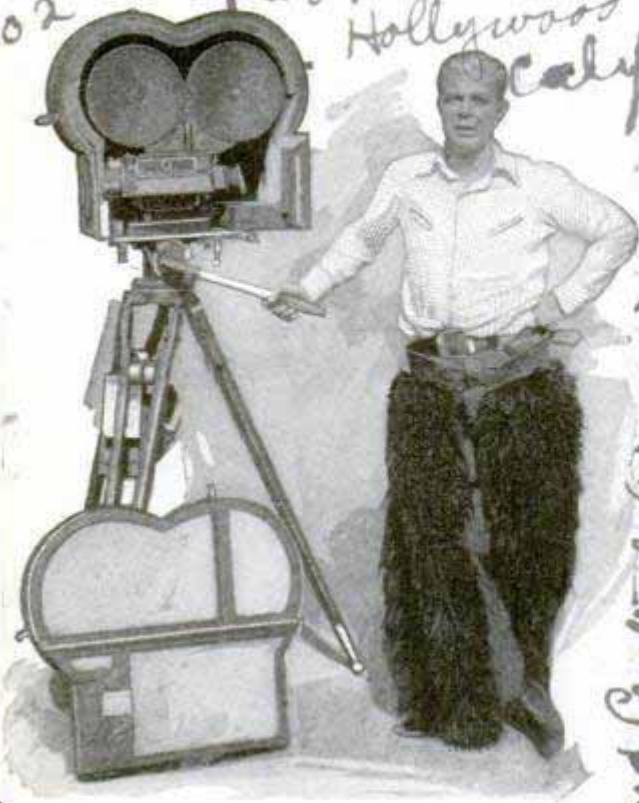

Built of Sound-Deadening Materials, This Movie-Camera Hood Is Being Used for the Talkies

"BLIMP" MOVIE CAMERA STOPS NOISE IN TALKIES

To smother the sound of operation of a moving-picture camera without the necessity of placing both camera and operator in a sound-proof "ice box," a shield resembling a hood for the camera is being used in Hollywood studios. The covering for the camera, when used for talkies, is known as a "blimp" and is constructed of sound-deadening materials, including yucca wood, soft rubber, felt, velvet and wood fiber. The blimp is cheaper than the large boxes in which cameras have been inclosed heretofore to make them sound-proof, and gives greater flexibility in the use of camera angles. It also improves photography by eliminating the plate-glass windows of the ice box, which shut out part of the actinic rays so necessary to photography. The hood weighs about forty pounds.

SOIL STERILIZED WITH STEAM TO CURB EARTHWORMS

By sterilizing the soil with steam, earthworms, which often cause damage to potted plants and other growths in greenhouses, are effectively curbed, workers at the Illinois agricultural experiment sta-

tion have found. The steam method was the most satisfactory of all tested, but good results also were obtained by watering with corrosive sublimate, one ounce in ten gallons of water.

TRAFFIC LIGHTS FOR PLANES TO AVERT ACCIDENTS

Traffic lights for airplanes, similar in operation to the red and green stop-and-go lights governing automobile traffic, are being installed at a Los Angeles airport to avert collision between arriving and departing ships at night. The signal is a large octagonal frame mounted on a fifteen-foot post. Reflectors, thrusting outward from its sides, face alternately up and down and each row of reflectors has alternating lights so that, when the red light is on in the upward-facing row, the downward beams are green. An arriving plane, if given the red light, knows that another ship is about to take off and stays clear until it gets the green lights, signaling the field is ready. In like manner, the pilot on the ground will not take off while the beacon's rays facing downward are red. The signal revolves, and there is a flasher light in the center. The beams are visible 1,000 feet in the air and 2,000 feet from the field.



Model of Traffic Signal for Planes: When Downward Lights Are Green, Opposite Ones Are Red

Used by Hood Lubson

State Natural History Survey Urbana, Ill.

3594 Grand Central air terminal

Los Angeles Calif. 11 N. Ave 24th

see letter in misc. file

Ind. C.A. - Block Farm Traffic Signal

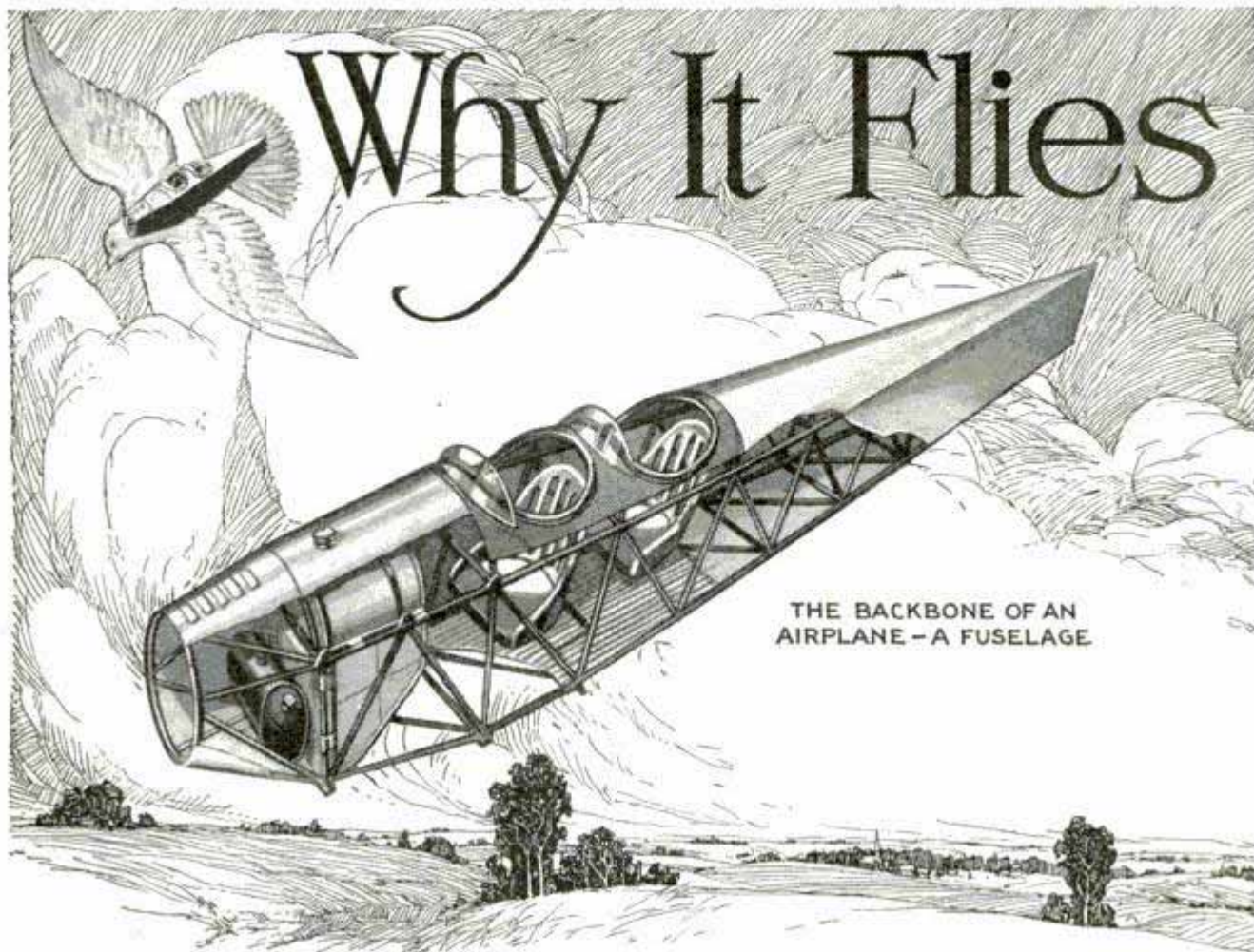

THE BACKBONE OF AN AIRPLANE - A FUSELAGE

By MAJ. REED LANDIS

Famous Flyer and War-Time Ace

WHY does an airplane fly? Though the world last December joined in celebrating the twenty-fifth anniversary of the Wright brothers' first flight at Kitty Hawk, N. C., the principles of successful flight remain more or less a mystery to many laymen.

After all, there is nothing mysterious about a plane. You can find most of its parts in a bird, a boat and a fish. There are the wings and tail and the body of the bird, the rudder of the boat and the keel fin of a boat or back fin of a fish. Add an engine and a propeller to offset your inability to move your wings, as a bird does, and you have a flying machine, or omit the engine and propeller and soar on rising air currents, as the bird sometimes does, and you have a glider.

Whether that flying machine is the best that can be built nobody as yet knows. For years there has been talk of helicopters, ornithopters and orthopters, the first being airplanes which fly straight up and

hover in the air, and the latter two types of machines with flapping wings. A brilliant Englishman once exclaimed that an ornithopter represented the designer's idea of how a bird's wing works, and an orthopter was the designer's idea of how a bird's wings ought to work. But after all, one doesn't really want a helicopter; one doesn't want his airplane to take off vertically from the housetop and land on the roof of the movie show. It may do those things, but their disadvantages outweigh the advantages. Would you prefer to fall slantwise or straight down? A gliding landing will always be the easier.

But why does a ship fly? Take one apart, in your mind, or, better still, build one up from the ground. We'll start with a body for our imaginary ship. It's going to be a body of welded steel tubing, somewhat similar to the skeleton of a bird. Back of the engine we will install a gasoline tank, and then an instrument board and two seats, and behind them carry the

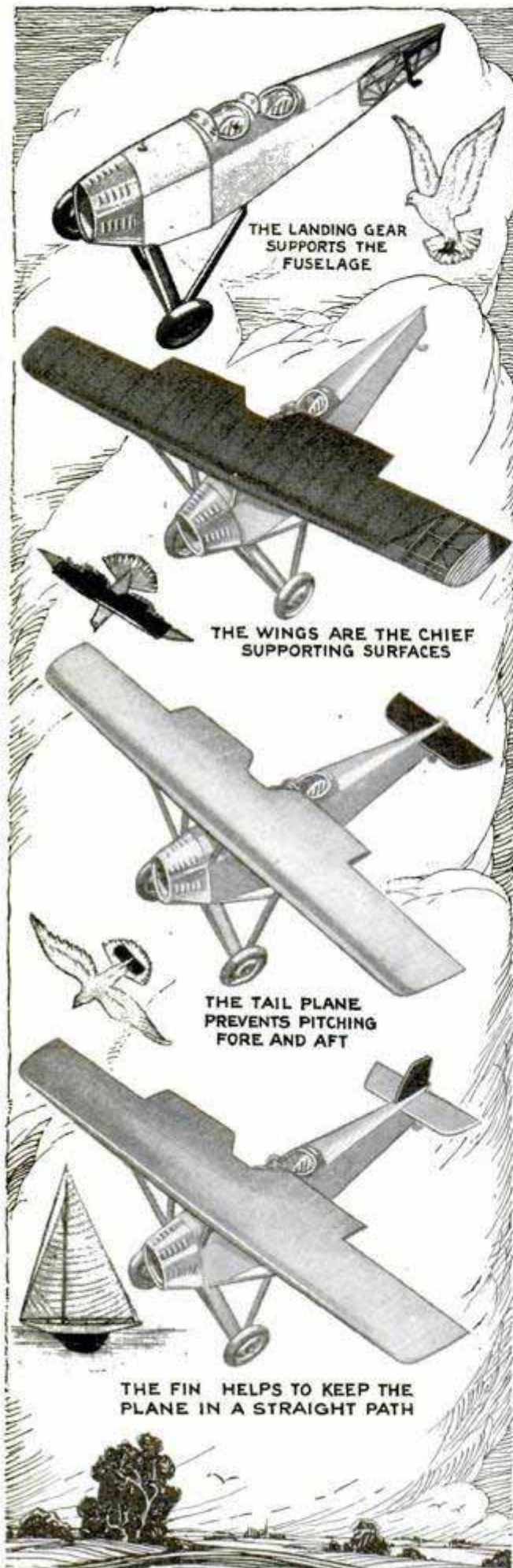

fuselage in a long streamlined tail. That much of our ship in shape and proportions resembles the body of the bird. Next we want a landing gear on which to mount it. Instead of the bird's two feet we will add a pair of wheels, on suitable struts. Next comes the wing, just like the bird's wing, except that it is immovable. In the big planes, our own Ford-Stout air liners, for example, the wing is built up of metal, internally braced and fairly thick—thick enough, in fact, to contain within it the gasoline tanks and baggage compartments. In any airplane, the shape of the wing is a matter of the utmost importance. In general, a modern wing is expected to lift from eleven to fifteen pounds for each square foot of surface; so the size of the wing depends on the weight of the ship, engine, fuel supply, pilot and passengers, or pay load, to be carried.

Next we will add the tail surfaces, of which there are four. First comes the horizontal stabilizer. It is really a small wing, but is not generally intended to exert a lifting effect. Instead it gives the plane longitudinal stability, as the rush of air sweeping back from the propeller tends to keep it in the same plane as the fore part of the ship, that is, keep the airplane in level flight. In most ships the stabilizer is adjustable over an arc of a few inches, and can be set while in flight to balance up the distribution of the load and make the ship easier to fly.

But we will not always want to maintain level flight, for our ship must go up and down, so, at the rear edge of the stabilizer, we hinge a pair of small wing surfaces called elevators and hook them, with proper control cables, to our control stick in the pilot's compartment. The controls are so arranged that if we push the stick forward the elevators tilt down, and if we pull it back they tilt up. What happens then will be explained a little later.

Another fixed surface is needed at the tail to keep the ship on a straight course. This is a vertical fin, rising up from the fuselage, like the back fin of a fish. Sometimes, instead of being parallel to the longitudinal axis of the plane, the vertical fin is set at a slight angle. The reason is that every single-motored plane has a tendency to turn on one side because of

the torque of the motor. To offset this tendency, one of two things must be done, either the pilot must always carry a certain amount of opposite rudder, or the fin may be set at sufficient angle to just overcome the turning impulse.

The rudder completes our tail assembly. It is hinged to the vertical fin and moves between the pair of elevators. It works just like the rudder of a boat, for when it is turned one way or the other, the rush of air striking the exposed surface pushes the tail of the ship in the opposite direction, and the nose therefore points to one side.

We need one more control to complete our plane, before adding the engine and propeller. That one is the ailerons, by which we keep the wings leveled up when a gust of wind attempts to upset our lateral balance, or raise one and lower the other when we want to bank the ship on a turn, to prevent it from skidding, just as a fast automobile would skid at a turn on an unbanked road. When we build the wing, we cut away a portion of the rear, or trailing, edge, near either end, and here we hinge the two ailerons. To make the controls as simple as possible, the connecting cables are attached to the control stick, which is swiveled to move in any direction. Moving it fore and aft works the elevators at the tail, while moving it from side to side raises one aileron and lowers the other.

We have already seen how the rush of air striking one side of the rudder pushes the ship's tail in the opposite direction. The same power makes our elevators work. In normal flight the air currents flow smoothly over them, but when we pull the stick back the elevators are raised, the wind pushes the tail down, and the nose points up; when we push the stick forward the elevators are depressed, the wind strikes their underside, the tail is flipped upward, sending the ship into a downward course.

Pushing the stick to either side lowers one aileron and raises the other, decreasing the lifting effect of one wing and increasing that of the other, with the result that the ship banks, the wing toward which the stick is pushed dropping and the other rising. A bird gets the same result by warping its wings, but, as our

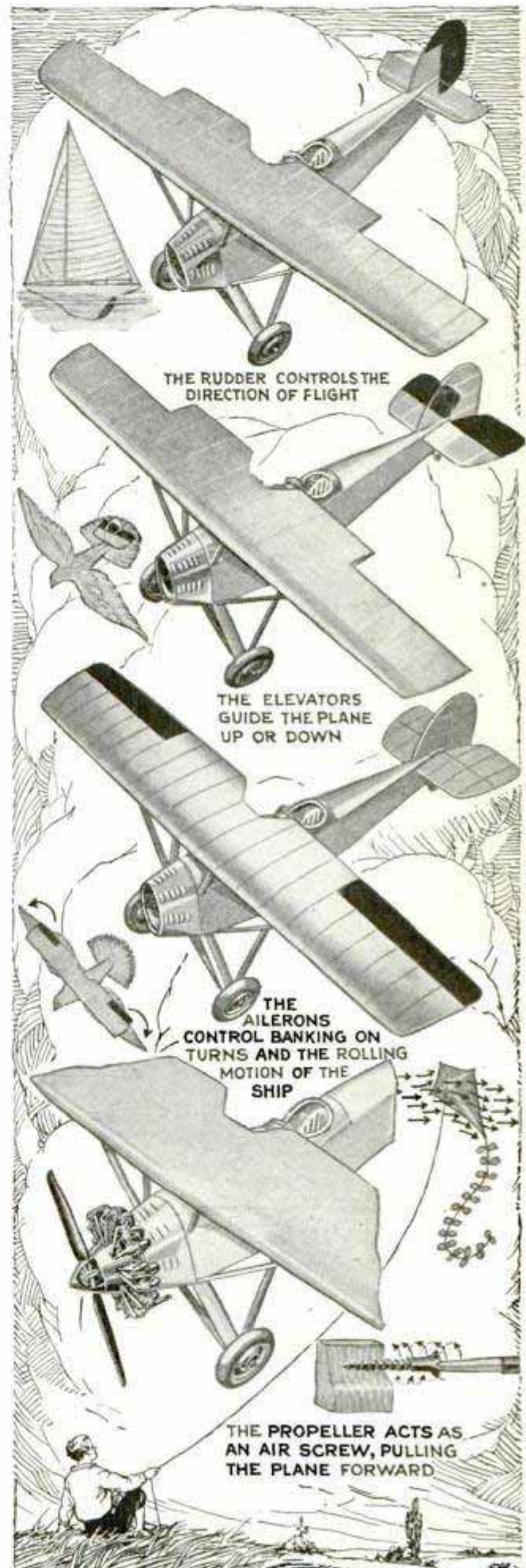

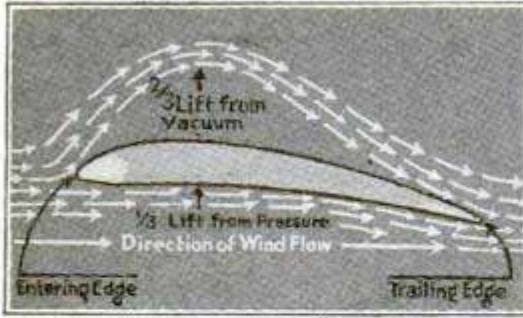

MORE THAN TWO-THIRDS OF WING LIFT IS THE RESULT OF SUCTION ABOVE AND THE REMAINDER IS PRESURE BELOW

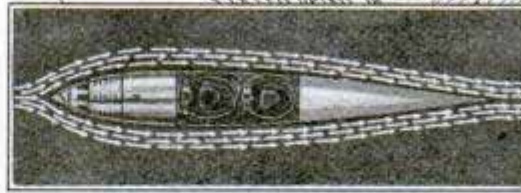

THE PATH OF THE WIND AROUND THE FUSELAGE



AN IDEAL STREAMLINE

Pictures Courtesy Standard Oil Company of New York

plane wing is rigid, we use ailerons.

Add the engine and propeller, and our ship is complete. Abroad, the propeller is usually called an air screw, and the name is really better than our word, for it describes its action much more truly. It bores its way through the air just as a screw bores its way into a piece of wood when turned by a screwdriver.

Now that we have completed our ship, we are back to the original question: why does it fly? Stick your hand out of the window of a fast-moving automobile or train, tilt your palm slightly upward, and you will find your arm trying to rise. Or go back to your kite-flying days and remember how a kite, when tilted forward against the wind, starts to climb.

The same thing happens to our airplane wing when it is pulled through the air at high speed. How soon it will get off the ground depends upon the size of the wing in relation to the load, and somewhat upon its design. Some planes take off at thirty-eight to forty miles an hour, and some take off at sixty—the bigger

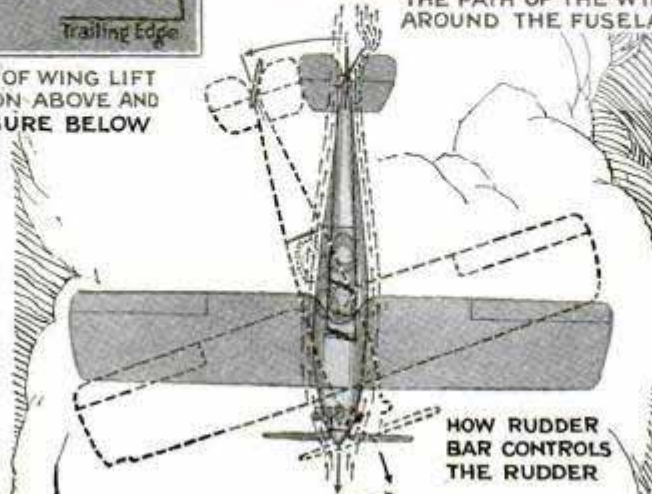

HOW RUDDER BAR CONTROLS THE RUDDER

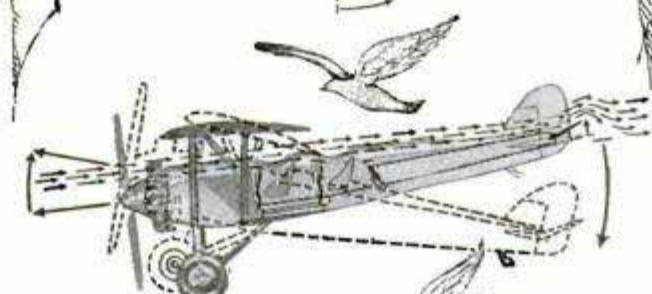

THE CONTROL STICK SHIFTS THE ELEVATOR

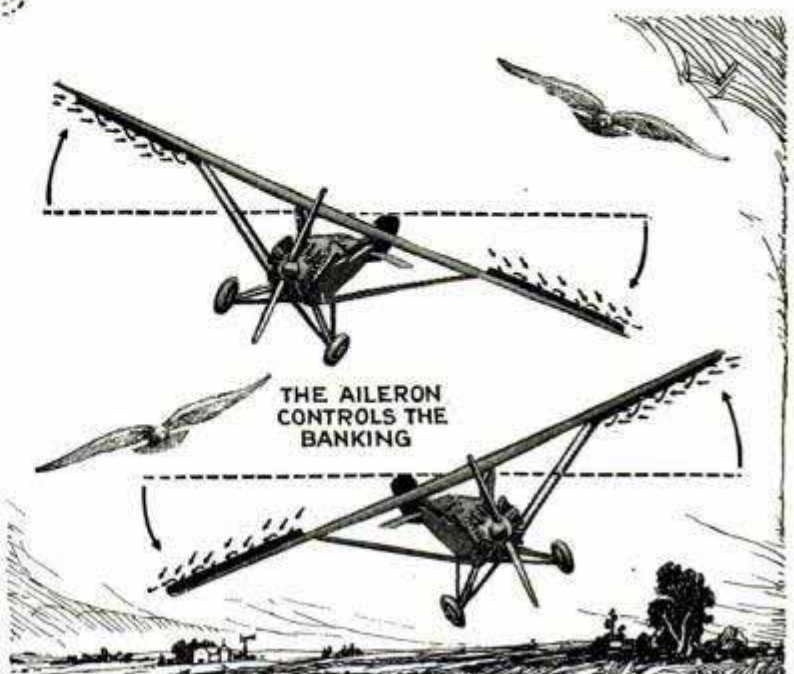
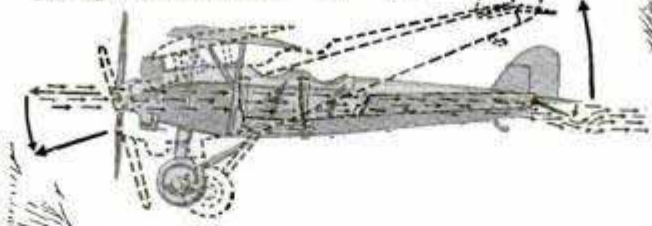

THEAILERON CONTROLS THE BANKING

the load per square foot of wing surface the higher the speed must be to get off the ground and remain in the air.

The lifting effect of the wing, however, is not, as so many believe, due to the air pressure on its underside. Actually not more than one-third of the lift is due to the pressure from below. The other two-thirds is due to a partial vacuum on the top of the wing, and here it is that good wing design plays such an important part. The

*a year's worth of
Solving Farm Problems
1924-1929*

upper surface has a pronounced curve or camber. An air current rushing across this curve does not follow and cling to the surface, but rather is slightly deflected, and the air along the wing surface is drawn up into this higher-speed current, leaving a partial vacuum, into which the wing is pushed by the air below it, only to have the vacuum always keep a step ahead.

ARTIFICIAL-HAIL TESTS SHOW DAMAGE TO CROPS 3575

Interesting facts concerning the damage to corn crops by hailstorms have been revealed in a series of tests at the Illinois agricultural experiment station. The effect of ~~real~~ hail was simulated by cutting the leaves and otherwise mutilating growing corn plants. It was found that clipping off the tip half of the blades was slightly worse than cutting out alternate four-inch sections on each side of the midrib. Each of these operations was more harmful to the plant than the loss on one side of all the leaves or the removal of half the number of blades. The tests were made in cloudy weather or in the evening to reduce injury from excessive water loss.

TOOL SHELF ON TOP OF LADDER GIVES ADDED SAFETY

Useful features of both ladder and platform have been combined in a safety-platform ladder now on the market. The ladder is of the spreader type with steps in the front and rungs in the rear. About three feet from the top is a substantial platform extending from the front to the rear rails. The top is fitted with slots for tools, nails or screws, and is hollowed out at the front so as not to interfere with the movements of the person on the platform. The ladder is held in position by a spreader near the platform and may be folded compactly for carrying.



BLACKBOARD FOLDS LIKE BOOK TO ADD WRITING SPACE

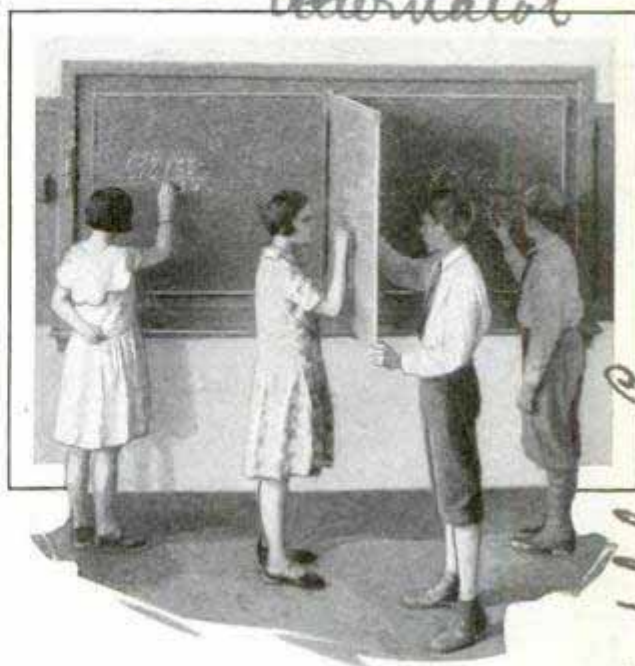

A Swinging Blackboard Which Takes Up Little Wall Space but Gives Large Writing Area

Resembling a giant book, a swinging blackboard with four leaves, or eight pages, now is being installed in many schools. Such a board does not take up much wall space, but affords a large writing area. The leaves may be fastened firmly in any position, enabling four students to work at the blackboard at once by turning one of the leaves at right angles to the wall. It may also be suspended by a pipe framework where the wall type is not desired. Other advantages of the swinging board are that future work may be placed on it by the teacher, and permanent records may be kept on its leaves without risk of erasure. It may be adjusted so pupils obtain the best light and may be locked securely.

TRANSPARENT PRINTS TO SHOW COLOR COMBINATIONS 3589

Transparent prints are being employed to show the effects of various color combinations for automobiles, wall and floor coverings and clothing. A line cut of the object to be colored is printed with a solid background on transparent paper. Sample color cards are then inserted beneath the transparent print to show the actual appearance of the color combinations when applied to the article.

The Patent Scaffolding Co.

Miss B. R. Allen 273

*3507
K. M. Supply Co. 119 W. 8th St. Kansas City, Mo.
more Springfield, Mo.
State St.*

CATWALK TO SUPPORT SUSPENSION-BRIDGE CABLES

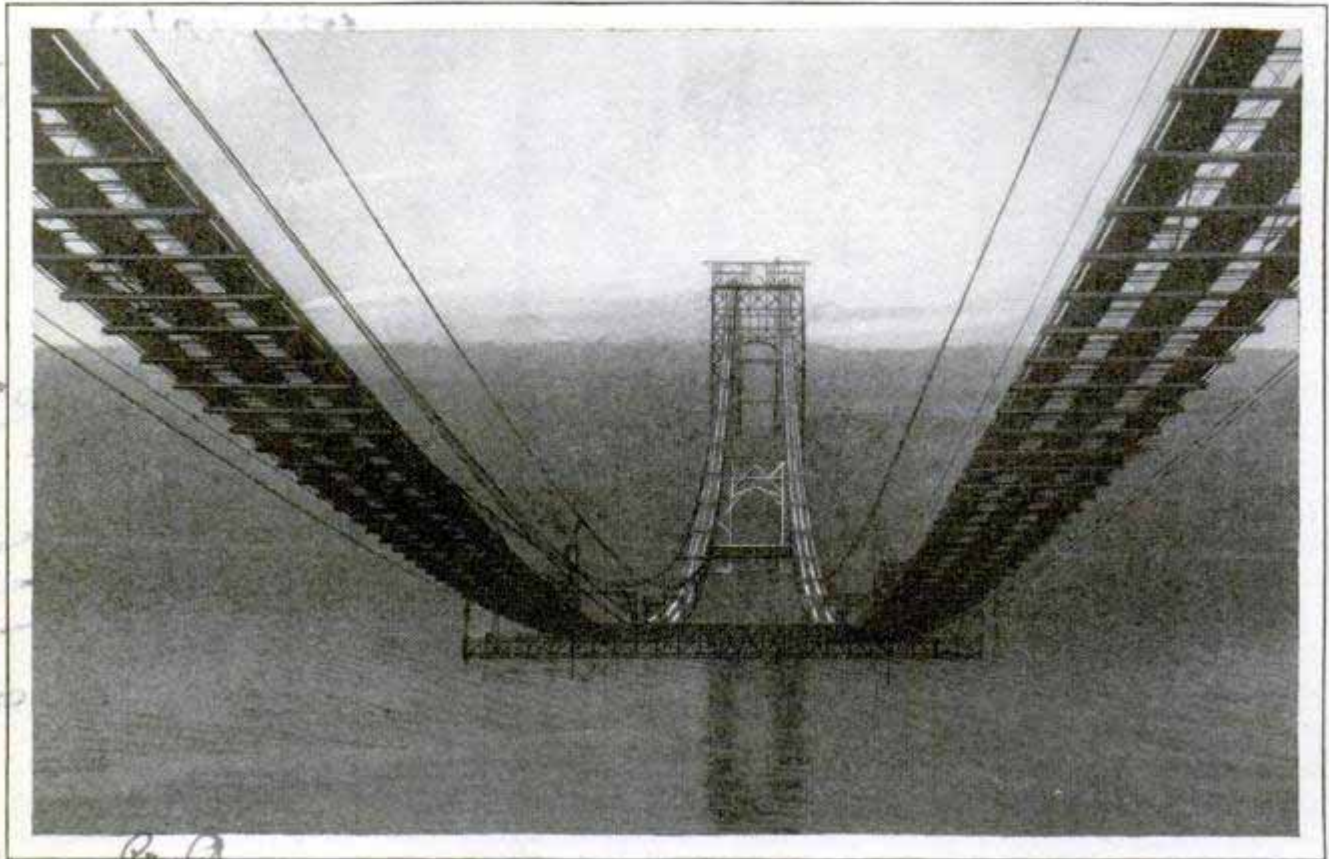

Catwalks for the Longest Suspension Bridge in the World, Connecting New York City and Fort Lee, N. J.; on the Catwalks Are Being Spun the Cables to Support the Structure

Catwalks of the Hudson river bridge between New York City and Fort Lee, N. J., have been completed and on them are being spun the four thirty-six-inch cables which will support the central span of what will be the longest suspension bridge in the world. The towers are 635 feet high, with an additional eighty feet of temporary steel on top. The bridge will be 8,500 feet long, 120 feet wide and will have eight vehicular traffic lanes. The cost is expected to be \$60,000,000 and it is estimated that the bridge will be completed early in 1932.

steel wire corresponding to the point of the ordinary needle. Lengthening or shortening this protruding part regulates the sound, and a range of one millimeter (one twenty-fourth of an inch) represents the difference between loud and soft music. The wire fits into the play groove, distributing friction equally instead of boring into the groove or scraping along the sides. A point too long or bent may be broken off the wire, after which it plays as before. The permanent needle is said to play 50,000 records or more without any attention other than adjusting it for pitch.

LASTING PHONOGRAPH NEEDLE PRESERVES RECORDS

Eliminating the necessity of frequent changes of needles on the phonograph, a permanent needle now is on the market which, the makers claim, preserves the records and renders loud or soft music as desired. The needle is inserted in the sound shaft like the ordinary kind. Near its end is a small adjustment screw and, out of the shorter shaft, protrudes a fine

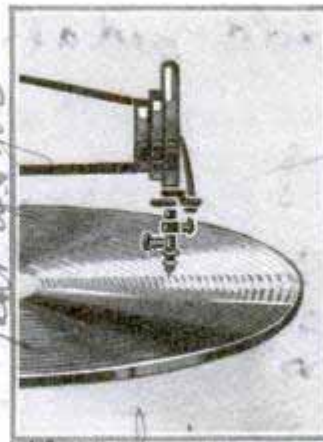

An unbreakable saxophone and clarinet reed has been made of aluminum, thus eliminating this annoyance as well as splits and warping.

E. Lynn, Beaver Falls, Pa.

Handwritten notes on the left margin: '3605 Kingsbridge Ave. Industry, N.Y.' and '3/30'.

Handwritten note: 'permanent needle does for'.

Early Express 9/26/29

Tried out in Paris theater

**MAGIC-LANTERN STAGE SCENES
LOWER COST OF SETTINGS**

3604

Two Austrian scientists have found a means of projecting stage scenery on a white background through an ordinary magic lantern in such a way that actors may stand within two feet of the scenery without casting a shadow. As far as the audience is concerned, the setting is indistinguishable from that made in the ordinary way, and the cost is much lower. A system was found for drawing the slides so that the lantern in the back wings need be only two feet in front of the curtain, the setting being projected at a sharp angle. In making the slides, it is necessary to work backward from the projection desired, and the slides resemble a meaningless jumble of lines and angles. In tests, persons in the audience were unable to distinguish real pillars from projections on the screen of similar pillars. It is expected the apparatus will make possible more scenes and a greater variety of them.



A Rear Light Mounted on Luminous Card, Worn by London Pedestrians to Avoid Accidents

**AUTOMOBILE RACK THAT TIPS
REPLACES SERVICE PIT**

Saving the installation of a more expensive service pit, an automobile rack that teeters like a seesaw now is being installed in garages. The rack is mounted on an angled base, so that when the car is driven onto it the apparatus tips forward to leave the auto in horizontal position, while elevation is afforded by running the car backward on the support, causing the rack to tip. It is used for alinement, brake adjustments, washing and greasing and has axle press, and axle and tracking gauges.

Teeterack

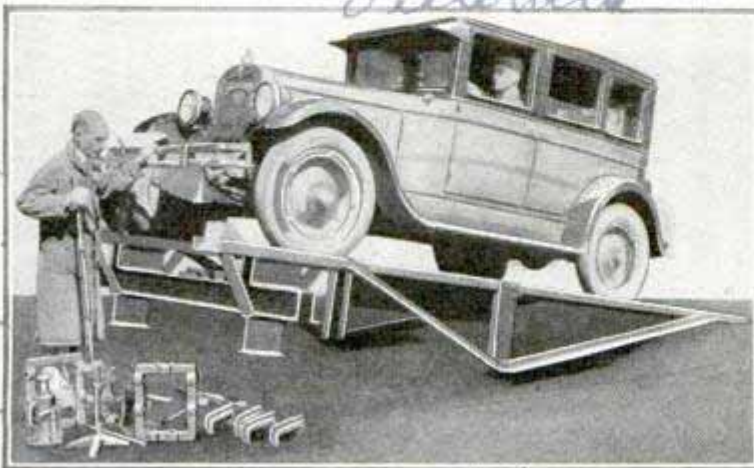

An Automobile Rack That Tips Forward or Backward, According to the Position of the Car

**REAR LIGHT FOR PEDESTRIANS
TO AVOID ACCIDENTS**

Traffic in London is so congested that cautious pedestrians are equipping themselves with lights to warn motorists of their presence on the streets. One of the forms is a rear light, consisting of an electric lamp and reflector mounted on a luminous card that is worn on the back and is suspended by a cord from the shoulders.

**PADDLING WATER KEEPS
FISH ALIVE**

Chinese inventiveness is responsible for an effective, if unscientific, way of aerating the water in the large tubs where carp fry are being kept while being shipped. An arrangement of floats, which is operated by an attendant, paddles the surface of the water, and by this simple means sufficient fresh air is introduced into the water to allow the fish to breathe during the journey.

at Singapore

1914 - 8/15:00

Oscar Inf. Co. York

G. H. Cousins

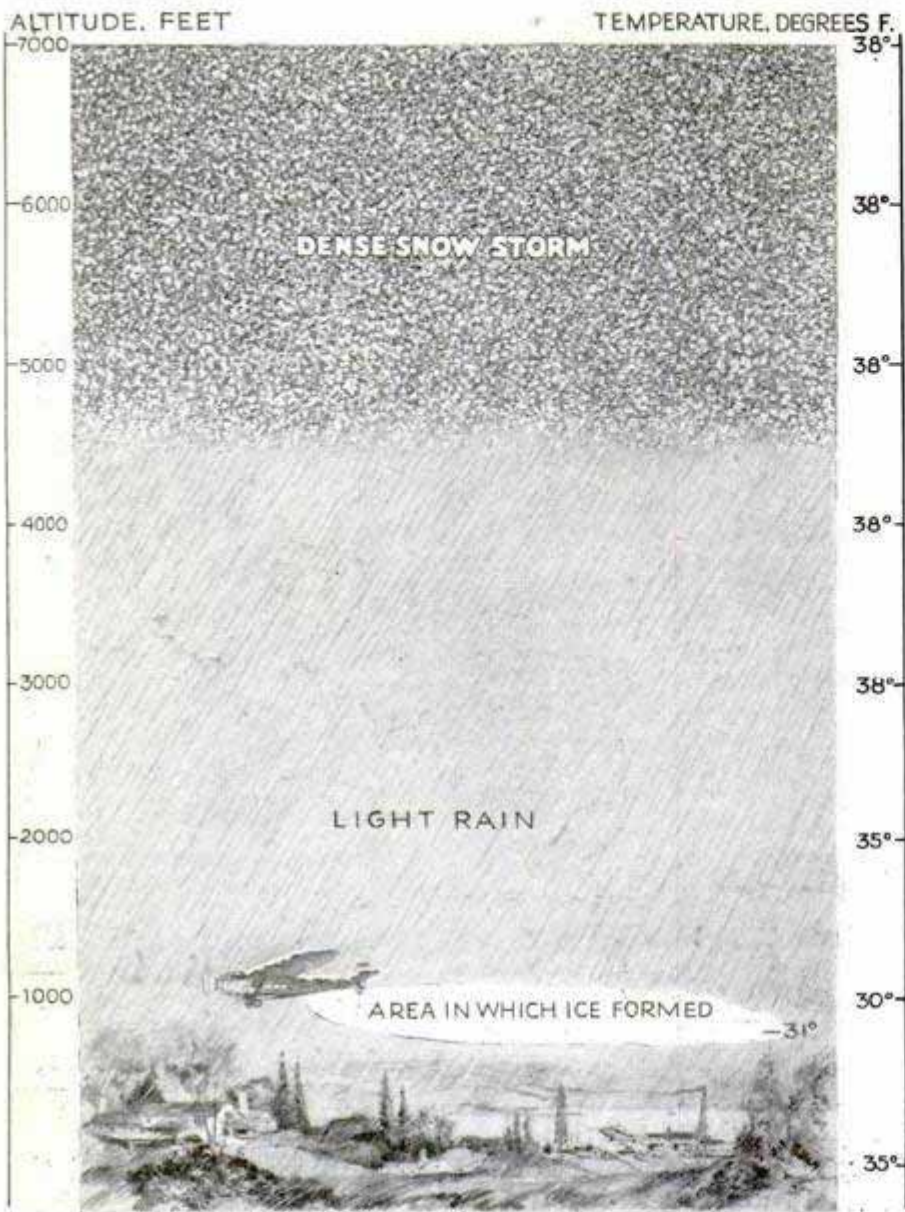

Sketch Showing Conditions under Which Ice Dangerous to Planes Is Likely to Form on Wings and Fuselage

STUDY ICE FORMING ON PLANES FOR SAFER FLYING

Interesting tests conducted by the National Advisory committee for aeronautics at Langley field, Va., have revealed important facts concerning the menace of ice formation on airplanes while in flight. Aviators long have recognized the danger, as, under certain conditions, ice coats the edges of the wings and struts, "mushrooms" into irregular shapes and seriously impedes the flying efficiency of the ship or forces it down. The Langley field tests, performed with a plane equipped with special thermometers and surfaces for the more accurate study of the formations, further emphasized the ice peril, but, contrary to popular belief, the greatest haz-

ard, the experiments revealed, is confined to a limited range of temperatures and ways are available for avoiding the perils resulting from ice gathering, although adequate means to prevent the formation are not known. The real danger zone was found to lie in a narrow temperature belt just below thirty-two degrees Fahrenheit, when clouds, fog or rain were encountered. At thirty-one degrees, for instance, or slightly lower, dangerous clear mushroom ice was deposited. The tests showed that this menacing ice can be identified by its lack of color and that, by means of distance thermometers set in the wings and enabling the pilot to determine the temperature of the air through which he is flying, the danger zone can be avoided by going to levels where warmer or colder air will be encountered. At temperatures well below thirty-two degrees, ice gathered on the

plane, but it was pure white in color, more like snow, did not produce formations detrimental to flying and often blew off as fast as it gathered. Neither kind of ice presented a hazard due to extra weight, the experiments indicated, as the weight of the deposit practically canceled the weight of the fuel consumed. It was found that oil, grease, wax and paraffin were of little good in preventing the formation of ice; in fact, the substances were a greater hazard than the plain surface.

Popular Mechanics Magazine does not publish the name of the maker or seller of any device described in its pages, but this information is kept on file and will be furnished free upon application to our Bureau of Information.

Technical note # 3 / 3

THE NEW MOON AT SUNSET IN ALL CLIMES

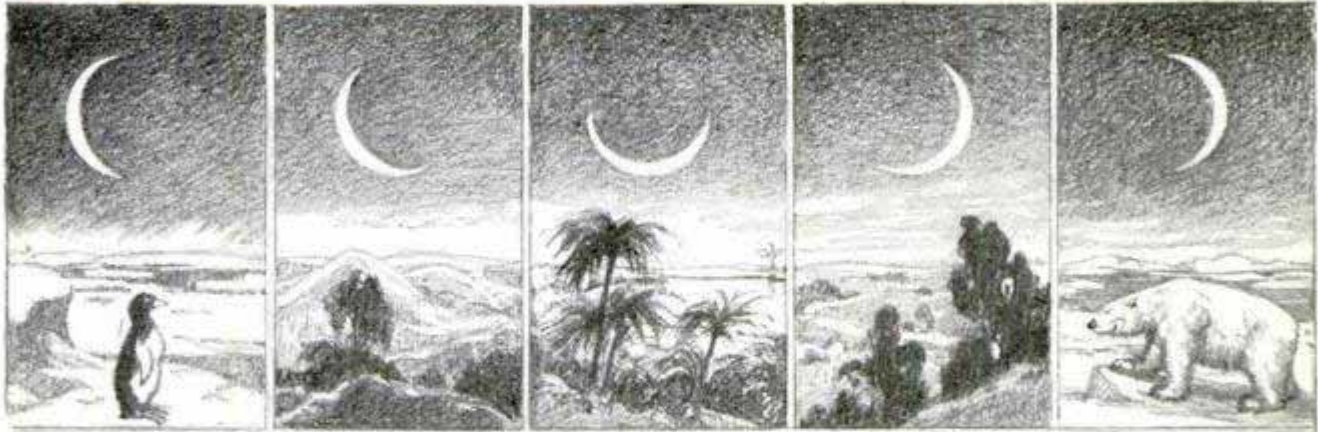

ANTARCTIC SOUTH TEMPERATE TROPICS NORTH TEMPERATE ARCTIC

THE OLD MOON JUST BEFORE SUNRISE WOULD BE THE REVERSE, THAT IS, RIGHT AND LEFT (THE MIRROR REFLECTION).— FOR DIFFERENT LATITUDES WITHIN THE CLIMATIC ZONE AND, FOR DIFFERENT SEASONS OF THE YEAR, THERE WOULD BE SLIGHT VARIATIONS FROM THE APPROXIMATE POSITIONS SHOWN

Artists accustomed to inserting a new moon in a picture in the most artistic position often transgress the laws of nature, as the horns of the crescent moon must always point in a definite direction, depending primarily on the latitude of the observer. In the north temperate zone, the new moon as seen just after sunset always points upward and to the left. In this latitude the sun circles to the south and, as it approaches the western horizon, descends obliquely from left to right. The new moon, following the sun, takes approximately the same course, and since the horns always point away from the sun, they turn upward and to the left. In the southern part of the earth, the reverse is true, while in the tropics the horns point almost directly upward. The position of the old moon as it rises in the morning is the reverse of that of the new moon as viewed from the same latitude.

SYMPHONIES IN COLORED LIGHT PLAYED MECHANICALLY 353

Colored light may be made to sway, bend and sweep over displays or buildings by a control mechanism like a piano-player roll, the perforated paper fed into the apparatus making the color combinations. Dimming is accomplished without flicker, and the changes are made in a predetermined order. As the perforated paper roll passes the openings in a tracker bar, the functions of turning on and off circuits and the operation of the dimmers are performed automatically. The cir-

cuits operate independently, as does the dimmer, giving great flexibility of combinations. Manual operation is also provided by a console keyboard like that of a pipe organ.

WATER SHOES MAKE SAILBOAT FOR NOVEL SPORT 353

Water shoes in which the passenger stands upright form the basis for a sailing-shoe plane, or sailboat, in which the sailor's body becomes part of the craft. To the shoes is anchored a reversible sail, and a rudder, enabling change of direction of the craft by a movement of the body, while speed is regulated with the sail, is attached to the shoes and body.

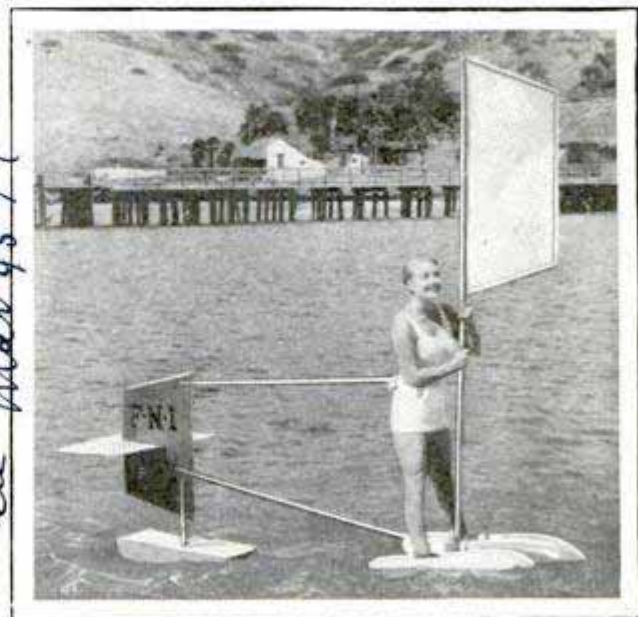

A Nifty One-Passenger Sailboat, the Basis of Which Is a Pair of Oversize Water Shoes

before illumination of engineering society

W. H. Colfax
 see Mar 45 7

no further information
 sailboat and fronton - 6 ft. long
 on Scherke's Antoinette, 33rd. Wabash, Chicago

I. J. Stewart Chicago

W. W. Scherke

My Twin-Cylinder

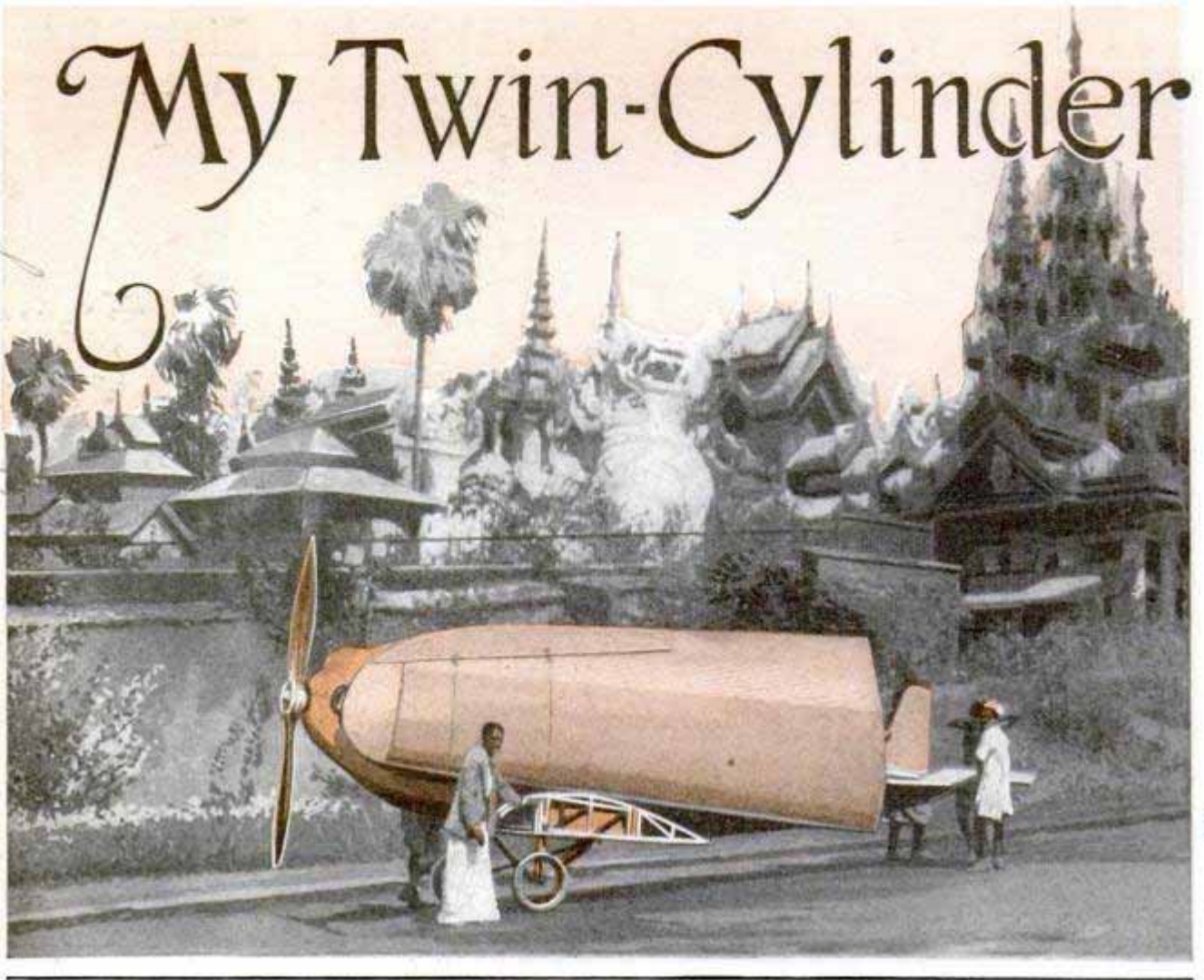

The Two-Cylinder Ship in Which Baron Warthausen Circumnavigated the Globe Being Pulled through the Streets of Rangoon, Burma, with Its Wings Folded; the Little Plane Cost \$1,800

By **BARON KOENIG WARTHAUSEN**

In an interview with Andrew R. Boone

I HAD no intention of flying around the world when I took off at Berlin a year ago for a non-stop flight to Moscow. Yet the world called, and, as my little machine seemed thoroughly trustworthy, I went on.

Fashions in adventure do change. Two years ago, one attempting such a flight would have loaded his plane with all sorts of safety devices preparatory to flying over long stretches of water. I have undertaken no such hazardous flights. Mine is purely a private, sporting expedition, started as a one-day flight and lengthened into a year's world tour.

The fact that my little monoplane is powered with a tiny two-cylinder engine which develops a maximum of twenty horsepower should not cause you to think I am foolhardy in flying thousands of miles with such little power to pull me

along. It has proved quite sufficient, especially in view of the low landing speed of the plane. Seldom does it move more than twenty miles an hour when the wheels touch the earth, yet it flies easily at seventy miles an hour.

When I left Berlin in August, 1928, I had done only seventeen hours' flying, and I had never flown at night. Since the trip to Moscow would require sustained flight extending longer than the duration of daylight hours, I started at night, sure I could maintain a true course by watching my magnetic compass carefully.

Sure enough, when dawn broke, I saw the Baltic sea far on my right and knew I had not lost my way. When I reached Moscow I thought I might as well go on to Baku, and when I reached the Caspian sea I decided to fly to Teheran. I spent

321
paid to Aeromarine 613. I wrote to Theatre. Bldg. San Diego, Calif. Glenn Corp.

Paramount Bldg

3278

Flight Around the World

four weeks in the Persian capital, sight-seeing and awaiting the end of the Indian rainy season. As the only way to return was by air, I decided to fly to the Persian gulf and return by ship. I still did not want to turn back, however, and went on to Calcutta, Akyab, Rangoon and Bangkok.

Strangely, the only three incidents that slowed my progress at all occurred in Persia, during the early half of my flight. On one occasion, a downdraft, or descending air current, along a mountain range brought me to a forced landing while yet at an altitude of 8,400 feet, and on two other days a depleted petrol supply and a loosened gasoline

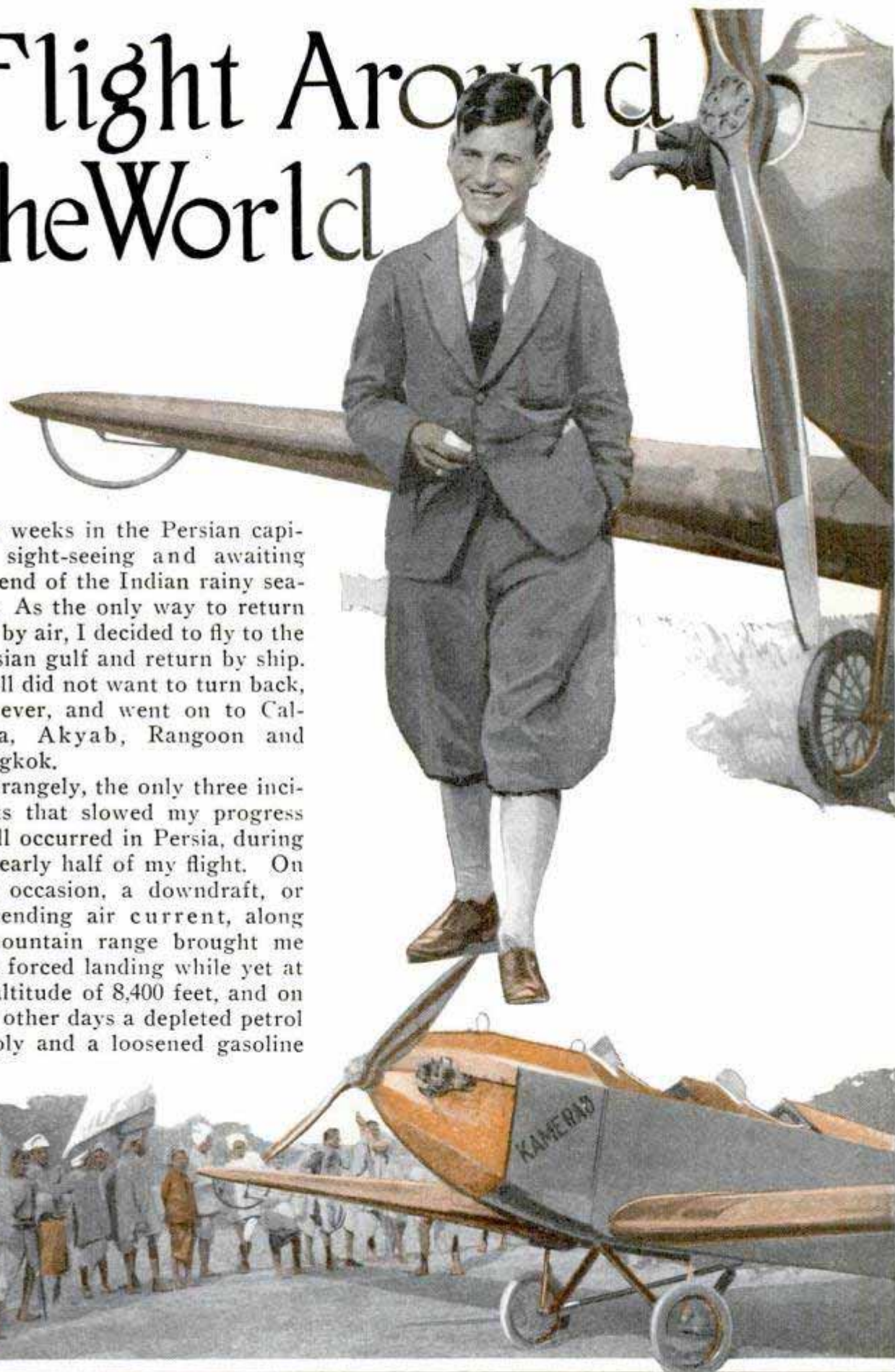

Above, the Twenty-Three-Year-Old German College Student, Who Set Out on a Day's Journey and Continued around the World; Below, Burma Natives Admiring His Tiny Plane

connection caused me to descend hurriedly, though these were not in a strict sense forced landings.

The worst of these befell me when the petrol supply became exhausted. I was flying between Shiraz and Bushire, in Persia. I left Shiraz with just enough fuel to complete the journey. I had to cross successive mountain ranges rising to 12,000 feet and I was afraid the machine might not be light enough to rise to an altitude of 14,000 feet, its maximum being 15,000. I flew at 14,000 feet meeting heavy winds. Just as I cleared the last mountain range the engine stopped—no more petrol! Fortunately I was able to bring the plane down to the desert and land near a small village, where I stayed with the local sheik until two men brought fuel on a camel.

In the same neighborhood, a severe downdraft along the side of a mountain range literally pushed me into the ground. My plane touched the earth at an altitude of 8,400 feet. I had never landed so quickly and effectively before. There I was—no food, no water and apparently far from habitation. While there was plenty of fuel in the tanks, I could not take off from the small area offered and could not pull the plane alone to an open space about a half mile distant.

So, I took to my feet and walked six hours down to a dry river bed, where I found a camp. There I got help and, more important, food and drink. Fortunately

I had taken the trouble when in the Persian capital to learn something of the language. My German, French and English would have been of no avail here. On the following day, with a group of Persians, I walked back to the plane. They helped me push it the half mile to a place where the sand was not so soft, and I took off again. The only other unforeseen landing took me down along the coast of Persia. A screw had worked loose on the gasoline line and my engine revolutions dropped from 2,900 to 2,700. Naturally I was not sure of the cause, and as I was then flying at an altitude of 300 feet, I felt it would be safer to descend and locate the trouble. Afterward, I continued my journey to Karachi. Had more serious trouble developed, I might have spent some time on that island. On another occasion I flew into a flock of thousands of flamingoes in Baluchistan. This presented the danger of a broken propeller, and I pulled away from the birds quickly.

I had a deal of luck in escaping these situations without undue delay and at times felt I was fighting for my life, especially since I was totally unfamiliar with the terrain. Very fortunately, good weather opened up ahead during nearly every day of flight. From Moscow southward, I followed the railway. Across Persia the general trend of the mountain chains guided me, and from the Persian gulf onward, the greater part of the route lay along the coast line.

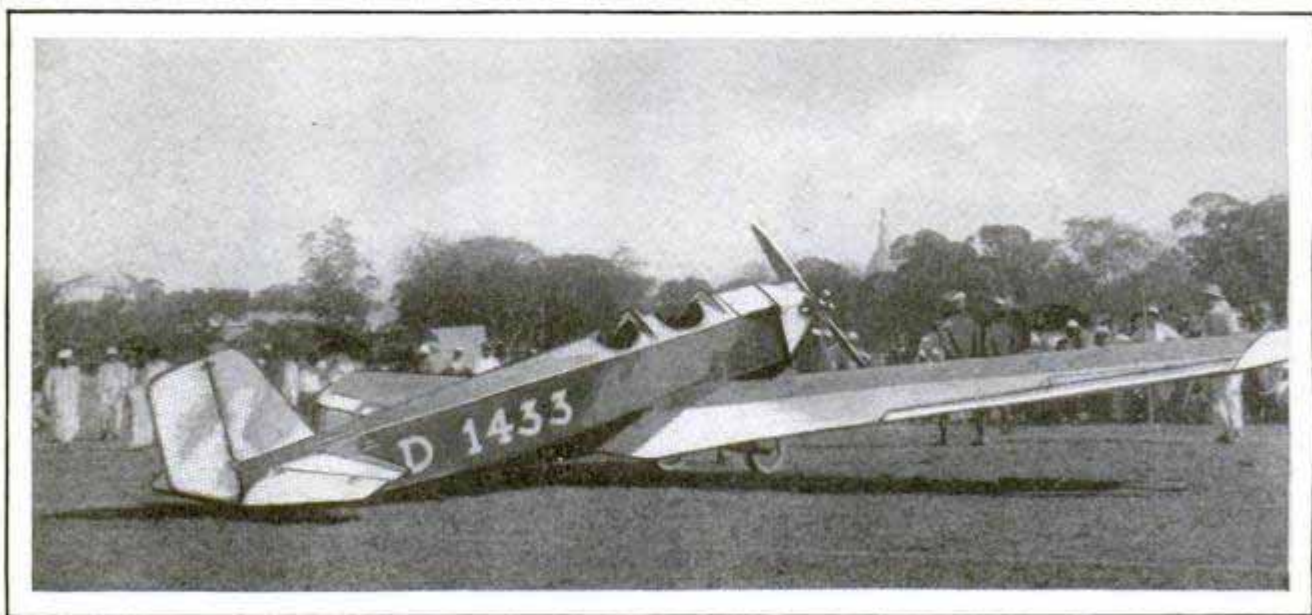

Another View of Baron Warthausen's Ship at Rangoon, with Wings Spread for Flight; the Only Untoward Incidents of the Small Craft's Journey Were Three Forced Landings in Persia



Admiring Natives Who Greeted the Baron's Plane in India; His Trip Showed, He Declared, That the Peoples of All the World Are Familiar with Aviation as a New Mode of Travel

The little machine I fly is a low-wing monoplane, powered with a two-cylinder Mercedes-Benz engine. I bought it for \$1,800. Half of this paid for the engine, which was entirely hand-made. Although the motor develops no more power than a motorcycle engine and gives fifty miles to the gallon, it has had no serious mechanical breakdown throughout the journey. I had no thought of "blazing new trails." In all respects, the flight has been a pleasure trip made for my own enjoyment.

I hope, however, that it will have helped throw the world open to any flyer with a small machine and the necessary impulse. Since aviation has developed to its present state, countries are not farther removed from each other than cities once were. One attempting such a jaunt need not pursue dangerous courses. He need not fly over the sea. He usually can follow air routes of a sort and have reasonable assurance of reaching his destinations.

Wherein does the value of such a flight lie? It demonstrates what can be done with a light plane within the reach of modestly lined pockets. These small planes operate economically. Recently, on my trip from San Francisco to Los Angeles, the journey was made on \$1.80 worth of gasoline and oil. The plane's speed is sufficient. I was in the air on the Berlin-Moscow leg only fourteen hours and five minutes. Throughout my tour I will have seen only fifty flying days, cov-

ering in that time approximately 16,500 miles. It should be explained that the engine is geared down to the propeller at a ratio of three to one. The engine turns about twice as fast as the average American airplane motor, yet it is this high speed that develops sufficient horsepower in such a small power plant.

A plane of low landing speed manifestly is the best type for such a cruise. Low wings give greater stability close to the ground and enable a plane of low horsepower to get off with a shorter run. This is especially valuable, as one never knows just how small a space he may have to land in. Many times I have gotten my plane off in eighty feet. Its very light weight (560 pounds) has helped on several occasions, too. Such a plane can take off from a sand runway where a heavier plane would sink over the tires or nose over. The all-wood wings have given good service, being hung in such a fashion that they can be folded against the fuselage for storing or transportation.

Only five instruments are mounted on the dash. These include a small magnetic compass, air-speed meter, altimeter and tachometer (engine-speed meter) and a thermometer.

One of my most profound conclusions gained from the flight is that, while the world may not be air-minded in all regions, it certainly has become aviation-conscious.

4039, Madison Ave. N.Y.C. No.

3514

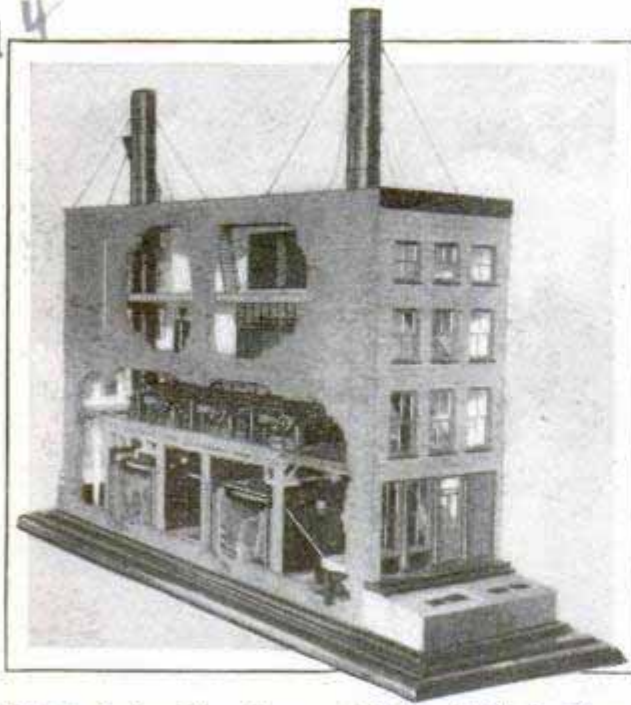

Model of the First Commercial Electric-Light Plant, Designed by Thomas A. Edison.

FIRST ELECTRIC-LIGHT STATION MODEL IN FORD MUSEUM

Built on a scale of one-half inch to one foot, a model of the first commercial electric-light station, designed by Thomas A. Edison, has been constructed for the Ford Museum at Dearborn, Mich., where Mr. Edison's achievements and the buildings in which he worked are being assembled or reproduced. This station was the Pearl street generating plant in New York, which started operation in 1882 and was destroyed by fire in 1890. The lower floor shows coal-handling equipment, furnaces and boilers, the next contains the six dynamos, each connected to a steam engine, and on the top floor is the bank of 1,000 lamps, used for testing and handling variations in the load. Each dynamo had a capacity of 1,200 sixteen-candlepower 110-volt lamps.

CAMOUFLAGE MAKES AUTOS CROW LIKE ROOSTERS

Automobiles with exhausts that imitated all the barnyard sounds from the crowing of roosters to the barking of dogs were used in recent sham battles staged by the British war department. The barnyard exhaust was placed on various war machines to deceive outpost scouts listening for movements of the "enemy" forces. Anti-tank machines were disguised to look like open-air food stalls, and

armored cars were built so low they could creep unseen along banks, while baby automobiles were used for scouting purposes in the field.

HARNESS WINTER SUN FOR HEAT TO CUT FUEL COSTS

3562

Harnessing the winter sunshine for heat, to aid in cutting fuel bills, is being attempted by engineers who have found that the solar energy on bright winter days penetrates into artificially heated buildings with southern or southeastern exposure and raises the temperature from fifteen to twenty degrees. The engineers, attempting to capitalize this natural phenomenon, use a sunshine recorder as the exterior member of the solar heating plant. It contains two bulbs between which is sealed a small quantity of mercury. When sunshine centers on the bulbs, it acts on the mercury to complete an electrical contact, the circuit being linked to the thermostatic-control system regulating the artificial-heating plant. The arrangement is such that, during bright days, the heating plant will provide from fifty to sixty degrees of the indoor temperature required, leaving the sun to do the rest to maintain the indoor heat at seventy degrees. A saving of twenty-five per cent in fuel thus may be effected.

NEEDLE CUSHION FITS ON SPOOL TO KEEP SEWING IN ORDER

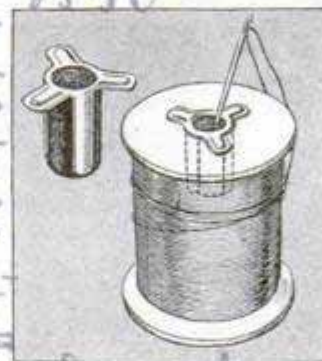

Needle and thread are kept together, without the necessity of running the needle into the tightly wrapped thread on the spool, by means of a needle cushion which is attached to the

latter. The cushion is contained in a round piece of metal which slips into the hole in the end of the spool, and may be used repeatedly.

ⓐ A power site of more than 20,000 horsepower has been discovered in Alaska by aerial survey.

3552

3550

Concise

Piano

ART OF MAKE-UP TAUGHT IN STRANGE SCHOOL



order to accentuate some peculiarity or characteristic of the person they are to represent. Wigs and costumes also are among the subjects studied. At the upper left is a man's face changed to represent a skull, while other pictures show operatic characters making up.

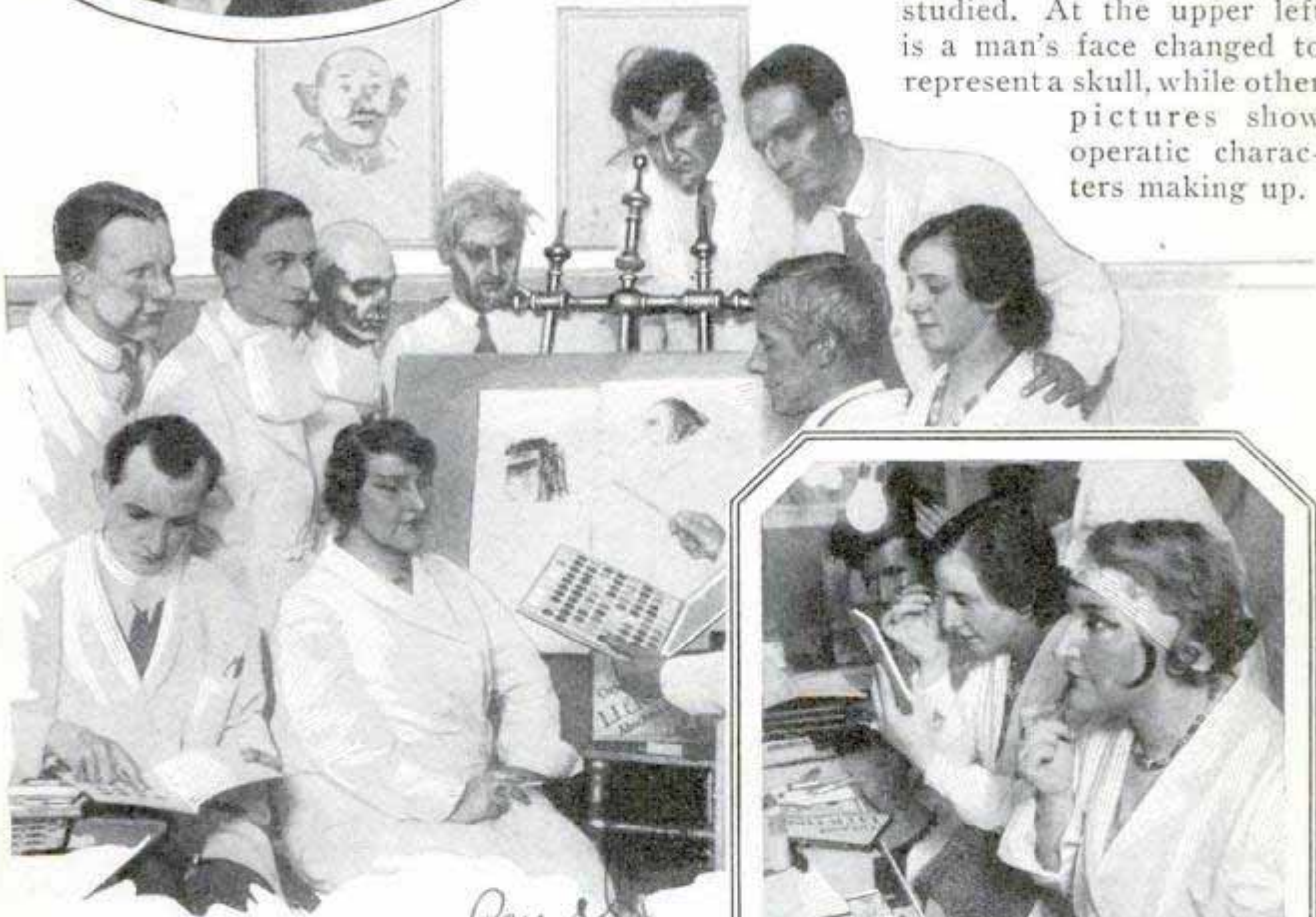

Believing that the preparation of stage make-up for the portrayal of character parts is an art in itself, a Berlin instructor has opened a school to teach embryo actors and actresses the fine points of impersonation. The students learn how to mix colors and how to apply them in

Paul

Life Raft

lamp bulb, the situation is different. There no air, ground or water is available against which to push and the rocket is the only known means of propulsion. Because of the lack of atmospheric resistance, the kick of the



Flexible Life Raft Tossed Overboard; Right, Extended to Support Several Persons

FLEXIBLE LIFE RAFT HOLDS TWELVE

Compressed, when folded, into a space little larger than that occupied by the ordinary life preserver, a flexible life raft has been made, which, when extended, affords support for more than a dozen persons. The raft, when in use, unfolds to form a rectangle with cross supports to sustain the weight of those clinging to it.



ROCKET AIRPLANE HERALDS SPACE VOYAGING

Trips through space are forecast as a result of recent successful tests in Germany of a rocket-propelled airplane built by Fritz von Opel, who, a year ago, demonstrated a rocket automobile. Interesting as is the development, it is unlikely that rockets will ever displace combustion engines in terrestrial travel, or be used in planes flying in the lower portions of the atmosphere. The rocket has a low efficiency because it depends for its power on the kick given by the explosions, uses fuel very rapidly and is able to utilize only a small part of the energy created. In traveling through space containing less air than the vacuum of an incandescent-

explosion in the vacuum would create more speed. Several years ago an American physicist startled the world by suggesting that a rocket flight to the moon would be possible in eleven hours, but his idea was not that it should carry a passenger, but only a charge of flash powder, the explosion of which on impact with the moon's surface, would be observable from the earth through telescopes.

HONEY AS SUGAR SUBSTITUTE SWEETENS ICE CREAM

Honey may be used instead of sugar to sweeten ice cream, tests at the Illinois agricultural experiment station have shown. Twelve kinds of honey were studied, the alfalfa and clover varieties seeming to have the most desirable flavor. The tests were successful on practically all kinds of ice cream except vanilla. Honey and vanilla do not blend well, the experimenters found. The honey ice cream was smoother but had a tendency to be somewhat crumbly.

in the material... 3580

All signs progress in...

Smith
St. Andrews Works
Crofton Park, S.E. 4
39

THROAT PHONES TO ELIMINATE ROAR OF AIR MOTOR

Telephones for use in noisy airplane cockpits, where conversation otherwise would be inaudible, are arranged for attachment to the throat. A sounding piece pressed against the throat transmits words, in the form of larynx vibrations. Another improvement in telephone apparatus is an "iced" telephone receiver for hot-weather use by persons desiring to carry on a long-distance conversation lasting a quarter of an hour or more. The receiver remains cool for fifty minutes and is being tested in London.

Emb. W. J. Williams
Larynx telephone

OIL STOVE FILLS ITSELF FROM BIG TANK

Keeping the oil stove supplied with fuel is accomplished automatically with a kerosene feeder attached to piping connecting stove and oil tank. The feeder is a small cylinder with a float valve inside, the oil flowing by gravity from the tank to the feeder which regulates the amount fed to the stove by the float-valve arrangement. The appliance also may be used for incubators and brooders. At the bottom of the feeder is a faucet where kerosene may be obtained for other uses in the home.

Automatic

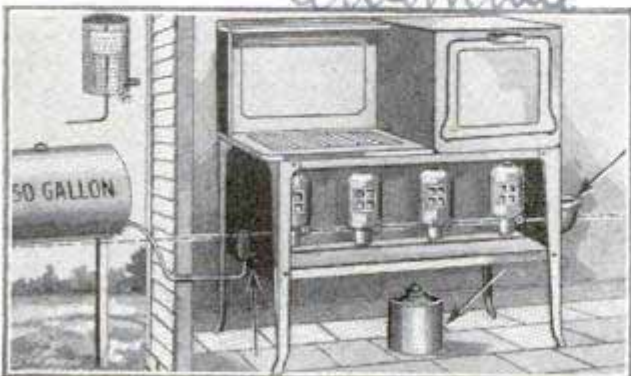

The Small Cylinder with Float Valve (Upper Left) Automatically Feeds Fuel to Oil Stove

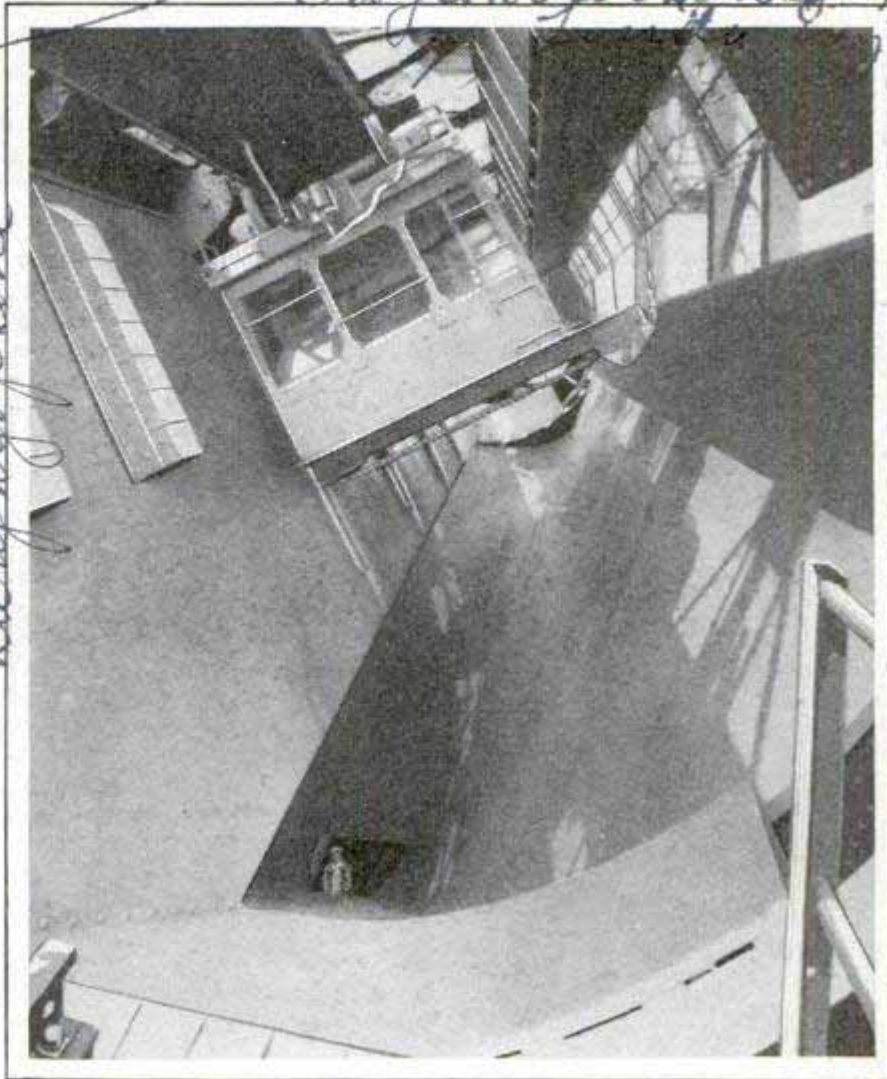

This Coal-Car Dumper Picks Up Car and Contents, Turns It Upside Down, and Sets It Back on the Track Upright

Emb. W. N. Jennings
45 S. 17th St. Phila.

DUMPER OVERTURNS COAL CAR TO EMPTY ITS CONTENTS

Dumping coal cars has been simplified by a device used by one of the eastern railroads which picks up the car and its contents, turns the car upside down to empty the coal into a steel chute, then rights the car and sets it back on its rails, all in a few minutes. The dumper operates through a series of steel fingers which pick up the car and hold it firmly while it is turned over.

ALCOHOL MAKES LEAVES RED

Leaves turn red in autumn because of alcohol, according to Samuel G. Hibben, of the Westinghouse Lamp company, who has been investigating the matter. They age, and certain chemical products accumulate, among them various alcohols. These act on other substances in the leaves to make the bright-colored pigments.

Spray John Beari hly e
Lansing, Mich

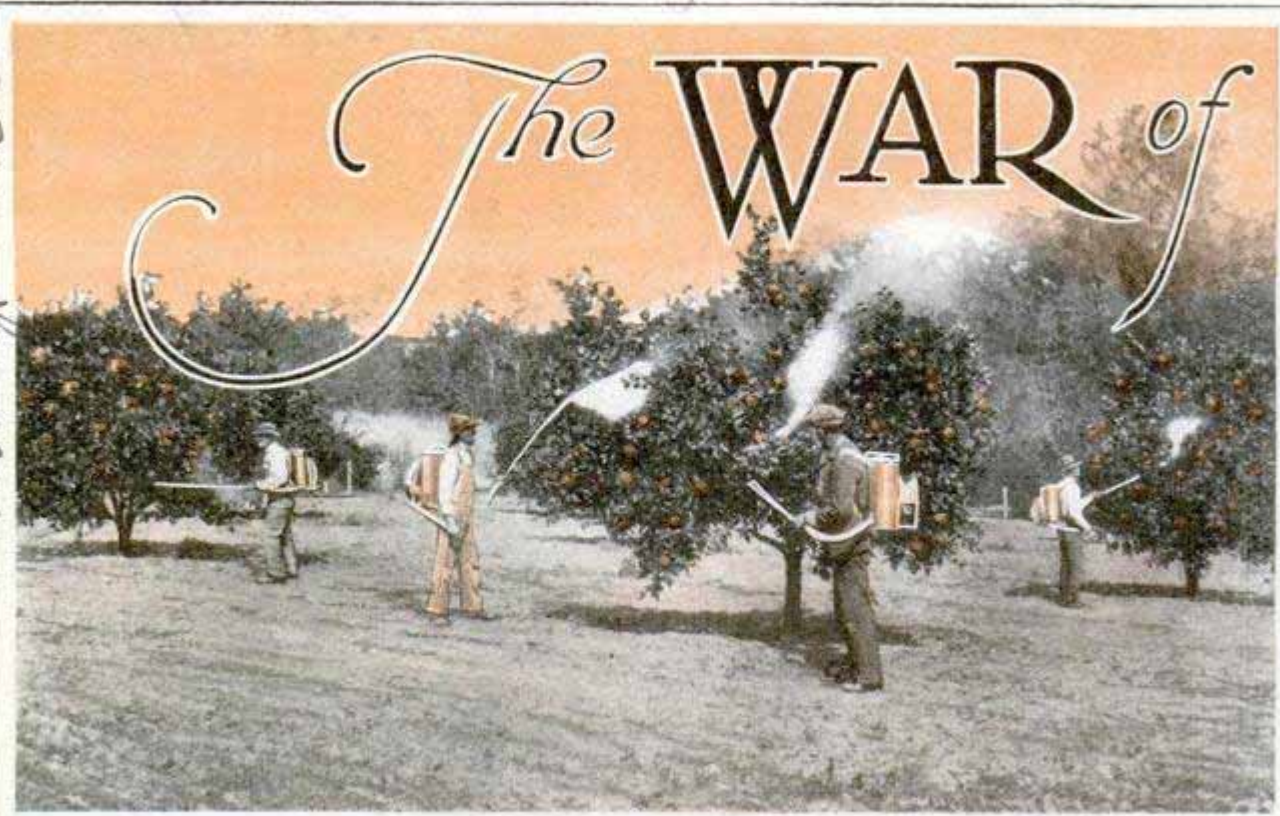

Spraying Citrus Trees in Polk County, Fla., Where More Than 5,000 Men Were Enlisted in the Warfare against the Destructive Mediterranean Fruit Fly

MAN and insect, bitter enemies, are about to discover who wields the balance of power on earth. It will mark the culmination of the longest-drawn battle known, the first engagement dating back to prehistoric times.

Following the footprints of explorers, the "domesticated" insects have spread as rapidly as the frontiers of civilization. The six-legged pests have ravaged crops, destroyed man's garments and injured his health so effectually that he is driven into open hostilities.

The latest cry of alarm comes from Florida. There, the most recent immigrant from overseas, the Mediterranean fruit fly, combats 5,000 fighting men. Unless the fruit fly is routed, its regiments may spread like a consuming flame to every state in the nation.

The work of quelling this pest may be judged from an expert's prediction that if one fly evades the quarantine, which is backed by an appropriation of \$4,250,000 from congress, every fruit-growing state in the union will suffer. Another possibility, not so remote, is that this species may ally itself with other insect tribes and wreak havoc in every country where it finds food.

In its size and general shape, the fruit fly resembles an ordinary house fly, but differs greatly in the color pattern of the body and wings and in its habits. The female fly punctures fruit skins with the sharp end of her body; through these tiny holes, she lays her eggs. Each egg is only one-twenty-seventh of an inch long; several hundred eggs may be deposited in one cavity by a succession of flies. They cannot inflict bodily injury to man. But the adult fly continually seeks fresh fruit in which to lay eggs. They die in three or four days if without food; if sufficient nourishment is at hand, they may live from 200 to 300 days. The department of agriculture has advised growers that the destruction of infested fruits and spraying are measures that should go hand in hand. Sprays are applied to kill the adults; fruits must be destroyed to kill the eggs.

The only certain, now known method of protecting plants against fruit-fly attacks is to cover them, when still very green, with ordinary cheesecloth sewed into bags large enough to be slipped over the tree and tied around the trunk.

Property worth \$1,800,000,000 is threatened by the fruit fly in the United States.

the AGES

A report from a committee of experts on the Florida front states that eradication of the pest is possible, and will be accomplished with sufficient financial aid.

Down the ages, mosquitoes also have tormented man. If they were merely bothersome, we would have justification for war against them. When we consider that a certain species found in the south will transmit yellow fever and breakbone fever, no further argument is needed.

Mosquito-breeding places are very diverse. Some species breed only in tree holes; others, in crabholes on sea beaches; still others, in any chance accumulation of water. The house mosquito in the north, the rain-



barrel mosquito and the yellow-fever mosquito in the south breed in every receptacle of water about residences.

Almost any refuse pile, or cavity where water can accumulate, is ideal for mosquito multiplication. They use even the footprints of cattle and horses for breeding, as well

as places around water pipes, washbasins and fire buckets. Where water must be stored, it is advisable to use screens.

Spirits of camphor or pine oil rubbed upon the face and hands will help keep mosquitoes away, but a single application will not last all night. If not averse to the odor of oil of citronella, that also may be used effectively. A solution of one ounce of oil of citronella and four ounces of liquid petrolatum has been tried successfully. A few drops on a bath towel hung over the head of the bed will keep common house mosquitoes away. When they are abundant, a few drops rubbed on face and hands will keep them away.

A very satisfactory mosquito remedy is



Top to Bottom, Head of Digger Wasp; Robber Fly Killing Smaller Rival, and Pincers of Tiger Beetle

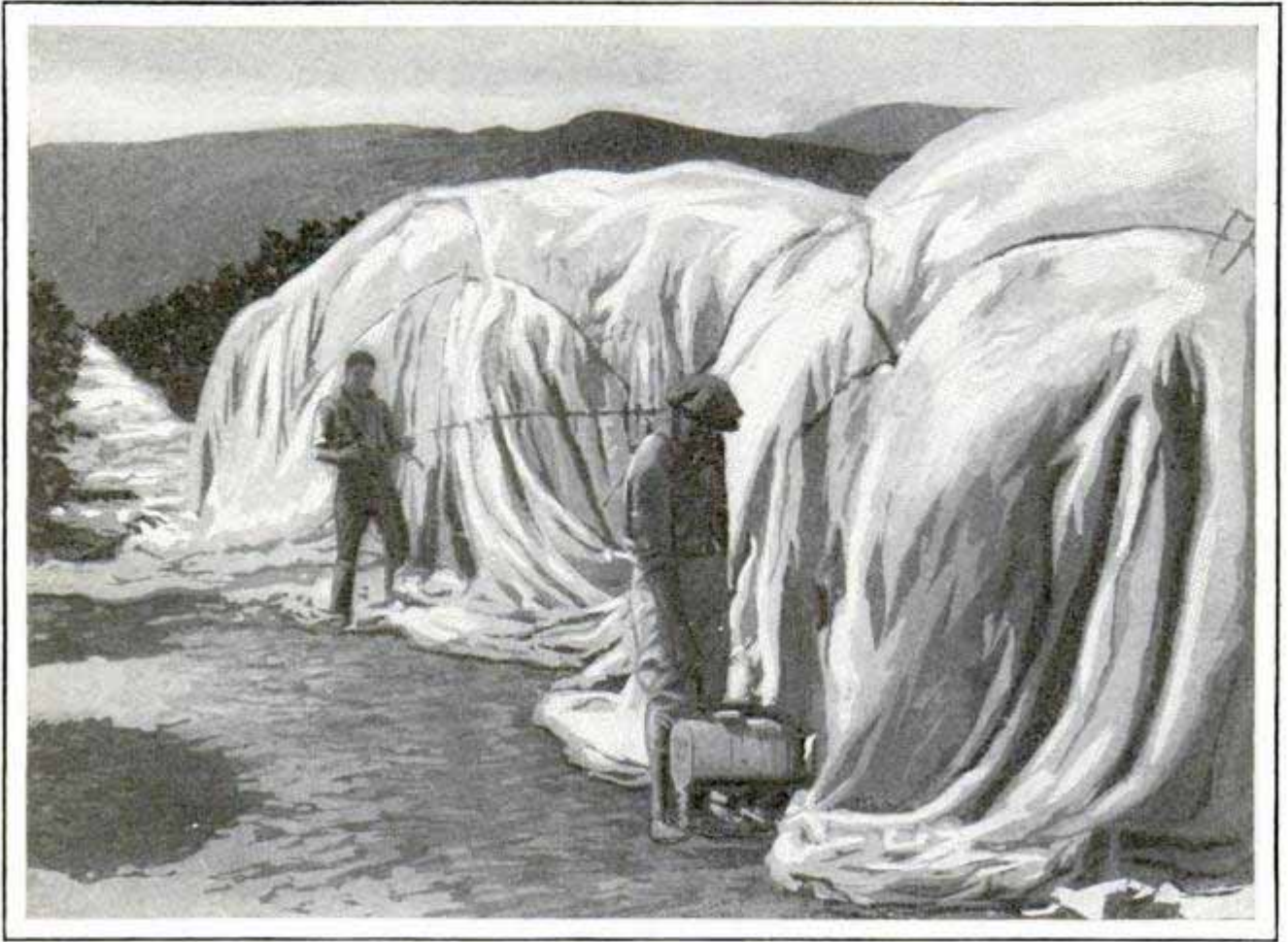

Fumigating Citrus Trees with Hydrocyanic Acid Gas to Kill Scale Insects; the Canopies over the Trees Insure a More Thorough Treatment

moist soap. Wet the end of a piece of ordinary toilet soap and rub it gently on the puncture, and the irritation will soon pass away. Household ammonia, alcohol or glycerine are effective, too. Holding one's hand near a hot lamp chimney will also relieve irritation.

Of about 500 species of fleas, less than one dozen are of importance in the welfare of man and the lower animals. The human flea, the dog flea, the cat flea, the stick-tight flea, hen flea and rat flea are the principal species that concern man.

In dealing with fleas, as with most other insects, it is important to eliminate breeding places first and deal with living members afterward. Fleas breed copiously on soil or in dust containing animal and vegetable matter protected from wind, rain and sun, but at the same time watered somewhat. Animals and poultry should be prevented from passing beneath buildings, infested areas sprayed with creosote oil, and the breeding grounds covered with salt and thoroughly wetted down.

House infestations may be prevented by

eliminating pet animals and applying gasoline to floors after all rugs have been removed and the floors scrubbed with soap and water. Applying derris powder to pet animals, or washing them in a weak solution of saponified creosote, will destroy fleas upon them.

Fleas affect us both as disease carriers and annoyers. The awful bubonic plague was transmitted by fleas.

Roaches are a common and offensive nuisance. In temperate countries, only four or five species belong among our household pests; essentially, roaches belong to tropical countries, where their variation and abundance are among the world's wonders.

House roaches are commonly dark-brown, this being a protective coloration device. The head is bent under the body, so that the mouth points directly backward, and the eyes down.

These insects have senses so highly developed that we must show them some respect. Unless routed out of their hiding places, they are very rarely seen.

They gnaw at woolens, leather, over-stuffed furniture, the paste on oilcloths and book bindings. Besides, of course, they consume practically all kinds of animal and vegetable matter.

In addition to their cunning and stealth, the roaches have an amazing ability to guard against enemies. They display real intelligence in avoiding poisons and food doctored with insecticide. Some students believe that their highly developed senses are the inheritance of centuries, during which man fought to control them. When cornered, a roach will play dead and watch the effect on his hunter. He will not show himself to a housewife, but in restaurant kitchens, where everybody is busy, he will walk boldly.

Some simple roach poisons are sodium fluoride, borax, pyrethrum and sulphur. Fumigation is often resorted to, in ridding premises of roaches.

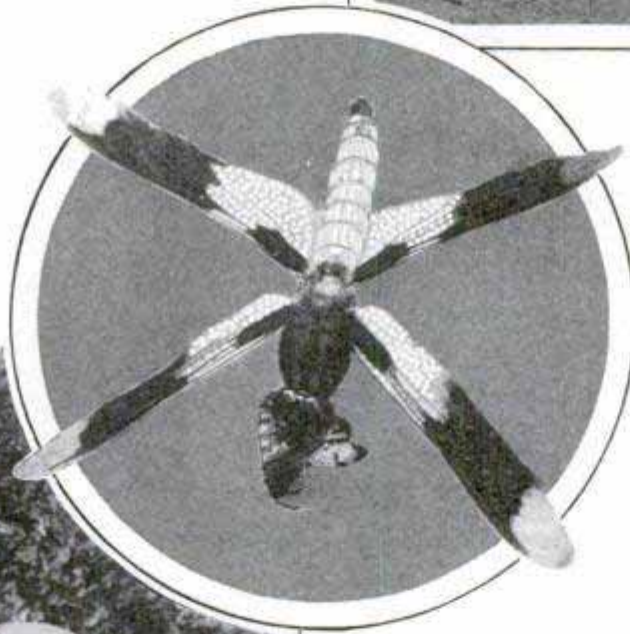
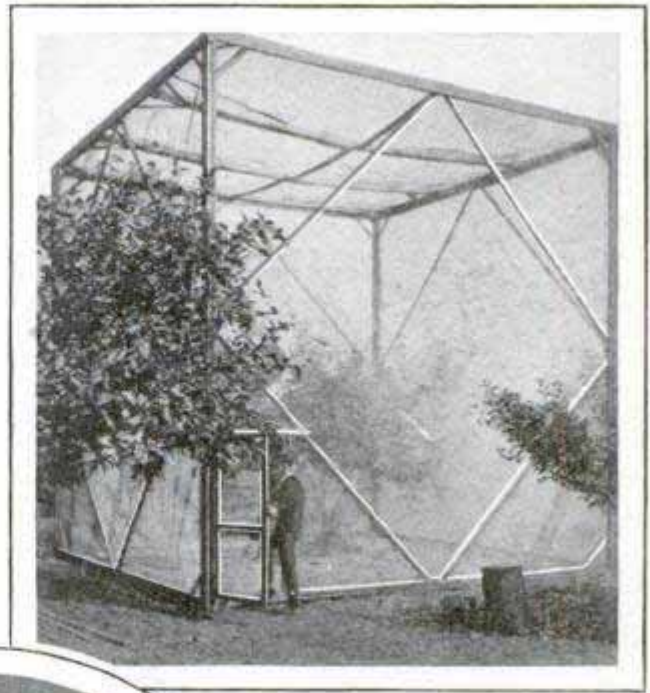

But extreme precautions must be taken to avoid the effect of these gases on human beings and pet animals. Carbon-disulphide gas is commonly employed.

Chigger bites will spoil the best human disposition. These pests flourish during the summer months. After careful study under

a microscope, it has been determined that chiggers do not burrow under the skin. They remain attached only by their mouth parts, and engorged like ticks. After some days, they release this hold and fall off. Also, it is maintained authoritatively, that chiggers do not enter skin pores. Their attachment is purely superficial.

One method of controlling chiggers is to wear close-mesh, tight-fitting garments. High-top shoes or boots give good protection. Spiral puttees also may be worn. But on account of the heat and discomfort of leg apparel, chemical means have been devised for warring on chiggers. Flower of sulphur dusted over the clothing makes a deterrent. After application, the powder should be rubbed down. A talcum-powder shaker aids in distributing the sulphur evenly.



Field Cage for Inclosing Infected Trees; Dragon Fly Eating Prey, and Small Sprayer in Operation

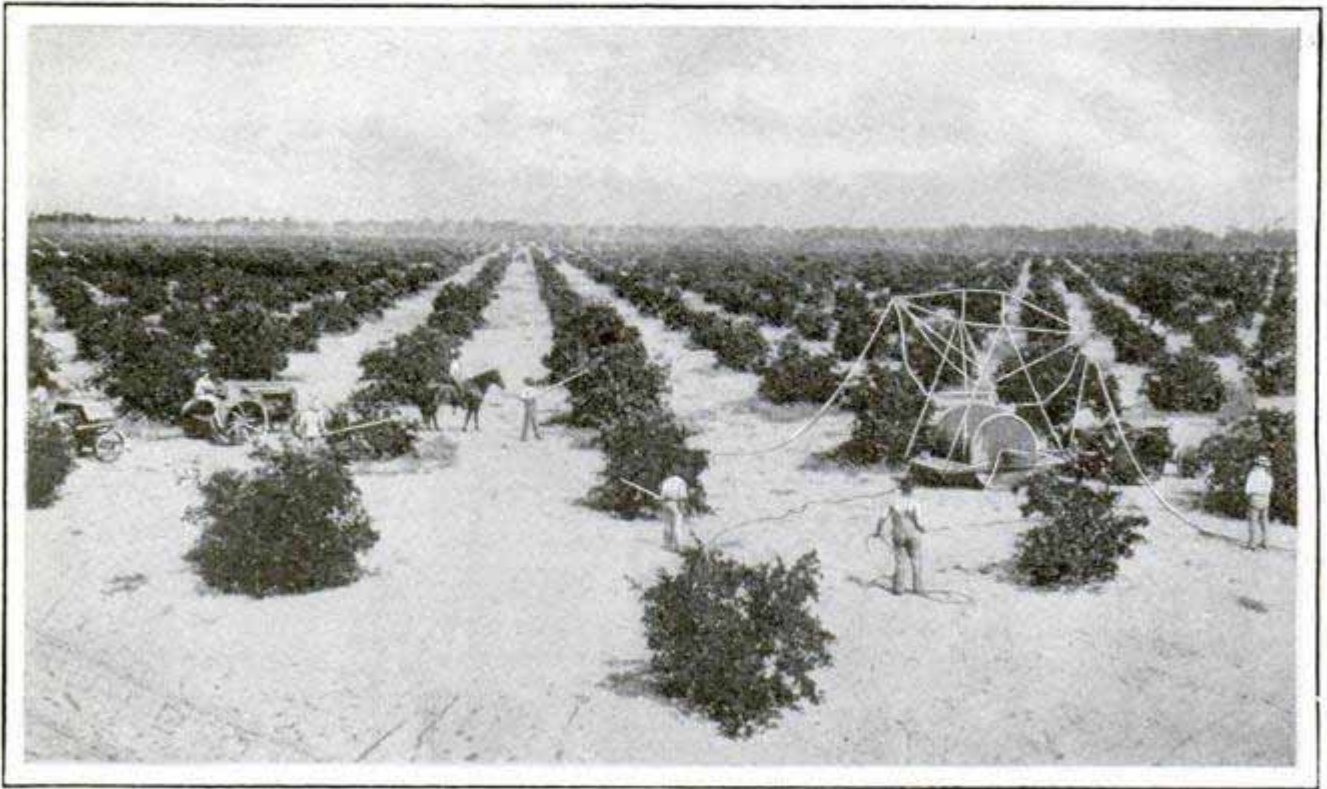

Spraying Large Grapefruit Orchard with Tractor Outfit That Permits Application to Several Trees at One Time and Affords Sufficient Pressure for Reaching Difficult Places

Four common species of buffalo moths afflict households. In reality, they are not moths but fall in the classification of beetles. They are capable of subsisting on dried animal remains, but thrive especially on fine silks, wool, hair, feathers and fur. They remain secluded in dark nooks, beneath carpets and in garments.

In tight chests and trunks, protection may be had against carpet beetles by the use of crystals of naphthalene, or camphor, or fumigants such as carbon disulphide and carbon tetrachloride. Where infestation is general throughout a house or is serious in closets, it is advisable to fumigate with hydrocyanic acid gas or sulphur. But none of these fumigation methods should be performed by a person not instructed in their use.

Another control measure is to store susceptible articles in cold-storage rooms where the temperature is 50 degrees Fahrenheit, or lower.

The Japanese beetle has been successful in establishing quarters in this country. The adults attack important crops, such as the foliage and fruit of the apple, peach, and cherry trees, and grape, beans, clover, alfalfa and sweet corn.

Since the insect is a strong flyer, its spread from year to year has been steady.

Only in the summer of 1916, it was first discovered in the United States, near Riverton, N. J. The pest's few natural enemies have allowed it to multiply amazingly. It is now firmly established; on the other hand, it is being successfully curbed in the areas it has infested the longest time.

In Japan, the beetle is not regarded as a serious pest, probably because it has its native parasites. But here, this insect has found ideal resorts for its depredations. It is known to feed on at least 200 different species of plants.

The federal government enforces yearly quarantines, restricting the passage of nursery stock as well as farm produce. A scouting force operates over the eastern states and determines the spread of the insect from year to year.

Mixtures of arsenate of lead are the most promising insecticides for use against the adult beetle.

In his relentless war on insects, man seizes every device that may be applied to curbing wholesale devastation. The recent adoption of airplane equipment by agricultural interests is a case in point. In the last several years, a number of commercial firms have begun to specialize in the "air-dusting" industry.

In the south, airplanes have been used successfully in fighting the boll weevil. At army cantonments, beach resorts and industrial centers, airplanes have eradicated mosquito-breeding haunts. And in a case just reported from Canada, vast timber lands were saved from the ravages of caterpillars by a pilot of the Ontario flying service.

The Canadian department of agriculture states that, over an area of eighty square miles dusted with poisonous chemicals, it is difficult to find a single caterpillar, whereas, before the dusting, from fifty to seventy pests could be found on a two-foot twig.

TEST MACHINE FINDS DEFECTS IN FRONT END OF CAR

Locating and correcting faulty alignment in the front end of the automobile without removing the wheels or other parts is made possible with a tester now available for garages. Front-wheel alignment, turning-range alignment, bent spindles or axles, wheel wobble, axle tilt, wheel camber, and kingpin or spindle-bolt pitch, all are shown by instruments on the machine, which also reveals when the defect has been corrected. The tester, on a rack, includes axle press, hydraulic jacks, camber and caster tool, axle level, wheel-alignment machine and a longitudinal sight and target. Locating front-end troubles takes only a few minutes with the tester, and they may be corrected on the

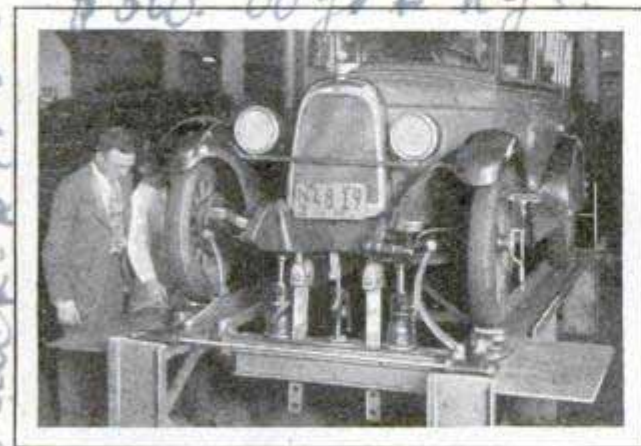

This Apparatus Automatically Indicates Faulty Alignment of the Auto's Front End

rack without heating the axle or removing the wheels. The equipment occupies small space and is portable.

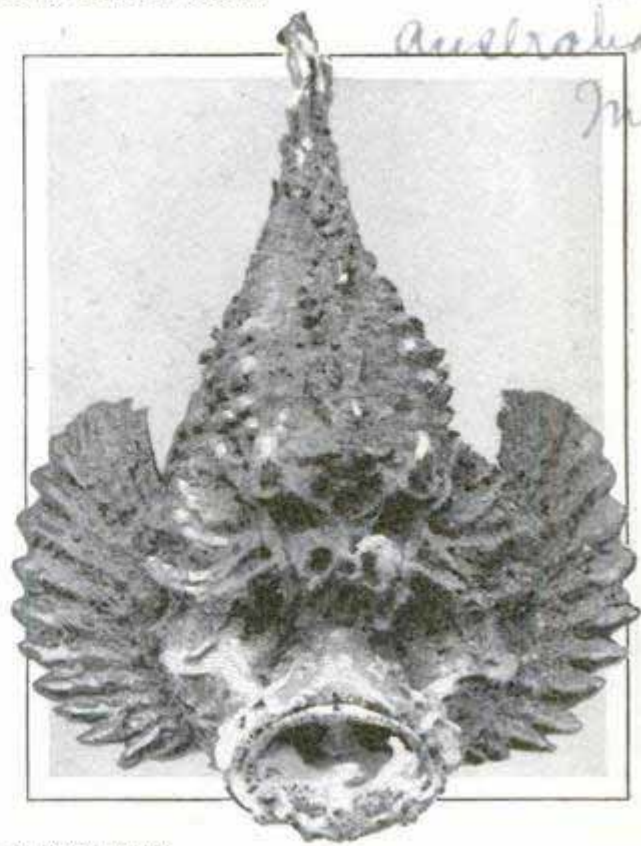

© Henry Miller

Rare Specimen of the Stone Fish Which Closely Resembles Coral among Which It Lives

RARE "STONE" FISH IS FOUND HIDING IN CORAL

Two scientists visiting the Great Barrier Reef, Queensland, recently captured a specimen of the rare and poisonous stone fish whose camouflage so closely resembles the coral among which it lives that it often is mistaken for an inanimate stone. It has poisonous spines, a scratch from which causes intense pain and, sometimes, death. Its skull-like head is distorted into a series of bumps and hollows of lemon-yellow, pock-marked with gray, while the spines also are yellowish. Body and fins are brown with yellow or red warts. The specimen died within a few hours and was presented to the Australian museum.

TRAIN IS COOLED BY ICED AIR

Ice-cooled railroad passenger cars have been tested successfully in France. An electric fan in the passenger coach blows air through a chamber filled with about half a ton of ice, the draft being controlled at will, to filter and cool the air. During tests, the temperature outside registered from ninety-three to ninety-five degrees, but the passengers were cool and comfortable.

Black 8/140-00

Australia Museum

3516
before 11/29

Accurate for...

checked...

Chicago Tribune 11/19/29
Chicago Tribune 11/19/29



Drawing Showing How an Airplane Trailed a Carrier Pigeon to Its Home to Capture the Ingenious Blackmailer Employing the Bird

If low, pure sounds are made, the strip of light ripples smoothly, but discordant tones cause it to move irregularly and writhe like a serpent. For all graduations of harmony there is a distinct wave, different for each sound, even down to discrepancies in tone too fine for the ear to distinguish. The instrument used is a development of the "Osiso," used for some time to photograph voice and music characteristics. The development consists in substituting a moving picture for a still. In it is a mirror, vibrating under control of an electrical current from a microphone that picks up the sounds to be pictured. The mirror reflects a beam of light through revolving mirrors, and by this means music students are given a pattern of a perfect sound and attempt to reproduce it in the light. The instrument is so delicate that it even showed a record when a pianist struck his fingernails on the keys in playing, and is to be used extensively to calibrate the harmony of musical instruments.

Chicago Tribune 11/19/29

AIRPLANE TRAPS BLACKMAILER BY TRAILING PIGEON

German police have successfully employed an airplane to foil a blackmail plot, although the criminal was ingenious enough to use a carrier pigeon in his operations. A Hamburg resident received a package containing the pigeon and a letter, instructing him to attach notes amounting to 5,000 marks to its neck and release it. Two pilots in an airplane trailed the pigeon and photographed from the air the dove cote in a suburb on which it alighted. Confronted with this evidence, the criminal confessed.

MUSIC TRANSFORMED TO LIGHT AS AID TO STUDENTS

To aid music students in perfecting their technique, musical sounds have been transformed into ribbons of light that write their characteristics on a screen to give a moving picture of the sounds.

RUBBER BOOT FOR SHIFT LEVER PROTECTS CLOTHING

Affording protection from grease and oil around the shift lever of the automobile, which frequently soils the clothing of the motorist, a rubber boot for this part of the car is now obtainable. The boot slips down over the base of the gear shift, without interfering with its action.

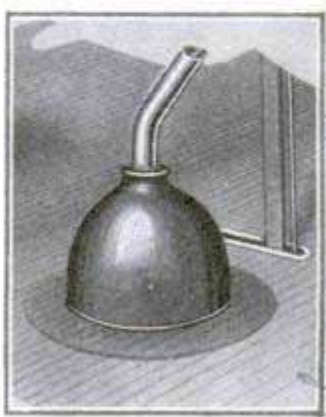

Chicago Tribune 11/19/29

Chicago Tribune 11/19/29
Refer to A. A. Hill Instrument
and in Head Westinghouse Co.

ARE YOU A GOOD DRIVER? AVOID THESE FAULTS

One out of every 120 or so people in the United States will be involved in an automobile accident next year, judging from 1928 accident reports tabulated by Dr. Louis I. Dublin, of the Metropolitan Life Insurance company. In other words, automobile-accident deaths and injuries are around a million a year. The United States, which leads the world in the percentage of fatal accidents, with seventy-eight per 100,000 population, had 27,500 automobile deaths in 1928, and 950,000 non-fatal injury cases. Widening roads to handle the increased auto traffic has failed, recent surveys show, to materially reduce accident totals because of the careless habits developed by drivers on the wider high-speed pavements. Analysis of driving faults on the wider well-marked highways, discloses the leading ones are straddling two lanes, which not only is dangerous but reduces the capacity of the wide road to that of a narrower one; cutting across traffic from one lane to another; forcing approaching cars into the ditch by straddling lanes; parking on the pavement to make repairs and change tires, and driving at low speed in center lanes, forcing faster cars to pass on the right instead of the left.

PULLING POWER OF HORSES IS MAINLY DUE TO WEIGHT

Large horses are better than small ones for pulling heavy loads, tests at the Illinois agricultural experiment station have disclosed, although many horse owners have insisted that a "good little team" will out-pull a big one. Trials were made with 144 different teams, and accurate measurements of their performance taken with a dynamometer. It was also found that a good disposition was an important factor in the animals' success as pullers, and skillful driving was shown to be as necessary as good horses. Unshod animals were unable to hold their own against well-shod teams. It was also proved that horses must be in good flesh to do their best. One team's performance was the equivalent of starting a load of 38,960 pounds for fifteen or twenty consecutive times on a granite-block pavement.



STRADDLE TWO LANES

CUT ACROSS TRAFFIC

GET OUT OF YOUR LANE

STOP ON THE PAVEMENT

HOLD CENTER AT LOW SPEED

Here Are Posed Pictures Showing Five of the Commonest Causes of Automobile Accidents

Canada's Flying

By J. EARLE MILLER

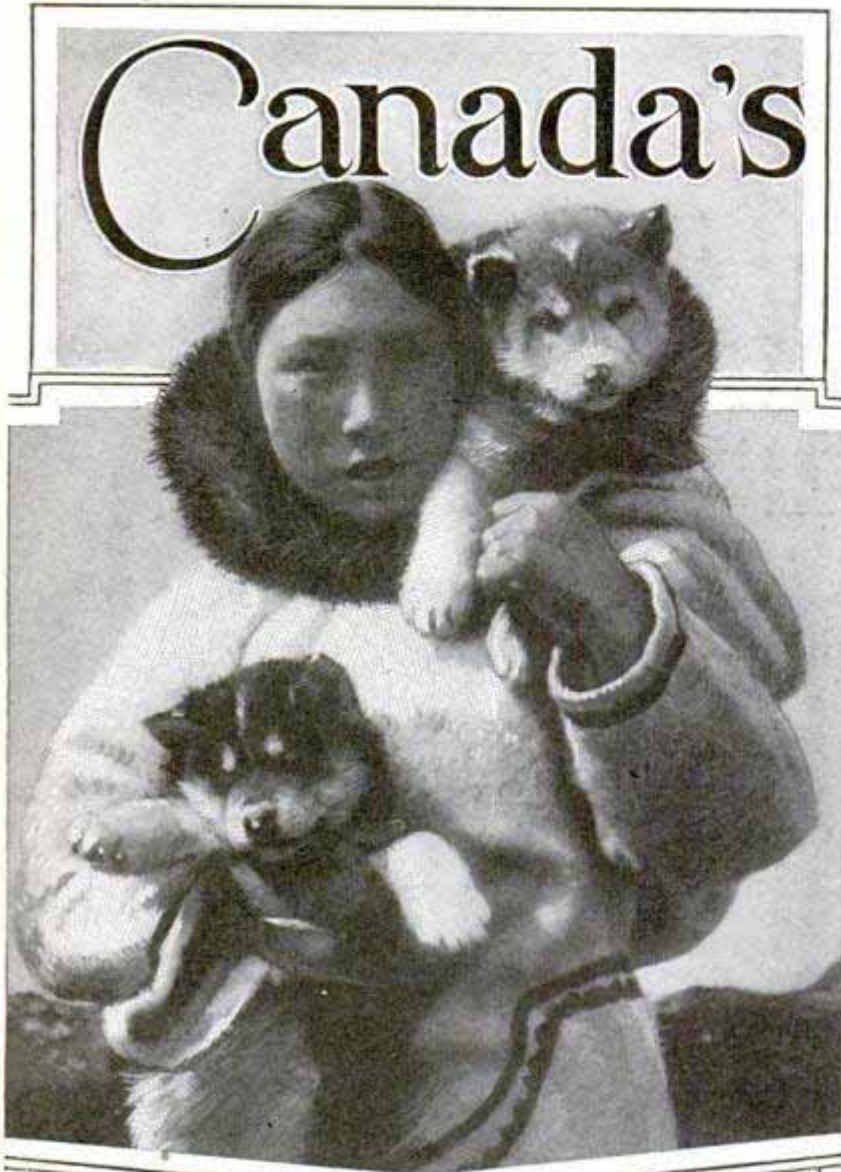

A FEW weeks ago an airplane circled a time or two over a little unmapped lake in the wilds of far northern Saskatchewan, the roar of its motor died away to a soft purr as the pilot "cut the gun" and it swooped down to come to rest, straddling high above the water on the tall, stilt-like legs that supported the cabin fuselage above the seaplane pontoons.

The pilot cracked the throttle a trifle, the song of the big "Wasp" engine picked up an octave or two, and the Fokker taxied ashore, until the pontoons were wedged for a quarter of their length on the sandy beach. Out of the cabin stepped a mining engineer whose curiosity had brought him out from Winnipeg to learn why Indians had given the little lake a name that means, in English, rottenstone. The little lake was

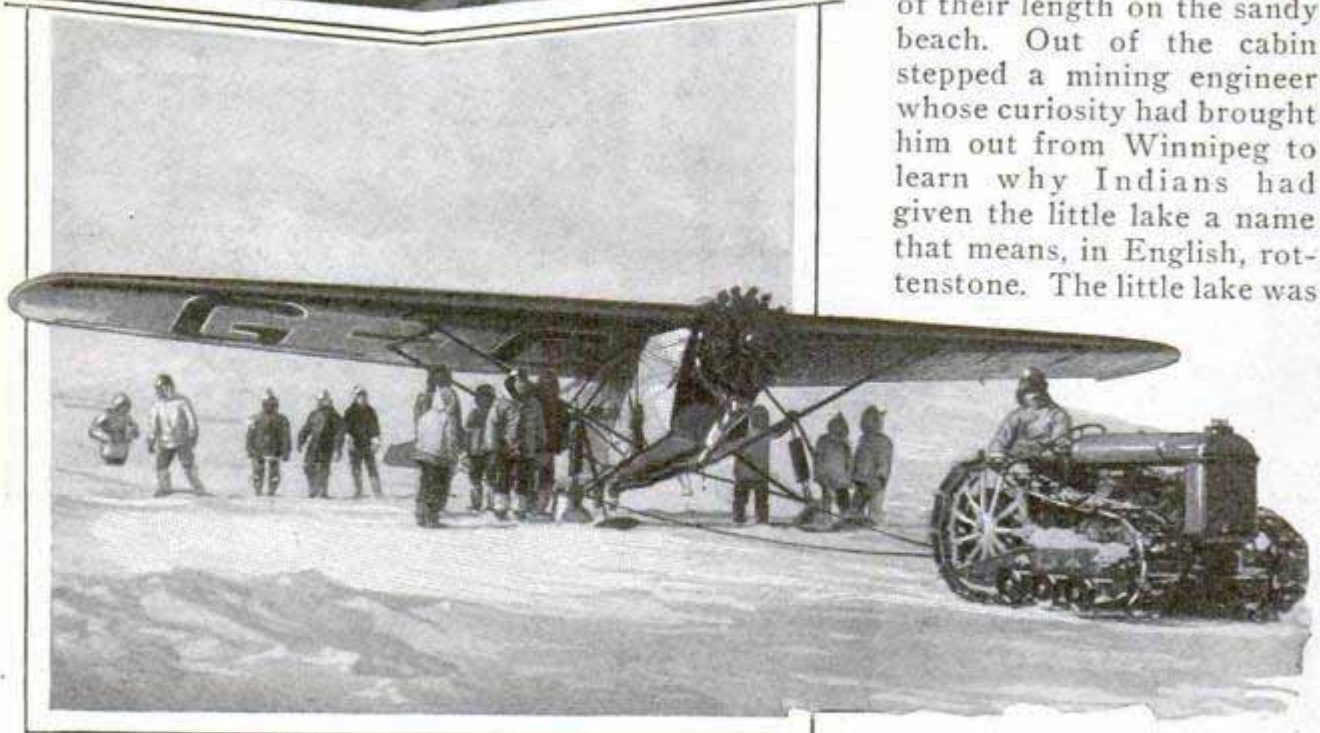

Eskimo Girl with a Pair of Malamute Pups Too Small for Sled Training, and a Fairchild Plane of the Hudson Strait Patrol Being Towed from the Hangar by a Tractor

1402-4
Converse
Adelaide
Sheppard
Toronto
Culcan.

Gold Rush



Fairchild, Belonging to Northern Aerial Minerals Exploration, on the Banks of the Laird during a Prospecting Trip into the Far Northwest and across the Barren Lands

so unimportant it doesn't appear even on mining maps of the district.

As the engineer stepped ashore, directly in front of him, on the north bank of the lake, rose a low mound, shaped like a domed anthill, thirty-five feet high and 165 feet in diameter. Its almost bare sides were dull green and gray, the "green-stone" of the Canadian prospector, the only rock formation in which important ore finds have been made, the pre-Cambrian shield, the oldest stone in the north country, so old that its weathered seams and strata have chipped and cracked and broken, and let the gold and silver, platinum, copper, nickel and zinc, and the lead extrusions force their way through. And that was the answer to the enigma of the lake's name, a vast mound of aged and rotted stone.

A few hours' work collected a bagful of samples, so rich that the naked eye could almost estimate their value. The entire mound was one vast heap of wealth, piled up in plain sight, not under the ground like most mines, but set out where anyone passing by for many centuries might have seen it. Those samples as-

sayed \$40 to the ton, forty dollars of gold, copper, nickel, platinum and zinc. With the exception of cobalt, lead and silver, everyone of the important metallic minerals of Canada was represented.

In this one story is summarized all the main facts of a revolution in mining, a revolution that has, in three years, put Canada to the forefront as one of the greatest mining areas in the world; a revolution that brought a new form of transportation to prospecting, combined flying and gold hunting and moved the clock of time forward at least fifty years.

Two years ago one of the oldest forms of transportation, the canoe, reigned supreme in all the vast stretch of country from the north line of the Canadian National to the Arctic ocean in summer, and the dog team did the same in winter. Today, except for short local journeys, the dog team and the birchbark or canvas canoe are almost as rare as horses on Fifth avenue, New York, Michigan avenue, Chicago, or Market street, San Francisco.

The story of the discovery of Rottenstone lake is romantic and unusual only because it came from a "hunch," from the



curiosity of a man in a distant city office, who suspected the Indians had some good reason for giving the lake the name they did. The rest of the story, the use of an airplane to do in less than one day what would have taken a party of guides and prospectors an entire summer to accomplish by canoe, is just one of dozens of similar stories. By air you can hop off after breakfast, fly two or three hundred miles out from civilization, knock off a few samples of greenstone with a geologist's hammer, and fly back home in time to have them assayed before supper. Hundreds of men—prospectors, geologists, mining engineers and mining-syndicate scouts—are doing this, and, in fact, are doing it practically every day.

At the time this is being written, the annual report on mineral production in the Dominion

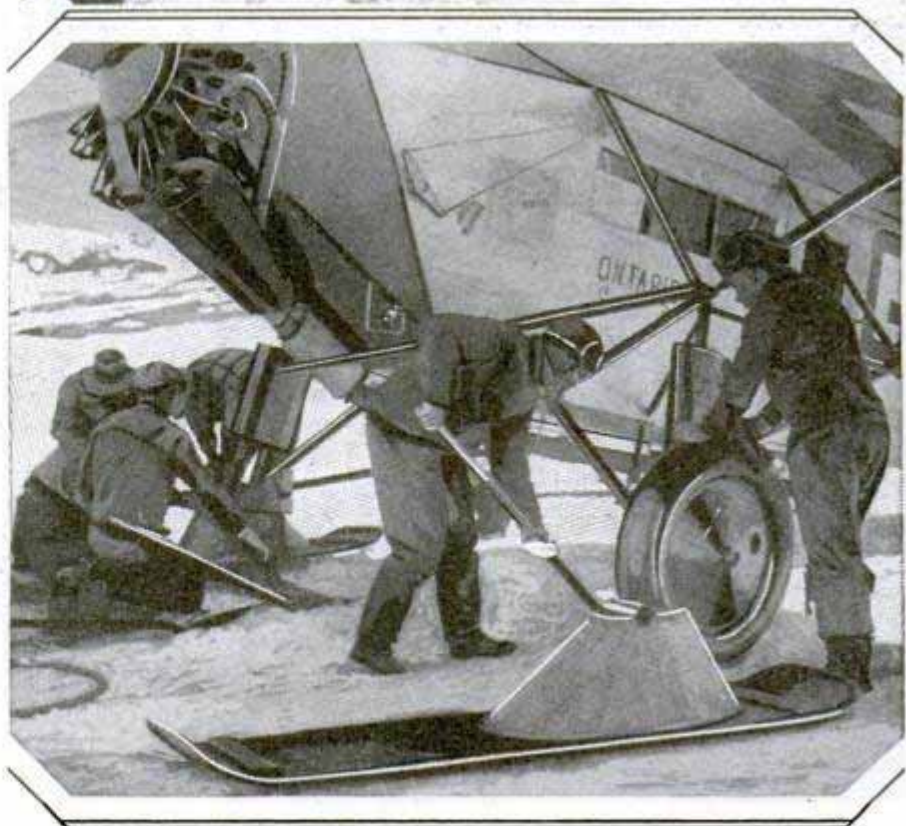

Top, Using an Eiderdown Sleeping Bag to Shield the Motor While Heating the Oil; Center, Cleaning Snow from a Fokker's Wing, and, Bottom, Changing Wheels to Skis

of Canada in 1928 was not completed, but a preliminary report, published by the Dominion bureau of statistics, shows \$273,446,864 was extracted from the ground last year, and the surface has hardly been scratched.

The vast pre-Cambrian shield stretches over a large part of the north country, and it is in this oldest of rocks that the precious minerals are found. Canada contains ninety per cent of all the pre-Cambrian shield in the entire world. The other ten per cent stretches south of the border into Michigan and Minnesota. From that ten per cent, with intensive prospecting, the United

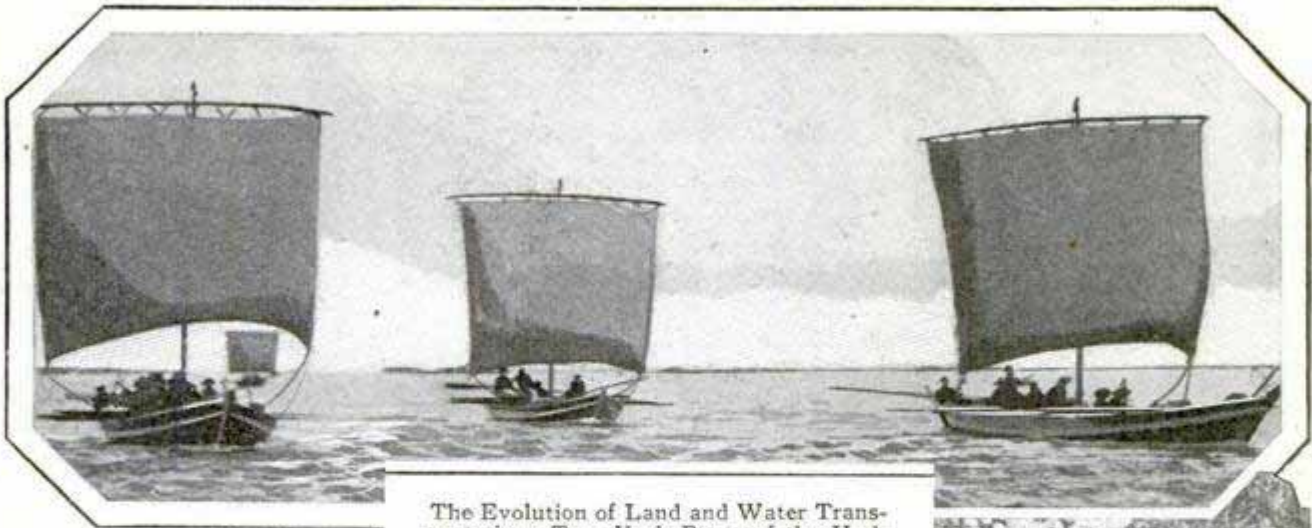

The Evolution of Land and Water Transportation; Top, York Boats of the Hudson's Bay Company under Sail on the Bay, and, Center, Bullock Carts Used for Transport on the Portages between Lakes and Rivers; Although Canada Is Studded with Thousands of Rivers and Lakes, the Connecting Portages and Those around Rapids and Falls Have Always Proved a Difficult Problem

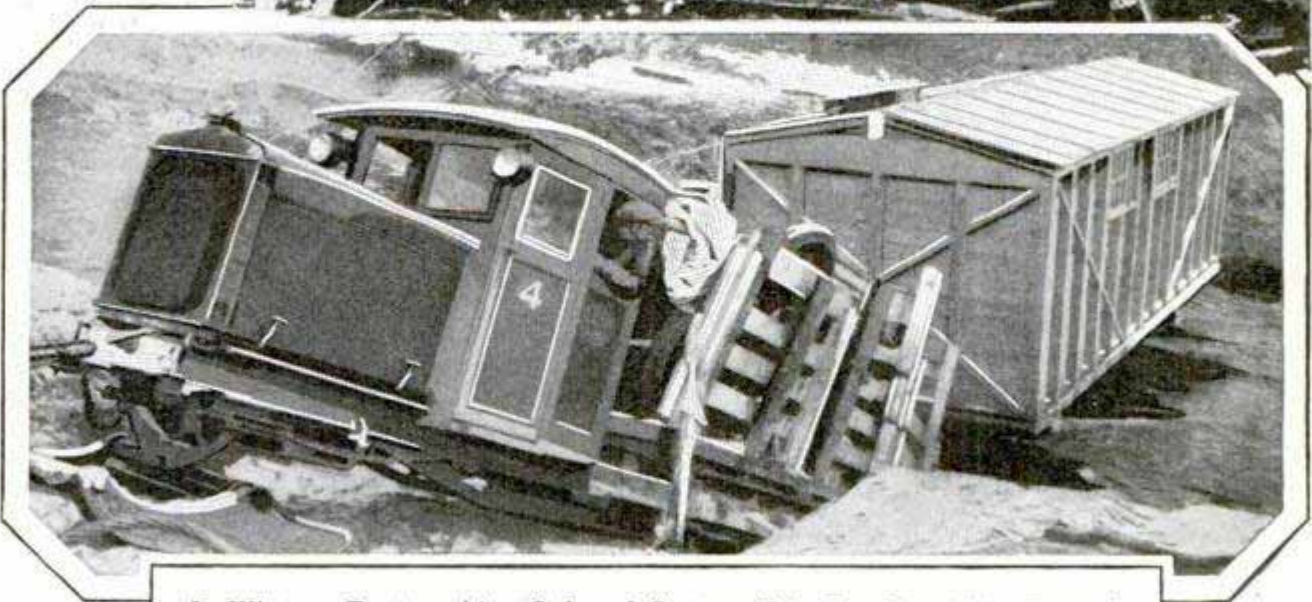
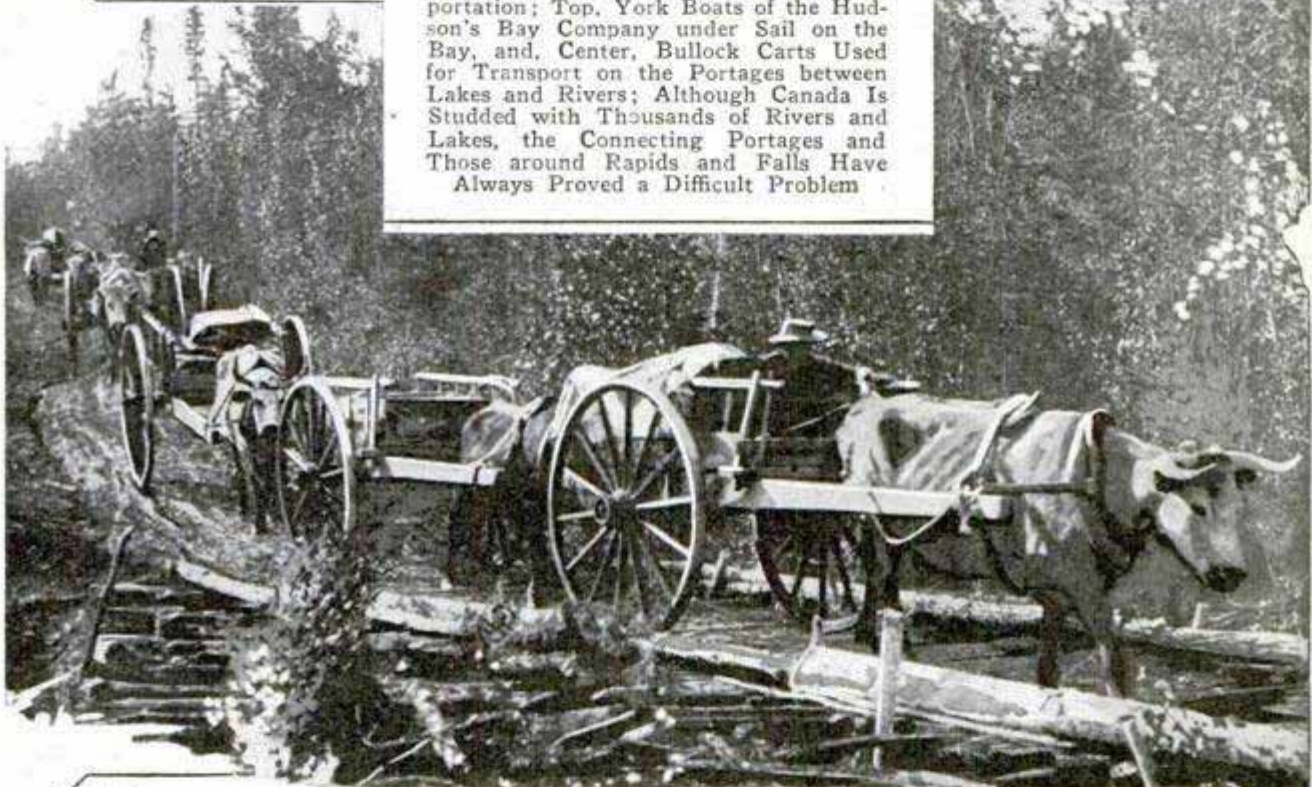

In Winter a Tractor with a String of Cars on Sleds Can Move Fifty Tons of Freight over the Snow and Maintain a Regular Schedule Day and Night



Planting the "Discovery Post" on a Mining Claim in Northern Ontario; the Next Step Is a Dash to the Mining Recorder's Office Somewhere along the Railroad to Record the Find

States has developed the marvelously rich iron mines of the Messaba range, and the fabulously wealthy copper mines of the Calumet district, in upper Michigan. If, say Canadian geologists, mining engineers and prospectors of the United States, with only ten per cent of the pre-Cambrian rock, can take out the wealth of Messaba and Calumet, what can't Canada do with the other ninety per cent?

Kipling once wrote of aviation that the world had reached the opening verse of the opening page of the chapter of endless possibilities, or words to that effect. That is the status of Canada today as a mineral producer. All the four billion dollars' worth of minerals, taken out of her ground in the past half century or more, represent only samples picked here and there from a mineralized land so vast that a great part of it has never been mapped, and, until the airplane came, had never even been seen by white men's eyes.

In 1915 a party of half a dozen old-time prospectors, led by Jack Hammell, paddled out from the end of steel at The Pas to see what they could find to the northwest. With huge thirty-foot birch-

barks, capable of carrying four tons of men and supplies, and a crew of Indian helpers to paddle and portage the supplies from lake to lake, they swung up the Saskatchewan almost before the last ice floes had cleared the river, turned north at the old Hudson's Bay post of Cumberland House, spread big square sails and skimmed along before the wind through the chain of lakes to what is now Sturgeon Landing, turned west again, upstream and over portages around rapids, until they reached Amisk lake, crossed it and portaged again into Athapapuskow lake, and on its north shore made camp. There, something like a hundred miles from The Pas as a bird flies, they staked claims that it has taken just fourteen years to develop. They had to fight and win a provincial election to interest the Manitoba government, for the claims were hardly a stone's throw east of the Manitoba-Saskatchewan border. Then, turning the birchbarks and Indian canoemen again, they had to transport an entire provincial legislature through the miles of lakes and rivers and show them the spot before they could convince the law-

makers that Manitoba really had a future as a mining center. And finally they got a railroad in, a branch line leading off from the Hudson Bay road north of The Pas, and the branch was opened for service in the last week of July of this year, though equipment for the mill had already been transported in before the ballast had been completed. Fourteen years of work, and these claims, now in the hands of the Whitney syndicate of New York, are do-

Flyer in Winter Garb Ready to Take Off on the Hudson Straits Ice Patrol in the Far North

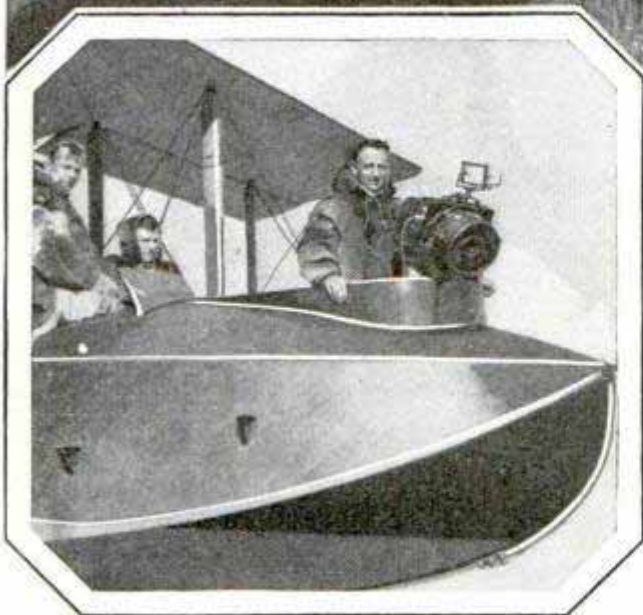

Typical Bush Country; from the Air It Looks Like Rolling Meadows. But Actually It Is Almost Impenetrable Jungle of Jack Pine, Tamarack and Birch; Below, the Modern Surveyor's Instrument Is a Camera

ing development work that will represent an investment of \$50,000,000 before much ore is taken from the ground.

In the winter of 1925-26, Lorne Howey and his brother staked their discovery claim at Red lake and started the wildest gold rush the north country has seen since Klondike days. The Red lake district lies a hundred miles or so, as a bird flies, from civilization, as represented by the little trading post, flag-stop town of Hudson, on the northern line of the Canadian National, some 240 miles east of Winnipeg, and about the same distance north of Duluth, Minn.

Leaving his brother to watch the claim, Howey trekked out to the railroad, and

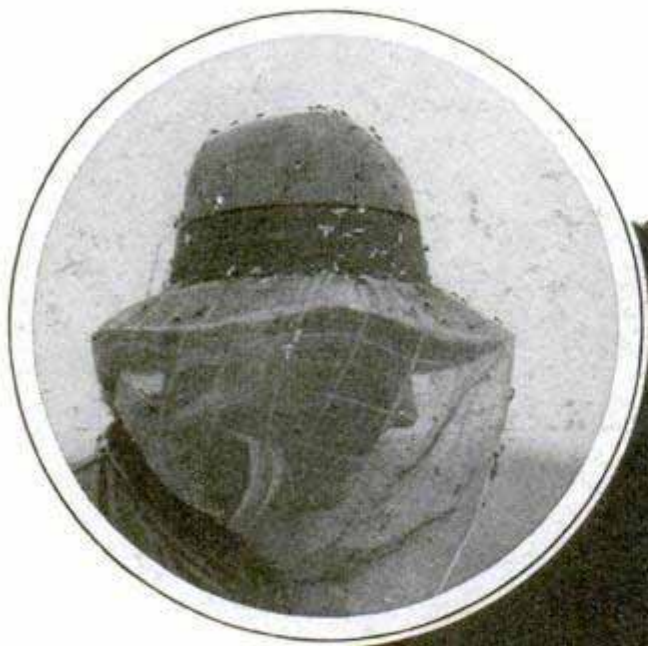

got word through to his old friend, Jack Hammell. With the fastest dog team they could procure, they started, and in twelve days of grueling going reached Red lake and, after crosscutting and trenching through the snow to check the extent of the surface showing of ore, closed the deal whereby Hammell took over the development of the claim.

News spreads fast even in the bush, and by that time prospectors were pouring in by the hundreds and the shores of Red lake were staked as far as the eye could see. They came by dog team and on snowshoes, carrying food packs on their backs, and in their wake came the first airplane. In that plane Hammell flew out to civilization in one hour over the route that had taken the fastest dog team twelve days to cover. From that day the future of flying in the north was assured.

Gold has a lure for men, and, even though it is far from being the most useful mineral resource, a gold discovery invariably brings a stampede, where the

more prosaic minerals may pass almost unnoticed. Because of that eager search for it, it is only natural, perhaps, that the value of the gold output should exceed that of any other metallic mineral—

\$39,091,472 last year out of a total value of \$131,904,603 for all the metallics, and that list ranged from arsenic, bismuth, cadmium and cobalt, down through copper, gold, iron, lead, nickel, palladium and rhodium, to platinum, silver and zinc.

The whole mining industry of Canada, from gold to grindstones, and actinolite to volcanic dust, which also has its place in commerce, represents an investment of \$700,000,000 and gives employment to 85,000



What They Wear in the Bush during Fly Season; Indian Comic Mask from One of the Canadian Tribes; Jack Hammell, Left, and "Sandy" McIntyre

men. With \$50,000,000 being spent on one modern mining plant at Flin Flon, and a total mining investment of only \$700,000,000 in all Canada, some idea is gained of the relatively small extent to which the surface has been scratched.

The lack of transportation, which has held lode-mining development to a narrow fringe along the Great Lakes and St. Lawrence, and to a fairly small portion of British Columbia, is rapidly becoming a thing of the past, and with the development of lode mines, the invested capital will grow by leaps and bounds.

The Klondike and the early mines in northern British Columbia and the adjacent Peace river country were mainly placer developments, in which free gold is found scattered through alluvial gravel. Placer gold can be extracted with an investment of a few dollars in a pick and shovel and pan; it can be washed out faster by being sluiced through wooden boxes with rows of riffles to trap the heavy



Photos Courtesy Canadian National and Canadian Pacific Railways, N. A. M. E., and Canadian Government Bureaus

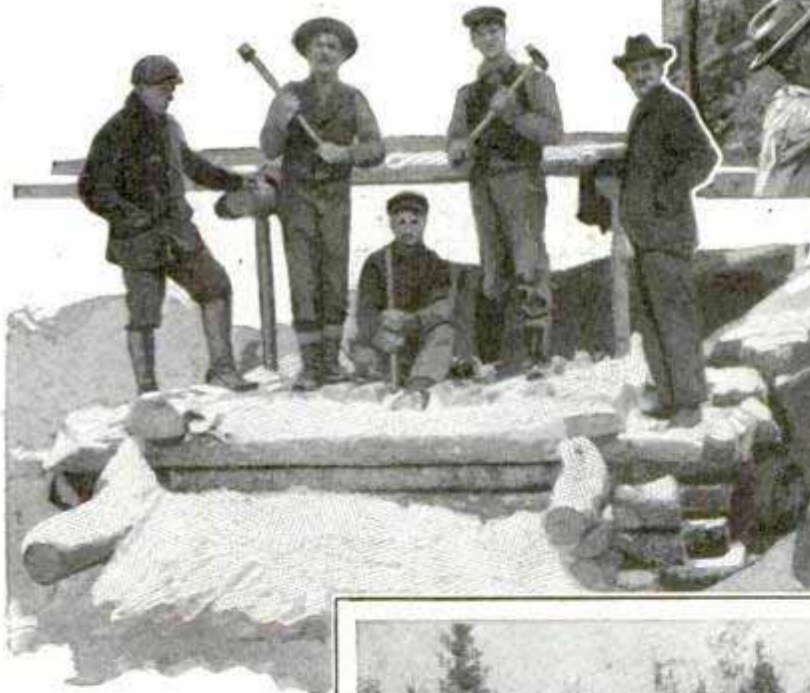

Prospectors Placing a Summer Cache in a Tree to Protect It from Bears, and, Left, Sinking a Winter Shaft

metal; whole hill-sides can be washed away and into the sluice boxes with a giant nozzle, if sufficient water power is available; or a gold dredge may be used, but, regardless of the method, the invest-



Examining Rock Specimens from a Trench Cut across the Face of a Silver Vein, at Lorrain, Northern Ontario

ment is fairly small. Compared with that, the extraction of the precious metal from hard rock requires an elaborate underground mine, with compressed-air drills, dynamite and a railway; an expensive mill to crush the rock to a fine powder, and



Summer at the Entrance to Hudson Strait, with a Plane of the Ice Patrol Coming In to Port Burwell; the Ice Does Not Leave the Cape Chidley Neighborhood until Early August, the Patrol Found

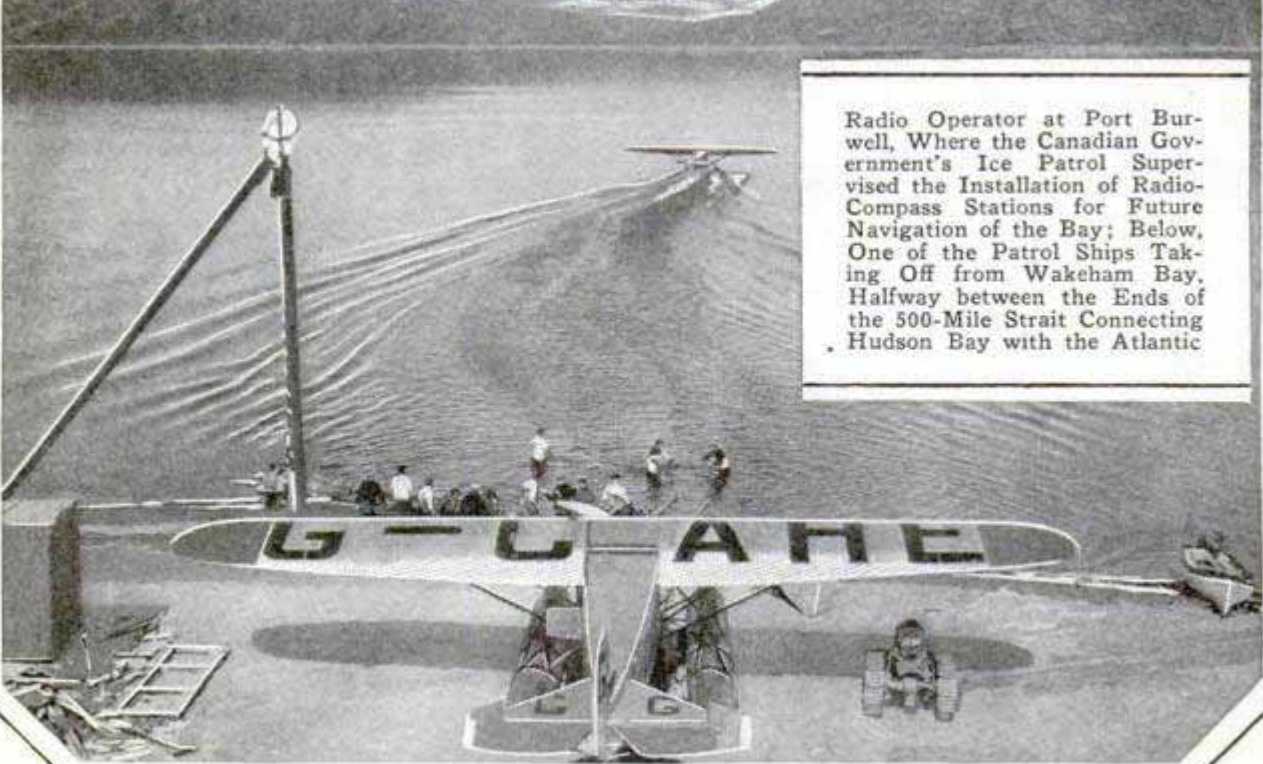

Radio Operator at Port Burwell, Where the Canadian Government's Ice Patrol Supervised the Installation of Radio-Compass Stations for Future Navigation of the Bay; Below, One of the Patrol Ships Taking Off from Wakeham Bay, Halfway between the Ends of the 500-Mile Strait Connecting Hudson Bay with the Atlantic

finally an elaborate cyanide plant to separate the metal from the rock. All that entails an immense investment, and the bulk of the machinery makes some form of heavy transportation imperative.

Consider the situation of Rottenstone lake. A million-dollar mound of \$40-a-ton ore, heaped up on the lake shore, is a fine sight to contemplate, but if there is nothing more there, that mound may remain for many years to come, for in itself it is not sufficient to warrant building transportation in to the site, and, at present, packing even forty-dollar ore all the way to the railroad and then shipping it to a smelter, probably Trail, B. C., would not be a paying venture.

But there are two hopeful things about Rottenstone. For one, the mother vein may be found, and prospectors and geologists are there as this is being written, trying to trace it down. The hunt is complicated by curiously disarranged geological conditions. The mound rises almost from the shore of the lake. Behind it is a high ridge of granite, which precludes the possibility of the vein dipping in that direction. On the opposite side of the mound it might dip out under the lake, but all the prospecting done to date seems to indicate an incline which angles away to the right in an effort to pass around the granite ridge.

The other hopeful factor is Lac La Ronge, sixty miles or so to the south. A wide vein of low-grade copper ore, three miles long and assaying \$7 to the ton, has been discovered at this lake. Its extent indicates it may warrant building a railroad from the end of steel at Paddockwood, just north of Prince Albert, for \$7 copper can be worked to advantage, if there is enough of it. With a railroad built as far as Lac La Ronge, a vein may yet be uncovered at Rottenstone to warrant the additional sixty miles of tracks.

These are some of the problems the prospector faces when he takes to the bush to hunt a mining claim.

(To Be Continued Next Month)

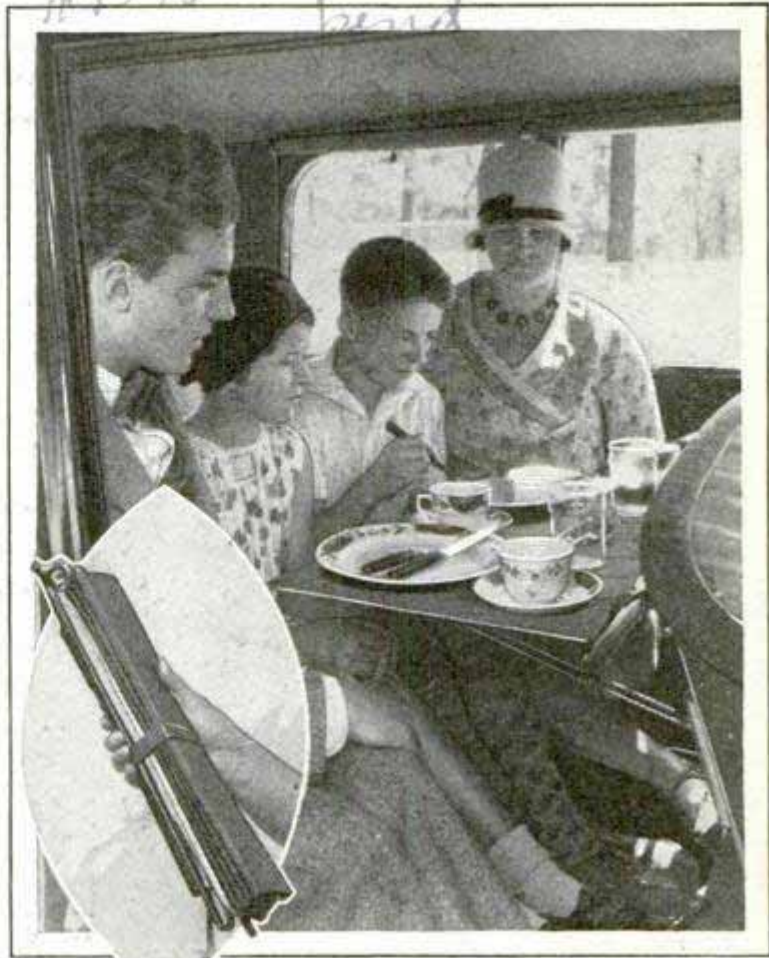

Folding Auto Table for the Tourist, Which Attaches to the Back of the Front Seat and Is without Legs

COLLAPSIBLE TABLE FOR AUTO ATTACHES TO FRONT SEAT

Added convenience for the tourist or camper is afforded by a folding auto table which attaches to the robe rail, robe cord or to special loops that fasten to the back of the front seat. The table, sixteen by twenty-eight inches in size, will carry a portable typewriter and is suitable for lunches, or for writing in the car. There are no legs, and, when collapsed, it folds into a compact bundle to be inserted into a case and is slipped under the seat.

AIRWAY LIGHTS IN U. S. COVER TEN THOUSAND MILES 0457

Airway lights in the United States now cover 10,180 miles and additional 2,085 miles are being equipped with beacons. There are 263 intermediate landing fields, 1,406 airway beacons, 164 weather-reporting stations, twenty-seven communication stations and seven radio range beacons on the country's airways.

*Charles M. ...
Director ...*

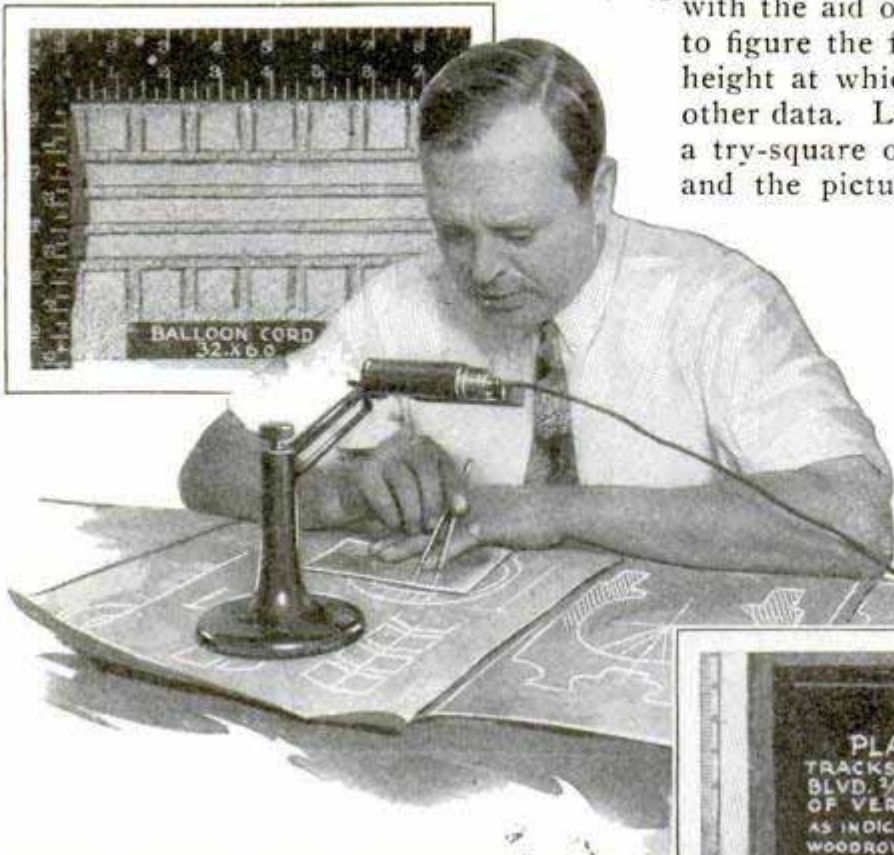

Bandit Cars Being Identified by Comparing "Finger-printed" Tire Treads with Tire Specifications

FINGERPRINT AUTO-TIRE TREAD TO CATCH CAR THIEVES

Identifying bandit automobiles by their "fingerprints," the marks left by their tires, has been undertaken by the Los Angeles sheriff's office with successful results. There are about 450 patterns of tires in existence, and methods of photographing tire treads for identification purposes heretofore had to be worked out

with the aid of a mathematician who had to figure the focal length of the lens, the height at which the camera was set, and other data. Los Angeles authorities place a try-square on the imprint of the tread, and the picture of the imprint and the square provide a means of showing the tire size, if other information is available for comparison. Such pictures reveal the size and make of the tire and the diameter of the wheel, and when compared with specifications from the tire manufac-



turers, it is often possible to tell the kind of car, the load it carried, the approximate mileage, and whether it has been used mostly for country or city driving.

"ELECTRIC SHADOW" OF PLANE IS USED FOR RADIO

"We are now passing over Gunpowder river; altitude 2,400 feet; speed, 100 miles per hour." This was just a plane radio message like thousands floating down from the air to the earth every day. Yet it opened a new epoch in radio communication between a plane flying and the ground. It marked the first utilization of the "electric shadow" of a plane and ended the costly practice of shielding and bonding airplane motors—making them electrical units—to prevent interference with ground communication from the air. C. Francis Jenkins, noted inventor, is dis-

coverer of the electric shadow, a fan-shaped non-interference field at the rear of a plane with reference to its motor's electrical high-tension wires. As explained by Mr. Jenkins: "We have discovered that an electrical shadow follows an airplane, opening out fan-wise from its body to the rear, in which there is no interference from the high-tension wires of the motor. In this shadow we tow our antenna. Here perfect reception and transmission are possible. Bonding and shielding, therefore, may be done away with." In proof of his theory, Mr. Jenkins made two flights in an unbonded and unshielded plane, and no difficulty in transmission or reception was encoun-

A. J. ...

1579 Connecticut Ave Washington D.C.

tered at any time. The antenna for the test was made fast to the top of the airplane rudder. It was reeled from the fuselage through a guide attached to the rudder. A wind cone "canvas arm sock" carried it back 125 feet. The non-interference field has been determined to extend 1,500 feet behind a plane. The shielding and bonding of an airplane motor costs over \$1,000. That cost is now eliminated, and also the danger of electric leaks.

TOOL MARKS BLIND HOLES FOR SCREWS 3561

Elaborate layout and uncertain guesswork in locating blind screw holes are eliminated by a simple combination called a thread-button set. Each "button" consists of a hardened screw, similar to a headless setscrew, with a hexagon-shaped projection on one end. The end of the hexagon is shaped into a center-punch point. In use, the buttons are screwed into the part containing the blind holes, with the marking points out. This part is then laid in position over the piece in which are to be drilled the holes for the bodies of the screws and tapped with a hammer. The points of the buttons mark the centers of the body holes. The set of buttons is held, when not in use, in a handle, which also forms the socket wrench for the purpose of placing them.

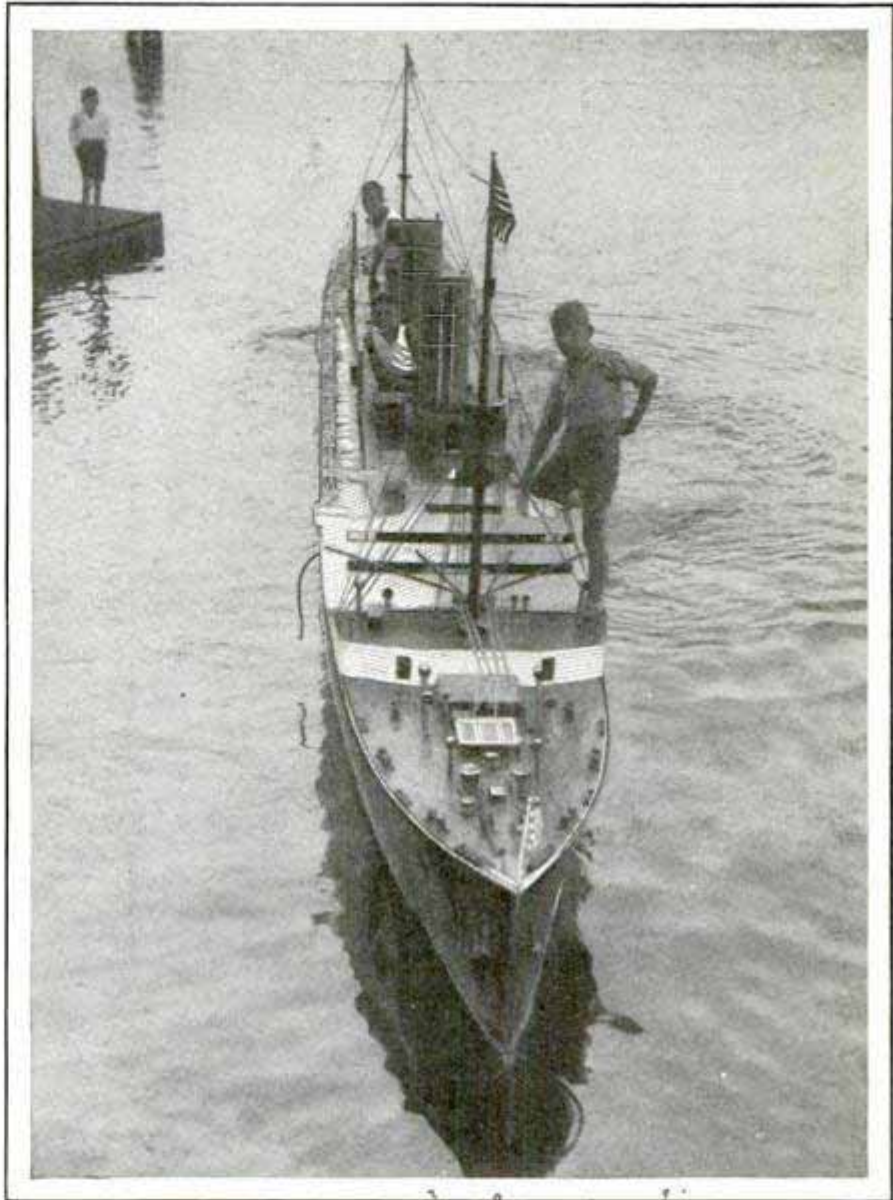
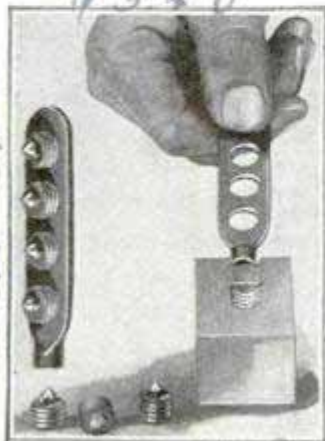

© P. & A.

This Exact Model of a Big Ocean Liner Is the Pride of a Crew of Boys in Berlin, Who Man the Trim-Looking Craft

BOY-SIZE OCEAN-LINER MODEL IS EXACT MINIATURE

Modeled along the exact lines of a big ocean liner, a miniature giant of the seas has been built in Berlin. The little ship is manned by a crew of boys.

BLUE RATS ARE LATEST 3588

If you see a blue rat, don't be alarmed. Dr. Elmer Roberts, of the University of Illinois, reports the appearance of a blue strain of rats among those kept at the laboratories for experiments. Inasmuch as this color has never before been observed in several generations of the rats, it is believed to be of evolutionary character.

Make - Shur

Natural Ma...

Dec 1915 - 415 - 21 10/3/15

FLYING SKYROCKET BLAZES WAY ACROSS THE SKY

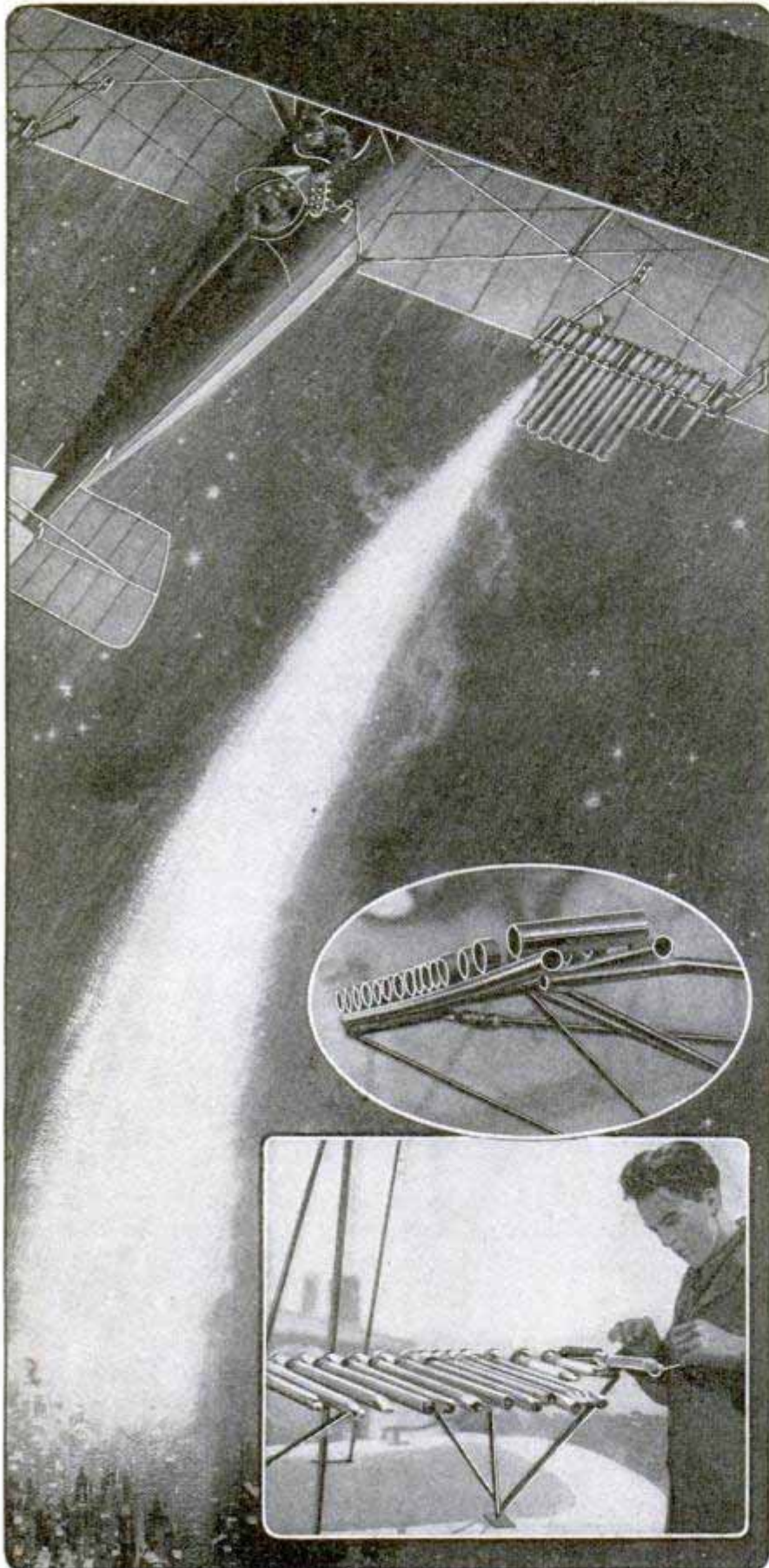

An airplane has been designed to spray fireworks across the night sky. Its operation was explained at the Stewart Aircraft company's hangar by William A. Butters and his assistant, Dale F. Dryer. The plane carries twelve "falls" and three magnesium flares on each side, in special racks that have been attached to the lower wing. Falls are like Roman candles without the balls, Pilot Butters explained, and they are set off by means of electrical contact through wiring from a six-volt storage battery. There are eight switches in all, four for each side of the plane, and they are installed where Dryer, who sits in the middle seat of the three-place ship and faces Butters in the rear cockpit, can easily reach them to set off the fireworks. Butters keeps his eyes from the brilliant display or he would be temporarily blinded and handicapped in maneuvering the plane, which is put through loops, spins and other stunts. From his position, Dryer is able to tell at once when a piece has been burned up. Pressing another switch sends the current that sets off the next flare or fall. During the exhibition, a wind-driven siren, which can be shut off or turned on at will, attracts the attention of all those of the crowd who at first are not aware of the presence of the spectacular "comet on wings."

Artist's Drawing of the Fireworks Plane in Flight, and Insets Giving Close Views of the Rack and the Falls Being Inserted; Man Facing the Pilot Fires the Flares by Pressing Electric Buttons

3563

221. "Invariable Bridge"

See next page



The Towers at Each Side of the Royal Gorge, on Which Will Rest the Highest Suspension Bridge in the World; It Will Be 1,052 Feet above the Arkansas River

HIGHEST BRIDGE IN THE WORLD TO SPAN ROYAL GORGE

With an altitude of 1,052 feet, the bridge now being constructed over the top of the Royal Gorge, near Canon City, Colo., will be the highest suspension bridge in the world, reaching more than twice the height of its nearest rival, which is in southern France. The length of the main span of the Grand Canon bridge will be 880 feet, and the total length 1,260 feet. From its eighteen-foot roadway may be seen the waters of the Arkansas river far below, and tracks of one of the western railroads. Steel towers on each side of the gorge rise 150 feet, and two cables, each nine inches in diameter, will have a strength of 120,000 pounds per square inch. Some idea of its height can be

gained by the fact that two Washington monuments could be placed end on end under the structure, yet not reach the bridge.

ALINEMENT OF AUTO'S WHEELS SHOWN ON DIAL

Checking faulty alinement of automobile wheels is made easy with an indicator being installed in service stations. The customer is enabled to check his own wheels by driving onto a platform resembling a scale, and glancing at a dial, the hand of which indicates the number of feet side slip due to wheels being in or out. Attention is called to excessive misalinement by a bell. The front wheels are tested first, and then the rear wheels are run onto the platform.

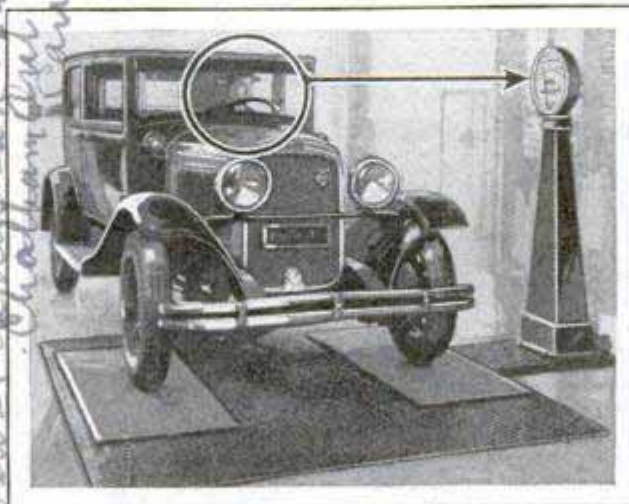

Faulty Alinement of Auto Wheels Is Shown by Driving on the Platform and Reading the Dial

Chicago. Wheel & Logani's 69th St. 2050-A & 69th St.

Weaver Mfg. Co.

"BLIND" PILOT PAVES WAY TO CONQUEST OF FOG

*directional indicator
artificial horizon
407 Doolittle Ave
Brooklyn, N.Y.*

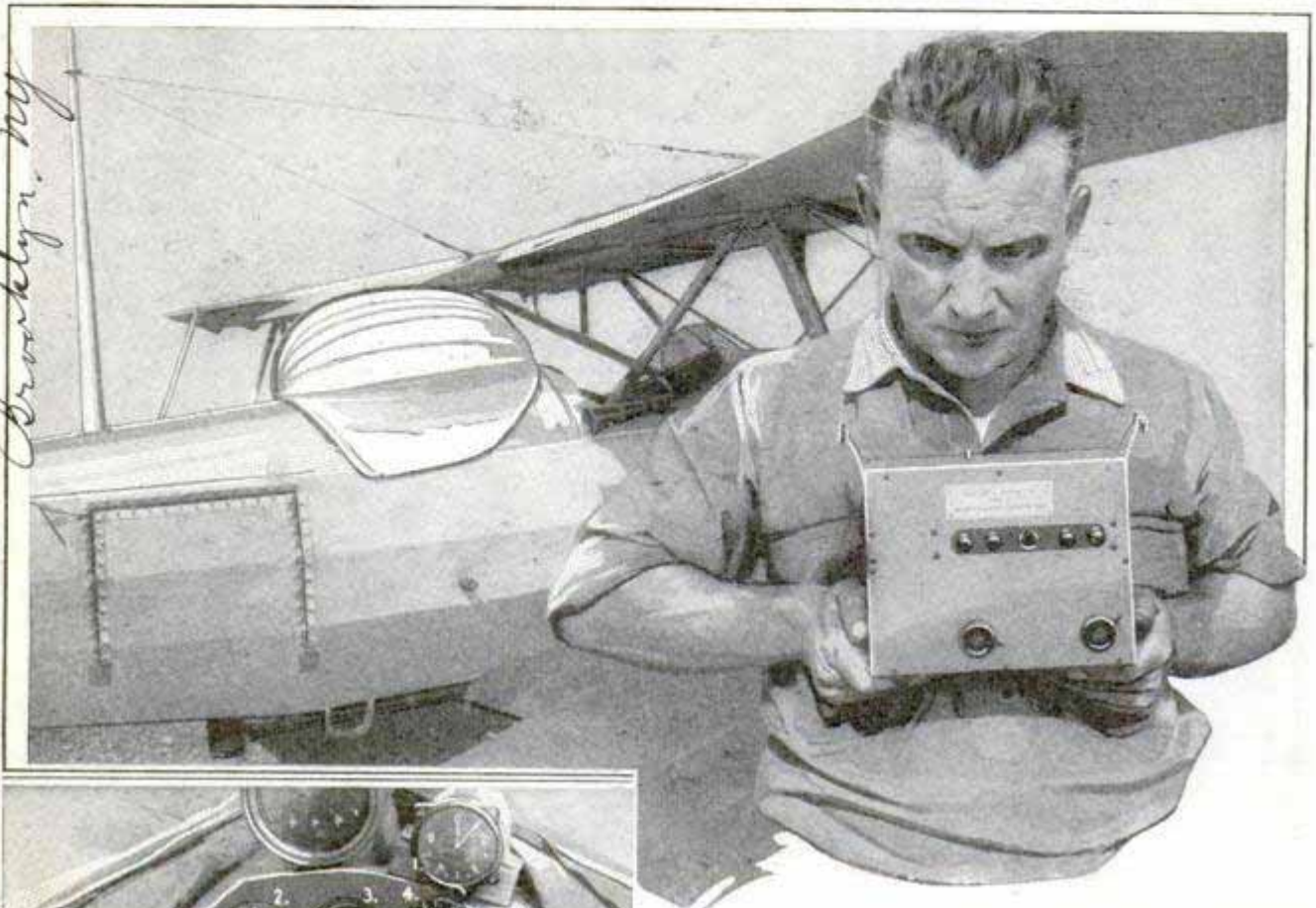

The Covered Cockpit in Which a Pilot Made a "Blind" Flight, and Instruments Which Guided Him

Foreshadowing the time when fog, man's greatest enemy in the air, will be defeated, Lieut. James H. Doolittle, army flyer, recently took off, flew over a fifteen-mile course, and landed a plane without once seeing outside the cockpit. The "blind" flight, sponsored by the Daniel Guggenheim Fund for the Promotion of Aeronautics, marked the first instance in which a pilot negotiated a complete flight from take-off to landing by relying on nothing but the instrument board in front of him. An emergency pilot was ready to take over the dual controls at any time the flyer in the shrouded cabin encountered difficulties, but his services were not required. The instruments by which Lieut.

tenant Doolittle was able to perform the feat comprised only three beyond those used in everyday flying. These were a barometric height indicator registering in ten-foot units instead of 100 feet, a gyroscopic direction indicator and a special artificial horizon which at all times shows the plane's position with relation to the ground. The two latter instruments enabled the blind pilot to make a perfect turn, a landing, or any maneuver normally accomplished in daylight. A radio receiver of the vibrating-reed type kept the pilot on a definite course, the right or left reed vibrating excessively as he deviated. The radio was capable of two-way communication, and the pilot sent messages to the radio-beacon station on the ground during his flight. While still in the experimental stage, it is hoped that the instruments will form the basis for making flights of the future independent of weather or visibility conditions.

☐ There are deposits of coal in the antarctic regions.

**HOLE IS BORED TO CANADA
 FOR MOTOR CARS**

Boring under the Detroit river to link Detroit and Windsor, Ont., by a tunnel which will accommodate 2,000 automobiles an hour is being accomplished without disturbing traffic in the streets or jeopardizing adjacent buildings. An army of workmen is pushing its way through the ground behind the protection of a gigantic steel shield. The shield is a circular steel face pressing against the clay that is to be dug away. Behind it the men, known as "sandhogs," dig through slots in the shield until enough earth has been removed to allow hydraulic jacks to push it forward eight inches. To protect the workers against cave-ins, the inside of the tube is steel-lined as it moves forward, this being done by a circular arm which swings inside the shield, carrying a steel band that is clamped in place and welded much like a barrel hoop. The underwater section of the tunnel is formed by steel tubes, weighing 4,000 tons each, sunk and concreted together.

**FILLING STATION FOR PLANES
 AT LONDON AERODROME**

British aviators using the Hanworth aerodrome, near London, may fill up their gasoline tanks in the same manner as the motorist. The field is equipped with filling stations, a line on an extension running from the pump by an overhead support to the plane. The airport caters to private owners and gives them instruction in flying their ships.

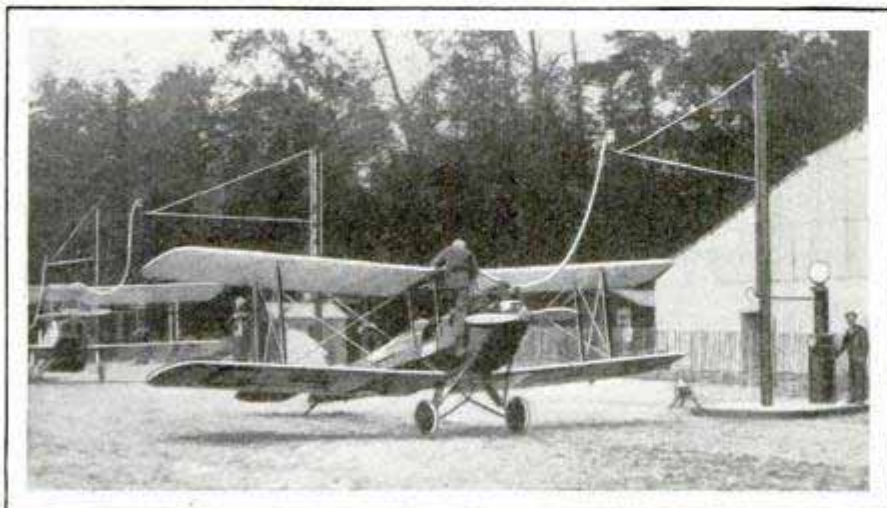

A British Airport Equipped with Stations Where the Aviator May Fill His Tanks Just as the Motorist Does

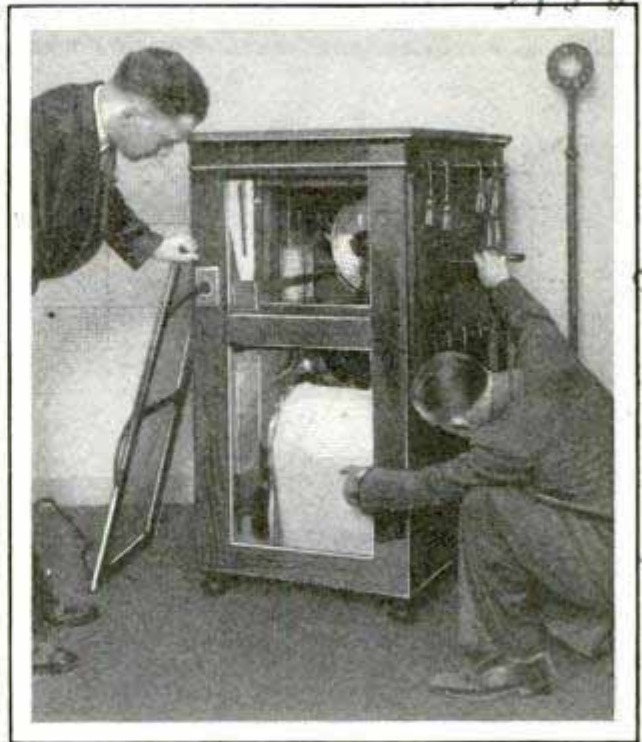

This Cabinet Contains Apparatus for Imitating a Score of Sounds in Radio Broadcasting

**QUEER RADIO SOUND EFFECTS
 ARE MADE TO ORDER**

Noise makers and amplifiers capable of producing twenty different sound effects frequently used in radio broadcasting are contained in a single cabinet employed in some radio studios. The apparatus resembles an ordinary radio cabinet, except that, along one side, are push buttons, cords, cranks and levers. Inside are dry cells operating electric bells, a hollow cylinder filled with sand, an electric fan, a large horn and several other sound-producing instruments. Among the effects are bells of every type from the ringing of the telephone to the gong at the prize fight, a vast miscellany of whistles, from fog horns to locomotives, the roar of a locomotive, the whir of an aeroplane, and the sounds made by automobiles and galloping horses. Dog barks, the roar of the lion and the sounds of falling water and beating surf also are imitated.

☐ The average life of a passenger automobile is seven years.

Handwritten notes:
 Dingham, N.Y.
 Sound of...

Handwritten notes:
 made up, 1/27.

3190

The Detective of the

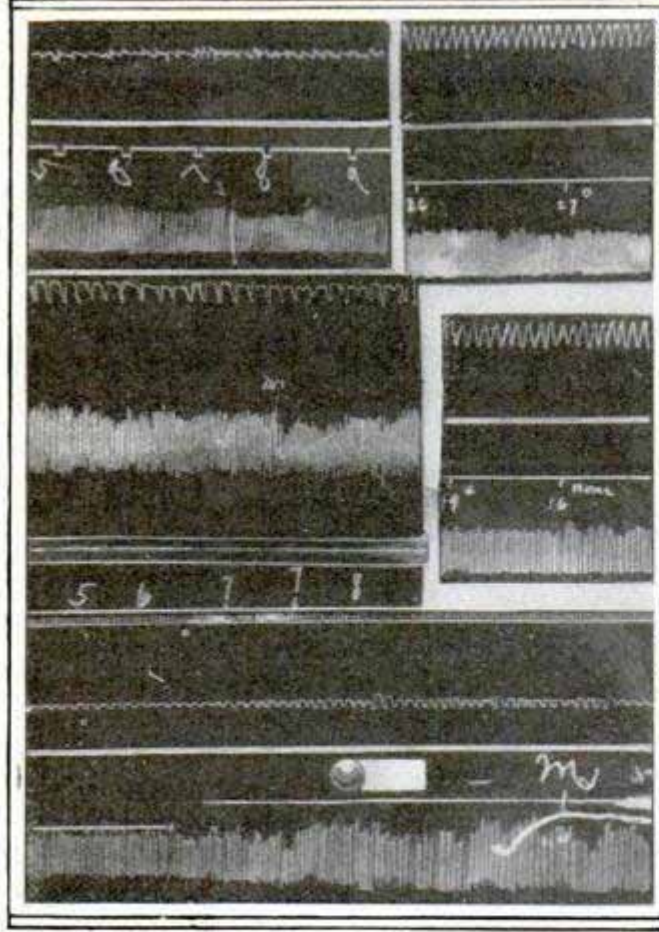
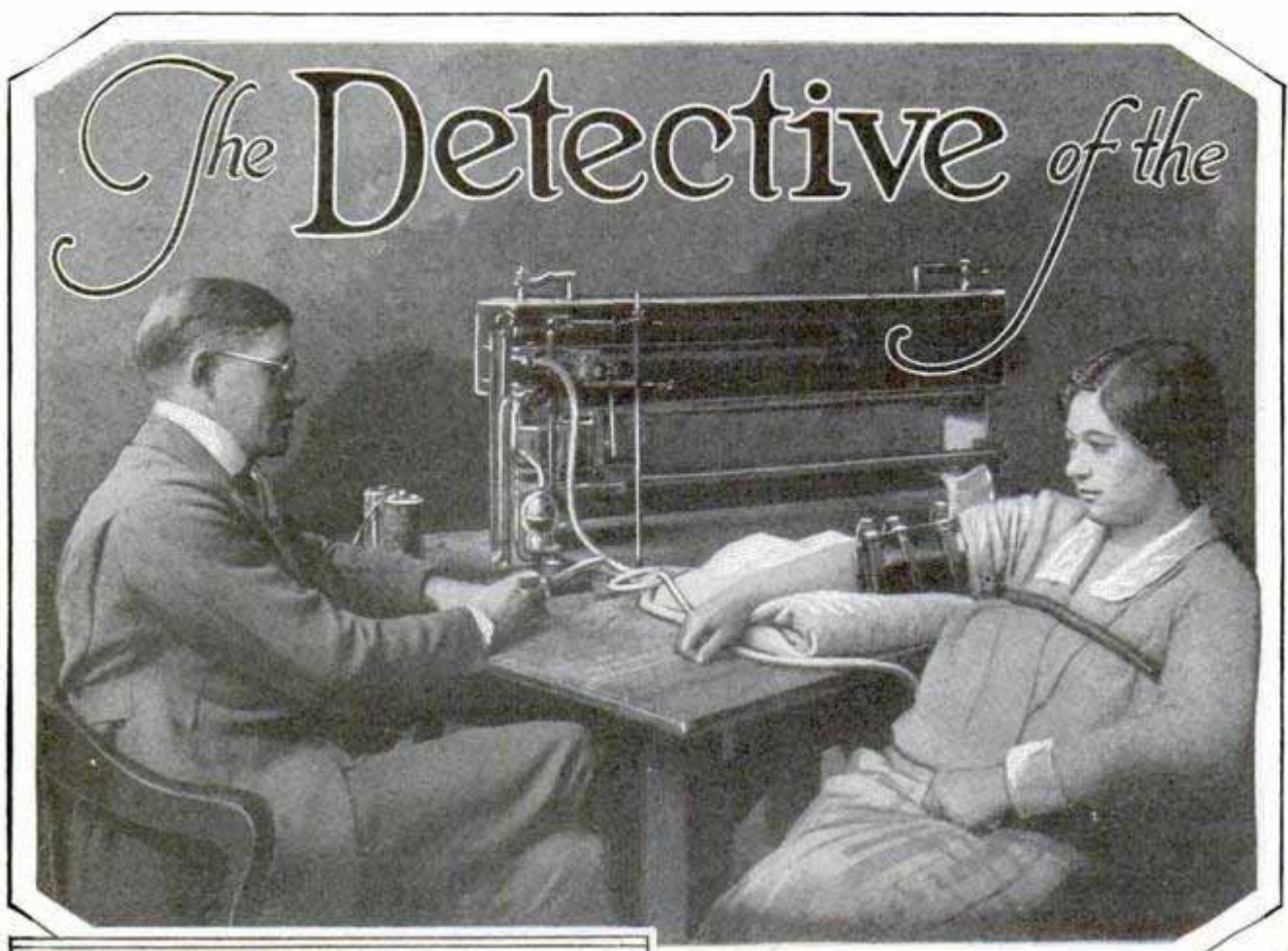

Dr. John A. Larsen Using the "Lie Detector," and Reproduction of Some of the Instrument's Records of a Subject's Emotional Reactions

By H. H. DUNN *Calif*
4351 Georgia St San Diego
"CIVILIZATION of the future must look to science for its protection from crime."

August Vollmer speaking, at his desk in Berkeley, Calif., where he has created and established what is said to be the only "scientific police force" in the world, with such success that crime has been prevented, acts against life and property checked, and young boys and girls of wayward bent turned back to lives of honesty. This fall, Chief Vollmer became head of the department of police science in the first college of criminology in the world, just established by the University of Chicago. Six months of each year he will direct this department and the other half year he will be found in headquarters at Berkeley.

"The policeman of the future, whether patrolman or detective, will be a trained scientist," continued the chief. "If we are to stem the current of crime, we must do it by scientific methods, and this is what the University of Chicago aims to accomplish."

Future

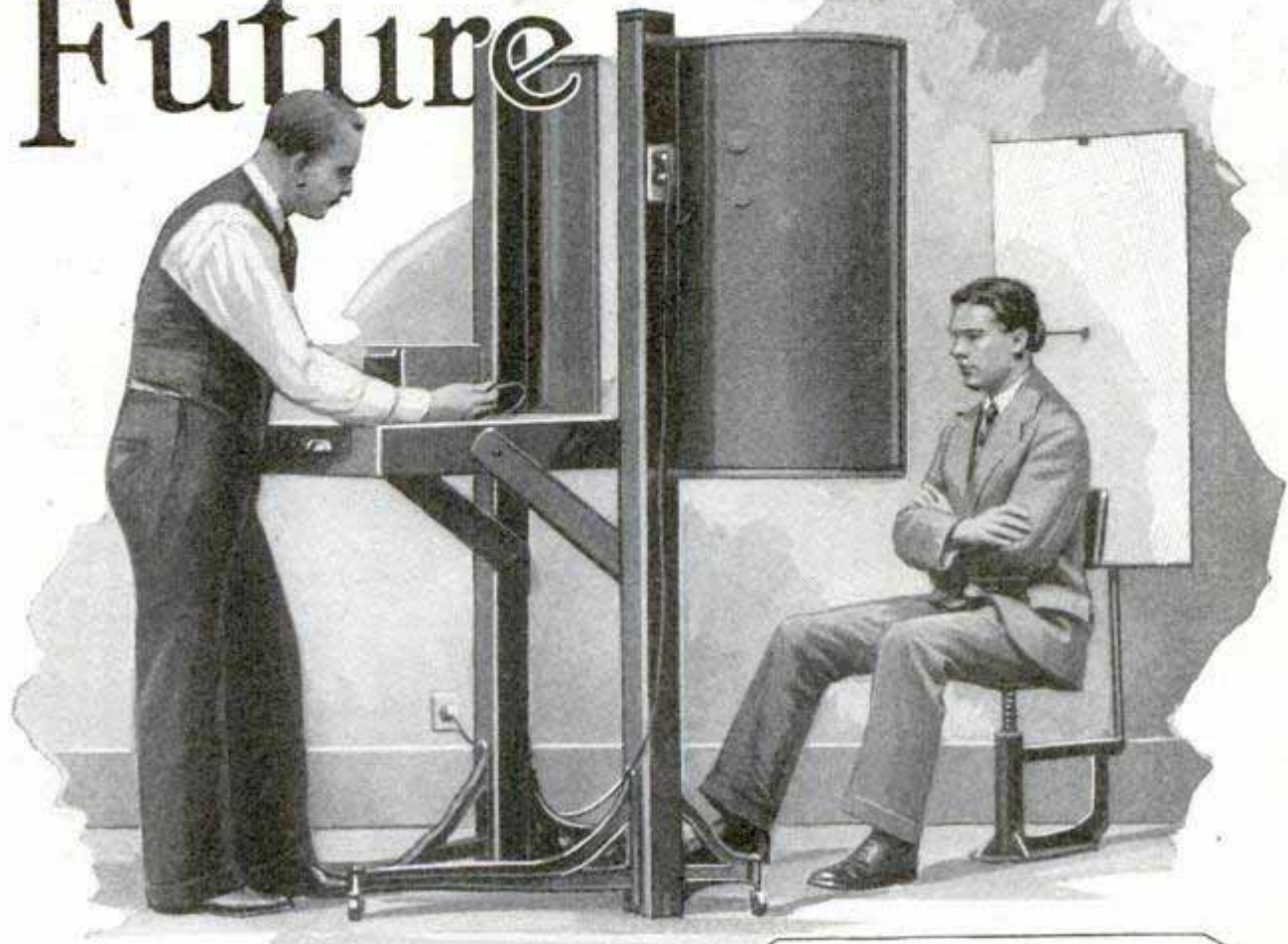

"We are turning to the study of the mechanics of crime and the mentality of criminals for the control and correction of the anti-social individual. The collection and co-ordination of statistics will form the basis of this work."

While Chief Vollmer looks to prevention as the ultimate remedy for crime in the abstract, he realizes that, under present conditions, the immediate necessity is an understanding of the mechanics of crime—how the criminal does his work and how each criminal worker may be found, identified, convicted, and his further operations checked. For this, he turns to the laboratory and the technical workshop, as he turned with his force of policemen in the city of approximately 100,000 inhabitants, where he is at the head of the department.

"The University of Chicago plans to set up the preliminary machinery for the placing on a scientific basis of the detection and prevention of crime," the chief continued. "There, men will be prepared with scientific training to be professional



Improved Apparatus for Taking Identification Photographs, and Coroner Herman N. Bundesen Seeking Bullet Clues in Stump



“From the experiences of hundreds of police departments all over the world, we shall be able to deduce laws for the distribution of the police force in any city—a most important factor in the prevention of crime. From microscopic, photographic and laboratory work on dust, hair, finger nails, fibers, foods, tobacco and drugs, will come improved methods of identification. In the future, we shall have patrolmen capable of going into the laboratory and making their own tests, with perfect assurance that they will obtain correct results.

“By means of the lie detector, devised by Dr. John A. Larsen, simple and easily applied deception tests will be developed, and undoubtedly also other means discov-

police officials. Mentally, physically and morally, they will be educated as officers of the police ‘army’ of American cities, just as men are trained at West Point and Annapolis to lead our fighting forces in time of war. At first, there will be offered a course in police organization and administration; then will come a department of police science, and eventually a college of criminology—though it may not bear exactly this title. To science alone may we look for the laws which govern crime. For instance, we know that back of every so-called ‘crime-wave,’ there is a reason; what that reason is we do not know, but after long comparison of correct statistics on employment, housing, living costs, wages, and many other factors, we will be able to deduce a law which will tell us not only why a series of crimes has been committed in any given community, but approximately when another such series is most likely to occur.

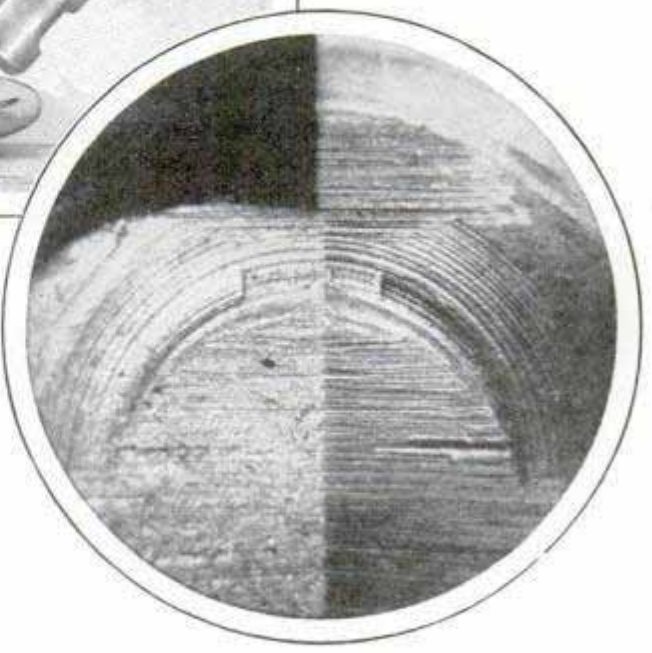
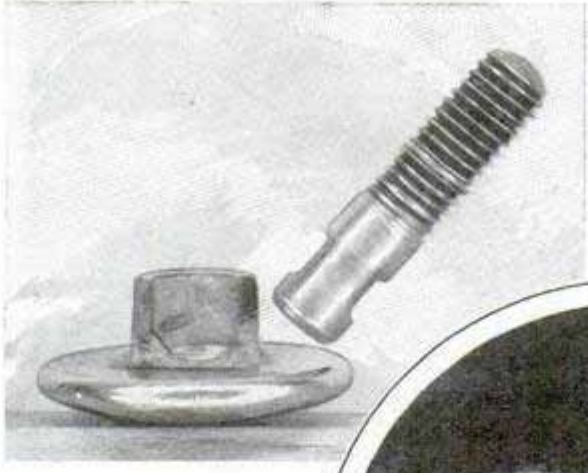
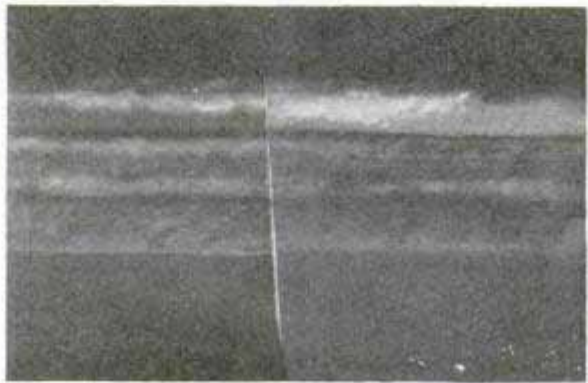

Inspector Charles P. Carmody, of Detroit, with Murderer's Palm Print; and Paint and Bolt Clues in an Auto Death

ered whereby criminals may be made to reveal themselves and their activities. The identification of criminals is in its infancy as a science, but it is a field in which accurate, unsentimental, mechanical equipment will play an ever-increasing part. The study of weapons and implements used in crimes against life and property forms another avenue leading to identification, a highway on which we have only recently entered.

"It is probable that racial characteristics, as well as individual identity, are revealed by fingerprints. We are beginning to believe that there is hereditary transmission of fingerprints, to such an extent, at least, that lines of descent may be traced. Careful comparison and technical study of these marks alone will establish the laws which govern them, and only in research institutions, where all scientific equipment is available, can such studies be made.

"With the microscope and the camera united for micro-photography, handwriting identification and classification—somewhat similar to the much-needed single-fingerprint classification and co-ordination—will be established. Undoubtedly, back of all handwriting there are certain laws, about which as yet we know little or nothing. Only by mechanical means, possibly by the use of instruments not yet devised, will we be able to learn these laws.

"The vast field of 'methods' of criminals—considered so important that California has established a state bureau for the collection and preservation of its records—is the province of the mechanic. When we have in our files the record telling exactly how every known criminal operates, we shall be able to trace every crime immediately to the person who committed it. It is well known that every safe blower, for example, has his own method of opening strong boxes, differing in some



Mrs. Millicent Cooper, of Lewistown, Mont., an Expert in the Identification and Classification of Fingerprints

constant detail from that of every other safe blower. Virtually every crime against property bears in itself an identification of the criminal. To a slightly less extent, every murder for gain, that is to say, every killing in a holdup, robbery, or burglary, also carries the trade-mark of the killer.

"The automobile has brought to crime a tremendous aid. Traffic regulation is by no means the only automotive problem with which the police have to deal, though this will be studied and taught. Closer checking of purchases, titles, ownership and operation of all forms of automotive vehicles must be made. Probably we shall arrive at the point where the known criminal will be forbidden to own or drive an automobile, so that when found driving, he may be 'picked up.' Without doubt, many crimes could be forestalled by such a legal weapon in the hands of policemen, particularly traffic officers and highway patrolmen.

"What we really need, however, is a systematic nation-wide method for the prevention of crime in its early stages, in place of the often futile attempts to reform criminals after they are well started on their devious careers. Our police school for wayward boys, conducted by Frank

Waterbury, of the Berkeley police department, has been highly successful, and could be applied to any city in this country. The woman in crime presents an increasingly serious problem to every police department. More clever and less easily trapped than man, it is almost imperative that her activities be checked while she is in the adolescent stage. Scientific analysis of the 'underminded girl' from which class is drawn the greater part of the women in crime, will reduce that problem."

Beyond the prevention and detection of crime, however, the University of Chicago is preparing to develop an advisory bureau of police activities for the aid of every American municipality. While the university trains men for the position of police executive, this bureau will take up the crime problem of any city and help that community's police itself to solve the crook question. The primary purpose of the university in taking August Vollmer to its new college, is to organize police work and put it on a business basis, so that, eventually, every American city will have a scientific police force, and will

co-operate with every other city in the prevention of crime and the elimination of the criminal, rather than, as now, merely in the suppression of his activities.

"The plan in a nutshell," said the chief, "is to put the police in the same position in the fight on crime as the physicians of America occupy in their constant battle against disease. Realizing that only by the aid of the mental and physical sciences can we hope to protect society from the crook, we are approaching the problem with open minds. The men at the head of this college of criminology must first

establish definite principles—battle plans of crime—and these can be obtained only through long study and comparison of data on criminal activities from every community in this country. Hence, the new police-science institution will be, first of all, a huge research laboratory, mental and mechanical, and, second, a school for the training of men who will be able, from the information obtained in the laboratory, to carry on the campaign against the 'disease' of crime.

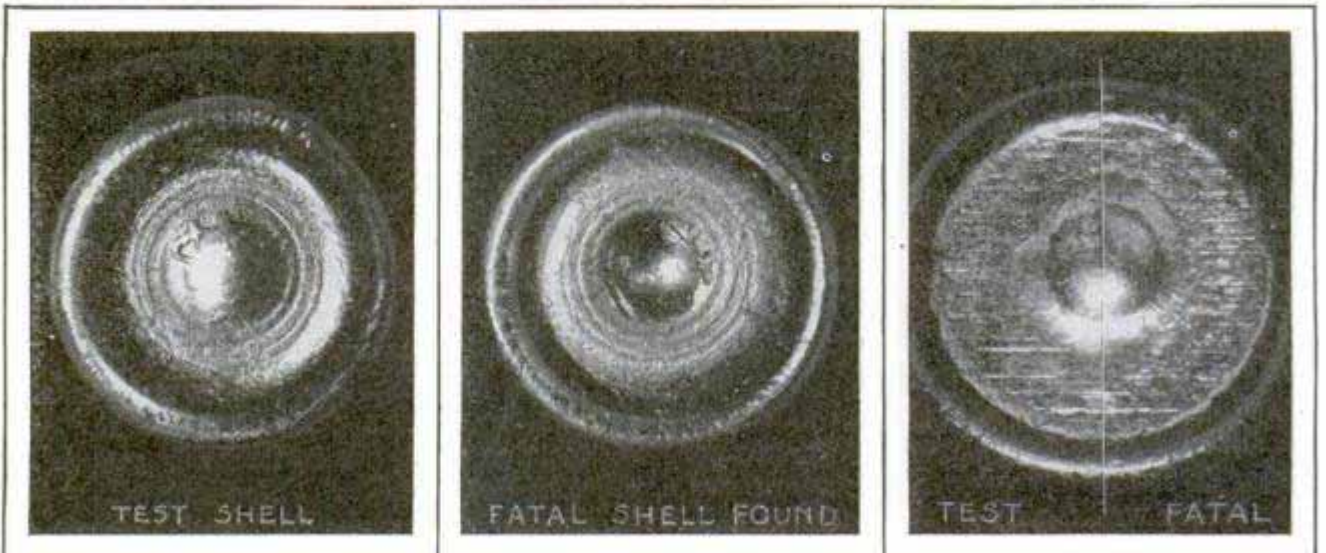

Above, Two Shells Fired from Same Pistol to Show Identical Markings, and, Below, Test and Fatal Shells in Detroit Holdup Case; They Led to the Murderer's Confession

"Apparently there is a direct relation between the number of automobile registrations and the number of robberies of all kinds in every city. There seems to be a relativity between the comparative employment of women and men in a community, and the number of crimes committed there. It is suggested that there is a traceable relationship between the prosperity of a city and the number of crimes against property. But at present we do not know the laws governing these relationships. That there are such laws, there can be little doubt, and when we know them, we shall know not only with what kind of crimes but what sort of criminals we shall have to deal in every community. Moreover—and this is equally important—we shall know approximately when, in the future, we shall be confronted with a series of crook activities."

TRI-CORNERED CHUTE REDUCES LANDING SHOCKS

Slower landing speed with resulting decrease in the shock and improved maneuverability are features claimed for a triangular parachute developed by Maj. E. L. Hoffman and tested with satisfactory results at Wright field, the Cleveland airport, and other places. The principle of operation remains practically unchanged as to the method of opening and other details, but instead of being round, the new parachute has two rounded corners, while the third is straight. There are no shroud lines across this square corner, which thus forms a tail-like vent through which the air can escape, enabling the canopy to be propelled horizontally at varying speeds according to wind conditions and the action of the jumper. The chute is also said to swing but little, the pilot parachute has no springs and, when folded up, it is said to be more comfortable to wear.

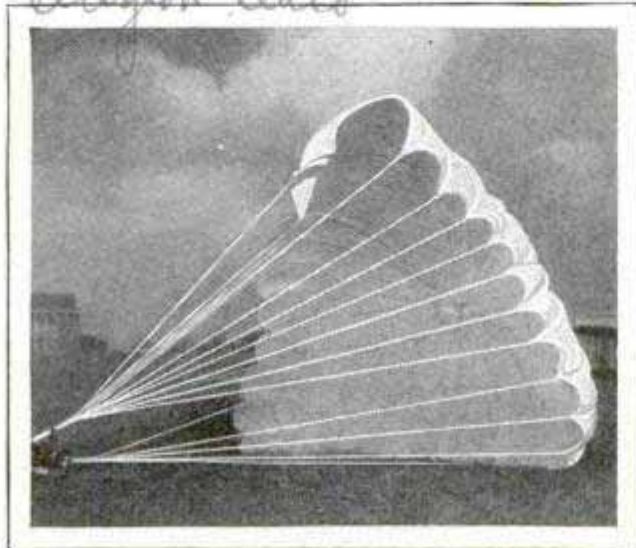

A Tri-Cornered Parachute Which Is Able to Land at a Lower Speed Than the Round Ones

GUN THAT PATCHES SUBMARINE ALSO AIDS IN RESCUES



A "Fixer" Which Plugs a Hole in a Submarine as Easily as an Inner Tube Is Patched

Holes in sunken submarines can be repaired about as quickly as a patch is placed on an inner tube, according to reports, with a submarine "fixer" recently introduced and tested at the navy yards. It weighs fifteen pounds, is about two feet long, and, working on the principle of high explosives, although it is said to make no loud noise and is safe to use, drives steel pins through the steel of the submarine so that a patch can be tacked on in a short time. Navy experts point out that the device can be used in different ways. In case men are trapped inside the hull, hollow pins could be driven through the hull so that liquid foods could be given to the prisoners or signals could be exchanged. The fixer is easy to use. It shoots a steel pin three and one-half inches long and half an inch in diameter through the five-eighths-inch side of a sub.

no further information

37 57 and pro... Temple, Senior engineer

*see May 1932. 795
Pray Person. Temple Velocity
to help Co. 120... Newford
Cm. James H. Miller Dayton Terrace
304 W. Washington St*

Saylor Ohio

3480 THESE TUBES DO WORK OF THREE HUNDRED BOYS

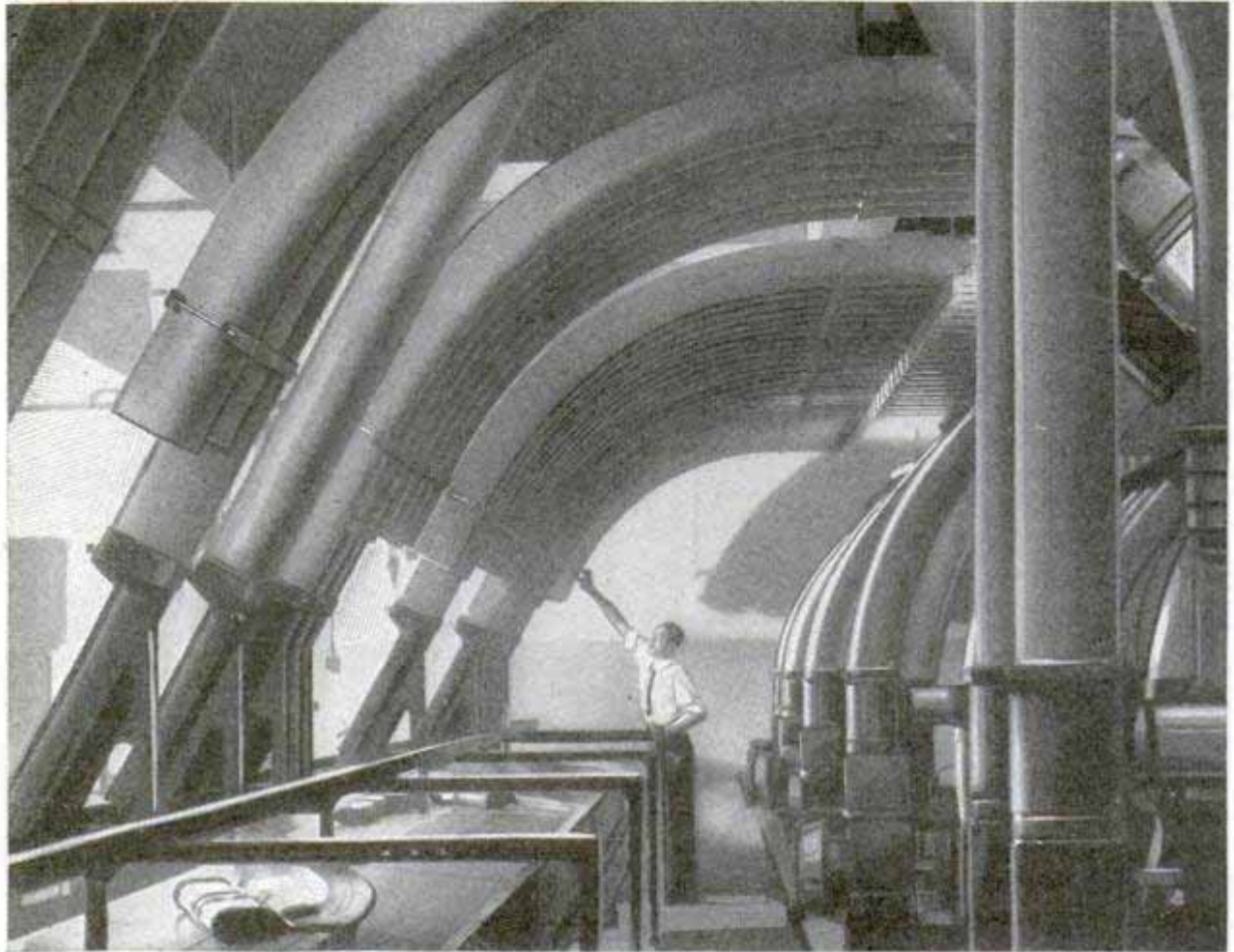

Pneumatic Tubes in a New York Office Building Which Handle over 20,000 Messages Daily, a Task That Would Require the Full Time of More Than 300 Messenger Boys

Pneumatic tubes are being employed to do the work of messenger boys, particularly in large office buildings. The New York Life Insurance building, in New York, is equipped with pneumatic tubes which shoot the leather carriers containing the messages up seventeen floors in seven seconds. Thirty-six operators are required to man the tubes, which deliver more than 20,000 messages daily between various departments, a task that would require the employment of 300 messenger boys. The tubes go to the basement, where all messages are rerouted and sent on their way in other tubes. Telegraph companies have pneumatic tubes, extending over many miles, connecting their branch offices in some of the larger cities, and newspapers are in communication with press-association offices in like manner, the news of the day flashing into the newspaper offices after traveling under

the streets in the pneumatic carriers, often at a speed of fifty miles per hour. Some of the underground tubes used by telegraph companies have been operating efficiently for more than fifty years.

473 PROFIT IN TIN CANS

Salvaging millions of tin cans around western mining camps has been found a profitable business. The process recovers both the tin and the steel, an average of three tons of tin being recovered weekly and molded into ingots to be used for making new cans. The labels are removed by a mangling and shredding machine, the tins are crushed and put through an incinerator, and then go into a chute of churning water from which they pass to a vat of caustic solution which separates the tin from the steel. The steel then is pressed into compact form for shipping.

Metals Recovery Co.
1857 E. 25th St. S. Minn.

ICE WELL IS GOOD REFRIGERATOR FOR DAIRY

Ice wells for cooling and storing milk and cream on the dairy farm where the usual methods are too expensive or impracticable, have been tested with satisfactory results by the North Dakota Agricultural college. The ice well consists primarily of a pit in the ground in which a large solid cake of ice is formed by running a small quantity of water into the hole daily during freezing weather. The spot selected should be well drained and near both well and milk house. The experimental well was eight feet square and nine and one-half feet deep with boarded sides and gravel bottom, a small house being erected over it. During the winter months a solid cake of ice, eight feet square and six and one-half feet deep, was frozen. Storage was started in May and fifty-eight cubic feet of ice still was left in September.

SHELF BRACKET FOR RADIATOR GIVES EXTRA TABLE SPACE

Radiator shelf brackets now are on the market to make available the heretofore waste space on top of radiators. One bracket serves a radiator of three or four sections, and two care for that of ordinary width. The brackets are attached by wing-nuts, and may be extended or contracted to the width of the radiator. They may be used to transform radiators into tables for various purposes, window seats or book shelves.

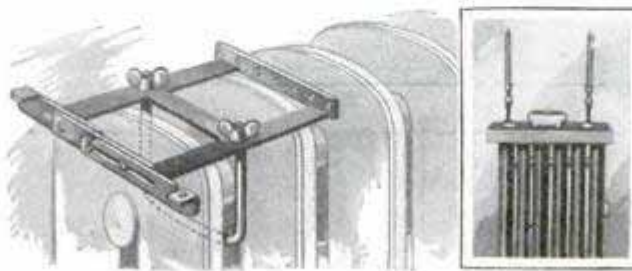

Shelf Brackets for the Radiator Which Transform It into a Table or Window Seat



Sound Waves from a Siren aboard This Airplane Operated to Turn on Searchlights on the Landing Field 2,000 Feet Below

LIGHTS TURNED ON BY SIREN ON SPEEDING PLANE

Operation of sound-control apparatus, which enables aviators to turn on the lights of air ports while high over landing fields, has been successfully demonstrated by engineers of the Westinghouse Electric and Manufacturing company. In the tests, a big horn, resembling those used on old-fashioned radio loud speakers, carried the sound from the siren, 2,000 feet above the earth, to the delicate control apparatus. This apparatus clicked softly, and immediately the huge searchlights blazed forth, throwing beams of light that could be seen for miles. Since only one tone operates the control apparatus, all other noises have no effect.

Chicago & Co. Edwards, 1617 Thorne Ave

2347

22. 7. 1900. ...
to ...

Strange Adventures in

By HAROLD T. WILKINS

AROUND the walls of a room known as the "Graveyard" in the Royal Exchange, the home of the famous shipping corporation of Lloyd's, London, are many hundreds of green-backed volumes telling strange tales of adventures at sea.

The records range back for more than a century, yet, even in these scientific days of transatlantic radio telephones from ship to shore, direction finders and echo-sounding devices against the perils of fog and

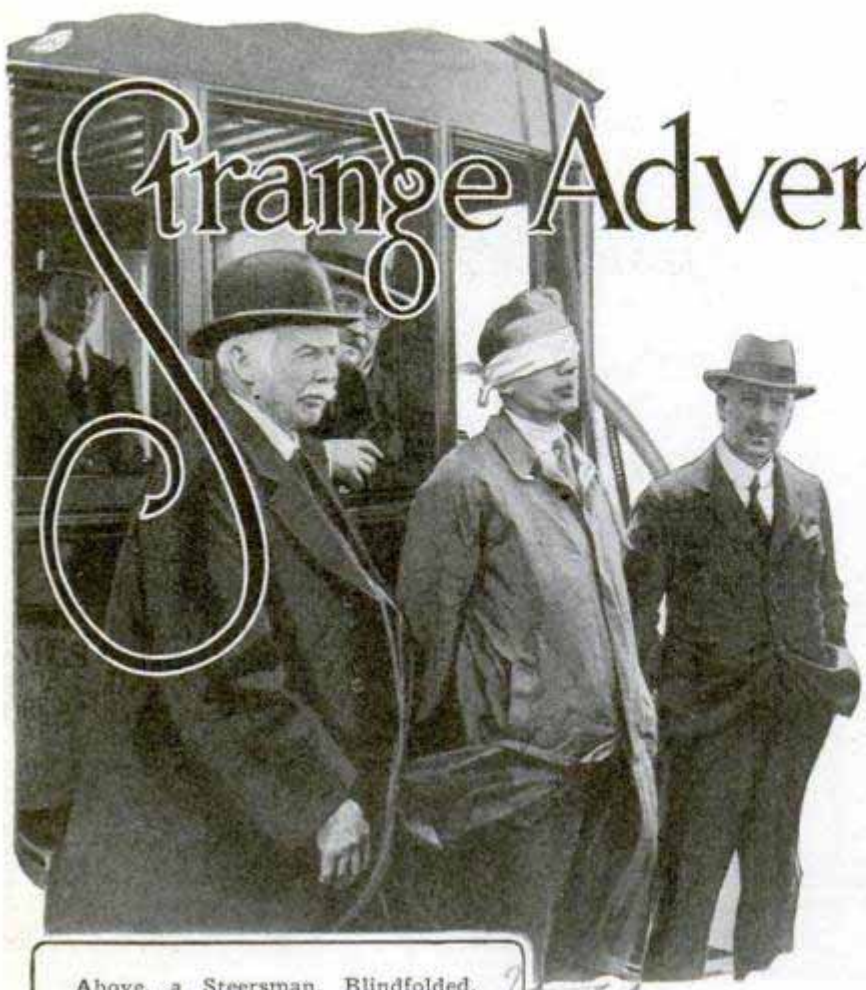

Above, a Steersman, Blindfolded, Guiding a Steam Tug into Port by Listening to Sounds of Diaphones near the Harbor Entrance; This Device Aids Boats in Entering and Leaving Ports during Foggy Weather

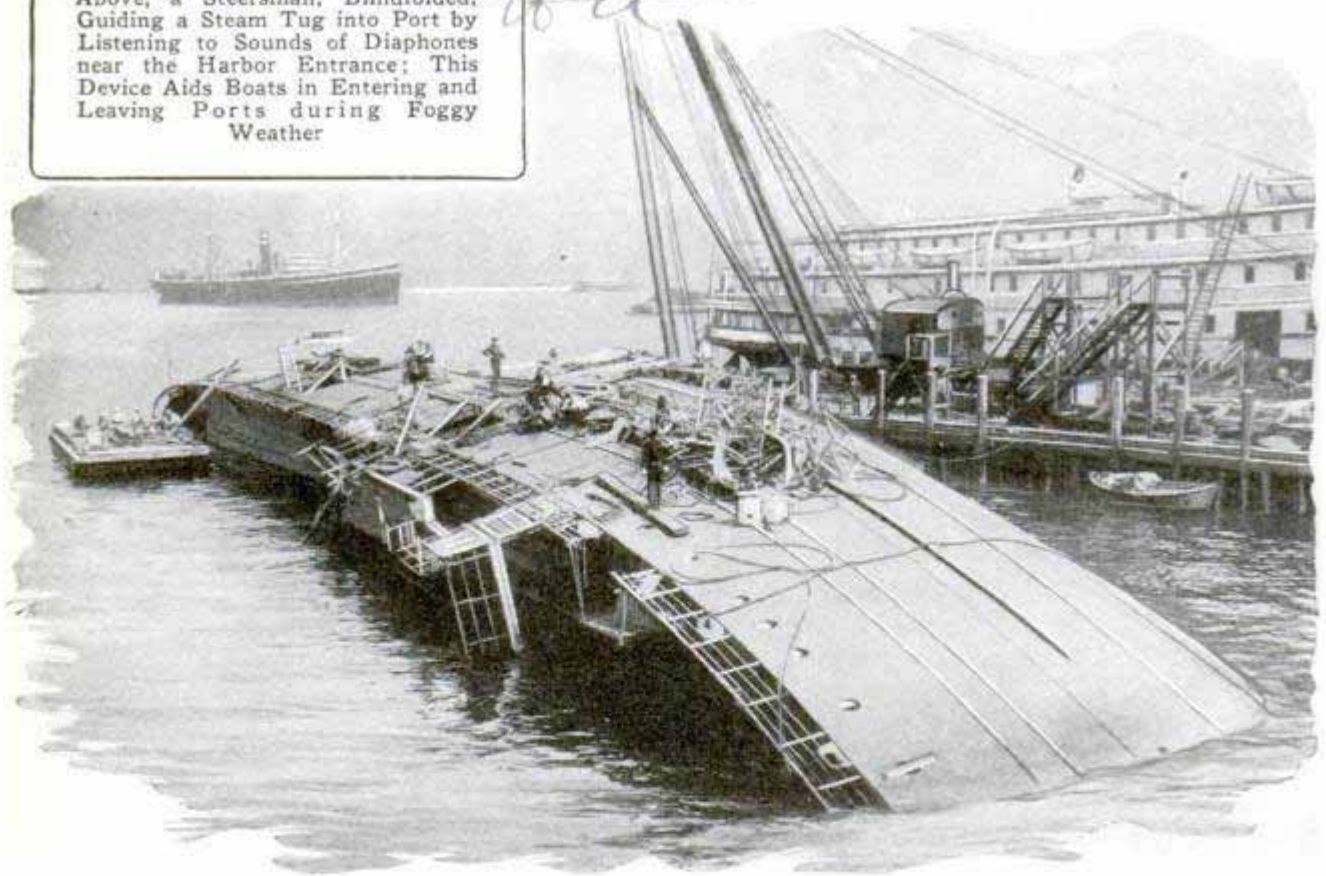

The S. S. "Kershaw," Being Raised after Catching Fire and Sinking. While Undergoing Repairs at Baltimore

darkness, Lloyd's are continually adding to these secret archives tales as true and strange as any ever written in the far-off days before the first paddle steamer

Davy Jones' Graveyard

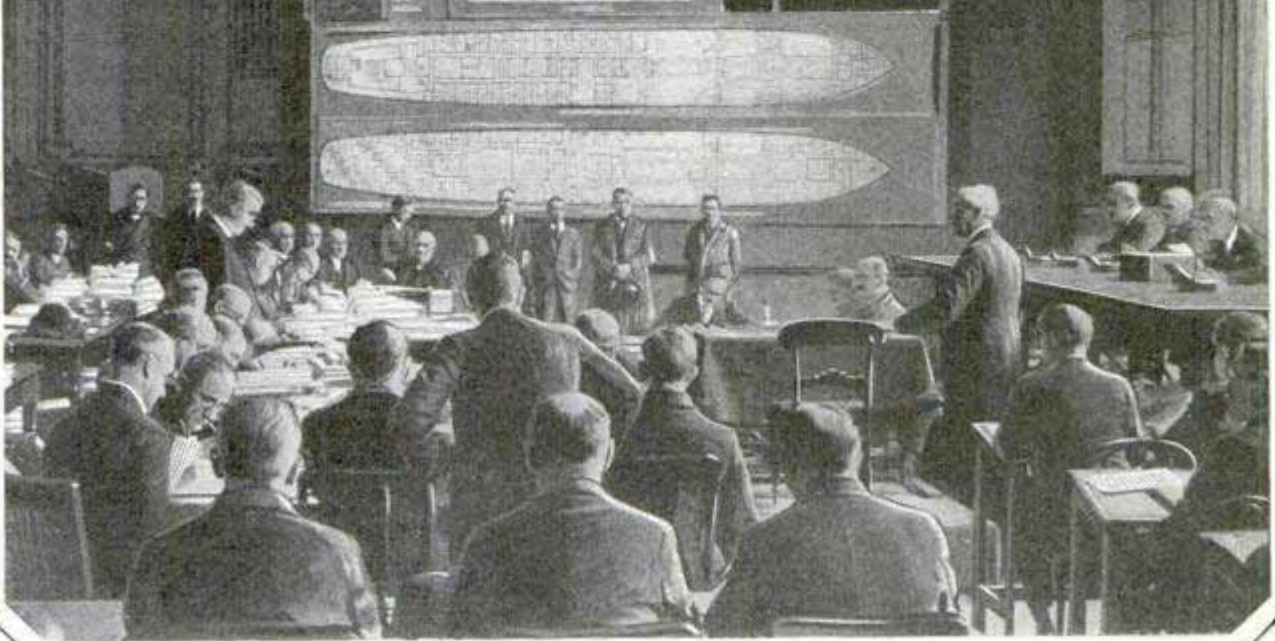

Scene at British Inquiry into Sinking of the "Vestris" with a Loss of 114 Lives; Plans of the Liner Are Displayed on the Walls; It Was Decided That the Vessel Was Overloaded

churned the waters on the long track from Liverpool to New York.

Many of these skeletons in Davy Jones' cupboard are never revealed to newspaper readers. Some of them are in the shape of genuine bottle messages cast ashore years after a startling sea disaster. A few months ago, a man was walking at evening along the sands of a quiet bay, the Mumbles of Swansea, South Wales, when he picked up a bottle containing a note, a gold scarfpin with a stone missing, and a photograph of two men. Said the writer: "This is the last moment the great ship 'Titanic' sank. I am left here with my brother-in-law, John Williams, wife, and little child Jean, having left the doomed ship on the last boat. The band are still playing, the officers are running here and there, although their tasks are hopeless; men are going mad, while. [unreadable]."

This tragic last message, so strangely cast up from Davy Jones' graveyard in 1929, seventeen years afterward, throws light on the last moments of the liner "Titanic," which collided with an iceberg in

mid-Atlantic on her maiden trip, on April 15, 1912, when she sank with 1,635 passengers out of a total of 3,510 on board.

On December 14, 1928, a steel three-masted barque, the Danish sailing ship "Kjobenhavn," sailed from Montevideo, Uruguay, for Melbourne, Australia, with fifty naval cadets. Cables and radio reported ice floating in the southern ocean right along the track she would take. She was a 3,901-ton ship, said to be the world's largest sailer, and carried no able-bodied seamen, but was to be handled by the cadets. Her radio had only a short range, and to reach shore stations messages would have to be relayed by passing ships. Auxiliary motor engines could have driven her one screw, in case of need. Seven days after she left Montevideo, she sent a message regarding her progress, then nothing more was heard.

Next, on June 18, 1929, the cables hummed with a message when Capt. H. Kristensen of the motor ship "Mexico" came into Table bay, Cape Town, with a riddle to solve:

23477

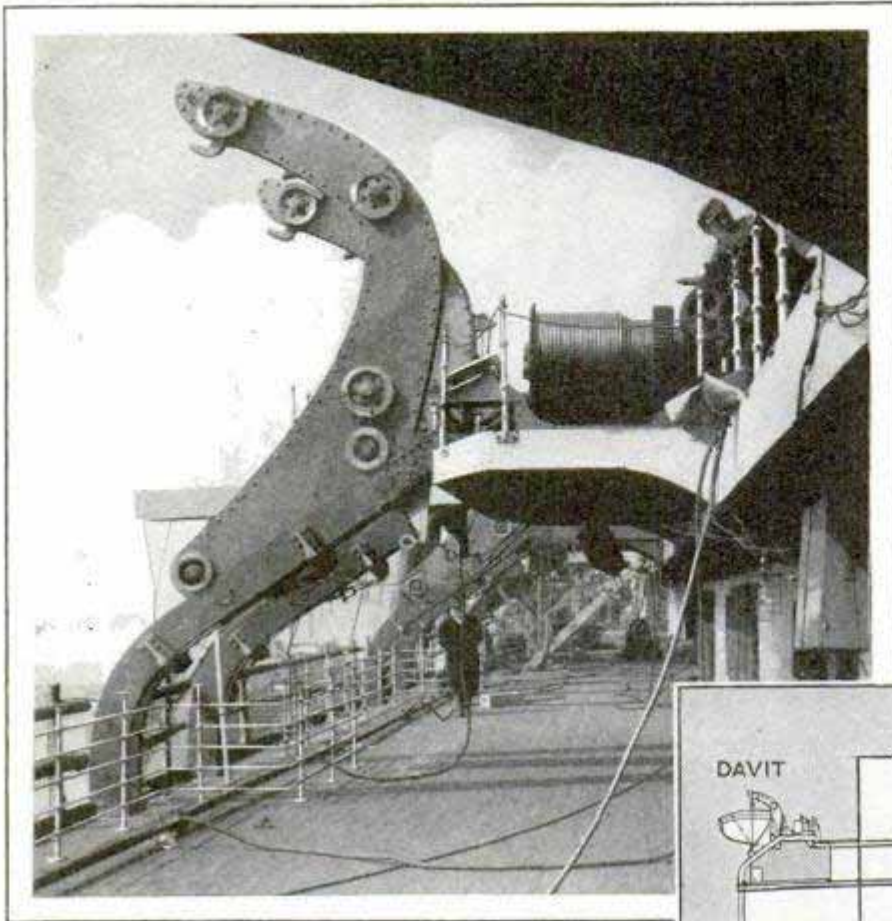

Above, Davit for Launching Lifeboat from German Liner "Bremen"; at Right, Method of Operation

"I find that on January 21 last the 'Kjopenhavn' passed Tristan da Cunha, with her sail reduced to a single jib, and fore, lower and topsail. Other sails carefully stowed and furled. She came drifting on the current, a quarter of a mile off Tristan reef. Nobody was seen aboard, and her helm was unmanned. When she was near striking the reef, she turned and the current carried her into the mist, in which she vanished. It is as puzzling as the 'Marie Celeste' mystery. Either the 'Kjopenhavn' had been abandoned or her whole crew was down with disease or poisoning. The islanders are sure she was undamaged, but slightly down by the stern. I reckon she is still afloat or has been washed up on the desert coast of southwest Africa or in the Antarctic."

The tale of the "Eltham" steamer is a strange one. The villagers of the lonely Cornish hamlet of Chapel Porth woke up after a night of roaring gales and tumultuous seas, on November 18, 1928, and walked down in the gray dawn to the edge of granite cliffs, where they looked down on a steamer, lying 200 yards from the

shore with a broken back. Fishermen put out in boats to the submerged wreck and found she was the "Eltham," a 687-ton steamer owned by a Liverpool firm, and bound for Rouen, France, with a cargo of coal from Swansea, which she had left the previous Thursday. There was no sign of her crew, and coastguards near by had seen no flares or rockets in the night. A few hours later,

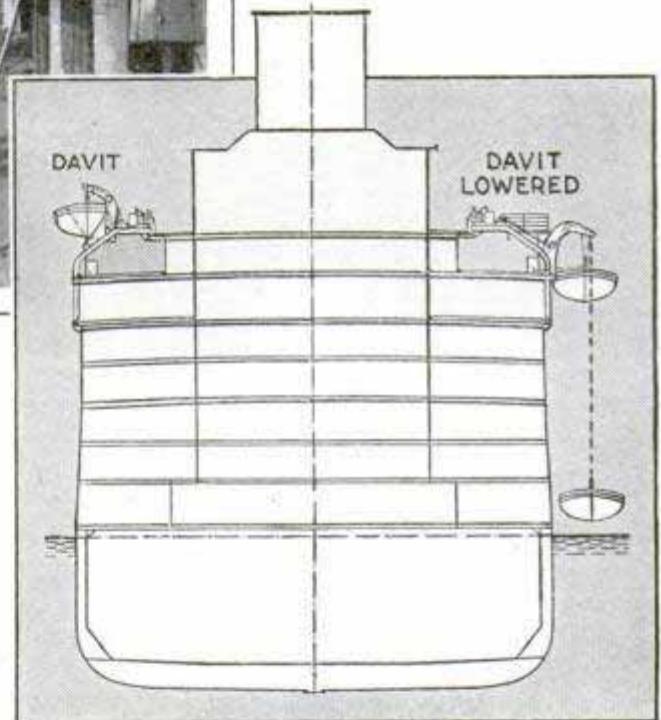

a smashed lifeboat, bearing the name "S. S. Eltham," was washed ashore in a cove six miles away. Many small and storm-bound ships lay at anchor in near-by havens, but none had sighted the "Eltham" when they fled from the hurricane.

Ten days later, the seas abated enough for a volunteer fisherman to board the wreck of the "Eltham" at low tide, with a life line tied to his waist. He found the steamer badly holed, but no logbooks or papers of any kind. Her anchors and chains were stowed away, but there was no sign of any cargo. Fittings had been washed away, but engines and boiler were still intact, and there was nothing to show why the crew had abandoned her, save for the hole in her hull, which might have

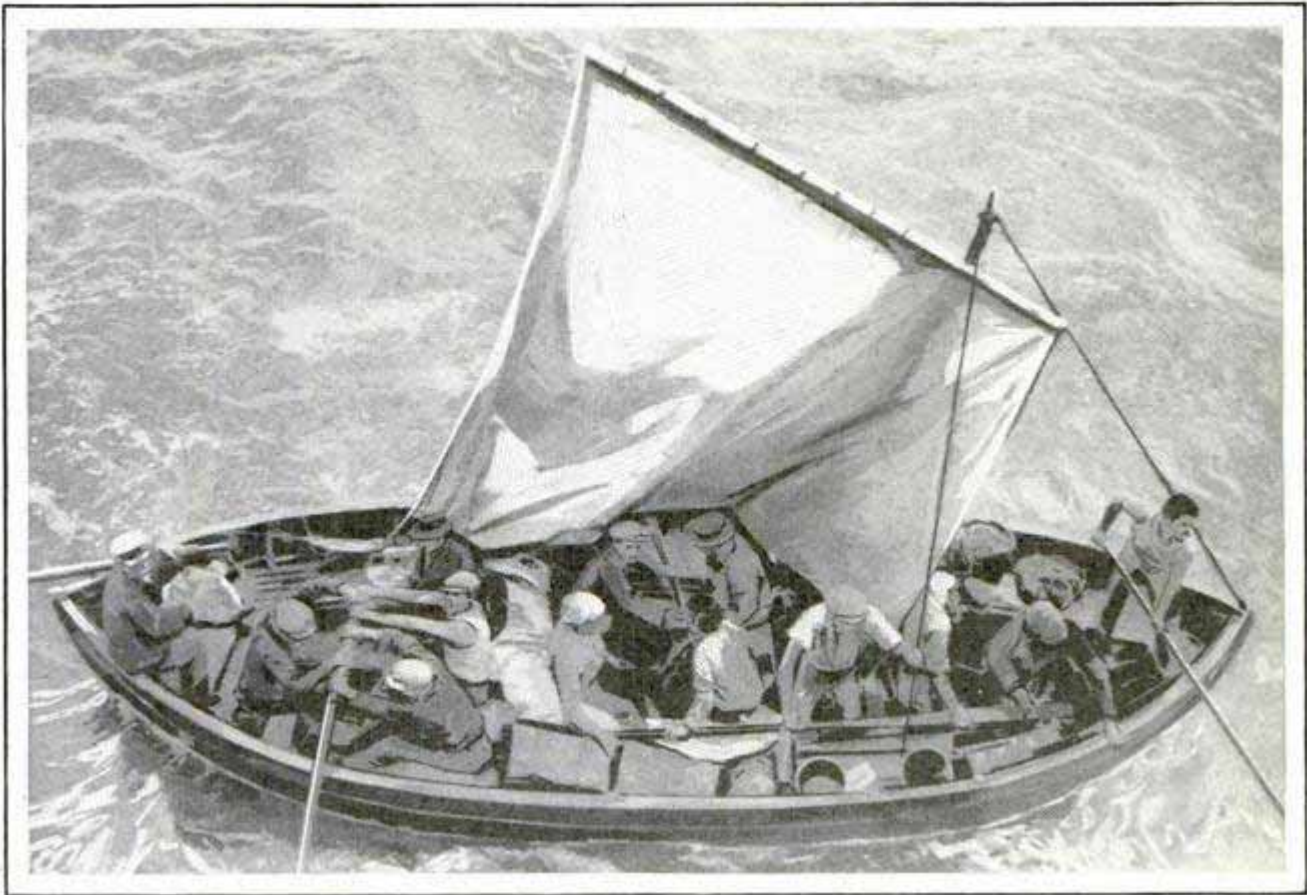

The Crew of Twenty-Five of the German Freighter "Quimistan," Just before Their Rescue by a Steamer; the "Quimistan" Took Fire, and the Crew Spent Three Days in the Boat Shown

been due to breakers on the shore. Was the "Eltham" deserted many miles away in mid-Atlantic, and did she drive derelict to her doom with no crew aboard? If so, what became of her cargo?

"SOS. Urgent. Explosion!" was the startling message received by the French tug "Iroise," waiting with steam up off Brest, in December, 1928. There was no statement of the distressed ship's position, or her nationality or name, and the mystery remains as insolvable as the fate of the survivors of the American oil tanker "David C. Reid," which, in the previous month, wirelessly the Leyland liner "Delilian" that she was sinking fast. The American tanker passed Gibraltar, at the southern tip of Spain, on October 6, 1928, on a voyage from Samarang, Java, to Philadelphia. When the Leyland liner reached the position given in the SOS, all she found was a great patch of oil on the ocean. Then there is the queer story of the 420-ton Latvian steamer "Laima," missing since January 25, 1929, when it is supposed she was lost with all hands in a gale in the Baltic sea. No lifeboats or wreckage were ever found, and the theory is that the steamer became incased in ice,

and was overwhelmed by gigantic waves.

The Atlantic, in 1929, has maintained its reputation as Davy Jones' graveyard. During a tremendous gale and icy seas in January, liners and freighters from all quarters were rushing to the aid of an American tanker, an Italian freighter and the West Hartlepool cargo steamer, the "Teesbridge." At 5:30 on a Monday morning, the American freighter "Maine" heard a desperate SOS from the "Teesbridge," then about 400 miles east of Cape Race, Newfoundland: "Water in stokehold. Two hatches stove in. Using emergency wireless. Latitude 48.31 N, longitude 41 West." The "Teesbridge" had a crew of thirty. When the captain of the "Maine" reached the spot, he saw no trace of the ship or wreckage and hung around till next day. A Belgian liner and a French freighter joined the search, with no better luck. No one knows if the position was wrongly reckoned by the "Teesbridge" or whether her wireless transmitter was put out of action after great seas had drifted her away from the position she indicated.

A strange tale of an explosion heard at sea, off Yarmouth, England, on the night of Sunday, July 7, 1929, adds another grim

skeleton to Davy Jones' cupboard. The captain of the Swedish steamer "Anne Berg" was in the chart room working out his course to pass a lightship, when he was struck motionless. "I heard a tremendous explosion reverberate across the water," he said; "the helmsman shouted to me and I jumped up to the wheelhouse. I was just in time to see a vessel, about four miles away across the port bow, disappear into the sea. She went down at an angle of about sixty degrees, and I saw only the head and foc'sle of the ship. The rest of her had already gone down. We steered at full speed to the spot, reaching it in twenty minutes. There was no sign of wreckage—not a piece of wood or oil or anything. I reckoned, from what the helmsman told me, that she was a ship like our own, Swedish and about 3,000 tons. We sent out an SOS and North Foreland wireless station told us a gunboat and a mine sweeper were rushing to the spot. We gave the exact position. About midnight, the British mine sweeper 'Selkirk' came alongside and hailed us, and we told her by Morse lamp that she was in the correct position. We said we had seen nothing,

and asked if we might proceed, and the 'Selkirk's' commander wirelessly: 'Yes, thank you very much.'

The gunboat and the mine sweeper searched the sea for hours without result.

There also are "ghost ships" in Davy Jones' graveyard. A Dutch liner, not long ago, reported boarding a tramp steamer in the vast Caribbean sea, which seemed derelict. The only living creature they found on board was a big retriever dog, frantic with fear. Down below, steam was still in the boilers but shut off from the engines, and in the chart room, a pen with the nib "still wet with ink," was found in the pages of a logbook. The Netherlanders saw no signs of storm or strife, but two lifeboats and a skiff were missing. Then a French sailing ship, the "Emilie Gallieni," was passing through the Straits of Magellan when she had an adventure which sounds like an episode from a novel. Icebergs and dancing green floes packed the waters and the captain was steering his ship gingerly toward clearer water when he saw a vast iceberg, and in a fissure, 120 feet above the sea, was entombed a big three-masted sailing ship.



© Topical Press

A Scene at Lloyd's, London, Where the Records of Every Ship in the World Are Available and May Be Looked Up in the Index in Less Than One Minute

all her sails and rigging intact and not a boat missing from her davits. The crew of the French ship shouted, but no response save the echoes of their own voices came from the weird berg.

This incident may be contrasted with another true story. Let the reader imagine himself penned in a narrow steel tomb in a steamer's engine room, under the boilers, while flames roar over him and he lies in water which grows hotter and hotter till it nears the boiling point. Such an incident actually occurred in October, 1928, on board the Blue Star oil tanker "Trojan Star" in mid-Pacific, bound for Vancouver. An oil jet burst and a rush of flame cut off eight of the engine and stokehold staff, who had to seek shelter in the bilges under the boiler, while for three hours they lay in oil and water, and flames roared above them. A Welsh fireman sang songs to keep up the spirits of the sufferers. Then a steam pipe burst and the escaping vapor smothered the flames.

The strange tale of the liner "Waratah," a new ship carrying 300 passengers and crew, which, in July, 1909, mysteriously vanished between Durban and Cape Town, South Africa, right in the track of ten other steamers all of which safely reached port, had light thrown on it in May, 1929, when an Englishman wrote to a well-known London newspaper stating that, in 1913, he met a white trader at the mouth of the river Xora, near the native reserve of the Trans Kei, near East London, South Africa, who told a queer story. "One very wild night in July, 1909," he said, "I saw a large steamer close inshore off a dangerous coast with terrific surf running on razor-edge reefs. Wondering what on

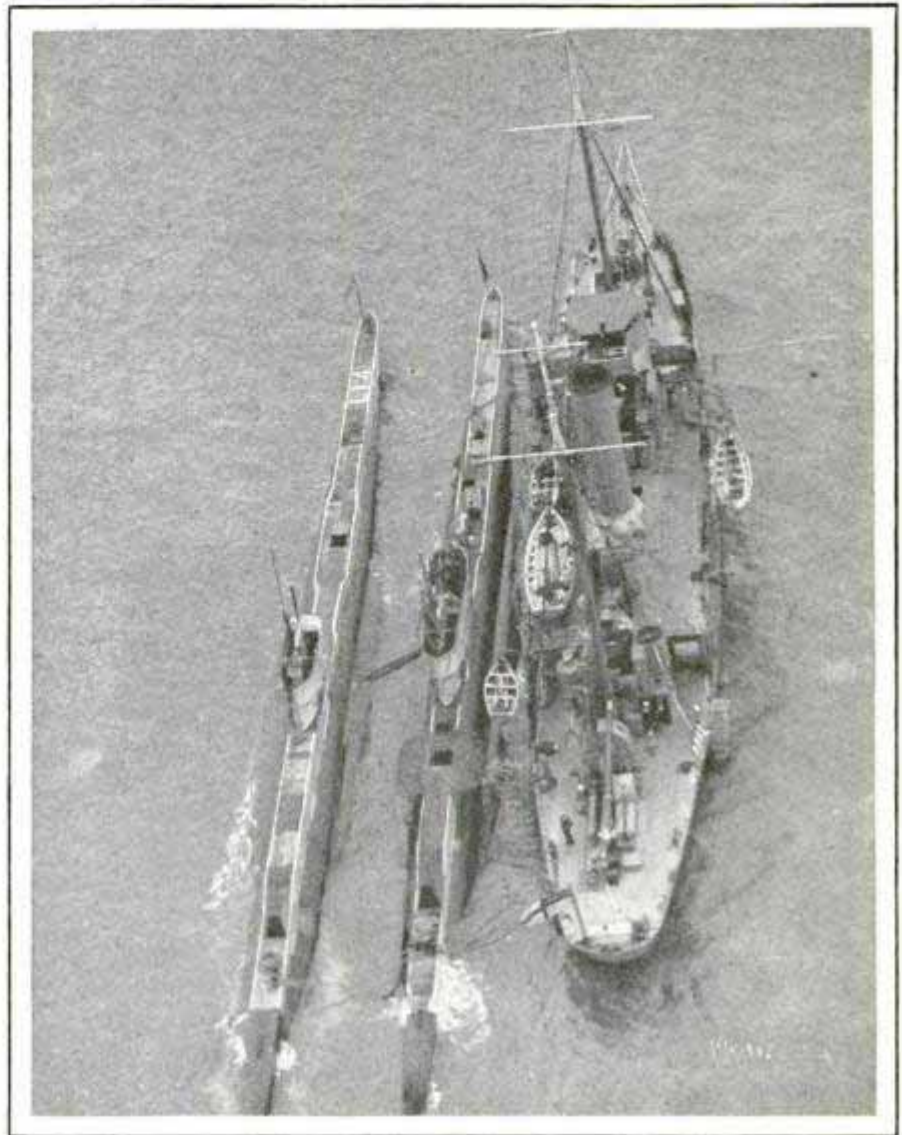

© London Daily Mail

The Submarine in the Middle, Pictured Shortly after It Had Collided with and Sunk Another British Sub

earth she was doing in so dangerous a spot right off the steamer track, I went to my hut to get my night glasses, but on returning to the shore, I found the steamer had vanished. Three months later, I heard of the loss of the 'Waratah.' I am certain it was the same steamer. I have a piece of wood with the letters 'War' carved on it. A tremendous depth of water runs outside the reefs and it is quite conceivable that a ship could turn turtle and leave no trace. Sharks would kill any human being even if he or she could keep afloat in such strong tides." One theory of the disappearance of the "Waratah" is that she was top-heavy, and went to the bottom, after turning turtle in a hurricane.

☛ Coal has been found 800 miles north of the arctic circle.

Berlin,

due independence

China

DUMMY LEAPS FROM AIRPLANE TO TEST PARACHUTES

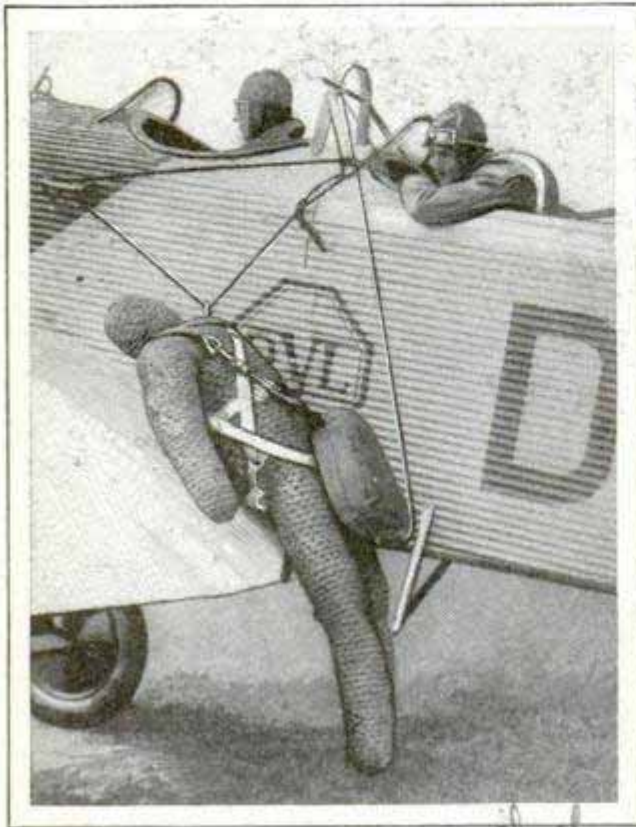

A Dummy Dropped from an Airplane by German Aviators to Test New Parachutes

German aviators have constructed a dummy to test their newly developed parachutes. The dummy, with the parachute strapped to its back, is carried aloft fastened to a rope outside the plane, and when at the proper height, is released. The observers take notes on the time required for the parachute to open and the manner in which the dummy lands.

SPEEDWAY FOR AUTO TRAFFIC OVER RAILROAD

Utilizing air rights over railroads for automobile-traffic speedway purposes is anticipated in Detroit, where the Grand Trunk system is planning a twenty-six-mile toll road above its tracks from Detroit to Pontiac, Mich. The total cost of the project, including electrification of that portion of the railroad, is expected to be \$100,000,000. The plan includes construction of a four-track electrified railway surmounted by a forty-foot motor speedway, supported by steel pillars. Throughout its length, the highway will pass over streets and railroads, there being no traffic lights to delay motorists. It

is planned to divide the road into zones, the charge being based on the number of zones the motorist traverses. Four streams of traffic are anticipated, the inner one on each side being for high-speed travel. Traffic will enter and leave by ramps.

CHINESE FISH WALKS ON LAND

Home aquariums now may avail themselves of a Chinese fish that is almost a landlubber. If taken from the water and placed on land, the fish crawls along the ground and, it is claimed, will cover half a mile in this fashion. The walking fish is several inches long and is beautifully colored, with a bright spot resembling an eye near the tail.

SPHEROID SHAPE OF OIL TANK GIVES ADDED STRENGTH

Oil tanks of spheroid design have been found by tests to be more economical and to be stronger than the cylindrical containers for large-capacity requirements. The spheroid tank with flat bottom was designed to make the shape as near as possible that taken by a flexible container under gas and liquid pressure, as illustrated by partly filling a rubber balloon and placing it on a flat surface, whereupon it becomes a spheroid, circular in plan but with a flat bottom. In the ordinary cylindrical tank, the bursting force is resisted by the vertical shell, but in the spheroid considerable pressure is transferred to the top and bottom of the container. High stress near the bottom was lessened by curving the container sharply there.

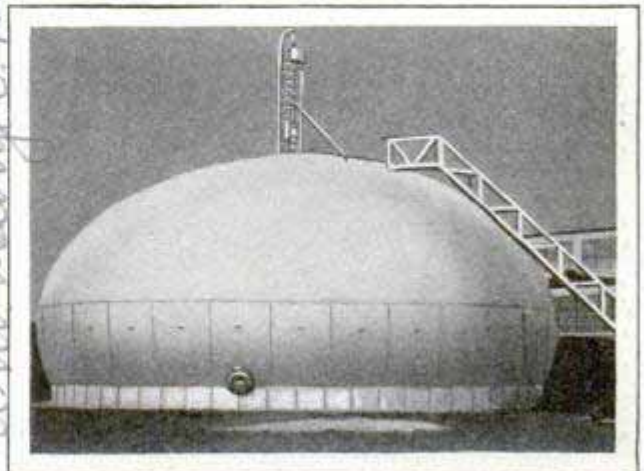

Huge Oil Tanks of Spheroid Design Have Been Found Stronger Than Cylindrical Ones

vertical section in the air

vertical section in the air

3519

24

3519

3470

Ans. Kenneth May
c/o Miss Nancy Smith,
POPULAR MECHANICS

8226 Sunset Blvd., Calif
Hollywood, Calif

AUTO TRUCK HAULS SIX HORSES EACH IN OWN STALL

Transporting horses and cattle by motor is simplified by a truck, designed especially for this purpose, which hauls six horses, each in an individual stall. The stalls are removable so that the truck may be used for other hauling. The animals enter from the side, the side boards dropping

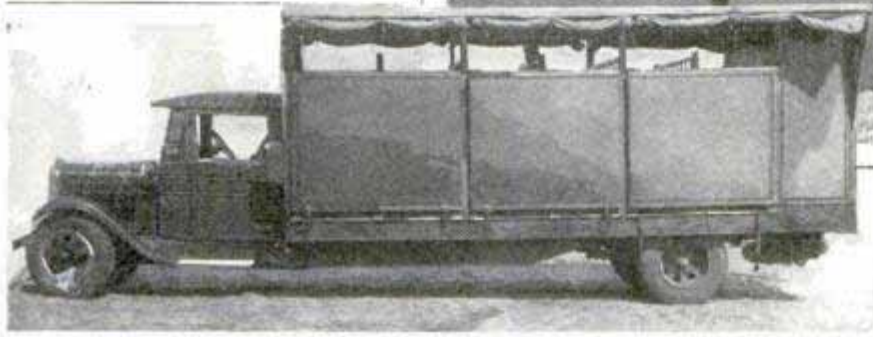
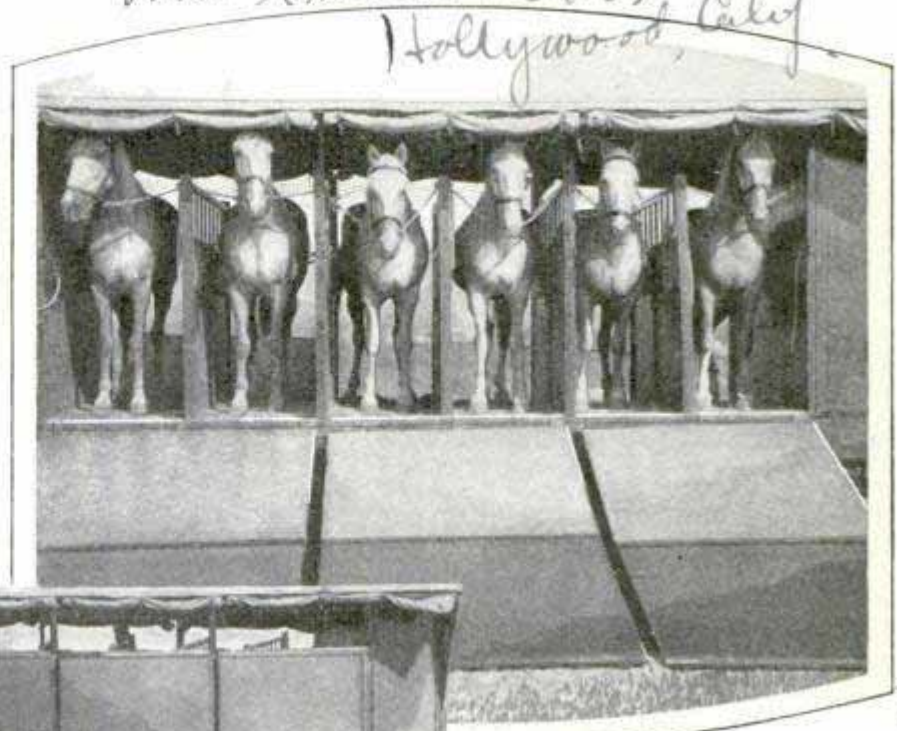

Truck Containing Individual Stalls for Six Horses, the Sides Dropping Down to Make a Runway for the Animals

down to make a runway. When the side-walls are in place, sufficient space is provided at the top for the heads of the animals to protrude outside the folding runway doors. A cleated runway is provided to be placed over the sidewall runway when it is dropped on its hinges.

ANESTHETIC TAKES AWAY FEAR OF SURGEON'S KNIFE

Removing most of the apprehension which many patients suffer before an operation, an anesthetic has been developed which has fewer unpleasant aftereffects and involves less danger than many other preparations used for the same purpose. It goes under the impressive name of "isomylethyl barbituric acid" and was found during experiments to offset bad effects of some local anesthetics, including poisoning, convulsions, nausea and vomiting. The anesthetic has been used experimentally and for the benefit of patients more than 1,000 times and, in no case, has there been poisoning or convulsions, and nausea has been greatly lessened or entirely

eliminated, while it was also found to quiet the patient before operation and to add to comfort afterward by producing a semiconscious state lasting for several hours. More work must be done, however, before the anesthetic is brought into common use.

LADDER IS KEPT FROM SLIPPING BY ADJUSTABLE RODS

Dangerous slipping of ladders is prevented by a German invention consisting of sliding rods mounted at the bottom of the ladder in eyes that form an integral part of a plate attached to the sidepieces. The rods are drawn downward in operating position by a lever and link pivoted to the mounting, and locked in the desired position by

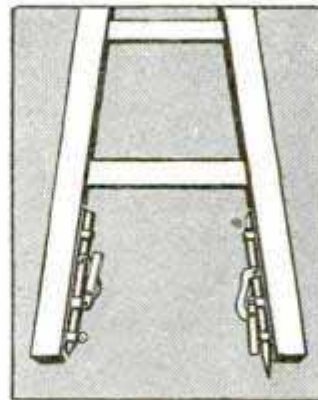

the lever. The safety equipment adds but little to the ladder's weight.

The antelope is the swiftest of North American mammals.

Professor of Pharmacology
University of Kansas
Rich Bruch, Magdeburg,
Germany.
Fabrikstrasse
No. 8, Sackstrassen.

Wm. J. Security
New York, N.Y.

3230

In Step With

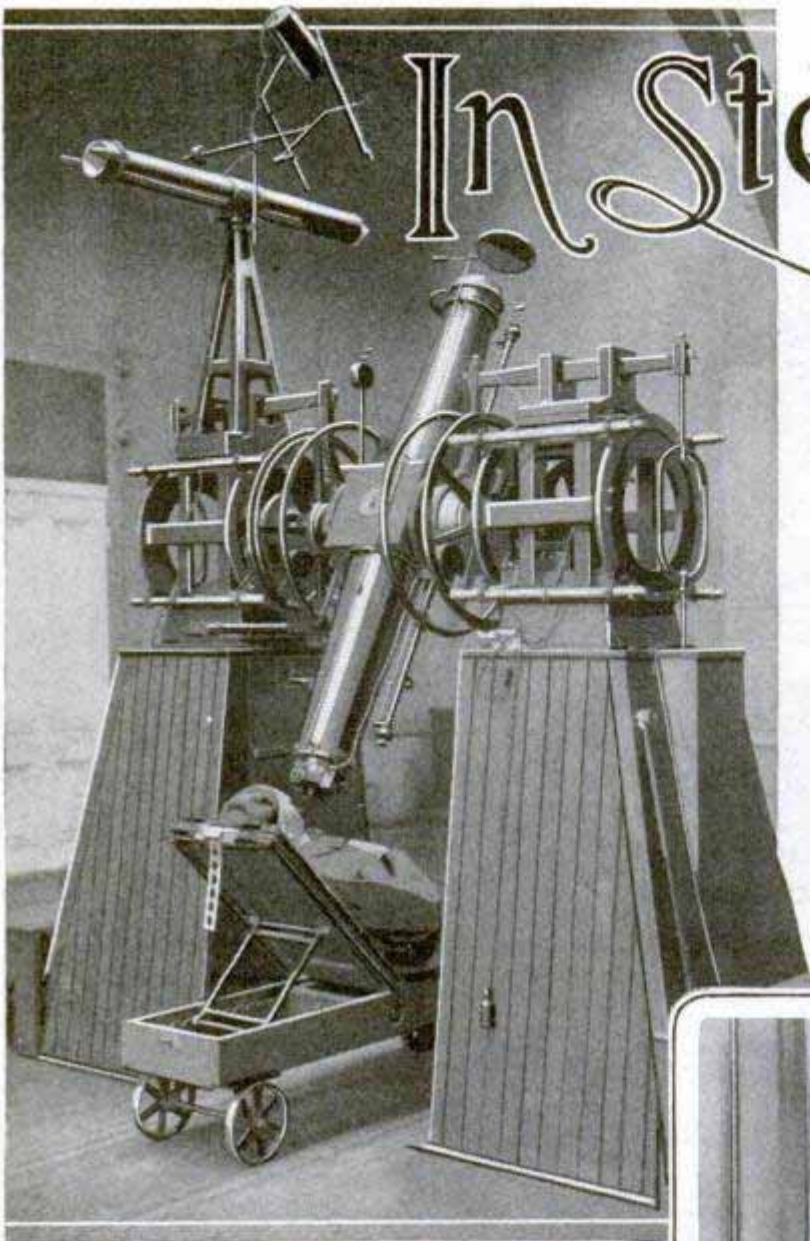

by only thirty seconds, many people and governments would suffer losses and disappointments. Radio messages would become garbled, astronomical predictions would mislead navigators, and nations would be cheated of land.

The pineapple planter and antarctic explorer each go to lunch at the exact stroke of twelve. Chronometer manufacturers are slowing down production because skippers depend less and less on cabin time-pieces. But the radio announcer,

By DON GLASSMAN *u*

"STAND by!" sings out the radio man; "We are about to broadcast the correct time. When the gong strikes, it will be one minute and forty-five seconds after nine o'clock, eastern standard time."

People were never more punctual and precise. In this age of swift tempo, we have gone beyond splitting mere minutes. Machines grind, trains roar, airplanes fly and ships sail on schedules having a startling approximation to the astronomical events. Seconds are split!

The Pacific fleet, steaming over the Arafura sea; the Atlantic fleet, bucking the Gulf Stream swell; a tramp freighter rounding the Horn; a whaler docked at Reykjavik, and the Byrd antarctic expedition—all have their routine attuned to the stars. If the world were out of step

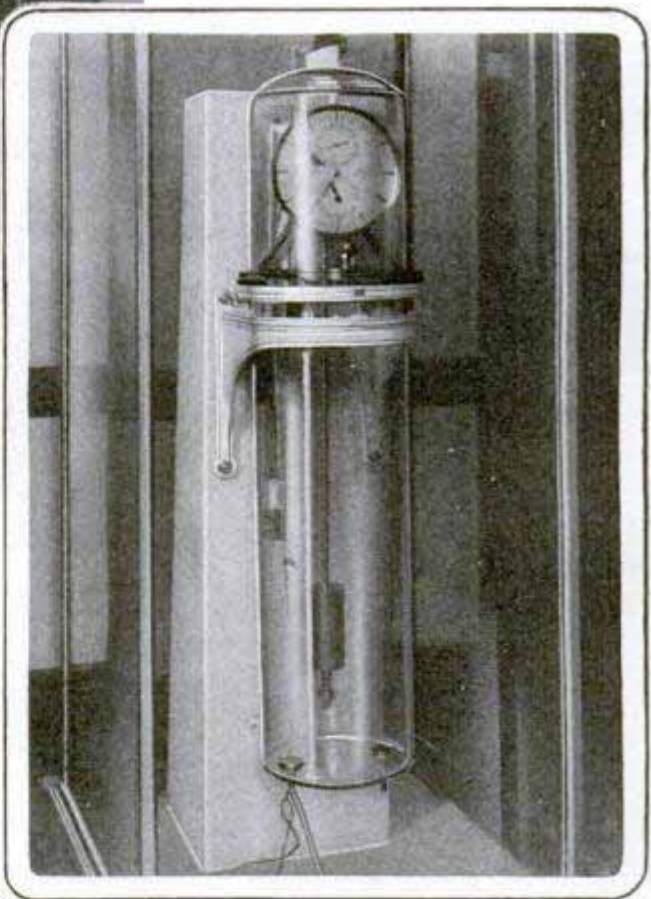

Observing "Clock" Stars through Transit Instrument, and, Below, Master Clock That Keeps Time for the United States

The Stars

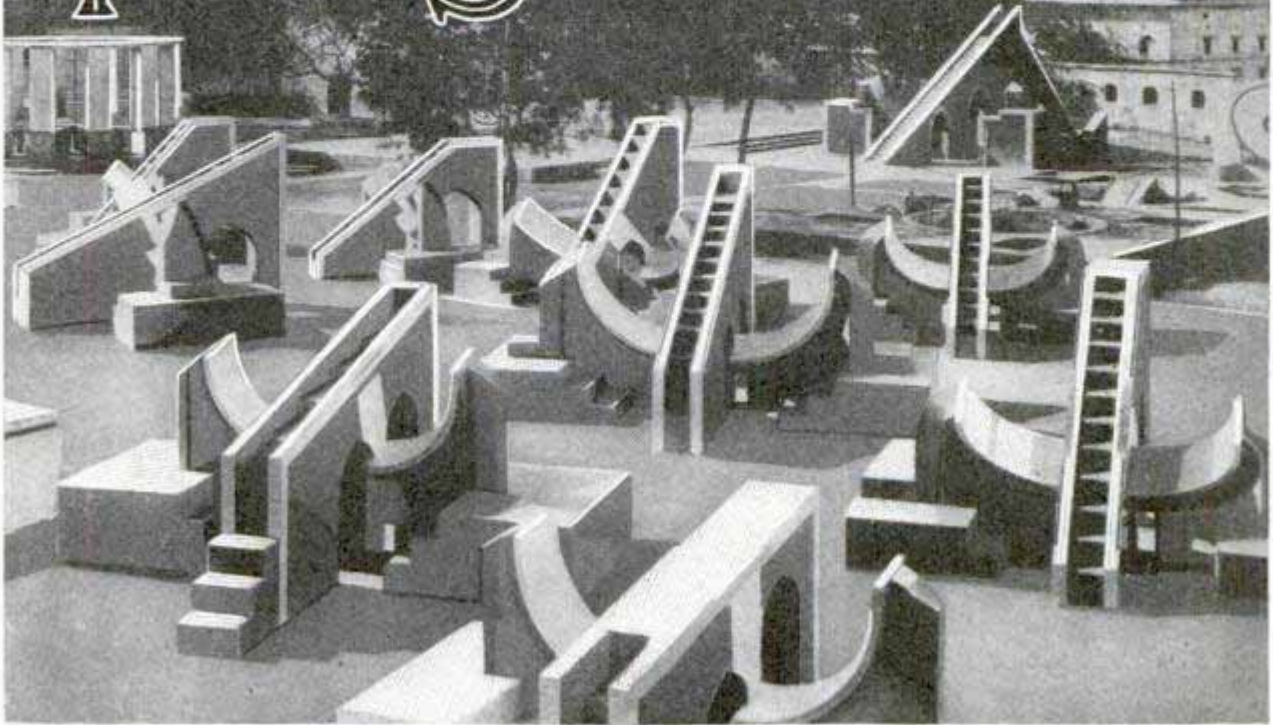

Queer Observatory in India; the Units Represent the Signs of the Zodiac, the Courses of the Planets and Various Other Phenomena; Calculations Are Computed According to Shadows Cast by the Luminaries

skipper and pineapple planter are not experts in astronomy. How do they know when the clock strikes twelve? Merely by setting their watches to the rhythm of the universe as broadcast by the United States naval observatory.

The greatest clock face has a diameter of billions of miles. It is the sky. "Clock" stars move across the heavenly vault with such precision that it is possible to chart their movements years in advance. That is a vital part of the observatory's business. As our earth rotates, the stars appear to rise in the east and set in the west like the sun. The positions of stars are only slightly affected by the revolution and rotation of the earth. On a proportionate scale, the globe is merely racing around a tiny back-yard track, and all its motions are hardly perceptible when one considers the dimensions of the heavens. The stars swing overhead in a great arc. They march in solid phalanx—regiments, battalions and companies. In Washington, the observatory has erected a fixed six-inch telescope whose eyepiece is bisected by a hair line. An astronomer con-

sults a printed table and notes that a certain star is scheduled to cross the observatory's meridian or "finish" line in five minutes. The star looms suddenly. It seems to move, but really it is the earth's rotation that brings the star across the hair line.

The observer operates an apparatus which causes interruptions in an electric circuit. The interruptions are recorded on a sheet of paper fixed round a cylinder, the chronograph or "time writer." The same sheet records the ticks of a standard clock. Comparing the two graphs, it is simple to determine the difference of clock time from astronomical time. Then the standard timepiece, made of gears and springs, is adjusted to the rhythm of celestial mechanics. The stars are relied upon to settle all arguments. For ascertaining daily time, observations are made on eight or ten clock stars. The average of these determinations is broadcast to the world.

Determinations of correct time by two expert observers usually agree within .002 of a second. A layman can hardly imagine

3230

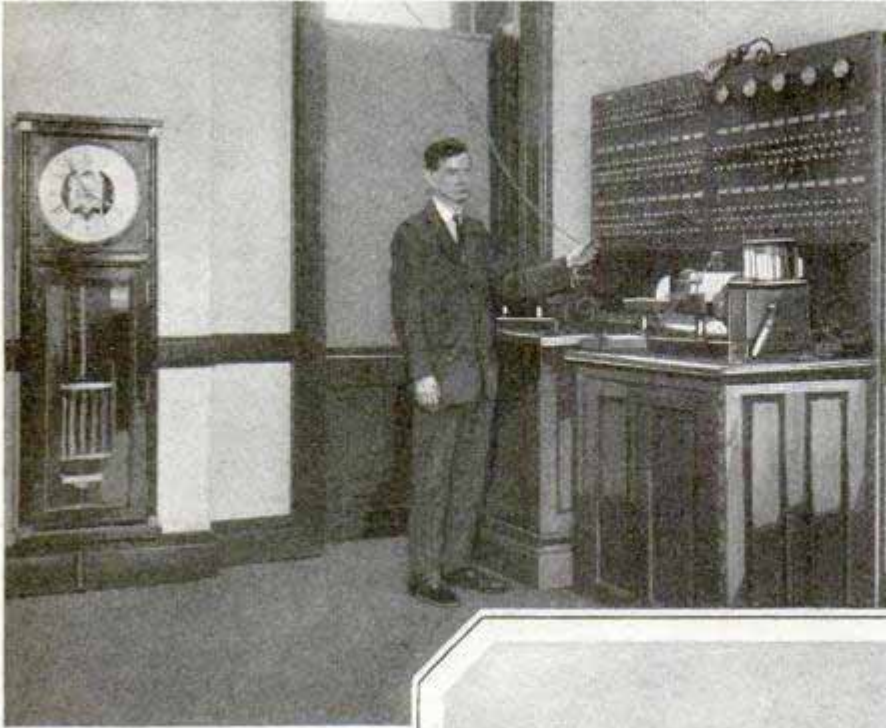

business. School gongs ring at nine o'clock and factory whistles blow at five. Fair or stormy, time is inexorable in its flight. When skies are clouded, the world must rely on mechanical inventions for the correct time.

Three standard clocks at the observatory are hidden in a basement vault, under uniform temperature and air pressure. These clocks keep sidereal, or star, time. They are never

what lofty mathematics enter into such a calculation. Weird symbols and signs invented by the ancients and inherited by Einstein play roles in this performance. These hieroglyphics do not interest people who think in simple digits. What the nation at large cares about is how accurately the observatory delivers daily time. Consulting the latest data, I find that the average error is .031 second. The observers admit that on two occasions in the past year their errors crept up to .44 and .62 second. They offer apologies and ask you to remember that normally their maximum error is .19 second.

Every clear night, a naval observatory astronomer lies on a couch and consults the charted heavens. If the sky is overcast, he cannot observe. Consequently, millions of clocks march out of step, and there can be no adjustment until the vapory curtain melts. While astronomers wait on weather, the world goes about its

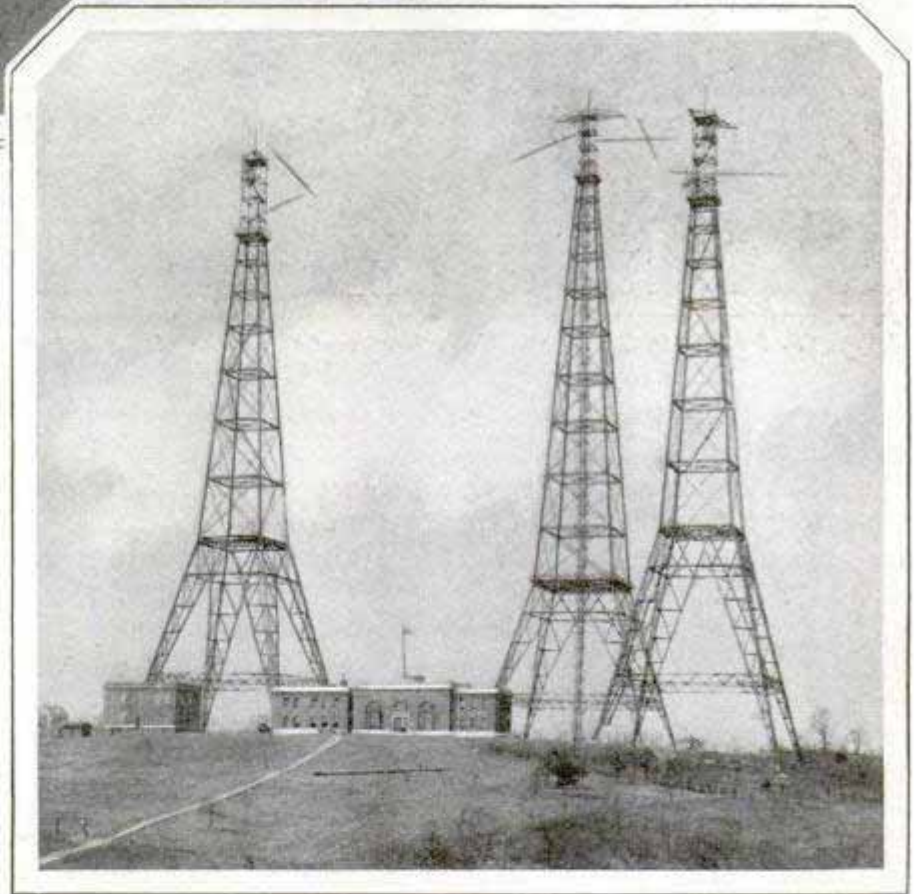

Clock and Switchboard That Control Time-Sending Wire Circuits, and the "Three Sisters of Arlington" Where Time Signals Are Sent

touched by hands, save for necessary repairs. They have pendulum rods that do not change with temperature variations. These timepieces have a tendency to run fast. During the first year after cleaning, their daily rates are likely to increase one-hundredth of a second per month. But the actual increase is not so important, so long as it is regular. At present, the rate is about .01 second per day.

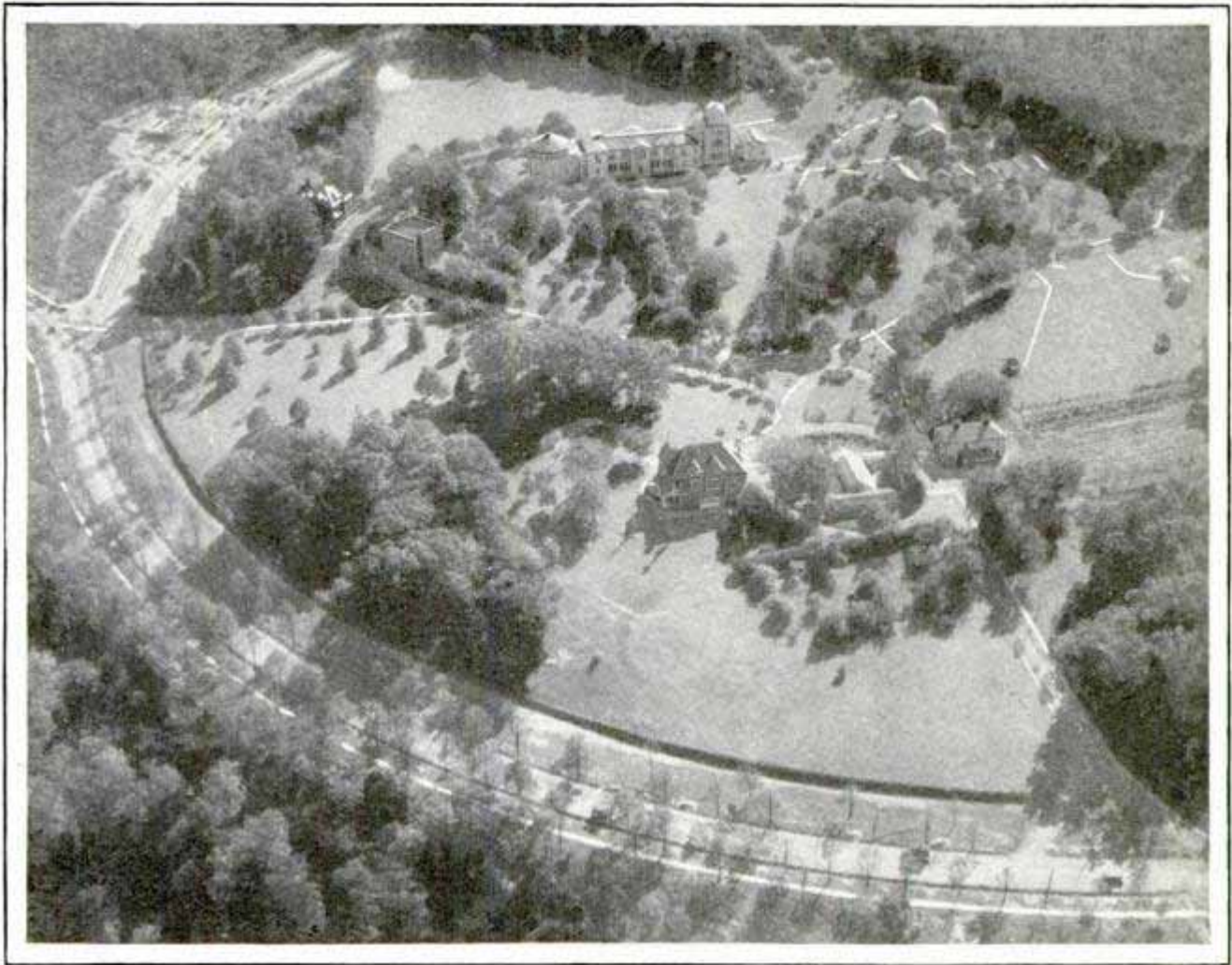

Aerial View of the United States Naval Observatory Grounds, Where the "Rhythm of the Universe" Is Interpreted in Correct Time and Broadcast to Widely Scattered Points throughout the World

The standard clocks are linked by a telegraph circuit to what is called the transmitting room. A transmitting clock coincides at all times with the standard time-pieces. Thrice daily, at noon, 3:00 a.m. and 10:00 p.m., the transmitting room sends telegraphic time signals. The human voice takes no part in this performance. Telegraphic wires sound the seconds as sharp clicks, and the radio sounds them as buzzes. Signals begin five minutes before the exact hour and end on the last second of the sixtieth minute. An ingenious way has been devised to denote the end of each minute and half minute. The ticker is silent for the fifty-fifth, fifty-sixth, fifty-seventh, fifty-eighth and fifty-ninth seconds. After this pause, listeners-in know that the very first click will mark the birth of a new minute and the death of an old one. To denote the end of a half minute, the tickers omit the twenty-ninth second.

After these delicate operations are completed, the observatory's responsibility

ceases. The telegraphic pulse beats are picked up by six wires leading from the transmitting room. Via telegraph and wireless, the navy broadcasts correct time all over the earth. The air hums with electrical waves that streak around the globe seven times in one second. Battleships, merchantmen, islanders, explorers, even aviators may tune in on correct time.

Impulses speed to Annapolis over leased wires. Signals from NSS, the navy wireless, are very powerful and may be picked up in most parts of the world. The telegraph companies rent thousands of clocks that are geared to master hands at the observatory. They, too, have standard clocks for use in case telegraphic communication should suffer interference. Ordinary broadcasting stations obtain correct time from rented clocks.

A century ago, people were content with the time calculations of sundials. Radio and telegraph were unborn. Early in the forties, the observatory began to

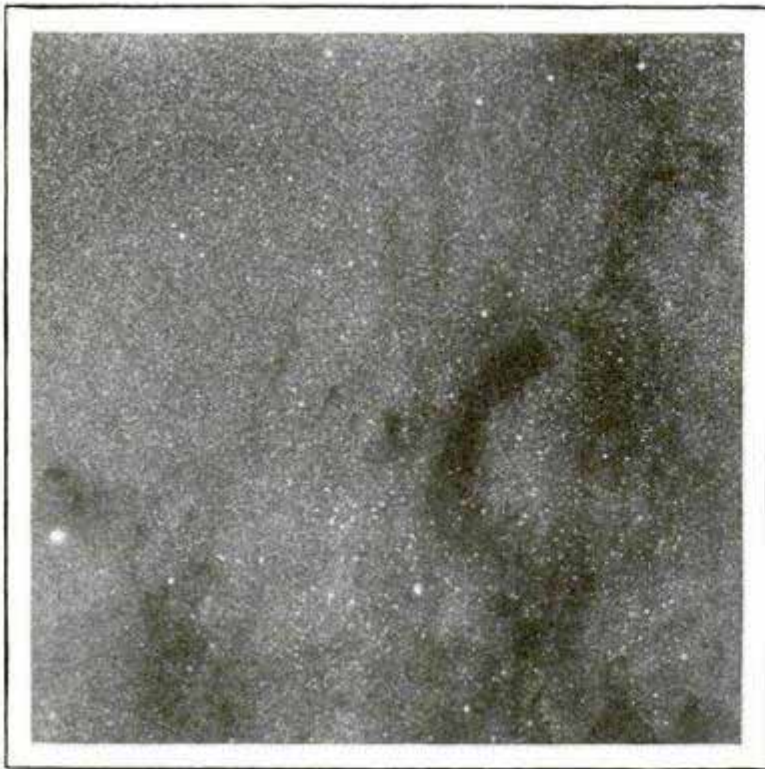

Part of the Heavens' Great Clock Face, the Most Accurate Time-piece Known and the One That Keeps the World in Step

drop a time ball from the building's roof. If a citizen happened to pass, he might adjust his watch. During Lincoln's administration, the observatory began supplying Washington fire stations with signals over wires ordinarily used to ring alarms. Then a telegraph operator thought it would be novel to tell his colleague in Baltimore when to cease work. And the key man in Baltimore relayed the signal down the line. Norfolk and Annapolis told Charleston. Charleston told Savannah. Savannah told Key West. Before long, telegraph operators from Portland, Ore., to Portland, Maine, were enjoying the convenience of correct time. At length the citizenry learned of this innovation, and the age of rented clocks was the upshot.

COST OF MAKING ELECTRICITY

Generation today constitutes only a small part of the cost of electric service. Except in special instances, it varies from a little less than one-half cent to a little more than one cent a kilowatt-hour, depending on conditions. Carrying the power to the consumer, including the expense of poles, towers, wires and the land these occupy, and the loss in transportation, constitute the bulk of the expense,

and added to this is the cost of distribution to each individual consumer after the power has been transported in bulk. Transportation of electric power from producer to consumer is unique in that the product cannot be made in advance except to a very limited extent, and cannot be stored up in slack seasons for the busy periods.

PARACHUTE AND SEAT COMBINED FOR AIR SAFETY

Greater safety in the air for passengers is afforded by a combination seat and parachute which allows the pilot, in case of danger, to discharge his passengers through the floor of the plane, the parachute opening automatically to bring the passenger to earth in

the seat he occupied in the plane. In an emergency, the pilot throws a lever which simultaneously releases the upholstery from all seats, springs raising upholstery and harness up and forward over the shoulders of the passengers to afford protection. Passengers insert their arms through large holes in the harness of the parachute and fasten two snaps, the operation requiring less than two seconds. The control wheel then drops one passenger each eighth of a turn, one normal turn releasing eight passengers. A pull ring to open the parachute is carried in a pocket on the left side of the upholstery within easy reach of the passenger as the fall starts.

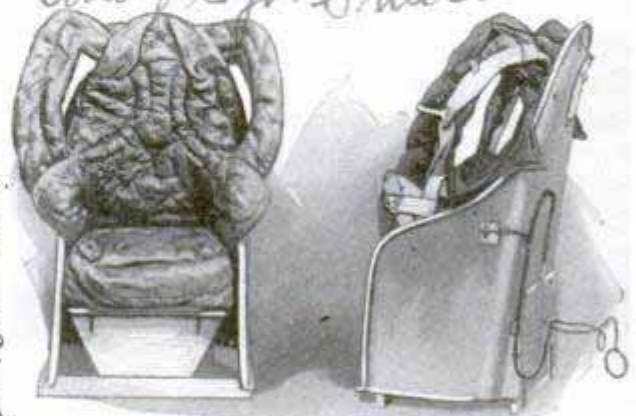

Combination Airplane Seat and Parachute, Used to Land Passengers in Case of Danger

3230

3415

3464

Wulden

N.E. Utility News
N.E. Postal Pushing Service

Switlik Mfg Co
13 Maple Ave Sts.

LARGER AIRPLANES PROMISE LOWER FLYING FARES

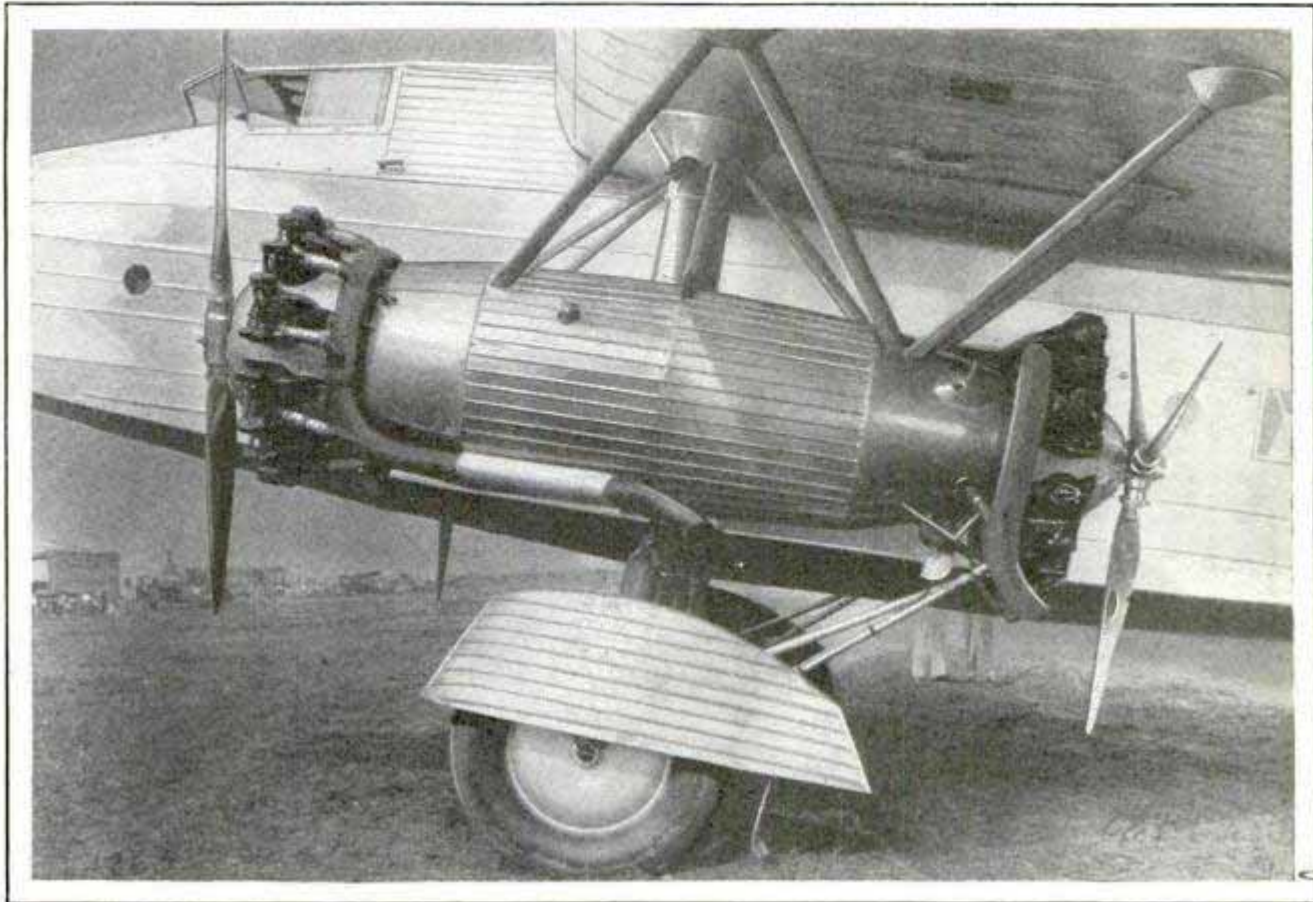

Tandem Motors of the Thirty-Two-Passenger Fokker Monoplane Built for the Universal Air Lines; Note the Two-Bladed Metal Propeller in Front and the Three-Bladed Adjustable Propeller in the Rear

Reductions in passenger rates on air lines are seen as a result of planes with larger capacity and consequent greater earning power, such as the thirty-two-passenger Fokker monoplane recently completed for the Universal Air Lines. In the opinion of William P. MacCracken, former assistant secretary of commerce for aeronautics, such planes probably can be operated at a lower expense per passenger-mile. Anthony H. G. Fokker, designer and builder of the big plane, which is equipped with berths so that sixteen passengers can be accommodated on night journeys, also believes that lower rates are assured in the near future. The latest Fokker plane has tandem motors of 525 horsepower each. There are two engines on each side. The front propellers are of metal, are adjustable and have two blades, while those in the rear have three blades to afford a better "bite" in the blast from the front "props." The ship has a wing span of ninety-nine feet, carries a crew consisting of two pilots, radio operator and steward. On a test flight, it made 157

miles an hour air speed. Assuming such large planes can be operated at \$1.50 per mile, which Mr. MacCracken regarded as not improbable, and that the average number of passengers carried is twenty-five, the cost per mile would be six cents. Could the operators of thirty-two-passenger planes procure full loads, the operating cost on this basis would be less than five cents per passenger-mile, he stated. Indeed, with planes of larger than thirty-two-passenger capacity, rates as low as those on trains are not impossible, especially if cost of Pullman accommodations is added, he asserted.

WHITE FINISH FOR ALUMINUM

Aluminum, naturally a dull gray, may be given a dead-white finish by a simple and inexpensive process reported to the American Electrochemical society. The metal is boiled in milk of lime to which a little calcium sulphate has been added. This coating is being tested as a base on which to apply paints and enamels.

Fokker Aircraft Corporation of America
 110 E 42nd St. New York

3347

Ca. Pittsburgh

The American Electrochemical Society
 Report, Pittsburgh

Great Lakes dredge & lock Co
104 S. Michigan

1590 ^{Chicago} HUGE DREDGE TURNS WATER OF LAKE INTO LAND

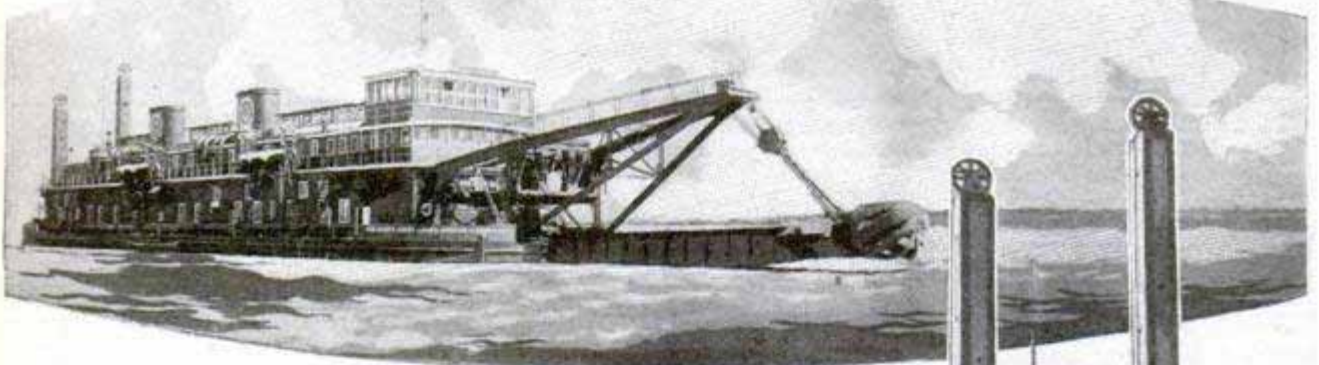

The "New Jersey" Filling in a Section of Chicago's Lake Shore for Frontage Improvements; Water and Sand Are Pouring from the Big Outlet Pipe, Forced from the Dredge in the Distance

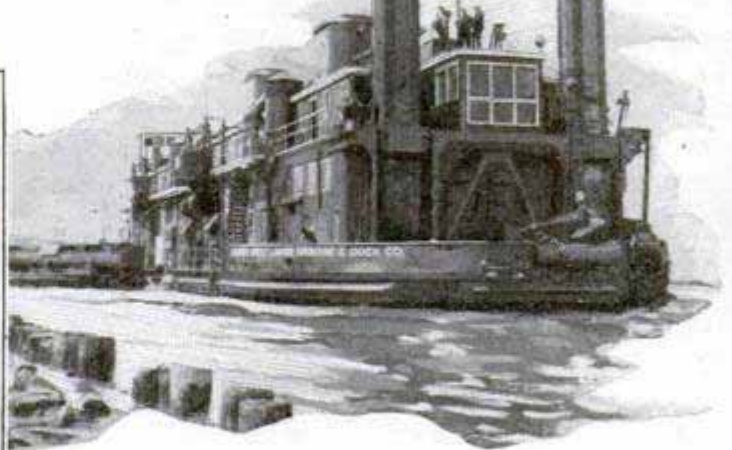

Closer View, Showing the "Spuds" or Feet by Which the Dredge Is Anchored and Moved Forward; at Left, the Revolving Cutter of Special Steel; It Loosens the Material for Passage through the Outlet Pipe; the Dredge Required the Construction of a Special Tug for Towing It

3809
538 S. Clark
Chicago

PALATIAL DREDGE "WALKS" ON EIGHTY-TON FEET

The dredge "New Jersey," recently constructed for use along the great lakes, at a cost, with its equipment, of approximately \$2,000,000, has luxuries usually found only on passenger vessels. It has been described as the "largest and most expensive contractors' tool ever built." It is of the cutter type, that is, it has a huge revolving blade of vanadium-steel alloy to loosen the material under the water so that it can be discharged in semi-liquid form to the point desired through big pipe lines. The intake, thirty-four inches in diameter, is in the center of the cutter. As the big blade, driven by a 600-horsepower motor, whirls, sand, clay and small gravel are sucked up by a 3,000-horsepower pump and sent through the pipes. A thirty-inch stream can be forced a distance of 10,000 feet. The "New Jersey" has two spuds, weighing eighty tons each, as feet on which it "walks" forward as the work proceeds. One spud is lowered at a time to form a pivot on which the dredge turns. When it is necessary to move, this spud is hoisted and the opposite one lowered. Electric current for operating the machinery is generated through four Diesel engines of 5,000 combined horsepower. If used for lighting alone, the plant would furnish electricity sufficient to illuminate a city the size of Albany, N. Y. There are fifty-seven motors in all. A crew of from forty to fifty-two men, worked in three shifts when conditions demand, are housed in comfortable quarters, attractively finished in plywood and fitted with electric fans, shower and bathrooms, a social room, large dining hall, a laundry and modern kitchen with an oil-burning range. The dredge has its own telephone system for communication throughout the craft and to the end of the pipe line, which may be more than a mile away and therefore obscured by fogs. The "brains" of the dredge are in the forward control room, overlooking the cutter and the gauge that shows the depth of the excavation being made. Here, the operator manipulates the controllers that govern the speed of the cutter and the pump and watches the instruments that show how the machinery is functioning.

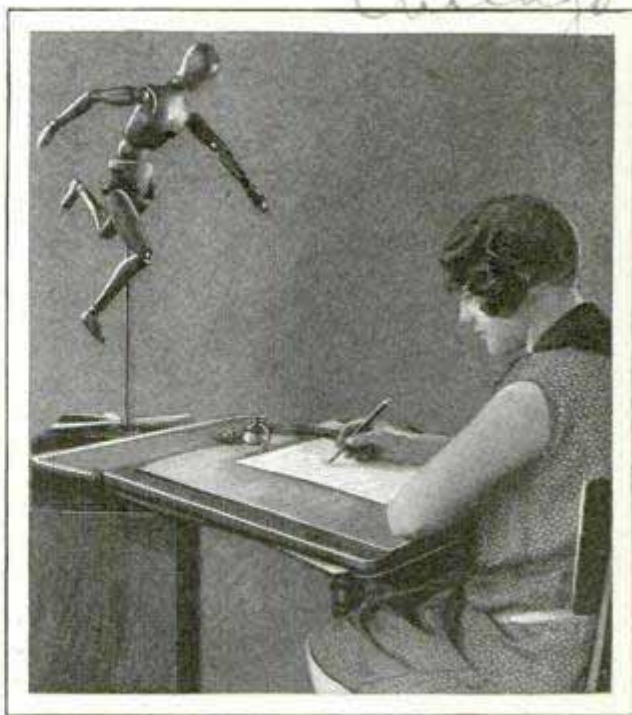

Sketching from the Jointed Wooden Model of Human Form Adaptable to Many Different Poses

JOINTED MODEL FOR ARTISTS TAKES MANY POSES

As a substitute for a live model, a jointed wooden figure, with arms, legs and torso that may be arranged in many poses has been introduced for artists. It is accurately shaped as to scale and proportions, easily manipulated and, when not in use, may be taken apart and stored in small space.

BOTTLE OPENER ON PENCIL TIP FITS IN VEST POCKET

Pencil and bottle opener are combined into one handy instrument that is now on the market. The opener fits over the end of the pencil so that both may be carried in the vest pocket, the two occupying no more space than the ordinary lead pencil.



As high as the tallest modern automobile, and with a "wheelbase" of about 140 inches, the skeleton of a prehistoric hog has been mounted at the University of Nebraska.

5822
Pencil and Bottle Opener
Cedar Rapids, Iowa

332
General Motors Research Lab.
Detroit, Mich

Hurdles To Jump

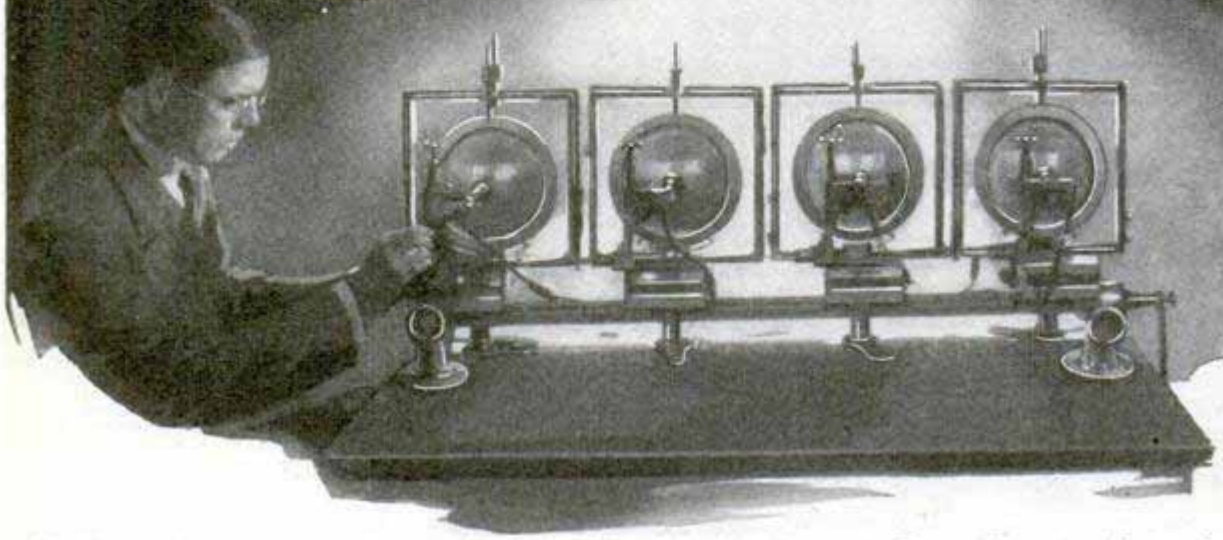

Headlamps Are among the Automobile Accessories to Receive Thorough Tests; Here Are Shown Some of the Lights Being Tested to Determine Their Point of Highest Efficiency

By C. F. KETTERING

Inventor of the Automobile Self-Starter and Head of the General Motors Research Laboratories

THE WORLD is eager for new ideas. The field of invention has no boundaries. Everyone is curious about something new and will buy it if he can. And the better it is, the longer he will keep buying it. Industry awaits each new device that is technically sound, can be produced economically and sold.

During the past three years, over 35,000 inventions have been brought to the attention of one group of business men. Only a small number survived. Only these few fulfilled the threefold conditions—technical, production and sales. Therefore, something is wrong somewhere with the way people invent.

It is not only a matter of disappointment and punctured ambitions; it is an unjustifiable economic waste of money and labor, particularly the latter. And the waste does not make half so much difference to anyone as to the inventor himself.

Admittedly these statements are harsh. They immediately put many persons on

Rayton Albee
the defensive who will argue that what was true of 35,000 inventions does not hold for all inventions, or in all arts and industries, and that the particular group of business men does not represent industry as a whole. People will resent the implication that the inventor is at fault. These arguments and others would deserve careful consideration if it were the purpose at present to defend inventors. But success takes care of itself. Faults in inventing are the things to look for. Trouble, honestly faced, is the beginning of progress; and the rejection of thirty-odd thousand devices is trouble enough to start with. Instead of trying to determine whether the business men were right in rejecting the devices, why not find out exactly what the attitude of business really is with regard to inventions? Why not find out some of the things that the inventor must do if he is to be successful in the business of inventing?

Frankly, business is always on the lookout for good new devices. The manufac-

For Inventors

turer wants them as sources of profit. He recognizes that everyone is becoming more and more mechanically minded. Washing machines and ironers, vacuum cleaners, automatic refrigerators, sewing machines, with all their latest improvements, are making the wives engineers as well as housewives. Radios, automobiles, talking machines, talking movies and a numberless list of everyday utilities are all business enterprises. All depended in the beginning on new ideas and devices.

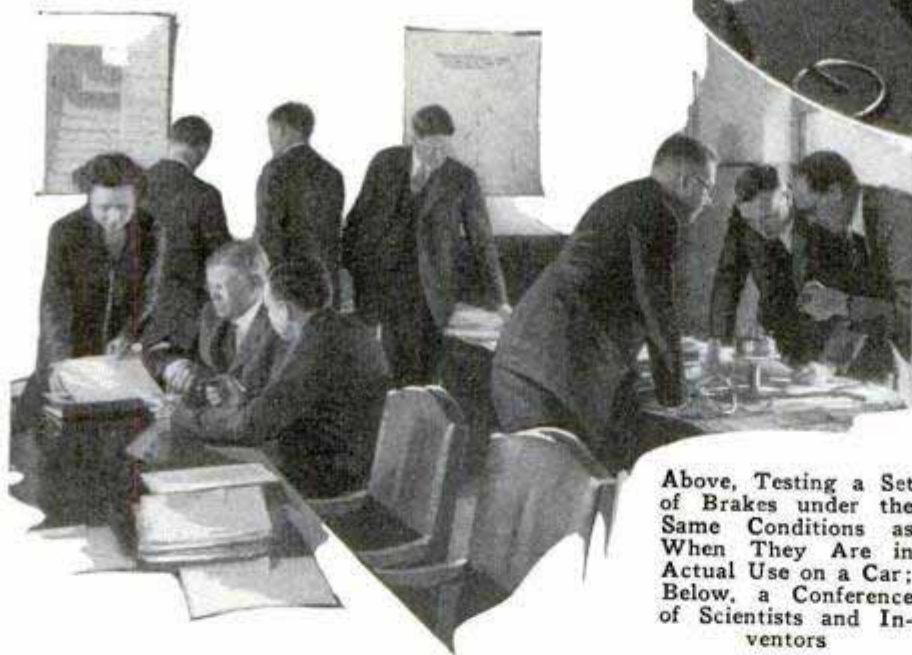
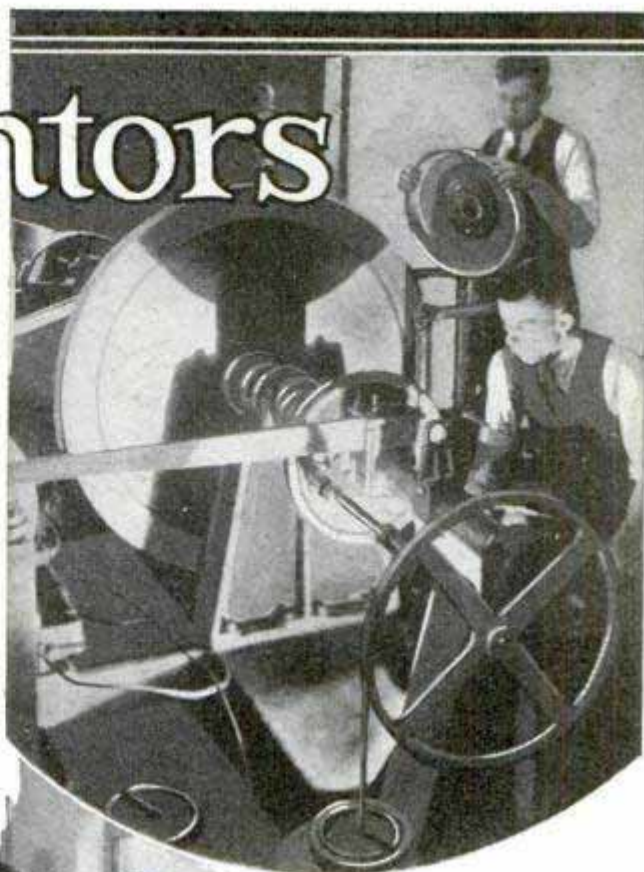

Above, Testing a Set of Brakes under the Same Conditions as When They Are in Actual Use on a Car; Below, a Conference of Scientists and Inventors

But there are no park benches in progressive business. No industry can remain permanently successful by sitting complacently on any invention, however good. While a fortunate invention or discovery may have started a concern, only brains and dissatisfaction can keep it going. The men at the head of a concern must be eternally dissatisfied with their own products and must be eternally doing something about it—everlastingly on guard to find ways and means to improve and develop. This healthful policy of being dissatisfied and doing something about it operates in nearly all industries. It was behind the automobile in every stage of its advancement: self-starting,

dual-beam headlights, time-payment financing, nitrocellulose lacquers, and so on. The very same policy has transformed the wireless telegraph into the very latest alternating-current radio set. And while bringing about these greater values and enjoyments to the people who buy, it has also produced profits to the manufacturers

with brains enough to be dissatisfied, and profits to those who helped the manufacturers to progress.

Some of those who help must search for new devices, methods and principles. Others must develop designs and production methods. Still others have the field of distribution and merchandising. No one in an organization is responsible for progress to the exclusion of his colleagues. Sometimes the engineer or inventor who holds the patent, claims the entire credit. But in ninety-nine cases out of a hundred, a device would be utterly useless were it not for the production man, the accountant, the financier and the salesman.

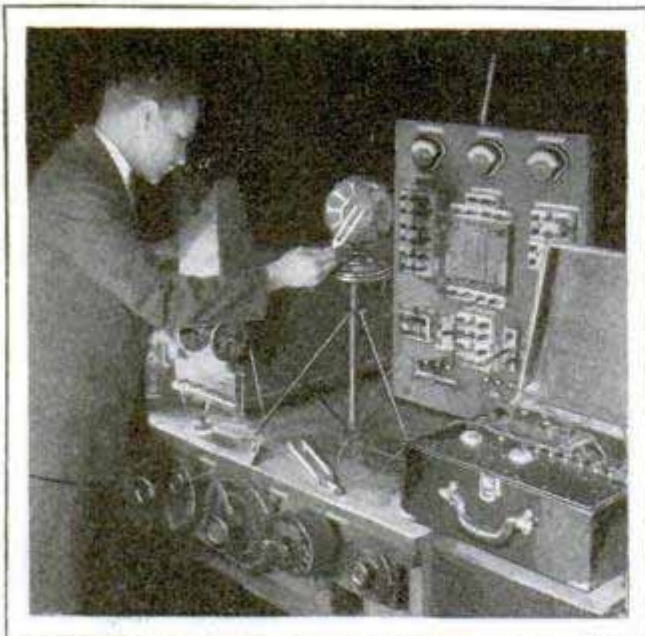

pany payroll, they are expected to apply their talents to the solution of a definite problem which has, or is thought to have, a definite relation to the company's profits. This connection may be obvious, as in tracing down the cause of breakage in a spring leaf, or it may be obscure, as in measuring the surges in a condenser.

Then, too, the engineer must be orderly and make constructive progress in his work. He is spending the company's money, not his own; and normally a company is not in business to make experiments but to make money. No engineer on the payroll can invent in red ink. Engineering is a combination of brains and material. The greater the brains, the less

the material and the less the cost. This does not mean that inventors outside of an industry cannot have a definite purpose in their work, cannot have a commercial point of view and cannot appreciate economy; quite the contrary, many inventors are just as orderly and just as businesslike as any engineer. Con-

Of course, there is no question of the importance of the engineer. He is the man who is hired to look for the troubles in a product and remedy them. He is a professional fault finder and fixer. His stock in trade are intelligent imagination, clear thinking, accurate explanation, careful observation and definite recording of facts. If, in addition to these, he has a fair share of business acumen and a pretty big share of common sense, he ought to be a good engineer or almost anything else. Business men have come to appreciate the commercial value, in dollars of profit, accruing from men with these characteristics. They are being put more and more on the company payroll as consulting engineers, research engineers, metallurgists, chemists, physicists, and what not. They are very seldom, if ever, called inventors. But, in a way, they must be, for it is their job to find remedies in concrete designs and materials. For example, engineers invented the harmonic balancer, orthophonic victrolas and the bimetallic disk for electric irons. When engineers are on the com-

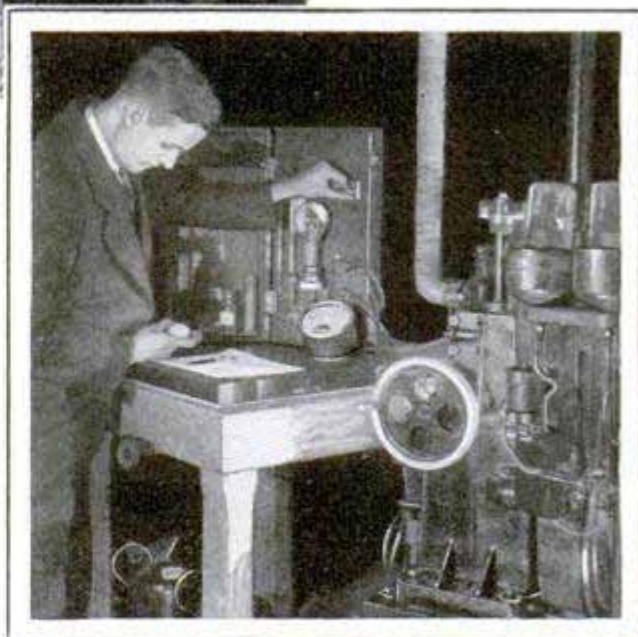
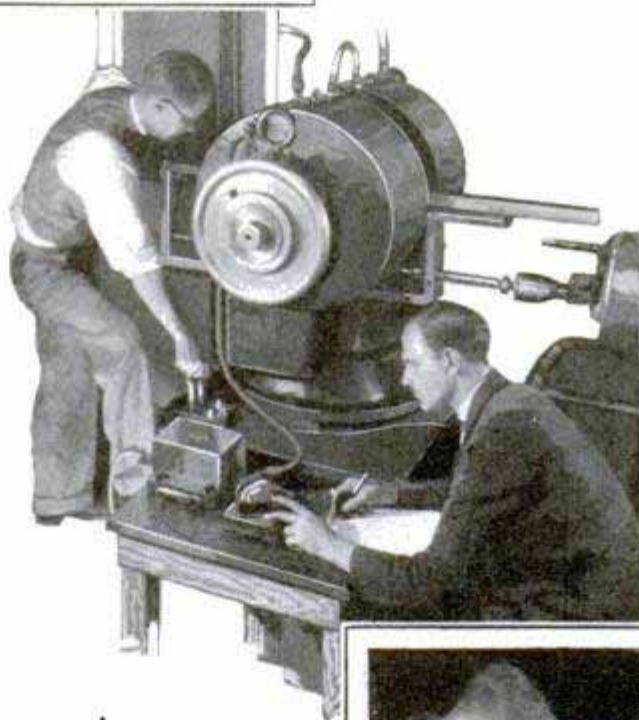

Top, Sound Tests to Eliminate Car Noises; Center, Magnet to Test Defective Steel; Bottom, Studying Knock in a One-Lunger

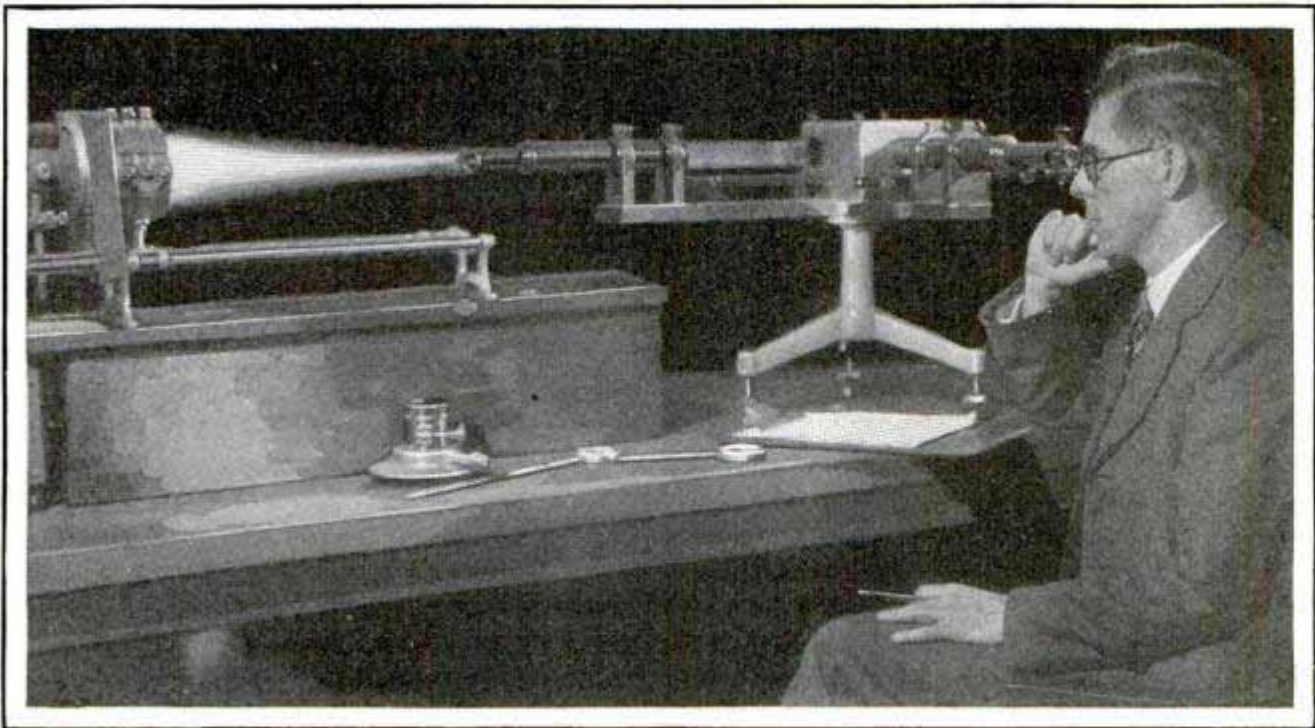

Detecting Impurities in Metals with the Spectroscope, Which Separates Light from Hot Metallic Vapors into Component Colors Just as the Raindrops Separate Colors to Form the Rainbow

versely, many company engineers are neither. But this much is true: Definiteness of purpose and an appreciation of the commercial situation involved constitute the most rigid base of understanding between the men on a company payroll and those on the outside. This is particularly true if the latter have something to sell.

However many engineers or inventors a company has on its payroll; however much in equipment and laboratories, it can never hope to think of all the improvements for its own products. Good ideas and devices are bound to originate on the outside. The race of good inventions is open for all. But it is a hurdle race. Attempts to run around or ignore two or three hurdles account for nearly all failures in inventing. So advice to inventors can be reduced to just this: Do not run around these hurdles; jump over if you can. Be aware that in many lines of endeavor invention has largely passed away from the single inventor working by himself and is now to be expected from a group of individuals working closely together. In General Motors research laboratories, for instance, much inventive engineering is being applied to the power plant of automobiles. No one is trying to do the thing by himself. One is investigating valves and camshafts, another

pistons; another combustion chambers; another carburetors and manifolds; another the atomic structure of fuel, and another is inventing instruments which will reveal the pressure changes that take place in a combustion chamber. But the significant fact is that each recognizes his dependence on the others for the complete success of his own work. The engineer will not be successful in a combustion-chamber study unless he takes full advantage of all that the fuel-research engineer has to give him, and vice versa. The inventions and discoveries of the individual are largely due to co-operation.

Of course, it is not always possible to work with others in the growth of one's own ideas. Nevertheless, co-operation remains as an ideal limit. Wise inventors are taking every advantage of what others have to contribute to their own ideas.

Familiarize yourself with the commercial development in the art. As pointed out above, business is aggressive in finding and trying new ideas. It has tried thousands of things that would be beneficial if they would work, but, as a matter of fact, do not work or cannot be produced economically or sold. So it seems useless for an inventor to go ahead with these same old ideas without finding out, first, why business rejected the ideas; second, if the causes of the previous rejection still

operate. The chances are that many inventors never even take the trouble to find out if their idea has been tried. They too often spend their own time and money first only to meet disappointment later.

Familiarize yourself with previous work in the art. Mighty few startle the world with a completely new mechanism. Most inventions are only the development of some device or process already well-known. Nearly every development has a long history to which each inventor contributes a little. It will save the inventor a great deal if he first investigates this history. Possibly the very same ideas he has in mind have already been thought of, adopted and then discarded for a better plan. This may be disheartening, but inventing is serious business and must rely on facts, not fancies.

If an inventor has determined exactly the previous commercial and technical history of his device, made up his mind to use the experience of others as a working tool and then feels that his device is still worth something, he has jumped the highest hurdles. A few low ones remain.

Keep detailed notes of your daily efforts. It would be unwise to make any general statement here on legal matters but at General Motors, from the legal point of view alone, every research engineer is required to keep daily memoranda of his ideas, conversations, plans, tests and efforts relating to his work. These notes are signed and dated every day. They are witnessed and filed away in the vault as an undeniable evidence of diligent and consistent work. They are a record of what the engineer set out to do, how he proceeded, what his difficulties were and his plans to overcome them. With these things in mind, he is in a position to carry out orderly, purposeful and successful research and inventive thinking.

Be on guard to simplify your device. Generally speaking, simplicity means reduced costs, ease in manufacturing, quick understanding on the part of customers and greater satisfaction in their service. To a large extent, successful invention reduces the complexity of a mechanism or decreases the mental anxiety of the operator. Since these things determine the life or death of a device, an inventor will do well to simplify his device. If it weighs

ten pounds, try to make it equally strong at six. If it has forty parts, try to make it operate better with only twenty-three.

Look at your device as a problem of science. Pretty much without exception, devices are all problems in physics and chemistry. The chemical formulas are the language of the inventor who looks at his device in fundamentals. The concepts of the science may appear technical, but inventing is technical business. The greater danger is that the laws of science are considered too superficially simple, whereas they demand precise and clear thinking. For example, take the case of the inventor of a battery that apparently produces more electrical energy than does an ordinary battery. Very frequently the output of such a battery is remarkable for a few hours and then the battery fails. The trouble very likely is that the inventor did not look at his battery as a problem in chemistry. He knew that if he put in two metals with an electrolyte between, he could get an electric current. He did so and took the first step in making a remarkable battery. But he did not go far enough. He failed to see the chemistry in the reaction of metals with acids. That is why his battery failed: The electrolyte corroded the plates.

Subject your device to tests and obtain quantitative measurements of its performance. Even if this battery inventor had been no chemist, still, with an open mind, he should have discovered that something was wrong with his battery. If he had put it to honest test, time would have shown him. The test is the thing.

It is the easiest thing in the world to conduct a test to prove anything you want, if at the outset you are convinced that your device is all right. But it is unquestionably better to find the facts regardless of their consequences. This may require a great deal of careful study, for often the test is more than half the problem of inventing something. But test or no test on the part of the inventor, the test is coming just as sure as taxes, as the manufacturer undoubtedly will test the device before he agrees to buy it.

When the public buys it, they will test it. They will use it under all sorts of conditions. If it doesn't stand up, they will not continue to buy. The chief trouble with

letting the public do the testing is this: When the public makes its report on the device, if the report is bad, the inventor is powerless to do anything about it.

It is a great deal better for the inventor to do his own testing. About the only equipment he needs to start with is a state of mind that is forever open. And the test should disclose how the device performs.

Be rather pessimistic of your own achievements. Imagination is what sees possibilities for improvement. Watt's imagination at his mother's teakettle saw the steam engine. Then he went ahead and built an engine which worked. His was a working imagination; another kind is a wishbone imagination. Inventors with a wishbone imagination see a valuable improvement and wish it were accomplished. They wish so hard, they finally imagine they have brought it about.

Years and years ago people invented flying machines by the wishbone method. The Wright Brothers used the working method. Possibly a little hard pessimism about your own ideas and achievements will be fairly sure to make your imagination work to some useful end. If not, it will at least save much embarrassment.

Realize that a device must be adaptable for production if intended for general use. This hurdle is just common sense. Any inventor who honestly tests his invention and is somewhat pessimistic will jump this hurdle naturally. After all, inventing is just one phase of industry, and inventors must have as much commercial sense as inventive genius.

Focus your effort on the problem and not entirely on your device which you think solves the problem. This is just common sense also. Unfortunately a great many inventors are heart and soul in their device and never find out that the



Determining Exact Carburetor Performance by Placing It in a Mercury-Sealed Box and Observing Data from Instruments

device does not come within a gun shot of helping the situation. But these are not the wise inventors.

Select a reliable patent attorney. When the manufacturer is interested and the public wants the device, the only equity the inventor has is patent claims. The lawyer is probably the only man who can write patent claims. So the only thing the inventor can do is to be mighty sure that the lawyer is worthy of this great responsibility and trust.

It is difficult to sell an undeveloped idea. Edison could not sell the idea of electric lights but he could and did sell the lights. An inventor can sell his services or he can manufacture and sell a product or patents or rights under patents. But he can rarely sell an idea. Inventors often approach business with "a big idea" and ask for a large sum of money. It would be more to their interest and better business practice to offer a drawing or sketch or description duly protected.

These are some of the hurdles. There may be others. If you find any more, jump over them.

2549
University Research
Pedagogical Research
250 Park Ave N.Y.C.

Dr. Alexander Scott
255 W. 23rd St. New York City
Dr. Alexander Scott
255 W. 23rd St. New York City

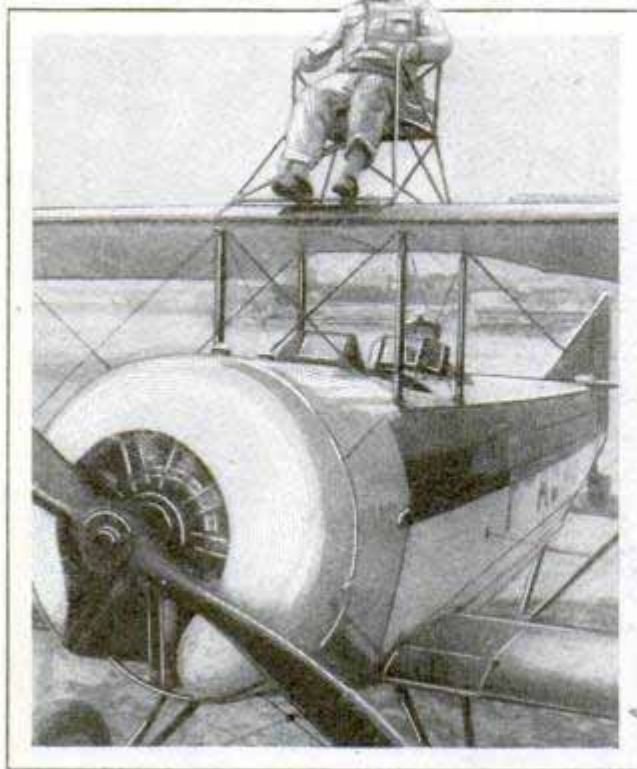

Chair Fitted to an Airplane for the Convenience of Parachute Jumper or Stunt Performer

CHAIR ON TOP OF PLANE WING FOR JUMPER OR STUNTER

For the convenience of the person engaged in parachute jumping or performing stunts from an airplane, a French inventor has devised a special chair. It is of metal and securely braced to the top of the wing of a biplane, just above the pilot's seat. This gives the jumper immediate and easy access to either wings or fuselage.

CROOKED HOOK HELPS LAND FIGHTING FISH

Combining lever and corkscrew action when a pull is exerted, a fish hook with a crooked shaft has been made, to enable the easier landing of game fish. The hook

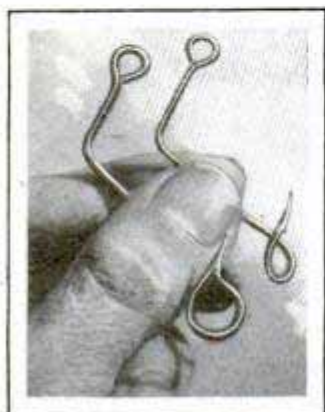

also allows the bait to revolve in the water, simulating life. The shaft is bent almost at right angles about an inch below the eye, and the hook likewise is curved outward from the shaft much more sharply than the

ordinary hook. A pull exerted at the eye causes the hook to turn much like a corkscrew in reverse action, and at the same time gives leverage. It may be used with or without a barb and is easily removed when the catch is landed.

LUMINOUS FLY PAPER CATCHES INSECTS AT NIGHT

Luminous fly paper that lures light-loving insects to a sticky doom, at night as well as in the daytime, has been produced by combining phosphorescent pigments with the coating which shines when the paper is in the dark. Phosphorescent materials also are being used for signboards, house numbers and on life buoys to make them visible in the dark.

TINY ELECTRIC WATER HEATER CARRIED IN POCKET

Heating water where the usual facilities are unavailable is simplified with a small electric outfit which is so compact that it may be carried easily in a pocket or traveling bag. The heater operates quickly, as it is placed directly into the water. It is constructed of aluminum, and the manufacturers claim there are no parts to get out of order.

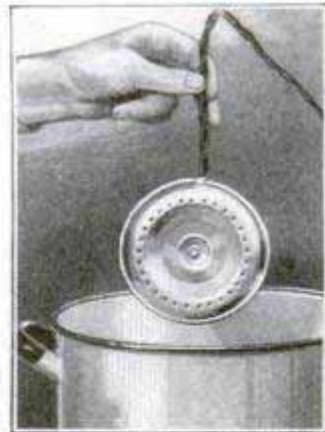

SHAVE CATHEDRAL WINDOWS

Safety-razor blades have been used to save the priceless fourteenth-century stained-glass windows of Somerset cathedral in England from what seemed irretrievable ruin. After exhaustive chemical and microscopic examinations, experts decided that the windows, as befitted their age, were growing chemical whiskers, and they were saved by being literally shaved with ordinary safety razors. Sulphuric acid fumes from gas lamps combined with dust from the stone with which the cathedral is paved caused the incrustation on the stained glass.

Dr. Alexander Scott
255 W. 23rd St. New York City

**HIGHWAY SIGNS
GUIDE PILOTS**

Marking of highways to guide airplanes has been undertaken under supervision of the aeronautics division of the department of commerce.

The plan provides for marking all federal and state highways in characters of ten to thirty feet in height in yellow or white traffic paint. The markers show the route number and the "U. S." or state abbreviation. A highway, viewed from the air, stands out clearly and is one of the pilot's best landmarks if he knows what road it is. The markers would appear at intervals of from ten to twenty miles and at road intersections.

**MOTORCYCLE RUNS CANDY CART
AT SMALL EXPENSE**

Combining a secondhand motorcycle and an old pair of automobile wheels, a Santa Monica, Calif., cripple has constructed a motorized candy cart to supply tobacco and sweets to anglers on the Santa Monica pier. The motorcycle pro-



A Motorcycle Furnishes Motive Power for This Candy Cart, Mounted on Old Auto Wheels

vides sufficient power to move the portable store from place to place along the beach and cost less than \$300.



© P. & A.
One of the Classroom Coaches of a German School Train Where Road Employees Learn the Theory and Practice of Railroading

**SCHOOLS ON WHEELS TO HELP
TRAIN RAIL WORKERS**

Traveling "school trains" have been organized by the German government, which operates the railroad, to teach employees the theory and practice of the business. The road has equipped a number of passenger coaches as classrooms, each in charge of an instructor. These cars move from place to place, classes being held at each stop, where employees, without loss of much time, are given instruction in the operation of trains. The cars have all necessary demonstration equipment.

HEALTH JUDGED BY EYELASHES

Long eyelashes, generally considered a mark of beauty, have been found by a Japanese physician to be a sign of ill health in many cases. After a two-year study, the doctor came to the conclusion that most children in poor health have long eyelashes. He found the lashes of consumptive children grow twice as long as those of children that are in good health. The lashes of the latter grow about an eighth of an inch the first year of life, while those of scrofula sufferers grow twice as long. No explanation of the condition has been offered, nor has it been accepted as a definite criterion of the state of a child's health.

*3500
University of Michigan*

*David Strauss, Inc., 275 North Ave
 not in file 12/20/37
 Strauss mechanical toy Co
 200-5th Ave New York*

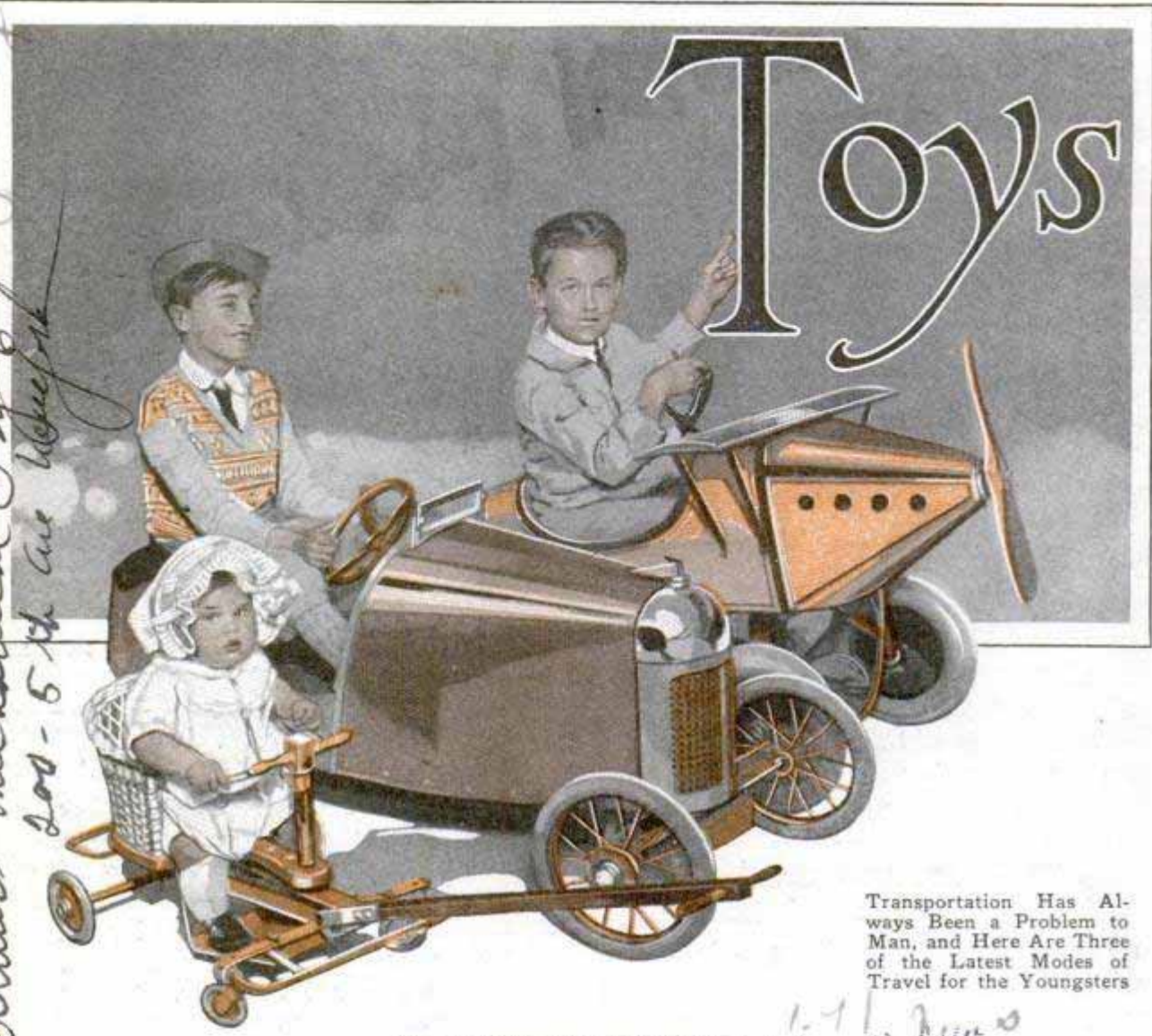

Transportation Has Always Been a Problem to Man, and Here Are Three of the Latest Modes of Travel for the Youngsters

By ALFRED ALBELLI

VERY often the careers of great men in various scientific fields have found their first inspiration, according to Ferdinand Strauss, head of a large toy factory, in the playthings which amused and fascinated them in childhood.

He goes so far as to assert that there is no inventor who cannot recall the influence, slight and subtle as it might have been, which tinkering with toys has had on his bent to inquire into what composes their mechanical elements, and in eventually shaping his life's course.

"Many a youngster," said Mr. Strauss, "is started early on a career through the encouragement he receives as he takes his first toy apart to see how it works, and then tries to put it together again.

"The desire to know what a toy is made of and why, what it is supposed to do and how it does it, teaches the child many things. History is full of examples of

men who received the incentive for their future life work from their playthings.

"Everyone knows that Thomas A. Edison spent all of his playing time with tools. Neither did the Wright brothers invent the airplane by accident. During their childhood days they continuously played with balloons. They would inflate different-sized balloons and float them at various heights to observe how the wind blew them and see which floated highest.

"Carl F. Akeley, the inventor and big-game hunter, also spent his play hours as a boy with various types of small implements. The gift of a folding pocket foot-rule, he has told me, gave him a big thrill, and with his tools he made toys and useful articles for the house. In later years, during his famous exploits in the jungle, hundreds of miles from any source of supplies, this ability of construction stood him in good stead. His fun with a tool chest

Make the Man

as a boy now turned to great practical worth in facing the crises of travel and shelter.

"Another great man in whom the influence of toys is traceable is Dr. George Ellery Hale, of the Mount Wilson observatory. He is one of the world's foremost astronomers. Among his favorite toys were engines, yachts, and other machines that afforded opportunity for mechanical construction.

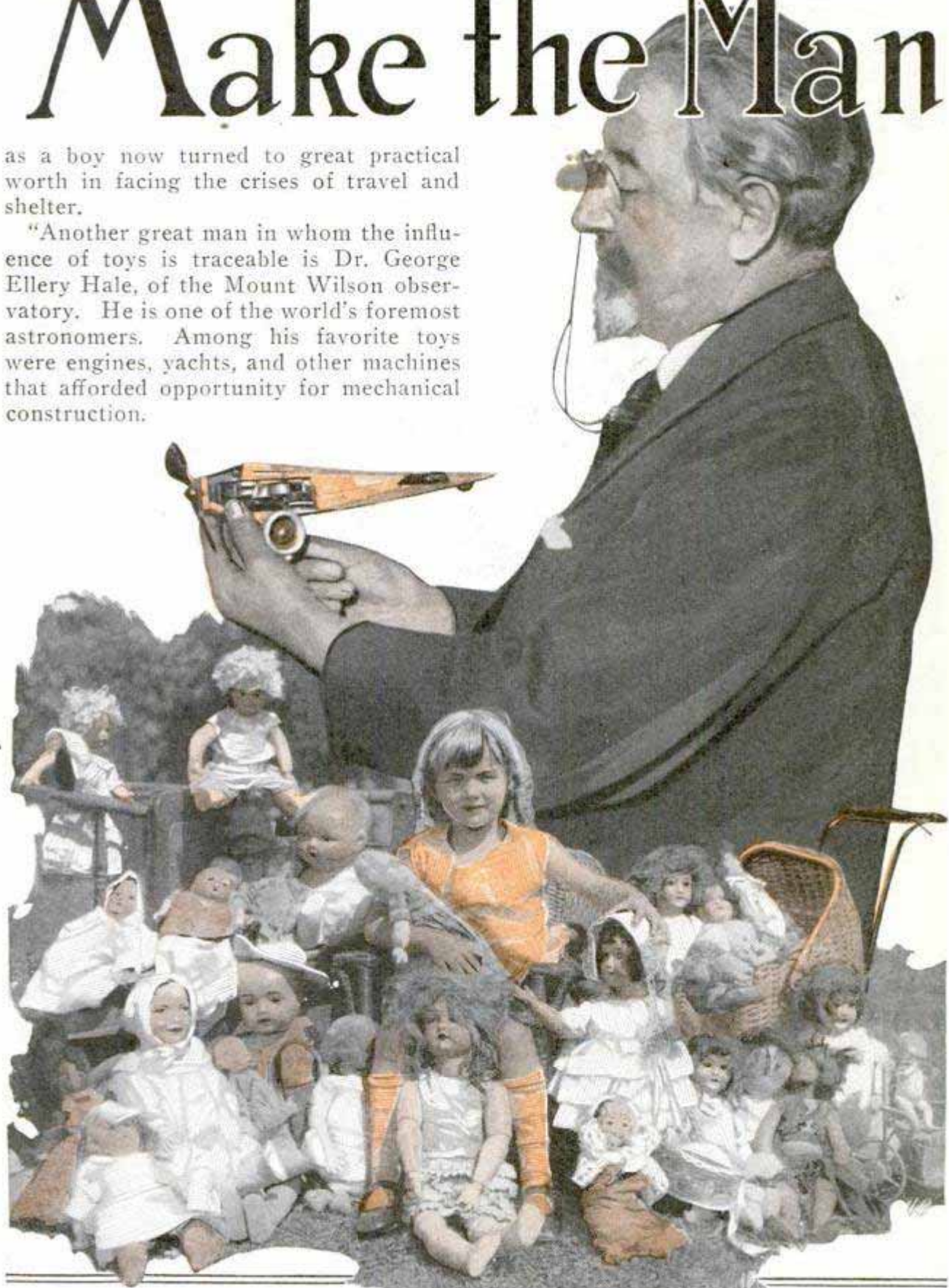

The Advance in Aeronautics within the Last Few Years Has Made Its Effect Felt in Toyland, and the Ingenious Models and Toy Airplanes Have Proved a Source of Almost as Much Amusement to Grown-Ups as to Children; at the Right, an Airplane Model That Appears to Have Caught the Fancy of Someone Long Since Removed from Childhood; Below, a Little Girl and Her Family of Forty Dolls. Including Almost Every Kind, from the Sawdust-Filled Rag One to the Dainty China Dolls That Talk and Cry and Walk

Overell Mfg Co

New York

2130 964

POPULAR MECHANICS

Madame Henriette & Co



"When he was ten years old, his father gave him a tool chest, and this became the nucleus of a small workshop that he built eight years later. He had a lathe, a scroll-saw, a microscope, a camera, a telescope and other apparatus with which he equipped a small laboratory. There he began to design simple physical and astronomical instruments. Doctor Hale still uses some of the 'toys' of his boyhood.

"And there is Rear Admiral Wm. A. Moffett, the chief of the bureau of aeronautics, U. S. N., who has told me that, as a boy, he was most interested in flying kites. I would go so far as to wager that if Lindenthal and Modjeski, the great

Above, the Manufacture of Dolls in a Toy Factory, and, Below, Inmate of an Old Men's Home at Work on Christmas Toys

Phila

bridge builders, were to tell you of their childhood, you would learn that as boys they spent a great deal of their time making toy bridges.

"Toy making has its own peculiar psychology. Toys should be a diminutive duplication of the instruments of man. For instance, a child hears of the Zeppelin. There is a link between his imagination and reality which I try to transplant in the miniature toy Zeppelin which I invent for his pleasure. I try to incorporate into the toy the principles by which the genuine article operates. Then the toy not only amuses the child, but also teaches the fundamentals involved.

"Another thing—the toys must have durability. They must be able to stand the use and abuse that children necessarily give them. A doll should not lose its stuffing when it falls to the floor, nor should a mechanical toy cease and desist, as we say, after the fifth winding. If the child is disappointed in the toy, he will not think much of the article it imitates.

"For many years, mechanical toys have been the favorite playthings, and in a comparatively short span of time they have shifted from foreign factories to America, where they are the foundation of an established industry. About eighty per cent of the mechanical toys sold in America are of American make. These go into hun-

dreds of thousands of homes, and the volume of business runs well into millions of dollars.

"All through my toy-business career I have tried to impress my workmen and my customers that toys are not only bought for emotional reasons, as when little Mary's birthday rolls around, or because Johnny is a good boy.

"I have tried arduously to show that the appeal of toys was more profound than is readily thought; that the child has a vivid imagination, that he is in the formative stage and that impressions he gets from playing and experimenting with his playthings will do much to mold his future. Quite often it creates the spark of what later becomes mechanical or creative genius.

"Lastly, there is the commercial aspect, too, which is very vital. Most children have a superiority complex. Toys, like autos, trolley cars and derricks, which enable them to operate these in a manner they believe similar to the manipulations of the real thing by their elders, create in them a feeling of superiority. Children also yearn to play with miniature reproductions of objects which score popularity with the general public."

Zeppelins with two propellers that revolve when the ship is pulled along the floor, are among the "newest" toys this

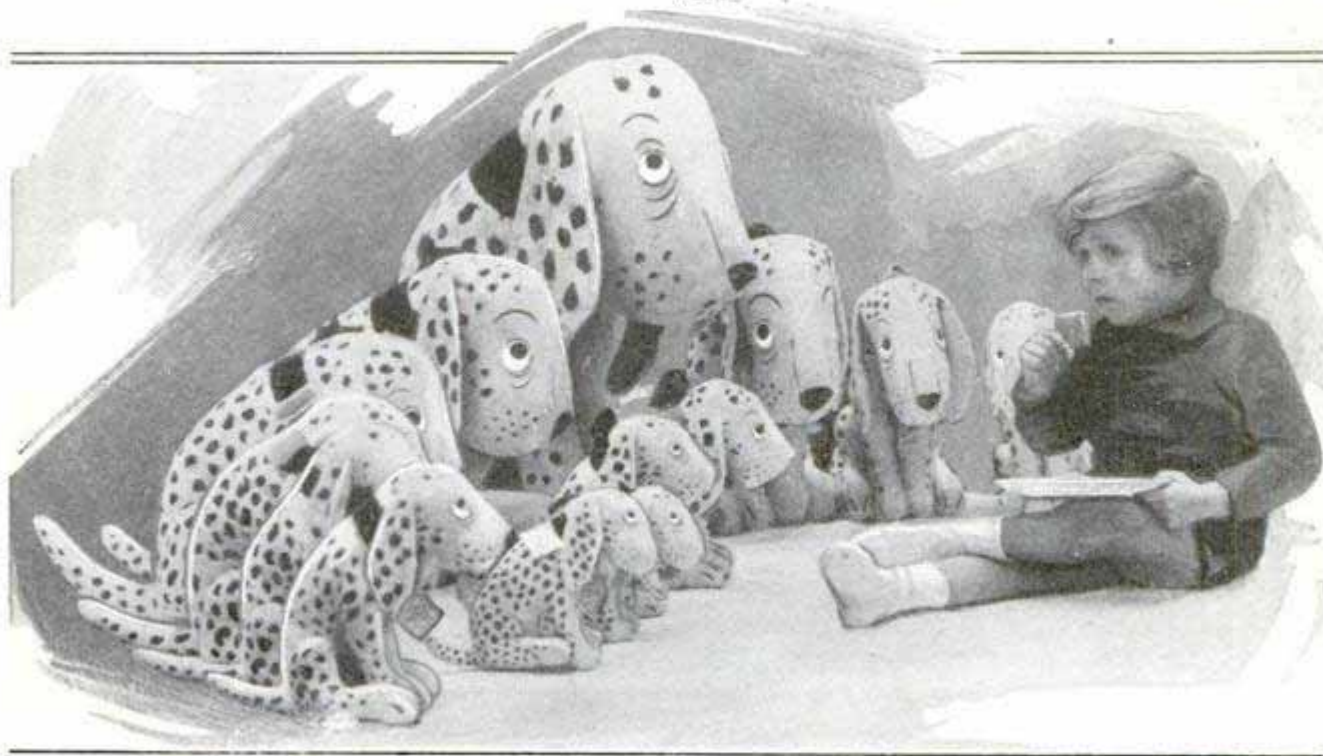

"Dismal Desmond" Is the Latest Addition to the Soft Toy-Dog Family, and Here Is a Little Devotee of the Desmond Family with Quite an Assortment of the Sober Puppies

George Borgfeldt & Sons

Knapp Electric Co 200-5th Ave
New York

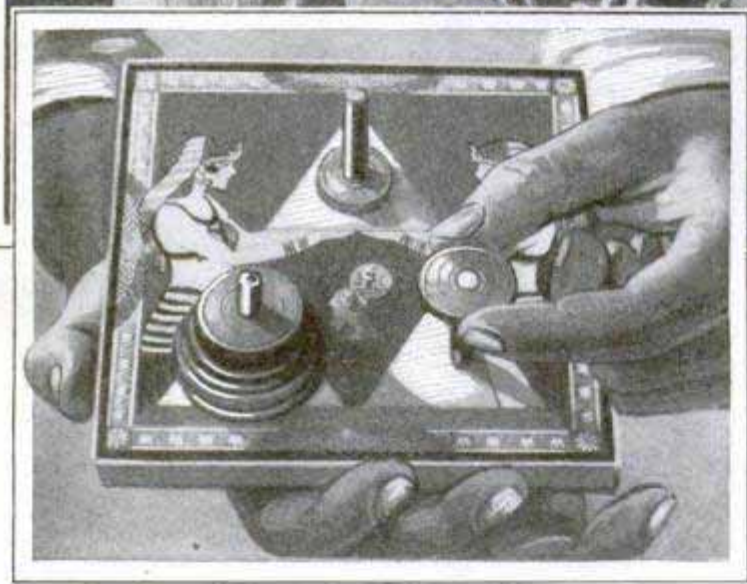

Above, Santa Claus' Automobile Fleet for Good Little Boys; Left, "Pyramids," One of the Games of Skill

season, R. C. Gibson of Marshall Field and company, pointed out, declaring that since the child's world is a "minature edition" of that of the adult in many respects, it is only natural to have the youngsters intensely interested in what concerns their parents, especially when that interest is represented in an effective way as in a toy. For the same reason, model airplanes and other toy aircraft of a wide variety are sweeping the stores just as aviation is claiming the nation's interest.

"Mechanical toys that simply run have comparatively little appeal these days," said Mr. Gibson, explaining the decreased interest in climbing monkeys and other things of that kind. "The toy that is accurately and realistically made and that functions as nearly as possible like the real article wins the child's heart. There

are scarcely any absolutely 'new' toys. Possibly some inventors are overlooking a profitable field in this direction, but, as in other forms of mechanics, a wholly new idea is difficult to originate. However, there are constant improvements over existing ideas."

He demonstrated a mechanical tractor, another new article this year. It is a faithful replica of the endless-tread affair and climbs steep steps and mounts other obstructions with ease. The tread is a large corrugated rubber band, moved by a strong spring motor. Toy dogs are not new, but this year finds the well-stocked store with supplies of realistic models of different breeds of dogs. Children are no longer content with just a toy dog, they want a chow, an airedale or a terrier, and the manufacturers have answered the demand with a remarkable line of animals that have all the markings and colors of the live dogs.

Three-compartment electric stoves with three switches and a thermometer just like the full-sized kitchen cookers, sets of

toy dishes with electric percolators that actually operate, and tiny sets of furniture closely modeled in style and color after the modern ideas are available for the little girls, and, although their interest in dolls has not waned, they demand better-dressed ones and sets of clothing that can be laundered. Toy merchants declare the model planes and other aircraft, as well as many forms of mechanical toys designed expressly for boys, are just as popular among the girls, but the boys are rarely willing to play with girls' toys.

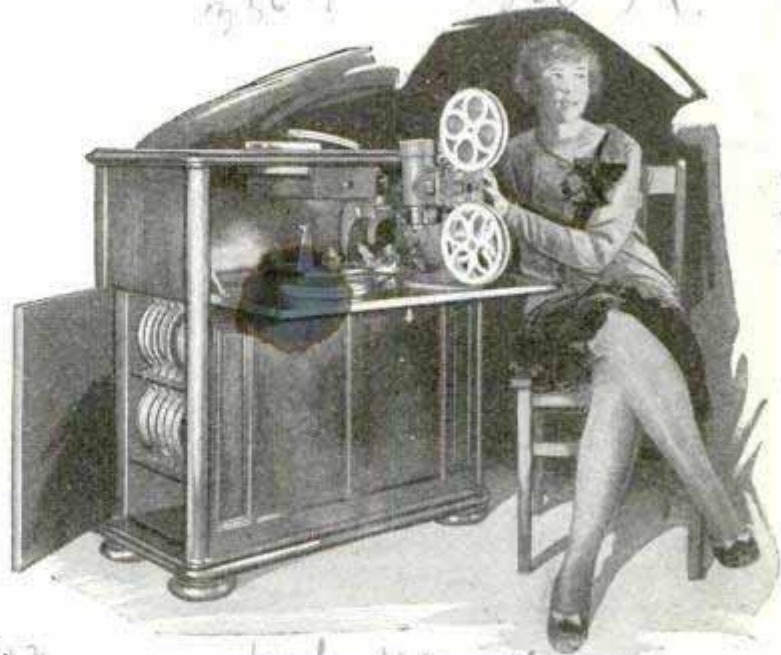

COLOR-DOTTED GOLF BALL IS EASIER TO FIND

Golf balls on which are marked twelve brightly colored dots now are on the market, to help improve the game and reduce the cost of playing it. The dots make the lost ball easier to find, and the various combinations in which they are arranged simplify identification. In addition, it is claimed they make the pellet look larger and give a better target by providing a point on which to focus the shot.

CATAPULT TO SHOOT LIFE LINE RESEMBLES CANNON

Somewhat resembling a cannon, a catapult to launch a life line has been invented by Santos Dumont, European pioneer in aviation. The catapult, mounted on two wheels, is easily transported and designed

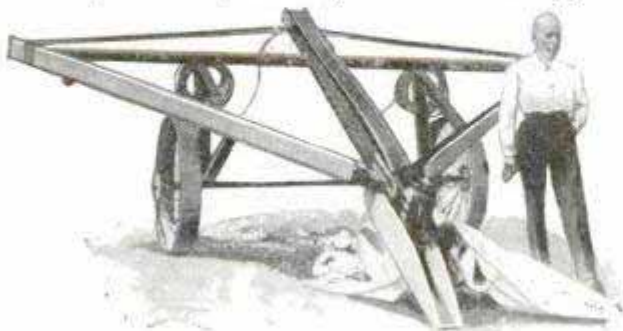

This Apparatus, Which Looks like a Cannon, Is a Catapult That Launches a Life Line

to shoot a line to persons in distress when it is impossible to launch boats to go to their aid.

Projector in Operating Position on Cabinet; It Is Slipped into Rear Compartment When Not in Use; Note Film Racks at End

HOME-MOVIE CABINET HOLDS PROJECTOR AND SCREEN

For showing movies at home, an attractive cabinet that holds the projector, splicing machine, camera and other units, besides a screen and space for storing forty-five 400-foot reels in humidor cans, has been placed on the market. When closed, it forms a convenient desk or stand. An upper hinged panel drops down to form a shelf and to expose the projector, which is easily removed from its compartment and adjusted for running. Plugs for attaching to wall sockets are installed. The shelf provides a convenient base for the projector when pictures are shown and also serves as a working table for editing, splicing, rewinding and title making. At either end of the cabinet are racks for storing the film cans, and there are also compartments for the camera, tripod and title printer. The back of the cabinet is the screen. This is easily removed and mounted at any convenient place in the room. The outfit is adjustable to different heights, weighs but fourteen pounds, and the screen will not wrinkle or buckle, thereby insuring better displays. The entire cabinet rests on concealed casters.

Whenever you find that you wish to know more about any article in this magazine, write our Bureau of Information.

*Wm. Curran
Chicago
Apr. 10, 1917*

Engineering Corp
420 2 31 st
New York

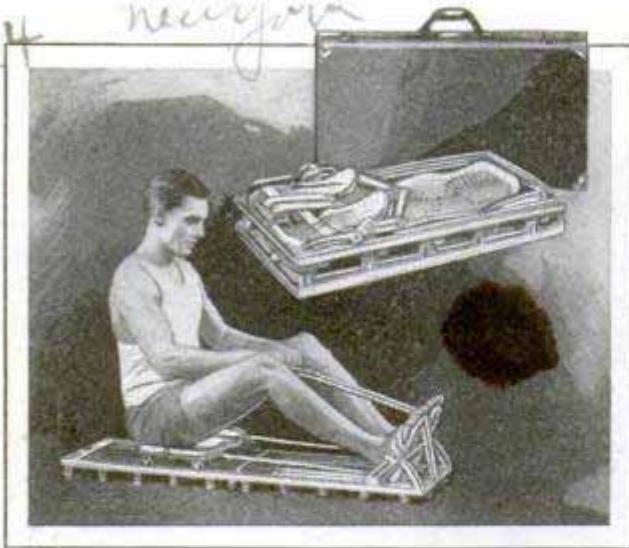

A Portable Rowing Machine, So Compact When Folded That It Fits in a Suitcase

ROWING MACHINE IN SUITCASE IS EASILY CARRIED

So compact and light in weight that it may be carried easily in a suitcase, a portable exercising machine, constructed entirely of aluminum, is on the market. It reproduces the exercise of rowing and has rubber-tired wheels and base, so that it may be used in hotels without disturbing other guests. Being adjustable for tension, it can be adapted to the use of weak or strong persons.

HOUSE OF THE FUTURE IS SEEN IN GLASS BUILDING

Constructed entirely of glass, a building at a recent exposition at

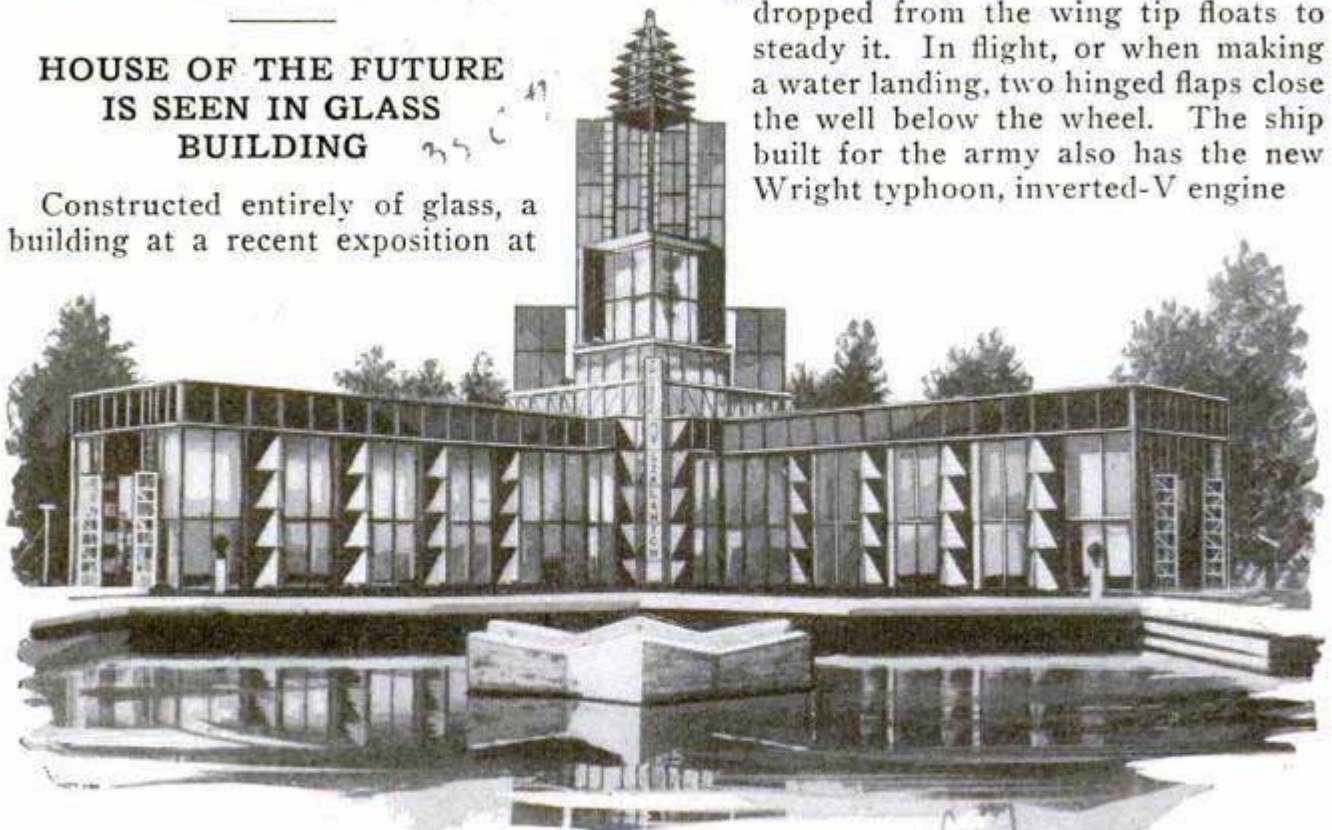

A Possible Hint of Structural Material of the Future Is Given in This Glass House of Modernistic Design Which Attracted Much Attention at a Recent Polish Exposition

Poznan, Poland, excited considerable interest, and possibly gave a hint as to the structural material of the future. The walls and even a tower were built of glass, and triangular effects in the walls gave the structure a futuristic appearance.

ONE LANDING-WHEEL PLANE ACCEPTED BY ARMY

A Loening amphibian with only one landing wheel, mounted in a well in the center of the boat hull's keel, has been accepted by the army after trials. The one-wheel landing gear was patented in 1924 by Grover Loening, and in 1926 the army equipped an old training plane with a single wheel, based on his patents, and made several successful landings, which showed the idea was fundamentally sound. As a result of the tests the army placed an order for one of the planes. The single wheel draws up into the well, which is a water-tight compartment like the center-board well on a yacht. Mr. Loening also has equipped his Moth sport plane with the single wheel, and none of the three ships show any tendency to turn over on the ground. After the ship comes to rest, supports, ending in small rollers, are dropped from the wing tip floats to steady it. In flight, or when making a water landing, two hinged flaps close the well below the wheel. The ship built for the army also has the new Wright typhoon, inverted-V engine

One Park Place.

3524

New York

Link

Paris, France

SUBSTITUTES FOR COAL AND OIL TESTED

French scientists, looking to the time when natural supplies of coal and oil will be exhausted, are making experiments with five substitutes to furnish power for mankind. The researches include a plan to tap the thermal energy of the sea by utilizing the difference in temperature of a current such as the Gulf Stream and the surrounding sea; a device, which already has proved its worth, for utilizing the energy of the tides; a method of using the wind; a plan to use the difference in temperature between tropical and arid regions by harnessing the heat of the desert, and a plan to create an artificial fall of water between two neighboring bodies of water of different altitude, such as the Mediterranean and the Dead Sea, the volume entering the lower body equaling the amount of evaporation. Another idea, evolved by a German engineer, includes damming the Mediterranean at the Dardanelles and at the Atlantic end and using the overflow to produce electrical energy and irrigate the Tunisian Sahara. One French scientist is engaged in laying a pipe, 5,000 feet long, into the sea to demonstrate that the thermal energy of the ocean can be made to work, while another experiment involves laying a tube along the incline of the Atlas mountains on the theory that heat rises in columns or cones of energy and that this energy can be canalized in the pipe and transformed into electrical power. One way to tap the energy of the tides has been found by an inventor who has made a water wheel to enable ships to move against the current upon power derived from that current.

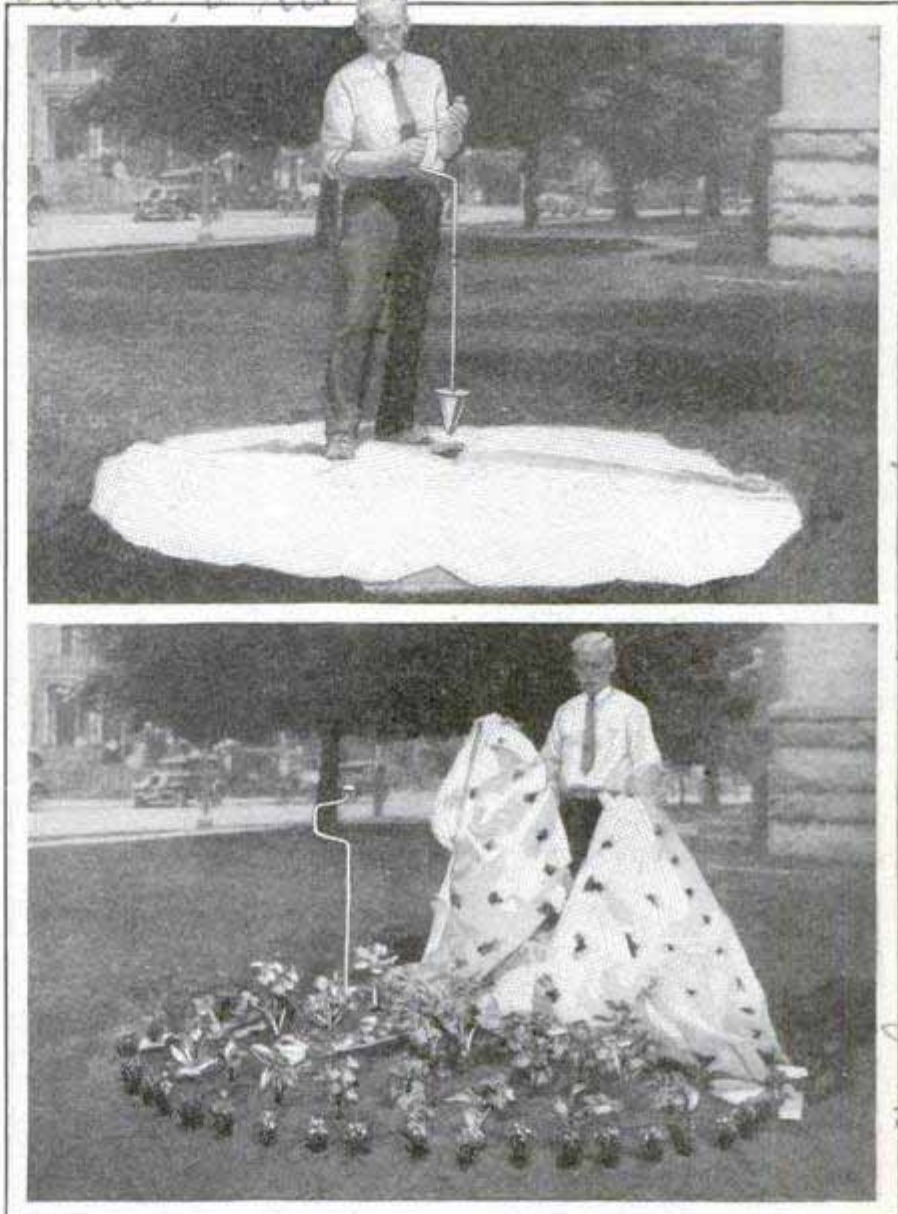

Uniformity in Garden Design Is Attained with a Planter Which Prepares the Holes, and a Paper Pattern of the Design

GARDEN TOOL PREPARES HOLE FOR SETTING OUT PLANTS

Setting out plants is simplified by a garden tool which prepares the hole to receive the plant while the operator remains in an upright position. The base of the planter is shaped like an inverted cone and is adjusted to a rod with an axle similar to a brace, which, when revolved in the dirt, makes the required opening. When used for field plants, the hole is made at an angle and may be closed by stepping on the ground. Use of this tool together with designs on paper of various-shaped beds enables uniform planting of flowers in any desired pattern.

☛ Fast-flying birds have stiff, trim feathers.

Edm. Wilson Logan, 206 Franklin Ave. Columbus, Ohio. 11

Sky Harbors of the

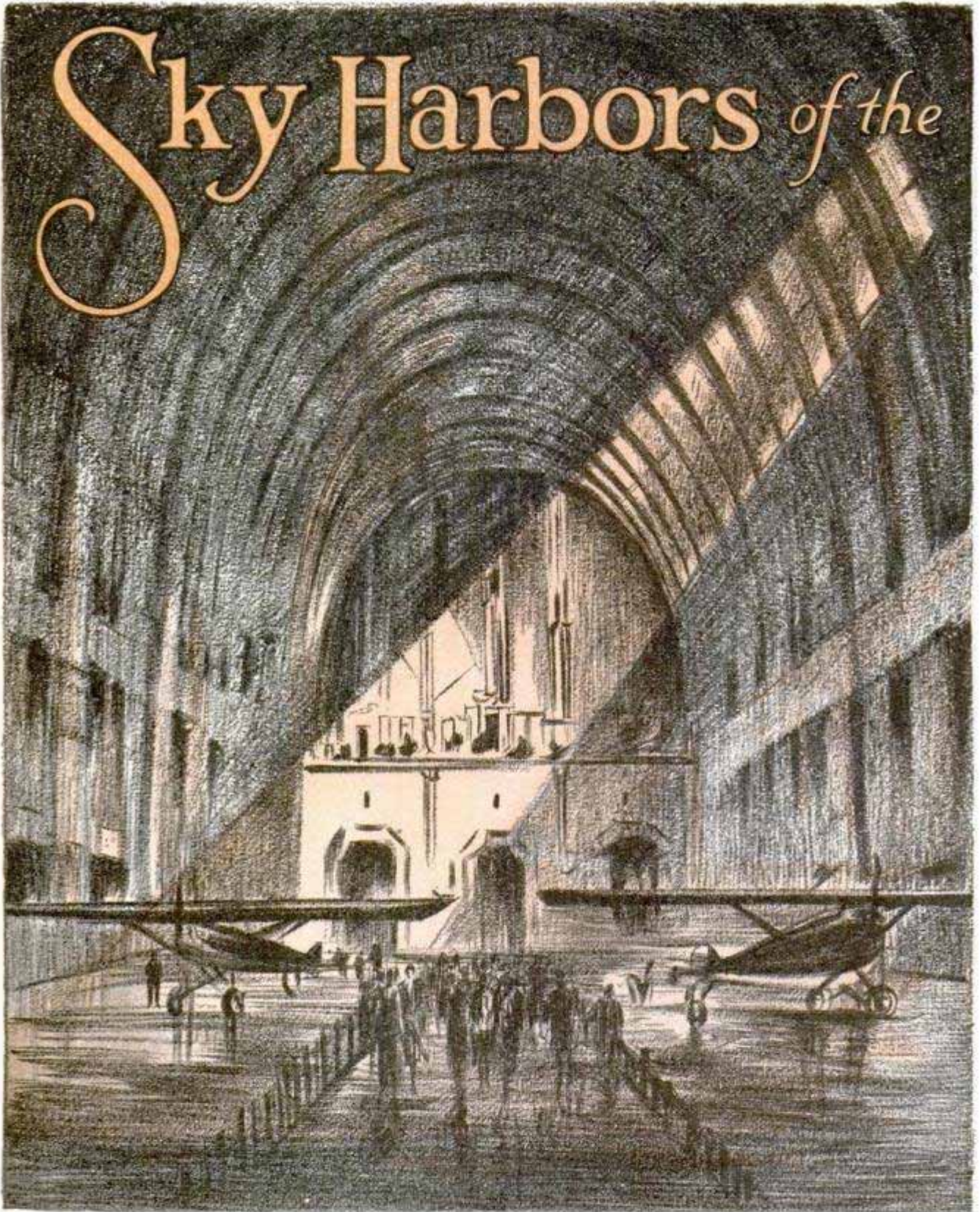

An Architect's Conception of a Future Airport, Designed like a Railway Terminal, the Planes Being Towed by Electric Truck to a Field Outside after Loading or Unloading

By HAMILTON M. WRIGHT

*5 Park Ave
New York*

WITH forty million dollars having been spent on aviation development in the United States during 1929, and with the airplane leaping into popularity more swiftly than did the motor car in its early

days, it is obvious that every city and town in the United States that wishes to keep in step with modern progress is developing its own airport, as the new gateway to the city.

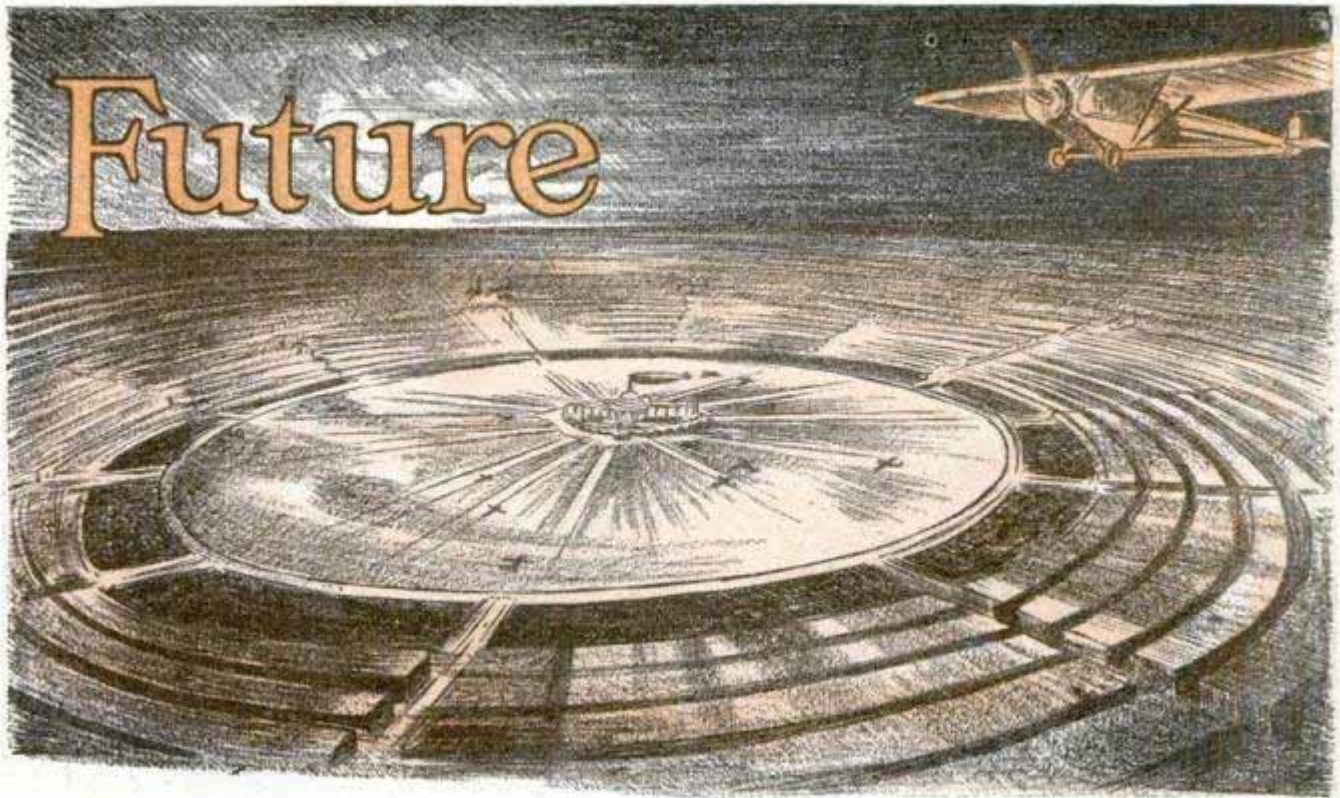

Another Conception of a Future Air-Minded City with Streets Radiating from a Central Airport and Railroad Terminal, 7,500 Feet in Diameter, with Space for Hangars and Hotels

The desirably situated airport is to be regarded as a paying investment not only in the increased prestige and advancement accruing to the community which possesses a modern air field, but in the return from the airport itself. Well located suburban property near a thriving center is almost always sure to grow in value. When the great railroads selected their rights of way, switching yards and terminal locations, the land was given as a bonus by the government or could be bought for a song. It has, since those early days—generally speaking from thirty to eighty years ago—appreciated in value by billions of dollars. Today, aviation, the latest medium of swift transportation, is confronted, similarly, with the necessity of locating its terminals, and while it cannot buy land at the low figures obtained by the railroads, it will save money by acting with vision to provide amply for its future growth. In importance and value, experts believe the larger airports of the future will rank with the great railway terminals of today. Near the smaller cities and towns, airports will be as necessary as the local railway depots. Moreover, since the airport is the key of all commercial aviation, great air-transportation companies in the process of expansion

and of the absorption of smaller rivals will undoubtedly desire to pre-empt and improve the best airport locations.

The head of one of the largest real-estate associations in the United States said recently: "Great crowds of people even now visit our airports on Sundays and weekdays to watch flying activities. Since real-estate values follow the crowds, it is easy to see the influence of airports on adjacent land areas.

"The modern airport is becoming a gateway to the city or community it serves. It may be very directly compared to a railroad terminal in its functions, facilities and general character. The airport crowds are in holiday mood, demanding food, care and entertainment. The field personnel, including ground attendants, the administration officials and the pilots, must be housed and fed. All this activity in connection with airports is creating new uses for real estate."

The more immediate sources of profit, however, arise from the airport itself. Like the gasoline filling station and garage, it has definite services and supplies to offer. Among them are the retail sale of gasoline and oil. Rental of hangar space is another item. The average rental is about \$40 per month, ranging from \$15

8293

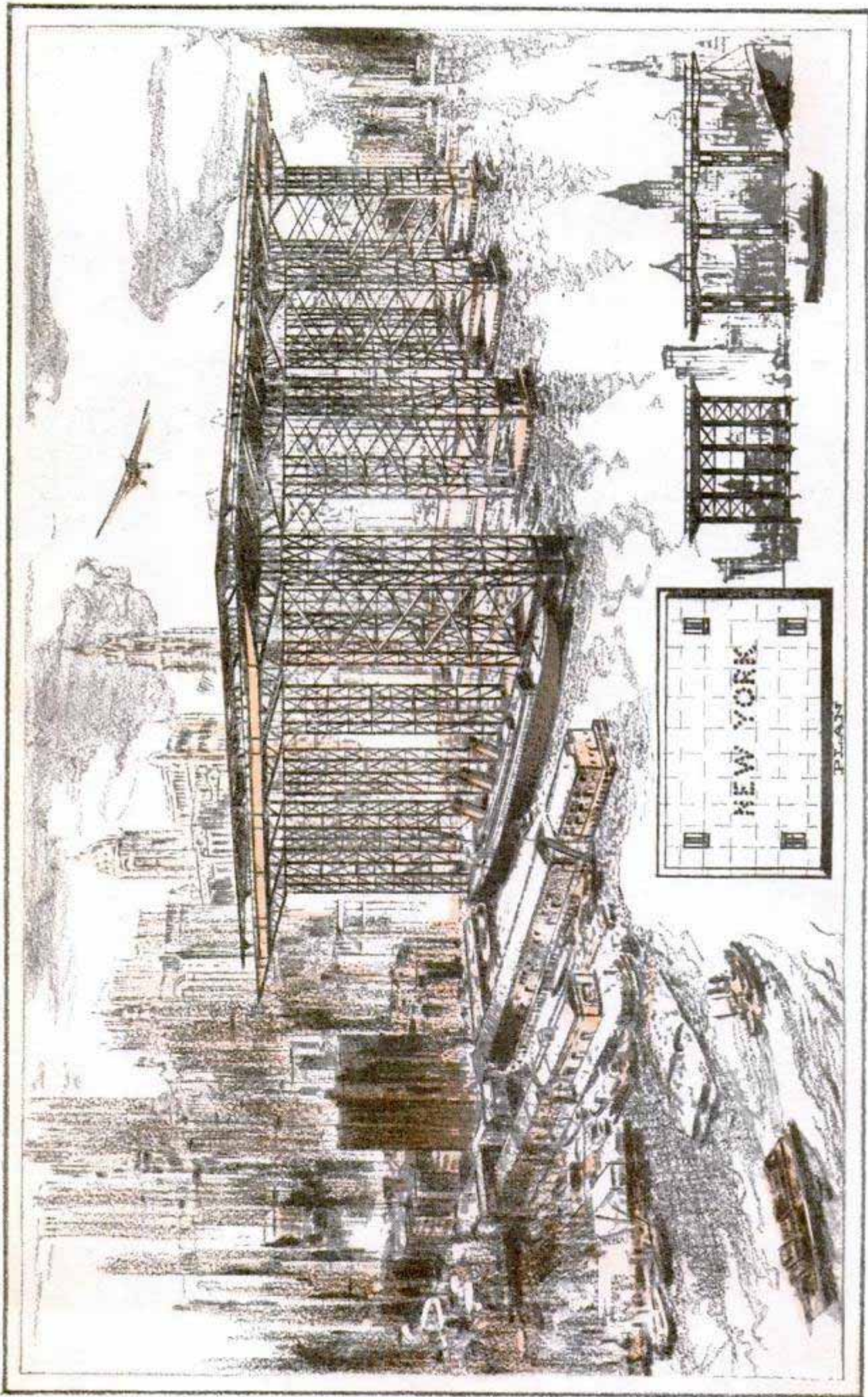

A Scheme for Utilizing the Space above New York Wharves and Railway Sidings for an Elevated Airport, So Small Planes Could Convey Passengers and Mail Close to the Business Center and to Boats and Railroads and Near-By Airports, Thus Saving Much Valuable Time

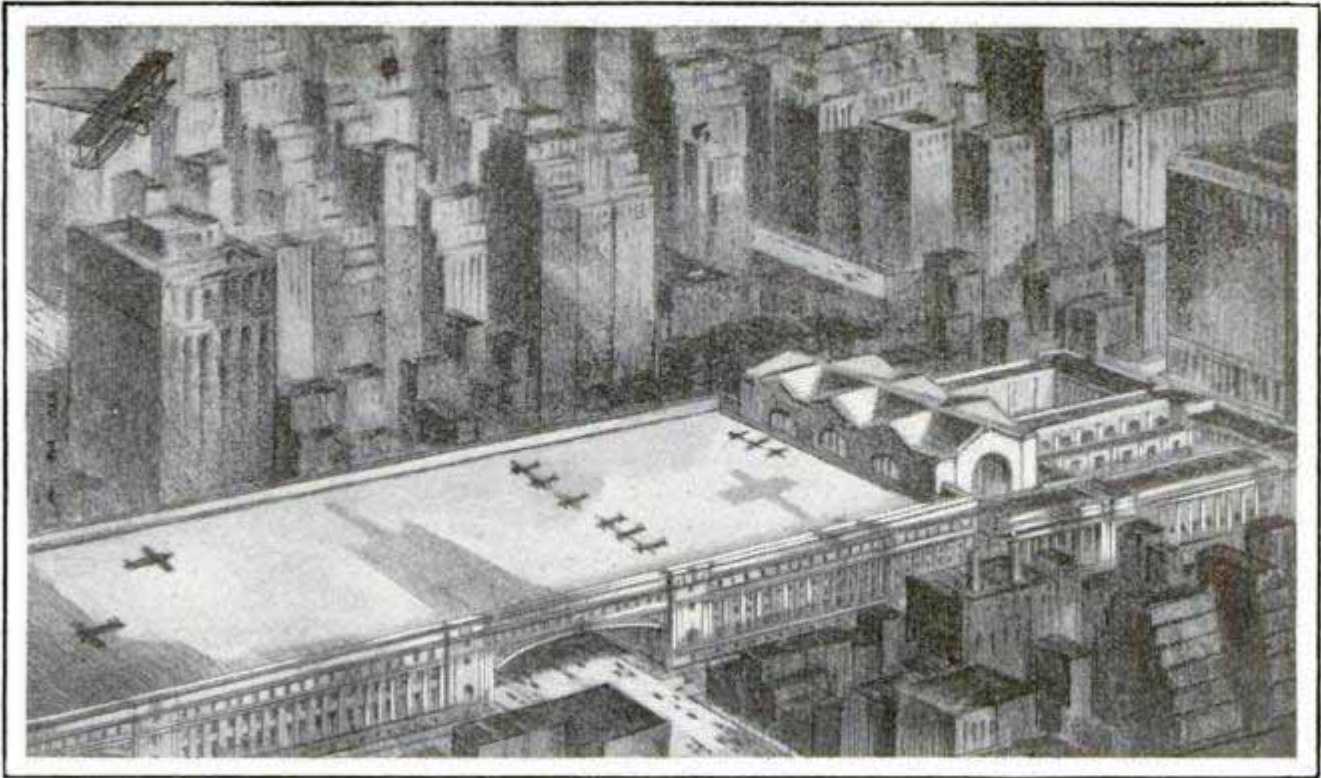

An Architect's Idea of How a Landing Field Might Be Built on an Elevated Platform above the Pennsylvania Station in New York; Pneumatic Tubes Would Handle Air Mail from It

to \$30 for a small plane up to \$60 to \$75 for a large one. Repair service, concessions, such as hot-dog stands, restaurants, bowling alleys and rifle galleries, and the rental of parking space for automobiles near the airport are among other profit yielders. The average cost of looking over a plane is about \$2 an hour. Then there are passenger hops above the surrounding country, already an important Sunday and holiday pastime and source of revenue. The publicity manager of a southern resort city instituted bridge parties in the air and afternoon teas in airplanes starting from the municipal airport.

As the number of airports throughout the country increases, cross-country taxi air service will come more and more into vogue as a future source of income. A fifty or hundred-mile hop to the next town will be a money-making trip for the successful salesman, increasing his number of daily calls. The visit of the taxi plane means more servicing and gas and oil and food or refreshments sold to passengers and pilot. The airport, like the successful garage and filling station, must cultivate popularity. Some fields charge from one to three cents per horsepower for every plane that lands. But usually such a plan is bad business, as it keeps planes away.

The first consideration in selecting the

airport site is accessibility. The airport should be located on a main highway but out of the congested area. If, in the case of small towns, it can be reached in, say, fifteen minutes from the commercial center of the town, so much the better. The second consideration is ample area, which is absolutely essential. The field must be large enough to enable planes to land in safety. And third, but also of vital importance, is the nature of the terrain. The field must be level and free from obstructions and have a sufficient number of runways, long and wide enough to make landing safe, no matter from what quarter the wind blows. Of the nearly 1,500 airports now reported in the United States—and more are coming into existence every week—a competent authority states, less than 200 are considered perfectly safe in emergency landings or when the wind is from an unfavorable direction.

The question of accessibility presents a more difficult problem when the airport is to be laid out near a large town or city. The future of aviation can only be realized by the assumption that the great air terminals of the future will justify expenditures of millions of dollars for site, construction and equipment. They will handle a volume of traffic compared with the great rail terminals of today. They must

possess ticket, freight and express offices, custom, quarantine and immigration stations, post offices, baggage departments, news stands, rest rooms, drug stores, restaurants, first-aid stations, meteorological stations, pilots' quarters, managerial offices and other equipment. The landing field must be of sufficient area and of an all-way plan to permit the departure of large planes every few minutes of the day and night. As the air mail is the backbone of commercial aviation in this country, and mail pilots at this writing are flying 40,000 miles each twenty-four hours, the problem of providing for the expeditious handling of this mail either now or in the future is a vital one in the case of all airports in communities that want air-mail service. A prominent postal official is quoted as predicting that all first-class mail will go by air within three years. But at present, on short flights, the transport of air mail between airport and terminal may often take longer than the actual time the plane has been in the air. To overcome this handicap, prominent architects, aviators, engineers and postal officials have recommended the installation of pneumatic tubes between airports and post offices.

What size should an airport be and how costly? In the opinion of a large number of experts, the size of the field, provided it meets with the minimum requirements for safety and does not ignore the possibility of future expansion, must depend upon

the population of the surrounding district and nearest town. There is scarcely any limit as to cost. An airport may cost a million or more. Hangars and buildings may run up to half a million. But this need not prevent any community from making a start and establishing a first-class landing field at comparatively small outlay.

Every town will start with the idea of eventually acquiring a No. 1 rating. Under the airport-rating regulations of the department of commerce, the field, to secure this rating, should have at least 2,500 feet of effective landing area in all directions with clear approaches and must be in good condition at all times. Or it should have landing strips not less than 2,500 feet long and 500 feet in width, permitting landing in at least eight directions at all times, the landing strips not to cross or converge at angles of less than forty degrees. The very minimum of safety for the largest planes is 1,500 feet of runway, but as a matter of fact the runways should be 2,500 to 3,000 feet in length. The ideal field would be a mile square, 640 acres. A 160 to 200-acre plot of level land will serve most smaller communities.

The builder of an aviation field in central New York state approached the local chamber of commerce in reference to securing a site. The chamber in turn took the matter up with public-spirited citizens and leading farmers of the vicinity. A farmer was found who was glad to lease

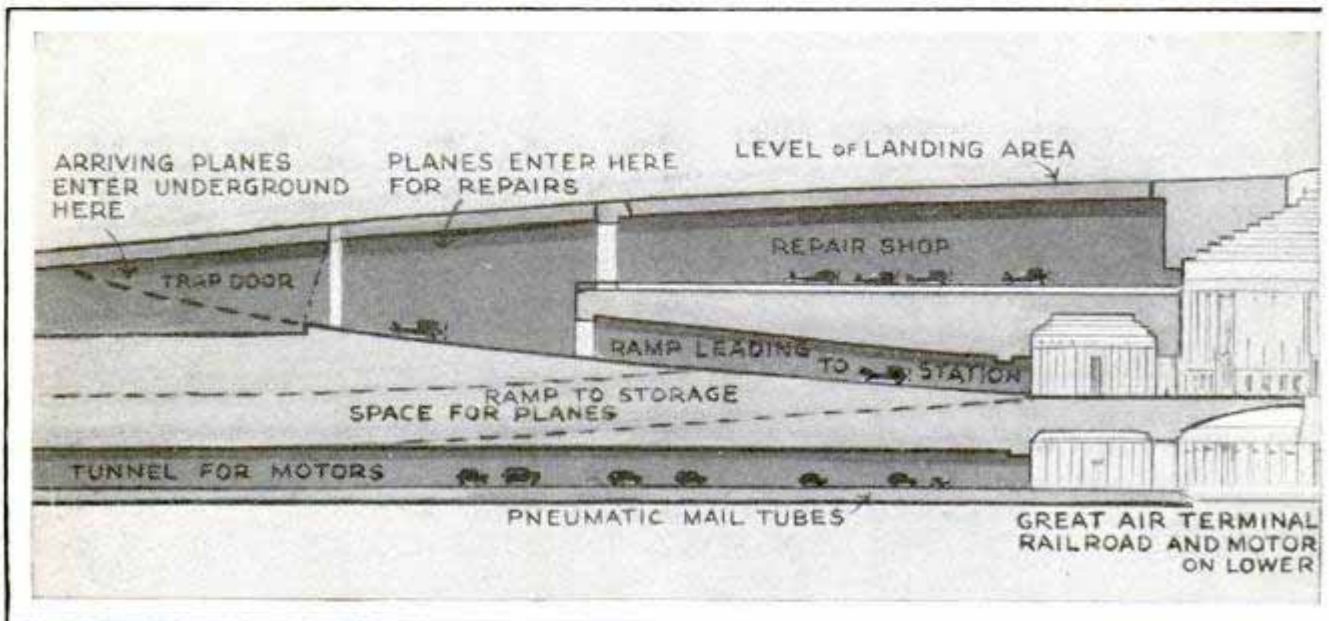

A Plan for an Underground Airport Terminal with the Cone-Shaped Field Free of Every Obstacle, Including People; at the Top Are Trapdoors through Which Planes Enter and Leave

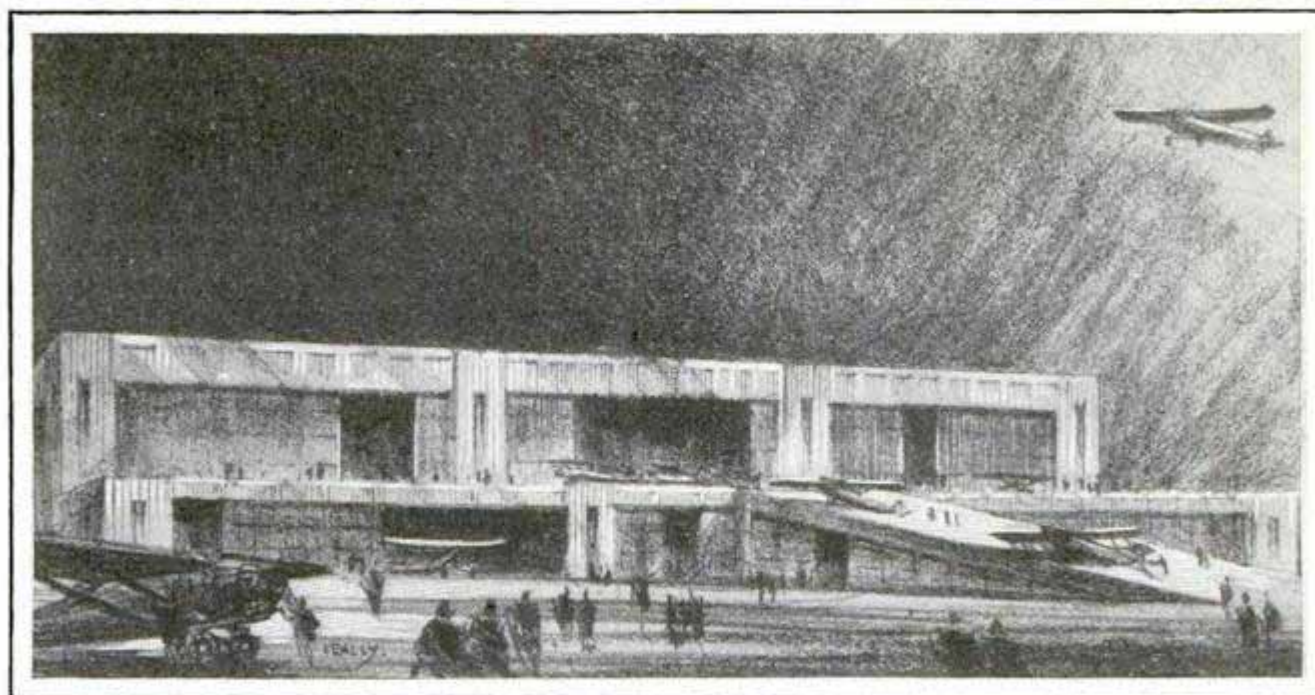

Perspective of a Two-Story Airplane Hangar Developed with a Concrete Ramp, the Second Story Being Used for Small Ships, and the Ground Floor for the Large Commercial Planes

a square level plot of 160 acres, free from high-tension wires or other obstructions, at a low rental for a term of twenty years. The promoter of the project was careful also to lease some land on the other side of the highway adjoining the landing field, as a parking site for motor cars.

The process of getting the field in shape was that which will be adopted in most instances. A runway was staked out in the direction of the prevailing wind. Then two other runways in the direction of the next prevailing winds. All obstructions, small pines and other trees, ditches and small gullies were removed. Obstacles in

the vicinity of the field were marked with red flags. A mowing machine was run over the land which was leveled and graded. A large white circle was marked in the center of the field which could be spotted from the air, designating it as a landing field, with an arrow pointing north so that a pilot flying over the field could see it clearly. A wind indicator also was installed.

A field like this one shows how quickly the basis of an airport can be established. Drainage should be accomplished by a grade of about one and one-half per cent and not over two per cent.

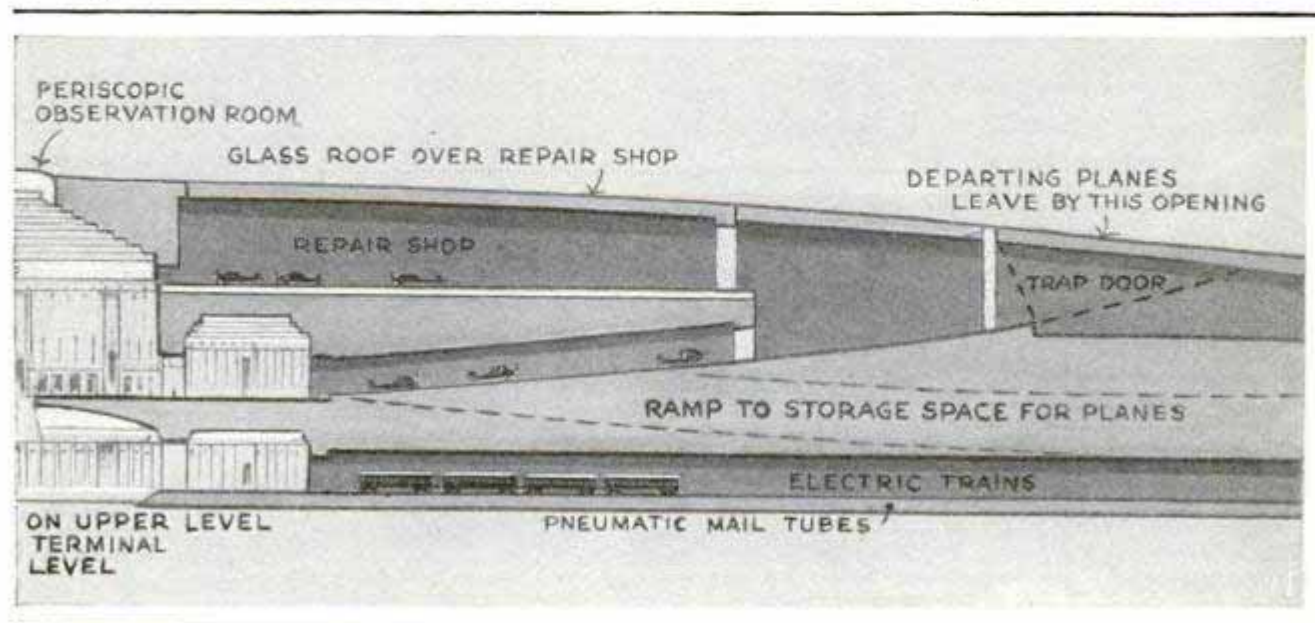

The Underground Terminal Would Contain Railway Lines, Motor and Bus Lines, Pneumatic Mail Tubes, Hangars, a Hotel and Restaurant as Well as the Repair Shops for the Planes

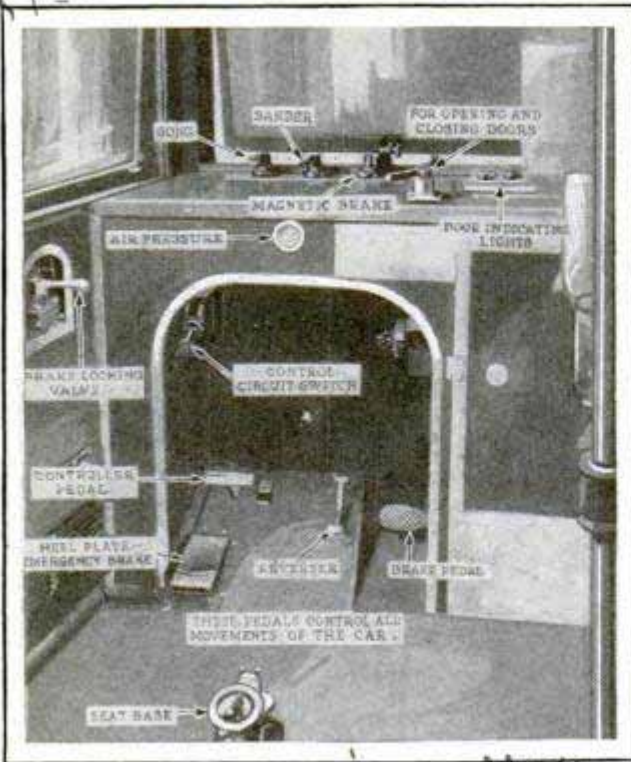

Control Board of Street Car with Foot-Operated Speed and Brake Pedals like an Auto

FOOT-CONTROLLED STREET CAR OPERATED LIKE AUTO

Increasing speed, safety and comfort, a foot-controlled street car, operated like an automobile, has been introduced in Albany, N. Y. On the floor of the trolley car are the controller pedal, corresponding to the accelerator of the automobile, a brake pedal, reverse control, and emergency brake, all operated by the feet. The gong, sander, magnetic brake and brake-locking valve are manipulated by hand.

PLANT FOOD DOUBLES GROWTH

Containing the extracts of several chemicals essential to plant growth, a plant food now is available, which, tests show, will double the rate of growth and the size of water and garden plants. The preparation comes in liquid or solid form and was developed primarily for water lilies, but has been found equally effective for other forms of plant life.



A Revolving Serving Tray for the Dining Table, Which Allows Guests to Help Themselves

SIXTY-THREE-STORY BUILDING IS MOST ECONOMICAL

For city realty where land is worth \$200 a square foot, a sixty-three-story building will yield the greatest return on the investment, according to results of a survey for the American Institute of steel construction. Where land is worth double that amount, a seventy-five-story building would pay best. The engineering difficulties of a building 2,000 feet tall, or nearly 200 stories, could be overcome, the survey showed, but such a structure would not be feasible economically, and even a building 131 stories high would not return a net income. An eight-story building would cost \$22,193,000 to build and would yield 4.22 per cent on the investment, while the sixty-three-story building, costing \$39,100,000, would return 10.25 per cent. For higher buildings the return decreased, although on higher land values, the seventy-five-story building was found to give the greatest return. The limit to buildings is imposed chiefly by the elevators, as the cables gradually become too heavy for greater heights, while the normal human eardrum cannot stand an elevator speed over 1,500 feet per second, necessary in a 2,000-foot building.

REVOLVING DINING TABLE TRAY DOES WORK OF SERVANT

Doing the task ordinarily required of one servant, a revolving serving tray for the dining table has been made in Germany. The tray has double ball bearings and is equipped with knobs at the edge to facilitate turning by any person seated about the table. Dishes from which guests are to be served are placed on the tray which, when turned, brings the desired food before the person revolving the container. It may be covered with felt or a doily to protect the surface from blemishes from hot dishes.

Handwritten notes:

- 13
- 520
- Plant food...
- ...tray...
- ...tray...
- ...tray...

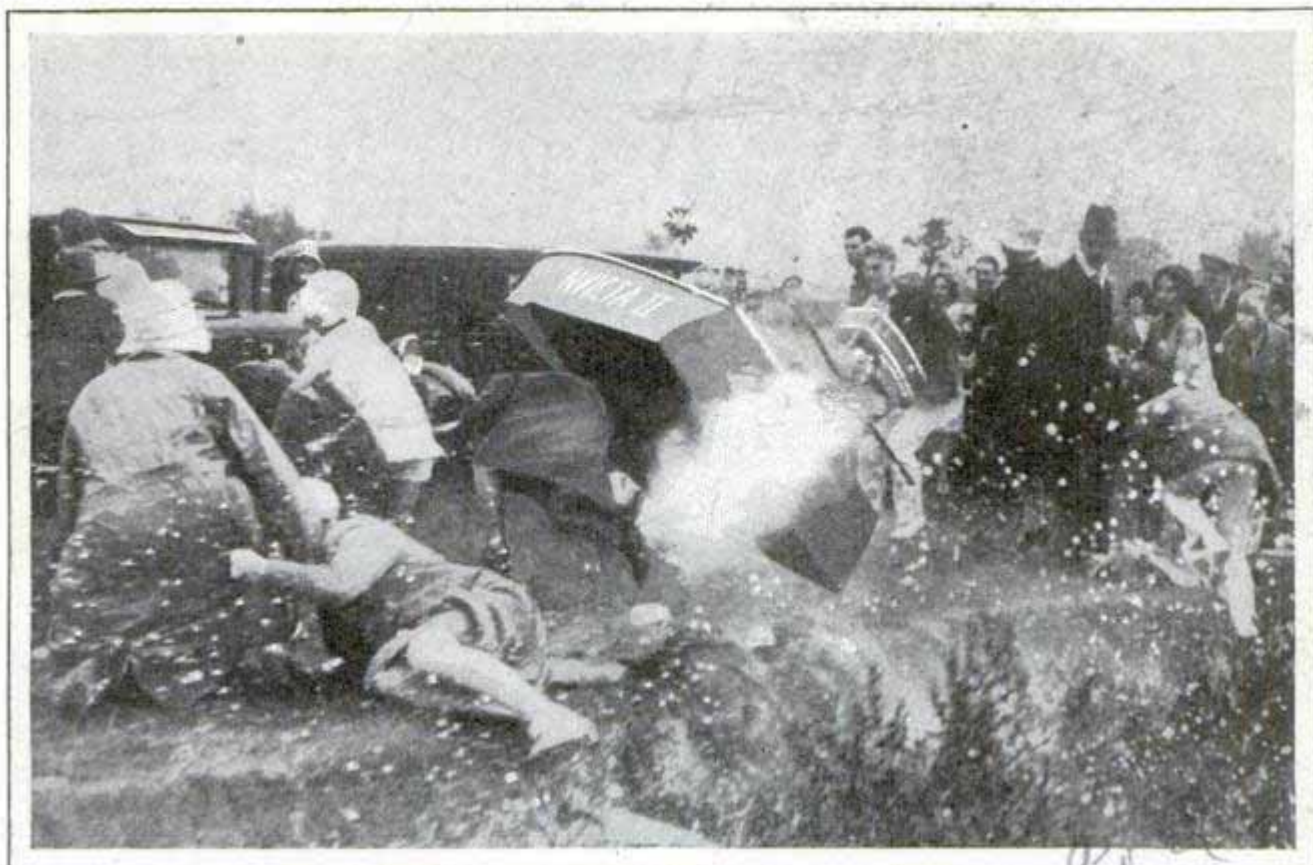

Spectators at a British Outboard Motorboat Race Are Seen Dodging for Cover as One of the Boats Leaped Out of the Water and onto the Bank When the Pilot Was Thrown Out

SPEED BOAT LEAPS ONTO BANK WHILE OUT OF CONTROL

Spectators at the outboard motorboat races at Rickmansworth, England, recently were afforded an extra thrill when one of the boats leaped out of the water and onto the bank, landing among automobiles and onlookers. The boat came catapulting through the air from the water when the pilot was thrown out while making a sharp turn. Neither pilot nor spectators were injured.

and are also trying to plug another hole in the bottom of the lake. The lake is used by the state as a breeding and hatching place for trout.

Henry Parkson

3471

JEWELERS' REVOLVING STAND KEEPS TOOLS IN ORDER

For the use of the watchmaker and jeweler, a revolving tool stand on a ball-bearing base now is on the market. The stand is of hardwood and has space for from sixty to 150 tools which fit in holes of varying size, keeping them always within sight and reach of the worker. The stand also contains bottles to hold materials or small parts and serves to keep delicate instruments and constantly required tools off the workbench.



C. D. Argood, 5 1/2 Market Square, Hamilton, Va.

BEAVERS STOP LAKE SEEPAGE WHEN ENGINEERS FAIL

When engineers and members of the state game commission three years ago failed to stop the seepage from Goose lake, one of the greatest trout lakes in the state of Washington, they decided to let beavers do the task and liberated a pair there. An examination recently showed the increased colony had built a dam which prevents the water from running into a crater and makes the water level several feet higher. The animals still are improving their dam although it is about water-tight,

414

Carl Paul

Radium is found in extremely small quantities in living plants and animals, according to a Russian scientist.

2881

Em. N. P. & W. R. Co., Chicago
Supervisor, Pennsylvania R. R.
Grand Rapids, Mich

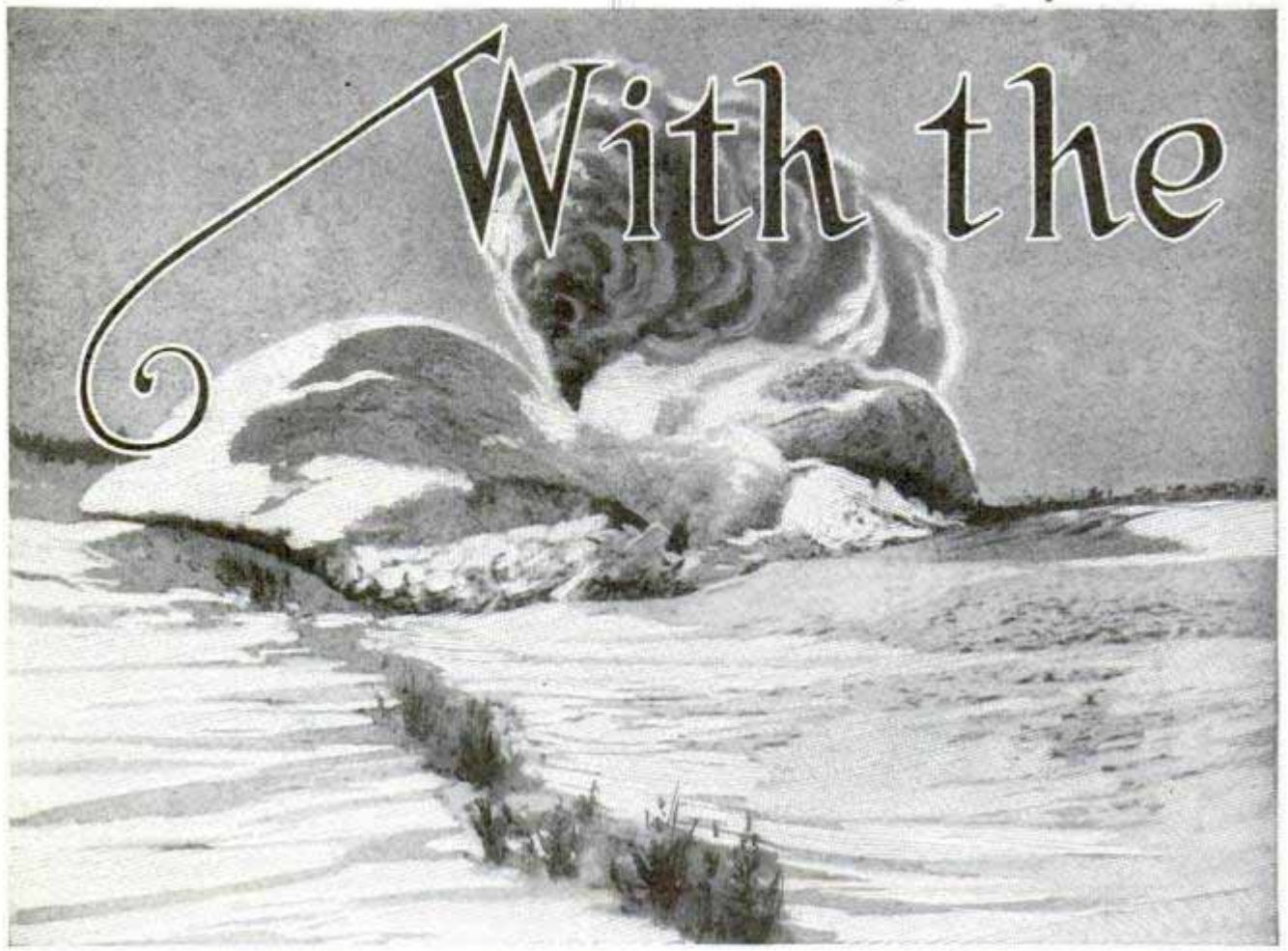

Bucking a Drift That Has Filled a Railroad Cut; Winds Add Their Toll to the Annual Cost of Keeping the Lines Open, Especially Where Depressions Catch the Snow

By PAUL D. PADDOCK

"IT'S snowing again. A stiff gale is blowing and the snow is drifting badly. Looks as though the trains will need some help."

A mirthless grin spread over the face of the Pennsylvania railroad train dispatcher at Grand Rapids. "I thought we'd hear from you before night," he barked back. "Well, don't worry. The 'felt-boot' boys will dig you out. So long."

The phone call was from a northern Michigan town, far up in the snow country, where drifts, ten, fifteen and sometimes twenty feet high, pile into the railroad cuts, choking traffic and challenging the crews of felt-boot boys, the railroad's name for the snow-fighting squads, picked men who know every inch of the tracks and who can stand the rigors and bitter cold of rides with the plows in the dead of night and in sub-zero temperatures.

The snow battle is a winter struggle for many railroads, a fight that costs thou-

sands of dollars annually. Its hardships and technique are well illustrated on the Pennsylvania's Michigan line, where the tracks run consistently northward, giving the prevailing winds that sweep across the land at right angles, a clear chance to fill the cuts with snow. In one stretch, only forty-eight miles long, there are 172 cuts, open invitations to drifts. In spite of the heavy snows of last winter, more than ninety per cent of the line's passenger trains made schedule time during the winter months, and freight traffic was kept moving.

The first call for help is the signal for the snow battle to begin. The dispatcher calls the various stations along the line, jotting down the reported temperatures and the snow measurements for each place. The power man, in charge of engines, calls for a locomotive and a plow, the crew is summoned, the dispatcher clears the line for the snow fighters and

Snow Fighters

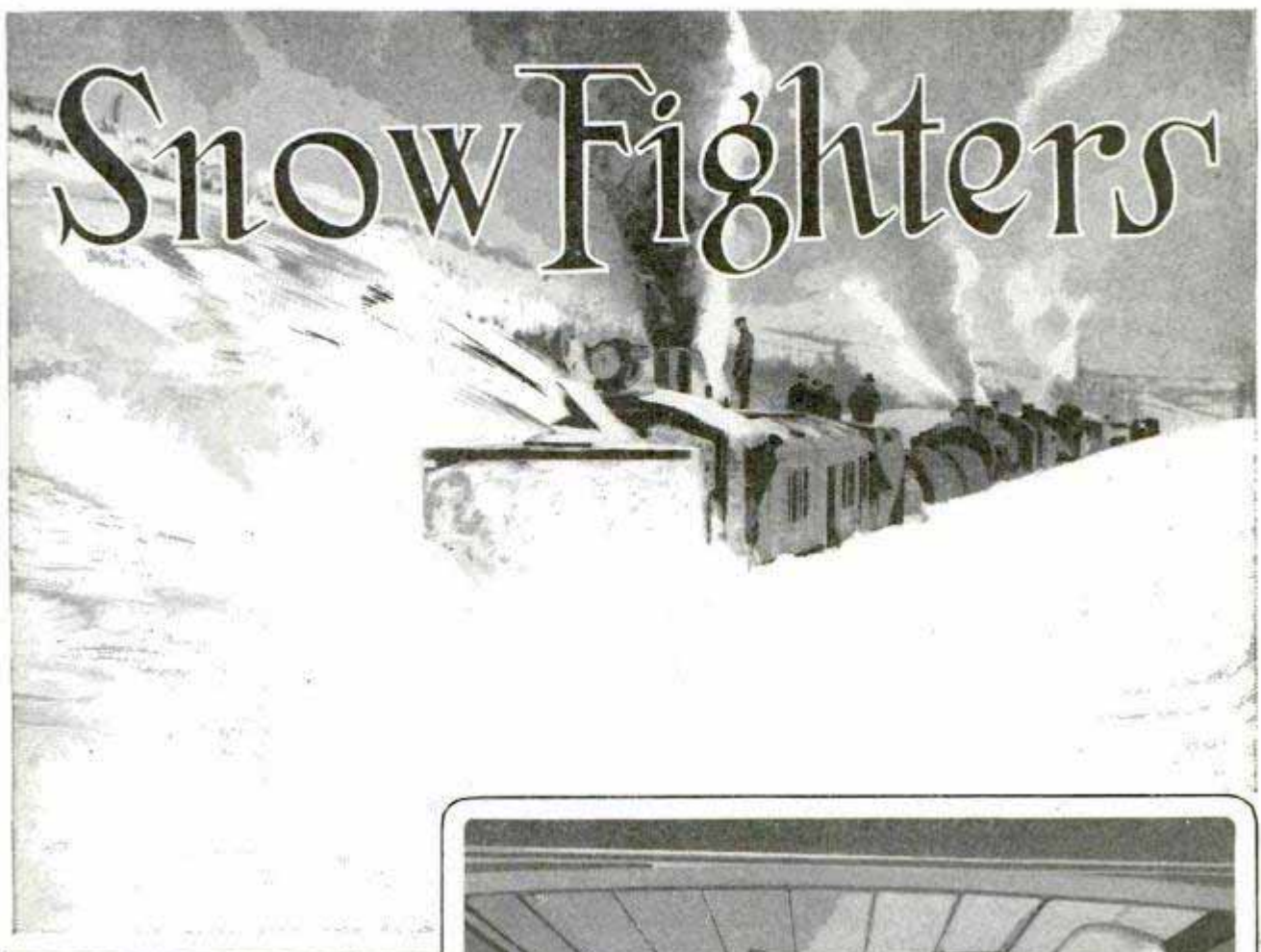

they are off, frequently in the dead of night when the tracks are less occupied with other traffic, or in a blinding storm with a roaring wind hurling sleet and snow upon the rails almost as fast as the plows can remove it.

The plow, of course, is at the front, behind is the locomotive and then the caboose. The engine cab and space between the cab and tender are hooded with a big canvas shield that also covers the coal to keep out the snow and ice. The front windows of the cab are boarded up to protect them from chunks of ice and hard snow. The engineer and firemen are literally bottled up inside their engine. The train is directed by the men in the plow. They communicate with the engine crew by electric signals.

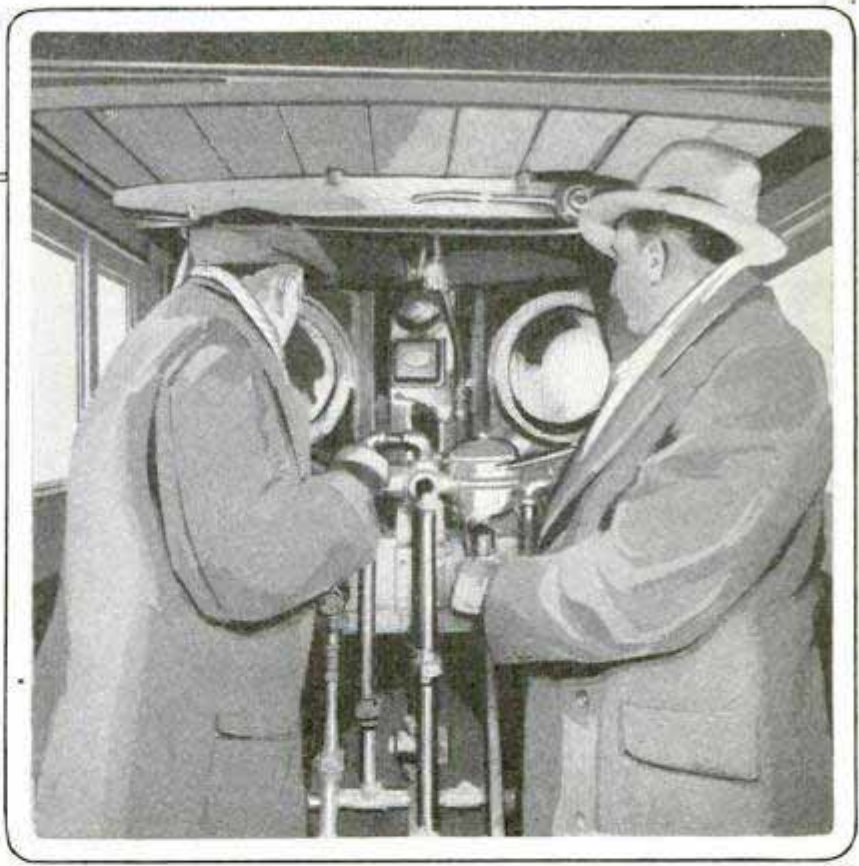

Rotary Plows Fighting the Drifts on the Union Pacific and, Below, inside the Operating Cabin of a Pennsylvania Pusher Plow

"All set?" asks the conductor who sits on the right side of the cupola, far to the front of the plow.

"O. K. here." reply the men in the plow's cabin. Two maintenance-of-way men are

usually carried on the plow beside the two who sit up in the cupola. The conductor reaches up, and pushes the electric button twice—the starting signal. Two short blasts of the engine's whistle reply, and the snow train clatters out of the yards.

The odd-looking train, with its ugly-faced knife-nosed plow at the front, has left the city and reached the main track. Five buzzes on the electric signal tell the engineer to increase speed. Through the small windows in the cupola, the headlight, a powerful beacon attached to the front of the plow, shows the storm a whirling mass, obscuring the rails and the right of way for yards ahead. The men rub the windows every few minutes with waste, saturated with wood alcohol to keep the interior surface free from frost. The 100-ton plow is springless and it bumps and jolts as it strains through the snow. Chunks hurtle against the sides and strike the windows. The noise is terrific. Both men are anxiously straining their eyes to pierce the blinding film outside.

The order is to plow and flange the main line and passing sidings between Grand Rapids and Cadillac. The flanger

is the smaller hidden plow that extends down from the bottom just ahead of the rear trucks. It is V-shaped and slices out the snow and ice between the rails. It is lowered to about three inches above the rails when the plow is in operation, and so must be raised when the train approaches planked road crossings, switches and frogs. The big wings that stick out at the sides of the plow must also be pulled in at mail cranes, sidings, station buildings and other obstacles along the line. For this reason, the men who operate the levers that perform these functions by means of compressed air from the engine, must be familiar with the track. If the obstructions are not visible, the crew must know where they are, so that the flanger and the wings can be withdrawn to safety.

A green light looms hazily out of the foreground. "Get your wing in," the conductor yells at his companion. In flies the brakeman's lever, and the ponderous wing that normally protrudes at an angle of thirty degrees, strikes the side of the plow with a crash as the train shoots by the switch at thirty miles an hour. The hissing of the compressed air, the crashing of the snow, the roar and creaking of the

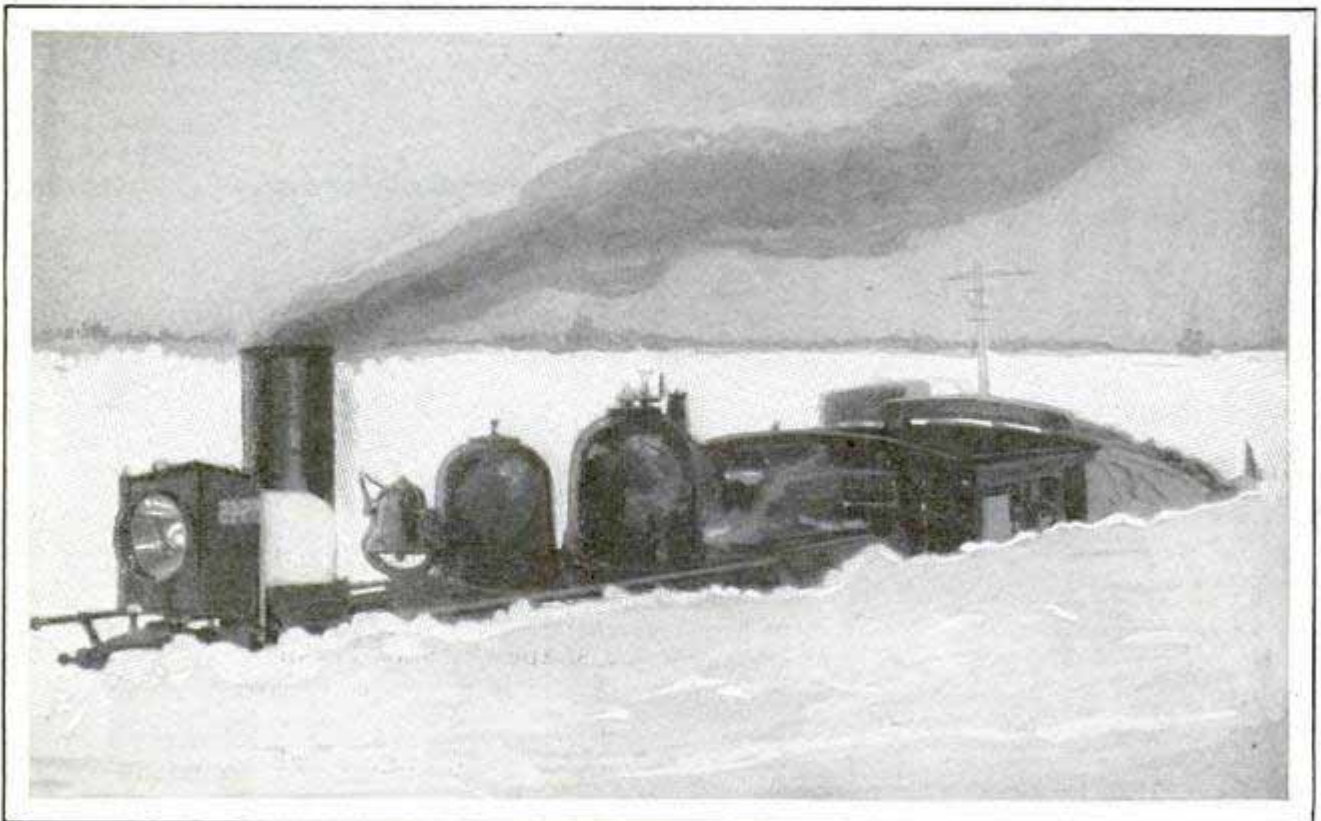

Northern Michigan Offers the Snow Fighters Some of the Stiffest Battles of the Year; Winds Often Fill Cuts like This, and the Snows Are Deep on the Level

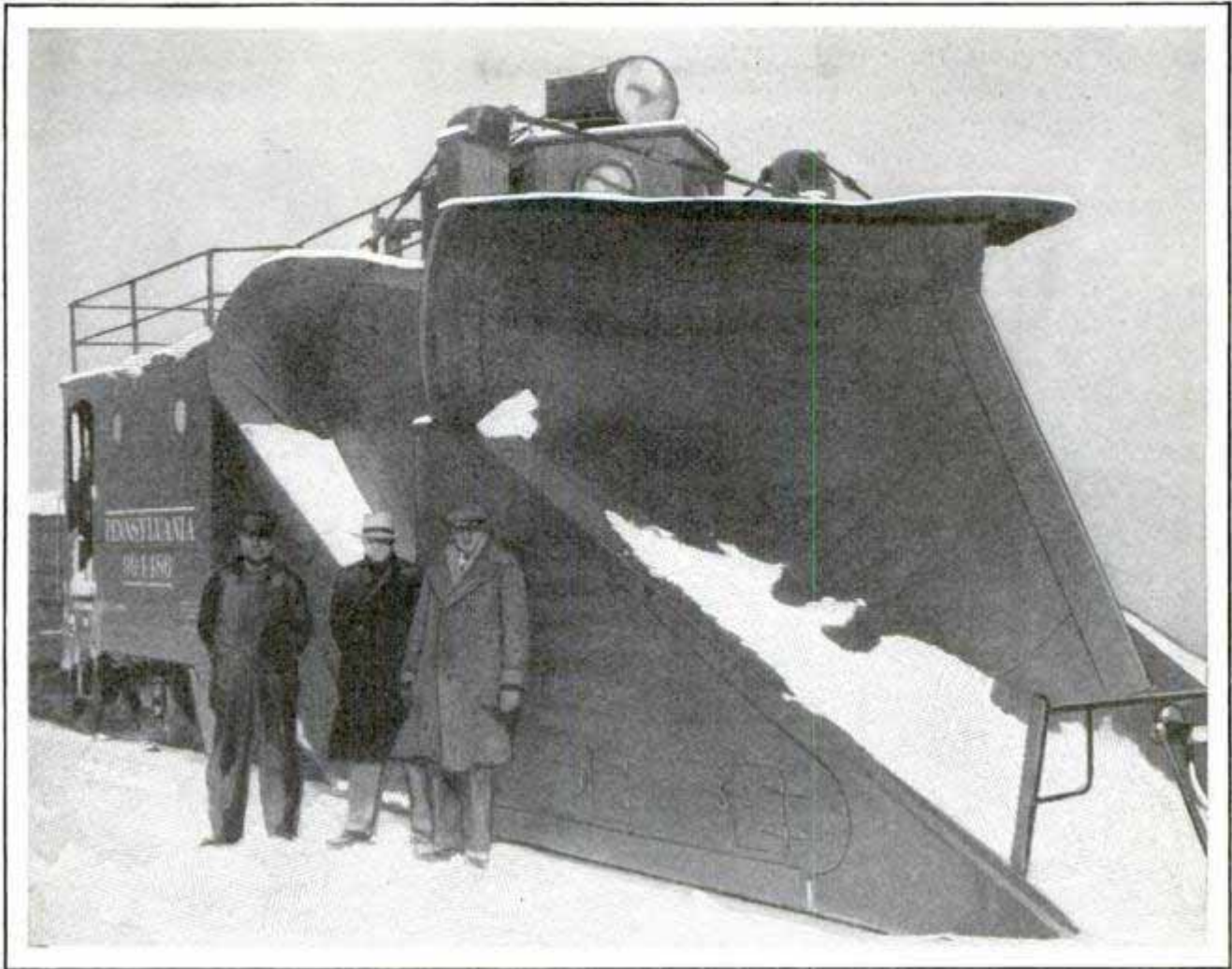

Exterior of a Pusher, Showing the Long, Sharp Nose, the Lookout Windows, Searchlight and the Wings, Folded Back Here and on Each Side behind the Nose

plow make conversation in normal tones impossible. Orders are yelled at the top of the voice, although the men are as close together as they would be in a submarine.

"Look out, we're going into a big one"—and as the plow buries its nose into a drift, there is a lunge and slackening of speed. The impact is almost violent enough to throw the men out of their seats, but they are braced for it. There are no lights inside the plow when it is operating, and the only gleam visible is that of the headlight, but this is now hidden as crashing breakers of snow cascade over the plow, plunging everything into total darkness. Another drift!

This time the speed decreases until there is danger of stalling. "Get your wings in quick," shouts the conductor as he pulls at his own lever. Both wings fold inward just in time. Stalling in a big drift with the wings out is "fatal," one of the unpardonable sins of snow fighting, for with the wings out, the train cannot

back up or go ahead and the plow is stuck, may be for hours, until it can be dug out by hand. Pulling the wings in reduces the side pressure. The big road locomotive snorts and the plow groans through the tightly packed mass of snow. But still the inside of the cupola is in darkness. The snow has stuck to the plow and the windows. The conductor gives two buzzes. The train stops on the other side of the cut and the maintenance-of-way men, who have been hugging the stove back in the plow cabin, climb out and shovel the snow away from the windows and the nose of the plow. The moment's lull gives the conductor an opportunity to confer with the engineer. The engine is a shapeless mass of snow and ice. Under the canvas canopy, although the thermometer is well below zero outside, the heat in the engine cab is oppressive, and both the engineer and fireman are sweating. "If that last one had been 200 feet longer, we never would have made it." de-

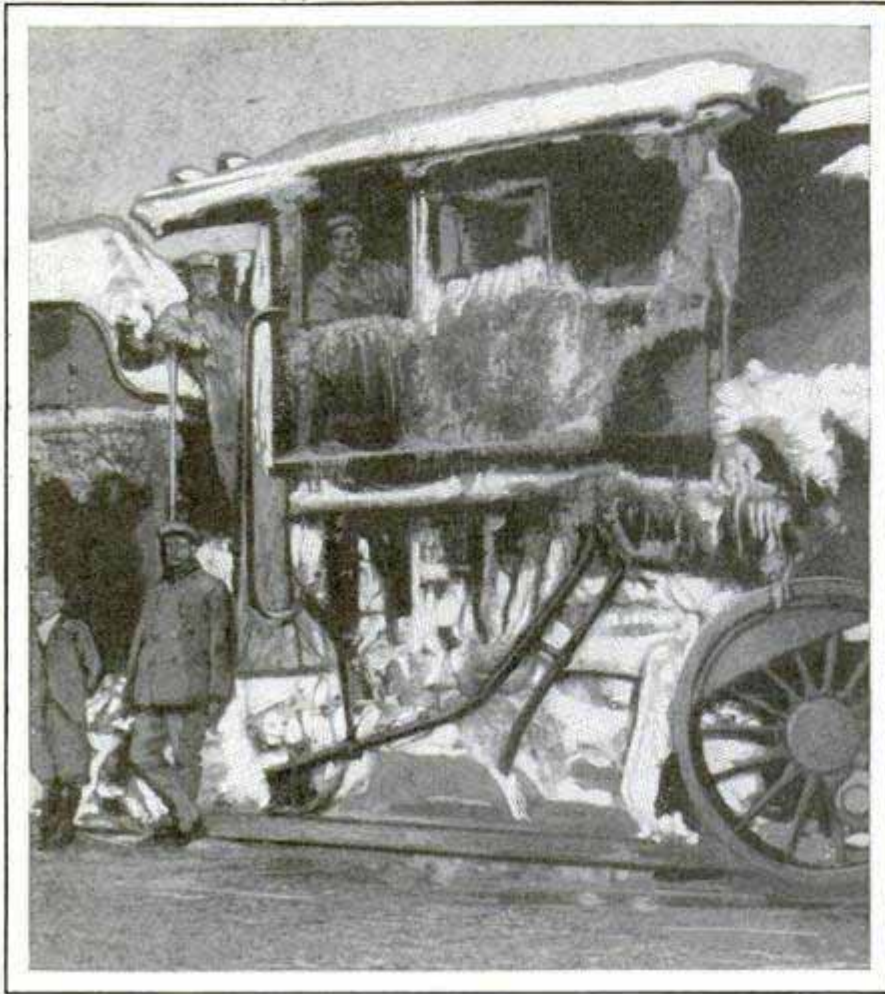

© International News
Snow Clogs the Engine Cab as Well as the Tracks; Engines Used behind the Pushers Are Generally Sheathed in Canvas to Protect the Crew and Coal

a half during last winter. At one point, there was a total snowfall of nearly forty-eight inches during January and February, and twenty-foot drifts were encountered at many places. Where it is practical, many lines prefer the pusher plow, for, although it does not hurl the snow so far out of the right of way as do the big rotaries with their huge blades, it can be operated more rapidly. The rotaries function through a gear arrangement of limited speed, but the pushers can be shoved ahead as fast as the snow will allow.

The technique of snow fighting on the railroads changes but little from year to year, and the task is about as difficult now as it was a decade or more ago. But improved weather service has aided, as the plows can be in

clares the engineer, wiping his face and getting a breath of fresh air for the first time since the train started. The ventilator in the cab is covered with canvas so circulation inside is none too good.

Sometimes the plow gets stuck even when the wings are pulled in. In such a case, the train is backed up for a mile or so and the plow makes a run at the drift, bucking into the pile at fifty or sixty miles an hour. The most efficient plowing speed is twenty-five or thirty miles an hour.

Off again, plunging through one drift after another. A little town flashes by, just a few lights showing through the gloom, one in the operator's office at the station, and the other, the block light. The station agent waves a greeting as the big plow roars through. He is glad to see the plow, for it means an open line and less worry.

The five big pusher plows on the Pennsylvania's Michigan line cleared nearly 9,000 miles of track in three months and

order and often at the scene before the snow has had time to pack and freeze.

ARTIFICIAL DAYLIGHT IS BEST FOR COLOR MATCHING

Artificial daylight electrically produced was urged before the Illuminating Engineering society as a substitute for the traditional north skylight favored by artists for color matching. Tests have shown that daylight from the northern sky, far from being standard, actually varies in intensity and character each hour of the day. White light, corresponding to noon sunlight on a clear day, was found to be the proper standard for accurate color matching and color discrimination. While this is available naturally only an hour or two a day, tungsten incandescent lamps and color filters can produce it artificially whenever needed. Artificial northern skylight, like the real article, is bluish, making certain colors appear bluer and suppressing certain other colors.

Science & Art
#4427-9-12/29

*with Daylight reproduction
restoration of Taints & Colors*

U. S. HAS THE WORLD'S LONGEST DIRECT PHONE CIRCUITS

With the completion recently of a direct telephone circuit from New York to Tampa, Fla., a distance of 1,225 miles, another link was added to the telephone system that connects distant cities directly, without the necessity of switching calls through intermediate points. The direct-circuit network already includes the world's longest continuous telephone line, or rather twin lines, for there are two such circuits, each 3,412 miles long, between New York and Los Angeles. Supplementing this direct coast-to-coast service, there are four 2,600-mile circuits from Los Angeles to Chicago and thirty-three direct circuits between Chicago and New York. This latter group requires 29,882 miles of wire. Among other long direct circuits is one of 1,900 miles from New York to Dallas; two of 1,700 miles from New York to Havana, including in their mileage the world's longest submarine telephone cable, from Key West to the Cuban capital; four of 1,400 miles each from New York to Miami, and three of 1,450 miles each from New York to New Orleans. These lines enable distant calls without delay.

WHEEL CHAIR FOR INJURED DOG AIDS IN ITS RECOVERY

Convalescent dogs now enjoy many comforts, including wheel chairs. "Jackie," pet of a Dallas, Tex., family, was run over by an automobile and crippled. A wheel chair was provided, and the animal, while

A Wheel Chair Provided for a Dog That Was Injured in an Automobile Accident



unable to walk, learned to pull himself about with his front paws.

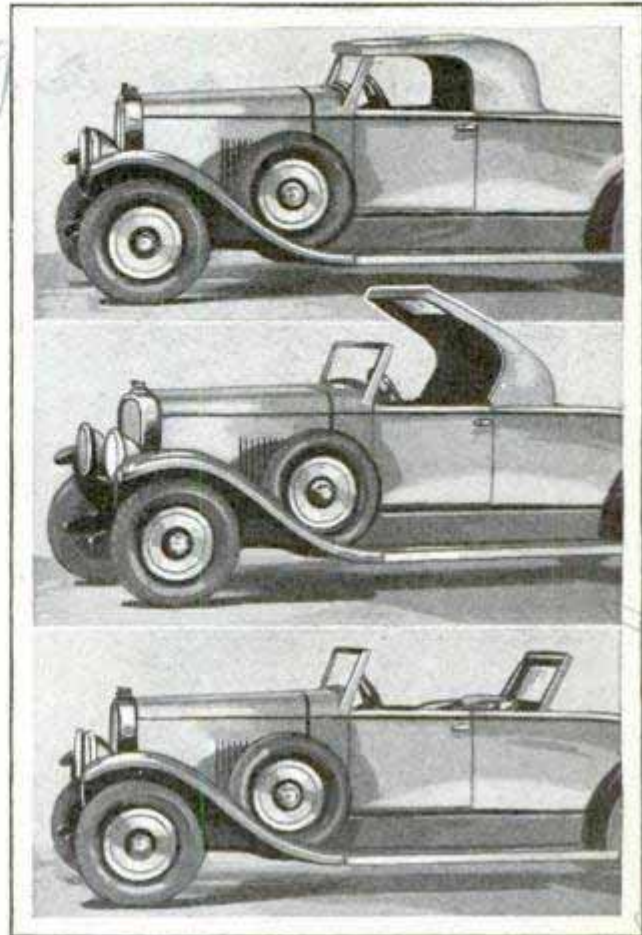

Three Views of the All-Metal Top, Which Slides into the Body of a Convertible Coupe

CONVERTIBLE COUPE PROVIDED WITH A METAL TOP

Motorists who like an open coupe in fair weather and a fully inclosed one in bad weather will be interested in a convertible coupe with a metal top now on the market. The convertible feature is gained by dropping the top partly into the body; the forward portion of the roof extending above the body and serving as a windshield for the deck seat by reason of the transverse window in this part of the roof. The metal top has its lower edges flared outward at sides and rear, this flanged portion normally pressing against a rubber strip at the edges of the body surface, to provide a waterproof junction. The flange is wider at the rear to give sufficient clearance for the top when it is moved backward into the body. When down, the top has the same backward tilt as the forward windshield. When the top is up and the door windows raised, the car conforms in appearance with usual coupe-body designs. The raising and lowering of the top is accomplished as easily as moving the deck seat.

3212
3,412
42
Ellerbe
42

Tilted Coal Truck Fitted with Chutes from Which Baskets Are Filled without Shoveling



COAL TRUCK FILLS CONTAINERS WITHOUT HAND SHOVELING

Delivery baskets are filled from German coal trucks without hand shoveling by means of a device at the rear of the truck. The truck itself is tipped up and the coal pours out through two hoppers into the baskets which are held beneath them in a fixture attached to the truck.

CHEMISTRY TO OUTLAW WAR SAYS NOTED SCIENTIST

Modern chemistry and modern aeronautics have virtually made another war impossible, for they would render armies useless, Francis Patrick Garvan, of New York, recently awarded the Priestly medal, the highest honor in chemistry, has declared. In case of a modern war between great powers, he said, it would be foolish and useless for a battleship to leave its dock or for an army to take the field, because modern chemistry and the airplane could destroy both. He advocated strengthening the possibilities of both agencies as weapons of war in order to discourage offensive wars.

ENGINE BUILT LIKE A BARREL TO HELP FLYERS

A barrel engine, which, unlike previous motors of the type, has a fixed barrel, was demonstrated at the British Aero Show, in London. A similar engine, the "Almen," was flown several years ago in America, and another was flown recently in Switzerland, but both these had revolving barrels, and met the same objection as was applied to the now discarded Gnome rotary engine. The new motor, which has been tested successfully in a six-horsepower compressed-air-driven model, is a radical departure. The six cylinders are arranged lengthwise around the shaft in one end of the barrel. The pistons, moving back and forth in them, impart undulating or oscillating movements to a ring fitted with teeth. There are four toothed rings which take up the oscillating motion and transform it into shaft revolutions. The speed of the shaft is controlled by the ratio of teeth in one of the ring pairs, the test engine producing 500 revolutions for every 2,500 piston cycles. The engine, it is claimed, can be equipped to operate either on gasoline or heavy oil as easily as any other motor, for the cylinder and valve end conforms to standard practice, save for the cylinder arrangement. The advantage claimed for the barrel type is the very small frontal area, which causes less wind resistance and makes nose cowling for an airplane more practical. In large units, it is claimed that another cylinder and piston unit can be placed on the other side of the oscillating member.

RUBBER TAIL LIGHT FOR TRUCK PREVENTS BREAKING

Tail lights for trucks, set in a rubber base to prevent breakage, now are on the market. The rubber frame bends when an obstruction is encountered. The light is proof against water and dust as well as vibration.

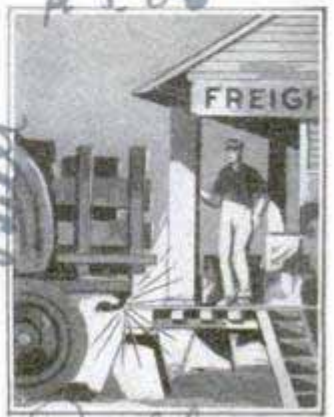

Champion Rubber
Lamo Co. 1236 W. 55 St

Shooting at the Moon

By JOHN T. BRADY

SHOOTING a rocket from the earth to the moon is no longer merely a fantasy of the mind. In fact, the first shot has been fired in what promises to be the most spectacular "battle of the century"—man's struggle to conquer interplanetary space.

And as a result of the success of the experiment, Prof. Robert H. Goddard, of Clark University, claims that he has now solved all the major problems of accomplishing such an amazing feat. Moreover, he declares that the first practical test, outside a laboratory, of a working model of his rocket at Worcester, Mass., proved to his own satisfaction and that of other scientists who witnessed it, that a larger rocket of similar design operating on the same principle can be constructed which will have sufficient velocity to escape the earth's attraction and soar to any desired altitude—to the moon or any one of the planets in the solar system.

Startling, indeed, are such statements, even in this age of scientific wonders. Yet, coming as they do from a conservative, cautious scientist, with a high reputation at stake, and who has spent twenty years in research and experiment on the problem of reaching extreme altitudes, they must be given serious consideration.

And one needs no other stimulant to the imagination to conceive that in the not distant future passenger-carrying air-



Prof. Robert H. Goddard, of Clark University, with Model of Rocket He Has Devised to Explore Atmosphere at Great Heights

planes propelled by the rocket-principle engine will shoot across the Atlantic, the Pacific, or the United States in a few hours, and that eventually man may journey to the moon, or Mars and Venus.

Professor Goddard describes the working model of his rocket as being nine feet long and two and one-half feet in diameter, with an outer shell of aluminum, highly polished and tapered at the nose to offer the least wind resistance.

Inside the shell is a highly complex mechanism, the result of many years of study and experiment, but Professor Goddard is maintaining strict secrecy as to how it works and the nature of the propellant that he is using. Explaining the reason for this secrecy he said:

"There are many things about this great undertaking which cannot be made pub-

7-301
986

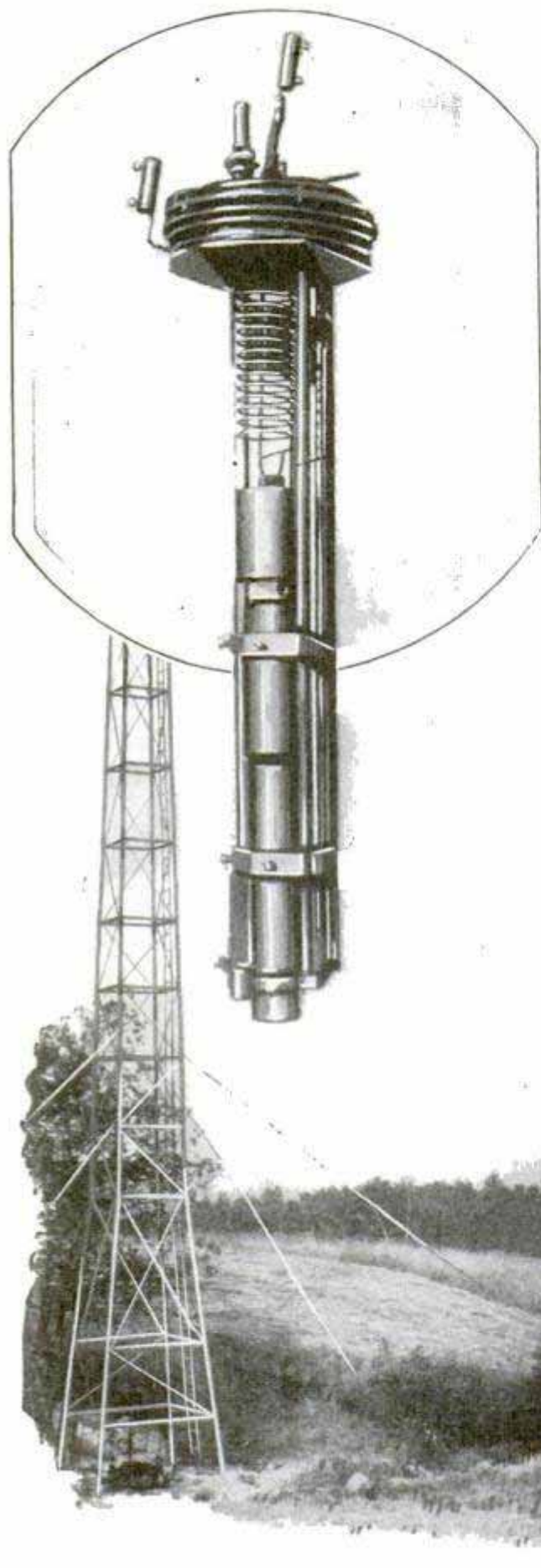

lic at this time if the United States would maintain its supremacy in this field of scientific achievement and retain secrets of physics that may prove of inestimable value in safeguarding the life of the nation in case of war."

He said, however, that the propellant he is using is something new, a combination of liquids and gases that has taken him nine years to develop, and that the propelling force is not a series of explosions, but is continuous.

No high-powered machinery was used to give the rocket its initial lift skyward. It was launched from a sixty-foot steel tower, with guide rails, under its own power, and the initial velocity was upward of five miles per second. It carried instruments for recording the altitude which it reached and the temperature there, and the whole apparatus was brought safely back to earth by parachutes and was recovered immediately.

"By George, it was a tremendous thrill to watch it go," exclaimed Professor Goddard. "It is almost indescribable. Naturally there is considerable noise when it is being lifted which might be mistaken for a big explosion. But the sound as it hurtles along in flight is more like the moaning of the projectile from a big gun, or a long-drawn-out rumble of thunder.

Professor Goddard then stated that the term "moon rocket," as applied to his in-

Inset Shows Inner Mechanism of One of Professor Goddard's Early Experimental Rockets, and Below Is the Scene of a Recent Test; Rockets Are Launched from Guide Rails on Sixty-Foot Tower

vention, is somewhat of a misnomer, and that it would be more correct to call it a "rain rocket," because the practical purpose of his rocket experiments is to find some method of exploring the upper reaches of the earth's atmosphere for valuable meteorological data. But in the very next breath he admitted that his ultimate object, the highest goal of his ambitions, is to send an aerial messenger to the moon and then to the planets.

"But suppose you eventually succeed in developing a rocket powerful enough to reach the moon; how are you going to prove that it arrived at its destination?" he was asked.

"The only reliable procedure would be to send a charge of flash powder to the dark surface of the moon, when in conjunction (that is the 'new' moon), in such a way that it would be ignited on impact. The light would then be visible in a powerful telescope," he replied.

Speaking of the practical value of developing rockets by means of which the earth's upper atmosphere can be explored, Professor Goddard pointed out that the greatest altitude at which soundings of the atmosphere have been made by balloons, is only about twenty miles—but a small fraction of the height to which the atmosphere is supposed to extend. "Above that altitude lies the most interesting, and in some ways the most important part of our atmosphere," he said.

"Some authorities say the temperature begins to increase with height after a certain altitude is reached, and that it runs up as high as 1,000 degrees centigrade. Others say the temperature decreases tremendously. The earth's outer atmosphere may be very hot although nearly a vacuum. But we have no direct evidence about it. Nor do we know how the pressure falls off or the composition of the air beyond a height of about twenty miles.

"Another thing is the electrical nature of the upper atmosphere. Something like sixty miles up, there is a very rarefied gas charged with electricity and without it long-distance radio transmission would have to go out of business.

"Other problems are the nature of the aurora, the nature of radioactive rays from matter in the sun, as well as the ultraviolet rays from that body."

ELECTRIC PARACHUTE FLARE SOLVES FLYING PROBLEM

The Pilot Is Holding an Electric Parachute Flare for Navy Planes Which Continues to Burn after Landing in Water

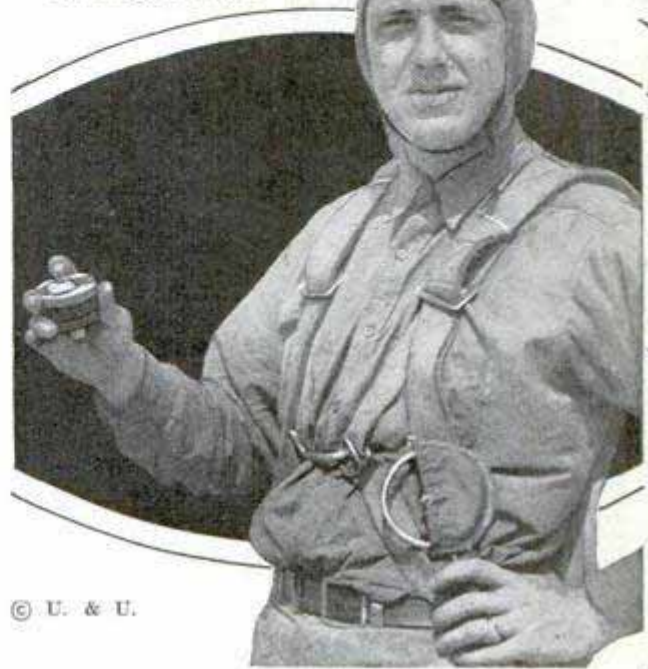

© U. & U.

An electric-lighted parachute flare for navy planes, tested recently at the naval air station, Washington, solves, in the opinion of pilots, the problem of making night landings on water safe. The ordinary magnesium flare is extinguished as soon as it reaches the water and seaplane pilots have felt the need of a light that would continue to burn and mark the water level on which they were trying to land. The new flare, which is hardly larger than the palm of the hand, consists of a powerful electric light, operated from a tiny battery containing sufficient energy to keep the lamp burning for approximately an hour. When released from the plane, the light floats down beneath its parachute, with the rays directed downward on the water, but when it lands a cork float turns it over and the beam is directed upward. Lieut. A. P. Storrs, who made the tests, accomplished a half dozen successful landings at the Haines Point seaplane harbor, in front of the air station, using from one to two flares each time.

Names and addresses of manufacturers of articles described in this magazine will be promptly furnished, free, by our Bureau of Information.

Not made at request of General Electric Co

*Standard Inland Navigation Co
St Louis, Mo*

3466

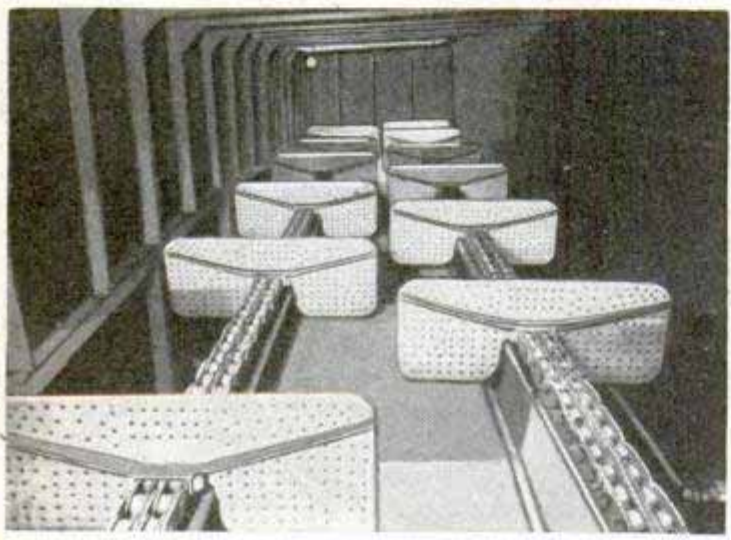
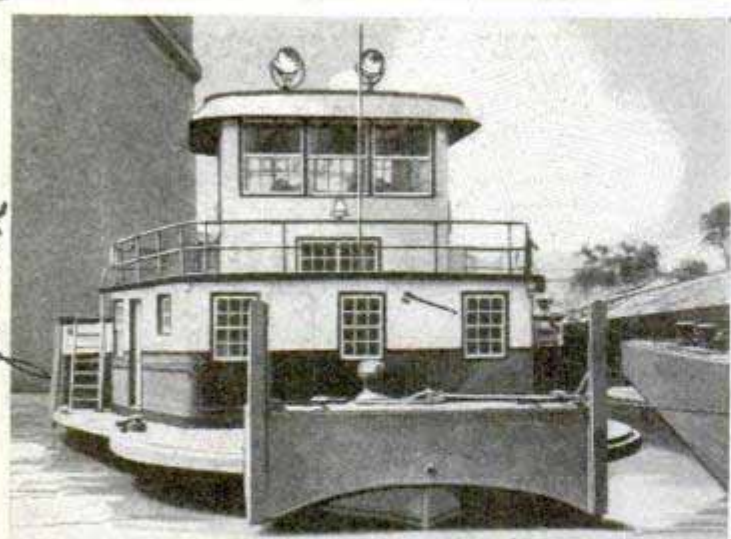

Electric system

*Envelope. Mississippi Valley Barge Line - Co.,
408 Gene St. St. Louis, Mo.*

Above, an Electrically Propelled Towboat, and, Below, the Chain with Blades Giving It a Caterpillar Drive

CATERPILLAR BOATS ON RIVER PULL BOX-CAR BARGES

Application of railroad methods to river transportation is attracting the attention of river men and shippers of freight along the Mississippi, the Ohio, the Missouri and other inland waterways. The very latest creations in river-boat construction are electrically propelled towboats with caterpillar drive, and barges that look like railroad box cars. Small electric towboats, which draw only two to three feet of water, act as switch engines and collect the barges from shipping points along the smaller streams. The "train" or fleet of barges is then towed to distant points by larger towboats of similar or other design. As the barge fleet travels up or down a river, one of the smaller towboats detaches a barge from the fleet and takes it to a dock, where it may pick up another

barge and attach it to the fleet. This can be done without stopping the barge fleet. Wireless telephones eventually will connect the towboats. Electrical equipment for these novel towboats was designed by engineers of the Westinghouse Electric and Manufacturing company. Power for the generators is furnished by Diesel engines which burn crude oil. The smaller towboats have a fuel consumption at full load of about three gallons per hour, which means a fuel bill of approximately eighteen cents an hour. The drive on each side of the towboats consists of a chain with blades attached in a manner resembling the method of attaching buckets on a conveyor. Separate motors operate the two chains. By reversing one drive, the towboats can be turned around in their own length, and because of their small draft, the smaller towboats can reach docks unavailable to steamboats.

PLATINUM SUBSTITUTE FOUND IN "KONEL"

"Konel" is the name applied to a new metal which is being used extensively as a substitute for platinum in the manufacture of filaments for radio tubes. It is credited with being much stronger than other metals at high temperatures and can be used in the moving parts of internal-combustion engines and other extremely hot places. Originally it was developed as a platinum substitute, but was found to be harder to forge than high-speed steel, and to be very tough at high temperatures, when most metals lose their strength. Engineers believe the metal will be useful in making valves, valve stems and turbine blades. As a substitute for platinum, they estimate the metal represents a saving of \$250,000 a month, because platinum costs \$180 an ounce while konel costs \$15 a pound. Tubes equipped with konel filaments may be operated 175 degrees colder than those with platinum fixtures. Konel is also resistant to most acids.

3483

*Westinghouse Electric
St. Louis, Mo.*

TUNGSTEN CARBIDE PENETRATES THE HARDEST METALS

Tungsten carbide, the hardest compound known to science, for years a mere curiosity, has found a commercial use, for with it hard alloys, including manganese steel and armor plate, can be machined in lathes, planers or shapers. Tungsten itself, as used in electric-light filaments, is so soft that it can be drawn into fine wires, but when combined with carbon, it makes a substance second in hardness only to the diamond, and will scratch a sapphire. At first it was too porous to stand the strain imposed on a cutting tool, but this difficulty has been overcome, and in its more useful form it is known as "carbolyd." While many operations impossible with any other cutting tool are performed with the compound, it has limitations as it will break down under very heavy pressure.

CAMERA REVOLVES TO "SHOOT" FROM ANY POSITION

Mounted on a large wheel that is revolved by a crank in a still larger wheel, Hollywood has a moving-picture camera that photographs from any angle or position in which it is placed. It is powered by motor and may be used, for instance, to create the illusion of a topsy-turvy world by exposing the film as it is revolved.



A Motion-Picture Camera That May Be Revolved to Shoot from Any Position or Angle



Upper Berths for Sleepers Provided with Windows, Which Furnish More Air Than Ventilators

WINDOWS FOR UPPER BERTHS ADD COMFORT TO TRAINS

Upper berths of sleepers on one western road now are equipped with windows to add to the comfort of passengers. The windows are smaller than the regulation car window, but provide more circulation than the ventilators in the roofs, commonly employed to supply the occupants of the uppers with fresh air.

OVER NINE MILLION VISITORS TO WASHINGTON MONUMENT

During the forty-one years that the Washington monument has been open to the public, 9,098,118 persons have visited it, recent figures show. The daily average has been 615 persons since 1888, and the greatest number in one day was 10,078, who went to the top on April 1, 1929. More than 2,500,000 energetic sightseers climbed to the top, while the remainder took the elevators.

Richmond Lewis Hayden State Limited

Rich Park Police

3206

Making



This Folding Ironing Board Has a Metal Holder for Hot Irons to Prevent Scorching and Fires; It Folds Up with One Motion for Storage in Small Space



Boiling Eggs Exactly the Desired Time Is Easy in This Aluminum Kettle; a Simple Device at Top Is Set, and at the End of the Period, the Eggs Automatically Are Lifted Out of the Water

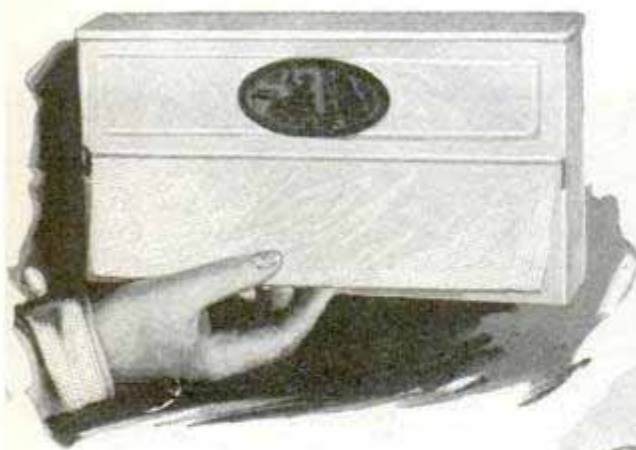

The Cabinet Above, Furnished in Various Colors, Holds a Package of 125 Small Towels of Absorbent Material for Many Uses about the House; They Save Laundry Bills and Extra Steps; the Cabinet Takes Up Little Room and May Be Placed in Any Convenient Location



Here Is a Vacuum-Cleaner Bag with a Side Vent Opened and Closed by Interlocking Clasps for Quickly Emptying the Dirt; the Vent Saves Removing the Entire Bag, Prolongs Its Life and Protects the Operator from Dirt

Home Tasks Pleasure



By Pressing a Spring, the Top of This Double-Purpose Tray Can Be Raised and Tilted at Various Angles for Reading; the Sturdy Stand Prevents Tipping; Below at Right, Is a Compact Motor Unit for Beating, Extracting Juices, Slicing Vegetables, Grinding Meats and Polishing Silverware; the Set Weighs Only Forty Pounds and Is Economical to Operate



With a Portable Tipping Stand for the Washtub, the Task of Filling and Emptying the Container Is Greatly Simplified; Clamps Hold the Tub Securely in Place While Allowing Quick Removal

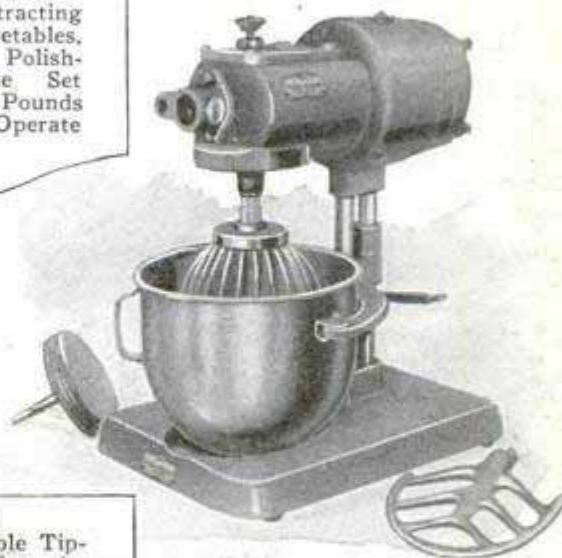

*107. ...
Aeromobile*

3478



A Toaster Which Heats the Inside of a Bun Instead of the Outside for Toasted Sandwiches

TOASTER HEATS INSIDE OF BUN INSTEAD OF OUTSIDE

Toasting the interior of a bun to receive the filler of frankfurter is the purpose of a novel toaster now on the market. It consists of an upright bar inserted in a long bun, or a flat plate over which a sliced round bun is slipped. Makers claim that sandwiches prepared in this way are more palatable than those with the outside toasted, and less time is required for the operation.

PILOTS FLY SPIRAL COURSES WHEN BLINDFOLDED

3467

Experiments by the national advisory committee on aeronautics have demonstrated that airplane pilots, when blindfolded, will nearly invariably show the same tendency to deviate from the straight path of flight and take up a spiral one, that a blindfolded person does when in motion on the ground. The blindfolded pilots, accompanied by a reserve pilot who acted in emergency, were found to bring the ship after a short flight into a properly banked turn, and most of them made the turns shorter and shorter with a tendency to turn the plane into a diving spiral. About an equal number of right

and left turns were made and the right or left-handedness of the subject pilots apparently had no relation to such turns. The experiments demonstrated that muscular balance plays a relatively small part in flying, except in correlation with visual reference. Pilots flying in the dark, it was pointed out, have this visual reference in their instruments, which provide an artificial horizon and show the course the plane is taking at all times, so that the blindfold test is more stringent than any pilot is likely to face in actual flight.

FOOT IMPRESSION ON INKED PAD REVEALS ILLS

Taking an impression of the sole of the foot to reveal pedal troubles without removing the shoe is made possible by the "pedograph," a wooden cabinet containing an inked pad. The foot is placed on a rubber sheet beneath which is a chart and when the weight of the body is pressed on the apparatus, the impression of the foot is left on the chart when it comes in contact with the pad on the underside of the sheet. It shows the condition of the arches, bearing points of the foot, callous spots and the degree of its elongation or widening.

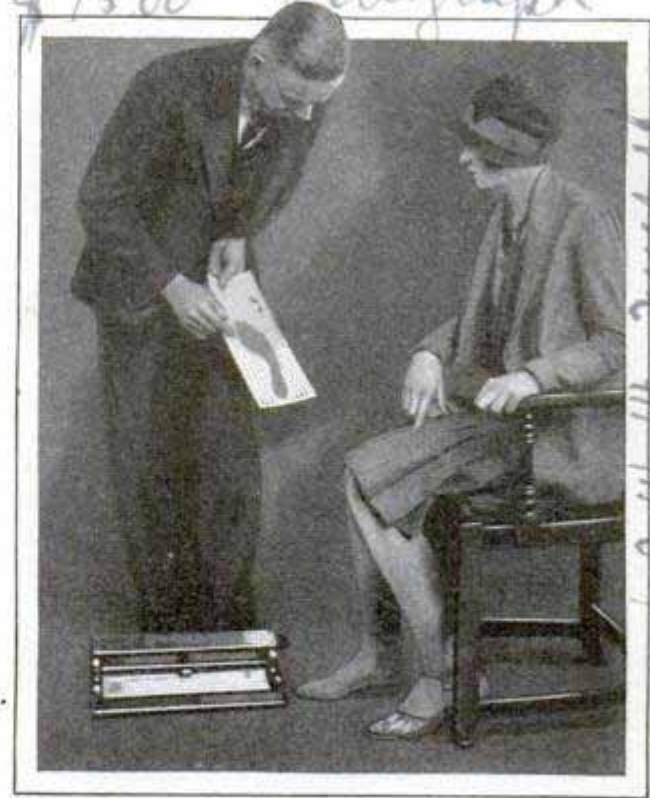

Making a Foot Impression on an Inked Pad to Show Foot Troubles without Removing the Shoe

The St. Charles ... Co

U.S. Navy 9/9/29

to 2 W. 14, New York

GIANT LOCOMOTIVES SQUEEZE THROUGH TUNNELS

A new series of twenty steam locomotives for the Canadian Pacific railway, the first of which was recently placed in serv-

pass under low bridges. The engines are in the 2-10-4 class, with ten main drive-wheels, and, in addition, twin-cylinder

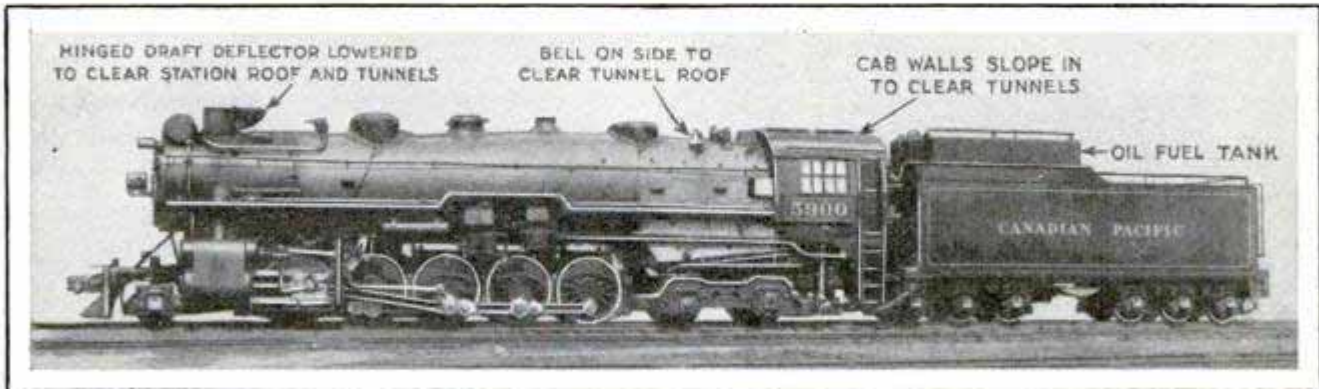

An Engine So Large That It Was Necessary to Hinge the Draft Deflector, Slope the Cab Walls Inward and Place Bell and Whistle on the Side to Enable It to Pass through Tunnels

ice, have carried locomotive building to such large dimensions that considerable effort was required to produce a shape that would squeeze through existing railroad tunnels, and get into passenger terminals without scraping the roof. The sidewalls of the engineer's cab curve inward to keep them from rubbing tunnel walls, and the bell and whistle, instead of being placed on top of the boiler on the center line, have been moved down the side until their highest points come within the cab-roof clearance line. The stacks also are fitted with hinged smoke deflectors which can be turned back and down to get through tunnels, just as tugboats are sometimes built with hinged stacks to

booster engines on the tender wheels to increase the tractive force when starting a heavy load and then automatically cut out when a speed of twelve miles an hour is reached. The locomotives weigh 750,000 pounds, making them the largest two-cylinder railroad engines ever built in the British empire, and develop a tractive force of 78,000 pounds, in addition to the 12,000 pounds supplied by the booster. Rated at over 4,200 horsepower, they are eighty-five times as powerful as Stephenson's famous "Rocket," yet this has been achieved with only eighty times the weight, and, incidentally, at an expenditure only forty-five times the cost of the original engine.

TISSUES OF FOWL KEPT ALIVE FOR SEVENTEEN YEARS.

Tissues, taken from a fowl seventeen years ago, still are kept alive by Dr. Alexis Carrell of the Rockefeller Institute of New York. The tissues taken from the heart of a chicken are kept in a vault maintained at about blood heat, and not only live but grow so fast under rigid conditions affording proper heat, light, moisture and food, that they must be trimmed frequently. Portions of the tissues at times have been transplanted to other small flasks similar to that in which the original is kept, and they likewise are thriving. Every few days the tissues are freed from their own waste which in time

would be destructive, and the nutrients are supplied through the medium in which the tissues are bathed, the process being similar to that which kept the tissues growing when they were part of the living chicken. Then the blood supplied nutrition and the circulation removed the waste. So expertly have the same methods been simulated, that Doctor Carrell believes the tissues can be kept living indefinitely. Human tissues might be kept alive in similar manner, Doctor Carrell said, adding that the reason the cells far outlived the body of which they were a part is that nutriment can be given and waste removed under ideal conditions, something that would not be possible in the living body.

2787

3454 Piedmont Ave.
Oakland, Calif

How the Plane

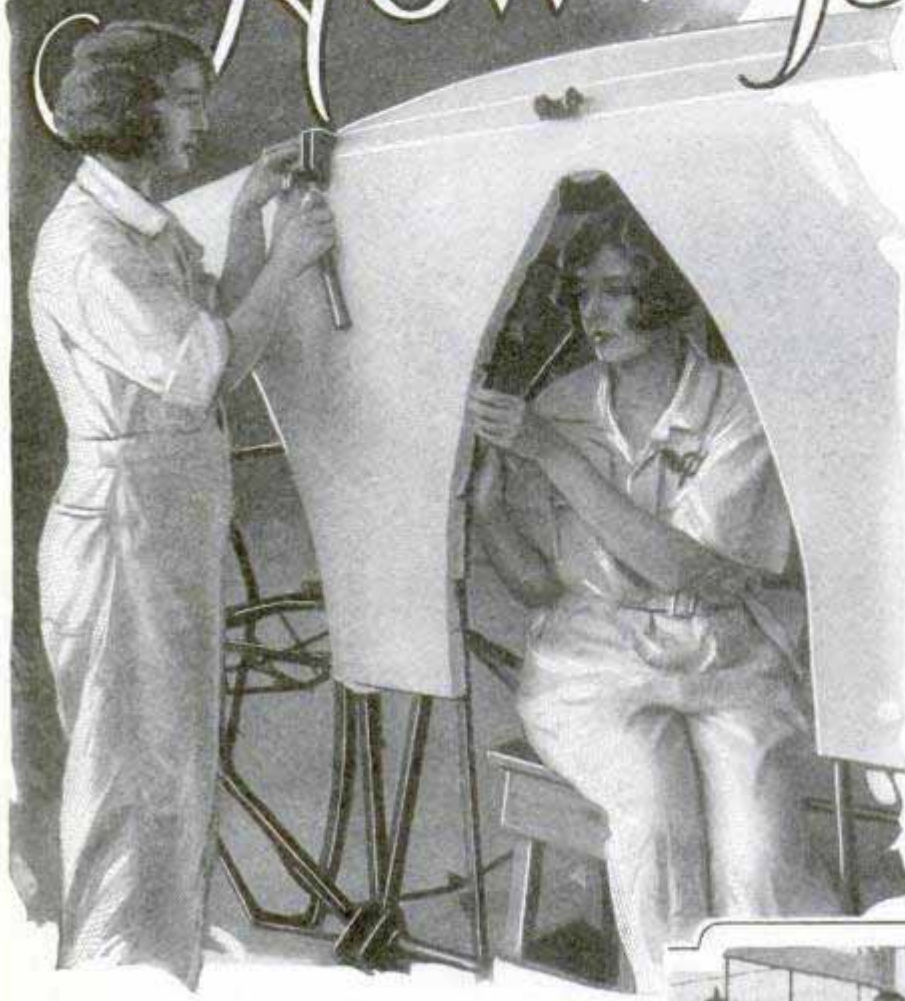

every section of tubing in the framework of body and wing is air and moisture-proof, a precaution against inside rust.

As the welders put the parts together, an eighth-inch hole is drilled at every point where tubes are joined, and an eighth-inch plug is inserted at the top of the fuselage, at the end of the tail, and at the top of the front wing-beam member. The wing and top fuselage plugs are at the highest points when the ship is resting on the ground, and the plug at the tail skid at the lowest. The oil pump is attached to the latter, and when oil

Courtesy Mahoney-Ryan Aircraft Corporation
Girls Are Skilled in Covering Wings, Fuselage and Tail Members; Below, Men at Work on a Bellanca

"THEY are now," announced Frank La Vista, general superintendent of the Fairchild Airplane Manufacturing corporation, "about to oil up the fuselage," and before your eyes another of the unexpected things in an airplane factory begins to take place.

What layman ever heard of oiling up the gaunt steel tubing structure of fuselage and wing? Yet they do just that, and it takes forty-four gallons of linseed oil, heated to just below the boiling point, to do the job.

But why the hot oil? Because, the superintendent explains, the inspectors can tell by feeling each longeron, strut and brace, each spar and rib, whether the oil is passing through it.

For the oiling job is just a quick and clever way to determine whether the welders did a good job, and whether

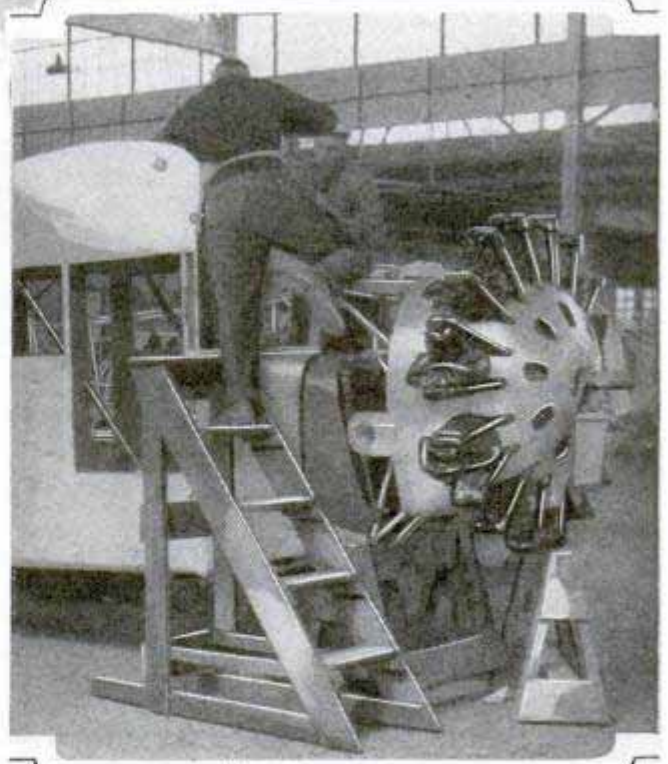

begins to run out of the top holes the inspectors know that every steel tube is full.

Is Built

After the test, the oil is drained out at the tail, the holes plugged, and the metal frame given two coats of aluminum enamel.

Building an airplane is a job for specialists and experts. It takes trained men from other industries, sheet-metal workers, machinists, welders, woodworkers, cabinetmakers, upholsterers, cloth cutters, seamstresses, painters and others, gives them a special course in airplane building, and fits them for big business' newest venture—for multimillion-dollar mergers have, in the space of a few short months, turned the outcast child of a few years ago into a rising young giant.

America built 4,049 planes last year; turned out 2,000 in the first few months of 1929, and, at the rate material orders have been placed, the total production for this year may reach 10,000.

It takes trained men and women to turn out planes, and in every airplane plant in the land, specialists are being created as fast as experienced instructors can turn them out. At St. Louis, where the Mahoney-Ryan plant moved after Colonel Lindbergh flew a Ryan to Paris, men and women of seventy trades fashion and assemble the 5,506 parts which, exclusive of motor, assembled accessories, instruments, nails, screws and cotter pins, go to make a Ryan "Brougham."

At Wichita, which claims the title of "airplane center of the world," factories are as thick as automobile plants at Detroit, and this one town turns out more planes in a year than the entire country did only a couple of years ago.

How does one get to be an airplane builder? The first question every applicant is asked is, "What can you do?" and

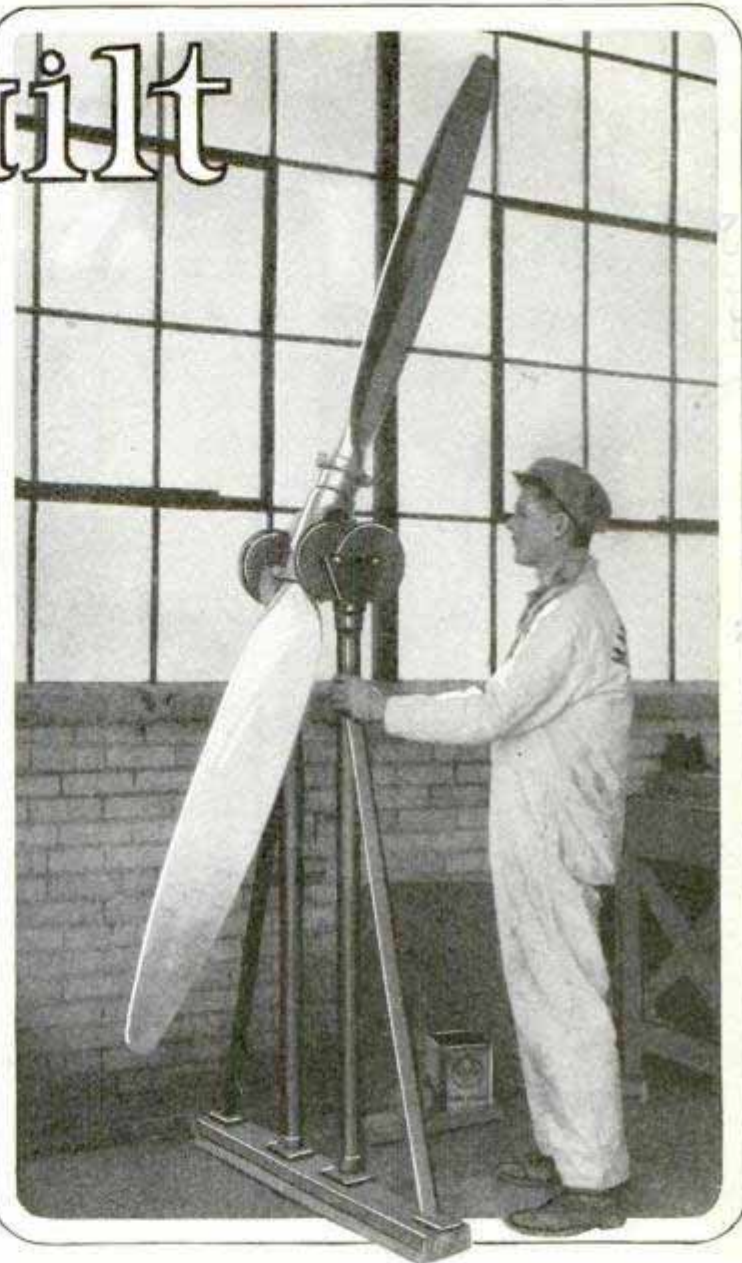

Checking Balance and Pitch of a Propeller; It Is So Nicely Adjusted That a Piece of Paper Causes It to Turn

if the answer is, "Oh, I can do anything mechanical," the applicant probably will be shown the door. For building the intricate framework of wood and steel and fabric to which the lives of many passengers must be entrusted is not a job for a jack of all trades.

The airplane factories do not necessarily want workmen with experience in building airplanes, but they do want men who are to some degree specialists in particular trades. That does not mean there are no openings for the inexperienced, for there is a big field for apprentices to learn under the guidance of more experienced workers.

The heart of most modern planes is the welded tube fuselage of special chrome-

*W. Frick Relay
Pittsburgh, Pa.
National Seamless Tube Co. Shelby, Ohio
Ohio Seamless Tube Co. Shelby, Ohio*

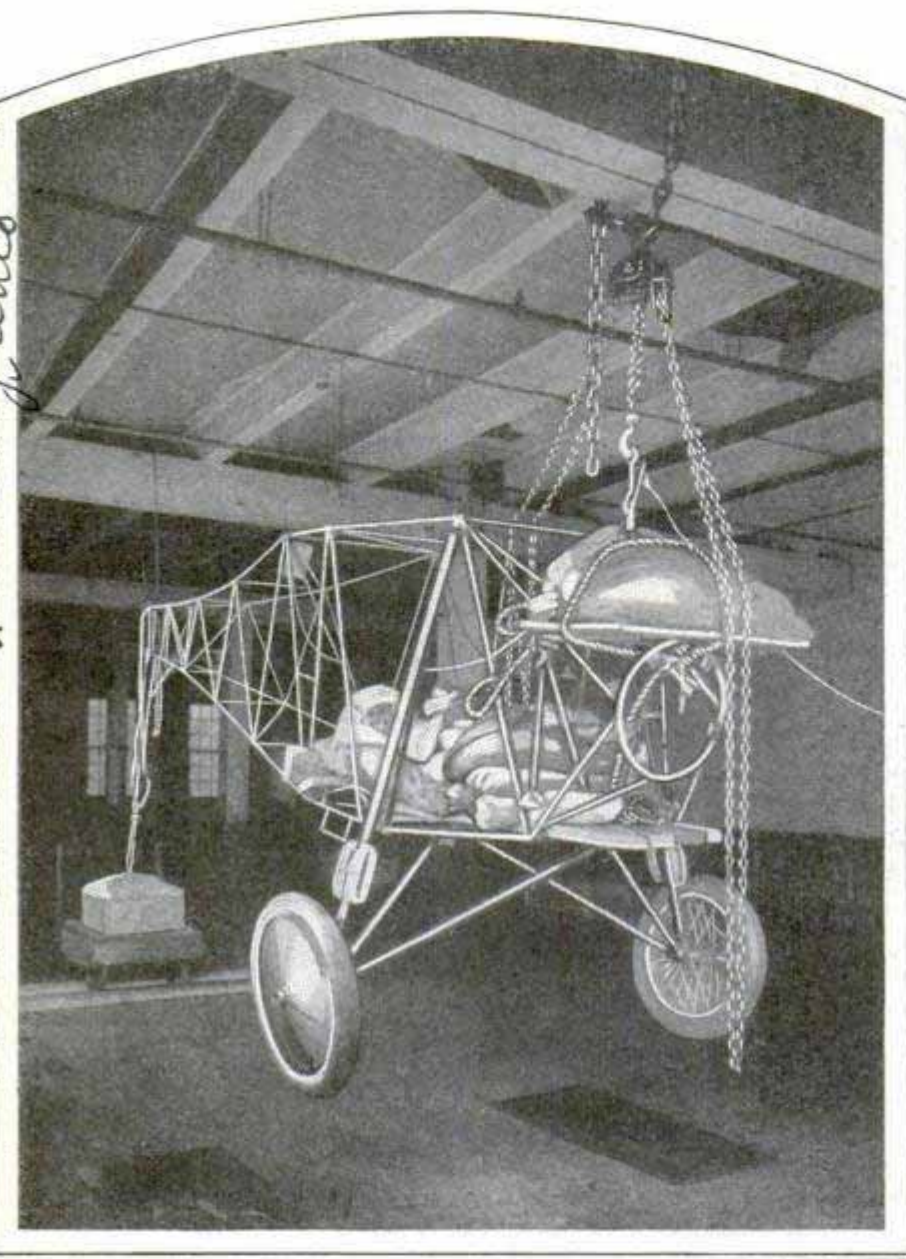

Testing a Monoplane Frame for Strength by Loading It with Heavy Bags of Sand and Metal

Delaware Seamless Tube Co., Auburn, Pa.
molybdenum steel. With a tensile strength approximately double that of ordinary steel and many times the strength of wood, it is not only lighter but is used in sizes of correspondingly smaller cross-section area. To weld such delicate tubing properly requires the best of specially trained welders. A man who can weld street-car track joints or steel building beams, and do a satisfactory job, may lack the delicacy of touch and the ability to turn out the kind of joints the airplane factory demands, for a good weld must be stronger than the tubing itself, and frequent tests of parts make sure that it is.

Every pound that goes into the building of an airplane means one pound less of fuel or pay load to be carried. When

the Wrights built the engine for the first airplane it developed one horsepower for about thirteen pounds of its weight. That was just enough power to get the ship, with one passenger and a small amount of gasoline, off the ground, and the "ceiling" of that original airplane probably was about as high as the top of the statue of Liberty. A modern air-cooled engine weighs about one and a half pounds per horsepower, and all the saving in weight goes toward lifting a heavier plane, more fuel, a pay load, and in reaching a higher ceiling.

It would be easy, however, to use up the excess power in build-



Showing the Evolution in Steel Tubing; Although the Tubes at Right Are Much Thinner, All Have the Same Tensile Strength

ing the ship, if planes were built like automobiles, wagons, houses, or anything else that has been built before. It is because they are not, that specialists are needed, not only in the factory but in the engineering and design departments.

Consider the wing, on which the airplane's ability to fly depends. Engineers for years have used trusses and cantilever construction in buildings and great

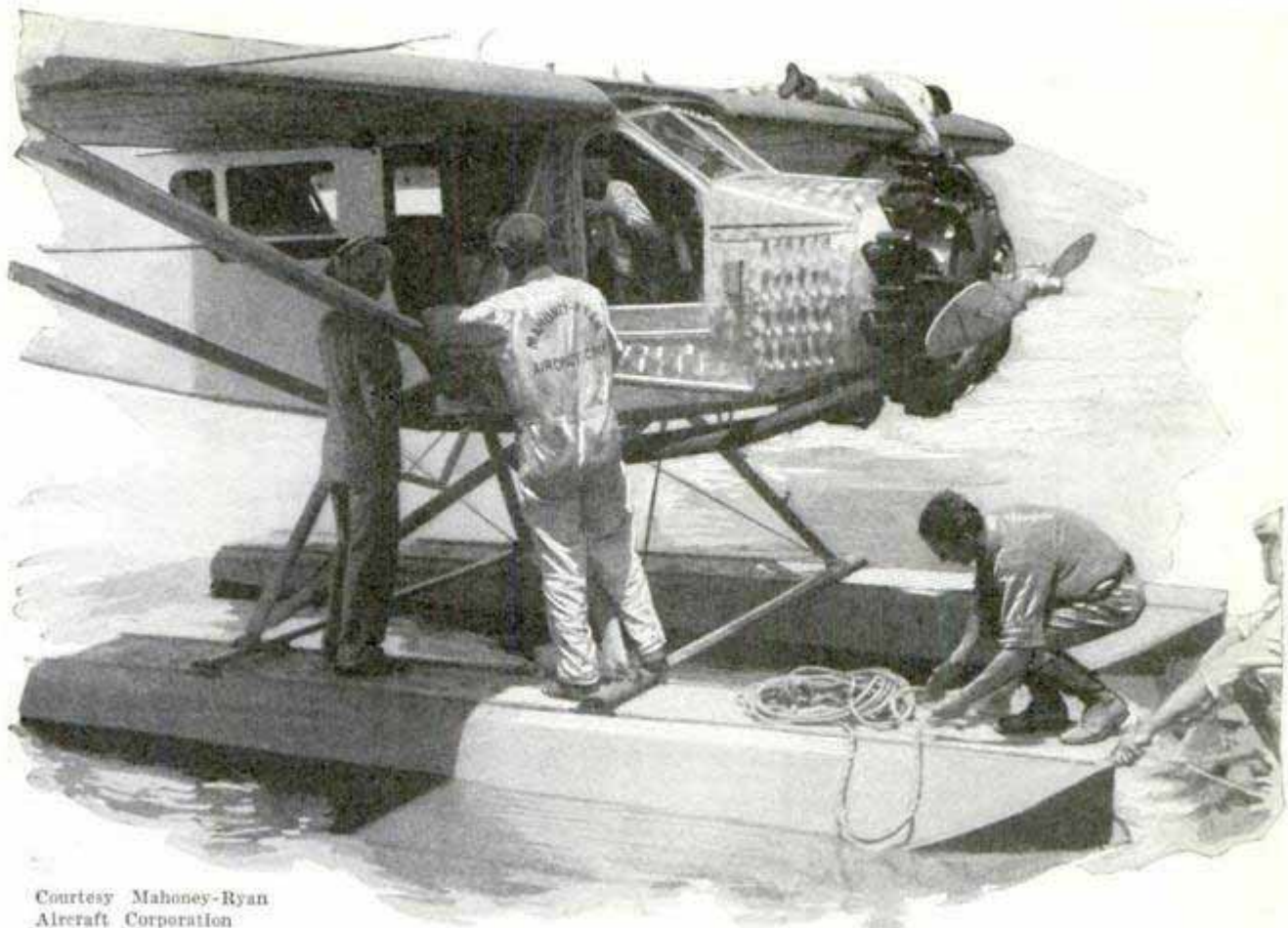

Courtesy Mahoney-Ryan
Alcraft Corporation

Putting the "Sea Legs" on a Ryan Plane; Ships of This Type Are Being Used in Alaska, China and Other Distant Countries Where the Terrain Is Hazardous

bridges, but when the modern airplane was developed they turned out trusses and cantilever wings so delicate that, in one successful glider, the wing ribs are made of "kraft" paper, yet so strong that an internally braced structure, seventy, eighty, or a hundred feet long, can be pulled through the air at better than a hundred miles an hour without breaking or bending.

One sport plane has a wing built up of spruce ribs, each weighing but two and three-quarter ounces. Yet these tiny trusses are so perfectly made that each will support a 200-pound weight without deflection, and, if the load is evenly distributed, hold up from 250 to 275 pounds without failure.

The efficiency of wing designs has gained enormous impetus from the rapid development of cabin and open-cockpit monoplanes. Although, of ships in actual service, biplanes still outnumber monoplanes about two to one, practically all cabin ships are now monoplanes. Of the 850 cabin ships manufactured in 1928, only sixty-nine were biplanes, and in the

multi-engined transport-ship class, only five out of fifty-eight air liners were biplanes. In the small open-cockpit field, however, the vast majority of the 2,348 planes built during the year were biplanes, for only 171 of them had a single wing.

Aviation engineers have turned to the monoplane largely because of its greater aerodynamic efficiency. If built as a full-cantilever, internally braced, it eliminates struts and flying wires with their drag, which cuts down speed, and in such a thick wing ample gasoline tanks can be installed, leaving more room in the fuselage for the pay load.

While the metal fuselage has become almost general in use, wings continue to be built of wood, wood and metal, and all metal, and in each class some are covered with cotton fabric and some with metal.

The wing-covering department in a factory using fabric wings offers a field for women. In the Ryan plant women are used exclusively for this work, for it has been found they do a better job than men. The cotton must be laid on smoothly and

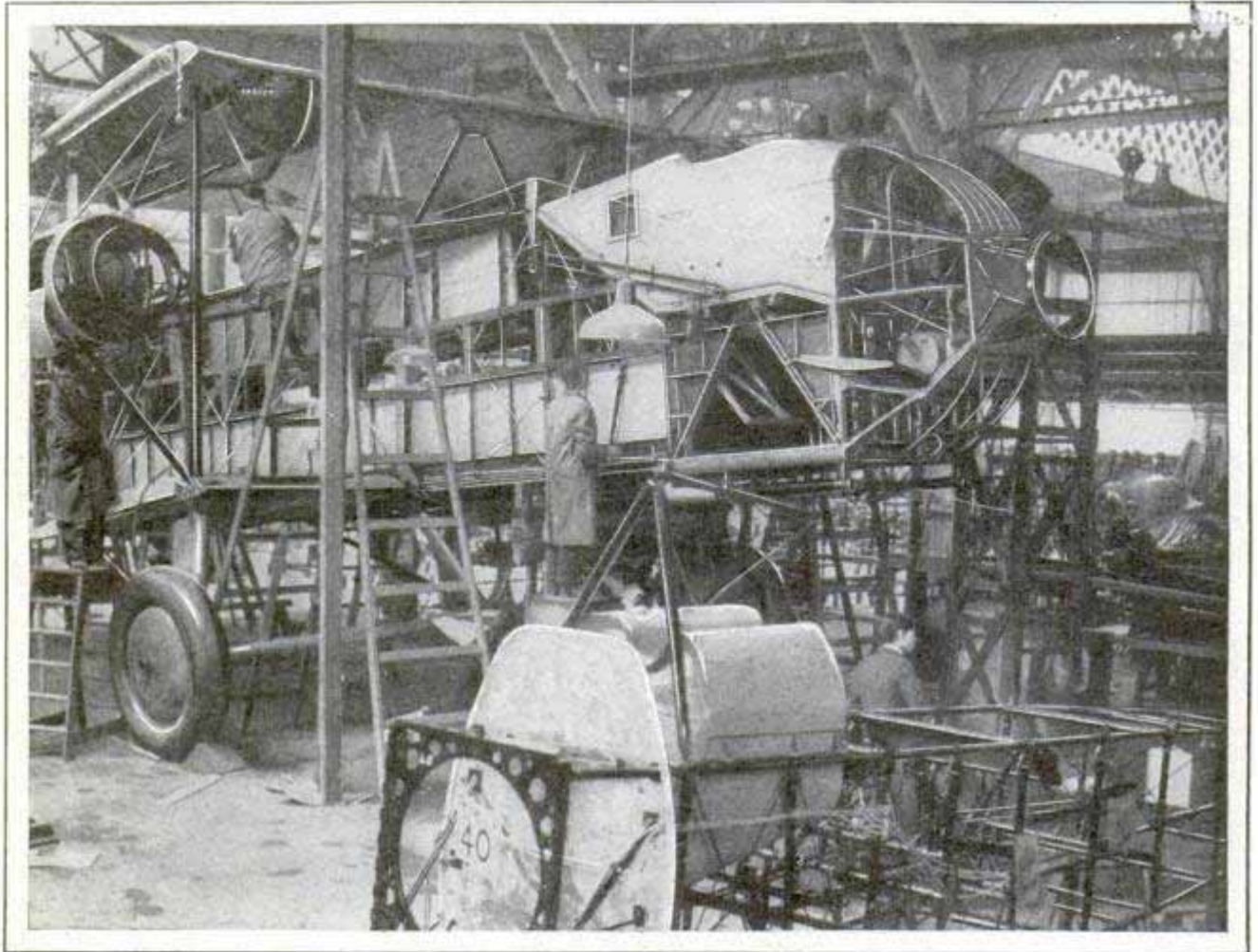

© P. & A.

Putting the Finishing Touches on a Giant Air Liner to Sail the England-to-India Route; Note the Special Baggage Compartment below the Central Engine Mounting

under equal tension, so that, when the five coats of wing "dope" are applied, it will shrink to drumhead tightness in every part.

Wing doping is a job for painters, but it takes several months for even an experienced painter to become a good wing doper. The dope is a nitrocellulose product, closely allied to guncotton, and, under some conditions, equally dangerous while in the liquid state. For this reason the dope department is usually in a separate fireproof building, and is watched with care.

Building a ship, or rather, assembling one, for no airplane is completely built in its own factory, is a production-line job. The motors, instruments, and similar accessories are purchased outside, and come ready for installation. Wood and metal for fuselage and wings, doors, windows and the cabin fittings and upholstery are the parts worked in the plant. While one department turns out the fuselage, an-

other builds the wing, and the two then come together for assembly and covering. And after that the engine, motor, propeller, landing gear, stabilizer, rudder, tail fin, tail skid or wheel, and other parts, are added.

RATS PROVE ACQUIRED TRAITS ARE OFTEN INHERITED

A great and much debated question of evolution has been put to a practical test with twenty-three generations of rats. From observing the behavior of the rats in a tank of water, Prof. W. G. McDougall, of Duke University, has found that a trait acquired by one generation of animals appears to be transmitted to their descendants. Doctor McDougall placed the experimental rats in a tank with two gangways leading to dry land. One gangway was brilliantly lighted and was electrically wired so that the rat that chose it was sure to receive a slight electric

ck, strong enough to be unpleasant. In such a situation, every rat learned sooner or later to avoid the lighted gangway and to choose the less conspicuous path to shore. Rats whose ancestors for many generations were placed in the tank learned to take the shockless route after experiencing from three to seventy-five shocks, or an average of forty shocks, Doctor McDougall said. On the other hand, rats whose families had no such background of tank experiences, would take an average of 150 shocks, before they learned to solve the problem.

HUMIDIFIER AND AIR CLEANER ONE UNIT 346

Cleaning and moistening the air passing through a hot-air furnace in a single operation is the purpose of a humidifier which also serves as a cold-air shoe to be attached at the air-intake point. The shoe contains a series of water pans, one inch deep and four inches wide, extending across the shoe and arranged one above the other so that dirt or dust passing by the first row will be caught in the next. Besides the series of staggered pans, there is a large pan at the bottom. All of the pans may be removed easily and all are filled simultaneously by pouring



ing water into a funnel at the top, overflow tubes sending the water to each row of pans in succession as the row above is filled. Sewer connections may be made to the bottom overflow tube.

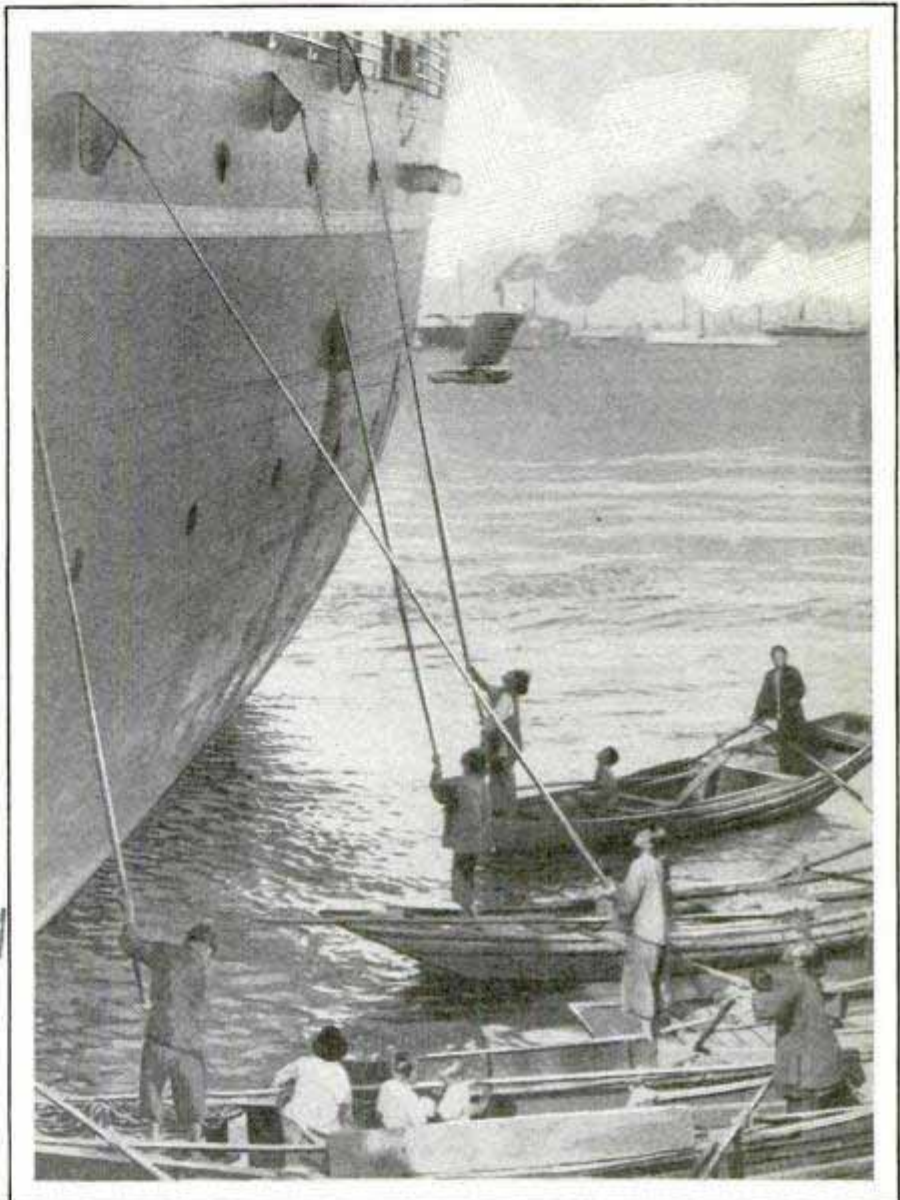

Shanghai River Beggars Meeting Incoming Ships Use Nets on the Ends of Long Poles to Receive Alms

RIVER BEGGARS COLLECT ALMS WITH BASKETS

River beggars in Shanghai have found that it pays to meet incoming ships before they dock and solicit alms from the passengers grouped along the rail. They run alongside the vessels, and extend bamboo poles with nets to receive the coins.

PINK OYSTERS ARE WHOLESOME 3487

Pink oysters, after undergoing ten years of examination, have been given a clean bill of health by the state of New York. Chemists found the pink bivalves to be as wholesome as those of normal color, while previously, dealers often destroyed consignments of pink oysters, believing them unfit for food.

Adding Audio Stages S-G Receiver

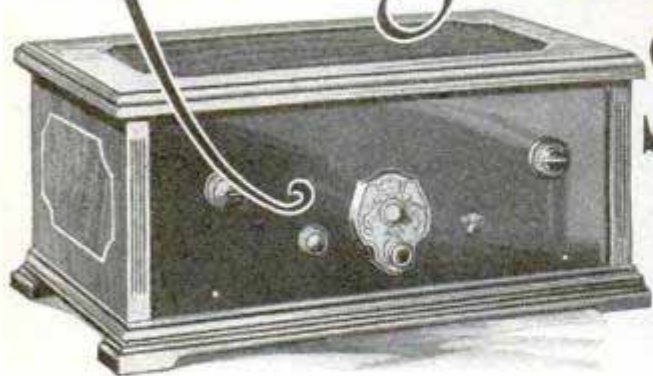

THE SIMPLE one-tube receiver described in the November issue was designed for beginners and was a complete receiver in itself; the layout, however, was planned so that either one or two a.f. amplification stages could be added with ease. No extra A or B-batteries are required for these audio stages, but there is an additional $4\frac{1}{2}$ -volt C-battery in series with the former C-battery for the purpose of biasing the grids of the tubes to be added. In the two-tube receiver shown in the first diagram and diagram No. 1A, both C-bias values may be shifted to obtain best results. For example, $1\frac{1}{2}$ -volts C on the control grid of the screen-grid tube may give better results than 3 volts, and the 9 volts C on the grid of the first audio tube may not give as good results as a lower value.

Resistance-coupled audio amplification

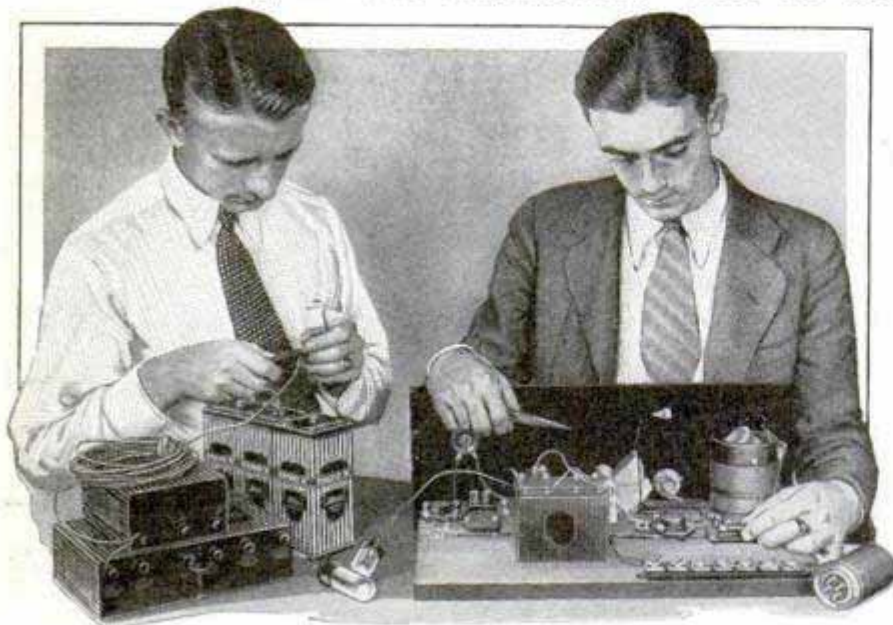

Adding the Second Audio Stage to the Screen-Grid Receiver

is used to advantage with the screen-grid tube, all that is required in the way of additional apparatus for the first audio stage being a CX-299 tube, socket, 30-ohm rheostat, a double resistor mounting, two resistors of the gridleak or "cartridge" type, and a .01-mfd. fixed condenser.

The parts are mounted on the baseboard as shown in the simplified wiring diagram on page 1001 and in the photo at the upper right on page 1003. The positive A-battery lead for the 299 tube is taken from the set side of the filament switch, and the negative filament supply is taken directly from the negative post on the dry-cell A-battery and run through the 30-ohm rheostat. The 135-volt B-line is tapped for the plate resistor and goes to the point indicated as positive-B on the resistor mount. The line to the lower phone post is then connected to the P-post of the 299 tube. The .01-mfd. fixed condenser is connected directly to the P and G-posts of the resistor stage. When all connections to the tube socket and resistor stage are made as shown in the diagram, connect the flexible leads to the batteries

and insert the 299 tube in its socket. The flexible leads, indicated as 1, 2 and 3 in the upper photo on page 1003, are the negative-A lead to the rheostat, and the two leads for the C-battery connections.

The two-tube receiver is now ready for operation. Turn on the filament switch and then turn the rheostat knob to the right until a hissing sound is heard in the phones. The tuning is done exactly as described in the preceding article. The volume on local stations is suffi-

to Beginner's

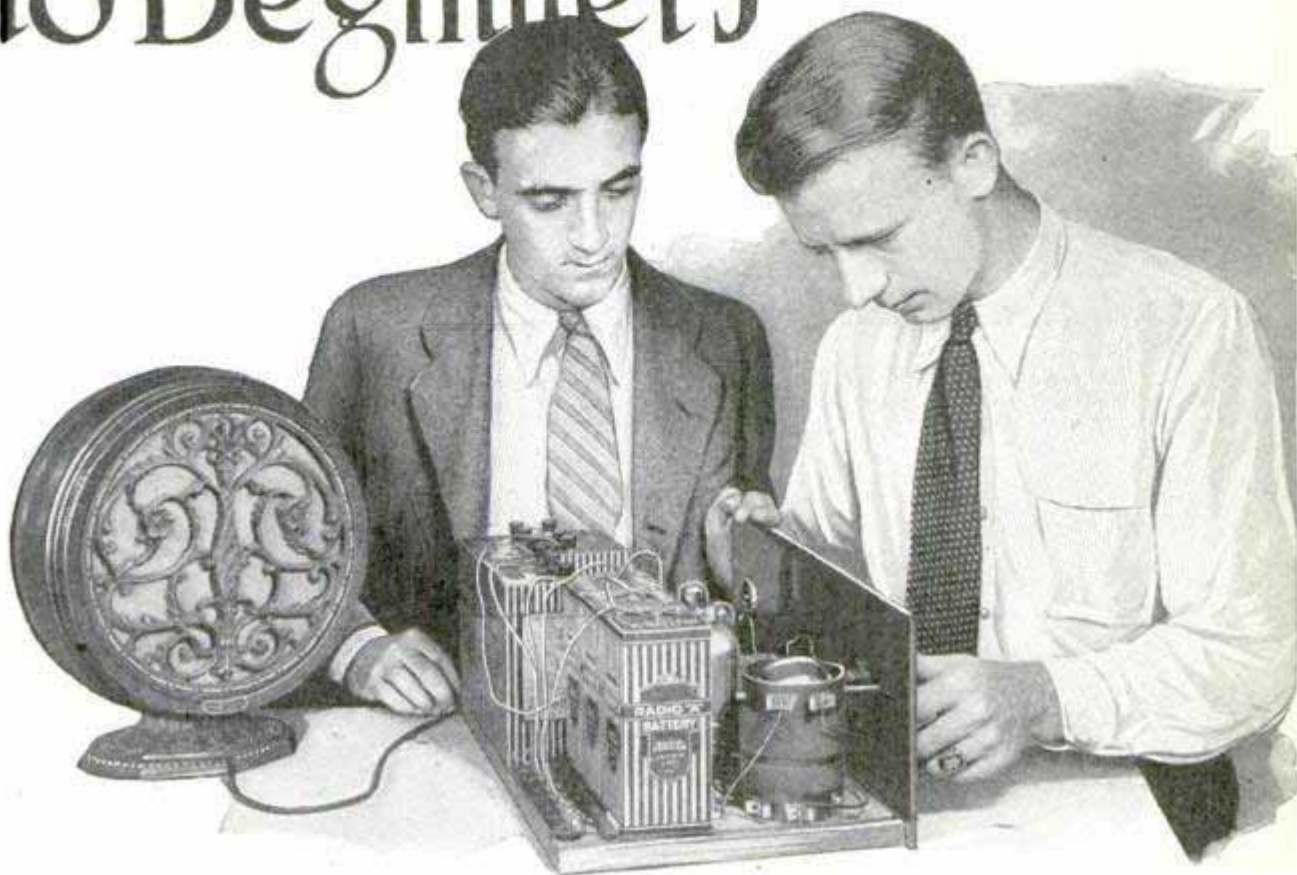

cient to operate a loud speaker; for headphones the volume may be reduced with the variable resistance in series with the antenna.

To add the third tube, which is also a UX-299, no further apparatus except the tube, socket and resistor-stage unit are required. The resistor-stage unit is a duplicate of the first stage, and the connections are clearly shown in the diagram on page 1002. The plate lead to the lower speaker terminal is cut as before and moved up to P on the last socket, and P of the preceding socket is connected to P on the resistor unit. Flexible leads 1, 2 and 3 are the same as before, and lead No. 4 is the 9-volt C-battery connection from the F-post on the second audio-stage resistor unit. The 135-volt B-line is again

tapped for the plate resistor, and the filament connections to the last tube socket are merely extensions from the preceding tube, placing them in parallel where they are both controlled by the 30-ohm rheostat. The photo at the upper left on

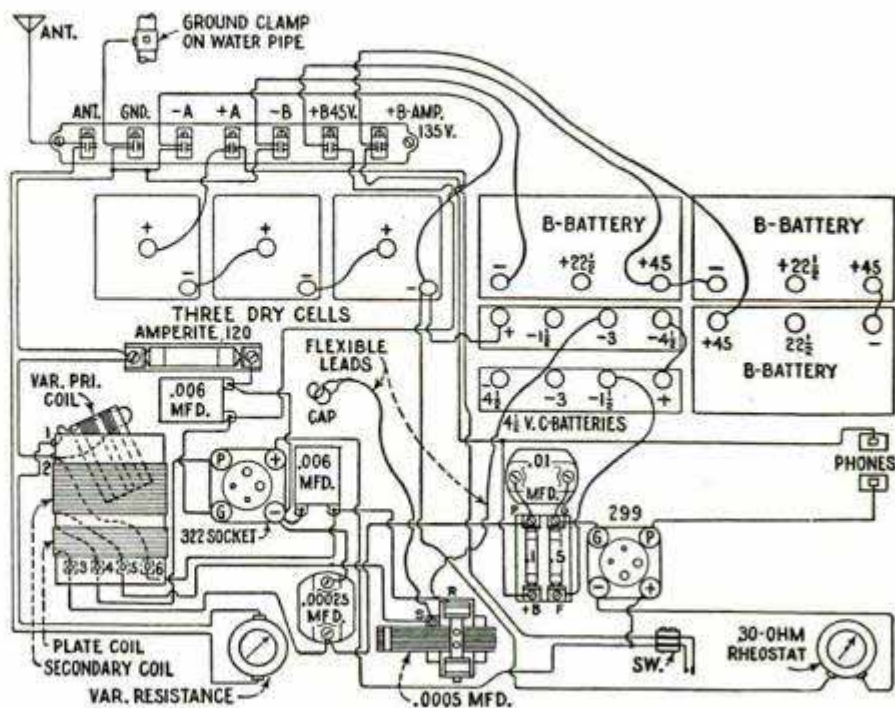

Simplified Wiring Diagram of the Two-Tube Screen-Grid Receiver

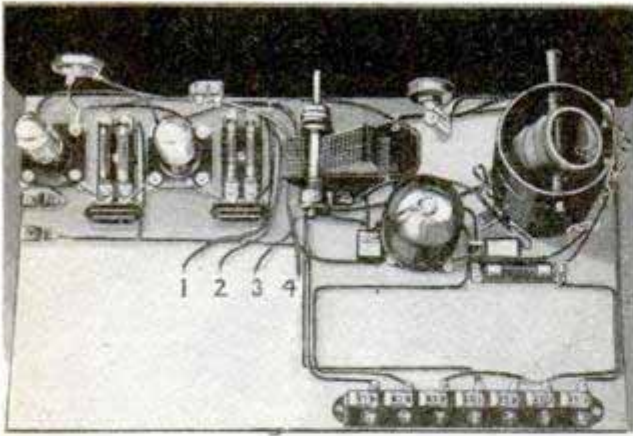

Above, Three-Tube Receiver Assembly; Below, Schematic Diagram of the Three-Tube Set and Simplified Wiring Diagram

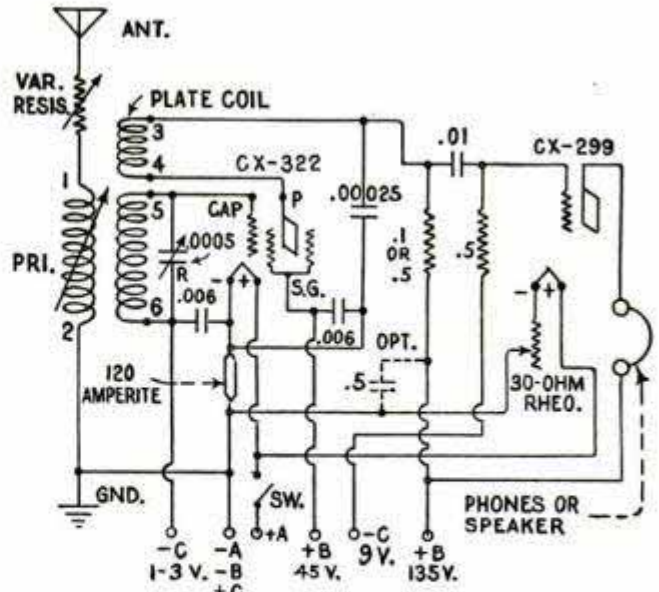

DIAGRAM NO. 1 A

this page shows the completed three-tube receiver ready for the batteries. The tubes always must be removed before the

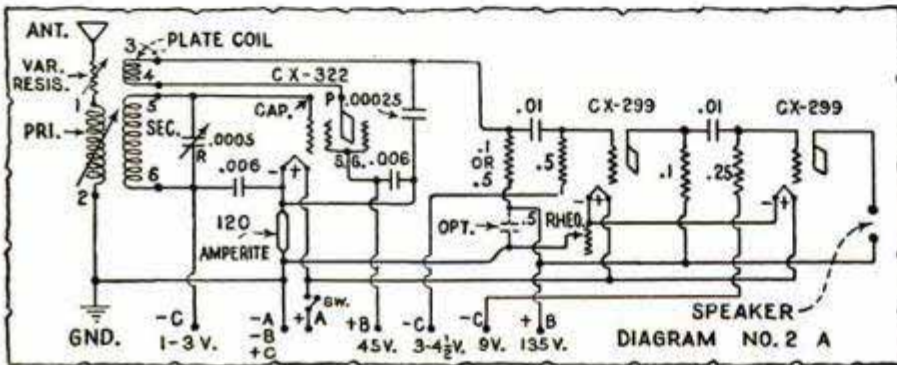
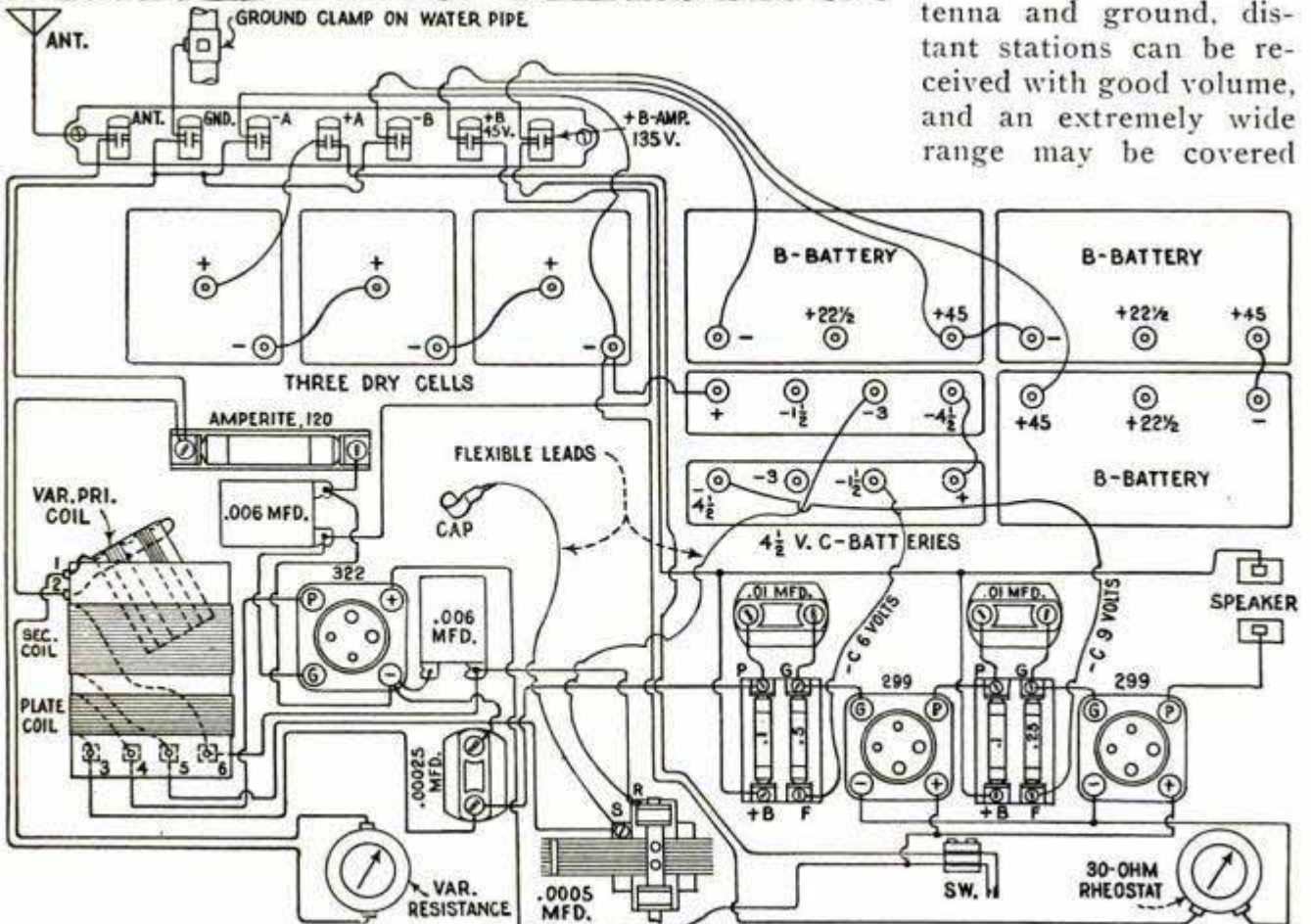

DIAGRAM NO. 2 A

batteries are connected, to prevent an accidental short which would burn them out.

The volume of the three-tube set is sufficient to operate any type of loud speaker, and the tone is all that could be desired. With a good antenna and ground, distant stations can be received with good volume, and an extremely wide range may be covered



with the headphones. Shift the C-bias voltages until the best results are obtained. Tuning is done as before; do not turn the condenser dial by jerks, but move it slowly and, when a station is picked up, adjust the volume control and the position of the variable primary coil until the station comes in loud and clear. These adjustments come with practice. The rheostat need be advanced only as the dry-cell A-batteries gradually drop off; never turn this rheostat higher than just necessary for good reception.

With ordinary use, the dry cells should last for several months, while the B-batteries will outlast several sets of A-battery cells and will need replacing about twice a year. The three tubes require but $\frac{1}{4}$ amp., and this drain on the dry cells is within practical limits for ordinary use. If, however, the filament switch is left on for long periods when the set is not in use, the dry cells will require frequent replacing. Those who desire may use a 4-volt storage battery and a B-eliminator with the set; standard 201-A, 5-volt tubes with a 6-volt storage battery may also be used, the screen-grid tube remaining as it is with the exception that a type 622 amperite must be used instead of the type 120. The 30-ohm rheostat should be

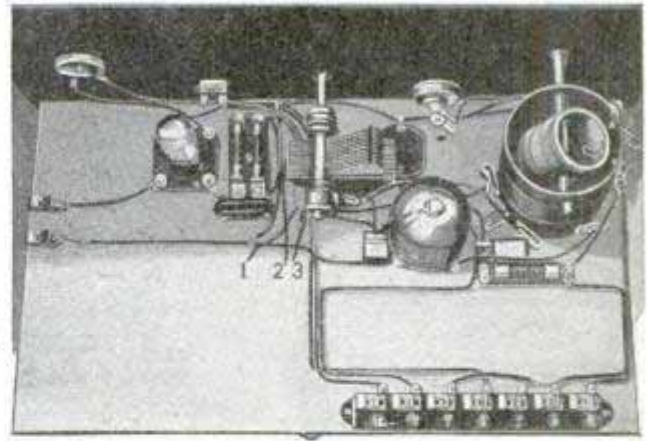

Two-Tube Screen-Grid Receiver

changed to a 20 or 25-ohm type for the larger tubes, or a type 1-A amperite may be used for each audio tube. If using larger tubes and a storage battery, the dry-cell space may be utilized to spread the baseboard layout in order to make room for a box shield for the coil.

The completed receiver together with the dry cells and B-batteries in either the one, two or three-stage type may be installed in a standard-size cabinet, as shown in the illustration at the left in the headpiece.

Blueprint No. 148, for this set, price 25 cents, from the Radio Department.

Radio Compass for Small Craft

A recent demonstration in New York harbor of a newly designed radio compass for yachts and small craft showed its efficiency in a unique test. A fog, seemingly made to order for the test, enveloped the harbor. The earphones of the instrument were given to the pilot, and to be doubly sure that he could not see, a handkerchief was tied over his eyes. With only the radio signals to guide him while lookouts watched for other

craft, the pilot held to his course for several miles through the fog, proving the dependability of this smaller type of radio compass. Three radio beacons send their automatic signals out over New York harbor and the water beyond for several hundred miles, just as other radio beacons protect all leading harbors all over the world.

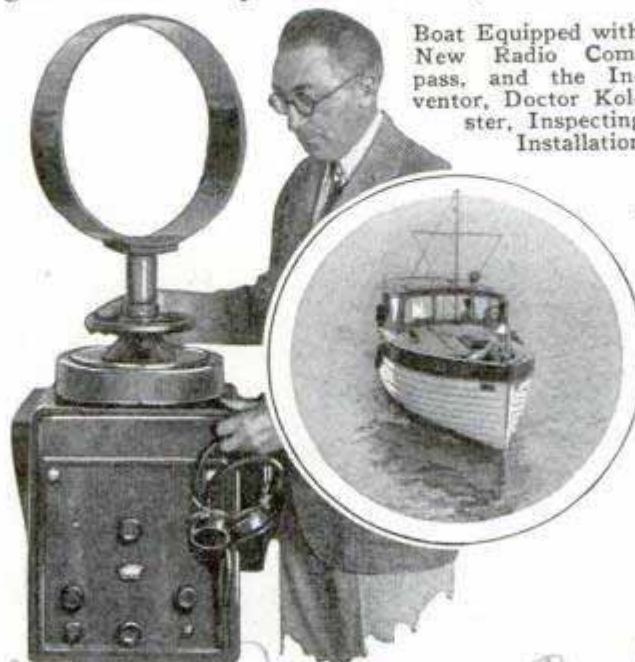

Boat Equipped with New Radio Compass, and the Inventor, Doctor Kolster, Inspecting Installation

☐ To test speaker windings, connect the speaker to the 110-volt a.c. line, with a 10-watt carbon lamp in series with the line, and listen for the hum.

Doctor Kolster Radio Corp.

110-volt

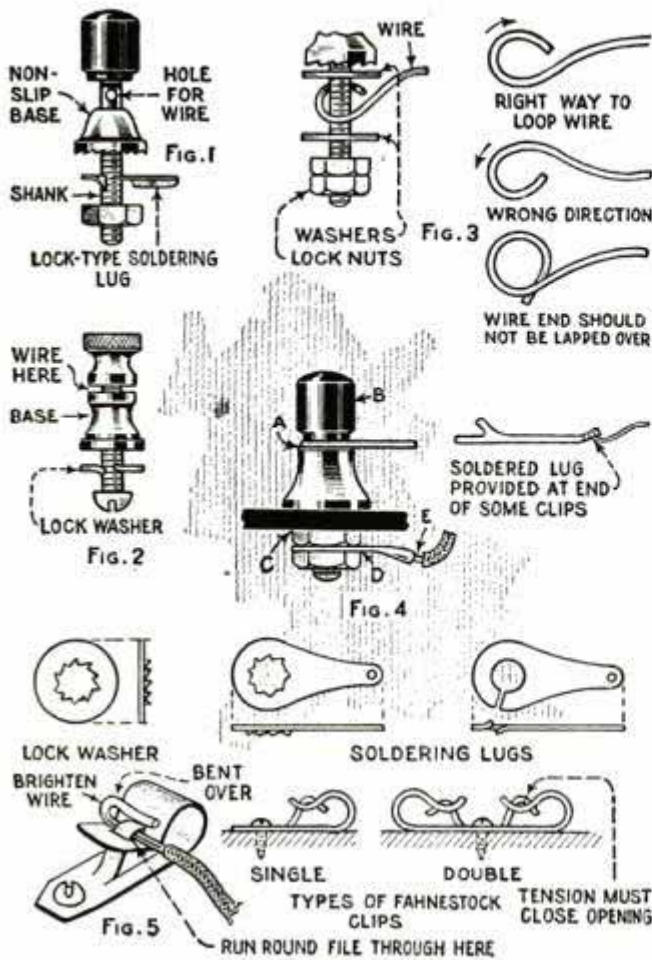

Good Connections Important

Few radio fans or service men realize the important part binding posts or connector clips play in the proper working of a set. Improper installation and poor soldering of these parts will seriously affect reproduction. When servicing a set, the first thing to do, after the power system has been found faultless, is to see that the connections to the set are in perfect condition. Styles in binding posts are many, but their fundamental construction is similar to those shown in Figs. 1 and 2. In Fig. 1, the wire passes through a hole in the stud and a knob is screwed down upon it to hold it tight. The base piece is crimped underneath, which prevents its turning on the panel or binding-post strip. Suitable nuts and washers below the strip or panel hold the stud from turning. Other binding posts of this type use a plain stud around which the wire is turned. The post shown in Fig. 2 employs a base piece in which is inserted a short stud on which the knob above is turned down. Underneath, the base is tapped for a machine screw. When installing the type in Fig. 1,

it is necessary to use at least one lock washer, or soldering lug with lock washer incorporated, to prevent the nut below from turning out and allowing the post to turn. If no lug is used, use a lock washer and two nuts below to thoroughly lock the base in position, as in Fig. 3. A lock washer or lock-type lug should also be used in post Fig. 2. In either case, if the wire is turned about the lug or screw, place it between the top lock washer or lug and the bottom of the strip. In every instance when the wire is turned about the post, loop it, clockwise. For quick and efficient connections nothing is so popular as Fahnestock clips; when using these, file all points of contact as in Fig. 5. They come in several types, both single and double, as shown in the sketches at the right. After long use, if noises develop in a set, examine the points indicated at A, B, C, D and E shown in Fig. 4 to ascertain if corrosion has taken place. When building a new set, as an extra precaution it is well to disassemble all binding posts and brush them with alcohol or gasoline to remove any grease or lacquer before mounting them in the set.

Soldering Iron Works like Fountain Pen

A soldering iron of the electrically operated type which differs materially from the usual device is shown in the illustration. Its distinguishing feature is that the solder is melted within the iron and flows to the point where it is controlled by a valve. This iron is made in three sizes and costs only a little more than the ordinary one.



Light-Socket Antenna Kink

To determine which of the two wires of the house wiring gives the best results for signal strength and selectivity, tune in a distant station and reverse the plug in the socket. The best position being determined, mark both so that this position may be maintained.

atinal - 2/24 - 2/24 - 2/24

Humless A-Eliminator for Radio Receiver

By MAXWELL P. GILLILAND

THERE are two things every radio enthusiast really desires: a perfect A-eliminator and the same kind of dynamic speaker. The A-power supply for the set enables the owner to operate his d.c. receiver in connection with a B-eliminator on the house-lighting circuit, retaining all the good characteristics of the tubes. This unit, being the hardest to get, is of course most desired. The average A-unit available today has a slight hum; though hardly noticeable, yet it is there. Responsibility for this defect is not directly traceable to any one part of the assembly as it is usually caused by a combination of several conditions.

As to the dynamic speaker, it is generally conceded that the battery-operated type is best, in that there is no hum as with the a.c. types employing the usual rectifiers. The hum in some types is more pronounced than in others, but in all cases it occurs when the set is not tuned in on a station. The a.c. hum is kept at a minimum by the use of audio-frequency chokes designed to operate in the neighborhood of 50 cycles. Unfortunately this has the

same suppressive effect on the lower notes. Many dynamic speakers employ a half-wave rectifier operating from a small step-down transformer to supply the voice-coil current, and as there is no filter to smooth out the current ripple, the result is the hum.

The d.c. dynamic costs less than the a.c. type, and if a source of pure d.c. at approximately 10 volts is available, both the receiver and speaker may be operated at minimum expense and maximum efficiency. Experimenting along this line led to the design and construction of the unit described and illustrated in this article, the result being an A-eliminator that fills the requirements without a hum.

After many trials, the writer has found that the only satisfactory method of obtaining pure d.c. for this purpose is to use tubes rectifying both halves of the 60-cycle a.c. supply. With large-capacity condensers and efficient choke coils, it is possible to maintain a constant potential and a very smooth current output.

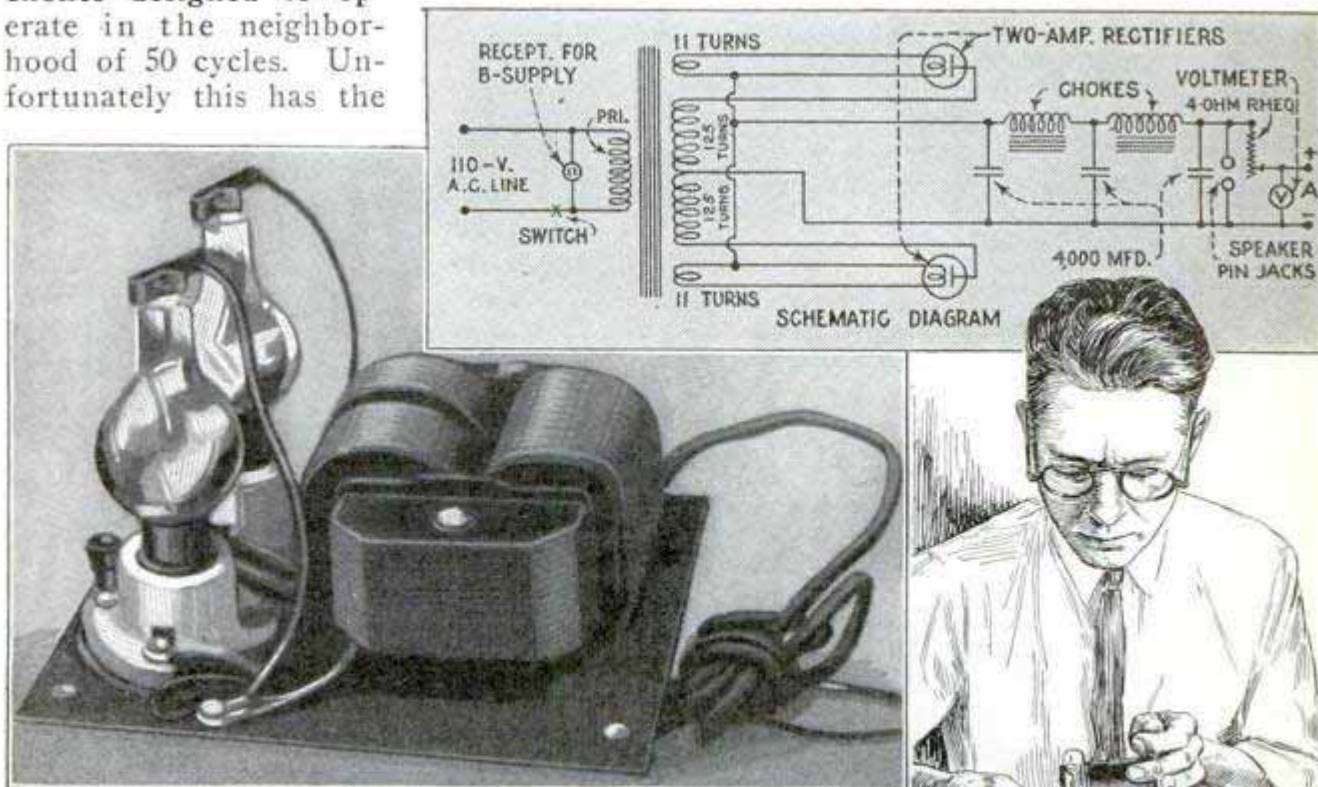

Upper Right, Schematic Diagram of Connections; Below, Clamping Choke-Coil Assembly Together; Left, Transformer and Rectifier-Tube Assembly

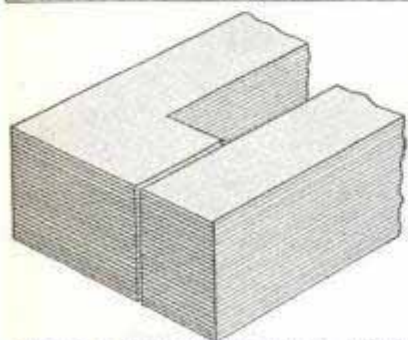
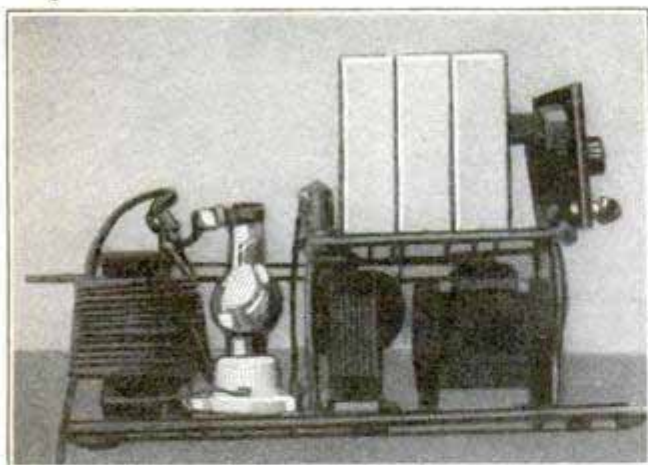

METHOD OF STACKING LAMINATIONS

Upper Left, Side View of Completed Unit; Right, Details of Panel and Platform Assembly

The transformer that supplies the tungar rectifier tubes must be carefully and generously designed; suitable apparatus may be purchased, but the average experimenter will prefer to make his own. A large amount of iron is necessary for the core; otherwise it will operate at too high a current density with little or no current regulation. Improperly gapped chokes saturate at very low current values. The chokes described have an inductance value of $\frac{1}{4}$ henry and are specially designed with heavy iron cores for use with the large-capacity filter condensers. The transformer is of the closed-core type, the details of which are shown on this page. The over-all dimensions are $5\frac{3}{8}$ by $3\frac{1}{8}$ by $1\frac{1}{2}$ in., and the laminations are cut and stacked in the manner shown. It will be noted in the diagram on page 1005 that there are four secondary windings, the outer two of which supply the filaments of the tungar rectifier tubes. The primary coil consists of 550 turns of No. 20 s.c.c. wire, layer-wound and placed on one leg of the transformer. It should be properly insulated from the iron core by means of "fish" paper or empire cloth, and wedged to the core so that no vibration will occur.

Each of the filament secondaries consists of 11 turns of No. 12 d.c.c. wire and are placed on either side of the plate windings on the other leg of the transformer. The coils supplying the higher plate po-

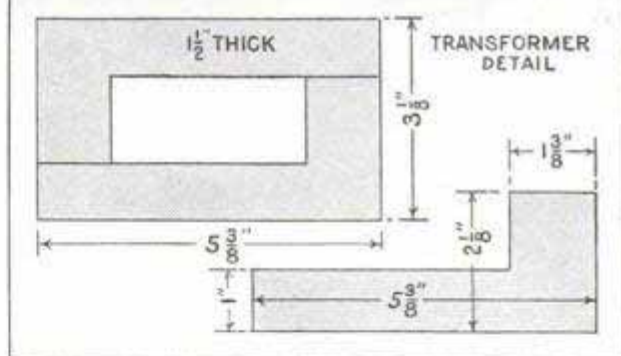
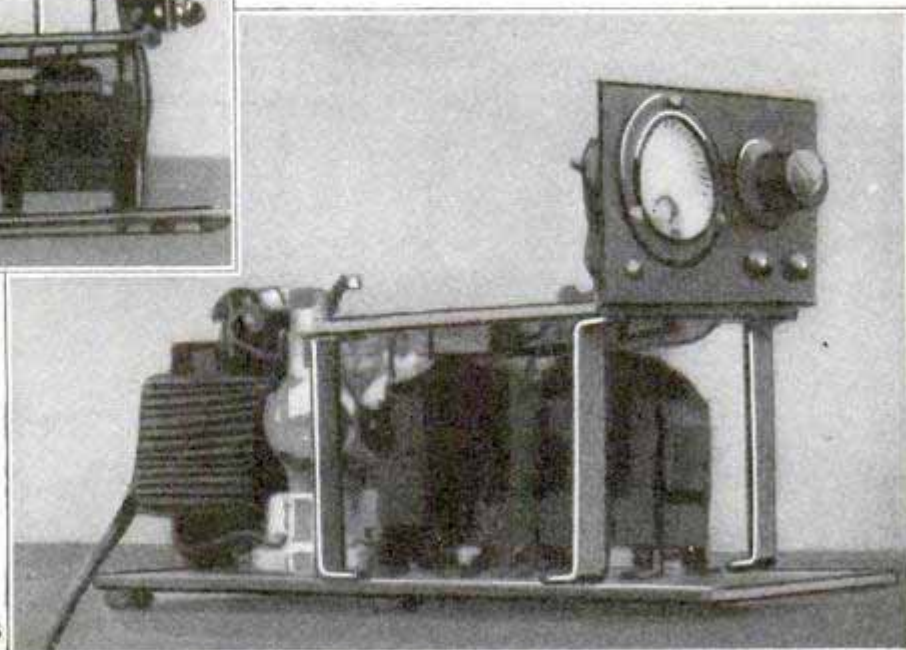

tential to the rectifiers have 125 turns of No. 16 d.c.c. wire. All of these coils are layer-wound and insulated carefully.

The choke coil details are shown on page 1007; the cores are $2\frac{3}{8}$ by $3\frac{7}{8}$ by $1\frac{3}{8}$ in., and the air gap, as indicated in the diagram, approximates .015 of an inch. Fish paper of this thickness is recommended for spacers between the legs. The winding is placed on one leg only and consists of 390 turns of No. 16 enameled wire.

The layout of the completed unit is clearly shown in the photos. It will be noted in the diagram that a receptacle has been provided for the B-supply, which is shunted across the primary winding so that both units may be operated by the same line switch.

To wind all coils, prepare wooden mandrels the size of each leg. A layer of

heavy cord is first wound on the mandrel, as shown in the upper sketch on this page. Next, over this, is placed a layer of insulating cloth or fish paper, then the regular winding of wire. Over each layer of wire place another covering of paper or cloth, and be sure that the insulating material is held firmly in place. To remove the coil from the mandrel, unwind the layer of cord. The core laminations should be stacked until the specified thickness has been reached, after which the laminations are bound together with a bit of tape. Over this, slip the finished coil, as shown in the sketch at lower right on this page, and wedge the coil into place with small pieces of the insulating material. The other leg of the transformer is assembled in the same manner, and the two halves of the core are then clamped by means of either wood, bakelite or metal strips, bolted together at top and bottom. In the case of the chokes, no winding is placed on the second leg.

Assemble the unit on a baseboard as shown in the photos; the two 2-amp. tungar tubes used are of the type usually employed in battery chargers and fit into ordinary screw-type porcelain sockets.

The filter condensers are of the new 4,000-mfd. dry self-healing type, the terminals of which must be correctly connected for polarity. The positive

terminal is the red lead and the negative is black; these leads must not be reversed.

After the current is passed through the filter system, the output is pure d.c. at approximately 10 volts. This is carried directly to two heavy-duty pin jacks and two binding posts, as shown in the diagram. In series with the positive post, is a 4-ohm rheostat with a current-carrying capacity of 5 amp., and an 0 to 10-volt d.c. voltmeter is connected across the final output. The voltmeter is optional, but will be found very useful and, for best result, should not be omitted. The pin jacks are for the field or "voice coil" of the dynamic speaker. Very even and minute voltage adjustments may be obtained by means of the rheostat for the operation of practically any d.c. receiver. When, at the end of a year or so, the output of the tubes drops slightly, the rheostat may be set up a bit and things go on without further adjustment.

The rheostat, voltmeter, A-power supply posts and the pin jacks for the speaker field supply are mounted on a small bakelite panel with angle-iron brackets.

Blueprint No. 147, for this eliminator, 25 cents from the Radio Department.

Upper Right, Pointing Out Gap in Core of Choke-Coil Assembly; Below, Placing Coil on Core Leg

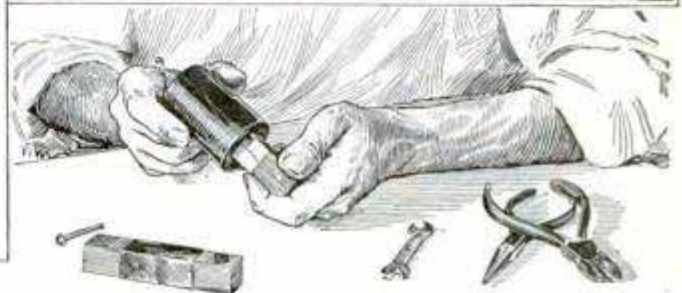
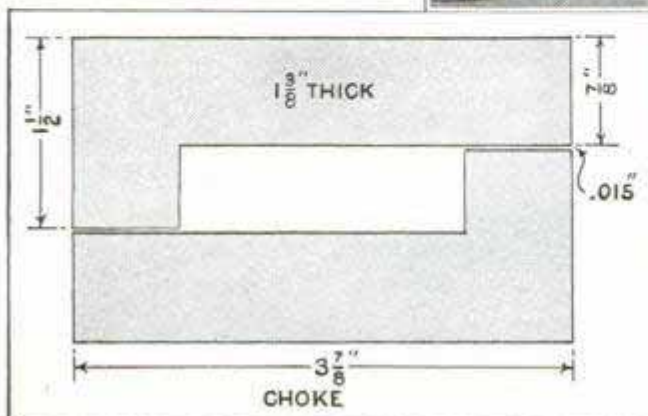
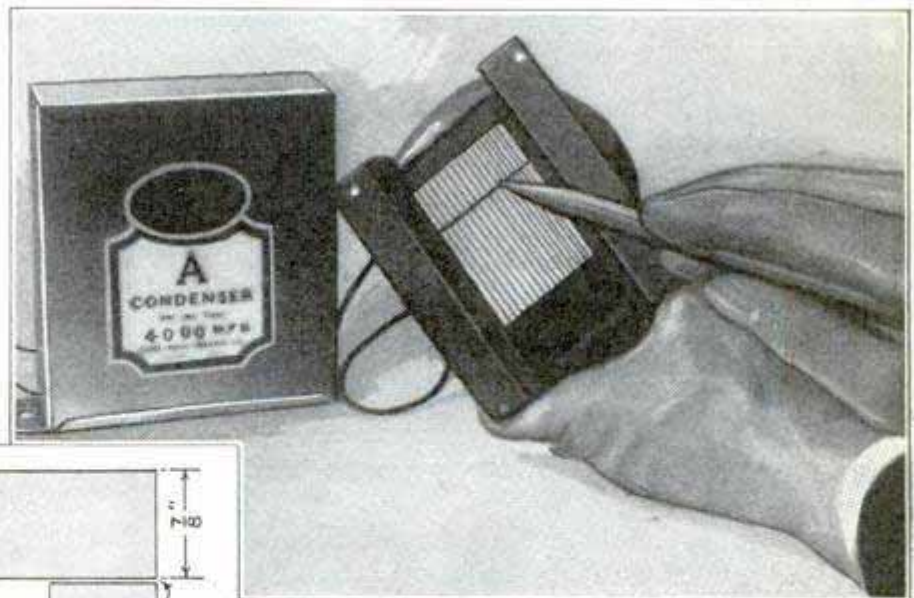
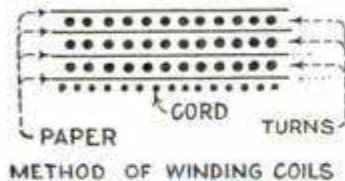

Making a Midget Multimeter

By WILLIAM H. WENSTROM

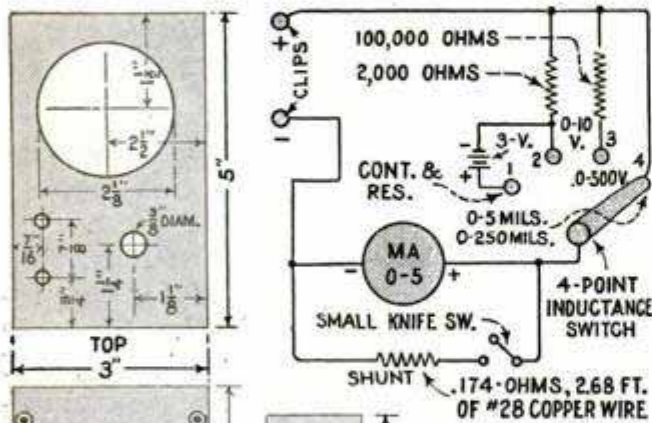

Fig. 1

DETAIL OF CASE

RESISTANCE MEASUREMENTS			
MILS. CURRENT	EXTERNAL RESIST.	MILS. CURRENT	EXTERNAL RESIST.
1.5	0	0.7	2,300
1.4	140	0.6	3,000
1.3	300	0.5	4,000
1.2	500	0.4	5,500
1.1	700	0.3	8,000
1.0	1,000	0.2	13,000
0.9	1,300	0.1	28,000
0.8	1,850	0.05	58,000

TABLE 2

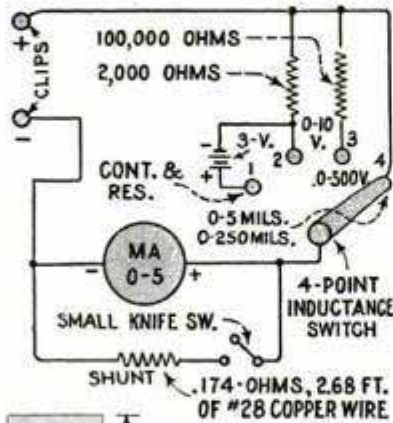

Fig. 2

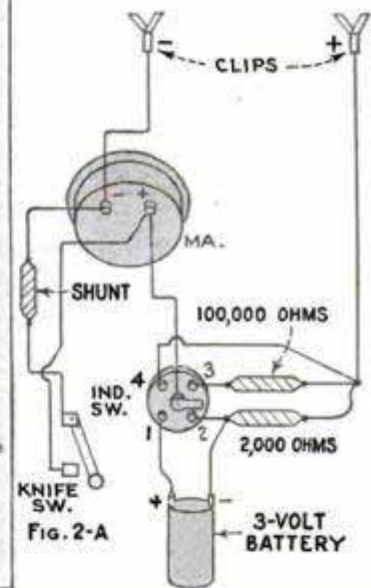
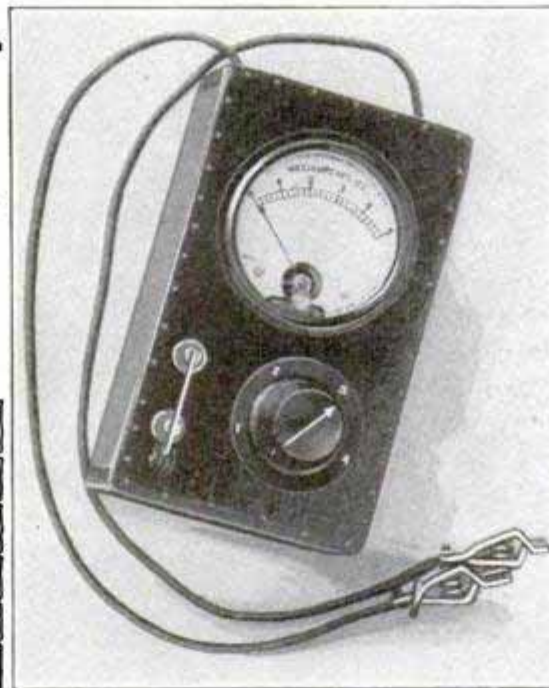

Fig. 2-A

tained miniature flashlight battery, it makes continuity tests and functions as an approximate ohmmeter for measuring external resistances between 100 and 50,000 ohms. It will not, of course, make alternating current and radio-frequency measurements; for these, separate instruments are required.

The following parts are needed for the instrument: 1 Weston, Model 506, milliammeter, 0 to 5 mils.; 1 four-point inductance switch; 1 miniature single-pole, single-throw knife switch; 1 resistor, 2,000 ohms, of the gridleak size; 1 five-watt resistor, 100,000 ohms; 1

THE ELECTRICAL or radio worker must have instruments for intelligent work; these instruments need not be expensive and soon pay their way in checking complicated circuits where an error may easily result in serious damage to costly apparatus.

In the midget multimeter described in this article, maximum usefulness has been combined with minimum size and cost, amounting to less than \$10. All apparatus is contained in a wooden case, the dimensions of which are 2 by 3 by 5 in. Yet it measures voltages through the ranges 0 to 10 and 0 to 500, and currents through the ranges 0 to 5 milliamp. and 0 to 250 milliamp. In addition, with its self-con-

KNIFE SW.	IND. SW.	RANGE	COR. FACTOR
OPEN	1	CONT.-RES.	SHORT 1.5 MILS
OPEN	2	0-10 V.	1.00
OPEN	3	0-500 V.	1.05
OPEN	4	0-5 M.	1.00
CLOSED	4	0-250 M.	1.00

TABLE 1 - RANGES

three-volt flashlight battery and a small wooden case of the size shown, made from 1/4-in. white pine. The connections may be made with ordinary hookup wire, and two small bulldog clips are employed at the ends of the flexible test-terminal leads.

The bottom of the case, detailed in Fig. 1, must be removable for battery replacement; the knife switch, milliammeter and inductance switch are mounted on a bake-

lite panel as shown in the photo. The shunt resistance consists of $32\frac{1}{2}$ in. of No. 28 silk-covered copper wire, which is wound on a wooden dowel, $\frac{1}{4}$ by 2 in., the ends of the fine wire being soldered to the ends of the larger connecting wires, and thrust through small holes in the dowel. The resistances and shunt are soldered directly to the connecting wires, without mounting clips; the resistances are both wound with friction tape to cover all bare connections, as they must be crowded into the box.

After all connections have been made, as shown in Figs. 2 and 2-A, the multimeter is calibrated against larger standard instruments, preferably of the accurate laboratory type.

Table 1 gives the various ranges and switch positions, and a like chart should be made up and glued to the side of the box. To calibrate the 0 to 10-volt scale, for instance, place the multimeter and a standard low-scale voltmeter across some given voltage, such as the filament of a tube which is in series with a battery and rheostat. If the standard voltmeter reads exactly 5 volts when the multimeter reads, say, 4.9 volts, a correction factor is necessary, and would, in this case, be 5 divided by 4.9 or 1.02. In other words, all multimeter readings on the 0 to 10-volt scale must be multiplied by 1.02 to give a true reading. The 0 to 500-volt scale is calibrated in exactly the same manner.

In calibrating the current ranges, the multimeter is connected in series with a standard milliammeter and a suitable current source. No correction factor is needed for the 0 to 5-mil range, as the milliammeter itself is very accurate. On the 0 to 250-mil scale, if the correction factor is less than .95, take a turn or two off the shunt; if the factor is greater than 1.05, add a turn or two.

For resistance measurements see table 2. The self-contained battery for continuity tests and resistance measurements is connected in series with the milliammeter and the 2,000-ohm resistor; a direct short circuit of the multimeter terminals shows a current of 1.5 mils. With table 2 the multimeter can be used as an approximate ohmmeter, measuring external resistances between 100 and 50,000 ohms with an accuracy of about plus or minus 10 per cent.

Of course, the battery must show very close to 1.5 mils on short circuit if this accuracy is to be maintained.

Handling Charged Filter Condensers

The high-voltage filter condenser is capable of holding a charge for a considerable length of time. Consequently shocks are possible if proper precautions are not taken when checking the modern power-supply unit. A simple method of avoiding such shocks is to make it a practice always to discharge such condensers before handling them. This is done by merely shorting the condenser terminals with a piece of wire, a screwdriver, or any other metal conductor.

Radio Set in Octagon Table Top ^{24 20 11}

The radio receiver shown in the illustration is a useful combination of a standard octagon table and a set with dynamic speaker. The antenna, ground and power connections are concealed in the table legs; there is no exposed wiring above the floor, and the table is wired for a lamp connection. All parts and tubes are



Hinged Top of Table Raised, Exposing Chassis of Receiver, and Home Installation

easily accessible for servicing by simply raising the hinged top of the table.

See book for details

Television Broadcasting in England

OFFICIAL television broadcasting is about to begin in Great Britain, operated on the Baird system which recently came through exhaustive tests before the postmaster-general and a parliamentary committee. Mr. Baird's results are said to be all that the average man could desire, except, of course, the absence of color, and a size, which has the appearance of being about one-third that of life.

The drawing on the opposite page features the scanning disk or "reproducing wheel" in particular, and the upper left units A, B, C and D show how the spots of light passing the spiral of holes completely traverse the subject. These sketches incidentally show the famous tobacco-smoke test, the graduations being transmitted with exceptional clearness.

The transmitting end of the apparatus is diagrammed below and the receiving televisior at the upper right in the full-page illustration. Certain secret details recently developed by Mr. Baird are not

brought out in the illustrations; for example, there is a double spiral of scarcely discernible holes in some of the disks employed, and a really efficient synchronizing gear is now operated at the hub of the scanning disk.

Some remarkable effects are produced by this television apparatus, as shown in the various sketches. When adjustments prior to transmission are taking place, effects known as "rain" or "confetti" may be seen in the televisior similar to those shown in Figs. 1 and 2. In the latter the image may be almost blotted out by a shower of spots of light. The subject, seated before the photo-electric cells at the transmitter in the lower illustration, experiences a dazzling sensation as the swiftly moving pencils of light traverse her face. The reflected light is converted into like current fluctuations by the photo-electric cells and broadcast as such, in the same manner as voice and music are handled by a microphone, and the sound

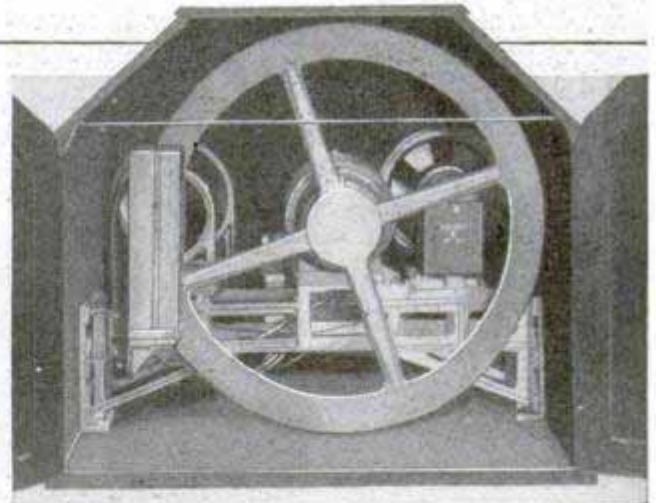
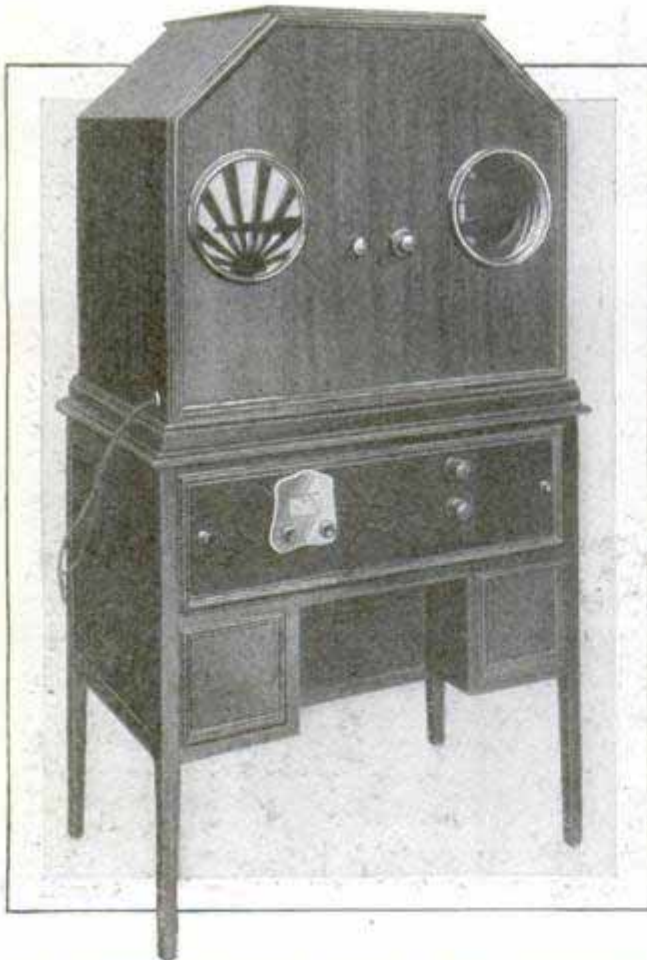

is transmitted as electrical impulses of corresponding fluctuations.

This "televisor" is the commercial installation that will shortly be seen in many English homes. Housed in a neat console, the apparatus consists of a suitable radio set, speaker for vocal announcements and regular broadcast programs as well as the equipment for picture reception. The images are viewed through the lens shown at the right, and the speaker grill is located at the left.

Left, Complete Television Receiver Soon to Be Seen in English Homes; Right, Rear View Showing Reproducing Wheel, Motor and Synchronizer

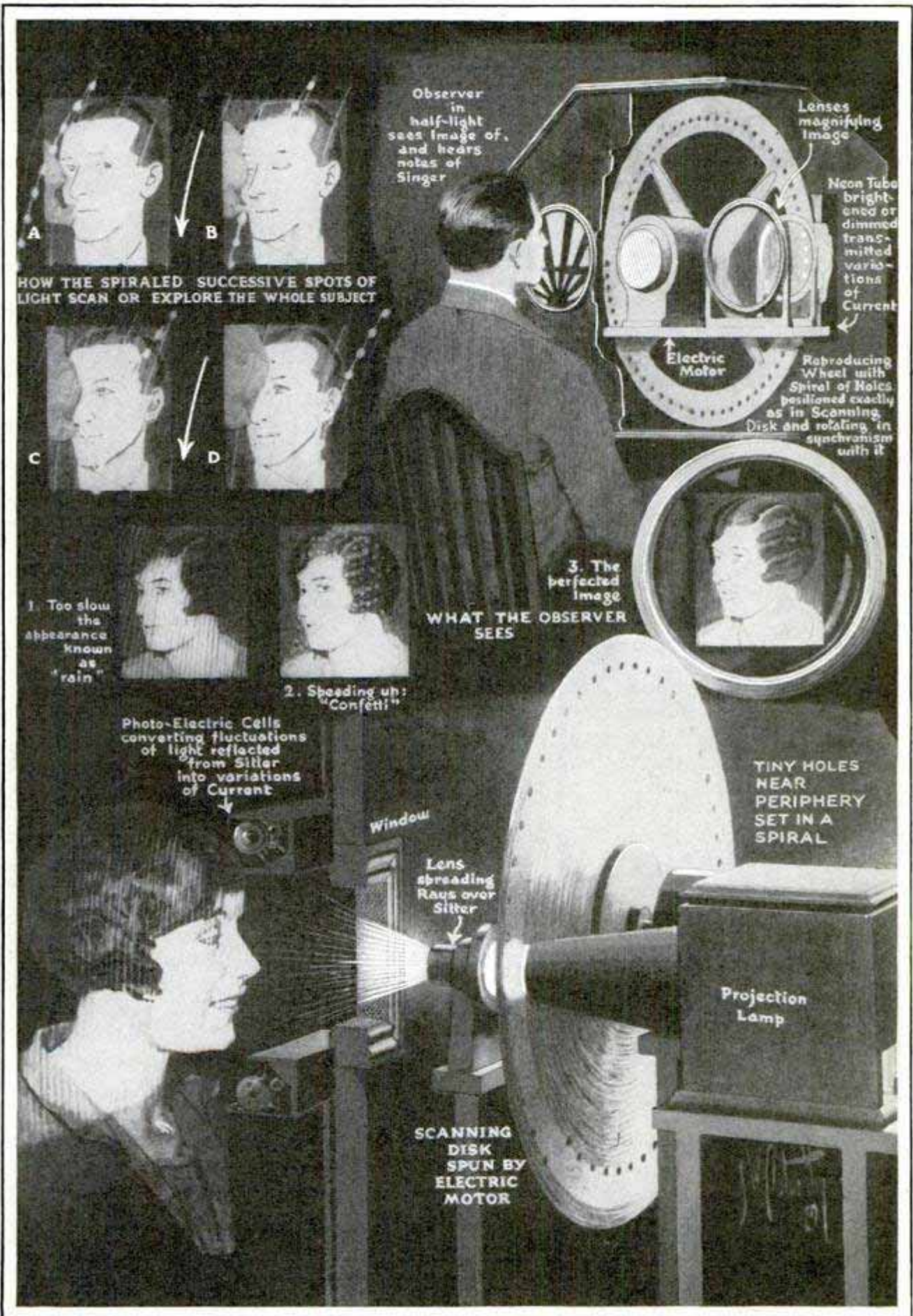

Copyright, S. W. Clatworthy

Upper Right, Sectional Diagram Showing Television Receiver in Operation; the Observer Views the Image through the Lens at Right; Below, Transmitter, Showing Pencils of Light Traversing the Subject Transmitted to the Receiver Above

Receiver Employs Five Screen-Grid Tubes

The ten-tube receiver shown in the upper photo is a powerful custom-built as-

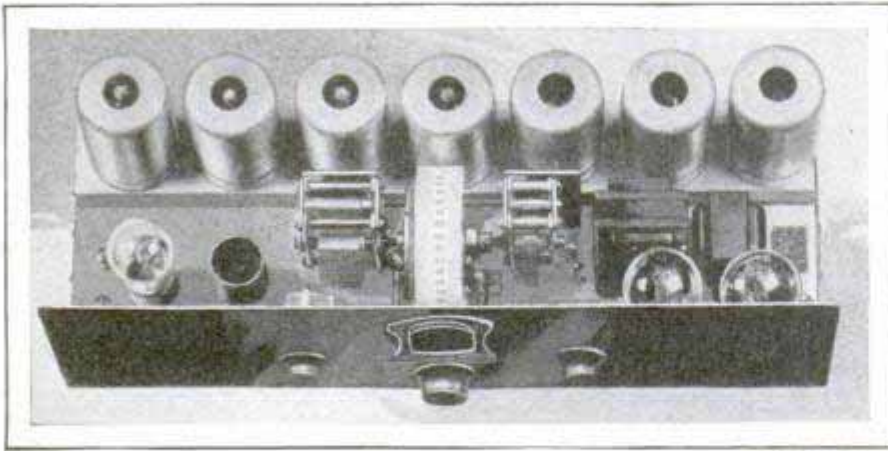

Upper Left, Receiver Ready for Installation, Showing Compact Assembly; Below, Power Unit

sembly, employing five type-224, three type-227 and two type-245 tubes. The power unit below is a specially designed instrument, the filter system of which is equipped with a heavy choke and the new self-healing condensers of 24-mfd. capacity. An automatic line ballast and regulator levels out all fluctuations in line voltage from 95 to 130 volts. This line regulator may be switched out if not required; a type-280 rectifier tube is employed in the power unit. The receiver is very compact and is designed to fit current models of fine consoles. The amplification system is built around the new a.c. screen-grid tubes, the amplification factor

of which is exceptionally great. This tube is especially adapted to the intermediate-frequency stages of the superheterodyne receiver. Since they operate at only one frequency in this circuit, all tendency toward oscillation is eliminated. One of these tubes is the detector upon the plate of which is impressed 175 volts. This new system of power screen-grid detection prevents overloading the detector, even at maximum. A plug-in

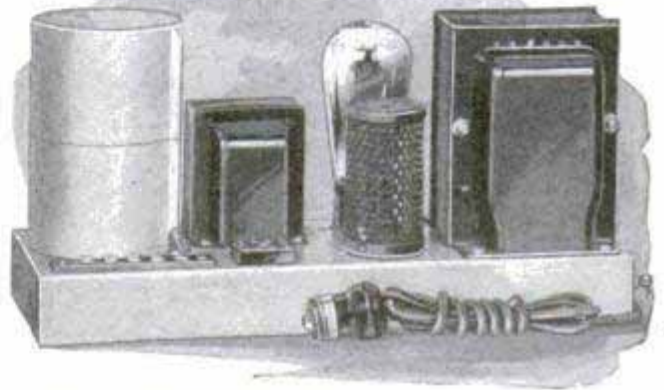

jack is provided for the instant attachment of an electric phonograph pick-up system. The entire audio system is used for this purpose. Good selectivity and coast-to-coast range combined with humless a.c. operation are claimed for this new receiver.

Bringing Out the Bass Notes

The diagram shows a simple and effective method of bringing out the bass notes that add so much to the quality of any program. The "darkening" condensers placed across the secondaries of the a.f. transformers may be any good fixed type, and have the effect of lowering the frequency of the

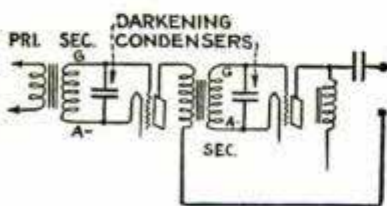

coils to favor the low-frequency bass notes. As it is advisable to try a number

of different capacities, condenser mounting brackets should be provided to make

possible quick change of values. Transformer characteristics vary considerably and hence no set values can be given, but the proper capacities will be somewhere between .0005 and .006 mfd.

Cleaning Tip of Soldering Iron

Good work cannot be done with a soldering iron that is not kept clean and well tinned. A small wire brush is useful for cleaning the tip of the iron before tinning. A woolen cloth or asbestos pad should be used to keep the point clean.

Popular Mechanics radio department offers its information service free to all readers of our magazine.

H/C S. P. G.

Plug-In Coils Wound on Tube Bases

The use of plug-in coils, especially with short-wave receivers, is increasing. Many experimenters would like to make their own, but are deterred by lack of the necessary construction details. This article illustrates and describes a simple and inexpensive method of winding coils of this type, employing the bases of old tubes for the necessary plug-in forms. Choose tubes having bases as long as possible. Old rectifying tubes and power tubes have longer bases than ordinary receiving tubes, and burned-out tubes of this type may often be obtained from the local service man or dealer. The tube may be removed from the base either by painting the cemented joint with alcohol or by immersing the base in warm water until the tube is loosened. When employing the latter method, be careful that the water is not too hot or the base will be damaged. When the tube is loose, heat the ends of the prongs with a soldering iron, and the tube and leads may then be lifted clear. Turn the tube base over and drill out the prongs for a clear passage. The four small holes for the tickler and primary windings are then drilled in the side of the base, as shown in the construction diagram. The writer uses No. 28 enameled wire

for winding all coils down to those for the 20-meter band. As the higher frequencies are approached, however, better results are obtained by using d.c.c. wire of a larger diameter, such as No. 22. For the tickler coil, a bared end of wire is inserted in the bottom hole in the tube base, passed down through the prong and bent over as shown. The end of the wire is fastened in place with a drop of solder, which is then filed down in the same manner as on the tube. The tickler coil is now wound tightly and clamped to the base, and the upper end of the bared wire passed through the second hole and prong and served as before. The primary winding is done in the same manner. It will be noted that the two large prongs are always used for the tickler leads and the slender ones for the primary leads. When connected in this manner, the coils will all be alike and work satisfactorily in sockets where like connections are made. When complete, file away all excess solder and brighten the prongs to make good

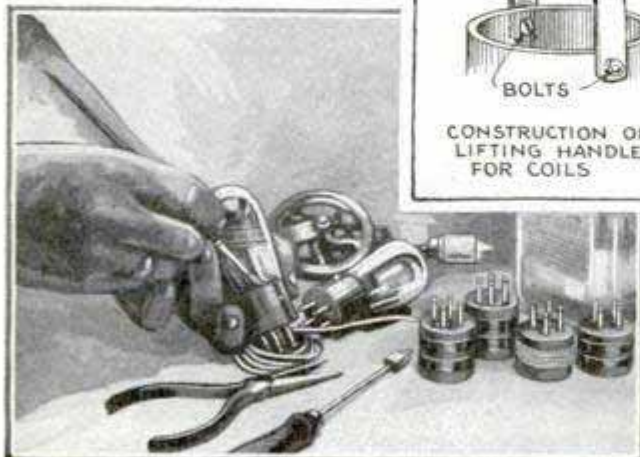
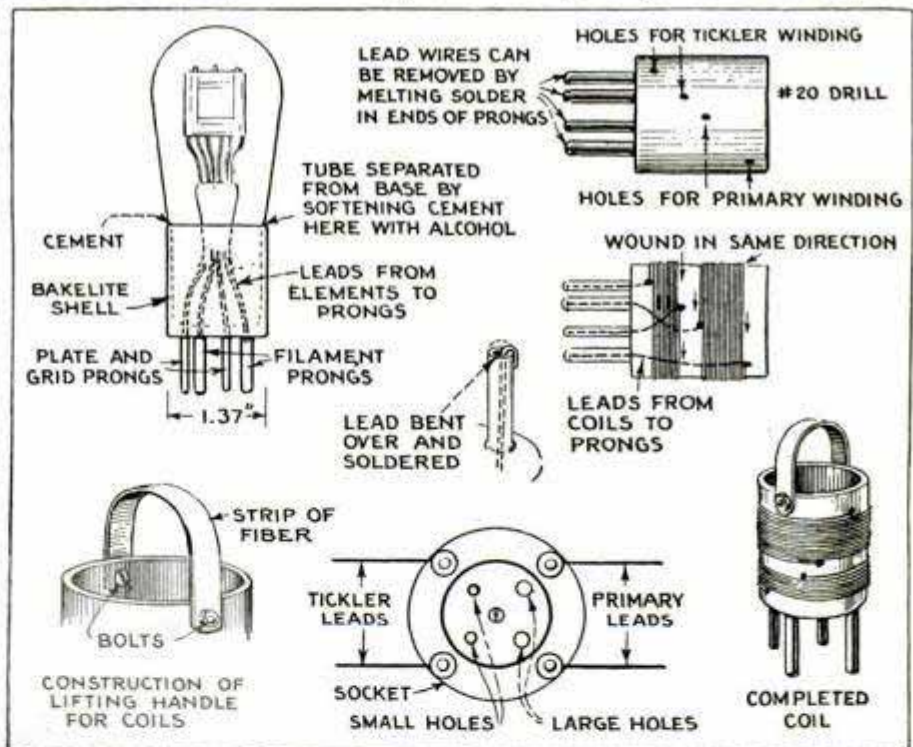

Above, Detailed Construction Diagram; Left, Painting Tube Joint with Alcohol to Loosen Cement; Completed Coils Ready for Lifting Handles

contact in the socket. Two holes are then drilled in the top of each coil form to take short 6-32 machine screws for the lifting handles. These handles may be made from strips of fiber, drilled and bent to form bails as shown, and are held by the machine screws and small hexagon nuts on the inside of the form. A table of turns for the various wavelengths is

rather difficult to give, owing to varying condenser capacities employed in differ-

trouble. In many instances, the loss in sensitivity may be traced to changed resistance values, usually upward rather than downward. Since the sensitivity of the circuit depends upon constant and definite resistance values, the answer, of course, is new resistors.

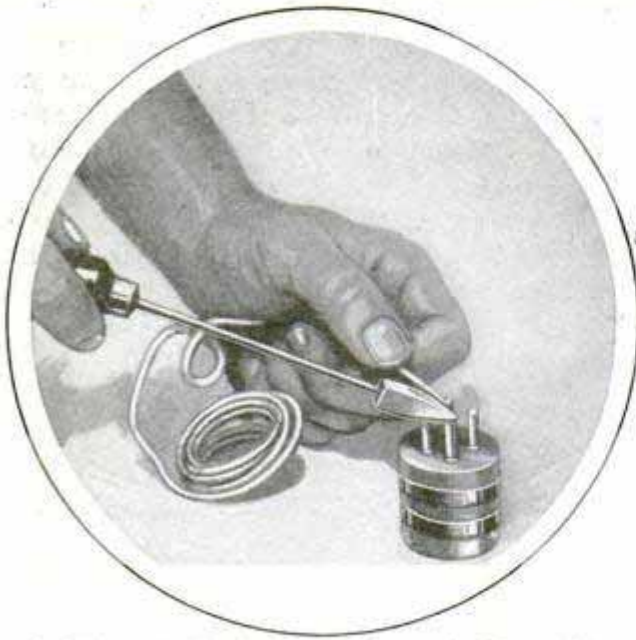

Soldering the Projecting Leads to the Prong Tips

ent circuits. With a five-plate wavelength condenser and one of eleven plates for regeneration, the writer employs coils of the following turns with good results: For the 150-meter band, tickler, 42 turns and secondary, 18 turns; for 80 meters, tickler, 22 turns, secondary 12 turns; for 40 meters, tickler, 9 turns, secondary, 10 turns. For the 20-meter band use No. 22 d.c.c. wire, employing 7 turns on the tickler coil and 4 turns on the secondary coil. For the 10-meter band use 5 turns of the same size wire for the tickler and 3 turns for the secondary. These coils cover each band, overlapping above and below to cover the entire short-wave range.

Regaining Lost Sensitivity

Many old sets are discarded because of lost sensitivity, and when the set begins to lose its ability to bring in the distant stations, the owner usually buys new tubes and batteries, which may or may not remedy the

New Television Scanner Employs Shutter

A combination scanning drum and selector shutter has recently been demonstrated by the Jenkins Television corporation engineers. The new arrangement takes the place of the former scanning drum with the light-conducting rods and four-plate neon glow lamp. It is claimed to be more efficient and to give better detail and illumination than the former device. Silhouette transmissions appear with sharp black-and-pink definition, and half-tone pictures are also handled with good results. The use of the selector shutter in combination with a standard neon tube and a small scanning drum, so that the drum rotates four times in flashing each 48-line picture, results in retaining the compact dimensions formerly obtained, yet the equipment is reduced to the simplest and most economical terms.

Emergency Clips for Screen-Grid Tubes

Experimenters with screen-grid tubes will often find themselves in need of clips

for the control-grid cap. Six emergency clips for the tube caps are shown in the sketches and have been found to meet the requirements. The materials are to be found around any experimenter's work table and the cost is practically nothing. The always adaptable Fahnestock clips, snap cuff buttons, small spring clips and ends of grid-leaks, also are good material for clips.

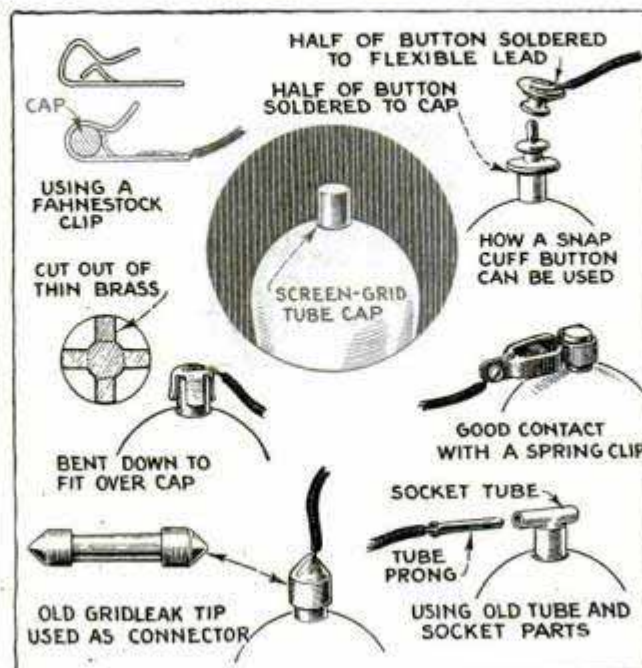

Various Ways of Making Clips for Control-Grid Caps from Odds and Ends

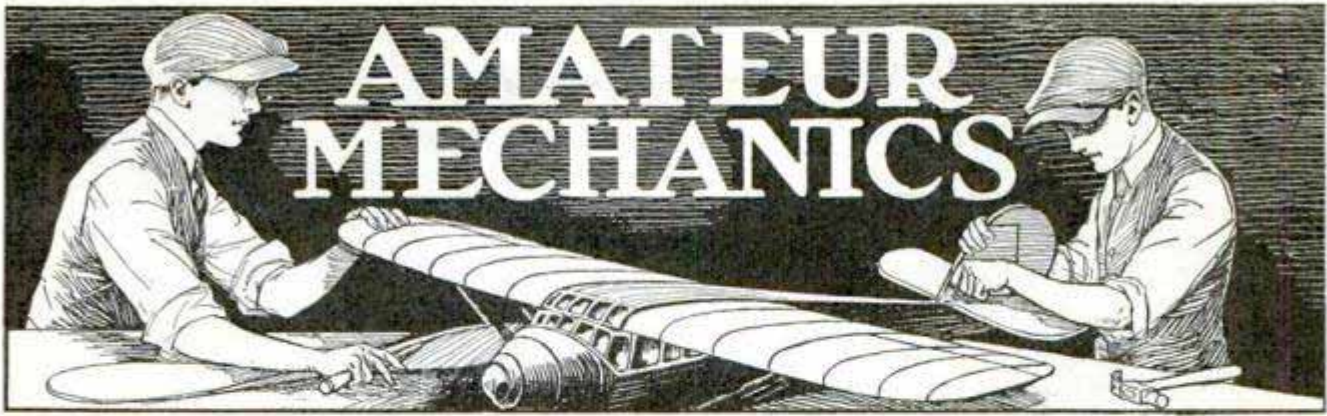

Easy Chemical Tricks

By SAM BROWN

151 *Carroll St
Marion
Ohio*

MMAGIC has many divisions. That section dealing with tricks based on chemical reactions contains a wide variety of novel and excellent effects, and

The chemical agent in this effect is that simple preparation called collodion. The sugar is previously dipped into this solution. This must be done rapidly, and the

sugar should be held there for only an instant. After the dipping, the sugar should be allowed to dry for about 24 hours.

The prepared lump, when dropped into the coffee, will sink instantly, but, as the sugar dissolves rapidly, the



Above, the Mysterious Sugar Cube Bobs to the Surface; Right, Parlor Fireworks from an Orange Rind and a Candle

the little preparation necessary for the presentation of these mysteries is well worth while.

First, "The Ghost Sugar." In this effect, the performer drops a lump of sugar into his coffee. It sinks to the bottom of the cup immediately, and in a manner thoroughly unmagical. But, wait! Presently the sugar bobs up on the surface, where it floats around buoyantly and smiles sarcastically at an amazed audience.



framework of collodion will presently bob up on the surface of the coffee. I might say, in passing, that the collodion lump should not be left about, for its appearance is quite like any other lump of sugar, and someone might—oh, well!

Why wait for the "grand and glorious Fourth" to have fireworks? If you will take a thick orange peel and squeeze the juice from it into a candle flame, you will witness a pyrotechnic display of golden stars which is entirely out of proportion to anything so plebian as "just a rind."

In the next effect, the performer exhibits an ordinary moth ball. He drops the ball into a glass of water. It sinks. Then, on command of the performer, the moth ball rises to the surface of the water.

On a further command it goes to the bottom again, then, finally, to the top, when it is removed by the magician and passed for inspection.

Really, there's nothing to it. The moth ball is simply a moth ball; the water is carbonated water procured from the corner drug store. When the moth ball is dropped into the water, it naturally sinks to the bottom. At the bottom of the glass, however, it breathes gas from the carbonated water, and presently becomes light enough to bob its way to the surface, only to sink again as the gas escapes. The magician need only time his commands to synchronize with the chemical reaction—and there you are!

Did you ever happen to hear the story about the girl and the magic candle? Well, anyhow, the candle went out, and left the girl in fearsome darkness. "Oh, dear me," she wailed, "what'll I do?"

And then she remembered a fairy story, and, touching the candle wick to the edge of a glass of water she was carrying to her sick grandmother, she received her flame back again! No fooling!

That last is the "patter"; the actual trick is done with a small piece of phosphorus about the size of a pinhead. This is stuck to the rim of the glass with a minute piece of tallow. When the hot wick of the candle touches the phosphorus, it



The Obedient Moth Ball Obeys Its Master's Voice; Lighting a Candle from a Glass of Water; Right, It's Easy to Ignite Sugar

ignites immediately and lights the candle. At the instant of lighting, the tumbler should be tilted so that the candle appears to be relighted from contact with the water. Phosphorus, by the way, should be kept moist when not in use, as it ignites with extraordinary quickness at a comparatively low temperature.

The average person imagines that lump sugar being almost pure



Top, Right, Making a Soap Bubble Go Boom and "Faw Down"; Below, If You Have No Matches, Be Nonchalant, Light the "Cig" with a Piece of Ice

carbon, will burn readily, but, fact is, it does nothing of the kind; it merely melts away when a lighted match is held under it. Of course, if you are a magician—well, you know how clever some people really are!

The secret is simple. The sugar must be previously casually rubbed into some cigaret ash, and the ash, adhering to the lump, will give it sufficient "timber" to burn readily.

Did you ever hear a soap bubble go "bang"? Go on! How could the gossamer sheen of a soap bubble go bang? Well, here's the how. Take a bubble pipe and wad a small sponge soaked with gasoline inside it. Fumes from the gasoline will be largely the contents of the bubble; and when held near a candle flame, these bubbles will explode with a quaint bang which is quite mystifying.

In the next number, the performer dem-

onstrates just how convenient it is to be possessed of the magical touch. With no matches available, the magician lights his cigaret from a piece of ice which he has removed from the iced tea. How's that for service?

Of course, no one is supposed to know that his cigaret has been previously treated, and that a small bit of potassium has been inserted in one end, as shown in the sketch. When the potassium comes in contact with the wet ice, it instantly ignites, and lights the cigaret.

Must I say it? Be sure you know which end of the cigaret is which, before you proceed with the nonchalant gesture.

☞ When a copper-lined or porcelain tank for cold water leaks from small holes, dry off the surface thoroughly with a rag; then locate the leak, and pour hot paraffin or drop wax from a candle on it.

Tractor Used as Locomotive

Equipped with four large flange wheels to fit regular railroad tracks, an ordinary



Gasoline Tractor, Equipped with Flanged Wheels to Fit Railroad Track, Serves as Locomotive for Hauling Cars of Dirt and Stone

gasoline tractor was transformed into a small locomotive and was found highly satisfactory for hauling cars of earth and rocks. As a tractor usually has only two drivewheels, side rods are used to provide all the wheels with equal tractive power. A pipe frame covered with canvas protects the driver or engineer from the weather.—Carlton Groat, Portland, Oreg.

A Green Lawn without Grass

From a distance, the front yard shown in the photo looks like any other well-kept lawn with grass, flowers and shrubs, and only a close view shows that the lawn is in reality rough cement painted green. Cement is used instead of sod for reasons of



California Home Owner Has Green-Painted Concrete Lawn Resembling Grass

economy, as the cost of water for irrigation in this locality is too expensive.—George B. Bowers, San Diego, Calif.

Eradicating Poison Ivy

Poison ivy can be eradicated by spraying with low-grade kerosene, which suffocates the cells in the plant tissue and causes destructive chemical action. Higher grades of kerosene are not so effective for the purpose as they are too volatile. The treatment preferably should be applied in hot weather when the soil and air are dry. Crude oil will serve equally well. Repeated cutting of the plant close to the ground facilitates destruction through starvation. The cutting causes the plant to use up all the food stored in its roots and, due to the withering of the foliage, it cannot provide new food for regrowth.

Insulating an Electric Extension Cord

Dangerous electric shocks are often occasioned by handling extension cords in basements. To prevent this, the metal sockets are sometimes covered with friction tape. It is necessary, however, to continue the wrapping of tape on the cord, especially near the socket and plug ends, where the wire is likely to wear quickly, owing to constant bending and

strain. A better method of insulating the extension cord is to get a piece of rubber tubing of the same length as the cord and slip it over the latter. Use a rubber plug and an insulated socket and then bind the ends of the tubing to the plug and socket with friction tape, in order to prevent the entrance of water. A cord covered in this way is easy to handle, will not kink and is safe to use anywhere, even in a flooded cellar.

Brads Steady Small Pictures

Wall pictures, especially small ones, often hang crooked, not because they were hung so in the first place but because of vibration of the building. To eliminate the necessity of daily readjustment of the pictures, drive a small brad into each of the two lower corners of the frame, on the back. The heads are then cut off with a pair of wire cutters, leaving a sharp point. The brads should not project more than $\frac{1}{8}$ in., and the points can readily be pressed into the surface of the wall so as to hold the picture level.—Douglas Leechman, Ottawa, Can.

Anti-Rattler for Front Auto Fender

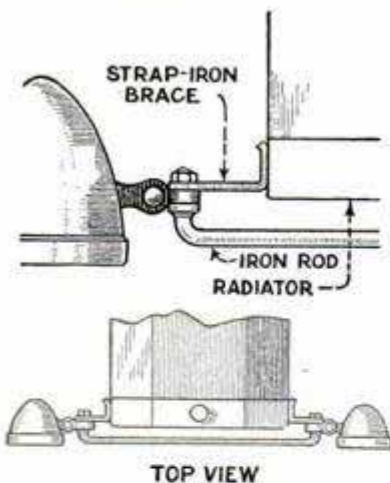

You can prevent the front fenders of certain types of small cars from rattling by installing two small pieces of strap iron as shown in the drawing. The strap iron should be about $\frac{3}{16}$ in. thick and the pieces about $3\frac{1}{2}$ in. long. They are bent at right angles, and a hole is drilled at the outer end, to fit on a lug of the lamp bracket. The installation shown was made on a Chevrolet of the 490-type. Before drilling the holes, place the pieces beside the radiator shell so that they will spring tightly against it after they have been attached to the lamp-bracket lug.—Guy E. Clark, Everett, Wash.

You can prevent the front fenders of certain types of small cars from rattling by installing two small pieces of strap iron as shown in the drawing. The strap iron should be



Old Bathtub Sunk into the Earth Makes a Good Fish Pond

Old Bathtub Makes Fish Pond

The photo shows a practical fish pond which consists merely of an old bathtub sunk into the earth. It is the idea of Loren Grey, twelve-year-old son of Zane Grey, American novelist and sportsman. A 4-in. layer of sand was spread over the bottom and suitable water plants were added to make the pool attractive.

Fingerprint as Check Protector

Fingerprints make excellent check protectors. Merely press your thumb on a stamp pad and make an impression over the figures denoting the amount of the check, as shown in the drawing. It will be very difficult for anyone to change the figures without any trace of the attempt. Those who do not feel justified in purchasing a mechanical check protector will find this method very satisfactory, and the expense is negligible.



Dressing Up the

By Dick Cole

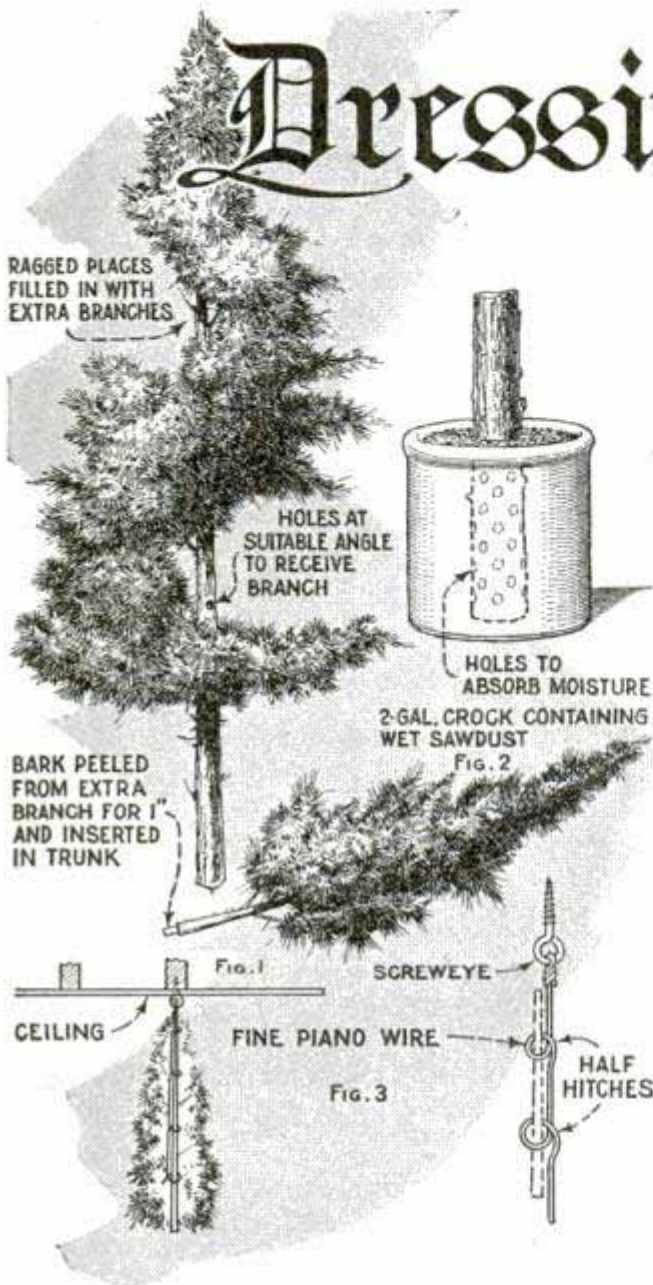

applying a little ingenuity you can shape almost any tree into a perfect cone. To do this some extra branches are necessary. If these cannot be obtained, it is well to buy a second cheap, misshaped tree, and use its branches for making one good tree.

Wherever the branches of the tree are sparse, extra branches are used to fill in. One of these is cut to suitable length and the bark peeled off the thick end for about 1 in. A hole the size of the peeled branch is bored in the trunk of the tree and the branch is inserted. It should fit tightly, but glue is not necessary. Of course, care should be taken when boring the hole so the branch will fill in where needed. Fig. 1 shows how this "grafting" operation is done.

Often the lower branches of a Christmas tree droop. This irregularity is remedied by holding up the drooping branches with lengths of fine wire or thread attached to the middle of the branches and to a higher point on the trunk. Fine enameled wire is almost invisible when used for this purpose, although several lengths of dark-green silk thread will serve.

After the tree has been shaped, the next operation is to set it up. There are many patent stands for Christmas trees, but unless they have a very wide base or are screwed to the floor, the tree can easily be tipped over. Where there are little children in the home, their curious fingers are bound to reach for the glistening ornaments, and an upset tree is a common consequence, sometimes with disastrous results. This danger can be avoided by suspending the tree as is shown in Fig. 3.

A long, slender screw-eye is driven into an overhead rafter. If a small drill is used to pierce the plaster, no disfiguring mark will be left when the screw-eye is removed. A length of fine piano wire is attached to the screw-eye and led down the trunk of the tree with a series of half hitches. This

THE ANNUAL dressing up of the Christmas tree can either be a mediocre job or a work of art. During the holiday season you see hundreds of trees posed in the front windows of residences. Many you pass by without a second look. They are mere commonplace Christmas trees, loaded with tinsel and gaudy baubles. Other trees compel attention. They fascinate the eye. It is not the tinsel and baubles and glamour that hold the attention, but the symmetry, the color harmony and the background.

To decorate a tree, the first requisite, of course, is the tree itself. Sometimes it is difficult to obtain a perfectly symmetrical tree of the size you require. The tree may be ragged on one side, or the layers of branches may be too far apart. But by

Christmas Tree

method offers another very good feature, namely, means of watering the tree. Every one knows that, in a heated house, a Christmas tree soon dries out and the needles fall. But if the base of the tree is submerged in water, the tree will live for months, and with the tree suspended, it is a simple matter to place a crock or jar under its base. Rather than filling the crock with water, which might be slopped over, it is better to pack the space around the base with sawdust or sand and keep it wet. It is also well to bore a few radial holes in the base so that water can reach the heart of the trunk, as in Fig. 2.



You are now ready to string up the lights. These are the bugaboo of many Christmas-tree decorators. It is quite troublesome to locate a burnt-out lamp because the bulbs are wired in series, that is, the current passes out of one light into the next throughout the string. If any one lamp burns out it opens the circuit on all the others. Each lamp must then be tested separately to locate the bad one, which often means getting out the stepladder and disturbing the fragile ornaments. This trouble can be eliminated. It is customary to use two, three, four or more strings of lights on a tree, and by rewiring these into a system called "series-parallel," a warning is immediately given if a lamp burns out, and the bad lamp can instantly be located and replaced. Figs. 4 and 5 explain this method of wiring.

First one must prepare the leads to the lamp sockets. These vary in length to conform to the conical shape of the tree, the longer leads being at the bottom. In the case of rewiring four strings of lights, prepare four sockets with 8-in. leads; four each with 12, 16, 20-in. leads, and so on up to 36 in. Additional wire will be necessary, and a good, well-insulated kind should be used.

After the eight sets of sockets and leads are ready, cut off eight 1-in. lengths of $\frac{1}{4}$ -in. fiber tubing. Drill two sets of four holes in each piece as shown in Fig. 5. The leads to each socket of a set are drawn into these holes—one wire in the top hole, the other wire in the corresponding bottom hole. The wires are then poked out through the nearest end of the

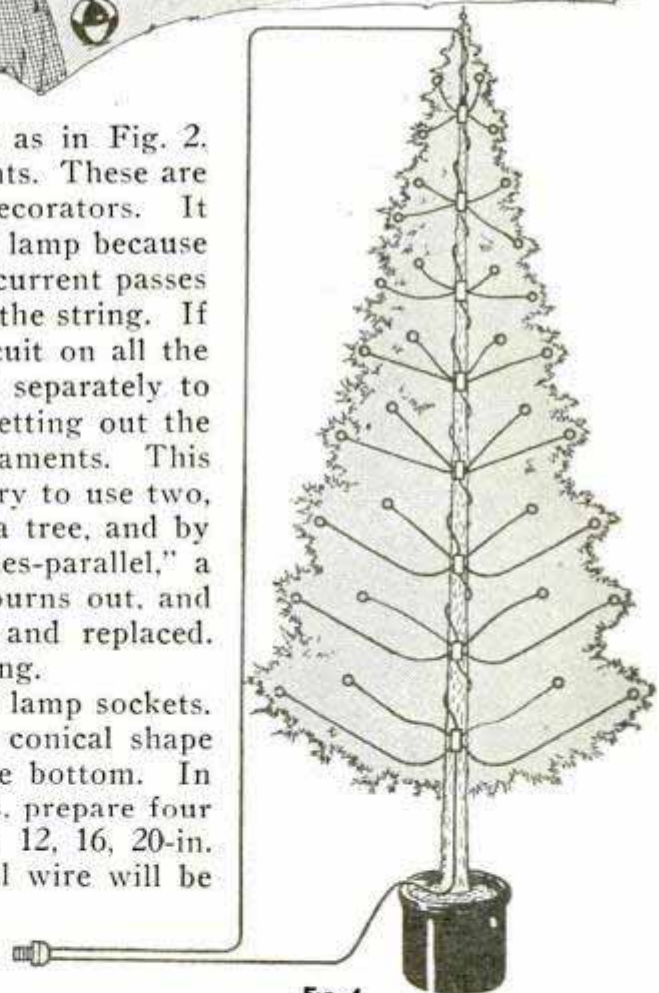

FIG. 4

fiber tubing and are twisted together. When the eight groups have been prepared, they are joined with 12-in. lengths of ordinary insulated wire. The connections should be soldered, taped, and then forced back into the tubing to make a good-looking job.

*Sh has for letter and
Diagram*

In use, the main feeder is stretched along the trunk of the tree with an occasional wind around it. The leads to the lamps can be twisted around the stems of the branches so as to be almost invisible. With the ordinary Christmas-tree lights, the wire must be draped from branch to branch in an unsightly manner.

After the strings of lights have been wired into series-parallel, if one lamp burns out, the other three of the group will brighten up considerably, while the remainder of the lights on the tree grow dim. The fourth lamp of the bright group is, of course, instantly recognized as the bad lamp. The series-parallel wiring should not be applied to less than three strings of lights. Four strings are better. Even though this rewiring may take a little time and money, the result obtained is well worth it. When the tree is finally taken down, the string of lights can be stored away and used year after year. The first cost is the only one.

After the lights have been installed on the tree, there are many ways of proceeding with the decorating. The common way is to drape the tree with tinsel cord, and to hang shiny, colored ornaments here, there and everywhere. Perhaps "barber-pole" candy canes and overstuffed netting stockings add to the miscellaneous decorations. The result is just an ordinary Christmas tree like thousands of others. But a tree decorated according to the following directions will be different. It will be one of those exceptional trees which commands the attention of the passer-by. Just as it will be pleasing to those without, so it will be pleasing to those within.

The first operation is to spray the whole tree with thin varnish. Any varnish thinned down with turpentine will do. A "fly-tox" sprayer will also serve as a varnish sprayer. During the spraying, it is well to surround the tree with an old bed-sheet or with sheets of wrapping paper, so that the varnish mist will be confined

and will not settle on the furniture and drapery of the room.

After the branches have been thoroughly sprayed, cornstarch is sprinkled over the tree. The best way is to use a flour sieve above the topmost branch, and allow the starch to settle softly on the upper side of the branches. During this operation there should be no draft through the room. After a few minutes, the tree is again sprayed and again "starched." These operations are repeated until a sufficient bank of "snow" has been built up on the branches. Then, after a final spraying with varnish, flake mica is sprinkled over the tree. The flour sieve cannot be used for this purpose. The mica must be sprinkled gently from the hand. So-called "imitation snow" is flake mica. Some of the powders used in tire casings are finely crushed mica and can be used. Of course, it must be the glittering kind.

The lamps should be in the sockets during the varnish spraying, and immediately afterward be wiped off with a rag dipped in turpentine. If the sockets are left open during the spraying, varnish may enter and will

act like glue when the lamp is screwed in. Tinfoil "icicles" add a pleasing effect to any tree and should be used freely. These should always hang straight; never be draped from branch to branch. If the narrow strips of foil are twisted, a better effect will be obtained from indirect lighting. A reasonable number of spherical ornaments are now hung from the branches and spaced symmetrically about the tree. Use mostly colorless ornaments with a mirror surface. Ample color will be provided by the color scheme to be described later. If you can obtain some glass prisms such as were used on the old-time lamp in the parlor in pre-electric days, they can be used to good advantage on a Christmas tree. With indirect lighting, the prisms reflect all the colors of the spectrum.

All of the foregoing decorating sugges-

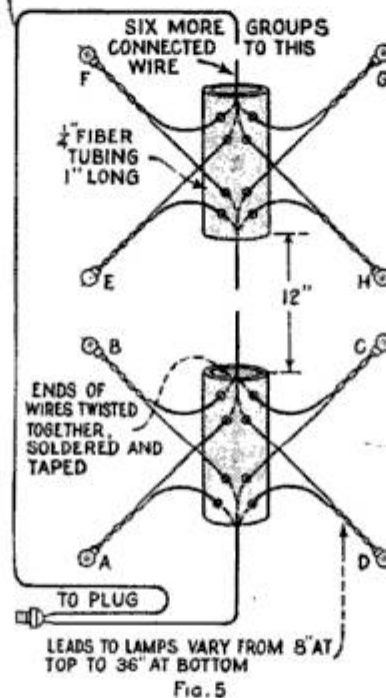

FIG. 5

tions have been made with a view to enhancing the beauty of the tree with indirect lighting, as well as with the string of lights. With the string of lights alone, the tree is exceptional; with indirect lighting and color screens, it is spectacular. Indirect lighting is very easy to install. See Figs. 6 and 7. A 100 or 150-watt lamp is fitted within a sheet-metal shield with one narrow opening, and a color screen revolves around it. Two of these fixtures are used and are placed so that the beams of light fall upon the tree at an acute angle. Any large can with a removable lid will serve as a shield for the lamp. A piece of $\frac{3}{16}$ or $\frac{1}{4}$ -in. rod, about 3 in. long, is threaded at one end and fastened to the center of the removable lid with two nuts. The other end is tapered off to a sharp point to act as a pivot point for the revolving color screen. As many holes as possible should be cut in the top and bottom of the can to allow free circulation of air. Make a very small slot in the side of the can first, then, after the fixture is in place, enlarge the slot until the beam just floods the tree.

A cone is made from ordinary tin. The face of this is slotted, and sections are bent up to form fan blades. A cylinder of colored celluloid is suspended from the rim of the cone. It is best to use the primary colors—red, yellow and blue. Note that the color bands are in a spiral around the cylinder. This gives the effect of the changing colors settling down on the tree instead of flashing on it.

It takes from five to ten minutes for the lamp to become hot enough to establish air circulation through the can. The flow of hot air is very trifling, in any case, so the pivot point must be made as sharp and frictionless as possible.

Since there is no synchronization of the color screens, they will not revolve at exactly the same speed. Thus the blending of the primary colors will produce nearly every tint of the color scale. The effect is fascinating. Particularly the violet tint on the imitation snow.

In rural districts where electric light is not available, revolving color screens can be used with gasoline lanterns. The mica chimney is replaced with a slotted sheet-metal cylinder. The dome top is removed to give better air circulation. It is also necessary to remove the handle. See Fig. 8. As celluloid is highly inflammable and a gasoline lantern gets rather hot, it is best to leave a space of at least two inches between the celluloid and the metal sleeve.

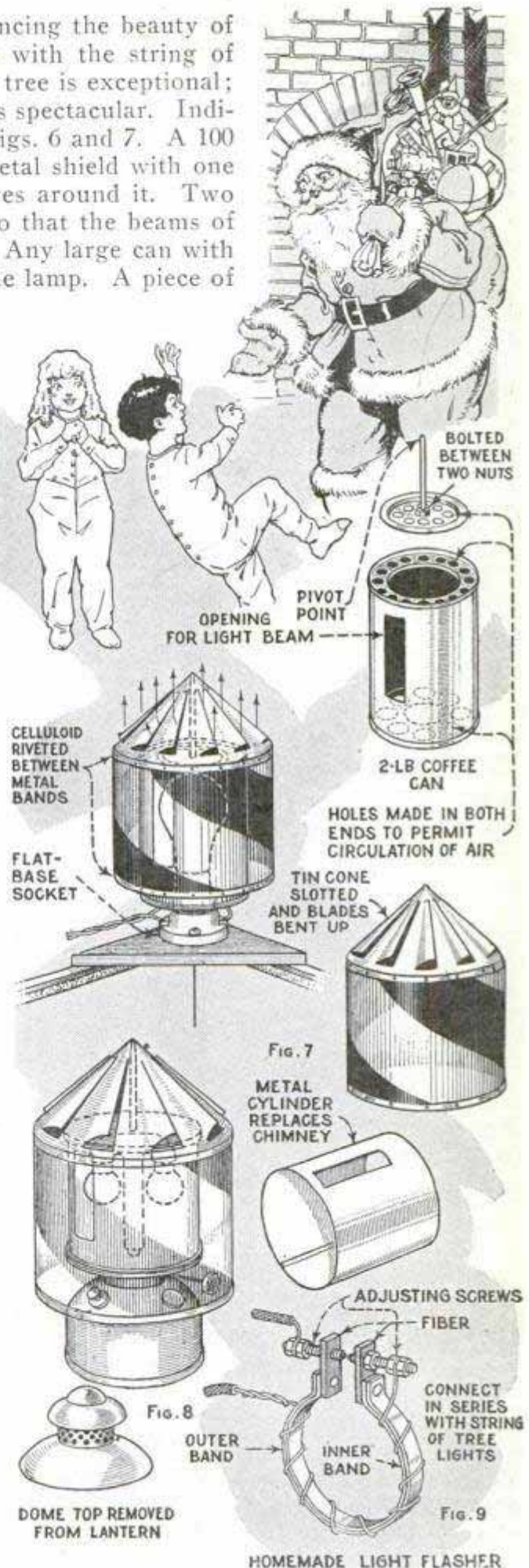

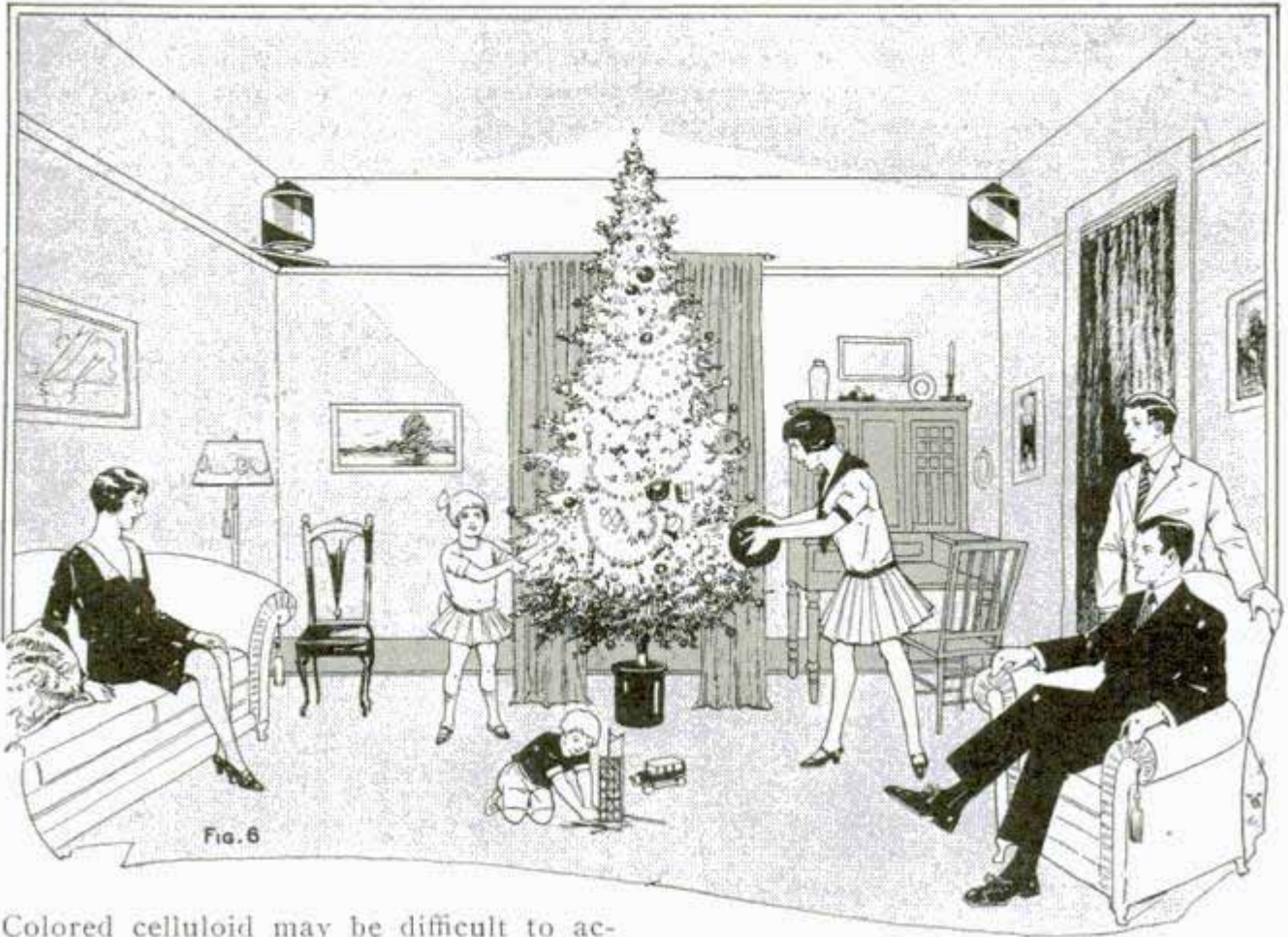

FIG. 6

Colored celluloid may be difficult to acquire in rural districts. But old 8 by 10-in. negative films can be procured from the town photographer. The emulsion can be washed off and the film colored. Common glue, thinned out with hot water and colored with red, green or blue ink, will make a very good temporary color film on the celluloid. It will pass much more light than the so-called "color varnishes."

A homemade thermostatic flasher for a string of lights can easily be made, as is illustrated in Fig. 9. The drawing explains the operation. It might be well to mention that fine iron wire can be used

in place of nichrome wire, and ordinary iron or brass screws instead of the contact adjusting screws from a distributor. However, the use of the former makes frequent adjusting necessary, as the soft points burn away when the contact is broken. The operation of the flasher should be obvious. When the screws are in contact, the current passes through the resistance wire wrapped around the ring. As the ring heats, the aluminum band expands more than the steel and the contact is broken. The wire then cools down, and the contact is re-established.

Rubber Band for Model Airplanes

Often the maker of a model airplane wishes to try out his plane but has no rubber band on hand for the purpose. Get a few large rubber bands at a drug store and cut them as shown in the drawing. By this method you

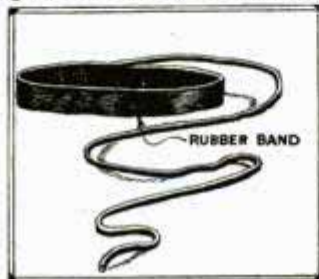

can get a band 30 in. long, and any number of these can be tied together.—Asa Arent, Humboldt, Iowa.

Cement for Celluloid Rims

Celluloid rims of eyeglasses can be repaired by acetic acid or acetone, which is obtainable at any drug store. The acid is applied to the broken ends, and they are then held together tightly for several minutes until the cement has dried. The

acid softens the celluloid, which makes it more or less sticky, and if the pieces of celluloid are pressed together while in this condition, the joint will be nearly as strong as an unbroken piece of the material. When repairing rims in this way care must be taken to set the lens at the correct position in the rim. However, this repair should be attempted only in case you are sure the glasses are used for correcting simple near or far-sightedness without astigmatism.—Jesse T. Simmons, Salt Lake City, Utah.

Winter Protection for Bush Fruits

Covering the tips of black raspberries with dirt to protect them during the winter can be done conveniently and quickly in the following way: Pin the bushes down against the ground with a pitchfork, placing the fork about halfway to the top of the bush. While they are held in this position, throw a few shovelfuls of dirt on the tips to hold them down. The bent bushes catch the winter's snow and this protects them against the weather.—C. Bernard Peterson, Buffalo, N. Y.

Cable Replaces Noisy Brake Rods

Rigid brake rods often rattle annoyingly and many of the older cars have an offset bend which tends to straighten out when

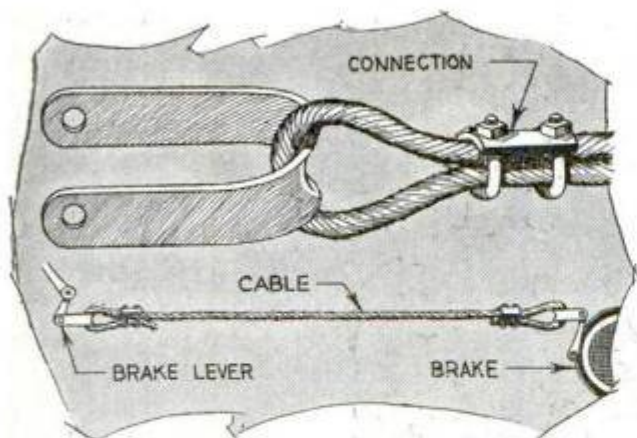

Substituting Steel Cable for Rigid Brake Rods Eliminates Rattle and Gives More Positive Brake Control

pulled, making it difficult to get a smooth and effective brake grip. These objections can be overcome by using stranded steel cable. Such a substitution can be made by any car owner. The method of clamping the cable to the brake connections is shown in the illustration.



Window Shelf over Table in the Breakfast Nook Provides Additional Space

Shelf for the Breakfast Nook

An auxiliary shelf will be found a great convenience in the breakfast nook for holding the sugar bowl, salt and pepper shakers and other table accessories, which must be removed from the table when the cloth is changed. Besides, the shelf provides additional space when the table is crowded. It consists merely of a 1-in. board of suitable length, finished nicely to match the woodwork, and supported on angle brackets as indicated.—Hi Sibley, Pasadena, Calif.

Lace Curtains Used for Stencils

Wide-mesh lace curtains can be used for stenciling wall panels. The curtain is first cut to the desired size and is tacked over a light wooden frame after which it is given one or more coats of thin shellac to stiffen it. Too much shellac should not be used if there are any small openings in the curtain design. The purpose of stiffening the fabric in this way is to prevent it from pulling out of shape when used. The stenciling is done in the usual manner by means of a stippling brush. It is advisable, in taking up this idea, to experiment a little in order to get the paint of the proper consistency. If it is desired to use one stencil for a number of panels of different size, mount it on two round sticks from which as much or as little can be unrolled as required to fill the space.—J. S. Hagans, Chicago.

Page my on materials & the

reprints discontinued
supplying material out of business

A Scale-Model Plane



View of the Ford Tri-Motor Scale-Model Plane, Mounted as Though in Flight; Note the Realistic Appearance of the Ship as Compared with the Full-Size Plane on the Opposite Page

By **WALTER BULLOCK**
Pilot, Northwest Airways, Inc.

THE BIG all-metal tri-motored Ford air liner, with its silvery corrugated duralumin covering, its three big Wasp engines and shining steel propellers, makes one of the best of all planes for the exhibition-model builder to copy, for a well-made scale model is not only beautiful, but represents hours of careful and interesting work.

This is the story of how to build an exact model on a scale of $\frac{5}{16}$ in. to 1 ft. This scale gives a wing-spread of $24\frac{5}{16}$ in. and a length over all, from the boss of the propeller hub to the tip of the tail, of $15\frac{1}{2}$ in. That's just a nice size to hang from the chandelier, place on the bookcase or mantel, or, possibly, sell or rent to a merchant who wants an unusual window display.

Because duralumin cannot be soldered, we will build our model of thin sheet brass, nickel-plated, on a fuselage and wing made of wood. The brass used is .008 in. thick,

and can be obtained already corrugated and nickelplated. To build the model, you will need, besides the usual saws, planes, hammer, and other common carpentry tools, a draw or spokeshave, to carve out the wing, soldering iron, small nose pliers, tinner's snips, and a supply of small round-head brads in $\frac{1}{4}$ and $\frac{3}{8}$ -in. lengths, to represent the rivets of the original ship. The brads can be obtained ready nicked to match the covering.

We will start with the wooden framework for the fuselage. It consists of a tail block, nose block, bottom board, two sides, a bulkhead between the passengers' and pilot's compartment, and a floor block for the pilot's cockpit. Tail, nose and floor blocks are of white pine, and sides, bottom and bulkhead of three-ply wood, $\frac{1}{8}$ in. thick. In lieu of plywood cigar-box wood can be used,

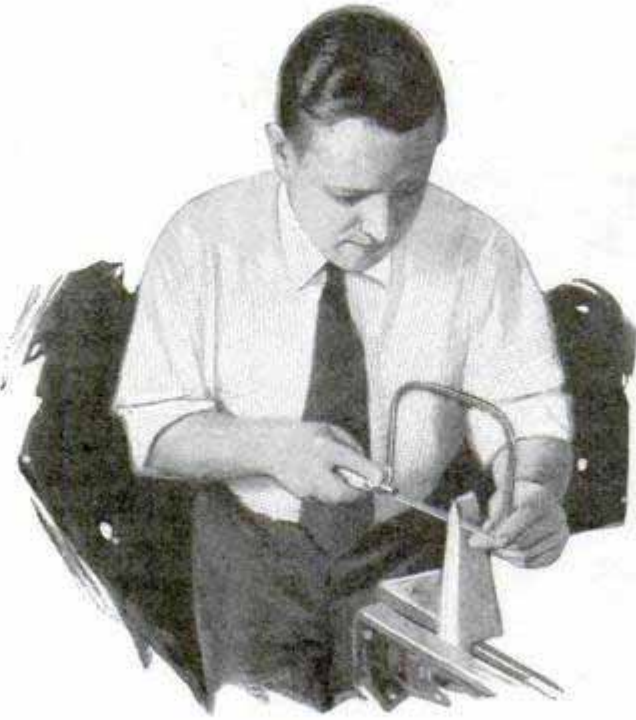

but the former is preferred, as less likely to split under bending strains.

is Easy to Build

The tail block, shown in Figs. 1 and 1A, comes first. It is cut from a block of white pine, $9\frac{11}{16}$ by $2\frac{1}{2}$ by $1\frac{1}{2}$ in. Lay out the side pattern first from Fig. 1, which is full size, except that it is "broken." The projecting part, curved on the underside, fits over the top of the wing. Care should be taken to follow the proportions of the curve exactly in constructing your pattern. The $\frac{1}{8}$ by 1-in. slot at the other end is to take the horizontal stabilizer. After you have cut the block to the side dimensions, lay out the top pattern, and, with a scrollsaw, complete the sides, taking care not to break the thin ends.

The nose block, Fig. 2, comes next. It is cut from a block of white pine, $1\frac{1}{4}$ in. square and $1\frac{3}{8}$ in. long. Measure in $\frac{3}{16}$ in. from one end around three sides of the block, and take a saw cut $\frac{1}{8}$ in. deep. On the corresponding faces of the end, measure in $\frac{1}{8}$ in. and saw down, cutting away the three pieces, forming the rabbets in which the sides and bottom will fit.

Find the center of the other end of the block and inscribe on it a $\frac{3}{4}$ -in. circle. If a lathe is available, the block can be turned down to this dimension, as shown in the sketch. Otherwise it may be cut down with the chisel and finished with a fine file and coarse sandpaper. The sides are slightly curved, and not straight as in a true cone. The



Above, a Northwest Airways Ford Ship in Flight; Inset, Mr. Bullock, the Author of the Article

curve will carry out the lines of the fuselage when completed. The block tapers out, when finished, from the $\frac{3}{4}$ -in. nose to the $1\frac{1}{4}$ -in. rabbeted back. The drawing, Fig. 2, might seem to indicate that the block tapered up from the rabbeted end, but this is due to the perspective, and the block really tapers the other way. A reference to the photo on page 1031 will make this clear.

The floor block for the pilot's cockpit is cut from white pine $\frac{9}{16}$ in. thick. It is $1\frac{1}{8}$ in. wide at one end and 1 in. at the other, as in Fig. 3.

Next comes the bottom of the passenger compartment. A full-size template for this is given in Fig. 4, so no special instructions are needed. Either $\frac{1}{8}$ -in. plywood or other material of similar thickness is used, cut out and filed to size.

The sides of the fuselage are shown in the full-size template, Fig. 6. There are six windows in a row and a smaller

A complete set of parts can be obtained, at a moderate cost, for making this splendid model. Write to Amateur Mechanics Dept. for list and prices.

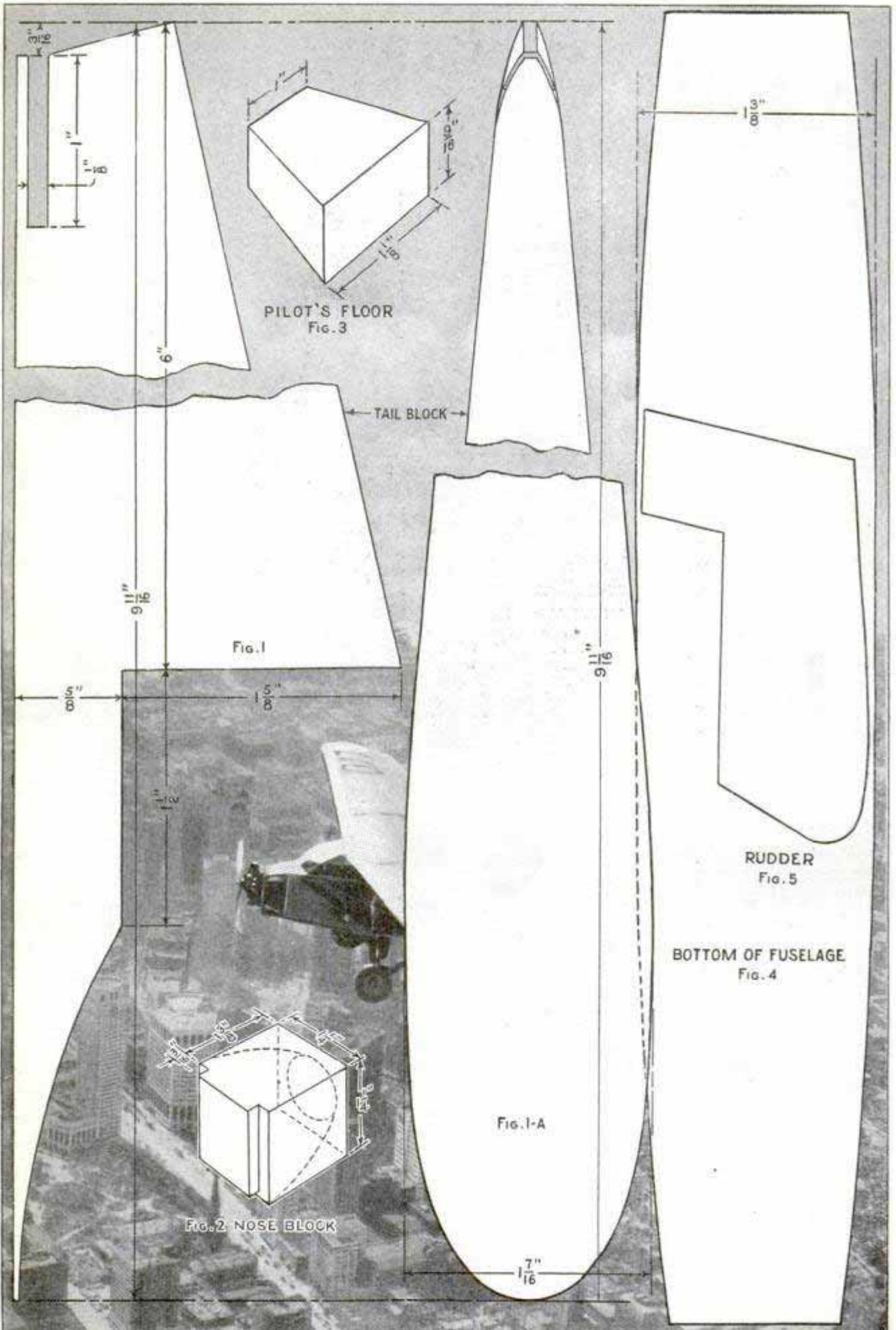

window above the forward one. The V-shaped notch in the top, with its upper side slightly curved, takes the rear, or trailing, edge of the wing, when the assembly is completed. Two sides are needed, so, after transferring the pattern to a piece of the $\frac{1}{8}$ -in. stock, fasten two pieces together with small brads and saw them at the same time. This saves time and insures the two sides being exactly alike. Drill holes in the spaces marked for the window openings, thread the blade of the coping saw or jig saw through the holes, tighten it in the frame, and saw out the openings. It is best to cut the outline of the pieces first, however, as, if one attempts to cut the window openings first in a large sheet of the plywood, it is found

that the swinging of the saw is awkward in some places. Cut the pieces from the sheet to the approximate size necessary, trace the pattern on one, brad them together, and then saw out the outlines of the pieces, leaving the windows to the last.

Fig. 8 shows the bulkhead or partition between the passenger compartment and the pilot's cockpit. The illustration is full size, and can be transferred with carbon paper to a suitable scrap piece of the $\frac{1}{8}$ -in. material.

Fig. 7 gives the dimensions for the vertical fin. The long side is the base, which later will be attached to the tail of the fuselage. Cut the fin, like the rest of the

tail assembly, from $\frac{1}{8}$ -in. stock. The rudder is shown in Fig. 5, full size, and is transferred direct to the stock by using carbon paper.

Fig. 9 shows the horizontal stabilizer, with all dimensions, and Fig. 10 the elevators, of which two are needed. Both can be cut at once by tacking two strips of the $\frac{1}{8}$ -in. stock together, after laying the pattern out on one piece.

The ailerons are shown in Fig. 11. Be sure to cut these to exact size, as they must fit into recesses to be cut in the wing.

This completes the woodwork of the fuselage, and you are now ready to assemble the parts, round off the top and finish it. Set up the tail block and hold one of the sidepieces against it, matching the V-notch in

the top of the side with the overhang of the tail block, into which the wing is to

fit. Mark the top and rear edges of the side on the tail block, and cut out a recess to a depth of $\frac{1}{8}$ in. Do the same with the other side, then cut a $\frac{1}{8}$ -in. rabbet in the bottom of the tail block to take the floor of the fuselage. One end of the bottom board measures $1\frac{1}{16}$ in.; this end is the rear. Glue it to the tail block, and reinforce the joint with some small brads.

Glue and nail the other end in the recess in the nose block. Be sure that the after side of the nose block and the forward end of the tail block are square with the center line of the bottom, to prevent the fuselage



WALTER BULLOCK, an old-time pilot, as pilots' ages go, who got his start barnstorming in the days when planes wore their propellers behind and were pushed through the air instead of being pulled by tractor air screws, is, in his spare time between runs, a builder of fine scale models. His models of the big Wasp-engined tri-motored Ford air liner, which he flies between Chicago and St. Paul-Minneapolis, have been widely acclaimed for their fine workmanship and exact detail. In this and subsequent articles Mr. Bullock tells how to build a metal-covered scale model of the plane he flies.

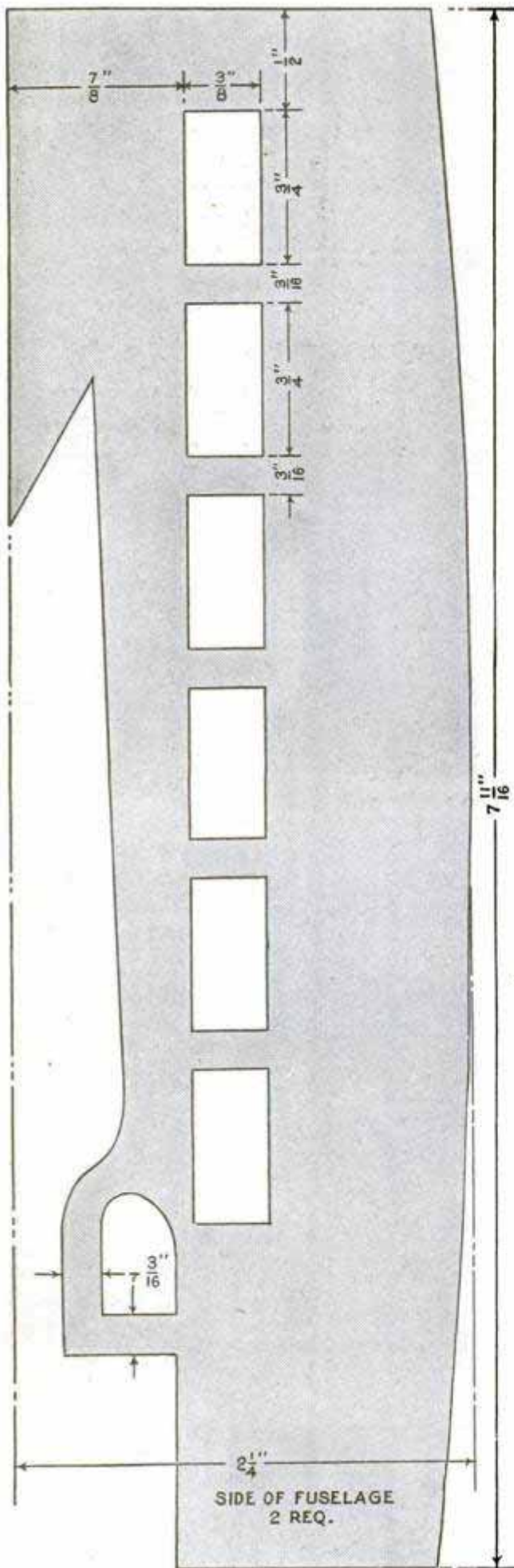

Fig. 6

from being "in wind" or twisted when the sides are put on.

You are now ready for the sidepieces. First glue and nail them to the tail block, taking care that the notch in the side exactly matches the curving overhang of the tail block. Next, gluing and nailing as you proceed, bend them to fit against the bottom board, and bend the latter until it matches the edge of the sides. A few small clamps will aid greatly in this operation. Bend the pieces gently to fit each other, following the bend up with small brads, carefully driven in to avoid splitting the thin wood. Take the same precaution when fitting the sides as with the bottom board, that is, see that they fit the recesses or rabbets in the nose and tail blocks properly, and that neither the nose nor the tail is "cocked" up or down in relation to the sides. There is little difficulty in assembling the pieces, but some precaution is essential, if the finished fuselage is to be perfect.

Countersink the nails with which you attach sides and bottom to the nose block,



STABILIZER Fig. 9

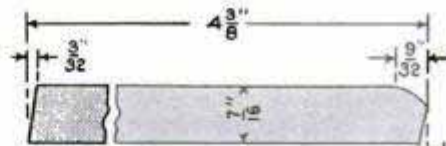

AILERONS, 2 REQ.

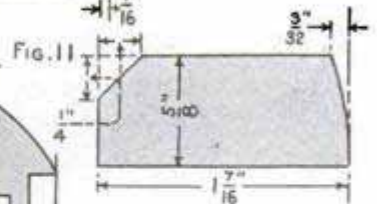

ELEVATOR, 2 REQ.

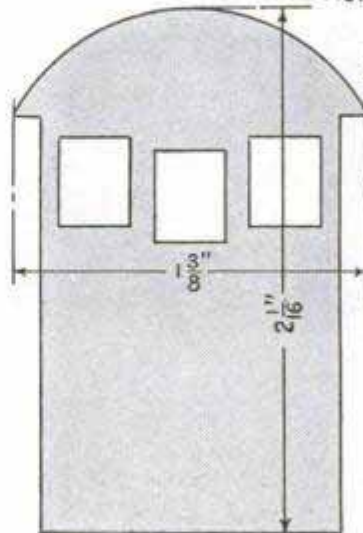

BULKHEAD

Fig. 8

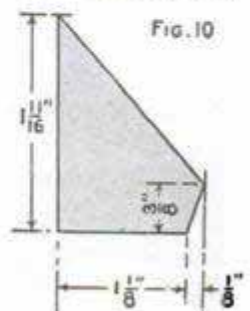

VERTICAL FIN

Fig. 7

and with chisel or knife and sandpaper smooth the sides and bottom to match the curve of the nose block.

Rounding off the top of the tail block is next in order. Draw a line from the rear point of the V-notch in the sidepieces to the lower edge of the stabilizer slot, on either side of the tail block, and round the block down, from the top center line to the side lines, giving it an easy, smooth curve.

Glue the floor block for the pilot's compartment to the floor, sides and nose block, and glue the bulkhead in place behind it. The bulkhead should be flush with the projecting portion of the sides, which contain the small upper window.

That completes the wooden portion of the fuselage. Next comes the cowling around the pilot's cockpit. This is cut from a thin sheet of galvanized iron, $\frac{1}{2}$ by 5 in., to the template given in Fig. 12. Transfer the pattern to the galvanized iron, and with a cold chisel cut out the windows, smoothing the edges of the cuts with a small file.

Next, with tinners' snips, cut out the outline. Bend the two center flanges to a right angle. Then bend the strip in the center in a right angle, as shown, and make the two 45° bends to bring the sides back parallel.

Drill the two small nail holes, as shown. Place the cowling over the nose, matching its rear side windows with the small upper windows in the fuselage, and nail it in place with two small brads. The small flanges on the sides of the cowling, below the windows, are not bent out, neither are they fastened to the fuselage at this stage. The metal covering that is to be applied later holds them down. The small brads on the front flanges are withdrawn when the metal covering is applied and, after the covering is replaced, driven into place again through the metal.

The dotted lines in the drawing at the right in Fig. 12 show the points where the bends are made. The small flanges are bent to suit the nosing of the plane, and the other bends as shown in the drawing at the left. The full lines in the latter sketch indicate the sides of the cowling and the outer edges of the small flanges; the dotted lines, to which the degree arrows run, are the vertical portions of the cowling, at the front.

You are now ready to make the wing, and next month's article will give instructions for this, and also tell you how to apply the metal covering to wing and fuselage, and fashion the roof of the pilot's compartment, while succeeding installments will be devoted to the making of the landing, propelling and control gear and the rigging of tail surfaces and ailerons.



Below, Framework of Fuselage Completed; Note the Position of the Bulkhead and How the Cowling Is Fitted to Nose Block and Sides

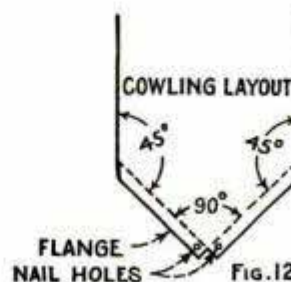
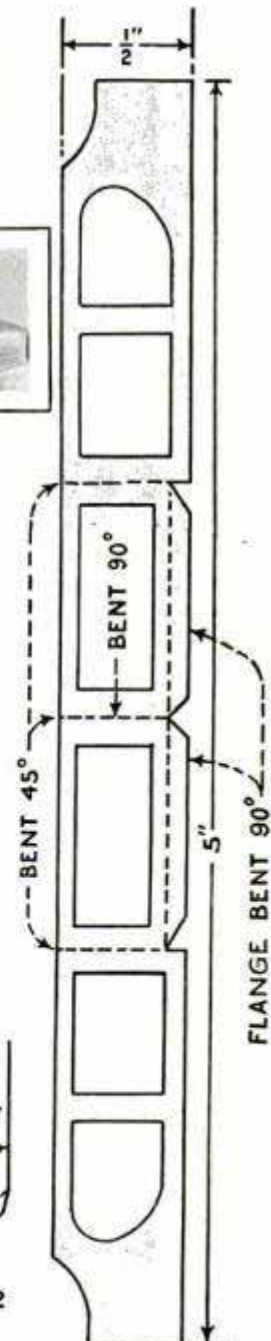
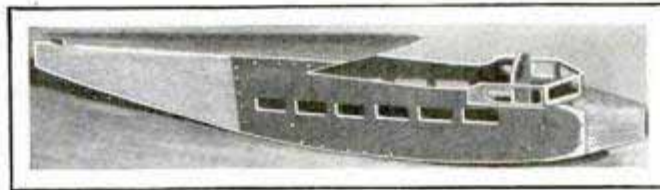

Canvas Floor Covering for the Kitchen Is Cheaper than Linoleum

Canvas floor covering for the kitchen, porch or summer cottage has been found entirely satisfactory for those who do not desire to purchase linoleum, and the cost of the canvas is less. It is also very easy

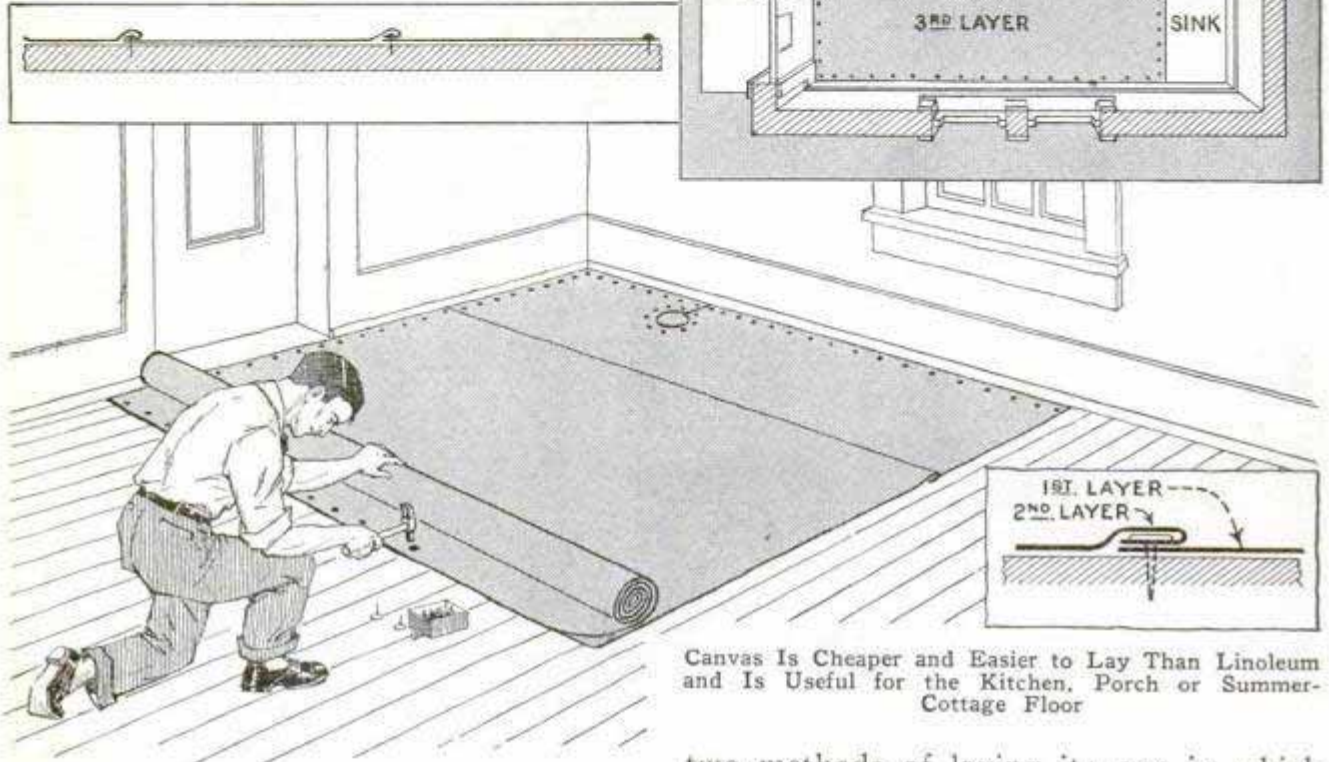

Canvas Is Cheaper and Easier to Lay Than Linoleum and Is Useful for the Kitchen, Porch or Summer-Cottage Floor

to lay, as it is pliable, permitting it to be rolled and folded to get around stoves, boilers and cupboards. The finished job is waterproofed by painting and varnishing it, and this practically cements the canvas to the floor. Get 12-oz. duck of 30-in. width for the purpose. There are

two methods of laying it; one in which the tacks at the joints show, and the other where they are completely hidden. The latter method is preferable as the tack heads will eventually rust if exposed, due to the paint wearing off. The details of laying the canvas are shown in the illustration.—John Steinke, Cleveland, Ohio.

Auxiliary Magazine for Shotgun

Owners of single-barrel shotguns will find the auxiliary barrel, shown in the illustration, quite a convenience, as it permits quick action. It consists of a bicycle-pump cylinder, a coil spring, just fitting inside of it, and three spring-brass clamps, one for the open end of the pump cylinder and the other two

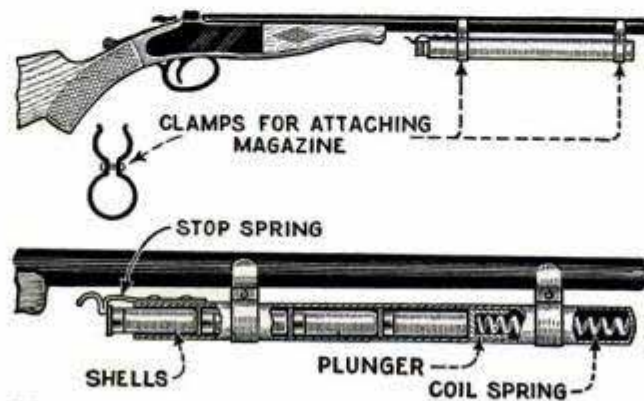

Handy Cartridge Magazine Made from Old Bicycle Pump for Single-Barrel Shotgun

clamping the cylinder to the gun barrel as indicated. A wooden plunger fitting loosely inside of the cylinder is also provided. In use, the loaded shells are pushed against the plunger and into the magazine. After a few shells are pushed in the stop spring is brought down, preventing the shells from being ejected. To remove a shell, the stop spring is pushed up.—C. M. Wilcox, Torrington, Conn.

Postage Stamps Prevent Headlight Glare

Sticking postage stamps on the left side of your glasses to protect the eyes against glare from approaching autos is a good measure for a motorist to adopt. In the absence of stamps, use the gummed part of an envelope or a piece of adhesive or friction tape.—W. G. Webb, Hudson Falls, N. Y.

Regluing Veneer on Curved Surfaces

A problem often met with by the home mechanic is that of refastening veneer which has been loosened as a result of water-soaking or drying of the glue. This occurs frequently on chair joints and seats, on curved dresser fronts and a variety of places where rare veneers are used. In factories, cauls or specially shaped forms are used, but these would take considerable time to make at home. The following method has been used with success: First loosen the veneer with a knife and scrape away the dust and old glue between the veneer and the solid wood or core. Then apply glue to both surfaces. Have ready some fine, clean sand that has been heated in a pan. Fold a quantity of the sand inside of a piece of heavy cloth or canvas to form a cushion. Put the cushion over the loose veneer

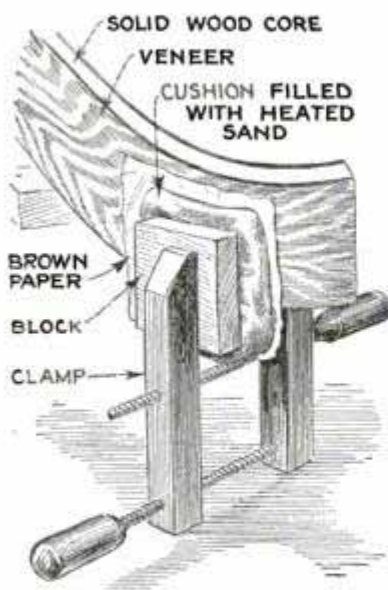

with a piece of brown paper between them. Lay a block of wood over the cushion and clamp together, as indicated in the drawing. Under the pressure of the clamp the veneer will be held against the wood at all points. Allow the glue

to dry for 24 hours and then remove the cushion. Usually the paper sticks to the wood, but this can be removed with a moistened cloth.—E. L. Bilodeau, Corry, Pennsylvania.



Arranging Flowers in Shallow Dish

Cut flowers with short stems are rather difficult to arrange in a shallow dish. Partly submerged, they float around in the water and it is almost impossible to keep them set in an attractive way. By using moist sand instead of water the flowers will look just as fresh as they do in water, and any desired effect in color scheme and general makeup can be obtained with assurance that it will last as long as the flowers live.

Spreading Liquid Glue Quickly

Difficulty is sometimes experienced in spreading liquid glue evenly and quickly over a large surface. This can readily be done, however, by using a spreader made by notching the edge of a piece of linoleum or stiff cardboard, about 6 or 8 in. long. The notches are cut at intervals of $\frac{1}{2}$ in. on the long side of the linoleum, producing a sort of comb. It is advisable to make the tool about 5 in. wide, so that the fingers will not come in contact with the glue. Then pour glue on the surface to be covered and you will find how evenly and quickly it can be spread.—Douglas Leechman, Ottawa, Can.

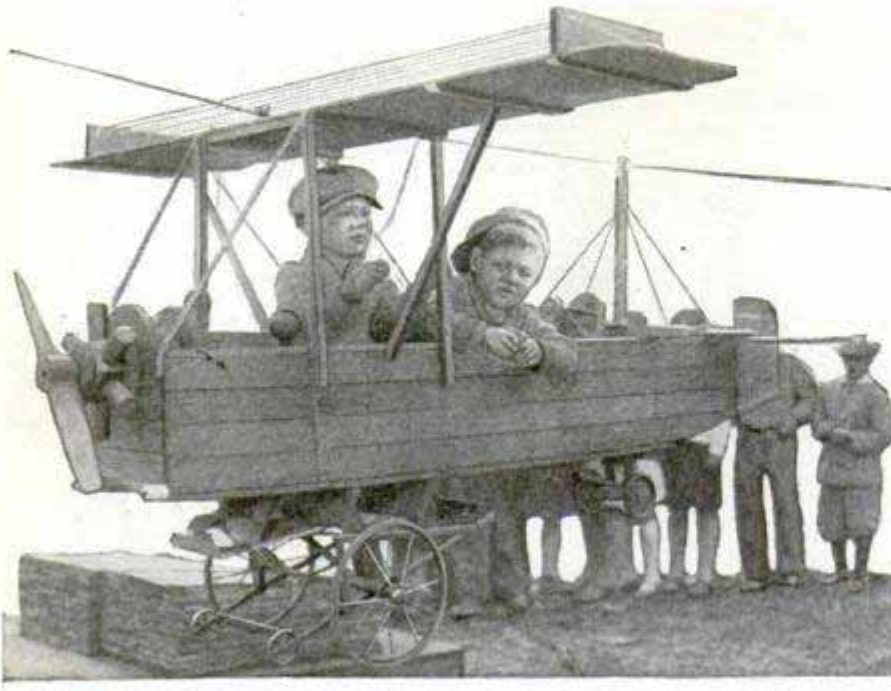

Small Wooden Airplane Supported on Strong Overhead Cable Brings Large Profits to Its Child Owners

There's Money in Aviation

This novel trolley airplane brings its young owners five cents per ride and all the children in the neighborhood are just eager to take the air in it. The plane is made of wood and is supported by a stout overhead wire cable securely fastened at both ends. The propeller is made of wood pivoted on a pin so that it will turn, but the real propelling force is a boy who is glad to push the plane for a small portion of the profits. One day the profits amounted to \$3.15.

Handy Spark-Plug Container

Spark plugs will be safe from being broken if carried in a simple wooden container made from a piece of 2 by 4-in. stock. Four or more holes are drilled in the piece, as shown, to accommodate the

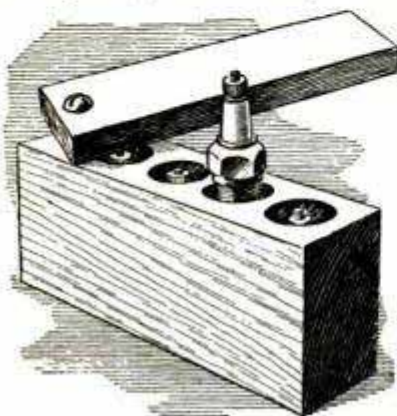

spark plugs, and a wooden cover, made of 1/2-in. stock, pivoted to one end with a wood screw, holds the spark plugs in the case. It may be mounted on

the motor side of the dash or carried in the tool box.—A. C. Wilson, Columbia Cross Roads, Pa.

Imitation Brick for the Christmas Fireplace

For the Christmas fireplace and other decorations involving the use of imitation brickwork, realistic effects are obtained by making "bricks" from 2 by 4-in. wood and painting them red. The mortar joints are closely imitated by using strips of plaster-board, sawed a trifle narrower than the bricks. Materials such as ma-

sonite and celotex can be used to furnish shades of brown and buff mortar. "Headers," that is, bricks laid end to the surface of the wall, are made half the size of regular bricks or "stretchers." If it is desired to make the finished job more or less substantial, long nails can be driven through the bricks to hold them together.

Automatic Shut-Off for Outboard Motor

In racing outboard motor boats many use a motorcycle twist grip on the throttle control. It frequently happens that the racer tips over and finds that one or both of his cylinders are cracked owing to water getting in through the breather pipe. This can be prevented by using a rubber band cut from an old inner tube. The band is attached to the handle by means of an improvised wire hook, and is slipped over the control lever of the throttle so that the moment one releases the twist grip, the throttle will close.—H. E. Whiting, Rochester, Minn.

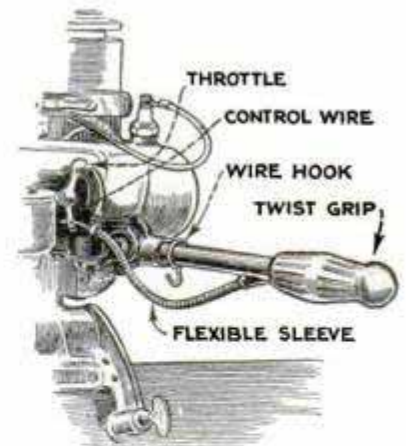

Improving the Crosscut Guide

Large work often has to be cut with a small saw, and an extension of the crosscut guide as shown in the drawing will facilitate the performance. Its principal object is to support the outer end of long work when making a square cut, or tenoning and grooving with the dado head. In this instance, the guide was made to the dimensions given for a 15 by 17-in. table. The wood used was seasoned hard maple, $\frac{7}{8}$ in. thick. Quartered oak of the same thickness may be used as a second choice. Rip a piece of either material 2 in. wide and of the required or desirable length. Plane the edges carefully, making sure that they are perfectly square and true lengthwise. The beveled piece C is 30 in. long and 5 in. wide. Cut out a portion of it so that the iron guide will fit as indicated. Drill $\frac{1}{8}$ -in. holes through the face of the iron guide and fasten it with wood screws to a piece of stock set on edge against the piece C. Be sure to bring the guide exactly to the square position. Part A consists of two pieces, each 5 in. long, glued together and fastened to the guide with screws and glue, being rabbeted as shown to ride on the underside of the saw table. Only sufficient clearance should be allowed for the guide to move easily. If the table edge is rough, smooth it with a file. The pieces B are fastened with screws and glue. The curved piece is sawed to the shape shown, about 10 in. long, and serves to support the guide in case the saw is run in or the dado goes some way beyond the edge of the work. Screws are also used to fasten it. Although it is necessary to cut into the guide with both the dado and the saw, the guide will not be impaired if the operator is careful to let the cut run no farther than necessary.—W. Clyde Lamme, Downers Grove, Ill.

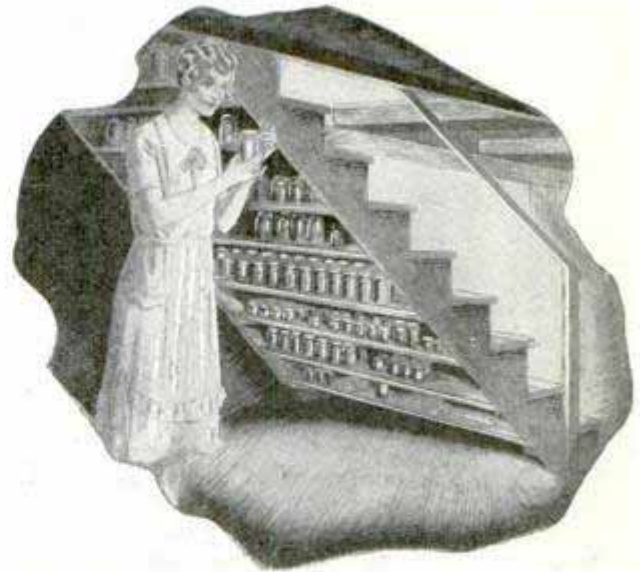

Extra Shelves behind the Basement Stairway Provide Good Place for Preserves

Extra Shelves in the Basement Provide Storage for Preserves

Extra shelves that are out of the way can be readily built behind the basement stairs. The shelves stretch the full width of the stairway and cleats are nailed on each side, as shown in the photo, to support them. Paint cans, preserves, etc., can be kept on these shelves without any risk of being knocked off.—Morton Schwam, Philadelphia.

Black Ink for Writing on Glass Does Not Spread

Writing on glass with black ink is usually not successful, as nearly everyone has found, but it can be done with a solution made of silicate of soda, 2 parts, and india ink, 20 parts. Use an ordinary writing pen of good quality. This ink will not flow out on the glass surface after being applied, but will remain just as written.—L. H. Georger, Buffalo, N. Y.

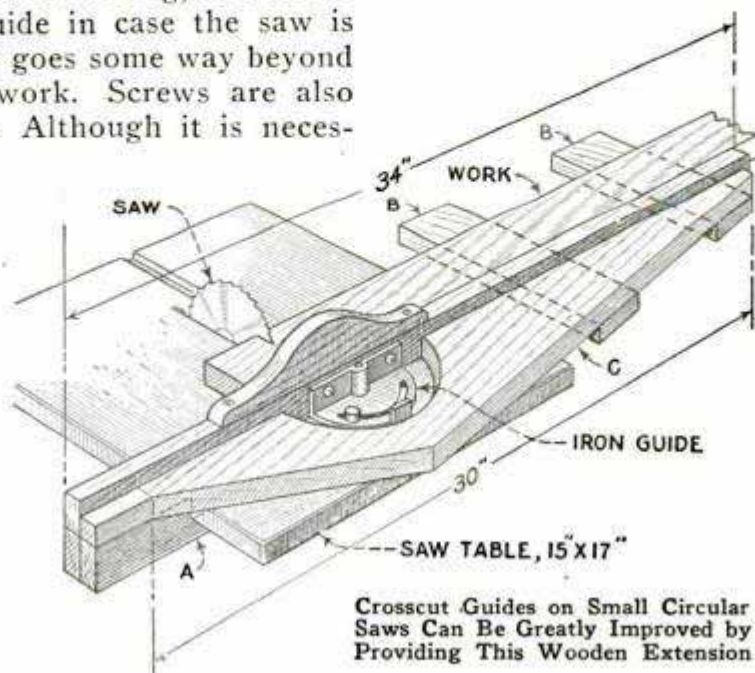

Crosscut Guides on Small Circular Saws Can Be Greatly Improved by Providing This Wooden Extension

A Heated Cafe for Birds

By D. R. VAN HORN

THE FIRST time your winter birds poke their heads into this heated winter shelter, with warmth radiating from a lantern inside, they will no doubt wonder what it's all about. But it won't take them long to decide that this is a pretty decent place to swap gossip and warm their toes, to say nothing of the food. By setting up this cafe, all the birds in the neighborhood will make it their rendezvous this winter.

An ordinary storm-proof lantern, which you no doubt have on hand or can get for a small sum, furnishes the heat inside. The large door faces the south and this is partly covered with a frame to which a sheet of celluloid or glass has been fastened. This keeps out most cold breezes or storm—yet lets the sunlight through.

Set at the top of a pole mounted between two posts, the cafe can be lowered quickly at any time for refueling or put-

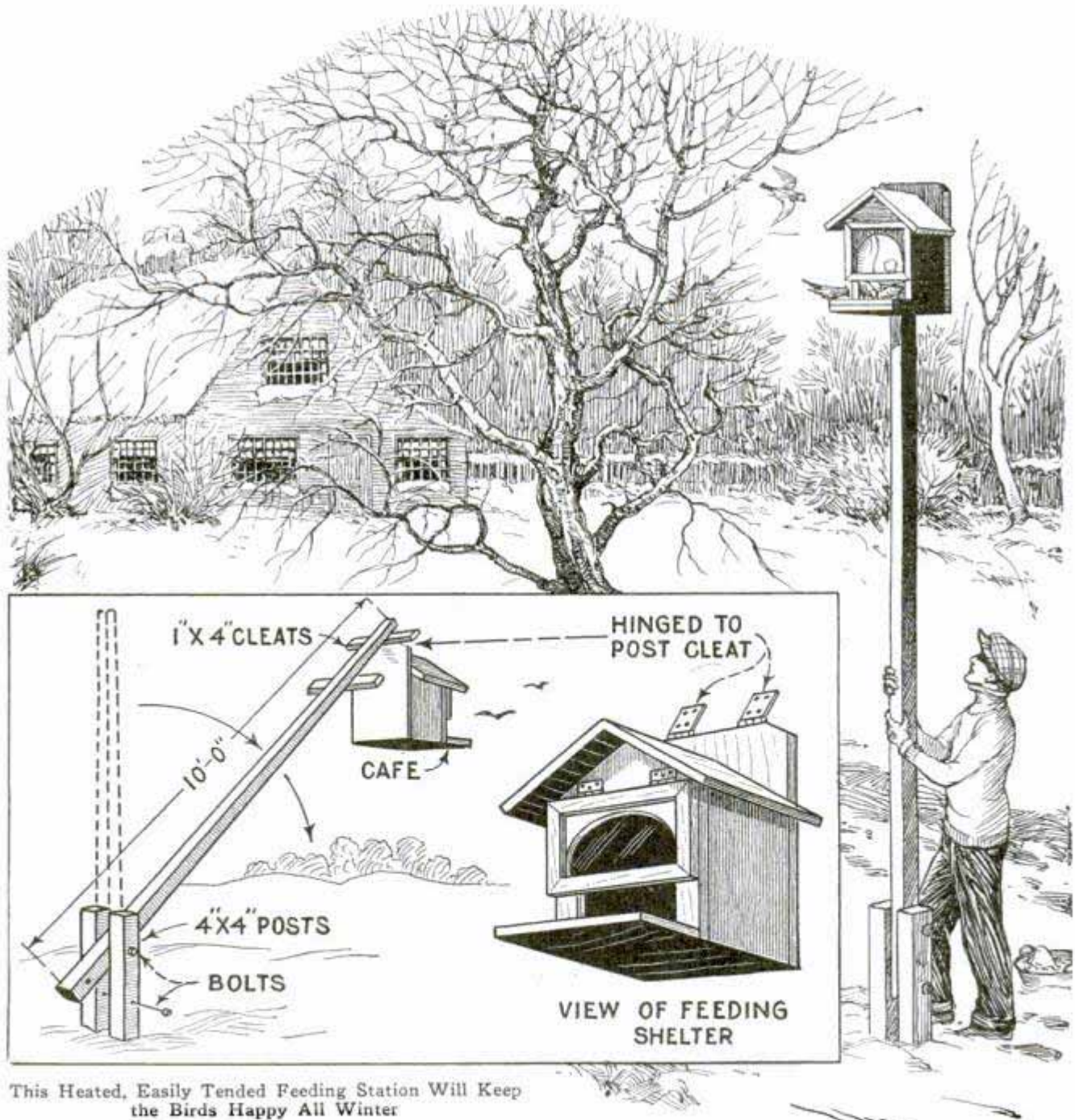

This Heated, Easily Tended Feeding Station Will Keep the Birds Happy All Winter

ting out more feed. The box is hinged at the top and hangs vertical when lowered.

While the dimensions may be varied to suit, a good size is 12 in. wide, 10 in. deep and 18 in. high. You can also alter the design, but the one shown represents a snug, attractive and weatherproof affair, easily made from $\frac{1}{2}$ -in. lumber, straight from the mill or from old boxes.

Make the front side nearly all open, consistent with good appearance. Let the backboard extend above the peak of the roof 2 in., as a pair of hinges go here. The floor also should extend 2 or 3 in., and if you feed oats or other light grain, you may find that a low railing, about 1 in. high, will be helpful in preventing grain from blowing out.

Next, build a frame for the front from $\frac{1}{2}$ -in. material, 1 or $1\frac{1}{2}$ in. wide. Miter the corners and use four-penny finish nails to hold the pieces together. Cut a shoulder around the inside back edge for glass if glass is to be used. If a celluloid or cello glass sheet is being used, simply tack this down. A ribbon of rubber cement about its edge will make the joint tight. Now hinge the frame at the top to the front side of the cafe.

Use a pole from 10 to 12 ft. high between the two posts, for the support. Nail two cleats, spaced 12 in. apart, at the top and then hinge the top of the backboard to the top edge of the upper cleat. The lower cleat simply makes a broader spot for the lower part of the cafe to rest against. In a hard wind this will swing out slightly, but not enough to cause damage.

All that now remains to do is to fill the lantern and set it inside by raising the front glass frame. The frame of the lantern will keep the flame far enough away so that there will be no danger of fire. During cold weather, especially when the ground is covered with snow, the cafe should be lowered daily and more feed put in. The lantern can also be filled once every one or two days, the wick being turned down until there is only half the normal flame.

One of the best winter feeds for birds is, of course, suet. Put out, with this, bread crumbs and various kinds of grains. You can tell, with a little experimenting, which kinds of grain are in greatest demand.



Hookless Fastener Applied to Child's Bedding Insures Keeping Covers On

Cover for the Child's Bed

As a means of preventing a child from kicking aside its bed clothing on a cold night, the arrangement shown in the drawing will be found serviceable. The cover is pinned to the side of the crib and is made to open and close in the center by means of a hookless fastener. Such fasteners can be salvaged from discarded garments or bought at department stores.

Rubber Tube Keeps Spark Plugs Dry

When moisture gets under the hood of an automobile, as is often the case when the car is washed or when it stands out in a driving rain, the spark plugs will not function. This is due to the high-tension



current short-circuiting over the wet porcelain section of the plug between the top and the body. To prevent such trouble, slip a 3-in. length of rubber tubing over the cable end and porcelain section of the spark plug, as shown in the drawing.—F. W. Wilhelm, Cincinnati, Ohio.

Washer Makes a Good Hermaphrodite Attachment for Dividers

For use with the ordinary dividers, a satisfactory hermaphrodite attachment



can be improvised by the use of a washer. Take a washer $\frac{1}{4}$ or $\frac{3}{8}$ in. in diameter, and bend it double, laying a small nail between the sides as they close at right angles to the bend, and then hammering them

down over the nail. This makes a small sleeve or pocket for the divider point. The washer can be conveniently held against the work while scribing.

Potting House Plants

A common mistake with potted plants is that of overfilling the pot. A properly potted plant should not have the earth heaped up around its stem and left level with the rim of the pot, but should have the ground level an inch or so lower than the rim in moderate-sized pots and more than that in large ones. There should be room for the water of a moderate irrigation to stand for a few moments, while it soaks down into the soil, without washing any of the dirt over the edge.

Another sin we are apt to commit against the plant is one of omission: We are prone to want to fill the pot with good, rich soil, without providing for ventilation or bottom drainage. The hole in the bottom of the pot should be covered loosely with a broken bit of another flowerpot or some such potsherd. Then a layer of loose pebbles or cinders should be shaken on the bottom, and on top of this the soil in which the plant is to be set. The soil of ordinary back-yard gardens is too heavy and close for potted plants. It should be mixed with sand, and especially should it have leaf mold, or

humus from the woods, added to it. This will give it a much lighter, porous character, decreasing its tendency to puddle after watering. It will also enable the pot to drain more quickly, giving better soil aeration; roots need air as well as water.

Our usual tendency is to overwater plants, and then let them stand with their roots in the mud, threatening them with "smotheration." Water may be supplied in the usual way, by pouring it on top, or by setting the pot in a deep pan of water and letting it soak up from the bottom. In either case, however, the pot should be set aside to drain for a while. The common practice of setting a potted plant in a jardiniere half full of water and leaving it there should by all means be discouraged. The plant should be lifted out of the jardiniere for watering, then returned and set on a couple of blocks of wood, and be left standing there so it will drain. Water should never be allowed to accumulate in the jardiniere. When the leaves of ferns, for example, begin to turn brown, the common assumption is that the plant requires water, whereas, as a matter of fact, it may be getting too much water from standing in a half-filled jardiniere.

Photographing Moving Objects

Taking photos of moving objects is greatly simplified by the camera sights

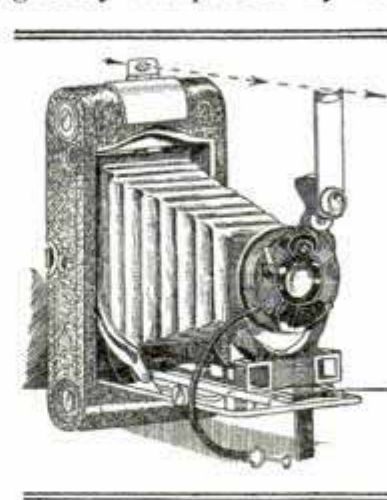

shown in the drawing. They are made of sheet metal and two small hinges having one screw hole. It is necessary to arrange the sights so that, when the user sees the object through them, it will be in the range of the

camera. When not in use, the rear-sight hinge is folded down flat and the front sight is turned in front of the lens. The release string can be coiled up in the usual way.—George Thompson, Thermopolis, Wyo.

*U. S. Gypsum Co.,
300 W. Adams
Chicago*



Decorating with a Pastry Gun

Albert Beck Co., 1200 W. 35th St., New York
By J. S. HAGANS. *2.15*

FOR the decoration of plaques, panels and other decorative objects, texture or similar plastic paint, applied with a pastry gun, or, as it is sometimes called, an icing gun, offers endless possibilities. By the simple process described almost any degree of relief can be obtained, and almost any form of ornament applied. The only equipment required is the pastry gun, and the only material a quantity of the plastic-paint powder.

Almost any kind of base will serve for the application of the decoration, although, for the plaques, etc., that the process is specially suitable for, wall-

board forms the lightest and most desirable base. Given the object to be decorated, the first step is the preparation of a suitable background. In the examples shown, this is done by the application of a coat of the plastic to the surface with a brush. While still wet, the surface is manipulated with the tips of the fingers, sweeping them in a circular motion over

Using the Pastry Gun to Form the Outline of a Ship for Plaque; Right, Design for Picture Frame or Display Stand

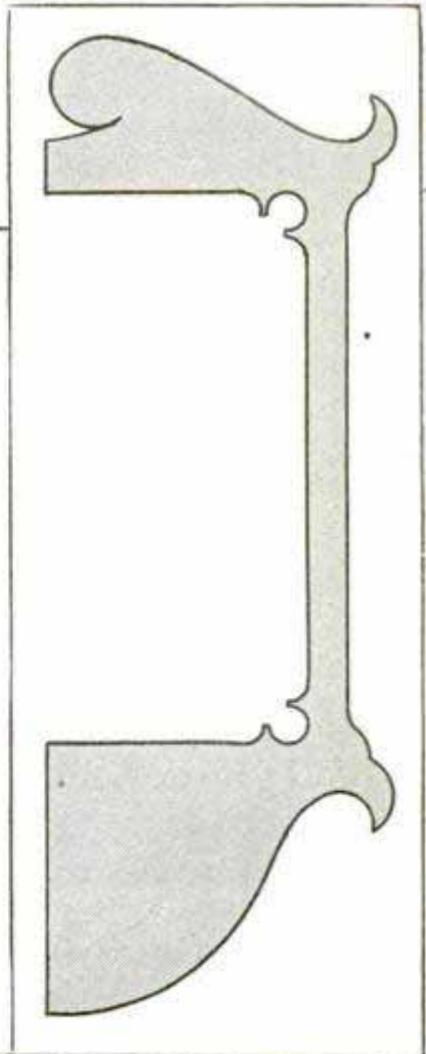

the plastic, and forming an irregular background of pleasing form, but with no suggestion of pattern. Allow the work to dry, which will take overnight, and then sandpaper down the rough ridges of the plastic.

Assuming that the design for an ornamental border has been selected, the next thing to do is to trace this onto the surface of the piece. The pages of magazines offer an endless variety of designs suitable for the process of decoration. If the design selected for the border or panel is small, it is recommended that it be enlarged to the proper dimensions by means of a cheap pantograph, which can be obtained at any art store, unless, of course, one has some ability as a free-hand draftsman, when the design can be sketched directly onto the background. When laying out borders for frames, panels, etc., it is sometimes difficult, even for the experienced draftsman, to get both sides of the design alike. This difficulty is overcome by drawing one half of the design, full size, on a sheet of paper, as in the sketch, page 1039, and then tracing this half onto the background. The paper is then turned over, matched with the first tracing, and the other half traced. The design, of course, is drawn heavily enough so that no difficulty is encountered in following it on the back of the paper.

With the outline drawn on the background, it is only necessary to fill the gun with the plastic paint and follow the outlines, in exactly the same manner as the pastry cook decorates her cakes, leaving a stream of the plastic to form the design. This is allowed to harden.

The whole is now coated with white shellac to kill the porosity of the ma-

terial. In the examples shown in the illustrations, the raised outlines of the pictures have been coated with glossy black enamel, and this is done after the shellac is dry. With the outlines coated, the remainder of the background is then colored. This can be done either in solid color, or by an adaptation of the polychrome method.

In the latter method, the part to be decorated is coated with paint and allowed to dry. Then a coat of some contrasting or harmonizing color is applied, and, while still wet, a part of this is wiped off. This removes the second color on the high spots, allowing the first coat to show, while the second color remains in the lower parts of the background. Sometimes three or more colors are used. An examination of a commercial article will show the process of polychroming in a few minutes.

No directions as to color can be given, as obviously this depends entirely on the article being decorated, but it may be said, in general, that for small objects, bright colors may be used, while for larger ones the colors must be more subdued if the effect is not to be glaring.

The articles illustrated at left on the opposite page, while not entirely decorated by the pastry-gun method, show what can be done in the way of furniture decoration with plastic paint and wallboard, either for the home or for window-display purposes. With the exception of the "pottery," all the articles are built up from wallboard. These few examples will suggest numerous others to the alert reader. For example, the antique lantern, in imitation of beaten copper or iron may be made either



Bird-of-Paradise Design for a Wall Panel, an Article of Furniture That Will Brighten Any Living Room

from thin wood or wallboard. Skill in joining the parts is unnecessary, as the joints are all covered afterward by the plastic. The hammer marks are formed in the "metal" by daubing the moist sur-

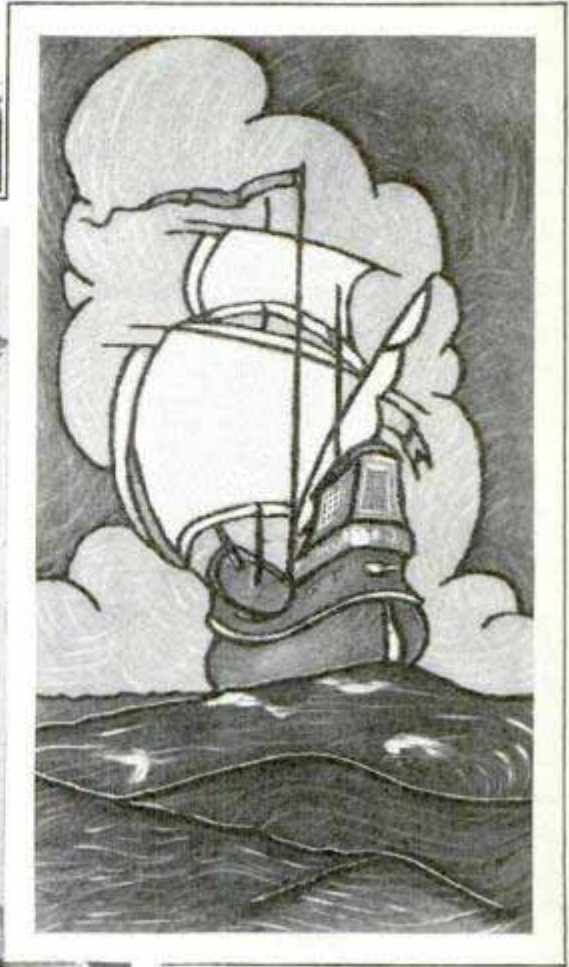
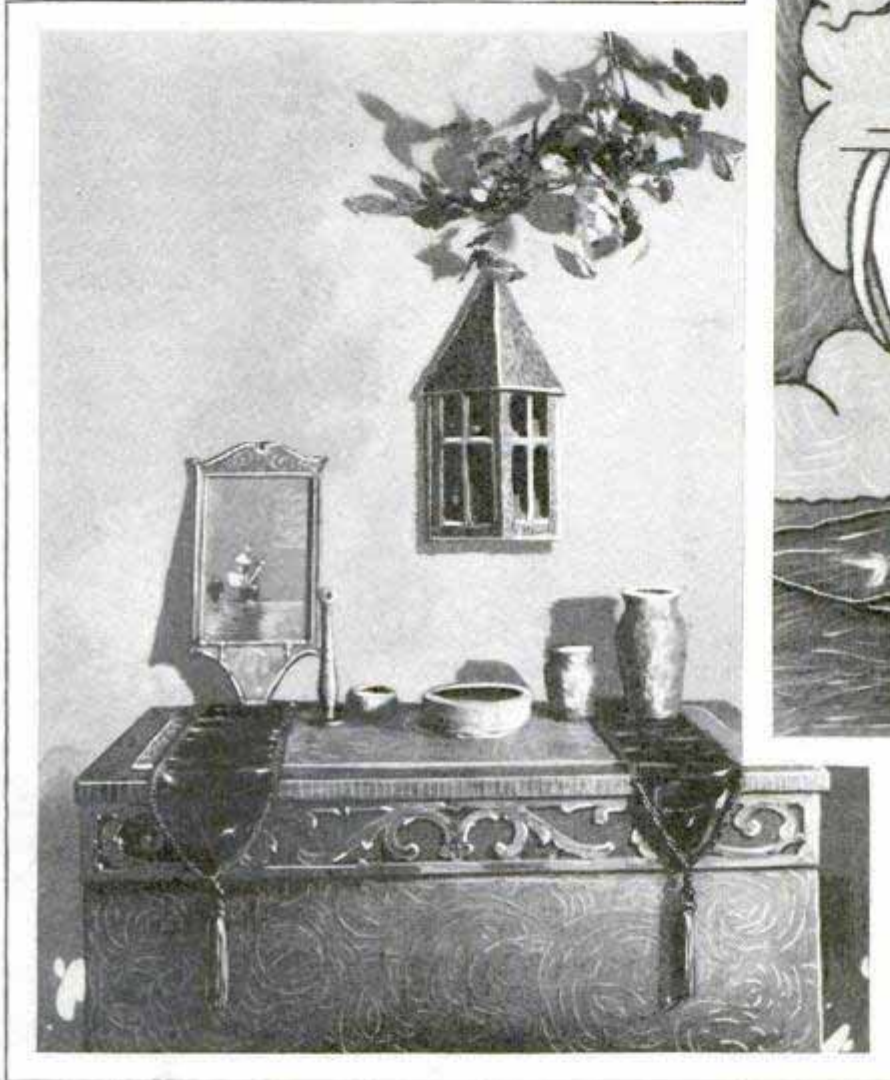

Right, Another Decorative Wall Panel; Left, All the Articles Shown in This Photo, Including the "Pottery" and the Chest, Are Finished with Plastic Paint, in the Simplest Manner

face with the finger tips. If the effect of iron is desired, the surface is painted dark gray and allowed to dry. Then apply a coat of aluminum paint and wipe off the high spots. When dry, kill the high gloss of the aluminum with a thin glaze coat of burnt umber. For antique copper, use a green-paint base and a copper-bronze overcoat in the same manner.

The frame at the left of the lantern is made of wallboard also, the relief decorations being applied with the gun. A narrow brush can be used for these, if desired. This frame is finished in gold, with a second coat of green, wiped off as before. The pottery on the table is just cheap glassware of the "five-and-ten" variety. They are simply coated with plastic and given various polychrome finishes. In

this to dry, and then apply the paint coats that are to be wiped off. Some bronze paints absorb color from the second coat, and this is particularly true of aluminum bronze, so, wherever this is used, apply a coat of white shellac over it before putting on the color coat.

The antique chest is built up of plywood, or, if it is to be used solely for display purposes, and if it will bear no great weight, it may be made of wallboard over a wooden frame. The panel effect on the top is quite simply obtained by tacking down a rectangle of wallboard over the top proper, no matter what the construction of the box. The ornamental border is cut with a coping saw from a thin strip of plywood and tacked in place. The whole box is then given a coat of plastic, tex-

dry or powdered. paint or drug stores

finished with circular movements of the finger tips, the border design being modeled with the tip of one finger. The edge of the lid is textured by making a series of vertical grooves with the finger. When hard, the surface is lightly sanded to soften the effect, and finished as desired. The one in the photo is treated with black paint and silver-bronze to produce the popular antique-silver effect.

Handy Shop Bulletin Board

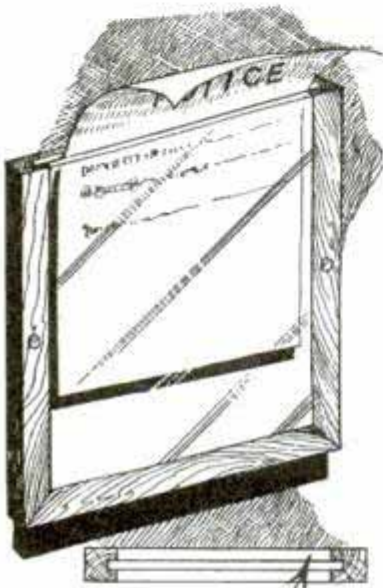

Where framed signs and notices have to be changed frequently, the frame, unless it has been especially made for the purpose, must be taken down to insert a new sign after the old one has been removed. This inconvenience can be overcome by using the bulletin board shown in the illustration. It consists of a three-sided wooden frame with a groove on the inside to receive a glass pane. Insertion or removal of notices is made through the open top.—Herman R. Wallin, Brooklyn.

Correct Method of Repairing Car Chassis

Loose frame members in autos are a source of rapid depreciation, cause considerable noise and involve an element of danger. Cracks frequently start from holes in which rivets have loosened owing to vibration and strain. Looseness and cracks can best be detected by rubbing chalk on the outside of the member around the head and then squirting penetrating oil against the other side. Another test, but one which requires more skill, is tapping the rivet with a hammer. Avoid welding whenever possible, because of the spoilage of near-by paint and possible injury to heat-treated metal parts. Shear off the head of the loose rivet with a

chisel and hammer or drill it out. If a crack has started from the rivet hole, trace it to its end and drill a $\frac{1}{8}$ -in. hole through the frame at that point, to check further cracking. As rivet holes will usually be found to be elongated, enlarge the hole by reaming to about .004 in. under the diameter of the next larger cap-screw. If the threaded portion of the latter is a trifle less than the combined thickness of the frame members, it will be necessary to chase the threads down nearer to the head with a die. The collar of the screw should be a tight drive fit in the hole. Use an extra-thick new lock washer, and tighten the nut as much as possible without stripping the threads. The writer has used this repair for many years and his experience is that it will prove permanent.—Paul Leo, Elizabeth, New Jersey.

Holding Small Objects in a Vise

When small objects, such as brass terminal heads, have to be tapped, there is considerable difficulty in holding them in a vise. I have found it better practice to grip the tap in the vise and hold the object between a pair of dies of the sliding type. It is then an easy matter to tap the work.—L. Moran, Dublin, Ireland.

Device for Testing Valve Springs

The drawing shows a simple method of testing the strength of valve springs, making use of a scale, a length of 2 by 4-in. stock, a number of stop blocks and a cleat.

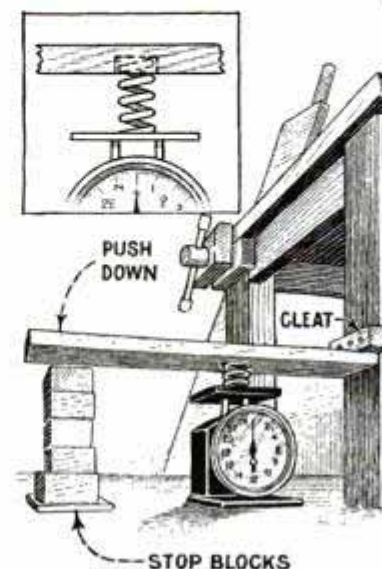

The cleat is nailed to the bench leg, a hole is bored part way through the 2 by 4-in. material to receive the end of the spring, which is set on end on the scales, and the stop blocks are arranged as indicated. By pushing on

the improvised lever thus arranged, the strength of the various springs can readily be determined and the weakest ones replaced. The stop blocks insure that exactly the same amount of pressure is applied to each spring.

Test Shows Filter Reduces Oil Changes

If automobiles are equipped with oil filters, frequent changes of the oil in the crankcase are unnecessary, a test trip across the continent tends to show. On the trip, during which the speedometer showed 10,025 miles of travel, it was found that, after a change of oil, the viscosity dropped rapidly for about 200 miles, and then changed little for 500 miles. The tests on acidity showed much the same results, the acidity rapidly rising for about 200 or 300 miles, and then showing small variation. In addition to the oil filter, the car was fitted with a crankcase ventilator, and both carburetor intake and breather were protected against dust.

New Type of Filing Cabinet Takes Little Space

Light and compact, this novel filing cabinet, made in the form of a sloping box,



has handy features which make it highly useful for certain purposes. It is 37½ in. high at the back and 22 in. high at the front, and measures 16 by 24 in. in length and width. The opening of the box is 31 in. long and is divided into 22 compartments. The divisions consist of pieces of wallboard slipped into 7/16-in. slots cut in the sides. The material used for building the cabinet is white pine. A hinged lid, made by placing a wallboard panel in a suitable frame, is provided.

☛ A piece of cord is useful as an emergency gauge in resetting a camera tripod, or in preventing it from shifting.



Reflecting Light into Dark Corners Saves the Workman's Time

Work Lighted by Reflector

Polish the surface of an ordinary celluloid visor or place a mirror on your cap so that it will reflect downward on the work, as shown in the drawing. In this way any dark corner, or bottom of a hole where a screw must be driven, can be lighted sufficiently to save considerable time.—Geo. K. Sangster, Namu, B. C., Canada.

Using a Hacksaw in Confined Places

When it is necessary to use a hacksaw in confined places, try the method indicated in the illustration. The blade is ground down to a point and is held in a handle made of pipe. The pipe is cut through lengthwise on one side and two screws are used to tighten the handle on the blade. This tool has been found especially useful by electricians in cutting through metal lath, armored cable, scraping insulation and many other operations. It can be assembled in a few minutes and will serve as a valuable supplement to any tool kit.

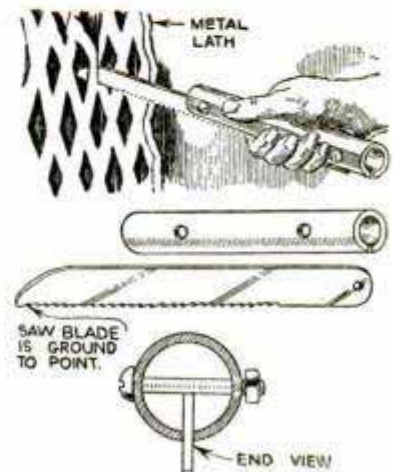

Angle-Iron Corner Fixture for Clamps

Difficulty is often experienced in fastening mitered corners together while the work has to be held square. Fig. 1 shows

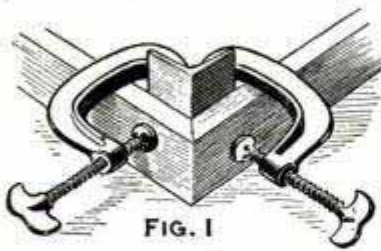

FIG. 1

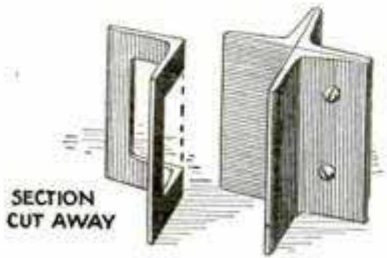

FIG. 2

how a piece of 2-in. angle iron of appropriate length and a pair of clamps can be used to advantage. Fig. 2 illustrates a fixture that is of considerable value in working with sheet metal, for holding the pieces together while welding, brazing or other operations. Three pieces of angle iron are fastened together, while a fourth piece, of which the center section is cut away, is also provided. In use, the work is placed inside of the main part of the fixture, and the slotted section is pushed in against the work to hold it firmly in position, after which clamps are applied. The fixture can be laid on a bench horizontally so that melted solder or spelter will run into the corner of the work instead of collecting along the sides.

Repairing a Short-Circuited Armature Section

To locate a short-circuited armature section, pass a current from a dry cell or storage battery through the armature, using the brushes of the machine. Using a low-reading voltmeter—a millivoltmeter if possible—touch its lead wires to one pair after another of adjacent commutator bars. A zero deflection of the voltmeter indicates a short-circuited section. It will be noticed, at periodic intervals in passing around the commutator, that the voltmeter deflection reverses, and that just before this transition point the deflection is less than normal. This merely indicates a passage from one pole to another on the winding. On a four-pole armature, for instance, there will be four such reversals of the meter deflection. Switching

of lead wires is all that is necessary to make the meter read in the right direction. If a short circuit is found, clean out the spaces between commutator bars, to be certain no small bits of metal or copper dust are responsible. Failing thus to locate the trouble, carefully lift out the coil connected to the bars to which the short was traced, and repair any breaks in the insulation. Shellac and silk ribbon are the best materials for this work. Apply the ribbon smoothly, coating it thoroughly. A broken circuit in the winding itself may be located by connecting a battery through the ammeter to two metal strips, held apart by a piece of wood at such a distance that they will touch adjacent commutator bars. Holding this device against the commutator, turn the armature slowly by hand. A reduced deflection of the ammeter indicates a broken or open-circuited winding. The only resort, in this case, is to lift out the damaged coil, solder the ends together, re-insulate and replace the wire in the slots.

Automatic Milk Cooler

Cooling milk automatically with the illustrated device saves the farmer considerable time and keeps the milk more sanitary. It consists of a wooden tub in which a milk can is placed, and a paddle arranged inside of the can. The paddle is actuated by means of a pivoted crossarm, to the ends of which small cups are attached. The cups fill and empty alternately with water, the weight of which causes them to drop, and they are then automatically turned over so that the water runs out and causes the emptied cup to rise while the other one goes down and is emptied in the same way. The arrangement for filling the



cups alternately is simple. A container, which is funnel-shaped at both ends, is pivoted on a vertical rod, which supports the entire moving apparatus. Two brass or copper tubes, soldered to the end of each opening of the upper container, lead down to the two cups, the bails of which are swiveled on the ends of the cross-arm. A small hinge is soldered to the lower edge of each cup and to the side of a metal trough large enough to receive the water from the cup. When the cup is filled, it swings over and pours the water into the trough. Each trough is drilled to permit the water to run down into the wooden tub. This hastens the cooling of the milk. The paddle moves from side to side as the cups go up and down on the ends of the crossarm. A water hose is clamped to the upper container so that the water runs into one cup while the other one is being emptied.—Bert T. Williams, Clintonville, Wisconsin.

How to Hold a Fender Bow

When removing dents or bends from a damaged auto fender, it is often rather hard to keep it from flaring outward while hammering the metal back to shape. A Cleveland workshop made the illustrated device to prevent this. It consists of lengths of $\frac{1}{4}$ by $1\frac{1}{4}$ -in. flat iron. Two long pieces have loops at one end to allow a third length to slide in them so that the bar can be adjusted to any desired length. Thumbnuts or setscrews are provided to hold the pieces together after the proper adjustment is made. Short lengths of flat iron and thumbnuts, arranged in a similar manner, are used to clamp the bar to the fender as illustrated.—A. E. Granville, La Grange, Ill.

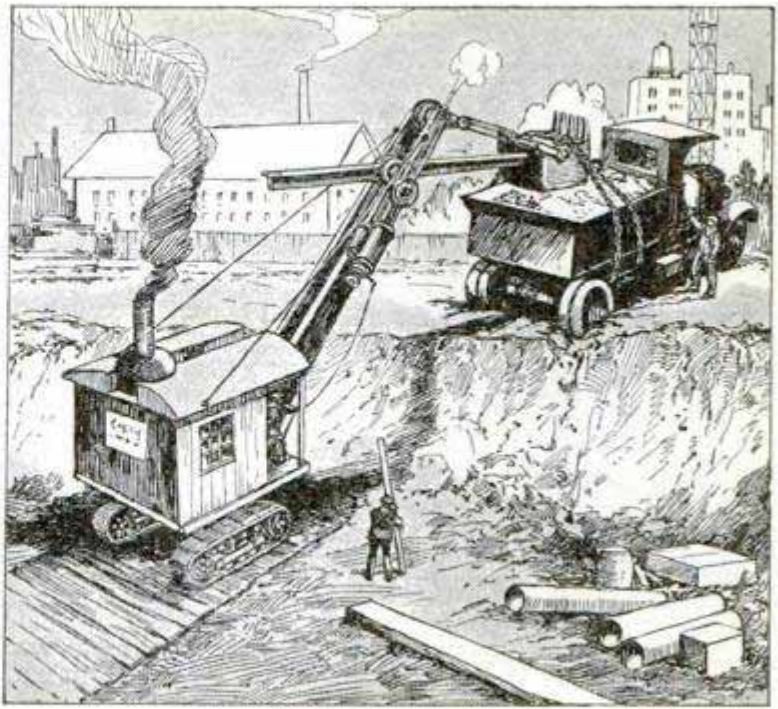

Arrangement of Steam Shovel Enabling It to Lift Truck Sunken into Soft Dirt near Excavation

Steam Shovel Lifts Heavy Truck

After sinking into soft dirt near the edge of an excavation, where a steam shovel was loading dirt into it, a five-ton truck was unable to pull out on its own power. No tractor was available to tow it and it seemed that the work would be held up for some time. However, the resourceful engineer of the steam shovel solved the difficulty in a few minutes by giving the truck a lift. A heavy chain was slipped around the truck and the top portion hooked over the shovel.

Prolonging the Life of Hammer Handles

The life of a hammer handle may be prolonged if the wedges and head are removed and the end soaked in linseed oil. The end should be placed in the oil and allowed to remain for three or four days. It should then be removed, wiped off and allowed to dry for a week before the head and wedges are replaced. The resulting toughness will be surprising.

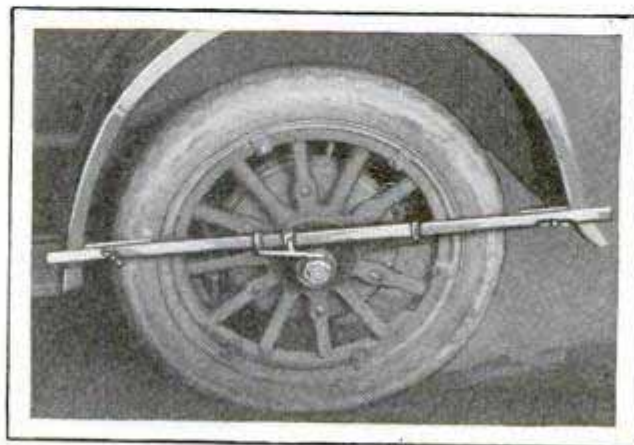

Adjustable Bar Holds Auto Fenders in Shape While Dents Are Hammered Out

*Edward Thatcher
Bearsville, Ulster County
New York*

A Practical Home Made

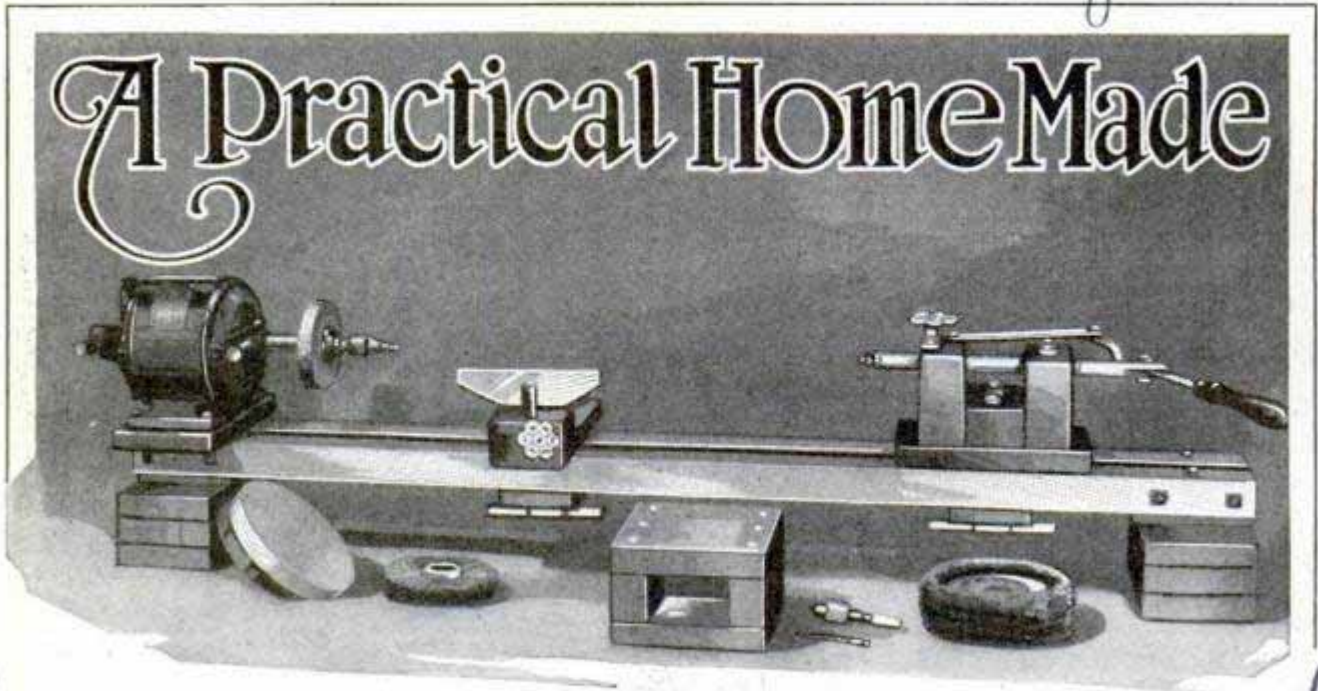

By EDWARD THATCHER *Bearsville
Ulster Co. New York*
PART II

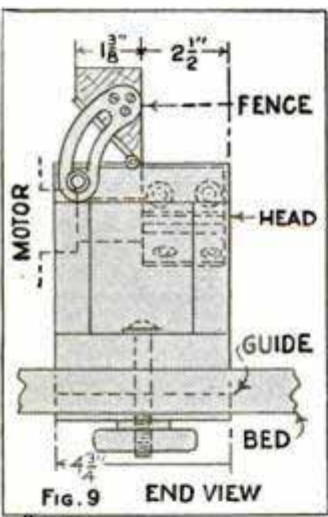

THE JOINTER attachment for the combination workshop is shown in Figs. 9, 10 and 11. As may be seen from the drawings, the base of the jointer is a 1 1/4 by 4 3/4 by 16-in. piece, and above this are screwed two "boxes" made of 1-in. stuff, 5 5/8 in. long, 4 3/4 in. wide and 3 15/16 in. high. The exact height that the boxes are made will depend, of course, on the height of the spindle of the lathe and the size of jointer head to be used. The lower parts of the jointer bed may be of soft wood, if hardwood is not available, but the jointer tables, which are fastened on top of the boxes, should be of hardwood

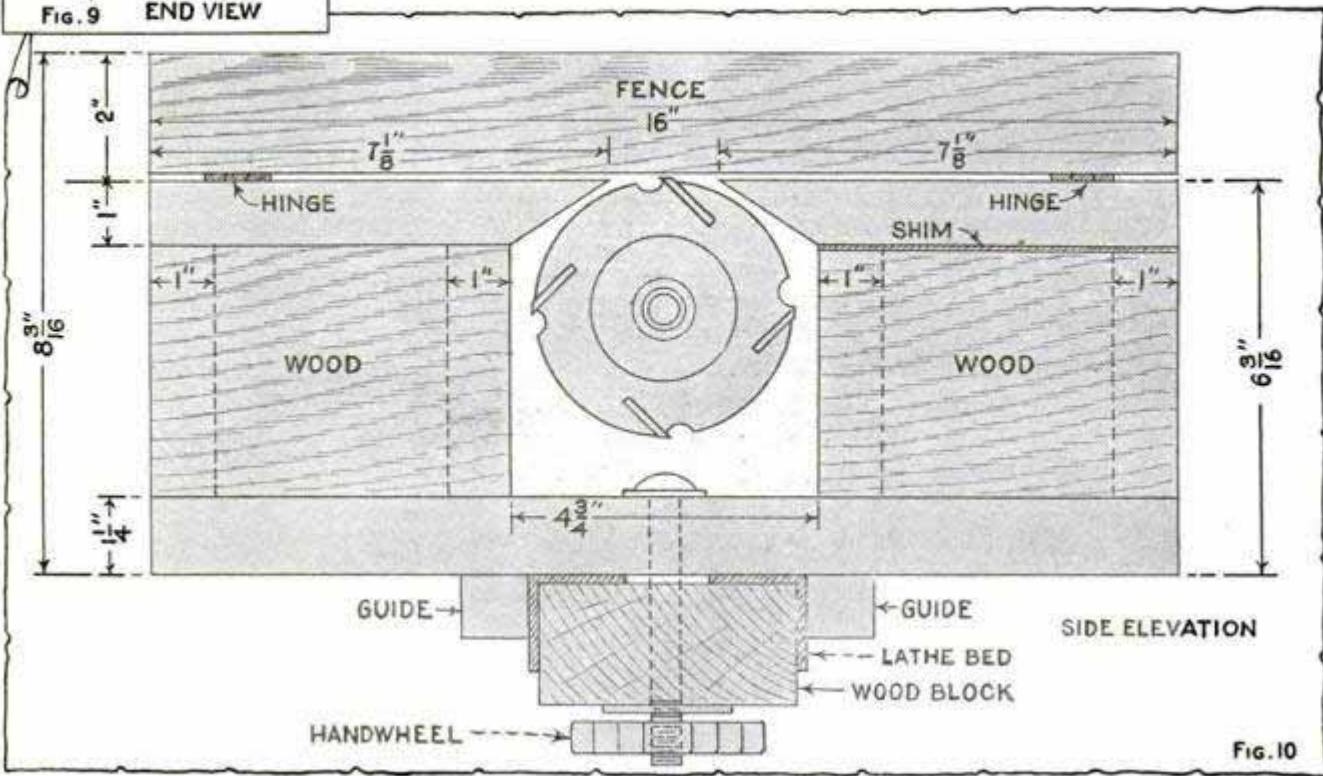

Fig. 10

Combination Workshop

having a smooth, even grain. The tables are 1 in. thick, beveled back to accommodate the head used, as shown in the drawing, Fig. 10. The bed is fastened to the ways of the lathe by means of a bolt and handwheel, in the same manner as the other attachments, and guide strips, glued and screwed to the underside of the base, locate it positively with reference to the spindle of the lathe as shown in Fig. 10.

The tilting fence or guide is of hardwood, 16 in. long and $1\frac{3}{8}$ in. thick, to suit the 2-in. jointer head used on the original. The fence is beveled on the lower back edge so that stock can be planed at any angle up to 45° , and is hinged to the tables in the manner shown in Figs. 9 and 10. The curved guides that support the fence and enable it to be locked in any position may be made of sheet brass or steel, $\frac{1}{16}$ in. thick, either sawed out with a coping saw or cut with a chisel.

When the attachment is clamped to the lathe bed, over the head, as shown by the dotted lines in Fig. 9, the outfeed or table farthest from the operator is raised about $\frac{1}{2}$ in. by means of a shim of heavy cardboard of the same dimensions as the table. This gives the jointer a cut of $\frac{1}{2}$ in., sufficient for ordinary purposes. For heavier cuts, use a heavier shim. The adjustment of the cut should be made with the head

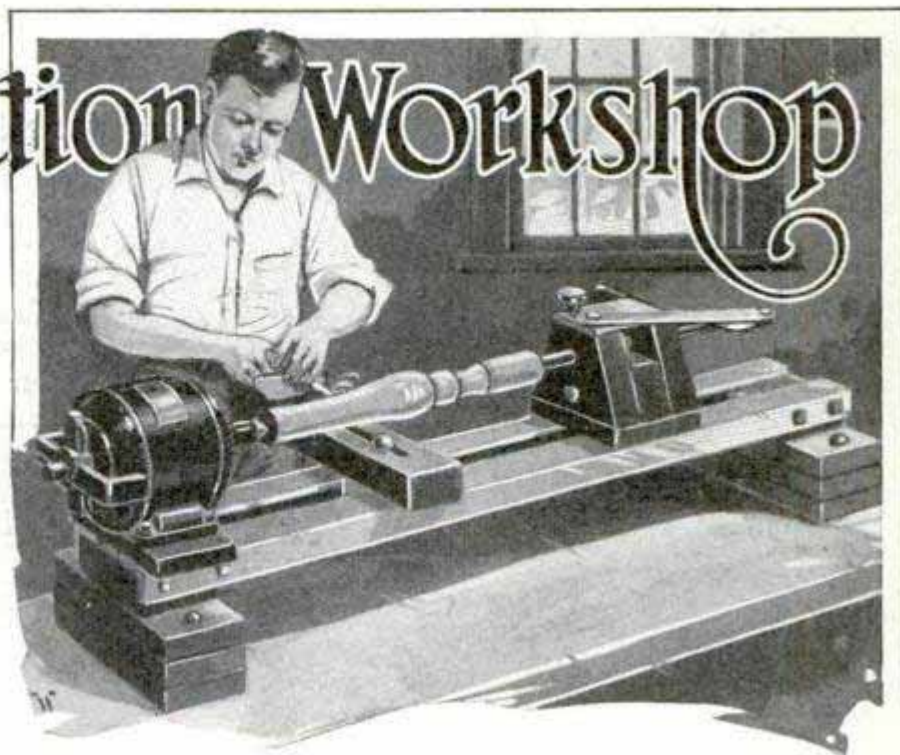

in place. A steel straightedge is placed flat on the rear table (the outfeed table) and projecting across the edges of the knives in the head. Each knife is adjusted in turn until it just touches the straight-edge when the head is turned by hand. Of course, the knife-edges should be square with the table tops, and firmly locked in the head before the motor is started.

The head used, Fig. 12, is one supplied by a commercial house, and costs about \$7. It dresses stock up to 2 in. wide and does the work very cleanly and smoothly.

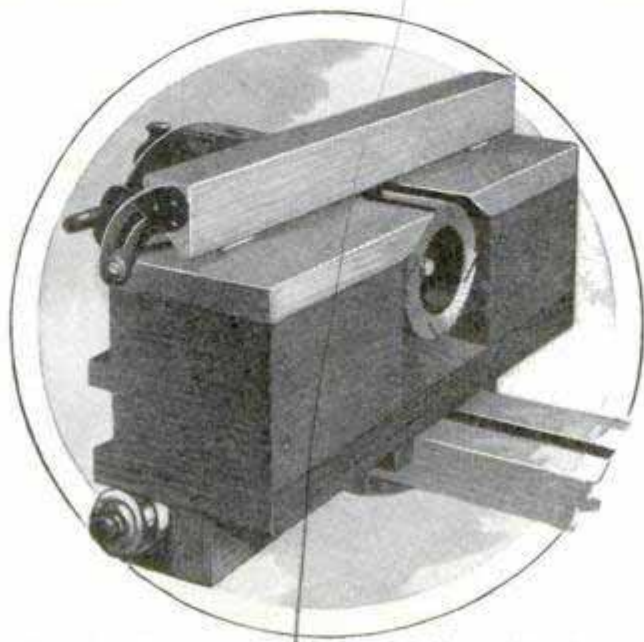
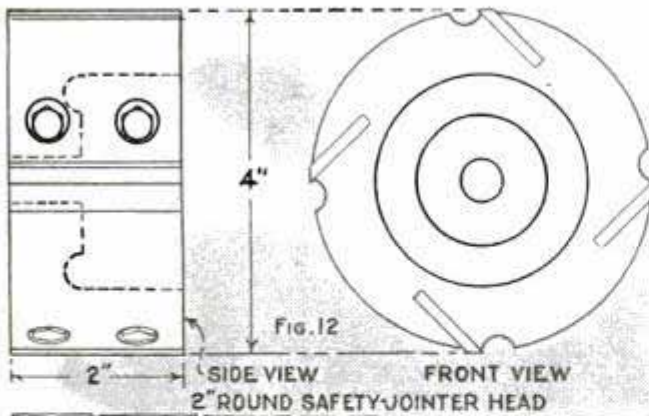

Fig. 11, a View of the Completed Jointer Attachment, Mounted on the Lathe Bed over the Headstock

As to accessories for the lathe proper, the most used ones are illustrated in Fig. 13. The spur center may be made from a combined countersink and drill used in brake-lining machines in a number of garages. A dull one can be had for nothing, or a new one for 25 cents. Soften it by heating to a dull red and allowing it to cool under fine ashes, then file or

*Paul J. Levitt Chelan
1901 S 2nd*

Paul J. Levitt 1047



Another way is to use a section of mild-steel rod that fits the tailstock spindle. The end of this piece is drilled and tapped for a No. 8-32 screw. Screw tightly in place, saw off the head, and file to a tapering point. A sleeve is now made of mild steel to fit over the center, the outer end being turned down to a sharp beveled edge. The sleeve is held in place with a rivet passing through it and through the other parts as shown.

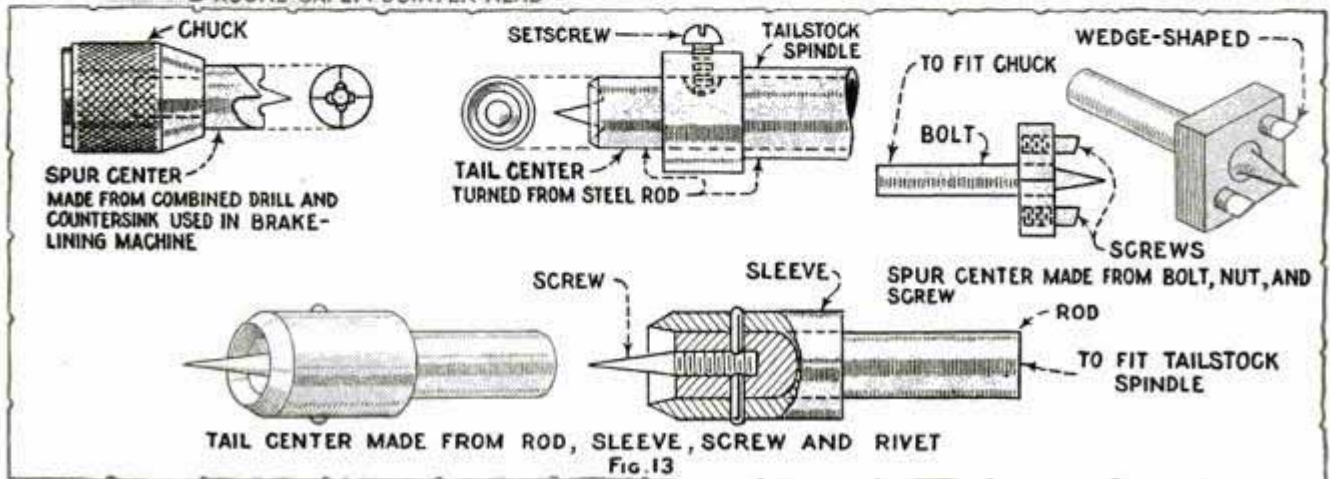

grind it to shape as shown. Place the shank in the lathe chuck and carefully file the short drill point down to a tapering point. The four chisel-like spurs of the center are easily filed up from the four countersink edges already on the tool. If you can, you may retemper the center, but it stands up very well in the soft state.

Another simple spur center is made up from a bolt and some screws. Saw the head off a $\frac{1}{4}$ -in. bolt, so that, when a nut is screwed down on the threaded end, the bolt will rest against the face of the drill chuck. Chuck it in the lathe and file the end of the bolt down to a sharp point. Drill and tap for two No. 6-32 screws in the opposite corners of the nut, insert the screws tight, cut off the heads and file the projecting length to chisel-edged spurs.

A tail center may be turned for the tailstock if you understand turning metal with hand tools in a speed lathe. Use a piece of $\frac{1}{2}$ -in. mild-steel rod, mounted in a hole turned for it in a block of hardwood, which, in turn, is mounted on the faceplate of the lathe. Form the center as shown in Fig. 13, and drill a spot on the shank for the setscrew of the tailstock spindle.

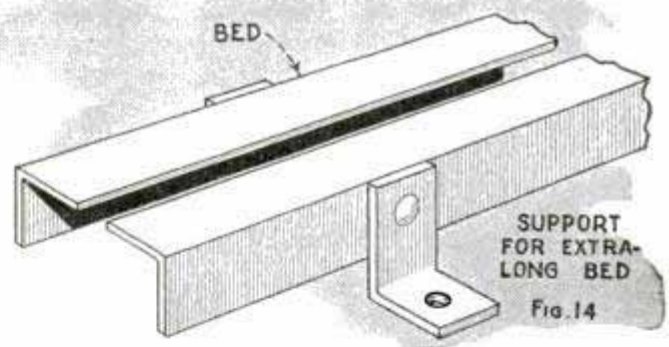

Fig. 14 shows the form of the supports used if the lathe bed is made longer than the original specifications.

The lathe and its attachments were painted with black and aluminum paint, as indicated in the various photographs accompanying this article, the wooden parts being given two coats of black enamel. The aluminum paint makes a very attractive and durable finish for the angle-iron bed of the lathe and other iron parts, as well as for the top of the tables on the sander and jointer. The inside of the angle-iron bed was painted a bright red in true small-lathe style.

It must be understood that the various dimensions given for the attachments describe those used on the original, and that any changes in the center height of the

lathe, etc., will necessitate corresponding changes in the dimensions of the various attachments.

Overheating of Motor Caused by Water Pump

It cost me more than \$100 to gain the experience related here, although \$2 would have paid for the remedy at the beginning of the trouble. On a long drive my auto began to overheat and it became so serious that the radiator had to be filled several times daily. In an effort to have the fault corrected, I stopped at a garage and had the carbon removed, the valves ground, the ignition checked, a large fan installed and finally an entire new radiator put on, but the trouble persisted. Going over the entire motor carefully, it was discovered that the gland on the pump had been tightened too much after the packing had worn thin, in order to stop leakage, so that it pressed against the impeller of the pump, and, instead of helping to cool the water, the pump was actually heating it. By this time the pump was ruined, so that I had to replace it. Thereafter the cooling system functioned perfectly.—William H. Leach, Cleveland, Ohio.

Running Truck with Broken Rear Axle

After one of the axles had broken off inside of the rear wheel, I placed the ambulance under the frame to support the rear end and removed the wheel. By locking the jackshaft, often referred to as the drive axle, I was able to move the truck to a repair shop with the opposite wheel for a distance of seven miles.—Oli-ver Hahn, Allentown, Pa.

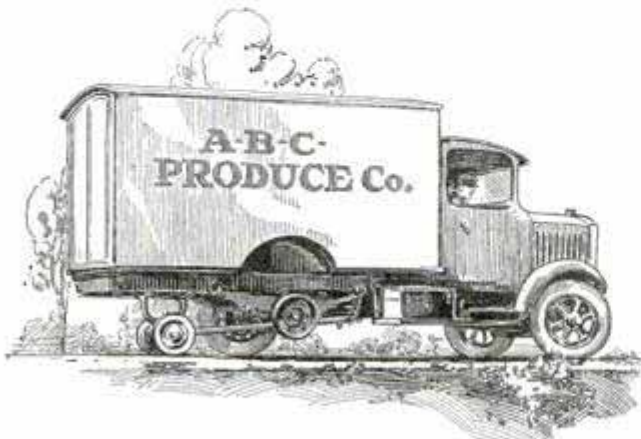

Truck with a Broken Axle Can Be Driven to Repair Shop on Its Own Power

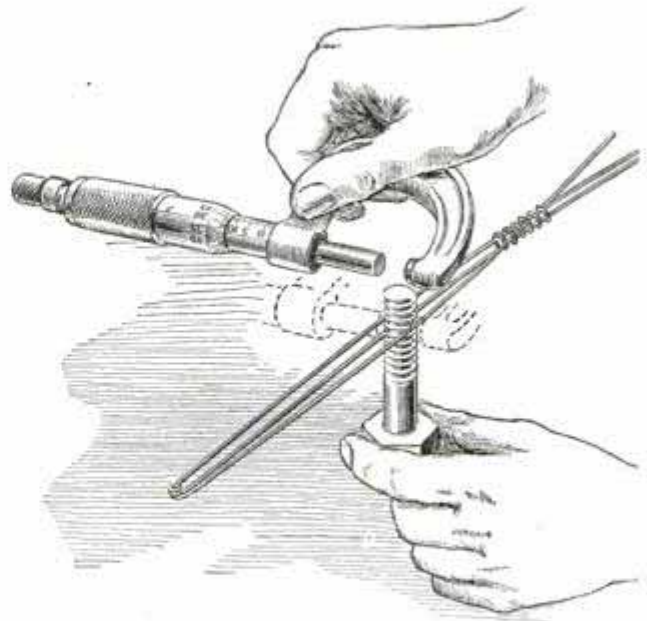

Small Coil Spring Slipped over Wires Makes It Easier to Check Threads

Device for Checking Threads

The three-wire method of checking gauges, bolts, etc., for pitch is in general use, but it is hard to hold the three wires, the bolt and the micrometer at the same time. The difficulty can readily be overcome by slipping a small coil spring over the ends of the wires as shown in the drawing. This holds the wires on the thread securely. Grasp the bolt with the left hand and the micrometer between the ball of the right-hand thumb and the palm so that the thumb and forefinger are free to adjust it.—Fred C. Wegener, Indianapolis, Ind.

Painting Imitation-Brick Joints

When painting a large warehouse, sided up with tin that was pressed to resemble brick, I found it a lengthy job to cover the imitation mortar with a small brush. To do the work quicker, I glued a layer of felt from an old hat around a paper-hangers' roller and found it quite satisfactory for my purpose. A small quantity of the lining color was put on a flat board and the roller pushed through a few times until the felt became well saturated with paint. After that, the roller is simply run in the depression and the paint is pressed on, causing the imitation lining to stand out in bold relief. Quite a large surface can be covered with one "rollerful" of color, and the work is neat in appearance.—C. A. Soots, North Salem, Ind.

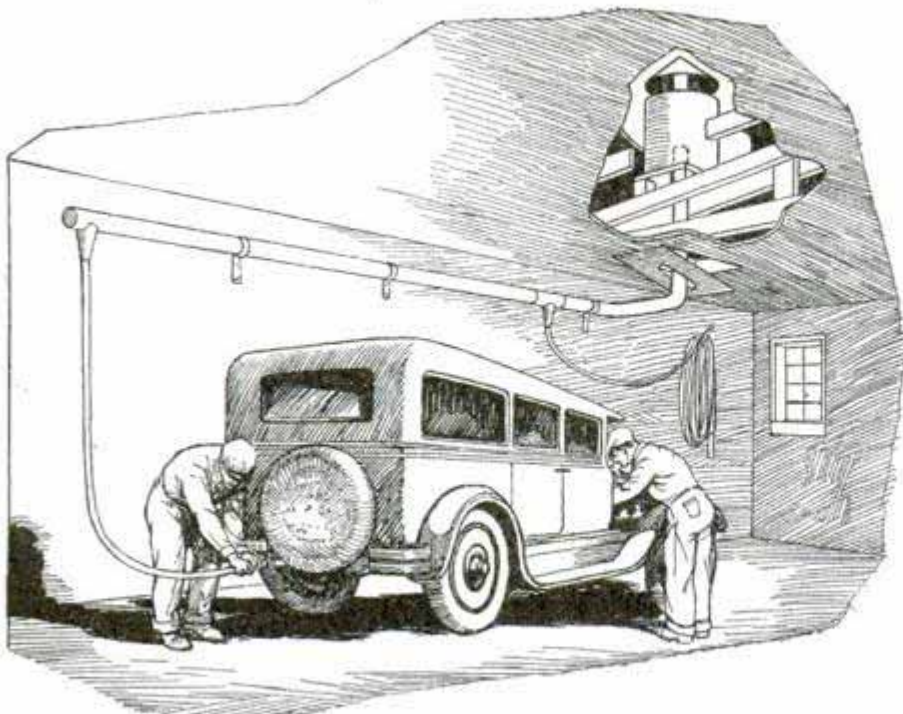

Installation of Piping Connected with a Roof Ventilator to Exhaust Deadly Carbon-Monoxide Gas from Garage

Removing Monoxide Gas from Garage

It is generally known that carbon-monoxide gas is deadly when produced in a closed garage but every year there are car owners who succumb to the fumes after having forgotten to provide sufficient ventilation. Even in large garages where ventilation is provided, running motors often produce so much of the gas that, though it may not be noticeable, it, nevertheless, has harmful effects on the workers who constantly breathe it. To avoid the presence of this gas in his garage, one owner provided the arrangement shown in the illustration whereby the gas is immediately removed from the exhaust pipe of the auto and is conveyed through a pipe to a roof ventilator, which forces it outside. This arrangement can be followed by anyone who is interested in bettering the working conditions of the garage. The pipe connected to the roof ventilator is run along the wall and has tees at in-

tervals where hose can be connected to reach the exhaust pipes of the cars. In the case illustrated, the roof ventilator was provided with an exhaust fan, which forced the gas up through the pipe. The use of such a fan is essential as the monoxide gas is heavier than air and will not rise through the pipe of its own accord.—E. Moutoux, Riverhead, N. Y.

Machines Oiled at Close of the Day Start Easily in Cold

When running machinery in cold weather even hot oil, put on before starting, sometimes cools in the oil passages and does not flow to the bearing surfaces until undue friction warms them enough to soften it. To overcome this difficulty, oil the machinery immediately after shutting down at night. The bearings being slightly warm, the oil gets to the bearing surfaces, and is ready for the start next morning, when more oil can be put on if required to prevent overheating.

Power Saw Cuts Disks Quickly

To saw off disks from rods, or washers from tubing, on a power hacksaw, the illustrated method was found highly satisfactory. Instead of using only one blade, three blades are fitted to the saw frame, with spacers between them so that three equal pieces are cut off at once. The work can then be accomplished in one-third of the time required when a single blade is used.—Geo. Linquist, Philadelphia.

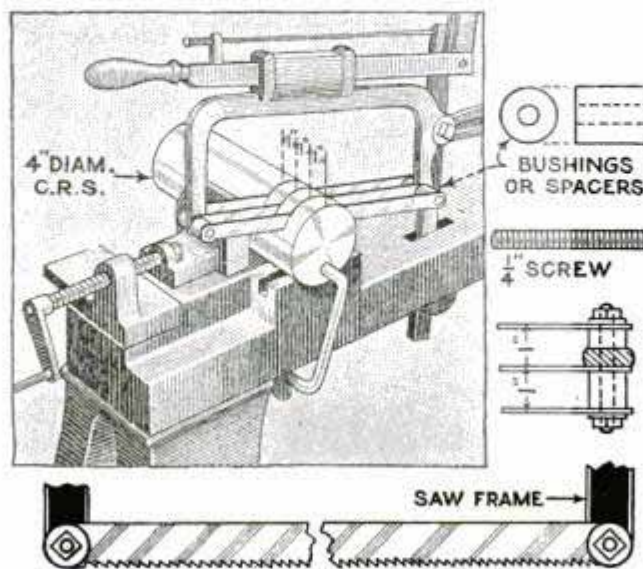

Tripling the Speed of Cutting Off Disks and Washers on a Power Hacksaw

Making a Hammered-Copper Pipe Holder

By DICK HUTCHINSON

A RATHER novel and very useful pipe holder is the one illustrated below. It is very simple to make, will prevent the spilling of ashes over the desk or table, incidentally saving the pipe smoker from a lot of scoldings, and, if fastened permanently where it is most used, will eliminate many searches for that pipe that was just laid down "some place." The only material necessary is a piece of 23-gauge soft copper, 9 in. long and $3\frac{1}{4}$ in. wide.

Cut out a thin cardboard pattern or template to the shape and size shown in the drawing. Lay this down on the copper and trace around it with the point of a scribe or sharp pencil. Cut out the copper with a pair of tin shears and then smooth down the rough edges carefully with a file.

The base, or flaring part, which is 2 in. wide at the end and 4 in. long, should now be hammered carefully with the ball end of a light ball-peen hammer. Turn the piece over and hammer the "neck" on the opposite side, also the wings; then turn the piece over again and hammer the other side of the wings up to the pointed end. The piece is turned over because, as may be seen from the drawings, that part

of the neck which is on the same side of the stock as the hammered part of the base will form the underside when the holder is bent to shape. Drill two small holes, in the positions shown, for a rivet to hold the parts together.

Place an old broomstick in the vise and, with the aid of the hammer, bend the neck and wings around it, then place a 40-penny nail just under the wings and bend these sharply upward, thus forming the holder for the bowl of the pipe. Now lay the pieces across the broomstick and carefully bend the neck back on the base until the rivet holes come together. The neck and base are then riveted together with a brass escutcheon pin.

To finish the job, get five cents' worth of liver of sulphur at the drug store. Dissolve this in a tray of water and, after washing the pipe holder thoroughly with soap and water, immerse it in the solution until it turns a reddish-brown color. Wash it off and allow it to dry, then polish and lacquer it. A good make of banana oil will answer as a lacquer, if you are unable to procure a regular metal lacquer. The oil or lacquer may be applied with a brush.

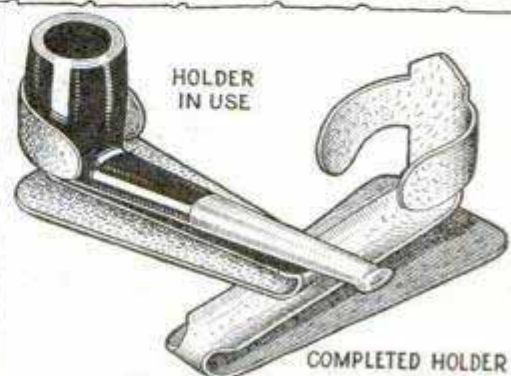
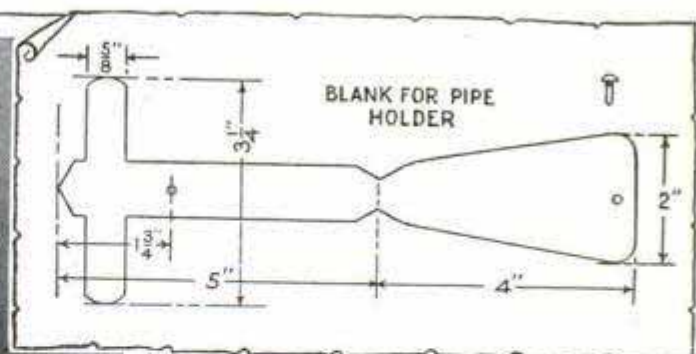
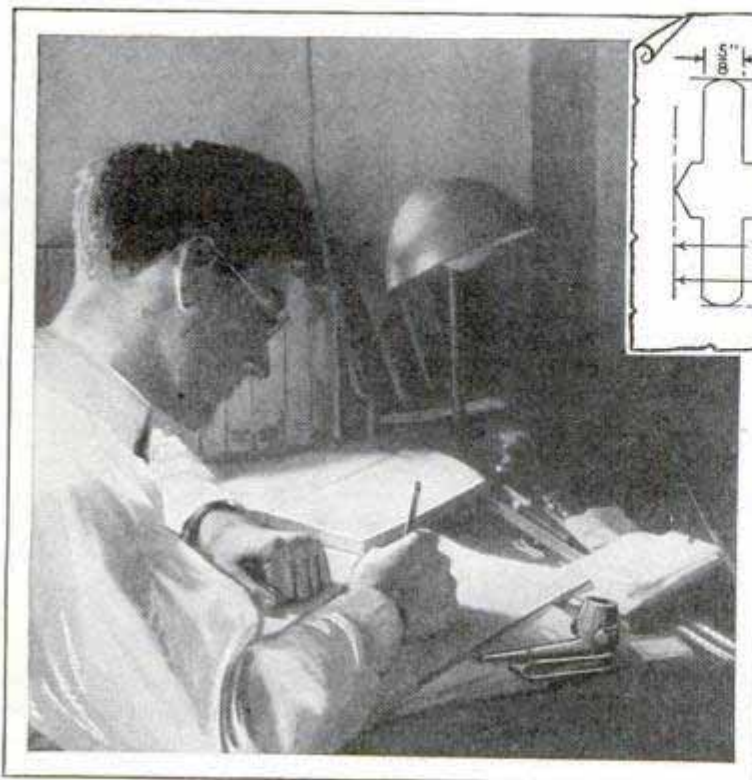

Holder That Will Keep the Pipe in Upright Position and Prevent Spilling of Ashes over Desk or Table

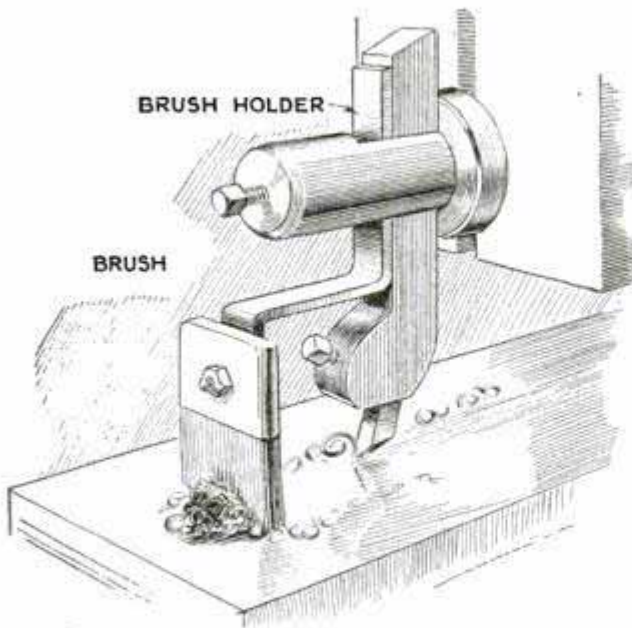

Small Brush Attached to Planer Keeps the Surface of the Work Clean

Brush Holder for the Planer

It is well to know just how a tool is behaving on a big job, but when planing cast iron it is impossible to see clearly, owing to the cuttings which collect on the surface of the work. For this reason a hand brush is often used to clear the cuttings away. Brushing the machined surface, however, is awkward, and sometimes involves some danger. One planer hand sawed the handle off a brush and fastened to it a length of strap iron, which he attached to the tool as shown in the drawing. With each stroke of the tool the cuttings were brushed away.

Punching Holes in Sheet Metal

One of the problems of a sheet-metal shop is to punch clean and accurately sized holes, without excessive burr, in thin sheet metal. A hand punch is ordinarily used for work of this kind, and the punch is backed with a block of wood or lead, or occasionally with a block of steel, drilled with a hole corresponding in size to the diameter of the punch. The wood and lead blocks do not support the punch adequately, and an excessive burr is formed when anything but the lightest grades of sheet metal are punched. When a steel block is used, it is rather difficult to place the punch directly in line with the hole in the block. After considerable experimentation with various materials, I

have found that a block of "type metal" is the best material for the purpose. This is melted and molded to convenient shape and size. Burrs are kept to a minimum, and a clean, accurate hole can be made, yet the metal is comparatively soft so that the punch will not be quickly dulled.—V. C. Darby, Cedar Rapids, Iowa.

Substitute for Stickers in Advertising Local Celebration

In a small town, where the local printing shop was not equipped to print small stickers to be attached to envelopes, and where the town committee wished to patronize home industry in a campaign advertising a forthcoming celebration, the sticker effect was obtained by "overprinting" the envelopes. Envelopes already printed with the usual corner return notice of merchants, professional men and officials were collected. A notice of the celebration was printed in red ink, directly under the return notice. This not only saved the cost of special envelopes, but enabled the merchants to profit by having their names associated with the celebration.—Edgar Sherman, Tucumcari, New Mexico.

Tool Tray for the Lathe Bed

It is always a temptation for a lathe operator to place files, calipers and other tools on the ways of the machine. If a rubber tread, such as is used on auto running boards, is laid on the ways, this practice may be followed without injury to the lathe bed. The tread is tacked to a piece of three-ply wood veneer to give it the necessary rigidity.—J. Hollis Deery, Los Angeles, Calif.

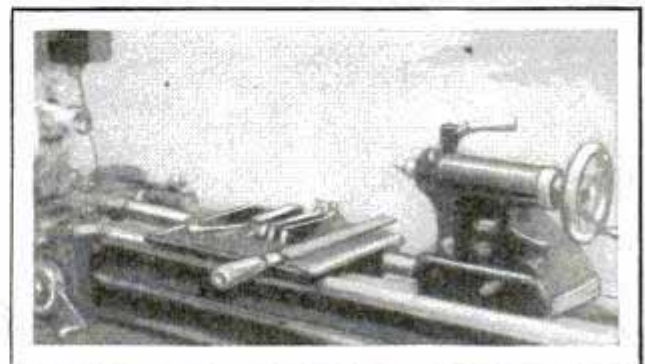

Rubber Tread, Tacked to Piece of Veneer, Makes Good Tool Tray for the Lathe Operator

Soldering Stainless Steel

Stainless steel can be soldered without difficulty so that firm, strong joints are produced. For pickled-finish sheets, muriatic acid cut with zinc is used. For polished sheets, it is necessary to dull the surface with the following solution before attempting to tin: muriatic acid, 90 parts, ferric chloride, 50 parts, and nitric acid, 3 parts, by volume. This solution should be allowed to act for from 5 to 10 minutes, or longer if necessary, and then wiped off. Tinning is done in the usual way. After soldering, all traces of acid must be removed by washing thoroughly, as any acid left on the surface will continue to attack the metal. Owing to the low thermal conductivity of the metal, it is advisable to use a large soldering iron in order to heat the steel thoroughly.

T-Handle Bolt Saves Time as Substitute for Setscrew

For use on delivery cars and trucks, where storage batteries must be removed frequently for charging and overhauling,

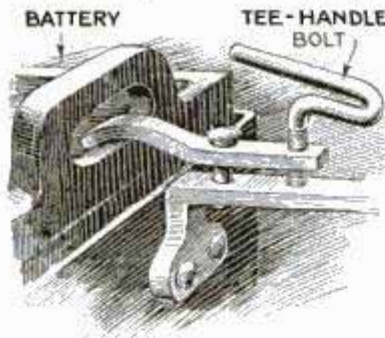

it will be found convenient to replace the setscrews that hold the battery-box clips down tight, by T-handle bolts as shown

in the illustration. By doing this, the need for a wrench to tighten and loosen the screws is entirely eliminated, as it can readily be done by hand. It has been found similarly advantageous also to substitute T-handle bolts for setscrews on brake adjustments, tire racks, and in places where oil and grease plugs are used.

Durable Homemade Putty

You can make a durable and thoroughly efficient putty by adding 1 lb. of white lead and enough boiled linseed oil to 10 lb. of whiting to make a mixture of doughy consistency. Add $\frac{1}{2}$ gill of the best olive oil you can get and mix it in thoroughly.—E. J. Cutting, Marilla, N. Y.

Auxiliary Ice-Box Lid, Resembling an Inverted Box, Saves Considerable Ice



Auxiliary Lid for the Refrigerator

When the iceman leaves a block of ice that is too large for the ice box, the lid of the refrigerator cannot be closed and the ice will melt very quickly. To eliminate this waste, I made an auxiliary lid to fit over the regular lid, as shown in the photo. This increased the size of the ice compartment so that I never had to bother about the lid not closing. This lid is also handy when going away for a few days as the box can be well packed with ice. The lid shown in the illustration is hinged, but this is not essential, as an ordinary wooden box of suitable size may be used for the purpose.—Harry Moore, Hamilton, Ontario, Can.

Thumbtack Puller

For loosening thumbtacks the illustrated device, which is made by cutting off the end of a can opener, will be found convenient and quite saving on the finger nails. The prongs should be bent over a little as indicated. To remove a thumbtack insert the prongs under the head and push down on the key.—Louis Andrews, St. Louis, Mo.

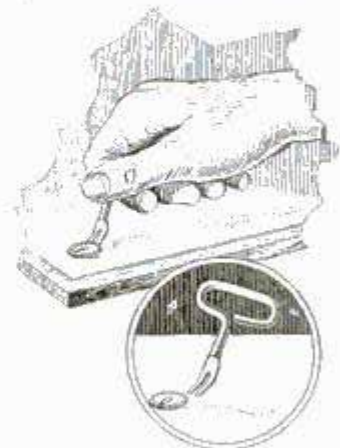

Sheet brass should be inclosed in a large wrought-iron pipe, closed at one end, when being annealed.

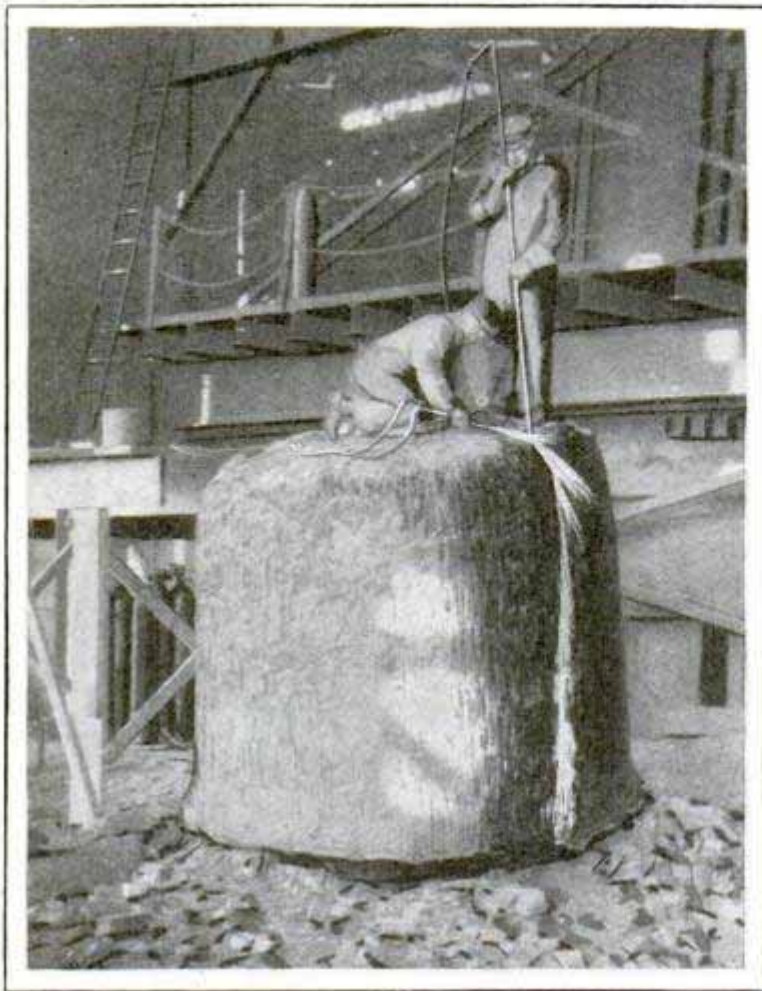

Reclaiming an Eight-Foot Mass of Steel, Frozen in a Ladle, by Means of an Oxygen Lance and a Cutting Blowpipe

Ladle of Frozen Steel Cut in Two with Oxygen Lance

It is not generally known that the oxy-acetylene process can be used to cut masses of iron and steel of almost unlimited thickness. At steel mills the breaking up of salamanders and the removal of furnace spills have been long, expensive operations, but such problems are now successfully solved by the use of an oxygen lance in conjunction with an oxy-acetylene cutting blowpipe. The photo shows a 65-ton ladle of frozen steel, 8 ft. high, being cut to handling size. A delay in pouring, brought about by a breakdown of the crane, caused this molten mass to freeze solid in the ladle. Its reclamation presented a real problem to the manager until he was assured that it could be handled by the oxyacetylene process. The ladle was first broken away, exposing the solid mass of steel. While this was done, an oxygen lance was rigged up. It consisted merely of an 8-ft. piece of $\frac{1}{8}$ -in. steel pipe connected to a source of

oxygen. Pressure was controlled by a regulator on a manifold to which several oxygen tanks were connected. A length of hose connected the steel pipe to the manifold. The cutting blowpipe was used to start the cut at one side, and the lance was then brought into play to carry the cut down to the bottom of the mass. Meanwhile the blowpipe was moved along the line of cut at the top surface, and the lance was then raised to pick up the blowpipe cut and again carry it to the bottom. This sequence of operations was continued until the cut was completed. The two pieces thus obtained were cut by the same process into smaller pieces of such size that they could be placed in the furnace and remelted.

Tool for Cutting Open Pasteboard Boxes

Pasteboard cartons, sealed with strips of heavy adhesive paper, are usually opened by means of knives, screwdrivers, etc., but such tools are not especially adapted to this purpose, as the narrow, sharp point is likely to be pushed too far into the box, with resulting damage to the merchandise. A special tool for cutting the adhesive strip can be made from an old Ford motor valve. Grind the end to a square point and bend it over at right angles as shown in the drawing. Touch the point up with a file so that it can easily tear open the paper strips. Its shape makes it impossible for the point to suddenly slip too far into the box. Nor is it easily lost for, when not in use, it is set on the flat end so that it can be easily seen.—Frank W. Bentley, Jr., Missouri Valley, Iowa.

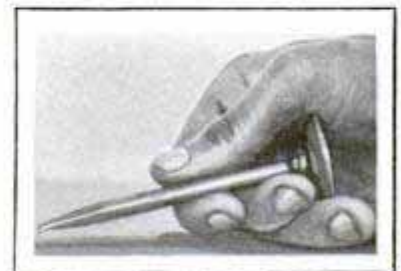

☛ Soapy water, applied over joints in gas or pressure pipes, will locate leaks.

War Veterans Will Like This House



WILD beasts, rain, a torrid sun, enemies waiting to pillage and kill, zero weather are some of the hazards man has had to protect himself against as a home owner. The necessity for defense and self-preservation not only influenced the plan and style of primitive houses, but when you survey the history of home building, it is surprising to note how many of the early methods of defense have been carried down into our present-day architecture as style features.

From one end of Europe to the other you'll find hundreds of castles built with round towers. A tower at each corner of the chateau, two more flanking a moat and smaller towers at convenient places where yeomen could defend their lord and lady by pouring molten metal on attacking enemies. Towers were always a part of a castle plan. In later and more peaceful years, the tower was retained as a vital part of the seigneur's chateau, not for defensive purposes, but because it added a note of distinction.

During the great war, many American doughboys sought refuge from shrapnel and shell in a Normandy tower or others like it. Smaller houses of peasants followed

the style of their masters, so that today, when we speak of Normandy, we automatically think of tower houses.

Usually the early towers contained circular stairways from one floor to another. Even today American houses patterned after the Normandy tower idea feature circular stairways; but aside from this circular stairway, the tower itself introduces a highly decorative feature into modern house design. Porches, dormer windows, streamlines, slip-fast roofs have done much to relieve American houses of what otherwise might prove a monotonous appearance when four plain walls and roof are erected for shelter.

It is this relief of monotony that makes the Norman tower so valuable architecturally. A well-designed Norman house simply cannot look commonplace, monotonous, or "just another house." By introducing a tower into modern small-house designs, you bring a curved surface into contrast with the vertical and horizontal sidewalls, and this combination adds interest and variety to the exterior.

Normandy tower houses are growing in popularity with American home builders. We are glad to show you a new tower-

Popular Mechanics Magazine will supply readers a one-sheet blueprint of any house appearing in the magazine for \$1.

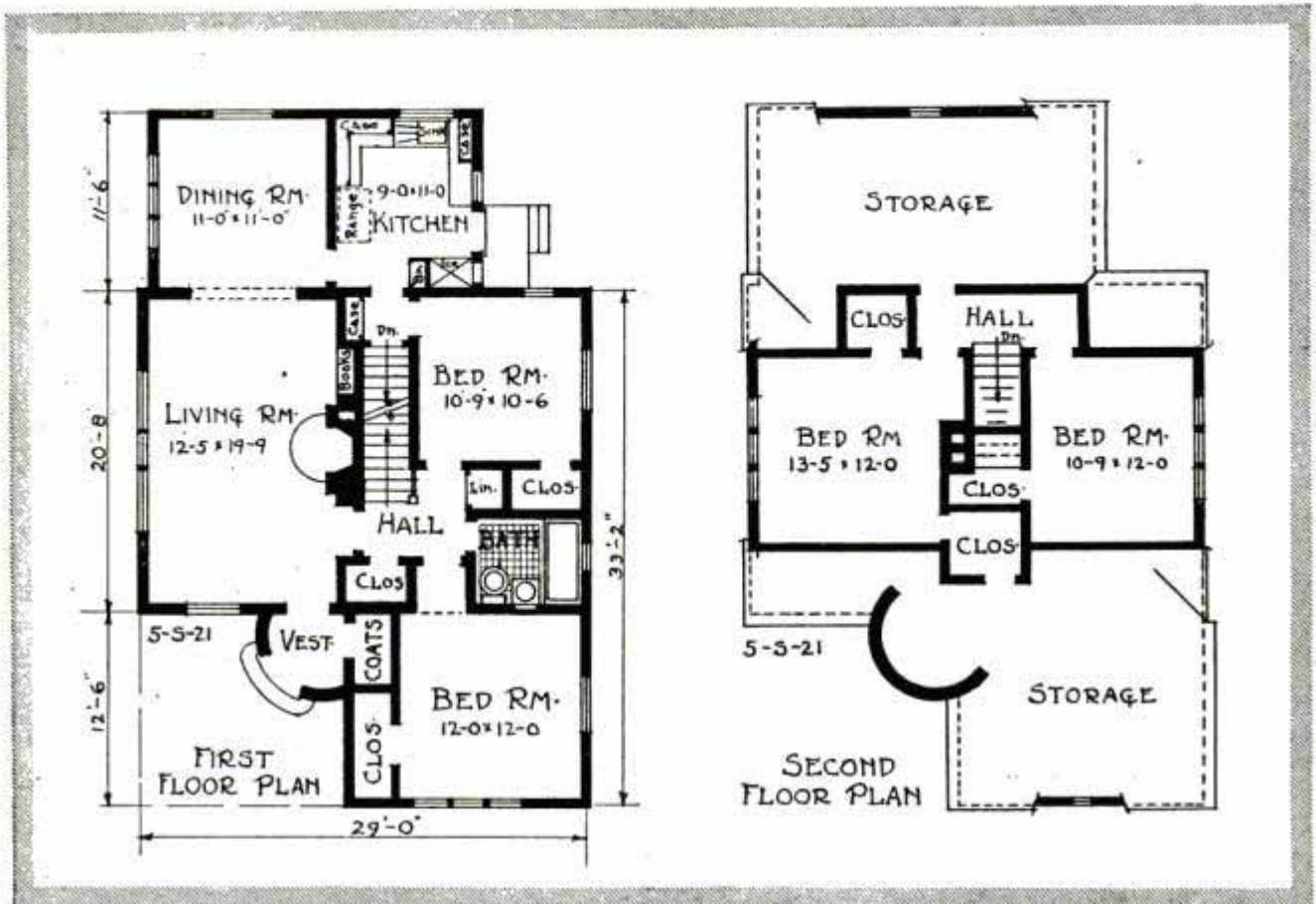

type design this month, prepared especially for Popular Mechanics readers. This is a small house nestling close to the ground. In fact, so small that a circular stairway is not practical, although the tower is none the less useful for storage purposes.

The house is planned for a forty-foot lot. It would look well on a corner lot. Construction is frame with stucco on metal lath, or tile with stucco, or white-washed brick. There is a full basement and complete insulation.

The plan calls for five rooms on the first floor, or complete bungalow equipment. On the second floor are two more bedrooms, abundance of closet space and two exceptionally large storage rooms.

The gable ends of the house are of wide siding or shingle in natural brown finish. The half timber on the tower shows a small overhang, supported by brackets or corbels.

Casement windows throughout carry out the spirit of Normandy style, and a heavy beamed ceiling in the living and dining rooms maintains an old-world tradition. The fireplace is built of fieldstone with a heavy beam for a mantel. The roof may be asbestos shingle, slate or cedar shakes.

There is everything in this house average folks require in the way of sound construction, style, and modern equipment, all at prices within the capacity of the average pocketbook. The designer says \$6,000 should build this house under normal conditions. Prices vary, depending upon location, however. Under any condition, this house offers large value at moderate cost.

It is a plan, too, that lends itself to later enlargement, when the needs of a growing family demand more space. Without destroying the charm of the house, the rear roof can be raised and the second-floor storage space turned into one very large or two small bedrooms; or, as an alternative, the kitchen water pipes and sewer connections can be extended upstairs and one end of the storage space turned into a second bathroom and the other used as a bedroom, serving room or playroom.

PLAN BOOK FOR READERS

A NEW BUNGALOW BOOK: Sixteen selected low-cost bungalows in popular styles, at prices ranging from \$5,000 down to \$2,000. Each house fully described and illustrated. Send ten cents in stamps to cover mailing.

Dealers are ready with "Yankee" Tools for Christmas

Three different size screw-drivers in one.



To bore holes for screws, a man needs a "Yankee" Automatic Push Drill No. 41—with eight sizes of drill-points, $\frac{1}{16}$ " to $\frac{1}{4}$ ". Price, \$2.60.



"Yankee" No. 15—a ratchet driver, has thumb-turn on blade for starting wabby little screws with thumb and forefinger. Price (4 in. blade), 80c.



No. 90 is a husky "Yankee" plain screw-driver that stands all sorts of use and abuse. Price (8 in. blade), 75c.



The finest tool on earth of its kind is "Yankee" Ratchet Bit Brace No. 2100. Price (10 in.), \$8.20. Lucky man, who gets a "Yankee" Bit Brace.

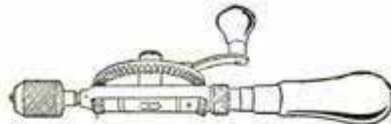

"Yankee" No. 1530 Ratchet Hand Drill (above), and No. 1555 Ratchet Breast Drill are fine gifts for motorists. These drills have five ratchet adjustments; they work where others can't. Price: No. 1530, \$5.25; No. 1555, \$11.00.

"Yankee" Tool Set No. 105—ratchet tool holder with nine attachments. For the man who works on radio and home electric appliances. Price, \$3.25.

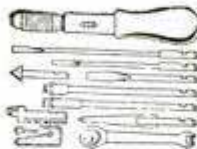

MEN take pride in ownership of "Yankee" Tools! Ingenious . . . interesting! Give a man—or boy—a "Yankee" Tool and you have made a fine gift. Your hardware man is expert in knowing what tools to give a mechanic; what tools the handyman wants for the home workshop.

Every man wants this "Yankee" Spiral Ratchet Screw-driver No. 30-A. Drives all sizes of screws, quick and easy—simply by pushing on the handle. Price, \$3.00. Three sizes of bits included.

"YANKEE" TOOLS

MAKE BETTER MECHANICS

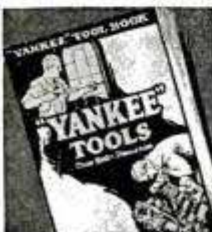

NORTH BROS. MFG. CO., Lehigh Avenue, Philadelphia, U. S. A.

Readers of Popular Mechanics, who like to own good tools, are invited to send this coupon for "Yankee" Tool Book (free) illustrated with action pictures of "Yankee" Tools in use, showing how these ingenious tools save time and labor.

Name.....

Address..... (pm)

Own a car

your friends can admire

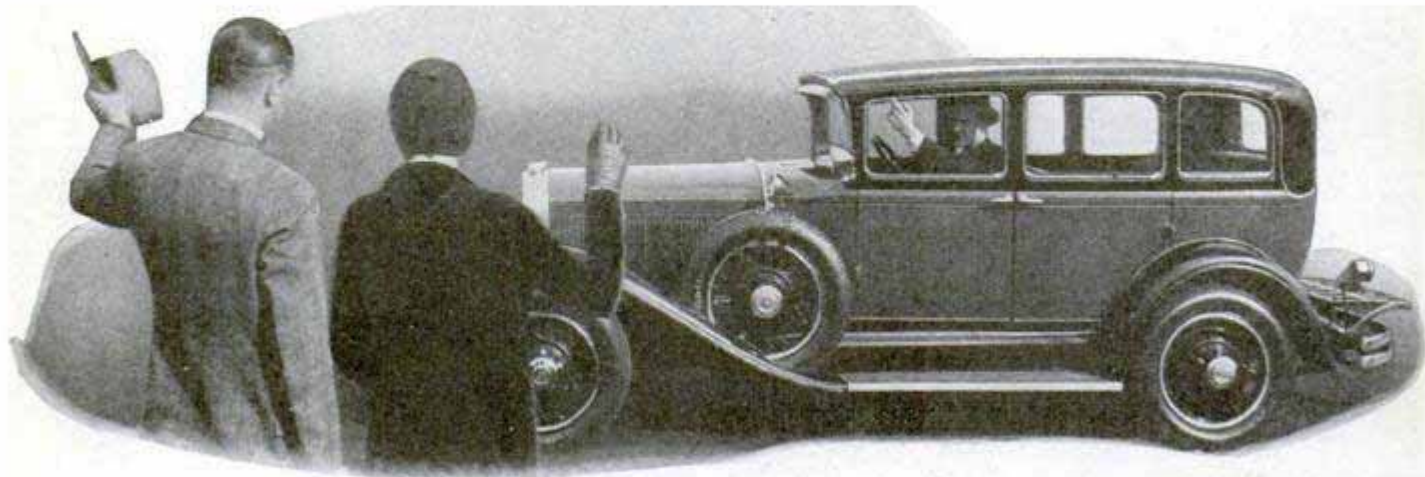

YOU needn't envy your friend's fine car — or be ashamed of your own — when you can buy a fine quality motor car for little money. Many good used cars have their original beauty, style and distinction, with thousands of unused miles.

Pledge to the Public on Used Car Sales

- 1 Every used car is conspicuously marked with its lowest price in plain figures, and that price, just as the price of our new cars, is rigidly maintained.
- 2 All Studebaker automobiles which are sold as **CERTIFIED CARS** have been properly reconditioned, and carry a 30-day guarantee for replacement of defective parts and free service on adjustments.
- 3 Every purchaser of a used car may drive it for five days, and then, if not satisfied for any reason, turn it back and apply the money paid as a credit on the purchase of any other car in stock — new or used. (It is assumed that the car has not been damaged in the meantime.)

© 1928 The Studebaker Corporation of America

And you can buy a really fine used car for the price of a cheap new car.

By buying your used car under the terms of the famous Studebaker Pledge, you get positive satisfaction-insurance. The Pledge gives you five days driving trial with any used car you select. You get a 30-day guarantee on all Certified cars. And all prices are plainly marked — there are no code prices on a Pledge-backed used car.

This free booklet, "How to Judge a Used Car," will teach you many fine points about used car buying. The Studebaker Pledge will thoroughly protect your motor car investment. Act now to give your family a better car — mail the coupon *today!*

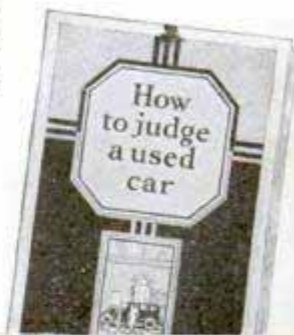

THE STUDEBAKER CORPORATION OF AMERICA
Dept. 1512, South Bend, Indiana

Please send me copy of "How to Judge a Used Car"

Name.....

Street.....

City..... State.....

STUDEBAKER

Builder of Champions

How to File Circular Saws

Told by the World's Foremost Makers of Saws

DISSTON Circular Saws, and all other Disston Saws, are made of Disston Steel, from Disston's own steel furnaces. This steel, and the skill of Disston craftsmen, made Disston the world's foremost saw makers.

You want Disston Steel in your circular saw. There is no substitute for it. This steel takes

and holds a keener cutting edge; cuts easier, and stays sharp longer. In great lumber mills, Disston Circular Saws are standard equipment. You will find that you, too, can do better work if you use only Disston Saws in your home workshop.

Ask for Disston! Circular Saws and Band Saws, Hand Saws, Hack Saws, and Files.



Files for the Wood Worker

Disston Cabinet Files (fine teeth) for smoothing and finishing wood surfaces, easing tight doors and drawers, etc. Disston Wood Rasps (coarse teeth) for rough and fast cutting, enlarging holes, etc. Half-round 8" Cabinet File, 65c. Flat 8" Wood Rasp, 50c.

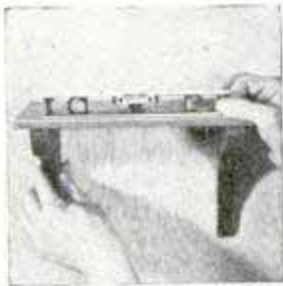

Handiest of Pocket Levels

For truing up construction work, leveling shelves, etc., use a Disston Featherweight Pocket Level. The lightest and handiest level made. Length, 9"; weight, 2 oz. Aeroplane aluminum. Three proved glasses. \$1.25.

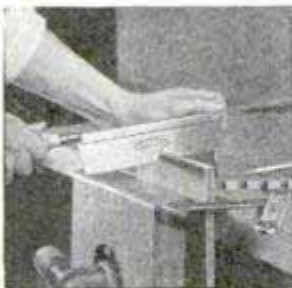

For Cutting Dovetails, etc.

Wherever the finest possible joint is needed, and for dovetailing, pattern making, etc., use a Disston No. 68 Dovetail Saw. Blade extra thin, with fine teeth. The 8" blade, 17 points to inch, is most popular. \$1.60.

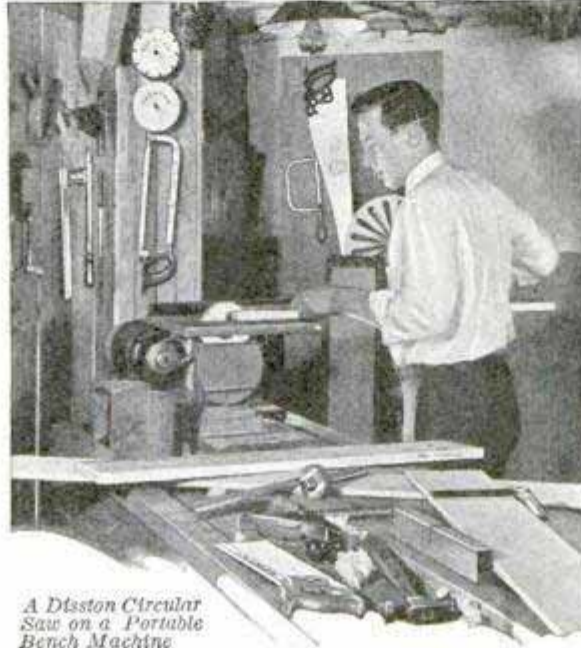

A Disston Circular Saw on a Portable Bench Machine

TO sharpen small circular saws, you need a filing clamp or vise; the proper files, and a saw set, or an anvil and hammer, to spring the teeth. The Disston No. 7 Circular Saw Filing Vise is handiest, taking saws from 4" to 16". On cross-cut and combination saws, use Disston Taper Files, 6" or 7"; on circular rip saws use Disston Mill Files, 6" or 7", with one round edge.

First joint the saw, getting all teeth same length. Turn saw backward by hand on mandrel, holding emery stone lightly against tops of teeth until all are touched.

Then put saw in vise and set the teeth, using a Disston No. 18 Triumph Saw Set (Illustrated; \$1.50). Be careful not to carry the set down too far on the teeth. Follow the original set of your saw. Note that one tooth is set to right and the next to left.

Next file the teeth as near to their original shape as possible. Keep all gullets of same depth and width. Bevel teeth alternately, following original angles. In filing, do not reduce length of teeth; simply bring them up to a sharp point. Bevel on both face and back should be about one-third the length of the teeth.

On a combination novelty saw, which cross-cuts, rips, and miters, do not set the raker teeth; set only the scoring teeth. No teeth of a hollow-ground combination saw should be set. Do not bevel raker or cleaner teeth, but file them straight through.

Your hardware dealer has in stock, or can get for you quickly, Disston Circular Saws for any machine.

DISSTON

Makers of "THE SAW MOST CARPENTERS USE"



"The Saw Most Carpenters Use"

The two handiest saws for the home work-shop are the 26-inch 8-point for cross-cutting, and the 26-inch 5½-point for ripping. You will need these on almost every job. The popular "D-8" Lightweight cost \$3.45. Many other styles and sizes available.



Band Saws for Better Work

Disston "Thin Gauge" Narrow Band Saws are 2 to 3 gauges thinner. They run better on machines with wheels up to 26" diameter. Saw 9' 8" long, 1½" wide, 25-gauge, brazed, \$2.03. Other sizes in proportion.

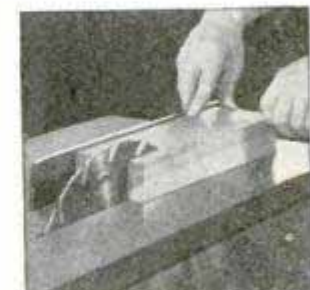

Disston Combination Saw

This type of Circular Saw, known as a Combination Novelty Saw, does cross-cutting, ripping, and mitering equally well. It is made either flat ground for general work or hollow ground for smoother cutting.



"Disston Small Circular Saws and How to Use Them" is a new bulletin which tells how to operate and refit saws. It will be of interest and value to every owner or prospective owner of a small electric bench saw outfit. The coupon will bring it to you.



Henry Disston & Sons, Inc., Philadelphia, U. S. A.
(In Canada, address Henry Disston & Sons, Ltd., Toronto)
Please send Bulletin on Circular Saws, and other data.

Name and Address

How to be *Generous* to a man at Christmas

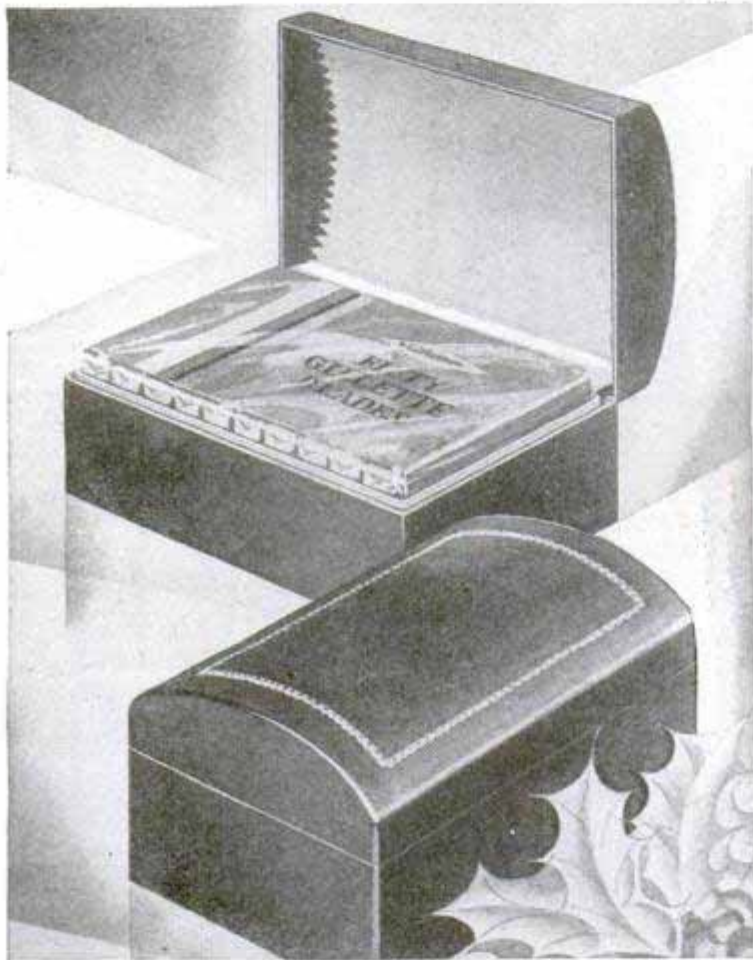

Five Dollars

JUST how does the Gillette Fifty Box qualify as the ideal Christmas gift for a man? Here's how—on these eight counts:

It is practical . . . Man, famous for his practical mind, insists on useful gifts.

Yet he probably wouldn't buy this for himself . . . From long habit, he is used to getting his blades in packs of five and ten. This will be a new and refreshing idea for him.

He'll be sure to use it . . . Blades are a daily necessity in every man's life. The Gillette Fifty Box is the most convenient way to have them.

It is personal . . . It's all to himself, for his own intimate, bathroom use.

It is good looking . . . Packed, as you see, in a

metal box, velvet lined, with a spring-hinge cover. Blades are enclosed in brilliant Cellophane.

It is truly generous . . . With fifty smooth, double-edged Gillette Blades in easy grasp, a man can look forward to more continuous shaving comfort than he has probably ever enjoyed before in his life.

It will last well beyond the Christmas season . . . For months his mornings will be free from all thought of buying Gillette Blades.

It is reasonable in price . . . Five dollars buys this *ideal* gift. On sale everywhere.

Gillette



Give him shaving comfort in abundance with the famous Fifty Box of Gillette Blades

Xmas Gifts Smart-Modern JEWELRY

10 DAYS'
FREE TRIAL



Sent for \$1 Balance
12 MONTHS
TO PAY

Guaranteed Savings

Direct Diamond Importations and large volume buying for both our National Mail Order business and our Chain Store system enable us to offer you superior quality genuine diamonds, fine standard watches and exquisite jewelry at saving prices which are beyond comparison. All of this with no extra charge for the added convenience and advantage of dignified, liberal credit.

How to Order

Just send \$1.00 with your order and your selection comes to you on 10 Days' Free Trial. No C.O.D. to pay on arrival. After full examination and free trial, pay balance in 12 equal monthly payments.

Satisfaction Guaranteed 10 Days' Free Trial

You have the full privilege of 10 days' free trial—if not completely satisfied return shipment at our expense and the entire deposit will be refunded. Written guarantee bond with every purchase.

All Dealings Strictly Confidential

A whole year to pay! No extra charge—no red tape. You take no risk—satisfaction absolutely guaranteed or money back.

Gift Cases Free

Every article comes to you in a most beautiful and appropriate presentation case.

Send for this **CATALOGUE!**

Write Now for
Your Copy

FREE To Adults

Completely illustrated new catalog of genuine diamonds; Bulova, Elgin, Waltham, Hamilton, Howard, Illinois watches; fine jewelry and silverware at special prices.



ESTABLISHED 1895

ROYAL DIAMOND AND WATCH CO.

Address Dept. 11-Z, 170 Broadway, New York

\$50.00



DT1-Newest Butterfly design, of 18K Solid White Gold engagement ring set with sparkling, genuine blue-white diamond. \$4.08 a mo.

\$29.50

DT28-Gorgeously hand engraved 18K Solid White Gold "Bridal Blossom" wedding ring; 5 fiery genuine blue-white diamonds. \$2.37 a mo.



\$75

DT23-Modern, square-prong, engagement ring in new "step" design 18K Solid White Gold set with specially selected dazzling, genuine blue-white diamond. \$6.16 a month.

No Red Tape
No Delay



\$50

DT7-New, massive, gentleman's ring of 14K Solid Green Gold and 18K Solid White Gold top; with a flashing, genuine blue-white diamond. \$4.08 a month.



\$27.50

DT31-Nationally known ELGIN or WALTHAM! Handsomely engraved new style case. Guaranteed Elgin or Waltham movement. Warranted 14K White or Green Gold filled 25-year case. Latest style flexible mesh wrist band to match. \$2.21 a mo.



\$27.50

DT22-Gentleman's massive, hand engraved ring of 14K Solid White Gold Imported black Onyx with a genuine diamond and any carved initial or emblem desired. \$2.21 mo.

IT'S A
BULOVA
\$29.75



DT5-Nationally advertised guaranteed 15-jewel Gent's BULOVA watch. White Gold filled case, "dust-tite" protector; radium dial and hands; latest style woven wrist band to match. \$2.39 a mo.

12
Months
to Pay

\$42.50



DT27-The "Bridal Blossom"—Hand pierced lace design engagement ring of 18K Solid White Gold, genuine blue-white diamond of rare brilliance. \$3.46 a mo.



\$48.50

DT12-Dazzling cluster of 7 perfectly matched genuine blue white diamonds; hand pierced 18K Solid White Gold lady's mounting. Looks like \$750 solitaire. \$3.96 a mo.



\$42.50

DT10-Gorgeous lace design hand pierced 18K Solid White Gold dinner ring; 3 fiery, genuine, blue-white diamonds; 2 French-blue sapphires. \$3.46 a mo.



\$29.50

DT26-Latest style, modernistic effect 18K Solid White Gold lady's ring; fiery genuine blue-white diamond. \$2.37 a month.

\$37.50



DT8-Diamond wrist watch, 14K Solid White Gold engraved case; 2 genuine diamonds, 8 emeralds or sapphires. Guaranteed 15-jewel movement. Pierced flexible bracelet with sapphires or emeralds to match. \$3.04 a month.

\$24.50



DT9-The "Princess Pat"—14K Solid White Gold engraved case, guaranteed 15-jewel movement. Engraved genuine "Wristocrat" flexible bracelet to match. \$1.96 a month.



\$27.50

DT19-Nationally known 15-jewel WALTHAM movement; 20-year warranted engraved White Gold filled, 12 size, thin model, decagon case. Tested and regulated. White Gold filled knife, fine Waldemar chain. All complete in handsome gift case. \$2.21 a mo.

Shave All Year with just ONE Blade

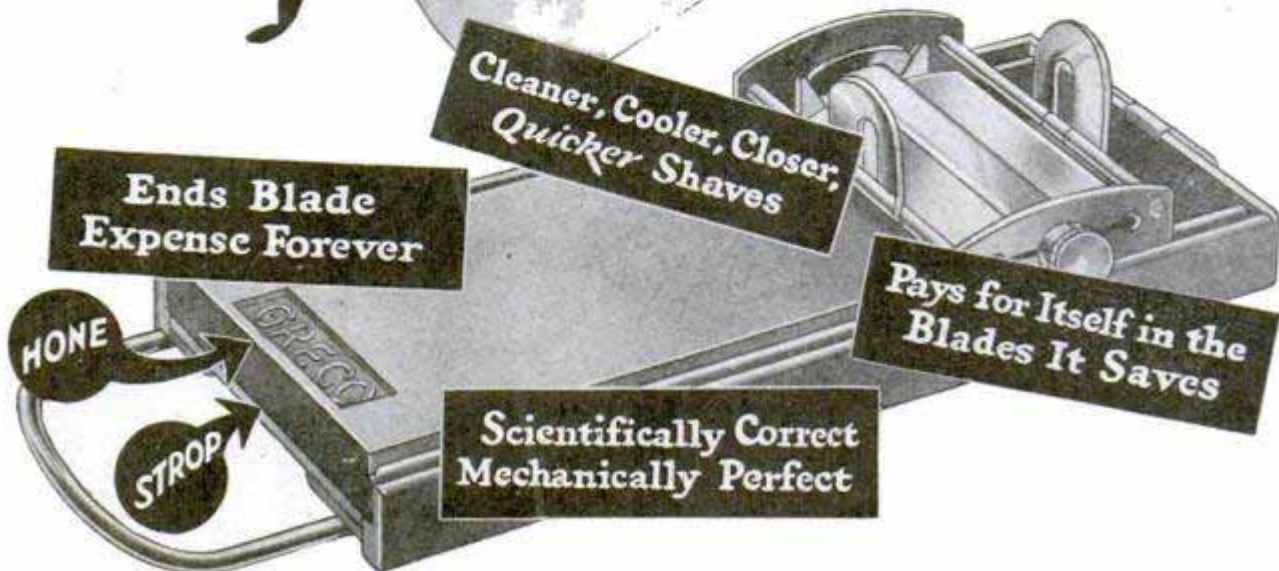

EVERYBODY knows that a safety razor maker could afford to give away the holder and grow rich on the profits from blades. Because one good and one or two indifferent shaves are all that you can expect from even the best blade. Most men have to use a new blade every day. At cut rate prices for blades this amounts to \$25.19 a year. If you get two shaves from a blade you pay \$12.60 a year for new blades;

and for three shaves your yearly blade bill comes to \$8.40; and you *don't* get "head barber" shaves.

Scientific Invention Ends Blade Expense

There has never been a device for Gillette type blades like the GRECO Sharpener. It actually lets you get better shaves all year from ONE blade than you would get from 365 new blades.

You know that the only way to sharpen an edged tool is to use a *STONE* . . . a Grindstone, a Whet-

stone or a Hone, depending on the kind of edge to be sharpened.

You know that a razor needs to be honed when it is dull.

That's just exactly what the GRECO Sharpener does. With a few quick strokes it HONES a Gillette type blade on a special Pike hone to form NEW cutting edges . . . and then, on fine shell leather, STROPS the new edges to shaving keenness.

It does this to both sides of both edges automatically without removing the blade from the carriage. Beautiful, simple . . . lightning quick; nothing to get out of order or rust. Precision built of heavy bronze-brass, fully plated.

Read What a Few Users Say

H. S. W. writes: "I have used but 3 blades in 18 months since I got your GRECO Sharpener. One blade cracked and my wife used the other to scrape paint off the window or I would

have used but two. I formerly used a new blade every other day." G. L. said: "In the six months that I have had your GRECO Sharpener I have used but one blade and expect to use it forever if it retains its temper." D. M. B. tells you: "I have tried almost every blade sharpening device; the GRECO Sharpener, which both hones and strops the blade, is the only one which really does the work properly."

Your Money Back If You Want It

If the GRECO Sharpener will do for YOU what it does for others you want it. For it pays for itself every six months in the blades it saves and gives you better shaves as well. So I want to send you one . . . on 30 days FREE trial. If you don't like it, return the GRECO Sharpener in good condition and I'll send back every cent you paid. For I'd rather have your good will than your money. If you're dissatisfied. But you won't be. So clip the coupon, pin your check or a \$5. bill to it and mail it to me today.

Accept My 30 DAY FREE TRIAL OFFER

Send today for a GRECO Sharpener; use it in your own home for 30 days. I Guarantee that you will be delighted. If you're not, just return the GRECO SHARPENER in good condition and I'll return your money without argument. If I knew of a fairer offer I'd make it to you.
Bert A. Sinclair

Bert A. Sinclair, Sales Director
The GRECO DISTRIBUTING COMPANY
91 Warren St., New York, N. Y.

I'll try the GRECO Sharpener for 30 days. If it doesn't give me the clean, cool, close, quick shaves that I expect I'll return it in good condition and you'll return my \$5, sent herewith.

Name.....

Address.....

City..... State.....

If interested in Agency offer check below:

Full Time Spare Time

BERT A. SINCLAIR, Sales Director

THE GRECO DISTRIBUTING COMPANY
91 Warren Street NEW YORK, N. Y.

LOOKING INSIDE A CLOSED CYLINDER

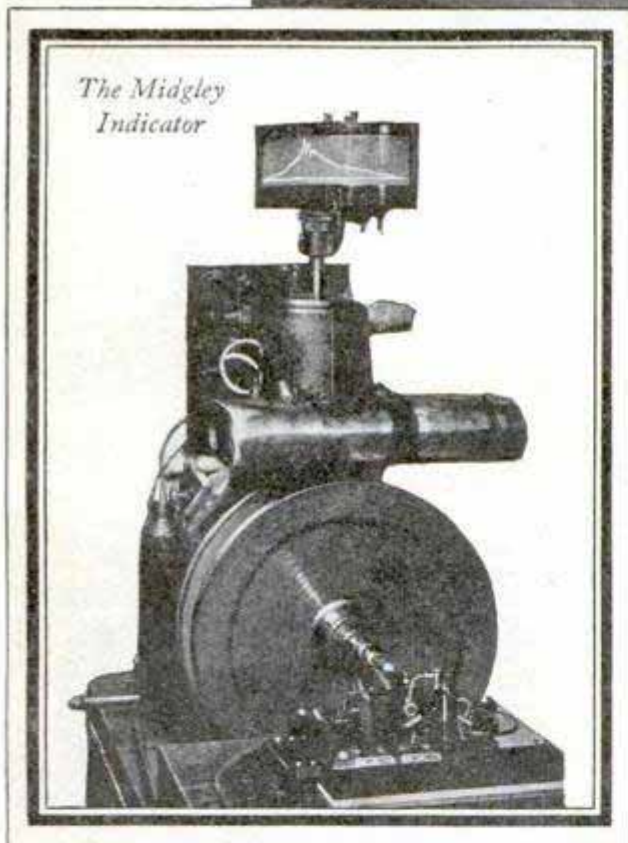
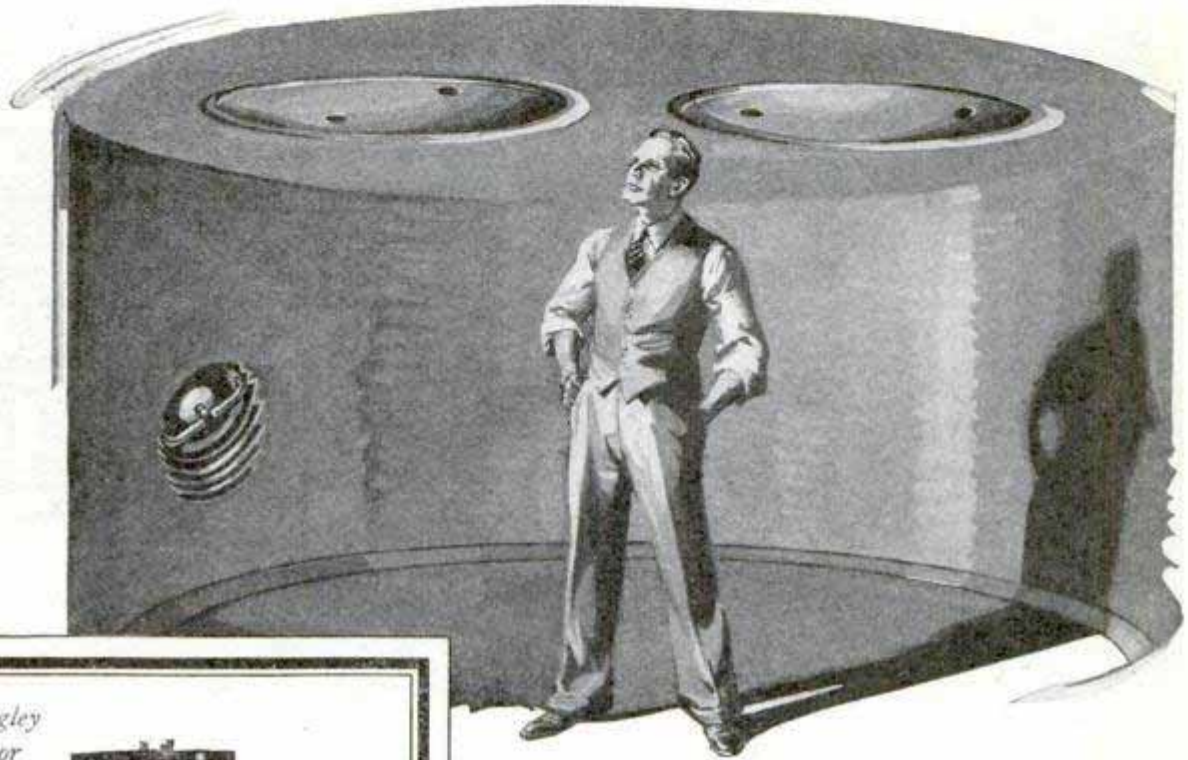

© E. G. C. 1929

THE famous Midgley Indicator was devised to enable the scientists in General Motors' Research Laboratories to look inside the closed cylinder of a gasoline engine.

The indicator is an ingenious and sensitive mechanism which records the pressure inside the cylinder while the engine is running. By studying these pressures the scientists found out exactly what caused an engine to "knock."

Gasoline, even the best, they found, explodes too fast when compressed beyond certain limits. So they developed Ethyl fluid, which controls the combustion rate under increased pressures.

Today Ethyl Gasoline—good gasoline to which Ethyl fluid has been added—has created a new standard of motoring efficiency and comfort. It has made possible the new so-called "high-compression" cars, and it improves the performance of older cars.

Try Ethyl in your car.

Ethyl Gasoline Corporation, 25 Broadway, New York City; 56 Church Street, Toronto, Can.; 36 Queen Anne's Gate, London, England.

ETHYL

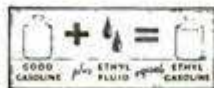

Knocks out that "Knock"

GASOLINE

NEW MODEL SOUTH BEND

LATHE BUILDERS FOR 24 YEARS

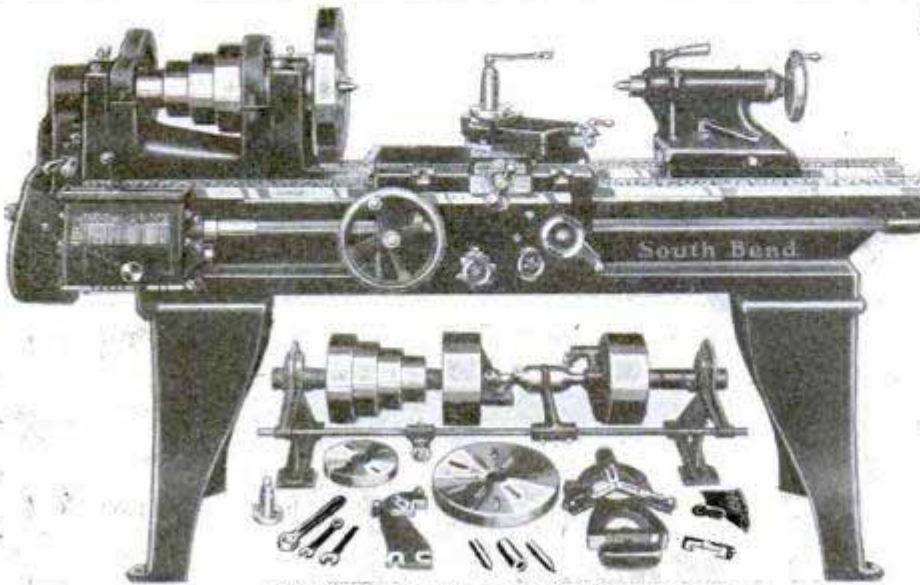

16"x6' Quick Change Gear New Model South Bend Lathe..... \$598.00

96 Sizes and Types of New Model South Bend Lathes

for the

- Manufacturing Plant
- Tool Room
- Machine Shop
- Service Station
- Electrical Shop
- Engineering Shop
- Laboratory
- Marine Shop
- Airport Machine Shop
- General Repair Shop

and
All Classes of Precision Screw Cutting and Machine Work.

Prices of Popular Sizes of Quick Change Gear Lathes with Lathe Equipment

Size of Lathe	Shipping Weight	Countershaft Drive	Silent Chain Motor Drive
9"x3'	490 lbs.	\$294.00	\$413.00
11"x4'	725 lbs.	\$359.00	\$526.00
13"x5'	1110 lbs.	\$443.00	\$645.00
15"x6'	1550 lbs.	\$543.00	\$749.00
16"x8'	2035 lbs.	\$638.00	\$846.00

A Few Recent Purchasers

- Standard Oil Company
 - Pennsylvania Railroad Co.
 - Eastman Kodak Company
 - Dohler Die Casting Company
 - Frigidaire, Inc.
 - General Electric Company
 - Commandaire, Inc.
 - Fokker Airplane Company
 - Victor X-Ray Company
 - Cadillac Motor Car Company
 - Formica Insulation Co.
 - Raytheon Man. Company
 - White Truck Company
 - General Motors Corporation
 - Victor Adding Machine Co.
 - Nicholson File Company
 - U. S. Government
 - Western Electric Company
 - Kohler of Kohler
- used in 78 countries

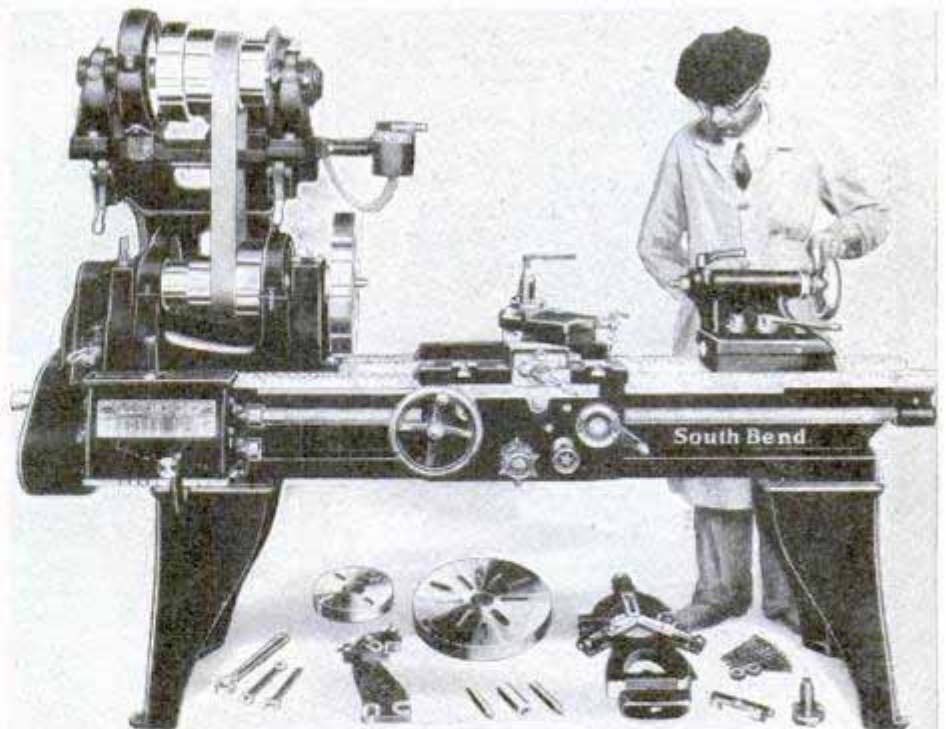

18"x8' Quick Change Gear Silent Chain Motor Driven Lathe..... \$1049.00



Established 1906

Lathe Builders Exclusively

The South Bend Lathe Works is represented by machinery dealers and importers throughout the world, who carry South Bend Lathes in stock.

SCREW CUTTING LATHES

OVER 46,000 LATHES IN USE

The New Model South Bend Lathe is a back geared, screw cutting engine lathe with improvements and new features that make it the most remarkable lathe value in the world. It is practical for handling the finest and most accurate work coming up in the modern plant and shop.

Easy Payments as Low as \$11.41 a Month

Our Easy Payment Plan allows you to install a South Bend Lathe by making one payment with the order the balance to be paid month by month the amount depending on the size of the lathe you select

Write for Catalog No. 90P which describes the Easy Payment Plan

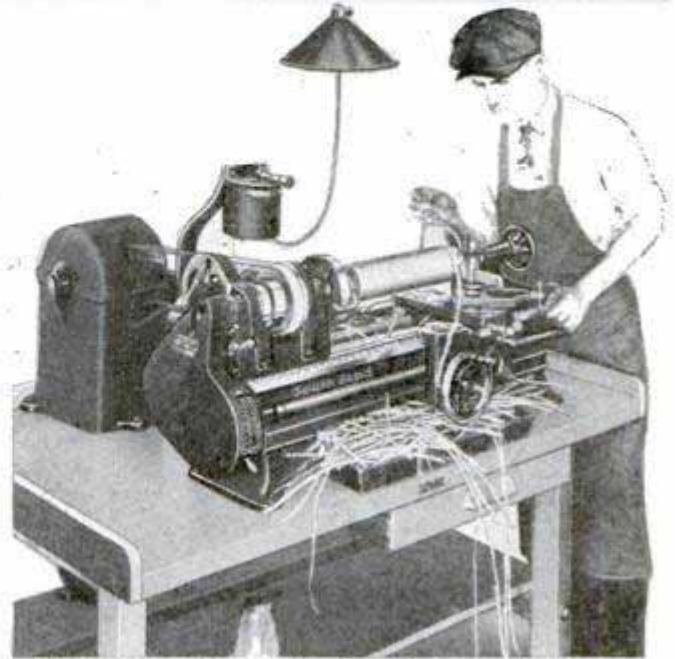

9"x3' New Model Junior Horizontal Motor Driven Bench Lathe complete..... \$254.00

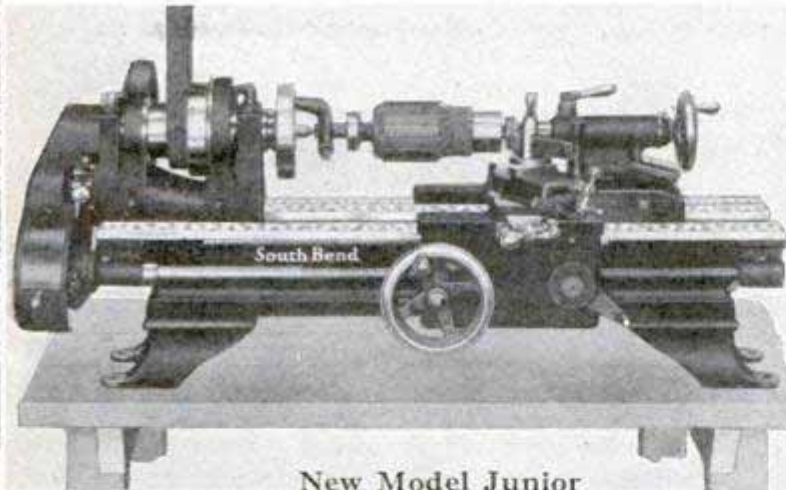

New Model Junior 9" x 3" South Bend Bench Lathe with Countershaft and Equipment \$169 Weight 375 lbs.

New General Catalog No. 90A just out illustrates and describes the 96 sizes and types of New Model South Bend Lathes from 9" swing to 18" swing.

Write for this free catalog mentioning size of lathe in which you are interested and 16 page Bulletin will also be sent describing lathe in detail.

Other 9-inch Junior Lathes
The Prices include Lathe Equipment

Size of Lathe	Shipping Weight	Countershaft Drive	Horizontal Motor Drive	Motor Drive Without Motor
9"x2½"	350 lbs.	\$163.00	\$248.00	\$165.00
9"x3"	375 lbs.	\$169.00	\$254.00	\$171.00
9"x3½"	400 lbs.	\$175.00	\$260.00	\$177.00
9"x4"	425 lbs.	\$182.00	\$267.00	\$184.00
9"x4½"	450 lbs.	\$190.00	\$275.00	\$192.00

SOUTH BEND LATHE WORKS
612 E. Madison St.
SOUTH BEND, IND., U. S. A.

Free Catalog Write for it

SOUTH BEND LATHE WORKS
612 E. Madison St., South Bend, Ind., U. S. A.
Gentlemen - Send free postpaid. () New Lathe Catalog No. 90-A () Time Payment Catalog.

Name.....
Address.....
City.....
State.....

Lift the hood

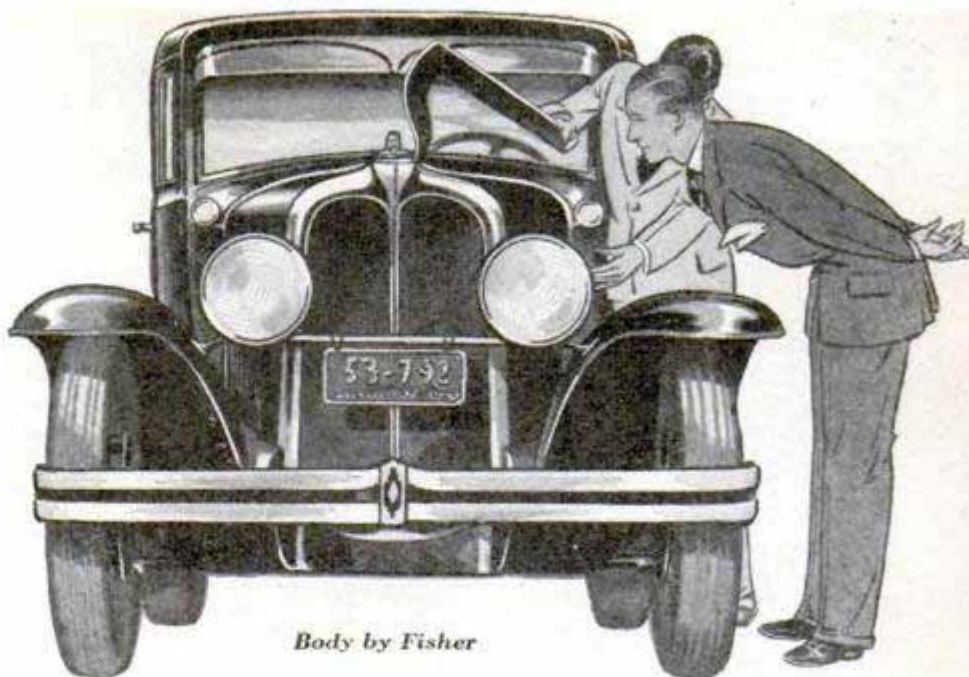

and you'll readily see why the Pontiac Big Six is mechanically the greatest value in its field

If you are interested in the "works" of a fine automobile, we promise you a real thrill when you lift the hood of the Pontiac Big Six. For there you'll see the "inside story" of why Pontiac is acknowledged the greatest motor car value at its price

Greatest for Power—200 cubic inch piston displacement, large L-head engine developing 60 brake horsepower at moderate engine speed—more power with less wear and strain.

Greatest for Speed—Ahead of anything in its class—proved by the "fifth wheel," the most accurate speed measuring device known to automotive engineers.

Greatest for Snap—Gets away like a dart—swiftest acceleration of any low-priced six—again proved by the "fifth wheel."

Greatest for Safety—Self-energizing internal-expanding four-wheel brakes—noiseless, unaffected by weather. Full tread axles—front and rear. Rugged hardwood-and-steel bodies by Fisher. Foot-controlled headlights, dimmed or brightened while both hands are free to guide the wheel.

Greatest for Durability—Prolonged top performance and longer life due to full pressure positive lubrication at all speeds—crankcase ventilation preventing dilution of oil—Harmonic Balancer eliminating torsional vibration—non-squeak brake bands often good for 30,000 miles—Cross-flow Radiator with automatic temperature control—no watching, no overheating.

Greatest for Economy—Low first cost, thrifty operation, high resale value. Of 996 cars of 33 makes operated in 1928 by one large corporation, Pontiac cost one cent less per mile than any other low-priced six used!

In addition, Pontiac's long, low lines, its smart chrome plating, refreshing Duco color combinations and roomy, luxurious bodies by Fisher supply the finishing touches that mean greatest satisfaction, comfort and convenience for every dollar invested. See your nearest dealer, drive the Pontiac. You'll be amazed at how easily you can own this leader of low-priced sixes.

Pontiac Big Six, \$745 to \$895, f. o. b. Pontiac, Mich., plus delivery charges.

OAKLAND MOTOR CAR CO., PONTIAC, MICH.

PONTIAC



BIG SIX

\$745
2-DOOR SEDAN
F. O. B. PONTIAC, MICH.

PRODUCT OF GENERAL MOTORS



Hello boys!

Tell'em you built it with

GILBERT "Big-Boy" Tools

"Constructed for Service"

BOYS, here's your chance to give Mother and Dad the surprise of their lives! Build furniture, airplanes, toys, bird houses, and hundreds of other practical things. Tell Dad you'll start right in as soon as you get your Big Boy Set. Lift the lid of one of my big red brass-bound tool chests and you open up a whole new world of exciting thrills. Call in your pals. Oh, Boy! How their eyes will pop! Boy Builder's Plan Book tells exactly how each job is done. And there's a tool for every purpose.

Find out right away how smart you are with your hands. Look over my Big Boy Tool Chests and machine shop outfits at any good store. Pick out your set and start right in building wonderful things.

A.C. Gilbert

When You Buy Your Tool Chest See that you get these Feature Tools

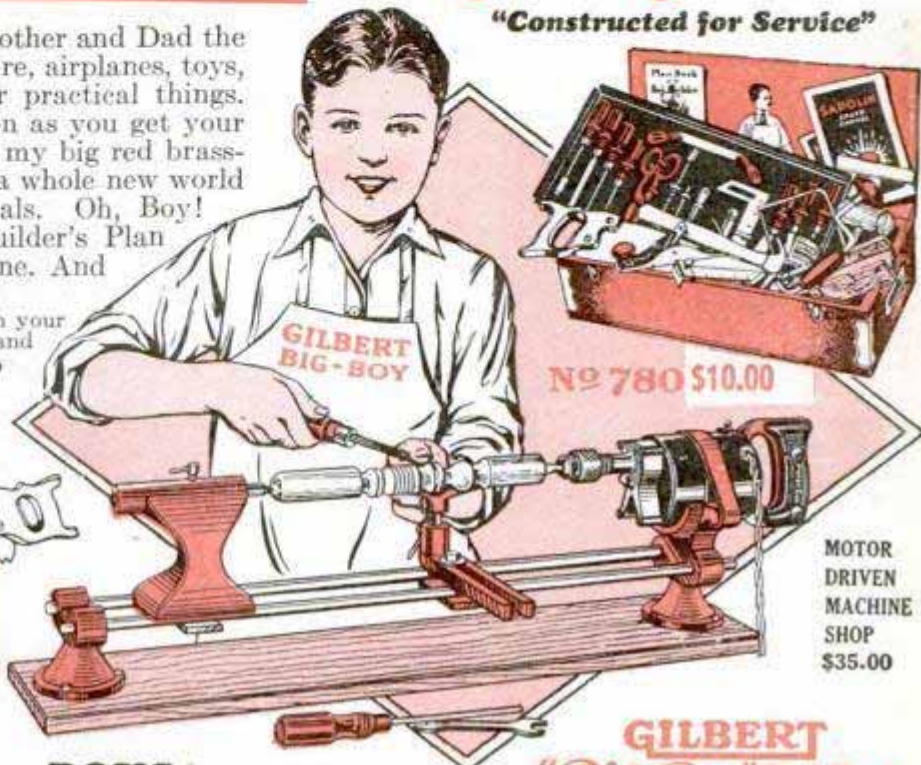

No 780 \$10.00

MOTOR DRIVEN MACHINE SHOP \$35.00

LET'S GO!

Boys, want to make things hum? My brand new Motor-Driven Machine Shop is the greatest thing I've made for boys since I invented Erector. A complete scientific workshop—a combination portable lathe, demountable drill, emery wheel, scratch brush, buffing wheel, etc. And—Boy, here's news, this workshop's equipped with a 1/8 H. P. Universal Motor and A. C. or D. C., with toggle switch, cord and plug. Send the coupon and get the booklet that tells you all in words and pictures.

BOYS!

This big (No. 780) is the treasured possession of thousands of red-blooded boys. They wouldn't swap it for a million dollars. 26 pieces in all—18 pounds of scientific fun—the kind of fun you'll never get tired of. Real he-man tools for the boy builder. Two complete books that show clearly and exactly how to build hundreds of wonderful useful things. See "Big Boy" at your favorite toy shop.

A. C. Gilbert's Free Plan Book

Send for your copy of my Plan Book, which tells how to construct dozens of interesting things, including Toys, Bird Houses, Household Utilities, Boats, Etc. PLANBOOK and catalog describing various Big Boy Tool Chests come to your door free for the asking. Just fill out the little coupon below and mail to-day.



FREE! Send for it!

GILBERT "Big-Boy" Tool Chests Consist of DAD'S SIZE

- HOUSEHOLD TREASURE CHEST No. 780. 26 pieces of real he-man tools including big 16-inch cross cut saw and 7 1/2 inch plane. A regular outfit. Two plan books and color chart. Packed in brass-bound chest. Sapolin speed enamel.....\$10.00
- THE MASTER CARPENTER SET No. 785. Practical selected high grade tools. 33 pieces, 2 plan books and color chart. 15-inch steel level, 16-inch cross-cut and dandy keyhole saw, also 9-inch plane. Packed in brass-bound chest. Sapolin speed enamel.....\$15.00
- THE DELUXE CARPENTER SET No. 790. Feature set of Big Boy line. 37 pieces including 9-inch plane, ratchet brace, 15-inch level, 20-inch cross, 18-inch rip, and dandy keyhole saws. 2 plan books and color chart. Every needed tool for master builders. Packed in big red chest, brass corners and lock. Sapolin speed enamel.....\$25.00

BOY'S SIZE

- LITTLE FELLOW'S SET No. 701. Contains 11 pieces with plan book.....\$1.00
- DANDY BIG SET No. 701E. The set for the beginner. Contains 12 pieces with plan book.....\$1.50
- PRACTICAL YOUNG CARPENTER'S SET No. 702. 16 pieces with plan book....\$2.50
- HANDY SET No. 707. Practical set for boys, 19 pieces including plan book....\$3.50
- FAMOUS No. 765. Feature set in Boy's Size Group. Dandy Set. 24 pieces. Real tools for practical service. Packed in big red chest with plan book.....\$5.00

THE NEW 1929 LINE INCLUDES THESE IMPORTANT DESIRABLE FEATURES

When you are looking for a Genuine Chest of Tools, be sure to get these big exclusive features contained in the Dad's Size Chests.

1. Big Boy Tool Chests have more and better tools than other chests of equal value.
2. All metal spirit level in No. 785 and up.
3. High quality ground faced block plane in No. 765 and No. 780.
4. Bench plane, the kind that real carpenters use, in No. 785 and up.
5. Sapolin color chart, Home Manual, Plan Book and Sapolin Speed Enamel, in all Dad's Size Chests.
6. New 1929 Plan Book in all sets.
7. Carpenter's apron in No. 785 and up.
8. Drop forged hammers in Dad's Size Chests.
9. Big Boy Saws.
10. Metal Tray.
11. Big red brass-bound chest.

THE A. C. GILBERT COMPANY, NEW HAVEN, CONN., U.S.A. Manufacturers of the Famous Erector and Chemistry Sets, Magic, Motors, Etc.

A. C. Gilbert's Radio Sports Talks. See Station Listings Page 133

THE A. C. GILBERT COMPANY, 97 ERECTOR SQUARE, NEW HAVEN, CONN. Please send me free copy of Plan Book and Gilbert Toy Catalog.

NAME.....
STREET.....
CITY.....

an entirely new principle in micrometers

No. 24

Range 0 to 1" by ten-thousandths of an inch.

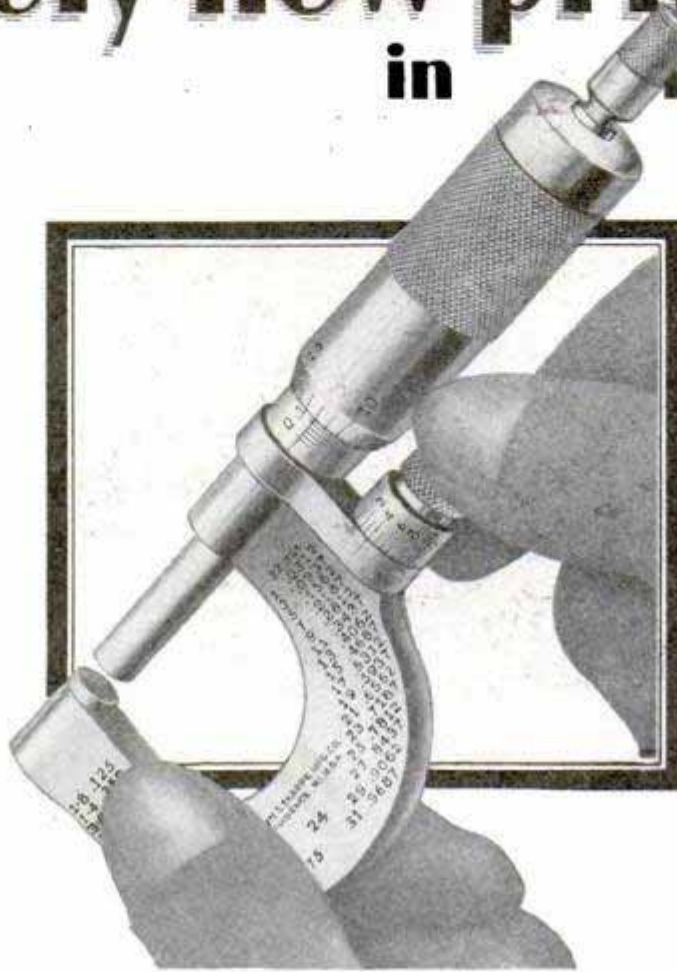

*A better way to read
ten-thousandths*

The new Brown & Sharpe Micrometer Caliper No. 24 measures direct by ten-thousandths in a new, easy way. Ten-thousandths can be read as easily and positively as thousandths on an ordinary micrometer. Notice the widely spaced graduations on the lower thimble where the ten-thousandths are read.

Compact in design, easily used, easily read—there are no gears or intricate mechanisms to get out of order.

Ask your dealer to show you this new micrometer or write us for circular. Dept. P. M., Brown & Sharpe Mfg. Co., Providence, R. I., U. S. A.



"WORLD'S STANDARD OF ACCURACY"

BROWN & SHARPE TOOLS

*Lionel Electric Trains
are priced from
\$7.00 to \$325.00*

*Send for the FREE
Lionel Railroad
Planning Book.*



HERE'S A LIONEL ELECTRIC RAILROAD THAT ANY BOY CAN BUILD

THIS photograph tells the whole story better than a thousand words. It shows you how *Lionel Model Electric Trains* look in action! It pictures the realism of these remarkable locomotives and cars. It shows you what you can do with your *Lionel* trains and accessories this Christmas.

With such a *Lionel Electric Railroad* you learn many of the details of actual railroading, for *Lionel Railroad Systems* are true-to-life models of the big railroads of the Country.

See the new *Lionel Steam Type Loco*—electrically driven by the famous *Lionel "Bild-A-LoCo"* motor—the motor that may be removed in a jiffy, taken apart and reassembled again.

Also, see the new *Lionel electric type locos*. These "Giants of the Rails" are the most powerful model electric locos ever built.

LIONEL ELECTRIC TRAINS

Model Railroad Accessories • "Multivolt" Transformers

Remember, too, that *Lionel* trains can be controlled and operated by *Lionel "Distant-Control"*—which enables you to start, stop, reverse or switch your trains at any distance from the track. This is a feature that every boy is enthusiastic about.

Write for the catalog today—it shows all the new *Lionel* models. See the *Lionel* demonstrations at your local stores.

ON THE RADIO STARTING NOV. 8th

Every Friday night, 6:30 to 7:00 Eastern Standard Time, "Uncle Don" and his *Lionel Engineers' Club* over stations WOR, WLW and WBBM. Listen-in and enjoy this wonderful *Lionel* radio program, and laugh with "Uncle Don."

BOYS: SEND FOR FREE BOOK

FREE: Don't delay another instant. Write today for a FREE copy of the new *Lionel* 46 page handsomely illustrated *Railroad Planning Book* and catalog, and pick out the set you want for Christmas. The *Lionel Corporation*, Dept. C, 15-17-19 East 26th St., New York City



THE LIONEL CORPORATION, Dept. C, 15-17-19 East 26th Street, New York City

Announcing—

The NEW 1930 Models

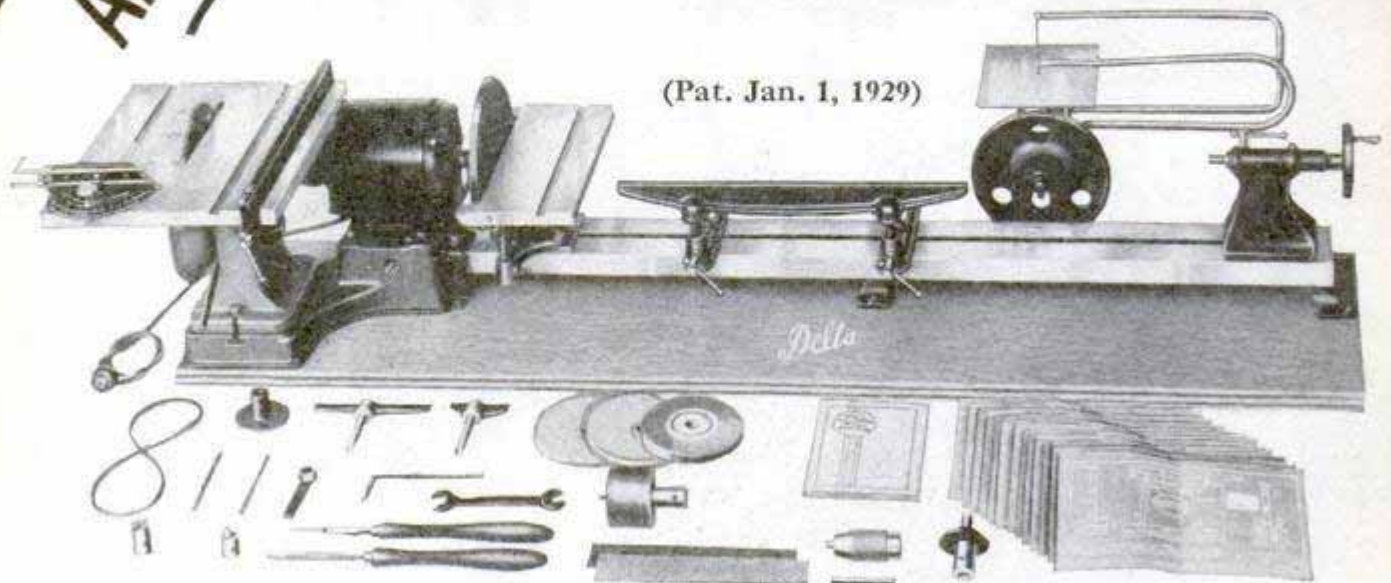

(Pat. Jan. 1, 1929)

"Delta" Electric Handi-Shop

A complete motorized workshop for craftsmen including all necessary equipment for Circular Sawing, Wood Turning, Scroll Sawing, Sanding, Drilling, Grinding and Buffing. Full instructions and blue prints furnished.

New "DELTA" Moulding Cutter

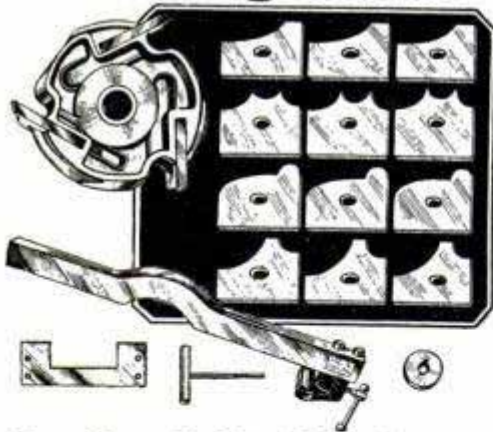

Cuts Over 50 Moulding Shapes With Only 4 Sets of Blades

Interchangeable high speed blades produce over 10,000 cuts per minute at 3500 RPM. Blades require no individual adjustment. Quickly and easily locked in position. Special guide fence. Unusually low price. Below are a few of the many attractive mouldings that can be made with this Delta Moulding Cutter.

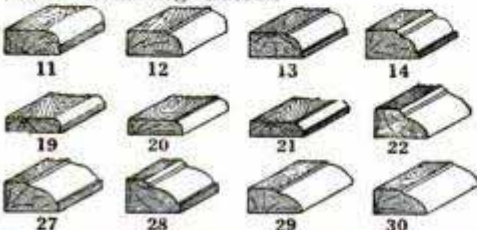

Practical Design—Dependable Quality Plus Many Exclusive Features

that's what you find in every woodworking unit bearing the Delta trademark. Craftsmen, artisans, farmers, mechanics—all who use wood in their daily labors or spare-time hobbies—are delighted with the sturdy construction, splendid efficiency and moderate cost of Delta equipment. They appreciate keenly such practical constructional features in the Handi-Shop as:

1. Two-shaft motor that permits carrying on two important operations at one time without continually dismantling set-up.
2. Heavy U-shaped Lathe Bed (no rods) guaranteed not to chatter.
3. Automatically Oiled Bronze Bearings.
4. Patented Tilting-Tables.
5. Circular-Saw Raising lever.
6. Absence of interference when sawing large pieces of lumber; and many other important improvements found only in Delta products.

10-DAY TRIAL EASY TERMS

For complete details and full description of the new 1930 Delta line, send coupon for FREE illustrated literature. You will learn also how you can try any Delta equipment for 10 days under actual working conditions at our risk. Your choice of three convenient payment plans. Mail coupon on opposite page today. It describes numerous items of interest to those who work with wood.

Delta SPECIALTY Co.

Delta Woodworking Units

for HOME CRAFTSMEN, FACTORIES,
SHOPS, CONTRACTORS AND FARMERS

The introduction of the Delta Jointer and Circular Saw Units marks a new era in moderate-priced woodworking equipment. Now, for the first time, are available sturdy, practical machines in compact, convenient form at price levels astonishingly low. The new Delta Units include:

Combination 4-Inch Jointer 8-Inch Circular Saw Motor Driven

A convenient, efficient combination. Permits sawing, sizing, and smoothing in one quick operation. Both Jointer and Circular Saw are run from the same motor with separate belts. Neither Unit interferes with other. Can be operated together or separately. Mounted on sturdy welded steel stand of convenient height. A rugged portable outfit at an attractive low price. Furnished with or without motor as desired.

4-Inch Jointer Unit

Consists of new Delta 4-inch Jointer mounted on separate welded steel stand. Produces smoothly finished work in surprisingly short time. Built to give years of satisfactory dependable service on production work. Incorporates numerous exclusive features such as Self-Aligning Fence with accurate graduations permitting fence to be set quickly at any angle from 0°-45°; Fool-proof guard; Automatically-oiled bronze bearings; Non-slipping V-belt drive. Furnished with or without motor.

8-Inch Circular Saw Unit

Consists of new Delta 8-inch circular saw on gracefully designed welded steel stand. Practical design and sturdy construction make it ideal for steady production work. Has Automatically-oiled bronze bearings; Patented tilting table; practical Miter-gage and Rip gage; Raising and Lowering Crank Screw permitting micrometer-like adjustment; V-belt drive. Furnished with or without motor.



4-Inch
Jointer
Unit

8-Inch
Circular
Saw Unit

"DELTA"
Means Quality in
Every Detail

Send coupon today for FREE Illustrated Literature showing many items of interest to those who work with wood.

Dept. A.129

Division of Delta Manufacturing Co.
1661-67 HOLTON ST. MILWAUKEE, WIS.

Delta Specialty Co., Dept. A.129
Division of "Delta Manufacturing Co."
1661-67 Holton St., Milwaukee, Wis.

Please send me without obligation, FREE Illustrated literature showing new 1930 Delta line. Also full details of your 10 day trial offer and easy terms.

- (Check proper square)
- I am particularly interested in Delta Electric Handi-Shop.
 I am interested in new Delta Woodworking Units.

Name

Address

Ride Away

—Get the THRILL of Your Life

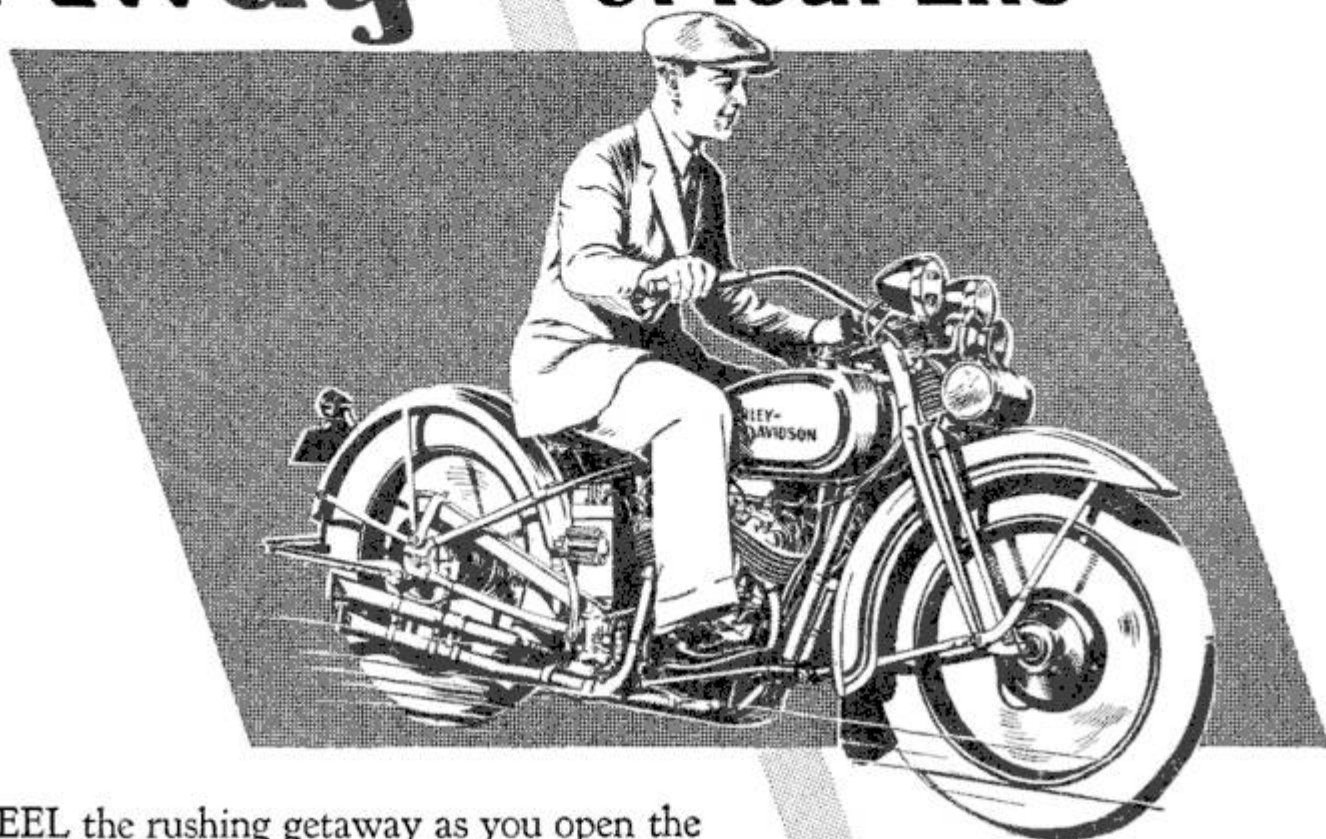

"45 Twin" for 1930
— a very popular model. The ideal solo motorcycle.

FEEL the rushing getaway as you open the throttle — the quiet speed as you flash down the road — the eager power as you zoom over a hill!

That's motorcycling, on a Harley-Davidson 45 Twin — and no other sport has such a "kick". You will find new thrills every mile— whether you ride on long tours, short jaunts, or just to work and back. And the total cost is barely 2 cents per mile, including everything.

Let your nearest Harley-Davidson Dealer show you the 1930 models — look over their new features and improvements. Ask about his Pay-As-You-Ride Plan.

*Mail the
Coupon!*

HARLEY-DAVIDSON

Motorcycles

Mail This Coupon

—for literature showing our full line of Singles, Twins, and Sidecars. Prices range from \$235, f. o. b. factory.

HARLEY-DAVIDSON MOTOR CO. Dept. P., Milwaukee, Wis.
Interested in your motorcycles. Send literature.

Name.....
Address.....
My age is 12-15 years 16-19 years 20-30 years 31 years and up.
Check your age group.

not
just making things . .

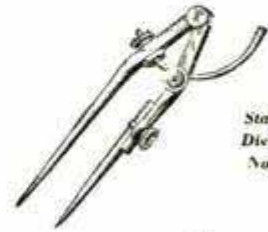
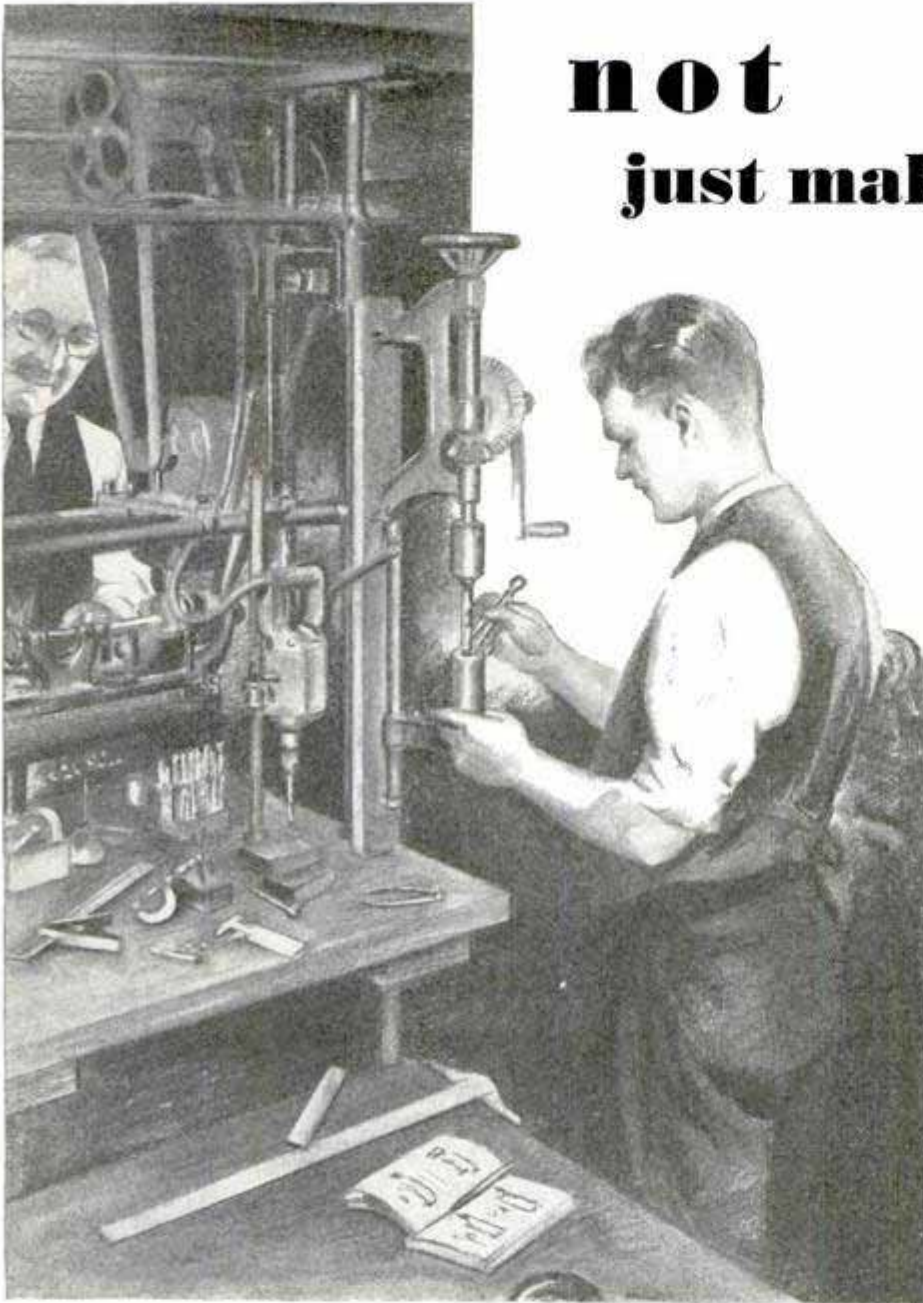

Starrett
Dividers
No. 92



Starrett
Micrometer
No. 320



Starrett
Combination
Square No. 94



Starrett Pistol
Grip Hack Saw
Frame No. 153

NOT just making things, but making them right—that's the big kick you get out of your shop down cellar when you work with Starrett Tools.

Each of the Starrett Tools shown here—and many another besides—should be in your tool-chest. They are accurate, practical, dependable.

Write for Catalog No. 24 "AP" showing over 2500 Starrett Tools. Your dealer will be glad to show you the tools you select.

THE L. S. STARRETT CO.

*World's Greatest Toolmakers
Manufacturers of Hacksaws Unexcelled
Steel Tapes—Standard for Accuracy
ATHOL, MASS., U. S. A.*

Use Starrett Tools

>> ON DUTY WITH THE NEW YORK STATE POLICE

FROM THE CANADIAN BORDER TO LONG ISLAND
SOUND, PATROL CARS CARRY THIS UNFAILING
WINTER PROTECTION « « EVEREADY PRESTONE



READ what Major John A. Warner, Superintendent, has to say about the use of Eveready Prestone, the perfect anti-freeze, in the cars used by the New York State Troopers in the performance of their duties:

"We have had no single instance where complaint has been found with it. It has been employed under the most trying of weather conditions. Frequently our men are on the open roads for hours at a time, during which their cars must function under all sorts of stress and strain.

"It is gratifying to us that during the past two years Eveready Prestone has contributed so materially to the success with which the State Police have been able to carry on their work."

Wherever men, engaged in hazardous cold-weather duties, entrust their lives and reputations to motors, there you will find Eveready Prestone. At Army flying fields. At Navy air stations. With Commander Byrd in the Antarctic. And one supply of Eveready Prestone will provide your motor with the same complete, permanent protection against freezing. It possesses all the properties pointed out by the National Bureau of Standards as essential for an anti-freeze.

A single supply added to the

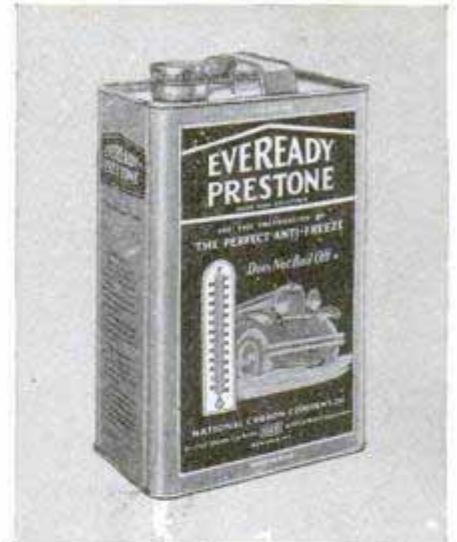

Eveready Prestone does not contain any alcohol or glycerine.

9 POINTS OF SUPERIORITY

- 1 Gives complete protection.
- 2 Does not boil off.
- 3 Positively will not damage cooling system.
- 4 Will not heat up a motor.
- 5 Circulates freely at the lowest operating temperatures.
- 6 Will not affect paint, varnish or lacquer finishes.
- 7 Non-inflammable.
- 8 Odorless.
- 9 Economical—one filling lasts all winter.

EVEREADY PRESTONE

FOR PREPARATION OF THE
PERFECT ANTI-FREEZE

radiator will provide trouble-free surety against all freezing hazards through all kinds of weather. You can buy it at the nearest garage, filling station, automobile supply shop or hardware store.



Thoroughly tested and 100% approved by the American Automobile Association.

NATIONAL CARBON CO., Inc.
General Offices:
New York, N. Y.

Branches: Chicago Kansas City
New York San Francisco
Unit of  and Carbon Corporation

The New 1930
Waco
Red Jacket

INVITES
YOU
TO

BE A REAL CRAFTSMAN

Enjoy the thrill of your new skill in making things this modern motorized way!

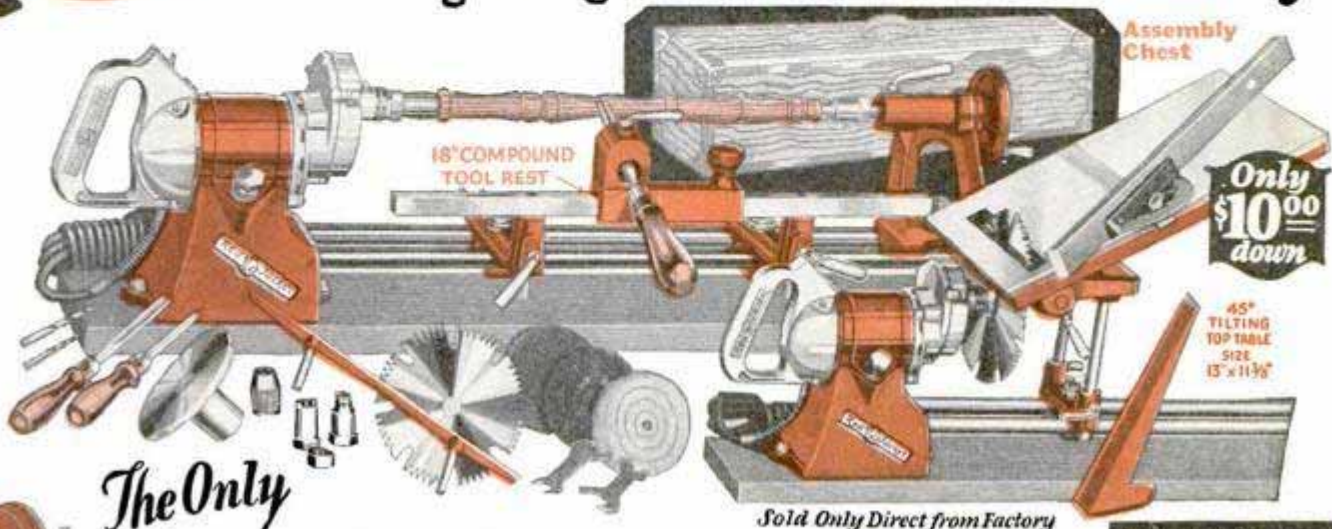

Assembly Chest

18" COMPOUND TOOL REST

Only \$10.00 down

45° TILTING TOP TABLE SIZE 13" x 11 3/8"

Sold Only Direct from Factory

The Only

Complete Interchangeable Power Shop - Improved Features - Exclusive Advantages

The right kind of tool-equipment is even more necessary than your own ability and desire. Now, you can do the things you long have wanted to—at home in your own modern motorized work shop—with this new, improved Waco Red Jacket Wonder-Shop. No other compares with it in its complete, interchangeable, power features, efficiency, exclusive advantages and quality.

Join the Happy Family of Waco Wonder-Shop Workers

Red Jacket Equipment is designed, tested, approved and guaranteed by Wm. L. Aylward, a nationally known craftsman and manufacturer who has developed his own life's hobby into a cooperative association of thousands of amateur and professional craftsmen. He invites you to join. He will instruct, guide and help you. A new zest in doing things awaits you.

The new 1930 Red Jacket Combination brings you the powerful Red Jacket Master Drill Motor with direct drive to the Waco Craftsman's Wood Turning Lathe (capacity 9" x 36"), Compound and 18" Rests, Tilting Top Mitre Saw with both depth and side gauges, Sander Disk, Scroll and Jig Saw, Improved Band Saw, and all accessories for both portable and stationary power drilling, buffing, grinding and cleaning. Attaches to light socket. Converts your work bench into a complete private tool and machine shop—a complete chest full of electrically driven tools for your own private use.

Add New Special Equipment Any Time as Desired

Take your choice of four different assemblies to fit your present ideas and uses. Any time you wish to expand or add new special equipment you can do so. The Waco Red Jacket Assortment is the most complete available anywhere. *Avoid Imitations!* Waco Red Jacket is the pioneer—foremost in the field—sold only direct from the factory; not through stores.

Professional Quality and Efficiency

The choice of professional as well as home craftsmen. Red Jacket Shops are making money for their owners all over the country. You can be one of the Red Jacket Guild chain and market your products if you want under our new plan.

Buy It NOW On Easy Terms

Only \$10 down. Easy monthly payments. Liberal discount for cash. No hardship to own a Waco Red Jacket. You can make it more than pay its way in profits if you want, as well as in the pleasure of doing things for yourself.

Send NOW This Coupon for Interesting Literature

FREE Detailed descriptions and specifications. You will be surprised and fascinated by the possibilities afforded. Just see what you can make and do. Fill in and MAIL TODAY.

WACO TOOL WORKS, Inc.
5216 W. Kinzie St., Chicago, Ill.

Manager, Dept. 112: Please send me all free information and literature on Red Jacket Assemblies and FREE Services.

Name

Address

City and State



45° Tilt - Top Table Band Saw

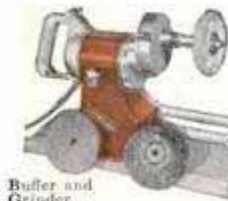

Buffer and Grinder Assembly



Belt Drive Jig Saw

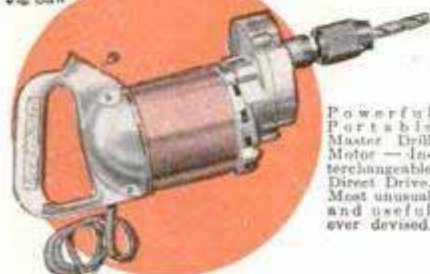

Powerful Portable Master Drill Motor - Interchangeable Direct Drive. Most unusual and useful ever devised.



Auxiliary Head Stock—For any kind of power hook-up.

Make Them Yourself!



Special Craft Course FREE

All there is to know about handcraft methods, raw materials, carving, turning, sawing, designing, etc., etc., is taught you by correspondence.

FREE Blue Prints

The WACO GUARANTEE

If it is not what you want when you get it—send it back.



Gee, Dad! Couldn't We Have Fun with One of Those Chests!

A set of tools—what do they mean? To the boy—boats and airplanes and swords and heaps of shavings; to Dad—a workshop—hours of interesting recreation with his boy.

Boys or men, the fascination is the same. Why not a chest of Stanley Tools for them this Christmas? There are ten different sets all packed in sturdy chests. From \$10.85 to \$90, there is one to fit every purse.

There are also twenty-five Stanley Plans giving step by step instructions how to make twenty-five useful household articles. The book, "How to Work with Tools and

Wood," is a practical textbook and guide for tool users. Plans cost 10c each; book, \$1.00.

Your hardware dealer will be glad to show you these tool chests. Ask him for a copy of Stanley Tool Chest Catalog No. S35d or send to us for a copy.

THE STANLEY RULE AND LEVEL PLANT
NEW BRITAIN, CONN.



STANLEY TOOL CHESTS



Hello boys! now you can build this Giant Air Liner with **ERECTOR**

HELLO, BOYS! The boy who gets my new TRAIL BLAZING No. 8 ERECTOR for Christmas will sure be the talk of the town. When you've built your 5-foot model of a real trans-atlantic Zeppelin, your pals will flock from miles around to look it over—with its giant silver bag, gondolas, propellers, landing mast. And that's not all. You can build almost every mechanical invention you can imagine.

Think what a thrill you'll get building these wonderful models that whiz and hum along when operated with your big powerful Erector electric motor. Airplanes, Automobiles, Trains, Steam Shovels, Locomotives, Derricks, Bridges, Power Plants, are only a few.

Now, boys, here's the way to get this barrelful of red blooded fun. Send for the amazing Mysterious Erectorscope and Catalogue that tell all about Erector. Show it to your Dad—then take him to any good toy store. Let him see Erector himself. It's a sure way to get the World's Greatest Toy for Christmas.

A.C. Gilbert

SUNDAY
AFTERNOONS

Tune in on
**RADIO'S
ZIPPIEST
FEATURE**

A. C. Gilbert's Famous
Sports Talks

Let me introduce to you Babe Ruth and other great Sports Heroes of 1929! Hear them broadcast their inspiring messages to the boys of America. Every Sunday afternoon beginning November 10th. Remember the Time—5:30 Eastern Time, 4:30 Central Time, 3:30 Mountain Time, 2:30 Pacific Time. Cut out the list of stations below and choose the one you get best on your radio receiver.

- WEAF New York
- WEEI Boston
- WJAR Providence
- WTAG Worcester
- WCSH Portland, Me.
- WFI Philadelphia
- WCAE Pittsburgh
- WRC Washington, D. C.
- WGY Schenectady
- WGR Buffalo
- WSAI Cincinnati
- KYW Chicago
- WWJ Detroit
- KSD St. Louis
- WCCO Minneapolis, St. Paul
- WOC Davenport
- WHO Des Moines
- WOW Omaha
- WDAF Kansas City
- WTMJ Milwaukee
- WEBC Superior, Wis. & Duluth
- KOA Denver
- KSL Salt Lake City
- KFO San Francisco
- KOMO Seattle
- KFI Los Angeles
- KGW Portland, Ore.
- KHQ Spokane

and other N. B. C. Chain
Radio Stations.



THE TRAIL BLAZING NO. 8, The Set That Builds the Zeppelin, \$25
The giant ship of the skies, and hundreds of other great inventions. Includes girders for Zeppelin frame and landing mast, silver bag, gondolas, propellers, stabilizers, and in addition includes all the parts of the Sensational No. 7 1/2 Erector.

SENSATIONAL NO. 7 1/2 Motorized Erector BUILDS the CHASSIS, \$15

Here's the set I know will give you the greatest thrill you ever had. Fun? Oh, Boy! It's the real thing. From this great assortment you can build over 800 models. Automobile Chassis, Tractors, Scooters, Fire Engines, and a Hook and Ladder are only a very few. Packed in a big, red, brass-bound chest: 15 inch steel truck body, steel model building tray, 88 page manual, powerful electric motor, completely assembled gear box, steel disc wheels, oversize balloon tires, fenders, radiator, hood, bumper, springs, steering wheel, heavy truck axles, cab top, steam boiler, steam shovel—in fact, 25 lbs. of scientific thrills for every day of the year.

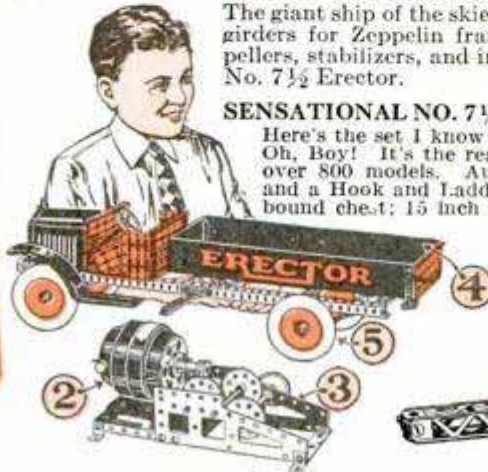

Why the New 1929 ERECTOR is the world's greatest toy

1. PATENTED ERECTOR GIRDER. A real genuine girder like engineers use. The interlocking edge, a novel, exclusive ERECTOR feature, eliminates bending and makes it possible to connect two girders, sturdy and strong, with a single bolt and nut, and a four piece square girder with two screws only. (In all Erector Sets.)
2. PATENTED ERECTOR MOTORS. Powerful Battery Motor in No. 4, 6, 7, 7 1/2 and 8. Famous Polar Cub 110-volt Universal Motor in No. 9 and 10.
3. PATENTED ASSEMBLED GEAR BOX. Adaptable to every possible gear combination, and for reversing movements. Convertible into 3-drum hoisting engine. Standardized for use with either battery or 110-volt Motor. Included assembled in the Famous No. 4 Set and up.
4. HEAVY STEEL TRUCK BODY. 15 inches long. Exclusive ERECTOR feature. In No. 7 1/2 Set and up.
5. 3 3/4 INCH SOLID STEEL DISC WHEELS WITH BALLOON TIRES. An exclusive ERECTOR feature. In No. 7 1/2 and up.
6. PATENTED BIG GIANT CHANNEL GIRDERS, straight and curved. Electrically baked in brilliant red. Exclusive ERECTOR feature. In No. 7 and up.
7. LARGE STEEL MODEL BUILDING TRAY, pierced with ERECTOR standard holes. Patent pending. Exclusive ERECTOR feature. In No. 6 and up.

NEW ERECTOR ZEPPELIN FEATURES

Patented Erector Zeppelin girder, silver bag, gondolas, propellers, stabilizers, rudders, etc.

OTHER EXCLUSIVE SENSATIONAL FEATURES

Patented curved girders (in all sets); giant fly wheel machine frame (making possible the building of machinery models); Patented duplex base plate (double standard holes), making it possible to use axles of two sizes; Erector Dredge Bucket, Tip Bucket.

EXCLUSIVE MECHANICAL WONDER FEATURES

Duplex Plate, Cam, Flat and Cone Pulleys, Quarter and Internal Gears, Eccentric Loop, etc.

EXCLUSIVE ERECTOR AIRPLANE FEATURES

Fuselage, wings, cylinders, propellers, stabilizers, rudder, pontoons, struts, nose, swivel.

SENSATIONAL AUTOMOTIVE FEATURES

Truck body, fenders, radiator, hood, axles, steering wheel and knuckle, springs, bumper, heavy duty disc wheels, etc.

FREE! As long as they last
A. C. GILBERT'S AMAZING
AND MYSTERIOUS
ERECTORSCOPE

The first lucky 100,000 boys will get absolutely free the Mysterious Erectorscope. It will fool the smartest boy. You have never seen anything like it. Just look through the Erectorscope; you will not believe your eyes. Everybody will want to look through it. Mail the coupon today, and get your Erectorscope and Gilbert Toy Catalog.



Famous ERECTOR Sets

- THE NEW BIG NO. 7.** The Set that builds the Steam Shovel. **\$10.00**
- THE WONDERFUL NO. 6.** In the Big Red Chest with the Steam Boiler. **\$7.50**
- THE FAMOUS NO. 4.** With powerful Electric Motor and Gear Box. **\$5.00**
- DANDY BEGINNER'S SET NO. 1.** The Set that builds the Square Girder. **\$1.00**
- THE ADVANCED NO. 3.** The Set with the long girders. **\$2.50**
- THE GIANT NO. 9.** The Mechanical Wonder Set, with 110-volt Motor. **\$35.00**
- THE DELUXE SET NO. 10.** Complete, Unsurpassable, ERECTOR in all its glory. **\$50.00**
- ERECTOR ELECTRICAL SET NO. 3005.** The Set that electrifies and illuminates. **\$5.00**
- THE BIG GIRDER SET NO. B.** The Set that builds the Ferris Wheel. **\$9.50**
- ERECTOR AIRPLANE SET NO. C.** Files by an electric motor **\$10.00**

Also Manufacturers of
**BIG BOY TOOL CHESTS,
GILBERT CHEMISTRY, AND
MYSTO-MAGIC**

THE A. C. GILBERT CO.
123 Erector Square, New Haven, Conn.

Please send me my free copy of the Mysterious Erectorscope and Gilbert Toy Catalogue.

Name.....
Street.....
City.....State.....

All Around the World!

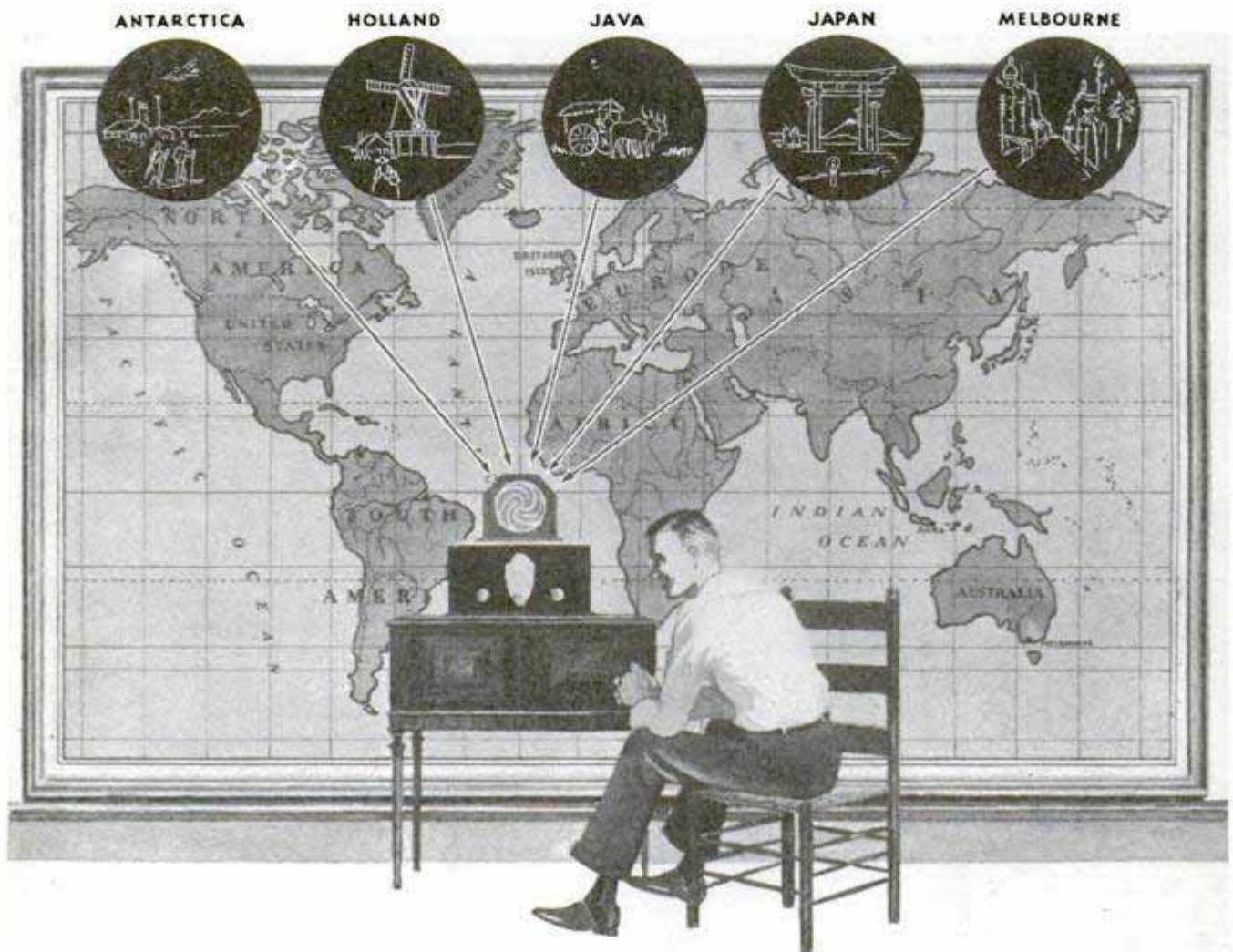

YOU can hear words and music from Java, Australia, England, France,—from all around the world,—with the NATIONAL Screen-Grid SW-4 THRILL BOX.

Already many famous broadcasting stations abroad and in this country are putting their regular programs on the short waves, too. More and more stations are doing this. These broadcasts may be received anywhere else in the world, in cities, in the country, at the frozen poles, in the jungles and the deserts, with the NATIONAL THRILL BOX.

This simple Four-Tube Screen-Grid THRILL BOX is a trim, neat receiver with single dial tuning and smooth sensitivity-control. It is free from annoying radiation and the design eliminates "tuning holes," formerly a troublesome short-wave difficulty. The special audio system with 171-A Power Tube gives excellent loudspeaker operation, and the plate supply may be taken from the

lighting circuit, through the NATIONAL Velvet-B,—a feature not usually found in shortwave receivers. The interchangeable tuning transformers are kept in special storage sockets *inside* the cabinet, protected from dust and damage, and always ready for use.

The cabinet itself is more than just a box. It is of simple and very attractive design and finish, which harmonizes with the most tasteful surroundings.

Write us for full information and prices today mentioning Popular Mechanics Magazine.

NATIONAL COMPANY INC.
ENGINEERS & MANUFACTURERS
61 SHERMAN ST., MALDEN, MASS.

Est. 1914 . . . W. A. Ready, Pres.



NATIONAL THRILL BOX
SCREEN-GRID SW-4

WURLITZER
TRADE MARK REGISTERED
 THE WORLD'S LARGEST MUSIC HOUSE

Try Any Wurlitzer Instrument in Your Own Home

EXAMINE IT, show it to your friends, play it as much as you wish. An ample free trial—no obligation to buy. We make this liberal offer because we want you to see for yourself this superior quality of Wurlitzer instruments, the result of 200 years' experience. Noted musicians praise them for unusual tone quality, artistic workmanship and ease of playing. They are used in the finest bands and orchestras throughout the country.

Easy Payments

If you decide to buy, payments are arranged in small monthly sums. A few cents a day pays for your instrument. Special offers on complete musical outfits.

SEND FOR New Catalog

The greatest musical catalog ever published! Over 3,000 articles—every known instrument described and illustrated; many of them shown in full colors. Gives you lowest prices and all details of Free Trial, Easy Payment plan. All sent FREE—no obligation. Send coupon below.

Clip
and
Mail

THE RUDOLPH WURLITZER CO., Dept. 1779
 117 E. 4th St., Cincinnati

Send me, absolutely free, new illustrated catalog, with prices and details of Free Trial Easy Payment plan. No obligation.

Name _____

Address _____

City _____ State _____

Instrument _____

(State instrument in which you are interested)



SALES KIT WORTH \$15.25

Set Yourself Up In Business For Only \$4.75

BE our special sales representative, full or part time. Enjoy pleasant work taking orders for one of America's largest leather goods concerns. Sell quick-moving, fine-quality genuine leather articles suitable for gifts and personal use. *Big commissions!* Call on your friends, business people, lodge brothers. Every article in extensive line made by the owners of the Famous Halvorsen Patents. This guarantees the quality.

Order the kit now; receive excellent assortment of sample articles at cost, \$4.75: Halvorfold Calfskin Billfold (Value \$5.00), Halvor-Key Case of Pin Seal (Value \$3.75), Halvor-Card Case of Steer Hide, laced and embossed (Value \$3.75), Morocco Letter Case (Value \$2.75), all articles cornered in gold. Also handsome pocket kit case for carrying outfit, with your name in 23K Gold across cover. Order book and pricelist included. Retail value \$15.25.

Remember, \$4.75 sets you up in business. Act now! Whether you work full or part time you'll make big commissions. Get complete information. Send coupon at once! The gift season is on! Get in on the profits that are easily yours.

Dept. PM, U.S. LEATHER GOODS CO. 564 W. Monroe St., Chicago, Illinois

I want to be your special sales representative and am enclosing \$4.75, cost price of complete kit as described. Send full sales equipment. My name as below to appear on kit in 23K Gold. I am to receive liberal commission. If not satisfied in any particular, I will return outfit and my money will be refunded immediately.

Name _____
Name to appear in 23K Gold

Address _____ 12

Reduce at will / — this positive harmless way



ONLY \$39.50

10 DAYS FREE TRIAL

6 MONTHS TO PAY AT LESS THAN 20¢ A DAY

WRITE for DETAILS

Thousands of these Reducers sold at 79.50! Our policy of selling direct makes new low price possible. Satisfaction guaranteed or your money refunded. SCIENTIFIC ELEC. CO. Mfrs. of Health Appliances 99 Brookline Ave. Boston

Silver Ace Models



Winter Flying

IF Christmas brings you a SILVER ACE, you won't have to wait months for warm weather to enjoy it. With these new pyralin skis, designed in type similar to those used by Commander Byrd in the Antarctic, you can, in one day, build a SILVER ACE Spirit of St. Louis or Fairchild cabin model, and fly it over deep snow and ice. Attachable with five minutes' work to all SILVER ACE convertible models, or to our famous flying Fokker with special wires. Skis, \$1.50 a pair extra at all dealers. Add 25 cents if shipped by us.

And remember SILVER ACES are world famous for their beauty, scientific design, demountable, silk covered waterproof wings, and above all for their thrilling performance. They are designed by aeronautical experts, and cost less in the long run. A steel winder with every set.

Send 10 cents for 32 page catalog describing 18 genuine SILVER ACE models and sensible construction sets.

Sailplanes, Monoplanes, Biplanes, Seaplanes Ready to Fly, Partly Assembled, Knocked Down. Prices, \$1.50 to \$25.00

Sold by 1000 dealers. 50 cents extra if shipped by us.

AERO MODEL COMPANY
Dept. M 12, 111 North Wacker Drive CHICAGO

AGENTS AND SIGN MEN

Now Making \$50.00 to \$100.00 and Up Per Week Selling Our GOLD LEAF SIGN LETTERS



For store and office windows, board signs, trucks and glass signs. We also make to order script signs and business emblems singly or by the thousands. A permanent business. No capital or experience required. Big demand in every city. Samples and Literature Free.

CONSOLIDATED SIGN LETTER CO. 71-X W. Van Buren CHICAGO, ILL.

MOTORCYCLES

Direct to you at wholesale prices Send 10c today for the latest Illustrated Bulletin and Confidential Price List of Guaranteed Indians Harleys Hendersons SuperX etc. (Small Weekly Payments Now—Spring Delivery at Winter Prices)
CRANDALL CYCLE CO. 826-28 State St. Shipments to all parts of the world
Motorcycles Since 1905 Springfield, Mass.

Ford Owner Stop that ruinous chatter on your car. **MAKE THIS TEST**—take out your floor boards, pull your emergency brake back and forth. If you notice play at the ball joint, you need Bredar's Ball Shim. Price \$1.50. Ask your Dealer or order direct. Demand Bredar's Shim.
NIC BREDAR'S SON MFG. CO., Rock Island, Ill.

TRICKS MAGIC JOKES FREE

SCIENTIFIC NOVELTY CO. CATALOG POSTAL BRINGS IT
88-E PARK PLACE, N.Y.C.



WADE AMATEUR MECHANICS, REPAIR SHOPS, INVENTORS, STUDENTS

BENCH LATHE
A real machine tool for the home work bench—capacity 4" dia. x 12' length. For Metal—Wood—Composition materials. Turning—Facing—Boring—Drilling—Winding—Thread Cutting. Accurate—Strong—Quiet—Compact. Slide-rest has travel entire length of bed. Leadscrew inside bed. No. 1 Lathe, plain headstock, \$40.00. No. 2 Lathe, back-gear headstock, \$68.00. Extra for lathes with 18 inches between centers, \$7.00. Complete line of accessories at equally low prices. Write for free catalog.
THE GEROLD CO. Dept. P-58 120 Liberty St. New York

Boys! here's a Million Dollars worth of FUN!

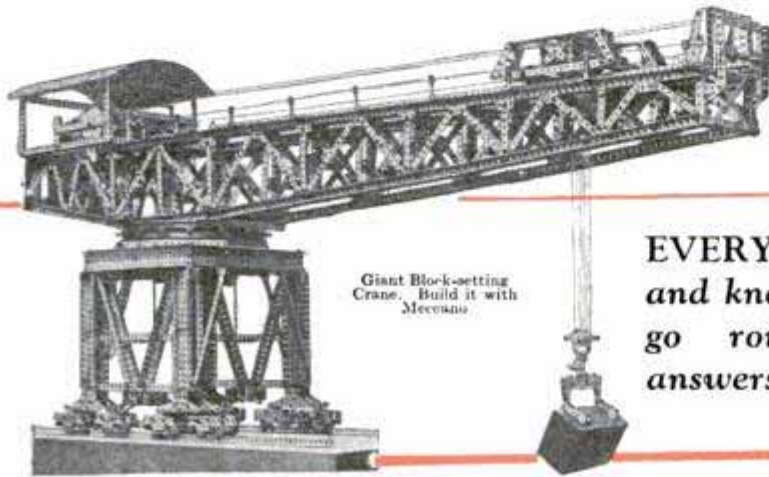

Giant Block-setting Crane. Build it with Meccano



Self-operating Jib Crane. Build it with Meccano

EVERY BOY likes to see, and know why the wheels go round. Meccano answers every question.

IT'S dead easy making models with Meccano. There are more than 200 accurately machined parts—a part for every purpose—of sturdy steel strips, with holes every half-inch apart; Brass Pulleys, Gears, Girders, Axle Rods, Couplings, Nuts and Bolts, Miniature Dunlop Rubber Tires and a host of other parts forming a perfectly interchangeable mechanical system.

There is simply no end of fun with it, building models of every mechanical invention known to the engineering

world. What's more, these models actually operate when hooked up with the powerful Meccano electric motor, which comes with outfits No. 5 and Nos. 20 to 70.

If you want to become a famous Engineer, commence now. All models illustrated in our manuals are built on correct engineering principles.

FREE—The big Meccano booklet tells all about Meccano. It is free, by sending the names and addresses of three of your pals.

Meccano Co., Inc., Dept. D-1, Elizabeth, N. J.

MECCANO OUTFITS

No. 0	Makers	472	Models	\$1.50
No. 10	"	727	"	3.50
No. 5	"	496	"	5.00
No. 20	"	737	"	7.50
No. 30	"	785	"	10.00
No. 40	"	836	"	15.00
No. 50	"	893	"	25.00
No. 60	"	936	"	35.00
No. 70	"	983	"	55.00



Trans-Atlantic Monoplane. Build it with Meccano



Steam Roller. Build it with Meccano

Real miniature Dunlop Tires For Meccano automobiles. With Outfits No. 5 and Nos. 20 to 70

MECCANO

TOY ENGINEERING FOR BOYS

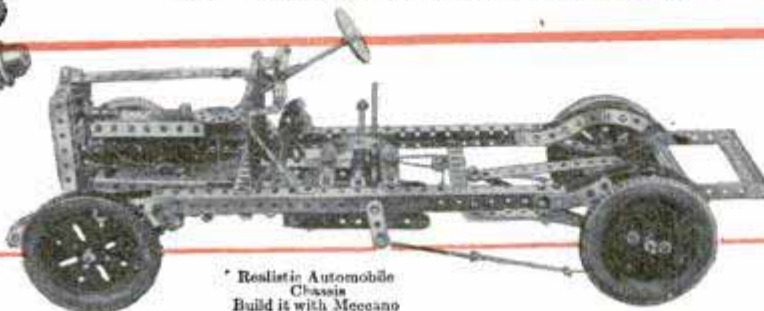

Realistic Automobile Chassis. Build it with Meccano





Where's the can of PLASTIC WOOD?

(Reg. U. S. Pat. Off.)

The North Wind doth blow, and keeps blowing right through the edges of the window casing. Stop the drafts with Plastic Wood—force it in the cracks around the frame. No matter what the house construction—wood, tile, brick, stone—Plastic Wood will hold permanently fast. It handles like putty and hardens into wood.

Use it for cracks around the baseboard, too—under door sills, in floors, in doors—wherever the cold air seeps in. It is waterproof and weatherproof, and takes paint or varnish perfectly.

Plastic Wood Solvent

When working, it sometimes is desirable to soften or thin Plastic Wood, and because of its adhesiveness it will stick to tools or fingers. To soften or remove it use Plastic Wood Solvent, in 25 and 50 cent cans.

Handles
Like
Putty



Hardens
Into
Wood

1 lb. can \$1.00

¼ lb. can 35 cts.

At Hardware and Paint Stores

ADDISON-LESLIE CO., 422 Bolivar St., Canton, Mass.

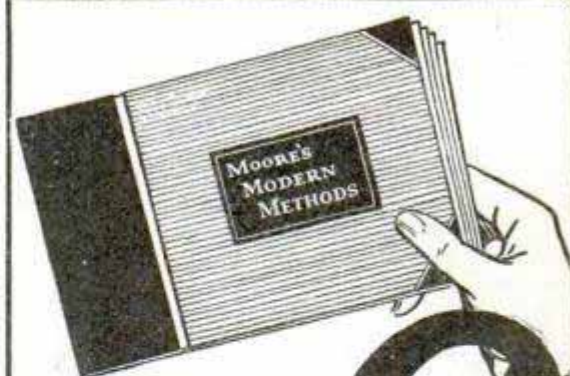

140-Page Book of record-keeping forms, filled in to show you their uses. It answers problems of accounting for office, factory and professions. This Free Book describes and illustrates Moore's Security 4-Post Binders, the simplest, easiest handled on the market. To insert or remove sheets takes but a moment. Low in cost—long in life. Moore's Binders are Different.

Write on your business stationery for this Free Book on up-to-date Loose-Leaf equipment

Free

A great help
toward simple
and accurate
record-keeping

Write for it
today!

JOHN C. MOORE CORP. Est. 1839
6044 STONE STREET ROCHESTER, N. Y.



GEARS IN STOCK— immediate delivery

Gears, speed reducers, sprockets, thrust bearings, flexible couplings, pulleys, etc. A complete line is carried in our Chicago stock. Can also quote on special gears of any kind. Send us your blue-prints and inquiries. Write for catalog No. 10.

Chicago Stock Gear Works
769-773 W. Jackson Blvd., Chicago, Ill.

MASTER INTERLOX SLIDE RULE

Every kind of inside measurement. Just slide out the MASTER till it reaches from stop to stop. No guessing. Quick results. Locks rigid in use. Without equal for outside measure, too. Dealers and Agents Wanted.

MASTER RULE MFG. CO., Inc., 821 E. 136th Street, NEW YORK CITY

**EXACT
INSIDE
MEASURE**

Ask the Dealer or send 20c each lineal foot.

\$5 BRINGS YOU THIS SAW COMPLETE MOTORIZED UNIT

GUARANTEED 10 DAYS' FREE TRIAL

This big, sturdy, powerful 8" Saw with ¼ H. P. Motor—shipped to you on approval for only \$5.00. 10 Days' Free Trial. Then convenient monthly terms if you keep it. Send for complete facts on this offer and details on Lathes, Circular and Jig Saws, Jointers and complete portable work shop. Write today.

MIDLAND APPLIANCE CORPORATION
Dept. 1215 225 N. Michigan Avenue CHICAGO

NATION-WIDE CONTEST TO ENCOURAGE APPRECIATION AND PERFORMANCE OF MUSIC BY THE YOUTH OF AMERICA

\$1000

in PRIZES

**for
BOYS
and
GIRLS**

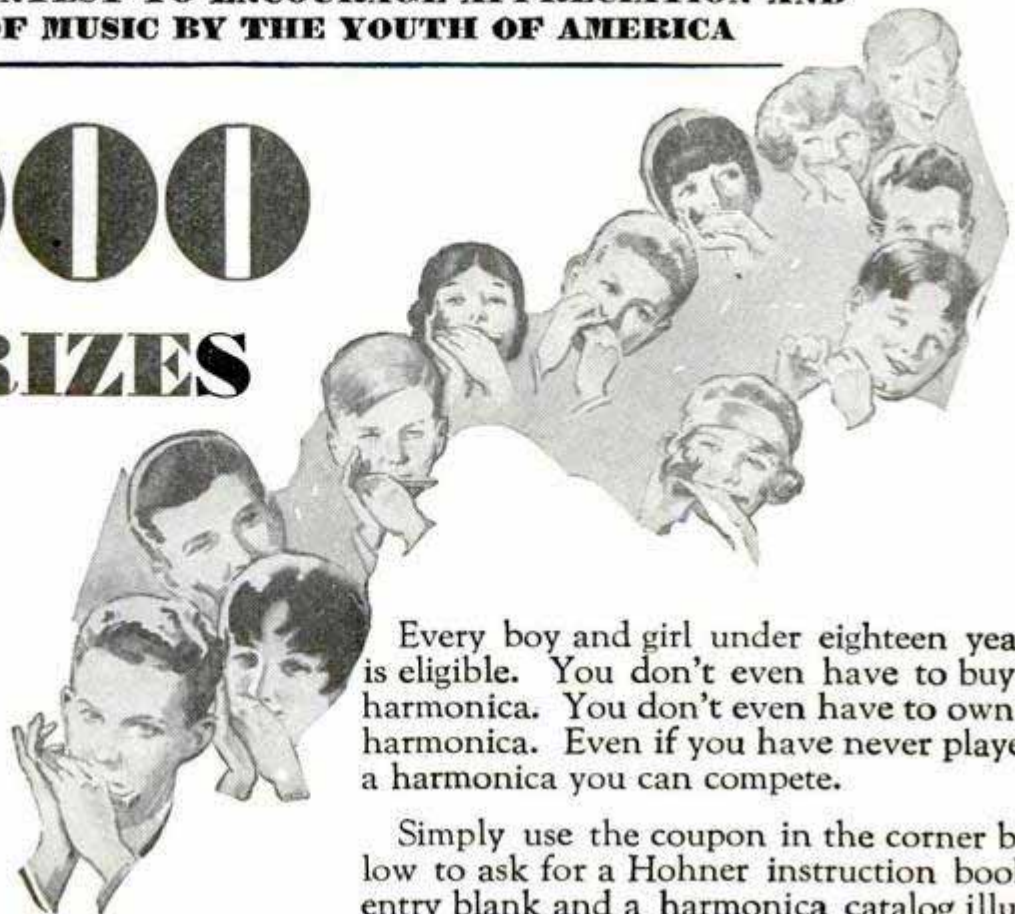

Every boy and girl under eighteen years is eligible. You don't even have to buy a harmonica. You don't even have to own a harmonica. Even if you have never played a harmonica you can compete.

Simply use the coupon in the corner below to ask for a Hohner instruction book, entry blank and a harmonica catalog illustrating and describing almost 50 of the famous Hohner harmonicas. The entry blank will tell you just what to do.

EMINENT musicians, educators, civic authorities and public leaders have been so eulogistic in their praise of the harmonica that this nation-wide contest has been inaugurated to intensify the already keen interest in this universal musical instrument.

Free TO EVERY ENTRANT



Whether you enter the contest or not, the Hohner instruction book will be a big help to you. Playing a harmonica adds to your personality and popularity.

How to Enter the Contest

Here is your opportunity to win a valuable prize and to have plenty of fun while doing it. More than five hundred fine prizes will be awarded. The contest is for the best compositions on the subject: "My Experience with the Harmonica."

If you cannot obtain the model you want from your dealer, send money order to us direct.



Hohner "MARINE BAND." The ideal instrument for the beginner, embodying almost two octaves in the diatonic scale. Price 50c

Hohner "SUPER CHROMONICA." 3 full chromatic octaves with all half-tones. Patented wind-saving device provides increased volume and adds tonal qualities. Key of "C." Price \$4.00.

HOHNER
Harmonicas

Contest Editor, Dept. 508-M

M. HOHNER, Inc., 114 E. 16th St., New York

Please send me FREE items checked below:
Instruction Book Catalog Entry Blank

Name _____

Address _____

City _____ State _____

**IDEAL—THE MOST RELIABLE NAME
IN MODEL AIRPLANES**

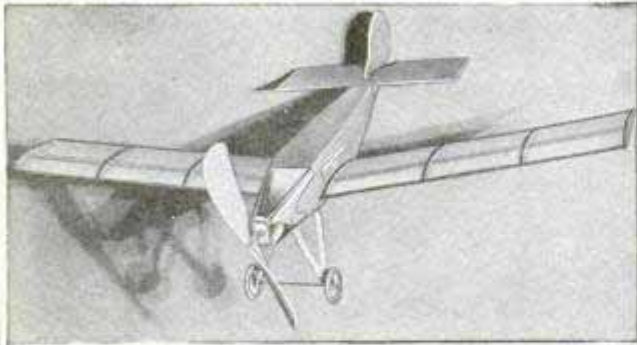

The IDEAL
American Eagle

**The Greatest Development
in Flying Model Airplanes**
Wing Span: 26 in. Weight: 3¹/₂ oz.

AN entirely new, light-weight, fast-flying Model; distinctive appearance, realistic in flight, unique construction details. Balsa wood fuselage, with specially designed aluminum bulkheads; built-up wings with ready-formed ribs; removable tail assembly. Finished in modern color decorations. Just the Model Airplane you have been wanting; simple in construction, and a reliable, fast flyer.

Construction Set: Assembled
\$2.50. Model: \$5.00.

**For Fun and Instruction Build and Fly
IDEAL SCALE AIRPLANES**

The most perfect copies of real airplanes possible to make in Flying Models; true miniature duplicates of famous planes, with realistic parts and fittings. Build them the IDEAL way, and we guarantee them to fly. IDEAL Construction Outfits show how and contain everything required. Here are several types; pick yours now and get it for Christmas:



FORD MONOPLANE—a dandy 3-ft. Model of this giant ship. All the distinctive features of the original are duplicated in this Model. Complete Construction Outfit, \$8.50

New York-Paris Mono-plane—3-ft. Model of the most famous airplane in the world. A Model every amateur aviator should build and fly. Complete Construction Outfit.....\$7.50

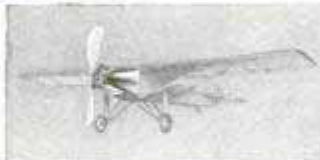

FOKKER MONOPLANE: 3-ft. Model "North Pole" type. Complete Construction Outfit.....\$8.50
DeHAVILLAND BiPlane: 3-ft. Model of this famous original. Complete Construction Outfit.....\$7.50
Cecil Peoli Racing Airplane: 36 in. size. A Championship Winner. Complete Outfit.....\$3.75
Ask for IDEAL Model Airplanes in your local Toy, Hardware or Sporting Goods store. If unobtainable, send your order direct to us. (West of Denver, Colo., and in Canada, add 10% to the prices above.)

64-page Catalogue of Models, Parts, Materials for Model Builders, 5 cents

Ideal Aeroplane & Supply Co., Inc.
Established in 1911—18 years ago
26 West 19th Street New York City

Pay as You Please



Select your own payment terms for a Mead instrument. Make money playing in local orchestras. Be the "life" of the party wherever you go. **10 DAYS FREE TRIAL**—no obligation to buy and no cost to you. Mead instruments are easy to play and a joy to learn. If you can hum a tune, you can play. Free instruction book—new simple method. Send a postcard today for free instrument catalog with marvelous offers and terms.

CYCLE CO.
Mead
DEPT 254S CHICAGO

Keds At \$1.00, \$1.25, \$1.50, \$1.75 and up to \$4.00. United States Rubber Company

WOOD Samples of 33 rare woods \$2.00. 20 cabinet and 20 inlay \$1.75, or your choice \$1.00
Sets labeled and postpaid. Free Price List.
CRAFTSMAN WOOD SERVICE, K-715 E. 62nd St., Chicago

BIG MONEY
easily made by floor surfacing contractors who average \$40 per day. The New **"American High Production"** Machine does the work—makes you the money and builds you a business of your own. No dull seasons—no large capital nor experience required. complete information free without obligation—write today.
THE AMERICAN FLOOR SURFACING MACHINE COMPANY
523 So. St. Clair St. TOLEDO, OHIO

SAVE 1/2 ON PLUMBING HEATING

Cut-to-fit Heating System
New Easy method enables any man to install his own **PLUMBING and HEATING**. Lowest wholesale prices on Highest Quality Grade A goods.

WE SHOW YOU HOW
Send for our new free catalog telling how you save waste material and high labor costs by being your own plumber. This book has saved money for builders, home-owners, farmers and mechanics for over 50 years. Send for your copy today.

MILLION DOLLAR BONDED GUARANTEE PROTECTS YOU

OVER 50 YEARS **HARDIN-LAVIN Co.** EST. 1876
122-32A West Pershing Road, Chicago, Ill.

Entirely **NEW...**

REGISTERED TRADE MARK
CHEMCRAFT
THE CHEMICAL OUTFIT

...real fun with Chemistry!

LEARN the Science of Chemistry with CHEMCRAFT; work hundreds of wonderful and useful experiments; make soap, inks and dyes; test foods, water and soil; produce amazing chemical changes and perform surprising tricks of magic. All these experiments, and many more, can be done with CHEMCRAFT, the original and leading chemistry set. These NEW sets are greatly improved, the finest we ever made. More chemicals, more apparatus, more and better experiments. Get CHEMCRAFT, then you can invent new experiments of your own and learn useful chemical facts all the time.

Six Fine Sets to Choose from:

No. 1—\$1.00	No. 5—\$ 5.00	No. 15—\$15.00
No. 3— 3.00	No. 10— 10.00	No. 25— 25.00

Each set complete with chemicals, apparatus and Manual of Instruction. Look for them in the Toy Department. If unobtainable, send your order direct.



This is the No. 15 Set

Packed in handsome wooden cabinet with extra tray designed so it stands upright to form an enclosed laboratory. Contains 115 chemicals and pieces of apparatus, including many not found in other sets. More than 649 experiments are explained in the book. **\$15.00**

The **TELEPHONE BOOK**
with the **MAGIC MICROPHONE**



**Build your own
ELECTRIC
TELEPHONE!**

Read the inside story of the telephone and build a real, electric broadcasting telephone of your own. You can also make a Super-sensitive Microphone, a Detectophone, a Stethoscope and other sound-detecting instruments. You can have great fun experimenting with them and learn about telephonic and microphonic science—the science of sound detection.

Complete in New Book-Box
All parts, wiring and apparatus are included; everything in an unique **Book-Box**..... **\$5.00**
Sold by Toy Departments and Book Stores. If unobtainable, send your order direct.

Try Chemistry
for **25c**

Get CHEMCRAFT Junior, the set that will introduce you to chemistry. Sent post-paid for 25 cents.

Send for
Free Magazine

Contains fine ideas on Chemistry, Woodworking and Electricity. Tells all about the sets mentioned on this page. It's Free, just ask for your copy.

**The PORTER
CHEMICAL
COMPANY**

78 East
Washington St.
**HAGERSTOWN
MD.**

WOODCRAFT
The **BOYS' HOME
WORKSHOP**



**Design and Make Many
Useful Articles of Wood!**

WOODCRAFT will show you how to plan, construct and decorate lots of practical things. Each set is a complete home workshop for boys, with good tools, blueprint plans and all materials for making bookshelves, tie holders, bird houses, air gliders and other useful articles. WOODCRAFT is more than a tool box—these sets show you what to do and how to do it. Two different sizes, each in a strong, wooden cabinet:

No. 5—\$5.00 No. 10—\$10.00
Sold in Toy Departments. Ask for WOODCRAFT. If unobtainable, send your order direct.

DIAMONDS

The Old Reliable Original Credit Jewelers Largest in the World

LOFTIS

BROS. & CO. 1858

Address Dept. G-894 108 N. State St. Chicago, Ill.

WATCHES

No. 918
\$37.50
\$1.00 a week

No. 913
\$150
\$3.75 a week

No. 917
\$50
\$1.25 a week

Genuine Diamonds Guaranteed—CASH or CREDIT

Give a Diamond for Christmas! Buy from Loftis, the Direct Importer, and be sure of highest quality and most value for your money. Our ring mountings are the latest creations in solid 18-k white gold, elaborately carved and pierced. Set with sparkling blue white Diamonds, radiantly beautiful. **Satisfaction guaranteed, or money back. Goods sent for your free examination on request.**

CREDIT TERMS: Pay one-tenth down; balance weekly, semi-monthly, or monthly at your convenience. All goods delivered on first payment.

Christmas Catalog FREE!

HOW TO ORDER: Send first payment—state article desired—name of employer—kind of work you do—how long in position—age—married—where live—how long there. **STRICTLY CONFIDENTIAL.**

Standard Railroad Watches on Credit at Cash Prices. Guaranteed to stand inspection. NO CARRYING CHARGE.

Wrist Watch No. 866—14-k white gold. High grade 15-Jewel movement. Fancy corners; \$15. \$1.50 down & \$1.50 a mo.

Our References: Any Bank or Banker in the U. S. A.

No. 897—Elgin "Legionnaire". New Elgin for men—with white or green gold-filled case and raised figured dial, \$25.00—\$2.50 down and \$2.50 a month.

No. 916
\$100
\$2.50 a week

No. 919
\$125
\$3.25 a week

No. 907
\$100
\$2.50 a week

\$100 a Week Showing Merchants It Pays to Advertise
R. O. Gosden made \$321 in 9 days—sold 5 machines in 2½ hours.

THE EUREKA ADVERTISER
(Automatic Wrapping Paper Printer)

Automatically prints the merchant's "ADS" on his wrapping paper in one or two colors. Costs only what it costs to have "AD" printed on twenty rolls of paper. Flint of New York sold four machines in two hours. You collect and keep your commission. We deliver. Every merchant a prospect. Many buy five or more machines—one for each paper rack they use.

SALESMANAGER, Dept. A-10, 1201 Cortland Street, Chicago, Illinois

RACING AND SPORT EQUIPMENT
Direct from Manufacturers

Bodies for Ford and Chevrolet
\$18.75 and up
Hi-Compression Heads, under-slung Parts, Racing Gears, Cowl Lamps, Roadlites, Seat covers, Also Boats, Canoes, Portable Radio, Bicycles, and Camping Outfits. Send 10c for Catalog showing bodies of rare beauty and complete equipment.

SPORT FACTORIES Dept. K-2
Build a Real Auto from Used Chassis
AURORA, ILL.



\$1.50 **INKOGRAPH** **FREE TODAY'S TRIAL**
PENCIL POINTED PEN

Writes with ink smooth as a lead pencil on cheapest or finest paper, without miss, skip or blur. Won't blot, scratch or leak.

Makes 3 carbon copies at one time with original in ink. Anyone can use your Inkograph—hard pressure cannot spread or injure its 14 Kt. gold point. Patent automatic feed prevents point from clogging. No complicated mechanism. Best material and workmanship. Fully Guaranteed.

Send No Money. Pay postman \$1.50 plus postage. Sent prepaid if remittance accompanies order. Money back if not satisfied within 10 days.

INKOGRAPH CO., 161-77 Centre St., NEW YORK

AGENTS Send for Inkograph or FREE sales plan booklet. Sells on sight, no investment, immediate commissions.



DOUBLE ACTION AUTOMATIC Patented **\$1.79**
Pull the Trigger—Out Pops a Cigarette

Protect yourself against hold-up, rowdies, etc., with this clever cigarette case of light weight metal. Looks like genuine automatic! Pull the trigger and out shoots a cigarette through the muzzle. Holds nearly a full pack of cigarettes. Handsome gun metal finish. **Double action.** Lots of fun scaring friends and a great protection. Order one to-day. When your friends ask for a cigarette, shoot one to them and enjoy a big laugh. Either enclose money order for \$1.79 or pay postman \$1.79, plus postage on arrival. **Money back if not satisfied.** **PATHFINDER CO., Dept. 812, 200 Hudson St., New York**



You Can't Beat This for Value!

Here's Boice's newest workshop—the 5-machine Handi-Bench, complete from floor to switch! Designed for industrial or home use. Each machine complete in itself and ready to run.

Boice's Handi-Bench No. 5

As illustrated below, consists of following equipment: 12" Handi-Band Saw. 7"x40" Handi-Lathe. 4" Handi-Jointer. Universal Jig Saw. Universal Handi-Saw. 2 Motors, double shaft, ½ h. p. each. 3'x8' Bench with legs.

Price complete..... **\$205.00**

Boice's Handi-Bench No. 3

Not illustrated. Universal Handi-Saw, 7"x40" Handi-Lathe, Jig Saw, one ½ h. p. double shaft motor and 3'x6' bench with legs.

Price complete. **\$111.85**

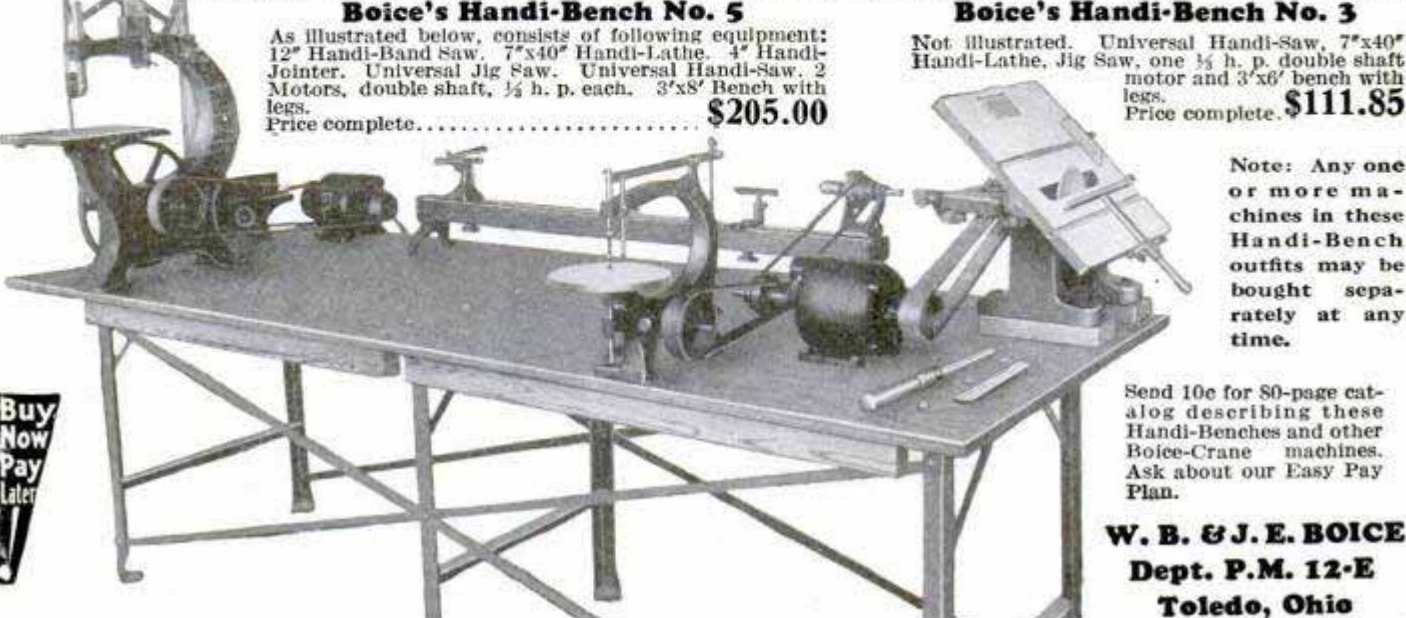

Note: Any one or more machines in these Handi-Bench outfits may be bought separately at any time.

Send 10c for \$0-page catalog describing these Handi-Benches and other Boice-Crane machines. Ask about our Easy Pay Plan.

W. B. & J. E. BOICE
Dept. P.M. 12-E
Toledo, Ohio

Buy Now Pay Later

TRY IT 30 DAYS FREE BEFORE YOU BUY

FACTORY TO YOU - SAVE 50%
Choice of beautiful **DYNAMIC** Consoles

1 Year Guarantee

9 tube - perfected
SCREEN GRID, PUSH-PULL

MIRACO
TRADE MARK REGISTERED

CATHEDRAL TONED, SUPER SELECTIVE, POWERFUL DISTANCE GETTER

\$49.88 only
COMPLETELY ASSEMBLED

Compare with costliest sets before you buy!

You needn't send us a cent! America's big, old, reliable Radio Factory springs its 10th Anniversary Surprise in high-grade full-year guaranteed sets at history's lowest prices! With its latest perfected Screen-Grid, push-pull, super-powered and hum-free AC electric Miraco's—you are guaranteed satisfaction, values and savings unsurpassed.

At our risk compare a Miraco with highest priced radios, for 30 days in your home. Surprise and entertain your friends—get their opinions. Unless 100% delighted, **don't buy!** Your decision is final—no argument!

Only marvelously fine radios, of latest perfected type, at rock-bottom prices, can back up such a guarantee. Send postal or coupon for *Amazing Special Factory Offer!*

Don't Confuse with Cheap Radios

With Miraco's rich, clear cathedral tone, quiet operation, razor-sharp separation

of nearby stations, tremendous "kick" on distant stations and latest improvements—you'll be the envy of many who pay 2 or 3 times as much!

Send for proof that delighted thousands of Miraco users cut through locals, get coast to coast, with tone and power of costly sets. Miraco's are custom-built of finest parts—product of 10 years' successful experience. Approved by Radio's highest authorities.

DEAL DIRECT WITH BIG FACTORY

Miraco outfits reach you splendidly packed, rigidly tested with everything in place ready to plug in! No assembling! Entertain yourself 30 days—then decide. Liberal year's guarantee on each set. Play safe, save lots of money, insure satisfaction—deal direct with Radio's old, reliable builders of fine sets—10th successful year. **SEND POSTAL OR COUPON NOW!**

MIDWEST RADIO CORP., 407-ED Miraco Bldg., Cincinnati, O.
Get our Send No Money 10th Anniversary Offer

Dealers Write! - mail coupon right Now!



BEAUTIFULLY ILLUSTRATED LITERATURE

Free! Amazing Special Factory Offer

All the proof you want—of our honesty, fairness, size, financial integrity, radio experience and the performance of our sets—including Amazing Factory Offer—sent without obligation!

User Agents Wanted! Exclusive Territory

DEMONSTRATOR SENT GET OUR PROPOSITION

Excels \$425 Outfit
My 30 days trial on my Miraco AC-9 is up and if you would offer me \$200 extra for it back, I would tell you nothing doing. We had some very expensive sets in our home, one a \$425 9-tube AC set. Thanks to you I have a set that gets any and all stations. I have got stations in 45 states, also Cuba and Canada. It is beyond words to tell you what we think of our wonderful bargain. I will always praise Miraco's to everyone. **J. W. LAUDERBACK, Barberton, Ohio.**
Coupon brings proof like this from people in YOUR locality, too.

SPECIAL! ELECTRIC AC-7 \$39.85

BATTERY SET \$29.50

THIS COUPON IS NOT AN ORDER

MIDWEST RADIO CORPORATION
10th Successful Year
407-ED Miraco Bldg., Cincinnati, Ohio

WITHOUT OBLIGATION send latest literature, AMAZING SPECIAL FREE TRIAL OFFER, testimony of nearby users, etc.

User Agent Dealer

Check here if interested in an EXCLUSIVE TERRITORY PROPOSITION.

Name

Address

SHOOT

THE REAL THING!



Here is that famous genuine pump boys everywhere are turning to. Single stroke outshoots all others. Two to three strokes now give full shooting force. New rear peep sight, leak-proof valves, fully enclosed action. A beauty. Amazing accuracy. Full factory guarantee for one year. Uses regular air rifle lead shot. Photo shows flattening power at 30 ft. on steel target. The biggest money's worth in genuine air rifles ever offered.

"The Shooter's Art" FREE
Tells how to hold, aim and handle rifles; helps you guide others in correct knowledge of guns. Gives facts that make crack shots. Contains safety and common sense instructions every parent and boy should have. Helps to make boys leaders. Your copy free. Write at once.



\$5 at your dealer's or sent postpaid
NEW MODEL "G"
BENJAMIN
Genuine Pump Air Rifle
BENJAMIN AIR RIFLE & MFG. CO., 645 N. Broadway, St. Louis, Mo.

PARKS

WOODWORKING MACHINES

Cabinet Shop Special No. 10

\$290

With Motor

You ought to have this handy Parks in your shop. Compact, complete machine designed like a big production outfit at 1/3 the cost. Floor space required only 42x72 in. Does any kind of cabinet and joinery work. Write for circular.



The Parks Woodworking Machine Co.

Builders of quality woodworking machines since 1887
1500-10 Knowlton St. Cincinnati, Ohio

Canadian Factory: 338 Notre Dame East, Montreal

Photos ENLARGED

Size 16x20 inches
Same price for full length or bust form groups, landscapes, or pet animals, etc., enlargements of any part of group picture. Safe return of your own original photo guaranteed.

98c

SEND NO MONEY Just mail photo or snapshot (any size) and within a week you will receive your beautiful life-like enlargement size 16x20 in. guaranteed fadeless. Pay postman 98c plus postage or send \$1.00 with order and we pay postage. **SPECIAL FREE OFFER** With each enlargement we will send FREE a hand-tinted miniature reproduction of photo sent. Take advantage now of this amazing offer -- send your photo today!
UNITED PORTRAIT COMPANY
1652 Ogden Ave. Dept. W-1019 Chicago, Ill.



So Easy Play Before Xmas!

YOU can play a Pan-American Trombone, Saxophone, Trumpet or any instrument with a few lessons and three weeks' practice, because Pan-American Band Instruments are noted for easy blowing qualities, true tones and accuracy.

For free trial offer, write

Pan-American Band Instrument & Case Co.
1203 Pan-American Bldg.,
ELKHART INDIANA

Moderately Priced
No hardship to pay for Pan-American. Can be purchased on easy payment plan after FREE TRIAL. Only complete line of nationally advertised, moderately priced FACTORY GUARANTEED instruments made. Universally approved by teachers and bandmasters.



MOVIES AT HOME

LET US SEND OUR INTERESTING AND FREE CATALOGUE OF MOVIE MACHINES - AS LOW AS \$3.75 POSTPAID - USE STANDARD OR 16mm SIZE - COMPLETE LINE OF FILM SUBJECTS AVAILABLE WITH EXCHANGE SERVICE - LOWEST PRICES - DON'T DELAY - WRITE FOR FREE CATALOGUE NOW!

PARAMOUNT MFG. CO.
BOSTON DEPT. B-22 MASS.

RUN SHOWS EARN EXTRA MONEY!



MOTORCYCLES

Price \$10 and up purchased through our Co-Operative Plan for as low as \$1.00 down and \$1.00 per week

Indians Harley-Davidsons Ace Henderson and Clevelands

Send ten cents for Bulletin A.
Motorcycles shipped to all parts of the world

WALKER-INDIAN CO., 1309 Boylston St., BOSTON, MASS.



Now! Do Your Own Electric Nickel Plating

Introductory Offer ONLY **\$6.50** Plus Postage

Make \$150 to \$500 a Week

NO EXPERIENCE REQUIRED. DO YOUR OWN Electro-Plating in Your Home, Garage, Office or Place of Business. Electrically Deposit Metal—Nickel, Brass, Copper, Silver, or Gold. You can successfully do all the plating on your Automobile, Electric Fixtures, Faucets, Spoons, Forks, Chandeliers, Tools, Coffee Urns, Surgical and Dental Instruments, Utensils, large or small, Iron Stoves, Music Instruments; recondition worn plating or plate New Work; do it Instantly without interrupting the Service or without removing the parts to be plated with the

ALADDIN PORTABLE ELECTRO-PLATER

Simple and Economical to operate. Not a toy, but a practical Plating Outfit with which Perfect and Durable Work can be done. Positively Guaranteed to do as we claim. **BE YOUR OWN BOSS!** Build up a Profitable Aladdin Electro-Plating Business of your Own. This offers wonderful ECONOMY to users and BIG MONEY-MAKING possibilities to AGENTS. Thousands in Service since 1924. Write for FREE Booklet and Testimonials and 30 Day Trial Offer Today.

P. J. F. BATENBURG, Dept. 121, RACINE, WISCONSIN

—AGENTS— WANTED EVERYWHERE



Young Man! Here Is Your Opportunity to Make BIG MONEY

START in business for yourself now! You can do it with the Foley Automatic Saw Filer. Nothing else like it in the world. Files hand, band and circular saws **automatically** with such mechanical accuracy that they cut faster, and stay sharp longer. Better than the most expert hand-filing. **Easy work** to file 5 and 6 hand saws an hour. **No experience necessary**—even boys of 14 are operating the Foley Filer. Simply adjust the saw in the machine and snap on the switch. You don't have to be a skilled mechanic to do it—very simple to operate. With a little practice you can turn out **perfect cutting saws** that will please your customers and bring you plenty of repeat business.

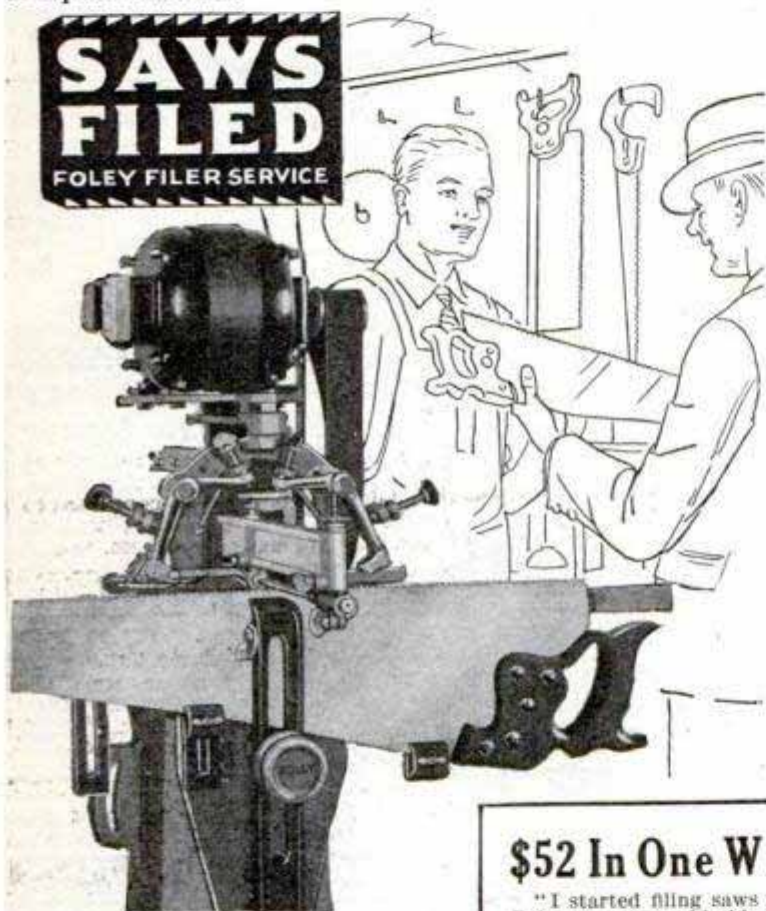

Start At Home In Spare Time

Make \$2 to \$4 an hour in spare time while starting. No high-rent store necessary, very little capital needed. You can start in your garage, basement, attic, or anywhere. Soon you will have plenty of business to keep you busy full time. J. J. Southwick writes, "Enclosed find contract for my second Foley Filer. The first machine easily paid its own way and increased business, and I am expecting this to do the same." Frank Huber says, "It is very easy to pick up enough work to pay for the machine in a short time."

No Canvassing

You can get all the business you can handle from carpenters, contractors, schools, factories, hardware stores, and others. William G. Diederick writes,

"I am kept busy filing saws. To tell the truth, I get more saws than I can handle." Thomas Hoadley has filed between 25,000 and 30,000 saws during the last two years with his two machines.

\$52 In One Week

"I started filing saws on the Foley as a sort of hobby in my spare time. I got my first machine and in five months had to buy another. Have filed \$52 worth in one week and am absolutely satisfied. Instead of a playtime hobby it has gotten to be a regular business."

E. V. Harper.

"Made a new record Monday, filing fifty saws in less than 9 hours."

M. S. Gray.

Get Started Now!

Lots of men, old and young, are making **big money** filing saws on the Foley. They have a fine paying, steady year-'round cash business of their own. Many started in their spare time. Our **Free Plan** shows you how to get started. Others are making **big profits** from the Foley Filer—get in the game! Be your own boss—don't delay—mail coupon **NOW!**

Foley Manufacturing Co.
246 Foley Bldg., 11 Main St. N. E.
MINNEAPOLIS, MINNESOTA

**Foley
Manufacturing
Co.**

246 Foley Bldg., 11 Main St. N.E.
Minneapolis, Minnesota

Please send me **Free Plan** telling me how I can start my own business in spare time and make **big money** with the Foley.

Name

Address

City State

Mail Coupon for FREE PLAN

NOW —
GET MY
GREATEST
Log Saw
Offer



Fastest Cutting

Saws 15 Cords a Day

ONLY \$39

Used by
The United States Government

It's easier, now, than ever before to own this fastest-cutting, easiest-moved, most powerful Log Saw. Now you can make big money sawing firewood, stove-bolts, ice, shingle timber, etc. WRITE TODAY FOR FULL DETAILS.

Try 30 Days

— ONE WHOLE MONTH to use the OTTAWA at your own sawing. Every saw shipped on trial—

Backed by 10-Year Guarantee

FREE Send me your name and address on a postcard today for my wonderful new edition of the "Wood Sawing Encyclopedia." Be sure to investigate—it will help you to make big money.

C. E. WARNER, Pres.,
OTTAWA MFG. COMPANY
1745-L Wood St., Ottawa, Kans.

Put the OTTAWA Working For You!

350 Cuts a Minute!

Take any size log — in a few seconds it's all sawed up — without any hard work!

FREE Wood Sawing Encyclopedia

Cut the Family Barber Bills



Belle City Home Electric Hair Clipper

Anyone can trim or bob hair, shorten bangs, clip neck or underarms in a shape almost impossible with hand clippers or shears. Operates on direct and alternating current. Will not clog or cut the skin, and cuts as cleanly as a razor. Thousands in use. Rigidly guaranteed.

TEN DAYS' FREE TRIAL

If your hardware or electrical dealer can't supply you, write for interesting booklet, or order from this ad. Send no money — pay postman \$8.75. Return it in ten days if not satisfactory. State whether 110, 220 or 32 volt current is used.

Dealers and Representatives Wanted
Belle City Appliance Co., 1022 12th St., Racine, Wis.

Fits Any Light Socket

SALESMEN WANTED!

SELL COX HOLDFAST SCREW DRIVERS



Sells on sight to mechanics for Auto, Radio and Electrical Work. Self Holding, Self Releasing.

Send 50c for sample and ask how to get Salesman's Outfit Free.
S. J. COX Dept. F. FRANKLIN, PA.

A Genuine Robbins & Myers

1/4 H. P. Electric Motor



for 110 V., 60 Cycle light circuit at the low cost of \$10.70 net. A tool that will lighten your chores, connected to your lathe, grinder, pump, washer, etc. Always ready for service.

ROBBINS & MYERS, Inc.
Department A, Springfield, Ohio

CRESCENT SAW TABLES



Portable and heavy, 16 types and sizes. This No. 14 Portable is well built, highly efficient, and exceptionally convenient for light work. Tilting top; table raises and lowers, etc. 30 other Crescent wood-working machines include band saws, self feed rip saw, shapers, jointers, planers, planer and matcher, variety woodworker, disk grinder, cut-off table, swing cut-off saws, borers, hollow chisel mortisers, tenoners, universal woodworkers, universal variety saw.

THE CRESCENT MACHINE CO.
93 Columbia St., Leetonia, Ohio

Send for FREE BULLETINS

A red handle with a gold stripe marks the most popular blow-torches in the world. They are Clayton & Lambert blow-torches.

CLAYTON & LAMBERT MFG. CO.,
DETROIT, MICH.

LE PAGE'S GLUE

HOW TO MAKE YOUR OWN ATTRACTIVE FURNITURE

Send 10 cents for LePage's New Third Home Work Shop Book, containing complete directions for making 20 different projects. LePage's Craft League, 724 Essex Ave., Gloucester, Mass.

IT'S NEW



A Real Drill for Every Man!

It's a brute for work. Drills in metal or wood. Lots of power. Will operate grinding and polishing wheels, wire brushes, sanders, buffers, etc. Westinghouse Motor. Full ball bearing spindle. Long life. A mighty good drill to have around. None better is made. Rated 1/4-inch general drilling in steel, overall length 11 3/4 in., weight 4 1/2 lbs. Price only \$24.00.

Specify voltage in ordering, No. 1051—110 volts; No. 2051—220 volts. Secure one today at your dealers, or send check or money order direct to

GOODSELL-PRATT CO., Greenfield, Mass., U. S. A.

Chicago Office 38 No. Clinton St. New York Office 107 Lafayette St. London Office 127 Queen Victoria St.

\$24.00

Products of the Toolsmiths

A Steady Income

Start your own Business with this NEW Low-Priced Electric Woodworker.

7

Machines in One

Circular Saw
Band Saw
Lathe
Jointer
Shaper
Mortiser
Sander
Performs 35 Woodworking Operations.

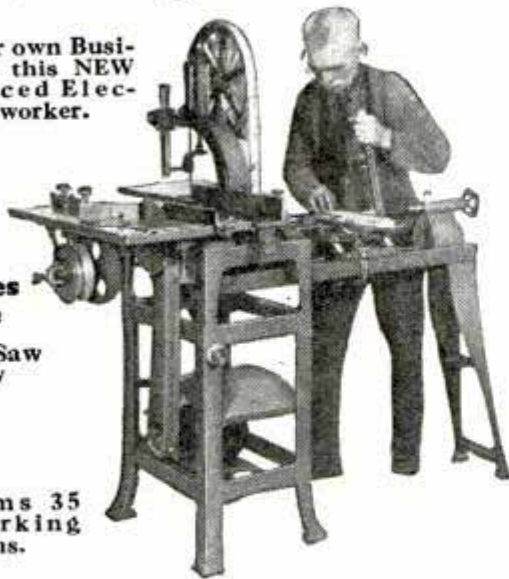

The Electric Carpenter

Runs from any Light Socket

You can earn good profits . . . in spare time or full time . . . making screens, storm sash, mouldings, cabinet work, mill work, etc. Performs every woodworking operation with speed and accuracy . . . Mitering, shaping, mortising, tenoning, paneling, rabbeting, boring, sanding, etc.

WRITE TODAY for full details and LOW PRICE

THE WOODWORKING MACHINERY CO., INC.
Eleventh and Vine Sts., Philadelphia, Pa.

BURN YOUR NAME ON TOOLS

WITH THE ARKOGRAF

PROTECT YOUR TOOLS FROM THEFT
Write with electricity any name or design on the hardest and finest tools and instruments, or any metal, like writing on paper with pen or pencil. Complete outfit \$3.50 — Prepaid Anywhere today. Agents wanted. Interesting illustrated circular free. Write today. Agents wanted.
ARKOGRAF PEN CO., 1171 E. Stark St., Portland, Oregon

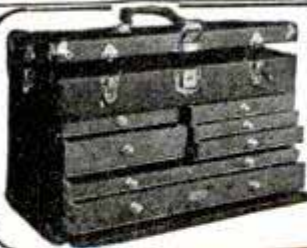
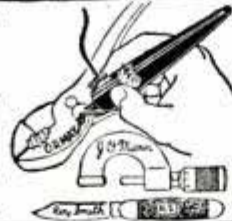

BETTER GIFTS for Christmas. Practical

GERSTNER Tool Chests are practical, desirable, and ideal. TOOLMAKERS and MACHINISTS, choose your own gifts from our Free Catalog.

Gerstner & Sons

472 Columbia Street, Dayton, Ohio

CALCULATIONS

in Office, School, Store and Shop can be instantly made with the Midget Slide Rule. It gives the answer to any problem involving fractions, mixed numbers, decimals, whole numbers, roots, powers, Logs, and Trig. Functions. Thousands of these rules are used by Accountants, Engineers, Clerks, Students, etc. It is the most versatile calculator ever invented. If you have any figuring to do, order a Midget Slide Rule on trial. Made of aluminum with figures on white celluloid. Size 4". Price with Instruction Book \$1.50. Fabricoid Case 50c extra. Catalogue Free. Sent C. O. D. if desired. Your money back if you are not satisfied.
GILSON SLIDE RULE CO., Stuart, Fla.



Makes Old Ford a Tractor

Now you can convert that old Ford car into a useful farm tractor without altering any Ford parts. We furnish the traction wheels, drive gears and auxiliary axle and mountings, ready to clamp on to the Ford frame. Pulls 16" plow.

We supply a Belt Pulley also



Write for Free Particulars.
Shaw Mfg. Co., Dept. PM12, Galesburg, Kan.

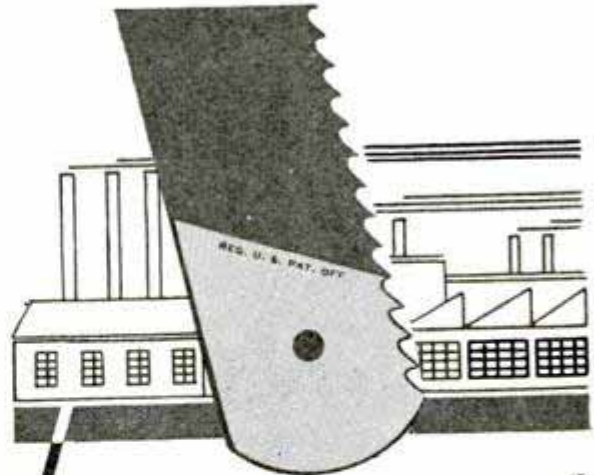

has
"RED STREAK"
hit
YOUR plant?

Let "Red Streak" Hack Saws prove they out-perform any blade you've ever used.

WHEN you have a metal cutting job, you want it done as quickly and as easily as possible . . . you want the easiest and fastest cutting hack saw on the market.

You want "Red Streak" Hack Saw Blades! Mechanics in all types of trades praise the improved cutting qualities in "Red Streak" Blades. Electric furnace steel makes "Red Streaks" wear-resisting. Evenly set teeth make the cut go straight. They're made for those who handle a hack saw roughly.

Test the "Red Streak" in your hack saw frame and you'll be a booster, too. Look for the blade with the red end.

SIMONDS

SAW AND STEEL COMPANY
FITCHBURG, MASS.

"RED STREAKS"

"The Saw Makers"

Established 1832

cut like lightning!

Branch Offices and Service Shops in Principal Cities



**Mr. Happy-Man Says:—
“Give HIM an
ATKINS Saw**

**for His Home—
Shop or Tool Kit”**

IT'S not a bit too early to select HIS Christmas gift at your Hardware Store, NOW!

For the man who is handy with tools, there's no finer gift than an ATKINS "400" or "401" Hand Saw. Its "Silver Steel" blade will cut faster and easier than any other saw he ever used; its Perfection Handle gives the saw balance, beauty, and eliminates all wrist strain. He'll use and appreciate one of these famous saws, for a lifetime.

For boys who like tools, an ATKINS "Junior Mechanic" Hand Saw is the ideal gift. A really good saw, with a 20-inch blade.

Dozens of other fine ATKINS Saws for home craftsmen! Hack Saw Frames, with "Silver Steel" Blades, which cut TWICE as fast, and last six times as long. Back Saws for fine work. Compass and Keyhole Saws. Circular Saws. Band Saws. Cabinet Scrapers, Saw Filers, Saw Sets, Files, etc.

Every tool user should have the four SAW BOOKLETS shown below. They're free. Send coupon.

ATKINS
"400"
"401"
Hand
Saws

ATKINS
"Junior
Mechanic"
Hand
Saws

ATKINS
Back
Saws

ATKINS
Hack
Saw
Frames
and
Blades

At your
Hardware
Store.

ATKINS SILVER STEEL SAWS

GET THESE SAW BOOKLETS FREE



E. C. ATKINS & CO.
Est. 1857 426 S. Illinois St.
Indianapolis, Ind.

Send "Saws in the Home," "Circular Saws," "Dado Heads," and "Saw Sense"; also information on your offer to pay \$10 for best home workshop photo.

Name

Address

My Dealer is

**PLIERS
-for radio work**

You'll find there is a Crescent-Smith & Hemenway Plier for every phase of radio and electrical work. Long, slim noses for hard-to-reach places, keen diagonal cutters for skinning and cutting wire, and many others for general work—all with characteristic Crescent easy action, dependability and long life. See them at your hardware dealer's.

CRESCENT TOOL COMPANY
210 Harrison Street
Jamestown, N. Y.

CRESCENT and Smith & Hemenway TOOLS

Catalog on request

**Engines & Motors
Big Catalog No. 30**

Illustrating Electrical, Mechanical and Model Maker's Supplies, Small Steam & Gasoline Engines, Motors, Generators, Lathes, Drill Presses, Bench and Band Saws, etc., 16-32 & 64 Watt Dyna-Motors, School Projects, Engine Castings, Motor Parts, etc., Books, Blue prints, Brass and Steel Tubing, Gears, Pulleys, Hangers, Experimental Material.

Send for Copy. Mailed anywhere for 30 cents, 25 cents Canada, refunded first order.

LOOMIS ELECTRIC & MFG. CO., 2822 N. CALIFORNIA AVE., CHICAGO, ILL.

Chesterfield
The MILD cigarette that SATISFIES

WITTE ENGINES

LIFETIME GUARANTEE

ALL SIZES AND STYLES

MAGNETO EQUIPPED

ALSO ON IRON BASE

ALL FUEL—ALL PURPOSE—POWER

Inventive skill coupled with mechanical perfection has produced in this wonderful engine the most reliable power for every need of home, farm, shop or mill. Runs as efficiently on cheap fuels as on gasoline—a big saving factor. All parts interchangeable—no costly repairs. A Witte unit pays dividends from the start. Put one to work now!

Ask your dealer or write us for free catalog

WITTE ENGINE WORKS Kansas City, Mo.

ENGINE BUILDERS SINCE 1870

AR-CON UTILITOO

—the KING of them all

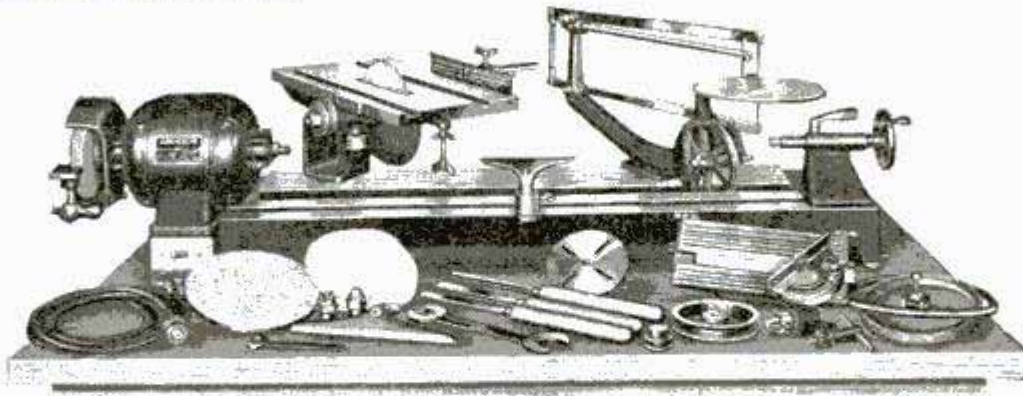

A Workshop You Don't Need to Coddle

A WORKSHOP that won't do all that you want it to do is, after all, only an expensive plaything. Make sure before you buy that the outfit you choose has the power to handle any load within its capacity; and the rigidity, strength and precision construction essential to fast and accurate workmanship. Then your choice unquestionably will be the Ar-Con Utilitool—the workshop that means satisfaction with every job you do.

Free Trial! Easy Terms!

Mail the coupon now for fully illustrated descriptive circular, together with details of our 10-day free trial offer and liberal time payments applying to the complete outfit or any unit or combination of units you may desire.

THE AR-CON TOOL CO.

500 Fassett St., Toledo, Ohio.

Mail me complete information, prices and terms on Ar-Con Utilitool with details of your free trial offer.

Name.....
Street.....
City and State.....

THE AR-CON TOOL CO. TOLEDO, OHIO

Exploding WEDGE...

Big Money For Agents
Write For Particulars

For splitting Logs, Rails, Pit Posts, Fence Posts, Cord Wood, etc. Will do more work than ten men. Will split any log up to Rail Lengths, no matter how large or tough. Pays for itself in a few hours. Satisfaction guaranteed or money refunded. Parcel Post prepaid to any address in U. S.—\$5.00. Send money order, check or cash to
HUTCHISON MANUFACTURING CO.
7741 Susquehanna St. Pittsburgh, Pa.

ONE-MAN SAW MILL

Makes lumber, shingles, cross ties, fence posts, laths, fruit and vegetable crates and boxes, dimension blanks for furniture, etc. Splits blocks into firewood. Needed by farmers, timber owners, contractors. Pays for itself in a week, or on one job. **Guaranteed.** Sold direct from factory. Write today for Special Offer and Free Book "How To Make Lumber".
BELSAW MACHINERY CO.
BOX 104-E PLEASANT HILL, MO.

\$39 BRINGS IT TO YOU

Andy Sannella Talks to Reed Players. Get this Free Book!

On the air tonight, and every night, Andy Sannella is earning a **fabulous salary** with his Selmer Sax. In his book of "Advice to Saxophone Players" he gives **more valuable information** than in ten private lessons. This book is free to all reed players. Send a postal today for your copy. No obligation.

If you will mention the Instrument you play, we will send also, free sample of our **Alexandre Reeds. They Play!**

Selmer

58 SELMER BUILDING, ELKHART, INDIANA
In Canada: 516 Yonge St., Toronto

In the Far Corners of the Globe

CORNWELL TOOLS

are Known

KNOWN throughout the world for their phenomenal strength and amazing performance, CORNWELL tools are prized by mechanics everywhere. They accomplish remarkable results under the most adverse conditions and do work that no other tools will do. They are made by our special CORNWELL processes, which insure their unvarying quality.

There Is No Substitute for Cornwell Quality

Mechanics are amazed at the startling tests which demonstrate the superior quality of CORNWELL tools. Your money back if any tools fail to do what we claim.

We Stand the Risk

You are fully protected by our guarantee that covers every tool. You take no risk. If tools are not exactly as represented send them back and we will refund your money.

CORNWELL CATALOG - FREE

Published in English and Spanish

The Cornwell Quality Tools Co.,
Dept. R, Mogadore, Ohio.
(Formerly at Cuyahoga Falls, Ohio)
Send me new illustrated catalog with prices on full line of CORNWELL Handmade Tools.

.....Where Employed

Name.....
Address.....
City.....State.....



Hand him one!

Who?

The grocer or druggist.

What?

A dime.

Why?

For a cake of Lava Soap that'll get the grimeiest hands clean in 58 seconds. You can see the pulverized Italian pumice in Lava Soap drag out the dirt, but you can't feel it. Lava makes a rich, creamy, penetrating lather in the hardest water. But it won't harm your skin. It's the busiest hand cleaner you've ever tried.

George, the Lava Soap Man

Lava costs a dime (or 6c for the medium size cake) at any drug or grocery store. But if you want to try it at our expense, mail this coupon.

Procter & Gamble, Dept. W-1229
Cincinnati, Ohio

George: I want a free sample cake of your Lava Soap.

Name.....

Street.....

City.....State.....

NEW VEST POCKET ADDING MACHINE

BABY CALCULATOR
CHICAGO U.S.A.
PATENT APPLIED FOR

0 0 0 0 0 0

ADDITION
SUBTRACTION
MULTIPLICATION
DIVISION

Guaranteed

ADDS, SUBTRACTS, MULTIPLIES, DIVIDES

Does work of \$300 machine. Guaranteed 5 years. NOT A TOY. Made of steel and indestructible. Million dollar capacity. Fits in pocket. Will not make mistakes. So simple child can operate it. Instructions furnished. Everybody should carry one for figuring.

FREE TRIAL \$2.50 Total Cost

SEND NO MONEY—Just name and address. We will ship Calculator immediately. On delivery pay postman \$2.50 (Plus few cents Postage). (If outside U. S. send cash.) 10c additional in Leatherette Case. If not satisfied after 10 days trial you get your money back. THOUSANDS OF SATISFIED USERS.

This is lowest priced practical calculator made. "Why pay more for inferior imitations?" Order from this ad.

Mail Coupon Today

BABY CALCULATOR MACHINE CO., (MANUFACTURERS)

Dept. 41, P. O. Box 1118, CHICAGO, ILL., U. S. A.

I am enclosing \$2.50—send adding machine prepaid.

Send Adding Machine C. O. D. \$2.50 plus 18c postage. (10c additional in Leatherette Case)

Name.....

Address.....

City.....State.....

AGENTS Write for big commission and territory proposition.

FREE New Book FACTORY PRICES

Save 1/3 to 1/2

New FREE book quotes **Reduced Factory Prices. Lower terms—year to pay.** Choice of 5 colors in New Porcelain Enamel Ranges. New Circulating Heaters—



\$34.75 up. 200 styles and sizes. Cash or easy terms. 24-hour ship-ments. 30-day FREE trial. 360-day test. Satisfaction guaranteed. 29 years in business. 750,000 customers. Write today for FREE book.

Ranges \$37⁷⁵ up

Furnaces \$59⁰⁰ up
KALAMAZOO STOVE CO.
391 Rochester Ave.
Kalamazoo, Mich.

"A Kalamazoo Direct to You"
Trade Mark Registered



BOYS! Make Big Money

BUILD BIRD HOUSES

Boys! Here's a real money maker. With my simple instructions any boy can build and erect Grandpa Bird Houses. They sell at \$2 to \$97.50 each. \$2,000 worth sold in Oak Park, Ill., in one year. Send \$1 for 16 Blue Print Drawings showing correct building plans so you can build my famous bird houses. Valuable book on song birds with tips and advice on making sales included free. Get busy—act Now—Today.

GEO. J. BREIDERT, 1040 N. Elmwood Ave., Oak Park, Ill.

Beautiful HOUSES \$900 and BUNGALOWS

CAN BE BUILT FOR AND UP

This and many others in my new book, Building Plans for Modern Homes, will save you hundreds of dollars. One of the most complete and comprehensive books of plans ever published by any architect. New edition just off the press. Nearly 600 floor plans and photographs of Colonial houses, bungalows, etc., costing from \$200 up; gives sizes and cost to build. Sent postpaid for \$3.00.



FREDERICK H. GOWING
ARCHITECT
101 Tremont St., BOSTON, MASS.

Go INTO BUSINESS AT HOME FOR YOURSELF!



We Set You Up in Business

Don't waste your time working for others. Get into a profitable business for yourself. You can earn good money making and selling toilet articles, perfumes, soaps, flavoring extracts, household specialties, etc. No experience necessary. We furnish everything and show you how. Wonderful opportunity for both men and women to make money at once!

Send for Free Booklet Today

Write immediately for free booklet explaining our proposition. This is your opportunity to become independent and have a profitable business absolutely your own. Don't delay. There is no obligation, so write for booklet NOW.

National Scientific Labs. 1927 W. Broad St. Richmond, Va.

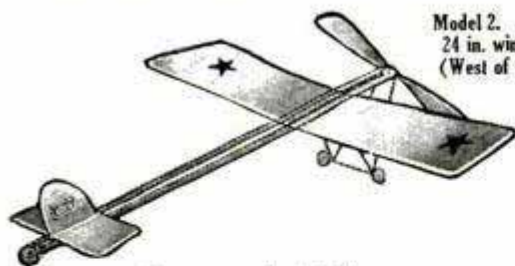

Model 2. Racing Type
24 in. wing spread \$2
(West of Miss. \$2.20)

Compete and Win with the "SILVER ARROW"

Beat the other fellows! With this plane you can confidently get into competition with boys who have other planes, and consistently win the contest. Here's a plane that flies—flies!!—not just once or sometimes, but repeatedly. Fool-proof, trouble proof, it does not disappoint you. More flights, too, because it's durable—built to stand rough usage. Launches by hand or "taxies" and "takes off." Zooms way over the housetops on long continuous flights. Not a construction toy but a fully built plane. A few moments to assemble and it's ready to fly. Designed by Charles H. Grant, one of the foremost pioneer designers and builders of model airplanes in the United States. That's the reason! New expert construction. Wings and body of light Balsa wood reinforced with aluminum braces; aluminum propeller; strong elastic motor. Durable, stable and beautifully "finished." Three models: No. 1, Racing Type, 18 in. wing spread, \$1.00; No. 2, Racing Type, 24 in. wing spread, \$2.00; No. 21, Cabin Type, 22 in. wing spread, \$2.50. (West of Miss., \$1.10, \$2.20, \$2.75.) Get the plane that really flies—all the time. If your dealer hasn't the Kingsbury thriller, order direct. Kingsbury Mfg. Co., 83M, Myrtle St., Keene, N. H.

KINGSBURY MOTOR DRIVEN TOYS

Send 10c for this Eraser: A steel disc wheel from a Kingsbury Toy with a "balloon"



tire of solid eraser rubber. Set of four, 35c. Toy catalog free.

Agents: \$6 a Day

Build a permanent business with regular customers and big repeat orders every week. 300 high-quality Household Necessities at low prices. All fast sellers. Easy to make \$6 to \$9 profit in a day. No dull seasons. Steady income all year 'round.



\$83 FIRST 5 DAYS

That's what Baumann made. Mrs. Hodges makes \$18 to \$20 a day. I'll give you same opportunity. No capital needed. New Ford Tudor Sedan offered as bonus, in addition to your big cash profits. Write today!

ALBERT MILLS, Pres.
6874 Monmouth Ave., Cincinnati, Ohio



Do Your PRINTING

Cards, stationery, circulars, tags, labels, advertising, etc. Save money. Print for Others, Big Profits. Junior Press, \$5.90. Job Presses \$11 up, Rotary \$149. Will do popular Raised Printing like Engraving. Easy rules sent. Send for catalog outfits. **THE KELSEY CO., 5-37, Meriden, Conn.**

\$1 Greatest Value Ever Offered \$1

MACOY'S 5 WINDOW PASS CASE



Morocco Goatskin

Well made in every way. Edges turned and stitched; pocket for business cards; FREE emblem if desired. Gold stamping, name and address, 35c per line extra. **Clip this adv. and enclose \$1 bill.**

- 5 Window Pass Case \$1.00
- 9 Window Pass Case \$1.50
- 13 Window Pass Case \$2.00

Enclose another dollar for beautiful solid gold Masonic Pin (Illustrated). Catalogs Masonic Books; Jewelry; Novelties; Leather Goods; for Xmas gifts. State one wanted.



MACOY PUB. & MASONIC SUPPLY CO.
35 W. 32nd St. (Est. 1849), New York



This Christmas Gift Brings You Popularity

Thousands will start toward musical success on Conns this Christmas. The one gift that brings you fun... popularity and endless chances to make extra money. Join a band or orchestra. It's easy. Anyone who can whistle a tune can learn quickly.

Easy to Play

Saxophone, Cornet, Clarinet, Trumpet, Trombone—any band or orchestra instrument you choose. Conn makes them all. And Conns are easiest of all to play. The choice of Sousa and the world's greatest artists. Especially recommended to beginners for quick progress. *Easiest* to blow. *Easiest* to finger. *Easiest* to play in perfect tune. The result of more than 50 years' experience and patented processes of manufacture exclusive with Conn—the world's largest maker. Yet a genuine Conn costs you no more than any so called standard make.

FREE TRIAL, Easy Payments

Any instrument sent for free trial in your own home. Easy payments if you wish.

Write for FREE BOOK

Write now for interesting booklet illustrating the latest models in colors. Tells everything you want to know about your favorite instrument. Mention instrument.



Artists-Ballroom Trombone



Victor Cornet



All-Metal Clarinet



New Era Trumpet



C. G. CONN, LTD., 1231 Conn Bldg., Elkhart, Indiana
Gentlemen: Send free literature and details of free trial offer on

(Instrument)
Name.....
St. or R. F. D.....
City.....
State, County.....

MAIL THIS COUPON

Own Your Own Big Money-Making Business

A NEW BUSINESS IN YOUR TOWN

A delightful, dignified and fascinating business. Make and sell Crispettes. Delicious confection. Young and old like them. Come again and again for more. Easy to make. I supply everything. Raw material plentiful and cheap. Profits big. No town too small. Start now.

QUICK SUCCESS POSSIBLE anywhere—cities, towns, villages, crowded streets; surging throngs at parks, carnivals, fairs, etc.; open a little retail store; or, begin at home; wholesale to stores, grocers, bakers, druggists, parks, baseball games, picnics, wayside stands.

EXCEPTIONAL (not average) PROFITS \$11,265 sales in 3 months reported by California man. New Jersey \$4,000 profits in less than 2 months. Revel of Michigan wrote: "Made \$25 on my first day". A. Leib of Montreal wrote: "My sales averaged \$400 per week".

WE START YOU IN BUSINESS for little money. Supply machines, secret formulas, and raw material. Little capital starts you. No experience needed.

WRITE FOR "BOOK OF FACTS"

—It's free, contains success letters from others—shows their places of business, tells how to start.

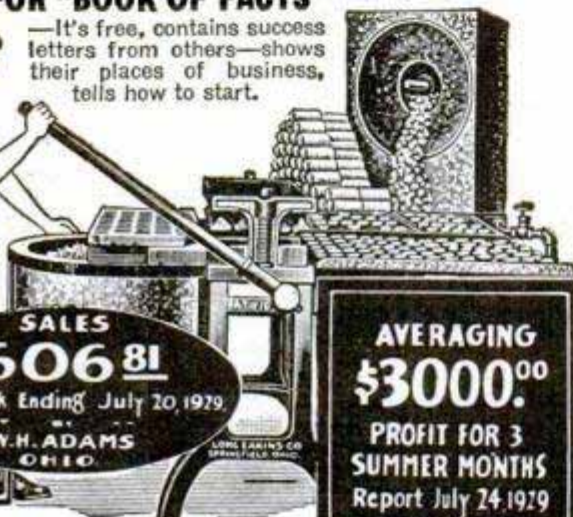

AVERAGING \$3000.00
PROFIT FOR 3 SUMMER MONTHS
 Report July 24 1929
E R NABOR
 MASSACHUSETTS.

SALES \$606.81
 One Week Ending July 20 1929
 W. H. ADAMS
 OHIO

EAKINS CO.,
 1228 High St., Springfield, Ohio

Name _____
 Address _____

\$640.00
 10 HOURS ESTIMATED OUTPUT OF A CRISPETTE MACHINE

You Need This—

COMPLETE HOME GYMNASIUM

It gives you facilities at home for playful, health-building exercise—to strengthen weak muscles—to reduce flesh—to keep vigorous and physically contented while indoors. Fits in 3 1/4 x 4 1/2 ft. floor space—it is so compact.

Is of durable tubular metal construction, attractively finished. Hundreds have been purchased and set up in dens, bedrooms, basements, sleeping porches, attics, garages, play-rooms, etc.

- Punching Bag
- Rowing Machine
- Chest Weights
- Parallel Bars
- Wrist Developer
- Massage Reducer
- Chinning Bar
- Swimming Machine
- Wall Ladder

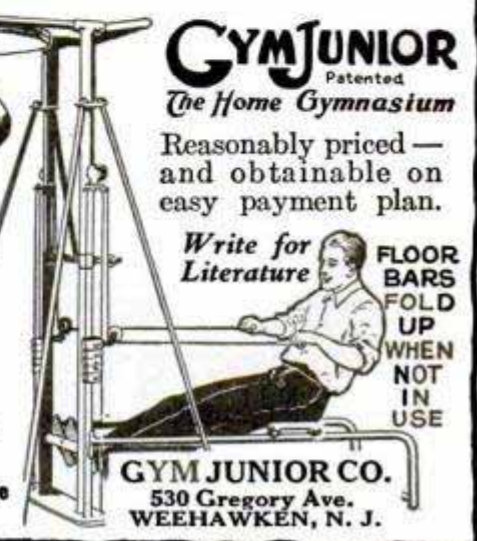

GYM JUNIOR

Patented
 The Home Gymnasium

Reasonably priced—and obtainable on easy payment plan.

Write for Literature
FLOOR BARS FOLD UP WHEN NOT IN USE

GYM JUNIOR CO.
 530 Gregory Ave.
 WEEHAWKEN, N. J.

Set, with all parts and full directions, postpaid in U. S. and Canada, only 50c (no stamps). Satisfaction or money back. Send today and print your address plainly.

MANN & BENTON
 Chillicothe, Ohio

12-INCH SCALE MODEL

of Lindbergh's Spirit of St. Louis. Scientifically designed and very realistic. Rises from ground by own power and flies 40 ft. or more. Only flying scale model sold at this price. Easily built in 2 or 3 hours. No tools needed. Construction

30 Days' Free Trial

New Models now ready for delivery direct from our factory. Astonishing low prices and terms. Do not buy until you get them.

RIDER AGENTS WANTED to ride and exhibit sample. Make big money. Many models \$21.50 up. Guaranteed \$1.50 each, wheels, lamps, horns, equipment at half usual prices. Send No Money. Write for our marvelous prices and terms on RANGER Bicycles.

Mead CYCLE CO. Dept. B110 CHICAGO

NEW AUTO LIGHT STICKS ANYWHERE

GRIP-LITE has magnetized base. Stick tight to any metallic surface. Ideal Auto "Trouble Light." Leaves both hands free! Attached in 5 seconds by clips. No batteries to wear out. Gives powerful shielded light. Protected bulb. Also serves as emergency headlight, tallight, or camping light.

AGENTS MAKE \$50 TO \$100 WEEKLY
 Sells at sight. Every autoist, garage man, repair man a prospect. Sells at only \$3.00. W. Miller: "Sold 6 in one hour!" C. H. Streater: "Selling 90 a week easy!" Many cleaning up.

10 Day Trial Send for sample at special Agents price of \$2.00 C.O.D. 10 Day trial. Also details of money-making plan. State make and year of car. Satisfaction guaranteed or money back.

MAGNO CO., 6 Beacon St. Dept. 169A Boston, Mass.

New Men's Strap Watch

CUT PRICE SALE

\$3.99

Two years guaranteed with this Jeweled Swiss watch. Choice in square, tonneau, round or cushion shape—same price. Radium dial, accurate timekeeper. Satisfaction guaranteed. Rush order. Send no money. Pay postmaster \$3.99. **JENKINS, 685 Broadway, New York, Dept. 12-F-23.**

HOMES

Get Free Book, 100 Home Plans, wholesale, mills-to-you prices, and our 15-year Payment Plan. Write **GORDON-VAN TINE** 1402 CASE ST. Davenport, Iowa

MOULDS

For Making Toy Soldiers, Indians, Cowboys, Animals, etc.

With one Mould you can make many HUNDREDS OF CASTINGS, whole Armies. Outfits, including material for casting, enamel paints and everything complete, \$4.50. Easy enough for any boy to make and great fun for grown-ups. Sport for the whole family. Write for illustrations of dozens of patterns you can make.

MAKE-A-TOY COMPANY, Dept. E, 1696 Boston Road, N. Y. CITY

Your BRAINS and this machine can make anything

Why waste your time and money on toy machines when you can get this real rig at such a low price?

The SAFETY-SAW MODEL N

- RIPS...MITERS...
- CROSS-CUTS...
- BEVELS...DADOES...
- PLOUGHS...
- GROOVES...
- RABBETS...
- SANDS...
- BORES...
- GRINDS...
- POLISHES...ETC.

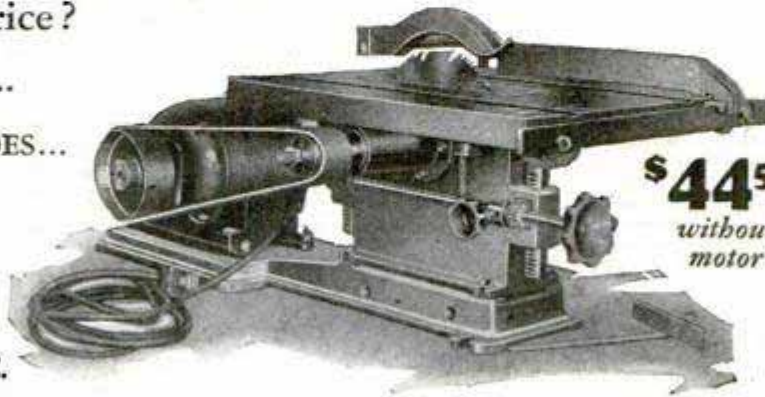

\$44⁵⁰
without motor

Easy to operate
Easy to own
BALL BEARING
Table Top 18" x 14"
Raises and lowers on a level.
Saw Arbor 3/4" Dia.
Cuts 2 1/2" Thick
Rips 12" Wide
Cross-cuts any width
Bevel Rips to 45°

Send Coupon Now for Details, Illustrations and EASY TERMS

TRY THIS Safety-Saw AT OUR EXPENSE

Put this machine on your work bench . . . give it a thorough test . . . compare it with others . . . and then if you're not more than satisfied with it in every way . . . send it back and we'll return every cent of your down payment and pay the transportation charges both ways. You can't lose a nickel, but you can gain a lot. Don't buy any machine until you've read our FREE descriptive folder . . . It shows Bench Saws . . . Band Saws . . . Lathes . . . Jointers . . . and all equipment.

SAFE TOOL MFG. CO. • BRIDGEPORT, PA.

SAFE TOOL MFG. CO., Bridgeport, Pa.

Please send me full information about your woodworking machines.

Name.....

Address.....

GET DETAILS NOW

EASY \$100 a Week

FUGO FIRE EXTINGUISHER

Unusual opening for live agents in every locality. Make \$5,000 or more a year—easily. Fugo—the instantaneous automatic fire extinguisher—is needed and wanted in every home, store, theatre, garage, shop, school, automobile, etc. Cheapest fire protection available today. Within reach of all.

1 Qt. Size \$5.00 2 Qt. Size \$7.50

Recharged in a jiffy

Amazing 30-second demonstration clinches sale—each one sold sells others. Territory going fast. Write at once for wonderful proposition that will **MAKE YOU BIG MONEY.**

The National Formetal Co., 6535 Metta Ave., Cleveland, Ohio

Let us recommend the best books to study on any subject. Popular Mechanics Press, Chicago, Illinois



ARTISTIC PORTRAIT ENLARGEMENTS

only **98¢** each

FROM ANY PHOTO or SNAP-SHOT~ SIZE 16 x 20 INCH

(or smaller if desired)
The usual price of this work is \$5.00 but by taking advantage of this Special

Offer you can get a beautiful life-like enlargement of that favorite picture of mother, dad, sweetheart, baby or any friend for **only 98 cents.**

SEND NO MONEY—Just mail us the photo—any size (Full figure, bust or group) and in about a week you will have your enlargement guaranteed never to fade. It comes to you C.O.D. On arrival pay postman 98c plus a few cents postage, or send one dollar cash with order and we pay postage. Money back if not delighted. You can send us your most treasured photograph, it will be returned to you unharmed.

FREE In order to advertise this remarkable offer we send free with every enlargement ordered, a **Highly-Glazed Hand Painted** miniature reproduction of the photo sent. These miniatures alone are worth the whole price charged for the enlargement. Take advantage of this really **Amazing Offer** and send your order today. **DO IT NOW.**

ALTON ART STUDIO, Dept. 46
5654 West Lake St., Chicago, Ill.

Please enlarge artistically the enclosed photo. Return enlargement and **FREE** Hand Painted miniature, C.O.D. 98c plus postage. (If \$1.00 is enclosed you are to send postage paid.)

Check Size Wanted
 16 x 20 in.
 10 x 16 in.
 11 x 14 in.
 8 x 10 in.

Name.....
 Address.....
 Town..... State.....

AGENTS 500% PROFIT

GENUINE GOLD LEAF LETTERS

guaranteed to never tarnish. Anyone can put them on stores and office windows. Enormous demand, large profits. Paul Clark says: Smallest day \$28.70. R. L. Reel made \$920 in two months. Write today for free sample and liberal offer to general agents.

METALLIC LETTER CO. 433-B N. Clark St., CHICAGO

only **\$100** DOWN

10 Day FREE Trial

You can have a genuine L. C. Smith (the world's only ball bearing typewriter) for \$1 down. Lowest price ever offered! Easiest terms. All the 1928 operating attachments. Re-newed. **GUARANTEED FOR FIVE YEARS.** \$1 down and we ship. No delay. No red tape. 10 day Free Trial. Free Typewriter Course, Tools, Waterproof Cover if you act now. Write for \$1 down offer and free manual.

Smith Typewriter Sales Corp., 11-C-469 E. Ohio St., Chicago, Ill.

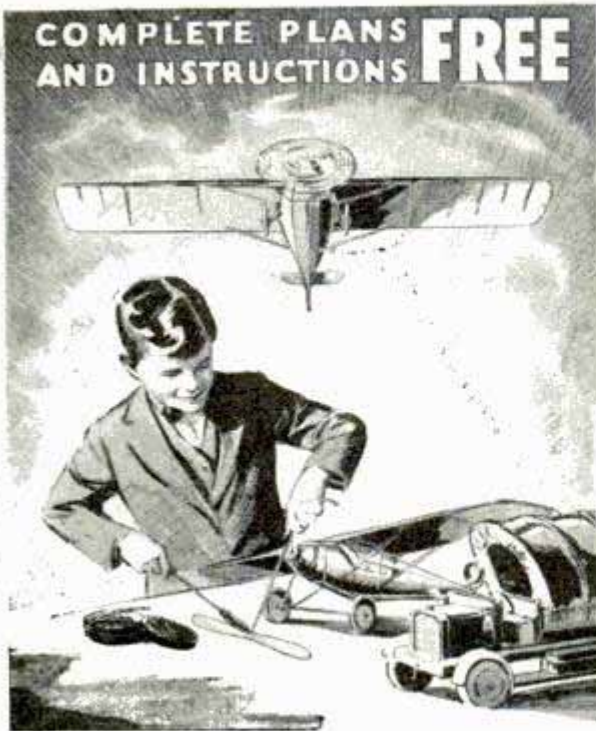

Build these of metal yourself!

Be up-to-date! The latest airplanes, trucks, etc., are of ALL-METAL construction. Build your models that same way! Working with metal is fascinating fun. It's easy to make an all-metal monoplane model like the "Spirit of St. Louis" or an all-metal model army truck with the complete Plans and Instructions we give you FREE.

All the materials you need are tin, wire and solder. You can get these anywhere and soldering is made simple with Kester Metal Mender—the genuine wire solder with the flux right inside. We send you a FREE sample to use.

There's a new thrill for you in building things of metal. Win a Metalcraft Merit Medal! Be the first in your neighborhood! Just write today for FREE Plans and Instructions and we'll mail you full particulars about the Medal Awards with them. Be sure to state your age and address.

KESTER SOLDER COMPANY
Formerly Chicago Solder Company
4212-04 Wrightwood Ave., Chicago
Makers of Kester Metal Mender Established 1899

DO YOU WANT a new business profession of your own, with all the trade you can attend to? Then become a foot correctionist, and in a few weeks earn big income in service fees,—not medical nor chiropody—easy terms for home training, no further capital needed, no goods to buy, no agency. Address Stephenson Laboratory, 1 Back Bay, Boston, Mass.

FLY THIS COMBAT MONOPLANE!



This realistic copy of a military monoplane is an unusually graceful flyer. Wing-spread 18 in. Weight only 7/8 oz. Will take off by own power and fly over 80 ft. Markings in red and blue. Can be built in 2 hrs. without tools. Construction set includes 6-in. aluminum propeller with shaft, 1/4 in. disc wheels, wood struts, rubber band motor and all other parts, with clear directions. Complete set, packed in unbreakable container, only \$1.00, postpaid in U. S. and Canada. Order today. Satisfaction or money refunded.

The MIDLAND MODEL WORKS, Chillicothe, Ohio
(We cannot make C.O.D. shipments. No retail catalogue issued.)

Super Elto Quad

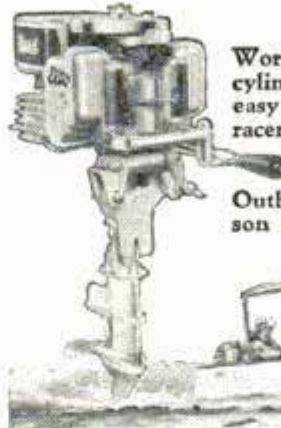

World's finest outboard motor. Four cylinders. Powerful, vibrationless, easy starting. The motor for fastest racers, luxurious runabouts, comfortable cruisers. Send for Catalog. ELTO DIVISION, Outboard Motors Corporation, Mason Street, Dept. AA, Milwaukee.



MOTORCYCLES

WE WILL TRUST YOU
Pay As Low As \$2.00 per Week
Hendersons, Harley-Davidsons, Indians
Slightly used and rebuilt. Hundreds to select from.
Send 10c for list today.

MYEROW BROS. CO., 15 Berkeley St., Boston, Mass., U. S. A.

MAKE FORD Into The "ACE" YOUR

\$599 Red-i-Kut life size patterns Class—Snap



Famous sure-fit RED-I-KUT life-size patterns and picture instructions show how you can easily convert your Ford into this Fast, Saucy, Sport-Car as thousands have done with easily obtained materials. No need to buy up the car. Makes wonderful 4-passenger car. Send 10c coin for actual photo of sport car and new manual of distinctive sport car patterns from \$5.50 up—"RKO" Steel "Spring-Lo" Irons. Tops, Windshields and many speed necessities. ORDER RIGHT NOW and get a real thrill.

KUEMPEL COMPANY, 115 Kuempel Bldg., GUTTENBERG, IOWA

DENINGER WILL TRUST YOU
SEND 50c IN STAMPS FOR CATALOGUES
BIG MONEY SAVING FOR YOU
Used and rebuilt motorcycles \$25 to \$100, used bicycles \$9.50, tandems \$20. All machines fully guaranteed. New bicycles and motorcycles at factory prices, save dealers' profits. Motorcycle and automobile tires \$3. Complete live frames, engines, supplies.
DENINGER PRICE CUTTER, ROCHESTER, N. Y.
PAY AS YOU RIDE

HAND MADE ITALIAN ACCORDIONS
Best in the world. 10-year guarantee, lowest prices. FREE instruction, ask for FREE catalog. RUATTA, SERENELLI & CO., 1014 Blue Island Ave. Dept P, Chicago, Ill.

Catch Fish!
Eels, Mink, Muskrats with our new folding galvanized STEEL WIRE TRAP. Write for our FREE TRAP OFFER and Bargain Catalog. \$1 Box of our famous Fish Bait FREE to introduce our traps. WALTON SUPPLY CO., 3502 JUNIATA AVE., ST. LOUIS, MO.

\$4.99 22 Cal. Blank Automatic
WITH 100 CARTRIDGES GIVEN!
You need no license or permit to own this 6 shot Automatic. Use for fun or self-defense. Keeps away tramps, frightens thieves, scares away dogs—A real home protector. Fool your friends. Same as an expensive automatic in construction, finish, appearance, durability; automatic magazine loading and ejection of cartridges, instant and powerful report. Guaranteed absolutely safe. Send no money. Pay on delivery \$4.99 plus shipping charges. 100 cartridges. JENKINS, 683 Broadway, New York, Dept. 12-3-23

NO PERMIT REQUIRED
6 SHOT

Campbell's Infra-Red Ray Lamp

Relieves Pain Quickly

Write for
Factory
Price

30 Days
Home
Trial

Relieve That Troublesome Ailment

Write at once and let me tell you how to relieve that troublesome ailment with Infra-Red treatments in your own home. The Campbell Infra-Red Ray Lamp throws out mild beams of Infra-Red Rays which penetrate deeply into the tissues and bring a soothing *internal heat*—best, because it works where the congestion is, and restores active blood circulation. Medical authorities say most ailments are due to congestion—relieve the congestion and you relieve the ailment because nature itself does the healing through active, normal blood circulation.

Why Suffer Needless Pain?

Are you troubled with Sinus Irritation, Sore Throat, Neuralgia, Bronchitis, Rheumatism, Neuritis, Lumbago, Tonsillitis, Catarrh, Ear Trouble, Gall Bladder trouble or similar ailments? Just let me send you this wonderful lamp on approval. Use thirty days according to directions and see if it does not bring you wonderful results.

Harmless You or anyone in your home can use the lamp on instant notice. It is on an adjustable stand—easily carried to any room—easily placed in any position. Leading health authorities recommend it. Letters from satisfied users everywhere tell of wonderful results. Just a few treatments will surprise you. First cost only cost. Connect with any electric light socket.

Easy Payments Shipped by parcel post or express direct to you from factory at lowest cost. Don't delay—if you or some friend have some troublesome ailment. Write and let me send it at once.

Get Our Book on Infra-Red Rays

This book quotes leading medical authorities and hundreds of users. Mention your ailment when writing and we will send you free valuable suggestions on how to treat it with Infra-Red Rays. Thirty day trial period.

WILLIAM CAMPBELL CO.

Dept. 1040

ALLIANCE, OHIO

BASHFUL?

"Shame on you!" Are you nervous, embarrassed in company of the other sex? Stop being shy of strangers. Conquer the terrible fear of your superiors. Be cheerful and confident of your future! Your faults easily overcome so you can enjoy life to the fullest. Send 25c for for this amazing book. RICHARD BLACKSTONE, BA-4712 Flatiron Bldg., N. Y.



A Bargain at \$4.69

Genuine Imported French Binoculars—Never before offered at our special price. Powerful lenses. Magnifies vision many times. Solid metal, elegantly finished. Complete with carrying case and genuine leather straps. Ideal for gifts. A real buy at our special price of \$4.69. Worth more. Send no money. Pay on

delivery \$4.69 and postage.
JENKINS, Dept. 12-U-23, 685 Broadway, N. Y.

NEW EASY WAY TO SIFT FLOUR



At last—the end of tedious, time-wasting flour-sifters. This great invention holds the flour while you sift. No need to pour and re-pour from dish to sifter and back again. No muss or waste flour. Lighter, fluffier cakes assured.

\$54 in 6 Hours is
agent's Profit

Montgomery made \$54 in 6 hours. Mrs. Lohrman writes "They sell themselves." Men and women agents wanted. Get liberal sample offer. Kwik Factories, 715 Kolmar Avenue, Dept. W-130, Chicago, Ill.

PATENT

Protect Your Ideas

Take the First Step Today

If you have a useful, practical, novel idea for any new article or for an improvement on an old one, you should communicate with a competent Registered Patent Attorney AT ONCE. Every year thousands of applications for patents are filed in the U. S. Patent Office. Frequently two or more applications are made for the same or substantially the same idea (even though the inventors may live in different sections of the country and be entirely unknown to one another). In such a case, the burden of proof rests upon the last application filed. Delays of even a few days in filing the application sometimes mean the loss of a patent. So lose no time. Get in touch with me at once by mailing the coupon on the opposite page.

Prompt, Careful, Efficient Service

This large, experienced organization devotes its entire time and attention to patent and trade mark cases. Our offices are directly across the street from the U. S. Patent Office. We understand the technicalities of patent law. We know the rules and requirements of the Patent Office. We can proceed in the quickest, safest and best ways in preparing an application for a patent covering your idea. Our success has been built on the strength of careful, efficient, satisfactory service to inventors and trademark owners located in every state in the Union.

NO CHARGE for Information On How to Proceed

The booklet shown here contains valuable information relating to patent procedure that every inventor should have. And with it I will also send you my "Record of Invention" form on which you can sketch your idea and establish its date before a witness. Such evidence may later prove valuable to you. Simply mail the coupon and I will send you the booklet, and the "Record of Invention" form, together with detailed information on how to proceed and the costs involved. Do this NOW. No need to lose a minute's time. The coupon will bring you complete information entirely without charge or obligation.

My Patent Law Offices
Just Across
Street From
U.S. Pat. Office



Above is a view of my drafting and specification offices where a large staff of experienced experts are in my constant employ. All drawings and specifications are prepared under my personal supervision.

NEWS

Inventors
Write for these **Free Books**

Strict Secrecy Preserved

All communications, sketches, drawings, etc., are held in strictest confidence in strong, steel, fireproof files, which are accessible only to authorized members of my staff. Feel free to write me fully and frankly. It is probable that I can help you. Highest references. But **FIRST**—clip the coupon and get my free book. Do **THAT** right now.

Clarence A. O'Brien

*Registered Patent Attorney
& Attorney-at-Law*

Member of Bar of: Supreme Court of the United States; Court of Appeals, District of Columbia; Supreme Court, District of Columbia; United States Court of Claims. Practice confined exclusively to Patents, Trademarks and Copyrights

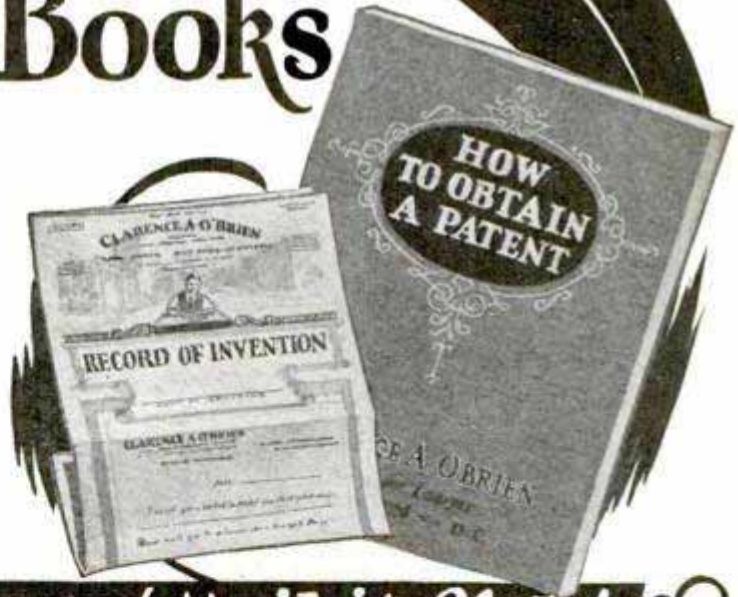

Clip this Coupon and Mail it Now!

CLARENCE A. O'BRIEN, Registered Patent Attorney & Attorney-at-Law

70-Y Security Savings and
Commercial Bank Bldg.,
Washington, D. C.

OR

Suite 1106 Woolworth Bldg.,
New York City

Please send me your free book, "How to Obtain a Patent," and your "Record of Invention" form without any cost or obligation on my part.

Name.....

Address.....

(Important—Write plainly and address office nearest you)

PATENTS TRADE MARKS COPYRIGHTS

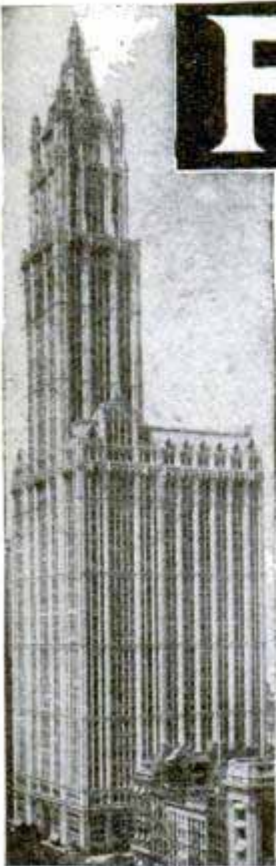

Our New York Office
Suits 1007 Woolworth Bldg.



Our Philadelphia Office
328 Fidelity Phila. Trust Bldg.



VICTOR BUILDING
Our New Building Nearly Opposite U. S. Patent
Office Specially Erected by Us for Our Own Use



Have You An Idea?

Our Offer: FOR THE PROTECTION
OF YOUR INVENTION

YOUR FIRST STEP

The inventor should write for our blank
form

"RECORD of INVENTION"

This should be signed and witnessed and
returned to us together with model or
sketch and description of the invention for

INSPECTION AND ADVICE

No Charge for the Above Information

Our Five Books Mailed

Free to Inventors

Our Illustrated Guide BOOK

How to Obtain a Patent

Contains full instructions regarding U. S. Patents.
Our Methods, Terms, and 100 Mechanical Move-
ments illustrated and described.

Our Trade Mark Book

Shows value and necessity of Trade Mark Protec-
tion. Information regarding *Trade Marks and un-
fair competition in trade.*

Our Foreign Book

We have Direct Agencies in Foreign Countries, and se-
cure Foreign Patents in shortest time and lowest cost.

Progress of Invention

Description of World's Most Pressing Prob-
lems by Leading Scientists and Inventors.

Payment of Fees in Installments

It is not necessary that the total cost for the preparation and
prosecution of a patent be paid in one payment. Our custom
is to permit our clients to pay for their applications in three
installments as the preparation of the application progresses in
our office. This plan makes the payments easy for the inventor.

We Regard a Satisfied Client as our best advertise-
ment, and furnish anyone, upon request, lists of clients
in any state for whom we have secured patents.

*Highest References—Prompt Service
—Reasonable Terms*

VICTOR J. EVANS & CO.

Patent Attorneys, Established in 1898

Main Offices: 789 9th St., N. W., Washington, D. C.

Nearly Opposite U. S. Patent Office

DELAYS ARE DANGEROUS IN PATENT MATTERS

IMPORTANT! To Avoid Delay!

YOU SHOULD HAVE YOUR CASE MADE SPECIAL IN OUR OFFICE to save correspondence, secure protection and early filing date in the Patent Office. To secure **special preparation** of your case send \$25.00 on account with model or sketch and description of invention.

ACT NOW—Often two or more inventors file applications for practically the same idea. In such cases the burden of proof rests upon the last application filed. Therefore, delays often cause the loss of a patent.



MAIN OFFICE, VICTOR J. EVANS & CO.—VICTOR BUILDING, WASHINGTON, D. C.

Our Large, Comprehensive Organization has been established for 30 years and offers Prompt, Efficient and **Personal Service** by experienced Patent Lawyers and Draftsmen. Every case is in charge of a Specialist who has been selected for his knowledge and experience in certain lines of invention. Our Lawyers practice in all U. S. Courts and defend clients in suits involving Patents, Trademarks and Copyrights. **All Communications and Data** strictly Secret and Confidential. We shall be glad to have you consult us or to answer any questions in regard to Patents, Trademarks or Copyrights without charge or obligation.



Our Chicago Office
Suite 1640-42 Conway Bldg.



Our Pittsburgh Office
Suite 514 Empire Building



Our San Francisco Office
Suite 1010 Hobart Building

**FREE
COUPON**

VICTOR J. EVANS & CO.
PATENT ATTORNEYS *Established
in 1898*

NEW YORK OFFICES
1007 Woolworth Bldg.

CHICAGO OFFICES
Suite 1640-42 Conway Bldg.

PHILADELPHIA OFFICES
828 Fidelity Phila. Trust Bldg.

PITTSBURGH OFFICES
514 Empire Bldg.

SAN FRANCISCO OFFICES
1010 Hobart Bldg.

MAIN OFFICES: 789-9th Street, N. W., WASHINGTON, D. C.

Gentlemen: Please send me *Free of Charge* your books as described on preceding page.

Name _____

Address _____

PATENTS

TRADE-MARKS • DESIGNS
FOREIGN PATENTS

MUNN & CO.
PATENT ATTORNEYS

Associated since 1846 with the Scientific American

SCIENTIFIC AMERICAN BUILDING
625 F Street, Washington, D. C.

1303 TOWER BUILDING
Corner of Michigan Blvd. and Madison St.
Chicago, Ill.

1551 SCIENTIFIC AMERICAN BUILDING
24 West 40th Street, New York City

HOBART BUILDING
582 Market Street
San Francisco, Calif.

511 VAN NUYS BUILDING
Spring and Seventh Streets, Los Angeles, Calif.



Books and Information on Patents and Trade-Marks by Request.
Associates in All Foreign Countries.

\$165,000 REWARD FOR AN IDEA

That sum was paid to the inventor of "Kiddie Kars." Here is a remarkable book which tells you what inventions are NEEDED in every field. Don't waste your ideas. Send today for

1000 NEEDED INVENTIONS

Prepared by Raymond F. Yates, famous inventor, former managing editor of Popular Science Monthly, who knows what manufacturers want. New, revised 1929 edition. This book may start you toward a fortune. Send no money. Just write a postcard. Pay mail man only \$1.50 plus postage when book arrives. Money back after 10 days if desired. Limited offer. Write now. Get started in right direction. (Outside U. S. \$1.70 cash with order.) Bureau of Inventive Science, 312 Wisner Bldg., Rochester, N. Y.

PATENT YOUR INVENTIONS

EDWARD GOTTLIEB

Attorney in Patent Causes

5 Beekman Street New York
Inventions Developed—Representatives for
BLAIR TOOL AND MACHINE CORP.

INVENTORS

May now arrange to obtain PATENTS

and pay for them on the basis of

DEFERRED PAYMENTS

INVENTORS SERVICE BUREAU

Dept. B, Union Trust Building, Washington, D. C.

PATENTS

PROTECT YOUR IDEAS

Write today for FREE INSTRUCTIONS—or send Drawing or Model of your Invention for Examination.

Promptness Assured with Best Results

CARL MILLER

REGISTERED PATENT ATTORNEY

Former Member Examining Corps U. S. Patent Office
255 McGill Building Washington, D. C.

PATENTS TRADE-MARKS

Don't Lose Your Rights
To Patent Protection

Before disclosing your invention to anyone send for blank form "EVIDENCE OF CONCEPTION" to be signed and witnessed.

LANCASTER & ALLWINE

480 Ouray Bldg. WASHINGTON, D. C.
Originators of forms "Evidence of Conception."

PATENTS

Booklet Free **Highest References**
Promptness Assured **Best Results**

Send drawing or model for preliminary examination and advice.

ALL BUSINESS GIVEN PROMPT AND PROPER ATTENTION

Listed Patent Lawyer in the latest editions of the Rand-McNally Directory of Bankers and Bonded Attorneys, published by Rand-McNally & Co., Chicago, Ill.; The Baggott & Ryall Directory of Guaranteed Attorneys, published by Legal Directory Corporation, Boston, Mass.; Flugel's Law List, published by Legal Directory Publishing Co., St. Louis, Mo.; American Lawyers Annual, published in Cleveland, Ohio; Bankers Service Legal Directory, published by Bankers Service Co., Boston, Mass.; Eyre's Law List, 9 Park Place, New York City; Walters Legal Directory, Omaha, Nebraska, and the National Directory of Attorneys, Baltimore, Maryland.

WATSON E. COLEMAN,
 REGISTERED PATENT LAWYER

Victor Building, 724 Ninth Street, N. W.
WASHINGTON, D. C.

PATENTS

TERMS IF DESIRED

Don't let lack of ready money keep you from protecting the idea which may prove the turning point in your life.

FORMER ASSISTANT EXAMINER OF U. S. PATENT OFFICE

will now handle your patent matters on easy payments. Write today for free information and particulars.

M. S. CAYNE

(Registered Patent Attorney)

Main Offices

BANKERS BLDG., 105 W. Adams St., CHICAGO
 (With Offices in Washington, D. C.)

PATENTS

To the Man with an Idea

PATENTS Procured. **Trade Marks** Registered. —A comprehensive, experienced, prompt service for the protection and development of your ideas. Preliminary advice gladly furnished without charge. Booklet of information and form for disclosing idea free on request.

IRVING L. McCATHRAN, Patent Lawyer
 Formerly with and successor to **RICHARD B. OWEN**
 704 International Bldg., Washington, D. C.
 41-E Park Row, New York City

TRADE-MARKS
REGISTERED

PATENTS

Trade Marks, Copyrights, Patent Litigation Handbook with illustrations, 100 mechanical movements. Sent free on request.

ALBERT E. DIETERICH
 formerly member Examining Corps U. S. Patent Office

REGISTERED

PATENT LAWYER and SOLICITOR

621-A, Ouray Bldg.

30 Years' Experience Washington, D. C.

PATENTS

As one of the oldest patent firms in America we give inventors at lowest consistent charge, a service noted for results, evidenced by many well-known Patents of extraordinary value.

Book, Patent-Sense, free. **Lacey & Lacey, 646 F St., Washington, D. C. Estab. 1869**

\$10.00 PER MONTH BUYS Fibre-Life Limbs



NEXT TO NATURE. BRACES MADE TO ORDER. AGENTS WANTED. FREE FIBRE SAMPLE **WORMAN CO., 252-P HENNEPIN AVE. MINNEAPOLIS, MINN.**

Patents **Trade Marks**

Edward C. Sasnett

Atty. at Law, Registered Patent Atty.

Formerly a Principal Examiner U. S. Patent Office

516 McGill Bldg., Washington, D. C.

Personal Service

Let us recommend the best books to study on any subject. Popular Mechanics Press, Chicago, Illinois

INVENTORS PROTECT YOUR IDEAS

Write for our Guide Book, "HOW TO GET YOUR PATENT," and Evidence of Invention Blank, sent Free. Tells our terms, methods, etc. Send model or sketch and description of your invention for **INSPECTION and INSTRUCTIONS FREE.** **Terms Reasonable.** **Best References.**

.....WRITE TODAY.....

RANDOLPH & COMPANY, Patent Attorneys
 301 VICTOR BUILDING, WASHINGTON, D. C.

Name

Address

Turn a Corner of Your Shop into EXTRA MONEY with this Amazingly Simple Plan

I NSTALL a Reflex Battery Charger. No attention required whatever. Works 24 hours a day. Brings new business to you. **Steady profits year 'round.** No overhead. Batteries charged for less than 6c apiece.



Special Price to You

This "New Model" Reflex Battery Charger (any size) shipped to you direct from factory at Special Low Price. Cannot overcharge or discharge. Operates on regular light current. Guaranteed. Half hour installs it. We show you how. Write TODAY!

Th's "New Model" on Easy Payments

Small down payment brings it to you. Balance on very easy terms. **Satisfaction guaranteed or money back.** Begins making money immediately. Low price, economy of operation and long life cannot be surpassed in any other make.

Mail this Coupon for Complete Details

Get detailed information today on this amazing Reflex Battery Charger. Quickly pays for itself.

REFLEX
BATTERY CHARGER
1 to 15 Battery Capacity
Complete Only **\$58 00**

THE REFLEX SPARK PLUG CO.

10808 Berea Road, Cleveland, Ohio

Gentlemen: Without obligation, send me complete details on the specially priced Reflex Battery Charger, explaining how I can operate a battery charging service on a big, profit paying basis.

Name.....

Address.....

Now... THE Super Parasol Sea Plane



Thus again the Super Parasol proves the Super power of the HEATH-Henderson combination. Fit pontoons and fly your Super Parasol from the water.

Complete pontoon equipment \$200.00. Complete set pontoon blue prints \$2.00.

Send 10c in stamps or coin for large illustrated booklet describing America's most popular Sport Plane which you can build for \$199.00.

HEATH AIRPLANE COMPANY
1727-29 Sedgwick St., Dept. P-12, Chicago, Ill.

One Year
To Pay

No. A-172—\$63.00
\$2.00 Deposit—\$1.25 Weekly

A more beautiful ring never was designed. It's exquisite. Set with a fine quality, full-cut, blue-white genuine diamond, full of fiery brilliance—of scintillating beauty. Mounting is 18 Karat real white gold, gorgeously hand-engraved—fit for a queen. As an engagement or friendship ring it will make any girl happy. Everyone will admire it and think you paid much more. Guarantee certificate. Handsome gift case FREE.

No Red Tape
10 Days Trial

SEND NO MONEY On delivery pay postman only \$2. Wear it 10 days free. If you keep it, pay only \$1.25 a week for about one year. All credit dealings kept strictly confidential—No orders accepted from persons under 20 years of age.

PRICE CUT TO \$63.00—WORTH \$100.00

You can buy this gorgeous ring at the wholesale price. Compare it with similar rings at \$100. We guarantee it to stand any test or comparison. Greatest bargain offered by any Diamond Importer. We allow 8% annual increase in exchange for a larger diamond ring.

Write for FREE Illustrated Catalog

It brings our large Jewelry Store right into your home. Gives weights, grades and complete description so you can buy diamonds like an expert. Gives you information other jewelers dare not tell.

Genuine Blue-White Diamonds as low as \$197.00 a Carat.
AGENTS WANTED—EARN \$100 WEEK. Write for details.

STERLING & DIAMOND CO. INC.
DIAMOND IMPORTERS—\$1,000,000 STOCK—ESTABLISHED 1879
1540 BROADWAY DEPT. 2682 NEW YORK

Money Back GUARANTEE

We are an old firm of diamond importers. You take no risk. If you are not satisfied that the ring is the biggest bargain you ever got, return it and we will refund every cent that you paid, cheerfully.

"At 61"

"I thought I was through. I was half-living—getting up nights—constantly tormented with aches and pains. At 62 my condition became almost intolerable. Then at 63, I shook off 20 years almost overnight."



"How I Licked Wretched Old Age at 63"

I N 65% of all men, the vital prostate gland slows up soon after 40. Pain may not appear instantly. But gradually symptoms often develop that lead to sciatica, backache, bladder weakness, constipation, etc. But now a new, safe way has been discovered by a simple home treatment to restore the prostate to normal health. The reports on many cases are amazing. Many physicians use and recommend it. No drugs, medicine, surgery, or electric rays.

FREE! A 24-page illustrated book fully describes it. The edition is limited. Send for a free copy. Every man past forty should know the meaning of these frank facts. Simply write The Electro Thermal Co., 2124 Morris Ave., Steubenville, Ohio. Western Address: Dept. 21-A, 303 Van Nuys Bldg., Los Angeles, Cal.

WIN \$1000 CASH

NAME THIS SHAMPOO

This Offer Open to Every Reader of this Announcement

It makes no difference who you are or where you live, we want you to send us a name for this new and unusual shampoo. Whoever sends the most suitable name will win \$1,000.00—nothing else to do. Just write or print the name on any kind of paper. Neatness does not count.

ANY NAME MAY WIN

No matter how simple you think your suggestion is, you cannot afford to neglect sending it at once. Any name may win. The names of people, flowers, trees, birds, etc., may be submitted for a name or you can send a coined word or a word made by combining two or more words such as "Sun-gleam," "Youth-glow," etc., or your name might suggest the handy new container, our latest sanitary tube, from which the shampoo is simply squeezed out. No bottle to break, leak or spill, no cake of soap to lie around and collect germs. Nothing safer or more sanitary and convenient for travel. There is nothing more to do, simply the person sending the most suitable suggestion for a name will receive \$1,000.00 in cash or, if prompt, \$1,100.00 in all.

Nothing to Buy—Nothing to Sell

Win this \$1,000.00 cash prize by a few moments' thought. How can you earn this amount of money easier or more quickly? Remember, there is no obligation! The person submitting the winning name will have nothing else to do to win the \$1,000.00 and the extra \$100.00 if prompt, there is nothing to buy or sell. Only one name will be accepted from each contestant. We are offering one hundred other big cash prizes ranging from \$8,000.00 down as a part of our novel advertising plan to make the products of the Paris American Pharmacal Company better known. Everyone sending us a name for our shampoo, regardless of whether it wins or not, will be given an opportunity to win the \$8,000.00 first prize or one of the other one hundred cash prizes. The winner of the \$1,000.00 cash prize (\$1,100.00 in all if prompt) offered for a name for our shampoo may by participating in our other prize offers win an additional \$8,000.00 or a total of \$9,100.00. You have everything to gain and nothing to lose as it costs you nothing to send a name. Do it today. The very name you think least of may be the winner.

\$100 EXTRA FOR PROMPTNESS

To get quick action we are going to pay the winner an extra \$100.00 for promptness, or \$1,100.00 in all—so send your suggestion AT ONCE!

CONTEST RULES

This contest is open to everyone except members of this firm, its employees and relatives. Each contestant may send only one name. Sending two or more names will cause all names submitted by that person to be thrown out. Contest closes April 30, 1930. Duplicate prizes will be given in case of ties. To win the promptness prize of \$100 extra, the winning name suggested must be mailed within three days after our announcement is read.

PARIS AMERICAN PHARMACAL CO.,
 PM McCune Bldg., Des Moines, Iowa.

Enclosed with this coupon on separate sheet is my suggestion for a name.

Date this announcement was read.....

Date my suggestion is mailed.....

Name.....

Address.....

NOTE: Being prompt qualifies you for the extra \$100.00 as outlined in this announcement.

RADIO CONSTRUCTORS "Radio Design" Quarterly

Now official organ Radio International Guild, keeps you posted on latest radio, short-wave, television. Send 50c for 4 issues, one year's membership in the Guild, lapel pin, etc.

RADIO DESIGN, 103-J, Broadway, Brooklyn, New York City

Information on any book free. Write Popular Mechanics Press, Chicago, Ill.



VICAM STANDARD MOVIE CAMERA

Make your own action movies of events, trips, parades, etc. Takes 25 feet of standard film. Equipped with F.5 universal lens. Loads in daylight. Films developed free. Film can be projected from any standard projector. All-Metal Camera \$18.50. An ideal gift for Christmas for any member of the family.

Order today C. O. D. or send 10c in stamps for illustrated booklet.

VICAM PHOTO CO. 1222 Belmont Ave. PHILA., PA.

\$13⁵⁰

F.O.B. Phila.

GET TWICE THE STATIONS

Tune Scientifically



RADDEX lists every station in America in the order in which they will come in on your dial. Thus you can identify programs the instant received and know where to set dials for any station you want even those never received before.

Only Correct Method of Tuning a Radio Set

RADDEX

Complete hour-by-hour program of all chain features

THE RADDEX PRESS, 1365 East 6th St., CLEVELAND, OHIO

At Leading News Stands and Radio Stores or sent postpaid for

25c

Cal. 30-40 Six Shot

Price \$9⁷⁵



KRAG CARBINE

All the qualities of a high price rifle. In fine used condition, all working parts guaranteed for one year. Send today for our Free 50-page illustrated catalog of money saving values; Guns, Ammunition, Cutlery, Sports and Gov't goods.

Terms Cash. No C. O. D.

W. Stokes Kirk, Dept. P. M. 12, 1627 N. 10th St., Philadelphia, Pa.

WET CELLARS MADE DRY from the Inside!

DAMP musty cellars are unsanitary, a danger to health and a poor place to store valuable material.

Where water or moisture seep in through cracks or porous spots in the floor or walls, you can make and keep your cellar dry and sweet—a fit place to work, free from odor, mold and rust—by filling the cracks and coating the moist surface with Smooth-On No. 7.

This is the one practical waterproofing that you can apply yourself, easily, from the inside, to wet or dry surface and with every assurance of thorough water-tightness, even in the wettest seasons.

Excellent also for patching concrete floors, waterproofing garage, stable and washroom floors, brick walls, cisterns, septic tanks, water troughs, fountains, fish ponds, swimming pools, manure pits, etc.



Write for **FREE BOOK.**

About 25 pounds of Smooth-On No. 7 are required for each 100 square feet of surface covered, and no experience is necessary. Complete instructions on the package.

Sold in 5-pound cans and 25 and 100-pound kegs.

SMOOTH-ON MFG. CO., Dept. 37,
574 Communipaw Ave., Jersey City, N. J.
Please send the free Smooth-On Repair Book.

Name.....
Address.....

**Return this coupon for
FREE copy of Booklet**

12-29



The FARRAND RAPID RULE

The rule good craftsmen are proud to use and to show. Six or eight foot rules coil easily in small container no larger than a watch. Are both rigid and flexible.

Write for six inch sample and descriptive folder.

HIRAM A. FARRAND, Inc., Berlin, N. H.



Why Not Start Welding Shop Of Your Own?

- Welding Outfits.....\$25.00 Up
- Lead Burning Outfits... 18.00 Up
- Soldering Outfits..... 8.00
- Paint Sprayers..... 14.00 Up
- Regulators and Gauges... 9.50 Up
- Lead Burning Torches... 6.00 Up
- Welding Torches..... 10.50 Up
- Cutting Torches..... 30.00 Up

Write for catalog—also our payment plan.

SUPERIOR OXY-ACETYLENE MACH. CO., P. O. Box 285, Hamilton, Ohio

Every Coo-Coo-\$2.75 to You!

Coo-Coo Auto Horn (patented) sells itself at \$5.00—Costs \$2.25. Agents making high as \$25 an hour. No house-to-house—stand around garages, service stations—coo-coo and clean up! Installed by anyone in 3 minutes. Cleverly sings "coo-coo." A jolly greeter. Send \$2.25 for sample or write for further information.



PACIFIC COAST PRODUCTS CO.
1233 Taft Building HOLLYWOOD, CALIF.

The man who studies gets ahead. Popular Mechanics Press will advise you what books to read to advance in your trade. 200 East Ontario Street, Chicago, Illinois.



Attractive New Binders

For Popular Mechanics Magazine

Your choice of colors; blue, green, brown, red or black in these beautiful and durable art binders. Ideal for the home or for libraries, schools, reading rooms, etc. **Price \$1.25 each, postpaid.** Your name in gold on front cover for 25 cents extra. Address **POPULAR MECHANICS COMPANY** 200 E. Ontario Street, CHICAGO, ILL.

PROFIT WHILE YOU PLAY! BECOME A M.C.H.C. OWNER-DEALER!

BUY FOR 1/3 REGULAR RETAIL PRICES 1930 SCREEN GRID LATEST WORLD-FAMOUS ALL-ELECTRIC RADIOS



Roosevelt Model 20
A De Luxe modern console of two-tone walnut plywood, with inset of Spanish marquetry. Improved screen grid, totally enclosed, 7 tubes, including rectifier; all-electric; Utah Dynamic Speaker.

All Roosevelt De Luxe Consoles are equipped with the latest world renowned Utah Dynamic Speakers.

Model 20
Regular Retail Price... \$218.00
Special Sale Price... \$120.50
Owner-Dealer Price... **\$69.50**
Complete with tubes for this Xmas offer.

OUR SPECIAL XMAS OFFER
On Xmas orders received immediately, we will include seven latest type Diatron Screen Grid tubes, valued at \$23, at the prices quoted—Model 20 at \$69.50 and Model 94 at \$79.50. Write at once and receive this amazing extra value absolutely **FREE!**

Look in the big city stores and the high class magazines! You will see these famous Screen Grid sets and these cabinets featured at high prices, under famous manufacturers' names. Through our organization, you can put this same radio perfection into your own home at one-third the prices you see there.

These sets and cabinets are big surplus stocks of leading manufacturers' latest approved models. We bought them at tremendous discounts which enable us to give them to you at less than original factory prices. They are decidedly not seconds. Every Roosevelt is a perfect instrument of the highest grade—the only totally enclosed Screen Grid Chassis made, with all the newest improvements, exactly as shown. Under our liberal plan, merely to own one of these Radios qualifies you to act as an Owner-Dealer. You can buy your own set at the Owner-Dealer price. Enjoy it in your own home! Show it to your friends with our advertising. Then sell for one-half Regular Retail Prices and make 50% profit.

FREE Send for amazing offer giving full details and specifications. Clip, fill out, mail now for Owner-Dealer Offer.

MERCHANDISE CLEARING HOUSE CORPORATION
Dept. 509, 1737 S. Michigan Ave., Chicago

Roosevelt Model 94
A De Luxe console cabinet of genuine matched walnut with burl overlay and carved pilasters. True screen grid receiver and tubes; push-pull amplification, shielded reception; balanced condenser; three tuned stages; 7 tubes, including rectifier; all-electric; Utah Dynamic Speaker.



Model 94
Regular Retail Price... \$243.00
Special Sale Price... \$133.00
Owner-Dealer Price... **\$79.50**
Complete with tubes for this Xmas offer.

The Roosevelt Screen Grid Chassis

the only one totally enclosed.

MERCHANDISE CLEARING HOUSE CORP.
Dept. 509, 1737 S. Michigan Ave., Chicago, Ill.

Without obligation send me your FREE catalog and Special Owner-Dealer Offer.

Date.....

Name.....

Address.....

City.....State.....



saving machinery. The turret revolves. Any desired tool instantly ready for use. A postal will bring full particulars. Send for it NOW.

Tessmer Machine & Tool Co., 1425-1445 RIVARD ST., Detroit, Michigan



How to Obtain A Better Looking Nose!
Improve your personal appearance
My new Model 25 Nose Shaper is designed to improve the shape of the nose by remoulding the cartilage and fleshy parts, safely and painlessly. This is accomplished thru the very fine and precise adjustments which only my patented Model 25 possesses. Results are lasting. Can be worn at night, or during the day. Money refunded if not satisfied after thirty days' trial. Write for free booklet to
M. TRILETY, Pioneer Nose Shaping Specialist
Dept. 61 BINGHAMTON N. Y.

OLD MONEY and stamps WANTED



POST YOURSELF! It pays! I paid J. D. Martin, Virginia, \$200 for a single copper cent. Mr. Manning, New York, \$2,500 for one silver dollar. Mrs. G. F. Adams \$740 for a few old coins. I want all kinds of old coins, medals, bills and stamps. I pay big cash premiums.

WILL PAY \$100 FOR DIME
1894 S. Mint; \$50 for 1913 Liberty Head Nickel (not buffalo) and hundreds of other amazing prices for coins. Get in touch with me. Send 4c for Large Illustrated Coin Folder. It may mean much profit to you. Write today to

NUMISMATIC COMPANY OF TEXAS
Dept. 324 FORT WORTH, TEXAS
[Largest Rare Coin Establishment in U. S.]

DIAMONDS

(Sent Free Examination)

here 60% of Market Prices

10 large loan firms combined (world's oldest, largest association of its kind—rated over \$1,000,000.00), loans money on diamonds. A few such loans not repaid. Diamonds originally sold by outstanding jewelers. Of course we can loan but a fraction of real values. You get the advantage in Unpaid Loans at cash prices you can try to match at full 60% more. Every liberal privilege.—Examination free—No obligation to buy.

Free List of Unpaid Loan Diamond Bargains Every diamond accurately described. Radically low amounts you can borrow (like Insurance Policy loan guarantee). Get full details of free examination offers. You don't risk a penny. 1/2 century old house (references: Bank of Pgh., Union Trust Co., 3rd Nat'l Bank). Lists limited—Send now. For **FREE LIST** write today to **Jos. DeRoy & Sons, Opp. P. O. 1987 DeRoy Bldg., Pittsburgh, Pa.**



Unpaid Loans
Low as **\$60** per Carat

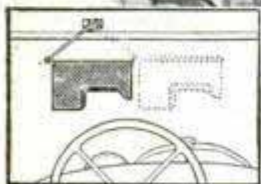

ADJUSTS TO ANY POSITION

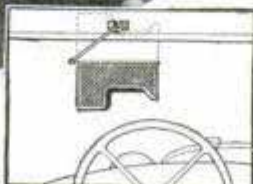

OUT OF THE WAY WHEN NOT IN USE

Glaring Lights Can't Blind You!

Now—end that nervous tension and peril that faces you when glaring headlights flash in your eyes on dark, narrow roads or winding curves. Face-a-Lite is more than a glare shield. Note description above.

\$33 Profit In One Hour

Incidentally, if you need extra money, here is your chance to clean up. A. H. Wilkinson made \$33 in one hour demonstrating Face-a-Lites to eager car owners. Lewis Carpenter made \$51 in seven hours. And Samuel M. Davis reports sales "from noon Tuesday to noon Wednesday" that give him \$263.10 profits! Over half a million car owners have paid Face-a-Lite agents wonderful profits. And no wonder! Face-a-Lite is the one glare shield that dims blinding lights without blocking your view. Note the illustration above. Just hand one to any car owner—let him look at glaring lights and he's sold.

Car owners and spare time workers are invited to get the Face-a-Lite liberal introductory offer and easy "extra income" plan as explained in my free book—"A Sure Way to Safety and Profit." End that night driving menace—and make extra money doing it. Mail coupon below to

W. M. WILLY, Pres.
FACE-A-LITE MFG. CO.
W-79 Logan Bldg., Mitchell, So. Dakota.

W. M. Willy, Pres.,
Face-a-Lite Mfg. Co.,
W-79 Logan Bldg., Mitchell, So. Dakota.
Without obligating me, send free book,
"A Sure Way to Safety and Profit." Also
full description of Face-a-Lite and your
liberal introductory offer.



Name.....
Address.....
City..... State.....

RADIO FREE CATALOG

NEW SCREEN GRID SETS

Wholesale Prices

Everything in radio at wholesale prices—New, Screen Grid, A. C. Humless All Electric Sets—Standard A. C. Sets—battery operated sets—

Priced as Low as **\$15.95**

Also an attractive array of beautiful consoles—accessories, parts, kits.

Most complete catalog in radio—196 pages of unusual price values. Write for it today!

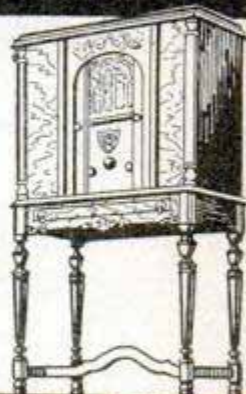

ALLIED RADIO CORPORATION

711 W. LAKE ST. DEPT. 66 CHICAGO

RADIO! RADIO!!

AGENTS: Make big money selling nationally known radios to consumer. Liberal discounts. We finance installment sales. Sold through 1,000 franchised retailers for last five years. Live agents wanted for open territories. Write

SALESMANAGER, Box 1142, CHICAGO



CHI-RAD RADIO COMPLETE WITH DE FOREST AUDIONS. Eight years selling \$139.50

quality radio equipment—now we've made an all A.C. set of our own, "The Chi-Rad". Has all the latest features: Power detection, Thordarson Audio Trans., push-pull amp, with new 245 power tubes, Magnavox Dynamic Speaker, walnut console, etc. Unusual guarantee.

Agents We have an attractive selling proposition for you. Write today for details.

Set Builders Write for Money-Saving Catalog
CHICAGO RADIO APPARATUS CO., Dept. P.M.
415 S. Dearborn St. Chicago, Ill.

22 Cal. Blank Automatic

NO PERMIT REQUIRED

You can own this 6-shot Automatic (for Blanks only) without a license. Get one for fun or real protection, to frighten off tramps and thieves and scare dogs away. Identical in construction and appearance to genuine Automatic Pistol. Load report. Full blue steel finish, rubberstock. Send no money. Price \$4.29, plus express charges. 3 for only \$11.99. Address



WITH 100 CARTRIDGES FREE!

\$4.29

WINEHOLT MAIL ORDER, Box B-25, Woodbine, Pa.

GET INTO THE VENDING MACHINE BUSINESS LARGE PROFITS BEING MADE!



You buy machines and place them in stores paying merchants 25% of receipts. Gum and peanuts used allow you from 100% to 200% profit! Start with small capital during spare time. A route of our machines will make you financially independent!

Write for catalog and full details To day!

D. ROBBINS & COMPANY 28-P DODWORTH ST. BROOKLYN, N.Y.



METAL TURNING LATHES

and SPEED LATHES



\$10.50 and up.

Goodwin Mfg. Co. 435 Keota St., Ottumwa, Ia.

Big Christmas Catalog Ready!

202 ILLUSTRATED PAGES OF THE LATEST ILLUSIONS, TRICKS, NOVELTIES, PUZZLES AND SENSATIONAL ESCAPES. Send only ten cents (United States stamp or coin) for this interesting catalog fully describing over six hundred eighty articles. Each one pictured. Write for it today or make a note of it and include with your order of any of the tricks described below.

Stage Money



New Bills To Conform With Small Size Currency

With these bills it is easy for a person of limited means to appear prosperous by flashing a roll of them at the proper time. By peeling off a genuine bill or two from the outside of the roll, the effect created will be all that can be desired. Prices, postpaid: 50 bills 20c; 130 for 50c, or \$3.00 thousand postpaid.

Nose Blower



Concealed in the handkerchief. Proceed to blow your nose and your friends

will think they hear a steam engine or something. You can blame the whole noise on a very bad cold and keep up the fun as long as you like. Price 10 cents; 3 for 25c, or 75c doz. postpaid.

Fire-Eater

A great trick by which you appear to breathe fire from mouth. Quite harmless. All necessary apparatus sent complete for only 30c, postpaid.



Black Art

This book tells of the sciences of Magic, Witchcraft, Alchemy, Necromancy, Mesmerism, etc. It tells how to make persons think of you, how to charm those you love, etc. The book contains 122 pages. Price 30c prepaid.



OAKS' MASTER BOX OF TRICKS

Mystery and entertainment for every day in the year. Whole evening's entertainment complete for \$1.00. Without practice or experience, anyone can give a complete entertainment with these mechanical and self-working tricks so simple that a child can perform. Contains apparatus for 7 complete tricks. The Magic Ball and Vase Trick. Wooden ball is placed inside, and upon replacing the lid has disappeared and is found in someone else's pocket; Disappearing Spots. This trick consists of changing four Kings to four Aces, and then to blank cards; Magnetic Wand. Magician's Wand clings to fingers and floats about as if magnetized, yet falls when anyone else tries; Ribbon Factory from the Mouth Trick. A seemingly endless supply of colored paper ribbon comes out of the mouth; Disappearing Handkerchief. Handkerchief held in the mouth mysteriously vanishes; Enchanted Bottle. No one but yourself is able to make it lie down; Great Hat and Dice Trick. Large dice is placed on top of hat, disappears, and is found underneath, yet no one has touched the hat. Only \$1.00 for all.



MAGIC CARD BOX



This mysterious box is useful in performing many card tricks. You ask two persons to each select a card from any ordinary pack of cards. One of the cards is now placed in this box and a second later when the box is opened the card has mysteriously disappeared. The other card is now placed in the box and when it is again opened the first card appears and the other one is gone. You can make several cards disappear and at command they all appear at once. You can tear a card up and place it in the box and when you open the box again it will be found whole. All easy to perform after reading our simple directions. Price 25 cents. Better grade, made of highly finished wood, \$1.25.



Seebacroscope

With this instrument to your eye you can see what is going on behind your back. Many times things occur when no one thinks you are looking. Just like having eyes at the back of your head. Price 25c postpaid.

OAKS' CARD MIRACLES



Complete box of our most popular card tricks. Easily performed with instructions for each trick. Box contains Disappearing Spots, Hindoo Cards, Phantom Cards, Pick It Out Cards, Satan Card Trick, Educated Card Dice Trick, Knock-out Cards, Diminishing Card Trick and Wonderful Ace Trick. If purchased separately would cost \$1.00. Special complete, only 50c.

Serpent's Eggs



When lit with a match each egg hatches itself into a snake several feet long, curling and twisting in life-like manner. Box of 12, 10c postpaid; 3 for 25c.

Exploding Cigarettes

JUST LIKE ORDINARY CIGARETTES, BUT SUCH REAL STARTLERS! The box contains ten genuine cigarettes of excellent quality. They appear so real, but when each cigarette is about one-third smoked, the victim gets a very great surprise as it goes off with a loud BANG! A great mirth provoker yet entirely harmless. Price 25c box.



Buddha's Money Mystery

With this contrivance it is apparently possible to change a blank piece of paper into a bill of any denomination. Can be performed easily by anyone. Price only 25c.



Magic Nose Flute

A unique and novel musical instrument played with nose and mouth combined. Just a little knack required to enable you to produce sweet music that resembles a flute. No fingering. Effect is charming when played as an accompaniment to piano or other musical instrument. Price 10c postpaid.



THE JUMPING PEG

A very effective pocket trick which will puzzle them all. The performer introduces a small wooden paddle into which a number of holes are bored. A wooden peg is then inserted in the upper hole, both sides of the paddle being shown, proving the peg enters on each side. Upon the performer simply waving his hand, the peg mysteriously jumps from the upper hole to the middle hole, then to the lower one and back again while both sides of the paddle are continually shown. Price 15 cents.

WANDERING DICE THROUGH HAT

A solid dice after being inspected by the company, is placed on the crown of a borrowed hat which the conjurer holds by the rim. An examined cover is now put over the dice, and upon command, passed through the hat and falls upon the floor. This is easy to do, and so clever that no one can possibly discover the secret. Price complete 35c. Best made.



MULTIPLYING BILLIARD BALLS



Magically producing a solid billiard ball, the conjurer simply moving his hand thru the air, causes a second ball of the same size to appear beside it. Everyone watching closely, a third appears in like manner. Then to the amazement of all, a fourth appears. Make them vanish singly until hand is empty. Per set, 35c. Larger sizes, \$1 and \$1.25.

BIG FREE OFFER

Our large die box trick is sent to you when you have orders amounting to only \$25 within one year. You have twelve full months from the date we receive your first order to make your purchases totaling \$25. We are the largest dealers in tricks of all kinds in the world. Order from this advertisement or send for our big catalog immediately. Above are only a few of more than six hundred and eighty new tricks, puzzles, illusion and novelties. Deal with us and get satisfaction.

OAKS MAGICAL CO.

Dept. 802
OSHKOSH, WISC.

Four-In-One QUAD UTILITY SAWS

With
**FIVE
BLADES** **\$1.95**

Here's a utility saw with a thousand time and labor saving uses. Four different saws in one—adapted to any cutting problem in the shop, on the road, or in the home. Works easily in holes or corners; cuts in tight places without laborious filing or chiseling. With QUAD you can make a *true* flush cut; cuts broken nipples or bushings *inside* pipes; finest "key-hole" saw you ever used.

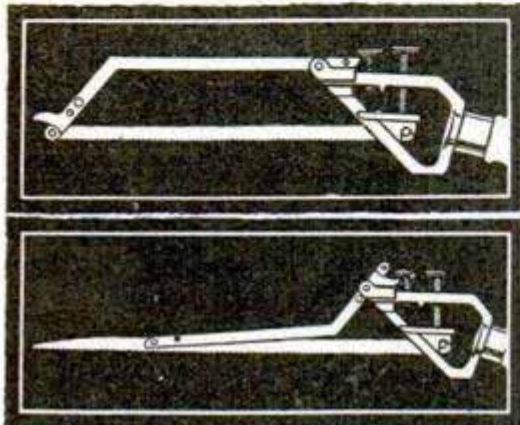

Illustrations show two of the four set-ups changed in a jiffy. Each set-up gives a reinforced blade with positive tension controlled by the fingers.

Just write a postal or sign coupon and mail. When postman arrives deposit \$1.95 plus postage. Use QUAD for 10 days—if not satisfied, return it and get your money back. This offer limited—write today.

Send no money—
MAIL THIS COUPON TO-DAY

With QUAD Four-In-One Utility Saw goes 5 Tungsten Steel Saw Blades. Address

ROGERS PRODUCTS CO., INC.
190 Pacific Avenue, Jersey City, N. J.
Please send 1 QUAD Saw with 5 Blades to

Name.....
Street.....
City..... State.....

Build a CLOCK for Pleasure or PROFIT!

FREE BOOK of Clock Making, Money Making ideas. Gives details, prices of movements, parts. Write NOW for copy!

AMERICAN CHIME CLOCK COMPANY
1670-P Ruffner St. Philadelphia, Pa.

Shows How YOU Can Make Fine Clocks Right at Home —for yourself, or to sell at Big Profits. We furnish instructions, parts. Works \$1.95 up; others with chimes, all prices. Make case or assemble parts. Cash-in on demand for Mantel, Banjo, Grandfather's Clocks. Write for Special Blue Print Offer, FREE Catalog.

25 POWER \$1
GERMAN POCKET MICROSCOPE

A marvelous German 25 power microscope, size of pencil, enlarges diameter 25 times, area 625 times. Fine lenses give extra large field and great light. Only 4 3/4 inches by 3/4 inch; weighs but one half ounce. Used in schools and colleges throughout the country. Fine for biology, geology, botany, nature study, examining stamps, finger prints, insects, cloth, metals, photographs and thousands of other things. 40-50-60X, 1 1/2 oz. \$4. \$1 prepaid. Money back guarantee. Discount for 6 or more.

BINOCULARS Over 200 Glasses All Makes \$1-\$110

Everything in binoculars, field glasses, telescopes and optical instruments. The finest and largest assortment in America. Catalog gives all information how to choose the best for your individual needs at the **LOWEST PRICE.**

Try America's Leading Binocular House First DuMaurier Co., Dept. 2012, Elmira, N. Y.

THIS DEMONSTRATION GETS ORDERS!

The flashing movement of Dazzler and Rainbow Glow Electric Signs—the brilliant illumination of Diamond Neon Signs—the gorgeous colors, the exact materials and construction—all are embodied in the special demonstrator signs that our successful salesmen are using with amazing results.

MEN WANTED
in exclusive territory to demonstrate this most remarkable line of electric signs. Sold at low prices and on easy terms to stores, cafes, Theatres, etc.

BIG MONEY!
Jones earned \$517 in 3 weeks. Shedrick made \$177 in 4 days. Fauley earned \$257 in 21 days. Same opportunity is yours. No experience needed. We instruct you how to demonstrate and take orders. Big commissions paid promptly.

FREE BOOK Send today for beautifully illustrated book of Dazzler, Rainbow Glow and Diamond Neon Electric Signs and full details of money making proposition. **Write today!**

CHICAGO SIGN SALES CO. Dept. 121 Charlotte, N. C.

See our Big Catalog on Steam and Gasoline Engines, Battery Motors, Dyna-Motors, Lathes, Drill Presses, Gears, Books, Blue Prints, Pulleys, Hangers, Bench Saws, Display Tables, Model Makers' Supplies and Materials.

Sent Postpaid for 20c to Canada
25c refunded first order

HOWARD ENGINE & MFG. CO.
2417 N. Ashland Ave. CHICAGO, ILL.

C-A Sanding, Grinding Buffing and Polishing KIT

ARBOR, SAND DRUM and THREE 6 in. WHEELS

It is a big outfit for real jobs! **SANDING DRUM** 3 in. by 2 in., wonderful for model making, floor sanding, refinishing furniture, smoothing metal. Three 6 in. interchangeable wheels of **CLOTH, WIRE BRISTLES** and **EMERY**. The **ARBOR** is simply constructed, sturdy as finest materials and design can make it and is easily converted for use on either electric hand drill or motor. An efficient time and labor saving unit easily worth double its price. Complete only \$4.95. **MONEY BACK IF NOT SATISFIED!**

\$4.95

Complete with Sand Drum Arbor 3 Wheels and Polishing Comp.

Write for Folder — Dept. B
ADJUSTABLE BEARING CO., Inc.
Indianapolis, Ind. U. S. A.

A \$100 SHIP MODEL FOR \$4⁹⁸

You can put a beautiful Ship Model together in a few hours of pleasant pastime



Let the World's Largest Builders of Ship Models supply you with all the necessary parts cut to fit and ready to put together for the models, Santa Maria, Mayflower, or La Pinta. You need not know anything about ship building to assemble one of these models. If you have never seen a ship model you can put one of these models together in a few hours by following our diagram and instruction sheets which explain and show you exactly what to do with each part. All you need is a small tack hammer to tap the parts in place. The diagram making it impossible for you to go wrong. These models when completed are exact in every detail of the famous old ships they represent, and when completed will add a distinctive touch to your home. We also have parts for the model for the Constitution and Flying Cloud at \$6.98; all other models listed at \$4.98 each.
 La Pinta—Size—26 in. high, 11 in. wide, 27 in. long... \$4.98
 Mayflower—Size—26 in. high, 10 in. wide, 30 in. long... 4.98
 Constitution—Size—25 in. high, 8 in. wide, 29 in. long... 6.98
 Flying Cloud—Size—33 in. long, 7 in. wide, 24 in. high.. 6.98

\$4⁹⁸

SANTA MARIA
25" High; 11" Wide; 27" Long

Write for our beautiful illustrated booklet containing photos and information on all of our models.

Miniature Ship Models, Inc.,
Dept. RT, 3216 BARING STREET,
PHILADELPHIA, PA.

MINIATURE SHIP MODELS, INC., Dept. RT
3216 Baring Street, Philadelphia, Pa.

Please send me the complete parts cut to fit and ready to put together for the Model.....
 I will pay postman..... plus a few cents postage.
 Please print name and address plainly to avoid delay.

Name.....
 Street or R. F. D.....
 City.....
 State.....



CORRECT Your NOSE!

Improve your appearance with the ANITA NOSE ADJUSTER. Shapes flesh and cartilage—quickly, safely and painlessly, while you sleep. Results are lasting. Doctors praise it. 68,000 users. Write for 30-Day TRIAL OFFER and FREE BOOKLET.

ANITA INSTITUTE, N-12, Anita Bldg., Newark, N. J.

Is Your Car..... A Gas Eater

New Invention Increases Mileage on Auto Gas Eaters

An astonishing new device has been perfected that is amazing car owners everywhere. Thousands have been installed and users report greatly increased mileage. In addition power is increased, instant starting and flashy pick-up is noticed and carbon formation disappears. Every car owner in the country needs this new invention. Its cost is so trivial it pays for itself in a few days time, yet it will save hundreds of dollars for its owners in gasoline.



\$100 a Week Territory Open

\$5.00 an hour for spare time. Men are needed in every locality to take care of the tremendous local demand. Sales ability is not required. Every car owner will buy on sight. Ideal for spare time workers.

FREE To help our workers we furnish them with this marvelous Whirlwind gas saver free for their own cars. Quick action is necessary. Be the one in your locality to cash in on this device which every auto owner will buy. Send today for full particulars and free sample offer.

Whirlwind Mfg. Co., 999 57-A Third Street, MILWAUKEE, WISC.

RADIO BARGAINS!

Brand new 7 tube A. C. chassis, fully guaranteed..... \$29.75
 Short Wave 1 tube sets..... 4.75
 Used 5 tube radios as low as..... 9.90
 Power Transformers and Condenser Blocks at extremely low prices. Send for bargain list of sets, accessories and parts.

CHAS. HOODWIN CO., Dept. N2, 4240 Lincoln Ave., Chicago
 Dealers in Bankrupt Radio Stocks

Signals Auto Driver When Tire Needs Air

SAVES TIRES & TUBES
Prevents Accidents



SALESMEN and DISTRIBUTORS can make \$350 to \$1000 per month. Write for Big Money Making FREE SAMPLE Offer.

Name.....
 Address.....
 Size of Tire.....

Simpson Manufacturing Co.

Dept. G. 307 West Douglas, Wichita, Kan.

The World's Premier Custom-Built RADIO



COMPLETE FACTORY WIRED AND TESTED UNITS

Band-Filter Tuning
Screen-Grid Amplifier
Six Tuned Circuits
World-Wide Range

REGARDLESS of cost, no radio produced in mass can even approximate the skilled perfection of the new Custom-Built "HiQ-30." Here is the newest, most efficient model ever presented by Hammarlund — the climax of five years of unequalled custom designing and famed throughout the world for power, selectivity and tone. Assemble it yourself in two hours or we'll recommend a local custom-builder to do it for you. Choice of magnificent cabinets and speakers. \$139.50 to \$1,175 complete, less tubes.

Mail coupon for 48-page "HiQ-30" Manual



Hammarlund-Roberts, Inc.
424-38 W. 33rd St., N. Y.
Enclose 25c (stamps or coin) for "HiQ-30" Manual
Name.....
Address.....

Paint expertly with

DOMESTIC AUTO SPRAY

and your motor car!



Only \$11.00 Complete



Apply paint, lacquer, varnish or enamel with the DOMESTIC AUTO SPRAY and get results you believed only skilled painters could accomplish. No experience and practically no effort required. Idling engine of any auto, truck or tractor, with valve of the DOMESTIC inserted in spark plug opening, furnishes necessary power to operate this highly developed air brush. Just the outfit for homeowners, farmers, etc. Furnished complete, ready for instant use.

W. R. BROWN CO.
5837 W. Ohio St., CHICAGO

AGENTS

Here's a BIG opportunity to make BIG money. Write today!



INCREASE YOUR POULTRY PROFITS!

By proper Breeding, Feeding, Housing, Culling and Marketing AMERICAN POULTRY JOURNAL tells how to do it, and in addition a series of

COLORED PICTURES

with explanatory text tell and show many things you should know. They are not just colored pictures of birds but pictures of an educational nature, something never before shown by a poultry paper. 12 issues of American Poultry Journal contain about 1000 pages—

Price 25c a year—5 years \$1.
AMERICAN POULTRY JOURNAL, 14-536 S. Clark St., CHICAGO



RAISE CHINCHILLA AND NEW ZEALAND WHITE FUR RABBITS

Make Big Money We Supply Stock and pay you following prices for all you raise: Chinchillas average \$3 each—New Zealand Whites \$2 each. 32-page illustrated book, catalog and contract, also copy of Fur Farming magazine, tells how to raise rabbits for big profits, all for 10c. Address

OUTDOOR ENTERPRISE CO., Box 1021 Holmes Park, Missouri



WONDERFUL POULTRY BOOK Now FREE

The Nation's Great Poultry Manual; tells about mammoth hatchery, 52 BREEDS pure tested poultry, Feeding, Housing, Diseases and Remedies.

LOWEST PRICES, best Fowls, Eggs, Chicks, Brooder Houses and Stoves. Stamps appreciated.
BERRY'S POULTRY FARM Box 29 Clarinda, Iowa



HUNDRED HUNTING HOUNDS

Cheap. Fur Finders. Money Makers. Dog Feed. Remedies, Collars, Hunting, Fishing, Camping Equipment. Agents Wanted. Catalog.

KASKASKIA, M-144, Herrick, Ill.



SQUAB BOOK FREE

Breed PR squabs for rich trade. Sold by millions for more than chickens. Write for free 48-page book telling how to do it and how to profit by new sales method.

PLYMOUTH ROCK SQUAB CO.
634 H Street Melrose Highlands, Mass.

WHY BALD? At 40?

Lucky Tiger Corrects

Scalp Ailments and stops falling hair, like Whyte-Fox No. 2 knocks head colds, skin and rectal irritations. Used by millions. Money-Back Guarantee. A toilet necessity. A valuable booklet free on request.



At Barbers, Druggists, Beauty Parlors
Kansas Dept. City, Mo. A LUCKY TIGER REM. CO.

Save Your Feet

When all else fails end your suffering with the flexible "no metal"

Heefner ARCH SUPPORT

WRITE FOR FREE BOOKLET



HEEFNER ARCH SUPPORT CO., 672 M. E. TAYLOR BUILDING, LOUISVILLE, KY.

XMAS \$\$\$ FROM SPARE TIME WOOD-WORKING

18 Tools in One



Bench Saw \$35.00

Make hundreds of useful, attractive articles with the famous No. 8 "Wonder" Combination Saw. Will rip, cross-cut, bevel, miter, mortise, drill, groove, grind, polish, etc. Complete with 1/2 H. P.-A. C. motor with double shaft extension and table that will tilt without removing insert, price \$35.00.

The new No. 77 S. & B. Junior 7-inch Combination Saw has 1/2 H. P.-A. C. motor; otherwise equipped same as 8-inch saw above. Favorably priced at \$29.85. Planer attachment, \$5.00 extra for either saw. Shipped on 15 days' approval at manufacturer's risk. Valuable book of plans included FREE!

Finest Performance At Lowest Cost

Every piece of S. & B. equipment gives dependable, economical service. The "Wonder" Scroll Saw is ideal for fine craftsmanship and costs only \$15.00. The motor-driven Lathe is the biggest value you can find at \$35.00, without extra tools. The 3-speed Lathe, without extras or motor, \$32.50. Sell your handiwork at a handsome profit and pay for your S. & B. tools in a few months. Write today for catalog!



Scroll Saw \$15.00



Lathe Motor Driven and 3-Speed

Also Band Saw Grinder Jointer Bench Drill

S. & B. MFG. CO.

4601-L W. 40th St., CHICAGO, ILL.

AGENTS! SELLS LIKE WILD FIRE



New improved window washer eliminates all muss and fuss wherever there is glass to be cleaned. Restricted territory to Producers. Write today.

CARTER PRODUCTS CORP.

951 Front Street Cleveland, Ohio

8" COMBINATION SAW OUTFIT \$35 F.O.B. Phila.

An Ideal Xmas Gift for growing Boy or Handyman, though not a Toy. Make thorough comparisons before you place your order, particularly check on these specifications:

Our outfit includes 1/4rd H.P. Double Extension Shaft Motor; table tilts to 45 degree angle, and may be raised or lowered to cut any depth from 0" to 2 1/4". We also include necessary attachments to Rip, Crosscut, Bevel, Grind, Mitre, Groove, Sand, Mortise, Tenon and Polish.

Everything is complete, ready to plug in any light socket. Same specifications, but with Ball Bearings, and 12" by 18" table top—\$45.00. Saw Table only with Combination Blade and 1/4 H.P. Motor \$30.00. Catalog Free in which this Saw Outfit is more clearly pictured. It also contains Bench Lathes, 12" Band Saw, Complete Work Shop and Hardware Specialties, **WILBAR CO., INC., 2020 E. Arizona St., PHILA., PA.**

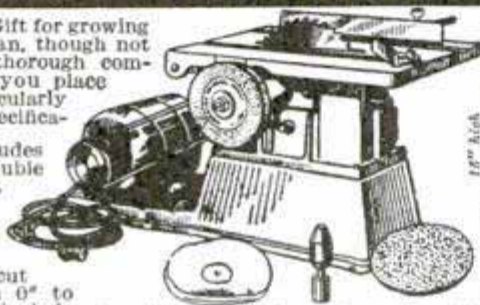

Base 28" long by 8" wide. Table top 16" by 12"



BOW LEGS?

THIS GARTER (Pat'd) Makes Trousers Hang Straight If Legs Bend In or Out

Free Booklet—Plain Sealed Envelope

THE T. GARTER CO., Dept. E South Bend, Ind.

12 IN ONE TOOL! A Whole Tool Kit in One

Salesmen Making Over \$100 A Week

A patented invention never before presented to the trades. Used by carpenters, cabinet makers, machinists, millwrights and workmen in any craft. Also a handy tool in the home. Instantly adjustable—True—Precise. Use it as a Tri-Square, T-Square, Mitre Gauge, Bevel Square, Inside-Rule, Extension Rule, 30°, 45°, 60° angles, Marking Gauge, Compass and Two Foot Rule. Has many uses. Price \$2.50.

Send Money Order or will be sent C.O.D. in U.S.A. We pay postage. This tool was featured editorially on Page 191, August, 1929, Popular Mechanics.

Twelve in One Tool Co., Not Inc. 11 So. La Salle Street CHICAGO, ILL.

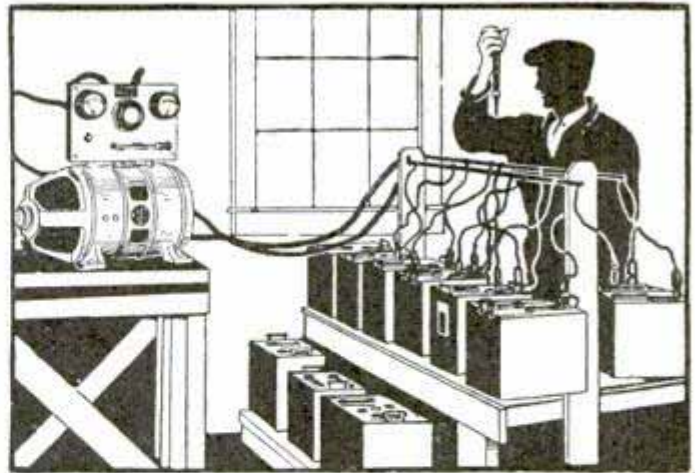

You Can EARN \$150 to \$300 MONTHLY

Charging Batteries in 8 Hours

Start a Money Making Business of your own. Mechanics, Filling Stations, Repair Shops, Garages and Battery Stations are all making BIG MONEY with HB 8 Hour Battery Service. Recommended by the leading car and battery makers. Constant Potential lets you give a better charge than the other fellow in one-third the time, and at a saving of 30% to 50% on current. Anyone can operate. Check coupon below for full information on how to get started in this money making work.

Shouldn't Cost You a Cent Pays for Itself—Brings a Big Profit Besides **Only \$16 Monthly** 30 DAYS' TRIAL AT OUR RISK



CAR WASHER

Largest Profits

The best paying work in automotive field today is 20 minute car washing. Puts you above competition—eliminates all drudgery! Users report \$100 weekly profits. Liberal trial, easy terms. Savings in labor and material over other methods will easily pay for it.

Earn 5 Men's Wages

Portable Paint Spray does the work of five brush painters. You get four men's wages as profit. Paints Cars, Houses, Garages, Barns, Furniture. No experience necessary to operate. Check coupon for trial offer and terms.



Paint Spray

Air Service

Only \$12 Monthly



Free Air Service costs you only \$12 monthly for a few months. Fully Automatic day and night service will draw customers to your shop as well as operate your air tools. Check coupon for full details without obligation.

Hobart Brothers Box M129 TROY, OHIO **Tear off and Mail Today**

Hobart Brothers, Box M129, Troy, Ohio. Send me complete information on the items I've checked—your thirty-day trial offer—easy payment terms—information on how HB equipment will increase my earnings.

- HB 8 HOUR BATTERY CHARGER
- HB TEST BENCH
- HB PAINT SPRAY
- HB AIR SERVICE
- HB CAR WASHER

Name..... Address.....

\$175.00
KOLSTER DYNAMIC
REPRODUCER

Combined with
 210 Power Amplifier and
 "B" Supply Unit

\$49.50

Special without tubes



Height 42"
 Width 25 1/2"
 Depth 19"

Model K-5

This famous genuine Kolster K-5, AC Electro-Dynamic Reproducer is complete with a 210 Power Amplifier and "B" Supply Unit all self-contained on a steel frame. This real fine matched rugged Unit weighs 45 lbs. without the Cabinet. The Cabinet itself is Pencil-Striped Walnut, beautifully designed with Cathedral grille.

If desired, the 210 Power Amplifier will also supply 22, 67 and 90 volts "B" current, sufficient for any set using up to 8 tubes. An automatic voltage regulator tube, UX-874, maintains the "B" voltage silent and steady.

This Electro-Dynamic Reproducer can be used with any battery or AC set, replacing the last audio stage, or be used with all tubes of the set. Wherever used it will bring out every shading and range of tone; every note is reproduced with utmost faithfulness, pure and undistorted. It will modernize any radio receiver.

Uses 1—UX-210, 2—UX-281 and 1—UX-874 tubes.

A 20-ft. cable is included with each instrument. Operates direct from 50-60 cycle, 110-120 volt AC current.

Brand new in original factory cases and guaranteed. Every Reproducer is serial-numbered and has factory guarantee tag enclosed.

AMERICAN SALES COMPANY

19-21 Warren Street, Dept. M, New York City

A Fight Against Rupture

ATTENTION
VS.
NEGLECT

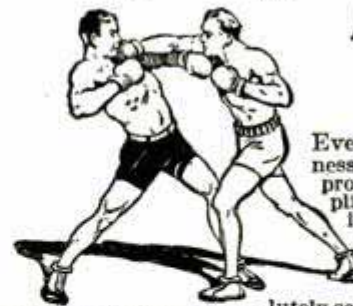

Everyone should realize the seriousness of Rupture, even where the protrusion is small. The Brooks Appliance is the finest kind of mechanical support for reducible rupture that it is possible to build. Hard pads and stiff springs are entirely eliminated. Our Automatic Air Cushion, light, cool and absolutely sanitary, is protected by patents in the United States and all important foreign countries.

Your name and address pinned to this advertisement will bring complete details of our free trial plan in plain sealed envelope. No need to write a letter.

BROOKS APPLIANCE CO., 107C State St., Marshall, Mich.

QUIT TOBACCO



No man or woman can escape the harmful effects of tobacco. Don't try to banish unaided the hold tobacco has upon you. Join the thousands of inveterate tobacco users that have found it easy to quit with the aid of the Keeley Treatment.

KEELEY

Treatment For Tobacco Habit
Successful For Over 50 Years

Quickly banishes all craving for tobacco. Write today for Free Book telling how to quickly Free yourself from the tobacco habit and our Money Back Guarantee.

THE KEELEY INSTITUTE, Dept. A-928, Dwight, Illinois

BOYS! GET READY FOR NATIONAL MODEL PLANE CONTEST



Big Cash prizes are won yearly by contestants. Send 10c today for 48 page illustrated catalog and contest particulars. Hurry—no time to lose.

GREAT FUN FOR EVENINGS

MICHIGAN MODEL AIRPLANE SUPPLY CO.
 4758-F Grand River Ave. Detroit, Mich.

BUCHSTEIN'S FIBRE LIMB



is soothing to your stump—strong, cool, neat, light. Easy payments. Braces for all deformities.
D. BUCHSTEIN CO., 610 3rd Ave., So. MINNEAPOLIS, MINN.

Send for Catalog Today

Stop Using a Truss

STUART'S ADHESIF PLAPAO-PADS are entirely different—being mechanico-chemico applicators—made self-adhesive purposely to keep the muscle-tonic called "Plapao" continuously applied to the affected parts, and to minimize danger of slipping and painful friction. The fabric is soft as velvet, and being adhesive—clings closely



to the body without straps, buckles or springs. Easy to apply, comfortable, inexpensive.



For almost a quarter century stacks of sworn testimonials from many different countries report success—without delay from work. The epidermatic absorption of Plapao utilizing "mechanico-chemico" therapy tends toward a natural process of recovery, after which no further use for a truss.

Awarded Gold Medal

Awarded Grand Prix

MAIL COUPON BELOW TODAY

FREE TEST COUPON

PLAPAO CO., 193 Stuart Bldg., St. Louis, Mo.

Send me a FREE 10 day test supply of the remedial factor Plapao and 48-page illustrated book on Rupture; no charge for this now or later.

Name.....

Address.....

STRANGE INVENTION!
PAYS YOU \$90 A WEEK
NEW FIELD for AGENTS

Sell only device in the world that prevents kinking, snarling and tangling of telephone and electric iron cords. Housewives and business men buy 1 to 50.

NEW KIND OF CORD SET FREE
 Every Neverknot Salesman is given FREE the complete Neverknot Switch Plug Cord Set pictured. This new kind of ironing cord automatically coils itself out of the way and a new kind of switch plug prevents scorching and saves electric bills. This set is a "gold mine" for house-to-house workers. It's different and it's yours free if you work for us. Don't delay! Send now for free offer.



NEVERKNOT CO.
 Dept. 12-V, 4503 Ravenswood, Chicago

The Plug That Saves Electric Bills

An ad like this



Started Him Making \$700 a Month

How'd YOU like a Job like his?

Why plug along on \$40 or \$50 a week when over 1800 Popular Mechanics readers, like you, now make \$500 to \$1000 a month as Clarke FlorKraftsmen? Stop doing drudgery. Quit wasting the years in which you should be laying up money for the future. Get into Clarke FlorKraftsmanship now and earn big pay.

Be a Clarke FlorKraftsman Earn \$25 to \$75 a Day

This ad tells you the low-down about Clarke FlorKraftsmanship. There is no applesauce about Clarke's statements of what you can make. \$25 to \$75 a day is the pay men get for turning old floors into new ones and for sanding floors in new houses with the Clarke Vacuum Portable Sander.

A. E. Sweeney, Alturas, Calif., writes: "I made \$76 the first week." Fred S. Gail, Cody, Wyo., says: "The little Devil, as it is called around here, paid for itself on the first job." Millard W. Dalby, San Marcos, Calif., writes: "In one hour I had my 200 sq. ft. of that floor as clean and new as any new lumber would have been. My price for that work is 10c a foot." W. G. Roe, Clarke FlorKraftsman, Richmond Hill, L. I., N. Y., "I have made from \$40.00 to \$45.00 per eight hours with my Clarke."

You Don't Have To Learn a Trade Go To School or Pay Tuition

This is not a school course or training system. You pay no tuition—buy no books. We teach you to run the Clarke Vacuum Portable Sander in a half hour or less. You get paid for the first day's work you do with it.

You don't need to be a carpenter or a painter to get into FlorKraftsmanship. Clerks who never made over \$30.00 a week, mechanics who couldn't earn enough at their old jobs, young fellows just out of school, are highly paid FlorKraftsmen today.

The same opportunity is open to you. You need only about \$100 to start. No office or shop required. The Clarke and some sandpaper puts you in FlorKraftsmanship.

The Clarke sands 900 to 2200 square feet of new floors a day—and you get paid 2 1/2c to 5c a foot. On old floors the Clarke does 300 to 1000 square feet every eight hours. Here you get 7c to 15c a square foot. Many operators do far more footage than this. No wonder FlorKraftsmen own cars and homes and still save for a rainy day.



Stop Wishing and Start Earning

Put an end to your long-houred, low-paid, no-future job. Get the facts that have put so many on the road to independence. Learn the real truth about Clarke FlorKraftsmanship. Use this coupon. Send it today. Don't wait till you see 3 or 4 more Clarke ads and learn that 3000 instead of 1800 readers of Popular Mechanics have seized this chance. Let one of these new FlorKraftsmen be YOURSELF. Stop wishing and start earning.

CLARKE SANDING MACHINE CO. DEPT. T-212

3831 Cortland Street CHICAGO, ILLINOIS

CLARKE
POWERFUL FAST CUTTING
VACUUM PORTABLE SANDER

CLARKE SANDING MACHINE CO.,
Dept. T-212, 3831 Cortland Street,
Chicago, Illinois.

Tell me, without obligation, how I can make
\$25 to \$75 a day as a FlorKraftsman.

Name.....

Address.....

City.....State.....

50c The Copy

HOW to BUILD and FLY GLIDERS

GLIDERS

On All News-stands

100 Pages 4-Color Cover

FLY A GLIDER!

Gliding, the New Sport of the Sky

Nothing during the past twenty-five years has taken the world so much by storm as aerial gliding. Here is a brand new sport that is as safe as it is exciting. Gliders are airplanes without engines, and can be flown by anyone with a little skill. Nothing in the entire world of sport can compare with glider flying.

It is Now Possible for Anyone Who Can Handle Tools to Build a Practical Glider Costing from \$50.00 Upwards. "GLIDERS" is the first complete book in a new aerial-mechanical field. It is the only authoritative American book on the subject.

It Contains All of the Latest Glider Advances in Germany Where This Sport Has Become a National Institution During the Past Two Years.

Recently, a German stayed up in the air for 14 hours in a glider. You can do the same or better the record.

This book enables you to build and fly your own glider with little work and small expense. The entire book is written by expert gliders, both German and American.

Some of the main chapters are:

- "The Glider"—How to Build and Fly It, by John Pierce.
- "Practical Gliding," by S. Staner and A. Lippisch.
- "Early Days of Gliding"—How to Build a Primary Glider, by Wallace Bamber.
- "Glider Construction and Design," by Alfred Gymnich.
- "The 1928 Rhön Soaring-Flight Contest," by A. Lippisch.
- "The Laws of Sail-Flight," by W. Gvepferich.

This is a large book, containing 100 pages, with beautiful cover, in four colors. Size 9 x 12 inches. With over 200 illustrations.

You Can NOW Buy this TWO DOLLAR BOOK for

50c at most of the larger newsstands. If your newsdealer cannot supply it, send check, money order, cash, or stamps, to

POPULAR BOOK CORP.
94 Park Place, New York, N. Y.

Simplex Screw Jacks

For the Home, Workshop, or Manual Training

WITH this 500 lb. capacity Simplex Jack, you can straighten window or door frames and avoid planing or resetting locks—level radiators, plumbing, drain pipes, ice box—straighten or clamp glued work, radio cabinets, etc. This little—

"Jack in the Box"

is for the man who uses tools, or the boys interested in manual training or mechanical toys. It has hundreds of uses. Sturdily built, beautifully finished, and unconditionally guaranteed.

Its purpose is to demonstrate and advertise the exclusive safety feature of the visible screw and power of the larger Simplex Jacks, and will be sent you prepaid for 35 cents—Canada 45 cents. Money refunded without question and instantly if not satisfied.

3 Inches High When Closed Capacity 500 lbs.

Templeton, Kenly & Co. 35¢

ESTABLISHED 1899
1020 So. Central Av. Chicago Ill. U.S.A.

Gentlemen: Please send me postpaid 1 Simplex Miniature Jack at 35 cents and at 35 cents each for my friends. A total of \$..... is enclosed.

Name.....
Street.....
City..... State.....
Mark color desired: Red, Blue, Green.

NO JOKE TO BE DEAF

—EVERY DEAF PERSON KNOWS THAT



I make myself hear, after being deaf for 25 years, with these Artificial Ear Drums. I wear them day and night. They stop head noises and ringing ears. They are perfectly comfortable. No one sees them. Write me and I will tell you a true story, how I got deaf and how I make you hear. Address



GEO. P. WAY, Artificial Ear Drum Co. (Inc.)
80 Hoffman Bldg., Detroit, Mich.

STOPS ACHES—SUPPORTS BACK

THE NATURAL BODY BRACE



Takes strain off the back, the abdomen; relieves nervousness, constipation. Gives wonderful sense of relief and well being. For men and women.

COSTS NOTHING TO TRY IT

Write for our 30 days free trial offer, free illustrated book, measurement blank, etc.

NATURAL BODY BRACE CO.
Howard C. Rash, Pt., 77 Rash Bldg., Salina, Kansas

Palmolive Shaving Cream

"5 New Delights for Men"

ART GLASS LANTERNS

made at home. Interesting and profitable work easily learned by our simple method—or have us make it for you. Inquire if you want anything in Glass.

The Glass Company, 1346-23rd Avenue, Dept. B, San Francisco

The man who studies gets ahead. Popular Mechanics Press will advise you what books to read to advance in your trade. 200 East Ontario Street, Chicago, Illinois.

LATHES FOR WOOD TURNING

8 in. swing x 3 ft. bed, \$12.50
Motor driven lathes, \$23.50. Two speed motor driven lathes with circular saw table, \$38.50. Practical machines for your shop.

HALLIN MACHINE CO., Parkers Prairie, Minn.

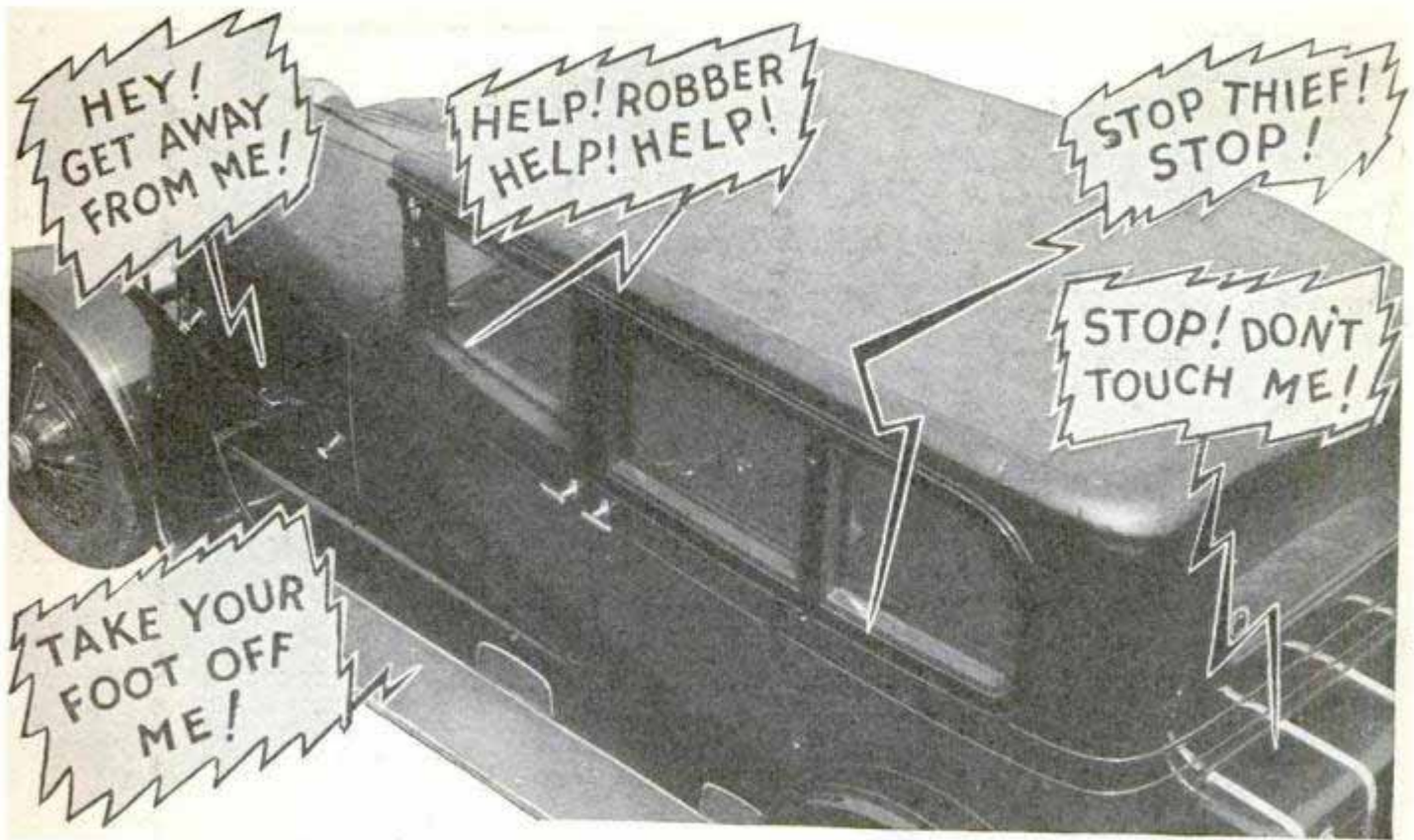

Astonishing Invention Protects Your Car From Thieves

This unquestionably is the queerest, most incredible invention since the first discoveries of radio! A magical, shouting, automatic watchman that actually is far more than human! Never sleeps, rests or gets tired! Stands guard over your entire car from spare tire to headlights

and steering wheel! Endorsed by police! Approved by insurance companies and Motor Associations! Now offered on generous 10-day free test basis! The coupon brings full details.

No Wonder This Startling, Uncanny 3-Minute Demonstration Brings Fortunes To Agents

W“WHAT makes it work?” “Where on earth did you get it?” “Bet you five dollars he’s got some one hiding in there!” “It simply can’t be true.” A running fire of comment like this breaks out whenever and wherever this new invention is exhibited. And why not? When no one ever heard of such a startling, uncanny device before! In fact few people would even dare to dream there could be such a thing! So this, men, is something really NEW, something to grip the imagination of everyone, something that sells to every autoist on sheer novelty alone. Distributors, “star” salesmen, every man who wants to double and triple his present income should note carefully the following facts.

ing features is the fact that it can be installed by anyone in 3 minutes or less. There is absolutely no cost for operation. It will last as long as the car. Fits any car from Ford to Rolls Royce without adjustment or fussing.

For introductory purposes a special 10-day test offer is now being made. If you are interested in learning about the most astonishing inventions since the radio first came in, use the coupon at once. If your present income is less than \$75 a week, the profit possibilities as our agent will astonish you. The coupon brings details of all offers. Mail it now.



The Secret of a Theft-Proof Car

Now in this amazing new way, every car can be protected from theft for 24 full hours a day. In the garage or parked on the street, if any thief so much as pulls at your spare tire or touches his foot to your running board—ZOWIE! A riot of noise starts instantly! And your car never shuts up till the thief leaves. And listen to this. Even if the thief is wise to what’s up, you alone place the secret control button anywhere you want it around the car. The thief can’t possibly find it. If he wastes time looking for it—Bingo! He’s caught and on his way to jail! This astonishing invention guards your spare-tire, head-lights and spot-light as well as the car itself.

Installed in 3 Minutes—Costs Nothing to Operate

The inventor has asked the U. S. Government to protect his patent rights in this revolutionary discovery. Because of its uncanny powers and to distinguish it from everything else on earth this queer discovery is now called “Devil Dog.” Among its amaz-

TEMME MFG. CO., Dept. W-10
411-419 No. Trumbull Avenue
CHICAGO, ILLINOIS



Temme Mfg. Co., Dept. W-10,
411-419 No. Trumbull Ave., Chicago, Ill.
Rush details of your big 10-day test offer and big profits for agents.

Name.....
Address.....
Town.....State.....

Check here if interested only in one for your own car and not in agents' money-making offer.



Boys! Here's Fun Galore

Zip! Here they come! Around a turn and down the home stretch to cross the finish line with a last furious burst of speed!

You want things that will "GO"—things you can race with—scooters, pushmobiles, small autos with motorcycle engines, wind wagons, etc.—Whether on spinning wheels or glistening runners—fast ice yachts, skis, toboggans, bobsleds, motor driven sleds and snow speedsters.

You air-minded boys enjoy gliders and model airplanes.

Turn your back yard into a regular amusement park with all these thrillers—ferris wheels, roller coasters, merry-go-round swings, etc.

How fascinating to imitate the big engineers and make small water wheels, pile drivers, aerial cableways and other things that "work."

When at camp or on the water you need plenty of ideas for new ways of having fun. Here are dozens such as water bicycles, push boats, water coasting toboggans, water games, etc.

On rainy days and other times when working in your home shop you have the hardest time finding interesting things to make. Here are any number such as electric locomotives, motion picture cameras, wood turning lathes, etc.

But why try to describe this great

Boy Mechanic Library

Boys, it simply cannot be done. You must actually have these books in your hands and see them before you can begin to realize that the four big volumes contain enough interesting things to last you until you are a grown-up man.

THINK OF IT!

4000 Worth While Things to Make and Do

Don't envy the other boys on account of the things they have. Be the boy in your neighborhood to make the others wonder where you get all your ideas—and it doesn't cost a lot of money, either. These wonderful books show you how to take parts from old cast-off things and perhaps get a few cents' worth of material from a hardware store—or have a blacksmith or shop man help you bend some iron, and thus make something that works just as well as though you had paid several dollars for it. Best of all—you get the thrill of having "Made It Yourself."

Everything is pictured out and made easy. Don't try to get along without these books any longer. Save or earn the money to buy them right away.

The complete library of 4 volumes, each book 7x10x1 1/2 inches and with 460 Pages. **Price \$7.00**
or single volumes at \$2 each. Each volume complete in itself.

Books are numbered: 1, 2, 3 and 4. State the ones you want when ordering. Sent postpaid when remittance is sent with your order, or will be sent C. O. D. anywhere in the U. S. Pay postman price plus extra postage for this service.

Popular Mechanics Press, Room P 12 Chicago
200 E. Ontario St.

Get this

The Only Catalog of Its Kind in Existence

FREE CATALOG

600 PAGES of 5000 items

DOMESTIC AND IMPORTED NOVELTIES, PUZZLES, TRICKS, GAMES, JEWELRY, HOME APPLIANCES, CAMERAS, SPORTING GOODS, MUSICAL NOVELTIES, CURIOSITIES IN SEEDS, RUBBER STAMPS, UNUSUAL BOOKS, ETC., ETC.

Nothing else like it. Far more interesting than a magazine. And it's FREE! Doesn't cost you a cent. Nothing to buy to get it. Nearly 600 pages packed full of pictures and descriptions of odd items from all parts of the world—amusing, entertaining and useful articles you never knew existed—hundreds of items that stores don't sell—dozens of things you've always wanted but never knew where to find.

They're all in this amazing FREE catalog. All the latest tricks and magician's equipment, including trick cards, magic boxes, vanishing devices, etc.—many games, joke books, real and trick fountain pens and pencils—musical instruments of all kinds—fireworks—imported novelties—puzzles such as "Bootlegger's Puzzle," "Automobile Puzzle" and a hundred others—water and blank cartridge pistols—enchanted cigar box—exploding jewel case—loaded cigars and cigarettes—squirrel badges—amateur and professional make-up of all kinds, including wigs, funny noses, teeth, ears and whiskers of all types—good luck rings—mystic rings—odd books—sneezing powder—real diamond jewelry—everything you can think of and hundreds of things you never dreamed of.

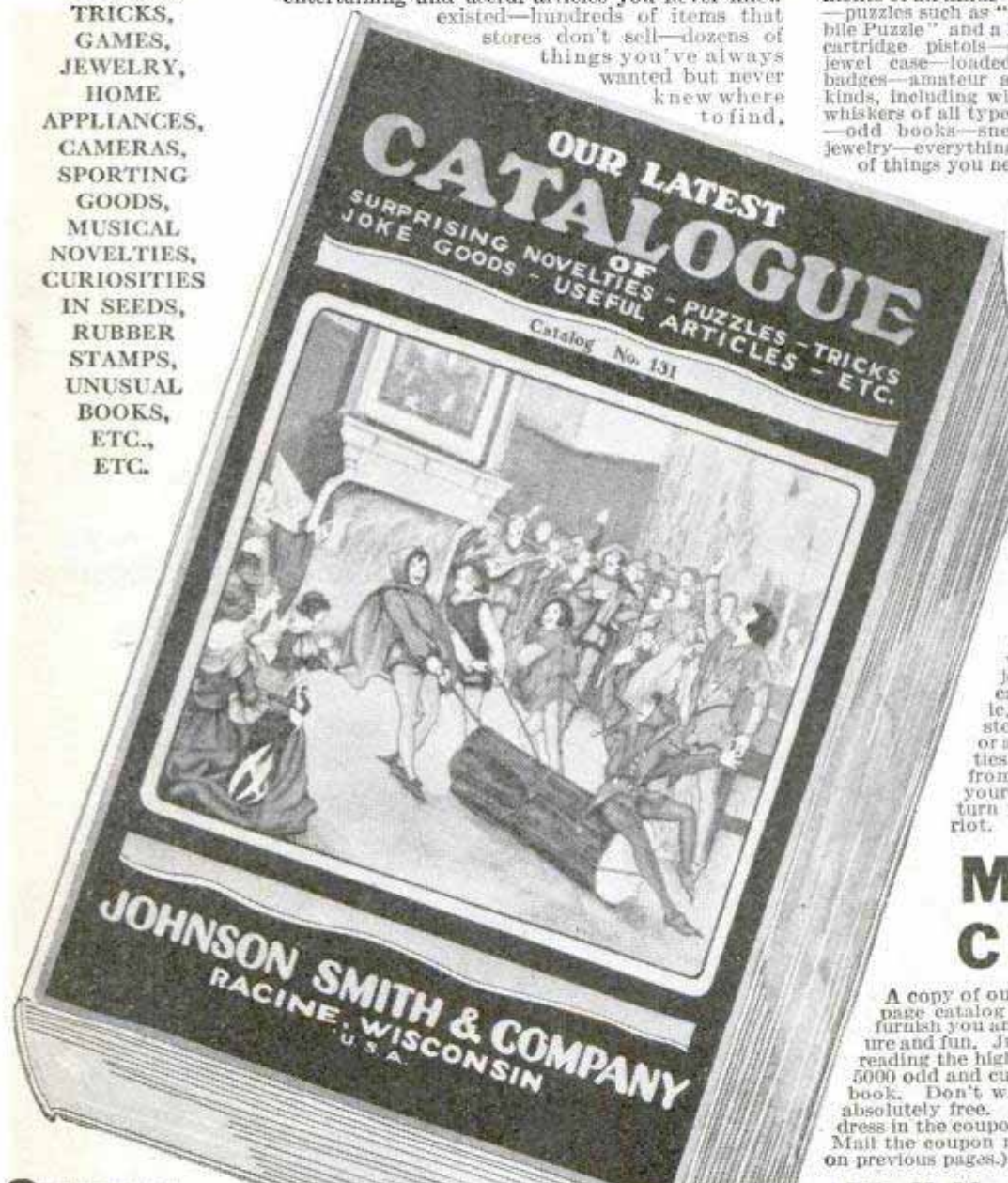

2000 ITEMS under 25c

Over 2000 of the items shown in this fascinating book cost less than 25 cents and every one is good for 25 dollars' worth of fun. Think of it! 2000 unusual items for entertainment or use.

Put Real "Life" Into Your Next Party

Go thru your catalog—when it arrives. Pick out a half dozen fun makers and put them to work at your party. "BINGO" shooters placed under telephone, plates, books, chair legs or in a dozen other places explode violently but harmlessly when object covering them is moved. Trick cards, some of our imported "Magic," one of our artificial indoor snow storms, some of our sneezing powder or any one of hundreds of other novelties shown in our catalog and costing from five cents to a quarter will get all your guests acquainted quickly and will turn your party into a good natured riot.

MAIL the COUPON

A copy of our new 1930 edition of this big 600 page catalog is waiting for YOU—waiting to furnish you an endless amount of genuine pleasure and fun. Just think of the hours you can pass reading the highly interesting descriptions of the 5000 odd and curious items listed in this amazing book. Don't wait—don't hesitate—the book is absolutely free. Simply fill in your name and address in the coupon below and mail it to us at once. Mail the coupon now—today. (See our other ads on previous pages.)

Mail Now!

JOHNSON SMITH & CO., Dept. 845, RACINE, WIS.

- Send me FREE Catalog.
- Send me De Luxe Catalog with hard-bound, permanent, cloth cover, 25c enclosed.

Name

Address

Town State

SPECIAL De Luxe Edition

The 600-page book which we mail entirely free of charge has a lithographed paper cover. But there are many of our friends who want this book in a permanent binding for their library shelves. For them we have prepared the De Luxe Edition of our catalog—a beautiful hard cloth binding—nearly 100 more pages—many pages in color—and the book itself is printed on very high grade paper. This De Luxe Edition will be mailed you postpaid for 25 cents. This price is, of course, but a fraction of the cost of this beautiful book. Check coupon and enclose 25 cents if you want the De Luxe Edition.

JOHNSON SMITH & CO.
Dept. 845 Racine, Wisconsin

LUMINOUS PAINT

Make Your Watches, Clocks, Etc., Visible by Night

The very latest discovery in the scientific world, Hitterto, practically unobtainable except at an exorbitant price, we have at last succeeded in producing this remarkable LUMINOUS PAINT, which, applied to the surface of any article, emits rays of white light, rendering it perfectly visible in the dark. THE DARKER THE NIGHT, THE MORE BRILLIANT IT SHINES. Quite simple to use. Anyone—you can do it. A little applied to the dial of your watch or clock will enable you to tell the time by night. You can coat the push buttons or switch plates of your electric lights, match boxes, and innumerable other articles; make your own Luminous Crucifixes, Luminous Rosaries, etc. Small bottle, price 25c. Larger sizes, 50c and \$1 postpaid. JOHNSON SMITH & CO. Dept. 845 RACINE, WIS.



CIGARETTE MAKER

Roll your own and save money. Better and quicker; saves more than half. Use your favorite brand of tobacco. Neat, useful, handy. Pocket size, weighs 1/2 oz. Made entirely of metal, nickel plated. 25c, 3 for 65c postpaid anywhere.



GOOD LUCK RING

Very striking, quaint and uncommon. Silver finish; skull and crossbones design, two brilliant, flashing gems sparkle out of the eyes. Said to bring good luck. Only 25c ppd.



Exploding Cigarettes

JUST LIKE ORDINARY CIGARETTES. BUT SUCH REAL STARTLERS! The box contains ten genuine cigarettes of excellent quality. They appear so real, but when each cigarette is about one-third smoked, the victim gets a very great surprise as it goes off with a loud BANG! A great mirth provoker yet entirely harmless. Price 25c box.

NOVELTY BADGES



Kissing Permit 10c Garter Inspector 10c
Two very novel metal badges, nickel plated, that you can wear, giving you fun out of all proportion to their trifling cost. 10c, each badge, 3 for 25c, or 75c per doz. postpaid anywhere.

MIDGET BIBLE

GREAT CURIOSITY Smallest Bible in the World. Size of a postage stamp. 200 Pages. Said to bring good luck to the owner. A genuine work of art. Must be seen to be appreciated. Make good money selling them to friends, church acquaintances, etc. PRICE 15c each, 3 for 40c, 12 for \$1.35, 100 for \$7.50. Also obtainable in Leather Binding, with gold edges. Price 50c each, 3 for \$1.25, \$4.50 per doz. Magnifying Glass for use with Midget Bible 15c.



STAGE MONEY

With a bunch of these bills, it is easy for each person of limited means to appear prosperous by flashing a roll of these bills at the proper time and peeling off a genuine bill or two from the outside of the roll, the effect created will be found to be all that can be desired. Prices, postpaid: 40 Bills 20c, 120 for 50c, or \$3.50 thousand postpaid.

MAGIC NOSE FLUTE

The Magic Nose Flute, or Humannote, is a unique and novel musical instrument that is played with nose and mouth combined. There is just a little knack in playing it which, when once acquired after a little practice, will enable you to produce very sweet music that somewhat resembles a flute. There is no fingering, and once you have mastered it you can play all kinds of music with facility and ease. When played as an accompaniment to a piano or any other musical instrument, the effect is as charming as it is surprising.

Useful Knots, Hitches, Splices, etc. How different knots are made and what they are used for, knots that are unsafe, etc. Over 100 illustrations. All about wire rope attachments, lashing, blocks, trolleys, etc. PRICE 20 CENTS OR THREE COPIES FOR 50 CENTS POSTPAID.

Address orders for all goods on this and following pages to
JOHNSON SMITH & CO. Dept. 845 RACINE, WIS.
Postage Stamps accepted

BLANK CARTRIDGE PISTOL

Protection against Burglars, Tramps, & Dogs Special Offer
1 Blank Cartridge Pistol
100 Blank Cartridges
1 600-page Novelty Catalog
ONLY \$1.50
The Lot Shipped by Express Only Cash With Order Only

Well made and effective, modified on latest type of Revolver; appearance alone is enough to scare a burglar. When loaded it may be as effective as a real revolver without danger to life. It takes standard .22 Cal. Blank Cartridge—obtainable everywhere. Special cash with order offer: 1 Superior quality Blank Cartridge Pistol, 100 Blank Cartridges, and our new 550 page De Luxe Catalog of latest novelties; all for ONLY \$1.50. Shipped by Express only. Cannot go by parcel post. Extra Blank Cartridges 50c per 100. Special Holster (Cowboy Type) for pistol 50c. No C. O. D. shipments.

LOOK 35¢ LOOK Wonderful Instrument.

Greatest thing yet. Nine separate articles in one. Everybody delighted with it. Odd, Curious and interesting. Lots of pleasure as well as very useful. It is a double Microscope for examining the wonders of nature. It is also an Opera Glass, a Stereoscope, a Burning Lens, a Reading Glass, a Telescope, a Compass, a pocket Mirror, and a Laryngoscope—for examining eye, ear, nose and throat. It is worth all the cost to locate even one painful cinder in the eye. Folds flat and fits the pocket. Something great—you need one. Don't miss it. Sent by mail. Only 35c or 3 for \$1.00

Combination Sun Watch and Compass
PERPETUAL WATCH
Never needs winding. As true as the sun. Cannot fail or get out of order. Always reliable and correct. No delicate mechanism, no spring to wind or break, no regulating, no cleaning wherever the sun shines, and that is everywhere.
PRICE ONLY 50c postpaid anywhere.

Watch Charm Pistol \$1.75

Exact reproduction of a real pistol; actually fires REAL BLANK CARTRIDGES of miniature size. Illustration is actual size. 1 1/4 inches long, with ring at end for attaching to watch chain. Loads like a regular pistol. Pull the trigger and it goes off with a loud bang. Pistol in break open type; illustration shows position for loading. Made entirely of high grade steel, nickel plated, octagon barrel, handsomely engraved handles, complete in box with cleaning rod. PRICE \$1.75. Also furnished with pearl handles. \$2.50. BLANK CARTRIDGES, 50c per box of 25. JOHNSON SMITH & CO., Dept. 845, RACINE, WIS.

SURPRISE MATCHES

More fun than fighting with your wife. Look just like ordinary matches. Put up in boxes just like regular Safety Matches. As the victim tries to light one he gets quite a surprise. Price 10c per box, 3 boxes for 25c, 12 for 75 cents.

STAR TOY MAKER

Greatest boys' book written. Tells how to make a Pinhole Camera, a Canoe, model Railroad, a Telephone, Boomerang, Telegraph Instrument, Box Kite, Talking Machine, Microscope, Electric Motor, Electric Door Bell, Water Wheel, Paddle Raft, a pair of Skis, a Dog Sled, Bird House, Rabbit Yard, etc. 64 pages. 150 Illustrations. PRICE 10c postpaid.

Wonderful X-Ray Tube

A wonderful little instrument producing optical illusions both surprising and startling. With it you can see what is apparently the bones of your fingers, the lead in a lead pencil, the interior opening in a pipe stem, and many other similar illusions. A mystery that no one has been able to satisfactorily explain. Price 10c, 3 for 25c, 1 dozen 75c. Johnson Smith & Co.

NOSE BLOWER

When some men blow their noses it sounds like a trombone. Now the NOSE BLOWER has come to torment us. It is a starter! It is ingeniously concealed in the handkerchief. Proceed to blow your nose and your friends will think they heard a steam engine or something. You can blame the hideous noise to your having a very bad cold and keep up the fun as long as you like. PRICE 10c, 3 for 25c, or 75c doz. postpaid.

Serpent's Eggs

Box contains 12 eggs. When lit with a match, each one gradually hatches itself into a snake several feet long, which curls and twists about in a most life-like manner. Price per box, 10c postpaid, 3 for 25c

ARTESIAN DEVIL

A Clever Novelty
Just Press Top and the Devil Dives to the bottom—Let Go and It Comes Up Again.
Most Interesting and Amusing

The Devil in the Tube is a most interesting and amusing novelty. There is a glass tube nearly six inches long, a little glass devil and a rubber cap which fits tightly over the top of the glass tube, effectively sealing it. The tube is filled with water, the glass devil placed inside, and the rubber cap placed over top of tube. All you have to do to make the devil dive is to press the rubber cap with the finger, as shown in the illustration, and the devil immediately sinks to the bottom. As soon as you release the pressure the devil dives to the surface again. Or you can cause him to suspend half way, or even dance up and down in the water inside the tube. The effect is considerably heightened if a colored liquid is used. It is a scientific little curiosity that is well worth having. PRICE ONLY 25c Postpaid. JOHNSON SMITH & CO., DEPT. 845, RACINE, WIS.

BOYS! BOYS! BOYS! Throw Your Voice

Into a trunk, under the bed, under a table, back of the door, into a desk at school, or anywhere. You get lots of fun fooling the teacher, policemen, peddlers, and surprise and fool all your friends besides.

THE VENTRILO

is a little instrument that fits in the mouth out of sight. Cannot be detected. It is used in connection with the above, and with the aid of this wonderful **DOUBLE THROAT**, or **VENTRILO**, you can imitate many kinds of birds, animals, etc. Remember you get everything for **ONLY TEN CENTS**—a booklet giving you full instructions how to become a ventriloquist and throw your voice, the **Double Throat**, or **Ventrilo**, and our big 600 page catalog of novelties, tricks, puzzles, masks, books, etc., **ALL SENT POSTPAID TO ANY ADDRESS FOR ONLY 10 cents**



INVISIBLE INK Rubber Cigarettes

The most confidential messages can be written with this ink, for the writing makes no mark. Cannot be seen unless you know the secret. Invaluable for many reasons. Keep your posts and other private memoranda away from prying eyes. Great fun for playing practical jokes. Only 15c a Bottle; 3 for 40c.



It is just like a regular package of chewing gum and looks so real that it fools everybody. Of course no one suspects it is not genuine until they start to chew it. There's a world of fun in this rubber chewing gum—5 sticks to the package. Price, 10c Pkg.; 3 for 25c; 12 for 75c postpaid.

Rubber Chocolates... Box 25c Rubber Cigarettes. Price per Box. 20c
Rubber Dagger... Price 25c Rubber Matches. Price per Pkg. 10c

MAGICIAN'S BOX OF TRICKS

Apparatus and Directions for a Number of Mysterious Tricks, Enough for an Entire Evening's Entertainment..... \$1.00

ANYONE CAN DO THEM
It is great fun mystifying your friends. Get this Conjuror's Cabinet, and you will be the cleverest fellow in your district. It contains the apparatus for ten first-class tricks, including the **MAGIC BALL AND VASE TRICK** (a wooden ball is placed inside, and upon replacing the lid has disappeared and is found in someone else's pocket); the **HINDOO TRICK CARDS** (can be made to change completely no less than five times); **DISAPPEARING COIN BOX** (a coin, placed in the wooden box, vanishes entirely or changes into a coin of another denomination); the **GLASS GOBLET TRICK** (a coin is dropped into a glass of water and when the water is poured out the coin has vanished and is found somewhere else); the **RIBBON FACTORY FROM THE MOUTH TRICK** (a seemingly endless supply of colored paper ribbons comes out of your mouth); the **DISAPPEARING HANDKERCHIEF** (a handkerchief held in the hand mysteriously vanishes); the **WIZARD'S RING COIN TRICK**; the **ENCHANTED BOTTLE** (no one but yourself is able to make it lay down); the **GREAT HAT AND DICE TRICK** (a large dice is placed on top of a hat, disappears, and is found underneath yet no one has touched the hat), and last, but not least, the **GREAT PHANTOM CARD TRICK**, or two from five leaves nothing. Full instructions are sent for performing each trick. In addition to the above, a number of other feats and illusions are fully explained for which you can easily make or procure the necessary apparatus. Price complete \$1.00 postpaid. **JOHNSON SMITH & CO.**



U. S. BABY TANK

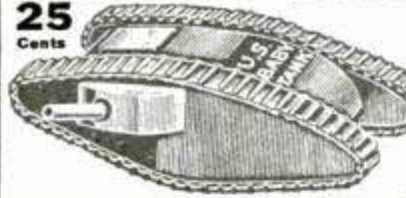

It goes with real Yankee Pep—by its own power. Most remarkable toy ever invented. By drawing the Tank backward, either with the hand or over the floor or table and then placing it down, it will crawl along, overcoming all obstacles, in the same life-like manner as the larger Tank that proved so deadly in the great war. What makes it go is somewhat of a mystery, for there is no mechanism to wind up as is usually understood with mechanical toys, yet this tank will keep plodding along ten times longer than the ordinary run of toys. It will perform dozens of the most wonderful stunts: 2 1/2 inches long. Price only 25c prepaid. Stamps accepted. **JOHNSON SMITH & CO.**

THE NEW POTATO PISTOL



This is surely the most ingenious of all air pistols. For ammunition **ALL YOU NEED IS AN ORDINARY POTATO**, and that isn't hard to get. Merely place the point of the barrel of the pistol into a potato, as shown in the illustration, withdraw the pistol and fire. Nothing could be simpler. It fires quite a distance, goes off with a report like all air guns, and there is absolutely no danger. Will stand strongly made entirely of metal. Price Postpd. Only 35c.

Great Fire Eater

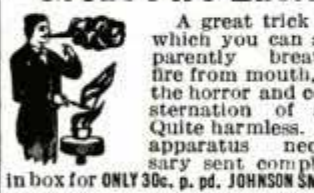

A great trick by which you can apparently breathe fire from mouth, to the horror and consternation of all. Quite harmless. All apparatus necessary sent complete in box for **ONLY 30c, p. pd.** **JOHNSON SMITH**

SEEBACKROSCOPE



Place this clever instrument to your eye, you see what is going on behind your back. Very interesting things sometimes occur when no one thinks you are looking. Just like having eyes at the back of your head. **PRICE 25c POSTPAID**

Send remittance (Postage Stamps accepted) for all articles listed above, also in our other ad on previous page

RESURRECTION PLANT

Great curiosity. Place in water, plant opens up and starts to grow in few minutes. Taken out it dries up and goes to sleep until put in water again. **PRICE 10c, 3 for 25c 75c dozen, postpaid.**



MAGIC MADE EASY 250 MAGIC TRICKS 10c
An excellent little book containing 250 Parlor Tricks, tricks with cards, handkerchiefs, eggs, rings, glasses, etc. So simple that a child can perform them. Profusely illus. Sent postpaid to any address for only 10c, 3 copies for 25c.

Comical Motto Rings
Lots of harmless fun and amusement wearing these rings. Made in platinumoid finish (to resemble platinum), with wording on enameloid, as illustrated. **Price only 25c Postpaid.**

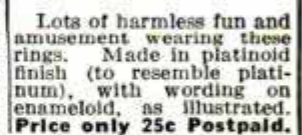

The "Little Giant" Typewriter

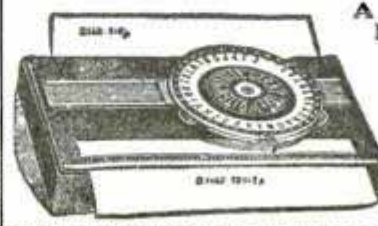

A First Class Writing Machine For \$1.50
A perfect little typewriter for \$1.50. There are thousands of persons who would like to use a typewriter but whose needs and business do not warrant the expense attached to the purchase and use of a fifty or seventy-five dollar machine. To such persons we confidently recommend our Little Giant. It is strongly made, but simple in construction, so that anyone can quickly learn to operate it, and write as rapidly as they would with pen and ink. The letters of the alphabet 1 to 10, and the punctuation marks being together. With this machine you can send your best girl typewritten love letters, address envelopes, make out bills, and do almost any kind of work not requiring a large, expensive machine. With each typewriter we send a tube of ink and full printed instructions for using the machine. **Price complete \$1.50 by mail postpaid to any address in the world.**

most frequently used are so grouped as to enable one to write rapidly, the numerals

Mac WORKSHOP
THE POPULAR MECHANIC
 Electrically Operated
 dependable
 accurate

AMAZINGLY BETTER WORK SHOP!

Home Mechanics, Inventors, Model Makers, Craftsmen! Now you can expect new things—amazing improvements, new easy ways to make and repair a thousand and one different articles right in your own home. Here is everything you need to gratify your creative instincts—and to make big money, too. Even in unskilled hands results are surprising. MAC is a strong, sturdy, practical workshop—designed to perform the most difficult feats of woodcraft.

Now Sent on 10 Days' FREE TRIAL!

We'll gladly send you this superb craftsman's shop on approval for 10 days' FREE TRIAL. Embraces everything necessary for a complete motorized workshop. 1.3 H.P. Motor; 8-inch Circular Saw; 36-inch Lathe; 4-in. Jointer; Sturdy Jig Saw and complete accessories for all woodworking operations. Guaranteed to give the highest degree of service. Never before has machinery of this character and quality been offered at such amazingly low prices.

Small Monthly Payments

Complete outfit shipped to you on approval. 10 days' Free Trial. Then convenient monthly terms if you decide to keep it—as low as \$5.94 per month. The things you make will be worth many times the small monthly payments.

Plans and Instructions Given

We'll help you to develop your mechanical talents. A complete service, including instructions and plans, is given. It is simple to master the art of wood turning. In a short time you can become an expert cabinet maker.

Write Today for Complete Details!

Send us your name and address and we will mail literature illustrating and describing MAC—The POPULAR MECHANIC Workshop—and details of our Free Trial offer and liberal monthly terms. Write today!

MIDLAND APPLIANCE CORPORATION
 Dept. 1210, 225 N. Michigan Ave., Chicago, Ill.

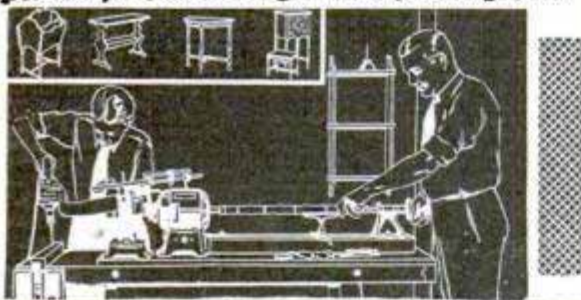

CLASS PINS 35¢
 FREE CATALOG SHOWING 200 DESIGNS
 EITHER DESIGN SHOWN, SILVER PLATE 35¢ EA., 12 OR MORE, \$3.50 DOZ.; STERLING SILVER OR GOLD PLATE, 50¢ EA.; 12 OR MORE, \$5.00 DOZ.; 1 OR 2 COLORS ENAMEL, ANY 3 LETTERS AND DATE.
BASTIAN BROS. CO., 925 BASTIAN BLDG., ROCHESTER, N. Y.

WE WANT MEN WHO CAN SELL

We want to hear from live, ambitious men who can sell a high class article to businessmen and the better class of homes. We have a real selling proposition that will keep on month after month, bringing in big money for a man not afraid of hard work.

The K-S Telegage is the leading hydrostatic gauge used to measure the liquid contents of large or small tanks at a distance.

Experience not necessary. We teach you how to sell the K-S Telegage. Write today for full details of our selling plan. Address Sales Manager, Industrial Department, King-Seeley Corporation, 314 Second Street, Ann Arbor, Mich.

Ship Models with Electric Lights ^{ONLY} \$6⁵⁰

We furnish you with all the parts cut perfect. No trouble to fit them together and in a very little time you will have a beautiful ship model that you will be proud to own, placed on your radio or mantel and lighted with the electrical equipment that comes with each model. They give the effect of a ship at sea sailing along on the quest of adventure.

We have the following models, all parts cut to fit and ready to be put together, a complete diagram and instruction sheet numbered so that you cannot go wrong.

Flying Cloud...26 1/2" long, 7 1/2" wide, 19" high.
 Santa Maria...27" long, 10" wide, 25" high.
 Mayflower.....30" long, 10" wide, 26" high.
 La Pinta.....27" long, 12" wide, 26" high.
 Constitution...32" long, 10" wide, 30" high.

Every Model Guaranteed Money Back If You Want It

We will send you any of the above models C.O.D. anywhere in the United States. Money order or check must accompany all foreign orders.

All models shipped same day as order is received.

Model Woodworking Co.
 Dept. D PERKASIE, PA.

ELECTRIC LIGHTS ANYWHERE

110 Volt—complete plant with all Wiring, Fixtures and Lamps for 7 rooms \$147.50, Direct-To-You.

Ideal for Farms, Camps, Summer Homes.

Also runs Household Electrical Appliances. Install it yourself. Write for circular.

D. W. ONAN & SONS \$147.50
 26 Royalston Ave. Minneapolis, Minnesota.



PANTS MATCHED

TO ANY SUIT—FREE SAMPLE

DON'T DISCARD YOUR OLD SUIT. Wear the coat and vest another year by getting new trousers to match. Tailored to your measure. With over 100,000 patterns to select from we can match almost any pattern. Send vest or sample of cloth today, and we will submit FREE best match obtainable.

AMERICAN MATCH PANTS CO.
 Dept. C.P., 6 W. Randolph St., Chicago, Ill.



\$50 and up Weekly

Making Amazing Demonstration

Commission checks for all money due mailed every Saturday to our men. Work full or spare time making amazing demonstration that will save prospects thousands of dollars.

Demonstrator Furnished

We will furnish outfit for sensational demonstration. No investment for stock—no deliveries or collections. Every one a prospect. Show in homes, stores, garages, schools, offices, and to farmers, etc. Many of our men now making \$300 to \$600 a month. Write at once to

FYR-FYTER COMPANY

90-Z Fyr-Fyter Bldg., Dayton, Ohio

IN ONE MINUTE

Ten of these sensational demonstrations a day should pay you \$50 a week. No experience necessary—we show you how.



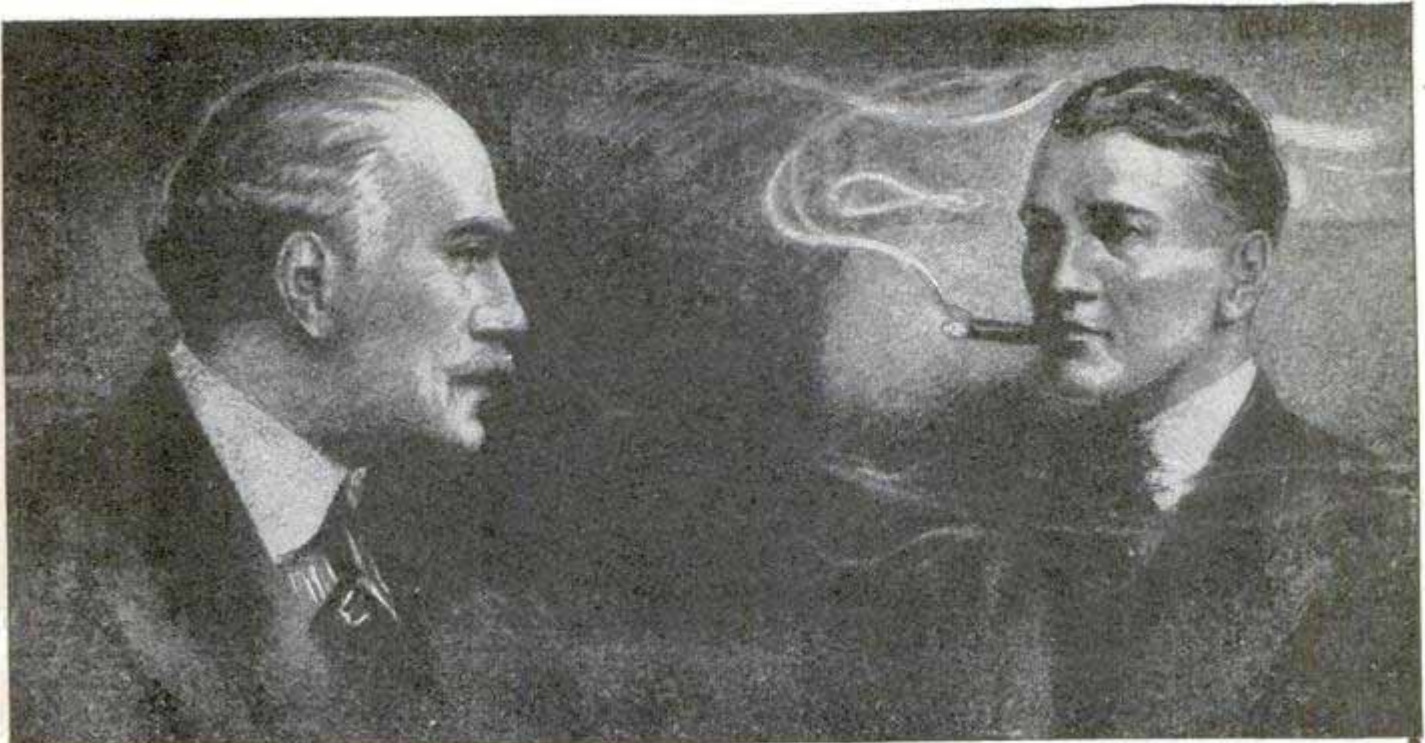

Tobacco Is Hurting You

Look the facts square in the face, Mr. Tobacco User. You may think tobacco is not hurting you.

That is because you haven't as yet, perhaps, felt the effects of the nicotine poison in YOUR system. For you know that nicotine, as absorbed into the system through smoking and chewing tobacco, is a slow working poison. Slow, yes—but sure.

Tobacco lowers efficiency. It slows a man down. Makes it harder to concentrate the mind on work. Tobacco users seldom have the amount of "pep" and energy of those who do not use the weed. There's many a man older than you in years who is younger in energy, simply because he lets tobacco alone.

Some day, probably, you will realize to what an alarming extent tobacco does undermine the system.

When your hands begin to tremble—
and your appetite begins to fail—
and your heart seems to "skip a beat" now and then—
and slight exertion makes you short of breath—
then you have a right to suspect that
TOBACCO is getting the upper hand.

Any well-informed doctor will tell you that these are only a few of many symptoms of tobacco poisoning.

And YOU know that the use of tobacco in any form is an expensive, utterly useless habit. You know you ought to quit.

Tobacco Habit Banished Let Us Help You

It doesn't make a particle of difference whether tobacco has been used for a single month or fifty years, or how much, or in what form—whether cigars, cigarettes, pipe, plug, fine cut, or snuff. In most cases, Tobacco Redeemer removes all craving for tobacco in any form in a very few days. Not the slightest shock to the nervous system. The tobacco craving will usually begin to decrease after the very first dose—there is no long waiting for results.

Tobacco Redeemer contains no habit-forming drugs of any kind and is quick, safe, pleasant and thoroughly reliable.

It is in no sense a substitute for tobacco. After finishing the treatment, there is usually no desire to use tobacco again or to continue the use of the remedy. It helps to quiet the nerves and makes one feel better in every way.

Results Guaranteed A single trial will convince you. Our legal, binding, money-back guarantee goes with each full treatment. We will refund every cent you pay for the treatment if, after taking it according to the easy-to-follow directions, it should fail to banish the tobacco habit completely.

SEND Coupon for Free Proof Let us send you our free booklet on the injurious effects of tobacco, together with testimonial letters from men all over the country telling how they have been absolutely freed from the tobacco habit by this simple home treatment. You could not ask for stronger proof that Tobacco Redeemer does do the work than the evidence we will gladly send on request. Just mail the coupon—or a postal will do.



Free Book Coupon

NEWELL PHARMACAL CO.

Dept. 300 Clayton Station St. Louis, Mo.

Please send, without obligating me in any way, your free booklet regarding the tobacco habit and proof that Tobacco Redeemer does positively relieve the tobacco habit or money refunded.

Name.....

Street and No.

Town..... State

NEWELL PHARMACAL CO.
Dept. 300 Clayton Station St. Louis, Mo.

Build POWER AMPLIFIERS Like this!



This **NEW BOOK** Tells How

Finest Tone Quality Greatest Power

SEND today . . . right now . . . for FERRANTI'S NEW Power Amplifier Book; most helpful volume of its kind ever published. Contains diagrams, components and instructions for building 10 perfectly engineered 2 and 3 stage amplifiers . . . even 3 stage push-pull for 250 and 245 tubes. You need this new FERRANTI Book if you are interested in Amplifiers. And for Amplifiers of the finest tone quality and most power be sure to use Ferranti Transformers. They supply an undistorted output ranging from 25 to 8000 cycles. At dealers or direct, FERRANTI'S NEW Power Amplifier Book mailed for 15c. coin, to help pay production and mailing cost.

130 W. 42nd St. Suite 1012



New York, N. Y.

\$5 BIASCOPE



AMERICAN MADE FIELD GLASSES FOR YOU WHO

hunt, hike, fish, motor, camp or study birds. Great for movie, theatre or field sports. Makes everything look 6 times as big. Precise optical qualities. Fine finish. Leather case free.



POCKESCOPE

Compact telescope magnifies six times. Same finish and optical qualities as Biascope. Supplied with leather case. Both at your dealer or sent direct postpaid. Money back guarantee. Catalog free.

Wollensak Optical Co.
870 Hudson Avenue
Rochester, New York

PAINT with ELECTRICITY

the New and EASY WAY



THE Paint-O-Mister

THE EVEN PRESSURE SPRAYING MACHINE

The latest development in an electric cup gun spraying machine — The Paint-O-Mister. Made by the makers of the Atomister. A larger, more powerful, more durable machine. Maintains an air pressure of 25 to 30 pounds.

Sprays paint, lacquer, varnish, disinfectants, insecticides. For use in the home, factory, garage, dairy, farm, sign shop, boat yard, greenhouse, etc.

\$39.50 complete

Write for Booklet At your dealer's — or from us.

THE ATOMISTER CORPORATION
32 Hamilton St., Rahway, N. J.

For Xmas — Make Your Boy [or Yourself] Happy with the H&A LATHE



Sturdy, well balanced, splendidly accurate — a truly wonderful machine at surprisingly low cost. A gift that will delight expert or novice. Prompt shipment. Write for catalog.

HESTON & ANDERSON
612 Market St., Fairfield, Ia.

BOYS — Something New



in model aeroplanes. If you install a superpowered motor, with mechanical controls, made according to our directions your model airplane will make perfect loops, tail spins, dive, zoom, fly figure 8, circles or any other maneuver same as high powered army pursuit plane. Motor can be made by anyone, nothing complicated. Will work successfully in any flying model plane. Complete directions and drawings 50 cents coin. No stamps. Superior Machine & Mfg. Co., Albert City, Iowa

Make \$100 a Week!



GET PAID DAILY — EXTRA CASH BONUS
I'll give you your own business. Won't cost you a penny. Make big money showing famous all-wool, tailored-to-measure suits, \$23.50 up. Daily commissions, liberal bonus. Super-values, guaranteed fit, mean easy orders, steady customers. No experience required. FREE outfit, 200 all-wool fabrics, Union tailoring. Write, give experience and age.

ALL-WOOL Suits \$23.50

W. Z. Gibson, Inc., 500 Throop St., Dept. M-516, Chicago



HIGH GRADE MECHANIC'S KNIFE HAND-FORGED FROM RAZOR STEEL AND WARRANTED. STAG HANDLE, NICKEL-SILVER FINISH, FILE TESTED.

A GENUINE \$2.00 KNIFE FOR \$1.18 POSTPAID
3 for \$3.00 Postpaid

FACTORY PRICE SAMPLE \$1.18

Best Knife for Mechanics, Farmers, and Sportsmen.

Send for our free list and "HOW TO USE A RAZOR"

Established 1877 MAHER & GROSH CO., 106 A St., Toledo, Ohio

IF YOU SKI

you already own or know about
NORTHLAND SKIS

To identify the fast, durable skis that have won every Nat'l Championship since 1917, look for the deerhead trademark. Our new booklet, "How to Ski", is ready. Write for your free copy.

How about Northlands as Christmas gifts?

NORTHLAND SKI MFG. CO.
World's largest Ski Mfrs.
95 Merriam Pk. St. Paul, Minn.



PRINT YOUR OWN

Bulletins, Circulars, Programs, Letters, etc.—with this Amazing New "EXCELLOGRAPH"

Simple and easy. Prints anything written with pencil or typewriter. Just make stencil and print 1,000 copies per hour. Wonderful for illustrations drawn or traced. All supplies and instructions furnished. Guaranteed 10 years. Prints any size from postcards to sheets 9x14. Does beautiful work.

SAVE MONEY—MAKE MONEY

Saves and makes money for Merchants, Ministers, Teachers, Offices, etc. Use it to build your business. Do work for others at big profits.

Write for Free Book — Today
Shipped at our risk. Positive money-back guarantee. Amazing value. Thousands in use. Get free book describing all details and easy payment plan.



Only \$39.00
Easy Terms

PITTSBURGH TYPEWRITER & SUPPLY COMPANY
Dept. M-2—339 Fifth Avenue Pittsburgh, Pa.

JENKINS Watch-Lighter \$4⁹⁷



Guaranteed 6 Jewel watch and new design elegant quality lighter in one. Watch is of excellent Swiss make, tested and adjusted. Two years' written guarantee. Radium dial—tells time in dark. Lighter is of sturdy construction and can be opened with one hand. Gives instant flame. Large fluid capacity. Easily replaceable flints. Elegant covered case. **SEND NO MONEY.** Pay on delivery \$4.97 plus postage. Satisfaction guaranteed. **JENKINS, 683 Broadway, New York, Dept. 12-A-23.**

PANTS MATCHED!

Why Throw Away That Coat and Vest? Save \$25 or more! Let us match your coat and vest with new trousers and save the price of a new suit. Each pair tailored to your measure. (Average price \$8.50). Over 100,000 patterns. Mail sample of suit, or your vest which will be returned together with **FREE Sample for your approval.**



Originators and Largest Pants Matchers

MATCH PANTS CO., Dept. 100, 20 W. Jackson Blvd., CHICAGO

New Food Idea Pays Big Profits!

Men! Women! Investigate the wonderful NEW Brown Bobby GREASELESS Doughnut. Sells like wildfire! You can easily make \$50 week spare time; \$5000 to \$8000 year full time. Investment small. No experience needed. Write today for big special offer. **Food Display Machine Corp., Dept. 3-W, 500-510 N. Dearborn St., Chicago**

AGENTS: The DUO-PAC is a Whirlwind Seller



Duo-Pac holds package cigarettes, also regular book matches in special slides on side. Variety colors baked enamel also plated. Most convenient little article ever invented. A sale every time shown with big profit. Beautiful gift men and women. Nothing like it.

Write for full particulars
MUTUAL SERVICE FACTORIES
Desk 22—522-24 McKnight Building
Minneapolis, Minn.

Patents Pending
SAMPLE 50c
3 for \$1.00

FREE! This Big SAXOPHONE BOOK

Use Coupon Below



First Lesson Illustrated — explains all about

BUESCHER

True Tone Saxophones

Write today for the Buescher Saxophone Book. See the first lesson chart—look over all the different saxophones—get acquainted with the many strictly Buescher features that make the Buescher Saxophone the easiest of all instruments to play.



Easy to Play Easy to Pay

Learn why you can be playing popular pieces within two weeks and be able to take your place in an orchestra at the end of three months. You'll find it possible because only a Buescher gives you all these features:

- Patented snap-on pads.
- Patented automatic octave key.
- Perfect scale accuracy.
- Convenient key arrangement.
- Hands stay in one playing position.

These features are explained fully in the new Buescher Book. Besides being easy to play, we make it easy to pay for a Buescher. A little down and a little each month makes it possible for you to play while you pay.

SIX DAYS' TRIAL

After you have read the Buescher Saxophone Book take any Saxophone or other instrument on 6 days' trial in your home. See it—play it—hear it—convince yourself that you can master it. Write today for free copy of the Buescher Book—use the coupon.

BUESCHER BAND INSTRUMENT CO.
2957 Buescher Block Elkhart, Indiana

BUESCHER BAND INSTRUMENT CO. (547)
2957 Buescher Block, Elkhart, Indiana.

Gentlemen: Without obligating me in any way please send me your free literature.

I am interested in the following instrument.....

Name.....

Address.....



Weighs Only Four Pounds

Only \$18.75

Weights Only 4 Pounds

Universal Motor

Write for our catalog showing complete line.

Yet will do a better, cleaner, quicker job than a large drill for light and intermittent work. Sturdy, practical—an electric drill specially built for tight corners. Guaranteed fully for one year. The ideal drill for garages, woodworking shops, machine shops, and wherever light drilling is done.

Uses direct or alternating current, and is supplied to you for 110 to 125 volts, 200 to 250 volts or 32 volts. Fitted with a special Jacobs Chuck. Bore up to 1/4". Stop and start switch in the handle. Comes complete with 10 feet of cord and socket. Price post-paid anywhere in the U.S.A.—\$18.75.

Send check or money order. If not satisfied return in 5 days and money will be gladly refunded. In ordering, be sure to specify voltage used.

Jones Motrola Sales Co.
Dept. 9, 370 Gerard Avenue,
New York.

Enjoy the Thrill of Electrified RADIO at Small Cost!

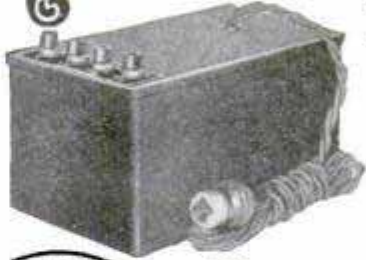

Make Good Reception Easy

Thousands of users marvel at the difference in reception with a Townsend "B" Power Unit. Full, sweet tone, clarity, volume and greater distance are among the many advantages reported daily.

ONLY \$6.85 COMPLETE

Townsend "B" Power Unit

Hooked up in a few minutes; just plug into the light socket and forget it. Delivers up to 100 volts on any set—D.C. or A.C.—any cycle.

Approved and Passed by the rigid laboratory tests of "Popular Radio" and "Radio News."

Over 150,000 Now in Use

There's no longer any reason for putting up with the expense and undependable performance of "B" Batteries—when you can own a good "B" Power Unit for \$6.85. Over 150,000 Townsend "B" Power Units now in use—a substantial proof of satisfaction.

ance of "B" Batteries—when you can own a good "B" Power Unit for \$6.85. Over 150,000 Townsend "B" Power Units now in use—a substantial proof of satisfaction.

TRY IT FREE!

We are so sure the Townsend will do all we claim for it, we give you the privilege of trying it ten days at our risk. A new joy in radio reception awaits you. Write for complete details today!

HAS ONLY WORDS OF PRAISE
Please send me another Eliminator. I have had one of your Eliminators in constant use on a 5 tube set for over two years and have only words of great praise for it. An accident with it is my reason for wanting another.
J. Cassidy,
531 Sterling Place, Brooklyn, N. Y.

TOWNSEND LABORATORIES
715 Townsend Street Chicago, Illinois



FREE RADIO CATALOG

The New SCREEN GRID models

Write for latest catalog just off the press—148-page book offering hundreds of radio bargains

—New Humless Screen Grid, A.C., all-electric and battery operated sets—beautiful consoles, accessories, parts and kits—all at wholesale prices. **\$15.95**
Complete sets as low as

Chicago Salvage Stock Store
509 So. State St., Dept. 110, Chicago



THREAD CUTTING LATHE

A REAL Lathe. 9" swing; 30" between centers. Speedy and accurate. Special attachments and tools available. Write today for Circular and other machines.
12" Band Saw
Powerful, practical. Not a toy. Has tilting table. Price **\$30**
Bronze bearings. **only \$30**
Rossbacher Machine Co., 1516 Fernwood Ave. TOLEDO, OHIO

30 DAYS TO TRY FREE MEAD Ranger RADIO

—10 Months to Pay
SAVE \$25 TO \$100

All Electric With Dynamic Speaker Screen Grid Tubes

The Ranger Radio is a result of 7 years' development. It is to-day fast becoming the most favorably known radio—now leading the field, as its predecessor, the Ranger Bicycle, has for 30 years. The Screen-Grid Tube Ranger Neutrodyne (with 9 tubes) with 2 No. 245 tubes in "Push-Pull" is licensed by R. C. A. Ranger assures you of selective reception from near and distant stations. You may now own one of these distinctive Rangers with Dynamic Speaker in a Deluxe Console by paying as low as \$10.00 down and balance in 10 months. Table models as low as \$40.00. Rangers come all ready to use—simply insert tubes and plug into your electric light socket—no more trouble than to connect an electric floor lamp.



Write today for big catalog

MEAD CYCLE CO. MEAD has been known for Ranger Precision Products for 30 Years. Write for marvelous new introductory offer—easy terms DEPT. J173 CHICAGO

By An Amperite for every tube.
Dr. Radio Engineer

The Prescription for Better Radio Reception

AMPERITE automatically maintains the most efficient tube voltage. Improvestone, sensitivity, volume. For every tube. \$1.10 with mounting (in U.S.A.). At all dealers.

AMPERITE Corporation
561 BROADWAY, NEW YORK

FREE—"Amperite Tube Chart." Write Dept. PM12.

AMPERITE
REG. U.S. PAT. OFF.
The "SELF-ADJUSTING" Rheostat

This symbol in a radio diagram means—



JB Johannesburg South Africa
JIPP Tokyo Japan
5SW Daventry England
2BL Sydney Australia
AKF Berlin Germany
D7RL Copenhagen Denmark
FL Paris France
EAM Madrid Spain
SQBE Bahia Brazil



ASSEMBLE YOUR OWN SHORTWAVE RECEIVER

Seventy-eight stations in 21 countries and 49 in the U. S. broadcast programs on shortwaves. Listen to entertainment from England, France, Spain, South Africa and even Japan and Australia. Shortwaves carry many times farther than long waves.

- BAIRD 1-T Kit complete in all details assembled in 30 minutes.....\$29.50
- BAIRD 2-T Kit—Detector and 1 stage screen grid R. F., Complete, assembled in one hour.....\$39.50
- BAIRD 4-T Kit—Detector, 1 stage screen grid R. F., 2 stages Audio, complete as er-bled in 2 hours.....\$59.50

Set of Four \$5

OCTOCOILS—for Shortwave Sets. Sturdiest and most efficient shortwave coils; 16 to 225 meters; simply plug into regular socket. OCTOCOILS are genuine moulded Bakelite wound with Nos. 12-14-16-25 enameled wire.

If your dealer cannot or will not supply you with our parts, we will ship, prepaid on receipt of price.

SHORTWAVE & TELEVISION LABORATORIES, INC.

70 Brookline Avenue Desk 31 Boston, Mass.

FREE RADIO CATALOG

GREATEST OF ALL!
Nothing to compare with new 1930 Wholesale Radio Service catalog. Fully describes biggest bargains ever offered. Unequaled dollar for dollar value.

VERY LATEST EQUIPMENT
Shows all standard equipment, kits, parts, batteries, accessories. Everything offered at substantial savings. FREE RADIO ADVICE and information.

WRITE TODAY FOR COPY
Get your copy of this great radio guide and catalog ABSOLUTELY FREE. Don't miss this offer! Simply send name and address. Postal will do. But you must act quick before supply is exhausted. Write today!

Dealers and Agents:
Lowest wholesale prices offered on all equipment. Confidential price list. Personal advice. Write for our plan.

1930 RADIO CATALOG
WHOLESALE RADIO SERVICE CO.

Now perfected LAFAYETTE A.C. Screen-Grid Receiver. Highest cathedral toned reception. 245 push pull audio. Gorgeous cabinets, consoles. Catalog describes all. **BARGAINS.**

WHOLESALE RADIO SERVICE CO., INC.
36 VESEY ST. Dept. C-11 NEW YORK

CLAROSTAT

Not merely a product; nor again an entire line of products; nor still again a resistance for every purpose. More than all that, it is the name of a service dedicated to

AIDS TO BETTER RADIO

ranging from improved wave interception to detector action; radio and audio amplification, volume control, tone quality and all manner of new and experimental applications.

WRITE for data on Clarostat line or ask your dealer about it.
CLAROSTAT MFG. CO., Inc., 285 N. 6th St., BROOKLYN, N. Y.

SOLDERALL

METAL IN PASTE FORM

The only convenient metal solder

Every Electrical Connection needs Solderall for perfect reception.

25¢

The **SOLDERALL CO., NEWARK, N.J.**



Choice of 1200 Newest RADIO VALUES

SEND for our wholesale 1930 catalog. Filled with amazing values in screen grid radios, 245 push pull audio, radio consoles, kits, parts. Guaranteed merchandise at wholesale prices.

FREE

WESTERN RADIO MFG. CO.
128 W. LAKE ST. CHICAGO ILL.

ADJUSTABLE SLIDING CLIP

U. S. Pat. 1676869 & Pats. Pend.

Build a Better Eliminator

with

TRUVOLTS

TRUVOLT is the SAFE Resistance for radio battery eliminators and power packs. Built for accuracy and durability. Heavy nichrome wire cleverly wound for direct air cooling. Fixed models have sliding clip, quickly set for exact value desired. All usual sizes. TRUVOLT Variable has a knob-control and one hole mounting. Lasts longer owing to endwise travel of contact over wire. 22 sizes \$2.50 each.



175 Varick St., New York, N.Y.

ELECTRAD

Mail coupon for data

ELECTRAD, INC., Dept. PM12, 175 Varick St., N. Y. C.
Enclosed 10c for folder, "What Eliminator Shall I Build?"
Name.....
Address.....

\$1.00
Brings Your Choice
10 MONTHS TO PAY
SO EASY TO BUY GIFTS THIS MODERN WAY

WHAT YOU DO—
 Send \$1.00 with name, address and number of article desired. Tell us 1. How long at address, 2. Age, 3. Married or single, 4. Name of employer, 5. Nature of work, 6. How long employed. All information confidential. No inquiries to employer.

WHAT WE DO— On arrival of order we open 10-Month Charge Account, and send article for approval and 15-day trial. Convince yourself of value offered. If satisfied, pay balance in ten equal monthly payments. Otherwise, return and \$1 will be promptly refunded.

None sold to persons under 20

73 - Appropriate size AA1 diamond in beautifully carved 18K W. G. mounting. \$1.00 with order; \$2.85 a month.

\$29.50

74 - New Parisian design with seven AA1 diamonds in unique "step" arrangement. 18K white gold. \$1.00 with order; \$5.15 a month.

\$52.50

76 - Ladies 18K white gold ring with diamond and sapphire on each side of large brilliant blue-white diamond in center. \$1.00 with order; \$3.85 a month.

\$39.50

BULOVA Lone Eagle

67 - Created by Bulova in honor of Col. Lindbergh. 15 - Jewel movement; radium dial, engraved dust-proof case; flexible link bracelet. In gift box. \$1.00 with order; \$3.65 a month.

\$37.50

BULOVA Gift Combination \$49.75

78 - Bulova gift combination exclusively sold by us. Two blue-white diamonds and four sapphires in case; 15-Jewel movement. Comes in attractive gift box with expansion bracelet set with two sapphires. Silk grosgrain ribbon. \$1.00 with order; \$4.88 a month.

Ladies KENT

82 Ladies Kent 14K solid white gold case with 15 Jewel Kent jolt-proof movement. Flexible expansion bracelet. \$1 with order; \$2.65 a month.

\$27.50

KENT \$29.75

28 - Famous jolt-proof watch for men with guaranteed 15 Jewel movement in Sweet Quality case; radium dial; new woven band. In gift box. \$1.00 with order; \$2.88 a month.

L.W. SWEET INCORPORATED
 Dept. 69-T
 1670 Broadway
 New York, N.Y.

SENT TO ANY ADULT

Our new 1930 Book is ready with large selection of Diamonds, Watches and Jewelry. 10 Months to pay on everything. Send for it TODAY.

BIG MONEY MAKER

Selling Kit Furnished

"A great idea!"

Something different—an original idea—never before seen on the market. Every man and boy a prospect.

Hook-Fast Belt and Buckle made to individual order—no two alike. Every buckle with personal initials and emblems—according to individual taste. Splendid profits made easily—**HANDSOME SELLING OUTFIT FURNISHED**—contains actual samples.

Become the official representative of Hook-Fast Belt and Buckle in your locality—Make big money—Sells itself.

Belt made of genuine English cowhide—never wears out—Buckle made of attractive plati-eroid—lasts a life time, bright and untarnished—Specially patented Hook-Fast catch never slips.

Red-Hot selling proposition. Get in on it now! Write for free particulars.

NATIONAL CRAFTS COMPANY
 20 West 27th Street, Dept. B-126 New York City

YOUR TREASURE SHIP!

Get this yellow book crammed with golden ideas. Follow a hobby that turns spare hours into money. True hand-carved ship models built from Hancock parts are readily sold. See Nancy Lee and Jumbo. Send 10c for copy right now.

ROY HANCOCK
 323 Douglas Ave. Portsmouth, Va.

TRICKS MAGIC JOKES FREE

SCIENTIFIC NOVELTY CO.
 88-E PARK PLACE, N.Y.C. CATALOG POSTAL BRINGS IT

AMAZING BURNER

Use **Ordinary Kerosene**

The most startling heat producing burner ever made. Indispensable on the farm, in factory, for boiling, cooking, and heating. Ideal for butchers, dairies, repair shops, stoves, boilers, ovens, cooking equipment and numerous other uses. Will boil any quantity desired in half the usual time.

BOILS 50 GALLONS IN LESS THAN HOUR!

TERRIFIC HEAT!

SILENT BLUE FLAME

NO NOISE NO SMELL NO SMOKE NO SOOT

Think of it! Improved oil burner produces twice the heat of city gas at half the cost. Regulate to any degree desired. So simple, Easily installed and operated. Double generator assures continuous operation without shut-downs. Nothing to wear out. Starts in a jiffy. Will last a lifetime. Every burner guaranteed fully to give complete satisfaction.

"I would not take \$500 for it if I could not get another," writes J.H.Cox, Mich. "It is worth its weight in gold and is the best on the market." J. B. Ashcraft, O. "Produces terrific heat and saves lots of kerosene." H.C.Kistler, Pa.

Also Burners for Cook Stoves and Heaters
 Let us send you our catalog of Improved Therm-O-Gas Burners.
HOME MFG. CO., Dept. 3813, 20 E. Kinzie St., Chicago

AGENTS BUY DIRECT FROM IMPORTERS! AT WHOLE-SALE PRICES. MAKE \$10 TO \$20 A DAY EASY

Has Compass Here



Red
Black

No. 267—DUPLEX PENCIL. Turn to the right and a black lead appears, turn to the left and a red lead appears. An ideal mechanical pencil or may be used for marking or checking. **Sells for \$1. WHOLESALE SAMPLE 67c. DOZ. \$6.60.**

No. 10 Fountain Pen-Pencil With Compass!
Serves the Purpose of a Fountain Pen and Pencil

GUARANTEED 2 YEARS
Guarantee Given With Each Pen.

8 GROOVES in Point
Permits an Even Flow of Ink.

Rubber Sponge Keeps Point Moist, Thus Pen Will Write Instantly. Pencil Expels and Repels.

Sells for \$1.25
SEND ONLY

39c
Doz. \$3.95
Gross \$39.60

F. SPORS & CO.
1029 Main St.
LESUEUR CENTER, MINN.



STOP LOSING YOUR COMB
JUST OUT NEVER LOSE COMBS
CAN BE FASTENED ANYWHERE ON DRESS COAT VEST OR SHIRT

No. 285—A special patented clip enables you to fasten anywhere as illustrated. May be used as a necktie clasp. Very attractive, comes in assorted colors. **Sells for 25c. WHOLESALE SAMPLE 10c. DOZ. 95c.**



Mends all metals, except aluminum. Excellent for radio work, mending of pots, pans, kettles, etc. Simply clean the parts to be mended. Put on Spors Simple Solder. Apply heat. The job is done. Instructions in each box. **Sells for 35c. WHOLESALE SAMPLE 18c. DOZ. \$1.75.**



No. 216—COMBINATION SHARPENER, sharpens knives and scissors; cuts glass and opens cans. A very useful tool. **Sells for 35c. WHOLESALE SAMPLE 15c. DOZ. \$1.20.**



No. 281—PENCIL SHARPENER. Sharpens standard size pencils. Will not break the lead. Blade can be removed and sharpened. Convenient for pocket, home, school, and office use. **Sells for 15c. WHOLESALE SAMPLE 9c. DOZ. 67c.**

No. 123—MAMMY DOLL shimmies and hops, bound to please all. All you do is wind the spring and the fun begins. Made of heavy gauge metal. Face and arms are black, apron is white. Other dancing dolls in imitation of Santa Claus, rabbit, or dog. **Sells for 35c. WHOLESALE SAMPLE 23c. DOZ. \$1.98.**



No. 119—DEVIL TONGUE BALL. Painted in bright color. When the ball is pressed the tongue and ears stick out making you laugh. A real fun maker. **Sells for 15c. WHOLESALE SAMPLE 10c. DOZ. 65c.**



No. 33p—Twenty-four inch necklace. Has rhinestone set clasp. All uniform graduated pearls. Very attractive, closely resembling the genuine, also have 72 different kinds, styles and colors of beads, write for prices. **Sells for 55c. WHOLESALE SAMPLE 15c. DOZ. \$1.56.**



MONEY BACK IF NOT PLEASD. Goods that do not please you may be returned any time within 60 days from date of purchase for refund.

FREE

Upon request, our wholesale catalog showing over 400 fast sellers, from many parts of the world. Many ideal Xmas gifts shown.

Buy a Watch the Modern Way

This 21 Jewel - Santa Fe Special

Sent You On-Approval Wear 30 days Free!



Thank you for making it possible for me to own a 21-jewel Santa Fe Special, writes thousands of our customers.

Buy Direct

Our catalogue is our showroom. Any watch will be sent for you to see without one penny down. No obligation to buy.

Save 1/3 to 1/2

on the price you pay for a similar watch made by other Manufacturers. Most liberal offer. Our "Direct to You" offer and Extra Special Distribution Plan is fully explained in the New Santa Fe Special Booklet just off the press. The "Santa Fe Special" Plan means a big saving of money to you and you get the best watch value on the market today. Watch sent for you to see without one penny down.

Railroad Accuracy Beauty Unsurpassed Life-long Dependability

These watches are now in service on practically every railroad in the United States and in every branch of the Army and Naval service. Thousands of them are distributed around the world. You will never miss the few cents a day that will make you own one of these watches.

—all are combined in the highest degree in the famous "Santa Fe Special" Watch.

Just Out! Send coupon for our New Watch Book—just off the press. All the newest watch case designs in white or green gold, fancy shapes and thin models are shown. Read our easy payment offer. Wear the watch 30 days FREE.

SANTA FE WATCH CO.
Dept. C-6 Thomas Bldg. Topeka, Kans.

SANTA FE WATCH CO., Dept. C-6, Thomas Bldg., Topeka, Kansas.

Please send me your New Watch Book with the understanding that this request does not obligate me in any way.

Name.....

Address..... State.....



Dr. Wu
Famous Chinese magician, the originator of the Block and Ball trick which mystified the world.

This trick, now contained in Set No. 2 of the Knapp Master Magic sets, is one of the many famous tricks included in this series.



Fellows... be a real Master Magician

HERE'S a chance to give real magic shows all your own. With the Knapp Master Magic Sets you can now do as famous magicians have done—pick things out of the clear air—make coins disappear—escape from locked chains—use the magic wand—these and many other feats of magic are yours for the asking. All of the world famous tricks in the Knapp Master Magic Sets are easy to do, yet they will completely mystify your friends. With each set you get the "Secrets of Master Magic" instruction book. You can't go wrong after you've read it. It's easy as ABC. This is your one big chance to be the Master Magician of your Neighborhood. Get the sets at your local dealer now—or if he hasn't them, write to us.



Set No. 1 Price \$1.00. Set No. 2 Price \$3.50, (Illustrated above) Set No. 3 Price \$5.00
Slightly higher Denver & West

Send for free booklet "P" KNAPP ELECTRIC, INC. Indianapolis, Ind.
3029 East Washington St.

KNAPP Master Magic

LOOK FOR THIS TRADE MARK ON ALL KNAPP MASTER MAGIC SETS

\$21¹⁵ A WONDER!



10" swing, 25", 35" and 45" centers. Weight 60 lbs. Biggest lathe value yet. Send 6c for 32 page catalog on lathes, saws, etc. Largest line of small lathes in America.

SYMPHER MFG. CO. Dept. D-12 TOLEDO, OHIO

GOVERNORS

To control speed of any make of auto engine, regardless of load changes, when used as a stationary engine. Driven by flat or V belt. Driving pulley, 3 1/4" dia. Governor speed range, 400 to 2000 r. p. m. State approximate speed you desire. The Governor is built to be easily attached to any make of engine. Fully Guaranteed. \$10. with order or sent C.O.D. with examination privilege.

C. S. GO. CO. 215 No. L. A. St. Los Angeles

MODEL SHIPS

Would you like to build a real fine ship model?

We can supply construction sets and all sorts of parts such as semi-finished hulls, blocks, dead-eyes, special flags, anchors, steering wheels, capstans, figureheads, blue prints, books, etc., for building a Flying Cloud, Constitution, Spanish Galleon, Mississippi River Steamboat, Sovereign of the Seas, Mayflower, Bluenose, Half Moon and many others. Also special construction sets for racing sail boats, power boats, model steam engines, propellers, etc., and fine tools for the model maker. Our large 48-page photographically illustrated booklet contains valuable information and hints for building ship models in addition to prices and full description of the above articles. Many people only slightly interested in models have become greatly enthused upon receiving this booklet. A copy will be sent postpaid upon receipt of 15 cts. (coin preferred).

Whether you spend your spare time in building a ship model for pleasure or profit, you will find this work to be the most interesting and fascinating hobby in the world.

Model Ship Supply Co., Dept. A, Mineola, N. Y.



5 Ft. Workshop INCLUDES
 4" Planer, 8" Circular Saw, 6" x 36" Lathe, 8" Disc Sander, 6" Buffer, 5" Grinder, 3/4" Drill Chuck, 1/2 H. P. G. E. Motor, 110 V., A. C., 60 Cycle. Endless V Belt, Two 2-step 4" and 2 1/2" Pulleys, Cast Iron Sub Base, 10 ft. Cable with separable Plug. Planer and Saw may be purchased separately — \$25.00 each.

>> HERE'S A Real Man's HOBBY

J. D. WALLACE & COMPANY,
 Adams St. at California Ave., Chicago, Ill.
 Please send me full information about the Workace Electric Woodworker and also the Workace Machines checked below.

Workace Jig Saw Workace Band Saw
 Workace Shaper Workace Planer Workace Radial Saw

Name.....
 Address.....
 City..... State.....

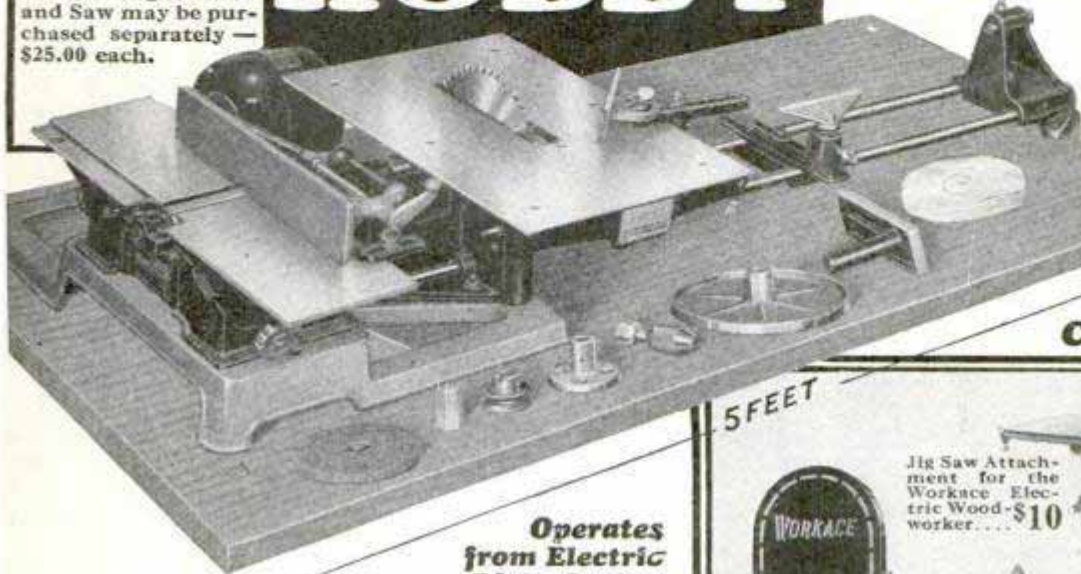

\$9⁰⁰ DOWN
\$89⁰⁰ COMPLETE

Mail Coupon Above

Operates from Electric Light Socket

WORKACE Electric WOODWORKER

PRODUCT OF J. D. WALLACE & CO.

HERE'S A HOBBY that offers relaxation from everyday cares—bringing pleasure and profit. Thousands of men have adopted the Workace hobby. Make hundreds of things with the Workace Electric Woodworker. Under the magic of the whirling saw, planer, lathe, sander, drill, grinder and buffing wheel (all included in the Workace Woodworker) raw lumber is easily converted into furniture, household necessities and countless other articles. Work out your ideas with your own complete electric workshop.

There's no better gift for the growing boy than Workace. It provides a wholesome man-building outlet for his energy and enthusiasm. Man or boy will appreciate Workace. \$9.00 down will bring it. Send coupon now for details.

J. D. WALLACE & COMPANY
 Adams Street at California Avenue, CHICAGO
 11 W. 42nd St., New York 268 Market St., San Francisco
 Consult telephone directory for branch addresses in other cities

5 FEET

Jig Saw Attachment for the Workace Electric Woodworker... \$10

Workace Electric Shaper—high speed, direct drive, portable... \$95

14 in. Workace Band Saw, fast, accurate, economical... \$75

Workace Radial Saw, Saws at any angle... \$140

Workace Portable 4 in. Planer... \$25 Complete with motor 360

Cast Iron Table \$10 Extra
 Cast Iron Legs \$15 Extra

AMAZING NEW TABLECLOTH

LOOKS LIKE LINEN
 WASHES LIKE OILCLOTH

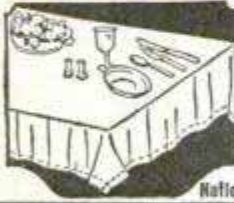

New material rivals Irish linen in appearance—washes without laundering. Stainproof. Does not crack, peel. Saves time, laundry bills. A five piece set given to all agents.

AGENTS
 \$15 daily easy! Write for Free Sample Offer and full details.

National Industries, 67 E. Lake, Dept. 15-L Chicago

High School Education!

Go to High School this easy, inexpensive way at home. 15 fascinating "Question and Answer" books is your complete education!

Think of it—only \$19.85 on easy monthly payments—for every subject. Now used in 12,000 High Schools. Certificate awarded.

Send for FREE Book

Learn how you can prepare at home for bigger business and social success. Send this ad with name and address for FREE booklet, "What High School Education Can Do for Me."

High School Home-Study Bureau,
 31 Union Square, Dept. 9379 New York, N.Y.

Complete \$19⁸⁵ Easy Terms

2 1/2 Tons HEATS 6 ROOMS

"Our Bulldog Furnace uses only 2 1/2 tons to heat 6 rooms!" So writes Frank H. Taylor, Dunning, Neb. Many users report saving 1/2 to 3/4 their fuel. The Bulldog comes completely erected. Sent free for inspection. No money down. Small monthly payments.

Write for big free book! Address
BULLDOG FURNACE CO., Dept. 13-59,
 19th and California Ave., Chicago



Mechanical Engineering

Learn at Home

MECHANICAL Engineering embraces the design, construction and operation of machines and machine tools. It is a profession which offers almost unlimited opportunities to men who combine natural mechanical ability with technical training.

For this is The Age of Machinery. Almost every convenience, luxury or necessity which we enjoy depends on machinery for its production or adaptability to our needs. Every new invention multiplies the opportunities for competent designers, builders, erecting engineers, etc.

One of the best ways to train yourself to secure a position as a Mechanical Engineer is through the home-study courses of the International Correspondence Schools.

These courses are complete and up-to-date, and especially arranged to meet the needs of the student who studies at home.

They are particularly helpful because they are written by well-known mechanical engineers with years of practical experience, who know the quickest, best way to solve every problem.

Just mark and mail the coupon and we'll gladly send you Free Booklets describing the I. C. S. courses in Mechanical Engineering or any other course in which you are interested.

INTERNATIONAL CORRESPONDENCE SCHOOLS
Box 5656-F, Scranton, Penna.

Without cost or obligation, please send me a copy of your booklet, "Who Wins and Why," and full particulars about the course before which I have marked X in the list below:

- | | |
|--|---|
| <input type="checkbox"/> Mechanical Engineering | <input type="checkbox"/> Toolmaking |
| <input type="checkbox"/> Mechanical Course | <input type="checkbox"/> Blacksmithing and Forging |
| <input type="checkbox"/> Drafting | <input type="checkbox"/> Patternmaking |
| <input type="checkbox"/> Mechanical Drawing | <input type="checkbox"/> Foundrywork |
| <input type="checkbox"/> Complete Shop Practice | <input type="checkbox"/> Machine Shop Practice |
| <input type="checkbox"/> Architect | <input type="checkbox"/> Plumber and Steam Fitter |
| <input type="checkbox"/> Architectural Draftsman | <input type="checkbox"/> Plumbing Inspector |
| <input type="checkbox"/> Building Foreman | <input type="checkbox"/> Foreman Plumber |
| <input type="checkbox"/> Concrete Builder | <input type="checkbox"/> Heating and Ventilation |
| <input type="checkbox"/> Contractor and Builder | <input type="checkbox"/> Sheet-Metal Worker |
| <input type="checkbox"/> Structural Draftsman | <input type="checkbox"/> Steam Engineer |
| <input type="checkbox"/> Structural Engineer | <input type="checkbox"/> Marine Engineer |
| <input type="checkbox"/> Electrical Engineer | <input type="checkbox"/> Refrigeration Engineer |
| <input type="checkbox"/> Electrical Contractor | <input type="checkbox"/> R. R. Positions |
| <input type="checkbox"/> Electric Wiring | <input type="checkbox"/> Highway Engineer |
| <input type="checkbox"/> Electric Lighting | <input type="checkbox"/> Chemistry <input type="checkbox"/> Pharmacy |
| <input type="checkbox"/> Electric Car Running | <input type="checkbox"/> Mining Engineer |
| <input type="checkbox"/> Telegraph Engineer | <input type="checkbox"/> Navigation <input type="checkbox"/> Assayer |
| <input type="checkbox"/> Telephone Work | <input type="checkbox"/> Iron and Steel Worker |
| <input type="checkbox"/> Civil Engineer | <input type="checkbox"/> Textile Overseer or Supt. |
| <input type="checkbox"/> Surveying and Mapping | <input type="checkbox"/> Cotton Manufacturing |
| <input type="checkbox"/> Bridge Engineer | <input type="checkbox"/> Woolen Manufacturing |
| <input type="checkbox"/> Gas Engine Operating | <input type="checkbox"/> Agriculture <input type="checkbox"/> Fruit Growing |
| <input type="checkbox"/> Automobile Work | <input type="checkbox"/> Poultry Farming |
| <input type="checkbox"/> Aviation Engines | <input type="checkbox"/> Mathematics <input type="checkbox"/> Radio |

BUSINESS TRAINING COURSES

- | | |
|--|---|
| <input type="checkbox"/> Business Management | <input type="checkbox"/> Business Correspondence |
| <input type="checkbox"/> Industrial Management | <input type="checkbox"/> Show Card and Sign Lettering |
| <input type="checkbox"/> Personnel Management | <input type="checkbox"/> Stenography and Typing |
| <input type="checkbox"/> Traffic Management | <input type="checkbox"/> English |
| <input type="checkbox"/> Accounting and C. P. A. Coaching | <input type="checkbox"/> Civil Service |
| <input type="checkbox"/> Cost Accounting | <input type="checkbox"/> Railway Mail Clerk |
| <input type="checkbox"/> Bookkeeping | <input type="checkbox"/> Mail Carrier |
| <input type="checkbox"/> Spanish <input type="checkbox"/> French | <input type="checkbox"/> Grade School Subjects |
| <input type="checkbox"/> Salesmanship | <input type="checkbox"/> High School Subjects |
| <input type="checkbox"/> Advertising | <input type="checkbox"/> Cartooning |
| | <input type="checkbox"/> Illustrating |

Name.....
Address.....
City..... State.....
Occupation.....

If you reside in Canada, send this coupon to the International Correspondence Schools Canadian, Limited, Montreal, Canada

MOTOR BARGAINS

Heavy starting duty, 110 Volts, 60 Cycle Single Phase, 1725 Speed, General Electric Repulsion Induction MOTORS in original cartons.

1/4 H. P. only \$13⁵⁰



1/6 H. P.

\$12⁵⁰

1/3 H. P.

\$15⁰⁰

These motors were built by the G. E. Co., for a concern that failed before delivery could be made. We purchased 1500 of them at a very low price. You can buy one or more at prices quoted above until stock is exhausted. Furnished with feet or rubber cushion base. Shaft diameter 5/8 inch. Pulleys 75c extra. Grinding and buffing attachment spindle \$1.95. Six inch by 5/8 grind wheel \$1.75. Cotton Buffing Wheel 60c.

OTHER MOTOR BARGAINS

We have a large stock of new and rebuilt motors. Write us your requirements. We can save you money on any type and size motor.

NORTHWESTERN ELECTRIC CO.
410 So. Hoyne Ave. CHICAGO, ILL.

factory prices!

on Nationally Popular
21-JEWEL—Thin Model

STUDEBAKER

The Insured Watch

The only high-grade watch sold direct from factory!

Imagine being able to purchase these magnificent thin model watches at lowest factory prices on easy payments out of your income, or for cash! Let us send you one of these marvelous watches—you are under no obligation to keep it. You'll agree it is the world's greatest watch value. Write for free 6-color book and learn the true facts!

FREE
6-Color Book

If you write at once we will send beautiful style book, showing lowest factory prices on these lifetime insured watches. Thousands save money this way. Write today!

WRITE!

Luxurious strap and bracelet watches at remarkably low prices! Write for free style book TODAY!

STUDEBAKER WATCH COMPANY
Directed by the Studebaker Family—known for Three-quarters of a century of fair dealing
Dept. NZ-103 South Bend, Indiana
Canadian Address: Windsor, Ont.





Chock
Full of Real
Money-Making
Facts!

This Book Has Shown 7143 Men How to MAKE MORE MONEY

AND it will do the same for you! All I ask is a chance to prove it.

If you are the sort of a fellow who is content to grind all your life for poor pay you'll not be interested in what it has to tell you.

But if you are looking for an honest-to-goodness opportunity to earn more money—if you look forward to having a business of your own—if you really have **THE WILL TO WIN**—

Then you owe it to yourself to send for this amazing book.

You have never read anything like this straight-from-the-shoulder, intensely human story. Read it and find out how 7143 men—*average* men, just like *yourself*—men with the same problems you are now up against—read how I helped them ac-

complish exactly what *you* would like to do. Read and be inspired to action.

Your spare time a few evenings a week is worth money, *real* money. I am ready to pay you for it—from \$25 to \$60 a week. And you can keep your present job.

I don't ask you to take my word for it. I'll give you the names of men who are doing it every day. My plan is simple—thoroughly tested and proven. The facts are there in the book for you to read and judge for yourself.

Investigate. Send for this book and get the whole wealth-bringing story. Convince yourself that I can help you make extra money. Start now by mailing the coupon. Be sure to give your county.—
J. Matheson Bell, *Pres.*

See for yourself the record of a man who has made \$10,900 out of Ozarka. And another who made \$1750 last year; another \$1645; another \$1848; and so they go—\$1212, \$1708, \$1028 for last year's work. Hundreds of them with their names. Make me prove that what they have done, you can do.

OZARKA, INC.

122 Austin Avenue, Chicago, Illinois

MAIL THIS COUPON NOW!
OZARKA, INC., 122 Austin Ave., Chicago, Ill.
Gentlemen—I want to know how I can make more money.
Please send me a copy of your book, "The Will To Win."
Name.....
Address.....
County.....

This New VIX will SAVE $\frac{1}{4}$ to $\frac{1}{2}$ your GAS

WILL YOUR CAR DO IT ?

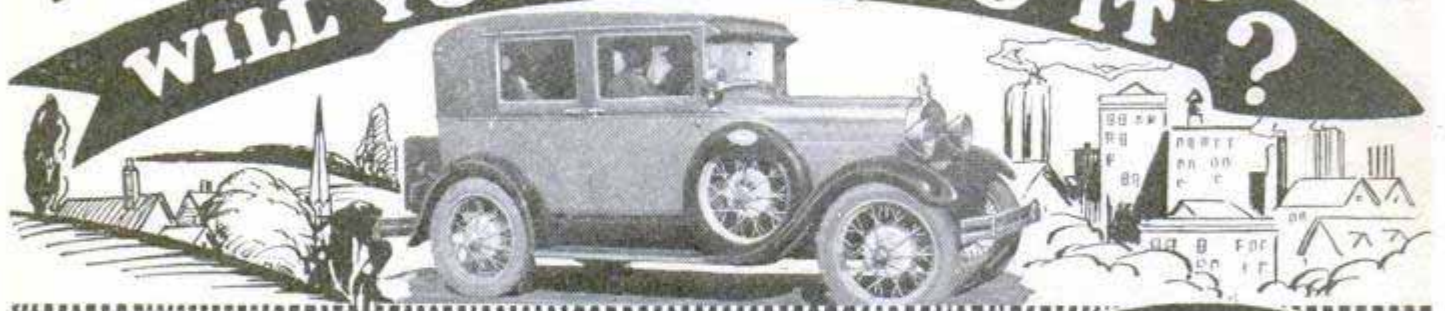

New Moisture Humidifier & Carbon Eliminator

for all Makes of Cars, Trucks, Tractors and Engines

An amazing NEW Scientific Vapor Humidifier and GAS SAVER has been patented throughout the World that beats anything ever gotten out before. It makes engines run ALL THE TIME with the same wonderful efficiency they do on a cool moist night. It gives MORE pep and power—HIGHER topspeed—automatically ELIMINATES hard carbon from engine—and causes engine to give AMAZING MILEAGE RECORDS NEVER EQUALLED BEFORE.

ENTIRELY UNLIKE ANY OTHER DEVICE. This startling invention is radically different from every other kind. It uses MOISTURE from the radiator and makes the car run like on a damp cool night. It is GUARANTEED to save from $\frac{1}{4}$ to $\frac{1}{2}$ the gas and oil, stops boiling and steaming, makes engine start easier in all kinds of weather, and completely de-carbonizes the engine as you run.

This new principle device has been extensively tested out by Technical Engineers and Experts and found to give vastly more mileage, with largely increased power and pep from the engine. With it the engine used approximately 90% air, 6% moisture and ONLY 4% of gas.

Big Profits

to Man with Car Spare or Full Time

\$350 to \$1500 a month

1 man \$4,939.66 in 3 $\frac{1}{2}$ months
Another \$1,656.60 in 58 days
\$5,150.00 in 5 months to another. **BIG MONEY** can be—**IS** being made

Fitting Motors With Vix
One man sold 8 first morning
Another sells all 3 men can install

Another's profits as high as \$100.00 a day

VIX sells itself by 8 STARTLING demonstrations—**BIG, STUNNING, ASTOUNDING DEMONSTRATIONS.** Successful VIX men make MORE MONEY than they ever made before.

Free Trial TRY This New Principle Gas Saver AT MY RISK

Try this wonderful VIX Moisture Humidifier and Carbon Eliminator AT MY RISK on YOUR OWN CAR to prove that VAPOR MOISTURE (drawn from Radiator to Engine) gives you that wonderful night driving effect ALL THE TIME with MORE mileage from gas and oil—eliminates hard carbon accumulation—gives MORE power, a SNAPPY, PEPPY motor, FASTER acceleration, a SMOOTHER, QUIETER running engine and HIGHER top speed.

VIX will PROVE ITS MONEY SAVING MERIT on your own car by 8 DEMONSTRATIONS—conducted by yourself AT MY RISK—the most SENSATIONAL, most ASTOUNDING, most CONVINCING DEMONSTRATIONS you ever saw. If you don't find from your tests that it does MORE than I claim; return it and it COSTS YOU NOTHING. I want wide-awake hustling, County, State, Province and National Agencies everywhere, part or full time, to make \$350 to \$1500 per month filling the great DEMAND for this wonderful invention wherever introduced. Write for my FREE TRIAL and MONEY MAKING OFFER. Use coupon below.

WALTER CRITCHLOW

Inventor and Manufacturer, 805-W 8 Street, WHEATON, ILL., U. S. A.

FREE VIX Mail Now offer

WALTER CRITCHLOW, INVENTOR and MANUFACTURER, 805-W 8 Street, Wheaton, Ill., U. S. A.

Please send me without obligation or charge your FREE TRIAL and MONEY MAKING VIX OFFER.

Name.....

Address.....

Town..... State.....



Pictures here and at top show Model "B" VIX attached to my own New Model A Ford. This car is wonderfully improved in performance with the VIX Moisture Humidifier. So is every Auto, Truck, Tractor, Taxi, Bus, Marine, Stationary and Aircraft Engine, both American and all Foreign makes.

GUARANTEED TO SAVE { $\frac{1}{4}$ to $\frac{1}{2}$ Gas
Carbon Cleaning
Engine Repairs
or Costs You Nothing

Start to Play Very First Day

This Year Give Yourself
Lifelong Fun
Profit and
Popularity



PARENTS!

What greater gift can you confer on your children this year than lifelong fun and entertainment?

Love of music means love of home, an appreciation of the finer things in life. Here is a chance to give your boy or girl that love without the tedious practice that most instruments require. The Xylorimba is easy to play. No teacher is needed. Practice is actually a joy.

Remember, the Xylorimba is the guaranteed product of a company established nearly half a century ago—a company that stands back of every promise it makes.

THINK of the best Christmas gift you have ever received. Multiply the pleasure it gave you by ten, and still you have only an idea of the joy you can give yourself this Christmas if you act at once.

Start to Play the Very First Day!

Haven't you, like millions of others, envied the fellows who "bring down the house" with snappy xylophone or xylorimba numbers? Haven't you longed to create your own music, to be looked up to wherever you go, to be able to make real money in spare time? If you have, this ad spells O-p-p-o-r-t-u-n-i-t-y. The xylorimba—wonderful for home, in demand at dances and gatherings—is nevertheless *the easiest of all instruments to play*. In fact, on the very day you get yours you play simple melodies, even if you can't read a note of music right now. In a few weeks you astonish your friends and family. *All your life* you have the joy that comes to those who can entertain.

Plays 20 Minutes; Gets \$20!

Ralph Smith, Chicago, played twenty minutes at wedding; his "pay" was \$20. Altho only 12, Turk McBee, Jr., plays big-time vaudeville exclusively. Harry Breuer, New York, has

made thousands of friends thru his xylophone selections on the radio. L. E. Hallman, Reading, Pa., writes: "Made \$300 in 5 weeks—spare time."

And now J. C. Deagan, Inc., (world's largest manufacturer of xylophonic instruments) has made it so easy to own a xylorimba that nothing stands in your way. Sizes and styles to fit every age and pocketbook. A five-day free trial that eliminates risk. Free, easy lessons that make teacher unnecessary—and, best of all, such easy payments that they are hardly noticed.

Will You Investigate?

Everyone wants to be popular. Everyone wants to make extra money. Everyone wants to be *center of attraction* at gatherings. But these advantages don't come by themselves. Opportunities must be seized. This is *your* opportunity—will you pass it up without investigation? The accompanying coupon will bring our big FREE book to your door. It tells all about the Deagan line, the free trial, the easy payments. Remember, no cost or obligation! Simply fill in and mail the coupon—but do it before it slips your mind. Today is as good a day as any. Do it NOW!

YOUR
MAGIC
KEY

to Popularity

Mail
Now!

Send for
BIG FREE
Book!

Please send me full details on the Free Trial offer and easy payment plan of the Deagan Xylorimba.

J. C. DEAGAN, Inc.
Dept. 1459, 1770 Berteau Avenue, Chicago

Name _____
Address _____
City _____
State _____



THE BLADE

THE WONDER WORKER

THE FACE

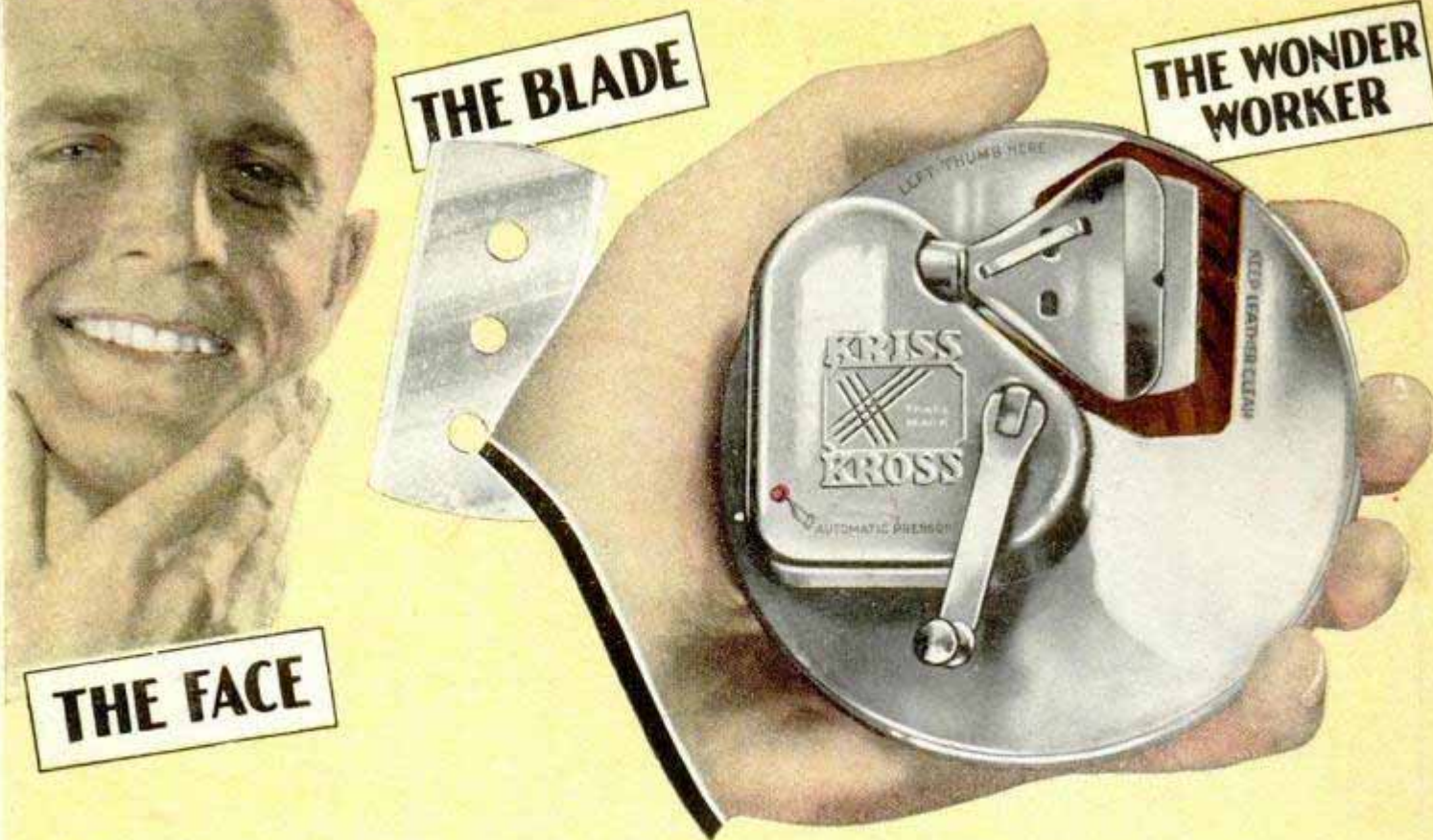

365 Shaves With the Same Blade!

- and Still Going Strong

THINK of it! 365 keen, cool shaves a year—and not one penny for blades during the whole time! That's what an amazing new shaving invention did for J. W. Starksbury of Oklahoma! And W. D. Carroll of Pennsylvania got *two* solid years of shek shaves out of an old blade that was just about worn out to begin with! No wonder experts everywhere are simply astonished!

KRISS KROSS—the remarkable invention that makes such long-distance shave records possible—deserves to be called much more than a stropper. Rather it is a *super-stropper* or blade *rejuvenator*. Almost literally, it makes a new blade out of an old one every day—makes hundreds of keen, quick shaves blossom where only one grew before. Until you've seen KRISS KROSS and tested its uncanny ingenuity, you'll never know how really sensational it is!

MAGIC DIAGONAL STROKE

KRISS KROSS employs the diagonal stroke, same as a barber uses. Never before has anyone captured the secret of reproducing this stroke automatically. Eight "lucky leather grooves" do the trick in 11 seconds with a precision it takes a master barber years to attain. But that's not all. KRISS KROSS embodies still another feature that has hitherto baffled mechanical reproduction. It stropps from *heavy to light*. It's absolutely uncanny the way the strokes grow lighter and lighter until an adjustable, automatic jig flies up and notifies you that your blade is ready—ready with the keenest cutting edge that steel can take!

NEW-TYPE RAZOR BLADE FREE!

To introduce KRISS KROSS stropper, we are including this month free samples of a revolution in razor blade construction. Made to fit your present razor. Guaranteed to last longer and shave better

KRISS KROSS
KRISS KROSS CORP.

Dept. W-3714 1418 Pendleton Avenue St. Louis, Mo.
World's Largest Manufacturers of Mechanical Stroppers.

Canadian Add-ess:
CANADIAN KRISS KROSS CO.

than any other. Expect a new shaving sensation—KRISS KROSS blades are made of a unique steel, made a new and better way.

GET FREE OFFER!

Send for full information on these surprising new inventions today. KRISS KROSS products are never sold in stores. You deal direct with me or my authorized representative. Write for illustrated description and full details of free razor blade offer. It's even more remarkable than I can tell you in this short space. Clip the coupon now. Mail it today.

Makes \$66 IN ONE DAY

Make big money with KRISS KROSS. Giving away FREE razor blades boosts your profits amazingly. H. King made \$66 in one day. N. C. Paige made \$104 in 3 days. SPARE-TIME workers, OFFICE and FACTORY men make \$6-\$12 extra in a day showing KRISS KROSS to friends and fellow employees. Get details at once. Check bottom of coupon and mail it tonight!

KRISS KROSS CORPORATION, Dept. W-3714,
1418 Pendleton Ave., St. Louis, Mo.

Send me details of KRISS KROSS Stropper. Also send free sample of your new-type razor blade for.....
Razor. (Fill in your make of razor.)

Name

Address

City State

Check here for agents' money-making plan, full time or spare hours.