

# POPULAR MECHANICS

## MAGAZINE

YOU CAN UNDERSTAND IT

REG'D TRADE MARK, GREAT BRITAIN, NO. 410426

REG. U.S. PAT. OFF.



SEE PAGE 368

# Start to Play Very First Day

This Year Give Yourself  
*Lifelong Fun*  
*Profit and*  
*Popularity*



## PARENTS!

What greater gift can you confer on your children this year than lifelong fun and entertainment?

Love of music means love of home, an appreciation of the finer things in life. Here is a chance to give your boy or girl that love without the tedious practice that most instruments require. The Xylorimba is easy to play. No teacher is needed. Practice is actually a joy.

Remember, the Xylorimba is the guaranteed product of a company established nearly half a century ago—a company that stands back of every promise it makes.

THINK of the best gift you have ever received. Multiply the pleasure it gave you by ten, and still you have only an idea of the joy you can give yourself right now if you act at once!

## Start to Play the Very First Day!

Haven't you, like millions of others, envied the fellows who "bring down the house" with snappy xylophone or xylorimba numbers? Haven't you longed to create your own music, to be looked up to wherever you go, to be able to make real money in spare time? If you have, this ad spells O-p-p-o-r-t-u-n-i-t-y. The xylorimba—wonderful for home, in demand at dances and gatherings—is nevertheless the *easiest of all instruments to play*. In fact, on the very day you get yours you play simple melodies, even if you can't read a note of music right now. In a few weeks you astonish your friends and family. *All your life* you have the joy that comes to those who can entertain.

## Plays 20 Minutes; Gets \$20!

Ralph Smith, Chicago, played twenty minutes at wedding; his "pay" was \$20. Altho only 12, Turk McBee, Jr., plays big-time vaudeville exclusively. Harry Breuer, New York, has

made thousands of friends thru his xylophone selections on the radio. L. E. Hallman, Reading, Pa., writes: "Made \$300 in 5 weeks—spare time."

And now J. C. Deagan, Inc., (world's largest manufacturer of xylophonic instruments) has made it so easy to own a xylorimba that nothing stands in your way. Sizes and styles to fit every age and pocketbook. A five-day free trial that eliminates risk. Free, easy lessons that make teacher unnecessary—and, best of all, such easy payments that they are hardly noticed.

## Will You Investigate?

Everyone wants to be popular. Everyone wants to make extra money. Everyone wants to be center of attraction at gatherings. But these advantages don't come by themselves. Opportunities must be seized. This is *your* opportunity—will you pass it up without investigation? The accompanying coupon will bring our big FREE book to your door. It tells all about the Deagan line, the free trial, the easy payments. Remember, no cost or obligation! Simply fill in and mail the coupon—but do it before it slips your mind. Today is as good a day as any. Do it NOW!



Send for  
**BIG FREE**  
Book!

Mail  
Now!

J. C. DEAGAN, Inc.  
 Dept. 1456, 1770 Berteau Avenue, Chicago  
 Please send me full details on the Free Trial offer and easy payment plan of the Deagan Xylorimba.

Name \_\_\_\_\_  
 Address \_\_\_\_\_  
 City \_\_\_\_\_  
 State \_\_\_\_\_

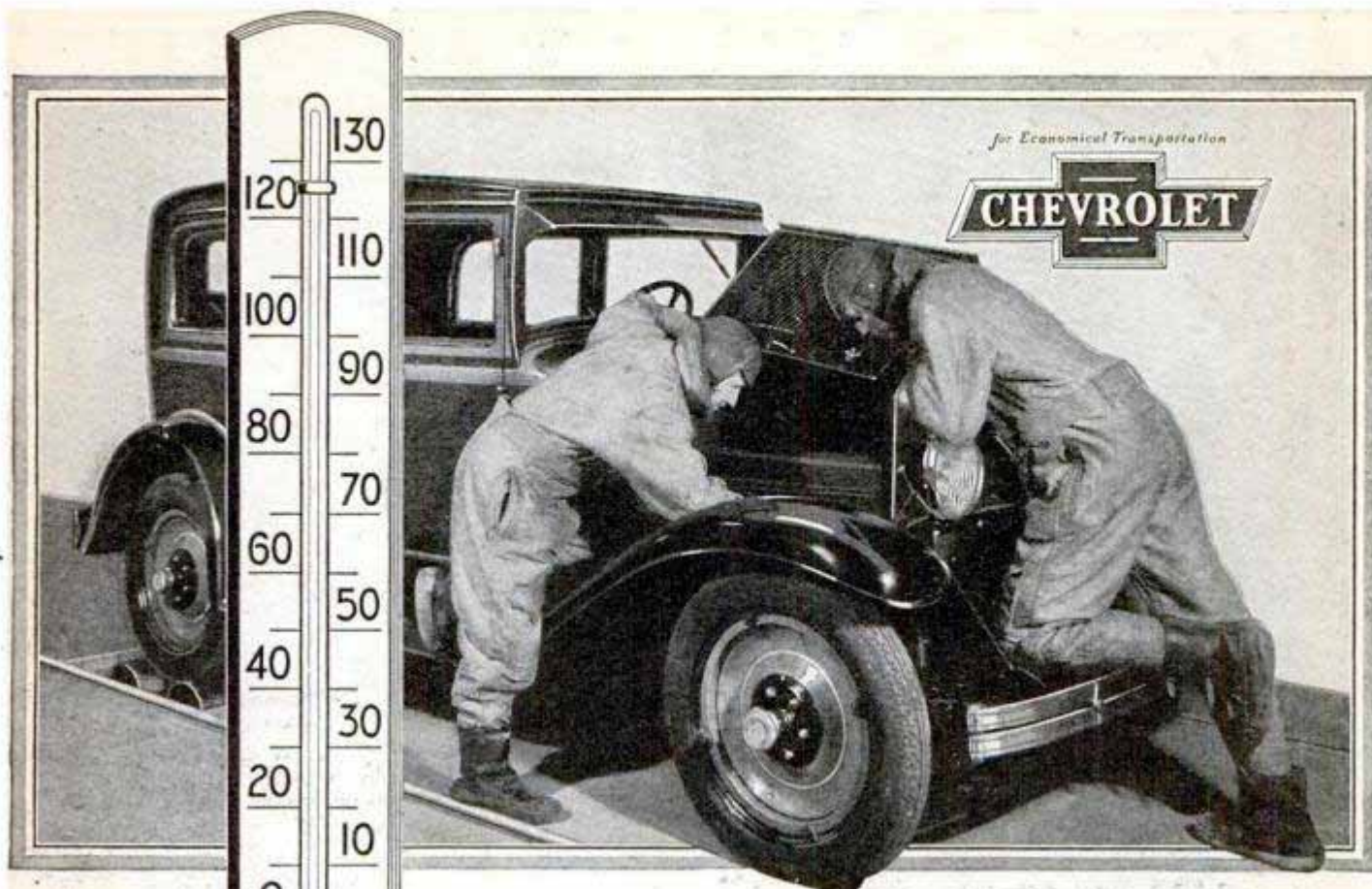

## Testing the Chevrolet Six at 30° below ZERO

Outside the thermometer is hovering around 90 degrees in the shade. But in the "cold room" of the General Motors Research Laboratories engineers are at work in fur-lined aviators' clothing!

A Chevrolet Six is under test. The temperature has been reduced to 30 degrees below zero. And the engineers are able to check every detail of winter operation just as if they had the car north of the arctic circle. Quick starting—economy of gasoline and oil—easy gear-shifting—proper engine temperatures—all are determined with scientific accuracy, thus assuring the owner of a Chevrolet Six satisfactory performance during the bitterest winter spells, no matter where he lives.

The sub-zero test—which takes five days and nights to complete—is one of hundreds of unusual engineering tests employed to advance Chevrolet design and to maintain Chevrolet quality. For the Chevrolet Six is built for those buyers who want the advantages of smooth performance in a Six of high quality that sells in the price range of the four.

CHEVROLET MOTOR COMPANY, DETROIT, MICH.  
Division of General Motors Corporation

The ROADSTER....	\$525
The PHAETON.....	\$525
The COUPE .....	\$595
The COACH.....	\$595
The SPORT COUPE .....	\$645
The SEDAN .....	\$675
The IMPERIAL SEDAN .....	\$695
The Sedan Delivery..	\$595
The Light Delivery Chassis.	\$400
The 1½ Ton Chassis..	\$545
The 1½ Ton Chassis with Cab.	\$650
All prices f. o. b. factory Flint, Mich.	

**A SIX IN THE PRICE RANGE OF THE FOUR**

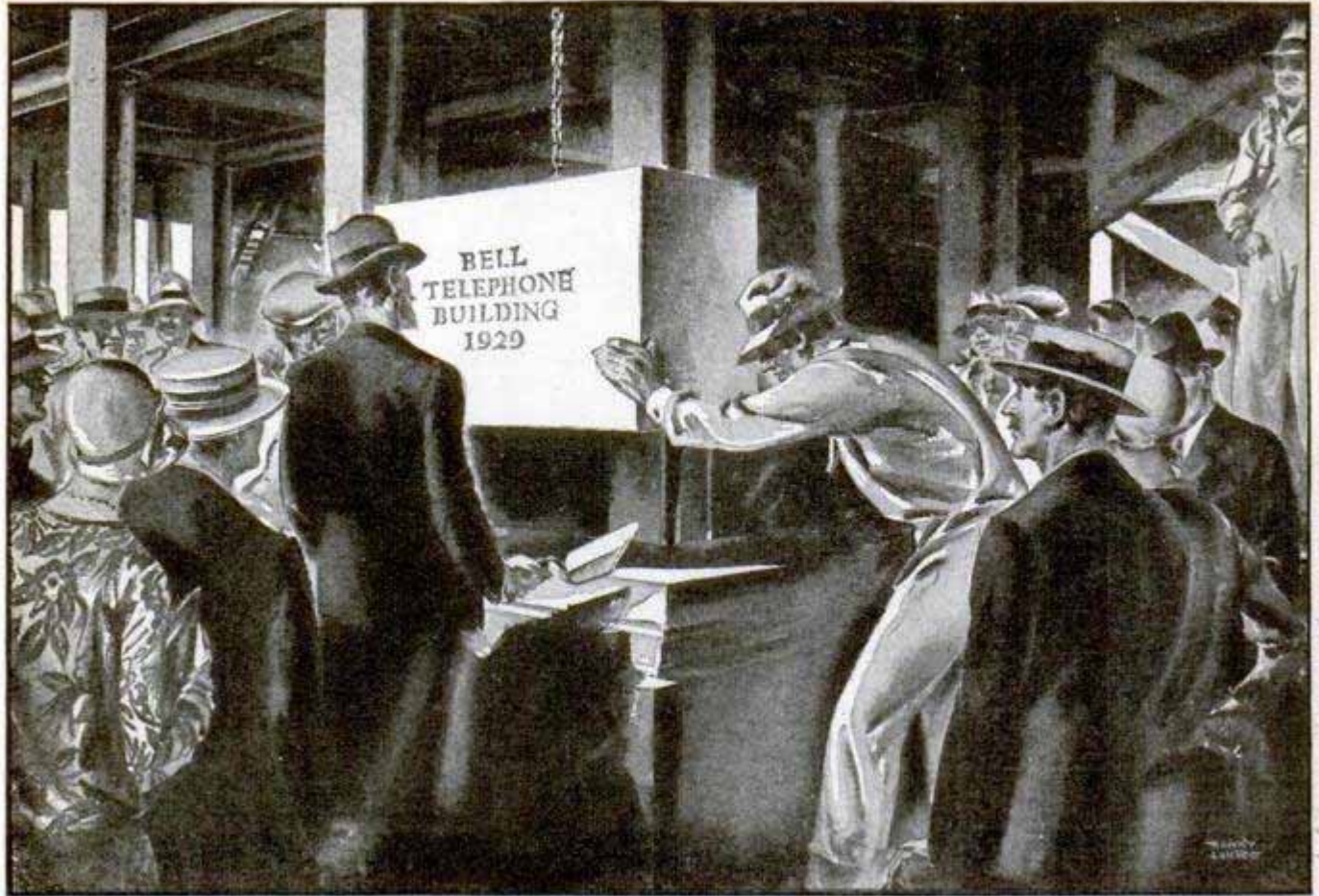

THE BELL SYSTEM IS BUILDING AHEAD OF THE GROWTH OF THE COUNTRY

# This is the telephone's job and goal

*An Advertisement of the  
American Telephone and Telegraph Company*

THE United States is developing a new civilization. The telephone is an indispensable element in it. The Bell System is building ahead of the growth of this civilization. In 1929 the telephone budget for land and buildings is 54 million dollars, with new buildings rising in 200 cities. New equipment for central offices will cost 142 millions; exchange lines 120 millions; toll lines 119 millions.

The Bell System's total expenditure for plant and service improvements this year will be 559 million dollars.



This outlay is required because the telephone is a universal servant of this democracy. Business uses it to create more prosperity. Homes use it for comfort and protection, for keeping friendships alive and enriching life. Its general use enables each personality to extend itself without regard to distance.

The telephone ideal is that anyone, anywhere, shall be able to talk quickly and at reasonable cost with anyone, anywhere else. There is no standing still in the Bell System.

# Popular Mechanics Magazine

200 E. Ontario Street, Chicago, U. S. A.

H. H. WINDSOR, Founder

H. H. WINDSOR, Jr., Editor and Publisher

London: Hachette & Cie.,  
16-17 King William Street, Charing Cross, W. C. 2

Paris: Hachette & Cie.,  
111 Rue Reaumur

Melbourne: Gordon & Gotch  
509-513 Little Collins St.

ISSUED MONTHLY

SUBSCRIPTION:

SINGLE COPY, 25 CENTS

In United States and its possessions, also Canada, Cuba, and Mexico, per year, postpaid - \$2.50

To all other countries in the Postal Union - 3.00

All subscriptions are discontinued at expiration. Please examine the date printed on your wrapper.

Entered as Second Class Matter Sept. 15, 1903, at the Post Office at Chicago, Illinois, under Act of March 3rd, 1879.

Entered as Second Class Matter at the Post Office Department, Canada.

Published monthly by POPULAR MECHANICS CO.

Copyright, 1929, by Popular Mechanics Co.

Copyright in Australia. Copyright in France

Vol. 52

Contents for September, 1929  
Special Feature

No. 3

With the Mystery Ships .....	370
Where Is the Pole Star Going? .....	380
If There Were No Gulf Stream .....	387
Unsung Heroes of Polar Dashes .....	394
Secrets of Ancient Torture Chambers .....	402
Trackless Trains Open Northland .....	411
Schools for the Man-Hunters .....	418
The Inventor's Hall of Fame .....	426
Exploring the Stratosphere .....	434
The Father of the Steamboat .....	442
The Army's Flying Class Room .....	466
Acoustics—how echoes are found in unbuilt buildings	459
Agricultural Implements	
shell-like, breaks up hardpan .....	393
two-way walking plow .....	408
Airplanes	
army gets new monster of the air .....	416
"bootleg" planes built from wrecks .....	408
painted propellers flash danger signal .....	414
pusher plane gives better view of ground .....	433
timed by camera and clock .....	410
Animals—in zoo live longest .....	369
Army, U. S.—armored tank has speed of 80 miles .....	393
Automobiles	
portable brake tester .....	440
streamline trailer increases speed of .....	457
tow block with spring relieves strain .....	465
word "stolen" flashes when car is stolen .....	379
Automobiles—Accessories	
automatic carbon remover .....	416
coat hanger adjusted on window pane .....	407
combination oil gauge, choke and match box .....	441
fuel-tank lock thwarts thieves .....	385
lever operates safety chain from driver's seat .....	460
shield protects spark-plug wiring .....	439
writing pad hooks to steering post .....	417
Automobiles—Driving—lights turned by dash knob for safer .....	470
Automobiles—Fuel	
gasoline flow thin as a hair makes car go .....	471
reserve tank for motor oil .....	460
Automobiles—Racing—future speedway seen in bed of dried-up lake .....	424
Automobiles—Repairing—hoist tilts car on side .....	458
Automobiles—Tires—what happens when front tire blows out? .....	369
Aviation—automatic radio beacon guides planes in fog .....	401
Birds	
find Venezuela is winter resort .....	470
that fly the airways .....	378
Broiler—charcoal, is easily carried .....	423
Camera	
and clock combined .....	379
depth is given to photos by combined lenses .....	425
Camping—collapsible home on trailer .....	385
Cathedral—St. Peter's dome is illuminated .....	417
Chemistry—squeeze chemicals from gas under high pressure .....	400
Clothes Hook—hanger bar on .....	448
Copper—more precious than gold .....	450
Crime—radio burglar-alarm system .....	425
Dead Sea—to yield millions in mineral treasures .....	458
Dummy—serves as a footman .....	432
Earthquakes—linked to moon .....	392
Education—college travels on wheels .....	400
Fire Alarm—camera on box to prevent pranks .....	440
Fire Fighting—wall hose rings alarm .....	392
First-Aid—dolls teach methods to miners .....	431
Fish and Fishing—flashlight for angler tells when fish bite .....	391
Floors—steel, to increase strength .....	460
Furniture—model, of plywood .....	470
Gold Mines—how badgers find .....	440
Golf—holder for tee on edge of bag .....	458
Granite—melt, to save labor in moving building .....	417
Hat—celluloid ribs inside keep it in shape .....	449
Hedge—resembles big piano .....	431

[Continued on Page 4]

Alarm, Radio 425

Aguel Holder  
Sand lighter  
460

*Filter for can hear all*  
*26*

Vise  
 curved jaws give better grip ..... 456  
 rod cutter fitted on, saves time ..... 471

War Maneuvers—great guns on rail trucks guard the Capital ..... 461

Water Faucet—has attachment for washing bottles ..... 413

Weather—rheumatism as prophet approved by science ..... 393

Window—removable pane eliminated storm sash ..... 369

Wood—in tube-paste form ..... 425

Woodworking—set on wheels ..... 433

AMATEUR MECHANICS

Airplane—make this prize-winning tractor monoplane ..... 500

Automobiles—Accessories—side-window wiper ..... 496

Automobiles—Repairing  
 closing bolt holes in rear of Ford coupe ..... 497  
 grounding wires on distributor ..... 494  
 handy brake-lining wrench ..... 510

Birds—practical feeders made from tin cans ..... 498

Boats and Boating  
 how to remedy "galloping" outboard motor ..... 498  
 speedy lightweight kayak easily built ..... 487

Camping  
 kitchen mechanics for camper ..... 508  
 remedy for back-firing camp stove ..... 505  
 waterproof cover for tourist's bedding ..... 495

Cleaning—homemade fluid ..... 488

Dandelion—getting rid of ..... 505

Doll House—made without joinery ..... 499

Fish and Fishing—how to repair and refinish rods ..... 506

Insects—checking fly-breeding in manure piles ..... 497

Ladder—safety, provides its own anchorage ..... 489

Lamps—floor, made from old rifle ..... 497

Linoleum  
 old wears longer if painted ..... 489  
 takes place of tile on bathroom walls ..... 507

Musical Instruments—hook over shoulder holds saxophone ..... 497

Paints and Painting  
 non-evaporating brush holder ..... 488  
 painting lead pipe ..... 498

Photography  
 diffusing screen for camera or enlarger ..... 496  
 easily made photo lamp ..... 495  
 wire coil holds stirring rod ..... 505

Roller Skates—sail used to harness wind in skating ..... 495

Rugs—fruit-jar rubbers prevent skidding of ..... 497

Screens—wallboard and wallpaper make beautiful ..... 490

Trees—protection for base and roots ..... 499

Twine—holder for ball of ..... 507

Wallpaper—papering painted walls ..... 510

SHOP NOTES

Angle Iron—marking and center-punching ..... 512

Automobile—Homemade racer has novel features ..... 520

Automobiles—Repairing  
 curing knock in Ford ..... 525  
 useful brake-lining kink ..... 522

Camera—transverse handle on reflecting ..... 515

Crucible—electric, choke coil controls ..... 522

Die—stock spring for blanking ..... 525

Doors, Screen—assembling ..... 514

Ferris Wheel—a backyard ..... 511

Filter—for used crankcase oil ..... 526

Flagstones—making concrete ..... 521

Furniture—how to finish unpainted ..... 516

Gardening—knee protector made from old inner tube ..... 513

Lathe—making concave knurls ..... 513

Lead—converting into small bars ..... 524

Paints and Painting—scraper for tinnern ..... 526

Patterns—using antimony in making ..... 513

Pearls—renovating ..... 520

Sander—making a disk ..... 523

Saws and Sawing—spring guide for bench saw ..... 515

Soldering—rest for the iron ..... 525

Steel—hardening ..... 515

Sulphur—sets rods and bolts in concrete ..... 515

Vise—holding work in a heavy ..... 514

Waste—care of oil-soaked ..... 514

Wheelbarrow—swinging side boards for ..... 525

Wood—removing lead from ..... 526

*plow 31*

Hill—moved overhead without stopping traffic ..... 464

House—built of driftwood ..... 378

Household Devices ..... 462

House Plan ..... 527

Insects—locusts flee as airplanes war against them ..... 448

Inventions—British inventors set record ..... 416

Lifeboats—pneumatic, prove value on "Graf Zeppelin" ..... 449

Light—water-faucet plant serves in emergency ..... 456

Locks—detachable knobs for easy change of door ..... 425

Loud Speaker—calls doctors on tennis court ..... 417

Magnets—to lift sunken treasure ship ..... 432

Metals—motor-driven metal cutter ..... 456

Milk Wagon—electric, guided by a "joystick" ..... 439

Models—train of postage stamp size ..... 423

Motorcycle—on skis replaces dogs ..... 410

Moving Pictures  
 fabric film transmits sound without distortion ..... 449  
 talking pictures are sent by light beams ..... 465

Nail Set—is self centering ..... 417

Naphtha—deadly when mixed with air ..... 456

Navy, British—secrets of superwarships revealed in England ..... 461

Newsstand—customers make own change in buying papers ..... 432

Niagara Falls—America and Canada join to preserve ..... 409

Nitroglycerine—is used as lubricant ..... 432

Office Equipment—machine does work of clerks ..... 391

Outboard Motor—truck for, keeps it upright ..... 414

Paints and Painting—"buggy" gives painters access to pipes ..... 385

Radio  
 automatic clock starts set ..... 477  
 tips from the laboratory ..... 484

Radio—Application—toy train operated by voice over radio ..... 431

Radio—Cabinets—all metal cabinet is easy to make ..... 478

Radio—Coils—disk coils for the experimenter ..... 481

Radio—Condenser—keeping ganged condensers in step ..... 483

Radio—Eliminator  
 adjusting C-bias from B-eliminator ..... 482  
 correcting trouble of an A-eliminator ..... 476

Radio—Loud Speaker  
 polarizer for electrostatic speaker ..... 477  
 using phonograph horn as ..... 476

Radio—Receiver  
 automatic control for A-battery sets ..... 480  
 neutralizing the old neutrodyne ..... 486  
 new dial shows scale in colors ..... 482  
 sectional shields on short-wave set facilitates assembly ..... 483

Radio—Reception  
 tracing interference ..... 486  
 volume control handles high currents ..... 477

Radio—Repairing  
 bared leads aid in voltage testing ..... 486  
 soldering tips on tinsel cord ..... 477

Radio—Television—the latest in ..... 472

Radio—Tubes  
 shielding screen-grid tube leads ..... 480  
 testing screen-grid ..... 483

Railroads  
 bar red clothing ..... 377  
 placed on stilts to span mountains ..... 448

Rays—giant lamp makes sunshine for crippled children ..... 441

Roads—made of cotton ..... 441

Screwdriver—crooked shank gives rotary action ..... 401

Ships and Shipping—cross ocean in thirty hours in liner of the future ..... 408

Siren—serves as city clock ..... 407

Skyscraper  
 steel of first, still well preserved ..... 440  
 sway in wind ..... 414

Smokers' Accessories—holder that lights cigarets ..... 460

Smuggling—rum-running autos detected by lights and mirrors ..... 401

Snowplow—rotary, to keep mountain passes open ..... 471

Soil—petrify with chemicals ..... 465

Sports, Water—swimmers get new thrills from old tires ..... 414

Stretcher—of pole and rope used in mountains ..... 410

Tennis—electric scoreboard keeps gallery posted ..... 413

Theater—open-air, has colored-light curtain ..... 415

Tools  
 adjustable threading tool ..... 461  
 folding square saves time in calculating angles ..... 439

Totem Pole—gift to Chicago school children ..... 400

Toys—exchange lets children borrow playthings ..... 470

Ventilation—congress kept cool or warm ..... 433

*Burglar alarm 425*  
*Patent. manuals from lead 451*

*Treasure recovered from magnets*

# DRAKE'S PRACTICAL MECHANICAL BOOKS

## THEY WILL RAISE YOUR PAY—

### ORDER ON 5-DAY TRIAL

The books listed below will perfect you in your chosen trade—pave the way to the top. Written in non-technical language—easy to read and understand. Each book covers its subject completely. An entire course of instruction is condensed into one volume. Your choice sent postpaid—you benefit 5 days if not entirely satisfactory. Order direct from this page.

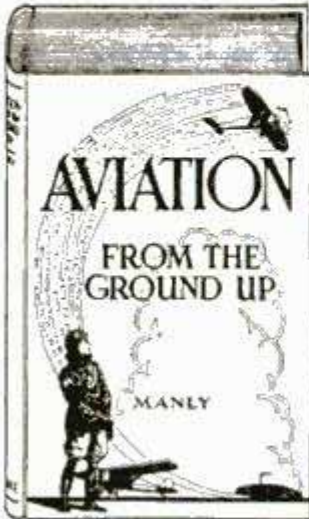

#### Aviation and Auto Books

- Aviation From the Ground Up... \$3.50
- Automobile Starting, Lighting and Ignition, by Manly... 700 pp. \$3.00
- Brookes' Automobile Handbook... \$2.00
- Ford Motor Car, Truck and Tractor, by Manly... Cloth \$1.50
- Auto and Radio Battery, Care and Repair, by Manly... Leatherette \$2.00
- Motorcycle Handbook, by Manly... \$1.50



#### Shop Practice Books

- Practical Heating Systems, Trouble Jobs and Ventilation... \$4.00
- Sheet Metal Workers' Manual... \$2.00
- Oxy-Acetylene Welding and Cutting... Cloth \$1.25
- Slide Rule and Logarithmic Tables... \$2.00
- Handbook for Millwrights... Cloth \$2.00
- Machine Shop Practice... Cloth \$2.00
- Mechanical Drawing and Machine Design... Cloth \$2.00

#### ORDER DIRECT FROM THIS PAGE — ON OUR MONEY-BACK PLAN

The books listed above are only a few of the many in our catalogue, which you will receive promptly after filling out and mailing us the attached coupon. For quick action order direct from this page—cross name of each book wanted and send in with price quoted. We prepay postage and send the books on our money-back plan.

### FREDERICK J. DRAKE & CO.

Publishers

R508—179 No. Michigan Ave. CHICAGO

Drake Books Are For Sale at All Book Stores

Mail Coupon For Free Catalogue  
Your Guide to Home Study



#### Carpentry Books

Cloth Binding

- Modern Carpentry, 2 vols... \$3.00
- The Steel Square, 2 vols... \$3.00
- Modern Estimator... \$1.50
- Timber Framing... \$2.00
- Builders' Architectural Drawing... \$2.00
- Concretes... \$1.50
- Practical Bungalows... \$1.00
- Roof Framing, by Van Gaasbeek... \$1.50

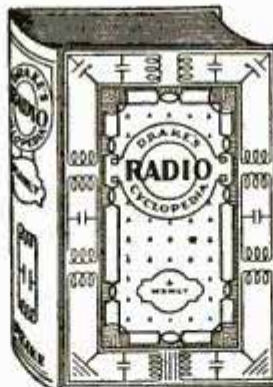

#### Drake's Radio Cyclopaedia

By H. P. Manly

920 Pages, 1025 Illustrations, 1700 Subjects, arranged alphabetically. For Service and Repair Men, Dealers, Salesmen, Experimenters and Designers. Bound in Art Buckram. Price... \$6.00

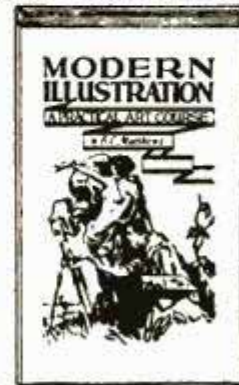

#### Painting and Decorating

- Modern Illustration... \$3.50
- The Laquer System of Sign Painting... Cloth \$3.00
- Practical Estimating for Painters and Decorators... Cloth \$2.00
- How to Draw Funny Pictures—a Complete Course in Cartooning... Cloth \$3.00
- Layouts for Advertising... \$3.00
- Furniture, Furniture Finishing, Decoration and Patching... \$5.00
- Ross Crane Book of Home Furnishing and Decoration... \$3.00
- House Painting Methods... Cloth \$2.00
- Interior Wall Decoration, by Vanderwalker... Leatherette \$4.00
- The Mixing of Colors and Paints, by Vanderwalker... Cloth \$2.00
- Studio Handbook—Letter and Design... \$3.00
- A Show at Sho' Cards... Cloth \$4.00
- Sign Painting, by Atkinson... Cloth \$4.00
- Strong's Book of Designs, Leatherette \$4.00
- Modern Painters' Cyclopaedia, Cloth \$2.00
- Automobile Painting... Cloth \$1.50
- Wood Finishing, Plain and Decorative... Cloth \$2.00

#### Steam Engineering

- Swingle's Handbook for Steam Engineers and Electricians... Leatherette \$4.00
- Examination Questions and Answers for Marine and Stationary Engineers... Leatherette \$2.00
- Steam Boilers... Leatherette \$2.00
- Swingle's Catechism of Steam, Gas and Electrical Engineering... Leatherette \$1.50

#### Modern Languages

- By Prof. P. S. Allen, U. of Chicago
- French without a Teacher... Cloth \$1.25
- Spanish without a Teacher... Cloth \$1.25
- German without a Teacher... Cloth \$1.25
- Everyday French... \$1.25
- Everyday Spanish... \$1.25

FREDERICK J. DRAKE & CO.  
R508—179 No. Michigan Avenue  
Chicago, Ill.

GENTLEMEN:—Please send me free, postage paid, your illustrated catalogue which lists and describes 200 Practical Mechanical Books for Home Study.

My name

This One

and my c



1UTJ-X3R-F6SA

# Neglect of Home-Study Training Cost This Man \$47,424!

*How much are you paying to stay untrained?*

Some time ago we received a letter which every man working for a living ought to read—whether he's making \$20 a week or \$200. Here it is:

"During the forty years that I have been working, my salary has averaged less than twenty-four dollars per week with the exception of the last two years while I have been acting as foreman. I made good in this position and saw, through the failings of others, what would happen to me unless I found a way to train for larger responsibilities.

"I had read of correspondence courses and began searching for one I thought would benefit me. I found it in the LaSalle Modern Foremanship course, and benefited by it, my salary being nearly doubled, and I was promoted from foreman to factory superintendent.

"This happened in a period of about ten months, and by devoting only about four or five hours per week to the studies.

"I am now enrolled as a member of the Industrial Management course, and find the work very interesting and beneficial. It can be applied every day in the factory, and brings results.

"I regret that I put it off to so late a day in life to reap the benefits I am now enjoying, and can truthfully say to younger men that if they would only profit by the experience of others they can gain more knowledge through one year's training by LaSalle methods than can be obtained in ten years' practical experience by hard work."

We quote the above letter not because the man who wrote it is making a staggering salary as a result of his training, but because it illustrates so clearly the principle behind LaSalle training.

Here is a man who all his life had accepted the thought that he was compelled to work for little or nothing.

For one thousand, nine hundred and seventy-six weeks the writer of this letter *paid at least \$24 a week for the doubtful privilege of staying in the ranks of untrained men.*

Can anyone doubt that training would have doubled his salary just as easily when he was thirty-eight years younger—when he could attack his work with the abundant energy of a younger man?

Yet his neglect of this main avenue of progress cost him—leaving simple and compound interest out of the reckoning—the appalling sum of \$47,424—a fortune in itself.



## If You Could Use \$47,424, Pause Before You Turn This Page

Perhaps you are already making quite as much as the writer of that letter—perhaps more. Perhaps, on that account, you may think that his experience does not apply to YOU.

But if training in Higher Accountancy—or Modern Salesmanship—or Business Management—or Law—or Business Correspondence—or any of a dozen other branches of business could change your forty-eight dollars into no more than \$72 a week (which is easily possible) and if you now NEGLECT to advance yourself—will you not find it difficult, thirty-eight years from now, to explain to those who are dear to you why you threw away \$47,424?

We're not going to moralize. We're not even going to cite any of the thousands of letters from men who have not merely increased but doubled and tripled their incomes through home-study training under the LaSalle Problem Method. We have the letters. We will show them to you, if you like. But understand, please, that they would not

alter the facts—they would merely *emphasize* them. Below this text there's a coupon. It will bring you not only full details of the training that appeals to you, but also a copy of that most inspiring book, "Ten Years Promotion in One."

If you are sincere in your desire for advancement, you will not turn this page until you have clipped the coupon, filled it in, and by placing it in the nearest mail box placed *yourself* on the road to real success.

— — — Find Yourself Through LaSalle! — — —

## LaSalle Extension University

The World's Largest Business Training Institution  
Dept. 964-R Chicago

I would welcome an outline of the LaSalle plan, together with a copy of "Ten Years' Promotion in One," all without obligation.

- |   |   |
|---|---|
| <input type="checkbox"/> Business Management            | <input type="checkbox"/> Law—Degree of LL.B.                  |
| <input type="checkbox"/> Modern Salesmanship            | <input type="checkbox"/> Commercial Law                       |
| <input type="checkbox"/> Higher Accountancy             | <input type="checkbox"/> Credit and Collection Correspondence |
| <input type="checkbox"/> Traffic Management             | <input type="checkbox"/> Industrial Management                |
| <input type="checkbox"/> Railway Station Management     | <input type="checkbox"/> Modern Foremanship                   |
| <input type="checkbox"/> Banking and Finance            | <input type="checkbox"/> Personnel Management                 |
| <input type="checkbox"/> Modern Business Correspondence | <input type="checkbox"/> Expert Bookkeeping                   |
| <input type="checkbox"/> Business English               | <input type="checkbox"/> Commercial Spanish                   |
| <input type="checkbox"/> Effective Speaking             | <input type="checkbox"/> C. P. A. Coaching                    |
| <input type="checkbox"/> Telegraphy                     | <input type="checkbox"/> Stenotypy—Stenography                |
|   | <input type="checkbox"/> Railway Accounting                   |

Name .....

Present Position .....

Address .....



# POCKET EDUCATORS

For all BUILDERS AND MECHANICS



Read Audels Pocket Educators for advancement and profit in your work. Every mechanic in the building trades should have this inside trade information at his fingers' ends. Learn the scope and possibilities of your profession. Any job can be done better if you are well informed. To earn more, learn more.



## AUDELS CARPENTERS AND BUILDERS GUIDES—4 VOLS. \$6



4 Vols. \$6

\$1 PER MO.

Inside Information for Carpenters, Builders, Joiners, Building Mechanics—all Woodworkers. **1600 pages; 3700 diagrams; flexible; pocket size.** Short-cut instructions, new methods, ideas, solutions, plans, systems—money saving suggestions. An easy progressive course for the apprentice. A practical daily helper and Quick Reference for the master worker. A Helping Hand to Easier and Better Work and Better Pay. To get this aid for yourself, simply fill in and mail the FREE COUPON below.

### INSIDE TRADE INFORMATION ON:

How to use steel square; How to file and set saws; How to build furniture; How to use mitre box; How to use chalk line; How to use rules; How to make joints; Carpenters' arithmetic; Mensuration problems; Estimating strength of timbers; How to set girders and sills; How to frame houses and roofs; How to estimate costs; How to build houses, barns, garages, bungalows, etc.; How to read and draw plans; Drawing up specifications; How to excavate; How to use settings 12, 13 and 17 on the steel square; How to build hoists and scaffolds—skylights; How to build stairs; How to put on interior trim; How to hang doors; How to lath—lay floors; How to paint.

"Audels Guides worth four times their price—handy too as I carry them in pocket for reference." W. J. Bates, Knoxville, Pa.

## AUDELS PLUMBERS AND STEAMFITTERS GUIDES—4 VOLS. \$6



4 Vols. \$6

\$1 PER MO.

A new set—just out! A practical, illustrated, Reference Library and Study-Course for Master Plumbers, Journeymen and Apprentice Steamfitters, Gas Fitters and Helpers, Sheet Metal Workers, Draughtsmen, Master Builders, Engineers and all Building Trade Students. **1670 pages; 3642 diagrams; flexible; pocket size.** Guides explain all the principles, advances and short cuts of the Plumbing and Heating trade. Contains instructions on how to figure and estimate jobs. Use FREE COUPON below to examine, without obligation, this valuable work.

### INSIDE TRADE INFORMATION ON:

Soldering, tinning, joint wiping, bending, beating. Pipe—iron—steel, threading. Mathematics, tables, physics. Materials—iron, steel, copper, brass, lead, tin, antimony. Sheet metal—galvanized—plate. Sanitation, syphonage, tanks. Drainage, sewage, purification. Fixtures—bath—kitchen. Pipe fittings, soil pipe, tools. Laying out work. Roughing. Screwed fittings, flanges, joints. Pipe bending, examples. Elbows. Heating, ventilation, refrigeration. Water supply, mains, wells, tanks. Gas-fittings. Underwritings. Sheet metal work, problems, methods, brazing, heating, lead burning. Welding, various welds, methods. Blacksmithing, forges, tools.

"Audels Guides are practical, easy to understand, reliable. Cover the field in plain language." W. F. Arminger, Annapolis, Md.

## AUDELS MASONS AND BUILDERS GUIDES—4 VOLS. \$6



4 Vols. \$6

\$1 PER MO.

A new, complete, illustrated trade reference library, for Bricklayers, Cement Workers, Plasterers, Tle Setters and Stone Masons, including a practical outline of Steel Construction. **1100 pages; 2067 diagrams; flexible; pocket size.** A practical Trade Assistant explaining modern methods of masonry construction. Easy to understand and apply. A reliable and authentic reference work and study-course for Master Journeyman and Young Mechanic. Use FREE COUPON below and find out for yourself, without obligation, whether this set will benefit you.

### INSIDE TRADE INFORMATION ON:

Bricklaying, tools, materials; Brick designs, patterns, bonds; Setting frames and foundations; Mortars, scaffolds, estimating; Mortars and mortar mixing; Tile setting, mosaic, hollow tile; Straight edge test, troweling; How to figure brick work; Safe loads, piers, chimneys; Boiler settings, anchors, fire stops; Labor tables; Concrete, forms; How to figure concrete work; Stucco—on old and new buildings; Plastering—wood lath—metal; Plasterers agreement; Plastering on various surfaces; Stonemasonry; Cutting, finishing, estimating stone; Derricks, rigging; Steel construction; Fire proof; How to read blue prints.

"Audels Masons Guides are the best books on the subject. Have laid brick 12 years and am able to judge." H. A. Sonnett, Corliss, Pa.

## PRACTICAL ELECTRICITY — 1 VOL. \$4

Audels Handy Book of Practical Electricity is a simplified Ready Reference and Study Course in one pocket size, leather bound volume—for Engineers, Professional Electricians and Students. **1040 pages; 2600 diagrams; flexible red leather bound.** A reliable authority and handy helper for every electrical worker. Contains important and valuable wiring diagrams, calculations, machine sketches, helps on maintenance and repair. Use this FREE COUPON today and find out, without obligation, how this handy book will help you in your daily work.



Complete in one handy, red leather bound volume

1040 Pages 2600 Diagrams

### INSIDE TRADE INFORMATION ON:

Electro-Therapeutics, X-Rays, Shocks, Welding, Brazing, Radio Hook-ups, Motion Pictures, Telephone, Telegraph, Cranes, Bells, Elevators, Pumps, Tools, Ship Drive, Railways, Vehicles, Automobile Electric Systems, Ignition, Generation, Lighting, Plant Management, Power Plans, Armature Winding, Repairing, A. C. Motors and Apparatus, D. C. Motors and Apparatus, Alternator Construction, Dynamos, Wiring Diagrams, Sign Flashers, Cable Splicing, Power Wiring, Outside Wiring, Switches, Lightning, Rectifiers, Converters, Transformers, Fuses, Circuit Breakers, Rheostats, Electro Plating, Electrolysis, Storage Batteries, Magnetism, Electrical Energy, Conductors, Insulators, Static, Dynamic, Radio Electricity, Applications, Ready Reference and Index Covering the entire field of Modern Electricity.

## Learn More and You Will Earn More!

Know your job and you'll never be without one. The skilled man is always in demand. Knowledge is power. Learn your trade thoroughly by easy reading. This coupon is your opportunity for advancement and better pay. You risk nothing in sending for Audels Guides for free examination. Send it NOW!

**FREE EXAMINATION COUPON**

**THEO. AUDEL & CO.,**  
65 W. 23 ST., NEW YORK CITY

Please mail me for free examination the books marked (x) below. If I find them satisfactory, I agree to mail \$1 in 7 days, on each set ordered, and to further mail \$1 monthly on each set until I have paid the purchase price.

4 CARPENTERS GUIDES \$6     4 PLUMBERS GUIDES \$6

4 MASONS GUIDES \$6     1 ELECTRICIANS HANDY BOOK \$4

NAME .....

ADDRESS .....

OCCUPATION .....

EMPLOYED BY..... 9T30

# Answer This Ad!

## If You Want Quick Success and Big Pay In **AUTOS**



### Morrision Did!

When Morrision of Parkersburg, West Virginia, wrote for my auto book he was working in a steel mill for low pay. In six short months he doubled his earnings and got into business for himself—even before he finished his "Job-Way" Training. You can have the same book that started Morrision on the road to success. Clip the coupon—and mail it today.

## Earn Up to \$100 a Week

Get YOUR share of the \$7,000,000,000 spent every year on auto upkeep. Just think of it—more than 25,000,000 autos in the U. S. No wonder there are so many big pay jobs! Get into this fascinating game, now. Don't put it off another day. Get the facts. Mail coupon for big, FREE auto book. Learn of the countless opportunities in the World's Biggest Business where real jobs and big pay come quick. See how \$50—\$75—\$100 a week is possible for you now. Learn how "Job-Way" Training has brought big money—promotion—shops of their own to scores of men. Find out about my Employment Department—how it helps you get a good job in the auto business.

**3 Working Outfits**  
also included FREE of extra charge if you act quick!

## Learn at Home in Spare Time

"Job-Way" Training is the short cut to Auto Success. No need to quit your present job—no need to leave home—just use your spare time to prepare for a brilliant future—a real job paying up to \$100 a week. All you need is common schooling. I don't care if you never touched an auto before, I can train you at home. You should be able to make extra money quick—a few weeks after starting. Men from all walks of life who worked

long, hard hours for low pay are becoming garage owners, foremen and superintendents. If you like autos—if you're between 15 and 55—get the facts now. "Job-Way" Training covers everything about autos—Mechanical and Electrical Work, Starting, Lighting, Ignition, Welding, Vulcanizing, etc.—Everything you need to get in line for a big money job as an Electrical and Mechanical Auto Expert.

It's the trained man who gets the good jobs and "Job-Way" Training is COMPLETE yet so simple, so easy that you get it quick.

## Send Coupon for FREE Auto Book

Get my FREE Auto Book. Learn how "Job-Way" Training has brought success to hundreds. See what it can do for you. Find out how my Employment Department helps you get a good job—about the three big outfits you get. Read my money-back agreement, my aviation course offer and many other features.

**B. W. Cooke, Directing Engineer**  
**Motor Institute of America**  
Motor Institute Bldg. Dept. 2166  
EVANSTON, ILLINOIS  
(Chicago's Largest Suburb)



### Do It NOW!

Don't delay another day. Clip the coupon before you turn this page. Take the first step to a big-pay auto job. Now.

**B. W. Cooke, Directing Engineer.**  
**MOTOR INSTITUTE OF AMERICA,**  
Motor Institute Bldg., Dept. 2166, Evanston, Ill.

Send me your free auto book. I want to succeed in the auto business. Tell me about "Job-Way" Training—about your Employment Department and your 3 testing and repair outfits offer. No obligation on my part whatever.

Name.....  
Address.....  
Town.....State.....  
Age.....Occupation.....

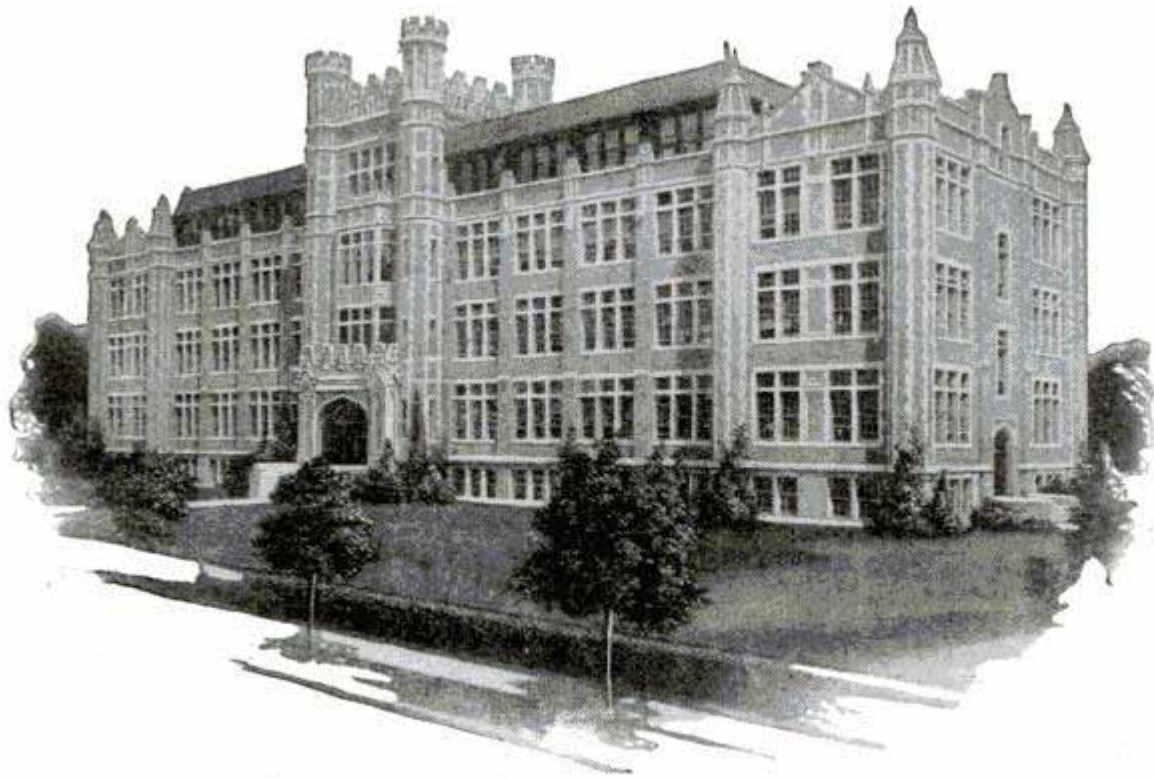

## Go to High School at Home

You can secure a high school education right at home by studying the splendid new courses recently prepared by the International Correspondence Schools.

These courses are equivalent to the courses given in resident high schools. They have been specially arranged for men and women who wish to meet college entrance examinations, to qualify for a business position, or to make up the education they missed when forced to leave school too soon.

The College Preparatory Course, the High School Commercial Course and the High School English Course include English, algebra, ancient, medieval, modern and U. S. History, physiology, literature, geography, Latin, bookkeeping, drawing, geometry, shorthand, physics, chemistry, salesmanship, advertising, civics, trigonometry, economics, American business law, corporation finance, money and banking, business and trade economics, etc. A diploma is given at graduation.

The lessons are easy to understand and you will make rapid progress because you will be *in a class by yourself* and you will study under the guidance of instructors who are sincerely interested in helping you to get ahead and achieve the bigger things in life.

Just mark and mail the coupon and we will gladly send you interesting free booklets

describing the High School Courses of the International Correspondence Schools or any other subject in which you are interested.

---

### INTERNATIONAL CORRESPONDENCE SCHOOLS

"The Universal University"

Box 5633-F, Scranton, Penna.

Without cost or obligation, please send me a copy of your booklet, "Who Wins and Why," and full particulars about the subject before which I have marked X in the list below:

- College Preparatory Course
- High School Commercial Course
- High School English Course
- High School Vocational Course
- High School Agricultural Course

#### BUSINESS TRAINING COURSES

- |  |   |
|--|---|
| <input type="checkbox"/> Industrial Management                   | <input type="checkbox"/> Advertising                                      |
| <input type="checkbox"/> Personnel Management                    | <input type="checkbox"/> Business Correspondence                          |
| <input type="checkbox"/> Traffic Management                      | <input type="checkbox"/> Show Card and Sign Lettering                     |
| <input type="checkbox"/> Accounting and C. P. A. Coaching        | <input type="checkbox"/> Stenography and Typing                           |
| <input type="checkbox"/> Cost Accounting                         | <input type="checkbox"/> English  |
| <input type="checkbox"/> Bookkeeping                             | <input type="checkbox"/> Civil Service                                    |
| <input type="checkbox"/> Secretarial Work                        | <input type="checkbox"/> Railway Mail Clerk                               |
| <input type="checkbox"/> Spanish <input type="checkbox"/> French | <input type="checkbox"/> Common School Subjects                           |
| <input type="checkbox"/> Salesmanship                            | <input type="checkbox"/> High School Subjects                             |
|  | <input type="checkbox"/> Illustrating <input type="checkbox"/> Cartooning |

#### TECHNICAL AND INDUSTRIAL COURSES

- |   |  |
|---|--|
| <input type="checkbox"/> Electrical Engineering | <input type="checkbox"/> Architect                                       |
| <input type="checkbox"/> Electric Lighting      | <input type="checkbox"/> Architects' Blueprints                          |
| <input type="checkbox"/> Mechanical Engineer    | <input type="checkbox"/> Contractor and Builder                          |
| <input type="checkbox"/> Mechanical Draftsman   | <input type="checkbox"/> Architectural Draftsman                         |
| <input type="checkbox"/> Machine Shop Practice  | <input type="checkbox"/> Concrete Builder                                |
| <input type="checkbox"/> Railroad Positions     | <input type="checkbox"/> Structural Engineer                             |
| <input type="checkbox"/> Gas Engine Operating   | <input type="checkbox"/> Chemistry <input type="checkbox"/> Pharmacy     |
| <input type="checkbox"/> Civil Engineer         | <input type="checkbox"/> Automobile Work                                 |
| <input type="checkbox"/> Surveying and Mapping  | <input type="checkbox"/> Airplane Engines                                |
| <input type="checkbox"/> Metallurgy and Mining  | <input type="checkbox"/> Agriculture <input type="checkbox"/> Navigation |
| <input type="checkbox"/> Steam Engineering      | <input type="checkbox"/> Mathematics <input type="checkbox"/> Radio      |

Name.....

Street Address.....

City..... State.....

Occupation.....

Persons residing in Canada should send this coupon to the International Correspondence Schools Canadian, Limited, Montreal, Canada

# Let Me Train You for a BIG PAY ELECTRICAL JOB

## GO INTO ELECTRICITY

Why stick to a line of work that pays small money and offers but little chance for advancement? Go into Electricity, where the Big Money is being made today,—where there are a Thousand fascinating Big Pay jobs for the Trained Man to choose from.

60,000 new Trained Men are needed in Electricity every year and even this enormous demand is steadily growing larger and more urgent.

Instead of turning good men away, as so many other industries are doing, Electricity is literally begging for Trained Men, and offering handsome salaries to get them.

## EARN \$60 A WEEK AND UP

Get out of the small pay class. Break away from that disagreeable routine job. Stop worrying about bills and debts and the things you wish you had, but can't afford. Determine NOW to get into a line of work that pays big money, like John Armitage and hundreds of my graduates are making.

As a Coyne Trained Electrical Expert you will have unlimited opportunities to earn \$60 a week and up. Or you can go into business for yourself and make all the way from \$3,000 to \$10,000 a year, as many of my "boys" are doing.

**90 Days  
to  
SUCCESS**



H. C. LEWIS, President

You don't have to wait until you are an old man to win success. You don't have to wait 12 months, 6 months, nor even 4 months. Just 90 days;—that's all the time I need to make you a Successful Man. Just spend 90 days here with me in my Big Coyne Shops, and your Future is assured. Never again will you have to worry about a job or the size of your weekly pay envelope. Your services will **always** be in demand and you will **always** make good money.

## LEARN BY DOING

**Not by books or correspondence,** but by actual work in my Big Shops on the very same kind of Electrical Equipment that you will find out on the job. In this way you not only learn twice as fast, but you graduate as a trained PRACTICAL man, a man capable of stepping into any Electrical job anywhere and proving by his work that he is a trained man.

## EDUCATION OR EXPERIENCE UNNECESSARY

You do not need advanced education or previous experience to learn Electricity **my way**. Most of my students never went beyond the grade school and 90% of them knew nothing of Electricity before coming to Coyne. Yet they had no trouble in learning Electricity **through actual work on Electrical equipment**, nor in securing splendid Electrical positions when their 90 days of training were up. And YOU can do the same, if you will only let me help you.

## FREE EMPLOYMENT SERVICE FOR LIFE

Through our big Employment Department we are in constant touch with Electrical concerns all over the country, and will give you every assistance in locating just the job you want. Employers know that all Coyne men have had PRACTICAL TRAINING on the very same Electrical equipment that they have in their plants, and they are mighty glad to have us recommend our graduates to them.

And if you need spare time work to help pay your expenses while at School, we'll help you to get that, too. We'll do everything in our power to help you in every way,—because, after all, your success is our success.

## Fill in Coupon on Next Page for FREE Book

If you will act QUICKLY, I will give you along with my regular course, and at absolutely no extra charge, a complete special training in Aviation, Radio and Auto Electricity. Also, I'll allow you your railroad fare to Chicago. But to take advantage of these Big Special offers, you must **act at once**.

So clip the coupon, and **mail it today**. Find out how EASILY and QUICKLY you can prepare for a big pay job. Get my Big Free Book, and all the Facts about Coyne Training. This will only cost you a two cent stamp, while it may be the means of bringing you a Better Job, More Money, Happiness and all the good things of life.

# My Training Pays!

*John Armitage*

## \$1000 a MONTH!

Dear Mr. Lewis:

No doubt you will be surprised to hear from me, but I am still employed by the same company that I was after I left school—I am pulling down a pretty fair pay check. \$1,000 a month, car furnished and expenses paid when I am away from home. I had 120 men under my supervision on our last job. We just completed a \$150,000 power plant for the Arkansas River Electric Co. I owe my success to Coyne training and always recommend your training.

I hope to be up and see you in February if the opportunity permits. Well I must close as I have some blue prints to run over.

As ever, your successful student.

JOHN ARMITAGE.

Address furnished on request.

**SEND TODAY FOR MY BIG FREE BOOK THAT STARTED JOHN ARMITAGE ON THE ROAD TO SUCCESS.**

**H. C. LEWIS**

**Fill Out—Mail TODAY!**

**H. C. LEWIS, President**  
**COYNE ELECTRICAL SCHOOL, Dept. 69-72**  
**500 S. Paulina Street, CHICAGO, ILLINOIS**

Gentlemen: Send me your big free catalog with full particulars concerning your Electrical course.

Name.....

Address.....

Town..... State.....

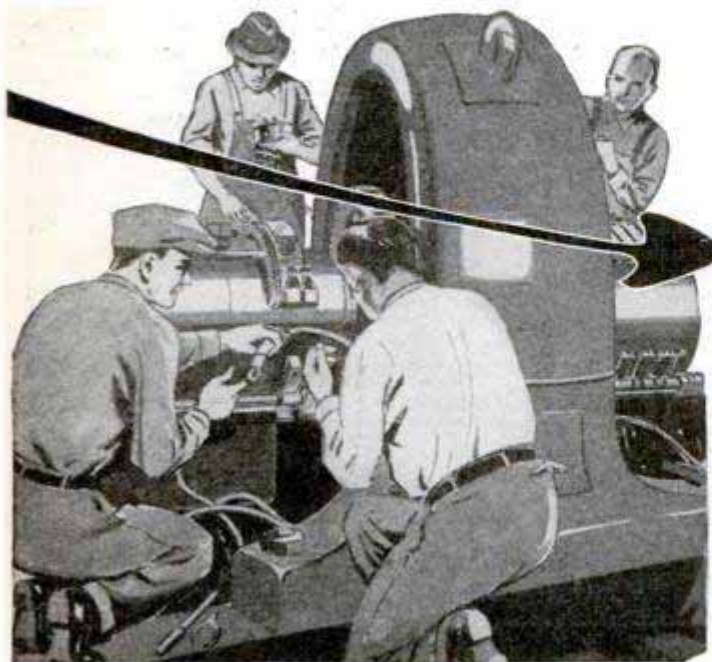

# HERE'S THE QUICKEST WAY TO BREAK INTO AVIATION!



Adventure,  
popularity, big pay—  
yours in Aviation!  
MAIL COUPON BELOW

## Wanted:—Daring Young Men!

**S**“SO you want to break into aviation, eh? Why?”  
“Because I feel like a caged bird slaving away in a stuffy office or smelly shop. I want to get out in the open air. I want thrills, adventure, popularity, excitement! That’s what aviation offers red-blooded men, doesn’t it?”

“You bet, but that’s not all. There’s big money in this game, now and in the future. Air travel is revolutionizing transportation. In a short time you’ll see big freight and passenger liners soaring between New York and San Francisco. And the men who jump in now ahead of the second guessers will get first chance at the big pay jobs. But first tell me this—have you had any aviation training?”

“Well, no. I thought I could get all my training here.”

“Listen, buddy. Let me save you a lot of time and grief. If you want to break into aviation the right way, get your preliminary training first before you ask for a job.

“Do you know how to control an airplane? Can you read an air map, an inclinometer, an altimeter? How would you take off? How does the weather affect flying? These and a hundred other things you should know before you look for a job in aviation. They haven’t got time around a busy aerodrome to give you this basic training.

“Why don’t you take up a home study course in the basic fundamentals of aviation? All the known principles of aviation are down on paper. And they’re easy to absorb—and mighty fascinating. Then when you’re finished training, you’ll find it twice as easy to get a job—and you’ll be promoted twice as fast as the untrained men. Hey, Bill! What’s the name of that aviation school in Chicago? That’s it—American School of

Aviation, the oldest school of its kind in the country. Write them for full information.”

### Aviation Book—FREE!

Some men wouldn’t recognize Opportunity if it walked up to them and knocked their hats off. But somewhere in America there are hundreds of red-blooded daring young men that want ACTION! They want romance, adventure, thrills, fame, popularity and a big income.

Are you this type of man? Then prove it! Send the coupon for our new free booklet, *Opportunities in the Airplane Industry*. This book costs you nothing. Simply mail the coupon below for your copy today.

### AMERICAN SCHOOL OF AVIATION



Dept. 1356, 3601 Michigan Ave., Chicago, Ill.

American School of Aviation,  
Dept. 1356, 3601 Michigan Ave., Chicago, Ill.

Without any obligation on my part, please send your FREE book, *Opportunities in the Airplane Industry*. Also information about your Home Study Course in Practical Aviation.

Name..... Age.....

Address.....

City..... State.....

### PICK YOUR JOB!

Flying  
Airplane Instructor  
Airplane Engineer  
Airplane Repairman  
Airplane Assembler  
Airplane Mechanician  
Airplane Salesman  
Exhibition Manager  
Airplane Contractor  
Airplane Motor Expert  
Airplane Designer

# We trained these men— Then Placed them!



"I have obtained a position as a junior draftsman with the Muncie Oil Engine Co., and so far I like the work real well and think it will continue so. I appreciate your aid in obtaining this position very much."  
**Maurice N. Bareham**

"It will be of interest to you to know that Mr. Maurice N. Bareham called at our office yesterday; also that we have engaged him as a junior draftsman. The work he showed was very neat."  
**W. R. Brown**  
 Muncie Oil Engine Co.



"I think that the letter that you sent to my employer had great weight in his decision to employ me. I like the position that I have very well."  
**William L. Olsasky**,  
 712 Stanton Ave., Shawnee, Kansas.

"I want to express my gratitude and appreciation to the American School for helping me to secure my present position as First Operator of one of the Hydro-Electric Plants of the Southern California Edison Company. I enrolled with the American School early in January, 1928, for the Electrical Engineering Course—and in less than six months completed sixty-five lessons when I asked you to assist me in getting this position."  
**William Roy Elrod**



"I thank you ever so much for your assistance in helping me in getting located in electrical work. As a result of your assistance, I am now with the Virginia Public Service Company. My future meters will be reading, install refrigerators."  
**Sam Ray**,  
 South Boston, Virginia.



"I appreciate your efforts in helping me get a job. I have accepted a job with the Franklin County Light & Power Co. of Farmington, Me. The job is running a two generator power plant."  
**Austin R. Chelf**,  
 69 Pine St.,  
 Madison, Me.



"Mr. William Olsasky is proving up in a very satisfactory manner indeed. We are using him in the drafting room and find that his preparatory work in that line was quite thorough and he became immediately valuable to us."  
**W. E. Upham**,  
 Chief Engineer, Columbian Steel Tank Co.

During the past few months we have helped HUNDREDS of men find good positions with big manufacturers, architects,

contractors, power and other companies. Most of these men used to be poorly-paid clerks, mechanics, beginners and laborers. Today they are doing work they like, getting well paid and best of all, they are in positions with **real chances to advance still further.**

If you are trying to solve the same sort of personal problems you will welcome the help we can give you. Read the letters above, and you will see that the way to a better job and a raise is easier than you think. Let us tell you about it. . . .

**Approved by Employers**

You may wonder how we can get good jobs for the men we train. . . . We made it our busi-



Dept. G-647, Drexel Avenue & 58th Street CHICAGO, ILL.

ness to find out first what employers require **men to know.** Then we hired noted engineers and executives from some of the biggest corporations in America to explain the newest methods in such simple language that any man could prepare for the job ahead.

It is not difficult to find good positions for men who know their stuff. Today we are placing men from coast to coast. And now we are finding employment for **students half way thru their training,** as well as for our graduates. We enjoy the confidence of hundreds of employers, because they have come to learn that our training **does** prepare men for better positions and we only recommend them when they are well prepared.

**Let Us Help You—**

We repeat, the way is easier than you think. In many cases it takes only a little help to climb up one step in responsibility and salary. All you need is a sincere desire to get ahead. The cost and terms have been placed within your reach. The instruction has been simplified so you will have no trouble in mastering it. Industry is calling for trained men—if you want a better job, just mark on the coupon below the kind of work you'd like to do—attach a little note telling us about your schooling and experience—and we'll show you how you can do as well as these other men—without risking a penny of your money.

**The American School**  
 Dept. G-647, Drexel Ave. and 58th St., Chicago, Ill.  
 I am interested in work marked X below. Please send me without cost or obligation your offer to train and place me. I attach a note telling about my schooling and experience.

.... Architecture	.... Drafting
.... Contracting, Building	.... Mechanical Engineering
.... Electrical Engineering	.... High School in two years
.... Business Management	

Name..... Age.....  
 St. No.....  
 City..... State.....



# 5 Easy Ways to Make \$3.00 an hour in Your Spare Time in RADIO

Each of these plans, developed by the Radio Training Association of America, is a big money-maker. Set owners everywhere want to get rid of static, to have their sets operate from the electric light socket, the tone improved, and the volume increased, and transformed into single-dial controls. Phonograph owners want their machines electrified and radiofied. If you learn to render these services, you can easily make \$3.00 an hour for your spare time, to say nothing of the money you can make installing, servicing, repairing, building radio sets, and selling supplies.

Over \$600,000,000 is being spent yearly for sets, supplies, service. You can get your share of this business and, at the same time, fit yourself for the big-pay opportunities in Radio by joining the Association.

## Join the Radio Training Association of America

A membership in the Association offers you the easiest way into Radio. It will enable you to earn \$3.00 an hour upwards in your spare time—train you to install, repair and build all kinds of sets—start you in business without capital or finance an invention—train you for the \$3,000 to \$10,000 big-pay radio positions—help secure a better position at bigger pay for you. A

membership need not cost you a cent. The Association will give you a comprehensive, practical, and theoretical training and the benefit of its Employment Service. You earn while you learn. Our cooperative plan will make it possible for you to establish a radio store. You have the privilege of buying radio supplies at wholesale from the very first.

**Earned \$2,000 In Spare Time**  
 Frank J. Deutsch, Penn.: "I have made over \$2,000 out of Radio in my spare time."  
**Radio Engineer In One Year**  
 Claude DeGrave, Canada: "I knew nothing about Radio when I joined a year ago. I am now a member of a very exclusive organization of Radio Engineers, and my income is 225% greater than it was."  
**Doubles Income In 6 Months**  
 W. E. Thon, Chicago: "Six months after I enrolled I secured the managership of large Radio store and doubled my income."

**Radio Training Association of America**  
 Dept. PM-9, 4513 Ravenswood Ave., Chicago

Gentlemen: Please send me by return mail full details of your Special Membership Plan, and also copy of your Radio Handbook.

Name.....

Address.....

City..... State.....

### ACT NOW—If You Wish the No-Cost Membership Plan

To a limited number of ambitious men, we will give Special Memberships that may not—need not—cost you a cent. To secure one, write today. We will send you details and also our handbook filled with dollars-and-cents radio ideas. It will open your eyes to the money-making possibilities of Radio.

**Radio Training Association of America**  
 4513 Ravenswood Ave., Dept. PM-9, Chicago, Ill.



# How Strong Are You?

## Can You Do These Things?

*Lift 200 lbs. or more overhead with one arm; bend and break a horseshoe; tear two decks of playing cards; bend spikes; chin yourself with one hand.*

**C**AN you do any of them? I can and many of my pupils can. It is remarkable the things a man really can do if he will make up his mind to be strong. It is natural for the human body to be strong. It is unnatural to be weak. I have taken men who were ridiculed because of their frail make-up and developed them into the strongest men of their locality.

### I Want You for 90 Days

These are the days that call for speed. It once took four weeks to cross the ocean—now it takes less than one. In olden days it took years to develop a strong, healthy body. I can completely transform you in 90 days. Yes, make a complete change in your entire physical make-up. In 30 days I guarantee to increase your biceps one full inch. I also guarantee to increase your chest two inches. But I don't quit there. I don't stop till you are a finished athlete—a real strong man. I will broaden your shoulders, deepen your chest, strengthen your neck. I will give you the arms and legs of a Hercules. I will put an armor plate of muscle over your entire body. But with it come the strong, powerful lungs which enrich the blood, putting new life into your entire being. You will be bubbling over with strength, pep and vitality.

### A Doctor Who Takes His Own Medicine

Many say that any form of exercise is good, but this is not true. I have seen men working in the factories and mills who literally killed themselves with exercise. They ruined their hearts or other vital organs, ruptured themselves or killed off what little vitality they possessed.

I was a frail weakling myself in search of health and strength. I spent years in study and research, analyzing my own defects to find what I needed. After many tests and experiments, I discovered a secret of progressive exercising. I increased my own arms over six and a half inches, my neck three inches and other parts of my body in proportion. I decided to become a public benefactor and impart this knowledge to others. Physicians and the highest authorities on physical culture have tested my system and pronounced it to be the surest means of acquiring perfect manhood. Do you crave a strong, well-proportioned body and the abundance of health that goes with it? Are you true to yourself? If so, spend a pleasant half hour in learning how to attain it. The knowledge is yours for the asking.

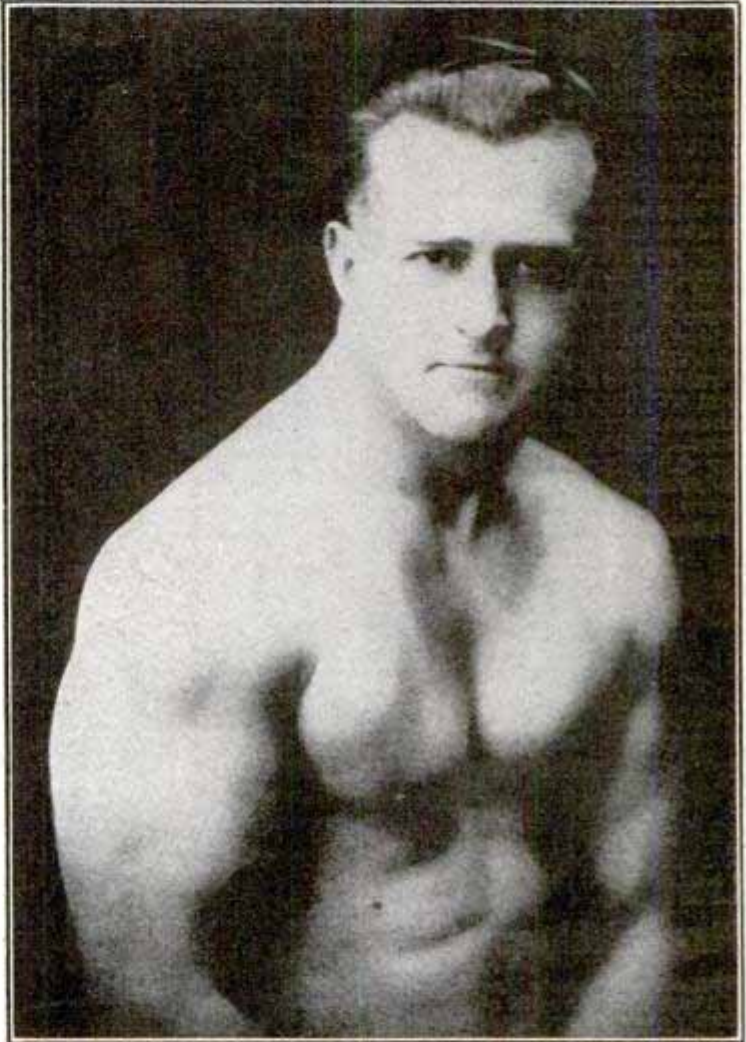

**EARLE LIEDERMAN, The Muscle Builder**

*Author of "Science of Wrestling," "Muscle Building," "Secrets of Strength," "Here's Health," "Endurance," Etc.*

Send for My New  
64 Page Book

# "Muscular Development"

**IT'S FREE**

It contains forty-eight full-page photographs of myself and some of the many prize-winning pupils I have trained. Some of these came to me as pitiful weaklings, imploring me to help them. Look them over now and you will marvel at their present physiques. This book will prove an impetus and a real inspiration to you. It will thrill you through and through. This will not obligate you at all, but, for the sake of your future health and happiness, do not put it off. Send today—right now, before you turn this page.

**EARLE LIEDERMAN**

**Dept. 2009, 305 Broadway, New York City**

**EARLE LIEDERMAN,**  
Dept. 2009, 305 Broadway,  
New York City, N. Y.

Dear Sir: Please send me, absolutely FREE and without obligation on my part whatever, a copy of your latest book, "Muscular Development."

Name.....AGE.....

Street.....

City.....State.....

*Please write or print plainly.*

# Hawaiian Guitar

## GIVEN

Worth \$20

to our Students

This Hawaiian Guitar expert and professor wants the opportunity to welcome you as a student so you will quickly learn how to play a Hawaiian Guitar—yes, you will be able to play just like the native Hawaiians. To get you started and help your musical success, which will bring you popularity, you will receive a beautiful Hawaiian Guitar, the same as the one pictured, when you enroll. Our short cut method of instruction will enable you to play a piece almost from the first lesson. Rush coupon for full particulars today and we will reserve a Hawaiian Guitar for you.



### Learn to Play Quickly

With our short cut method of instruction you will quickly learn how to play Hawaiian Guitar, which will bring you popularity and social success. You learn to play from notes. If you never had any musical training, you will quickly get on, because our experts have perfected a course of home instruction which is as simple as learning A, B, C's.



### PICTURE and PHONOGRAPH RECORD METHOD EASY

We don't depend upon printed lessons only for your success, but we furnish pictures of our professors playing, diagrams, charts and phonograph records for each lesson. This practically brings our professors from our studio to your home and enables you to listen to their playing just as if they were actually in front of you. To prove this is easy, we will send you your first lesson free.

### RUSH COUPON—Send No Money

So positive are we that you will become one of our students, we will send free, without obligation, our first lesson. Also receive our free big book which gives particulars about our course. Write for your free book and your free lesson today.

HAWAIIAN STUDIO No. 52099, of New York Academy of Music, 100 Fifth Avenue, New York, N. Y.

Please rush your free book, "How to Learn Hawaiian Guitar," and my first free lesson. Also reserve a Hawaiian Guitar for me. This obligates me in no way whatever.

Name.....

Address.....

## AIRPLANE DRAFTING

### THOUSANDS OF MEN

will make fortunes in Aviation. Airplane Drafting and Designing are the biggest jobs ahead in this fastest growing industry. A new field of opportunity for you is opened in our improved method of training.

EASY TO LEARN. STUDY AT HOME. PAY AS YOU GO. EMPLOYMENT SERVICE.

Write for booklet outlining courses in Airplane Drafting and other aviation subjects, including the famous Weem's System of Navigation—endorsed by Col. Lindbergh, Commander Byrd, Lincoln Ellsworth, Admiral Moffett, etc.

Name.....

Address.....

City..... State.....

AIRPLANE DRAFTING

AIRPLANE MOTORS

AIRPLANE MECHANICS

PACIFIC TECHNICAL UNIVERSITY SAN DIEGO CALIFORNIA

## ELECTRICAL ENGINEERING

Intensive, practical—technical courses. Engineering degree in 2 years. Diploma in 1 year. Also Special Short Courses in Practical Electricity—Power Plant Operation—Armature Winding—Radio—Electric Refrigeration—Aviation Electricity—Electric Welding. LOW TUITION RATES. Faculty of recognized experts. Extensive Laboratories. Free employment service for graduates. We help secure part-time work during training. 28th year. Write for catalog. FINLAY ENGINEERING COLLEGE 1001-A Indiana Ave. Kansas City, Mo.



# FOREMEN!

FACTORY WORKERS AND ALL MECHANICS



\$1.98 (Worth \$25) Lecture Course Complete in 1 Volume

SEND NO MONEY

Every foreman, factory worker, manager and ambitious mechanic will find a gold mine of inside information in "The Modern Foreman" by Robt. Grimshaw. The 28 chapters of this great work are shop talks pointing the way to success, efficiency, better pay and the job higher up. A complete study course in leadership; a handy, dally reference and guide.

**SUBJECTS COVERED INCLUDE:**—The Magic Wand of Efficiency, The New Type of Foreman, Teamwork, The Kicker, The Agitator, Bonus Plans, Self-Improvement, How to Handle Men, Hiring and Firing, Assigning Men to Jobs, How to Keep Records, How to Cut Out Waste of Time and Materials, New Inventions, Modern Methods, The Inspector, Health and Character Requirements, What the Foreman Should Know, Mathematics, Business Law, The Foreman as "Top Sergeant," Factors of Success, Leadership, What is "Labor"? Time and Idleness, Knowledge is Power, "Morale," The Value of Mistakes.

"The Modern Foreman" has 297 pages, quick reference index, many tables, diagrams, illustrations and forms; big type, easy to read and understand; rich binding, gold stamped. Size 6 x 9 x 1 1/4. Reg. price \$2.50. Our special sale price \$1.98. Send no money. Satisfaction guaranteed. Mail this coupon TODAY!

GREGG PUBLISHING CO., 20 W. 47 St., New York, N. Y.

Send me "The Modern Foreman." I will pay postman \$1.98 and postage on arrival. My money is to be refunded if I am not satisfied.

Name.....

Address..... AA

# LOW PAY.. LONG HOURS.. ROUTINE.. NO FUTURE



Always worrying over money. Always skimping and economizing—going without the comforts and luxuries that every man **DESERVES** for his family and himself.



The Time Clock—a badge of hawk-like supervision and The Rut. A constant reminder that one is "just another name on the pay-roll."



Human cogs in a great machine. No chance to meet people, travel or have interesting experiences. A long, slow, tiresome road that leads nowhere.



Always wondering what would happen in case of a "lay-off" or loss of job. No chance to express ideas and ability—no chance to get ahead. **COULD** there be a way out?

# I Said "Good-bye" to It All After Reading This Amazing Book—Raised My Pay 700%!



## Where Shall We Send Your Copy—**FREE**?

**WHEN** a man who has been struggling along at a low-pay job suddenly steps out and commences to earn real money—\$5,000, \$7,500 or \$10,000 a year—he usually gives his friends quite a shock. It's hard for them to believe he is the same man they used to know—but such things happen much more frequently than most people realize. Not only one, but **HUNDREDS** have altered the whole course of their lives after reading the amazing book illustrated at the right.

True—it is only a book—just seven ounces of paper and printers' ink—but it contains the most vivid and inspiring message that any ambitious man can read! It reveals facts and secrets that will open almost any man's eyes to things he has never even dreamed of!

### Remarkable Salary Increases

For example, R. B. Hansen, of Akron, Ohio, is just one case. Not long ago he was a foreman in the rubber-curing room of a big factory at a salary of \$160 a month. One day this remarkable volume, "The Secrets of Modern Dynamic Salesmanship," fell into his hands. And from that day on, Mr. Hansen clearly saw the way to say "good-bye" forever to low pay, long hours, and tiresome routine! Today he has reaped the rewards that this little volume placed within his reach. His salary runs well into the

5-figure class—actually exceeding \$10,000 a year!

Another man, Wm. Shore of Neenach, California, was a cowboy when he sent for "The Secrets of Modern Dynamic Salesmanship." Now he is a star salesman making as high as \$525 in a single week. I. H. Lundstedt, Chicago, read this free book, and increased his earnings over 600%! C. V. Champion of Danville, Illinois, raised his salary to over \$10,000 a year and became President of his company in the bargain!

### A Few Weeks—Then Bigger Pay

There was nothing "different" about any of these men when they started. None of them had any special advantages—although all of them realized that **SALESMANSHIP** offers bigger rewards than any other profession under the sun. But, like many other men, they subscribed to the foolish belief that successful salesmen are born with some sort of "magic gift." "The Secrets of Modern Dynamic Salesmanship" showed them that nothing could be farther from the truth! Salesmanship is just like any other profession. It has certain fundamental rules and laws—laws that you can master as easily as you learned the alphabet.

City and traveling sales positions are open in every line all over the country. For years, thousands of leading firms have called on the N. S. T. A. to supply them with salesmen. Employment service is free to both employers and members, and thousands have secured positions this way.

### Free to Every Man

See for yourself **WHY** "The Secrets of Modern Dynamic Salesmanship" has been the deciding factor in the careers of so many men who are now making \$10,000 a year. Learn for yourself the **REAL TRUTH** about the art of selling! You do not risk one penny nor incur the slightest obligation. And since it may mean the turning point of your whole career, it certainly is worth your time to fill out and clip the blank below. Send it now!

### National Salesmen's Training Association

Dept. M-102, N. S. T. A. Bldg., CHICAGO, ILL.

National Salesmen's Training Assn., Dept. M-102, N. S. T. A. Bldg., Chicago, Ill.

Without cost or obligation you may send me your free book, "The Secrets of Modern Dynamic Salesmanship."

Name.....  
Address.....  
City..... State.....  
Age..... Occupation.....

# Learn Electricity

## IN LOS ANGELES

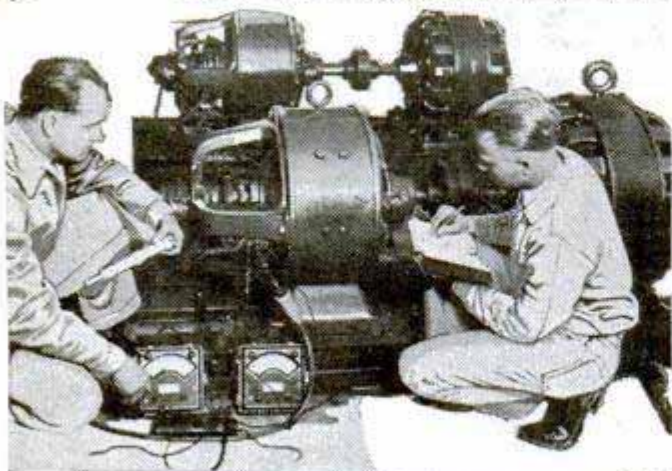

and **LEARN IT RIGHT!**

### 1. What Kind of a School Is NATIONAL?

NATIONAL is a Million Dollar institution—established in 1905—recognized throughout the electrical industry as one of America's foremost trade schools. NATIONAL offers practical, intensive training in all electrical branches. All technical essentials included. No age limit. No previous experience necessary. Life Scholarship privileges. Start any time of the year.

### 2. How Long to Learn Electricity?

NATIONAL properly trains you in the short time of 6 to 9 months. Upon completing this Condensed Course you are fully qualified as a Practical, Competent Electrician, and you have not risked your chances of employment because of inferior, incomplete instruction.

### 3. What Employment Service Does NATIONAL Guarantee?

NATIONAL GUARANTEES to give unlimited and efficient Employment Service to students wishing to earn living expenses while learning; and to graduates getting started in the electrical field. This is the most any reputable school can be expected to do.

### 4. What Inducements Does NATIONAL Offer?

NATIONAL offers YOU the very best technical-practical training that money can buy at a cost within every man's reach. It does not offer to pay your railroad fare, room and board or other personal expenses, preferring to limit its activities to the PROPER TRAINING OF MEN FOR SUCCESS.

### 5. Why You Should Come to LOS ANGELES!

LOS ANGELES is the heart of the country's most rapid electrical development—as well as the world's most ideal city in which to live and prepare for success in electricity

**WRITE for FREE BOOK NOW!**

## NATIONAL Electrical School

Dept. 535, 4006 Figueroa St.,  
Los Angeles, California.

Send me your big free illustrated catalog of Electrical Opportunities showing how I can learn quickly and get a Big-Pay Electrical Job.

Name.....

Address.....

Age..... City..... State.....



*Learn to Write*

## I Teach by Mail

I CAN make a good penman of you at your home during spare time, no matter where you live or how poorly you now write. My simplified system has shown thousands of others the way to good penmanship during the past twenty years — it can and will do the same for YOU!

### Beautifully Illustrated Book "How to Become a Good Penman"

It contains general information, with testimonials and beautiful specimens of penmanship showing what others have accomplished by the Tambllyn System. (Your name elegantly written on a card if you enclose stamp for postage.) **WRITE TODAY. Address**

**F. W. TAMBLYN**

418 Ridge Bldg., Kansas City, Mo., U. S. A.

*F. W. Tambllyn*

## LAW

**STUDY AT HOME**  
Become a lawyer. Legally trained men win high positions and big success in business and public life. Be independent. Greater opportunities now than ever before. Big corporations are headed by men with legal training. Earn **\$5,000 to \$10,000 Annually** during spare time. Degree of LL.B. conferred. We guide you step by step. You can train at home. LaSalle students found among practicing attorneys of every state. We furnish all text material, including fourteen-volume Law Library. Low cost, easy terms. Get our valuable 64-page "Law Guide" and "Evidence" books FREE. Send for them NOW. LaSalle Extension University, Dept. 964-L, Chicago. The World's Largest Business Training Institution

## "STAMMERING

Its Cause and Cure"

You can be quickly cured if you stammer. Send 10 cents coin; or stamps, for 288 page cloth bound book on Stammering and Stuttering. It tells how I cured myself after Stammering and Stuttering for 20 years. BENJAMIN N. BOGUE  
11121 Bogue Building, 1147 N. Ill. St. Indianapolis



**WHY NOT** spend Spring, Summer and Fall gathering butterflies, insects? I buy hundreds of kinds for collections. Some worth \$1 to \$7 each. Simple outdoor work with my instructions, pictures, price-list. Send 10 cents (not stamps) for my illustrated Prospectus before sending butterflies. MR. SINCLAIR, DEALER IN INSECTS, San Diego, Calif. Dept. 6. Box 1424.

## WORLD NEEDS PLUMBERS

Old style plumbers are fading like the horse and buggy. The world demands modern Plumbing and Skilled Trained Mechanics to do it. Unlimited, swift growing field. Make \$50 to \$100 a week or start own shop. We train you quick. Learn in 8 to 12 WEEKS to do any job with skill and science. Need no previous experience. Strictly tool using system. Opportunity knocks. Investigate today — amazing offer — low tuition. World's greatest school.

Write—**UNIVERSAL PLUMBING SCHOOL**  
2130 Troost Ave. Kansas City, Mo.



## What Hinton Training Is

A complete course of instruction in the working knowledge, principles and practical operation of Aviation. You study it at home, under the direct personal supervision of Walter Hinton, one of America's most famous flyers—thirteen years in Aviation, over 400,000 miles of flight behind him. You learn motors, plane design and construction, theory of flight, carburetion and ignition, repairs, maintenance, management. You get the thorough groundwork that you *must* have first. Then if you want to fly, Hinton arranges special rates for you. If you want a job on the ground, his Employment Department puts you in touch with employers.

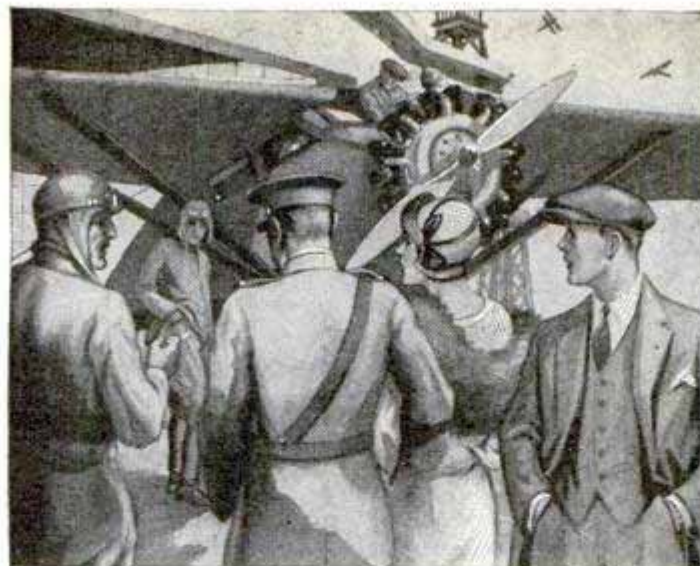

# What's keeping You out of AVIATION?

## Is it Lack of Training?

WALTER HINTON speaking . . . What's keeping YOU out of Aviation? Lack of ambition? I don't believe it. Is it failure to see the tremendous opportunities, the profits that the Industry offers you? I can't believe that either. Something is making you wait. I don't know what that "something" is, but I *do know* that I can give you the one thing you need to get started. I can give you the one thing that will make you eligible with the hundreds of Aviation employers who are demanding More Men. I can give you TRAINING!

## Are you 18 years of age?

If you are, I'll show you how to get started *without delay*. I can't drive home the importance of that too strongly. A month in Aviation sees practically as much progress as a year in any other industry. Yesterday's employees are today's bosses. Today's beginners can be tomorrow's *successes* in this richest field of all! The coupon below will bring you my book, "Wings of Opportunity." It has *already started* hundreds of men. It's vital—it's FREE. If you're eighteen or over—if you're serious—if you're ready to learn *facts about Aviation* and FACTS ABOUT YOUR OWN CHANCES IN AVIATION—mail the coupon now!

Walter Hinton, Pres.

**AVIATION INSTITUTE OF U.S.A.**  
1115 Conn. Ave. Washington, D. C.



I-Y

Tell me more about MY chances in Commercial Aviation. Send me your FREE Book, "Wings of Opportunity."

Name.....

Street.....Age.....

(Must be 18)

City.....State.....

## What Hinton Training Does

It puts Aviation from A to Z at your fingertips—then backs up that training with an Employment Service that *gets results*. J. W. Boehm, 47 Seventh Ave., Brooklyn, N. Y., has connected with the Sikorsky Company. Thomas Lapworth, 1414 Vine St., Hollywood, took the course, gave up his job and is now with the Douglas Airplane Co. Warren Mengel, 1301 N. 11th St., Reading, Pa., now has a real job with Wright. Myron H. Rettberg, Whitney Point, N. Y., credits the course and service for landing him with Pratt & Whitney. Hinton's Course gives you your start to be an Engineer, Designer, Pilot, Mechanic, Rigger, Electrician, Wood Worker, Inspector, Airport Operator, Assemblyman, Salesman—your choice of *over 40* big-pay jobs, on the ground or in the air!



### WALTER HINTON

Pilot of the NC-4, first trans-Atlantic plane. First flyer from North to South America. Famous war-time Navy instructor. First and only world-known aviator to give home-study students the cream of his knowledge. His FREE Book is ready to show you how to start—how to get ahead—how to *succeed* in Aviation!

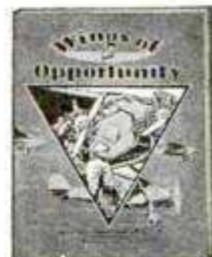

### FREE BOOK

You can have a man-to-man half-hour talk with one of America's pioneer Aviators—one of Aviation's greatest instructors. You can get the facts you've waited for, and *can't afford to wait for a day longer*. This FREE Book brings them. The coupon brings the book. Mail it now.



# - takes only 8 weeks to get a big job



George Smith owns an agency and repair shop in West Alexandria, Ohio. He makes \$200 a week.

## and Earn \$75 to \$125 a Week as Auto or Aviation Expert

Learn the auto and tractor business by the McSweeney method, then step out and get a good job at \$75 to \$125 a week or open your own repair shop and make up to \$10,000 a year. Trained men are needed everywhere. Opportunities galore! Eight weeks' training fits you to open repair shop or to go on with one of the big firms waiting for trained men. Read what George Smith and C. E. Gillespie have done. Hundreds of other McSweeney trained men can tell as interesting facts. Every month McSweeney men who complete their training are taking the place of half-trained and incompletely self-trained men.

### Money Back Guarantee

If, after completing my training, you are not satisfied, if you are not qualified to accept a big-pay job, your tuition will be refunded.

## AVIATION Course

AVIATION is paying tremendous incomes to trained men! Coupon brings complete details about complete course in Aviation. Learn on real airplane engines under experienced instructors. Ask about special course in FLYING. Don't miss this remarkable opportunity. Save by enrolling at once. The sooner you start the sooner you will be ready to earn big pay or get into business for yourself.

### MAIL COUPON FOR FREE BOOK TO SCHOOL NEAREST YOU

McSweeney Auto, Tractor and Aviation Schools, Dept. A-11-J, Chester at 30th St., Cleveland, O., or 263 Madison St., Memphis, Tenn.

Without cost or obligation, send me your big FREE book on Autos and Aviation, also full details of your special tuition offer.

Name.....  
 Street.....  
 Town..... State.....



## Learn in Only 8 Weeks

Simple, thorough, practical shop methods. You learn the "why" of everything you do, then learn to do it right. You do real work with real tools and real equipment. No book studying. Very little schooling necessary. Any man from 16 to 60 can learn. Write today for Big Special Limited Time Tuition Offer. Write for Big, Illustrated Book FREE!

### Learn on Real Machines



# McSWEENEY Auto, Tractor and Aviation SCHOOLS

Dept. A-11-J  
 Chester at 30th St., Cleveland, O. or 263 Madison St., Memphis, Tenn.



## 1,000 Hotel Positions Open!

HOTELS, restaurants, clubs, apartments, hospitals, institutions, schools and colleges everywhere need trained men. Over 70,000 high-class positions paying \$2,500 to \$10,000 a year open annually in the hotels of the United States. Nearly one and three-quarter billions of dollars' worth of NEW HOTELS, CLUBS AND INSTITUTIONS being built this year will need over 200,000 trained men. Hotels start you at salaries up to \$3,500 a year, with living usually included. At any time there are over 1,000 hotel positions open.

### Previous Experience Unnecessary

You can have one of these fascinating, big-pay positions. Thru our Simplified Home Study Plan we give you the valuable knowledge that it has taken some of the most successful hotel men years to obtain. Age is no obstacle—young and old alike have equal chances for success. Past experience absolutely unnecessary. A common school education is all you need.

We train you in your spare time and put you in touch with big opportunities. All of your training under the personal supervision of Clifford Lewis, who has been appointed Managing Consultant by over 300 hotels throughout the United States. Our students employed by leading hotels everywhere.

Send coupon today for Free Book, "Your Big Opportunity," showing how we can train you for one of these splendid positions, and explaining our Money-Back Agreement.

### FREE BOOK COUPON

LEWIS HOTEL TRAINING SCHOOLS, Room BR-385, Washington, D. C.

Send me without obligation the Free Book, "Your Big Opportunity."

Name.....  
 Address.....  
 City..... State.....

## PIN A DOLLAR BILL TO THIS

Get this genuine leather 5 window card case, with gold corners, Masonic emblem stamped in heavy gold. Your name or other stamping 35c extra, per line. Money back guarantee.



Please send catalogue

- No. 10. Books, Monitors, Jewelry
- No. 11. Lodge Supplies

Established 1859

Redding Masonic Supply Co. 200 Fifth Ave., Dept. P. M., New York

"Everything Masonic"

## Learn Photography at HOME

Make money taking pictures. Prepare quickly during spare time. Also earn while you learn. No experience necessary. New easy method. Nothing else like it. Send at once for free book, OPPORTUNITIES IN MODERN PHOTOGRAPHY and full particulars

AMERICAN SCHOOL OF PHOTOGRAPHY  
 Dept. 1356 3601 Michigan Ave. Chicago, U. S. A.

## STAMMERING

easily, permanently corrected. Win happiness and success. Ask for full information and special phonograph record. Send dime for postage

12972 Woodward Ave., LEWIS INSTITUTE, Detroit

## Learn Watchwork, Jewelrywork and Engraving

A fine trade commanding a good salary, and your services always in demand. Address **Horological**, Dept. P, Bradley Institute, PEORIA, ILLINOIS, for our latest catalog.

# Easy as A-B-C



# Here's a Queer Way To Learn Music!

*No teacher—no monotonous exercises. Just a simple, easy home-study method. Takes only a few minutes—costs only a few cents a day. Every step as clear as A-B-C.*

WHO would have ever thought that the learning of music could be simplified? Seems almost too good to be true to think of learning to play your favorite instrument without long hours of practice—tedious scales and expensive teachers, doesn't it? Yet that's exactly how you learn this new way. The only thing that is queer about this amazing method is the fact that it's so different from all ordinary methods.

But although this marvelous home-study method is different and comparatively new, it has already been carefully tested and proved by over half a million people all over the world. Judge from that how satisfactory, reliable and easy it must be.

## Musical Talent Not Needed

Even if you have never touched an instrument before, you can't go wrong this amazingly easy way. For every step, from beginning to end, is right before your eyes in print and picture. You always know

what to do and how to do it. No guesswork. No delays. If you make a mistake you correct it yourself and continue. It's really *fun* learning to play this way, you proceed so rapidly. From the start you are playing real tunes perfectly by *note*. And almost before you realize it you will be able to play anything—the popular "Jazz" or those classical selections for which there is always a big demand at concerts

## PROOF!

"I have completed only 20 lessons and can play almost any kind of popular music I wish. My friends are astonished."

*Turner B. Blake, Illinois.*  
"Since finishing the course I have been teaching, playing in churches and at recitals, and receiving a fine salary. I have made money, come into contact with new friends and greatly increased my popularity."—*Ruth M. Peacock, North Carolina.*

"Since I have been taking your lessons I've made over \$200 with my violin."  
*Melvin Freeland, N. J.*

and home entertainments. Best of all, no matter which instrument you choose the cost of learning is just the same in each case, just a few cents a day!

## Have Fun—Win New Friends

Just think of all the pleasure you've been missing by not being able to play some musical instrument. Instead of being the center of attraction at parties—you've been unnoticed—out of the social picture. While you've been playing wallflower others have always had something to offer. Now you have a wonderful chance to turn the tables—to treat yourself to some real fun—to surprise your friends! Take some good advice. Learn to play this new easy way. Get your share of a musician's pleasure, popularity, profit. Start Now!

## Free Booklet and Demonstration Lesson

If you are in earnest about wanting to join the crowd of entertainers and be a "big hit" at any party—if you really do want to play your favorite instrument, to become a performer whose services will be in demand—fill out and mail the convenient coupon asking for our Free Booklet and Free Demonstration Lesson. These explain our wonderful method fully and show you how easily and quickly you can learn to play at little expense. The booklet will also tell you all about the amazing new Automatic Finger Control. Instruments are supplied when needed—cash or credit. U. S. School of Music, 79 Brunswick Building, New York City.

**U. S. School of Music**  
79 Brunswick Bldg., New York City

Please send me your free book, "Music Lessons in Your Own Home," with introduction by Dr. Frank Crane, Free Demonstration Lesson and particulars of your easy payment plan. I am interested in the following course:

..... Have You Instr.? .....

Name.....  
(Please Write Plainly)

Address.....

City..... State.....

## Pick Your Course

- |                                     |                          |
|-------------------------------------|--------------------------|
| Piano                               | Violin                   |
| Organ                               | Clarinet                 |
| Ukulele                             | Flute                    |
| Cornet                              | Saxophone                |
| Trombone                            | Harp                     |
| Piccolo                             | Mandolin                 |
| Guitar                              | 'Cello                   |
| Hawaiian Steel Guitar               |                          |
| Sight Singing                       |                          |
| Voice and Speech                    | Culture                  |
|                                     | Drums and Traps          |
|                                     | Automatic Finger Control |
| Banjo (Plectrum, 5-String or Tenor) |                          |
| Piano Accordion                     |                          |

# The real money is in these professional fields

## DRAFTING—ARCHITECTURE ENGINEERING—ELECTRICITY

A real salary—a steady five-figure income—a dignified out-of-the-grades-class position or a business of your own. That, briefly, is what Engineering, Architecture, Electricity or Drafting can mean to you. For in these fields, billions are spent annually. Millions go to those men specially trained to lay out and superintend construction work. Industry needs trained Draftsmen,

Engineers and Architects. Everywhere big salaries and bonuses are being paid. Men are at a premium. You're needed—and wanted if you're trained.

### Chicago Tech Gives You That Training

For 26 years one institution—the Chicago Technical College—has been developing trained specialists in drafting and engineering. Its graduates are in great demand. Its courses represent the last word in tested and proved practical training for young men.

### 3 Easy Plans

You need not be without this training. 3 Plans make it easy for you no matter what your circumstances.

Come to Chicago if you can. Enter our resident school in either the 2 year Diploma or 3

year B. S. Degree Course. Either of these courses gives you the maximum in thorough, up-to-the-minute and practical training. Mark *Plan No. 1* on the coupon if interested in these courses. It brings you our free 80 Page Blue Book and all the facts.

If your time is limited, consider our 4 months' course in Drafting—just mark *Plan No. 2* on coupon.

And finally, if you can't come to Chicago, then study at home—earn while you learn—and mark *Plan No. 3* on the coupon.

But get the coupon going now—for you can't afford to be without the facts that show you how to get into these 4 Big billion dollar fields.

### Earn While Learning

Chicago offers opportunities for part time work to help defray expenses. The College assists students in making desirable employment connections.

### Mail Free Book Coupon

Chicago Technical College,  
Dept. M-77, 118 E. 26th St., Chicago.

Please send me your 'Free Book and other information about plan of training marked below.

Name .....

Address .....

City ..... State .....

#### Check plan in which you are interested.

No. 1.—Complete College Training (2 yr. Diploma—3 yr. Degree) Engineering or Architecture at the College in Chicago.

No. 2. 4 months' Special Drafting Course at Chicago Tech. Earn while learning.

No. 3. Home Study—College-Training-At-Home in Drafting. Your spare time is enough.

# CHICAGO TECHNICAL COLLEGE

Dept. M-77, Chicago Tech. Bldg., 118 East 26th St., Chicago, Illinois



# If You Want

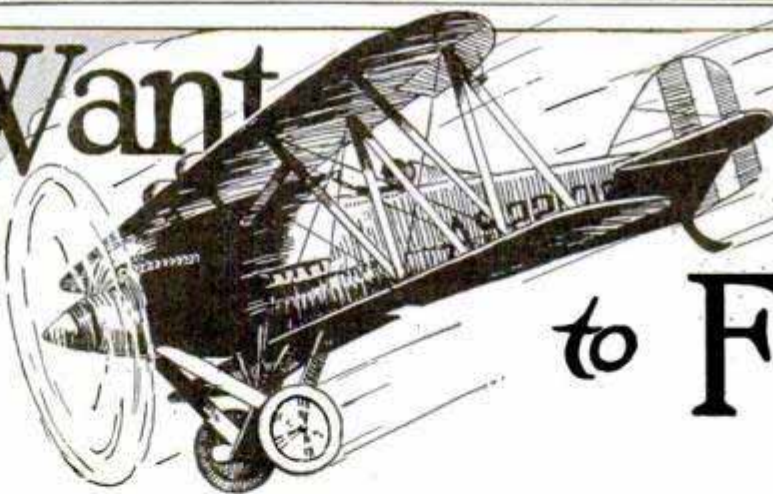

# to Fly

## Let Alexander Klemin, brilliant engineer, tell you about it in the most practical and easily understood fashion

It is no longer necessary to have a background of many years' study of mathematics, physics and mechanics for an understanding of basic flying principles.

Do you know that you constantly come in contact with nearly all the principles of flight in your daily life? For instance, when a boy hunts for a flat stone to throw because it "sails" better than a round one, he is making direct application of an important principle governing airplane flight.

Prof. Klemin uses many of these familiar illustrations to make an understanding of flying as simple as A B C.

### Send \$2.50

and we will forward a copy of

**"If You Want to Fly"**

postpaid, or, if you live in the U. S., we will send it C. O. D. Simply pay postman \$2.50 plus postage when delivered.

Your money back if not satisfied

Think what it means to have the whole course of training made crystal clear.

Lindbergh says, "As flying activities increase, a basic education in elementary aviation is becoming a necessity for everyone."

Lieut. Maitland, first non-stop flyer to Hawaii, remarks, "Every student of aeronautics, before attempting to pilot an airplane, should read Mr. Klemin's great book."

Just what you want to know about the science of flight, the construction of the airplane and the aircraft engine is given in this astonishingly informative book.

**POPULAR MECHANICS PRESS, Room P-9, 200 East Ontario Street, CHICAGO**



# Get into AVIATION



**Major Rockwell  
World War Flyer  
Who Will Teach You**

Major Rockwell is a famous world war flyer, decorated with the Legion of Honor and the War Cross. He is now devoting himself to teaching Aviation, and he will train you for a position in this great new industry as only a Veteran World War Flyer can train you. Under Major Rockwell's guidance your future in Aviation is assured.



## Major Rockwell, U.S.R. Air Corps, Says: "I'll Train You at Home

**—and in 12 Weeks You Can Master Every Principle of Ground Training Which Is Necessary Before You Are Ready to Take Your Place in Any Branch of Aviation"**

Of course you want to get into Aviation quickly! Every man, young and old, is eager to take his place and insure his future in this fastest growing industry which is paying big incomes to trained men. **Aviation is the only field in which manufacturers and airports are literally raid-**

**ing each other for men with proper training!** Now is the time for you to start! And my Home-Study Course is the easiest, quickest, least expensive way for you to make the start. Mail coupon for my fascinating book which gives all details.

### You Learn Aviation Ground Work at Home —Then Choose Any of the 40 Ground Jobs

Right in your own home, devoting about an hour a day, I teach you the essential Aviation fundamentals covering every phase of ground work, as well as the principles of flying and navigation. This is the same instruction that you would receive if you went away to a ground school. It makes no difference whether you intend to fly or to make your mark in Aviation as a designer, rigger, motor expert, repairer, inspector, builder or in any of the 40 big-pay ground jobs, **you must have this**

**highly important ground work instruction to land any real good job in this new fast-growing industry.** I will help you find your proper place in Aviation and start you on the right road to sure success. Manufacturers, Transport Companies and Airports prefer Rockwell trained men. Then if you want to go farther and take up actual flying, you can come here to Dayton where I'll see that you get your flying instructions at one of America's finest airports—**at my special reduced prices.**

#### 40 Ground Jobs for Every Airplane

Every airplane in service means 40 men on the ground, all highly paid.

- Riggers
- Designers
- Electricians
- Metal Workers
- Draftsmen
- Plane Mechanics
- Motor Inspectors
- Air Port Managers
- Welders
- Transport Managers
- Etc., etc.



### Your Jobs Here

### No Advance Education or Experience Needed

You don't need to have any previous education to master my course. You do not even need to know anything about airplanes or mechanics. My home study course is thorough and complete. Everything is clearly explained with easy-to-understand text and pictures. In a few short months you will have grasped every

fundamental principle of aviation ground work and you will be well on the road to qualify for any important aviation job paying \$300 to \$400 a month. My Home Study Course will also give you all the knowledge necessary to pass the Government's written examinations for mechanics' or pilots' licenses.

### Aviation Begging for Trained Men

Only TRAINED men can command the high salaries. Employers are glad to pay big money for men who know Aviation—builders, mechanics, service and maintenance men, and flyers. Let me prepare you for one of the many high salaried Aviation jobs open to the trained man. I will prepare you at home to take your place in the most fascinating, fastest growing industry in the world. Rush this coupon to me for a copy of my famous free book.

#### Money Back Guarantee

I am so certain of your success in Aviation that if you are not satisfied after completing my course, I will refund every cent of your tuition.

#### Employment Service

After you graduate I help you get a job without cost. There's a great demand for men with Rockwell training!

**MAJOR ROB'T L. ROCKWELL**

**THE DAYTON SCHOOL OF AVIATION  
Desk K-1 DAYTON, OHIO**

**Get My No-Risk Plan  
My Big Book  
Explains ALL  
I'll send it FREE**



**Major Rob't L. Rockwell  
The Dayton School of Aviation  
Desk K-1, Dayton, Ohio.**

Dear Major:—Please send me FREE and without obligation a copy of your famous book on Aviation; also your special tuition and position offer.

Name.....  
Address.....  
Town..... State..... Age.....

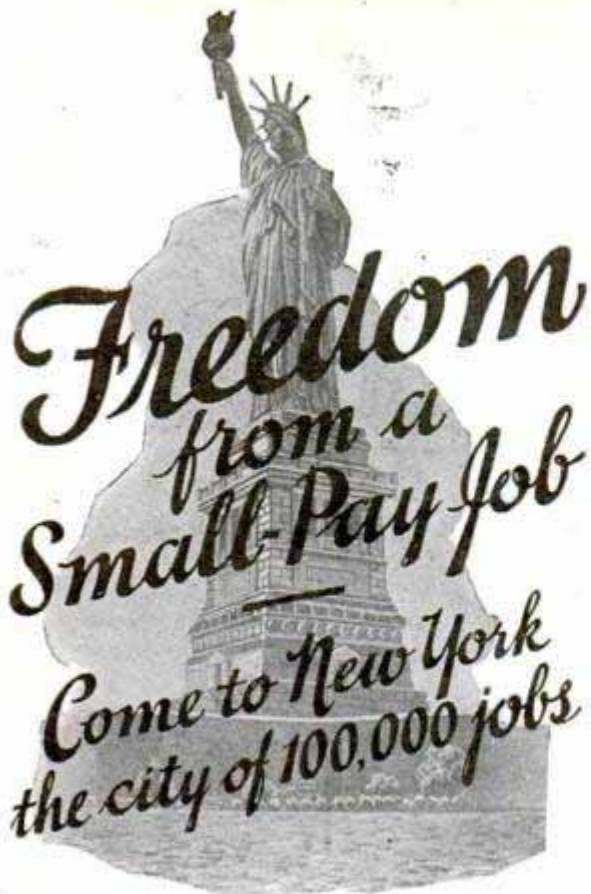

**A**NY MAN who can read and write and use a pair of pliers can become an electrical expert and free himself forever from the long hours and drudgery of a small pay job.

And you can learn the BIG PAY profession of electricity right in New York City—the heart of the electrical world—the city of 100,000 jobs. At the same time you are learning the BIG PAY profession you can be enjoying the sights and wonders of New York, the modern Bagdad.

### Be an Electrical Expert

Graduates of the NEW YORK ELECTRICAL SCHOOL are in demand by all the big electrical companies. Or, if you prefer the independence of a business of your own, there are thousands of opportunities for efficient, dependable men to become electrical contractors. When you are your own boss the money you can make is limited only by your own energy and ability.

### Personal Instruction

The NEW YORK ELECTRICAL SCHOOL is not a correspondence school. You learn by doing—by personal instruction on full size standard electrical equipment under the personal supervision of trained instructors.

At N. Y. E. S. you train your hands and mind at the same time. You learn the theories of electricity—and then you are shown how to put the theories into actual practice by solving the problems with your own hands.

The man who has learned electricity by actually doing electrical work under intelligent personal instructors can go to any part of the world and be sure of a good living. There are N. Y. E. S. graduates in all the countries of the world.

Write today for the 48-page booklet giving full information about the N. Y. E. S. Course and showing pictures of the equipment available for your personal use in our two seven-story buildings. Mail coupon now! The New York Electrical School, 44 W. 17th Street, New York.

The New York Electrical School  
44 W. 17th Street, New York

Please send me FREE your 48-page booklet. It is understood that this request puts me under no obligation.

Name.....

Address.....

## THE CHICAGO DAILY NEWS School and College Bureau

### Offers You Its Specialized Services in Choosing a School

Last year the School and College Bureau of The Chicago Daily News saved many busy parents and questioning boys and girls both time and worry by sending them prompt, reliable information about just the kind of school they wanted—personal requirements as to location and tuition charges being considered in each individual case.

Again this year many young people will be perplexed by the problem of finding the right school. Why not let us help you?

The Chicago Daily News maintains this service absolutely free of charge to you. No need to hurriedly select a school on mere hearsay when expert advice can be obtained by telephoning Dearborn 1111, writing or calling for a personal interview at

## THE CHICAGO DAILY NEWS

School and College Bureau

Dept. K, Daily News Plaza, 400 W. Madison St., Chicago, Ill.

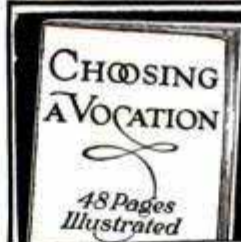

### SENT ON REQUEST

Helpful discussion of this important problem and of fastest growing of Vocational Trades—Mechanical Dentistry. Of special interest to men of all ages. Send for Bulletin 2.

### BODEE INSTITUTE

1755 Broadway, New York  
1305 N. Broad St., Philadelphia  
85 Court St., Brooklyn

## BE AN ARTIST

WE CAN TEACH YOU DRAWING in your own home during your spare time. Twenty-five years of successful teaching proves our ability. Artists receive large salaries.

Write Today for Art Year Book

SCHOOL OF APPLIED ART  
ROOM NO. 2 BATTLE CREEK MICH.



## LEARN WATCHMAKING

and become independent. We help you secure a position. Easy to learn. Send for FREE CATALOG.

ST. LOUIS WATCHMAKING SCHOOL Dept. 5, ST. LOUIS, MO.



### GIVEN!

Boys! Here's the great Navy model Airship. Large 6-foot air bag with inflators, parachute with automatic release and complete instructions for flying. Will fly for miles at height of 1000 feet. Great chance to study aerial navigation. Send name and we'll send 6 of our new art pictures to dispose of on special 25c offer. Send the \$1.50 you collect and as a reward for this service we will send this wonderful Airship with full instructions free.

C. M. THOMAS, 337 W. Madison St. 9K91 Chicago

**MICHIGAN STATE  
AUTO SCHOOL  
AND  
GREER COLLEGE  
AMERICA'S GREATEST  
TRAINING SHOPS  
NOW UNDER MANAGEMENT  
OF  
ERWIN GREER**

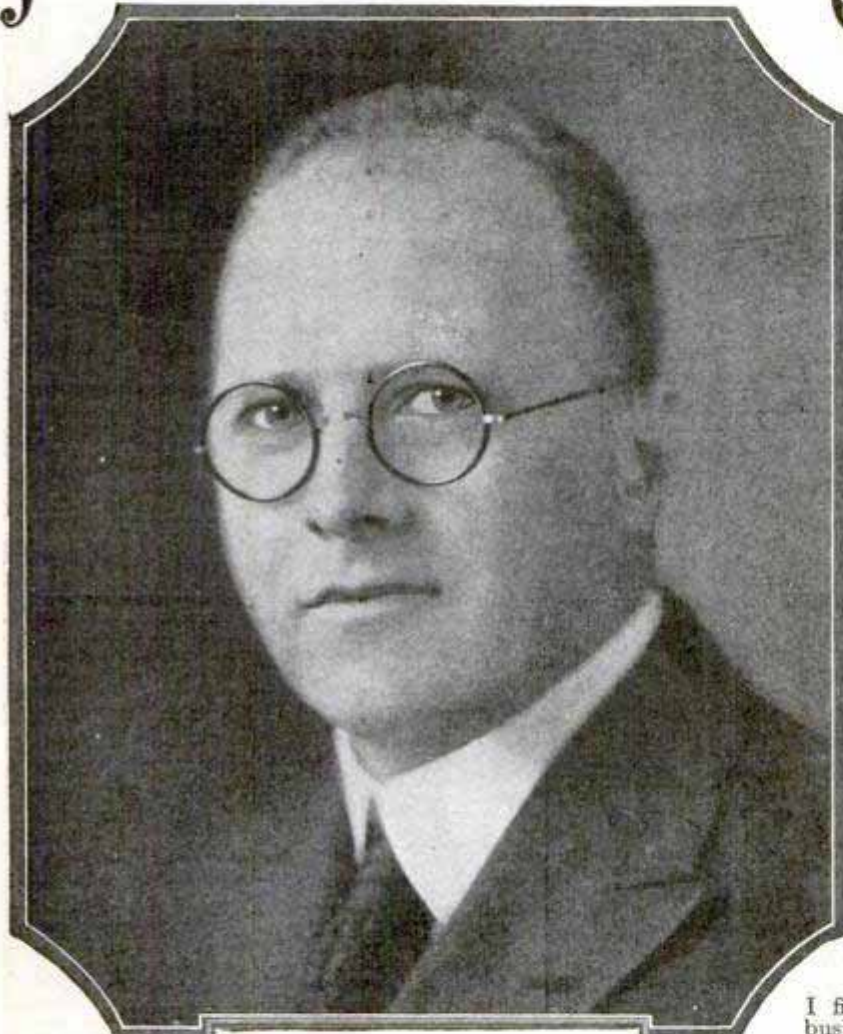

**ERWIN GREER, President**

**LET ME HELP You to the  
Sunny Side of Life**

My Free Auto Book will tell you about these remarkable GREER COLLEGE FEATURES: *Railroad Fare included from any point of the United States—Easy Terms—Big Equipment—Help you get a Job while learning—Man's size income and YOUR FUTURE as a trained AUTO EXPERT.* I will and can solve your life's money-making problem. While your fine ambition is urging you on—**ACT—SEND FOR MY FREE AUTO BOOK.**

**ERWIN GREER, President  
GREER COLLEGE**  
Dept. 901 A.T.  
2024 Wabash Ave., Chicago, Illinois

**LEARN AUTOS**

Seven Billion Dollars are spent each year to repair Twenty-four Million Autos, Trucks and Tractors. Tinkering Mechanics are losing out. EXPERTS, trained on Big Equipment, by EXPERT TEACHERS are demanded at Big Pay. Thousands of Garage owners make up to \$15,000 a year.

**New Purchase of Big School Gives Me Big Advantage**

I recently bought the famous Michigan State Auto School, formerly of Detroit. NOWHERE ELSE I know of, is there NOW such Auto TRAINING SHOPS as GREER COLLEGE, where you get practical training on a world of equipment.

**Up to \$15,000 a Year**

Clip coupon below for Free Auto Book. Learn how I fit you for Big Jobs. I have trained thousands to earn over \$100 a week. Ninety Thousand men, in 26 years, have started their Auto careers at Greer College. Welding, Ignition, starting, Lighting—EVERYTHING—I teach you. MY TRAINING IS COMPLETE—no dull books or deep theory.

**A Job for You While Learning**

My Free Book shows how you DON'T NEED a lot of MONEY or EDUCATION, and how I PAY YOUR FARE HERE—how I HELP GET YOU A JOB WHILE LEARNING, to help pay your living expenses and tuition—also another one at graduation. Send for this great book today.

**Only 3 Months—Then Big Pay**

It takes me ONLY THREE MONTHS to fit you for big pay. In this great seven story building (shown above) which is filled with machinery and training equipment, I fit you for every branch of the auto business. There are AMAZING OPPORTUNITIES for Foremen, Garage Owners, Auto Specialists the country over. Let my Free Book show you.

If unable to come to Chicago, now for resident course, write for information about Home Study Course!

**SCISSORS FOR SUCCESS BOOK**

**ERWIN GREER, Pres.**  
GREER COLLEGE,  
2024 Wabash Avenue,  
Dept. 901 A.T.,  
Chicago, Ill.

Dear Sir:  
Send me your Big Auto Book—Free of Charge and without obligation to me.

Name.....

Street and No.....

City..... State.....



## Increased His Income "Many, Many Times"

—thanks to Higher Accountancy

"I'm not going to put off specialized training another day!" So said G. Roy Eshelman to himself—and what a profitable decision it turned out to be!

At that time he was earning \$16 a week—as clerk in the purchasing department of a big manufacturing concern.

Today, thanks to his home-study training with LaSalle, he heads his own firm of Public Accountants, at Decatur, Illinois, and in a letter to LaSalle he adds, "It is sufficient to say that my present income is many, many times greater than when I enrolled."

Mr. Eshelman's advancement came about in the most natural way you could imagine.

First, he became really interested in Accountancy—stayed after hours to watch the auditor at his work. Result: he was soon placed in the Auditing Department and given a 50 per cent increase in salary. Shortly afterward, as he progressed with his training, came another "raise"—of 40 per cent.

"My studies rapidly equipped me to strike out for myself," writes Mr. Eshelman. "At present I have an extensive practice as a Public Accountant and employ several accountants, all of whom have secured training by home-study methods."

"I am writing this letter," states Mr. Eshelman, "believing that many of the clerks and bookkeepers of today are asleep to the opportunities existing for trained accountants. I believe also every business man and banker should avail himself of the information in LaSalle Higher Accountancy training."

Send for Free Book—

"Accountancy, the Profession that Pays"

Why not investigate the opportunities in this highly profitable profession—find out how thousands of LaSalle-trained accountants have advanced themselves to positions paying \$3,000—\$5,000—\$7,500—\$10,000 a year, and even better?

Two books placed G. Roy Eshelman on the path to greater earning power. They are "Ten Years' Promotion in One" and "Accountancy, the Profession that Pays." LaSalle will send them to you FREE.

Your biggest opportunity is as near you as the point of your pencil. If you are determined to make progress, clip and mail the coupon NOW!

— Find Yourself Through LaSalle! —

## LaSalle Extension University

The World's Largest Business Training Institution

Dept. 964—H. R. Chicago

I would welcome details of your salary-increasing plan, together with copy of "Accountancy, the Profession that Pays," also a copy of "Ten Years' Promotion in One," all without obligation.

Higher Accountancy

Other LaSalle Opportunities:

LaSalle opens the way to success in every important field of business. If more interested in one of the fields indicated below, check and mail now.

- |   |   |
|---|---|
| <input type="checkbox"/> Business Management                  | <input type="checkbox"/> Law—Degree of LL.B.            |
| <input type="checkbox"/> Modern Salesmanship                  | <input type="checkbox"/> Modern Business Correspondence |
| <input type="checkbox"/> Traffic Management                   | <input type="checkbox"/> Stenotypy—Stenography          |
| <input type="checkbox"/> Railway Station Management           | <input type="checkbox"/> Expert Bookkeeping             |
| <input type="checkbox"/> Banking and Finance                  | <input type="checkbox"/> C. P. A. Coaching              |
| <input type="checkbox"/> Commercial Law                       | <input type="checkbox"/> Business English               |
| <input type="checkbox"/> Industrial Management                | <input type="checkbox"/> Commercial Spanish             |
| <input type="checkbox"/> Modern Foremanship                   | <input type="checkbox"/> Effective Speaking             |
| <input type="checkbox"/> Personnel Management                 | <input type="checkbox"/> Telegraphy                     |
| <input type="checkbox"/> Credit and Collection Correspondence |   |

Name.....

Present Position.....

Address.....



## BEDFORD YMCA TRADE SCHOOL

Auto Mechanic  
Aviation Mechanic  
Starting, Lighting, Ignition  
Electric Welding  
Oxy-Acetylene Welding  
Machine Shop. Battery Repair  
Electrical Course. Radio Mechanic  
Plumbing, Brick-laying  
Plastering, Tile Setting  
Mechanical, Architectural Drawing  
Blue Print Reading  
Building Estimating  
Show Card Writing  
Window Dressing. Sign Painting  
Commercial Art. Fine Art  
Write for Catalog 50  
Brooklyn Engineering Institute  
(Operated by Bedford Y. M. C. A.)  
1125 Bedford Avenue, Brooklyn  
New York City

**BIG PAY**  
**THRILLING WORK**

**BE A**

**MOVIE OPERATOR**

Make big money in this easy and pleasant work. Big demand for trained operators. We help you earn while learning. Complete course in 6-10 weeks. Don't Wait. Write to-day.  
**MOVIE OPERATORS SCHOOL**  
61 Sprout St. Detroit, Mich.

Learn

## Advertising

at HOME

Send your name and address for free booklet giving interesting information and vital facts about Advertising. Find out how we prepare you at home, in your spare time, for the opportunities open in this fascinating business. Practical work. No text books. Old established school. Successful graduates everywhere. Just the plan you have always wanted. Write today. No obligation.  
**PAGE-DAVIS SCHOOL OF ADVERTISING**  
Dept. 1356 3601 Michigan Ave. Chicago, U. S. A.

## LEARN WATCH REPAIRING

You can learn by our modern and original system of instruction every part of the **Watch Repairing Trade** at home as good or better than at a shop. You can earn money while learning and secure a well paying position or start in business after completing our course of instruction. Good watch repairers are always in demand and earn from \$50 to \$75 per week. For particulars apply to the **Wisconsin School of Watch Repairing**  
166 Mason St., MILWAUKEE, WIS.

## HOT PIANO

Ultra-modern Piano

Jazz taught by mail. Note or ear. Easy rapid lessons for adult beginners. Also Self-instruction system for advanced pianists. Learn 358 Bass Styles, 976 Jazz Breaks, hundreds of Trick Endings, Hot Rhythms, Sock, Stomp and Dirt Effects; Symphonic and Wicked Harmony in latest Radio and Record Style. Write for Free Booklet.  
**WATERMAN PIANO SCHOOL, 1826 W. Adams St., Los Angeles, Calif.**

## STAMMER

IF YOU

Write for my free book "Millard's Advanced Natural Corrective Course" and a free copy of my speech magazine. 10,000 cases successfully treated. Est. 24 years. Largest school for stammerers in world. Millard Inst. of Normal Speech, 2317 Millard Bldg., Milwaukee, Wis.



## ZIP-ZIP SHOOTER

THOUSANDS of boys are made happy with this wonderful Zip-Zip shooter, scientifically and practically made. If you like hunting and outdoor sports, get a Zip-Zip shooter with plenty of pep and force. If your dealer happens not to have them, order from us. Zip-Zip shooter 35c or three for \$1.00; send stamps, coin or money order.

Automatic Rubber Co., Columbia, S. C.





# Speechless...When a Few Words Would Have Made Me!

*But now I can face the largest audience  
without a trace of stage fright*

**T**HE annual banquet of our Association—the biggest men in the industry present—and without a word of warning the Chairman called on me to speak—and my mind went blank!

I half rose from my seat, bowed awkwardly and mumbled, "I'm afraid you'll have to excuse me today," and dropped back in my chair.

Speechless—when a few words would have made me! The opportunity I had been waiting for all my life—and I had thrown it away! If I could have made a simple little speech—giving my opinion of trade conditions in a concise, witty, interesting way, I know I would have been made for life!

Always I have been a victim of paralyzing stage fright. Because of my timidity, my diffidence, I was just a nobody, with no knack of impressing others—of putting myself across. No matter how hard I worked, it all went for nothing—I could never win the big positions, the important offices, simply because I was tongue-tied in public.

And then like magic I discovered how to overcome my stage fright—and I was amazed to learn that I actually had a natural gift for public speaking. With the aid of a splendid, new method, I rapidly developed this gift, until, in a ridiculously short time, I was able to face giant audiences—without a trace of stage fright!

Today I am one of the biggest men in our industry. Scarcely a meeting or banquet is held without me being asked to speak. My

real ability, which was hidden so long by stage fright, is now recognized by everyone. I am asked to conferences, luncheons and banquets as a popular after-dinner speaker. This amazing training has made me into a self-confident aggressive talker—an easy, versatile conversationalist—almost overnight.

\* \* \* \* \*

No matter what work you are now doing nor what may be your station in life; no matter how timid and self-conscious you now are when called upon to speak, you can quickly bring out your natural ability and become a powerful speaker. Now, through an amazing new training you can quickly shape yourself into an outstanding influential speaker, able to dominate one man or five thousand.

**In 20 Minutes  
a Day**

This new method is so delightfully simple and easy that you cannot fail to progress rapidly. Right from the start you will find that it is becoming easier and easier to express yourself. Thousands they can acquire the ability to speak so easily and quickly that they are amazed at the great improvement in themselves.

**Send for this Amazing Booklet**

This new method of training is fully described in a very interesting and informative booklet which is now being sent to everyone

mailing the coupon below. This booklet is called *How to Work Wonders with Words*. In it you are told how this new, easy method will enable you to conquer stage fright, self-consciousness, timidity, bashfulness and fear. Not only men who have made millions but thousands of others have sent for this booklet and are unstinting in their praise of it. You are told how you can bring out and develop your priceless "hidden knack"—the natural gift within you—which will win for you advancement in position and salary, popularity, social standing, power and real success. You can obtain your copy absolutely free by sending the coupon.

**Now  
Sent  
Free**



**NORTH AMERICAN INSTITUTE**  
3601 Michigan Ave. Chicago  
Dept. 1356

**North American Institute**  
3601 Michigan Avenue  
Dept. 1356, Chicago

Please send me FREE and without obligation my copy of your inspiring booklet, *How to Work Wonders with Words*, and full information regarding your course in Effective Speaking.

Name .....

Address .....

City ..... State .....

## What 20 Minutes a Day Will Show You

- How to talk before your club or lodge
- How to address board meetings
- How to propose and respond to toasts
- How to make a political speech
- How to tell entertaining stories
- How to make after-dinner speeches
- How to converse interestingly
- How to write better letters
- How to sell more goods
- How to train your memory
- How to enlarge your vocabulary
- How to overcome stage fright
- How to develop self-confidence
- How to acquire a winning personality
- How to strengthen your will-power and ambition
- How to become a clear, accurate thinker
- How to develop your power of concentration
- How to be the master of any situation

# WANTED- for murder!



## \$1,000 Reward!

In a dirty, forelorn shack by the river's edge they found the mutilated body of Genevieve Martin. Her pretty face was swollen and distorted. Marks on the slender throat showed that she been brutally choked to death. Who had committed this ghastly crime?

Crimes like this are being solved every day by Finger Print Experts. We read in the papers of their exploits, hear of the mysteries they solve, the rewards they win. Finger Print Experts are the heroes of the hour.

### More Trained Men Needed

The demand for trained men by governments, states, cities, detective agencies, corporations, and private bureaus is becoming greater every day. Here is a real opportunity for YOU. Can you imagine a more fascinating line of work than this? Often life and death depend on finger print evidence—and big rewards go to the expert. Many experts earn regularly from \$3,000 to \$10,000 per year.

### Learn At Home in Spare Time

Now, through this amazing new, simple course, you can learn the secrets of this science easily and quickly at home in your spare time. Any man with common school education and average ability can become a Finger Print Detective in surprisingly short time.

### FREE—The Confidential Reports No. 38 Made to His Chief!

IF YOU ACT QUICK—We will send you free and with no obligation whatsoever, a copy of the gripping, fascinating, confidential report Secret Service Operator No. 38 made to His Chief. Mail coupon NOW!

Write quickly for fully illustrated free book on Finger Prints which explains this wonderful training in detail. Don't wait. You may never see this announcement again! You assume no obligation. Mail coupon NOW—while this offer lasts!

### Institute of Applied Science

Dept. 13-56 1920 Sunnyside Avenue, Chicago

### INSTITUTE OF APPLIED SCIENCE, Dept. 13-56 1920 Sunnyside Avenue, Chicago, Ill.

Gentlemen: Without any obligation whatever, send me your new, fully illustrated, FREE book on Finger Prints and the free copy of the Confidential Reports of Operator No. 38 made to His Chief.

Name .....

Address .....

Age .....

## BIG MONEY IN THE AIR!



The big jobs in Aviation always go to the College-trained Aeronautical Engineer. Get ready now to take your place in the world's fastest growing BIG MONEY industry.

### NOW! 2 1/4 Year College B. S. Course

In just 108 interesting weeks Tri-State College gives you the equivalent of four years of the usual technical College work.

Intensive course eliminating frills and specializing in laboratory, science, field work, Mathematics.

Bachelor of Science degree authorized by the State of Indiana.

### LOW COST—NO ENTRANCE EXAMS

Tuition about half. Living expenses low. Fine equipment—competent teachers. For 45 years TRI-STATE has been chosen by men short on time, money and education, but strong in ambition. Terms start

Sept., Jan., March and June. FREE Catalog and record of successful graduates. State course that interests you.

### Engineering Courses

- Given:
- Civil  Aeronautical
  - Mechanical  Chemical
  - Electrical  Commerce
  - Administrative

### TRI-STATE COLLEGE

Box AE-6113 Angola, Ind.

## ACCOUNTING

How to  
learn  
Accounting

THOUSANDS of ambitious men are earning more money today because they know Accounting. Send for our 80-page book, "How to Learn Accounting," and the first lesson. Both will be sent free.

International Accountants Society, Inc.

A Division of the

ALEXANDER HAMILTON INSTITUTE

Dept. 74 3411 So. Michigan Ave., Chicago, Ill.

## Electrical Engineering

Course for men of ambition and limited time. Over 5000 men trained. Condensed course in Theoretical and Practical Electrical Engineering including the closely related subjects of Mathematics and Mechanical Drawing.



Students construct motors, install wiring, test electrical machinery. Course designed to be completed in one college year. Prepare for your profession in the most interesting city in the world. Est. 1893. Catalog on request.

## Bliss Electrical School

119 Takoma Ave., Washington, D. C.

## MUSIC LESSONS IN YOUR HOME

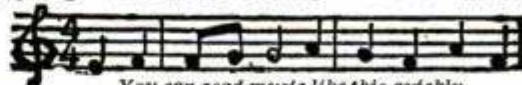

You can read music like this quickly

Write today for our FREE BOOKLET. It tells how to learn to play Piano, Organ, Violin, Mandolin, Guitar, Banjo, etc. Beginners or advanced players. You pay as you learn. Costs only a few cents a day. Thousands of satisfied students.

AMERICAN SCHOOL of MUSIC, 51 Manhattan Bldg., CHICAGO

## GOV'T. POSITIONS

\$35 TO \$75 WEEKLY

MEN-WOMEN

- |   |  |
|---|--|
| <input type="checkbox"/> Ry. Mail Clerk               | <input type="checkbox"/> Steno-Typist        |
| <input type="checkbox"/> Prohibition Inv.             | <input type="checkbox"/> Immigrant Inspector |
| <input type="checkbox"/> R. F. D. Carrier             | <input type="checkbox"/> Seamstress          |
| <input type="checkbox"/> Special Agent (Investigator) | <input type="checkbox"/> Auditor             |
| <input type="checkbox"/> City Mail Carrier            | <input type="checkbox"/> Steno-Secretary     |
| <input type="checkbox"/> Meat Inspector               | <input type="checkbox"/> U. S. Border Patrol |
| <input type="checkbox"/> P. O. Clerk                  | <input type="checkbox"/> Chauffeur-Carrier   |
| <input type="checkbox"/> File Clerk                   | <input type="checkbox"/> Watchman            |
| <input type="checkbox"/> General Clerk                | <input type="checkbox"/> Skilled Laborer     |
| <input type="checkbox"/> Matron                       | <input type="checkbox"/> Postmaster          |
|   | <input type="checkbox"/> Typist              |

GOVERNMENT INSTRUCTION BUREAU, 111 Arcade Bldg., St. Louis, Mo. Send me FREE particulars How To Qualify for positions marked "X". Salaries, locations, opportunities, etc. ALL SENT FREE.

NAME .....

ADDRESS .....

AGE 18 TO 55

# A FRANTIC CALL FOR MEN WHO CAN READ BLUE PRINTS OF BUILDINGS

## Leads Quickly to Jobs Paying \$4,000 to \$12,000 a Year

See how easy it is to get into the building game. Nowhere else does such simple training count for so much. Nowhere else can a man make \$4,000 to \$12,000 a year so quickly and so easily. Nowhere else are there so many countless thousands of openings as there are with contractors, builders, and real estate firms, who are constantly calling for men who can read blue prints. Six billion dollars a year is spent for building. Trained men are at a premium in this gigantic industry. Untold thousands are needed at steady salaries far above the scale wage.

# 90

**DAYS' EASY TRAINING PUTS YOU IN THE 6 BILLION DOLLAR BUILDING FIELD**

NO longer is it necessary to start at the bottom of the building trades and spend years to work up. Now you can get three years' training in three months. There are no barriers to your success in the great outdoor building field. You do not need more than a common school education. We train you at home, in spare time, by the fascinating blue print method with lessons that are as easy to read as your newspaper.

These tested plans come to you from one of the oldest and largest schools of building construction and superintendence in the country. This course is endorsed by leading contractors and master builders. These tested, practical plans and lessons are the kind of training that puts men in \$5,000 to \$15,000 jobs and in profitable building and contracting businesses of their own. You learn from actual blue print plans—from practical building experts—you learn how to read all the plans, estimate the costs and supervise the entire construction of a building—you learn everything a contractor has to know when he undertakes the construction of a building.

Amazing opportunities are open to you when you know blue prints, plans, estimating and construction. There is building superintending—the best outdoor profession on earth—that pays handsome salaries and often a bonus for efficient work. Clifford Scholl went from clerk to Asst. Superintendent at 49% increase in salary in 8 months. Thousands of builders and contractors need men like Clifford Scholl.

**IF YOU LIVE IN OR NEAR CHICAGO**

Visit our School for Builders, open day or evening. Thousand men attend each year. Enter any time. You can get the same training at home, by mail. Same plans; same lessons; same instructors. The Coupon brings all facts FREE.

**Every Job Must Have a Contractor**

The building field is wide open for men who want to go into business for themselves. Henry Mehl, Pa., a policeman, now owns his own contracting business. Burgert, Ill., stepped into a foremanship at 200% increase in salary. Busch, Kan., writes, "I have been offered \$300 a month several times." Boyes, Can., writes, "Your school has increased my wages 40% already." Patrick, Mich., says: "My salary has been increased 92%." Marchand, La., writes, "I am getting along fine. My salary is now increased 196%."

**Chicago Technical School for BUILDERS**

Dept. M-142, 118 E. 26th Street, Chicago, Ill.

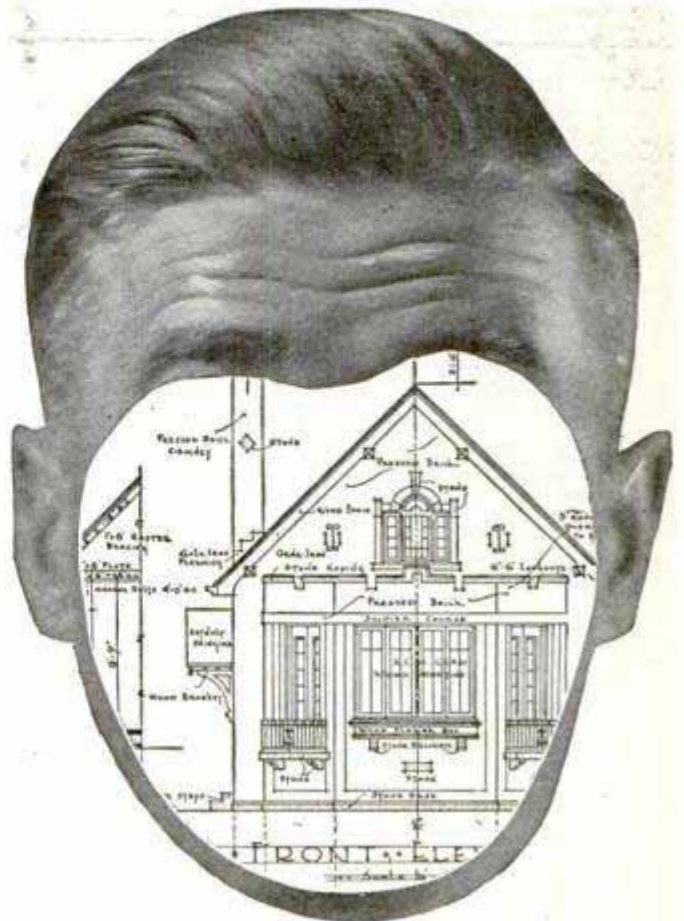

If you really want more money—if you hope to own a business of your own—get into the building business . . . no matter what your job is now. No overcrowding in this tremendous field—room for thousands every day. Why buck competition in crowded industries where only a few men can succeed?

Clerk or carpenter—office man or bricklayer—salesman or superintendent—it makes no difference. You can get into the building business quickly . . . easily. Or if you are in it at present, get this training now that you must have for success.

## FREE Trial Lesson

Simply mail the coupon below for an intensely interesting free book, "How to Read Blue Prints," and full information. See what fascinating fun this first trial lesson is. Get these facts before you. See what amazing opportunities open up for you in the Six Billion Dollar Building Field. Don't wait or delay. Act now. Simply mail the coupon below.



Chicago Technical School for Builders, Dept. M-142, 118 E. 26th Street, Chicago, Ill.

Send me, without obligation, your free book, "How to Read Blue Prints," and full details of the course and the opportunities in the Building Field. It is understood that no salesman will call on me.

Name.....  
 Address.....  
 City..... State.....  
 Age..... Occupation.....



## High School Course in Two Years!

### You Want to Earn Big Money!

And you will not be satisfied unless you earn steady promotion. But are you prepared for the job ahead of you? Do you measure up to the standard that insures success? For a more responsible position a fairly good education is necessary. To write a sensible business letter, to prepare estimates, to figure cost and to compute interest, you must have a certain amount of preparation. All this you must be able to do before you will earn promotion. Many business houses hire no men whose general knowledge is not equal to a high school course. Why? Because big business refuses to burden itself with men who are barred from promotion by the lack of elementary education.

#### Can You Qualify for a Better Position

We have a plan whereby you can. We can give you a complete but simplified high school course in two years, giving you all the essentials that form the foundation of practical business. It will prepare you to hold your own where competition is keen and exacting. Do not doubt your ability, but make up your mind to it and you will soon have the requirements that will bring you success and big money. YOU CAN DO IT.

Let us show you how to get on the road to success. It will not cost you a single working hour. Write today. It costs you nothing but a stamp.

### American School

Dept. H-647 Drexel Ave. and 58th St., Chicago

#### American School

Dept. H-647 Drexel Ave. and 58th St., Chicago

Send me full information on the subject checked and how you will help me win success.

- |                              |                            |
|------------------------------|----------------------------|
| .... Architect               | .... Business Law          |
| .... Building Contractor     | .... Lawyer                |
| .... Automobile Engineer     | .... Machine Shop Practice |
| .... Automobile Repairman    | .... Mechanical Engineer   |
| .... Civil Engineer          | .... Shop Superintendent   |
| .... Structural Engineer     | .... Employment Manager    |
| .... Business Manager        | .... Steam Engineer        |
| .... Cert. Public Accountant | .... Foremanship           |
| .... Accountant and Auditor  | .... Sanitary Engineer     |
| .... Bookkeeper              | .... Surveyor (& Mapping)  |
| .... Draftsman and Designer  | .... Telephone Engineer    |
| .... Electrical Engineer     | .... Telegraph Engineer    |
| .... Electric Light & Power  | .... High School Graduate  |
| .... General Education       | .... Wireless Radio        |
| .... Vocational Guidance     | .... Undecided             |

Name.....

Address.....

## BUILD AND FLY MODEL AIRCRAFT

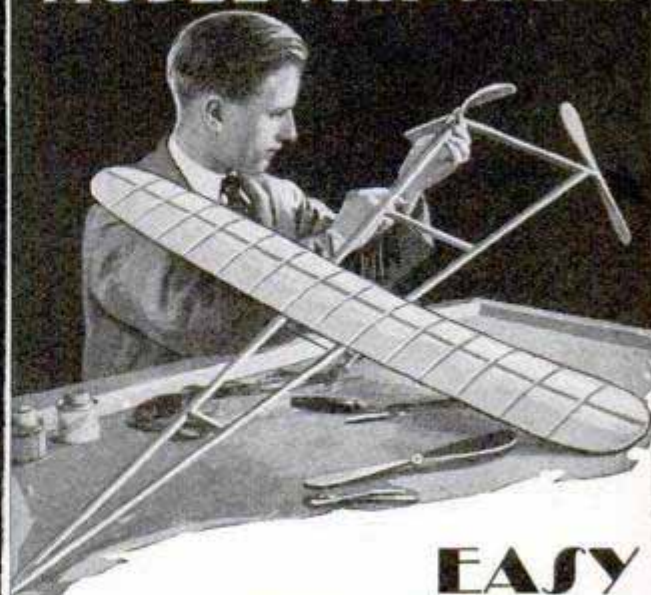

### EASY EXCITING INTERESTING

What a thrill to see your own creation rise from your hand and soar like the most famous life-size planes! Some of these sturdy little craft fly more than a mile and remain in the air for several minutes.

### These Planes Are More Than Mere Toys

and are a definite part of the aviation enthusiasm that is sweeping the country.

Get our complete, easily followed instructions for making all types, including many prize-winners for outdoor flying contests, models for indoor flying, scale models for exhibition purposes, such as Lindbergh's "Spirit of St. Louis," and others.

This official book bears the stamp of approval of authorities like Wright, Lindbergh, Ford, Byrd and Government Officials.

#### ORVILLE WRIGHT

*Father of Aviation, says:*

"My first interest in aviation started with a model flying machine when I was a boy."

**Mail us \$2.25** and we will forward a copy of "Building and Flying Model Aircraft" postpaid, or, if you live in the U. S., we will send it C. O. D. Simply pay postman \$2.25 plus postage when delivered.

*Money refunded if not satisfactory*

**POPULAR MECHANICS PRESS**  
Room P-9 200 E. Ontario St. CHICAGO



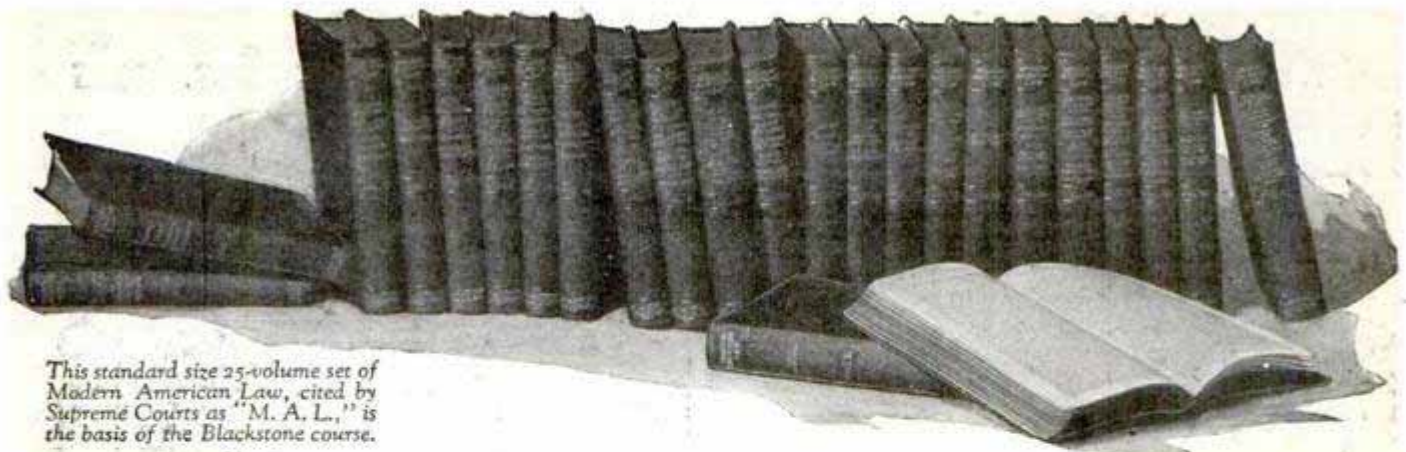

This standard size 25-volume set of *Modern American Law*, cited by Supreme Courts as "M. A. L.," is the basis of the Blackstone course.

# LAW TRAINING = SUCCESS

**T**HIS message is directed to the man who is contemplating the study of law—  
And where is the man who has not at some time yearned for law training and the certainty of success it brings?

## The Aristocrat of Studies

Law is the aristocrat among training courses. Law students are stamped as men of discernment and dignity. They are looked upon with respect. A knowledge of law is an absolute necessity in every line of business or professional activity. Law enhances earning power and serves as the means of certain advancement. The demand for a law training is growing constantly.

For years the Blackstone Institute, through its home-study law course and service has been meeting and satisfying this demand. Today the Institute can point to more than 50,000 people, among them being corporation officials, business executives, bankers, lawyers, public accountants and others, who have received financial, personal or business benefits from this training. Graduates of the course are practicing law in every state.

## The Outstanding Course

The Blackstone Institute delivers to its students immediately upon enrollment the complete set of text books for the entire course—not one volume at a time.

This is the famous 25-volume *Modern American Law* library, cited as standard and authoritative by the courts of last resort. (See illustration in miniature above.) This library forms the basis of the course and serves immediately as a valuable reference work upon the entire field of modern-day law. Many students have said that the library alone is worth the modest tuition fee asked for the entire course.

## Elaborate Lesson Material

But the set of text books is only one part of this rather unusual course. There is, in addition, the elaborate lesson material mailed at regular intervals. The lessons direct the student's study efforts care-

fully, provide him with the written work to be done, and call his attention to rules of law pertaining to his regular daily affairs. LL. B. degree conferred.

This text and lesson material was prepared by a group of eighty of the most prominent law authorities in the United States. Included in the list of authors are Justices Taft and Sutherland of the United States Supreme Court, the deans of eight leading resident law schools, university law professors, and state supreme court judges.

## No Exaggerated Claims

The Institute makes no claim that the study of its course will bring a startling increase in income to every student. Yet most students have reported increases, some as high as 200% before completing the course.

Neither does the Institute claim that a law training will enable you to earn from \$10,000 to \$35,000 a year, yet a great many law-trained men earn in excess of that.

The Institute does claim that a law training is the best foundation for a successful business or professional career, and that its course is without a peer in the field of non-resident law instruction.

## Mail Coupon Today

The Institute prides itself on the value in text and lesson material delivered and the quality of educational service rendered. Full details may be had by asking for a copy of the Institute's 128-page book, "The Law-Trained Man."

Here again is definite value and full recompense for the effort involved in writing for your copy, for this little book contains some valuable legal tips and pointers which you can apply at once in your daily business affairs.

There is no charge for the book. It is free, and you may have a copy with our compliments if you will send a post card request or use the convenient coupon below. Address Blackstone Institute, Dept. 56, 307 N. Michigan Ave., Chicago, Ill.



## 3 GOOD REASONS

- 1 Blackstone Institute teaches one subject only—Law, and its present course is based on 36 years of experience in non-resident educational work.
- 2 The instruction method is a combination of text reading and study of leading illustrative cases—a method recognized as the best and most thorough plan yet devised.
- 3 The authors of the Blackstone course are outstanding authorities in the field of law. They know what law you need and how to teach it to you.

## BLACKSTONE INSTITUTE

Dept. 56, 307 N. Michigan Ave., Chicago, Ill.

Please send me by mail, and without obligation, a copy of your 128-page book, "The Law-Trained Man," and details of your law course and service.

Name \_\_\_\_\_

Business Position \_\_\_\_\_

Business Address \_\_\_\_\_

City \_\_\_\_\_ State \_\_\_\_\_

## You can play the HAWAIIAN GUITAR just like the Hawaiians!

Play all the latest hits just as the Hawaiians do. Be the most popular member of your set, a happy crowd always around you, everybody enjoying and admiring your playing. Get in on all the good times. Entertain your friends—or play professionally. We will help you.



### Native Hawaiian expert directs you

You get expert instruction, directed by a world-famous player and teacher, Prof. Walter Kolomoku. He quickly reveals to you the secrets of this fascinating instrument.

### Complete Conservatory Course

You get 52 complete printed lessons. Nothing is omitted. Pictures explain every move. And no matter how little you know about music when you begin, no matter if you have never touched a musical instrument, you can positively learn to play by our plain, easy picture method. You are sure to learn! What we can do for others we can do for you. 51,000 successful students. This record assures your success.

### Learn at home in spare time

Study in spare time—in absolute privacy—when you like—as long as you like. Even if you don't know one note from another, our method is so simple you begin a piece your first lesson. In half an hour you can play it!

### Only 4 motions to learn

Then you can play any music—popular songs, classical, old-time melodies, native Hawaiian airs—or real jazz—separately or with accompaniment. You'll never be lonesome after you learn to play on this beautiful Hawaiian Guitar.

**GIVEN** when you enroll—  
**\$18 to \$20**  
**Hawaiian Guitar**  
With Genuine Seal Grain Fabrikoid Cover and Complete Playing Outfit

Reliable retailers ask \$18 to \$20 for a similar instrument and outfit without the fine Fabrikoid Case, which alone is valued at \$3.50. Yet you receive this sweet-toned splendidly built Hawaiian Guitar, case and entire playing outfit, including picks, steel playing bar, tuning pipe, etc., without one penny of expense, as soon as you enroll.

### Pay as you play

We make it easy for you. Start any time with a small first payment—then pay while learning. It comes to only a few cents per lesson. And bear in mind: Your only investment is the cost of the course—we furnish everything else.

### No waiting—begin now

No waiting for a class to form—begin at once. The sooner you do, the sooner you will realize your ambition to become a real Hawaiian Guitarist. ACT!

OTHER COURSES ] Tenor Banjo, Violin, Tiple, Tenor Guitar, Ukulele, Banjo Ukulele—well-known instructors.

**FIRST HAWAIIAN CONSERVATORY OF MUSIC, Inc.**  
9th Floor Woolworth Bldg.  
Dept. 648 New York, N. Y.  
Approved as a Correspondence School Under the Laws of the State of New York.  
Member of National Home Study Council.



### Send This Coupon for Liberal Offer!

**FIRST HAWAIIAN CONSERVATORY OF MUSIC, Inc.**  
9th Fl., Woolworth Bldg., Dept. 648, New York, N. Y.

Please send full information about your 52-lesson Hawaiian Guitar Course. I am not obligated to enroll unless I want to.

Name \_\_\_\_\_

Address \_\_\_\_\_

City \_\_\_\_\_ State \_\_\_\_\_

## attractive professions ART and ADVERTISING

Meyer Both Company, a dominant factor for 28 years in art and advertising service, with over 5,000 clients thruout the English speaking world, offers practical instruction in these two fascinating fields open to both men and women. This instruction—based upon so wide an experience—translates the maze of vague theory into demonstrated fact. Individualized home study instruction. If interested in a career in either of these well paid professions send for free book on (1) Art (...) or (2) Advertising (...).

**MEYER BOTH COMPANY**  
MICHIGAN BLVD. AT 20TH ST. Dept. 16, CHICAGO

## Earn More Money as Traffic Manager

Are you anxious to earn real money—\$3,000, \$5,000, \$7,500, \$10,000 a year, and even better? Then become an efficient Traffic Manager. Learn in your spare time to do quickly, accurately and scientifically what the untrained traffic man can do only slowly and with many blunders—learn the whys and wherefores of routes, classifications, rates, procedure before the I. C. C., these and many another accomplishment that marks the difference between the plugger and the specialist. Find out today about LaSalle home-study training in Traffic Management—how it won for Walter Baker the chairmanship of the traffic group of the Retail Trade Board of Boston; how it enabled John R. Meeks, of Sheffield, Ala., to increase his income more than 500 per cent; how it helped Samuel Moss, Jr., bill clerk at \$55 a month, to organize an independent traffic bureau yielding him better than \$10,000 a year. Low cost; easy terms. Send for 64-page book, "Opportunities in Traffic Management." It's FREE.

LaSalle Extension University, Dept. 964-T, Chicago



Wonderful, new device, guides your hand; corrects your writing in a few days. Big improvement in three hours. No failures. Complete outline FREE. Write C. J. Ozment, Dept. 34, St. Louis, Mo.

### LEARN WATCHMAKING AND ENGRAVING

BY OUR PROFIT-SHARING PLAN  
**OUR GRADUATES SUCCEED**

One of our Iowa students started in a very small way—now doing over \$30,000 a year. Another in Wisconsin, over \$10,000 the first year. Day or night classes. Call or write for FREE BOOK.

Chicago School of Watchmaking, Dept. 5601, 549 W. Randolph St., CHICAGO

### BE A DRAFTSMAN

LEARN UNDER ACTUAL WORKING CONDITIONS  
A few months in our big drafting rooms in Cleveland gives you all the training and experience you'll need to get into a big pay job. We help you to employment so you can earn while you learn. Write today.  
NATIONAL INSTITUTE OF DRAFTING, 1201 Ulmer Bldg., CLEVELAND, OHIO

## LEARN ELECTRICAL TRADES

Practical Training on Massive Lay-Out of Expensive Electrical Equipment. Armature Winding, House Wiring, Electric Welding, Electric Refrigeration, Power Plants, Switchboards, Transformers, Motors, Generators, Radio Batteries. Automobile Course included without extra cost. Write Today for Free Catalog.

COLEMAN ELECTRICAL SCHOOL, 1628 Main St., Kansas City, Missouri

# When Thomas Edison groped in the dark

**I**N 1859 Edison was a newsboy on the trains in and out of Detroit. He spent every hour he could spare in the public library "grappling bravely with a certain section, and trying to read it through consecutively, shelf by shelf, regardless of subject."

Admirable determination! Edison was destined to be well read, just as he was destined to become the greatest inventor of all time. But his early desire for fine reading was a blind groping in the dark. The books in a modern public library would take fifty lifetimes to read!

## Now—Everyone Can Be Well Read

Just as America's great inventor brought light into the world through the great medium, electricity — America's great educator brought light to everyone through the medium of good reading. Dr. Charles W. Eliot, from his lifetime of study, selected the pure gold from the world's literature. Into a single set he assembled the essentials of a liberal education, the books that everyone must know to be well read. In the Five-Foot Shelf are the carefully selected writings of 302 immortal authors.

## Dr. Eliot's Plan of Reading FREE

The Five-Foot Shelf is not a "rich man's library." By the famous Collier plan these wonderful books are brought within easy reach of everyone. Do not put off finding out more about this invaluable set.

## Dr. Eliot's Five-Foot Shelf of Books

*(The Harvard Classics)*

Carlyle once said, "If time is precious, no book that will not improve by repeated readings deserves to be read at all." Time nowadays is more precious than ever before. We cannot, like the young Edison, attack the countless shelves of public libraries. Probably none of us possesses the persistency and patience which guided his early reading. We must have only the really great literature, the books that make us think straight, talk clearly and increase both our power to succeed and our enjoyment of life.

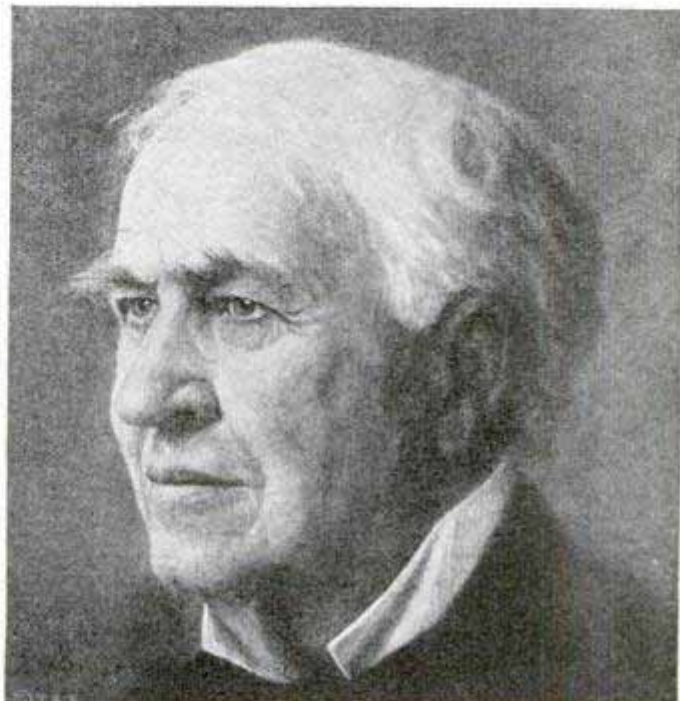

The Harvard Classics answer these requirements to the last detail. Already they are read and cherished in thousands of cultured homes. They are constantly bringing keen enjoyment and deeper understanding into busy lives. "Reading," as Edison himself says, "will never take the place of doing, but it enables us to travel twice as far with half the effort."

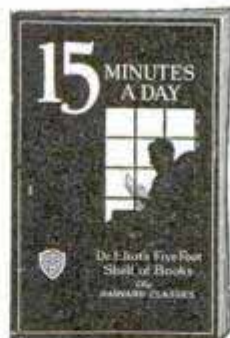

**Mail the Coupon  
TODAY!**

**P. F. COLLIER & SON CO.**  
250 Park Ave., New York City

By mail, free, send me the booklet that tells all about the most famous library in the world, describing Dr. Eliot's Five-Foot Shelf of Books (The Harvard Classics) and containing the plan of reading recommended by Dr. Eliot. Also please advise how I may secure the books by small monthly payments.

Name } .....  
Mr. }  
Mrs. }  
Miss }

Address .....





# "I'm going to raise his salary"

"I've had my eye on him for some time and I know he can handle bigger work."

"He studies those I. C. S. textbooks every chance he gets, and I want to tell you it has made him a valuable man for this business."

"I'm going to raise his salary and give him that new job we were talking about. I wish we had more men like him."

How do you stand when your employer checks up his men for promotion? Does he pass you by as just a routine worker, or does he think of you as a man who is ambitious to get ahead? Won't you be far more likely to get the promotion if he knows you are studying at home and are really preparing yourself to handle bigger work?

Think it over. Then act. It takes only a moment to mark and mail the coupon and find what the International Correspondence Schools can do for you, yet that one simple little step may be the means of changing your whole life. "Do it now."

**Mail the Coupon for Free Booklet**

**INTERNATIONAL CORRESPONDENCE SCHOOLS**  
Box 5636-F, Scranton, Penna.

Without cost or obligation, please send me a copy of your booklet, "Who Wins and Why," and full particulars about the course before which I have marked X in the list below:

**TECHNICAL AND INDUSTRIAL COURSES**

- |  |   |
|--|---|
| <input type="checkbox"/> Architect               | <input type="checkbox"/> Automobile Mechanic                                |
| <input type="checkbox"/> Architectural Draftsman | <input type="checkbox"/> Aviation Engines                                   |
| <input type="checkbox"/> Building Foreman        | <input type="checkbox"/> Plumber and Steam Fitter                           |
| <input type="checkbox"/> Concrete Builder        | <input type="checkbox"/> Plumbing Inspector                                 |
| <input type="checkbox"/> Contractor and Builder  | <input type="checkbox"/> Foreman Plumber                                    |
| <input type="checkbox"/> Structural Draftsman    | <input type="checkbox"/> Heating and Ventilation                            |
| <input type="checkbox"/> Structural Engineer     | <input type="checkbox"/> Sheet-Metal Worker                                 |
| <input type="checkbox"/> Electrical Engineer     | <input type="checkbox"/> Steam Engineer                                     |
| <input type="checkbox"/> Electrical Contractor   | <input type="checkbox"/> Marine Engineer                                    |
| <input type="checkbox"/> Electric Wiring         | <input type="checkbox"/> Refrigeration Engineer                             |
| <input type="checkbox"/> Electric Lighting       | <input type="checkbox"/> R. R. Positions                                    |
| <input type="checkbox"/> Reading Shop Blueprints | <input type="checkbox"/> Highway Engineer                                   |
| <input type="checkbox"/> Telegraph Engineer      | <input type="checkbox"/> Chemistry  |
| <input type="checkbox"/> Telephone Work          | <input type="checkbox"/> Pharmacy   |
| <input type="checkbox"/> Mechanical Engineer     | <input type="checkbox"/> Coal Mining Engineer                               |
| <input type="checkbox"/> Mechanical Draftsman    | <input type="checkbox"/> Navigation <input type="checkbox"/> Assayer        |
| <input type="checkbox"/> Machine Shop Practice   | <input type="checkbox"/> Iron and Steel Worker                              |
| <input type="checkbox"/> Toolmaker               | <input type="checkbox"/> Textile Overseer or Supt.                          |
| <input type="checkbox"/> Patternmaker            | <input type="checkbox"/> Cotton Manufacturing                               |
| <input type="checkbox"/> Civil Engineer          | <input type="checkbox"/> Woolen Manufacturing                               |
| <input type="checkbox"/> Surveying and Mapping   | <input type="checkbox"/> Agriculture <input type="checkbox"/> Fruit Growing |
| <input type="checkbox"/> Bridge Engineer         | <input type="checkbox"/> Poultry Farming                                    |
| <input type="checkbox"/> Gas Engine Operating    | <input type="checkbox"/> Mathematics <input type="checkbox"/> Radio         |

**BUSINESS TRAINING COURSES**

- |  |   |
|--|---|
| <input type="checkbox"/> Business Management                     | <input type="checkbox"/> Business Correspondence      |
| <input type="checkbox"/> Industrial Management                   | <input type="checkbox"/> Show Card and Sign Lettering |
| <input type="checkbox"/> Personnel Management                    | <input type="checkbox"/> Stenography and Typing       |
| <input type="checkbox"/> Traffic Management                      | <input type="checkbox"/> English                      |
| <input type="checkbox"/> Accounting and C. P. A. Coaching        | <input type="checkbox"/> Civil Service                |
| <input type="checkbox"/> Cost Accounting                         | <input type="checkbox"/> Railway Mail Clerk           |
| <input type="checkbox"/> Bookkeeping                             | <input type="checkbox"/> Mail Carrier                 |
| <input type="checkbox"/> Secretarial Work                        | <input type="checkbox"/> Grade School Subjects        |
| <input type="checkbox"/> Spanish <input type="checkbox"/> French | <input type="checkbox"/> High School Subjects         |
| <input type="checkbox"/> Salesmanship                            | <input type="checkbox"/> Cartooning                   |
| <input type="checkbox"/> Advertising                             | <input type="checkbox"/> Illustrating                 |
|  | <input type="checkbox"/> Lumber Dealer                |

Name.....  
 Address.....  
 City..... State.....  
 Occupation.....

If you reside in Canada, send this coupon to the International Correspondence Schools Canadian, Limited, Montreal, Canada

**Learn ELECTRICITY in 90 Days**  
**Earn \$50 to \$150 Weekly!**

You can do it easily and quickly in electricity. Come to my famous school where, in 12 short weeks, you will be qualified to fill one of the many high paid jobs in this interesting field.

**Learn on Machines—No Books**

You work with expert instructors on full size motors, generators, batteries, switchboards, telephone and telegraph systems. McSweeney Trained Men get the biggest pay jobs because they receive such complete and thorough training.

**No Experience or Education Needed**

It is easy to learn Electricity in my fascinating, practical workshop. No books to read. No dry lectures to listen to. You learn by doing. No matter how little you know about Electricity now, I guarantee that, when you graduate you'll know Electricity from "A" to "Z." And if you cannot fill a big pay job I'll refund every penny of your tuition.



**SATISFACTION GUARANTEED**

If you are not satisfied upon graduation your tuition will be refunded.



**McSWEENEY ELECTRICAL SCHOOL**  
Dept. E-10-J Cleveland, Ohio

**BIG BOOK SENT FREE**

Today — now, decide to get out of the low pay rut. Take the first step by sending for my big illustrated book on ELECTRICITY and special tuition offer.

**New Way to Improve YOUR ENGLISH**



A command of effective English gives you added advantages and better opportunities. Poor English handicaps you more than you now realize. You can improve your English through Sherwin Cody's 100% self-correcting invention.

If you are ever embarrassed by mistakes in grammar, spelling, punctuation, or pronunciation, this new free book "How to Speak and Write Masterly English" will prove a revelation to you. Send for it now. It is free. Address **SHERWIN CODY SCHOOL OF ENGLISH** 59 Searle Building Rochester, N. Y.

**PLAY BANJO**



LET the sweet-voiced, easy-playing Gibson banjo help you make your dreams come true. Gibson banjoists play everywhere — on the records, over the radio, on the stage, for dances and parties. The Gibson is easy to learn. Francis Henry, at left, with Guy Lombardo, plays a Gibson banjo. You learn to play a Gibson easily, quickly.

**Gibson** FREE Trial, Easy Payments

Send the coupon for information and free book, "The Road to Happiness." Check the instrument desired.



**GIBSON, INC., 903 Parsons Street, Kalamazoo, Michigan.**  
 Gentlemen: Please send free book and complete information about  
 BANJO  GUITAR  MANDOLIN  
 Name.....  
 St.....  
 City.....

# I Will Train You at Home to Fill a Big-Pay Radio Job



If you are earning a penny less than \$50 a week, send for my book of information on the opportunities in Radio. It's FREE. Clip the coupon NOW. A flood of gold is pouring into Radio creating hundreds of big pay jobs. Why go along at \$25, \$30 or \$45 a week when the good jobs in Radio pay \$50, \$75 and up to \$250 a week? "Rich Rewards in Radio" gives full information on these big jobs and explains how you can quickly learn Radio through my easy, practical home-study training.

**Salaries of \$50 to \$250 a Week Not Unusual**

The amazing growth of Radio has astounded the world. In a few short years three hundred thousand jobs have been created. And the biggest growth is still to come. That's why salaries of \$50 to \$250 a week are not unusual. Radio simply hasn't got nearly the number of thoroughly trained men it needs.

**You Can Learn Quickly and Easily in Spare Time**

Hundreds of N. R. I. trained men are today making big money—holding down big jobs—in the Radio field. You, too, should get into Radio. You can stay home, hold your job, and learn in your spare time. Lack of high school education or Radio experience are no drawbacks.

**Many Earn \$15, \$20, \$30 Weekly on the Side While Learning**

I teach you to begin making money shortly after you enroll. My new practical method makes this possible. I give you SIX BIG OUTFITS of Radio parts and teach you to build practically every type of receiving set known. M. E. Sullivan, 412-73rd St., Brooklyn, N. Y., writes, "I made \$720 while studying." G. W. Page, 1807-21st Ave., S., Nashville, Tenn., "I picked up \$935 in my spare time while studying."

**Your Money Back if Not Satisfied**

My course fits you for all lines—manufacturing, selling, servicing sets, in business for yourself, operating on board ship or in a broadcasting station—and many others. I back up my training with a signed agreement to refund every penny of your money if, after completion, you are not satisfied with the lessons and instructions I give you.

**Act NOW—64-Page Book Is FREE**

Send for this big book of Radio information. It has put hundreds of fellows on the road to bigger pay and success. Get it. See what Radio offers you, and how my Employment Department helps you get into Radio after you graduate. Clip or tear out the coupon and mail it RIGHT NOW.

J. E. SMITH, President, Dept. 9WP,  
National Radio Institute,  
Washington, D. C.

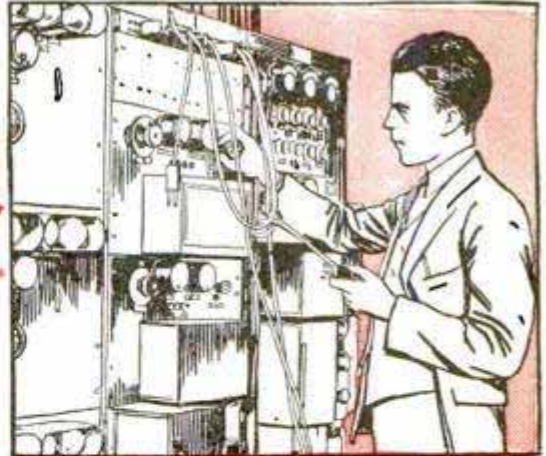

**You can build 100 circuits with the six big outfits of Radio parts I give you**

**3 of the 100 you can build**

**Find out quick about this practical way to big pay**

**Mail This FREE COUPON Today**

J. E. Smith, President,  
Dept. 9WP, National Radio Institute,  
Washington, D. C.  
Dear Mr. Smith: Send me your Free book "Rich Rewards in Radio" giving information on the big-money opportunities in Radio and your practical method of teaching with six Radio Outfits. I understand this places me under no obligation.

Name..... Age.....  
Address.....  
City..... State.....  
Occupation.....

**Here's the PROOF**



**\$375 One Month in Spare Time**

"Recently I made \$375 in one month in my spare time installing, servicing, selling Radio Sets."  
Earle Cummings,  
18 Webster St.,  
Haverhill, Mass.



**\$450 a Month**

"I work in what I believe to be the largest and best equipped Radio shop in the Southwest and also operate KGFI. I am averaging \$450 a month."  
Frank M. Jones,  
922 Guadalupe St.,  
San Angelo, Tex.

**Employment Service to all Graduates**  
**Originators of Radio Home Study Training**

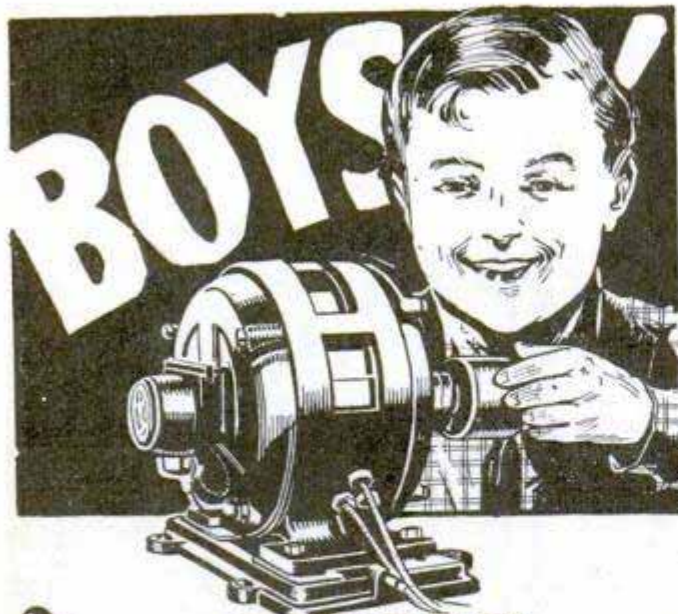

## Here's **FUN** and **SPENDING MONEY**

How'd you like to have a pocketful of spending money all the time—\$5 or \$10 or even \$15 every week—all your own—and a lot of real fun at the same time! It would be great, wouldn't it? Well, you can have it! Hundreds of boys still in school are getting it! And they're no different from you except that they are "Cooke" Trained—they know how to do little electrical jobs in their spare time, after school hours, for which they get real money. I showed them how. And I'll show you, too, just as easily!

### I Will Train You at Home

With my easily learned, fascinating Electrical Course, I'll train you at home like I've trained hundreds of other boys who are now successful men with jobs paying \$60 to \$100 a week! It's all done after school hours, without interfering with your school work or with your regular job if you're working. And it's more like play than study. But it's practical. It's sound. It's up-to-the-minute. It fits you thoroughly to land a Big-Pay job when school days are over. And it pays for itself as you learn and gives you plenty spending money besides, through the spare-time work I tell you how to get, how to do and what to charge for.

### Tools—Apparatus and Radio Course— Given Without Extra Charge

You'll need tools to do Electrical work with, so I give them to you—six big outfits of instruments and apparatus, and a real electric motor—a dandy layout that you can do any kind of spare-time work with—and it's all yours for "keeps." And not only that, but I also give you a brand new Course in Radio! All without extra cost!

#### Makes \$200 a Month

"Dear Mr. Cooke: When I began with you I was a sophomore in High School. Was making \$40 a month as grocery clerk. Now I am a \$200 a month electrician. Not so bad for a 17 year old boy, eh?"  
Oliver P. Cooper  
1131 Middle St.  
Ashland, Pa.

### Mail Coupon Now!

You want lots of spending money! You want a Big-Pay job when you're through school! Sure, you do! Then don't wait a minute—don't hesitate a second—act right this instant to get into this Big-Pay field where you can make \$2 or \$3 or more spare-time money every day while learning. Mail coupon at once and I'll send you my big 72-page book and a sample lesson, too—All FREE. See for yourself how easy it is. Fill in and mail coupon this minute!

**6 BIG  
WORKING  
OUTFITS  
—  
NO EXTRA  
CHARGE**

### Use this FREE BOOK COUPON

L. L. COOKE, Chief Instruction Engineer.  
L. L. COOKE School of Electricity,  
Dept. O16, 2150 Lawrence Ave., Chicago, Ill.

Send me your big Electrical Book, Sample Lesson and particulars about your Electrical Course and extra Radio Course. This does not obligate me in any way.

Name.....

Address.....

(This Coupon only for boys 15 years old or more)

## \$2500 DRAWING \$298 COURSE for



Haven't you often wished that you could draw cartoons, illustrate some idea, sketch some pretty face, etc.? You can do all of these things. One of America's most famous Cartoonists and Illustrators has developed a great, simple system for success in all branches of Commercial Art. This system has revolutionized the entire theory of drawing. It means that drawing can be as easy for you as writing—much simpler than learning shorthand, bookkeeping or typewriting. We are now placing this original system for learning Drawing, Art and Cartooning, consisting of 34 lessons with over 500 illustrations, within reach of every one. If you will devote a few hours each week to the Course WE ABSOLUTELY GUARANTEE that you will learn to draw and draw well before you have half finished the Course. If we fail to make this claim good, we will refund every cent paid us. By eliminating a large office force for answering correspondence, expensive catalogs, etc., we are enabled to make a price of \$2.98, the cheapest price ever known for a high-grade, home study course. Many have sent us letters similar to that of Rob't P. Davis of Detroit, who wrote: "I can't see how you ask so little. It is more than I expected." Learn to draw. It is a big asset, no matter what field you are in.

### Send No Money

Just order the course and **\$2.98**

on arrival pay postman plus a few cents postage, payment in full for the entire Course and Drawing Outfit. If not entirely satisfied, return within five days and we will Refund Money. Address:

LEDERER SCHOOL of DRAWING, Dept. 924-Q, Chattanooga, Tenn.  
Orders from outside the U. S. A. are payable \$3.28 cash with order.

If you order the course at once, we will include a drawing outfit, consisting of artist's pencils, pens, paper, erasers, thumb tacks, etc., enabling you to go to work without any additional cost.

## 500,000 have learned MUSIC this easy way.

Send for free demonstration lesson, and illustrated book. They explain all about this remarkable method whereby anyone can learn to play his favorite instrument by note—quickly and easily at home, without a teacher. If new friends, good times, social popularity appeal to you—take this opportunity to make your dreams come true! No obligation. Address:

U.S. SCHOOL OF MUSIC, 179-A Brunswick Bldg., NEW YORK

## BIG Demand for Skilled Mechanics!

The entire country is calling for skilled mechanics! Good pay—steady work—good opportunities for advancement! Master this fascinating trade with the aid of the

### AMERICAN MACHINISTS' LIBRARY

6 volumes—2,000 pages—2,500 illustrations

(A combined home-study course and reference library)

This library of machine shop practice was written for practical men. It gives you the best methods for every kind of machine shop work. It explains machine tools and their operation, tool work, gears and grinding, jigs and fixtures, automatic screw machines, their tools, punches, dies, etc. Plainly written—completely illustrated—the best kind of help to the machine-shop man who wants to advance himself.

Free  
T  
R  
I  
A  
L

No money down—  
only 7c  
a day

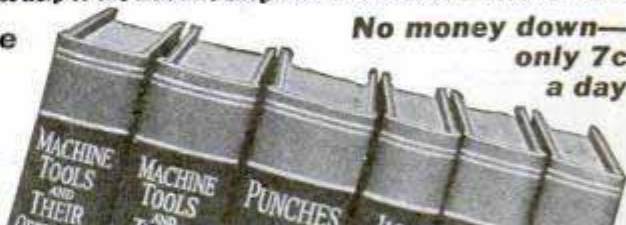

### FREE EXAMINATION COUPON

McGraw-Hill Book Co., Inc., 370 Seventh Ave., New York

Send me for 10 days' free examination the AMERICAN MACHINISTS' LIBRARY. If satisfactory, I will send \$1.50 in 10 days and \$2 monthly until the special price of \$17.50 is paid. If not wanted, I will return the books at your expense.

Signed.....

Address.....

City and State.....

Position.....

Company..... P. M. 9-29

*"The Von Hoffmann Graduate Qualifies"*

# Von Hoffmann Aircraft School

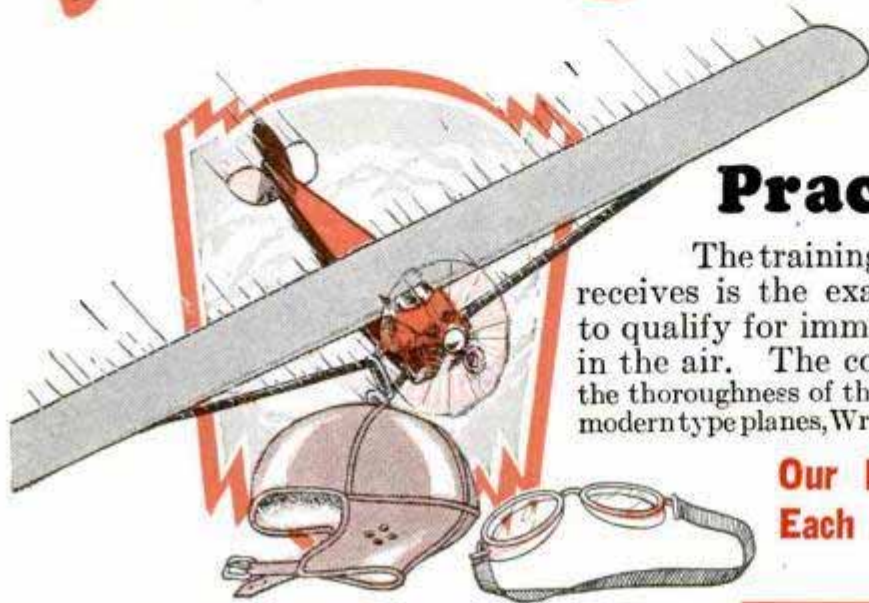

## Will Give You a Thorough— Practical Training

The training which the Von Hoffmann student receives is the exact training which he must have to qualify for immediate positions on the ground or in the air. The cost is low considering daily flying, the thoroughness of theoretical and ground instruction on latest modern type planes, Wright Whirlwind and other standard motors.

**Our Instructors Are Ex-Army Pilots  
Each with Over 3000 Hours of Flying**

Our School Registered, All Instructors and Airplanes Licensed by U. S. Government, Aeronautics Branch, Dept. of Commerce

All Airplanes used by us for both instruction and passenger service are planes licensed by the U. S. Government and our instructors are U. S. Licensed Transport Pilots and U. S. Licensed Mechanics. Our equipment is new and of modern design, subject to daily U. S. Government Inspection. (We have a resident U. S. Government Inspector on the field—think what this means to you.)

### Ground Course



### Easy Monthly Payments

It is easy to pay the Von Hoffmann way because small monthly payments are extended. Let us show you how you can start now and pay later, even after you have finished the course of training.

### Von Hoffmann Aircraft School

121 Lambert-St. Louis  
Flying Field  
(Lindbergh's Own Field)  
St. Louis,  
Mo.

### A Record to Be Proud Of

Our record to date shows that every Von Hoffmann graduate has received a U. S. Government License.



### Flying Course

We teach you by actual flying and practical instruction; no long course needed. No student bond required.

# Start NOW!

**Free Information Coupon—**  
 Von Hoffmann Aircraft School,  
 121 Lambert-St. Louis Flying Field (Lindbergh's Own Field), St. Louis, Mo.  
 Please mail FREE information at once.  
 Name .....  
 Address .....  
 Town .....  
 State .....  
 Age .....

Students at work on 1929 Packard Str. 8. Other 1929 Models include: Buick, Studebaker, Marmon, Auburn, Nash, Eco, Essex, DeSoto, Chev., Ford, Oakland—and 11 more chassis.

**\$25,000 worth of 1929 cars for you to work on!**

**Learn Autos IN LOS ANGELES**

**and LEARN IT RIGHT!**

**1. NATIONAL—America's Best Equipped Auto School**

NATIONAL is a Million Dollar institution—established in Los Angeles in 1905—recognized throughout the automotive industry as one of America's foremost trade schools. NATIONAL offers practical, intensive training in all automotive branches. No age limit. No previous experience necessary. You learn by "Actual-Shop" Methods. Life Scholarship privileges. Start any time of the year.

**2. NATIONAL Qualifies YOU to Make Good**

NATIONAL properly trains you in the Auto Trades in the short time of 4 to 6 months. Upon completing this Condensed Course you are fully qualified as a Practical, Competent Automobile man, and you have not risked your chances of employment because of inferior, incomplete instruction.

**3. NATIONAL Guarantees YOU Efficient Employment Service**

NATIONAL GUARANTEES to give unlimited and efficient Employment Service to students wishing to earn living expenses while learning; and to graduates getting started in the automobile field. This is the most any reputable school can be expected to do.

**4. NATIONAL'S Training in Every Man's Reach**

NATIONAL offers YOU the very best technical-practical training that money can buy at a cost within every man's reach. It does not offer to pay your railroad fare, room and board or other personal expenses, preferring to limit its activities to the PROPER TRAINING OF MEN FOR SUCCESS.

**5. Come to LOS ANGELES—the Playground of America!**

LOS ANGELES is the heart of the country's most prosperous automobile section—as well as the world's most ideal city in which to live and prepare for success in the auto game.

**WRITE for FREE BOOK NOW!**

**National Automotive School**

NATIONAL AUTOMOTIVE, Dept. 726, 4006 Figueroa St., Los Angeles, Calif.

Send me, absolutely free, your big illustrated catalog of Automotive Opportunities.

Name.....  
Address.....  
Age..... City..... State.....

*Your Future assured!*

National Automotive LOS ANGELES

**BIG PAY**

**CAMERA MEN PHOTOGRAPHERS**

You can soon qualify for the wonderful opportunity in this big pay profession.

**BE A MOVIE OPERATOR**  
Projector Given  
Learn at Home.  
Big Demand by Movie and Vaudeville Theatres.

**CAMERA FREE BOOK** explains opportunities as Motion Picture Camera Man, Portrait, Commercial or News Photographer or in your own business. Learn at Home or in our great New York Studios. Write for Free Book and Job Chart.

**N. Y. INSTITUTE OF PHOTOGRAPHY**  
10 West 33rd St., N. Y. Dept. A-1404

**A NEW CAR in 30 minutes**

Get the **BEAUTY** and **LUSTRE** of a **NEW PAINT JOB** at a small fraction of the cost. Do it Yourself with **NUKAR**. NOT a Wax. NOT a Paint. NOT a Polish. This New Chemical discovery instantly restores Original Color to dull faded cars; and gives a Beautiful, Brilliant, Mirror-Like Lustre that lasts for months. Does not hold Dirt or Dust. Actually makes old Shabby Cars look **NEW**. No rubbing—No hard work. Flows on like water from a sponge. No Waiting—No Delay—Drive a **NEW CAR** the same day. Results Guaranteed.

**MEN! Amazing Cash Profits**  
Are being made by Agents, Distributors and Service Station operators. Get in on the biggest thing in the automobile business today. Earn up to \$50 a day. Full or part time. Millions of cars need NUKAR. Makes a Sensational sales compelling Demonstration. We back you to the limit with powerful Sales Co-operation and give you **FREE**—a Business Start that Money could not Buy. Let us send Prepaid and without charge a **FREE SAMPLE** and our Big Book in colors. **Act NOW. Write TODAY.**

**FREE SAMPLE PROVES IT**

**Atlas Solvent Co., 5647 Harper Ave., Dept. 163, Chicago, Ill.**

**BART'S NEW CHALK TALK BOOK**

"Their Best Stunts" from 25 chalk experienced talk artists. \$1.25 prepaid, 5-day trial. Also catalog "A," Art Supplies, or "S," Show Card Supplies.

**BART SUPPLIES, 522 Eustis Bldg., Minneapolis, Minn.**

**DRAFTING**

**BOOKS SENT FREE!**

Only fifteen minutes a day with these **WONDER BOOKS** will prepare you for a good Drafting job in less than a year! Mechanical and Architectural Drafting from simple straight lines to important, complex plans, a step at a time! Built especially for beginners, for men with only grammar schooling. Drafting room practice plus engineering made easy and clear!

**For Beginners**  
Written so you can understand every word, by 18 famous Engineers and Architects. Deluxe, flexible binding. 1750 pages, 1050 blue prints, charts and diagrams. Prepares you for a good Drafting job in mechanical or architectural lines. Sent for 15 days' free use. If you mail coupon immediately.

**Big Field—Big Demand—Big Pay!**  
Competent Draftsmen are urgently needed right now in all building and manufacturing lines at \$50 to \$100 a week. That's just the beginning—for draftsmen have the best chance for advancement! Pleasant, fascinating work, easy to learn and do. Learn quick with these books—send coupon for a set **FREE**, and see for yourself!

*A year's Consulting Membership in the American Technical Society now given free to all readers of this famous Cyclopedia of Drafting. Many say that's worth more than cost of books.*

**Modern American Homes FREE!**

American Technical Society  
Dept. D619, 58th & Drexel Ave., Chicago

Send for 15 days' free use 4-volume set of **DRAFTING**. In return for mailing this coupon promptly send absolutely **FREE** "Modern American Homes," 112 plates, exteriors, interiors and plans. I will pay the few cents delivery charges. If I wish I may return books in 15 days and owe you nothing. But if I prefer to keep them I will send \$1.50 after 15 days, then \$2.00 a month until \$14.50 (special reduced price) is paid.

Name.....  
Address.....  
Employed by.....  
Address.....



Broadcasting Station WISN is operated from The School of Engineering; also Amateur Station W9SO.



Established 1903. Chartered by State of Wisconsin.

**Oscar Werwath, E. E.**

Director of the Extension Division, School of Engineering — Pioneer in electrical training for 25 years.

**"NOW I will train YOU for BIG PAY in ELECTRICITY IN YOUR OWN HOME Just as I have trained 25,000 Graduates in my Great Electrical School"**

**N**OW, through my Extension Division, I will train you for advancement and **MORE PAY** in Electricity without your leaving your home! You will get the same course, the same methods, the same faculty of skilled engineers that have made The School of Engineering internationally famous.

Behind your training will be an institution specializing in Electricity. Not a mere correspondence college but a fully established college, over 25 years old, recognized by the U. S. Gov't. Thousands of S. of E. graduates now employed in important positions with largest concerns in the country.

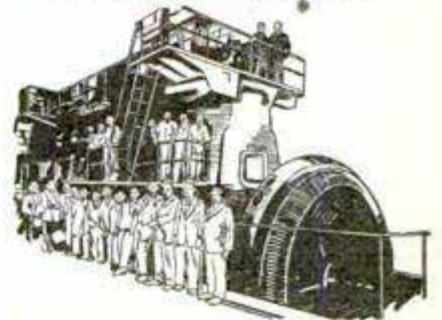

Diesel Engines for the Panama Canal, on which S. of E. Students assisted with acceptance tests at the request of U. S. Government.

**ELECTRICALLY TRAINED MEN Earn \$3,000 to \$10,000 a Year**

In Radio, Television, Aviation, Automotives, Refrigeration, Moving Pictures, Super-Power, Lighting—Electricity is the key. Big manufacturers are pleading for men trained in **Practical Electricity**. Salaries of **\$3,000 to \$10,000** a year now are common. Here is a vast field for you, with unlimited opportunities. **Now** is the time. Start on the road of Electrical Training that leads to bigger pay—bigger opportunities—and **SUCCESS!**

**EARN AS YOU LEARN**

Cash in on your Electrical Training while you're learning. Many students report increased earnings, advancement, even while studying. Train in your spare time at home. Employment Service renders **FREE** aid for life. Lifetime Consultation Service. Many exclusive features available nowhere else. Mail the coupon today for full particulars.

**EXTENSION DIVISION SCHOOL of ENGINEERING**

Dept. 30, Milwaukee, Wisconsin

**FREE!**

Send Coupon **TODAY** for **FREE** illustrated Catalog — "Practical Electricity—the Key to Success"—and full details of Extension Division Training.

**MAIL COUPON NOW!**

Extension Division, Dept. 30  
SCHOOL OF ENGINEERING  
Milwaukee, Wisconsin

Please send me, without obligation, **FREE** illustrated catalog, "Practical Electricity—the Key to Success," and details of Extension Division training.

Name.....

Address.....

**Home Shop-Laboratory Without Extra Cost!**



A Full-sized Home Shop-Laboratory (not toys) that you can't duplicate for \$80, included with each course without extra charge.

**Exclusive Patented Laboratory Equipment**

that cannot be secured elsewhere. **Special Unit Board System** makes fascinating sport of laboratory experiments. Amazingly easy to use.



**Learn By Doing**



No mere book on theoretical study—but **PRAC-TICAL** training on full-sized motor, switchboard, circuits, and electrical equipment.

**Satisfaction Guaranteed**

You can take S. of E. Home Shop-Laboratory training without risking a penny. **Guarantee Bond** protects you.



# BARBERING

Now One of the Highest Paid Professions! \$90 to \$150 Every Week!



**Easy to Learn—Quick**

**to Earn!** That's BARBERING for YOU! And the best part of it all is this—scientific barbering, as taught the modern MOLER way, makes YOU a Master Barber in a short course of intensive training, at small expense! You soon step out as your own Boss, if you wish, in your own Shop, which we will gladly help you equip.

**MOLER Graduates are Always Busy!** MOLER trained Men are always given the preference, for they alone possess the valuable, thorough MOLER training in the application of all the latest scientific Barbering methods, including the Electric hair cutter, the mechanical massage, and the latest vogues in ladies' hair bobbing. MOLER also gives special training in ladies' marcelling and an easy practical course in the treatment of skin diseases.

**EARN WHILE LEARNING!**  
 "Where there's a Will there's a Way" to earn BIG pay! Write to the nearest MOLER College, there is one near you, and learn how you can earn while you learn the barber trade. Ask for the new FREE MOLER Barbering Booklet B. Find out HOW MOLER helps you help yourself AFTER you graduate, as well as BEFORE! Find out why MOLER Men are making DOUBLE the money others made last year, before Ladies' Shingle Bobbing became so popular. You're NEXT in line for big pay—the MOLER way. Send Coupon TODAY!

**Standardized Branches**

## Moler System of Colleges

- |                                   |                                    |
|-----------------------------------|------------------------------------|
| 139 E. 23rd St., New York City.   | 109 S. 15th St., Omaha, Nebr.      |
| 512 N. State St., Chicago, Ill.   | 501 E. Water St., Milwaukee, Wis.  |
| 810 N. 6th St., St. Louis, Mo.    | 81 Forsyth St., N.W., Atlanta, Ga. |
| 801 Main St., Kansas City, Mo.    | 81 S. Second St., Memphis, Tenn.   |
| 206 E. 4th St., Cincinnati, Ohio. | 912 Main St., Dallas, Texas.       |
| 215 Huron Road, Cleveland, Ohio.  |                                    |
| 559 Michigan Ave., Detroit, Mich. |                                    |

**Address Nearest Branch**

Please send me without obligation on my part your Booklet B,

Name.....  
 Address.....  
 City..... State.....

# Why Good Dancers Are Popular

Everyone admires and wants to dance with the person who knows the latest steps. There is no need of being a wallflower! By my remarkable new easy method anyone can learn the newest dances at home in a few hours. Much less expensive than from a personal teacher. No music or partner needed. So simple even a child can learn quickly. Almost one half million have learned dancing this easy way. Your own success is guaranteed.



To prove I can quickly and easily make you an accomplished dancer, I will send you FREE my new book, "The Short Cut to Popularity," and FIVE TEST LESSONS. To pay the cost of mailing, handling, etc., send 25c. Learn in private—surprise your friends. Act now and be a good dancer soon!

ARTHUR MURRAY, Studio 943, 7 E. 43rd St., New York

## NEW AUTO-MATIC RADIO GAS LIGHTER

LIGHTS GAS LIKE MAGIC  
 No Flint—No Friction

Make \$36 A Day

No spark or flame. Lights instantly mantles, gas stoves, jets, and heaters. Held directly over gas flow. Flame appears instantly. Absolutely safe.

Light Gas by RADIO Gas Lighter

A big 25c seller, paying 400% clear profit. A gross easily sold in a day brings \$36.00 and costs you \$10.00. You make \$26.00 clear profit. Rush \$10.00 for gross, or \$1.00 for sample dozen, with amazing new sure-fire self-selling plans.

MASTERLITE MFG. CO.  
 Dept. RJ-19, 110 E. 23d St., New York City



Lincoln got his education chiefly by home-study. So can YOU.

## HIGH SCHOOL EDUCATION AT HOME

Fascinating Question and Answer method. Used in High Schools. Certificate awarded. Write for FREE BOOKLET, "New Way to Get a High School Education at Home." HIGH SCHOOL HOME STUDY BUREAU. 31 Union Sq., Dept. K-8, New York.

**\$19<sup>85</sup>**

## ELECTRICAL ENGINEERING IN 2 YEARS

Get Ready for a Professional Position

Come into Electrical Engineering, the \$20,000,000,-000 field offering wide variety of big pay jobs. The "Success-building" Course is at TRI-STATE. Only 96 weeks to a B. S. Degree (state authorized) and then up the ladder to \$5000 to \$10,000 a year.

**STANDARD COURSE AT LOW COST**

We save you time and money by leaving out frills of 4-year course, and by concentrating on laboratory, science and field work. Tuition and living expenses unusually small.

No Entrance Exams—No H. S. Diploma Needed

We give you preparatory training if needed. Fine equipment—competent teachers. For 45 years, TRI-STATE has been chosen by men short on money and education, but strong in ambition. Wonderful bunch of students. Terms start Sept., Jan., March and June. Send coupon for FREE catalog on course that interests you.

### TRI-STATE COLLEGE

Box EL-6113, ANGOLA, IND.

Tri-State College, Box EL-6113, Angola, Indiana.

Administrative  Business Course  
 Aeronautics I  Electrical  Civil  
 Mechanical  Chemical

"The College of Successful Graduates"

Please send your free catalog on checked (x) subjects.

Name.....  
 Address.....

Every Universal instructor is a transport pilot with many years experience in student instruction. Right: Gov. licensed planes with air cooled motors used at all stages of instruction in Universal Schools.



## Prepare Now For Next Year's Aviation Opportunities. Before 1930 **LEARN TO FLY**

**Y**EAR-ROUND instruction is available in Universal Aviation Schools. Start now to earn your wings. By spring you may become a full fledged transport pilot. All your training will be behind you and you will be ready for the bigger opportunities which will be forthcoming in aviation next spring.

Universal training is found in the fact that Universal flight students are insurable through a master insurance policy—the first of its kind covering flight students ever issued by an insurance firm. Courses in Aviation Mechanics, Aviation Welding and Aviation Business are available either during days or at night. This training is probably the most thorough in the industry. Schools are located conveniently nearby. Send for complete description of Universal Courses, their prices and description of individual schools.

### All Types of Training in Universal Schools

Almost any young man can learn to fly under Universal methods of instruction. Modern, easy-to-handle planes are used exclusively. Only transport pilots, with many hours of experience in student instruction, are employed. Complete ground instruction is included in each flying course. Evidence of the safety of

### FREE: Mail Coupon

A beautifully illustrated book, "Aviation—What It Means To You," is yours for the asking. It answers all questions and gives you an honest, sincere picture of what aviation is doing and can offer you. Mail the coupon for your free copy.

## Universal Aviation Schools

Universal Flying School, St. Louis, Mo.  
Universal Flying Sch'l, Minneapolis, Minn.  
Porterfield Flying Sch'l, Kansas City, Kan.  
Universal Flying Sch'l, Oklahoma City, Ok.  
Universal Flying School, Rochester, Minn.

Universal Flying School, Marion, Ill.  
Universal Flying Sch'l, St. Paul, Minn.  
Universal Flying Sch'l, Memphis, Tenn.  
Universal Flying Sch'l, Cleveland, Ohio  
Universal Flying School, Wichita, Kan.



Department of Commerce Flying and Ground School rating applied for by all Universal Flying Schools.



Universal Aviation Schools  
1047-56 Boatman's Bank Bldg.  
St. Louis, Mo.

Please send me at once your free book, "Aviation—What It Means To You." I am interested in:

- Flying Course  Business Course  
 Aviation Mechanic's Course

Name.....Age.....  
Address.....  
City.....State.....

**CLIP THIS COUPON**

NR325



Class of flight students receiving instruction on theory of flight.

The Universal Welding Course prepares a man to step into a good paying position.



Students taking Aviation Mechanic's Course receive thorough training.

Aviation Business Course prepares Student for business side of aviation.



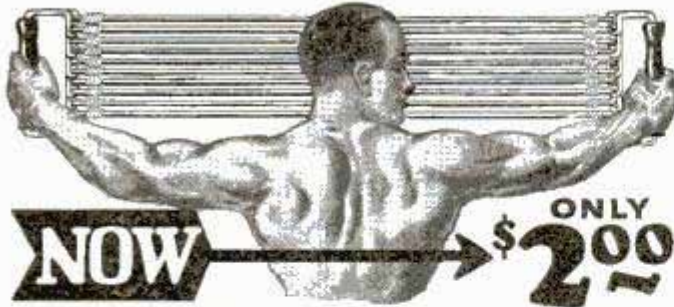

**NOW** → **ONLY \$2.00**  
**Giant Chest Expander**

**and Progressive Exerciser**

Be a muscular marvel. Have the muscles of a superman. Become strong for your health's sake or to astound your friends with extraordinary feats which only men of giant strength can do. In a few short weeks you will easily do stunts which now seem difficult—then real muscles and strength will be yours—and yours to keep. If you want exercise to just keep in good shape you can reduce the strength of the Progressive Exerciser by eliminating as many cables as you wish. If you want great resistance so as to build up big solid muscles then use the full strength.

**Send No Money Use This Money Saving Coupon**

**How the Giant Chest Expander and Progressive Exerciser is Made**

The Giant Chest Expander and Progressive Exerciser is made with new live, springy rubber so as to give it long wearing and great resisting qualities. Do not pay more for an exerciser that has forty or less rubber strands to each cable. Get the best and most durable. The Giant Progressive Exerciser has 50 strands of the finest rubber procurable to each cable.

**Free Instructions**

We do not think it enough to send you an exerciser worth double what we ask, so for a limited time, we will also include instructions absolutely free. These instructions are interesting and simple to follow—they show you the short cut to health and strength. Order today before this wonderful offer is withdrawn.

**Your Guarantee**

The Giant Chest Expander is sold with a guarantee that you will say it is the finest you ever saw or your money back.

**5 Cables or double 10 Cables for strength for**

**\$2** The double strength exerciser has resistance of over 200 lbs. **\$4**

**How to Order—Send No Money**

Sign your name and address to coupon below and get your Giant Exerciser at the present low introductory price by return mail. The price is made low because we want everyone to enjoy muscles and strength at the lowest possible cost. Don't pay more—order from us—get the most for your money. Use coupon now.

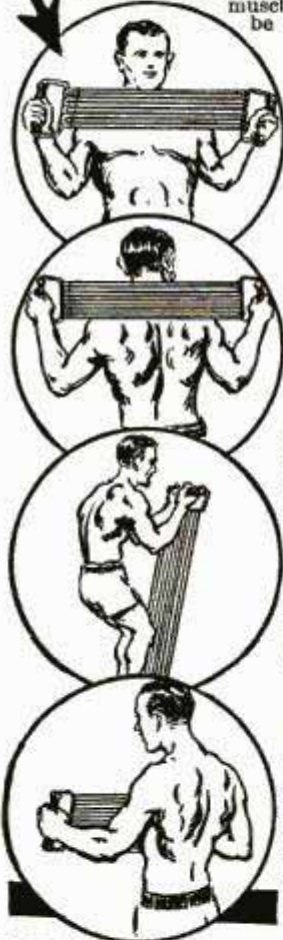

**PROGRESSIVE EXERCISER CO.,**  
 4009 Langdon Bldg.,  
 Broadway and Duane Street, New York

Please send  Your 10 cable Progressive.  
 Your 5 cable Exerciser.

Check the Exerciser you want, and it will be sent you by return mail. Pay postman introductory price, plus few cents postage on arrival. It is understood that if you are not entirely satisfied with your exerciser you may return it within 5 days and get your money back.

Name.....  
 Street.....  
 City.....State.....

If you live outside the United States, send cash with order.



**VALUABLE BOOK ON ELECTRIC REFRIGERATION**

Just off the press—an amazing new book, **Rich Rewards In Electric Refrigeration!** Sent absolutely free without obligation to ambitious men. Reveals unlimited opportunities in America's biggest new industry backed by General Motors, General Electric, etc. Urgent need for trained experts—big pay positions open in every branch!

**NOW . . . QUICK TRAINING AT HOME**

By a new, wonderfully simple course right at home in spare time. Learn while you earn. Fascinating—simple as A.B.C. Endorsed by authorities—highly praised by Servel, Kelvinator and others. No textbooks—entirely practical throughout. Quickly prepares you for the "cream" positions in this uncrowded, fastest-growing field.

**INVESTIGATE AT ONCE!**

Send no money. Simply write today. See for yourself without cost or obligation how marvelously easy it now is to become a highly paid refrigeration expert. **Utilities Engineering Institute, Dept. 19, 4403 Sheridan Road, Chicago, Illinois.**

**Learn to PAINT SIGNS and SHOW CARDS**

We quickly teach you by mail, or at school, in spare time. Big demand. Big future. Interesting work. Oldest, foremost school. **EARN \$50 TO \$200 WEEKLY**

Otto Wiegand, Md., home-study graduate, made \$12,000 from his business in one year. John Vassos, N. Y., gets \$25 for a show card. Crawford, B. C., writes: "Earned \$200 while taking course." Write for complete information.

**DETROIT SCHOOL OF LETTERING**  
 150 Stinson Ave. Est. 1899 DETROIT, MICH.

**WANT THIS JOB?**  
**\$1700 to \$2300 a Year**  
**MAIL CARRIERS—POSTAL CLERK**  
 Men 18 up  
**Steady Work Paid Vacation**  
 Write immediately for FREE list of positions and full particulars telling how to get a position.

**FRANKLIN INSTITUTE**  
 Dept. A-301 Rochester, N. Y.

**LEARN TO Mount Birds**

We teach you At Home by Mail to mount Birds, Animals, Heads, Tax Furs and Make Rugs. Be a taxidermy artist. Easily, quickly learned by men, women and boys. Tremendously interesting and fascinating. Decorate home and den with beautiful art. **Make Big Profits from Spare Time Selling Specimens and Mounting for Others.**

**Free Book—**Yes absolutely Free—beautiful book telling all about how to learn taxidermy. Send Today. You will be delighted. **Don't Delay!**

**Northwestern School of Taxidermy** 2376 Elmwood Bldg. OMAHA, NEB.

**Learn Watchwork, Jewelrywork and Engraving** A fine trade commanding a good salary, and your services always in demand. Address **HOROLOGICAL, Dept. P, Bradley Institute, PEORIA, ILLINOIS,** for our latest catalog.

**LEARN MECHANICAL DENTISTRY**  
**EARN UP TO \$5000 A YEAR**

THIS money-making profession easily learned in a few months in day or evening sessions. Practical training. Individual instruction. Easy terms. Railroad fare allowed—no extra cost. Write NOW for free catalog P, and special tool offer. Address—**SCHOOL OF MECHANICAL DENTISTRY, 147 W. 33rd St., NEW YORK**

**10c NEW SCIENTIFIC WONDER**  
**"X-RAY" CURIO**

**3 for 25c** SILVER ONLY

**BOYS** You apparently see thru Clothes, Wood, Stone, any object. See Bones in Flesh. **FREE—PKG. RADIO BIG FUN PICTURE FILMS.** Takes pictures without camera. "You'll like 'em." 1 pkg. with each 25c order.

**MARVEL MFG. CO. Dept. 31 NEW HAVEN, CONN.**

**"MORE PAY!!  
MORE PAY!!"**

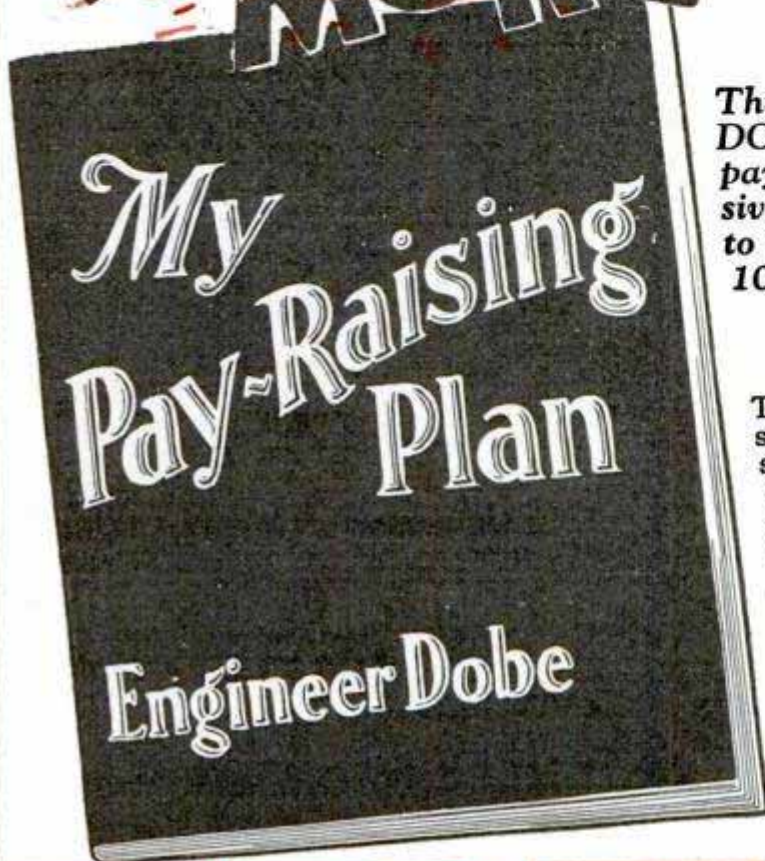

The everlasting cry! And it DOES require more pay and still more pay to live in this fast-moving, expensive age. Write for this book prepared to help you get more pay. More than 10,000 men have asked for it.

—Engineer Dobe

▲ ▲ ▲  
This book is not a catalog. It is just what I say it is, "My Pay-Raising Plan." It contains sound money-making advice. I tell you what training will do for you if you want to get ahead. For instance, I can prove that John Savadge, trained by me, makes \$300 a month. A. H. Bernier, trained by me, earns \$7,000 to \$9,000 a year. Arthur DeWalt, trained by me, makes more than \$400 a month. D. C. Stroop, trained by me, makes \$475 a month. L. V. Broughton, trained by me, makes \$300 a month.

**This Book is Mailed**

**FREE** Write for It

I send you this book FREE in connection with my offer to train you at home in drafting. Large and growing industries have more and more jobs waiting for draftsmen year after year.

Many of the higher executive positions in plants, factories and business houses are filled by men with a foundation originally as Draftsmen.

The construction of all buildings, all machinery, all automobiles, all motor busses, all airships, all electrical apparatus, all manufacturing and construction of any sort, depend upon draftsmen.

I train you at home by mail in your spare time. You keep your job while learning. As soon as you become my student, I give you an opportunity to earn extra money.

When trained by me, I help you get a job without charge. Employers of draftsmen come to me for competent draftsmen at \$60-\$70—up to \$100 a week straight salary.

No previous experience is necessary. You do not need to be a college man or high school graduate. I'll train you 'til you're in a position and EARN MORE PAY at steady work. ALL TOOLS are FURNISHED BY ME.

**Mail This Coupon**

**If You Earn Less Than \$70 a Week**

If you will mail this coupon now, I will send you "My Pay-Raising Plan". Many of the 10,000 and more men who have sent for it are now in good paying positions. The book will come to you postpaid and free.

**1951 Lawrence Ave., Chicago  
Engineer Dobe, Div. 1356**



"I train you at home."  
—Engineer Dobe

**"FREE" Pay-Raising Plan**

**ENGINEER DOBE,**

**1951 Lawrence Ave., Div. 1356 Chicago**

Please send me, free of all cost, "My Pay-Raising Plan". I also want to earn MORE PAY.

Name.....Age.....

Address.....

Post Office.....State.....



Lawyer



Auto Expert



Civil Engineer



Business Manager

# Which Job do YOU Want



Try for it This way

Men don't just fall into easy jobs of big pay positions—they prepare for the big chance before it comes. Make up your mind today what you want to be, then take the first step at once. You don't have to go to college to get ahead. Other men have gone there for you and have put the things they learned there and through years of practical experience into easily understood books which give you a short cut to a better and a bigger job.

We have picked 13 of the best paying professions and have published for your benefit new editions of the most practical, the most valuable books we have ever printed on the subjects covered.

### JIFFY INDEX

Our new Jiffy Index makes each book a quick reference work—no time need be wasted in search or study—put your finger on the facts you want instantly.

### Special Price List of Pay-Raising Books

Automobile Engineering, 5 volumes, over 2,000 pages.....	\$24.80
Civil Engineering, 9 volumes, 3,900 pages, 8000 pictures....	29.80
Practical Business Administration, 12 volumes, 3,400 pages. (Extra volume containing self quiz reading course of 80 lessons included free)	39.80
Electrical Engineering, 8 volumes, 4,300 pages, 3,200 illustrations.....	34.80
Modern Shop Practice, 7 volumes, 7,250 pages, 3,000 pictures.....	29.80
American Law and Practice (with reading course), 13 volumes, 6,000 pages, illustrated.....	49.80
Telephony and Telegraphy, 4 volumes, 1,728 pages, 2,000 pictures.....	14.80
Sanitation, Heating and Ventilating, 4 volumes, 1,454 pages, 1,400 pictures.....	14.80
Drawing, 4 volumes, 1,578 pages, 1,000 pictures, blue prints, etc.....	14.80
Employment Management and Safety Engineering, 7 volumes, 1,800 pages, 540 illustrations, charts and diagrams.....	24.80
Architecture, Carpentry and Building, 5 volumes, includes 58 beautiful architectural plates free.....	24.80

### SHIPPED FREE

Words alone cannot describe the full value these books may be to you, so we ship Free for Examination. Pick the set you want, the price is plainly shown, but **Send No Money**; just your name and address, and the books will be sent promptly. Take fifteen full days to read, test and examine them. You'll realize at once what a tremendous force for a better future they can be. After fifteen days you send only \$2.00; then \$3.00 per month until the balance is paid. **There Are No Interest Charges of Any Kind**; the price shown is the total cost.

### MEMBERSHIP FREE

Anyone who takes advantage now of this opportunity to "Raise his Pay" will be given absolutely free, a certificate of membership in the American Technical Society, which entitles him to full consultation privileges with our experts in his chosen field. This is good for a whole year and is of tremendous value in solving special problems.

American Technical Society, Dept. X619, Drexel Ave. at 58th St., Chicago, U. S. A.

Please send me set of.....

for Fifteen Days' examination. I will examine the books thoroughly and if satisfied, will send \$2.00 within 15 days and \$3.00 each month until I have paid the special price

of \$..... If I decide not to keep the books I will return them at your expense at end of 15 days.

Name.....

Address.....

Reference.....

## NEW FREE BOOK

On How to Raise Poultry for Profit will be sent postpaid, on request to readers of Popular Mechanics. It tells how we help you start a highly profitable spare-time or full-time business of your own or get a good job at good pay. One of our students, J. L. Mosher, of Buffalo, N. Y., for example, started at \$35 a week after tenth Lesson.

Read of the International Poultry work done by Harry M. Lamon, whose methods of increasing egg production, culling out non-layers, saving on feed, raising fat broilers quick, etc., have doubled poultry profits—have raised salaries—have brought good jobs to men and women all over the country. You need this Book. It shows how you too can make poultry pay, make big money quick. Write for your FREE copy—today. Address, National Poultry Institute, Dept. 411-P, Washington, D. C.

## LEARN TO PLAY

VIOLIN, TENOR BANJO, HAWAIIAN GUITAR, BANJO, CORNET, UKULELE, BANJO UKULELE, GUITAR, BANJO MANDOLIN, BANJO GUITAR, MANDOLIN, SNARE DRUM, FIELD DRUM, PIANO OR ORGAN



at home, this new and "easy to learn" way. No teacher or talent required. Entirely different from any "chart" or "diagram" system. Lessons are so simplified and so easily mastered most pupils play by note after only 10 lessons. Thousands of men, women, boys and girls have learned to play quickly and profitably by our Home Study method. Your opportunity to become popular and play for profit or pleasure. A few cents a day pays for lessons. Pay while you learn. Write to-day for full particulars and free trial. No obligation. Instruments except Piano and Organ furnished at cost if desired.

CHICAGO CORRESPONDENCE SCHOOL OF MUSIC, INC. 1632 No. Halsted St., Dept. 10, Chicago, Ill.

## FREE BOOK ON MIND TRAINING

An instructive book which explains an amazing system of mind training already used by more than 650,000 people.

Let us send you a free copy of "Scientific Mind Training." It will show you how and why Peimanism is the only system of teaching for developing all the mental powers at the same time. Endorsed by such distinguished men as Judge Ben B. Lindsey, Sir Harry Lauder, Jerome K. Jerome, Prince Charles of Sweden and hundreds of others. Write TODAY to

### THE PELMAN INSTITUTE OF AMERICA

71 WEST 45th STREET DEPT. 69 New York City

## Learn to PAINT SIGNS and SHOW CARDS

We quickly teach you by mail, or at school, in spare time. Enormous demand. Big future. Interesting work. Oldest and foremost school. **EARN \$50 TO \$200 WEEKLY** Otto Wiegand, Md., home-study graduate, made \$12,000 from his business in one year. John Vassos, N.Y., gets \$25 for a show card. Crawford, B. C., writes: "Earned \$200 while taking course." Write for complete information.



DETROIT SCHOOL OF LETTERING 154 Stinson Ave. Est. 1890 Detroit, Mich.

## Learn Watchwork, Jewelrywork and Engraving

A fine trade commanding a good salary, and your services always in demand. Address **Horological**, Dept. P, Bradley Institute, PEORIA, ILLINOIS, for our latest catalog.

## YOU CAN OIL PAINT

Amazing new method teaches men or women to earn after first lesson. OIL PAINT photos—portraits, landscapes or art subjects. Earn \$16 to \$40 and more a week. OIL PAINT OUT-FIT GIVEN. Send now for free illustrated book. PICTORIAL ART STUDIOS Inc. Dept. MP, 2926 Broadway, Chicago, Ill.

### QUICK RELIEF for

## Hay Fever

Send for this free book. Tells how our Violetta for home use produces instant violet rays and pure ozone so helpful to sufferers from hay fever, summer colds, asthma and respiratory ailments. No medicine. Beneficial also for neuritis, rheumatism, sprains, and many other ailments. Simple, safe, pleasant. No home should be without a Violetta. Lasts for years. Send for all the facts and our liberal free trial offer.



### Address VI-REX COMPANY

Dept. 931 2300 Warren Avenue, Chicago, Ill.

# OIL HEAT



A **LACO**  
for **EVERY HOME**



The **LACO** WUNDER BURNER

**AMAZING- Revolutionized!**  
**Oil Gas Burner**  
Jumps from 68<sup>th</sup> to 9<sup>th</sup> Place  
in Sales Almost Overnight

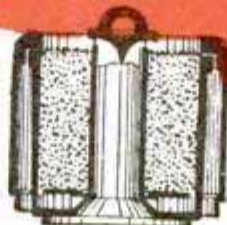

by **EXCLUSIVE PATENTED MINERAL WICK!**

**Mineral Wick**  **ONLY BURNER, SO EQUIPPED!**  
**LACO Burner Places Oil Heat Within Reach of Rich and Poor!**

At last the oil burner industry's greatest problem is **SOLVED!** Waste of oil is eliminated! The **INDESTRUCTIBLE Mineral Wick**, exclusive feature of the Laco, only Wick-Type Burner on the market, does it! Now, **LOW OPERATION COST** is combined with **LOW INITIAL COST!**

Here is the Ford of Oil Burners. It's the first and only burner to use an age-old practical principle others overlooked. It now cuts the costs of an oil-heat system to a fraction of present oil burner prices! By burning **AIR** and **OIL** it eliminates waste, incombusted and unburned gas, and **SOLVES THE FUEL COST PROBLEM!**

## Dealers Wanted Quick

Preferably rated men—but also the man who will invest a small capital in demonstrators—then get out and **SELL**. If this description fits **YOU**, we will offer you an opportunity **BIG ENOUGH FOR ANY MAN.**

**No More Fires to Build Dirty, Heavy Coal to Carry**  
You've adopted the radio, vacuum cleaner, automobile. Why continue the drudgery of ancient coal and wood heat? Our easy purchase plan enables you to have comfort and convenience in your home this very year!

## FITS ANY FURNACE OR STOVE!



The Laco Oil-Gas Burner in one minute turns your present hot-air furnace, steam-heating or vapor-heating plant; kitchen range, parlor furnace, etc., into a modern up-to-date oil heating system!

## Same Even Heat Day or Night

Automatic temperature control. Operates quietly. Nothing to adjust. It's installed and you forget about it. Designed to last a lifetime. Guaranteed. Complies with all ordinances. Actually safer than the ordinary gas range used in a kitchen!

## SOLD ON EASY TERMS

Now—once and for all time—end ashes, dirt, smoke, odor, chopping, shoveling, carrying dirty, heavy coal and wood. The Laco does it for you!

**Write for Details and Special Introductory Low-Price Offer**

Tell type of heating system you now have. Special offer if you mail the convenient coupon now!

**LACO OIL BURNER CO.**

123 Union Street

GRISWOLD, IOWA

## MAIL THIS COUPON ~

Laco Oil Burner Co., 123 Union Street,  
Griswold, Iowa.  
Send facts about your burner, the new Mineral Wick and Special Low-Price Offer.  
Name.....  
St., or Rt.....  
Town.....State.....  
Kind of heating system I now have.....



## “Mary, I Owe It All to You”

“MR. WILLIAMS called me into his office today and told me he was going to raise my salary \$50 a month.

“I am glad to give you this opportunity,” he said, “for the best reason in the world. You deserve it.

“You may not know it, but I’ve been watching your work since the International Correspondence Schools wrote me that you had enrolled for a course of home study. Keep it up, young man, and you’ll go far. I wish we had more men like you.”

“And to think, Mary, I owe it all to you! I might still be drudging along in the same old job at the same old salary if you hadn’t urged me to send in that I. C. S. coupon!”

How about you? Are you always going to work for a small salary? Are you going to waste your natural ability all your life? Or are you going to get ahead in a big way? It all depends on what you do with your spare time.

More than 180,000 men are getting ready for promotion right now in the I. C. S. way. Let us tell you what we are doing for them and what we can do for you.

**Mail the Coupon Today**

### INTERNATIONAL CORRESPONDENCE SCHOOLS Box 5635-F, Scranton, Penna.

Without cost or obligation, please send me a copy of your booklet, “Who Wins and Why,” and full particulars about the course before which I have marked X in the list below:

#### TECHNICAL AND INDUSTRIAL COURSES

- |  |   |
|--|---|
| <input type="checkbox"/> Architect               | <input type="checkbox"/> Automobile Mechanic                                |
| <input type="checkbox"/> Architectural Draftsman | <input type="checkbox"/> Aviation Engines                                   |
| <input type="checkbox"/> Building Foreman        | <input type="checkbox"/> Plumber and Steam Fitter                           |
| <input type="checkbox"/> Concrete Builder        | <input type="checkbox"/> Plumbing Inspector                                 |
| <input type="checkbox"/> Contractor and Builder  | <input type="checkbox"/> Foreman Plumber                                    |
| <input type="checkbox"/> Structural Draftsman    | <input type="checkbox"/> Heating and Ventilation                            |
| <input type="checkbox"/> Structural Engineer     | <input type="checkbox"/> Sheet-Metal Worker                                 |
| <input type="checkbox"/> Electrical Engineer     | <input type="checkbox"/> Steam Engineer                                     |
| <input type="checkbox"/> Electrical Contractor   | <input type="checkbox"/> Marine Engineer                                    |
| <input type="checkbox"/> Electric Wiring         | <input type="checkbox"/> Refrigeration Engineer                             |
| <input type="checkbox"/> Electric Lighting       | <input type="checkbox"/> R. R. Positions                                    |
| <input type="checkbox"/> Reading Shop Blueprints | <input type="checkbox"/> Highway Engineer                                   |
| <input type="checkbox"/> Telegraph Engineer      | <input type="checkbox"/> Chemistry  |
| <input type="checkbox"/> Telephone Work          | <input type="checkbox"/> Pharmacy   |
| <input type="checkbox"/> Mechanical Engineer     | <input type="checkbox"/> Coal Mining Engineer                               |
| <input type="checkbox"/> Mechanical Draftsman    | <input type="checkbox"/> Navigation <input type="checkbox"/> Assayer        |
| <input type="checkbox"/> Machine Shop Practice   | <input type="checkbox"/> Iron and Steel Worker                              |
| <input type="checkbox"/> Toolmaker               | <input type="checkbox"/> Textile Overseer or Supt.                          |
| <input type="checkbox"/> Patternmaker            | <input type="checkbox"/> Cotton Manufacturing                               |
| <input type="checkbox"/> Civil Engineer          | <input type="checkbox"/> Woolen Manufacturing                               |
| <input type="checkbox"/> Surveying and Mapping   | <input type="checkbox"/> Agriculture <input type="checkbox"/> Fruit Growing |
| <input type="checkbox"/> Bridge Engineer         | <input type="checkbox"/> Poultry Farming                                    |
| <input type="checkbox"/> Gas Engine Operating    | <input type="checkbox"/> Mathematics <input type="checkbox"/> Radio         |

#### BUSINESS TRAINING COURSES

- |  |   |
|--|---|
| <input type="checkbox"/> Business Management                     | <input type="checkbox"/> Business Correspondence      |
| <input type="checkbox"/> Industrial Management                   | <input type="checkbox"/> Show Card and Sign Lettering |
| <input type="checkbox"/> Personnel Management                    | <input type="checkbox"/> Stenography and Typing       |
| <input type="checkbox"/> Traffic Management                      | <input type="checkbox"/> English                      |
| <input type="checkbox"/> Accounting and                          | <input type="checkbox"/> Civil Service                |
| C. P. A. Coaching  | <input type="checkbox"/> Railway Mail Clerk           |
| <input type="checkbox"/> Cost Accounting                         | <input type="checkbox"/> Mail Carrier                 |
| <input type="checkbox"/> Bookkeeping                             | <input type="checkbox"/> Grade School Subjects        |
| <input type="checkbox"/> Secretarial Work                        | <input type="checkbox"/> High School Subjects         |
| <input type="checkbox"/> Spanish <input type="checkbox"/> French | <input type="checkbox"/> Cartooning                   |
| <input type="checkbox"/> Salesmanship                            | <input type="checkbox"/> Illustrating                 |
| <input type="checkbox"/> Advertising                             | <input type="checkbox"/> Lumber Dealer                |

Name.....  
 Address.....  
 City..... State.....  
 Occupation.....

If you reside in Canada, send this coupon to the International Correspondence Schools Canadian, Limited, Montreal, Canada



## Aviation Stories of the Future

**Air Wonder Stories** is a revelation in Science Fiction Stories of the Air. Many monthly contributions by noted science fiction writers.

**Thrilling—Daring—Visionary**

Read one issue and you will be impatient for the next.

On Sale at all newsstands—25c the copy. Special subscription offer—one dollar—eight months.

**Stellar Publishing Co.**  
98 West Park Place, N. Y. C.

# How To Secure A Government Position

Why worry about strikes, layoffs, hard times? Get a Government job! Increased salaries, steady work, travel, good pay. I'll help you become a Custom House Clerk, Railway Postal Clerk, Post Office Clerk, City Mail Carrier, Rural Carrier—or any other Government job you want. I was a Secretary-Examiner of Civil Service Commission for 8 years. Have helped thousands.

**Now FREE**

My 32-page book tells about the jobs open—and how I can help you get one. Write TODAY ARTHUR R. PATTERSON, Civil Service Expert, PATTERSON SCHOOL 89 Winner Building, Rochester, N. Y.



# BE A RAILWAY TRAFFIC INSPECTOR

## A Quick Way to a Permanent, Big Pay Job

Would you like to earn \$250 per month salary in Railway Traffic Inspection? Many of our graduates do—and many of them have been promoted to salaries of \$5000 to \$10,000 a year. It only takes a few weeks of our spare time home training and you'll be qualified to step into a position paying at least \$120 per month to start.

—and after completion of your training, we'll assist you to a position at a definite salary or refund every penny of your tuition.

Traffic Inspection is healthy, outdoor work with regular hours. You'll be practically your own boss, see new faces and places each minute, deal only with high officials. Promotions to \$150, \$175, \$200 and up per month come rapidly.

**Send for Free Booklet**

For 11 years we have trained and placed men in this interesting profession. Read what they say about it in our free booklet, which also shows why we are able to assist you to a position after graduation, or refund your tuition. Send coupon for free booklet.

**MAIL THIS COUPON TO-DAY**

**STANDARD BUSINESS TRAINING INST.**  
Div. -2, Buffalo, N. Y.

Please send me your free booklet "A Profession of Protection."

Name.....  
 Address.....





# Learn AVIATION at GREER COLLEGE

## Come into Aviation

**Man's Dream Is Answered—Aviation Is Here**

**Transport Flyers will train you**

Greer Air Transport supervises all flying instruction. Greer pilots have had long experience in instruction and transport flying. You are safe and will learn quickly with their expert help.

**C. L. Laird superintends ground training**

C. L. Laird, with years of Aviation

**Adventure—Prestige—Thrills—BIG PAY—Easy, Fascinating work—that IS Aviation.**

experience as a designer and builder, supervises all ground training. He has been in Aviation and actual flying since 1911.

**Earn Big Money in a 4 Hour Day**

What are a Flyer's hours? **Four Hours**—not work—but fun—nevertheless those are usually the hours for him.

And the pay! Many make \$300 on a single Sunday. My Free Book gives astonishing details. Send for it now!

**I'll allow you railroad fare from any point in the United States**

Come to Chicago. I'll pay your fare when you enroll. Here is the **real** hub of the Aviation Industry. The World's finest and biggest Airport is here. Get my Free Book — tells all remarkable facts.

**LEARN DAYS OR EVES A Job while Learning**

You can attend the Great Shops of Greer College and learn Aviation either days or evens. We even help get you a job so you earn as you learn—in short—what does this wonderful training cost? Nothing!



Erwin Greer



### HOW!

I offer you a \$100 a week opportunity, perhaps more. But you must prepare. \$100 a week jobs mean nothing unless you can hold those jobs—so Prepare. I make it easy—26 years doing it—proves it, so when those jobs arrive—be ready—I'll help you get them—but be able to hold them.

**SUCCESS**

**TODAY** Tomorrow is just a day—but think—is it to be a day **wasted** or a day **rushing** to success? Think of it. Tomorrow may be just the second day to your real triumph—but tomorrow can't possibly come before today. I ask you to do nothing but find out for yourself. My Book is Free. Look at it at least, it costs you nothing and it **will** help you if you enroll or don't.

Sincerely, **ERWIN GREER, Pres.**

## GREER COLLEGE

Dept. 901

2024 So. Wabash Ave.

CHICAGO



**SCISSORS FOR FREE BOOK**

**ERWIN GREER, President**

Dept. 901  
2024 So. Wabash Avenue,  
Chicago, Illinois

Send Free Book and details of Special offer, without obligation to me.

Name.....

Address..... Age.....

# Electrical Experts are in Big Demand!



It's a shame for you to earn \$15 or \$20 or \$30 a week, when in the same six days as an Electrical Expert you could make \$60 to \$100—and do it easier—not work half so hard. Why then remain in the small-pay game, in a line of work that offers no chance, no big promotion, no big income? Fit yourself for a real job in the great electrical industry. I'll show you how.

## Be an Electrical Expert Learnto Earn \$3,000 to \$5,000 a Year

Today even the ordinary Electrician—the “screw driver” kind—is making money—big money. But it's the trained man—the man who knows the whys and wherefores of Electricity—the Electrical Expert—who is picked out to “boss” the ordinary Electricians—to boss the big jobs—the jobs that pay \$3,000 to \$5,000 a year. Get in line for one of these “Big Jobs.” Start by enrolling now for my easily learned, quickly grasped, right-up-to-the-minute, Spare-Time Home-Study Course in Practical Electricity.

### Age or Lack of Experience No Drawback

You don't have to be a College Man; you don't have to be a High School Graduate. I know exactly the kind of training you need, and I will give you that training. My Course in Electricity is simple, thorough and complete and offers every man, regardless of age, education, or previous experience, the chance to become, in a short time, an electrically trained man, able to make from \$60 to \$100 a week.

### Satisfaction or Money Back

So sure am I that you can learn Electricity—so sure am I that after studying with me, you, too, can get into the “big money” class in electrical work, that I will agree in writing to return every single penny paid me in tuition, if, when you have finished my Course, you are not satisfied it is the best investment you ever made. And back of me stands a two million dollar institution, thus assuring to every student enrolled a wonderful training in Electricity.

#### FREE Book on Electricity

I want you to read my Electrical Book and other material, all Free. These cost you nothing and you'll enjoy them. Make the start today for a bright future in Electricity. Send in Coupon—Now!

**L. L. COOKE,**  
Chief Instruction Engineer

**L. L. Cooke School of  
Electricity**

**2150 Lawrence Ave.  
Dept. 16 Chicago**

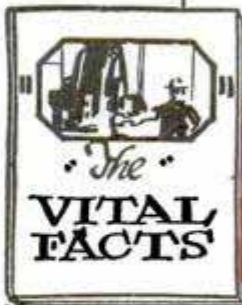

**GET  
MY  
FREE  
BOOK!**

L. L. COOKE, Chief Instruction Engineer  
Dept. 16, 2150 Lawrence Ave., Chicago, Ill.

Send me at once without obligation your big illustrated book and complete details of your Home Study Course in Electricity, including your outfit and employment service offers.

Name.....  
Address.....  
Occupation.....

**I Will  
Train You at  
Home for a  
Big Pay Job**  
*L.L.C.*

**5 Big Fine  
Outfits  
to work with  
No Extra Charge**



With me, you do practical work—at home. You start right in after your first few lessons to work at your profession in the regular way and make extra money in your spare time. For this you need tools, and I give them to you—5 big complete working outfits, with tools, measuring instruments, and a real electric motor—5 outfits in all.

**The “Cooke Trained Man is the “Big Pay” Man**



#### \$20 a Day for Schreck

“The biggest thing I ever did was answer your advertisement. I am averaging \$500 a month from my own business now. I used to make \$18 a week.”

A. SCHRECK, Phoenix, Ariz.



#### \$700 in 24 Days

“Thanks to your Course, I made \$700 in 24 days in Radio. I run from \$10 to \$40 clear profit every day.”

FRED G. McNABB  
7 W. 16th St.,  
Atlanta, Ga.

# Classified Advertisements

WORLD'S BEST WANT AD MEDIUM

Advertisements in this section, 30 cents per word, each insertion, minimum 10 words, payable in advance. To be inserted under proper classification in October issue, copy should be in our office August 19th

## ADVERTISING AGENCIES

**ADVERTISERS.** Our 32 years mail order experience at your disposal. 68 page self-help guide, with United States map in colors, giving complete information best paying daily, weekly and monthly publications sent free. Frank W. Lenhoff Advertising Agency, 66 East Lake St., Chicago.

**ADVERTISE** in 24 big Sunday newspapers, 24 words \$15.00. Excellent for securing agents, salesmen and business opportunities. Catalog listing 1,000 leading dailies, weeklies, mail-order magazines, everything. Free. Wade Agency, Great Northern Bldg., Chicago.

**BEFORE** Advertising get our catalog. No charge. 25 years in business. The largest classified agency in the world. Ankrum Advertising Agency, 100 No. LaSalle St., Chicago, Ill.

**FREE**—New 1929 Advertisers Rate Guide, 44 pages. Includes everything. Lowest rates. E. H. Brown Advertising Agency, 140 S. Dearborn, Chicago.

**INCH** Display 50 Monthlies Thrice \$8.00. Meyer Agency, 4112M Hartford, St. Louis, Mo.

**INCH** Display advertisement 50 magazines year \$32. Wood's Popular Services, Atlantic City, N. J.

**TIME** Counts in applying for patents. See pages 138 and 139. Clarence A. O'Brien, Registered Patent Attorney, Washington, D. C.

## FOR ADVERTISERS

"THE Master Letter-Writer." Including 500 successful letters, by Ad-Man Davison, world-famous letter expert; 704 pages, \$3. Circular sent. Opportunity Press, Westport, Conn.

**ADVERTISE** 500 Country newspapers, 28 words, \$10. Business getter. Lists free. Keator, Hartford Bldg., Chicago.

**RESULTS** From advertising—how produced. Something new—learn methods that have produced results instead of waiting for the inspiration of an idea. Send today for this remarkable book called "Psyching the Ads" by Carroll Rheinstrom. It will open a new world of profit to many an advertiser. Sent C. O. D. if preferred. Pay postman \$5.00 plus postage when delivered. Popular Mechanics Press, Room 809, 200 E. Ontario St., Chicago.

## SALES PROMOTION

\$50 TO \$50,000 Daily sales secured for our clients. Manufacturer sought new program to extend sales. Our recommendations embodied a \$5,000 expenditure for try-out. Sales produced at cost of less than 2%. Within two years sales under this same program expanded, climbed to \$800,000 in single month. 35 years' salesmanship-in-print experience back of our campaigns. Submit sales problems for free diagnosis. 10 years Sales Promotion Manager Larkin Co., James C. Johnson, 118A Woodbridge Ave., Buffalo.

**LETTERS** That talk—If you need sales letters that really sell. Mailing lists; form letters; any direct-mail advertising service. Write Omaha List & Letter Co., Box 1172, South Omaha, Nebr.

**LETTERS** That sell—Banning Advertising Service, Times Building, Watertown, N. Y.

## MAILING LISTS

1,000 1929 IOWA Farmers' names, \$1.00. J. Mitchell, 3853 Marmora Ave., Chicago, Ill.

**SEND** \$1.00 For \$1,000 rural women buyers names. Sheagreen, PM1427 North Penn, Minneapolis, Minn.

## BRANCH OFFICE SERVICE

CHICAGO—6 No. Michigan Ave. A real address. Write Russell Albin.

## AUTOMOBILE SUPPLIES

**PREVENT** The accident. Sales experience unnecessary. We furnish you proven plan to make money. Sensational seller. Marvelous Auto Safety Signal. No longer necessary to rely on faulty misleading hand signals. Illuminated hands combined with stop and tail light tell in an unmistakable manner the driver's intention to turn right, left, stop or back-up. Reasonably priced. Highly endorsed. Every car and truck driver wants one. Write for literature. Convince yourself. Act quickly. Your territory fortune. Safety Signal Mfg. Co., 501 Colorado Bldg., Denver, Colo.

"**SEEBACK**" Mirror goes on hinge, no vibration. New \$3.90. Seat leg springs, coach seat rides like a big easy chair, 75c pr. New Ford brake rod antirattlers, set of 10 \$1.50. New Chevrolet set of 20, stops all rattles \$4.00 set. Antirattlers for all cars. "Universal," made of steel tempered in oil." Western Auto Supply stores and all dealers handling quality products or order direct; money back guarantee. Universal Spring Co., 53 Grand Ave., Grand Rapids, Mich.

**COLORED** Initials on your headlights (red or green) identify your car at a glance. Beautiful at night, attractive during the day. Agent's full size show sample of two 6½-inch transparent initials \$1. Skinner Mfg. Co., 509 Fifth Ave., New York City.

**STEERING** Wheel tires. If your dealer does not sell them, write to Rid-Ged Grip Company, Akron, Ohio. Price \$1.50.

**RADIATORS** At wholesale prices. All standard makes. Satisfaction guaranteed. Send for prices, stating make and model. Independent Radiator Co., 1119 S. Wabash Ave., Chicago.

**USED** Air compressor, fully automatic, upright space saving type, beltless, fully automatic. Reconditioned and guaranteed like new. Shipped on trial and easy terms. Also a few test stands, car washers, battery chargers and paint sprays. E. M. Connor, Box M-996, Troy, Ohio.

**DO** Your auto license plates rattle? Rusty nuts and screws hard to get off? Then get the new E-Z On-Off License Clamps. See page 122.

**1** AUTO Gas saver sent. To introduce. All autos. Amazing mileage increases. Critchlow, RG-805 Wheaton, Ill.

**OPEN** Car owners. Don't "give" your car away. Equip it with Badger Enclosures and enjoy it for several more years. Car owners, dealers and agents write for catalog and special prices. Badger Auto Enclosure Co., 5501 Broadway, Chicago.

**AUTO** Parts new and used. Lowest prices. Bankrupt supplies, motors, wheels, radiators, transmissions, generators, gears, carburetors, touring tops complete \$15. Brakelining 50% off. Brightman, 2065 Main St., Hartford, Conn.

**YOU** Are wanted to resilver mirrors at home. Immense profits plating autoparts, tableware, etc. Write for information. Sprinkle, Plater, 77, Marion, Ind.

**DYKE'S** Famous Automobile Encyclopedia—Latest edition, the 15th. Fully revised to cover all latest facts regarding newest developments in automobile field, including new Model A Ford. Information given on repairing and adjusting every part of all motor cars. How to find trouble and fix it. 1,250 pages. 4,200 illus. Price, cloth, \$6. Flexible Morocco \$7.50. Pay postman price and postage when he delivers book. Popular Mechanics Press, Room 808, 200 E. Ontario St., Chicago.

## AUTOMOBILES

**TIME** Counts in applying for patents. See pages 138 and 139. Clarence A. O'Brien, Registered Patent Attorney, Washington, D. C.

## AUTOMOBILE SERVICE EQUIPMENT

**SAVE** Money—Garage equipment reconditioned and guaranteed like new. Unusual bargains in test stands, car washers, battery chargers, air compressors, etc. Shipped on trial, easy terms. What do you need to complete your equipment? E. C. Galbreath, Box M-994, Troy, Ohio.

**BIG** Opportunity in 8-hour battery charging. Let me tell you how you can install equipment with practically no investment. Earn \$150 to \$300 monthly from it. Bargains in used outfits. Write today. Also have a few reconditioned car washers, paint sprays, automatic air compressors. I. C. Helmick, Box M-995, Troy, Ohio.

**1** AUTO Gas saver. To introduce. All autos. Amazing mileage increases. Critchlow, RJ-805, Wheaton, Ill.

**RUBBER** Top dressing made from old inner tubes, makes old tops new. Send \$1.00 for formula and instructions. Glover Rubber Co., Rome, Ga.

**ELECTRICAL** Trouble shooting on the motor car. Don't trust to luck or guess work. Learn to make every motion count in testing and repairing. Send for our standard 493-page book for auto electricians, 300 diagrams. Hundreds of practical tests. Pay postman \$4.00 plus postage when delivered. If outside U. S. remit when ordering. Popular Mechanics Press, Room 809, 200 E. Ontario St., Chicago.

## BATTERIES AND BATTERY SUPPLIES

**BATTERY** Shop—How to run. Most complete and authoritative information ever compiled on tools needed, shop equipment, charging methods, opening batteries, work on plates, jars, case, etc. Covers auto, radio and farm lighting batteries. Send for big 550-page book and pay postman \$5.00 plus postage when he delivers same. If outside U. S. remit when ordering. Popular Mechanics Press, Room 809, 200 E. Ontario St., Chicago.

## FOR FORD OWNERS

**1** AUTO Gas saver sent. To introduce. All autos. Amazing mileage increases. Critchlow, RH-805, Wheaton, Ill.

**AURORA** Underslung parts and 3.1 racing gears. Speedster bodies, headlights, hi compression head. See Sport Factories ad page 135.

## MOTORCYCLES, BICYCLES AND SUPPLIES

**MOTORCYCLES** \$25 To \$50. Easy terms. Tires \$2.50, frames \$3, forks \$3, tanks \$5, wheels \$4, chains \$2, saddles \$5, handle bars \$5, engines \$15, side cars \$25, transmissions \$12, belts \$6, airplane engines \$15, airplane wheels \$5, bicycle tires \$1.25, velocipedes \$7.50, bicycles \$9.50, new auto tires \$3, used auto tires \$2.50. Send 50c for catalogs. Price Cutter Deninger, Rochester, N. Y.

**MOTORCYCLE** Bargains, lowest prices, bargain sheets for stamp, special ariators supplies, motorcycle accessories largest line in America, lowest prices. Largest motorcycle mail order house in the United States. Rochester Harley Davidson Corporation, 129 West Main St., Rochester, N. Y.

**HARLEY-DAVIDSON** Bargains at a tremendous sacrifice. All models and prices. Guaranteed. Send for our catalog, "Money Saving Motorcycle Bargains." Knuth's Harley-Davidson Agency, 2525 Fond du Lac Ave., Milwaukee, Wis.

**GOOD** Running bicycle \$18.00 cash. Write Young, 314 Oak St., Chattanooga, Tenn.

**BARGAINS** Used motorcycle parts for all makes. Goodyear balloon tires, \$8.25. J. B. Dahl, 3661-63 Archer Ave., Chicago, Ill.

**MOTORCYCLES**—Largest stock used motorcycles and parts in middle west. Indian scouts \$35 up. Send 15c for latest motorcycle catalog. Indian Motorcycle Sales, Kansas City, Mo.

**MOTORCYCLE** Parts, new and used. Lists free. Tower Cycle Co., Pine Lawn, Mo.

### AVIATION

**BOYS!** Giant Chic-A-Dee R. O. G. construction kit builds record-breaking model plane! All parts die-cut from balsa. All wire parts formed. Sweepback wings insure stability. This model made a record flight of 7 minutes, 15 seconds! Created sensation at recent contest in Detroit! Complete kit only \$1.00. Big, new catalog sent free with order, or separately for 10c. Order now from Broadfield Aeroplane Co., Hempstead, L. I., N. Y.

**SPEAK** And understand the real "inside" language of aviation. New Sky Slang Dictionary explains hundreds of mysterious slang and technical terms used by pilots and aircraft engineers. Instructive, but funny. Puts you "in the know." You need it and will enjoy it. Handy pocket size. Postpaid \$1. Aero Book Co., Dept. 15, Wichita, Kans.

**BUILD** A glider. Complete blue prints and plans for building. Get our three books, "Glider and Soaring," "Manual on Gliders and Soarers," and "Starting and Landing." Write for price list. Kenyon Press, Wauwatosa, Wis.

**\$175 WILL** Build our low powered, one place, steel fuselage monoplane. Plans \$1. Wings for this Heath, Russell, \$185 complete. Best material. Literature 10c. Barney Snyder, E. San Diego, Calif.

**THE Easiest** plane to fly is America's popular sport plane. You can build it yourself for \$199. Send 10c for large illustrated booklet. Heath Airplane Co., Chicago, Ill.

**THE American School of Aviation** announces a new correspondence course in mechanics of aviation. A thorough training in practical aeronautics. American School of Aviation, Dept. 1872, 3601 Michigan Ave., Chicago, Ill.

**AVIATION—Salary** \$18 to \$35 a week while under instruction for U. S. government aviation license in our factory and on the airport. Write for information, without obligation. Aero Corporation of America, Department GL, 63 Second St., Milwaukee, Wis.

**KITS—Byrd's** Anarctic, Lockheed Transcontinental, Army Pursuit or Navy Seaplane scale models, quarter each. Indoor tractor, 50c. Three foot twin pusher, \$2.00. All postpaid, all guaranteed. Casson-Craft, Canton, Mass.

**DURALUMINUM** Construction set, pursuit type single seater. Straightaway and stunt flyer \$1.25 postpaid. Send five cents for manual; teaches building and flying this plane. Foster's Model Airplanes, 5503 Hudson Boulevard, North Bergen, N. J.

**HALF-PRICE** Model airplane supply house. 3c for catalog. O. Wagensell, 15 Parkway East, Mount Vernon, N. Y.

**MODEL** Aeroplane builders! Big, new Broadfield catalog lists everything needed in model plane construction, at unusual prices. Build better champion models with Broadfield supplies, from plans to paint! Send 10c in stamps to Broadfield Aeroplane Co., Hempstead, L. I., N. Y.

**LEARN** Aviation through our new complete home-study course. Easy text; many pictures. Gives you a quick start toward a job and a real career. Low cost; easy terms. Get out of the rut! Get into aviation! Send name today for interesting free literature. Braley School of Flying, Dept. C, Wichita, Kans.

**HEATH** Propellers are designed to fit, built to measure. They represent the last word in aerial drive efficiency. 4c brings our large propeller booklet. Heath Airplane Company, Chicago, Ill.

**\$100 FLYING** Course. Six hours, including solo. Only \$10 an hour for additional solo time. Allison Airplane Co., Lawrence, Kans.

**"IF** You want to fly" let Alexander Klein, brilliant engineer, teach you. With great skill whole course of training has been simplified and made crystal clear. Remarkable book teaches in most practical and easily understood fashion. Recommended by skilled flyers. Sent C.O.D. anywhere in U. S. Simply pay postman \$2.50 and postage when delivered. Sent postpaid to any address upon receipt of \$2.50. Popular Mechanics Press, Room 808, 200 E. Ontario St., Chicago.

**AIRPLANE** Machine gun, Aldis telescope sights, 30" long, sacrificed at \$4.50. Air Transport Co., Garden City, N. Y.

**NEW** Burd piston rings for OX-5, 10c each. Brand new Hispano Stromberg carburetors, complete, \$35.00; new type extra strength ribbed wrist pins for OX-5, \$1.00; OXX-6, \$1.00. Hispano, \$1.00; new Bering OX-5 magnetos, \$60.00. Gasoline level gauges, \$2.50, any depth. Dixie converted booster magnetos, \$7.50. Air Transport Equipment, Inc., Carle Place, N. Y.

**SPORT** Monoplane at small cost. Flies with motorcycle engine. Easy to build. Send dime for folder and drawing. Airplane Publishers, 324 Bay, Springfield, Mass.

**FLYING** Clubs: Are you interested in organizing a flying club? The Marshall Flying association wants you as a member and will tell you how to secure the money and start your club. Wings and membership card for all members. Address Marshall Association, % Marshall Flying School, Dept. 630, Marshall, Mo.

**CONVERTED** Ford motor with propeller hub, \$50. George K. Heine, Orwigsburg, Pa.

**BUILD** Model airplanes that fly. 52 page catalog illustrates 26 flying and exhibition models. Complete line of accessories and supplies. Send 10 cents for big catalog. U. S. Model Aircraft Corporation, 397F Bridge St., Brooklyn, N. Y.

**YOU** Can easily fly a "Flying Flivver." Build it yourself. Blueprints \$5. Circulars 10c. Storms Aviation Co., Spartanburg, S. C.

**INSTRUCTION** Book. Five hundred aviation questions correctly answered. Postpaid \$1.00. George Tuck, 73 South Shirley Ave., Pontiac, Mich.

**PARAGON** Propellers, new, y pipe water pump, zenith carburetor, propeller hubs, OX5. Rudders, fin, clipped wing ailerons, for standard. Give-away prices. Crofts Shop, Moberly, Mo.

**2c POSTAGE** Stamp brings you complete Model Airplane Supplies price list. A. A. C. Model Aircrafters, 340 East 188th St., New York.

**HEATH-HENDERSON** Light plane motors represent refinement that cannot be had elsewhere. A real airplane motor at motorcycle prices. 10c for large illustrated booklet. Heath Airplane Company, Chicago, Ill.

**SPORTPLANE—\$25** Payments. Buy the Alco Junior coupe monoplane. We deliver the knockdown parts to you express prepaid in eight convenient groups. Blueprints sold separately, \$2.50 per set of four big sheets. Allison Airplane Co., Lawrence, Kans.

**SELLEY** Champion semi-constructed miniature airplanes and supplies. Junkers Bremen set complete \$6.25 postpaid. 8" aluminum adjustable pitch propeller 60c. Send 5c for catalog. Selley Co., 1405 Gates Ave., Brooklyn, N. Y.

**TIME** Counts in applying for patents. See pages 138 and 139. Clarence A. O'Brien, Registered Patent Attorney, Washington, D. C.

**MODEL** Aircraft supplies. Write Ward Williamson, R. 4, Tottenham, Ontario, Can.

**\$1.00 COMPLETE** Kit to build 16 inch model pursuit plane. No catalog. Beachland Model Works, Box 3654, Beachland Sta., Cleveland, Ohio.

**MOTORCYCLE** Engines for airplanes, motor boats, ice sleds; wheels, gasoline oil tanks, frames, less than half price. Send 50c for catalogs. Price Cutter Deninger, Rochester, N. Y.

**PLANS** For constructing sport monoplane. Use Ford or Chevrolet motor. Bergholt Aircraft Co., 143 East Lake St., Minneapolis, Minn.

**GET** The new 1929 sportplane Constructor-book containing 8 full page blueprints, drawings, photographs, etc. Answers hundreds of questions, sizes, weights, material, dimensions, methods, motors, flight instruction. All for \$1.00. Circular five stamps. Russell Aero, Box 455, Toledo, Ohio.

**AVIATORS'** Goggles; helmets, jackets, coats, flying-suits; lowest prices. Catalog free. Rochester Harley-Davidson Corp., 129 Main St., W. Rochester, N. Y.

**MOUNTED** Propeller, 12" with circulars on free three foot model. 25c postpaid. Aero Shop, 3050 Huribut Ave., Detroit, Mich.

**BIGGEST.** Best catalog model airplanes; parts, supplies; 5c postpaid. Ideal Company, 19 West 18th St., New York.

**VARIOUS** Sizes wood, reeds, bamboo, rubber band, wheels, propeller, onion skin covering and other supplies. Big bundle for 25c, five for \$1.00. No stamps. Will also send circular on free three foot model. Aero Shop, 3050 Huribut Ave., Detroit, Mich.

**"SKYWARD Ho!"** Wonder book on aviation—32 pages, 150 illustrations. Shows you complete training for flying career, fame, fortune! Sent free. Write today! Parks Air College, 213 Mo. Theatre Bldg., St. Louis, Mo.

**PROPELLERS—4'**, \$8.75; 5', \$13.25; 6', \$18.50; Special Henderson propeller, \$15.00; Aerodrive boat or sled blueprints, 50c each. Helmets, \$3.00; goggles, \$3.00, both only \$5.00. Engines, fuselages, Ostergaard Aircraft, 4303 North Narragansett, Chicago.

**MODEL** Airplane builders. Send for free catalog. Model Airplane Supply, 29 North Ave., New Rochelle, N. Y.

**BARGAINS** in model airplanes and supplies. Catalog 5c. Marx Aircraft, 320 South 4th East, Salt Lake, Utah.

**AIRPLANES** Motors and propellers bargains. Smith, Box 2343, Houston, Tex.

**BOYS:** Get a pursuit tractor kit complete 35c. No stamps. Send 5c for price list. W. & J. Aeroplane Shop, 200 Maple St., Wyandotte, Mich.

**BUILD** And fly model aircraft. Complete instructions cover all types including tournament prize winners. Lindbergh's famous "Spirit of St. Louis" and others. Great sport and very instructive. Official handbook approved by Lindbergh, Wright, Ford, Byrd, government officials and others. Sent C.O.D. anywhere in U. S. Simply pay postman \$2.25 and postage when delivered. Sent postpaid to any address upon receipt of \$2.25. Popular Mechanics Press, Room 808, 200 E. Ontario St., Chicago.

### BOOKS AND PERIODICALS

**4TH EDITION,** revised "Radio Theory and Operating," by Mary Texanna Loomis. The standard radio text and reference book of America. 992 pages, 800 illustrations, flexible binding. Price \$3.50 postage paid. For sale by hundreds of book dealers throughout America and many foreign countries. Or may be purchased direct from the publishers. Send check or money order to Loomis Publishing Company, Dept. 18, Washington, D. C.

**INDUSTRIAL** Alcohol. Wright's book. Full directions for making, fully illustrated. \$2.50. Spon & Chamberlain, 120 P.M. Liberty Street, New York, N. Y.

**CATALOG** Of 5,000 books on practical subjects will be sent upon receipt of request by Popular Mechanics Press, 200 E. Ontario St., Chicago.

**PROTECT** Your books with Silverart Bookplates. Send 10c for album of beautiful designs and samples. Silver Mail Service, 6327 Glenwood (Uptown), Chicago, Ill.

**THE** Cause of Hard Times, 25c. Modern Publishing Co., Station A, Box 162, San Diego, Calif.

**MONEY** Making, worthwhile books. Wholesale prices. Catalog. Crown Supply, Box 241, Ottumwa, Iowa.

**HYPNOTISM** Easily learned. Lessons guaranteed. Postpaid, \$1.10. Smith Pub. Co., Dept. 3, Springfield, Mass.

**FAMOUS** Bailey Handbook—the book that prepares you to pass the examination for any grade of license for stationary, marine and Diesel engineers, firemen and boiler inspector in any state of the Union or any province of Canada. Flexible cover. Handy pocket size. Pay postman \$2.00 plus postage when he hands you the package. Popular Mechanics Press, Room 807, 200 E. Ontario St., Chicago, Ill.

### PICTURES AND POSTCARDS

**FRENCH** Lovers photos. Love scenes of French girls and fellows. Taken from live poses. Imported direct from France. 12 for \$1.00. All different poses. Carrano Novelty Co., Dept. (PM), West Haven, Conn.

**SHOWBOATS** And Ohio river steamboats; six real photographs \$1.00. View Shop, Box 233, Vevay, Ind.

**ART** Pictures—220 all different. 160 samples \$1.00. Particulars 10c. Howard Sales Co., Dept. 15, Box 529, San Francisco, Calif.

### NOVELTIES, CURIOS, ETC.

**HAVE** Fun. Pilot's license, 4 other blank forms, all postpaid, 50c. Box 1108, Los Angeles.

GET Descriptive list interesting woods novelties. C. Peltier, Ontonagon, Mich.

### GAMES, ENTERTAINMENTS AND PLAYS

**PLAYS,** Musical comedies and revues, minstrels, comedy and talking songs, black-face skits, vaudeville acts, monologs, dialogues, recitations, entertainments, juvenile plays and songs, musical readings, make-up goods. Catalog free. T. S. Denison & Co., 623 So. Wabash, Dept. 11, Chicago.

**LEARN** Ventriloquism by mail—small cost. 2c stamp brings particulars. Geo. W. Smith, Room 8-358, 125 N. Jefferson St., Peoria, Ill.

**CHALK-TALK** Your way to popularity. Audiences at your feet if you learn how to entertain with a few simple pictures. Little artistic ability needed. "How to Chalk Talk" tells what to say and what to draw. Profusely illustrated. Make \$1 and more a night. Just order on a postal. Pay postman \$1.00 and postage when delivered. Popular Mechanics Press, Room 808, 200 E. Ontario St., Chicago, Ill.

### MAGIC TRICKS, BOOKS AND JOKER NOVELTIES

**RARE Offer!** 10 amazing, closely guarded secrets of master magic men all for \$1.00, sent prepaid—with our complete illustrated catalog of magic, and a book on card tricks thrown in. Think of it! Less than 10c apiece for these spectacular, mystifying illusions of the great—the cut cord restored—reading dates on unseen coins—picking weird objects from thin air—etc., etc. And every purchaser will receive coupon entitling him to "Trix and Chatter," a large, finely bound, 286-page \$1.00 book for only 75c. Biggest value ever! Only few sets left. Mail in your dollar today. Palmer Magic Shop, 119 South State St., Chicago.

"THE Book of 1,000 Wonders" explains many mystifying tricks with coins, cards, handkerchiefs, etc. Also, contains complete catalog of magic tricks, jokes, puzzles, books, escapes, mind-reading acts, spiritualistic effects, illusion plans, curios and imported novelties. Largest assortment, lowest prices. Amaze and mystify your friends! Send 10c today. Lyle Douglas, Station A-5, Dallas, Tex.

**MAGIC—Tricks, Books and Supplies.** For amateurs as well as the great professionals. Anyone can learn through our instructions. Feature Acts in Mind-Reading, Spiritualism, Rope Ties, etc. Large illustrated professional catalog, 20c. Chicago Magic Co., 149 So. Dearborn St., Dept. B, Chicago, Ill.

**MAGIC Tricks, books on magic, hypnotism, ventriloquism, etc.** List free. Geo. Fenner, Louisville, Ky.

**MAGIC Catalog 20c.** Lynn's, 105 Beach, Dept. 3, Jersey City, N. J.

**NEW Magic trick, 50c.** Catalog free. Eagle Magic, Minneapolis, Minn.

**FREE** With \$25 order die box. Send 20c for our large catalog of tricks, wigs, sensational escapes. Oaks Magical Co., Dept. 548, Oshkosh, Wis.

**VANISHING Coin trick—Mysterious, bewildering.** Amaze your friends. 20c silver. Dana, 413-M Rose Place, Long Beach, Calif.

**FREE—Big magic offer!** Or get six tricks, paraphernalia, magic catalog, 25c. Weber, 647-E 62nd, Chicago.

**SEVEN Magical Delusions and catalogs—25c.** Gilmagico, Morgan Park, Ill.

**MAGIC Tricks and novelties.** Send 15c for illustrated catalog. E. Kay Magic Shop, 8832 Commercial Ave., Chicago, Ill.

**ELECTRIC Fun!** Seventy stunts, 110 volts, \$1. Kutting Sons, Campbell, Calif.

**ESCAPE** From Sacks, Rope, Ties and Chains. Easy with these complete instructions. Give an evening's entertainment and mystify the "wise ones." Let them tie you hand and foot, place you in a bag and seal the bag. In a minute you are out. Complete instructions in "33 Rope Ties" and "Sack Escapes." Pay postman \$1.50 and postal charge for these two books when delivered. Popular Mechanics Press, Room 808, 200 E. Ontario St., Chicago, Ill.

### STAMP COLLECTING

**FREE—80-Page price list.** Send for the 80-page Scott price list, giving you a choice of more than 1,000 packets, sets and dime sets. It also describes the full line of Scott Albums, accessories, hinges, tongs, magnifying glasses, etc. Every collector should possess this price list. It is free for the asking. Scott Stamp and Coin Co., 1 West 47th St., New York, N. Y.

**MYSTIC "Queer Country" Packet!** Contains scarce stamps from the following strange lands: San Marino, Antioquia, Congo, Cyprus, Fiji Islands, Gwalior Hyderabad, Iceland, Jhind, Kenya, Uganda, Lebanon, Monaco, North Borneo, Nyassa, St. Thomas Prince, Eastern Roumelia, Siam, Sierra Leone, Tanganyika, Trinidad Tobago, Ubangi, Upper Volta, Wallis Futuna, Alaouties. Get this wonderful packet of "freak countries" and make your friends envious! Price only 10c to approval applicants! Write today. Mystic Stamp Company (Dept. 8), Camden, N. Y.

**500 DIFFERENT Stamps for 25c.** Big collection from Bosnia, Crete, Epirus, Honduras, Iceland, Kenya, Liberia, Malta, Nyassa, Quelimane, Siam, Zambesia and other "hard" countries. Catalog value \$10. Price 25c to approval applicants! Bargains, 1,000 different 79c; 15 triangles 49c; 100 Africa 45c; 100 Asia 50c; 100 Balkans 35c; 100 British Colonies 30c; 100 French Colonies 35c; 100 Portuguese Colonies 50c. Eight packets for \$3.00! Illustrated lists free. Loma Stamp Co., 3926 32nd St., San Diego, Calif.

**ANCHERS \$\$\$ Outfit—only 12c!** Fine triangle stamp; set German stamps with (pre-war) value forty million dollars (interesting!); perforation gauge, mme scale; airmail set; scarce stamp from smallest republic on earth; newspaper set; packet good stamps and Travancore, Malay, Dutch Indies, etc. Entire outfit for 12c to approval applicants! (Nice pocket stock book, value 25c, with every order!) Ancher Stamp Co., Box 126, Rutherford, N. J.

**FREE! Largest stamp in the world!** Fine packet 65 different stamps from Cape Verde, Jamaica, Mozambique, Syria, etc., including dying soldier, beautiful women, ships, maps, savages, airplane, scenes, bird and animal stamps, for only 5c to approval applicants. Largest Stamp in the World (Rare China Wild Goose Special Delivery) given absolutely free with each order. Supply limited! Send your 5c today! Western Philatelists, 6021 Harper Ave., M9, Chicago.

**FREE—Canada (15 Var.)** for new applicant of my 1c, 2c and 3c approval, and also my 50% discount. Chas. W. Schmidt, P. O. Box No. 4832, Frankford Sta., Phila, Penna.

**ILLUSTRATED Descriptive U. S. list, 1929,** price 50 cents; also large U. S. list free; stamps bought. Stanley Gibbons, Inc., 38P Park Row, New York City.

**1,000 NICELY Mixed stamps, 25c** postage; 1,000 hinges 10c; 2,000 17c. Approvals. Price lists. Sunshine Stamp Co., 549 East Maryland St., St. Paul, Minn.

**3c APPROVALS,** including Liberia, Nyassa, etc. Also 14,000 averaging 1 1/2c. References. Philatelic Exch., Huntington, W. Va.

**FREE—31 Different stamps** to applicants for Royal Approvals. 2c return postage. Royal Stamp Company, 120 Jefferson Ave., Bristol, Pa.

**ANNIVERSARY Offer!** (15c) seven beautiful sets: "Airmail," "Commemorative," "Red Cross," "Occupation," "Charity," "Prisoners," "Pictorial," also three packets: (International) (Colonies) (Bulgaria), Approvals. G. W. Deering, 164 Albion, Somerville, Mass.

**CRETE: 5 Varieties free** to approval applicants. Allison, Angola, Ind.

**FREE—1,000 Mixed U. S. stamps;** particulars, 2c. Weatherby, Station A, Cleveland, Ohio.

**BIG Bargain: 5,000 stamps** only \$1.00; fine 100-page illustrated album, 50c; airmail cover carried by Lindbergh, 50c. Longacre Hobby Shop, 106 West 42nd St., New York City.

**TWO Canadian first flight covers,** 30c. Chapin, 4803 Seminole, Detroit.

**SIAM Airmail set** of 4 weird stamps only 10c to applicants of our low-priced approvals. Lists free. E. P. Johnson, Box 692, San Jose, Calif.

**ALL Approvals one cent.** "Pyron," 214 So. Pearl St., Birmingham, Ala.

**AFRICA, Big value pkt. of 25 all diff.** for 5 cents, to approval applicants only. Harry Brown Co., Elsmere, N. Y.

**WATERMARK Detector free.** 4c postage. Tatham Stamp Company, 49 Van Horn, West Springfield, Mass.

**DANZIG Stamps free—Interesting packet** from Danzig with big catalog free for 2c. Midland Stamp Company, Toronto, Can.

**100 DIFFERENT Foreign stamps** from 100 different foreign countries, including Africa, Asia, Australia, Europe, West Indies, etc., for only 20c. Free with each order, our pamphlet which tell "How to Make a Stamp Collection Properly," together with our price lists of albums, supplies, and hundreds of bargains in sets, packets, etc. Queen City Stamp & Coin Co., Room 36, 604 Race St., Cincinnati, Ohio.

**ONLY 25c** For a five months' subscription to The Stamp Collector, America's finest stamp magazine. 100 all different stamps given free to each subscriber. Money refunded if you are not more than pleased. The Stamp Collector, Dept. P. M., 515 Sedgwick Drive, Syracuse, N. Y.

**500 UNUSED Stamps 50c.** Lists, Lowe, Box 1387, Spokane, Wash.

**100 DIFF. United States 25c.** 1,000 mixed 25c. 70% approvals. Burton, Madison, N. Y.

**PACKET 15c.** 1,000 Hinges 9c. Approvals. Peerless, 1005 Tuscaloosa Ave., Birmingham, Ala.

**FREE Sets** to approval applicants. Koenig, 968 First Place, Woodcliff, N. J.

**SCARCE Canadian queen.** Cat. 25c and slaughter price list 5c. Prospect Stamp Co., Broadview, Toronto, Can.

**FREE Outfit!** 52 stamps, hinges, pocket wallet. Postage 4c. Approvals. Milton Angle, South Berkeley, Calif.

**25 SCANDINAVIAN 10c.** M. Gustafson, 766 East, New Britain, Conn.

**FINE One-cent approvals.** Jerome Atwood, 3831 Cliff Rd., Birmingham, Ala.

**100 DIFF. Foreign stamps** and 1,000 hinges, 15 cents with approvals. Shepardson, 4222 Raymond St., Seattle, Wash.

**105 CHINA, Etc., 2c.** Album (500 illustrations) 3c. Bullard, Sta. BB, Boston.

**100 ALL Different British Colonial stamps** for 25 cents. To those asking for approval selections only. Lists free. Humber Stamp Co., 401 Quebec Ave., Toronto 9, Canada.

**FREE—New set beautiful Portugal** by asking for my approvals. Reference. E. Southward, 260 Pleasant St., Willimantic, Conn.

**FREE! 15 French Colonies.** Postage 2c. R. F. Roberts, 901 Fourth, Bay City, Mich.

**82 FAR Off countries** only 10c—Quelimane, Inhambane, Travancore, Kouang Tchou, Syria, Liban and 76 other countries—82 different stamps from 82 different countries for 10 cents with approvals and illustrated lists with each order. Reimers, 40 Flatiron Bldg., Fort Worth, Tex.

**STAMPS Free.** 12 large showy picture stamps, also 12 diff. British colonies for a request for my popular approvals at 50% discount. None better. Good supply of U. S. postage, 2c. A. Bauer, Palmyra, N. J.

**WHITE Russia, complete country** for 8c. Approvals. Victoria Stamp Shop, 1453 Victoria, Chicago, Ill.

**SPECIAL! 100 Different stamps** 10c. Approvals. Norono Stamp Company, 4401 National Ave., Milwaukee, Wis.

**CANADA Airmail stamp free,** if you ask for approvals and send 15c for 25 different airmails or 30 different Canada and Newfoundland, both packets only 25c. We list 282 countries in our dime packets. Special bargains—500 different 25c; 1,000 different 75c; 2,000 different \$2.50. Victoria Stamp Co., London, 4, Canada.

**111 DIFFERENT Stamps,** including Iceland, French Colonies, etc., free to approval applicants. Postage 2c. Leader Stamp Company, 2056 East 24th St., Brooklyn, N. Y.

**5c ONLY.** 25 Different fine U. S. stamps; \$1.00 Canada postage; scarce Slam. Air mail with approvals. L. W. Hudson, Box 118, Plainfield, N. J.

**ATTRACTIVE Approvals** at 50% discount and 25% discount. Noemus Stamp Co., 312 East 23rd St., New York.

**UNITED States \$2 present issue** (catalogs 50c) for ten cents to approval buyers. State size of collection. Leduc, Redlion, Penna.

**KOREA, 1886.** 25 And 50 mn., 10c to 50c approval applicants (ref. required). Brunel 4c 1926, 5c; 3 Abyssinia, 10c. Illustrated album, perf gauge, hinges and 75 stamps from 20 countries, 12c. 1,000 mixed 30c. Price list free. Argonaut Stamp Company, Dept. 144, New Canaan, Conn.

**PENNY Approvals** that Satisfy. Neil Gronberg, Box 5441, Philadelphia, Pa.

**FREE!** 115 Different stamps to approval applicants, 2c postage. Paige Stamp Co., Oak Park, Ill.

110 DIFFERENT Stamps, many unused, high values, free to collectors requesting our net approvals. Postage 2 cents. Christensen, Milwaukee, Wis.

100 FOREIGN Stamps 3 cents. Lufbery Stamp Co., Branford, Conn.

COMPLETE Sets on approval. References necessary. Kenneth White, Rockville, Conn.

FREE! Triangles, airmail, Iceland and 50 others to approval applicants inclosing 3c postage. Hawkeye Stamp Co., Cedar Rapids, 39, Iowa.

150 GOOD Mixed foreign stamps 3 cents. Stanton, Niantic, Conn.

UNITED States—Send on approval. Send me your want list. Ref. please. M. Hanna, New Kensington, Pa.

STAMPS On approval 1/4c up. Premium 2c. Kelgwin, Middletown, N. Y.

110 NEW Europe All Different, a wonderful collection cataloging several dollars, free to collectors requesting our Net Approvals. Postage 2 cents. Badger Stamp Co., Milwaukee, Wis.

24 VARIETIES Cuban stamps, 10 cents. List of 6,000 low-priced stamps free. Address Chambers Stamp Co., 111P, Nassau St., New York City, N. Y.

STAMPS Sent on approval at 70% discount. Reference required. Emory Renoll, Hanover, Pa.

FREE 50 British Colonials, if approvals requested. Postage 4c. Berkeley Stamp Co., South Berkeley, Calif.

COVERTCO Packet, 10 different Fiume, 10 cents, with 60% discount approvals. Covert Stamp, 39 State, Rochester, N. Y.

200 DIFFERENT stamps 10c; 1,000 hinges 10c. R. H. Carlton, 380 W. So. Temple, Salt Lake, Utah.

STAMPS, 100 Varieties, Africa, Brazil, Peru, Cuba, Mexico, etc., 10c; 25 different U. S. 25c; 1,000 mixed, 40c; 1,000 hinges, 15c. List free. C. Stegman, 5941 Cote Brillante, St. Louis, Mo.

ONLY 5c! 10 Airmail stamps, including scarce Estonian triangular stamp; Portuguese Red Cross set and 10 different Central Lithuanian stamps. Approvals and free lists with each order. Curhan Stamp Company, Gloucester, Mass.

STAMPS, 100 all different. Postage 2c. Lists free. P. M. Quaker Stamp Co., Toledo, Ohio.

DANDY Mint stamps 2c to those requesting approvals. Harvey Teeple, Decatur, Ind.

BARREL Of foreign stamps while they last. 25c-1,000 or pound \$1.00 (over 4,000). Approvals sent. Hinges 3,000-25c. Elmer, 61 Court St., Boston.

FREE—20 Different Argentine. Approvals. List. Send 4c today for postage, etc. Reuter, Santa Ana, Calif.

STAMP Collectors, magazine. Finest monthly stamp paper. Write for free sample copy. Philatelic Publishing Co., Inc., 15 John St., New York, N. Y.

MAGNIFICAROCIOUS Packet free—Beauties from distant lands, many richly colored, unusual designs. 2c postage. Empire Stamp Co., Toronto, Can.

BEST One cent approvals in America. F. P. Hand, 1117 So. 60th St., Philadelphia, Pa.

101 STAMPS Free with approvals. Postage 2c. Johnson Stamp Co., (PM) Jamestown, N. Y.

REVENUES—Telegraphs—Every country. Pretty—Intriguing—Cheap. Mint \$5.00 revenue free to applicants with references. Vanderhoof, 1114 Logan, Denver, Colo.

STAMP Collecting, why and how. Makes this a more interesting hobby than ever. The story that lies hidden in your stamps gives every page in your album a richer meaning. If you are a stamp collector, send for this delightful book at once. Pay postman \$2.50 plus postage when delivered. If outside U. S. remit when ordering. Popular Mechanics Press, Room 809, 200 E. Ontario St., Chicago.

#### RARE COINS

OLD Money wanted. Do you know that coin collectors pay up to \$100.00 for certain U. S. cents? And high premiums for all rare coins? We buy all kinds. Send 4c for large coin folder. May mean much profit to you. Numismatic Co., Dept. H. Ft. Worth, Tex.

45 EMERGENCY Bills, 15c. Catalog, three coins, 10c. Wacker, Minster, Ohio.

\$5 TO \$500 Each paid for hundreds of old or odd coins. Keep all old money. Many very valuable. Get posted. Send 10 cents for illustrated coin value book, 4x6. Buying and selling. Guaranteed prices. Coin Exchange, Box 5, Le Roy, N. Y.

RARE United States, foreign coins, war medals, Chinese coin and catalog 10c. Alexis Mengelle, Colorado Springs, Colo.

OLD Coins, large fall selling catalog of coins for sale free to collectors only. Catalog quoting prices paid for coins, ten cents. William Hesslein, 101A Tremont St., Boston, Mass.

AMERICAN Coins, bought, sold. Coin value booklet, 12c. Frank Saco, 735 45th St., Brooklyn, N. Y.

3 DIFFERENT Fine bronze or nickel coin, 2 large crisp bank notes and catalog 10c. George Best, Cedar Rapids, Iowa.

CALIFORNIA Gold—Quarter size, 27c; 1/2 size, 53c; 3c piece and catalog, 10c. Norman Shultz, Box 746, Salt Lake, Utah.

GET Profit and pleasure in collecting old coins. Send 10c for large illustrated coin catalog. You'll be delighted with it. Send for it right now. B. Max Mehl, Numismatist, Mehl Bldg., Dept. P. Fort Worth, Tex. Largest Rare Coin Firm in the U. S.

UNITED States. Large cent, two-cent bronze, three-cent nickel and bargain list, 25c. Thirteen dates large cents, \$1.00. George Coffin, Greenwood Mountain, Me.

STAMP Album—For beginners, the Modern Album is unsurpassed in usefulness. Spaces for 12,000 stamps, 5,000 illustrations, 330 pages. Large size 9 1/4 x 11 inches. Cloth bound. Price only \$2. Either pay postman when delivered or if outside U. S. remit when ordering. Prices and descriptions of other albums for more advanced collectors furnished upon request. Popular Mechanics Press, Room 809, 200 E. Ontario St., Chicago.

#### CAMERAS AND PHOTO SUPPLIES

FREE. Our bargain book listing hundreds of slightly used cameras, kodaks, lenses and supplies at great saving. A few sample bargains: 2 1/2 x 4 1/4 Kodak Special with Zeiss Kodak f:6.3 lens, Acme Shutter \$27.50. Graflex series B 4x5 with Kodak f:4.5 lens, \$69.50. Leica roll film camera f:3.5 lens Focal Plane Shutter \$64.50. Every item guaranteed fully and sold on ten days' trial. Send for your copy now. Central Camera Co., 230 S. Wabash Ave., Dept. P.M.9c, Chicago, Ill.

TINTED 8x10 98c, 5x7 48c. Prints 5c, rolls 9c. Quality. Send film, cash. Prompt. Photocraft, Aberdeen, Md.

HOME-TALKIE Units, \$49.00. New DeVry 16mm camera \$39.50, projector \$37.50. Send cash with order. Harold Tyndale, Carroll, Iowa.

ENLARGEMENT 8x10 Hand colored 60c, film developed 7c, prints 3c (coin). Globe Photo Service, 816 Hennepin Ave., Minneapolis, Minn.

KODAK Films developed—Six glossy prints, one beautifully hand colored, 25c. Careful work. Quick service. Falls Foto Finishers, Glens Falls, N. Y.

EXPO Watch camera. Twenty pictures in a watch and every tick a picture. Complete \$5—outfit post paid \$3.98. Send for our Diamond Jubilee sales list of thousands of cameras at less than wholesale to celebrate our 75 years in business. G. Gennert, Inc., 24 East 13th St., New York, N. Y.

MAKE Money in photography. Learn quickly at home. Spare or full time. New plan. Nothing like it. Experience unnecessary. American School of Photography, Dept. 3432, 3601 Michigan Ave., Chicago.

HAVE You a Camera? Write for Free sample of our big magazine, showing how to make better pictures and earn money. American Photography, 116 Camera House, Boston, 17, Mass.

FILMS Developed. Special Trial Offer. Any Size Kodak film developed 5c, prints 3c each. Trial 6x10 Enlargement in handsome folder 40c. Overnight Service. Roanoke Photo Finishing Co., 209 Bell Ave., Roanoke, Va.

PROFIT From your camera. You want to know what will sell and where to sell to advantage—also correct methods to follow in every phase of photography in order to make your camera pay. All given in valuable book "Photography for the Amateur," by French. Pay postman \$3.50 and postage when delivered or, if outside U. S. remit when ordering. Popular Mechanics Press, Room 809, 200 E. Ontario St., Chicago.

EARN Big money with your camera in your spare time, using Halderson Home Portrait Lamp. Write for booklet "Home Portrait Photography" and catalog—both free. The Halderson Company, 4746 N. Western Ave., Chicago.

GERMAN Cameras. Lenses. Barttro, 129 W 3rd St., Los Angeles, Calif.

TIME Counts in applying for patents. See pages 138 and 139. Clarence A. O'Brien, Registered Patent Attorney, Washington, D. C.

SAMPLE Enlargement—dime, and negative (returned). Trial roll, glossy prints, 25c silver. Brown, Warsaw, N. C.

\$50.00 FOR Photographs—This price paid for photographs meeting our requirements. Perhaps one of yours will bring this amount. Full particulars free. Redkrafts, Denver, Colo.

#### MOTION PICTURES

SOUND Motion Pictures! The great and only authoritative text book on this subject by James Cameron, world's foremost authority. 400 pages complete information on all systems—Vitaphone, Movietone, Phototone. Methods of recording, maintenance of equipment. Complete information for projectionists and all interested. Thousands sold. Send for your copy, \$5.00 postpaid. Bass Camera Company, Motion Picture Headquarters, 179 W. Madison St., Chicago, Ill.

PRACTICALLY New Sept. combined still and motion picture camera with f:3.5 lens, six magazines and carrying case, \$24.50. Model C Kodascope \$42.50. Eastman Cine model B camera with f:1.9 lens, \$115.00. Every item guaranteed and sold on ten days' trial. Send for your copy of our free bargain book listing hundreds of other used bargains. Central Camera Co., Dept. P.M.-9c, 230 So. Wabash Ave., Chicago, Ill.

\$1,250 FOR Original photoplay story. Our sales department sold unknown author's first story for above amount. We revise, copyright and market stories for both silent and talking pictures. Located in the heart of motion-picture industry. We know the demand. Established 1917. Free booklet. Universal Scenario Company, 206 Western and Santa Monica Bldg., Hollywood, Calif.

THE Bass Bargaingram No. 198 hot off the press, culminating twenty years of success with a tremendous offering of bargains in rebuilt standard and amateur Motion Picture Cameras, Projectors, Accessories, Text Books. The great bargaingram will be sent to you for 4c in stamps. Send for your copy today. Bass Camera Company, Motion Picture Headquarters, 179 West Madison St., Chicago, Ill.

BE A Movie exhibitor. Big opportunity. Only moderate capital required. Complete equipment at remarkably low prices. Write Atlas Moving Picture Co., 624 South Michigan Ave., Chicago, Ill.

ODD Reels \$2.25; News \$2.50; Western \$3.00. Hoffman Film Service, 57 Broad, Albany, N. Y.

300 FEET \$1.10, Comedy Dramas. Clifford Hoffman, 25 Hamilton, Albany, N. Y.

SCHOOL Days, with Wesley Barry. Other bargains. List. Rector Film Service, Champaign, Ill.

WESTERNS—Comedies, novelties, scenes, cartoons, serials. Big specials \$3.00 reel up. Lists. Leonard Lowe, Apt. No. 6, Norfolk Bldg., Cincinnati, Ohio.

LEARN—Modern theatre management. Big opportunities. Free particulars. Theatre Managers Institute, 307 Washington, Elmira, N. Y.

TIME Counts in applying for patents. See pages 138 and 139. Clarence A. O'Brien, Registered Patent Attorney, Washington, D. C.

NEW And rebuilt projectors for theaters, schools, churches, traveling shows. Supplies and complete theater equipments. Bargain prices. Free catalog. Monarch Theatre Supply Co., Memphis, Tenn.

MOVIE Films, 1,000 ft. reels, \$2.50 each; shipped anywhere on receipt of remittance. Particulars on request. Independent Films, 177 Golden Gate Ave., San Francisco, Calif.

AMATEUR Movie-making—Make films that rival professional in quality and screen interest. Valuable book by H. C. McKay reveals the secrets used by the professionals yet is written for the amateur. Pay postman \$3 and postage when delivered or if outside U. S. remit when ordering. Popular Mechanics Press, Room 809, 200 E. Ontario St., Chicago.

**SPRING** Motor 35m movie camera \$25; movie projector, \$35. Negative stock 2 cents foot. Pathex camera and projector, \$33. Bargains in 16m cameras, kodaks, type-writers. Ray, 266 W. 46th St., New York.

**FILMS** \$3.00 Reel. Talking equipment \$49.00. Stewart Marshall, Rome, Ga.

#### CHALK TALKS

**LAUGH** Producing program, \$1.00. Catalog free. Balda, The Cartoonist, Oshkosh, Wis.

#### SCENERY TO RENT

**WORLD'S** Most Beautiful Settings for operas, plays, minstrels. Amelia Grain, Philadelphia.

#### RADIO SETS AND SUPPLIES

**\$5 RADIOS** All makes Atwater-Kent, Majestic, R. C. A., and others. Hundreds—world's best makes. Used, new and rebuilt. Going at \$5 to \$65. Many formerly priced at \$150 to \$300. Amazing bargains. Backed by responsible guarantee and 30 years' experience. Write for big free list today. Brown's Radio Exch., Dept. E, 3018 East 91st St., Chicago.

**RADIO** Service Men. Send for valuable free bulletins. Louis Horning, Jr., Laboratories, Elizabeth, N. J.

**NEW** 300-Mile pocket radio \$3.50, complete with special loud receiver. No tubes or batteries required. Order direct. Spencer Laboratories, 116 Atlas, Akron, Ohio.

**TIME** Counts in applying for patents. See pages 138 and 139. Clarence A. O'Brien, Registered Patent Attorney, Washington, D. C.

**ALL-ELECTRIC** Radio Sets—First book on subject—just out. Kenneth A. Hathaway, well known radio adviser of the Chicago Daily News has written this clear, interesting and non-technical book. It covers dynamic speakers also. 120 pages. Illustrated. Pay postman only \$1.50 plus postage upon delivery. Popular Mechanics Press, Room 808, 200 E. Ontario St., Chicago.

#### TRADE AND TECHNICAL SCHOOLS

**BE** A blue print reader. Write for facts. See how men in your trade got to the top. What's your trade? Carroll Ramsey, Drexel Bldg., Philadelphia.

**DRAFTSMEN!** Be an expert. By our method we train you quickly. Books and tools furnished. Write for illustrated catalog. Columbia School, 204P Drexel Bldg., Philadelphia.

**OUR** Commercial radio operating and junior engineering course pays our graduates \$150 to \$300 monthly from start. Rapid advancement. Fall term begins in September. Write for catalog of course including Extension Course. Loomis Radio College, Dept. 5-E, Washington, D. C.

**LEARN** Morse and wireless telegraphy. Big salaries. Tremendous demand. Expenses low, can earn part. Catalog free. Dodge's Institute, Fern St., Valparaiso, Ind.

**HILES** Watchmaking and engraving school. The largest and best equipped school in the west. 5330 Mission St., San Francisco, Calif.

#### BUSINESS OPPORTUNITIES

**PREVENT** The accident. Sales experience unnecessary. We furnish you proven plan to make money. Sensational seller, Marvelous Auto Safety Signal. No longer necessary to rely on faulty misleading hand signals. Illuminated hands combined with stop and tail light tell in an unmistakable manner the driver's intention to turn right, left, stop or back-up. Reasonably priced. Highly endorsed. Every car and truck driver wants one. Write for literature. Convince yourself. Act quickly. Your territory fortune. Safety Signal Sales Co., 501 Colorado Bldg., Denver, Colo.

**REPRESENTATIVES**, District managers and distributors. \$500 to \$1,000 a month profits with amazing lighter pencil. Combines handy pencil with sure-fire cigar lighter. Light, handy, guaranteed. Sells for only \$1.00 retail. If you have a crew, you can "clean up" with this big seller. Also sell to merchants; counter display card of 12 Pencillites furnished. Great advertising novelty for manufacturers, etc. Names and trade slogans imprinted. Write at once for big money-making proposition. The Lyco Co., 700-708 E. 40th St., Dept. H-93, Chicago.

**THAXLY** Formulas produce perfect products. All lines. Catalog free. B. Thaxly Co., Washington, D. C.

**LOIDLAC**. Chemist's amazing new discovery. Forever ending automobile polishing and repainting! Instantly restores all colors, producing hard, brilliant lustre-finish. Guaranteed water, sun and weather-proof. You make Loidlac from my guaranteed exclusive copyright-protected formula for \$1.40 gallon, sell at \$14.00 a gallon profit! Write for exceptional offer. Miller, Chemist, 707 Jetton, Tampa, Fla.

**ARTIFICIAL** Marble sanitary flooring instructions, covering wood or cement flooring 1/2 inch thick. Fireproof, waterproof, all colors, low cost. Ornamental casting, concrete, plaster, papier-mache decorations, garden furniture, statuary, flexible molds. 18 years instructing the public; particulars and illustrations free. Chris. Mahler, Huntington, N. Y.

**MAIL** Order business your opportunity. Breniser's famous hand books by expert 28 years' experience show how to start selling articles you make or buy—all or part time—small capital. Fascinating, profitable. Set eleven books, \$3.25. Breniser Company, 1607 P. Sanson, Philadelphia. Sample book, 25c, pay \$3 for other ten if satisfied.

**\$15.00** A BUSHEL For potatoes. That's what people pay you when you sell potato chips. With complete outfit and instructions they are amazingly easy to make. \$1.00 starts you after receiving outfit. Complete outfit with instructions \$5.00. Instructions without outfit \$1.00. Send money order to A. Wiltmer, 812 F St., Sparrows Point, Md.

**UNPATENTED** Ideas can be sold. I tell you how and help you make the sale. Free particulars (Copyrighted). Write W. T. Greene, 910 Barrister Bldg., Washington, D. C.

**SIGNS** And showcards easily painted. If you use Letter Patterns. Write for free samples. John Rahn, B2120 Neva Ave., Chicago.

**FLORAGRAPH** Show cards, paintless, clean, paying, home business, mastered first day. No hand lettering. Learn today, earn tomorrow. Ideal for ladies. Circulars. Two gorgeous, unmounted samples, 50c. Laird's Floragraphs, 5925m Eggleston, Chicago.

**WANTED**, Branch manager for your city to represent old established Chicago concern. Rare opportunity. Big profits. Small investment required. Dept. B, 6208 Winthrop, Chicago.

**\$100** STARTS Route automatic vending machines. Large steady profits. Write Chevitt Corp., Dodworth St., Brooklyn, N. Y.

**DRY** Cleaning business of your own. Cleaning hats, clothing, dyeing, pressing. Particulars free. Dry Cleaner, 408 Grand St., Buffalo, N. Y.

**SIX** Hours a week spare time and twelve numbered gum venders placed with good merchants will earn you \$500.00 monthly. Sample \$18.00. Write for territory. Sanders Mfg. Co., Nashville, Tenn.

**SUCCEED** With your own products. Make them yourself. Formulas, processes, trade-secrets. All lines. Catalog, circulars free. B. Thaxly Co., Washington, D. C.

**WHEN** in need for new mechanism ideas send sketch, \$5.00 and stamped envelope to Box 13, Stockdale, Tex.

**ASSOCIATED** Chemists, Indianapolis, Ind. Write for formula lists latest household, toilet, automobile, medical and animal specialties. Long profits easily made.

**ODD** Things—Opportunities galore! Everything that's new, different. Special three months' subscription, 10c postage. Odd Things, 1516 Prospect, Cleveland.

**WIN** Money! Subscribe to "Current Contests." Sayville, N. Y. \$2 a year.

**FREE** Booklet describes 67 plans for making \$20-\$100 weekly in home or office business of your own. Elite Co., 84 Elizabeth St., New York.

**START** Magazine subscription agency, 150 lines typewritten information 25c. Lee, 405 Castle Hall, Indianapolis, Ind.

**PHOTOFINISHING**, Home, prints, 1c, charge 5c. Profitable instructions, post-paid \$1.00. Photocraft, Aberdeen, Md.

**CHEMICAL** Expert will furnish formulas and trade secrets. All lines. Lists free. W. L. Cummings, Ph. D., 228 Gordon Ave., Syracuse, N. Y.

**SELL** by Mail! Books, novelties, bargains! Large profits! Particulars Free! B-Elfco, 525 South Dearborn, Chicago.

**DO** You want an independent business of your own, one you can start on small capital? Start a Free-Lance Advertising Bureau. Opportunities everywhere. Details. Carolina Business System, Box 511, Columbia, S. C.

**AGENTS**, Dealers, handle our line of Mexican curios, Indian novelties, jewelry, feather cards. Uncompeted field. Liberal discounts. Samples fifty cents. None free. G. Medina, 78-P La-Rosa St., Mexico City, Mex.

**MIRRORS** Resilvered at home. Costs near 5 cents per square foot; you charge 75 cents. Immense profits plating like new, brass, worn-off autoparts, reflectors, tableware, etc. Outfits furnished. Details free. Sprinkle, Plater, 127, Marion, Ind.

**MAIL** Order business for sale. Bogren, 2264 Hermany Ave., New York.

**MAKE** Big profits with a fur farm in your backyard. Chinchilla rabbits, muskrat, mink. Write for facts. 252 Conrad's Ranch, Denver, Colo.

**DELAWARE** Charters; fees small; free forms. Chas. G. Gayer, Wilmington, Del.

**SIXTY** Meritorious big-profit mailorder products, trade secrets, sales plans. Success assured. K. Home, 3949 Metropolitan, Chicago.

**NEWEST** Decorative Scheme—Imitation rubble or range stone; materials cheap, large profits. Inside or outside work. Illustrations and particulars 25c, stamps or coin. M. & M. Decorators, 628 1/2 East Harry, Wichita, Kans.

**STOP** Renting—Build cheaply with rammed earth. Lasts for generations. Full information, instructions \$2. Mrs. Effie Wilson, Rotan, Tex.

**AMAZING** Screw-holding screw driver! Factories, garages, workers buy on sight! Profit 75c each. Exclusive territory. Free trial offer. Jiffy, 1166 Winthrop Bldg., Boston.

**TIME** Counts in applying for patents. See pages 138 and 139. Clarence A. O'Brien, Registered Patent Attorney, Washington, D. C.

**BUSINESS** Profession of your own and earn income in service fees. See Stephenson Laboratories, display ad page 132.

**GO** Into Crispette business—Everybody likes Crispettes; make a lot of money. Geo. Alexander, Pennsylvania, reports "profits \$3,000 in four months." We start you. Write for facts. Long-Eakins, 1960 High, Springfield, Ohio.

**MAKE** Your own products. Employ agents yourself. Toilet articles, soap, extracts. We furnish everything. Valuable book free. National Scientific Laboratories, 1984W Broad, Richmond, Va.

**MECHANICS**, Painters, carpenters, start furniture refinishing, painting, handyman shop on nearly nothing; winning plan brings customers quickly. John Braceland, 1439 So. Ninth, Philadelphia, Pa.

**LEARN** The collection business. Good income, quick results. Interesting booklet, "Skillful Collecting" free. National Collectors Assn., Long St., Newark, Ohio.

**A BUSINESS** of your own making—Sparkling Glass Name and Number plates. Checkerboards, signs. Big book and sample free. E. Palmer, 540, Wooster, Ohio.

**WE** Start you in business, furnishing everything Men and women, earn \$40 to \$100 weekly operating our original "New System Specialty Candy Factories." Begin home spare time. Unlimited opportunity. Valuable booklet free. W. Hillyer Bagdale, Drawer 4, East Orange, N. J.

**"SCHEMER"** Subscribers surely succeed. One reports \$50,000 from one tip; another \$25,000 from three Schemes; another \$10,000 from one formula. Try your luck! Year, \$1.00; three months, 30c. Patterson, Publisher, Alliance, Ohio.

**FREE** Book. Start your own little business anywhere, selling novelties by mail. My beginner's outfit contains everything required, novelties, circulars, instructions, etc. Descriptive book free. Hadwil, 3A-74 Cortlandt St., New York.

**LEARN** Telephone advertising. New profession. Chance for \$100 weekly. Man or woman. Capital and experience unnecessary. Booklet free. Teleplan, Brown Bldg., Wichita, Kans.

**I** MADE \$30 a week home. French bread-making. 15 years' experience; free booklet tells. Ashbrook 67, Marengo, Ohio.

**\$200 WILL** Start your own business; chance to enlarge; unlimited money-making possibilities; you manage, distribute and collect; experience unnecessary. For particulars, address Manager, 603 N. Eutaw St., Baltimore, Md.

**AMATEUR** Cartoonists: Sell your cartoons. New plan. Smith's Service, PA-1194, Wenatchee, Wash.

**SUPPLIES** For making chipped glass house numbers and signs. Tinfoils, glass and frames. Osborne Sims, 13580 Tuller, Detroit, Mich.

**CHARTERS:** Delaware; best, cheapest; free forms. Colonial Charter Co., Wilmington, Del.

**COMPOSITION** Floor making earns industrious men \$12 and more daily if used as trade. Or make business of it with profits up to \$10,000 yearly. Openings everywhere. Semi-Tile, Box 43, Hollis, N. Y.

**MAN** In each town to plate auto parts, reflectors, bathroom fixtures, refinish beds, mirrors, chandeliers; by new method. No capital or experience required. Simple plan of manufacturing at home starts you in big money-making business. Outfit furnished. Free particulars and proofs. Gun Metal Co., Ave. H, Decatur, Ill.

**AN** Honest circular mailer looking for business. Make up a package, key them, inclose what you think a fair price and I guarantee to mail every piece to live prospects. No nude pictures or etc. Edward Armour, 136 East 28th St., New York.

**MANUFACTURING** Concrete building blocks is your home town opportunity. Particulars free. Concrete Machine Co., 5 Main, St. Louis, Mo.

**501 WAYS** To make money. Particulars free. Arthur A. Terry, 1964 West 7th St., Brooklyn, N. Y.

**15,000 FORMULAS** In "Scientific American Encyclopedia of Formulas." Includes following and many others: Accidents and emergencies, agriculture, alloys and amalgams, artist's materials, beverages, cements, glues, pastes, mucilages, bleaching, renovating, coloring metals, dyeing, glass, heat treatment of metals, household formulas, ice cream, confectionery, chewing gum, lapidary work, exterminating vermin, lubricants, paints, varnishes, photography, condiments, canning formulas, rubber, soap, candles, soldering, toilet preparations, perfumes, waterproofing, fireproofing, writing materials. Send no money. Just write a postal. When postman hands you book pay \$5.50 and postal charges. Popular Mechanics Press, Room 806, 200 E. Ontario St., Chicago, Ill.

#### TELEGRAPHY

**LEARN** Morse and wireless telegraphy. Big salaries. Tremendous demand. Expenses low, can earn part. Catalog free. Dodge's Institute, H St., Valparaiso, Ind.

#### CHEMISTRY

**YOUR** Chemical problems solved and formula or process furnished for \$5.00. Write me. W. Stedman Richard, Industrial Chemist, Box 2402, Boston, Mass.

#### FORMULAS AND TRADE SECRETS

**3,000 VALUABLE** Formulas prepaid \$1. National Service, 3937 Marburg, Cincinnati, Ohio.

**FORMULAS** And manufacturing instructions of Crepe Weighter Finish, guaranteed the best. Joseph Colucci, 409 Crosby Ave., Paterson, N. J.

**MAKE** Washing a pleasure for \$1.00. Will send formula how to make eight gallons of Universal Soap for \$1.95. S. Croft, Moberly, Mo.

**FORMULAS**—Make your own products. Employ agents yourself. Toilet articles, household remedies, etc. Any formula 50c. Catalog free. Universal Laboratories, 193 Hanover St., Boston, Mass.

**10,000 FORMULAS.** A real Gold Mine of money-making ideas. Tells how to make almost everything under the sun. You can make and sell cosmetics, mucilage, anti-freeze solutions, battery solutions, beverages, cheese, chewing gum, cleaning preparations, extracts, hair preparations, inks, bluing, leather polish, mirrors, perfumes, polishes, typewriter ribbons, carbon paper, washing powders, liquid soap, and hundreds of other profitable articles. Send No Money. Just write a postal for "Henley's 20th Century Book of Formulas." Pay postman postage and \$4. Popular Mechanics Press, 200 E. Ontario St., Room 807, Chicago, Ill.

**INDUSTRIAL** Chemist furnishes formulas, processes; all lines. Moderate charges. Individual service. All inquiries answered personally. L. Clore, Industrial Chemist, Crawfordville, Ind.

**BEST** Tested formula ever used—Liquid automobile polish. Worth \$5.00, special \$2.00. Joseph Colucci, 409 Crosby Ave., Paterson, N. J.

**FREE** Formula, catalog. Latest money makers. Western Chemical, Salem, Ore.

**LIQUID** Ice; congeals; keeps foods. Formula 25c. "Erie," Waukegan, Ill.

**SUCCEEDED** With your own products. Make them yourself. Formulas, processes, trade secrets. All lines. Catalog, circulars free. B. Thaxly Co., Washington, D. C.

**LIQUID** Leather, plastic wood, cider made overnight. Delicious ice cream for 50c gallon. Make them yourself. Any formula \$2.00. Moscato, 757 E. 107th St., Brooklyn, N. Y.

**ICE-MAKING** Formula (machinery unnecessary). 25c. Neil Tasker, Shamokin, Pa.

**POISON** Ivy. Formula \$1.00. A. Becker, 3341 Louisiana, St. Louis, Mo.

**BEST** Tested formulas. Catalog literature free. Grinstead Company, Oswego, Kans.

**GUARANTEED** Formulas, best science can produce for making popular, biggest-selling specialties all lines. Don't buy formulas till you've received valuable eye-opening literature. Miller, Chemist, 706-F Jetton, Tampa, Fla.

**MAKE** Your own products. Employ agents yourself. Toilet articles, soap, extracts. We furnish everything. Valuable book free. National Scientific Laboratories, 1984W Broad, Richmond, Va.

**FORMULAS:** Guaranteed, catalog free. Bestovall Laboratories, 6720 Oconto Ave., Chicago.

**10,000 MONEY-MAKING** Formulas. Tells you how to make and sell almost everything under the sun; cosmetics, mucilage, anti-freeze solutions, battery solutions, beverages, cheese, chewing gum, cleaning preparations, extracts, hair preparations, inks, bluing, leather polish, mirrors, perfumes, polishes, typewriter ribbons, carbon paper, washing powders, liquid soap, and hundreds of other profitable articles. Send No Money. Just write a postal for "Henley's 20th Century Book of Formulas." Pay postman postage and \$4. Popular Mechanics Press, 200 E. Ontario St., Room 808, Chicago, Ill.

#### AGENTS WANTED

**PREVENT** The accident. Sales experience unnecessary. We furnish you proven plan to make money. Sensational seller. Marvelous Auto Safety Signal. No longer necessary to rely on faulty misleading hand signals. Illuminated hands combined with stop and tail light tell in an unmistakable manner the driver's intention to turn right, left, stop or back-up. Reasonably priced. Highly endorsed. Every car and truck driver wants one. Write for literature. Convince yourself. Act quickly. Your territory fortune. Auto Safety Signal, 501 Colorado Bldg., Denver, Colo.

**AGENTS** \$100 A week and more with amazing novelty—combination cigar lighter and writing pencil. Pencilite produces a big red-hot flame by simply pulling off cap—also furnishes a writing pencil that does the work of \$5 mechanical pencils. Sells for only \$1.00. You make big profits. Also furnished as advertising premiums, with names or trade slogans imprinted. World's fastest seller. Write for facts. The Lyco Co., 700-708 E. 40th St., Dept. H-91, Chicago.

**START** An honest-to-goodness, successful-paying business that's yours. Making world's greatest sellers! Investment small. Profits great. Start anywhere. Get my valuable "eye-opening" literature about specialty manufacturing—How you can easily make guaranteed exclusive automobile specialties, including wonderful LoidLac, finest household cleaners, best soaps, high-grade toilet preparations, modern insecticides, delicious food and beverage lines fastest-selling carded specialties. 32 years unequaled reliable service. Miller, Chemist, 706-J Chemical Building, Tampa, Fla.

**WANTED**—Agents and state managers. Steady income to mechanically-inclined salesmen with car, selling guaranteed line of socket wrenches and other time saving tools. Protected territory. York Co., Dept. SP1, 2640 Greenview Ave., Chicago.

**AGENTS** Men or women, earn \$6 day, introduce finest line guaranteed hosiery you ever saw. Guaranteed to wear and satisfy or replaced. High class proposition. No experience needed. No license to pay. Credit given. Auto to producers when earned. Spare time satisfactory. Earn silk hose for own use. Write for sales plan. Wilkmit Hosiery Co., Dept. 1631, Greenfield, Ohio.

**MAKE** Steady money. Amazing one-year guarantee sells Rosecliff shirts fast. 24 hour shipments. No substitutions. Big advance commissions. Customer gets free initials. Earn your own shirts. Get free outfit including ties. Write today Dept. ME-9, Rosecliff Shirts, 1237 Broadway, New York.

**AGENTS:** Something new, different. Every car owner will buy Autow Cable at \$1.25; your profit 75 cents. Compact, neat. Rolls into small coil. Fits pocket of car. Contains forty-eight strands flexible steel wire. Twice the strength of ordinary tow line. Just show it; sells itself. Send 50 cents for sample. Autow Cable Co., 230 West Woodbridge St., Detroit, Mich.

**ODD** Things for agents. Everything that's new, different. Opportunities galore! Special three months' subscription, 10c postage. Odd Things, 1518 Prospect, Cleveland.

**SELL** 5c Candy specialties to stores. Big profits. Confectionery Supply Company, Richmond, Va.

**400% PROFIT** Selling flower drops. One drop lasts a week. Melrose Works, Box 731, Chicago, Ill.

**HOSIERY**—Real money selling Montgomery hosiery. Great satisfaction in selling better quality for less. Catalog free. Montgomery Hosiery Co., Dept. 101, Trenton, N. J.

**CHRISTMAS** Cards. We have complete quality line. Popular prices make easy sales. Box assortments and personal. Big profits to workers. Grote, Box 277, New Brunswick, N. J.

**A BIG** Opportunity. \$50 to \$100 weekly selling Save-O-Silk. Full or spare time. Experience unnecessary. Write today for sales plan. Save-O-Silk Laboratories, Box M-89, Troy, Ohio.

**1 AUTO** Gas saver sent. To introduce. All autos. Amazing mileage increases. Critchlow, RK-805, Wheaton, Ill.

**FREE** Booklet describes 67 plans for making \$20-\$100 weekly in home or office business of your own. Elite Co., 84 Elizabeth St., New York.

**FAST-SELLING** Specialties—Make them yourself! Appoint agents. List free. Girard Research Laboratories, Wheeling, W. Va.

**NEW** Invention lights gas without sparks. Free sample. Other necessities. Maywood, M-925, Broadway, New York.

**\$100 WEEKLY** Selling locally and by mail stainless tablecloth. Looks like linen, no laundering, literature furnished your name. Free samples. Dancrafts Co., Los Angeles, Calif.

**DISTRICT** Managers! Crew managers! General agents! Wanted: Men and women to appoint saleswomen to sell "New Idea" imported sanitary necessity. New feature never before used. Every woman buys and repeats. New sales plan nets you big profit on sub-agents. Exclusive territory to producers. Write, Box J-708, Meriden, Conn.

**THAXLY** Formulas produce perfect products. All lines. Catalog free. B. Thaxly Co., Washington, D. C.

**JUST** Out: Drew's steam pad, a simple device for steaming the beard before shaving. Hospitals, barber shops, beauty parlors buy them wholesale. Every man you meet a possible customer. Write quick. W. L. Drew & Co., Puento, Calif.

**JUST** Out—New kind of electric lamp. 101 lamps in one. So beautiful women can't resist. So useful men buy instantly. Wonderful spare or full time proposition. Sell C. O. D. or deliver as you sell. Big profits daily. Write for money-making plan. Falcon Mfg. Co., Dept. L-91, 2550 Sullivan, St. Louis, Mo.

**FREE** Booklet describes 67 plans for making \$20-\$100 weekly in home or office business of your own. Elite Co., 84 Elizabeth St., New York.

**HOME** Economy oil gas burners for stove or furnace \$20.00. Agents wanted. M. E. Page Sales Co., Watkins Glen, N. Y.



**A REAL Money-maker.** Our Christmas box assortment makes real money for live men and women agents. 21 superb Christmas cards and folders. Biggest value ever offered. Ribbioned, parchment folders, Florentine, water color, engraved, embossed designs. All in beautiful Christmas box. Actual value \$2.80. Sells for \$1.00. Costs you 50c. Get in on this quick—Today! Free samples and particulars. Waltham Art Publishers (established 30 years), Dept. SS, 7 Water St., Boston, Mass.

**AGENTS Earn \$7 day.** Sell guaranteed hosiery. Select line fastest selling, biggest money making style numbers. Can't be beat for beauty and quality. Guarantee bond protects customers. Earn silk hosiery for your own use through new plan. Write quick. Silknet Hosiery Co., Dept. 1031, Dayton, Ohio.

**MAKE \$85 Weekly.** Amazing one-year guarantee sells Rosecliff shirts fast. 24 hour shipments. No substitutions. Big advance commissions. Customer gets free initials. Earn your own shirts. Get free outfit including ties. Write today. Dept. PM-9, Rosecliff Shirts, 1237 Broadway, New York.

**MAKE Your own products.** Employ agents yourself. Toilet articles, soap, extracts. We furnish everything. Valuable book free. National Scientific Laboratories, 1984W Broad, Richmond, Va.

**\$60-200 A WEEK.** Genuine gold letters for store windows. Easily applied. Free samples. Liberal offer to general agents. Metallic Letter Co., 438-B North Clark, Chicago.

**BIG Money applying gold initials** on automobiles. Easiest thing today. No experience needed. \$1.45 profit every \$1.50 job. Free samples. "Ralco," A1043 Washington, Boston, Mass.

**MAKE \$95 Weekly;** sell Broadway tailored shirt and new Rayon lined ties. Big commissions in advance. Quick sellers. Steady repeats. Guaranteed satisfaction. Free outfit. Write today. Dept. PM9, Big Bob, 489 Broome St., New York.

**EARN Big money,** representing established shoe manufacturer. No experience necessary. Big catalog and information sent free. Address Consolidated Shoe System, Dept. 68, Eau Claire, Wis.

**BECOME Your home town leading business man.** Sell full line of groceries, motor oils, paints. Everybody a customer. No capital or experience necessary. Selling outfit free. Write Loverin & Browne, 1602J So. State, Chicago.

**SELLING Like blazes!** Beautiful toilet goods assortment at \$1.50, with 24-inch pearl necklace free to your customers, 100% profit. E. M. Davis, 234 North Ave., Dept. 530, Chicago.

**\$5.00 HOURLY.** Mercerized damask scalloped table cloths. Size 58x58", 75¢! Tremendous demand. Other bargains. Big sample line free. American Braiding, C-329 W. Monroe, Chicago.

**\$20.00 DAILY.** Latest trench coats \$2.98. All colors. Also Dupont's tablecloths \$1.30. 74 other big money makers. Samples free. American, 724-LD Roosevelt, Chicago.

**RESTRICTED Territory** for new 25c household necessity. Repeats every four months. Every home will use \$3.00 worth. If looking for real money maker write for free sample. Zoro-B, 129 No. Halsted, Chicago.

**YOU Can make big money in the food business.** No capital or experience needed, credit given. Here is your chance to establish a permanent business of your own in exclusive territory. We furnish free sample case and free samples for customers. Repeat orders every week. Ask now! Federal Pure Food Co., A2307 Archer, Chicago.

**FIBRE Brooms** for home and industrial trade. Repeat business. Good profits. Perfect. 147C New Jersey Ave., Brooklyn, N. Y.

**YOU Can make big money daily,** selling Public Service ties and shirts styled on Fifth Ave. Largest assortment in the field. Splendid values, liberal commissions. Finest complete sales outfit free. Write today. Public Service Mills, 4939CF Hudson Boulevard, North Bergen, N. J.

**SUCCEED With your own products.** Make them yourself. Formulas, processes, trade-secrets. All lines. Catalog, circulars free. B. Thaxly Co., Washington, D. C.

**AGENTS Calling on garages** to handle Ritex Automatic Valve Grinders—side line. Weight 18 oz. Ritex Co., 840 E. 5th, Los Angeles, Calif.

**SELL Quick Trick automobile polishing cloths** at 50c. 100% profit. Removes traffic grime from Duco and lacquer finishes. Fast seller. Everyone a prospect. Walter S. Doe & Co., Kent, Ohio.

**GOLD-LEAF Sign Letters;** copyrighted manufacturing instructions; profits 1,000%. Johnston Co., Quincy, Ill.

**CARTER Window washer.** Cleans, dries, polishes, one operation. 10 sales daily nets you \$120.00 monthly. Good territories open. Write today. Carter Products Corp., 981½ Front St., Cleveland, Ohio.

**MAKE \$50.00, \$100.00,** Schwer's popular box 22 Christmas cards. And other original novelties. Altogether different. No investment. Write Charley Schwer, Dept. PMS, Westfield, Mass.

**TIME Counts in applying for patents.** See pages 138 and 139. Clarence A. O'Brien, Registered Patent Attorney, Washington, D. C.

**CASH Paid for Butterflies, Insects.** See Sinclair Display Advertisement on page 18.

**AGENTS—Make a dollar an hour.** Sell new kind of sharpeners. Sharpens all knives and tools quickly. Demonstrating sample 10c. Premier Mfg. Co., Dept. 95, Detroit, Mich.

**MAN Or woman wanted with ambition and industry,** to introduce and supply the demand for Rawleigh's Household Products to steady users. Fine openings near you. We train and help you. Rawleigh dealers can make up to \$100 a week or more. No experience necessary. Pleasant, profitable dignified work. Write today. W. T. Rawleigh Co., Dept. I-53PPM, Freeport, Ill.

**\$50 WEEKLY.** Men wanted to demonstrate and take orders daily direct from motorists. Amazing magnetic trouble light. Sticks anywhere! More orders, bigger pay. Write for demonstrator and particulars. Magno, Beacon Bldg., Dept. 16-C, Boston, Mass.

**JUST Out—New patented apron.** No strings or straps—\$20.00 a day every day; over 100% profit; commissions daily. Write for free outfit. Sta-Put Co., Dept. 209, St. Louis, Mo.

**AGENTS: Free catalog 200 household specialties,** toilet preparations, food products, portraits, frames, photo pillows, medallions, religious goods, pictures. Credit. James C. Bailey Co., Station C-9, Chicago.

**SALESMEN—Earn \$100 weekly** taking orders for Dazzler and Rainbow glow electric signs. Big commission. Exclusive territory. High grade proposition. Write Chicago Sign Sales Co., Dept. 80, Charlotte, N. C.

**SNAPPY Shirt line ready!** Season's best values. Agents cash in big. Nothing to invest. Get free outfit and handsome samples. Special features. Gracefit, Dept. 511, 504 Sixth Ave., New York.

**SELL Razor blades;** large profits; samples 15c. Information for stamp. Kramer, 161 St. Paul's Ave., Jersey City, N. J.

**MERCHANTS Buy on sight,** fast selling sales cards of razor blades (Gillette type). Also flints and wicks for cigar lighters. Samples free. Metro Specialty Co., 43 West Sixth St., Cincinnati, Ohio.

**SOLE RENU,** Aliquid leather completely resoles for few cents; spreads over sole; dries over night; wears like leather; sample can 50c. A. Wright, 3705 Fifth Ave., Pittsburgh, Pa.

**YOU Get quick, sure, steady income,** easy, from commissions selling our line advertising pencils. Surprisingly profitable, spare time or full time. Particulars free. Advertising Pencil Company, Walbrook M, Baltimore, Md.

**\$75.00 WEEKLY Placing Genuine Gold Leaf Signs.** Experience unnecessary. Demand unlimited. Best agency offer. Premier Company, 179 N. Wells, Chicago.

**START Fords new way.** Chevrolets, too, with clever E-Z Finger Dash Control starter. Needed by millions everywhere. Sells on sight. Up to 150% profits daily, the year 'round. Get details and plan free. Metalcraft Corporation, Dept. L-10, 5101 Penrose Ave., St. Louis, Mo.

**MAKE \$100 Week** placing electric advertising cigar lighters and fans on dealer's counter. Flashing colored advertisements. Write Drake Mfg. Company, Dept. M, Milwaukee, Wis.

**AGENTS: 100% Profit.** Sell Wipe-a-shine Auto Towels. Cleans and polishes auto finish with one application. Nothing to break, nothing to shake. Lasts indefinitely. Sells for \$1.00. Send 50c deposit for full size sample. Money refunded on first order. Zenith Chemical Works, 5526 W. Lake St., Chicago.

**\$85 WEEKLY** Selling nationally advertised dresses, lingerie, hosiery, amazing values. Complete equipment and earn your own clothing. Sure profit plans furnished. Shaughnessy Knitting Co., 348 Shaughnessy St., Watertown, N. Y.

**AMERICA'S Greatest tailoring line—Free.** 150 large samples. All wool—tailored to order—union made—sensational low price. Big commissions paid daily. Cash bonus besides. Exclusive territory to producers. Hustlers making \$100 a week and up. Get outfit at once. Address Dept. 203, Goodwear, 844 Adams, Chicago.

**STRANGE New electric iron cord!** Prevents scorching. Saves electricity. Cannot kink or snarl. Used on telephones also. \$25 daily. Samples free. Neverknot, Dept. 9-A, 4503 Ravenswood, Chicago.

**2 NEW Patent auto accessories,** exclusive territory, no competition. Wholesale and retail sales. Satisfaction guaranteed. Samples 50c. Desk 3, Ball Manufacturing, 9441 Pleasant, Chicago.

**WELLS Cleared \$620.00 in one month** with Business Guide and free legal service. Write for free outfit. Prof. Nichols, Dept. 56, Naperville, Ill.

**HOMEOPATHIC And Biochemic preparations** sent postpaid to all parts of the world. Manual and booklet free. Halsey Bros. Co., 5547 Ravenswood Ave., Chicago, Ill. Established 1855. Agents wanted.

**BIG Ohio corporation wants county manager.** Opportunity \$50 to \$75 weekly. Earnings start immediately. Good for \$5,000 yearly. We furnish everything, deliver and collect. Capital or experience unnecessary. Fyr-Fyter Co., 1906 Fyr-Fyter Bldg., Dayton, Ohio.

**AGENTS—Earn \$19 daily** demonstrating and wearing fine felt hats and showing them to friends. Smartest styles. Latest shades. \$2 to \$5 saving on every hat. Samples free. Write Taylor Hats, Dept. MC-135, Cincinnati, Ohio.

**Where To buy 500,000 articles at lowest wholesale prices,"** 1929 Directory. Distributors wanted. Pruitt System, Brookfield, Ill.

**AGENTS—Make big profits** selling gas or oil wash furnaces. Profits each sale \$3.00 to \$5.00. Every home a prospect. Adams Manufacturing Company, Dept. A, Commerce, Tex.

**BRANDNEW 50c Specialty,** 150% profit. Quick demonstration sells every housewife. Pocket sample. Deliver on spot. Great side line. Agents, distributors cleaning up \$65 to \$124 weekly. Territory going fast. Write today sure. Harker Co., Battletree, Mich.

**AGENTS—Absolutely new!** Our hand-colored popular priced photo statuettes going big! Everyone wants them! Agents making \$10-\$25 daily! Samples furnished. Craver Mfg. Co., J82456 Jackson, Chicago.

**HOSIERY Agents—Take orders** for startling new hose. Absolutely no competition. Not sold through stores. Every woman buys. Big repeater. Outfit free! Racine Feet Knitting Co., Dept. 20-9, Beloit, Wis.

**AGENTS, Clean up selling well-known Cee-dar Crystals** for 35c. Paddle that hangs on hook 25c. Box DeLuxe 50c. Kills moths, deodorizes. Free particulars. Cee-Dar, H77 W. Washington, Chicago.

**AGENTS—Write for free sample Dri-Klean-It.** Makes your car look like new. Removes mud, dirt, dust. No soap or water used. American Accessories Co., Desk 5431, Cincinnati, Ohio.

**\$2.45—RAINCOATS.** All colors. Trench-coats, tweeds, alligators, leatherettes. Sample coat and bonus to workers. Beautiful outfit free. Bradley, Dept. AB-9, 230 S. Wells, Chicago.

**AGENTS, Give customer two pounds toilet soap** free with \$1 bottle superior vanilla. 100% profit. Midwest Drug Company, Dept. B-9, Columbus, Ohio.

**AGENTS, Distributors making big money** with fast selling 50c specialty. Repeater. Ask how we guarantee sales. M. & M. Company, Box 34, Attica, Ind.

**AGENTS** Big money. Bonus besides. Sell best line guaranteed hosiery. All styles. Big profits. Credit given. Spare time satisfactory. Write for sales plan. Auto to producers when earned. Betterknit Hosiery Co., Silk 5031, Columbus, Ohio.

**MAKE** Your own products. Employ agents yourself. Toilet articles, soap, extracts. We furnish everything. Valuable book free. National Scientific Laboratories, 1984W Broad, Richmond, Va.

**AGENTS**—New style tablecloth. No laundering; hemstitched, flannel back; several colors. Sells itself. Samples free. Puritan Mills, 43 Tremont St., Boston, Mass.

**LET** Me add \$30 a week to your pay without interfering with your present occupation. Interesting, pleasant work. Particulars free. Albert Mills, 3778 Monmouth, Cincinnati, Ohio.

**MANUFACTURER** Of Guaranteed Shoes, 25 years in business, offers big, money-making opportunity. New 96-page catalog, sales manual and complete details of proposition sent free. Write Mason Shoe Mfg. Co., Dept. H-17, Chippewa Falls, Wis.

**MIRRORS** Resilvered at home. Costs near 5 cents per square foot; you charge 75 cents. Immense profits plating autoparts, reflectors, tableware, stoves, refinishing metalware, etc. Outfits furnished. Details free. Write Sprinkle, Plater, 128, Marion, Ind.

**AGENTS**, Housewives everywhere buy our dollar ironing board cover and unburnable pad. Tremendous demand. High commissions assure unlimited earnings. Full-spate time. Mardo Co., 105 Wooster St., Dept. B9, New York.

**BIGGEST** Money maker tailoring line pays \$4.00 to \$7.00 order. Cash bonuses. Free suits to producers. All wool serges, cassimeres, top coats. Quality worsteds, heavy weight overcoats. Giant outfit, 1/4 yd. samples free. Dept. PM9, Olympic, 5th Ave., at 19th St., New York.

**SELL** Personal Christmas cards, names embossed in gold, \$1 dozen up. 50% commission. Samples free. Also box assortments. Dunbar Corp., New Brunswick, N. J.

**BIG** Money selling shirts and ties! Wonderful values. Finest line now ready. 54 latest New York styles. Big outfit and special samples. Everything free. Pioneer Mills, 1225 Broadway, Dept. B16, New York.

**SELL** "Prevents Runs." Guaranteed to prevent runs in silk hosiery. Large profits. Particulars. Specialty Mfg., 307 West First, Los Angeles, Calif.

**BIG** Money weekly. Newest window letters out. Easiest to put on. No experience needed. Free samples. "Ralco," 1045 Washington, Boston, Mass.

**MAKE** Your own products. Employ agents yourself. Toilet articles, soap, extracts. We furnish everything. Valuable book free. National Scientific Laboratories, 1984W Broad, Richmond, Va.

**MEN!** Get the new sensational Gitsknife counter card. Good for \$20.00 daily. Free offer! Gits Co., D5419 Chicago Ave., Chicago.

**BIG** Money daily, selling shirts of all kinds, lumberjackets, underwear, hosiery, sweaters, playsuits, overalls, pants, raincoats, leather coats! Outfit free! Experience unnecessary. Nimrod Co., Dept. 8, 4922-28 Lincoln Ave., Chicago.

**NO** Matter what you are selling postal addressed to Excello Sales Co., Shreveport, La., will bring best money making offer you ever received.

**"THE** Ringside," patented wind-operated boxing match. "A Million Rounds For One Dollar." Six dollars per dozen. Sample 60c postpaid. Weatherwise Toys, Georgetown, Mass.

**MYSTERY** Polishing cloth in tin cans sell like hot cakes. Write free sample. Mohler, Box 453DZ, Chicago.

**SELLING** Like sixty. New product kills moths, flies, mosquitoes and other insects. Immense profits. Dairymple Co., U-294, Benton Harbor, Mich.

**WRITE** Atlas Sign Works for free working equipment. Beautiful gold window sign letters. Penny each! Any size. Wonderful offer to general agents. K1032 E. 55th St., Chicago, Ill.

**PERFUMES**, On counter display cards. High quality. Low prices. Large profits. Helen of Troy, 58 West 93rd St., New York.

**MAKE** \$20 To \$35 a day selling Imprint Book Matches, spare or full time. Big repeat business—no investment—every merchant a prospect. Send 50c for selling outfit which includes complete samples. Imprint Book Match, Dept. 116, 877 Meigs St., Rochester, N. Y.

**OVER** 200 Reliable manufacturers need agents in every locality in the United States. Learn all about it in the current issue of Opportunity Magazine. Free sample copy sent on request. Opportunity Magazine, Dept. M39, 750 N. Michigan, Chicago.

**\$15.00 DAILY** Selling new tablecloth. Requires no laundering. Tyrrell Company, Martins Ferry, Ohio.

**AGENTS**—New shirt proposition. No capital or experience needed. Commissions in advance. Samples free. Madison Company, 566 Broadway, New York.

**ARE** You old at forty? See our advertisement on page 153 of this issue. The Electro Thermal Company, 2120 Morris Ave., Steubenville, Ohio.

**LATEST** Craze! Show new kitchenware in 5 appealing colors to housewives. Kitchen necessities. \$90 weekly easy. Big repeat sellers. No experience or cash needed. Beautiful colorful selling outfit free. See page 157 this magazine. Full particulars. Modern Kitchenware, Dept. 6-MM, 176 W. Adams, Chicago.

**AGENTS**, Opportunity seekers. Make amazing profits. Write Empire, Shawano, Wis.

**RIM** Tool—Complete tire change 24 seconds. Exclusive territory. Victory Tire Rim Tool Co., Santa Monica, Calif. 1516 Pico Blvd.

**BUILD** Profitable business of your own, distributing samples. Write for particulars and samples. Rudman, 1751 Anthony Ave., New York City.

**\$12.00 DAILY** Showing new table cloth. Looks like linen. Wash like oilcloth. No laundering. You just take orders. We deliver. Pay daily. Sample free. Bestever, 152 Irving Park Station, Chicago.

**LADY** Or gentleman—Sell sparkling glass name plates, house numbers, signs. 150% profit. Sample free. O. Vance, Wooster, Ohio.

**LOCAL** Representatives for Duplex Adjustable Sash Balance make big money. Sells on sight. Duplex Manufacturing Co., 632 N. La Pere, Los Angeles, Calif.

**\$75 WEEKLY** Up placing Aspirin, Notarar, Lighter Flint, Silk-Tone and other self-selling counter display cards with merchants, soda fountains, cigar stores, etc. Over 100% profit. Steady repeats. Sterling Company, F, Baltimore, Md.

**AMAZING** Discovery triples life of silk hosiery. Every woman a prospect. Enormous profits; quick repeater. Eston, Box 688, Birmingham, Ala.

**A BUSINESS** Of your own—Making sparkling glass name and number plates, check-boards signs. Big book and sample free. E. Palmer, 512, Wooster, Ohio.

**AGENTS** Wanted—On a fast selling 25c item for the kitchen, costs you 8 1-3c. Sample sent parcel post prepaid for 10 cents. P. Seed Filter Mfg. Co., Inc., 353 Broadway, New York.

**MEN** With autos sell Koehler signs. 717 North Fourth, St. Louis, Mo.

**SELL** Goodyear raincoats; \$2.95 up. Goodyear Rainwear, 346 Sixth Ave., New York.

**AUTOMOBILE** Specialties. Guaranteed formulas for all latest money makers. Lowest prices. Write for free lists. Murphy, Chemist, Tujunga, Calif.

**AUTO** Mitten Duster. Season's biggest selling hit. Cost 20c. Sells like hot cakes for 50c. Sample given. National Brushes, St. Louis, Mo.

**PORTRAIT** Men: Why not Pasco portraits? We refund your money for all you cannot deliver. Frame, catalog free. Portrait Agent's Supply Co., Dept. F, La-Porte, Ind.

**AGENTS**—Mosco Corn and Callous Remover will build you a steady repeat business. Send today for pocket-size trial outfit. The Moss Company, 435 Searle Bldg., Rochester, N. Y.

**FLAVORING** Extracts—Bottle yourself! Concentrated. Free labels. 600% profits! Whirlwind moneymaking proposition! Write Thomas Manufacturing Company, Indianapolis, Ind.

**100% CLEAR** Profit! Men and women! Enormous profits can be made selling new \$2.00 patented Pinless Curtain Stretcher. Miniature demonstrator furnished. Article sells itself. Exclusive territories available to first applicants. Western Newell Mfg. Co., Freeport, Ill.

**NEW** Style needle books pay \$22.00 daily profit. Free clever threader invention to customers creates eager buyers. Sweeping country. One billion Paty needles sold. Proof free. Sample 10c. Paty Needle Co., West Somerville, Mass.

**\$200 MONTHLY** Selling amazing new automobile trouble light. Sticks anywhere on car. Electro magnetic. It's also an everlasting flashlight. Send for demonstrator and prices. National Electric Corporation, 223 High St., Newark, N. J.

**OUR** Special plan makes sales easy! Make us prove it! Guaranteed products. Details, samples free! Write today! Togstad Co., 30 Punion St., Kokomo, Ind.

**400% PROFIT** Selling imported and American novelties A \$5.00 investment will earn \$160.00. Valuable and useful samples—complete information 25c. Northwestern Novelty Co., 543M No. Ashland, Chicago.

**\$5 SALE**—\$5 Commission. Combination life-accident policy. Address Underwriters, PM-55, Willow Hill, Ill.

**MAN** In each town to plate auto parts, reflectors, bathroom fixtures, refinish beds, mirrors, chandeliers; by new method. No capital or experience required. Simple plan of manufacturing at home starts you in big money-making business. Outfit furnished. Free particulars and proofs. Gun Metal Co., Ave. H, Decatur, Ill.

**REPLATE** Brass worn-off automobile parts, reflectors, bath room fixtures, worn spoons, forks, etc., with pure silver. Looks like new. Use U-Kan-Plate Polish. Positively no mercury. \$1.00 half pints. Post paid. Satisfaction guaranteed. Agents wanted. Dept. A, U-Kan-Plate Co., Philadelphia.

**AGENTS**—Clever Invention! Inkspoon makes every pen a fountain pen. Fast office seller; big profit, demand increasing everywhere. Exclusive territory offered. Sample free. H. Marui Company, Tribune Bldg., New York, N. Y.

**TWO** Money makers for agents. "Francia" Pocket Adding Machine retails \$4.85. To you \$1.00. "Excellograph" Rotary Stencil Duplicator \$37.50 retail. Write Type-writer Supply, 102 Hersch Bldg., Pittsburgh, Pa.

**WE** Start you without a dollar. Soaps, extracts, perfumes, toilet goods. Experience unnecessary. Carnation Co., 641, St. Louis, Mo.

**BIG** Profits! Fast sales! \$9.75 automatic washing machine. Guaranteed. Write Storm Royalty Co., 3601 Enright, St. Louis, Mo.

**CALIFORNIA** Perfumed beads selling like hot cakes. Agents coining money. Big profits. Catalog free. Mission Factory P, 2328 W. Pico, Los Angeles, Calif.

**SELL** Supreme No-Cement tire and tube patches. 300% profit. Particulars. Supreme, 135 Winder, Detroit, Mich.

**\$50,000** PICTURE Man Friedman made canvassing. Beginners can make \$100.00 weekly with my sales talk. Experienced men make more. Free book "Profits in Portraits" explains. Sample free. Picture Man Friedman, Dept. 8, 109 West Austin, Chicago.

**BIG** Money and Fast Sales. Every owner buys Gold Initials for his auto. You charge \$1.50; make \$1.34. Ten orders daily easy. Write for particulars and free samples. American Monogram Co., Dept. 40, East Orange, N. J.

**SELL** Stores 5c carded Breathlets, mints, etc. Lorrac Products, Albany, N. Y.

**SHOE** Creme, cleans, polishes all color shoes. Fred Heitmueller, 830-A Cherry, Jamestown, N. Y.

**AGENTS**, "Strike a gold mine" when selling Nulustre cloths at 25c; cleans, polishes all metals; the duller the metal, brighter it shines. Everybody delighted. Agent sells 102 boxes in 116 calls. Write for free samples, proof. Shef Mfg. Co., 1 Shef Bldg., Weehawken, N. J.

**AGENTS**—Make large profits handling our hand engraved name plates, signs, numbers, etc. Brett Bros., Winthrop, Mass.

**AGENTS**—Here's a new one. "Bestever Powdered Hand Soap." Sells like wildfire. Marvelous discovery. Removes grease, paint, ink, oil, in fact anything from hands. Cannot harm skin. 150% profit. Great repeater. Agents simply coin money. "Free Samples Get the Business." Write immediately. Bestever Products Co., 4315W Irving Park, Chicago.

**POLMET** Polishing Cloth removes tarnish from metals without the use of liquid, paste or powder. Our agents say it sells like "hot cakes." Retail 25c; sample free. Gale & Co., Inc., 15 Edinboro St., Boston, Mass.

**32 SECONDS** Complete tire change by Detmer, Ohio, with Morey Quick Action Rim Tool. Sold, singly, 49 three days cleared \$100. Anderson, Mont., sold 1,400 in 14 weeks. Get details for good territory. Harvest time now. M. Morey Rim Tool, Buffalo, N. Y.

**MAKE** Your own products. Employ agents yourself. Toilet articles, soap, extracts. We furnish everything. Valuable book free. National Scientific Laboratories, 1984W Broad, Richmond, Va.

**AGENTS.** Our cigar lighters, musical novelties and salesboards sell quick. Large wholesale catalog free. Joseph Sales Company, 223 Madison St., Chicago.

**GENUINE** Gold Leaf Letters anyone can put on store windows. Guaranteed to never tarnish. Large profits. Enormous demand. Free samples. Write today. Metallic Letter Co., 438-D North Clark, Chicago.

**MANUFACTURE** Auto Specialties: Radiator Seal, Hand Soap, Puncture Plugger, Silk Life, Glass Cleaner. Get my free list. John Mickman, Chemist, St. Paul, Minn.

**SELL** Men's neckwear—wonderful proposition. Astor-M, 39 East 28th, New York.

**REMNANT** Store, Bethel, Ohio. Greatest Dry Goods Bargains on Earth. Agents and Dealers.

**MONOGRAM** Automobiles. \$1.35 Profit ten minutes' work; every owner wants them; millions without; particulars free. Motorists Accessories Co., Mansfield, Ohio.

**GOLD-LEAF** Window letters and script signs; no experience; 500% profit; samples free. Consolidated, 69-T West Van Buren, Chicago.

**GET** Our free sample case—Toilet articles, flavoring and specialties. Wonderfully profitable. LaDerma Co., Dept. A, St. Louis, Mo.

**AGENTS:** Stamping names on pocket-key protectors. Sample check with your name and address, 25c. Stamping outfits, Emblem checks, check-fobs, name plates. Hart Mfg. Co., Desk 2, 303 Degraw St., Brooklyn, N. Y.

**WORKERS** Buying and applying Axtell Metal Weather Strips to door bottoms make \$1.00 to \$3.00 hourly. Prices, territory, etc. E. L. Church Co., Whitman, Mass.

#### HIGH-GRADE SALESMEN WANTED

**PREVENT** The accident. Sales experience unnecessary. We furnish you proven plan to make money. Sensational seller. Marvelous Auto Safety Signal. No longer necessary to rely on faulty misleading hand signals. Illuminated hands combined with stop and tail light tell in an unmistakable manner the driver's intention to turn right, left, stop or back-up. Reasonably priced. Highly endorsed. Every car and truck driver wants one. Write for literature. Convince yourself. Act quickly. Your territory fortune. Safety Signal, 501 Colorado Bldg., Denver, Colo.

**AMAZING** Pencil sells like magic. Combination cigar lighter and writing pencil for only \$1.00. You make big profits selling direct. Also sell to merchants—hand-some display card holding 12 Pencillites furnished. Can be sold as splendid advertising. Novelty for business firms; with names or trade marks imprinted. Write immediately for remarkable money-making proposition. The Lyco Co., 700-708 E. 40th St., Dept. H-92, Chicago.

**FEW** \$1,000 Monthly earnings ads are truthful. Our men actually earn \$300 to \$500 regularly selling our lines. Adelite, the newcomer in electric window salesmen, is making a big hit. More for the money than anybody gives. Business posters for every line. Changeable letter system too. Permanent business for you working with us. Territory protected and repeats credited. Fat commissions. Full details will prove very interesting. Display Products, Ltd., 409-A East 31st St., Kansas City, Mo.

**CASH** In on million dollars publicity campaign. No investment. In a week Diederichs earns \$78. Wilde \$91. Crile \$102. Hickson \$119. Pay check weekly. Take orders for our dependable trees, shrubbery. Landscape service. Every home a prospect. Work entire year, full or spare time. Complete cooperation. Inexperienced men trained. Write us today. Perry Nurseries, Desk R-9, Rochester, N. Y.

**SALESMEN**—Become independent. Own your business; experience unnecessary. Selling our \$10,000 Accidental Death; \$50 Accident; \$25 Sick Weekly Benefits—\$10.00 yearly. Other amounts proportionate. Guaranteed steady income from renewals. \$250,000 deposited Insurance Department, Universal Policy Dept. A, 40 Clinton St., Newark, N. J.

**PAYING** Position open. I'll put you in the shoe and hosiery business. Permanent income, protected territory, full commission on repeats. Experience not necessary. Handsome sample outfit, literature—everything you need to become a successful shoe merchant. Send for free booklet "Getting Ahead." Wm. J. Mishel, Tanners Shoe Mfg. Co., M, 2009 C St., Boston, Mass.

**\$40.00 SUITS** For \$23.50! Union made to special order, of finest quality virgin wool. You don't have to know anything about selling clothing. We guarantee your success if you are honest and willing to work. Write at once. Goodwear, Inc., 844 West Adams, Dept. 204, Chicago.

**EVERY** Call a prospect. Every sale means big repeat business. Complete line—attractively packaged. Nationally used household chemical necessities, etc. Protected territory to producers. Big earnings. Opportunity to build up permanent business. The Holmerden Company, Stratford, Conn. Dept. P.

**MAKE** \$125.00 Weekly selling biggest tailoring values in America for \$24.75. Custom tailored to measure all virgin wool worsted suits—your profit \$4.00 in advance, plus bonus of 50c to \$2.50. Satisfaction guaranteed. Write immediately for free sample case. Camden Clothes, 317 S. Market, Dept. J-13, Chicago.

**SALESMEN** Calling on power users to sell belting as a side line; auto traveled territory preferred. Teuscher Pulley & Belting Co., 801 N. 2nd St., St. Louis, Mo.

**WONDERFUL** Invention. Seals fifty envelopes minute. Sells on sight at \$3.50. Attractive proposition. Square deal. Bank references. Kendall Sealer Co., C-15, East Jaffrey, N. H.

**COVERALL** Salesmen—Make \$20 daily selling new \$3.50 improved coveralls, also service coats with customer's name embroidered on back. Unusual construction. Commission 75c! Wonderful advertising value. Lowest priced; highest commission. Free outfit. Am. B. Co., AU-329 W. Monroe, Chicago.

**AUTO** Seat cover line pays \$100 weekly. Sell direct to automobile owners. Low priced—excellent quality. Elaborate 4x7 samples free. Marvelo, 2302 Wabansia, Chicago.

**WELL-KNOWN** Mfg. needs sideline salesmen. Sell leather gladstone bags to stores. Retail under \$10.00. Liberal commission. Lome, 625 S. Racine, Chicago.

**\$78.00 MADE** By Iowa salesman first day selling new electric hot dog machines. Sells \$18.50; commission \$8.50. Direct factory connections. Leonard E. Dickerson, Dept. E-16, Springfield, Mo.

**MEN** Of ability—To represent manufacturer direct selling superior line of advertising thermometers. All or part time. Liberal commissions. Marshall Mfg., Coshocton, Ohio.

**SPLENDID** Sideline. Excellent profits selling to trade, finest complete line vending machines, etc. No samples. Sell from catalog. Specialty Mfg. Co., W617 W. Division, Chicago.

**EARN** \$20 A Day. Establish income for life selling for \$1 a year. \$1,500 accident policy. Write W. C. Stone, 11 So. LaSalle, Chicago.

**35% COMMISSION.** Liberal repeats. New sales-producing service increases business 20% to 50%. Every retailer live prospect. Sales Stimulators, 339 W. Madison, Chicago.

**SALESMEN!** Sell Bostonian Shirts. Direct to wearer. Start in a money-making business of your own without a penny of capital. No experience necessary. Wonderful complete selling outfit free with everything you need to start collecting your profits at once. Write today, sure! Bostonian Mfg. Co., 106 Bickford St., Boston, Mass. Est. 1863.

**A MONEY-MAKING** Sideline. A new quick seller to merchants and banks everywhere. Sales outfit free. Comm. paid daily. Carroll Co., Carroll and Albany Aves., Dept. 206, Chicago.

**AUTO** Specialty men, high grade, as exclusive distributors in each city or county, to sell our patented rubber products. Pneumatic door cushion and universal pedal cushion to dealers. Write personally, Inventor Milbender, 1424 East 38th St., Los Angeles, Calif.

**AMAZING** Screw-holding screw driver! Factories, garages, workers buy on sight! Profit 75c each. Exclusive territory. Free trial offer. Jiffy, 1162 Winthrop Bldg., Boston.

**100% PROFIT** Demonstrating motorists magnetic emergency light. Sells on sight. Sticks anywhere on car. Quick-Set Co., 3218 Avenue Eye, Dept. C9, Brooklyn, N. Y.

**NEW** Discovery astounds America. Salesmen cleaning up \$75 to \$125 weekly. "Elastishine" destined to revolutionize automobile painting. Flows on like magic over old paint. Brush marks disappear instantly. Guaranteed not to chip, peel or crack. Free starting offer. Southern Products Co., Dept. 46, Hopkinsville, Ky.

**SANTA** Claus money—Amazing new low cost trade stimulator for retailers. Big commissions on new and repeat business. Moyer, 440 McKnight Bldg., Minneapolis, Minn.

**STATE** Mgr. Marvellous invention seals 3,000 envelopes hourly! Sells \$4.50 only; equals work expensive electric machines. Offices buy 1-100. Exclusive territory. Opportunity earn \$7,000 yearly. Free trial offer. Write quick! Rede, 35 Winthrop Bldg., Boston.

**FREE** Outfit—Trousers bonus. \$15.00 daily writing orders for guaranteed tailored-to-measure trousers. World's greatest pants value. Big commissions. Wonderful pocket sideline. Hutchins Pants Co., Dept. 363, Cincinnati, Ohio.

**OUR** Captive base ball, Eclipse wrapping bands and auto-light deflectors are a new and attractive sideline for reliable salesmen. Martin Mfg. Co., 1204 5th N. W., Canton, Ohio.

**LUSTROUS** Aluminum stove pipe. Beautiful, durable, inexpensive. Displaces black pipe on gas stoves and heaters. Every housewife a prospect. Hardware stores, furniture dealers also. Sold under money-back guarantee. McCarthy Mfg. Co., Pear Ave., Cleveland, Ohio.

**WANTED** District managers—Capable men to represent us in prosperous territories with direct home office contract. Our organization is the oldest of its kind in the health and accident business and offer exceptionally remunerative compensation. Write today for information. Dept. 18, Inter-State Business Men's Accident Association, Brown Bldg., Des Moines, Iowa.

**BUSINESS** Stationery—Largest line; highest quality; quickest delivery; biggest commissions; liberal bonuses. Free copyrighted cuts every business. Experience unnecessary. Instructions and outfit free. Willens Co., Dept. 245, 2130 Gladys Ave., Chicago.

**GOLD-LEAF** Window letters and script signs; no experience; 500% profit; samples free. Consolidated, 69-V West Van Buren, Chicago.

**PATENTED** Invention cuts gasoline bills in half. Proved by automotive engineers. Fast seller on simple demonstration. 2 sales daily pays \$60 week. Exclusive territory. Write for free trial offer. Aerostat Co., 3601H Vliet St., Milwaukee, Wis.

**BIG** Money daily, selling shirts of all kinds, lumberjackets, underwear, hosiery, sweaters, play suits, overalls, pants, rain-coats! Outfit free! Experience unnecessary. Nimrod Co., Dept. 65, 4922-28 Lincoln Ave., Chicago.

**ARE** You old at forty? See our advertisement on page 153 of this issue. The Electro Thermal Company, 2120 Morris Ave., Steubenville, Ohio.

**\$18 TO \$25 Daily**; biggest selling line of 2-piece suits, \$9.95 and \$12.50; 3-piece wool suit, \$17.95 (regular \$28.00 value). All-wool overcoats \$18.50. Splendid raincoats, slickers and boys' suits. Biggest commission. Free outfits. "Jim" Foster, Inc., Dept. 29, 2250 S. Spaulding Ave., Chicago, Ill.

**OVER 200** Reliable manufacturers need salesmen in every locality in the United States. Learn all about it in the current issue of Opportunity Magazine. Free sample copy sent on request. Opportunity Magazine, Dept. M49, 750 N. Michigan, Chicago.

**SALESMEN:** Make big money supplying business printing. Low prices sell merchants and professional men easily. 30% commissions daily. Profitable as side line. Write for sales portfolio. Mercantile Printing Bureau, 114 North Second, Rockford, Ill.

**EXTRA Money—Easy!** Sell Christmas cards! Make 50¢ on each \$1 box of 24 finest assorted engraved designs. 40% on personal greetings. Deal direct with manufacturers! Write for samples and details. Thistle Engraving & Pub. Co., Dept. P, 20 Vesey St., New York.

**RIGHT Now!** Wonderful chance to represent big shirt manufacturer. Best season coming. Easy work. Commission in advance. Outfit given free. Write Gracefit Company, Dept. 511A, 504 Sixth Ave., New York.

**GALLOPING Ivories.** New game that's thrilling all America. Absolutely legal. Every cigar counter waiting for you. \$125-\$200 weekly. Hurry K&S, 4308 Ravenswood, Chicago.

**PUNCHBOARD** Salesmen make \$200.00 weekly selling punchboards and vending machines. Big repeat commissions. Beautiful 3-color catalog free. Best season now. Write today. Old reliable company, established 20 years. Lincoln Sales, 116 S. Wells, Chicago, Dept. D.

**MAKE** Your own products. Employ agents yourself. Toilet articles, soap, extracts. We furnish everything. Valuable book free. National Scientific Laboratories, 1984W Broad, Richmond, Va.

**ADVERTISING** Pencils. Quick-action sideline money-maker. Free samples for real salesmen. Northern Pencil Works, 128 So. Clinton, Chicago.

**SALESMEN.** Wonderful sideline. 40% commission paid daily. Sells all merchants. Pocket outfit free. David Lionel Press, 312 S. Hamilton, Dept. 84, Chicago.

**\$60-\$200 A WEEK.** Genuine gold letters for store windows. Easily applied. Free samples. Liberal offer to general agents. Metallic Letter Co., 438-A North Clark, Chicago.

**SUCCESS** is no accident! You will fully understand this slogan when you examine our automatic credit and collection plan. Copyrighted, brand new, unusual. You make 250% on original sale. Half cash on repeats without call-backs. Commonwealth J. Publishing Company, 508 So. Dearborn St., Chicago, Ill.

**SALESMEN—Four** \$15.00 sales to merchants net you \$40.00 daily. Sayers Systems, 2813 Sheffield, Chicago, Ill.

**ALL Year** round profitable business. Earn extra money spare time selling wonderful new water softener and cleanser. Cleans like magic, grease, ink and dirt from every thing. Every home and business place a live prospect. 100% profit. Big repeat orders. Agents protected. Trial case \$4.00 delivered. U. S. A. Seacoast Laboratories, Inc., Sea Bright, N. J.

**SELL** Printing—40% commission daily; lowest prices; with or without deposit. Copyright cuts free. Inquiry brings pocket outfit. Merchants Assn., Insurance Center Bldg., Chicago.

**TO Market** 3A garage door holders, simple automatic action, quickly installed, instantly attracts garage owners, builders, dealers. Write for exclusive territory proposition. Knowlson-Stevenson Co., 1118 Packard, Ann Arbor, Mich.

**NEW Invention—Sell** every business. Four \$15 sales daily pay \$288 weekly. Walker made \$165 first day. Exclusive territory. Adjustment Service, Dept. PM, Mobile, Ala.

**LADY** Or gentleman—Sell sparkling glass name plates, house numbers, signs. 150% profit. Sample free. O. Vance, Wooster, Ohio.

### HELP WANTED

**WILL** Finance married man 25-60, good appearance, fair education in a paying business of his own. Profits to start will average only about \$30.00 weekly but will increase as you learn the business. Must furnish AI references and have car for delivery. Make application in own hand writing to McConnon & Company, Room B-6609, Winona, Minn.

**WANTED:** Women who need quick money. "New Idea" imported ladies' necessity sells on sight; everyone buys; representatives everywhere are cashing in big. Miss Ely has made \$1,900; Mrs. Hart \$2,200, without experience. New salesplan put you in business for yourself. Sample free. Write Mary P. Coleman, Meriden, Conn.

**AMBITIOUS** Women make big money selling Priscilla dress fabrics, dry goods, hosiery, lingerie, specialties. Full or spare time. Pleasant work. Samples furnished. Write Fitzcharles Co., Dept. 46, Trenton, N. J.

**CASH** Paid for Butterflies, Insects. See Sinclair Display Advertisement on page 18.

**OBTAIN** Employment desired, quickly, anywhere. Use "Ways That Win." Write Box 39-201, Station K, New York.

**THE** Boulder dam, Eight years' work. Latest information regarding conditions, employment, concessions, etc., sent by return mail for \$1.00. Money back if dissatisfied. M. Roberts Service Bureau, Box 1051, Denver, Colo.

### EDUCATIONAL AND INSTRUCTION

**WANTED** Immediately, men-women, 18-55, qualify for permanent government positions, \$105-\$250 month; no gov't experience required; paid vacations; common education; many needed soon. Write Ozment Inst., 101, St. Louis, Mo.

**STAMMERING.** Stuttering, other speech troubles, corrected. Wilson Schools, Dayton, Ohio.

**MAIL** Carriers, postoffice clerks. \$1,700-\$2,300 year. Steady work. Men 18-45. Frequent examinations. Common education. Particulars free. Write Franklin Institute, Dept. A-14, Rochester, N. Y.

**"THE Personal Liberty Course"**—A clever combination of mirth, information and instruction for quickly overcoming fear, bashfulness and physical complexes in men. No drugs, no gymnastics. Full particulars free, sealed. Harry J. Gardener, P. O. Box 607, Station C, Los Angeles, Calif.

**LEARN** Aircraft welding, auto mechanics, electricity, Magnetos, radio. Big pay. Big demand. Low rates. Free catalog. Stevinson School, 2008A Main, Kansas City, Mo.

**MEN—Women,** 18 up. Want a government job? \$105.00 to \$280.00 month. Steady work. Short hours. Paid summer vacation. Common education usually sufficient. Experience usually unnecessary. We coach you without leaving home. 32-page book with full particulars and sample coaching free. Write immediately. Franklin Institute, Dept. A-3, Rochester, N. Y.

**INVESTIGATING** And tracing. Work home or travel. Experience unnecessary. Write American System, 2188 Broadway, New York.

**MEN, Women,** everywhere. Manage your own business. Learn local advertising (distributing and supervising the distributing of free samples, folders, circulars, etc., and tacking-up signs). Unlimited opportunities. Complete instructions one dollar. John Wagner, Box 457, Palo Alto, Calif.

**FIREMEN,** Brakemen, baggagemen (white or colored), sleeping car, train porters (colored). \$150-\$250 monthly. Experience unnecessary. 810 Railway Bureau, East St. Louis, Ill.

**DOUBLE** Entry bookkeeping 60 hours with 8 keys; guaranteed. (Diplomas.) International Bookkeeping Inst., 8 Springfield, Mo.

**DON'T** Prepare for any civil service examination without seeing our catalog. Free. Columbian Correspondence College, Washington, D. C.

**BIG Demand** for photoplay talking picture and magazine stories. We revise, develop and copyright. Sell on commission. Established 1917. Booklet free. Universal Scenario Company, 406 Western and Santa Monica Bldg., Hollywood, Calif.

**BECOME** A landscape architect. Uncrowded profession; wonderful opportunity for money-making. Easily mastered by mail. Earn while you learn. Est. 1916. Write for details. American Landscape School, 29 Plymouth Bldg., Des Moines, Iowa.

**U. S. GOVERNMENT** Wants men, \$1,700-\$1,900 and up at start. Railway mail clerk examination coming. Let our expert (former government examiner) prepare you for this and also rural carrier, post office, customs, internal revenue, and other branches. Write today for free booklet. Dept. 8, Patterson School, Rochester, N. Y.

**AMATEUR** Cartoonists: Sell your cartoons. New market. Smith's Service, PR-1194, Wenatchee, Wash.

**TRACE** Missing people. Excellent paying work. Open to all. Write National Headquarters, 169 East 83rd, New York.

**LEARN** Linotype—Pays good salary; home or college course; small cost; free catalog. Linotype School, Maumee, Ohio.

**STUDY** A scientific profession. Microbiology, Bacteriology, Sanitation. Extension-residential course. Diplomas, degrees granted. Urinalysis outfit—prospectus free. College of Microbiology, 23 State, Hammond, Ind.

**LEARN** Mechanical dentistry in Los Angeles. Earn \$40 to \$125 week. Day or night classes. 3 to 9 months course. Practical laboratory instruction. Professional standards. Free employment service. Write for free book. Smith Dental Institute, 747 South Hill St., Dept. 9, Los Angeles, Calif.

### INFORMATION, SERVICE, COUNSEL

**TRACING.** Make secret investigations. Work home or travel. Experience unnecessary. Write American System, 2188 Broadway, New York.

**FLORIDA** Information—Any five questions answered immediately, one dollar. Mr. Van, Gen. Del., Wildwood, N. J.

**LOS ANGELES, Calif.,** Information. Anybody, any subject, \$1. Bureau, Box 313, Arcade Station.

### TYPEWRITERS AND SUPPLIES

**TYPEWRITERS**—Factory rebuilt Royals, Remingtons, Underwoods, New Royal, Remington and Corona portables. New "Excelsior" Rotary Stencil Duplicator \$37.50. Catalog free. Pittsburgh Typewriter Supply, Dept. 945, Pittsburgh, Penna.

**TYPEWRITERS,** All standard makes, \$10 up. Fully guaranteed. Free trial. Write for complete illustrated lists. Northwestern Typewriter Exchange, 121 N. Francisco Ave., Chicago.

**TYPEWRITERS**—All makes, \$8 to \$32. Fully guaranteed. Dee Typewriter Exchange, Ada, Okla.

### ADDING MACHINES

**NEW** \$3.50 Automatic adding machine. Adds, subtracts, multiplies, absolutely accurate. Capacity \$999,999.99. Fully guaranteed. 75,000 pleased users. Makes adding easy, positive, quick. Eliminates mistakes. Saves time. Postpaid \$3.50. Bassett Co., 1458-C, Hollywood Ave., Chicago.

### PRINTING, ENGRAVING AND MULTIGRAPHING

**1,000 BOND** Letterheads, envelopes, billheads, statements, cards, \$3.45 each. Satisfaction, samples. H. Curtis, 811 Harrigan, Kalamazoo, Mich.

**PRINTING**—All kinds. Superior work—low prices. Samples. Battlefield Printers, Box 306, Gettysburg, Penna. Battlefield souvenir.

**"NEARGRAVURE"**—If particular. Special 250 envelopes, 500 8½x11 letterheads \$4.44 postpaid. Solidays, Knox, Ind.

**1,000 BUSINESS** Cards \$2.75 postpaid. Samples free. John Miller, Montgomery Ave., Narberth, Pa.

**INTRODUCTORY** Special! 50 cards, 50 letterheads and 50 envelopes, all for \$1.00. Quotations on various printing solicited. Congress Printing Company, 2402 West Division, Chicago.

**MULTIGRAPHING** Business correspondence two dollars thousand. Hammermill letterheads, four dollars; inexpensive quality, three dollars. Miscellaneous printing. Mayera Corporation, Monmouth, Ill.

**ART** Ad slips, 3¼x5½, 200 words, attractive colors: 1,000, \$2.00; 5,000, \$5.00, prepaid. All printing low prices. Samples. Goodprint, Harrisonburg, Va.

**PRINTING**—Low prices, fine work. New price list and samples. Stationery, circulars, folders, booklets, catalogs, ruled forms. Sell direct, large or small orders. Large modern plant in small town, low operating cost. Shenandoah Publishing House, Inc., Box 1110, Strasburg, Virginia.

**QUALITY Printing!** Reasonable Prices! Send for Free Standardized samples and prices. Folders, Circulars, Catalogs our specialty. Earnest Fantus, 525 South Dearborn, Chicago.

250 BOND Letterheads, Envelopes, Billheads, Cards, \$1.35 each. Economic Press, Leonia, N. J.

WE Print stationery, booklets, catalogs, circulars. Samples. Commercial Press, Batavia, Ohio.

200 LETTERHEADS And 100 envelopes \$1.00. 200 letterheads, 8 1/2 x 11, 150 envelopes \$2.00. 250 cards \$1.00. Hoosier Print Shop, Portland, Ind.

200 NOTE Sheets and 100 envelopes \$1. Brown, Warsaw, N. C.

SAMPLES Raised letter printing with special prices free. LaClyde Service, Westfield, Mass.

#### PRINTING OUTFITS AND SUPPLIES

PRINT Your own stationery, cards, bookplates, Christmas cards, circulars, books, pamphlets, etc. Junior press, \$5.90; job press, \$11; rotary, \$149. Print for others. Easy and interesting; rules sent. Write for catalog presses, type, paper, etc. Kelsey Company, L-14, Meriden, Conn.

PRINTING Outfits—Presses, type supplies, type novelties. Send stamp for catalog. Model Press, York, Penna.

#### GUMMED LABELS

1,000 PRINTED: Name, business, address 50c. JBS Company, Box 93, Holyoke, Mass.

#### RUBBER STAMPS

RUBBER Stamps! Name, address, two lines 25c; three lines 35c. DeLux Stamp Works, B572M, Auburn, Nebr.

#### DUPLICATORS AND DEVICES

YOU Can make 50 to 100 copies of a letter, notice, etc., at a cost of three cents on a Heyer Quality Duplicator. Write for free trial offer. The Heyer Duplicator Co., 909 Jackson Blvd., Chicago, Ill.

"EXCELLOGRAPH" Portable rotary stencil printing duplicators \$39. Terms. Description, testimonials, printed samples, free. Pittsburgh Typewriter Supply Co., Dept. 531, Pittsburgh, Pa.

#### FOR THE HOME

GRANDFATHER'S Clock Works, \$5.00. Build your own case; instructions free; make good profits selling your friends. Clock works with chimes for old or new cases. Write for full particulars. Clock Co., Ruffner St., Philadelphia.

CEDAR Chests only \$11.65—"Red-1-Kut" complete with rich copper trim—you assemble and save half—send for pictures. Kuempel Furniture Company, Guttenberg, Iowa.

#### FOR MECHANICS

A BIG Opportunity in 8-hour battery charging, or 20 minute car washing. Let me tell you how you can install equipment with practically no investment. Earn \$150 to \$300 monthly. Bargains in used outfits. Also a few reconditioned buffers, grinders, air compressors, paint sprays, arc welders. Write today. Ken Byrum, Box M, Troy, Ohio.

MINUTE Man pants eliminate belts and suspenders. Olivdrab sample, \$2.75. Two \$5.00 postpaid. State size. Veteran Outfitters, 7516 97th Ave., Ozone Park, New York.

AUTO Mechanics demonstrate new auto invention on side. \$50 extra money each week. Free trial offer. Aerostat Co., 3601-P Villet St., Milwaukee, Wis.

#### FOR SMOKERS

TOBACCO. Virginia Gold Leaf. Smoking, chewing, mild, mellow. Like rare old wine. Four pounds \$1 postpaid. Belmont Farms, Box A, Chatham, Va.

#### FOR MEN

EXTRA Special offer. Men's fancy socks. Guaranteed first quality. For a limited time only, we offer these at \$4.95 a dozen pairs, postpaid to your address. Satisfaction guaranteed. Badger Sales Co., Dept. A, Whitewater, Wis.

#### RAZORS AND BLADES

GILLETTE Razor blades sharpened to perfection, 1c each. Petter Wetterquist, Rockford, Ill.

#### BOATS AND LAUNCHES

MAKE 16' Rowboat. Blueprint 30c. Weesho-Uco, 31st Office, Detroit, Mich.

BUILD Your own boat using our ready cut semi assembled materials. 55 designs. Outboard speedsters, cruisers, runabouts, launches, sail, row. Send 10c for catalog. Hurry if for this season's use. Brooks Boat Co., Inc., Saginaw, Mich., Box NN.

HUBBELL Marine Coolers convert Ford engine into marine motors. Booklet free. Ford speedboat easily built, large blueprint and directions one dollar. C. C. Hubbell, Perry Ave., Norwalk, Conn.

TWENTY Mile outboard racer. Complete plans 25 cents. Free boatbuilding catalog. The Rodder, 15 Murray St., New York.

#### FIELD GLASSES, TELESCOPES AND MICROSCOPES

9-in. NEWTONIAN Telescope mirror glass, 1 1/2" thick, fully 6 ft. focus, fine figure \$250. Also 5 in. fully 4 ft. focus 1" thick \$75. James Greenlees, 273 North Ave., Hartford, Wis.

#### GUNS, FISHING TACKLE, SPORTING GOODS

SPORTING Goods: Baseball, boxing, tennis, golf, rifles, shotguns, poker racks, binoculars, etc. Send stamps for catalog. Hudson, W52 Warren St., New York.

#### ANTIQUES, WAR RELICS AND INDIAN GOODS

STEER Horns, six feet spread for sale. From the longhorn species of cattle now extinct. L. Bertillon, Mineola, Tex.

WAR Relics and guns. Lists fifteen cents. Young, 175 Washington Ave., Belleville, N. J.

SEND 5c For fine new list Indian relics, antique firearms. F. E. Ellis, Webster Groves, Mo.

#### MINERALS AND SEMI-PRECIOUS GEMS

WE Are dealers in rough and polished minerals and polished semi-precious gems for scientific, educational, cabinet display or jewelry craft purposes. List of gem minerals and their varieties, table of birthstones and price lists free with an order for any of the following. PM Special—Six assorted rough and polished minerals for \$1. Four genuine mined, fully polished gem stones \$1. Two interesting Montana mineral specimens 35c. Any of these postpaid, correctly labeled and with satisfaction guaranteed. The Gem Shop, Box 373, Wolf Creek, Mont.

#### PHONOGRAPHS AND RECORDS

BUILD Your own phonograph. Parts catalog and instructions to build new horn, mailed for 10c. American Phonograph Co., 4116 West 24th Place, Chicago.

#### MUSIC AND MUSICAL INSTRUMENTS

BANJO Ukulele, \$2.10; circular free. Press, 708 No. E. 31st, Portland, Oreg.

SONGWRITERS! Melody for your words, one dollar. Frank Littig, Nipomo, Calif.

VIOLINS—Hand-made masterpieces. John Lehto, 935 14th San Pedro, Calif.

FREE! Song Writers Guide. Beaver, 1257 Elm, Green Bay, Wis.

MAKING Violins. Plans and instructions free. For particulars write Rodell Music House, New Bedford, Mass.

SONGWRITERS—Successful songs earn fortunes. Submit poems. Brennen, Musical Director, L1656 B'way, New York.

POEMS Wanted. Work guaranteed. We publish. Great Eastern Song Bureau, Dept. 27, Thomaston, Me.

SEND Song poems, 50-50 plan. Indiana Song Bureau, (Brookside), Salem, Ind.

COMPOSERS—Verse or music. Brilliant opportunity. Write Van Buren, 1875 McClurg Bldg., Chicago.

SONG Poem writers. Write Sequoia Songwriters' Service, Sherman Branch, Los Angeles, Calif.

VIOLINS. Deep, mellow, soulful—on credit. Easy terms for wonderful instrument. Get details today. Gustav F. Henning, 302 University Building, Seattle, Wash.

SONG-POETS—"Your Best Bet." Healy, Liberty Theater, Colorado Springs, Colo.

CORNETISTS—Trombonists—Saxophonists—Clarinetists. Get "Free Pointers." Name instrument. Virtuosi School, Buffalo, N. Y.

PLAY Piano by ear. A sound system. Booklet free. Boucher's Harmony Studio, Ottawa, Can.

SONG Poem writers: "Real" proposition. Hibbeler, D.I., 2104 N. Keystone, Chicago.

"MUSIC Composed" to words. Bauer Bros. (formerly of Sousa's Band), Oshkosh, Wis.

SONG Writers. Send for our "Publishing Agreement." McKinley Music Printers, 1501 E. 55th St., Chicago.

WRITE Songs. Big money and reputation. Write for information. J. Gordon Pub. Co., 201 N. Hoyle Ave., Chicago.

SONG Poems solicited. A different proposition. Richard Broughton, Sioux Falls, S. Dak.

#### PATENT ATTORNEYS

TIME Counts in applying for patents. See pages 138 and 139. Clarence A. O'Brien, Registered Patent Attorney, Washington, D. C.

LACEY'S Patent Sense. Valuable book free. See ad page 143.

PATENTS—Write for our free book, "How to Obtain a Patent" and Record of Invention Blank. Send model or sketch of invention for inspection and instructions free. Terms reasonable. See advertisements on pages 140 and 141. Victor J. Evans & Co., 934 Ninth, Washington, D. C.

PATENTS Procured under my easy payment plan. See ad page 143. M. S. Cayne.

PATENTS Procured. Prompt, careful and efficient service. Highest references. Moderate fees. Send sketch or model for actual search and advice. George P. Kimmel, Master of Patent Law, 54-I Legal Bldg., Washington, D. C.

INVENTIONS Patented; inventions developed; correspondence invited; confidential advice; trademarks registered; copyrights. Edward Gottlieb, Patent Attorney, Engineer, 5 Beekman St., New York.

PATENTS Procured; trade marks registered—preliminary advice furnished without charge. Booklet and form for disclosing idea free. Irving L. McCathran, 704 International Building, Washington, D. C.

UNPATENTED Ideas can be sold. I tell you how and help you make the sale. Free particulars (Copyrighted). Write W. T. Greene, 906 Barrister Bldg., Washington, D. C.

SELL Your invention before patenting. Write for free particulars. W. T. Greene, 901 Barrister Bldg., Washington, D. C.

PATENTS, Trade-Marks, Designs. This firm has 27 years' experience and gives expert personal service at reasonable rates. We properly protect your invention. Write for free information and exact cost of procuring patent before proceeding. John B. Thomas & Co., 902 F St., N. W., Washington, D. C.

MONROE E. MILLER, Ouray Bldg., Washington, D. C., Patent Lawyer; Mechanical, Electrical Expert. Booklet and Priority Record blank gratis.

ESTABLISHED 1864. Milo D. Stevens Company. Free Booklet. Patents, Trade-Marks, Copyrights. Offices, Monadnock Block, Chicago; Barrister Building, Washington, D. C.

INVENTORS—Write for our Guide Book, "How to Get Your Patent," and Evidence of Invention Blank. Send model or sketch of your invention for our prompt examination and instructions free. Randolph & Co., Dept. 430, Washington, D. C.

PATENTS. Prompt personal service. Write for information. Albert E. Dieterich, Registered Patent Lawyer, 621 1/2 Ouray Bldg., Washington, D. C.

LANCASTER and Allwine, 221 Ouray Bldg., Washington, D. C. "Originators of the Form Evidence of Conception." Before disclosing your invention to anyone send for blank form to be signed and witnessed. Form and patent information bulletin free.

PATENTS. Send sketch or model for advice. Free book: "How to Obtain a Patent." Established thirty years. Highest references. Prompt service. Reasonable charges. Chandlee & Chandlee, 910 F St., Washington, D. C.

INVENTOR'S Adviser with mechanical movement's sent free. Labiner, Three Park-row, New York.

**PATENTS.** Booklet free. Highest references. Best results. Promptness assured. Send model or drawing for preliminary examination. Watson E. Coleman, Patent Lawyer, 724 Ninth St., Washington, D. C.

**PERCY S. WEBSTER,** 203 Saving and Loan Building, Stockton, Calif. Patent booklet free.

"**INVENTOR'S Guide,**" valuable information, free. Frank Ledermann, Registered Attorney-Engineer, 1712 Woolworth Bldg., New York.

**PATENTS**—Write for free instructions. Send drawing or model for examination. Carl Miller, Registered Patent Attorney (former Patent Office examiner), 259 McGill Bldg., Washington, D. C.

**PATENTS** Procured at reasonable rates with time to pay. Sales negotiated. Staff of registered attorneys and engineers. A complete service for inventors. Write for particulars. Inventors Service Bureau, Dept. B. Union Trust Bldg., Washington, D. C.

#### FOR INVENTORS

**PATENTS.** If you have an invention which you wish to patent you can write fully and freely to Munn & Co., for advice in regard to the best way of obtaining protection. Please send sketches, or a model of your invention and a description of the device, explaining its operation. All communications are strictly confidential. Our Hand-Book on Patents is sent free on request. This explains our methods, terms, etc., in regard to patents, trade marks, foreign patents, etc. "Scientific American" contains patent office notes, decisions of interest to inventors and particulars of recently patented inventions. Munn & Company, Solicitors of Patents, 524 Scientific American Bldg., Washington, D. C.; 1523 Scientific American Bldg., 24 W. 40th St., New York City; 1313 Tower Bldg., Chicago, Ill.; 666 Hobart Bldg., San Francisco, Calif.; 521 Van Nuys Bldg., Los Angeles, Calif.

**TIME** Counts in applying for patents. See pages 138 and 139. Clarence A. O'Brien, Registered Patent Attorney, Washington, D. C.

**INVENTIONS**—Write for our free book "How to Obtain a Patent" and Record of Invention Blank. Send model or sketch of invention for inspection and instructions free. Terms reasonable. See advertisements on pages 140 and 141. Victor J. Evans & Co., 157 Ninth, Washington, D. C.

**LACEY'S Patent Sense.** Valuable book free. See ad page 143.

**UNPATENTED** Ideas can be sold. I tell you how and help you make the sale. Free particulars. (Copyrighted). Write W. T. Greene, 907 Barrister Bldg., Washington, D. C.

**IF** You can't sell your patent, address W. T. Box 131, East Ave. Station, Rochester, N. Y.

**I MAKE** Patent models, drawings. Mechanism ideas, prices reasonable. Louis Uhler, 561 S. Waterman, Detroit.

**GET** Your own patents. Legal blanks, complete instructions \$1. Cutting Sons, Campbell, Calif.

**INVENTORS** Universal - Educator - contains 900 mechanical movements; 50 perpetual motions. Tells how to obtain and sell patents. Suggests new ideas. Explains how to select your attorney and avoid patent sharks. Price (revised edition) \$1.00 postpaid. Albert E. Dieterich, 621 Ouray Bldg., Washington, D. C.

**PATENTS.** Patents pending sold to manufacturers. You pay for results only. W. Nestle, 852 Belmont Ave., Chicago.

**INVENTORS**—Ideas developed and working models built. Electrical problems solved. Lowest charges and confidential service. Industro Electric Tools Co., Petersburg, Va.

**I SELL** Patents. Established in 1900. A nationally-known service. Experienced, respected. Why take chances? Charles A. Scott, 773PM Garson Ave., Rochester, N. Y.

**SELL** Your invention before patenting. Write for free particulars. W. T. Greene, 902 Barrister Bldg., Washington, D. C.

**INVENTORS**—Cash in on your invention now! Don't delay the sale any longer! Send for a free copy of our specially prepared booklet, "Turn Your Patent Into Money," today! It contains helpful information for all inventors. M. L. Rund, Mgr. Classified Advertising, Popular Mechanics Magazine, 200 E. Ontario St., Chicago, Ill.

**INVENTIONS** Wanted—Patented, unpatented. If you have an idea for sale, write Hartley, Box 928, Bangor, Me.

#### PATENTS FOR SALE

**OUTRIGHT** Or royalty. Swimming device No. 1,661,499 U. S. A. Combination pleasure, health and muscle building. Collapsible features. Manufactured in Canada. Sold by leading stores. Universal rights possible. Inventor, 1090 E. 21st Ave., Vancouver, Can.

**BATHERS** Waterproof cigarette and match case. Formed of sheet metal. Outright or royalty. Louis D. Bartucci, 2131 DeKalb St., Chicago, Ill.

**OUTRIGHT** Or royalty. Child's toy. Propelled by a pleasing and muscle developing motion of the body. E. B. Ware, 108 West Lane Ave., Columbus, Ohio.

**ROYALTY**—Latest wire soap dish, soap removed without lifting. Patent pending. J. J. Kilbride, Scotch Plains, N. J.

**FOR** Sale or royalty—Maxime carpet protector. Necessary in every hotel and private home. Rhoda Ahlstedt Lenzinger, 2926 Pine Grove Ave., Chicago, Ill.

**FOUNTAIN** Pen and lead pencil together in one, with center bushing working both ends; fine novelty. Herman Wiese, 3429 Broadview Rd., Cleveland, Ohio.

**OUTRIGHT** Or royalty—Patented keyless automatic door lock. Jay Westcott, 103 Wilmore Pl., Syracuse, N. Y.

**OUTRIGHT** Or royalty. Frying pan and Fryer turner for frying oysters, fish or any food in fat. Food is turned without use of fork. The turner reverse in pan cooks articles on both sides. Model and patent papers furnished interested manufacturers. H. E. Stampley, Sibley, La.

**CASH** Or royalty. Patent on new invention used in digging wells or telephone post holes, for loosening rocks and clay. Adjustable, simple and cheap to manufacture. Needed by telephone companies everywhere. Einar Carlson, 620 9th Ave., Two Harbors, Minn.

**BAGGAGE** Attachment, No. 1,715,865 for sale. Mendel Rosenfeld, Wallingford, Conn.

**MOTION** Picture camera mechanism. New type shutter; simple, compact. Louis Uhler, 561 S. Waterman, Detroit.

**OUTRIGHT** Or royalty—Automatic golf bag, pronounced best ever by golfers. Internal extension lengthens bag to receive clubs full length, making rigid positively locked case. Patent U. S., Canada, Great Britain. W. L. Howland, 400 3rd Ave. S. E., Independence, Iowa.

**EDUCATIONAL** Devices: Teachers' desk combination. J. T. Harrison, Dwight, Ill.

**PATENT** For sale: Window shield to protect cashier's booth in banks. Bullet proof and operated with electric motor. Have perfect working model. Cash or royalty. J. D. Lawrence, 1348 Brooklyn Ave., Detroit, Mich.

**TYPEWRITER** Improvement, adjustable, inexpensive, time-saver, royalty, outright basis—Sale, outright, royalty, valve stem for inner tubes of pneumatic tires. Screw threaded connections eliminated. Two money making propositions. A. Preisser, 708 Trinity St., Dallas, Tex.

**OUTRIGHT** Or royalty, a novel moving sign. For indoor or outdoor advertising. Address James F. Casey, 1666 Third Ave., New York, N. Y.

**PATENT** Fly catcher; most effective and simple means for destruction. Want active partner to finance development and manufacture. Box 395, Emporia, Kans.

**NEW** Auto light. Bright roadway—no glare. Clover-Light, John Betzer, Hillsboro, Ore.

**INK** Process: Huge profits. Pipe wrench unpatented; other devices. Ideas developed. Inventor, Howard James Pritchard, 575 Columbia Ave., Akron, Ohio.

**FOR** Sale—A new setting tool for corrugated fasteners; works as nail set. A. Lundeen, Lynbrook, N. Y.

**OUTRIGHT**—Combination tray and reading table; fine for old peoples' home or lying-in hospitals. Nothing like it. A. Griggs, 936 San Pascual Ave., Los Angeles, Calif.

**GARDENING** Implements patent for sale. Number 1,713,396. \$5,000.00 cash. 10% royalty. The implement for truck farms and big lawns. Inventor, Box 618, Beeville, Tex.

**COMBINATION** Motor truck, concrete and mortar mixer; establishing a new mixing principle and will prove a big money maker to manufacturer. Chas. Payne, 27 Fulton Ave., Waukegan, Ill., U. S. A.

**TIME** Counts in applying for patents. See pages 138 and 139. Clarence A. O'Brien, Registered Patent Attorney, Washington, D. C.

**FOR** Sale or royalty—New non-skid automobile appliance, patent pending. Best thing out for wet, icy roads or hills; cheap to manufacture. For information Campbell & Finstad, Drummond, Wis.

#### MODELS AND MODEL SUPPLIES

**LET** Our experience be your guide. Models that are models; tools and equipment for economic manufg. Patterns of all types; manufacturing in all branches. Satisfaction guaranteed. United Machinery Company, Cincinnati, U. S. A.

**POWER** Models for modelmakers. Steam and gasoline engines, boilers. Ship, railway and steam fittings. Metals. Catalog 20c. Chas. Cole, 1355 Church St., Ventura, Calif.

**INVENTORS**—We build models. Send us your rough idea. Our master mechanics will develop it for you into a practical working model. Thirty years successful experience doing this very thing. Confidential service guaranteed. Bank references furnished. Send for free booklet "The Road To Success." Crescent Tool Co., Dept. A, Cincinnati, Ohio.

**TIME** Counts in applying for patents. See pages 138 and 139. Clarence A. O'Brien, Registered Patent Attorney, Washington, D. C.

**MODELS.** Experimental work. Equipped for complete machine construction any description. Hullt & Company, Machinists, 115 South Clinton, Chicago.

**READ** The Model Yacht! The only national magazine in America devoted to the interests of the model yacht sailor. Published monthly. \$1.50 the year, 15c the copy. Yachting, Inc., 215 East 42nd St., New York.

**WORK** With master machinist; 15 years experimental experience, well equipped shop. Albert Weiss, 161 W. 21st St., New York City.

**THE** Modelmaker, a magazine for all interested in making working models, boats, etc. Sample 10c. Modelmaker, 122 Liberty St., New York.

**SHIP** Model Fittings; Send Dime for booklet. A. J. Fisher, 1002 Etowah Ave., Royal Oak, Mich.

**WE** Make working models for inventors and do experimental work and carry a complete stock of brass gears and model supplies. Send for catalog. The Pierce Model Works, Tinley Park, Ill.

**SPECIAL** Machine builders, tool and die makers, inventors' models production work of all kinds. Dept. L. Quality Hardware & Machine Corporation, Ravenswood and Thorndale Aves., Chicago, Ill.

**MODEL** Steam engines and boilers for miniature power boats. Boat and boiler fittings. New catalog 15c. Model Machine Shop, 212 Price St., Rahway, N. J.

**THREE** Ship model plans for \$1. Catalog 6 cents. Richter's, 3217 Walnut St., Milwaukee, Wis.

#### MANUFACTURING

**LARGE** Factory exceptionally well equipped to manufacture your product complete, warehouse it and ship to your instructions. Dies, stampings, casting, screw machine, wire products, plating, enameling, assembling, cartons and printing. Quantity production. Estimates promptly furnished. A reliable and efficient organization. Majestic Products Mfg. Company, Box 877, Chicago.

**MANUFACTURING** Models, dies, stampings, brass work, one or thousands. Circular free. Baum's Metal Specialties, Kansas City, Mo.

**SPECIAL** Machinery or parts, dies, tools, metal specialties, models, special gears, stock gears and model supplies. Send for Catalogue. The Pierce Model Works, Tinley Park, Ill.

**WIRE** Goods made to order. Cooley Mfg. Co., 530 N. Western Ave., Chicago.

**MANUFACTURING** Specialists. Dies, metal stampings and contract manufacturing metal parts. Schroer Manufacturing Co., 2221 Campbell, Kansas City, Mo.

**ELECTRICAL**

**NEW Electrical Dictionary.** Complete up-to-date electrical dictionary to which has been added a special dictionary of radio words and terms together with illustrations of electrical symbols, radio diagrams and other wiring diagrams. 191 Pages—Vest pocket size. Price only 35c postpaid. Popular Mechanics Co., Room 810, 200 East Ontario St., Chicago, Ill.

**KINKS On Metal Work.** 419 discoveries for anyone who works with metal. For mechanic, machinist or the man who tinkers at home. 287 illustrations. Send no money. Just write a postal asking for "Machinist's Kinks." When postman hands you book pay postage and price of book, \$1.50. Popular Mechanics Press, Room 810, 200 E. Ontario st., Chicago, Ill.

**MACHINERY, TOOLS AND SUPPLIES**

**NO. 3 CINCINNATI Universal Milling Machine** with dividing heads, \$550.00; 14 in. x 6 ft. Von Wyck lathe, \$140.00; No. 60 Head Grinder, \$275.00; 20 in. Hendy Shaper, \$225.00; 24 in. Steptoe Back Geared Crank Shaper \$550.00, 36 in. x 18 ft. Niles Lathe, \$775.00; 20 in. Barnes Drill Press, complete, \$65.00; Quincy Air Compressor with tank and hose, \$65.00; 10 in. Bench Drill Press, \$23.00. Terms to suit. Write for catalog. Cincinnati Machinery & Supply Co., 27 West Second St., Cincinnati, Ohio.

**USED Arc welders, air compressors, buffers, grinders, reconditioned and guaranteed like new.** Shipped on trial and easy terms. If you're in need of good guaranteed equipment, write today to Bob Jones, Box M, Troy, Ohio.

**DIES, Stampings, machine work.** B. L. Nortwed, Mitchell, S. Dak.

**500 BRAND New Westinghouse 1/4 hp. 110 volt, a.c. electric motors,** price \$8.00 each. While they last. Botwinik Brothers, Inc., 67 Water St., New Haven, Conn.

**CONCRETE Building block machines and molds.** Easy payments. Catalog free. Concrete Machine Co., 5 North Main St., St. Louis, Mo.

**START Business of your own, small investment required, doing nickel, copper and silver plating.** This work in big demand. Information free. Electro Platers Supply Co., 28 W. Second St., Cincinnati, Ohio.

**753 TIME, Labor and Money Saving Ideas for all who own, drive or repair autos.** These practical kinks are based upon the actual experiences of hundreds of owners and repairmen. Three books, Auto Owners', Auto Repairman's and Auto Tourists' Handbooks, regular \$1.50 value will be supplied at 98c plus the postage C. O. D. for a limited time only. Send your order today to Popular Mechanics Press, Room 808, 200 E. Ontario St., Chicago.

**ENGINES, MOTORS AND DYNAMOS**

**BARGAINS—Elec. drills, \$11.95; bench saw outfit, \$7.35; elec. bench grinders, \$13.20; combination lathe, \$8.15; scroll saw, \$5.60; motors, generators, farm plant equipment, flexible shafts; 100 other bargains.** Send for special bargain bulletin. Acme Tool Co., 627 W. Washington, Chicago.

**NEW 10v. 5 Ampere battery charging generators \$6.50. A.c. 110v. 1/4 hp. motors, \$7.50. 1/2 hp. \$16.50. 3/4 hp. motors, 1/2 hp. \$19.50; 1-3 hp. \$12.50; 1/4 hp. \$8.50. 3/2v. motors with emery, buffer, drill chuck \$8.00. 12" a.c. desk fans \$8.00. Large stock motors and generators. Queen City Electric, 1736 Grand Ave., Chicago.**

**SAVE Money—automatic air compressors, constant potential battery chargers, reconditioned and guaranteed like new.** Unusual value—shipped on trial and easy terms. If you can use, better write today to D. W. Baker, Box M, Troy, Ohio.

**STEAM Engines. 1 hp. \$18. 1/2, \$12. James Chambliss, Bessemer, Ala.**

**TIME Counts in applying for patents.** See pages 138 and 139. Clarence A. O'Brien, Registered Patent Attorney, Washington, D. C.

**ELECTRIC Motors—Yours for rewinding or make your own quarter, half and one horse-power electric motors.** A.c. induction motor winding models show winding connections plain sight. Learn quick, easy way. Gaines Bros., Box 481, Gainesville, Tex.

**NEW 1-3 Horse Westinghouse 110 volt alternating current motors.** \$10.50. 1/4 horse, \$7.00. 3/2 and 110 volt 500 watt generators, \$18.50. All with pulleys. Hundreds of other bargains. Electrical Surplus Company, Dept. 12, 1911 Chicago Ave., Chicago.

**NAVY Surplus, 800 new radio generators d.c. and 500 cycles. Unusual prices.** List. Henry Kiengle, 501 East 84th St., New York.

**FOR Sale—1-6-1/4 hp. motors, 60 cycle, alternating current, slightly used, first class condition; all motors tested before shipping \$4.50 and \$5.00 while they last. Cash with order.** The Maytag-Chicago Co., 337 W. Madison St., Chicago, Ill.

**ELECTRIC Motors, reconditioned equal to new, a.c. or d.c. 1/4 h.p. \$16.50; 3/4 h.p. \$18.50, 1 h.p. \$24.00. Others to 10 h.p.** Tell us your motor problems. Temps Bros. Motor Company, 123 Nostrand Ave., Brooklyn, N. Y.

**EDISON Phonograph motors with speed governor. Westinghouse dictaphone motors, both universal, \$5.00 plus express 10 lb.** Geo. Schulz, Calumet, Mich.

**WELDING AND SOLDERING**

**LUMINITE Solders anything aluminum.** Perfect work, easily done by anyone. Crank-cases, waterjackets, gears, models, sand-holes, etc. No preheating, no dismantling. Builds up missing and broken parts. Large or intricate work. Used by automobile manufacturers, garages, factories, etc. Prepaid \$3.75 lb.; \$2 1/2 lb. Large sample, several job size \$1. Money back guarantee. Du-Maurier Company, Elmira, N. Y.

**BENDING MACHINES**

**THE Famous Hossfeld "Wrenchless" Universal Iron Bender is the last word in bending machines.** Bends metal, cold or hot, into most any conceivable shape, including Eye Bolts and Automobile Spring Eyes. Bends up to 1" bars or 1 1/2" pipe cold. Thousands in use by all classes of trade, from the smallest shops to the largest railway system. Write for circular and prices. Hossfeld Mfg. Co., Winona, Minn.

**SURVEYING INSTRUMENTS**

**SAVE On transits and levels.** Rebuilt and guaranteed. All kinds and makes. Terms if desired. Write today for descriptive list M-39. Warren-Knight Co. (Manufacturers of "Sterling" Transits and Levels), 136 N. 12th St., Philadelphia, Pa.

**COMPLETE Farm level outfit \$25.00. Combination transit \$45.00.** Sent prepaid for cash. Money back guarantee. Wissler, 639 No. Broadway, St. Louis, Mo.

**LUMBER**

**SAMPLES 20 Cabinet woods, 20 inlay woods all labeled, choice \$1.00 postpaid; both \$1.75. Fancy woods, panels, lumber.** Send for free sample and catalog. Craftsman Wood Service, 715 A East 62nd St., Chicago.

**FARM LANDS**

**LAND Opening—The Great Northern Railway serves an agricultural empire in Minnesota, North Dakota, Montana, Idaho, Washington and Oregon.** These states abound in opportunities for small farmers or large operators to rent or purchase a farm at lowest prices and best terms of many years. Every kind of farming, grain, livestock, dairying, fruit, poultry; large acreage or small suburban tracts, rich cutover or high producing irrigated land. Write for free Zone of Plenty book with detailed information. Low home-seekers' rates. E. C. Leedy, Dept. 457, St. Paul, Minn.

**FLORIDA—For sale, 20 acres, N. W. Florida, DeFuniak Springs; poultry, grapes, fruits, truck; good roads, schools, churches; co-operative marketing; sunshine year round; big bargain; only \$500; \$200 down payment. You get clear title deed immediately; balance \$18 a year; no interest. Great opportunity. Excursion every Tuesday. Round trip, \$36.89. Chamber of Commerce booklet free. McCaskill Estates, 7 S. Dearborn St., Chicago.**

**TWO Room, furnished cottage, lake front, for sale.** Guy Crockett, Guilford, Me.

**MICHIGAN'S Best, lowest-priced farms.** Stocked, equipped. Free booklet. Paras, 432 Linden St., Hartford, Mich.

**CASH For your property, farm, business or residence.** No matter where located. Free information. International Realty Co., Ford Bldg., Detroit.

**STROUT'S Farm catalog, just out! 152 big pages, over 1,000 bargains, 800 pictures.** Farms every kind many states, equipped; village homes, roadstands, auto inns, sportsmen's tracts; lowest prices. Don't buy without it. Copy free. Strout Agency, 255-P Fourth Ave., New York City.

**\$5.00 DOWN, \$3.00 Monthly, buys 2 1/2 acres No. Michigan fruit or poultry farm.** Camp Site or Summer Home, \$100.00. Burt Lake, Cheboygan county. Finest hunting, fishing, boating, swimming. Good auto roads. Get free booklet and map. O. Hermann, 3106 Indiana Ave., Chicago.

**CALIFORNIA Small fruit and poultry farms near Los Angeles; 5 advisers; U. S. rabbit exp. station; co-operative marketing.** Illus. booklets. Write owner, Fontana Farms Co., 631 (R) S. Spring, Los Angeles, Calif.

**PECAN-Orange-Fig groves "On the Gulf."** Monthly payments. Guaranteed care. Big, quick returns. Suburban Orchards, Dept. M., Biloxi, Miss.

**OZARKS—10 Acres near White river and proposed power dam, \$100, \$5 monthly.** Alvin Zimmerman, 1802 N. 5th, Kansas City, Kan.

**GET Quick cash sale for your property anywhere.** Details free. Write Fisher Agency, Hannibal, Mo.

**SELL Your property quickly for cash, no matter where located. Don't pay big commission.** Particulars free. Real Estate Salesmen Co., Desk B, Lincoln, Nebr.

**MONEY Made in Mich. potatoes, \$10 down now and easy terms buys land near markets, lakes, streams.** Write today. Swigart & Co., P-601, 32 N. State St. Bldg., Chicago, Ill.

**REDUCE Labor on your farm and increase income.** One farmer writes he would not part with the information for \$100 if it could not be duplicated. Send today for our valuable "Farmers' Handbook" and get ready to put some of the 861 practical ideas into operation for your own benefit. Pay postman only 98 cents plus postage when delivered. Popular Mechanics Press, Room 808, 200 E. Ontario St., Chicago.

**MUSKRATS**

**MUSKRATS From our pens and our advice assure success to amateur fur farmers.** Young or proven breeders for immediate or fall shipment. Terms and particulars free. Peoria Breeding Co., Peoria, Ill.

**MAKE Money From Muskrat Fur—Raise Muskrats in dry land pens or hutches.** Get the facts. 652 Conrad's Ranch, Denver, Colo.

**RABBITS**

**MAKE Big profits with Chinchilla rabbits.** Real money-makers. Write for facts. 852 Conrad's Ranch, Denver, Colo.

**DOGS AND PETS**

**LOVE Birds \$6.00 pair. Beautiful Aviary bred. Safe arrival guaranteed.** Bird Wonderland, Vannuys, Calif.

**ST. BERNARD Puppies! Registered thoroughbreds.** Priced reasonable, duty free, photos submitted. Write Helvetia Kennels, Dept. P, Napierville, Que.

**POLICE Dogs.** Handsome, intelligent. Write for circular describing dogs and pups. Hillside Rabbity, Route 5-K, Kewaunee, Wis.

**FOR Sale.** Minks, squirrels, raccoons, foxes, ferrets, muskrats, ginseng, rabbits, skunks, wolf pups, opossums. B. Tippman, Caledonia, Minn.

**WHITE Collies and other colors.** Beautiful and useful. Dept. P, Shomont Kennels, Monticello, Iowa.

**DOG Lovers—Every fact regarding every phase of dog training (all breeds) including psychology, obedience, guarding, swimming, rescue work, hunting, herding flocks, teaching tricks, finding lost articles, racing, war service, police dogs, sled dogs, etc., will be found in "Training the Dog," by Will Judy. Price only \$1.50. Pay postman when delivered or, if outside U. S., remit when ordering.** Popular Mechanics Press, Room 809, 200 E. Ontario St., Chicago.

**WANTED—MISCELLANEOUS**

**OLD Gold, silver, discarded jewelry, etc.** Highest prices paid, goods returned if our offer is refused. Newark Refining Co., Box 268, Newark, N. J.

**MAIL Us your discarded jewelry, gold, crowns and bridges, watches, diamonds, silver, platinum.** Money promptly mailed. Goods returned if offer refused. United States Smelting Works (The Old Reliable), Dept. 71, Chicago.

**BUILD** Your own boat—Complete directions make it comparatively easy. 14 different types for all purposes including row, motor, sail, canoe, out-board motor boats, etc. With this book is included "Outdoor Sports the Year Round" on making all sorts of devices for outdoor recreation. Pay postman \$1.98 plus postage when delivered. Popular Mechanics Press, Room 808, 200 E. Ontario St., Chicago.

#### PENMANSHIP SPECIALISTS

**IMPROVE** Your handwriting. Send quarter for your signature 12 styles. Meub, Expert Penman, 1944 Loma Vista, Pasadena, Calif.

#### FOR SALE—MISCELLANEOUS

**ADDRESSOGRAPHS.** Letter folders, multi-graphs, envelope scalers, duplicators, less than half price. Guaranteed. Pruitt Co., 117 No. Wacker Drive, Chicago.

**SPEEDY** Outboards—Many prize-winners. Complete instructions with blueprints for building 35 different boats. Pay postman only \$3 and postage when delivered. If outside U. S. remit when ordering. Popular Mechanics Press, Room 809, 200 E. Ontario St., Chicago.

#### POULTRY

**\$4,223.00 PROFIT** From a town lot in one year. H. Cecil Sheppard tells you his disastrous and profitable experiences in raising chickens from the start until in the sixth year he took the above net profit. He would have gladly paid \$100 for this information during the first years. Send for his book. Price only \$1. Pay postman when delivered, or, if outside U. S., remit when ordering. Popular Mechanics Press, Room 809, 200 E. Ontario St., Chicago.

#### ARCHERY

**ARCHERY**—How to shoot accurately with the bow and arrow. Target shooting exclusively. New book "Modern Archery" by A. W. Lambert, champion shot, just what every enthusiast needs. Fully illustrated. Pay postman \$3 and postage when delivered, or if outside U. S., remit when ordering. Popular Mechanics Press, Room 809, 200 E. Ontario St., Chicago.

#### PERSONAL

**BUNIONS**—Natural, painless, home correction information free. Eugene Eaton, D106. Bandon, Ore.

**TOBACCO** Or snuff habit cured or no pay. \$1.50 if cured. Remedy sent on trial. Superba Co., N3, Baltimore, Md.

**ADVICE.** Information, any subject, 25c coin. References. Fred Klotz, Reading, Pa.

**YOUR** Photo, 20, \$1.00. Confidential. Send photo. Pop-Goo, Box 471, New York.

**DRY** Clean your brain. Results amazing. Money back if not satisfied. Morris, 3608 Warren St., Philadelphia.

#### ROOTS AND HERBS

**HERBS.** Roots, barks, seeds. All kinds, 25c box. Lists free. Botanic, 145 West 112th St., Chicago.

#### MISCELLANEOUS

**TATTOOING** Outfits, supplies. Illustrated, list free. "Waters," 965 Put-nam, Detroit.

**NOISE-MAKERS:** Cat cry, nose blower, metal rooster, rattling blow snake, squawker balloon, and horn that says "Mamma." All 6 for 50c inc. postage. Tall-N-R Novelties, 3108 N. Griffin Ave., Los Angeles.

**MIRRORS** Resilvered at home. Cost near 5 cents per square foot; you charge 75 cents. Immense profits plating autoparts, reflectors, tableware, stoves, refinishing metalware, etc. Outfits furnished. Details free. Write Sprinkle, Plater, 288, Marion, Ind.

**COMIC** Art. Complete short course especially for high school and college students, by return mail \$5. 10c brings synopsis, comics. Greene Studio, 1753 W. 46th St., Los Angeles.

**NEW** Fad; collecting monograms; yours designed \$1.00. Cregier, 732 N. Main, Goshen, Ind.

**SEND** 25c For guidelet on real estate law, salesmanship, etc. Macdonald Co-operative Realty, San Diego, Calif.

**TIME** Counts in applying for patents. See pages 138 and 139. Clarence A. O'Brien, Registered Patent Attorney, Washington, D. C.

**CASH** Paid for Butterflies, Insects. See Sinclair Display Advertisement on page 18.

**ARE** You old at forty? See our advertisement on page 153 of this issue. The Electro Thermal Company, 2120 Morris Ave., Steubenville, Ohio.

**CARTOONISTS**—Publish your work. New magazine tells you how. Send 25 cents for copy or \$2 for year. Cartoon Stories, Clifton, N. J.

**CARTOONISTS.** Sell your drawings. Proven plan. Castle Studios, Independence, Missouri.

**I** CATCH From 45 to 60 foxes in from 4 to 5 weeks' time. Can teach any reader of this publication how to get them. Write for particulars. W. A. Hadley, Stanstead, Que.

**WEEDS**—Cut them with cutter bar on Shaw Garden Tractor. Also plows, cultivates and runs belt machinery. Low prices. Immediate delivery. Shaw Manufacturing Company, Dept. C, Galesburg, Kans.

**AIR** Navigation and meteorology—New, simple, nontechnical book needed by every flyer. Nothing else on the subject like it. Written by Captain Duncan who has over 3,000 hours of flying to his credit. 225 pages. Flexibly bound. 80 pictures, maps, etc. Pay postman \$3.00 when he delivers book. Popular Mechanics Press, Room 808, 200 E. Ontario St., Chicago, Ill.

**ARTISTS** And art students are printing 250 signs or pictures an hour without machinery. Sample and particulars 10. Straco, 1013 Mulberry, Springfield, Ohio.

**AMATEUR** Cartoonists: Sell your cartoons. New market. Smith's Service, PN-1194, Wenatchee, Wash.

**CUTS** Anybody can make. Simple, cheap process, \$1.25. Specimens, particulars. 2c stamp. M. Day, Windfall, Ind.

**TELL** An army of 3,000,000 live readers all about your offer! If you have anything to sell, buy or exchange, or if you have any reasonable proposition, tell our readers about it—they'll respond quickly. Our booklet "How to Create More Business" contains some very interesting, helpful facts. Write today for your copy—it's free. M. L. Rund, Manager Classified Advertising, Popular Mechanics Magazine, 200 E. Ontario St., Chicago, Ill.

## FREE PROOF YOU CAN MAKE

# BIG MONEY in RADIO!



A glorious future awaits you in this huge industry. Millions of sets need servicing, thousands of ships require radio operators . . . manufacturers and broadcasting stations throughout the land are eagerly seeking trained men . . . and now, nation-wide radio telegraph service, telephony, television, photoradiograms open up thousands of new and amazing opportunities.

#### Learn At Home

By means of this marvelous, simplified home training course,

sponsored by the Radio Corporation of America . . . you can now prepare for success in every phase of Radio. The remarkable outlay of apparatus given to you with this course . . . enables you to learn by actual practice how to solve every problem in radio work. That's why you, too, upon graduation can have the confidence and ability to command big money.

#### Backed by RCA

Graduates of this school are always posted in newest developments in Radio. That's why they are always in big demand. The progress of Radio is measured by the

accomplishments of the Radio Corporation of America. This gigantic organization . . . sponsors every lesson in the course.

#### Money Back If Not Satisfied

As a student you will receive an agreement signed by the president of this school assuring you of complete satisfaction upon completion of your training—or your money instantly refunded.

## Free!

This fascinating book on Radio's glorious opportunities . . . written by one of America's well-known radio experts.



RADIO INSTITUTE OF AMERICA  
Dept. P. M. 9  
326 Broadway, New York, N. Y.

Gentlemen: Please send me your FREE 50-page book which illustrates the brilliant opportunities in Radio and describes your laboratory-method of guaranteed instruction at home.

Name .....

Address .....



# How I Made \$100,000 With a "Fool" Idea

**Learn my money-making secret—Be a Real Estate Specialist—Start at home, in your spare time—Use my successful System—Free book shows how**

"IT'S a fool idea!"

That's what my friends said, when I told them about my idea for starting a real estate business "on the side."

But with that "fool" idea I made more than one hundred thousand dollars net profit.

No matter who you are, where you are, or what your sex or present occupation, if you want to do what I did—if you want to get out of the \$25-a-week crowd and build up a high-class, money-making business of your own—right at home—in your spare time—send at once for my free book which opens wide the door of the biggest and best money-making business opportunity you ever heard of in your whole life.

## Use My Successful System

When I started in real estate, I tossed overboard all the hit-or-miss, haphazard, rule-of-thumb methods of the past, and put into operation a system of my own which is as superior to the old way as the modern Mazda lamp is superior to the tallow candle of our forefathers.

With little education—no experience—no influence—and less than five dollars capital—I started in my spare time and met with instant success.

If you want to follow in my footsteps—if you want to use my amazingly successful system—send for my free book now. It tells how I succeeded—how I have helped other men and women win big success—how you, too, can succeed—how

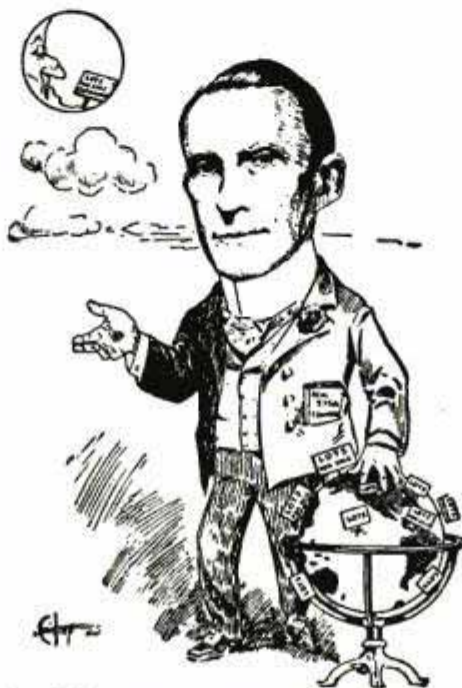

A well-known cartoonist's conception of my idea

you can have a splendid business of your own and make more money than you ever made before.

## A Wonderful Business

Real Estate—conducted my way—is a great business. It is as permanent as the earth itself. It is getting bigger and bigger as the country grows. It doesn't require years of study to learn like most other businesses and professions. It offers enormous earnings to ambitious men and women. Users of my system are making \$1,000—\$5,000—\$10,000—on single deals—as much as the average man gets for months and years of hard work. And the business is practically unlimited. Ten million properties are now on the market for rent, sale or exchange. And you can start with little or no capital—

right at home—in your spare time. I did. So did others. So can you. My free book tells you how.

## Read These Records

Here are just a few brief extracts from the many letters received from happy users of my money-making real estate system:

"Made \$5,500 on first deal after getting your system."—Mrs. Evalynn Balster, Illinois (Former School Teacher). "Sold a lot by my methods in less than one hour and my commission was \$800."—J. A. Furguson, Florida (Former Dry Cleaner). "Sold over \$100,000 worth of property my first year with your methods."—H. D. Van Houten, New Jersey (Former Grocery Clerk). "Have sold thousands of dollars worth of property your way. Have deals that will go beyond the \$300,000 mark."—Carrie Marshall, Mississippi (Former Housekeeper). "My first day's work in real estate netted me \$435. I recommend your system to anyone wishing to get into a pleasant and profitable business."—F. B. Bennett, California (Former Traffic Manager). "Have sold one \$5,000 lot and 3 houses so far, with your system."—Mrs. B. H. Morehouse, New York (Former Housewife).

These are just a few samples of success that you will read about in my free book. Get it. Read it. Follow its instructions. Make big money my way.

## Get Free Book Now

My big, new, illustrated book is filled with fascinating facts about my kind of a real estate business—what I did—what others are doing—what you can do.

Mail coupon right now and get this valuable, money-making information free. It doesn't cost you a nickel to find out what this book can do for you. So, act at once. You will never forgive yourself if you turn your back on this unusual chance to win big, business success. Address PRESIDENT, American Business Builders, Inc., Dept. J-44, 205 East 42 Street, New York.

## Mail Coupon



## for FREE Book

PRESIDENT,  
American Business Builders, Inc.,  
(Established 1917—Capital, \$500,000),  
Dept. J-44, 205 East 42 Street, New York, N. Y.

Mail me your free book telling how you made \$100,000 in a new kind of real estate business—how others are making big money—and how I can do the same.

Name.....

Please print or write plainly

Address.....

City..... State.....

# We Will Train You in a Few Months



**Day and Night Schools in Chicago, Detroit, Cleveland, Boston, Phila.**

**No Books—  
No Classes—**

**Wonderful Future in this Uncrowded Field**

**Experts Earn Up To**

**\$125 A WEEK**

**as MECHANICAL DENTISTS**

We teach you to make rubber plates, crowns, bridge work, metal base dentures, etc., for dentists. After graduating you are ready for a job or can open your own laboratory. We assist you.

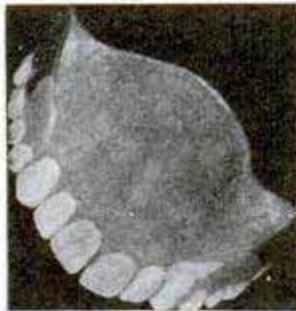

## Big Demand for Men!

Mechanical Dentistry is the laboratory bench work which the dentist turns over to the laboratory worker. Master this profession and help meet the demand of 64,000 dentists for laboratory work. Every city and every town where dentists are located offers work to the mechanical dentist. We train you in a few months in day or night school for this uncrowded field—no classes—no books—no mechanical experience necessary. **No Educational Requirements.**

## Work Your Way Thru School

We will help you find a job to meet your expenses while taking our training. And we will help you find satisfactory living quarters when you arrive.

**Schools located in Chicago, Detroit, Cleveland, Boston, Philadelphia. Day and night schools.**

## INTERESTING FREE BOOK

Our illustrated free book on Mechanical Dentistry will acquaint you with some surprisingly interesting facts. It tells about the thriving profession of Mechanical Dentistry—the way to swift and certain success. And it tells about the progress of many of our graduates—men who have succeeded beyond their expectations, also full details of our liberal offers. Mail the coupon and find out more about this fascinating opportunity.

**McCarrie School of Mechanical Dentistry  
1338 S. Michigan Ave., Dept. 342, Chicago, Ill.**

**McCARRIE SCHOOL OF MECHANICAL DENTISTRY  
1338 S. Michigan Ave., Dept. 342, Chicago.**

Without cost or obligation, send me your illustrated book on Mechanical Dentistry, and complete information as to my opportunities in dental laboratory work.

Name.....

Address.....

# DRAW CARTONS

**Turn Your Talent Into Money**

Cartoonists earn from \$50 to \$250.00 per week—some even more. Remarkable new Circle System of Drawing teaches you in half the usual time. Send for **booklet** and sample **lesson plate** explaining full details of the Course.

**THE NATIONAL SCHOOL OF CARTOONING  
623 Penton Building Cleveland, Ohio**

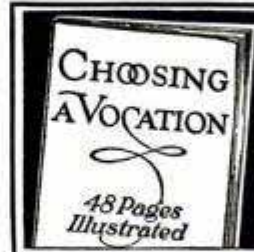

## SENT ON REQUEST

Helpful discussion of this important problem and of fastest growing of Vocational Trades—Mechanical Dentistry. Of interest to men of all ages. Send for Bulletin 2.

**BODEE INSTITUTE**

1755 Broadway, New York  
1305 N. Broad St., Philadelphia  
85 Court St., Brooklyn

## Rider Agents Wanted

Select from **44 Styles**, colors and sizes of **Mead Bicycles**. Ride and exhibit sample **RANGER** and make money.

**Factory to Rider!** We ship on approval for **30 Days' Free Trial**, direct from **FACTORY**. Get our marvelous offers before buying.

**Tires** Lamps, horns, wheels, parts, equipment, and repairs at half usual price.

**Mead Cycle Company**  
Dept. P-109 Chicago



Write us today for free catalog

## EVERY FLYER NEEDS

Practical Air Navigation and Meteorology: the new, simplified, non-technical treatise by Capt. Richard Duncan, who has over 3000 hours of flying to his credit. No subject is of greater importance to the flyer. 243 Pages. 70 Illustrations, Maps, Charts, etc. \$3 postpaid.

Popular Mechanics Press, 200 E. Ontario St., Chicago

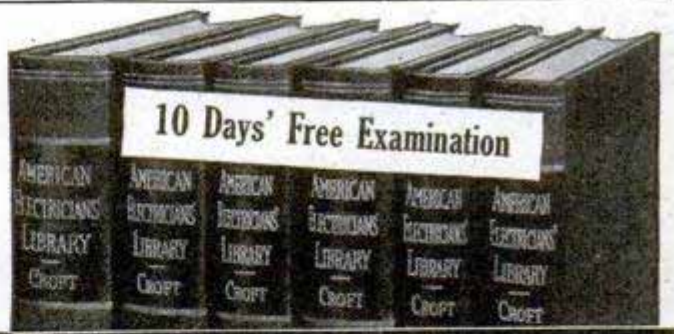

## Get into the electric wiring field—big demand—big money!

**T**HE whole wiring field covered. Kinks; helps; short cuts; practical, on-the-job electrical data, written particularly to help wiremen, trouble shooters, maintenance men, armature winders, electrical contractors and students.

**American Electricians' Library  
6 volumes, 2000 pages, illustrated, \$17.50 payable  
\$1.50 in ten days and \$2.00 a month**

The books tell you all you must know about conduit wiring, armature winding, wiring for lighting circuits and switches, wiring for machinery, circuit troubles, circuit testing, or electrical machinery erection. Through a study of this great set you can push yourself into a big-pay job for life.

**See it FREE—Send no money—ACT**

## FREE EXAMINATION COUPON

**McGraw-Hill Book Co., Inc.  
370 Seventh Avenue, New York**

Send me the American Electricians' Library for 10 days' free examination. If satisfactory, I will send you \$1.50 in 10 days and \$2 monthly until the full price, \$17.50, is paid. If not wanted, I will return the books at your expense.

Name.....

Address.....

City and State.....

Position.....

Company..... P. M.-9-29

# ASSEMBLE YOUR OWN EXERCISER - AT HOME - QUICKLY AND CHEAPLY!

Only \$12.00



It's easy to own an Exerciser and Reducer today! All you need is the new SCIENTIFIC EXERCISER KIT and a small inexpensive motor. Why pay a high price when you can make your own Exerciser so easily!

## Easily Assembled

Simple, complete instructions show you exactly how to quickly assemble this Reducer. No special tools—no mechanical skill—merely follow the directions. Anyone can do it.

## All Latest Improvements

When assembled, this Exerciser and Reducer will give you all the benefits of the highest priced machine on the market. 4 strokes—2 speeds—can be adjusted for any degree of massage desired.

## Send No Money

Three days' free trial. Order by post card—today! Delivered anywhere in U. S., parcel post, prepaid, C. O. D., for \$12.00.

MONEY BACK GUARANTEE

**SCIENTIFIC ELECTRIC WORKS**  
90 C Brookline Ave., BOSTON, MASS.



# LEARN CARTOONING

## AT HOME DURING SPARE TIME

with the course that has trained HUNDREDS of beginners successfully. The Landon Picture Chart Method of teaching ORIGINAL drawing by mail makes cartooning easy to learn. This school is a Member of The National Home Study Council. Write today for sample picture chart to TEST YOUR ABILITY and examples of the work of successful students now earning from \$50 to \$200 and more per week. Enclose 6c in stamps and STATE YOUR AGE.

**THE LANDON SCHOOL, 2838 National Bldg., Cleveland, Ohio**



## Big Profits Charging Batteries

**Starts You.** Let me show you how to make big money in the battery charging business. I've prepared a free book explaining all details. My charger is years ahead of ordinary chargers—will handle 50 per cent more batteries. Get into a business of your own with a very small investment. Write for my book today.

**C. F. Holmes, Chief Engineer**  
**INDEPENDENT ELECTRIC WORKS**  
Dept. P. M., 5116 Ravenswood Ave., Chicago

Write for **FREE BOOK**



## Be a MEAT CUTTER



Harry Holtzer stepped into \$50 a week job as Meat Cutter through NATIONAL training. You, too, can do the same. Previous experience not necessary. We teach you through our Home-Instruction Course. Don't get by—get ahead. Write today.

*FREE book, "Big Pay the NATIONAL Way."*  
**National School of Meat Cutting, Inc.**  
Dept. M Toledo, Ohio

# WANT SOME MONEY? Here's A Wonderful Way To Get It!

**YES** you can—anybody can make a lot of money right at home, and what's more, have real fun doing it. We show you how, we furnish everything necessary on an easy basis.

**COSTS NOTHING** to learn about our plan, all details are given you free. Write today for beautifully illustrated idea book telling all about our methods which have made so many women independent. Learn how easy it is to make from \$10 to \$25 per week in the most delightful home work you can imagine. Don't miss this opportunity.

Write Now—It's **FREE**  
**FIRESIDE INDUSTRIES, Dept. 66-M, Adrian, Mich.**

**FIRESIDE INDUSTRIES, Dept. 66-M, Adrian, Mich.**  
Please send me, **FREE**, the book on Fireside Industries showing how to earn money at home by decorating Giftwares.

Name.....

Address.....

City.....State.....



Mail this Coupon today!



# Here's an Amazing New Business THAT PAYS UP TO **\$1,000 A MONTH**

**MEN**, here is a real, red hot money-making opportunity! It's a chance to jump into business for yourself and make more money every week than the average man makes in a month.

Surprising as it may sound, we actually put you in a business, with the first day's profits often running from \$18 to \$55. \$350 to \$600 the first month is not unusual for ambitious men.

## Cut in on the Big Money

All you need is the ambition to make real money. We supply you with complete equipment to make and sell that famous new food specialty—Brown Bobby—a greaseless doughnut baked by electricity!

It's a crispy, flaky, delicious new kind of doughnut cooked without one drop of oil or grease. Easily digested by everyone. More appetizing than old-style doughnuts ever were. Costs less to make. Sells four times as fast. No baker's skill required. Just add water to our prepared "Mix." You can open a shop; rent cheap floor space in a grocery, delicatessen, lunch-counter, drug store, etc. Or start at home—and make up to \$250 your very first week.



"I made \$3,000 in 3 months from my greaseless doughnut business!" — T. Chas. Minch, Fla.

## Start at Once ANYWHERE!

Men and women everywhere are starting in this business daily! YOU cannot afford to delay! Details will gladly be sent without obligations of any sort. Such an amazing money maker may never come your way again. So fill in and send the coupon at once! TODAY—

## MAIL COUPON NOW!

Food Display Machine Corp.,  
Dept. 3-M, 500-510 N. Dearborn St., Chicago, Ill.

Gentlemen: Please send me the plan by which I can cash in on Brown Bobby, the Greaseless doughnut. It is understood that this obligates me in no way whatever.

Name.....

Address.....

City.....State.....

## SAVE 1/2 ON PLUMBING HEATING

**Heating Cut-to-fit System**  
New Easy method enables any man to install his own PLUMBING and HEATING. Lowest wholesale prices on Highest Quality Grade A goods.

**WE SHOW YOU HOW**  
Send for our new free catalog telling how you save waste material and high labor costs by being your own plumber. This book has saved money for builders, home-owners, farmers and mechanics for over 50 years. Send for your copy today.



MILLION DOLLAR BONDED GUARANTEE PROTECTS YOU

OVER 50 YEARS **HARDIN-LAVIN Co.** EST. 1876  
122-32A West Pershing Road, Chicago, Ill.

**JOSEPH FALK,**  
Albino, Mass., earned \$4,000 playing a Conn saxophone while in college. Appeared in 8 countries; plays 22 instruments, nearly all Conns.

# Popular

**LEARN** saxophone, cornet, trombone—any band instrument. Be popular—make more money. It's easy. Play tunes first day. Ready for band or orchestra in 60 to 90 days. The world's greatest band leaders and soloists endorse Conns. Easiest blowing qualities; speediest action. Yet these superior instruments cost no more. Write for Free Book and full details of FREE TRIAL and Easy Payment offers. Mention instrument. C. G. Conn, Ltd., 931 Conn Bldg., Elkhart, Ind.

# CONN

WORLD'S LARGEST MANUFACTURERS OF BAND INSTRUMENTS

# NEW Sprayit

for All PAINTING and SPRAYING

**CONNECTS TO ENGINE**

Simply connect valve in place of spark plug on auto, or other engine. Idling motor generates powerful compressed air for spray gun. Used for any painting, any finish, any surface. Covers 100 square feet in about 6 minutes. Does floors, walls, furniture, machinery in minutes instead of hours. Pays for itself many times over.

**USE IT ANYWHERE FOR ANY JOB**

25 ft. hose makes any job accessible, indoors or out—even greater lengths can be used. In addition to paint, varnish, lacquers, etc., will spray all insecticides, germicides, whitewash. Few minutes' spraying keeps barn, stalls, pig pens, hen houses 100% sanitary. Price complete \$19.75. Clip and mail coupon below for complete details of the new Auto-Sprayit, made by the makers of the famous Electric Sprayit.

*The AUTO SPRAYIT*

## FREE

**The Electric Sprayit Co., Inc.**  
209 East Colfax Ave., South Bend, Ind.

Send me the new Auto-Sprayit at \$19.75 F.O.B. South Bend.

Send me literature completely illustrating and describing the new Auto-Sprayit.

Name.....  
Address.....  
Town.....State.....

## MAIL THIS COUPON NOW!



**Says one man who sent for this book:**

"I owe my all to the International Accountants Society. My income has increased over 300%."

HUGH J. DAVEY, JR., Auditor  
Robbins Body Corp.  
Indianapolis, Ind.

# How to become an Accountant

**T**HOUSANDS of ambitious men are earning more money today because they know Accounting.

Accounting is the uncerowded profession. It is a highly paid profession. For years the opportunity in Accounting has been extraordinary. The demand for capable Accountants exceeds the supply. Men who are adequately trained in Accounting are so rare that if one concern does not recognize their value and reward it, there are scores of others that will.

Besides being profitable, Accounting is fascinating. As an Accountant you are the trusted adviser of big business men. You are always in the confidence of the owners because you are at the throttle of profit control. Accounting gives you a new viewpoint in business. It gives you a bird's-eye view of business as a whole. It gives you fresh enthusiasm for your work—enthusiasm which comes from your new insight into financial programs.

## At 45 he made a fresh start

You will find inspiration in the story of Mr. A. T. Hull of Bristol, Virginia.

In the spring of 1918 he was working at a meagre salary. Suddenly, at the age of 45, he realized that he had wasted many of the best years of his life.

Mr. Hull decided to make up for his years of lost opportunity. He enrolled with the International Accountants Society. It was the beginning of a new life for him. Upon completion of the course, he became Auditor of Emory & Henry College in Emory, Virginia, at the same time building up a private practice in Public Accounting work. He received his certificate as a Certified Public Accountant and increased his income 100%.

## His sons did not wait until they were 45

His own success assured, Mr. Hull resolved that his two sons should not waste the golden years of opportunity as he had done.

They enrolled, and later Mr. Hull wrote us:

"One of my sons has just secured his C. P. A. certificate from the State of Virginia and is now practicing with me. The other is now taking your Course, and I expect him shortly to secure a certificate and attain full membership in the firm."

## Get this FREE BOOK if you would like to know

- How you can get a better position
- How you can become an accountant without interfering with your present work
- How you can increase your income
- How you can shorten the path to success
- How you can find the greatest opportunities in the Accounting field
- How to tell what sort of Accounting you should specialize in
- How much money Accountants make
- How to test your present knowledge of Accounting
- How to tell if training in Accounting will benefit you in your present position
- How you can learn Accounting in your spare time at home
- How this training in Accounting can be made to fit your individual needs
- How to prepare for the C. P. A. examination
- How much this training in Accounting costs you
- How to enroll

The same opportunity that brought success to Mr. Hull, and opened the doors of opportunity to his two sons, is yours for the asking.

Fortunately you can learn Accounting while you carry on your regular business. The International Accountants Society has made this possible. In only a few hours a week, and at moderate expense, you can learn this fascinating profession.

In the last twenty-six years thousands of men have trained themselves in Accountancy. They have enrolled with the International Accountants Society. They are now making more money than they ever made before.

The International Accountants Society was organized in 1903. It is conducted by a group of prominent Certified Public Accountants, among whom are John B. Tanner, C. P. A., formerly president of the Wisconsin State Board of Accountancy; Stephen Gilman, B. S. C., C. P. A., prominent author of financial textbooks; Jefferson H. Millsaps, A. B., B. S., LL. B., J. D., C. P. A., member of the American Association of University Instructors in Accounting; Paul W. Pinkerton, Ph. B., C. P. A., formerly President of the American Society of Certified Public Accountants; and William T. Sunley, C. P. A., formerly President, Michigan Association of Certified Public Accountants.

## Send for the facts

There is not room enough on this page to tell you all the wonderful things Accounting can do for you. But the interesting 80-page book shown above gives you all the facts.

This book gives you all sorts of interesting information about the great and growing profession of Accounting. It tells you how you can qualify easily, quickly, inexpensively, and without interfering with your present work.

If you are the sort of man who wants to lift himself forever out of the class of men of which there are too many, into the class of men of which there are too few, you should send for this book immediately. Do not put it off. Do not delay. There is no cost. There is no obligation.

Mail the coupon now.

## INTERNATIONAL ACCOUNTANTS SOCIETY, INC.

A Division of the

## ALEXANDER HAMILTON INSTITUTE

TO THE INTERNATIONAL ACCOUNTANTS SOCIETY, INC., 3411 South Michigan Avenue, Chicago, Ill.  
Send me free, "HOW TO LEARN ACCOUNTING," and tell me how  
I can increase my income as your other students have done.

Name..... (Please write plainly)

Business Position.....

Street..... City..... State.....



DR. HARLAN TARBELL  
MASTER OF MAGIC



*I'll Teach*  
**YOU**  
*Real Professional*  
**MAGIC**

*at Home ~ By MAIL*



**Big Stage Illusions  
Secrets of the Orient**

Master Illusions from Europe, India, China, Japan. Guarded secrets of the Orient—over 250 tricks from small effects to Big Stage Illusions, with nearly 3000 illustrations, *that and more* is what you get in the Tarbell Course in Magic!

**Read This Great Endorsement**

Dr. A. M. Wilson, Editor of the Sphinx, Official Organ of The Society of American Magicians, pays the Tarbell Course this tribute:

"The greatest work on Magic ever attempted and will mark an epoch in Magic greater than the revelations of Robert Houdini, Father of Modern Magic, 60 years ago."

**Money-Back Guarantee  
Protects YOU**

The Tarbell course in Magic protects you with an Iron Clad Guarantee to refund your money if you are not satisfied. You can't lose. You have everything to gain.

**Get Started on the  
Road to Big Money**

You need not give up your job. You can make nice money entertaining on-the-side as a semi-professional, or if you want to, you can become a big Magician, make big money, enjoy fame and glory.

**Tarbell System, Inc.**

1926 Sunnyside Avenue, Studio 13-56 Chicago, Ill.

The first  
and only  
Course in  
Magic

ever offered to the  
public teaching  
real professional  
Magic!

**Mail This Coupon NOW!**

**Tarbell System, Inc.**  
1926 Sunnyside Ave., Studio 13-56 Chicago

Tell me about Dr. Tarbell's new and simple system by which I can learn the secrets of MAGIC. Also tell me about your Low Price and Easy Terms Offer. No obligation on my part.

Name.....

Address.....

Age.....

**COLLEGE COURSES**

*at Home*



Carry on your education. Develop power to initiate and achieve. Earn credit toward a Bachelor degree or Teaching Certificate. Select from 450 courses in 45 subjects, including English, Mathematics, History, Education, Art, Psychology, Economics, the Sciences, the Languages, etc. Write for catalog.

**The University of Chicago**

427 ELLIS HALL

CHICAGO, ILL.



**"BECOME A LIGHTNING  
TRICK CARTOONIST"**

Send \$1.00 for Laugh Producing Program of 23 Trick Drawings with Instructions. Catalog of Chalk Talk Supplies Free. BALDA ART SERVICE, Dept. 1, Oshkosh, Wis.



**I POSITIVELY  
GUARANTEE**

to increase your arms one-half inch in size, chest one full inch, strength 25%, health 100% in one week's time, by following my instructions and using my exerciser 10 minutes mornings and at night. Send \$2 for complete course and exercisers. Satisfaction guaranteed or money refunded. Booklet free.

Prof. J.A. DRYER, Box 1850-P, Chicago, Ill.

**It Is Dangerous to  
STOP Tobacco**

without precautions against injurious effects on the nervous system. Baco-Curo gives the necessary assistance. No sudden stoppage; use tobacco while you take it. Has aided hundreds. Vegetable and harmless. Complete treatment of 3 boxes guaranteed to accomplish results or money refunded. Price \$5.00. Single box \$2.00 postpaid. Write for booklet. EUREKA CHEMICAL CO. Dept. 14 Schultz Building, Columbus, Ohio

**Knowledge  
PAYS**



**K**NOWLEDGE pays big dividends in business, and in social life. And here—in one amazing volume is ALL man's worth while knowledge; a liberal education in concise form; a background that will broaden any mind. THE OUTLINE OF MAN'S KNOWLEDGE, by Clement Wood, contains all you need to know about History, Art, Science, Literature, Philosophy and Religion. A book to balance your judgment, to inspire, and to enable you to discuss intelligently everything that man has learned and done!

The man who KNOWS wins out in business; the woman who KNOWS leads social circles. So send for this great volume—on FREE trial—and have all man's knowledge at your command.

**FREE Examination**

125,396 have already read this book of books for that concentrated knowledge so vital to success and culture. Will you, too, read it for 7 days at my expense? Just mail the coupon without money. Prove to yourself that here is what you ought to know. At the end of one week, either return the book or send us only \$1.50 first payment and two dollars a month for two months thereafter. Fill in the coupon below and mail it NOW.

LEWIS COPELAND COMPANY, 119 West 57th Street, Dept. 550, New York

LEWIS COPELAND COMPANY,  
119 West 57th St., Dept. 550, New York, N. Y.

Kindly send me THE OUTLINE OF MAN'S KNOWLEDGE, illustrated, handsomely bound. Within 7 days I will either return the book or remit \$1.50 as first payment, and then \$2.00 per month for two months, a total of \$5.50. (Ten percent discount for cash with order. Same return privilege.)

Name.....

Address.....

City..... State.....

If outside continental U. S. send \$5.00 with order

I Will Allow Your Railroad Fare to Chicago Without Extra Cost

# This funny juice-

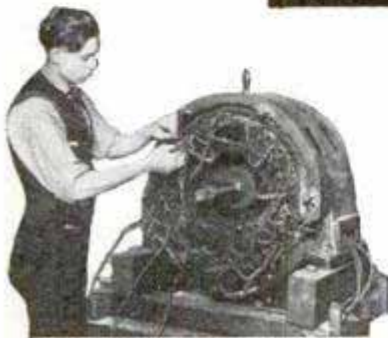

A 25 H. P. Motor for student practice

- helps to run automobiles
- makes radio possible
- makes your telephone work
- makes the wheels go round in thousands of factories
- illuminates homes, factories, office buildings and city streets
- toasts bread, percolates coffee and heats flat-irons
- runs street cars and fast trains

No one knows what it really is—it is called Electricity—but you can learn how to handle it.

—AND IT WILL PAY YOU

## \$1<sup>00</sup> per Hour to \$5,000<sup>00</sup> per Year

IF you get a real "kick" out of this subject of Electricity you're *crazy* if you don't make it earn you real money. Pretty plain speaking—but I want to make you *think*. The world's greatest, most successful men were men who worked at things *they liked*. Work is fun if you like your job. If YOU like electricity, *make it pay you real money*.

### Here's Your Chance

To get somewhere you've got to start, haven't you? It'll mean breaking away from home for about 12 weeks—but you and the family will be mighty glad you *started* and *finished* something. Especially something that pays so big. We'll take mighty good care of you here in the big Greer Electrical Shops. You'll be in company with hundreds of men temporarily away from home, like yourself. And you'll learn Electricity—*oh man*—how you'll learn it! You'll marvel at the way a subject apparently so mysterious is made so easy to understand. Just wait till we turn you loose among our hundreds of motors, rotary converters, generators, telephone and radio equipments. Competent, friendly instructors will show you

how to take 'em apart and put 'em together till you can do it in your sleep.

### How to Get This Training

The coupon at the bottom of this page is the open door to pleasant work and big money in the Electrical Profession. We can't tell the whole story here because it takes a Book to tell it. The book is free. Mail the coupon, and be thankful the rest of your life for doing it. Delayed action never put money in the bank. DO IT NOW.

### What About Automobiles?

Maybe automobiles interest you as much as electricity—or more. There's a lot of money in fixing autos, too. The well trained auto man is never out of a job. He's ready to go in business for himself. Would you like that kind of work? \$6 a day to \$20,000 a year is what it pays you. Then mark the coupon for the free book on our Automotive Course. We've helped make automobile experts out of thousands of men who didn't know a carburetor from a universal joint when they came to our big training shops. How much does it cost? You'll be surprised to learn *how easily you can afford it*. Mail the coupon NOW for complete information.



Using the "Waver Crane" in the Automobile repair department. Here you learn about all up-to-date auto equipment — by actually using it. Real experience on all makes of cars, under supervision of an expert.

## Greer College

Dept. 901.E

2024 S. Wabash Ave., Chicago

### FREE Employment Service

Our employment department is ready to help you—while in training and for life. Day and evening classes. Low cost. Easy terms.

ERWIN GREER, President, Greer College  
Dept. 901.E, 2024 S. Wabash Ave., CHICAGO.

Please send me your FREE BOOK and offer for Electric-1  course  
Automotive  course  
It is understood I am not obligated in any way

Name .....

Address .....

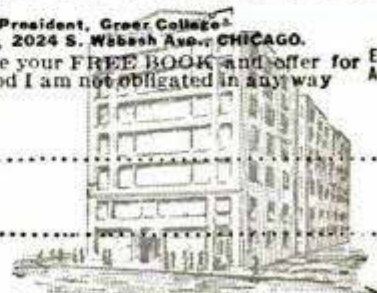



## “I had to make more money—for her”

“THREE weeks after I met Ann we were engaged. It was when we began talking about rents and furniture and such things that I woke up.

“I’d been drifting along in a routine office job for years. I knew I didn’t deserve a raise. And yet I had to make more money—a lot of it—and quick. It was Ann herself who suggested the International Correspondence Schools. She believed in me so thoroughly that she made me believe in myself, and I started studying the I. C. S. course in Accounting in my spare time.

“That was a year and a half ago. We’ve been married six months and I just got my third promotion. I’m head of the cost accounting department now. My I. C. S. course was the finest investment I ever made.”

Are you one of the thousands of young men who need a bigger salary and a better job? In an hour a day of your spare time you can secure the training that will bring you advancement. Without cost, without obligation, find out what the I. C. S. can do for you. Mark and mail this coupon now!

### INTERNATIONAL CORRESPONDENCE SCHOOLS

Box 5634-F, Scranton, Penna.

Without cost or obligation, please send me a copy of your booklet, “Who Wins and Why,” and full particulars about the course before which I have marked X in the list below:

#### TECHNICAL AND INDUSTRIAL COURSES

- |  |   |
|--|---|
| <input type="checkbox"/> Architect               | <input type="checkbox"/> Automobile Mechanic                                |
| <input type="checkbox"/> Architectural Draftsman | <input type="checkbox"/> Aviation Engines                                   |
| <input type="checkbox"/> Building Foreman        | <input type="checkbox"/> Plumber and Steam Fitter                           |
| <input type="checkbox"/> Concrete Builder        | <input type="checkbox"/> Plumbing Inspector                                 |
| <input type="checkbox"/> Contractor and Builder  | <input type="checkbox"/> Foreman Plumber                                    |
| <input type="checkbox"/> Structural Draftsman    | <input type="checkbox"/> Heating and Ventilation                            |
| <input type="checkbox"/> Structural Engineer     | <input type="checkbox"/> Sheet-Metal Worker                                 |
| <input type="checkbox"/> Electrical Engineer     | <input type="checkbox"/> Steam Engineer                                     |
| <input type="checkbox"/> Electrical Contractor   | <input type="checkbox"/> Marine Engineer                                    |
| <input type="checkbox"/> Electric Wiring         | <input type="checkbox"/> Refrigeration Engineer                             |
| <input type="checkbox"/> Electric Lighting       | <input type="checkbox"/> R. R. Positions                                    |
| <input type="checkbox"/> Reading Shop Blueprints | <input type="checkbox"/> Highway Engineer                                   |
| <input type="checkbox"/> Telegraph Engineer      | <input type="checkbox"/> Chemistry  |
| <input type="checkbox"/> Telephone Work          | <input type="checkbox"/> Pharmacy   |
| <input type="checkbox"/> Mechanical Engineer     | <input type="checkbox"/> Coal Mining Engineer                               |
| <input type="checkbox"/> Mechanical Draftsman    | <input type="checkbox"/> Navigation <input type="checkbox"/> Assayer        |
| <input type="checkbox"/> Machine Shop Practice   | <input type="checkbox"/> Iron and Steel Worker                              |
| <input type="checkbox"/> Toolmaker               | <input type="checkbox"/> Textile Overseer or Supt.                          |
| <input type="checkbox"/> Patternmaker            | <input type="checkbox"/> Cotton Manufacturing                               |
| <input type="checkbox"/> Civil Engineer          | <input type="checkbox"/> Woolen Manufacturing                               |
| <input type="checkbox"/> Surveying and Mapping   | <input type="checkbox"/> Agriculture <input type="checkbox"/> Fruit Growing |
| <input type="checkbox"/> Bridge Engineer         | <input type="checkbox"/> Poultry Farming                                    |
| <input type="checkbox"/> Gas Engine Operating    | <input type="checkbox"/> Mathematics <input type="checkbox"/> Radio         |

#### BUSINESS TRAINING COURSES

- |  |   |
|--|---|
| <input type="checkbox"/> Business Management                     | <input type="checkbox"/> Business Correspondence      |
| <input type="checkbox"/> Industrial Management                   | <input type="checkbox"/> Show Card and Sign Lettering |
| <input type="checkbox"/> Personnel Management                    | <input type="checkbox"/> Stenography and Typing       |
| <input type="checkbox"/> Traffic Management                      | <input type="checkbox"/> English                      |
| <input type="checkbox"/> Accounting and C. P. A. Coaching        | <input type="checkbox"/> Civil Service                |
| <input type="checkbox"/> Cost Accounting                         | <input type="checkbox"/> Railway Mail Clerk           |
| <input type="checkbox"/> Bookkeeping                             | <input type="checkbox"/> Mail Carrier                 |
| <input type="checkbox"/> Secretarial Work                        | <input type="checkbox"/> Grade School Subjects        |
| <input type="checkbox"/> Spanish <input type="checkbox"/> French | <input type="checkbox"/> High School Subjects         |
| <input type="checkbox"/> Salesmanship                            | <input type="checkbox"/> Cartooning                   |
| <input type="checkbox"/> Advertising                             | <input type="checkbox"/> Illustrating                 |
|  | <input type="checkbox"/> Lumber Dealer                |

Name.....

Address.....

City..... State.....

Occupation.....

If you reside in Canada, send this coupon to the International Correspondence Schools Canadian, Limited, Montreal, Canada



### No. 151.

It is the only Glareshield, regardless of price, with an automatic locking hinge permitting the shield to be turned at right angles for day driving, that will not jar down.

When placed on line, a trifle to the left of driver's normal view, the road is clearly seen, but all glaring rays from approaching headlights are cut off, and still allowing a clear vision of the road. Nothing to get out of order. A flip of the finger puts it in position for use. Retail Price, 35c.

Wholesale Sample, 15c — Dozen, \$1.56 —  
2 Dozen, \$2.88 — Gross, \$14.40

F. SPORS & CO., 729 Main St., Le Sueur Center, Minn.



## NEW IMPROVED PAYNTGUN LACQUERS CARS AND FURNITURE

Skillful painting easy for anyone this new simplified way. Exclusive Payntgun features cut painting time in half. Sturdy. Compact. Powerful spray. Complete Outfit \$9.65

**FREE** Attractive folder on Perfect Painting ready for you. Write for it NOW!

**HAYWOOD  
EQUIPMENT CO.**

**AGENTS  
WANTED**

2345-M Ogden Ave., CHICAGO, ILL.



## Start for Yourself

With Practically No Expense

Get into profitable arc welding business with equipment that's sure to earn tremendous profits, with lower current costs. HB "Constant Arc" Welder starts you on the road to success. COSTS ONLY \$30 MONTHLY—liberal trial on money back guarantee to prove its worth. Write today to Hobart Brothers, Box M993, Troy, Ohio.

A red handle with a gold stripe marks the most popular blow-torches in the world. They are Clayton & Lambert blow-torches.

**CLAYTON & LAMBERT MFG. CO.,  
DETROIT, MICH.**

## RADIO BARGAINS!

Used radios low as \$9.90. Free catalog of radios, accessories and parts sent on request. CHAS. HOODWIN CO., 4240 Lincoln Ave., Dept. 923, Chicago  
Dealers in Bankrupt Radio Stocks

**Aero  
Call**

Free booklet on request giving details of Aero Call, new factory-built short-wave converter that plugs into any radio set. Shielded—filtered—no motor heating. A. G. & D. C. Models \$25. Write today for full information.

**FREE**

**AERO PRODUCTS, INC.,** 4611 E. Ravenswood Ave., Dept. 499 Chicago, Ill.

## ATTRACTIVE NEW BINDERS

For POPULAR MECHANICS MAGAZINE  
Your choice of colors; blue, green, brown, red or black in beautiful and durable art binders at \$1.25 postpaid. Your name in gold on front cover for 25 cents extra. Address  
**POPULAR MECHANICS CO., 200 E. Ontario St., CHICAGO**

## INVENTORS —

Read the marvelous history of American Inventions, the most impressive record in the annals of human achievement. A very limited edition of Waldemar Kaempffert's Popular History of American Invention in 2 vols. 1034 Pages. Over 500 Illustrations. Cloth. \$5 per set postpaid (just half price of original edition).

**Popular Mechanics Press, 200 E. Ontario St., Chicago**



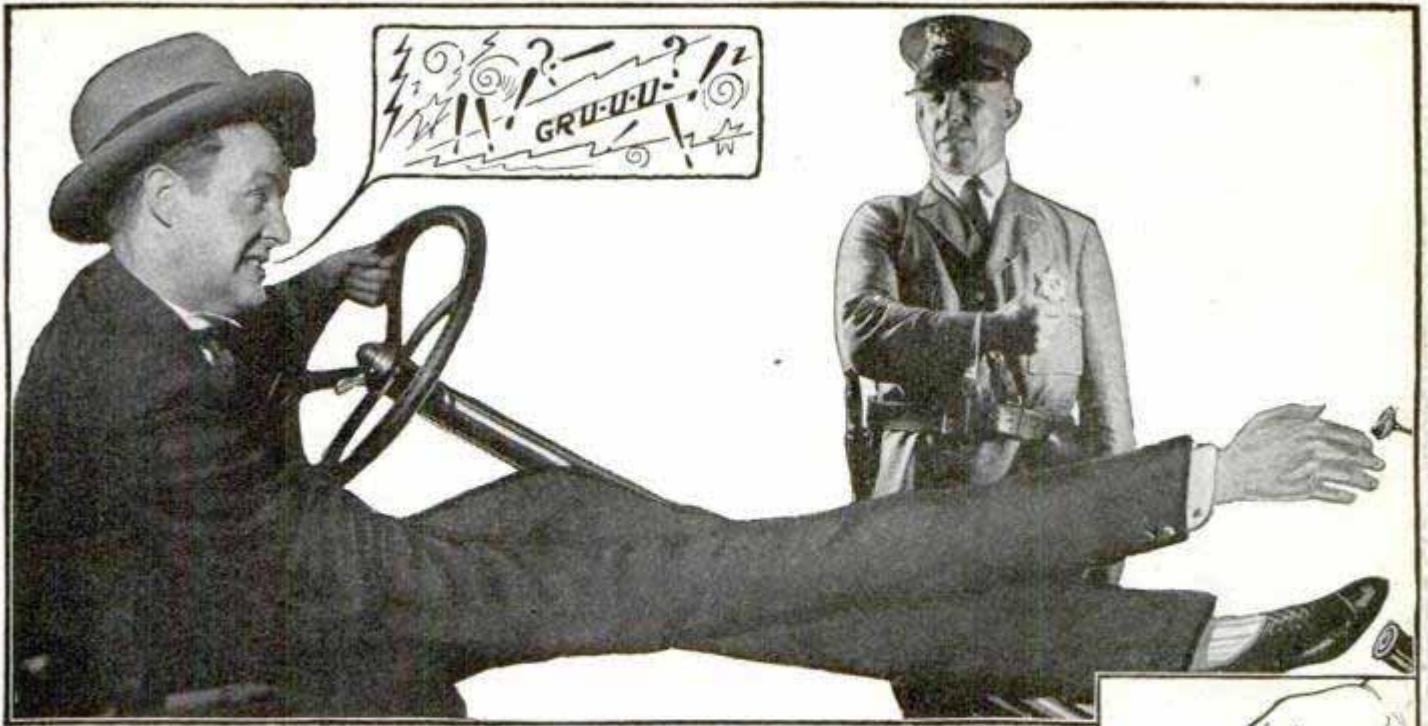

# Don't Swear. Start Fords New Easy Way With Amazing Finger Dash Control!



Here, Men, Is A Message That's Just Bubbling Over With Opportunity For You! The Discovery Of An Astonishing New Device—The E-Z-Finger Dash Control Starter—Now Makes Fords And Chevrolets Surprisingly Easy To Start. Millions Of Car Owners Need It, Want It And Buy On Sight—Pays 100% Profit Daily The Year 'Round.

**For  
Chevrolets  
Too**

**N**OW comes the biggest sensation in years to revolutionize Ford and Chevrolet starting! A remarkably simple and convenient starting device has been discovered, creating an unprecedented money-making opportunity that every smart, ambitious man in America will recognize and grasp at once.

## Entirely New . . . Revolutionary

You've never seen anything as practical and desirable as the E-Z-Finger Dash Control STARTER! Nor can you fully appreciate its wonderful speed and convenience in starting until you have actually enjoyed the thrill of its amazing performance.

Just think—you simply pull out the magic control right on the dash front of you with two fingers and presto—the most stubborn engine starts instantly. And you choke it, too—all in one quick, easy operation. So astonishing and convincing in action that every motorist who is thoroughly fed up on having to double up and use hands and feet in ordinary starting, wants to own an E-Z STARTER at once!

## A Sure-Fire Seller That Pays BIG PROFITS Quick!

If ever there was a device that offers you every chance in the world to reap a golden harvest of profits, here certainly is one! Mechanically this sensational "Finger Dash Control" is perfect, in spite of its simplicity. Easily and quickly installed, too. And the demand for it is pressing, immediate, unlimited!

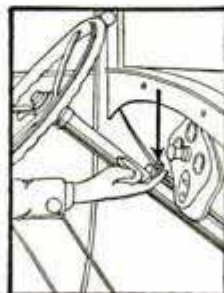

## Millions Need It—Waiting To Buy

What a market! What a wealth of untouched profits in every nook and corner of America! Close to a million new Fords and Chevrolets built in 1928—actually 40% of the new cars on the street today! Ford is turning out machines at the rate of 7,000 a day. During the first four months of 1929 he produced 662,000—a rate that means close to two million this year! And Chevrolets will approach the million mark.

So with ready market everywhere—with easy sales paying you a 100% profit every day—figure out for yourself what a gold mine this remarkable E-Z-Finger Dash Control STARTER offers you!

## Mail Coupon For FREE Facts

Investigate this unusual opportunity at once, if you are serious about steady, big earnings. Don't send a penny. Just fill in and mail the coupon. It brings you without cost or obligation details of this new invention, together with a liberal plan that will show you how you can quickly make the kind of money you want. But write today—Now!

Metalcraft Corporation, Dept. L-90, 5101 Penrose Ave., St. Louis, Mo.

Metalcraft Corporation,  
Dept. L-90, 5101 Penrose Ave., St. Louis, Mo.

Yes, send me at once without cost or obligation full facts about your Amazing E-Z-Finger Dash Control STARTER and your liberal money-making plan for agents.

Name.....  
Address.....  
City..... State.....



# FREE! Body Chart

If you will mail the coupon below, this Anatomical and Physiological Chart will be mailed to you without one cent of expense. It shows the location of the Organs, Bones of the Body, Muscles of the Body, Head and Vertebra Column and tells you how the nerves radiate from your spinal cord to all organs of the body. This chart should be in every home.

## Where Is That PAIN?

It may be in the neck, back, hips, stomach, liver, legs or arms. Wherever it is, the chart will help to show you the location and cause of your ailment. For instance, this chart will help you locate verminiform appendix pains. Hundreds of lives might have been saved if people had known the location and character of the pain and had received proper attention.

# Stop that Pain

By Relieving the Cause with  
**Violet Ray - Vibration  
 Ozone - Medical Electricity**  
 The Four Greatest Curative Powers Generated by This  
**Great New Invention!**



Elco Health Generators at last are ready for you! If you want more health—greater power to enjoy the pleasures and delights about you, or if more beauty is your desire—write! Ask for the book on these inventions which has just been prepared. It will be sent to you without cost. It tells you how Elco Health Generators aid you in leaving the lethargy and hopelessness of bad health and weakness behind forever. Re-vitalize yourself. Bring back energy. Be wholly alive. Write today!

Here's What Elco Users Say—

"Wouldn't take \$1000 for my Elco." "Has done me more good in 2 weeks than doctors did in three years." "Cured my Rheumatism." "My Eczema gone." "Cured my stomach trouble." "Cured my weakness." "Now I sleep soundly all night." "Thanks to Elco my strength and vigor are back." "No more pain." "Colds never bother me now." "Chronic Constipation banished."



These great new inventions generate Violet Ray, Vibration, Electricity and Ozone—combined or separate. They operate on the electric light in your home or on their own motive power at less than 50 cents per year. Elco Health Generators are positively the only instruments which can give you in one outfit Electricity, Violet Ray—Vibration and Ozone—the four greatest curative agents. Send the coupon below. Get the Free Book NOW!

## MAIL COUPON for FREE BOOK

Do not put this paper down without sending the coupon. Don't go on as you are with pains and with almost no life and energy. You owe it to yourself to be a better man or woman. You were put here to enjoy life—not just to drag through it. So do not rest another day until you have put your name on the coupon here. That will bring the whole story of these great new inventions. Do it today—now.



**Lindstrom & Co. [Makers of Therapeutic Apparatus since 1892.]**

2322 Indiana Avenue Dept. 13-56 Chicago

Please send me your free book, "Health—Power—Beauty" and full information of your 10-day Free Trial Offer.

Name.....

Address.....

# Become a Trained Radio-Technician in 90 Days

Thousands of trained men are needed for Radio Service, Radio Engineering, Broadcasting, Television, Station-operation and Radio Merchandising. Get into this wonderful, fast-growing field NOW! Good pay, big opportunities. Become trained Radio-Technician in 3 months at this splendidly equipped school (which Station WISN operates). Complete practical course covers Radio Broadcasting, Merchandising and Television. The only radio course in the country approved by a radio trade association. Graduates receive "Class B" license without examination. Moderate tuition fee. Our illustrated free catalog gives details of how to become a trained radio technician in 90 days. Send for it today. No obligation.



## SCHOOL of ENGINEERING of Milwaukee

Founded 1905 Dept. P. M. 929A Milwaukee, Wis.



## CODE Morse or Radio with Omnigraph

AT HOME. Leads quickly and naturally to jobs of unlimited opportunities. TELEGRAPH and RADIO SHORT WAVE CODES sent at all times. World's hobby for 20 yrs. The Automatic Omnigraph teaches you easily and cheaply. Catalog Omnigraph Mfg. Co., 810 E. 39th St., P. B., Brooklyn, N.Y.

# BASHFUL?

"Smile on you!" Are you nervous, embarrassed in company of the other sex? Stop being shy of strangers. Conquer the terrible fear of your superiors. Be cheerful and confident of your future! Your faults easily overcome so you can enjoy life to the fullest. Send 25c for this amazing book. RICHARD BLACKSTONE, 479 FLATIRON BLDG., NEW YORK



**\$4.99 22 Cal. Blank Automatic**

WITH 100 CARTRIDGES. You need no license or permit to own this 6 shot Automatic. Use for fun or self-defense. Keep away RIGGED traps, frightens thieves, scares away dogs—A real home protector. Fool your friends. Same as an expensive automatic in construction, finish, appearance, durability; automatic magazine loading and ejection of cartridges, instant and powerful report. Guaranteed absolutely safe. Send no money. Pay on delivery \$4.99 plus shipping charges. 100 cartridges. JENKINS, 683 Broadway, New York, Dept. 9-J-23

NO PERMIT REQUIRED 6 SHOT



**BUCHSTEIN'S FIBRE LIMB**

is soothing to your stump—strong, cool, neat, light. Easy payments. Braces for all deformities. D. BUCHSTEIN CO. 610 3rd Ave., So. MINNEAPOLIS, MINN.

Send for Catalog Today

# QUIT TOBACCO



No man or woman can escape the harmful effects of tobacco. Don't try to banish unaided the hold tobacco has upon you. Join the thousands of inveterate tobacco users that have found it easy to quit with the aid of the Keeley Treatment.

## KEELEY

Treatment For Tobacco Habit Successful For Over 50 Years

Quickly banishes all craving for tobacco. Write today for Free Book telling how to quickly Free yourself from the tobacco habit and our Money Back Guarantee.

THE KEELEY INSTITUTE, Dept. A-925, Dwight, Illinois

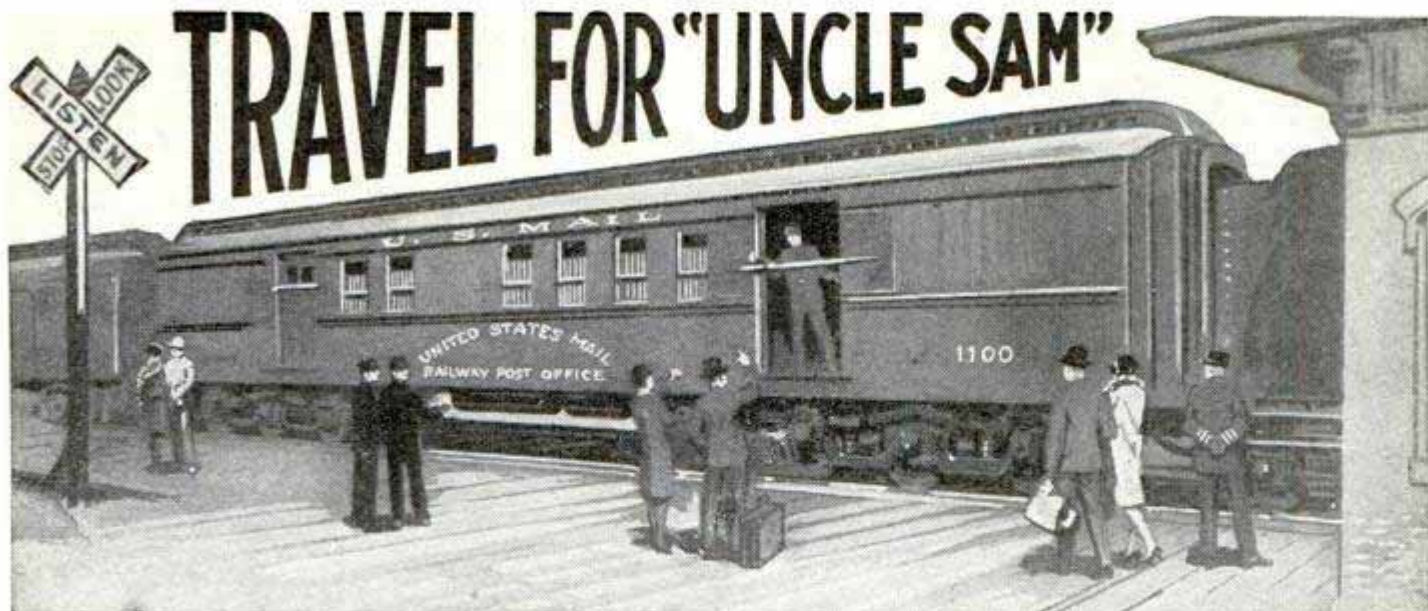

# Railway Postal Clerks

**\$158 Month First Year**

**Raise to Maximum of \$225 Month**

**Many Other U. S. Government Jobs Open to Men and Boys 18 Up**  
**POST OFFICE CLERKS RURAL MAIL CARRIERS CITY MAIL CARRIERS**  
**GENERAL CLERKS PROHIBITION AGENTS**

These are steady positions. Strikes, poor business conditions, lockouts or politics do not affect them. U. S. Government employees get their pay for full twelve months every year. There is no such thing as "HARD TIMES" in the U. S. Government Service.

### ALLOWANCE FOR HOTEL EXPENSES

Railway Postal Clerks now get \$1900 the first year regular, being paid on the first and fifteenth of each month. \$79.16 each pay day. Their pay is increased \$100 and \$150 a year. The maximum is \$2700 a year. \$112.50 each pay day. They get extra allowance for hotel expenses when away from home.

### PAID VACATIONS

Railway Postal Clerks, like all Government employees, are given a yearly vacation of 15 working days (about 18 days). When on runs they usually work 3 days and have 3 days off duty or in the same proportion. During this off duty and vacation, their pay continues just as though they were working. When they grow old, they are retired with a pension. As Railway Postal Clerks are continually traveling, they have an excellent chance to see the country.



### CITY MAIL CARRIERS—POST OFFICE CLERKS

Clerks and Carriers get \$1700 the first year regular and automatically increase \$100 a year to \$2100 with further special increase to \$2300. They also have 15 days vacation. City residence is unnecessary.

### What Will You Earn 5 Years From Now?

Compare these conditions with your present or your prospective condition, perhaps changing positions frequently, kicking around from post to pillar, no chance in sight for PERMANENT employment; frequently out of a position and the year's average salary very low. **DO YOU EARN \$1900 EVERY YEAR? HAVE YOU ANY ASSURANCE THAT A FEW YEARS FROM NOW YOU WILL GET \$2700 OR MORE A YEAR. EVERY YEAR?**



**FRANKLIN INSTITUTE**  
 Dept. A-173  
**ROCHESTER, N. Y.**

Rush to me entirely free of charge 32 page book with (1) a full description of the position checked below; (2) a list of U. S. Government jobs now obtainable; (3) tell me how to get the position checked.

- Railway Postal Clerk ..... (\$1900-\$2700)
- Post Office Clerk ..... (\$1700-\$2300)
- City Mail Carrier ..... (\$1700-\$2100)
- Rural Mail Carrier ..... (\$2100-\$3300)
- Clerk and File Clerks ..... (\$1260-\$2500)
- Prohibition Agent ..... (\$2300-\$2800)

### Get FREE List of Positions

Fill out the coupon. Tear it off and mail it today—now, at once. **DO IT NOW**—This investment of two cents for a postage stamp may result in you getting a U. S. Government Job.

Name.....

Address.....

Use This Coupon Before You Mislays It—Write or Print Plainly

MAIL COUPON TODAY

# BRAND NEW GENUINE Model 3 CORONA

LOWEST PRICE EVER OFFERED



**\$2.00**  
DOWN  
BALANCE  
EASY  
TERMS

**H**ERE'S your chance to own that brand new Genuine Model 3 Corona you've wanted—on the easiest terms ever offered—at **LOWEST PRICE** ever offered! Complete in every detail; back spacer, etc., **MANUFACTURER'S GUARANTEE**. Recognized the world over as the finest, strongest, sturdiest, portable built. Only a limited number of these splendid machines available. To get one, you must act now!

**Yours for 10 Days FREE—  
Send No Money**

Experience the joy this personal writing portable typewriter can give you! Use it 10 days free! See how easy it is to run and the splendidly typed letters it turns out. Ideal for the office desk, home, traveling. Small, compact, light, convenient. Don't send out letters, reports, bills in poor handwriting when you can have this Corona at such a low price or on such easy terms. Remember these are brand new machines right out of the Corona factory.

**Carrying Case Included—If  
You Act Now**

Leatheroid carrying case, oiler, instructions free on this offer. Send no money—just the coupon. Without delay or red tape we will send you the Corona. Try it 10 days. If you decide to keep it, send us only \$2—then \$3 a month until our special price of \$39.90 is paid. Now is the time to buy. This offer may never be repeated. Mail coupon now.

**MONEY SAVED  
By Using This Coupon**

**Smith Typewriter Sales Corp.  
(Corona Division)**

**469 E. Ohio St., Chicago, Dept. 39**

Ship me the Corona, F.O.B. Chicago. On arrival I'll deposit \$2 with express agent. If I keep machine, I'll send you \$3 a month until the \$37.90 balance of \$39.90 price is paid; the title to remain with you until then. I am to have 10 days to try the typewriter. If I decide not to keep it, I will repack and return to express agent, who will return my \$2. You are to give your standard guarantee.

Name .....

Address .....

Employed by .....

## FREE BOOK CATALOG

Send today, without obligation, for our new 72 page catalog, describing books on more than one hundred and fifty practical and scientific subjects, including books on Aviation, Automobiles, Air Brakes, Alloys, Electricity, Horology, Heating, Hydraulics, Model Making, Metallurgy, Radio, Ship Models, Soaps, Perfumes, Recipes, Plumbing, Inventions, Tanning, Television, etc.

Norman V. Henley Publishing Co., 2 West 45th St., New York, N. Y.

**SIGNS AND SHOWCARDS**  
EASILY—If YOU USE LETTER PATTERNS  
PAINTED WRITE FOR FREE SAMPLES  
J.F. RAHN, 2120 NEVA AVE., CHICAGO

## TELEGRAPHY

(Morse and Wireless) and RAILWAY ACCOUNTING, taught thoroughly. Big salaries. Tremendous demand. Oldest, largest school. Endorsed by Telegraph, Railway, Radio, and Government officials. Expenses low—opportunities to earn large portion. Catalog free. **DODGE INSTITUTE**, Jones St., Valparaiso, Ind.

## MEN for RAILROADS

Nearest their homes—everywhere—to train for Foremen, Brakemen; Average wages \$150-\$200 monthly. Promoted to Conductor or Engineer—highest wages on railroads. Also clerks.

**RAILWAY EDUCATIONAL ASSOCIATION**, Dept. D-1, Brooklyn, N. Y.

## NERVES?

Are You Always Excited? Fatigued? Worried? Gloomy? Pessimistic? Constipation, indigestion, cold sweats, dizzy spells and bashfulness are caused by **NERVE EXHAUSTION**. Drugs, tonics and medicines cannot help weak, sick, nervous! Learn how to regain vigor. Calmness and Self Confidence. Send 25c for this amazing book.

**RICHARD BLACKSTONE, N-479 FLATIRON BUILDING, NEW YORK**

## Learn Without Study



**READ Your  
Way to a  
Better JOB**

**Amazing Opportunities are now  
open in Electricity**

Electricity is the power behind radio, telephoning and telegraphing; it furnishes power for vast industrial plants; and is probably the most important subject in the world today. We have published a new edition of **Electrical Engineering** full of important money making information so arranged that you can at once understand how to do many electrical jobs. Fit yourself for advanced electrical work by referring to these facts, through the **JIFFY INDEX** which makes them instantly available. No long hours of unnecessary study; no tedious grind; put your finger on the facts you want to know and do it **QUICKLY**.

**Electrical  
Engineering  
Revised  
Edition**

8 Volumes, 4300 Pages.  
3200 Illustrations.  
Gold Stamped Flexible Binding.  
Jiffy Index—Vital facts instantly available.  
Electrical subjects fully covered, including **A. C. radio practice**. Note: If you send now we will include **FREE** a consulting membership in the American Technical Society.

## Eight Big Books Shipped FREE

Yes, just your name and address brings ALL of these books to you at once. Pay only the few cents delivery charges, look them over, read them, test the Jiffy Index, find out anything you want to know before you decide to keep them. Remember, you alone are the judge of their value. Send the coupon and take advantage of this liberal offer.

**The American Technical Society,  
Dept. E619,  
Drexel at 58th St., Chicago, Ill.**

Send me the 8 big books on electrical engineering for free examination. I will pay the few cents delivery charges and if satisfied that these books will raise my pay I will send you \$2.00 and after that \$3.00 a month until a total of only \$34.80 has been paid. Otherwise I will return the books collect in fifteen days and will owe you nothing. I am sending now, in order to get the membership in the American Technical Society **FREE**.

Name .....

Address .....

Employer's Name .....

Employer's Address .....

# Strongfort—Man Builder tells you how to be powerful

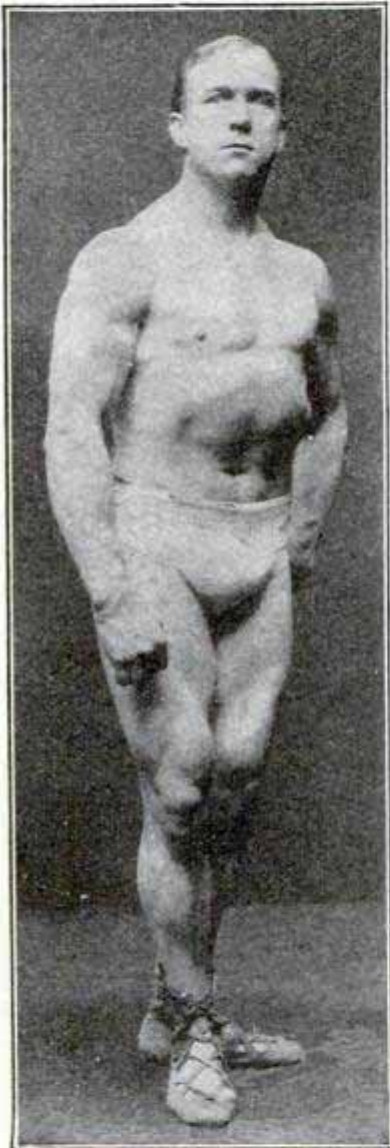

**STRONGFORT  
Builder of Men**

book, "Life's Energy Through Strongfortism." It will tell you frankly how you can make yourself over into a vigorous specimen of vital manhood. It will teach you how to fit yourself to be a credit to your social and business associates. Just mark the subjects on the free consultation coupon on which you want special confidential information and send to me. It's a man-builder and a lifesaver. Send for my **FREE BOOK**—Right Now. **TO-DAY!**

**STRONGFORT INSTITUTE**  
LIONEL STRONGFORT, DIRECTOR

Physical and Health Specialist  
For Over 30 Years

DEPT. 946

NEWARK, NEW JERSEY, U. S. A.

**YOU**—like every other man worthy the name of "man"—have a burning desire to be strong—to be dynamic—to be vigorous—to be capable of defense—to be an outstanding figure—admired and respected by men and women. You know the penalty of weakness. You know that the skinny fellow with hollow chest and sallow face—like the flabby fellow with too much stomach and too little wind—is a ridiculous object, laughed at and despised—undesirable in company, unsought as a companion.

You don't have to be one of this kind. *You can be a real 100 per cent man.* You can be just such a man as any one of the splendid fellows I have instructed. The world holds no parallel for the work I have accomplished in upbuilding weak men. And what I have done for others I can do for you through **STRONGFORTISM**—my world famed Course of health and strength building.

## **STRONGFORTISM** Will Do Wonders For You

I have made powerful men out of mere weaklings and many have become nationally famous. You may not seek tremendous strength. You may not want to become a professional strong man. But you do want good health and manly strength—*every man wants that!* You want energy and vitality. You want a clear, unflinching eye and a steady nerve. You want courage, "sand" and pep! And you can get all these by following in the paths in which I have directed thousands—*you can be a real man.* Above all, you can rid yourself of disheartening weaknesses and blighting ailments such as constipation, indigestion, rheumatism, high blood pressure, nervousness, lassitude, insomnia, catarrh, chronic colds, etc., if you are so afflicted.

## **Vibrant Life Awaits You**

Many young men write me the most pathetic letters about their sorry plight and their hopeless state of mind. What I reveal to them, what I do for them, transforms their lives, makes them happy, joyous souls, with an entirely new outlook on life. My methods give to them speedily a bodily feeling so new, so different, so vigorous that they are like men reborn—vibrant with life, bubbling with energy, eager for contact with others, full of ambition and pep. Results are truly marvelous. Thousands testify to this fact. They tell a story of rejuvenation, restoration and rebuilding of the human body that is beyond dispute.

### **My Scientific Methods Are Beyond Physical Culture**

Do not confuse the *Science of STRONGFORTISM* with gymnastic or ordinary physical culture courses. I am not merely a muscle developer. I am far more than that, for I have devised a system that restores sick, ailing, hopeless men to the Glory of Powerful Manhood—to the Summit of Health, Strength, Happiness and Success—without the use of dope and drugs, lifting and stretching-machines, unnatural deep breathing, starvation diets, nerve-racking routines or other foolish fads and fancies. What I have done for thousands of others I can do for you.

### **SEND FOR MY Free Book**

The experience and research of a lifetime are contained in my wonderfully instructive

### **Send this Coupon**

#### **FREE CONFIDENTIAL CONSULTATION**

Mr. Lionel Strongfort, Strongfort Institute, Dept. 946, Newark, N. J.—Please send me absolutely free my copy of your book, "LIFE'S ENERGY THROUGH STRONGFORTISM". This does not place me under any obligation. I have marked (X) before the subjects in which I am most interested.

- |              |                  |                          |
|--------------|------------------|--------------------------|
| ... Catarrh  | ... Constipation | ... Lung Troubles        |
| ... Colds    | ... Rheumatism   | ... Round Shoulders      |
| ... Asthma   | ... Nervousness  | ... Stomach Disorders    |
| ... Headache | ... Overweight   | ... Increased Height     |
| ... Rupture  | ... Weak Back    | ... Muscular Development |
| ... Thinness | ... Weak Eyes    | ... Great Strength       |
| ... Pimples  | ... Short Breath |                          |
| ... Insomnia | ... Weak Heart   |                          |

Other Ailments.....

PRINT

Name.....

Age.....Occupation.....

Home Address.....

City.....State.....



# Choose as Your Profession Electrical Engineering

Electricity offers a brilliant future to the young man who is about to choose his career. Never before has there been such a wonderful opportunity in this great field. Big paying positions in electrical work the world over are open to trained men—men who possess specialized, practical knowledge. Come to the School of Engineering of Milwaukee—the foremost and best equipped electrical school in America. Here you are trained in both theory and practice by a faculty of experts. You learn in large, completely equipped laboratories. If you have 14 high school credits or equivalent, you can become an Electrical Engineer with a Bachelor of Science degree. Any credits you may lack can be made up in the short intensive course covering Electricity and technical high school subjects.

**B.S. Degree  
in 3 Years**

## A Complete, Practical, Electrical Education

Learn by the thorough, approved scientific methods which our 25 years of specializing enable us to give you. In addition to Electrical Engineering, the following complete courses are given: **A. C. and D. C. Armature Winding—Wiring and Testing—Commercial Electrical Engineering—Radio Sales Service and Broadcasting—Electrical Refrigeration.**

## Earn While You Learn

By our special system ambitious men who can finance their tuition may earn part of their way while learning. If you are in earnest our Employment Men will help secure you a position to which you may devote a part of each day, spending the remainder at the school. Cooperation with large Milwaukee electrical industries affords Students splendid opportunities. Low tuition fee. Board and room reasonable. Daily Broadcasting. School Orchestra. Fraternities.

**Fall Term  
Sept. 4th**

## Write for FREE Catalog

Write today for our free, illustrated catalog. Read about this wonderful institution and the great opportunities that lie before you. Find out about our specialized method of training and the details of our "Earn While You Learn" Plan.

### SCHOOL of ENGINEERING of Milwaukee

FOUNDED 1903

Dept. P. M. 929, E. Wells & Jackson, MILWAUKEE, WIS.

**SCHOOL OF ENGINEERING OF MILWAUKEE**  
Dept. P. M. 929, E. Wells & Jackson, Milwaukee, Wis.

Without obligating me in any way, please mail free illustrated book, "Electricity and the One Best Way to Learn It," and particulars regarding the course I have marked with an X.

**RESIDENT COURSES:**

- .... Electrical Engineering, B. S. Degree. (3 years)
- .... Commercial Electrical Engineering. (H. S. graduates 1 year—others 1½ years)
- .... Armature Winding.
- .... Light Motor Wiring and Testing.
- .... Electrical Refrigeration.
- .... Master Electrician.
- .... Radio Sales Service and Broadcasting.
- .... Home Laboratory Service. (Home Study Course)
- .... I am interested in your "Earn While You Learn" plan.

Name..... Age.....  
 Address.....  
 City..... State.....  
 Education.....

Save  
\$20.00  
with this  
OFFER  
Send no  
money

Get Strong  
WITH  
These Improved  
Muscle Builders  
All for \$5.00

GUARANTEE  
SATISFACTION  
OR  
MONEY  
BACK



Why pay an extravagant price for strength—here's an opportunity to get all the equipment you require along with an excellent course of instructions for only \$5.00. Realize your ambition and develop muscles of a super-man. Get strong and amaze your friends. We show you how to easily master feats which now seem difficult—or if you just want physical culture for your health's sake, this equipment is just what you need. With this special offer you save at least \$20.00. We furnish a ten cable chest expander which is adjustable to give resistance up to 200 lbs. It is made of new live extra strength, springy rubber so as to assure long wear and give the resistance you need for real muscle development. You also get a pair of patented hand grips for developing powerful grip and forearms.

We include wall exercising parts which permits you to develop your back, arms and legs—a real muscle necessity. You know that business men and athletes, too, first show their age in their legs. Develop your leg muscles with the foot strap which we furnish. This will give you speed and endurance—but that isn't all that you get. In addition we include a specially written course which contains pictures and diagrams showing you how to develop any part of your body so that you will quickly get on with these exercises and gain the greatest advantage from their use. Act now while you can get in on this special offer. It might be withdrawn, so rush the coupon.

**SEND NO MONEY**

All of the items pictured on this page are included in this big special reduction offer. Sign your name and address to the coupon below and rush it to us. We will send you ten cable chest developer, the wall parts, a pair of hand grips, foot strap and the course by return mail. Pay the postman only \$3.00, plus the few cents postage on arrival. (If you desire to send check or money order in advance, we pay postage.)

**GUARANTEE**

All Crusader products are guaranteed to give entire satisfaction or money back.



**Crusader Apparatus Co.,**  
Dept. 109, 44 Parker Ave., Maplewood, N. J.

I accept your offer. Send me everything described in your advertisement by return mail. I will pay postman \$5.00 plus postage on arrival. It is understood if I am not entirely satisfied after examination I can return the goods and you will refund my money.

Name.....

Street.....

City..... State.....

**Boys!**

*I'm surely happy  
that I can earn  
these dandy Prizes!*



Any one of these prizes can be yours without costing you a cent of your own money. Hundreds of boys are doing it. You can do the same. Send the coupon now and learn how easily you can earn money & prizes.



By being a Crowell Junior you will have an opportunity to earn the things you want most. The prizes shown here are only a few of the 300 you can get. Every prize is of the finest quality and one you would be proud to own.



How proud you would be and how your chums would envy you if you owned this snappy wrist watch or fielder's glove. Every prize is of the finest quality. The coupon mailed today will bring you information on how to quickly get it.



Smiling Ted Thomas is the proud owner of his own baseball equipment. He is one of the many hundreds of boys who are earning their own money, baseball equipment, bicycle, radio, wrist watch and many others selected from our Big Book of Prizes.

Ted is a Crowell Junior Salesman. He delivers The American Magazine, Woman's Home Companion and Collier's, The National Weekly, to regular customers. These well known magazines make Ted's work as easy as play.

Your name and address mailed on the coupon will bring you full information and start you in business at once. Send the coupon now!

Mr. Jim Thayer, Dept. 116  
The Crowell Publishing Company  
Springfield, Ohio

Dear Jim: I want to earn money and prizes. Please start me off as a Salesman.

My Name.....

Address.....

Town.....State.....

*Mail this Coupon Now* →

# Swear Off Tobacco



Tobacco Tells on Nervous System



Tobacco Ruins Digestion



Tobacco Stunts Boy's Growth



Tobacco Robs Man of Virility



Tobacco Steals from You the Pleasures, Comforts, Luxuries of Life

## Tobacco Habit Banished Let Us Help You

### Quick Results

Trying to quit the tobacco habit unaided is often a losing fight against heavy odds, and may mean a serious shock to your nervous system. So don't try it! Make the tobacco habit quit you. It will quit you if you will just take **Tobacco Redeemer** according to directions.

It doesn't make a particle of difference whether you've been a user of tobacco for a single month or 50 years, or how much you use, or in what form you use it. Whether you smoke cigars, cigarettes, pipe, chew plug or fine cut or use snuff—**Tobacco Redeemer** will positively remove all craving for tobacco in any form in a few days. Your tobacco craving will usually begin to decrease after the very first dose—there's no long waiting for results.

**Tobacco Redeemer** contains no habit-forming drugs of any kind and is marvelously quick, scientific and thoroughly reliable.

### Not a Substitute

**Tobacco Redeemer** is in no sense a substitute for tobacco, but is a radical, efficient treatment. After finishing the treatment you have absolutely no desire to use tobacco again or to continue the use of the remedy. It helps to quiet the nerves, and will make you feel better in every way. If you really want to quit the tobacco habit—get rid of it so completely that when you see others using it, it will not awaken the slightest desire in you—you should at once begin a course of **Tobacco Redeemer** treatment for the habit.

### Results Absolutely Guaranteed

A single trial will convince the most skeptical. Our legal, binding, money-back guarantee goes with each full treatment. If **Tobacco Redeemer** fails to banish the tobacco habit when taken according to the plain and easy directions, your money will be cheerfully refunded upon demand.

### Let Us Send You Convincing Proof

If you are a slave of the tobacco habit and want to find a sure, quick way of quitting "for keeps" you owe it to yourself and to your family to mail the coupon below or send your name and address on a postal and receive our free booklet on the deadly effect of tobacco on the human system, and positive proof that **Tobacco Redeemer** will quickly free you from the habit.

**Newell Pharmacal Company**  
Dept. 300, Clayton Station, St. Louis, Mo.



### Free Book Coupon

**NEWELL PHARMACAL CO.,**  
Dept. 300, Clayton Station, St. Louis, Mo.

Please send, without obligating me in any way, your free booklet regarding the tobacco habit and proof that **Tobacco Redeemer** will positively free me from the tobacco habit or my money will be refunded.

Name.....

Street and No.....

Town..... State.....





Actual size of Magic Dot, which weighs less than 1/25 of an ounce, yet holds rupture more securely than pounds of steel springs, and hard, gouging cushions.



# Beware the Small Rupture THAT "DOESN'T BOTHER MUCH"

*Light as a Feather*

# Yet... Holds Rupture!



Now—An Ohio Scientist Is Helping Nature Rescue Thousands Of Rupture Victims From The Eternal Horror Of Many Dangerous Cumbersome Trusses And Other Torturous, Harness-Like Contraptions. He Has Perfected A Tiny, Feather-Weight Magic Dot That Frequently Offers Joyous Relief And New Comfort From The First Day. Countless Former Truss Victims Everlastingly Thank This Interesting Discovery For Their New Happiness. Just Mail The Coupon For Free Sample If You, Too, Want New Freedom.

**S**CIENCE has at last developed a tiny, interesting rupture device weighing less than 1/25 of an ounce, which has freed and amazed thousands of rupture sufferers and won the admiration of many doctors and scientists.

Its results are often so remarkable—so quick—you may wonder how such a simple, tiny invention can accomplish almost miraculous benefits. It makes utterly obsolete all painful trusses, gouging knobs, steel springs and unsanitary, cumbersome leg straps.

## It "Breathes" Air

Magic Dot anchors a flesh-soft padlet composed of a newly perfected substance named Airtex. This is honey-combed with microscopic air cells that tend to "breathe" air with each movement of your body. It expands and contracts as easily as your own flesh. When you walk, run, bend or exercise it tends to squeeze itself—not the part of the body it rests against.

It is so light—so comfortable—the wearer as a rule hardly knows he has it on. It does not produce that "hot spot" feeling. Sanitation is now more sure—because the padlet can be washed clean and sweet in a jiffy.

Immediate relief and new comfort are not the only things the New Science System should accomplish. Of far greater importance is the comfort you have dreamed of—the possibility of ultimate FREEDOM! This should be possible because this amazing new method gives nature a chance to heal the rupture automatically. This is not possible with gouging trusses that prevent free circulation.

## Test Sample Free

Send no money. Just mail the coupon for Free Sample of remarkable Airtex. With it we send, without charge, latest copy of a very new and informative book on Rupture and Hernia that should open your eyes.

### NEW SCIENCE INSTITUTE

2164 Clay Street

Steubenville, Ohio

New Science Institute,  
2164 Clay St., Steubenville, Ohio.

Without obligation send me a no-cost Airtex sample with new book about rupture and hernia relief.

Name .....

Address .....

City..... State.....

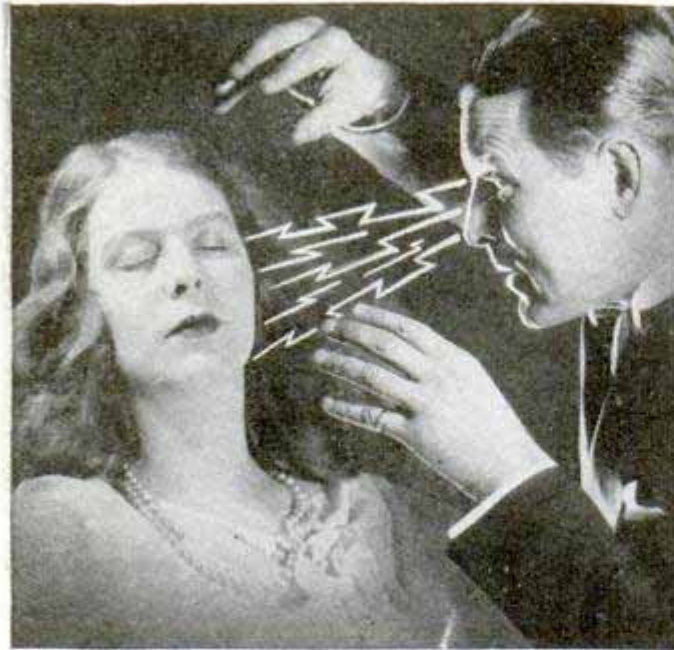

# See How Easy You Can Learn **HYPNOTISM** TRY FREE 5 DAYS!

**S**EE for yourself how easy it is to master the great science of Hypnotism—how quickly you can learn to bend people to your will—banish fear, worry and opposition—**increase your earnings**—and **force others to give you the recognition, power, and admiration you deserve.** I'll show you how to use this great force to help you master every situation or **The Five Day Trial is FREE!**

In just a few hours I'll teach you the hidden secrets of Hypnotism—the methods used by the great operators—the amazing things you can accomplish once you understand this mighty power. You can use it to overcome obstacles, achieve your fondest ambitions and become **MASTER** of yourself, friends and acquaintances—either sex. Now you can quit being just one of the crowd—now you need not be unpopular, lonesome or unhappy a minute longer. Through this strange power you can learn how to stand out—dominate—to make your life what you want it to be!

In his startling **NEW** book, *The Science of Hypnotism*, the world famous hypnotist—Prof. L. E. Young—reveals the most carefully guarded secrets of this fascinating subject. He not only explains the methods of a real hypnotist, step by step—but tells clearly all about the nine stages of hypnotism, The Hypnotic Mirror, Mental Telepathy, how to select your subjects, magnetic healing, methods of hypnotizing, how to wake the subject, how to make money out of hypnotism!

**Try 5 Days FREE—  
Send No Money**

So confident are we that Prof. Young and his great book will quickly teach you the science of Hypnotism, that we will send you a copy without one cent in advance! Simply clip and mail the coupon below. When the book arrives pay the postman the special low price of \$2.50 plus few cents postage. Then test the powers of Hypnotism 5 days! If not amazed and delighted, return the book and money will be refunded at once.

**FRANKLIN PUBLISHING CO.,  
Dept. L-70, 809 No. Clark Street, Chicago, Illinois**

## Mysteries of Hypnotism Revealed

How to Hypnotize at a Glance  
Susceptible Subjects  
How to Hypnotize by Telephone  
How to Give an Entertainment  
How to Make Others Obey You  
Overcoming Bad Habits  
How to Do Dozens of Hypnotic Feats  
Use of Hypnotism in Operations

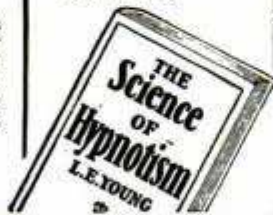

Franklin Pub. Co., Dept. L-70,  
809 No. Clark St., Chicago, Ill.

Please send me your amazing new book—*The Science of Hypnotism*—by Prof. Young. When book arrives, I'll pay the postman only \$2.50 plus postage. If I am not satisfied after 5 days' trial, I may return the book and you are to refund my money.

Name .....

Street and No. ....

Town ..... State .....

If you are likely to be out when postman calls, send \$2.50 with coupon and we'll pay delivery charges. Customers outside U. S. send cash with order.

# MOULDING A MIGHTY CHEST



**Get a 46 Inch Chest**  
Complete Course on Chest Building  
**ONLY 25c**

Learn the real secret of powerful chest building. Know all about the muscles that lift, widen and deepen the chest and broaden the shoulders. Practice the specialized exercises which will make **YOUR** chest massive and powerful. The greatest analysis of vital, vigorous chest development ever written. Learn the Hindoo religious system of exercises that makes their wrestlers and strong men invincible. A Hindoo strong man and wrestler threw Zybsco in two seconds. Many other methods unknown to the American body builder, are explained. Complete with anatomic illustrations on which are indicated the little known vital spots in creating vitalic internal strength. You can build for yourself a Herculean chest. The author, George F. Jowett, built his chest from 32 inches of weakness to 48 inches of colossal muscular strength. Develop your chest with straps of big steel muscle. Fill it full of unresisting vital strength energy.

**WORTH ITS WEIGHT IN GOLD—GET IT TODAY**

To each purchaser will be given a **FREE COPY** of *THE THRILL OF BEING STRONG*. It is a priceless book to the strength fan and muscle builder. Full of pictures of marvelous bodied men who tell you decisively how you can build symmetry and strength the equal of theirs.

**REACH OUT—GRASP THIS SPECIAL OFFER**

**JOWETT INSTITUTE of PHYSICAL CULTURE**

422 Poplar Street, Dept. 4-W, Scranton, Penna.

Dear Mr. Jowett: I am enclosing 25c. Please send me the course "MOULDING A MIGHTY CHEST" and a free copy of "THE THRILL OF BEING STRONG."

Name .....

Address .....

# No More Razor Blades To Buy!



## 365 KEEN SHAVES

### A Year With One Single Blade

"I want to say that KRISS-KROSS Stropper is the best thing I ever saw. I have been using one blade continuously for one year and nine months and have no idea how much longer it will last."

C. S. Stephenson, Okla.

# Inventor Discovers Amazing New Way to Shave! -Without Buying Blades!

**K** EEN, velvety shaves forever and no more blades to buy! That's what the astonishing invention of a St. Louis man offers the great army of American shavers today!

KRISS-KROSS is destined to revolutionize all existing traditions of shaving! Its performance is so sensational that it seems hardly fair to call it a stropper. Rather it is a *super-stropper* or blade-rejuvenator! No longer do you find that your blades "die" after five or six shaves. KRISS-KROSS "brings 'em to life" a surprising way! Actually—you can take a blade right out of a fresh package and improve it as much as 100% in eleven seconds with KRISS-KROSS!

### MAGIC DIAGONAL STROKE

KRISS-KROSS employs the famous *diagonal stroke*, same as a master barber uses. Never before has anyone captured the secret of reproducing it automatically. Eight "lucky leather grooves" do the trick in 11 seconds with a precision it takes a master barber years to attain. Stropps from *heavy* to *light*. Adjustable, automatic jig flies up and notifies you that your blade is ready—*ready with the keenest cutting-edge that steel can take!*

KRISS-KROSS produces unbelievable sharpness and prolongs the life of any razor blade for months and even years. Fits all brands and makes except Durham. Eliminates 83% of shaving costs and solves your blade problem for all time!

### NEW TYPE RAZOR BLADE FREE

To introduce KRISS-KROSS stropper, we are including this month free sample of a revolution in razor blade construction. Made to fit your present razor. Guaranteed to last longer and

*Rhodes* **KRISS KROSS**

**Kriss-Kross Corp.**

Dept. M-3714 1418 Pendleton Ave. ST. LOUIS, MO.

Largest Manufacturers of Mechanical Stroppers in the World.

shave better than any other. Expect a new shaving sensation—KRISS-KROSS blades are made of a unique steel, made a new and better way.

### GET FREE OFFER

Send for full information on these surprising new inventions today. KRISS-KROSS products are never sold in stores. You deal direct with me or my authorized representative. Write for illustrated description and free sample blade. It's even more remarkable than I can tell you in this short space. Clip the coupon now. Mail it today.

## Agents \$30 a Day

Make big money with KRISS-KROSS. Giving away FREE razor blades boosts your profits amazingly. H. Klug made \$66 in one day. N. C. Paige made \$104 in 3 days! Others average \$350 and up to \$750 a month! Spare-time workers, Office and Factory men make \$6-\$12 extra a day showing KRISS-KROSS to friends and fellow employees. S. Kantala made \$154 extra just working evenings 3 weeks. Get details at once. Check bottom of coupon and mail it tonight!

Kriss-Kross Corporation,  
Dept. M-3714, 1418 Pendleton Ave., St. Louis, Mo.  
Send me details of Kriss-Kross Stropper. Also send free sample of your new type razor blade for.....Razor.  
(Fill in your make of razor.)

Name.....

Address.....

City..... State.....

( ) Check here for agents' money-making plan, full time or spare time.

# At Last

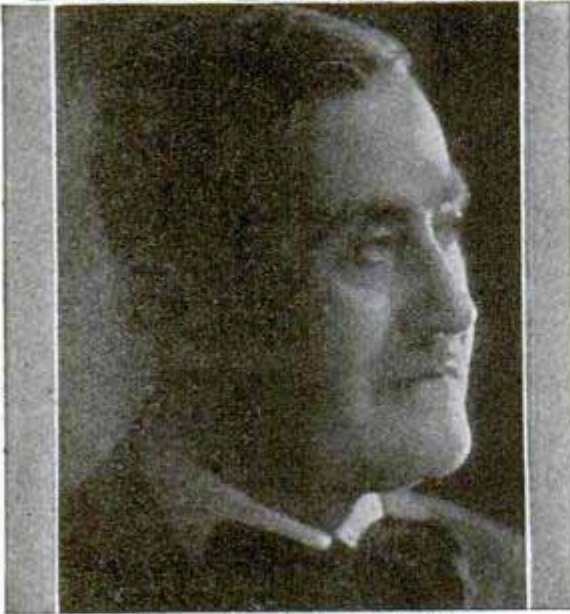

Eugene Feuchtinger, A. M.

## Voice Teacher Who Actually Guarantees Results!

NOW!—YOU can be *sure* of possessing a rich, strong, beautiful, magnetic voice! Prof. Feuchtinger, descendant of a long line of European musicians, *guarantees* to improve *any* normal voice *at least 100%* or refund every penny.

Eugene Feuchtinger does not merely teach you how to sing. He actually develops the voice! No monotonous, tiresome scale work. He teaches you to build up the strength and elasticity of your vocal organ by scientific muscular exercise—*silent exercises!*—which you may practice in the privacy of your home. Thousands of men and women have been astonished to see how their voices have been *marvelously* improved—even when other methods have failed.

*No matter how hopeless your case may seem, send for this*

### Physical Voice Culture Book

**FREE** Your voice has marvelous possibilities that you may not even suspect. "Physical Voice Culture" will reveal them to you. Send for this great book. Read the astounding *true stories* of what others have done. Learn how to build up a rich, strong, beautiful, magnetic voice and all about Prof. Feuchtinger's wonderful guarantee offer to improve your voice at least 100%—or refund every penny!

### Perfect Voice Institute

1922 Sunnyside Avenue, Studio 13-56 Chicago

MAIL COUPON NOW!

Perfect Voice Institute, Studio 13-56  
1922 Sunnyside Ave., Chicago, Ill.

Please send me, FREE and without any obligation, Prof. Feuchtinger's new book, "Physical Voice Culture." I have checked the subject in which I am most interested.

- Weak Voice       Stammering  
 Singing             Speaking

Name.....

Address.....

City.....

State.....



Ask your barber  
for a free appli-  
cation of Murine

## CLEAR EYES are a business asset

Clear, bright eyes make a far better impression than do those which are dull and bloodshot. A few drops of harmless *Murine* will quickly clear up bloodshot eyes resulting from over-use, late hours or exposure to wind and dust.

# MURINE

FOR YOUR  
EYES

## EARN BIG MONEY IN SPARE TIME!

Ambitious spare-time workers can make \$40 to \$75 weekly selling greeting cards, favors, table decorations, etc., to clubs, lodges, stores, and friends. Big Christmas and holiday demand. Permanent business in every community as authorized A. G. I. representative. Write Dept. M351, Art Gift Industries, 542 So. Dearborn St., Chicago.

## Boils 50 Gallons In Less Than Hour

No Other Compares With This

## Improved Oil Burner

Use Ordinary Kerosene or Coal Oil

[Burns Outdoors as Well as Indoors]

THE most remarkable Kerosene Burner ever built. Boils down apple cider, maple syrup, molasses, etc., in half the ordinary time. Ideal burner for dairies, butchers, indispensable on the farm.

PRODUCES TERRIFIC HEAT WITH  
SILENT BLUE FLAME

**NO** NOISE  
**SMELL**  
**SMOKE**  
**SOOT**

So efficient it produces twice the amount of heat of City gas at half the cost. So simple anyone can install and operate. Double generator assures continuous operation without shut-downs. Nothing to wear out, starts in a jiffy, will last a life time. Every burner guaranteed fully. Write for special introductory price and free catalog of outdoor utility and kitchen stove oil burners.

HOME MFG. CO., Dept. 3513, 20 E. Kinzie St., CHICAGO



**\$350 a month**

**\$500 a month**

**\$450 a month**

"I feel proud of my success in Radio to date. My profit during the last two months amounts to \$700. I am making good and I have not finished my N. R. I. course yet. I am grateful for your training and co-operation to date and look forward to still bigger success when I graduate."

Clarence Heffelfinger,  
Temple, Penna.



"When I enrolled with the N. R. I., I was a motorman on a trolley car. Now I have a fine, fast-growing Radio business. When only half way through the course started bringing in extra money. I made \$420 in my spare time. Now I have a bank account of \$2800 and about \$300 worth of stock. It has all come from Radio since graduating less than six months ago. I cannot begin to express my thanks to you and all those connected with N. R. I. for what you have done for me."

Richard Butler, 3535 Sheffield St.,  
Philadelphia, Pa.

"In addition to my regular work in what I believe to be the largest and best equipped Radio Shop in the Southwest, I am now operating KGFI. I am proud of the fact that I installed and put KGFI on the air without help of anyone except the N. R. I. I am averaging \$450 per month."

922 Guadalupe St Frank M. Jones,  
San Angelo, Tex.



# READ what Big Money my men make in RADIO

\$350, \$450, \$500 a month. That's making real money. What business other than Radio offers such opportunities after six to twelve months training? None that I know of. More proof—last year electricians, farmers, mechanics, clerks, railroad men, bookkeepers, preachers, doctors, and men from 78 other trades and professions enrolled with me to prepare for the Radio field.

## Big Growth Making Many Big Jobs

A WONDERFUL business, you will say, to make men trained for other fields, give them up for Radio. Yes, but they had their eyes wide open. They know what you and I know—that big growth makes big jobs and many opportunities to earn big money. Heffelfinger, Jones, and Butler couldn't make anything like this money before, although they probably worked just as hard—maybe harder. Trained men are needed for the big jobs the amazing growth of Radio is creating.

## Salaries Up To \$250 a Week

WHY go along at \$25, \$30, \$35 a week when the good Radio jobs pay \$50 to \$250 a week? Cut loose from drudgery, small pay, no-future jobs. Get into a live-wire field that offers you a real chance. You don't need a high school or college education to become a Radio Expert. Many of my most successful graduates didn't finish the grades.

## Practical Experience With Course

I GIVE you six big outfits of Radio parts. With them you can build and experiment with one hundred different circuits—learn the "how" and "why" of practically every type of set made. This makes learning easy, interesting, fascinating, your training complete. Nothing else equals my method.

## TELEVISION also Included

YOUR knowledge of Radio will be right up to the minute with Radio's progress and inventions when you take my training. Television, the new field for Radio experts, is included. Not one system for sending and receiving pictures by Radio, but all of them—Jenkin's, Cooley's, Bell's, Baird's, Belin's, Alexanderson's.

Television can easily and quickly become as large as the whole Radio industry is today. Broadcasting stations will soon need trained men, so will manufacturers for the designing and building of sending and receiving sets. It won't wait for you. Get ready quick.

**I GIVE YOU THE RADIO PARTS FOR A HOME EXPERIMENTAL LABORATORY**

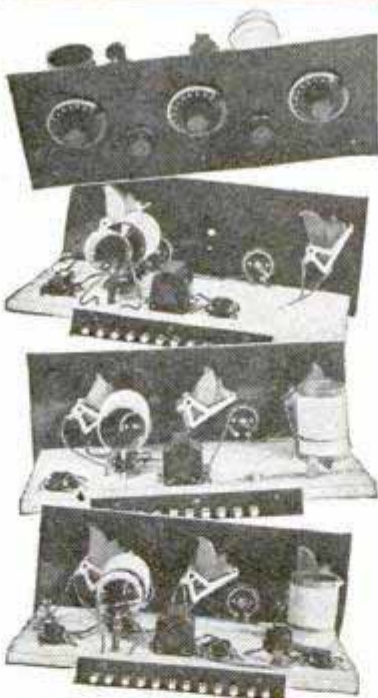

**WITH THEM YOU CAN BUILD 100 CIRCUITS. 4 YOU BUILD ARE SHOWN HERE. MY BOOK EXPLAINS THIS PRACTICAL FASCINATING WAY OF LEARNING RADIO**

*Get a copy free*

**I Will Train You at Home in Your Spare Time**



NO NEED to leave home. Hold your job, give me one-half to one hour a day of your spare time. In six to twelve months you can be a trained Radio Man, ready to step into a new job with a real future.

## \$10 to \$30 a Week While Learning

MANY of my students make \$10, \$20, \$30 a week extra while learning. I teach you to begin making money shortly after you enroll. G. W. Page, 1807 21st St., Nashville, Tenn., made \$935 in his spare time.

## Money Back If Not Satisfied

I KNOW the kind of training you need. I have put hundreds of men and young men ahead. I am so sure that I can satisfy you too that I will agree to refund your money if you are not satisfied when you complete my course.

## Find Out What Radio Offers You

MY 64-page book explaining where the big jobs are and what you can make is FREE. Mail coupon. No obligation. Address: Dept. 9 WPP J. E. Smith, Pres., Nat'l Radio Institute, Washington, D. C.



## Send this Coupon

J. E. Smith, President,  
Dept. 9 WPP National Radio Institute,  
Washington, D. C.

Dear Mr. Smith—Send me your book. I want to know about the opportunities in Radio and your practical method of teaching at home with six big outfits of Radio parts. This request does not obligate me to enroll.

Name ..... Age.....  
Address .....  
City ..... State.....

**THIS IS RADIO'S BIGGEST YEAR**

# Fix that Car!



Learn How Easily



**JIFFY INDEX** in These Five New Big Auto Books Makes All Facts Instantly Available. Find Anything You Want to Know in a Moment in This Latest Edition

All Shipped **Free**  
Don't miss a word of our free shipment offer. We ship without receiving one penny.

Repair any auto fault, learn how now. You can do it easily in this new simple way. These five big automobile books are the most interesting, the most practical books we have ever published on automobile construction, operation and repairs. Brimful of facts, photographs and explanations so easy to understand that anyone can learn how to repair auto faults in almost no time. Over 2,000 pages full of diagrams, data sheets and everything else needed to make anyone an authority on automobiles. Whether you want to qualify as garage owner, auto repair expert or merely wish to know how to keep your own car 100% efficient, you will recognize the amazing value of these five big books, especially on our

## No Money Offer

A very liberal plan of distribution brings these books to you for examination without one cent of payment to us. We don't ask a cent of you, but ship the books free. Look them over, read them as much as you want to, note the splendid photographs and drawings, and then if you decide you want them, send only \$2.00 and then \$3.00 a month until only \$24.80 is paid. That is all. Nothing more to pay us. There is no further obligation.

## American Technical Society Membership Free

Yes, we include a certificate of membership in the American Technical Society, which entitles you to free consultation for one year on any subject relating to automobile engineering. We have over a million dollars of resources enabling us to get co-operation of the largest automobile manufacturers and dealers who have furnished us plans and photographs. You can write or wire any time for special information. Answers will be sent promptly without cost.

## Learn All About AUTOS

Get these five big books on this liberal offer and learn all the things you want to know about autos—carburetors, engines, springs and spring suspension, brakes, 4-wheel drive, lubricating system—all are fully covered. These complete and comprehensive books are yours if you want them on this easy plan. Send for a set now. Fill in the coupon.

### FIND FACTS QUICKLY

One of the best things about these money making books is the *Jiffy Index*, which puts vital facts at your finger tips. You don't have to read the books through; you don't have to spend long hours over them. This Index enables you to put your finger on the information wanted in a jiffy.

### DON'T HESITATE

There are no strings to this offer—it means just what it says. Send name and address on the coupon and all of the five big books will be sent you. Remember, one fact alone may save you an expensive repair or help you to a better job.

American Technical Society, Dept. A619  
Drexel Ave. at 58th St., Chicago, Ill.

I would like to look at the five big auto books—send them on your free offer. I will pay the few cents delivery charges. If I like them I will send you \$2.00 when I have had the books fifteen days, and then \$3.00 a month until the special low price of only \$24.80 is paid. Otherwise I will return the books at your expense. You are to include, without charge, free consulting membership certificate in the American Technical Society.

Name .....

Address .....

Employer's Name .....

Employer's Address .....

**FOR FREE OFFER USE COUPON**



## Signals Auto Driver When Tire Needs Air Increases Tire Mileage

A simple new tire attachment that automatically warns the auto driver when any tire becomes partly deflated or needs air, and, as a result, makes it easy to keep tires up to proper air pressure at all times and get increased mileage, is the invention of D. B. Simpson, 3000M—307 W. Douglas, Wichita, Kansas. Now broken down casing walls and rim-cuts, due to running on half-deflated tires, are banished forever. Anyone can install a set on his tires in a few minutes and no special tools are required. To introduce, the inventor offers to send a sample on free trial at his risk. He wants distributors and agents who can make \$350 to \$1,200 a month handling the big business to be built up. Write him today.

## NEED A BETTER GRIP ON MATHEMATICS?



SEND for a copy of "Mathematics for the Practical Man," only \$1.50. By common sense methods it removes the mystery and difficulties so that algebra and even calculus are made simple.

Assuming your knowledge is limited to arithmetic you quickly and easily gain a working knowledge of Algebra, Geometry, Trigonometry and Calculus. Simply pay postman price of book plus the postage when he hands you the package.

Popular Mechanics Press  
Room P9  
200 E. Ontario Street, Chicago

## Sell Shirts Direct From Factory!

### EARN \$85 A WEEK!

Take care of the big demand for Packard Tailored Shirts in your locality. Finest shirts in America. Sold direct at manufacturer's low prices. Satisfaction guaranteed. Show magnificent selection of patterns and materials. Orders come fast. W. L. Roseberry made \$8 first hour. J. N. Papadakis made \$30 one afternoon. Join the money-makers.

**Men or Women**  
You can make steady big cash earnings selling Packard Tailored Shirts. Full or spare time. No experience necessary.



**Essex Coach Given**  
We supply free sample outfit, complete instructions and FREE Essex Coach offer.

Write Now for Free Samples.

Packard Mfg Co  
Dept. 301 466-470 W. Superior St.  
CHICAGO, ILL.

# YOU'RE NEXT

## Now Watch YOUR Muscles GROW!

**O**NE—TWO—THREE! Just like that the man you see at the right changed from a puny weakling into a physical **GIANT!** Looks like magic, doesn't it? But it isn't. It's just an example of what Titus Training has done for thousands upon thousands of men.

I've taken fellows of every size and condition and transformed them into perfect specimens of manhood! I've been doing it for years. "Miracles worked in Muscle" people call them. But they are *scientific* miracles, because I've made a science of building men. Nobody else knows the secret of my methods—but *I* know, and I know they'll do the same for you as they did for the lad shown here.



**ONE!** This boy looks pretty hopeless, doesn't he? I'll bet he hated to step out on the beach in a bathing suit, and he had to stand a lot of bullying from the other boys in the gang.



**TWO!** Here's a real man! Just look at the wonderful improvement that muscles make in a man's appearance.



**THREE!** And this picture shows every muscle in his body developed to giant size. Don't you want to look like this? Need I urge YOU to mail the coupon?

## I'll Increase Your Muscles by INCHES

Yes sir, and all I want is 30 days—and just 20 or 30 minutes a day. In that short time I'll put layer after layer of muscle all over your body till they stand out like iron bands. And they'll be panther muscles, friend—muscles as live as spring steel—with the speed of lightning and the power of a battering ram. Those are the kind of muscles that make champions, the kind of muscles that will make you laugh at men twice your size.



### Wear This Medal

Strong men all over the world wear it. Made of solid statuary bronze and given to you free.



**FREE!**  
Amazing Book  
Of Muscle-  
Building Facts

Tear off that coupon! Mail it today! It will bring you **FREE** the greatest book you've ever seen—a book filled with astounding photographs of men rebuilt—a book packed full of Titus's own secrets of making muscles **grow**. No cost or obligation—just rush the coupon to Dept. M-142.

The One and Only **TITUS** 105 E. 13th St. New York City

**TITUS, Dept. M-142**  
105 E. 13th St., New York, N. Y.

Dear Titus: Sure I'd like to have your book. Send it free.

Name.....

Address.....

Town..... State.....



# Mechanical Engineering

## Learn at Home

MECHANICAL Engineering embraces the design, construction and operation of machines and machine tools. It is a profession which offers almost unlimited opportunities to men who combine natural mechanical ability with technical training.

For this is The Age of Machinery. Almost every convenience, luxury or necessity which we enjoy depends on machinery for its production or adaptability to our needs. Every new invention multiplies the opportunities for competent designers, builders, erecting engineers, etc.

One of the best ways to train yourself to secure a position as a Mechanical Engineer is through the home-study courses of the International Correspondence Schools.

These courses are complete and up-to-date, and especially arranged to meet the needs of the student who studies at home.

They are particularly helpful because they are written by well-known mechanical engineers with years of practical experience, who know the quickest, best way to solve every problem.

Just mark and mail the coupon and we'll gladly send you Free Booklets describing the I. C. S. courses in Mechanical Engineering or any other course in which you are interested.

INTERNATIONAL CORRESPONDENCE SCHOOLS  
Box 5637-F, Scranton, Penna.

Without cost or obligation, please send me a copy of your booklet, "Who Wins and Why," and full particulars about the course before which I have marked X in the list below:

- |  |   |
|--|---|
| <input type="checkbox"/> Mechanical Engineering  | <input type="checkbox"/> Toolmaking   |
| <input type="checkbox"/> Mechanical Course       | <input type="checkbox"/> Blacksmithing and Forging                          |
| <input type="checkbox"/> Drafting                | <input type="checkbox"/> Patternmaking                                      |
| <input type="checkbox"/> Mechanical Drawing      | <input type="checkbox"/> Foundrywork  |
| <input type="checkbox"/> Complete Shop Practice  | <input type="checkbox"/> Machine Shop Practice                              |
| <input type="checkbox"/> Architect               | <input type="checkbox"/> Plumber and Steam Fitter                           |
| <input type="checkbox"/> Architectural Draftsman | <input type="checkbox"/> Plumbing Inspector                                 |
| <input type="checkbox"/> Building Foreman        | <input type="checkbox"/> Foreman Plumber                                    |
| <input type="checkbox"/> Concrete Builder        | <input type="checkbox"/> Heating and Ventilation                            |
| <input type="checkbox"/> Contractor and Builder  | <input type="checkbox"/> Sheet-Metal Worker                                 |
| <input type="checkbox"/> Structural Draftsman    | <input type="checkbox"/> Steam Engineer                                     |
| <input type="checkbox"/> Structural Engineer     | <input type="checkbox"/> Marine Engineer                                    |
| <input type="checkbox"/> Electrical Engineer     | <input type="checkbox"/> Refrigeration Engineer                             |
| <input type="checkbox"/> Electrical Contractor   | <input type="checkbox"/> R. R. Positions                                    |
| <input type="checkbox"/> Electric Wiring         | <input type="checkbox"/> Highway Engineer                                   |
| <input type="checkbox"/> Electric Lighting       | <input type="checkbox"/> Chemistry <input type="checkbox"/> Pharmacy        |
| <input type="checkbox"/> Electric Car Running    | <input type="checkbox"/> Mining Engineer                                    |
| <input type="checkbox"/> Telegraph Engineer      | <input type="checkbox"/> Navigation <input type="checkbox"/> Assayer        |
| <input type="checkbox"/> Telephone Work          | <input type="checkbox"/> Iron and Steel Worker                              |
| <input type="checkbox"/> Civil Engineer          | <input type="checkbox"/> Textile Overseer or Supt.                          |
| <input type="checkbox"/> Surveying and Mapping   | <input type="checkbox"/> Cotton Manufacturing                               |
| <input type="checkbox"/> Bridge Engineer         | <input type="checkbox"/> Woolen Manufacturing                               |
| <input type="checkbox"/> Gas Engine Operating    | <input type="checkbox"/> Agriculture <input type="checkbox"/> Fruit Growing |
| <input type="checkbox"/> Automobile Work         | <input type="checkbox"/> Poultry Farming                                    |
| <input type="checkbox"/> Airplane Engines        | <input type="checkbox"/> Mathematics <input type="checkbox"/> Radio         |

### BUSINESS TRAINING COURSES

- |  |   |
|--|---|
| <input type="checkbox"/> Business Management                     | <input type="checkbox"/> Business Correspondence      |
| <input type="checkbox"/> Industrial Management                   | <input type="checkbox"/> Show Card and Sign Lettering |
| <input type="checkbox"/> Personnel Management                    | <input type="checkbox"/> Stenography and Typing       |
| <input type="checkbox"/> Traffic Management                      | <input type="checkbox"/> English                      |
| <input type="checkbox"/> Accounting and C. P. A. Coaching        | <input type="checkbox"/> Civil Service                |
| <input type="checkbox"/> Cost Accounting                         | <input type="checkbox"/> Railway Mail Clerk           |
| <input type="checkbox"/> Bookkeeping                             | <input type="checkbox"/> Mail Carrier                 |
| <input type="checkbox"/> Spanish <input type="checkbox"/> French | <input type="checkbox"/> Common School Subjects       |
| <input type="checkbox"/> Salesmanship                            | <input type="checkbox"/> High School Subjects         |
| <input type="checkbox"/> Advertising                             | <input type="checkbox"/> Cartooning                   |
|  | <input type="checkbox"/> Illustrating                 |

Name.....  
 Address.....  
 City..... State.....  
 Occupation.....

If you reside in Canada, send this coupon to the International Correspondence Schools Canadian, Limited, Montreal, Canada

# TEST YOUR ART ABILITY FREE

**HERE** is your opportunity to find out how much talent you have. Our simple, scientific Questionnaire tests your natural sense of design proportion, color, perspective, etc. It may show you the way to a bigger future—a real career.

**Federal Students Are Successful**

Many Federal School students are making \$2,000, \$4,000, \$5,000 and \$6,000 yearly. The Federal School is recognized everywhere by employers of artists and by buyers of art work. Big prices are paid for drawings.

**Learn Commercial Art at Home**

If you like to draw, an almost sure indication, of talent, the Federal Course will quickly develop your ability to earn money. Some students earn more than the cost of the course while studying. Many nationally known artists have contributed exclusive illustrated lessons to the Federal Course. No previous training is needed. You will receive personal, individual criticism on your work.

**Send TODAY for Questionnaire!**

Just fill out and mail the coupon, stating your age and occupation. There is no cost or obligation to you.

## Federal School

### of Commercial Designing

645 Federal Schools Bldg., Minneapolis, Minn.

Send me your analysis questionnaire without cost or obligation.

Name.....  
 Occupation.....  
 Age..... Present.....  
 Address.....



# ELECTRICITY

*the*  
**BIG  
PAY  
FIELD**

**A** NEW WAY to prepare yourself. Motion pictures train you for a big pay job in electricity. Easier, Quicker. Appeals instantly to every man who wants to get ahead, to be somebody, to make *real* money.

Movie machine and films furnished for real movies of electrical work in your own home no matter where you live. Explains everthing. Easy. Fascinating. Colleges use them. The quickest and best home training method ever devised. In an amazingly short time you are ready for a big pay job.

You can't lose. We agree in writing to give you the training and employment service necessary to get a better job at bigger pay or refund every cent. Big Free book tells everything. Mail coupon today and find out how easy it is to take this short-cut to real money-making. No obligation. Write now, while low introductory price is in effect.

*Take The  
Film Way  
to  
Bigger  
Pay*

**\$60  
to  
\$150  
WEEKLY**

*Motion Pictures*  
**TRAIN YOU  
QUICK**

**Mail  
this  
Coupon**



**THE NEW WAY IS THE BEST WAY**

As the 150 mile an hour monoplane is swifter than the old Pony Express so is our new MOTION Picture training superior to the old methods.



THE NATIONAL SCHOOL OF VISUAL EDUCATION, Dept. 9-II  
537 S. Dearborn St., Chicago, Ill.  
Send book, "The Film Way to Bigger Pay," with facts about this new, easier way to master electricity.

Name \_\_\_\_\_  
St. or R. F. D. \_\_\_\_\_  
City \_\_\_\_\_  
State \_\_\_\_\_  
Age \_\_\_\_\_

**The NATIONAL SCHOOL of  
VISUAL EDUCATION**

*"The Film Way to Bigger Pay"*

8/16

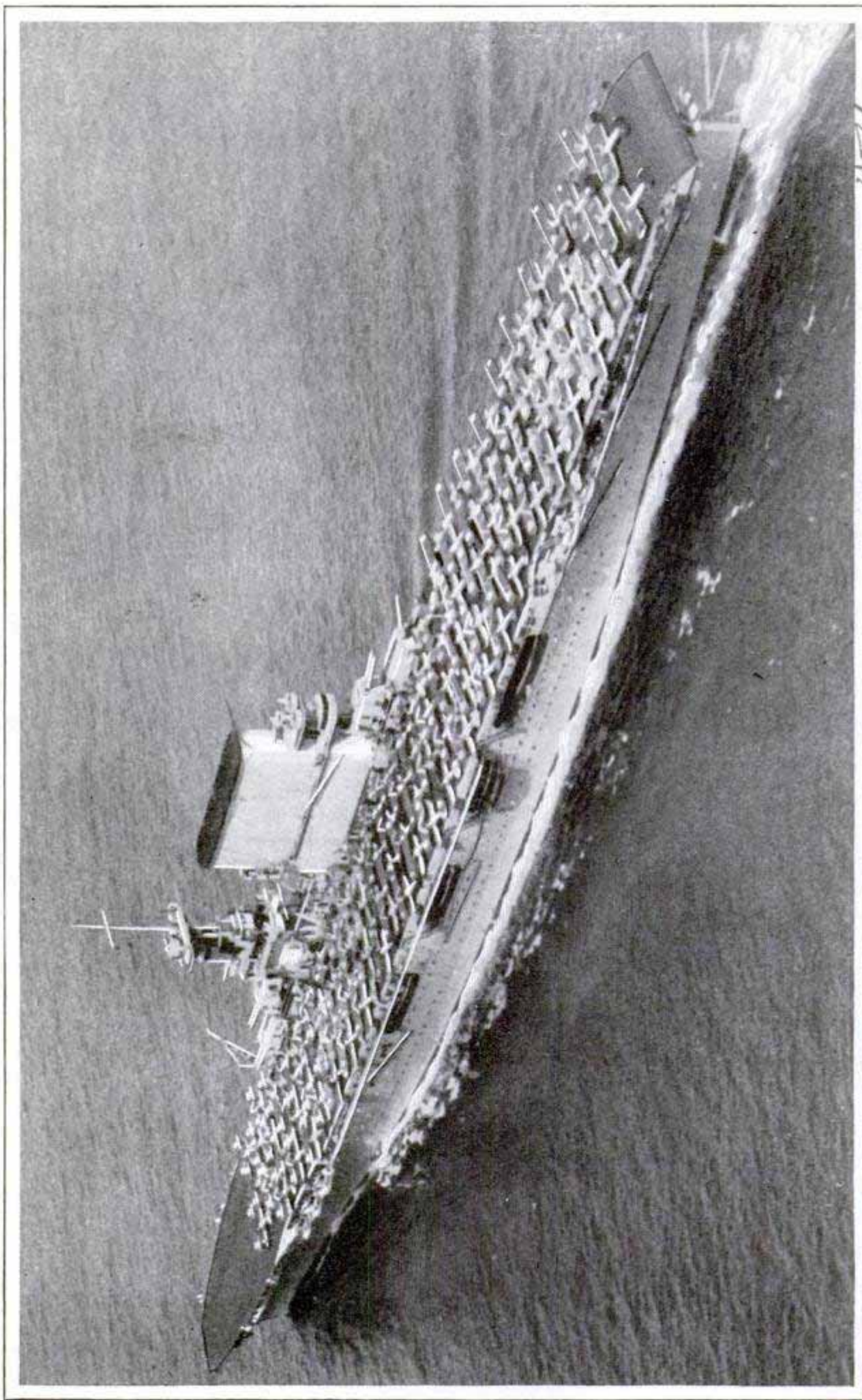

454

More than Eighty Fighting and Bombing Planes Are Here Seen Accommodated with Ease on the Top Deck of the U. S. S. "Saratoga," the Navy's Giant Aircraft Carrier.  
the Mother Ship Becoming a Veritable Floating Airport When It Goes to Sea with Its Full Complement of Winged Fighters

# Popular Mechanics Magazine

REGISTERED IN U. S. PATENT OFFICE

WRITTEN SO YOU CAN UNDERSTAND IT

Vol. 52

SEPTEMBER, 1929

No. 3

3175

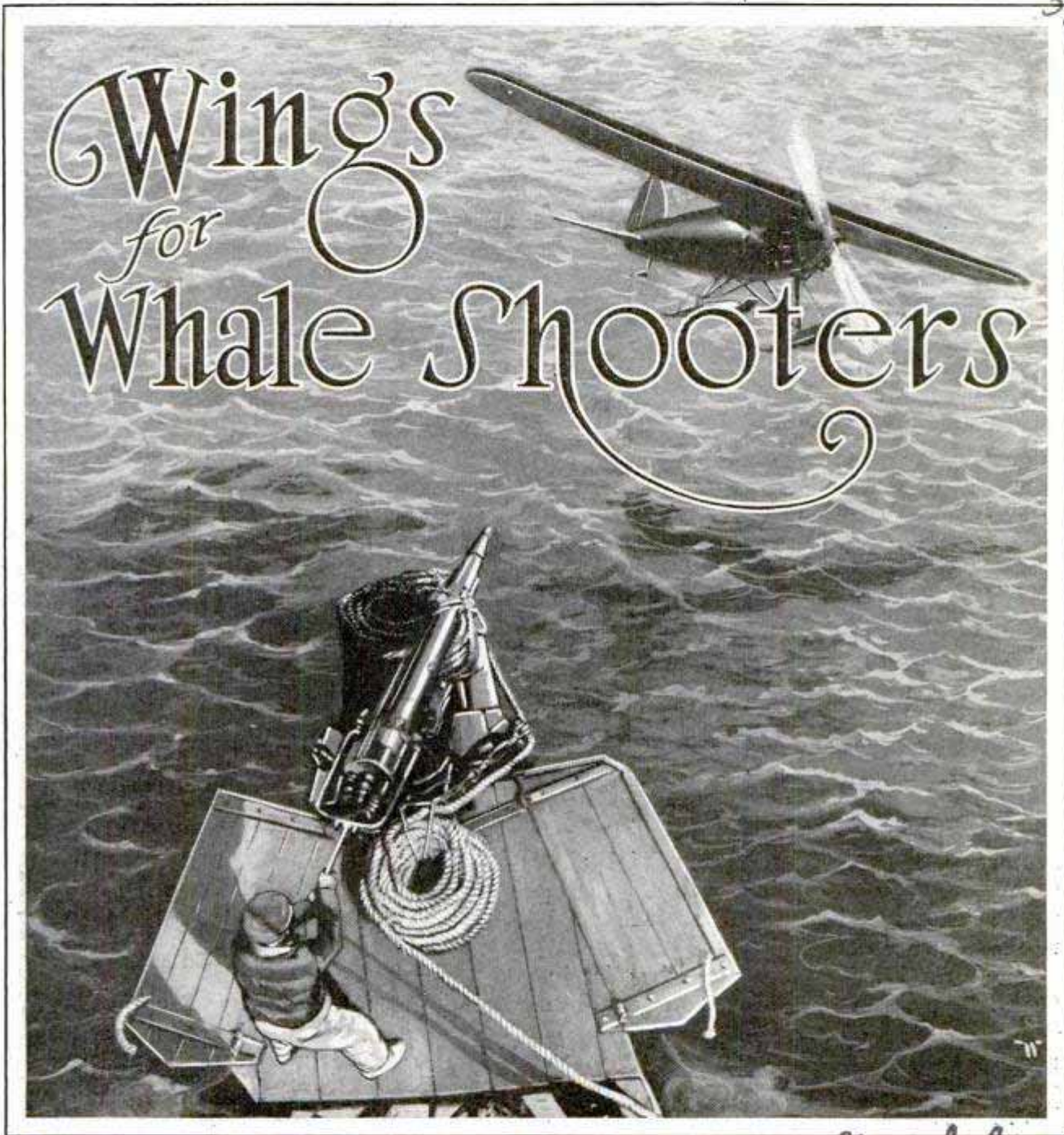

By ANDREW R. BOONE

*613 Spreckels  
Theatre Bldg.*

THE "whale shooters," those members of that select and very exclusive fraternity of Norwegians who amass large fortunes from the frigid sport of arctic and antarctic whaling, are to be augmented by aerial observers. Two pilots from the royal Norwegian navy, already known to the world for their daring ex-

ploits during the Amundsen and Nobile rescue expeditions of 1925 and 1928, are to spot schools of whales along the antarctic ice banks.

Whale shooters come from a small section around Sandefjord. Rarely does an outsider join the ranks of the Norwegian whaling fleets; outsider, that is, in a whal-

*San Diego, Calif. 353*



Capt. Sir George Hubert Wilkins flew across the north pole. The other is a Norwegian navy reconnaissance, two-place, open-cockpit, low-wing monoplane, powered with a 260-horsepower water-cooled engine. The American plane is powered by one of the famous "Whirlwinds" which have carried many flyers across oceans. These ships of the air will be transported to the scene of their frigid operations aboard the "Norvegia," a small vessel of 285 tons that is attached to the whaling fleet. The American monoplane will enable the flyers to remain aloft thirty-eight hours during their long flights, many of which will be made far out of sight of their icy base.

Airplanes do not fly in the Antarctic on gasoline and oil alone, however. Provision must be made to meet the intense cold that is encountered. The Holm-Larsen American plane carries, in addition to the necessary apparatus for heating the engine and oil before starting, large special grease

ing sense. Yet Commanders Rit-zow Holm and H. Riiser-Larsen, having been granted leave from their naval duties, accompany a twenty-whaling-ship expedition which left Norway in the early part of August for the ice banks of the Antarctic, where, from two model airplanes, they will endeavor to spot the whale schools and guide the surface ships to them.



The tragedy of antarctic whaling lies in the fact that during some years the schools of whales seem to disappear. Commander Holm, during his recent trip to the United States, explained that one of his missions will be to study whale habits and to learn if possible whether whaling men can anticipate their movements from year to year and thus gather in the annual harvest of 30,000 leviathans of the southern deep.

Commander Holm, who will be the pilot, and Commander Larsen, who will serve generally as observer, will look out upon the antarctic wastes from two planes. The larger is a Lockheed monoplane approximately duplicating that in which

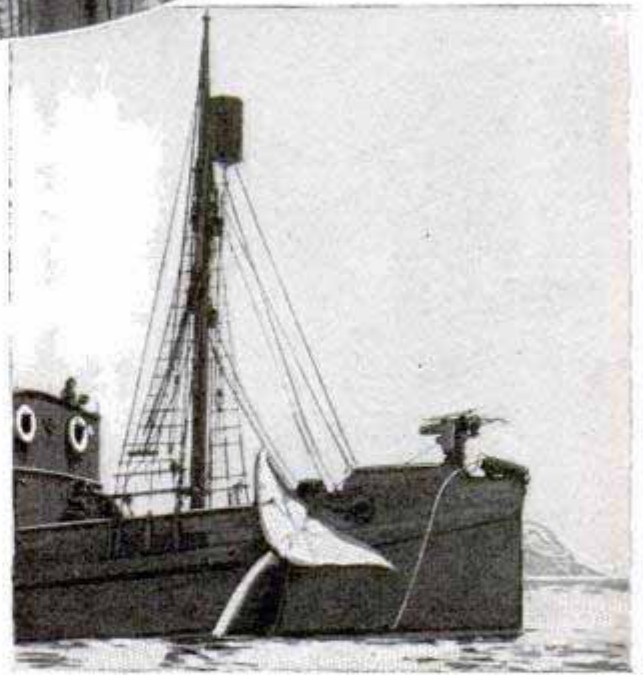

Top, Cover to Keep Engine Warm; Center, Playing a Harpooned Whale; Below, Hauling It Aboard

containers for the rocker arms. A flyer never would be able to start his engine in those high latitudes, were it not for mechanical heat aids. Commander Holm arranged, when in California, to insulate engine, lines and crankcase against cold.

In starting the engine on a cold and frosty morning, he lights two oil heaters held in a metal container immediately below the radial engine, which is swathed in three layers of cold-resisting material. Next the metal is a jacket of canvas, while the second layer consists of a quilted blanket. On the outside is laced a covering of rubberized balloon cloth. A woven rope, its ends bound in metal tips, laces the covering tight, to prevent escape of heat. When the intake manifold is warmed to ninety degrees, the engine is started and immediately a helper pours the oil, which meanwhile has been heated, into the crankcase. A special cowling protects the engine against the intense cold while in the air.

Of course, the value of airplanes in antarctic whaling work remains to be seen. On the basis of his arctic experiences, however, Commander Holm believes their great range and speed, coupled with the added visibility from altitudes, will help speed the whaling fleet's work.

Holm and Larsen will operate their planes either from the water or from the hard surface offered by the ice. Three sets of skis, a set of pontoons with replacements and a set of wheels accompany them for use as landing gear. Radio has been installed in the American plane. On spotting a school, the old familiar, "There she blows," will speed through the air on wings of electricity to radio operators on the ships below.

But how will these flyers find their way about with no points of reference to watch as they fly out of sight of their ships? Sun compasses of German design will show them at all times their exact location by registering the spot on a glass plate. The sun compass turns with the same speed as the sun. It is operated by clock mechanism. The compass also is inclined to the path of the sun. Therefore, as the sun shines into it, consideration having been taken of the sun's angle and the speed of flight, the spot on the glass plate indicates the direction of flight.



Dummy Dressed as Policeman Calls Attention of Motorists to Traffic Signs in Indiana Town

### DUMMY "COP" CALLS ATTENTION TO TRAFFIC SIGNS

Dummies dressed in police uniforms serve as traffic "cops" in West Lafayette, Ind. The figures are placed at the street intersections, where there are stop signals and other traffic directions, and serve to call the attention of motorists to them.

### NUMBERS PRESSED IN STEEL BY ROTARY STAMP

Saving time lost in picking out and inserting figures, a numbering stamp with a



rotary steel wheel is on the market for hand impressing of numerals. The compact instrument contains twelve characters in each wheel and fits in the vest pocket. It also uses various-size wheels which are interchangeable.

*3161*  
*West Lafayette, Ind*  
*Mr. & R. Warren*

*Apex Products Co.*  
*54 Van Cortlandt*  
*Paris, N.Y.*

*no change*

*holder and one wheel - \$0.50*

356

FIRE STATION IN TREE TOP GUARDS BIG FOREST

Cont. Frank S Reynolds 65 W. Railroad Ave. Fort Morgan, Colorado  
3011  
on Duinault Indian Reservations near Hopkain, Wash.

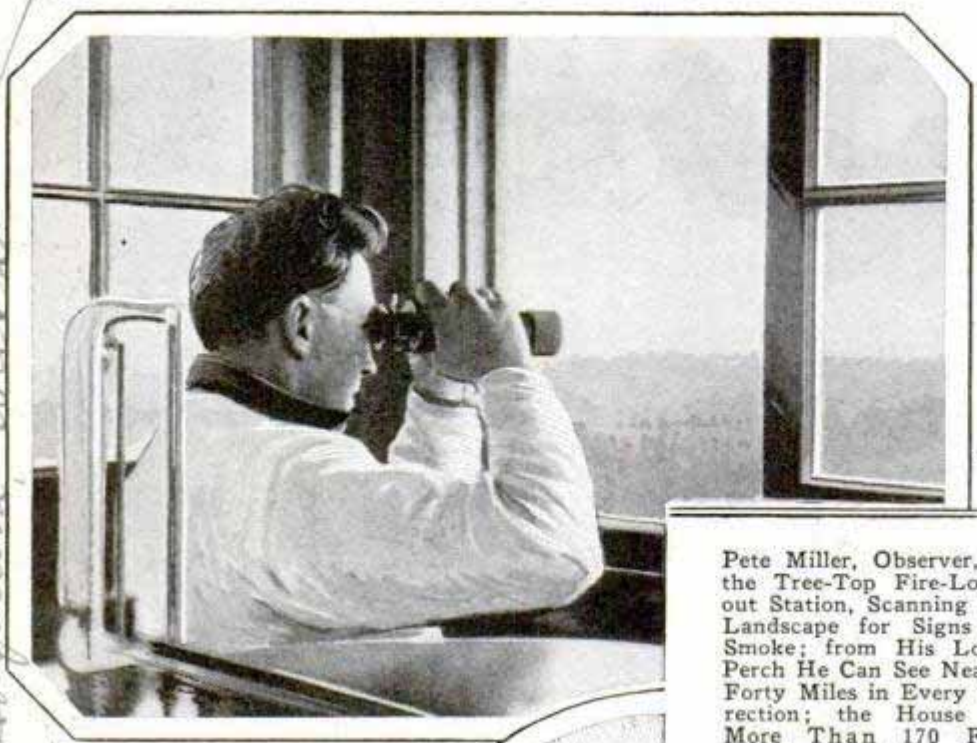

Pete Miller, Observer, in the Tree-Top Fire-Lookout Station, Scanning the Landscape for Signs of Smoke; from His Lofty Perch He Can See Nearly Forty Miles in Every Direction; the House Is More Than 170 Feet above the Ground

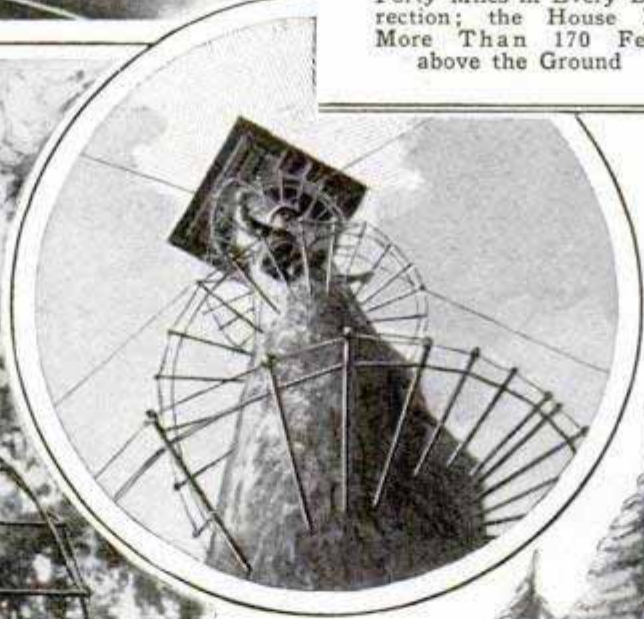

Miller at the Base of the Tree, Which Is Eight Feet in Diameter; Detail of the Ladder, a Spiral Series of Inch Steel Rods, Threaded with Steel Cable, and View of the Whole Lookout; the Tree Is Securely Guyed by Steel-Wire Ropes, Fastened Just below the House and Attached to Stumps near the Base; the Lookout Station Is Connected to a Fire Headquarters by Telephone; at the Observer's Command, a Speedy Gasoline Truck and Trailer, Loaded with Pumps, Hose and Tools, Are Dispatched to the Scene of a Blaze



1440

3/5 7

Made in Belgium by Stamp & Vertonghe

### PLANE "GROWS UP" AS THE STUDENT PROGRESSES

Easily adaptable to conversion, a mono-biplane which "grows up" with the student pilot operating it has been placed on the aviation market. Designed to advance in performance as its owner improves in flying, it is operated first as a biplane with throttle blocked, thus making an ideal training plane for the novice. As the student demonstrates his ability, the throttle block can be advanced or removed entirely, giving full benefit of biplane performance, and when the final stage of training has been reached, the biplane wings may be replaced by one of monoplane type. In this form the ship has a wide cruising range, relatively high speed and ability to land in 225 feet and take off in 200 feet with a full load. Tests have shown that it will throttle to less than thirty miles an hour in the air, and reduce the risk of stalling or spinning.

312

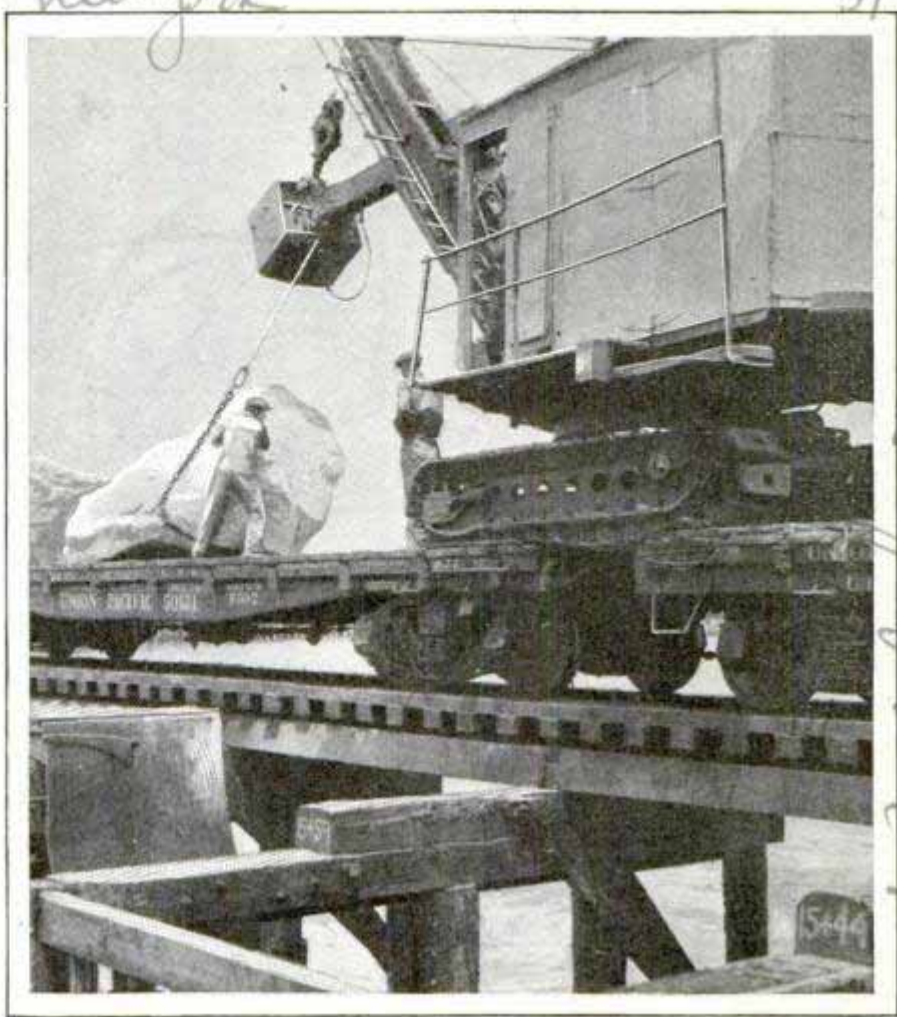

A Power Shovel on Crawlers, Which Travels from One Flat Car to Another and Quickly Unloads an Entire Train

### POWER SHOVEL ON FLAT CARS QUICKLY UNLOADS TRAIN

Carried on a train composed entirely of flat cars, a power shovel equipped with crawlers is used by a Long Beach, Calif., construction company to lift and shovel huge granite boulders into the bay where a breakwater is being built. After the removal of side boards and brake staffs from the cars, the shovel moves from car to car, dumping rocks weighing up to fifteen tons, although the shovel weighs only two and one-half tons more.

### ELECTRIC EGG COOKER NEEDS NO WATCHING

Without watching or timing, an electric egg cooker boils, poaches or fries eggs and stops automatically when they are done. Water is poured in the top of the cooker in specified amounts, the water completing the electric current and being turned to steam to cook the eggs. When the water is gone, the eggs are cooked, and the current is broken. The cooker has a capacity of eight eggs and is equipped with poaching pan and boiling tray.



### TYPEWRITER PRINTS MUSIC

After several years of effort an Italian composer has made a typewriter for composing music which he calls a "dactylo-musicograph." The machine resembles an ordinary typewriter, and is operated in the same manner. It types all kinds of music and is able to inscribe on the page either vertically or horizontally.

Electric egg cooker for 970 volt

nothing address

Cont. Mel Wharlock 709 Avenue de la Gare Bldg Los Angeles Calif

Kansas City Times 6/14/19

3116

Hankcraft Co. 121 N. Lincoln St.

Magnor Ferrato

La Porte, ch. d

Will be used by Lieut. Kind von  
Klein - Haas, Royal Danish  
Army Corps. Warsaw



Non-Sinkable Suit Enabling Flyers to Remain Afloat Three Days; Oval Shows Suit in Use, with Flag to Attract Attention and Breath Condenser Supplying Drinking Water



### NON-SINKABLE AVIATOR'S SUIT FOR OCEAN FLYERS

Ocean flyers who meet with ill luck and are forced to make a water landing may keep themselves afloat for three days or more with a non-sinkable suit equipped with a breath condenser, to provide a supply of drinking water. The suit also has a red flag which stands upright when the aviator is in the water for the purpose of attracting passing ships.

### SERIAL NUMBERS FOR BULLETS SO THEY MAY BE TRACED

To aid in tracing the ownership of bullets that have been fired, a method of registering the leads in each cartridge has been devised. The maker stamps the serial number on the bullet and, when sold to the wholesaler, requires a receipt for the bullet of that number. The wholesaler in turn obtains a receipt from the retailer, and the individual buyer also acknowledges with his signature the serial number. Police officials, who have endorsed the plan, say that many murder cases could be solved if ownership of the bullets causing death could be determined, but admit that "bootleg" ammunition without the serial numbers probably would appear.

Cont. from page 357  
Heinrich, 207 Voorhes

### DISKS MAKE TIRE PUNCTURE-PROOF

Eliminating the use of metal in making automobile tires puncture-proof, a tire engineer has utilized hard-rubber disks to form a section across the entire width of the tread. The puncture-proof unit is made up of a soft-rubber cushion into which are vulcanized disks of sufficient strength to stop a sharp object from penetrating the inner tube. The disks are arranged in superimposed position in the soft rubber, being imbedded so they do not work loose and do not interfere with the normal yielding of the tire. The

tires weigh little more than the ordinary kind. The size of the disks varies according to the tire size, and the equipment, it is claimed, also tends to prevent blowouts or stone bruises through the tread.

### PORTABLE MOTOR INSIDE DRUM IS EASILY MOVED

Inclosed in a water and dust-proof flanged drum, a portable motor for farm use has been brought out in Germany. On the drum is wound the supply cable which is connected to a power line, as farming in Germany is generally electrified with power available from numerous substations. In use the motor is simply

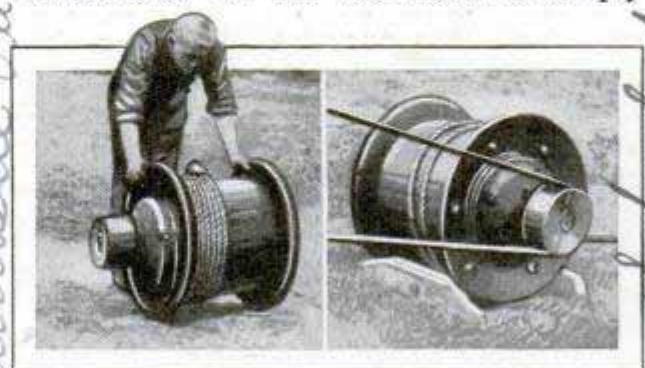

The Drum Contains a Portable Motor, Easily Rolled About and Blocked Up When in Use

blocked up and belted to the implement to be operated.

3/14/44  
W. A. Schuchert

Germany  
Berlin - Siemensstadt, Schuchert

Siemens



317

# ALL FUN AND NO WORK WITH PAILFUL OF BALLS

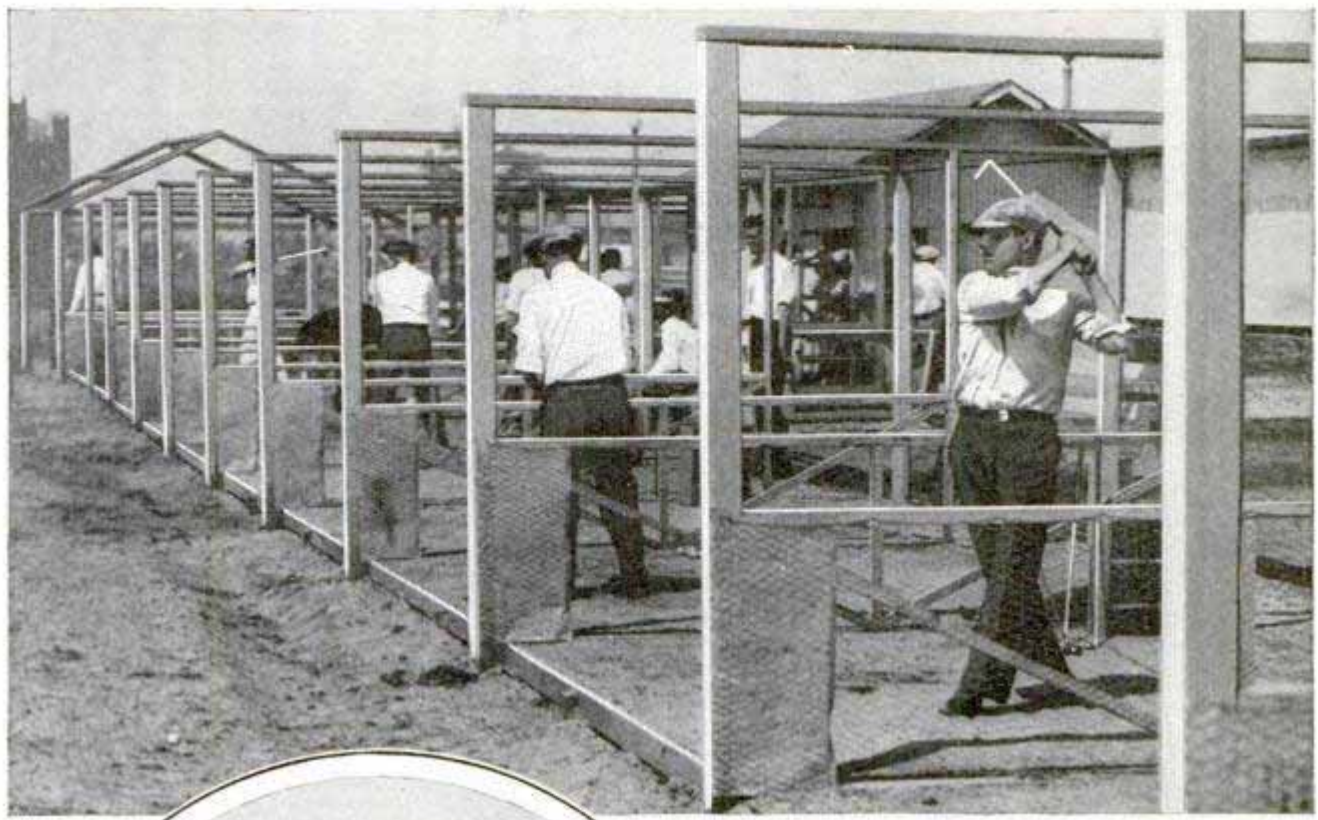

Above, a Practice Stand Where Golfers Rent a Pail of Balls and Drive Steadily for an Hour; Below, Retrieving the Balls, and the Pails Ready for the Next Enthusiasts

Practice stands for golfers to provide all fun and no work are popular along Chicago highways. Individual stalls are erected for the golfers at one end of a fairway. The golfer brings his clubs, pays from fifty cents to a dollar for the use of a stall for an hour, is provided with a pail full of balls and shoots to his heart's content, forgetting about the ball after he

hits it. Managers of such stands say that few golfers stay the entire hour, tiring more quickly than they expected. During intermissions caretakers retrieve the balls. On one such course, 400 feet long, 12,000 balls were driven in one day. The arms and wrists quickly become tired, golfers have found, when they try to drive continuously for an hour.

2821



# Flying

flivver roadster and tooling a ten-ton truck down the highway. Anybody who can drive the truck is competent to drive the flivver, but a lot of flivver chauffeurs would come to grief with a ten-ton juggernaut.

When the government took over control of flying and established license requirements, it was decreed that a pilot must have 200 hours in the air and pass stiff physical and technical ex-

"Winding Up" to Start a Motor and View of the Dual Controls in a Tri-Motor Plane

By J. EARLE MILLER

A BIG Ford tri-motored passenger plane, with pilot and mechanic in the cockpit and fourteen persons riding in the cabin behind them, trundles out across the flying field. The motors roar as the three throttles are shoved forward, the trio of tachometers flick around the dial to 1,600 revolutions, the ship's tail comes up as it picks up speed, and at sixty miles an hour it leaves the ground.

What, asks someone in the crowd behind the barrier fence, is the difference between flying one of those big transport planes and a little open-cockpit job? So, this is the story of how an air liner flies and is flown.

The difference between being the pilot of a privately owned sport plane and sitting at the controls of one of the big air liners is the difference between driving a

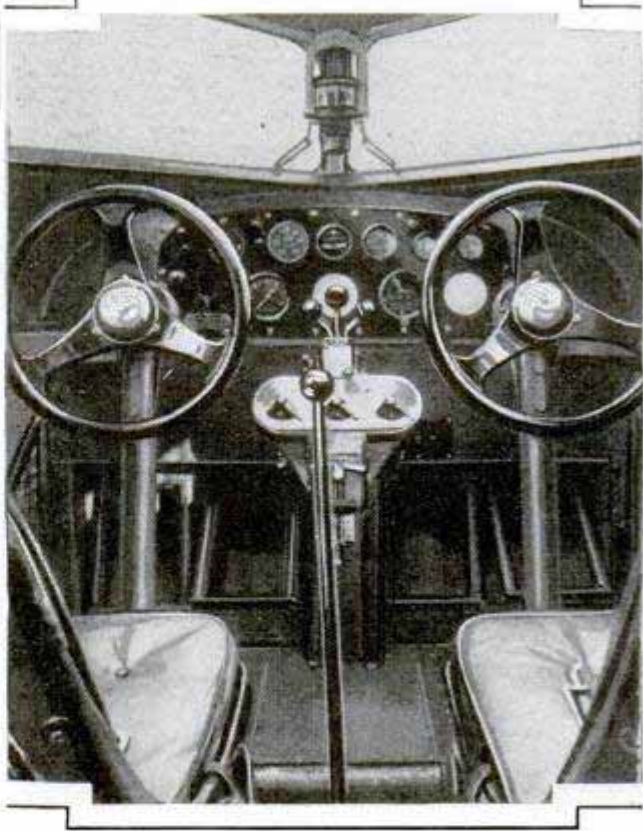

aminations before he could be licensed as a transport pilot, free to fly any ship anywhere and carry either passengers, ex-

# *the* Air Liners

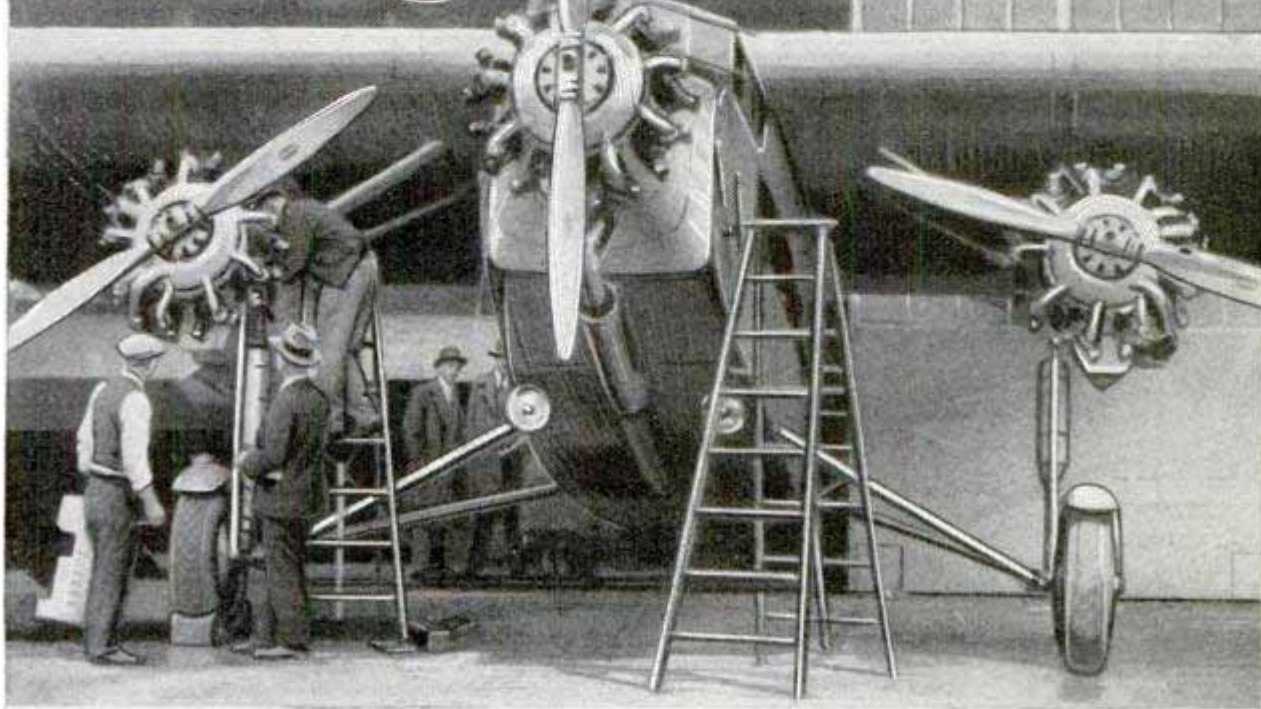

A Final Inspection before the Flight; Engineers Predict That the Tri-Motor Plane Will Be Largely Replaced in the Near Future by Ships with Four or More Engines

press, mail or freight for hire. Nothing was said, however, about the type of ship in which the 200 hours' experience was to be gained, and, in effect, a pilot who had 200 hours at the stick of a Heath "Parasol"—the smallest sport plane built in America—got the same kind of license as the man who had 200 or 2,000 hours at the controls of a big passenger liner. The only difference in their rank was that, when they applied for work, the air-line operators hired according to the applicants' experience and abilities.

Now all that is to be changed, for the aeronautic branch, department of commerce, is preparing to issue at least four grades of transport licenses for pilots who have flown small ships, medium-size planes, bigger ships, and the biggest ones. And the new regulations also will require a certain amount of night flying. About the only thing that will not be required, for the present, is "blind" flying through clouds and fog, and as soon as experiments, now being conducted in conjunc-

tion with the Guggenheim fund for the promotion of aeronautics, are completed, it is probable that that, too, will be added. The German Luft Hansa air lines already require every pilot to fly several hundred miles between two cities, with windows covered, so that only the compass can give the course and only the flying instruments can be used to keep the ship in level flight.

Outside of greater weight, higher take-off and landing speed, and a difference in gliding angle, the big transport planes fly very much like their smallest brothers. Most of them, because of their size, use the Deperdussin wheel control for ailerons instead of a stick. In the smaller ships, a movement of the stick forward or back changes the angle of the elevators at the tail and causes the ship to dive or climb, while a movement of the stick to either side raises one aileron at the wing tip and lowers the other, banking the ship for a turn.

With the "Dep" control, the stick still

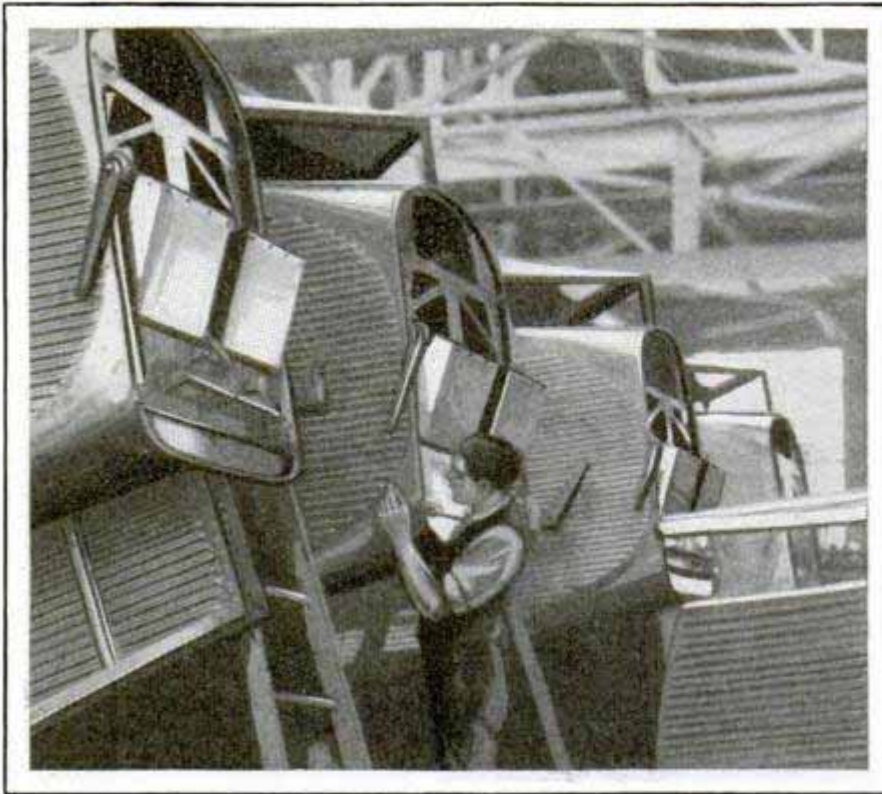

Along the Assembly Line at the Stout Metal-Airplane Factory, a Division of the Ford Motor Company

moves fore and aft to work the elevators, but a wheel, like an ordinary automobile steering wheel, is mounted at the top of the stick and the aileron controls are attached to it. The wheel, because of its size, gives greater leverage in moving the long ailerons of a big ship with enormous wing spread, and, because it makes it easier to fly with both hands, enables the pilot to exert more force with less energy consumption—an important factor in bumpy air.

How does it feel to take off and fly one of the big multi-motored planes? The novice who has trained in smaller ships with the usual stick control, finds several things radically different. For one, in the big transport liners, such as the Fokker and the Ford, his seat has moved up in the nose and much higher from the ground—a momentous change because he must accustom himself to a new point of view in landing, and, with a faster ship, coming in at eighty miles an hour and landing at sixty, accurate judgment of distance is necessary to level out at the right moment and set several tons of plane down in a perfect three-point landing.

The instrument board, too, has changed. If the ship has three motors, there are three oil-pressure gauges, three tempera-

ture recorders, three tachometers and three ammeters to watch, and three throttles to handle instead of one of each. Rudder pedals haven't changed, but auxiliary brake pedals have been added to them, and, if he has never flown a ship with brakes, the pilot must learn to use them to turn the ship in taxiing it on the ground, and to check its speed, if a short field makes a quick stop necessary.

The higher take-off speed, sixty miles or better in most of the big ships, as compared with forty in the small training and sport planes, requires a longer run, but, aside from that, the big

liners are about as easy to handle as their smaller relatives. The pull of two or three propellers and the rush of wind at the higher speed over the tail surfaces make it practically as easy to shove the wheel forward and get the tail up into flying position, and, with speed attained, the wheel can be eased back and the ship, as pilots say, "flies herself off the ground."

Most monoplanes—and virtually all big passenger ships in America are monoplanes—are somewhat tricky on the controls, but this tendency, which is marked in the small two to four or six-passenger ships, is offset in the bigger weight carriers by the enormous wing spread necessary to lift a load of more than a ton and a half of passengers and baggage. It is virtually impossible to put one of the big ships into a spin, the most dreaded of aerial maneuvers.

Along with their greater wing spread, they have correspondingly larger control surfaces, and the longer ailerons, together with the leverage of the "Dep" wheel, make it easier to keep the wings level, or to bank for a turn, than in many of the smaller planes.

Landing a big liner, though, is markedly different from landing a sport plane. The pilot who has been accustomed to

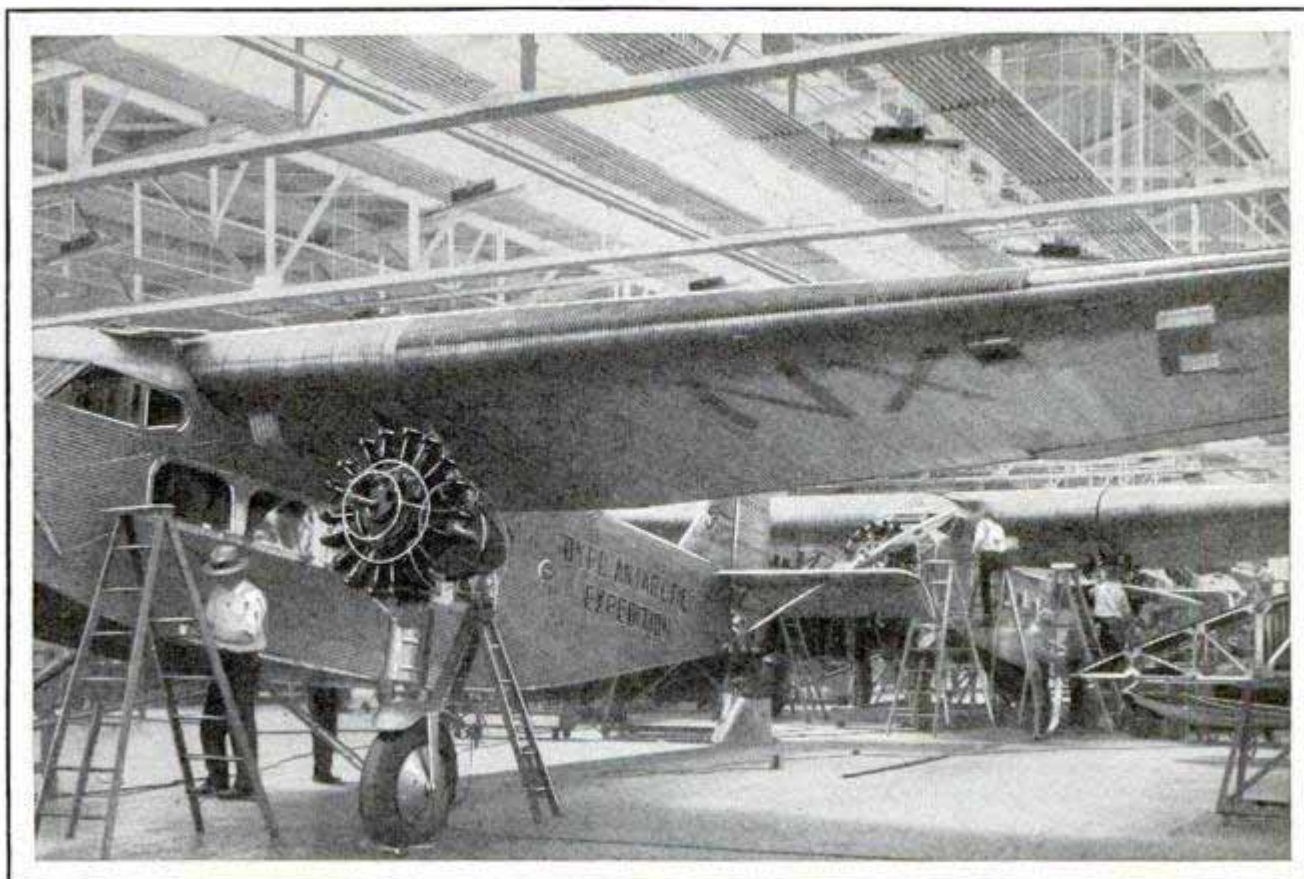

Finishing One of the Big Ford Ships for the Byrd Expedition; Constant Developments in Aluminum Alloys Have Produced a Metal That Is Extremely Strong and Durable in Any Climate

diving in over the tree tops, "fish-tailing" his ship to lose flying speed, and then setting it down within a few hundred feet of the boundary line, is in for a surprise. Monoplanes, regardless of size, have the reputation among pilots of "floating forever" when gliding in for a landing. This is true whether the ship is a little three-passenger cabin job, such as the Curtiss "Robin" with its ninety-horsepower OX-5 engine, or one of the big tri-motored craft with space for fourteen to twenty passengers and more than 1,200 horsepower in its three engines.

A plane cannot be forced to land faster than its rated landing speed, for that speed is the one point where the air ceases to sustain its weight. If the flying speed is ninety or a hundred or 120 miles an hour and the landing speed is sixty, the excess, plus the speed due to its descending glide, must be lost before the wheels and tail can be set down on the field. The only way to lose it is to extend the glide, and that explains why the big liners get back a couple of miles or more from the field to start their glide. The careful pilot cuts his engine speed down to the point where the pull of the motors, plus

the effect of the glide, totals eighty miles an hour air speed, and holds it there until the ship is over the border of the field, a hundred feet or so off the ground. The last twenty miles of speed and the last hundred feet of altitude are quickly lost.

One trick the pilot of a multi-motored ship must learn is to keep his engines turning up to the same speed. A wing engine running faster than its mate has a tendency to turn the plane, a tendency that can only be corrected by carrying considerable opposite rudder. Because of the smallness of their dials, the inertia lag of the needles and their vibration, due to the motors, it is impossible to get a correct tachometer reading within ten or twenty revolutions. What the instruments fail to supply, the ear fills in, however, for it is possible to keep two or three motors in step as easily as one tunes out interference on the radio.

Unless the exhaust roar of the engines synchronizes, so that the explosions come together, there is a lack of resonance that manifests itself in a pounding sound, easily detected. Moving the throttles until the pounding fades out puts the engines in step.



Being the "Skipper" of a Tri-Motor Transport Plane Is One of the Best Pilot Positions Aviation Offers Today, and the Demand for Competent Men Is Increasing

There is a good field for pilots capable of flying the big ships. When Transcontinental Air Transport was getting ready to establish its combined rail and air route across the country, in conjunction with fast trains on the Pennsylvania and Santa Fe, Maj. Tom Lanphier, in charge of operations, announced that, of more than thirty pilots needed, he had been able to

sign up but seventeen whom he regarded as of sufficient experience to fly passenger liners. To fill the other places he engaged junior pilots, to fly under the supervision of the seniors until they too had qualified for ranking positions.

Most of the air-line pilots at the controls of the big Fords, Fokkers, Sikorskys, Loenings, Keystones and similar

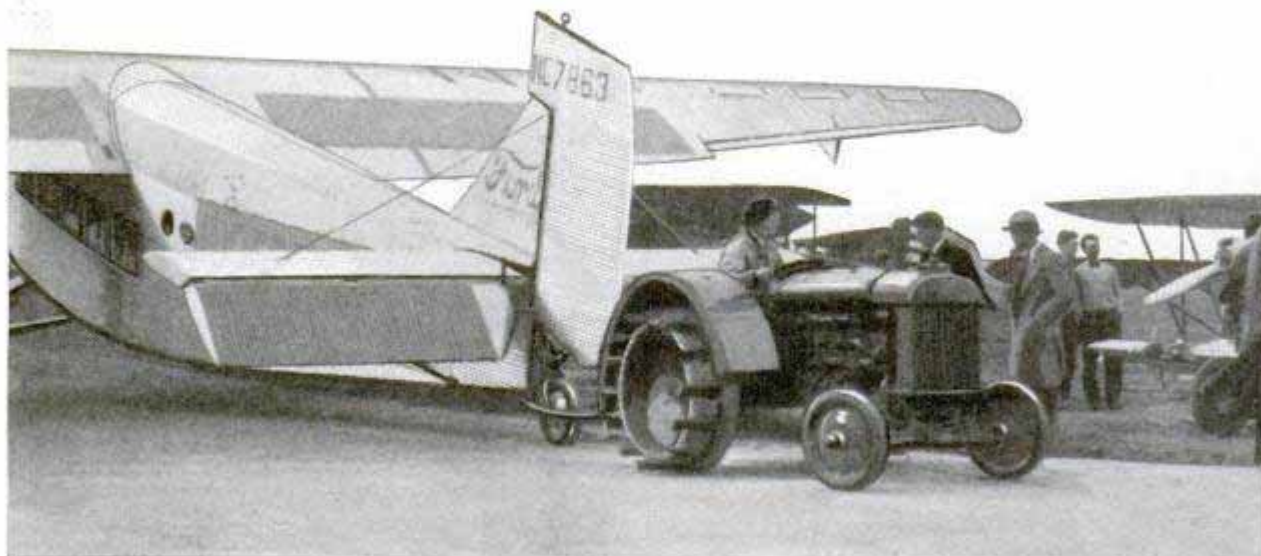

The Big Ships Fly, but It Sometimes Takes a Lowly Tractor to Pull Them In; Pilots of the Stout Air Lines Learn How to Care for Their Planes and How to Build Them

ships, have 2,000 or more hours of experience. To get 200 hours—the minimum requirement for a transport license—costs \$4,000 or more, but even before that time, the pilot who can afford to buy his own ship can begin to make money by barnstorming for joyride passengers, which he is permitted to do on a limited commercial license after fifty hours of solo flying.

Several novel plans to enable young pilots to work up their time for the big ships have been considered or put in operation recently. Some of them will be described next month in a continuation of this article, which also will describe the flying of the smaller cabin ships.

(To Be Concluded)

### MAGIC "SLEUTHS" SHOW STRAIN ON RAILS AND BRIDGES <sup>2974</sup>

How much does a concrete stadium sway and vibrate under the weight of thousands of rooters at a football game? What and where are the strains on a bridge as a heavy train thunders over it? As a passenger train roars at eighty miles an hour along the rails, what happens to the track bolts? These, and many other important questions, are answered by an efficient electric "detective" hidden away at a point where the stress is to be measured. It is known as a telemeter and is now extensively used in studying strains and stresses under actual operating conditions. The result is recorded on a strip of photographic film. Telemeters are mounted in the cockpit of an airplane to register the strains in all parts of the ship during flight; they are likewise adapted to automobiles, naval guns, elevators and structures of all kinds. They have been especially useful on concrete and other dams. They can be buried deep inside the material and, since they register conditions that could not be seen by the eye, are valuable in revealing displacements or strains that might result in breaks. Freight cars are being tested with them.

*Francis S. Tatnall  
Hon. Washington D.C.*

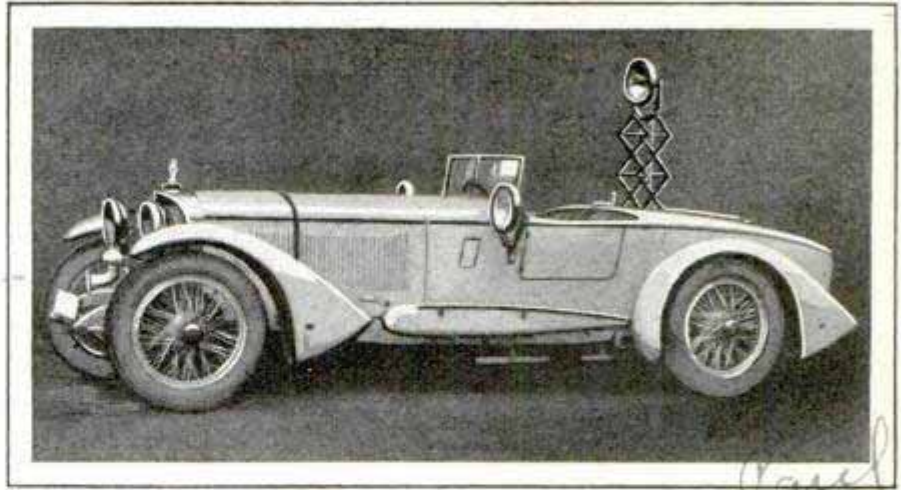

A Maharajah of India Goes Hunting in This Streamline Car, Equipped with Powerful Searchlights to Help Spot Game

### SEARCHLIGHTS ON HUNTING CAR HELP RAJAH SPOT GAME <sup>d. Chopal</sup>

Five powerful searchlights have been mounted on a streamline automobile to aid a maharajah of India in spotting big game when he goes on a hunting trip. The hunting car has an extension light rigged up behind the driver's seat and four other searchlights ranged along the front, to spot or confound the tiger or other game the rajah's party is hunting.

### MERRY-GO-ROUND FOR HOME OPERATED BY CHILDREN <sup>3127</sup>

Accommodating four children who provide the motive power themselves, a merry-go-round for the home is giving the youngsters loads of fun. It may be placed in the house or outside and is operated by levers, similar to those on hand



Children Operate the Levers to Furnish Motive Power for This Indoor Merry-Go-Round

cars, each rider pulling one. The speed is governed by the pull of the rider.

*Yager Shop  
Metal 9, 11*

*Horse show, English army at Tidworth Park, England*



Driving a Saber through a Target as His Mount Clears a Barrier Is the Difficult Feat Accomplished by This English Cavalryman

### CAVALRYMAN PIERCES TARGET AS MOUNT LEAPS BARRIER

Swordsmen of the English cavalry are being trained in the difficult feat of jumping a horse over a barrier and thrusting simultaneously at a target with their weapons. Both horse and rider must prove their mettle in order to time the mount's jump and the thrust of the sword so that the weapon plunges home in the target as the horse leaps the obstacle.

### SHIFT IN RADIO-BEACON WAVES REVEALED BY INDICATOR

To give warning when radio-beacon waves directing airplanes shift from their fixed course, an instrument known as a course-shift indicator has been devised for installation on switchboards in beacon stations. The appliance indicates instantly to attendants whether the beacon is being maintained in a fixed position and also may be used on aircraft as a course indicator. The needle of the instrument remains in the center of the scale when the plane is in the middle of the radio beacon course, but moves if it deviates.

*Bureau of Standards*

### NEW PLANT YIELDS THREE VALUABLE PRODUCTS

Brotex, a plant evolved by an English scientist, yields three valuable products which agriculturists say may result in its extensive cultivation with benefit to farming. It grows from seed and in its early stages, resembles the ordinary cabbage, but is a slow grower and takes from twelve to eighteen months to attain maturity, when it is from eight to ten feet high and has a stem of some ten inches in diameter. It yields fiber for textiles, wood cellulose from its core for paper making, and seed for the manufacture of cattle food. It

also can be planted in the spring and harvested in the fall for its fiber alone. When matured, the yield per acre is about a ton and a half of fiber, five and a quarter tons of wood and two and one-half tons of seed. Profit from the crop has been estimated at about \$250 an acre.

### APARTMENT HOUSE FOR BIRDS BUILT LIKE SKYSCRAPER



Birds, like city dwellers, are taking to apartment houses and skyscraper tenements. A bird lover of Lawrence, Kans., has erected a skyscraper bird house accommodating more than one hundred martins in comfort. The dwelling has five platforms with a two-story apartment above each platform, the skyscraper being built with setbacks and a spire like the modern city structure.

*J. S. Hunt*

*6/19*

*A new Poughkeepsie 3/13 We buy*

*Brotex Cellulose & Wood. No*

*Sam Brown*  
*Chas. N. J. over*  
*Eng.*

*W. James 6/20/2309*



*Vienna engine near  
Built by J. M. Voith*

### PROPELLER AND RUDDER COMBINED ENABLE QUICK STOPS

Functions of a screw and of steering apparatus are performed by an improved propeller introduced in Germany. Four blades are arranged on vertical axes upon a rotor which is also on a shaft, vertical with respect to the boat. The blades or scoops have a swinging motion, due to their mounting, and by means of an auxiliary motor inside the propeller, their pitch can be changed in such a way that they serve as rudders to guide the craft. According to reports of a test run of 600 miles, a boat equipped with this propeller was stopped from full speed ahead in less than its own length.

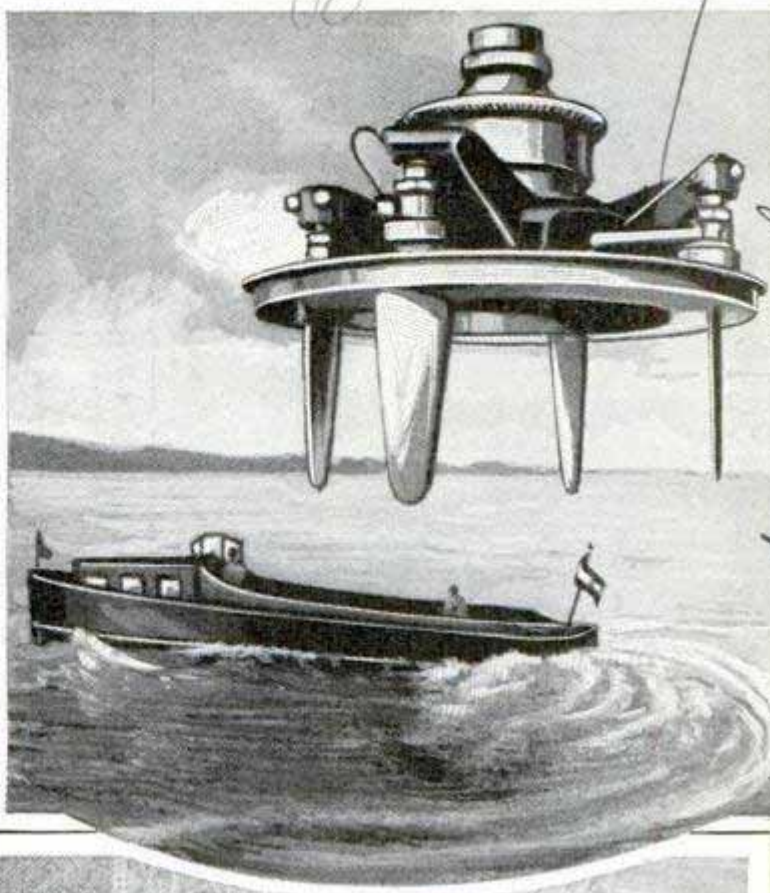

*Heidenheim  
ad Brenz  
J. M. Voith Maschinen-Fabrik  
St. Colten, Niederosternich*

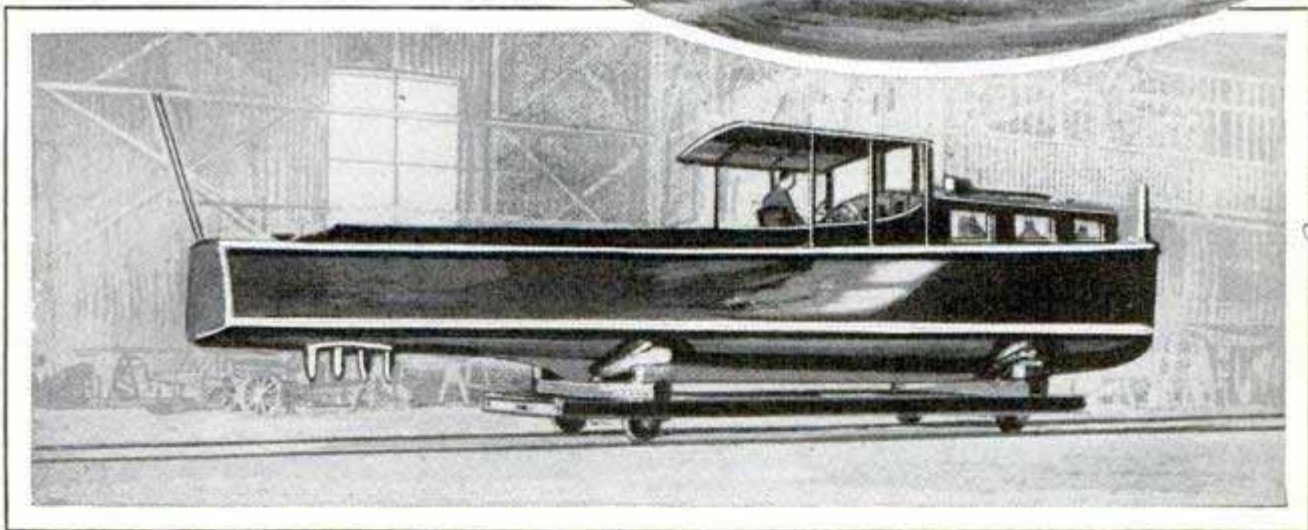

Close View of the Propeller, Drawing of Boat Making a Sharp Turn with Its Aid, and How the Propeller-Rudder Combination Looks When Installed

### REPAIRING OLD OCEAN CABLES

Repairing ocean cables, although a highly developed profession, still is a job where the fates, in the form of sea and weather, play a hand. Frequently ships grapple for days for cables reposing in the soft ooze of the ocean bottom, and if the sea becomes rough, mark the position with a buoy moored by anchor to hundreds of fathoms of line while the ship rides out the bad weather. Even after the ship has made a successful grapple, the job

is far from finished, because the slightest error in judgment will cause the cable to snap as it is raised, particularly if it is an old one with armor wires worn and corroded. The raising of a cable twenty-five or thirty years old is so delicate a task that movement of the 2,000-ton ship a few feet one way or the other may spell success or failure. Strain on the cable as it is raised is constantly watched aboard ship on a dynamometer. A sudden lurch of the ship often undoes the work of weeks in a few seconds.

*Western Union Telegraph Co  
195 Old Broadway*

*lots and slashes  
no. 7 July 1919*



Operator Using a Smoke Tank to Conceal Important Buildings from View of Aerial Enemy

### SMOKE SCREEN FOR BUILDINGS PREVENTS AERIAL ATTACK

Experiments are being conducted in Germany with a type of smoke intended to lay screens about important industrial and commercial centers to guard against

aerial attack in time of war. Aside from its official status as a defense precaution, attempts also are being made to convince owners of important industrial plants that they should provide their establishments with tanks of smoke for the purpose of foiling a surprise aerial attack just as they provide fire extinguishers.

### PLANE USES HOOK AND LINE TO SPEED OCEAN MAIL

2954

Three-day mail service between Europe and the United States will be made possible by equipment installed on the "Leviathan," which enables an airplane to snatch mail from the ship's deck with a hook and line. The ship's equipment consists of a steel contrivance that serves as an alley guiding the hook to the mail bag which is attached to a wire stretched between two stanchions. The pick-up line is a wire attached to the plane's fuselage. At the end is a three-pound ball and a three-pointed hook. The ship's direction is regulated so that the plane, flying about 200 feet overhead, can face the wind and thus reduce its speed while the pick-up is accomplished. The plane is to meet the ship regularly about 600 miles at sea.

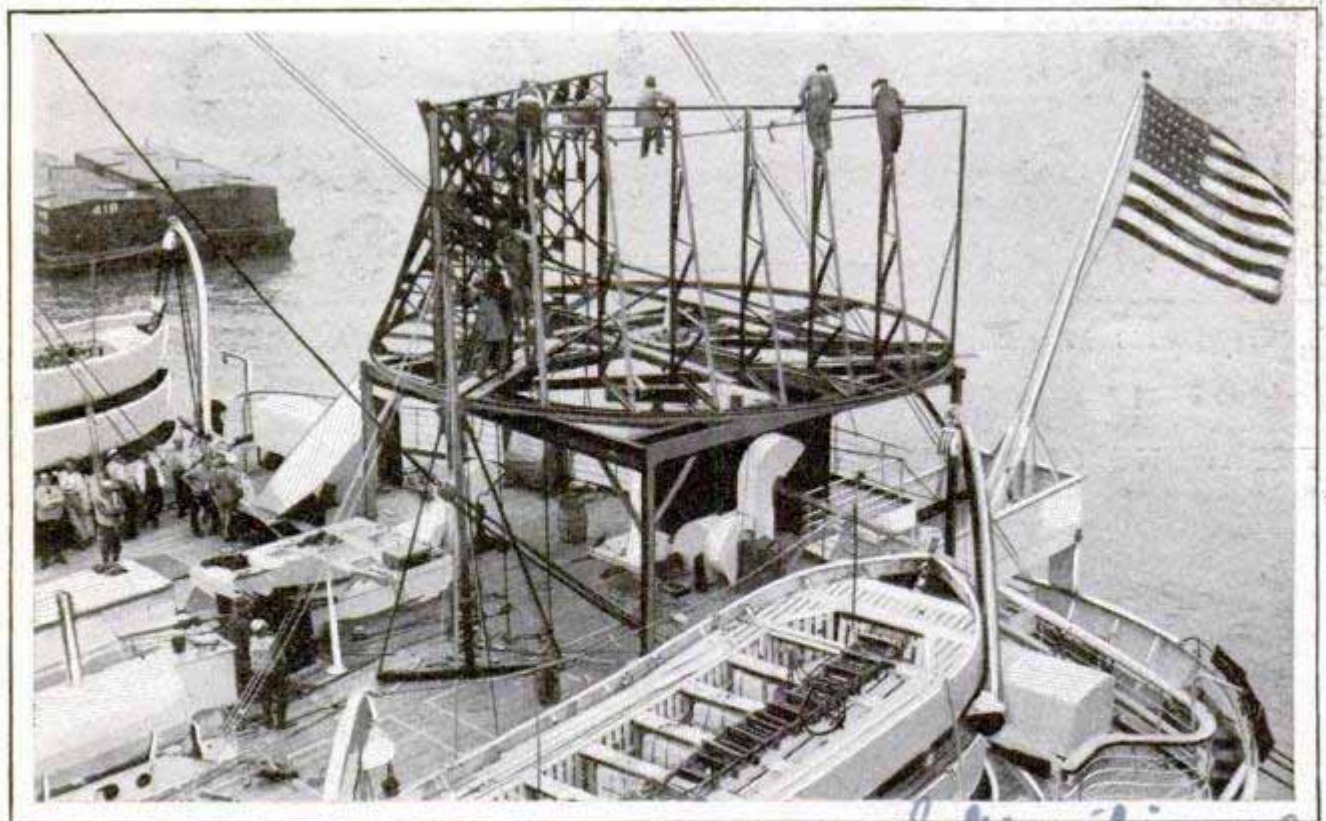

*International*

Workmen Are Here Shown Erecting the Runway or "Alley" on the Deck of the "Leviathan," from Which an Airplane Snatches the Ship's Mail While the Craft Is 600 Miles at Sea

# WHAT HAPPENS WHEN A FRONT TIRE BLOWS OUT?

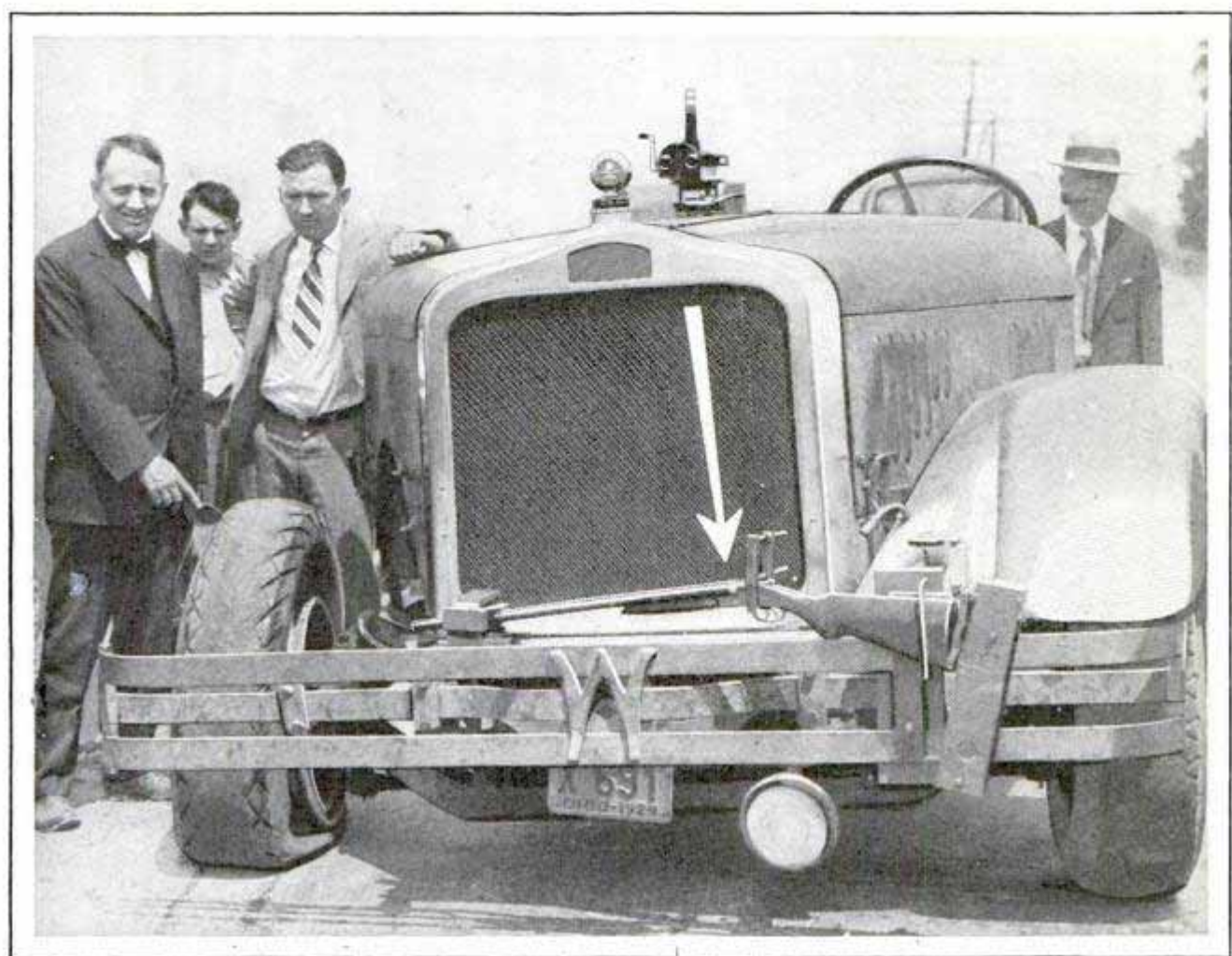

This Blowout Was a Complete Success; the Shotgun Was Arranged to Burst the Tire to Determine What Happened When a Tire Blew Out on a Bus Going Sixty Miles an Hour

What happens to a passenger bus traveling sixty miles an hour when a front tire blows out? A bus-manufacturing company wanted to know, but each time a blowout was arranged the tire deflated so slowly that engineers were unable to judge the effect. Finally a shotgun was rigged on the front fender, its muzzle pointing at the tire and its trigger operated by a cable behind the driver's seat. The gun was fired when the bus attained the proper speed and the tire deflated immediately, after which the bus ran 250 feet under braking without swerving from its course.

elves. One official told of wild birds that frequented zoo cages where those of similar species were held, and even built their nests just outside the cages, apparently anxious to join the captives.

## REMOVABLE PANE IN WINDOW ELIMINATES STORM SASH

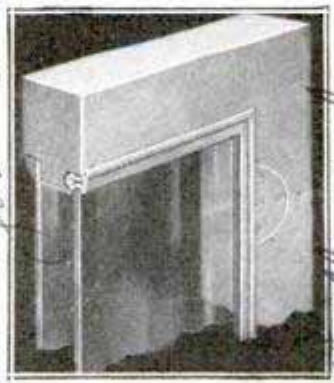

Taking the place of the usual storm windows, a wood sash now on the market has a removable inner pane. This helps keep out dust and noise as well as cold, insures a frost-proof window, and the sash is so constructed that special frames are not necessary.

## ZOO ANIMALS LIVE LONGEST

Investigation by zoo officials has disclosed that most animals live longer in captivity than in their natural haunts. This is attributed in part to the better care and feed the zoo animals receive, as compared with those that forage for them-

*White In-car*  
*Chicago - C. J. Speed - 190 N. La.*  
*3868*  
*Harold Tribune 6/17/19*  
*Director National Zoo*

2862

*Water meter...*

2744

# With the Mystery

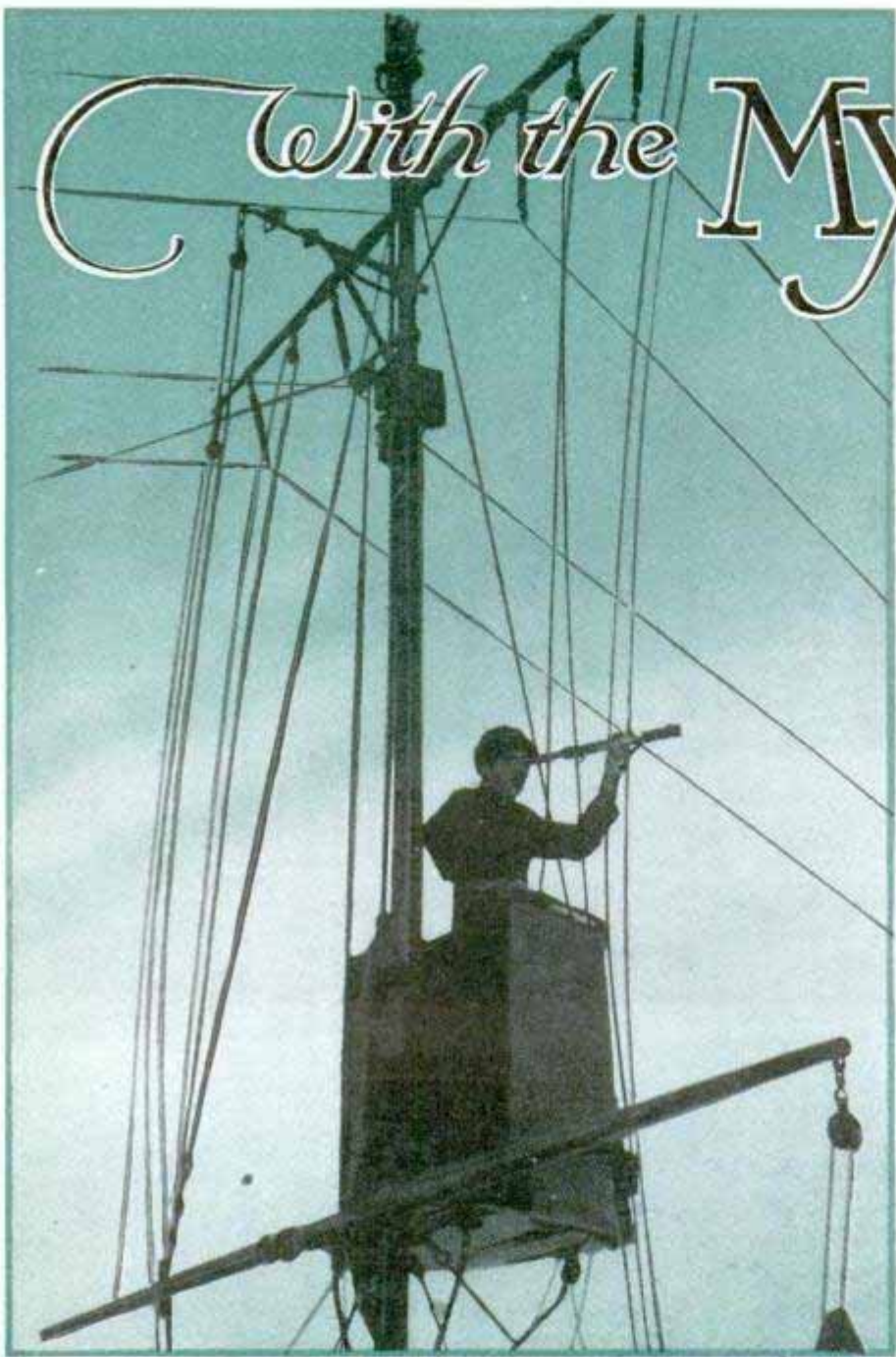

The great majority of commercial vessels sunk by the U-boats were sent down by gun fire, with the submersible coming to the surface and stopping its victim, ordering the people aboard to the boats and then opening fire with shells. It could not have been otherwise. Torpedoes are highly expensive engines. The element of cost is important. More important is the fact that, a submarine being a comparatively small vessel and a torpedo being a large missile, a submarine could carry only a limited number.

A special Q-ship section in the British admiralty directed the campaign of the mystery ships against the U-boats. Officers, crews and ships were selected. The men were the very best of the British navy—they had to be for the

By **LOWELL THOMAS**

Author of "Raiders of the Deep," "Count Luckner, The Sea Devil," and "With Lawrence in Arabia," etc.

*Pauling, N.Y.*

**T**HE SCIENCE of deception raised to the Nth power—that was the Q-ship. A falsehood, a whopping lie was developed with a technique complicated and ingenious enough to be worthy of some high branch of scholarship or mechanics. The Q-ship was an elaborate decoy set to trap submarines. Seemingly it was the most innocent of ships, usually an old tramp steamer. Actually it was an auxiliary cruiser armed to the teeth, with heavy guns, with depth bombs, often with torpedoes.

dangerous work, the "Suicide Club," as it was called. The vessels were sometimes windjammers, which had the advantage of looking particularly innocent; were independent of coal supplies, could stay at sea for indefinite periods, and had no engines to interfere with the use of hydrophones in listening for submarines. Tramp steamers, however, made the best Q-ships. A tramp could be armed heavily and could put up a stouter fight.

The state of things aboard the Q-ship was evidence indeed that "clothes maketh

# Ships

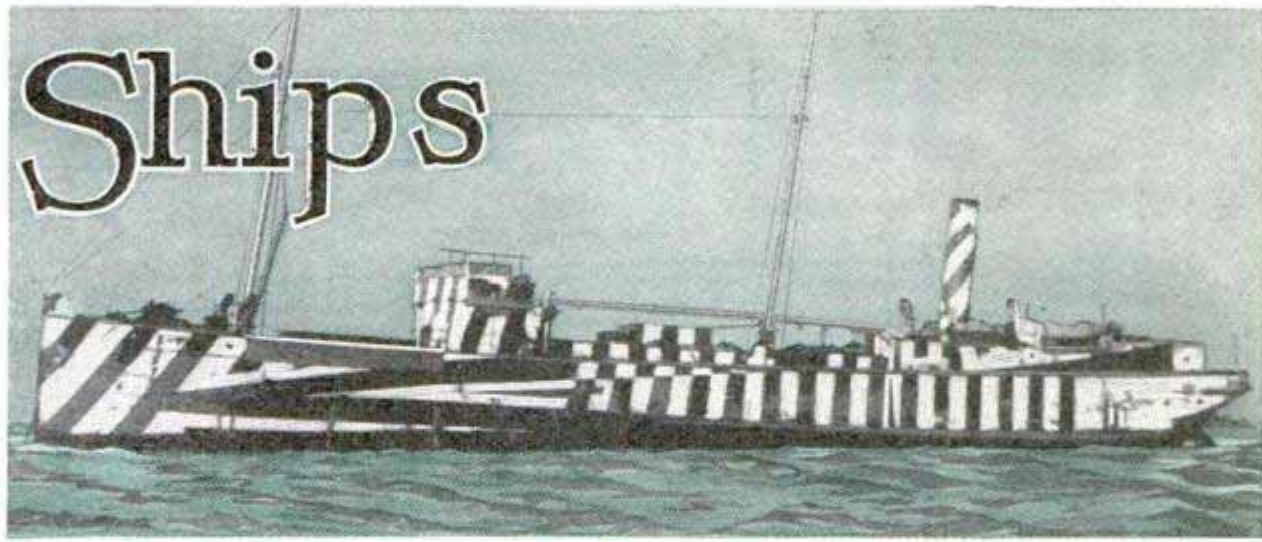

Tramp Steamship, Converted by Skillful Camouflage into a Mystery Ship, to Decoy German Submarines to Their Doom; This Q-Vessel Was Named the "Lothbury"

the man." The officers, when ashore, were among the smartest and best turned out of all the British navy. The mystery-ship crews were crack seamen, disciplined to the minute, picked men from the Grand Fleet. But if you could have stepped aboard a Q-ship, you never would have suspected it. No natty uniforms, no crack discipline, no saluting, no trim navy appearance anywhere. Instead, you would see a crew as villainous-looking as any that ever sailed the seven seas, unshaven, clad in hand-me-downs, disorderly and dirty. One Q-ship commander wore a false mustache and dressed as if he were a commercial traveler aboard the tramp. Another paraded the deck in a flaxen wig and squat hat—what submarine commander would take him for anything save a Dutch pilot? A favorite ruse was the lady aboard, a sailor dressed up in the kind of feminine finery you would expect on such a craft.

If the old tramp was originally filthy, it remained so. If it was too clean, it was dirtied a bit. The guns were cleverly concealed behind flaps that could be let down at a moment's notice. The hiding of the guns was, of course, the all-important thing, and they often were so neatly tucked away that they could not be seen from the tramp's own deck. On many a Q-ship, a casual visitor might be shown around and never suspect he was aboard a decoy fighting craft.

There were various devices to fool the U-boat. One Q-ship could produce a good

imitation of a shell exploding on deck, to make the submarine captain believe he had scored a hit with his gun. Another would blow off steam to pretend that her boilers had been hit. Sometimes a side of fresh beef would be hung in conspicuous sight. The Q-ship skipper, who perhaps had served in submarines himself, knew that aboard underwater craft canned food is the rule, and how tired men get of it. The U-boat officers were always boarding captured ships to pick up fresh provisions, and a side of fresh beef in plain sight was sure to be well-nigh irresistible bait.

The U-boat commander was not officially credited by the German admiralty with sinking a ship unless he could report its name and particulars. Bringing back the ship's papers was excellent proof, for instance. Sometimes the submarine would send a boarding party on a captured vessel, but more often the U-boat commander would get information, and, if possible, papers, from the crew after they had taken to the boats. A U-boat would order the crew of the supposed tramp to the boats, and part of the crew would take to the boats as if it were the real thing. This act was elaborately staged, with every detail as correct as in an expensive London theatrical performance. Those who carried out this part of the hoax were known as members of the "panic party." And while they were making off, the rest of the crew would remain hidden aboard the apparently deserted vessel, ready to open a sudden and unexpected fire as soon as the

X 9 X 4

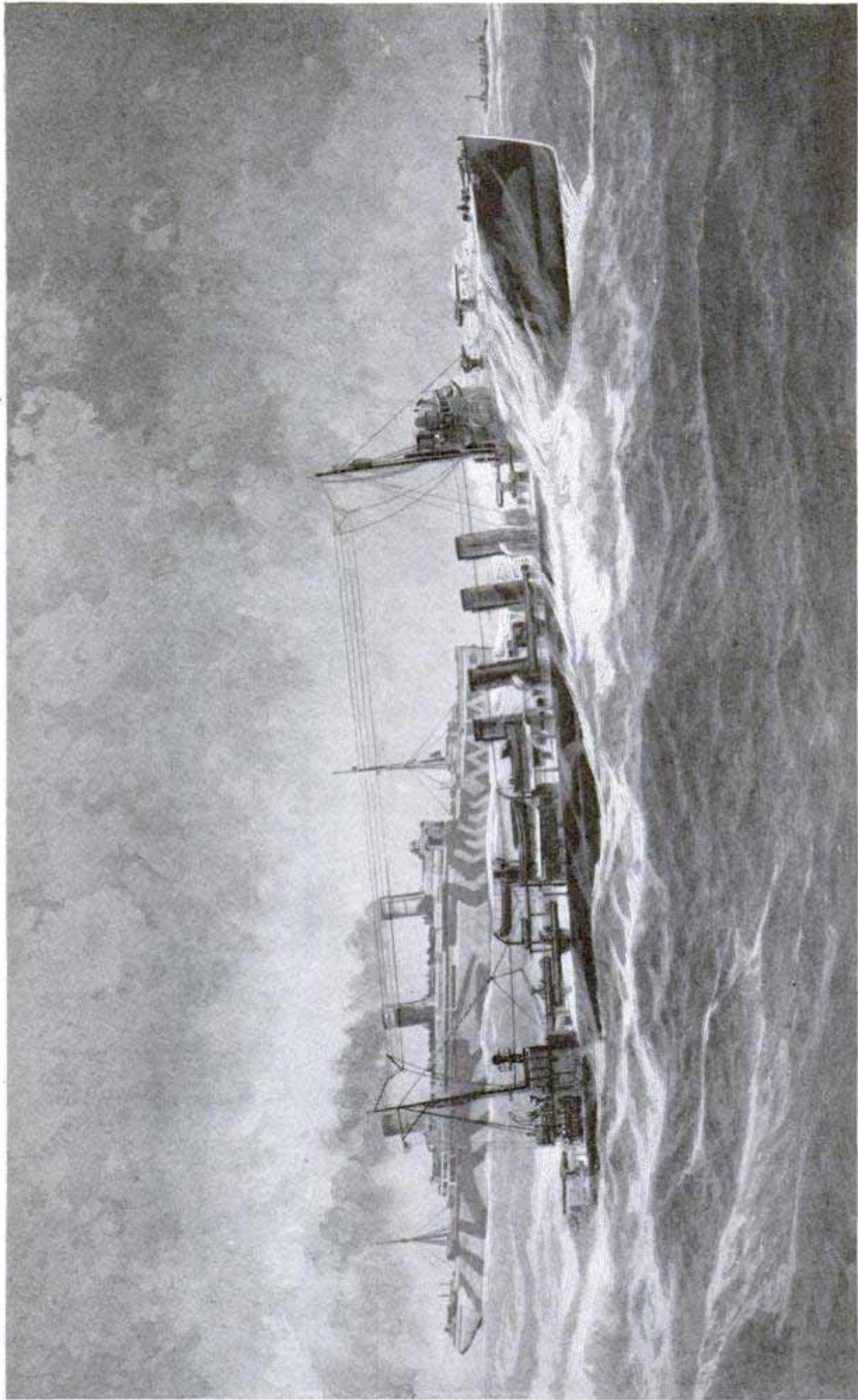

"A Fast Convoy," One of a Series of Paintings by Burnell Poole, Presented to the Naval Historical Foundation by the E. I. Du Pont de Nemours Company and on Exhibit at the Naval Academy

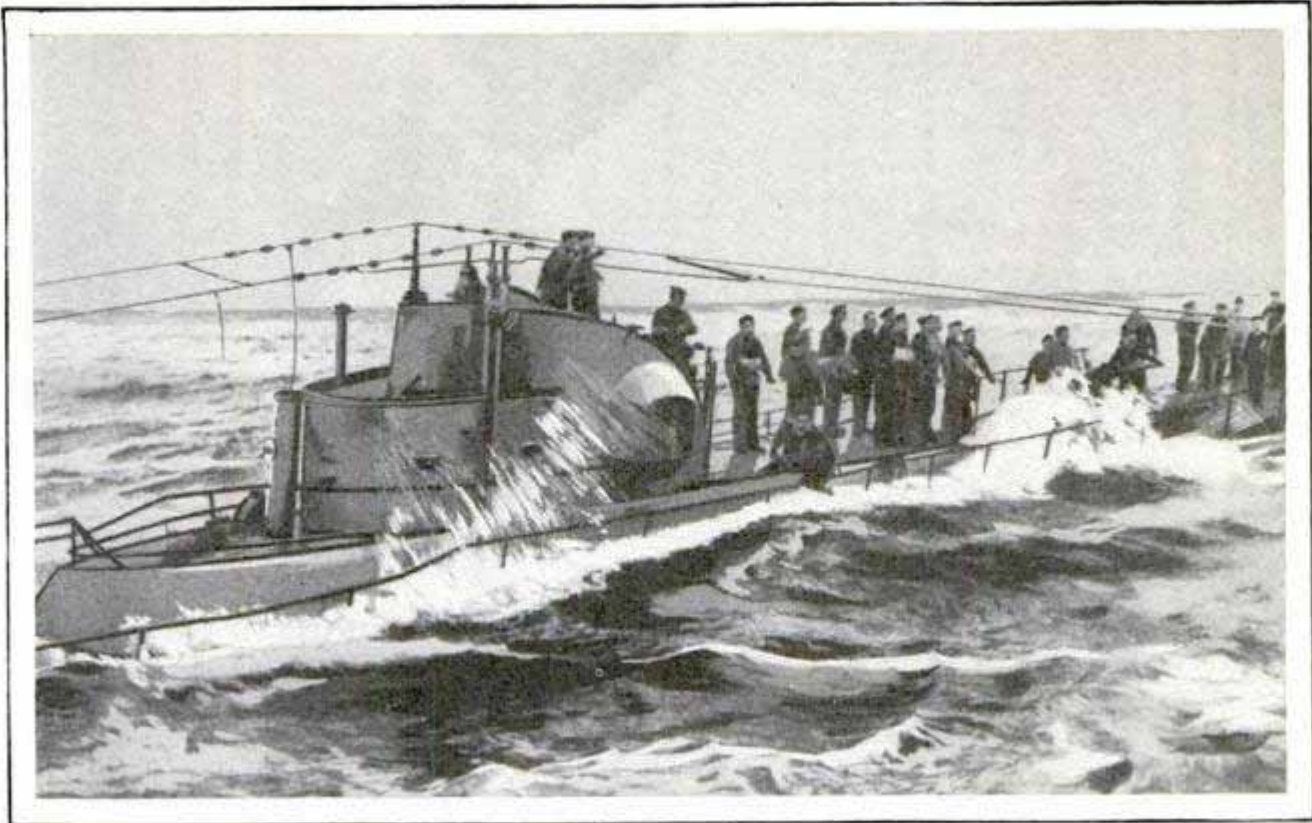

Capture of the "U-58" by the U. S. Destroyer "Fanning"; This Was the First U-Boat Taken by the United States in the World War

submarine would come nearer to question those in the boats.

In the first part of the Q-ship campaign, the U-boat commanders were quite unaware of the trap the British had prepared for them, and more than one unfortunate submarine commander, when about to send what seemed to be an easy victim to the bottom, found himself in the position of Rastus who, while fishing, found an alligator on the end of his line and asked himself, "Is dis nigger fishing, or is dis fish niggering?"

But, of course, the first U-boat to escape from an encounter with a Q-ship returned to Germany and spread the alarm. Thereafter every merchant vessel was handled gingerly, as though it were a potential Q-ship. From then on, the Germans made it a rule to approach a ship either from dead ahead or astern, where guns, if there were any, could not be brought to bear. They also shelled each apparently deserted ship from a range comparatively safe for them, and rarely came close until they had first searched their prospective victim with many shells. This diminished the effectiveness of the Q-ships, but, at the same time, made the game all the more exciting and brought about some of the greatest fights that have ever been staged on the sea.

It soon got so a Q-ship would not drop its disguise and open fire until it had been raked with shells and appeared almost ready to sink. This scheme meant that special methods were devised so as to keep afloat even when it might look to the U-boat people as though the tramp were doomed. The Britishers stowed their holds with barrels, or buoyant lumber, stuff that would keep them up long after they had been torpedoed or thoroughly riddled by shell fire. Then the battle would be on and often it was a case of a battered derelict suddenly coming to life for a grim struggle with the attacking submarine, sometimes to lose, sometimes to win, sometimes to lose while winning—for there were instances of a riddled Q-ship sinking after having dispatched its adversary, the submarine.

The first encounter between an Allied mystery ship and a German undersea raider occurred in July, 1915, when the "Prince Charles," in the guise of a loafing old coal ship, met the "U-36," which submarine, as it happens, had a certain small historic interest and a considerable interest to me personally. In my book, "Count Luckner, the Sea Devil," I told the tale of the jolly seadog count who took a sailing ship raider through the British

blockade and went buccaneering on the seas, sinking Allied ships. The old windjammer that he took was a former American-owned clipper ship which the Germans had captured. She had been picked up in the North sea by a submarine and brought into port. The undersea craft that made the capture was, precisely, the "U-36," which, not long after daybreak of a bright July morning in 1915, sighted what seemed to be nothing more than a grimy, slovenly collier, but in reality was a deadly trap.

The German had just stopped another ship, and was preparing to sink it. "Why not make it two fish at one cast?" we can hear Herr U-boat Kommandant say to himself. So the "U-36" heads toward the collier. "Abandon ship"—and a shell cuts across her bow to enforce the order. Panic party, and men aboard the collier take wildly to the boats. Then the submarine begins to bombard the collier to sink her, slowly closing up so as to waste fewer shells. Aboard the "Prince Charles," Lieutenant Wardlaw and his gun crew lay con-

cealed with shells bursting around them. They wait until the "U-36" is within 600 yards, and then the collier drops her mask. Gun ports fall away. British Jack tars run up the war ensign while their comrades open fire with a deadly precision. The Germans on the U-boat's deck leap into their conning tower and the "U-36" tries to dive. But the Q-ship shells are ripping into her. She gets under water, but she's sinking. So they blow her tanks and she jumps to the surface again, right back into that rain of shell fire. The Germans are scrambling out of the conning tower as the "U-36" takes her final plunge.

The "Prince Charles" picked up fifteen men, including the submarine commander, out of a crew of thirty-three.

The second U-boat sunk by Q-ship attack provided an international sensation—the "Baralong" case. In August, 1915, the "U-27" stopped and prepared to sink the American steamer "Nicosian," which carried a cargo of contraband and was therefore subject to seizure. The Q-ship "Baralong," disguised as a tramp, came on the

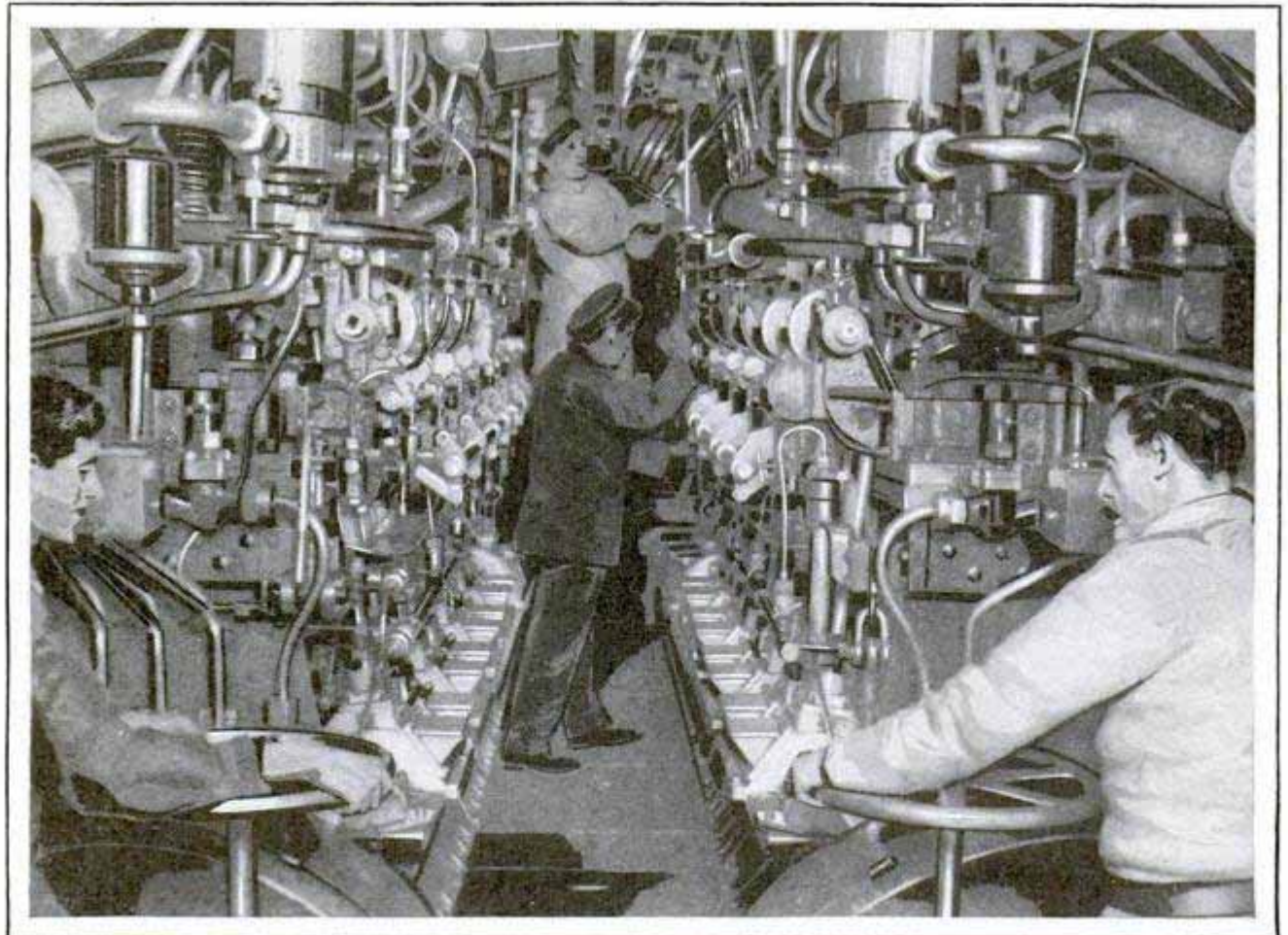

At the Controls of a Submarine's Engine Room in War Time; in Restricted Spaces Such as This, Tactics That Played an Important Part in the Struggle Were Executed



scene as the "U-27" was shelling the abandoned "Nicosian." The submarine paid no attention to the disguised tramp until the "Baralong" had crept within deadly range. Down dropped the "Baralong's" flaps. A hail of short-range fire, and the "U-27" quickly foundered. A large part of her crew was on deck, and they were left swimming in the water. At this point the controversy begins. The Germans, backed by the statements of some of the people of the "Nicosian," hold that the crew of the "Baralong" lined the rail and shot the Germans in the water as they tried to swim to safety, and killed most of them, including the U-boat captain. The British deny this. There were diplomatic protests to neutral governments and a great deal of wrangling. To this day the affair is shrouded in mystery.

One of the memorable cases of a U-boat sunk by a Q-ship was that of the "U-88," which went down in May, 1917. The "Stonecrop," a small steamer rigged out as a decoy, under Commander Blackwood of the British navy, was attacked, pretended to run away and was heavily shelled. She set her smoke apparatus going, to make it appear as if she were on fire. These were times when the U-boat commanders were very cautious, and it took many devices to fool them. The "Stonecrop" seemed afire from stem to stern. The supposed crew had taken to the boats. The hidden gunners aboard waited an interminable time. The "U-88" lay off watching, at a safe distance. It was not until the "Stonecrop" seemed to be gutted with the fire that the undersea craft ventured close to sink her with a final few shots, and even then the

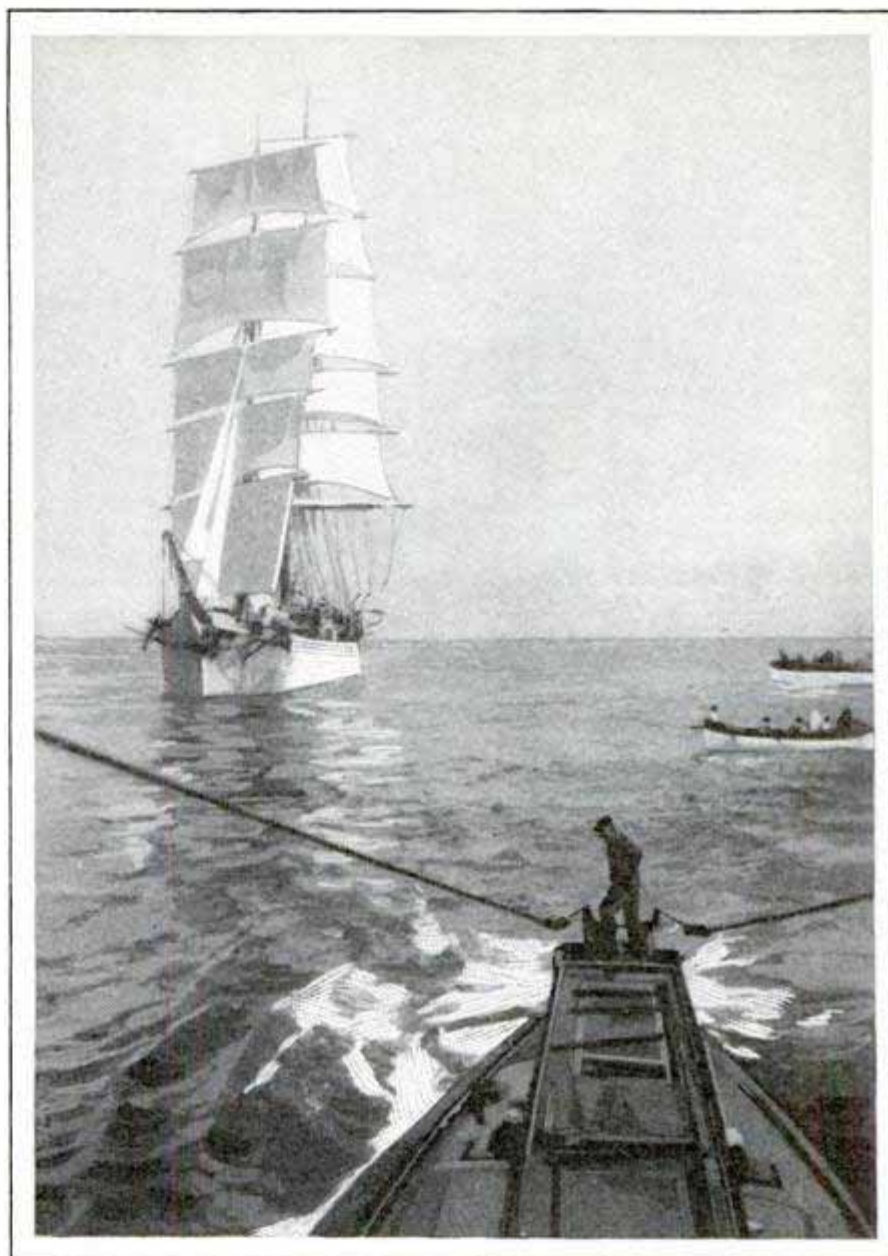

A German U-Boat Orders a Sailing Ship to Stand By for Torpedoing; the Crew Takes to the Boats

gunners aboard the Q-ship had to open fire at long range. Their gunnery was good, though. They hit the "U-88" squarely, and she sank with all hands. Her captain—and this held the deeper drama of the situation—was Lieut. Comm. Walter Schwieger, the man who sank the "Lusitania."

Not many months ago, I talked with Capt. Harold Auten, V. C., a paladin of the Q-ships, who, next to the famous young admiral, Gordon Campbell, ranks at the top of the list of Q-ship aces. He told me of his most exciting fight, and a desperate affair it was. It illustrates one of the cardinal facts pertinent to the campaign of the Q-ships—that these decoy craft often had a very bad time of it, and,

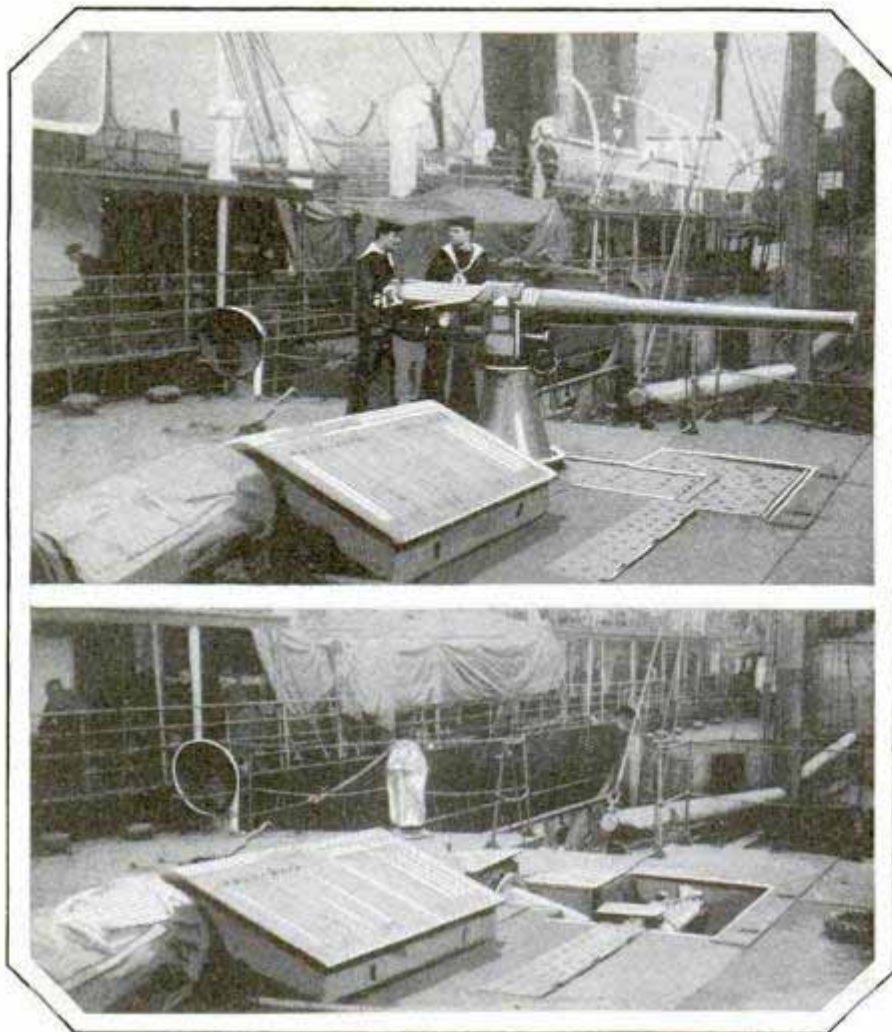

How Mystery Ships Concealed Quick-Firing Guns on Vanishing Platforms;  
Gun Withdrawn in Lower Photograph

trap or no trap, found themselves in desperate corners.

At the end of July, 1918, the small Q-ship "Stock-Force," under Auten's command, was cruising along to the north of France.

"At four in the afternoon," Captain Auten relates, "I was in my cabin playing a rubber or two of bridge with three officers off duty. A loud clanging, and the alarm bells were ringing. Cards flew in all directions as we dashed out. And there I saw a white streak on the water, the wake of a torpedo. Some devilish submarine out there must have suspected us of being a Q-ship, or he would not have wasted a torpedo on such a small craft. The torpedo hit us fairly. The 'Stock-Force' was only a hundred and sixty feet long. The explosion tore a hole, forty feet wide, clear through the hull from one end to another. You can't imagine such a terrific blow-up. I was on the bridge, and the bridge was entirely destroyed. I

remember describing a curve in the air, while my cabin table simultaneously landed on top of me. The foredeck was bent, the derricks blown overboard. The air was filled with debris, planks and beams and unexploded shells and a huge column of water, and all of that came down on us with a fearful clatter, wounding everybody. The chart table, which had landed on me, was on top of me and saved me. The men who were most shaken became violently sick.

"We were sinking, but the hold was crammed with wood, and that was keeping us afloat for a while. The guns fore and aft were intact, and capable of opening fire. There might still be a chance for a little fun, I thought. 'Panic party,' I ordered. And the men, nearly all of whom were wounded,

proceeded to stage a panic party. They were as cool as ice, and went through all the disguise maneuvers of the drill. These, together with the real havoc that had been wrought, made it surely the most realistic panic party ever staged.

"Aboard we waited, hidden at the guns. We could feel the 'Stock-Force' settling beneath us. How long would she last? And that U-boat was altogether too careful. He must have guessed we were a Q-ship, because, derelict as we were, he was not coming near to finish us with gun fire. We waited and waited. Every minute was agony for us and a few inches deeper in the water for the slowly sinking ship. Wasn't he ever coming up to finish us? Half an hour passed. No, he was going after the lifeboats. He was going to get his information from them. And now the lifeboats were rowing as hard as they could. They were drawing the submarine into the range of our fire. It was a long and tedious process. Every moment I was

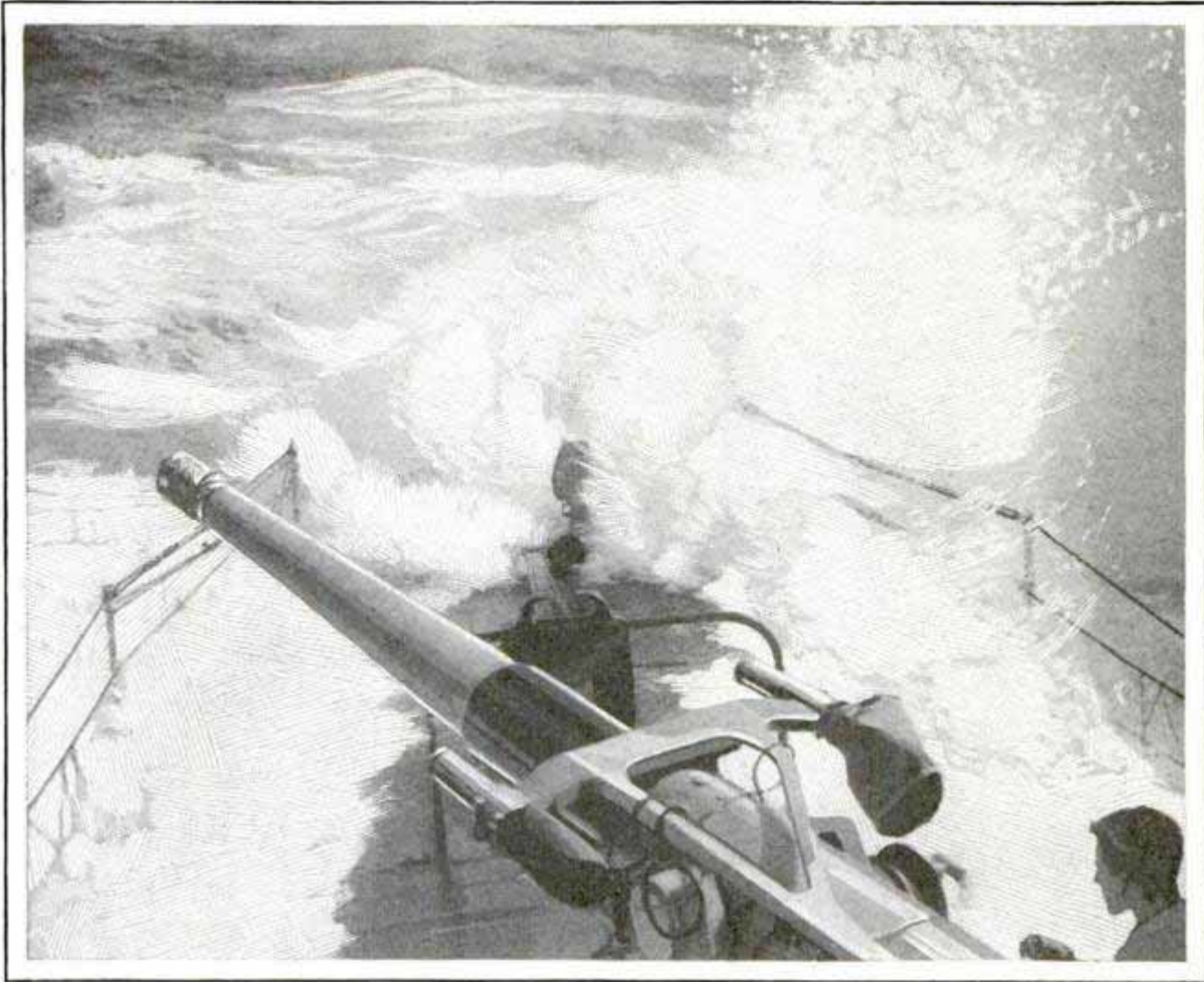

Heavy Seas Breaking over the Stern of a United States Destroyer; in Spite of Storms, These Sturdy Craft Are Able to Make Fast Time

about to order the guns to fire, although the range was not good. I was afraid the ship would take a plunge under us, and then our chance would be gone for good. Then finally the lifeboats had drawn the submarine into as good a position as we could hope for.

"Stand by the guns; fire!" I commanded. The gun ports dropped away with a bang, and the fight was on.

"Our first shot carried away the periscope and the wireless. Good shooting—but we had to do good shooting. Our second hit the conning tower, and blew a man into the air. Another found the hull just below the conning tower. The stern of the U-boat began to sink. Smoke was pouring out of her. Evidently one of our shells had exploded inside of her. We continued to fire. Her bow was rising straight in the air, and she went down.

"The panic party came back on board. We hoped to be able to do something to keep the 'Stock-Force' from sinking. Some

trawlers, attracted by the firing, appeared. They tried to take the 'Stock-Force' in tow and beach her on the shore eight miles away. It was no use. The good old ship was sinking under our feet. We took to the boats, and down she went."

Auten got the V. C. for this exploit. Then, after the war, a curious thing was discovered. The U-boat, which was last seen sinking, stern first, had got back to Germany. Her crew had been able to right her under water, and although she was almost fatally damaged, they somehow managed to bring her home.

#### RAILROAD BARS RED CLOTHING

"Because of the possibility of being mistaken for signals, wearing of red clothing about the right of way is forbidden," reads a safety booklet recently published by a western railroad. The decree officially bars the red flannel shirt and necessitates hiding the red bandanna handkerchief.

*Examiner 5/31/29*

2983

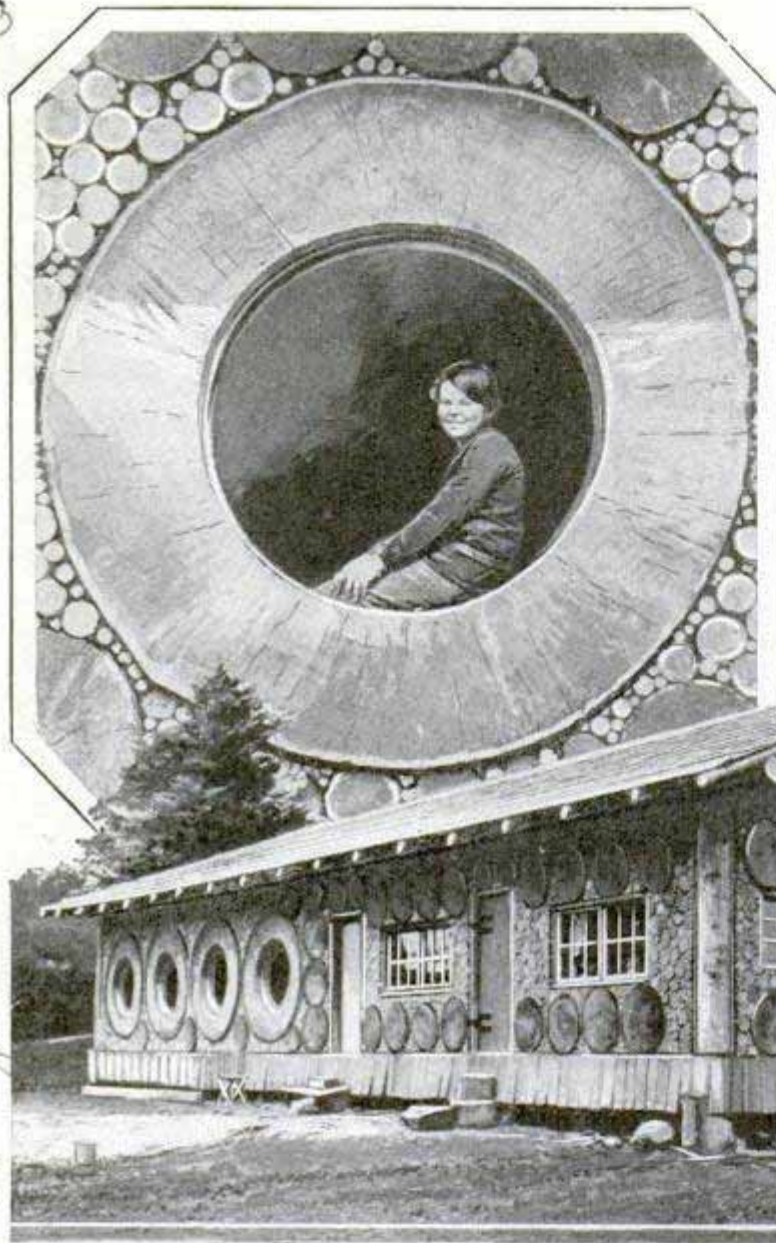

### DRIFTWOOD HOUSE BUILT BY SEA CAPTAIN

Depending on the sea to bring his building materials to him, a retired sea captain has constructed a home entirely of driftwood on the Olympic peninsula, Washington. The cabin differs from the usual design as the walls are made of crosscuts of cedar logs and stones chinked with concrete, while some of the windows, resembling portholes of a ship, are formed by huge sections of logs from which the cores have been removed.

*at the mouth of the Elwah River*

The Sea Furnished the Lumber for This House, Constructed Entirely of Driftwood; Above, a Close-Up of a Window, Made by Removing the Core from a Cedar Log

### BIRDS THAT FLY THE AIRWAYS GIVE THRILLS TO PILOTS

Pilots flying the transcontinental air routes in Europe and America have been asked to aid in studying bird life at high altitudes as a result of recent encounters of the birdmen with the feathered flocks. At least one fatality was due indirectly to such a meeting, when two eagles attacked a plane over the Pyrenees, tore and clawed at wings and rudder and tried to dislodge the pilot with their wings. After half an hour, the pilot, in a badly damaged plane, was forced to descend in a wild part of the mountains and was fatally injured while his passenger was hurt. An-

other pilot, in a similar encounter over the Alps, was able to repulse an eagle with revolver shots. Birds are rarely sighted above 3,000 feet, although large ones have been seen as high as 12,000 feet. Scientists hope the airmen will be able to aid them in giving the height and speed attained by birds and in furnishing information of the flights of birds in migration. Many birds of smaller type show no fear of airplanes and swifts often gambol and wheel gracefully about the planes, being able to outfly them. Airmen have lost races with teal and mallards, only to see these birds overtaken by the swifter falcon. Recently an aviator witnessed a battle between a seagull and a hawk, in which the

*Wood  
3. Oberley Beach  
5. Mr. Lundy Bay  
Capt. J. J. Williams  
Colombier, 29 Ocean*

hawk emerged successfully, flying with its prey to the mast of an incoming ocean liner. It is believed that a bird's power of hearing waves above the human range of audibility may direct it in migrations. Many birds have eyesight 100 times keener than that of human beings, and aviators are expected to help also in studying the sight of the birds. The kestrel, for instance—a species of hawk—can detect small insects on the ground hundreds of feet below.

**"STOLEN" FLASHES ON CAR IF THIEF TAKES IT**

Stolen automobiles are able to tell the world that they are in the possession of thieves, if equipped with an accessory devised by an Australian. The automobile burglar alarm consists of an electric sign on the radiator which blazes out the word "Stolen," when a thief attempts to switch on the ignition, the sign remaining illuminated as long of the car is operated. It is controlled by a secret box attached to the ignition system, which must be unlocked before the ignition is switched on to prevent the sign from lighting.



Thieves Taking This Car Light the "Stolen" Sign When They Switch on the Ignition

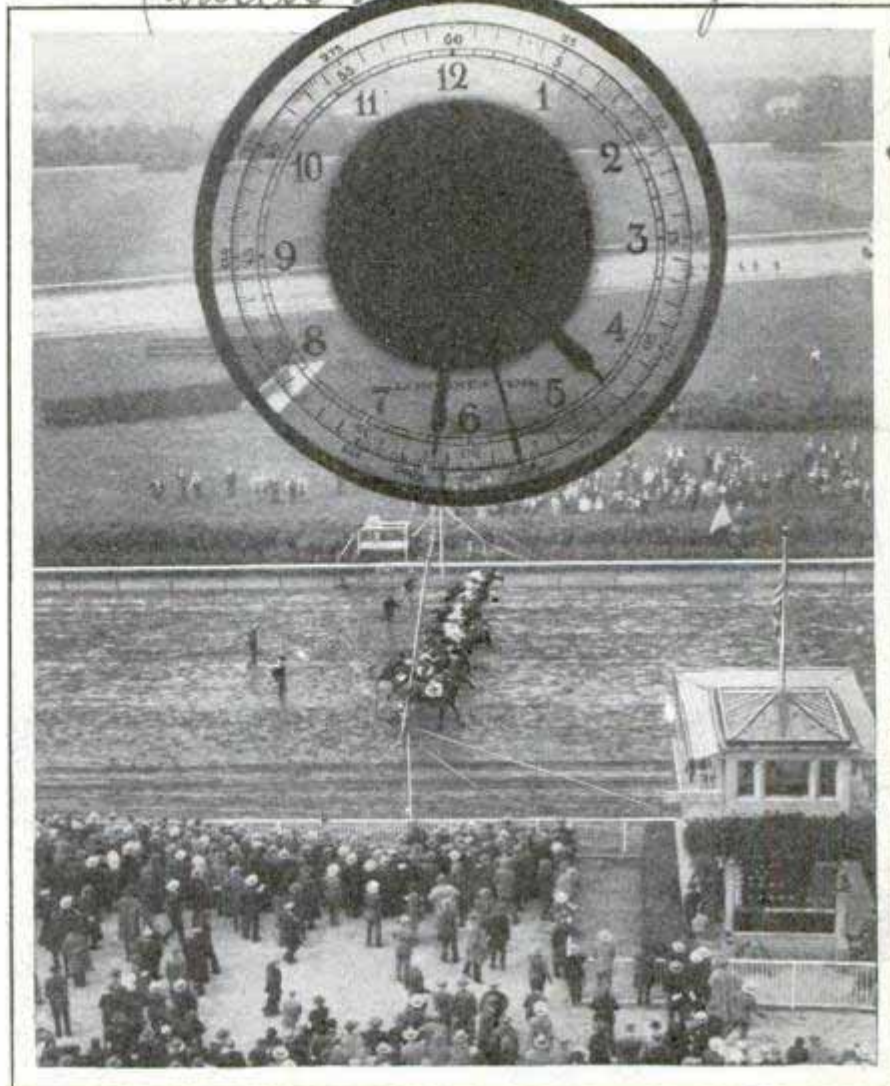

Beginning of a Race with Exact Starting Time Recorded on the Picture by a Watch with Transparent Dial in the Camera

**CAMERA AND CLOCK COMBINED TO TIME SPORTING EVENTS**

Exact elapsed time of a race or other sporting event may be recorded on a picture showing the finish of the event by means of a transparent watch set in a camera. The watch is set next to the plate, and a lever is moved to set the watch in motion when the race starts. When the shutter is clicked to take the picture of the finish, the hands on the dial stop, and the watch image is reproduced on the negative, giving both the picture of the end of the event and the exact time.

Popular Mechanics Magazine does not publish the name of the maker or seller of any device described in its pages, but this information is kept on file and will be furnished free upon application to our Bureau of Information.

Refer me to A Wittauer Co, 402-57th Ave. New York  
 make Enquiries Chronograph

And Mr Jackson  
 Sydney Australia  
 Letter recd

3047  
 watch maker  
 independent

2872

Mr. E. W. Clavering  
8, Shakespeare Road  
Herne Hill London S.E. 24  
Eng.

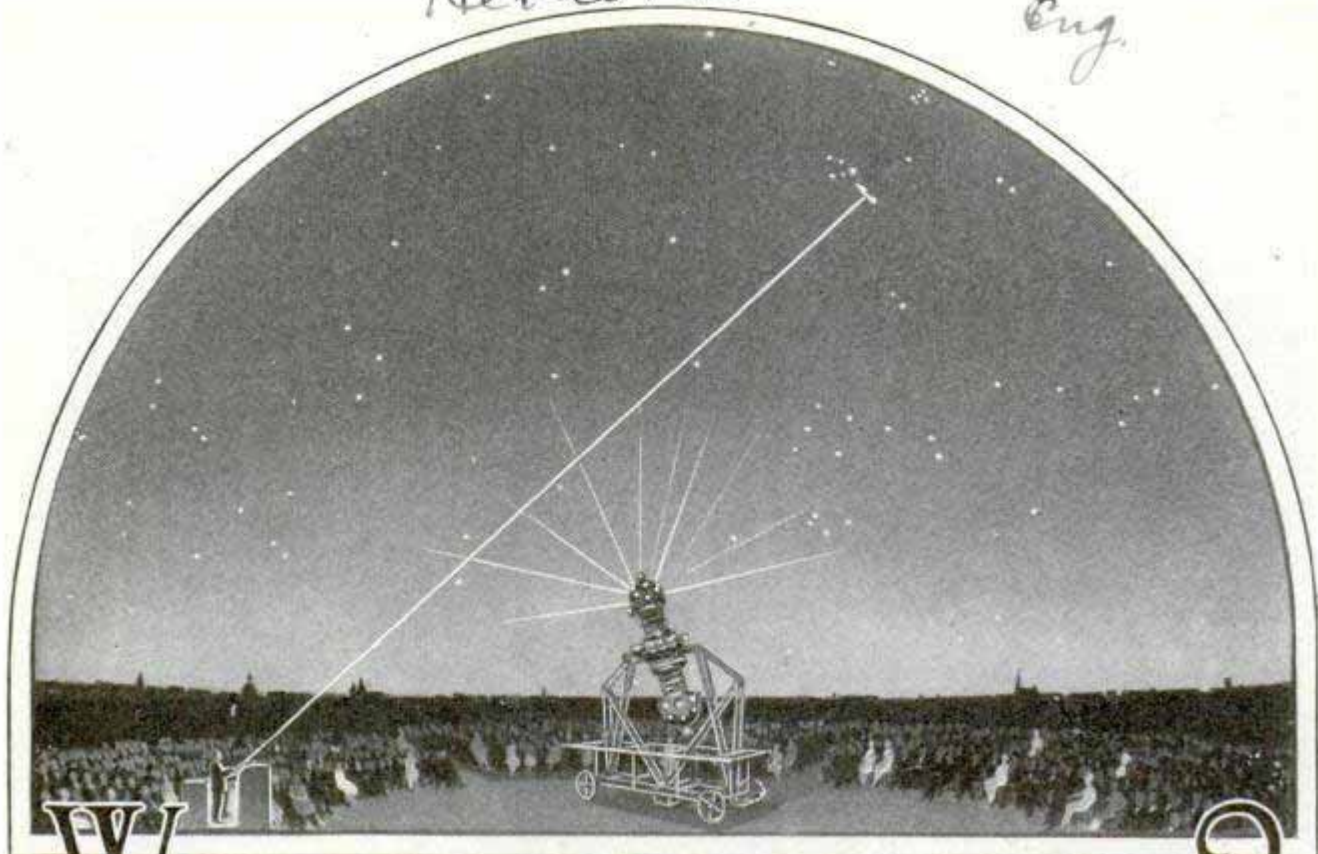

# Where is the Pole Star Going?

**I**N THE YEAR 2102, an event is due to take place in the northern sky that no one since the dawn of recorded history has ever seen—the arrival of Polaris—the pole star—at the north pole.

When that happens, the star and the celestial north pole will be less than one-half of one degree apart, twenty-eight minutes of arc to be exact. But when they meet, the pole star will pass on without a pause, and in a few more centuries will be so far away that there will be no north star.

The star, which mariners first named Polaris, has been used as a guide to the true north for so long that men have forgotten the time when there was no pole star, but there have been many such times, and there will be again, for it is only once in 26,000 years that the north pole of the celestial sphere and this particular star come so close they virtually meet. The ancient Greek sailors did not recognize any pole star, for the latter was then ten or twelve degrees from the pole, which was nearer the constellation of the Great Bear, and it was the latter, which they

called Cynosure, they steered by. The Great Bear in those days was the cynosure for all eyes at sea, and the Greek word still survives in that sense.

Why the pole star apparently wanders around the heavens is one of the simplest of stellar problems, for it isn't the star, but the earth that is to blame. Instead of revolving constantly in the same plane, its axis slowly changes its direction from year to year as the earth moves about the sun. If this axis was continued as a mighty pointer sticking out into space from the north pole, the tip of the pointer would describe a gigantic circle in the sky, taking just under 26,000 years to make one trip around its orbit. In its course, the tip of the pointer would point once at the pole star, as it is going to do in 2102, and then pass on, to approach in turn, at intervals sometimes of several thousand years, other stars and constellations.

It is a curious coincidence that sailors undertook their first long voyages across the seas at a time when Polaris was near enough to the true north to serve as a fairly efficient guide and supplement to



Drawing on Opposite Page Shows Interior of German Planetarium with the Pointer of Light Lecturer Uses; Above, Planetarium to Be Constructed in Chicago, and, Below, the One at Dusseldorf, Germany

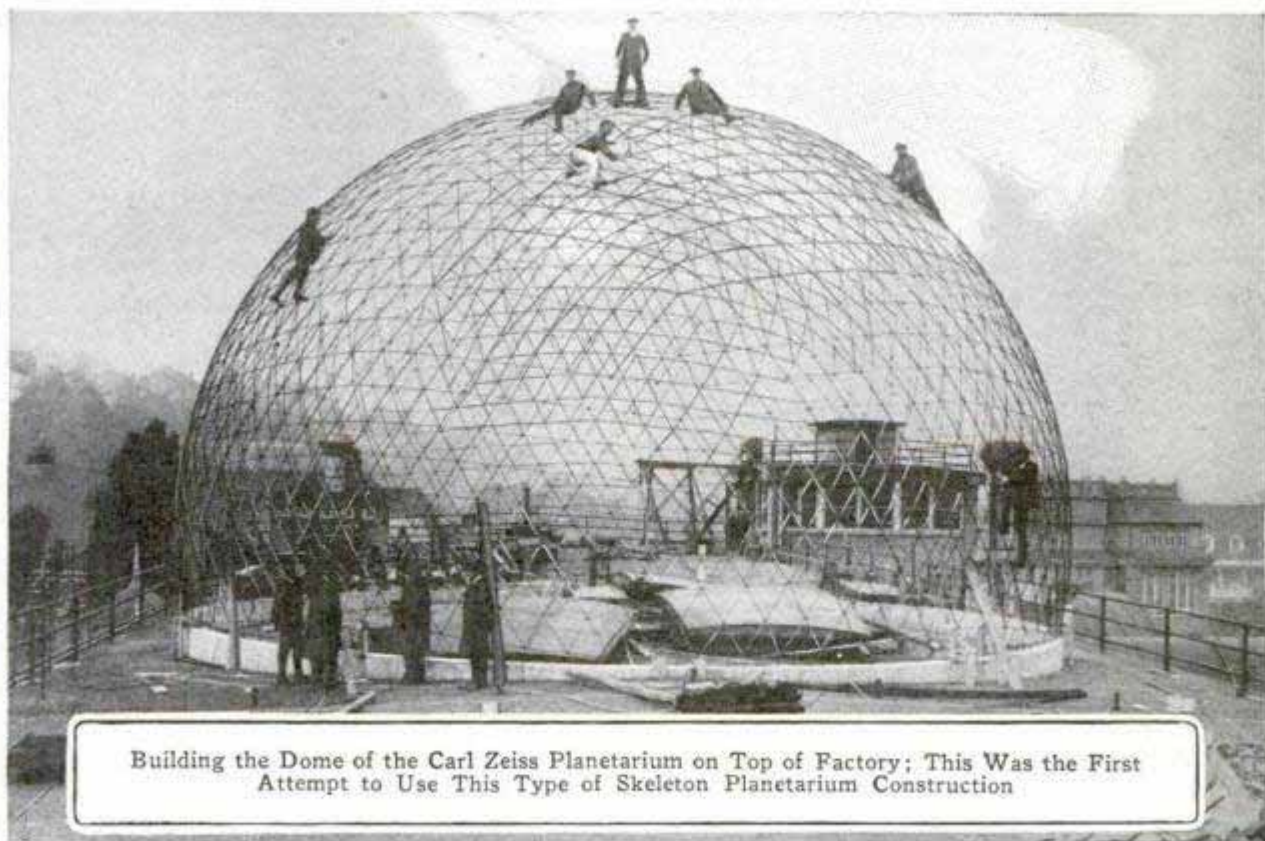

Building the Dome of the Carl Zeiss Planetarium on Top of Factory; This Was the First Attempt to Use This Type of Skeleton Planetarium Construction

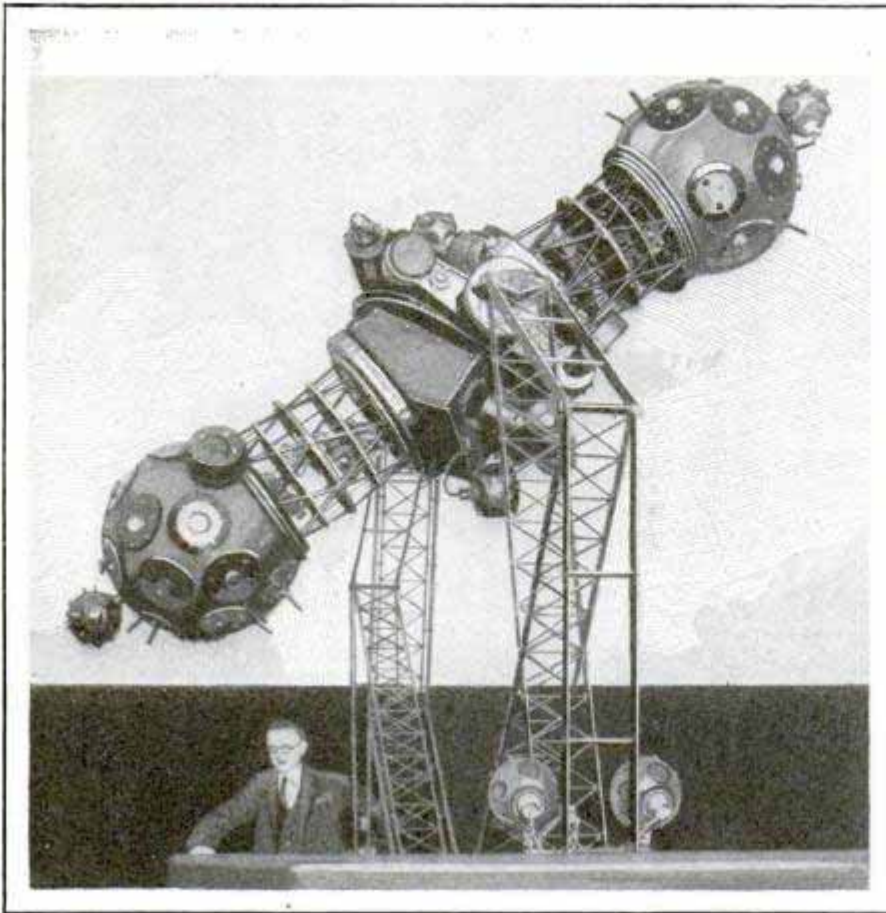

Close View of the Projector Which Casts Beams of Light to Represent Stars and Is Adjustable to Many Positions

their crude methods of navigation. Some idea of the speed of modern development, as compared with the slow processes of time in the heavens, is gained from the fact that in the period it has taken the star to shift those few degrees nearer the pole, the entire science of navigation has been developed, and reached the point where Polaris no longer plays any part in sailing, save for an occasional use in reckoning the latitude, a use that can be served as well by any number of well-known stars scattered throughout the heavens.

Because of the inclination of the earth's axis, some stars never set for most of us, some rise and set, and others are never seen, if the observer remains in his own latitude. The stars that never set are those between the pole and a circle whose edge would just touch the observer's horizon. The stars in that zone of the sky are therefore never seen by people living in the same latitude in the other hemisphere. The astronomer calls these stars, because they are always visible, the stars of "perpetual apparition." The group at the other extreme of the celestial sphere, which never rise, are termed stars of "per-

petual occultation." In between the two circles are the stars that rise and set. Those to the north, if the observer is in the middle northern latitudes, travel most of their course above the horizon, and those near the southern horizon barely rise above it.

The working of this system can best be imagined by picturing the observer seated in the center of a circular platform suspended horizontally in the center of a huge hollow globe, representing the celestial sphere, the globe built to turn on pivots placed on the line of the earth's axis. The platform represents the horizon, and the observer can see nothing that happens below it. Paint the constellations on the inside of the sphere,

start it turning, and the whole machinery of the universe is visible at a glance.

That, as the artist has pictured it in one of the illustrations, is the essence of any demonstration of the solar system. The planetarium evolved in Germany has improved on it by reducing the globe to one hemisphere, in the form of a dome, which is fixed in place, while the stars are replaced by lights projected onto the ceiling, and the mechanism of the projector provides the movement, doing away with the necessity of revolving the globe.

The planetarium has another advantage, for, while the pivots of a huge globe would necessarily be fixed, and the heavens could only be shown, therefore, as they appeared or will appear at one fixed date, the planetarium projector can be geared to shift at will to simulate the wobbling of the earth's axis, and the projected lights made to represent the sky as it appeared at any date in the past, or as it will appear at any date in the future. One of the interesting things about the planetaria established in Germany is their ability to show the sky as Charlemagne or Julius



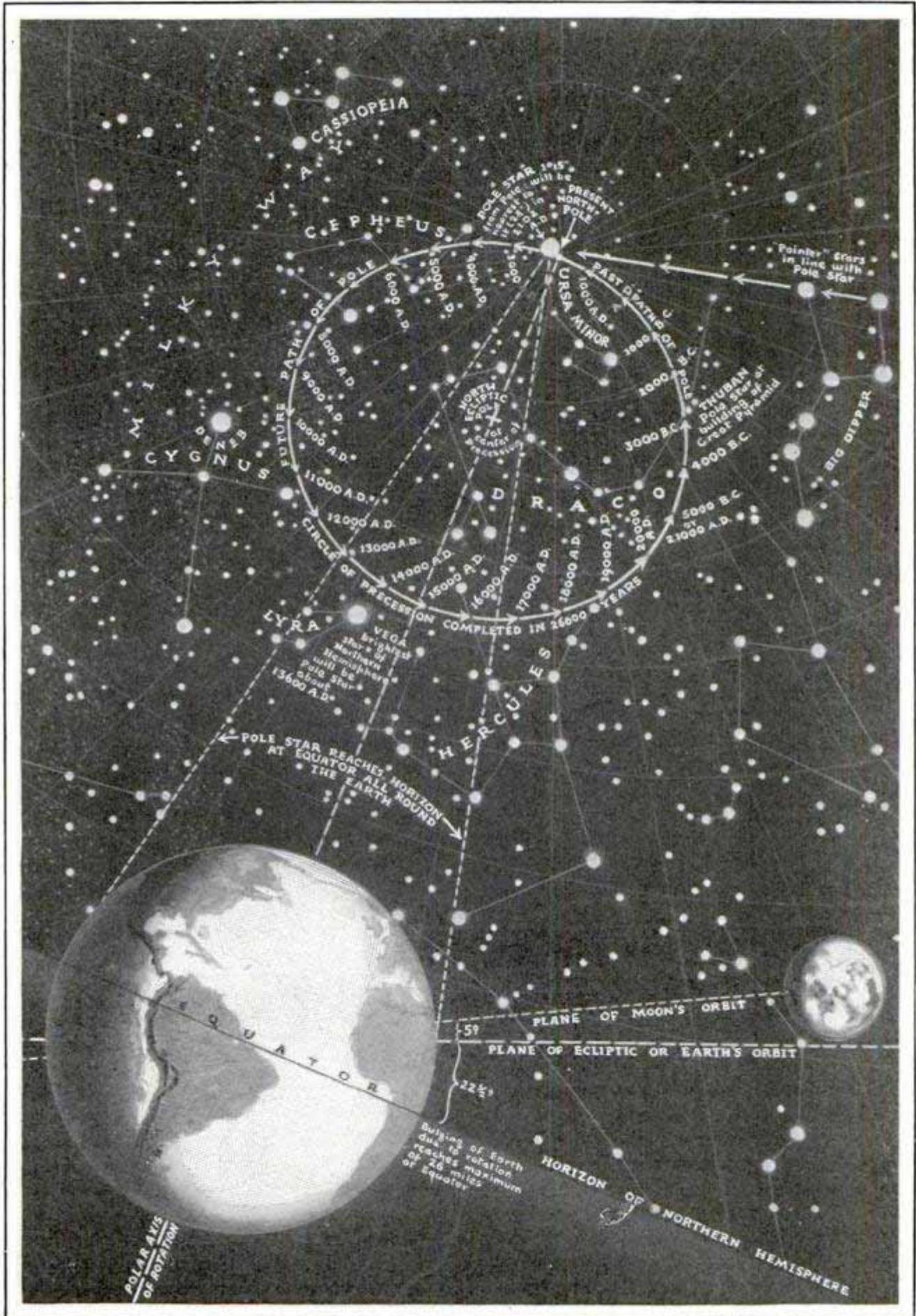

Copyright, S. W. Clatworthy

Drawing to Illustrate the Effect of the Bulge of the Earth at Equator in Relation to the Sun and Moon; It Causes the Polar Axis to Waver

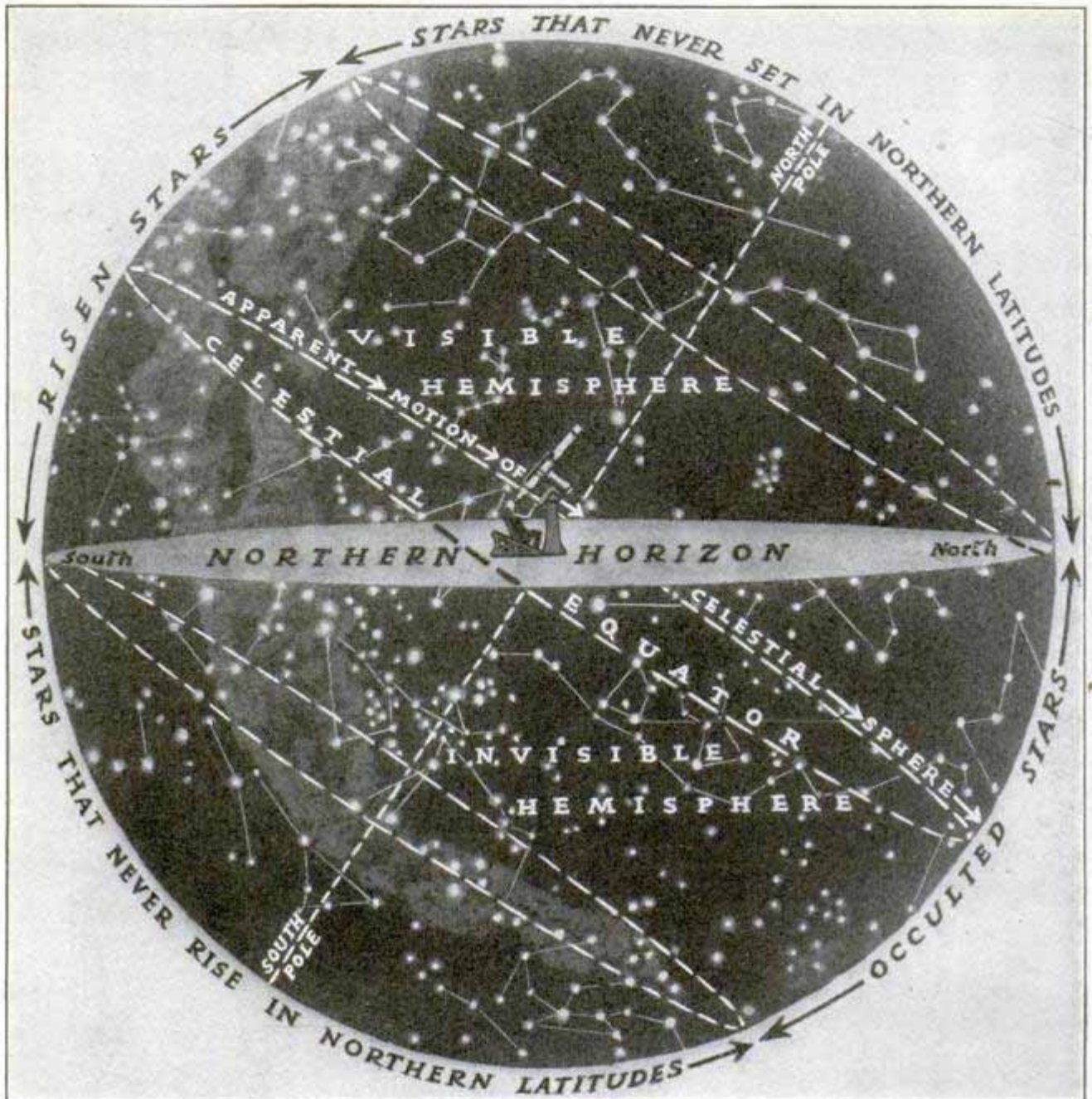

Copyright, S. W. Clatworthy

Looking through a Telescope at a Latitude Approximately That of Chicago, to Show the Relation of the Visible and Invisible Hemispheres and Their Stars

Cæsar saw it, or as it appeared to Noah while he navigated the ark.

The Chicago planetarium, surmounted by an eighty-five-foot copper dome, on the inside of which the stars are to be pictured, is being built on an island in Lake Michigan. When it is completed, the projection machine will be able to show the heavens as they appear from any point on the globe. A touch of a button will transfer the onlooker to the north pole as easily as the radio takes him to distant climes, and another touch will transport him to the south pole, with the Southern Cross shining directly overhead. The Zeiss pro-

jector is so built that it can be speeded up until the planets and their satellites dart through the sky at such a rate an entire year's movement can be shown in seven seconds. Or the operator can stop the movement of all but the sun and moon, and show their paths for a year or more through the maze of distant constellations.

☐ Popular Mechanics Magazine does not publish the name of the maker or seller of any device described in its pages, but this information is kept on file and will be furnished free upon application to our Bureau of Information.

*Corpus. Curran Bldg 2020  
25 Broadway, New York*

**GASOLINE-TANK LOCK  
THWARTS THIEVES**

*Tanklock 3099*  
Replacing the ordinary cap on an auto gasoline tank, a recently developed locking cap offers additional protection against theft of the car. A sleeve takes the place of the old cap on the tank, and is fastened immovably. Over this sleeve the locking cap is screwed. By screwing the cap down tight, and locking it, the tank is made air-tight, and no gasoline will flow to the vacuum tank. By unscrewing the cap a couple of turns and relocking, air is admitted to the tank and the normal flow to the vacuum tank is resumed. For cars equipped with a pressure gasoline feed the process is reversed. In this case, when the cap is not tight, no pressure can be built up in the tank, and the car cannot be started. When the cap is tight, the car is ready to operate.

*Suggest public banks*

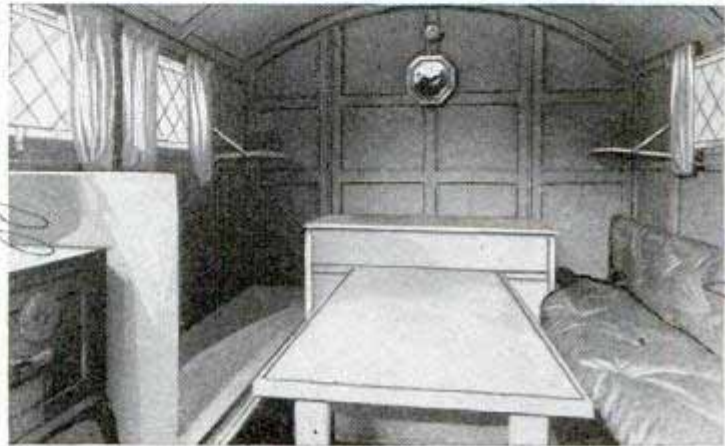
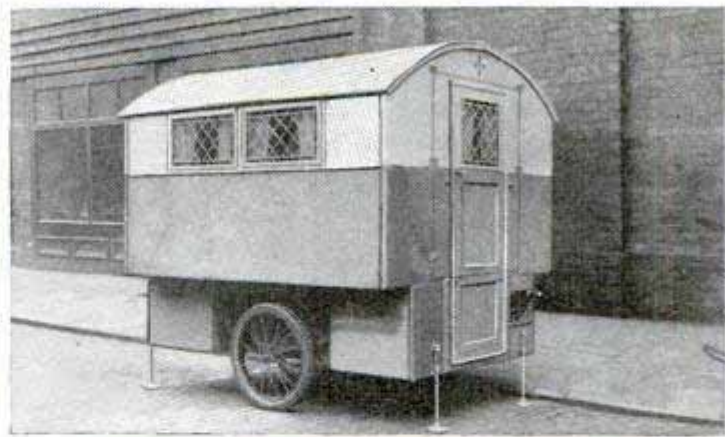

At Top, Campers' Collapsible Home on Trailer; Center, View of Interior, and, Below, Packed for Traveling

**"BUGGY" GIVES PAINTERS  
ACCESS TO PIPES**

*3063*  
Through the use of rubber-tired "buggies" on which a man can lie and propel himself in a pipe, a San Francisco water company has solved the difficult problem of completing the inside protecting paint coat at the joints of steel water pipes from sixteen to thirty-six inches in diameter.

In larger pipes, crawling is possible, but in the smaller sizes, the buggy has been used to allow men to enter pipe lines as far as 1,000 feet. The appliance consists of two axles, about four feet apart, and a light body of boards, the axles being bent to follow the curve of the pipe. Lying on the buggy, the painter propels himself with his feet and carries painting equipment in his hands.

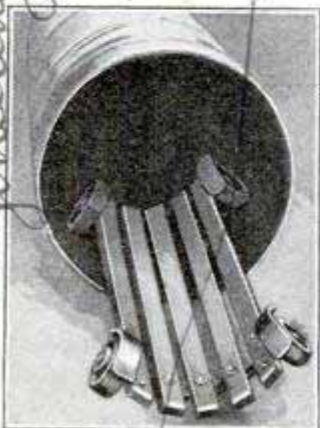

**CAMPERS' COLLAPSIBLE HOME  
IS MOUNTED ON TRAILER**

Campers who dislike tents now may take along a collapsible home mounted on an auto trailer. On the road, the van folds into one-third its normal size for towing, but when parked and opened, it becomes a roomy compartment with bunks, a lounge, baggage room, five cupboards, a clothes chest, stove, and cooking and dining equipment for three persons. It is fitted with a door and rear and side windows.

☛The first iron works in America was near Richmond, Va.

*Collapsible Home, Stanley & Leffers, London, Victoria Embankment, W.I. England  
S.A. Sanford*

*Engineering News Record 6/10/29*

*Club of Inverness 9/18/30*

*Spring Valley Water Co.*

2966

Ann...  
 Pedogram Co,  
 Box 840, Washington, D.C.

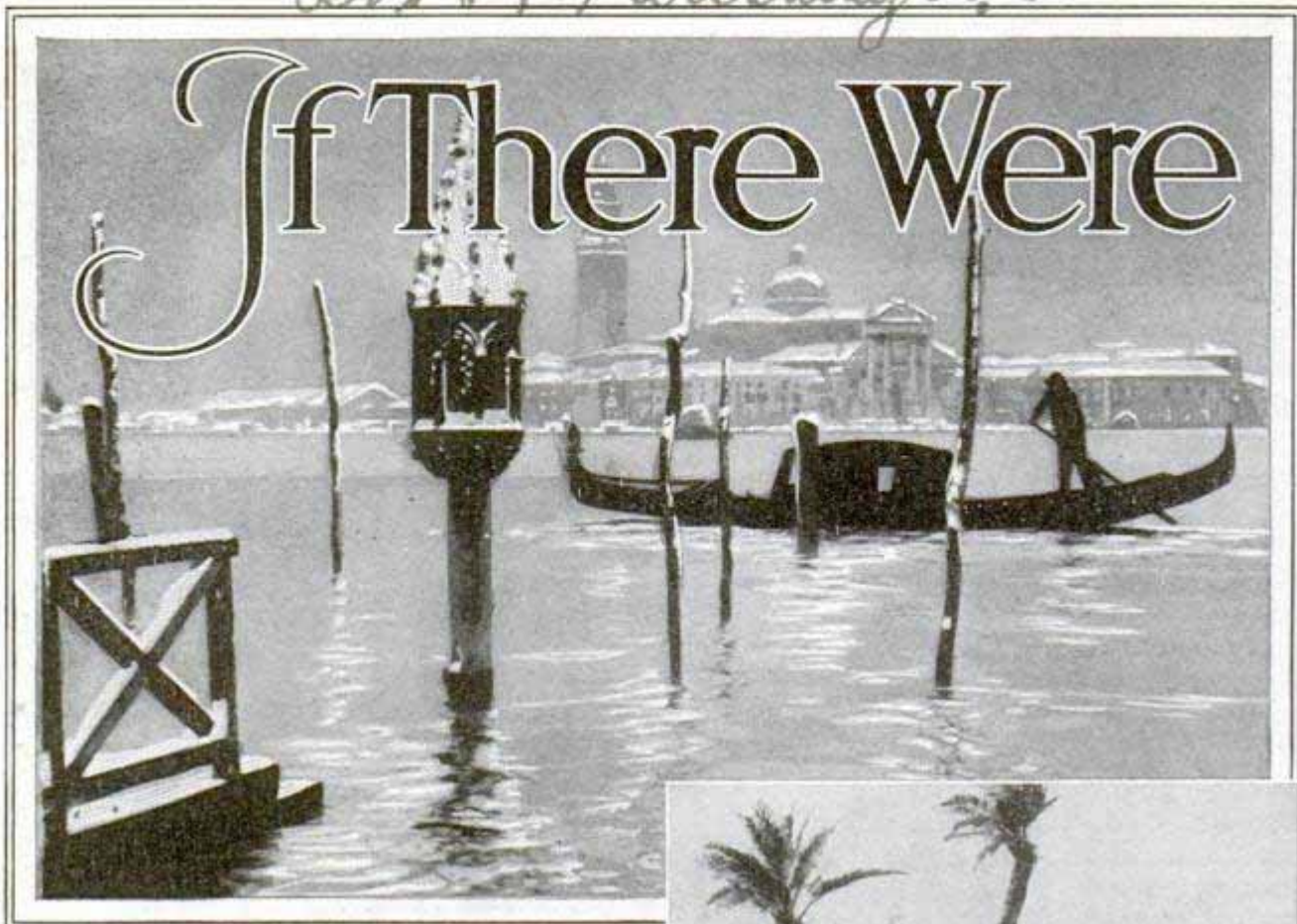

What a February Snowstorm Did to Venice This Year, and, Below, an Oasis Village in the Sahara

ONCE more science is busy with the Gulf Stream. The latest chapter in the long history of research relating to this most famous of ocean currents is now being written at the Straits of Florida. On board the three car ferries of the Florida East Coast railway, which make daily round trips between Key West and Havana, careful observers are making frequent measurements of the water temperature with tested thermometers. One of these ships, the "Henry M. Flagler," carries an elaborate instrument, which continuously and automatically registers the temperature of the water at the vessel's intake pipe, many feet below the surface of the ocean.

Meanwhile experts are digesting the results of these observations, figuring the speed of the current from the plotted drift of the ferries, and from the combined records of water temperature and water movement are trying to learn just how much heat from the tropics is delivered each day by way of the narrow passage between Florida and Cuba to the North Atlantic ocean, where it becomes one of

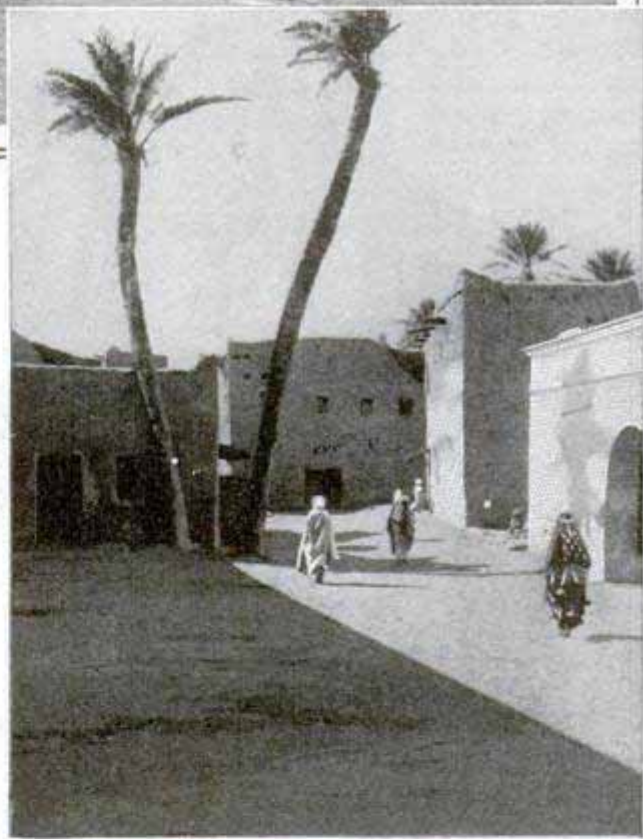

the chief factors in controlling the weather of adjacent lands.

Will this undertaking help to give us more accurate weather forecasts and enable an increase in the range of time for which such forecasts can be made? Certainly many meteorologists cherish such a hope, however cautiously they may express their views on the subject.

# No Gulf Stream

The idea of getting a line on coming weather by making observations at the fountainhead of the Gulf Stream is an old one. It dates back to the winter of 1845-46, which was very abnormal in England and elsewhere in western Europe. The weather was exceptionally mild and was accompanied by much rain and high southwesterly gales. An English scientist, Colonel Sabine, attributed this abnormality to an unusual extension of warm water from the Gulf Stream toward European shores. He suggested that such conditions might result from an unusually rapid flow of water through the Straits of Florida some months earlier, and that, if regular observations were made at the straits and reported to England, the occurrence of unusually warm or cold seasons might be forecast with fair certainty.

Since Sabine's time, a great deal has been learned about weather and likewise about the Gulf Stream, but the relations of this ocean current and others to weather are still somewhat obscure, despite a vast amount of controversy that has raged over this subject. Some relations between the Gulf Stream and the atmosphere are beyond question. Its movement is due chiefly to the trade winds, which, blowing from easterly quadrants, produce a great westward drift of water across the Atlantic in the equatorial region. This is called the Equatorial current. As its progress is blocked by the

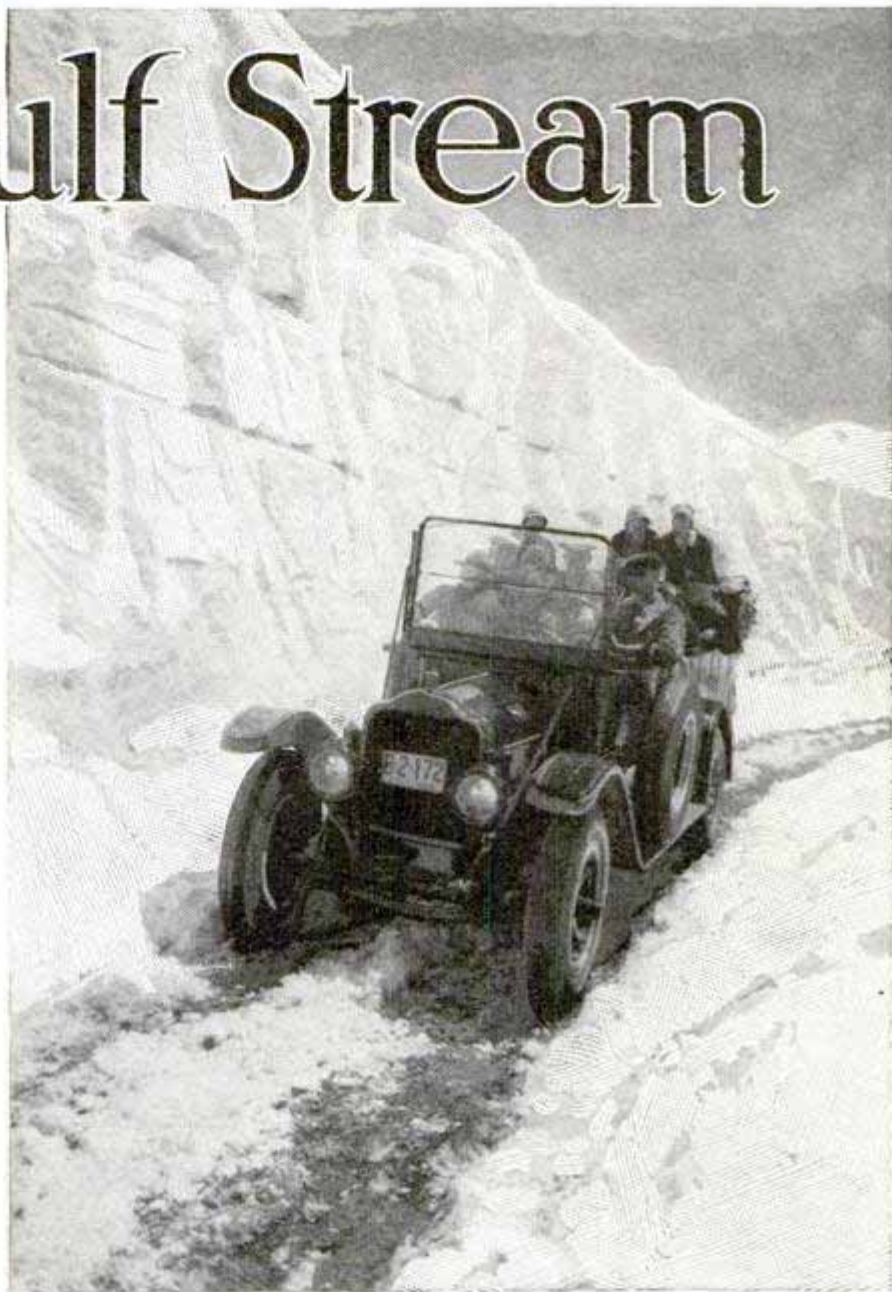

According to Scientists, Rocky Mountain Conditions Such as This Would Prevail in Sunny France If the Gulf Stream Were Cut Off

American continent, part of the water turns southward along the coast of South America, part (called the Antilles current) flows north to the eastward of Cuba and the Bahamas, but, mainly on account of the shape of the coast, the greater part passes through the Yucatan channel into the Gulf of Mexico.

Here the Gulf Stream proper is born. On account of the narrowness of the exit through the Straits of Florida, the water is banked up until it is a foot or more above the level of the Atlantic, and it is this "head" of water that gives the stream its swift flow northward along the coast of the United States. In the Gulf, also,

2966

the already warm water becomes even more strongly heated and grows very salty through excessive evaporation.

From the Straits of Florida the Gulf Stream emerges into the North Atlantic as the mighty swift-flowing indigo-blue "river in the ocean." As it leaves the Gulf, it is only about fifty miles wide and 2,100 feet deep. Even so, says Admiral Pillsbury, the water flowing through the strait each hour amounts on an average to 90,000,000,000 tons, and if this hourly supply were evaporated, it would yield more salt than a hundred times all the seagoing vessels afloat throughout the world could carry. The heat conveyed by the water from the torrid to the temperate zone is supposed to be more than would be produced by the burning of 2,000,000 tons of coal a minute.

Passing northward, the Gulf Stream is joined by the Antilles current, from which it receives an additional large supply of heat. Off the coast of Newfoundland, at a location that varies with the season and also to a considerable extent from year to year, it encounters the cold Labrador current, flowing down from the Arctic. The contrast in temperature between the two currents is so sharp that on one occasion a vessel of the International Ice Pa-

trol, passing from one to the other, measured a temperature of thirty-four degrees at the bow and fifty-six degrees at the stern at the same moment. Here, in spring and early summer, icebergs menace shipping, and at all seasons the mingling of the warm and cold air masses overlying the two currents produces the fogs for which this region is notorious.

East of the Grand Banks, the Gulf Stream water is driven by the prevailing westerly winds eastward toward the shores of Europe in a broad slow-moving shallow current known as the Gulf Stream drift. A branch of this drift curves south to join the Equatorial current, completing the circuit of waters around the great Sargasso Sea, while the rest sweeps on toward the British isles and northward in branches that bathe the coast of Norway, of Iceland and even of Spitzbergen, 700 miles north of the arctic circle. The water is still comparatively warm after its long journey across the Atlantic. The mean sea temperature off the Hebrides is more than forty-seven degrees higher than off the American coast in the same latitude and in the course of the Labrador current, while the influence of the warm water is sufficient to prevent ice from forming in the Norwegian fjords wherever

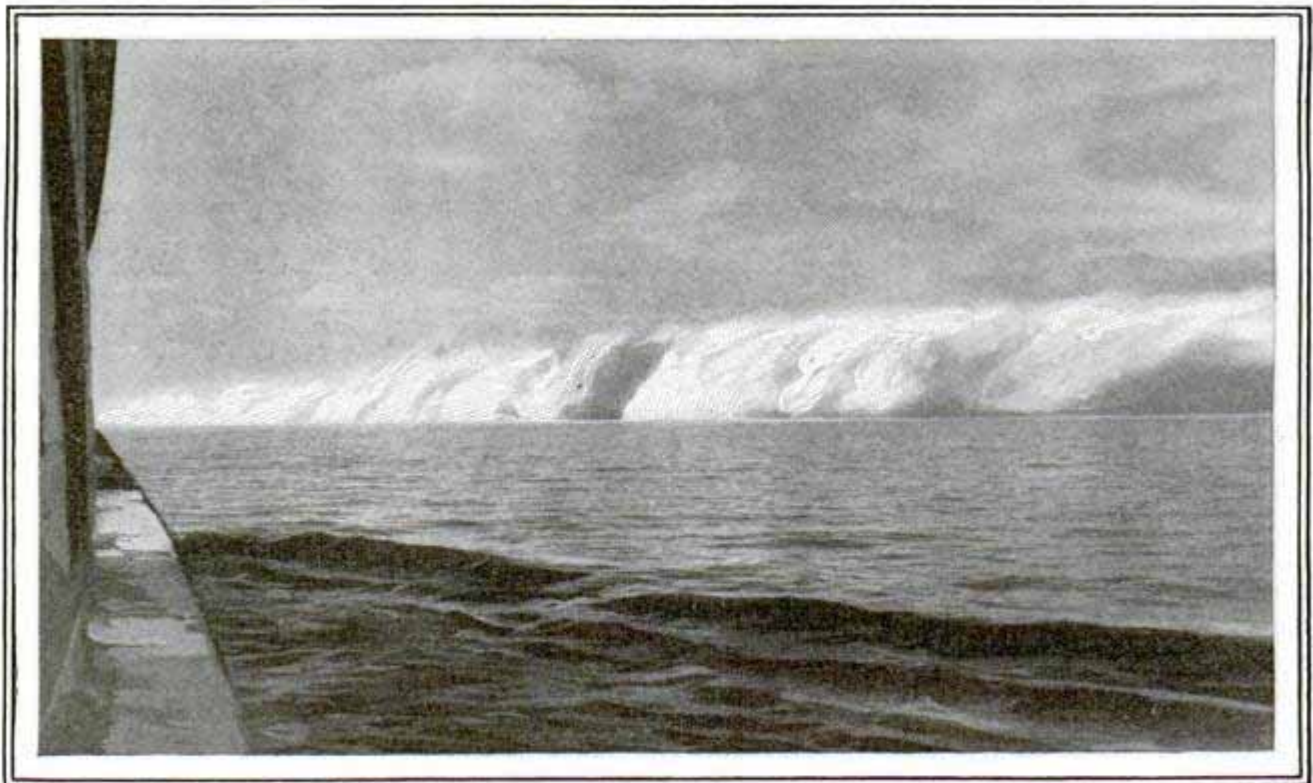

Where the Warm Gulf Stream and the Cold Labrador Current Meet, Fog Banks, like This One, Are Common; Long Dreaded by Mariners, They Are Now Feared by Aviators Venturing over the Ocean



they are freely open to it.

The gigantic volume of warm water that the Gulf Stream pours into the North Atlantic necessarily warms the air above it. What are the effects on weather and climate?

A marine current can affect weather on shore only through the agency of the winds. Both Europe and the United States lie in a region where there is a general drift of the atmosphere from west to east. Thus the influence of the Atlantic is more felt in western Europe than in the eastern United States; the former having milder winters and cooler summers than the latter. One of the principal regulators of weather in the North Atlantic region is a permanent low, lying usually to the south of Iceland and known as the "Iceland low." It is produced by the contrast in temperature between the warm ocean water and the cold ice caps of Greenland and Iceland. As the latter do not melt away in summer,

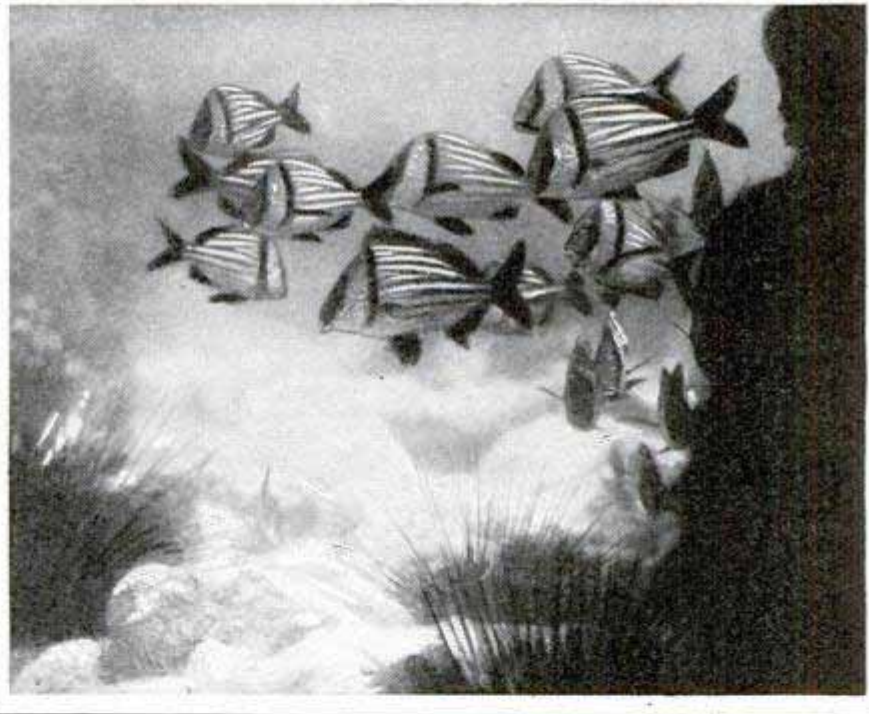

Courtesy The Carnegie Institution

Benjamin Franklin's Chart of the Gulf Stream, Published in 1770, and School of Pork Fish at Loggerhead Key, Florida

this low lasts throughout the year, but it varies greatly in location, size and intensity—partly, at least, on account of changes in the temperature of the Gulf Stream water—and these variations have marked effects on European weather. The circulation of air around the Iceland low causes Europe to have a great prevalence of winds from the southwest—hence from a relatively warm part of the Atlantic.

2966

The question is sometimes asked: What would happen if some radical change should occur in the course of the Gulf Stream, so that it no longer supplied its warm waters to the northern part of the Atlantic? While it is hardly possible to foresee all the consequences of such an event, some of them can be stated with more or less confidence. The cooling of the ocean water would weaken the circulation of the winds over it, and in the eastern United States, where the bulk of the rainfall is now due to winds from the Atlantic, the climate would become much drier.

The effects on the climate of Europe would be far more striking. The Iceland low would cease to exist. There would be a prevalence of northwesterly winds, which, blowing from a cold ocean and from the ice fields of the Arctic, would cause intensely cold winters in European countries. Warm weather might prevail in summer but, on account of the high latitude, it would be of comparatively brief duration. There would be a rapid growth of the glaciers, and, in short, a gradual return of the Ice Age. Eventually—perhaps in a few years or decades—the majority of storms would pass so far south that the now arid regions of northern Africa would receive copious rains. The Sahara desert would “blossom as the rose,” and the Egyptian peasants would no

longer need to irrigate their fields with the water of the Nile. Thus the same change that would ruin Europe would bring prosperity to the southern shores of the Mediterranean.

The permanent dislocation of the Gulf Stream, though not likely to be witnessed in our time, is not absolutely impossible. When the building of the Panama canal was first talked of, fears were often expressed that, by opening a passage to the Equatorial current, it might cause that current to flow into the Pacific and thus cut off the supply of the Gulf Stream. Of course, these fears were groundless, because any ordinary canal, even if built without locks, would be far too small to have such an effect. On the other hand, a broad sea-level channel cut through Central America—say at the Gulf of Honduras, which lies closer to the present course of the Equatorial current than does the Isthmus of Panama—would certainly deplete the Gulf Stream, and, if it were big enough, would obliterate it altogether. There is, to be sure, no likelihood that engineers will ever construct such a channel—but nature may. A tremendous earthquake, in that notoriously seismic region, might cause a subsidence of the land and open just such a passage.

The damming of the Straits of Florida would probably have pronounced effects



Where a Railroad Worried Weather Prophets; Some Predicted That This Viaduct over the Florida Keys Would Dam the Gulf Stream Sufficiently to Affect the Climate of Europe



*2891 Business Machines, Tabulating Machine Co.*

on the climate of Europe, despite the fact that much warm water would still be borne northward by the Antilles current. Prof. Alphonse Berget, of the Oceanographic Institute in Paris, has lately suggested that this may happen some day—not through the work of mankind but through that of reef-building coral "insects."

"Should the Gulf Stream be thus diverted from its course," he writes, "the British isles, France and Portugal would have rigorous winters, with temperatures down to thirty or forty below zero. Sleighs would be seen on the streets. People could indulge in winter sports, agreeable, no doubt, to some, but the change would be painful to most of us, habituated as we are to a mild climate."

Europe had a taste of such conditions last winter. There was nothing wrong with the Gulf Stream, but an immense area of high atmospheric pressure spread, for some unknown reason, over the northern part of the continent, and for several weeks the influence of the mild ocean was cut off. In many districts, the weather was the coldest ever known. Snow fell on the shores of the Mediterranean, and fifteen-foot snowdrifts were reported from Constantinople. Such was Europe, deprived temporarily of the genial warmth of Gulf Stream waters.

The important relations of the Gulf Stream waters to fisheries are recognized in the many investigations that have been carried on by the international council for the study of the sea on the European side of the Atlantic.

An example of this was experienced on our side in the year 1882, when a temporary shift of the stream, under the influence of heavy north winds, destroyed edible tilefish in enormous numbers. It was estimated that fully a billion of the fish were killed by exposure to cold water, and for some years the race was believed to be extinct.



It Does the Work of Several Persons in Keeping Books, Adding and Other Tasks; the "Business Brain" in Operation

**MACHINE AS "BUSINESS BRAIN" DOES WORK OF CLERKS**

Cards, properly punched, are translated into budget reports, sales analyses, statements and other lists on a time and labor-saving machine recently introduced in Los Angeles. Only three persons are needed to operate it, and it is said to perform the tasks of a bookkeeper, an adding machine, cash register and calculator.

**FLASHLIGHT FOR ANGLER TELLS WHEN FISH BITE**

Fish that toy with bait before they strike send flashlight signals to anglers whose rods are equipped with a visible warning apparatus consisting of a small battery and an appliance which fits on the fishing rod in such manner that contact is made



and a light flashes when the line is pulled even gently. The signal weighs but three ounces and may be used on rods or on tie-ups in ice fishing. When the fish is playing with the bait, the light flashes on and off, but when it strikes, a lever moves down to throw the light on constantly and at the same time automatically releases the line.

☐ Butterflies' wings are covered by scales.

*50 Broad St. New York*

*and Power*

*Shovel Toy Mfg. Co. Box 1009. Schenectady, N.Y.*

30 392

*Corvick, 9146*

*Woodward av. Detroit Mich*

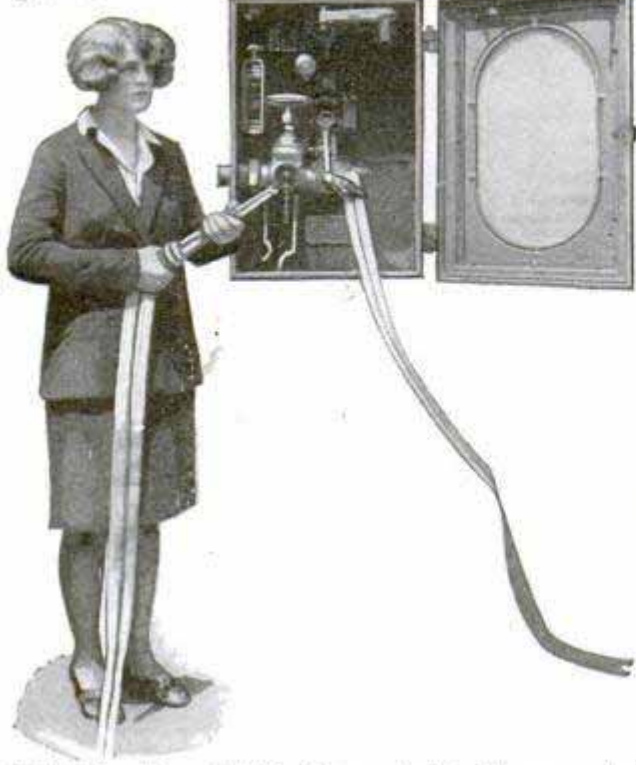

Wall Fire Hose Which Automatically Turns on the Water and Sends in an Alarm

**WALL HOSE RINGS FIRE ALARM WHEN LIFTED FROM HOOK**

Snatching a fire hose from an automatic wall cabinet will simultaneously open the hose valve, turn in a general fire alarm and register the location of the fire on an annunciator in the office of the building. For extremely large buildings there is also furnished a signal showing the approach to and location of the fire in the building, to avoid delay by the fire fighters in finding the point of the blaze. The appliance is operated when fifty feet of hose has been pulled from the cabinet which automatically releases the valve, this in turn starting the alarms and signals before the water has reached the nozzle of the hose. Ten seconds is the time estimated for the entire operation.

**QUAKES LINKED TO MOON**

The position of the moon has a definite relationship to some earthquakes, according to Maxwell W. Allen, of Sanger Calif., who has studied more than 1,200 earthquakes occurring in California since 1812. When an earthquake happens on a fault line, or crack, running northwest, the moon is likely to be in the western sky, or else has not risen and is in just the

opposite direction. "It appears that these shocks show a tendency to take place with the moon between the meridian and the western horizon, or between the nadir and eastern horizon," he said. "Shocks on the less numerous east-west faults cluster in the opposite quadrants. Where a series of quakes are observed in the same place, four or five of the stronger shocks occur with the moon within thirty degrees of the same part of the sky as the main shock of the sequence."

**AUTO TIRE CUTS REPAIRED WITHOUT DEFLATING**

Repairing surface cuts, blisters and sand pockets without removing the auto tire or letting out the air is made possible with an electric combination spot-and-tube vulcanizer. The appliance is used to repair surface cuts before they get deep enough to allow water to soak into the cords. The cut is cleaned and filled with raw gum, after which the portable heater is clamped to wheel and tire and left for twenty-five minutes. An automatic temperature control regulates the heater while the repair is curing. It also may be used as a plate



This Vulcanizer Repairs a Surface Cut without Removing or Deflating the Tire

and clamp for ordinary tube vulcanizing. In this capacity it heats in eight minutes.

*C.A. Shaler Co*

*held in Berkeley, Calif. Jan 20th*

*305*

*Arma Bull, 429-0 6/15/29*

*at Seismological. Dept. of America*

30 17 *Crusty tank*  
 POPULAR MECHANICS  
*United States Wheel + Track Laying Co.*  
 393

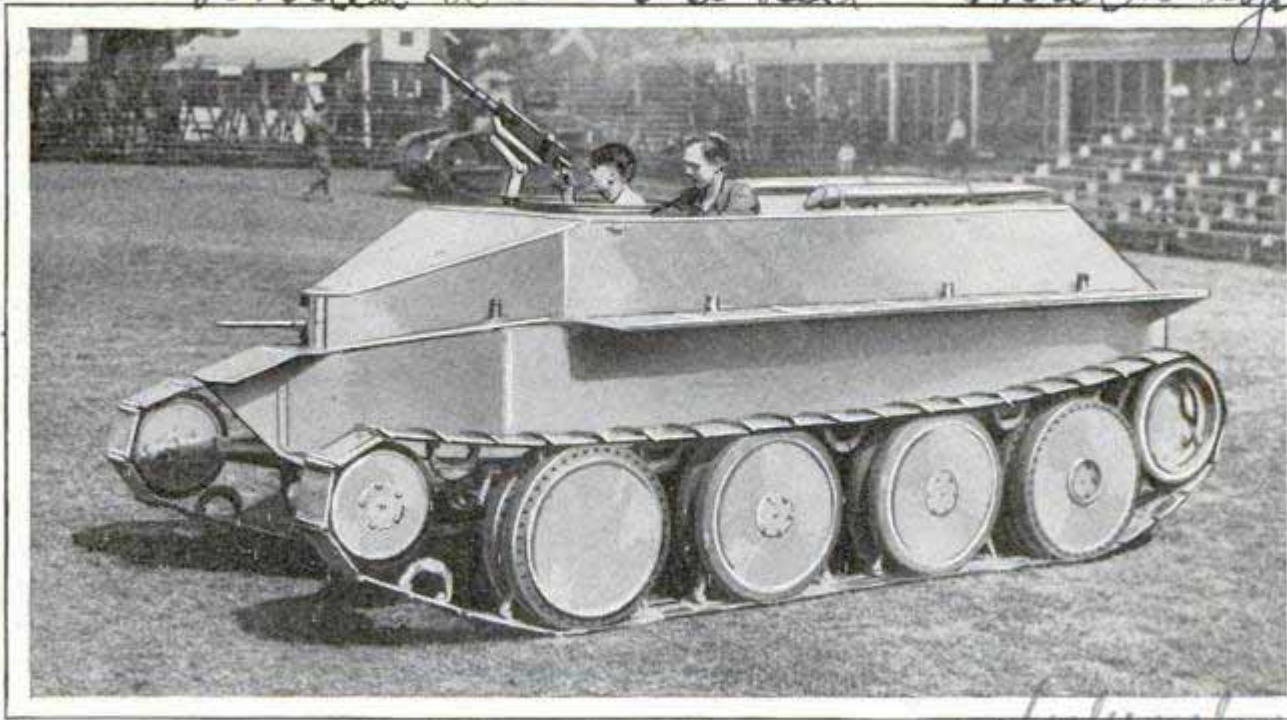

It Looks like a Motorboat on Barrels, but This New Instrument of War Makes Eighty Miles an Hour, in Contrast to the Lumbering Tanks of the World War

### ARMORED TANK MAKES SPEED OF EIGHTY MILES AN HOUR

Traveling over rough ground at sixty-five miles an hour, and going eighty miles over a smooth roadway, a high-speed tank, successor to the lumbering machines of the World War, recently was tried out at Governor's Island. Machine guns and anti-aircraft guns form part of the equipment of the speedy instrument of war.

### RHEUMATISM AS RAIN PROPHECY APPROVED BY SCIENCE

Scientific confirmation of the popular notion that persons suffering from rheumatism are good weather prophets has resulted from recent experiments for one year on 367 patients suffering from arthritis. For more than ninety per cent of the time, doctors found, there was a relation between the presence of storms and the increase of pain. For seventy-two per cent of the time the patients appeared to suffer more pain as barometric pressure fell and experienced relief with a rise, while for twenty-one per cent of the time the curve of pain went up when the barometric curve went down, and vice versa. Observations on humidity, temperature and atmospheric electricity were inconclusive, but it is believed possible

that these agents working together had some effect on the patients. Just how the change acts to increase the pain is not known, although a theory was expressed that the blood supply to the joints may be affected.

### SHELL-LIKE FARM IMPLEMENT BREAKS UP HARDPAN

Breaking up hardpan formed by continually plowing ground with the same plows is being accomplished in California

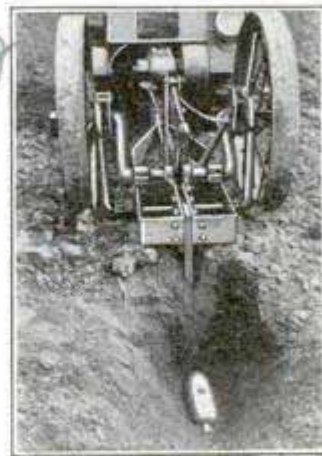

with an implement resembling an explosive shell. The tool, oblong and round with a point at one end, is known as a mole and is placed at the bottom of a furrow and pulled through the ground. It also is used for the purpose of providing

drains in land of such nature as to hold water.

Our Bureau of Information will answer all questions regarding articles appearing in this magazine.

*Chicago Daily News 6/24/29*

*International*  
*Alameda, Calif.*  
*Captn. C. W. Purcell*  
*3256 Kearfield Ave. Alameda, Calif.*

*Report to American*

# Unsung Heroes of



Sir Ernest Shackleton, Noted British Antarctic Explorer, Having a Wrestling Match with a Husky

By JOHN T. BRADY

COMM. Richard E. Byrd's desperate attempt to crown his glorious flying achievements by planting the Stars and Stripes at the south pole, as he did at the north pole, brings to a dramatic climax America's inspiring record of polar exploration.

But while you read, with patriotic pride, the thrilling accounts of the progress of the undertaking and praises for the courage of the commander and his men, give a thought occasionally to the dog heroes of the expedition, numbering close to one hundred. Think of these gallant canine explorers down there on the ice barrier, bucking into blizzards which lash and beat them like a million whips, struggling on though their feet be painfully lacerated by sharp ice and their bodies half paralyzed by the bitter cold, always leading the

way into the vast unknown emptiness and setting an inspiring example of determination and perseverance for their masters, with never a thought of pausing to rest until the exhaustion of human endurance demands it.

It is of these unsung heroes of the Byrd expedition and other efforts at polar exploration, these red-blooded utility dogs of the north who cannot speak for themselves and who know no religion except faithful service to man, their god, even though it mean death, that I sing, hoping to awaken the human sympathy and admiration which they so richly deserve. From the beginning of polar exploration, sledge dogs have played an important part, for almost every polar explorer relied upon them to guide and safeguard his footsteps over treacherous ice and ultimately drag him to his objective in the face of any difficulties.

Without their help, Peary, indomitable as he was, could never have reached within several hundred miles of the north pole, nor could he have returned alive. In acknowledging his debt of gratitude to them he says:

"It is an absolute certainty that the north pole would still be undiscovered but for the Eskimo dog to furnish traction power for our sledges, thus enabling us to carry supplies where nothing else could carry them."

That was written, of course, before the idea of flying to the top of the earth was dreamed of. But even today, when the airplane has reached a high degree of efficiency, Commander Byrd realized that without the help of sled dogs he could not hope to get within a safe flying distance of the south pole.

"They are the only possible insurance we can have for safety," Commander Byrd declared solemnly in telling why he considered them essential to the success of his expedition. "First we will need them

99  
Boston Sunday Post  
Mass

# Polar Dashes

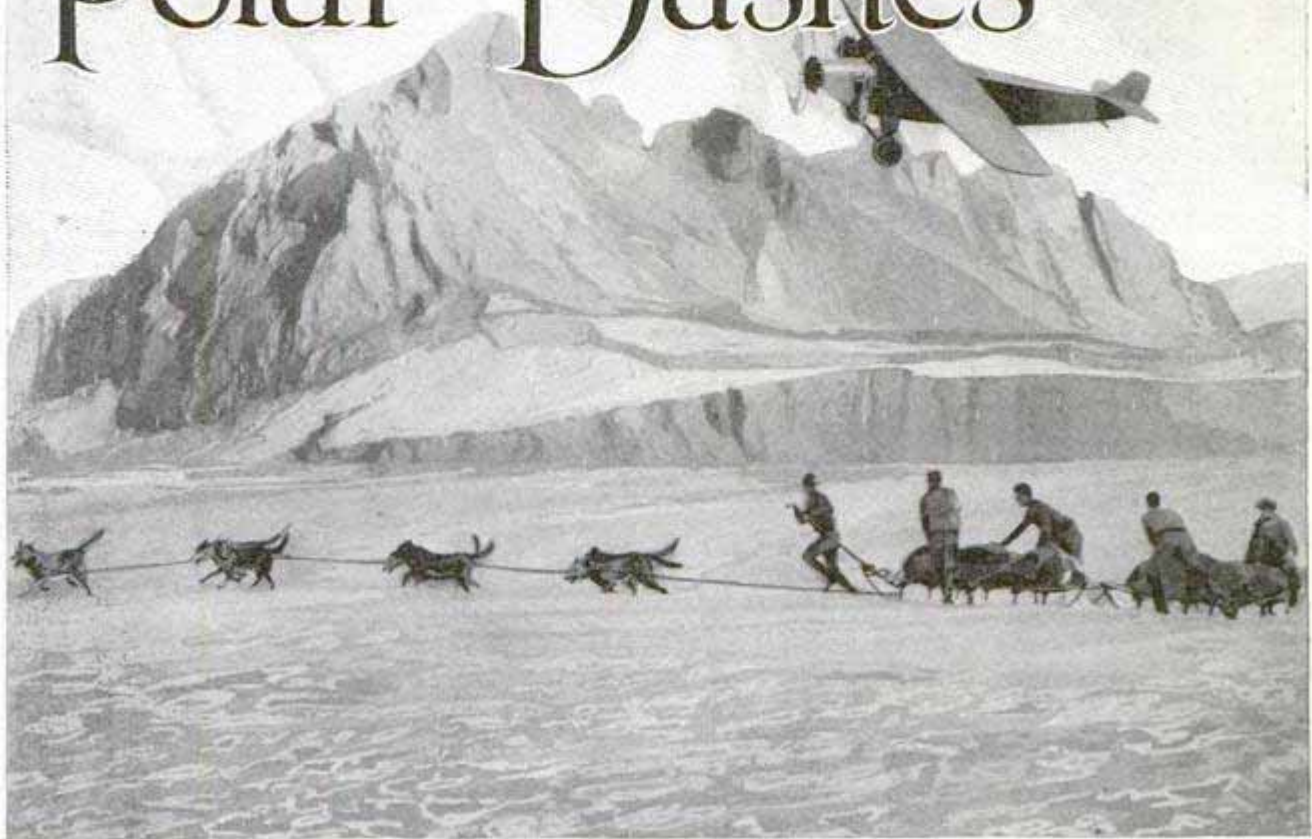

Composite Photograph Showing a Team of Byrd's Dogs, with Walden at the Gee Pole of the Forward Freight Sledge, as They Look in Action against the Antarctic Ice Barrier

in the work of hauling supplies. Then they will be used in searching for airplane landing fields and in setting up subbases. Thus, should my plane be forced down by one of the blizzards which start so quickly in the Antarctic, or by mechanical trouble, I will have some chance of landing near one of the emergency bases and surviving the storm. Also, with dogs and a couple of men at each subbase to help clear a runway, it may be possible to take off again after such a mishap, unless the plane is too badly wrecked.

"Without such emergency bases, I would indeed be in a desperate situation in case of a serious accident to my plane near the pole, and there would be no hope of reaching my main camp on foot, for animals for food do not exist in the antarctic interior, as Scott and Amundsen have already proved.

"So, if worst comes to worst, and I cannot fly back to the main base, I will be able to make a safe return by dog team. Snowstorms or blizzards may stop an air-

plane, but they won't stop a good team."

That's one reason why Byrd is using the oldest as well as the most modern form of transportation, but there is another based upon a tragedy which demonstrated the vital value of sled dogs to the antarctic explorer.

Once a great British explorer, Scott, made the fatal mistake of thinking that heavily furred ponies would be better than husky dogs to take him to the south pole. And he did reach it, but only to make a disappointing discovery. Amundsen, who had started later for the same goal by dog team, had reached it a month before him, and the Norwegian explorer's dogs brought him safely back, too, while Scott perished when his ponies failed him on the return trip.

"The whole difference between Amundsen's dash to the south pole and Scott's heroic struggle and tragic finish may be expressed in four letters, D-O-G-S, and this is said, not in a spirit of criticism but of sorrowful fact," commented Peary.

Remembering this most tragic episode of antarctic exploration, Commander Byrd wisely chose husky sled dogs as his "safety insurance." As long as they have a leg under them, as long as there is a limp left in their gaunt and weary bodies, they will forge on, game to the last breath. This was touchingly illustrated by the story of old "Spy," told me by one of the members of the Byrd expedition who spent some time in Antarctica, last winter, but returned to the United States on the ship that came back for necessary additional food, equipment, and more dogs to replace thirty-seven which had already given their lives to the cause, victims of contaminated water.

Though a rather old dog, "Spy" threw his bulk into the harness with all his strength, and his willingness, grit, and pulling power won the admiration of every man in the camp. But eventually he broke down under the strain, and one morning Commander Byrd found him more dead than alive from cold and exhaustion. He picked up the benumbed form of the animal and took it into his own quarters. After a few days of careful nursing, the dog began to gain strength, and as soon

as he was able to walk, he whined to be let out. Then he did something which wrung the hearts of the most unsentimental of Commander Byrd's followers.

While he was outdoors, the team in which he used to run drove up to the commander's headquarters. Old "Spy" greeted his former teammates with a joyous howl, and though one of his paws was still so sore that he could not touch it to the ground, he hobbled on three legs to his customary place in the team. And when the driver, after receiving orders about the load, made no move to harness him, it was pitiful, and wonderful too, to see "Spy" limp painfully back to the man's side, whimpering and begging as plainly as could be to be hooked in his place. Commander Byrd called to him as the team started mushing, but old "Spy" broke into a shambling run, and moving his poor stiff legs by sheer will power, limped along in his old place, until he dropped in his tracks.

Everybody in camp realized that old "Spy's" working days were over, and a rousing cheer went up when the commander announced that there would be no more trail for the dog, and henceforth



Siberian Huskies, Not So Large as Some Other Types, but for Combined Speed and Endurance on a Long, Tough Trail, They Cannot Be Beaten

"Spy" would be the mascot of the expedition, taking the place of "Chinook," who strangely disappeared into the icy antarctic wilderness when he felt he was no longer useful to man.

No wonder the owners of such huskies care little about fine points of pedigree, or whether they have drooping or upstanding ears, beautiful lines, markings, etc. They say blood will tell, but when a man's greatest need is the assurance that his dogs can make the grade when hundreds of miles of ice and snow and freezing wind lie between him and civilization, he must, if he values his life, call upon the red-blooded husky rather than the blue-blooded pedigreed thoroughbred.

It is quite generally agreed, however, that to be worthy of the name, a husky must have a strain of wolf blood, but the common belief that the Eskimo husky is almost identical with the wolf is erroneous, and this applies to the Baffinland, Greenland and Labrador huskies, the Siberian and Russian Samoyedes, the inbreds sired by "Chinook," and even to the Alaskan malemutes. As a general rule the so-called Eskimo dogs—Byrd has eighty of them—are short and stocky, averaging about seventy-five pounds in weight when full-grown, with large broad heads, upstanding ears, pointed muzzles, thick, long hair, furred legs, small, compact feet, and a plumed tail that curls up over their backs.

This description also applies in a general way to the speedier Siberians, though they are lighter, not so thick-set, slightly taller, shorter-haired and less quarrelsome. You find quite a mixture of colors among Siberians, and Leonhard Seppala, international champion dog musher and real hero of the famous serum run to Nome, who has bred them for years, thinks they are

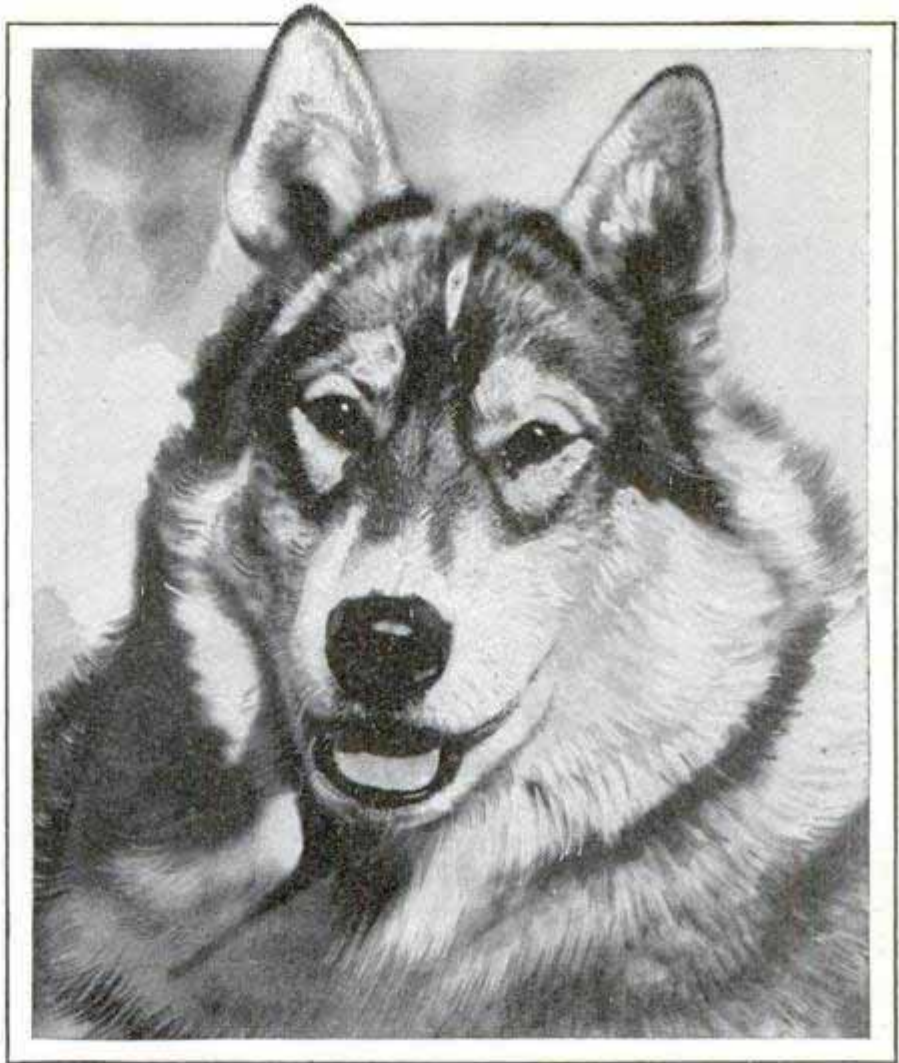

Beautiful Head of a Siberian Husky; Fierce When Angered but Loyal and Intelligent as a Worker

descended from the fox rather than from the wolf.

Nor does the husky possess the savagery of the wolf, which is frequently, but unjustly, attributed to him. When abused and half-starved, he can be savage enough, it is true. And he may show some of the savagery of the wolf in battling for his life with other dogs, but he is not a man-eater. The most ordinary kind of decent and fair treatment brings out the nobler traits of his nature, and makes him docile, tractable, and even a safer pet for children than some high-strung thoroughbred dogs of recognized breeds.

The training of huskies to harness begins when they are mere puppies, and is not so difficult as might be imagined, because they seem to enjoy it. The Eskimos of Coronation gulf make complete sets of harness for new-born pups and perform a peculiar ritual over them to endow them with the attributes of a good draft animal.

They pull their ears and bid them grow

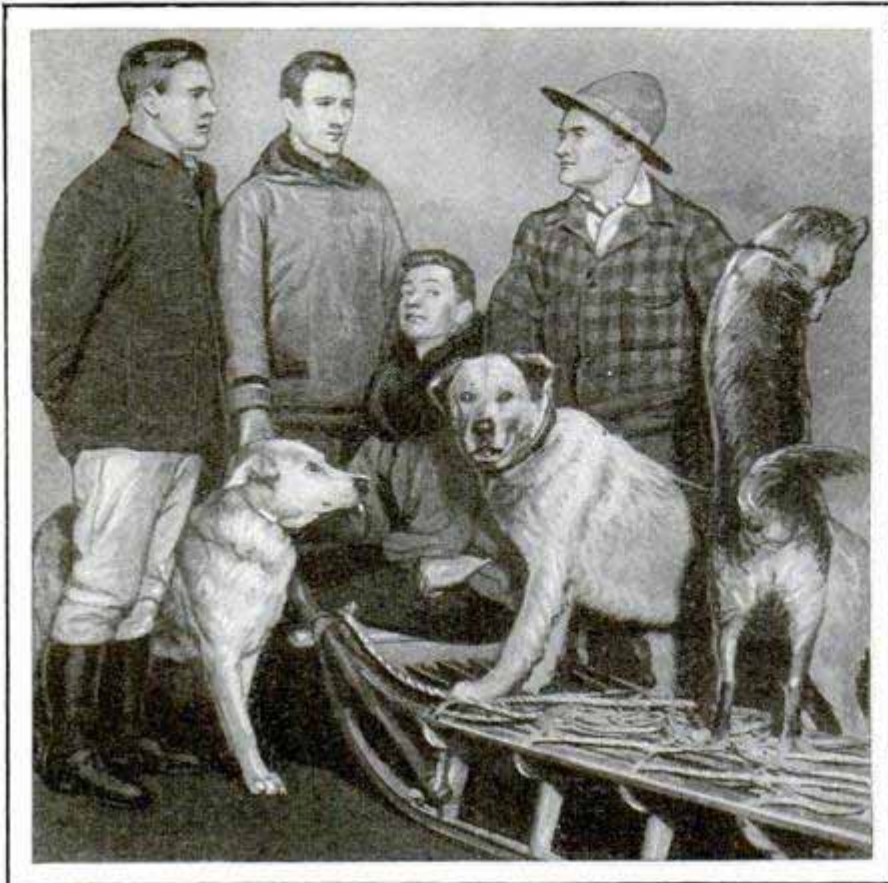

Sled-Dog Drivers, All of New England, Who Have Been Doing Great Work with the Byrd Expedition

the point of exhaustion. The weight of the log is increased as the dog's strength and pulling power grow, and later he is hitched to a loaded sledge. But care is taken at all times not to load him too heavily, lest he suffer a strain that may trouble him all his life.

After these preliminaries, Walden hitches a young dog between two old ones, and from his teammates the puppy soon learns to start at the command "Mush," to swing right at the order to "Gee," to the left when he hears "Haw," and to stop when the driver yells "Whoa." Of course some dogs learn faster than others, depending on their degree of intelligence, but the older dogs help greatly in training

long and sensitive so that their sense of hearing may be acute; blow into their nostrils to give them the most delicate sense of smell; slap and torment them until they snarl and snap that they may be fierce and savage and able to hold their own in a fray, and stretch their legs one after another praying that they may grow long and sturdy. Then a miniature harness of deerskin is put on the pup and his master pushes him away with one hand and pulls as hard as he can on the trace with the other, telling the dog meanwhile that he must pull like that on the sled when he grows up.

But the white man is more humane, practical and scientific in training his sled dogs, and rarely puts them in harness until they are at least six to nine months of age. Arthur T. Walden, the country's most famous sled-dog musher, who has charge of Byrd's huskies, will take a puppy born in February, for example, and start training him with the first snowfall of the following winter, but never earlier than that. He usually hitches a puppy to a small log of wood to begin with and makes him drag it until he is physically tired, but not to

the dunces by snapping viciously at them if they do the wrong thing or fail to respond to a command promptly.

As to the pulling power, speed and endurance of huskies, Walden is my authority for the statement that a dog team can go farther and faster on its own food than any other team in the world. Theoretically, a team of seven to nine dogs can travel with one man and a load of 1,200 pounds of food and equipment, a distance of 1,400 miles at an average of better than twenty miles a day.

Nine out of ten dogs will not face a blizzard but are inclined to turn tail and run with it, Scotty Allan once told me. But they can be led into it. So, a good leader must have enough pride and courage of dog blood to keep his teammates nosing into the frigid gale, and enough of the sagacity of the wolf to make him infallible on the trail.

Such a leader was old "Chinook," who twice saved his master's life in the White Mountains of New Hampshire. Many who read of "Chinook's" death with the Byrd expedition may be wondering still why Walden should have insisted on sub-



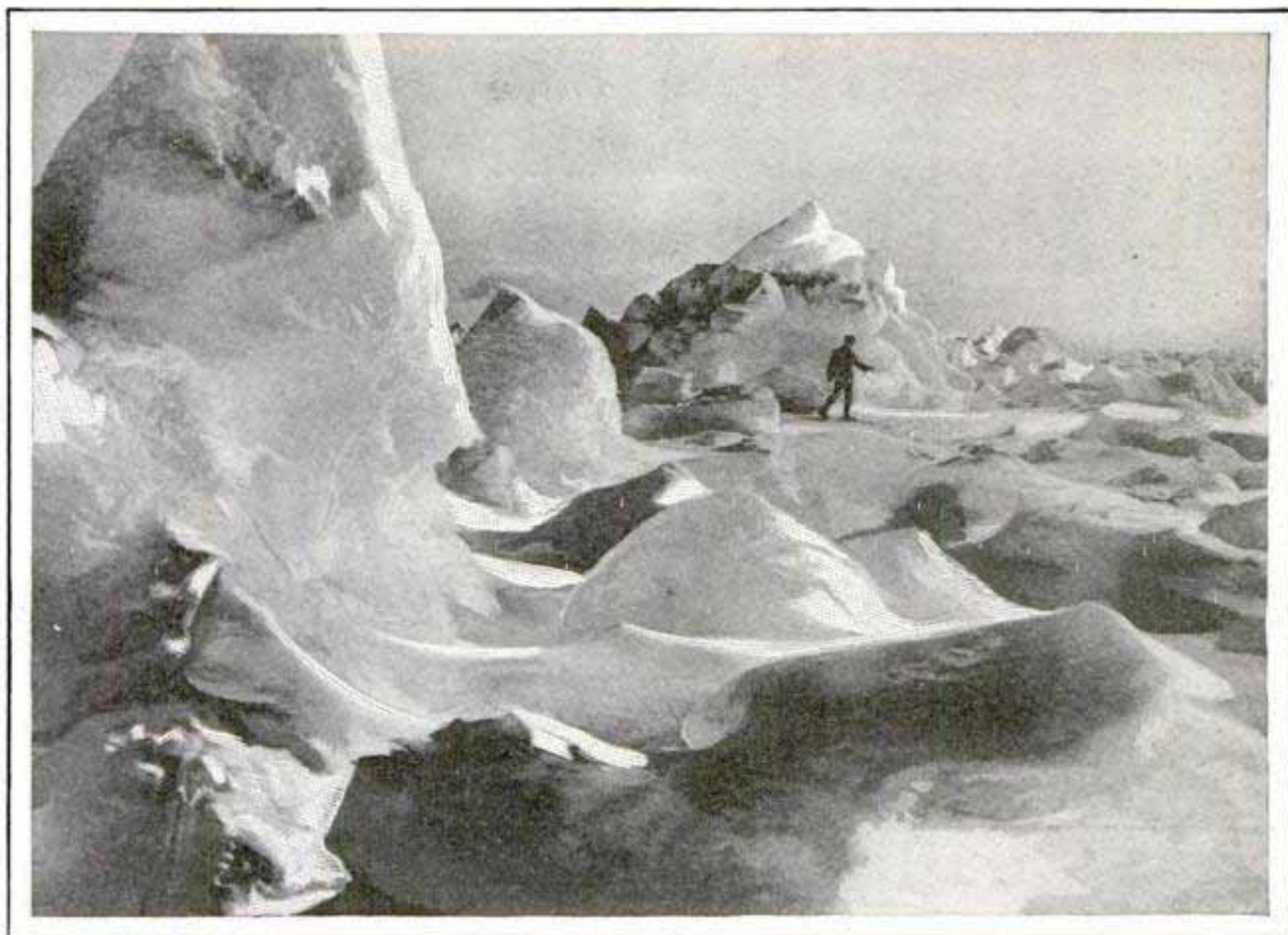

Glimpse of Antarctic Country, Showing the Rough Ice Fields Byrd's Men and Dogs Must Travel in Their Conquest of the South Pole

jecting such an old dog to the hardship of a venture into the antarctic terrain. Well, the sentimental attachment between the man and his dog is half the answer, and here's the other half:

A few years ago when Walden was attempting to go through Crawford Notch in the White Mountains in the middle of the winter with "Chinook" at the head of his team, a sudden snowslide struck the sleigh, twisted it out of his hands, and swept him down into a deep gully. After a desperate struggle, he managed to get his head above the surface of the snow, but the effort exhausted him, and as his team was nowhere in sight, he had visions of freezing to death there. Meantime the dogs had raced on, but had not gone far, when "Chinook" missed his master's voice and stopped short. Then he turned abruptly about and began to back-trail, fairly dragging his teammates behind him, and baying every two or three minutes until he heard the faint call of his name.

This helped him to locate the spot where Walden was struggling, and on reaching it, the dog maneuvered the sleigh so that

one of the runners came within his master's reach. To it Walden clung and the dogs quickly snaked him out of danger.

Again, when Walden drove his dog team up the icy slopes of Mount Washington—the stunt they said a dog team couldn't do—"Chinook" got him out of a dangerous situation. On reaching the lower spur of Chandler ridge, Walden found that he had to cross the crest of an ice-covered slope as near to perpendicular as it could be and still give foothold to a man with the sharpest of creepers on.

Downward for a quarter of a mile that slope extended, and when the dogs were halfway across it, the sled began to slip away from the driver and move down that deadly incline. Then the dogs, feeling the weight of the slipping sled, stopped and tried to dig their toes into the ice. By exerting all their strength, they were able to hold their footing, but could not move forward or turn back. For a few minutes they remained tense and rigid, then some of the younger dogs began to flinch under the strain, and turn their heads as though contemplating a downward dash that

*the American Association*

would have meant serious injuries and perhaps death to all.

But old "Chinook" did not waver for an instant. Head up to the vicious gale that swept the crest of the slope, he stood firm and steadfast, setting an example which held the other dogs from stampeding, until a rope was attached to the sled and it was pulled up so that the dogs, relieved of its weight, could proceed.

**WALKING OVER RIVER ON CABLE  
PLAY FOR BRIDGE WORKER**

*3082*

Walking across the Hudson river on slender cables is considered just part of the day's task by workmen erecting the largest suspension bridge in the world across the river in New York. One of the rope-walking bridge builders fell 150 feet off another span without injury. The cables are to support a footbridge for use in stretching the main cables.

**LAW MAKES SEAPLANE A BOAT  
WHEN USED FOR FISHING**

*3111*

When is a seaplane not a seaplane? The legal answer seems to be when it is a boat, and it becomes a boat when floating on the sea for fishing. The owner of an amphibian plane landed in the ocean off Atlantic City with a party of friends to fish. Government officials saw him and later notified the flyer that, if he used the plane for fishing purposes, he must conform to maritime regulations by equipping it with life preservers, fog horn, red and green running lights, a signal pistol and flare cartridges.

*Leurs Weichers*

**SQUEEZE CHEMICALS FROM GAS  
UNDER HIGH PRESSURE**

*3089*

University of Illinois chemists in experimental work are literally squeezing valuable chemical products out of various kinds of gases by subjecting the vapors to enormous pressures until they approach water in density. The work is being carried on in a specially constructed building, the research workers being protected from explosions by heavy steel plates surrounding the storage tanks and other pressure equipment. By subjecting the gases to pressures as high as 15,000 pounds to the square inch, the experimenters hope to utilize cheap gases in the manufacture of industrial chemicals. At present, the work is directed toward making sulphuric and other mineral acids from carbonic-acid gas, producing industrial alcohol from water gas, and transforming methyl alcohol into acetic acid. The chemists already have utilized benzine and carbon monoxide under pressure to make synthetic oil of bitter almonds. Industries are particularly interested in the production of alcohol from water gas and acetic acid from methyl alcohol. Combining atmospheric nitrogen and hydrogen under pressure has long been done to produce ammonia.

*Prof. Johnson of Industrial Chemistry*

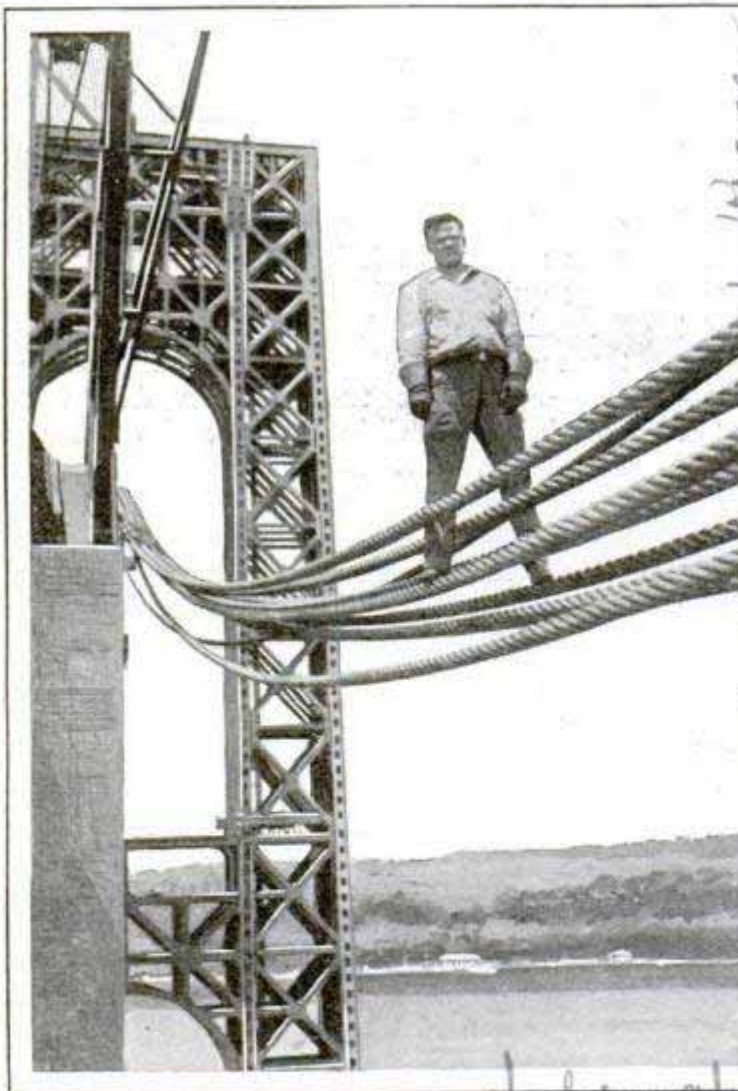

Cables over the Hudson River Test the Agility of the Men Erecting the World's Largest Suspension Bridge

*Ant. Jas. & Wright,  
201 Penn Ave.*

# AUTOMATIC RADIO BEACON GUIDES PLANES IN FOG

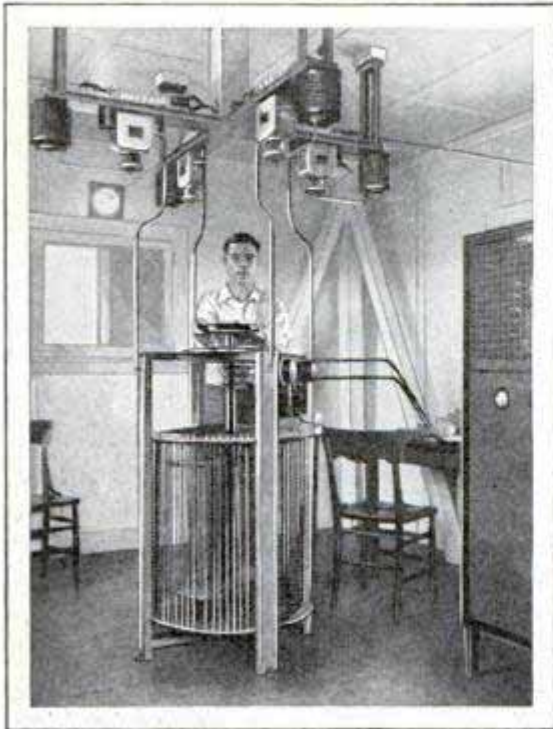

Operating Room Where Signals Are Sent; Center, Aerial Tower from Which Antennae Stretch to the Four Points of the Compass



This Appliance, the Goniometer, Causes Directional Radio Signals to Be Sent to the Point toward Which the Arrow Points



Guiding the paths of aviators from the ground, a radio aerial beacon has been placed in operation at Mitchell field, New York. It can guide flyers from the field within a radius of 400 miles by day and 1,400 miles at night, and has proved valuable in aiding pilots to hold their courses in foggy weather. It is operated automatically by an appliance known as a "goniometer" attached to aerials stretched to the four points of the compass. The aviator is guided by directional signals given after he has sent signals to the goniometer.

and, while questioning the motorists entering from Canada, are also able, by glancing in the mirror, to see the entire underside of the car. Any covering under the car is examined as a possible cache.

## RUM-RUNNING AUTOS DETECTED BY LIGHTS AND MIRRORS

Swimming-pool lamps and angled mirrors serve to detect automobiles carrying liquor at the United States end of the Peace bridge connecting Buffalo and Fort Erie, Ont. Four lanes of entry over the bridge past the custom offices are equipped with lamps sunk into the bridge floor, while mirrors are placed at an angle in the curbing opposite the lamps. Custom officers stop automobiles over the lights

## CROOKED SCREWDRIVER SHANK GIVES ROTARY ACTION

Rotary action is given to a screwdriver by a U-shaped crook in the shank with an elongated side nearest the handle, forming an angle between handle and blade which gives an easy action in driving a screw. Small screws can be started without holding and, in many cases, but one hand is required to do the work.

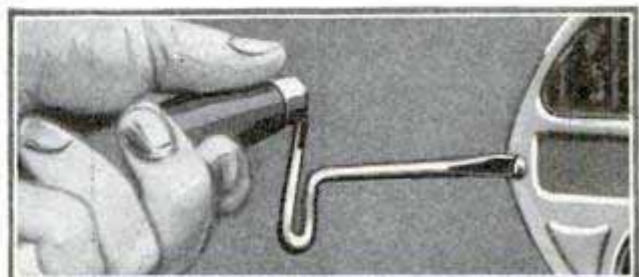

The U-Shaped Bend in This Screwdriver Is Designed to Give It Rotary Action

*Com. John W. Winter  
D. Leming 207*

*3010  
Triangle of security Co.  
First Ave. New York City*

1877

# Secrets of Ancient

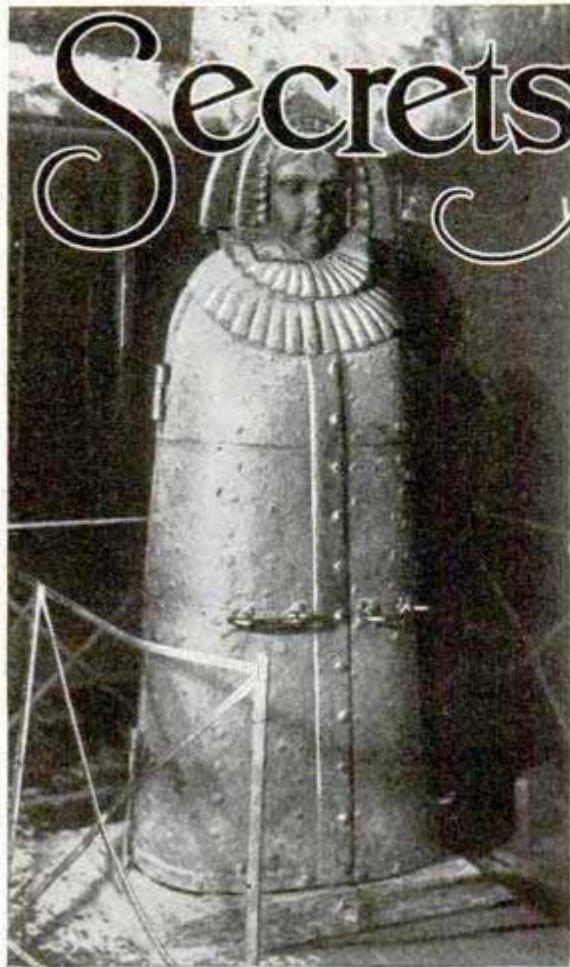

same captive. He found himself caged in iron from floor to ceiling. He looked up the lofty walls of this vast square cell and saw seven grated windows, heavily barred, set at irregular intervals in the wall, apparently to admit light and air. An iron bedstead, littered with straw, stood in a corner, and a vessel of water and a coarse dish holding coarser food.

The captive fell asleep. When he awoke, he saw a fresh pitcher of water and food in the cell, yet he had not heard a sound of anyone entering. The same thing happened the next night. In the morning, the puzzled captive, looking around his cell for an explanation of the mystery, noticed only five windows in the iron walls. He had left a wisp of straw

By HAROLD T. WILKINS

**H**IGH on a lonely rock, overlooking a bay on the wildest coast of Sicily, there stands today a castle which possesses a torture instrument more blood-curdling than anything imagined by fiction writers. Mention the name of this infamous stronghold, Tolfi, to the Sicilian peasant herding goats in the neighborhood, and he crosses himself with a shudder.

The heyday of this and other similar inventions was in the fifteenth century. At a time when Italy was torn with factions, a band of silent ruffians conveyed to Tolfi castle a bound victim, who had incurred the enmity of the sinister owner. They entered a dungeon cut deep into the solid rock, and passed through great folding iron doors, shut with a triple lock of enormous strength, into an iron cage. These iron doors never opened twice on the

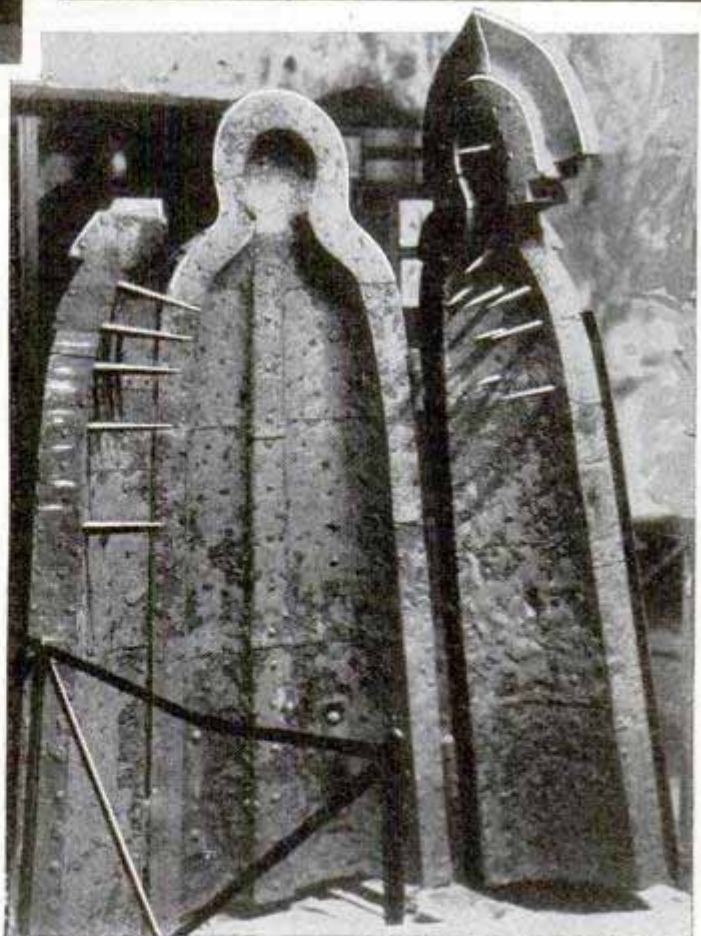

Courtesy Otto Mann  
Two Views of the "Iron Maiden," a Favorite Torture Device of Olden Times; Sharp Spikes Pierced the Victim Placed Inside

# Torture Chambers

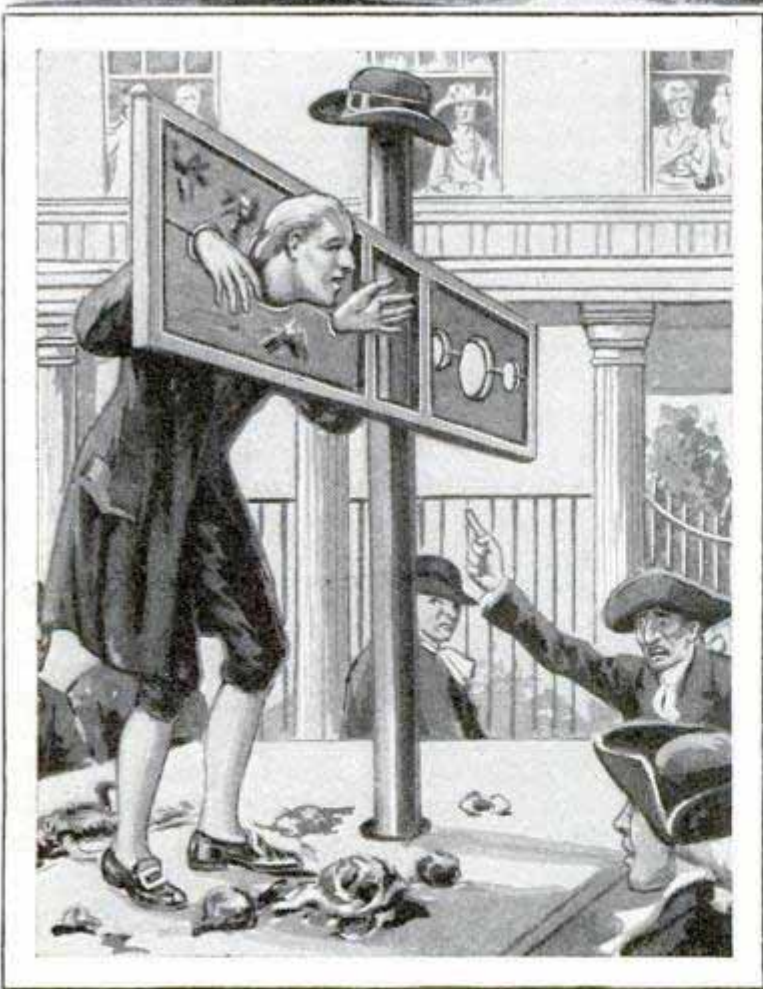
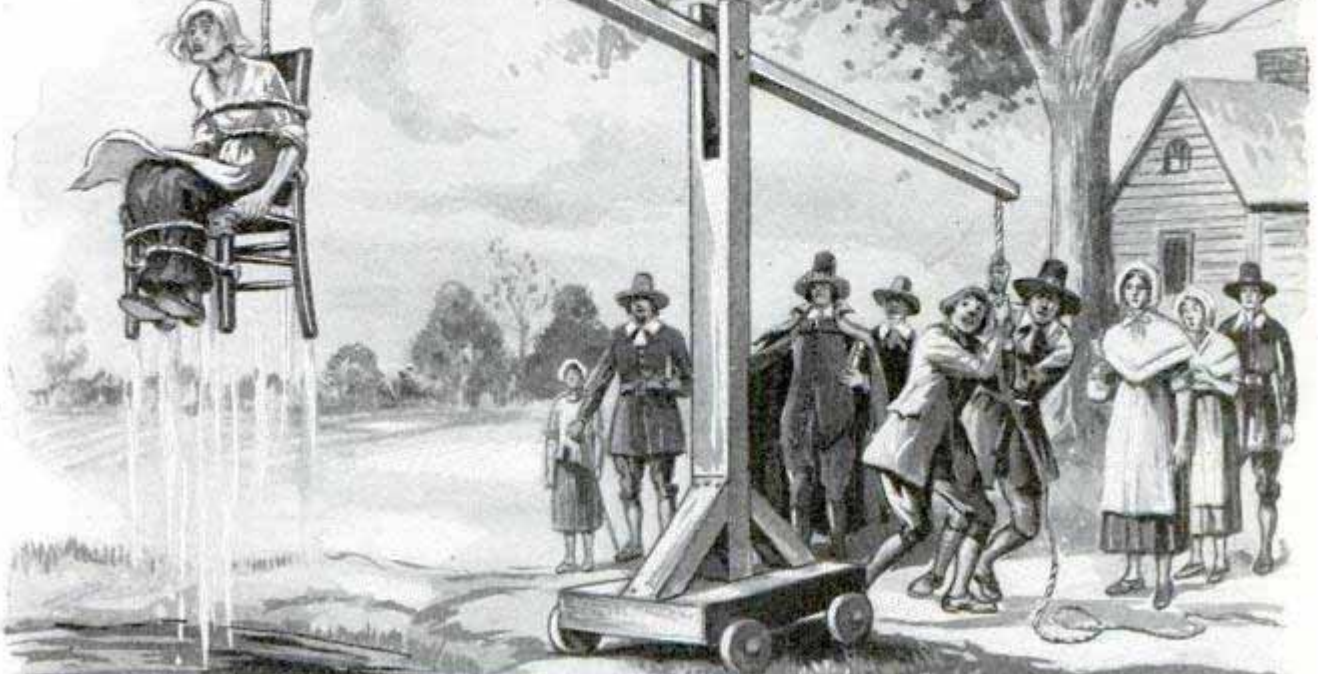

Commonly Used in the Days of Witchcraft, the Ducking Stool and the Pillory of 200 Years Ago

against the folding doors, so that any intruder would be bound to move it away. The straw lay just where he had placed it! Now he imagined that the dungeon had shrunk in size since he had entered it.

This iron prison was constructed as a cubical cage within another cubical cage, twice as large. The walls were thus double. There were two motions, a downward and an inward. The ceiling and walls, operated by a hydraulic engine, imperceptibly moved downward one section each twenty-four hours, masking one barred window of the seven on the iron wall. As soon as the downward

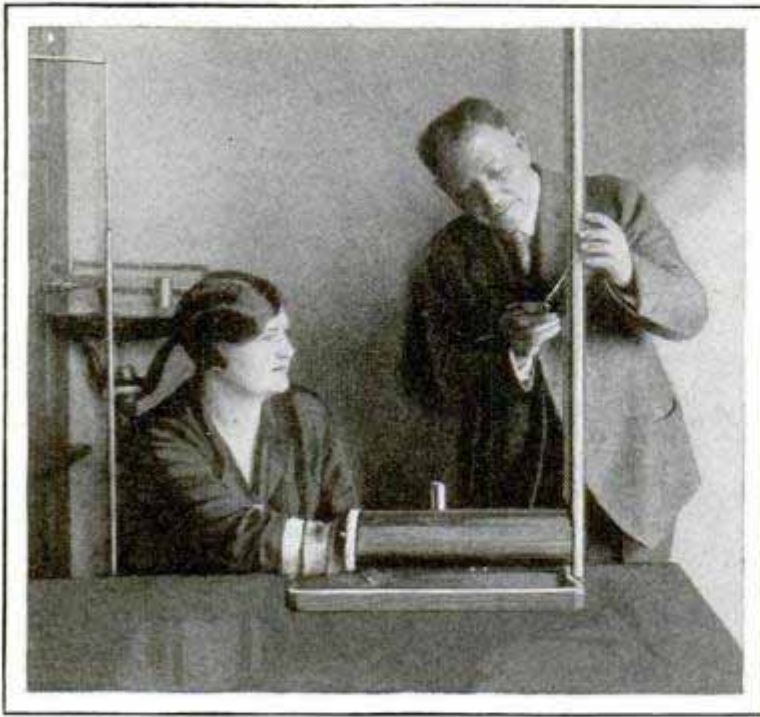

Painless but Based on Principles of the Old Torture Machines; This Apparatus Indicates Emotional Reactions of the Subject by Recording Changes in the Volume of the Arm Due to Inrush or Outflow of Blood to or from the Member

motion was finished, the inward motion began, in which the ceiling and floor dragged the inner walls inward a distance corresponding to one-seventh of their width. By the time the projecting parts of the ceiling and floor were in contact with the outer walls, the victim was dead.

For cruel ingenuity the old-time torture instruments of Europe make the blood of the American tourist run cold. The ancient records tell of the rack and the terrible "veglia," or "vigil." The victim's arms were tied behind his back in such a way that, when he was raised off the ground, the entire weight of the body rested upon the shoulder joints, wrenched violently from their sockets. The torture lasted as long as desired, and then the victim was let down slowly, released, unbound and his dislocated arms resettled in their places. That was the rack, for ordinary torture.

If this did not extract the desired confession, the veglia was applied. This abominable instrument was the invention of Girolamo Menghina of Siena. The victim was first completely shaven. Then the hangman fastened belts round his chest, and ropes pulling at his arms, bound together behind his head. His feet were lashed to a bar, and he was placed on a sharp stone perched on a stool. When

the victim's tense muscles touched this stone, it gave him almost unbearable pain.

The famous Palace of the Doges, at Venice, has a museum of instruments of torture. In one room of this palace was the famous "Bocca di Leone" (Lion's Mouth) into which anonymous charges were dropped. The terrible Council of Ten investigated the charges and swiftly punished the victims. The condemned man was taken into one of a block of horrible cells—still to be seen. A torch was placed in a loophole of the massive wall, for half an hour every day, to light the prisoner. By its glimmer, he scratched inscriptions on the wall with a rusty nail. In one cell, no man lived more than twenty-four hours.

The ghastly "chebba" hung on the walls of the famous campanile of San Marco, at Venice. The chebba was a wooden cage suspended from a pole, and the culprit was left in it to the mercy of wind and weather, for a day, a week, a month, a year or for life. An Englishman passing that way in the fifteenth century saw a man in the chebba who had been in it for a year.

The mysterious dungeons of old Seville were renowned for infamously ingenious instruments of torture. Some of them were in use when the liberating army of the French Republic swept them to the winds. The grand inquisitor held his court in the deep-vaulted cellar of a vast rotunda lit by two pale torches. A flight of steps led to the torture chamber.

The air of this living tomb was damp, and water dripped from walls, hung with the engines of the rack, the boot, enormous nails and thin and thick cords and gyves. A burning brazier in a corner darted out blue flames.

A prisoner was shown the implements of torture and urged to confess. If he refused, he was stripped and bound, and again entreated to speak, with promises of mercy. If he continued obstinate, he was shown more instruments of torture. Four masked men now tied his hands behind his back. He was to undergo the "torture of the pulley."

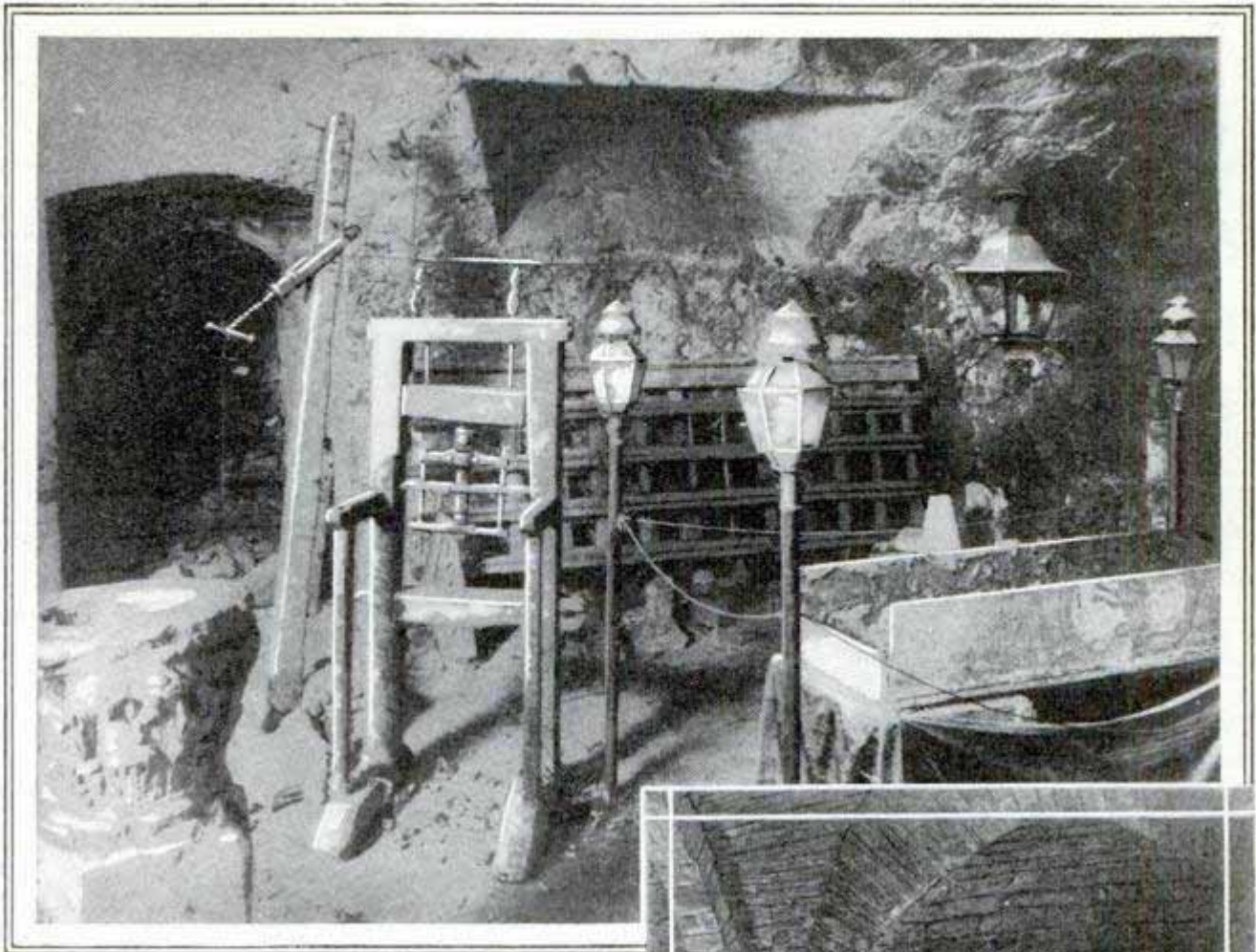

© P. & A.

Torture Chamber Unearthed in the Foundations of the Chancellor's Palace, at Granada, Spain

They suspended him by a cord running over a pulley and block. The executioners pulled hard on the cord and raised the man to the roof and then violently let him down within a few inches of the ground. His nerves were all taut and tense, and he expected to be smashed to pieces. He swooned, but as soon as he opened his eyes, the hangmen resumed the torture.

A repetition of the torture might be ordered, but any confession made under torture had to be confirmed after the victim had been removed from the torture chamber. As a rule, the torture was continued until the man or woman signified readiness to confess, when he or she was unbound and the confession was taken down in another room.

Another diabolical torture of the Spanish inquisition was known as the "water torment." The victim was first pinioned on a rack. A fine cloth, saturated with water, was placed over his face. One part of the cloth was introduced into the

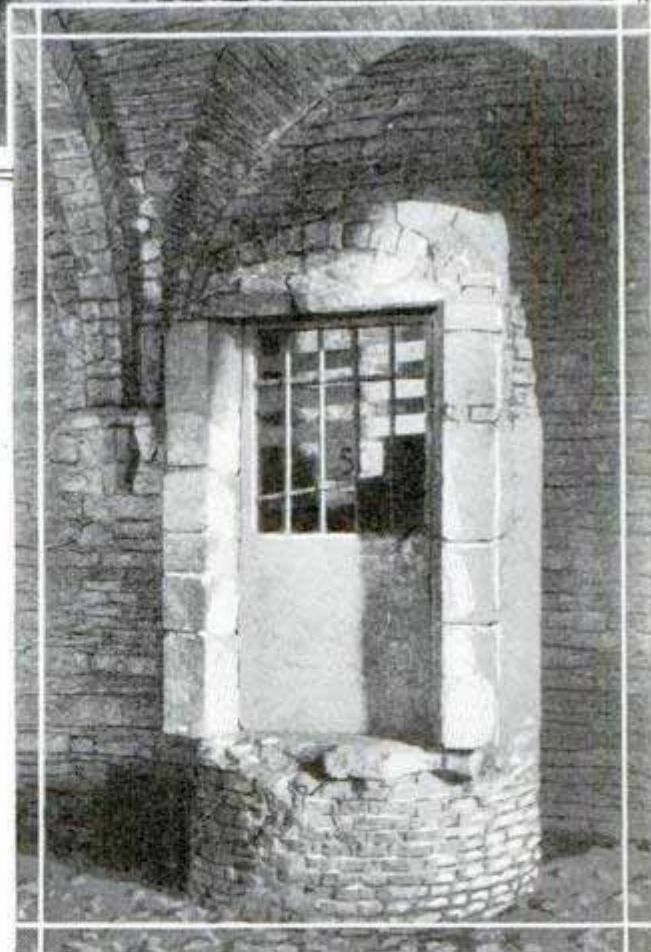

Well That Supplied Water for Torture Ceremonies in the Dungeon of the Castle at Ghent, Belgium

throat, the other covered the nostrils. Drop by drop, out of a funnel, the water trickled slowly across the saturated linen,

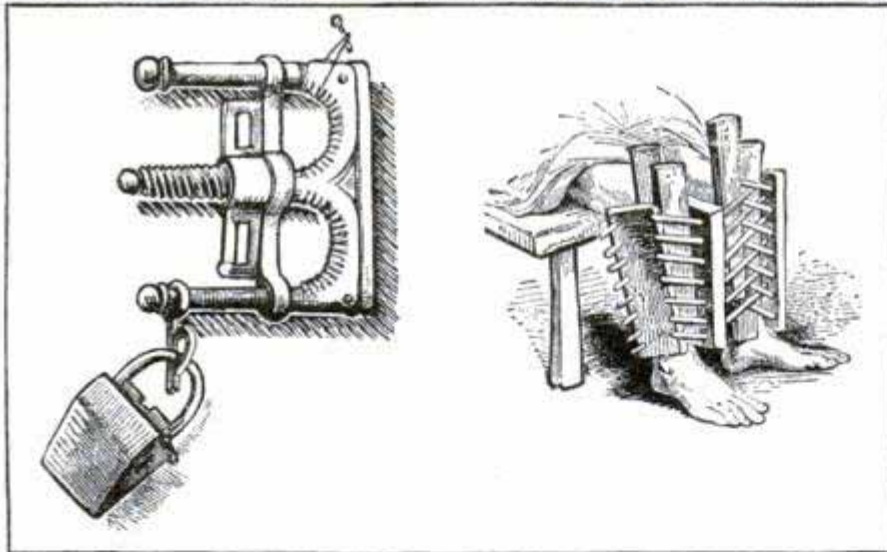

The "Five-Cornered Tower" at the Castle of Nuremberg, Germany, Where the "Iron Maiden" Was Kept, and Drawing of Thumbscrew and Boot

until presently the victim found it hard to breathe and simultaneously swallow the drops of water.

The Duke of Shrewsbury once arranged a remarkable exposition of instruments of torture in London. He had bought them at the royal castle of Nuremberg, Germany. Among them was the terrible "Iron Maiden." The face of a sphinx looked out from the exterior of this figure, which was a strong wooden sarcophagus, tied together with iron bands. Set in the walls of this instrument were two

doors, opened to allow the prisoner to be placed inside. The whole of the interior was fitted with long, sharp iron spikes, so that, when the doors were pressed shut, these prongs entered the victim's body.

The same exposition showed the Spanish "Donkey," which cut the body into halves; the wheel on which criminals were broken alive; the small lever with a sharp-toothed thumb and finger screw; the ducking cage for bakers found giving short weight; a pair of iron pincers with a screw for tearing out tongues; the Spanish mouthpiece or gag; the copper mask worn by the judge of the German robber barons; stretching gallows; garters to torture legs; mouthpieces for slitting the tongues of blasphemers; sieves through which boiling oil was poured on the victim's body, and iron gloves made hot before being put on the victim's hands.

American visitors to the "White Keep" of the Tower of London are shown a subcrypt or vault, today lighted by electricity, whitewashed and well ventilated, but

at one time a foul torture dungeon. In the old days of "Merrie England," the prisoners in the Tower descended a tortuous stone staircase, following the hangman or executioner who carried a candle whose dim light made the dark shadows more gloomy. Once in the dungeon, the victim's eyes fell on the instruments of torture ranged round the walls, and the doors, which were made thick to drown the cries of the tortured.

Opening into the torture chamber was the dungeon of "Little Ease," where a



prisoner could not even lie down on the cold flagstones, but had to maintain a squatting posture for days at a time. Neither light nor fresh air was admitted to the dungeon. Underneath it lay another great dungeon with no airshaft and in absolute darkness. In these damp, airless surroundings, 600 wretches were penned up in a place without standing room for 250 persons. They had no water, no food and no sanitary arrangements.

At the Tower there is still kept the "cravat" or engine for locking the hands, head and feet together, and nicknamed the "Scavenger's Daughter." This was made in two parts, with a broad hoop of iron fastened by a hinge. The prisoner had to kneel on the pavement and contract his body into the smallest possible space. Then the executioner knelt on his shoulders, introduced the hoop under the victim's legs, and compressed the victim closely until he was able to fasten the ends of the iron hoop over the small of the back. The time for this torture was one and a half hours, during which period the pressure of the infamous device made the blood gush from the nose, or, even, it was said, from the victim's hands and feet.

As late of 1750, a pirate tried at the Old Admiralty courts of England, refused to plead guilty to the indictment and was taken back to prison to be "pressed to death." This savage punishment was known as the "peine forte et dure," and under it a man was loaded with iron weights and pressed to death.

Stone chests with a bottom covered with sharp iron spikes are still to be seen in the manor house of Pucklechurch, Gloucestershire, England, wherein seris were shut down and pressed to death by robber barons in the "good old days." Secure within their moated castles and thick-walled keeps, these robber barons hung peaceable folk up by the feet in volumes of smoke to make them confess where they had hidden their money.

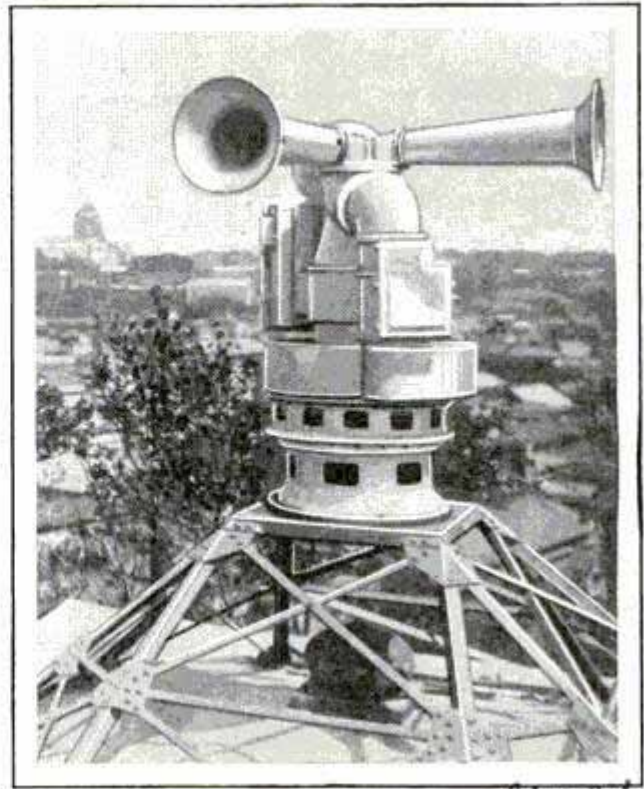

This Huge Siren atop a Tall Building Serves Residents of Tokyo as a City Clock

### SIREN SERVES AS CITY CLOCK REPLACING CANNON'S ROAR

Residents of Tokyo, Japan, in future will listen for the shriek of a siren instead of the roar of a cannon when they desire the correct time. A huge siren has been erected atop a tall building to signal to the city the hours of the day. It replaces the firing of a cannon at a near-by army post, which was discontinued by imperial order, as being a less distinctive sound than the shrill blast of the siren.

### AUTO SERVES AS A WARDROBE WITH HOOKS ON DOORS

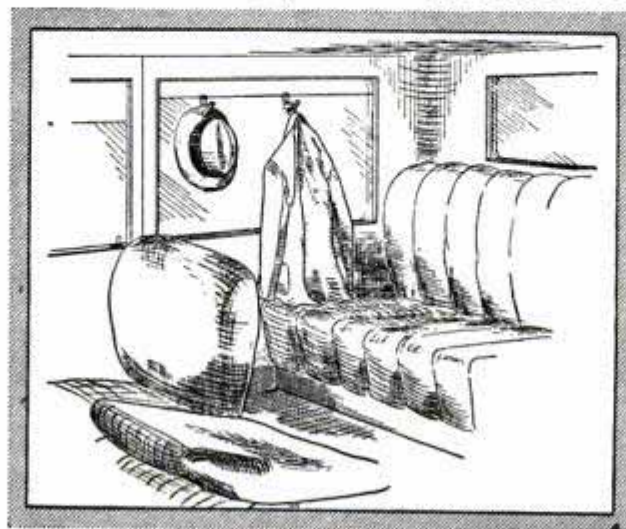

Hangers Adjusted on Auto Window Pane

Hat and coat hangers and other hooks that are easily slipped over the automobile windows, have been introduced to increase the usefulness of the car on camping or touring trips. They do not interfere with the opening or closing of the windows and may be removed quickly.

Frank Saxton  
old mech

3030  
Mr. Jean Vignaud.  
A. Le de la Jette, France



Model of Ocean Liner, Which It Is Claimed Can Cross the Atlantic in Thirty Hours

### CROSS OCEAN IN THIRTY HOURS ON LINER OF THE FUTURE

Crossing the Atlantic in thirty hours is claimed as a possibility by the inventor of an ocean liner somewhat resembling a cross between a large steamship and a giant dirigible. A model of the queer-looking craft has been undergoing tests off the coast of France to determine speed and endurance.

### "BOOTLEG" PLANES ARE BUILT FROM OLD WRECKS

"Bootlegged" airplanes, imitations of well-known makes but not licensed, and unsafe ships that have been reconstructed from the wreckage of other planes, have been discovered by inspectors of the aeronautics branch of the department of commerce. They warn prospective buyers to be on the lookout for such craft. To get possession of the license numbers and name plate of the manufacturer, an unscrupulous agent may purchase a wreck at a greatly reduced price and use the tags on

3046  
Donald E. Rye

Aviation 5/25/29

an unlicensed ship or employ parts in making a plane. Inspectors refuse to license such ships, but unwary customers may be deceived by the presence of the plates. Inferior parts, closely resembling those that have received official approval, are likewise used in some bootleg planes. The practice is dangerous, as such a ship may be unsafe, although, to the eye, it appears well constructed, inspectors point out. To curb the traffic in these airplanes, most ships are now licensed at the factories. Record is kept of all numbers allotted, so that any plane of a particular make, not already licensed and entered on the government list, may more easily be discovered. The detection of dangerous planes and the examination of pilots for licenses are two of the important duties of the inspectors of the service, in their efforts to promote safety in aviation.

### FARMER RIDES WALKING PLOW WITHOUT MAKING TURNS

3041

Turning at the end of a furrow is eliminated in a two-way walking plow to which may be attached a seat and appliance enabling the plowman to ride. The implement is fitted with two points set in opposite directions, and the moldboard is on a hinge with two faces, so that it can swing around. At the end of the furrow, the horses are turned on unplowed ground. This swings the beam and handles on a swivel. A chain attached to the handle flips the moldboard to the opposite side and the plow is ready to start back. This causes less waste of ground from dead furrows and from the trampling of the horses at the ends of the field as well as making unnecessary the dragging about of the plow.

A seat may be attached to the plow which then is held upright by a shoe running along the unplowed ground at a distance of about two feet, being low enough to allow the beam to swing over it when turned. The maker says it is both lighter and less expensive than a wheeled plow.



3048  
Mr. James Porter  
N. Fourth  
St. Paul, Minn.

# AMERICA AND CANADA JOIN TO PRESERVE NIAGARA

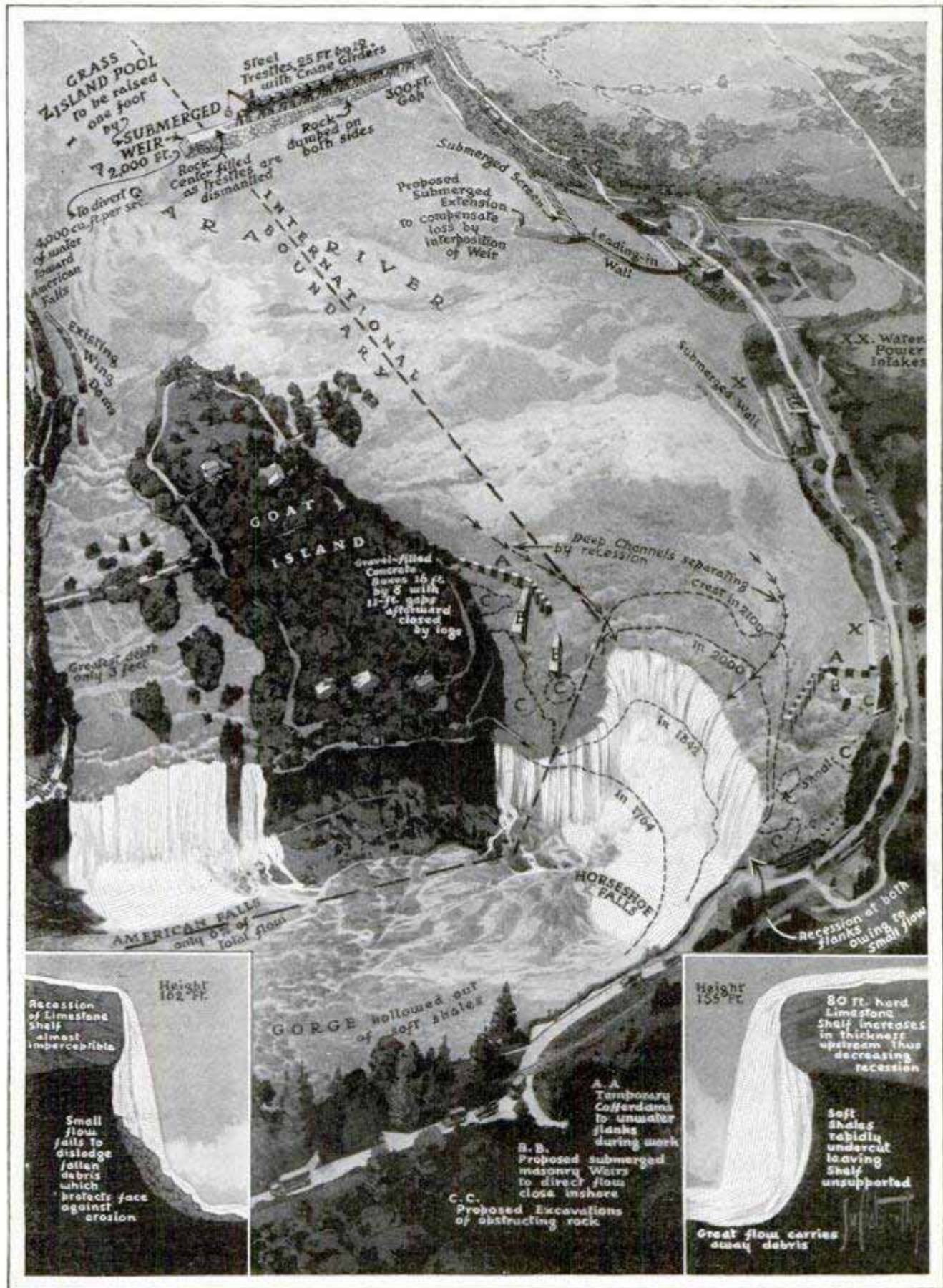

Drawing of Airplane View of Niagara Falls, Showing Various Works Now Being Erected with Double Object of Obtaining Water Power without Further Marring the Beauty of the Cataract

*Copyright, S. W. Clatworthy, Eng.*  
 18, Shakespeare Road,  
 Hill Lodge, London.

300

### STRETCHER OF POLE AND ROPE USED IN MOUNTAINS

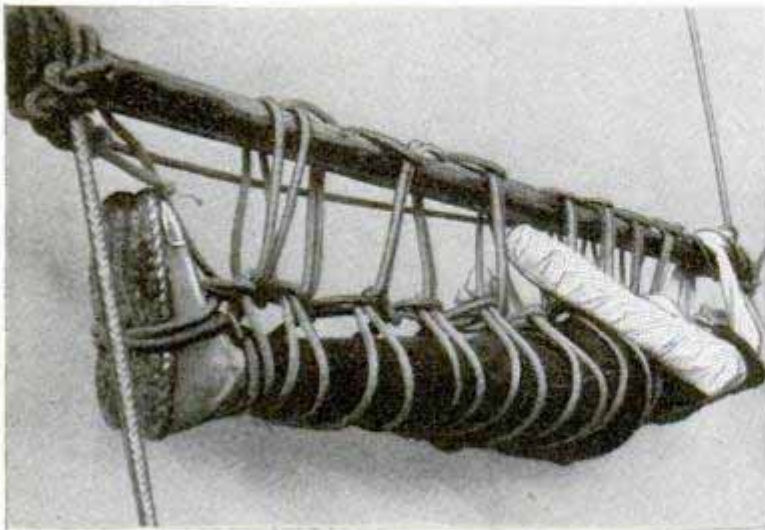

Injured Alpine Climbers Are Borne down Slippery Trails on This Stretcher, Improvised from a Pole and Rope

Mountain climbers faced with the necessity of carrying a disabled comrade down the slippery trails to lower levels, may have their task facilitated by improvising a stretcher from a pole and piece of rope. At the Dresden travel show recently, demonstrations were offered of how an injured person might be trussed into a comfortable position to be borne on the shoulders of his fellows. The rope is so wrapped and knotted as to provide a swing for the body suspended from the pole.

### HIGH-SPEED AIRPLANES TIMED BY CAMERA AND CLOCK

1. The terrific speeds anticipated in the international airplane races for the Schneider cup was a problem solved finally by combined use of a movie camera and a master clock. The automatic timer is made by adjusting camera and clock so that electrical impulses from the clock on a tape are photographed simultaneously with passage of the plane across the film and through a ring of circles interposed between lens and film. This method was used when a British flight lieutenant made a speed of nearly 320 miles an hour, with the difference that stop watches were used inside the cam-

eras and were photographed with passage of the plane into the measured distance. Possible fractional errors between two stop watches were eliminated by using the master clock. Previously, a timer pressed a stop watch after sighting the aircraft along two marks, a method found to be inaccurate for high speeds. Automobile-timing devices, including that of an electrical clock impressing dots on tapes at each end of the course, or recording on a photo-electric cell as the shadow of the car in passing broke a beam of light, were found wholly impracticable for the air races.

### MOTORCYCLE ON SKIS REPLACES DOGS

Eskimo dog teams in Alaska are losing out to progress with a motorcycle on skis skimming over the ice and snow that the huskies once traveled. It has replaced dog teams in delivering mail and supplies and obtaining furs at isolated outposts of an Alaskan trading company. The dogs took three weeks for the trips that the motorcycle is expected to accomplish in two days, and, besides, the dog sleds were so heavily loaded with fish for the animals that there was little room for a pay load. The skis are wide enough to support the weight of the machine and to pack down snow to a hard surface for a rear power wheel, which is equipped with heavy skid chains for traction. The machine also will carry the sick from trading posts.



Alaskan Dog Teams Mushed for Three Weeks over a Trail Covered by This Motorcycle on Skis in Two Days

*Cont. H. J. Williams, Colombering, 29 Bear's Road, Beverly 30, England*

*Chicago 1507 S. Michigan*  
*Harley-Anderson Motor Co. 3732 Juneyas*

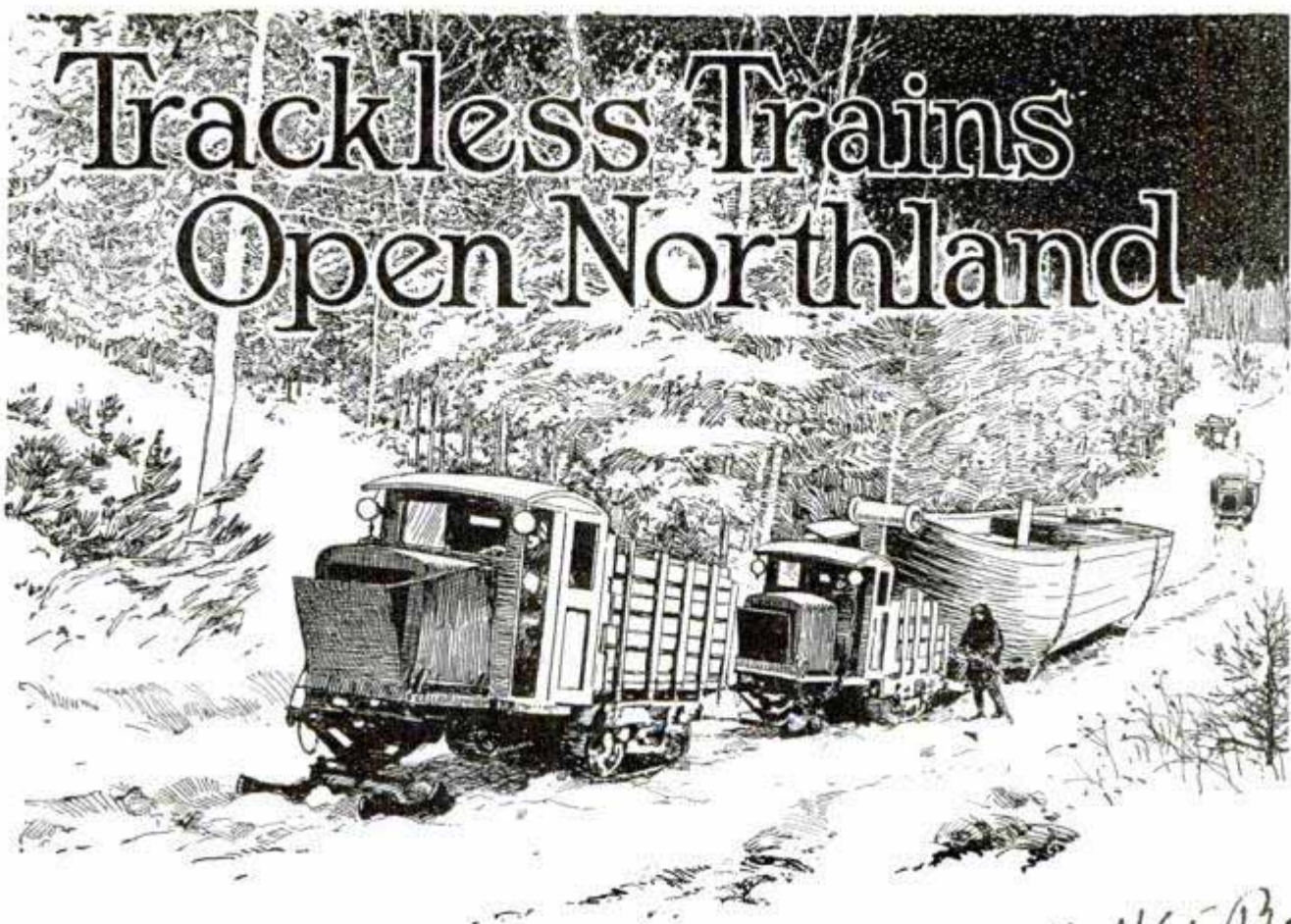

# Trackless Trains Open Northland

By JAMES MONTAGNES

*No. 304, 465 Bay St  
Toronto 2 Ont.  
Can*

A HORN honks. The northland express is off. Ahead, a trail of snow and ice; on both sides, trees as far as the eye can see. Furrows in the snow tell of a previous trip. A dip in the road and a vast expanse of frozen water. Snow-clad trees on its banks. Off the water the road continues. More lakes, more bush, some cabins in the distance. The train stops, the cars are unshackled, empty ones are placed behind the engine and the driver is ready to turn back.

All winter that continued. No smoke marred the horizon, no rail track ahead, no telegraph wires alongside the road. For the northland express consists of a tractor, a powerful engine pulling behind it six immense sleighs and a caboose. Over ninety miles of bushland road and frozen lake the express trundled its way. Only a telephone wire stretching in solitary silence high enough so that no wandering moose might entangle its horn in it, keeps the train in communication with either end of the road.

A copper mine whose wealth is estimated at hundreds of millions of dollars

needs electricity to bring the rich ore out of the ground and make it a commercial commodity. Seventy-five thousand horsepower is required to operate the drilling machinery, the smelters and all the apparatus used in a modern mine of such potential wealth. A town site for 5,000 people must be lighted and run on a month basis. For these purposes, a tractor is plowed through the northland every day and every night through snow and wind.

The mine is at Flin Flon, Manitoba. The power site is on the Churchill river at Island Falls. Ninety miles separate the two places. A single line of steel just completed connects the mine with The Pas, ninety miles to the south. Over 400 miles separate the mine and Winnipeg, the nearest big center.

No train on steel rails runs north of Flin Flon to Island Falls. To put one in would take too much time. So wood choppers went north, and a road was cleared through a purely Indian country. Then came the snow. The lakes froze. More snow, and where gravel had been dumped and felled trees had been laid to strengthen

the soft soil, a trail through the wilderness was practically ready for use. With a heavy V-shaped shovel before it, the first tractor train set out. It had to clear the road for those behind. With one sled behind it and a carrying load of twenty-five tons, it made its way through the white country to where the engineers were busy at Island Falls.

In all 23,000 tons were shipped by tractor train from the railroad siding at Flin Flon to the power site at Island Falls—an immense undertaking. But it was simply a problem for the engineers in Winnipeg to solve. They did so with the result that work progressed in weather which hovered around thirty-five degrees below zero all the time and often went down to fifty-three degrees and lower. Snowstorms or fair weather, the road was kept clear while the tractor trains hauled their loads with the regularity of the Twentieth Century.

There are other jobs in Canada where the tractor is replacing the railway. Several years ago, up in northern Quebec, a storage dam to hold ninety-five billion cubic feet of water had to be built. There were no roads north of the little town of Maniwaki. They were built in.

The job was completed and those roads today are serving for another similar undertaking, though not of such vast extent, 110 miles north of Maniwaki. The contractors were given a year to take in 1,000 tons of supplies for a storage dam for the Canadian International Paper company. The order is not very large, at least it doesn't seem so compared with other orders. But the road which had to be cut through some forty miles of virgin forest led through a mountainous country so that a straight trail was hard to plan. And another forty of the 110-mile trip led across water.

The contractors decided to use two tractors on the job and an aeroplane to supervise the work. They started last summer. They had to put in telephone lines for dispatching their tractors and carrying on communication. They had to get barges which could take the heavy tractors over the lake. During the freeze-up and the spring thaw, ways and means

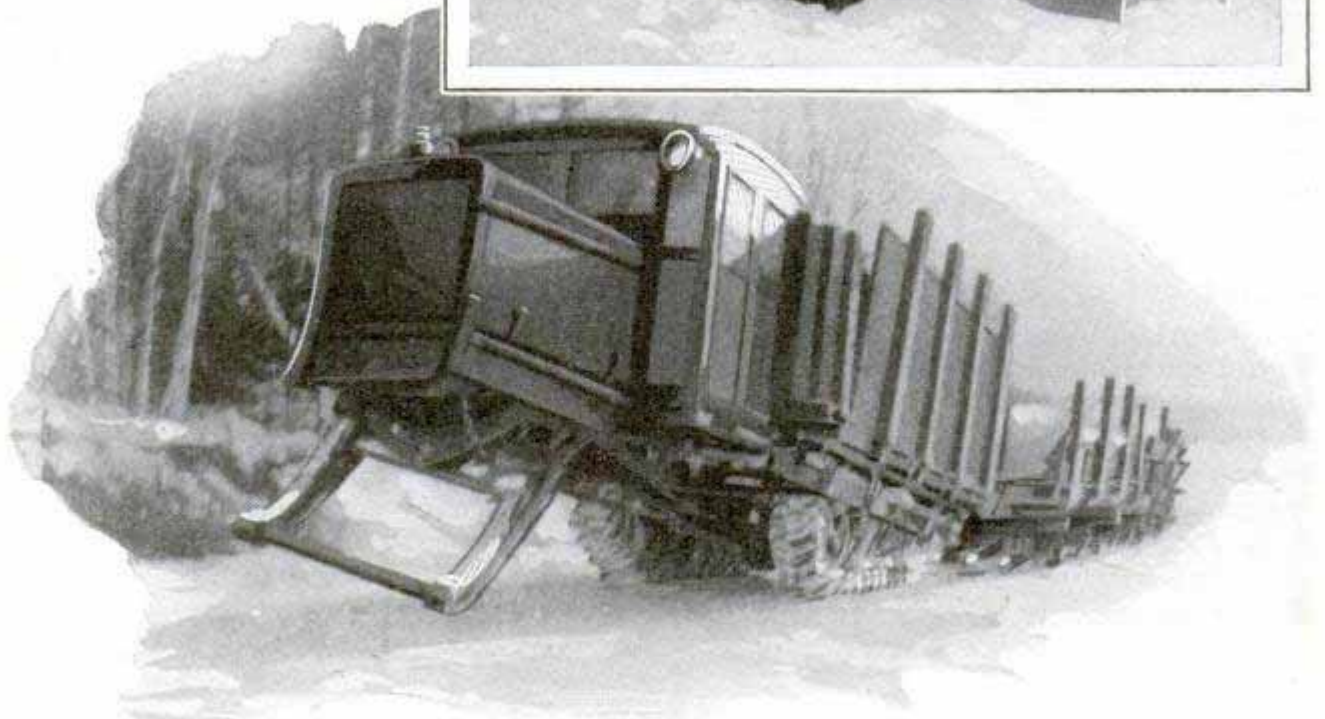

Powerful Endless-Tread Tractors Are Adapted to Haul Loads and Clear Roads of Heavy Snow; Note the Runners in Front to Help Keep the "Engines" of the Trackless Trains on the Trail

*No information*

*3012*

*nufa*  
*ar*

id to be devised for using every available way to complete the contract. In summer, the tractor could take six tons. In winter, when the lake was frozen solid, as much as ten tons could be carried. The thousand tons will be in there before the last day set down in the contract.

Trains, busses and aeroplanes operate on schedule on this continent. Their timing is to the minute. And in the north-land the tractor on a construction job takes the place of other means of transportation, operating on schedule. On one job in northern Quebec, the tractor stopped every five miles. Its driver would jump out, go to a near-by tree, take down the telephone receiver and call up the head office to let them know he was reaching his destination. Traveling in this way, a thorough check was kept on the movement of every tractor train.

Even the oldest company on the North American continent, the Hudson's Bay company, which was granted its original charter in 1670, is going to use the tractor to save a voyage of several thousand miles through the Arctic ocean past Alaska and so down the Pacific to Vancouver, by a 200-mile tractor trail near the northern part of Hudson bay. There is a channel of water known as the Fury and Hecla straits, where the ice flows swift and in broken fragments. This narrow waterway, only some seventy-five miles long, is the only southern outlet to the east for all the furs of the western arctic. Its navigation difficulties have necessitated the long trips to Vancouver.

To Wager bay at the northern end of Hudson bay, over bleak barren rocky country, the tractors will come out of the north loaded with furs. They will arrive from Cockburn bay, on King William island, where a fur post is being erected. To this new post will come by dog team the furs of the western arctic archipelago, and there they will be loaded onto a tractor which then starts south to Wager bay. Here boats or tractors, depending on the season, will take the valuable furs south to Fort Churchill, the northern terminus of the new Hudson Bay railroad. And by fast express they will travel to Winnipeg, Montreal, New York and London, fully six months ahead of their former arrival at the world's markets.

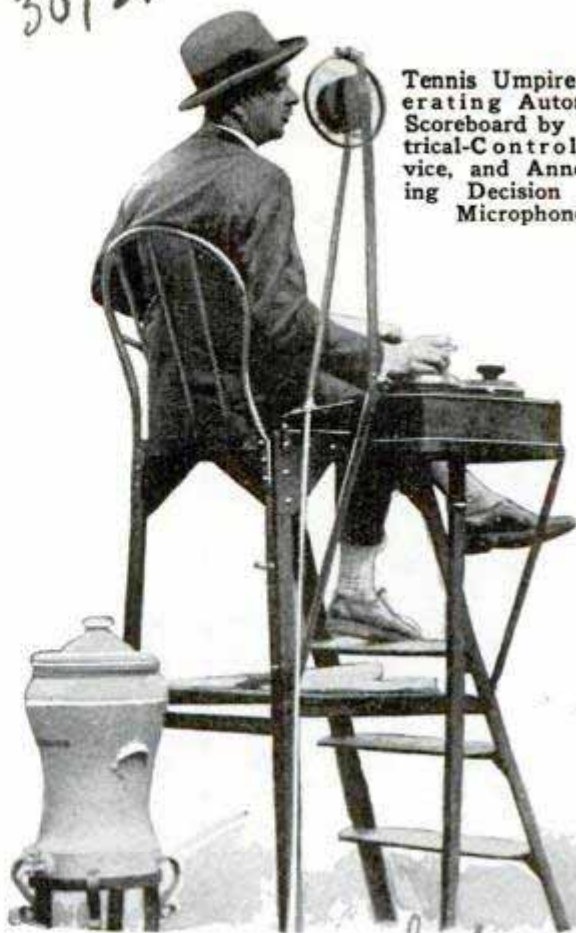

Tennis Umpire Operating Automatic Scoreboard by Electrical-Control Device, and Announcing Decision over Microphone

*International*

### ELECTRIC SCOREBOARD KEEPS TENNIS GALLERY POSTED

Tennis umpires on the Wimbledon courts this year announce their decisions over the microphone each time a point is scored. Simultaneously they mark up the score on a distant board by means of an electric-control knob placed beside the high stand on which they sit.

### BOTTLE WASHER FOR HOMES 99 FITS SMOOTH FAUCETS

For water faucets which have no screw threads for making attachments, a threaded faucet coupler has been devised.



It consists of a rubber lining which is twisted onto the faucet and about the outside of which is a metal screw thread to which may be attached a hose for running the hot water wherever needed. A bottle washer is made to attach to the faucet coupler.

*Grass Woods Mfg Co*  
*345 Eldert St*

*dog - 12 k. each*

3053  
414

*Springfield Pool*  
Phila

*Chicago*  
6/14/29

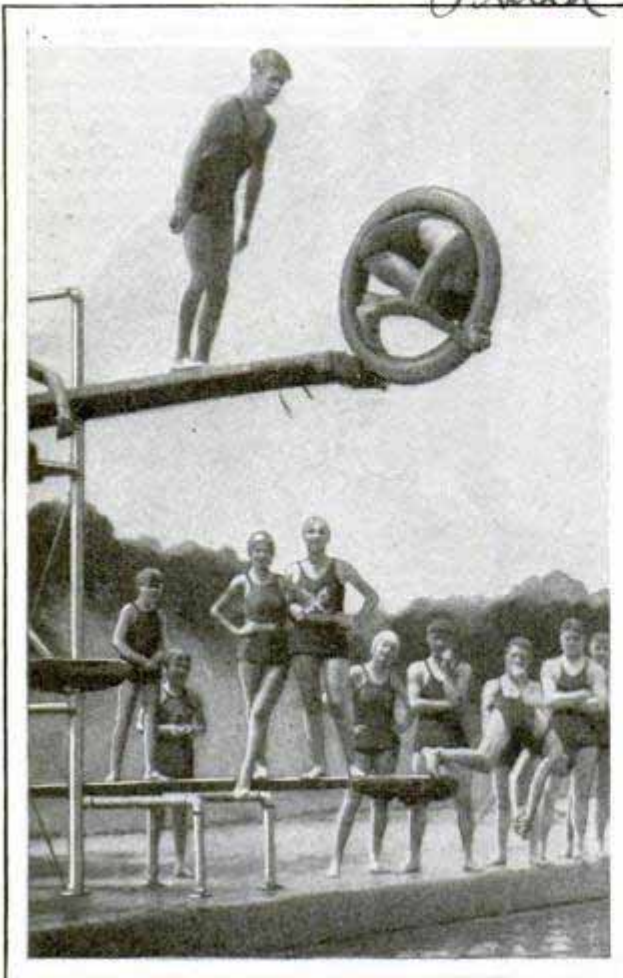

Diving off a Springboard inside an Auto Tire Provides New Thrills for Bathers

### SWIMMERS GET NEW THRILLS FROM OLD TIRES

Automobile tires, always a source of fun in the water, are being used to give divers an extra thrill. The tire is carried to the edge of a springboard, where the diver kneels inside it, bracing himself with feet, knees and shoulders against the inner rim of the tire. The tire with the diver inside then is rolled off the springboard.

### PAINTED PROPELLERS FLASH DANGER SIGNAL

Propellers of airplanes are being painted in brilliant hues to protect thoughtless persons visiting an airport from walking into the whirling blades. The circle of color of the revolving propeller attracts the eye and serves as a warning. The practice was started after it was found that erecting barriers about planes at airports did not prevent a few stragglers from getting past and walking into the path of danger.

*Airplane 2/9/29*

*3039*  
*20.00*

### SKYSCRAPERS SWAY IN WIND MEASUREMENTS SHOW

Strong gusts of wind against tall steel buildings cause the structures to sway and vibrate, tests have shown. According to reports, two of the tallest buildings in New York city bend as much as six inches at the top of their towers, three inches in either direction from the neutral or fixed position. Designers of a tall building soon to be built in Chicago allowed for a sway of two inches in either direction. A wind of about 100 miles per hour exerts a pressure of approximately thirty pounds to the square foot, and its effect on a high tower, when it blows in irregular gusts, is to cause the steel to vibrate or shake somewhat like a spring-steel bar when it is struck a sudden blow. Elaborate methods of wind bracing are employed in erecting tall steel buildings, one of the means used being the triangular pieces of steel commonly seen where girders join. These are known as gusset plates and were developed by the late W. L. B. Jenney, famous Chicago architect who built the Home Insurance building, recognized by some authorities as the world's first skyscraper. Due to the action of the tower sway upon water in tubs, pictures hanging on the walls and other movable objects within the building, exaggerated ideas have been formed as to the extent of sway. A slight tremor will set up a more pronounced action in such objects, but their motions do not give an accurate measurement of the sway of the building.

*3045*

*not found one near to, Brooklyne, N.Y.*

### TRUCK FOR OUTBOARD MOTOR 2035 KEEPS IT UPRIGHT

Installing or removing the outboard motor is simplified with a rubber-tired truck that saves carrying the engine and keeps it in an upright position. The conveyor is made of metal, allows the motor to be handled while hot, is always ready for service and takes little space.



*The Motor Boat Condenser Co.*

*The Motor Boat Condenser Co. 867 E 26th*



OPEN-AIR THEATER HAS COLORED-LIGHT CURTAIN

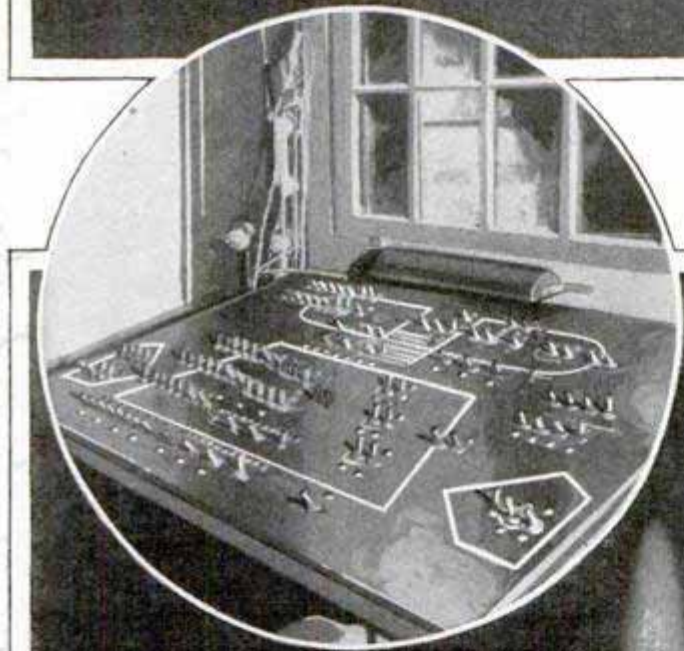

Fountains That Serve as a Curtain for the Du Pont Outdoor Theater near Washington, D. C. Arching Trees and Side Columns of Water Suggesting the Proscenium of a Stage

*Wilmington Del.*

Remote Control Board Where Lights Are Blended to Produce the Varying Hues, and, Below, a Closer View of the Water Curtain, Composed of Scores of Jets

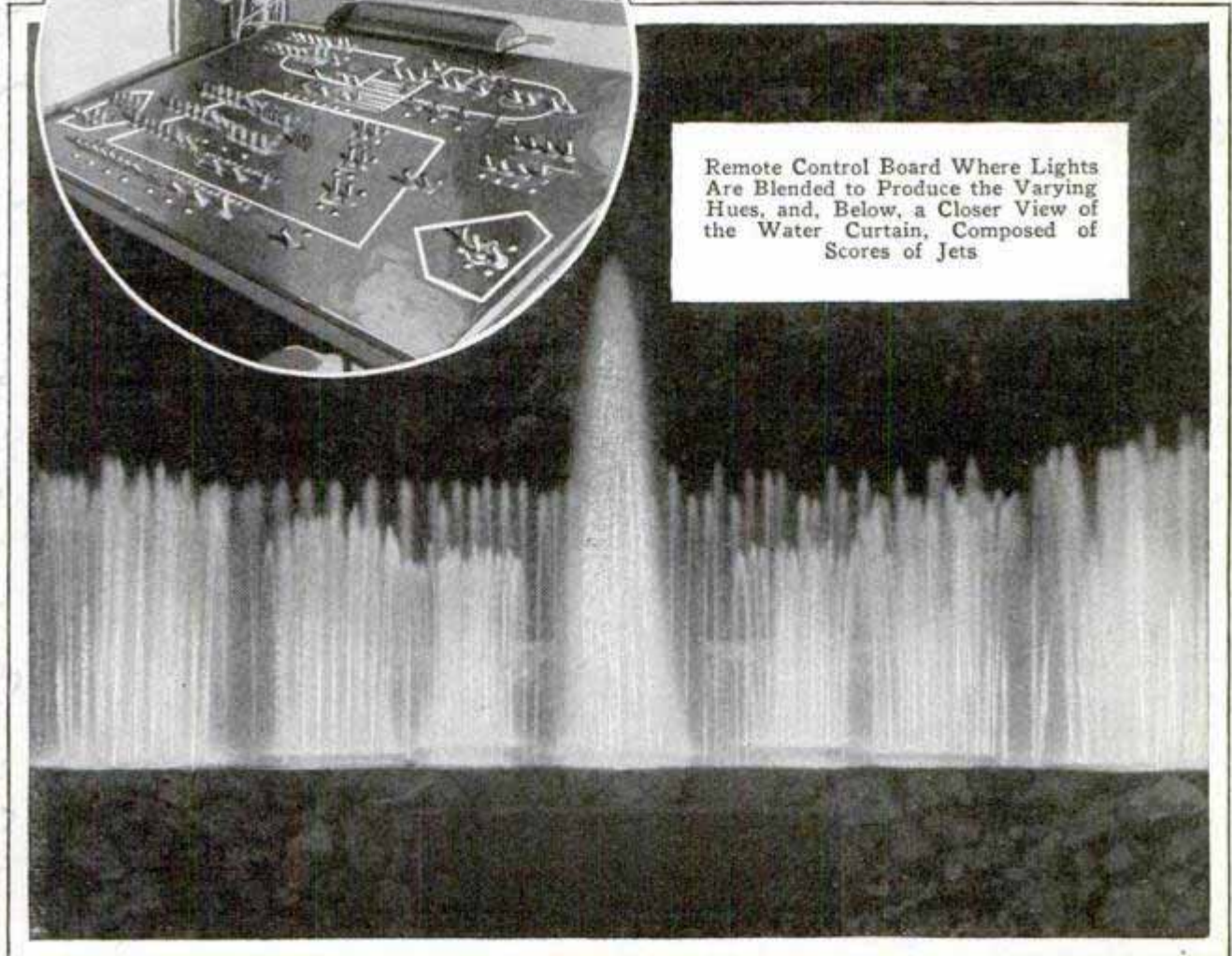

ARMY GETS NEW MONSTER OF THE AIR

Probably the most destructive fighting machine in the air today is the twin-engined bombing plane recently tested by the United States army. It weighs about five tons, is capable of carrying a load of 7,358 pounds, and can attain an altitude of 17,000 feet. Transporting 2,500 pounds of bombs, it can speed at 130 miles an hour.

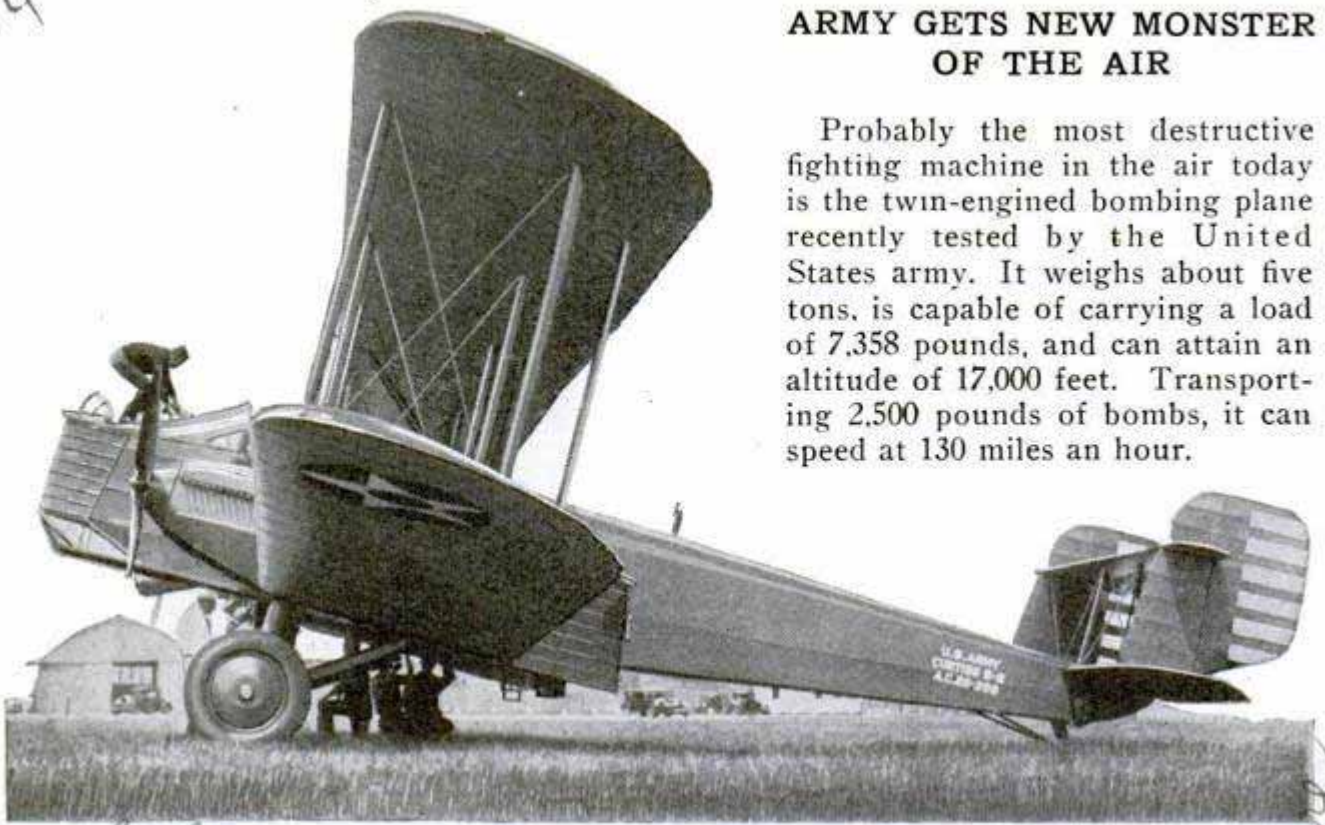

Capable of Carrying 2,500 Pounds of Bombs at 130 Miles an Hour, This Twin-Engined Army Bomber Probably Is the Most Destructive Fighting Machine in the Air Today

AUTOMATIC CARBON REMOVER WORKS AS CAR RUNS

Utilizing the breeze created while riding to clean spark plugs is the principle behind an automatic carbon remover which its makers say frees any motor of carbon and keeps it clean. An exhalator attached to the front of the radiator scoops up the air, forcing it through a cartridge containing a saturated material which forms harmless, odorless vapors as the car travels. The vapors are in turn led through a tube into the air stream going into the carburetor, promoting combustion of the carbon, the waste from which is expelled through the exhaust. The action is purposely slow to prevent chunks of carbon from getting under the valves. The only replacement necessary is the cartridge which is renewed every 500

miles. Manufacturers say that, aside from removing carbon as fast as formed, the appliance also saves fuel and oil.

BRITISH INVENTORS SET RECORD

British inventions reached their highest mark in 1928 when the patent office received 38,556 applications. Particular activity was shown in connection with loudspeakers, speaking films and electrical reproducing devices, and many appliances were patented for picture telegraphy and television. Much attention was devoted to low-temperature carbonization, automatic electrical machines and telephones and electrical heating for domestic purposes. Improving the propulsion of air and sea craft was the object of many patents. Women applied for 382 patents, compared with 348 in the preceding year.



Attached to the Radiator, This Automatic Carbon Remover Utilizes the Breeze Created by the Car

Report of Controller

Carlex Chemical Co. West End, N.Y.

3001

\$3.00

London, D. W. I. Inc. Carlex Chemical Co. West End, N.Y.

in this London

581 Eslenevood, Kansas City  
Fairmount Station  
POPULAR MECHANICS

### MELT GRANITE TO SAVE LABOR IN MOVING BUILDING

To save the tedious labor of chiseling away granite foundation blocks on which rests the county morgue at Pittsburgh, Pa., contractors planning to move the structure melted the granite rocks. The chiseling operation would have required two months, but the granite was transformed into molten lava in less than one month. An oxygen welder first was applied to the granite, eating out a small hole, after which a steel pipe attached to an oxygen tank was inserted in the hole and oxygen released into it. When the pipe started to melt, chemical reaction also served to melt the granite.

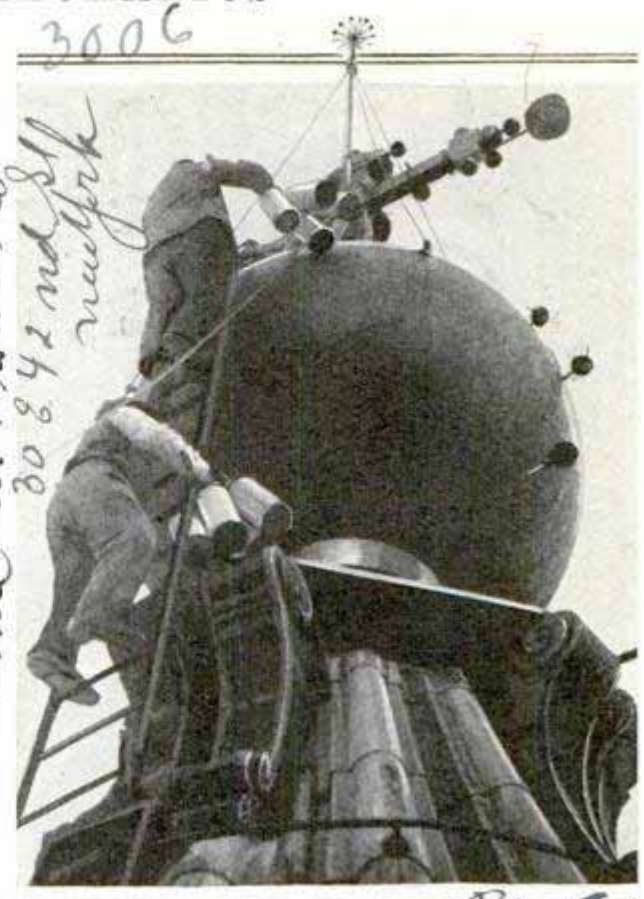

Workmen Placing Electric Lights for Exterior Illumination of Famous St. Peter's Cathedral

### NAIL SET IS SELF-CENTERING TO SAVE WOOD FINISH

Driving finishing nails home without marring the wood may be accomplished with a self-centering nail set which automatically adjusts itself over the nail head for the final blow to sink the nail into the wood. The appliance consists essentially of a steel tube at the bottom of which is a conical guide that performs the centering.



Inside is a plunger, attached to a spring and terminating at the bottom in a cup-shaped point to fit all finishing nails. The tool is capped over the head of the nail and the plunger given one blow with a hammer, saving time, fingers and wood finish.

### ST. PETER'S DOME IS LIGHTED WITH ELECTRIC LAMPS

Thousands of electric lamps were used to provide exterior illumination for the famous cathedral of St. Peter's in Rome recently. The occasion for the outside lighting of the old church was the beatification of Don Bosco, an Italian priest and educator of the nineteenth century.

### WRITING PAD FOR YOUR AUTO HOOKS TO STEERING POST 2883

For use of the business man, and others who transact business from automobiles, a writing pad, which attaches to the steering post of the car by a hook, has been developed. The holder contains a clip for securing the pad, road map or other papers the autoist may desire to have exposed before him.



### LOUD SPEAKER CALLS DOCTORS

Doctors of a Rochester, N. Y., hospital can play tennis without neglecting their patients. A loud speaker has been placed on the cornice of a staff dormitory adjacent to the courts, and when one of the doctors is wanted, his name is called by the telephone operator at the hospital, and plainly heard on the court.

Chicago 4139 W. Kenzie

Strom Memorial  
Cmt. 211 George W. Corner

Portland Ore

2874

Cont. of a ...  
25 Park Place  
New York

# Schools for the



importance of scientific methods in police work, created a highly efficient scientific laboratory where evidence is minutely examined.

Detroit and other police departments, keeping step with crime, are equipped with supermicroscopes that reveal the telltale marks on bullets, gun barrels, shells and other objects, resulting often in the solution of crimes that otherwise probably would have gone unpunished. Just recently, a photograph of a shell, picked up at the scene of a murder during a holdup in Detroit, led to the arrest of a suspect, his confession and execution in Pennsylvania on a previous charge.

In Practice for Their Annual Horse Show, a Group of New York Police Reserves Try a "Pyramid"

**T**HE BAFFLING mysteries of the future will not be solved by detectives relying on their personal skill, but by exact scientific methods, according to William Souder of the bureau of standards.

A grain of dust, the scratch of a pen, a spent bullet, will tear the mask from the face and hands of a criminal with absolute certainty, Mr. Souder said in discussing ways of identification now being standardized by the government.

As another step in modernizing crime-detection methods, the University of Chicago has created a special department to study means of detection and prevention under the leadership of August Vollmer, former police chief of Berkeley, Calif. Not long ago, Detroit officials, recognizing the



Patrolman Lawrence Spitzer Using an Automatic Rifle Which Fires 400 Shots per Minute

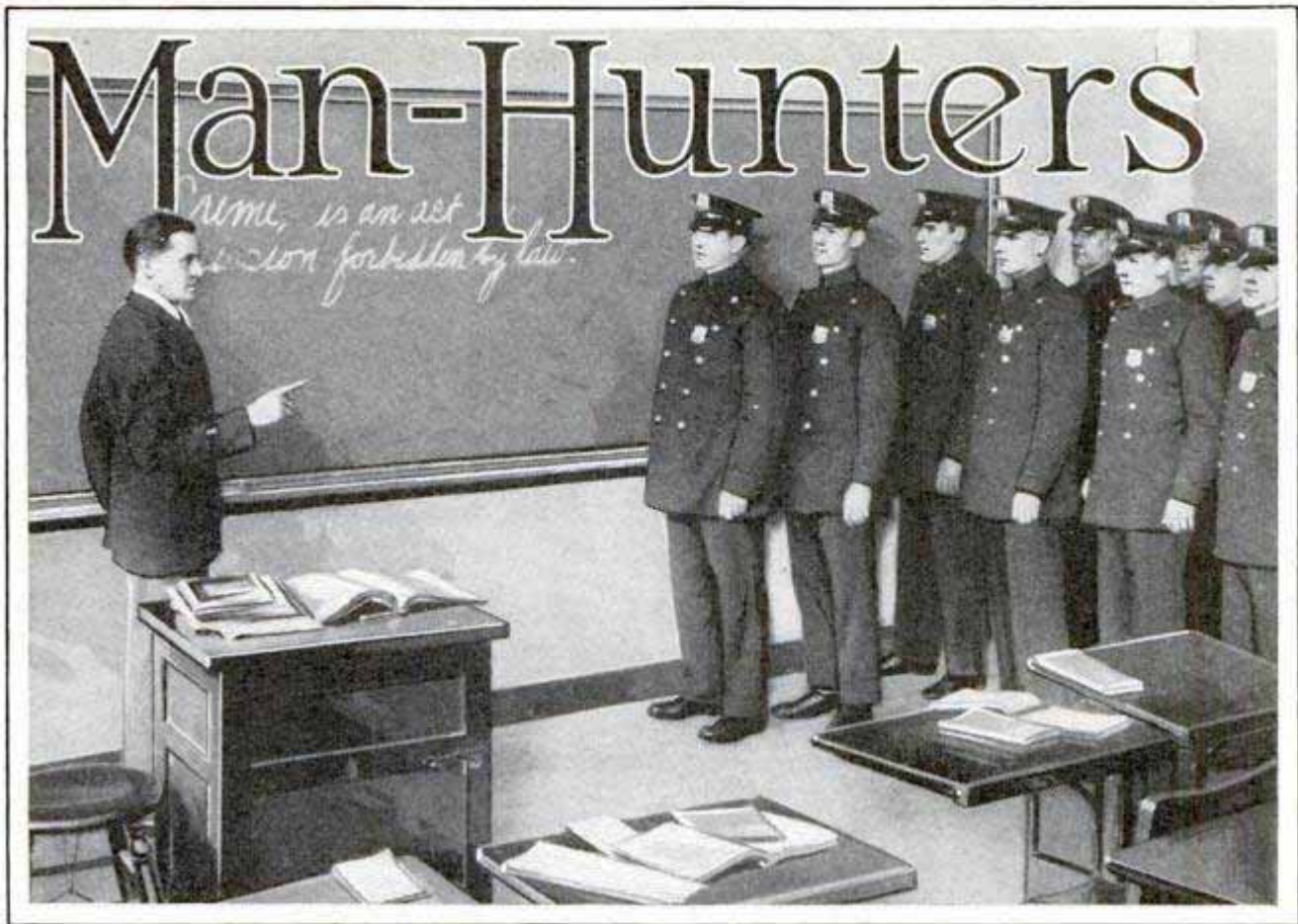

Rookies of the New York Police Department Receiving Classroom Instruction in Some of the Fundamentals of Their Work; Theory and Practice in Police Operations, as Elsewhere, Make a Good Combination

Speaking of the telltale marks left by typewriters, Mr. Souder said recently: "Attempts to destroy these beacon lights of evidence are seldom successful and would require, on the part of the one who seeks to mask them, a perfect analysis of every defect with equipment not readily available. Experts who make identifications in a logical, precise manner, will replace the detective who recognizes no limitations, no standards and no equipment as essential to his field. The cunning criminal who masks his face and gloves his hands, will find himself pitted against the cold scrutiny of microscopes that will tear his identity from a typewritten document, a pistol ball, a cartridge shell or a signature. Radio, now being adopted by several police departments to speed crime squads to the scene, will be another aid to the scientific detective, it is pointed out, when special squads, equipped with cameras, fingerprint apparatus and other tools, can hurry to the place of a crime in response to the call of the wireless and gather evidence before it becomes obscured.

One of the largest "academies" for the

training of policemen is in New York City. It was established in 1925 by Richard E. Enright, former police commissioner, and already has trained thousands of men for the special duties of the force. It is a branch of the City College of New York, and entrance is based on a civil-service examination, special tests covering a wide range of subjects, and, of course, a rigid physical examination.

Having passed the preliminary trials, the candidate is at once appointed a probationary patrolman, which rating he holds for six months, while he draws a salary equivalent to \$1,769 a year. With entrance to the ranks of the probationer, the real training begins.

For the first three months, the man is sent through a severe course in classroom and gymnasium work. He is instructed under police lieutenants who have specially qualified for the task, in discipline, deportment, government and civics. Then he is given a course in crime, involving a minute analysis in all its phases. With this instruction he gains familiarity not only with some of the scientific methods of investigating crimes but also comes to



know the ways of the criminal. The rest of the course takes him through lectures on the city ordinances, on court procedure, etc., and finishes with treatment of criminals from the moment they are arrested to the point where they are convicted or acquitted. So thorough is this branch of the training that, when he is assigned to his beat, he knows more about the job of a policeman than did the police captain of twenty years ago.

Dealing with criminals is not all that the student concentrates upon. He is drilled in conduct at fires, in accidents, patrol duty in general and in the duties of a traffic officer. During the final part of the course, he is taught co-operation with the federal government in curbing violations of its statutes.

Singular as it may seem, the New York policeman in the making is taught this fundamental principle: "It should be impressed upon the recruits throughout the academy work that warning and admonition will usually be found more efficient in the correction of many violations of the

ordinances than the serving of summonses or the making of arrests."

In the physical-training course, the recruit goes through severe taxation of his energies. Of the seven-hour academic day, four are spent in the physical-development department. It is the aim of his superiors to mold his body to perfection, capable of coping with any physical emergencies.

He is given military drill at first, followed by setting-up exercises. Next comes jujitsu work of which he is given an abundance. The same goes for boxing. For those who are not good swimmers, there is a special course. With

these forms of activities as starters, the recruit is launched on a heavy exercise schedule.

The aspiring rookies, ranging from the late teens to the early twenties in age, are given an expert course in the use of firearms. The object is to so train them that they will be able to use their revolvers under all circumstances; at night, when it is impossi-

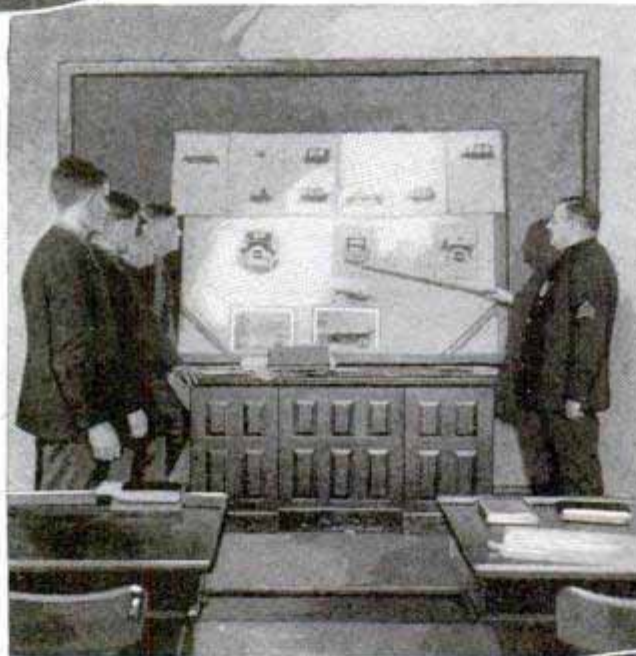

Learning to Fire a Revolver; Teaching by the Use of Pictures, and Practice with Acetylene Torch

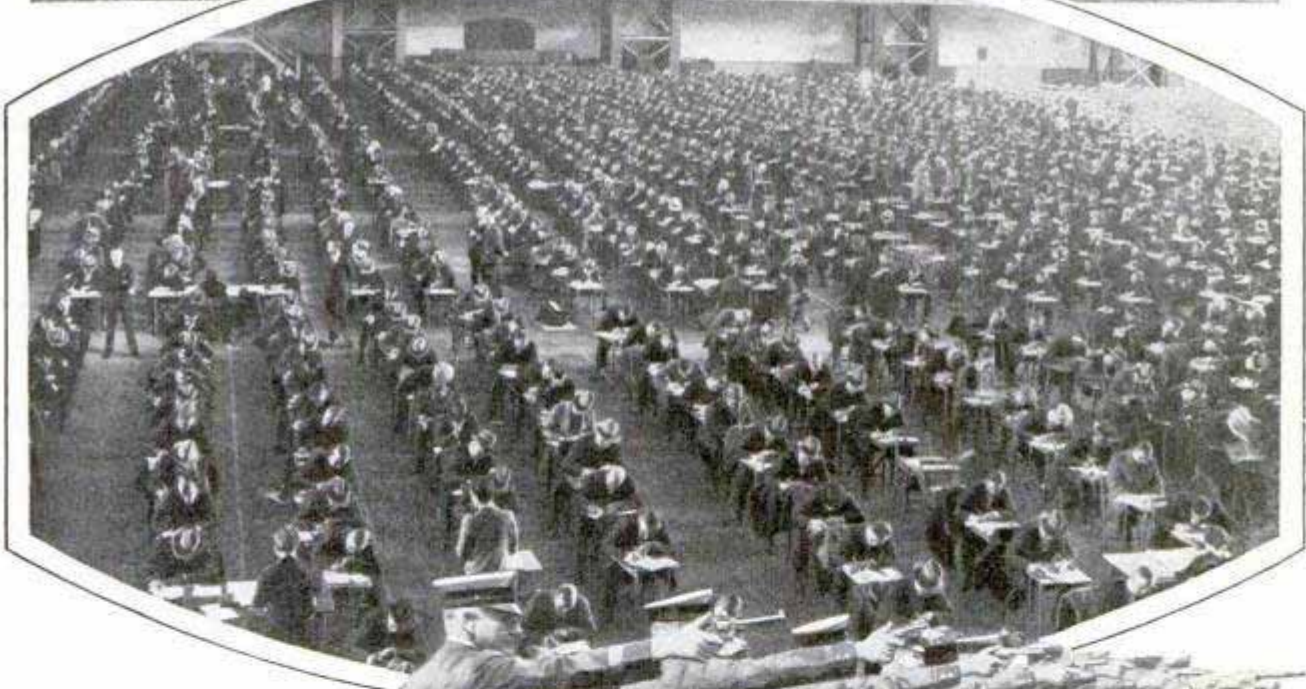
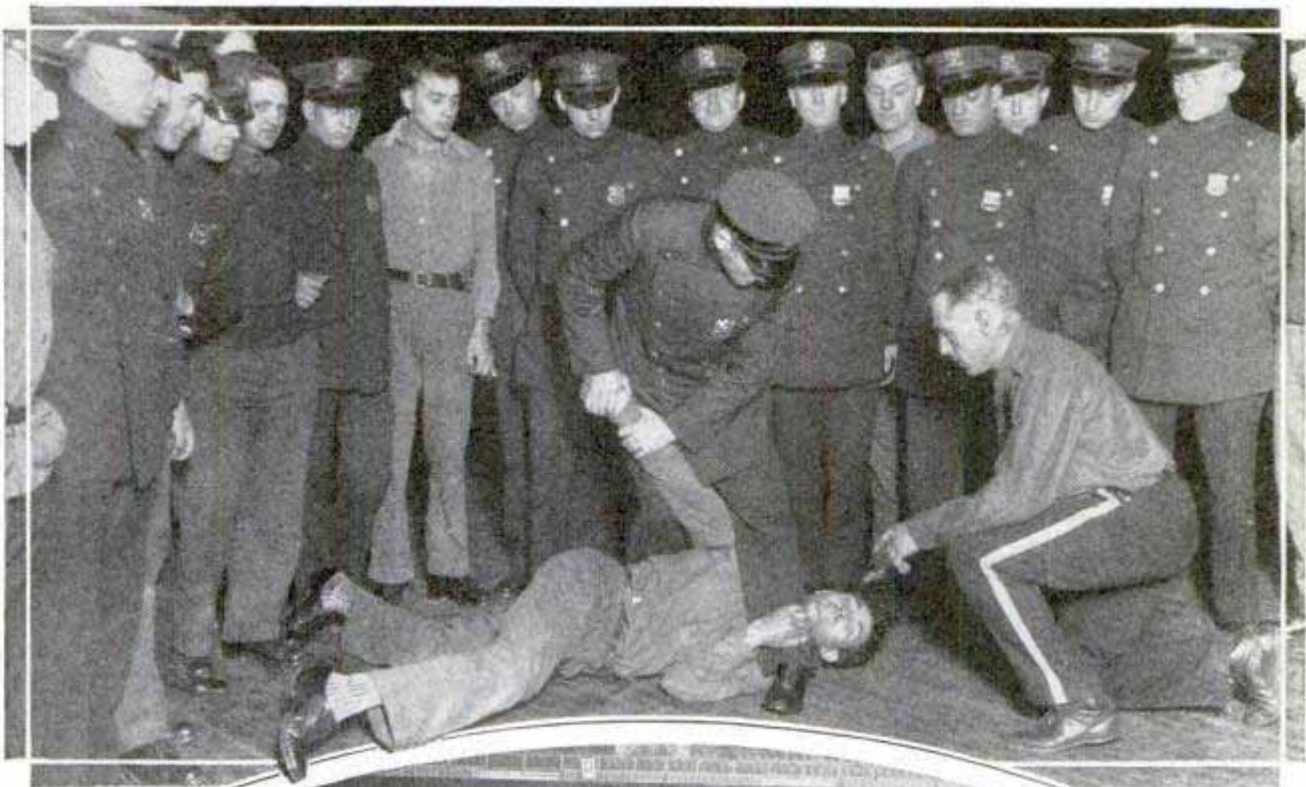

Police Rookies Learning Effective Holds to Be Used in Overpowering Crooks; 3,000 Police of New York Taking Civil-Service Examinations, and Crack Shots of the Los Angeles Police Department in Training for the National Marksmanship Competition; Practice on Ranges of Varying Distances, and with Moving and "Trick" Targets of Many Kinds, Gives the Police Valuable Experience in Learning to Fire under Battle Conditions When They Meet the Criminal

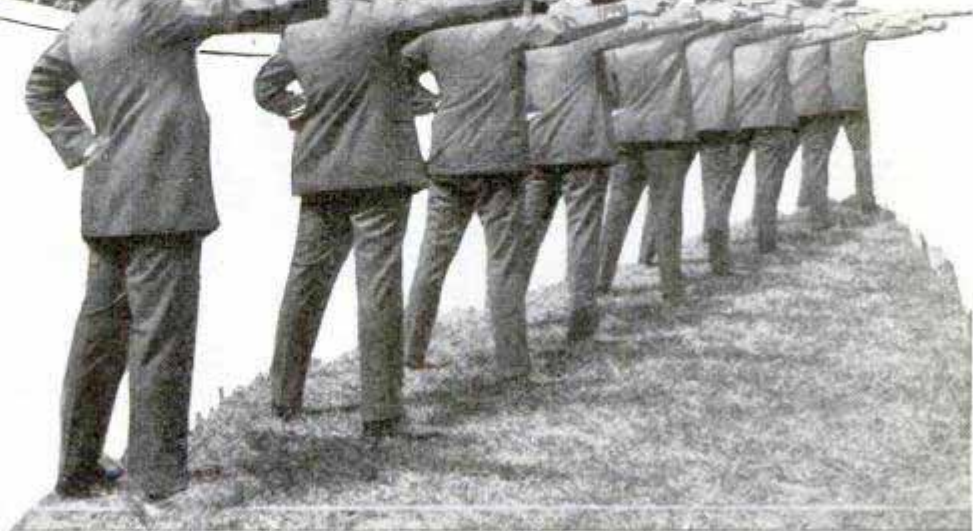

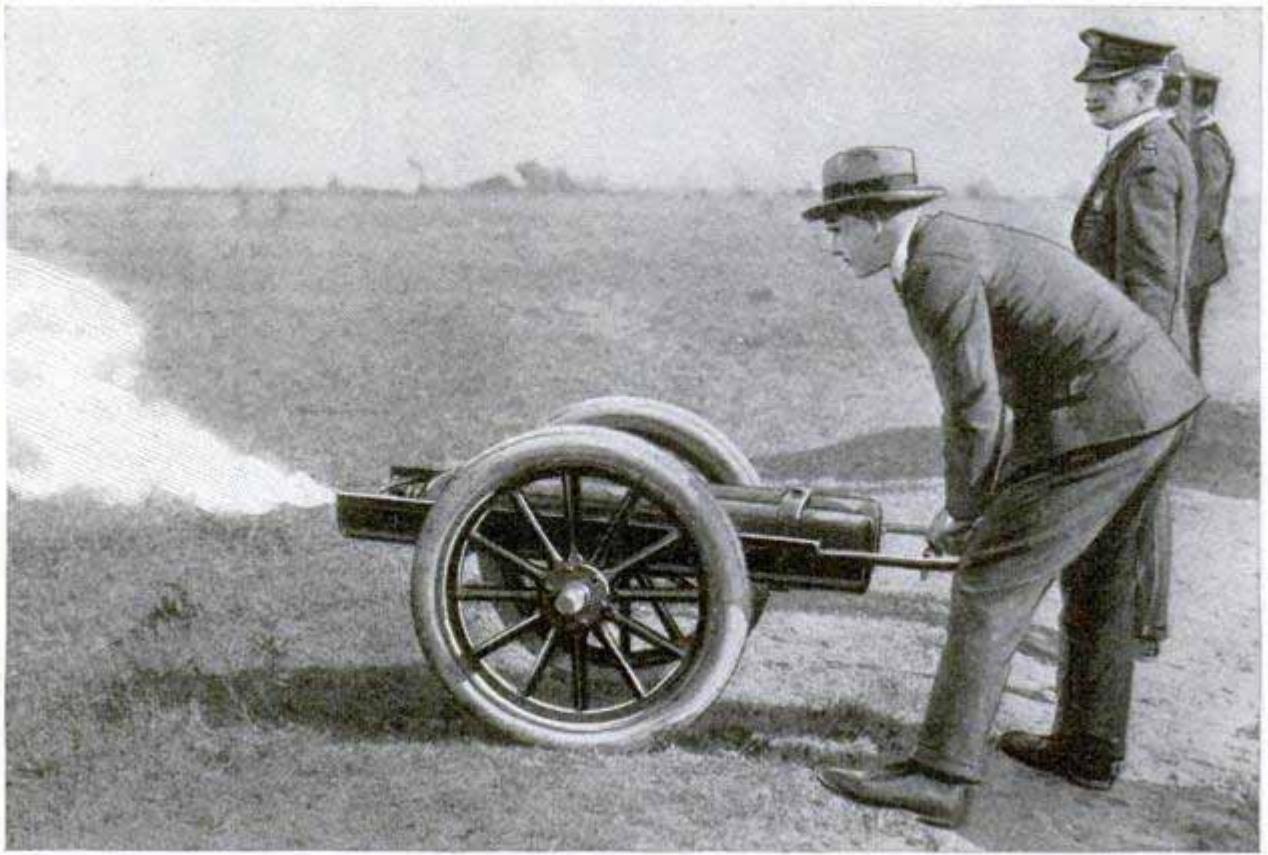

Chemicals Effective in War Have Been Adapted with Success to Police Needs; Here, Members of the Philadelphia Department Are Testing a Cannon That Spreads a Barrage of Tear Gas

ble to sight the piece in aiming, as well as in the daytime.

The recruit stays in the police academy three months and is then sent to a police station. This will not be a new sight to him for he already has spent some of his Saturdays and Sundays there.

In the next three months of the course, he goes through the gamut of the patrol-

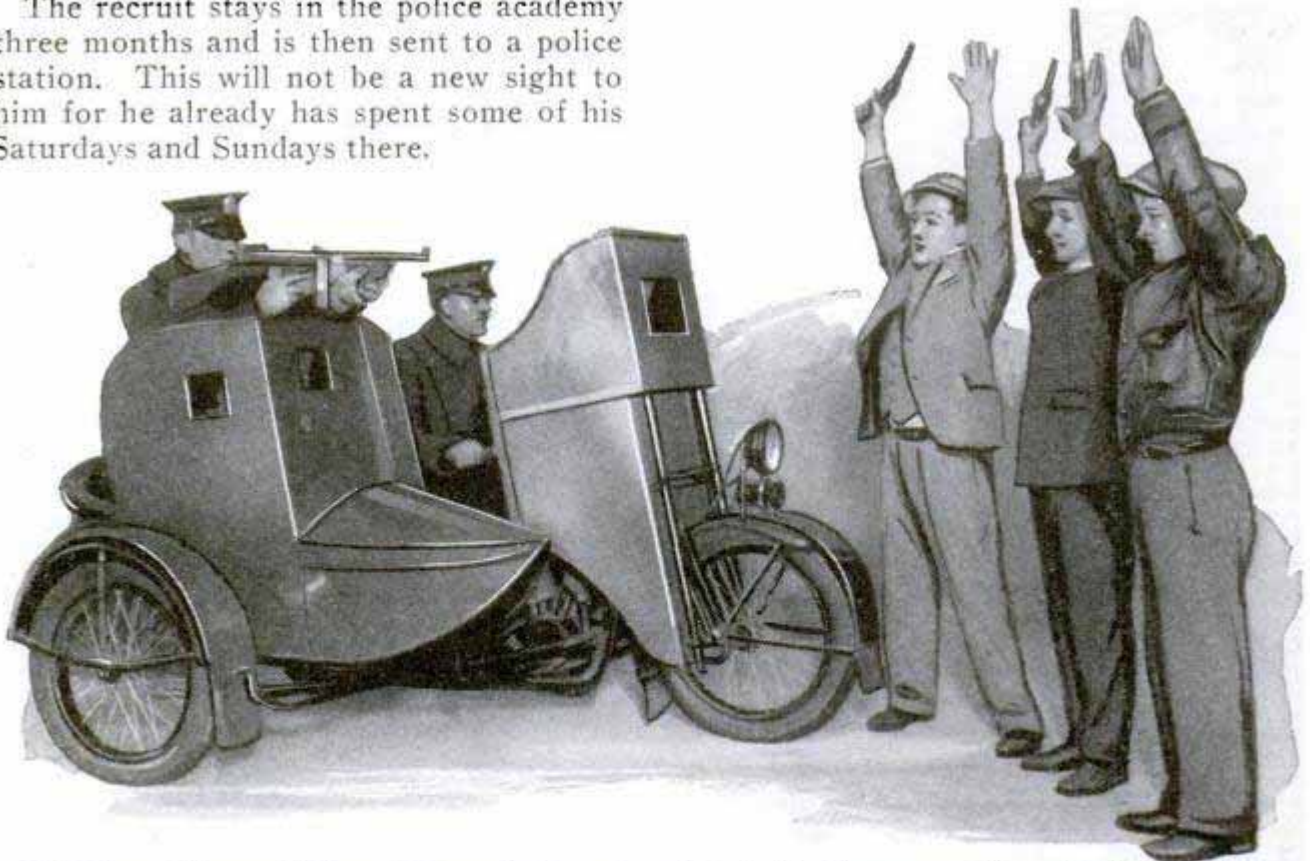

High-Powered Armored Sidecar Motorcycles Have Been Tested with Success as a Safe and Efficient Vehicle for Attacking Crook Gangs; the Units Are Literally Three-Wheeled Forts



man's duties. He covers a beat in the company of another policeman. He does traffic duty under the supervision of an experienced officer. Then he gets court duty, lectures and special instruction in first aid and personal hygiene. When his six months' course is up, he is made a regular patrolman. To achieve this goal, however, he must make an expenditure of \$250 to cover his outfit from head to foot. It has not cost him a cent in tuition to attend the police academy, but when he is done, he must purchase his own uniforms. The only thing which the city gives him free is his policeman's shield with his number on it.

Now, he sets forth on his career. He is raised to a salary of \$2,500 a year. If he remains in the ordinary patrolman class, and does not choose to rise above that station, he will get \$2,500 a year until the day he is eligible for retirement, which is at the end of twenty-five years of service. Then he is pensioned at half pay. If he is injured in line of duty, he is given full pay.

As a policeman, he may meet a multitude of opportunities. Distinction in service may win instant promotion for him. Even if he should not distinguish himself by any notable feat, a reasonably good standing may make him cited and advanced to plain-clothes duty, and his salary will leap ahead as he advances in his work as a detective.

There are examinations from time to time to fill openings in the ranks of sergeants. The same goes for lieutenants and captains later. So also for inspectorships. Yet, there is no telling when, as a policeman or detective, he might accomplish some heroic deed and be promoted by the police commissioner's command.

Of the 265 rookies who were admitted to the academy last spring, a survey showed that one-third had been mechanics, one-third chauffeurs and the remaining third came from various walks of life. Out-of-town police officials often sign up for courses. At one time, women were trained for police duty, but the courses were abandoned three years ago. Prison keepers are given a month's special course.

☐ An ant can pull 1,400 times its own weight.

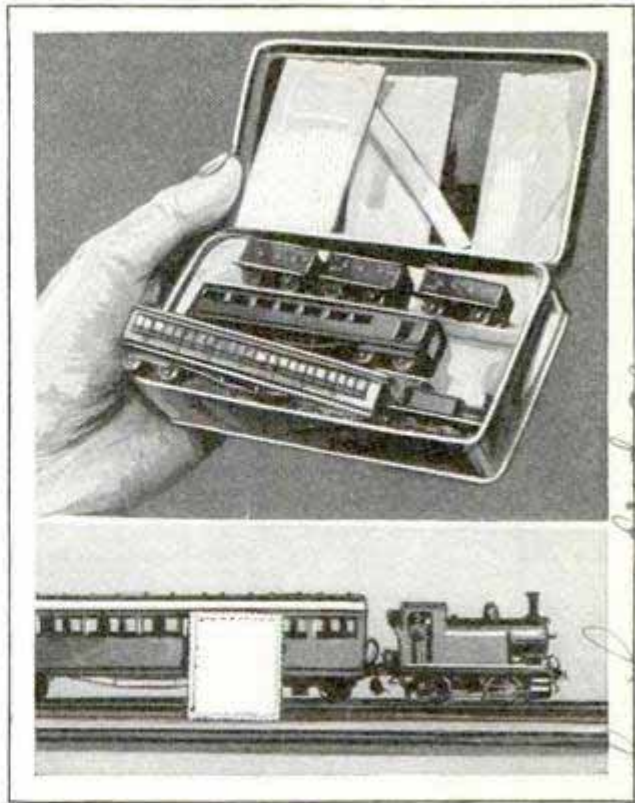

Tiny Model Train Packed in Small Box, and Compared with Postage Stamp to Show Its Size

**TRAIN OF POSTAGE-STAMP SIZE SHOWS MODELER'S SKILL**

One of the smallest working models of a railway was exhibited in London recently. It is only an inch high at the tallest part and runs on a track three-fourths of an inch wide. The scale is two millimeters to the foot. The train is run by a small electric motor which is concealed in the engine.

**CHARCOAL BROILER FOR PICNIC IS EASILY CARRIED**

A portable charcoal broiler with its heating surface along two sides in a vertical, instead of horizontal, position enables the hurried camper to broil both sides of meat at once in a holder slipped between the two heating surfaces. Coffee or vegetables may be cooked on a metal surface on top of the stove. It may be packed compactly for carrying in the automobile and burns charcoal briquettes ranged along the two sides.



*Made by J. L. Landridge, London Railway Club, 507 W. 10th St. St. Louis, Mo. U.S.A. Albert Co. 725 Grand Ave. St. Louis, Mo.*

*Albert Co. 725 Grand Ave. St. Louis, Mo.*

*Cons. U.S. ... Cape Town, South Africa*  
2989 **FUTURE SPEEDWAY SEEN IN BED OF DRIED-UP LAKE**

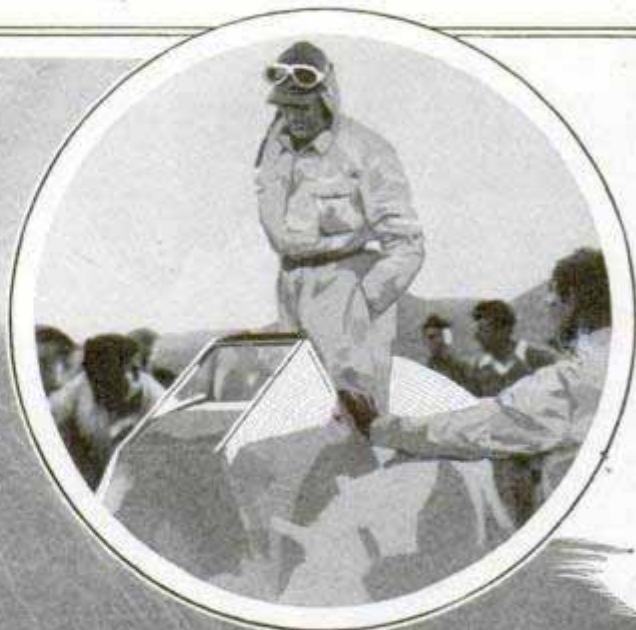
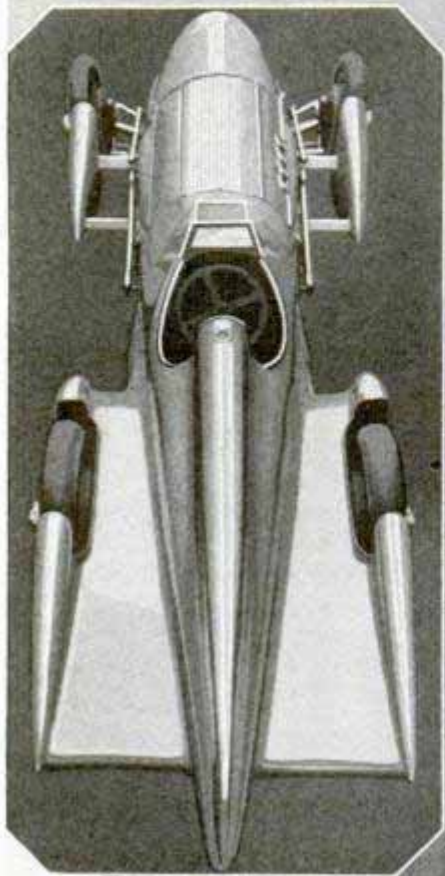

© Blythe Clayton

Lake Bottom in African Desert Hailed as the World's Future Speedway; Inserts, Captain Campbell and Racer Which Made 224 Miles an Hour on the Course

In the midst of a South African desert lies a sun-baked expanse of mud hailed by those who have seen it as the world's super-speedway of the future. Predictions that cars eventually may travel over this dried-up lake bed at 260 miles an hour were made after Capt. Malcolm Campbell, British driver, made a 6,000-mile trip there to test his "Bluebird" racing auto at 224 miles an hour, second only to that made by Maj. Henry Segrave at Daytona Beach of 231 miles an hour. Captain Campbell said that beach tracks, because of the hazards of shifting sands and high winds, can no longer be used for the records to be made in the future. "This desert track is

unique," he declared. "With some expenditure, it could be made so wonderful that all the world's records in the future would be made on it." The lake bed, seventeen miles long and eleven miles wide, is known as Verneuk Pan, deriving its name from the Dutch "verneuk," meaning "cheat," bestowed because of its mirages. Preparation of the track for Campbell's attempt cost about \$20,000, most of the money being spent in treating the surface, which consists of a six-inch layer of baked mud, creviced minutely, on a solid shale foundation. The cracks were filled with

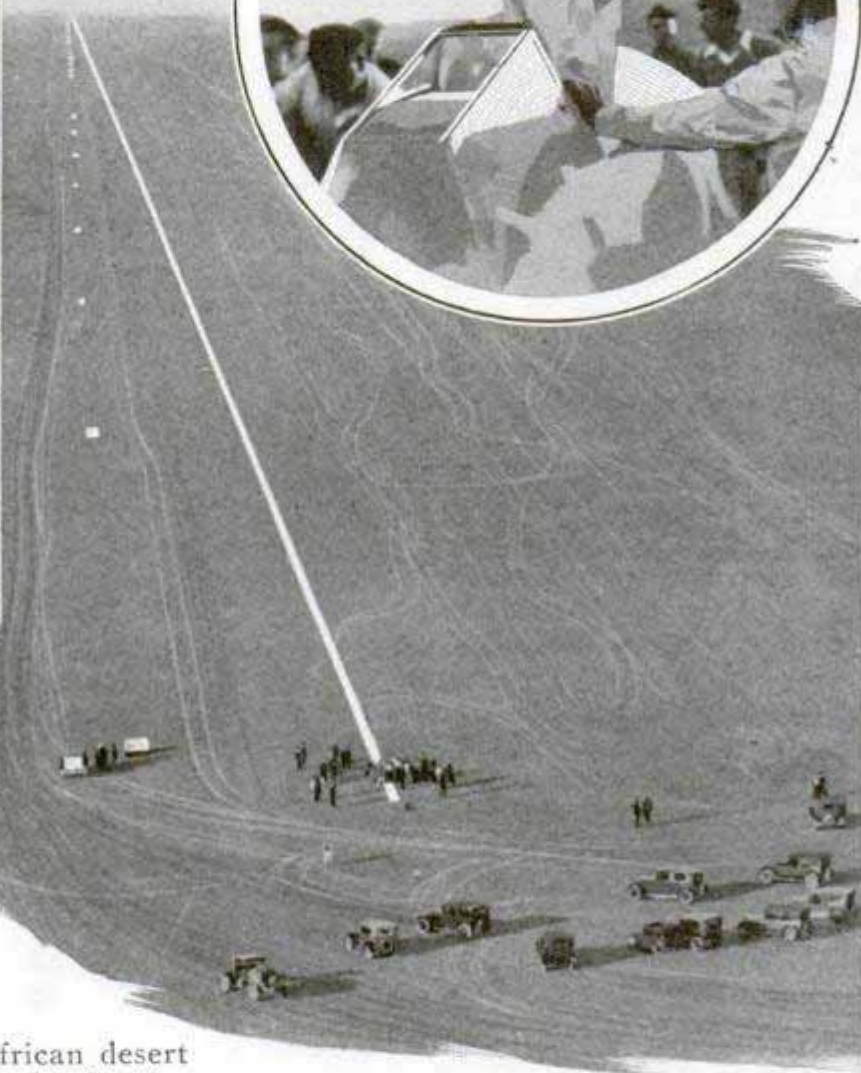

*Alarm, due*  
 POPULAR MECHANICS *Rochester, NY 425*  
*Seattle Wash* 3017 872 Hudson

liquid mud, making the track as smooth as a billiard table, and crude oil was sprayed over a section of it, binding it like asphalt and forming a glasslike, non-skidding surface that racers said would stand speeds of 260 miles an hour or more. Its one great handicap is that it lies in a desert country, 100 miles from the nearest railroad and forty miles from any village, but it is maintained that it offers the best substitute for the nearer beach tracks.

3009

**RADIO BURGLAR-ALARM SYSTEM  
 ANOTHER BLOW AT CRIME**

Proposing to establish a radio burglar-alarm system, a Seattle, Wash., corporation has applied to the federal radio commission for a wavelength of 109 meters for such a purpose. The radio already is employed in some cities to notify detective-bureau squads of commission of a crime. In Seattle, it is proposed to hook up a radio-signaling system with electrical wires in homes and business establishments. The transmitter would send out a buzzing tone signal to a central office.

3004

**DETACHABLE KNOBS FOR EASY  
 CHANGE OF DOOR LOCKS**

Locks with demountable knobs and interchangeable cylinders are being provided for office buildings and other semi-public places, to insure extra protection for tenants' valuables, particularly in their absence. These locks are of the key-in-the-knob type and operate as any other similar lock until it is desired to change the cylinder. A release key is then used to detach the knob, after which the cylinder may be changed and the knob replaced or a new knob with different cylinder inserted. The change may be made quickly without removing the lock from the door and is useful when changes of tenants occur, in which case the keying of a single lock or group of locks may be changed. Master keys operate all individual locks for a building so equipped.

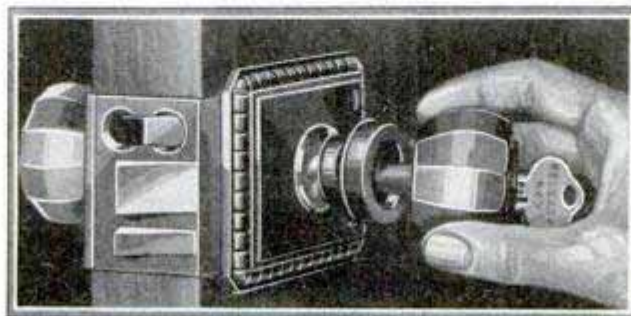

This Demountable Door Knob Contains a Detachable Cylinder Which Simplifies Changing Locks

*Chicago-150 Wacker Drive*  
 Sargent & Co., New Haven, Conn.



Sixteen Lenses Are Combined in One in This Camera to Give Depth to Portrait Photos

**DEPTH IS GIVEN TO PHOTOS  
 BY COMBINED LENSES**

Sixteen lenses have been combined into one to provide the eye for a portrait camera and give depth and naturalness to a photograph. This enables the grouping of persons as artists do instead of keeping them all on the same plane at equal distance from the camera. The multifocal lens gives speed and yet makes all objects in the picture appear clearly and free of distortion. Lenses of long, medium and short focus were combined by grinding them into many different zones to eliminate blurred backgrounds and shadows. Universal-focus lenses have been used in small cameras, but heretofore have not been applied to portrait cameras.

**WOOD IN TUBE-PASTE FORM  
 SIMPLIFIES REPAIRS**

A wood composition material, applied from a tube like glue, has been introduced for repairing furniture, filling cracks and for fixing various articles. It is easily squeezed out, and the tube reduces waste and keeps the substance in good condition. It has no grain and hardens upon exposure.

*Chicago-160 N. Wells*  
 \$175.00 to \$245.00

*Wood Air Product Co.*  
 40 Canal St. Boston, Mass.

2982

The

# Inventor's



glory of American invention.

"Their names are not flaunted in print, nor do they issue accounts of their researches. Because they're too busy now, chopping wood, planting corn, washing windows and shining shoes.

"The belief is widespread," he continued, "that the old-fashioned ways of invention are gone—replaced by research laboratories owned by corporations. I don't think so. Of course, we can't belittle the excellent work done by scientifically trained men. Captains of industry comb the world for talent, but seldom they produce basic inventions."

By DON GLASSMAN

545 W.

*Mch. 10 6 New York*

**I**F WALLS had tongues, the corridors, basements and galleries of the patent office would have reason to shout.

American inventors are jamming the classic stone structure in Washington at such speed that the patent commissioners are alarmed.

A lightning filing system has been devised. Necessity forced it. Enjoined by law to preserve copies of printed records, the custodians of the nation's patents evolved a housing plan for 1,800,000 inventions. There are now 120 miles of shelves. Approximately 1,000 patents are issued weekly, while twice as many are rejected.

Dr. William A. Kinnan, first assistant commissioner, was asked about his best customers. He replied emphatically that "free lances" still are the mainstay and

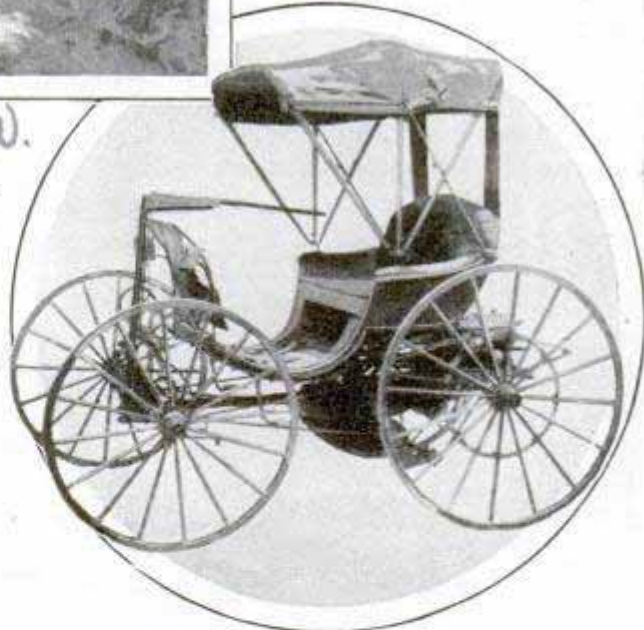

Upper Left, "The Genius of Invention," a Mural in the Patent Office Library, and, Below, Duryea Gasoline Automobile of 1893

"Is this a scientific age?" another official asked. "Perhaps. But look into the history of American invention and you find that basic, revolutionary devices were con-

# Hall of Fame

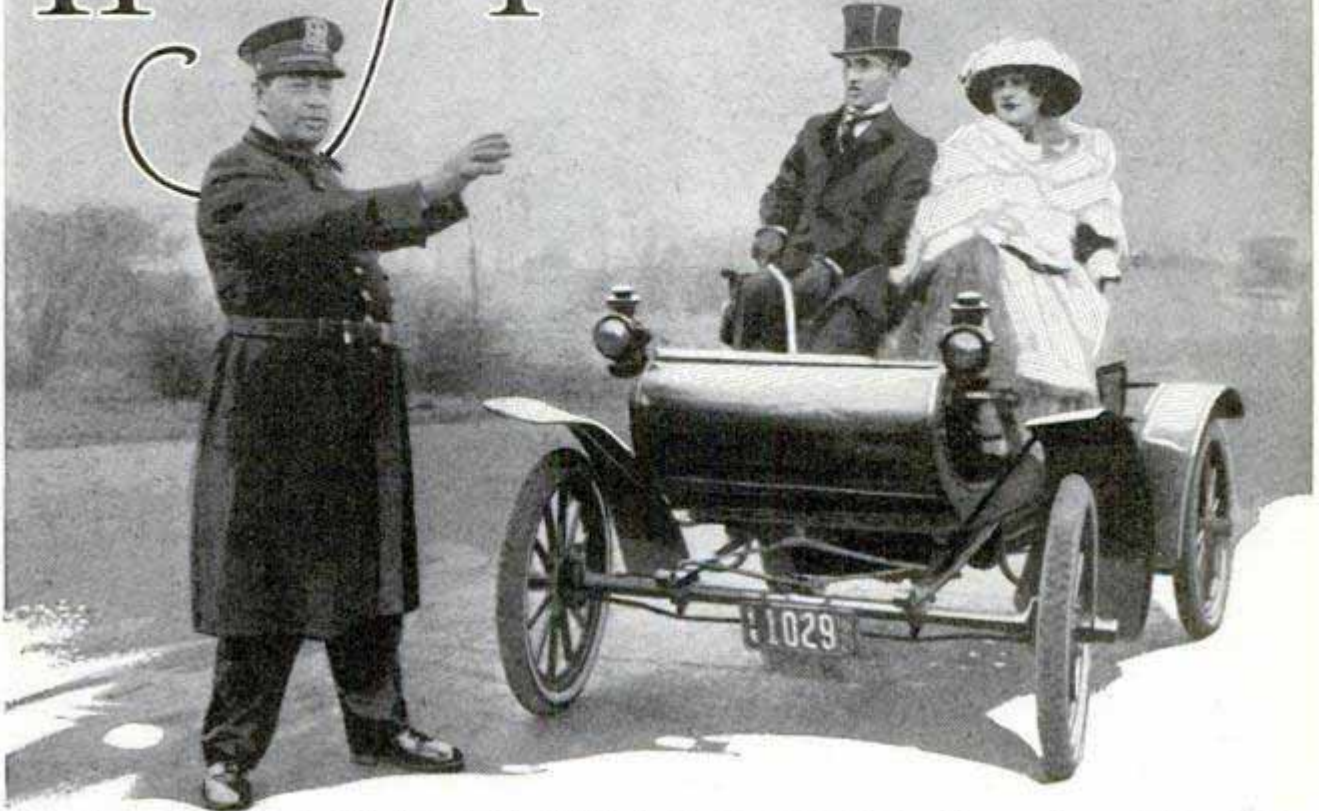

The License Plate Reads 1921, but the Car Obviously Is of a Much Earlier Vintage; Autos Such as This Were Considered the Last Word in the Early Motoring World

ceived by men who knew nothing about science—mad men and ‘fools,’ unlearned in scientific theory and ignorant of laboratory practice.”

In connection with the history of creative talent, an interesting piece of speculation is the first invention. Lincoln said, “Man’s first discovery was his nakedness. His first invention was the fig-leaf apron, which seems to have been the origin of clothing.” Another man holds that the alphabet was the first invention. Someone else claims a club as a weapon. Another says fire-making apparatus, and so on. Perhaps Lincoln summed the topic best, saying:

“All creation is a mine and every man a miner.

“In the beginning the mine was unopened, and the miner stood naked and knowledgeable upon it.

“Fishes, birds, beasts and creeping things are not miners, but feeders and lodgers merely. Beavers build houses, but they build them in no wise different or better than they did 5,000 years ago.”

Believe it or not, an investigation of why poor individuals take to inventing reveals that, in most cases, financial reward is the least consideration. Edison needs no money. Mark Twain invented a scrapbook, because there was no better way of filing news clippings about him. A Florida woman was asked why she invented a device for distributing fertilizer and answered:

“Laziness, I guess. I’m tired of bending my back the old way.” Can a woman invent and be lazy also? At any rate, one-fifth of all the patents granted are issued to women.

Pass down the shelves of fame—simple pamphlets illustrated by pen drawings. Some the world has never heard of; others have built giant industries and written deathless names. The age of mechanics rests on a foundation of seventy pillars, to wit: In agriculture, Whitney’s cotton gin and McCormick’s reaper; in transportation, the Wright brothers’ airplane and the Westinghouse air brake; in telephony, Bell’s telephone and Berliner’s

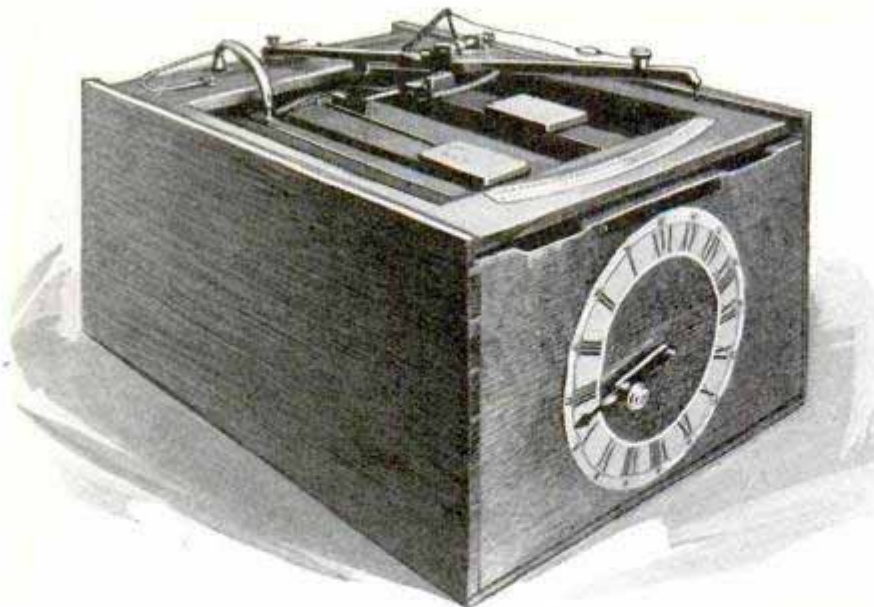

Courtesy of the National Museum

The Forerunner of the Modern Typewriter; It Was Called a Typographer and Was Invented by William A. Burt

transmitter; in warfare, Colt's revolver and Holland's submarine; in phonography, Edison's talking machine and Berliner's lateral disk record; in moving pictures, Edison's kinoscope and Jenkins' projector, and so on.

Think of electricity. Mysterious force. Ben Franklin enchanted a bolt of lightning and caused its descent from heaven. He should have been killed, theoretically. But he survived to tell how he had married sparks generated by man in a laboratory to electric bolts shot by lightning.

Edison, the news "butch," had the luxury of a traveling laboratory. Bottles, test tubes, chemicals and filters were lined on shelves of a train's baggage car. One day the engine shrieked to a sudden halt and upset the laboratory. Phosphorus set fire to the baggage car. The conductor arrived in time to smother the blaze. He gave the youngster a severe cuff on the ear as he booted him off the train.

Next we find him waiting for a new train at a railroad station. The station agent's son is playing on the track. A train approaches. Edison averts the boy's death, and is rewarded with free instruction in the secrets of telegraphy. At sixteen, he falls heir to the position of telegraph operator at Port Huron, Mich.

"Tell me why the telegraph works," he asked a line repairer.

"Like this: Suppose you had a dog, a dachshund long enough to reach from London to Edinburgh; if you pull his tail in Edinburgh, he will bark in London."

Today, hundreds of thousands have had experience with electricity, yet no one has improved on the lineman's explanation. An electric current is a gigantic question mark. But look how inventors manhandle question marks!

Edison spent much time learning what people needed. When he was convinced that an electric light would serve practical ends, he said:

"I'll make electrical lanterns so cheap that only rich men can afford

to burn candles."

Paper, metal, textiles and carbon compounds—all these were subjected to tests and experiments. He sought a substance to withstand the white glow of luminous electricity. Charred paper in an airless vessel stood up for about eight minutes. A cotton thread glowed behind sealed glass for forty hours, and the cost of the experiment was \$40,000!

One hot afternoon, he picked up a palm-leaf fan and saw it was trimmed with a strip of bamboo. And it made better filaments. He sent bamboo expeditions all over the world. But on completion of the hunt, discarded all imported samples, for he himself had discovered a carbon compound that was superior.

Samuel F. B. Morse, a portrait painter, was returning from Europe in 1832, when he was shown an electric magnet and told of experiments by the Frenchman Ampere. "An electric current passes instantaneously over a wire of any length," it was explained.

"If that is true," responded Morse, "then instantaneous communication is easy." At that moment he was still an artist. For twenty years he had struggled for fame in art. He worked for three years as an artist, seeking to subsidize himself as an inventor. His equipment was so crude that he feared to show it. And his living so stinted, that he smuggled food into his room at night.

Who symbolized himself better than Morse when he wrote the first telegraphic

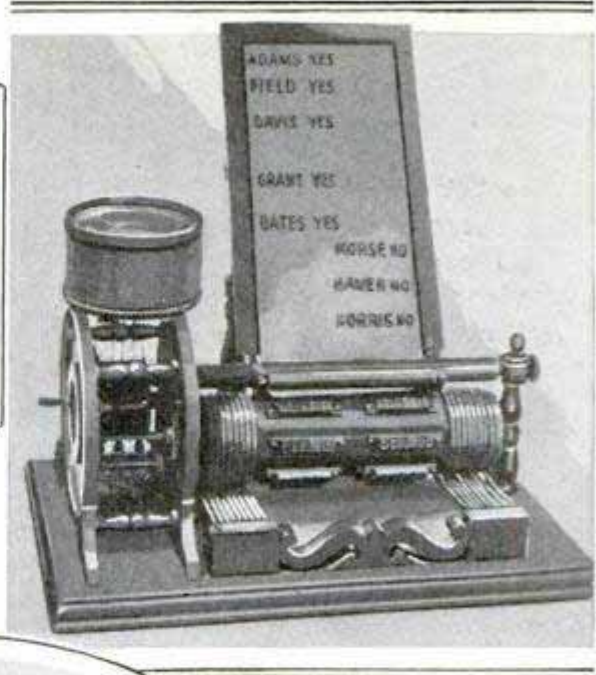
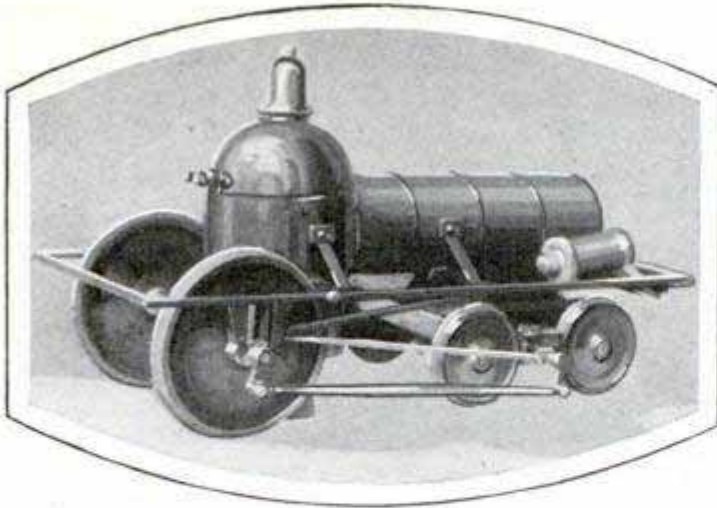

Model of the Baldwin Locomotive of 1840, and, at Right, Center, the Harmonic Reed Used by A. G. Bell in Developing the Telephone; from Such Comparatively Crude Beginnings, Two of Our Most Important Forms of Communication, Railway Transportation and Long-Distance Speech, Have Grown Far Beyond the Expectations of the Inventors

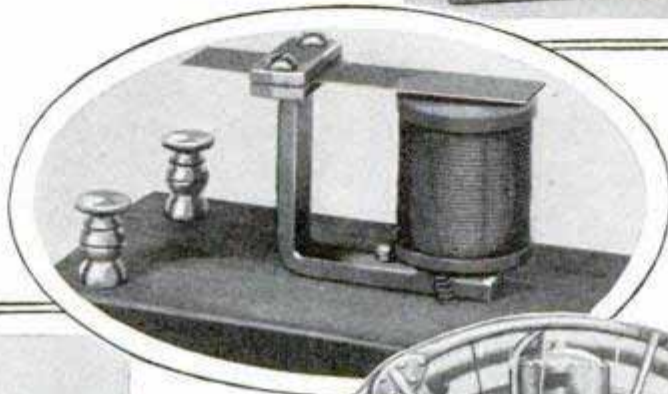

Not Much Like the Voting Machines of Today, but Intended for Somewhat the Same Purpose; the Vote Recorder, Thomas A. Edison's First Invention

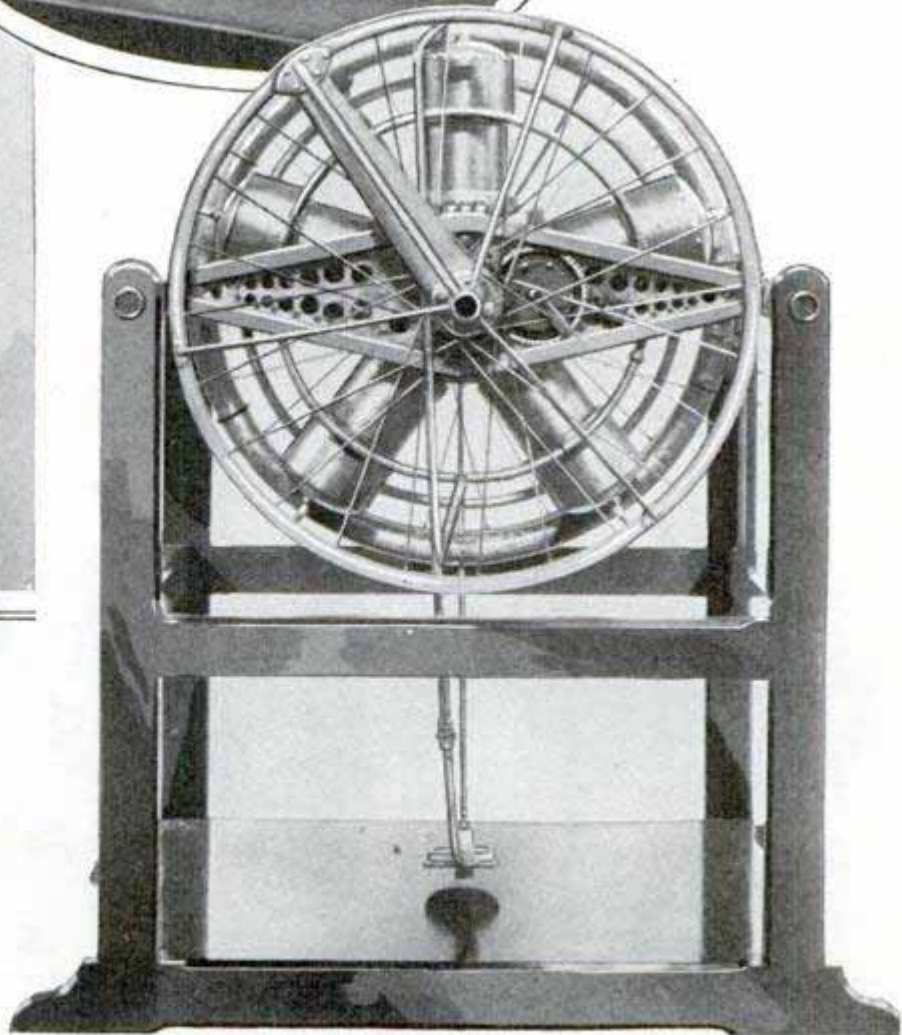
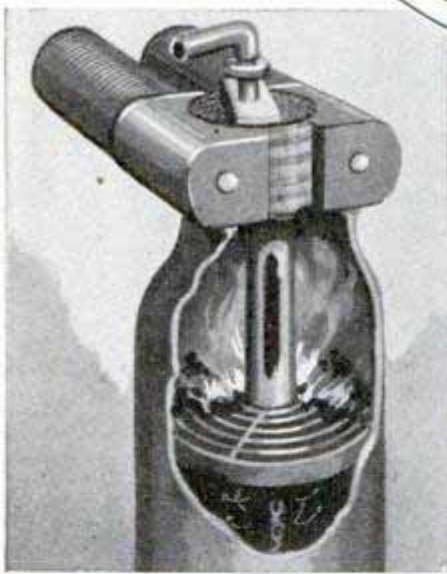

Sketch Showing the Interior of Edison's Pyro-Magnetic Motor Heated by Coal, and, at Right, Prof. Charles Manly's Airplane Radial Gas Engine; in 1903, It Was One of the Most Powerful for Its Weight, as It Developed Fifty-Two Horsepower; Today Further Necessity of Streamlining, to Decrease Wind Resistance, Indicates the Substitution of the Radial Motor for the More Slender "In-Line" Type

message: "A patient waiter is no loser." Or gave it a more sublime ending than, "What hath God wrought?" which bounded over a forty-mile circuit from Washington to Baltimore.

Another teacher, Alexander Graham Bell, instructed deaf-mutes.

"If I can make deaf-mutes talk, I can make iron talk," he assured himself.

At first his major interest was a music telegraph, with a number of keys like a piano, capable of sending a like number of different tones over a single wire.

It took months of experimentation to send the simple twang of a watch spring over a wire. That was convincing. All it needed now was refinement. He forgot his early lament about lacking a knowledge of electricity. He taught himself all about it.

Bell exhibited at the Centennial Exposition in Philadelphia. His table stood in the Education building, the last to be visited by a committee of expert judges. When they came, the modest inventor prayed silently for an appraisal of his device. All learned men, they came, saw and began walking away. For that plaything on Mr. Bell's table was a device to interest—well, other "fools" like Mr. Bell.

Dom Pedro, emperor of Brazil, picked up the receiver and shouted electrified words:

"My God! It talks!"

The judges returned and immediately pronounced Bell's telephone to be one of the greatest inventions in the world.

Another epic discovery: Heinrich Hertz,

professor at the University of Bonn, proved that electricity flows in waves—Hertzian waves, spanning oceans, scaling mountains, circumradiating the globe.

Who braved the magic air waves? Not scientists, nor professors absorbed in books, but an adolescent boy, Guglielmo Marconi, Irish-Italian. He shot a feeble voice into air, and listeners yelled, "Louder! louder!"

Came DeForest, the Yankee, and placed a throttle on radio. "If you want louder speech and greater distance, simply add another one of my vacuum tubes." But who thinks of tubes as he talks from San Francisco to London?

The automobile first appeared as a one-lung steam buggy. William Murdock ran it around Piccadilly Circus in 1784 and caused a panic in London.

But twenty years earlier, a French army captain sought to move heavy cannon. He mounted a steam engine on a three-wheeled tractor. His hopes collapsed when his machine was wrecked by running against a stone wall.

When oil began to gush from a hole in the ground at Titusville, Pa., the auto buggy found its real ally. The Stanley brothers began making a steam automobile, and Amzi Barber founded the Locomobile company. Haynes drove his gas buggy in Chicago and was ordered off the street by an irate policeman.

And so the patent-office files grow at the rate of about two miles a year—a glowing record of the Golden Age of Mechanics.



How the Boys of Oakland, Calif., Used to Spend Their Sundays and Holidays Not Many Years Ago; This Collection of Old-Time Bicycles Is Now in the Possession of Josiah W. Stanford



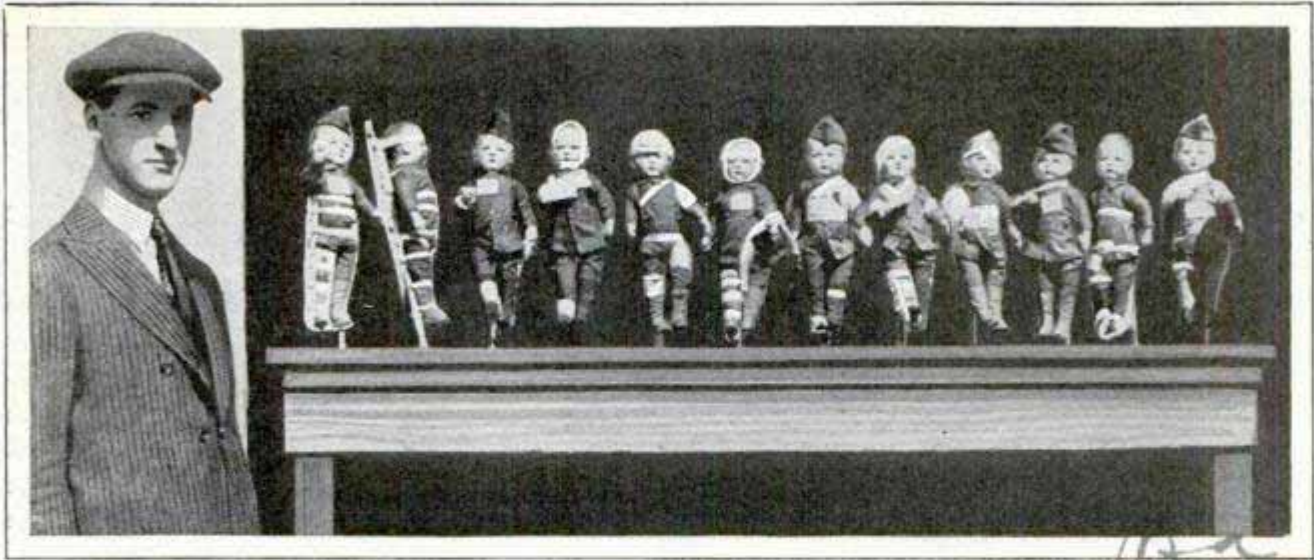

These Dolls Are Used by the Bureau of Mines to Demonstrate the Various Accidents That Befell Mine Workers and the First-Aid Treatment for Each Injury

**UNCLE SAM'S DOLLS TEACH FIRST-AID METHODS**

Dolls are used by the bureau of mines to demonstrate work in first aid to miners. For each injury likely to occur in a mine, there is a doll victim of a similar accident, with a bandage or other appropriate treatment in place. The crippled-doll display is intended to be useful in the moments immediately after an accident before medical help arrives. The dolls show the various kinds of accidents that befall mine workers, as well as the method of treatment, and also are intended to serve as a safety warning.

pulses received by the telephone transmitter. A command is carried through a radio detector tube to a special selector determining the polarity of the track upon which depends the direction in which the train moves. Two syllables, such as "go ahead," operate relay and selector to provide forward movement. An order in three or more syllables, such as "back up, Casey," sends the engine backward, and a single syllable, "stop," causes a halt.

**TOY TRAIN OPERATED BY VOICE BROADCAST OVER RADIO**

Controlled by a human voice broadcast over the radio from New York, a toy electric train in Pittsburgh obeyed verbal commands of the operator in a recent demonstration. The words controlling the train were carried by telephone from New York to Pittsburgh and then broadcast, being picked up on a regular radio receiver in front of which was an ordinary telephone connected by wire to the train. The train, called "Casey Jones," is dependent for operation on voice im-

**HEDGE RESEMBLING BIG PIANO TOOK TEN YEARS TO GROW**

After ten years of clever effort with a pair of clippers, a gardener of Bridgeport, Conn., has produced a hedge designed along the lines of a giant piano and now boasts being the only man to grow one. The hedge piano is twenty feet long, nearly six feet high, and standing beside it are a piano bench, lamp and chair.

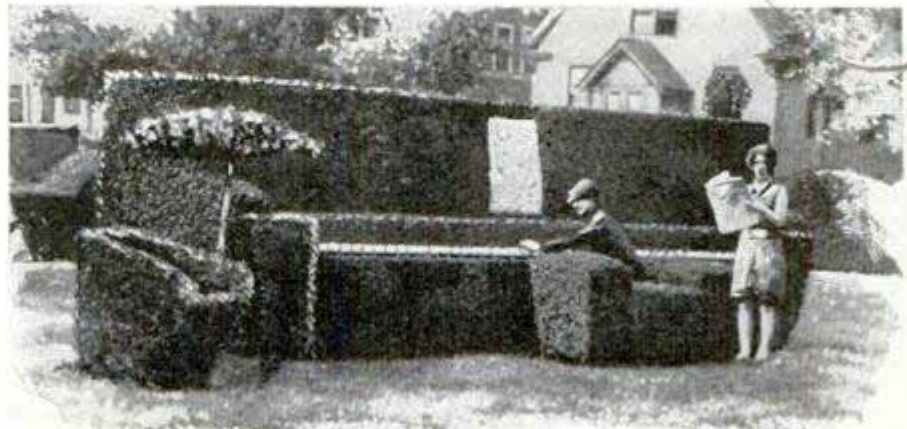

This Piano Took Ten Years to Grow; It Is Designed from Hedge, and Is Twenty Feet Long and Six Feet High

3047

3035

*J. Frank Zeto*

*News Bureau  
General Electric Co.*

*Letter returned  
8/26/29*

Journal 4/8/29



Serving without Pay, the Man with the Beard Makes an Inexpensive Footman; It Is a Dummy in Livery

Mary Duncan

### DUMMY SERVES AS A FOOTMAN AND SAVES OWNER CASH

Transporting a dummy dressed like a footman about the streets in a limousine may add to appearances even if it does not aid in opening auto doors, and the figure is certainly less expensive. A stage and screen star adopted the idea when her French footman returned to Paris. She ordered a dummy with the facial expression of her absent employe, put the footman's uniform on it and now the dummy accompanies her to any formal functions.

### MAGNETS TO LIFT SUNKEN SHIP AND RECOVER TREASURE

3050 Dynamite and powerful magnets are the implements being used to salvage a sunken ocean liner whose treasure room contains gold and silver valued at more than \$5,000,000. The ship is the "Egypt," which sank in 360 feet of water in the Bay of Biscay in 1922 with a loss of eighty-seven lives. In its hold is the bullion, which was consigned to the Egyptian treasury. Two Italian tugs bearing Genoese divers, renowned for their physical endurance, are attempting the salvage operation, the divers using 20,000-candlepower electric lamps to light up the ocean bed in their work. The wreck is first to be dynamited to release the section containing the treasure room, after which the magnets will be brought into play in efforts to raise the various parts of the shattered vessel. If the attempt is a success, efforts will be

Clardy Mail  
re. Nov. 1930. For 6/3/29

made to raise the Belgian liner "Elizabethville," sunk in 240 feet of water off the French coast with 13,000 carats of diamonds aboard.

### NITROGLYCERINE IS USED AS LUBRICANT

3025 Using nitroglycerine to grease the squeaky wheels of a cart or to oil boots may sound like madness, but it has actually been done without fatal results. It is related that in Germany nitroglycerine often is carried in zinc cans. The explosive, not entirely free of acids, sometimes ate through the cans and trickled over the cart wheels and in one instance was used as lubricating oil. In another case a bottle of explosive was accidentally broken by an experimenter who later found that his old woodcutter had used what was left to grease his boots.

### CUSTOMERS MAKE OWN CHANGE IN BUYING NEWSPAPERS

2993 Several hundred Los Angeles newsboys are so firmly convinced that the average person is honest that they leave money changers and stacks of papers at the curb, inviting customers to help themselves. Buyers deposit their coins in the changer and make their own change. The boys say their losses are negligible.



Patron Buying Paper and Making His Own Change in Los Angeles, Where Newsboys Trust Customers

Pa-a

PUSHER PLANE GIVES BETTER VIEW OF GROUND

Test flights with a pusher monoplane have been conducted in England and with satisfactory results, according to reports. In this type of airplane, the motor is be-

*at Brooklands*

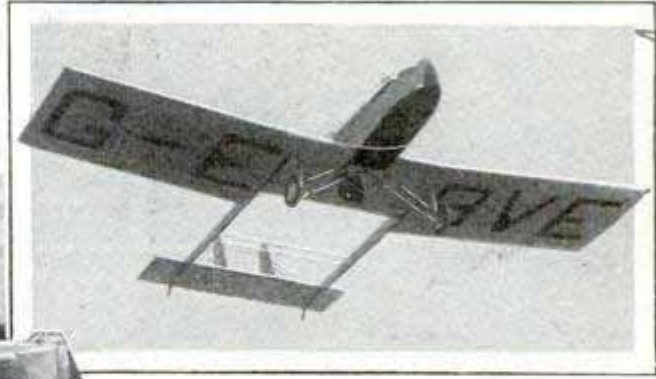

Two Views of the Pusher Monoplane, Showing the Passenger Compartment Far Forward, Commanding Wide View

hind the passengers, thereby affording a less restricted view, and there is less annoyance from the fumes from the engine. Greater flying safety has reduced the hazards of the pusher-type plane.

CONGRESS KEPT COOL OR WARM BY AIR CONDITIONING

*3055*

"Ten degrees cooler inside," the familiar theater sign, now may appropriately be hung on the door of the house of representatives in Washington where a system of air conditioning maintains a constant comfortable temperature for the lawmakers winter and summer. In winter, the temperature is maintained at seventy or seventy-two degrees, and in summer a steady temperature of from seven to ten degrees lower than outside is offered, but because all excess moisture is removed from the air, it actually seems much cooler. At ninety degrees outside, the house reading is eighty or eighty-three, but it appears to be around seventy-three, it being explained that an actual temperature of seventy-three would mean too great a change for persons coming in from outside. The system includes not only circulation of the air and regulation of temperature, but washing it to make it pure, and providing it with the proper amount of moisture.

house chamber and galleries. Similar equipment is contemplated for the senate, and is even being extended to some private homes. Ventilating engineers who worked out the system estimate that 72,000 cubic feet of pure air is forced into the house chamber each minute, and that all the air is renewed each four minutes. In one month of operation, about 500 pounds of dirt was removed from the air, but New York theaters report nearly three times as much removed in one week.

WOODWORKING SET ON WHEELS LATEST BUILDING AID

*2861*

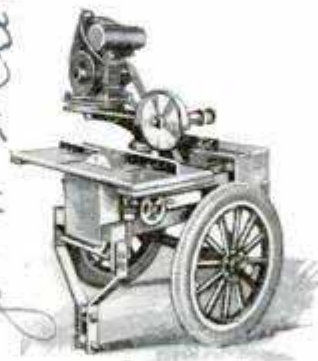

For crosscutting, mitering, ripping and many other woodworking operations, a portable saw outfit on wheels has been devised. It is run by a single-cylinder air-cooled gasoline engine, is

quickly set up and can be towed behind an automobile as a trailer to the place where work is to be done.

Century plants are relatives of the lily.

*No information on mahar.*

*Acacia senegal news Bulletin 4298 6/14/29*

*due Hutchinson idg G. 7-11-29*

2759

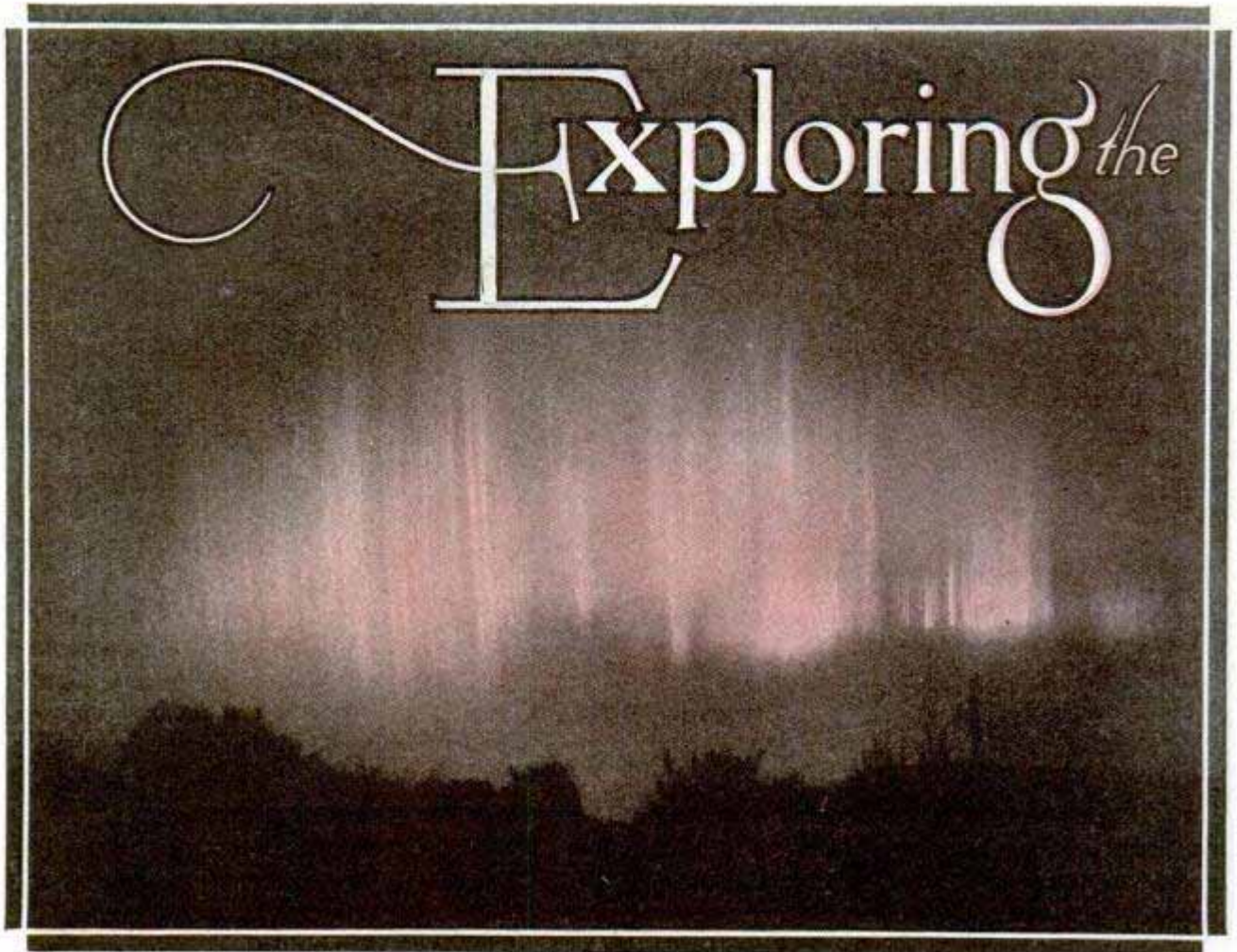

Northern Lights in Their Glory; a Brilliant Display of Auroral Streamers Photographed at Oslo, Norway, by Prof. Carl Stormer

By CALVIN FRAZER

*The Telegraph  
Co. Box 40, Washington, D.C.*

ABOUT twenty-five years ago meteorologists embarked with much enthusiasm upon a world-wide campaign of what was—and still is—described as “upper-air research.” It did not relate to the upper part of the atmosphere, but to a region extending a few miles above the earth. Previous to that time, investigations had been devoted mainly, though not entirely, to the bottom of the aerial ocean. The study of conditions somewhat higher up, undertaken with the aid of kites and balloons early in the present century, was felt to mark the beginning of a new era and hopes were entertained that, as a result, weather forecasters would be able to make almost perfect predictions.

Kite and balloon meteorology, otherwise known as “aerology,” is now an old story. Its results have not been quite so revolutionary as was expected, but it has led to at least one epoch-making discovery, and it has proved to be of great value

to forecasters, besides being an indispensable aid to aeronautics. Its methods have undergone no radical change during the last quarter of a century. Kites are still used, though they are less in favor than they were a few years ago. The mainstay of the aerologist is the pilot balloon—a small free balloon that is released and sighted through a theodolite for the purpose of measuring the winds aloft. Throughout the world, hundreds of thousands of these balloons are now sent up every year. Sounding balloons carry up featherweight instruments for measuring barometric pressure, temperature and humidity, but the recovery of their records is usually a very slow process. A promising substitute for both the kite and the sounding balloon, when prompt information is desired about atmospheric conditions other than wind at moderate altitudes, is the aeroplane, equipped with appropriate self-registering instruments.

# Stratosphere

There are at present several weather stations in this country and abroad where aviators make daily flights for the purpose of securing such data.

Though it is still customary to speak of sounding the "upper" atmosphere with the various devices above mentioned, the portion of the atmosphere that can be reached by them is really only a small fraction of its total vertical extent. The greatest height ever attained by a kite was six miles; by a sounding balloon, nearly twenty-two miles, and by a pilot balloon (according to a somewhat doubtful record made in Greenland), twenty-four miles. The atmosphere undoubtedly extends many hundreds of miles above such levels; just how far nobody knows. With increase of altitude it becomes greatly rarefied, but there is still enough gas present at higher levels to produce various effects that are not only of scientific interest but also of much practical importance to mankind.

Records obtained with sounding balloons have revealed the remarkable fact that the earth's atmosphere is divided into two distinct layers or shells. The lower, now called the "troposphere," extends from sea level up to a height averaging six or seven miles. This layer enjoys a monopoly of storms, ordinary clouds, rain, snow and most other things usually classed as "weather." Above it lies the "stratosphere," extending to an unknown height. These two shells of the atmosphere differ from each other in several respects. The difference first recognized was one of temperature. When a sounding balloon is sent up from the earth's surface, its thermometer shows a more or less steady fall of temperature until, at the top of the troposphere, it registers some sixty or seventy degrees below zero Fahrenheit. Individual readings vary a good deal, the average for the whole world and for all seasons being about sixty-three degrees below zero. As soon as the stratosphere

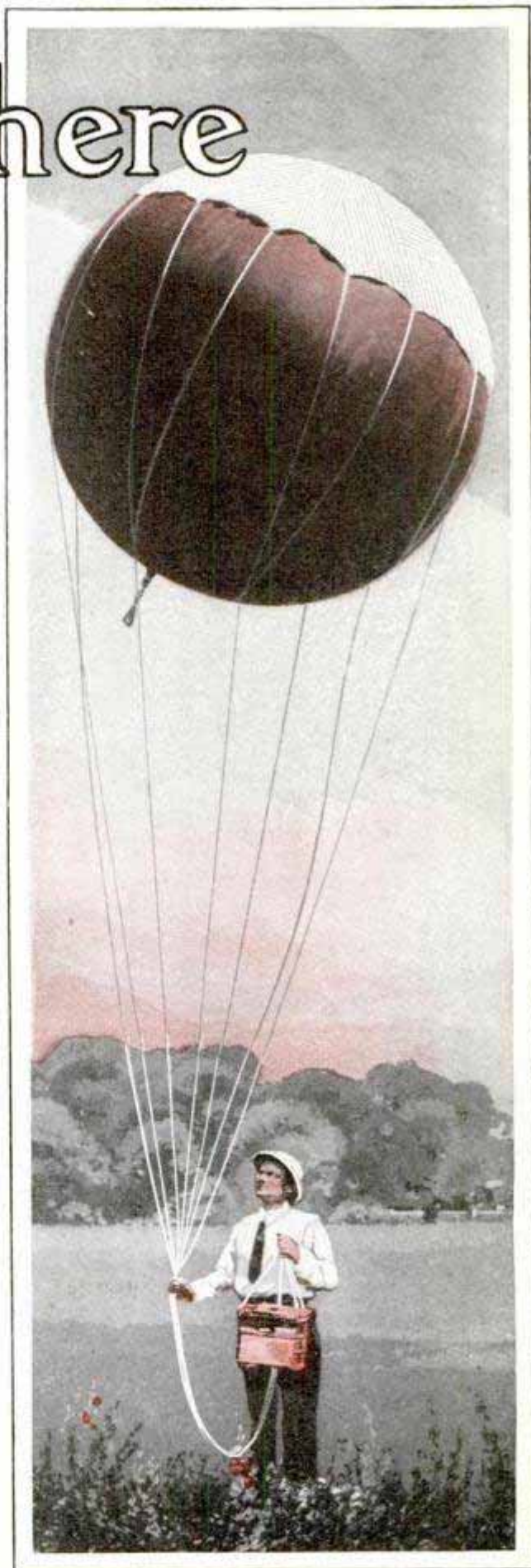

Sending Up an "Air-Sounding" Balloon with Automatic Instruments Contained in Suspended Cage; Temperature and Other Conditions Are Recorded at Heights Far above the Range of Airplanes

2759

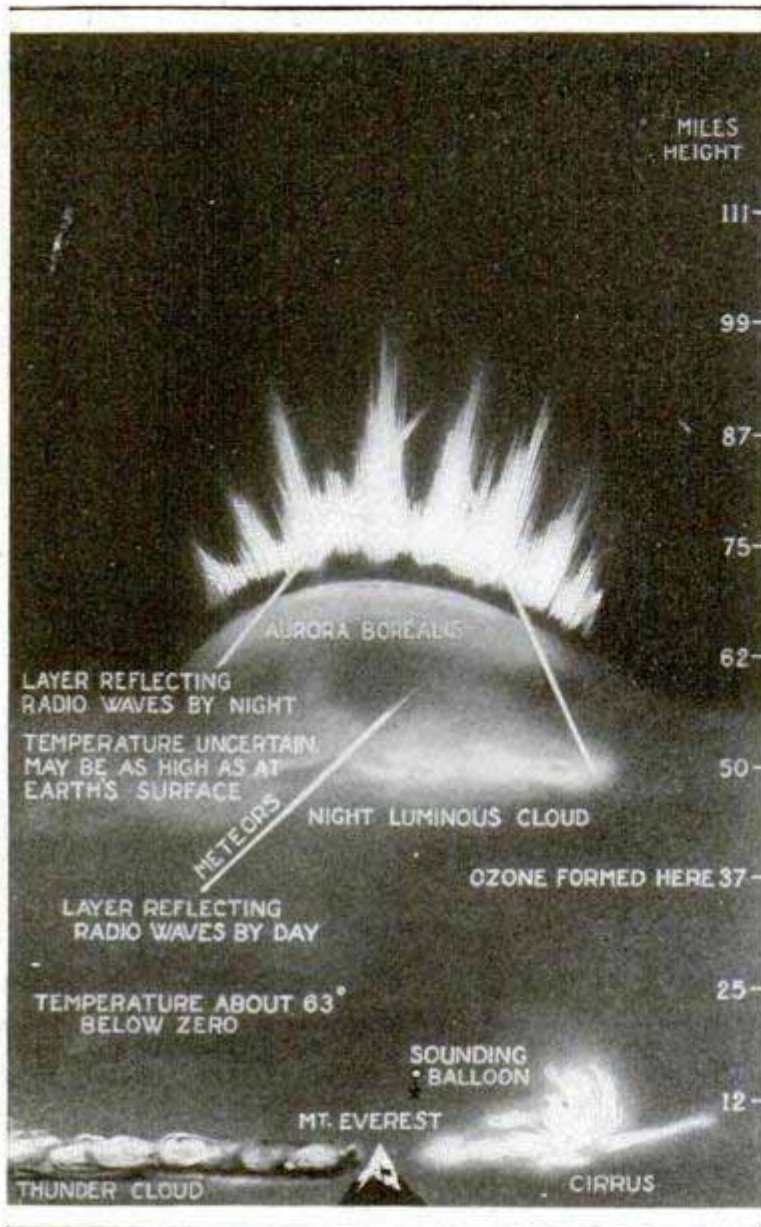

Diagram of Possible Upper-Air Conditions as Drawn by G. B. M. Dobson, of Oxford University; Note Position of Sounding Balloon

is entered, this steady fall in temperature ceases. Up to the greatest height thus far attained by sounding balloons, there are only small and irregular temperature variations in a vertical direction. Whether this uniformity of temperature continues upward indefinitely is a question concerning which the opinions of meteorologists differ.

The lower part of the stratosphere is supposed to have a system of winds quite unlike that prevailing in the troposphere, but information on this subject is rather meager at present. One more important difference between the two layers of the atmosphere is in proportions of the atmospheric gases they contain. In the troposphere, the winds keep these gases thoroughly mixed, so that their propor-

tions are substantially uniform at all levels. This may also be true in the lower levels of the stratosphere, but higher up, there is probably little or no wind, and under such conditions the gases of the atmosphere would tend to arrange themselves according to their relative weights; the lighter above and the heavier below. Thus the composition of the higher atmosphere is believed to vary with altitude. Its composition at great heights has been a subject of much controversy.

For many years Prof. R. H. Goddard, of Clark University, has been experimenting with a new kind of rocket, which will, it is hoped, carry apparatus for measuring temperatures and pressures, collecting samples of air, etc., up to far greater heights than can be reached by a balloon, and will thus solve some of the mysteries of the stratosphere. Meanwhile, there are several other ways by which this lofty region is being explored.

The duration of twilight, in clear weather, indicates the greatest height at which the atmosphere is dense enough to scatter sunlight. This is found to be about forty-five miles. Occasionally, in summer, curious silvery clouds have been seen shin-

ing through the night in the northern sky. These doubtless reflect the light of the sun and must therefore be at a great height. Certain photographic measurements seem to show that they are about fifty miles above the earth. What these clouds are made of is uncertain, but the most probable guess is that they consist of volcanic dust. It is well known that great explosive eruptions of volcanoes, such as that of Krakatoa in 1883, carry enormous quantities of dust to great height in the atmosphere, where, as there is no rain to wash it down, it remains suspended for long periods.

Meteors, or shooting stars, are visible up to a height of about 100 miles, and beams of the aurora have been seen to extend to heights exceeding 450 miles.



Prof. Carl Stormer at One of the Observation Stations in Southern Norway; They Are Connected by Phone as Headset Indicates So That Photographs Can Be Taken Simultaneously; Below, Professor Goddard and Rocket He Designed for Exploring the Upper Air

The heights of both meteors and auroras can be measured with considerable accuracy by means of simultaneous photographs taken from two or more places many miles apart. These objects are photographed against a background of stars, and their apparent positions, with reference to the stars in the different pictures, provide a means of calculating their heights as well as their distances from the point of observation.

The photographic measurement of the aurora has been carried on with great success for the past twenty years by Prof. Carl Stormer and his assistants in Norway, and more recently in other northern countries, so that a good deal is now known about the actual location of this phenomenon in space. It forms two rings, which vary greatly in extent from time to time and encircle the magnetic poles of the northern and southern hemisphere, thus giving us the "northern lights" and the "southern lights." Apparently it does not, at any time, extend down to the earth's surface, as was once supposed, but occurs only at heights of from about sixty miles upward.

An auroral display is an electrical discharge in the rarefied gases of the upper

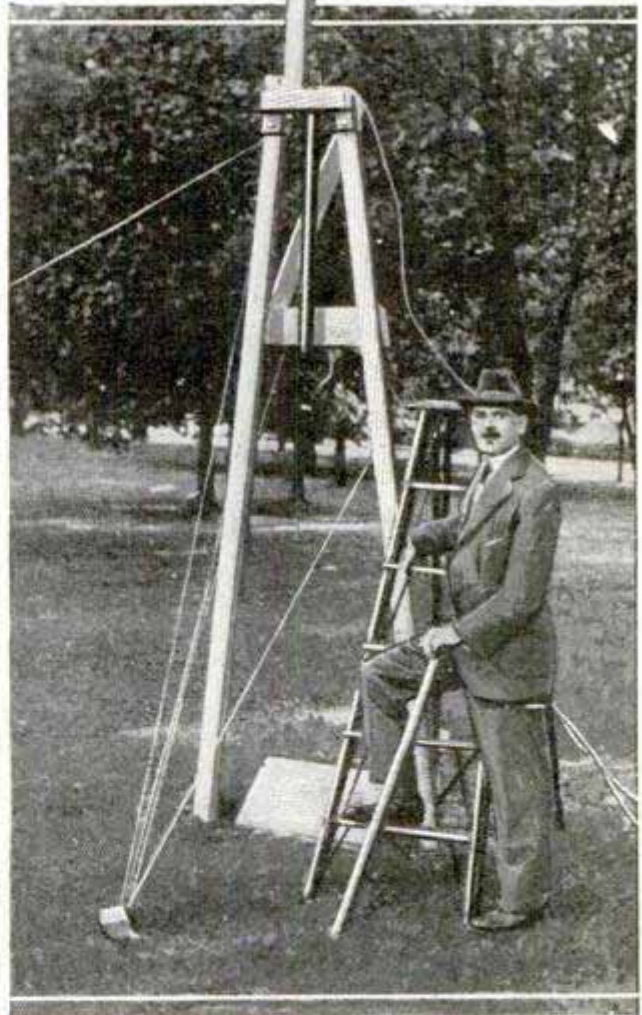

atmosphere, very similar to the discharges seen in the Crookes tubes of the laboratory. It is due to the bombardment of the atmosphere by electrified particles shot out from the sun, and this bombard-

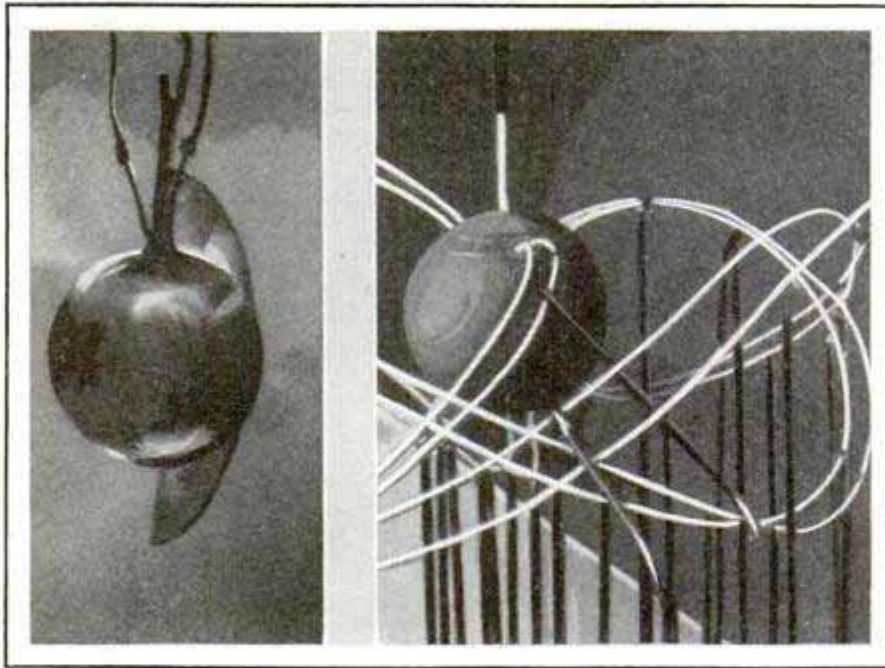

Laboratory Interpretation of the Aurora; Left, Artificial One Produced by Exposing Magnetized Iron Ball to Cathode Rays; Right, a Model

ment, in turn, is especially active at times when there are large sunspots. The earth is a great magnet, and, like other magnets, it has the property of deflecting from a straight path an electrical discharge occurring in its vicinity. This fact explains why the streams of electrified particles from the sun do not cause auroral glows all over the earth, but only in the two belts around the polar regions already mentioned. It also explains how the particles can be twisted so far from a direct course as to cause an aurora on the night side of the earth—the side turned away from the sun.

This whole process is beautifully demonstrated in an experiment in which a magnetized iron sphere, representing the earth, is suspended in a glass vessel nearly exhausted of air and exposed to a discharge of cathode rays. The sphere is coated with a phosphorescent substance, which glows under the discharge in two zones corresponding approximately in position to the auroral belts of the earth.

As the composition of a distant star or of the sun is indicated by its spectrum, one might reasonably expect that the spectrum of the auroral light would reveal the composition of the earth's atmosphere at the levels where the aurora occurs. The auroral spectrum contains some lines due to nitrogen, but its most conspicuous feature is a bright green line, the origin of which has caused an immense amount

of controversy for many years. The last word on this subject is the discovery recently made by McLennan and Shrum, at the University of Toronto, that the line in question can be produced in the laboratory when a discharge is sent through rarefied oxygen; especially when this gas is mixed with certain others, viz., argon, neon or helium. Thus it seems likely, at present, that the atmosphere at the levels where the aurora is visible consists mostly of oxygen. Higher up the lighter gas helium may

predominate, but we have no evidence on this point.

One of the most interesting recent discoveries about the upper atmosphere is that somewhere over our heads (though authorities differ considerably about the height) lies a well-defined layer of ozone—a particular kind of oxygen, which, at one time, figured conspicuously in the advertisements of health resorts and the like, as it was then erroneously supposed to be present in considerable amounts near the earth's surface. This so-called "ozone blanket" in the upper air absorbs a great deal of ultraviolet solar radiation, and prevents an excess of such radiation from reaching the earth. Too much ultraviolet sunlight would be as bad for mankind as too little.

There is another possible effect of the ozone layer that has led to much discussion. In absorbing solar radiation, it must be warmed, and this may lead to a general warming of the atmosphere for a considerable distance upward. Two English authorities believe they have found evidence in the behavior of meteors that the air above a level of about thirty-seven miles, instead of being intensely cold, as it is at the bottom of the stratosphere, is about as warm as on an average summer day at the earth's surface. They think these mild conditions prevail up to a height of about 100 miles, above which level the air again grows cold.



Last, but not least, the stratosphere contains something in which every radio fan is interested—the Heaviside layer. This is a sort of “radio roof,” consisting of electric particles, along which radio signals travel and are eventually reflected back to the earth, thus making long-distance transmission possible. The layer is named for the English physicist, Oliver Heaviside, who suggested its existence as long ago as the year 1902, when Marconi was making his pioneer experiments.

Where is the Heaviside layer? Up to a year or so ago, the authorities seemed to have definitely located it at a height of about thirty miles by day and fifty to sixty miles by night (which would explain why radio signals are heard farthest at night). Recent investigations, however, seem to show that there are two or more of these radio roofs, one above the other, within the atmosphere, and that in some cases radio signals pass outside the atmosphere and are later reflected back to the earth by something out in space—perhaps another planet, perhaps the same stream of electric particles from the sun that causes the aurora.

Meteorology is looking up, these days—much higher up than it did a quarter of a century ago.

**FOLDING SQUARE SAVES TIME IN CALCULATING ANGLES**



Besides packing neatly into any sort of tool kit, a folding square is designed to save time for carpenters in calculating angles and laying out work. The square is constructed on the

principle of a protractor, the arc of which is formed by a circular projection on the tongue. The tongue is snapped automatically into the desired position, and notches allow it to be set at angles representing miter cuts on rafters for roofs with varying pitch.

Ⓛ About half of the soft wood in this country is Douglas fir.

*Industrial Development Co., 292 Morrison St.*

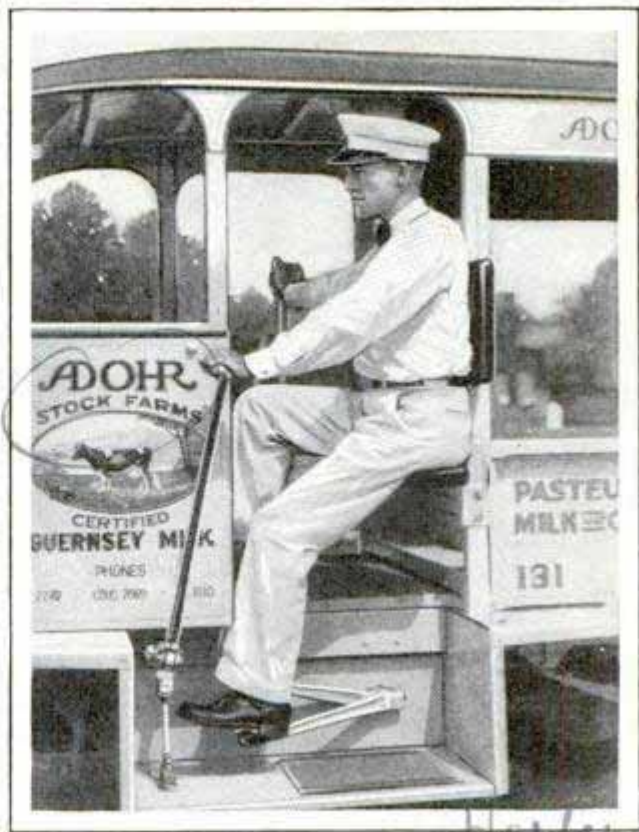

Side View of the Electric Milk Wagon, Showing the Position of the Foot Controls and the “Joystick”

**“JOYSTICK” MOTOR MILK WAGON OPERATED FROM SIDEWALK**

Designed especially for the milk man’s short-stop routes, a motor delivery wagon, guided by a “joystick,” that can be operated from the sidewalk as the driver walks along, has appeared in Los Angeles. There is a stick on either side of the wagon as well as brakes and clutch controls which are on the outside, so that the operator need not enter to run it

**SPARK-PLUG SHIELD PROTECTS WIRING FROM WEATHER**

Designed to protect spark plugs and wiring from rain, a shield of aluminum alloy is being manufactured to fit over the plugs and keep them entirely dry. It is attached to the intake manifold and when it is desired to examine or clean the plugs, it is only necessary to loosen two wingnuts, whereupon the shield cover can be swung open.

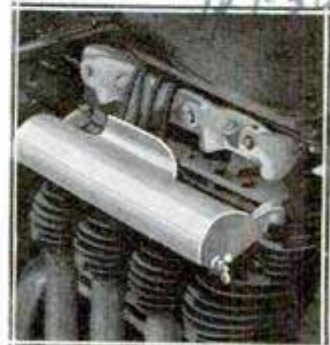

*Messrs. Driscoll & Jeanroy, 1217 W. ...*

June, 1929

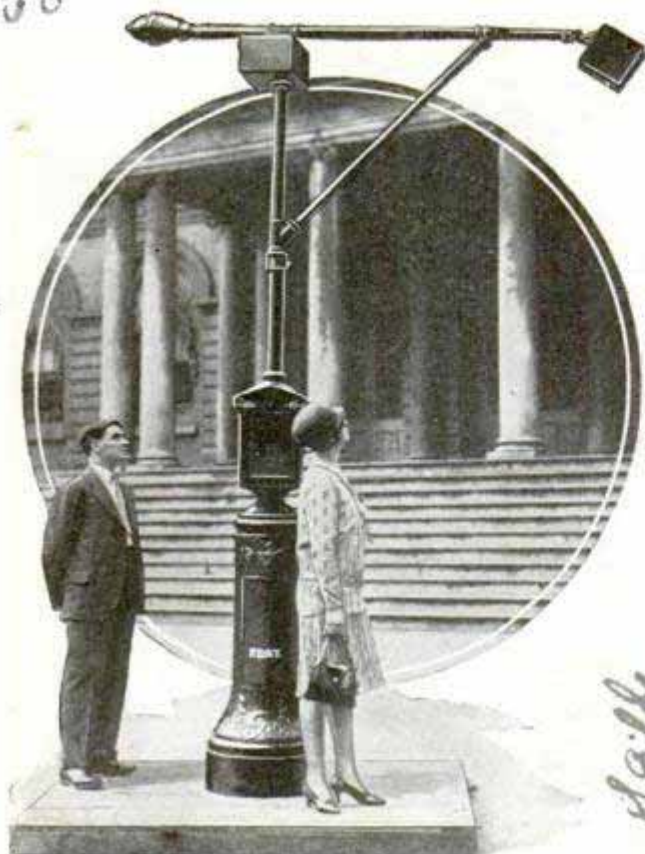

Camera Attached to Fire Box Takes Picture of Every Person Turning in an Alarm

### CAMERA ON FIRE-ALARM BOX TO PREVENT PRANKS

Experiments are being conducted in New York with a fire-alarm box equipped with a camera to detect the false-alarm joker and performers of other pranks that often lead to accidents and injuries to firemen. The camera, extending on an arm above the alarm box, is set at such an angle that anyone turning in an alarm is within its focus. Sounding the alarm automatically clicks the camera shutter, thus providing a picture of the person that sent the signal.

### HOW BADGERS FIND GOLD MINES

Because gold mines in Colorado and Nevada have been discovered after fragments of gold ore were found in badger holes, some miners and prospectors have decided that the animal possesses an instinct causing it to dig where the yellow metal is. Mining engineers and geologists, however, point out that hills frequented by badgers usually have an underlying formation of rock too hard for the badger's claws. While the badger has no nose for ore, it apparently has an instinc-

tive knowledge of rock formations and digs where the burrow will enter a fault or fissure, and so frequently uncovers gold because such breaks in the rock surface are logical places to find ore or veins.

### STEEL OF FIRST SKYSCRAPER STILL WELL PRESERVED

Steel beams and iron columns of the old Tacoma building in Chicago, said to be the first skyscraper ever built, were found to be almost as well preserved as when placed in position thirty-one years ago when the building was razed recently to make way for a taller structure. Experts who examined the metal frame said there was no sign of crystallization or rust.

### PORTABLE BRAKE TESTER GIVES ACCURATE RESULTS

An inexpensive portable brake tester, which indicates out-of-true drums, brake drag or other trouble, has been put on the market. The tester consists of two connected rollers which are shoved under one wheel at a time, after the brake has been set with a pedal. A hand lever brings the rollers in contact with the wheel and at the same time raises the wheel clear of the floor. A worm gear between the rollers is operated when a switch is turned, and the end thrust of the gear, caused by the pull against brake resistance, is transmitted to a gauge. All brakes are set simultaneously by one operation of the brake pedal, eliminating a chance for difference between wheels.

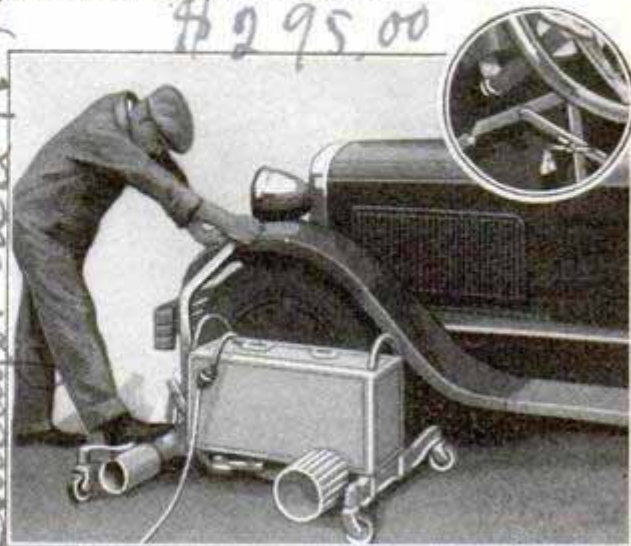

This Machine Finds Defective Brakes; Insert, Brake Pedal Which Maintains Uniform Pressure

Chicago, Carl H. Huber Co. 928 N. La Salle

\$295.00

3036

Cont. to Richardson  
Tomball, Nevada

Chicago, Carl H. Huber Co.

*and Dr. Benjamin Goldberg  
at Spalding School for Crippled Children*

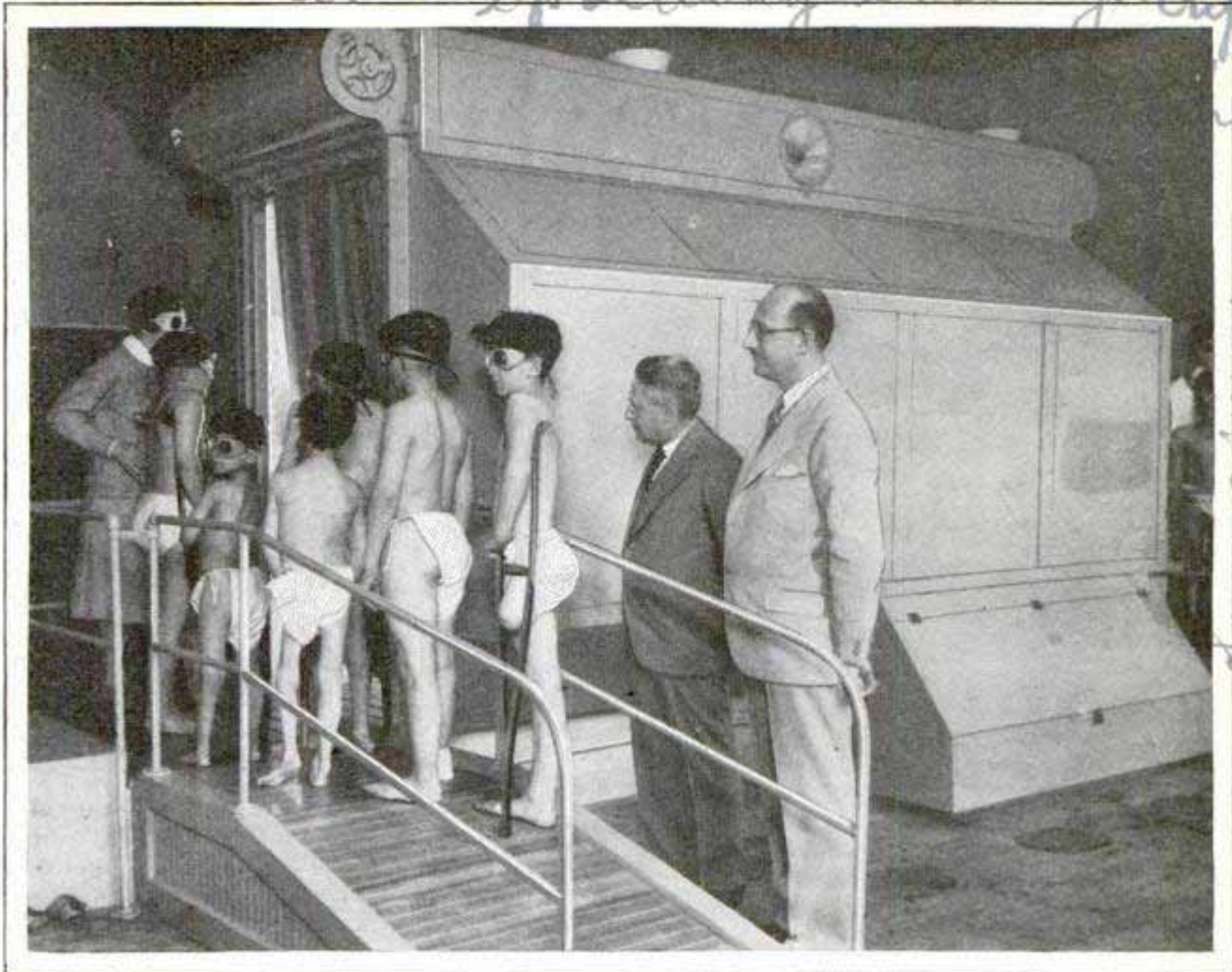

*Washington + Oakland  
Bureau of Charities*

Crippled Children of Chicago Entering Sun Bath, Where a Giant Lamp Administers Synthetic Sunshine to 150 of Them Every Hour; Goggles Protect Their Eyes from the Glare

### GIANT LAMP MAKES SUNSHINE FOR CRIPPLED CHILDREN

Synthetic sunshine is provided for crippled children of Chicago by a giant mercury-quartz lamp that administers treatments at the rate of 150 an hour and will cause sunburn within a minute. An automatic moving platform carries the children through the sun compartment, where the lights are so arranged that they reach every part of the body. Each little patient wears a minimum of clothing for the daily bath and is provided with colored goggles to protect his eyes from the glare.

### ROADS MADE OF COTTON

Cotton cloth covered with tar has proved a durable surface for dirt roads in experiments in South Carolina. The road is graded, leveled and smoothed, a coarse cotton cloth spread over it, and a thick coat of paving tar applied. The cloth

and tar keep the dirt road from becoming muddy and washing away in rainy weather, and even though the surface cracks, the tar fills up the fissures when the sun warms it. These cloth roads cost about \$3,000 to \$3,600 a mile, only a fraction of the cost of paving.

### THREE ACCESSORIES IN ONE FASTEN TO AUTO WHEEL



Three accessories in one, a combination oil gauge, choke and match box are contained in an instrument which may be attached to the steering wheel of a Ford. The oil gauge, adjusted on

the wheel, cannot leak, as there is no way for the oil to get out of the tube.

*Cont. see H. L. Coleman  
325 Industrial Ave*

*2122 Metal  
Product Co.*

*Down to Day on this*

2820

Swampy ...  
+ Stock Co  
Jeffersonville of Va

# The Father of the

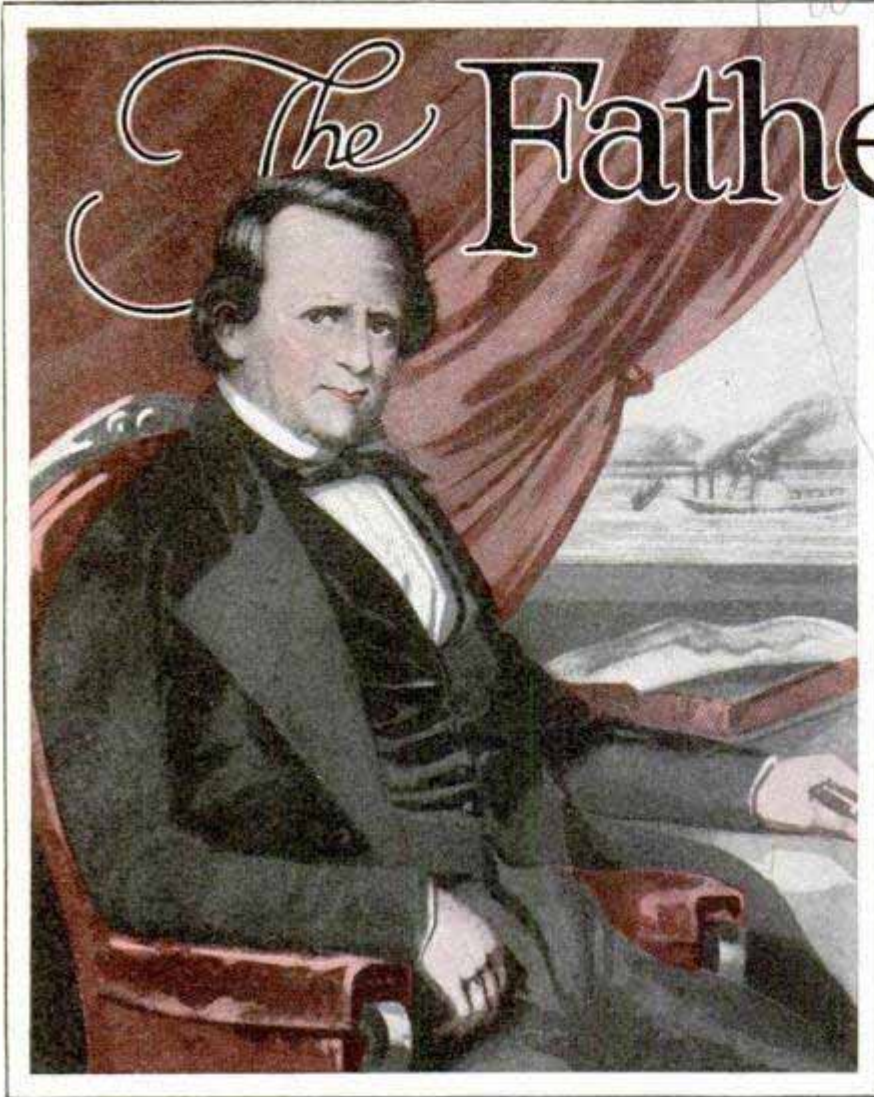

tain Tobin's 'J. M. White,' the second 'Robert E. Lee,' the 'John W. Cannon,' Commodore Laidley's 'City of Louisville,' 'City of Cincinnati,' and 'Indiana.'"

The speaker was James Howard, now president of America's oldest shipyards, at Jeffersonville, Ind. He was standing on the bluff Ohio banks watching the riveting on several huge steel barges, but his talk was all of the great white steamboats, famous in song and story, with twin tall smokestacks, tiers of cabins and jigsaw decorations, which once supplied the river cities with their sole means of transportation.

Henry Shreve, Inventor of the American Steamboat. One of the Most Important Single Factors in the Development of the West and South

By G. L. ESKEW 4/5/1  
Lakeview, Chicago

"FROM those ways," said James Howard, indicating a long series of greased tracks sloping down from the Ohio's muddy bank, "I have seen hundreds of steamboats slide into the water. The fact is, I built a good many of them myself, though my father and grandfather were really the famous steamboat builders in the days when the fine packets plied these rivers.

"In these days, when there is a general revival of various kinds of transportation in the Mississippi valley, and the towboats and barges, the railroads, the airplanes and the trucks are each coming in for their share, not many people recall the old-time wooden steamboats which built up the cities before the railroads came.

"There will never again be any such fine steamboats as the 'Ed Richardson,' Cap-

tain Tobin's 'J. M. White,' the second 'Robert E. Lee,' the 'John W. Cannon,' Commodore Laidley's 'City of Louisville,' 'City of Cincinnati,' and 'Indiana.'"

"To understand anything about steamboats," continued Mr. Howard, "you must first know that the problem of navigating the Mississippi by steam is very different from that of deep water. We have no big waves or storms, but we have shallow channels, sandbars, swift currents, in which no steamship that ever floated could operate successfully.

"In fact, it was these swift currents and shallow rivers that brought the steamboat into being. The steamboat is no descendant of the steamship. It stands by itself. Robert Fulton built the first practical steam vessel in America, the 'Clermont.' She was a deep-water craft—a steamship. Her machinery was in her hold. She had a single upright engine and boiler connecting with a shaft at right angles, which turned her side-wheels.

"The steamboat was something else altogether. The builder of the first was Henry Shreve, for whom the city of Shreveport, La., was named—a man who

# Steamboat

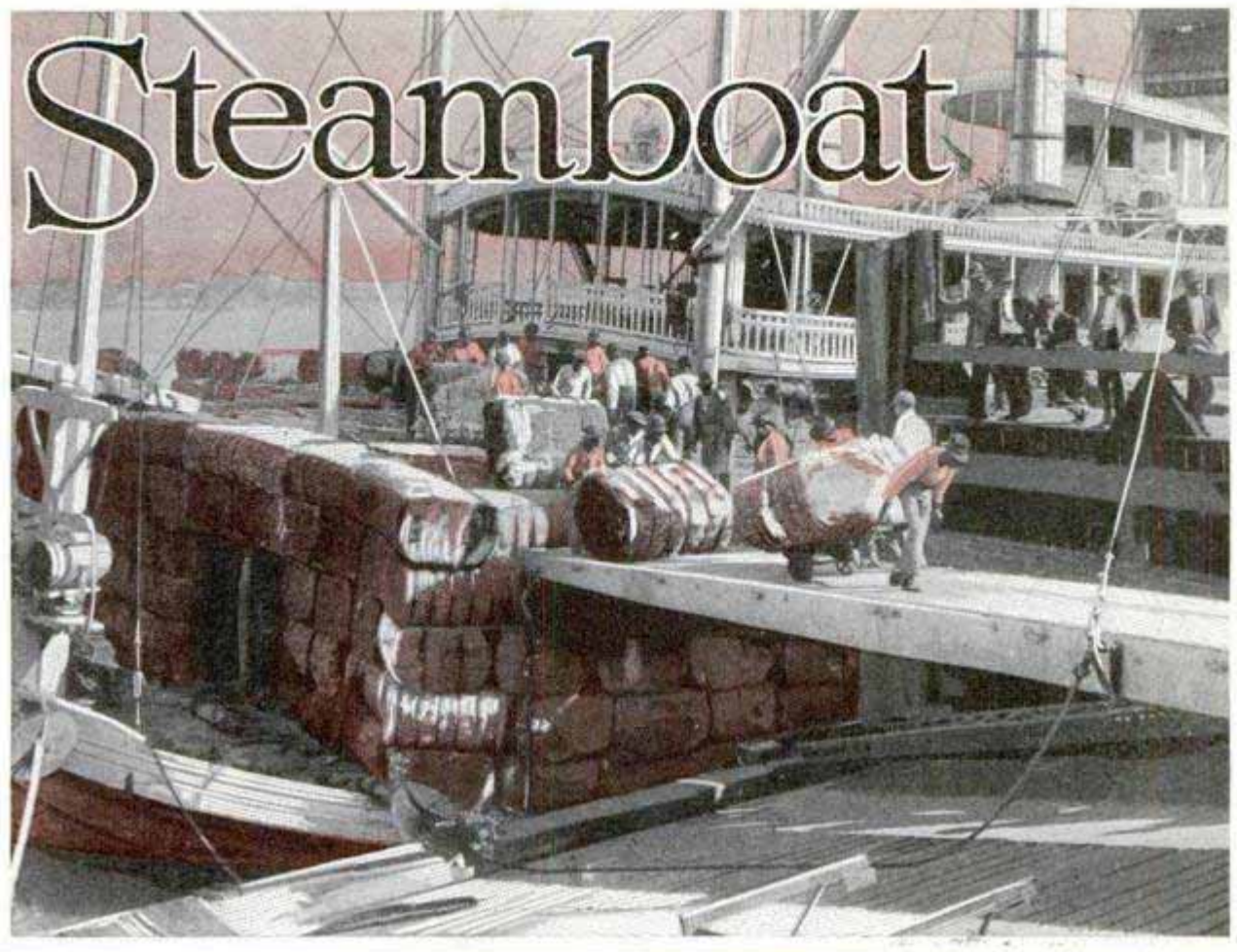

When Steamboat Traffic Was at Its Height; River Commerce Now Runs Largely to the Less Picturesque but More Efficient Barge Lines That Ply Far Northward

is practically forgotten. Yet the steamboats built on his model within thirty years represented a tonnage on the western rivers greater than those of the Atlantic seaboard and Great Britain combined.

"You might almost say Shreve learned from Fulton how not to build a steamboat; then he went ahead. For, though not many people know it, Robert Fulton and his associates came out here to the western rivers in 1812, after his success with the 'Clermont' on the Hudson river, and built several similar ships at Pittsburgh. But he failed to furnish any practical means of navigating the rivers, because he failed to grasp the fact that you can't navigate inland waters with ocean ships. Fulton sunk nearly a million dollars trying to do it. He succeeded in sending several ships down to New Orleans, but they couldn't come upstream and shortly sank or exploded. And that was when Henry Shreve stepped in and built the first steamboat, at Wheeling, W. Va.

"Shreve knew a radically different vessel from the steamship was needed to ply the rivers. He knew also from long experience that a keel boat hull was the best type for the rivers. It is nearly flat but slightly rounded, with a sharp bow. Fulton's steamship hulls, weighed down with heavy machinery, drew so much water that their keels dragged on every sandbar. They couldn't run in close to shore but had to anchor in midstream. And the Watt and Bolton engine which Fulton used was too weak to push a boat a hundred feet long upstream against a five-mile current.

"So Shreve, after Fulton's failure, set to work. His solution of the problem was simple. He merely built a keel boat hull 136 feet long, and instead of putting his engines in the hold, placed them on deck. Then, to make up for the space taken up by his machinery, he added another deck. He knew that Fulton's type of engine would never do. So he invented a new type and placed his cylinders and boilers

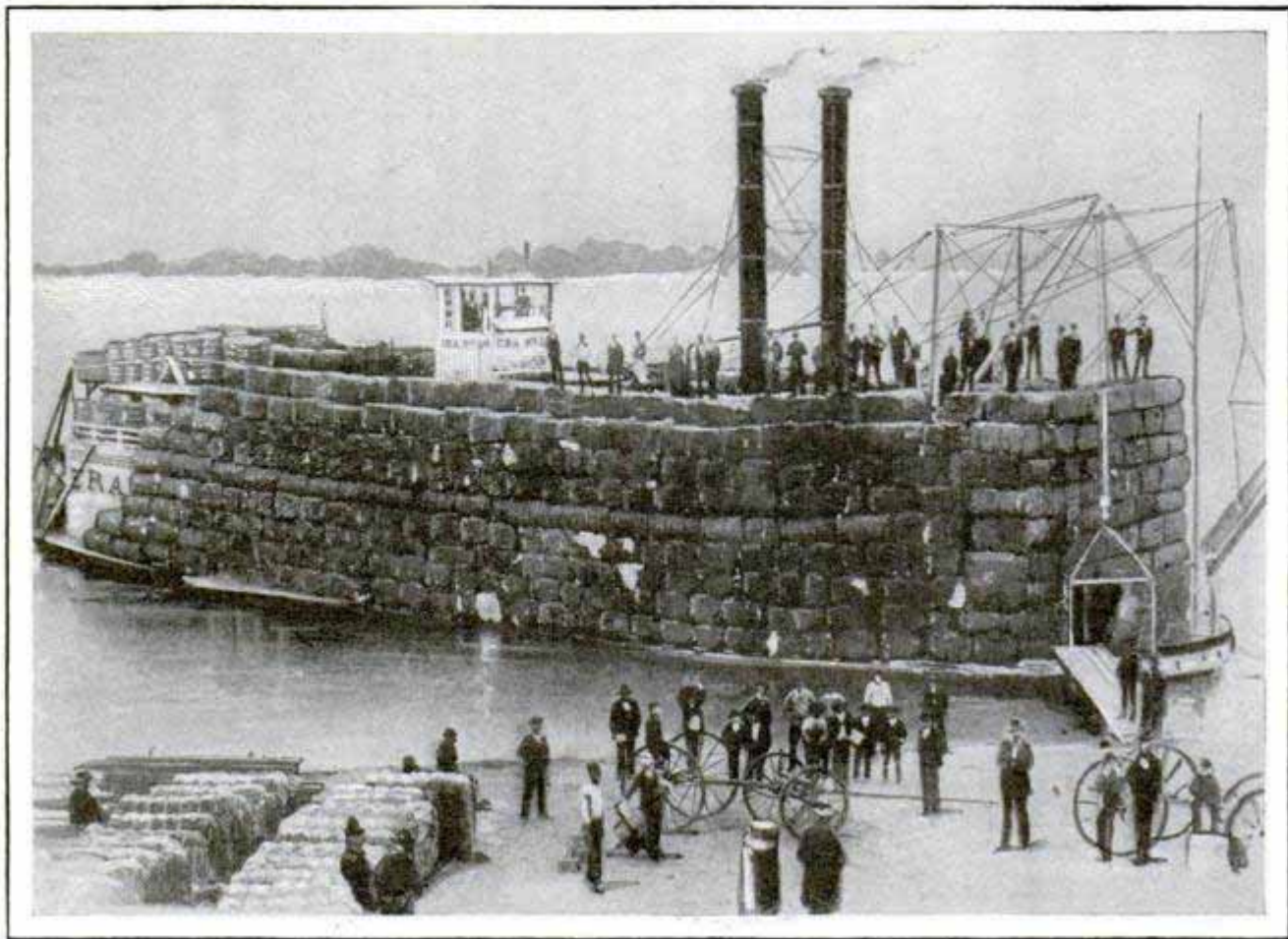

It Was the Western River Steamboat That Made Possible the Advance of the Southern States as the Chief Cotton-Growing Section of the World; a Typical Load of Olden Days

in a horizontal position instead of the then customary upright position. This new engine of Shreve's was somewhat like the engine of Daniel and William French, which had an oscillating cylinder. But Shreve made sweeping changes in it. He held the cylinder stationary, equipped the 'Washington' with double engines, unconnected, one for each paddle wheel. This enabled the pilot to go ahead on one engine and back on the other.

"That was the first American steamboat—nothing in the world but a steam-propelled keel boat, a boat to sail on the water instead of in the water. Her machinery weighed one-twentieth of the machinery of Fulton's ships. Shreve's engines could push the 'Washington,' which was as large as any of Fulton's ships, at a greater speed upstream against the current than the ships.

"Every steamboat built since Shreve's in 1817 has been constructed along the same lines. There have been a great many improvements, but the general type has remained, for the simple reason that it has proved better than any other.

"How many boats have we built in this plant? I have estimated it as best I could—no exact record was kept in my grandfather's time—and I think 2,800 would be about right. That, of course, represents craft of all kinds. Probably the most famous of all these boats was the 'J. M. White.' My father launched her in 1878 and Mark Twain and many others called her the finest steamboat of all. She was 325 feet long and her smokestacks reached seventy-five feet above the top deck. Their tops had feathery, lacelike decorations of oak leaves eight feet tall—for it was the custom to decorate all steamboats in a manner that would seem outlandish today. I recall that the 'Grand Republic,' another big steamboat, had a sunset scene painted on her wheel house. The 'White' had merely her name done in gold leaf in letters fifteen feet high. If you had rolled one of the 'White's' side-wheels alongside a building, it would have reached almost to the fourth floor. Her hub was a yard in diameter. The blades (we call them buckets) of her wheels were eighteen feet long. Each of her cranks weighed four

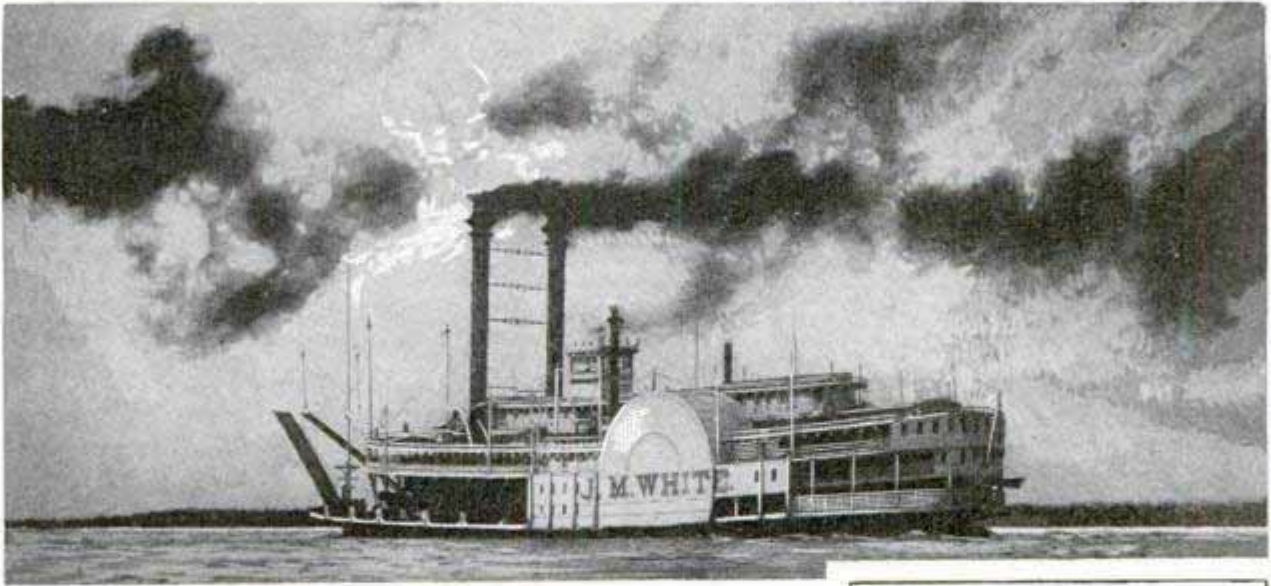

Efficient as Cargo Carriers, Many of the Famous Old Steamboats Were Also Luxuriously Equipped for Passenger Traffic

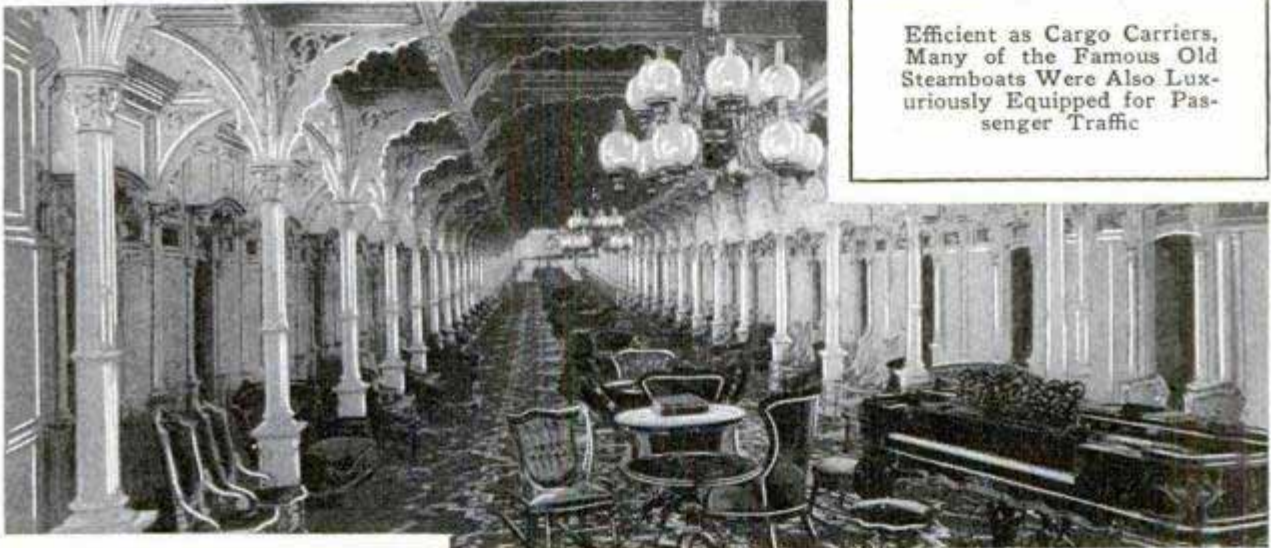

River Barges, Each with a Capacity of 2,000 Tons; Single Movements of More than 16,000 Tons Are Not Uncommon

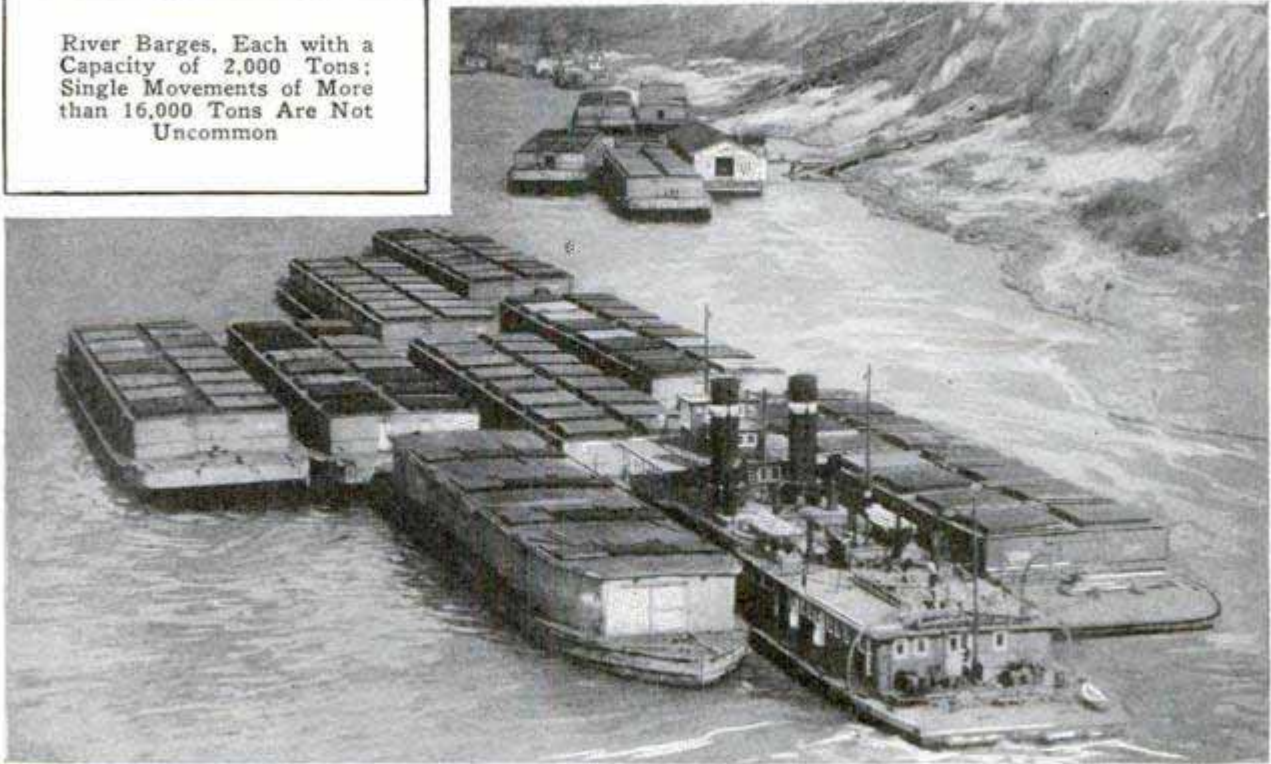

and a half tons, and each shaft without the crank weighed 28,000 pounds. Her engines were 1,600 horsepower each and her boilers carried 120 pounds of steam.

"I'll never forget what a magnificent picture the 'White' made as she lay in the river just after completion. She had perfect balance, and that was a difficult thing to accomplish, for we had no architect's drawings in those days. The placing of her engines and wheels—the wheels aft, to balance the engines forward—gave her just the correct set. She had a rakish and yet majestic look that was the delight of every steamboatman on the river. Twenty big chandeliers on heavily gold-leafed iron rings hung the full length of her saloon. She had a hundred first-class staterooms, four bridal suites and each door was dark walnut with an inlay of white walnut and had a glass knob."

The average American's idea of steamboating has mainly to do with gamblers, renegades from Natchez-under-the-Hill, the race of the "Robert E. Lee" and the "Natchez," with deck hands sitting on a pop valve and firing the engines with hams, and with Mark Twain's delightful stories. But these same western-river steamboats, with their tall chimneys and lacy filigree ornamentation, had a serious business to attend to. Long before the railroads had come definitely to the middle

west, fine lines of steamboats were connecting Cincinnati, Pittsburgh, Louisville and St. Louis with Memphis, Vicksburg and the far south.

Their astounding capacity as freight carriers has been the marvel of steamship builders in the east. Load a steamship of the same size as a western-river steamboat with the same amount of freight you could put on one of the latter, and it would sink. For example, the "J. M. White" had a capacity of 8,000 bales of cotton, 4,000 sacks of cottonseed, a huge quantity of miscellaneous freight, 200 cabin and probably 500 deck passengers.

As for speed, not only Mr. Howard, but numerous old pilots and captains, say that the "White" was the fastest boat that ever plied the river. Every time one of her huge forty-five-foot wheels turned over in still water it set the great hull forward about 130 feet. Twenty-five miles an hour downstream or eighteen to twenty miles an hour upstream was not considered especially fast time for the big steamboats. Most any of the big packets could have done it. But one evening at five o'clock the "J. M. White" left New Orleans, made fourteen stops for discharging and unloading freight and passengers, and it was one o'clock next morning when she steamed out of Baton Rouge, 135 miles away. That was running!

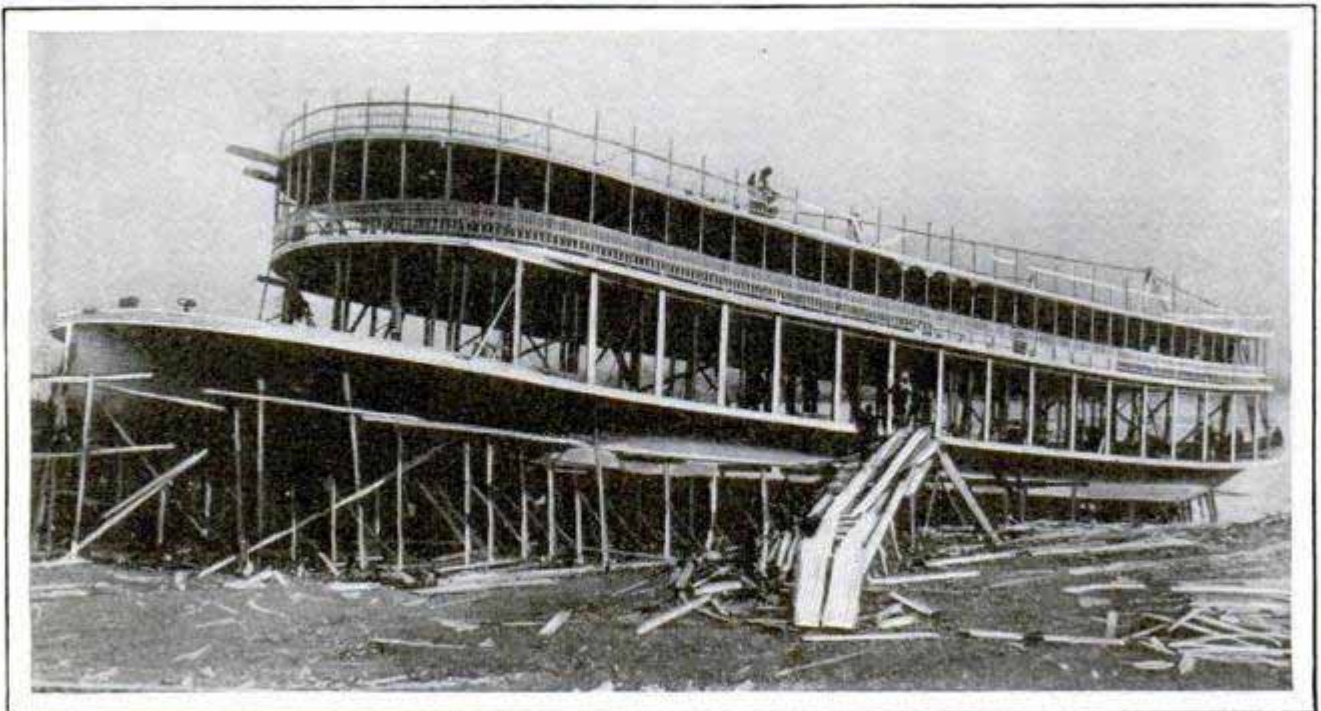

Building the Steamboat "J. S." for John Streckfus, of Rock Island, Ill.; Scenes Such as This Were Common at Busy Shipyards along the Navigable Rivers of the Middle West



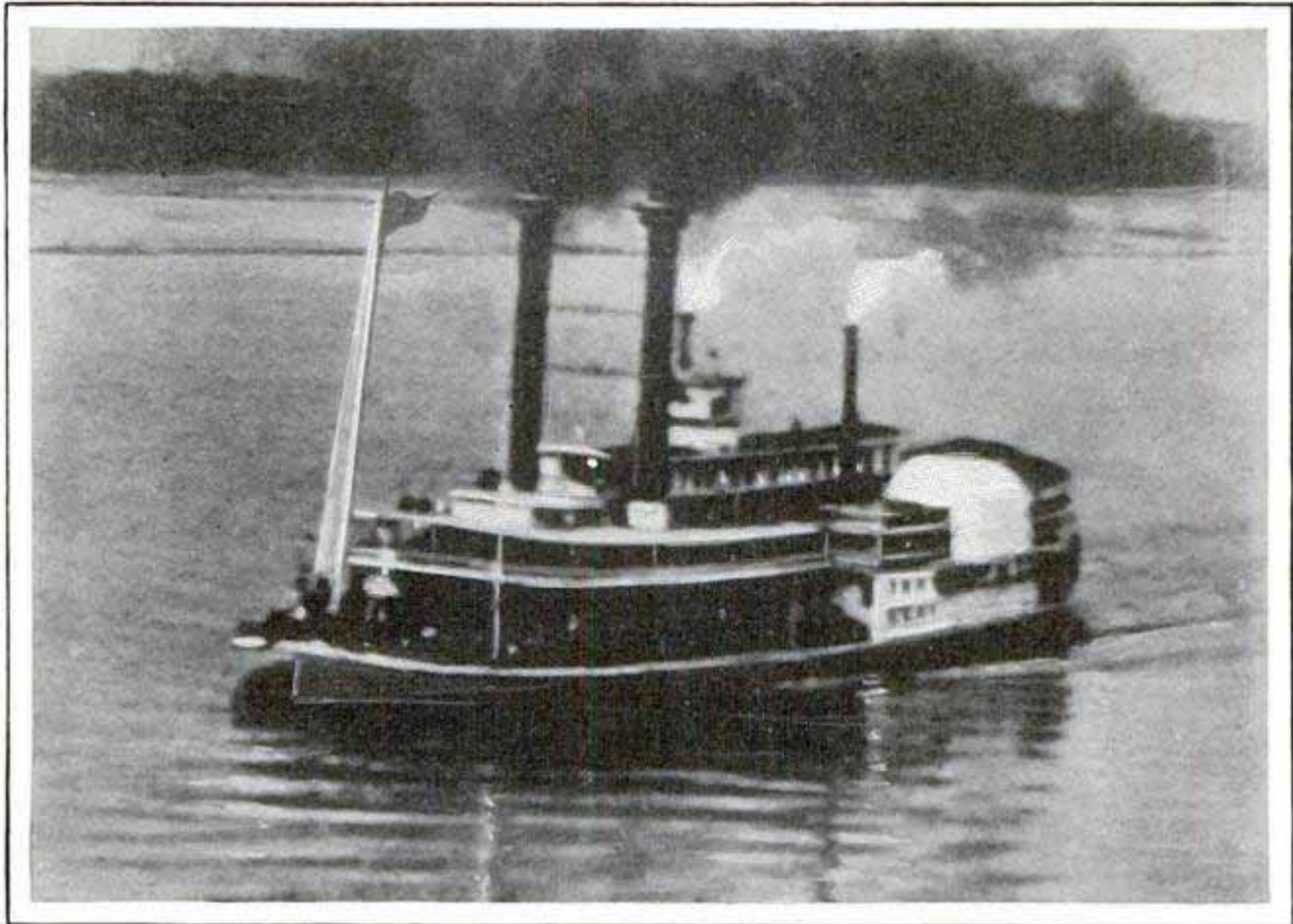

Only Known Photograph of One of the Most Famous Races in River-Steamboat History; the "Robert E. Lee" at Full Speed during the Race with the "Natchez"

The engines were geared to move slowly; fourteen or fifteen revolutions a minute was all that was necessary to send a big steamboat forward at a swifter speed than any contemporary deep-water ship. High-speed condensing machinery did not come in until later. The fact that the old steamboats worked with high-pressure engines, which moved at such a slow rate, accounts for the long life of many steamboat engines.

"Just the other day," Mr. Howard told me, "a towboat named 'New Orleans' sank near Slidell, La. The boat was formerly named the 'Louis Houck,' and was built in 1889. The machinery of the 'Houck' had been taken from the famous packet 'Thompson Dean II,' when that boat burned in 1882. Before that, the same machinery had been in 'Thompson Dean I,' when the boat was built in 1868, and any day I am expecting to hear that the 'New Orleans' towboat has been razed and her machinery salvaged to go into another boat! That will give you some idea of how long a western-river steamboat engine lasts.

"The fastest boat on the Ohio river and the prettiest was Commodore Laidley's 'City of Louisville.' She was 309 feet long and as slender and graceful as a girl. We built her in 1894 and, while she lacked the ornateness of the old boats on the lower Mississippi, she was a favorite from one end of the Ohio to the other. She and the 'City of Cincinnati' were both destroyed in the ice gorge of 1918. All the old steamboats have gone—sunk, burned, boilers exploded or worn out. The railroads took all the business away from the steamboats for a long time, but now freight traffic at least seems to be coming back to water lines, and I, for one, hope it won't be long before we see the rivers alive once more with both freight and passenger boats."

☐ The Popular Mechanics' Bureau of Information offers its free service to all readers of our magazine. Names and addresses of manufacturers and dealers in articles described, and any other details in our possession, will be promptly furnished by addressing the bureau.

*Switzerland*  
POPULAR MECHANICS  
*Bridge in the Esresone*

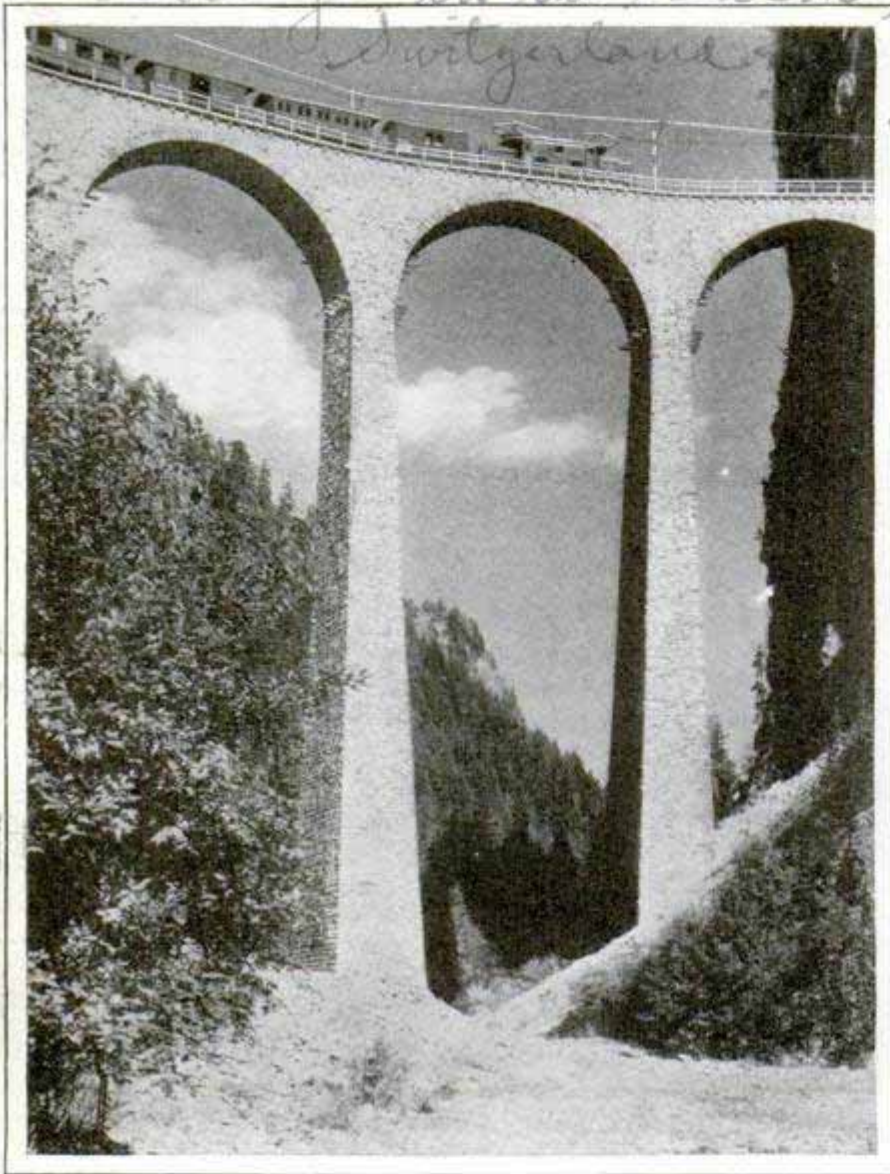

One of the Highest of Many Viaducts Enabling Railroads to Travel the Alps; Natives Call This One "The Stilts"

### RAILROAD PLACED ON STILTS TO SPAN MOUNTAINS

Trains negotiating the Swiss Alps have been placed on stilts to span the mountain crags. The trains on this line twist and turn, clinging to the walls of precipitous gorges, plunging into tunnels, gliding down a spiral inside a mountain and then on stilts leaping across a ravine. One of the tallest of the mountain-spanning bridges is officially known as the Landwasser viaduct, but to all the natives of the section, because of its height, it has become "the stilts."

Names and addresses of manufacturers of articles described in this magazine will be promptly furnished, free, by our Bureau of Information.

*2459 Piedmont Ave*  
*San Francisco, Calif*

### LOCUSTS FLEE AS AIRPLANES WAR AGAINST THEM

Using army airplanes to make war on the locust hordes in the Philippines was successful until recently, when the insects, apparently by intuition, have learned to avoid the attacks. The planes were used to spray poisonous dust on the crop destroyers and, at first, left the dead in windrows on the plantations the insects attacked. Then a change came over the locusts, and when an airplane motor was heard, they vacated areas in vast swarms, often flying into the paths of the planes and constituting a real menace to the pilots. These, however, have learned that they can ride herd on a cloud of locusts and now adopt the practice of keeping them moving in a general direction, and holding them in compact formation, much as cowboys herd cattle, until they have been chased

from the crop areas. The pilots say that locust punching is good training, for the flyer must be adept to avoid the insect columns and at the same time keep the swarms moving in front of him.

### HANGER BAR ON CLOTHES HOOK ADDS TO CLOSET CAPACITY

Useful in the home or when traveling, an extension hanger bar is attached to



a clothes hook without the need of nails or screws, to increase the capacity of the locker or closet. One bar is said to make an ordinary hook do the work of five. The attachment occupies but little space in a traveling bag, and is easily adjusted.

*2852*

*64 Central St*  
*San Francisco*

29

*Suggest Aircraft*  
POPULAR MECHANICS

*Airships, Inc. Hammondsport  
ny*

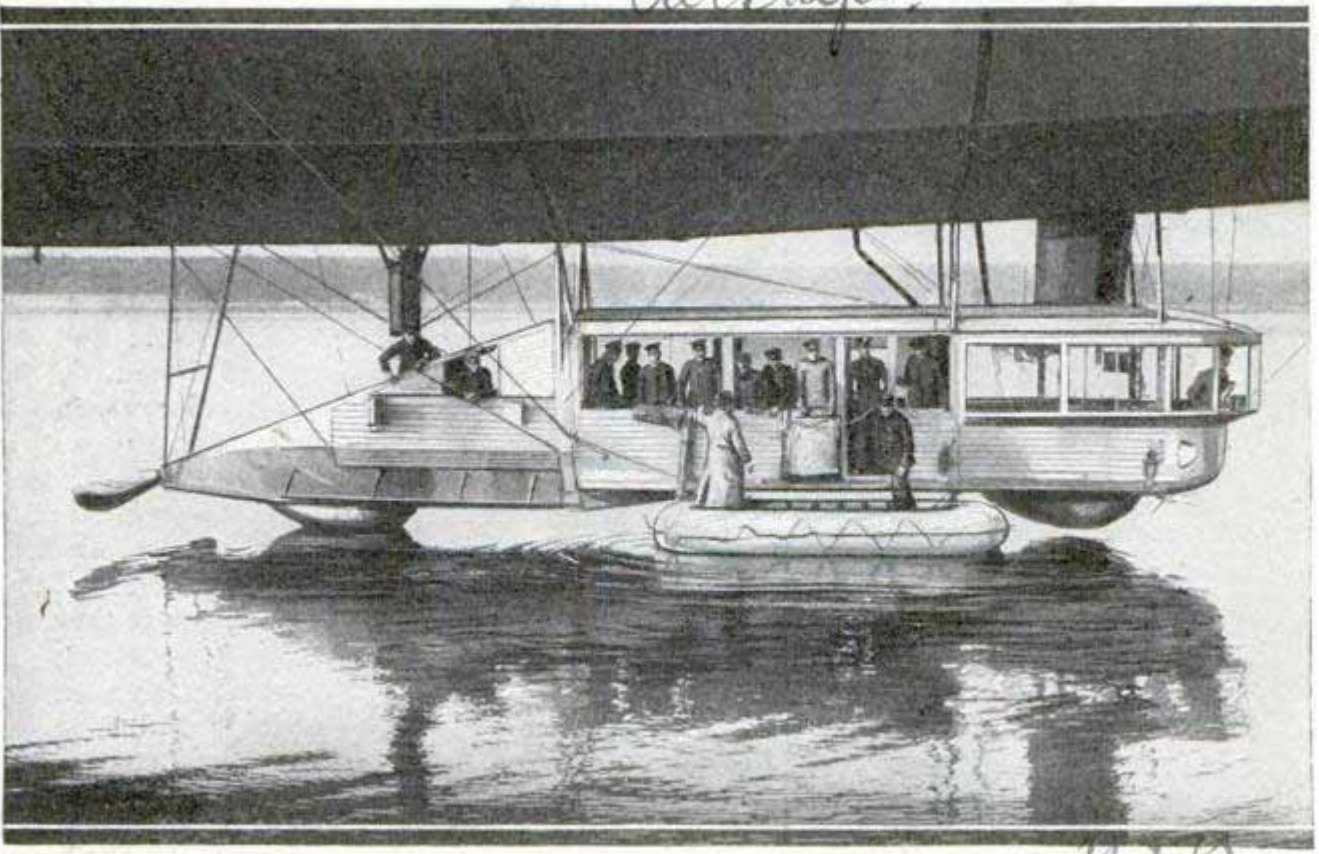

The Crew of the German Dirigible, "Graf Zeppelin," Is Here Seen Transferring to One of the Pneumatic Lifeboats Which Are Part of the Safety Equipment of the Air Liner

### PNEUMATIC LIFEBOATS PROVE VALUE ON "GRAF ZEPPELIN"

Pneumatic lifeboats, capable of carrying between forty and fifty persons, have been made a part of the equipment of the German dirigible, "Graf Zeppelin," for its transatlantic flights. The boats proved their value recently when the crew of the dirigible was able to board one of them during a forced water-landing test.

### FABRIC FILM TRANSMITS SOUND WITHOUT DISTORTION

Transmission of light beams, through a fabric film upon which positive sound images are recorded, has resulted, the inventor of the process says, in the reproduction of sounds without distortion. Projecting the light through the fabric medium for the purpose of translating sound images into musical or vocal sounds may be conducted either with or without motion pictures. The film, made of processed cotton, rayon, or other inexpensive materials, is said to be immune from spontaneous combustion, virtually scratch-proof and more durable than celluloid film. Images of objects may be projected

to a screen by reflected or transmitted light, the transmitted beams being employed to project the sound images recorded on the film to a photo-electric cell, where they are reconverted into audio impulses synchronized with the action of the images on the screen. The same result is obtained by reflecting the images from the fabric medium to the photo-electric cell. Use of the medium for sound translation without pictures is possible by substituting for a phonograph disk a positive film upon which have been recorded sound-impulse images, and using it with an audiophone to be attached to talking machine or radio amplifier. The greatest utility of the fabric film is expected to be in talkies and radio television.

### CELLULOID RIBS INSIDE HAT KEEP IT IN SHAPE



To keep felt hats creased and in shape, a patented celluloid rib is easily inserted when the hat is hung up. It

does not damage the lining and can be removed in a second.

*2 798  
\$1.00 for 25  
Mater Printing Co.  
567-3rd St*

*Penndelum Tree Relay Pullburgh Pa*

*dry ill. W.  
Hochstetter, etc.*

2539

# More Precious

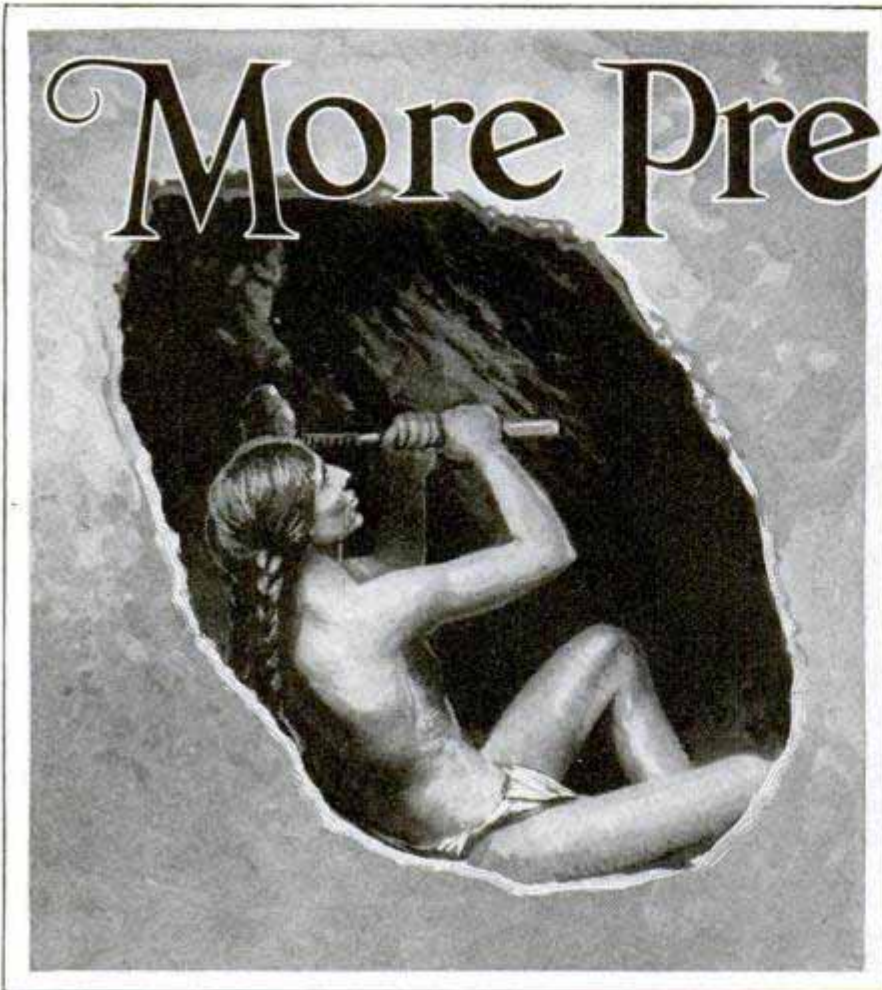

Mined with picks, hand shovels, scrapers, steam shovels, electric and air drills, and dynamite, the copper ore, largely in the form of sulphides, is loaded into cars by machinery, rushed to the mills by gravity, electric current, steam or Diesel power, and there the cars are picked up bodily in great cradles, overturned into pits, rolled back on their wheels again and returned to the deposit to be refilled. From the pits, other cars rush the ores to the crushers,

By H. H. DUNN

3728 1/2

*Pick and Shovel*

COPPER was the first metal known to man. Twenty thousand years before Columbus crossed the Atlantic, men mixed copper with zinc, silver or tin, and made for themselves a Bronze Age.

In 1927, modern man, outflying the birds, controlling the lightning, thwarting the hurricanes, prisoning history in celluloid, making the ether entertain him, demanded more copper than he did gold. The production of the red metal in the United States for that year—the last on which complete figures are available—sold for \$220,609,000, while all the gold mined here in the same year was worth only \$45,418,000.

The inventive genius of man created the colossal demand for copper. Mechanical ingenuity responded by devising new methods whereby the miners of the United States wrested from the hills and mountains 752,000 long tons of the "penny metal." Except in the production of steel, there never has been applied to any ore the high-speed methods of the copper mine, mill and refinery.

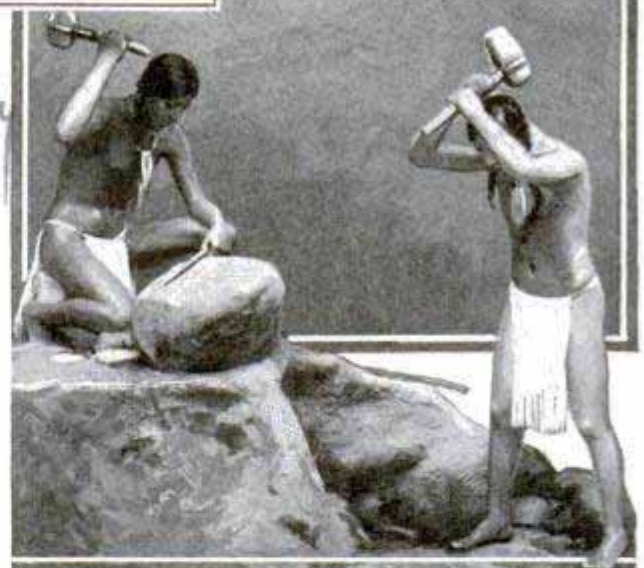

"Gophering" a Vein of Copper and Hammering a Spear Head; from Life-Size Restorations in Museum

where, when the stone has been ground fine enough, automatic metal watchmen release it, refill the crushers, mix water with the powdered ore and send it to the concentrating tables.

Thence, through the furnaces and the converters, and all the other equipment, of the largest and most costly ore mills in the world, machines, which all but regulate themselves, pass on the gradually

# Than Gold



Rotary Car Dumper to Speed the Unloading of Ore; by This Method About Five Times as Much Material Can Be Handled in a Day as Was Possible with the Drop-Gate Cars

cleansed metal until it comes out in "pigs" so pure that only chemical analysis could reveal its impurities. Copper production developed to such an extent that four times as great a quantity can be made in one eight-hour day this year as could have been made six or seven years ago.

Copper is found in almost all soils, and in myriad ores which are worked for other metals. It occurs in many mineral waters, in seaweed, the blood of man, and in certain creatures of the sea. Analysis reveals it in hay, straw, eggs, cheese and other foodstuffs, as well as in the liver and kidneys of most animals. It appears as "native," virtually pure, metal in the forms of filaments, thin sheets and lumps, one such lump weighing 400 tons having been found in the Lake Superior deposits. Sometimes it bears native silver imbedded like crystals in rocks. But the great value of copper, and the main reason why the world draws more than sixty per cent of its copper from the United States is that

its electrical conductivity is the highest of any of the non-precious metals. Yet, in point of value and of ingenuity devoted to its production, copper is in reality one of the most precious metals in the world.

A modern copper mine, as developed with the latest equipment, is a good-sized town in itself, literally an inverted community skyscraper, stood on its head half a mile or so in the earth. Three forty-story buildings, placed one on top of another, would not reach from the surface to the lowest workings of the deepest mines in Montana or Arizona. Still like a mammoth office structure, such a mine is provided with elevators, called "cages," which drop the hundreds of miners to their various levels and bring them back when the day's or night's work is done.

There are some mines on the surface, where whole mountains are blasted down, from the top to the bottom, without the men once entering a shaft or a tunnel. There is another in which the ore is so

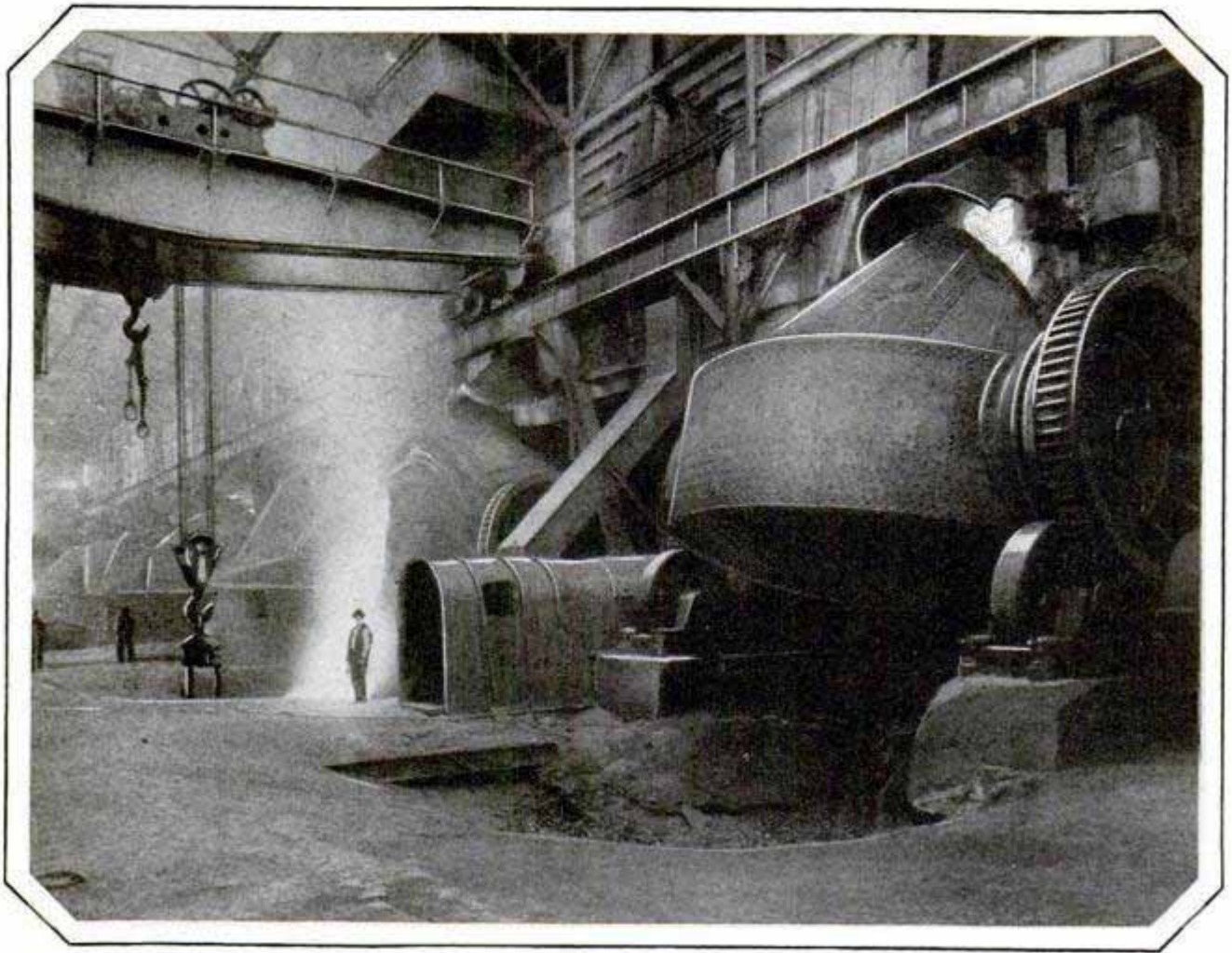

Converters Which Put the Final Touch to the Smelting Process in the Production of Copper; the Precious Metal Is Separated from Waste Materials Which Take the Form of Fumes and Slag

broken and soft that it is taken out with scrapers and steam shovels. Geologists estimate that this deposit, though of low grade, contains enough copper to supply the demands of the United States for at least 100 years.

But, in the majority of the copper mines, the miners at the "heads," that is to say, the inner ends of the tunnels which are driven to follow the veins, ride to their shifts down the automatically controlled cages, protected by safety devices which prevent falling more than one level, or "floor," in the great inverted structure. Arrived at his level, the miner steps on a small car, driven by a motor from a storage battery carried on board, and rolls away to the "face" of the working. There, he finds a compressed-air, or an electrically driven, drill set up, looking like a machine gun and working like a riveter's pneumatic hammer. With this, he drills eight to twelve holes, each an inch or more in diameter and six to eight feet in depth.

Into these holes go slender, yellow sticks of dynamite, looking as if they might have been designed for church candles and then changed their minds. Copper detonating caps are set into the ends of these sticks; copper wire carries the electric current to them, and a copper switch is thrown when the "buster" does its job. Thus refined copper is put to work to bring out and purify unrefined copper from the backbone of the world.

The blast breaks down the rocky wall, bringing about forty pounds of the red metal with each ton of stone and earth, and copper is worth, at the factory, rather less than twenty cents a pound. Only the highest of mechanical ability applied through the most modern machinery can make such mining profitable. Men shovel the broken "trap rock" and ore into little cars, which run electrically through the tunnel and to the shaft, where they stop and dump their burdens into big steel "skips" or buckets, which lift them to the waiting bins above, if the mill is at the

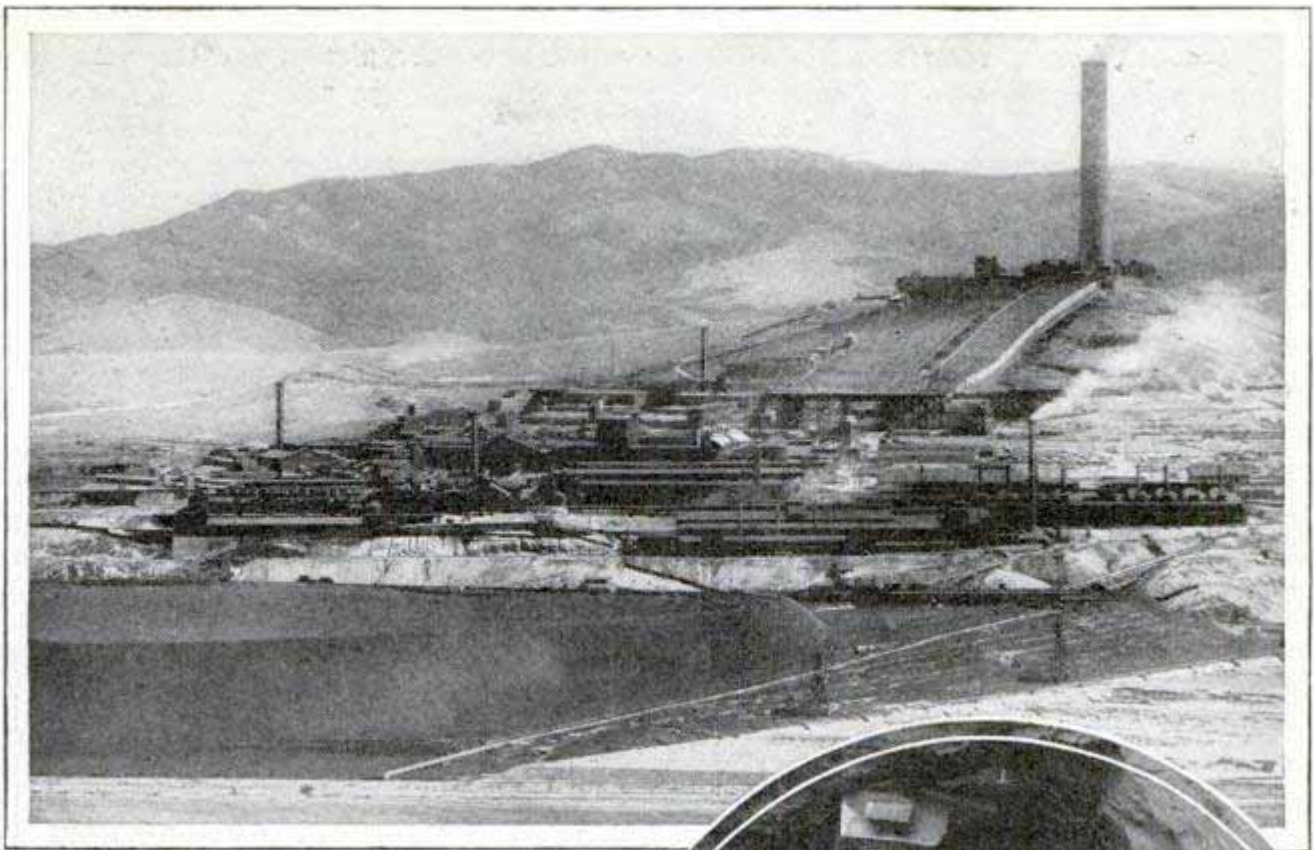

Huge Copper Smelter and Mills at Anaconda, Mont., and Boring Holes for Blasting

mine entrance. If it is at a distance, each skip drops its load into a steel gondola, very little smaller than the standard railroad car, which dashes down the hill, along with half a score of similar cars, and rolls into a huge steel cylinder, at the mill. As the gondola enters this roller, which has tracks to receive it, the car is detached from the others of its train. A man at one end of the cylinder pulls a lever, the cylinder turns, car, load and all, and the ore is dumped into a bin. The cylinder rolls back until its tracks meet those of the railroad, the empty car runs out, a full car runs in, and four cars are unloaded by one man in the same time that two men would have required to unload one car by the former method of opening a door in the bottom of the gondola. This is just one of the comparatively new devices which has made low-grade copper ore commercially workable.

The greater part of the copper ore mined in this country is in the form of a sulphide of copper, in which the red metal is mixed with iron and sulphur, and, usually, with some silver and a little gold. There are copper mines in which the gold and silver almost, or entirely, pay for the mining of the copper. Attached to every



copper mine is a laboratory, and from every carload of ore goes a sample to it for analysis. On this laboratory work depends much of the success of the mine, mill and smelter.

From the bin, the ore falls by gravity into constantly moving trains of steel cars, which carry the copper on its first jour-

ney in the complicated treatment which is to free it of other metals and of all impurities. It goes first to the concentrating mill, where, between great steel jaws and under the pressure of hundreds of tons, it is crushed to a powder, breaking down the rock structure to a fineness in which every particle may be made to yield its hard-held metal. Then the powder, as yet untouched by the hand of man, is mixed with water and passed to the shaking tables, where the lighter and valueless rock, and the free impurities, are washed away, leaving all the metallic values in the wet mass, known as "concentrate." Having been well soaked until it forms an almost solid sludge, the concentrate then passes by automatic, self-loading elevators, watched by one man, to the open tops of the roasting furnaces, whence the mass falls to the first hearth, where it is dried and oxidized. Blades, moving almost like human hands, slowly work the mass to holes in this hearth,

which are conserved and used, in most modern copper plants, for the manufacture of sulphuric acid as a by-product. The burning of the sulphur furnishes all the heat required for the operation of these six-story roasters. Showing a dull red color, the calcine then passes in covered steel cars, into which it is poured automatically from the roasters, to the reverberatory furnaces for the actual smelting.

By this time, the calcine contains forty per cent, or more, of copper, and is fed automatically and mechanically from the cars into the "reverbs" as copper-minded engineers call the furnaces, maintained by oil burners, again thermostatically controlled, at 2,800 to 3,100 degrees Centigrade, inside temperature. Inasmuch as this is about half the heat of the exterior of the sun, it is wasted energy to ask the furnace superintendent if "it's hot enough for him." In each of these furnaces bubbles and rolls from thirty to fifty tons of liquid

ore. In this roaring caldron, the copper calcine loses the remainder of its sulphur, and virtually all of the other waste products, with some of the iron. Most of the iron in the copper ore, however, combines with the copper to form what is known as "matte," the valuable product of the reverberatory furnace.

Traveling on rails or by crane, the matte, consisting now in large part of a mixture of copper and iron, comes

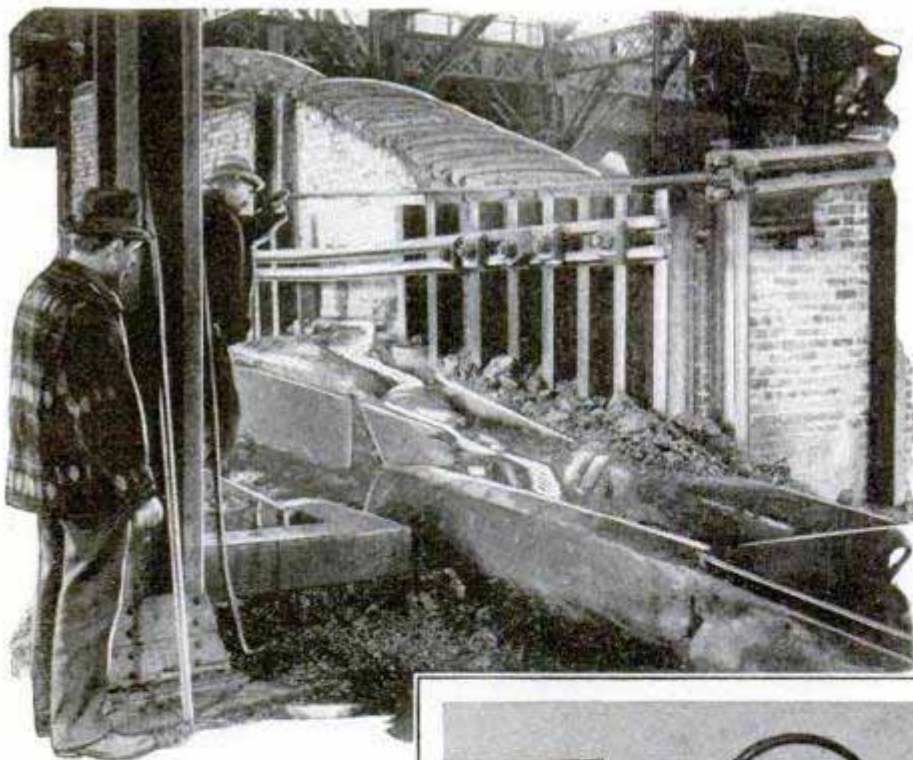

through which it falls, one by one, to five other and lower hearths. So the former concentrate emerges at the bottom as "calcine," with approximately seventy per cent of the sulphur driven off in the form of gases,

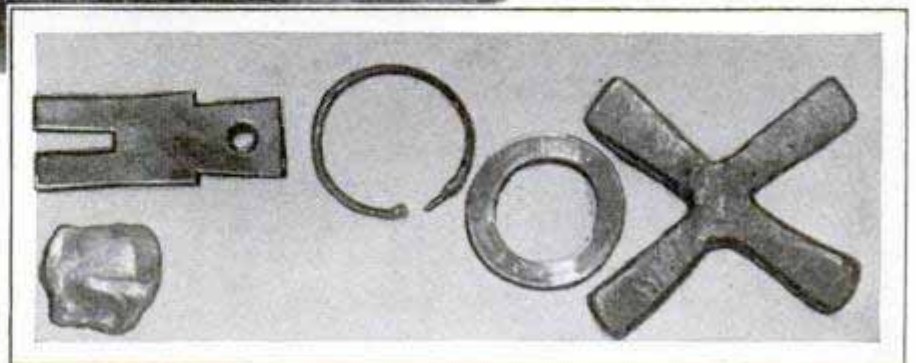

Floating Off Slag and Clinkers at a Copper Smelter, and a Few of the Odd Forms of Copper Money Used Many Years Ago



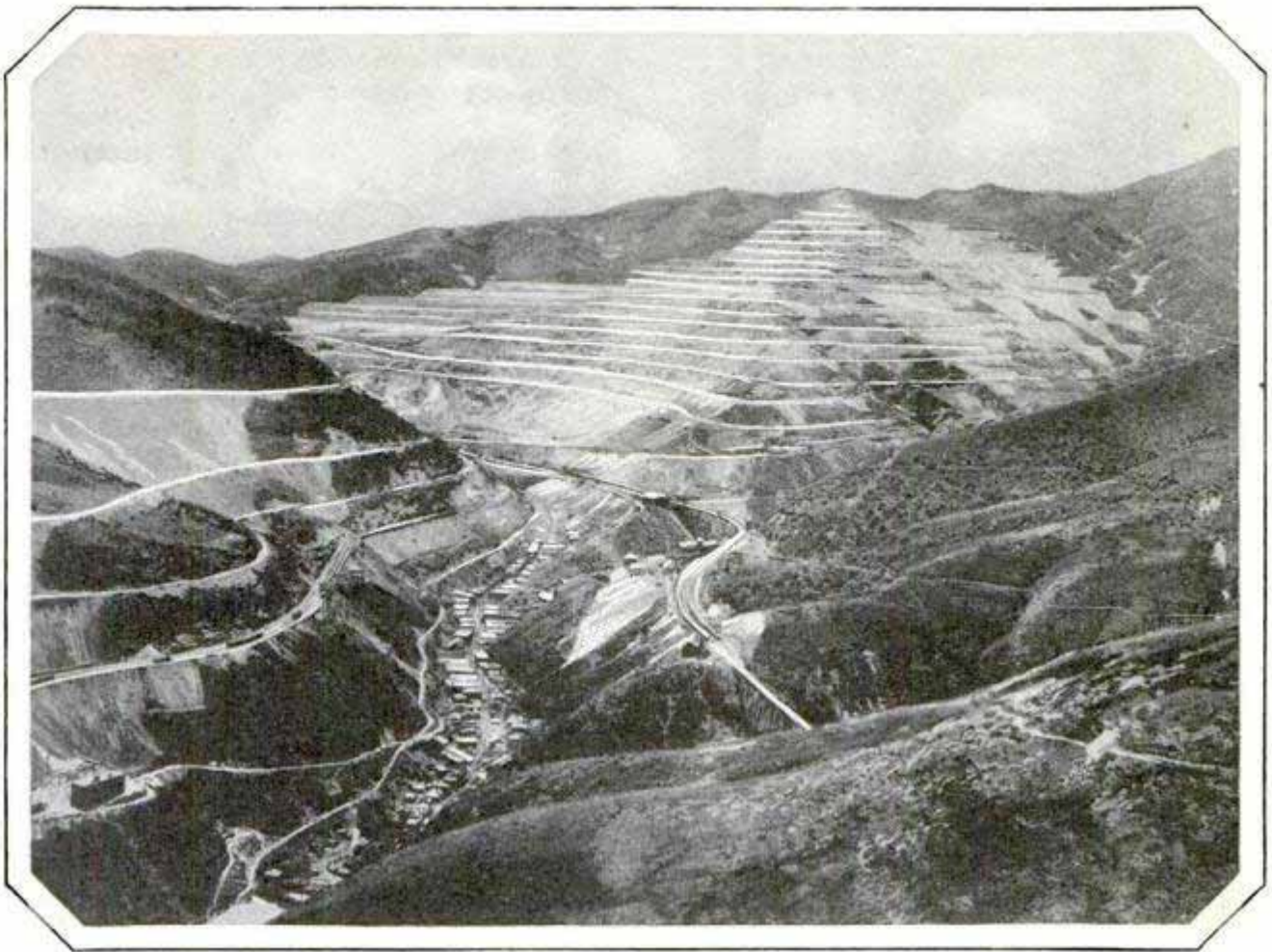

Where Low-Grade Copper Is Mined with Steam Shovels and Sent in Trainloads down the Zigzag Tracks by Gravity to the Smelters; These Hills Contain Enough Copper to Last the United States 100 Years

to the converters, steel barrels, the noisiest, and one of the most important, parts of the smelter. The mouth of one of the converters stands open. The great pot, filled with six tons of matte, swings into position. A hook drops slowly from the crane and engages an eye in the back of the ladle. The man in the crane housing touches a copper switch and an auxiliary motor tilts the pot in mid-air. A silvery-white stream slips into the converter, until the big ladle is bottom up. Then it is righted, to roll back to the reverbs.

The man at the controls tilts the open end of the converter forward into its section of the great flue, turns on the air blast, and the removal of the iron from the matte starts. The working through of one load of matte in a converter is called a "blow," and requires about four hours. During the latter part of the blow, the last of the waste materials, whatever they may be, are burned out, leaving only metallic copper, very nearly pure, in the huge steel barrel. The moment at which this purification is complete is the dra-

matic peak of the production of copper. To know when it arrives requires years of experience and an eye trained to fine skill in the detection of shifting colors.

Unlike the amateur cook, the foreman cannot poke his finger in the cake to see if it is done. Instead, eyes fixed on the flames, the foreman waits. It is an ill time to speak to him. Orange, yellow, red, white flames come out of the converter mouth and roar up the great flue.

As a blue flame blots out the other colors, the foreman waves a hand. In a control room a hundred feet away, another watcher throws a switch. The air blast is shut off. A motor hums, the great barrel tilts and rolls over. Through the bluff snout the interior glows with a light on which no man may look and see again. The opening drops lower. The foreman slips on heavy amber goggles. Just over a flat car of molds, the converter mouth pauses, sinks a trifle, and out rushes a stream of pure molten copper, too brilliant to be gazed upon, too hot to handle by other than mechanical means.

*Chicago Commerce*

2694

*Sales agent. J. Colford & Co. Iron Works, Troy, Pa.*

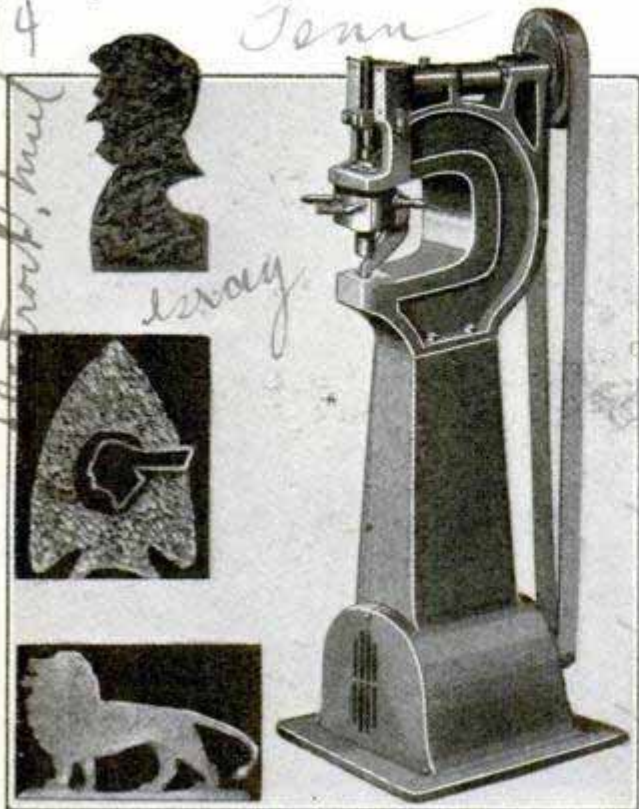

Metal Cutter and Samples of Some of Its Work; It Saves Time in Preparing Stencils and Templates

### MOTOR-DRIVEN METAL CUTTER SAVES SHOP TIME

For cutting templates, simple or intricate shapes and patterns in metal, a motor-driven cutter now on the market has been found serviceable in many shops. It takes three thicknesses of metal, vibration has been reduced to a minimum, and a special turret head may be adjusted to eight fixed cutting positions or used free to cut in any direction without turning the material.

### CURVED JAWS ADDED TO VISE GIVE BETTER GRIP

Adapted especially to holding pistons or similar objects of cylindrical shape in a vise, curved jaws now on the market are easily and quickly attached or removed.

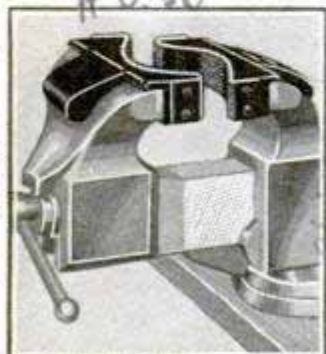

They are lined with a heavy canvas fabric that can be replaced when it becomes worn. The jaws are well adapted to work on horns, small electric motors, clocks, meters and other units.

### NAPHTHA DEADLY AS DYNAMITE WHEN MIXED WITH AIR

Scientists, warning against careless use of naphtha, gasoline and benzine in the home, have estimated that one gallon of naphtha mixed in proper proportions with the air, is as dangerous as seventy-five pounds of dynamite. Naphtha will flash at any temperature above zero and one gallon evaporates into 1,600 cubic feet of vapor, the range of explosibility varying from five to twenty per cent. Even when not in a condition of explosibility, the vapor can flash and burn. The vapor settles and stratifies, traveling along the floor as an invisible danger, so sensitive that it can be exploded by a spark from a cat's back. Naphtha and gasoline both have the ability to build up static electricity by coming in contact with solids, developing a spark that ignites or explodes the vapors. The washing of garments in naphtha is subject to this danger, particularly silk and wool, as these materials may be very highly charged. Straining the liquids also may develop static electricity. Necessary precautions in using naphtha include measures to eliminate friction and avoiding a flame even in the vicinity, keeping the air humid to dissipate the static, and grounding of any solids that may be likely to develop static by frictional contact with the liquid.

### WATER-FAUCET LIGHT PLANT SERVES IN EMERGENCIES

Emergency lights of theaters, schools, hotels and other places, are automatically lighted when the regular source of current fails by a special generator unit, operated by water power from the city mains. By means of a device on the control panel of the unit, the generator is started as soon as the regular current is cut off. This causes a needle nozzle to open, the water wheel is turned and, in three minutes, according to reports, the generator is supplying full voltage to the emergency lights over the exits and at other locations.

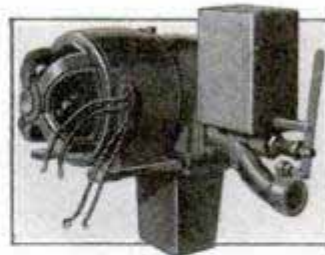

*National Steel Products Co. Toledo, Ohio 414 Ross St.*

*Utilities Service, Inc. Troy, Pa.*

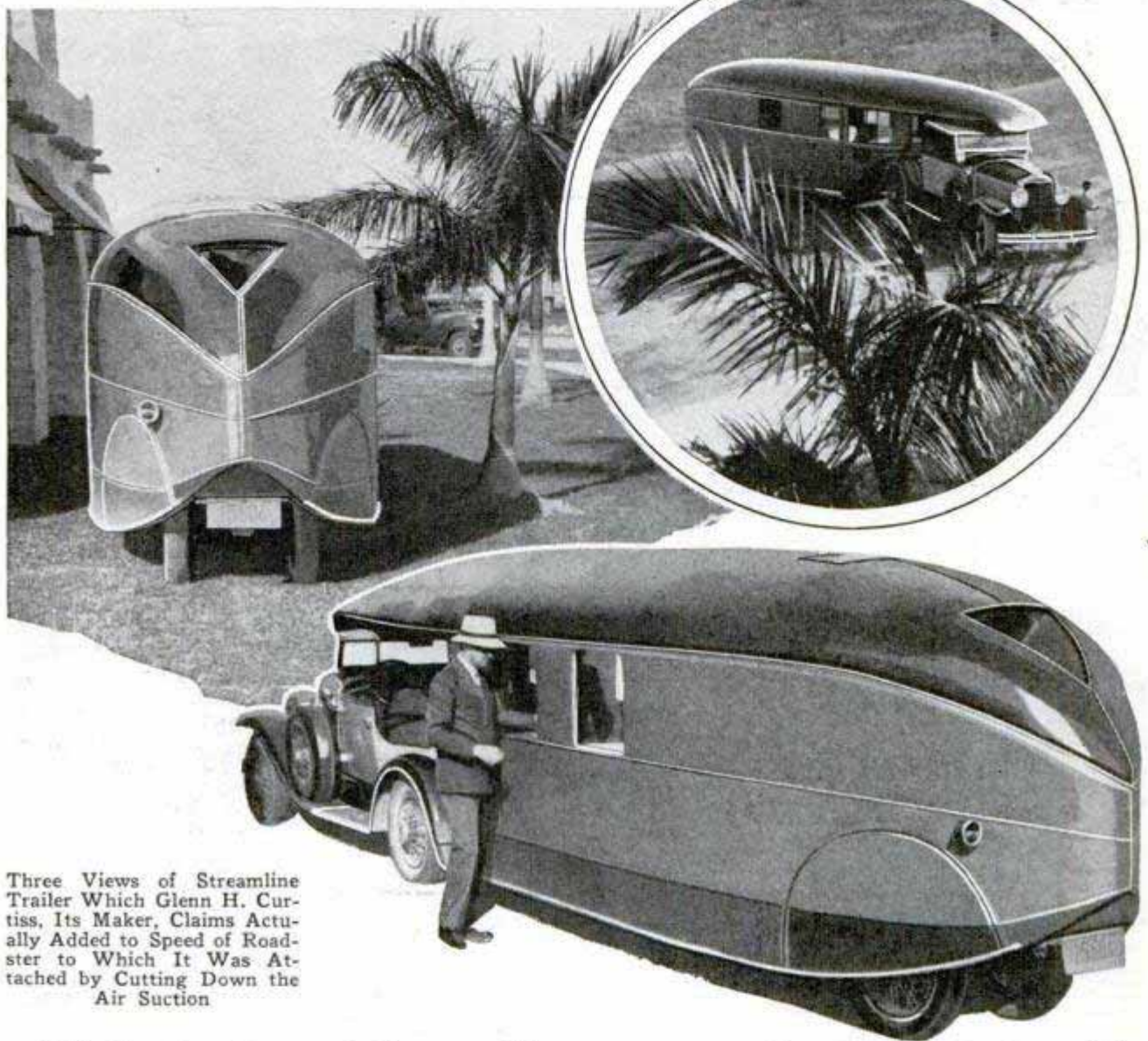

Three Views of Streamline Trailer Which Glenn H. Curtiss, Its Maker, Claims Actually Added to Speed of Roadster to Which It Was Attached by Cutting Down the Air Suction

Believing that the speed of automobiles may be increased by streamlining, Glenn H. Curtiss, airplane manufacturer, has experimented with a luxurious trailer which he calls an "aerocar" because its lines follow those of the airplane. Attaching the trailer to a roadster capable of making seventy-five miles an hour in tests, Mr. Curtiss said that the roadster with the added 1,500-pound trailer, increased its speed to eighty-three miles per hour. This increase he attributed to the streamline effect which obliterated the suction, or vacuum, following in the roadster's wake and tending to hold it back. When automobiles begin following airplane styles, he predicted, travel will be speeded up 100 per cent. Friction and head resistance are all that prevent a car traveling at far

greater speeds, said Mr. Curtiss, adding that at high speeds eighty per cent of the engine's power is used to overcome head resistance. The aerocar, light in weight, has only two wheels and provides seventy-five square feet of floor space. "We have been grossly extravagant in motor-car design," said the airplane maker. "With a cumbersome motor, over a ton of steel and an array of nickel trimmings, wheels, oversize fenders, lights and fittings, it still costs more to travel a mile than it did with a four-horse team and coach a century ago." Compared with the horse-and-buggy age, he said, the automobile has gained only in power and reliability.

☐The Dead Sea in Palestine is the lowest inland depression in the world.

*see Feb. 1929. 206.*

Corp. Jerusalem Palestine

2980

Dead Sea City data

scruffy

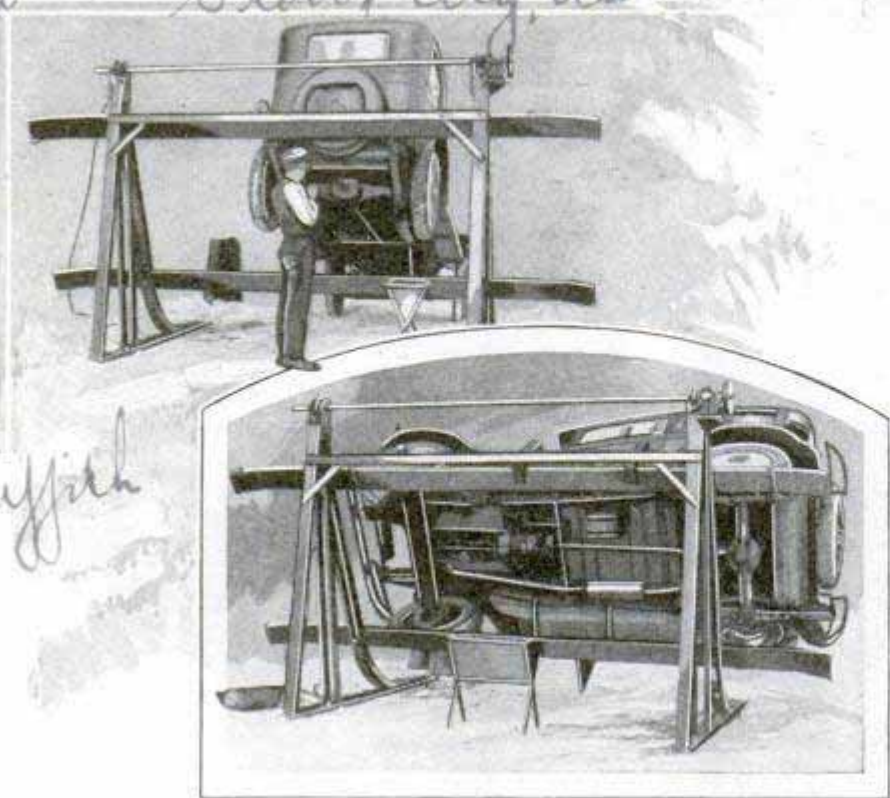

Mechanical Hoist Which Tilts Automobile on End or on Its Side, Making All Parts Easily Accessible for Repairs

### AUTO HOIST TILTS CAR ON SIDE FOR EASY INSPECTION

For easy access to the under chassis, an automobile hoist now on the market tilts the car on its side or end, thus eliminating the necessity of crawling beneath the car or working on it from a pit. The device consists essentially of an iron frame with a runway platform onto which the machine is driven and fastened. The platform is attached to two arms operated by a motor, which tilt the car to an almost vertical position if necessary. The hoist raises any car up to 7,000 pounds, allows easy access to all parts by the mechanic and inspection of the car or of the mechanic's work by the owner. By being able to tilt the car at any angle, mechanics find their work simplified even when working on the top of the motor, as they may remain in a standing position.

### DEAD SEA TO YIELD BILLIONS IN MINERAL TREASURES

Vast mineral resources of the Dead Sea are to be released to the world by a syndicate which has closed a contract with the British government. The body of water, 1,300 feet below the level of the Mediter-

ride. The cost of production is expected to be little, but transportation is a big problem. Although the Mediterranean is only forty-seven miles distant, Jerusalem, end of the railroad line, is more than 3,000 feet above the Dead Sea. It may be necessary to build a fifty-mile railroad. The French also have proposed to generate electrical energy necessary for the extraction of bromine by conveying water from the Mediterranean to the Dead Sea to supply power.

### HOLDER ON EDGE OF GOLF BAG PROVIDES PLACE FOR TEE

Golfers accustomed to search through their pockets for wooden tees now have a place to store this little contrivance. A spring holder for the tee clips over the edge of the golf bag, and the tee, when inserted in the holder, is kept secure and is extracted easily by pulling it sidewise.

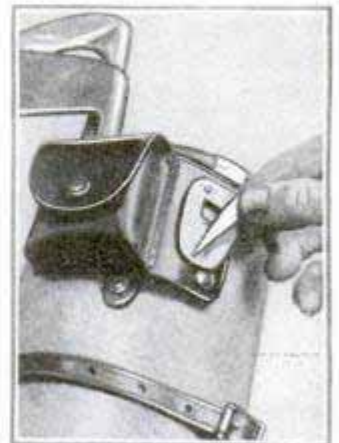

Clipping

cannot locate

3064

2964

# HOW ECHOES ARE FOUND IN UNBUILT BUILDINGS

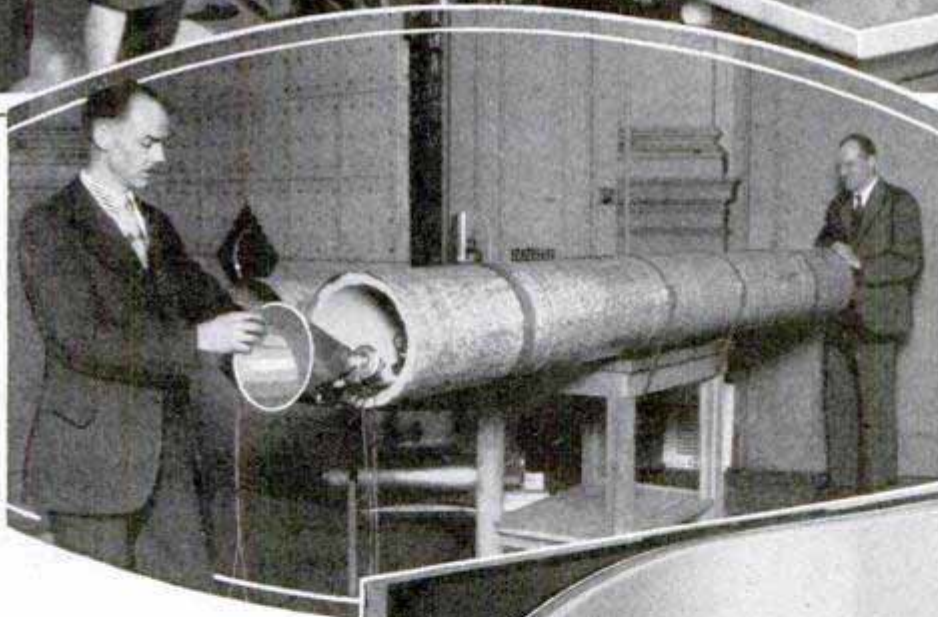
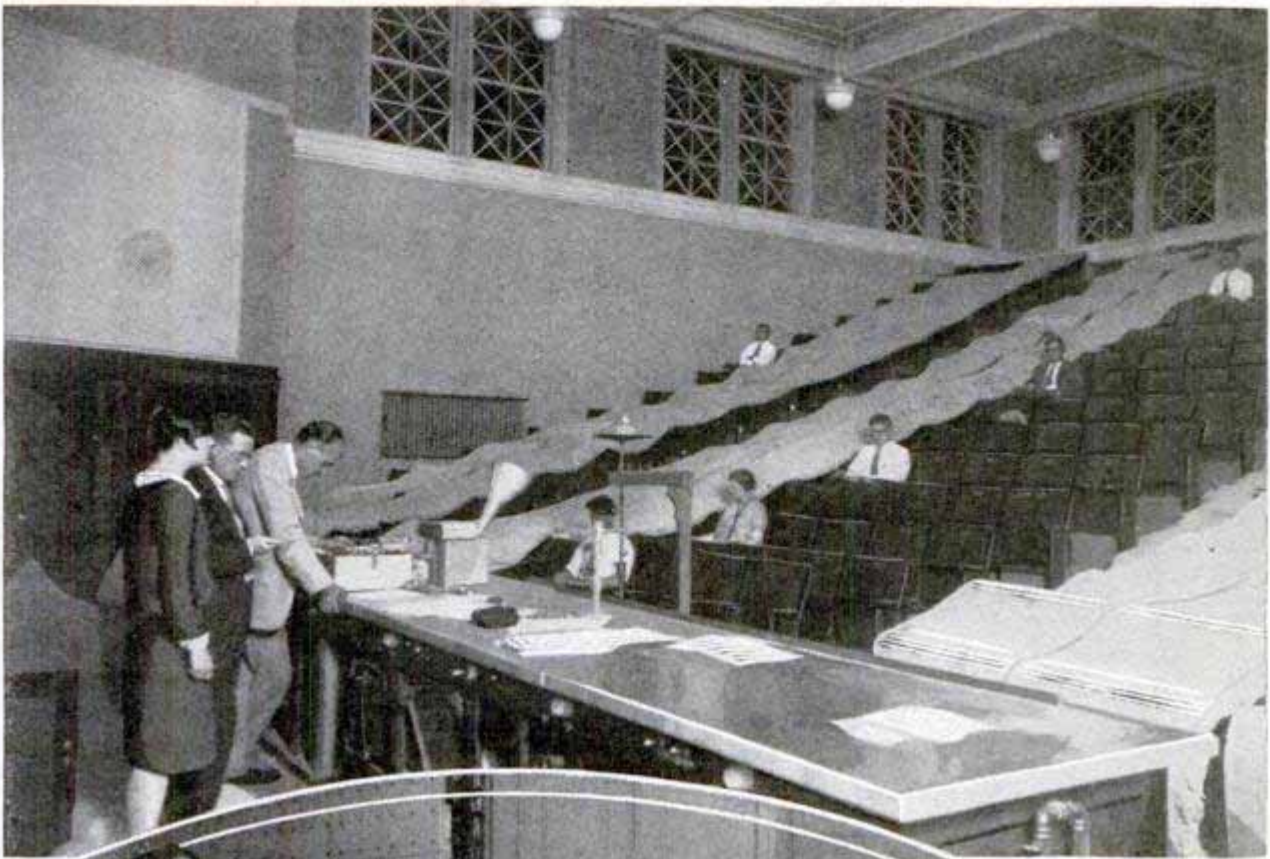

Testing Intelligibility in a Lecture Room; Insulation Is Spread across Some Seats, to Control the Period of Reverberation, an Acoustimeter Checks the Energy Level of the Voice, and a Pendulum, in Front of the Table, Is Used to Regulate the Speaker's Rate of Diction

*Chicago - 14 102 Monroe*

The Effect of Insulation in Deadening Sounds in Ventilation Ducts of Apartment Houses. Was Illustrated before the New York Electrical Society by Drawing a Loud Speaker, Mounted on Toy-Train Wheels, through an Insulated Pipe; the Tin Model of a Proposed Auditorium, at Right, Was Used, with a Small Light, to Illustrate Echo Locations by Reflection of Light Beams

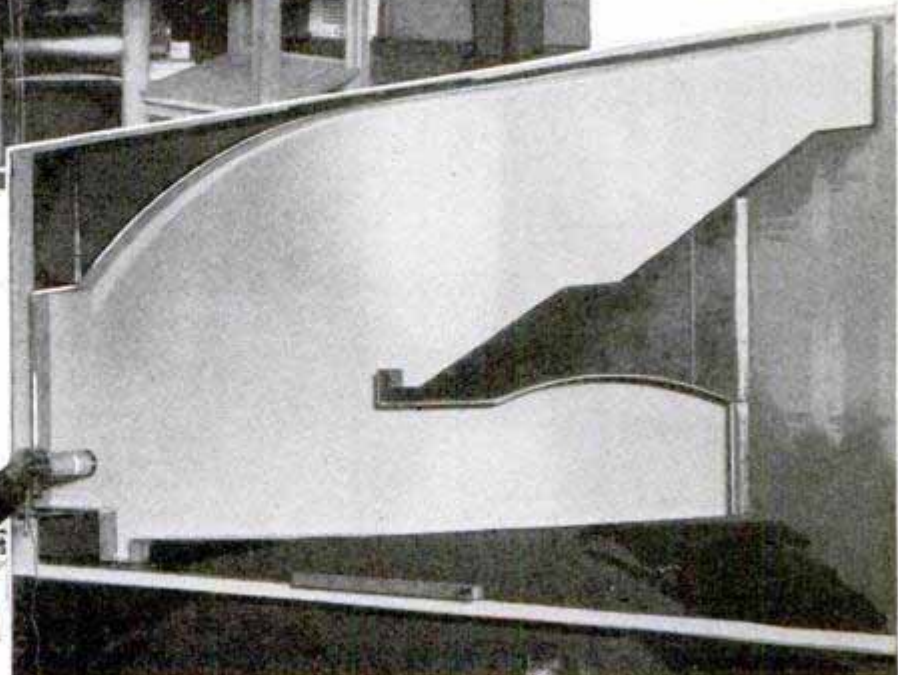

Courtesy C. F. Burgess Laboratories and New York Electrical Society

*2720 Maryland Ave  
Coul. N. C. McLeod, Baltimore Md*

*Heckerville Mich*

*Drum Age 5/20/29*

*chain not yet on wheel*

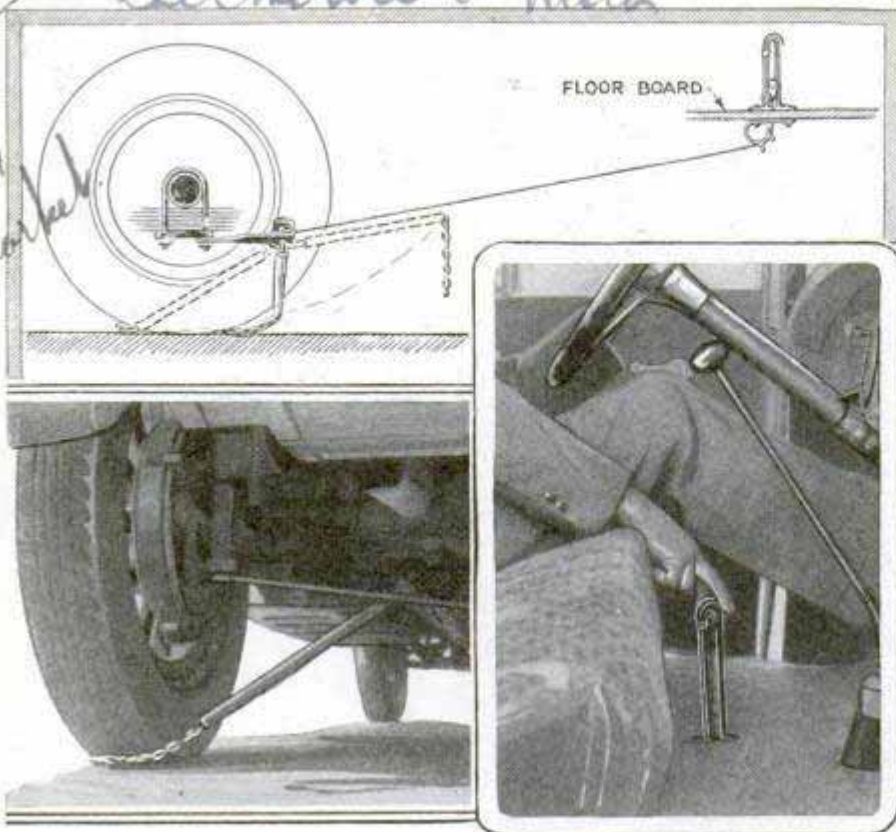

Photographs of the Chain and Control Lever, with Drawing to Illustrate the Entire Installation and Its Operation

### LEVER OPERATES SAFETY CHAIN FROM DRIVER'S SEAT

Safety chains are placed under the rear automobile wheels by means of a lever operated by the driver, and are removed in the same way, saving getting out of the car and providing an emergency aid that helps prevent accidents. The chain does not pass around the wheel but under it, through the action of the lever and spring apparatus provided with the installation. When the wheel has passed over the chain, the spring pulls the links out, whirls them around and lays them down in front of the car for another operation. The entire assembly weighs but eighty pounds.

### RESERVE TANK FOR MOTOR OIL SERVES ON LONG TRIPS

*2926*



To hold a supply of your favorite brand of motor oil when taking a long trip, a patented reserve tank holding two and one-half gallons is attached to the

motor by the head bolts. The top is of the air-vent type, allowing the oil to flow freely when the petcock is opened into the motor. The pipe from the tank is of flexible tubing, and there is a gauge which indicates how much of the contents has been released.

### STEEL FLOORING TO INCREASE STRENGTH

*2985*

Steel-plate floors for office and other buildings are being investigated by the American Institute of Steel Construction as a means of obtaining greater strength and stability in tall buildings, reducing the loads on the columns and giving

greater protection against possible distortion due to wind stresses. According to Lee H. Miller, chief engineer of the institute, it is proposed to develop a welded steel floor which will stand every service to which it may be subjected. The steel plates would be covered with cork tile or other material.

### HOLDER THAT LIGHTS CIGARETS SAVES USING MATCHES

*2864*

By pressing a button, cigarets are dispensed from a special holder now on the market and, as they fall into a small rack at the bottom of the container, an electrical connection is automatically made so that the cigaret is lighted. The current is turned off automatically when the cigaret has burned about one-sixteenth of an inch. Pressing the button is the only operation required to obtain the cigaret and have it lighted.

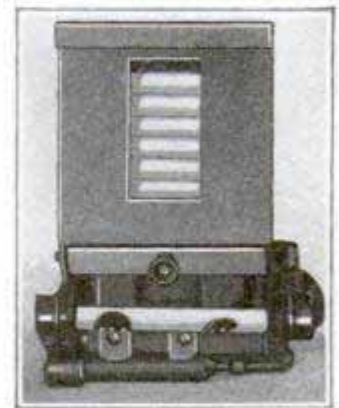

*And Frank Walker, 654 E 60th St.*

*And Harry Mann, 204 Broadway*

*Artillery Contingents*

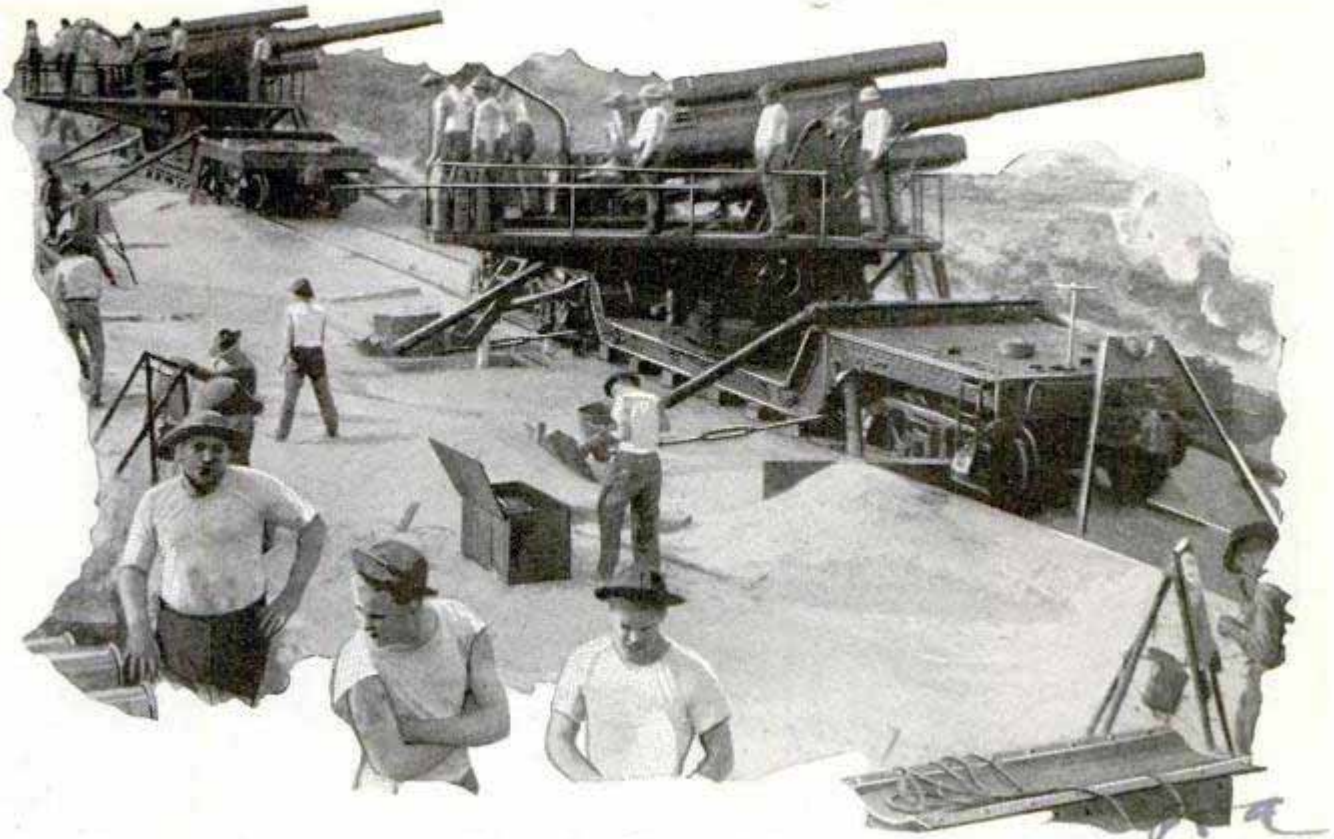

These Eight-Inch Guns, Mounted on Railroad Cars, Boomed Defiance at a Fictitious Enemy, Intent on Attacking Washington from the Sea during Recent War Maneuvers

### GREAT GUNS ON RAIL TRUCKS GUARD THE CAPITAL

Eight-inch cannon, mounted on railroad cars, were used recently at Cape Henry in maneuvers to resist an attack by a fictitious enemy fleet intent on proceeding up the Potomac river to lay waste Washington. The railroad guns were manned in the battle practice by coast artillery contingents of Fort Story, Virginia.

### SECRETS OF SUPERWARSHIPS REVEALED IN ENGLAND

Deck armor, more than six inches thick, protects two British warships, recently completed, from aircraft bombs and also from high-angle fire from other vessels. This armor, on the capital ships "Rodney" and "Nelson," is more efficient than that built into any other vessels. In addition, the ships have a main belt of armor, fourteen inches thick, around vital parts of the boats and the armor protecting the gun platforms and magazines is even thicker. In an effort to save weight in construction so that heavier armor could be used, lighter metals were substituted where possible, and even the heavy furniture was

*Chicago Tribune*  
*6/3/24*

redesigned in lighter woods, while weather decks were sheathed in Douglas fir instead of teak. The boats are armed with nine sixteen-inch guns in three turrets, twelve six-inch guns in six turrets, six anti-aircraft guns, eight two-pounders and have two submerged torpedo tubes.

### ADJUSTABLE THREADING TOOL SAVES TIME AND MATERIAL

Capable of adjustment to any size bolt up to one inch, a thread chaser, or rethreading tool, eliminates much waste in time, labor and material for mechanics and repairmen. Cutters and guides are contained within the body of the tool, and the cutting unit is adjusted by turning the

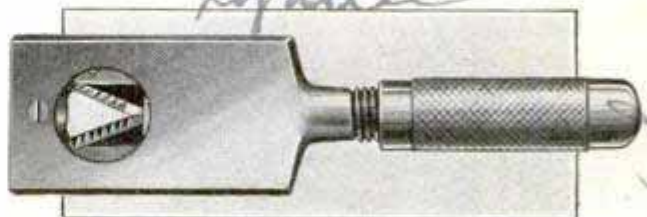

Thread Chaser, or Rethreading Tool, Which Makes New Threads for Bolts up to One Inch

handle of the compact instrument. The tool is capable of chasing standard as well as special threads.

*2924*  
*Shattuck*  
*794*

*2995*  
*Chicago Tribune*  
*Berkeley, Calif.*

269 7

# Making Home

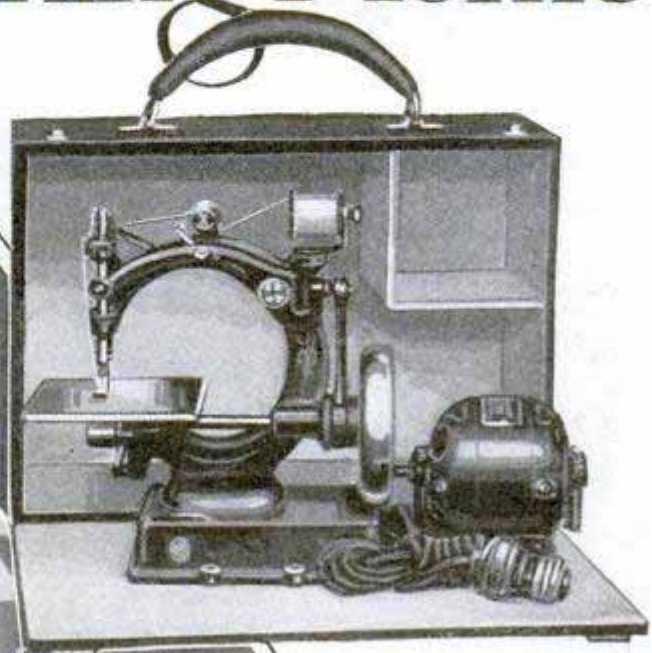

It Weighs Only Ten Pounds and Fits in a Case One Foot Long; the Portable Electric Sewing Machine, Operated by Hand or Knee Control on Direct or Alternating Current

To Save Time and Work, This Serviceable Floor Brush Has a Drying Attachment as Shown; Below Is an Efficient Water Filter Adaptable to Any Faucet or Sink without Obstructing the Field of Operations

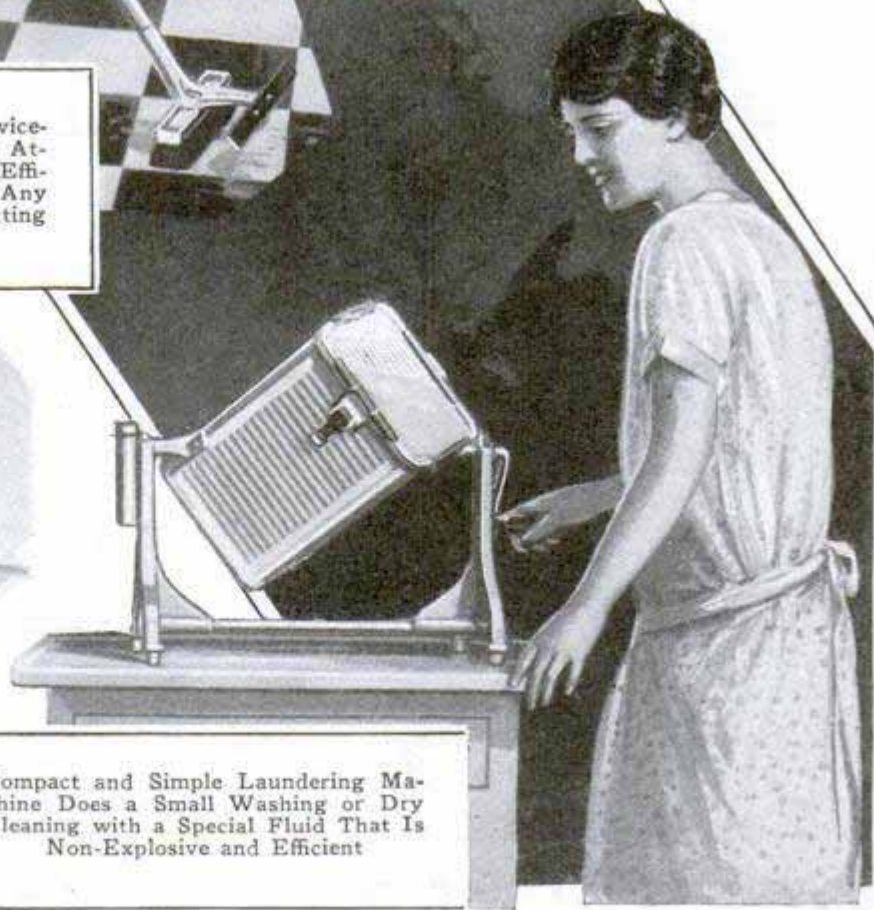
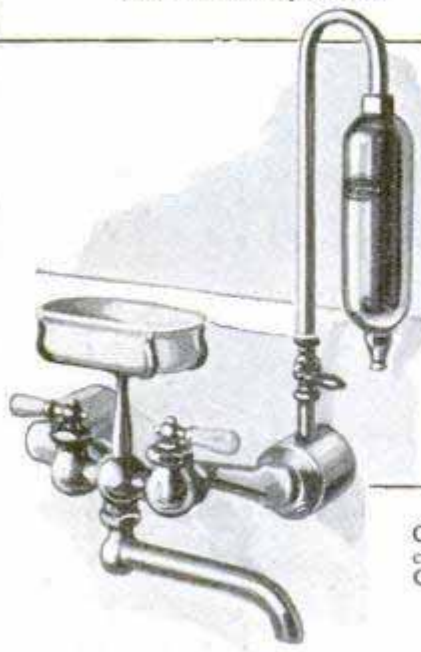

Compact and Simple Laundering Machine Does a Small Washing or Dry Cleaning with a Special Fluid That Is Non-Explosive and Efficient



Air

# Tasks of Pleasure

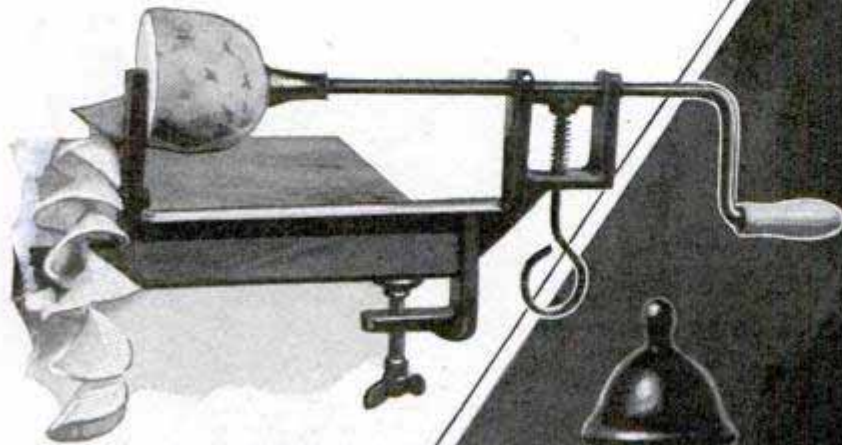

Potato Chips at the Turn of a Crank; This Adjustable Slicer Prepares Carrots, Turnips and Other Vegetables; Below, at Right, Is a Baby's Bottle Warmer That Brings the Milk to Exactly the Right Temperature with Water, Electrically Heated, in the Outer Chamber



Made of a Special Waterproof Fiber, the Apron Illustrated Above Saves Laundering, as It Is Wiped Off with a Damp Cloth When Soiled

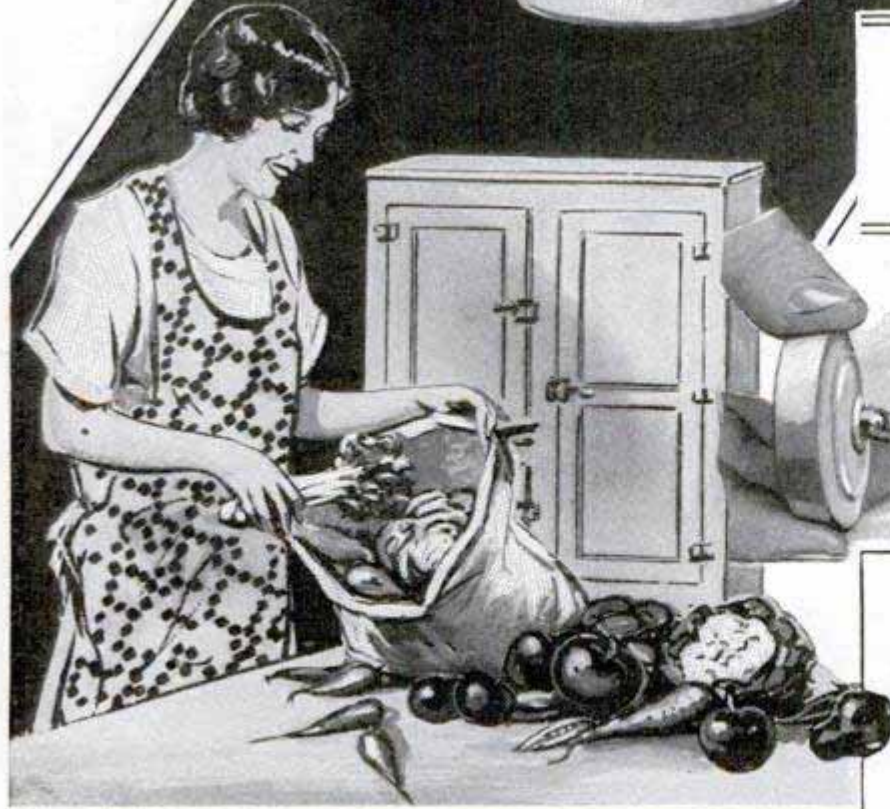

At Left, a Chemically Waterproofed Bag with Moisture-Retaining Inner Part for Keeping Vegetables Fresh and Sweet in the Ice Box, and, at Right, a Non-Separating Link for Bath-tub and Washbasin Plug Chains

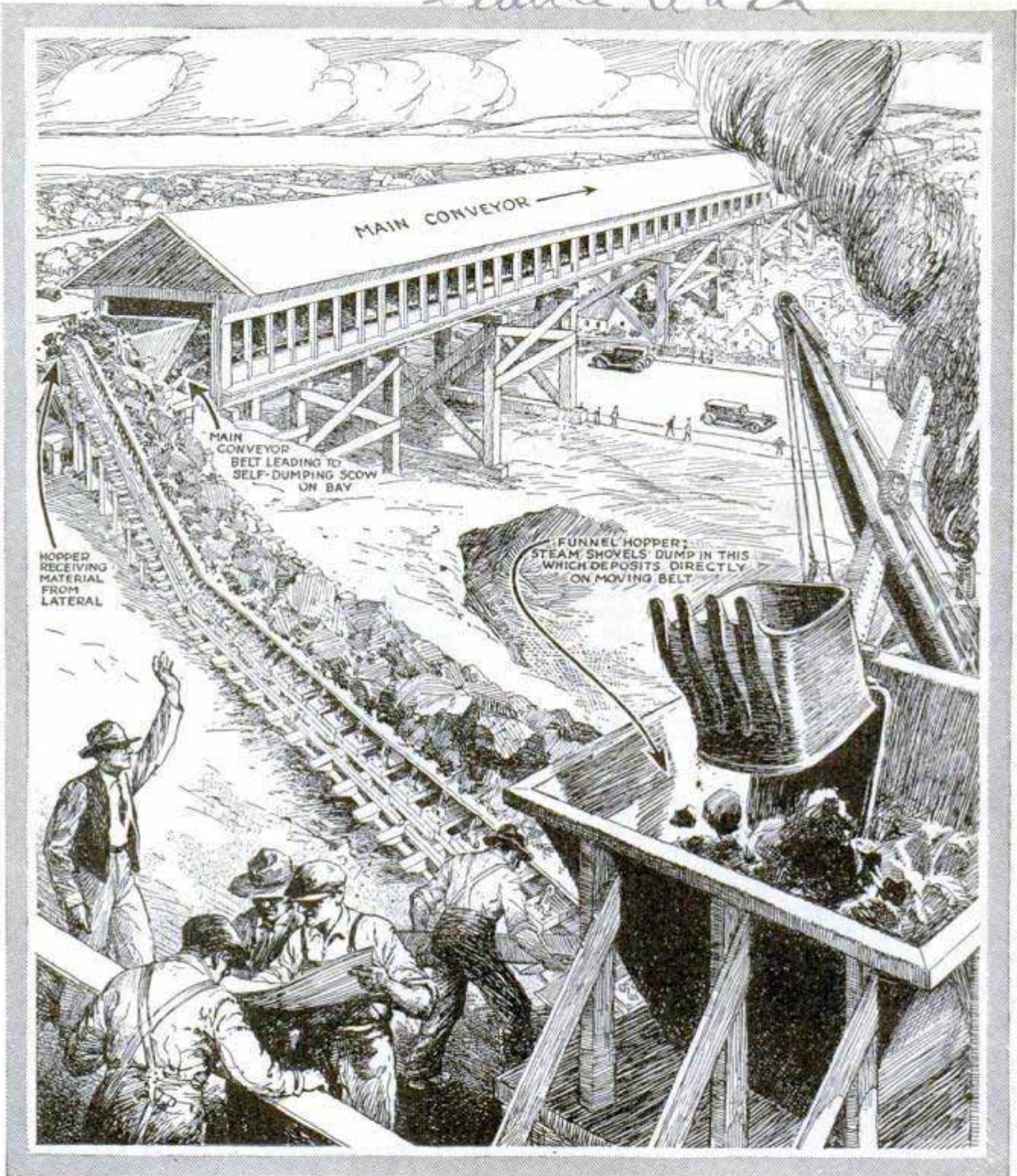

Drawing of the Hill-Moving Job at Seattle; Dirt Is Being Dumped into the Hopper for Conveying to the Permanent Line over the Streets, Where It Is Finally Emptied into the Dredges

### CITY HILL MOVED OVERHEAD WITHOUT STOPPING TRAFFIC

Moving a hill from the heart of a city, carrying it over streets without interfering with traffic, and dumping it from barges that turn turtle to empty themselves, is an interesting engineering task in progress at Seattle, Wash. The project involves the handling of approximately

4,500,000 cubic yards of earth and transporting it more than a mile to the bottom of Elliott bay. Motor trucks, hydraulic pumps or flumes could not be employed because of the congested downtown district from which the hill is being removed, so an overhead conveyor, into which the dirt is dumped from portable units, was constructed over the streets to the loading line at the water's edge. The conveyor

belts are run by electric motors, installed and constructed to eliminate noise, and the overhead trestles are tightly boxed in to prevent dust from sifting down upon the heads of persons walking below. Earth is removed in electrically driven shovels and deposited in the smaller conveyors, which feed the fixed unit that passes over the streets. The barges are especially designed for this job. When they are towed to the spot where the load is to be dumped, sea valves are opened and the barges capsize. Water remaining in the top side drains out during the return voyage so that the barge is ready for another load by the time it reaches the hopper at the end of the conveyor. Engineers estimate that nearly 400 working days will be required to complete the task.

**TALKING PICTURES ARE SENT BY LIGHT BEAMS**



Girl Seated before Apparatus Which Transmits Her Voice and Picture on a Ray of Light

Beams of light in the form of violet rays, instead of radio waves, have been used successfully in transmitting a talking picture. The demonstration was made with a beam about sixty feet long, but it was said the violet rays can carry the picture as far as twenty-five miles. The apparatus used was of the scanning-disk type, but instead of converting the light into electric impulses to be turned into radio waves, the machine reduces the light to violet rays. An apparently steady beam of light spanning the sixty feet to the receiving set was in reality flickering 15,000 times a second. Photo-electric cells on the receiving set converted the flickers into electric impulses which in turn operated a neon-light tube before the receiving disk. Violet-ray transmission is as good at night as in the daytime, and even penetrates fog, it was explained, but to transmit to homes, everyone would need a photo-electric cell with a filter admitting only violet rays from the sending station.

**PETRIFY SOIL WITH CHEMICALS**

Solidifying or petrifying the ground is made possible by a chemical process evolved by a European scientist. Compounds containing quartzlike materials are injected into the soil in quantities that accomplish the solidification in a few minutes. The process is based on the fact that, in nature, the combination of salts and acids present in the soil in the course of about a thousand years convert it into sandstone. The apparatus necessary is simple, and the treatment is cheap.

**AUTO TOW BLOCK WITH SPRING HELPS RELIEVE STRAIN**

Compact and always ready for service, an auto-towing tackle is fitted with a spring which takes up the strain at the start, and a steel cable is contained in a reel, eliminating the usual bothersome length of rope. The flanges of the block are grooved so that it may be used as a purchase block in obtaining extra leverage, when the car is stuck too firmly to be dislodged by a straight pull.

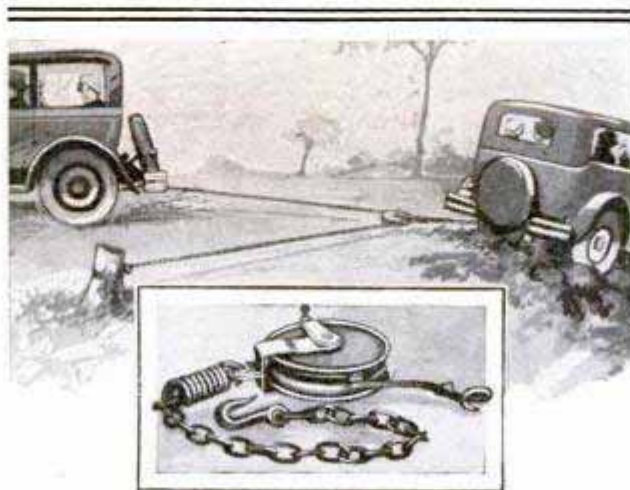

Close View of the Automobile Tow Block, and Illustration of Its Use in Connection with a Stump

*Handwritten note: 1700-1800-1900-2000-2100-2200-2300-2400-2500-2600-2700-2800-2900-3000-3100-3200-3300-3400-3500-3600-3700-3800-3900-4000-4100-4200-4300-4400-4500-4600-4700-4800-4900-5000*

*Handwritten number: 3067*

*Handwritten number: 2115*

*Handwritten note: 2978  
A. J. Radio Corp. with...  
1940 Broadway New York City*

*Handwritten note: 1940 Broadway New York City*

*Handwritten notes at the bottom of the page, including names and dates.*

27 41  
1906 H. St. NW, Washington 20 E

# The Army's Flying



Lieut. F. B. Tyndall, Rear, Studies His Maps, While Lieut. Edmund C. Langmead Takes His Compass Bearings

were now undoing their parachutes. "Say, Lieutenant, what are all them curious-looking doodads in there? All that radio and navigation stuff?"

"They're part of our flying class room," was the reply.

Lieut. Edmund C. Langmead went on to explain that this particular ship was the very latest training innovation introduced by officials of the army air corps in their efforts to develop the highest type of student flyer. Many novel engineering changes were made on the ship in accordance with the purpose of sending the students, toward the end of their flight training, on long navigation trips, the idea being to let each one individually put into practice the theories taught him in the ground class.

The novel training course began last January at Wright field, Dayton, Ohio, under the direction of Capt. Clyde F. Finter, Lieut. Albert F. Hegenberger and Bradley Jones. Lieutenant Hegenberger is

**T**HREE airplanes circled low in the midst of a fog that overhung Bolling field, Washington, the other day, and then, after a few graceful maneuvers, taxied, one after another, through the mud toward the hangars.

Their landing did not cause particular interest until one of the field's mechanics, getting ready to direct the ships into the adjoining sheds, happened to glance inside one of them—a standard tri-motored Fokker transport.

With an exclamation of surprise he beckoned to one of six youthful flyers, who, just having jumped out of the planes,

noted for the many flights he has accomplished mainly by virtue of expert navigation knowledge, particularly the one with Lieut. Lester J. Maitland, from Oakland, Calif., to Honolulu, Hawaii, in June, 1927. Captain Finter and Mr. Jones have devoted many years of study to astronomical methods of navigating planes.

Under present plans, the course is four months long and the class consists of six students. Besides Lieutenant Langmead, the original sextet are Lieuts. Phillips Melville, Edmund C. Lynch, Guy H. Gale, Frank B. Tyndall and Francis B. Valentine. All these flyers have made what is

# Class Room



Through the Trapdoor on Top of the Navigation Ship's Forward Cockpit, the Observer Can Rise with His Instruments to Take the Plane's Bearings

agreed to be the longest training flight in the history of air corps instruction. Spending approximately three weeks altogether, the students and their instructors, taking turns at flying the "Flying Class Room" and two other ships that accompanied them—one a tri-motored transport plane and the other an O-11 observation plane—covered virtually all of the so-called southern flying route. In other words, they flew from Wright field into St. Louis, Oklahoma, Texas, New Orleans, Florida, South Carolina, Alabama, Virginia, and the District of Columbia. Captain Finter was in command of the flight while Lieutenant Hegenberger was chief pilot of the "Flying Class Room."

Under the general heading of navigation—the flight's avowed purpose—come what the experts refer to as all types of astronomical, dead reckoning and radio "avigation." Included in this list of somewhat technical-sounding objectives was training the pilot to fly mainly by means

of navigation instruments in case of bad-weather emergencies, like fog, cloudy, stormy or unusually dark skies. Under such adverse conditions, it was explained to the students, they would, of course, frequently be unable to check their courses by means of landmarks and map studies.

The "Flying Class Room's" equipment fills virtually the entire interior of the transport. In the pilot's cockpit, for instance, the standard lower walls were replaced with triplex glass on both right and left sides, so as to afford fullest ground and landing vision. Above, the leading edge of the wing has been cut out to form an observer's cockpit for use in practice with the sextant. This revolutionary change in turn necessitated a change in the cockpit covering.

Using the forward upper point of the windshield as a fixed point, a roof of celluloid, braced by brass tubing, runs to the top of the wing spar. Immediately over the cockpits of the pilot and assistant pilot



able curtain has been hung, completely covering the left, or pilot's, side of the cockpit. In emergency cases, this curtain can be dropped to the rear and bottom of the cockpit by the mere pulling of a rip cord. The pilot's seat has a false bottom of two inches, to raise him higher in the cockpit and thus increase his field of vision.

All seats, baggage racks and usual furnishings have been removed from the cabin. The first bay is for the use of the navigator only. Certain structural members have been relocated and a ladder installed, to permit easy access to the observer's high seat in the wing's leading edge. This is a movable stool which may be swung out of the way when not in use.

In the cabin's floor, a slot, about eight by thir-

are two glass doors opening outward for use as an emergency exit. Above the observer's cockpit is also a glass door, which, when in the open position, serves as a windshield to the observer while he is making sextant readings; while set in each side of this cockpit, above the leading edge of the wing, is a square of flat, optical glass to enable the observer to take lateral horizon sights.

Even the gasoline-control installations have been moved. Usually they are directly to the rear of the pilot, but now they are on the extreme right side. An induction-compass controller has been installed to the left, very convenient for use of the pilots in communicating with the navigator or the students in the cabin.

For the purpose of instruction in blind flying, a quickly detach-



Top, Studying the Plane's Radio Set; Note the Special Braces and Supports for the Equipment; Below, Taking Sight from the After Cockpit of the Plane; the Process Is Essentially the Same as That Used at Sea



Interior of the Training Plane's Cabin Showing the Radio Equipment at the Rear Used by the Traveling Students in Communicating with Landing Fields

ty-six inches, covered with plate glass, has been cut for use in making drift readings; a drift meter has been placed at the front end of the slot, and another type of drift indicator at the rear end. Between these instruments is a stand, upon which a compass is mounted that serves to check the accuracy of the smaller compass devices.

Adjustable seats are installed in connection with the drift indicators, and the radio operator likewise has such a seat, besides a swinging table. Complete radio sending and receiving sets are installed, for which a 1,000-volt generator, on the right outboard engine, furnishes power.

The rear, or baggage, compartment has also been altered materially. The door usually serving as the passenger entrance to this section has been removed and the opening closed with fabric. The usual baggage door serves both as an exit and an entrance, and the roof of this compartment is a round opening provided with a quickly removable glass cover and windshield, furnishing a second region for ac-

curate taking of sextant readings. Beneath this opening is an adjustable seat that may be raised or lowered to suit the needs of the navigator.

The original students in this new navigation course have expressed themselves as highly pleased with the benefits it offered them, notably in connection with the practical first-hand utilization of almost every kind of modern navigation instrument. During the recent cross-country flight, the flyers plotted their location at various times by means of their instruments and checked the results with the pilot. At first, they met with indifferent success, but toward the latter part of the flight, their errors rapidly became less important, approaching the perfect stage.

☐ The Popular Mechanics' Bureau of Information offers its free service to all readers of our magazine. Names and addresses of manufacturers and dealers in articles described, and any other details in our possession, will be promptly furnished by addressing the bureau.

MODEL FURNITURE OF PLYWOOD FITS WITHOUT GLUING

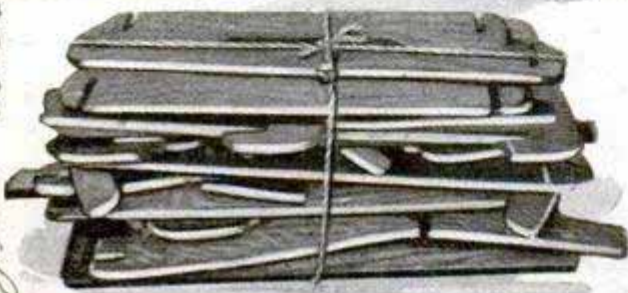
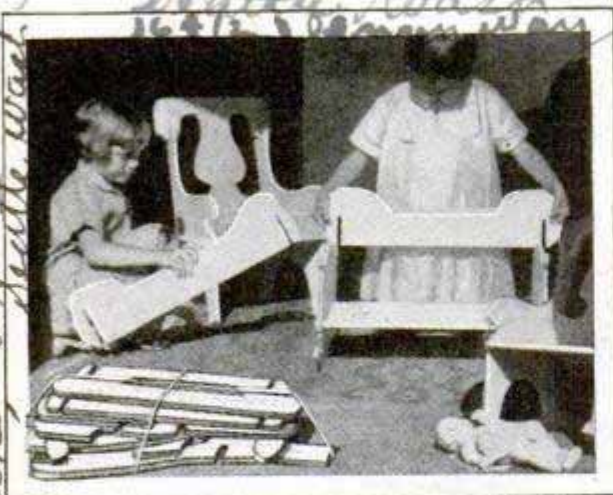

Children Assembling Furniture, and a Package Showing the Compact Form of the Pieces

Plywood furniture for the nursery, so strong that it will hold the weight of adults, is quickly fashioned from flat pieces designed by a western manufacturer. No screws, nails or glue are necessary, as the parts are tightly fitted together by interlocking parts. With a little practice, children can learn to assemble their own furniture and take it apart for packing.

TOY EXCHANGE LETS CHILDREN BORROW PLAYTHINGS

Boys and girls who tire of their toys may take them to a toy exchange and turn them in for other playthings more to their liking, under a system worked out by the playground association of Philadelphia for its recreation centers. The exchange operates along lines similar to the circulating library, toys being gathered at the playgrounds and the children selecting the playthings they like best and using them to their heart's content. When the novelty wears off, they return them and select something else. Many of the toys are donated by children having an overabundance of playthings. A scarcity of dolls has proved to be the biggest trouble.

Regardless of how old a doll may be or how many other playthings a little girl possesses, she usually is unwilling to part with even one of her "children."

U. S. BIRDS FIND VENEZUELA IS WINTER RESORT

Venezuela is the favorite winter resort of feathered North American tourists seeking warmer climes, an expedition sent there to study bird life by the National Geographic society has found. Although in the tropics, the varying elevations offer a variety of climates, many of which are comparable to those found in the United States, but the birds usually seek the warmer, sunnier regions. Among North American birds that sojourn in the country are redstarts, blackpoll, various kinds of warblers, summer tanagers and grosbeaks. They particularly like the coffee plantations where they are kept busy devouring insects.

LIGHTS TURNED BY DASH KNOB FOR SAFER DRIVING

Night driving has been made safer by an automobile-headlight control, operated from the dash of the car, which diverts the rays of the lamps when another car approaches without the necessity of dimming. The control changes the direction of the lights from the center of the road to the right side, thus eliminating the blinding glare without cutting down the intensity of illumination and throwing into relief the side of the road along which the car is proceeding. It is operated by pulling a knob on the cowl.

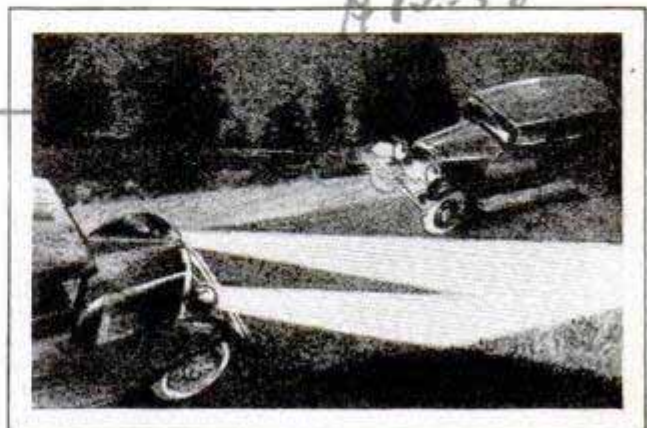

Pulling a Knob on the Dash Diverts Auto Headlights to Right Side, Thus Avoiding Dimming

2825  
2020-  
15th Ave  
Seattle, Wash  
G. O. Washke  
169 1/2  
Clms.  
Henry

Warney Vergible  
Headlight p. 33 or 335



Carnival locate 8/22/29

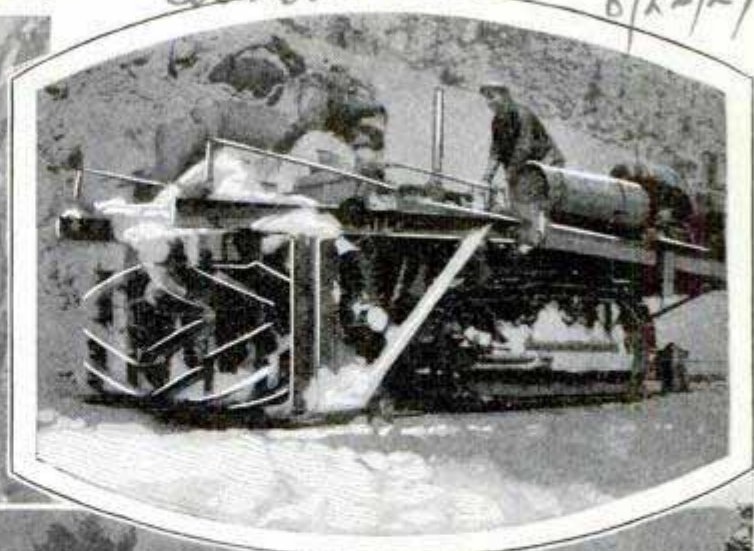
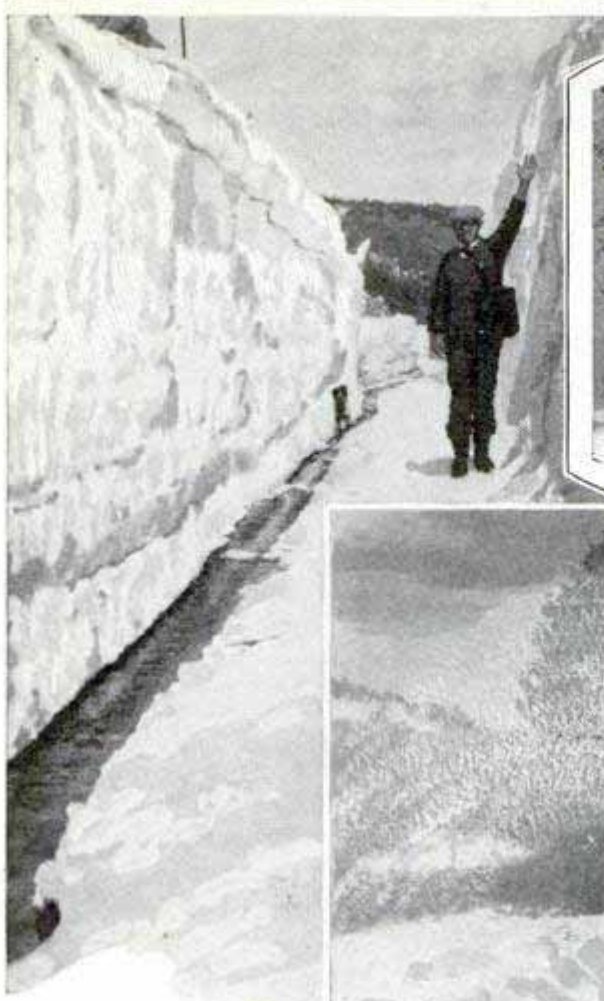

Rotary Snowplow Keeps Mountain Roads Clear; Left, a Road Freed of Snow; Upper Right, the Plow, Showing Large Blades, and, Below, the Machine Bucking a Drift

### ROTARY SNOWPLOWS TO KEEP MOUNTAIN PASSES OPEN

Designed to attack huge snowdrifts and keep mountain passes clear of snow, a rotary plow is powered with an endless-tread tractor and equipped with three rotary wheels or blades. Two vertical front blades are barrel-shaped and intended to cut and draw the snow into a center blade which deposits it to either side of the road as desired.

operate a car. The fuel consumption of an efficient locomotive is so small that, if it could take on its coal as it went along in the form of a solid bar, the bar would be no larger in diameter than an ordinary lead pencil.

### GASOLINE FLOW THIN AS A HAIR MAKES AUTOMOBILE GO

Figuring the efficiency of the modern automobile in terms of the stream of gasoline necessary to make it go, it has been estimated that a constant flow of fuel of little greater diameter than that of a hair would furnish all the power necessary to

### ROD CUTTER FITTED ON VISE SAVES TIME

Easily attached to the vise or to the workbench, a combination cutter has been introduced for the shop. It is useful in cutting drill rod, preparing templates or cutting sheet metal into any shape at a great saving of time. It is also adaptable for inside or outside nibbling.

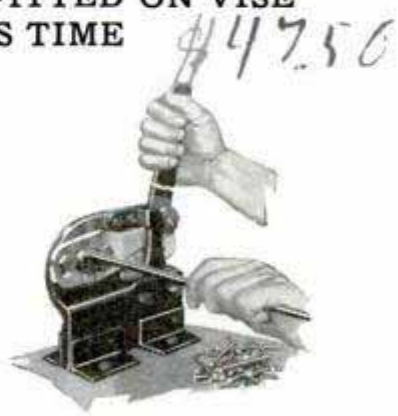

W. Schapere  
45 Academy St

Wilmington Machine  
Co. Inc. Raleigh

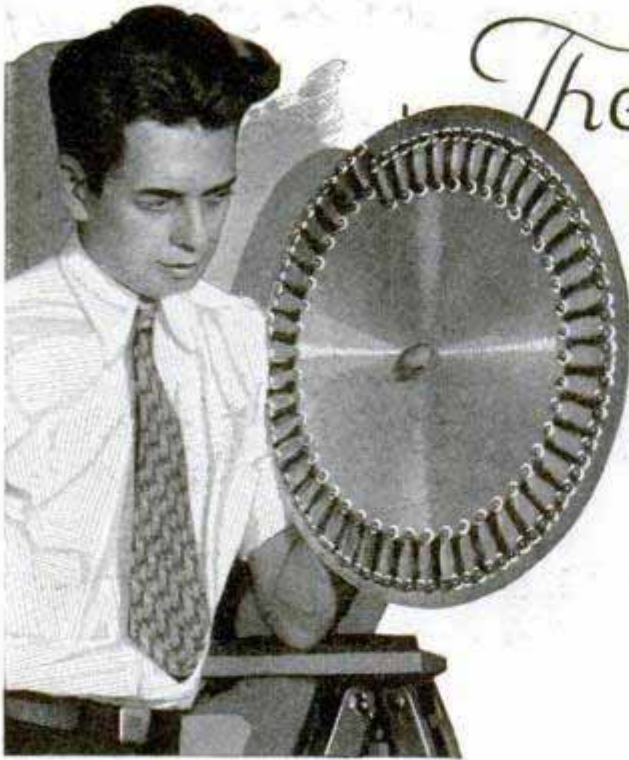

# The LATEST in

disk revolves in front of the lamp, and from it is projected the image, which is seen in the viewing frame.

Jenkins' transmitters, past and present, differ from others in that he employs a quartz-rod drum in place of the scanning disk. Thereby, he claims to get far better sharpness and detail of image. Particularly is this true in the case of the new transmitter, revolved by two powerful synchronous motors instead of one, and fully capable, tests have proved conclusively, of broadcasting halftones as well as the familiar silhouettes.

A short time ago, Jenkins started using his new transmitter, broadcasting from his recently completed laboratory near Washington, and, as many amateurs now know, he is transmitting movies every night, instead of only thrice a week. And, most important of all, he occasionally broadcasts in halftones, since the radio commission has lately granted him a suitable short wavelength for the purpose.

No one ever knows what Jenkins has up his sleeve for tomorrow, but today he's having a lot of fun experimenting with two other television devices recently invented: the first, a receiving apparatus for radio movies in the theater, and the other an "aerial television eye," designed to transmit airplane views of cities to a ground receiving station.

"ADJUST that synchronizing knob, my boy, and then beat it out of here. You've earned a rest," said a fatherly voice to a young research worker in a Washington laboratory the other day.

As the young fellow passed through the door, the older man, alone in one of the most famous workshops in the country, chuckled to himself: "Well, now, I guess that device will be well able to send out movies that in line and detail aren't so much inferior to the ones we see regularly at the corner theater."

The newest transmitter of C. Francis Jenkins is outstanding among the astonishing television developments of the past few months. As most every one knows, the average popular system of television today consists of a scanning disk that contains a series of holes arranged spirally and revolved by a synchronous motor in front of the image to be transmitted. As the disk rapidly revolves, the holes cut images into many sections and these affect a photoelectric cell, which is so arranged as to transmit a radio signal. At the receiving end these signals affect a neon lamp, the light of which varies directly with the current that operates it. A similar

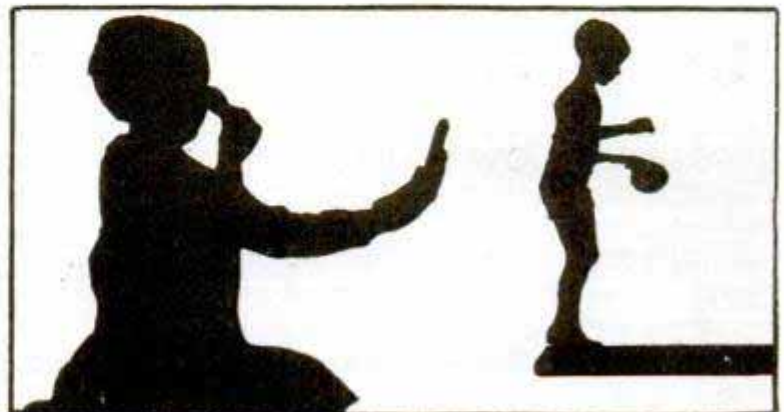

Some of the Famous

# TELEVISION

by  
James N. Miller

as his other receivers with certain technical differences. The area on which the picture is shown consists of forty-eight horizontal rows of flashlight lamps, with forty-eight lamps in each row. They are arranged in a like number of holes in a two-foot-square plate,

supported in a vertical position. The lamps are divided electrically into four banks, and each is individually wired to its particular contact of the switching gear. When the motor is started, the incoming amplified radio signals are distributed to the several lamps in succession, fully lighting some of them, lighting others to partial brilliancy and leaving others unlighted. The result is a picture built up in lights and halftone and shadow on the face of the plate.

The picture is made up of glowing lamp filaments which persist, in light value, for an appreciable time, say a tenth of a second. But as the exciting impulse is applied every fifteenth of a second, the lamp is aglow for the whole time the corresponding area of the scene at the transmitting station is alight. Which is to say that the whole of the received picture is on the plate all the time instead of only a

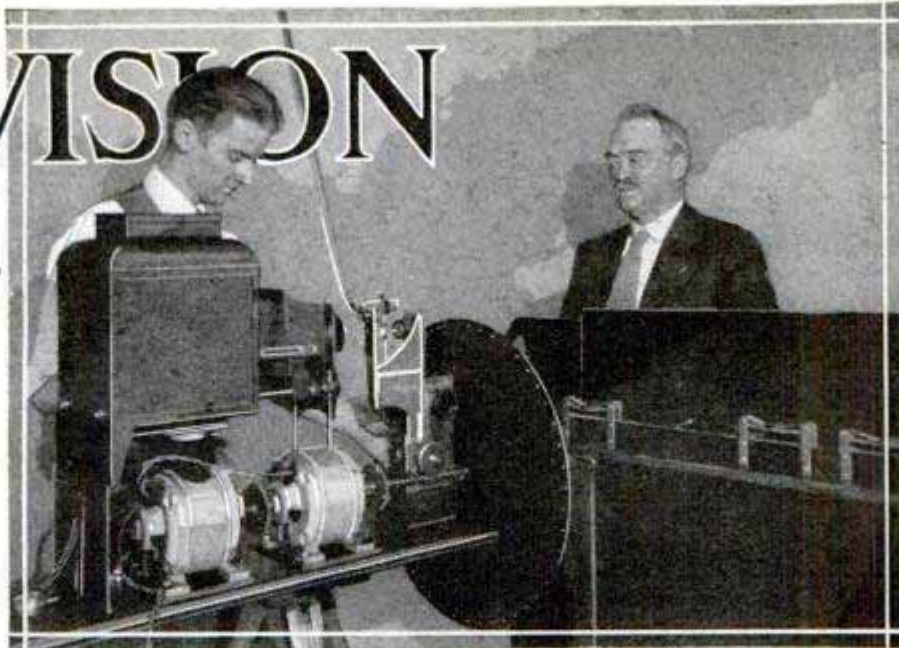

Jenkins' Latest Transmitting Device, Just Completed, Broadcasts Not Only Silhouettes, but Halftones as Well

fractional part of it. In front of the plate a lens is mounted for projecting it onto a theater screen. As the light source is the picture itself, the only loss is that resulting from the magnification. And, fortunately for the observer, the light is white, not the pink color characteristic of the neon lamp.

The aerial television eye is being tested in the inventor's new Curtiss plane. Army and navy officials have manifested keen interest in the invention, since it would have great military value in time of war. With its use, an army's general headquarters would be put within sight range of front-line operations. Constructed to insure refinement of visual detail, the device enables the panorama below to be recorded in the usual way by means of a large scanning disk, light-sensitive cell and other broadcasting paraphernalia. The scenes are received on regular tele-

vision machines set up in the Jenkins laboratories. The scanning eye focuses on the ground through an aperture in the bottom of the ship. The inventor, an experienced flyer, directs all maneuvers and pilots the plane while two assistants operate the television machinery.

Mr. Jenkins says: "We are repeatedly told that it will be from five to ten years before the public will have perfect television receivers. One might just as truth-

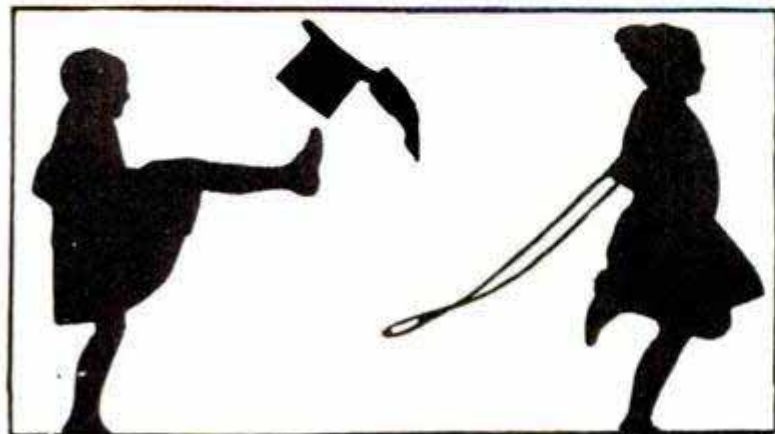

Jenkins Shadowgraphs



fully say a thousand years, for perfection is never attained. Fortunately for the inventor, the improver and the research man are never satisfied.

"However, the new industry is progressing by leaps and bounds. True, it is still wrapped in swaddling clothes. Nevertheless it should be borne in mind that animated pictures differ from still pictures only in the speed of presentation, and the process of sending the latter by radio is highly perfected.

"We are beginning to take television out of the peephole or one-man state. The problems of increased detail, better illumination and a more precise synchronization of the transmitting and receiving disks are in capable hands, and I regard their solution as a matter of a short time only."

Judging from the queries that come regularly to his laboratory, Mr. Jenkins says, there must be over 20,000 amateurs regularly receiving his movies. Official figures now available tell an even more surprising story. While they do not divide television into its still and movie chapters, they show that twenty-two visual broadcast stations, probably, by the time this is read, will be transmitting pictures and television images on channels assigned

by the radio commission. Moreover, the broadcasting now is on a nationwide basis, for twelve of the stations are in the east, four in the middle west, two in the far west and one in the south. Jenkins himself, from station W3XK, at Washington, (and his new station has the same number) has been using two channels simultaneously—the short-wave band



Taking a Movie in the Jenkins Laboratory; Already Television Has Reached the Stage Where the Whole Family Can Enjoy It

for long distance "lookers-in" and a regular broadcast channel for the enthusiasts at Washington and vicinity.

"We now are in a position to provide any number of scattered, independent broadcasters with facilities for inaugurating a television service," he says. "It is the first practical step which has been taken in the direction of a national distribution of television programs. Often I have been asked why I haven't always been broadcasting halftone movies, showing details of scenery and persons, instead of silhouettes or movies in black and white only. My answer is that the halftones, in regular movie film and in broadcasts from living subjects, require a broader band. However, bands 100 kilocycles wide have just been assigned by the radio commission for such work, so I shall gradually increase my output of halftone films, and soon expect to be broadcasting, for fire-

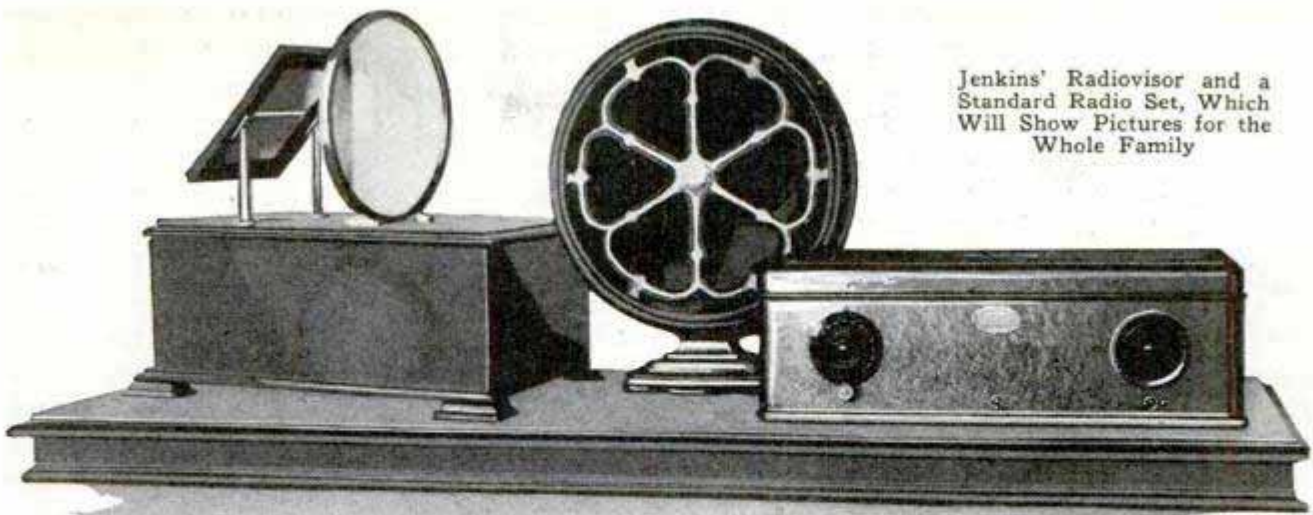

Jenkins' Radiovisor and a Standard Radio Set, Which Will Show Pictures for the Whole Family

side entertainment, pictures selected from those now shown in the theaters.

"The present halftone broadcasts are received in the nation's televisors just as easily as are the silhouettes. My present system of transmitting was undertaken principally to enlist the co-operation of the amateurs in order to learn the possibilities and the limitations of this new entertainment; and to build up a perfect

tion pictures to the theaters by means of radio instead of by film."

May we expect home talking movies shortly, and, if so, about how soon, the inventor was asked. "Probably within a couple of years," he replied. "Dr. De Forest's perfected high-vacuum tube is going to be the foundation of transmitted sound motion pictures, just as it is now the foundation of sound broadcasting. It is the

Aladdin's lamp which will enable vast audiences to see as well as hear through space."

Answering another question, Mr. Jenkins declared: "The chances are that the sight channels of radio communication will never seriously interfere with the proper reception



radio-movie technique.

"When I've picked up more valuable information in this connection and have perfected my new motion-picture theater receiver, I'll be able to play ball with some degree of efficiency with vast audiences of lookers-in; and then I can likewise help the producer to distribute mo-

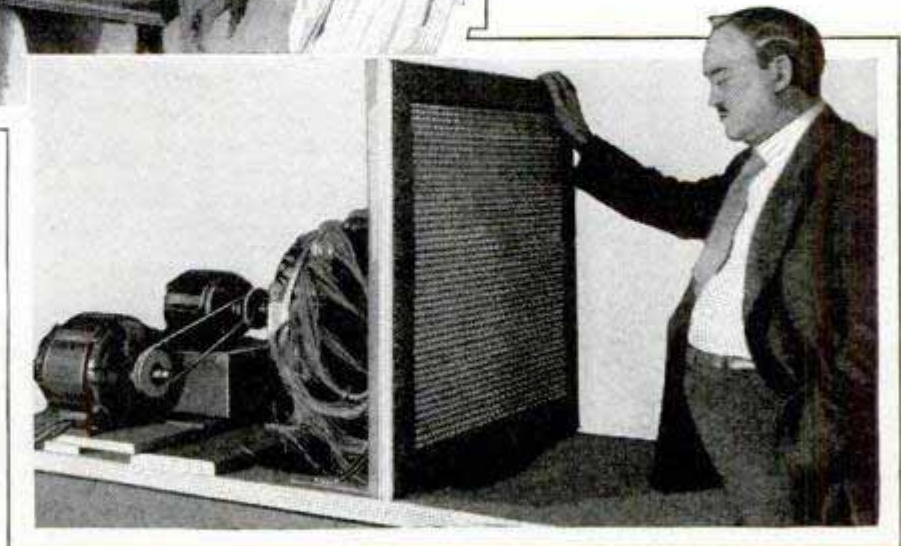

The Small Silhouette Above and the Two-Foot-Square Image of the Latest Receiver, Below, Illustrate the Strides Television Is Making

of sound. Nor will the reverse situation obtain. One day the radio fan, because of the new short wavelengths designated for television, will be able to watch the radio folks dance and sing while he likewise tunes in on the longer wavelengths for his sounds. The result should be a well-synchronized entertainment product.

"Television's greatest immediate problem is to produce a simple, practical and fool-proof televisior for the entertainment of the whole family circle. While I have built one that comes fairly close to meeting these requirements, there is still plenty of research work ahead. As for size, I lately have succeeded in magnifying the television image to a point where it can be viewed by as many as a dozen persons at one time.

"When radio service to the eye shall have a comparable development with radio service to the ear, the new era will bring to the fireside a fascinating teacher and entertainer without limitation of language, literacy or age."

### Correcting an A-Eliminator Trouble

A number of really good A-battery eliminators are now available for receivers formerly operated with a storage A-battery. All the good characteristics of the d.c. tubes, together with the advantage of full a.c. operation from the house lighting when the A-eliminator is used in combination with a B-eliminator, make this method of powering the set very desirable. There is one slight disadvantage, noticeable in some localities, which, however, may be easily remedied. Distant stations will be coming in about as usual, but powerful local stations may fade in and out in a puzzling manner. Most sets employ-

ing d.c. tubes have a volume control in the form of a filament rheostat in one or more of the r.f. stages for decreasing volume when desired. This is a rather critical filament adjustment, and when an A-battery eliminator is used instead of a storage battery, the slight fluctuations in the line may be reflected in the output of the set. To remedy this condition, a volume control of a different type should be installed, by connecting a potentiometer across the antenna and ground posts of the set, and the center tap of the potentiometer to the antenna lead-in wire. The former volume control, or controls, may now be left in the full-volume position, and the volume controlled with the potentiometer without disturbing the filament balance of the tubes. In this way, the slider of the potentiometer enables any desired part of the signal voltage to be impressed on the grid of the antenna-coupling tube.

### Using Phonograph Horn as Loud Speaker

The horn employed in a good phonograph makes an ideal radio speaker when no other speaker is available. The diagram shows a simple method of connecting the phonograph tonearm to the output of the radio set. The apparatus may be quickly attached or detached by simply backing off the setscrew that holds the phonograph needle in position. A steel knitting needle is soldered to the center of the phone diaphragm and to the point of the phonograph needle, and mounted as shown. A support of wood or metal is built up under the reproducer, so that the needle is held horizontally. The reproducer rests on sponge rubber. The vibrations pass through the knitting needle to the phonograph needle and the sound issues from the horn.

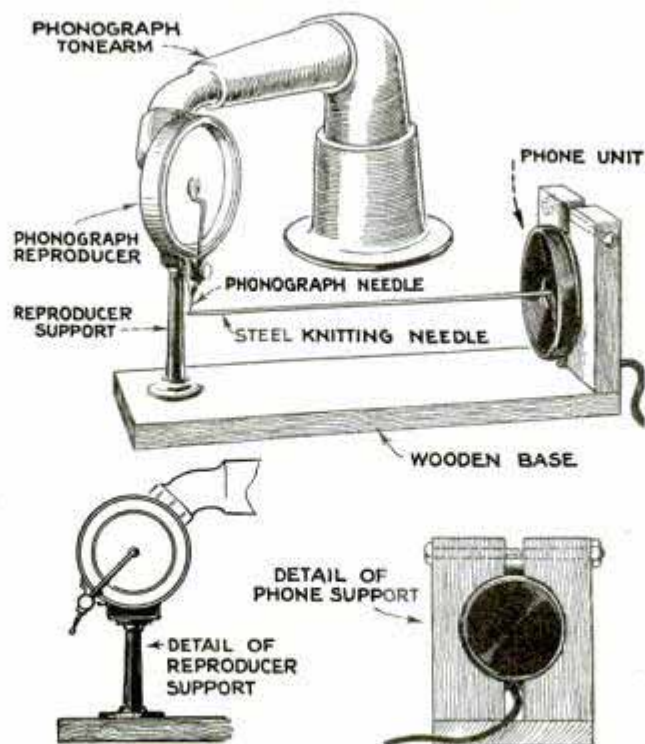

Phonograph Tonearm Connected to Headphone Unit, and Details of Both Supports

*Marchfield  
2317. R  
Mass*

**Soldering Tips on Tinsel Cord**

Headphone and loud-speaker tips break off after considerable use and render the connection useless. They can be resoldered, but this must be done carefully, because the circuit is through tinsel and not wire and the former will quickly melt under heat. The proper way is as follows and is the method used in factories for applying the tips: Push back the insulation from the tinsel about 1 in. and wind on a piece of fine copper wire spirally over the tinsel. Then clean out the tip by melting away the solder and drop in a fresh bit of solder. Place the wire-wound tinsel end in the tip and then heat the tip sufficiently to just melt the solder inside. This immediately surrounds the tinsel and wire and, upon cooling, a firm connection is made.

*2318 R*

**Volume Control Handles High Currents**

The high currents employed in modern radio receivers demand a volume control of great capacity. The unit shown in the illustration is made chiefly of metal and handles the current with ease, safely dissipating five watts. The application of the resistance element and the contact design are said to be thoroughly efficient. A special graphite paint is fused to an enameled-metal base so effectively that there was no perceptible wear and no appreciable change in resistance value after a test of 65,000 turns of the contact arm at lower left. Photos show the complete unit and the interior construction.

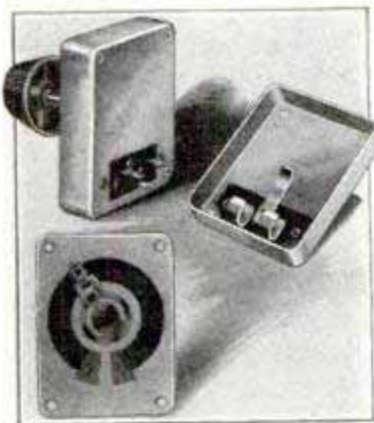

Photos show the complete unit and the interior construction.

Popular Mechanics' radio department offers its information service free to all readers of our magazine. We will be glad to help you with your problems, and will promptly answer all inquiries.

*Electrad. Corp.  
1935  
2101  
1935*

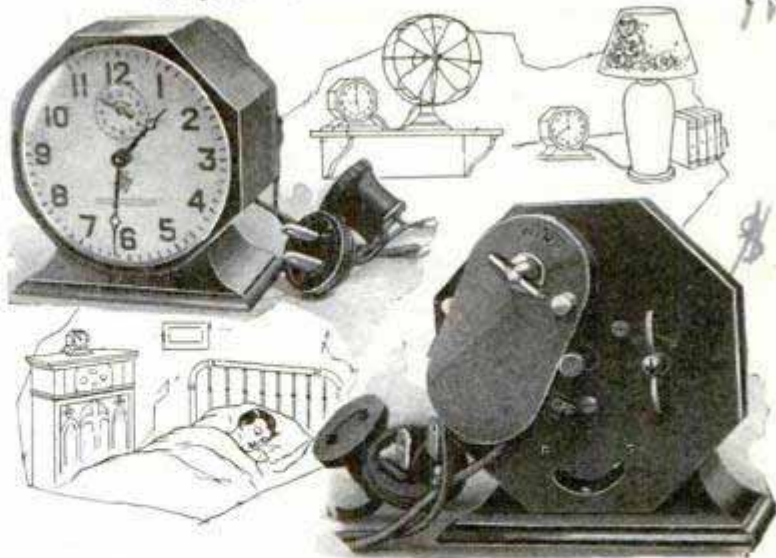

Automatic Clock Set to Control the Operation of a Lamp and Fan, and, Below, to Start the Radio Set for Morning Exercises

**A Radio Self-Starter**

The little clock shown in the illustration will perform various kinds of work. It can be set to turn the electric radio set on or off at any predetermined time. It will also control the operation of an electric fan, heating pad or lamp. A cord and plug are provided for the wall socket, and an outlet socket in this line is employed to take the plug from the electrical device to be controlled. The rear view shows the switching control "off." If this tab is pushed in, the word "on" appears. The clock is set for the time of operation in the same manner as an alarm clock, and it is necessary to wind the key for each setting.

**Polarizer for Electrostatic Speakers 2340. R**

The small unit shown in the photo furnishes the necessary 600 volts for the operation of the new "electrostatic," or condenser-type, speakers. This high-voltage unit is necessary to charge the surfaces of the speaker and is known as a polarizer. It consists of a small transformer, a blocking condenser and a rectifying tube. The latter delivers 3 to 4 milliamp., which suffices to charge the speaker.

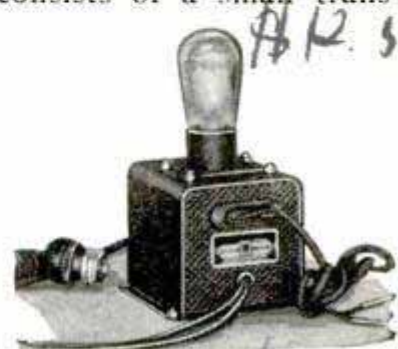

*National Company, Inc.  
61 Sherman St.*

# All-Metal Cabinet

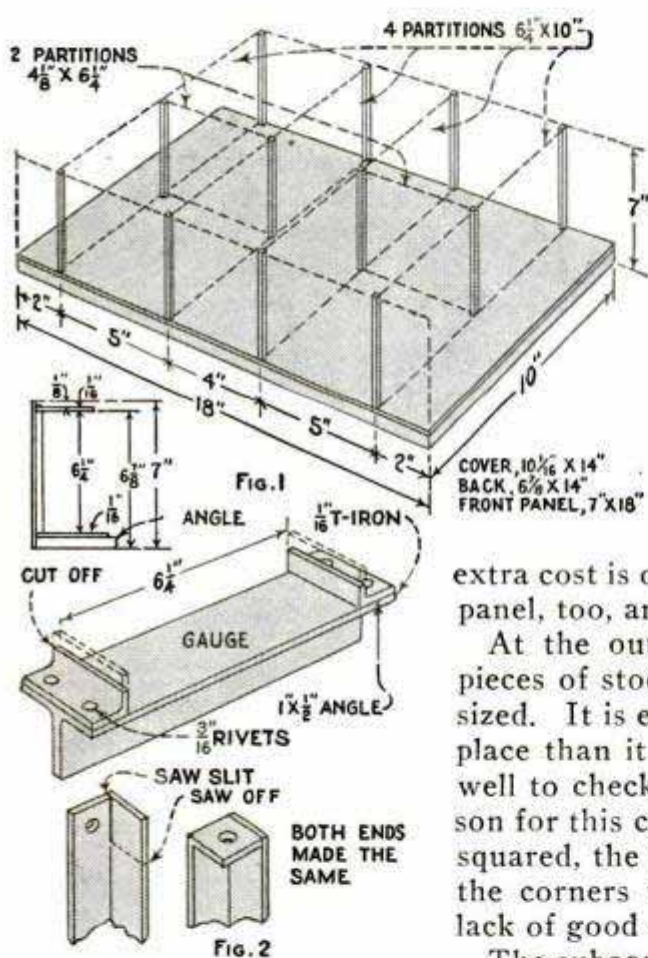
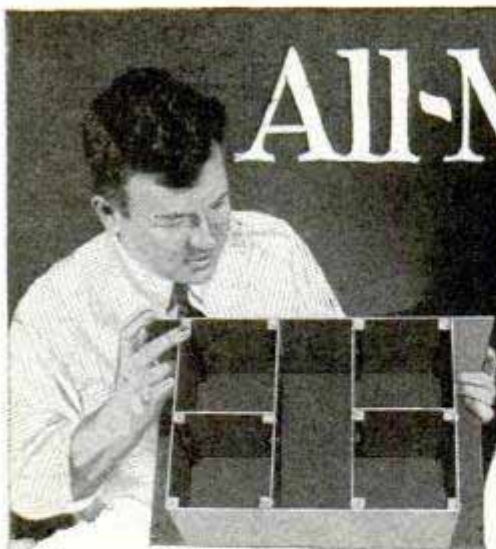

WITH every part of the set inclosed in a completely shielded compartment of its own, the interfering magnetic fields are as completely removed as it is possible to do. Furthermore, this shielding prevents the wiring, coils and other parts from serving as auxiliaries to the antenna, and thus selectivity is an additional product of thorough magnetic insulation.

With the exception of the front panel, this cabinet is built of sheet brass, the stock being approximately  $\frac{1}{16}$  in. thick. The subpanel should be at least of this gauge, but the cover, back and partitions may be somewhat lighter. However, for rigidity and general all-around results the heavier metal is to be preferred.

The cabinet, complete, will cost from \$6 to \$8, seemingly a rather high price, but if the four stage shields that would otherwise be required, are bought at a minimum of \$1.50 each, which is a low estimate, the extra cost is only \$1 or \$2; you have a metal panel and subpanel, too, and the outfit is complete and in a single unit.

At the outset, the importance of having the various pieces of stock square on all sides cannot be overemphasized. It is easier to have the stock cut square in the first place than it is to file it down later on, and it is just as well to check up before you start working. Another reason for this caution is that, unless all pieces are accurately squared, the finished job will be more or less out of line, the corners won't fit and, finally, the work will exhibit lack of good workmanship.

The subpanel, where the work will start, is a 10 by 18-in. sheet of brass, supported on all four sides by strips of brass angle, which are mitered at the corners and attached to the top with round-head machine screws in threaded holes. There is not a nut used in the complete assembly for the reason that it is easier to run the screws into threaded holes than it is to fumble with nuts, and besides, the job stays tight. All holes are drilled with a No. 35 drill and tapped with a 6-32 tap.

Holding the angle strips to the base with clamps, holes are drilled along a line scribed  $\frac{1}{4}$  in. inside the edge. If the finished job shows gaps at the corners or if a bit of additional strength is needed, solder may be used and dressed down later. The top is now removed and any burrs that may result from the drilling and tapping operations are filed off flush. This is important to remember as you go along with the work. It might also be well, while you're at it, to fasten a short piece of angle, say about 1 in. long, to the middle of the underside, in order to minimize any tendency of the subpanel to sag



# is Easy To Make

by J.S.Hagans

under the weight of the parts placed on it. After the subpanel has been completed, the next thing is to saw off 12 pieces of brass angle, no less than 7 in. long, and better  $\frac{1}{4}$  or  $\frac{1}{2}$  in. longer. These 12 pieces will form the supports to which the partitions, top and rear cover, and front panel will be attached. Fig. 1 shows how this should be done. The supports should be made  $6\frac{1}{4}$  in. over all. If additional cabinets of this type are contemplated, a gauge of the type shown will be found a convenience later.

When bending the ends over at right angles, to form the top and bottom of the supports, as shown in Fig. 2, make allowance for the thickness of the metal. In other words, the bend is made not on the scribed line, but slightly short of it, the difference depending on the thickness of the stock, but in general this will be approximately  $\frac{1}{16}$  in. After the lugs have been turned over in the vise, the bend can be beaten down with a hammer in order to make it as nearly square as possible. The upper end of each support is drilled and tapped, but the lower end is drilled with a  $\frac{3}{16}$ -in. drill, the subpanel being tapped for the screw. The  $\frac{3}{16}$ -in. holes allow a little play around the screws, so that the uprights may be shifted slightly to align them when assembling.

The next step is to scribe a line  $\frac{1}{4}$  in. inside the edge of each individual partition piece, on one side only, this line marking the position of the holes for the screws. A carpenter's marking gauge is the best tool for this purpose. Next lay out the position of the various partitions on the subpanel, using a scribe and square. In doing this, allow for the thickness of the partitions and scribe two lines, one, the outside line, to show the over-all dimension, and the inside line to show the thickness of the metal. It is along this latter line that the perpendicular supports are located.

As an example of the foregoing, if only the dimension line is shown and the supports located along it, then the finished job will be wrong at the end "ledges," which, instead of being 2 in. wide, will only be  $1\frac{15}{16}$  in., the difference representing the thickness of the metal at each end. Set the partitions inside the dimension lines. The interiors of the compartments will be made that much smaller, of course, but your dimensions will come out as you have planned them.

There now remains only the squaring up of the supports with their partitions, holding them securely with clamps while the holes for fastening the partitions to the supports are being drilled and tapped.

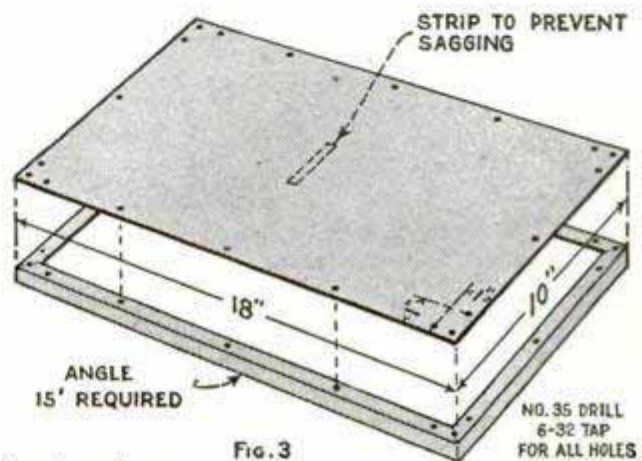

Fig. 3



The front panel is made of satin-finished aluminum. If you cannot buy such an article, get the bright finish, and "dull" it



Shielded Cabinet Nearing Completion; the Compartment-Arrangement May Be Altered to Accommodate a Variety of Circuits

with a wire scratch brush on a grinding arbor if available, taking care that the scratching is done in one direction only. This method can also be used for giving the completed job a final touch of good workmanship.

The cabinet illustrated was made for a particular job, and, of course, for different circuits some changes may be necessary, although the method is always the same. For example, the angle frame below the subpanel was  $\frac{1}{2}$  in. in this case, but if condensers are to be placed under the subpanel, it will be necessary to use  $\frac{3}{4}$ -in. angle in order to get sufficient height underneath and to change the length of the uprights. Such alterations should be figured out before the work starts.

### Shielding S-G Tube Leads

Shielded leads to the grid and plate of the screen-grid tube are recommended; in fact, such shielding, especially for the plate lead, is essential in all circuits employing these tubes. The control grid

lead in some circuits, however, shows a decided tendency to work better without the shield, and the builder should try the tube with and without shielding this lead to the cap. There are a number of ways to shield these leads, but the simplest method is to use the flexible insulated wire, covered with a woven metal sheath, now available for this purpose. Care must be taken when grounding this metal covering, especially on the plate lead. Keep the sheath cut back from each end of the lead, so that it will not come in contact with the terminals. When grounding the metal sheath, pull a bit of the woven metal from the insulation and solder this tip to ground. If the shielded lead passes through a small hole in a stage shield and makes contact on the grounded shield, no further grounding is necessary.

2172 R —

### Automatic Control for A-Battery Sets

A large number of owners of radio receivers, operated with a storage A-battery, are still throwing a series of complicated switches for the B-eliminator and charger. An automatic switch makes it unnecessary to insert and remove the plug from the light socket and turn several switches every time the set is used. It automatically takes care of the B-eliminator and trickle charger or either. It is available in several types according to the kind and number of tubes in the set, and a similar model of later design is available for use with a 2-ampere tungar charger where a trickle charger is not capable of keeping the battery charged up for the efficient operation of multi-tube sets. The connections are very simple, as the automatic control-switch is merely cut into one side of the A-battery line to the set and plugged into the light supply.

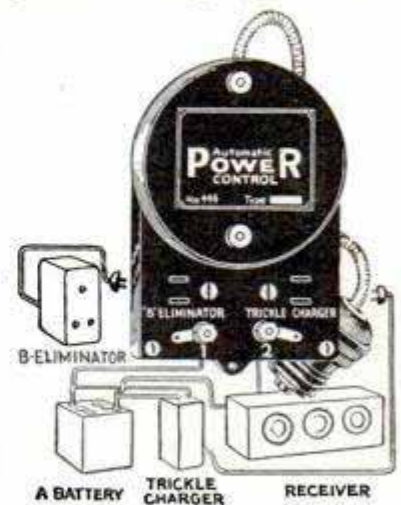

The charger and B-eliminator are plugged into the receptacles provided and the set is controlled by the original switch.

*Radio Rec. Supply Co.  
a S. Clinton*

# Disk Coils for the Experimenter

By EDWARD A. McMURTRY

**D**ISK coils have several qualities which will prove of interest to the experimenter and set builder with a limited pocketbook. They are easily made, compact and efficient, the field is restricted and they are adapted to any standard circuit with excellent results. The writer has used these coils in wave traps and in r.f. and regenerative circuits with good uniform results and sharp tuning.

Fundamentally these coils are composed of two disks of insulating material, 2 to 3 in. or more in diameter; a small brass bolt is passed through the center and a spacer between the disks provides the winding space. The terminals are brought out through holes in either or both disks as desired. A fine grade of paper-card stock,  $\frac{1}{16}$  in. thick, soaked in paraffin was used by the author and proved as satisfactory as thin hard rubber and fiber disks.

Fig. 1 shows the two disks clamped by a small bolt with the spacing washer A  $\frac{1}{8}$  in. thick. A 6-32 or 8-32 brass machine screw may be used and thin brass washers are put under the head of the screw and under the nut to prevent damage to the disks. Small dowel stock and short wood screws may be used instead of the ma-

chine screws and spacing washer if the builder desires to eliminate as much metal as possible from the core. Another method of making the forms is to cut the cardboard square, round off the corners and use an eyelet instead of the machine screw or bolt. In this case, an eyelet and spacing washer may be inserted in one or all four corners after the coil is wound and the unit mounted with a bolt and bracket on one corner.

When winding, the starting lead comes through a hole in the disk but the outside lead, after finishing the coil, is drawn through two holes to prevent loosening. The coils are random-wound with No. 26 d.c.c. or s.c. wire; do not wind the coils

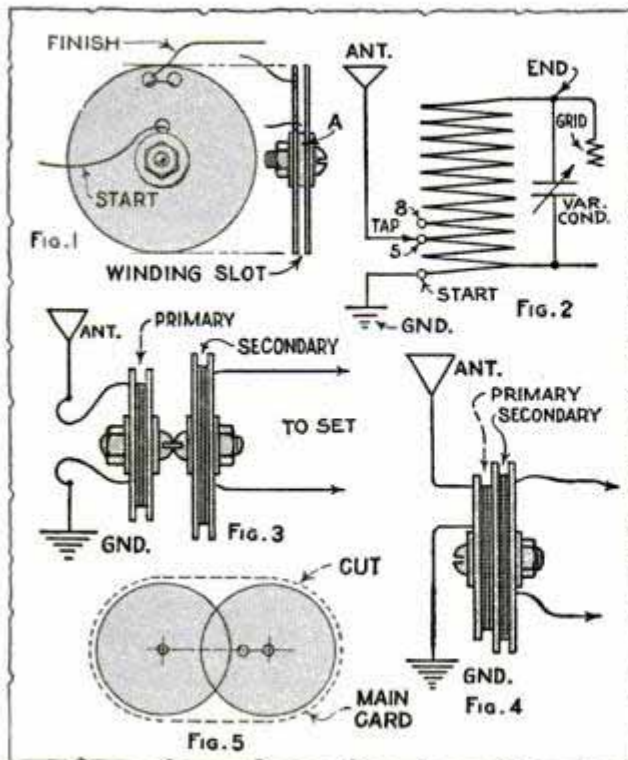

tightly as they are strong mechanically and a light tension tends to reduce capacity effects.

Disk coils are not rated by number of turns but by the length of wire wound on a form of given dimensions. Once you

have determined the correct measurements for a coil it can be duplicated very accurately by making up other forms of the same size and length of wire. To determine the proper coil construction for a given purpose, make up several 2-in. and 3-in. disks with  $\frac{1}{16}$ -in. winding space between them. Wind 25 to 40 ft. of wire on each and test them in the circuit, adding or taking off turns until the correct length is found for a given size of condenser. Then unwind and measure the wire so that you can duplicate the coil.

The coils referred to so far have been single-winding units as shown in Figs. 1 and 2. When winding the coil for the first tuned unit of, say, a five-tube tuned r.f. set, mark the wire at 5 and 8 ft., and as you wind, bring out small loops through holes in one of the disks at the marked places for antenna taps, Fig. 2. The starting lead goes to the ground, and the rotor of the tuning condenser and the grid of the tube are always connected to the end of the winding and to the other side of the variable condenser. Leads are soldered to the loops and run either to binding posts or to a tapped inductance switch. This coil, without the taps but with the same variable condenser across it, con-

nected to the grid of the tube and the negative-A line, may be used as the secondary and a separate disk coil as a primary. The latter may or may not be tapped as desired and 10 ft. of wire should be wound on it. Place it in inductive relation to the secondary as in Fig. 3. An adjustable bracket may be employed instead of bolting the two coils together so that the distance between the coils may be varied for selectivity.

This is an excellent arrangement for a set of the three-tube type where selectivity in the detector stage is required. However, if several r.f. stages are used as in a five or six-tube set, it is customary to use fixed couplers as in Fig. 4, and similar coils for the other r.f. stages. This coil consists of three disks,  $2\frac{1}{2}$  in. in diameter, spaced by two washers, the disk at the primary side being smaller. The spacing washers should be of fiber or other insulating material. The primary winding consists of about 10 ft. of wire and the secondary about 40 ft., both of the same size. It is a simple matter to mark the center of the wire used for the secondary, and bring out a tap for neutralizing a neutrodyne circuit.

(To Be Continued)

### New Dial Shows Scale in Colors

2846 *R*  
A new idea in the construction of dials has recently been introduced by an eastern

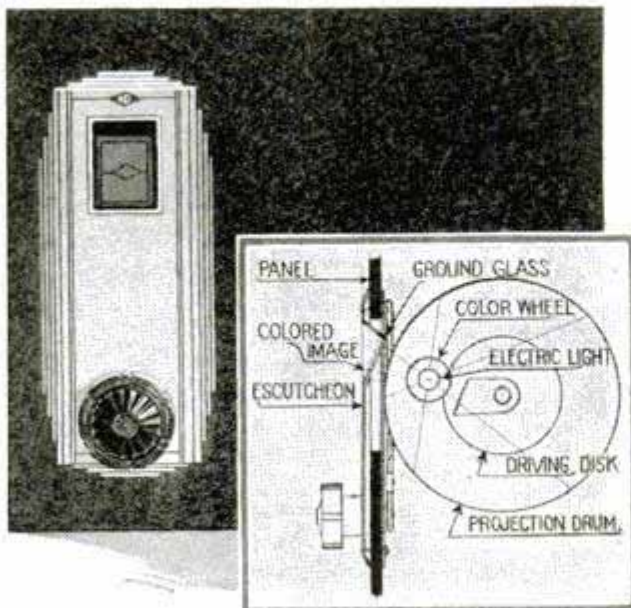

Mounted Escutcheon Plate and, Right, Diagram Showing How the Color Effects Are Obtained

manufacturer. When the set is turned on, the ground-glass front of the dial is illuminated and a single scale number appears. As the dial is turned, figures continue to appear and fade out, accompanied by a play of varicolored lights in the background.

### Adjusting C-Bias from B-Eliminator

A variable C-biasing voltage may be obtained from any B-eliminator that has a sufficient number of voltage taps, without making any alterations or additions in the power unit. Simply use the "Neg."-post on the eliminator for negative C; the post marked "Det." for negative B, and "Int." for the detector plate voltage. Now, when the usual detector-voltage control is turned to the left, the C-voltage is increased. To increase the detector voltage, turn the Int. control knob to the right. This simple arrangement has been used successfully by the writer.—Chas. Middleton, Laporte, Ind.

*National Co. Inc.*  
*61 Sherman*

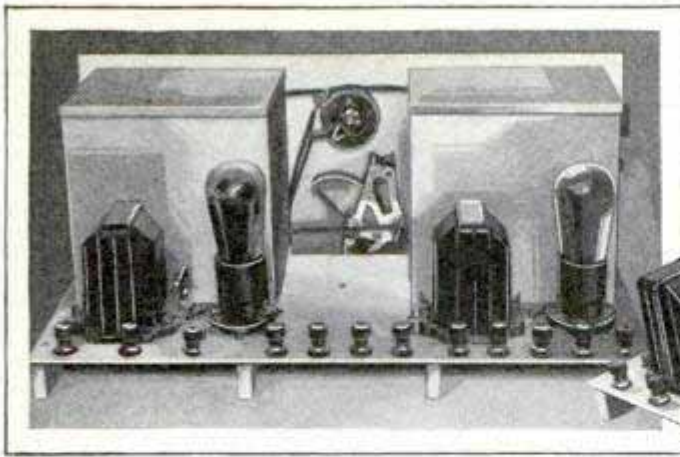

Rear View of Completed Short-Wave Receiver; Right, Rear Section of Shield Cans Removed to Show Stage Assembly; Below, Front Panel

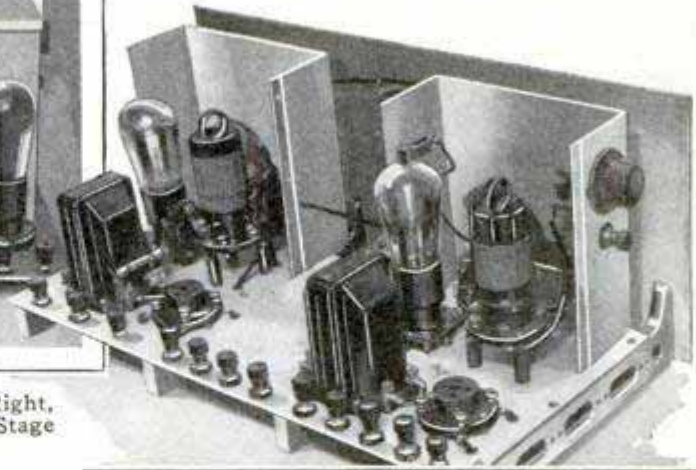

### Sectional Shields on Short-Wave Set Facilitate Assembly

The short-wave receiver shown in the illustration is available in kit form and employs a screen-grid tube in a tuned r.f. circuit. The shielded sections are in two parts which are held together with short machine screws when completely assembled. This type of construction makes wiring in close quarters a simple matter. The front panel and subpanel are also of metal and drilled with all the necessary mounting holes for the parts. The range of the receiver may be extended to cover the standard broadcast wavelengths by means of specially designed plug-in coils that fit into convenient receptacles inside the shield cans. The set, however, is particularly designed for the reception of programs from the short-wave broadcasting stations. The receiver is said to be less critical in operation than previous sets of the straight regenerative type because of the increased amplification of the screen-grid tube in the tuned r.f. position.

### Keeping Ganged Condensers in Step

The three or four-section ganged condenser will seldom keep the various circuits in step unless some method of balancing is employed. Worn bearings, loose nuts and slightly bent condenser plates will cause an unbalanced condition, preventing selectivity even in the finest sets. The best method is to use small condensers of the neutralizing or balancing type and connect them directly across each condenser in the ganged unit. These

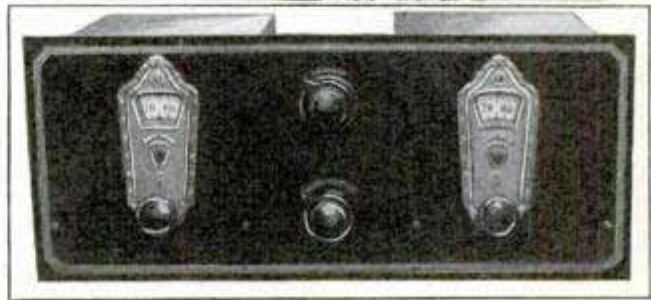

condensers take up very little room, and the capacity may be varied with a wooden "spudger" while the set is in operation. Only one section of the ganged unit may require adjustment, and in this case, the balancing condenser may be tried across one condenser section at a time. Tune in a weak signal about the middle of the dial and vary the balancing condenser. If the signal decreases, remove the small condenser, connect it to the next section, and adjust it until the signal comes in with maximum strength.

### Testing Screen-Grid Tubes

Many of the standard tube testers are not arranged for testing the new screen-grid tubes. This may be done, however, by connecting the grid, screen-grid and plate of the tube and then connecting them to the plate prong on a tube base or adapter. The filament prongs are connected in the usual manner to the tube base or adapter, which is then plugged into the regular tube tester. With 50 volts on the plate and the necessary 3.3 volts on the filament, the plate current on a good tube will show 12 milliamp. or better.

⚠ Never change power-unit connections without first disconnecting the supply.

# TIPS from the

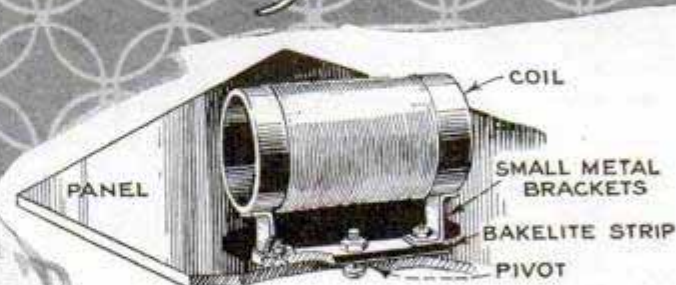

Left, Standard Aluminum Shield Employed to House a Push-Pull Stage Complete with Tubes, Resistors and By-Pass Condensers; Above, a Simple Method of Mounting Inductance Coils So That They May Be Turned at the Necessary Angle to Prevent Field Coupling

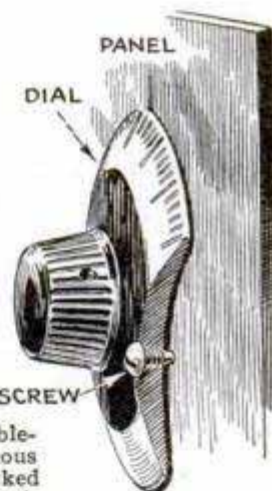
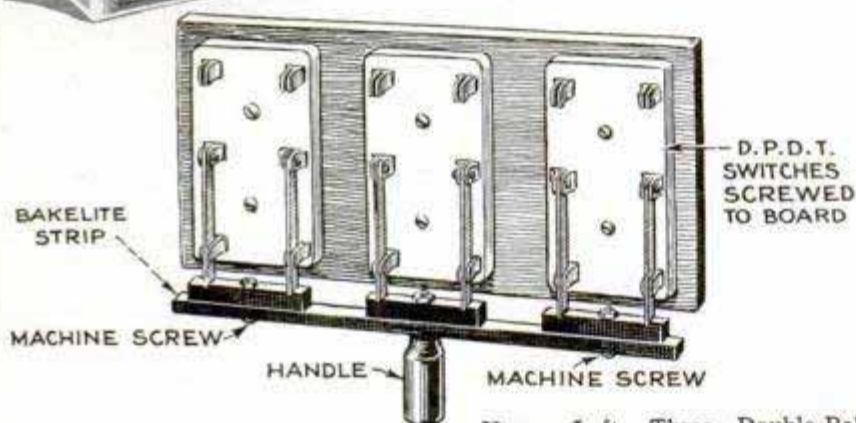

Upper Left, Three Double-Pole Double-Throw Switches Ganged for Simultaneous Operation; Right, Dials May Be Locked in Any Position by Machine Screw through Tapped Hole in Dial

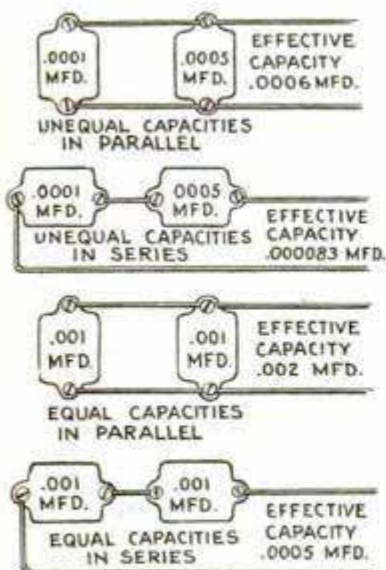

Left, Fixed Condensers Connected to Form Units of a Desired Capacity; When Connected in Parallel the Capacities Are Merely Added, but When Connected in Series the Condition Is Radically Changed and the Capacity of Two or More Condensers Is Less Than That of the Smallest Single Unit; Right, When Working with a Set Which Has Recently Been Connected to Batteries, Eliminators or Power Line, a Screwdriver with an Insulated Handle Should Be Used as Shown to Discharge By-Pass or Filter Condensers, to Prevent an Unexpected Shock; These Slight Shocks Are Not Dangerous, but May Cause the Operator to Jump and Knock the Set to the Floor

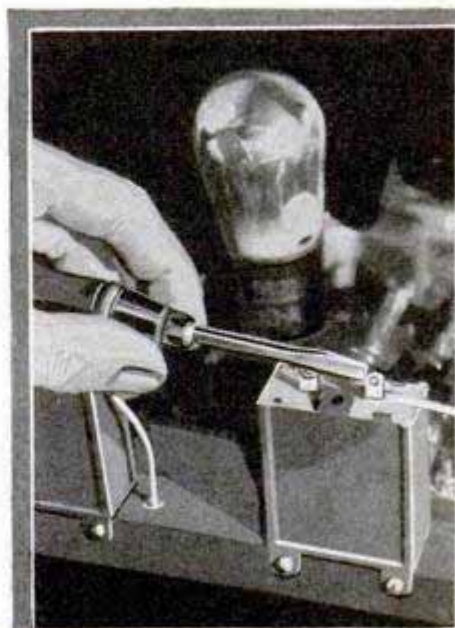

Take. Electrotechnician Co  
Canton, Mass.



Tracking Down Radio Interference by Means of a Specially Designed Portable Receiver

### Tracing Radio Interference

A midget portable radio set is the implement of science today in searching out elusive sources of interference that frequently disturb an entire neighborhood. These specially designed sets are extremely sensitive to radio interference and will trace troubles caused by electric refrigerators, oil burners or other electrically operated apparatus. The remedy is in the form of suitable filters which effectually stop such interference, once the source is located.

### Bared Leads Aid in Voltage Testing

Most B-power units have all the terminals covered with insulating material. This is a necessary precaution, but makes it rather awkward for the owner to find a place to put the prods of his voltage-testing meter. Loosen the terminals and pull

back the wires about 1/8 in. and fully tighten each terminal, 1 short bared wire for the test p makes it easy to obtain a corre quickly, and there is little dang ing a shock from the small unct ion of wire.—E. T. Gunderson, boldt, Iowa.

### Neutralizing the Old Neutr

When the radio-service man, man around the neighborhood, in to look over an old neutrodyn he usually runs up against a puz ation. Using the standard metho tralizing does not seem to work set continues to oscillate. This is due to the new type of tube bases of bakelite instead of bra remedy is to connect the metal the old-style sockets in the r.f. sta a short piece of wire and then n each stage in the usual manner. will then be restored to normal c without oscillation. If the tube X-type sockets, it will be nece wrap thin copper or brass bands the bakelite bases and connect tl bands as in the case of the shell: old-style sockets. Modern neu condensers of the screw-adjustme should be substituted for the old —D. A. Brown, Marion, Ohio.

### FOR THE RADIO BUILDER

- The blueprints below include the best of ular Mechanics tested circuits. When ord simply quote numbers of blueprints desire inclose proper amount addressed to P. Mechanics Magazine, Radio Dept., 200 E tario St., Chicago, Ill. Magazines cont full descriptions of the circuits can be obt Send 25 cents for each magazine desired, i date of publication.
- No. 111, Homemade Tube Tester July 1926
  - No. 115, 15 to 550-Meter Three-Tube Receiver . . . . . Nov. 1926
  - No. 116, Three-Tube Loop Set . . Dec. 1926
  - No. 123, Economy-Nine Super-heterodyne . . . . . Nov. 1927
  - No. 130, One-Tube Short-Wave Adapter . . . . . Mar. 1928
  - No. 134, Edison Type B-Battery July 1928
  - No. 138, Screen-Grid Perfect-Tone Six Receiver . . . Nov. 1928
  - No. 139, Simple Television Receiver . . . . . Dec. 1928
  - No. 140, Power Amplifier and B-supply for Television . . Jan. 1929
  - No. 142, Two-Tube Screen-Grid Short-Wave Adapter . . Mar. 1929
  - No. 143, Four-Tube Screen-Grid Receiver . . . . . May 1929

# RADIO LAB.

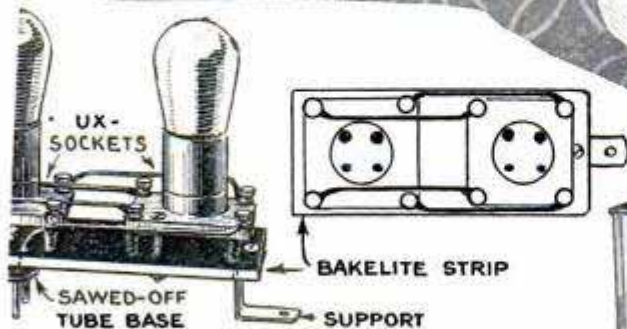

Tubes of the Same Type in Parallel in the Last Stage for Better Tone and Volume; the Unit Is Plugged into the Last Socket

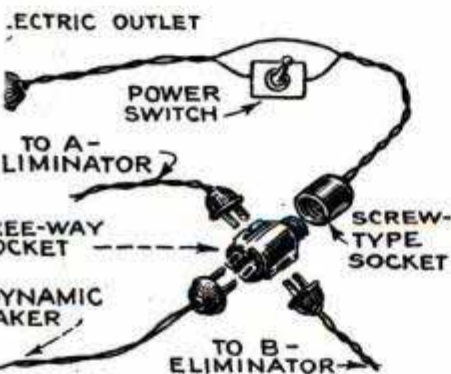

See, a Diagram Showing How a Single Switch of the Power Type May Be Used in the Line to Control Three Radio; Mount the Switch at Any Convenient Position on the Cabinet or on the Panel of the Set

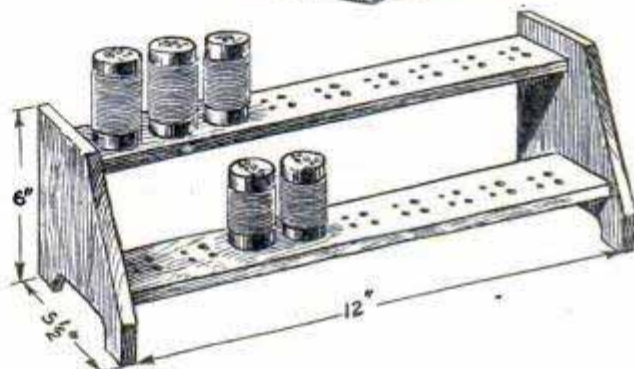

Above, a Handy Rack for Plug-In Coils or Tubes for the Workbench; the Coils Are Labeled for Identification with Cardboard Disks, as Shown



Left, a High-Resistance Unit, Provided with a Shunting Button and Designed for Controlling the Speed of a Television Motor, May Be Connected in One Side of the Line Supplying an Electric Soldering Iron to Prevent Overheating; for Quick Start, the Device May Be Turned On Full and the Button Pressed Down, after Which a Suitable Temperature May Be Maintained by Adjusting the Resistance; Right, a Drawing Triangle, Drilled and Cut to Be of Aid in the Drawing of Radio Circuits; Many Other Symbols besides Those Shown May Be Drawn by the Same Method

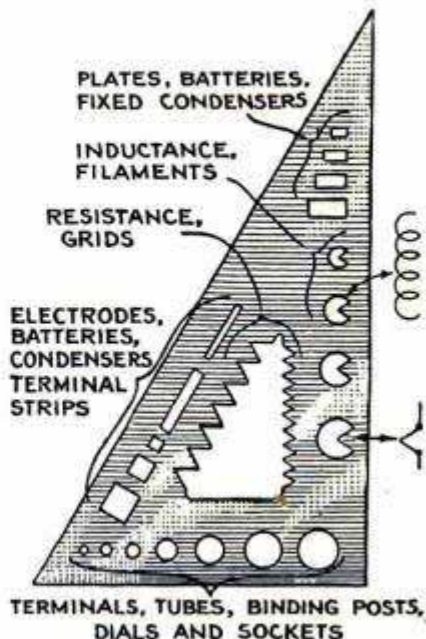





## Speedy Lightweight Kayak Easily Built

By D. R. HOAG, 2917 Magnolia Blvd, Spokane, Wa

**R**EMARKABLE speed and ease of handling, owing to its exceedingly light weight, are the features of the Eskimo kayak, a small water craft originally made of whalebone and sealskin by the native Eskimos. The modification described in this article is made of wood and canvas, but nevertheless is so light that, when loaded, it draws only 6 to 8 in. of water. This makes paddling very easy and considerable speed possible. While intended for one passenger, it can be enlarged to accommodate two, if desired. The weight of a one-passenger kayak is about 15 lb., and the cost of material approximately \$7.

The framework is first constructed. It consists of 1 by 1-in. white pine or spruce strips, which should be clear and straight-grained. Pieces having knots should not be used under any circumstances. The four stringers are 12 ft. long, and a number of crosspieces and ribs are spaced between them as shown in the deck plan and

side elevation. To prevent splitting the pieces, they should be kept wet an hour or so before bending them. All the joints are made by means of wood screws, driven into lead holes; the joints are reinforced with heavy wire. The reinforcing is done by drilling a fine hole through the rib, about 4 in. below the joint, then threading a wire through the hole and around the stringer, as indicated in the detail. A piece of rubber cut from an old inner tube is placed between the wire and the canvas to reduce wear. The best method of assembling the frame is to cut and fasten the ribs nearest the center of the stringer. Then the stringers are bent and the rest of the ribs fastened in place. The ends of the stringers are bolted together as follows: The upper right-hand stringer is bolted to the upper left-hand stringer, and the same procedure is followed with the other pair. Both pairs of stringers are then bolted together with two bolts at

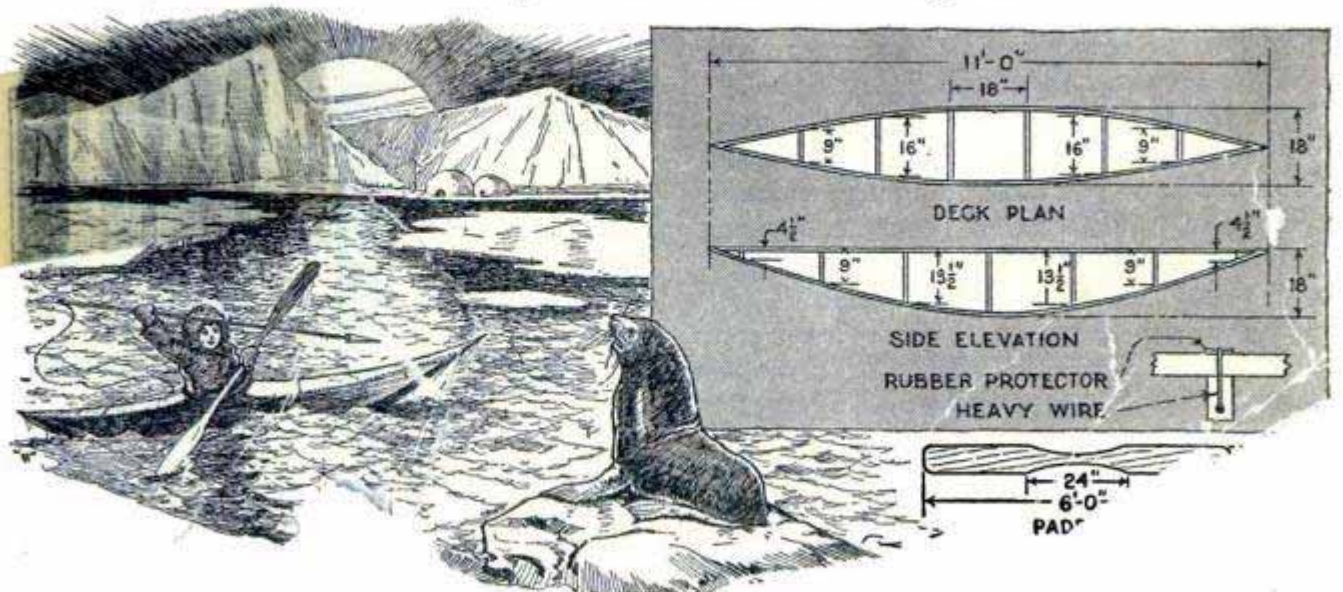

Only Fifteen Pounds and Draws But Speed and Ease of Manipulation

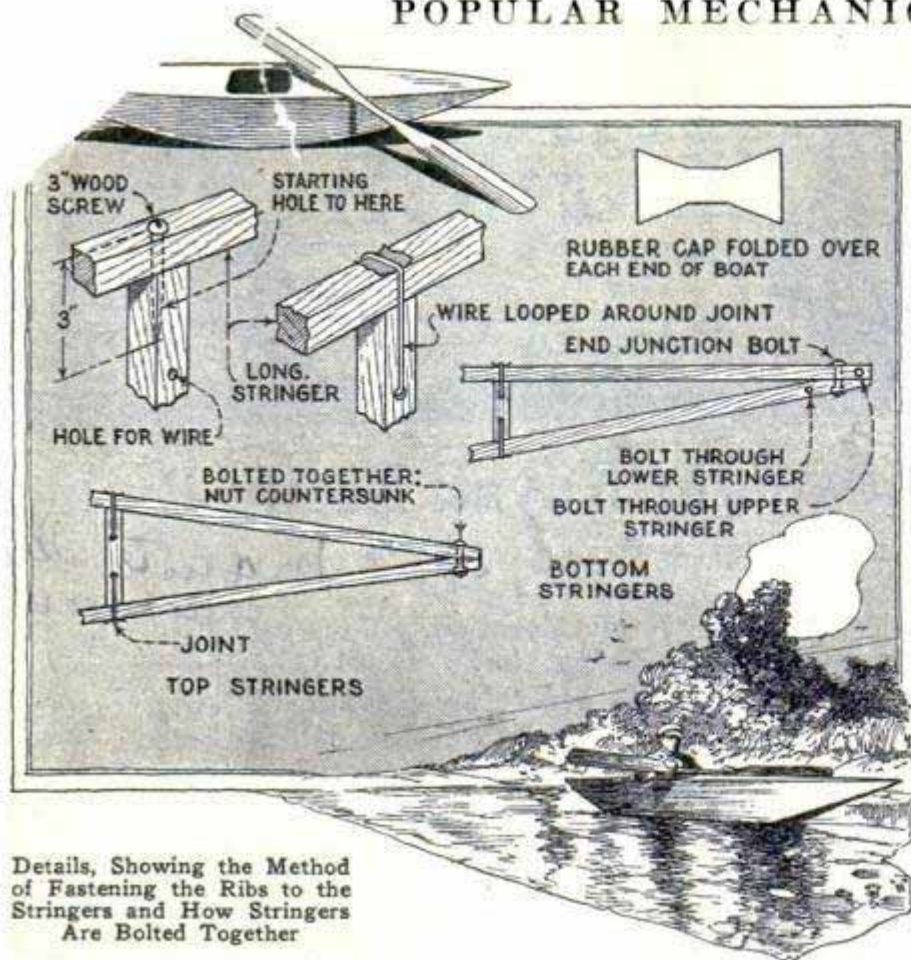

Details, Showing the Method of Fastening the Ribs to the Stringers and How Stringers are Bolted Together

each end. The heads of the screws and the nuts are countersunk, and a piece of rubber is cut to form a cap to fit over the ends as protection for the canvas. Altogether, the amount of lumber needed for the frame is six lengths of 1 by 1-in. stock, 12 ft. long.

Cover the frame with medium-weight canvas, of which about 6 yd. are required. It is cut to fit each side separately, and the pieces are sewed together on a sewing machine, leaving about two-thirds of one seam unsewed so that the cover can be slipped over the frame. The open seam is later sewed by hand. An opening, about 18 in. across, is left to form a cockpit, located in the exact center of the boat. The outside of the cover, when in place, is given an application of paint, consisting of white lead and linseed oil. The first coat should be very thin, so that it will soak into the fabric, and the second coat should have the consistency of ordinary paint. Finally, a coat of good enamel is applied, care being taken to avoid leaving spots.

is double-bladed, and is made of good wood as the framework. The blade is 1/2 in. wide, and 1 in. thick. The handle is sandpapered and

given two coats of waterproof varnish. As paddling a kayak requires some practicing, it is advisable, while learning, to fasten a gallon can, with the lid on tight, on each side of the boat, just at the waterline, to prevent capsizing.

### Homemade Cleaning Fluid

Here is a fluid that my wife has found very efficient in cleaning materials, from the heaviest and coarsest to the most delicate fabrics, without injury to them. All the chemicals used can be purchased at a drug store, and it will be found that it is cheaper to mix up a large quantity than a

small one. The constituents of the cleaner are as follows: Carbon tetrachloride, 80 per cent; diethyl ether and benzene, each 10 per cent.—P. C. Shera, Columbus, Ohio.

### Non-Evaporating Paint-Brush Holder

It is not practical to put paint brushes in turpentine or lacquer thinner in an open can for any length of time, as the liquid soon evaporates, leaving the brushes exposed, so that they will harden if they are not thoroughly cleaned out. A non-evaporating paint-brush holder is shown in the drawing and has been found successful. Take a fruit jar, preferably of glass for

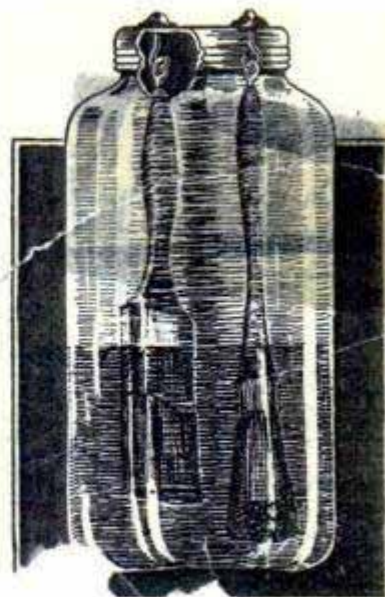

# Wallpaper Screens

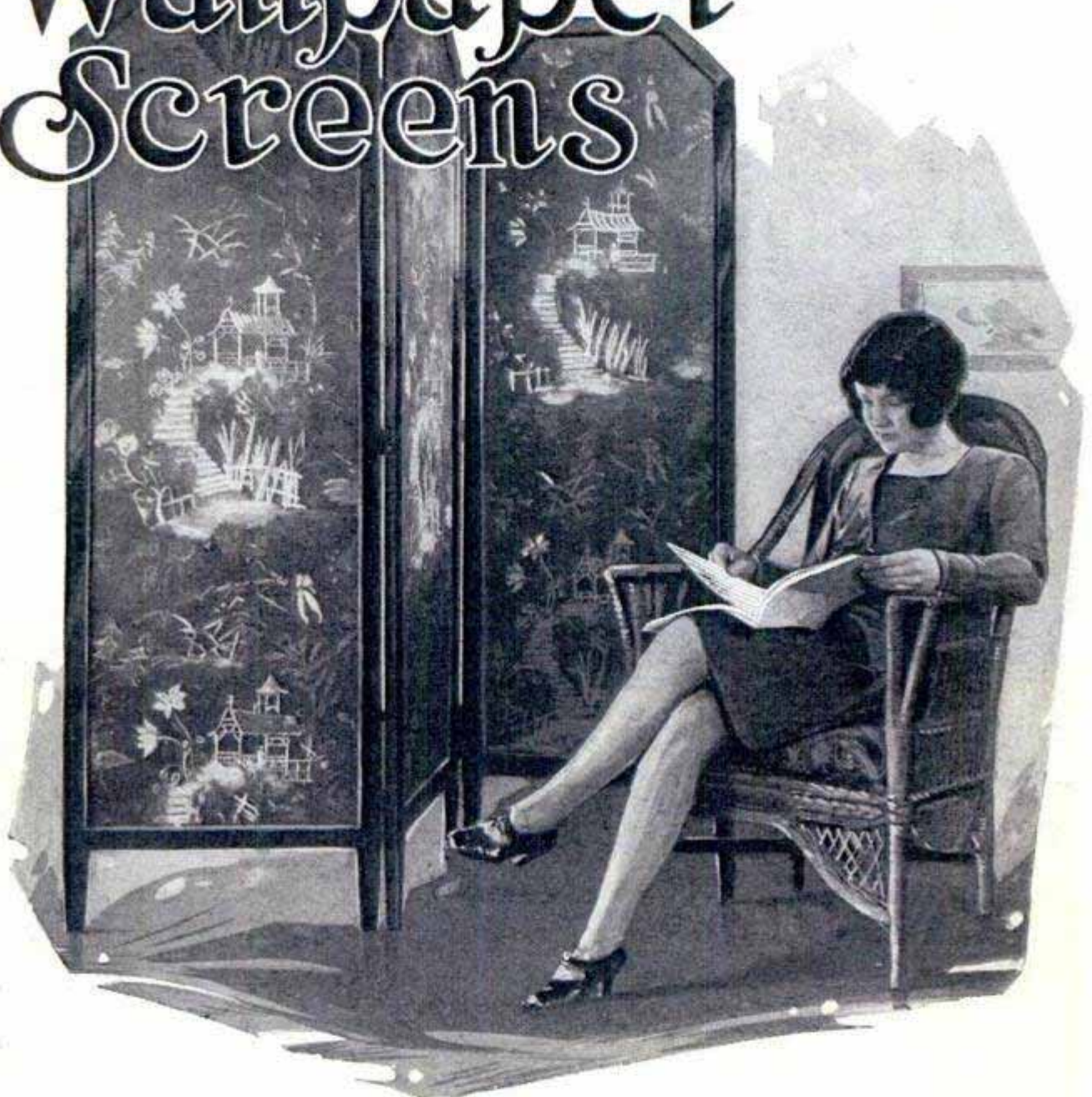

they can easily be overcome by following the methods described in this article. For best appearance, the lower crosspiece of the frame should be about 6 in. from the end, and the 6-in. portion extending beyond the crosspiece should be cut or planed off at a slight angle. This forms a neat foot and eliminates the appearance of bulkiness. Before planing the foot as just described, it is necessary to glue a small block of wood in the rabbet, as shown in Fig. 3, as the rabbet of the sidepiece should not extend to the end; if it did, it would involve a complicated joint for the crosspiece, and, if the rabbet were not filled in, it would look like poor work-

manship, even if done by an amateur. Therefore, it is suggested that the above method be carefully followed by those not familiar with woodworking procedure.

To make screen frames having the top built up of three separate pieces, as the screen in the right-hand photo of the heading, and in Fig. 2, it is necessary to make use of a miter box for cutting the ends accurately. In this case, the upper ends of the sidepieces and all the ends of the top pieces were cut at a  $22\frac{1}{2}^\circ$  angle. It is a good idea to cut these small pieces out of longer pieces already rabbeted. Now, the problem confronting the worker is how long to cut the three top pieces so



Upper Left, Rabbiting Stock; Inset, Antiquing the Frame; Lower Right, Tacking in Molding

that the straight-line span across them is exactly equal to the predetermined width of the frame. Guesswork will be eliminated entirely by following the simple method shown in Fig. 4.

A layout of the screen frame, exact size, with a square end, is made on a large sheet of paper. Equal distances AB and BC are then measured from the corners, after which a diagonal line is drawn from A to C, representing the outside edge of the frame. Take a length of the stock to be used and draw the inner line so that the two lines are parallel and the space between them is equal to the width of the stock. Repeat the procedure on the opposite corner. Now the dimensions can be readily taken and transferred to the wood to be cut. The pieces are then assembled and fastened together securely by doweling, by nailing with finishing nails, small holes being drilled to prevent splitting the wood, or by using corrugated

fasteners, all three methods being shown in Fig. 4. The doweling method is the best, but it is a trifle more difficult than the other methods as it involves drilling holes in perfect alinement. If you intend to use plastic paint on the wood for finishing, it is a good idea to use corrugated fasteners at the joints.

In respect to the width of the screen sections on which wallpaper is to be used, it should be remembered that wallpaper comes in certain sizes and

care must be taken that the frames are made

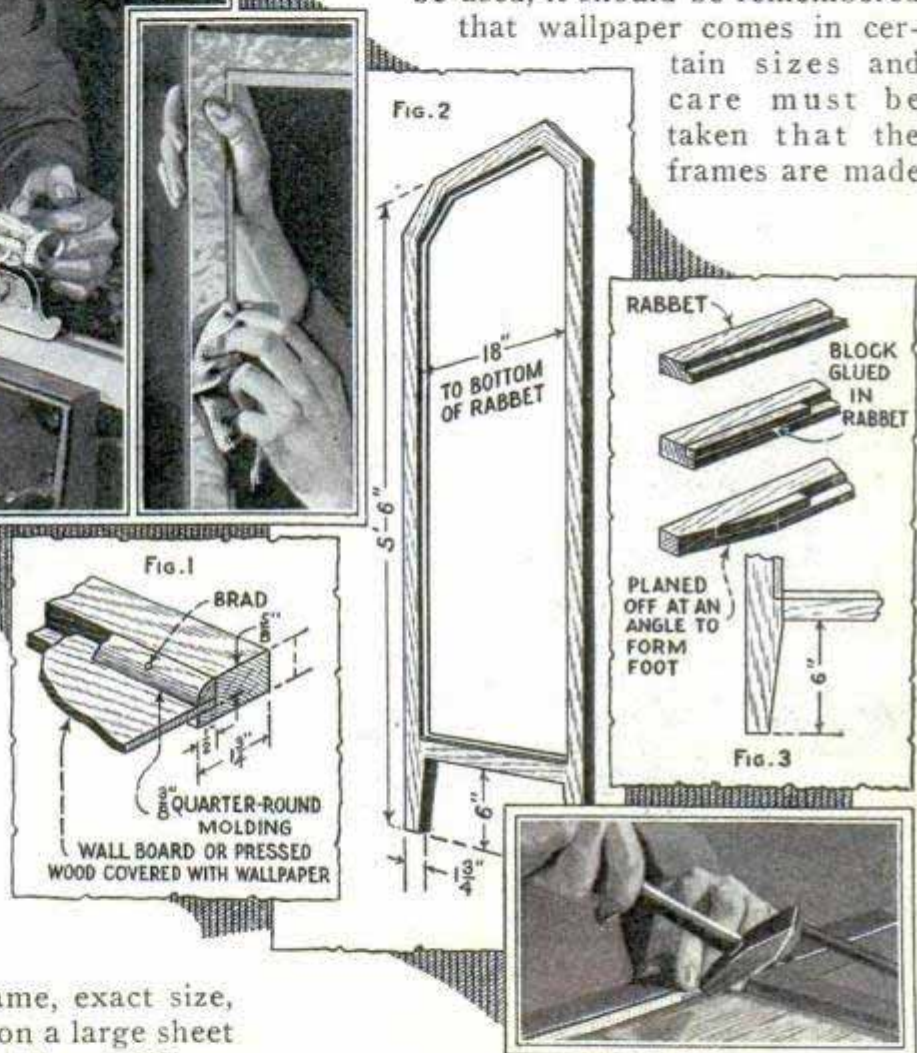

accordingly. Frames slightly narrower than the paper are permissible but the predicament of having a frame too large cannot be overcome except by remaking the frame. Most standard wallpaper made in this country comes in 18-in. widths, although much wider paper can be obtained, especially that of foreign manufacture. The width of the frame, from the bottom of the side-rail rabbets should be equal to or slightly smaller than the width of the wallpaper to be used, as indicated in Fig. 2, allowance being made for the trimming which is cut off.

The panel is now cut out of wallboard or pressed wood. See that it fits in the frame before applying the wallpaper. Get some wallpaper paste and mix it well until it is free from lumps. Give the paper a medium-heavy coating, and apply it to the wallboard. Trim off the projecting edges with a safety-razor blade and turn the panel over on a clean surface, so that wallpaper can be applied to the other side. It is a good idea to use the same kind of wallpaper on both sides, even if the design and coloring are slightly different, as one kind of paper expands much more than another after it has been moistened with paste, and upon drying, it will also contract much more and for this reason the use of two differ-

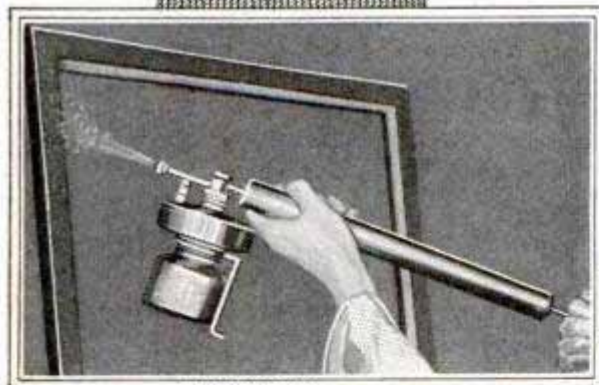

Anyone Can Saw the Wallboard; Apply the Paper and Finish the Frames as Shown in the Above Photos

ent kinds of paper may cause the panel to buckle slightly. Cover both sides of a panel, one immediately after the other, so that the drying out of both will take place at the same time, which reduces the tendency to buckle. Unless special washable wallpaper is used, one should apply a couple of coats of shellac to the finished surface, which makes it easy to keep the paper clean. However, there are some kinds of paper that have a printed finish which is ruined by the application of shel-

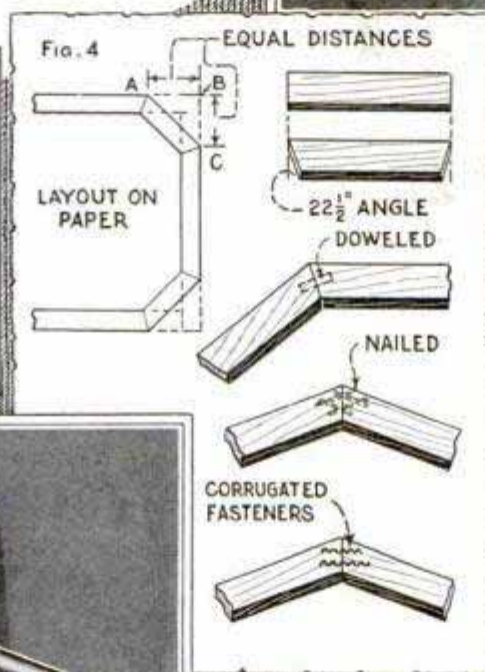

lac or any other transparent covering, and in such cases the paper should be left as it is.

The frames and molding are finished before the panels are set in. Slow-drying lacquer has been found handy for finishing. An excellent finish can be obtained by antiquing a red surface with burnt umber, using a wad of cloth to apply the umber. Another rich finish can be had by lacquering the frame black and then giving a very slight spray of gold bronze, varying the shading of the latter from a dust effect to a noticeably solid coating. A hand spray gun will be found useful for such work. Before finishing the frames, they should be well sanded and all the nail holes should be filled with plastic wood or putty. If, however, you find that the joints are marred more or less, and detract from the otherwise excellent appearance, make some imitation hinge leaves out of sheet lead, obtainable at a plumbing store. Two designs of such hinge leaves are shown on

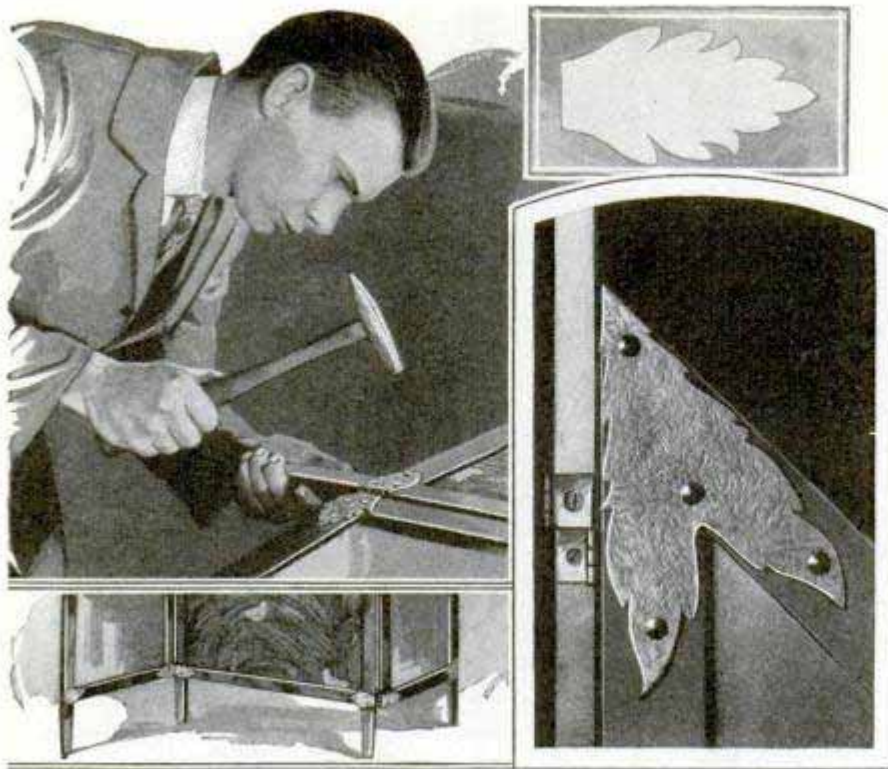

Ornamental Hinge Leaves. Cut from Sheet Lead and Painted with Gold Bronze. Cover the Joints and Add to the Appearance of the Screen

this page, the lower one being especially suitable for use on a sharp corner. The hinges used to fasten the screen sections together, should be attached between such ornamental leaves, as indicated, but this is done after each section is completely finished. Hammer the hinge leaves lightly with the cross-peen of a small hammer, to make them look like hammered brass, then coat them with gold lacquer on faces and edges, rubbing the gold off the faces before it dries. This will leave the gold in the hammer marks, and, when the leaves are applied with large-head hammered-iron nails, they will look very ornamental.

After the frame is ready, the panel is laid in and the molding is cut, painted to harmonize nicely with the rest of the frame, and it is then nailed on, small finishing nails being used for the purpose. The nails are countersunk and the holes above the heads are filled and afterward touched up with paint or lacquer. If the molding projects a trifle over the edge, remove it from the frame and lay it on a flat board. Use a small plane to reduce its size slightly, until it fits flush in the frame. After the individual sections of the screen have been completed, they are hinged together with  $\frac{3}{4}$ -in. double-acting brass hinges, which make it possible to set the

screen in almost any desired position.

The screen shown in the left-hand part of the headpiece has a center section 6 ft. by 30 in. in dimensions and is covered with a high-grade imported wallpaper having a peacock-feather design, green, yellow and black being the predominant colors. The sharp angles of the end sections give the screen a modernistic touch. Black lacquer is used to finish the frames, and over this gold bronze is sprayed, the coating being graduated from a solid gold at the corners to a dusted effect in the center. The right-hand screen has a

frame finished in antiqued red. A Japanese-design wallpaper, red on one side and black on the other, gives the screen a variety of color.

### Grounding Wire on Distributor Improves Engine Operation

The owner of a car which was provided with the usual distributor type of ignition system, found that the engine missed at certain speeds. Change of spark plugs, contact points and wiring did not remedy the trouble. The car had been driven

about 50,000 miles and the parts were worn to some extent, but not so badly as to necessitate an extensive overhauling. After some experimenting, the owner attached a ground lead from the head of

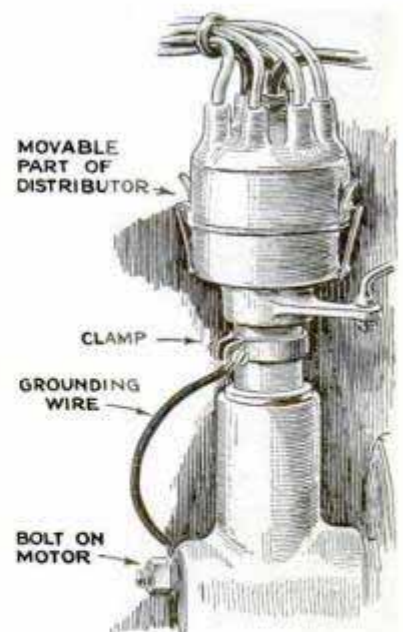

the distributor to the engine as shown. This was found highly effective in correcting the trouble. The fault evidently was due to wear of the distributor head and its sleeve, and the lubricant prevented a good ground.

### Easily Made Photo Lamp

An incandescent lamp that gives more actinic light than a small arc lamp, allowing full exposures in as short time as a second, can be made from a piece of tin, a socket and a suitable bulb. On a base of 1-in. material, mount a "mogul" socket as shown. A support for the socket can be obtained at an electrical store. Get a piece of bright tin, 14 in. wide and 15 in. high. Turn over the edges, to prevent cutting the hands, and also the bottom about  $\frac{1}{2}$  in., so that it can be attached to the base. Before mounting, cut the flange at 1-in. intervals and then roll the reflector to a concave form. Fit the socket with a 1,000-watt incandescent projection lamp, which is sufficient for ordinary exposures when a reflector is used. Two lamps will give enough illumination for motion pictures, or portraits of one-second exposures at  $f:11$ . Snapshots may be made with a  $f4:5$  lens. When using incandescent lights, it is important to remember that the farther the lights are from the subject, the more detail will be shown. A distance of about 10 ft. gives pictures in which the high lights are not "plugged-up."

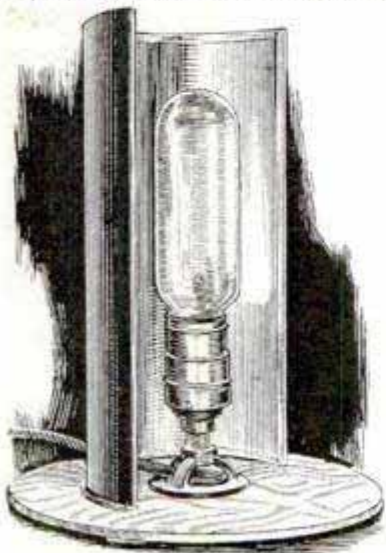

Sailing Fast over the Sidewalks on Roller Skates Was Found Great Sport by Two Cincinnati Boys

### Making the Most of the Summer Breeze

By using a sail as shown in the photo you can harness the wind to speed your skating. Two Cincinnati boys, Fred and Wilby Schafer, started the fun. Their sails consist merely of a piece of canvas attached to two stout crosspieces as shown, one of which is lashed to the end of a mast. A length of sash cord is tied to the ends of the lower crosspiece, and this is held over one forearm while the mast is held with both hands, as shown in the right-hand photo. To stop, it is merely necessary to let go the rope, permitting the sail to flutter freely in the breeze.—J. R. Schmidt, Cincinnati, Ohio.

### Waterproof Cover for Tourist's Bedding

A waterproof cover, made to fit over the tourist's bedding neatly folded on the top of the car, will solve the packing problem. The bedding can be removed without disturbing the arrangement of the other luggage. Snap fasteners, the kind used to button on auto side curtains, are attached to the edge of the top so that the cover can be fastened down securely.

### Diffusing Screen for Camera or Enlarger

Some photographs are more pleasing when slightly diffused or softened. One of the simplest methods of producing this effect is to hold a piece of finely woven



Many Photographs Can Be Improved Considerably by Diffusing the Light Rays during Exposure

wire screen in front of the lens of the camera or enlarger as shown in the photo. Bright bolting screen, such as is used in cereal making, has been found highly satisfactory for this purpose. Darker screen material produces less diffusion. The light is scattered slightly when passing through the screen, causing the desired

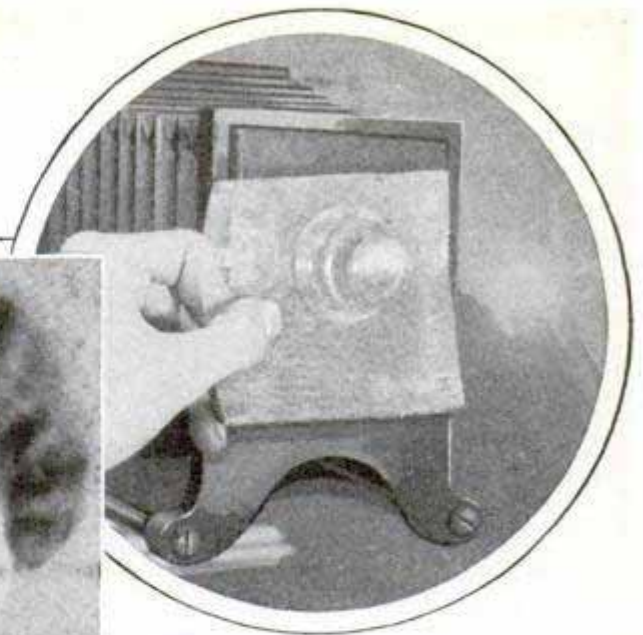

effect, but it is necessary to give a little longer exposure. The best practice is to make a sharply focused negative and then to do the diffusing with the enlarger. However, in moving-picture work, the diffusing screen is placed in front of the camera lens when taking the picture. Another little trick is to punch or burn a small hole in

the center of the diffusing screen so that a picture sharp in the center and diffused at the edges is produced. For a portrait, the screen should be held so that the eyes of the subject will be sharp. The accompanying photos show a portrait in sharp focus and one that was diffused by the use of a screen.

### Side-Window Wiper for Auto

To obtain clear vision through the side window of an auto during a rainstorm, an

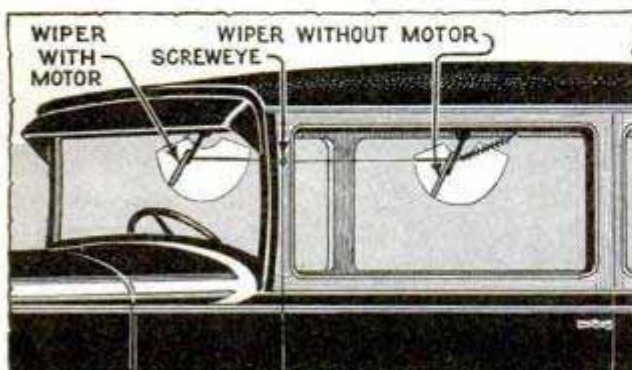

Extra Wiper Arranged on the Side Window Provides Vision during Rainstorm

extra window wiper may be installed, as shown in the drawing. I have used one for some time and find it absolutely satisfactory. The extra wiper is pivoted to the door frame, and a coil spring is attached as indicated, to pull the wiper toward the rear when the forward pull, accomplished by means of a string attached to the windshield wiper, is released. A small screw-eye is driven to guide the string into the corner post at this point.—Jerome L. Massett, Savannah, Ga.

☛ Woolen materials can often be darned with threads unraveled from the material, split silk, or hair so that the garment will again be presentable.



### Checking Fly-Breeding in Manure Piles

One of the most effective chemicals to apply to manure piles to check the breeding of flies is borax, which does not injure the fertilizing properties of the manure. As soon as the manure is removed from the barn, sprinkle some borax over it, using a fine sieve. Apply it around the outer edges of the pile, as the maggots seem to collect there; then throw a few gallons of water over the mass.

### Closing Bolt Holes in Rear of Ford Coupe

Ford model-A roadsters or coupes, which are not equipped with a rumble seat, have four bolt holes in the bottom of the rear compartment. The holes are located just ahead of the inclined ledge on which the rumble-seat cushion is placed, when one is supplied. The holes should be closed by bolts with washers, as otherwise water will be thrown from wet roads into the rear compartment through them.

### Floor Lamp Made from Old Rifle

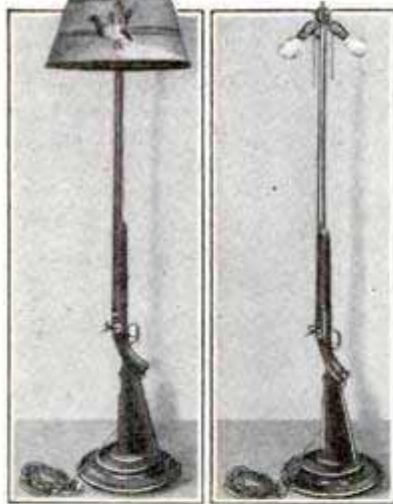

An old gun can be made into a useful and ornamental lamp as shown in the photo. Make a suitable base about 12 in. in diameter and about 2 in. thick. It should be turned down to a suitable shape on a wood lathe. The butt plate of the gun is removed and two large woodscrews or lag-bolts,  $\frac{5}{16}$  by 4 in., are used to fasten the gun securely to the base. Fittings such as double sockets for lamps can be purchased at a store handling electrical supplies. The cord is run through the barrel and, if desired, also through the stock, in which case a hole must be drilled for this purpose. In a muzzle loader, a hole is drilled through the breech or side of the barrel, large enough to pass the wire.—E. A. Cleveland, Montreal, Can.



Metal Hook Made to Fit on Shoulder Is Less Tiring Than a Neck Strap for Saxophonist

### Hook over Shoulder Holds Saxophone

As it is easier to carry a weight from the shoulder than from the neck, I found that a hook large enough to slip over my shoulder was more comfortable than a neck strap for supporting a saxophone. I made the hook out of some heavy wire that was not too difficult to bend. Obviously such a hook could also be made from a strip of flat, springy metal with felt on the inside if desired.—C. L. Meller, Minneapolis, Minn.

### Fruit-Jar Rubbers Prevent Rug Skidding

Slipping of rugs on polished floors can be prevented by sewing rubber fruit-jar rings to the underside of the rug, near the corners, as shown in the photo. For a small rug, one ring at each corner is sufficient, but for a larger rug several rings should be spaced at equal intervals along the edges. The rings, being thin, will not cause uneven wearing of the rug.



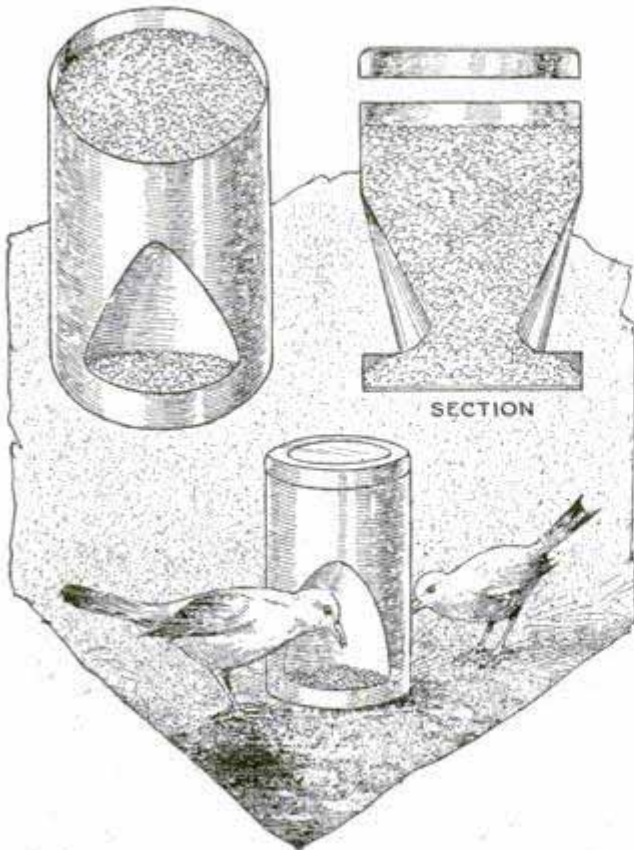

It Takes Only a Few Moments to Make These Bird Feeders from Tin Cans

### Practical Feeders for Various Birds Made from Tin Cans

Take a can of suitable size and cut a slit horizontally about an inch above the bottom, as shown in the illustration. This slit should be about  $2\frac{1}{2}$  in. long, if the feeder is to be used for chickens, and about 2 in. long for smaller birds. After the slit has been cut, simply press in the portion directly above it, making an opening which allows the bird to get at the feed but prevents the feed from running out of the can. If desired, two or three of these openings can be made in a can, depending on its size.—G. M. Beerbower, Hollywood, Fla.

### Painting Lead Pipe

Ordinary paint cannot be used successfully for painting lead surfaces unless some substance is added to serve as a primer to seal the lead and prevent sweating of the pipe. An effective primer for this purpose is waterproof varnish. One coat should be sufficient. After this has dried, apply the regular paint.—L. H. Georger, Buffalo, N. Y.

### How to Remedy "Galloping" Outboard-Motor Boat

Last year I built a step plane for outboard motor racing, and it ran well with a moderate-powered engine. However, when I used a larger motor it began to "gallop." Nose and stern would rise 5 or 6 ft. in the air and then slap the water with a whack, and every slap meant another black and blue spot on my anatomy. Naturally no boat could stand that terrific pounding for any length of time, and I soon discovered a broken crossframe and a split plank. In many boats this tendency to gallop can be overcome by tilting the motor back farther from the stern. If this does not correct the trouble, try cutting some wedges from 2-in. planks, bolting them to the stern to support the motor. This will enable you to tilt the motor back still farther, and may correct the galloping but will slow down the speed if the motor is tilted too much. Timing with a stop watch will tell you whether or not it is practical to tilt your motor. In my case, I had to extend the bottom of the boat about 1 ft. before the trouble was overcome. The drawing shows the details of this extension. It is a good plan to have the planking too long and then cut it down, sawing off an inch or so at a time and then trying the boat until you get satisfactory results. All the joints are well covered with liquid marine glue before they are screwed together. After the construction is finished, sand the planking and finish to match the boat.—H. E. Whiting, Rochester, Minn.

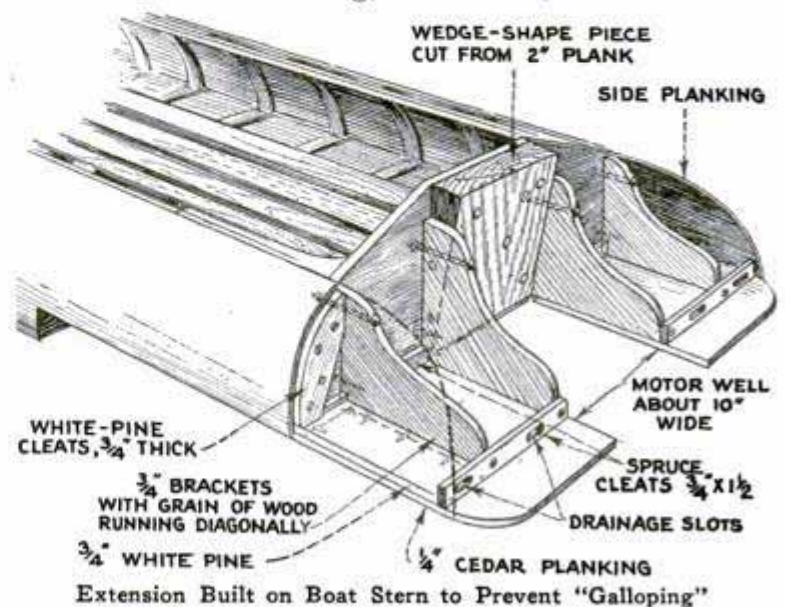

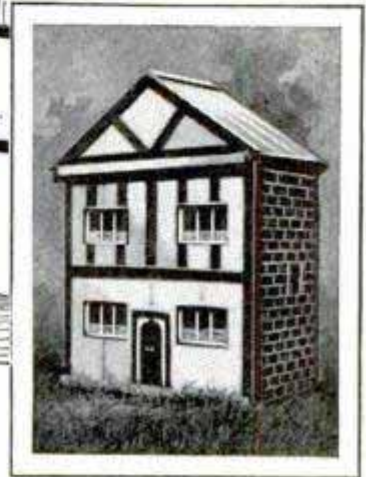
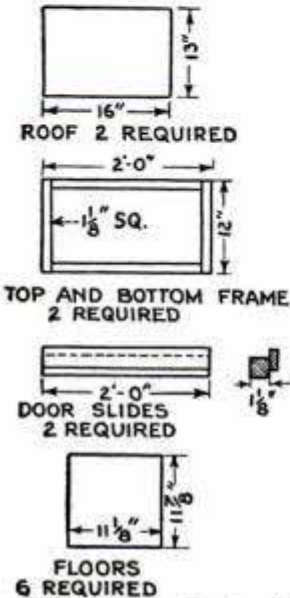
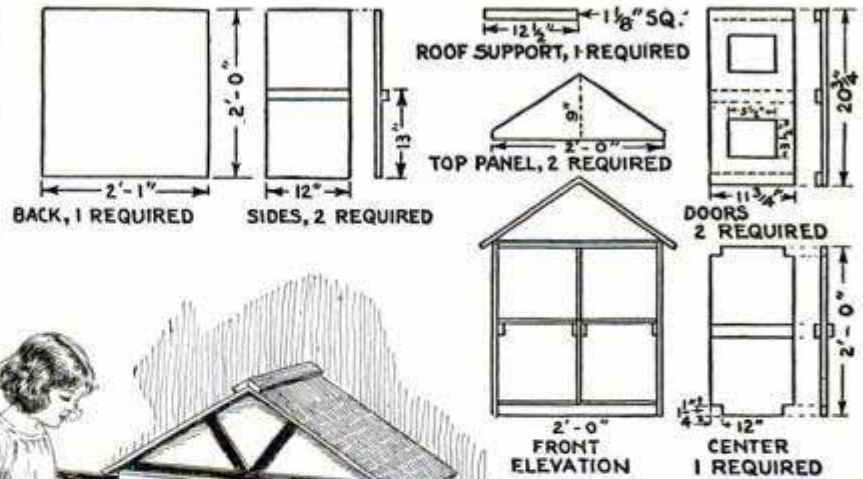
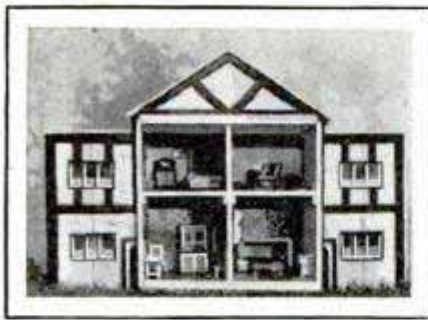

Doll's House Made of Wood without Any Joinery and Decorated Inside with Wallpaper; the Whole Front Opens to Expose the Interior

**Doll's House Made without Joinery**

A doll's house, having sliding doors and made entirely without any joinery, is shown in the illustration. The top and bottom frames are made from wood, 1 1/8 in. square. They are fastened together with screws, cross strips being tacked diagonally to brace them until they are in position. The sides, floors and top are made of 1/2 by 6-in. wood, nailed to the frames. The front of the house is divided in the middle and the halves slide outward to expose the whole interior. If desired, the inside of the doors can be covered with wallpaper to improve the appearance. The sides and back are covered with a crepe paper having a red-brick pattern, which is pasted to stiffer paper, the

latter being glued to the sides. Wallpaper having small patterns can also be used for the interior decoration. The front of the house and the doors are painted white, ordinary lath, painted black, being nailed on in some suitable design.—Harold Moore, Birmingham, Eng.

**Protection for Tree Base and Roots**

A neat and practical method of protecting a tree base and retaining moisture around it on a slope is shown in the accompanying photo. A semicircular concrete curb, from 18 to 24 in. deep, is built around the tree. This will not interfere in any way with the lawn, but will add to its appearance. Painted white, the concrete gives a pleasing decorative effect.



Concrete Curbing, Built around Tree Base on Slope, Retains Moisture, and Adds to the Appearance



# MAKE THIS TRACTOR

The Tractor in Flight; an Exceptionally Able Performer. This Simple Plane Can Be Built by Any Boy

ings are of an exact duplicate made by the two designers expressly for Popular Mechanics Magazine.

If constructed according to the accompanying drawings, Alex. Hixon and Buddy Wheaton say, any boy who has had some experience with tools should be able to make a copy that will fly 1,200 ft., and, under favorable conditions, remain in the air at least five minutes, as the original did.

With the exception of bamboo in the stabilizer and vertical fin, balsa wood is used throughout in the framework. This can be purchased in the required sizes from any retailer of model-airplane parts.

**T**HIS clean-cut little tractor weighs less than one ounce and is an exceptionally able performer. It was built by Alexander Hixon and Stannard Wheaton, and won first prize in the Pasadena Polytechnic High-School model-airplane contest and, in fact, flew so far

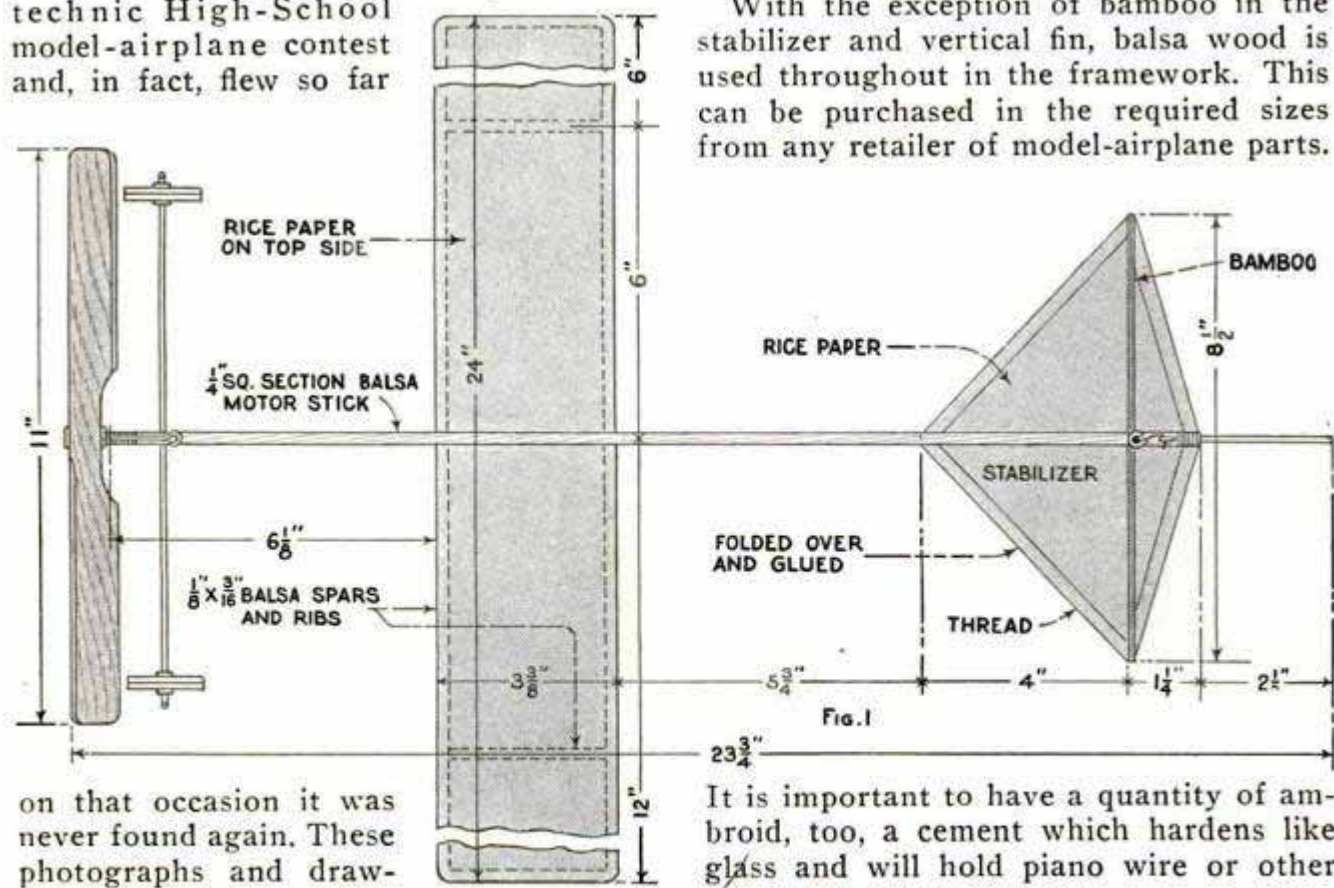

on that occasion it was never found again. These photographs and draw-

It is important to have a quantity of ambroid, too, a cement which hardens like glass and will hold piano wire or other

*Ambroid Co.  
227 Miller  
Pasadena, MS*

# PRIZE-WINNING MONOPLANE

by  
HI SIBLEY

metal as well as wood. Figs. 1, 2 and 3 give the general dimensions of the flyer, and illustrate the relative positions of the various members of the assembly. Begin with the motor stick or main frame piece. This is of  $\frac{1}{4}$ -in. square-section balsa wood,  $20\frac{1}{2}$  in. long. In spite of its lightness and apparent sponginess, it has surprising strength when properly applied in construction. First install the tail ring for the S-hook that carries one end of the rubber-strand motor. This hook, as well as landing-gear struts and propeller shaft, is made of piano or music wire, which is extremely stiff and strong. For the hooks

nose pliers comes in handy for bending.

The propeller-shaft bearing is made from a brad, about  $1\frac{1}{8}$  in. long, with the head and front portion flattened. A small hole for the shaft is drilled either with a fine twist drill or the tool shown in the center drawing, Fig. 4. This consists of a brad driven into a wooden handle, the

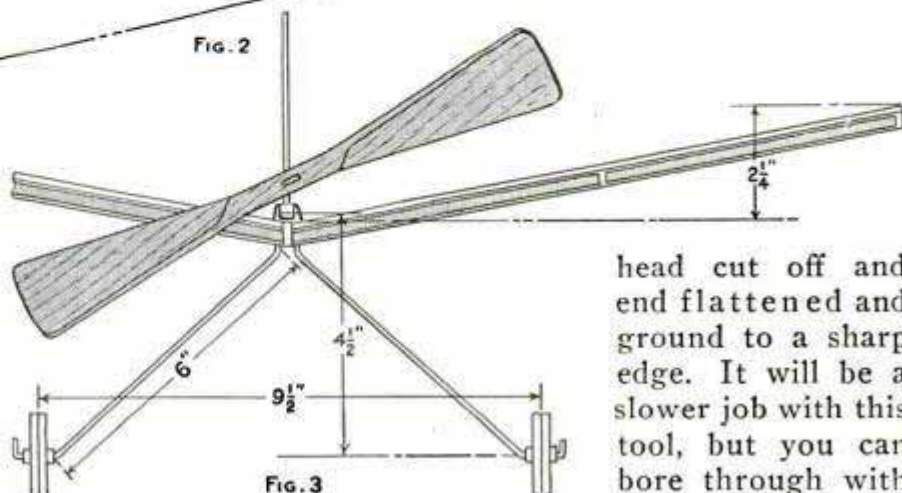
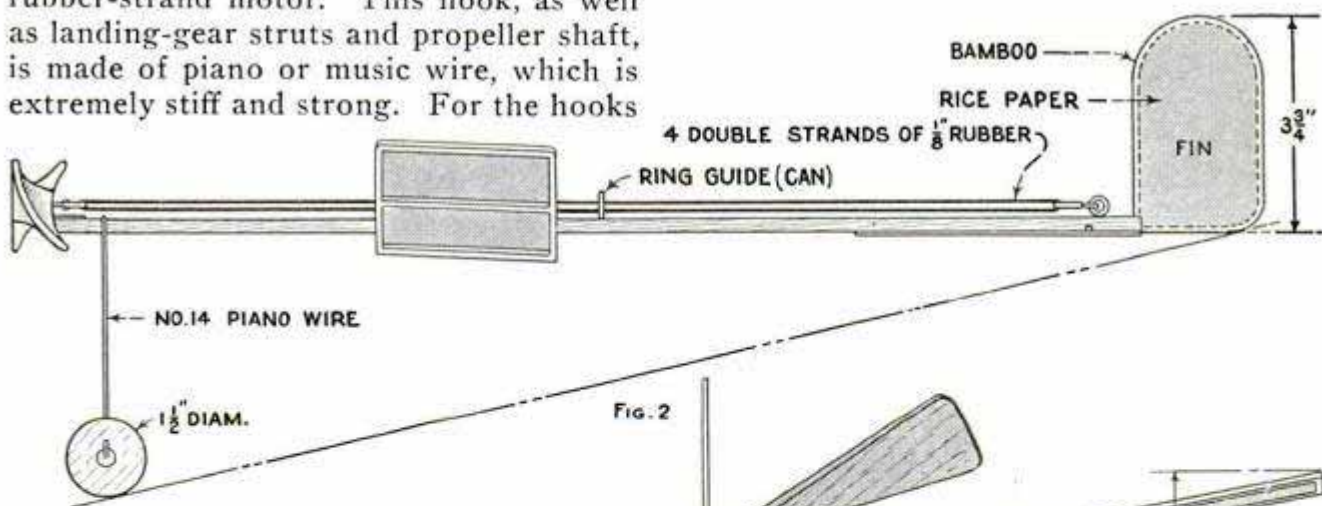

head cut off and end flattened and ground to a sharp edge. It will be a slower job with this tool, but you can bore through with

use about a No. 14 wire. If you are not familiar with piano-wire gauges, which are different from standard gauges, select a wire that is about the size of leads in patented magazine pencils, or a stout hairpin. A pair of small-

a little patience; and unless you have patience you should not attempt to make a first-class model plane.

Set the completed bearing on the front end of the motor stick so that it extends about  $\frac{1}{4}$  in. Cover liberally with ambroid and bind tightly with linen thread. In the center of the stick, mount a guide ring or "can." about  $\frac{1}{2}$  in. in diameter and made of No. 12 or finer piano wire. In bending the various pieces of wire to a round shape, use a piece of dowel stock

secured with ambroid and thread (Fig. 5 shows the assembly upside down, to illustrate the notching). Making the frame for the vertical fin will test your skill. This is of split bamboo, about  $\frac{1}{16}$  in. thick (the thickness should be as uniform as possible), and is bent to the required shape by heating the shiny side over a candle flame. Do this gently and gradually. The ends are set in grooves cut in the motor stick with a sharp knife. Ambroid and thread will secure them firmly to the stick.

The efficiency of the propeller depends entirely upon your skill in whittling balsa wood. The greatest caution is required, for a sharp knife will slice through as easily as in a dry cornstalk. Only light cuts should be taken; otherwise you may snip off a blade before you realize what has happened.

Mark the outlines, as in Fig. 4, on the flat side of a balsa block, 11 in. long,  $1\frac{1}{2}$  in. wide and 1 in. thick. Whittle away

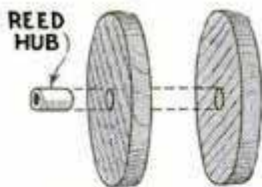
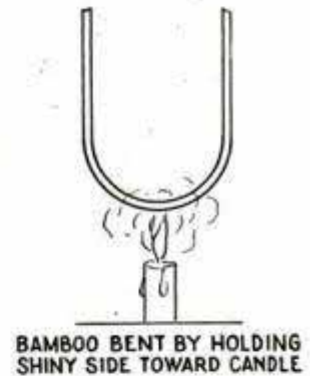
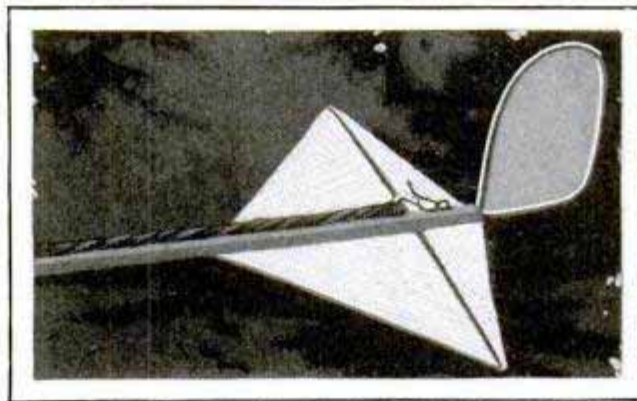
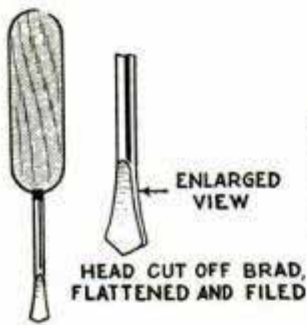
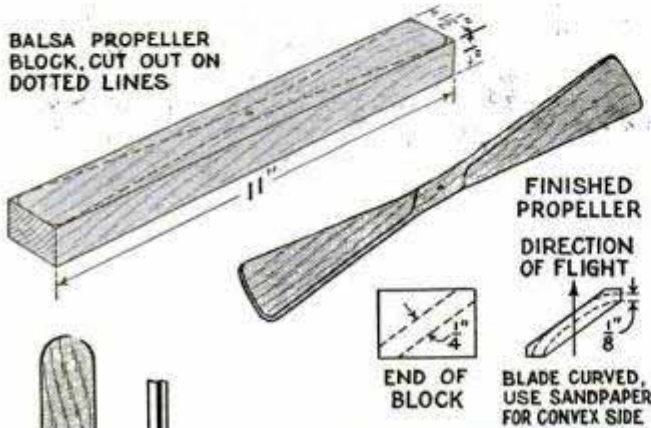

Balsa wheels made of two pieces glued together with grain at right angles

Fig. 4

Center Photo Shows Stabilizer and Fin; Note the S-Hook and Tail Ring

of the required size for a form. This can prevent the motor stick from springing under the strain of the wound-up motor. Tail ring, can, propeller bearing and S-hook are all detailed in Fig. 6 and the bearing also in Fig. 5.

Next in order is the cross spar for the stabilizer, Fig. 5. Use bamboo,  $\frac{3}{32}$  in. square and  $8\frac{1}{2}$  in. long. This is set in a notch on the bottom side of the stick and

the waste until you have two flat blades,  $\frac{1}{4}$  in. thick. Then start making them curved, so that they are convex on the

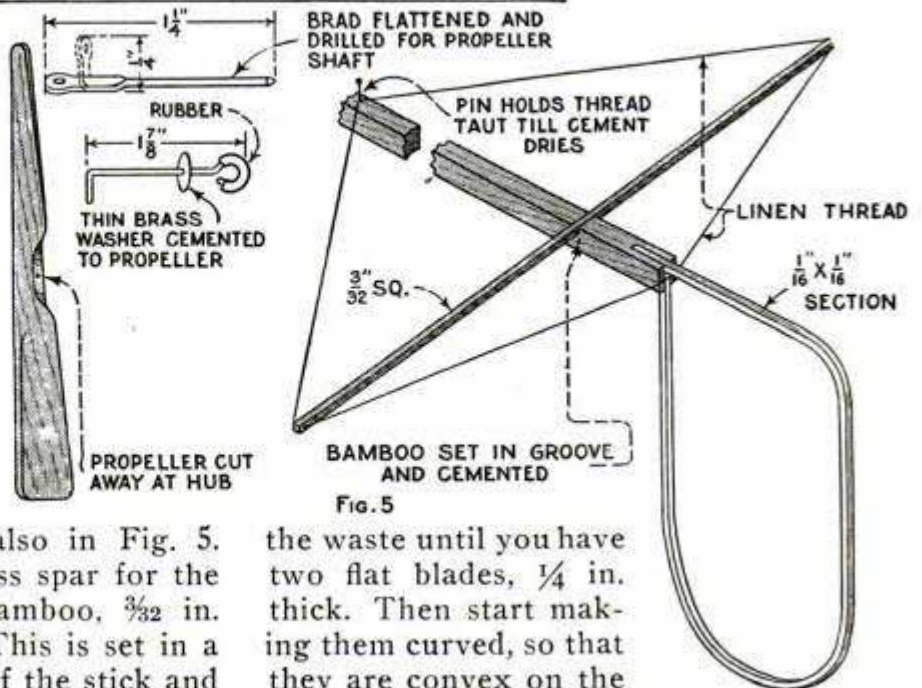
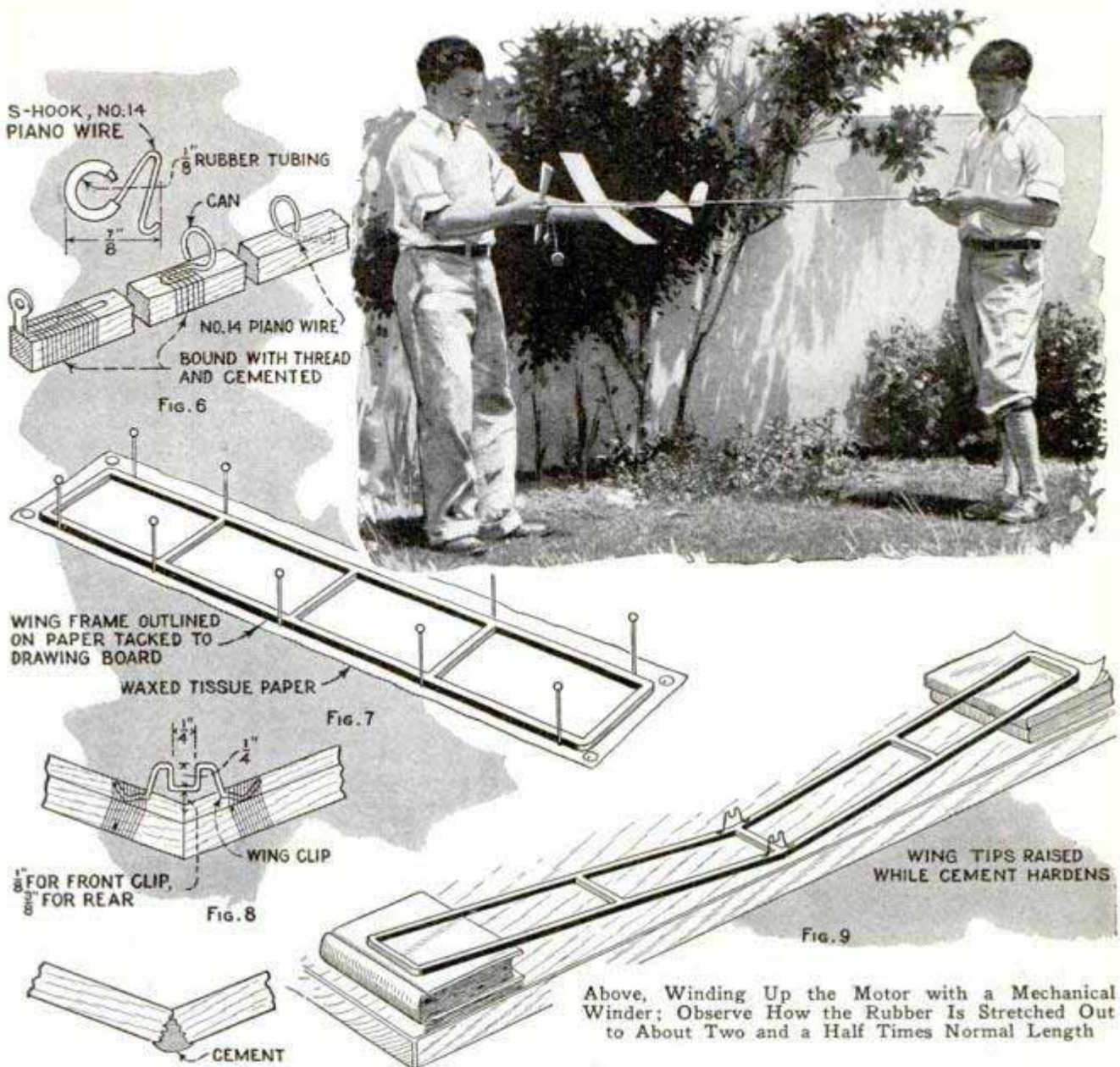

Fig. 5



Above, Winding Up the Motor with a Mechanical Winder; Observe How the Rubber Is Stretched Out to About Two and a Half Times Normal Length

front side and concave in back. The sanding is best done with a piece of coarse sandpaper over a block of wood rounded about the same as the finished blade is to be. The completed blades will then be about  $\frac{1}{8}$  in. thick and have a graceful form. To clear the motor stick, a section, about  $\frac{1}{2}$  in. deep and  $2\frac{1}{2}$  in. long, is cut away from the back side of the propeller at the hub. With a steel pin make the shaft hole exactly in the center and be sure it is square with the propeller. Otherwise the propeller will wobble. Make a small washer of thin sheet brass and secure it to the hub with ambroid. Now insert the shaft, bend a hook in the front end, press it back into the hub, Fig. 5, and cover with ambroid.

The wing-frame construction is simplicity itself. To facilitate the work draw

exact outlines of spars and ribs on a sheet of paper and tack to a drawing board. Lay a sheet of thin waxed paper over the drawing and place the balsa pieces in position on it. The waxed paper prevents the job from sticking to the paper, and can be trimmed away easily. See Fig. 7. Apply ambroid at the joints and draw them tightly together while drying by means of pins stuck into the drawing board. This assures a perfectly square and flat wing.

Apply a thin film of good glue to the top edges of ribs and spars and stretch Japanese rice paper tightly over them, holding the extending edge by means of thumbtacks or weights until the glue is dry. Rice paper is a better "fabric" than ordinary tissue paper because of its toughness. It does not tear easily. When dry, trim away the waste for a neat job. Paper can be fastened to the fin frame by gluing

the edges and, holding the plane sideways, pressing the frame down on a sheet of rice paper tacked to the drawing board, or merely laid flat. On the stabilizer the paper is glued at the edges and folded over about  $\frac{1}{4}$  in.

For proper performance, the wing should form a dihedral angle, that is, the wing tips should tilt up so they are  $2\frac{1}{4}$  in. higher than the center. This is accomplished simply by breaking the two spars at the center rib. This seems a crude way of doing the job, but, the designers explain, is better than making a clean cut halfway through, because the jagged edges of the broken wood hold the ambroid better. The rice paper is put on before breaking, for the simple reason that it is easier to glue the fabric when the frame lies flat. Two wing clips are made of No. 12

or finer piano wire in the manner shown, the forward clip being  $\frac{1}{4}$  in. lower than the rear one, to give the wing its angle of incidence or back tilt. These are also secured to the wing spars with ambroid. They allow the wing to be removed easily for adjustment forward or backward. The wing is held in place by a rubber band, looped under the motor stick and over the upper wing surface in the usual manner.

Landing wheels are cut from balsa sheet with a sharp knife. Two pieces,  $\frac{1}{8}$  in. thick and  $1\frac{1}{2}$  in. diameter, are used in each wheel, glued together with the grain at right angles so that they will not split. The hubs are made of small sections of  $\frac{1}{8}$ -in. reed, such as is used in porch furniture. Axle holes can be drilled with the tool described for boring the propeller-shaft bearing.

The piano-wire struts or landing-gear

legs straddle the motor stick  $1\frac{1}{4}$  in. from the front end and are secured with ambroid. At least a No. 14 wire should be used; heavier, if you have some on hand.

Four double strands of  $\frac{1}{8}$ -in. rubber band, such as the standard sold by parts dealers, are used for the motor. Do not stretch these between the propeller hook and tail ring, but at the same time they should not be loose enough to sag.

The plane is now ready to fly. Best results are achieved by detaching the S-hook at the tail end and winding with a mechanical winder, which is simply an egg beater with the blades removed and a hook or eye attached. Stretch the rubbers out about two and a half times their normal length and for the first few times do not wind over 75 or 100 turns of the winder. The limit is about 150 after the rubbers have been worked in. With a four-to-

one gearing on the winder, this will mean from 300 to 600 turns on the motor.

If winding by turning the propeller, fewer turns can be made because the rubber bands are not stretched as with a mechanical winder, and not more than 75 turns should be taken at first.

This plane is designed either to rise from the ground or to be launched in the air, but, of course, it will give greater distance by the latter method, since altitude is already gained and it does not have to expend its stored energy in a getaway. The wing should be set about 6 in. from the front end of the stick. If the plane has a tendency to dive, set the wing slightly forward. In case of climbing too fast, move the wing back until the proper location is determined.

Of all the planes the writer has seen in flight, this is far and away the best per-

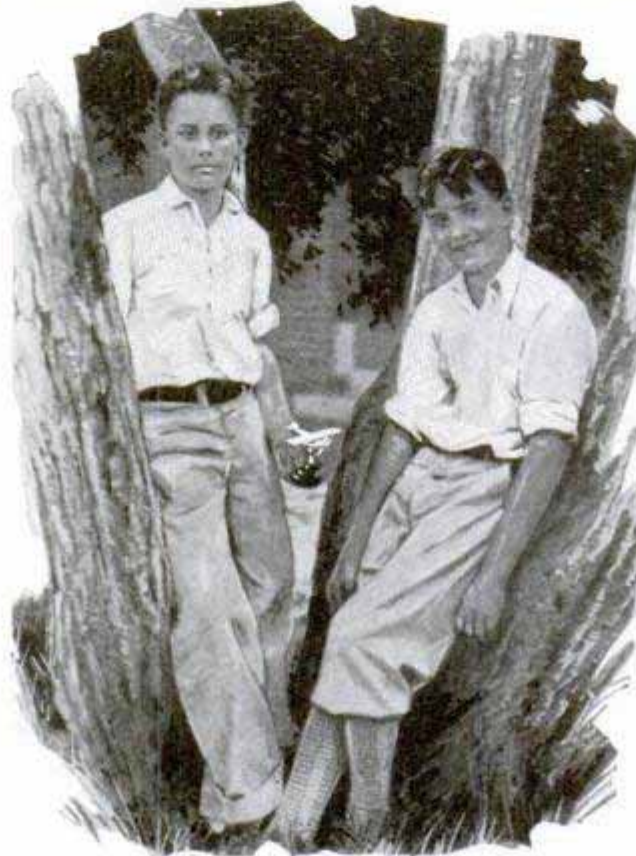

Buddy Wheaton and Alex. Hixon, with the Trophy, a Silver Plane, Won by Their Model Tractor



former for such simple design. But its perfection was achieved only through long and discouraging experience on the part of Alex. and Buddy. They have done all the hard work for us.

### Getting Rid of Dandelions

Provide yourself with a 3-oz. bottle of sulphuric acid and a medicine dropper. Fill the eye dropper with the acid and place a drop or two in the crown of each dandelion, which will soon destroy it so that it will never reappear. There are a few deep-rooted plants or weeds that need a second application.

### Remedy for Back-Firing Camp Stoves

Gasoline stoves, especially those designed for camping trips, frequently develop troublesome back-firing into the chamber where gasoline vapor and air are mixed. When this happens, the stove emits a steady roar, caused by the flame burning in the chamber, and the burners often go out. A remedy consists in placing a piece of fine wire gauze over the opening leading from the mixing chamber to the burner. This is best done by removing the top of the burner, placing the gauze over the opening, and clamping it down by reassembling the burner. Protruding edges can then be trimmed off. If no gauze is available, a piece of ordinary screen wire, folded to provide two or three thicknesses, will be suitable. It may be found necessary to cover several burner openings with screen before the stove burns right. The wire dissipates the heat so that the gas on the other side will not ignite.—W. E. Burton, Kenmore, Ohio.

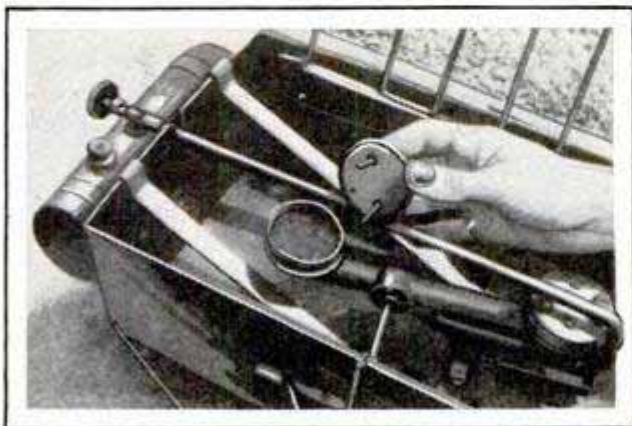

Fine Screen Placed over Opening from Mixing Chamber to Burner Prevents Back-Firing

### Wire Coil Holds Photographer's Stirring Rod

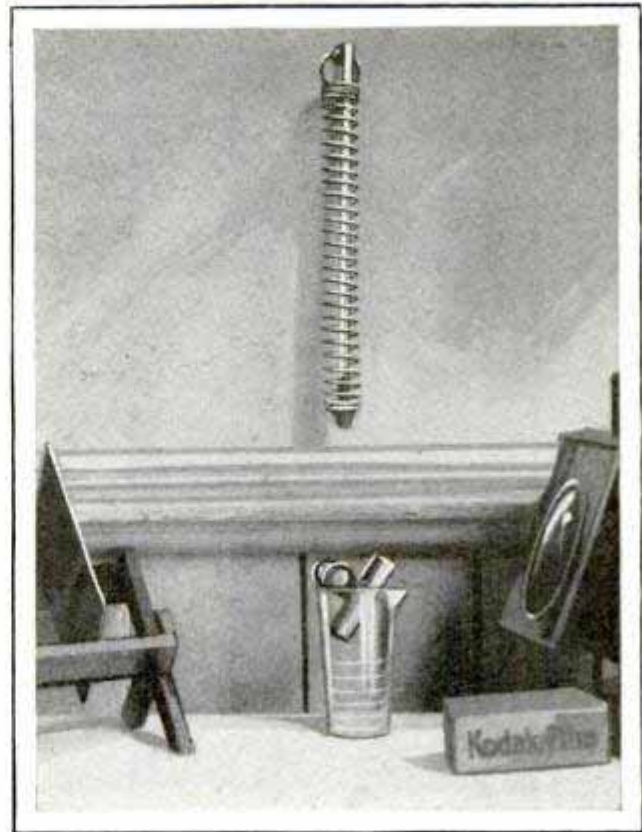

Coil Spring Hung on Wall Serves as a Holder for the Stirring Rod

To keep his stirring rod in a safe place, yet ready for instant use, one amateur photographer obtained a coil spring of the type shown in the photo. This was attached to the wall with a screw at the top. The coil spring was originally intended for holding moth balls, but if you cannot obtain such a coil, you can make one by wrapping smooth galvanized wire, about No. 12 gauge, about a dozen times around a broom handle. The lower end may either be wrapped around a nail close to the bottom or a wooden plug may be slipped into place and fastened with two small staples. Another type is made of insulated copper wire. This is softer than iron wire, but has the advantage of being wrapped with a soft material which serves as padding.—Peter P. Roccapriore, Middletown, Conn.

When an extension cord must be moved from one position to another occasionally, it will be found convenient to attach a number of spring-type clothespins to the joists at intervals of about 6 ft.; these will hold the cord securely and allow its removal at any time without damage.

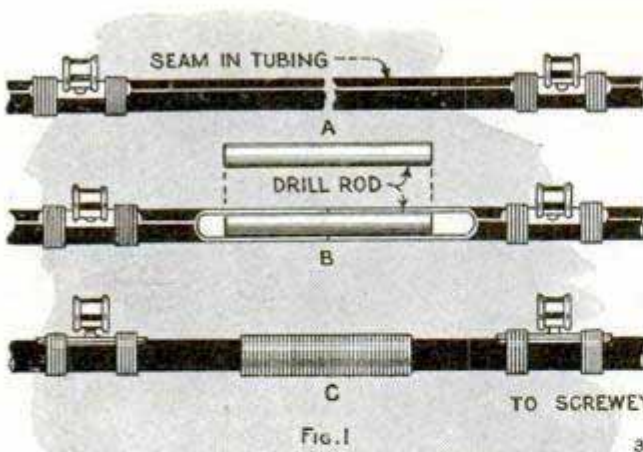

Fig. 1

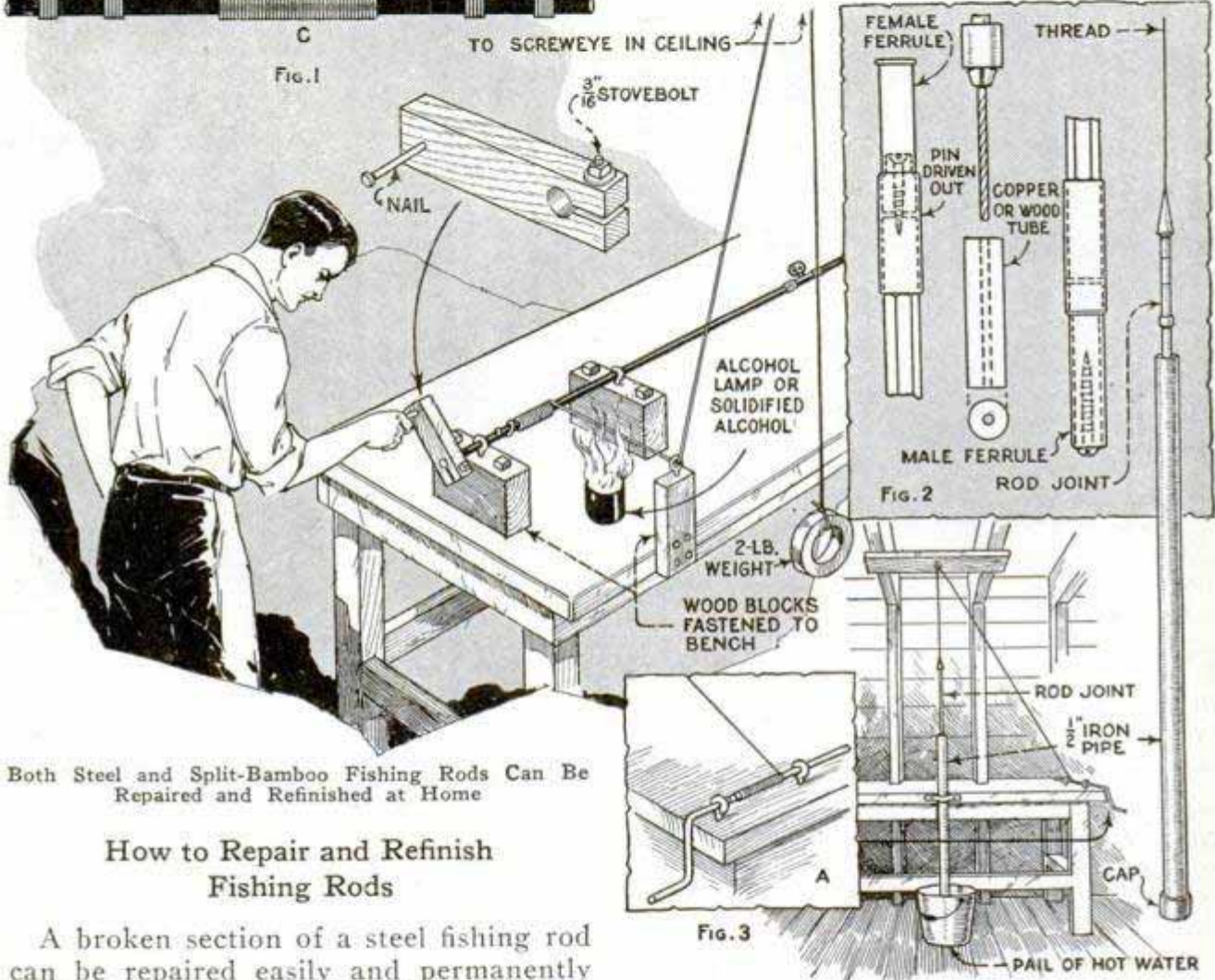

Fig. 2

Fig. 3

Both Steel and Split-Bamboo Fishing Rods Can Be Repaired and Refinished at Home

### How to Repair and Refinish Fishing Rods

A broken section of a steel fishing rod can be repaired easily and permanently by following the method shown in the illustration. First file the broken ends smooth and clean away the rust and scale from the inside of the steel tube for at least  $\frac{3}{4}$  in., and remove the enamel from the outside for about  $1\frac{1}{2}$  in. from the ends. Get a piece of drill rod,  $1\frac{1}{2}$  in. long, which fits exactly inside of the tube without spreading the seam. The shank of a discarded drill can be used for this purpose. Sweat the drill rod inside of the tubing with solder. Now wrap the outside with copper wire, No. 26, 28 or 30 gauge, as shown in the lower drawing. Rig up the rod on the bench in the manner indicated, and run the wrapping wire

through a screweye in the ceiling and through another screwed into a block fastened on the bench opposite the break; hang a weight on the end of the wire. Fasten the end of the wire to the line guide nearest the break and make a few quick turns to bring the wire to the point where the close wrapping begins. If the wire is drawn through the flame of an

alcohol lamp or of canned heat, the contraction of the wire on cooling will assure a tight wrap on the rod. Wrap for about  $\frac{3}{8}$  in. on each side of the break. While the strain is still on the wire, sweat the wire on the rod. When the solder has set, cut off the ends and smooth the job with emery cloth, after which enamel can be applied. Details A, B and C of Fig. 1 show a rod before, during and after the repair.

Frequently the ferrules on split-bamboo fishing rods, particularly of the casting variety, become loose. To reglue is only a temporary repair. A better method is

to expand the wood into the ferrules with wood screws, as shown in Fig. 2. To do this, it is necessary to drill a pilot hole for the screws. In case of the female ferrule, a bushing of copper tubing or hardwood should be used to center the drill. Before drilling, remove the crosspin with which most ferrules are originally fitted. In the male ferrule, drill the pilot hole of ample size so that the screw will not expand the ferrule itself. Should the ferrule loosen again, a slightly larger screw will immediately remedy the trouble.

Perhaps no article requires a better and more durable varnish job than a bait-casting rod. Not only is the rod dampened and dried off a dozen times in a day's use, but it is constantly bent and whipped, and the varnish is under perpetual strain. An even high-gloss coat can best be obtained by dipping the rod joints into the varnish. To do this, obtain a piece of  $\frac{1}{2}$ -in. pipe, about  $3\frac{1}{2}$  ft. long and capped at one end. Fill the pipe with high-grade spar varnish (1 pt. is enough) and place the pipe in a pail of hot water, as shown in the drawing. While the varnish is warming, rig up a miniature windlass with two screw-eyes and a piece of wire bent to form a crank, as shown in Fig. 3. Fasten one end of a length of thread to the windlass and pass the other end through a screw-eye driven into the ceiling directly above the pipe. When the varnish is nicely warmed insert one of the rod joints. The joint must be thoroughly clean, and a cork or wooden plug should be placed in the female ferrule. Both ferrules should be wrapped with paper to prevent contact with varnish. Attach the thread to the upper end of the rod joint and by means of the little windlass, slowly and evenly withdraw the joint from the varnish. The cohesion of the surface film of the varnish will draw all surplus varnish from the joint, leaving an even high-gloss finish.—Dick Cole, Los Angeles.



Inlaid Linoleum Used Instead of Tile for Wainscoting on Bathroom Wall; It Is Cheaper and Entirely Satisfactory

### Linoleum Takes Place of Tile on Bathroom Walls

Inlaid linoleum was successfully used as a substitute for tile in the bathroom shown in the photo. A California contractor, who has made a number of such installations, finds that the linoleum can be glued directly to the lathing while a house is under construction, or to the plaster in case of houses already built. Wainscoting made of this material is much cheaper than tile, and has been found satisfactory in every way.—Mary Gleeson, San Francisco.

### Holder for Ball of Twine

Two short pieces of rubber from an old inner tube, stretched over a ball of twine

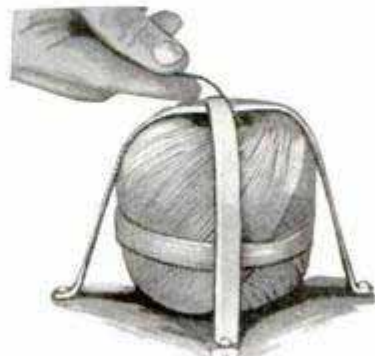

and tacked down as shown in the photo, will be found entirely satisfactory as a twine holder if the regular article is not available. As the rubber can be stretched, the twine can readily be removed and put back.—Frank W. Bentley, Jr., Missouri Valley, Iowa.

# Kitchen Mechanics



COOKING done on a camp stove is not always certain in its results, owing to wind and other weather conditions outdoors. Much improvement will result from covering the stove with a hood made of asbestos cloth and cementing sheet asbestos on the inside, as shown in Figs. 1 and 2. This will reduce the radiation of heat, which is the cause of the trouble. It is an easy matter to calculate the size and lay out a pattern for the hood. The joining edges should be sewed with asbestos cord or copper wire. In the case of stoves that allow the use of inside lining without interference with folding, the material can be fastened with ordinary stove or furnace cement. After the lining is applied, let

SHEET ASBESTOS CEMENTED AND RIVETED ON INSIDE OF OVEN

STITCHED WITH ASBESTOS CORD OR SOFT COPPER WIRE

ASBESTOS-CLOTH COVERING

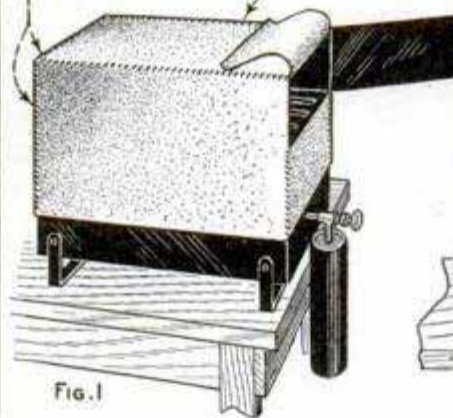

Fig. 1

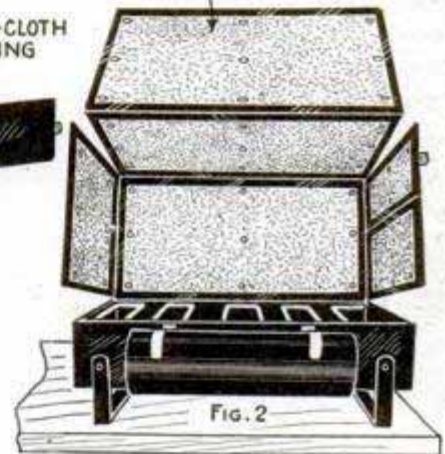

Fig. 2

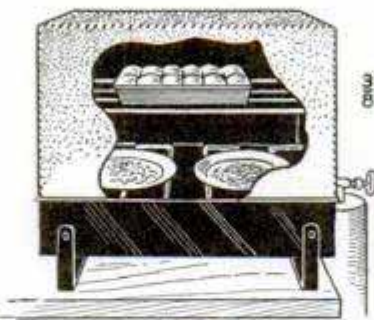

Fig. 3

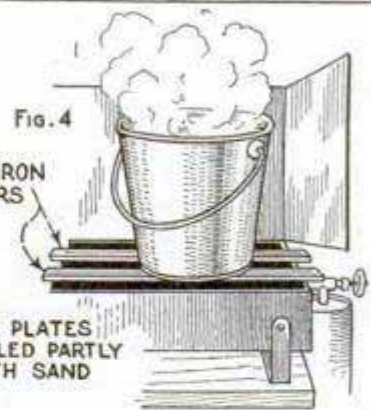

Fig. 4

ONE INCH IRON BARS

PIE PLATES FILLED PARTLY WITH SAND

the oven dry out thoroughly before using it. Much better baking can be done if tin plates (not aluminum), partly filled with dry sand, are placed in the oven over the burners. (Fig. 3) This distributes the heat more uniformly and helps to maintain a steady temperature. A pailful of water or a cooking utensil of considerable

Richard ...  
 233 E. ...  
 Los Angeles, Calif

# for the Camper

by  
**DICK COLE**

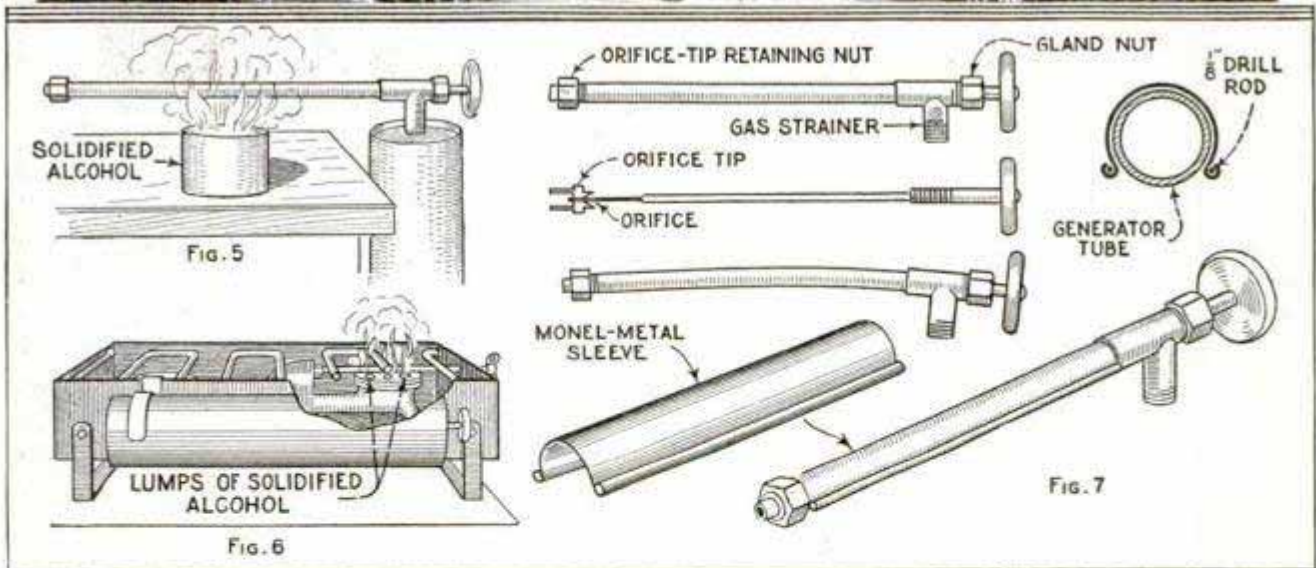

weight is likely to bend the grid. To prevent this, lay two 1 by  $\frac{3}{8}$ -in. iron bars across the stove as in Fig. 4.

If he uses a gasoline stove, the camper will find solidified alcohol, commonly known as "canned heat," of considerable help for preheating the generator. Where there is a quickly detachable generator,

the method indicated in Fig. 5 can be used, but if the stove has no such unit, small pieces of canned heat may be placed on the priming cup and burned, Fig. 6.

Just as the carburetor is the heart of a gasoline engine, so the generator is the heart of a gasoline stove. Practically all troubles experienced with such a stove

are due to a faulty generator, and are often caused by the simple fact that the generator is bent. The generator tube is made of a copper-base alloy because of its high heat-conducting property, but it is also easily distorted by expansion and contraction so that it gradually becomes curved, as shown in the detail of Fig. 7. When this occurs, the tip on the needle valve is jammed or broken off, or, if it does enter the orifice, which is a very small hole in the end of the generator, it reams and burnishes this hole until it gets too large and dirty for good operation, with the result that the flame is smoky and dirty. The proper functioning of any camp stove depends on the accuracy of the orifice opening. If it is enlarged even a few thousandths of an inch, the mixture of gasoline will be too rich, and the flame will burn yellow and soot will be deposited on the cooking utensils. A positive method of overcoming the bending or buckling of the generator is shown in Fig. 7. A piece of No. 18 gauge monel metal is shaped to form a semicircular sleeve, covering about two-thirds of the generator. The edges are rolled over two lengths of  $\frac{1}{8}$ -in. drill rod. The sleeve is made slightly smaller in diameter than the generator. To fit it in place, the orifice-tip retaining nut is removed, and the sleeve is pressed snugly over the tube. Of course, the exposed part of the generator should be next to the flame. Monel metal has a low coefficient of expansion and will withstand far greater heat without distorting than the generator. However it would not do to make the generator of this metal, for it is a comparatively poor conductor of heat and it would therefore take much longer to preheat it. The

use of a sleeve does not impair the heat conductivity of the generator. Monel metal can usually be obtained at a well-supplied hardware store.

### Papering Painted Walls

A painted wall or ceiling must be carefully prepared before applying wallpaper, to insure the adhesion of the paper. The surface must be scrubbed with soapsuds and then thoroughly rinsed and dried. The paste used on the paper should not contain any alum. To a pailful of paste add three sheets of isinglass, dissolved in 1 pt. of hot water, and then 2 oz. of glycerin. This paste will stick.

### Handy Brake-Lining Wrench

The fitting of new lining, on the brake shoes of four-wheel brakes of the internal expanding type, should be done with the lining tight against the shoes. This is essential, as it is almost impossible to equalize the brakes when the lining is improperly attached. A simple tool for stretching the brake lining tight on the drum is shown in the drawing. It consists of an open-end wrench, drilled and tapped for a cold-rolled-steel clamp screw, as indicated. The lining is first attached to one end of the shoe with rivets and the wrench is then clamped at the other end of the lining. By drawing the wrench over the end of the shoe, the lining will be pulled taut. The tool can also be made from a strip of steel plate, as shown at the left. — G. A. Luers, Washington, D. C.

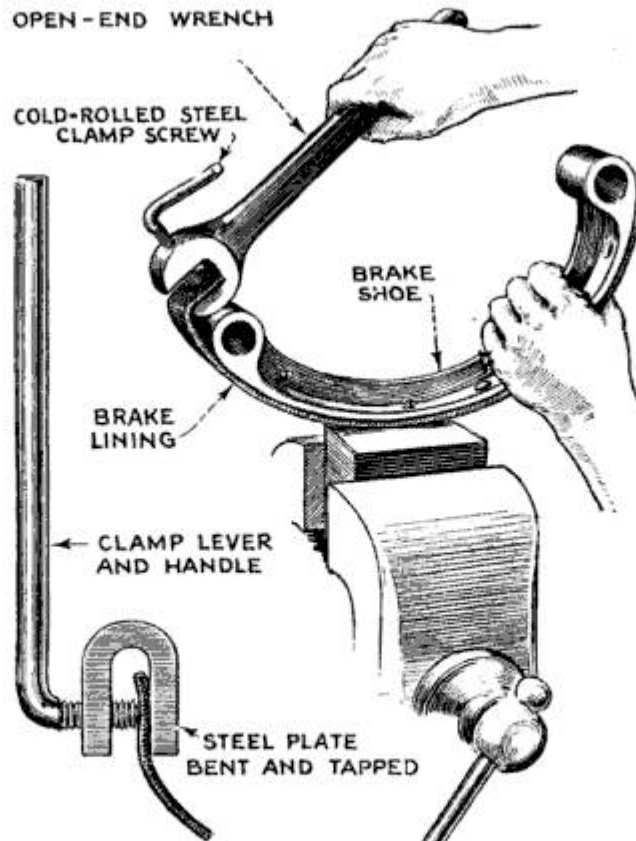

Brake Lining Can Be Held Taut against Shoe with This Easily Made Tool

☞ To clean felt hats, take a clean, dry rubber sponge, and rub it over the surface.

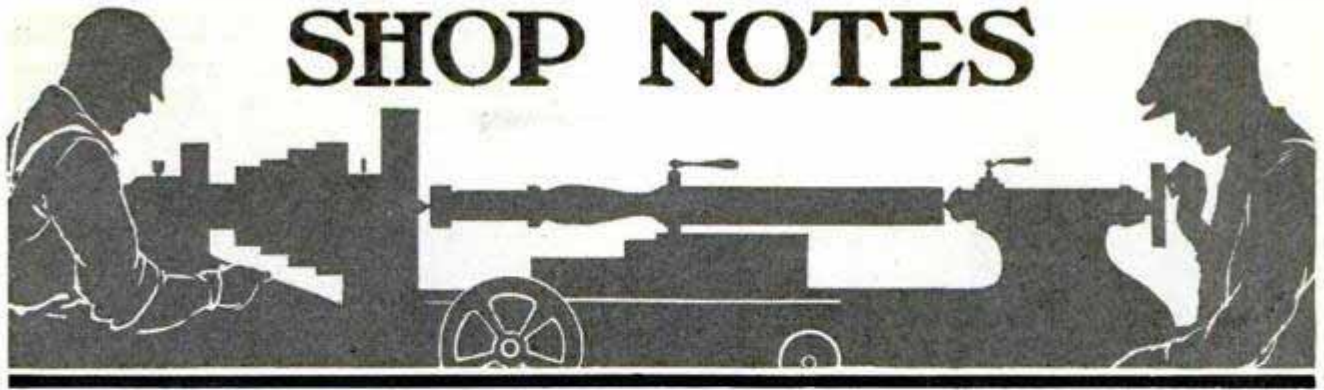

# SHOP NOTES

All Shop Notes published in 1928, in book form—Fifty Cents—from our Book Department

## A Back-Yard Ferris Wheel

By R. C. BRADBURY

ALL the fun of the fair is guaranteed to the youngsters if Dad constructs in the back yard the Ferris wheel shown in the illustrations, and the youngsters are not the only ones who will like to ride either. The total cost of this wheel was less than five dollars.

The construction is comparatively

simple, although care must be taken, of course, to make all joints and members amply strong, and, if the installation is to last for a few years, to paint the structure thoroughly, to guard against deterioration through weathering. The over-all diameter of the "wheel" is 18 ft. and the width 2 ft. 9 in. The two-by-fours forming the arms of the wheel are crossed at the center, and braced near the hub by short pieces of the same stock, as shown. The longer

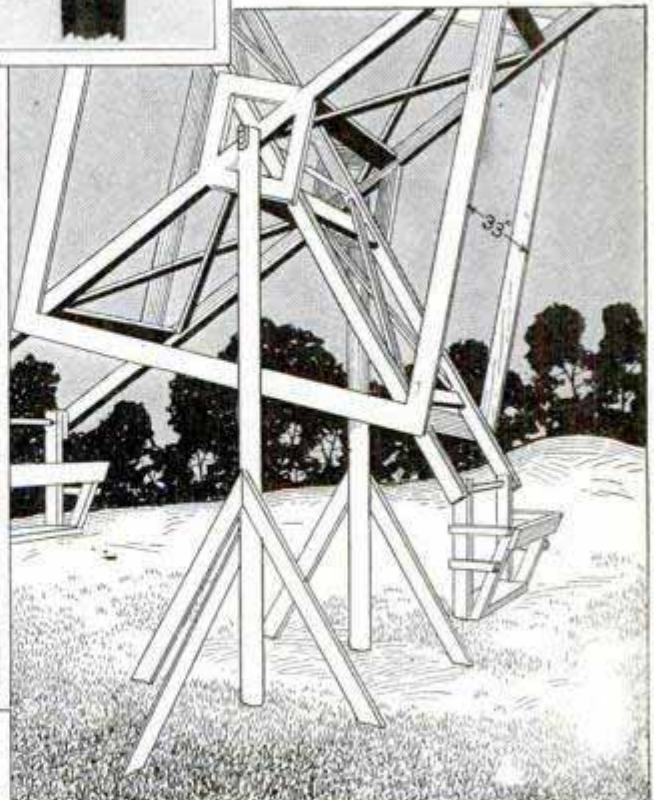
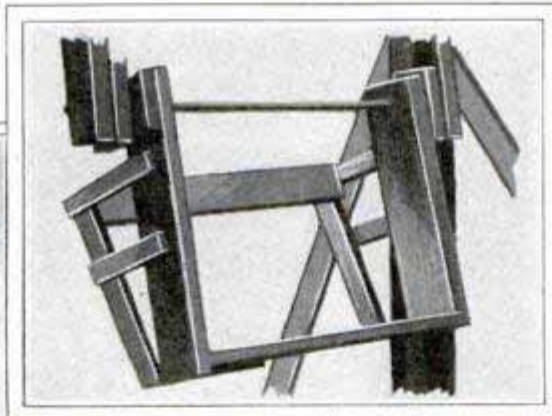
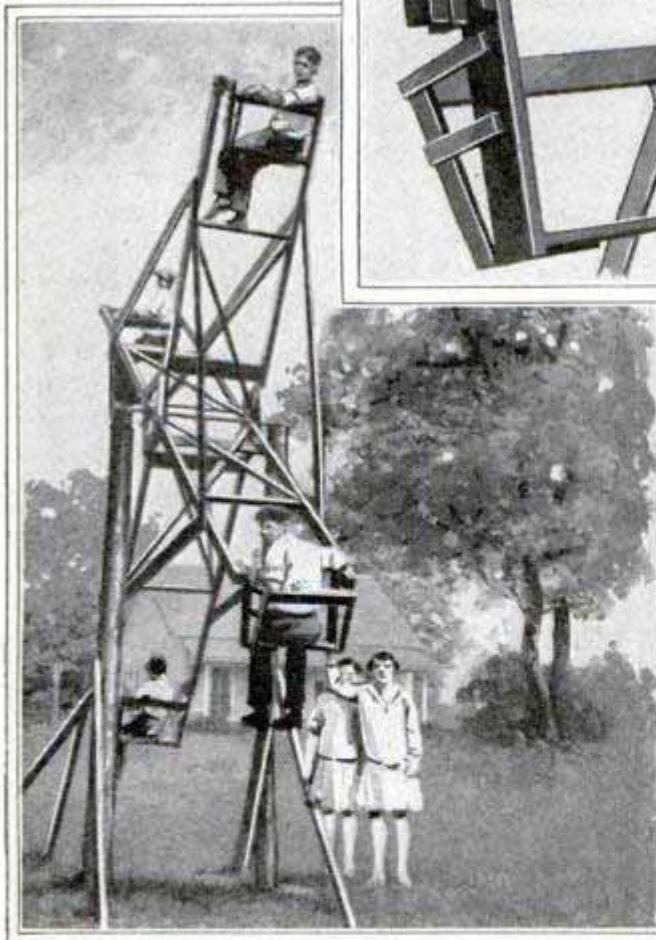

A "Kick-Power" Ferris Wheel for the Back Yard That Will Give the Youngsters All the Thrills of the Real Carnival Wheel

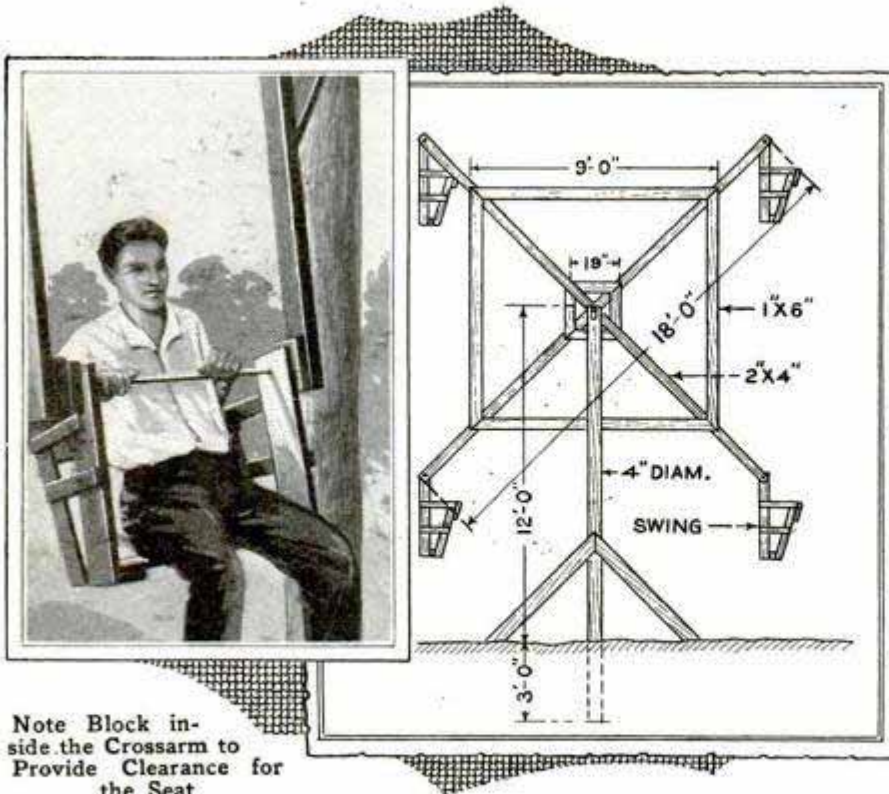

Note Block inside the Crossarm to Provide Clearance for the Seat

braces, forming the square near the outer ends of the arms, are of 1 by 6-in. stuff, 9 ft. long. Each set of arms being nailed together and braced, they are connected together by cross braces or bridging of 2 by 2-in. stock, 2 ft. 4 $\frac{3}{4}$  in. long, running across from arm to arm at the inner and outer braces. The assembly is further strengthened by 2 by 2-in. bridging, forming a cross between each pair of arms, and finally tied together by means of the  $\frac{5}{8}$ -in. rods on which the seats swing, which are threaded at each end and fitted with nuts and washers. These rods are 2 ft. 10 $\frac{1}{2}$  in. long. The length of the swing seats is 25 in., their width 12 in. and, at the top of the swing arms, 17 in. The construction and suspension of the seats are shown quite clearly in the photos.

Before putting the wheel together, bore a 1 $\frac{3}{8}$ -in. hole in the center of each of the 2 by 4-in. crossarms. Then file out four malleable-iron washers to fit a 1-in. pipe, and drill them, near the edge, for  $\frac{1}{4}$ -in. bolts, keeping the holes in line. Nail each pair of two-by-fours together, place a washer on each side, drill the crossmembers and bolt together with  $\frac{1}{4}$ -in. bolts, running through the members and the washers. The bolts hold the assembly firmly together, and the washers form the bearing on the 1-in. pipe axle. A  $\frac{1}{2}$ -in. hole is drilled at an angle through the joint of

the crossmembers, down to the axle hole, and a  $\frac{1}{4}$  by 4-in. pipe nipple driven in almost to the center hole. A grease cup, screwed in a coupling on the end of the nipple, on each side, serves to lubricate the bearing.

To fasten the pipe axle firmly in the tops of the 4-in. posts, a slot, wide enough to take the pipe, is cut in each post, and the axle dropped into place. Now, on each side, a piece of  $\frac{1}{4}$  by 1 $\frac{1}{4}$ -in. flat iron, 14 in. long, is bent U-shaped to fit over the pipe. The legs of the "U" are given a half twist, and are drilled and fastened to the side of

the post with  $\frac{1}{2}$  by 6-in. lagscrews. The wheel should be loaded so as to be in balance, although it is not necessary that all the passengers be of equal weight, as long as the heavier ones are seated on opposite sides.

### Marking and Center-Punching Angle Iron When a Vise Is Not Available

To mark and center-punch angle iron without the use of a vise is quite a difficult job. The accompanying drawing shows a method that has been found satisfactory when a vise is not available. The angle iron can be kept flat and measurements scribed without any difficulty.—Arthur W. Truell, Buffalo, N. Y.

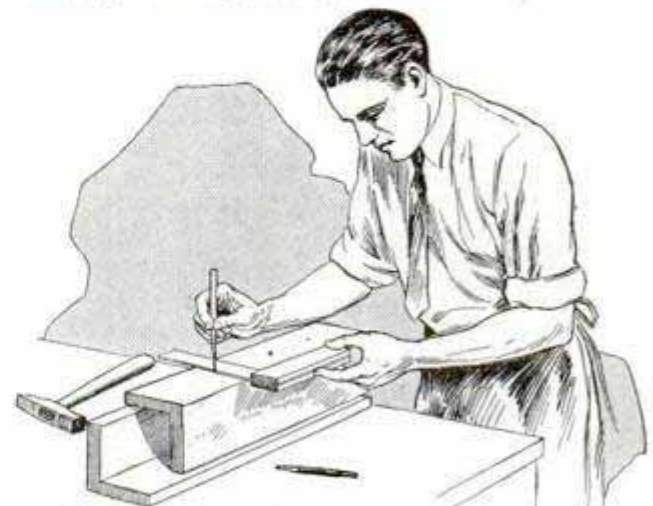

Marking and Center-Punching Angle Iron When a Vise Is Not Available



### Using Antimony in Making Patterns

When making patterns allowance should always be made for the contraction of castings in cooling. Where many patterns of the same kind are needed, as in small work, it would be convenient to make duplicates by casting from a single first pattern, if it were not for the double shrinkage that had to be allowed for. By making these duplicates out of a mixture of white metals containing 10 per cent or more of antimony the original size will be maintained. Antimony is of no use in any composition except to harden and to fill out. It does not mix when melted but remains suspended in granular form. Bismuth is also sometimes used for simple alloys. Bismuth goes antimony one better in that it expands with cooling. An interesting and valuable point about bismuth is the low melting point obtained when it is used in certain alloys. For instance, an alloy of bismuth, tin and lead will melt in boiling water.—Donald A. Hampson, Middletown, N. Y.

### Holding Light Work in a Heavy Vise

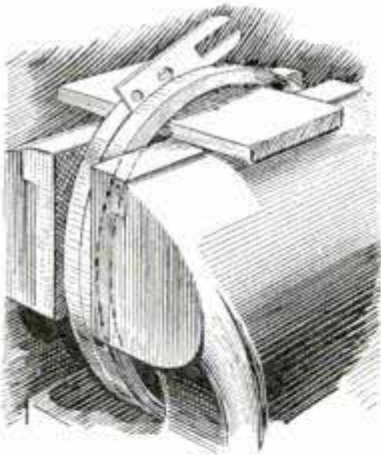

Trying to hold small, narrow work in the jaws of a large vise is a rather difficult task. However, when a large vise is all you have, the following method will overcome the difficulty: Lay a small block or flat piece of wood on the vise jaws and slip two piston rings over the wood and between the jaws, as indicated. The work can then be pinched between the rings. Several turns of string around the lower portion of one ring will make them pinch together squarely when the jaws of the vise are tightly closed.

❏ No difficulty will be had in starting a cap on the gas tank or radiator, if it is turned backward until it moves smoothly and on a level.



Pad Made from Old Inner Tube Protects Gardener's Knees from Mud and Moisture

### Knee Protector for the Home Gardener

A neat and practical knee protector for the home gardener can be quickly made from part of an old inner tube. Cut off a piece about 8 or 10 in. long, and remove the upper portion, leaving only a very light band at each end, as shown in the detail. The pad will not be too tight when stretched over the knee and will prevent getting the trousers wet and muddy.—F. W. Bentley, Jr., Missouri Valley, Iowa.

### Making Concave Knurls

A concave knurl is an expensive piece to make if a milling machine is used to cut the teeth. I have devised a method that is much cheaper and just as satisfactory for my work. It is as follows: A tap, with a fine thread about the right size, is placed in a lathe as shown. The knurl is fastened to a holder, which is placed in the tool post. The lathe is started and the teeth in the knurl are cut just about the same as a hob cuts teeth in wormwheels.—Chas. Kugler, Philadelphia, Pa.

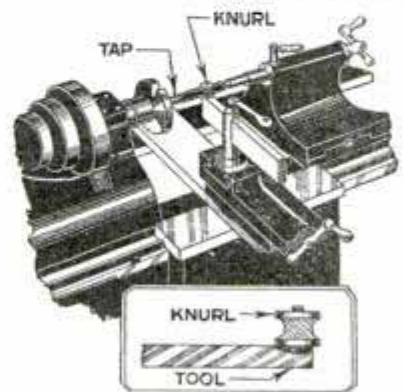

### Assembling Screen Doors

Here is a folding bench for the small workshop. When closed, it occupies a space of only 18 by 30 in., but when opened, is nearly 9 ft. in length. It has been found especially handy for assembling screen doors, although it lends itself to many other uses. The

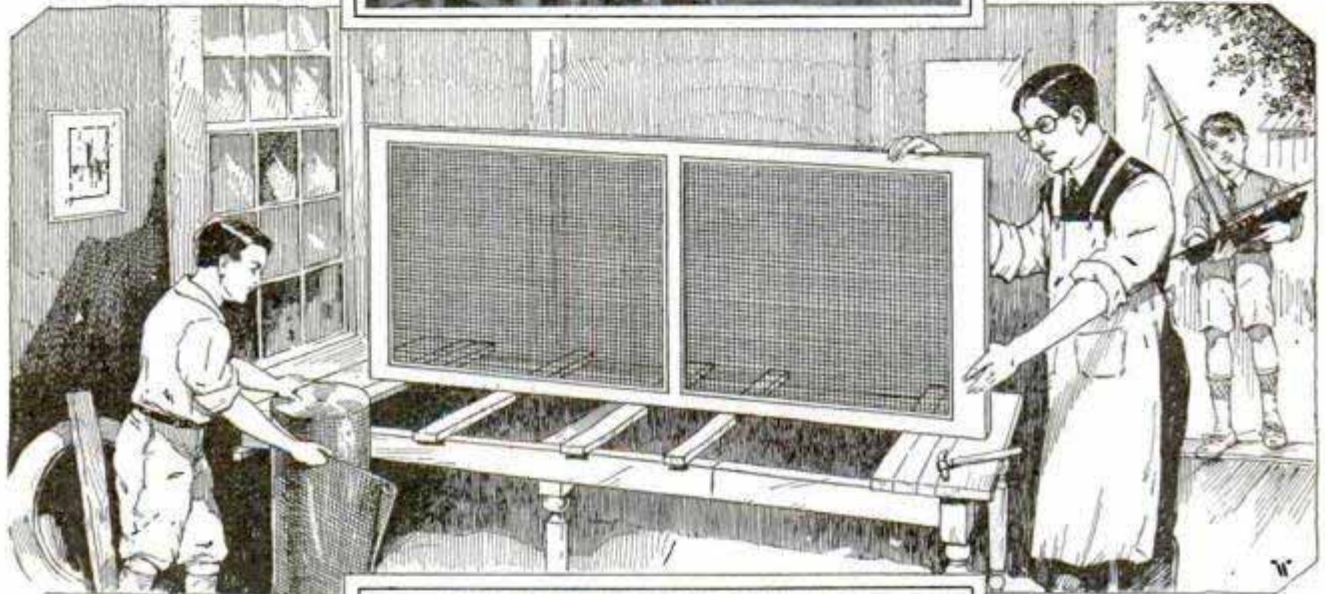
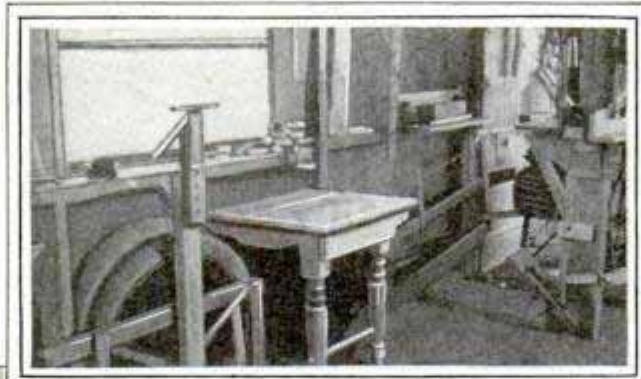

sliding units were taken from an old table having six legs. The two legs at one end were removed and this end was nailed to the wall under a window, as shown. Across each sliding unit, a 1 by 3-in. strip was nailed to provide suitable support for the work.

### Care of Oil-Soaked Waste and Rags

The danger of spontaneous combustion from rags or waste saturated with oil in shops, garages and residences is not sufficiently understood. This is, no doubt, because most people do not know that linseed oil will oxidize rapidly and, if cotton is soaked with oil, enough heat will be generated in a short time to char the cot-

ton. The addition of red lead seems to make the heating more rapid, as pipe fitters have frequently observed. It is a common thing for these men to clean the red lead and oil from a new joint by wiping it with a handful of waste. It is also common for the workman to carry the waste in his pocket. A pipe fitter once felt a hot spot against his

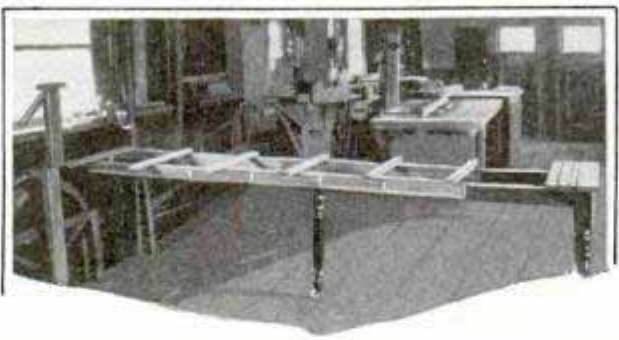

Folding Bench for the Small Workshop Especially Useful for Holding Long Work, Such as Screen Doors

body, which caused him to investigate his pocket, with the result that he found a pocket lining burned out and a mass of charred waste. If this jacket had been hung in the clothes closet at

home, a burned dwelling might have resulted, with the origin of the fire a mystery. The safe thing to do is never to put oil-soaked rags away. Either burn or wash them at once. In mills, power stations, shops, garages, etc., where there is a quantity of oil-soaked waste, cans should be provided to receive the discarded waste. The cans should be made of heavy sheet metal with riveted seams, and with iron legs to hold them several inches from the floor. Use a tight-fitting metal cover.—F. W. Bradly, Scranton, Pa.

## Hardening Steel

Hardening steels is a simple process of heating and quenching. As long as a steel has over one-half per cent of carbon in it, it can be hardened. This is accompanied by a brittleness that makes it impossible to bend or draw out the steel. Wrought iron cannot be hardened; it is very soft and ductile. There is also a steel that matches this ductility. Steel with more than 11 per cent of manganese in it refuses to get brittle when it is quenched from the hardening temperatures. On the contrary, it becomes ductile and can be drawn into wire. But although ductile, it cannot be cut with ordinary tools but must be ground.

## Spring Guide for Bench Saw

Although nearly all bench or table saws are fitted with a back guide, this often does not guide long boards accurately when these are sawed into strips, a common practice in joining and woodworking shops. The trouble is due to the inability of the worker to keep the board against the guide. To remedy this, provide an additional guide on the other side of the saw table, as shown in the drawing. The extra guide consists of an 8 by 18-in. piece of straight-grained hardwood in which a number of saw slots are cut about  $\frac{1}{4}$  in. apart, as indicated, to form a spring.—H. C. Stevens, East Boothbay, Me.

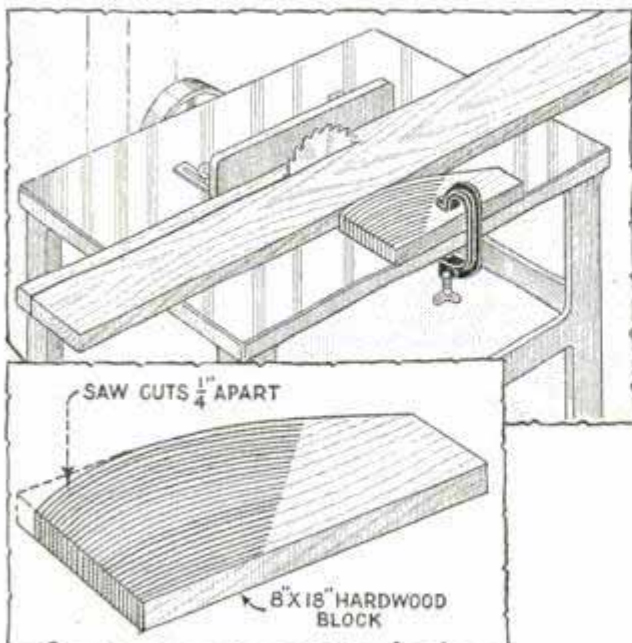

Additional Guide on Saw Table Helps Worker Saw Long Boards into Strips

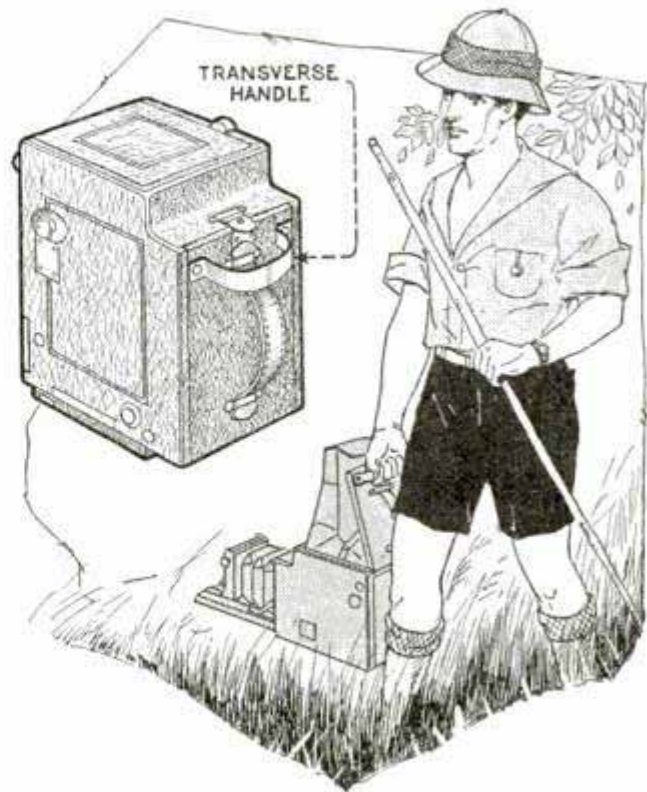

Extra Handle Arranged Transversely on Reflecting Camera for Carrying It When Open

## Transverse Handle on Reflecting Camera

Quite frequently users of reflecting cameras have occasion to take a number of photos in succession, and it would then be a great convenience to carry the camera from place to place without closing it. This is made possible by providing a transverse handle as shown in the drawing. To carry the open camera by the original handle, two fingers must be slipped through the upper end, and this is not only unhandy but very tiring, especially if the camera is heavy. The transverse handle remedies both troubles.—John Edwin Hoag, Honolulu, H. T.

## Sulphur Sets Rods and Bolts in Concrete

For setting rods and bolts in position in holes drilled in stone and concrete, melted sulphur is often used. Although it would seem that lead would be better for this purpose, it contracts upon cooling and would therefore not be tight in the hole. Similarly, iron and brass cannot be used for jobs of this kind. The writer knows of some iron fence posts that were set in sulphur something like 30 years ago and are fully as tight today as they were when first placed.—Donald A. Hampson, Middletown, N. Y.

# How to Finish



Lacquer is a strictly modern finish, characterized by its soft, subdued luster. It is easily kept in good condition, and, when it does become dingy, can easily be rubbed to a brighter finish with a soft cloth. It may also be waxed, if desired, producing a beautiful effect. Brushing lacquer, of course, is the type especially adapted to the home decorator. It dries in a few minutes, so that the furniture may be used within a very short time after the lacquering has been done. No

elaborate preparation of the surface or long-drawn-out undercoating is necessary. Good-looking work can be done by simply brushing a couple of coats onto the surface, starting the second coat as soon as finished with the first one. However, there are some principles in the application of brushing lacquer that will aid in the obtaining of the finest possible finish, and assure consistent results.

First, prepare the surface. While no extensive work is required, a little time spent in put-

**T**HE new trend in styles has given the home craftsman an opportunity to have the very latest in furniture, and at the same time save an appreciable amount in furnishing his home. This furniture, with its straight lines and sharp angles, is easily made at home with ordinary tools and from material available from any lumber yard. Unpainted furniture is also sold by stores to be finished and decorated at home.

The finishing of unpainted furniture, starting with the bare wood, is therefore of special interest now. A description of some of the finishes most in vogue, with instructions for producing them, follows.



New Wood Must Be Sanded with the Grain to Make the Surface Ready for the Finish



# Unpainted Furniture

by Berton Elliot



ting the surface in good condition will usually save at least one coat of lacquer, produce a better job and insure freedom from troubles sometimes encountered when no preparation of the surface is attempted. Fill all cracks, holes and surface imperfections with plastic wood, or a mixture of fine sawdust, whiting and shellac or lacquer. Then sandpaper the entire surface to platelike smoothness with No. 00 sandpaper, since practically no lumber or unpainted furniture is sanded at the mill to a suitable finish.

Next apply a thin coat of pure white shellac, allow it to dry thoroughly for one or two hours, then sandpaper to absolute smoothness

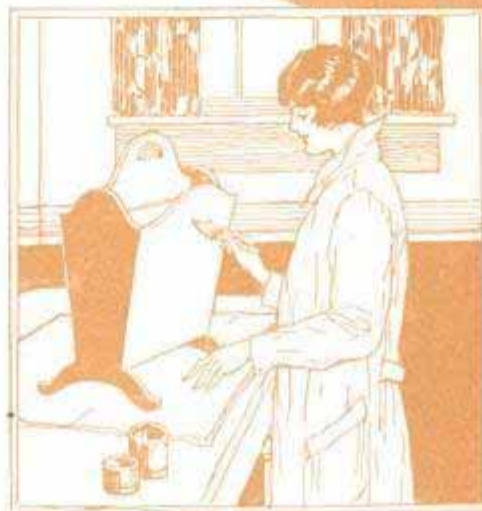

again. Most woods made up into unpainted furniture, such as poplar and whitewood, are soft and porous, and would absorb a first coat of lacquer like blotting paper. Even

the second coat soaks largely into the surface, so that, if shellac were not used, four coats of lacquer would be necessary for a good job in many cases. The shellac acts as a sealer, causing the first lacquer coat to stand on the surface of the work instead of sinking into it, and a two-coat job over shellac generally has a splendid luster. The second function of the shellac is this:



In Enameling New Wood, Some Turpentine Should Always Be Added to the First Coat, to Aid It in Penetrating the Wood

The grain of most woods is raised when wet with painting materials, so that a fuzz covers the entire surface. When sanding down the shellac coat, this fuzz is taken



off and does not appear again with subsequent coats. Finally dust off all loose particles of sand. Be sure the surface is absolutely dustfree before applying the lacquer, also that it is thoroughly dry and free from grease. Work in a dustfree place, and take care that no dust settles on the work before the lacquer dries.



Be sure your brush is clean, as disfiguring specks of dirt on the finished work often come from a dirty brush. Use a soft-hair brush, preferably a fitch or bear-hair, and remember that a new brush has always some dust and loose hairs in it which should be worked out before using. Apply the lacquer with a full brush and in long strokes, brushing as little as possible. Just flow it on and let it alone. Watch out for loose hairs shed into the work as you go along, and, if one is seen, poke it out immediately with the corner of the brush. Work quickly but carefully. In case the lacquer becomes roughened in any place through brushing it after it has started to set, smooth it out by going over the place with a fresh brushful of lacquer, or by

dipping the brush into lacquer thinner and brushing deftly over the roughened surface, which will dissolve the lacquer and cause it to run together again. Do not sandpaper between coats. Unless one is expert, it is difficult to sand lacquer satisfactorily, and the nature of the material is such that each coat levels itself to a perfectly smooth, even surface, so that sanding, as far as ordinary work is concerned, is unnecessary.

Two or more coats of lacquer should be applied, as necessary. If attractive colors are selected, and spottings, jewels and stripes of the trim color tastefully located, the piece will appear fully finished without further decoration. If an additional finishing is desired, it may be done with transfer patterns or stencils, which are now available in modern designs, so that the decoration may be in keeping with the spirit of the furniture.

Enamel is another modern finish, the porcelain-like luster of which is preferred by many to the more subdued tones of lacquer, and a workmanlike job of enameling is really something worthy of admiration. In enameling, the preparatory work is the same as for lac-

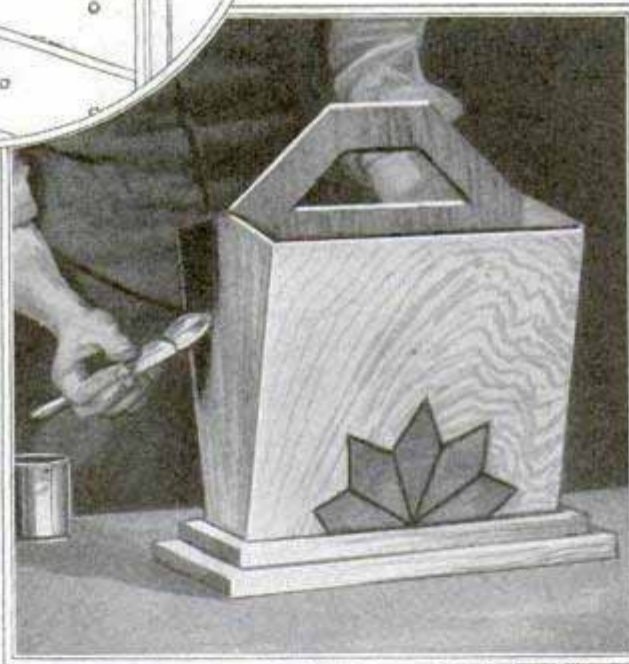

A First Coat of Shellac on Work to Be Lacquered Seals the Surface and Saves an Extra Coat of Lacquer



quering, except that no shellac is used. It is even more important with enamel to see that no dust settles on the work when it is wet, on account of the longer time the enamel takes to dry. Where practicable, it is advisable to provide some sort of cover, for example, by placing a couple of sticks across two chairs, and laying newspapers over the sticks. Underneath this arrangement the articles may be placed while drying.

Enamel differs from lacquer in that the finish is built up in a series of steps, the procedure, however, being very simple. Apply a coat of flat enamel undercoater. Allow this to dry 24 hours, then sand it to remove the brush marks and to level off the surface. Dust clean. Next apply a coat made of half undercoater and half enamel mixed, allow this to dry 48 hours, sand smooth and dust clean. Finally apply a third coat of straight enamel,

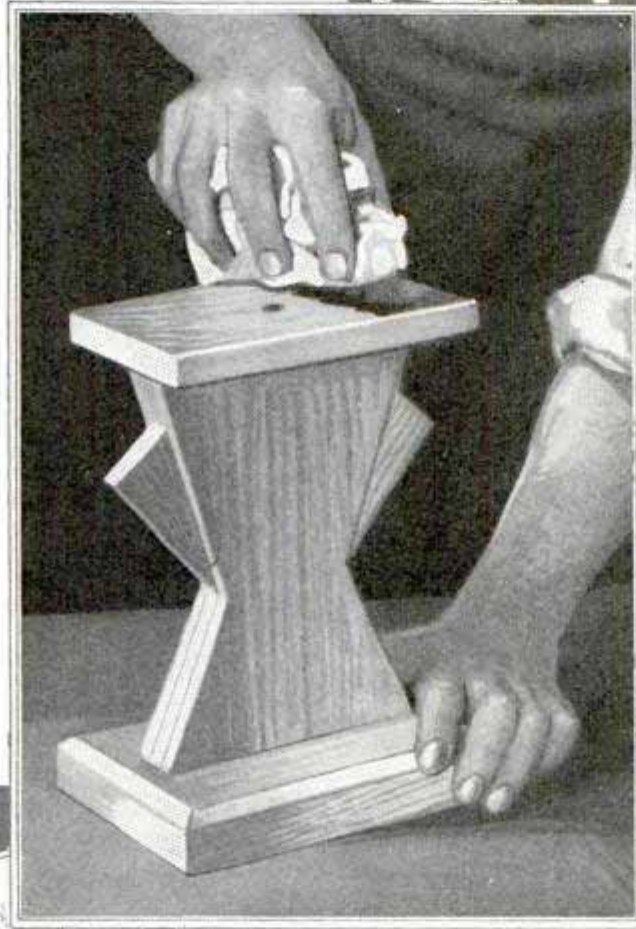

Open-Grain Work to Be Finished with Varnish Should Be Filled with a Paste Filler, Brushed On, and Wiped Off across the Grain

ing tightly sealed, it should be strained through several thicknesses of cheesecloth before it is used.

A three-coat job, as described above, should produce a first-class finish with any of the brighter or stronger colors. With white, ivory and the lighter tints, a four-coat job is always so much better as to be well worth while. In these cases, two coats of flat undercoater should be applied,

followed by a coat of the half-and-half mixture and a final coat of straight enamel. If it should be found that solid covering of the surface has not been obtained after the final coat, due to inexperience or to some unusual condition of the surface, sandpaper the final coat when thoroughly dry (not under 48 hours), dust clean and apply another coat of straight enamel.

For the flat coats, regular enamel undercoater may be obtained at all paint stores, but in white only. White lead,



flowing it on, and taking extreme care that no dust gets into it, either from the brush or from the room. If the enamel used has been standing without be-

thinned with flattening oil, is also very satisfactory, but not so convenient for the amateur to use. Flat wall paint makes a splendid undercoating, and may be obtained in colors approximating the color of the enamel, making it more easily covered with the finishing coats.

When enameling new wood, the first coat should carry more thinner than the first coat over previously finished surfaces, in order to satisfy the absorption of the wood and still have enough liquid left over to bind the paint film firmly to the wood. If enough thinner is not used, the film may chip off later.

Enamel may be rubbed with pumice-stone and rubbing oil to a semidull effect, sometimes known as a hand-rubbed finish. It may also be enriched with stencil and transfer, in the same manner as lacquer.

Natural and stained-wood finishes are at present enjoying renewed popularity, and some beautiful effects may be obtained by finishing novelty furniture with suitable transfer decoration, using the larger and more open designs extending over a considerable part of the surface, and in colors to blend in with the wood, rather than the mass design, contrasting with the background employed for enamel and lacquer in solid colors.

For the natural finish, sand the surface and dust clean. If the wood is soft and close-grained, apply a very thin coat of white shellac (ordinary "four-pound cut" commercial shellac reduced with an equal amount of alcohol). Sand down well. If the wood is of the open-grain type, such as oak, mahogany, walnut, etc., the pores must be filled with a paste wood filler (natural), instead of the shellac, applied with a brush and wiped off with a coarse cloth, against the grain. Allow the filler to dry, then finish with two or three coats of high-grade interior-finishing varnish, sanding lightly between coats and allowing each coat at least 48 hours to dry. The last coat may be flat or semidull varnish, or it may be rubbed down with pumice-stone and oil, as desired. The stain finish requires only two more operations than the natural finish, otherwise the steps are the same. After the wood is sanded, apply a coat of oil stain, for soft wood, or penetrating stain for hard woods. Next, apply paste wood filler, if an open-grain wood, colored to correspond to the stain used. Follow with a coat of pure shellac to seal the stain, using white shellac for the lighter finishes and orange shellac for such woods as dark mahogany. Finish with varnish as for the natural effect.

### Homemade Racer Has Novel Features

A novel racing car, built by J. S. Eastham, of Cottage Grove, Oreg., weighs only 465 lb. Ordinarily, such a light car would not be able to hold the road when traveling at a high rate of speed, but the special design of the hood, which slopes

downward, overcomes this trouble. The reason is that the air exerts a downward pressure on the hood. The two rudder-like projections on the hood and rear also help to steady the car, preventing it from skidding on sharp turns at high speed. Instead of having two drivewheels and a differential, this car has only one rear wheel, taken from an old motorcycle, and a chain drive. This arrangement is much lighter than a two-wheel drive.—Elbert Bede, Cottage Grove, Oreg.

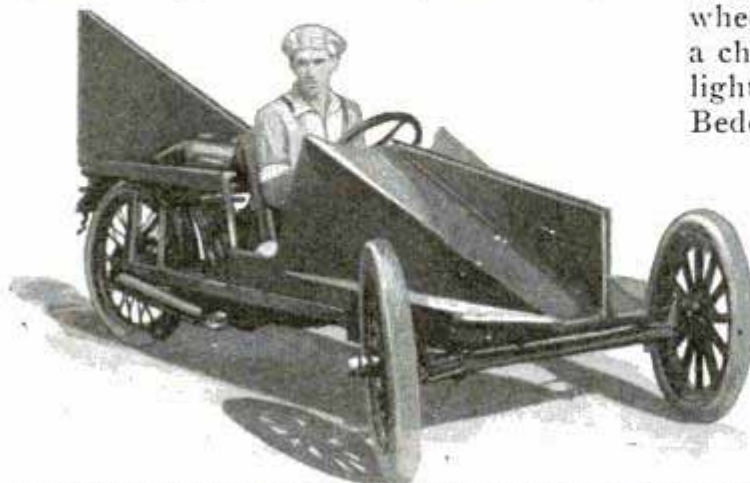

Lightweight Racing Car Has Specially Designed Body to Hold It to the Road at High Speed

### Renovating Pearls

When pearls have lost their luster, simply coat them with a thin film of liquid finger-nail polish, allow it to dry thoroughly, and the luster will be restored and will last indefinitely. Nail polishes come in tints from pearl gray to deep pink.



## Making Concrete "Flagstones"

Unquestionably the flagstone path is more fitting for the small house than the formal cement sidewalk. Certainly it is more attractive, and is in universal favor with landscape architects. Flagstones of concrete in picturesque, irregular patterns can be made easily by the home owner.

notes streaks of unmixed cement; brown quantities of sand without cement. Add the water gradually while mixing. The

Making Concrete "Flagstones" for the Garden Walk Is an Easy Job for the Amateur Mechanic, if the Method Shown Is Followed

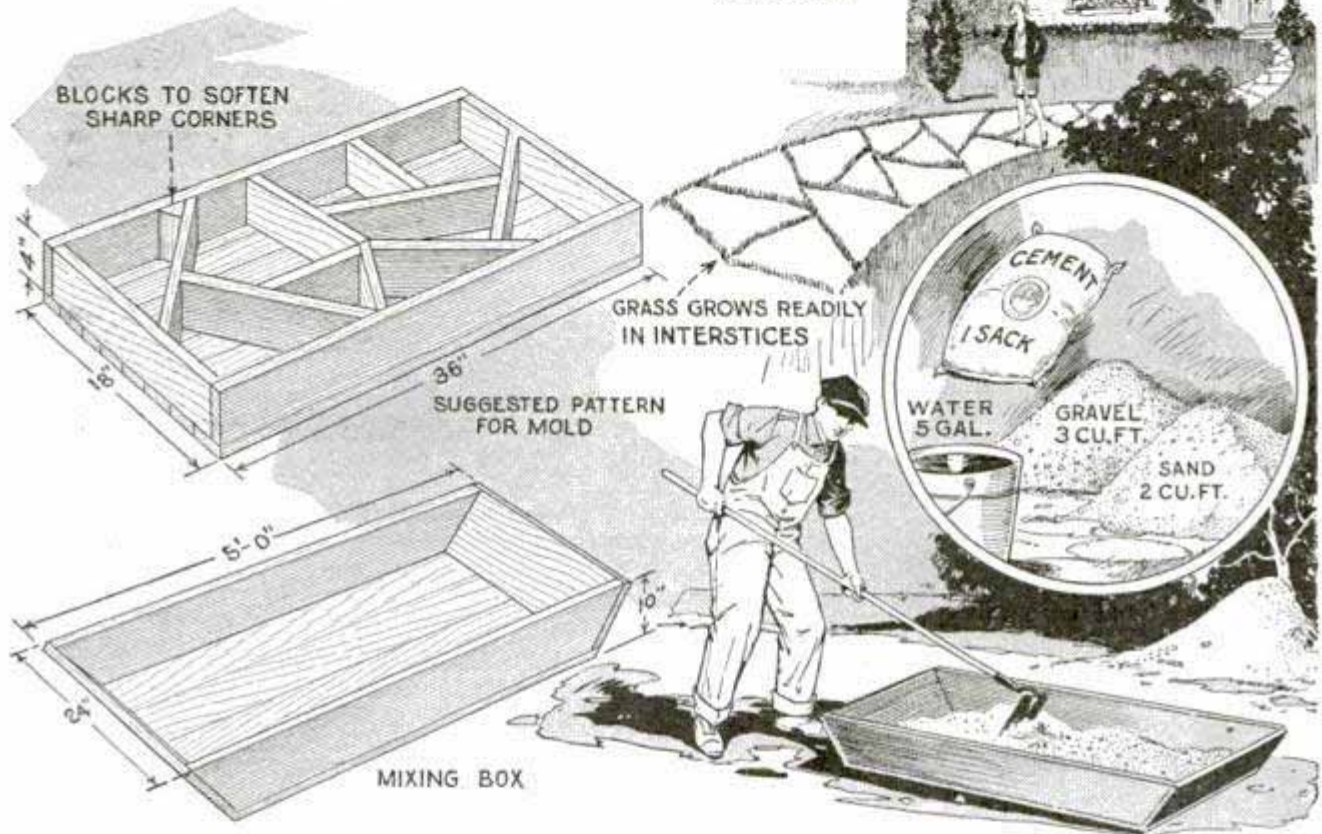

First make a mold of the approximate dimensions given, with a number of irregularly shaped compartments, of a design to suit your individual taste. By no means, however, make them in regular geometric patterns, for they will then deceive no one as to their origin. The odd sizes and shapes imitate flat stones just as they are picked up in field or quarry. Mixing the cement or concrete is much simpler than the uninitiated might think. A mixing box will greatly simplify the work, preventing the mass from slopping over as on a mixing platform. For work of this nature, mix about 2 cu. ft. of sand, 3 cu. ft. of fine gravel and 5 gal. of water to one sack of Portland cement. If the sand and gravel are very dry, use about 6 gal. of water; on the other hand, if they are very wet, use 4 gal. Before adding the water, however, the sand, gravel and cement should be turned over and over until the mix is of a uniform color. Gray de-

compartments of the mold should be oiled before filling with concrete. Discarded crankcase oil will serve the purpose. Fill the molds, tamp well into the corners, and allow the concrete to set for two or three days before removing. In the meantime, keep it moist by placing wet gunnysacks over the top. When the blocks are removed, a new set can be molded, until a sufficient number are completed to make your path. Take care that there are no hollows in the blocks; it is better that they be slightly crowned so they will always be dry after a rain. They should be set in the ground slightly above the sod level. The interstices between the blocks are filled with rich soil and seeded. In due time, you will have a most attractive grass-grown path through your garden.

Gas-stove burners may be cleaned by boiling in a strong solution of washing soda and water, then rinsing and drying.

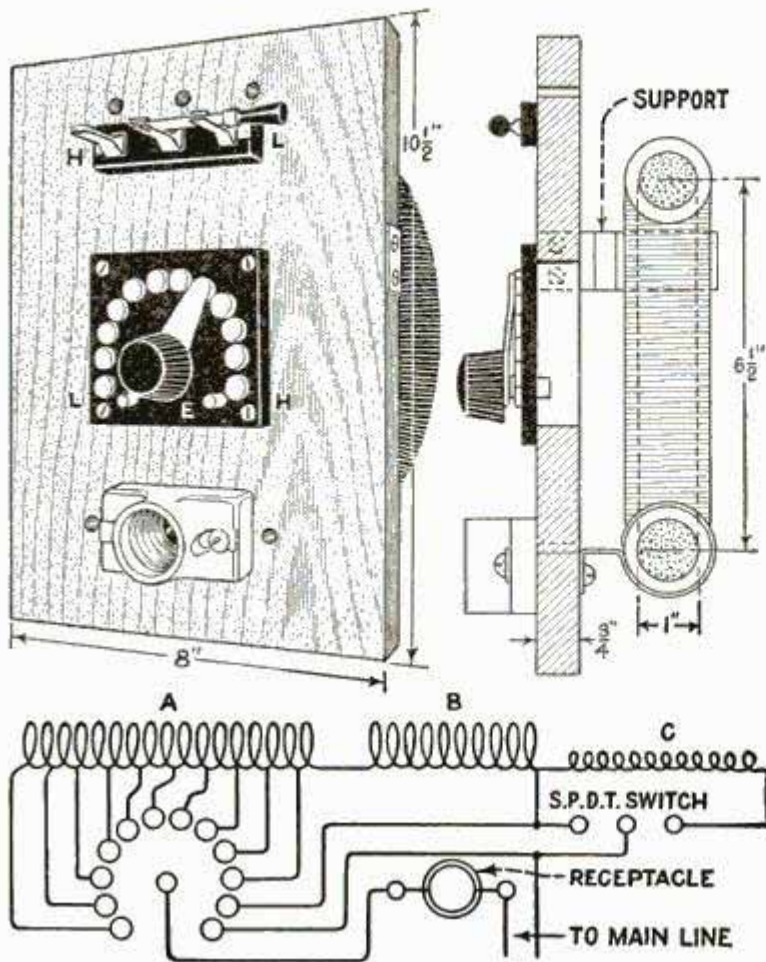

Tapped Choke Coil Permits Accurate Control of Small Electric Crucible; Diagram Shows Taps and Connections

### Choke Coil Controls Electric Crucible

In the January, 1928, issue of Popular Mechanics an article was published describing the construction of a small electric crucible. In connection with this, I made a choke coil to regulate the heating of the element. The crucible with the choke-coil control has been found very handy for heating test tubes in analytical-chemistry work, to ignite precipitates not requiring a blast lamp, and those that are easily fused, such as silver chloride. The materials required are 1 wooden panel, 8 by 10½ by ¾ in.; 1 single-pole, double-throw knife switch; 1 radio inductance switch with 12 points and 2 stops, mounted on a piece of bakelite; 1 cleat receptacle; 75 ft. of No. 18 copper bell wire and 125 ft. of No. 22 insulated-copper wire for making the coil; 3 brackets of 1-in. strap iron for supporting the coil; glass tubing for insulating the coil from the panel, and some screws. Also get some soft-iron wire such as stovepipe wire for the core. Wind the iron wire to form a small coil, about 6½ in. in diameter, as shown in the

detail at the right, wrap friction tape around the core thus formed and wind the bell wire around it, taking care that adjacent turns of the wire do not touch each other. Ten taps are taken off the first section of this winding at 7-ft. intervals, as indicated at A in the diagram. Continue winding the bell wire to form the second section, B, which is untapped except at the end. To the end of the bell wire attach the No. 22 wire and continue the winding as at C. All connections to switch points, receptacle and switch are indicated in the diagram. The use of the double-throw switch gives the 12-point inductance switch the capacity of 24 points.—Frank E. Gray, Ogden, Utah.

### Useful Brake-Lining Kink

The customary practice of replacing a brake lining is to cut it a little longer than the inner circumference of the brake band, ¼ in. for every 10 in. of length being the usual allowance. The lining is then buckled in the center and the ends riveted, whereupon the buckle is pressed down against the band. With this method a smooth surface cannot always be obtained at this point because friction against the brake band has prevented the lining from spreading out evenly toward the riveted ends. This can, however, be avoided by coating the surface of the lining and band with graphite grease. Not only does this allow the lining to conform better to the band but prevents the formation of rust, which is destructive to the band and lining alike.—Richard P. Cole, Paterson, New Jersey.

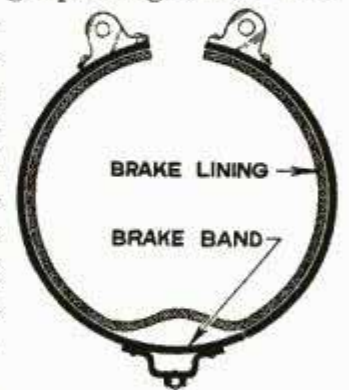

☛ A section of a bandsaw, or an old hacksaw blade, bent in the form of a "U" having its two ends fastened to a wooden handle, makes a good weed-cutting hoe.

# Making a Disk Sander

By W. C. LAMMEY

FOR smoothing and truing up small parts of furniture, and for a clean finish on the end grain, as well as smoothing short pieces of stock, a small sand disk has no equal. In fact, it is about the only effective smoothing and finishing medium driven by power the home worker has at his command.

The possibilities of a sand disk are determined by the size of the disk, the power, and the size of the table on which the work is supported. Where a wide range of work must be surfaced and edged, the table must be large enough to support it effectively. With an 8-in. disk and medium-grit paper, it is possible, with a framework and a suitable fence and supporting table, to surface work up to 14 or 15 in. wide and do an excellent job. For edging and smoothing end grain, the sand disk, aided by a supporting table of sufficient size, has no equal.

The arrangement shown in the illustra-

tions has been found to be most effective for handling such a range of work as the individual worker is likely to have. Mounted in this way, the disk will surface or edge with equal facility and at a speed and ease which puts hand sanding out of consideration entirely. Driven direct by a  $\frac{1}{3}$ -hp. motor, it has capacity for real work.

The construction of a supporting framework for the disk and motor is very simple. Fig. 1 shows a top view of the assembly minus the fence. The dimensions, of course, may be changed but will be found about right for easy portability and will support long pieces for either surfacing or edging. Cut two pieces from ordinary 1 by 4-in. stock, one 7 $\frac{1}{2}$  in. long and the other 24 in. House the shorter piece into the longer for the base, as in Fig. 2, and secure the joint with screws and glue. Cut a piece, 24 in. long, from 1 by 6-in. stock for the worktable and plane both surfaces smooth. Cut a recess on one edge, 8 in. long and  $\frac{1}{4}$  in. deep, as shown. Round the corners for neatness, and secure this piece to the base with screws and glue.



A Disk Sander of Real Capacity for Home Workshop: It Can Be Made in a Couple of Hours, and Saves Much Hard Work

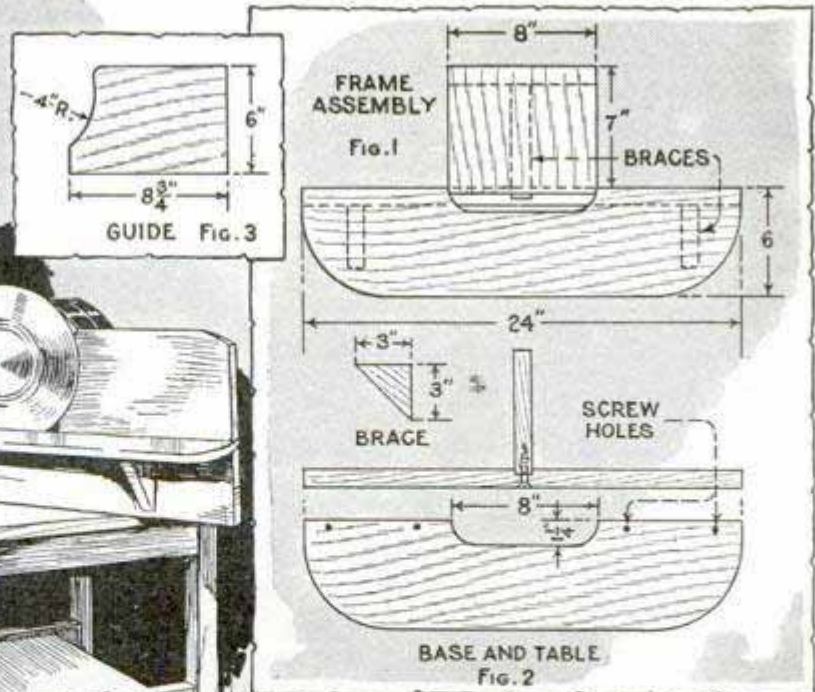

Cut a piece from 1 by 8-in. stock to 7 in. in length, square up and surface for the motor table. Lock it in place as in Fig. 1, with screws and glue. Note



Adjusting the Sand Disk to the Fence or Guide by Shifting the Motor on the Table

that one end of this base or support bears on the lengthwise piece of the base, to which it is nailed at each corner. This overcomes the tendency to vibrate when the motor is running.

For a guide or fence, saw out two pieces of the form and dimensions shown in Fig. 3. Fasten these by means of cleats, screwed and glued to the frame as in the rear photo. Test each guide piece with the square. Plane until the two sections of the fence are exactly at right angles with the table. Put on the disk and set the motor in place. Lay a length of 1 by 6-in. stock along the fence, edge up, and bring the disk up to this. Bore holes and fasten the motor with  $\frac{1}{4}$ -in. bolts, making sure that the surface of the disk does not project beyond the guide more than  $\frac{1}{16}$  in. at the most; the outfit will do better work if it projects less. Unlike hand sanding, it must be remembered that pressure on the work is not good practice when using a power sander, as the pressure, coupled with the high speed, will cause the paper to burn and scratch the work, leaving unsightly marks and dark streaks which are next to impossible to remedy. Only sufficient pressure to keep the work in contact with the disk should be applied, for garnet

paper running at high speed cuts freely and very fast. The work should be held by the fence, not by the disk.

For best results an 8 or  $8\frac{1}{2}$ -in. disk of good make should be used, on the shaft of a  $\frac{1}{3}$ -hp. motor. Always use a ball-thrust bearing between the disk collar and the motor bearing to absorb the end thrust and relieve the latter of undue wear. Both disk and thrust bearing are obtainable at most well-stocked hardware stores where small workshop-machine units are carried.

As will be seen from the illustrations, nearly the whole surface of the disk is brought to bear on the work. While not in accord with the usual arrangement, exposing but the upper half of the disk, this assembly increases the capacity materially. By using a very fine-grit paper, it is possible to put a smooth clean finish on work of considerable size.

### Converting Chunk Lead into Small Bars

Chunk lead can readily be converted into small bars for convenience in lead burning on storage-battery work. A piece of any kind of wood flooring having a good groove is placed in a bench vise and leveled with the groove up, which is then poured full of melted lead or solder. The pouring should be started from the center so that no dam will be required at the ends.—Fred W. Page, Winfield, Kans.

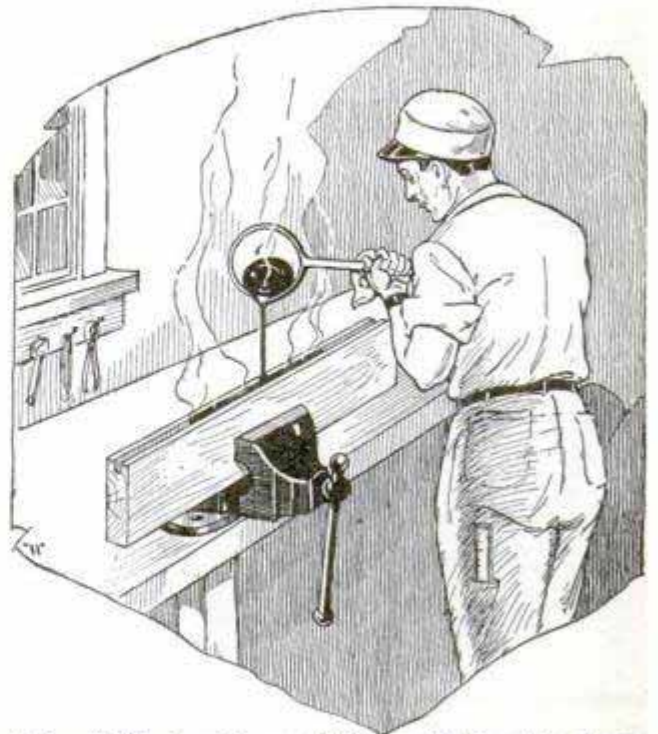

Strip of Flooring Forms Mold for Making Bars from Chunk Lead

### Curing Knock in Ford

To cure a knock which I have often noticed in the model-A Fords, I obtained the small pins and sleeves used to secure the Lincoln piston pins and fitted them on the piston pins of the Ford, doing away with the lock ring in the center of the pin. It is necessary to drill two  $\frac{3}{16}$ -in. holes in the piston bosses, and to slot the piston pins to fit the small pins; the small sleeves are cut to fit.—R. M. Shelton, Dallas, Tex.

### Stock Spring for Blanking Die

In designing and making combined piercing and blanking dies for small machine parts, a spring is usually needed to hold the strip of stock against one of the guides, so the pilots on the blanking punch will enter the pierced holes properly each time the strip is moved forward against the stop finger. The writer has found a flat spring, as shown in the drawing, easy to make and satisfactory to use. It is made nearly as wide as the guide is high, and of suitable thickness to give the required pressure. One end of the spring is held in a slot cut in the guide with a

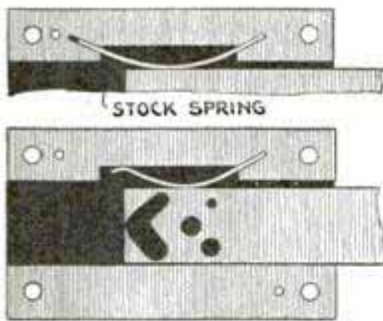

hacksaw of the right thickness to allow a tight fit, or the spring may be made long enough to enter a slot at each end, with one or both ends a free fit.

It may be applied to either the back or the front guide. The guide opposite the spring should be hardened. Cyanide hardening is sufficient for this purpose. The drawing shows guides separate from the stripper plate, but the stock spring may be set into a guide made integral with the stripper if desired.—Ernest L. Holcomb, Farmington, Conn.

### Swinging Side Boards for Wheelbarrow Facilitate Dumping

When repairing an old wheelbarrow, I decided to try swinging side boards, as shown in the illustration. They were hinged at the front end so that they would



Hinged Side Boards on Wheelbarrow Permit Load to Be Dumped Quickly

swing outward. Door bolts were fitted at the other end, near the bottom, to hold the sides securely when closed. Pulling the bolt, releases the board and enables the user to dump the load quickly to either side.—Leslie H. Phinney, Orange, Mass.

### Rest for the Soldering Iron

Here is a kink that will be appreciated by many who constantly use a soldering iron. One of the handiest rests for the iron can be made from an ordinary cotter pin, slipped over the shank, as shown in the drawing. The cotter pin used for this purpose should be of the heavy variety, and the legs should be cut off  $\frac{1}{2}$  or  $\frac{3}{4}$  in., and spread apart at an angle of  $45^\circ$ . The shank of the iron should be a loose fit in the eye of the cotter pin so that the latter can slip around easily. The legs of the pin will then always turn downward, which is, of course, desired when laying the iron aside.

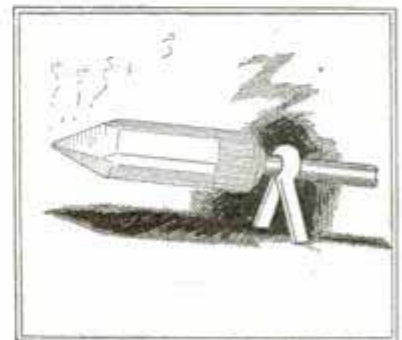

### Filter for Used Crankcase Oil

The drawing shows a device that has been found effective for filtering old auto crankcase oil.

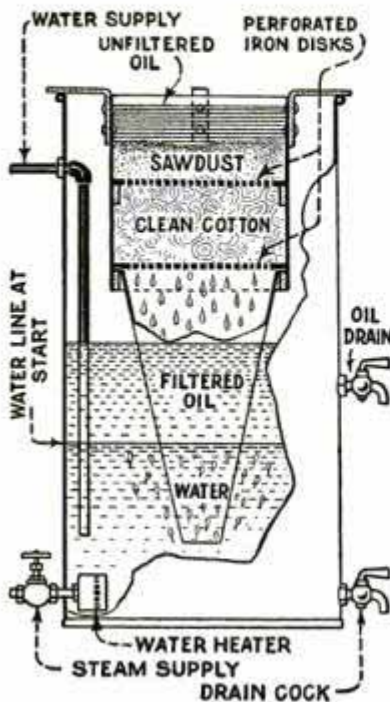

It consists of two sheet-iron tanks, the smaller being suspended inside of the larger one by means of a few flat-iron hooks riveted to the side. The bottom of the smaller tank is cut away except for a strip at the edge, which is used as a support for a sheet-

metal disk, perforated with small holes. A layer of clean cotton waste is laid on the disk, and another disk, of the same size as the first and similarly perforated, is placed over the cotton as indicated. It is supported by a narrow strip of flat iron riveted to the inside of the tank. A quantity of coarse sawdust, which has been washed and dried, is placed on the second disk. A large cone or funnel is attached to the bottom of the small tank. The best method of attachment is to bend the wide rim outward and slip it down into the small tank so that it will rest on the same flange as the first disk. Of course, the cone must be put in before the disk. In the larger tank, a drain cock and a steam water heater are fitted in the side near the bottom, an oil-drain cock about half-way up, and a water-supply pipe at the top, the pipe extending down toward the bottom, as shown. The large tank is filled about one-third with water, which is kept boiling by the heater. Old crankcase oil is emptied into the small tank, and as it filters through, more oil is added until the lower tank is filled up to the oil-drain cock. Keep the water boiling for six hours or more, and then let the oil cool. Draw off some of the water and replace this with cold water. The cleaned oil then

can be drawn off gradually as the cold water pushes it upward.—James E. Noble, Toronto, Can.

### Removing Lead from Wood

A contractor securing a job of refinishing some church benches, damaged in a fire, found that the melted lead from the skylight had spattered over some of them, burning into the wood wherever any of it struck. The problem was how to remove this lead. A scraper made no impression on it and sandpapering only rubbed the particles farther into the wood. After much experimenting, the finisher discovered that when the wood was thoroughly cleaned of the old varnish, the lead could be easily rolled out with sandpaper while the surface was wet with gasoline.

### Paint Scraper for Tinnners

In places where the temperature varies from hot summer weather to below zero in the winter, expansion and contraction often opens up the soldered joints in tin roofs of buildings, and as there is usually a heavy roof paint to be removed before the tin can be brightened and the seam resoldered, a scraper made like the one shown in the drawing, will be found of great help. It is made from an old flat file, which is heated and bent at right angles about 1 in. from the end. The file should be left to cool without tempering, as it can then be resharpened right on the job with another file, and will not be so apt to crumble. The end is round with a bevel on the inside. This places the cutting edge at an angle of 90° to the surface of the roof when scraping, as the handle usually is held at an angle of 45°. The side edges of the scraper can also be sharpened for working against the side of a lapped joint.



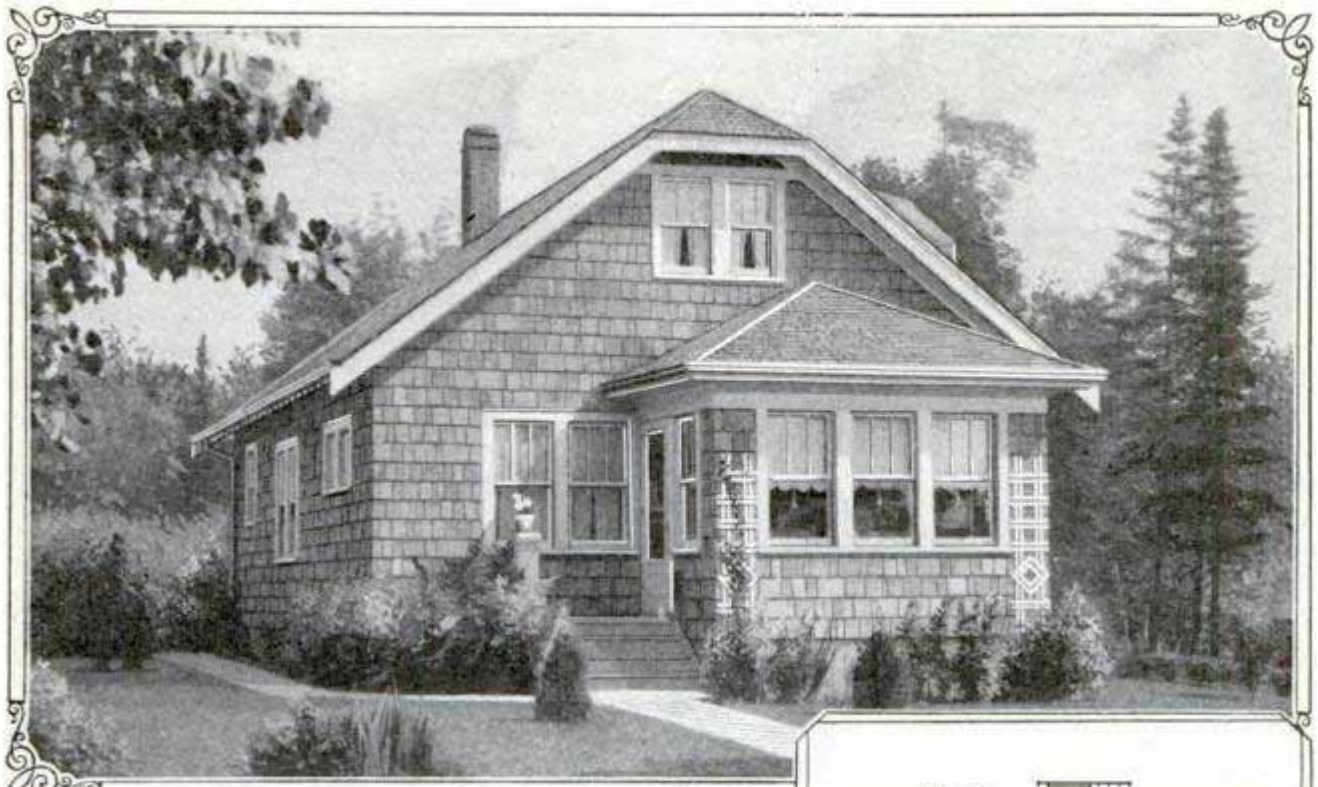

# Another Way to Save Money

Copyright, Popular Mechanics

Plan No. 5-W-11

A PENNY saved may be a dollar earned, if you save enough of them. Four hundred and fifty thousand pennies are tied up in a \$4,500 house. If, on the hundreds of items that go into the construction of a new house, you can save a penny here and a penny there, you may be able to roll up enough dollars to pay off a first mortgage in one-half the time it normally requires. It's worth figuring about.

Your house built on a "split-penny" plan need not be cheap or inferior in quality. Not at all. Splitting pennies merely means watching out, with an eagle eye, for the little things, the details, and taking advantage of the latest methods to save pennies.

For example, as many as fifty different tradesmen may profit on a little house costing \$4,500, to say noth-

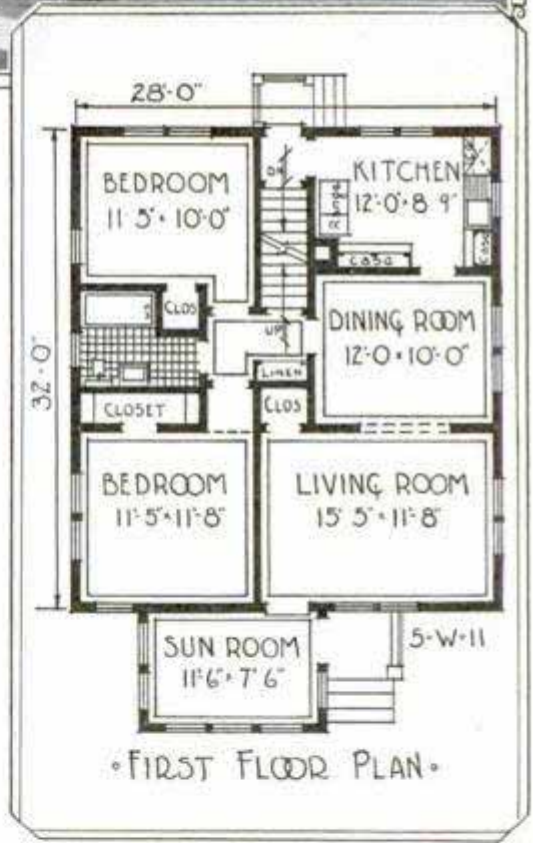

### HOW TO GET A BLUEPRINT

To help our readers get started on one of life's most glorious experiences—building and owning a home—Popular Mechanics Magazine will supply readers a one-sheet blueprint of any house appearing in the magazine for \$1. This blueprint does away with the necessity of first purchasing a complete set of plans to find out whether you can afford to build. It contains floor plans, elevations, a section detail, size of joists, studs, etc., and also a brief specification. Submit it to tradesmen and dealers for building estimates.

ing of the profit you pay dealers from whom you buy materials and the added profit to the manufacturers who fabricate the raw products. Five dollars saved on each one of these transactions amounts to \$250

earned That's the price of a pretty good heating plant. An easy way to save money is to use "stock" materials. What is meant by stock materials? Just this: In

the early days of hand labor, only the houses of the wealthy were equipped with fine millwork, beautiful moldings, expertly finished trim, etc. Hand labor was expensive and still is. Today, however, machines have been invented that produce, with the precision and skill of human hands, as finely wrought stock millwork and interior details as the most discriminating person may

ask for. And all within reach of the average pocketbook. Volume production in millwork, like volume production in automobiles, places at your disposal fine quality, good workmanship and, in many cases, super-finish at extremely low cost. You may obtain from most any lumber dealer reproductions of the world's most famous masterpieces in entrance doors, fireplace mantels, etc., at what may be truthfully called "five and dime" prices, compared with the price for hand labor.

A recent reproduction, by machine, of a famous colonial mantelpiece in a century-old Virginia mansion may be purchased from dealers' stocks, ready to use, at around \$30. It looks, for all the world, like a \$200 or \$300 job. This is typical of what many manufacturers are doing with the machine, to help you keep down cost and at the same time give you style, quality, fine finish and good workmanship.

As an added means of penny splitting toward dollar saving, why not design your house to fit stock-dimension lumber and other stock structural members carried in every dealer's warehouse. By so doing, you can eliminate much waste of lumber. This may not seem worth while, but it amounts to considerable money. Anything that cuts out waste and cuts down

labor means just that much money saved. So, watch out, when you plan your house, to see that ceiling heights, finish trim, millwork, in fact everything possible, tune in,

so to speak, with what's waiting for you, ready to use.

The bungalow illustrated this month is a stock job. There's not an item here that cannot be delivered almost instantly from dealers' yards and store-rooms. This is a lumber house with sidewalls and roof laid in red-cedar edge-grain shingles. Shingles, by the way, not only give excellent service but, when used over frame construction

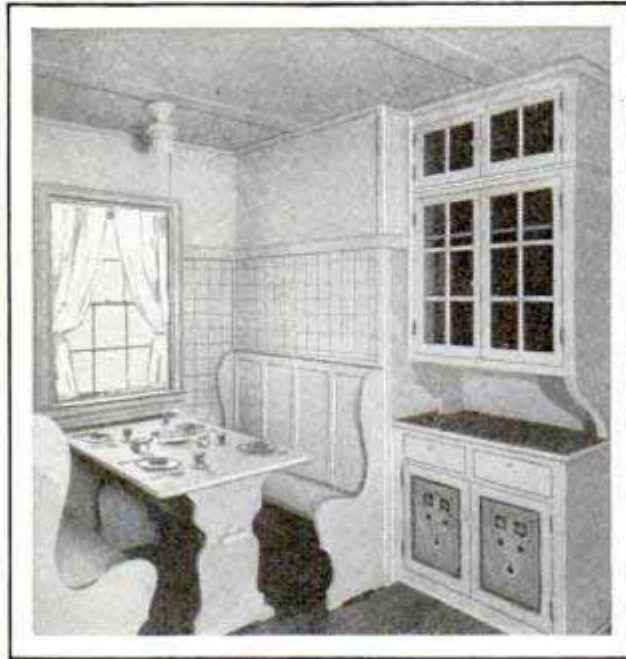

Courtesy Curtis Companies Service Bureau

for walls and roof, produce about as low-cost a home as you can build.

You have complete bungalow service on the first floor—including two sleeping rooms—with space above for more bedrooms and storage. If you want to rent a room, this is possible by cutting a door into the front bedroom, to open onto the sun porch. The sun porch is a feature. There's a full basement and the house is fully insulated, sidewalls and ceilings.

The choice of an insulation material depends on the climate and the amount of money you want to spend. There are a dozen or more brands of good insulations on the market, in blanket, board and poured forms. The cost depends largely on the thickness of the insulation.

In round numbers, this is a \$5,000 house. It may cost less and perhaps more, depending upon where you build it and the materials you select. Stick to stock materials. They save money. And, if possible, take a hand at the job yourself.

#### PLAN BOOK FOR READERS

**A NEW BUNGALOW BOOK:** Sixteen selected low-cost bungalows in popular styles, at prices ranging from \$5,000 down to \$2,000. Each house fully described and illustrated. Send ten cents in stamps to cover mailing.

Colonial Fireplace & Woodwork Road Chicago  
4603 W. Roosevelt



A  
TOOL



*that can't be too good*



**Y**OU give a screw-driver more abuse than any other tool. Pay a few cents more: get a genuine "Yankee"—a screw-driver you can depend on like a friend.

A tool with balance and comfort grip that make work easier. And with a blade that can't be loosened in handle, and won't twist, crack, break, or bend on the edge.

"Yankee" blades are forged from special steel. They are tempered to stand up in the work you expect a screw-driver to do.

And every blade, of every "Yankee" Screw-driver, is individually tested and twice tested at factory before delivery to dealer for you.

In your interest, "Yankee" toolmakers insist that a screw-driver can't be made too good! Ask dealer for "Yankee." Identified by name on tool.

#### "Yankee" Plain Screw-Drivers

No. 90.—Standard Style: Fifteen sizes, 1½" to 30" blades. Price for 5" blade, 50c; 6", 55c; 7", 65c; 8", 75c; 10", 95c.

No. 95.—Cabinet Style: Eleven sizes, 2½" to 15½" blades. 4½" blade, 40c; 5½", 45c; 6½", 50c; 7½", 60c; 8½", 65c.

# "YANKEE" TOOLS

----- TO HELP YOU MAKE THINGS -----



#### "Yankee" Vise No. 1993

Removable from base for holding work on drill-press or other machines. True all sides. Jaws open, 3½ inches; price, \$9.90. Other sizes, \$3.75 up.

NORTH BROS. MFG. CO., Lehigh Avenue, Philadelphia, U. S. A.

I want to know about easier and quicker ways to do work: Send me "Yankee" Tool Book, with action pictures showing new Two-speed (11-inch) Hand Drills, new Bit Braces with famous "Yankee" Ratchet, Quick-Return Spiral Screw-drivers, Adjustable Tension Push Drills, Ratchet Breast, Hand and Chain Drills, Automatic Bench Drills, Ratchet Tap Wrenches, Removable-base Vises, Etc.

Your Name .....

Address .....



(pm)

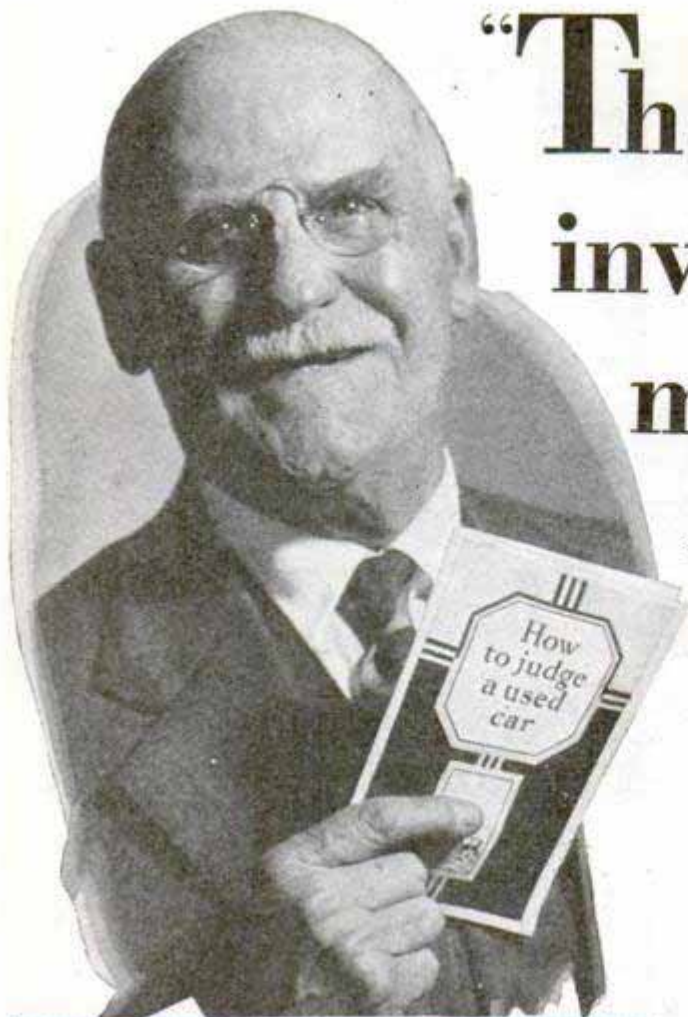

# "The best-paying investment I ever made—a 2¢ stamp"

"WHEN I invest hundreds of dollars, I look for a safe seven per cent return on my money. I want dividends, and a minimum of risk. The same thing applied when I decided to buy a car—I wanted dividends in pleasure and trouble-free performance, without too great a risk. I saw this free booklet advertised, "How to Judge a Used Car," and, figuring that I couldn't go wrong for only a 2c stamp, I sent for it. *That 2c stamp has been the best-paying investment I ever made*—because it not only saved me about \$200 on my car's original cost but it told me how to buy a used car wisely!"

You will find the 2c stamp you use to get your free copy of "How to Judge a Used Car" just as good an investment! It tells you trade secrets. It illustrates, in 32 pages of interesting text and pictures, just what to look for in the used car you buy—what speedometer readings mean, how to avoid "orphans," what code prices mean, how to set a fair price on a used car offered by a friend, and a host of other important points in used car buying. Send today for your free copy—spend 2c and avoid \$200 mistakes!

## Pledge to the Public on Used Car Sales

- 1 Every used car is conspicuously marked with its lowest price in plain figures, and that price, just as the price of our new cars, is rigidly maintained.
- 2 All Studebaker automobiles which are sold as CERTIFIED CARS have been properly reconditioned, and carry a 30-day guarantee for replacement of defective parts and free service on adjustments.
- 3 Every purchaser of a used car may drive it for five days, and then, if not satisfied for any reason, turn it back and apply the money paid as a credit on the purchase of any other car in stock—new or used. (It is assumed that the car has not been damaged in the meantime.)

© 1928 The Studebaker Corporation of America

THE STUDEBAKER CORPORATION OF AMERICA  
Dept. 159, South Bend, Indiana  
Please send me copy of "How to Judge a Used Car"

Name .....

Street .....

City..... State.....

# STUDEBAKER

Builder of Champions

# How to Use Your Hack Saws

Told by the Foremost Makers of Metal-Cutting Saws

**I**N this age of metals, Disston maintains its leadership with metal-cutting saws of amazing efficiency. Saws made of Disston Steel, from Disston's own steel furnaces. This great cutting steel has edge-holding qualities that only Disston's 89 years' experience as saw makers and as steel makers can put into steel.

Disston makes not only metal-cutting circular saws from ½ inch to 90 inches in diameter, and machine hack saw blades of Disston High-Speed Steel, but also hack saw blades for your use, in your hand frame.

Ask for "Disston"! Hand Saws, of course; but also Disston Hack Saw Blades.



**A Disston Hack Saw Frame for All-Around Use**

Disston No. 36½ Hack Saw Frame takes all blades from 8 to 12 inches long. Stretchers are reversible for sawing straight or sidewise. Hand hole large and comfortable. Frame, \$2.10.

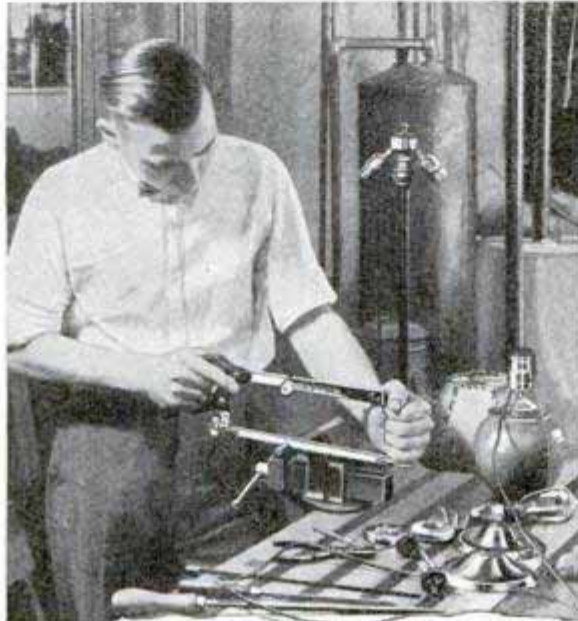

**A Disston Hack Saw Frame for Use in Close Quarters**

Disston No. 200 Hack Saw Frame enables you to cut where wide frames can't get in. Only 1 inch from tooth-edge to inside of back. Takes 8-inch blades. Frame, 70 cents.



**Files for the Metal Worker**

Disston makes all kinds, sizes and styles of files for every purpose. A Disston 8-inch Mill File, bastard cut, is fine for sharpening axes, lawn mowers, garden tools, and general work in the home and shop. Excellent for finishing metal surfaces. 25 cents each.

**U**SE Disston blades, which cut easier and stay sharp longer. Blades with 18 teeth to inch (regular), are best for general use; those with 24 teeth (medium), are best for cutting 16- to 20-gauge sheet metal or tubing, brass or copper, and those with 32 teeth (fine), are best for cutting thinner tubing and sheet metal.

Strain blade *tightly* in frame. Cut slowly—not more than 60 strokes per minute for best results. Put pressure on forward stroke; lift slightly on return stroke. Make each stroke do its work. Cut straight; do not bend blade. Bending, looseness of blade, and sawing thin metal with teeth too coarse for the job, all result in broken blades.

Disston Hack Saw Blades are made of Disston Steel. The teeth are milled at a special angle, to give them the greatest cutting speed and durability. Every third tooth is a "cleaner" tooth, to carry chips out of the cut and save the cutting edges.

Disston regular *All-Hard* (Chromol) Blades are suitable for general use. Disston *Flexible* (Duralflex) Blades are preferred where cutting is done in awkward positions, or in unstable material, such as flexible conduit, or where there is danger of breaking All-Hard blades.

**Disston All-Hard or Flexible Hack Saw Blades,**  
8", 60c doz.; 10", 65c doz.; 12", 75c doz.

Good hardware merchants everywhere sell Disston Hack Saw Blades and Disston Hack Saw Frames.

## DISSTON

Makers of "THE SAW MOST CARPENTERS USE"

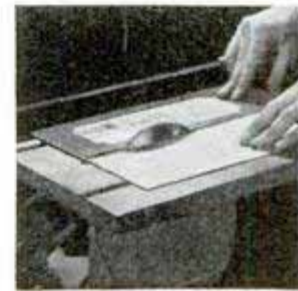

**For Cutting Soft Metals**

You can use a Disston Metal-Slitting Saw on your power outfit. Cuts sheet brass, zinc, copper, etc. Disston makes the most efficient metal-cutting circular saws of all types. Write for information on Disston Metal Cutting Saws for any purpose.

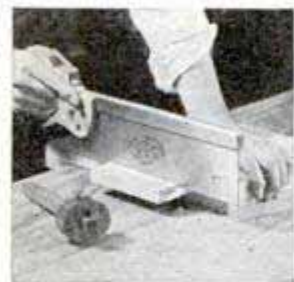

**Handiest of All Small Saws**

The Back Saw, with fine teeth and stiff back, enables you to do smooth, accurate cutting of mitres, grooves, etc., for making furniture, picture frames, etc. Disston No. 4, 12-inch size, 3 inches under back, 14-point, costs \$3.00.



**"The Saw Most Carpenters Use"**

The two handiest saws for the home workshop are the 26-inch 8-point for cross-cutting, and the 26-inch 5½-point for ripping. You will need these on almost every job. The popular "D-8" Lightweight costs \$3.45.



Every saw user will enjoy reading "The Disston Saw, Tool and File Book," an illustrated manual on the selection, care and use of tools. It tells how to file and set saws and contains much other helpful information. Sent free. Use the coupon, or write for it.



Henry Disston & Sons, Inc., Philadelphia, U. S. A.  
(In Canada, Henry Disston & Sons, Ltd., Toronto)  
Please send me "The Disston Saw, Tool and File Book."

Name and Address.....

A smooth shave  
*depends upon the correct stroke*  
 Which do you use...?

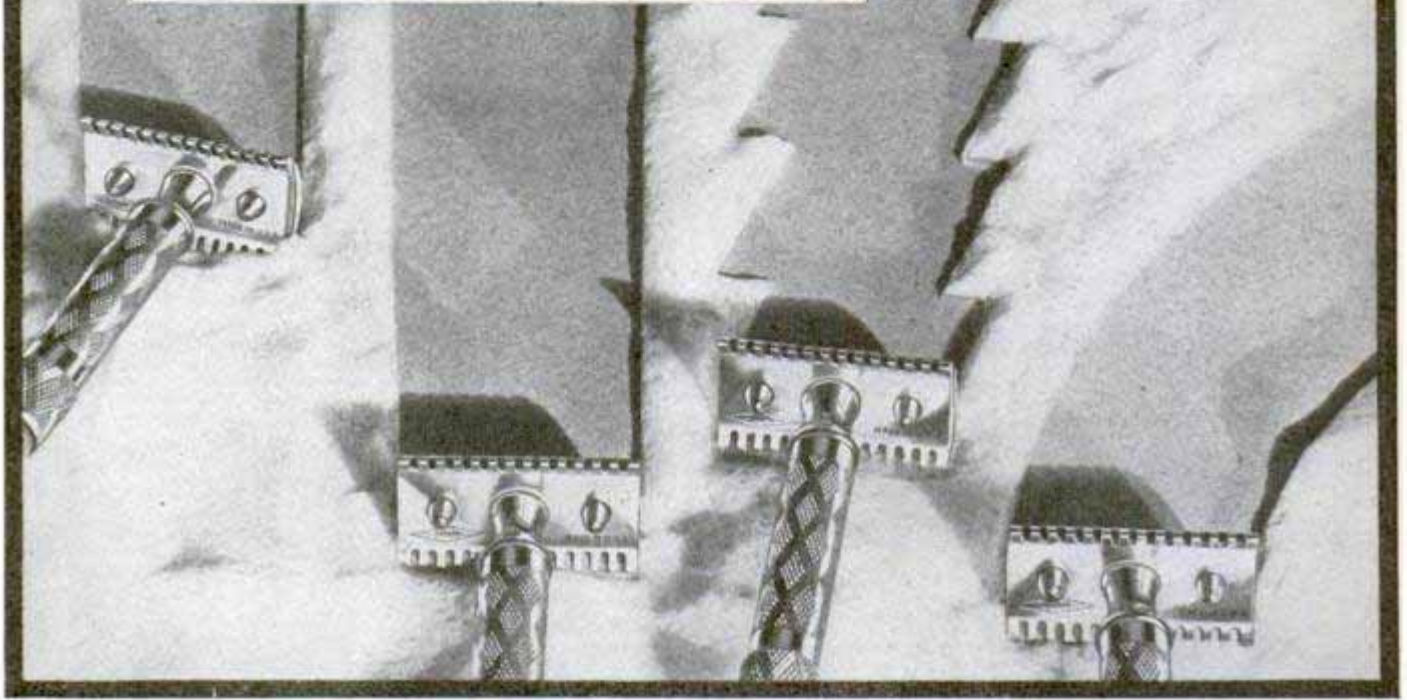

**E**IGHT out of ten American men shave with a Gillette Razor, and probably not more than half of them use the correct diagonal stroke shown at the extreme left.

But they all judge a shave on its face value, and they find the value *there* in every Gillette Blade, no matter what stroke they happen to use. Gillette has put it there — designed the blade to meet all possible changing conditions.

In the past ten years the Gillette plant has invested

\$12,000,000 in blade improvements alone. Today the work is done by amazingly skilful machines — adjusted to one ten-thousandth of an inch. And the product of these ma-

chines is tested and re-tested by a long line of inspectors who get a bonus for every blade they discard.

Tomorrow morning slip a fresh Gillette Blade into its holder. Lather well and use the correct diagonal stroke. Let the world's best blade in the world's best razor give you the best of all possible shaves. Gillette Safety Razor Co., Boston, U. S. A.

*King C. Gillette*



**T**HE only individual in history, ancient or modern, whose picture and signature are found in every city and town, in every country in the world, is King C. Gillette. This picture and signature are universal sign-language for a perfect shave.



**Gillette**

# WONDERFUL SPORT!

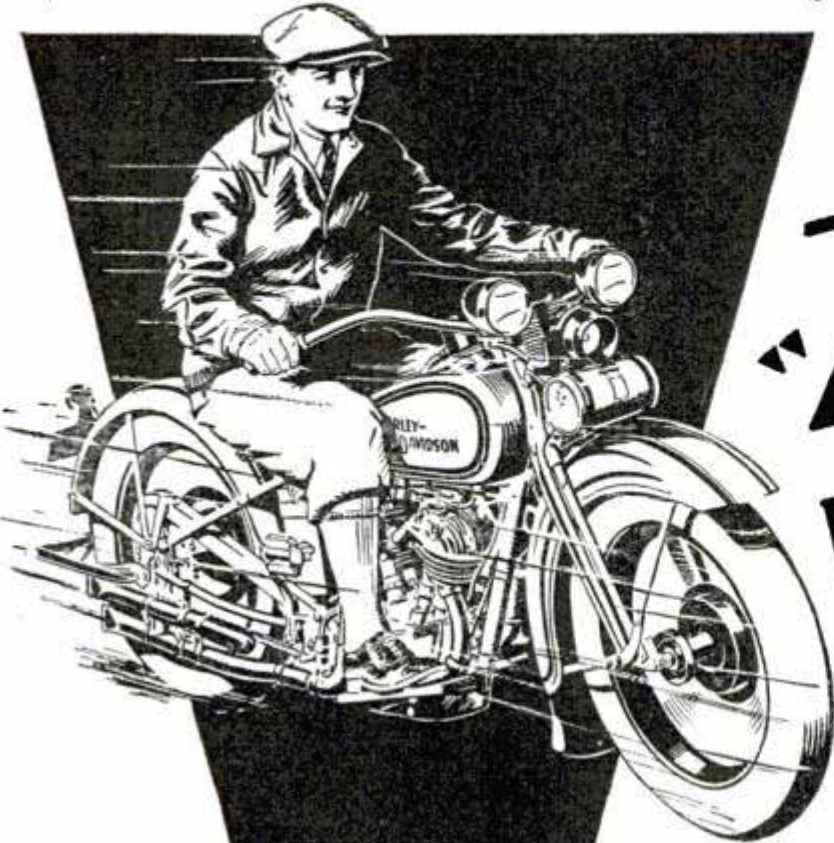

*- it's the*  
**"45" twin**  
**1930 model**

**S**WING into the comfortable saddle of this motorcycle—let its quiet, powerful motor whisk you over hills and down beckoning roads—feel its eager response to throttle and brakes, the perfect balance of its low riding position, the restful comfort of its springing and its big, 4-inch balloon tires. What a motorcycle!

Motorcycling is the Sport of a Thousand Thrills—and you enjoy it at its best with this latest "45" Twin. Wonderful performance, and running costs ridiculously low—barely 2¢ per mile!

*See the 1930 models at your local dealer's. Ask about his Pay-As-You-Ride Plan.*

**(6)**

## Important Improvements

Super-strength frame — drop forged fork. Drop-center rims—4" balloon tires. Improved clutch—long lived—velvety operation. Steering-head lock—thrift-proof. Automatic increase of generator output. Lowered riding position.

# HARLEY-DAVIDSON

**Mail the Coupon**  
 — for literature showing all our 1930 models, Singles, Twins, and Sidecars.

HARLEY-DAVIDSON MOTOR CO., Dept. P., Milwaukee, Wis.  
 Interested in your motorcycles. Send literature.

Name.....

Address.....

My age is  12-15 years  16-19 years  20-30 years  31 years and up. Check your age group.

# Keeping Pace With The Greater Demands *for* Accuracy

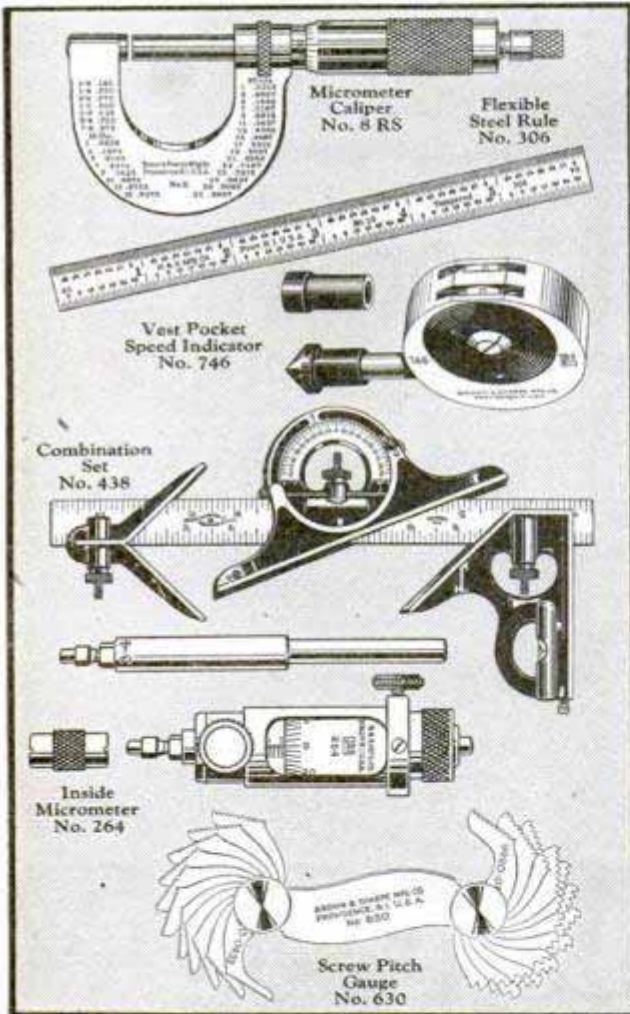

**W**ITH production schedules calling for greater output and, at the same time, standards of inspection becoming more rigid, the use of fine precision tools in industry becomes more important. Mistakes mean confusion all along the line.

It is with a recognition of this dependence on fine tools that more and more skilled mechanics and manufacturers are turning to Brown & Sharpe Tools. They know that the standard of accuracy maintained in Brown & Sharpe Tools is their greatest safeguard for accurate work.

The Brown & Sharpe Planer and Shaper Gauge No. 625 shown above is an exceptionally convenient tool for setting up cutting tools quickly and accurately. It is but one of over 2300 tools described in the new Small Tool Catalog No. 31. Your hardware dealer will be glad to give you a copy or you can get one from us. Address Dept. P.M., Brown & Sharpe Mfg. Co., Providence, R. I., U. S. A.



"WORLD'S STANDARD OF ACCURACY"

# BROWN & SHARPE TOOLS



# 3 Tons Heats 8 Rooms

"My furnace has been in use for 3 years and our eight room house is always warm, including floors. I used 3 tons of hard coal last winter to heat our eight room house. You can

#### "Heats as Good as Ever!"

In regard to the Bulldog Furnace: Our furnace has been in use 6 years and it heats as good as ever.—A. Cleopfil, R.F.D. No. 1, Rock Port, Mo.

#### Fuel Saved Pays for Furnace

"This is the second winter I have used the Bulldog and the savings in my coal bills have paid for my furnace!" Milton E. Spain, Casey, Ia.

#### Heats 8 Rooms Instead of One

"My 8 room house has 7 windows on the Northwest side downstairs, so it takes SOME heat! The Bulldog doesn't burn very much more coal than my old stove used to, and it heats the whole house, where my stove would heat only the one room it was in."

Ernest H. Marzoll,  
72 South St., Milford, N. H.

use anything that will burn in the Bulldog. We often warm and remove the dampness during a stormy period in summer with waste paper." Leon F. Coons, Ellenville, N. Y.

#### Cuts Coal Bills in Half

"I had a hot air furnace in our 7-room house before I got the Bulldog and our house was always cold. With the Bulldog it only takes *half* as much coal and we had weather below zero, and the house was nice and warm in the morning when we got up. We never have the draft on more than half an hour at a time, and it has the place red hot. It is easy to regulate and keeps the fire all day in mild weather."

Jess T. Conrad,  
1211 W. Arch St. Shamokin, Pa.

## No Money Down!

*Small monthly payments. Installed almost as easily as a cook stove!*

The Bulldog is sent to you for *free inspection*. Then, if satisfied, you make only small monthly payments at our remarkably low price. Write today! *Don't miss this chance to cut down your fuel bills! Install a Bulldog Furnace.* It comes to you completely erected—goes through any door—fits any height of basement—and you install it yourself in less than two hours! In fact, you can install the Bulldog just about as easily as

a kitchen cook stove. *Don't put up with the old fashioned stove heat or some outworn furnace—when you can so easily get the greatest advance in scientific heating at an astonishingly low price.* The Bulldog burns almost *any* kind of fuel, from hard coal to cheap screenings. Keeps a wood fire over night. We have factory connections in both east and west and ship from the nearest point.

## Send for Free Book

Learn how to have all the heat you want—where you want it—and save money! Remember the Bulldog is *different*—and *better!* Complete combustion of gases *save 25%* of your fuel bill. Exclusive Gable-Top Radiator receives *all* the direct rays of the fire. Exclusive oblong fire-pot is not only ideal for coal, but enables you to keep a wood fire over night. Remember—the Bulldog is sent for *free inspection*—then small monthly payments at an amazingly low price! Send for Free Book TODAY!

**Bulldog Furnace Co.,** 19th and California Avenue,  
Dept. 13-56 Chicago, Ill.

**Bulldog Furnace Co.,**  
19th and California Ave., Dept. 13-56, Chicago  
Without obligating me, please send me your free catalog and special offer on the Bulldog Furnace.

Have you a basement? Yes  No

Name .....

Street Address .....

Town .....

County ..... State .....

# Sillimanite Is

(Nature's Finest Insulator)

## Your Guarantee of Champion's Superior Performance



**C**HAMPION sillimanite is a rare mineral used exclusively in Champion Spark Plug insulators. Possessed of a natural high resistance to electric, heat, and mechanical shock, it is ideally adapted to withstand the ravages of combustion, intense pressures and temperatures of modern engines. Sillimanite insures the motorist of the full, even production of power which he expects from modern engines. With such obvious superiorities Champion Spark Plugs excel and outsell throughout the world.

# CHAMPION

## Spark Plugs

TOLEDO, OHIO

WINDSOR, ONTARIO

**PAINT with ELECTRICITY**

the New and **EASY WAY**

**THE Paint-O-Mister**  
THE EVEN PRESSURE SPRAYING MACHINE

The latest development in an electric cup gun spraying machine — The Paint-O-Mister. Made by the makers of the Atomister. A larger, more powerful, more durable machine. Maintains an air pressure of 25 to 30 pounds.

Sprays paint, lacquer, varnish, disinfectants, insecticides. For use in the home, factory, garage, dairy, farm, sign shop, boat yard, greenhouse, etc.

Write for Booklet **\$39.50** complete  
At your dealer's — or from us.

**THE ATOMISTER CORPORATION**  
32 Hamilton St., Rahway, N. J.

## FLY THIS ARMY PURSUIT SHIP!

Light and fast, this one-foot model is a realistic copy of a single-seater military pursuit plane. Will rise from ground by own power and fly 60 ft. Can be used indoors or out. Has air service insignia on wings, incabars. Construction set includes ready-made aluminum propeller, shaft, rubber band motor, stream-line wood wheels, pre-cut balsa wing ribs and all other parts, with clear directions. Can be assembled in 3 hours by average 14-year old boy, without tools. Complete set, packed in unbreakable mailing tube, only 75c, postpaid in U. S. Send check or money order today (no stamps). Print address plainly. Satisfaction or money refunded.



**LOGAN TOY WORKS, 35 E. Gay St., COLUMBUS, O.**  
(We cannot make C. O. D. shipments. No retail catalogue issued)

## \$125.00 Four Hours

That's what F. C. Benjamin made selling world's finest driving light for autos. 67,000 beam candle-power—NO GLARE. Low price, big profit. Just awarded Grand Prize, two gold medals, Paris exposition. We want you to sell this light. Write for amazing proposition TO-DAY.

**AERIAL ELECTRIC COMPANY 341 W. Ohio Street CHICAGO, ILL.**

SOLD ON EASY TERMS

## WORKACE Electric WOODWORKER

Complete Outfit Including Planer, Saw, Lathe, Electric Motor and Many Useful Attachments



Fast—Accurate—Complete

Price complete, \$89.00. Easy Terms.  
Write for complete information.

**J. D. Wallace & Co., 2845 Adams St., Chicago**  
11 W. 42nd St., New York 268 Market St., San Francisco





**LePage's Third Home Work Shop Book, only 10 cents, Shows How to Make These 20 Projects**

Cape Cod Chest of Drawers, Alexandria Nest of Tables, Old Salem Ship's Cupboard, Plymouth Built-In China Closet, Lady Washington Sewing Cabinet, Set-Back Book Shelves, Modernistic Desk, Modernistic Table, Modernistic Folding Screen, Modernistic Fire Screen, Chess and Checkers Table, Smoking Table, Caned Side Chair, China or Book Cabinet, Book Trough and Magazine Stand, Magazine Carrier, Vanity Case, Book Stand, Fernery Stand and Folding Sewing Screen.

**Job Plans 10 cents each. Order by number as indicated in Coupon.**

- 16 Sheraton Writing Desk
- 17 Sheraton Desk Chair
- 18 Colonial Hanging Book Shelves
- 19 Smoking and Reading Cabinet
- 20 Colonial Mirror
- 21 Tea Wagon
- 22 Telephone Cabinet
- 23 Stool for Telephone Cabinet
- 24 Manual Training Work Bench
- 25 Home Worker's Tool Cabinet
- 26 Spanish Galleon
- 27 Vanity Table

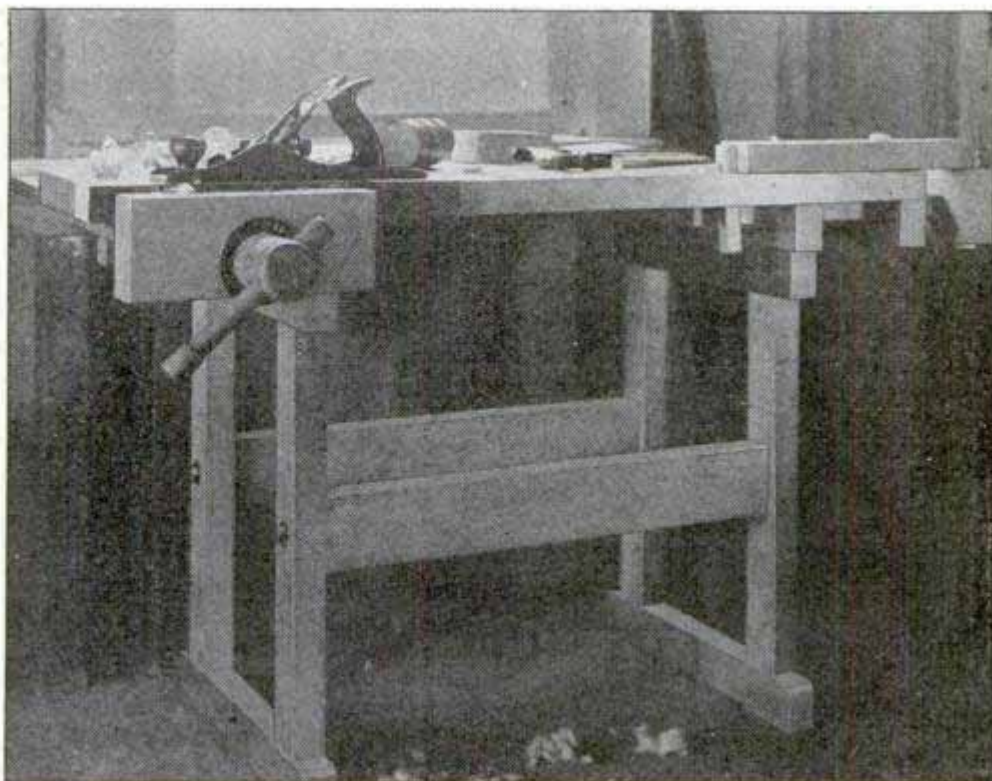

## A Work Bench

**You can easily make yourself**

*LePage's Complete Plans and Instructions Show You How*

What you have always wanted for your home work shop, a real work bench, in place of a makeshift table. Any man handy with tools can easily make this practical, substantial bench with the help of LePage's step-by-step printed directions and complete dimension drawings. It is an excellent introduction to the eleven other projects you can make with LePage's Job Plans and 20 other projects with LePage's Third Home Work Shop Book.

**Expert Instruction**

You have expert instruction to guide you. The designs, dimension drawings, photographs, step-by-step directions and the actual furniture itself were made by William W. Klenke, Instructor in Woodworking, Central Commercial and Manual Training High School, Newark, New Jersey. His experience as an expert gives assurance that each project and the directions

for making it are thoroughly practical.

To make the Work Bench as shown in the illustration, order LePage's Job Plan No. 24 at 10 cents. Look over the contents of LePage's book and the Job Plans available as shown in the column at the left. The price of the book is 10 cents. The Job Plans are 10 cents each and are for projects requiring more elaborate instructions than those shown in the Book. In all cases the instruction consists in printed step-by-step directions, dimension drawings or full-size patterns, and a photograph of the finished article.

**Send 10 cents for LePage's Third Home Work Shop Book**

Simply use the coupon below, sending it to us with 10 cents in coin or stamps, and we will at once send you a copy of this latest LePage's Book, postage paid.

LEPAGE'S CRAFT LEAGUE  
721 Essex Ave., Gloucester, Mass.

Gentlemen: Enclosed please find 10 cents (coin or stamps) in payment for LePage's New Third Home Work Shop Book. Please send a copy of this book to:

Name.....

Street.....

City..... State.....

Please also send the following Job Plans ..... (indicate by number those you want. See column at left), for each of which I enclose an additional 10 cents.

**Mail**

**This**

**Coupon**

**LE PAGE'S  
GLUE**

HANDIEST TOOL IN YOUR WORK SHOP

# Let GY-RO Wash and Polish Your Car —In One Operation!

Nothing has yet been invented to duplicate the performance of GY-RO WHIRL-O. It not only washes and polishes an auto in fifteen minutes without splash or spray, but it does the job more thoroughly than anything else. All you have to do is attach GY-RO to any ordinary hose and move it over the car. You don't have to dress for the job, either. GY-RO keeps the water on the car, where it belongs.

Water pressure revolves center brush



**No Water Runs Down the Handle!  
Cleans Without Scratching the Finish!  
One Brush Will Last the Life of Your Car—and longer.**

**Washes and Polishes at the Same Time!**

**GY-RO Also Cleans Screens, Outside Woodwork and Windows Perfectly**

We tell you frankly that GY-RO is easy to sell; and we can therefore offer salesmen a rare opportunity to make money handling this remarkable time and money

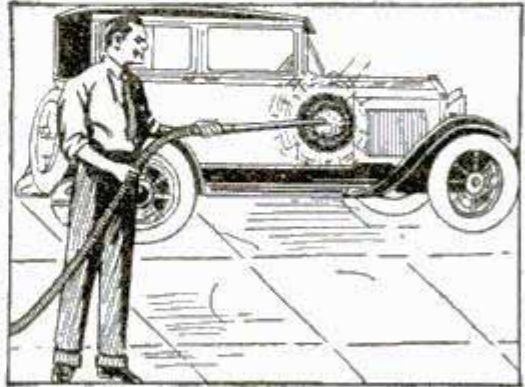

saver. We help you. We tell you how to sell it. You are just bound to take orders for GY-RO. We know this because men who never sold anything in their lives are sending in orders for 15 to 100 brushes. Your profit is \$1.31 to \$1.88 on each brush, depending on the quantity ordered. Get into this profitable business. The retail price is \$3.75. Send the coupon for all the facts. Better still for you, send \$3.75 (M. O.) for one brush and begin taking orders right away. You can't lose a cent. Your money will be refunded if you are not satisfied.

**Gyro Brush Co.,  
Ampere, N. J.**  
Gentlemen: Please send me a GY-RO WHIRL-O brush. I enclose \$3.75. M. O.  I am interested in your special offer to salesmen. Please send me full information.  
 Send me a GY-RO brush  
C. O. D.  
Name.....  
Address.....  
City..... State.....

**Gyro Brush Co., Ampere, N. J.**

**Oh, Boy!  
Win \$50**

**Building This Car from our PLANS!**

**40 Miles per Hour**

Any boy can build this car from our easy plans. Tread 36" wheel base 75". Send 50c today for detailed building plans, simplified so you can easily build this car. Also full information of prize contest. Five grand prizes. First prize \$50. Hurry. Write today.

**SYCO SALES CO., 1524 Fernwood, Toledo, Ohio**

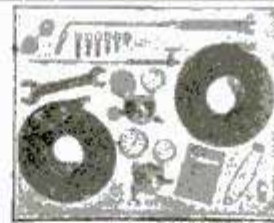

- Why Not Start Welding Shop Of Your Own?**
- Welding Outfits ..... \$25.00 Up
  - Lead Burning Outfits ..... 18.00 Up
  - Soldering Outfits ..... 8.00
  - Paint Sprayers ..... 14.00 Up
  - Regulators and Gauges ..... 9.50 Up
  - Lead Burning Torches ..... 6.00 Up
  - Welding Torches ..... 10.50 Up
  - Cutting Torches ..... 30.00 Up

Write for catalog—also our payment plan.

**SUPERIOR OXY-ACETYLENE MACH. CO., P. O. Box 285, Hamilton, Ohio**

**For Any INSIDE or OUTSIDE MEASURE**

Every inside measurement at a glance. Just slide out the Master till it reaches from stop to stop. (Runs out like tape—does not fold.) Exact measure figured for you. No guessing. Quick results. Other side for outside measure. Looks rigid in use. Ask Dealer, or send 20c each lineal foot.

**MASTER INTERLOX SLIDE RULE**



**MASTER RULE MFG. CO., INC. 821 East 136th St., N. Y. C.**  
DEALERS AND AGENTS WANTED

**LOST!  
AUTO LICENSE  
PLATE. FINDER  
PLEASE RETURN**

**This Never Happens IF You Use the E-Z ON-OFF LICENSE CLAMPS**

Made of high-tension spring steel. Vise-like grip. Easy to put on (snaps into place in a second). Easy to take off when changing plates. Replaces bent, rusty nuts, bolts and hand screws. Can't rust tight or rattle loose. Holds plates securely. Heavy nickel plate finish. Outlasts life of car. Send 25c for set of 4. (2 for each license plate.)

**The DILCAP CORPORATION  
Comstock Bldg. Port Chester, N. Y.**

Write for special agent's proposition—big profits! Every car owner and dealer your prospect. Millions of cars on the road today need the E-Z ON-OFF Clamps.

**HOMES!  
15 Years to Pay**

**Buy Direct from Mill!**

Get FREE Book 100 HOME PLANS MATERIAL PLAN-CUT. EASY TO BUILD!  
**GORDON-VAN TINE, 1366 Case St., Davenport, Ia.**

**AUTOMATIC WINDOW WASHER**  
Price \$1.95



**Washes, Cleans, Dries Polishes in One Quick Operation**

Amazing new invention. CARRIES OWN WATER SUPPLY! Eliminates all drudgery and splashing! 5 times as fast as old methods. Patented features: **No pail. No brush. No sponge. No chamois.** Can be used with or without a pole. **\$90-\$150 weekly easy for agents.** Sells on sight. Sensational demonstration! Every housewife, autoist, store-owner a prospect. Write for our **Free Sample Offer** and big money-making proposition. Be first.

**NATIONAL INDUSTRIES, 67 E. Lake St., Dept. 159, Chicago**

# New Model SOUTH BEND LATHES

BACK GEARED SCREW CUTTING LATHES

for the  
**Manufacturing Plant**  
**Tool Room**  
**General Repair Shop**  
**Machine Shop**  
**Service Station**  
**Electrical Shop**  
**Engineering Shop and Laboratory**

Used by  
**Manufacturers of**  
**Automobiles**  
**Electrical Parts**  
**Machinery**  
**Aircraft**  
**Textile Machines and**  
**Government Departments**  
**National and State**

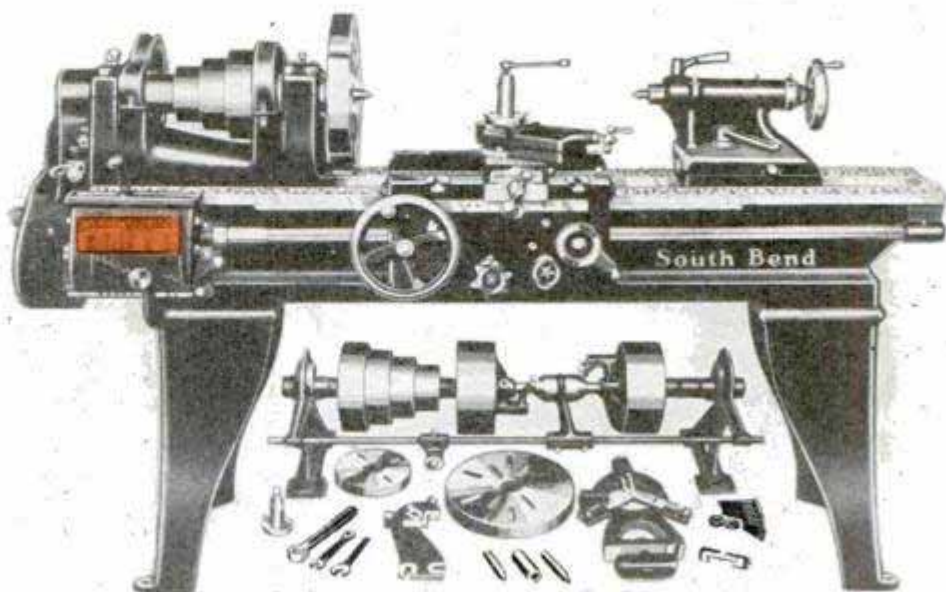

16" x 6' Quick Change Gear New Model South Bend Lathe, \$598

### Prices of Popular Sizes of Quick Change Gear Lathes with Lathe Equipment

Size of Lathe	Shipping Weight	Countershaft Drive	Silent Chain Motor Drive
9" x 3' (Junior Bench Lathe)	375 lbs.	\$169.00	\$273.00
9" x 3'	490 lbs.	294.00	398.00
11" x 4'	725 lbs.	359.00	498.00
13" x 5'	1110 lbs.	443.00	602.00
15" x 6'	1550 lbs.	543.00	720.00
16" x 8'	2035 lbs.	638.00	817.00

## New Free Catalog

Shows 96 Sizes from 9" to 18"

Write or send coupon today for the New South Bend Lathe Catalog. This complete book illustrates and describes 96 sizes and types of Countershaft Driven Lathes, Motor Driven Lathes, Quick Change Gear Lathes, Standard Change Gear Lathes, Tool Room Lathes, Gap Bed Lathes, Brake Drum Lathes and Bench Lathes.

Investigate the New Model Lathe as it has all the latest improvements.

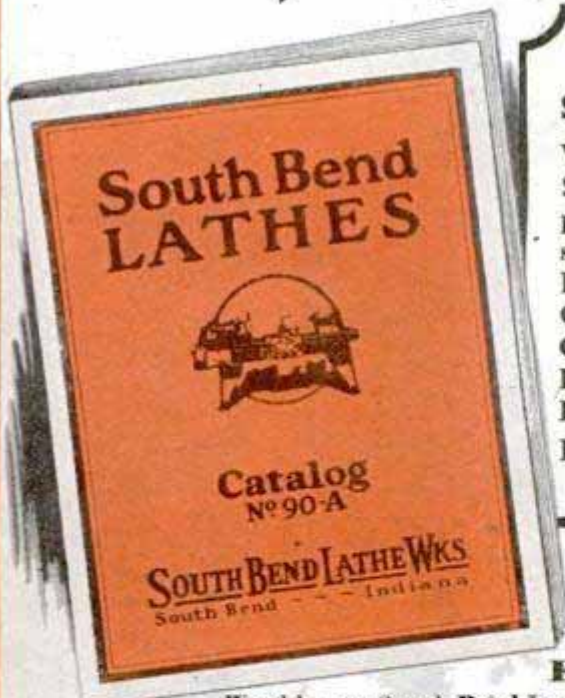

### Easy Payments

We ship any South Bend Lathe immediately upon receipt of only 20 per cent of Catalog Price. Balance in 12 equal monthly payments. Write for Time Payment Catalog.

## SOUTH BEND LATHE WORKS

609 E. Madison St., South Bend, Ind., U.S.A.

Lathe Builders for 23 Years—44,000 Users

SOUTH BEND LATHE WORKS, Ind. U.S.A.  
 609 E. Madison St., South Bend, Ind. U.S.A.  
 Gentlemen: Send free postpaid. ( ) New Lathe Catalog  
 No. 90-A. ( ) Time Payment Catalog.

Name.....  
 Address.....  
 City.....  
 State.....

...on the court it's

# FLASH!

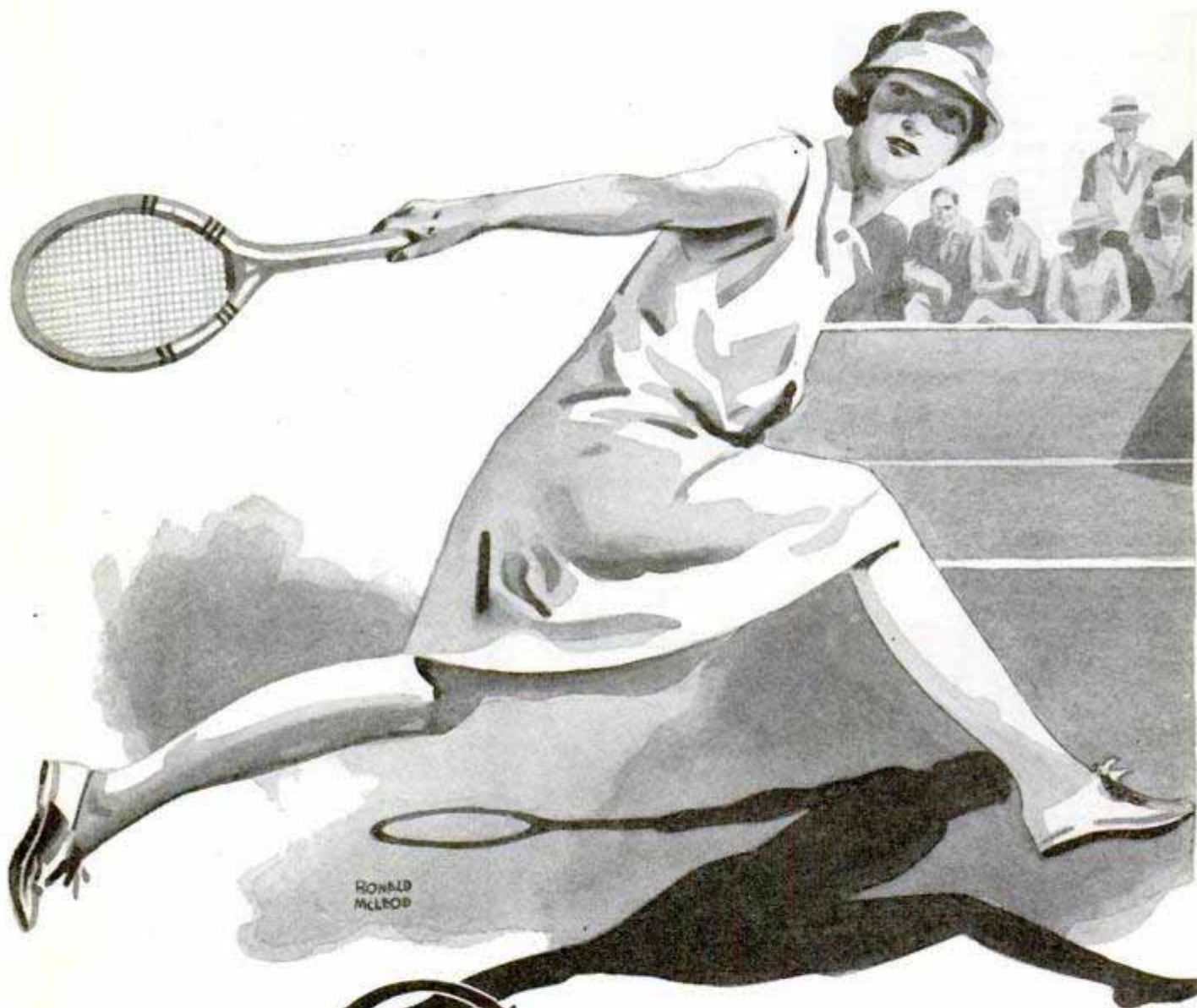

# Chester

FINE TURKISH and DOMESTIC tobaccos,

...in a cigarette it's

# TASTE!



A MAN once had four reasons for not buying a certain article. The first reason was no money—so the other reasons didn't matter.

Likewise, *any* two reasons will do in choosing a cigarette, if taste is *one*!

In other words, taste is what really counts—and taste certainly comes first in Chesterfield. Every tobacco type, every tobacco quality, is chosen for the *taste* it can add . . . Turkish for aroma, Virginia for satisfying character and mildness, Burley for "rounding out" the blend.

The tobaccos in Chesterfield are not only blended, but "cross-blended." This extra step, developed by our own scientists, produces a natural flavor and aroma in Chesterfield, with a freedom from irritation and harshness, that ordinary blending cannot approach.

*Good taste*—could any *ten* other reasons equal that?



TASTE *above everything*

# field

... not only BLENDED but CROSS-BLENDED



MILD... and yet  
THEY SATISFY



## Your Morning Shave Lasts Longer

**T**HERE is a satisfaction when, in the evening, you realize that your morning shave is lasting. This six o'clock satisfaction means you've had a really close shave in the morning. That means a properly moistened beard, and Colgate's guarantees that. Small bubbles—that's the Colgate secret of such efficiency. Small bubbles get down to the base of the beard and moisten it more thoroughly than big, air-filled bubbles.

### Two vital facts—easily proved

The minute you lather up with Colgate's, two things happen: 1. The soap in the lather breaks up the oil film that covers each hair. 2. Billions of tiny, moisture-laden bubbles seep down through your beard... crowd around each whisker... soak it soft with water.

Instantly your beard gets moist... easier to cut and pliable... scientifically softened right down at the base... then your razor can do its best work.

Better grooming—the utmost in shaving comfort. A world of critical men, after various experiments with big-bubble lathers, have found that Colgate's is supreme. You, too, will agree. Let us help you in deciding—note our offer below.



COLGATE, Dept. B-1781, 595 Fifth Avenue, New York  
In Canada, address Colgate, Toronto 8, Ontario  
Please send me, FREE, the seven-day trial tube of Colgate's Rapid Shave Cream; also a sample bottle of "After-Shave."

Name.....  
Address.....

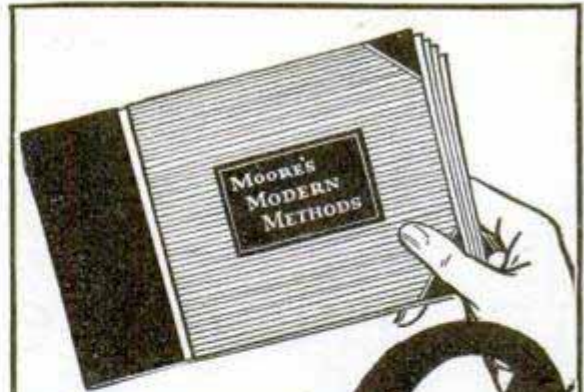

140-Page Book of record-keeping forms, filled in to show you their uses. It answers problems of accounting for office, factory and professions. This Free Book describes and illustrates Moore's Security 4-Post Binders, the simplest, easiest handled on the market. To insert or remove sheets takes but a moment. Low in cost—long in life. Moore's Binders are Different.

Write on your business stationery for this Free Book on up-to-date Loose-Leaf equipment

# Free

A great help toward simple and accurate record-keeping

Write for it today!

**JOHN C. MOORE CORP.** Est. 1839  
6024 STONE STREET ROCHESTER, N. Y.



## BIG MONEY

easily made by floor surfacing contractors who average \$40 per day. The New "American High Production" Machine does the work—makes you the money and builds you a business of your own. No dull seasons—no large capital nor experience required. Complete information free without obligation—write today.

**THE AMERICAN FLOOR SURFACING MACHINE COMPANY**  
523 So. St. Clair St. TOLEDO, OHIO

## ONE-MAN SAW MILL

Makes lumber, shingles, cross ties, fence posts, laths, fruit and vegetable crates and boxes, dimension blanks for furniture, etc. Splits blocks into fir-wood. Needed by farmers, timber owners, contractors. Pays for itself in a week, or on one job. Guaranteed. Sold direct from factory. Write today for Special Offer and Free Book "How To Make Lumber."

**\$39 BRINGS IT TO YOU**  
BELSAW MACHINERY CO.  
BOX 104-C PLEASANT HILL, MO.

## \$5 BRINGS YOU THIS SAW UNIT

**COMPLETE MOTORIZED UNIT**  
GUARANTEED 10 DAYS' FREE Trial  
Send only \$5 and we will ship this big, sturdy, powerful 8" saw with 1/3 H. P. motor. If not entirely satisfied we will take it back and refund your money. If you keep it you can pay for it on convenient monthly terms. An unequalled value. Write for complete details on Lathes, Circular and Jig Saws, Jointers and complete portable workshops.

**MIDLAND APPLIANCE CORPORATION**  
Dept. 910 225 N. Michigan Avenue CHICAGO

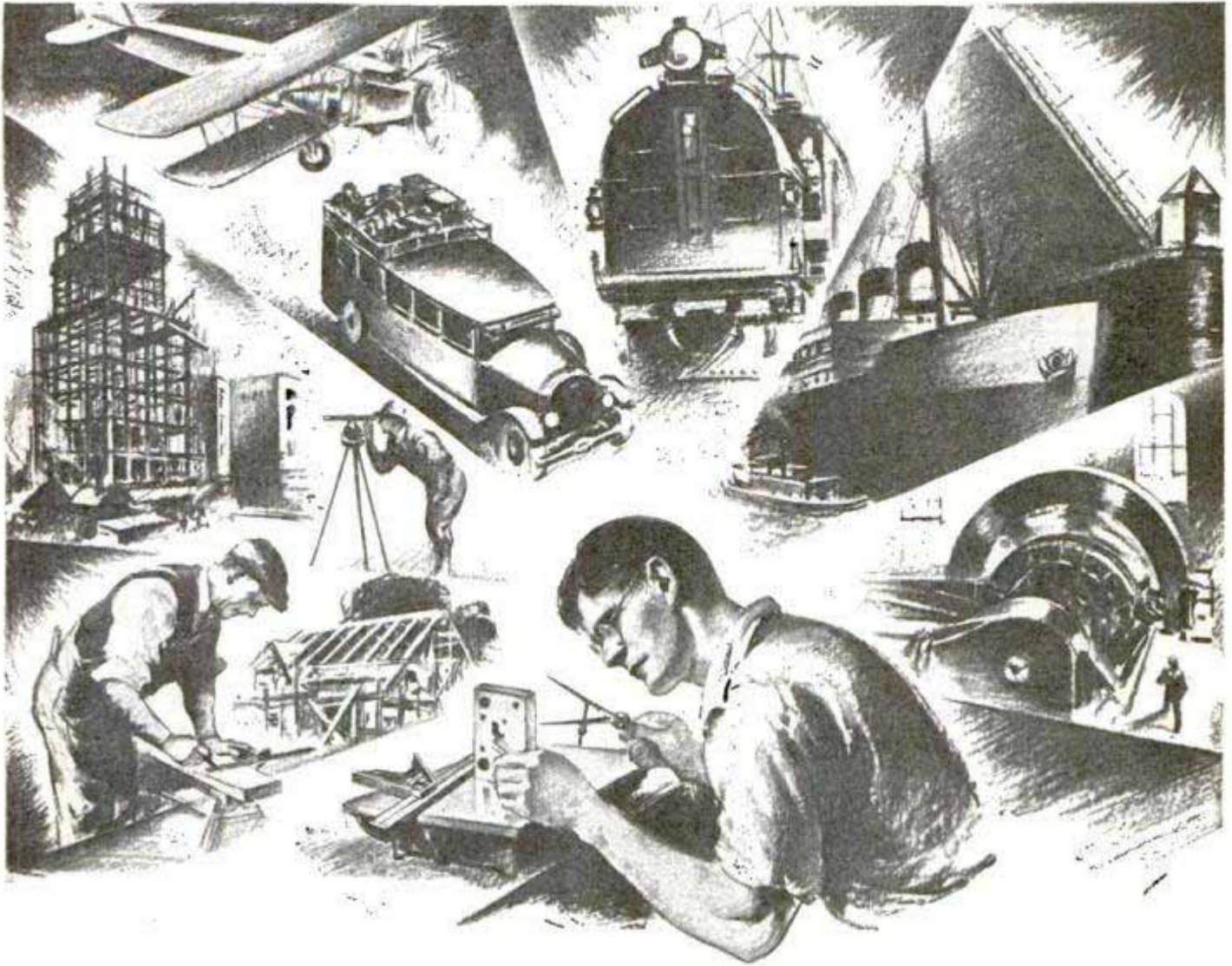

# THEY ALL DEPEND ON STARRETT ACCURACY

You like to do a job right. That's why you'll get a real "kick" out of owning and using Starrett Tools, the tools that are known and accepted the world over as the standard for accuracy.

Your dealer sells Starrett Tools. It pays to

look for "Starrett" or "The L. S. Starrett Co." on every tool you buy.

Let us mail you a free copy of the Starrett Catalog No. 24 "AP" containing full descriptions, illustrations and prices of over 2500 tools, tapes and hack saws.

THE L. S. STARRETT CO.

World's Greatest Toolmakers  
Manufacturers of Hacksaws Unexcelled  
Steel Tapes—Standard for Accuracy  
ATHOL, MASS., U. S. A.



# Use Starrett Tools



**YOU NEED**  
*this*

**Perrott MAT** Only **75¢ each**  
**IN YOUR CAR**  
POSTAGE PREPAID

Stop that hole your heel makes! This special-made Perrott Mat fastens securely and permanently to your rug, preventing that ugly worn spot in a new car, concealing it in an old one. Offered at this low price by mail.

**Extra Strong Wear-Resisting Rubber**

A selected durable rubber composition that withstands the knife edge friction of the heel. Wears like a tire. Will last the life time of a car. Attractively bound with black steel strips—deep set, corrugated, black rubber. Get one for your car.

**Install in Five Minutes**

Attached permanently to floor covering with patented split fasteners. Floor covering can be removed. Mat always in place. Order one on trial.

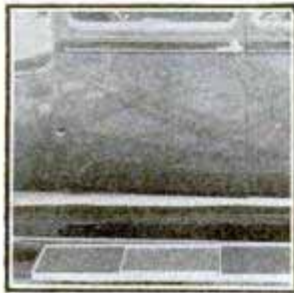

**Prevent That Wear on Your Running Board**

Perrott Running Board Step Mats, bound in bright, non-rusting aluminum—for any car, wood or steel running board. Size 8x13", preventing wear and adding smartness to car. Comes furnished with bolts for quick attaching.

**Same Quality—At Same Price**

Made of same wear-resisting rubber at same low price of 75 cents each. When purchased in set of four, price is \$2.75 complete, postpaid.

**USE THIRTY DAYS—at Our Risk**

Send for Perrott Heel or Running Board Mat today! Install on your car. If after thirty days use you are not completely satisfied return at our expense and money will be refunded without question. You cannot find finer mats for wear or price.

**PERROTT MFG. CO.**  
Beaver Falls, Pa.

**ORDER RIGHT FROM THIS AD**

Perrott Mfg. Co., Dept. P., Beaver Falls, Pa.

- I am enclosing \$.....—send mats checked prepaid.
- Send mats checked C. O. D. (Cost plus postage).
- 1 Perrott Auto Heel Mat..... Price 75c
- 1 Pair Perrott Running Board Step Mats. Price \$1.50
- 1 Set (4) Perrott Running Board Step Mats. Price \$2.75

Name.....

Address.....

... a New **IDEAL** Model Airplane

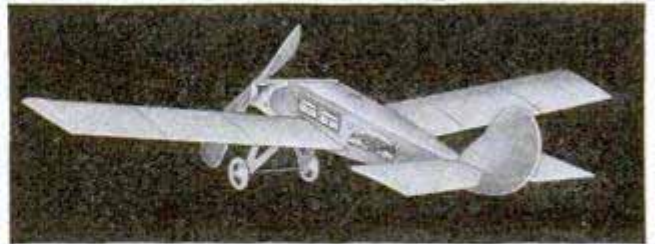

The "American Eagle"  
Wing Span: 28 in. Weight: 3 3/4 oz.

Distinctive in design... new in construction... a light, durable, fast-flying model with IDEAL'S twenty years' experience behind it, and months of dependable performance before it! Wonderful stability in the air, and GUARANTEED to FLY when hand or ground launched. Many new construction features; motor can be wound with winder without removing from fuselage; indestructible landing gear; new type propeller. Construction is easy; also sold completely assembled.

Construction Set—\$2.50 Assembled Model—\$5.00

Sold by Toy, Sporting Goods and Department Stores. Ask for the IDEAL "American Eagle" Model. If unobtainable, order direct. West of Denver, prices 50c higher.

64 pg. Catalog of Models, Parts and Supplies for builders — 5c

**IDEAL AEROPLANE & SUPPLY CO., Inc.**  
26 WEST 19th ST. NEW YORK CITY

**MOTORCYCLES**



Price \$10 and up purchased through our Co-Operative Plan for as low as \$1.00 down and \$1.00 per week  
**Indians Harley-Davidsons Ace Henderson and Clevalands**  
Send ten cents for Bulletin A.  
Motorcycles shipped to all parts of the world

**WALKER-INDIAN CO., 78 Brookline Ave., BOSTON**

**AGENTS** Make big earnings, taking orders for made-to-individual measure suits at less than ready-to-wear prices. Giant Chicago wholesale house makes world's greatest values at \$23.50 and \$29.50. Your profit \$4 and \$5 per sale in advance—we deliver and collect. No experience needed, work full or part time.  
**FREE OUTFIT** Send no deposit. Write for details of our unique money-making plan. Nothing like it ever before offered. Act at once.  
**GENERAL TAILORING CO., DEPT. 1, 529 South Franklin St., Chicago**

**GAS HEAT ANYWHERE**  
**1 1/2¢ an hour**



38 Below Zero is not too cold when you have a **Sunshine Radiant Heater** Makes and burns its own gas. Gives you clean, safe, healthful heat in 60 seconds from cold start. No piping, no installation costs. Easy to carry from room to room while in operation.

**15-Day Trial** We'll send you the **SUNSHINE** on 15-day trial. Use it in your own home or store. Prove to yourself how easy it does away with dirt, ashes, smoke and odor. **Sunshine** is bringing cheery comfort to thousands of homes, now.

**FREE** Startling low offer on new, beautiful 1929 Model—and book, how new heater brings comfort and ease. Get your copy. Write today.  
**SUNSHINE SAFETY LAMP CO.**  
335 Factory Bldg., Kansas City, Mo.

**AGENTS**  
**BIG MONEY—** easy sales on part or full time. **WRITE!**



# MAKE Your Own Summer Furniture

Patented Jan. 2, 1929

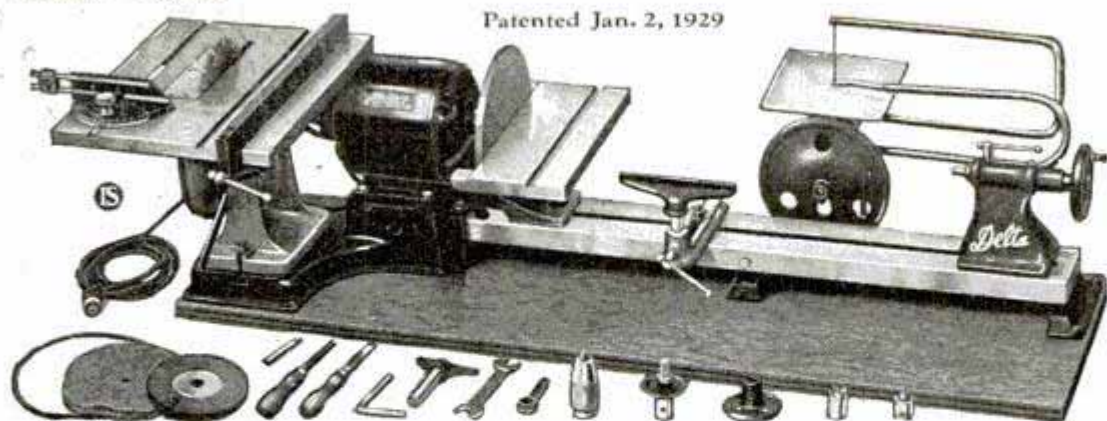

## With This "Delta" Electric Handi-Shop

Do your woodworking quickly, easily with this man-sized, motorized workshop. Efficient, practical in design. Equipped with powerful two-shaft motor that permits carrying of two or three important operations at one time. Numerous other exclusive features that practical craftsmen appreciate. Complete "Delta" Handi-Shop includes all necessary equipment for Circular Sawing, Wood Turning, Scroll Sawing, Sanding, Drilling, Grinding and Buffing. Full instructions and complete set of working blue-prints furnished.

**Blueprints**  
**\$1.00** We will be glad to furnish our complete set of 10 working Blue-prints of Summer Furniture separately upon receipt of \$1.00.

### Sent on 10 Days Trial Easy Terms

Without obligation, you can test the Handi-Shop under actual working conditions for 10 days in your own home. Send at once for FREE illustrated literature, giving complete description of the new 1929 Model "Delta" Handi-Shop, and full details of 10-Day Trial Offer and Easy Payment Plans.

## Delta Specialty Co.

1661-67 Holton St., Milwaukee, Wis. Dept. A.99

Delta Specialty Company, Dept. A.99, 1661-67 Holton St., Milwaukee, Wis.

Please send me, FREE, illustrated literature describing 1929 model "Delta" Handi-Shop. Also details of 10-Day Trial Offer and Easy Payment Plans.  
 I enclose \$1.00 for set of 10 Blue-prints of Summer Furniture.

Name.....

Address.....



## SQUAB BOOK FREE

Breed squabs and make money. Sold by millions at higher prices than chickens. Write at once for free 48 page book beautifully printed in colors telling how to do it. *You will be surprised.*  
 PLYMOUTH ROCK SQUAB CO., 634 H Street, Melrose Highlands, Mass.

Information on any book free. Write Popular Mechanics Press, Chicago, Ill.

## FOY'S BIG PIGEON BOOK

in NATURAL COLORS, a complete guide to successful squab and Poultry Raising. Tells how to feed, breed, grow and make money raising squabs. Quotes low prices.

Write today. FREE.  
 F. FOY Box 18 CLINTON, IOWA



## RAISE CHINCHILLA

AND NEW ZEALAND WHITE FUR RABBITS

Make Big Money We Supply Stock and pay you following prices for all you raise: Chinchillas average \$3 each—New Zealand Whites \$2 each 32-page illustrated book, catalog and contract, also copy of Fur Farming magazine, tells how to raise rabbits for big profits, all for 10c. Address: OUTDOOR ENTERPRISE CO., Box 1021 Holmes Park, Missouri

## Catch Fish!

Eels, Mink, Muskrats with our new folding galvanized STEEL WIRE TRAP. Write for our FREE TRAP OFFER and Bargain Catalog. \$1 Box of our famous Fish Bait FREE to introduce our traps. WALTON SUPPLY CO., 3502 JUNIATA AVE., ST. LOUIS, MO.



# Now! Do Your Own Electric Nickel Plating

Introductory Offer

## Make \$150 to \$500 a Week

ONLY \$6.50 Plus Postage



For Plating Nickel, Brass, Copper, Silver, Gold, etc.

NO EXPERIENCE REQUIRED. DO YOUR OWN Electro-Plating in Your Home, Garage, Office or Place of Business. Electrically Deposit Metal—Nickel, Brass, Copper, Silver, or Gold. You can Successfully do all the plating on your Automobile, Electric Fixtures, Faucets, Spoons, Forks, Chandeliers, Tools, Coffee Urns, Surgical and Dental Instruments, Utensils, large or small, Iron Stoves, Music Instruments; recondition worn plating or plate New Work; do it Instantly without interrupting the Service or without removing the parts to be plated with the

## ALADDIN PORTABLE ELECTRO-PLATER

Simple and Economical to operate. Not a toy, but a practical Plating Outfit with which Perfect and Durable Work can be done. Positively Guaranteed to do as we claim. BE YOUR OWN BOSS! Build up a Profitable Aladdin Electro-Plating Business of your Own. This offers wonderful ECONOMY to users and BIG MONEY-MAKING possibilities to AGENTS. Thousands in Service since 1924. Write for FREE Booklet and Testimonials and 30 Day Trial Offer Today.

P. J. F. BATENBURG, Dept. 109, RACINE, WISCONSIN

—AGENTS— WANTED EVERYWHERE

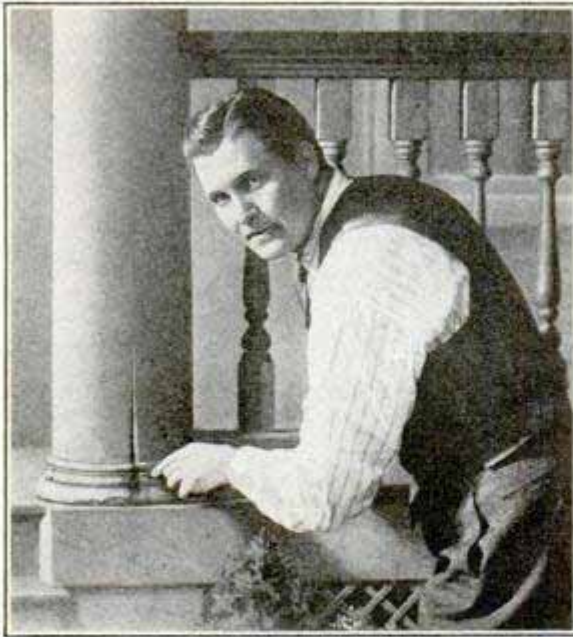

## Where's the can of PLASTIC WOOD?

(Reg. U. S. Pat. Off.)

On porches or other outside woodwork, when rot creeps in or cracks appear, Plastic Wood will save the wood. Scrape away all dirt, rot, and old paint and fill in, or build up, slightly above the surface with Plastic Wood. Then smooth off.

It handles like putty and hardens into wood, that is weatherproof and waterproof, will not disintegrate or split, takes paint, varnish or lacquer perfectly, and adheres firmly to wood, metal, or other material.

### Plastic Wood Solvent

To soften Plastic Wood, to clean it from the hands or tools, and to prevent it from hardening from too frequent opening of the can, use Plastic Wood Solvent. In 25 and 50 cent cans.

Handles		Hardens
Like		Into
Putty		Wood

1 lb. can \$1.00      1/4 lb. can 35 cts.

At Hardware and Paint Stores

ADDISON-LESLIE CO., 419 Bolivar St., Canton, Mass.

# SHOOT THE REAL THING!

Here is that famous genuine pump boys everywhere are turning to. Single stroke outshoots all others. Two to three strokes now give full shooting force. New rear peep sight, leak-proof valves, fully enclosed action. A beauty. Amazing accuracy. Full factory guarantee for one year. Uses regular air rifle lead shot. Photo shows flattening power at 30 ft. on steel target. The biggest money's worth in genuine air rifles ever offered.

**"The Shooter's Art" FREE**  
Tells how to hold, aim and handle rifles; helps you guide others in correct knowledge of guns. Gives facts that make crack shots. Contains safety and common sense instructions every parent and boy should have. Helps to make boys leaders. Your copy free. Write at once!



**\$5** at your dealer's or sent postpaid  
**NEW MODEL "G"**  
**BENJAMIN**  
*Genuine Pump Air Rifle*  
BENJAMIN AIR RIFLE & MFG. CO., 645 N. Broadway, St. Louis, Mo.

## the New Mobiloil

only **\$1.00** DOWN

**10 Day FREE Trial**



You can have a genuine L. C. Smith (the world's only ball bearing typewriter) for \$1 down. Lowest price ever offered! Easiest terms. All the 1928 operating attachments. Re-noved. **GUARANTEED FOR FIVE YEARS.** \$1 down and we ship. No delay. No red tape. 10 day Free Trial. Free Typewriter Course. Tools. Waterproof Cover if you act now. Write for \$1 down offer and free manual.

Smith Typewriter Sales Corp., 119-469 E. Ohio St., Chicago, Ill.

## Build a CLOCK for Pleasure or PROFIT!

**FREE BOOK** shows how YOU can Make Fine Clocks Right at Home

Check full of Clock-Making and Money-Making ideas. Gives full details, descriptions, prices of movements and parts. Write NOW for your copy.

THOUSANDS of men have built our Clocks. For their own use—or to sell at money-making prices. It's easy, fascinating. Only ordinary tools needed. We furnish plans, instructions, parts. Works all assembled, ready to install, as low as \$1.65; others with chimes at all prices. You make the case, or simply assemble knock-down parts. Cash-in on the demand for craftsman-built Mantel Clocks, Banjo Clocks, Grandfather's Clocks. Here's a hobby that PAYS—in pleasure, in ownership and in spare-time or full-time PROFITS!

Write for FREE Catalog and Special Blue Print Offer

**American Chime Clock Company**  
1670-J Ruffner St., Philadelphia, Pa.



# PARKS

WOODWORKING MACHINES

Cabinet Shop  
Special No. 10

**\$290**

With Motor

You ought to have this handy Parks in your shop. Compact, complete machine designed like a big production outfit at 1/2 the cost. Floor space required only 42x72 in. Does any kind of cabinet and joinery work. Write for circular.

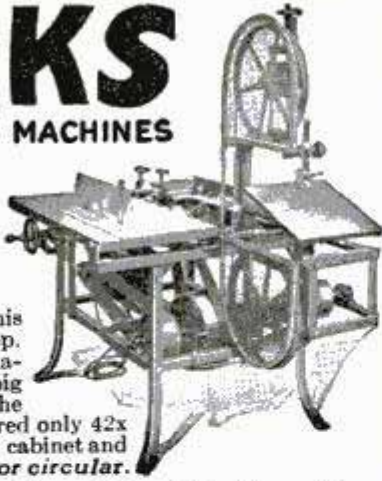

**The Parks Woodworking Machine Co.**

Builders of quality woodworking machines since 1887  
1500-40 Knowlton St. Cincinnati, Ohio

Canadian Factory: 338 Notre Dame East, Montreal



**Engines & Motors**

**Big Catalog No. 30**

Illustrating Electrical, Mechanical and Model Maker's Supplies, Small Steam & Gasoline Engines, Motors, Generators, Lathes, Drill



Presses, Bench and Band Saws, etc., 16-32 & 64 Watt Dyna-Motors, School Projects, Engine Castings, Motor Parts, etc., Books, Blue prints, Brass and Steel Tubing, Gears, Pulleys, Hangers, Experimental Material.

Send for Copy. Mailed anywhere for 10 cents, refunded first order.  
**LOOMIS ELECTRIC & MFG. CO., 2822 N. CALIFORNIA AVE., CHICAGO, ILL.**

**Beautiful HOUSES \$900 and BUNGALOWS**

**CAN BE BUILT FOR AND UP**  
This and many others in my new book. Building Plans for Modern Homes, will save you hundreds of dollars. One of the most complete and comprehensive books of plans ever published by any architect. New edition just off the press. Nearly 600 floor plans and photographs of Colonial homes, bungalows, etc., costing from \$200 up; gives sizes and cost to build. Sent postpaid for \$3.00.



**FREDERICK H. GOWING ARCHITECT**  
101 Tremont St., BOSTON, MASS.

**MAKE YOUR FORD Into The "ACE"**

**\$599 Red-I-Kut life size patterns**  
Class—Snap



**KUEMPEL COMPANY, 112 Kuempel Bldg., GUTTENBERG, IOWA**

Famous sure-fit RED-I-KUT life-size patterns and picture instructions show how you can easily convert your Ford into this **Fast, Saucy, Sport-Car** as thousands have done with easily obtained materials. No need to lay up the car. Makes wonderful 4-passenger car. Send 10c coin for actual photo of sport car and new manual of distinctive sport car patterns from \$3.50 up—"RKO" Steel "Spring-Lo" irons. Tops, Windshields and many speed necessities. **ORDER RIGHT NOW** and get a real thrill.

# MOTORCYCLES

**WE WILL TRUST YOU**  
Pay As Low As \$2.00 per Week  
Hendersons, Harley-Davidsons, Indians  
Slightly used and rebuilt. Hundreds to select from.  
Send 10c for list today.  
**MYEROW BROS. CO., 15 Berkeley St., Boston, Mass., U. S. A.**

**30 Days' Free Trial**  
on all **MEAD Bicycles**  
New Models now ready for delivery direct from our factory. Astonishing new price is and terms. Do not buy until you get them.  
**RIDER AGENTS WANTED** to ride and exhibit sample. Save big money. Many models, styles, wheels, lamps, horns, equipment at half usual prices. Send no money. Write for our marvelous prices and terms.  
**Mead CYCLE COMPANY** Write us today for free catalog  
DEPT. P-109 CHICAGO



# ATKINS SILVER STEEL SAWS

for Your Home Workshop

When you need new saws and saw tools for your home workshop, it will pay you to select "ATKINS." Only in ATKINS Saws do you get the world-famous "Silver Steel" which takes a sharper cutting edge and holds it longer. Ask your Hardware Store, or write us about the ATKINS Saws shown below, for home workshops.

Send Coupon for four Free Booklets on Saws.



**ATKINS No. 401 HAND SAW**  
SHIP POINT  
Finest saw made. Silver Steel, Ship Point blade. Perfection Handle of Rosewood.



**ATKINS CIRCULAR SAWS**  
Circular Rip, Cross-Cut and Miter Saws for fast, accurate work on any machine.



**ATKINS No. 2 BACK SAW**  
Rigid Silver Steel blade. Apple wood handle. 8 to 18 in. blade lengths to do fine work.



**ATKINS GROOVER OR DADO HEADS**  
The simple, easy way to cut smooth, even grooves from 1/8" to 1/2" width.



**ATKINS No. 10 HACKSAW**  
Nickel Steel adjustable frame. Non-breakable or Silver Steel Blue-End Blades.



**ATKINS SAWS FOR METAL CUTTING**  
In many diameters and thicknesses, to do quick metal-cutting.



**ATKINS BAND SAWS**  
Silver Steel Narrow Band Saws for small machines. All lengths and widths. Cut fast, true and easy.

**4 SAW BOOKS FREE**

**\$10** for Best Photo of a Home Workshop!  
**E. C. ATKINS & CO., Est. 1857**  
426 S. Illinois St. Indianapolis, Ind.  
Send "Saws in the Home," "Circular Saws," "Dado Heads," and "Saw Sense"; also information on your offer of \$10 for best home workshop photo.

Name .....

Address .....

My Dealer is .....

# New in Construction Stanley "100 Plus" Chisel

With its Head, Shank, Ferrule and Blade forged complete, the Stanley 100 plus Chisel presents a new idea in construction.

Because there are no mechanical joints, a blow struck on the head is transmitted to the cutting edge with undiminished force.

The handle also is new. It is made of an indestructible rubber composition, a material which possesses unusual resistance to breakage and is not affected by heat or moisture. In appearance it closely resembles highly polished tropical wood.

The combination of these new features in construction produces chisels that will withstand the most severe use.

Ask your hardware dealer to show you the Stanley 100 plus chisel. The Stanley Rule and Level Plant, New Britain, Conn.



## STANLEY TOOLS

The Choice of Most Carpenters



### THE KING OF THEM ALL

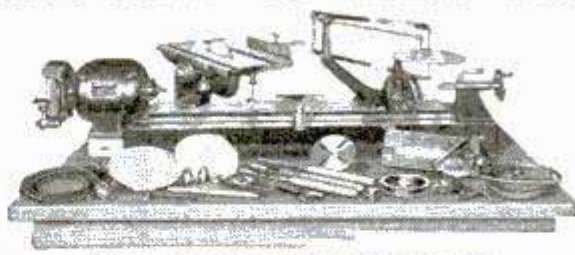

#### AR-CON UTILITOOl

Excels in power, strength and stamina. Send for fully illustrated circular, with prices and terms.

**THE AR-CON TOOL COMPANY**  
500 Fassett Street Toledo, Ohio

### BURN YOUR NAME ON TOOLS

#### WITH THE ARKOGRAF

PROTECT YOUR TOOLS FROM THEFT  
Write with electricity any name or design on the hardest and finest tools and instruments, or any metal, like writing on paper with pen or pencil.  
**Complete Outfit \$3.50**—Prepaid Anywhere  
Interesting illustrated circular free. Write today. Agents wanted.  
ARKOGRAF PEN CO., 1171 E. Stark St., Portland, Oregon



#### The Handy Outfit—Torit No. "23"

Uses acetylene only from a Presto auto tank. Finest thing you ever saw for Radiator and Battery Repairing, Soldering, Light Brazing, Heating, etc. Complete with 4 tips, soldering copper, hose, connections. **PRICE (except tank) \$7.50**

**ST. PAUL WELDING & MFG. CO.**  
177 W. THIRD ST. ST. PAUL, MINN., U. S. A.



### Electric Lights Anywhere

**\$130** 110 volt Electric light plant complete ready to run

Ideal for farms, camps, summer homes. Also runs household appliances and charges radio batteries. With all wiring fixtures and lamps \$147.50. Install it yourself.  
Write for circular.

**D. W. ONAN & SONS**  
21 Royalston Avenue, Minneapolis, Minn.



### SOLDERALL

METAL IN PASTE FORM

The only convenient metal solder  
Every Electrical Connection needs Solderall for perfect reception  
The **SOLDERALL CO., NEWARK, N.J.** **25¢**

## DO YOU

WANT a new business profession of your own, with all the trade you can attend to? Then become a foot correctionist, and in a few weeks earn big income in service fees,—not medical nor chiropody—easy terms for home training, no further capital needed, no goods to buy, no agency. Address

**Stephenson Laboratory, 1 Back Bay, Boston, Mass.**

### Makes Old Ford a Tractor

Now you can convert that old Ford car into a useful farm tractor without altering any Ford parts. We furnish the traction wheels, drive gears and auxiliary axle and mountings, ready to clamp on to the Ford frame. Pulls 16" plow.

Write for Free Particulars.  
**Shaw Mfg. Co., Dept. PM9, Galesburg, Kan.**





## QUICK REPAIRS



From the famous easily-adjusted Crescent Wrench to nimble, clean-cutting pliers there is a Crescent Tool for every repair job.

Crescent Tools are made of special steel, heat-treated and tempered by exclusive Crescent methods that insure perfect action and long life. All moving parts are machine made and every tool is guaranteed. Write for catalog.

CRESCENT TOOL COMPANY  
210 Harrison St., Jamestown, N. Y.

# CRESCENT and Smith & Hemenway TOOLS

Made under the supervision of and guaranteed by the originators of the Crescent Wrench



The **RIGHT** Tool Chest for Machinists and Toolmakers  
**GERSTNER CHESTS** are made for the most exacting Mechanics. Many sizes and styles in Free Catalog. Write for it.

*Gerstner & Sons*  
469 Columbia Street, Dayton, Ohio

## A Genuine Robbins & Myers



**1/4 H. P. Electric Motor** for 110 V., 60 Cycle light circuit at the low cost of \$10.70 net. A tool that will lighten your chores, connected to your lathe, grinder, pump, washer, etc. Always ready for service.

**ROBBINS & MYERS, Inc.**  
Department A, Springfield, Ohio

## SALESMEN WANTED!

SELL COX HOLDFAST SCREW DRIVERS



Sells on sight to mechanics for Auto, Radio and Electrical Work. Self Holding, Self Releasing.

Send 50c for sample and ask how to get Salesman's Outfit Free.  
**S. J. COX Dept. F. FRANKLIN, PA.**



**Wood Working Machines** of high quality—moderately priced—give users more for their money. Simple, accurate, easy to operate, carefully guarded, made of quality materials. Portable machines that do a wide range of work take power from any light socket; designed for small shop or to take out on job. Also big line of heavy equipment for factories—including bandsaws, saw tables, shapers, jointers, universal out-off saw, universal wood worker and many others.

**THE CRESCENT MACHINE CO.**  
93 Columbia St. Leontia, Ohio



Send for **FREE BULLETINS**

"The **Fastest . . .**  
*smoothest cutting File*  
*I've ever used"*



**THAT'S** what a good judge of tool quality says, and that's what you'll say too, when you use Simonds Files.

Every file that carries the name "Simonds" is rugged, durable, sharp-toothed. They are made from the finest steel. Their uniformly spaced teeth are arranged to give you easy cutting and long wearing qualities.

Keep Simonds Files in your home workshop at all times. It pays to buy and use the best. Ask your dealer.

"File Facts", a booklet that tells all about files, sent free. Write for it.

Simonds

**SIMONDS SAW AND STEEL CO.**  
FITCHBURG, MASS.

"The Saw Makers" Established 1832  
Branch Offices and Service Shops in Principal Cities

SAWS **FILES** KNIVES STEEL  
**SIMONDS**



**Amazing Tests Prove Quality**

Catalog describes remarkable tests by which the phenomenal strength and guaranteed quality of CORNWELL tools may be tested. Your money back for any tool that fails to do what we claim.

HERE is a convenient kit of CORNWELL chisels and punches that are forged from the very highest grade Chrome Molybdenum steel. They are hardened, heat treated and specially tempered by our exclusive CORNWELL process. They will withstand the hardest usage, and will accomplish results that no other similar tools will do. While costing slightly more than ordinary tools, figured in man-hours of performance and the resultant satisfaction from their use they are the cheapest in the end. CORNWELL tools will enable you to do better work in considerably less time.

**There Is No Substitute for Cornwell Quality**

Mechanics are proud of their CORNWELL tools because they know there are none others like them. They meet the most exacting requirements for hard usage. They withstand the most severe tests to which any tools can be put.

**Money Back Guarantee**

You are fully protected by our guarantee that covers every CORNWELL tool. You take no risk. If tools are not all we claim for them send them back and your money will be immediately refunded.



**This Catalog-FREE**

The Cornwell Quality Tools Co.  
Dept. N, Mogadore, Ohio  
(Formerly at Cuyahoga Falls, Ohio.)

Send me new illustrated catalog with prices on full line of Cornwell Hand-Made Tools.

..... Where employed  
Name .....  
Address .....  
City ..... State .....

**FREE New Book**  
**FACTORY PRICES**

Save 1/3 to 1/2

New FREE book quotes **Reduced Factory Prices. Lower terms—year to pay.** Choice of 5 colors in New Porcelain Enamel Ranges. New Circulating Heaters—



\$34.75 up. 200 styles and sizes. Cash or easy terms. 24-hour ship-ments. 30-day FREE trial. 360-day test. Satisfaction guaranteed. 29 years in business. 750,000 customers. Write today for FREE book.

**KALAMAZOO STOVE CO.**  
391 Rochester Ave.  
Kalamazoo, Mich.

Ranges \$37<sup>75</sup> up

**"A Kalamazoo Direct to You"**  
Trade Mark Registered

**GOODRICH SPORT SHOES** The style classics of canvas rubber-soled shoes. For camp and all outdoor summer sports. At the best dealers everywhere. The B. F. Goodrich Rubber Company, Akron, Ohio.

**A BIG MACHINE at a LOW PRICE!**  
Does 20 DISTINCT WOODWORKING OPERATIONS

TURN YOUR HOBBY INTO INCOME!

No trick at all with this amazingly low price Woodworker, which you may try, and pay for, on terms, to turn idle hours into profit. Does 20 wood-working operations. Ideal size, capacity for shop, home or the job. Economical to operate. The best buy in the market!

Just \$25.00 BRINGS IT TO YOU FREE TRIAL



**COMES COMPLETELY EQUIPPED!**

Comes complete with 8-in. Cross Cut, 8-in. Rip Saw; 12 in. Band Saw; Jointer, Lathe, Borer, Sander, Guides, Electric Motor. Investigate it!

**FREE** Working Drawings of Items You Can Make with Saw

SEND FOR FULL DETAILS!

A. S. ALOE CO.  
1831 Olive St.,  
St. Louis, Mo.

Without obligation, send me details on the Woodworker, and the Free Trial and Easy Terms Plan.

NAME .....  
ADDRESS .....

Own a **CORONA**

The Champion Portable Typewriter



Write for handsome descriptive booklet—free!

LC Smith & Corona Typewriters Inc., 51 Madison Ave., New York, N.Y.

**AGENTS AND SIGN MEN**

Now Making \$50.00 to \$100.00 and Up Per Week Selling Our **GOLD LEAF SIGN LETTERS**

**R**

For store and office windows, board signs, trucks and glass signs. We also make to order script signs and business emblems singly or by the thousands. A permanent business. No capital or experience required. Big demand in every city. Samples and Literature Free.

CONSOLIDATED SIGN LETTER CO. 71-X W. Van Buren CHICAGO, ILL.

**Certain Popularity and Easy to Learn to Play!**

IN ten days you start playing popular airs on your new Pan-American saxophone, clarinet, trombone — or any other instrument. You'll be in demand — you'll lead in popularity wherever you go. Act NOW—write today for FREE illustrated catalog and get our easy payment plan and FREE TRIAL offer. Pan-Americans are the only moderately priced, factory guaranteed band instruments in the world. Write

**PAN-AMERICAN BAND INSTRUMENT & CASE CO.**  
903 Pan-American Building, Elkhart, Ind.

Watch!  
It "Taxies"—

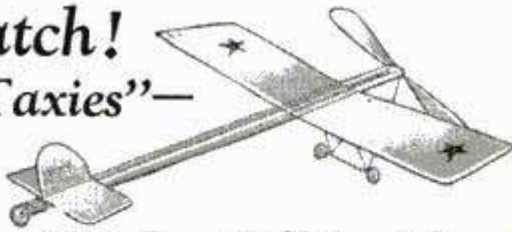

"Takes Off"—Flies!

**BOYS!** Picture a great aeroplane roaring down the runway—faster—faster—faster! Then, Z-O-O-M and she's up in the air. What a thrill! Well—now you can have a toy plane that has precisely the same flight action. The new Kingsbury "Silver Arrow" "taxies" over the ground, "takes off" and flies. Not a construction toy, but a fully built plane. A few moments to assemble and she's ready for flight. Wings and body of light Balsawood, reinforced with aluminum; aluminum propeller; powerful elastic motor. Model No. 1, 18 in. wing spread, \$1. (West of Miss \$1.10.) If your dealer hasn't it, order direct, KINGSBURY MFG. CO., 83-1 Myrtle St., Keesee, N. H.

Send 10c for a Kingsbury Disc Wheel, Balloon Tire Eraser.

**KINGSBURY MOTOR TOYS**  
DRIVEN



This 260 Page  
Wholesale Radio Catalog  
A Liberal Radio-Edu-  
cation Within Itself!

**FREE**

Containing 75 radio  
hook-ups, 1,000 illustrations,  
6,000 articles.

Build your own with Rasco parts.  
Positively lowest prices in the country.

**Radio Specialty Company**

98E Park Place NEW YORK, N.Y.

**30 DAYS TO TRY FREE** Mead *Ranger* RADIO

The Ranger Radio is a result of 7 years development. It is to-day fast becoming the most favorably known radio—now leading the field, as its predecessor, the Ranger Bicycle, has for 30 years. The Screen-Grid Tube Ranger Neutrodyne (with 9 tubes) is made under patents of R. C. A. Ranger assures you of selective reception from near and distant stations. You may now own one of these distinctive Rangers with Dynamic Speaker in a DeLuxe Console by paying as low as \$10.00 down and balance in 10 months. Table models as low as \$40.00. Rangers come all ready to use—simply insert tubes and plug into your electric light socket—no more trouble than to connect an electric floor lamp. The name MEAD has been known for Ranger Precision Products for 30 Years. Write today for Catalog. Prices and Terms and marvelous Mead Cycle Co., Dept. D-173, Chicago new introductory offer.

**RACING AND SPORT EQUIPMENT**  
Direct from Manufacturers

Bodies for Ford and Chevrolet  
\$18.75 and up  
Hi-Compression Heads, under-  
slung Parts, Racing Gears, Cowl  
Lamps, Roadlites, Seat covers,  
Also Boats, Canoes, Portable  
Radio, Bicycles, and Camping  
Outfits. Send 10c for Catalog  
showing bodies of rare beauty and  
complete equipment.



Build a Real  
Auto from Used Chassis.

**SPORT FACTORIES** Dept. K-2 AURORA, ILL.

**Super Elto Quad**



World's finest outboard motor. Four cylinders. Powerful, vibrationless, easy starting. The motor for fastest racers, luxurious runabouts, comfortable cruisers. Send for Catalog. ELTO DIVISION, Outboard Motors Corporation, Mason Street, Dept. AA, Milwaukee.

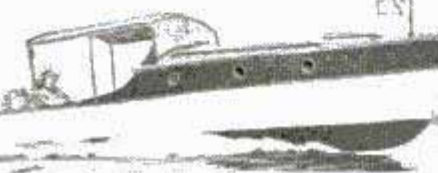

**Clean Hands**  
in  
**58**  
**Seconds**



Men—you who love to tinker—here's just the soap you need. Lava Soap cleans quickly and thoroughly the toughest-looking pair of hands that ever fussed around a work bench. Makes more lather in 15 seconds than ordinary soap in 60, and even hard or cold water won't discourage it. Millions use it. "Good old Lava," they call it. Gets hands clean! Not just "surface clean," but clean 'way down deep. As easy on your hands as fur-lined gloves—because it's made from pure vegetable oils and pulverized Italian pumice that's almost as fine as talcum powder. All grocers and druggists sell it.

Mail this coupon for free sample  
of Lava Soap

Procter & Gamble (Dept. W-929)  
Cincinnati, Ohio

Please send me a sample cake of LAVA, the hand soap that removes all the dirt and grease.

Name.....  
Street.....  
City.....  
State.....

**NEW VEST POCKET  
ADDING MACHINE**

**BABY CALCULATOR**  
CHICAGO U.S. A.  
PATENT APPLIED FOR

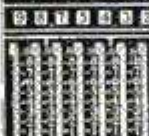

**ADDITION  
SUBTRACTION  
MULTIPLICATION  
DIVISION**

**ADDS, SUBTRACTS, MULTIPLIES, DIVIDES**  
Does work of \$300 machine. Guaranteed 5 years  
**NOT A TOY.**  
Made of steel and indestructible. Million dollar  
capacity. Fits in pocket. Will not make mistakes.  
So simple child can operate it. Instructions (in-  
cluded). Everybody should carry one for figuring.

**FREE TRIAL \$2.50**  
Total Cost

**SEND NO MONEY**—Just name and address. We will ship Calculator immediately. On delivery pay postman \$2.50 (Plus few cents Postage). (If outside U. S. send check.) 10c additional in Leatherette Case. If not satisfied after 10 days trial you get your money back. **THOUSANDS OF SATISFIED USERS.**

Guaranteed This is lowest priced practical calculator made. "Why pay more for inferior imitations?" Order from this ad.

Mail Coupon Today

**BABY CALCULATOR SALES CO., (MANUFACTURERS)**  
Dept. 41, P. O. Box 1118, CHICAGO, ILL., U. S. A.  
 I am enclosing \$2.50—send adding machine prepaid.  
 Send Adding Machine C. O. D. \$2.50 plus postage.  
(10c additional in Leatherette Case)

Name.....  
Address.....  
City..... State.....

**AGENTS** Write for big commission and territory proposition.

# LUMINOUS PAINT

**Make Your Watches, Clocks, Etc., Visible by Night**

The very latest discovery in the scientific world. Heretofore, practically unobtainable. LUMINOUS PAINT, which, applied to the surface of any article, emits rays of white light, rendering it perfectly visible in the dark. THE DARKER THE NIGHT, THE MORE BRILLIANT IT SHINES. Quite simple to use. Anyone—you can do it. A little applied to the dial of your watch or clock will enable you to tell the time by night. You can coat the push buttons or switch plates of your electric lights, match boxes, and innumerable other articles; make your own Luminous Crucifixes, Luminous Rosaries, etc. Small bottle, price 25c. Larger sizes, 50c and \$1 postpaid. **JOHNSON SMITH & CO., Dept. 842 RACINE, WIS.**



## CIGARETTE MAKER

Roll your own and save money. Better and quicker; saves more than half. Use your favorite brand of tobacco. Neat, useful, handy. Pocket size, weighs 1/4 oz. Made entirely of metal, nickel plated. 25c, 3 for 65c postpaid anywhere.



## Exploding Cigarettes

JUST LIKE ORDINARY CIGARETTES, BUT SUCH REAL STARTLERS! The box contains ten genuine cigarettes of excellent quality. They appear so real, but when each cigarette is about one-third smoked, the victim gets a very great surprise as it goes off with a loud BANG! A great mirth provoker yet entirely harmless. Price 25c box.

## GOOD LUCK RING

Very striking, quaint and uncommon. Silver finish; skull and crossbones design, two brilliant, flashing gems sparkle out of the eye. Said to bring good luck. Only 25c postpaid.

## NOVELTY BADGES



**Kissing Permit 10c**—Two very novel metal badges, nickel plated, that you can wear, giving you fun out of all proportion to their trifling cost. 10c, each badge, 3 for 25c, or 75c per doz. postpaid anywhere.

## MIDGET BIBLE

**GREAT CURIOSITY** Smallest Bible in the World. Size of a postage stamp. 200 Pages. Said to bring good luck to the owner. A genuine work of art. Must be seen to be appreciated. Make good money selling them to friends, church acquaintances, etc. PRICE 15c each, 3 for 40c, 12 for \$1.35, 100 for \$7.50. Also obtainable in Leather Binding, with gold edges. Price 50c each, 3 for \$1.25, \$4.50 per doz. Magnifying Glass for use with Midget Bible 15c.

## STAGE MONEY

With a bunch of these bills, it is easy for each person of limited means to appear prosperous by flashing a roll of these bills at the proper time and peeling off a genuine bill or two from the outside of the roll, the effect created will be found to be all that can be desired. Prices, postpaid: 40 Bills 20c, 120 for 50c, or \$3.50 thousand postpaid.

## MAGIC NOSE FLUTE

The Magic Nose Flute, or Humanatone, is a unique and novel musical instrument that is played with nose and mouth combined. There is just a little knack in playing it which, when once acquired after a little practice, will enable you to produce very sweet music that somewhat resembles a flute. There is no fingering, and once you have mastered it you can play all kinds of music with facility and ease. When played as an accompaniment to a piano or any other musical instrument, the effect is as charming as it is surprising.

## SURPRISE MATCHES

More fun than fighting with your wife. Look just like ordinary matches. Put up in boxes just like regular Safety Matches. As the victim tries to light one he gets quite a surprise. Price 10c per box, 3 boxes for 25c, 12 for 75c cents.

## STAR TOY MAKER

Greatest boys' book written. Tells how to make a Pinhole Camera, a Canoe, model Railroad, a Telephone, Boomerang, Telegraph Instrument, Box Kite, Talking Machine, Microscope, Electric Motor, Electric Door Bell, Water Wheel, Paddle Raft, a pair of Skis, a Dog Sled, Bird House, Rabbit Yard, etc. 64 pages. 150 illustrations. PRICE 10c postpaid.

## Wonderful X-Ray Tube

A wonderful little instrument producing optical illusions both surprising and startling. With it you can see what is apparently the bones of your fingers, the lead in a lead pencil, the interior opening in a pipe stem, and many other similar illusions. A mystery that no one has been able to satisfactorily explain. Price 10c, 3 for 25c, 1 dozen 75c. Johnson Smith & Co.

## NOSE BLOWER

When some men blow their noses it sounds like a trombone. Now the NOSE BLOWER has come to torment us. It is a starter! It is ingeniously concealed in the handkerchief. Proceed to blow your nose and your friends will think they heard a steam engine or something. You can blame the hideous noise to your having a very bad cold and keep up the fun as long as you like. PRICE 10c, 3 for 25c, or 75c doz. postpaid.

## Serpent's Eggs

Box contains 12 eggs. When lit with a match, each one gradually hatches itself into a snake several feet long, which curls and twists about in a most life-like manner. Price per box, 10c postpaid, 3 for 25c.

# BLANK CARTRIDGE PISTOL

Protection against Burglars, Tramps, & Dogs. Special Offer 1 Blank Cartridge Pistol 100 Blank Cartridges 1 500-pair Novelty Catalog ONLY \$1.50 The Lot Shipped by Express Only Cash With Order Only

## LOOK 35¢ LOOK Wonderful Instrument.

Greatest thing yet. Nine separate articles in one. Everybody delighted with it. Odd, Curious and interesting. Lots of pleasure as well as very useful. It is a double Microscope for examining the wonders of nature. It is also an Opera Glass, a Stereoscope, a Burning Lens, a Reading Glass, a Telescope, a Compass, a pocket Mirror, and a Laryngoscope—for examining eye, ear, nose and throat. It is worth all the cost to locate even one painful cinder in the eye. Folds flat and fits the pocket. Something great—you need one. Don't miss it. Sent by mail. Only 35c or 3 for \$1.00

**JOHNSON SMITH & CO., DEPT. 842, RACINE, WIS.**

## INVISIBLE INK Rubber Chewing Gum

The most confidential messages can be written with this ink, for the writing makes no mark. Cannot be seen unless you know the secret. Invaluable for many reasons. Keep your postals and other private memoranda away from prying eyes. Great fun for playing practical jokes. Only 15c a Bottle; 3 for 40c.

## Watch Charm Pistol \$1.75

Exact reproduction of a real pistol; actually fires REAL BLANK CARTRIDGES of miniature size. Illustration is actual size. 1 1/4 inches long, with ring at end for attaching to watch chain. Loads like a regular pistol. Pull the trigger and it goes off with a loud bang. Pistol is break open type; illustration shows position for loading. Made entirely of high grade steel, nickel plated, octagon barrel, handsomely engraved handles, complete in box with cleaning rod. PRICE \$1.75. Also furnished with pearl handles, \$2.50, BLANK CARTRIDGES, 50c per box of 25. **JOHNSON SMITH & CO., DEPT. 842, RACINE, WIS.**

## MICROPHONE TRANSMITTER BUTTON

You can easily make a highly sensitive telephone by using this Transmitter Button to collect the sound waves. You can build your own outfit without buying expensive equipment. It is simple and inexpensive. You can install an outfit in your home and hear conversations being held all over the house. You can connect up different rooms of a hotel. This outfit was used by secret service operatives during the war. It is being used on the stage. It is ultra-sensitive and is the greatest invention in microphones. You can mount the button almost anywhere—card board boxes, stove pipes, stiff calendars, on the wall behind a picture frame, etc. Button is so light and small it cannot be detected. Persons can be overheard without suspecting it. You can listen in on conversations in another room. A deaf person in the audience can hear the speaker. Connected to phonograph, piano or other musical instrument, music can be heard hundreds of feet away. Button may be used to renew telephone transmitters; often makes an old line "talk up" when nothing else will. The ideal microphone for radio use; carries heavy current and is extremely sensitive. Amplifies radio signals. Countless other striking uses will suggest themselves. Experimenters find the button useful for hundreds of experiments along the lines of telephones, amplifiers, loud speakers, etc. Many fascinating stunts may be devised, such as holding the button against the throat or chest to reproduce speech without sound waves. PRICE \$1.00. **JOHNSON SMITH & CO., DEPT. 842, RACINE, WIS.**

# JOHNSON SMITH & CO.

Dept. 842 RACINE, WIS.

A De Luxe Edition of our new 1929 CATALOG mailed on receipt of 25c. Handsome binding. Bigger and better than ever. Only book of its kind in existence. Nearly 600 pages of all the latest tricks in magic, the newest novelties, puzzles, games, sporting goods, rubber stamps, unusual and interesting books, curiosities in seeds and plants, etc., unobtainable elsewhere. Remit by Coin, Money Order, Check or unused U. S., Canadian and Foreign Stamps for all articles listed above.





# BOYS! BOYS! BOYS! Throw Your Voice

Into a trunk, under the bed, under a table, back of the door, into a desk at school, or anywhere. You get lots of fun fooling the teacher, policemen, peddlers, and surprise and fool all your friends besides.

## THE VENTRILO

is a little instrument that fits in the mouth out of sight. Cannot be detected. It is used in connection with the above, and with the aid of this wonderful DOUBLE

**THROAT, or VENTRILO, you can imitate many kinds of birds, animals, etc. Remember you get everything for ONLY TEN CENTS—a booklet giving you full instructions how to become a ventriloquist and throw your voice, the Double Throat, or Ventrilo, and our big 600 page catalog of novelties, tricks, puzzles, masks, books, etc., ALL SENT POSTPAID TO ANY ADDRESS FOR ONLY 10 cents**



### MEXICAN JUMPING BEANS



Scientists are unable to give a reasonable explanation for what purpose nature created these curious Jumping Beans. They are found growing on small trees in the high mountainous regions of Mexico. The Beans Wiggle, Move, Jump, Flop Over, Etc. It is amazing to see them keep up this endless activity. Send for a few of these great curiosities. Three Sample Beans sent for 25c, 12 for 75c, or One Gross (144) for \$7.50 Postpaid.

**JOHNSON SMITH & CO., Dept. 842, RACINE, WIS.**

### U. S. BABY TANK



It goes with real Yankee Pep—by its own power. Most remarkable toy ever invented. By drawing the Tank backward, either with the hand or over the floor or table and then placing it down, it will crawl along, overcoming all obstacles, in the same life-like manner as the larger Tank that proved so deadly in the great war. What makes it go is somewhat of a mystery, for there is no mechanism to wind up as is usually understood, with mechanical toys, yet this tank will keep plodding along ten times longer than the ordinary run of toys. It will perform dozens of the most wonderful stunts. 2 1/2 inches long. Price only 25c prepaid. Stamps accepted.

**JOHNSON SMITH & CO.**

### KEYLESS COMBINATION LOCK



These clever Locks cannot be opened unless you know the combination. Each Lock has a different combination, the secret of which we send with the Lock. No key is necessary, simply arrange the tumblers in the proper order and the Lock opens. For your locker, bicycle, tool chest, mail box, thousands of uses. A good, strong lock, weighing about 4 ounces, that will baffle the attempts of all unacquainted with the secret combination to open it. Price, with secret and full instructions Only 50c postpaid.

**JOHNSON SMITH & CO., Dept. 842, RACINE, WIS.**

### Great Fire Eater



A great trick by which you can apparently breathe fire from mouth, to the horror and consternation of all. Quite harmless. All apparatus necessary sent complete in box for ONLY 30c. p. d. **JOHNSON SMITH**

### SQUIRT ROSE



**A REAL STARTLER.** This is the most popular of all squirt tricks. The flower in your coat looks so fresh and sweet that everyone is tempted to inhale the delightful perfume. Then is the moment to press the bulb. Gee-whillikens. Don't they jump? There is a very long rubber tube that easily reaches to the pocket of your coat or trousers, and the bulb is large enough to make a dozen shots with one loading. **PRICE 25c each, or 3 for 65c postpaid.**

### SEEBACKROSCOPE

Place this clever instrument to your eye, you see what is going on behind your back. Very interesting things sometimes occur when no one thinks you are looking. Just like having eyes at the back of your head. **PRICE 25c POSTPAID**



Send remittance (Postage Stamps accepted) for all articles listed above also in our other ad on previous page

### MAGICIAN'S BOX OF TRICKS

Apparatus and Directions for a Number of Mysterious Tricks, Enough for an Entire Evening's Entertainment..... \$1.00

**ANYONE CAN DO THEM**

It is great fun mystifying your friends. Get this Magician's Cabinet, and you will be the cleverest fellow in your district. It contains the apparatus for ten first-class tricks, including the MAGIC BALL AND VASE TRICK (a wooden ball is placed inside, and upon replacing the lid has disappeared and is found in someone else's pocket); the HINDOO TRICK CARDS (can be made to change completely no less than five times); DISAPPEARING COIN BOX (a coin, placed in the wooden box, vanishes entirely or changes into a coin of another denomination); the GLASS GLOBE TRICK (a coin is dropped into a glass of water and when the water is poured out the coin has vanished and is found somewhere else); the RIBBON FACTORY FROM THE MOUTH TRICK (a seemingly endless supply of colored paper ribbons comes out of your mouth); the DISAPPEARING HANDKERCHIEF (a handkerchief held in the hand mysteriously vanishes); the WIZARD'S RING COIN TRICK; the ENCHANTED BOTTLE (on one but yourself is able to make it lay down); the GHEA HAT AND DICE TRICK (a large dice is placed on top of a hat, disappears, and is found underneath yet no one has touched the hat); and last, but not least, the GREAT PHANTOM CARD TRICK, or two from five leaves nothing. Full instructions are sent for performing each trick. In addition to the above, a number of other feats and illusions are fully explained for which you can easily make or procure the necessary apparatus. **Price complete \$1.00 postpaid. JOHNSON SMITH & CO.**



### RESURRECTION PLANT

Great curiosity. Place in water, plant opens up and starts to grow in few minutes. Taken out it dries up and goes to sleep until put in water again. **PRICE 10c, 3 for 25c, 75c dozen, postpaid.**



### DISSOLVING VIEWS

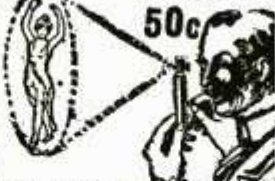

You may have a lot of fun with this little peep-show. A regular starter. Made entirely of metal, having a microscopic lens fitted into one end. While the victim is absorbed in admiration of the pretty picture, and turns the button in the confident expectation of seeing something interesting, a spring syringe is brought into action, and the observer experiences a very great surprise. **50c p. d. Johnson Smith & Co., Dept. 842, Racine, Wis.**



**Comical Motto Rings**

Lots of harmless fun and amusement wearing these rings. Made in platinumoid finish (to resemble platinum), with wording on enameloid, as illustrated. **Price only 25c Postpaid.**

### The "Little Giant" Typewriter

A First Class Writing Machine For \$1.50



A perfect little typewriter for \$1.50. There are thousands of persons who would like to use a typewriter but whose needs and business do not warrant the expense attached to the purchase and use of a fifty or seventy-five dollar machine. To such persons we confidently recommend our Little Giant. It is strongly made, but simple in construction, so that anyone can quickly learn to operate it, and write as rapidly as they would with pen and ink. The letters of the alphabet 1 to 10, and the punctuation marks being together. With this machine you can send your best girl typewritten love letters, address envelopes, make out bills, and do almost any kind of work not requiring a large, expensive machine. With each typewriter we send a tube of ink and full printed instructions for using the machine. **Price complete \$1.50 by mail postpaid to any address in the world.**

**JOHNSON SMITH & CO. Dept. 842 Racine, Wis.**

# PATENT

## Protect Your Ideas

### Take the First Step Today

If you have a useful, practical, novel idea for any new article or for an improvement on an old one, you should communicate with a competent Registered Patent Attorney AT ONCE. Every year thousands of applications for patents are filed in the U. S. Patent Office. Frequently two or more applications are made for the same or substantially the same idea (even though the inventors may live in different sections of the country and be entirely unknown to one another). In such a case, the burden of proof rests upon the last application filed. Delays of even a few days in filing the application sometimes mean the loss of a patent. So lose no time. Get in touch with me at once by mailing the coupon on the opposite page.

### Prompt, Careful, Efficient Service

This large, experienced organization devotes its entire time and attention to patent and trade mark cases. Our offices are directly across the street from the U. S. Patent Office. We understand the technicalities of patent law. We know the rules and requirements of the Patent Office. We can proceed in the quickest, safest and best ways in preparing an application for a patent covering your idea. Our success has been built on the strength of careful, efficient, satisfactory service to inventors and trademark owners located in every state in the Union.

### NO CHARGE for Information On How to Proceed

The booklet shown here contains valuable information relating to patent procedure that every inventor should have. And with it I will also send you my "Record of Invention" form on which you can sketch your idea and establish its date before a witness. Such evidence may later prove valuable to you. Simply mail the coupon and I will send you the booklet, and the "Record of Invention" form, together with detailed information on how to proceed and the costs involved. Do this NOW. No need to lose a minute's time. The coupon will bring you complete information entirely without charge or obligation.

My Patent Law Offices  
Just Across  
Street From  
U.S. Pat. Office



Above is a view of my drafting and specification offices where a large staff of experienced experts are in my constant employ. All drawings and specifications are prepared under my personal supervision.

# NEWS

*Inventors*  
*Write for these*

## Free Books

### Strict Secrecy Preserved

All communications, sketches, drawings, etc., are held in strictest confidence in strong, steel, fireproof files, which are accessible only to authorized members of my staff. Feel free to write me fully and frankly. It is probable that I can help you. Highest references. But **FIRST**—clip the coupon and get my free book. Do **THAT** right now.

### Clarence A. O'Brien

*Registered Patent Attorney*

Member of Bar of: Supreme Court of the United States; Court of Appeals, District of Columbia; Supreme Court, District of Columbia; United States Court of Claims. Practice confined exclusively to Patents, Trade marks and Copyrights

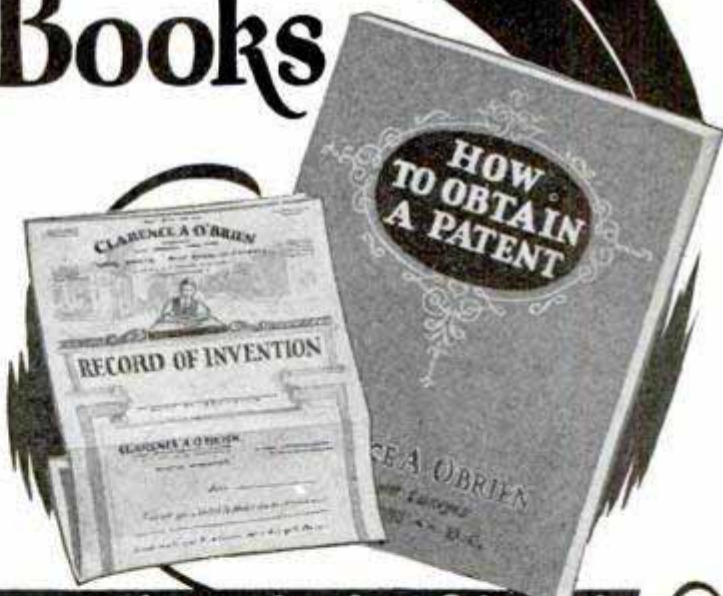

**Clip this Coupon and Mail it Now!**

**CLARENCE A. O'BRIEN, Registered Patent Attorney & Attorney-at-Law**

70-V Security Savings and  
Commercial Bank Bldg.,  
Washington, D. C.

OR

Suite 1106 Woolworth Bldg.,  
New York City

Please send me your free book, "How to Obtain a Patent," and your "Record of Invention" form without any cost or obligation on my part.

Name.....

Address.....

(Important—Write plainly and address office nearest you)

# PATENTS TRADE MARKS COPYRIGHTS

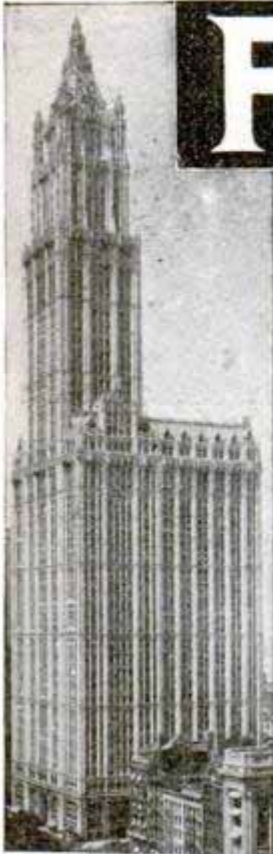

Our New York Office  
Suite 1007 Woolworth Bldg.



Our Philadelphia Office  
828 Fidelity Phila. Trust Bldg.



**VICTOR BUILDING**  
Our New Building Nearly Opposite U. S. Patent  
Office Specially Erected by Us for Our Own Use



**Have You An Idea?**

**Our Offer:** FOR THE PROTECTION  
OF YOUR INVENTION

## YOUR FIRST STEP

The inventor should write for our blank  
form

### "RECORD of INVENTION"

This should be signed and witnessed and  
returned to us together with model or  
sketch and description of the invention for  
**INSPECTION AND ADVICE**  
*No Charge for the Above Information*

**Our Five Books Mailed  
Free to Inventors**

*Our Illustrated Guide BOOK*

### How to Obtain a Patent

Contains full instructions regarding U. S. Patents.  
Our Methods, Terms, and 100 Mechanical Move-  
ments illustrated and described.

### Our Trade Mark Book

Shows value and necessity of Trade Mark Protec-  
tion. Information regarding *Trade Marks and un-  
fair competition in trade.*

### Our Foreign Book

We have Direct Agencies in Foreign Countries, and se-  
cure Foreign Patents in shortest time and lowest cost.

### Progress of Invention

Description of World's Most Pressing Prob-  
lems by Leading Scientists and Inventors.

### Payment of Fees in Installments

It is not necessary that the total cost for the preparation and  
prosecution of a patent be paid in one payment. Our custom  
is to permit our clients to pay for their applications in three  
installments as the preparation of the application progresses in  
our office. This plan makes the payments easy for the inventor.

*We Regard a Satisfied Client* as our best advertise-  
ment, and furnish anyone, upon request, lists of clients  
in any state for whom we have secured patents.

**Highest References—Prompt Service  
—Reasonable Terms**

## VICTOR J. EVANS & CO.

Patent Attorneys, Established in 1898

Main Offices: 789 9th St., N. W., Washington, D. C.

*Nearly Opposite U. S. Patent Office*

# DELAYS ARE DANGEROUS IN PATENT MATTERS

## IMPORTANT! To Avoid Delay!

YOU SHOULD HAVE YOUR CASE MADE SPECIAL IN OUR OFFICE to save correspondence, secure protection and early filing date in the Patent Office. To secure **special preparation** of your case send \$25.00 on account with model or sketch and description of invention.

**ACT NOW**—Often two or more inventors file applications for practically the same idea. In such cases the burden of proof rests upon the last application filed. Therefore, delays often cause the loss of a patent.

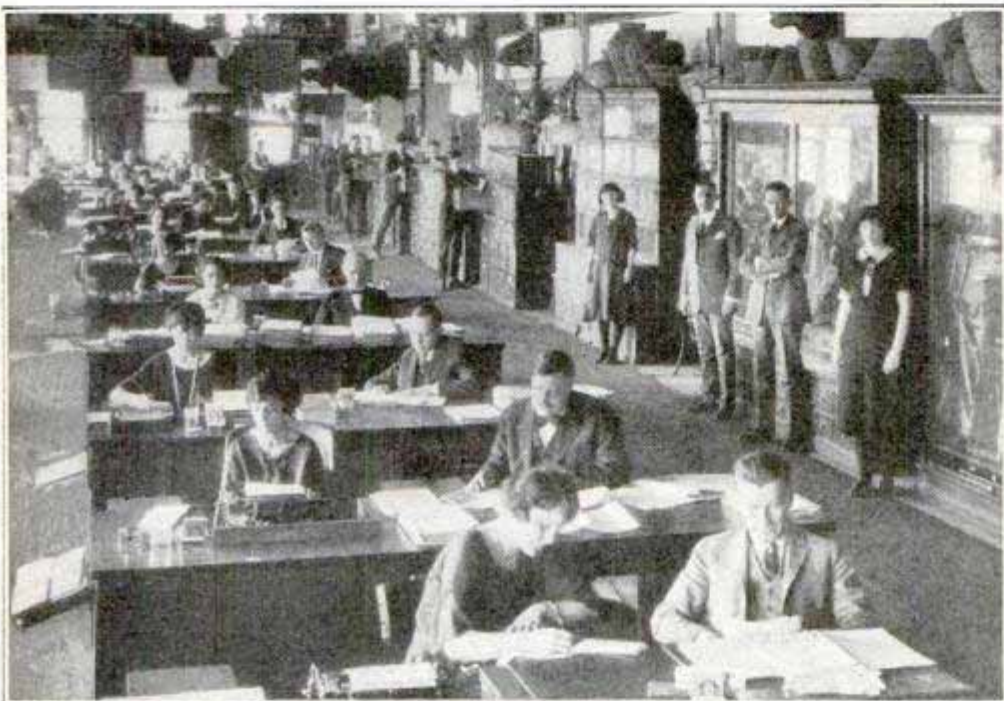

MAIN OFFICE, VICTOR J. EVANS & CO.—VICTOR BUILDING, WASHINGTON, D. C.

Our Large, Comprehensive Organization has been established for 30 years and offers Prompt, Efficient and **Personal Service** by experienced Patent Lawyers and Draftsmen. Every case is in charge of a Specialist who has been selected for his knowledge and experience in certain lines of invention. Our Lawyers practice in all U. S. Courts and defend clients in suits involving Patents, Trademarks and Copyrights. **All Communications and Data** strictly Secret and Confidential. We shall be glad to have you consult us or to answer any questions in regard to Patents, Trademarks or Copyrights without charge or obligation.



Our Chicago Office  
Suite 1640-42 Conway Bldg.



Our Pittsburgh Office  
Suite 514 Empire Building



Our San Francisco Office  
Suite 1010 Hobart Building

**FREE  
COUPON**

**VICTOR J. EVANS & CO.**  
PATENT ATTORNEYS *Established  
in 1898*

NEW YORK OFFICES  
1007 Woolworth Bldg.

CHICAGO OFFICES  
Suite 1640-42 Conway Bldg.

PHILADELPHIA OFFICES  
828 Fidelity Phila. Trust Bldg.

PITTSBURGH OFFICES  
514 Empire Bldg.

SAN FRANCISCO OFFICES  
1010 Hobart Bldg.

MAIN OFFICES: 789-9th Street, N. W., WASHINGTON, D. C.

Gentlemen: Please send me *Free of Charge* your books as described on preceding page.

Name .....

Address .....

# PATENTS

TRADE-MARKS • DESIGNS  
FOREIGN PATENTS

MUNN & CO.  
PATENT ATTORNEYS

*Associated since 1846 with the Scientific American*

SCIENTIFIC AMERICAN BUILDING  
625 F Street, Washington, D. C.

1303 TOWER BUILDING  
Corner of Michigan Blvd. and Madison St.  
Chicago, Ill.

1551 SCIENTIFIC AMERICAN BUILDING  
24 West 40th Street, New York City

HOBART BUILDING  
532 Market Street  
San Francisco, Calif.

511 VAN NUYS BUILDING  
Spring and Seventh Streets, Los Angeles, Calif.



Books and Information on Patents and Trade-Marks by Request.  
Associates in All Foreign Countries.



**This Needed Invention Paid  
\$135,000**

a year. Beverage manufacturers immediately adopted this simple crimped tin cap. This invention would have made you independently wealthy. Fortunes await inventors working along right lines. Concentrate on things that are **NEEDED**. Get Raymond Yates's new book **"1000 NEEDED INVENTIONS"**

Costs only \$1.50 and may lead to a big idea. Find out what industry needs and the public wants. That's where the money is! Mr. Yates's book tells you what these things are. This revised 1929 edition contains valuable chapters on Aviation and Television. Send no money. Just write postal. Pay mail man \$1.50 plus postage when book arrives. Your money back if you want it. This offer limited. Write now and get on the right track. (Outside U. S. \$1.70 cash with order.)

Bureau of Inventive Science, 39 Wisner Bldg., Rochester, N. Y.



**PATENTS  
TRADE-MARKS**  
*Don't Lose Your Rights  
To Patent Protection*

Before disclosing your invention to anyone send for blank form "EVIDENCE OF CONCEPTION" to be signed and witnessed.

**LANCASTER & ALLWINE**  
480 Ouray Bldg. WASHINGTON, D. C.  
*Originators of forms "Evidence of Conception."*

# PATENTS

Booklet Free Highest References  
Promptness Assured Best Results

Send drawing or model for preliminary examination and advice.

**ALL BUSINESS GIVEN PROMPT AND PROPER ATTENTION**

Listed Patent Lawyer in the latest editions of the Rand-McNally Directory of Bankers and Bonded Attorneys, published by Rand-McNally & Co., Chicago, Ill.; The Baggott & Ryall Directory of Guaranteed Attorneys, published by the Ryall Legal Directory Company, New York City; Flugel's List, published by the Legal Directory Publishing Co. of St. Louis, Mo.; the American Lawyers Annual, published in Cleveland, Ohio; Eyre's Law List, Bush Terminal Building, New York City.

**WATSON E. COLEMAN,**  
REGISTERED PATENT LAWYER

Victor Building, 724 Ninth Street, N. W.  
**WASHINGTON, D. C.**

# PATENTS

ON

# EASY PAYMENTS

Don't let lack of ready money keep you from protecting the idea which may prove the turning point in your life.

**FORMER ASSISTANT EXAMINER  
OF U. S. PATENT OFFICE**

will now handle your patent matters on easy payments. Write today for free information and particulars.

**M. S. CAYNE**

(Registered Patent Attorney)

Main Offices

**BANKERS BLDG., 105 W. Adams St., CHICAGO**

(With Offices in Washington, D. C.)

## PATENTS

Trade Marks, Copyrights, Patent Litigation Handbook with illustrations, 100 mechanical movements. Sent free on request.

**ALBERT E. DIETERICH**

formerly member Examining Corps U. S. Patent Office

REGISTERED

**PATENT LAWYER and SOLICITOR**

621-A, Ouray Bldg.

30 Years' Experience Washington, D. C.

## INVENTORS

who derive largest profits know and heed certain simple but vital facts before applying for Patents. Our book *Patent-Sense* gives those facts; sent free. Write **LACEY & LACEY, 646 F St., Washington, D. C. Established 1869.**

**PATENTS** Write for FREE Instructions. Send Drawing or Model for Examination.

**CARL MILLER, Patent Attorney**

former member examining corps U. S. Patent Office  
260 McGill Building Washington, D. C.

## STOPS FALLING HAIR

**Lucky Tiger Knocks Dandruff and Scalp Irritations like Whyte-Fox (1 and 2) Medicated Massage heals skin eruptions, and No. 2 Whyte-Fox knocks piles in 2 to 3 weeks. Used and endorsed by millions. Money-Back Guarantee. Write for free booklet. At Barbers, Druggists, Beauty Parlors.**



Kansas Dept. City, Mo. **LUCKY TIGER REM. CO.**



## BOW LEGS?

THIS GARTER (Pat'd)  
Makes Trousers Hang Straight  
If Legs Bend In or Out

Free Booklet—Plain Sealed Envelope

**THE T. GARTER CO., Dept. E**  
South Bend, Ind.

It's a **BULOVA**—Sent For \$1.00  
with a Mesh Band!

TAKE 12 MONTHS TO PAY

Send \$1.00 with order and tell us a little about yourself: (A) How long at present address, (B) Age, (C) Married or Single, (D) Name of Employer, (E) Position, (F) How long employed. All information held **strictly confidential**. We make no direct inquiries of anyone—not even from your employer.

**10 Days Free Trial—Satisfaction Guaranteed**

This genuine **Bulova** watch comes to you postage paid—no **C.O.D.** to pay on arrival. You take no risk—satisfaction guaranteed or money back.

Estab.  
1895



\$2975

**DGS-**

15 jewel **BULOVA** gent's wrist watch. White Gold filled case; "dust-tite" protector; radium dial and hands; latest woven mesh wristband. Guaranteed. \$1.00 now. \$2.30 a mo. *Nationally advertised cash price, no extra charge for credit.*



**Catalog** New catalog of genuine diamonds, standard nationally advertised watches, fine jewelry. Write for it now.

**ROYAL DIAMOND & WATCH CO.**

ADDRESS DEPT. 11-W 170 BROADWAY, N.Y.

## Do your own Printing!



Cards, stationery, circulars, tags, labels, advertising, book, menus, etc. Save money and time, cut cost in half. Easy rules furnished with every outfit.

**Print for Others  
BIG PROFITS**

A big opportunity to turn your spare time into cash, or develop a full time business of your own at small cost. **Now and popular Raised Printing like Engraving** done with any of our presses. **Junior Press \$5.00**, Job presses \$11, \$29; Rotary \$149.

Write for catalog No. 787 of presses, type, cards, paper, supplies and full information.

**The Kelsey Co., Meriden, Conn.**

## MOVIES AT HOME



Many models of genuine **MOVIE MACHINES**, some as low as \$3.75, all using standard size big theatre films. Our stock of films is the most complete and lowest in price—with an exchange service. Films of leading stars and religious subjects are available. **DON'T DELAY. WRITE FOR FREE INTERESTING CATALOGUE NOW!**

**PARAMOUNT MFG. CO.**

Dent. G-19

BOSTON, MASS.

# INVENTORS PROTECT YOUR IDEAS

Send for our Guide Book, **HOW TO GET A PATENT**, and Evidence of Invention Blank, sent Free on request. Tells our terms, methods, etc. Send model or sketch and description of your invention for **INSTRUCTIONS**. No charge for the above information.

**RANDOLPH & CO.**

301 Victor Bldg., WASHINGTON, D. C.

NAME \_\_\_\_\_

STREET \_\_\_\_\_

CITY \_\_\_\_\_ STATE \_\_\_\_\_

# Hotter than Coal ~ and no dirt



**A New Invention**

Do away forever with the drudgery of wood or coal. The most simple and economical invention on the market is now giving perfect satisfaction to enthusiastic users everywhere.

**Burns 96% Air—4% Cheap Oil**

The International Oil Burner fits in the fire box of your furnace or stove. Installed in a few minutes. No noisy motors or complicated parts.

**Costs only a Few Dollars**

Heats any stove or furnace just as well as a \$400 or \$500 oil burner without electricity or gas. Simply turn one valve and have all the heat you want. Cleaner and better for heating and cooking. Approved by engineers everywhere. Over 100,000 in use.

**30 Days FREE Trial Offer**

Try this wonderful International Oil Burner right in your own home at our risk. Act quickly and get our special low introductory price. Sold under absolute money-back guarantee. Write at once for our free booklet on home heating and free burner offer.

**AGENTS—Our men are making big money**

introducing International Oil Burners. The demand is enormous. We want spare or full

time workers immediately. If \$500 a month and more interests you, write or wire us for our protected territory offer.

----- Clip This Coupon -----

**INTERNATIONAL HEATING CO.**

Spring and Park Ave., St. Louis, Mo., Dept. S4

Send your free booklet and free details on home heating for stove  furnace . Also free burner offer.

Name.....

Address.....

Check if interested in making money as an International representative with protected territory.



**Andy Sannella**  
Talks to Reed Players.  
**Get this Free Book!**

On the air tonight, and every night, Andy Sannella is earning a fabulous salary with his Selmer Sax. In his book of "Advice to Saxophone Players" he gives more valuable information

than in ten private lessons. This book is free to all reed players. Send a postal today for your copy. No obligation.

If you will mention the instrument you play, we will send also, free sample of our Alexandre Reeds. **They Play!**

**Selmer**

58 SELMER BUILDING, ELKHART, INDIANA  
In Canada: 516 Yonge St., Toronto

## Photos ENLARGED

Size 16x20 inches Same price for full length or bust form groups, landscapes, or pet animals, etc., enlargements of any part of group picture. Safe return of your own original photo guaranteed.

**98c**

**SEND NO MONEY** Just mail photo or snapshot (any size) and within a week you will receive your beautiful life-like enlargement size 16x20 in., guaranteed fadeless. Pay postman 98c plus postage or send \$1.00 with order and we pay postage.

With each enlargement we will send FREE a hand-tinted miniature reproduction of photo sent. Take advantage now of this amazing offer -- send your photo today!

**UNITED PORTRAIT COMPANY**  
1652 Ogden Ave. Dept. L-369 Chicago, Ill.



### 12-INCH SCALE MODEL

of Lindbergh's Spirit of St. Louis. Scientifically designed and very realistic. Rises from ground by own power and flies 40 ft. or more. Only flying scale model sold at this price. Easily built in 2 or 3 hours. No tools needed. Construction

set, with all parts and full directions, postpaid in U. S. and Canada, only 50c (no stamp). Satisfaction or money back. Send today and print your address plainly.

**MANN & BENTON**  
Box D, Chillicothe, Ohio



**NO ONE CAN BEAT**

the enjoyment of building your own substantial and safe 20-mile SPEED boat, requires but little spare time. We furnish the materials machined ready to fasten. **\$29.75**

Also larger boats at corresponding attractive prices.  
**TRUSCOTT BOAT CO. - ST. JOSEPH, MICHIGAN**

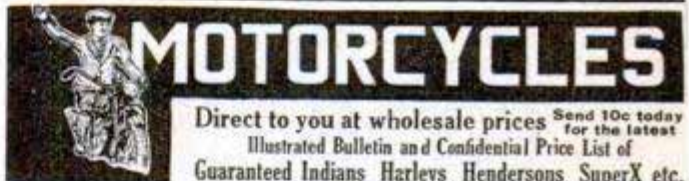

## MOTORCYCLES

Direct to you at wholesale prices Send 10c today for the latest Illustrated Bulletin and Confidential Price List of  
Guaranteed Indians Harleys Hendersons SuperX etc.  
*(Sold on easy terms if desired)*

**CRANDALL CYCLE CO.** 826-28 State St. Springfield, Mass. Shipments to all parts of the world  
Motorcycles Since 1905

## AGENTS 500% PROFIT

### GENUINE GOLD LEAF LETTERS

**S** guaranteed to never tarnish. Anyone can put them on stores and office windows. Enormous demand, large profits. Paul Clark says: Smallest day \$28.70. R. L. Reel made \$920 in two months. Write today for free sample and liberal offer to general agents.  
**METALLIC LETTER CO. 433-B N. Clark St., CHICAGO**

**Buy Now Pay Later**

## Boice Bargains Can't Be Beat



**\$30.00 Universal Handisaw**  
Table elevates for grooving. Cuts 2 3/4-inch stock. Takes 6x1-inch dado head, 8-inch sand disc, sand drum, 2-inch Jointer attachment, Boring table.



**4" Handi Jointer**  
Tables 20-inch ground and polished. Planes 1/4 x 4-inch. Fence tilts 45 degrees both ways. Improved rabbit arm. Bronze bearings. Safety guard \$3 . . . **\$25.**

Send 10c in stamps or coin for Boice's latest catalog, describing the finest collection of Bench Woodworking Machines ever offered. Boice-Crane Bench Circular Saws, 12 inch and 14 inch Band Saws, 4 inch Jointer, Lathes, Jig Saw, and Books of Designs.

**Universal Jig Saw**  
**\$12.00**



Table 8 inch dia., tilts 45 degrees both ways. Saw to frame 10 inches. Uses 1-16 inch fret blades, and heavy power blades, 1-8 inch to 3-8 inches wide. Unexcelled in the volume and variety of work it will do.

**W. B. & J. E. Boice, Dept. P. M. 9-E, Toledo, Ohio**





# PUT ME INTO THIS NEW BIG PAYING BUSINESS AND I WAS A SUCCESS RIGHT FROM THE START

## I Refinish Automobiles, Lacquer Screens, Radiators, Store and Household Equipment, and Make the Old Look Like New

### MY PROFITS NET ME \$150 TO \$350 EACH MONTH

That's what multitudes of AIR-O SPRAY PAINT business men would tell you if you met them face to face.

## THE AIR-O SPRAY METHOD IS REVOLUTIONIZING THE PAINTING AND REFINISHING TRADE

It is no more like the old time painting business—or costly, cumbersome spraying outfits—than the modern automobile factory is like an ordinary blacksmith shop. The AIR-O SPRAY business offers you two-fold advantages—(1) A business of your own with profits and a future that you cannot find in any other trade or business that we know of. (2) Building up a sales force to sell our sensational outfits direct to users.

The AIR-O Outfit pictured here is the kind of equipment that is creating an entirely new industry—AIR BRUSH PAINTING. The field for you is almost unlimited. Opportunities for business are on all sides of you. The long, slow, tedious methods of hand painting are gone forever. With the AIR-O Outfit and the wide range of attractive lacquer colors now available, one is enabled to keep pace with the trend of the times. There's color harmony in everything today.

### AN OPPORTUNITY THAT OPENS A REAL FUTURE FOR YOU

We show opposite a few of the features which you owe it to yourself to think about. Let us help place you in the bigger money class. Be one of the leading business men of your community. Write us today for full particulars of our offer—also for literature illustrating the amazing outfit which we are offering at only \$11.50 complete.

**BRIGHTEN UP EVERYTHING**

With the coming of the AIR-O LACQUERING UNIT, the old-style, slow handbrush is a relic of the past. Now you can spray Lacquers, Paints, Varnishes, Enamels, Shellacs and Bronzes, and make the work easier, look better and finish much faster. You can do all this with a wide range of color schemes and without a cumbersome separate motor. With the AIR-O you get your power by merely removing one Spark Plug from your auto, then screw on the Compressor Unit.

—COUPON—

The Air-O Spray Equipment Co., Dept. C, 60 South San Pedro Street, San Jose, California.  
Please send me at once full particulars of your offer to establish me in the Air-O Business; also literature, with the understanding that this will not obligate me in any way.

Name.....Occupation.....  
Address.....  
City.....State.....

**ONLY \$11.50 COMPLETE**

**OVER 61% PROFIT FOR YOU**

**The Air-O Spray Equipment Co. Dept. C  
60 So. San Pedro St., San Jose, California**

### HB PAINT SPRAY

"DOES THE WORK OF FIVE MEN"

**QUICK, EASY PROFITS!**

Practically no investment. Small space required. Steady demand and BIG PROFITS refinishing autos, furniture—painting houses and barns with HB quick spray method. One man does the work of five with brushes.

Pays for itself on easy monthly payments. 30 DAYS' TRIAL. Write today for details.

**EASY TERMS**  
30 DAYS TRIAL  
QUICKLY PAYS FOR ITSELF

**HOBART BROS. CO.**  
Box M-991, Troy, Ohio

## Diamonds

Cash Priced ~

# 60% of Market

## WHY Pay Full Prices

**10 large loan firms combined (world's oldest, largest association of its kind—rated over \$1,000,000.00), loans money on diamonds at a mere fraction of real values.**

Of course not all loans are repaid. These the real opportunities to buy at prices you can try to match at full 60% more. Every liberal privilege, with examination free without obligation to buy.

### Detailed List Free—NOW!

See this 70-hundredths carat solitaire at \$69.50. Try to match at \$115.00. Radically low prices for any quality, any size diamonds. This dependable house plainly lists, describes and guarantees each and every quality. The exact grade you want unquestionably in latest list of Unpaid Loans. Diamonds also from other unusual European cash deals. Free, all details; guaranteed amounts you can borrow; other guarantees, etc. Examine diamonds free at our risk. Lists limited—write at once.

### Unpaid Loans—Low as \$60 per Carat

Name.....  
Address.....

For Free List clip this now, fill in and mail to—  
Jos. DeRoy & Sons, Opp. P.O. 1984 DeRoy Bldg., Pittsburgh Pa.

Note: These offers made by a 3/4 Century Old Firm. Bank References by permission.—Bank of Pittsburgh; Union Trust Co.; 3rd Nat'l Bank; Any Mercantile Agency.

## DOES \$35.00 per day interest YOU?

That's what you can earn as a DENNIS Weather Strip Contractor

No experience necessary. No special tools. Quick cash profits on strips and labor. We furnish free working models and teach you how to get contracts. Patented "S" shape provides snug weatherproof seal that is self-adjusting and SAVES 1/4 FUEL. Quick application and low price enables you to double volume of contracts. No grooving or removing of sash or doors—saves labor, time and expense.

Comes in convenient Window and Door sets, and bulk.

**Easily Installed in New or Old Buildings**

Every property owner can be sold DENNIS metal strip at wood strip prices. A proven success endorsed by Contractors, Builders, Architects and Owners. Write now for details.

Mail Coupon Today

# DENNIS

ONE PIECE - DOUBLE CUSHION  
BRONZE WEATHERSTRIP

W. J. Dennis & Co., 2110 W. Lake St., Chicago, Ill.

Send Money-Making Plan for Contractors

Send.....Sample Window Sets at \$1.75 each postpaid

Send.....Sample Door Sets at \$2.00 each, postpaid

Name.....  
Street.....  
City.....State.....

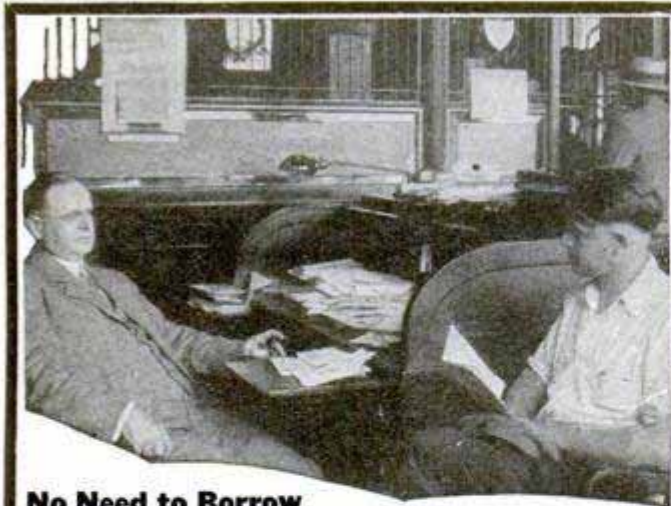

**No Need to Borrow  
Money When You Can Easily Earn  
\$150 to \$300 Monthly  
With Practically No Investment On Your Part**

Your banker will advise installing HB Equipment because it pays for itself without tying up your working capital, brings you big profits from pleasant work, is simple and easy to operate—and comes to you on

**30 Days' Trial**



**1. 8-Hour Battery Service** brings hundreds of new customers. Charges batteries in 1/2 the time and saves 30% to 50% of electric bills over rectifiers. For more information check No. 1 in coupon below.

**2. HB 20 Minute Car Washer** washes cars in twenty minutes, cleaner, better than hand methods. Eliminates drudgery—makes washing a pleasure. Will easily pay for itself. Check No. 2 below for details.

**3. Spray Painting with new HB Portable Paint Spray** does high class work at 1/5 the cost of old time brush methods. You get five men's income for one man's labor, painting autos, houses, barns, furniture, etc. For information check No. 3 below.

**4. Business Building Air Service** now available for as low as \$11 monthly for a few months. Brings car owners to your door day and night. Check No. 4 for full details.

You can have the moneymaking advantages of HB Equipment in your shop for as low as

**Only \$11 to \$16 Monthly**

for a few months—just a small part of the extra profits it will bring you. For full information without obligation, check and mail the coupon below.

**Hobart Brothers** **Box M99 Troy, Ohio**  
*'Successful Manufacturers since 1893'*

**Tear Off Coupon and Mail Today**

**HOBART BROTHERS CO.**  
 Box M99, Troy, Ohio.

Send me complete information on the items I've checked with your 30 day trial offer, easy payment terms, and information on how HB equipment will increase my earnings.

- 1  One Day Battery Service Profits
- 2  20 Minute Car Washer
- 3  Portable Paint Spray Business
- 4  Better Automatic Air Compressor

NAME.....  
 ADDRESS.....

**Electric Radio \$24<sup>00</sup>**  
 6 TUBE - A.C.

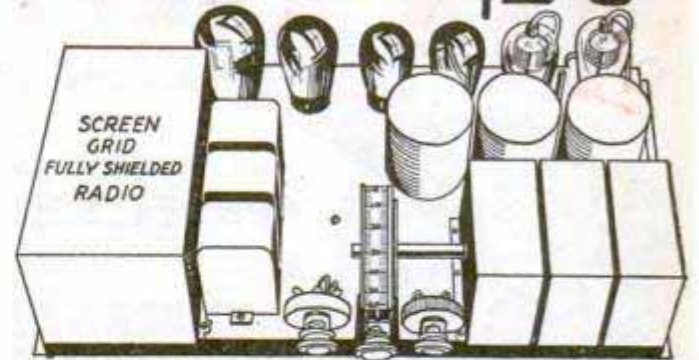

At last, a long distance electric radio at a price all can pay. Just plug in your electric light socket. Every owner of a battery operated radio will want one.

**AGENTS WANTED**

Keep your present job but add \$50 a week to your income. A demonstration means a quick sale—big profit. Sell in spare time—evenings. You'll equal the results of highest priced radio and yet sell for far less. Exclusive rights to men who make good.

Write for FREE illustrated literature today—don't delay, better still, telegraph.

**ELGIN RADIO CO., 4947 Crawford Ave., Chicago, Ill.**

**FACTORY PRICES!**

**21 JEWEL—Thin Model  
STUDEBAKER  
The Insured Watch**

The only high-grade watch sold direct from factory!

Let us send you one of these superb 21-Jewel Studebaker watches direct from factory. No obligation. If you like it and believe our low factory prices save you money—keep it. Pay for it in easy monthly payments or cash.

**FREE—6-Color Book**

To those who write immediately we will mail a beautiful 6-color style book showing complete line of Studebaker watches—all at factory prices. Write for it TODAY!

**WRITE!**

Handsome strap and bracelet watches in newest styles—at big savings. Write for FREE style book at once!

**STUDEBAKER WATCH COMPANY**

Directed by the Studebaker Family—known three-quarters of a century for fair dealing

Dept. N Q 103, South Bend, Ind.

Canadian Address: Windsor, Ont.



**RADIO SET-BUILDERS, Experimenters and Students:** Keep informed concerning the latest in radio, short waves, television, etc., by reading "Radio Design," a concise, clearly-written and illustrated quarterly edited by radio engineers. Send 15c for current issue or 50c for year's subscription (4 issues). **RADIO DESIGN, 103-K Broadway, Brooklyn, New York.**

**Auto Seat Covers \$2<sup>95</sup>** **Special Price Offer**

**AGENTS Make \$20 a Day**

**WRITE NOW!**

Write orders fast for this excellent Quality line Auto Seat Covers. Amazing values—quick sales. Cash daily. We deliver. Write for handsome Free Leatherette Sample Outfit. **Quality Sales, 515 S. Dearborn St., Dept. 916, Chicago**

# This New VIX will SAVE 1/4 to 1/2 your GAS



## New Moisture Humidifier & Carbon Eliminator

for all Makes of Cars, Trucks, Tractors and Engines

An amazing NEW Scientific Vapor Humidifier and GAS SAVER has been patented throughout the World that beats anything ever gotten out before. It makes engines run ALL THE TIME with the same wonderful efficiency they do on a cool moist night. It gives MORE pep and power—HIGHER topspeed—automatically ELIMINATES hard carbon from engine—and causes engine to give AMAZING MILEAGE RECORDS NEVER EQUALLED BEFORE.

**ENTIRELY UNLIKE ANY OTHER DEVICE.** This startling invention is radically different from every other kind. It uses MOISTURE from the radiator and makes the car run like on a damp cool night. It is GUARANTEED to save from 1/4 to 1/2 the gas and oil, stops boiling and steaming, makes engine start easier in all kinds of weather, and completely de-carbonizes the engine as you run.

This new principle device has been extensively tested out by Technical Engineers and Experts and found to give vastly more mileage, with largely increased power and pep from the engine. With it the engine used approximately 90% air, 6% moisture and ONLY 4% of gas.

## Big Profits

to Man with Car Spare or Full Time

\$350 to \$1500 a month

1 man \$4,939.66 in 3 1/4 months  
Another \$1,656.60 in 58 days  
\$5,150.00 in 5 months to another. **BIG MONEY** can be—**IS** being made

**Fitting Motors With Vix**  
One man sold 8 first morning  
Another sells all 3 men can install

Another's profits as high as \$100.00 a day.

VIX sells itself by 8 STARTLING demonstrations—**BIG STUNNING ASTOUNDING DEMONSTRATIONS.** Successful VIX men make MORE MONEY than they ever made before.

# Free Trial TRY This New Principle Gas Saver AT MY RISK

Try this wonderful VIX Moisture Humidifier and Carbon Eliminator AT MY RISK on YOUR OWN CAR to prove that VAPOR MOISTURE (drawn from Radiator to Engine) gives you that wonderful night driving effect ALL THE TIME with MORE mileage from gas and oil—eliminates hard carbon accumulation—gives MORE power, a SNAPPY, PEPPY motor, FASTER acceleration, a SMOOTHER, QUIETER running engine and HIGHER top speed.

VIX will PROVE ITS MONEY SAVING MERIT on your own car by 8 DEMONSTRATIONS—conducted by yourself AT MY RISK—the most SENSATIONAL, most ASTOUNDING, most CONVINCING DEMONSTRATIONS you ever saw. If you don't find from your tests that it does MORE than I claim: return it and it COSTS YOU NOTHING. I want wide-awake hustling, County, State, Province and National Agencies everywhere, part or full time, to make \$350 to \$1500 per month filling the great DEMAND for this wonderful invention wherever introduced. Write for my FREE TRIAL and MONEY MAKING OFFER. Use coupon below.

**WALTER CRITCHLOW**

Inventor and Manufacturer, 805-55 Street, WHEATON, ILL., U. S. A.

**FREE VIX offer Mail Now**

**WALTER CRITCHLOW, INVENTOR and MANUFACTURER, 805-55 Street, Wheaton, Ill., U. S. A.**

Please send me without obligation or charge your FREE TRIAL and MONEY MAKING VIX OFFER.

Name.....

Address.....

Town..... State.....



Pictures here and at top show Model "B" VIX attached to my own New Model A Ford. This car is wonderfully improved in performance with the VIX Moisture Humidifier. So is every Auto, Truck, Tractor, Taxi, Bus, Marine, Stationary and Aircraft Engine, both American and all Foreign makes.

**GUARANTEED TO SAVE** } 1/4 to 1/2 Gas  
Carbon Cleaning  
Engine Repairs  
**or Costs You Nothing**

# STOP THAT LEAK WITH SMOOTH-ON No. 1



**Y**OU can apply Smooth-On with radiator full or empty, hot or cold, without removal from the car and without putting inside anything that clogs the circulation.

Merely roll the Smooth-On into a stiff putty, press it against and into the leak with your thumb or pack it into the defect with a knife blade or screw-driver, and scrape off the excess. The leak will stop instantly, and the repair is permanent. For a few cents and in a few minutes you will have avoided all the delays and expense of a professional repair job that couldn't be any better.

**Cracked Water Jackets.** Water jackets of automobiles, stationary or marine gas engines which have developed long or short cracks or have even had pieces broken entirely out from freezing can be made thoroughly and lastingly serviceable by similar repair, or by applying Smooth-On under straps or a plate.

Smooth-On No. 1 can be used in a hundred ways in the household, and it often saves from \$50.00 to \$100.00 on the first job.

Keep a can of Smooth-On No. 1 with your tool kit and some day when caught with a repair job you will thank yourself for your forethought.

Get Smooth-On No. 1 in 7 oz., 1-lb. or 5-lb. tins at any hardware store or if necessary direct from us.



Write for **FREE BOOK.**



## Do it with SMOOTH-ON

SMOOTH-ON MFG. CO., Dept. 37, 574 Communipaw Ave., Jersey City, N. J.

Please send the free Smooth-On Repair Book.

Name.....

Address.....

9-29.....

# FREE

This booklet tells how to stop not only water leaks in radiators, cracked water jackets, and at loose hose connections, but also how to stop gas leaks from the tank, gasoline lines and exhaust system, and oil leaks at gaskets and at cracks in crank or gear case. It also tells how to make headlight posts, nuts, hub caps and bolts and grease cups stay tight, and shows dozens of simple money saving Smooth-On repair jobs.

Sent free if you return the coupon

SMOOTH-ON MFG. CO. Dept. 37, 574 Communipaw Ave. JERSEY CITY, N. J.

# 500 Shaves with one blade!



## SAVE MONEY!

Let one blade do the job of dozens! EASY HONE prolongs the life of a blade indefinitely. A keen, even cutting edge makes the last shave as smooth as the first. No need to buy blades continuously. EASY HONE sharpens the dulllest edge. Does not pull the beard or smart the face after sharpening.

## HONES and STROPS

EASY HONE combines the abrasive properties of a hone with the smoothing properties of a stropper. Gives you a new blade. BETTER THAN THE ORIGINAL ONE. Once you sharpen your blades with EASY HONE you will realize how indispensable it is.

## 30 DAY TRIAL

SEND NO MONEY—When EASY HONE is delivered, deposit \$5.00 with postman. Try the EASY HONE for 30 days—if not satisfied your money will be refunded. (Pays for itself out of money you save.)

**GREAT EASTERN SPECIALTY CO.**  
221-4th Avenue, Dept. 51, New York, N. Y.

## Stop Buying Blades!



## Heath Henderson

America's Only Practical light plane motor.

10c For Large Illustrated Booklet

## Heath Airplane Company

1721-29 Sedgwick St. Dept. P-9 Chicago, Ill.

## New Complete "Wonder" Workshop

Outfit saves you \$15.00



Now you can have this new, amazing 8-in. Combination Saw (18 tools in one) shipped on 15 days' approval, at manufacturer's risk. A complete ideal machineshop for factory, workshop or home; will rip, cross cut, bevel, miter, mortise, drill, groove, tenon, grind, rabbet, buff and polish. 1/2 H. P.-A. C. motor included with all attachments. Write quick for special 10 day offer.

SCOTT-BANSBACH CO. Dealers Wanted 142G-S. Clinton Street CHICAGO

# Wood Samples

Send for free sample and catalogue. CRAFTSMAN WOOD SERVICE, 715 E. 62nd St., Chicago, Ill.

Write Today for details

## Establish a Good Future

ONLY \$50.00

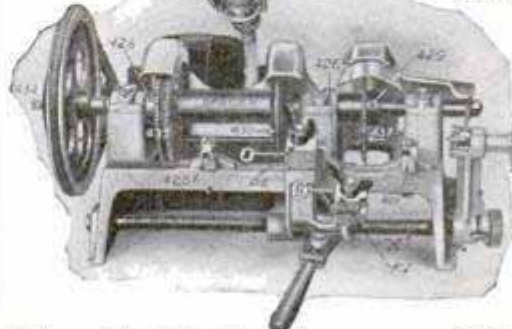

DOWN AND \$4.00 Weekly Starts a business of your own—No experience necessary. Instructions furnished. The only key machine that cuts ALL types of keys. No hand-filing. Make first keys by number of lock without taking lock apart.

Beisser Key Machine Company 407 Fort St. East Detroit, Mich., U. S. A.

# Look! Bald Men

One Full Ampoule of my amazing Hairerbs fluid which I discovered myself and which grew hair on my head.



# FREE

This Ampoule is absolutely free. Don't send any money. There is no C.O.D. No charge whatsoever. All I want is an opportunity to show you the fluid with which I grew hair on my own and on other men's heads. Merely mail the coupon below for free Ampoule.

## Here Is How I Used to Look

I was just as bald as this picture. It is a true photograph without any tampering or retouching. It is exactly as I used to look. Then look at the full head of hair I have in the picture on the left.

As I have stated so often, I don't know whether I am the first man who discovered this great secret, but I do know I have it, that I grew my own hair and that I am growing hair on the heads of other men.



## Bald Men It's No Joke to be Bald!

What I accomplished on my own head and on other heads I believe I can do for you, provided you are under 45 years of age and loss of hair was not brought about by burns, scars, or other causes leading to absolutely dead hair roots. Anyhow, I must succeed or your money is refunded in strict accordance with my guarantee. No apparatus. My home treatment is simple and easily applied.

## Mail This Free Coupon!

Mail the coupon today—Right Now—I will send you, immediately, one full Ampoule of my marvelous Hairerbs fluid which I discovered, of which I hold the secret and which grew my own hair on my bald head. Besides the Free Ampoule of Fluid, I will send photographs, names and addresses of men and women who successfully used my Hairerbs Fluid for Dandruff, falling and loss of hair.

## Vreeland

1356 Euclid-Windsor Bldg., Cleveland, O.



These are exact untouched photographs of Miss Augustine Raimondo, 2530 East 25th Street, Cleveland, who was almost entirely bald. House physicians, hospitals and clinics told her that she would be bald for life. She saw one of our advertisements, became interested and began taking treatments with Hairerbs. The growth of hair was surprisingly fast. Today Miss Raimondo has a full head of hair. This case is open for investigation by anyone.

## FREE COUPON

**Vreeland 1356 Euclid-Windsor Bldg. CLEVELAND, OHIO**

Please send me, entirely free, one full Ampoule of the same Wonderful Hairerbs Fluid which grew your hair.

My Name .....

My Address .....

State .....

# NEW!

## A Comfortable Folding Table for the INSIDE of Your Car

NOW you don't have to worry about the weather when out for a trip in your car. Have your lunch, do your writing or reading INSIDE the car in comfort, with Stone's Folding Auto Table (patent pending). Solid and substantial, 16 by 28 inches. Will hold a lot of weight. Plenty of leg room under the table. Just the thing for Picnickers, Tourists, Salesmen, Hunters, Fishermen and everyone.



### Fits All Sedans and Coaches

No tools necessary. Slips right on the robe rail, cord, or special loops furnished for cars not equipped with robe carrier. Covered with beautiful Fabrikoid. Folds up compactly.

### Money-Back Guarantee

Send your check or money order for \$4.75 and we will ship you a Stone's Folding Auto Table postpaid. If you are not perfectly satisfied, return it within 10 days and your money will be refunded. Or, write for descriptive circular.

**NEW ERA PRODUCTS COMPANY**  
206 South Front St. La Crosse, Wisconsin

Dealers: Write for proposition

# One Year To Pay

**No. A40—\$62**  
**\$2 Deposit—\$1.25 Week**

This exquisite, diamond ring is considered extremely handsome. A fine quality, full cut, genuine blue-white diamond full of fiery brilliance and sparkling colors, is set in this lady's, popular 18 Kt. white gold mounting. It makes a wonderful engagement ring or friendship ring. Your friends will think you paid \$100 for it. Everyone will admire it. The gift case is free. Sold on written guarantee.

**No Red Tape** **10 Days Trial**

**18 KARAT**

**SEND NO MONEY** When you get the ring, pay only \$2.00 to the postman. If you keep it, pay only \$1.25 a week for one whole year. All credit dealings kept strictly confidential—No orders accepted from persons under 20 years of age.

We are an old **Money Back** firm of diamond importers. **GUARANTEE** You take no risk. If you are not satisfied that the ring is the biggest bargain you ever got, return it and we will refund every cent that you paid.

**PRICE CUT TO \$62.00—WORTH \$100.00**

You can now buy this gorgeous ring at the wholesale price. Compare it with similar rings at \$100. We guarantee it to stand any test or comparison. Greatest bargain offered by any Diamond Importer. We allow 8% annual increase in exchange for a larger diamond ring.

**Write for FREE Illustrated Catalog**

It brings our large Jewelry Store right into your home. Gives weights, grades and complete description so you can buy diamonds like an expert. Gives you information other jewelers dare not tell.

Genuine Blue-White Diamonds as low as \$197.00 a Carat.  
AGENTS WANTED—EARN \$100 WEEK. Write for details.

**STERLING DIAMOND & WATCH CO. INC.**  
DIAMOND IMPORTERS—\$1,000,000 STOCK—ESTABLISHED 1878  
1540 BROADWAY DEPT. 2634 NEW YORK

# 100,000,000 Brake Drums to Be Re-Cut

Are You Realizing on the Dollars Passing Your Door Every Day?

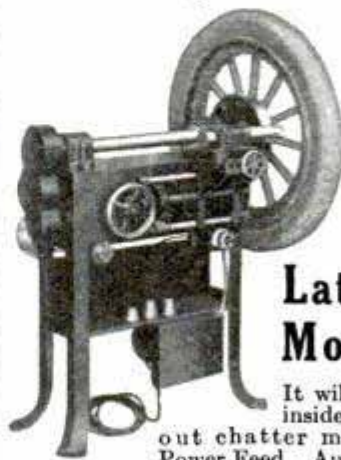

Millions of Brake drums are out of round and need truing up to give the owner maximum braking.

## This KORNAU Lathe Will Make Money for You

It will cut drums true to round, inside or outside—smooth without chatter marks. Six spindle speeds. Power Feed. Automatic Stops.

Operation experience unnecessary. Simply set depth of cut desired. The Lathe will do the rest.

**KORNAU Brake Drum Lathe with Tool Grinding Attachment (Weight 300 lbs.) . . . . . \$250.00 TERMS**

**KORNAU MACHINE COMPANY**  
NORTH SIDE CINCINNATI, OHIO

**GOODELL-PRATT**

*Here's an Automatic Screw-Driver that should be in every tool kit*

Strong, well built, powerful. Drives or draws screws quickly and with little effort. The most useful tool you can have around.

Drop in at your dealer's and examine these screw drivers—if he does not handle them let us know.

*If you love fine tools write for a copy of our Tool Handbook—it's free for the asking.*

**GOODELL-PRATT COMPANY**  
GREENFIELD, MASS., U. S. A.

# GOODELL PRATT

**1500 GOOD TOOLS**

**TRY IT 30 DAYS FREE BEFORE YOU BUY**

**FACTORY TO YOU - SAVE 50%**  
Choice of beautiful **DYNAMIC** Consoles

1 Year Guarantee

**9 tube - perfected**  
SCREEN GRID, PUSH-PULL

**MIRACO**  
TRADE MARK REGISTERED

**CATHEDRAL TONED, SUPER SELECTIVE, POWERFUL DISTANCE GETTER**

**only \$49.<sup>88</sup>**  
COMPLETELY ASSEMBLED

**Compare with costliest sets before you buy!**

You needn't send us a cent! America's big, old, reliable Radio Factory springs its 10th Anniversary Surprise in high-grade full-year guaranteed sets at history's lowest prices! With its latest perfected Screen-Grid, push-pull, super-powered and hum-free AC electric Miraco's—you are guaranteed satisfaction, values and savings unsurpassed.

At our risk compare a Miraco with highest priced radios, for 30 days in your home. Surprise and entertain your friends—get their opinions. Unless 100% delighted, **don't buy!** Your decision is final—no argument!

Only marvelously fine radios, of latest perfected type, at rock-bottom prices, can back up such a guarantee. Send postal or coupon for *Amazing Special Factory Offer!*

**Don't Confuse with Cheap Radios**

With Miraco's rich, clear cathedral tone, quiet operation, razor-sharp separation

of nearby stations, tremendous "kick" on distant stations and latest improvements—you'll be the envy of many who pay 2 or 3 times as much!

Send for proof that delighted thousands of Miraco users cut through locals, get coast to coast, with tone and power of costly sets. Miraco's are custom-built of finest parts—product of 10 years' successful experience. Approved by Radio's highest authorities.

**DEAL DIRECT WITH BIG FACTORY**

Miraco outfits reach you splendidly packed, rigidly tested with everything in place ready to plug in! No assembling! Entertain yourself 30 days—then decide. Liberal year's guarantee on each set. Play safe, save lots of money, insure satisfaction—deal direct with Radio's old, reliable builders of fine sets—10th successful year. **SEND POSTAL OR COUPON NOW!**

**MIDWEST RADIO CORP., 407-ES Miraco Bldg., Cincinnati, O.**

**Get our Send No Money 10th Anniversary Offer**

**Dealers Write! - mail coupon right Now!**



**BEAUTIFULLY ILLUSTRATED LITERATURE**

**Free!** Amazing Special Factory Offer

All the proof you want—of our honesty, fairness, size, financial integrity, radio experience and the performance of our sets—including Amazing Factory Offer—sent without obligation!

**User Agents Wanted! Exclusive Territory**

**DEMONSTRATOR SENT GET OUR PROPOSITION**

**Excels \$425 Outfit**

My 30 days trial on my Miraco AC-9 is up and if you would offer me \$200 extra for it back, I would tell you nothing doing. We had some very expensive sets in our home, one a \$425 9-tube AC set. Thanks to you I have a set that gets any and all stations. I have got stations in 45 states, also Cuba and Canada. It is beyond words to tell you what we think of our wonderful bargain. I will always praise Miraco's to everyone. **J. W. LAUDERBACK, Barberton, Ohio.**

Coupon brings proof like this from people in YOUR locality, too.

**SPECIAL! ELECTRIC AC-7 \$39.85**

**BATTERY SET \$29.<sup>50</sup>**

**THIS COUPON IS NOT AN ORDER**

**MIDWEST RADIO CORPORATION**

10th Successful Year  
407-ES Miraco Bldg., Cincinnati, Ohio

WITHOUT OBLIGATION send latest literature, **AMAZING SPECIAL FREE TRIAL OFFER**, testimony of nearby users, etc.

User  Agent  Dealer  
 Check here if interested in an **EXCLUSIVE TERRITORY PROPOSITION.**

Name .....

Address .....

***Mechanical superiority is  
unmistakably revealed in***

**THE PONTIAC BIG SIX**  
at \$745  
PRODUCT OF GENERAL MOTORS

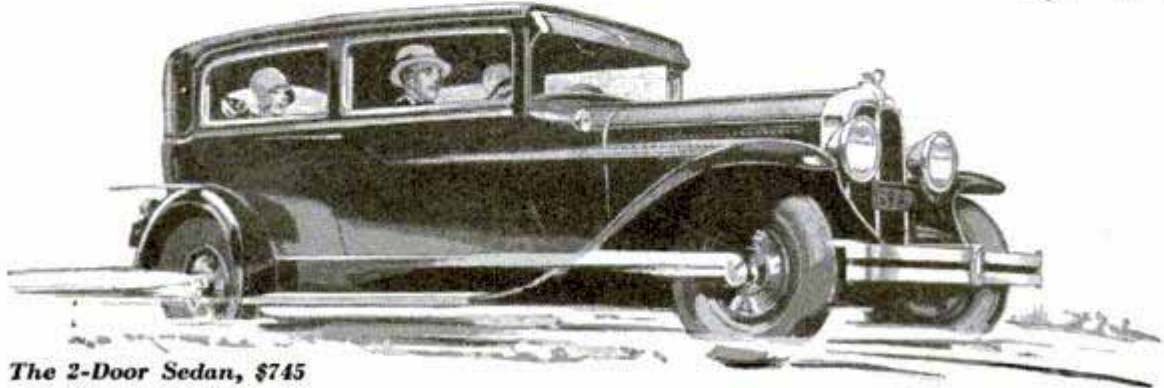

*The 2-Door Sedan, \$745  
Body by Fisher*

The striking superiority of the Pontiac Big Six in every detail of its mechanical construction has been responsible for much of Pontiac's amazing success. In this, as in every other respect, it is definitely the leader of the low-priced sixes—a car which the motorist interested in advanced automotive design will immediately recognize as offering *more* real value for every dollar invested.

**PONTIAC has more speed**

The "fifth wheel"—most accurate of all speed measuring devices—shows that Pontiac has the highest top speed of any six at the price.

**PONTIAC has more power**

Its larger engine—with 200 cubic inches of piston displacement—yields 60 brake horsepower at 3000 r.p.m.

**PONTIAC has more acceleration**

The "fifth wheel" test reveals that the Pontiac Big Six gets away faster than any other six-cylinder car in its price class.

**PONTIAC has more style**

It has strikingly smart bodies by Fisher, in a wide selection of popular Duco colors—concave belt moulding—flaring 70-inch fenders.

**PONTIAC has more safety**

Two completely independent braking systems—noiseless, enclosed, internal four-wheel service brakes—and a separate emergency brake working on the transmission—provide an extra margin of driving safety. Full tread axles—front and rear—give increased safety and handling ease on dirt roads.

**PONTIAC has more durability**

Its composite hardwood and steel body construction assures years of sturdy service. Numerous features contributing to longer life for its engine include the Harmonic Balancer which eliminates torsional vibration in the crankshaft—crankcase ventilation which prevents water from diluting engine oil—an adjustable feed lubricating system which holds bearing friction always at the minimum.

The Pontiac Big Six has many other fine car qualities—each one of which makes an important contribution to the pleasure and satisfaction of driving. Ask any Oakland-Pontiac dealer for a demonstration. Drive the car yourself. Learn at first hand why Pontiac remains unrivaled as the leader of the low-priced sixes.

Prices, \$745 to \$895, f. o. b. Pontiac, Michigan, plus delivery charges.

OAKLAND MOTOR CAR COMPANY, PONTIAC, MICHIGAN





# FREE To Men Past 40

A WELL-KNOWN scientist's new book about old age reveals facts which to many men will be amazing. Did you know that two-thirds of all men past middle age are said to have a certain seldom mentioned disorder? Do you know the frequent cause of this decline in vitality?

## Common Old Age Symptoms

Medical men know this condition as hypertrophy of the prostate gland. Science now reveals that this swollen gland—painless in itself—not only often cheats men of vitality, but also bears on the bladder and is often directly responsible for sciatica, backache, pains in the legs and feet, frequent nightly risings, and dizziness denoting high blood pressure. When allowed to run on it is frequently the cause of the dreaded disease cystitis, a very severe bladder inflammation.

## 65% Have This Gland Disorder

Prostate trouble is now reached immediately by a new kind of home treatment—a new safe hygiene that goes directly to the gland itself, without drugs, medicine, massage, lessons, diet or the application of electricity. It is absolutely safe. 50,000 men have used it to restore the prostate gland to normal functioning. The principle involved in this treatment is recommended by practically all the physicians in America. Amazing recoveries are often made in six days. Another grateful effect is usually the

immediate disappearance of chronic constipation. Usually the entire body is toned up, as much of your youthful vigor is restored. These results are guaranteed. Either you feel ten years younger in six days or the treatment costs nothing.

## Send for FREE Book

If you have gland trouble, or any of the symptoms mentioned, write today for scientist's free book, "Why Men Are Old at Forty." You can ask yourself certain frank questions that may reveal your true condition. Every man past 40 should make this test, as insidious prostate disorder often leads to surgery. This book is absolutely free, but mail coupon immediately, as the edition is limited. Address

**THE ELECTRO THERMAL CO.**  
2121 Morris Ave. Steubenville, Ohio

If you live West of the Rockies, address The Electro Thermal Co., 303 Van Nuys Building, Dept. 21-X, Los Angeles, Calif. In Canada, address The Electro Thermal Co., Desk 21-X, 53 Yonge St., Toronto, Ont., Can.

The Electro Thermal Company,  
2121 Morris Ave., Steubenville, Ohio

Please send me Free, and without obligation, a copy of your booklet, "Why Men Are Old at 40." Mail in plain wrapper.

Name.....  
Address.....  
City..... State.....

# BASHFUL?

"Shame on you!" Are you nervous, embarrassed in company of the other sex? Stop being shy of strangers. Conquer the terrible fear of your superiors. Be cheerful and confident of your future! Your faults easily overcome so you can enjoy life to the fullest. Send 25c for this amazing book. RICHARD BLACKSTONE, 8A-479 FLATIRON BLDG., NEW YORK

Cal. 30-40 Six Shot



**KRAG CARBINE**

Price  
**\$9.75**

All the qualities of a high price rifle. In fine used condition, all working parts guaranteed for one year. Send today for our Free 50-page illustrated catalog of money saving values: Guns, Ammunition, Cutlery, Sports and Gov't goods. Terms Cash. No C. O. D.

W. Stokes Kirk, Dept. P.M. 9, 1627 No. 10th St., Philadelphia, Pa.

# THOMPSON BETTER BUILT DUCK BOATS

**\$36 AND UP**

Swift, silent gliders, exceptionally steady—even in rough waters. Four models for open lake and river use and for still hunting in marshes and shallows. Two big Factories. Quick delivery from either one. Write for Free Catalog.

**THOMPSON BROTHERS BOAT MFG. COMPANY**  
213 Ann Street, Peshtigo WISCONSIN  
113 Elm Street, Cortland NEW YORK



## WAD E AMATEUR MECHANICS, REPAIR SHOPS, INVENTORS, STUDENTS

**BENCH LATHE**  
A real machine tool for the home work bench—capacity 4" dia. x 12" length. For Metal—Wood—Composition materials. Turning—Facing—Boring—Drilling—Winding—Thread Cutting. Accurate—Strong—Quiet—Compact. Slide-rest has travel entire length of bed. Leadscrew inside bed. No. 1 Lathe, plain headstock, \$28.00. No. 2 Lathe, back-gear headstock, \$58.00. Extra for lathes with 18 inches between centers, \$7.00. Complete line of accessories at equally low prices. Write for free catalog.  
**THE GEROLD CO.** Dept. P-55 120 Liberty St. New York

# SAVE YOUR BODY

Conserve Your Health and Efficiency First

**"I Would Not Part with it for \$10,000"**

So writes an enthusiastic, grateful customer. "Worth more than a farm," says another. In like manner testify over 100,000 people who have worn it.

## The Natural Body Brace

Overcomes WEAKNESS and ORGANIC AILMENTS of WOMEN AND MEN. Develops erect, graceful figure.

Brings restful relief, comfort, ability to do things, health and strength.

### Wear It 30 Days Free at Our Expense

Does away with the strain and pain of standing and walking; replaces and supports misplaced internal organs; reduces enlarged abdomen; straightens and strengthens the back; corrects stooping shoulders; develops lungs, chest and bust; relieves backache, curvatures, nervousness ruptures, constipation, after effects of flu. Comfortable and easy to wear.

**Keep Yourself Fit** Write today for illustrated booklet, measurement blank, etc., and read our very liberal proposition.

**HOWARD C. RASH, Pres. Natural Body Brace Co.**  
123 Rash Building SALINA, KANSAS



**For Boys and Girls Also**

## FREE RADIO CATALOG

Since the dawn of Radio, Barawik has been known the world over as headquarters for radio set builders and fans. Here, under one roof, is everything you need—sets, parts, supplies—thousands of products—ready to ship to you the same day your order arrives. Barawik prices save you money. Barawik service saves you time. Barawik merchandise always pleases. A quarter million satisfied customers say, "Barawik is Best." Let us send you the Big Barawik Book free and prove it to yourself.

**BARAWIK CO., 109 Canal St., CHICAGO, U. S. A.**



**AGENTS WANTED \$50 TO \$100 WEEKLY!** Take orders from Motorists for Electro Magnetic Trouble Light! Sticks to any part of car. Both Hands Free to Work. Amazing demonstration. Send for demonstrator and particulars. **WONDERLITE**, Industrial Trust Bldg., Dept. P.M., Providence, R. I.

## ELECTRIFY YOUR RADIO FOR ONLY \$6.85 COMPLETE

Why discard your present good set when you can electrify it for only \$6.85, and banish the annoyance and expense of buying new "B" batteries?



### Over 100,000 Townsend "B" Power Units in Use

Hooked up in a few minutes. Use same tubes—no changes. You'll be amazed at the improvement in reception and distance getting. Send name and address today for full details, proof and Free Trial Offer.

**TOWNSEND LABORATORIES**  
715 Townsend St., Chicago, Ill.

Please send me full information on the Townsend "B" Power and Free Trial Offer.

Name.....  
Address.....  
City..... State.....

## NO JOKE TO BE DEAF

—EVERY DEAF PERSON KNOWS THAT



I make myself hear, after being deaf for 25 years, with these Artificial Ear Drums. I wear them day and night. They stop head noises and ringing ears. They are perfectly comfortable. No one sees them. Write me and I will tell you a true story, how I got deaf and how I make you hear. Address



Medicated Ear Drum

**GEO. P. WAY, Artificial Ear Drum Co. (Inc.)**  
80 Hoffman Bldg., Detroit, Mich.

## Stop Using a Truss

**STUART'S ADHESIF PLAPAO-PADS** are entirely different—being mechanico-chemico applicators—made self-adhesive purposely to keep the herbal muscle-tonic called "PLAPAO" continuously applied to the affected parts, and to minimize danger of slipping and painful friction. The adhesive fabric is soft as velvet, and clings to the body

without straps, buckles or springs.

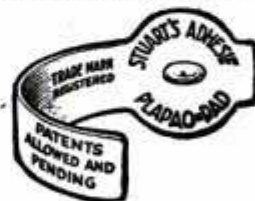

Easy to apply—comfortable—inexpensive.

For almost a quarter century stacks of sworn testimonials from many different countries report success—without delay from work. The epidermatic absorption of Plapao and the utilization of "plaster therapy" tend toward a natural process of recovery, after which no further use for a truss. Test of factor "PLAPAO" sent you **FREE**

Mail Coupon below **TODAY**

**Plapao Laboratories, Inc., 1307 Stuart Bldg., St. Louis, Mo.**

Send me **FREE** Trial Plapao and 48-page book on Rupture. No charge for this now or later.  
Name.....  
Address.....

# WIN AIRPLANE

(3 Passenger 90-h.p.) and Actual Pilot's Flying Course!  
 or \$3,745.00 in CASH!  
 If You Prefer.

HERE is the offer of the century! Amazing! New! Absolutely the first big free offer of its kind ever given. A new way for us to advertise and boost aviation. Last year we awarded to over 800 puzzle fans, automobiles and other valuable prizes, and in the next few months will give away between 200 and 300 more marvelous prizes to advertise in YOUR locality and elsewhere. Mrs. D. H. Ziler, Lewis J. Link, Mrs. Margaret Needham, C. F. Wieling, Mrs. R. A. Dobbins, each won automobiles or cash prizes from \$750.00 to \$3,500.00 in our last big advertising offers. Every year we spend over \$150,000.00 in this way, and this time we are giving away absolutely free a genuine 1929 90-horsepower Waco Airplane and free flying instruction at one of the best flying schools in the world—or \$3,745.00, all in cash! This greatest offer is now

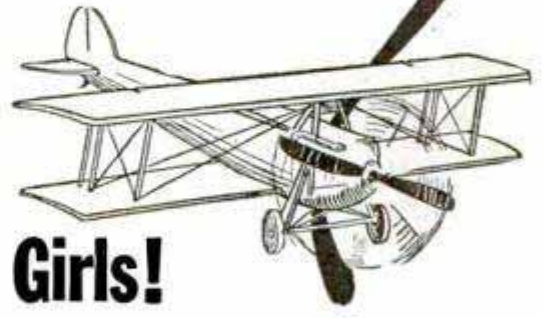

## Open to Women, Men, Boys and Girls!

This is YOUR chance—NOW! Learn to fly, and have your own Airplane or take this stupendous prize in cash! Think of it! You can make a world of money with your own Airplane, and we want to give you this marvelous Waco Airplane FREE and pay every cent to teach you how to fly at a great flying school. (You can have the cash if you prefer, however. Decide when you are announced winner.)

Someone who writes us will win this new Waco Airplane and the complete flying course, or \$3,745.00 in cash if preferred. That's not all. There are dozens of other wonderful prizes, including 5 marvelous aviation courses valued as high as \$1,000.00. So just send us your name and address now with the Prize Coupon below. Don't send any money. There is no obligation and nothing to buy now, later, or ever.

YOU

## \$500.00 Cash Extra for Promptness!

Therefore, act this minute! Don't delay a second. I am going to give a big special prize of \$500.00 for promptness, so hurry now. Rush! There's a fortune at stake. No matter what your age or occupation, you positively can win one of these big prizes if you act! The most startling advertising plan ever heard of. Just imagine being enabled to win \$500.00 in cash by acting quick right now. Learn about this sensational new prize plan. It's positively free. Everyone taking an active interest LIBERALLY rewarded. Send your name and address on the coupon right this minute so that it will reach the Judges in a hurry. There are no puzzles to solve or things like that—but act now!

L. S. RENO, Room 216  
 54 West Illinois St., Chicago, Illinois.

Dear Sir: I have read your advertisement, and am submitting my name as a candidate for the First Grand Prize, a new Waco Airplane and complete flying instruction, or \$3,745.00 in cash, AND ALSO PROMPTNESS PRIZE OF \$500.00. It is understood there is no cost or obligation to me, and it is not necessary to buy anything now, later, or ever.

Name .....

Address .....

Town ..... State .....



**MAKE VACATION PAY!**  
 Here's a pleasant way to earn extra money. During spare hours you can build and sell 20" model of FLYING Cloud. Set includes blueprints and complete instructions. Also hull shaped and sanded. Anchor, bell, capstan, spars, rigging line, cabin, etc. Complete for \$11. Postage 5 lbs. White metal figurehead 50c. Send 10c today for catalog and folder "See's a Clipper."  
 R. E. HANCOCK  
 323 Douglas Ave. Portsmouth, Va.

## Learn to Mount Birds

Learn at home by mail, to mount birds, animals, game heads; tax furs, make rugs and robes. Complete lessons. Easily and quickly learned by men, boys and women.

**FREE** Write today for Free Taxidermy Book. Tells all about it. Every Sportsman, Hunter, Trapper and Nature lover should know this wonderful fascinating art. Save your trophies. Big profits. Success guaranteed. Our school is 20 years old - 75,000 graduates. Investigate today. Write for Free Book.

Northwestern School of Taxidermy 9376 Elwood Bldg., Omaha, Neb.

# PATENTS

To the Man with an Idea

PATENTS Procured. Trade Marks Registered. —A comprehensive, experienced, prompt service for the protection and development of your ideas. Preliminary advice gladly furnished without charge. Booklet of information and form for disclosing idea free on request.

IRVING L. McCATHRAN, Patent Lawyer  
 Formerly with and successor to RICHARD B. OWEN  
 704 International Bldg., Washington, D. C.  
 41-E Park Row, New York City

# TRADE-MARKS REGISTERED

## The Waco Wonder Shop

Only \$10.00 DOWN NOW SENT ON TRIAL!

18" COMPOUND TOOL REST  
 45° TILTING TOP TABLE

**Make Things at Home**  
 A set of Red Jacket Electric tools brings a powerful Master Drill Motor, Waco Craftsman's wood turning lathe, compound and 18-inch rest, tilting saw table, scroll, jig and hand saws, and all accessories for drilling, buffing, grinding and cleaning. Attaches to light socket and gives you private machine shop. ONLY \$10.00 DOWN.

Free Crafts Course and Blueprint Service  
 Send Coupon for Interesting Literature. You will be surprised. Instructive, Fascinating, Beautiful.

WACO TOOL WORKS, Inc.  
 5216 W. Kinzie St., Chicago, Dept. 109  
 Please send me all information FREE.

Name .....

Address .....

# Cobb ELECTRIC Lantern

For Farmers, Campers,  
Motorists, Railroadmen  
and Marine Service

**\$4.50**  
Batteries  
Included

### ALL WEATHER DEPENDABILITY

NOT a flash light! Throws 40 foot circle of light. BURNS FOR 100 HOURS! Non-corrosive, positive action rotary switch throws light. Made of heavy brass for rough usage. Invaluable where open flame is dangerous. Handle adjustable to carry or hang. May be set on side or up-side down. Indispensable utility around house, garage or barn. Fully guaranteed. Uses standard batteries. Over 60,000 sold. Special price offer. Send check or money order. Postage paid.

NOTE THE EXTRA BULB

Two bulbs on one switch. Should one bulb burn out—half turn of switch instantly lights other bulb. You always have one bulb in reserve.

LANTERN SALES CO.  
Maxfield Bldg. Los Angeles, Cal.

## A Good Receiver Deserves The Best Volume Control

Control the tone and volume of your receiver with the **ELECTRAD TONATROL**—the Volume Control preferred by radio engineers, professional radio builders and others who know radio.



### Standard TONATROL

Rugged construction. Finest quality of materials and workmanship insure smooth, stepless variation and long life. With or without current switch, \$1.50 to \$3.00 at your dealers.

U. S. Pat.  
1593658-  
1034103-  
1034104  
& Pat. Pend.



### Super- TONATROL

Specially designed for use with high voltages. Resistance element fused to enameled metal base. Pure silver floating contact operates with amazing smoothness. Seven types, \$2.40 to \$3.50.

# ELECTRAD INC.

ELECTRAD, Inc., Dept. PM-9,  
175 Varick St., New York, N. Y.

Please send information on ELECTRAD Volume Controls.

Name.....  
Address.....

## SILVER ACE FLYING

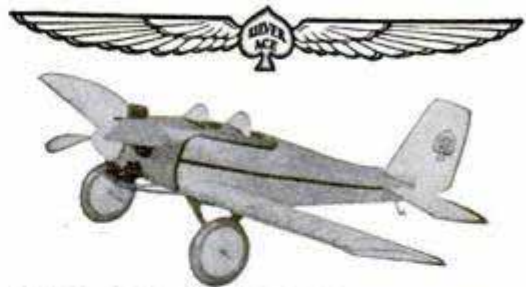

### F-21 LOW WING MODEL

Wing Span 25 inches      Weight 3 oz.  
Price, Ready to Fly, \$7.00

The entire fuselage of this fascinating new flying model is made of strong celluloid, beautiful in detail and color. Like all Deluxe Silver Ace ships, it has a semiflexible, detachable propeller, shock absorbing landing gear, and silk covered demountable wings. In design and performance it will thrill you.

Send 10 cents for illustrated catalogue of 18 Silver Ace models and construction sets. The most life like, longest flying, and most economical models produced by modern engineers. Light enough to save you disappointment in the air. Strength to give by far the lowest average cost per flight of any models you can buy or build. All first class dealers can supply you. If not, remit to us, adding 50 cents for packing and shipping.

### THE AERO MODEL CO.

Dept. M-9  
111 North Wacker Drive  
CHICAGO



## CONTROLS THE TRAFFIC THRU YOUR TUBES

Like the corner cop directing traffic, **AMPERITE** controls tube voltage. Self-adjusting, dependable, accurate. A type for every tube—A. C. or D. C. \$1.10 with mounting (in U. S. A.) at all dealers.



This symbol in a radio diagram means—



Radiall Company,  
50 Franklin St. NEW YORK  
**FREE**—“Amperite Blue Book”  
of modern circuits and  
valuable construction data.  
Write Dept. PM9.

# AMPERITE

REG. U. S. PAT. OFF.

The “SELF-ADJUSTING” Rheostat

## Speaking About Short Waves

There's no bunk about tuning in G5SW of England, PCJ of Holland, and other short-wave broadcasters, right in your own neighborhood. Others are doing it. You can. The secret is micrometric control of oscillation—maximum sensitivity without garbled sounds. The Clarostat regeneration control and accurate plate voltage is the answer. If interested—

**WRITE** for information on the complete CLAROSTAT line and how to apply it for broadcast and short-wave reception.

### CLAROSTAT MANUFACTURING CO., Inc.

Mem. R. M. A. Specialists in Radio Aids  
286 N. 6th St. Brooklyn, N. Y.

# CLAROSTAT



**EASY MONEY  
MANUFACTURING  
THESE PRODUCTS  
SPARE TIME-FULL TIME**

**200 to 500%  
PROFIT-  
Shown in this  
FREE Book**

People spend money willingly beautifying their homes. Decorative pieces in any color for porch, garden and lawn sell themselves. H. G. Young, New Jersey, invested \$97.00, made \$2,700.00 in spare time. A Michigan man sold \$2,000.00 worth to one concern. You can do the same. No experience needed. Make them spare time, or go into full time manufacturing. Nearly all profit. Big demand in your locality. Modest investment starts you. Expand from profit. The Colorcrete catalog tells how and shows equipment. Send for it now.

**COLORCRETE INDUSTRIES**  
570 Ottawa Ave., Holland, Mich.



**MODEL SHIPS**



We can supply construction sets and all sorts of parts such as semi-finished hulls, blocks, dead-eyes, special flags, anchors, steering wheels, capstans, figureheads, blue prints, books, etc., for building a Flying Cloud, Constitution, Spanish Galleon, Mississippi River Steamboat, Sovereign of the Seas, Mayflower and many others. Also special construction sets for racing sail boats, power boats, model steam engines, propellers, etc., and fine tools for the model maker. Our large 48-page photographically illustrated booklet contains valuable information and hints for building ship models in addition to prices and full description of the above articles. Many people only slightly interested in models have become greatly enthused upon receiving this booklet. A copy will be sent postpaid upon receipt of 15 cts. (coin preferred).

**Model Ship Supply Co., Dept. F, Mineola, N. Y.**

**Up-to-Date Home Craftsman Shop** For the man or boy who enjoys working with well-equipped electrically driven wood working machinery. Complete in every detail. Every purchaser given **FREE OF CHARGE** 12-months' course in Wood Craftsmanship and 27 blue-prints of various pieces of furniture, toys, models. Full details and illustrations sent without obligation. 10-day **FREE** trial. Can be purchased on monthly payment plan. Write today.

**Up-to-Date Machine Works, Dept. 38, 2915 S. Wabash Ave., Chicago, Ill.**

**NEW 8 DAY Strap Watch**



**\$7.49 LATEST INVENTION**

Something entirely new in wrist watches. Runs eight days on one winding. Guaranteed 6 jewel movement, accurate timekeeper. 2 adjustments. Radium dial. A real watch for those who can afford the best. Made by one of the best known watch factories in the world. Nickel-silver case. Our two years' written guarantee protects you. Send no money. Pay on delivery \$7.49 and postage.

**JENKINS CORP., 683 Broadway, New York, Dept. 9-2-23**

**VACUUM CLEANER MEN**

Your selection of 30 leading makes, rightly rebuilt vacuum cleaners. From \$5.00 up. All fully guaranteed. Perfect in action and appearance. Any quantity desired. Biggest vac bargain ever offered. Here's real money for you. **ATTACHMENTS**, bags, belts, brushes, all other parts, and new specialties. Highest quality. Lowest prices. World's Largest Factory Rebuilders. Complete **FREE** Catalogs

**United Enterprises, Inc., 13024 Athens Avenue, Cleveland, U. S. A.**



**Newest Craze  
KITCHENWARE  
in COLORS  
\$25 a Day EASY**

At last—here is the opportunity for which thousands of agents have waited! For the first time you can demonstrate new, popular **KITCHENWARE** in **COLORS** direct to homes. Latest craze sweeps in big profits—as high as \$60 a day. Fortunes waiting for those who act quick.

**FIVE SPARKLING NEW COLORS**

Imagine showing housewives samples of Bowls, Coffee and Tea Pots, Percolators, Kitchen and Bath Room Stools, Sauce Pots, and many other kitchen articles they use every day.



Show them in **five beautiful colors**: Green, Blue, Ivory, White, Orange, and Red! So beautiful, sparkling, rich looking is this kitchenware that women **insist** on owning it, and so low priced that every woman can afford to buy several articles! Made by 50-year old company. Guaranteed by Good Housekeeping Institute. This isn't selling at all—it's demonstrating and collecting profits!

**BIG SELLING FREE OUTFIT**

**No Charge No Deposit**

Get big selling outfit in original colors and see for yourself why 4 out of 5 order. Big profits even for spare time work. Rush coupon for Free Outfit, agent's prices, valuable new selling plans. Outfit mailed to you at our expense. No charge. No deposit. Mail Coupon.

**Modern Kitchenware Co.**  
Dept. 6-M, 176 W. Adams Street  
**CHICAGO, ILL.**



**Modern Kitchenware Co., Dept. 6-M,  
176 W. Adams St., Chicago, Ill.**

Gentlemen: Please rush details of plan to sell **MODERN KITCHENWARE** in five colors—also free selling outfit.

Name.....

Address.....

City.....State.....

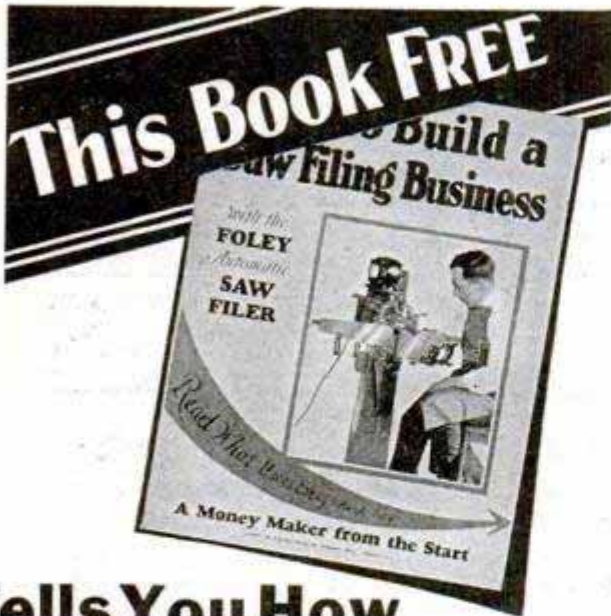

## Tells You How To Make Big Money In Your Own Cash Business

Hundreds of men who have sent for this FREE book have taken advantage of this wonderful opportunity of getting into business for themselves—a cash business that pays big profits. Very little capital required.

## No Canvassing

Roy P. Cross says, "Saw filing is fine, more coming in every day. People come from 30 to 35 miles." Men will not use anything but Foley-filed saws after they have once tried them.

### No Experience Necessary

You can turn out perfect cutting saws on the Foley—very simple to operate. Files every tooth exactly alike, automatically.



T. P. Wilson and his Foley Filer

## A Steady, Year 'Round Business

There is big money to be made filing saws on the Foley every month in the year. It offers you an opportunity to make an independent income—a permanent, successful business of your own.

## Mail Coupon for FREE Book

Foley Mfg. Co., 243 Foley Bldg.,  
11 Main St. N.E., Minneapolis, Minn.  
Please send me FREE Book "How to Build a Saw Filing Business" and make big money in my own business.

Name.....  
Address.....  
City..... State.....

For Craftsmen Who Want Something More Than a Toy!

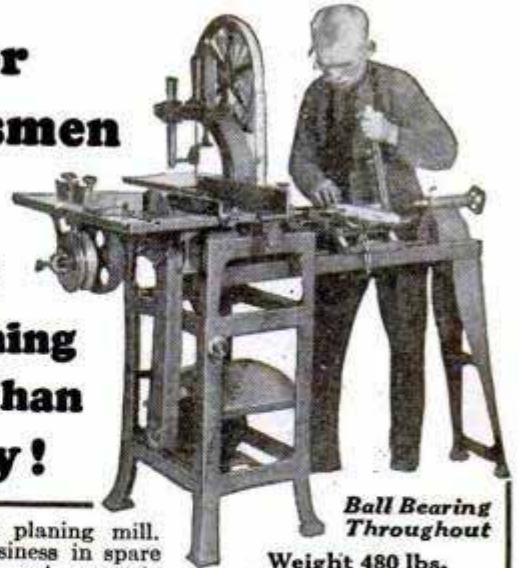

A complete planing mill. Build a business in spare time. Turn out accurate cabinet work. Ideal for the Home Craftsman. Saws 3 1/4" thick. Rips 12" wide. Lathe swings 10". Rugged cast-iron frame; no warping, twisting or vibration.

Ball Bearing Throughout  
Weight 480 lbs.

## The Electric Carpenter

Runs from any Light Socket

**7 Machines in One**

8" Circular Saw	Reversible Shaper
14" Band Saw	1/2" Hollow Chisel Mortiser
36" Lathe	Sander
10" Swing Jointer	
4" Jointer	
Does 35 Woodworking Operations	

Write today for New Folder P-99

We also build a complete line of single-purpose machines

**THE WOODWORKING MACHINERY CO., INC.**  
Eleventh and Vine Sts., Philadelphia, Pa.

## FREE Saxophone Book



Just send us your name and address and we will mail free and postpaid our new Saxophone Book. It explains and illustrates all Saxophones—gives first lesson chart—shows how exclusive Buescher improvements make it easier for you to play a



### True-Tone Saxophone

In one hour you can play the scale—in a few weeks you can play popular music—many join bands or orchestras in 90 days. No other wind instrument is so easy to learn and none more beautiful.

## Easy to Play Easy to Pay

The Saxophone harmonizes beautifully with piano—is great for solos, duets, quartettes and sextettes. It is ideal for home entertainment, lodge, church or school playing. Hundreds make big money playing in Dance Orchestras and on Radio Programs.



- Snap-On Pad
- Automatic Octave Keys
- Perfect Scale Accuracy
- Simplified Fingering

**6 Days' Free Trial** in your own home will prove to you how easily you can learn to play a Buescher Saxophone. Small down payment and a little each month lets you play while you pay.

Write for the Free Buescher Saxophone Book today  
**BUESCHER BAND INSTRUMENT CO.**  
2855 Buescher Block (539) Elkhart, Ind.



# The directors were amazed at his lightning calculations

...yet he solved their mathematical problems with a simple device that anyone can use.

ONE of the department heads was speaking. "Those appliances cost us \$9.16 each. Special advertising adds \$1.10 more. The selling price is \$18.00. That means our mark up will be \_\_\_\_\_." He reached for his pencil.

"Forty-three percent," said the President's young secretary. His answer had come like a flash. The directors were amazed at his lightning calculations. Especially so since he repeated the feat again and again during the meeting.

Yet the secretary's method was simplicity itself. He used a Multi-Vider—an amazing lightning calculator and mechanical pencil in one

that multiplies, divides, works percentages, proportions, etc. almost instantly.

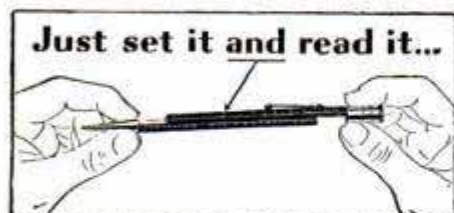

Busy men find the Multi-Vider invaluable for calculating stock yields, measuring areas and volume, estimating production and sales costs, figuring "mark ups" and "mark downs," and for quickly solving scores of other mathematical problems.

Has all the features of a high-grade mechanical pencil—plus the remarkable device for making rapid-fire calculations. Comfortable size—no writer's cramp; outside metal parts gold-filled or sterling silver-filled as desired; takes any standard thin lead; propels, repels, expels; oversized eraser and strong ball clip. Smart-looking, mechanically perfect—yet costs no more than any other fine mechanical pencil. Also makes a wonderful gift.

If your dealer cannot supply you, mail coupon and we will send you a Multi-Vider direct, with simple directions for use. On delivery, pay the postman only \$5.00. (Or \$10 if you prefer the gold-filled Executive model in handsome gift-box.) After five days, if not delighted, simply return it to us and money will be promptly refunded.

**The MULTI-VIDER**  
— multiplies — divides —

**Ruxton Multi-Vider Corp.,**  
4081 Graybar Bldg., New York City.

Please send me a Multi-Vider, with instructions for use. On arrival I will pay the postman price quoted below plus a few cents postage. Within 5 days, if not satisfied, I may return the Multi-Vider and you are to refund my money. I am checking the model I want.  
 Standard model \$5.  Gold-filled Executive model in handsome gift-box \$10.

Name.....  
 Address.....  
 City..... State.....

The Old Reliable Credit Jewelers

# LOFTIS

Dept. D-894  
108  
N. State St.  
Chicago, Ill.

## DIAMONDS WATCHES

Genuine Diamonds Guaranteed  
CASH OR CREDIT  
"Diamonds Win Hearts"

No. 900 \$37.50 \$1.00 a Wk.	No. 849 \$100 \$2.50 a Wk.	No. 859 \$125 \$3.25 a Wk.	No. 904 \$150 \$3.75 a Wk.	No. 27 \$75.00 \$1.75 a Wk.
------------------------------------	----------------------------------	----------------------------------	----------------------------------	-----------------------------------

Buy from the Importer  
Loftis Saves You Most Money

### Loftis Gives You the Best for Less!

Our Diamonds are radiant, sparkling, blue white gems, set in beautiful solid 18-k white gold rings, exquisitely engraved and pierced. Exceptional values—order today!

Satisfaction guaranteed or money back. Credit terms: Pay one-tenth down; balance weekly, semi-monthly, or monthly at your convenience. ALL GOODS DELIVERED ON FIRST PAYMENT. Our References: Any Bank or Banker in U. S. A.

### BIG VALUES IN WEDDING RINGS!

No. 897—Elgin "Legionnaire". New Elgin for men—with white or green gold-filled case and raised figured dial. \$25.00—\$2.50 Down and \$2.50 a Month.	No. 824 The "Elite" solid 18-k white gold. Set with 3 diamonds, \$22.50; 5 Diamonds, \$32.50; 7 Diamonds, \$42.50; 9 Diamonds, \$52.50; 12 Diamonds, \$67.50. All Platinum Wedding Rings, set with brilliant blue white Diamonds, from \$50 to \$200.	No. 898—Modern watch. Paris style. 16-jewel movement, chromium finish case, \$17.50. \$1.75 Down and \$1.75 a Month.
--	---	--

Standard Railroad Watches on Credit at Cash Prices  
All Guaranteed to Pass Inspection  
Hamilton No. 992, \$55  
Elgin's Latest Raymond, \$55  
Illinois "Bunn Special" \$50  
Terms to Suit Your Convenience

Send Today for FREE Catalogue  
Write for big free book of 2000 illustrations and descriptions of Diamond Rings in Platinum and Solid Gold, Dinner Rings, Pins, Brooches, All Standard Makes of Pocket Watches, Pearls, Dresser Sets, Silverware, Clocks, Kodaks, Leather Goods. Also many inexpensive novelties.

Books on all subjects are sold by Popular Mechanics Press, 200 East Ontario Street, Chicago, Illinois.

## 8" COMBINATION SAW OUTFIT \$35

F.O.B. Phila.

OUTFIT includes necessary attachments to rip, cross-cut, bevel, grind, mitre, groove, sand, mortise, tenon, and polish. Table tilts to 45° angle and may be raised or lowered, with one hand, in order to get any depth cut from 0" to 2 1/4". Base for saw and motor makes it portable.

Base 28" long by 8" wide. Table top 16" by 18"  
1/2 H. P. double extension shaft motor. Complete ready to plug into any light socket.

Send for Free Catalog giving details of Saw, Bench Lathes, 12" Band Saw, Complete Workshop and other Hardware Specialties.

### THE WILBAR CO., Inc.

2020 E. Arizona St., Phila., Pa.

## FUGO FIRE EXTINGUISHER

EASY \$100 a Week

Unusual opening for live agents in every locality. Make \$5000 or more a year—easily. Fugo—the instantaneous automatic fire extinguisher—is needed and wanted in every home, store, theatre, garage, shop, school, automobile, etc. Cheapest fire protection available today. Within reach of all.

1 Qt. Size \$5.00    2 Qt. Size \$7.50  
Recharged in a jiffy

Amazing 30-second demonstration clinches sale—each one sold sells others. Territory going fast. Write at once for wonderful proposition that will make you big money.

THE NATIONAL FORMETAL CO.  
6535 Metta Ave., N. E.    Cleveland, Ohio

## EARN ENORMOUS PROFITS

—WASHING CARS IN 20 MINUTES

HB Double action car washer easily washes complete car in 20 minutes—saves labor, material, time. Throws more water per minute, at high pressure, than any other outfit on market. Costs you—only \$20 Monthly easily paid from profits. You try it 30 days, at our risk, on money-back guarantee.

**Hobart Brothers** Write today for details  
Successful Manufacturers since 1893, Box M992, Troy, Ohio

**Ford Owner** Stop that ruinous chatter on your car. MAKE THIS TEST—take out your floor boards, pull your emergency brake back and forth. If you notice play at the ball joint, you need Bredar's Ball Shim. Price \$50. Ask your Dealer or order direct. Demand Bredar's Shim.  
NIC BREDAR'S SON MFG. CO., Rock Island, Ill.

# NOW GET MY GREATEST Log Saw Offer

Fastest Cutting

## Saws 15 Cords a Day

# ONLY \$39

Used by The United States Government

It's easier, now, than ever before to own this fastest cutting, easiest-moved, most powerful Log Saw. Now you can make big money sawing firewood, stove-bolts, ice, shingle timber, etc. WRITE TODAY FOR FULL DETAILS.

Try 30 Days **OTTAWA** Make Big Money—Wood selling at \$3 a cord brings owner \$45.00 a day. Go into the wood business. Don't let the lack of ready money stop you—Remember, we sell on very easy terms. To Save You Freight— and get your machine to you a few days after your order, I ship from factory or nearest to you of NINE BRANCH HOUSES.

—ONE WHOLE MONTH to use the OTTAWA at our own sawing. Every saw shipped on trial only—  
Backed by 10-Year Guarantee

**FREE** Send me your name and address on a postcard today for my wonderful new edition of the "Wood Sawing Encyclopedia." Be sure to investigate—it will help you to make big money.

**HARRY OVERMAN, Pres., OTTAWA MFG. COMPANY**  
1745-L Wood St., Ottawa, Kans.

Puts the OTTAWA Working For You!

350 Cuts a Minute!  
Now you have a log—in a few seconds it's all sawed up—without any hard work!

**FREE Wood Sawing Encyclopedia**



# The Latest—The Best—The Lowest Priced!

For 25 years the management of this firm has sold merchandise by mail. This is our guarantee to you—

"We promise courteous treatment and prompt shipments."

**Order Direct  
From this Page**

**WE PREPAY ALL ORDERS ABOVE 50 CENTS.**  
(Remit Five Cents extra postage for all orders below 50c)

**Money Refunded If  
Goods Unsatisfactory**

Remit by check, money order or U. S. Postage stamps. Canadian and foreign stamps not accepted.

## REAL PISTOL LUMINOUS PAINT MAGNIFIER MICROSCOPE FLUOROSCOPE

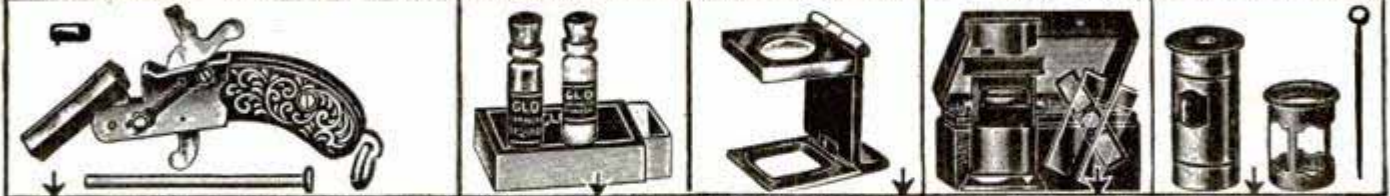

Here's a real pistol, yet small enough to be used as a watch charm. Illustration is full size. Imported, best European workmanship. Excellent reproduction of standard pistol. Cut shows pistol broken open to load blank cartridge. When trigger is pulled, cartridge goes off with a loud BANG, that can be heard for a block. Pistol entirely made of steel, nickel plated. Handle is beautifully engraved. Octagonal barrel. Comes in box, with cleaning rod and 25 blank cartridge. **AT NO EXTRA CHARGE.**

No. 8508 Pistol.....Prepaid **\$1.25**  
No. 8509A Set of 25 Cartridges.....Prepaid **25c**

Make your own luminous articles. Paint watch and clock hands, electric light switches, push buttons, key-holes, house numbers, etc. 1,000 uses. Articles treated stand out brilliantly in dark. The darker the room, the more brilliancy.

No. 8508-A **25c**  
No. 8508 Luminous Paint  
Large Size **\$1.00**

This fine folding pocket magnifying glass, also called linen tester, is made entirely of gold lacquer brass. Has powerful lens that magnifies everything 10 times. Has fixed focus. Just open it and it is ready. When folded this magnifier occupies a space about as large as a quarter and twice as thick.

No. 8516 Magnifier **35c**

Here is a real high power imported microscope for instruction and laboratory work. Has regulation rotating light mirror. Has adjustable lens for correct focusing. With it come 3 specimen slides. Entirely brass. Packed in neat leatherette box.

No. 8517 Microscope **\$1.90**  
Prepaid

This is a fine imported combination microscope. Really two instruments in one. One end used for high magnification, such as seeing bacteria in milk or water. Other end to see parts of insects, flower specimens etc. Finished in gold brass.

No. 8518 Fluoroscope **65c**  
Prepaid

## FOOLEM HOAX HANGER IO+COMPASS IO+ RUBBER !! BOOTLEG PUZZLE TRICK-SOAP



Box of sponge rubber cigarettes. Can't be told apart when mixed with real ones. Get the laugh on your friends. Nothing like it. This is one of the cleverest novelties ever designed and is made exceedingly well. Even the ends of the cigarette look like real tobacco.

No. 8501 Cigarettes **25c**  
Prepaid. Box

Latest novelty out. This trick coat-hanger looks just like the regulation article. But try and hang a coat on it and—FLOP down it comes. Hanger has a spring hinge—even a hat pulls it down. Hanger is fastened to wall with nails or screws. Nickel plated.

No. 8523 Hoax Hanger **25c**  
Prepaid

Fine imported magnetic compass. ACCURATE. Pocket size. Invaluable for hikers, automobilists. Often saves lives. Use it to tell live electric wires; make your own galvanoscope. Fully nickel plated. The actual article is about one-half again as large as illustration shown.

No. 8507 Compass **10c**  
Prepaid

Cigar is made of sponge rubber. Fools everybody. Deception is perfect.

No. 8500 Rubber Cigar **15c**  
Prepaid

Offer your friends or your girl some chewing gum—They try to chew it, till they find out its rubber! Five sticks in the packet.

No. 8519 Rubber Gum **10c**  
Prepaid

A real stinker. Just try and get the bottle off the boot. It will take you quite a while till you master the intricacies of this clever puzzle. Made entirely of metal. Nickel plated. Size of this puzzle is 2 1/4" x 2 1/4"

No. 8515 Bootleg Puzzle. **20c**  
Prepaid

Loads of fun with this trick soap. Looks harmless and is intended to "get" the chap who always uses your soap. When he uses it his hands get black as soot and he needs real soap to clean his hands.

No. 8512 Trick Soap **15c**  
Prepaid

## BLUFFGUN PERISCOPE CALLIOPE NOSE BLOWER WONDERSCOPE TELESCOPE



Bluff your friends with this gun. Made of composition metal handsomely nickel-plated. Exactly same size, weight and shape as real article. Fine to bluff burglars. Used also as desk paper weight. Size of this gun is 6 1/2" long and 3" wide.

No. 8505 Bluffgun **60c**  
Prepaid

See what's going on behind your back with this See-backscope. Used like a magnifying glass. No one knows you're watching them. Gives you "eyes in your back." This article is made in molded bakelite and its size is 2" x 1 1/2".

No. 8506 Periscope **10c**  
Prepaid

Musical Calliope. Latest novelty. Made in celluloid, light weight. 4 1/2" x 2". Eight keynotes produce perfect Calliope musical effect. Simple to play—just blow. Plays like Harmonica. Exceptionally loud. Finished in different, attractive colors.

No. 8521 Calliope **15c**  
Prepaid

The real article! Conceal nose blower in your handkerchief and blow into instrument while you pretend to blow your nose. Everyone stops and looks at you. There never was a terrible noise like it. Keep it up as long as you like.

No. 8510 Noseblower **10c**  
Prepaid

ACTUALLY MAGNIFIES 25 TIMES! Hair looks as big as a rope. Mes pores in your skin has double adjustable lens. For home, laboratory and shop. Full black enamel and clip. This little instrument must be seen to be appreciated.

No. 8503 Wonderscope **95c**  
Prepaid

Made entirely of brass as its bigger brothers. Lenses are scientifically ground. Nothing better made. Fits into pocket. Instrument is handsomely finished in gold lacquer brass and measures extended 8 1/4", closed 3 1/4"

No. 8504 Telescope **50c**  
Prepaid

## OOH-LA-LA RING



Handsomely carved gold filled ring. Looks just like any other ring. But, oh boy, wait till you look through the "VIEW." Strong magnifying glass shows French actress when viewed against light. Ring has large imitation diamond. When ordering enclose a strip of paper giving size of your finger.

No. 8511 Surprise Ring. **35c**  
Prepaid

## TELEGRAPH CODES

LETTERS	WORDS	OPERATIONS	KEYS
A	ALICE	+	1
B	BENNY	-	2
C	CHARLES	x	3
D	DICK	o	4
E	EDWARD	o	5
F	FRED	o	6
G	GEORGE	o	7
H	HENRY	o	8
I	IRVING	o	9
J	JACK	o	0
K	KENNETH	o	1
L	LARRY	o	2
M	MARY	o	3
N	NED	o	4
O	OSCAR	o	5
P	PETER	o	6
Q	QUINN	o	7
R	ROBERT	o	8
S	SAMUEL	o	9
T	TOM	o	0
U	URSULA	o	1
V	VICTOR	o	2
W	WALTER	o	3
X	XENIA	o	4
Y	YVONNE	o	5
Z	ZOE	o	6

For the astonishing small sum of 25c you can now learn telegraphy. Any wide awake boy or girl can learn the telegraph codes with this little outfit within from 30 to 60 days. Gives loud signals perfectly—nothing to wear out. No batteries. The instrument consists of hard fiber base, mechanical sander and telegraph key knob. Screw to table or carry it in pocket. Guaranteed to give exact reproduction of telegraph sounds just like regulation sets. We also furnish free a set of telegraph codes as shown, and full instructions of how to learn telegraphy.

No. 8525 **25c**  
Telegraph Set **25c**  
Prepaid

## NEW!! Spinthariscopes

Positively the most astounding scientific instrument ever developed. This instrument formerly sold from \$1.00 to \$50.00 upwards. Now it is possible to get it for a small sum. Witness actual destruction of thousands of worlds by simply looking through the lens of the instrument. Actual radium is disintegrated before your eyes. You see the atomic bombardment plainly. Instrument is guaranteed to contain a minute quantity of radium. There is no more enthralling sight in the whole world than what you see in the Spinthariscopes.

Nothing to wear out. Lasts forever. Adjust by extending lens to right focus and watch the spectacle.

No. 8524 **65c**  
Spinthariscopes **65c**  
Prepaid

## NEW!! CIGARET BANG

Here boys is THE novelty. Box contains a dozen tiny wood pegs—but they ARE "treated." Push the sharp end of peg into cigarette about 1/3 in. Pegs are so small they're invisible. Then offer your friends the cigarettes. BANG, BANG! they go off—YET ENTIRELY HARMLESS.

No. 8520 Cigarette-bang. **15c**  
Prepaid

## ACTUALLY MAGNIFIES 25 TIMES!

ACTUALLY MAGNIFIES 25 TIMES! Hair looks as big as a rope. Mes pores in your skin has double adjustable lens. For home, laboratory and shop. Full black enamel and clip. This little instrument must be seen to be appreciated.

No. 8503 Wonderscope **95c**  
Prepaid

## ACTUALLY MAGNIFIES 25 TIMES!

ACTUALLY MAGNIFIES 25 TIMES! Hair looks as big as a rope. Mes pores in your skin has double adjustable lens. For home, laboratory and shop. Full black enamel and clip. This little instrument must be seen to be appreciated.

No. 8503 Wonderscope **95c**  
Prepaid

# 7 Shaves for a Postage Stamp

That is all it costs you to try this unique new shaving method—we stake everything on this free trial



GENTLEMEN:

The postman is our best salesman. For he brings the test that wins men to our new product. The product actually sells itself daily in the greatest laboratory of the world—America's bathroom.

Each morning hundreds of new users try Palmolive Shaving Cream at our expense. And 86% of them, we find, discard their former methods for it. Thus, our problem is to get men to take our test. To sign and mail the coupon.

If we can win so many millions in so short a time, surely you want to try this remarkable cream yourself. We do not want to sell you sight unseen. First let us prove our case—then you will want to buy.

**Mail coupon—learn its 5 points**

You risk nothing. We undertake, in 7 shaves, to win you. It's an open-and-shut proposition, and you are the judge. So won't you mail the coupon?

**PALMOLIVE RADIO HOUR**—Broadcast every Wednesday night—8:30 to 9:30 p. m., E.T.; 7:30 to 8:30 p. m., C.T.; 6:30 to 7:30 p. m., mountain time; 5:30 to 6:30 p. m., Pacific time—over station WEAJ and 39 stations associated with The National Broadcasting Company.

4723

## 7 SHAVES FREE

and a can of Palmolive After Shaving Talc

Simply insert your name and address and mail to PALMOLIVE, P. O. Box 375, Grand Central Post Office, New York City

.....  
 .....  
 .....

Please print your name and address

## NEW COMPASS

*makes accurate  
drafting work easy!*

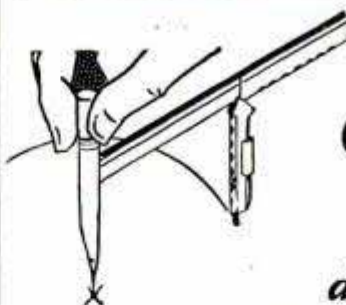

**T**HERE are dozens of jobs on which you need a good compass—radio hook-up diagrams, lighting outlets—no end to its workroom uses!

Now you can have an accurate compass without buying a set of cumbersome, expensive drafting instruments! This **ESTERBROOK COMPASS** is so small that it seems like a toy. It is very inexpensive, yet amazingly precise.

It works on an ingenious

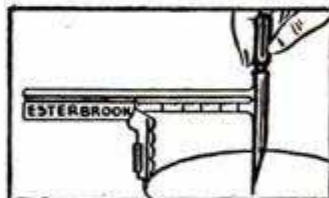

Above: Slide at the short radius.

new principle which prevents wobbling or slipping. Center-pin and pencil-lead are always parallel and vertical. Radius shown clearly and correctly on the beam, in inches or centimeters. Makes true circles from  $\frac{1}{8}$ " to 8" diameters. With slide reversed radius is exactly 2" greater than scale reading.

50¢ at all stations—or send direct to Esterbrook Pen Co., Camden, N. J. We mail postpaid.

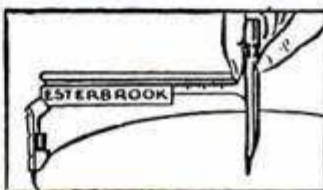

Above: Slide adjusted for long radius.

## THE JEWEL

# Santa Fe Special

Guaranteed a Lifetime

**No** Sold on  
**Money** Credit  
**Down**



WRITE FOR  
WATCH BOOK

We will send this famous Illinois watch, made and guaranteed by the Illinois Springfield Watch factory, express prepaid, for you to examine, to admire, to approve without one penny advance payment. Examine the watch and be convinced it's the best watch you ever saw. Just a small payment down, the balance in easy MONTHLY payments. You use the watch while paying for it.

### JUST OUT!—NEW "SANTA FE" WATCHBOOK

Send for our New Watch Book—just off the press. All the newest watch case designs in white or green gold, fancy shapes and thin models are shown. Read our easy payment offer. Wear the watch 30 days FREE. Nothing to risk. See the watch before you buy. Write for New Book Today—It's FREE. Select Your Watch NOW.

**FREE** A limited offer! With every Santa Fe Special, a beautiful gold chain or strand of exquisite pearls. Write today.

**SANTA FE WATCH COMPANY, 96 Thomas Bldg., Topeka, Kan.**

# No forced landings when you take-off in Keds!

**K**eds help you keep your feet like a good engine keeps a plane in the air. With Keds' light, tough, springy action, you can give your athletic motor full "gun," and out-distance the field safely.

Keds help you win because they help you run, and save you many a spill.

Keds are safer for foot-health because Keds are *specially designed* sports and play shoes—much more than ordinary "sneakers."

Leading physicians and coaches endorse Keds, and hundreds of the world's noted athletes wear them. Many aviators and parachute-jumpers wear them, too.

Keds' special safety-soles grip the smoothest surfaces, and absorb the roughest shocks.

Remember that Keds offer the most complete assortment of styles and models for all indoor and outdoor sports activities. Keds are made by the world's largest specialists in canvas rubber-soled foot-

wear. You'll find Keds in the best shoe stores in town—at all prices, too, from \$1.00, \$1.25, \$1.50, \$1.75 up to \$4.00.

Keds—Keds—Keds—Look for that name stamped on all genuine Keds.

Write for free booklet on games, sports, camping, vacation suggestions and other interesting subjects. United States Rubber Company, Dept. KM-99, 1790 Broadway, New York City.

United States



Rubber Company

Makers of "U. S." Raynster raincoats, "U. S." Giant Chain bicycle tires, "U. S." Spring-Step heels, as well as

# Keds

REG. U. S. PAT. OFF.

The more you pay, the more you get  
—but full value whatever you spend.



**Keds "Conquest" (BROWN)**

Made with the popular crepe sole, famous for wear. A special toe cap reinforcement that will let you scuff to your heart's content. "Feltex" insole, and Keds' cool canvas upper.



**Keds "Shortstop"**

This handsome shoe puts lightning in your feet and protects you against slipping! Note the special safety-sole. Keeps your feet cool and gives them protection whether you're playing baseball or taking the jolts of the trail.



## “He saves \$100 a month”

“SEE that man at the receiving teller’s window? That’s ‘Billy’ King, Sales Manager for The Browning Company. Every month he adds \$100 to his savings account.

“Three years ago he started at Browning’s at \$25 a week. Married, had one child, couldn’t save a cent. One day he came in here desperate—wanted to borrow a hundred dollars—wife was sick.

“I said, ‘Billy, I’m going to give you some good advice—and if you’ll follow it I’ll let you have the hundred too. Take up a course with the International Correspondence Schools and get some special training.’

“That very night Billy wrote to Scranton. In a few months he had doubled his salary! Next thing I knew he was put in charge of his department and two months ago they made him Sales Manager. It just shows what a man can do in a little spare time.”

Employers are begging for men with ambition—men who really want to get ahead in the world and are willing to prove it by training themselves in spare time to do some one thing well.

Prove that you are that kind of man! The International Correspondence Schools are ready and anxious to help you prepare for something better if you will only make the start. Do it now! Find out what the I. C. S. can do for you. *Mail the coupon!*

### INTERNATIONAL CORRESPONDENCE SCHOOLS Box 5638-F, Scranton, Penna.

Without cost or obligation, please send me a copy of your booklet, “Who Wins and Why,” and full particulars about the course before which I have marked X in the list below:

#### TECHNICAL AND INDUSTRIAL COURSES

- |  |   |
|--|---|
| <input type="checkbox"/> Architect               | <input type="checkbox"/> Automobile Mechanic                                |
| <input type="checkbox"/> Architectural Draftsman | <input type="checkbox"/> Aviation Engines                                   |
| <input type="checkbox"/> Building Foreman        | <input type="checkbox"/> Plumber and Steam Fitter                           |
| <input type="checkbox"/> Concrete Builder        | <input type="checkbox"/> Plumbing Inspector                                 |
| <input type="checkbox"/> Contractor and Builder  | <input type="checkbox"/> Foreman Plumber                                    |
| <input type="checkbox"/> Structural Draftsman    | <input type="checkbox"/> Heating and Ventilation                            |
| <input type="checkbox"/> Structural Engineer     | <input type="checkbox"/> Sheet-Metal Worker                                 |
| <input type="checkbox"/> Electrical Engineer     | <input type="checkbox"/> Steam Engineer                                     |
| <input type="checkbox"/> Electrical Contractor   | <input type="checkbox"/> Marine Engineer                                    |
| <input type="checkbox"/> Electric Wiring         | <input type="checkbox"/> Refrigeration Engineer                             |
| <input type="checkbox"/> Electric Lighting       | <input type="checkbox"/> R. R. Positions                                    |
| <input type="checkbox"/> Reading Shop Blueprints | <input type="checkbox"/> Highway Engineer                                   |
| <input type="checkbox"/> Telegraph Engineer      | <input type="checkbox"/> Chemistry  |
| <input type="checkbox"/> Telephone Work          | <input type="checkbox"/> Pharmacy   |
| <input type="checkbox"/> Mechanical Engineer     | <input type="checkbox"/> Coal Mining Engineer                               |
| <input type="checkbox"/> Mechanical Draftsman    | <input type="checkbox"/> Navigation <input type="checkbox"/> Assayer        |
| <input type="checkbox"/> Machine Shop Practice   | <input type="checkbox"/> Iron and Steel Worker                              |
| <input type="checkbox"/> Toolmaker               | <input type="checkbox"/> Textile Overseer or Supt.                          |
| <input type="checkbox"/> Patternmaker            | <input type="checkbox"/> Cotton Manufacturing                               |
| <input type="checkbox"/> Civil Engineer          | <input type="checkbox"/> Woolen Manufacturing                               |
| <input type="checkbox"/> Surveying and Mapping   | <input type="checkbox"/> Agriculture <input type="checkbox"/> Fruit Growing |
| <input type="checkbox"/> Bridge Engineer         | <input type="checkbox"/> Poultry Farming                                    |
| <input type="checkbox"/> Gas Engine Operating    | <input type="checkbox"/> Mathematics <input type="checkbox"/> Radio         |

#### BUSINESS TRAINING COURSES

- |  |   |
|--|---|
| <input type="checkbox"/> Business Management                     | <input type="checkbox"/> Business Correspondence      |
| <input type="checkbox"/> Industrial Management                   | <input type="checkbox"/> Show Card and Sign Lettering |
| <input type="checkbox"/> Personnel Management                    | <input type="checkbox"/> Stenography and Typing       |
| <input type="checkbox"/> Traffic Management                      | <input type="checkbox"/> English                      |
| <input type="checkbox"/> Accounting and                          | <input type="checkbox"/> Civil Service                |
| <input type="checkbox"/> C. P. A. Coaching                       | <input type="checkbox"/> Railway Mail Clerk           |
| <input type="checkbox"/> Cost Accounting                         | <input type="checkbox"/> Mail Carrier                 |
| <input type="checkbox"/> Bookkeeping                             | <input type="checkbox"/> Grade School Subjects        |
| <input type="checkbox"/> Secretarial Work                        | <input type="checkbox"/> High School Subjects         |
| <input type="checkbox"/> Spanish <input type="checkbox"/> French | <input type="checkbox"/> Cartooning                   |
| <input type="checkbox"/> Salesmanship                            | <input type="checkbox"/> Illustrating                 |
| <input type="checkbox"/> Advertising                             | <input type="checkbox"/> Lumber Dealer                |

Name.....  
 Address.....  
 City..... State.....  
 Occupation.....

If you reside in Canada, send this coupon to the International Correspondence Schools Canadian, Limited, Montreal, Canada

## Play Tunes The Very First Day!



### Be the Life of the Party

with this remarkable new instrument—the OCTOPHONE. Many play tunes in few minutes! No knowledge of music required. No long, tiresome practice. No expensive lessons. Play tunes right from the start—and learn music automatically as you play.



#### 8 INSTRUMENTS IN ONE!

“Octophone” is complete orchestra in one instrument—Ukulele, Tenor Banjo, Mandolin, Tenor Guitar, Mandola, Tiple, Taro-Patch, and Mando-Cello. Produces rich harmony, syncopated jazz. Astonish your friends. Loads of fun. Money-making chances in orchestras, radio and stage.

### FREE!

Write for FREE particulars about Octophone and full details of 7-Day Trial Offer and Easy Payment Plan.

#### 7-DAY TRIAL

in your own home. No risk. No obligation. Over 50,000 have learned to play this amazingly easy way. Easy Payments. Write today.

FERRY & CO. 1750 N. Damen, Dept. 177, Chicago, U. S. A.

## Agents: \$2 an Hour

taking orders for marvelous new free-lathering, all-purpose toilet soap. Made from South Sea Island plants. Lathers freely in any kind of water—hard or soft, hot or cold. Wonderful for face, hands, bath, shampoo—and baby. Tremendous demand. Nationally advertised. Thousands of sample cakes distributed. Priced amazingly low. Splendid repeater. \$2.00 an hour easily made.



### New Ford Tudor Sedan GIVEN

This wonderful soap is just one of the 350 fast-selling, profitable items in the ZANOL Line. Send no money—just your name. We’ll give you the most amazing offer ever made, and show you how to get a New Ford Tudor Sedan FREE of cost. Write today SURE.



THE AMERICAN PRODUCTS CO.  
2300 Monmouth Ave. Cincinnati, Ohio

### The International Motor Saw

does every sawing job from straight cutting to intricate scroll and design work: crosscuts, rips, miters, bevells, inside and outside jig sawing and scroll cutting. One saw instead of several.

Write for full description. Dept. S. The International Stamping Co., 400 N. Leavitt St., Chicago, Ill.

### VICAM STANDARD MOVIE CAMERA

Make your own action movies of events, trips, parades, etc. Takes 25 feet of standard film. Equipped with F.5 universal lens. Loads in daylight. Films developed free. Film can be projected from any standard projector. Order today C. O. D. or send 10c in stamps for illustrated booklet.

\$1850

F.O.B. Phila.

**VICAM PHOTO CO.** 1224 Belmont Ave. PHILA., PA.

# If the going's tough

~ ~ learn how others  
make \$500 to \$700  
a month

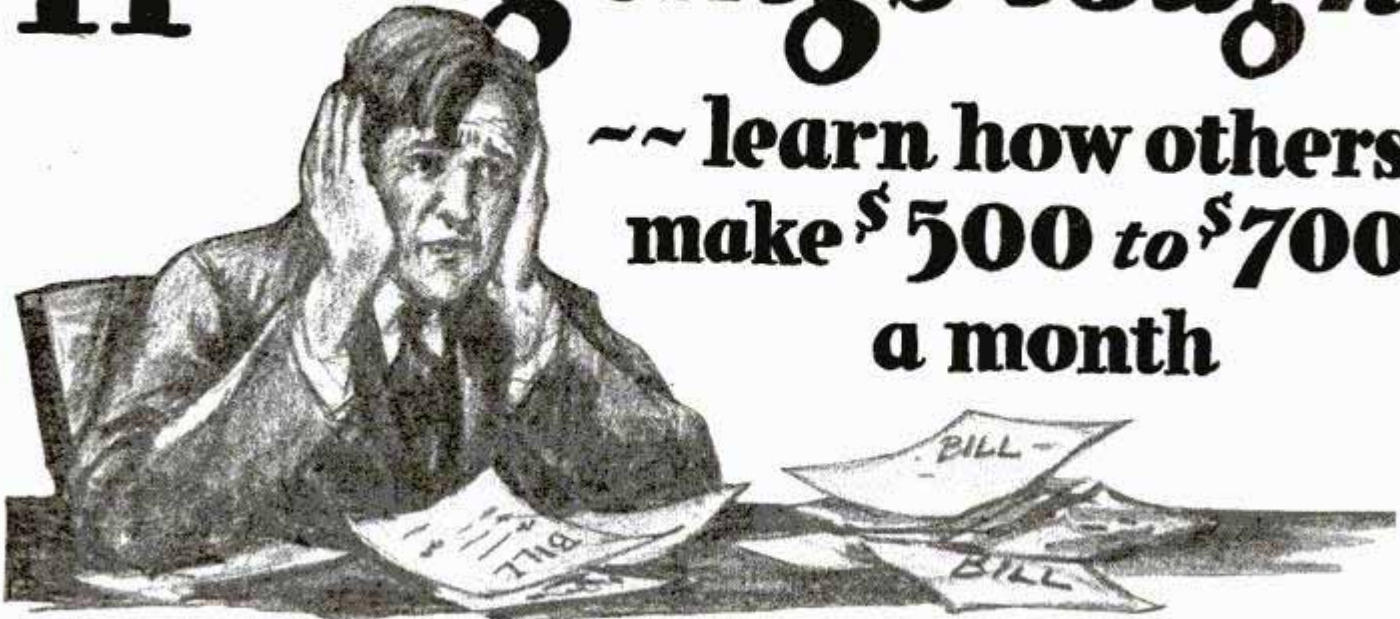

**DON'T** let the wage struggle lick you! There's a new profession calling you to earn \$500 to \$700 a month. Over 1600 Popular Mechanics readers are in it today.

Get an outline of the facts here and then write for more complete information than we can give you in this brief ad. Not a bit of cost or obligation to mailing the coupon printed below.

## FLORKRAFTSMANSHIP Needs Men

Perhaps you've heard about FlorKraftsmanship. You may have read an ad like this and figured some day you'd get the facts. But these other men no smarter than you *did* get the facts—and now they're making the money. They're full fledged Clarke FlorKraftsmen.

You can do what they've done—but not by putting it off still longer. The income the Clarke Vacuum Portable Sander offers to you is:

### \$25 to \$75 a Day

How can you earn \$25 to \$75 a day in the easy, inside job of Clarke Floor Surfacing? The Clarke Vacuum Portable Sander surfaces 800 to 2,000 square feet of new floor in 8 hours. The pay is 3 to 5 cents a square foot. That's \$24 to \$100 a day!

Don't confuse Clarke FlorKraftsmanship with the old time, laborious method once used to sand floors. The Clarke Vacuum Portable Sander weighs but 31 pounds—runs off a light socket—operates almost as easily as a vacuum cleaner. The *machine* does the work. You simply guide it. After a few hours practice you can go out and earn a big day's pay right alongside any veteran

sanding man. There's no course of study to take and no books to buy.

Many FlorKraftsmen make most of their money re-surfacing old varnished floors. The powerful, fast-cutting Clarke bites off 2 or 20 coats of old varnish at the rate of 300 to 1,000 square feet every 8 hours.

The pay is 7 to 15 cents a foot, depending on condition of floor. But even at 7 cents and assuming that you do only 300 feet a day, that's \$21 for 8 hours. And any experienced Clarke FlorKraftsman will get far more than 300 square feet in a day—600 is a fair average.

## More Men Needed

The market needs several thousand FlorKraftsmen today. You don't need an office or any other expensive equipment. About a hundred dollars is all the money required to start into this big pay work.

Get going now and be among the next hundred men to get into this big pay class. It will pay to get the free facts—and the coupon below will bring them to you direct from Clarke, the pioneer maker of Electric portable sanding machines.

Simply mail this coupon. Get the facts. Then decide for yourself. Act now. There is no charge, no obligation and you can prosper in this business.

## Clarke Sanding Machine Co.

Dept. T-29

3831 Cortland St. Chicago, Ill.

Originators and for 12 years manufacturers of Portable Sanding Machines

### MAIL THIS COUPON

Clarke Sanding Machine Co.,  
Dept. T-29, 3831 Cortland St.,  
Chicago, Ill.

Gentlemen: Please send me your free booklet, "Pointing The Way," and full facts about the Clarke Sander and about FlorKraftsmanship, without obligation to me.

Name.....

Address.....

City..... State.....

### What They Earn

"From April 1st up to noon April 16, have earned \$259.00." —Avery Lee.

"I made \$45 the first week and have about \$500 of work lined up now. I am perfectly satisfied with the machine." —D. S. Sall.

"I have made from \$40 to \$45 per 8 hours, with my Clarke." —W. G. Roe.

"I made \$76 the first week." —A. F. Sweeney.

"I have already taken in \$348 for work and have 1,100 feet of floors to do yet." —H. O. James.



# WURLITZER

Trade Mark Reg.  
THE WORLD'S LARGEST MUSIC HOUSE



**200 Years Ago** in the little town of Schoeneck lived Hans Adam Wurlitzer, Master Violin Maker. His shop was a gathering place for musicians of the time, for he was a true craftsman.

When he died his shop passed into the hands of his eldest son, and for seven generations, down to the present day, the descendants of Hans Adam Wurlitzer have carried on his work.

Today in every Wurlitzer instrument you will find a quality, a character, that could not come from mere excellence of manufacture. It is the heritage of these seven generations of music craftsmanship.



## Try any Wurlitzer Instrument in your Own Home

YOU may now have any Wurlitzer instrument for a generous free trial in your own home. Examine the instrument, show it to your friends, play it as much as you wish. No obligation to buy—no expense for the trial. We make this liberal offer because we want you to try for yourself these wonderful instruments, the result of 200 years' experience in musical instrument Building. Easy payments are arranged to suit your convenience. This is your opportunity to try a famous Wurlitzer instrument in your own home.



### Send for New Catalog

The greatest musical catalog ever published. Over 3,000 articles—every known instrument described and illustrated; many of them shown in full colors. Gives you lowest prices and all details of Free Trial, Easy Payment plan. All sent FREE—no obligation.

### Send this Coupon

THE RUDOLPH WURLITZER CO., Dept. 1776  
117 E. 4th St., Cincinnati

Send me absolutely free, your new illustrated catalog, with prices and description of every known musical instrument. Also tell me how I may try any instrument in my own home and pay for it in small monthly sums. No obligation.

Name.....

Address.....

City.....State.....

Instrument.....  
(State instrument in which you are interested)

## Build a Ship Model at Home

For Pastime and Pleasure



It is a wonderful fascination and a beautiful decoration for your mantel, radio cabinet or it may be used in any part of the home.

Santa Maria—Size—25' high, 10' wide, 27' long.....\$4.98  
La Pinta—Size—26' high, 11' wide, 27' long.....\$4.98

Mayflower—Size—26' high, 10' wide, 30' long.....\$4.98  
Constitution—Size—25' high, 8' wide, 29' long.....\$6.98  
Flying Cloud—Size—27' high, 9' wide, 36' long.....\$6.98

These prices are f.o.b. Philadelphia, plus a few cents postage. These models are sold in knock-down form. All parts are cut to fit and ready to assemble. They will be sent anywhere in United States C.O.D.

Money order or check must accompany all foreign orders.

Write for free illustrated catalog

### MINIATURE SHIP MODELS, Inc.

3216 BARING STREET PHILADELPHIA, PA.

## Do Better, Faster Work with H & A Saw Table



A sturdy, powerful, large capacity machine that will handle wide material. Accurate, speedy, reasonably priced. Use it for ripping, cross-cutting, mitering, grooving, rabbeting or dadoing. Equipped with tilting fence for bevel sawing; 1/2 or 3/4 H. P. motor; all bearing spindle. Write for catalog of woodworking tools.

HESTON & ANDERSON, 609 Market St., Fairfield, Iowa

### ELECTRIC LIGHTS ANYWHERE

110 Volt—complete plant with all Wiring, Fixtures and Lamps for 7 rooms \$147.50, Direct-To-You.

Also runs Household Electrical Appliances. Install it yourself. Write for circular.

D. W. ONAN & SONS \$147.50  
20 Royalston Ave. Minneapolis, Minnesota.



## Big Steady Pay—\$95.00 weekly!

Show Our \$25.00

### ALL-WOOL Tailored Suits

If you are ambitious to make money, we want you as our representative. Show wonderful values in union-made tailored-to-order Suits and Overcoats. Take orders. Easiest work, biggest earnings.

#### Pay Daily and Liberal Bonus

No selling experience required. Customers save \$10 to \$15. Satisfaction guaranteed or money back. Repeat orders bring steady, permanent income. Nearly 200 fabrics, carrying case and supplies, FREE. Write at once for local territory. Give complete details for immediate consideration. **Outfit Sent Free.**

PIONEER TAILORING CO., Dept. J-1116  
Congress and Throop Sts. Chicago, Ill.



## Filters a Gallon Every 4 Minutes



**Low Priced—Guaranteed**  
Amazing new invention—patented Home Filter for fruit juices and beverages. Nothing like it. Removes all sediment, pulp, fibres. Filters a gallon every 4 minutes. **Perfect results guaranteed.** No moving parts. Simple. Practical. Low priced. Lasts a lifetime. Thousands already in use.

### FREE HOME TRIAL—Agents Wanted

Try free at our risk and return if not satisfied. Send name and address TODAY for full particulars of this liberal offer. Act NOW. AGENTS WANTED. HOME FILTER CO., 429 CENTRAL AVE., BAY CITY, MICH.

# Amazing New Window Washer



**For homes,  
autos, offices,  
stores, factories**  
—wherever there  
is glass to clean  
**Sells for \$2.25**

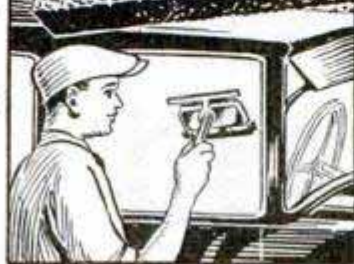

**CARTER  
WINDOW WASHER**



## Make \$25 to \$35

### a Day. A Marvelous Opportunity That Leads the Way to Your Financial Independence

**H**ERE it is at last!—An amazing invention that cleans windows in a jiffy, does away with water pails or sponges, prevents hands from getting wet or cold and absolutely eliminates all drudgery. Works like a charm. Operates three times as fast as any other method. Makes an instant appeal to every housewife and car owner as well as stores, factories, offices, etc. The Carter Window Washer sells like wild fire. The money-making opportunity for agents is simply amazing. \$25 to \$35 a day is easy. Hundreds of men and women are becoming financially independent by selling this marvelous device. You can do that, too. With our plan, you start as small as you like and quickly work up into the big money class.

#### Quick Demonstration—Sell on Sight

Carter Window Washers are easy to use. No parts can rust or get out of order. No instructions necessary. Quickly demonstrated right on the glass door of any home or nearby window. Any housewife understands its use and advantages in a few seconds. A thorough demonstration is completed in a minute's time and everybody wants one. No clever salesmanship required—just a courteous approach and a simple, quick demonstration.

#### Sell Every Home - - Every Auto

There is an astounding market in every city, town or village for the Carter Window Washer. Every home needs one; every auto driver should have one in his car; stores need them for show-cases. Wherever there is glass to clean there is an opportunity to sell a Carter Window Washer.

#### Send \$1 for Sample—

Take that sample and in one hour's time demonstrate the Carter Window Washer to nine homes. If you don't make three sales, return sample and we will refund your money.

**CARTER PRODUCTS CORPORATION**  
Dept. A1 — 983 Front Ave., Cleveland, Ohio

Sales come quick and fast. You find business wherever you go. Simply show this great invention to every home in your town and write up the orders.

#### Tremendous Margin of Profit

We give our agents an extraordinary margin of profit so that every sale at \$2.25 means a lot of money in your pocket. Here is the biggest money-making opportunity you ever had. Get in on it right away.

We are fast building up a large organization of money-makers throughout the country. New agents in every section are wanted. Get our complete proposition—make big profits—be independent and run your own business.

#### ESTABLISHED SALES FORCES Can Triple Profits

One salesman can make \$100 a week and more by his own efforts but managers of crews can multiply this income many times according to the size of their sales forces. Tell us what territory you cover thoroughly and we will explain sales quota required.

#### MAIL THIS COUPON **NOW**

Carter Products Corporation,  
Dept. A-1, 983 Front Ave.,  
Cleveland, Ohio.

I want you to show me how to make \$25 to \$35 a day. Send me full particulars.

Name.....

Address.....

Check here if you send \$1 for sample.

**"\$3.00 Spent on This Room NOW... Will Save You \$100!"**

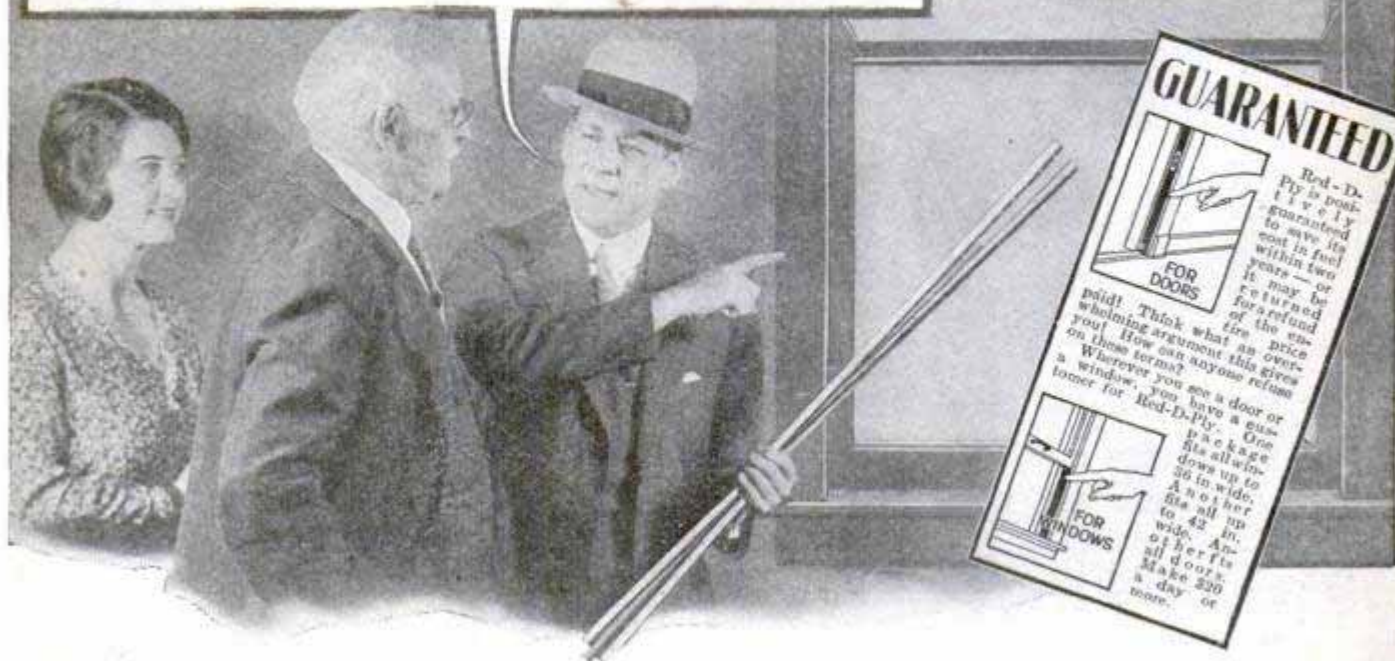

# Amazing Strips of Lifetime Bronze

## Save Home Owners \$30 to \$60 a Year!

**N**O More Big Fuel Bills! No More Cold, Draughty Rooms! No More Dust, Soot, and Smokel Amazing New Invention Is Creating Thousands of Big Money Opportunities for Live-Wire Representatives, Red-D-Ply, New Kind of Metal Weatherstrip That Anyone Can Apply to Any Door or Window in a Few Minutes Does the Trick. Keeps Cold Draughts Out, Heat In! Guaranteed to Save Its Trifling Cost in Two Winters! Snap Up This New Money-Maker Now!

"Our coal bills cut in half!" "Saved \$50 in a single winter!" "Not a luxury—a real investment." Folks have hitherto thought of metal weatherstripping as expensive, and difficult to install. Imagine their delight when you show them Red-D-Ply! Each package contains material to completely weatherproof any door or window in half an hour, with no experience and no tools but a tack hammer and scissors! Slides into position without removing sashes or doors. Completely closes chinks and cracks where cold draughts sneak in to steal heating dollars, besides causing endless discomfort and sickness. Red-D-Ply also keeps out rain, dust, and soot. Makes windows slide easier and banishes rattles! Does away with storm windows and doors. Is it any wonder Red-D-Ply offers such amazing profits to representatives?

**A Double-Barreled Money-Maker for Agents**  
**\$400 to \$600 a Month**  
**The Year Round!**

**Just Count Windows and Doors!**

A single block, even in small towns, may yield you as much as \$200 or \$300 in quick commissions! Just count the outside doors and windows in any home, figure up the fuel savings Red-D-Ply will give, and your sale is already half made! For Red-D-Ply is **GUARANTEED** to save its cost in two winters—and ordinarily does it in one! The cost averages about the price of an auto tire. And the saving goes on year after year—for no matter how windows and doors swell or shrink Red-D-Ply **AUTOMATICALLY** adjusts itself to suit.

**Repeat Business—Installation Profits**

The repeat business is simply enormous! Even if you don't sell a complete installation on the first call, make a test installation of one room or so—then come back for order after order, and

make the same or greater profit every time. Make extra money through installations.

**Territories Going Fast—Act at Once!**

Red-D-Ply offers such surprising profits in a new non-competitive field that hundreds are dropping everything to take over territory. Exceptionally generous proposition, with ready-cut selling plan absolute proof against failure. It insures repeat business. New buildings alone furnish a wonderful field—112,754 new homes built in 1928 need Red-D-Ply. We furnish everything to start a permanent, profitable business. This is only half the story. Will you risk a 2c stamp to hear the rest, if it means \$5000—\$7500 a year to you? Then mail the coupon for full particulars and a **FREE SAMPLE** of Red-D-Ply. No obligations. Get the facts and judge for yourself if this is not the proposition you have waited for all your life.

**Red-D-Ply Mfg. Co.**  
 Dept. M-10 3711-15 Parnell Ave. St. Louis, Mo.

**GET FREE SAMPLE**

**Mail Coupon**

RED-D-PLY MFG. CO., Dept. M-10  
 3711-15 Parnell Ave., St. Louis, Mo.  
 I want to make \$5000 a year or more. Send Free Sample of Red-D-Ply and full details of your proposition to Representatives. I am not obligated by this request.

Name.....  
 Address.....  
 City..... State.....

**Red D Ply**  
 The Universal Weatherstripping—Anyone Can Afford  
 It . . . Sell It . . . Install It





**Makes \$18 First Day**

"Received my first 24 Speedos yesterday; the entire lot is now delivered and more sold. In all my years of selling I never saw anything that met with such universal approval."  
—W. R. Duncan, Mont.



**\$5.00 His First Hour**

"Received Speedo outfit April 1st. Left the house at 6:30 P. M. Returned just one hour later with 6 orders. Speedos are a necessity in every home."—W. W. Marshall, Ill.



**Let These Twin Inventions Hand You**

**Double Profits...\$5 to \$11 IN AN HOUR!**

Men, here's a proposition that's amazingly simple. Yet the profit possibilities are nothing short of startling! For now, an old, well-known manufacturer offers you direct, TWO unique, patented inventions. Items used every day in every home. Yet so revolutionary that they positively sell on sight! So just read the facts below. Then mail coupon for FREE OUTFIT and FREE TEST OFFERS.

EVERY man who has cut his eye teeth in the selling game knows this! The big clean-ups are always made by men who get in on the ground floor with something new and sensational. Think, then, what a doubly sensational chance to coin money is now yours! For here are offered you two unique devices — pronounced by experts everywhere to be absolutely revolutionary—approved by Good House-keeping Institute, Modern Priscilla, etc.—and real necessities in every home. In your wildest dreams, could you conjure up such an amazing opportunity for quick, easy profits?

**A Real Million-Dollar Can Opener**

Imagine an automatic machine that opens any can, round, square or oval, simply at the turn of a crank. Cuts the entire top out, slick, smooth and clean! No more stabbing and hacking with old-style can openers. No more fingers cut and infected on jagged tin-can edges. For Speedo holds the can—strips the top out—flips up the lid—all in a couple of seconds! No wonder women simply go wild over it. And no wonder 4 out of 5 buy on a 10-second demonstration!

**The "Magic Groove" Sharpener**

Women never saw anything even remotely like this other "twin" invention, the Speedo Sharpener. Just

demonstrate the "Magic Groove" and watch their eyes pop open with amazement. Now anyone can put a keen, smooth edge on everything that cuts. Even scissors! Every woman sees instantly that here is an end to the drudgery of dull knives and tools. That's why agents report as much as \$10 and \$12 in a single hour with Speedo sharpener alone!

**Generous Co-operation**

This company has been in business over 20 years. Speedos are made entirely in our own big factories, under exclusive patents. Each item is backed by a printed guarantee of 5 years' perfect service. We give you exclusive territory. Over 100% profit! We train you from A to Z, and supply you with a complete selling outfit FREE.

**Mail The Coupon TODAY**

Any ambitious man with just ordinary common sense can see the possibilities of the proposition at a glance. If you are that kind of a man, I want to send you my FREE OUTFIT and FREE TEST OFFERS. I want to show you what real big money means. Mail the coupon today. Then get set to test the fastest, dizziest profit makers of your life. Write me this minute!



Sharpens Like Magic

Just rest blade on Magic Groove, turn handle. Sharpens a ten-inch knife in six seconds. Puts a razor edge on everything that cuts.



Opens Cans Perfectly

Rest blade against guide, give handle a couple of turns—Presto! Scissors are sharp as new.



Works Like a Charm

Just insert can in holder and turn crank. Top is cut completely out inside the rim. Juices can't spill out.



Food Pours Right Out

No fuss or muss. No scraping or "spooning." Even foods frozen in the can slip out easily.



No Jagged Edges

Speedo cuts the top out, smooth, slick, and clean. Ends danger of cut fingers.

**CENTRAL STATES MANUFACTURING CO.**

Dept. L-703, 4500 Mary Avenue, St. Louis, Mo.

Central States Mfg. Co., Dept. L-703, 4500 Mary Ave., St. Louis, Mo.

Rush me details of your proposition and FREE TEST OFFER.

Name.....

Address.....

Town.....State.....

Check here if interested only in one for own home.

*It's all the same to  
me—just so I get a*

# CAMEL

